

WWW.SURVIVALEBOOKS.COM

YOUR LAST LINE IN DEFENSE AND SURVIVAL

CHECK OUT OUR WEBSITE SOME TIME FOR PLENTY OF ARTICES ABOUT SELF DEFENSE,
SURVIVAL, FIREARMS AND MILITARY MANUALS.

<http://www.survivalebooks.com/>

Thank you for purchasing our ebook package.

Folks,

Introduction to Radio Equipment, NAVPERS 10172, 1946 was created just after WW II. It is a basic introduction to tube era elections and has specifics on typical radios at the end.

In this online version of the manual we have attempted to keep the flavor of the original layout while taking advantage of the Web's universal accessibility. Different browsers and fonts will cause the text to move, but the text will remain roughly where it is in the original manual. In addition to errors we have attempted to preserve from the original this text was captured by optical character recognition. This process creates errors that are compounded while encoding for the Web.

Please report any typos, or particularly annoying layout issues to info@hnsa.org for correction.

Richard Pikelney
Webmaster

[Search Introduction to Radio Equipment](#)



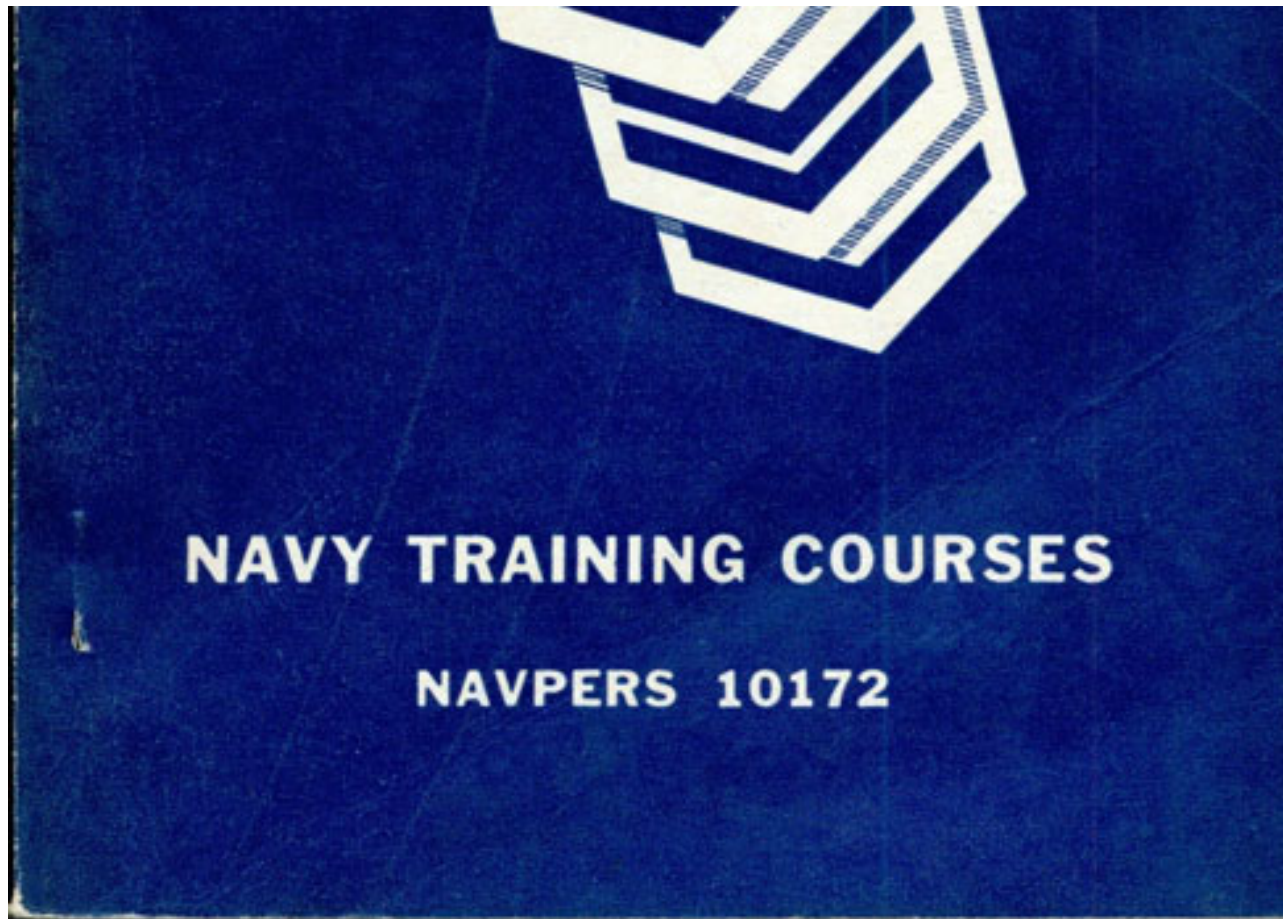

**INTRODUCTION TO
RADIO EQUIPMENT**

PREPARED BY
STANDARDS AND CURRICULUM DIVISION
TRAINING
BUREAU OF NAVAL PERSONNEL



NAVY TRAINING COURSES
EDITION OF 1946

UNITED STATES
GOVERNMENT PRINTING OFFICE
WASHINGTON: 1946

This page blank

PREFACE

This is one of a series of Training Manuals written to aid the RADIOMAN in performing his duties. The first 20 chapters contain a brief discussion of basic electricity, the principles of vacuum tubes, receivers and transmitters. Chapter 21 will be of special interest to all personnel of the radio communication rates, since it contains the latest information on radio wave propagation. It will prove particularly valuable in selecting the correct frequency for a transmission. The last two chapters contain brief descriptions and directions for operation of Navy transmitters and receivers most frequently used.

This manual should be issued to the radioman striker and be used by all rates until its usefulness has been exhausted. It must be understood that successful completion of this text is not a requirement for any rate. The specific sections that may be required for advancement must be in accordance with Part D of the Bureau of Personnel Manual.

No attempt has been made to include the large volume of subject matter necessary for servicing and repair of radio equipment. Where maintenance duties are required of a RADIOMAN, the Training Courses written for the Electronics Technician's Mates should be issued.

As one of the NAVY TRAINING COURSES, this book represents the joint endeavor of the Training Courses Section of the Bureau of Naval Personnel and those sections of Chief of Naval Operations especially cognizant of Naval Communication Training.

III

TABLE OF CONTENTS

Preface		<u>iii</u>
	CHAPTER 1	
What is electricity?		<u>1</u>
	CHAPTER 2	
Batteries		<u>17</u>
	CHAPTER 3	
Circuits		<u>25</u>
	CHAPTER 4	
Ohm's Law		<u>33</u>
	CHAPTER 5	
Magnetism		<u>41</u>

	CHAPTER 6	
Electromagnetism		53
	CHAPTER 7	
Generators		65
	CHAPTER 8	
Motors		79
	CHAPTER 9	
More about induction		87
	CHAPTER 10	
The condenser		103
	CHAPTER 11	
Resonance		113

V

TABLE OF CONTENTS (Continued)

	CHAPTER 12	
The vacuum tube		119
	CHAPTER 13	
Amplifier tubes		127
	CHAPTER 14	
More amplifier tubes		139
	CHAPTER 15	
Jobs of a vacuum tube		149
	CHAPTER 16	
Background to modern radio		157
	CHAPTER 17	
Introduction to transmitters		163
	CHAPTER 18	
Introduction to receivers		171
	CHAPTER 19	
Remote control system		189
	CHAPTER 20	

The antenna	201
CHAPTER 21	
Wave propagation	215
CHAPTER 22	
Navy transmitters	237
CHAPTER 23	
Navy receivers	307
Quiz	341
Index	361

VI



[Next Chapter](#)

Copyright (C) 2005 [Historic Naval Ships Association](#)

All Rights Reserved

[Legal Notices and Privacy Policy](#)

Version 1.00, 12 Nov 05

Search Introduction to Radio Equipment

Match: Format: Sort by:

Search:

Return to the [Historic Naval Ships Association home page](#).

All Rights Reserved.

[Legal Notices and Privacy Policy](#)

Version 1.00, 2 Nov 05

INTRODUCTION TO RADIO EQUIPMENT



CHAPTER 1 WHAT IS ELECTRICITY? MEET THE ATOM

A single atomic bomb demonstrated to a startled world that the ATOM is a source of a lot of energy. Since then the atom has been pictured as a new and untapped source of power.

Actually, it is neither new nor untapped. For years, man has known the atom to be composed of POSITIVE and NEGATIVE charges of electricity-that these charges have been used to turn the wheels of industry, power our trains, and energize our radio transmitters.

The story of how your transmitter sends a message begins with the atom itself. The ACTIVITY of the tiny negative and positive charges within the atom is the source of energy that sends your radio message to Singapore or Saipan.

YOU KNOW SOMETHING ABOUT IT

You have experimented with atomic energy man. times. Remember the fun you had rubbing your shoes on the rug and then giving an electric shock to another person by bringing your finger near the end of his nose? And

you probably have heard the snap and crack of electric sparks, as you stroked a cat's back. These little demonstrations were experiments with the positive and negative charges of the atom.

WHAT IS THE ATOM LIKE?

There are ninety-odd known kinds of atoms, ranging from simple hydrogen with ONE POSITIVE and ONE NEGATIVE charge to the famous uranium atom with many charges.

All atoms, whether simple or complex, have a similar basic arrangement. They have a concentration of material in a central mass called the NUCLEUS and a number of NEGATIVE charges revolving in ORBITS about the nucleus.

HYDROGEN ATOM

The structure of three single atoms-hydrogen, helium, and lithium-is given in figure 1. Hydrogen has ONE

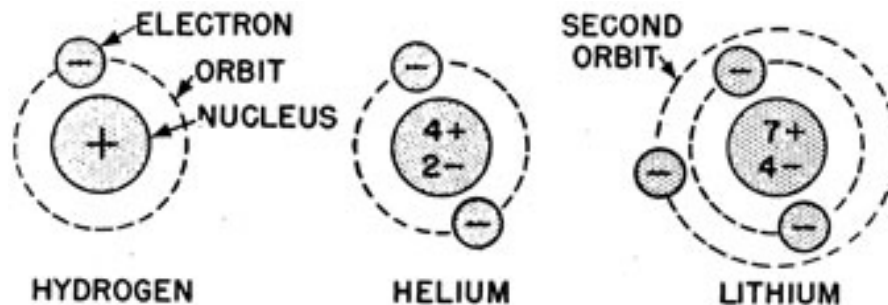

Figure 1.-Hydrogen, helium, and lithium atoms.

positive charge (PROTON) and ONE negative charge (ELECTRON). The PROTON is in the NUCLEUS, and the ELECTRON is floating about the nucleus in an ORBIT, like the moon revolving about the earth.

The second atom, HELIUM, has four protons and four electrons. ALL of the PROTONS and TWO of the ELECTRONS are in the nucleus, and the other two electrons are in the orbit.

The third element, LITHIUM, has seven electrons and seven protons. ALL of the PROTONS and FOUR of the

ELECTRONS are in the nucleus, and the remaining three electrons are in the orbits. Also notice that with lithium, a SECOND ORBIT is added.

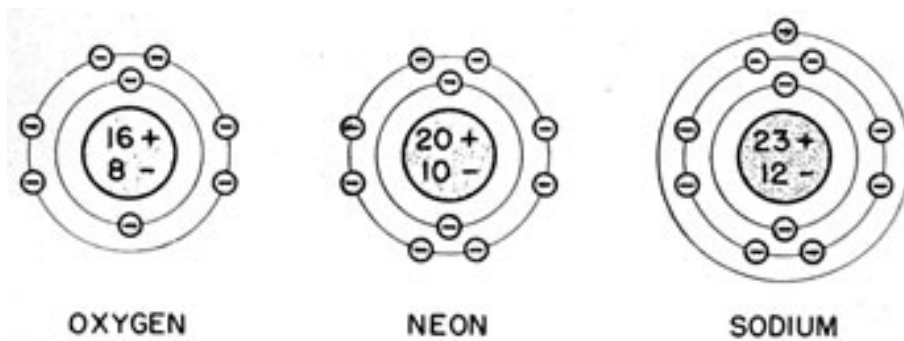

Figure 2.-Atoms of oxygen, neon, and sodium.

The atoms of oxygen, neon, and sodium, in figure 2, continue to show a systematic arrangement of electrons and protons. The atoms given so far show these facts-

ALL the PROTONS and approximately one-half of the ELECTRONS are in the nucleus, and the REMAINDER of the ELECTRONS are in the orbits. Each orbit has a maximum number of electrons that it can hold-for instance, TWO on the first, and EIGHT on the second.

THE NEUTRON

Of the six atoms so far described, NEUTRONS (N) are present in each atom except hydrogen. Don't be alarmed. The neutron is just one ELECTRON COMBINED with one PROTON to form one NEUTRAL CHARGE (NEUTRON)-

$$1 \text{ electron} + 1 \text{ proton} = 1 \text{ neutron.}$$

Neutrons are dead ducks so far as electricity is concerned, so don't let them trouble you.

Turn to figure 2 again. The helium nucleus contains four protons and two electrons. The two electrons combine with two of the protons to form TWO NEUTRONS. This leaves an excess of two PROTONS, which give the nucleus TWO POSITIVE CHARGES.

Helium has TWO ELECTRONS in the first orbit. Therefore, an atom of helium is balanced, since it has TWO

POSITIVELY CHARGED in the nucleus and TWO NEGATIVE charges in the orbit.

How about lithium ? It has four neutrons, three positive charges, and three negative charges. You can see that it is also a BALANCED atom. Similarly, oxygen, with eight neutrons, eight positive charges, and eight negative charges, is a balanced atom.

In each case an atom as an individual unit is a BALANCED, UNCHARGED piece of matter.

THEORY OF BUILDING A CHARGE

From the information given so far, it appears that all atoms have a balance of charges. That is true until you do something to destroy the balance.

Most atoms are eccentric things. Some have a tendency to GIVE AWAY ELECTRONS; others have a tendency to BORROW or STEAL ELECTRONS from other atoms.

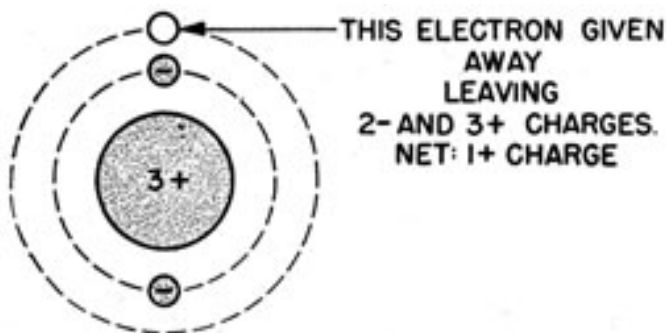

Figure 3.-How an atom becomes positively charged.

Lithium in figure 3 is an element that tends to GIVE AWAY one of its electrons. When it does this, the remaining charge will be-

2 electrons
with -leaving a net charge of 1 proton
3 protons

So by giving AWAY AN ELECTRON, lithium becomes positively charged.

Figure 4 shows how an atom of chlorine becomes negatively charged. It borrows an electron from some other atom to form-

8 protons
with -leaving a net charge of 1 electron
9 electrons

In each case it is the ELECTRON that DOES THE MOVING. BY GIVING ELECTRONS AWAY a POSITIVE CHARGE is produced;

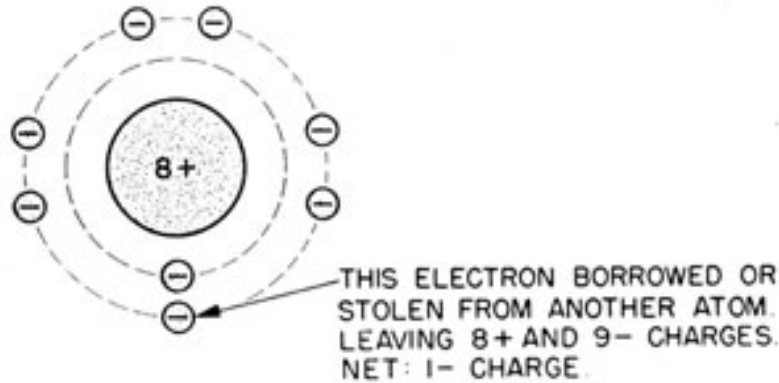

Figure 4.-How an atom of chlorine becomes negatively charged.

BORROWING ELECTRONS produces a NEGATIVE CHARGE. Remember those statements. They are **THE BASIS OF ELECTRICITY.**

But why doesn't the proton move? In some cases it does, but since the proton is about 2,000 times heavier than the electron, the proton will move only when great force is applied. It is like moving an aircraft carrier as compared with moving a whale boat.

With the exception of lithium, the atoms so far discussed are normally gases. Don't let that trouble you-at high enough temperatures lithium too becomes a gas. The same holds for all other atoms.

You now know the theory of producing a charge, and you're ready for some practical examples.

HOW YOU CHARGE AN OBJECT

Go back to the old trick of rubbing your shoes on the rug. The **FRICTION** between the sole of your shoe and

the rug removed some electrons from the leather, leaving a **POSITIVE** charge. Then, when you touched your finger to another fellow's nose, **ELECTRONS** jumped between your finger and his nose.

That little track of giving somebody an electric shock brings up some important questions-

How did the charge get from the shoe to your finger?

Why did the spark jump?

What was the spark?

The answer to the first question-the electric charge did not remain concentrated in one spot but distributed itself evenly over your whole body.

Why did the spark jump? Nature does not like **INEQUALITIES**. Since the other person's body had a different number of electrons than yours, some electrons moved from one body to the other to **EQUALIZE** the number of electrons on both.

HERE IS A LAW which applies to those first two questions-

"Nature always attempts to distribute **EQUALLY** the number of **ELECTRONS** on all objects, with the **EXCESS** electrons **MOVING** to areas where they are **FEWER** in number."

Now, what was the spark? A stream of electrons.

CREATING A CHARGE-ADDING OR SUBTRACTING ELECTRONS

When you create a charge-by stroking a cat's back, by combing your hair, or by running a leather belt over a pulley-the charge is produced by **FRICION REMOVING ELECTRONS** from one object and **ADDING** them to the other. The object that **LOSES** electrons becomes positive ; the one that gains electrons becomes negative.

LIKES REPEL, UNLIKES ATTRACT

The law of **LIKES** and **UNLIKES** needs little introduction. You've seen it in operation when a charged comb picks up bits of paper.

In figure 5, two negatively charged and two positively charged balls are placed near each other, and with each **LIKE** charge a force of repulsion exists.

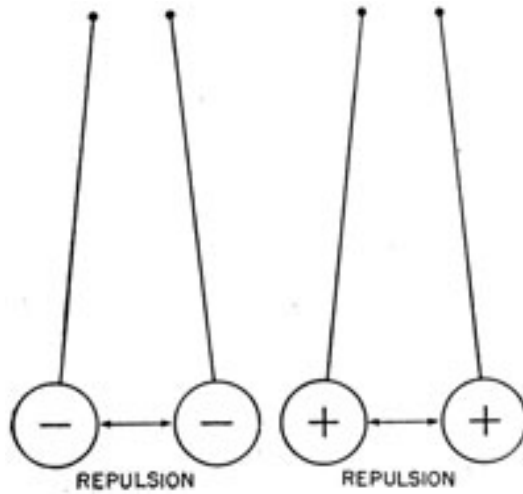

Figure 5.-Likes repel, unlikes attract.

Now if one ball is given a positive charge and the others a negative, as illustrated in figure 6, a force of attraction will exist.

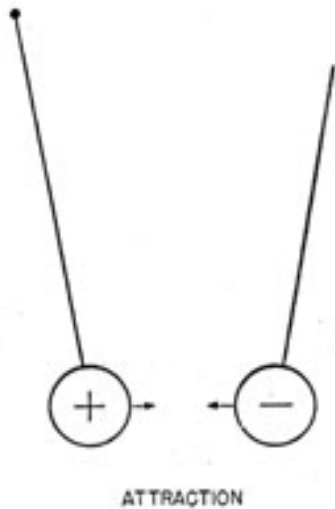

Figure 6.-Unlikes attract.

Since the positive charge is 2,000 times heavier than the negative, the positive will REMAIN almost FIXED while the negative charge is FREE TO MOVE. It is said, "the ELECTRON is attracted to the POSITIVE charge."

STATIC ELECTRICITY

The electrical charges that appear on your shoes, a comb, or a cat's back, are called **STATIC**, because they are standing still.

Surrounding the charges is an area that is influenced by the charges. This area is called the **ELECTROSTATIC** field. The stronger the charge, the stronger the field. If the charge is increasing in strength, the field is expanding. A decreasing charge will produce a contracting field.

Electrostatic fields are important in radio circuits. In some places you want them, in others you do not. Look inside any receiver or transmitter, and you will see metal walls or cans isolating certain coils, vacuum tubes and condensers from other elements in the circuit. These **SHIELDS** keep the electrostatic fields confined to the places where they are wanted, and away from areas where they can cause trouble.

CURRENT ELECTRICITY-MOVING ELECTRONS

When electrons of a static charge **MOVE**, it is no longer **STATIC** electricity, but **CURRENT** electricity. Think back to the electric spark again. The spark that jumped between your finger and some other object was a **STREAM** of electrons.

Certainly you have noticed that some sparks are large and others are small. More electrons are flowing in a large spark than in a small one. It's like comparing rivers of different size. The flow of a river is measured in units of gallons or cubic feet that pass a point each minute. The flow of electricity is measured by the **NUMBER** of **ELECTRONS** that pass a point each **SECOND**.

UNIT OF ELECTRICITY-COULOMB

No one has ever seen an electron or probably ever will ; so to simplify the job of counting them, individual electrons are grouped together into a large unit. It's like grouping grains of sugar into a large unit, the pound.

You probably never troubled to count the grains in a pound of sugar, but some one did CALCULATE the NUMBER of electrons in the UNIT of electricity, the COULOMB. He found that it contained 6.3 billion billion ELECTRONS. That number is 63 with 17 zeroes after it. And that is a lot of electrons.

RATE OF FLOW-AMPERE

The name given to the unit of electrons is the coulomb. Now when ONE COULOMB of electricity passes a point in a SINGLE SECOND, ONE AMPERE of electricity is flowing. Thus an AMPERE is to ELECTRICAL FLOW as the GALLON-PER-MINUTE is to WATER FLOW. It is the RATE of FLOW.

One-half coulomb per second is $\frac{1}{2}$ ampere; 1/1000 coulomb is 1/1000 ampere or one milliampere, abbreviated (ma.).

In radio work, the most-used unit of current is the MILLIAMPERE. With receiving circuits, the range is from one or two to about 50 milliamperes, while with transmitters, the current flow will range upwards of SEVERAL HUNDRED milliamperes.

THE VOLT

Volume of CURRENT is not always the same. It varies directly with the size of the charge. Since work is required to move electrons and create a charge, the size of charge may be expressed in units of WORK DONE to move the charge.

The VOLT is the unit used to express the amount of work done to create a charge. One VOLT of charge is created when one JOULE of work is done in moving a COULOMB.

A volt actually expresses more than degree of charge. When you pile up a surplus of electrons, you are creating a RESERVE OF ENERGY. ENERGY IN RESERVE IS POTENTIAL ENERGY. Thus a volt may also be used as an expression of the potential energy of an object.

699198°-46-2

VOLTAGES ARE DIFFERENCES IN POTENTIALS

Since no object is of zero potential, and it is possible to create a charge by either adding or removing electrons, the energy of two points is not expressed in ACTUAL potentials but in DIFFERENCES of potential.

So when you say an object has a potential of 200 volts, all you are actually stating is the DIFFERENCE in the potentials of two points.

Since all objects have some potential, it is a common practice to designate some point as ZERO potential. In a radio, zero potential is usually the frame or chassis of the set. Hence, when you say the plate of a vacuum tube is positive 200 volts, you are only stating that the plate is 200 volts more positive than the chassis.

The rate of current flow is influenced by the magnitude of the difference between the two charges. If the difference between the charges is small, the rate of flow will be low, but if the difference is large, the rate of flow will be large.

THERE ARE NEGATIVE POTENTIALS ALSO

Although the chassis of a radio is given as "zero" potential, it is possible for CERTAIN PARTS of a receiver or transmitter to be at a lower potential than the chassis. All these parts are said to have NEGATIVE potentials.

You will find the GRIDS of vacuum tubes stated as being -5, -10, or -50 volts. It means that the grids of those tubes are at a LOWER positive potential than the chassis, by 5, 10, or 50 volts.

Don't let a NEGATIVE potential fool you. There is just as much "wallop" between -200 volts and the chassis as between +200 volts and the chassis.

ALL VOLTAGES ARE ONLY RELATIVE

Now you are beginning to get the whole picture. Voltage is only a RELATIVE THING. Look at figure 7. Point *A* is given as being -200 volts in comparison to the chassis. And *B* is 200 volts more positive than the

chassis. Hence you may say, point *B* is 400 volts more POSITIVE than *A*. Turn things around-point *A* is 400 volts NEGATIVE in respect to *B*.

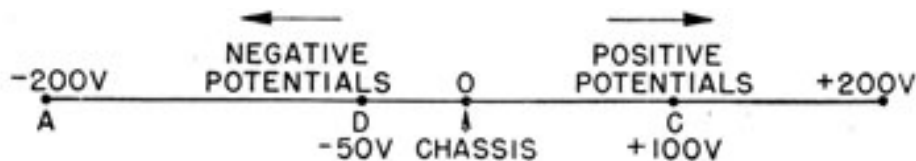

Figure 7.-Relative potentials.

How about point *C*? It is 100 volts positive in respect to the chassis, but 100 volts more NEGATIVE than point *B*. So in respect to *A*, *C* is 300 volts positive.

Now point *D*. It is 50 volts NEGATIVE in RESPECT to the CHASSIS but 150 volts positive in respect to *A*. Thus point *D* is also 150 volts more negative than *C*, and 250 volts more negative than *B*.

So you see all potentials (voltages) are ONLY RELATIVE THINGS. When you state the voltage of an element, remember that what you state is true ONLY in RESPECT TO ANOTHER POINT.

ELECTRONS FLOW TOWARD THE MORE POSITIVE

Here is a little statement to remember. "Electrons flow toward the MORE positive potential." Even if all potentials are given as negative, the electrons move from the MOST negative toward the LEAST negative potential.

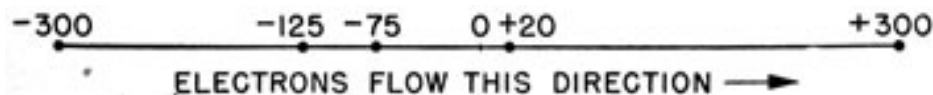

Figure 8.-Direction of electron flow.

It may look in figure 8 as if electrons are flowing up hill. Well, maybe so, but that shouldn't trouble you. You have seen other things pulled upwards, for instance, a magnet picking up a pin or nail. To place your mind

at ease, just think of electrons being PULLED TOWARD the MORE POSITIVE POTENTIAL.

The HIGHER the VOLTAGE-the greater the potential difference-the greater the flow of electrons.

RESISTANCE-OPPOSITION TO FLOW OF ELECTRONS

Thus far, only the voltage has been given as a factor influencing the rate of flow of electrons. But OBSTACLES in the path of the electrons have a great effect on electron movement.

Electrical obstacles are called RESISTANCES. All materials have resistance. In the case of most metals, the resistance is low. But with some substances, such as glass, rubber, and cotton, the resistance is great enough to stop the flow completely.

CONDUCTORS AND INSULATORS

The amount of resistance offered by a material depends upon the **NUMBER OF FREE ELECTRONS** in the substance. As an example, **COPPER** and **SILVER** have many free electrons, and offer a low resistance. These metals are called good **CONDUCTORS**.

Substances like **GLASS** and **RUBBER** with few **FREE ELECTRONS** have high resistance and are called **INSULATORS**.

Not all metals conduct current with equal ease. Some offer considerably more resistance than others. The table below shows six conductors arranged in order, with silver the best and iron the poorest. The insulators in the right hand column are not arranged in order.

CONDUCTORS	INSULATORS
Silver	Dry air
Copper	Glass
Aluminum	Mica
Brass	Rubber
Zinc	Asbestos
Iron	Bakelite

12

In addition to the **KIND** of conductors, three other factors-**SIZE**, **LENGTH**, and **TEMPERATURE**-also affect the resistance of a wire.

The larger the wire is in cross section, the lower its resistance. A long wire naturally has more resistance than a short one, and with most metals the resistance rises as the temperature of the wire goes up.

UNIT OF RESISTANCE

The unit of resistance is the **OHM**, which is usually stated in a roundabout manner. An ohm is defined as



Figure 9.-Schematic symbol for a fixed resistor.

the amount of opposition that will permit one ampere of current to flow in a circuit with an applied potential of one volt.

Figure 9 shows the schematic symbol for a resistance as used in radio circuits. More will be given about it in chapter 3.

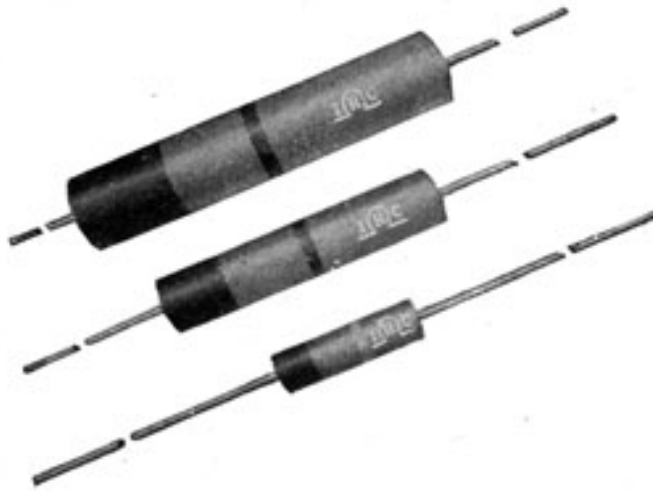

Figure 10.-Carbon resistors.
RESISTORS USED IN RADIO CIRCUITS

Radio circuits use a great variety of resistors. Some are simple and small, like the CARBON types given in figure

13

10 ; others are more complicated, like the tapped, wirewound varieties of figure 11.

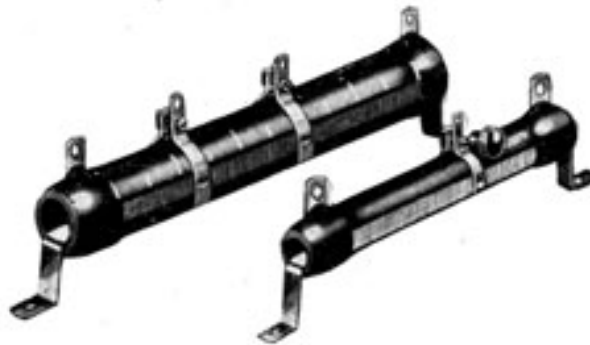

Figure 11.-Wire-wound resistors.

The carbon resistors are made by fusing and burning a mixture of carbon and clay. The amount of resistance is determined by the relative mixtures used.

Wire-wound resistors are formed by winding high resistance wire on a ceramic tube. The specific resistance of the wire and the length of the winding determine the resistance.

With the exception of a narrow strip down one side, the whole resistor is covered with a coat of enamel. The exposed strip of bare wire is made to permit you to TAP the resistor and obtain the desired resistance.



Figure 12.-Variable resistor.

The resistor in figure 12 is of the VARIABLE type. It is made by wrapping high resistance wire about a short section of a paper tube. The arm is movable, and by

14

turning the knob, this arm is made to tap-off any value between zero and the maximum resistance.



Figure 13.-Variable resistors.

Other forms of variable resistors are given in figure 13. When you turn up the volume on your radio receiver, it is one of these resistors you are adjusting.

15



[Radio Home](#)
[Page](#)



[Next Chapter](#)

Copyright (C) 2005 [Historic Naval Ships Association](#)

All Rights Reserved

[Legal Notices and Privacy Policy](#)

Version 1.00, 12 Nov 05

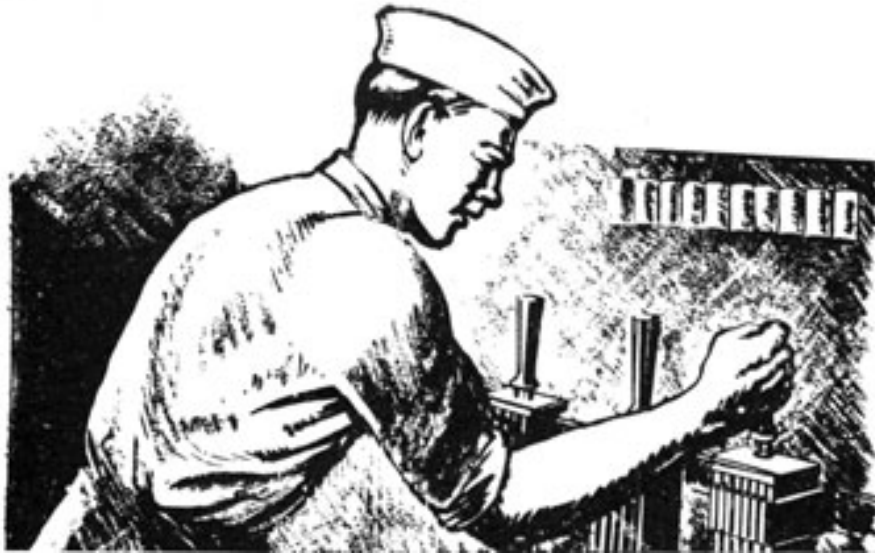

CHAPTER 2 BATTERIES ELECTROMOTIVE FORCE

ALL FORCES that tend to keep electrons moving through a conductor are called ELECTROMOTIVE FORCES. That should not be difficult to remember if you think of it as ELECTRON-MOVING-FORCE, or just EMF.

PRIMARY CELL

BATTERIES, or CELLS, as single units of a battery are called, are extremely common. If you have silver and gold fillings in your teeth, you are carrying a simple cell in your mouth.

Why ? A SIMPLE CELL is formed whenever you have TWO DIFFERENT METALS in an ELECTROLYTE.

GOLD is one metal; SILVER is another; and SALIVA is an electrolyte. An electrolyte is any liquid, such as an acid, saltwater or an alkali, that will CONDUCT ELECTRICITY.

A simple cell, sometimes called a primary cell, will continue to deliver current until ONE OF THE METALS has been EATEN AWAY, or until the ELECTROLYTE IS EVAPORATED.

The cell, once dead, **CANNOT BE RECHARGED**. The only way to bring it back to life is to put in new plates and replace the electrolyte.

HOW A PRIMARY CELL WORKS

Most metals have a tendency to give away **ELECTRONS** and become **POSITIVELY** charged. Some metals, like copper and silver, have a much stronger tendency to give away their electrons than do zinc and iron. Therefore if you place a strip of **COPPER** and another of **ZINC** in an electrolyte such as ammonium chloride (see figure 14),

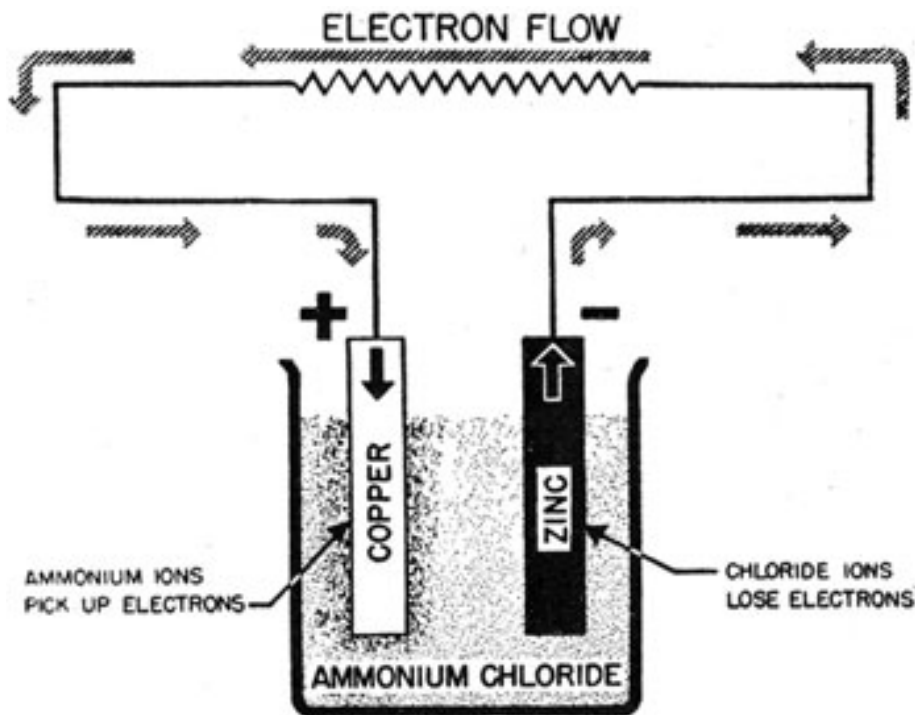

Figure 14.-A simple cell.

the **COPPER** will give up electrons and become **MORE** positive. In the external circuit, electrons will flow away from the zinc, through the resistor, and onto the copper plate.

The chemical action going on inside the cells is too complicated for a discussion at this time, but here is just a hint of what happens. The ammonium chloride breaks into positively and negatively charged particles called

IONS. These IONS act as FERRY BOATS to carry the electrons from the copper plate to the zinc plate. It is this CHEMICAL ACTION that produces the emf.

The COMBINATIONS of metal used play a big part in the action of the cell. The 10 metals and carbon given below are arranged in order, with gold, the most positive, on top.

Gold
Carbon (not a metal)
Mercury
Silver
Copper
Lead
Tin
Nickel
Iron
Zinc
Aluminum

The second most positive is carbon, next mercury, and so on down the list. In short any metal will be POSITIVE to any metal that appears BELOW IT. Now, imagine any two metals in a simple cell and connected by an external circuit. Electrons will flow through the external circuit FROM THE LOWER METAL TO THE HIGHER METAL.

The FARTHER APART the two metals appear in the table, the larger will be the difference in their potential. If gold and aluminum are used, the emf will be 2.69 volts. With carbon and zinc, the emf will be 1.8 volts; while with copper and zinc it is only 1.1 volts.

The output voltage of a cell will never be as great as the two metals used indicate, because the INTERNAL RESISTANCE of the CELL (electrolyte) SUBTRACTS from the potential difference of the plates. As an example, the actual emf of a carbon-zinc cell is only about 1.5 volts instead of 1.8 volts.

DRY CELL

While primary cells can be used with a liquid electrolyte, it is a common practice to mix the electrolyte

19

with a POWDER, usually manganese-dioxide, to form a paste. The result is a common DRY CELL.

The paste is placed inside a ZINC can, and a CARBON rod inserted into the paste as illustrated in figure 15.

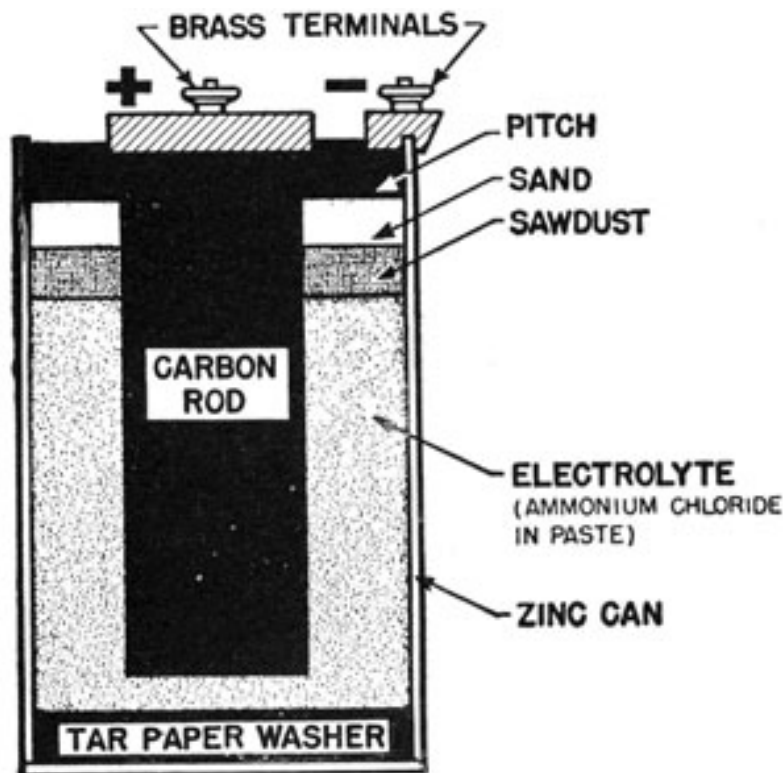

Figure 15.-Cross section of a dry cell.

A heavy paper washer is placed in the bottom of the can to prevent the carbon from touching the zinc. The sawdust, sand, and pitch form a seal to prevent the electrolyte from evaporating.

The dry cell becomes dead when the zinc can has been eaten away, and the electrolyte has evaporated. Dry cells can be brought back to life temporarily by punching holes in the zinc can and then submerging the cell in a pail of water for five or ten minutes. This is only an emergency measure, but it may help you out of a tight spot some time.

SECONDARY CELLS

SECONDARY or STORAGE cells are those that can be RECHARGED. They are used whenever a larger supply of current is needed than can be furnished by dry cells.

The plates of a storage cell are usually made of LEAD, and the positive plates are coated with LEAD PEROXIDE. The electrolyte is SULFURIC ACID.

In figure 16, when the cell is discharging, electrons flow from the negative lead plate through the load to the positive lead-peroxide plate. The lead-peroxide combines with sulfuric acid to form lead sulfate and water. During discharge lead sulfate is deposited on both plates.

When the cell is being charged (figure 16), the current is FORCED to reverse its direction. The lead sulfate is

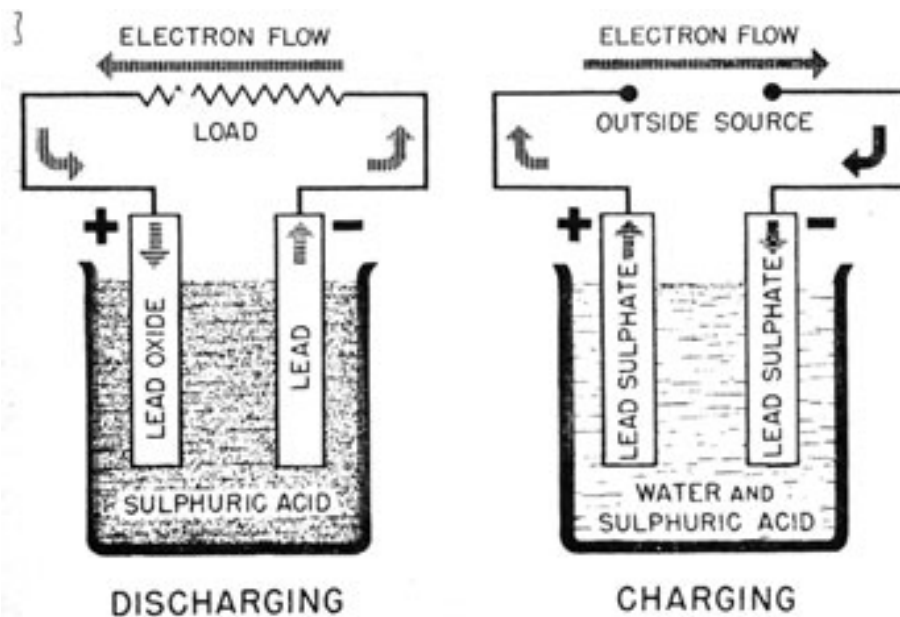

Figure 16.-Charging and discharging of a storage cell.

changed back to lead peroxide on the positive plate, and to lead on the negative plate. This action returns sulfuric acid to the electrolyte, which increases in strength.

In an automobile cell this process of charging and discharging goes on hundreds of times. When the cell discharges, it supplies current to the lamps, the starter, and

21

a host of other instruments. But while the cell is charging, a direct current generator forces electrons to flow backwards through the cell. This rebuilds the plates and restores the electrolyte.

The strength of the sulfuric acid is used to indicate whether the cell is charged or discharged. If the **HYDROMETER**-a battery tester-reads less than 1,100, the cell is almost dead, but when it shows a value greater than 1,350, it is well charged.

CELLS AND BATTERIES

When several individual units such as three dry cells are connected together, they form a **BATTERY**. A single unit is not a battery but a cell.

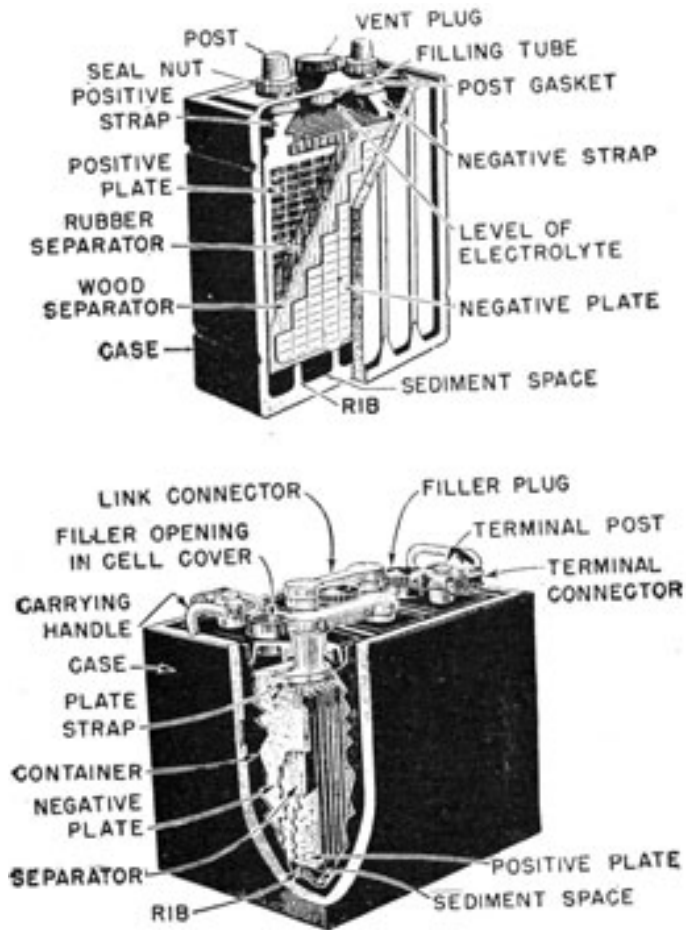

Figure 17.-Lead-acid storage cell and battery.

In figure 17 the top drawing shows a cutaway of a storage cell, while the lower drawing shows a three-cell battery.

CELLS IN SERIES AND PARALLEL

Cells are connected together to obtain either INCREASED emf or an INCREASED AVAILABLE SUPPLY OF CURRENT.

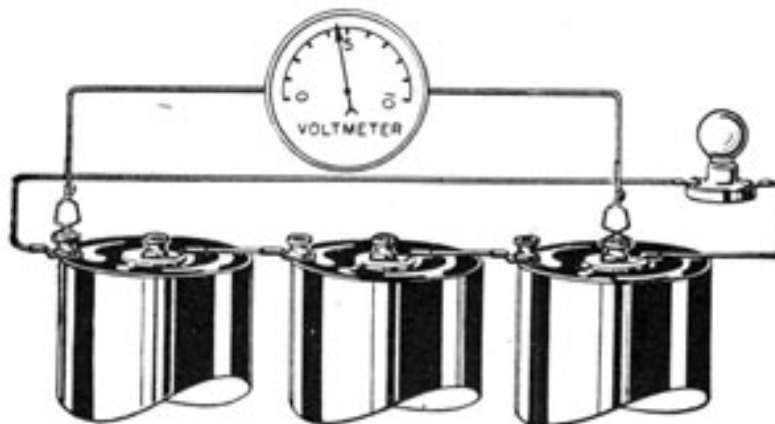

Figure 18.-Cells in series.

Connecting cells in series-that is, positive-to-NEGATIVE, positive-to-negative, and so on-increases the total emf output.

In figure 18 the three cells, each 1.5 volts, are connected in series. The total emf of the combination is 4.5 volts. If four cells are used, the output emf will be-

$$4 \times 1.5 = 6 \text{ volts}$$

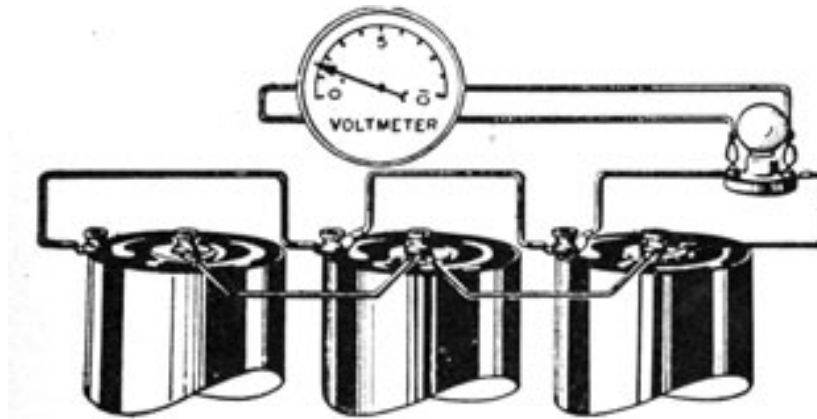

Figure 19.-Cells in parallel.

23

Each cell of the storage battery in figure 18 has an emf of 2 volts. The three connected in series will have an output voltage of-

$$2 \times 3 = 6 \text{ volts}$$

When you wish to obtain an INCREASED AVAILABLE SUPPLY OF ELECTRONS, you will connect the cells in PARALLEL-that is, connect together all the positive terminals and all negative terminals as indicated in figure 19.

The output voltage of cells in parallel is equal to that of a single cell-but the available current is approximately equal to the current of a single cell TIMES THE NUMBER of cells.

By making proper combinations of series and parallel cell connections, wide varieties of both emf and available current supply can be obtained.

SCHEMATIC SYMBOL FOR CELLS AND BATTERIES

Usually you will see the schematic symbol used to indicate a cell or battery, rather than a pictorial representation . The symbols for a single cell, cells in series, and



Figure 20.-Symbol for cells in series and parallel.

cells in parallel are given in figure 20. The LONGER LINE is the positive terminal of a cell.



[Previous Chapter](#)



[Radio Home](#)
[Page](#)



[Next Chapter](#)

Copyright (C) 2005 [Historic Naval Ships Association](#)

All Rights Reserved

[Legal Notices and Privacy Policy](#)

Version 1.00, 12 Nov 05

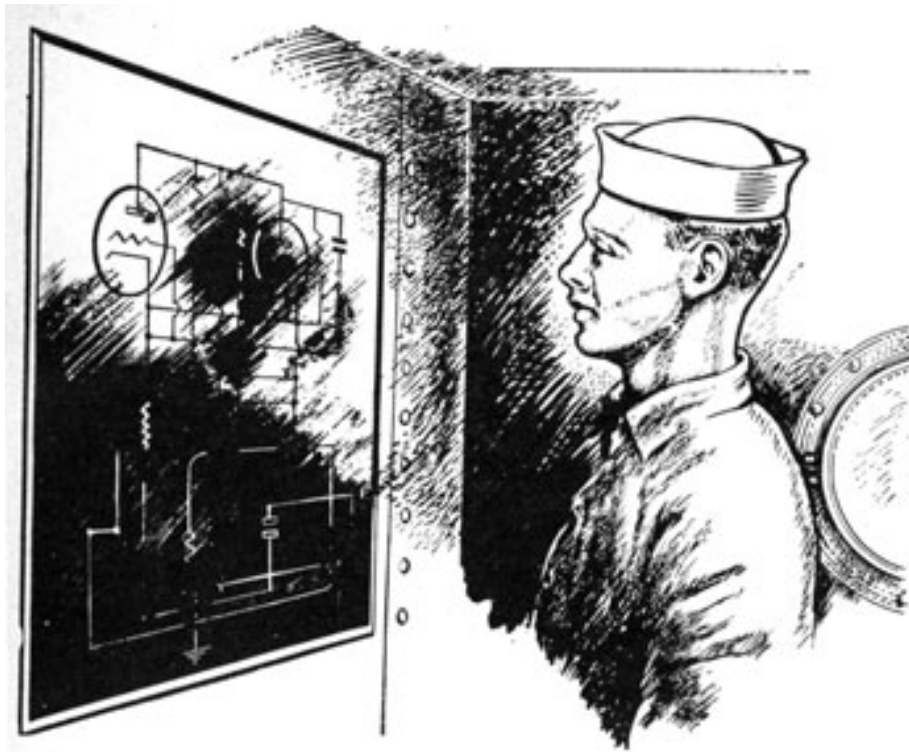

CHAPTER 3

CIRCUITS

THE PATH MUST BE COMPLETE

Before a current can flow, a **CLOSED** and **COMPLETE** path must be present for the electrons to follow. The path must extend from the source of emf through elements in the circuit and back to the source.

You have had some experience with circuits already, and you know something of their characteristics. As an example, when you flip a switch to turn on an electric light, you closed a circuit. And when you throw the switch in the opposite direction, you turn off the light by breaking the circuit.

A string of lights on a Christmas tree is an example of another type of circuit. If all the lights are good, and none are turned out of their sockets, all will remain lighted. But if one is burned out or loose in its socket, all will be out.

699198°-46-3

You know too, that if a fuse in a circuit is burned out, the electrical device, what ever it may be, will be dead. And before the device can operate, the fuse must be replaced. Thus in any electrical circuit, a **CLOSED AND COMPLETE PATH** from the source of emf through the electrical device and back to the source **MUST BE PRESENT** if the device is to operate.

Look at figure 21. A **COMPLETE PATH** is present from the negative terminal, through the lamp, and back to the

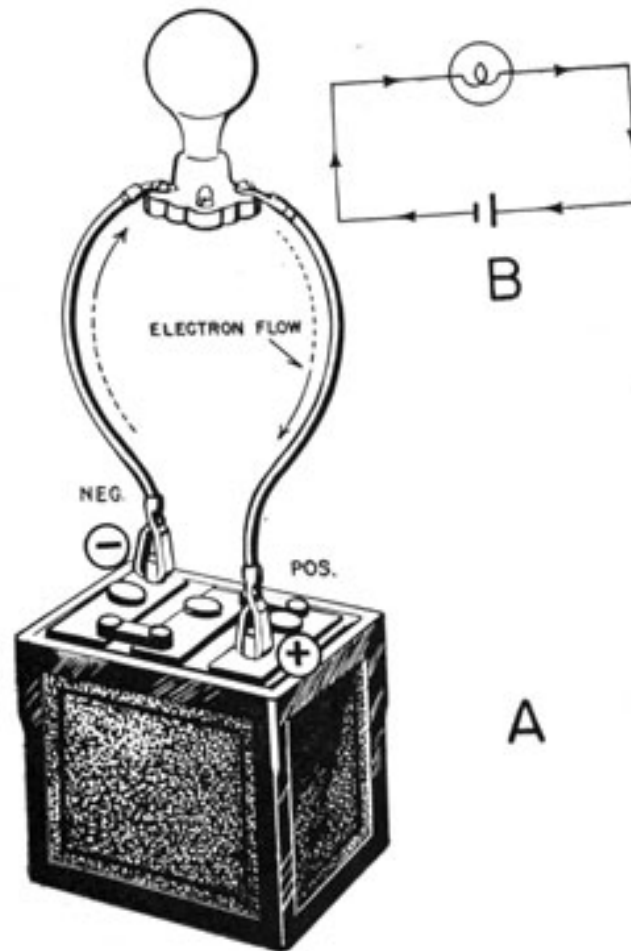

Figure 21.-A simple circuit.

positive pole of the battery. It is complete and without breaks.

If one clamp is removed from the battery, a conductor broken. or the lamp removed from the socket, the **CIRCUIT**

IS BROKEN, because a complete path is not present for the electrons to follow.

SWITCHES are placed in circuits to provide a safe and convenient way of making and breaking the paths. When the switch is closed, the circuit is complete, but when the switch is opened, the path is broken, and current ceases to flow.

SIMPLE AND COMPLEX CIRCUITS

Few electrical circuits are as simple as the one indicated in figure 21. Most radios contain hundreds of elements, but before the circuit will function, a CLOSED and COMPLETE path through all the elements must be present for the electrons to follow.

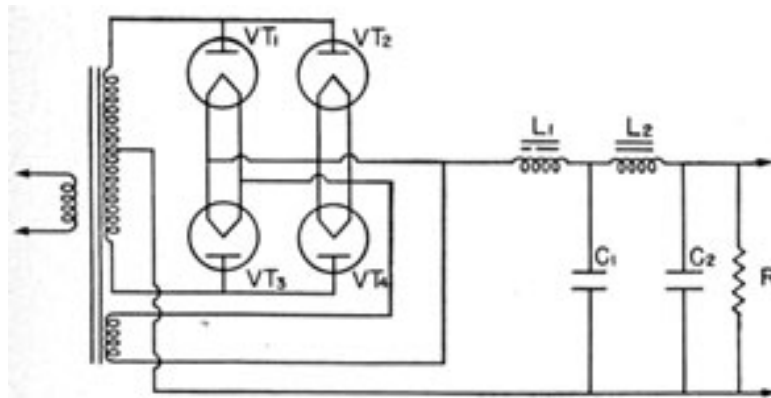

Figure 22.-A complex circuit.

Figure 22 is a complex circuit of the type you will find in some radios. Right now it may not make sense, but it does show the difference between the simple and complex types.

If you wish to see a really complex circuit, get a schematic diagram of an RBA or RAL receiver.

SERIES AND PARALLEL CIRCUITS

In spite of the complex nature of any circuit, all are just combinations of two basic types, SERIES and PARALLEL. The lamps in figure 23A illustrate a SERIES circuit, those in 23B a PARALLEL circuit.

27

In the series circuit, the current that flows through L_1 also flows through L_2 . But in the paralleled circuit, the current divides at point X, part flowing through L_1 and the rest L_2 . At point Y, the current combines and returns to the battery. Thus the current is the same at all points of a series circuit, while in a parallel circuit it is DIVIDED among the various branches.

If the resistances of the lamps in a parallel circuit are EQUAL, the CURRENT THROUGH EACH LEG will also be

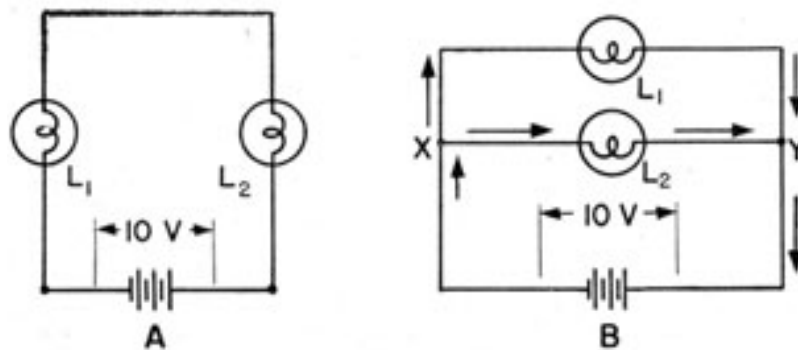

Figure 23.-Series and parallel circuits.

EQUAL. But if the resistance of ONE is LARGER than the other, the current will be UNEQUAL, with the LARGER PORTION of the current flowing through the SMALLER resistance.

The VOLTAGE DISTRIBUTION is also different in series and parallel circuits. In figure 23A, if 10 volts is applied to the lamps, and the resistances of the lamps are equal, half the voltage (5 volts) will appear across each. But if the resistance of one lamp is greater than the other, the LARGER portion of the voltage will appear across the LARGER RESISTANCE.

Actually the voltage distribution across the lamps is PROPORTIONAL to their resistances. As an example, if the resistance are 200 ohms in L_1 and 100 ohms in L_2 , two-thirds of the applied voltage will appear across L_1 and one-third across L_2 .

In PARALLEL CIRCUITS the voltage across ALL elements is EQUAL. In figure 23B, for example, the voltage across

28

L_1 and L_2 will be equal, even if the resistance of one is 100 times the other.

RESISTANCES IN SERIES

Resistances connected in series are just like a sequence of ladders connecting the lower decks with those topside. If you wish to go from the fourth deck to the first, it will be necessary for you to climb each ladder from 4th to 3rd, 3rd to 2nd, and 2nd to 1st.

The ladders are obstacles, or resistances, to be overcome-one after the other in series. Thus by the time you reach the first deck, the total opposition to your climb would be equal to the sum of all the individual obstacles.

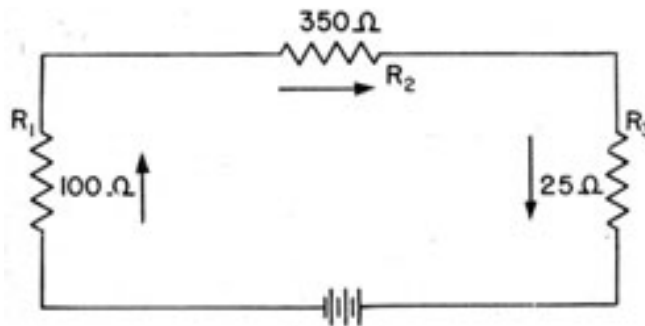

Figure 24.-Resistances in series.

In a series circuit you have the same story. The current flowing through the circuit in figure 24 must move through each resistor in series. Therefore the total opposition (resistance) to the flow of current is equal to the sum of all the INDIVIDUAL resistances, or-

$$R_T = R_1 + R_2 + R_3 = 100 + 350 + 25 = 475 \text{ ohms}$$

RESISTANCES IN PARALLEL

Resistances in parallel are like the SEVERAL ladders connecting any two decks. Suppose you have four ladders connecting the second deck to the first. The four ladders are ALTERNATE PATHS you may use to go topside.

29

If you are the only person desiring to go up, it will make little difference which ladder you use. But if you are having a drill to abandon ship so that everyone wants to get on deck in a hurry, the four ladders will allow four times as many to get on deck as would be possible with only one ladder.

If all ladders are the same width, four ladders will offer just 1/4 the resistance of one. If six ladders of equal width are present, the resistance will be 1/6 the resistance of one.

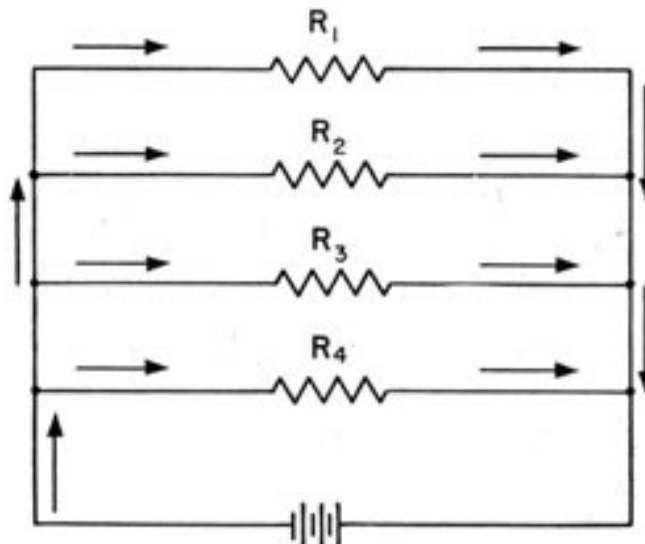

Figure 25.-Resistances in parallel.

Electrical resistances in parallel work the same way. Suppose the four resistances in figure 25 are of 100 ohms each. The total resistance of the circuit will be 1/4 of 100, or 25 ohms. The total opposition will be only 1/4 that of a single resistor.

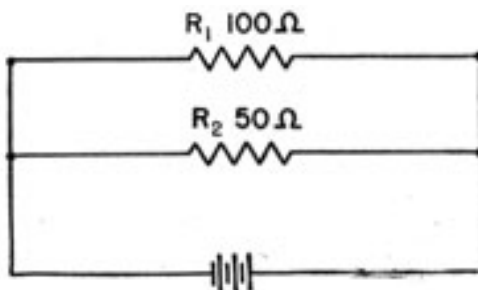

Figure 26.-Two unequal resistances in parallel.

30

Unfortunately, the resistances in parallel circuits are frequently not equal. Look at figure 26. Two UNEQUAL values are indicated.

Since R_1 is 100 ohms and R_2 50, the total resistance naturally will be less than the smaller-but how much?

There are several ways of finding the total resistance, but the easiest is to use the following formula-

$$R_T = (R_1 \times R_2) / (R_1 + R_2)$$

$$R_T = (100 \times 50) / (100 + 50) = 5,000/150 = 33.3 \text{ ohms}$$

Sometimes you will find three or more unequal resistances in parallel. To find the total resistance in such a circuit, proceed as indicated in figure 27.

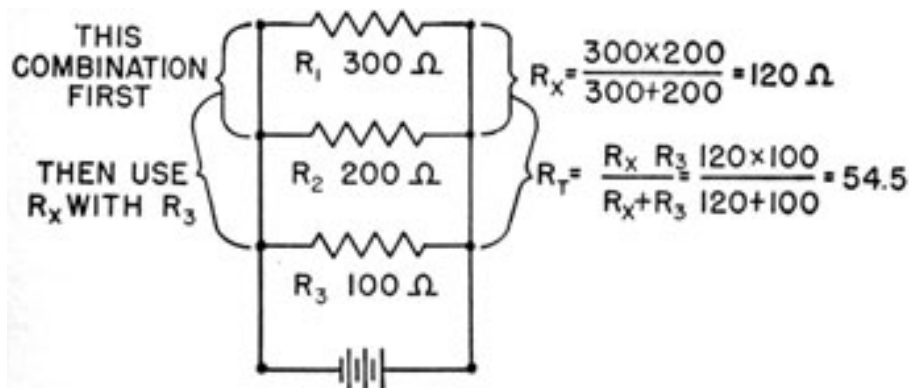

Figure 27.-Three unequal resistances in parallel.

First, find the combined resistance of R_1 and R_2 . This gives you the sub-total, R_x , equal to 120 ohms.

Then combine R_x with R_3 in the same manner to obtain R_T of 54.5 ohms.



[Previous Chapter](#)



[Radio Home
Page](#)



[Next Chapter](#)

Copyright (C) 2005 [Historic Naval Ships Association](#)

All Rights Reserved

[Legal Notices and Privacy Policy](#)

Version 1.00, 12 Nov 05

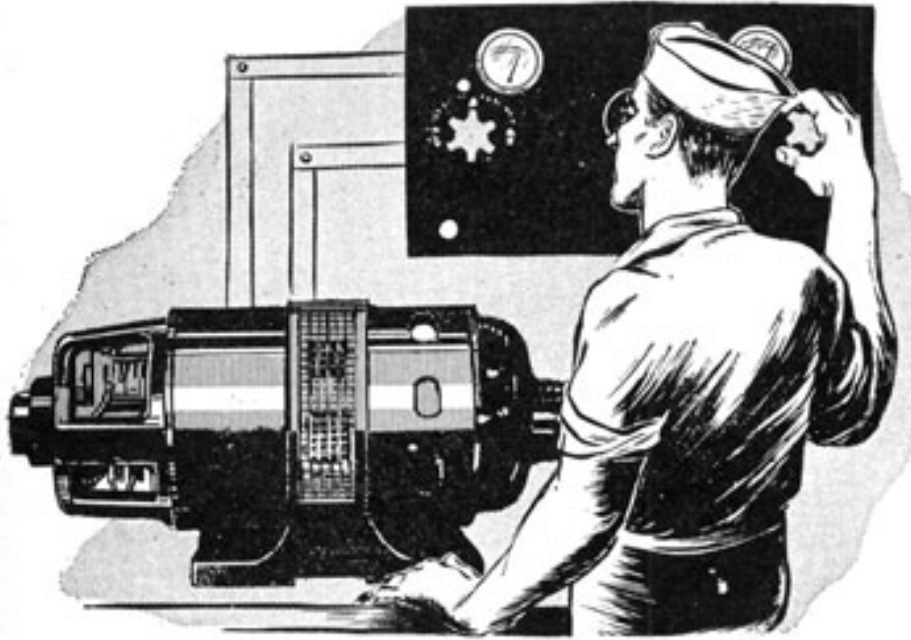

CHAPTER 4

OHM'S LAW

CURRENT-RESISTANCE-VOLTAGE

You learned in chapter 1 that the flow of **CURRENT** is influenced by both **VOLTAGE** and **RESISTANCE**. **INCREASE** the **VOLTAGE**, and you also **INCREASE** the **CURRENT**. But if you **INCREASE** the **RESISTANCE**, the **CURRENT DECREASES**.

In some respects, the flow of current in a circuit is like the movement of water in a pipe. The rate of water flow is influenced by the size of the pipe and by the amount of pressure applied to the water. Naturally a large pipe with few obstacles will allow more water to move through it than a smaller one. And if a high pressure is applied a greater flow will take place than if the pressure is lower.

Don't become confused by thinking that voltage and water pressure are exactly the same thing. While water pressure has an effect on the movement of water similar to the effect of voltage on the movement of electrons, they are not the same. Water pressure is a "push" from

behind, while electrons are "pulled" toward the higher voltage. The results of the two are much the same, but you should keep the difference in mind.

The relationship of the CURRENT to both VOLTAGE and RESISTANCE is given in Ohm's Law. It reads, "The current flowing in a circuit VARIES DIRECTLY as the VOLTAGE and INVERSELY as the RESISTANCE." Since Ohm's Law states the relationship as a PROPORTION, you may write the law in a simple formula-

$$\text{Current (I)} = \text{Voltage (E)} / \text{Resistance (R)} \text{ or just } I = E / R$$

FINDING THE CURRENT BY USING OHM'S LAW

Ohm's Law provides a simple method for finding the CURRENT flowing in a circuit if you know the VOLTAGE and RESISTANCE.

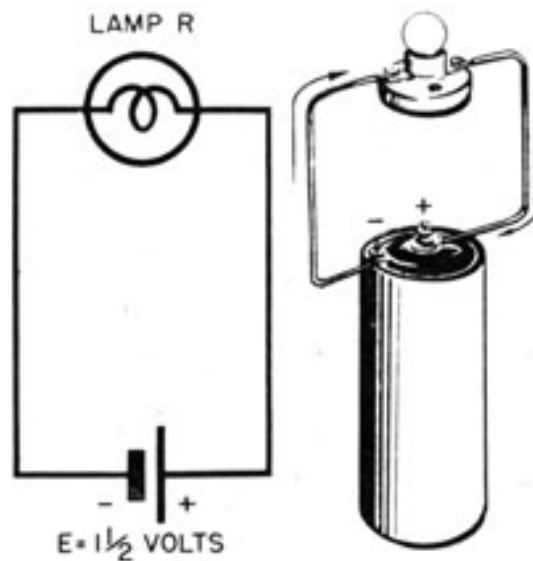

Figure 28.-Simple circuit.

In figure 28, a lamp is connected to a battery with an emf of 1.5 volts. The resistance of the lamp is 15 ohms. To find the current flowing, substitute the values of E and R in the formula of Ohm's Law and solve-

$$I = E / R = (1.5 / 15) = 0.10 \text{ amperes}$$

Thus whenever you know the applied VOLTAGE and the RESISTANCE of a circuit, you can find the current by using Ohm's Law.

FIND THE RESISTANCE BY USING OHM'S LAW

By performing an easy mathematical maneuver, Ohm's Law can be changed-

$$\text{from } I = E / R \text{ to } R = E / I$$

In this new form you use Ohm's Law to find the RESISTANCE of a circuit if you know the CURRENT and the APPLIED VOLTAGE.

The ammeter, in figure 29, indicates a current of 0.02 amperes flowing through the circuit. The applied E is

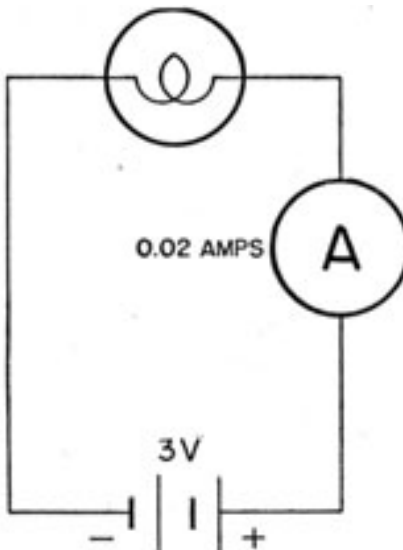

Figure 29.-Simple circuit.

three volts. To find the resistance of the circuit, substitute in the values of E and I in the formula-

$$R = E / I = 3 / 0.02 = 150 \text{ ohms}$$

FINDING THE VOLTAGE BY USING OHM'S LAW

When a current flows through a resistance, a DROP in voltage occurs. The LARGER the current and the HIGHER the resistance, the GREATER will be the DROP in voltage. To find this voltage drop, Ohm's Law is again changed

from $I = E / R$ to $E = IR$

The voltage in the new formula is equal to the PRODUCT of the current and voltage. Hence if you know the resistance, and the current flowing through it, you can find the VOLTAGE DROP ACROSS THE RESISTANCE. Voltage drops across resistances are usually called "IR" drops.

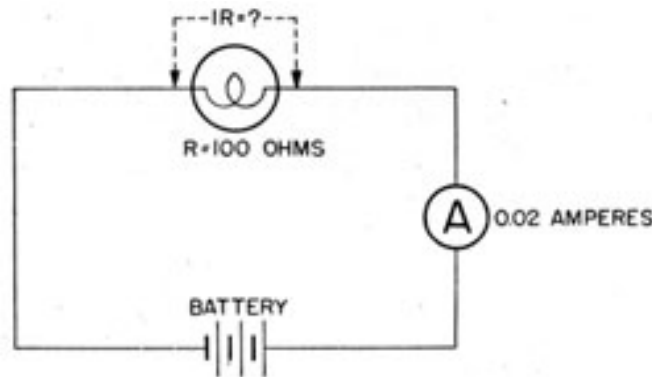

Figure 30.-Simple circuit.

The battery in figure 30 is forcing a current of 0.02 amperes to flow through a lamp whose resistance is 100 ohms. The IR drop across the lamp will be-

$$E = IR = 0.02 \times 100 = 2 \text{ volts}$$

IR DROPS ABOUT A CIRCUIT

It is not unusual for a circuit to contain several resistances in series. Since the same current flows through all the resistances, IR drop will be present across each resistor.

36

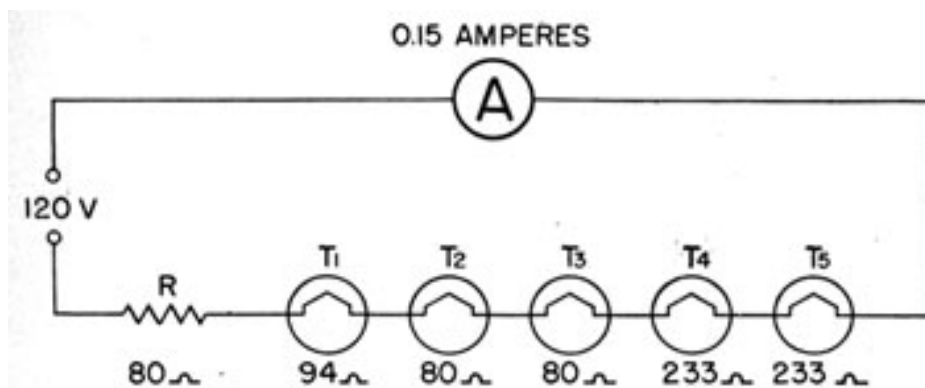

Figure 31.-IR drops about a series circuit.

Figure 31 is a basic filament circuit used in some small AC-DC receivers. The filaments of the 5 tubes T_1 T_5 are connected in series with an outside resistor R . The resistance of each filament is given below the tubes. An ammeter in the circuit indicates a current of 0.15 amperes to be flowing. The IR drop across each tube and resistor will be equal to-

resistance X 0.15

So for the series circuit the IR drops will be-

$$R - 80 \times .15 = 12.00 \text{ volts}$$

$$T_1 - 94 \times .15 = 14.00 \text{ volts}$$

$$T_2 - 80 \times .15 = 12.00 \text{ volts}$$

$$T_3 - 80 \times .15 = 12.00 \text{ volts}$$

$$T_4 - 233 \times .15 = 34.95 \text{ volts}$$

$$T_5 - 233 \times .15 = 34.95 \text{ volts}$$

Total 119.90 volts

All the IR drops added together equal 119.90 volts. Now look at the applied voltage-120 volts. It suggests that the sum of the IR drops about a closed circuit are EQUAL to the APPLIED E .

What happened to the other 0.10 of a volt (120 - 119.90)? It's distributed over the connecting wires and the meter.

Hence, in any circuit, "The sum of the individual IR drops is EQUAL TO the APPLIED VOLTAGE." That statement is known as Kirchhoff's First Law.

37

Kirchhoff also discovered a law about current. It states, "As much current flows AWAY from a point as INTO it."

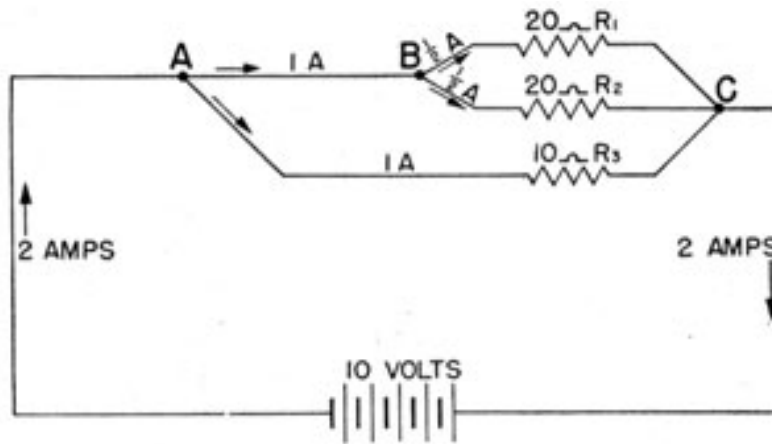

Figure 32.-Current flowing through a divided circuit.

The battery in figure 32 causes a current of 2 amperes to flow through the circuit. At point A, the circuit divides and 1 ampere flows through each leg. At point B, the circuit branches again with 1/2 ampere flowing through each branch. At point C, the three branches come together, and 2 amperes flow away.

In the case of each of the points, A, B, and C, AS MUCH CURRENT FLOWS AWAY AS INTO THE POINT. While this law may sound simple, it is one of the most useful in the study of electricity.

POWER

POWER is the RATE OF DOING WORK. Suppose you are assigned to help load ammunition. If you have a liberty coming up when the loading is done, you will work hard to get the job done in a hurry. But if you are not going any place, chances are you will do the job in a more leisurely manner.

In the first case, the RATE of doing work is high. You will use up a lot of energy in a short period of time. In other words, a lot of POWER will be exerted in doing the

38

job. But when you go about your job leisurely, energy is being expended at a slow rate and the power consumption is low.

In the same way, when a lot of electrons are forced through a resistor in a short period of time, a lot of energy is used and the power consumption is great. If fewer electrons are forced through the same resistor, less power is dissipated.

Actually, the amount of power consumed in forcing electrons through a resistor is proportional to the SQUARE of the CURRENT times the RESISTANCE, or-

$$\text{Power (in watts)} = I^2R$$

Thus, if 0.02 amperes is flowing through 1,000 ohms of resistance, the power being dissipated will be

$$\text{Watts} = .02^2 \times 1,000$$

$$\text{Watts} = 0.4$$

But if the current is increased to .04 amperes, the power goes up to-

$$\text{Watts} = .04^2 \times 1,000$$

$$\text{Watts} = 1.6$$

There are two other formulas that you can use to find the power of a circuit. One is-

$$\text{Watts} = E \times I$$

and the other is-

$$\text{Watts} = E^2 / R$$

You may use any of these three formulas to find the power. They all express rate of doing work.



[Previous Chapter](#)



[Radio Home](#)
[Page](#)



[Next Chapter](#)

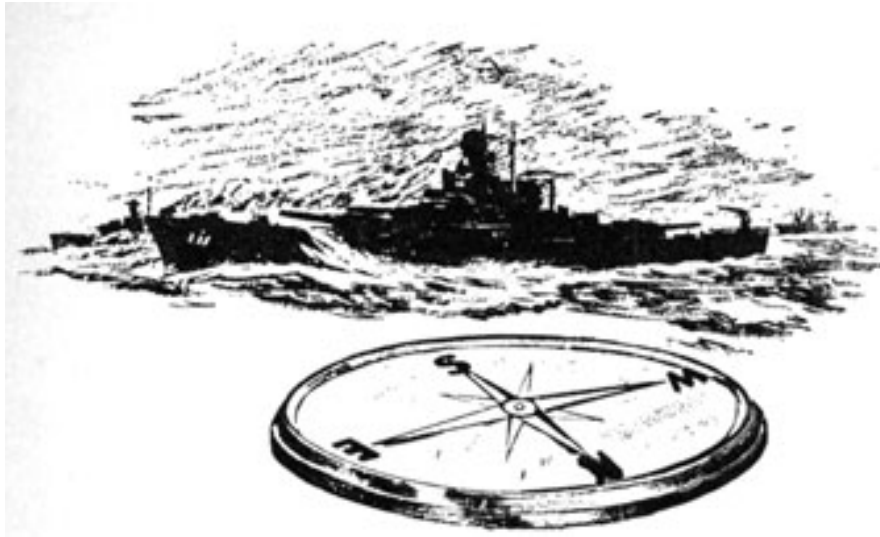

CHAPTER 5 MAGNETISM NATURAL MAGNETS

It may seem strange to you that, for centuries, magnets were of little practical value. Magnetism's first real use was in a compass to guide the ancient mariners. The first of these devices was little more than a magnetized needle on a block of wood floating in a dish of water. Crude as they were, these early compasses were the first step toward modern navigation.

Little by little other uses were found, but it was not until the 19th century that new discoveries and inventions showed magnetism to be one of the foundations of the science of electricity.

Not only are magnets important in many electrical devices that you will use directly, but also in hundreds of hidden and indirect ways, such as the generation of an emf to light the incandescent bulbs about the ship.

The discovery of magnetism dates back to the ancient shepherds of Asia Minor. They noticed that the iron tips of their staffs were attracted to certain types of stones. These stones were **NATURAL MAGNETS** known as **LODESTONES**, meaning "leading stone."

609198°-46-4

The shepherds also observed that the iron tips of the staffs, if left in contact with lodestones, soon acquired the ability to attract other pieces of iron. While these



Figure 33 -Lodestones.

ancients did not understand WHY these things happened, they were observing two types of magnets, NATURAL and ARTIFICIAL.

A lodestone, the NATURAL magnet, is a piece of rich IRON ORE, magnetite, and its source of magnetism is the

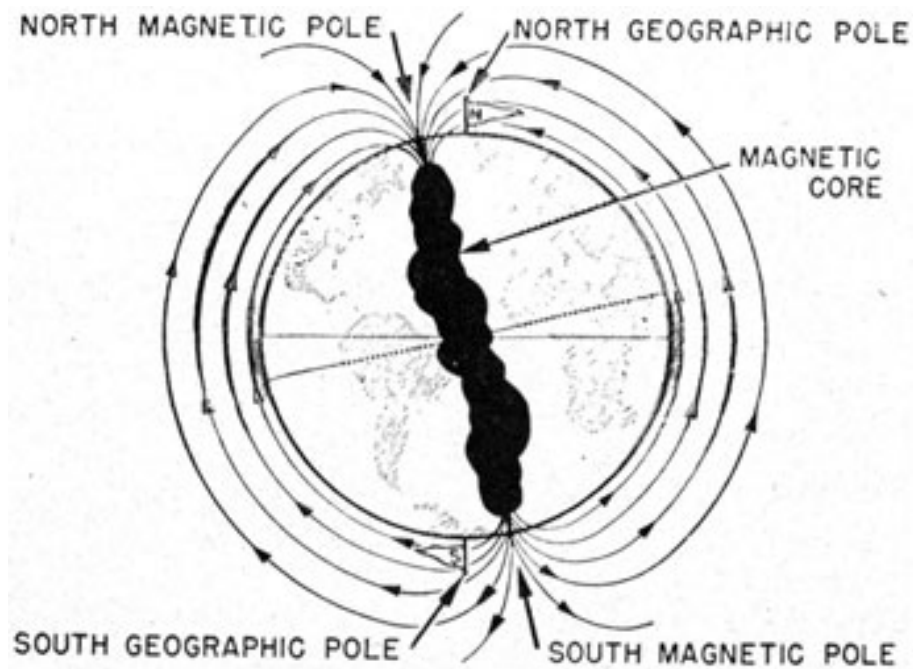

Figure 34.-Earth's magnetic and geographic poles.

earth itself. As illustrated in figure 34, the core of the earth is assumed to consist of iron, or a high grade iron ore.

During the past ages, the core became magnetized. The EFFECT of this magnetism seems to be concentrated in two areas, which are located near the north and the south GEOGRAPHIC poles.

The area near the north geographic pole is called the NORTH MAGNETIC POLE and the other the SOUTH MAGNETIC POLE.

ARTIFICIAL MAGNETS

Most NATURAL magnets have many north and south poles. The nails, sticking to the lodestone in figure 33, indicate the presence of three poles. Actually it may have many more. In addition to having many poles, the magnetic strength of a lodestone is too weak to be useful.

A few metals-iron, cobalt, and nickel-have the ability to become magnetized. They are ARTIFICIAL magnets, having but two poles and a greatly increased magnetic strength.

THEORY OF MAGNETISM

Probably no one knows exactly what happens inside an iron bar when it becomes magnetized, but a good explanation has been given. A piece of iron is supposed

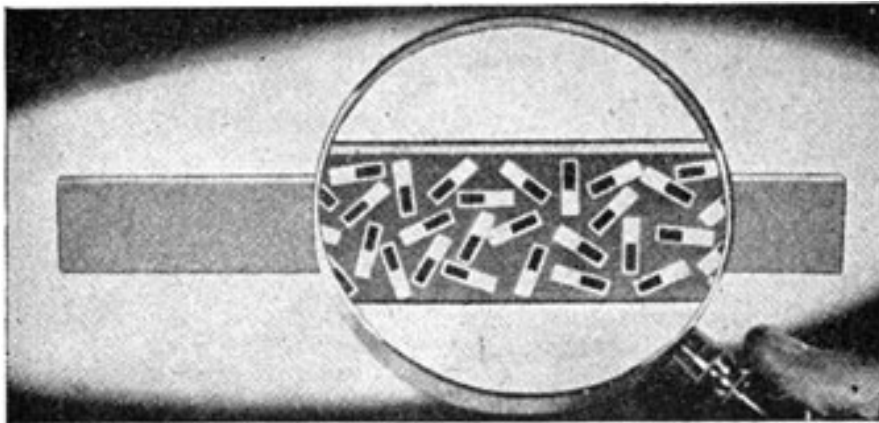

Figure 35.-Unmagnetized iron bar.

to be made of millions of small magnets. When the bar is unmagnetized, these small magnets have a "helter-skelter" arrangement as illustrated in figure 35. The magnetic forces of one molecule cancel the field of its neighbor.

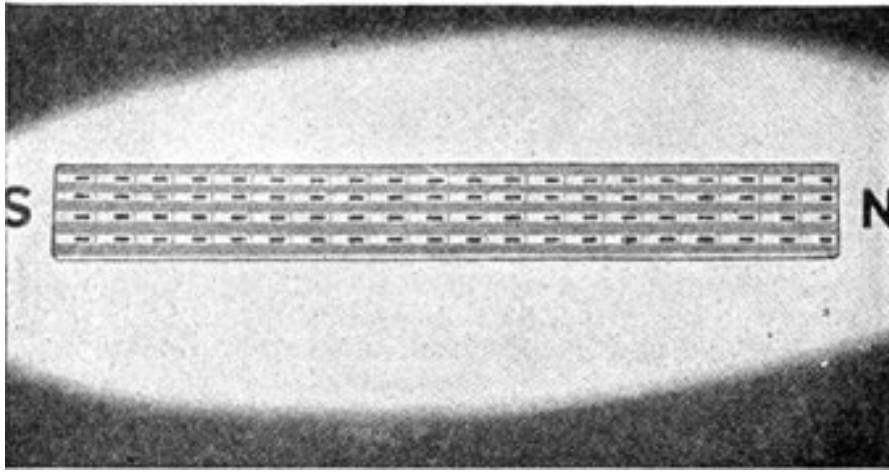

Figure 36.-Magnetized iron bar.

When the bar is magnetized, the small magnets are arranged so that ALL the north poles point in one direction, and all the south poles in the opposite direction. This systematic "line-up" of the individual magnets causes the whole bar to act as a SINGLE MAGNET. All the magnetism seems to be concentrated at the two ends of the bar, with one end designated as NORTH and the other SOUTH.

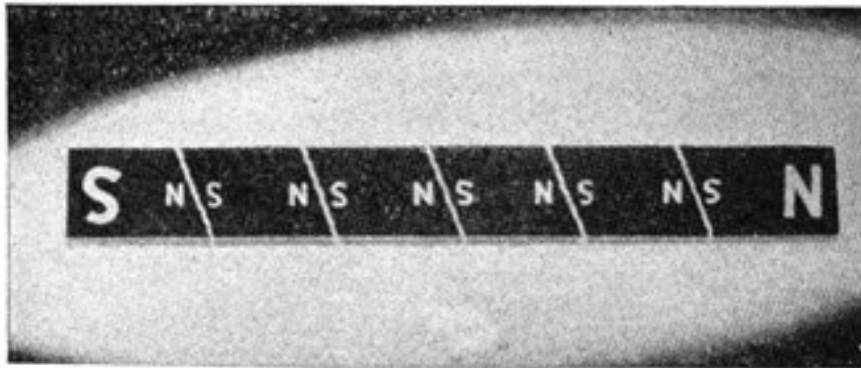

Figure 37.-Magnetic Poles.

Breaking the bar in half or into many pieces does not separate one pole from the other. As illustrated in figure

37, a magnet may be cut into many pieces, and each will have a north and a south pole.

MAKING A MAGNET

A bar of iron may be magnetized by stroking it with a lodestone or with another magnet. You must be careful always to stroke in the same direction, as illustrated in figure 38. It doesn't make any difference which way you

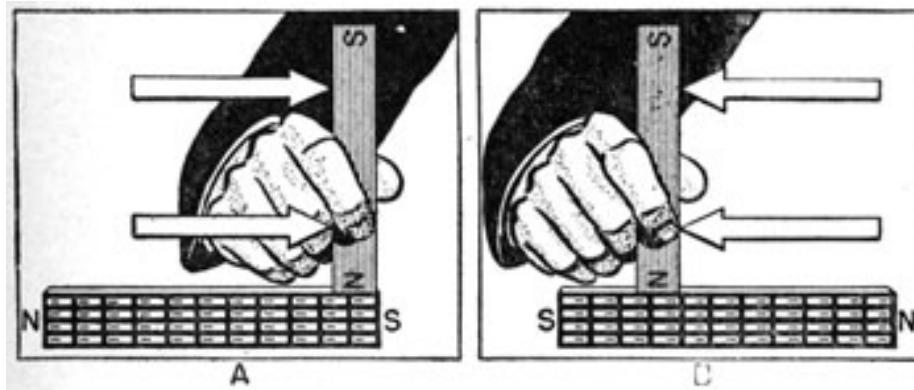

Figure 38.-Making a magnet by induction.

stroke the bar-just be sure you LIFT the stroking bar several inches away at the end of each stroke.

The stroking arranges the molecular magnets within the bar so that the N poles point in one direction and the S poles in the other.

If a bar of iron lies in contact with another magnet, the bar will in time become magnetized.

You may also produce a magnet by heating the bar to red heat and then placing it parallel to the magnetic field of the earth-that is, in a north and south direction. Heating the bar frees the molecular magnets so that they may arrange themselves in order with greater ease.

MAGNETIC FIELD

A magnet extends its influence a considerable distance away from the bar. This area of influence is known as the MAGNET'S FIELD.

If you place a pane of glass over a bar magnet, figure 39A, and sprinkle iron filings on the glass, you will get a

45

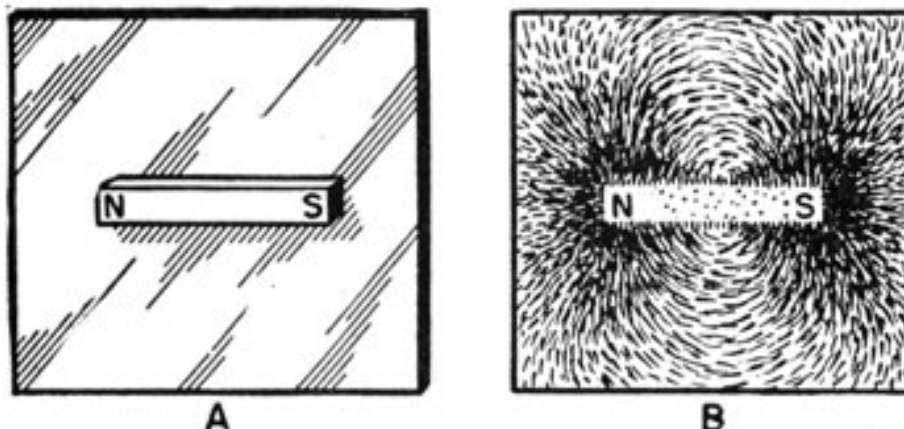

Figure 39.-Magnetic field.

pattern like figure 39B. The filings arrange themselves in DEFINITE LINES, with the GREATEST CONCENTRATION at the ENDS of the bar. The lines DO NOT cross, but run from one end to the other.

Notice only a few scattered filings are directly over the bar itself-indicating the presence there of only a few magnetic lines of force.

NORTH AND SOUTH MAGNETISM

One pole of a magnet is designated as being NORTH, and the other SOUTH. Just how it was decided which should be S and which N is not definitely known, but all the laws of magnetism have been built around this convention.

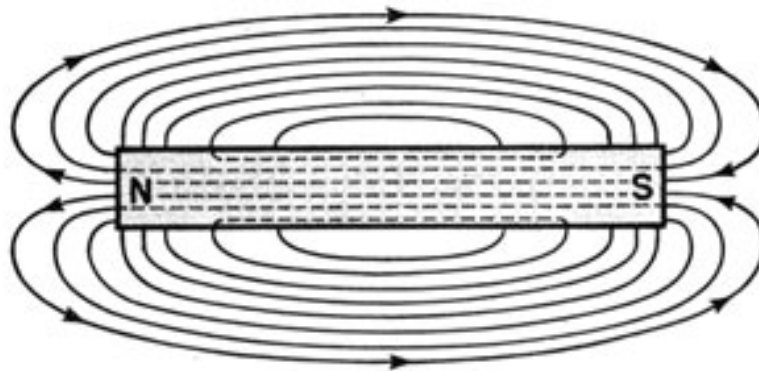

Figure 40.-Flux pattern about a bar magnet

The lines of magnetic force are called FLUX. Like current, the flux is said to flow. The direction of flow is FROM the NORTH pole TO the SOUTH pole.

The arrows on the lines of force in figure 40 indicate the flux to be LEAVING the NORTH and ENTERING the SOUTH pole.

The STRENGTH of a magnet is expressed by the NUMBER OF LINES OF FORCE in the CROSS SECTION AREA of the field. A FLUX DENSITY of 10,000 lines means there are 10,000 lines of magnetic force in a square inch cross section area of the field.

LIKES REPEL-UNLIKES ATTRACT

If you bring two north poles or two south poles together, a force of repulsion will exist between them. In figure 41, when the north pole of the suspended magnet

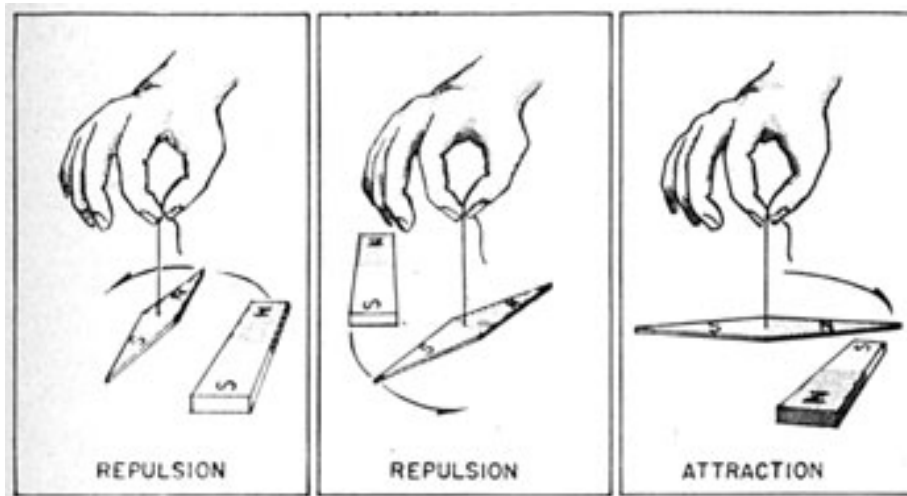

Figure 41.-Likes repel-unlikes attract.

is brought near the north pole of the bar magnet, the needle will swing AWAY. The same thing is true when you bring two south poles together. But if the north pole of the suspended magnet is brought near the south pole of the bar magnet, the needle will move TOWARD the bar, indicating a force of ATTRACTION.

When iron filings are sprinkled over the ends of two like poles, figure 42A, the filings arrange themselves in a

47

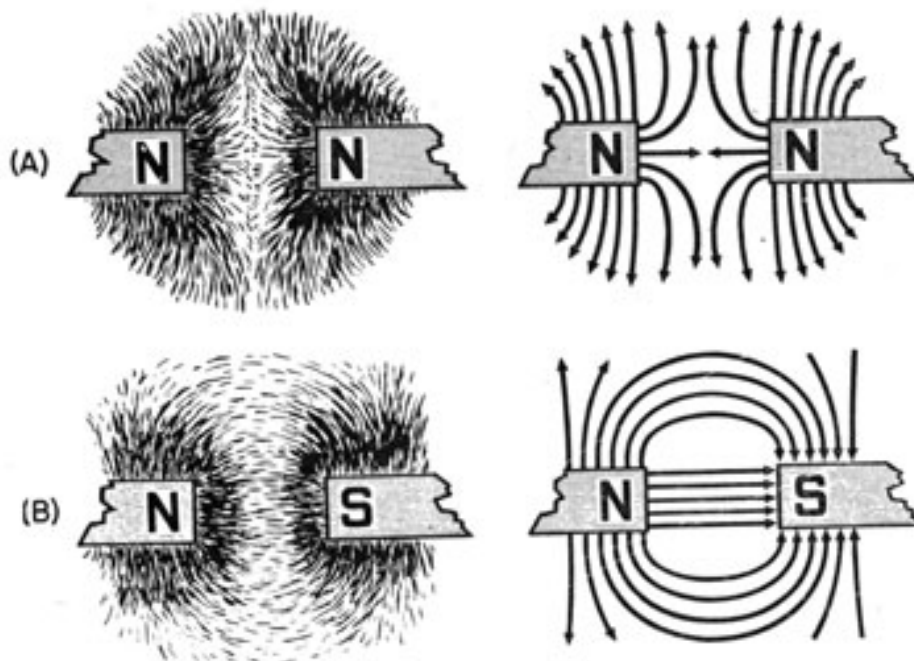

Figure 42.-Likes repel, unlikes attract.

manner that indicates a REPULSION. But with unlike poles, figure 42B, an ATTRACTION is evident.

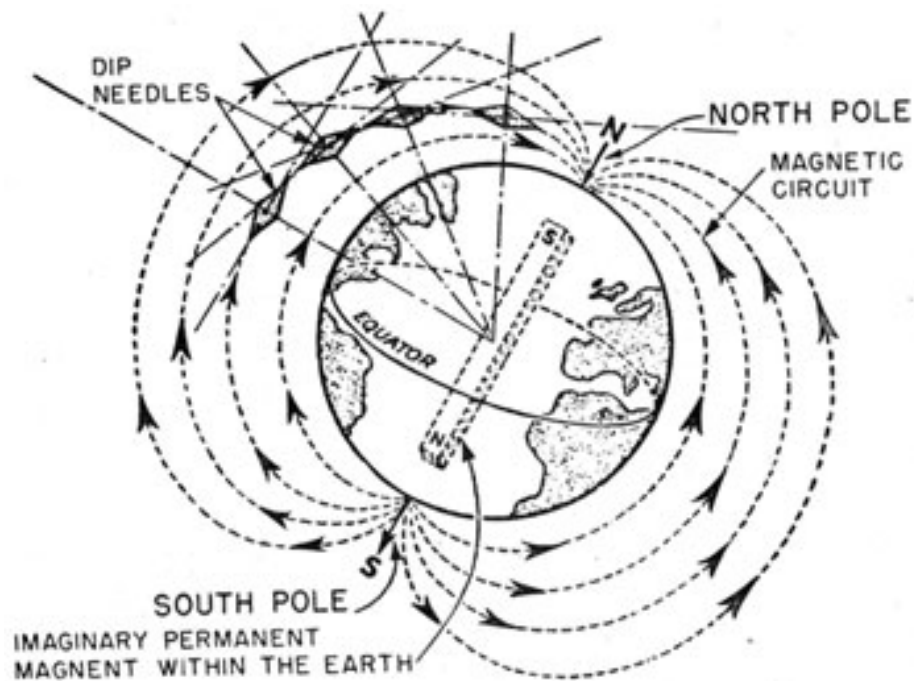

Figure 43.-North magnetic pole has south pole magnetism.

48

THE EARTH'S MAGNETISM

You were told in the first page of this chapter that the earth is a huge magnet and that the NORTH MAGNETIC POLE is near the north geographic pole. That is very true, but the north magnetic pole has SOUTH POLE MAGNETISM.

To help clear this confusion, look at figure 43. Think of the earth as having a huge bar magnet extending from pole to pole with the SOUTH POLE OF THE MAGNET pointing toward the NORTH geographic pole.

Now put together two things you know-

1. Unlikes attract.
2. Lines of magnetic force leave at the North pole and enter at the South pole.

Which end of a compass points north? The NORTH! Applying the first of the above points, the north magnetic pole must have SOUTH POLE MAGNETISM or it could not attract the north magnetism of the compass needle.

Second, experiments show the earth's lines of force moving from the SOUTH GEOGRAPHIC to the NORTH GEOGRAPHIC pole. Since magnetic flow is from north magnetism to south magnetism, the north geographic pole must have SOUTH POLE MAGNETISM.

MAGNETIC MATERIALS

Only a few substances are capable of being magnetized. The most common is iron. Nickel and cobalt also have magnetic properties.

While both iron in various forms, and its derivative, STEEL, are magnetic, they have different characteristics. Soft iron is easily magnetized, but it also loses its magnetism very quickly. Certain forms of steel require a great deal of energy to magnetize them, but when magnetism is once established it remains a long time.

Since steel keeps its magnetism a long time, it is said to have a high degree of RETENTIVITY, while soft iron is said to have little RETENTIVITY. The magnetism that remains AFTER the magnetizing force has been removed is called RESIDUAL magnetism.

49

Several ALLOYS have been developed in order to produce substances that have HIGH RETENTIVITY and others that have LOW RETENTIVITY. A mixture of aluminum, nickel, and cobalt, properly heat treated, produces a metal (ALNICO) with EXTREMELY HIGH RETENTIVITY and field strength. An alloy of iron and nickel, properly heat treated, produces a substance known as PERMALLOY. It is magnetized very easily, but loses its strength the instant the magnetizing force is removed.

ALNICO is used in the construction of loudspeakers, while PERMALLOY is used for transformer cores. More will be said about this later.

RELUCTANCE AND PERMEABILITY

Many metals, like copper, lead, silver, and aluminum, are without magnetic properties. Actually they STOP THE FLUX from passing through them.

Some substances like glass have a more or less neutral effect on the flux. They do not seem to stop the lines of force, neither do they aid their movement.

The DEGREE to which a substance STOPS the MOVEMENT of flux is described as the RELUCTANCE of the material. RELUCTANCE in magnetism can be compared with resistance in electricity. Both express the degree of opposition to flow. Metals with extremely high reluctance are used as MAGNETIC INSULATORS, just as substances with high resistance are used as electrical insulators.

SOFT IRON is an extremely GOOD CONDUCTOR of FLUX, or you may say that it is very PERMEABLE. Soft iron is so

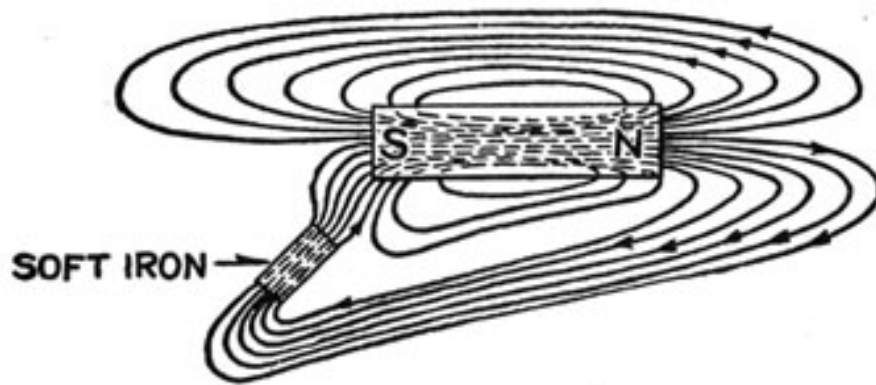

Figure 44.-Permeability of a piece of iron.

50

permeable that when it is placed in a magnetic field, the flux is actually concentrated into a small space. You can observe this in figure 44.

PERMANENT MAGNETS

Magnets of the type discussed in this chapter are called PERMANENT MAGNETS because they retain their magnetism AFTER the magnetizing force has been removed.

The magnets that lose their magnetism as soon as the magnetizing force has been removed are temporary magnets, a common example of which is the ELECTROMAGNETS.

51

 [Previous Chapter](#)  [Radio Home](#)  [Next Chapter](#)
[Page](#)

Copyright (C) 2005 [Historic Naval Ships Association](#)

All Rights Reserved

[Legal Notices and Privacy Policy](#)

Version 1.00, 12 Nov 05

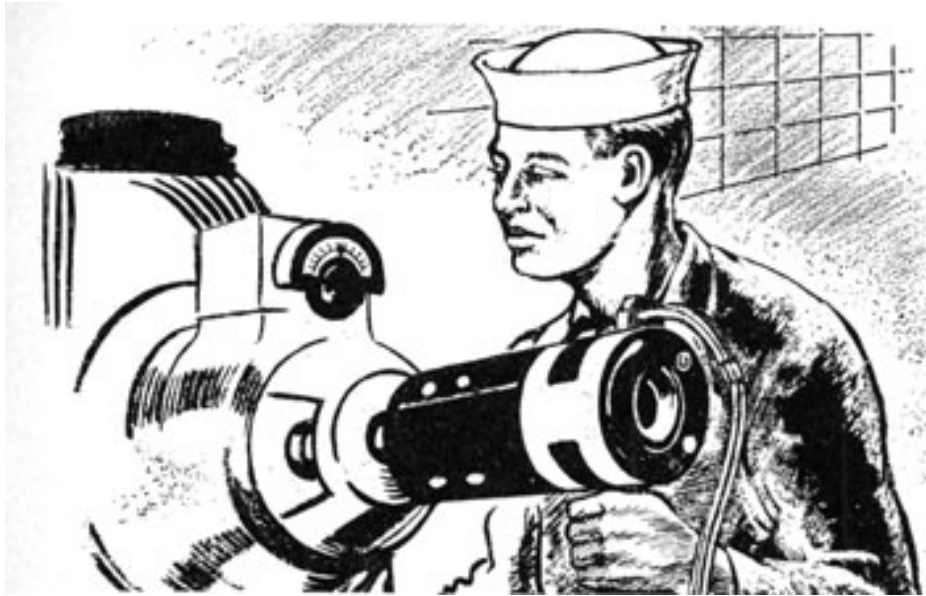

CHAPTER 6

ELECTROMAGNETISM

MAGNETS FROM ELECTRICITY

You probably have been warned not to bring your watch near an a.c. or d.c. generator, because the presence of the **MAGNETIC FIELD** may magnetize your watch. Or you may have seen how a compass needle behaves when a street car or an electric train approaches.

The use of electricity to obtain a **MAGNETIC FIELD** has so many common applications that we are apt to overlook its importance. The widespread use of electromagnets demonstrates their importance in our daily lives.

Electromagnets have two big advantages in their favor. First, you can turn them **ON** and **OFF** as you wish. That is not possible with permanent magnets. Bells, lifting devices, relays, and telegraph sounders use magnets that can be turned on and off.

The second advantage is the added field strength possible with electromagnets. And the **STRENGTH** of the field can be **REGULATED** by controlling the flow of current through the coils.

You can detect the presence of a magnetic field around a wire connected to the terminals of a battery. Just dip

the wire into a pile of iron filings. (See figure 45.) Some of the filings will "stick" to the wire as they do the permanent magnets.



Figure 45.-Magnetism produced by a current.

Disconnecting one end of the wire from the battery stops the current flow and the filings fall off. When you connect the wire to the battery again, the magnetic effect is restored. This little experiment shows that a **CONDUCTOR CARRYING A CURRENT IS SURROUNDED BY A MAGNETIC FIELD.**

You may observe more of the field about a conductor by sprinkling iron filings on a piece of cardboard through which the conductor passes. Actually, you are observing a cross-section of the magnetic field. You see a **CIRCULAR FIELD**, with the greatest concentration of filings near the center, where the field is strongest.

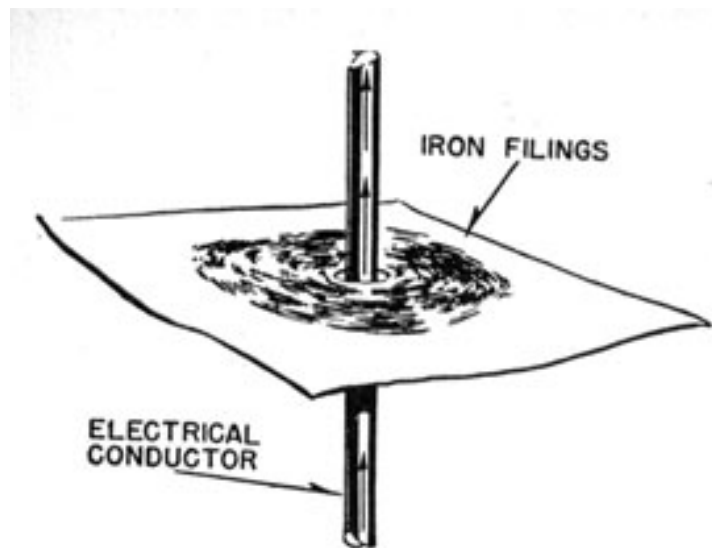

Figure 46.-Magnetic field about a conductor.

The small compasses placed in the field show that the magnetic flow also has DIRECTION.

In figure 47A, the CURRENT is flowing DOWN, and the compasses indicate the flux to be moving in a COUNTER-CLOCKWISE direction.

When the CURRENT is REVERSED, the needles of the compasses turn around, indicating that the FIELD is ALSO REVERSED.

It boils down to this-a conductor carrying a current is surrounded by a magnetic field, whose DIRECTION depends on the direction of the current flow.

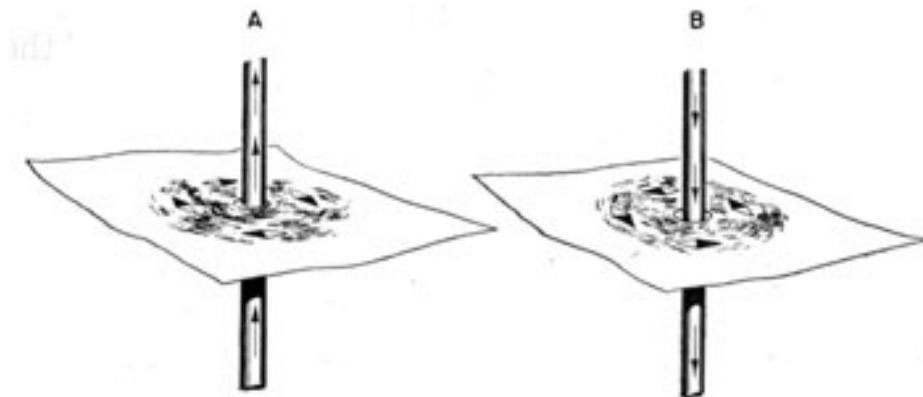

Figure 47.-Direction of the field about a conductor.

You can always find the direction of the field-grasp the conductor in your LEFT HAND with your THUMB pointing in the DIRECTION the CURRENT is flowing. Your FINGER S will POINT in the direction of the field around the conductor. This rule is demonstrated in figure 48.

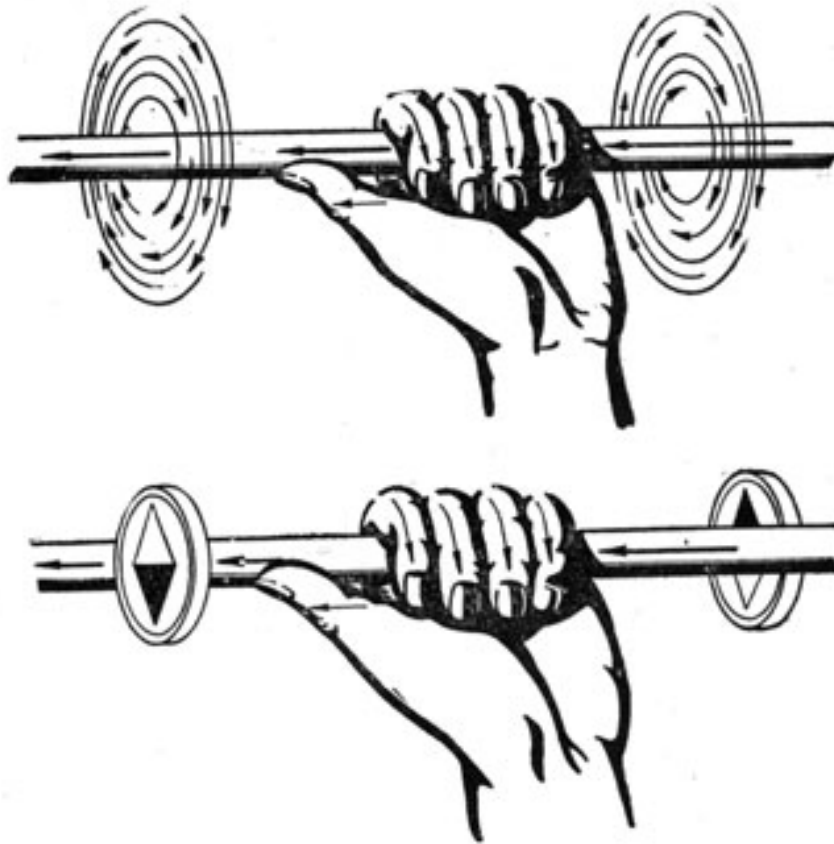

Figure 48.-Left-hand rule.

In some diagrams of electrical equipment it is necessary to "cut" conductors so that you view them from the ends. In such cases, it is impossible to use arrows to indicate the direction of current flow. Instead, you use a system of dots and crosses.

The DOT (figure 49A) indicates the current to be flowing OUT of the conductor (TOWARD you) . The CROSS indicates the current to be flowing INTO the conductor (AWAY from you) . Think of the DOT as the "point" of the arrow coming OUT of the wire, and the cross as the "tail" of the arrow ENTERING the conductor.

56

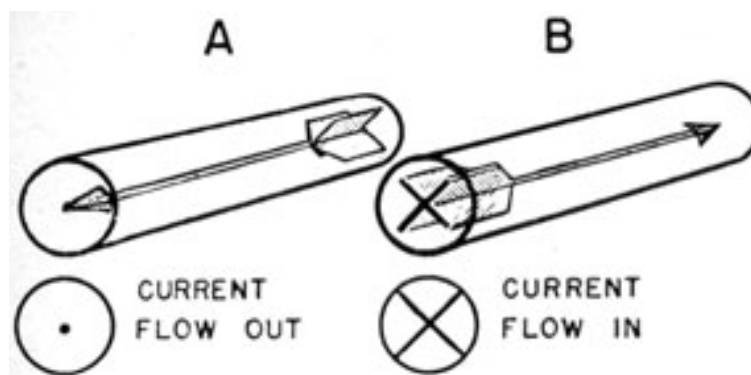

Figure 49.-Symbols used to indicate direction of current flow.

The two drawings at the bottom of figure 49 shows the direction of the field with the "dot" and "cross" system of indicating current flow.

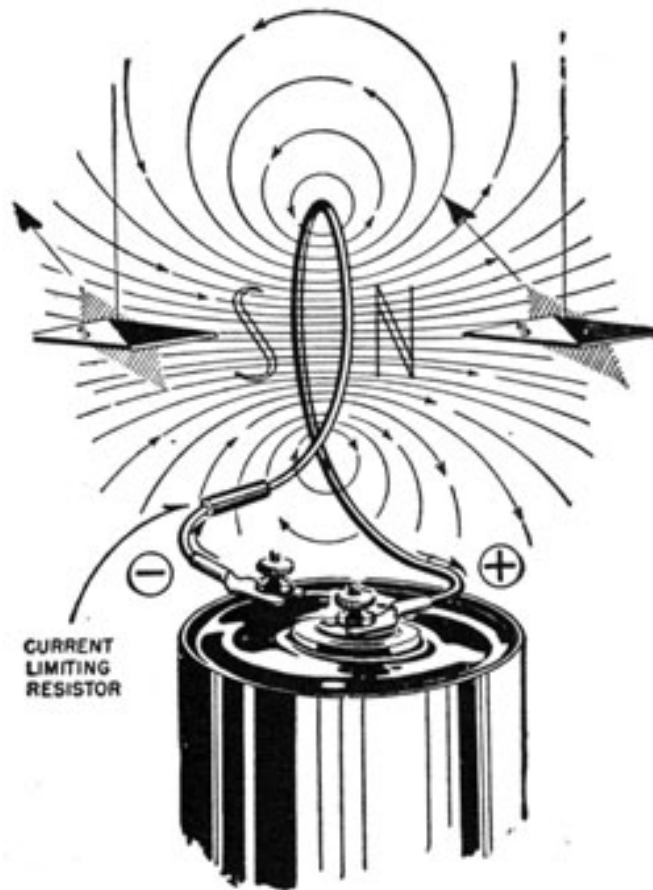

Figure 50.-Magnetic polarity of a loop.

699198°-46-5

A LOOP OF WIRE CARRYING A CURRENT HAS POLARITY

When a conductor is twisted into a loop and connected to a battery, as indicated in 50, the **MAGNETIC FIELD ABOUT** the loop will have north and south poles. Notice the direction of the field about the loop. It enters at the left and leaves at the right. Since magnetic lines of force enter at the south pole and leave at the north pole, the **LEFT** side of the loop will have **SOUTH** magnetism and the **RIGHT** side **NORTH** magnetism.

MAGNETIC FIELD OF A COIL

Several turns of wire, placed side by side, form a coil. The **INDIVIDUAL MAGNETIC FIELD** of each turn combines with fields of the other turns to give the coil north and south poles. In figure 51, the lines of force enter at the

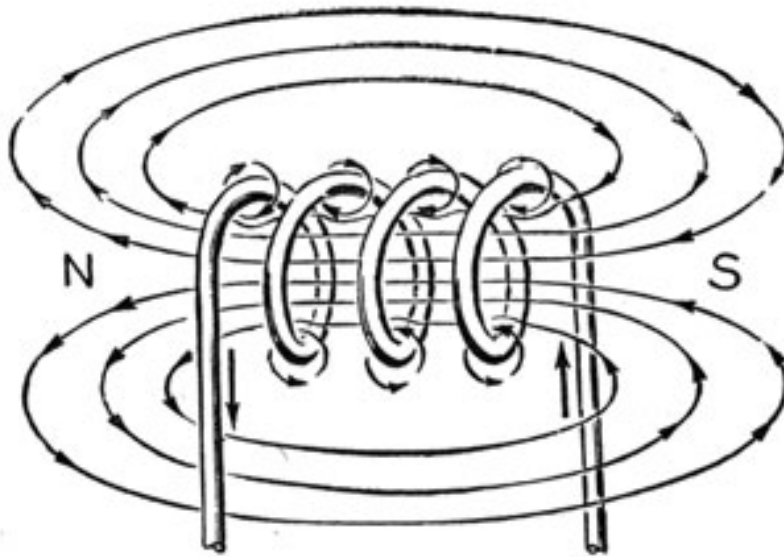

Figure 51.-Magnetic field of a coil.

south poles. In figure 51, the lines of force enter at the south pole and leave at north pole, just as they do with permanent magnets.

The north pole of a coil can be found easily, if you know the direction the current is flowing. Figure 52 shows you how. Wrap your LEFT hand about the coil with your

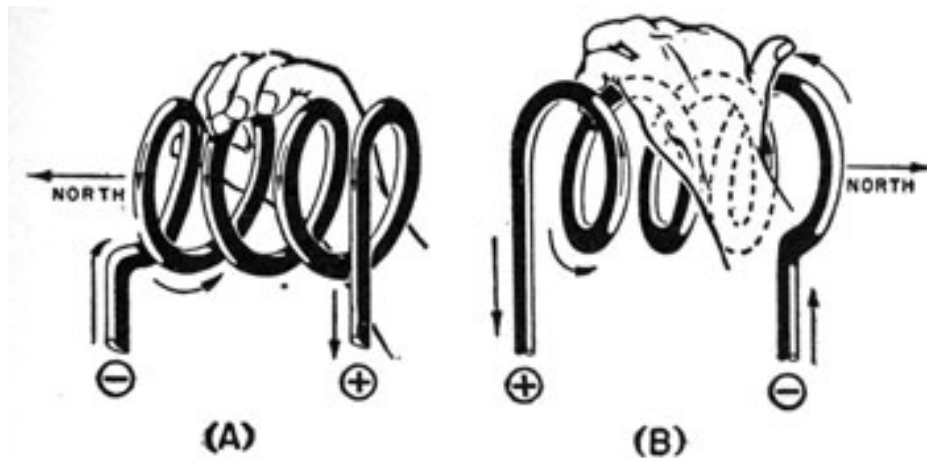

Figure 52.-Left-hand rule for coils.

FINGERS pointing in the direction of the current flow. Your THUMB POINTS toward the NORTH POLE.

STRENGTH OF A COIL

The MAGNETIC FIELD STRENGTH of a coil is determined by two things-the AMOUNT of CURRENT flowing through the individual turns, and the NUMBER of turns. The more turns and the larger the current, the greater the strength of the coil.

The field strength is expressed in AMPERE-TURNS. ONE AMPERE TURN is one loop of wire carrying one ampere of current. Two loops of wire carrying a half-ampere of current is also one ampere-turn.

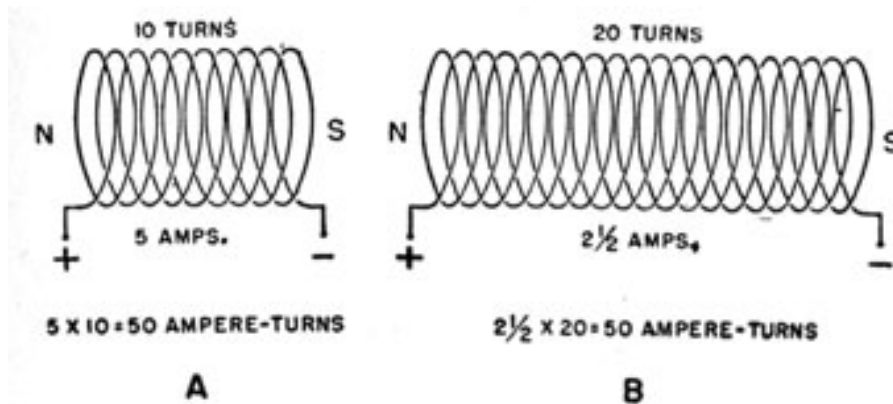

Figure 53.-Equal ampere-turns.

In other words, the PRODUCT of the CURRENT times the NUMBER OF TURNS gives you the strength of the coil in AMPERE-TURNS.

Here are two examples. Coil A with 10 turns carrying 5 amperes has a strength of-

$$5 \times 10 = 50 \text{ ampere turns,}$$

Coil B with 20 turns carrying 2.5 amperes has the SAME strength-

$$2.5 \times 20 = 50 \text{ ampere-turns.}$$

A very strong coil can be made by using MANY TURNS of fine wire carrying a small current. And an equally strong coil can be made by using only a few turns carrying a high current.

IRON CORES

The RELUCTANCE of SOFT IRON is low, compared to that of air. And soft iron also has a low RESIDUAL MAGNETISM. Put those two properties of soft iron together, and you have the reasons for

using soft iron cores in electromagnets.

The iron core **CONCENTRATES** the magnetic flux into a **SMALL USEFUL AREA**, but does not increase the ampere-turn strength of the coil. It simply holds most of the flux inside the coil, increasing the useful magnetism.

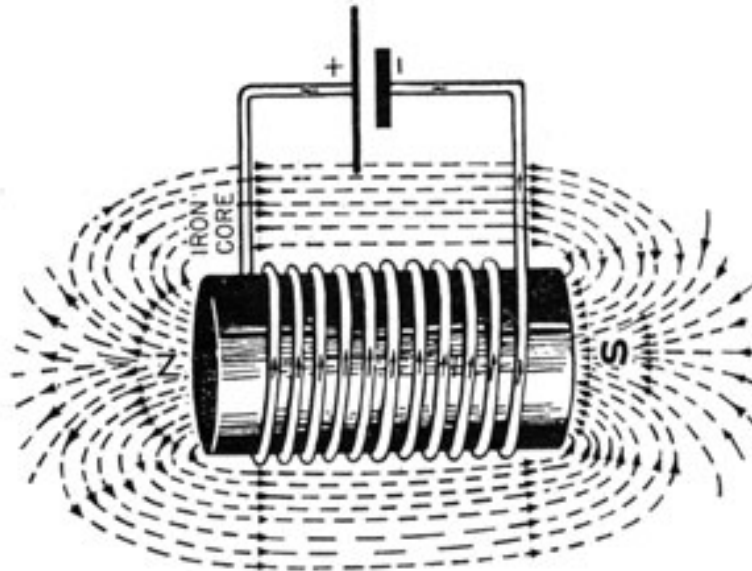

Figure 54.-Iron core electromagnet.

The core of an electromagnet is usually made of **BUNDLES** of **SOFT IRON** wires. If steel were used, a great deal of energy would be required to magnetize the cores. And when the current was turned off, the core would remain magnetized (**HIGH** residual magnetism).

Both conditions are undesirable, since you want the electromagnet to assume **FULL STRENGTH** the instant the current is turned on, and lose it **IMMEDIATELY** when the current is turned off.

You will hear more about iron cores of electromagnets when transformers are discussed.

USE OF ELECTROMAGNETS

Electromagnets have an almost endless list of applications in electric motors, generators, bells, telephones, telegraphs, and in thousands of other electrical devices. Radios use a number of electromagnets, for example in the earphone and loudspeaker.

Shipboard radio has a special application-**RELAYS**. They are used to control the operation of transmitters and receivers from remote points on your ship. The system used to "key" your transmitter is an example of this. You know that you may touch the hand key any place without getting a serious shock. Why? Because

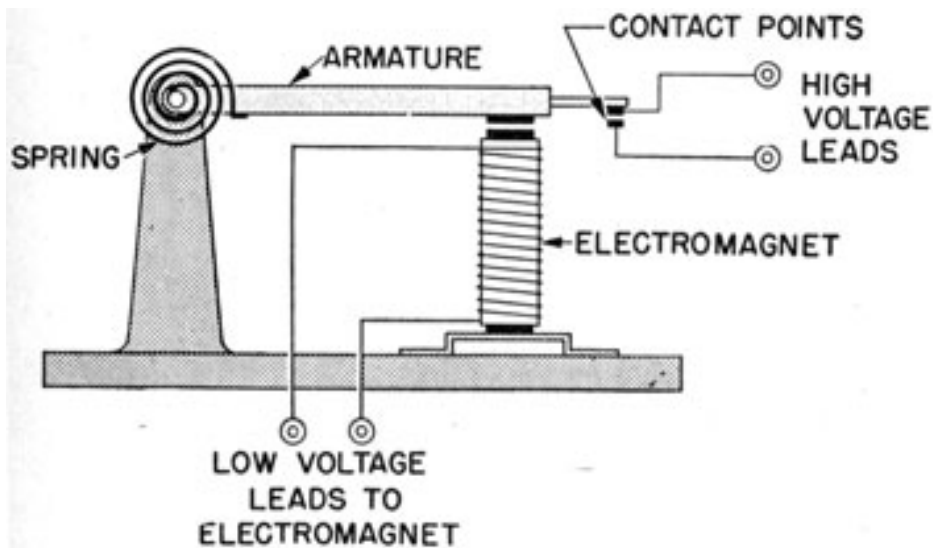

Figure 55.-Basic parts of a simple relay.

61

an electromagnet in the form of a RELAY is used to open and close a high voltage circuit.

RELAY

A basic relay has three major parts—an ELECTROMAGNET, a movable iron bar called an ARMATURE, and CONTACT POINTS. See figure 55. The spring attached to the armature holds the contacts open when no voltage is being applied to the electromagnet.

When a voltage is applied to the electromagnet, the magnetic field draws the armature toward the core, closing the contact points. Removing the current demagnetizes the magnet, and the spring pulls the armature upward, breaking the circuit again.

A typical arrangement for "keying" a transmitter is indicated in figure 56. The hand key is supplied with a

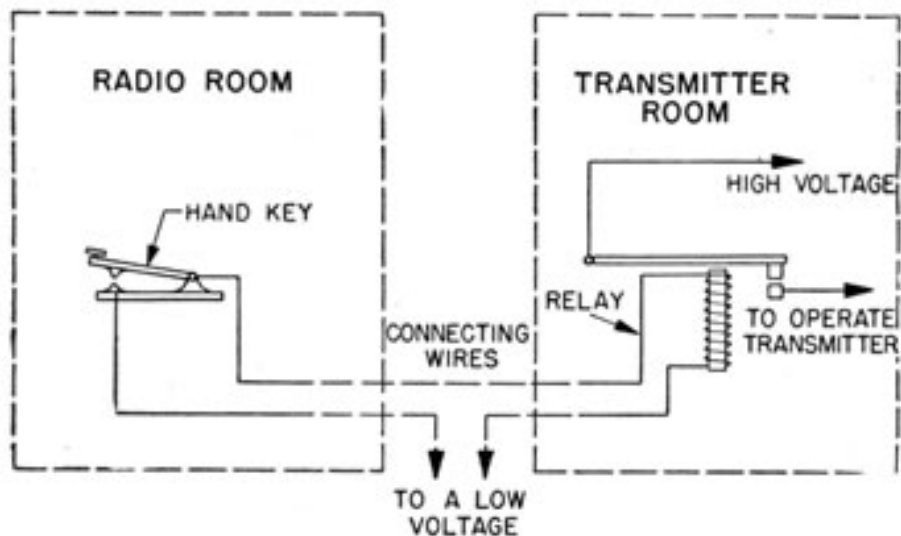

Figure 56.-A simple transmitter keying circuit.

low voltage to energize the electromagnet. The connecting wires from the operator's station to the transmitter may be several hundred feet long. The relay itself is usually located inside the transmitter cabinet so that none of the high voltage wire need be strung about the ship.

62

A relay not only makes it possible to keep high voltages away from the key, but also permits the installation of the transmitter in some out-of-the-way space instead of in the radio room.

Most relays are not as simple in design as those given in figures 55 and 56. Many have two or more sets of contact points. Some have a set of contacts above and another below, so that when one circuit is closed the other is opened.

Still other relays have a DELAYED-ACTION mechanism built into them to prevent the circuit from being opened or closed until a definite amount of time has elapsed.

63



[Previous Chapter](#)



[Radio Home](#)
[Page](#)



[Next Chapter](#)

Copyright (C) 2005 [Historic Naval Ships Association](#)

All Rights Reserved

[Legal Notices and Privacy Policy](#)

Version 1.00, 12 Nov 05

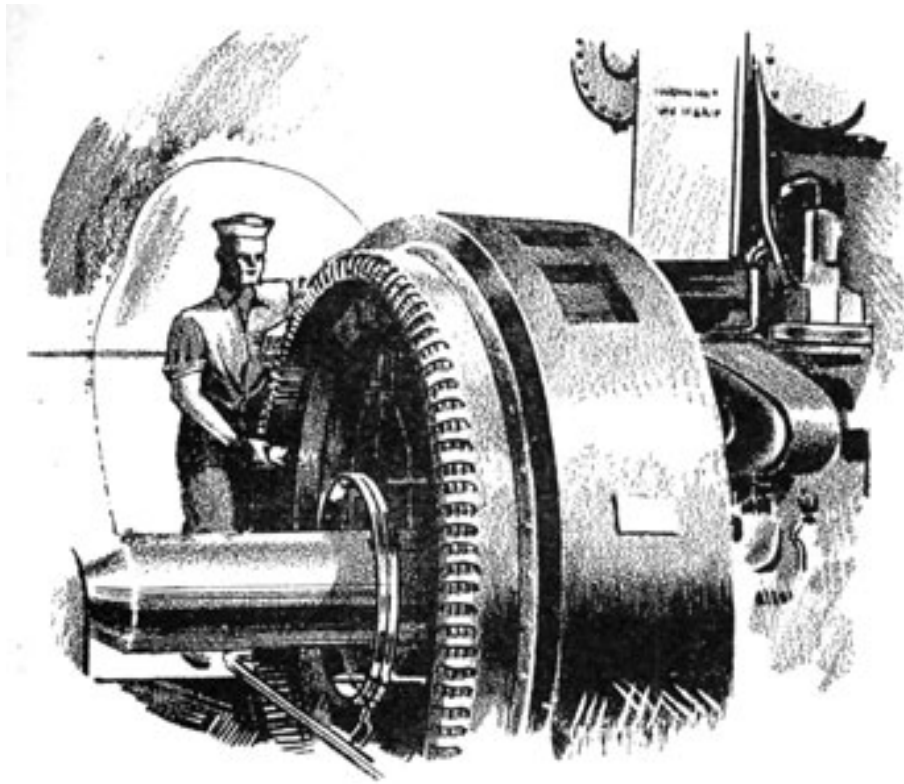

CHAPTER 7

GENERATORS

ELECTRICITY FROM MAGNETISM

The oldest and simplest known source of electricity, or emf, is the static charge. It is possible to build high static potentials of many thousands of volts. But these charges cannot be used as a source of electric power, because they have no **RESERVE** of **ENERGY** to call upon to keep the electrons flowing. With static charges, the potential falls almost to zero once the spark has jumped-the-gap.

Static charges can be created continuously in a number of different ways, but the **RATE OF BUILDING** is **TOO SLOW** to make the charges of practical use as a source of emf.

For a long time, primary cells were the only source of emf to power such devices as the telegraph and telephone. Electric motors, heating coils, and 101 types of heavy current consuming equipment, are common today. But in the early days, batteries alone could not furnish the

required amount of current for such equipment. The modern electrical machines had to wait until a cheaper, more efficient, and larger source of emf was found.

The development of the principle of obtaining electricity from magnetism is relatively new-within the last 100 years-and is credited to a Danish scientist, Oersted. Since the appearance of Oersted's first machine, rapid progress has been made. GENERATORS have been enlarged until now millions of kilowatts of power are delivered to homes and industry daily.

And you know the tremendous power of those big ship's generators. Battleships and carriers have generators capable of supplying a city of moderate size with enough electric power to run its factories, operate its street cars, and to supply all the other electric power requirements of the community.

The story of how a generator works starts with the principle of electromagnetic induction.

INDUCTION

Here's the process of induction in a nutshell. WHENEVER A CONDUCTOR CUTS ACROSS THE FLUX OF A MAGNETIC FIELD, AN EMF IS PRODUCED IN THE CONDUCTOR. If the two ends of the conductor are connected to an outside circuit, the induced emf causes current to flow in the circuit.

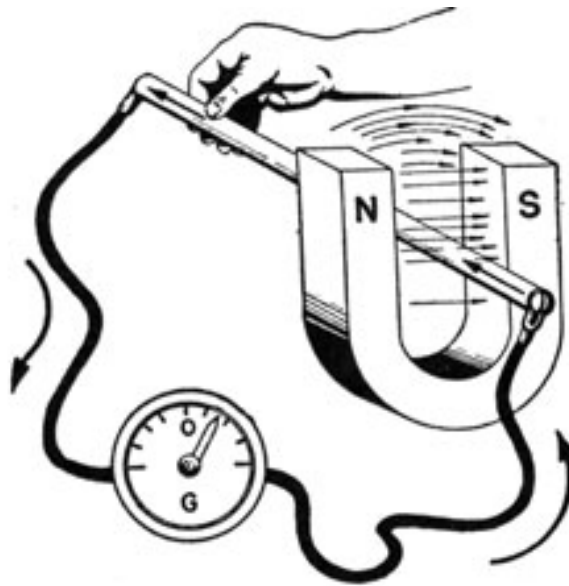

Figure 57.-An emf is produced when a conductor cuts a magnetic field.

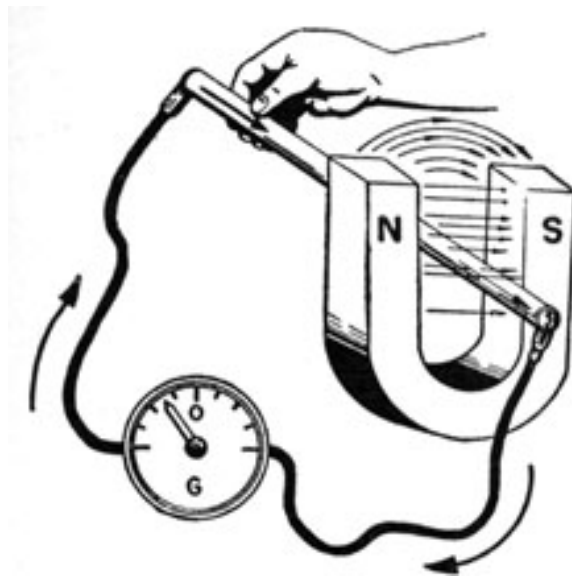

Figure 58.-Producing an emf by cutting a magnetic field.

Now, to see how induction works in a single set up, study figures 57 and 58.

In figure 57, the GALVANOMETER, an instrument that shows DIRECTION and AMOUNT OF CURRENT, is connected to a CONDUCTOR. When the conductor is thrust DOWNWARD into the FIELD between the north and south poles of a magnet, the meter needle is DEFLECTED, indicating a FLOW OF CURRENT in the conductor.

Moving the conductor UPWARD (figure 58) causes the needle to move in the OPPOSITE DIRECTION, indicating that the direction of current flow has been REVERSED.

If you hold the conductor MOTIONLESS, no deflection occurs.

A QUICK THRUST produces a LARGE DEFLECTION of the needle. And a slow movement of the conductor causes a small deflection.

Here is what you have observed-

Downward motion of the conductor causes current to flow in one direction.

Upward motion causes current to flow in the OPPOSITE direction.

The faster the movement, the greater the deflection.

No movement, no deflection.

In figures 57 and 58, the CONDUCTOR MOVED and the FIELD STOOD STILL. But a VOLTAGE can also be induced by MOVING the FIELD and holding the conductor STATIONARY. Thus, INDUCTION will take place whenever you have a MAGNETIC FIELD and a CONDUCTOR together, and a RELATIVE MOVEMENT occurs between the two.

PARTS OF ALTERNATING CURRENT GENERATOR

The Danish scientist, Oersted, discovered how to obtain an emf by ROTATING a LOOP of wire in a MAGNETIC FIELD. This device became known as the GENERATOR, a relatively simple machine with just four major parts-STATOR, ARMATURE, SLIP RINGS, AND BRUSHES (figure 59).

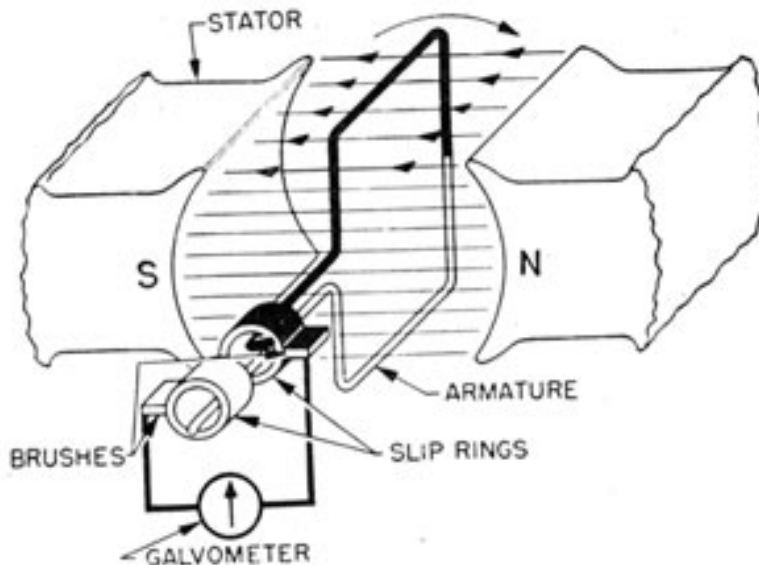

Figure 59.-Parts of a generator.

The STATOR is a PERMANENT MAGNET placed in such a position that the strongest field is between the two poles.

The ARMATURE is a loop of wire so placed in the magnetic field that during rotation the loop will cut across the flux lines.

The SLIP RINGS are two complete copper rings. In figure 59, the BLACK ring is attached to the BLACK leg of the loop, and the WHITE RING to the WHITE leg of the loop. While not shown in figure 59, the LOOP and both SLIP

RINGS are mounted on a SHAFT. Mechanical power is applied to the shaft, causing the slip rings to ROTATE with the loop.

The BRUSHES are pieces of carbon held stationary against the slip rings by the generator framework.

The GALVANOMETER is not a part of the generator, but is added to the drawing to indicate the direction of current flow.

OPERATION OF A GENERATOR

Here is how the generator works. In figure 60, the loop is rotating in a clockwise direction. At position A, the TOP leg is moving toward the north pole, and the LOWER leg toward the south pole. In position A, no flux lines are being cut since both legs are moving PARALLEL to the lines of flux. Since NO flux is cut, NO VOLTAGE is INDUCED, and the GALVANOMETER needle STANDS at ZERO.

In position B, the loop has rotated 1/4 of a turn (90°). The BLACK leg is moving DOWNWARD, and the WHITE LEG UP. In this position, BOTH legs are cutting across a MAXIMUM

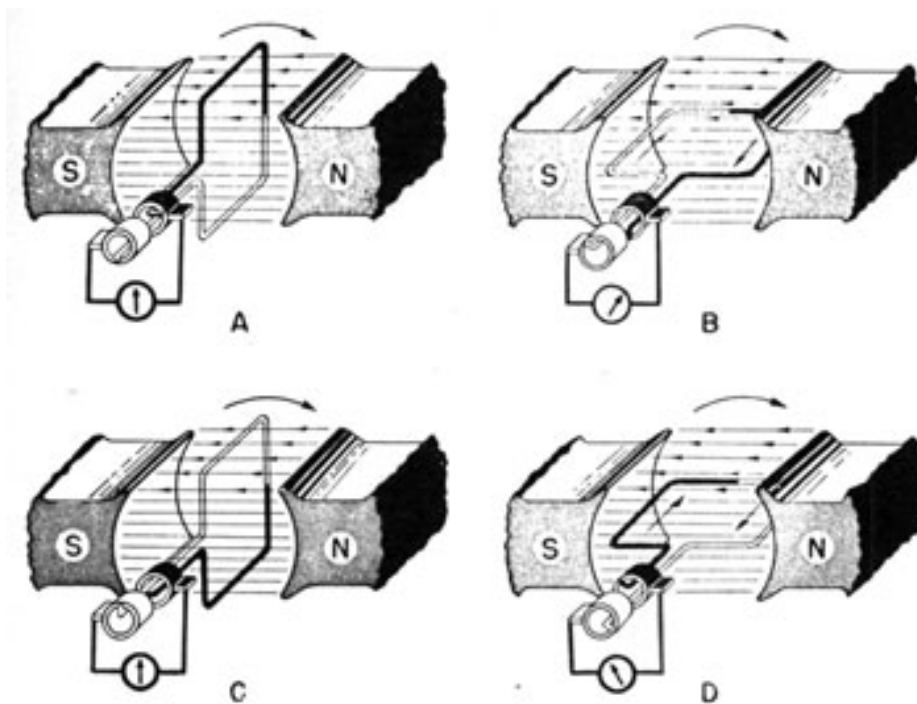

Figure 60.-Generation of an alternating emf.

NUMBER of LINES OF FLUX, and the emf, indicated by the galvanometer, is MAXIMUM.

At position *C* the loop has rotated 1/2 of a turn. The two legs are once more moving PARALLEL to the lines of flux, and the galvanometer stands at zero.

In the last drawing, *D*, the black leg is moving upward, and white leg downward. Both legs are again cutting a maximum number of lines of force, but in the direction OPPOSITE to that of position *B*. Since the legs are CUTTING the field in the OPPOSITE direction, the emf induced causes the CURRENT to FLOW in the OPPOSITE DIRECTION.

The next 1/4 turn brings the loop back to position *A*, and the cycle starts over again.

Now go back and see what happened during one rotation . The emf started at ZERO, increased to a MAXIMUM value in ONE DIRECTION, fell back to ZERO, increased to

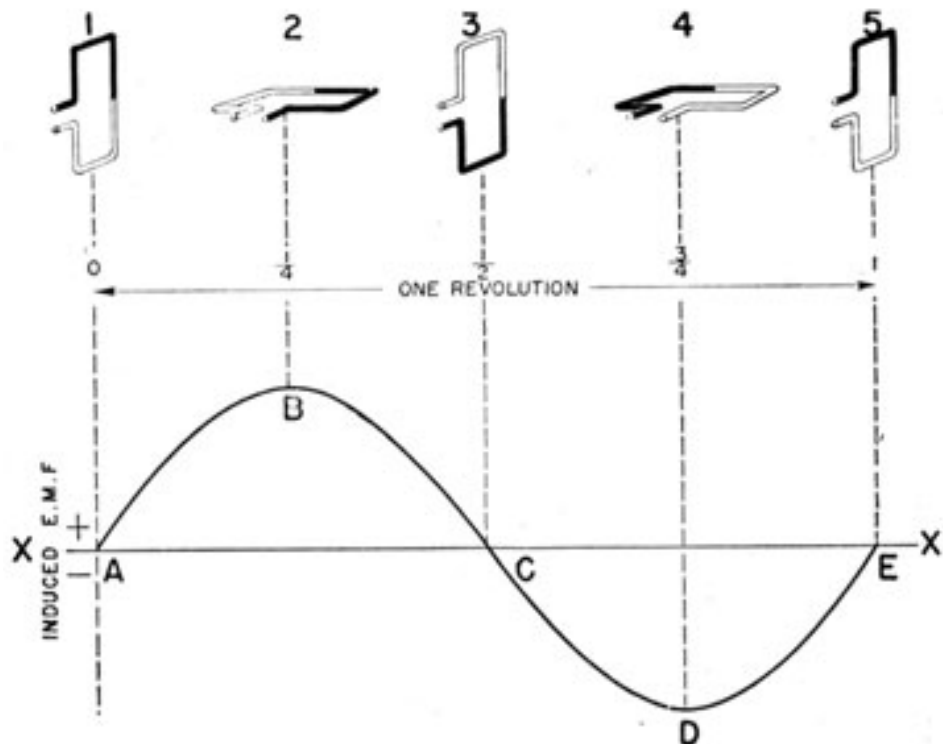

Figure 61.-An alternating emf.

MAXIMUM in the OPPOSITE DIRECTION, and then finally returned to zero.

Look at figure 61. The loop is shown in five positions. Below the loop diagrams is a graph of the induced emf.

Line $X-X'$ is the zero line. All the area above this line is positive (+), and the area below is negative (-).

In position 1, the loop is cutting no lines of force, so the induced emf is zero (point A on the graph).

One quarter turn later, the loop is in position 2. It is cutting a maximum number of lines of force, so the emf is maximum (point B).

At position 3, the loop has completed $1/2$ of a turn, and no lines of flux are being cut, so the emf is back to zero at point C .

In position 4, the loop is cutting the field in the direction opposite to that of position 2. The voltage induced in the coil is maximum, but in the opposite direction (point D).

Position 5 is the same as 1, so the loop is ready to start over again.

WHAT IS AN ALTERNATING EMF?

The emf produced by the generator in figure 60 is an ALTERNATING emf. It starts at zero, rises to maximum in one direction (+), falls back to zero, rises to maximum in the opposite direction (-), and then comes back to zero.

Notice in particular that the graph of an alternating emf lies on BOTH sides of the ZERO line.

An alternating emf causes the current to flow first in one direction and then the other. Hence the name, ALTERNATING CURRENT, or just plain A.C.

If the emf is ALL ON ONE SIDE of the ZERO LINE, whether all negative or all positive, it produces a DIRECT CURRENT. Hence, the emf of an ALTERNATING CURRENT is on both sides of the ZERO LINE (base line); but the emf of a DIRECT CURRENT remains on ONE SIDE.

THE SINE WAVE

A sine wave is actually a MATHEMATICAL expression showing the relationship between the ORDINATE and RADIUS values of a point as it rotates about the circumference

71

of a circle. But, don't let that floor you. You don't have to understand the mathematics of the sine wave. The important fact for you to know is that you get a sine wave picture when you plot induced emf against armature rotation in a generator.

So you should be able to recognize the sine wave and know something about its structure.

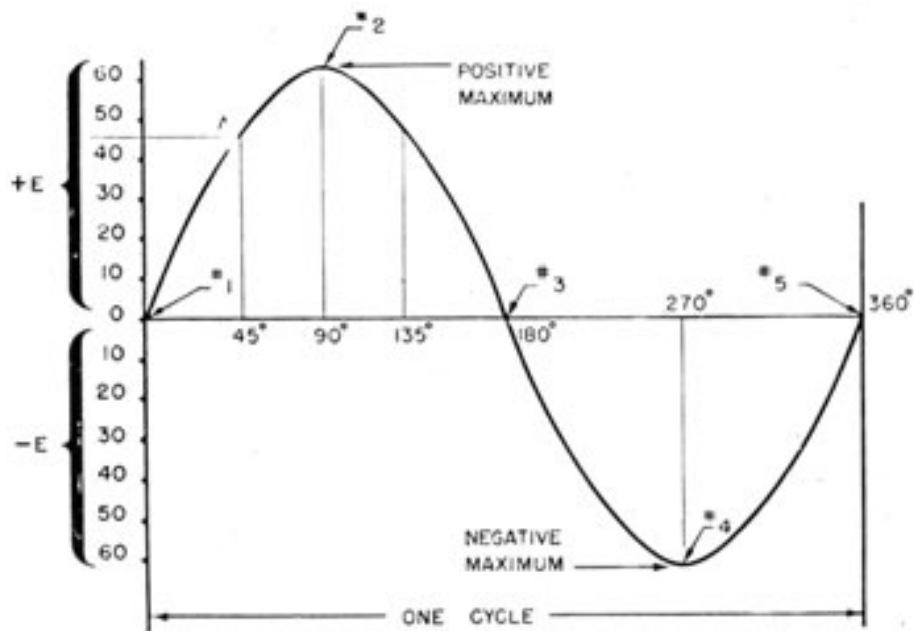

Figure 62.-A sine wave graph of an a.c. voltage.

In figure 62, point 1 is the same as point 1 in figure 61. Ninety degrees of rotation later, the loop is in position 2, and the voltage is maximum positive. The rising voltage generated by the first quarter rotation of the loop is included in the curve between points 1 and 2.

Directly below point 2, and on the zero line, the number 90° is written. The portion of the base line between 0° and 90° includes angular ROTATION of the FIRST 1/4 rotation .

Now if you want to know the emf generated after 45° of rotation, draw a VERTICAL line upward from the 45° point on the base line (half way between 0° and 90°) until it cuts the curve at point A. Draw a horizontal line from point A over to the scale to the left, and you

72

will find it to be about 43 volts-that is, if 60 volts is the maximum emf.

After the first 90° , the emf begins to fall. It continues dropping until it is back to "zero," after 180° of rotation (point 3). The loop has now completed 1/2 of a rotation and is ready to start upward.

One quarter of a turn later, 270° after the start of the rotation, the voltage is again maximum, but this time in a NEGATIVE direction (point 4).

Beyond point 4, the voltage again falls to zero as the loop returns to its starting point.

The next time around, the loop will generate the same alternating emf, and so on for each rotation.

A complete rotation is called a CYCLE, and each rotation thereafter is another cycle.

Thus, if 10 complete rotations are made in one second, the FREQUENCY of rotation is 10 CYCLES PER SECOND SIXTY ROTATIONS per second is a FREQUENCY of 60 cycles per second-the frequency of the ALTERNATING CURRENT used with commercial electricity power systems. You have heard about that before.

MORE ABOUT FREQUENCIES AND CYCLES

You will hear the word FREQUENCY used thousands of times in radio work. You will use it most commonly when referring to the tuning of your receiver or transmitter.

As an example, you may say your transmitter is tuned to a frequency of 4,200 kilocycles. What does it mean?

First of all, the word KILOCYCLE means 1,000 cycles per second; therefore, 4,200 kilocycles is the same as 4,200,000 CYCLES per SECOND. Thus your transmitter is generating an ALTERNATING CURRENT with a frequency of 4,200,000 cycles per second.

In radio, you will use three expressions of frequency-

- cycles
- kilocycles
- megacycles

699198°-46-6

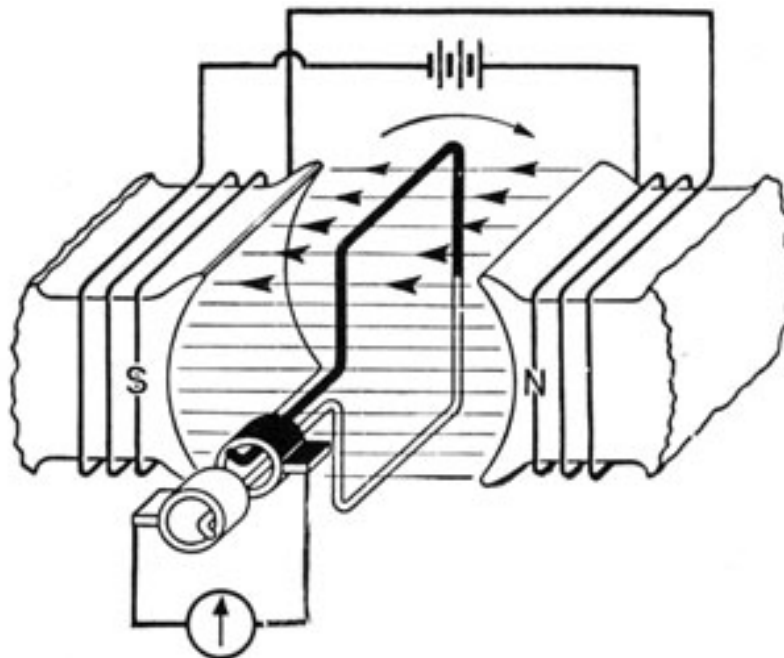

Figure 63.-A.C. generator with electromagnetic stator.

As you have been told, a KILOCYCLE is equal to 1,000 cycles. A MEGACYCLE is equal to 1,000,000 cycles.

Hence, a frequency of 31 megacycles is-

31,000 kilocycles, or 31,000,000 cycles

The megacycle is usually abbreviated Mc. or mc., the kilocycle Kc. or kc., and the cycle (\sim) just one cycle of a sine wave.

Frequencies used in radio are divided into two basic classes-

AUDIO FREQUENCIES, from about 20 to 20,000 CYCLES per second, are those your ear can HEAR.

RADIO FREQUENCIES are all GREATER than 20,000 cycles and extend well above 30,000,000,000 cycles (30,000 Mc.) .

It is the usual practice to refer to all frequencies BELOW 20,000 cycles as A.F. or a.f., and those ABOVE 20,000 cycles as R.F. or r.f.

ELECTROMAGNETIC STATOR

In order to obtain a larger emf, a stronger ELECTROMAGNET is used for a stator instead of a permanent

74

magnet. The diagram in figure 64 shows a simple a.c. generator with an electromagnetic stator. The source of power to EXCITE the stator is shown as a battery.

ARMATURE

The armatures used with actual generators have many turns of wire instead of a single loop. The wire is wound on a core made of SHEETS of SOFT IRON, tightly clamped together. The iron core is attached to shaft, which is turned by a pulley and drive belt.

PART OF A DIRECT CURRENT GENERATOR

If you make a slight change in the slip rings of an a.c. generator, you can obtain direct current instead of alternating current.

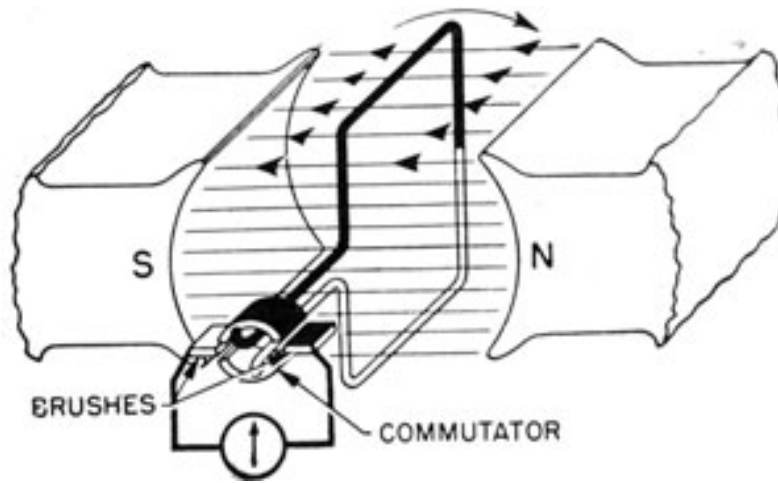

Figure 64.-Parts of a d.c. generator.

In figure 64, the two slip rings of figure 59 have been Changed to a SINGLE, TWO-SEGMENT RING. The BLACK leg of the loop is connected to the BLACK SEGMENT, and the WHITE LEG to the WHITE segment. The two segments are insulated from each other, so that no electrical contact is possible. The SPLIT RING is known as the COMMUTATOR.

The two BRUSHES are on opposite SIDES of the SPLIT RING, mounted in such a manner that each brush is in contact with only one segment at a time.

75

HOW A DIRECT CURRENT GENERATOR WORKS

The generation of the emf by the loop cutting across the magnetic field is the same in a d.c. as it is in an a. c. generator. The change to d.c. takes place at the COMMUTATOR.

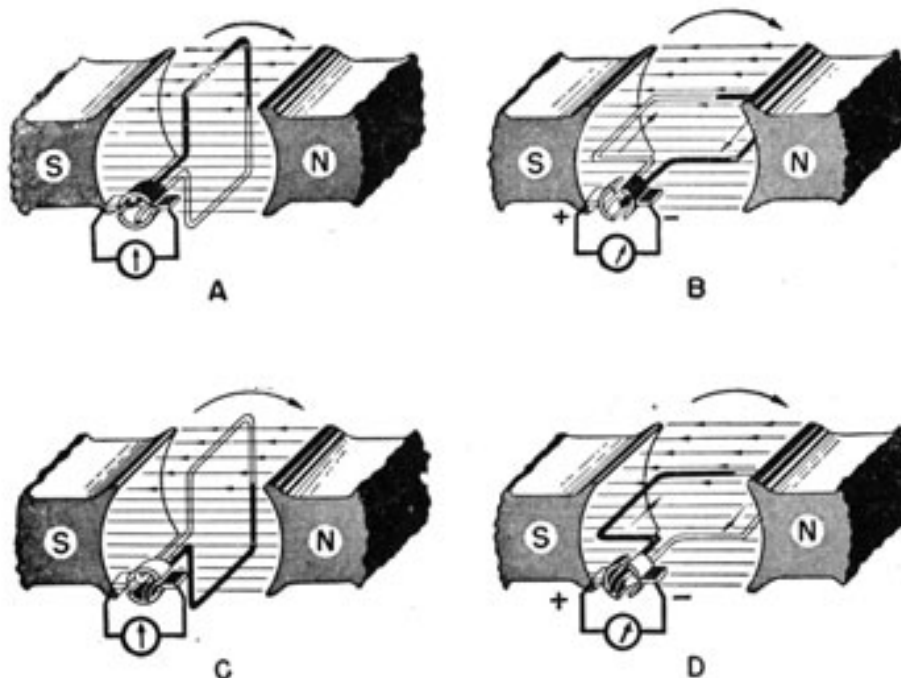

Figure 65.-Operation of a d.c. generator.

The loop in figure 65A is moving in a counterclockwise direction, parallel to the flux. Hence, no emf is generated. Notice that the BLACK BRUSH is just coming in contact with the BLACK segment, and the WHITE BRUSH with the WHITE segment.

In position B, the flux is being cut at a maximum rate. The BLACK BRUSH is contacting the BLACK SEGMENT and the WHITE BRUSH the WHITE SEGMENT. And the galvanometer needle is deflected to the RIGHT.

At position C, the loop has completed 180° of rotation. No flux is being cut, so the emf is zero. The important thing to observe in position C is the action of the segments and brushes. The BLACK BRUSH is SLIPPING off the black segment and ON TO the WHITE. At the same

76

instant, the WHITE BRUSH is leaving the WHITE segment, and going on to the BLACK.

The SWITCHING of commutator segments also switches legs of the loop. In this way the BLACK BRUSH is ALWAYS in contact with the leg moving DOWNWARD, and the WHITE brush in contact with the leg moving UPWARD. While the current is actually reversed in the loop it is ALWAYS FLOWING in the same direction through the galvanometer.

A graph for one cycle of a d.c. generator is given in figure 66. The generation of the emf for positions A, B,

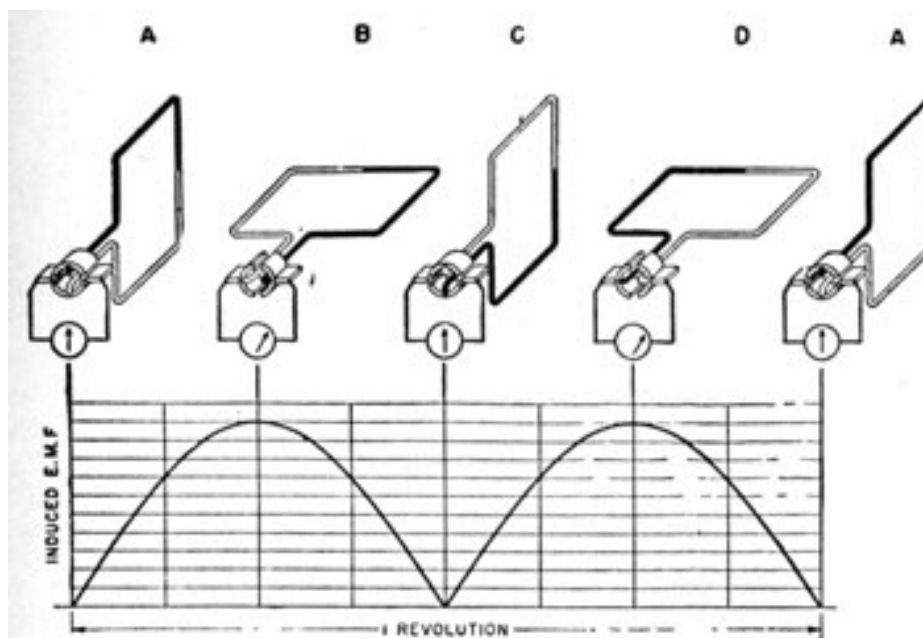

Figure 66.-Graph of a d.c. voltage.

and C is the same as for an a.c. generator. But at position C , the brushes, in moving from one commutator segment to the other, cause the current to flow in the positive direction rather than becoming negative.

The d.c. furnished by a single loop armature is very bumpy. It starts at zero, rises to maximum, and falls back to zero TWICE for each rotation of the loop. To produce a smoother d.c., more loops of wire are added to the armature.

77

In figure 67, two coils are used instead of one. There are now four segments but only two brushes in the commutator. With this arrangement, the voltage cannot fall any lower than point A , so the bump in the voltage

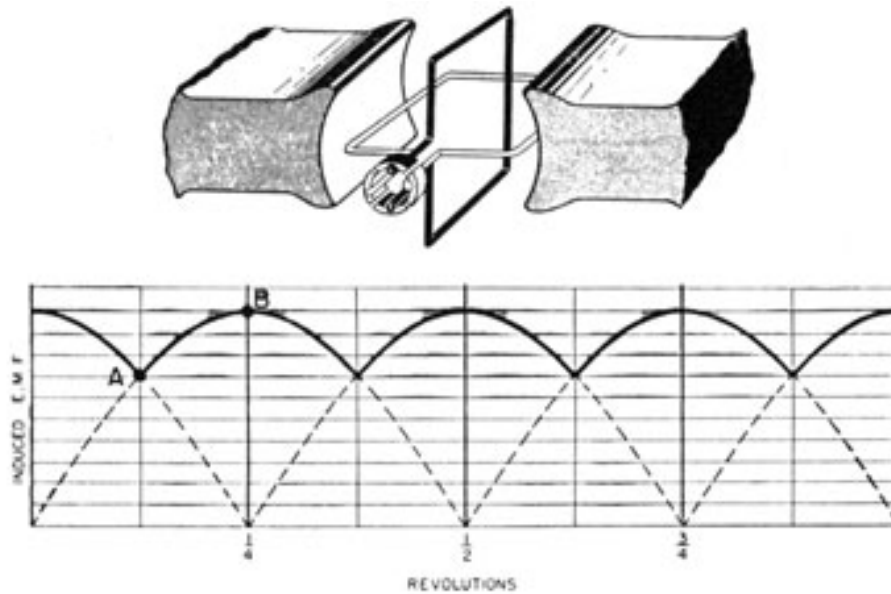

Figure 67.-Voltage from a two-coil armature.

(ripple) is limited to the rise and fall between points A and B . By adding still more armature coils, the voltage ripple can be further reduced.

78

←
↑
→

[Previous Chapter](#)
[Radio Home](#)
[Next Chapter](#)

[Page](#)

Copyright (C) 2005 [Historic Naval Ships Association](#)

All Rights Reserved

[Legal Notices and Privacy Policy](#)

Version 1.00, 12 Nov 05

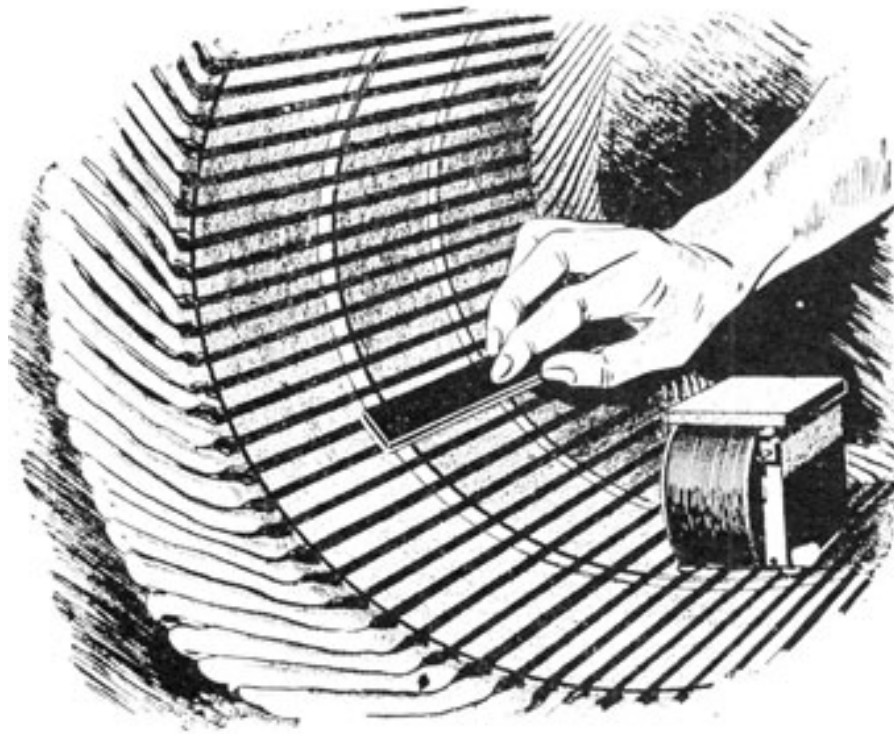

CHAPTER 8 MOTORS MECHANICAL ENERGY FROM ELECTRICITY

In the last chapter, the generator was described as a device used to change **MECHANICAL ENERGY** into electricity. In this chapter, the motor is described as a mechanism that changes the **ELECTRICITY** back into **MECHANICAL ENERGY**.

Radiomen do not have many contacts with motors, other than by pressing a button to start or stop them. But every man in the radio rates should know and understand the principles of electric motors.

The **MOTOR-GENERATOR** sets that power the large transmitters use an **ELECTRIC MOTOR** to drive one or two **GENERATORS**, depending upon the model of transmitter. The motors take their power from the 110-, 220-, or 440- volt ship's supply, and the **GENERATOR** delivers several voltages-both a.c. and d. c.-to the transmitter.

Your ship's real source of power is the oil in the tanks.

In the boilers, burning oil changes water to steam. The steam drives a turbine, and the turbine turns the ship's generators. The emf from the generators runs the motor of the transmitter's **MOTOR-GENERATOR** set-and the generator changes the motor's **MECHANICAL** energy back into the **ELECTRICAL** energy to operate the transmitter.

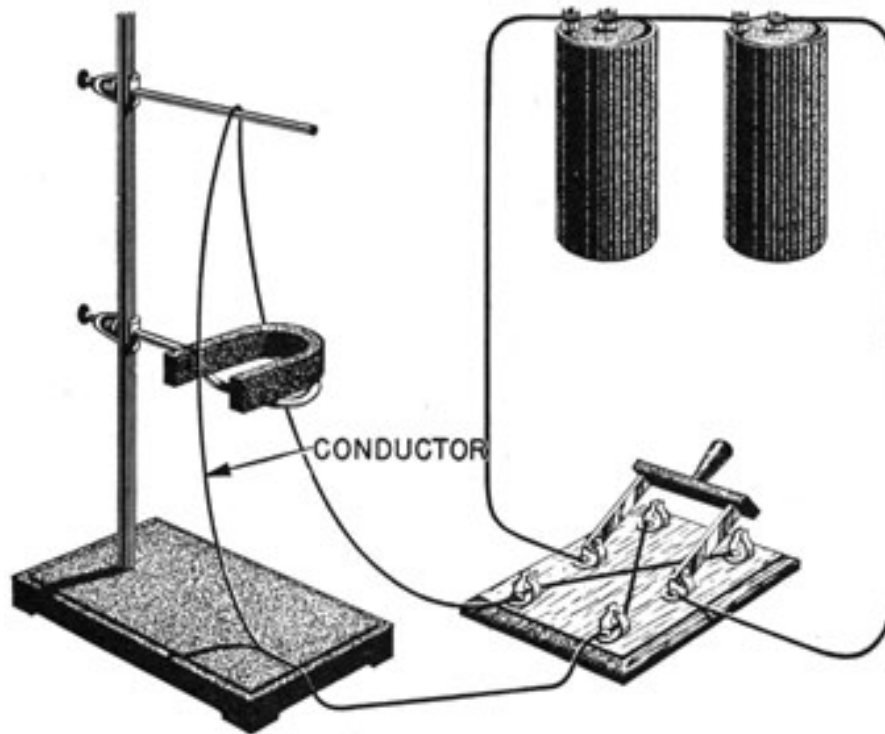

Figure 68.-Action of a conductor in a magnetic field.

The ACTION of a motor is based upon the old, familiar law-UNLIKE POLES ATTRACT, and LIKE POLES REPEL.

To review the laws, look at figure 68. A conductor is hung in a position that will permit it to swing freely either in or out of the horse shoe magnet. Two dry cells are connected to the wire through a double-pole, double-throw switch. The switch is so connected that by throwing the switch from one set of contacts to the other the current through the conductor is reversed.

Closing the switch in one direction causes the CONDUCTOR to move INTO the magnet. And throwing the switch

80

in the opposite direction causes the conductor to move OUT.

The conductor's movement is caused by the COMBINED ACTION of TWO MAGNETIC FIELDS-the field around the conductor and the field of the horse shoe magnet.

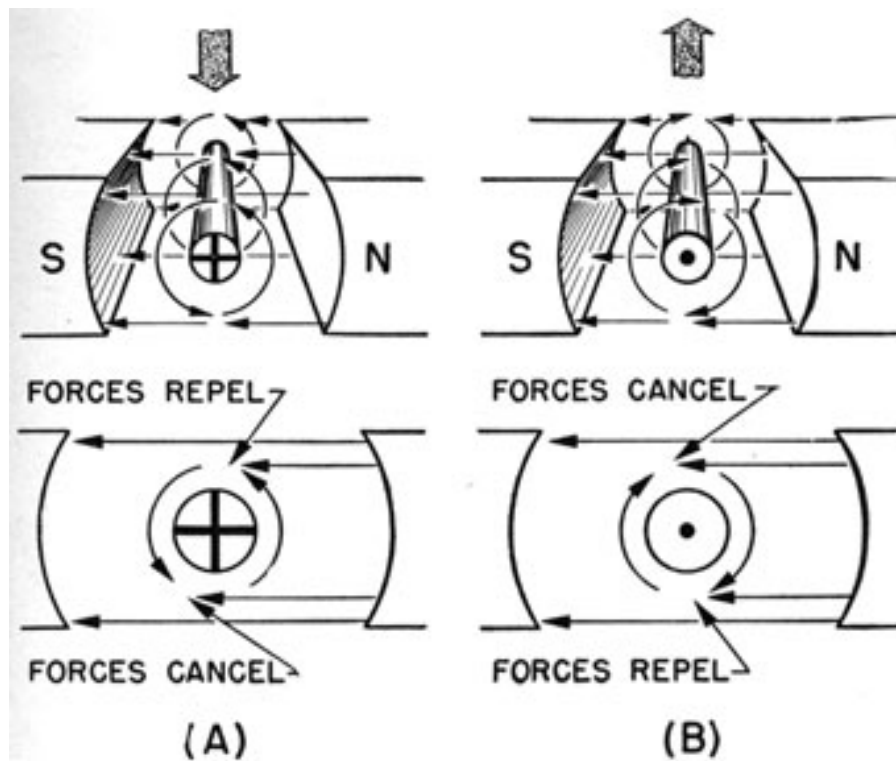

Figure 69.-Motor action.

In the bottom drawing of figure 69A, the conductor's field and the flux of the field coil combine to CANCEL each other at the BOTTOM and ADD to each other at the TOP. This leaves a GREATER FORCE tending to move the conductor DOWN than up-and the conductor will move DOWN.

In figure 69B, the current is flowing in the opposite direction, and the effect of the field is reversed. The two fields CANCEL ON TOP and ADD on the bottom, so the conductor moves UP.

81

The action of a conductor in a magnetic field is known by many different names, but the term "motor action" is as good as any.

PARTS OF D.C. MOTOR

The essential parts of a d.c. motor are similar to those of a generator. Look at figure 70. The four main parts are-STATOR, ARMATURE, COMMUTATOR, and BRUSHES. A battery attached to the brushes provides the energy to drive the motor.

The differences between a d.c. motor and a generator are usually only in the manner of mounting the brushes and connecting the windings. Actually, some d.c. motors may be used as d.c. generators without any change at all.

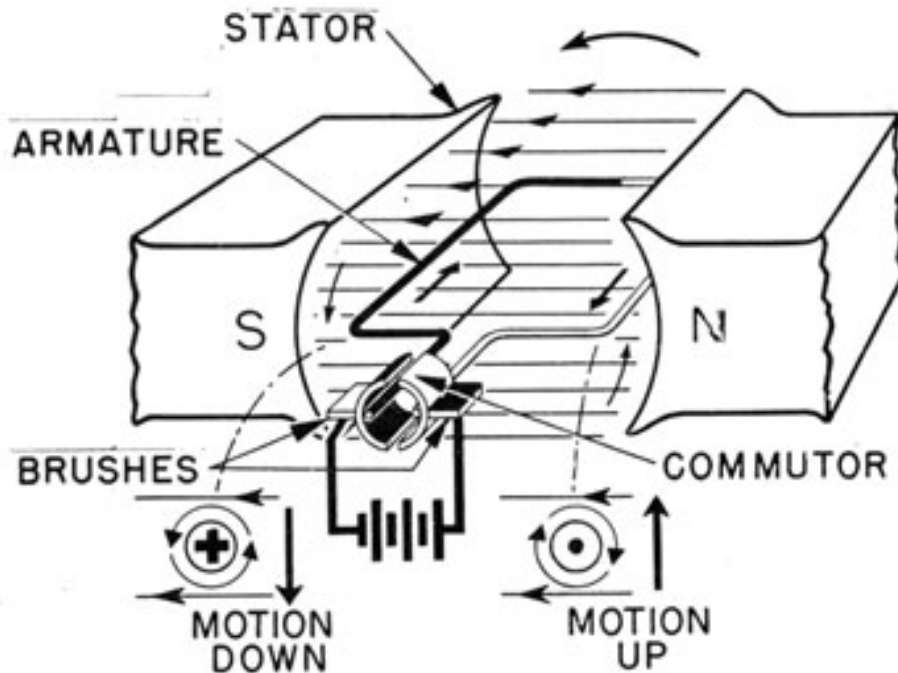

Figure 70.-Parts of an electric motor.

If you apply the **MOTOR ACTION** principle to the coil, the **WHITE** leg in figure 70 will go **UP**, and the **BLACK** leg will go **DOWN**.

When the loop has rotated 90° from its position in figure 70, the brushes will "slip" from one commutator

segment to the other, and the direction of the current in the loop will be reversed. The black leg will now move **UP** and the white leg **DOWN**.

THE ST. LOUIS MOTOR

While the St. Louis motor does not have any commercial uses, it does demonstrate the operation of a d.c. motor very well.

In figure 71 the **STATOR** (field yoke) is an electromagnet. The armature, figure 71D, is formed by winding the coil on a soft iron core.

The **COMMUTATOR** is a two-segment, copper ring mounted on the same shaft as the armature. Each segment

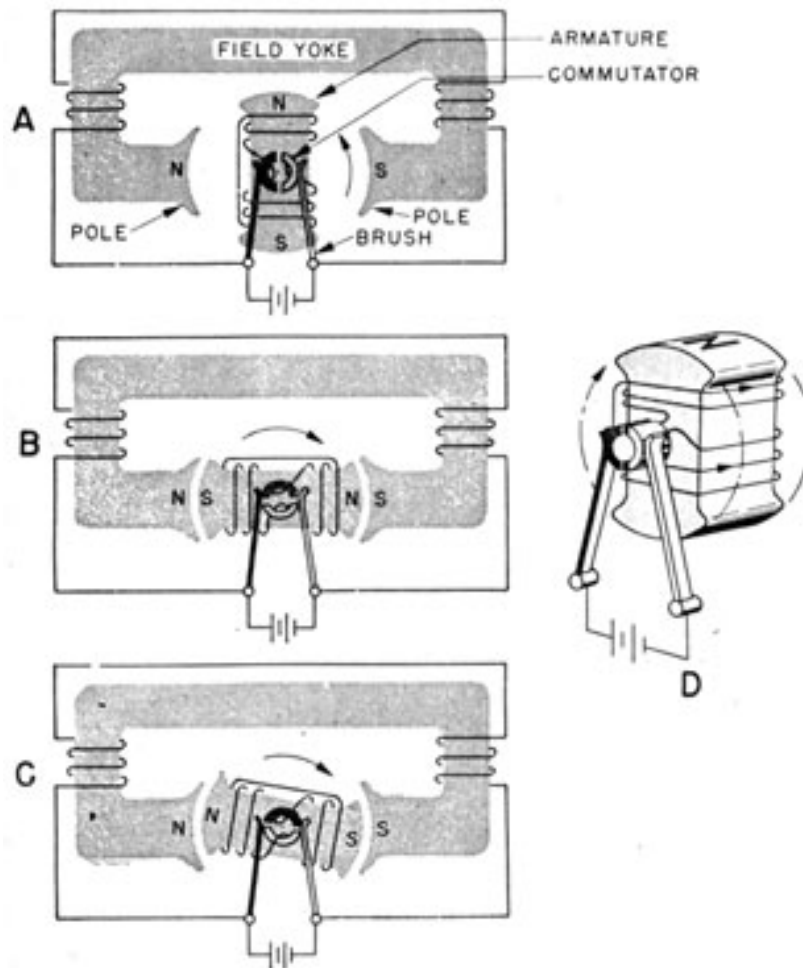

Figure 71.-St. Louis motor.

83

is insulated from the shaft so that no electrical contact is made between armature core and commutator. The BRUSHES are strips of copper.

To start a cycle of rotation, look at figure 71A. The commutator is in a position to give the armature the indicated polarities. Since unlikes attract, and likes repel, the armature will rotate in a **CLOCKWISE** direction.

When the armature reaches the position indicated in figure 71B, N is opposite to S. This would cause the armature to stop if it were not for the commutator. The **INERTIA** of the armature carries the commutator far enough for the black brush to move onto the white segment, and for the white brush to move onto the black segment.

The "trading" of segments reverses the direction of the current through the coil, and this in turn reverses the polarity of the core. Now look at figure 71C-N is opposite N, and S opposite S. The **REPULSION** between the coil and armature fields causes the armature to continue turning.

When the armature assumes the vertical position of figure 71, the repulsion is traded for attraction of the

opposite poles, and the cycle starts all over again.

While the d.c. motors used by the Navy are more elaborate in their windings and construction, the basic principle outlined here applies to the more complex types.

THE A.C. MOTOR

The a.c. motor is used more commonly than the d.c. types. The reason for this is not in the motor, but in the greater efficiency of using alternating current.

Some a.c. motors have WINDINGS, COMMUTATORS, and BRUSHES similar to those of d.c. motors. In addition a.c. motors have many variations. A few have armatures with no windings at all, just heavy bars of copper embedded in soft iron cores. Other armatures have windings but NO DIRECT electrical connection to the external source of power.

84

In many a.c. motors, it is INDUCTION that causes the armature to turn. A current flowing in the field coil causes a CURRENT to flow IN THE ARMATURE. The magnetic fields of these two currents oppose each other, causing the armature to turn.

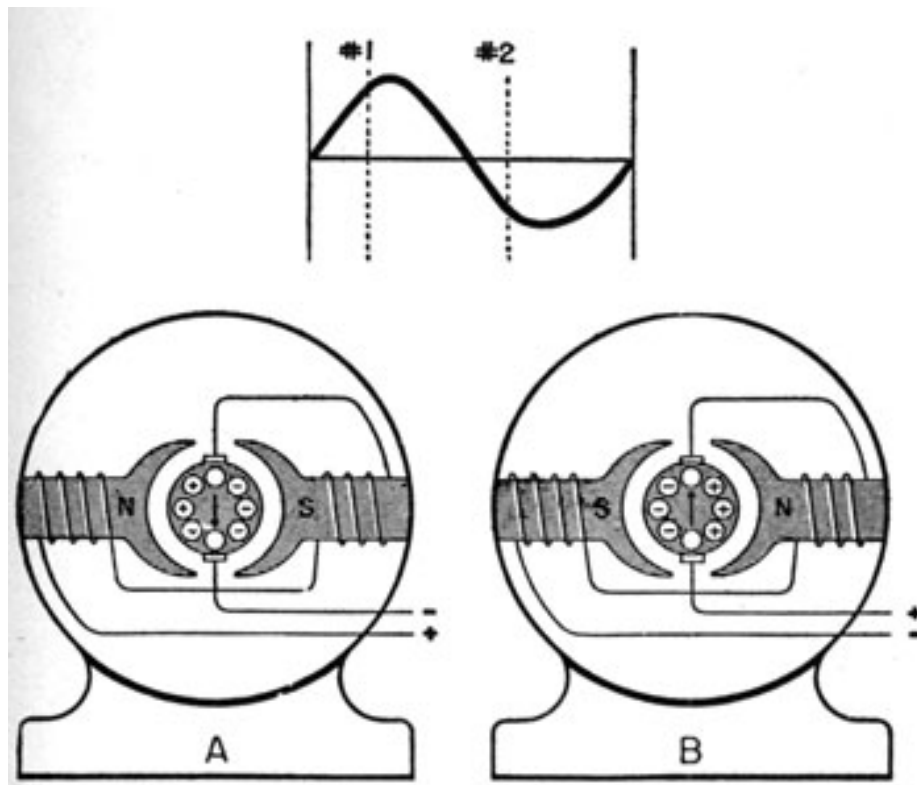

Figure 72.-Series a.c. motor.

One feature about the operation of an a.c. motor that differs radically from d.c. types is due to PERIODIC reversal of the current in a.c. circuits.

In figure 72A, when the TOP lead is NEGATIVE and the BOTTOM POSITIVE, the left pole is North and right South. In the armature, the current is flowing in at the left, and OUT the right side.

In drawing 72B, the current has reversed itself (other half cycle), making the top lead positive and the bottom negative. The polarity of the field is reversed, and current in the armature is flowing in the opposite direction.

85

The REVERSING of the CURRENT in a.c. motors has the same effect on the TURNING of the armature as the "trading" of segments in d.c. motors. It REVERSES the FIELDS so that ATTRACTION and REPULSION will cause the armature to rotate.

86



[Previous Chapter](#)



[Radio Home](#)

[Page](#)



[Next Chapter](#)

Copyright (C) 2005 [Historic Naval Ships Association](#)

All Rights Reserved

[Legal Notices and Privacy Policy](#)

Version 1.00, 12 Nov 05

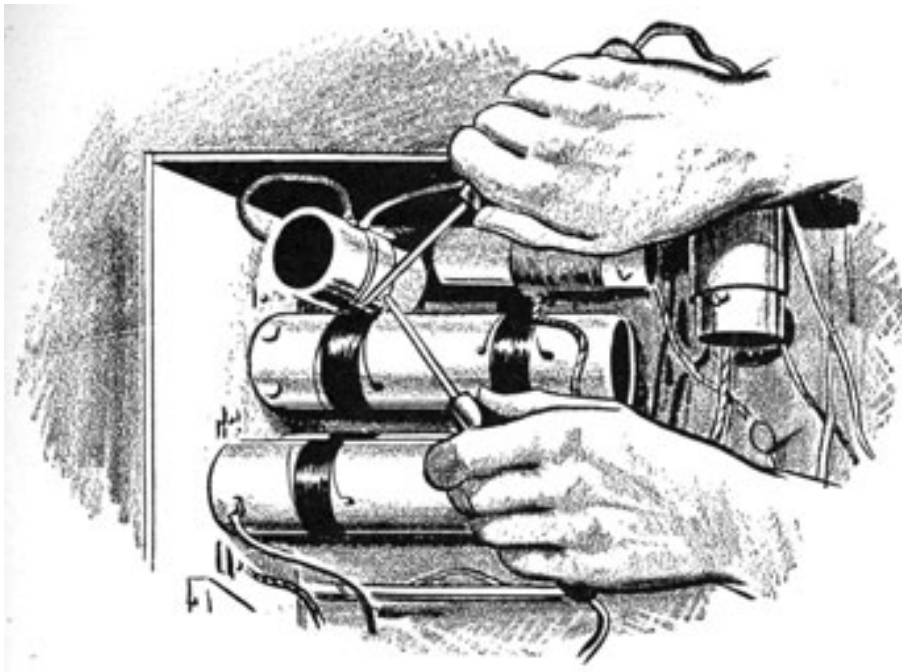

CHAPTER 9

MORE ABOUT INDUCTION

INTRODUCTION

So far, generators and motors are the only instruments described as using the principle of induction. **COILS** and **TRANSFORMERS**, while much simpler in design and containing **NO MOVING** parts, also depend upon **INDUCTION** for their operation.

Radios use hundreds of coils and transformers. Some are large, over a foot long, and several inches in diameter, while others are so small that a dozen could be placed inside a cigarette pack.

Many coils and transformers have special names, such as **CHOKES**, **POWER TRANSFORMERS**, **INTERMEDIATE TRANSFORMERS**, **INPUT TRANSFORMERS**, and many others. It will not be unusual to hear all coils and transformers called by a general name of **INDUCTANCE** or **INDUCTOR**.

SELF INDUCTION

One characteristic of induction is the ability of a **COIL** to **INDUCE** a voltage in **ITSELF-SELF INDUCTION**.

Look at figure 73. A coil of two turns is connected to a battery through a switch. When the switch is closed, the conductors will be surrounded by a magnetic field.

If only a SINGLE loop of wire were present, the magnetic fields would have little influence on the operation of the circuit. But it follows naturally that the field surrounding loop 2 also cuts across loop 1.

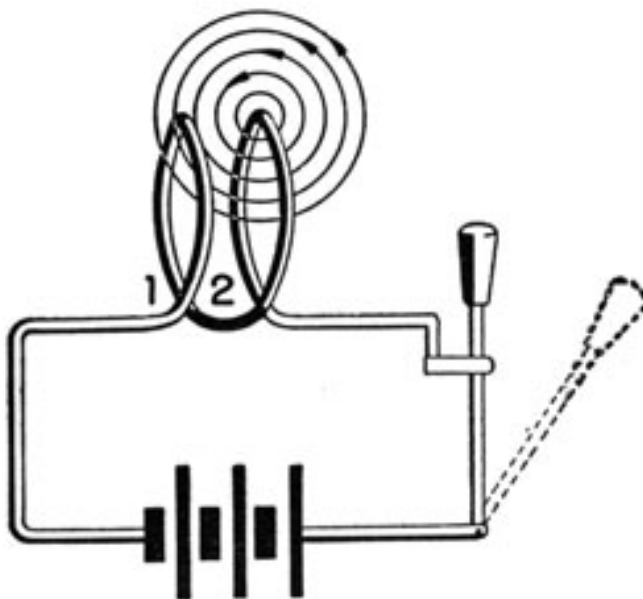

Figure 73.-Self induction.

When the switch is **FIRST** closed, the fields surrounding the loops are being **CREATED**. As long as the current is **INCREASING** the field is **EXPANDING**-in other words **MOVING**.

Now here is the situation. You have a **MOVING** magnetic field and conductors-loops 1 and 2-so what will take place?

Right! The field of loop 1 will induce a voltage in loop 2, and the field of loop 2 will induce a voltage in loop 1.

When the current through the coil becomes constant, the fields become stationary and no **INDUCTION** takes place. The field is **SUSTAINED** at a constant strength.

When the switch is opened, the **SUSTAINING** current falls. The field **BEGINS** to collapse, moving in a direction **OPPOSITE** to its motion when it was being created. In

collapsing, the field again induces a voltage in the turns of the coil. Thus, whenever the magnetic field of a coil is either EXPANDING or CONTRACTING, a VOLTAGE is INDUCED in its own TURNS.

COUNTER EMF

What happens to the voltage that is INDUCED in the turns of the coil ? Does it AID, or OPPOSE the battery voltage ?

Look at drawing A of figure 74. The switch has just been closed and the current is rising. The INDUCED VOLTAGE is ALWAYS in OPPOSITION to the voltage that CREATED IT. Thus, if the emf of the battery is 10 volts, and the induced emf is 2 volts, the resulting emf tending to cause the current to flow through the coil is-

$$10 - 2 = 8 \text{ volts.}$$

After the current has reached a steady value, the INDUCED VOLTAGE becomes zero, and the resulting emf is-

$$10 - 0 = 10 \text{ volts.}$$

As long as a steady current is maintained, no induced COUNTER EMF is present, and the magnetic field remains constant.

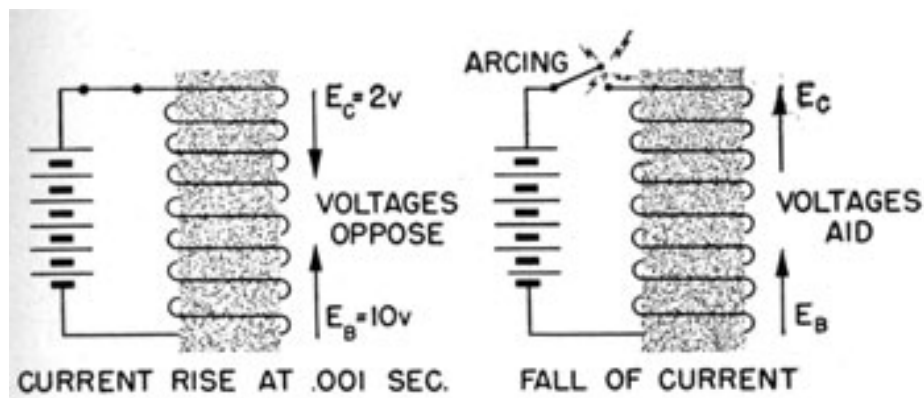

Figure 74.-Counter emf.

When the switch is suddenly opened, figure 74B, the magnetic field will collapse and induce a voltage in a DIRECTION OPPOSITE to the COUNTER emf, the SAME direction

699198°-46-7

as the APPLIED Voltage. Hence, on the collapse of a field, the INDUCED emf ADDS to the APPLIED emf.

If the switch is opened SUDDENLY, the induced emf from the collapsing field added to the battery voltage will cause a SPARK to jump between the terminals of the switch.

LENZ'S LAW

Here is something to remember. In any inductance, the INDUCED voltage is always in OPPOSITION to the VOLTAGE THAT CREATED it. When the current caused by the applied emf is rising, the induced voltage tends to reduce the current; but when the current from the applied voltage is falling, the induced voltage tends to keep it going. This statement is known as LENZ'S LAW.

ON INDUCTANCE AND A. C.

In figures 73 and 74 you learned what happens when d.c. is applied to a coil. Now observe what takes place when a.c. is applied to a coil.

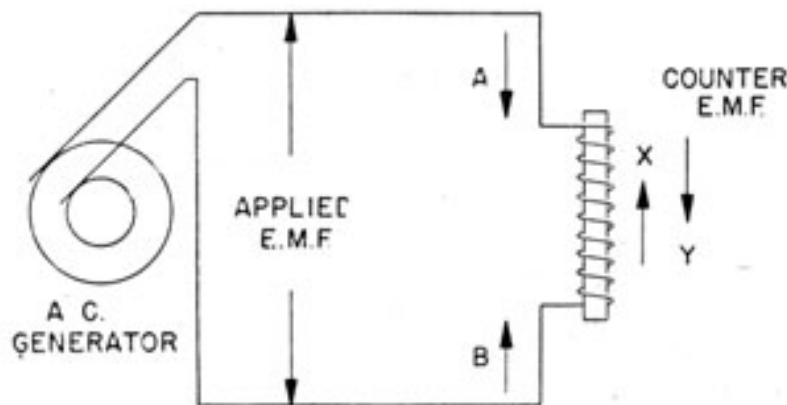

Figure 75.-Counter emf created by a.c.

In figure 75 an a.c. generator is delivering an emf to the inductance. During one half of the alternation, the current will be flowing in direction A, and during the other half-cycle, the current will flow in direction B. Since a.c. is never steady, a counter emf will be present at all times. The DIRECTION of this counter emf will always be opposed to the emf of the half-cycle that created it.

As an example, in figure 75, if the applied emf is in the direction indicated by arrow *A*, the counter emf will be in direction *X*, while on the next half alteration, the counter emf will be in direction *Y*.

INDUCTANCE OF A COIL

The magnitude of the counter emf depends upon two factors-the construction of the coil, and the **FREQUENCY** of the current.

The construction of the coil includes such factors as the **NUMBER** of **TURNS** per inch of the coil's length, the **DIAMETER** of the coil, the **NUMBER** of **LAYERS** of windings, and the **KIND** of **CORE**. All these factors are combined in a single unit and referred to as the **INDUCTANCE** of the coil.

The **UNIT** of inductance is the **HENRY**, and the **SYMBOL** used to designate **INDUCTANCE** is the letter *L*.

The actual calculation of a coil's inductance is an involved and difficult process. But here's all you need to remember-the **GREATER** the number of turns, and the **TIGHTER** the winding, the **HIGHER** the **INDUCTANCE**. And a coil with an **IRON CORE** has a **GREATER** inductance than a coil with an air core.

Inductance is a **PHYSICAL** property of a coil, and it **DOES NOT CHANGE** with an increase or decrease of frequency. A certain type of coil, known as a "swing choke," is designed to have a **HIGH INDUCTANCE** with low current, and **LOW INDUCTANCE** with **HIGH CURRENT**. While the second statement seems to contradict the first, the cause of the **CHANGEABLE INDUCTANCE** is in the **CORE** and not in the **COIL** itself.

Coils used with audio frequencies may run higher than 30 Henries, while those used with high radio frequencies may be as small as a few **MILLIHENRIES** (thousandths of a Henry).

REACTANCE OF A COIL

The **REACTANCE** of a coil is the **OPPOSITION** to the flow of current caused by the counter emf. The **AMOUNT OF**

REACTANCE depends upon the INDUCTANCE of the coil, and the FREQUENCY of the a.c. applied.

Since a counter emf is induced each time the current reverses its direction, the greater the number of reversals-the higher the frequency-the greater the counter emf will be.

The formula for finding the reactance of a coil is simple-

$$X_L = 2\pi fL$$

The symbol X_L designates the reactance in OHMS; f is the frequency of the a.c. in cycles per second; and L is the inductance of the coil in HENRIES.

The factor $2 \times \pi$ is derived from the ANGULAR rotation of a cycle. Don't let it bother you. Just think of it as equal to 2×3.14 , or 6.28. So now the equation above becomes-

$$X_L = 6.28 fL$$

Suppose you have a coil of two Henries inductance, carrying a 50-cycle current. What is the reactance? Substitute in the formula, and you get-

$$X_L = 6.28 \times 50 \times 2$$

$$X_L = 628 \text{ ohms}$$

But suppose the current is of an r.f. frequency of 2,000,000 cycles (2 mc). The reactance of the coil will now be-

$$X_L = 6.28 \times 2,000,000 \times 2$$

$$X_L = 25,120,000 \text{ ohms}$$

Remember, the HIGHER the FREQUENCY the HIGHER the REACTANCE. This feature is used extensively in radio work. You will hear a lot about it.

COILS USED IN RADIO CIRCUITS

The coils used in radio circuits are divided into two classes-those designed to be used with AUDIO FREQUENCIES, and the others to be used with RADIO FREQUENCIES.

Audio frequency coils, usually called A.F. CHOKES, have IRON CORES to increase their inductance. Figure 76 shows the schematic symbol and one example of an audio

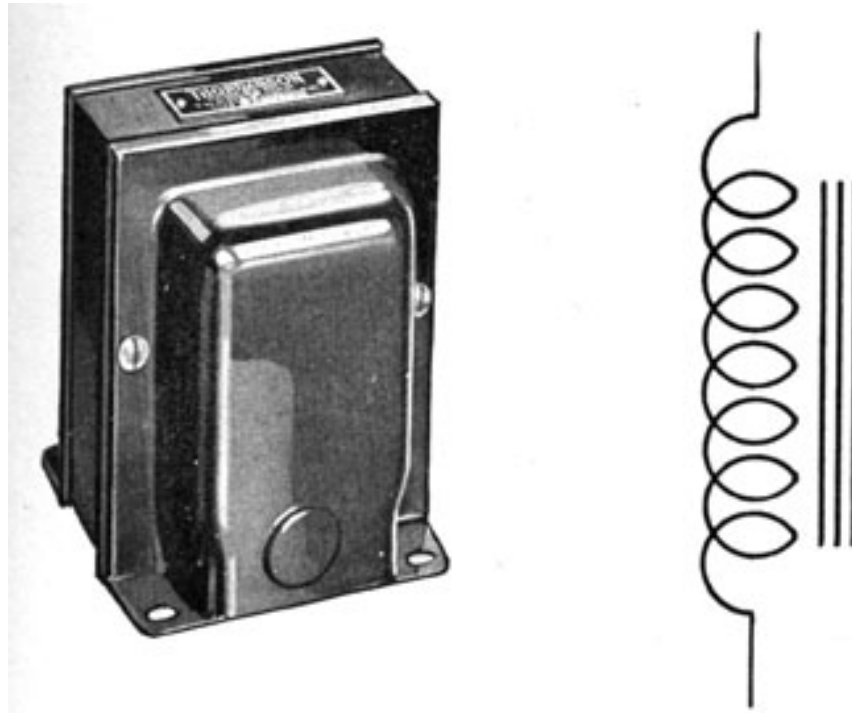
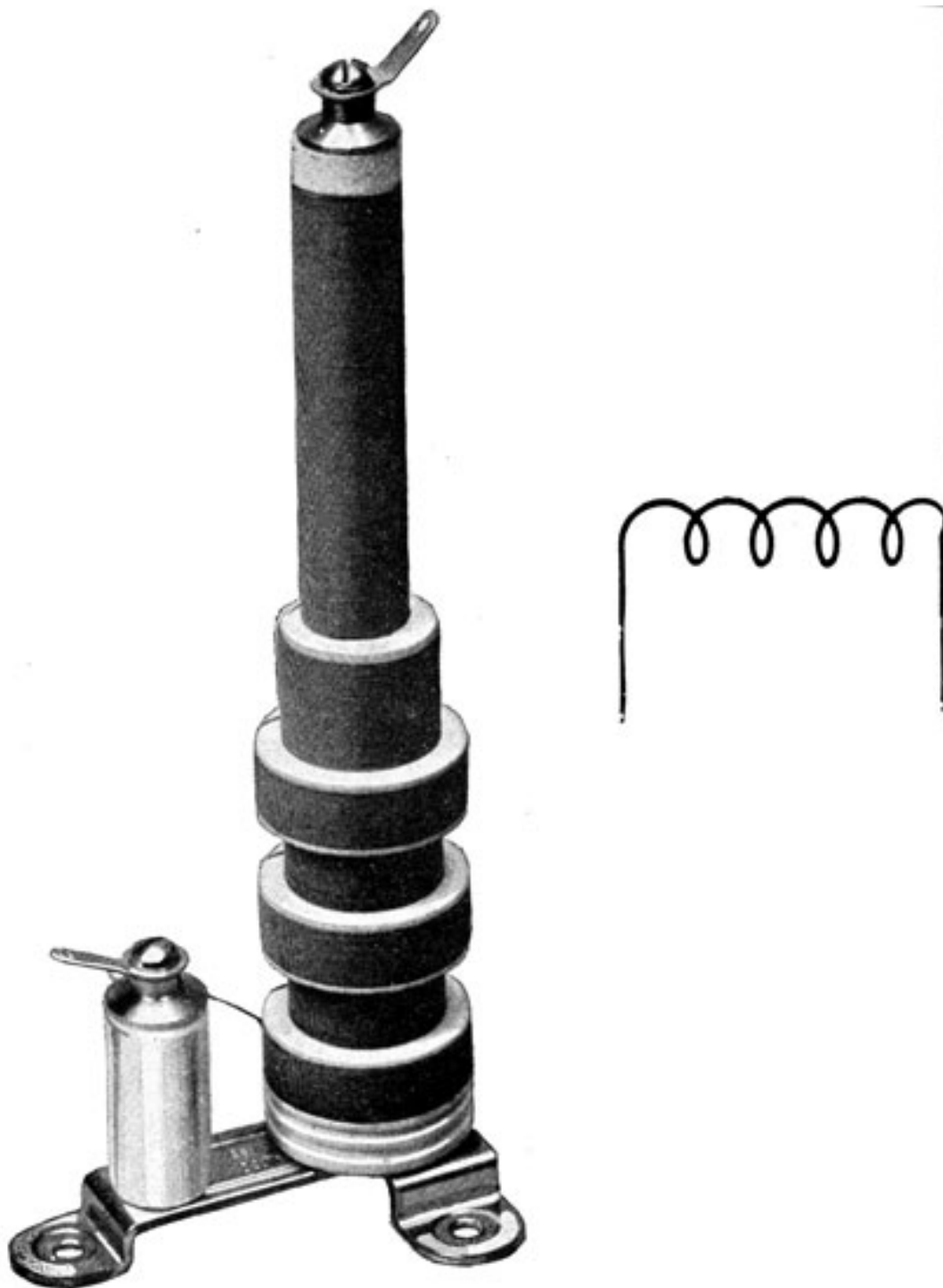

Figure 76.-Audio frequency choke.

frequency choke. While this example is one of the most common types, don't be surprised to find them of other designs.

Radio frequency coils, R.F. CHOKES, usually don't have iron cores. If they did, so much heat would be produced in making and destroying the field in the core that the coil would burn up.

R.F. coils have a greater variety of shapes and sizes than a.f. types. Some of the windings are of fine wire; others are made of large copper tubing with the individual turns widely spaced. Figure 77 shows the schematic symbol and one example of an r.f. choke.



**Figure 77.-Radio frequency choke.
MUTUAL INDUCTANCE**

When a coil is placed close enough to another coil so that the magnetic field of the first induces a voltage in the second. you have **MUTUAL INDUCTION**.

In figure 78, the magnetic field of coil *A* induces a voltage in coil *B*. If the coils are far apart, coil *A* will induce a small voltage in *B*. Moving the coils closer together **INCREASES** the emf induced in *B*. When the coils are very close together, the magnetic field of the induced current in *B* will induce an emf in *A*.

The relative position of the two coils is expressed as the **DEGREE** of **COUPLING**. If the first coil is just able to

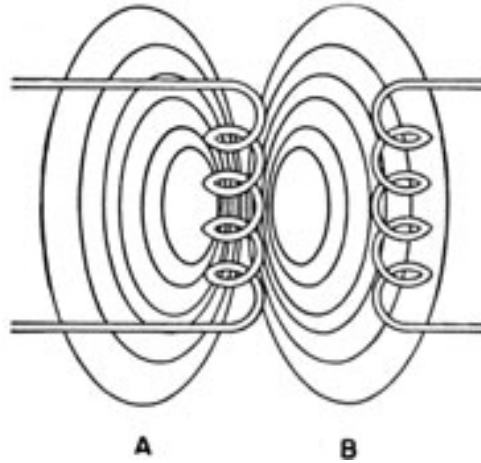

Figure 78.-Mutual induction.

induce an emf in the second, the coils are **LOOSELY** coupled. When coil *A* induces a maximum voltage in *B*, without *B* inducing a voltage in *A*, the coupling is **CRITICAL**. Any coupling greater than critical is **CLOSE**.

To keep the **TYPES** of **INDUCTION** straight in your mind, remember that **MUTUAL** induction requires **TWO** coils, while **SELF** induction needs but **ONE**.

THE TRANSFORMER

Mutual inductive devices are called **TRANSFORMERS**. In figure 78, coil *A* is the **PRIMARY** winding and *B* the **SECONDARY**. You can always tell which is the **PRIMARY** because it is the coil **WINDING** that receives the **APPLIED** voltage. The **SECONDARY** is the winding receiving the **INDUCED** voltage.

Transformers are used with both a.f. and r.f. Audio frequency transformers have iron cores, and the windings

are usually of heavier wire. Most radio frequency transformers **DO NOT** have iron cores. The wires used for the lower r.f. coils are fine and are wound on plastic tubes.

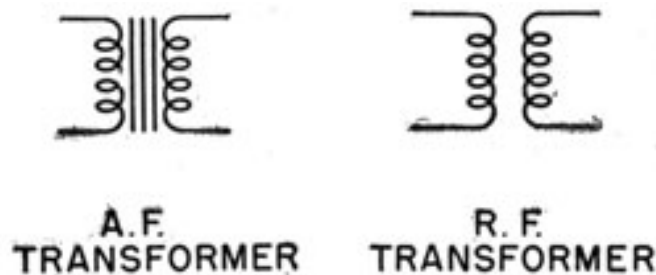

Figure 79.-Audio and radio frequency transformers.

In figure 79, the schematic symbols for both a.f. and r.f. transformers are given. You will see each type with different numbers of loops, but the identifying feature is the absence of the iron core with r.f. types.

Transformers operate on only a.c., because with d.c. induction takes place only when the circuit furnishing the applied emf is made or broken. Certain transformers are used with rapidly pulsating d.c., but these cases are few. You may never see one used.

AUDIO FREQUENCY TRANSFORMERS

The core in audio frequency transformers is used to increase its efficiency. The iron core forms a LOW

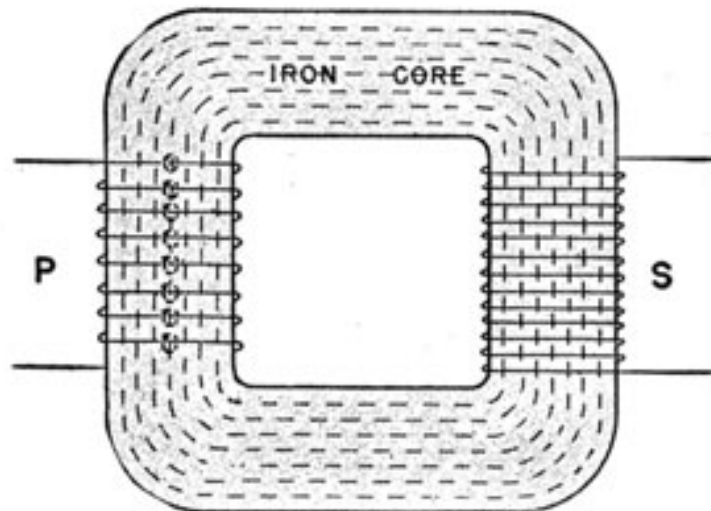

Figure 80.-A. F. transformer.

RELUCTANCE path for the flux to couple the primary and secondary windings together.

In figure 80, the iron core forms a complete circle for the flux to follow. In this way, any change in the primary current will be quickly carried to the secondary.

Not all transformers have cores and windings like the one in figure 80. In figure 31, four types of cores and windings are given. In drawing A, the core is circular,

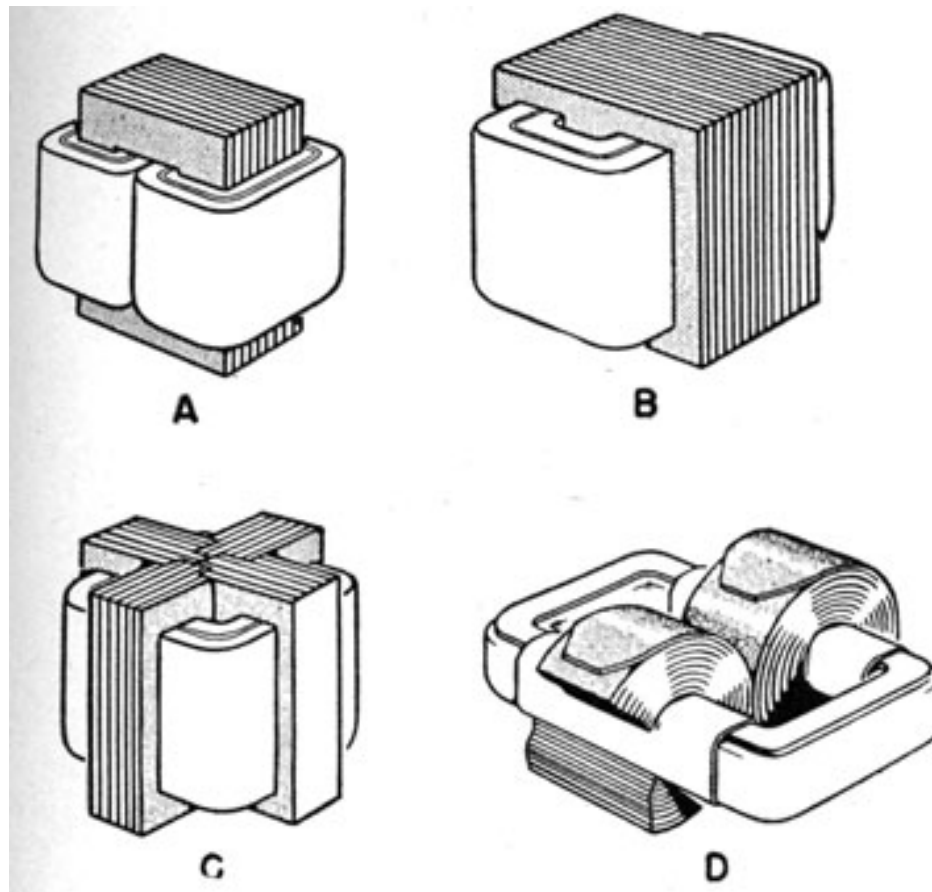

Figure 81.-Transformer cores and windings.

but PART of the PRIMARY and PART of the SECONDARY is wound on each side of the core. Both primary and secondary windings of drawing B are made on the CENTRAL LEG of the core. Core C is just double that of B, and core D is the one illustrated in figure 80.

TRANSFORMERS CAN INCREASE OR DECREASE THE VOLTAGE

The transformer's ability either to increase or decrease the voltage is probably its most valuable feature.

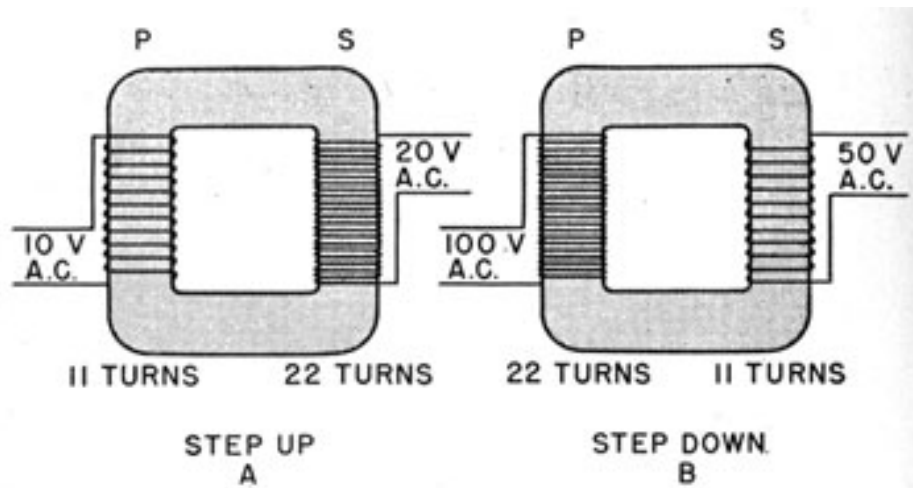

Figure 82.-Step up and step down transformers.

If there are MORE windings on the SECONDARY than on the primary, figure 82, the transformer is a STEP UP. If the windings are reversed, with MORE on the PRIMARY, the transformer is a STEP DOWN.

The amount of step up or step down is directly proportional to the TURNS RATIO between primary and secondary. Thus, in drawing 82A with 11 primary and 22 secondary turns, the voltage will be stepped up by a ratio of 1:2. Therefore, if 10 volts are applied to the primary, 20 volts will appear across the secondary.

With a step down transformer, if 22 turns are on the primary and 11 on the secondary, the step down is 2 to 1. Thus if 100 volts are applied to the primary, only 50 will appear across the secondary.

The step up and step down feature of transformers holds true for all ratios within reason. While, in theory, one turn on the primary and a thousand on the secondary should increase 10 volts to 10,000, ACTUALLY you would get much less. The difference between the THEORETICAL and ACTUAL performances is due to loss of efficiency with extreme ratios.

98

Efficient transformers with ratios as large as 20:1 are not uncommon, but when step up or step down ratios as large as 100 to 1 are desired, it is more efficient to use two 10 to 1 transformers.

Radio frequency also employs the step up and step down principle, but it is less commonly used because of the desire to obtain resonance in r.f. circuits. You will learn more about resonance in chapter 11.

Radios use many transformers that are both step up and step down at the same time. Look at figure 83. The top secondary winding is step up and lower secondary winding step down. It is not unusual to have a single

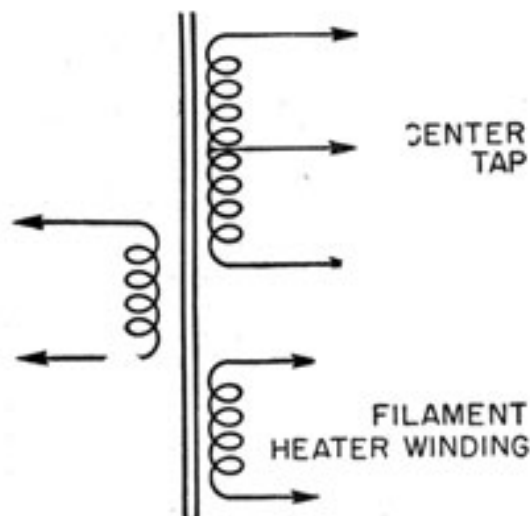

Figure 83.-Step up, step down transformer.

transformer in a radio receiver's power supply deliver potentials like 600, 6.3, and 5 volts from three secondary windings.

YOU CAN'T TAKE OUT MORE THAN YOU PUT IN

It may seem at first that you are getting more out of a transformer than you put in, but if you look a little further you will see this is not true.

First, you know that it is impossible to take more power out of a device than you put in. That also holds true for transformers. The power you take out of the secondary

99

is EXACTLY equal to the power put -in the secondary. Thus-

$$\text{Primary power} = \text{Secondary power}$$

or by using the power formula $W = E_p \times I_p = E_s \times I_s$

If the transformer is step up with a ratio of 1:2, and 50 volts with 10 amperes is applied to the primary, the secondary will have an emf of 100 voltage but a current of only 5 amperes because-

$$50 \times 10 = 100 \times 5$$

Thus if you STEP UP VOLTAGE, you STEP DOWN CURRENT.

RADIO FREQUENCY TRANSFORMERS

While most radio frequency transformers have primary and secondary windings, they are called COILS. Don't let that confuse you. If only one winding is present, it usually will be called an r.f choke.

You were told that most of the r.f. transformers don't have cores, but a few do have cores, made of IRON FILINGS imbedded in a piece of PLASTIC. The symbol for transformers with iron cores is given in figure 84.

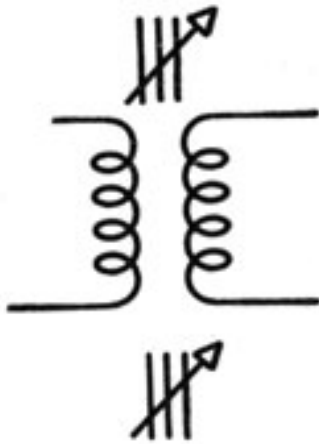

Figure 84.-Symbol for iron core r.f. transformers.

The windings of many r.f. transformers are of copper tubing and are held in place by strips of some special insulation material.



Figure 85.-Intermediate frequency transformer

Two of the many types of r.f. transformers are given in figures 85 and 86. The one in 85 is small, only 2 or 3



Figure 86.-Transformer used with transmitters.

101

inches long and about 1/2 inch in diameter. It is used in the INTERMEDIATE stage of a SUPERHETERODYNE receiver. You will hear more of these transformers later.

The transformer given in figure 86 is used with a low frequency, high power transmitter. The coil is large, over a foot long, and several inches in diameter.

102



[Previous Chapter](#)



[Radio Home
Page](#)



[Next Chapter](#)

Copyright (C) 2005 [Historic Naval Ships Association](#)

All Rights Reserved

[Legal Notices and Privacy Policy](#)

Version 1.00, 12 Nov 05



CHAPTER 11 RESONANCE YOU KNEW THE SPEED BY THE RATTLES

Ever sit at the wheel of your old Model A and say "Now we're doing 40-I can tell by the rattles"? If you changed your speed to 50 miles per hour, the rattles and vibrations also changed. You associated the various speeds of your automobile with the different rattles and vibrations that were heard.

What caused those rattles? Why did certain rattles show up at one speed and not at others?

Well, you know that all engines-even fine ones-vibrate. At different speeds, the frequencies of vibration are different. Every fender, bumper, and bolt in your automobile has a **NATURAL FREQUENCY** of vibration. If the engine is running at the correct speed to **GENERATE** the frequency of the right front fender, that fender will vibrate. If the engine is running at a speed that will produce the frequency of the rear bumper, that bumper will vibrate. And so on throughout the entire automobile.

The phenomenon of natural vibrations is common, but its importance is easily overlooked. It is part of every MECHANICAL and ELECTRICAL device. Of course, you may have trouble finding the NATURAL FREQUENCY of vibration for some objects, but the FREQUENCY at which an object will start vibrating is its RESONANT FREQUENCY.

SPECIAL RESONATORS

You can reinforce the sound of a musical note by using special resonators. Resonators on xylophones are round metal tubes; the violin has a wooden box; and the piano has a flat sounding board. These resonators are scientifically constructed to reinforce the vibrations coming from a weak source.

On a pipe organ or flute, the resonator is also the source of vibration. By changing the length of pipe in the organ or flute, the frequency (pitch) of the notes can be changed.

ELECTRICAL RESONATORS

You will run into special resonators in electricity, too. They will not be pipes or boxes, but just COILS and CONDENSERS in what are commonly called L-C circuits, or "TANK CIRCUITS."

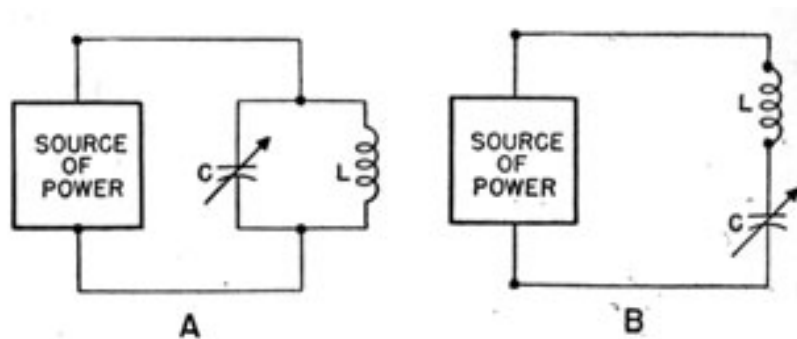

Figure 96.-Electrical resonators.

Two different ways of connecting coils and condensers to the source of power to form ELECTRICAL RESONATORS are given in figure 96. In drawing A, the coil and condenser are PARALLEL to each other, while in drawing B

the coil and condenser are in series with each other and the source of power.

Both types of connections are used in radio circuits. In some places they are used as a SOURCE of vibrations. In others, they are a part of a circuit used to REINFORCE other vibrations.

An L-C circuit that acts as a SOURCE of vibration is called an OSCILLATOR. The circuits used to reinforce the vibrations are called AMPLIFIERS.

WHAT HAPPENS IN AN L-C CIRCUIT

With musical resonators you may observe what is happening because you can actually FEEL and HEAR the vibrations. But in electrical resonators, you cannot observe the action as easily, since it is an ALTERNATING CURRENT that is GENERATED or REINFORCED.

Both mechanical and electrical resonators have several characteristics in common. Of these, here is the most important-neither MECHANICAL nor ELECTRICAL RESONATORS will RESPOND unless the CORRECT FREQUENCY of VIBRATION is PRESENT. The frequency at which a RESONATOR will RESPOND is the RESONANT FREQUENCY of the object.

That is why your model A would rattle one way at 40.1 miles per hour, another at 42.3, and still another at 58.

Electrical resonators will not respond unless the source of power is delivering an a.c. of the RESONANT FREQUENCY. You learned in the chapter on coils that when a.c. is applied to a coil, the magnetic field is continually EXPANDING and COLLAPSING.

You also learned in the chapter on condensers, that when an a.c. is applied to a condenser, it will be continually CHARGING and DISCHARGING.

Now put the coil and condenser in an L-C circuit. When an a.c. of a RESONANT FREQUENCY is delivered to an L-C circuit, like the one in figure 97, the CHARGE and DISCHARGE of the condenser is IN HARMONY with the MAKE and COLLAPSE of the coil's magnetic field.

115

At RESONANCE, the CURRENT produced by the COLLAPSE of the field is ABSORBED in charging the condenser, and the current from the CONDENSER'S discharge is used to build the coil's magnetic field. As long as a current of the

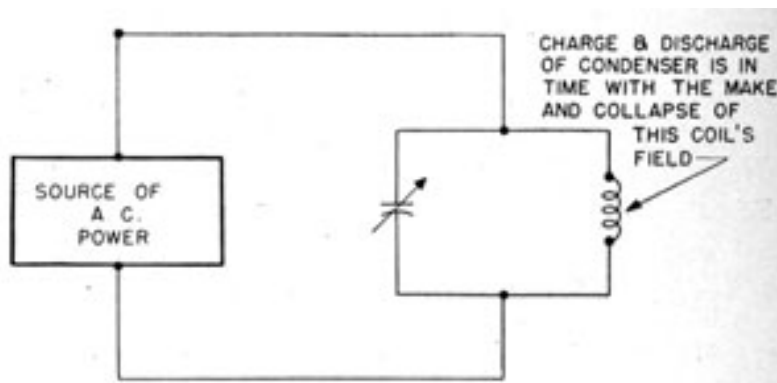

Figure 97.-At resonance the coil and condenser work together.

resonant frequency is being delivered to the L-C circuit, electrons will CIRCULATE back and forth, in and out of the coil and condenser.

The circulation of electrons in the tank circuit is much like the swing of a pendulum. As long as the proper amount of energy is supplied to overcome the losses due to friction, the swinging back and forth will continue.

In a pendulum, you INCREASE the RATE of motion by DECREASING the length of the bar. Increasing the length of the bar DECREASES the rate of swing.

In a tank circuit, you INCREASE the RESONANT FREQUENCY by REDUCING the ELECTRICAL LENGTH of the L-C circuit. And you DECREASE the electrical length by REDUCING the INDUCTANCE of the coil and the CAPACITY of the condenser, or BOTH.

This is important

If you want to INCREASE the RESONANT FREQUENCY of a tank circuit, you may do so by DECREASING the CAPACITY of the condenser, or by REDUCING the INDUCTANCE of the COIL.

If you wish to DECREASE the resonant frequency you can do so by INCREASING the CAPACITY or INDUCTANCE.

MAKING USE OF RESONANCE

Each time you tune your receiver you are either increasing or decreasing the resonant frequency of the receiver's tank circuit.

Suppose your receiver is tuned to 4,740 kc., and you want to listen to a station on a frequency of 3,880 kc. The receiver's resonant frequency is too high-4,740 kc.-so you twist a knob until the receiver's resonant frequency is 3,880 kc. And in comes in your station.

If you wish to bring in a station of any new frequency, you simply adjust your receiver so that its resonant frequency is the **SAME** as that of the station you want to hear.

A VARIABLE CONDENSER DOES IT

Most receivers are tuned by adjusting a **VARIABLE** condenser, or several condensers ganged together on the same shaft. **CLOSING** the condensers-increasing the mesh-**REDUCES** the frequency. Opening the condenser tunes the receiver to a higher frequency.

SWITCHING COILS CHANGES BANDS

As you know, most Navy receivers are made to tune over several bands of frequencies. As an example of this the **RAL** receiver which tunes from 0.3 to 23 mc. in nine bands. To change from one band to another, you rotate a switch. Each time you turn this switch, a **DIFFERENT** set of **COILS** are connected into the circuit.

The coils used to tune the receiver to the **LOWEST** band have the **GREATEST** number of turns. For each successive higher frequency band, the coils have fewer and fewer turns of wire. Thus the coils used with the **HIGHEST** frequency band have the **LEAST** number of turns.

When you rotate the switch to change bands you don't always connect in other **TUNING** condensers. Usually the same variable condenser is used to tune the **LOWEST** and **HIGHEST** bands.

WHERE ELSE ARE RESONANT CIRCUITS USED?

Transmitters also contain many resonant circuits. Most Navy transmitters use a tank circuit to **GENERATE** an a.c. of radio frequencies. This part of a receiver is the **OSCILLATOR**. You change the frequency of the oscillator by changing either the capacity of the condensers or the inductance of the coils.

In addition to the transmitter's **OSCILLATOR**, other tank circuits are used to **STRENGTHEN**, or **AMPLIFY**, the oscillator's feeble a.c. You will hear more about this later in this manual.



[Previous Chapter](#)



[Radio Home
Page](#)



[Next Chapter](#)

Copyright (C) 2005 [Historic Naval Ships Association](#)

All Rights Reserved

[Legal Notices and Privacy Policy](#)

Version 1.00, 12 Nov 05



CHAPTER 12 THE VACUUM TUBE INTRODUCTION

In the year 1883, Thomas A. Edison almost discovered how the vacuum tube worked. In his experiments with the incandescent light bulb, he was troubled by the repeated breaking of the fragile carbon filament. To give the filament more strength, he placed supporting wires alongside, but not touching the filament. A small piece of insulation provided the bracing link.

One day, Edison attached the **POSITIVE** terminal of a battery to the supporting wire and the negative terminal to the filament circuit. To his surprise, he saw that a **CURRENT** was flowing **OUT** of the bulb through the supporting wire. This wasn't according to the rules, since there was no conductor connecting the filament and the wire. Because he did not understand that current represents the flow of electrons, he wrote in his notebook-"When the positive terminal of a battery is connected to the supporting wire, a current seems to flow. This is an **INTERESTING** but **WORTHLESS** observation."

Interesting but worthless? In this case it paid dividends, but years later. In 1904, J. Ambrose Fleming, an English scientist who understood the flow of electrons, started to experiment with Edison's WORTHLESS observation.

He replaced the supporting wires with a large metal plate. With this new tube he conducted many experiments, the results of which are summed up in the following statements-

FIRST: When a filament is heated red hot, electrons will be given out by the metal and will form a cloud about the filament.

SECOND: When a positive potential is placed upon the plate, these electrons will flow from the filament to the plate. By placing larger voltages on the plate, the rate of flow can be increased up to a certain point, beyond which no additional current can be made to flow.

THIRD: If a negative potential is placed upon the plate, no current will flow in either direction.

Because Fleming discovered that current could flow in only one direction, the tube was known as "Fleming's Valve." The English vacuum tube is still called a valve.

Back in the United States, Lee DeForest continued an experiment in 1907 that had been suggested by Fleming. DeForest placed a screen of fine wire between the filament and the plate. He found that when these wires were made more negative than the filament, the flow of electrons to the plate was reduced. If the screen was made more and more negative, the flow was reduced still further. If the screen was made negative enough, the flow was stopped completely. The wires of this screen were wound on a frame so that they resembled the yard markers on a football field or gridiron. For that reason the screen is called a **GRID**.

The use of the **GRID** in a vacuum tube to control the flow of current from the filament to the plate is one of the most important discoveries in electricity. The grid allowed the vacuum tube to grow up.

You'll study the simple vacuum tubes first and take up the complex types later. Regardless of the number of elements that are included within a single GLASS ENVELOPE, every vacuum tube goes back to the principle discovered in Edison's worthless observations-electrons are given off by a hot metal filament.

DIODE VACUUM TUBE

The vacuum tube discovered by Fleming was a simple TWO ELEMENT device-and after 40 years it's still a useful tube. Nearly every radio has at least one DIODE tube. A high-powered transmitter may have several in places where the current must flow in ONLY ONE DIRECTION.

DIRECT-HEATER DIODE

The simple diode has only TWO ELEMENTS-the FILAMENT that is heated white hot and gives off electrons, and the PLATE that attracts the electrons when it is positively charged. You call the portion of the tube that gives off or EMITS electrons the CATHODE. And the part responsible for heating the cathode is the FILAMENT. In this simple diode tube, the CATHODE and FILAMENT ARE THE SAME. This is a DIRECT-HEATER TYPE of cathode.

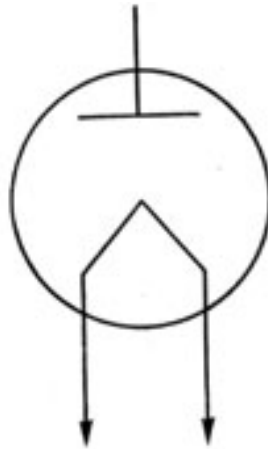

Figure 98.-Simple diode. Direct-heater type.

Figure 98 shows a simple diagram of a direct-heater diode. The plate is a sleeve that surrounds the pyramid-

699198°-46-9

shaped filament. When the filament (cathode) becomes red hot, electrons will be able to jump clear of the metal and form a cloud around the cathode. This electron cloud is the SPACE CHARGE.

The electrons in the space charge will move toward the plate, if it is positively-charged, and more electrons will come out of the cathode to replace those that move to the plate.

INDIRECT-HEATER DIODE

In many circuits, especially those that use A.C. to heat the filaments, the direct-heater cathode is a source of much objectionable noise. To reduce this noise, the CATHODE and FILAMENT are made as TWO SEPARATE UNITS.

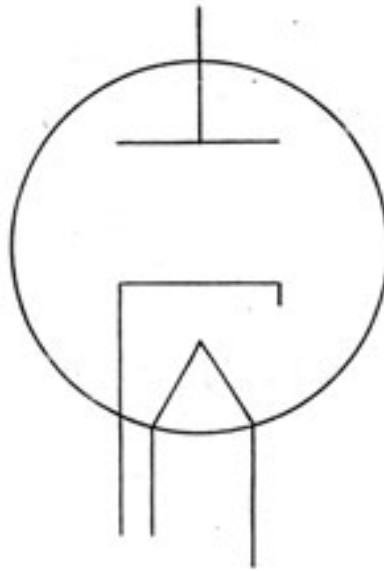

Figure 99.-Simple diode. Indirect-heater type.

Figure 99 shows a cut-away section diagram of an indirectly heated diode. The CATHODE is a METAL SLEEVE, and the FILAMENT extends up through the center of the sleeve like the heating element in a soldering iron (figure 100).

The filament does not touch the sleeve, but is embedded in a material that resembles plaster of paris. This filament may be heated with either a.c. or d.c. When the cathode becomes red hot, it will give off electrons to form

the space charge. The filament is not connected to the - cathode in any way, and the cathode alone gives off the electrons. In an indirectly heated tube, the only function of the FILAMENT is to HEAT THE CATHODE.

RIVER OF ELECTRONS FROM CATHODE TO PLATE

You remember that when the PLATE is POSITIVE, electrons will flow from the space charge around the cathode

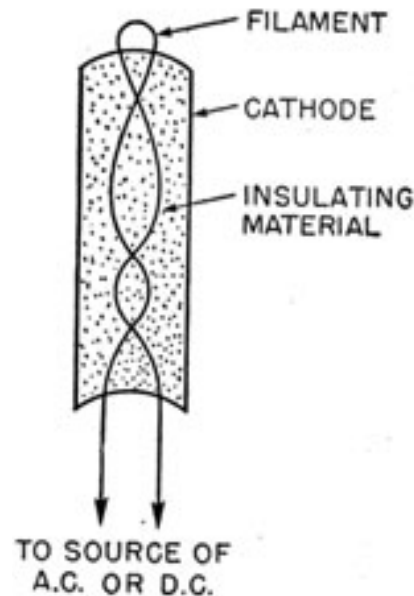

Figure 100.-Indirectly heated cathode.

to the plate. This stream of electrons is called PLATE CURRENT. In the standard abbreviations for radio terms, the PLATE is indicated by P or p , and the CATHODE is indicated by the letter K or k . By making a combination of I for CURRENT, and p for plate, you get the symbol I_p for the PLATE CURRENT.

The amount of current that will flow to the plate depends largely upon the voltage on the plate. The higher the plate voltage the larger the plate current. But the increase of plate current with increase of plate voltage does not go on forever. There is a point with every diode where the plate current will no longer increase regardless of the amount of increase in plate voltage. This is called the SATURATION POINT of the tube.

THE DIODE-A ONE WAY STREET

Remember the TURNSTILE at the circus or in the subway? You could push through it to go in. But when you tried to turn around to come out the same way, the turnstile locked, and kept you in. You could go in only one direction.

And that's just how a DIODE works-it lets the electrons get INTO the PLATE from the CATHODE, but it refuses to let them go back to the cathode.

The diode offers a low resistance from the cathode to the plate, but an extremely high resistance from plate to cathode. Actually the plate-to-cathode resistance is equal to an OPEN circuit. Therefore, the diode is an UNIDIRECTIONAL RESISTANCE. Since the diode is used most frequently with a.c., the resistance is called UNIDIRECTIONAL IMPEDANCE.

THE DIODE AS A RECTIFIER

One of the most useful applications of the diode is to CHANGE A.C. INTO D.C. Motor-generator units and other mechanical devices have been developed for this job, but for small amounts of power, none has the efficiency and convenience of the diode.

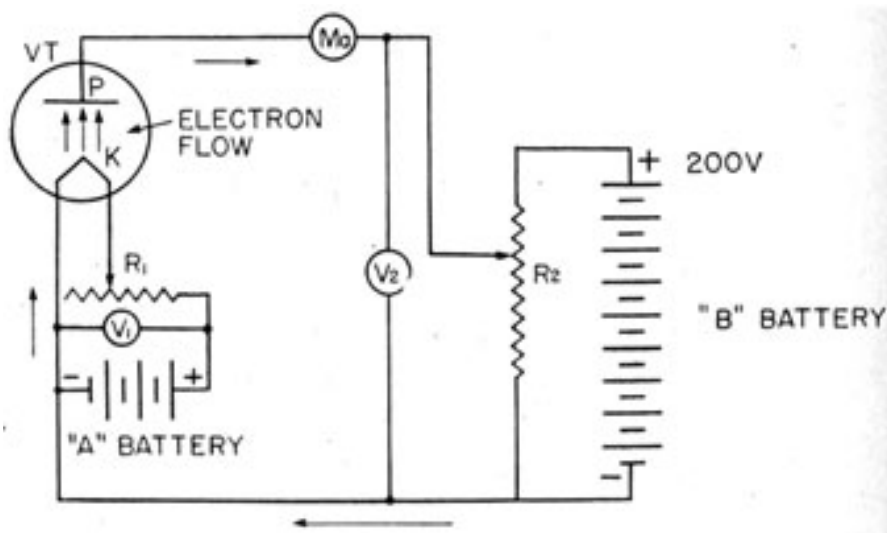

Figure 101.-The diode used as a rectifier.

The circuit for a diode rectifier is simple. In figure 101, a diode is inserted in the a.c. line. This arrangement will cause the diode to offer a low resistance in one direction and a resistance equal to an open circuit in the other.

On the half cycle when the plate is POSITIVE, the current will flow from the cathode to the plate. On the half cycle when the plate is negative, NO CURRENT WILL FLOW THROUGH THE TUBE. But on the next half cycle when the plate is again positive, the tube will again conduct current.

Thus the current flow through the load will be a pattern of the POSITIVE HALF CYCLE that is applied to the plate, but will cease to flow on the NEGATIVE HALF of the cycle.

Figure 102 shows this relationship of the a.c. voltage applied to the plate of the diode, and the current flowing

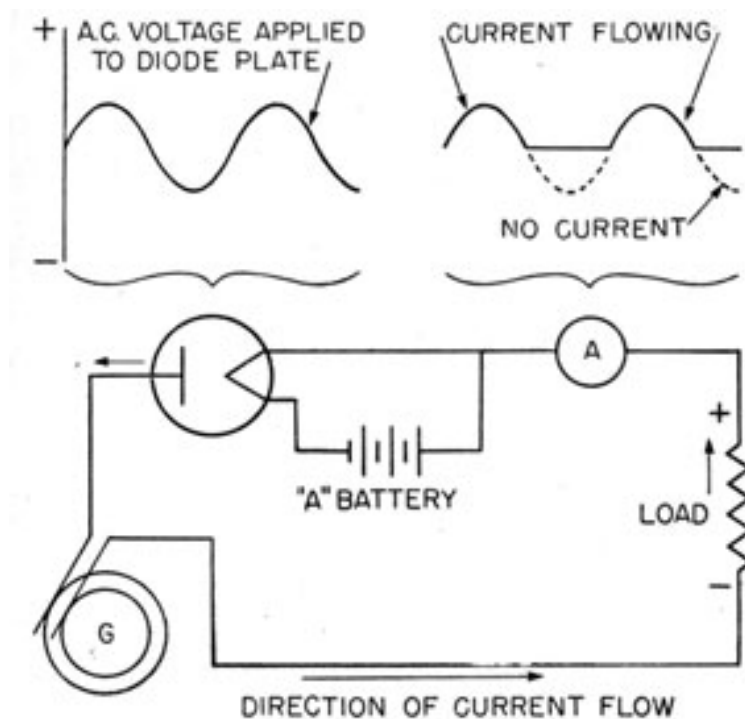

Figure 102.-Applied a.c. voltage and current flowing through a diode.

through the tube. Notice that you're using the POSITIVE half cycles. You are actually wasting ALL THE NEGATIVE

125

HALF CYCLES; but you have succeeded in causing the current to flow in ONLY ONE DIRECTION through the load.

A diode that causes the current to flow in only one direction is called a RECTIFIER.

126



[Previous Chapter](#)



[Radio Home](#)
[Page](#)



[Next Chapter](#)

Copyright (C) 2005 [Historic Naval Ships Association](#)

All Rights Reserved

[Legal Notices and Privacy Policy](#)

Version 1.00, 12 Nov 05

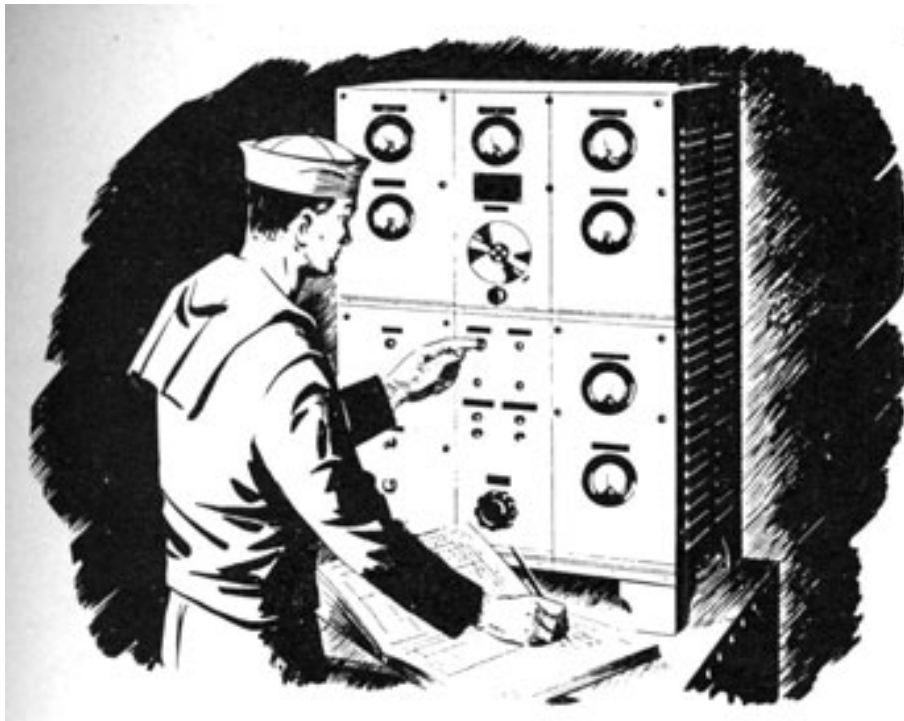

CHAPTER 15

JOBS OF A VACUUM TUBE USES IN RADIOS

The vacuum tube is used in so many places, and in such a variety of electronic gear, that a complete listing of all its applications would fill a book larger than the New York telephone directory.

Fortunately, this multitude of uses can be divided into a relatively small number of classes. And by limiting the gear to radio alone, the number is reduced to four

Rectifiers
Amplifiers
Oscillators
Detectors

VACUUM TUBE RECTIFIERS

You learned in Chapter 12 how a diode vacuum tube changed a.c. into a pulsating d.c. Practically all receivers, and many transmitters, have one or more of these RECTIFIER TUBES.

All radios require high d.c. voltages. Several devices, including batteries, are capable of supplying this d. c., but none has the convenience and efficiency of a rectifier, especially when a HIGH VOLTAGE with LOW CURRENT is desired.

The RECTIFIER TUBE, figure 110, is a PART of a circuit commonly called the POWER SUPPLY. In addition, the power supply also contains a TRANSFORMER and a FILTER.

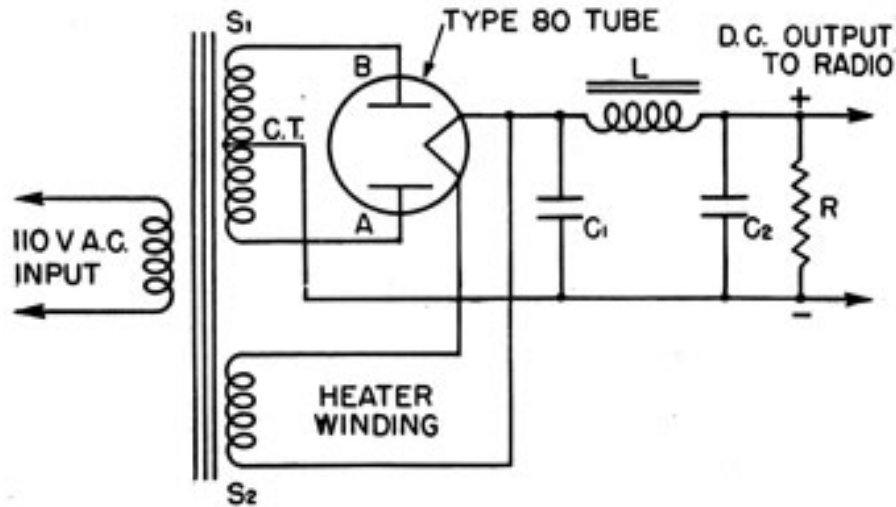

Figure 110.-Power supply.

The transformer has one primary and TWO secondary windings, S_1 , and S_2 . Winding S_1 , STEPS UP and S_2 STEPS DOWN the line voltage. As an example, S_1 may raise the primary voltage from 110 to 500 volts, while S_2 will reduce the primary voltage to 5 volts. The stepped UP

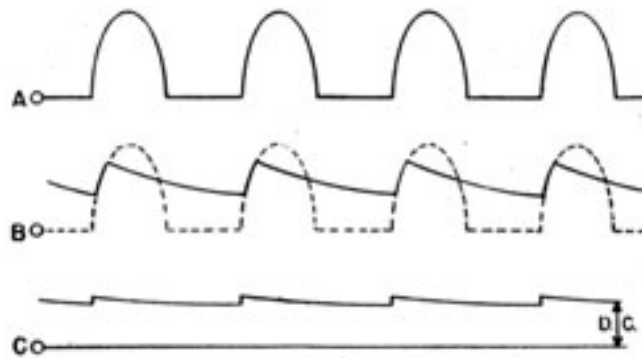

Figure 111.-Output of rectifier and filter.

voltage is applied to the plate of the diode, and the stepped down voltage is used to heat the rectifier's filament.

The diode changes the a.c. into a pulsating d.c., and that's where the FILTER comes in figure 111. The FILTER CUTS OFF the PEAKS of the pulses and FILLS IN the GAPS between them. While the d.c. output of the filter looks rather bumpy in drawing *B*, it actually is much smoother, more like line *C*. The small amount of irregularities left in the d.c. is called the RIPPLE, which is seldom greater than 5 percent of the output voltage.

VACUUM TUBE AMPLIFIERS

The word AMPLIFY means to INCREASE in SIZE. In Chapter 13, you learned how one volt of grid change produced as large a change in the plate current as 10 volts applied to the plate.

When proper resistors and condensers are correctly connected to the vacuum tube, with the necessary voltages applied to the circuit, an a.c. of one volt can cause an a.c. of 10 volts to appear in the plate circuit. Thus the vacuum tube, with its other related parts, has AMPLIFIED the a.c. TEN TIMES.

Pulsating d.c. may also be amplified. If the voltage applied to the grid of a vacuum tube starts at zero and rises to a maximum of two volts, and then appears in the plate circuit pulsating between zero and 100 volts, it has been amplified 50 times.

A vacuum tube and its immediate related parts is called a STAGE. The amplification of a stage is the ratio of the voltage you put IN on the grid, to the voltage you get OUT. Thus, if 0.5 volt a.c. is put into a stage, and 200 comes out, the amplification of the stage is-

$$200 / 0.5 = 400$$

Some times you will hear the amplification of a stage called the GAIN of the stage.

The amplification of a stage depends upon the vacuum tube and the condensers, coils and resistors used with the

vacuum tube. Some circuits using triodes have a very small gain-two, three, or four-while others using pentodes have gains of several hundred.

KINDS OF AMPLIFIERS

Radios use two kinds of amplifiers-AUDIO FREQUENCY and RADIO FREQUENCY. Each is designed to do its own work most efficiently.

Most RADIO FREQUENCY AMPLIFIERS use transformers to couple the stages together. A pentode tube is used with receivers and with low power stages in transmitters.

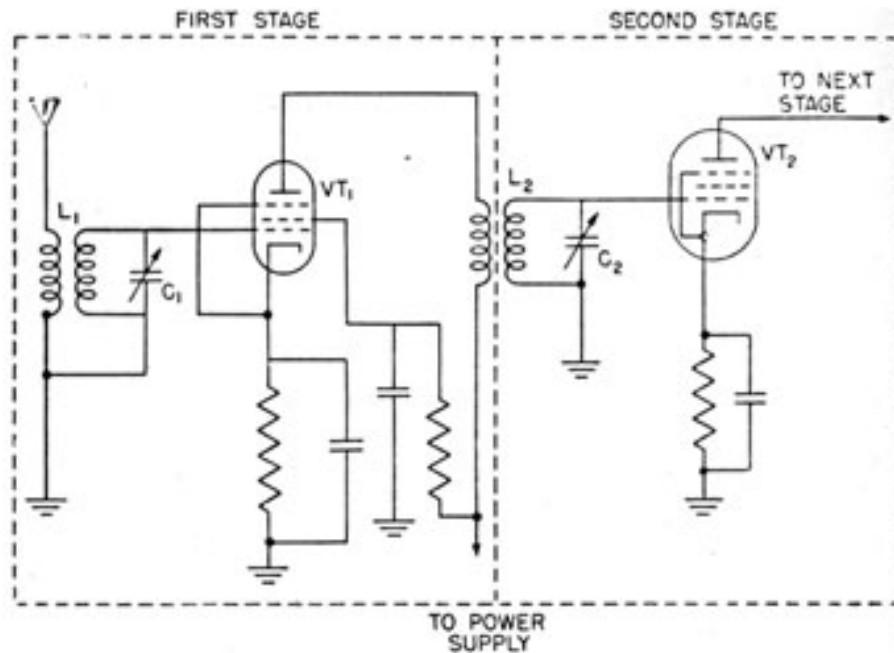

Figure 112.-Two stage r.f. amplifier.

The circuit in figure 112 is a two stage r.f. amplifier. Transformer L_1 is used to couple the antenna to the grid of the first vacuum tube. Transformer L_2 couples the first stage to the second amplifier stage. Notice that both vacuum tubes are pentodes.

Compare the two stage AUDIO FREQUENCY AMPLIFIER of figure 113 with the r.f. amplifier. Notice the coupling between the stages. In the a.f. amplifier C , R_1 , and R_2

form the coupling unit. This type of coupling is commonly called an R.C. COUPLING.

The input to the VT_1 is from a microphone. An audio frequency transformer T_1 couples the microphone to the grid of the tube. Notice that VT_1 is a pentode and VT_2 a triode. This indicates that BOTH pentodes and triodes are used in a.f. amplifiers.

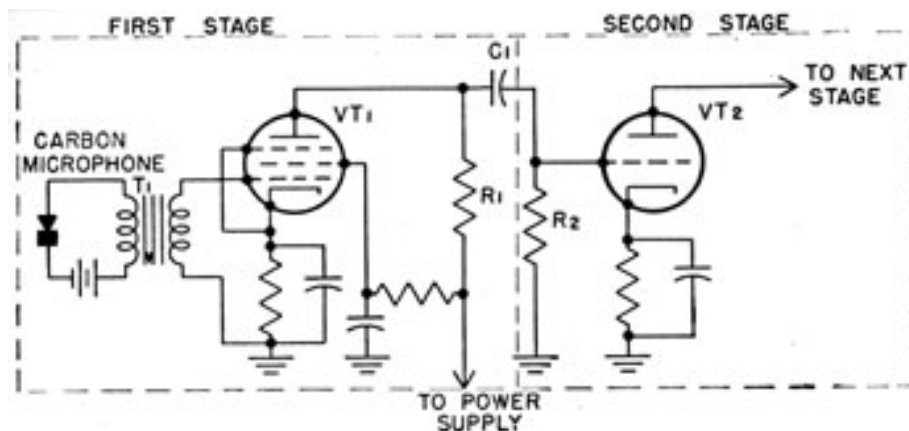

Figure 113.-Two stage a.f. amplifier.

Figures 112 and 113 are placed in this chapter to give you an idea of how the two kinds of amplifiers look in a schematic diagram. You do not need to trouble yourself to find out how they work unless you wish. It is enough to be able to RECOGNIZE the difference when you see the two circuits.

VOLTAGE AND POWER AMPLIFIER

Both a.f. and r.f. circuits have voltage and power amplifiers. A voltage amplifier is designed to increase the voltage, and a power amplifier is designed to increase the flow of current.

The FIRST stages of receivers, transmitters and audio amplifiers, in which the input emf is weak, use VOLTAGE amplifiers. In the output stages of all three, POWER amplifiers are used to increase the flow of current.

69919P-46-11

153

Pentodes and a few triodes are used in voltage amplifiers, while large triodes, beam power tubes, and specially designed pentodes are used in power amplifier stages.

If you wish to learn the types of tubes and the duties they perform, get some Electronics Technician's Mate to explain the tubes used in the specific receiver or transmitter that you are working with.

VACUUM TUBE AS AN OSCILLATOR

Back in Chapter 11 you read that an oscillator is just a high frequency a.c. generator, and that a COIL and CONDENSOR form the oscillator. Many times you will hear it stated that the VACUUM tube is an oscillator. That statement is not exactly correct, because NO PART of the vacuum tube OSCILLATES. It only SUPPORTS or REINFORCES the oscillations in the tank circuit.

A tank circuit, like the pendulum of a clock, must work against the opposition of all resistances that surround it. If it were not for these opposing forces, the oscillations, once started, would continue forever.

Since neither the pendulum nor a tank circuit is perfect, each requires that ENERGY be continually added to overcome the losses due to resistance. In the clock, a system of springs or weights provides the energy to keep the pendulum oscillating. In a tank circuit, a vacuum tube supplies the energy to keep the oscillations going.

While a vacuum tube is a necessary and essential part of all oscillator circuits, it is NOT the part that oscillates. It merely supplies the energy.

THE VACUUM TUBE AS A DETECTOR

In order that your message may travel from transmitter to a receiver, it is necessary to combine the AUDIO FREQUENCY SOUNDS with the RADIO FREQUENCY carrier wave at the transmitter. This combining of waves is called MODULATION.

The MODULATED CARRIER wave is a garbled combination of the two frequencies that cannot be heard by the human ear. Therefore, before the message can be understood

154

the audio frequency part of the carrier wave must be separated from the radio frequency components.

This separation of the a.f. and r.f. parts of the carrier wave is known by two names, DEMODULATION and DETECTION.

DIODE vacuum tubes are most commonly used as detectors in Navy receivers. The tube alone does not do the job. Additional coils, condensers and resistors are required to complete the circuits.

It is not necessary for you to know the exact action of the detector circuits. It is sufficient if you know that the a.f. portion of the carrier wave is sent on to the loud speakers or earphones, while the r.f. portion is discarded and cast aside.

OTHER USES OF VACUUM TUBES

You will find SPECIAL vacuum tubes used in a variety of places in both transmitters and receivers. One of the more frequent uses will be as a VOLTAGE REGULATOR. These tubes are special diodes containing a small amount of gas, and usually having cold cathodes.

A TUNING INDICATOR commonly called a TUNING EYE is used in some receivers. The RBO receiver uses one of these tubes. The purpose of the tube is to indicate the PRESENCE of a station, and also to indicate when the receiver is correctly tuned.



[Previous Chapter](#)



[Radio Home
Page](#)



[Next Chapter](#)

Copyright (C) 2005 [Historic Naval Ships Association](#)

All Rights Reserved

[Legal Notices and Privacy Policy](#)

Version 1.00, 12 Nov 05



CHAPTER 16

BACKGROUND TO MODERN RADIO

INTRODUCTION

How many of you remember the first radio receiver that was in your home town? Probably none, because that was about the time many of you were born.

In 1920, there were fewer radio receivers in American homes than ships in the Navy. Yet by 1940, only 20 years later, there were more home receivers in everyday use than automobiles on the highway.

Radio is such an important part of every American's daily life that we are inclined to think that it has always existed in its present form. Actually, the discovery of its principle dates back to only a few years before 1900.

DISCOVERY OF THE PRINCIPLE OF RADIO

Marconi is usually given credit for the invention of radio. Actually, he was just the first man to send a message successfully. The principle of wireless communication had been discovered at an earlier date by another European scientist, Hertz.

In 1888, Hertz observed that a compass needle when placed near a magnet would move each time the magnet was moved. Now that may seem like a simple observation, but he saw something NEW in an OLD principle, and that was-

ENERGY CAN BE TRANSMITTED THROUGH SPACE IN THE FORM OF A MAGNETIC FIELD.

Further experiments revealed that the range of transmission could be increased by using a.c. with an electromagnet to produce the magnetic field. It was also observed that still greater ranges of transmission were possible when the a.c. used was of HIGH FREQUENCY.

From this point on, the development of radio turned toward the development of a high frequency a.c. generator. Many devices were tried, but most of them failed.

SPARK GAP TRANSMITTERS

One of the first successful transmitters was an ELECTRIC SPARK. When an electric spark jumps from one terminal to another, the full discharge does not leap across the gap and stay there, but it jumps BACK and FORTH THOUSANDS of times before eventually coming to rest.

Each time the spark completes one round trip between the gaps, one cycle of a.c. is generated. If the spark jumps back and forth at a rate of 50,000 times a second, an a.c. of a 50,000 cycle frequency is generated.

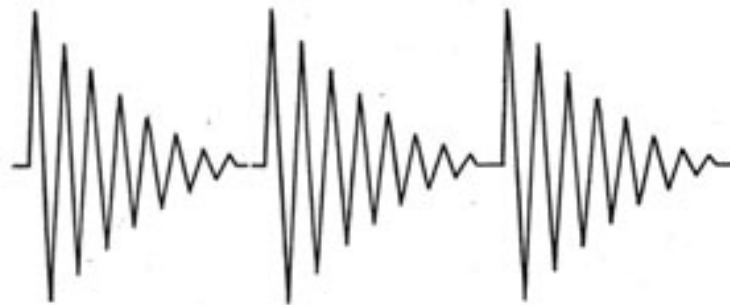

Figure 114.-Damped wave produced by an electric spark.

The oscillations produced by a spark are not uniform. They start strongly, but soon die out completely as illustrated in figure 114. When the next spark jumps the

gap, they start the process all over again. The a.c. wave produced by a spark is called a DAMPED wave.

A RADIO TRANSMITTER-ONLY A HIGH FREQUENCY A.C. GENERATOR

Although the electric spark was widely used with early transmitters, it was not completely satisfactory. An ideal generator must produce an arc that does not periodically die out, but rather a CONTINUOUS and uninterrupted chain of vibrations as illustrated in figure 115.

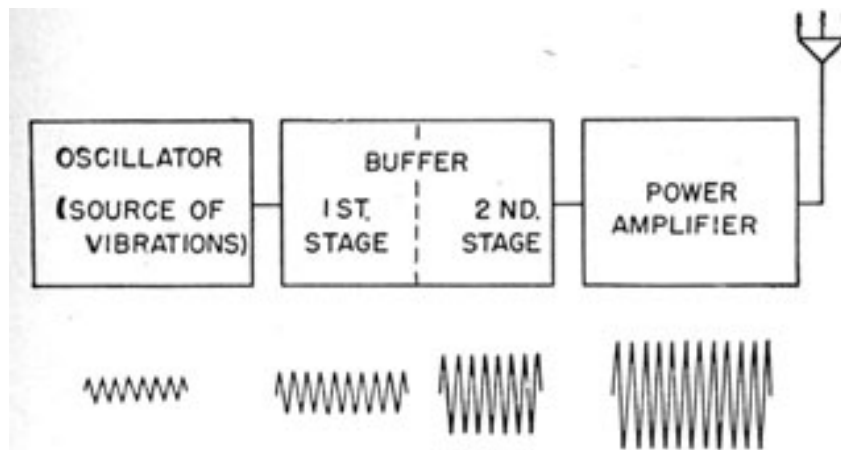

Figure 115.-Continuous wave produced by a transmitter.

The problem of building a useful high frequency a.c. generator was finally solved by the invention of the VACUUM TUBE. The vacuum tube, with a few wires, coils, condensers, resistors, and other little gadgets, provides the basis for the transmitter.

Always remember that regardless of how many wires, vacuum tubes, resistors, and other parts a transmitter may have in its circuit, it is essentially a HIGH FREQUENCY GENERATOR.

THE ANTENNA OF A TRANSMITTER REPLACES THE ELECTROMAGNET

Instead of using an electromagnet to produce the magnetic field, the transmitter uses a single wire or ANTENNA,

but still the magnetic field is produced in the same way-by a flow of electrons.

WHAT ARE RADIO WAVES?

You are familiar with water waves, sound waves, and the WAVES you used to pilot around a dance floor-but what are RADIO WAVES?

Here's an exact definition-radio waves are vibrating ELECTROMAGNETIC FIELDS IN THE ETHER. You know the meaning of vibrations and electromagnetic fields-but what is this thing called ETHER? Seems to be a little strange.

The ETHER is an IMAGINARY substance. It is present EVERYWHERE, even in a vacuum. Like the wind, no one has ever seen the ether, or probably ever will.

The ether's reaction to magnetic fields indicates that it is an ELASTIC substance, capable of being pulled or pushed out of shape. But when the force used to produce the distortion is removed, the ether springs back to its normal position.

HOW DOES A MESSAGE GET FROM A TRANSMITTER TO YOUR RECEIVER?

All of you are familiar with the movement of waves in water. When a stone is dropped into a pool, the waves

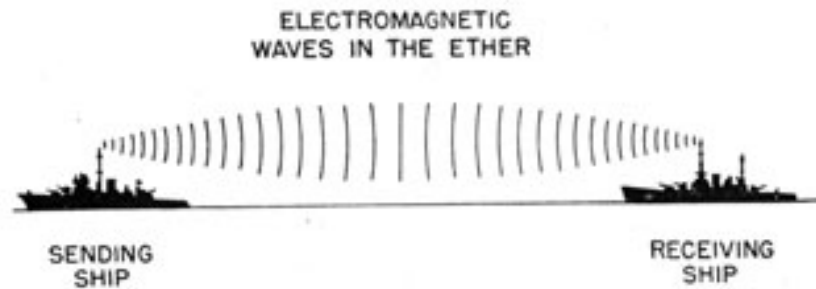

Figure 116.-How radio waves pass from the transmitter to receiver.

move outward in all directions until they either die out or reach the edges of the water.

Electrons in moving through a transmitter's antenna cause a disturbance in the ether just like a pebble being

160

tossed into a pond of water. As illustrated in figure 116, the electromagnetic field caused by the moving electrons expands outward in every direction and eventually will strike against a receiving antenna and deliver the message.

Because it is the electromagnetic radio wave that CARRIES the message to your receiver, radio waves are also called CARRIER WAVES. Many times they are merely referred to as the CARRIER.

There are many forces and outside influences that interfere with the perfect transmission of radio waves from the transmitting antenna to your receiver. Occasionally these outside forces are so strong that the wave is unable to reach the intended receiver, just as a strong cross-wind may prevent the ripples from a stone from reaching the opposite shore. In the last chapter of this book you will find a discussion of these interfering forces.

HOW FAST DO RADIO WAVES TRAVEL?

Radio waves travel at the speed of light-186,000 land miles or 164,000 nautical miles per second. That speed is fast enough to circle the earth at the equator about 7½ times in a single second. It may be useful to you in making adjustments on certain tactical equipment to know that radio waves travel at the rate of 382,000,000 yards in a second, or one mile in six microseconds, 6 / 1,000,000 of a second.

SOMETHING ABOUT FREQUENCIES

Several times you have read in this chapter that the frequency of the a.c. used with radio transmitters is

high, but no definite values have been given. The actual frequencies used extend over a wide range, from 30,000 cycles per second at the lower end to greater than 30,000,000,000 cycles a second at the top of the band. At the present time the upper limit is being raised rapidly so

161

that within a year the present high may be far below the top frequencies then being used.

Frequencies greater than 30,000 cycles a second are called RADIO FREQUENCIES. For the purpose of reference, the full radio frequency band had been divided into eight ' parts, as listed in the following table.

BAND	CYCLES PER SECOND	KILOCYCLE	MEGACYCLE
Very low	Below 30,000	Below 30	--
Low	Up to 300,000	30-300	--
Medium	Up to 3,000,000	300-3,000	.3-3
High	Up to 300,000,000	--	3-30
Very high	Up to 300,000,000	--	30-300
Ultra-high	Up to 3,000,000,000	--	300-3,000
Super-high	Up to 30,000,000,000	--	3,000-30,000
Microwave	Above 30,000,000,000	--	Above 30,000

Remember-if you use the expression 30 kilocycles, you actually mean 30,000 cycles. And if the expression 10 megacycles is used, it means 10,000,000 cycles.

Each of the various frequency bands possesses characteristics that are of an advantage for certain types of communication. The bands below 300 kc. are most used by shore stations for long-range communications.

The frequencies between 300 and 3,000 kc. contains the commercial broadcast band and some of the long-range, medium-wave communication frequencies.

Frequencies greater than 300 mc. are used most frequently with certain types of Navy tactical equipment. That's enough on frequencies for the present. The last chapter in this manual contains a complete discussion of frequencies and radio transmission.

162



[Previous Chapter](#)



[Radio Home](#)

[Page](#)



[Next Chapter](#)

Copyright (C) 2005 [Historic Naval Ships Association](#)

All Rights Reserved

[Legal Notices and Privacy Policy](#)

Version 1.00, 12 Nov 05



CHAPTER 17

INTRODUCTION TO TRANSMITTERS

MANY TYPES-BUT STILL SIMILAR

The Navy uses many different types of transmitters. Some are small enough to be carried away in your sea bag; others are large enough to bunk in. In spite of the variance in physical size, most transmitters are basically alike. To get off to a good start on transmitters, you should first see what the differences and similarities are among various types.

First, why the differences? Two things are largely responsible for determining the size of a transmitter-the **FREQUENCY** at which it transmits, and the **AMOUNT OF POWER** it delivers.

HIGH FREQUENCY transmitters are smaller, because the parts used-coils, vacuum tubes, etc.,-are small.

HIGH POWER transmitters have to be made large to prevent their destruction. Low **POWER** transmitters may be very small. You can see this difference by comparing the big TBK, 500 watts, with the portable TCS, 50 watts, and the SCR-536 Handy-Talkie of only .027 watts.

Second, what are the basic similarities? The general plan of all transmitters can be seen in figure 117, which shows the stages of a typical transmitter.

Every transmitter has an OSCILLATOR. It may be one of the SELF-EXCITED jobs already studied, or it may use a QUARTZ CRYSTAL as a source of high frequency a.c. At best, the a.c. generated by any transmitter is feeble, and it must be strengthened (amplified) before it has sufficient power to carry a message any great distance.

Hence, AMPLIFIERS come next in a transmitter. There are two types of amplifiers-VOLTAGE AMPLIFIER and POWER AMPLIFIER. As you can see in figure 117, the voltage amplifier is the stage immediately following the oscillator. The last or OUTPUT stage is the POWER amplifier.

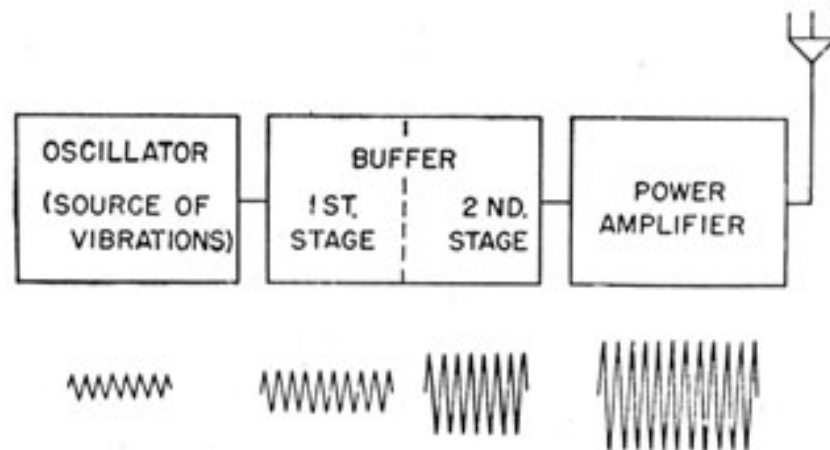

Figure 117.-Stages of a typical transmitter.

The stage next to the oscillator is called the BUFFER-so named because this stage ISOLATES the oscillator from the POWER AMPLIFIER. Without the buffer, changes in the power amplifier due to keying or roll of your ship would be REFLECTED back to the oscillator and cause it to change frequency. And if the oscillator changed frequency, the person copying your messages will lose contact momentarily and thus receive an incomplete message.

The POWER AMPLIFIER lives up to its name. It increases the flow of current in the antenna so that a strong electromagnetic carrier wave will be produced.

CONTINUOUS WAVE TRANSMISSIONS

The electromagnetic wave of a transmitter is like the sound wave produced by a steamship's whistle. As long as the valve is held open and the steam pressure holds steady, the whistle will send out sound vibrations at one strength and one frequency. A CONTINUOUS WAVE (C.W.) TRANSMITTER operates in a similar manner. It sends out a continuous stream of vibrations at radio frequency.

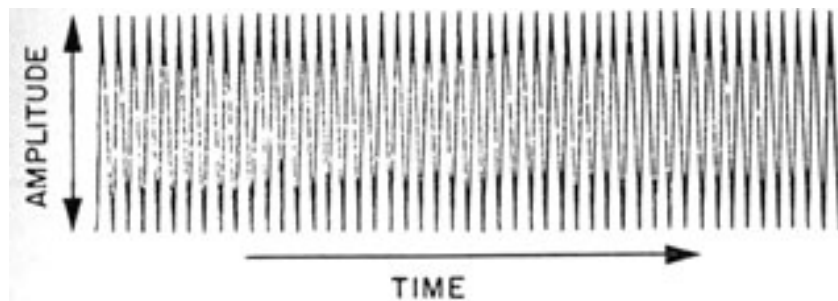

Figure 118 -Output wave of a c.w. transmitter.

The wave in figure 118 was produced by a c.w. transmitter. The oscillations are the same distance apart and have a **CONSTANT AMPLITUDE**.

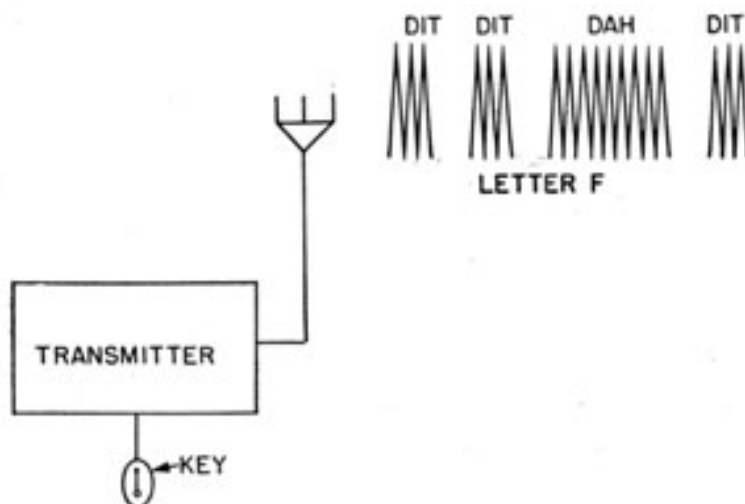

Figure 119.-How Morse code message is produced.

HOW TO SEND A MESSAGE WITH A CONTINUOUS WAVE TRANSMITTER

By blowing a series of long and short blasts, you can use your whistle to communicate with another ship. You can do the same thing with a c.w. transmitter. By inserting a switch, or **KEY**, in the transmitter circuit, you can send out long and short blasts of r.f. energy.

The output from a **KEYED** c.w. transmitter is given in figure 119. When the key is held down for a short interval, a **DIT** will be formed. If the key is held down for a longer period of time, a **DAH** will be produced. By making a combination of dits and dahs with a key, you can produce a Morse code signal. The (dit, dit, dah, dit) in figure 119 is the signal for the letter *F*.

HOW SOUND WAVES ARE TRANSMITTED

The device used to transmit sound waves is a combination c.w. transmitter and audio amplifier.

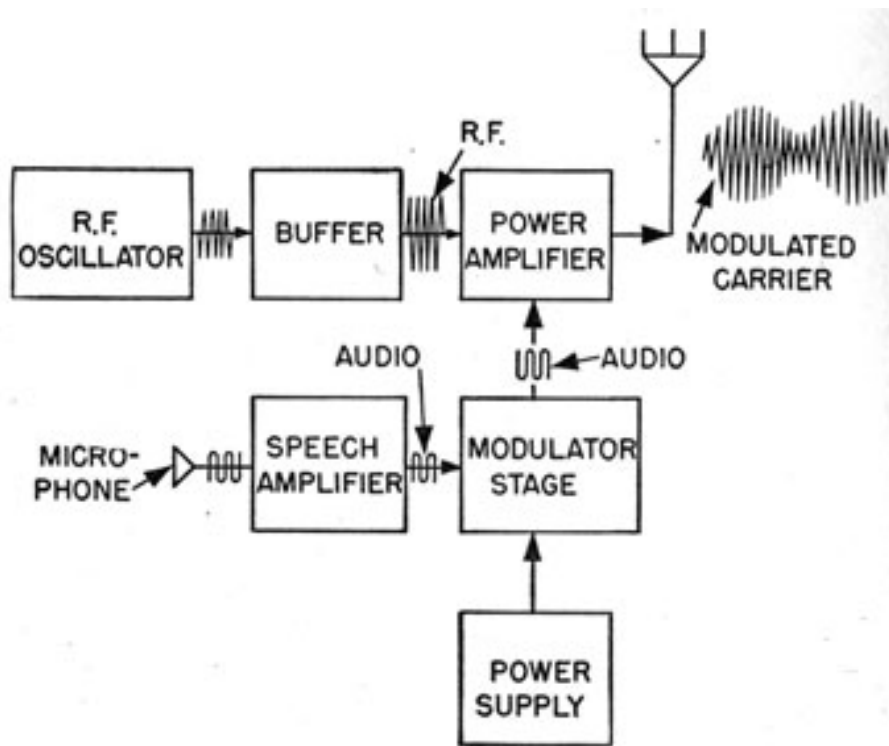

Figure 120.-Block diagram of a modulated transmitter.

166

In figure 120, the OUTPUT of the SPEECH AMPLIFIER is fed into a MODULATOR STAGE. In this stage, the RADIO FREQUENCY and AUDIO FREQUENCY VOLTAGES are COMBINED to form a CARRIER WAVE that contains characteristics of both. Notice in figure 121 that the CARRIER WAVE varies

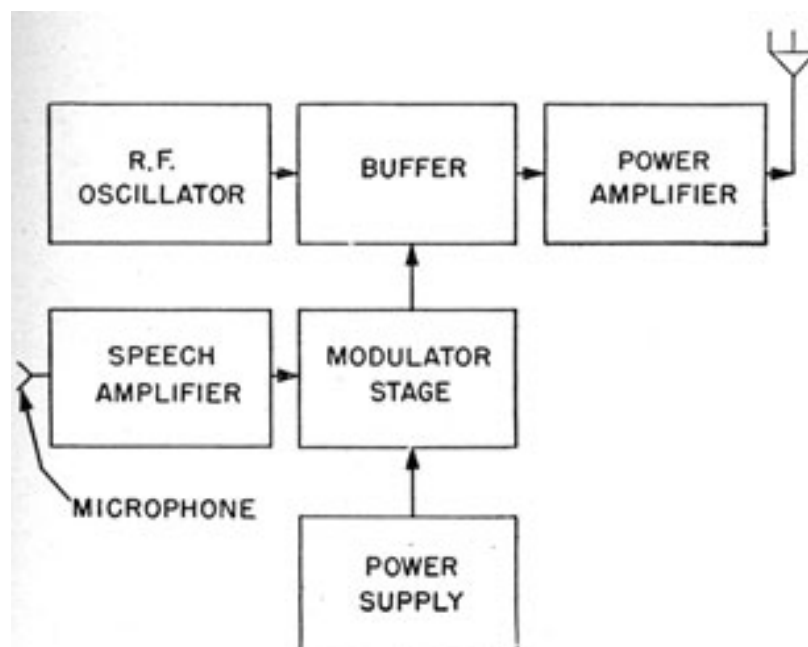

Figure 121.-Block diagram of a low-level modulated transmitter.

in amplitude in direct proportion to the SIZE and FREQUENCY of the AUDIO component.

The process of COMBINING the audio and radio frequency waves is MODULATION. The part of the modulated carrier wave that comes from the transmitter section is the R.F. COMPONENT, and the portion from the speech amplifier is the A.F. COMPONENT.

If the modulation voltage is sent into the POWER AMPLIFIER stage, such a transmitter is said to be using HIGH-LEVEL MODULATION.

When the modulation voltage is sent into the BUFFER stage, as in figure 121, the transmitter is said to be using LOW-LEVEL MODULATION.

167

MODULATED C. W. CODE TRANSMISSION

Some code transmitters combine the characteristics of the C.W. and MODULATED C.W. transmission.

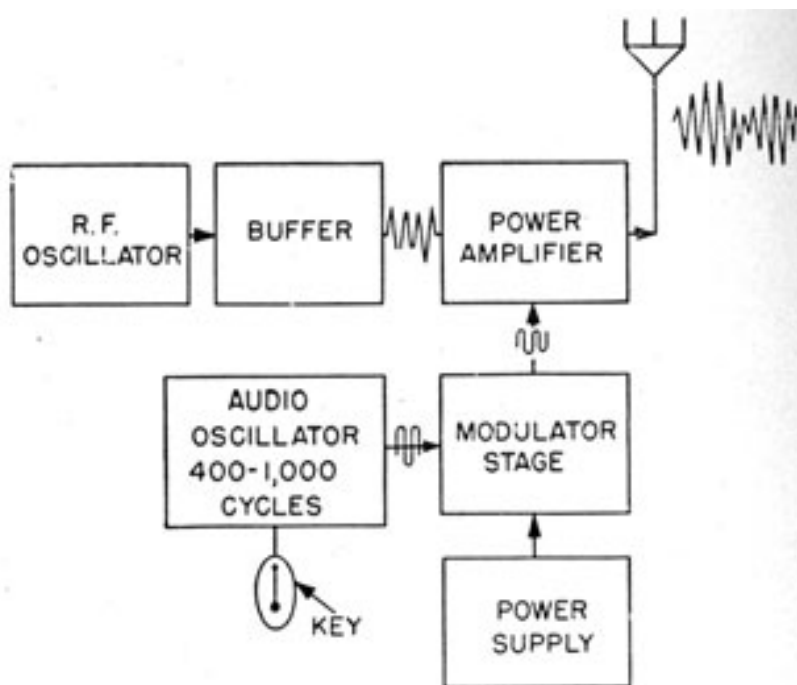

Figure 122.-Modulated C.W. code transmitter.

Figure 122 is a block diagram of a modulated c.w. code transmitter. An AUDIO FREQUENCY OSCILLATOR, generating a constant frequency note, is inserted in place of a speech amplifier.

The r.f. section of the transmitter produces a CONTINUOUS CARRIER WAVE. When the key in the audio oscillator is pressed, the audio frequency signal is sent into the power amplifier, modulating the carrier wave.

The sound produced at the receiving end of a modulated c.w. signal is at the frequency of the audio oscillator. If the oscillator is generating a frequency of 400 cycles, the frequency of the dots and dashes that you receive will also be 400 cycles.

TUNING THE TRANSMITTER

About the only contact you will have with transmitter; will be to tune them up when you change from one

168

frequency to another. If you are on a large ship where the transmitter room is considerable distance from the radio room, you may not get the opportunity to work with the transmitter very often. The ETMs will have that job.

In spite of the fact that you may not have the chance to tune them very often, you should know the correct tuning procedure. Then you can do the job yourself in an emergency.

Tuning a transmitter is largely a matter of following a routine of turning dials, and closing and opening switches. Unlike receiver operation, the operation of transmitter controls **MUST** be in the **PROPER SEQUENCE**, otherwise you will damage the transmitter.

In the chapter on Navy transmitters you will find brief instructions explaining the proper method for tuning some of the more frequently used transmitters. **WHENEVER** you desire more information about these or other transmitters, study the **INSTRUCTION BOOK** that comes with each set.

699198°-4,12

169





[Previous Chapter](#) [Radio Home](#) [Next Chapter](#)
[Page](#)

Copyright (C) 2005 [Historic Naval Ships Association](#)

All Rights Reserved

[Legal Notices and Privacy Policy](#)

Version 1.00, 12 Nov 05



CHAPTER 18

INTRODUCTION TO RECEIVERS

OLD FRIENDS AND NEW

Your first contact with radio probably was with a RECEIVER in your living room at home. Most likely your knowledge of what made the radio "tick" was limited. But you could turn it on and twist the knobs to bring in the ball game or dance band you wanted to hear.

While the home receiver is simple in design, and easy to tune in comparison to the Navy types, both are essentially the same kind of gear. Each is designed to PICK UP the electromagnetic wave sent out by a transmitter, and finally reproduce the sounds in the earphones or loud speaker.

The comparison of the home and Navy receivers is much like the relationship of the Piper Cub to the *F7F* Tiger Cat. Both planes are designed to fly, only one is made for slow leisurely flights, and the other is a fighter.

JOBS OF A RECEIVER

All receivers have five definite jobs to do-

- Pick up signals
- Select the desired station
- Amplify the weak signals
- Demodulate or detect the carrier wave
- Reproduce the audio signal

If any of the five are omitted, you do not have a receiver, but just a collection of wires and vacuum tubes. But when your gear does these jobs, in the order listed, you have a radio receiver.

PICKING UP SIGNALS

The RECEIVING of the signal takes place in the ANTENNA. The antenna may be a whip rising out of the top of your car, a loop of wire built into a portable radio, or a strand of wire strung between two masts on your ship.

The antenna and the magnetic field from a transmitter act together to form an a.c. GENERATOR. Earlier in this book you learned that if you have together a conductor and a magnetic field and a relative motion exists between the two, you have an a.c. generator which will induce a voltage.

Well, the antenna is the conductor, and the carrier wave from the transmitter is the magnetic field. Thus, when a radio wave from a transmitter CUTS ACROSS the antenna, an emf will be induced in the antenna. The induced emf is of exactly the same frequency and contains the identical VARIATIONS that were present when the carrier wave left the transmitter's antenna.

FIELD STRENGTH

The size of the emf induced in an antenna depends upon the LENGTH of the antenna and the STRENGTH of the carrier wave.

When the carrier wave leaves the transmitter's antenna, it is strong. As it travels, it gradually loses its strength, eventually dying out completely. If your ship is near a

transmitter, the carrier strength-FIELD STRENGTH-is great. But a thousand miles away, the same carrier wave will be very weak.

In the last chapter of this manual you will learn that factors other than distance influence the FIELD STRENGTH of a carrier wave, but for the time being you can consider distance as the only factor.

A carrier wave's FIELD STRENGTH is measured by the emf, in microvolts, that is induced in an antenna one meter (39.4 inches) long. For example-transmitter *A* induces an emf of 100 microvolts in an antenna one meter long. Transmitter *B*, which is nearer, induces an emf of 1,000 microvolts in the same antenna. By comparison, the field strength of the transmitter *B* is ten times that of transmitter *A*. Thus, if the field strength of a certain transmitter is 100 microvolts per meter, an antenna three meters long will have an induced emf of 300 microvolts.

The minimum field strength necessary to produce good reception depends upon the kind of receiver and the amount of noise interference in the neighborhood of your receiver.

RECEIVER SENSITIVITY

The sensitivity of a receiver is a measure of HOW WELL it can amplify weak signals. The average home radio can amplify the signals only a few hundred times, but the receivers used aboard your ship are capable of amplifying a signal millions of times. Because of this great amplification, a communications receiver can operate on weaker signals than a home receiver.

A receiver that STARTS with a SMALL signal and FINISHES with a LARGE signal has HIGH SENSITIVITY.

If you are in an area of strong local interference, you need strong signals to produce good reception. When the local interference has a FIELD STRENGTH of 100 mv. per meter, you will need a signal strength of 500 to 1,000 mv. per meter to drown-out the noise. But the same receiver, free from local interference, may give good reception when signal strength is less than 10 mv. per meter.

173

Although it is difficult to state the exact minimum field strength that is needed to operate a receiver satisfactorily, many communication receivers under ideal conditions are able to operate on a signal strength that is considerably less than 1 mv. per meter.

GETTING YOUR STATION

You TUNE your receiver by adjusting the variable condensers until the RESONANT FREQUENCY of tank circuits in the receiver is the same as the FREQUENCY of the station you wish to hear. Figure 123 is a TUNING CIRCUIT,

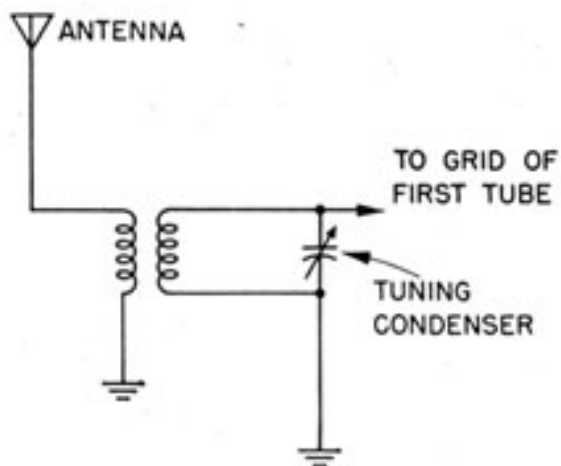

Figure 123.-Tuning circuit.

Usually two or more stages of tuning are needed to separate the stations that are transmitting on neighboring frequencies.

As shown in figure 124, the condensers are mounted (ganged) on the same shaft so that both are tuned with one twist of the knob. The greater the number of circuits used, the sharper will be the tuning. A receiver that tunes SHARP is said to be SELECTIVE.

HOW SELECTIVE

Some types of communication receivers may be more selective receivers than others. A receiver used for

174

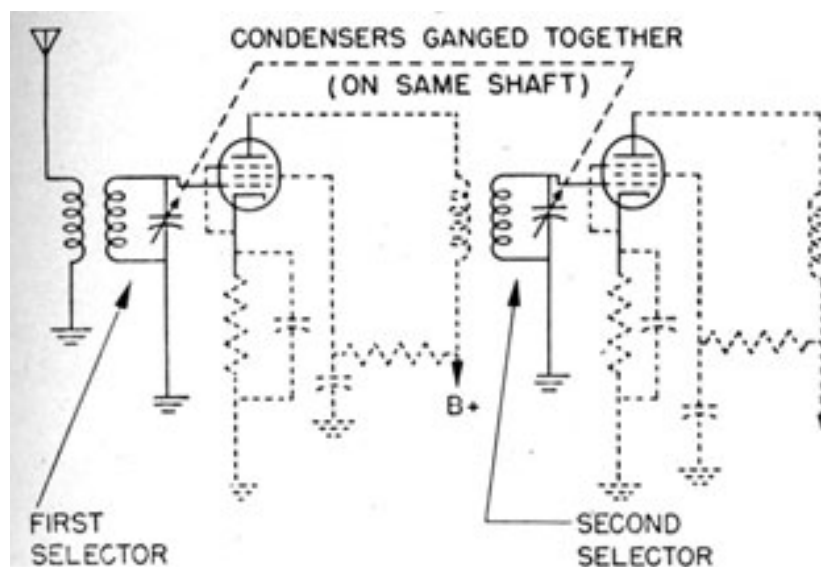

Figure 124.-Two-stage tuning.

C.W. code can be more selective than a voice receiver. A communications voice receiver is designed to tune more sharply than a common broadcast receiver that you'll use to pick up Dinah Shore and Benny Goodman. In general, communication receivers do not make good instruments for receiving music. The reason why is illustrated in figure 125.

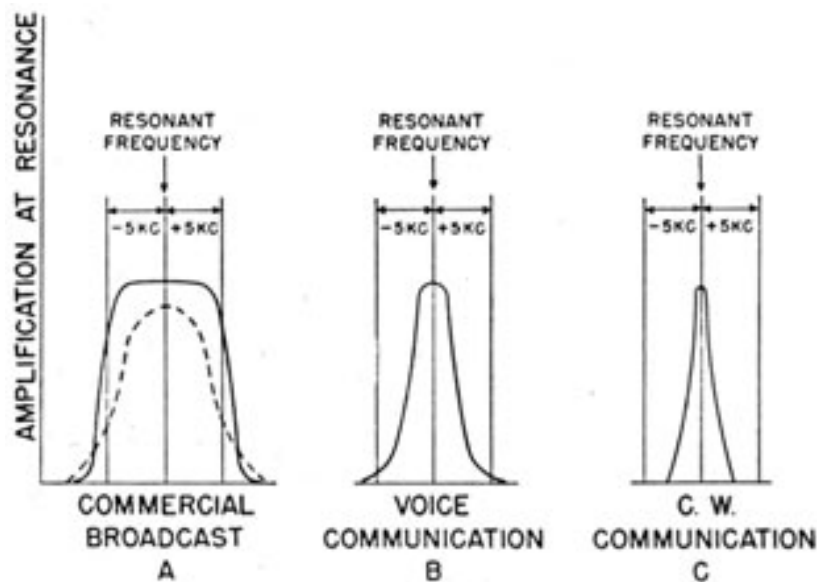

Figure 125.-Band widths of various types of receivers.

175

Carrier waves from commercial broadcast stations contain **SIDE-BAND FREQUENCIES** which extend five kc on either side of the **RESONANT FREQUENCY**. That means, if a station is transmitting on a frequency of 1,140 kc, the complete carrier wave will contain frequencies from 1,135 to 1,145 kc. If a receiver tunes too sharply, the higher side band frequencies will be lost. For this reason, broadcast receivers can furnish high-fidelity reception only if they tune broad enough to include **BOTH SIDE BANDS**.

Figure 125 shows the best **TUNING CURVE** for a broadcast receiver. The top is broad and flat and the sides are steep. Most cheap broadcast receivers have tuning curves as shown by the broken lines. This design permits a lot of station interference resulting in low fidelity.

The band width necessary for a satisfactory **VOICE COMMUNICATION** may be narrower than for the broadcast bands. Clear and intelligible messages can be obtained on bands that extend only one kc on either side of the resonant frequency. The voice may sound unnatural, but it will get through.

Transmissions for c.w. code messages contain no side-bands-just the r.f wave alone. Therefore c.w. receivers can tune very sharply.

VERNIERS AND SPREADERS

The first time you try to tune a Navy receiver you probably won't bring in a thing. You are accustomed to using broad-tuning home receivers, and you'll have to develop the touch-get that old safe-cracker's feel in your finger-tips-before you'll be able to tune a shipboard receiver. A hair's breadth movement of the dial can take you past a station without even hearing a good "bloomp."

And that brings up the tuning aids you'll find on communications receivers-VERNIERS, BAND-SPREADERS, TUNING EYES, AND TUNING METERS-all put on to help you find the station you want.

176

The VERNIER DIAL is the most common device. Many vernier dials have two or even three speeds. You use the COARSE adjustment to bring in the station, then the MEDIUM and FINE speeds to polish up the tuning.

Other receivers use a system of BAND-SPREADING. You put a small variable condenser having about one-tenth the capacity of the tuning condenser in parallel with the tuning condenser, as shown in figure 126.

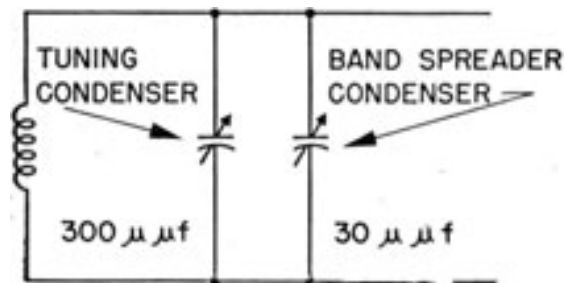

Figure 126.-Band spreaders.

When using BAND-SPREADING, you adjust the large tuning condenser to approximately the correct capacity and then complete the tuning by adjusting the small variable condenser. The small capacity of the band-spreader condenser permits wide movement of the dial and gives the appearance of spreading the station channel wide on the dial.

Some receivers have a SWITCHING ARRANGEMENT which permits preliminary tuning to be broad, and the final adjustment to be sharp.

Many receivers have TUNING EYES or TUNING METERS to indicate the presence of automatic volume control (A.V.C.) voltage, and this voltage appears only when a station is tuned in. You'll hear more about this later.

R. F. AMPLIFICATION

Look back at figure 124. In addition to the tuning circuits, you have TWO STAGES OF R.F. AMPLIFICATION. The amplifier circuits are similar to those you learned back in chapter 15. The tubes are PENTODES and the stages are COUPLED together by r.f. transformers.

177

THE DETECTOR STAGE

The DETECTOR follows the last r.f. amplifier stage. It is in this stage that the a.f. wave is separated from the r.f. component of the carrier wave. The r.f. component is cast aside and the a.f. portion is sent on to the audio stage for more amplification.

AUDIO FREQUENCY AMPLIFIERS

Most receivers have TWO a.f. amplifier stages. The first is a voltage amplifier used to drive the output POWER AMPLIFIER stage. It is in the POWER AMPLIFIER that the power of the a.f. wave is stepped up to a strength sufficient to operate the LOUD SPEAKER or EARPHONES.

RECEIVER CIRCUITS

There are a great number of receiver circuits being used to do the five jobs listed back on page 172. But the majority of Navy receivers fall into two classes—the TUNED RADIO FREQUENCY, and the SUPERHETERODYNE. Both receivers operate by having an emf induced in the antenna and by transforming this signal to a sound from the loudspeaker. But the WAY the two circuits perform their duties between the antenna and loudspeaker is quite different.

TUNED RADIO FREQUENCY RECEIVER

The TUNED RADIO FREQUENCY receiver, T.R.F., is simpler in design than the superheterodyne.

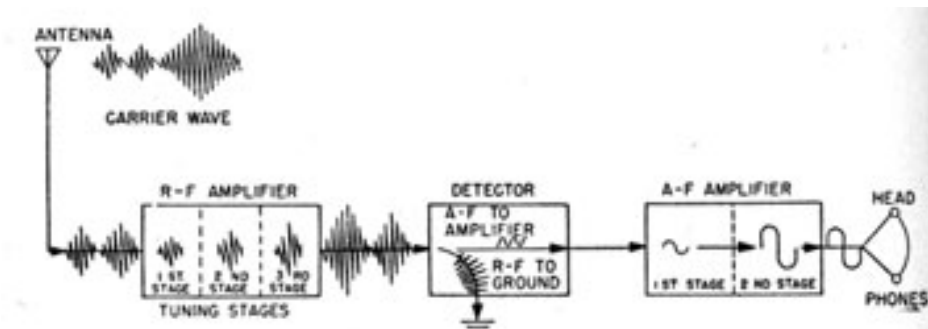

Figure 127.-Block diagram of a T.R.F. receiver.

The block diagram in figure 127 divides the T.R.F. receiver into its three major parts. The first part is the r. f. sections, containing one, two, or even three, stages of r.f. amplification. It is in these stages that the tuning of the receiver takes place.

Following the r.f. amplifiers is the DETECTOR, in which the a.f. component is separated from the r.f. portions of the carrier wave.

The a.f. wave is sent on to the third part-the audio frequency amplifier-where further amplification takes place. The last step is completed when the audio signal finally appears in the earphones (or loudspeaker) as a sound.

Look back again at figure 127 and trace the progress of the carrier wave through the receiver. In the beginning

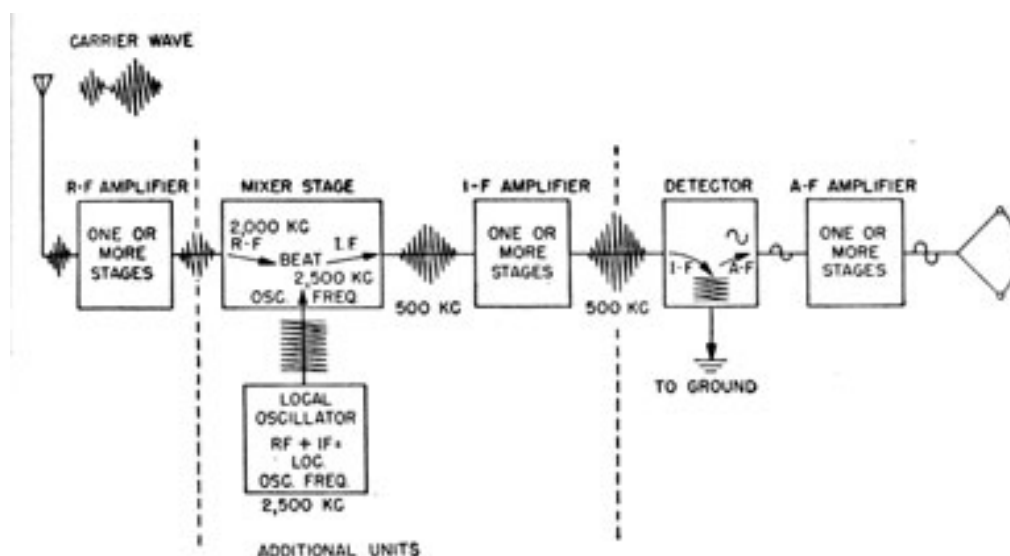

Figure 128.-Block diagram of a superheterodyne.

the carrier wave induces a FEEBLE emf in the antenna. Each stage amplifies this feeble voltage until it enters the detector with considerable strength. In the detector the r.f. and a.f. components are separated. The r.f. portion is carried to the ground, and the a.f. part goes to the a.f. amplifier stage.

THE SUPERHETERODYNE RECEIVER

The SUPERHETERODYNE receiver contains all the major units of the T.R.F.-with THREE ADDITIONS. In figure 128 the r.f. amplifier and detector of the T.R.F. have been cut apart, and the three additional units (MIXER, LOCAL OSCILLATOR, and INTERMEDIATE FREQUENCY AMPLIFIER) are inserted.

The operation of the r.f. detector, and a.f. stages is exactly the same as in the R.T.F. receiver, but new units change the basic operation of the circuit completely.

The object of placing the additional units in the circuit is to produce a SINGLE CONSTANT RADIO FREQUENCY. This constant frequency is called the INTERMEDIATE FREQUENCY. Here is the story-

The carrier wave from the r.f. amplifier is FED into the vacuum tube of the MIXER STAGE. A second higher r.f. is produced by a LOCAL OSCILLATOR, and fed into the SAME vacuum tube. In this tube, the r.f. signal BEATS against the local oscillator signal and produces a THIRD frequency, the INTERMEDIATE FREQUENCY.

How does all this come about? The word BEAT is the clue to the answer.

WHAT ARE BEATS?

Did you ever hear two persons playing musical instruments that were slightly out of tune with each other? Certainly you have. DISCORDS were produced, and those discords were BEAT NOTES.

Beat notes are produced when two wave motions of slightly different frequency strike, or beat, against each other. For example, suppose two notes, one of 1,200 cycles and the other of 1,500 cycles, BEAT against each other. Part of the time the two will work against each other, and part of the time they will work together. This produces TWO NEW NOTES, in addition to the two original notes. One equal to the sum of the original frequencies-

$$1,500 + 1,200 = 2,700 \text{ cycles}$$

The other is equal to the difference between the original frequencies-

$$1,500 - 1,200 = 300 \text{ cycles}$$

The 2,700- and 300-cycle notes are BEAT NOTES. In the same way, beat notes always appear when two unequal frequencies are mixed together. One of the new notes is equal to the SUM of the two frequencies and the other is equal to their DIFFERENCE.

HOW THE INTERMEDIATE FREQUENCY IS PRODUCED

Now go back to the superheterodyne, in which you wish to produce a SINGLE CONSTANT INTERMEDIATE FREQUENCY. Suppose the I.F. desired is 500 kc. You could produce it by mixing ANY two frequencies whose SUM or DIFFERENCE is equal to 500 kc. But in practice you would use only the DIFFERENCE to produce the WANTED frequency.

Remember, ANY two frequencies whose DIFFERENCE equals 500 kc. will do. Thus if the incoming CARRIER WAVE is 2,200 kc., the OSCILLATOR frequency must be 2,700 kc. to produce an I.F. of 500 kc. Or you may use any number of other combinations such as-

Carrier Frequency	Oscillator Frequency	Difference (I.F.)
2,400 kc.	2,900 kc.	500
3,150 kcs.	3,650 kc.	500
7,230 kcs.	7,730 kc.	500

And you could go on and fill the rest of this manual with other combinations whose differences are equal to 500 kc.

Notice the oscillator frequency. It is 500 kc. MORE than the incoming CARRIER WAVE.

$$2,900 - 2,400 = 500$$

$$3,650 - 3,150 = 500$$

Or turn it around-the oscillator frequency is equal to the carrier frequency PLUS the intermediate frequency-

$$2,400 + 500 = 2,900$$

$$3,150 + 500 = 3,650$$

To sum it up-in a superheterodyne receiver the oscillator generates a frequency that is always the I.F.

HIGHER than the incoming carrier wave. The **DIFFERENCE** between carrier and oscillator frequencies will always be the intermediate frequency.

The condenser that tunes the oscillator is connected, or ganged, to the **SAME** shaft that tunes the r.f. sections of the radio. And by turning a single knob, the oscillator is automatically tuned to the I.F. **HIGHER** than the incoming r.f. carrier wave.

Since the I.F. signal is a **COMBINATION** of the local oscillator and the carrier wave signals, it will be **MODULATED** and have the same characteristics as the carrier, only at a lower frequency.

Look back again at figure 128. The output from the mixer stage is sent into the I.F. **AMPLIFIER**, where the voltage of the I.F. is still further strengthened. And the output of the I.F. amplifier is sent into a detector where the r.f. and a.f. components are separated, just as they are in the T.R.F. receiver.

Sometimes you will hear the **MIXER** stage called the **FIRST DETECTOR** and the other detector stage the **SECOND DETECTOR**. Don't let it trouble you. The term **FIRST DETECTOR** comes from the fact that the production of beat notes is sometimes called **HETERODYNE DETECTION**.

WHY THE EXTRA PARTS

You may wonder why all the extra parts are added to a T.R.F. receiver to form a **SUPERHETERODYNE** when the T.R.F. does a good job. That is a sensible question. The answer is-the superheterodyne does a **BETTER** job. Increased **SENSITIVITY** and **SELECTIVITY** make the superheterodyne a much better receiver for the reception of weak signals. That is reason enough.

BAND SWITCHING

Practically all Navy receivers are made to tune over several **BANDS** of frequencies. The RBB/RBC receivers have four bands; the RAK has six and the RAL has nine. To change from one band to another, it is only necessary to rotate a switch to the band you wish to use.

When you are operating near the TOP of one band, you may find that you also receive the same station near the BOTTOM Of the, upper band. EXPERIENCE will tell you which setting gives the best results with your particular set.

Some receivers, especially the T.R.F. types, have TRIMMER controls that are adjusted each time you change frequency bands. This is done by opening the TUNING condensers to their widest mesh at the high end of the frequency band, and then adjusting the trimmer controls until the noise level is maximum.

This control is necessary because, in spite of the greatest care in manufacturing, coils have slight differences in their windings. This causes variations in the resonant frequencies of the several tuning stages. The trimmer controls correct these variations.

RECEIVER CALIBRATION

The CALIBRATION of a receiver is only the RECORD of the dial settings indicating where you can find a station of a certain frequency. As an example, if you lived near Chicago, you knew that WGN could be picked up by setting the dial at 720. Maybe your receiver was a little out Of adjustment and you got the station by setting the dial at 710 or 730. You didn't write these numbers down, you just remembered them. That is a rough example of calibration.

Most Navy receivers have several dials to be set for each station you receive. To save time wasted in hunting all over the band, and in trying to remember the proper settings, you will RECORD the positions of ALL the dials for EACH STATION you listen to. The resulting chart is the calibration of your receiver.

To calibrate a receiver properly you must very carefully check the settings of the dial against known frequencies. Then, when you are instructed to listen to a station transmitting on 2,120 kc, you can turn to the chart and find the exact setting for each dial.

VOLUME CONTROLS

In addition to the TUNING knobs, all Navy receivers have several other dials and controls to help you in operating the set.

The VOLUME CONTROL is the most familiar. With it you increase or decrease the volume of sound to the desired level. Your receiver at home has one of these controls.

The r.f. GAIN CONTROL, sometimes called sensitivity control, is closely related to the volume control. You can raise and lower the output sound level with it, but that is not its prime purpose. This gain control is usually located in the first r.f amplifier stages. When a very weak station is being received, this control is turned all the way up; but if you are tuned to a strong station, the control is turned DOWN to prevent

OVERLOADING the r.f. tubes. This is necessary since overloading causes **SERIOUS DISTORTION** in the signal.

AUTOMATIC VOLUME CONTROLS

The **AUTOMATIC VOLUME CONTROL**, **AVC**-sometimes called **AUTOMATIC SENSITIVITY CONTROL**, **ASC**-serves to keep the output volume at a constant level. This saves you the job of continually turning the manual volume control up and down each time the stations being received **FADE** and **REAPPEAR** in strength.

Most **AVC** systems have two controls, an **OFF-ON** switch, and an **AVC LEVEL** regulator. It is the usual practice to turn the **AVC** off while tuning the receiver. When the receiver has been tuned, the switch is turned **ON**, and the **LEVEL** is adjusted for the desired operation.

The **AVC** system in most Navy receivers is too rapid and pronounced to permit its use with voice reception. So the **AVC** usually will be **OFF** when you are receiving a voice message.

NOISE SUPPRESSORS AND OUTPUT LIMITERS

The high sensitivity of all communication receivers causes them to pick up a lot of local interfering noise

184

and natural static. This is especially objectionable when receiving code messages, because a crash of static may cause you to miss several letters in a code group.

The **NOISE SUPPRESSOR** works much the same as a **TONE CONTROL** in a home receiver. When this control is turned for **DEEP** or **BASS** reception, much of the noise is **FILTERED OFF** and is not permitted to reach the earphones. But the noise suppressor also reduces the volume. So on very weak, signals, it may be necessary to turn the switch that cuts it out of the circuit.

The **OUTPUT LIMITER** prevents sudden crashes of static from bursting your ear drums. There are several ways this can be done, but all work as a safety **POP-OFF** valve. When the output volume of sound reaches a certain level, the output limiter goes into action and prevents the sound from rising any higher.

Some receivers have circuits called **SILENCERS**, designed to keep the receiver silent when no signal is being received. This is very useful when you are standing by to receive a message.

Most output limiters and silencers have **OFF-ON** switches, and an **OUTPUT LEVEL** adjustment. The specific name used for these controls depends upon the particular make of the set.

OUTPUT METERS

Many receivers use a meter to show the level of SOUND OUTPUT. It is also useful as an aid in tuning the receiver, especially where you are SEARCHING for a station that is not on the calibration chart.

These meters are made to indicate the presence of a station even when the sound is considerably below the minimum level your ears can hear. Once the presence of a station is indicated by the meter, the volume can be brought up to audible level by turning up the sensitivity control.

Most output meters are calibrated in DECIBELS. A decibel is the SMALLEST difference in sound your ear can

699198°-46-13

185

detect, and ZERO decibels is the LOWEST level of sound your ear can hear. For most references, ZERO decibels is numerically equal to 6 milliwatts (0.006 watts).

The output meter is used by the Electronic Technician's Mate when he is aligning, or tuning up, your receiver. With this meter he will be able to tell whether a station with a certain signal strength can be heard.

OTHER METERS

Some receivers have two other meters-one to indicate the FILAMENT VOLTAGE, and the other the PLATE VOLTAGE. A control accompanies each meter, so that if the voltages are incorrect, you can correct them.

BEAT FREQUENCY OSCILLATOR

The BEAT FREQUENCY OSCILLATOR, B.F.O., is a part of every communication receiver designed to receive C.W. messages. When the receiver is being used to receive I.C.W., modulated C.W., or voice messages, the B.F.O. is always turned OFF.

With each B.F.O. is a TUNING control, sometimes marked A.F. TUNING. With this control, you adjust the PITCH of the audio note to the desired frequency.

The B.F.O. is usually connected to the detector tube in the T.R.F. receiver and to the second detector in the superheterodyne.

The frequency of the B.F.O. is about 1,000 cycles less than the incoming carrier wave with the T.R.F., and 1,000 cycles less than the I.F. in the superheterodyne receiver. For example, if the carrier frequency being received by a T.R.F. is 4,720 kc., the B.F.O. will be tuned to approximately 4,719 kc., so the BEAT

note produced will be-

$$4,720 - 4,719 = 1 \text{ kc. (1,000 cycles)}$$

In a superheterodyne, if the I.F. is 500 kc., the B.F.O. will be tuned to about 499 kc. This also will produce a beat note of 1,000 cycles. By adjusting the B.F.O. you can raise or lower the pitch of the beat note to a frequency slightly above or below the 1,000 cycle note.

186

A four position switch usually accompanies the B.F.O. tuning control. It is usually marked B.F.O.-ON, MOD-C.W., I.C.W., or VOICE. When using the receiver you will turn this control to the position that matches the type of message being received.

A CRYSTAL FILTER control is used in connection with many B.F.O.'s. Its purpose is to prevent interfering noises and notes from blotting out the tone of the C.W. signal. The filter has two controls, an OFF-ON switch, and a REJECTION control. Sometimes, the OFF position of the switch is marked BROAD, and the ON position, SHARP. The REJECTION CONTROL is adjusted for beat reception each time the filter is turned on.

Don't be surprised to find controls other than those just described. Almost every receiver has some special knob all its own. You can find all this specialized information in the manufacturer's instruction books.

187



[Previous Chapter](#)



[Radio Home](#)
[Page](#)



[Next Chapter](#)

Copyright (C) 2005 [Historic Naval Ships Association](#)

All Rights Reserved

[Legal Notices and Privacy Policy](#)

Version 1.00, 12 Nov 05

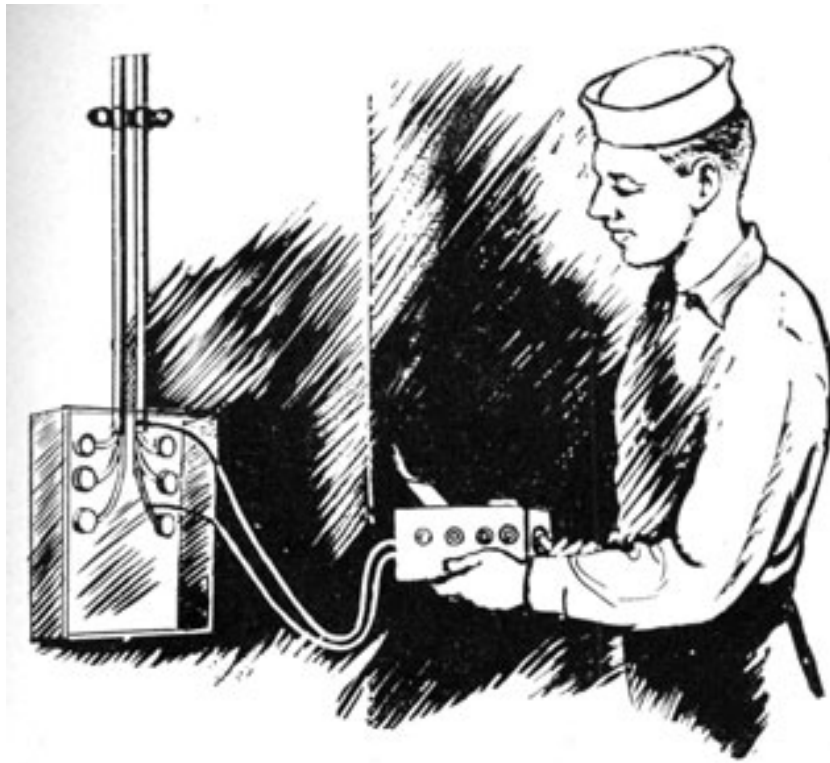

CHAPTER 19

REMOTE CONTROL SYSTEMS

WHY USE THEM?

Radio transmitters and receivers are sometimes located a considerable distance away from the operator's station.

The CIC-COMBAT INFORMATION CENTER-of an aircraft carrier is a good example of this. At the CIC, the FIGHTER DIRECTOR OFFICER, FDO, is in constant contact with the fighter squadrons, receiving reports from them and giving orders to direct their operations. You won't always find the TBS or TDQ TRANSMITTERS installed in the CIC, and yet the FDO must be able to control the transmitter without leaving his station. REMOTE CONTROL is the answer.

The compartments where the transmitters and receivers are actually installed vary with the class of ship and the modifications that have been made in the basic design of the ship. On a *BB* or a *CV*, the transmitters

are usually several decks below. On a *DD* or a *DE*, the transmitter and receiver may be on opposite sides of a bulkhead on one of the superstructure decks.

REMOTE CONTROL SYSTEMS not only eliminate the wasted energy of rushing below to start and stop the transmitter each time a message is to be sent, but they also permit the radio equipment to be operated from several control points about the ship.

With **REMOTE CONTROL** the operator can use either code or voice, can switch from one transmitter or receiver to another, can start, stop, or key the transmitter and can handle a number of other tasks necessary to maintaining communication-all without going near the transmitter room.

NOT ALL of these operations are completely automatic, to be achieved by merely punching a button. Several require the aid of an *E TM* or another *RM* to switch the **PATCH CORDS** on the **TRANSFER PANELS**, tune the receivers and transmitters, and make several other necessary operating adjustments.

PARTS OF A TYPICAL REMOTE CONTROL SYSTEM

Remote control systems on all Navy ships follow the same general pattern. The systems installed in a *BB* or *CA* have many circuits. Those on a *DD* have the same variety of parts, but not **AS MANY** pieces of each type of part. This relationship may be compared to the telephone systems in a large city and a small town. Both systems have the same parts-desk sets, switch boards, wires, and the like-but the larger city will have a greater number of each of these parts.

In figure 129, you see a typical **REMOTE CONTROL SYSTEM** that you will find installed in Navy ships. The circuits handle one transmitter, one receiver, and a remote station. If additional transmitters, receivers, and remote stations are used, the extra units and circuits will be **DUPLICATES** of these shown.

In addition to the two major units-the **TRANSMITTER** and the **RECEIVER**-a remote control system has a number

of other parts. In figure 129, the RECEIVER UNIT is in the lower left-hand corner. A KEY CONTROL PANEL is next to the receiver. From the key panel you can start, stop, and key the transmitter.

A JACK BOX with a receiver OFF-ON switch is connected to the receiver OUTPUT. The box has two outlets so that you can use two sets of headphones.

Another key control panel and jack box is indicated in the upper left-hand corner. This tells you that several of these units may be installed at various stations in the ship.

The TRANSMITTER-VOICE AMPLIFIER-MODULATOR UNIT is in the lower right-hand corner of figure 129.

The FREQUENCY METER between the transmitter and receiver units is used to check the frequency of the transmitter. This check can be made locally or, with some installations, from one of the remote stations.

The upper right hand corner of figure 129 contains a RADIOPHONE UNIT, with the controls necessary for maintaining both VOICE and C.W. COMMUNICATION.

Three TRANSFER PANELS-RECEIVER, TRANSMITTER, and RADIOPHONE-extend across the center section of the illustration. These panels are SWITCH BOARDS, similar to those used with telephone circuits. The E TM or RM who mans these boards can switch from one transmitter or receiver to another by pulling the PATCH CORDS out of one jack and inserting them in another.

CONNECTING CABLES and TERMINAL STRIPS for connecting the cables make up the rest of the remote control system.

KEY CONTROL PANEL

Figure 130 is a top and a sectional view of a KEY CONTROL PANEL. This unit is mounted so that the top of the panel is FLUSH with the top of the operator's desk. Notice that this panel contains the OFF-ON switch and INDICATOR light to show whether the transmitter is turned on or not. With the newer systems all you need to do to

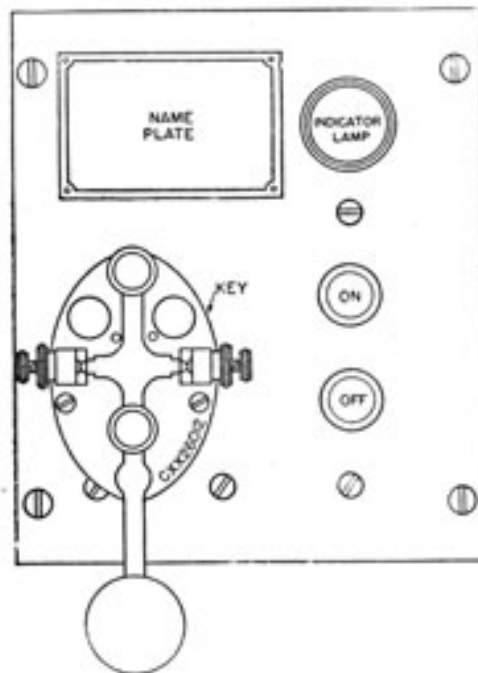

Figure 130.-Key control panel.

start the transmitter is press the ON button. And pressing the OFF button shuts it down.

RADIOPHONE UNIT

Figure 131 is the front panel of a RADIOPHONE UNIT. The unit is provided with a cover that is water-tight when closed and locked.

The radiophone has a combination microphone-and-receiver, similar to a handset telephone. When not being used, the handset is held in place on the unit by a clamp hook. When you remove the handset from the hook, a switch is closed, just as it is when you pick up the handset of a regular telephone. The "CARRIER-ON" BULB lights up when the handset is removed from the hook, indicating that power is being applied to the handset.

The intensity of sound produced by the earphone is regulated by the knob marked "EARPHONE LEVEL," near the center of the panel.

Two plugs for 5-tip jacks are mounted at the bottom of the panel. These are for use with extension handset or breastset phones.

The **KEY CIRCUIT OFF-ON SWITCH** is used only when you wish to send a C.W. message instead of a voice message. The **KEY** is a separate unit and may be installed some distance away from the **RADIOPHONE UNIT**.

The **NOISE SUPPRESSOR** is normally ON. This device reduces the level of the audible message, as well as the level of the noise. When the messages are at low-level intensity, you **PRESS** the button to **CUT-OFF** the noise suppressor so that the message will be stronger. When you release the button, the noise suppressor is automatically **CUT-IN** to the circuit.

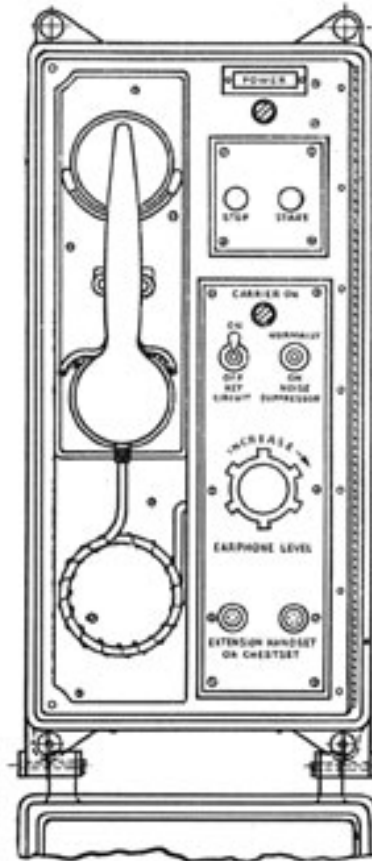

Figure 131.-A water-tight radiophone unit.

The **POWER START-STOP BUTTON** arrangement is just the same as on the key control panel.

JACK BOXES

Two types of **JACK BOXES** are used with most remote control systems. The type with a switch, identified by number 49029 in figure 129, is shown in figure 132. The other jack, identified in figure 129 by number 49063, is

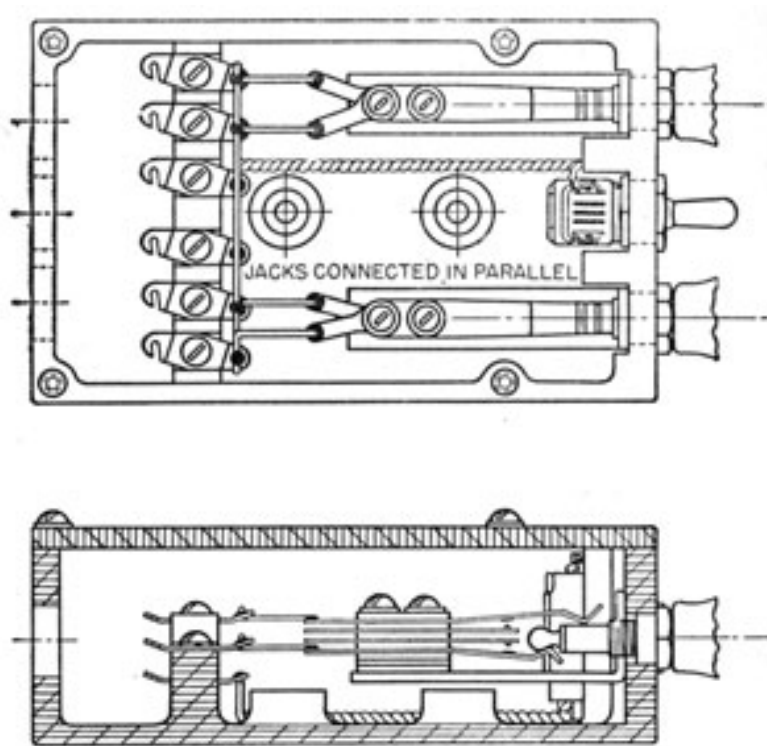

Figure 132.-Jack box with switch.

shown in figure 133. This type has six jacks, but no switch. It is used in figure 129, to connect the frequency meter to the transmitter.

TRANSFER PANELS

TRANSFER PANELS are sheets of bakelite or some other insulating material equipped with jacks or sockets to receive the **PATCH CORD PLUGS**.

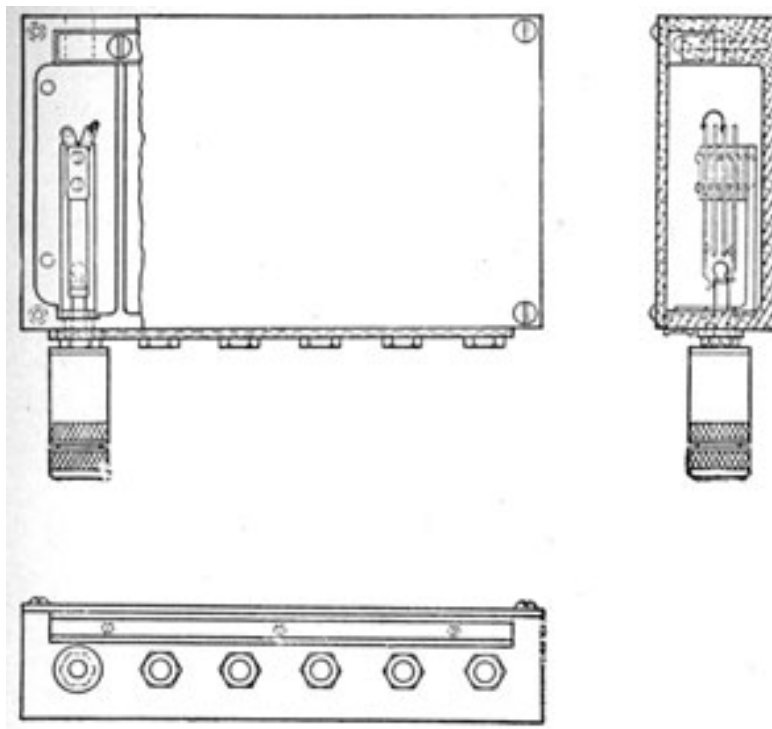

Figure 133.-Shielded jack box.

The RECEIVER TRANSFER PANEL uses jacks of the type shown in figure 133. At each end of the cords is a plug of the type shown in figure 134.

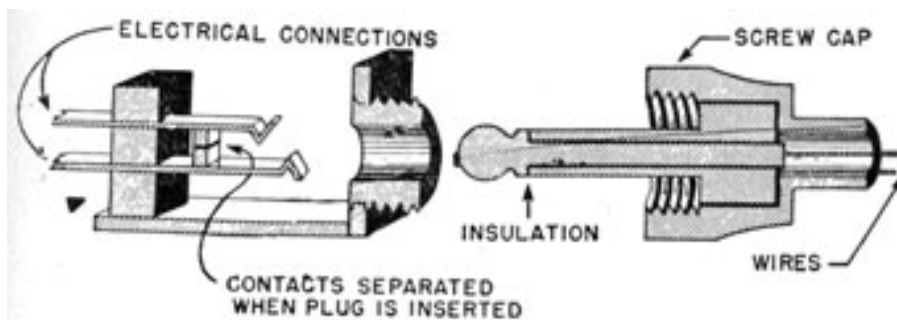

Figure 134.-Two-contact plug.

If the operator at the radiophone unit, in figure 131, wishes to check the frequency of the transmitter, he will insert one end of the patch cord in jack *C* and the other end in jack *I*.

If the operator wishes to cut-in on the receiver, he will plug one end of the patch cord into jack *H*, the other end into jack *C*.

The transfer panels for the TRANSMITTER and RADIO-PHONE unit are slightly different from the RECEIVER panel. The SOCKETS resemble vacuum tube sockets. The PLUG is similar to the base of a vacuum tube. The plug is prevented from slipping out of the socket by a COLLAR that fits over the plug and screws tightly to the base.

The spacing and the size of holes in the sockets prevent you from inserting the plug into a socket incorrectly.

THE RELAY

The RELAY is the device that really makes a remote CONTROL system work. You first heard about the relay in BASIC ELECTRICITY. Here is a brief explanation of its principles.

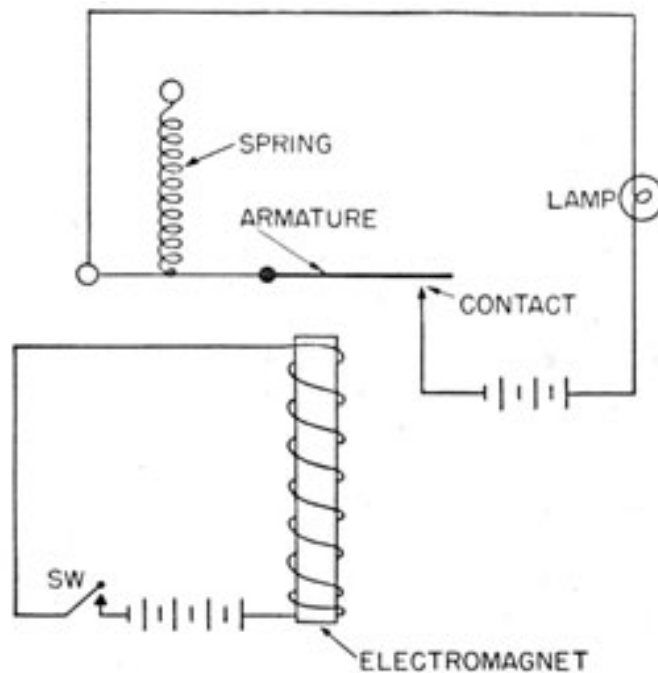

Figure 135.-Basic relay circuit.

In figure 135 when switch SW is closed, the electromagnet is energized and pulls the armature TOWARD the core of the magnet. When this happens, the contacts on

the armature close the circuit and turn on the light. When the switch is opened, the contacts open and the light goes out.

The relay in figure 135 is a single-contact, single-acting type. In addition to this type, the Navy uses many multiple contact and multiple pole relays. Some are designed to open one circuit and at the same time close another. Others close two and open one.

RELAY CLASSIFICATION

Relays used with Navy radio equipment are divided into three classes-OPERATIVE, PROTECTIVE, and CONTROL-according to their USE. The wide variety of applications is responsible for the many modifications in the basic design of the relay.

RELAY KEYING

Practically all Navy equipment uses a RELAY CIRCUIT to make-and-break the transmitter circuit in forming the dits and dahs of a code message. The use of a KEYING RELAY has two decided advantages-SAFETY, and CONVENIENCE of installation.

The potential used to energize the relay is Low, usually less than 10 volts a.c. or d.c. While a potential of 110 volts is not dangerous IN MOST CASES, relay keying gives assurance to the operator that he can touch any part of the key safely and without receiving a painful shock.

The transmitter usually is located some distance from the operator's desk. If a relay is not used, it is necessary to run the HIGH-VOLTAGE lines a considerable distance to reach the key. But when a relay is used, the high voltages are kept completely inside the transmitter cabinet where they belong, and you avoid the task of installing a high-voltage line.

The use of a relay requires additional equipment, but the convenience of installation, and the safety achieved, more than compensate for the additional expense. Seldom will you find a keying circuit that does not use a relay. The keying relay is an example of the OPERATIVE TYPE of relay.

PROTECTIVE RELAYS

A **PROTECTIVE RELAY** safeguards a piece of electrical gear from damage that may be caused by excessive current drainage. Some relays are designed to break the circuit **INSTANTLY**; others have **TIME DELAY** features that will permit small overloads for short periods of time. Still others are designed to **DELAY** the **TURNING-ON** of a high voltage until a certain length of time has elapsed.

The **DELAYED ACTION RELAY** **POSTPONES** the **CLOSING** of a circuit for a certain number of seconds after the operating button is punched. This type of relay is used in starting the transmitters. One of its actions is to defer the turning on of the high voltage until the filaments of the tubes are hot. Its action is not dependent upon the overloading of a circuit, as is true with the inverse-time-delay relay.

CONTROL RELAYS

CONTROL RELAYS are used to **START** and **STOP** electric motors. The heavy relay that actually applies the power to the motor is the **MAIN LINE CONTACTOR**. The relays

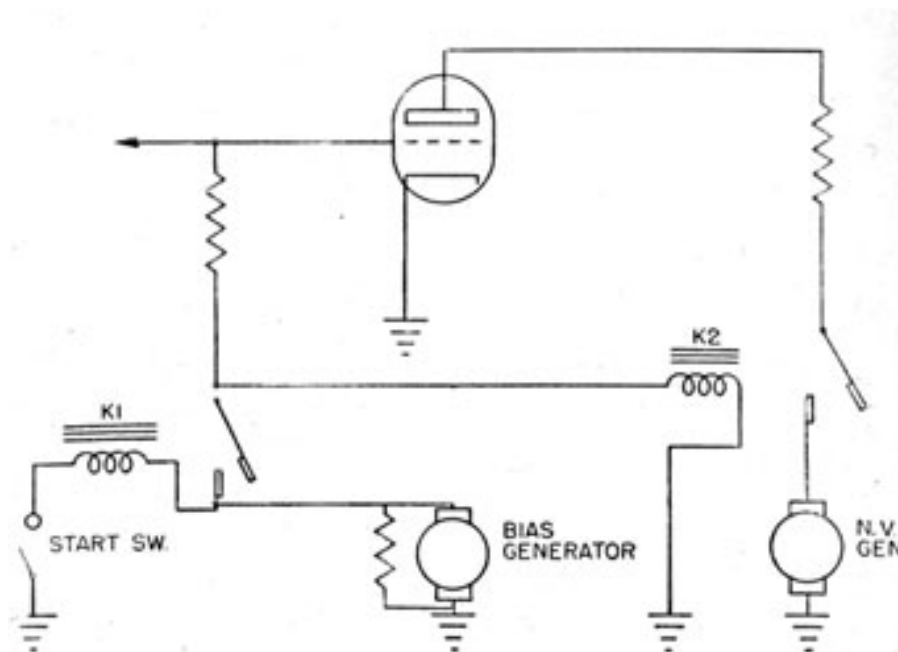

Figure 136.-Sequence closing relays used with grid and plate circuits.

that control the main line contactors are usually SERIES or SHUNT RELAYS. All of the relay units are referred to collectively as MAGNETIC CONTROLLERS.

SEQUENCE OF CLOSING RELAY SYSTEMS

Many circuits require that the voltages be turned on in the proper order. The grid and plate circuits of a transmitter are examples of this. If the plate potential is turned on before the grid voltage, the tube may be damaged by excessively high current. In figure 136, the potential applied to the grid circuit closes the plate circuit. If anything happens to make the bias voltage fail, the plate circuit will open, preventing damage to the tube.

Without relays, remote control systems would not be possible, and this in turn would greatly add to the task of operating transmitters.



[Previous Chapter](#)



[Radio Home](#)

[Page](#)



[Next Chapter](#)

Copyright (C) 2005 [Historic Naval Ships Association](#)

All Rights Reserved

[Legal Notices and Privacy Policy](#)

Version 1.00, 12 Nov 05



CHAPTER 20

THE ANTENNA

IT'S MORE THAN A PIECE OF WIRE

You may think a radio transmitter's antenna is just a length of wire running from the foremast to the mainmast, and that any dumb-bell can rig one. A receiver's antenna may be that simple, but that is not quite true for a transmitter antenna. An ANTENNA IS a piece of wire. It is cut to the PROPER LENGTH and CORRECTLY installed so that it will RADIATE EFFICIENTLY the energy delivered to it from the transmitter. The word "EFFICIENTLY" is the word you want to note well. ANY WIRE carrying an a.c. radiates electromagnetic energy-remember the HUM that your receiver picked up from a 60-cycle power line? And the static from a neon sign driven by an induction coil?

The power line and neon sign are not EFFICIENT RADIATORS because they were not designed to radiate energy. The power line carries energy from the power plant to your motor or light bulb, while a neon sign is built to produce light.

699198°-46-14

But an ANTENNA is designed to RADIATE, in the form of ELECTROMAGNETIC WAVES, the energy delivered to it by the transmitter.

THE DIPOLE

The BASIC ANTENNA is a DIPOLE—a WIRE with a length equal to HALF A WAVE LENGTH. If a station is operating on a wave length of 100 meters, the dipole to be used at that wave length will be-

$$100 / 2 = 50 \text{ meters, or about 164 feet.}$$

A transmitter operating on a wave length of one meter (300 mc.) will require a dipole 1/2 meter long—about 20 inches.

IMPEDANCE OF A DIPOLE

First of all, you must remember that an antenna carries a.c. Therefore the antenna will have inductive reactance as well as RESISTANCE. In a dipole, the impedance is MAXIMUM at BOTH ENDS, and MINIMUM at the

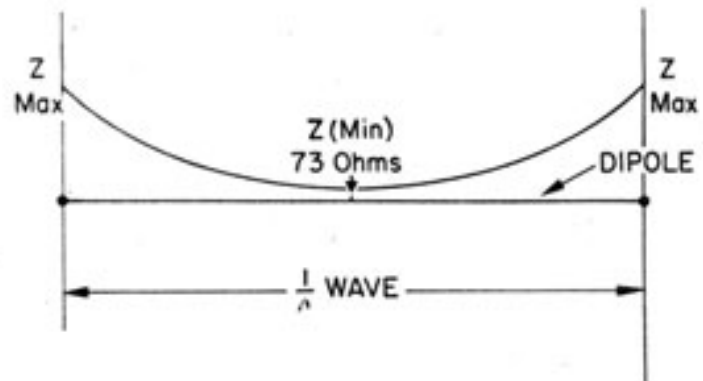

Figure 137.-Impedance of a dipole.

CENTER. In figure 137 the impedance is illustrated as being greatest at each end, gradually diminishing until it reaches minimum at the center.

Now this information, is just for your convenience—the impedance of a DIPOLE at its CENTER is approximately 73.2 ohms, REGARDLESS of what frequency you use.

CURRENT AND VOLTAGE IN A HALF-WAVE ANTENNA

If a feeder line from the transmitter is connected to the center of a DIPOLE, the antenna will operate as if you set

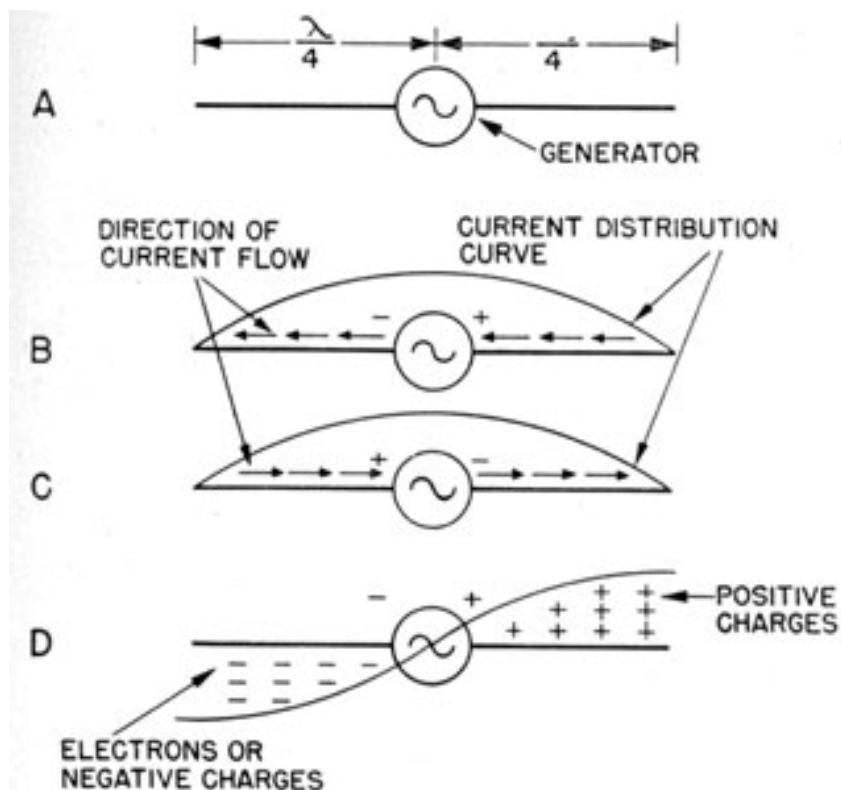

Figure 138.-Development of an antenna.

an a.c. generator between TWO QUARTER-WAVE antennas, as in figure 138.

During one half of the alternation, the electrons will flow from right to left, figure 138B. On the next half-alternation, the generator will make the electrons flow in the opposite direction, figure 138C.

In an antenna, as in any other circuit, the flow of electrons is the GREATEST where the IMPEDANCE is LEAST.

203

Therefore, more electrons will be moving at the CENTER of the dipole than at the ENDS.

What's the voltage along an antenna? Voltage is always GREATEST where the IMPEDANCE is the HIGHEST. Thus you will find the HIGHEST VOLTAGE at the ENDS of the dipole, figure 138D. During one half of an alternation, the left end of the dipole will be MAXIMUM NEGATIVE, and the right end will be POSITIVE. On the next half alternation, the POLARITY of voltages is reversed.

If the antenna extends EXACTLY one-quarter wave length on each side of the generator, the REBOUNDING or reflected ELECTRONS from the negative end of the dipole will return at the proper instant to reinforce the movement of other electrons already moving in that direction. But if the antenna is GREATER or LESS than one-quarter wave length on each side of the generator, much of the energy will be lost in the collision of electrons trying to flow in TWO directions at the same time.

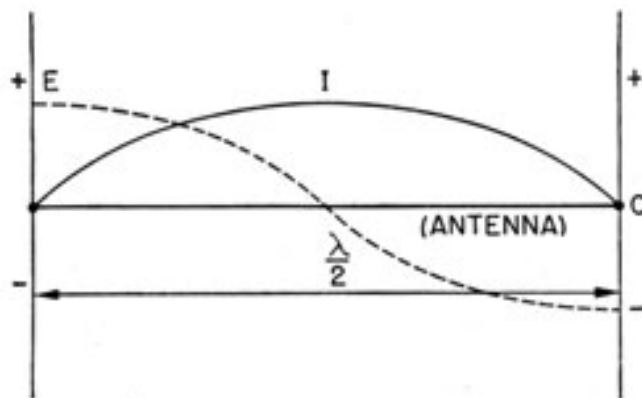

Figure 139.-Relationship of current and voltage in a dipole.

From the CURRENT-VOLTAGE diagrams of figure 139, you can see the CHARACTERISTICS of an antenna. The CURRENT is MAXIMUM at the CENTER. The VOLTAGE is maximum POSITIVE at ONE END and MAXIMUM NEGATIVE at the OTHER.

204

ELECTROMAGNETIC FIELD SURROUNDING A DIPOLE

A dipole suspended out in space away from the influence of the earth would be surrounded by an ELECTROMAGNETIC FIELD the shape of a DOUGHNUT, as shown in figure 140. You see that no radiation takes place at the ENDS of the dipole. If the antenna is mounted vertically,

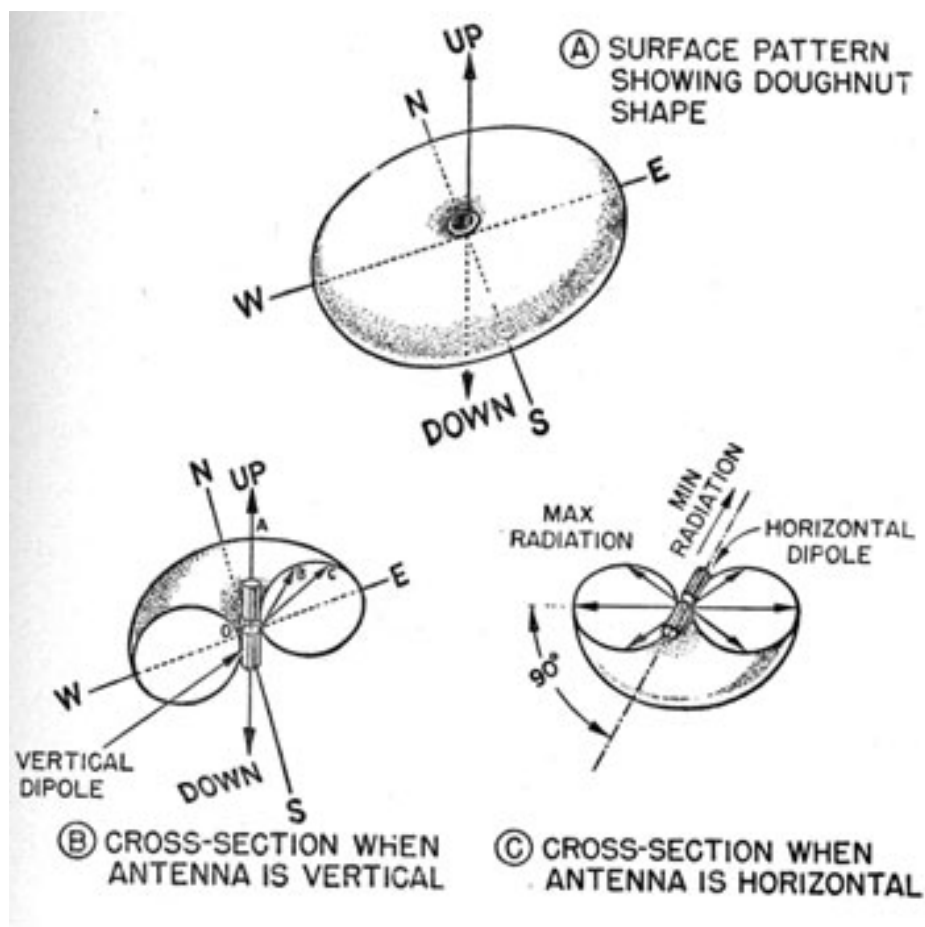

Figure 140.-Electromagnetic field surrounding a dipole.

the field will have the shape of a doughnut lying on the ground. All areas surrounding the dipole will receive a magnetic field of equal strength, as in figure 140B.

Set the dipole PARALLEL TO the surface of the earth-the field is the shape of a doughnut standing on edge. The GREATEST FIELD STRENGTH is along a vertical line PERPENDICULAR to the dipole.

205

ELECTROSTATIC FIELD SURROUNDING A DIPOLE

High voltage at each end of the dipole produce an ELECTROSTATIC FIELD which is at maximum strength at the ends of the dipole. But if the antenna is shorter or longer than a half-wave length, the electrostatic field strength will be greatest at the point where the voltage is maximum.

The electrostatic field is always present with an electromagnetic field. One cannot exist without the other. In most cases, only the electromagnetic will be discussed, but remember, the electrostatic is always there too.

STANDING WAVES

The electrostatic and electromagnetic fields surrounding an antenna each form STANDING WAVES. The two types of standing waves are as dissimilar as current and voltage. The electrostatic field is 90° out of phase with the electromagnetic field. The presence of an ELECTROMAGNETIC field can be shown by the glowing of a MAZDA lamp-loop in the presence of the field, while a NEON lamp will glow in the presence of an electrostatic field. The points along an antenna where the magnetic fields are MAXIMUM are called CURRENT LOOPS. The points where the electrostatic fields are maximum are called VOLTAGE LOOPS.

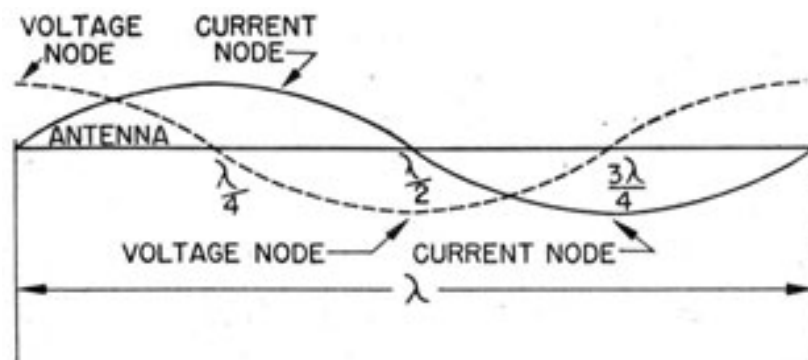

Figure 141.-Standing waves along full-wave antenna.

Figure 141 shows the location of the loop points along a full-wave antenna. The CURRENT LOOPS appear every

206

half wavelength, and a VOLTAGE LOOP appears every other half wavelength.

If you move a NEON bulb along an r.f. transmission line, the bulb will glow each time a voltage loop is reached. If the transmission line is several wavelengths long, several voltage loops will be spotted.

You can determine the wavelength of your transmitter approximately if you measure the distance between the loop points, since each loop is exactly one-half wavelength from the other.

ELECTRICAL LENGTHS AND ACTUAL LENGTHS OF ANTENNAS

An ideal antenna, one completely free from the influence of the earth, would have an ACTUAL LENGTH exactly equal to its ELECTRICAL LENGTH. For instance-an ideal half-wave antenna for use with a 100-meter wavelength would be 50 meters long.

Since no antenna is completely free from the influence of the earth, the PHYSICAL length of an antenna is approximately 5 percent shorter than its ELECTRICAL length. A half-wave antenna for a 100-meter station will be 50 meters minus 5 percent or 47½ meters long.

The physical length of a half-wave antenna for frequencies above 30 mc. can be calculated from the frequency by using the following equation-

$$\text{LENGTH (feet)} = (492 \times 0.95) / \text{frequency, in megacycles}$$

The number 492 is a factor for converting meters to feet. The correction factor, 0.95, is 100 percent minus the 5 percent loss due to the effect of the earth.

THE HERTZ ANTENNA

Any antenna that is one-half wavelength long is a HERTZ ANTENNA, and may be mounted either vertically or horizontally. The great length of HERTZ antennas makes them difficult and costly to build to handle low frequencies. Consider the problem of constructing a half-wave antenna

for a wavelength of 545 meters-550 kc. The antenna would have to be about 851 feet long! You can imagine the weight of a horizontal cable 850 feet long. And a vertical half-wave antenna would be as tall as the RCA building in New York's Radio City.

Because of the construction difficulties and costs, you will find that half wave antennas are seldom used with broadcasting transmitters operating at frequencies below 1,000 kc. But half-wave antennas are widely used with high-frequency communication transmitters. A half-wave antenna for a 30 mc.-10 meters-transmitter will be only a little over 16 feet long.

THE MARCONI ANTENNA

The MARCONI ANTENNA is also known as the QUARTER-WAVE ANTENNA, and the GROUNDED ANTENNA. Figure 142 illustrates the principle of a Marconi antenna

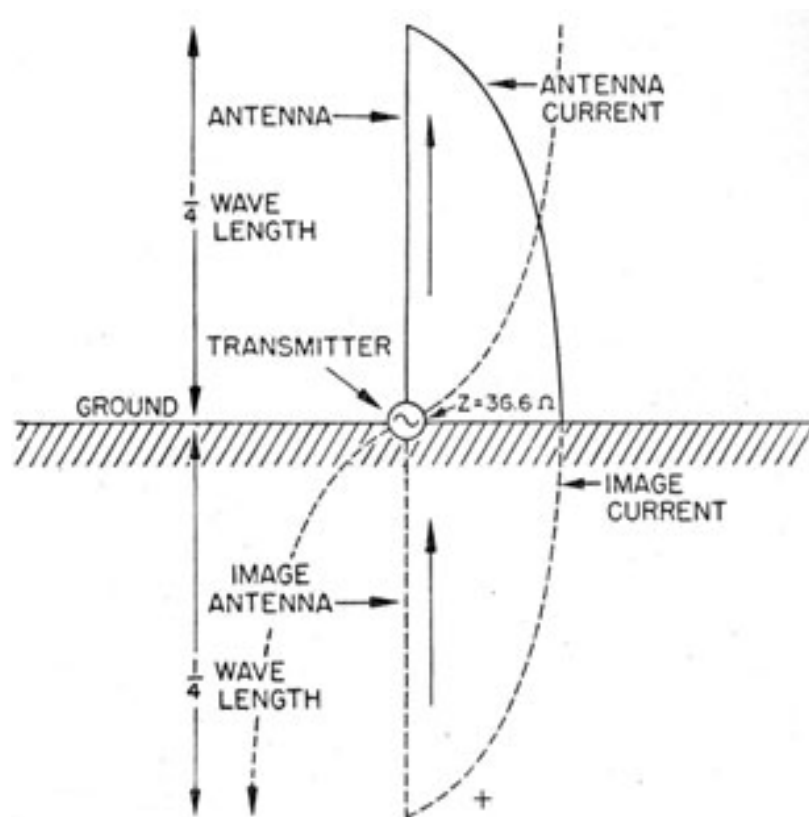

Figure 142.-Quarter-wave Marconi antenna, showing antenna images.

mounted ON the surface of the earth. The transmitter is connected between the BOTTOM of the antenna and the earth. Although the antenna is only ONE-QUARTER WAVELENGTH, the REFLECTION or IMAGE in the earth is EQUIVALENT to ANOTHER quarter-wave antenna. By this arrangement, HALF-WAVE operation can be obtained from an antenna only a QUARTER wavelength long.

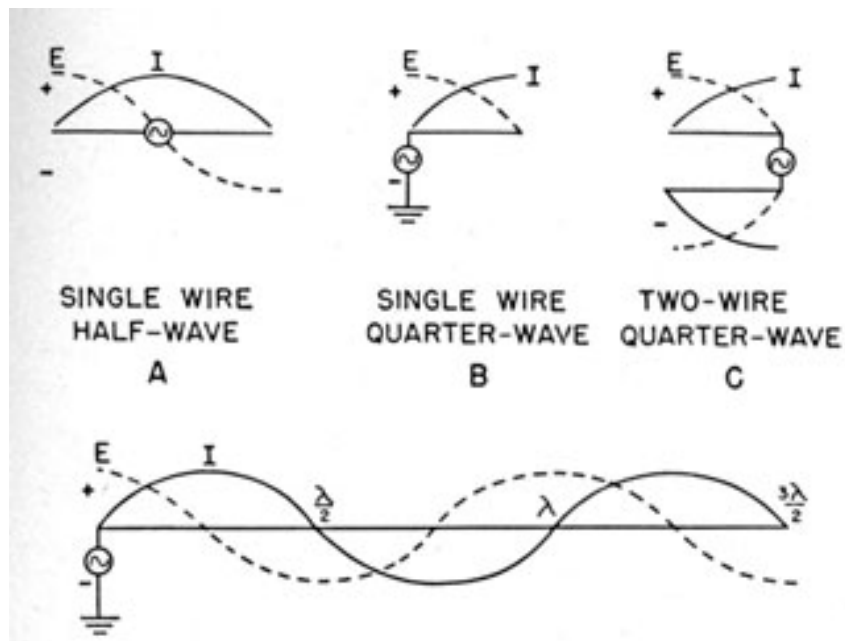

Figure 143.-Current and voltage relationships in antennas of various lengths.

The relationship of impedance, current, and voltage in a quarter-wave ground antenna are similar to those in a half-wave Hertz antenna. IMPEDANCE and VOLTAGE are MAXIMUM at the TOP of the antenna and MINIMUM at the BOTTOM. The flow of CURRENT IS GREATEST at the BOTTOM and LEAST at the TOP.

The advantage of using a Marconi antenna can be seen when you compare a length of 426 feet for a Marconi to 851 feet for a Hertz antenna at 550 kcs.

The quarter-wave antenna is used extensively with portable transmitters. On an airplane, a quarter wave

209

mast or a trailing wire will be the ANTENNA, and the FUSELAGE will produce the IMAGE. Similar installations are made on ships. A quarter-wave mast or horizontal wire will be the antenna, the hull and superstructure will provide the image.

ANTENNAS OF OTHER LENGTHS

Occasionally you'll need an antenna of some other length than one-quarter or one-half wavelength. You'll see some of the usual lengths in figure 143.

Figures 143A and 143C are examples of CURRENT FED antennas, while figures 143B and 143D are VOLTAGE-FED. The expressions VOLTAGE-FED and CURRENT-FED refer to the points along the antenna where the power is applied. In the CURRENT-FED antenna of figure 143A, the power is delivered to the antenna at the point of HIGHEST CURRENT. The antenna of figure 143B is VOLTAGE-FED, the power being applied to the point of HIGHEST VOLTAGE.

CORRECT THE ELECTRICAL LENGTH

After the antenna has been erected, you may find that its physical length is greater or less than its electrical length. If a grounded antenna is less than one-quarter wavelength, there will be a CAPACITIVE effect at the base, and an INDUCTANCE must be added in series to increase the ELECTRICAL LENGTH, as in figure 144A.

When the physical length of an antenna is GREATER than its correct electrical length, the antenna will have excess INDUCTANCE. In this case it will be necessary for you to add a CONDENSER in series with the antenna to SHORTEN its electrical length, as in figure 144B.

ANTENNA TUNING CIRCUITS

You will have to change the ELECTRICAL LENGTH of the antenna each time you change the FREQUENCY of the transmitter. Since you can't climb up the superstructure and chop off a piece of the antenna each time you

210

increase the frequency, you will use a combination of VARIABLE INDUCTANCES and CONDENSERS to adjust the ELECTRICAL LENGTH. Condensers and inductances used

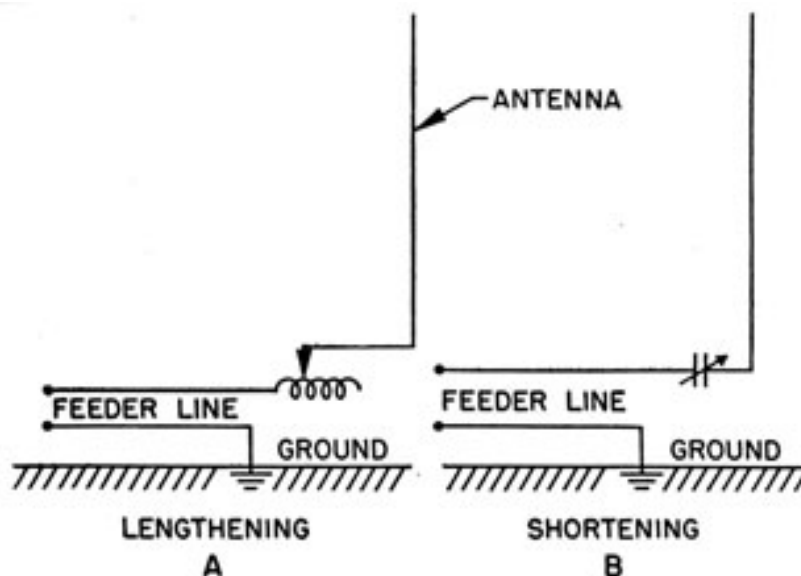

Figure 144.-Methods of correcting the electrical length.

for this purpose make up the ANTENNA LOADING or ANTENNA TUNING circuits.

TRANSMISSION LINES The construction of a transmission line to carry LOW-FREQUENCY a.c. is relatively simple, but the building of a

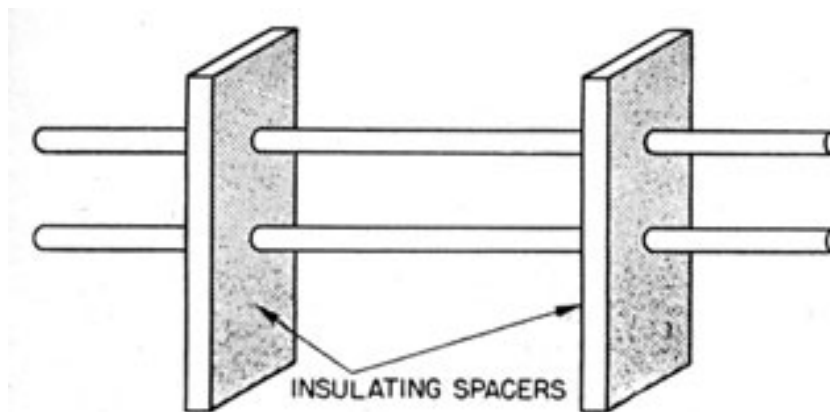

Figure 145-Open two-wire transmission line

211

line that will EFFICIENTLY transmit the energy of a HIGH-FREQUENCY radio transmitter to the antenna is something else.

Transmission lines used with frequencies below 300 mc. are of four general types-the OPEN TWO-WIRE system, the COAXIAL CABLE or CONCENTRIC LINE, the TWISTED PAIR, and the SHIELDED PAIR.

Figure 145 shows an open two-wire transmission line. Wires are held rigidly in a parallel position by INSULATED SPACERS. For 20 mc. and lower, a spacing of at least six inches is desirable. For frequencies higher than 20 mc. a spacing of four inches is best.

Figure 146 is a drawing of COAXIAL CABLE or a CONCENTRIC LINE. It consists of a copper tube with a copper wire extending down the length of the tube. The wire is held centered in position in the tube by INSULATED SPACERS

Higher operating efficiency is obtained by filling the tube of the CONCENTRIC LINE with NITROGEN under several pounds of pressure. But a pressurized line is often a source of trouble. Vibrations caused by gunfire or rough sea may cause leaks which allow the pressure to drop. If this happens, the efficiency of the line will drop.

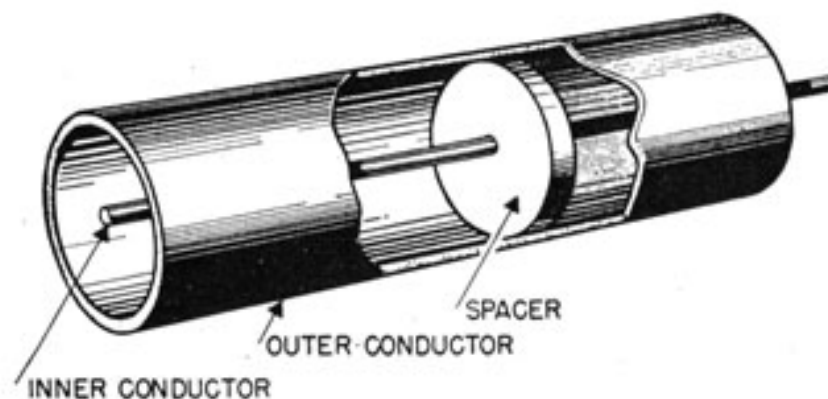

Figure 146.-Concentric line.

The concentric line has several advantages. The tube is **GROUND**ED This allows you to install the line in any convenient position Because the open two-wire system

212

lacks insulation, it must be carefully located. It is subject to stray capacitive and inductive coupling.

The **TWISTED PAIR** and the **SHIELDED PAIR** are not commonly used as transmission lines. Both types are shown in figure 147. The twisted pair is the least efficient. The

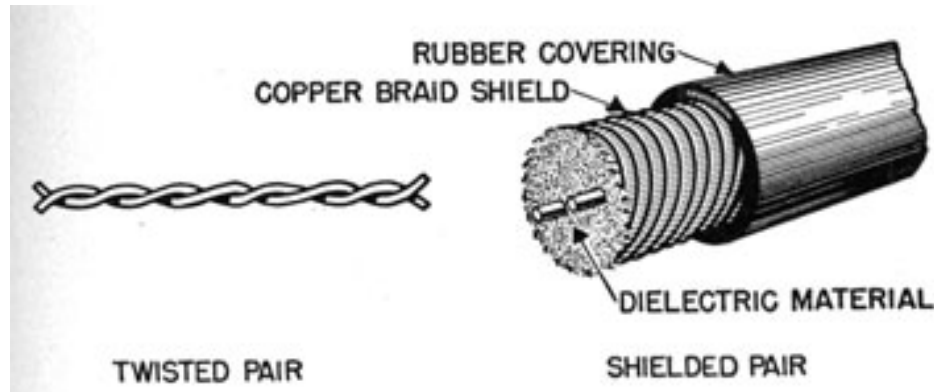

Figure 147.-Twisted and shielded pair transmission lines.

shielded pair possesses an advantage in having a **GROUND**ED OUTER SHIELD surrounding the two lines. This shield prevents stray capacitive and inductive couplings.

RESONANT AND NON-RESONANT TRANSMISSION LINES

Transmission lines are either **RESONANT** or **NON-RESONANT**. A **RESONANT** line has characteristic **STANDING WAVES**, while a **NON-RESONANT** line does not.

Remember the **STANDING WAVE** is the result of a certain amount of energy being **REFLECTED BACK** along the transmission line. Imagine a transmission line so long that **NONE** of the energy sent out by the transmitter ever reaches the end of the line. Naturally, since none reaches the end, none can be reflected back.

But no line is that long, so why not string up a line of convenient length and connect a device to the far end that will **ABSORB ALL** the energy traveling down the line? Since all the energy is absorbed, none is left to be reflected back. This gives you a **NON-RESONANT** line. To do this, the **IMPEDANCE** of the **ABSORBER** matches the **IMPEDANCE** of the **ANTENNA**. The absorber will collect all the energy

213

fed into the line and feed that energy into the antenna to be radiated as a magnetic field.

A RESONANT LINE does NOT have its impedance matched to the impedance of the antenna. This type of line is actually an ANTENNA whose length is some multiple-1, 2, 3, etc.-of a QUARTER wavelength. You fasten one end of the line to the antenna, the other end to the transmitter.

RESONANT lines are usually OPEN TWO-WIRE SYSTEMS, while the NON-RESONANT line may be TWO-WIRE, a CONCENTRIC, a SHIELDED, or TWISTED PAIR.

YOUR JOB AND ANTENNAS

You may never be called upon to rig an antenna, or even change an installation you are using, but the knowledge of what an antenna is, and what it does will help you in the tuning of your transmitters.

Remember the antenna's job is to radiate, in the form of electromagnetic energy, as much as possible of the energy delivered by the transmission lines from the transmitter. To do this, the antenna must be correctly built and correctly installed. But more important as far as you are concerned-the transmitter must be correctly tuned and coupled to the antenna. That is your job.

214



[Previous Chapter](#)



[Radio Home](#)

[Page](#)



[Next Chapter](#)

Copyright (C) 2005 [Historic Naval Ships Association](#)

All Rights Reserved

[Legal Notices and Privacy Policy](#)

Version 1.00, 12 Nov 05



CHAPTER 21

WAVE PROPAGATION

RADIO WAVES COVER THE EARTH

In this chapter you will learn how radio waves spread themselves over the face of the earth, carrying messages and music from Washington to Saipan and from San Diego to Suez in less than a second.

With your own broadcast receiver, you have probably made a few observations on the behavior of radio waves. The 1,000-watt station 700 miles away may come in clearer and stronger than a 5,000-watt station only 400 miles away. You know also that your receiver does not pick up stations as well in daylight as it does at night, and that you get more distance and better reception in the winter than you do in the summer. Again you may have observed that some places in the United States are good radio locations, while others are naturally poor places for receiving radio programs.

THE RADIO WAVE

When it leaves a vertical antenna, the radio wave resembles a huge doughnut lying on the ground, with the antenna in the hole at the center. Part of the wave

215

moves outward in contact with the ground to form the **GROUND WAVE**, and the rest of the wave moves upward and outward to form the **SKY WAVE**. This is illustrated in figure 148.

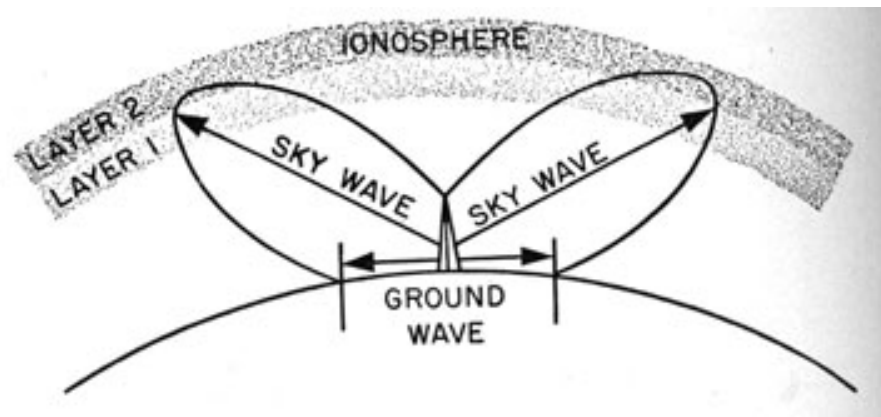

Figure 148.-Formation of the ground wave and sky wave.

The GROUND and SKY portions of the radio wave are responsible for two different METHODS of carrying the messages from transmitter to receiver.

The GROUND WAVE is used for SHORT-RANGE COMMUNICATION at high frequencies with low power, and for LONG-RANGE COMMUNICATION at low frequencies and very high power. Day-time reception from most commercial stations is carried by the ground wave.

The SKY WAVE is used for long-range, high-frequency daylight communication. At night, the sky wave provides a means for long-range contacts at LOWER FREQUENCIES.

THE GROUND WAVE

The ground wave is made up of four parts-DIRECT, GROUND-REFLECTED, TROPOSPHERIC, and SURFACE waves. The relative importance and use made of each part is dependent on several factors. The chief factors are-frequency, distance between the transmitting and receiving antennas, height of the antenna, the nature of the ground over which the wave travels, and the condition of the atmosphere at the lower levels.

216

The DIRECT WAVE travels directly from the transmitting antenna to the receiving antenna. For example-two airplanes are several thousand feet in the air and only a few miles apart. This direct wave is not influenced by the ground, but may be affected by the atmospheric conditions through which the wave travels.

The GROUND-REFLECTED WAVE permits two airplanes several miles distant and at low altitudes to communicate with each other. The wave arrives at the receiving antenna after being reflected from the earth's surface. When the airplanes are close enough and at the correct altitude to receive BOTH direct waves and ground-reflected waves, the signals may be either reinforced or weakened, depending upon the relative phases of the two waves.

The TROPOSPHERIC WAVE is the part of the wave that is subject to the influences of the atmosphere at the low altitudes. The effects of the atmosphere on this type of wave propagation are most pronounced at frequencies above the high end of the H-F band. Communication by the use of the tropospheric wave is

gaining in importance, both from the standpoint of its usefulness, and its frequent unpredictable ranges. This type of communication is discussed in more detail later in this chapter.

The SURFACE WAVE brings most of the low and medium frequency broadcasts to your receiver. These frequencies are low enough to permit this wave to follow the surface of the earth. The intensity of the surface wave decreases as it moves outward from the antenna. This ATTENUATION-rate of decrease-is influenced chiefly by the conductivity of the ground or water and the frequency of the wave.

As it passes over the ground, the surface wave induces a voltage in the earth, setting up eddy currents. The ENERGY to create these currents is PIRATED or taken away from the surface wave. In this way, the surface wave is weakened as it moves away from the antenna. increasing the frequency rapidly increases the rate of attenuation. Hence surface wave communication is limited to the lower frequency.

69019V-46-15

217

Shore establishments are able to furnish long-range ground-wave communication by using frequencies between about 18 and 300 kc. with EXTREMELY HIGH POWER.

Since the electrical properties of the earth over which the surface waves travel are relatively constant, the signal strength from a given station at a given point is nearly constant. This holds true in practically all localities, except those that have distinct rainy and dry seasons. There, the difference in the amount of moisture will cause the soil's conductivity to change.

It is interesting to note that the conductivity of salt water is 5,000 times as great as that of dry soil. The superiority of surface wave conductivity by salts water explains why high-power, low-frequency transmitters are located as close to the edge of the ocean as practicable.

Do not think that the surface wave is confined to the earth's surface only. It also extends a considerable distance up into the air, but it drops in intensity as it rises.

THE SKY WAVE

In behavior, the SKY WAVE is quite different from the ground wave. The part of the expanding lobe that moves toward the sky "bumps" into an IONIZED layer of atmosphere, called the IONOSPHERE, and is bounced or bent back toward the earth. If your receiver is located in the area where the returning wave strikes, you will receive the program clearly even though you are several hundred miles beyond the range of the ground wave.

THE IONOSPHERE

The ionosphere is found in the rarified atmosphere, approximately 30-350 miles above the earth. It differs from the other atmosphere in that it contains a higher percentage of positive and negative ions.

The ions are produced by the ultra violet and particle radiations from the sun. The rotation of the earth on its axis, the annual course of the earth around the sun, and the development of SUN-SPOTS all affect the number

218

of ions present in the ionosphere, and these in turn affect the quality and distance of radio transmission.

You must understand that the ionosphere is constantly changing. Some of the ions are re-combining to form atoms, while other atoms are being split to form ions. The rate of formation of ions and recombination depends upon the amount of air present, and the strength of the sun's radiations.

At altitudes above 350 miles, the particles of air are too sparse to permit large-scale ion formation. At about 30 miles altitude, few ions are present because the rate of recombination is too high. Also few ions are formed, because the sun's radiations have been materially weakened by their passage through the upper layers of the ionosphere with the result that below 30 miles, too few ions exist to affect materially sky wave communication.

LAYERS OF THE IONOSPHERE

Different densities of ionization make the ionosphere appear to have layers. Actually there is no sharp dividing line between layers. But for the purpose of discussion a sharp demarkation is indicated.

The ionized atmosphere at an altitude of between 30 and 55 miles is designated as the D-LAYER. Its ionization is low and has little effect on the propagation of radio waves except for the ABSORPTION of energy from the radio waves as they pass through it. The D-layer is present only during the day. This greatly reduces the field intensities of transmissions that must pass through daylight zones.

The band of atmosphere at altitudes between 55 and 90 miles contains the E-LAYER. It is a well-defined band with greatest density at an altitude of about 70 miles. This layer is present during the daylight hours, and is also present in PATCHES, called "SPORADIC E," both day and night. The maximum density of the regular E-layer appears at about noon, local time.

The ionization of the E-layer at the middle of the day is sufficiently intense to refract frequencies up to 20 mcs.

219

back to the earth. This is of great importance to daylight transmissions for distances up to 1,500 miles.

The F-layer extends from the 90-mile level to the upper limits of the ionosphere. At night only one F-layer is present. But during the day, especially when the sun is high, this layer separates into two parts, F_1 and F_2 , as illustrated in figure 149.

As a rule, the F_2 -layer is at its greatest density during early afternoon hours. But there are many notable

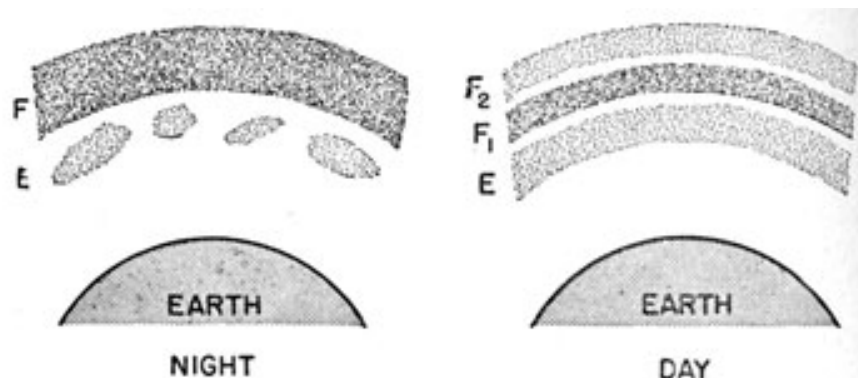

Figure 149 -E-layer and F-layer of the ionosphere.

exceptions of maximum F_2 density existing several hours later. Shortly after sunset, the F_1 - and F_2 -layers recombine into a single F-layer.

SPORADIC E LAYER

In addition to the layers of ionized atmosphere that appear regularly, erratic patches occur at E-layer heights much as clouds appear in the sky. These clouds are referred to as SPORADIC-E IONIZATIONS. These patches often are present in sufficient number and intensity to enable good radio transmission over distances where it is not normally possible.

Sometimes sporadic ionizations appear in considerable strength at varying altitudes, and actually prove harmful to radio transmissions.

EFFECT OF IONOSPHERE ON THE SKY WAVE

The ionosphere has three effects on the sky wave. It acts as a CONDUCTOR, it absorbs energy from the wave,

and it REFRACTS or bends the sky wave back to the earth as illustrated in figure 150.

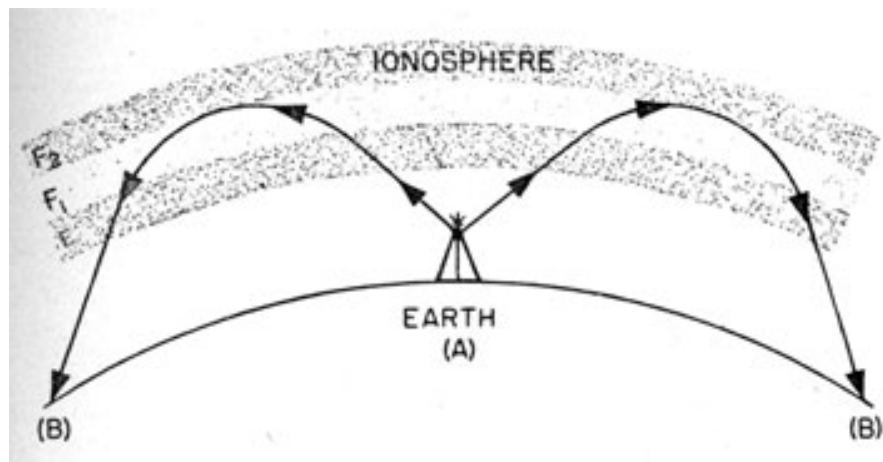

Figure 150.-Refraction of the sky wave by the ionosphere.

When the wave from an antenna strikes the ionosphere, the wave begins to bend. If the frequency is correct, and the ionosphere sufficiently dense, the wave will eventually emerge from the ionosphere and return to the earth. If your receiver is located at either of the points *B*, in figure 150, you will receive the transmission from point *A*.

Don't think that the antenna reaches as near the ionosphere as is indicated in figure 150. Remember the tallest antenna is only about 1,000 feet high.

The ability of the ionosphere to return a radio wave to the earth depends upon the **ANGLE** at which the sky wave strikes the ionosphere and upon the **FREQUENCY** of the transmission.

For discussion, the sky wave in figure 151 is assumed to be composed of four rays. The angle at which ray 1. strikes the ionosphere is too nearly vertical for the ray to be returned to the earth. The ray is bent out of line, but it passes through the ionosphere and is lost.

The angle made by ray 2 is called the **CRITICAL ANGLE** for that frequency. Any ray that leaves the antenna at an angle **GREATER** than theta (θ) will penetrate the ionosphere

221

Ray 3 strikes the ionosphere at the **SMALLEST ANGLE** that will be refracted and still return to the earth. Any smaller angle, like ray 4, will be refracted toward the earth, but will miss it completely.

As the **FREQUENCY INCREASES**, the size of the **CRITICAL ANGLE DECREASES**. Low frequency fields can be projected straight upward and will be returned to the earth. The **HIGHEST FREQUENCY** that can be sent directly upward and still be returned to the earth is called the **CRITICAL Frequency**. At sufficiently high frequencies, the wave will not be returned to the earth, regardless of the angle at which the ray strikes the ionosphere.

The critical frequency is not constant. It varies from one locality to another, with differences in time of day, with the season of the year, and according to sunspot cycle.

This variation in the critical frequency is the reason why you should use issued predictions-**FREQUENCY**

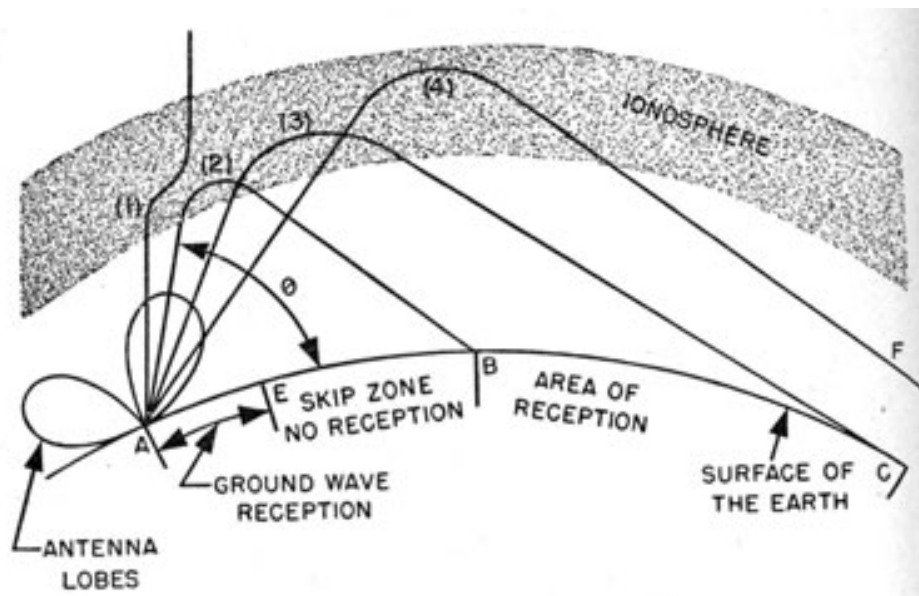

Figure 151.-Effect of angle of refraction on sky wave.

TABLES or NOMOGRAMS-to determine the MAXIMUM USABLE FREQUENCY (MUF) for any hour of the day.

Nomograms and frequency tables are prepared from data obtained experimentally from stations scattered all

over the world. All this information is pooled and you get the results in the form of a long-range prediction that removes most of the guess work from radio communication.

Refer again to figure 151. The area between points *B* and *C* will receive the transmission via the REFRACTED SKY WAVE. The area between points *A* and *E* will receive its signals by GROUND WAVE. All receivers located in the SKIP ZONE between points *E* and *B* will receive NO transmissions from point *A*, since neither the sky wave nor the ground wave reaches this area.

EFFECT OF DAYLIGHT ON WAVE PROPAGATION

The INCREASED IONIZATION during the day is responsible for several important changes in sky-wave transmission-

First-It causes the sky-wave to be returned to the earth NEARER to the point of transmission.

Next-The EXTRA ionization increases the ABSORPTION of energy from the sky-wave. If the wave travels a sufficient distance into the ionosphere, it will lose all its energy.

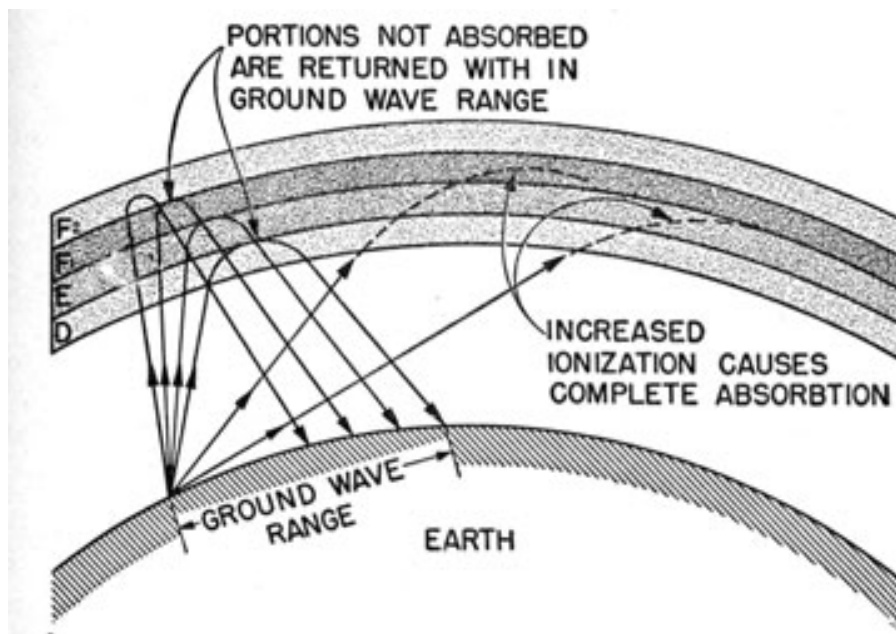

Figure 152.-Effect of daylight on medium-frequency sky-wave transmission.

223

And-The presence of the F_1 - and E -layers with the F_2 -layer make long-range, high-frequency communication possible by all three layers, provided the correct frequencies are used.

In figure 152, you see the results of daylight in increasing refraction and absorption. These two factors usually combine to reduce the effective daylight communication range of low-frequency and medium-frequency transmitters to surface wave ranges.

HIGH-FREQUENCY, LONG-RANGE COMMUNICATION

The high ionization of the F_2 -layer during the day, enabling refraction of high frequencies which are not greatly absorbed, has an important effect on transmissions of the HF band. Figure 153 shows how the F_2 -layer

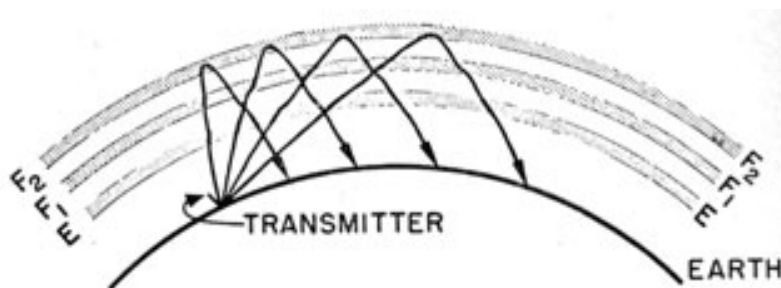

Figure 153.-Effect of the F_2 -layer on transmission of high-frequency signals.

completes the refraction and returns the transmissions of these frequencies to the earth, making possible long-range, high-frequency communication during the daylight hours.

The waves are partially bent in going through the E -layer and F_1 -layer, but are not returned to the earth until the F_2 -layer completes the refraction. At night, when only one layer is present, very-high-frequency waves may pass right through the ionosphere.

The EXACT FREQUENCY to be used to communicate with another station depends upon the condition of the

224

ionosphere and upon the distance between stations. Since the ionosphere is constantly changing, you must use the nomograms and tables to pick the correct frequency for desired distance at a given time of day.

MULTIPLE REFRACTION

Many times the REFRACTED WAVE will return to the earth with enough energy to be bounced back up to the ionosphere, and then be refracted back to the earth a second time.

In figure 154, the ray strikes the earth at point A with sufficient force to be reflected back to the ionosphere

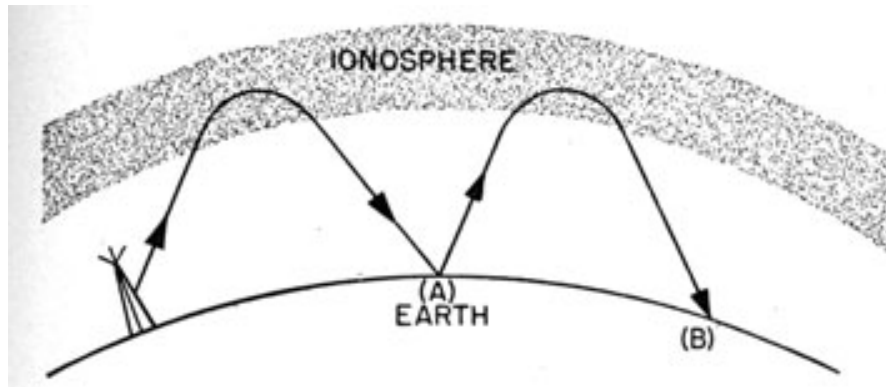

Figure 154.-Multiple refraction and reflection of a sky wave.

and then refracted back to the earth a second time. Occasionally a sky wave has sufficient energy to be refracted and reflected several times, thus greatly increasing the range of transmission.

FADING

FADING is the result of variations in signal strength at the receiver. There are several causes. Some are easily understood, others are more complicated. One cause is probably the direct result of interference between single-hop and double-hop transmissions. If the two waves arrive IN PHASE, the signal strength will be

increased, but if the phases are opposed, they will cancel each other and weaken the signal.

Interference fading is also severe in regions where the ground and skywave are in contact with each other. This is especially true if the two are approximately of equal strength. Fluctuations of the sky wave with a steady ground wave can cause worse fading than sky-wave transmission alone.

The way the waves strike the antenna and the variations in absorption in the ionosphere are also responsible for fading. Occasionally, sudden ionospheric disturbances will cause complete absorption of all sky-wave radiations.

Receivers that are located near the outer edge of the skip zone are subjected to fading as the sky wave alternately strikes and skips over the area. This type of fading is sometimes so complete that the signal strength may fall to near zero level.

FREQUENCY BLACKOUTS

FREQUENCY BLACKOUTS are closely related to some types of fading, but this fading is complete enough to blot-out the transmission completely.

Changing conditions in the ionosphere shortly before sunrise and after sunset may cause complete **BLACKOUTS** at certain frequencies. The **HIGHER** frequencies pass through the ionosphere, while the **LOWER** ones are absorbed by it.

IONOSPHERIC STORMS-turbulent conditions in the ionosphere-often cause communication to be erratic. Some frequencies will be completely blotted out, while others may be reinforced. Sometimes these storms develop in a few minutes, and at other times they require as much as several hours. A storm may last several days. You can expect these storms to recur at about every 27 days.

When frequency blackouts occur, you will have to be on the ball to prevent complete loss of contact with other ships or stations. When the storms are severe, the critical frequencies are much lower, and the absorption in the lower layers of the ionosphere is much higher.

V. H. F. AND U. H. F. COMMUNICATION

In the recent years, there has been a trend toward the use of frequencies above 30 mc., for short-range, ship-to-ship, and ship-to-airplane communications.

Early concepts suggested that these transmissions traveled in straight lines. This naturally leads to the assumption that the V.H.F. transmitter and receiver must be within sight of each other to supply radio contact.

Extensive use and additional research show the early "line-of-sight" theory to be frequently in error because radio waves of these frequencies are refracted. The transmitter does not always need to be in sight of the receiver.

This type of communication still is called by its popular name, "Line of sight transmission." But it is better to call it V.H.F. and U.H.F. transmission. It is true that U.H.F. and V.H.F. waves follow approximately straight lines, and large hills or mountains cast a radio shadow over areas in much the same way as light creates a shadow. A receiver located in shadow will receive a weakened signal, and in some cases, no signal at all.

In theory, the range of contact is the distance to the horizon, and this distance is determined by the heights of the two antennas. But communication is often possible many miles beyond the assumed horizon range. Be sure to remember this point when your ship is in waters where radio security is essential.

EFFECT OF ATMOSPHERE ON V. H. F. AND U. H. F. TRANSMISSIONS

The abnormal ranges of V.H.F. and U.H.F. contacts are caused by abnormal atmospheric conditions within a few miles of the earth. Normally, you will find the warmest air near the surface of the water. The air gradually becomes cooler as you gain altitude. However, unnatural situations often develop where WARM bands of air are above the COOLER layers. This unusual situation is called a TEMPERATURE INVERSION.

227

Whenever TEMPERATURE INVERSIONS are present, the AMOUNT OF REFRACTION-called INDEX OF REFRACTION-is different for the air trapped WITHIN the inversion than it is for the air outside the inversion.

The differences in the index of refraction form CHANNELS or DUCTS that will pipe V.H.F. and U.H.F. signals many miles beyond the assumed normal range.

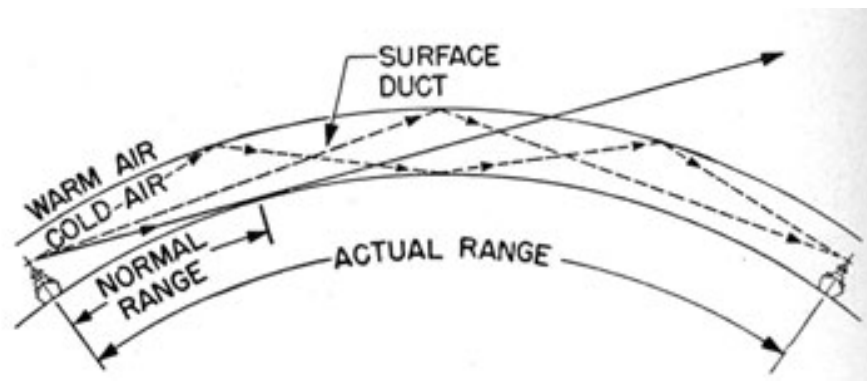

Figure 155.-Duct effect on V.H.F. and U.H.F. transmissions.

Sometime these ducts will be in contact with the water and may extend a few hundred feet into the air. At other times the duct will start at an elevation of about 500 to 1,000 feet, and extend an additional 500 to 1,000 feet in the air.

If an antenna extends into the duct or if wave motion lets the wave enter a duct after leaving an antenna, the transmission may be conducted long distances to another ship whose antenna extends into the duct. This is illustrated in figure 155.

WHEN WILL DUCTS BE FORMED?

When operating this high-frequency equipment, you must be able to recognize the weather conditions that lead to DUCT FORMATIONS. Since the duct is not visible to the eye and since complete aerological information is not always available, you must rely on a few simple visible evidences and a lot of common sense.

228

The following rules have exceptions, but you can expect a duct to be formed when-

1. A wind is blowing from land.
2. There is a stratum of quiet air.
3. There are clear skies, little wind, and high barometric conditions.
4. A cool breeze is blowing over warm open ocean, especially in the tropic areas and in the trade-wind belt.
5. Smoke, haze, or dust fails to rise, but spreads out horizontally.
6. Your receiver is fading rapidly.
7. The moisture content of the air at the bridge is considerably less than at the sea's surface.
8. The temperature at the bridge is 1 or 2 degrees F. HIGHER than at the sea's surface.

GENERAL USE OF FREQUENCIES

Each frequency band has its own special uses. The uses depend upon the nature of the waves-surface, sky, or space-and the effect that the sun, the earth, the ionosphere, and the atmosphere have upon them.

It is almost impossible to lay down fixed rules for the use of what frequency for what purpose. Some

general statements can be made, however, on what FREQUENCY BANDS are best used for what purposes. COMINST, in Article 6520, lists each frequency band and what its best use is.

Most rules for the use of frequencies deal with VARIATIONS that are beyond human control. This is particularly true of medium- and high-frequency transmissions using the SKY wave.

Make intelligent use of nomograms and tables.

One SURE rule-if you want to be reasonably certain that a LONG-RANGE COMMUNICATION gets through, use HIGH POWER and LOW FREQUENCY. That's what the international communication systems and most of your big FOX stations use. However, this takes an antenna array

229

so large that it's not usable with shipboard transmission. So, to be certain a message for a distant point gets through, RELAY IT-send it to the nearest large shore station.

Note in figure 156 how the SKY WAVE builds up to a peak of daytime usefulness in the H.F. band. At night the peak is in the top third of the M.F. band. Note also how the usefulness of the GROUND, or surface, WAVE declines steadily as the higher frequencies are reached, until it is altogether useless in H. F. But as the SPACE WAVE, it becomes the only means of communication in V.L.F. and for a certain range above V.L.F.

And be sure you remember that all SKY WAVE transmission-and that means almost all from 1,600 to 30,000 kc.-is associated with SKIP DISTANCES. In other words you can get great range, but in the process you'll skip a lot of receiving stations in between-possibly the one you most want to receive your message.

THE NAVY FREQUENCY BAND

Most important to you in the chart is the shaded area in the M.F. and H.F. bands-from 2,000 to 18,100 kc. (2 to 18.1 mc.) . That, as you should already know, is the standard band for NAVAL COMMUNICATIONS from SHIP-TO-SHIP and SHIP-TO-SHORE. It's the band you'll use most frequently for TRANSMITTING messages, the one which your standard transmitters, such as the TBK, TBL, and TBM, cover.

It's right in the SHORT-WAVE area. Thus, it's SKY-WAVE TRANSMISSION and is affected by SKIP DISTANCES. As the chart shows, when you want range in DAYTIME, use the UPPER PORTION of the band-roughly from 3 mc. to 18 mc. But for NIGHT communication, drop down below 3.5 mc. The three frequencies most commonly used in this band are 2,716 kc. (2.716 mc.), 2,844 kc. (2.844 mc.), and 4,235 kc. (4.235 mc.)-the good old NERK series.

To help you in the use of this band, and to utilize properly knowledge of SKIP DISTANCE, the Navy publishes NRPM's containing tables which show the best

FREQUENCY		RANGE OF TRANSMISSION			
SYMBOL	KCS (OR MCS)	DAYTIME		NIGHTTIME	
		SKY WAVE	GROUND WAVE	SKY WAVE	GROUND WAVE
VLF	BELOW 30 KC	NONE	LONG RANGE WHEN VERY HIGH POWER USED	NONE	SAME AS DAY
LF	30-300 KC	NONE	SIMILAR VLF BUT SOMEWHAT LESS EFFECTIVE	LIMITED AT UPPER END OF BAND	SAME AS DAY
MF	300-550 KC	NONE	MAXIMUM FEW HUNDRED MILES	EFFECTIVE-DEPENDS ON SKIP DISTANCES	SOME
	550-1600 KC (BROADCAST)	NONE	MAXIMUM FEW HUNDRED MILES	EFFECTIVE-DEPENDS ON SKIP DISTANCES	SOME
HF	1600-3000 KC (INTERNATIONAL "SHORT-WAVE")	SOME	LIMITED [STANDARD NAVAL BAND - 2 TO 18 MC]	LONG RANGE-DEPENDS ON SKIP DISTANCES	VERY LITTLE
	3-30 MC (INTERNATIONAL "SHORT-WAVE")	LONG RANGE-DEPENDS ON SKIP DISTANCES	LIMITED	USUALLY NONE	USUALLY NONE
VHF	30-300 MC	NONE	TROPOSPHERIC WAVE	NONE	TROPOSPHERIC WAVE
UHF	300-3000 MC				
SHF	3000-30,000 MC				

Figure 156.-Recommended frequency chart.

frequencies within this band for communication with various shore stations. These tables are issued QUARTERLY. There will be a separate one for EACH major shore station. They give the recommended frequency for every HOUR of day for every distance 250 to 5,000 miles for some stations. The DIRECTION of the receiving station from your ship is also taken into account.

Look at the table in figure 156. It's a sample, but it's for communication with Balboa during February 1945. Your ship is 750 miles off the Pacific coast of Central America during that February, the time is 1200 GCT, and you wish to get a message to NBA, Balboa. Look at your table for the proper time, then move over to the third column-500 to 1,000 miles-in the second vertical row of figures, since Balboa is east of you. The recommended frequency is 4 mc. Send your message.

These tables will be supplied to your ship in the form of NRPM's and will cover three months, with a separate table for each month and for each shore station.

NOMOGRAMS

As a further aid, you'll also be supplied with NOMOGRAMS-again in NRPM's. They cover three-month periods, and each nomogram covers a range of 10° in latitude. A nomogram may be used for any path where the midpoint lies within the range of latitude of the particular nomogram. It will give you the

proper frequency for any time of day in Local Civil Time-LCT-for any transmission of from 1 to 2,200 miles. With proper use of nomograms and the frequency tables you should be all set for communicating in the Navy H-F band.

Figure 157 shows a nomogram that is typical of the series you'll use most frequently. To use one, first locate approximately the midpoint of the transmission path on the map shown on the last page of each published nomogram series. Determine the latitude, local time, and the "zone" at this midpoint. (The zones are labeled E, W, and I on the map to represent East, West and

232

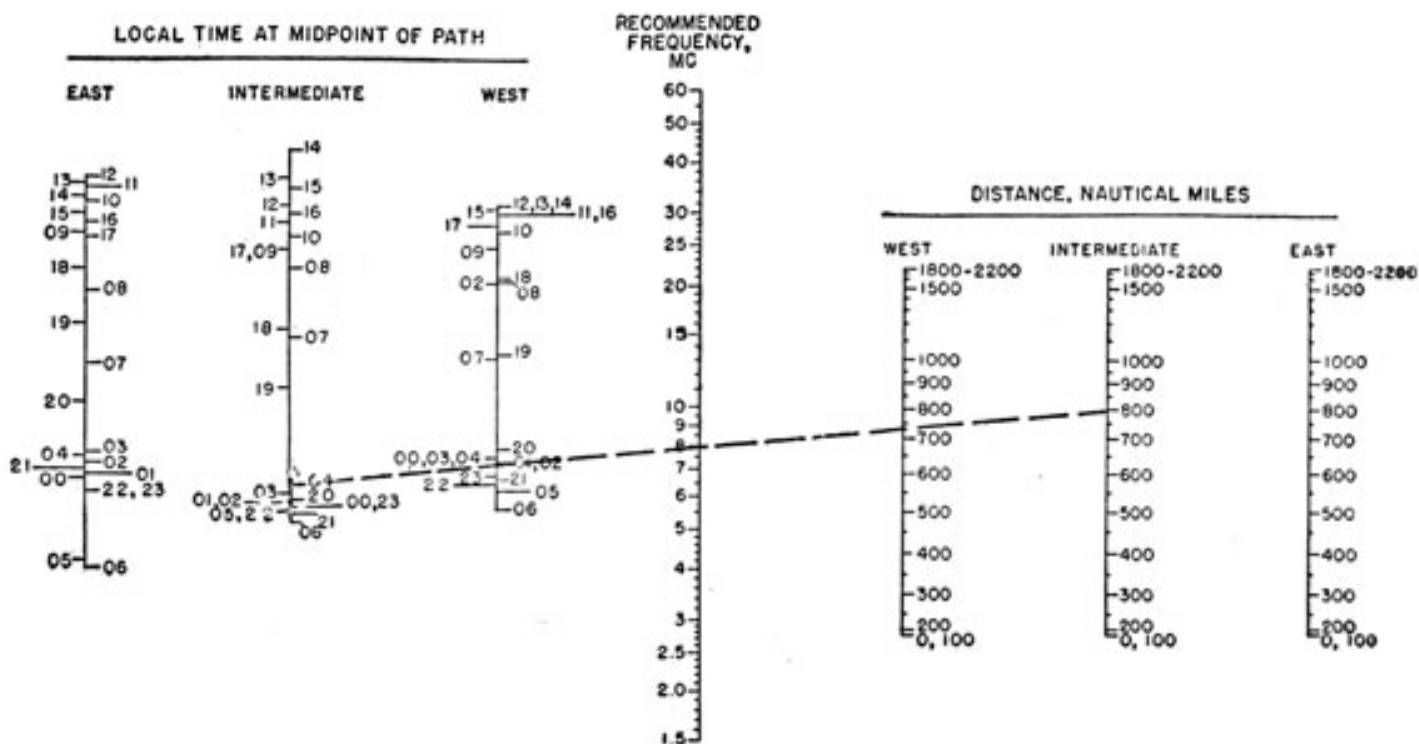

Figure 157.-Nomograms.

699198°-46-16

233

Intermediate.) Then line up a ruler through the distance of transmission (right-hand column) and the local time (LCT) at the midpoint of the path, which is on the left-hand column. Where the straight edge intersects the frequency scale in the middle of the nomogram, you'll find the recommended frequency.

For instance, you want to make a transmission of 800 nautical miles at 0400. You have consulted the map and found that the midpoint of the path is at roughly 30° north latitude and lies in the *I* (Intermediate) zone. Local time at this point is approximately the same (0400). Line up your straight edge on the nomogram in figure 157 between the Intermediate Zone MILES Line on the right side and the Intermediate Zone TIME Line on the left. Then look at your recommended frequency column in the middle. You'll note that it is intersected right at 8 mc. by the diagonal line made by the ruler. That's your frequency-8 mc.

BUT THERE ARE OTHERS

The so-called Navy band is not the only one used. It's the standard ship long-distance communications frequency-your chief TRANSMITTING frequency. But the major FOX skeds are more generally broadcast way down the line in the V.L.F. and L.F. bands. NGP's major sked, for instance, is broadcast on 19.8 kc., and NSS's is on 18 kc. True, the big stations also broadcast FOX in the M.F. and H.F. bands and some of the secondary skeds are broadcast only in the higher frequencies. But if you want to be sure to get that FOX, flip the receiver dial way, way down.

Scooting up again into V.H.F. and U.H.F., you enter your TACTICAL bands. When it's radio phone communication over the TBS or TDQ/RCK, go on up and start playing around with the SPACE WAVE. And remember your range limitations.

As a final tip on the proper use of frequencies, be sure you know the proper PUBLICATIONS to use. Appendix I of COMINST gives the big shore station circuits, the FOX

234

stations and the frequencies they use, the ship-shore facilities provided by the shore organizations, and the stations giving DF calibrating service on frequencies ranging from 150 to 1,500 K.C., as well as those giving HFDF service.

Also, of course, there's the CONFIDENTIAL publication-The U. S. Naval Radio Frequency Usage Plan-which lists them all and what the Navy's currently using them for. And there are the IRPL Radio Propagation Handbook (DNC13-1), USF-70, current NRPM's and circular letters to turn to for further up-to-date frequency data when needed. DNC-22 gives the dope on V.H.F. propagation.

235



[Previous Chapter](#)



[Radio Home](#)
[Page](#)



[Next Chapter](#)

Copyright (C) 2005 [Historic Naval Ships Association](#)

All Rights Reserved

[Legal Notices and Privacy Policy](#)

Version 1.00, 12 Nov 05



CHAPTER 22

NAVY TRANSMITTERS

WHY YOU TUNE A TRANSMITTER

You **TUNE** a transmitter to get **MAXIMUM POWER** from the transmitter into the antenna. This can be likened somewhat to adjusting a heating plant to get the maximum amount of heat into the radiators.

You adjust a heating plant by opening and closing valves which regulate the fuel and air supply. If these are not in **PROPER PROPORTIONS**, you don't get maximum heat. Also, if some of the valves in the steam line are opened too widely, and others closed too tightly, the radiators can't do their best job of heating. Suppose you want to turn down the heat. There are two common ways of doing this—turn off the radiator, or reduce the fuel input to the boilers.

Now notice the comparison between a heating plant and a transmitter. The **POWER** (fuel) to operate the transmitter might be considered the pilot that **STARTS** the transmitter's operation. Now, unless the **CORRECT**

237

ADJUSTMENTS of all the stages between the oscillator and antenna are made, little or none of the energy from the power lines will get into the antenna and be radiated as electromagnetic energy. It's **TUNING** that does the trick.

WHAT IS TUNING?

A transmitter is tuned by setting each stage of the transmitter to the frequency of oscillations generated by the oscillator. Here is how this procedure works out.

You are instructed to tune up on a frequency of 3,746 kilocycles. Follow the steps shown in figure 158. The

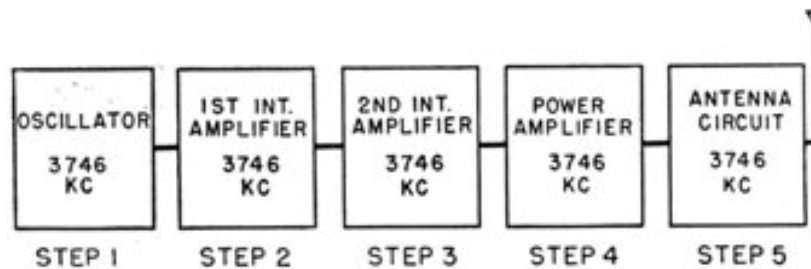

Figure 158 -Order of tuning steps for a transmitter.

FIRST step is to set the OSCILLATOR TUNING DIALS to the position, indicated on the calibration card, where a frequency of 3,746 kilocycles will be generated.

Next, step 2, tune the stage following the oscillator to the same frequency, 3,746 kcs. The 2ND INT. AMPLIFIER, step 3, is next tuned to a frequency of 3,746 kcs., followed by the POWER AMPLIFIER stage, and then the ANTENNA CIRCUIT.

Briefly, here's the routine of tuning the *AF* STRAIGHT THROUGH transmitter, one that has EACH STAGE tuned to the frequency of the oscillator-first tune the oscillator to the right frequency, and then tune each successive stage after the oscillator to the frequency of the PRECEDING stage.

RESONATING A STAGE

TUNING a stage to the desired frequency is sometimes called RESONATING the stage. Thus the expressions

238

TUNING the stage and RESONATING the stage may be used to say the same thing.

The RESONANT FREQUENCY of a stage is the FREQUENCY at which it will oscillate. You have had many contacts with RESONANT frequencies. Recall your experience with an automobile. When driving at a certain speed, certain RATTLES and VIBRATIONS would be present. At other speeds, different vibrations and other rattles appeared. It seemed that every speed had its own rattle, and, by knowing your rattles, you could tell your speed.

Why did certain rattles and vibrations appear at one speed and not at others? Because the automobile, when traveling at one speed, produced the frequencies of vibration of some rattles but not of others. At other speeds, other frequencies of vibration were produced.

Similarly, if the oscillator is generating a radio frequency current of 2,136 kc., and the following stage is tuned to 2,251 kc. the stage following will not vibrate, or oscillate, until the oscillator frequency is RAISED to 2,251 kc., or the stage following is REDUCED to 2,136 kc.

In RESONATING a stage, you adjust the variable inductance, or condenser, until the RESONANT frequency of the stage is the same as the one preceding it.

INDICATORS OF RESONANCE

How do you know when a stage is tuned to resonance? The METERS on the operating panel of the transmitter tell you.

Two general classes of meters are used with transmitters-GRID CURRENT meters showing the current flow in the grid circuits, and PLATE CURRENT meters that indicate the current flowing in the plate circuits. In addition, most transmitters have an ANTENNA CURRENT meter to show the current in the antenna circuit.

Here is a general rule for using the meters-GRID current meters show resonance by a MAXIMUM indication, while PLATE CURRENT meters show resonance with a MINIMUM

239

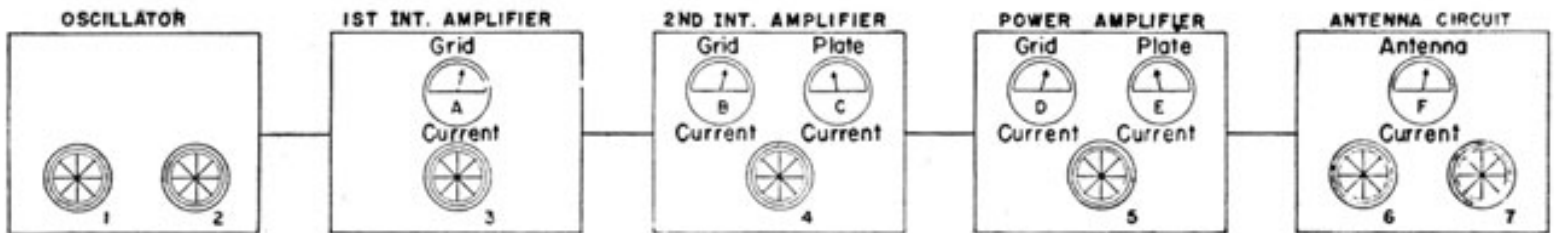

Figure 159.-Tuning dials and meters of a typical transmitter.

240

indication. Resonance in ANTENNA CIRCUITS is revealed by a MAXIMUM reading also. Don't be surprised if no indication at all appears. The reason for this will be explained later. Figure 159 is a typical arrangement of the meters found in one of the Navy's transmitters.

The tuning controls in figure 159 are indicated by the numerals 1 to 7. They may be marked as follows-

1. OSCILLATOR FREQUENCY.
2. OSCILLATOR TUNING.
3. 1ST INT. AMPLIFIER TUNING.
4. 2ND INT. AMPLIFIER TUNING.
5. POWER AMPLIFIER TUNING.
6. ANTENNA COUPLING.
7. ANTENNA TUNING.

The first step in tuning this arrangement is to set dial 1 to the desired frequency. You will do this by referring to the calibration card, and checking against a FREQUENCY METER. More about this later.

Next, adjust dial 2, until a MAXIMUM indication is obtained on meter A. That shows the OSCILLATOR stage to be TUNED to RESONANCE.

Now, adjust dial 3, until a MAXIMUM indication is obtained on meter B. The 1ST INT. AMPLIFIER is now tuned to resonance.

Adjust dial 4 until a MINIMUM reading is obtained on the PLATE CURRENT meter *C*. When this is done, a MAXIMUM deflection will be obtained on GRID CURRENT meter *D*. You have now tuned the 2ND INT. AMPLIFIER to resonance.

Finally, you adjust dial 5, until a MINIMUM indication is obtained on PLATE CURRENT meter *E*. The power amplifier has also been tuned to resonance.

Notice again how each GRID CURRENT meter gave a MAXIMUM indication, while the PLATE CURRENT meter gave a minimum indication as the stages were tuned to resonance.

241

RESONATING THE ANTENNA CIRCUIT

Resonance indications in the antenna circuit vary with the type of TRANSMITTER, the FREQUENCY of emission, the LENGTH and TYPE of antenna used. Resonance in the antenna circuit is sometimes indicated by a MAXIMUM ANTENNA current and at other times by a RISE in the POWER AMPLIFIER PLATE CURRENT, meter *E*.

Here is the procedure-after tuning the POWER AMPLIFIER to resonance, INCREASE slightly the setting of CONTROL 6, ANTENNA COUPLING. Adjust ANTENNA TUNING, dial 7, until a MAXIMUM antenna current is shown on meter *F*. If an indication on meter *F* CANNOT be OBTAINED, resonance in the ANTENNA CIRCUIT will have been achieved when the POWER AMPLIFIER PLATE CURRENT, meter *E*, stops rising. Remember these two types of indications. You will use both of them.

When the ANTENNA CIRCUIT has been resonated, INCREASE the SETTING of the ANTENNA COUPLING, dial 6, until the POWER AMPLIFIER PLATE CURRENT meter *E* indicates approximately the proper OPERATING current. READJUST controls 5 and 7 slightly as you increase the setting of control 6, until the proper POWER AMPLIFIER PLATE CURRENT is obtained.

Tuning the power amplifier and antenna requires considerable practice and much care. Remember that it varies from set to set, from one frequency to another, and with the conditions of the seas.

OVERCOUPLING OF POWER AMPLIFIER TO ANTENNA

In tuning, one mistake easily made is to increase the coupling between the POWER AMPLIFIER and ANTENNA CIRCUIT too much. When this happens, the POWER AMPLIFIER stage is detuned, and efficiency goes down. The table on page 283 tells how you may check for the presence of OVERCOUPLING. When you find it, reduce the coupling.

242

LOADING UP A STAGE

LOADING UP A STAGE is an expression you will frequently hear in connection with tuning a transmitter. Refer back to the adjustment of dial 2 in figure 159. When this dial was set to resonance as indicated by a rise in GRID CURRENT of METER A, you performed the task of LOADING UP the 1ST INT. AMPLIFIER STAGE. Also, when you resonated the 1ST INT. AMPLIFIER STAGE by adjusting dial 3, you LOADED UP the 2ND INT. AMPLIFIER STAGE.

Occasionally you will find it impossible to load up a following stage by resonating the preceding one. The common cause of this failure is lack of coupling between the preceding and following stages. When this happens, call a technician.

OPERATING WITH REDUCED POWER

Often it is desirable to operate the transmitter at less than full power. Some transmitters have special switching arrangements to cut out the last amplifier stage and couple the antenna circuit directly to the 2nd intermediate amplifier. The *TBK* is an example of this type of transmitter.

Other transmitters require that you reduce the coupling between the power amplifier and antenna circuits. This practice has the effect of permitting less energy to reach the antenna. Remember? This is like turning down a steam valve on a radiator.

Some transmitters allow you to reduce power by turning down the voltage applied to the power amplifier. This method of reduction is more like cutting down heat at the radiator by reducing the fuel supply to a boiler.

It is very important that you know the permissible methods of reducing the output power. Check the instruction books to gain this information.

HARMONICS

You were briefly introduced to the subject of harmonics in chapter 18 on receivers. Now you will get a fuller story of what they are.

You recall that a bell, or tuning fork, gives out a note of the same pitch each time you strike it. If you could take the sound waves apart and examine them, you would find that instead of a single note of one frequency being present, there are several notes of different frequencies.

The note with the LOWEST frequency-usually the STRONGEST note-is called the FUNDAMENTAL, Or the FIRST HARMONIC. As an example, say the fundamental frequency is 500 cycles. Oddly enough, the note with the next higher frequency will have exactly TWICE the frequency of the FIRST HARMONIC, or $500 \times 2 = 1,000$ cycles. And the frequency of the THIRD HARMONIC will be 3 times the frequency of the first harmonic- $500 \times 3 = 1,500$ cycles. And so on.

This SERIES of HARMONICS goes on up indefinitely, becoming weaker and weaker until their intensity is too weak to be recorded.

Oscillators used with radio circuits also produce a series of harmonic frequencies. For example, if an oscillator has a first harmonic of 2,500 kc., it also has a series of harmonics following it-

1st harmonic-2,500 kc.
 2nd harmonic-5,000 kc.
 3rd harmonic-7,500 kc.
 4th harmonic-10,000 kc.
 5th harmonic-12,500 kc.
 6th harmonic-15,000 kc.

Notice how these harmonics are used in the next section.

FREQUENCY MULTIPLYING

- It is easier to design and build a stable oscillator for low frequencies than it is for high frequencies. In addition, if crystals are used to control the oscillator

244

frequency, the crystals for very high frequencies must be ground so thin that they would easily crack while vibrating.

To overcome this difficulty, oscillators are made to generate a relatively low 1st HARMONIC. The high frequencies are obtained by making the following stages

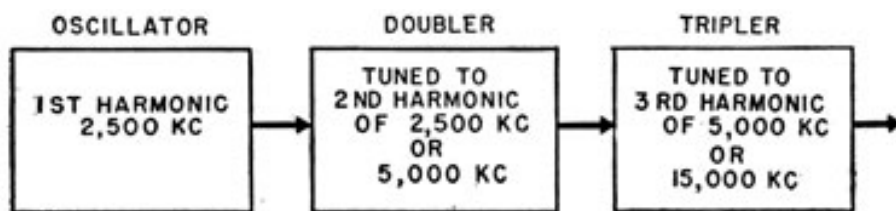

Figure 160.-Frequency multiplying.

tune to HIGHER HARMONICS, such as the second or third. The practice is known as FREQUENCY MULTIPLYING. Here is how it is done.

In figure 160, the oscillator is tuned to the first harmonic, 2,500 kc. The next stage, the DOUBLER, is tuned to the SECOND HARMONIC, 5,000 kc. In the doubler stage, the 5,000 kc frequency ALSO HAS HARMONICS, and as far as the next stage, the tripler, is concerned, the 5,000 kc. frequency can again be considered the FIRST HARMONIC. Therefore, the tripler stage may be tuned to the THIRD harmonic of 5,000 kc.-15,000 kc. Thus, the output of the tripler stage is SIX times the frequency of the oscillator-

$$2,500 \text{ kc.} \times 6 = 15,000 \text{ kc.}$$

You will find this system of frequency DOUBLING and TRIPLING used with several Navy transmitters. Sometimes, the oscillator is followed by a tripler, and then by a doubler stage. The operation is the same

whichever the case may be.

PICKING THE CORRECT HARMONIC

The use of frequency multiplying makes it very important for you to understand that an oscillator has MANY HARMONICS. Here is why.

245

If you tune the doubler stage to the WRONG harmonic, the frequency of transmission will be wrong. You can easily do this because some transmitters can be tuned to the WRONG harmonic as easily as to the correct one. The *TBK* series is an example of such a transmitter.

Systems of PICKING and COUNTING the harmonics can easily be developed with the aid of an experienced operator. But until you have developed this technique, you'd better practice resonating the stages VERY CLOSE to the position indicated on the calibration card.

FREQUENCY METER

Frequency meters are just ACCURATELY CALIBRATED OSCILLATORS. You use them to check the frequency of the transmitter oscillator. Briefly, here is what a frequency meter does.

When you wish to check the transmitter's frequency, you first set the frequency meter ACCURATELY to the desired frequency.

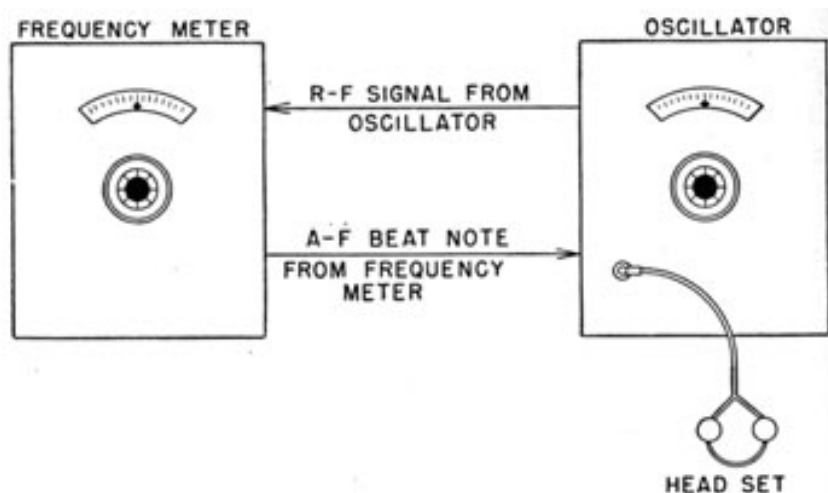

Figure 161.-Use of the frequency meter.

An r.f. signal from the oscillator, as illustrated in the figure, is then fed into the frequency meter. The signal from the frequency meter is BEAT against the signal from the oscillator. If the OSCILLATOR frequency is EXACTLY

246

the same as the signal of the FREQUENCY meter, no audio beat note will be heard in the HEADSET. But if the oscillator frequency is slightly higher or lower, a whistling note will be heard.

The next step is to adjust the oscillator tuning control slightly until the BEAT NOTE DISAPPEARS. The oscillator is now tuned to the correct frequency-you can turn the frequency meter off, and proceed with the tuning of the transmitter.

Be careful that you DO NOT beat a higher OSCILLATOR HARMONIC against the frequency meter, because it, too, will give a ZERO BEAT. That is why it is wise always to set the OSCILLATOR TUNING DIAL as near to the correct frequency as possible by referring to the calibration card.

The way the frequency meter is coupled to the transmitter varies greatly from one installation to another. Therefore, it will be necessary for you to get an experienced operator to explain your setup.

NAVY TRANSMITTERS

The Navy transmitters discussed in the following sections are representative of the most common installations. Probably you will not find all models on your ship, but it is possible. At least, if you are transferred from ship to ship, you certainly will come in contact with most of them.

The information given for each model is extremely brief. It is little more than an introduction to the sets. Therefore, it is well to refer often to the INSTRUCTION BOOKS for more complete information.

THE TBK-TBM TRANSMITTING EQUIPMENT

The *TBK-TBM* transmitters are similar in both construction and general appearance. But they differ in that the *TBK* is intended for C.W. transmission only, while the *TBM* is provided with a separate MODULATOR for voice M.C.W. communication.

The similarity in construction and design makes it possible to use a single set of instructions for placing

247

either transmitter in operation. However, remember that individual differences in the two models must be taken into consideration when the equipment is being tuned or adjusted.

Both the *TBK* and *TBM* are capable of tuning over a frequency band from 2,000 to 18,100 kilocycles. The full power output is about 500 watts at low frequencies, gradually decreasing to 300 watts at 18,100 kilocycles.

The frequency of the transmitter controlled by an electron-coupled, master oscillator, followed by doubler stages. The oscillator itself tunes over a range of 1,000 to 2,262.5 kilocycles. The first intermediate stage operates as a STRAIGHT-THROUGH amplifier up to 4,000 kilo-cycles, and as a doubler for frequencies from 4,000 to 9,050 kilocycles. Frequencies above 9,050 kilocycles are obtained by doubling in the SECOND intermediate amplifier. The power amplifier stage operates as a straight-through amplifier over the entire frequency range.

Extreme care must be exercised in tuning the *TBK-TBM* transmitters not to tune any of the stages to the wrong harmonic. That is especially true in tuning the DOUBLER CIRCUIT. The final setting of the tuning dials will be within a very few scale divisions of the settings indicated on the calibration card.

Provisions are made for low power operation with a nominal output of 75 watts in the range of 2,000 to 9,050 kilocycles. You do this by switching the final amplifier out of the transmitter circuit, and connecting the 2nd intermediate output directly to the antenna circuit.

Legend for Figure 162.

- | | |
|---|--|
| 1. INDICATOR LIGHTS | Five lights-STARTING SOLENOID, PLATE VOLTAGE, HEATER CURRENT, BIAS VOLTAGE, and M. O. FILAMENT. |
| 2. MASTER OSCILLATOR STAND-BY FILAMENT POWER SWITCH | This switch energizes the M. O. filaments when the rest of the transmitter is off. |
| 3. TEST KEY. | This control has the same effect as closing a telegraph key. You use it when tuning the transmitter. |

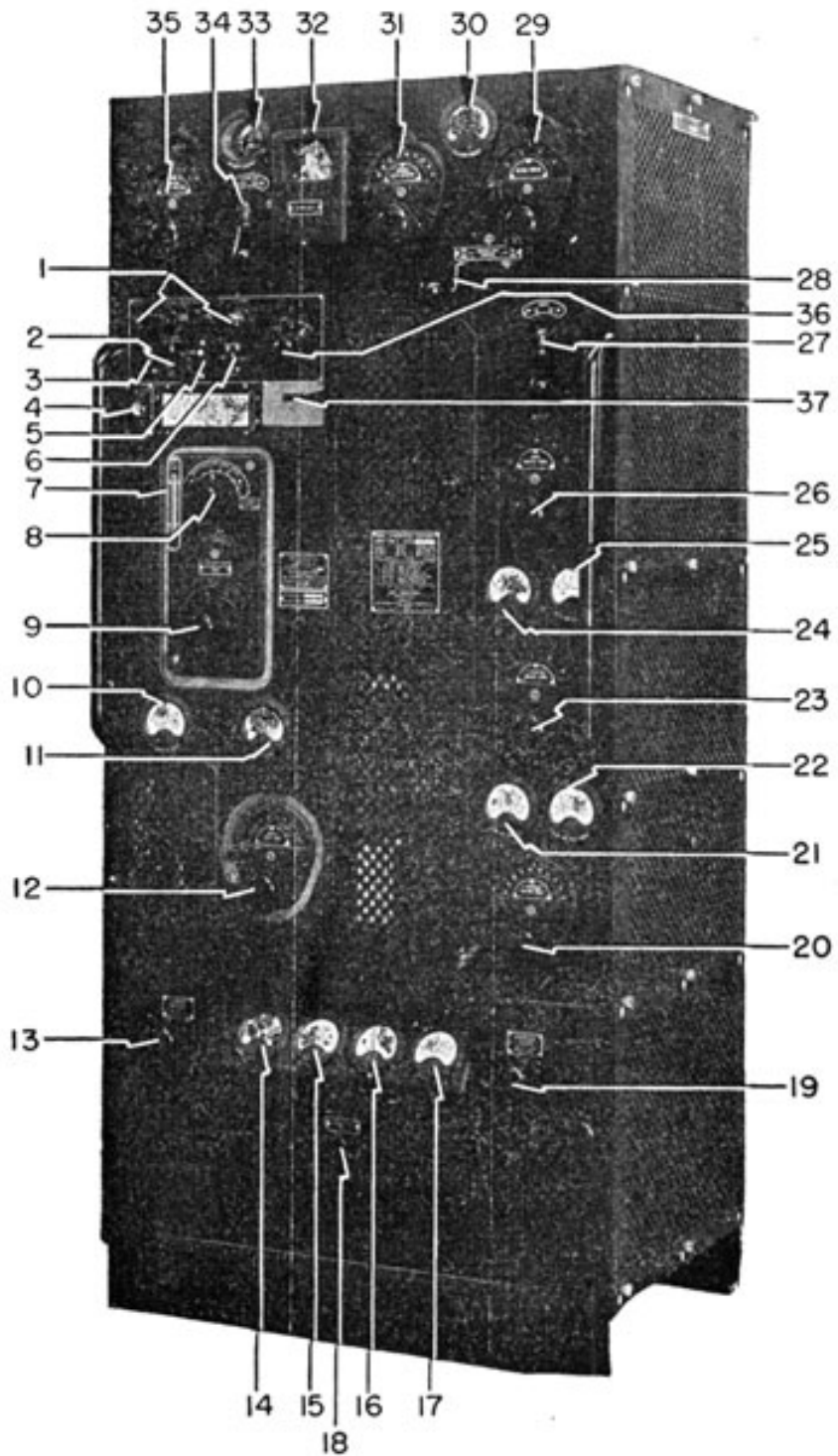

Figure 162.-The TBK-TBM transmitter.

699198°-46-17

4. FREQUENCY METER AUDIO OUTPUT JACK. The output jack for the headphones when you are using the frequency meter.
5. START-STOP SWITCH Turns the transmitter ON and OFF.
6. REMOTE-LOCAL CONTROL Switches the control of the transmitter to either REMOTE or LOCAL operating station.
7. THERMOMETER Indicates the temperature inside the M. O. heat chamber.
8. MASTER OSCILLATOR RANGE SWITCH, control A. An eight-point switch used to select the correct inductance for the desired frequency.
9. MASTER OSCILLATOR TUNING CONTROL B. This control adjusts the variable condenser in the oscillator tank circuit.
10. M. O. SCREEN GRID CURRENT METER. Indicates the current flowing in the screen grid circuit of the M. O.
11. M. O. PLATE CURRENT METER Indicates the current flowing in the M. O. plate circuit.
12. DOUBLER CIRCUIT TUNING CONTROL C. Control C tunes the doubler circuit following the M. O.
13. FILAMENT VOLTAGE CONTROL This control regulates the filament voltages.
14. FILAMENT VOLTAGE METER Indicates the filament voltage. Should indicate 10 volts.
15. P. A. HOURS This meter indicates the number of hours the power amplifier has been in operation.
16. BIAS VOLTAGE METER Indicates the bias voltage applied to the amplifier tubes.
17. P. A. PLATE VOLTAGE METER Indicates the power amplifier plate voltage.
18. OVERLOAD RELAY RESET Manual reset for the overload protective relay.
19. GENERATOR FIELD. Controls the voltage being applied to the field of the motor-generator. If the plate voltage is too low, this control is turned up.

20. 1ST INTERMEDIATE AMPLIFIER TUNING CONTROL <i>D</i>	Tunes the 1st Intermediate amplifier.
21. 2ND INT. AMP. GRID CURRENT METER	Indicates the current flowing in the 2nd intermediate amplifier grid circuit.
22. 1ST INTERMEDIATE AMPLIFIER PLATE CURRENT METER	Indicates the plate current flowing in the 1st intermediate amplifier circuit.
23. 2ND INTERMEDIATE AMPLIFIER TUNING CONTROL <i>E</i>	Tunes the 2nd intermediate amplifier stage.
24. P. A. GRID CURRENT	Indicates the grid current flowing in the power amplifier stage.
25. 2ND INTERMEDIATE AMPLIFIER PLATE CURRENT METER	Indicates the plate current flowing in the plate circuit of the 2nd intermediate amplifier.
26. POWER AMPLIFIER TUNING CONTROL <i>F</i> .	Tunes the power amplifier stage.
27. POWER, HIGH-LOW SWITCH	Connects and disconnects the power amplifier stage to the antenna circuit.
28. FREQUENCY RANGE CONTROL <i>L</i> .	A two-position switch-2,000-4,000 and 4,000-18,100 kilocycles.
29. ANTENNA COUPLING CONTROL <i>H</i>	This control adjusts the degree of coupling between the P. A. and antenna circuits.
30. P. A. PLATE CURRENT METER	Indicates the current flowing in the power amplifier plate circuit.
31. ANTENNA TUNING CAPACITOR CONTROL <i>J</i> .	This control adjusts the variable condenser in the antenna coupling circuit.
32. KEYING RELAY	This is the relay that "keys" the transmitter.
33. ANTENNA CURRENT METER	Indicates the R.F. current flowing in the antenna circuit.
34. ANTENNA COUPLING	A two-position switch; connects the antenna tuning circuit to the antenna for either a CURRENT or VOLTAGE feed system.

- 35. ANTENNA TUNING INDUCTANCE CONTROL *K*. This control adjusts a variable inductance in the antenna circuit.
- 36. TUNE-OPERATE SWITCH The use of this switch is explained in tuning procedure.
- 37. EMERGENCY SWITCH This switch is used for an emergency shutdown of the transmitter.

OPERATION OF THE TBK-TBM TRANSMITTERS

GENERAL

1. The lettered controls (*A*) through (*L*) are used in TUNING the transmitter. You will use them in ALPHABETICAL ORDER. The meters accompanying the controls indicate when the dials have been properly set.
2. The tuning of all stages, especially the doubler, requires extreme care-you may tune up on the WRONG HARMONIC. Usually you will find the final dial settings to be within a very few scale divisions of the positions indicated on the calibration card. If you find considerable error in the final settings, call someone to check your work.
3. The routing followed in resonating and loading the antenna circuit is subject to considerable variation . It depends upon the frequency of transmission, length of the antenna, and the condition of the sea (whether the ship is rolling and pitching or not) . Therefore, the procedure given here for tuning the antenna circuit is a suggested procedure rather than an absolute pattern to follow.

TUNING PROCEDURE FOR HIGH POWER CW. EMISSION

1. Set the following controls and switches in the indicated positions.

CONTROL	POSITION
START-STOP	STOP
LOCAL-REMOTE	LOCAL
TUNE-OPERATE	TUNING, STEP 1

EMERGENCY SWITCH	ON
ANTENNA COUPLING, CONTROL <i>H</i> .	NEAR ZERO
LETTERED CONTROLS, A through <i>L</i> .	To POSITIONS INDICATED ON CALIBRATION CHART for the desired frequency.

2. Press START button. Adjust GENERATOR FIELD rheostat until plate voltage meter indicates 1,000 volts. Adjust FILAMENT VOLTAGE control until filament meter indicates 10 volts.
3. Set the FREQUENCY METER to the correct frequency. If the frequency meter is coupled to the grid circuit of the master oscillator stage, the frequency meter must be set on the master oscillator frequency. Should the frequency meter be coupled to the output plate circuit of the master oscillator, the frequency meter must be set on TWICE the master oscillator frequency. (Check this coupling system with your chief.)
4. Insert headphone jack in FREQUENCY METER output jack, and adjust MASTER OSCILLATOR, tuning control *B*, until zero beat is obtained. Be sure you are on the CORRECT harmonic. It will be very close to the setting indicated on the calibration card.
5. Operate TEST KEY. The M. O. PLATE CURRENT should be about 60 ma., and M. O. SCREEN CURRENT near 11 ma.
6. Turn the TUNE-OPERATE switch to TUNING, STEP 2. Increase GENERATOR FIELD rheostat until PLATE VOLTAGE METER indicates 2,000 volts.
7. Operate TEST KEY and adjust DOUBLER, control *C*, until a maximum indication is obtained on the 1st INT. AMP. PLATE CURRENT meter. The final setting of this control should be within 2 or 3 scale divisions of the position indicated on the calibration card.
8. With test key depressed, tune the 1st INT. AMP.,

253

control *D*, to resonance. It will be indicated by a maximum indication on the 2nd INT. AMP. GRID CURRENT meter. Be sure you are on the correct harmonic. It will be close to the indicated setting.

9. With the TEST KEY depressed, tune the 2nd INT. AMP., control *E*, to resonance. It will be indicated by a maximum indication of the P. A. GRID CURRENT meter.

PRECAUTION: Observe the P. A. PLATE CURRENT. If it becomes excessively high, reduce the plate voltage by turning the GENERATOR FIELD rheostat counterclockwise.

10. Adjust POWER AMPLIFIER TUNING, control *F*, until a minimum indication is obtained on the P. A. PLATE CURRENT meter.

11. Tune the antenna circuit to resonance by varying the ANTENNA TUNING CAPACITOR, control *J*, and ANTENNA TUNING INDUCTANCE, control *K*, until a rise in P. A. PLATE CURRENT is indicated. At this point, an indication of current may also be observed on the ANTENNA CURRENT meter.
12. If resonance cannot be obtained, move the ANTENNA FEED, Control *F*, to the OTHER position, that is, CURRENT to VOLTAGE, or VOLTAGE to CURRENT. repeat the tuning procedure outlined in step 11. If you still fail to obtain resonance, increase the setting of the ANTENNA COUPLING, control *H*, and repeat steps 11 and 12.
13. If the P. A. PLATE CURRENT meter indicates over 150 ma., reduce ANTENNA COUPLING, control *H*, and readjust control *K*, until the minimum P. A. PLATE CURRENT is just slightly less than 150 ma.
14. Set the TUNE-OPERATE switch on OPERATE, and increase GENERATOR FIELD rheostat, until the PLATE VOLTAGE meter indicates 3,000 volts.
15. Close TEST KEY and readjust ANTENNA TUNING capacitor, control *J*, for a maximum indication on the ANTENNA CURRENT meter. (See NOTE.)

254

At the same time readjust the ANTENNA COUPLING, control *H*, to keep the P. A. PLATE CURRENT from exceeding 350 ma. While these adjustments are being made, it may be necessary to readjust slightly the P. A. TUNING, control *F*, to obtain a MINIMUM indication on the P. A. PLATE CURRENT meter.

NOTE: Sometimes it is impossible to obtain an ANTENNA CURRENT indication. In such cases, it is necessary to use the P. A. PLATE CURRENT as an indication of resonance. When the P. A. PLATE circuit has been tuned to resonance, ANTENNA RESONANCE will be indicated by a rise in P. A. PLATE, CURRENT to a maximum value. Be very sure that the rise in power amplifier plate current is not due to DETUNING the power amplifier stage.

16. Check for the presence of overcoupling, using the procedure outline on page 283.

ADJUSTMENTS FOR LOW POWER OPERATION

1. Place TUNE-OPERATE switch in TUNING 2 position. Throw the HIGH-LOW POWER switch to LOW position. This action disconnects the POWER AMPLIFIER for the circuit, making the 2nd INT. AMPLIFIER the final amplifier stage.
2. Return TUNE-OPERATE switch to OPERATE position and adjust ANTENNA COUPLING, control *H*, until the 2nd INT. AMP. PLATE CURRENT does not exceed 150 ma. Reducing coupling may also make it necessary to retune slightly the 2nd INT. AMP. PLATE circuit for a minimum 2nd INT. AMP. PLATE CURRENT indication.

REMOTE OPERATION

1. When the transmitter has been tuned, place the REMOTE-LOCAL switch in REMOTE position. The transmitter can be started, stopped, and keyed from remote stations. When returning or adjusting, it is always best to return the control to LOCAL.

THE TBM MODULATOR EQUIPMENT

The TBM transmitter can be operated independently of the modulator unit. However, when the transmitter is installed with the modulator, the mode of transmission-C.W., M.C.W., or VOICE-is determined by the setting of the EMISSION SELECTOR switch on the modulator unit.

When the EMISSION SELECTOR is set in C.W. position, the operation of the transmitter is independent of the modulator's controls. Start, time, and adjust the transmitter as outlined in the preceding section.

When you are preparing the *TBM* for M.C.W. and VOICE transmission, reduce the P. A. PLATE CURRENT of the transmitter from 350 to 270 ma., by decreasing the setting of the ANTENNA COUPLING, control *H*. The modulator is started and stopped simultaneously with the transmitter.

HOW TO ADJUST MODULATOR FOR M.C.W. OPERATION

1. Turn C.W.-M.C.W.-VOICE switch to VOICE.
2. Operate TEST KEY on transmitter, and readjust ANTENNA COUPLING, control *H*, until P. A. PLATE CURRENT is not over 270 ma.
3. Turn C.W.-M.C.W.-VOICE switch to M.C.W., and key as desired from a local or remote station, as designated by the setting of the REMOTE-LOCAL CONTROL switch on transmitter.
4. Check the modulator's meter readings against the chart on page 259 to determine whether the set is operating properly.

Legend for Figure 163.

- | | |
|--------------------------------------|---|
| 1. PLATE VOLTAGE INDICATOR LIGHT | Indicates whether or not plate voltage is being applied to the modulator. |
| 2. BIAS VOLTAGE INDICATOR LIGHT | Indicates the presence of bias voltage. |
| 3. STARTING SOLENOID INDICATOR LIGHT | Indicates the starting switch is closed. |

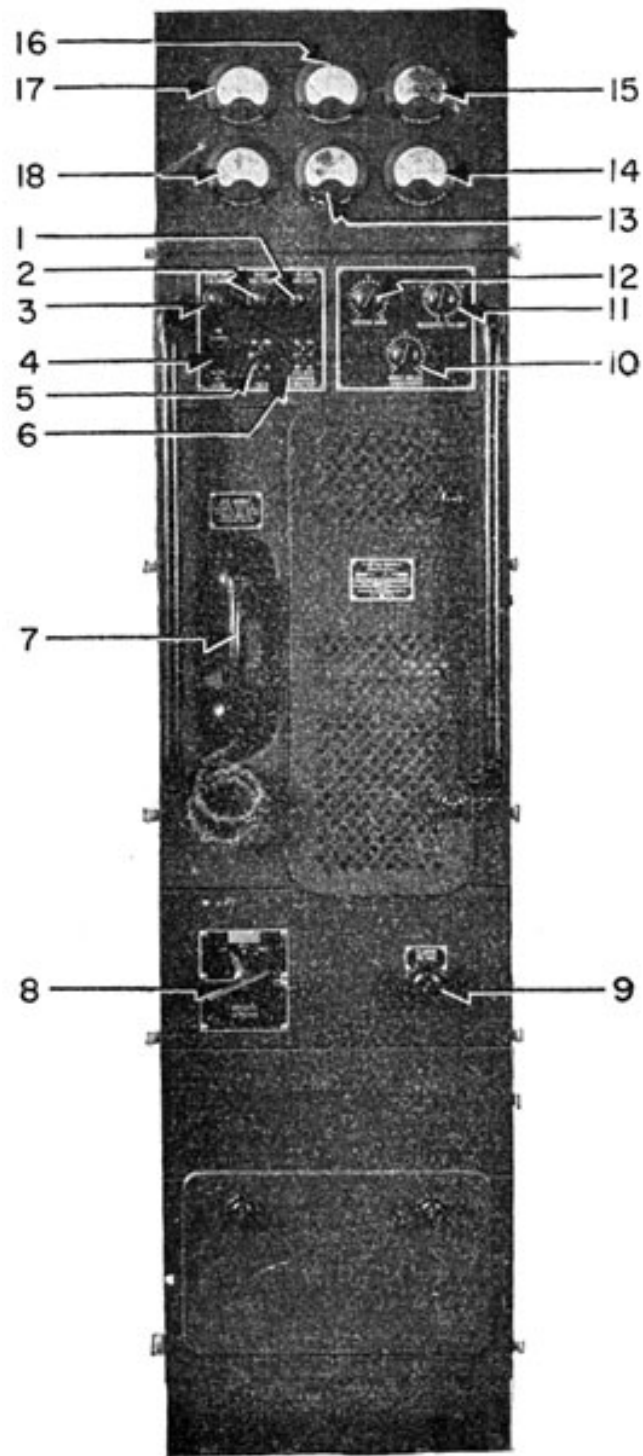

Figure 163.-Modulator for TBK-TBM transmitter.

4. AUTOMATIC-MANUAL GAIN SWITCH

This control is intended to eliminate the necessity for the operator continually to increase and decrease the SPEECH GAIN attenuator. Usually the ship and background noise is too great to permit its use.

5. TALK SWITCH

A three-position switch. In the up position it acts as a key. In the DOWN position, it closes the proper circuits for VOICE transmissions. In the MIDDLE position, the switch is OFF.

6. CARRIER CONTROL SWITCH

Usually set in MANUAL position because background noises are too great to permit use of AUTOMATIC GAIN.

7. TEST HAND SET

Microphone and receiver used in testing the modulator and transmitter.

8. EMISSION SELECTOR

Selects the type of emission, C.W., M.C.W., or VOICE.

9. FILAMENT VOLTAGE RHEOSTAT

Adjusts the voltage applied to the filaments of the modulator tube.

10. VOICE RELAY ATTENUATOR

Seldom used since AUTOMATIC GAIN does not work well.

11. RECEIVER VOLUME ATTENUATOR

Controls the volume of sound coming from the receivers.

12. SPEECH GAIN ATTENUATOR

Gain control for microphone input to modulator. This control is adjusted to get correct degree of modulation.

13. INTERMEDIATE AMPLIFIER PLATE CURRENT METER

It does what its name indicates.

14. FILAMENT VOLTAGE METER

Indicates the filament voltage.

15. PERCENTAGE MODULATION METER

Indicates the percentage of modulation present.

16. MODULATOR PLATE CURRENT METER

Indicates the plate current flowing in one of the push-pull tubes of the last stage.

17. MODULATOR PLATE CURRENT METER

Same at 16.

18. INPUT AMPLIFIER PLATE CURRENT METER

Indicates plate current flowing in the first amplifier stage.

TYPICAL MODULATOR METER INDICATIONS

	M.C.W. Operation		VOICE MODULATION; MANUAL - AUTOMATIC GAIN SWITCH IN MANUAL position	
	Key up	Key down	0% Modulation	100% Modulation
INPUT AMPLIFIER PLATE CURRENT METER (19)	0	0	3	3
INTERMEDIATE AMPLIFIER PLATE CURRENT METER (14)	120	130	120	140
MODULATOR PLATE CURRENT METER (17)	50	160	50	160
PERCENTAGE OF MODULATION METER (16)	60	60	0	100
FILAMENT VOLTAGE METER (15)	10	10	10	10
MODULATOR PLATE CURRENT METER (18)	50	160	50	160

How TO ADJUST TRANSMITTER FOR VOICE OPERATION

1. Turn C.W.-M.C.W.-VOICE switch to VOICE position. Operate TEST KEY on transmitter, and reduce P.A. PLATE CURRENT to 270 ma. by decreasing the ANTENNA COUPLING, control *H*.
2. Remove HANDSET from microphone hook. Place CARRIER CONTROL switch in MANUAL position. Press the button on the handset and talk into the microphone.
3. Adjust SPEECH GAIN attenuator until PERCENTAGE MODULATION meter indicates the transmitter is being modulated.
4. Do not increase the SPEECH GAIN attenuator beyond a point where the PERCENTAGE OF MODULATION

meter indicates 60 percent when the syllable, "Ah" is spoken normally into the microphone held one inch from the lips. This setting is used to prevent instantaneous over-modulation on certain expressions.

5. Check the level of sound being received from the receiver. If too low, increase the RECEIVER VOLUME ATTENUATOR.

6. Turn the transmitter's REMOTE-LOCAL CONTROL switch to REMOTE-the transmitter is set for remote operation.

7. Check the meters on the modulator to see that they do not materially exceed the values given in the chart on page 259.

8. Set MANUAL-AUTOMATIC GAIN switch in AUTOMATIC position. This eliminates the need for further adjustments of the SPEECH GAIN ATTENUATOR.

9. Suppose the operator stationed at the MODULATOR desires to exercise control over the remote stations. He can do so by removing the TEST HANDSET from the hook, or by moving the CARRIER CONTROL switch to MANUAL and the TALK switch to OFF. By doing this, the operator can cut off all transmissions from remote stations.

THE TBL RADIO TRANSMITTING EQUIPMENT

The TBL radio transmitting equipment has two different operating panel arrangements. This feature gives the impression that the two types are quite different in circuit design, but actually they are very similar. Models 4, 8, and 9 have one panel arrangement, and 5, 6, 10, and 11 have another. Careful examination of the controls on the two panels will reveal their identity.

Models TBL 10 and 11 are intended primarily for shore installations. The others are intended for smaller surface craft and submarines. In this discussion, only the TBL 5-6 is considered.

The TBL 5-6 is actually two transmitters in a single cabinet. The INTERMEDIATE FREQUENCY section, 175 to

260

600 kc., occupies the portion of the cabinet to your right, and the HIGH FREQUENCY section, 2,000 to 18,100 kc., the portion to your left.

Unlike the TDE transmitting equipment, the TBL sets use common vacuum tubes for all stages of both sections except MASTER OSCILLATORS. The tuning inductances and capacitors belonging to individual circuits are separate. A TRANSFER SWITCH changes the vacuum tube connection from one transmitter section to the other. When the TRANSFER SWITCH is in either position, the controls of one section are inoperative.

All TBL transmitting sets may be used for C.W., M.C.W., or VOICE communication. When VOICE transmission is desired, a Navy Type CRV 50064 speech input equipment must be used.

The nominal output power is 200 watts on C.W., 100 watts for M.C.W., and 50 watts on VOICE. You may reduce the power output on C.W. transmission by turning the plate voltage control counterclockwise, or by decreasing the coupling between the power amplifier and antenna circuits. On M.C.W. and VOICE, it is advisable to reduce the power by decreasing the ANTENNA COUPLING.

A unique method is used to indicate the controls that govern the individual transmitter circuits. The L.F. CONTROLS have a BLUE background, and the H.F. controls a GREEN background. The lettered controls *B* through *M* are used to tune the H.F. section, and *N* through *V* the I.F. section. Control *A* is the H.F.-I.F. TRANSFER SWITCH, and *W* the ANTENNA TRANSFER SWITCH.

COMMON CONTROLS

- | | |
|---------------------------------------|---|
| 1. START-STOP SWITCH | Local switch to start or stop the transmitter. |
| 2. REMOTE-LOCAL SWITCH | Designates the location of the control. When this switch is in REMOTE position, the transmitter can be started or stopped from remote stations. |
| 3. LINE VOLTAGE, NORMAL-HIGH | This switch is used to connect protecting circuits into the temperature control |
| 261 | |
| 4. OVERLOAD RELAY RESET | Reset the overload relay after it has opened. |
| 5. INDICATOR LIGHTS | MOTOR SOLENOID (BLUE)
PLATE VOLTAGE (RED)
HEATER POWER (AMBER)
BIAS VOLTAGE (GREEN) |
| 6. PHONE-C.W.-M.C.W. SWITCH | Sets the type of emission. |
| 7. PLATE VOLTAGE RHEOSTAT | Adjusts the voltage applied to the amplifier tubes. |
| 8. FILAMENT VOLTAGE RHEOSTAT | Regulates the voltages applied to the vacuum tube filaments. |
| 9. M.O. HEAT CHAMBER THERMOMETER | Indicates the temperature in the M.O. heat chamber. |
| 10. TEST KEY | This switch is used to test the operation of the transmitter while you are tuning it. |
| 11. FREQUENCY METER AUDIO OUTPUT JACK | A jack for a pair of head phones to be used in checking the frequency of the transmitter against a frequency meter. |
| 12. EMERGENCY, ON-OFF SWITCH | A switch that can be used to turn the transmitter off in emergency. |

13. P.A. GRID CURRENT SWITCH

A two-position switch. To RAISE and to LOWER the grid currents.

14. TUNE-OPERATE SWITCH

A three-position switch-TUNE 1, TUNE 2, and OPERATE. This switch protects the transmitter from damage and undesirable transmissions while tuning is in progress.

15, 16. CALIBRATION CHARTS

Indicates the dial settings for the various frequencies.

A. TRANSFER SWITCH, H.F.-L.F.

Transfers the power from one transmitter section to the other.

W. ANTENNA TRANSFER SWITCH L.F.-H.F.-RECEIVER

This is the switch that connects the antenna to one section of the transmitter, or receiver.

HIGH FREQUENCY SECTION-TUNING CONTROLS

B. MASTER OSCILLATOR RANGE An eight-position switch used to set the frequency range for the master oscillator.

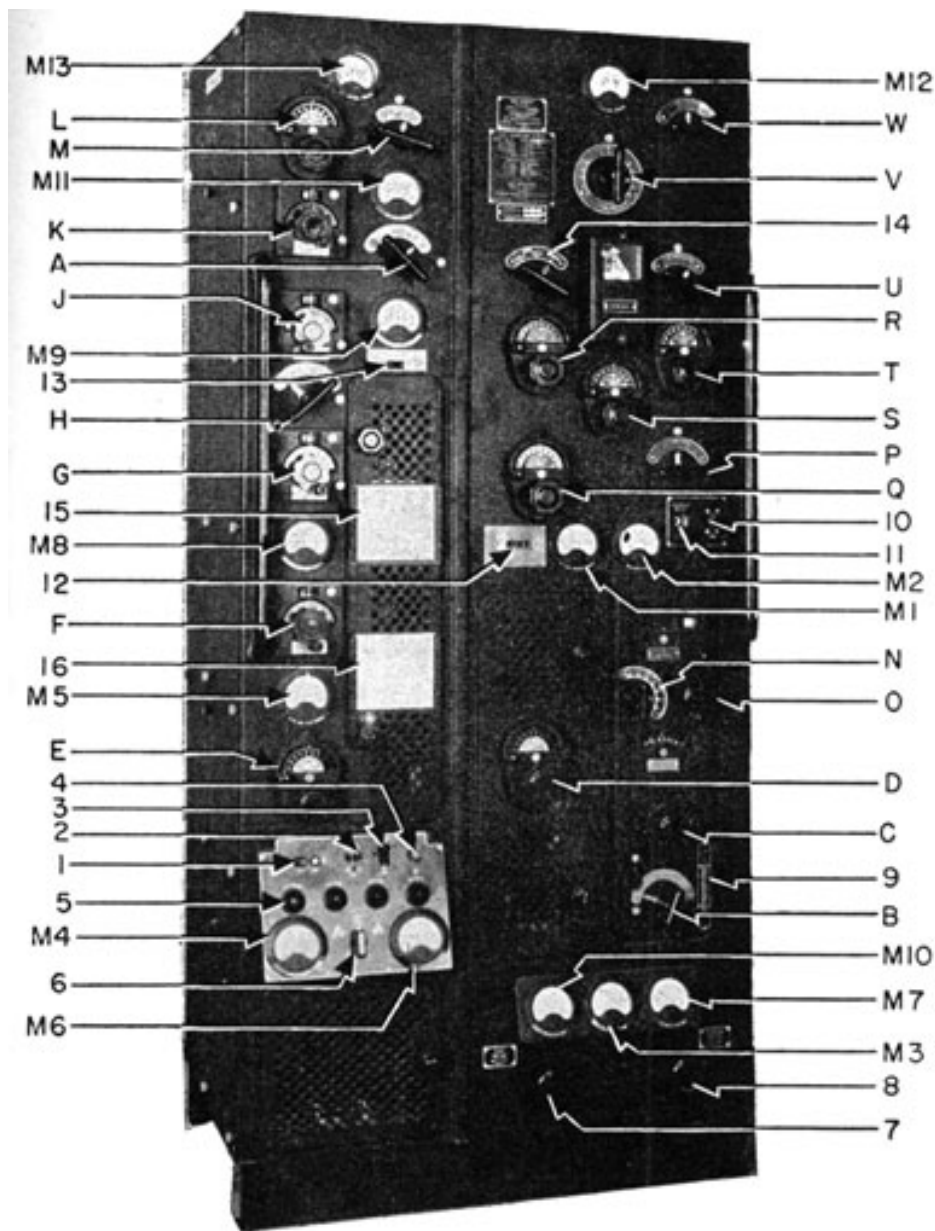

Figure 164.-The TBL-5 transmitter.

- C. MASTER OSCILLATOR TUNING A variable inductance that selects the frequency within the frequency range determined by the setting of control *B*.
- D. DOUBLER CIRCUIT TUNING This control tunes the grid circuit of the first intermediate amplifier stage.

- E. 1st INTERMEDIATE AMPLIFIER TUNING Tunes the plate circuit of the 1st intermediate amplifier stage.
- F. 2nd INTERMEDIATE AMPLIFIER TUNING This control tunes the plate circuit of the 2nd intermediate amplifier.
- G. POWER AMPLIFIER TUNING Tunes the plate circuit of the power amplifier stage.
- H. RANGE SWITCH Selects the frequency range for the tuning of the intermediate and power amplifier stages.
- J. ANTENNA COUPLING CONTROL Sets the degree of coupling between the power amplifier and antenna circuits.
- K. ANTENNA TUNING INDUCTANCE This control adjusts a variable inductance in the antenna circuit.
- L. ANTENNA CAPACITOR This control adjusts a variable capacitor in the antenna circuit.
- M. ANTENNA FEED SWITCH A two-position switch. Selects either CURRENT or VOLTAGE feed, depending on the length of the antenna and the frequency of the transmitter.

LOW FREQUENCY SECTION-TUNING CONTROLS

- N. MASTER OSCILLATOR RANGE A seven-position switch that sets the frequency range for the master oscillator.
- O. MASTER OSCILLATOR TUNING A variable inductance that tunes the oscillator within the frequency range determined by the setting of control *N*.
- P. RANGE SWITCH A five-position switch that selects the frequency range for the tuning of the intermediate and power amplifier stages.
- Q. INTERMEDIATE AMPLIFIER TUNING Tunes the plate circuit of the intermediate amplifier plate circuit.
- R. POWER AMPLIFIER TUNING This control tunes the plate circuit of the power amplifier stage.
- S. ANTENNA COUPLING Sets the degree of coupling between the power amplifier and antenna circuits.
- T. ANTENNA TUNING Adjusts a variable inductance in the antenna circuit. This control is used in conjunction with control *V*.
- U. ANTENNA SERIES CAPACITOR A two-position switch. It connects IN, or shorts OUT, a series condenser in the

antenna circuit. This antenna permits you to use higher frequency antennas on this low frequency range.

V. ANTENNA INDUCTANCE A 15-position switch that connects the desired amount of inductance into the antenna circuit. It is used in connection with control *T*.

METERS ON THE TBL 5 TRANSMITTING EQUIPMENT

M1. H.F., M.O., SCREEN CURRENTS	Indicates H.F. master oscillator screen current.
M2. H.F., M.O., PLATE CURRENT	Indicates the H.F. master oscillator plate currents.
M3. MASTER OSCILLATOR PLATE VOLTAGE	Indicates the plate voltage applied to the master oscillator circuit.
M4. LINE VOLTAGE	Indicates the line voltage.
M5. 1st INTERMEDIATE AMPLIFIER PLATE CURRENT	Indicates the current flowing in the plate circuit of the 1st intermediate amplifier stage.
M6. BIAS VOLTAGE METER	Indicates the bias voltage.
M7. FILAMENT VOLTAGES	Indicates the filament voltage.
M8. 2nd INTERMEDIATE AMPLIFIER PLATE CURRENT	Indicates the current flowing in the plate circuit of the 2nd intermediate amplifier.
M9. POWER AMPLIFIER GRID CURRENT	Indicates the grid current flowing in the power amplifier grid circuit.
M10. PLATE VOLTAGE	Indicates the voltage applied to the amplifier plate circuits of the amplifier.
M11. POWER AMPLIFIER PLATE CURRENT	Indicates the current flowing in the plate circuit of the power amplifier stage.
M12. ANTENNA CURRENT, I.F.	Indicates the I.F. antenna circuit.
M13. ANTENNA CURRENT, H.F.	Indicates the H.F. antenna circuit.

6991980-46-18

OPERATION OF THE TBL-5 TRANSMITTER

GENERAL

1. In this discussion the dial settings indicated on the calibration card are assumed to be correct. Extreme care must be exercised in tuning the H.F. master oscillator doubler circuit that you don't select and tune to the wrong harmonic. If resonance cannot be obtained within two or three dial divisions of the position indicated on the calibration card, recheck the calibration.
2. The method employed in using the frequency meter to check the master oscillator frequency, depends upon the inter-connecting circuits between frequency meter and oscillator. Check with your chief for the proper procedure with your particular installation.
3. The maximum permissible power amplifier plate current varies with the transmitter's frequency. Therefore, it is necessary to check the instruction book of the calibration card for the correct values each time you change frequency or type of emission.
4. The output power of the transmitter can be reduced by decreasing the coupling between the power amplifier stage and the antenna circuit, or by reducing the plate voltage by turning the PLATE VOLTAGE rheostat counter clockwise. The reduction in output power from C.W. to M.C.W. or VOICE operation is usually accomplished by reducing the coupling.

TUNING THE HIGH FREQUENCY SECTION FOR C. W. EMISSION

1. Set the following controls and switches in the indicated positions.

CONTROL	POSITION
TRANSFER SWITCH, control A	H.F.
ANTENNA TRANSFER, control W	H.F.

266

ANTENNA COUPLING, control J	0
OPERATE-TUNE switch	TUNING 1
PHONE-C.W.-M.C.W.	C.W.
P.A. GRID CURRENT CONTROL TO RAISE	
EMERGENCY SWITCH	ON

2. Set the following controls in the position indicated on the calibration card for the desired frequency.

MASTER OSCILLATOR RANGE, control *B*
MASTER OSCILLATOR TUNING, control *C*
DOUBLER CIRCUIT TUNING, control *D*.
1st INT. AMP. TUNING, control *E*
2nd INT. AMP. TUNING, control *F*
POWER AMPLIFIER TUNING, control *G*
RANGE SWITCH, control *H*
ANTENNA FEED, control *M*

3. Press the START button. Then adjust FILAMENT VOLTAGE rheostat until FILAMENT VOLTAGE meter, *M7*, indicates 10 volts.

4. Set frequency meter to the desired frequency, and with the test key depressed, tune the master oscillator to zero beat. BE SURE you are tuning on the correct harmonic. The final setting of the M.O. TUNING, control *C*, will be within two or three scale divisions of the setting indicated on the calibration card.

5. When ZERO BEAT has been obtained, depress the TEST KEY. The M.O. SCREEN CURRENT meter should indicate about 11 ma., and the M.O. PLATE CURRENT should be about 40 and 60 ma., depending on the frequency setting of the oscillator.

6. Place the TUNE-OPERATE switch in the TUNING 2 position. Depress the TEST KEY and tune each of the following stages to resonance as indicated. BE VERY CAREFUL in tuning the DOUBLE CIRCUIT, or you may tune on the WRONG HARMONIC. The correct setting will be VERY NEAR the setting indicated on the calibration card.

267

a. Adjust DOUBLER TUNING, control *D*, for maximum indication on the 1st INT. AMP. PLATE CURRENT, meter *M5*.

b. Adjust 1st INT. AMP. TUNING, control *E*, for maximum indication on the 2nd INT. AMP. GRID CURRENT, meter *M8*.

c. Adjust 2nd INT. AMP. TUNING, control *F*, for maximum indication on the P.A. GRID current, meter *M9*. PRECAUTION: If the P.A. PLATE CURRENT becomes excessive, reduce the plate voltage by turning the GENERATOR FIELD rheostat counter clockwise.

d. Adjust P.A. AMP. TUNING, control *G*, for minimum indication on the P.A. PLATE current, meter *M11*.

7. Adjust ANTENNA INDUCTANCE, control *K*, and antenna CAPACITOR, control *L*, until a maximum antenna CURRENT indication on meter *M13*, or an increase in the P.A. PLATE CURRENT, meter *M11*, is obtained. If no indication can be obtained, or a rise in power amplifier plate current is not observed, slightly increase the setting of the antenna COUPLING, control *J*, until an indication is obtained.

8. If it is still impossible to obtain an antenna current indication or a rise in power amplifier plate current,

change the setting of the ANTENNA FEED, control *M*, to the OTHER position, and continue the adjustments of controls *K* and *L*, until resonance is obtained.

9. As soon as resonance has been obtained, place the TUNE-OPERATE switch in the OPERATE position, then adjust the PLATE VOLTAGE rheostat for a 2,000 volt indication on the PLATE VOLTAGE, meter *M10*.

10. Increase ANTENNA COUPLING, control *J*, and readjust controls *K* and *L* until a maximum antenna current is obtained with exactly 350 ma. of plate current as indicated by meter *M11*.

268

11. Check for the presence of overcoupling as outlined on page 283. If overcoupling is present, reduce the setting of ANTENNA COUPLING, control *J*, until the condition is remedied. Don't be surprised if the maximum obtainable plate current without overcoupling is less than 350 ma.

12. Check the P.A. GRID CURRENT, meter *M9*. If the indication is more than 90 ma., place the P.A. GRID CURRENT, control *I3*, in the TO LOWER position.

13. Final check. Observe all meter indications. If they are much in error from the indications given on the calibration card, slightly readjust the controls necessary to correct the indications. The P.A. PLATE CURRENT must not exceed 350 ma, with 2,000 volts applied to the plate circuit.

ADJUSTMENTS FOR VOICE EMISSION

1. Tune as outlined for C.W. emission. When tuning has been completed, place the PHONE-C.W.-M.C. W. switch in the PHONE position. Reduce the output power by reducing the setting of the ANTENNA COUPLING, control *J*, until the proper P.A. PLATE CURRENT indication is obtained for the frequency of transmission.

ADJUSTMENTS FOR REMOTE OPERATION

1. Place the REMOTE-LOCAL switch in REMOTE position. The transmitter then can be started, stopped, and keyed from the remote stations about the ship. Complete supervisory control always remains with the operator at the transmitter regardless of the setting of the REMOTE-LOCAL switch.

TUNING THE LOW FREQUENCY SECTION FOR C.W. EMISSION

1. Set the following controls and switches in the indicated positions.

CONTROL	POSITION
TRANSFER SWITCH, control <i>A</i>	I.F.
ANTENNA TRANSFER, control <i>W</i>	I.F.
ANTENNA COUPLING, control <i>S</i>	ZERO
ANTENNA SERIES CAPACITOR, control <i>V</i>	OUT

TUNE-OPERATE, SWITCH	TUNING 1.
PHONE-C.W.-M.C.W. SWITCH	C.W.
REMOTE-LOCAL SWITCH	LOCAL
P.A. GRID CURRENT CONTROL	To RAISE
EMERGENCY SWITCH	ON

2. Set the following controls in the positions indicated on the calibration card for the desired frequency.

MASTER OSCILLATOR RANGE, control *N*.
 MASTER OSCILLATOR TUNING, control *O*.
 RANGE SWITCH, control *P*.
 INTERMEDIATE AMPLIFIER TUNING, control *Q*.
 POWER AMPLIFIER TUNING, control *R*.

3. Press the START button, and adjust the FILAMENT VOLTAGE rheostat until a 10 volt indication is obtained on the FILAMENT VOLTAGE, meter *M7*.

4. Set frequency meter to the desired frequency, and with the TEST KEY depressed, tune the master oscillator to zero beat. Be sure you are tuning to the correct harmonic. The final setting of the M.O. TUNING, control *O*, will be within two or three scale divisions of the setting indicated on the calibration card. When properly set, the M.O. PLATE CURRENT, meter *M2*, should indicate 45 ma.

5. Place TUNE-OPERATE switch on TUNING 2, and adjust PLATE VOLTAGE rheostat until an indication of 2,000 volts is obtained on the PLATE VOLTAGE, meter *M10*, with the TEST KEY up.

6. With the TEST KEY depressed, tune each of the following stages until resonance is indicated.

a. INT. AMP. TUNING, control *Q*, for minimum indication on the P.A. PLATE CURRENT, meter *M8*.

b. P.A. TUNING, control *R*, for minimum indication on the P.A. PLATE CURRENT, meter *M11*.

7. Increase the setting of the ANTENNA COUPLING, control *S*, by approximately 20 scale divisions.

8. Rotate the ANTENNA TUNING, control *R*, throughout its entire range for each setting of the

ANTENNA INDUCTANCE, switch *V*, until resonance is obtained. Resonance will be indicated by a rise in P.A. PLATE CURRENT, an indication on the ANTENNA CURRENT METER, meter *M12*, or both. Continue to adjust controls *T* and *V* until a maximum indication is obtained on the ANTENNA CURRENT, meter *M12*.

9. Place the TUNE-OPERATE switch in the OPERATE position.

10. Increase the setting of the ANTENNA COUPLING, control *S*, until the P.A. PLATE CURRENT stops rising. NEVER EXCEED 350 ma. indication on the P.A. PLATE CURRENT, meter *M11*.

11. Check for the presence of overcoupling as outlined on page 283. If overcoupling is present, reduce the setting of the ANTENNA COUPLING, control *S*, until the condition is remedied. Don't be surprised if the maximum obtainable plate current without overcoupling is less than 350 ma. Do NOT readjust the P.A. TUNING, control *R*. It was correctly tuned when the ANTENNA COUPLING was set near zero.

ADJUSTMENTS FOR M.C.W. OR VOICE EMISSION

1. Tune as outlined for C.W. emission. When the tuning has been completed, place the C.W.-M.C.W.-PHONE switch to either M.C.W. or PHONE. decrease the output power by reducing the setting of the ANTENNA COUPLING, control *S*, until the proper P.A. PLATE CURRENT indication is obtained for the type of emission selected at the frequency of transmission.

ADJUSTMENTS FOR REMOTE OPERATION

1. Place the REMOTE-LOCAL switch in REMOTE position. The transmitter then can be started, stopped, and keyed from the remote stations about the ship. Complete supervisory control always remains with the operator at the transmitter regardless of the setting of the REMOTE-LOCAL switch.

THE TDE RADIO TRANSMITTING EQUIPMENT

The TDE radio transmitter is actually two separate transmitters in a single cabinet. The INTERMEDIATE FREQUENCY units, 300 to 1,500 kc., occupies the section to your right. The HIGH FREQUENCY components, 1,500 to 18,000 kc., are housed in the section to your left. Controls and meters common to both sections are mounted on the middle section of the control panel.

The bottom part of the assembly contains the power supplies, rectifiers, filters, and motor-generator set. Some installations have the power supply and transmitter units separated. This allows the transmitter to be placed on a bench, with the power supply unit in some out-of-the-way place.

The output of the transmitter may be C.W., M.C.W., or VOICE. The nominal output power is 125 watts on C.W., 35 watts on M.C.W., and 20 watts with voice. The output power from either transmitter may be varied from full power to about 1/4 full power by decreasing the ANTENNA COUPLING CONTROL, which is in the antenna circuit of each transmitter.

The antenna circuits contain a switching system which permits the antenna feed to be switched from CURRENT to VOLTAGE feed. The setting of the ANTENNA FEED CONTROL depends upon the length of the antenna and the frequency of the transmitter.

A MODULATOR UNIT, common to both the I.F. and H.F. transmitters is included in the transmitter assembly. When the transmitter is set on M.C.W., the modulator unit acts as an audio oscillator, producing an 800 cycle note.

The equipment can be controlled and keyed by using either the remote control unit supplied with the TDE transmitter, or the Navy standard four-six wire remote control systems. For remote telephone operation, either the remote control unit supplied, or a Navy Radiophone unit (Navy type 23211 or 23172) may be used.

272

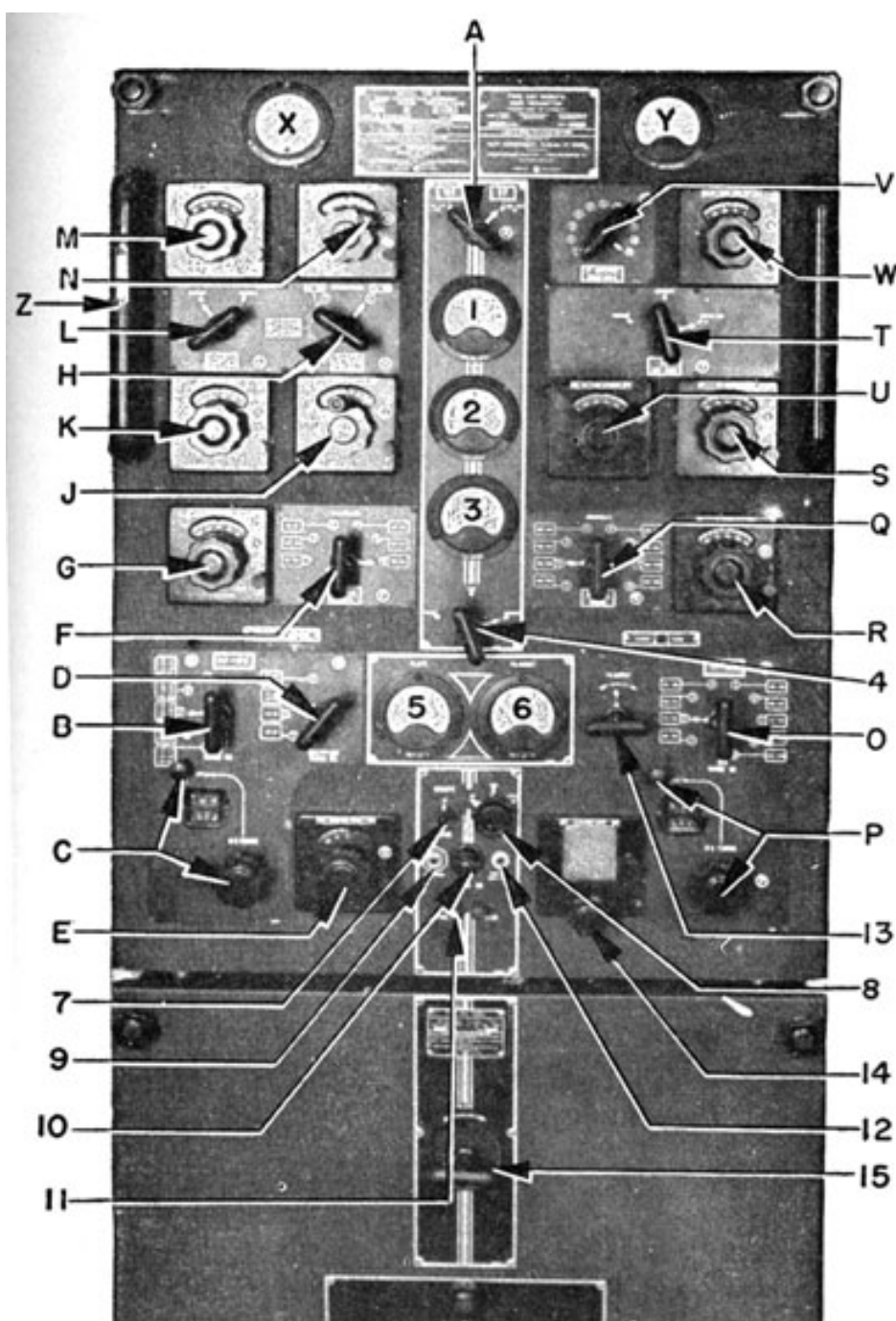



Figure 165.-The TDE transmitter.

273

Legend for Figure 165.

COMMON CONTROLS

- | | |
|--|--|
| 1. POWER AMPLIFIER PLATE CURRENT METER | Indicates the plate current flowing in either the I.F. or H.F. section of the power amplifier stage, depending on the setting of control A. |
| 2. POWER AMPLIFIER GRID CURRENT METER | Indicates the grid current flowing in the grid circuits of either the I.F. or H.F. sections of the power amplifier stages, depending on the setting of control A. |
| 3. INTERMEDIATE AMPLIFIER GRID CURRENT METER | Indicates the grid current flowing in the grid circuits of either the I.F. or H.F. sections of the intermediate amplifier stages, depending on the setting of control A. |
| 4. ADJUST-TUNE-OPERATE SWITCH | The ADJUST position permits the tuning of the oscillator, but disconnects the INT-AMP, and P.A. from the circuits. The TUNE position operates all stages, but at reduced power. The OPERATE position applies full power to all stages. |
| 5. PLATE VOLTAGE METER | Indicates the plate voltage being delivered by the high voltage generator. |
| 6. FILAMENT VOLTAGE METER | Indicates the filament voltage being applied to the tube filaments. |
| 7. REMOTE-LOCAL SWITCH | Sets the location of control for transmitter. |
| 8. C.W.-M.C.W.-VOICE SWITCH | Selects type of emission for the transmitter. |
| 9. MICROPHONE JACK | Self explanatory. |
| 10. PILOT LIGHT | Indicates whether power is ON or OFF. |
| 11. START-STOP SWITCH | Self explanatory. |
| 12. FREQUENCY METER OUTPUT JACK | You plug a set of earphones into this jack to check the transmitter's frequency. |

- | | |
|---------------------------|--|
| 13. FILAMENT RHEOSTAT | Adjusts the voltage applied to the vacuum tube filaments. |
| 14. CALIBRATION CHART | Indicates the settings of the controls for the various frequencies. |
| 15. PLATE VOLTAGE CONTROL | Adjusts the voltage being applied to the plate circuits of the vacuum tubes. |

274

- A. I.F., H.F. SELECTOR SWITCH Selects the section of the transmitter to be used. Operation of this switch transfers the COMMON controls and meters from one section to the other.
- Z. TEST KEY Use to test transmitter while tuning.

INTERMEDIATE FREQUENCY BAND CONTROLS

(Operative when I.F., H.F. switch is set in I.F. position)

- | | |
|--|---|
| Y. ANTENNA CURRENT | Indicates the antenna current. |
| V. ANTENNA INDUCTANCE CONTROL | This switch selects the portion of the antenna loading coil necessary in the tuning of the antenna circuit. |
| W. ANTENNA TUNING INDUCTANCE | A FINE control for the tuning of the antenna circuit. |
| T. ANTENNA FEED CONTROL | Selects the type of antenna feed, CURRENT or VOLTAGE. The setting of this control depends on the frequency and length of antenna. |
| U. ANTENNA TUNING CAPACITOR | Adjusts a variable condenser in the antenna circuit. Used with antenna tuning inductance to resonate the antenna circuit. |
| S. ANTENNA COUPLING CONTROL | Adjusts the degree of coupling between the PA and antenna circuits. |
| Q. POWER AMPLIFIER RANGE CONTROL | Selects the degree of capacity and inductance in the plate circuit of the power amplifier stage. |
| R. POWER AMPLIFIER TUNING CONTROL | This control adjusts a variable inductance in the plate circuit of the P.A. stage. Used to make the FINE adjustments in tuning of the P.A. stage. |
| Q. MASTER OSCILLATOR RANGE CONTROL | Selects the degree of inductance and capacity required for the tuning of the M. O. |
| P. MASTER OSCILLATOR TUNING CONTROL AND LOCK | This control adjusts a variable inductance in the grid circuit of the M. O., for the FINE adjustment of the oscillator. |

HIGH FREQUENCY BAND CONTROLS

(Operative when the I.F., H.F. switch is set in I.F. position)

X. ANTENNA CURRENT Indicates the current flowing in the antenna circuit.

275

M. ANTENNA TUNING CAPACITOR

This control adjusts a variable condenser in the antenna circuit. It is used with the ANTENNA TUNING INDUCTANCE in resonating the antenna circuit.

N. ANTENNA TUNING INDUCTANCE

This control adjusts a variable inductance in the antenna circuit. It is used with the ANTENNA TUNING CAPACITOR in resonating the antenna circuit.

L. ANTENNA FEED CONTROL

Selects the type of feed, CURRENT OR VOLTAGE, necessary to resonate the antenna circuit. The setting of this control depends upon the FREQUENCY and LENGTH of the antenna.

H. POWER AMPLIFIER RANGE CONTROL

Selects the proper amount of inductance necessary for the tuning of the P. A. stage.

K. ANTENNA COUPLING CONTROL

Adjusts a variable condenser between the P. A. plate circuit and the antenna circuit. The condenser determines the degree of coupling between the two circuits.

J. POWER AMPLIFIER TUNING CONTROL

This control adjusts a variable condenser and inductance in the plate circuit of the P. A. stage. This control is used to resonate the P. A. plate circuit.

G. INTERMEDIATE FREQUENCY TUNING CONTROL

This control adjusts a variable condenser in the plate circuit of the I.A.

F. INTERMEDIATE FREQUENCY RANGE CONTROL

This control is a rotary switch that Selects the proper degree of inductance for the tuning of the I.A. plate circuit.

E. MULTIPLIER TUNING CONTROL

This control adjusts a variable condenser in the grid circuit of the I.A. stage. It is used with the MULTIPLIER RANGE CONTROL.

D. MULTIPLIER RANGE CONTROL

A rotary switch that selects the proper amount of inductance for the tuning of the grid circuit of the I.A. The reason for calling it a MULTIPLIER is that it is usually tuned to a HARMONIC of the M. O.

B. MASTER OSCILLATOR RANGE CONTROL

A rotary switch that selects the proper degree of inductance and capacity for the tuning of the M. O. grid tank.

276

C. MASTER OSCILLATOR TUNING CONTROL This control adjusts a variable inductance in the grid circuit of the master oscillator for the fine adjustments of the oscillator's frequency.

OPERATION

GENERAL

In these instructions it is assumed that the transmitter has been calibrated, and the dial settings from the various frequencies are correct as indicated. If discrepancies are present, or the transmitter fails to operate properly as indicated by the meters, call a technician.

PRECAUTIONS

The maximum permissible plate current for the final amplifier for the three types of emission, **WHEN LOADED TO THE ANTENNA CIRCUIT**, is as follows:

C.W. 175 ma. at 2,000 volts

M.C.W. 120 ma. at 2,000 volts

Voice 110 ma. at 2,000 volts

Under conditions of non-resonance in the P.A. tank, the product of plate current and plate voltage should not exceed 125 watts.

TUNING THE HIGH FREQUENCY SECTION FOR C.W. EMISSION.

1. Set the following controls and switches in the indicated positions.

CONTROL	POSITION
H.F.-I.F. switch, control <i>A</i>	H.F.
REMOTE-LOCAL switch	LOCAL
ADJUST-TUNE-OPERATE switch	ADJUST
C.W.-M.C.W.-VOICE switch	C.W.
PLATE VOLTAGE rheostat	FULLY COUNTERCLOCKWISE
ANTENNA COUPLING, control <i>K</i>	15
ANTENNA TUNING CAPACITOR, control <i>M</i>	0
ANTENNA TUNING INDUCTANCE, control <i>N</i>	0

2. Set the following controls in the positions indicated on the calibration card.

M. O. RANGE, control *B*
M. O. TUNING, control *C*
MULTIPLIER RANGE, control *D*
MULTIPLIER TUNING, control *E*
I. A. RANGE, control *F*
I. A. TUNING, control *G*
P. A. RANGE, control *H*
P. A. TUNING, control *J*
ANT. FEED, control *L*

3. Set up the FREQUENCY METER on the desired transmitter frequency, and make the necessary patch cord connections between transmitter and frequency meter.

4. Press the START button and adjust FILAMENT rheostat control until the FILAMENT meter indicates 10 volts.

5. Press TEST button on the handrail, and tune the M.O. by adjusting the M.O. TUNING, control *C*, until a zero beat is obtained in the vicinity of its preliminary setting. Disconnect frequency meter.

6. Place ADJUST-TUNE-OPERATE switch in TUNE position .

7. If MULTIPLIER RANGE, control *D*, is in the 1.5 to 3.0 mc. position, the MULTIPLIER TUNING, control *E*, is inoperative. In this condition, the I.A. GRID current should not exceed 0.5 ma. When the MULTIPLIER RANGE, control *D*, is in ANY OTHER POSITION, adjust MULTIPLIER TUNING, control *E*, for maximum I.A. GRID current. It should read between 2 and 5 ma.

8. Adjust I.A. TUNING, control *G*, for maximum P.A. GRID current. It should be between 30 and 50 ma.

9. Adjust P.A. TUNING, control *J*, for minimum P.A. PLATE current.

10. All the adjustments in the next following step are performed with the TEST button depressed.

11. Perform ONLY AS MANY STEPS, *a* through *c*, as is necessary to resonate the antenna circuit. Resonance will be indicated by a MAXIMUM antenna current, or an INCREASE in P.A. PLATE CURRENT, or both. Do not continue to make adjustments after resonance has been obtained.

a. Rotate ANTENNA TUNING CAPACITOR, control *M*, to about midscale, and at the same time rotate the ANTENNA TUNING INDUCTANCE, control *N*, to the highest limit of the dial reading. If resonance is not obtained, continue to rotate ANTENNA TUNING CAPACITOR, control *M*, to the highest limit of the dial reading.

b. If resonance still has not been obtained, change the setting of the ANTENNA FEED, switch *L*, to the other position.

c. Rotate ANTENNA TUNING CAPACITOR, control *M*, to about midscale, and at the same time rotate the ANTENNA TUNING INDUCTANCE, control *N*, from its highest setting to the lowest setting. If resonance is not obtained, continue to rotate ANTENNA TUNING CAPACITOR, control *M*, to the lowest limit of the dial.

d. If resonance still has not been obtained, and the P.A. RANGE switch is set for 1.5 to 2.6 range, try successively the other positions of this switch, each time repeating the procedure outline in steps *a*, *b*, and *c*.

e. Should you still be unable to tune the antenna circuit to resonance, increase the setting of the ANTENNA COUPLING, control *K*, by 10 divisions and repeat steps *a* through *d*.

12. When the antenna circuit has been tuned to resonance, place the ADJUST-TUNE-OPERATE switch in the OPERATE position, and adjust the PLATE VOLTAGE rheostat to a position where the PLATE VOLTAGE meter indicates 2,000 volts.

279

13. To insure full power operation, readjust the following controls slightly until the indicated meter readings are obtained.

a. P.A. TUNING, control *J*-for minimum P.A. PLATE current.

b. ANT. TUNING CAPACITOR, control *M*-for maximum ANTENNA current.

c. P.A. TUNING, control *J*-for minimum P.A. PLATE current.

d. Increase ANTENNA COUPLING, control *K*, 5 to 10 dial divisions and repeat steps *a*, *b*, and *c*.

14. Repeat step 13 as many times as it is necessary until a P.A. PLATE current of 175 ma. is obtained without overcoupling. (See note on overcoupling on page 283.) If overcoupling exists between power amplifier and antenna circuits, REDUCE the coupling until the condition is remedied, REGARDLESS of whether the indication on the P.A. PLATE current meter is of the maximum value or not.

ADJUSTMENT FOR M.C.W. EMISSION.

1. Repeat the tuning procedure for C.W. emission, and then place the C.W.-M.C.W.-VOICE switch in the M.C.W. position. Adjust the ANTENNA COUPLING, control *K*, decreasing or increasing as necessary, to obtain a P.A. PLATE CURRENT not in excess of 120 ma. Be sure the antenna circuit is not overcoupled to the power amplifier stage. For each change in ANTENNA COUPLING, repeat step 13.

ADJUSTMENTS FOR VOICE EMISSION.

1. For voice operation, the tuning procedure is the same as for C.W. emission, except the power amplifier stage is not loaded in excess of 110 ma. remember, with this transmitter you reduce the loading of the power amplifier by reducing the ANTENNA COUPLING.

280

TUNING THE INTERMEDIATE FREQUENCY SECTION FOR C.W. EMISSION.

1. Set the following controls and switches in the indicated positions.

CONTROL	POSITION
REMOTE-LOCAL switch	LOCAL
C.W.-M.C.W.-VOICE switch	C.W.
H.F.-I.F. switch	I.F.
ADJUST-TUNE-OPERATE switch	OPERATE
PLATE VOLTAGE rheostat	FULLY COUNTERCLOCKWISE
ANTENNA COUPLING, control <i>S</i>	0
ANTENNA FEED, control <i>T</i>	CURRENT

2. Set the following lettered controls to the position indicated on the calibration card:

M.O. RANGE, control *O*.
 M.O. TUNING, control *P*.
 P.A. RANGE, control *Q*.
 P.A. TUNING, control *R*.

3. Repeat the tuning procedure outlined in steps 3 through 7 for tuning the H.F. section of the transmitter.

4. Adjust P.A. TUNING, control *R*, for minimum indication on the P.A. PLATE current meter.

5. Increase the ANTENNA COUPLING, control *S*, to read 15 scale divisions.

6. All the adjustments in the next step are performed with the TEST button depressed.

7. Perform ONLY AS MANY STEPS, *a* through *d*, as is necessary to resonate the antenna circuit. Resonance will be indicated by a MAXIMUM antenna current, or an INCREASE in P.A. PLATE current, or both. Do not continue to make adjustments after resonance has been obtained.

a. Rotate the ANTENNA TUNING INDUCTANCE, CONTROL *W*, throughout its entire tuning range. If resonance cannot be obtained, continue to rotate

699198°-4a-19

281

the ANTENNA TUNING INDUCTANCE, control *W*, throughout its entire tuning range for each position of ANTENNA INDUCTANCE, switch *V*.

b. If resonance has not been obtained, place ANTENNA FEED, switch *T*, on SERIES CAP position and repeat step *a*.

c. Should it still be impossible to obtain a resonant setting, place ANTENNA FEED, switch *T*, on VOLTAGE, and repeat step *a*.

d. If resonance still is not obtained, increase the dial setting of the ANTENNA COUPLING, control *S*, by 10 divisions, and continue the tuning outlined in steps *a* through *c*, until resonance is obtained.

8. Place the ADJUST-TUNE-OPERATE switch in the OPERATE position, and adjust the PLATE VOLTAGE rheostat until an indication of 2,000 volts is obtained on the PLATE VOLTMETER.

9. Retune the antenna system for maximum antenna current, then adjust the ANTENNA COUPLING, control *S*, for a reading of 175 on the P.A. PLATE current meter, or until the antenna current stops increasing as the coupling is increased, whichever occurs first. Do not readjust the P.A. TUNING, Control *R*, during this final tuning step.

ADJUSTMENT FOR M.C.W. EMISSION.

1. Place the C.W.-M.C.W.-VOICE switch on the M.C.W position. Adjust the ANTENNA COUPLING, CONTROL *S*, so that the P.A. PLATE current meter does not indicate over 120 ma.

ADJUSTMENT FOR VOICE EMISSION.

1. Place the C.W.-M.C.W.-VOICE switch on the VOICE position. Adjust the ANTENNA COUPLING, control *S*, until the P.A. PLATE current meter does not indicate over 110 ma.

CONTROL OF THE TRANSMITTER.

1. Control of the transmitter can be given to any

remote station by placing the REMOTE-LOCAL switch in the REMOTE position, and then making the necessary patch cord connections on the transfer panels. Remember, regardless of the setting of the REMOTE-LOCAL switch, the transmitter may be started or stopped by the operator at the transmitter.

OPERATION WITH REDUCED POWER.

1. The output power of the transmitter can be reduced to about 25 percent of its full rated value by decreasing the coupling between the power amplifier and antenna circuits. In the H.F. sections, this is done by decreasing the setting of ANTENNA COUPLING, control *K*. In the I.F. section, it is done by reducing the setting of ANTENNA COUPLING, control *S*.

CHECKS FOR DETERMINING THE PRESENCE OF OVER-COUPLING.

The table on this page will aid you in determining whether or not overcoupling exists between the power amplifier and the plate circuit. Remember that you vary the controls only SLIGHTLY off resonance in making the tests.

CONTROL VARIED	METER INDICATION	OVERCOUPLED
ANTENNA TUNING CAPACITOR	DECREASE IN P.A. PLATE CURRENT	NO
ANTENNA TUNING CAPACITOR	INCREASE IN P.A. PLATE CURRENT	YES
ANTENNA COUPLING INCREASED	DECREASE IN P.A. PLATE CURRENT	YES
ANTENNA COUPLING INCREASED	INCREASE IN P.A. PLATE CURRENT	NO
ANTENNA COUPLING INCREASED	DECREASE OF ANTENNA CURRENT	YES
ANTENNA COUPLING INCREASED	INCREASE OF ANTENNA CURRENT	NO

THE TBS RADIO TRANSMITTING AND RECEIVING EQUIPMENT

The TBS radio transmitting and receiving equipment is designed to provide short-range communication between surface craft such as task forces or convoys. While in theory the radius of communication of the TBS is limited to approximately the horizon, actual contacts of many times this range are on record. (See chapter 14.) The type of emission may be either VOICE or M.C.W., with 50 watts of power.

Transmitter frequency is determined by a crystal oscillator within a single band of 60 to 80 mc. The NUMBER of usable frequencies is determined by the supply of available crystals that will produce an output frequency within the band.

The frequency marked on the crystal holder is actually the third harmonic of the crystal. The output frequency is four times the crystal frequency, and is obtained by two frequency doubler stages following the oscillator. Each time you wish to change transmitter frequency, it is necessary to exchange the crystal being used with the one of the desired frequency.

The oscillator stage of the receiver is also crystal controlled, so that you must change crystals each time you wish to change the receiver's frequency. Tuning the receiver is done by adjusting the r.f. sections, so that the incoming signal will produce with the oscillator frequency, an intermediate frequency of 5.3 mc.

Control of the set can be exercised either locally or from several designed TBS remote control units. These remote control units have outlets for a handset, a chestset, and a loudspeaker.

Power to operate the TBS is derived directly from motor-generator sets, with appropriate magnetic controllers. The power to drive the motor-generators is obtained from a variety of d.c. and a.c. sources. The chief difference in the various TBS models is in the motor-generator units used.

284

A single antenna serves both the transmitter and receiver. When the Press-To-Talk switch on the handset or chestset is closed, the antenna is connected to the transmitter by a relay. While the Press-To-Talk switch is open, the antenna is connected to the receiver. This feature permits continued monitoring for incoming signals.

The transmitter section may be turned on from a remote station, but the receiver must be switched on locally. The power to operate the receiver is taken directly from a 110/120 volt, 60 cycle, single-phase line. By this arrangement, the receiver may be used as a separate unit while the transmitter is not energized.



Figure 166.-The TBS transmitter-receiver.

When necessary, the transmitter and receiver may be separated and used as individual units, but design and construction make for better operation when the two sections are installed as a single unit.

285

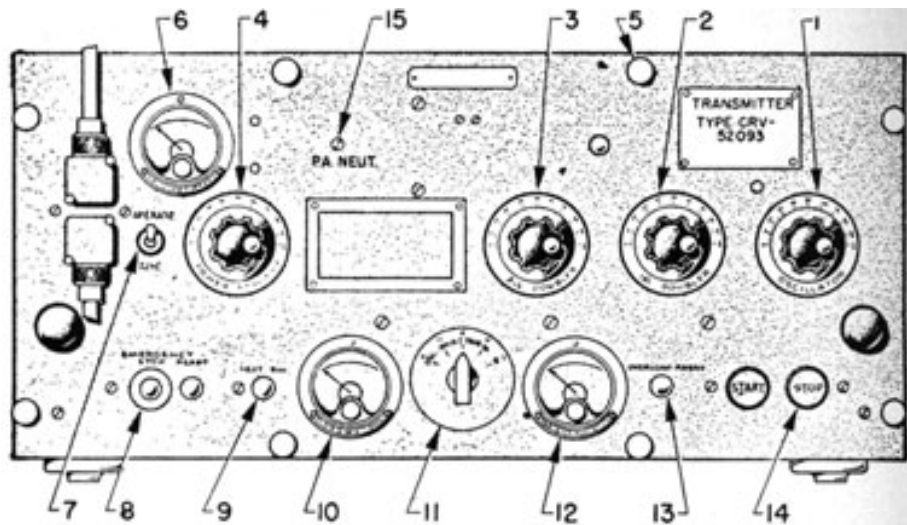

Figure 167.-The TBS transmitter control panel.
TRANSMITTER CONTROL PANEL

- | | |
|----------------------------------|---|
| 1. OSCILLATOR DIAL | Tunes the oscillator plate circuit. |
| 2. 1st DOUBLER DIAL | Tunes the plate circuit of 1st amplifier stage to twice the oscillator frequency. |
| 3. 2nd DOUBLER DIAL | Tunes the plate circuit of the 2nd amplifier stage to twice the frequency of the 1st amplifier stage. |
| 4. POWER AMPLIFIER DIAL | Tunes the power amplifier plate circuit to resonance at the frequency of the 2nd amplifier stage. |
| 5. PILOT LIGHT BULL'S-EYE | Indicates when the motor-generator set is running. |
| 6. R.F.-LINE CURRENT METER | Indicates the r.f. current flowing in the antenna circuit. |
| 7. TUNE-OPERATE SWITCH | Limits the current flowing through the tubes while you are tuning the transmitter. When the set is tuned, this switch is always in the OPERATE position. |
| 8. EMERGENCY STOP-RESET SWITCH | You press the stop button when it is necessary to make a quick shut down of the set. |
| 286 | |
| 9. TEST SWITCH BUTTON | You press this switch to TEST the transmitter while tuning. Pressing this button applies power to the tubes; releasing the button shuts off the power. |
| 10. PLATE AND GRID CURRENT METER | This meter shows the current flowing in the plate and grid circuits of the transmitter. The current indicated depends upon the setting of the METER SWITCH. |
| 11. METER SWITCH | A five-position switch-O.S.C. I_P -1 DOUB. I_P -2 DOUB. I_P -P.A. I_P - and P.A. I_G . |
| 12. PERCENT MODULATION METER | Indicates the percent of modulation present with the carrier wave. |

13. OVERLOAD RESET BUTTON

This control resets the overload relay after it has been opened by an overload circuit.

14. START-STOP PUSH BUTTON

Used to start and stop the motor-generator.

15. P.A. NEUT. ADJUSTMENT

This adjustment is seldom used by the operator. When this control requires adjustment, call a technician.

RECEIVER CONTROLS PANEL

1. POWER PILOT LIGHT

Indicates power ON or OFF.

2. ANTENNA KNOB

Tune r.f. input to the receiver.

3. LINK KNOB

Tunes the plate circuit of first r.f. stage.

4. DETECTOR KNOB

TUNES the grid circuit of the first detector stage.

5. 2nd DOUBLER KNOB

Tunes the plate circuit of 2nd doubler stage to twice the frequency of the 1st doubler stage.

6. 1st DOUBLER KNOB

Tunes the plate circuit of 1st doubler stage to twice the frequency of the oscillator stage.

7. OSCILLATOR KNOB

Tunes the plate circuit of the crystal oscillator stage.

8. OUTPUT METER PUSH BUTTON Pressing this button connects the output meter into the output of the last audio stage.

287

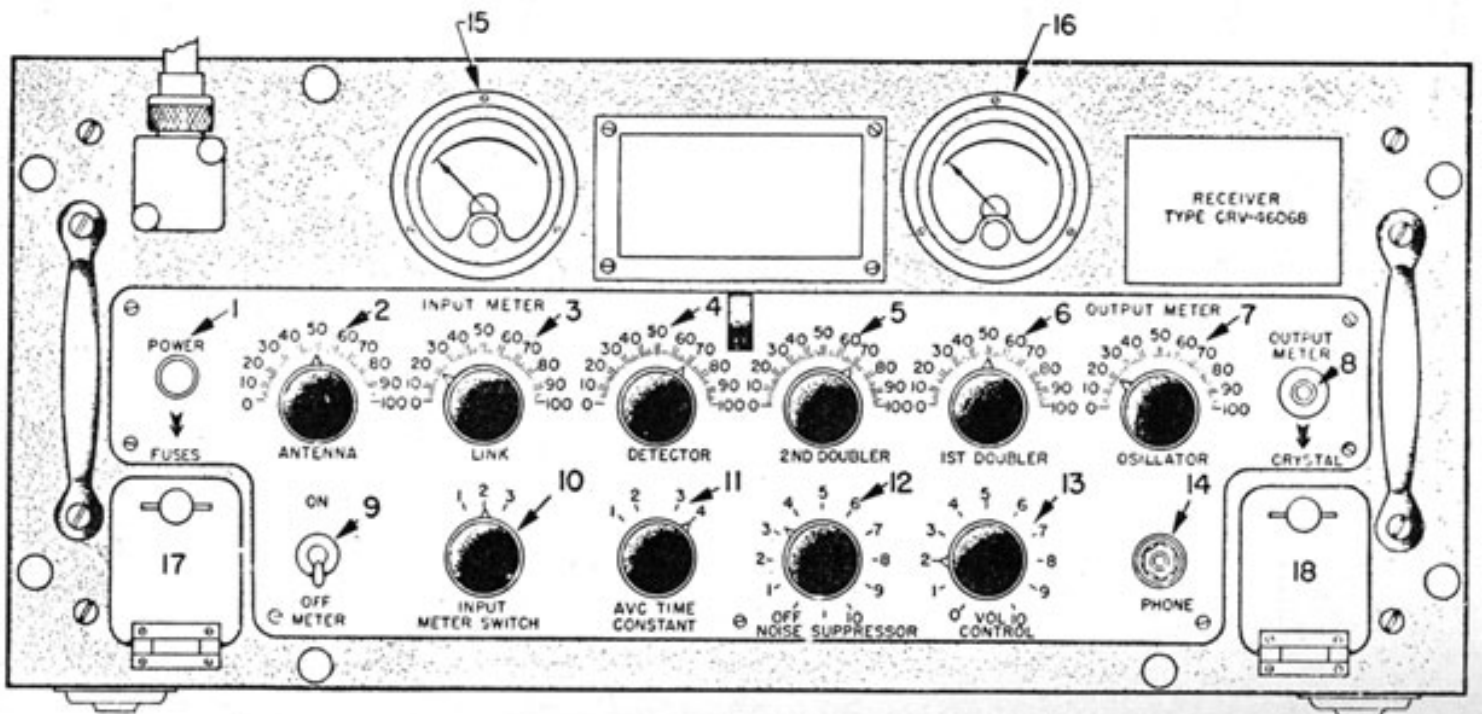

Figure 168.-The TBS receiver control panel.

288

- | | |
|---------------------------------|--|
| 9. POWER, OFF-ON, SWITCH | This switch turns the receiver ON and OFF. |
| 10. INPUT METER SWITCH | This is a three-position switch. It connects the input meter into the cathode circuits to show current flowing in the R.F. AMPLIFIER, 1st DETECTOR, and I.F. AMPLIFIER stages. |
| 11. A.V.C. TIME CONSTANT SWITCH | A four-position switch that sets the speed at which the A.V.C. reacts. |
| 12. NOISE SUPPRESSOR KNOB | Set the level of noise suppression desired. This control also reduces the volume, so that on low signal strength it may be necessary to turn this control off. |
| 13. VOL. CONTROL KNOB | This control sets the level of the desired volume. |
| 14. PHONE JACK | A jack for plugging in a headset. |
| 15. INPUT METER | Indicates the current flowing in the cathode circuits to 1st R.F. AMPLIFIER, 1st DETECTOR, and I.F. stages. |
| 16. OUTPUT METER | This meter indicates the level of audio signal being delivered to the remote or local headsets. |
| 17. FUSE CHAMBER | Access to this chamber is gained through a small door to your left on the panel. |
| 18. CRYSTAL CHAMBER | This chamber contains the crystal for the local oscillator. To change crystal, open access door, remove crystal, and insert the one of the desired frequency. |

OPERATION OF THE TBS TRANSMITTER

1. Check the following controls to see they are set in the indicated positions:

CONTROL	POSITION
START-STOP	STOP
OVERLOAD RESET	PRESS
EMERGENCY	RESET
TUNE-OPERATE	TUNE
METER SWITCH	OSCILLATOR

2. Release thumb screws and lift top cover of transmitter. Insert the crystal of the desired frequency in the crystal holder found in the right-front corner of the chassis. Close and fasten cover.
3. Set all tuning dials in approximately the correct position as indicated by calibration card. Press START button.
4. Adjust OSCILLATOR dial until the PLATE and GRID CURRENT meter drops to minimum. It should indicate about 25 ma. This is just a preliminary setting of the OSCILLATOR dial.
5. Turn METER SWITCH to 1st DOUBLER position. adjust 1st DOUBLER dial until a minimum indication is obtained on PLATE and GRID CURRENT meter. It should be about 35 ma. Make this adjustment CAREFULLY, because the dip may be slight, and can be missed easily.
6. Rotate METER SWITCH TO I_p -1st DOUBLER position. Adjust 2nd DOUBLER dial until a minimum indication is obtained on PLATE and GRID CURRENT meter. It should read about 40 ma.
7. Set METER SWITCH on I_p -PA. Adjust POWER AMPLIFIER dial until a minimum indication is obtained on the PLATE and GRID CURRENT meter. It should read about 70 ma.
8. Place TUNE-OPERATE switch in OPERATE position. The PLATE and GRID CURRENT meter should show close to 115 ma. If the meter indicates a current either above or below this value, call a technician to make the necessary adjustments.
9. Turn METER SWITCH to I_G -PA. Carefully adjust both DOUBLER dials until a MAXIMUM indication is obtained on PLATE and GRID CURRENT meter. Next, detune, the OSCILLATOR slightly by moving the OSCILLATOR dial a few points TOWARD the HIGH end of the dial. The PLATE and GRID CURRENT meter should show about 35 ma.
10. Lock all tuning controls in place. The transmitter is now ready for operation.

290

To change frequency, turn transmitter off, replace the crystal with one of the desired frequency, and repeat the tuning procedure outlined above.

OPERATION OF THE TBS RECEIVER

1. Set the following receiver controls (lower row) in the indicated positions:

CONTROL	POSITION
INPUT METER SWITCH	3
A.V.C.TIME CONSTANT	1
NOISE SUPPRESSOR	OFF
VOLUME CONTROL	5

2. Turn receiver ON and allow it to warm several minutes before tuning. With INPUT METER switch on position three, adjust OSCILLATOR dial slowly until there is a sharp dip of the INPUT METER needle. Then move the OSCILLATOR dial SLIGHTLY to the right of the point where the minimum indication is obtained.
3. Place INPUT METER switch on position numeral. Adjust the 1st and 2nd DOUBLER dials until a maximum reading is indicated on the INPUT METER. These dial settings will be close to the settings of the OSCILLATOR dial.
4. Turn INPUT METER switch to position one, and adjust ANTENNA, LINK, and DETECTOR dials until a maximum is obtained on OUTPUT METER, or until a maximum NOISE is heard in the headset or loud speaker. When frequencies near the lower end of the band are being used, all the tuning dial settings will be nearly the same. At the high end of the band, the antenna, link, and detector dials may vary from the oscillator setting.
5. After tuning is completed, the VOLUME CONTROL is usually advanced to about 6 or 7 depending on the strength of the signal and background noises.
6. Turn the NOISE SUPPRESSOR up until as much as possible of the undesirable background noise is

291

eliminated without cutting off the weakest signal. With very weak signals, this control may have to be turned all the way off.

7. Set the A.V.C. TIME CONSTANT to the position indicated for the condition of the operation described.

POSITION 1 High speed telegraphy; telephone communication; when rapid fading is present.

POSITION 2 Medium speed telegraphy; medium rates of fading.

POSITION 3 Slow telegraphic speeds; slow fading.

8. After final adjustments have been completed, close hinged door and lock in position. If signal strength falls off, check tuning of receiver. If tuning is correct, turn up volume control. With very weak signals, it may be necessary to turn the noise suppressor down.
9. Remember, the receiver can not be turned on or off from a remote station. You must do that manually at the set.

THE TDQ RADIO TRANSMITTING EQUIPMENT

The Navy model, TDQ radio transmitting equipment is a very high frequency transmitter, 115 to 156 mc., specifically designed for voice or M.C.W. communication with aircraft.

A crystal oscillator containing four interchangeable crystals determines the specific frequency being used.

The nominal output power of the transmitter is 45 watts. The modulator unit is capable of voice modulating the carrier wave up to 100 percent. On M.C.W. transmission, modulation up to 85 percent with a 1,000 cycle note is possible. Keying speeds up to 40 words per minute are permissible.

You may operate the transmitter on a 115 volt or a 230 volt, 50/60 cycle line supply. It may also be used with a 440 volt, 50/60 cycle supply by using an

292

appropriate step down transformer. When 115 or 230 volt d.c. supply is to be used, a motor-generator unit with a magnetic controller must be used.

Three separate units are contained in the TDQ cabinet. The radio frequency equipment occupies the top portion, the modulator the middle section, and the power supply the lower portions of the cabinet.

Operation of the transmitter is possible from either a local or any one of several remote stations. The TDQ is intended to be used with the RCK receiver. Both transmitter and receiver can be controlled from any remote unit.

A single vertical dipole antenna is used with the TDQ, and is connected to the transmitter by a coaxial

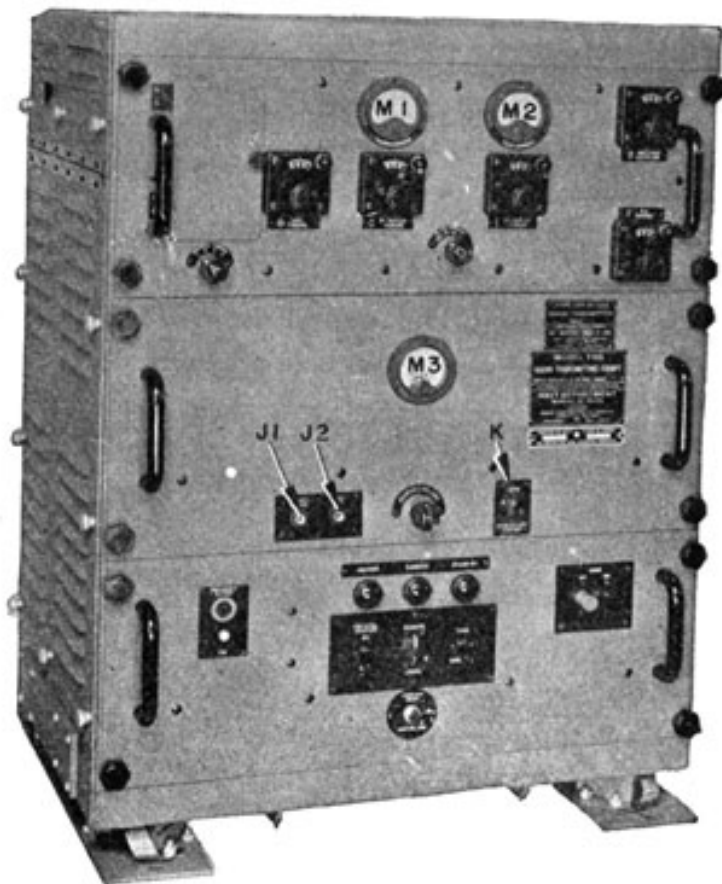

Figure 169.-The TDQ transmitter.

transmission line. A special 10 foot length of coaxial cable is used with all installations that require a transmission line over 100 feet.

RADIO FREQUENCY SECTION

- | | |
|--|---|
| A. CRYSTAL SWITCH | A four-position switch. Selects the crystal for the frequency desired. |
| B. OSCILLATOR TUNING | This control tunes the plate circuit of the oscillator to resonance. |
| C. FIRST TRIPLER TUNING | This control tunes the plate circuit of the first amplifier stage to resonance at the third harmonic of the crystal frequency. |
| D. PLATE CURRENT SWITCH | A four-position switch-OSCILLATOR, 1st TRIPLER, 2nd TRIPLER, and POWER AMPLIFIER. By using this switch, a single meter, <i>M2</i> , can be used to show the plate current flowing in each of the four indicated circuits. |
| E. 2nd TRIPLER TUNING | This control tunes the plate circuit of the second amplifier stage to resonance at a frequency equal to three times the frequency of the first amplifier stage. |
| F. POWER AMPLIFIER TUNING | Adjusting this control tunes the plate circuit of the power amplifier stage to resonance at the frequency of the second amplifier stage. |
| G. ANTENNA COUPLING | Adjusts the degree of coupling between the power amplifier plate circuit, and the antenna circuit. |
| M1. POWER AMPLIFIER GRID CURRENT METER | Indicates the grid current flowing in the power amplifier grid circuit. |
| M2. PLATE CURRENT METER | This meter indicates the current flowing in circuits selected by the plate current switch. (Modulator section.) |
| M3. DECIBEL METER | Indicates the level of the audio volume delivered by the modulator unit to the transmitter. |
| J1. MICROPHONE JACK | The jack for the microphone. |
| J2. HEADSET JACK | The jack for the headset; used when adjusting the transmitter. |
| H. HEADSET VOLUME | Controls the level of sound being delivered by the modulator to the headset. |

K. TEST KEY A three-position SWITCH-LOCK, NEUTRAL, and MOMENTARY. Used in testing the transmitter while you are tuning it.

POWER SUPPLY SECTION

EMERGENCY STOP SWITCH	Used to turn the transmitter off when the situation demands a quick shut-down.
INDICATOR LIGHTS	HEATER indicates when the heater circuit for the crystal heat chamber is energized. CARRIER-this light is on when the microphone, PRESS TO TALK, button is closed. STANDBY - this light indicates when the modulator and r.f. units are energized.
CRYSTAL HEATER SWITCH	Two-position switch, ON and OFF. Applies the energy to the CRYSTAL HEAT CHAMBER.
REMOTE-LOCAL SWITCH	Transfers control of transmitter from a remote unit to you at the transmitter.
START-STOP SWITCH	Turns the set on and off.
TUNE-OPERATE	This switch is used to prevent damage to the transmitter while tuning is in progress.
OVERLOAD RESET	Resets the overload relay after it has opened.

OPERATION OF THE TDQ TRANSMITTER

GENERAL

1. The frequency of the TDQ transmitter is limited to the frequencies of the harmonics produced by the four crystals. If other frequencies within the 115-156 mc. range are desired, it is necessary to interchange crystals. The door above the crystal selector switch provides access to the crystal heater chamber.

2. Tuning the r.f. sections consists of resonating the oscillator plate circuit to the crystal frequency, the 1st tripler plate circuit to the third harmonic of the crystal frequency, and the 2nd tripler plate circuit to the third harmonic produced by the 1st tripler stage. The power amplifier is tuned to the frequency of the 2nd tripler stage.

STEPS IN TUNING

1. Set the following controls and switches in the indicated positions.

CONTROL	POSITION
EMERGENCY SWITCH	ON
CRYSTAL HEATER	ON
REMOTE-LOCAL	LOCAL
ANTENNA COUPLING, control G	ZERO
TEST KEY	NEUTRAL (middle)
TUNE-OPERATE	TUNE
START-STOP	START

2. Set the CRYSTAL SWITCH, control *A*, in the position of the desired frequency.

3. Place TEST KEY in LOCK position.

4. Turn PLATE CURRENT switch, control *D*, to O.S.C. position.

5. Refer to the calibration card and set O.S.C. TUNING, control *B*, in the position indicated by the card. Starting from slightly BELOW the correct setting, adjust the control until a minimum indication is obtained on the PLATE CURRENT, meter *M2*. Then continue to rotate control *B* toward the HIGH frequency end of the dial, until the PLATE CURRENT meter needle has increased about 1/2 a scale division. Lock control *B* in place.

6. Turn PLATE CURRENT, control *D*, to "1st *T*" position, and quickly adjust 1st TRIPLER TUNING, control *C*, until a minimum indication is obtained on the PLATE CURRENT, meter *M2*.

7. Turn PLATE CURRENT, control *D*, to "2nd *T*," and quickly adjust 2nd TRIPLER TUNING, control *E*, until a minimum indication is obtained on the PLATE CURRENT, meter *M2*.

8. Turn PLATE CURRENT control *D*, to "P.A." position, and quickly adjust P.A. TUNING, control *F*, until a minimum indication is obtained on the PLATE current, meter *M2*.

NOTE: For ALL THE FOLLOWING STEPS, place the TEST KEY in MOMENTARY position, when you are ACTUALLY ADJUSTING a dial. At all other times keep it in NEUTRAL position.

9. With the PLATE CURRENT, control *D*, in P.A. position, place the TUNE-OPERATE switch in OPERATE position. The plate current should read 100 ma., if the r.f. section is properly tuned.
10. Slowly increase the ANTENNA COUPLING, control *G*, a few degrees. Readjust control *F*, until a minimum indication on the PLATE CURRENT, meter *M2*, is obtained.
11. Continue to increase ANTENNA COUPLING, control *G*, and if necessary readjust P.A. TUNING, control *F*, until the PLATE CURRENT meter reads 230 ma. Do NOT increase plate current beyond 230 ma.
12. Check the P.A. GRID CURRENT, meter *M1*. It should indicate 11 to 15 ma. If it is either too high or too low, call a technician.
13. Press STOP button, and place the REMOTE-LOCAL switch in REMOTE position.
14. The transmitter can be started or stopped, and transmit voice or M.C.W. messages from any remote station.

ROUTING OPERATION OF THE TDQ TRANSMITTER

1. Do NOT operate transmitter-that is, press TEST KEY, TELEGRAPH KEY, or PRESS-TO-TALK microphone button-unless the transmission line is connected to the transmitter.
2. When the transmitter is properly tuned, the TUNE-OPERATE switch will be in OPERATE position, the TEST KEY in NEUTRAL, and the EMERGENCY switch ON.
3. Normally the CRYSTAL HEAT switch will be ON at all times. The HEATER indicator light will be on unless the heater chamber is above 70° C. The thermostat will then open the heater circuit and turn Out the HEATER indicator light. When the

699198 °-X46-20

temperature of the heater chamber falls below 70° C, the thermostat will close and turn the indicator light on.

LOCAL TEST FOR OPERATION OF THE MODULATOR

1. Place REMOTE-LOCAL switch in LOCAL position. Insert microphone plug in MICROPHONE jack, and headset plug in HEADSET jack.
2. Hold the PRESS-TO-TALK microphone button. The CARRIER indicator lamp will come on and stay on as long as the PRESS-TO-TALK button is closed.
3. To hear the incoming signal, provided the TDQ has the necessary receiving equipment installed with it, release the PRESS-TO-TALK button. The incoming message will be received instantly. However, if the transmitter is being used for M.C.W. transmission, a one second delay will occur before the incoming message can be heard.
4. To control the volume of either the OUTGOING or INCOMING signal, adjust HEADSET VOLUME, control *H*.

THE TBY TRANSMITTER-RECEIVER EQUIPMENTS

The Navy model TBY sets are very high frequency, portable, transmitter-receivers. They are capable of two-way communication by either VOICE or M.C.W. telegraphy on any one of 130 different channels within a frequency range of 28 to 80 mc.

These sets have battery power supplies, and are designed for transportation as a knapsack load. They also can be operated by the man who is carrying them on his back.

Both transmitter and receiver are housed in a lightweight aluminum cabinet to which the battery power supply is strapped. The entire assembly is contained in a canvas carrying case. The case may be partially or fully removed from the transmitter-receiver as is desired for the operation of the set.

298

All the operating controls are located on a recessed front panel. The top of the cabinet is equipped with a strap handle to facilitate carrying when the unit is out of its case.

The antenna supports are located on the left side of the cabinet. The antenna itself is in 10 sections, fitted together in a "fish-pole" fashion to form a completed unit nine feet long. The length and diameter of each section depends on its position in the completed assembly. The end of each section is color coded to facilitate the proper assembly of the antenna.

Microphone-headphone assemblies consist of an aircraft anti-noise type microphone and a special lightweight headphone. The microphone is equipped with a PRESS-TO-TALK switch, which transfers the transmitter-receiver units from "receive" to "transmit" when pressed. Each transmitter-receiver unit has two jacks, which permit the simultaneous use of two microphone-headphone assemblies.

Only one operator may actually control the equipment at a time. The second operator acts as a monitor during the operation. Control of the equipment may be transferred from one operator to the other at will.

The key, cord, and plug assembly consists of a specially designed key housing in a small aluminum box. In addition to the key, this unit contains a SEND-RECEIVER switch that performs the same function as the press-to-talk switch on the microphone. The whole unit is covered with a rubber cap. This protects the key when the set is operating in rain or in the presence of spray.

The battery pack is strapped to the underside of the transmitter-receiver unit. It is equipped with a receptacle which automatically makes the electrical connection to the transmitter-receiver unit when the battery is installed, thereby facilitating rapid change of batteries. The complete battery unit is encased in a lightweight metal container which protects the battery from becoming defective when set in water or other foreign matter up to a depth of approximately two inches.

299



Figure 170.-The TBY transmitter-receiver.

THE TBY TRANSMITTER-RECEIVER CONTROLS

TRANS. TUNING CONTROL	This is the vernier control used in the transmitter.
TRANS. BAND SWITCH	A four-position switch that roughly selects the transmitter's frequency.
TRANS. ANT. LOADING CONTROL	This control tunes the transmitter antenna circuit.
RECEIVER TUNING CONTROL	This is the vernier control used in tuning the receiver. The two dials to the right of this knob indicate the setting of the RECEIVER TUNING control.
RECEIVER BAND SWITCH	A four-position switch that roughly selects the receiver's frequency.

300

REC. ANT. TUNING CONTROL	This control tunes the input r.f. stage of the receiver.
LOCK	The two locks on either side of the meter lock the tuning controls in place.
VOLUME CONTROL	Controls receiver volume.
REGEN. CONTROL	Regulates the operation of the detector.
METER	This meter indicates the a.f. filament voltages, r.f. filament voltages, and transmitter plate current, depending on the setting of the METER SWITCH. The "white square" at the middle of the meter face is the only marking used in reading the meter.
METER SWITCH (Directly below meter)	A three position switch that connects the meter into the following circuits: "AUDIO FIL."-Voltage. "TRANS PLATE MA."-Current. "R.F. FIL."-Voltage.
AUDIO FIL. RHEOSTAT	Adjusts the voltage applied to the filaments of the a.f. tubes.
R.F.FIL. RHEOSTAT	Adjusts the voltage applied to the filaments of the r.f. tubes.
PHONE AND MIC. JACKS	Jacks for receiving plugs from handset or chestset cords.
POWER, ON-OFF SWITCH KEY jack	Turns transmitter-receiver ON or OFF. Jack for receiving plug from hand-key cord.
CRYSTAL, ON-OFF SWITCH	This switch connects calibration crystal either IN or OUT of the circuit.
TELEGRAPH KEY (Box on top of cabinet)	This box contains the telegraph key and SEND-RECEIVER switch.

OPERATIONS OF THE TBY TRANSMITTER-RECEIVER

The frequency range of this equipment, as previously explained, is 28 to 80 megacycles. Throughout this range, the equipment is calibrated for operation on any one of 130 channels separated from each other by

400 kc. The calibration chart on the top cover of the transmitter-receiver unit gives the dial settings and antenna sections to be used for each of these channels. The channels are numbered from 1 through 130, with No. 1 channel being

301

the 28 megacycle point and No. 130 the 80 megacycle point. No reference to frequency is made on the calibration chart as all data are listed according to the channel number. Operation should therefore be conducted on channel assignments rather than frequency assignments. Typical tuning data is included in the chart below.

CHANNEL NUMBER	ANTENNA SECTIONS	TRANSMITTER BAND - DIAL	RECEIVER BAND - DIAL
50	6	3-279	2-998
51	6	3-304	2-1014
52	6	3-328	3-167

If the equipment is to be operated at a fixed location, the operating site selected should be clear and free from obstructing objects such as trees, hills, and the like.

When the equipment is to be operated from a man's back, the tuning procedure for the transmitter differs slightly from the procedure for a fixed position.

PRELIMINARY

1. Remove the antenna sections from their pocket in the side of the canvas case, and assemble the NUMBER of sections indicated in the calibration chart for operation on the desired channel.
2. Remove the combination microphone-headphone assembly and the key, cord, and plug assembly from the pocket at the top of the knapsack. Plug them into the proper receptacles in the front of the panel.
3. Refer to the calibration chart and set the TRANSMITTER BAND and RECEIVER BAND selector switches and both TRANSMITTER and RECEIVER TUNING CONTROLS to the points indicated for the desired CHANNEL. Turn set ON.
4. Turn METER SWITCH to R.F. FILAMENT voltage, and adjust R.F. FILAMENT RHEOSTAT until the meter needle is in the center of the white mark. Next turn the METER SWITCH to AUDIO FILAMENT voltage and adjust AUDIO FILAMENT RHEOSTAT until the meter needle is in the center of the white mark.

302

RECEIVER ADJUSTMENTS

1. Adjust the VOLUME control to approximately its mid-position. Then advance the REGENERATION control clockwise from its extreme left hand position until a definite "rushing" or "hissing" sound is heard in the headphone.
2. Set RECEIVER ANTENNA TUNING control to approximately resonance. This is an estimated setting. When the control is in the extreme counterclockwise position, it is set for the high frequency end of the band.
3. Tune in the desired signal by slight readjustment of the RECEIVER TUNING control, if necessary. correct tuning is indicated by the presence of a minimum of hissing noise.
4. Complete the RECEIVER ANTENNA TUNING until a minimum amount of hissing noise is heard in the headset.
5. Make the final adjustment of the REGENERATION control by setting it at a point just ABOVE the point where the hissing noise appears.

TRANSMITTER ADJUSTMENTS

1. Turn METER SWITCH to TRANSMITTER PLATE MA. position. Push press-to-talk button on the microphone, or place the SEND-RECEIVE switch on the key to SEND position.
2. With the SEND-RECEIVE switch in SEND position, adjust TRANSMITTER ANTENNA LOADING control until the meter needle is in the center of the white mark on the meter face. This adjustment should always be made by approaching the proper plate current value by a clockwise rotation of the antenna control from a ZERO setting.

TELEPHONE OPERATION

1. For telephone operation, after the above adjustments have been made, it is only necessary to press the press-to-talk button on the microphone and talk normally into the microphone. The SEND-

RECEIVE switch on the key must be in the RECEIVE position when telephone operation of the transmitter is being used.

TELEGRAPHIC OPERATION

1. For M.C.W. operation of the transmitter, place the SEND-RECEIVE switch in SEND position and operate the key. While M.C.W. operation is being used, a side tone is heard in the headphones making it possible for the operator to hear his own message.

OPERATION WHILE BEING TRANSPORTED ON A MAN'S BACK

1. The operation and tuning of the receiver when the transmitter-receiver unit is being transported on a man's back is exactly the same as it is for operation from a fixed position, since the receiver is not affected by the proximity to the man's body.

2. However, transmitter operation and output frequency are somewhat affected by the nearness of the man's body to the antenna. Therefore, a few slight changes in tuning of the transmitter are necessary.

3. First, tune the transmitter in the normal manner while it is setting in a fixed position. After a normal tuning, ADVANCE the TRANSMITTER ANTENNA LOADING control until the meter needle is about 1/8 inch beyond the white mark.

4. Lift the transmitter to the man's back, and notice the reduction in TRANSMITTER PLATE current. If the needle comes to rest in the center of the white mark, the adjustment is correct. If the needle remains above the white mark, reduce the TRANSMITTER ANTENNA LOADING control until the setting is correct. If the TRANSMITTER PLATE current is less than normal, increase the setting of the TRANSMITTER ANTENNA LOADING.

RECALIBRATION OF TBY TRANSMITTER-RECEIVER

Changing of vacuum tubes, long protracted usage of the set, and even periods of inoperation may cause the

304

frequency of the transmitter-receiver to shift. The amount of change in frequency is often great enough to cause the dial settings to be considerably in error. The crystal oscillator in the set permits you to discover the error and to make the necessary adjustments to compensate for this frequency change.

The crystal in the calibrator circuit is of a 5 me. frequency. The transmitter-receiver frequency is checked on some multiple of this frequency-such as 30, 35, or 40 me.-throughout the frequency band. The settings of the tuning controls for the 10 check points are clearly indicated on the calibration chart.

It is a good practice, to insure being on frequency, to make calibration checks each time before tuning, especially if the set has had continued use, or has been subjected to extensive handling. When making a calibration check, always use two or more check points. Don't depend on a single check to insure

accuracy.

RECEIVER CALIBRATION CHECK PROCEDURE

1. Turn the CRYSTAL ON-OFF SWITCH to ON. Set RECEIVER TUNING at the points indicated for the check point selected on the calibration chart. Adjust RECEIVER TUNING control, and RECEIVER ANTENNA TUNING control if necessary, to a point where the hissing sound is minimum. The receiver is tuned to the frequency of the crystal.
2. Turn crystal ON and OFF several times. If the hissing sound appears and disappears each time the crystal is turned off and on, you have the receiver tuned to the correct harmonic of the crystal. If the signal does not appear and disappear, adjust tuning control until it does.
3. When the receiver has been tuned sharply to the crystal frequency, record the dial settings. Check these settings against the calibration chart. If calibration of receiver is correct, these settings will be the same.
4. If the dial readings and indicated chart settings are different, record this difference and use it as a

305

"correction factor" in tuning the receiver. Example: If the chart indicates the RECEIVER TUNING should be set on 3-983, but the calibration shows the setting to be 3-987, the chart settings of the dial are four points TOO LOW. Therefore, for each setting on the calibration chart, add four points.

5. If the difference between the actual setting and chart indications is as much as 20 points, take the set to a technician for adjustment.

TRANSMITTER CALIBRATION CHECK PROCEDURE

1. Place the set in operation in the normal procedure, and tune the transmitter to one of the indicated check points.
2. Turn the CRYSTAL ON-OFF SWITCH to ON. Adjust the TRANSMITTER TUNING control until a whistling beat note is heard. Continue to adjust the tuning control until the low pitched beat note just disappears. If the tuning control is correctly set, the beat note will reappear when the tuning control is moved in either direction.
3. While you are making the above adjustment, remain IN ONE POSITION, preferably as far below and to the right of the antenna as possible.
4. When making calibration checks be sure to keep TRANSMITTER PLATE MA. normal at all times.
5. If the settings for the controls indicated on the chart are correct, they should be the same as the dial settings. If the dial setting and chart indications are different, use this difference as a correction factor the same as with the receiver sections. Be sure, if the dial settings are lower than the chart indications, to subtract the differences from the chart indications.

6. If calibration shows chart settings to be considerably in error, take the set to a technician.

306



[Previous Chapter](#)



[Radio Home
Page](#)



[Next Chapter](#)

Copyright (C) 2005 [Historic Naval Ships Association](#)

All Rights Reserved

[Legal Notices and Privacy Policy](#)

Version 1.00, 12 Nov 05



CHAPTER 23

NAVY RECEIVERS

INTRODUCTION

Navy receivers are precision instruments, designed to bring in messages under the most adverse conditions. They are highly selective and sensitive, but careless, improper tuning can cause the set to lose half or more of its efficiency. Therefore, it is necessary for you to learn properly and practice diligently the tuning procedures. After a short time the operation of receivers such as the RBB or RBC will become nearly automatic.

The Navy receivers discussed in this chapter are not the only types you will find on ships and shore stations, but they are the sets you will find most frequently. Some of the models will be used daily and others only occasionally for special purposes. Regardless of how much or how often, you must learn how to tune all models on your ship or station. You can expect to be called upon to operate any set in an emergency.

The instructions in this chapter have been taken from the manufacturers' instruction books. They are

summaries and will serve as a guide while learning. You should obtain the manufacturers' instruction books at the earliest opportunity and study them.

You can expect to find variations in the techniques of tuning. Step 3 may become step 1, and step 5 omitted entirely, but whatever the method or system used, be sure you are getting the most out of your receiver.

The use of special controls designed to eliminate the interference of noise and static is of considerable importance. A good operator, by intelligent use of these CONTROLS, can bring in a message clearly where a careless and inefficient operator will have his signal completely masked in noise.

THE MODEL RAK/RAL RECEIVERS

The models RAK/RAL are companion receivers, usually installed in pairs. They are designed to cover two

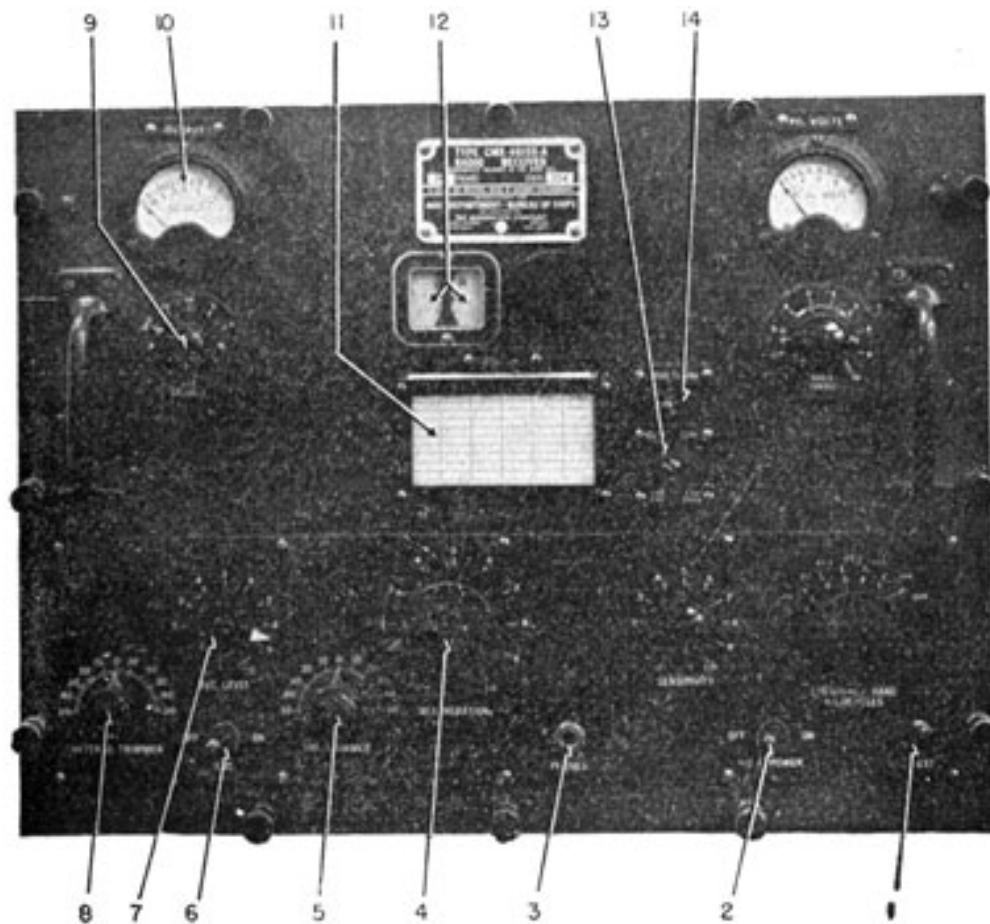

Figure 171A.-The RAK receiver.

frequency ranges-15-600 kc. in 6 bands for the RAK, and .3 -23 mc. in 9 bands for the RAL.

Both receivers are TRF, using two stages of tuned r.f. amplification and a regenerative detector, followed by two stages of audio amplification. Both have an output limiter circuit.

The sets are designed for C.W. reception, but can be used on I.C.W. or MOD.-C.W. The high selectivity, and the low-pass filter in the audio section of the RAL, results in considerable distortion of VOICE reception.

The production of the BEAT NOTE for C.W. reception is obtained by incorporating an AUTODYNE oscillator in the regenerative detector circuit. Since this type of oscillator requires frequent adjustment, a REGENERATION CONTROL is mounted on the operating panel. For C.W. reception, the REGENERATION control is adjusted to produce

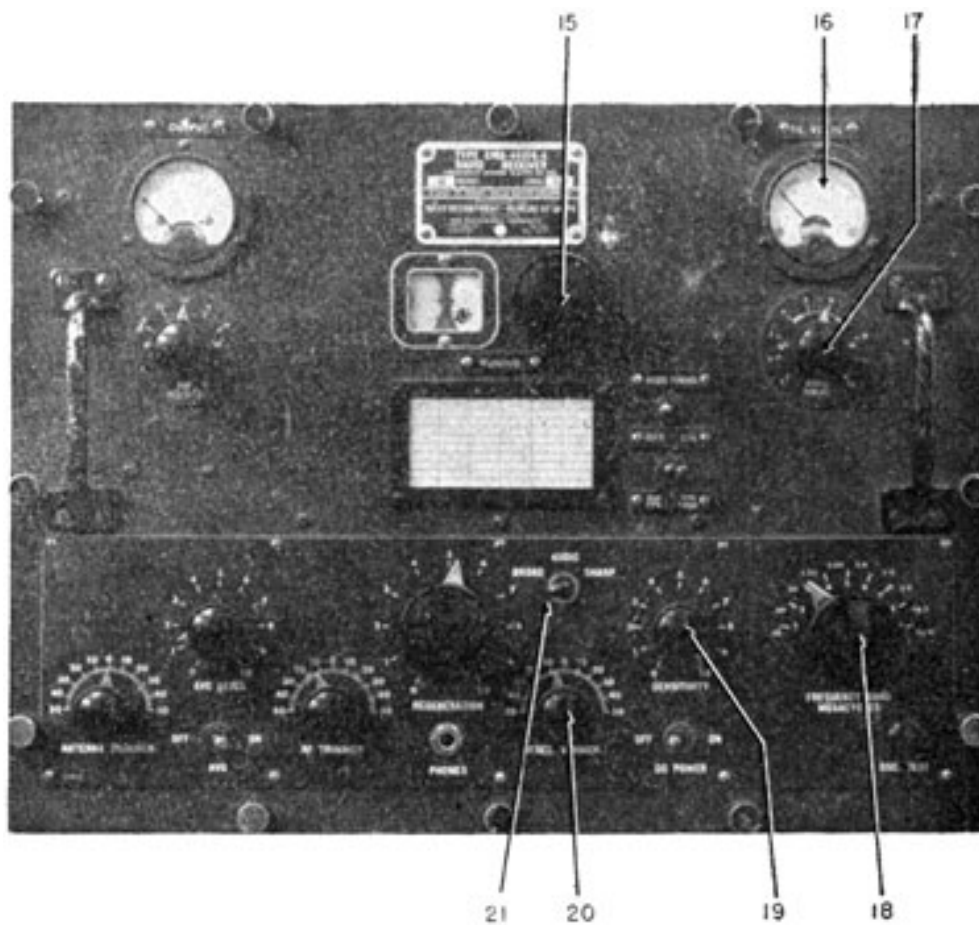

Figure 171B.-The RAL receiver.

oscillation; for I.C.W. and MOD.-C.W., the control is set just below the point of oscillation.

The RAL receiver has a FREQUENCY VERNIER connected into the autodyne circuit that permits variations in the pitch of the audio beat note. This control is not a part of the RAK equipment.

A LOW-PASS FILTER is included in both the RAK and RAL circuits. This filter has three controls: OFF-ON, a RANGE SWITCH, and a 10 point AUDIO TUNING dial. The RANGE SWITCH selects one of two frequency bands, 450-770 or 770-1300 cycles. The TUNING DIAL selects the desired frequency within these ranges.

The original RAK and RAL receivers were designed for d.c. operation. All subsequent modifications are designed for 110/120 volt, 60 cycle, single-phase, a.c., but have provisions for emergency d.c. operation.

Modifications 1 through 5 are substantially the same receiver. Modifications 6, 7, and 8 have increased protective shielding to prevent high frequency radar interference.

It is recommended that each RAK and RAL have a separate antenna, but when it is necessary to operate both from a common antenna, a loose input coupling must be used.

- | | |
|-------------------------|--|
| 1. OSCILLATOR TEST | This PUSH-BUTTON is used to determine whether the detector circuit is oscillating or not. When the button is depressed, a click is heard in the earphones. When released, another click is heard if the detector circuit is oscillating. No click, no oscillation. |
| 2. BATTERY OPERATION | This switch is used when set is being OFF-ON SWITCH operated from batteries. It is shorted out of the circuit for a.c. operation. |
| 3. PHONE JACK | Output of receiver for headset. |
| 4. REGENERATION CONTROL | Controls the oscillation of the regenerative detector. |

310

-
- | | |
|--------------------|---|
| 5. R.F. TRIMMER | Trimmer condenser in grid circuit of the 2nd r.f. stage. It is usually adjusted for maximum background noise at the high end of the dial each time the band is changed. |
| 6. A.V.C. OFF-ON | Automatic volume control, off-on switch. Always OFF for modulated signal reception. |
| 7. A.V.C. LEVEL | Sets the level of output volume when the a.v.c. switch is ON |
| 8. ANTENNA TRIMMER | Used the same way as the R.F. TRIMMER. Located in grid circuit of first R.F. stage. |
| 9. ADD DECIBELS | A five-position switch-OFF, 15, 10, 5, and 0. Used in connection with OUTPUT METER. |

10. OUTPUT METER	Indicates the level of output volume.
11. CALIBRATION CHART	Record of dial settings for various frequencies.
12. CALIBRATED DIALS	Indicates position of main tuning control.
13. AUDIO TUNING BAND SWITCH	Selects one of two a.f. bands-450-770 or 770-1,300 cycles.
14. AUDIO TUNING, OFF-ON SWITCH	Cuts the audio filter IN or OUT.
15. MAIN TUNING CONTROL	The main r.f. tuning control. It tunes both r.f. stages, and the detector.
16. FILAMENT VOLTS	Indicates whether power is off or on. Should be about 6 volts.
17. AUDIO TUNING	A 10-position switch. It selects the desired a.f. beat note between 450-770 or 770-1,300 cycles, depending upon the setting of the AUDIO TUNING BAND SWITCH, 13.
18. FREQUENCY BAND SWITCH	Selects the desired frequency band. RAK, 6-positions; RAL, 9 positions.
19. SENSITIVITY	An r.f. control. Acts as a manual volume control.
20. FREQUENCY VERNIER	(RAL only.) Used to obtain small variations in the pitch of the a.f. beat note produced by the heterodyne oscillator.
21. AUDIO, BROAD-SHARP	(RAL only.) Connects a low pass filter into the circuit when in the SHARP

311

position. Removes the filter when in the BROAD position. Aids in reducing background noise with C.W. reception.

INSTRUCTIONS FOR OPERATION OF THE RAK-RAL RECEIVERS

TUNING FOR C.W. SIGNALS

1. Turn on the power to the set you desire to operate. If you wish to use both, turn on both sets. remember, if the installation is a double RAK/RAL unit, the switches are on the CONTROL UNIT. If a single set is installed, the switch is on the POWER UNIT.

2. If the frequency of the station to be received is known, set the following controls in the INDICATED POSITION-

AUDIO TUNING	OFF
A. V. C.	OFF
AUDIO, BROAD-SHARP	BROAD (RAL only)
FREQUENCY VERNIER	ZERO (RAL only)

3. Set **FREQUENCY BAND** switch to the band number that includes the frequency of the station desired.
4. Refer to calibration chart and set tuning dial to the position indicated by the chart.
5. Advance sensitivity control until perceptible noise is obtained. Adjust **ANTENNA TRIMMER**, and **R. F. TRIMMER** for maximum noise output. Be careful not to advance the **SENSITIVITY CONTROL** too far, because too much noise will **MASK** the signal.
6. Increase **REGENERATION** control until a double **CLICK** is heard when the **O.S.C. TEST** button is pressed and released indicating the director is oscillating.
7. Reset **TUNING** control until desired signal is heard, then adjust **ANTENNA TRIMMER** and **R.F. TRIMMER** until maximum signal is obtained.
8. On **RAL** only. Adjust **FREQUENCY VERNIER** control until the desired beat note is heard.

312

9. Turn up **SENSITIVITY** control until a perceptible noise level is present, but not in excess of 10 **DB**. Throw **A.V.C.** switch **ON**, and adjust **A.V.C. LEVEL** until a copyable signal is obtained.
10. Place **AUDIO TUNING** switch **ON**. Select the desired **AUDIO RANGE**, 450-770 or 770-1,300. Adjust **AUDIO TUNING** to the selected audio signal frequency. With the **RAL**, the **FREQUENCY VERNIER** may be used for the final adjustment.

TUNING FOR M.C.W. VOICE SIGNALS

1. Procedure is the same as outlined for **C.W.** reception, except that the **REGENERATION** control should be adjusted to a point just below oscillation.
2. To adjust the **REGENERATION** control properly for and **MOD.-C.W.**, increase the **REGENERATION** control until a click is just heard when the **O.S.C. TEST** button is pressed. Now retard the **REGENERATION** control until the click does not appear when you press the test button. The regenerative **CONTROL** is set just below the point where the set will break into oscillation.
3. The **RAK/RAL** receivers are not expressly designed for voice or other modulated **C.W.** reception. With the **RAL**, the low-pass filter cuts off all audio signals above 1,200 cycles, and this results in considerable distortion.

THE RAO-RBH RADIO RECEIVERS

The RAO-RBH radio receivers are very similar in panel design and tuning control arrangement. Electrically, the two receivers have variations in component parts and circuit design to accommodate differences in frequency bands. But the tuning and operating procedures for the two are nearly the same.

The RAO has a frequency range from 540 to 30,000 kcs. in five bands, and the RBH has a frequency range from 300 to 1,200 and 1,700 to 16,000 kcs., also in five

699198°-46-21

313

bands. Both receivers may be used for C.W.-M.C.W. or VOICE reception.

Superheterodyne circuits are used in each receiver. They contain a beat frequency oscillation for C.W. reception and a crystal filter in the intermediate frequency stages to eliminate interfering signals when the sets are operating on C.W. The crystal filter circuit is usually turned off for VOICE reception, because the extreme selectivity when the crystal filter is ON will not permit intelligible voice signals to come through.

Provisions are made for headset and loudspeaker outputs. The headset jack is on the front of the operating panel, while two speaker outlets are on the back of the cabinet. The receiver is designed to use a Navy Type CNA-49106 loudspeaker.

Do not place the loudspeaker on the top of the receiver cabinet, because speaker vibrations may cause microphonic noises in the form of "mechanical feed-back" to distort the receiver's signals.

Since the RAO receiver tunes over the broadcast band, and is also adaptable for use with a loudspeaker, it is often used for program entertainment.

The receivers have their own built-in power supplies, and can be operated from any 115/120 volt, 50/60 cycle single-phase line supply.

The antenna length used with either receiver is not critical. A single wire varying in length from 50 to 20 feet is satisfactory. A low-impedance transmission line of not less than 70 ohms may be used to connect the antenna to the receiver.

1. SIGNAL STRENGTH METER Shows the signal strength in the last I.F. stage
2. POWER SUPPLY, OFF-ON This switch turns the receiver on and off.
3. METER SWITCH STRENGTH Closing this switch puts the SIGNAL meter into operation.

314

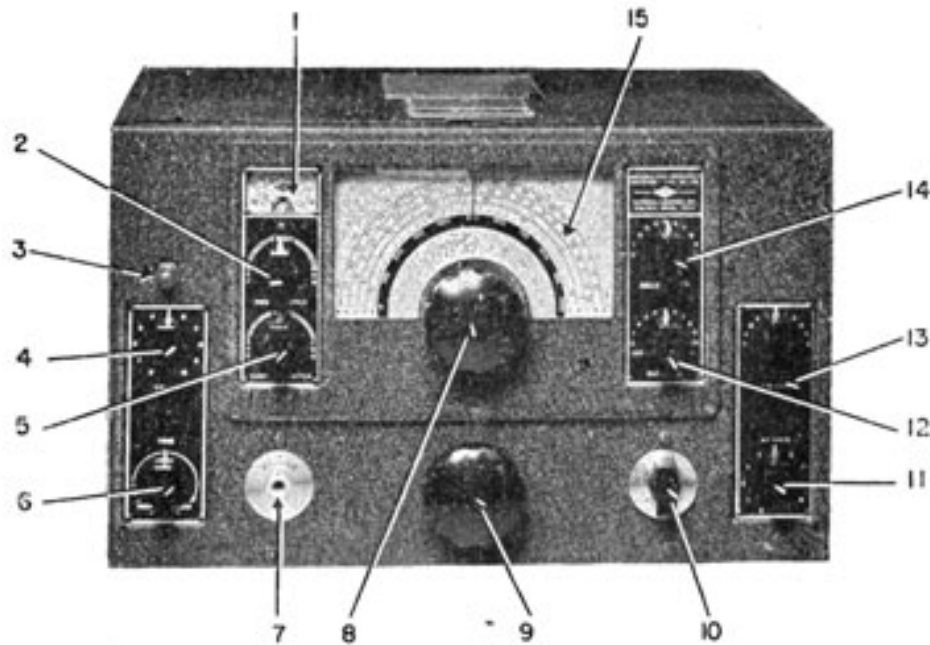

Figure 172.-The RBH Receiver. (Front view).

4. LIMITER CONTROL

This control limits the maximum signal strength to come through the receiver. When set on 0, all but the strongest signals come through. When set on 10, only the very weakest can get through.

5. CONTROL SWITCH A.V.C.-M.V.C.-C.W.O. In A.V.C. position, the automatic volume control circuits are operating. In M.V.C. position, the automatic volume control circuits are off. In C.W.O., the B.F.O. is turned on and the A.V.C. off.

6. TONE CONTROL

In the N position all normal audio tones come through. When in HIGH position, all frequencies below 100 cycles are cut off. Low position cuts off all frequencies above 1,000 cycles.

7. PHONE JACK

Output jack for headset.

8. MAIN TUNING KNOB

This knob tunes the receiver.

9. BAND CHANGING SWITCH

This knob switches the receiver from one frequency band to another.

10. R.F. GAIN CONTROL

This gain control manually regulates the gain of the first r.f. stage.

11. A.F. GAIN CONTROL

Manual volume control.

12. PHASING CONTROL In the OFF position, the crystal filter is out of the circuit. Increasing the setting of the control from OFF to *O* connects the filter into the circuit. Increasing the control from *O* balances the crystal bridge circuit to eliminate undesirable beat notes. This control determines the pitch of the C.W. beat note.
13. C.W. O.S.C. CONTROL The degree of selectivity for the crystal filter is regulated by this control.
14. SELECTIVITY CONTROL The degree of selectivity for the crystal filter is regulated by this control.
15. MAIN CALIBRATION Shows the setting of the tuning control.

OPERATION OF THE RAO-RBH RECEIVER

M.C.W. OR VOICE RECEPTION

1. Set the following controls in the indicated positions:

CONTROL	POSITION
POWER SUPPLY	ON
LIMITER	0
TONE	N
R.F. GAIN	8 to 10
A.F. GAIN	4 to 6
PHASING	OFF
SELECTIVITY	MAX. NOISE
CONTROL SWITCH	A.V.C. or M.V.C.

2. Turn the BAND CHANGING switch to the correct band, and set the MAIN TUNING knob in the position indicated on calibration card for receiving the desired frequency.
3. When the control switch is set for M.V.C. operation, be careful not to advance the R.F. GAIN CONTROL to a point where signal distortion occurs. In general, it is recommended that the A.F. GAIN control be set about half way on, and audio output adjusted by means of the R.F. GAIN control.

4. With the CONTROL switch in A.V.C. position, the R.F. GAIN control should be advanced as far as receiving conditions permit, or until background noise becomes objectionably loud. Audio output should be adjusted entirely by means of the A.F. GAIN control. Remember, the automatic gain control is not effective unless R.F. GAIN is fully advanced.
5. If a signal is weak and partially obscured by background noise and static, best signal-to-noise ratio will be obtained by turning the TONE towards the LOW position. The most effective setting must be determined by trial.
6. When a signal is accompanied by crashes of static, advance the LIMITER control towards 10. Best setting must be determined by trial. Too much limiter action will impair the audio quality. If static peaks are extremely strong, best LIMITER action is obtained with the CONTROL switch in M.V.C. position . In such cases, both R.F. GAIN and LIMITER controls must be carefully adjusted for optimum operation.
7. After tuning has been completed, switch crystal filter on by setting the PHASING control at any position greater than 0. For M.C.W. operation, a normal setting is 5.
8. The normal setting of the SELECTIVITY control for M.C.W. reception is at the position that affords minimum SELECTIVITY. This position is near the middle of the selectivity scale and is accurately determined by the point where the background noise is maximum.
9. The PHASING control is used to eliminate interfering beat notes that are often present when crystal filter is "in." If the note is above 1,000 cycles, set the control near the mid-point of the dial. If the note is near 300 to 400 cycles, optimum setting is near either end of the dial.
10. For M.C.W. reception, set the tone control in HIGH position. VOICE communication that is

317

accompanied by serious background noise can sometimes be improved by setting the TONE control in Low position.

C.W. OPERATION

1. The initial adjustments of the RAO-RBH for C.W. operation are the same as for M.C.W. or VOICE, except that the CONTROL switch must be in C.W.O. position, and the C.W.O. O.S.C. control must be set at mid-scale.
2. The action of the TONE and LIMITER CONTROLS are the same as for M.C.W., except that both controls may be advanced considerably more.
3. Adjust the C.W. O.S.C. control until you obtain the beat note of the desired pitch.

4. Increase the setting of the PHASING control, and increase the SELECTIVITY by moving the control toward 0. For best operation it will be necessary to try several combinations of these controls.

THE RBA RECEIVER

The model RBA radio receiver is a low frequency T.R.F. receiver designed for VOICE, C.W., and M.C. W. reception. The frequency range is from 15 to 600 kc., in four bands, 15-38, 38-95, 95-235, and 235-600 kc.

While voice reception is possible, many natural characteristics are lost due to the high selectivity and the filters employed in the r.f. stages. When attempting to receive a voice message, the AUDIO switch, NO. 10, should be in the BROAD position. For C.W. reception it should be set for SHARP reception.

A beat-frequency heterodyne OSCILLATOR is incorporated into the circuit for C.W. reception. The oscillator is ganged to the MAIN TUNING CONTROL, 13, and is automatically tuned to the correct frequency to produce a beat note of 1,000 cycles for each setting of the r.f. stages.

The selection of the FREQUENCY BAND is accomplished by rotating a four-position switch. All r.f. and oscillator coils are changed by the movement of this switch.

318

TUNING is accomplished by a panel-operated, 5-gang, variable condenser which tunes the input, r.f. amplifier, and B.F.O. circuits. The setting of the tuning control is indicated by the MAIN DIAL, 5, and the VERNIER DIAL above the main tuning control. The top scale of the main dial has arbitrary numbers such as 0, 50, 100, 150, and 1,000. The vernier dial has 100 equal divisions. The lower scale of the main dial is calibrated approximately in kilocycles.

The MANUAL GAIN CONTROL regulates the gain in the r.f. and a.f. stages. An additional gain control is geared to the main tuning control, so that as the receiver is tuned toward the high end of the band, the volume is reduced. This arrangement insures a uniform output over the entire tuning range.

An OUTPUT LIMITER is used in the circuit to prevent sudden crashes of static from reaching the earphones.

The automatic regulation of the receiver's output volume is a unique feature of this set, because it permits the use of any number of headphones between 1 and 20 without material loss in the output volume.

Legend for Figure 173.

- | | |
|----------------|--|
| 1. ADD DECIBEL | The ADD DECIBEL SWITCH and the OUTPUT METER work together. |
|----------------|--|

2. CALIBRATION CHART Indicates the proper dial settings for various frequencies the receiver may be tuned to.
3. OUTPUT METER WHEN NOT USING THE OUTPUT METER, BE SURE SWITCH IS IN OFF POSITION TO PREVENT DAMAGE TO THE METER.
4. BAND SELECTOR SWITCH A four-position switch that selects the frequency band.
5. MAIN TUNING SCALE Indicates the setting of the main tuning control. To obtain readings of dial settings, add the readings of the vernier dial to the next smaller reading in 100's on the main dial. Example: vernier 56, main dial between 300 and 400. Actual reading $300 + 56 = 356$.

319

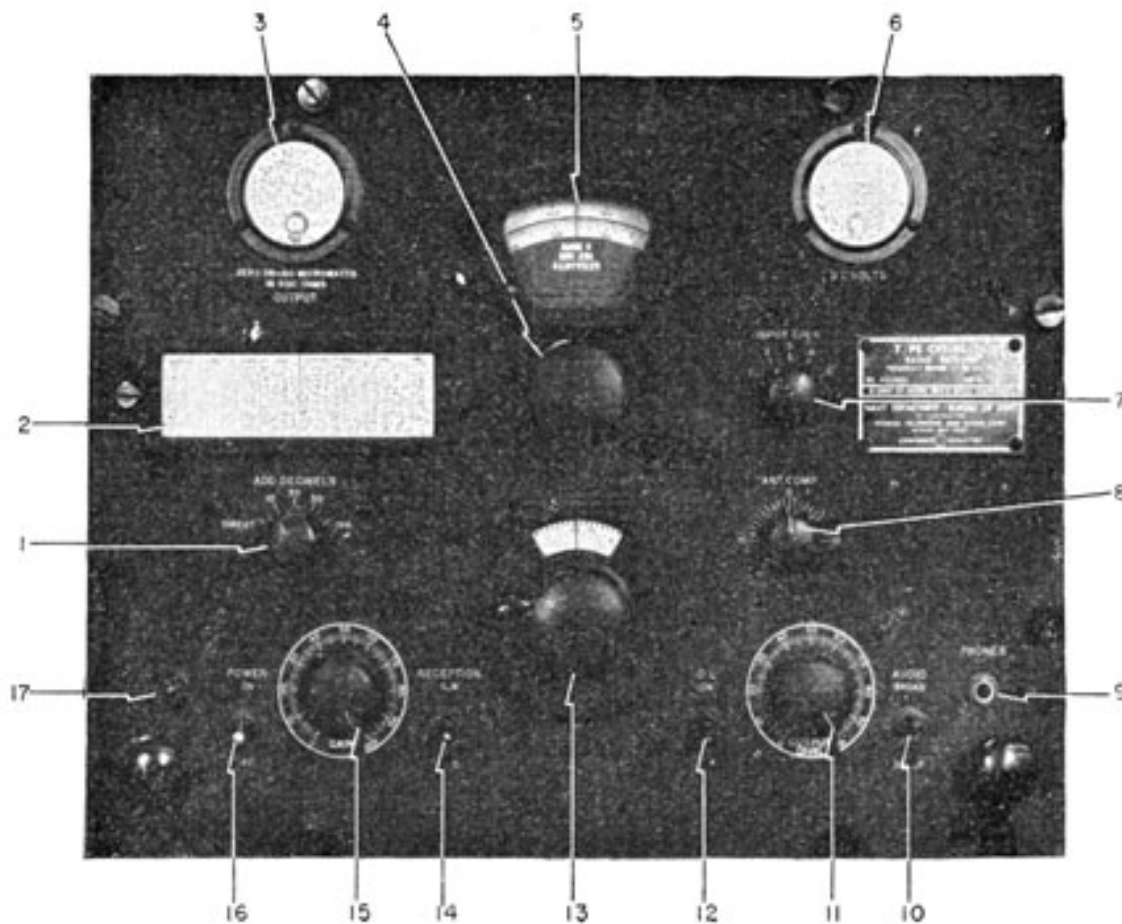

Figure 173.-The RBA receiver.

6. D.C. VOLTS Indicates the voltage applied to the plate circuits of the amplifier tubes. Normal is 240 volts; may be between 175 and 225.
7. INPUT COUPLING A five-position switch that adjusts the degree of coupling between the antenna and first r.f. stage. Correct coupling produces loudest signal.
8. ANTENNA COMPENSATOR A small variable condenser used to compensate for variations in antenna lengths. Correct adjustment gives loudest signal.
9. PHONES Jack for headset output.

320

10. AUDIO, BROAD-SHARP SWITCH Used to reduce side noise interference. For VOICE communication, set switch to BROAD; for C.W., to SHARP.
11. OUTPUT LEVEL This control works with the OUTPUT LIMITER. It sets the maximum level to which the sound is permitted to rise.
12. O.L. ON-OFF The OUTPUT LIMITER switch. Should be OFF while completing the fine tuning adjustments, and ON when operating. When searching for stations, or receiver in stand-by, the switch should be ON.
13. MAIN TUNING KNOB This control tunes the receiver scale. Directly above the knob is the VERNIER DIAL.
14. RECEPTION, MOD.-C.W. Switch. For VOICE and M.C.W., turn to MOD. For C.W. messages, set to C.W.
15. GAIN Manual volume control of recliner.
16. POWER, OFF-ON Switch for turning the set ON or OFF.
17. POWER, OFF-ON PILOT LIGHT Indicates application of power to equipment.

INSTRUCTIONS FOR OPERATING THE RBA RECEIVER

TUNING FOR C.W. OPERATION

1. Set the following controls in the indicated position:

CONTROL	POSITION
INPUT CPLG.	5
ANT. COMP.	0
ADD DECIBELS	OFF
AUDIO, BROAD-SHARP	BROAD
OUTPUT LEVER	60-80

O. L.	OFF
RECEPTION	C.W.
GAIN	60-80
POWER	ON

- Turn BAND SWITCH to the desired frequency band.
- Turn MAIN TUNING dial to a signal near the high frequency end of the band. If no signal can be found near this setting, turn the MAIN TUNING dial to a point of maximum noise.

321

- Reduce the audio output to a low level by turning the OUTPUT LEVEL control counterclockwise.
- Adjust ANT. COMP. to resonance as indicated by a maximum signal. The signal strength at this point should drop off sharply at each side of this resonant point. If this point cannot be found, move (ANT.) CPLG. control to position 4 and then successively to 3, 2, and 1, if necessary, to resonate the antenna circuit. The normal setting of this control with most antennas will be 4 or 5. After one tuning adjustment on a fixed antenna has been made, further adjustments are usually unnecessary.
- Adjust MAIN TUNING dial until a maximum signal is heard in the headset, or indicated on OUTPUT meter. To activate the OUTPUT meter turn ADD DECIBELS SWITCH to 30. If a readable deflection is not obtained with the 30 setting, move the switch successively to 20, 10, or DIRECT as is necessary to obtain a good reading, but no further.
- Set OUTPUT LEVEL control to a point where the audio volume is of the desired level. If a strong signal causes distortion in the audio signal, reduce the setting of the GAIN control, and then readjust OUTPUT LEVEL to the desired volume.
- If crashes of static are objectionably strong, throw O. L. switch to ON position.
- When interfering tones appear with the C.W. beat note, move the AUDIO switch to SHARP. This will cut out practically all but the 1,000 cycle beat note.

TUNING FOR M.C.W. AND VOICE RECEPTION

- Set all controls as listed in paragraph 1 for C.W. tuning, except RECEPTION switch, which should be set on MOD.
- Repeat all other tuning steps, 2 through 8. If the output limiter circuit interferes with intelligible reception of audio signals, place the O. L. switch in the OFF position.

THE RBB-RBC RADIO RECEIVING SETS

The RBB-RBC radio receiving sets are companion receivers designed to cover a frequency range of 0.5 to 4.0 mc for the RBB and 4.0 to 27.0 mc. for the RBC. Many sections of the two receivers are identical and can be interchanged. The chief variations are in the component parts of the tuned radio frequency stages.

The sets are usually installed in pairs, giving a complete frequency coverage from 0.5 to 27 mc. Signals of C. W., M.C.W., and VOICE may be received by either.

POWER SUPPLIES are separate from receivers, and can be installed behind, to the side of, or below the receiver cabinets in the space available. They may be operated from 110/120 volt, 60-cycle, single-phase power lines.

The OUTPUT CIRCUITS are designed to accommodate from one to twenty pairs of 600-ohm headsets with only a slight reduction in volume. This feature makes it possible to use these receivers to feed several remote radio-phone stations about the ship.

Both sets contain several auxiliary circuits to aid you in receiving code and voice communications under adverse operating conditions. The OUTPUT LIMITER circuit prevents strong crashes of static from reaching the headset. The SILENCER CIRCUIT blocks the receiver and keeps background noise at a minimum when the receiver is in stand-by condition.

The AUDIO SELECTIVITY FILTER, used only with C.W. reception, limits the audio output sharply to a 1,000 cycle beat note, thus further reducing the extraneous noises.

Both receivers may be operated from a single antenna. but when this is done, a link coupling inside each receiver cabinet must be opened to insert a decoupling resistor in the antenna circuit. This prevents one receiver from interfering with the operation of the other.

Legend for Figure 174.

1. ANT. COMP. CONTROL This control is used to compensate for variations in the capacity of the various antenna circuits.

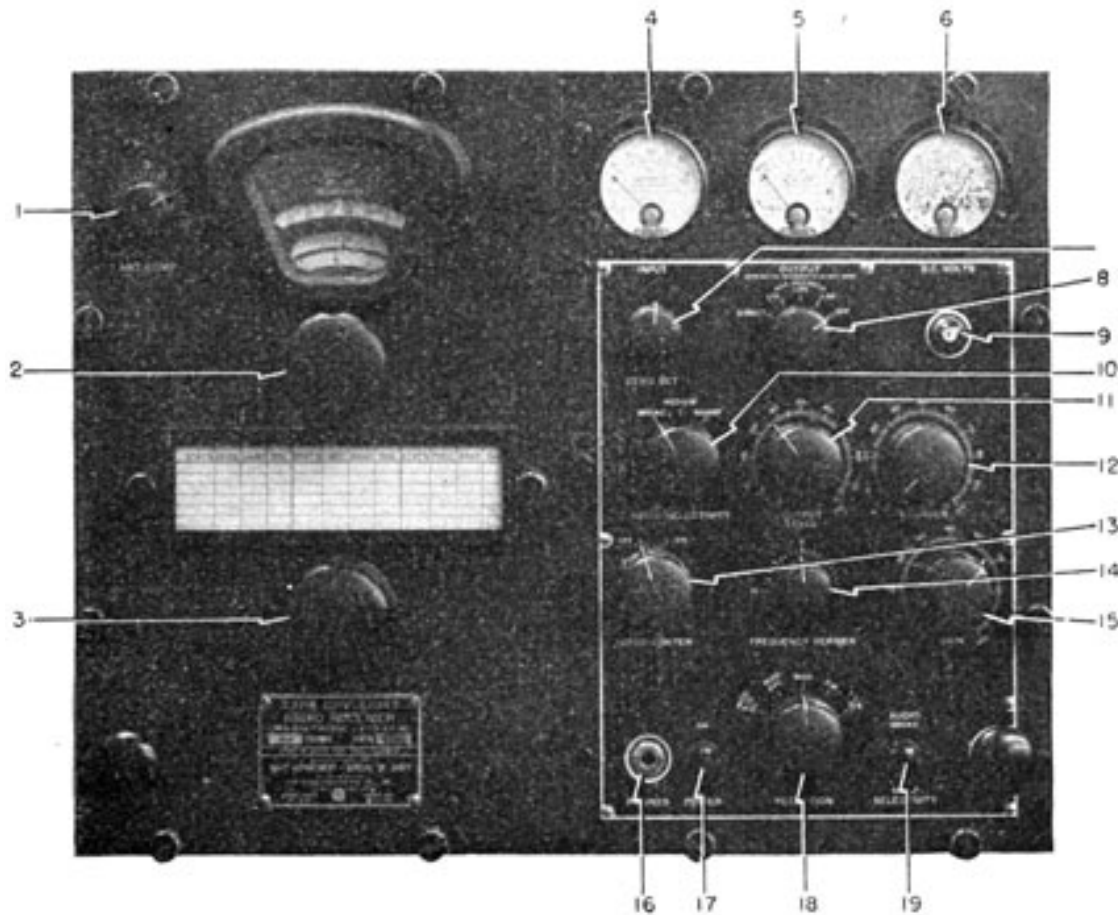

Figure 174.-The RBB/RBC: receiver. (Front View)

- | | |
|--------------------------|--|
| 2. FREQUENCY BAND SWITCH | This control selects the frequency bands. |
| 3. MAIN TUNING KNOB | The receiver is tuned by this control. |
| 4. INPUT METER | Indicates the strength of the input signal at the 1st I.F amplifier stage. |
| 5. OUTPUT METER | Indicates the strength of the audio frequency signal. |
| 6. D.C. VOLTS METER | This meter shows the D.C. voltage applied to the a.f. amplifier tubes. |
| 7. ZERO SET | This control is used to set the INPUT meter at zero. |

- | | |
|-------------------------------|---|
| 8. ADD DECIBELS SWITCH | This switch is used to turn the output meter on and to set its RANGE of the meter readings. |
| 9. PILOT LIGHT | Indicates whether set is turned ON or OFF. |
| 10. RADIO SELECTIVITY SWITCH | This switch sets the degree of selectivity for the receiver. |
| 11. OUTPUT LEVEL CONTROL | A manual audio volume control. |
| 12. SILENCER CONTROL | The setting of this control determines the degree of silencing action. |
| 13. NOISE LIMITER CONTROL | This control turns the noise limiter circuit ON or OFF. |
| 14. FREQUENCY VERNIER CONTROL | This control adjusts the pitch of the C.W. beat note. |
| 15. GAIN CONTROL | Manually regulates the gain of the R.F. and I.F. amplifier sections of the receiver. |
| 16. PHONE JACK | Phone jack for headset. |
| 17. POWER, ON-OFF SWITCH | This switch turns the set ON or OFF. |
| 18. RECEPTION SWITCH | This switch selects the mode of reception for the receiver such as M.C.W., C.W. or VOICE. |
| 19. AUDIO SELECTIVITY | A two-position Switch, BROAD and SHARP. In the SHARP position, an audio filter is inserted in the circuit to eliminate all audio signals except a 1,000 cycle note. |

USE OF SPECIAL CONTROLS

ANTENNA COMPENSATOR:

When you have changed frequency bands, a signal should be tuned in near the high frequency end of the band. The ANTENNA COMPENSATOR should then be adjusted for a maximum signal strength.

ZERO SET:

The INPUT meter is set to "0" with the ZERO SET control-tune the receiver to a minimum signal at some point NEAR the location of the signal, and then adjust the ZERO SET until the INPUT meter indicates "0."

ADD DECIBELS:

The normal position of this switch while operating is OFF. When you desire an OUTPUT meter reading, turn the ADD DECIBELS switch first to 30. Advance the switch to 20, 10, and DIRECT only when you are sure the signal will not overload and injure the meter.

RADIO SELECTIVITY: The initial tuning of the receiver is usually done with switch in BROAD position, and then advanced to MEDIUM and SHARP for the final adjustments in tuning. For VOICE reception, this switch may require a MEDIUM or BROAD setting. Attempts to perform initial tuning with the RADIO SELECTIVITY control in SHARP position may cause you to pass over a signal.

SILENCER:

The silencer circuits reduce the receiver's audio output to zero when no signal is being received. Advance the SILENCER control just enough to keep down set and background noises when the receiver is in stand-by condition, but not so far as to BLOCK the signal. The SILENCER control is operative only when the RECEPTION switch is in MOD.-A.V.C.-SIL. position.

RECEPTION SWITCH:

MOD.-A.V.C.-SIL.: This position is used principally when the receiver is in stand-by condition on voice communications. Do not attempt to tune set when the control is set in this position unless SILENCER CONTROL is set at zero.

MOD.-A.V.C.: This is the normal operating setting for VOICE and M.C.W. signals. May be left in this position during the tuning of the set for VOICE and M.C.W. signals.

MOD: This setting may be used for reception of VOICE and M.C.W. signals when fading is not serious. This setting is recommended for tuning, especially for inexperienced operators.

C.W.: The B.F.O. is connected into the circuit. Recommended position for tuning in C.W. signals. This setting may be used for operating when crashes of static and fading are at a minimum.

C.W.-O.L.: Normal operating setting for the reception of C.W. signals. The OUTPUT LIMITER'S effects, on this mode of reception, is similar to A.V.C. action. With this setting, the INPUT meter is inoperative. Operate NOISE LIMITER AND AUDIO SELECTIVITY With the FREQUENCY VERNIER until the best copyable signal is received.

AUDIO SELECTIVITY: When objectionable background noises interfere with receiving C.W. signals, set this control on SHARP. adjust FREQUENCY VERNIER until the 1,000 cycle note is obtained.

TUNING PROCEDURE FOR C.W. OPERATION

1. Set the following controls in the indicated position:

CONTROL	POSITION
POWER	ON
RECEPTION	C.W.
AUDIO SELECTIVITY	BROAD
NOISE LIMITER	OFF
FREQUENCY VERNIER	0
GAIN	60-90
RADIO SELECTIVITY	BROAD
OUTPUT LEVEL	60-90
ADD DECIBELS	OFF
SILENCER	0

2. Tune in a signal, or set TUNING dial to a position of maximum noise near the high frequency end of the band you have selected. Adjust ANT. COMP. for a maximum signal as indicated by the OUTPUT meter or sound in the headset. Further adjustment of the ANT. COMP. is unnecessary as long as you operate on the one frequency band. Changing frequency bands requires further adjustment.

3. Turn MAIN TUNING dial to a point of minimum noise NEAR the desired signal. Adjust ZERO SET until the INPUT meter needle is at ZERO.
4. Tune in desired station. The correct setting of the tuning dial will be indicated by a maximum deflection of the INPUT meter needle.
5. Set RADIO SELECTIVITY Switch successively to MEDIUM and SHARP, and make final tuning adjustments until a maximum indication is obtained on the INPUT meter.
6. Adjust OUTPUT LEVEL, and operate ADD DECIBEL switch until the desired output volume of sound is obtained.
7. Turn NOISE LIMITER to ON, RECEPTION switch to C.W.-O.L., and FREQUENCY VERNIER to "0."
8. If considerable noise is present with the C.W. beat-notes, place the AUDIO SELECTIVITY switch in SHARP position. Make slight adjustments of the FREQUENCY VERNIER until a pure beat note is obtained. When the AUDIO SELECTIVITY switch is in BROAD position, the pitch of the beat note may be varied by the FREQUENCY VERNIER.
9. Make final adjustments of GAIN control if an extremely strong signal is causing distortion. Set the OUTPUT LEVEL control to a position that produces the desired audio level.

TUNING PROCEDURE FOR M.C.W. AND VOICE RECEPTION

1. Set all controls as listed in paragraph 1 of C.W. tuning instructions, except RECEPTION, which should be set at MOD.
2. Perform all tuning steps, 2 through 6, as listed for C.W. operation.
3. Turn RECEPTION switch to MOD.-A.V.C., and adjust OUTPUT LEVEL until the desired level of volume is obtained.
4. When conditions require stand-by VOICE operation, turn RECEPTION switch to MOD.-A.V.C.-SIL., and adjust SILENCER control until you obtain the

desired degree of damping on background noise. Do not advance SILENCER control too far. It may cut out part of the signal.

THE RBK RECEIVER

The Navy model RBK receiver is a very high frequency receiver capable of receiving amplitude and frequency modulated signals within a frequency range of 27.8 to 143 megacycles.

The circuit is that of a conventional superheterodyne with one stage of tuned radio frequency preceding the first detector.

To change from the reception of amplitude modulated to frequency modulated signals, you merely turn a switch on the operating panel of the receiver. A single audio frequency amplifier is used for both the A.M. and F.M. sections of the receiver.

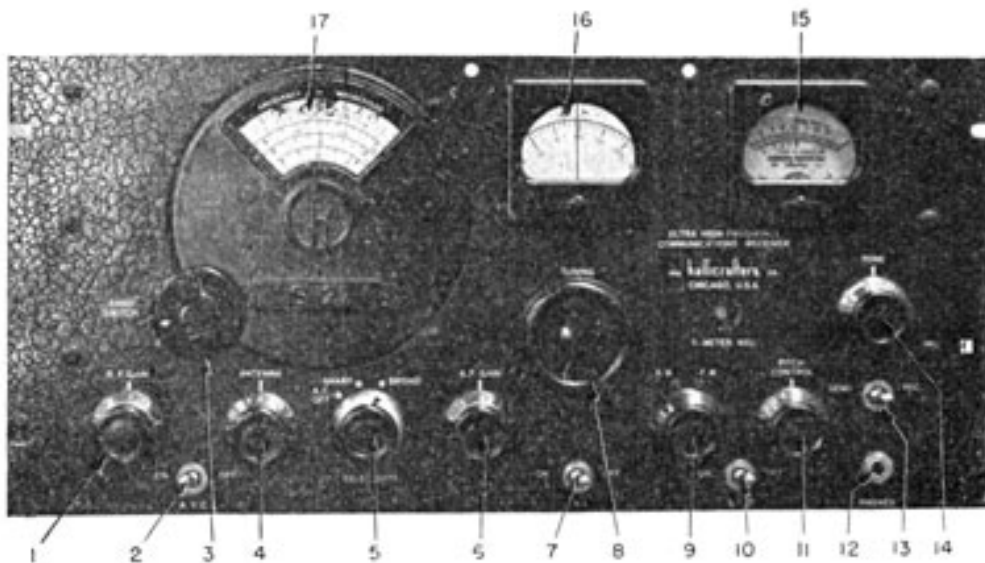

Figure 175.-The RBK receiver. (Front view).

The frequency range of the receiver, and the fact that it is capable of receiving both A.M. and F.M. signals makes this set valuable for short range, such as communication between aircraft and ground forces employing frequency modulated transmitters.

699198°-46-22

Reception by C.W., M.C.W., or VOICE is possible with this receiver. When it is necessary to locate a weak signal, the beat frequency oscillator may be switched on to increase the sensitivity of the set.

When the RBK is being operated in an area free from local interference, a single wire about 75 feet long is recommended. Where reception is subjected to strong local interference, and the frequency band of reception is narrow, a dipole antenna of the doubler type is best.

Legend for Figure 175.

1. R.F. GAIN CONTROL This control adjusts the sensitivity of the r.f. amplifier sections.
2. A.V.C. OFF-ON SWITCH Turns A.V.C. circuits ON or OFF.
3. BAND SWITCH This switch selects one of the receiver's three frequency bands.
4. ANTENNA TRIMMER The ANTENNA trimmer is a small variable condenser in the input to the first r.f. stage used to compensate for variations in the antenna capacity.
5. SELECTIVITY SWITCH This switch controls the selectivity of the I.F. amplifier stages.
6. A.F. GAIN CONTROL A manual volume control.
7. A.N.L. ON-OFF SWITCH This switch is used to eliminate local electrical interference that may originate with ignition systems and the like.
8. TUNING DIAL This is the receiver's main tuning dials.
9. A.M.-F.M. SWITCH This switch designates whether the set is to receive A.M. or F.M. signals.
10. B.F.O. SWITCH This control turns the B.F.O. ON or OFF.
11. PITCH CONTROL Adjusting this control sets the pitch of the beat note when receiving C.W. signals.
12. PHONE JACK Output jack for the headset.
13. SEND-RECEIVE When this switch is in the SEND position, the receiver is in stand-by condition. The filaments of the tubes remain heated, but the plate voltages are off. Placing this switch in RECEIVE position energizes all of the circuits.

14. **TONE CONTROL** This control is used to regulate the pitch of the audio tone. This is especially useful for VOICE reception. Proper adjustment of this control can be used to eliminate objectionable background noises.
15. **TUNING METER** This meter indicates the strength of the signal applied to the second detectors. It is useful in tuning the receiver, since it will indicate the presence of a signal even if its strength is too weak to be heard.
16. **VERNIER SCALE** Scales 16 and 17 together indicate the settings of the TUNING dial.
17. **MAIN CALIBRATED SCALE**

OPERATION OF THE RBK RECEIVER

TUNING FOR C.W. OPERATION

1. Set the following controls in the indicated position:

CONTROL	POSITION
R.F. GAIN	7 TO 9
A.V.C.	ON
BAND SWITCH	TO DESIRED BAND
SELECTIVITY	BROAD
A.F. GAIN	5 OR 6
A.N.L.	OFF
PITCH CONTROL	0
SEND-RECEIVER	RECEIVE
TONE	NORMAL

2. Place the A.M.-F.M. switch in A.M. position to receive the type of modulation being transmitted.
3. Operate the TUNING wheel, and set MAIN CALIBRATED scale to approximately the correct position for receiving the desired signal.
4. Adjust ANTENNA control and at the same time readjust the TUNING wheel slightly, until a maximum signal is heard or indicated on the TUNING meter.
5. Adjust the A.F. GAIN for desired volume. Reduce

R.F. GAIN as necessary to eliminate signal distortion.

6. When interfering signals make it necessary, turn SELECTIVITY control to SHARP. Adjust PITCH CONTROL until you obtain the beat note of the desired pitch.

7. Make final adjustments of tuning, gain, pitch, and tone controls until the best copyable signal is obtained.

TUNING FOR M.C.W. AND VOICE RECEPTION

1. Tuning is the same as for C.W. reception, except for the following points-the B.F.O. is OFF, the SELECTIVITY control is usually left in the BROAD position, and the A.M.-F.M. switch is turned to the position to receive the type of modulation being transmitted.

2. Set the TONE control and other tuning signals. The A.V.C. switch must be ON and the R.F. GAIN set at maximum gain.

USE OF THE TUNING METER

1. When using the TUNING meter with A.M. signals, the A.V.C. switch must be ON and the R.F. GAIN set at maximum gain.

2. While using the TUNING meter with F.M. signals, the meter needle will be deflected to one side of zero as you approach the carrier frequency, and to the other side when the carrier is passed. When the receiver is correctly tuned, the meter needle will stand near ZERO.

THE MODEL RCK RADIO RECEIVER

The model RCK radio receiver is one of the newer high frequency types to be introduced to the Navy. It operates in the V.H.F. band between 115 and 156 mc.

This receiver is designed to be used with the TDQ transmitter for short range, line-of-sight, voice communication between ship and aircraft, and between ship to ship.

The receiver itself is a superheterodyne, with a single r.f. preselector stage, followed by a mixer and five I. F. amplifier stages. The second detector is of the diode type. Three stages of audio amplification follow the detector. The audio section also contains a circuit that can be set from the control panel to the desired level of CRASH suppression.

The TUNING of the receiver is limited to four predetermined channels to match the four frequencies of the TDQ transmitter. The frequency of each channel is CONTROLLED by one of the four crystals in the local oscillator stage. The frequencies of these channels can be changed to any other within the band range merely by switching crystals in the receiver to match the change of crystals in the TDQ.

This receiver has fewer controls and is easier to operate than many Navy types. It is designed to supply a single set of headphones, and by using a suitable amplifier, it may feed remote stations about the ship.

The ANTENNA used with this receiver is a fixed dipole, connected to the receiver by a 50-ohm coaxial transmission line. The maximum length of the transmission line shall not be over 100 feet, and it is recommended that it be as short as possible.

The POWER SUPPLY is built into the same cabinet as the receiver, and may be operated from any 110/120 volt, 55/60 cycle, single-phase power source. The power consumption is about 110 volts, and the set is protected by two 3-ampere fuses.

Legend for Figure 176.

1. CHANNEL SWITCH Connects the crystals into the oscillator circuits to match the TDQ frequency.
2. TUNING CONTROL Tunes the r.f. and local oscillator circuits.
3. DIAL LOCK Locks the tuning dial in the desired position. To release, turn counterclockwise.
4. LINEAR DIAL SCALE Indicates the TUNING CONTROL settings.
5. DIAL SCALE IN M.C. Indicates the frequency in megacycles to which the receiver is tuned.

699198°-46-23

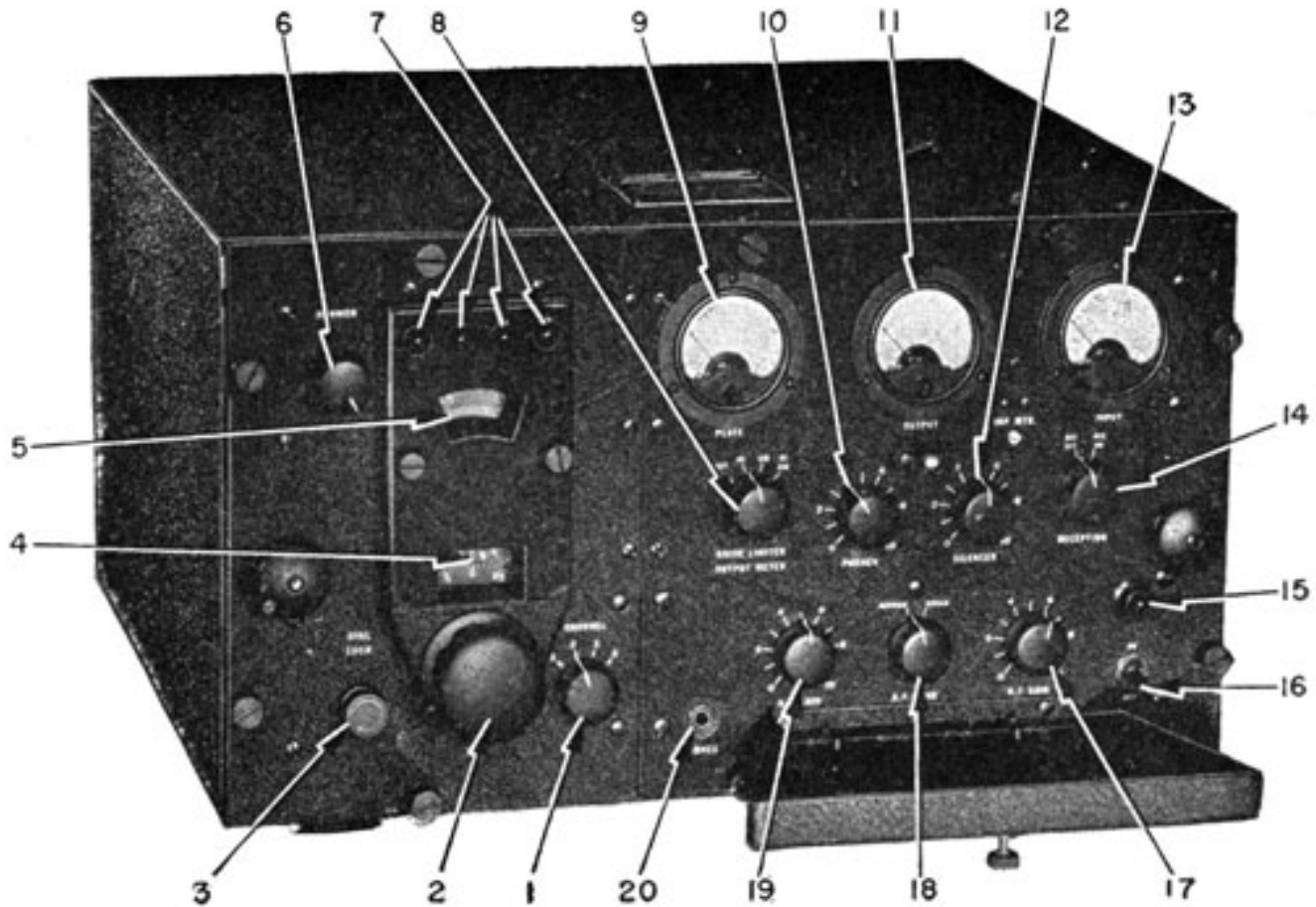

Figure 176.-The RCK receiver.

- | | |
|---|---|
| 6. DIMMER | Controls the brilliancy of the channel indicator lights. |
| 7. CHANNEL LIGHTS Indicates the frequency channel to which the receiver is tuned. | |
| 334 | |
| 8. NOISE LIMITER OUTPUT METER | A four-position switch.-Noise limiter, N.L.-Output meter, O.M.- both N.L. and O.M. at once. |
| 9. PLATE VOLTAGE METER | Shows the value of voltage on the plate of the second a.f. amplifier tube. |
| 10. PHONE | Controls the output level of sound delivered to the phones. |
| 11. OUTPUT METER | Shows the output level of sound delivered to the headphones. |
| 12. SILENCER | Adjusts the level of the permissible noise when no signal is being received. |
| 13. INPUT METER | Shows the amount of plate current flowing in the third I.F. amplifier stage. |
| 14. RECEPTION | A.V.C. ON-OFF switch. When OFF, the output meter and silencer are also out of the circuit. |
| 15. PILOT LIGHT | Indicates application of power to receiver. |

- | | |
|-----------------------|--|
| 16. OFF-ON SWITCH | Applies power to equipment. |
| 17. R.F. GAIN CONTROL | Controls the sensitivity of the r.f. amplifiers and 1st, 2nd, 3rd, and 5th I.F. amplifiers. |
| 18. A.F. BAND | The switch that cuts in and out of a filter in the a.f. amplifier. When noise is bad turn to NARROW. |
| 19. A.F. GAIN CONTROL | A manual audio volume control. |
| 20. PHONES | Headphone output. |

INSTRUCTIONS FOR OPERATION OF THE RCK RECEIVER

TUNING FOR M.C.W. AND VOICE OPERATION.

1. Set the following controls in the indicated position:

CONTROL	POSITION
ON-OFF	ON
R.F. GAIN	8
A.F. BAND	BROAD
A.F. GAIN	8
NOISE LIMITER- OUTPUT METER	OFF
PHONES	8

335

CONTROL	POSITION
SILENCER	0
RECEPTION A.V.C.-ON	

2. Release DIAL LOCK and set CHANNEL switch to the desired channel.
3. Refer to calibration card and adjust dial until a maximum indication is obtained on the INPUT meter.
4. Turn NOISE LIMITER-OUTPUT METER switch to O.M. Adjust A.F. GAIN, until the audio output of the receiver is at the desired level as indicated by the OUTPUT meter.
5. If the signal received is very strong, and is causing considerable distortion, reduce the R.F. GAIN CONTROL until an undistorted signal is obtained. Readjust A.F. GAIN for desired audio output.

6. The final setting of the NOISE-LIMITER-OUTPUT METER switch will depend upon the character of the reception. Usually it will be set at N.L. For normal operation, it is not advisable to have switch in either O.M. or N.L.-O.M. positions. Turn on output meter only when actually adjusting or checking set.
7. Increase setting of SILENCER control to a point where silent operation is obtained when the receiver is in stand-by condition. Do not increase setting of the SILENCER control so much that it cuts off the first part of the incoming message. Too much silencer action will also block weak signals.
8. The setting of the PHONE control will be according to instructions from the operators at remote radiophone stations. Usually this control will be near maximum, because the earphone level can be reduced at the remote stations also.
9. The A.F. BAND switch is used when you are receiving M.C.W. messages. In the NARROW

336

position, a band-pass filter is inserted in the audio circuit, and limits the audio signal sharply to the pitch of the M.C.W. note. Place this control in the NARROW position when set and background noises interfere with the reception of the M.C.W. signals.

337

How Well Do You Know-

INTRODUCTION TO RADIO EQUIPMENT

339

QUIZ CHAPTER 1 WHAT IS ELECTRICITY?

1. All atoms are composed of _____ and _____.
2. An object becomes positively charged by _____ and NEGATIVELY charged by _____
3. The law of charges states _____
4. What is a static charge?
5. What will happen if a copper wire is connected between two static charges?
6. Electrons in motion is the definition of _____
7. A coulomb per second is equivalent to an _____
8. A volt is the expression of _____
9. A. Arrange the following potentials in order from most NEGATIVE to highest positive: -, 75, -135, -2, 425, 0.
B. What is the magnitude of the potential difference between the highest and lowest value?

10. The opposition of a conductor to the flow of current is_____
11. Select the materials from the following list that are considered insulators: Mica, carbon, bakelite, zinc, dry air.
12. Name three types of resistors commonly used in radio circuits.

CHAPTER 2 BATTERIES

1. Any force that tends to keep electrons moving is_____
2. What materials are necessary to form a cell?
3. Copper and lead are used to make a cell. Which pole will be positive?
4. The_____action within a cell is responsible for causing the current to flow.
5. The dry cell is an example of a_____cell, and the storage cell is an example of a_____cell.
6. Secondary cells can be, while primary cells cannot.
7. The degree of charge of a storage cell is checked with a_____
8. Cells connected in either series or parallel are called_____
9. Connecting cells in series increases the_____, while connecting cells in parallel increases the available_____

341

CHAPTER 3 CIRCUITS

1. An electrical circuit requires a_____for the electrons to follow.
2. In a series circuit, the same current_____, of the circuit, while in parallel circuit, the current_____with the larger portion flowing through the _____ resistance.
3. What is the resistance of a series circuit that contains the following resistors: 100 ohms, 200 ohms, 300 ohms. If the three resistors are in parallel?

CHAPTER 4 OHM'S LAW

1. State Ohm's Law?
2. A circuit has an emf of 100, and a resistance of 20,000 ohms. What is the current? What is it when expressed in milliamperes?
3. The IR drops about a series circuit are 18 volts, 22 volts, 112 volts, and 84 volts, what is the applied emf?
4. A potential of 2,000 volts is being applied to the vacuum tubes of a transmitter, and a current of 300 milliamperes is flowing, what is the power being dissipated?

CHAPTER 5 MAGNETISM

1. Make a drawing of an unmagnetized and magnetized bar showing the probable arrangement of the molecules.
2. The magnetic flux is another name for_____
3. The flux is said to flow from_____to_____
4. Steel and alnico are materials used to make_____ magnets, while soft iron and permalloy are used to make
5. The term used to express a metal's ability to conduct magnetic flux is_____. Retentivity expresses the metal's ability to_____

342

CHAPTER 6 ELECTROMAGNETISM

1. If the current in a conductor is slowing in a wire TOWARD YOU, what is the direction of the field?
2. What effect does the forming of a conductor into a coil have on the magnetic field?
3. What is the rule for finding the north pole of a coil carrying a current?
4. Placing an iron core in a coil serves to_____the flux.
5. The cores used in electromagnets must have_____ retentivity.
6. What device in Navy transmitters and receivers makes special use of electromagnets?

CHAPTER 7 GENERATORS

1. List the three factors that must be present before induction can take place.
2. Name the four parts of a generator.
3. What type of current is generated by the generator in figure 59?
4. What is the difference between an alternating current and a direct current?
5. a. A current is said to have a frequency of 60 cycles. What does it mean?
b. How many sine waves are completed each second?
6. State the range of audio frequencies. Radio frequencies?
7. What is the relationship of the expression "cycle" to kilocycle and megacycle?
8. What parts are different in a d.c. generator than in an a.c. generator? What do the parts in a d.c. generator do?
9. What is a pulsating d.c.? Answer by making a drawing.

CHAPTER 8 MOTORS

1. How does the law of "likes" and "unlikes" apply to a motor in getting it to turn?
2. Name the four major parts of a motor. 3. Where are motors used in your communication equipment?

CHAPTER 9
MORE ABOUT INDUCTION

1. Define self induction.
2. What is a counter emf?
3. What does Lenz's Law say about counter emf?
4. What factors determine the inductance of a coil?
5. *a.* What is reactance? *b.* What factors determine the magnitude of reactance of a coil?
6. What is the reactance of a 0.01 henry coil to a current with a frequency of 100 cycles? 1,000,000 cycles?
7. What is the basic physical difference between an a.f. choke coil, and an r.f. choke coil?
8. *a.* What is mutual induction? *b.* What type of electrical instrument makes wide use of mutual inductance?
9. You have an r.f. and an a.f. transformer. How can you determine which is which?
10. A transformer has 100 turns on the primary and 300 turns on the secondary. Is it a step-up or step-down? What is the turns ratio?

CHAPTER 10
THE CONDENSER

1. What is the general physical structure of a condenser?
2. Name four types of condensers used in radio circuits.
3. What type of condenser is used in tuning your receiver?
4. What unit is used to describe the "electrical size" of a condenser?
5. What is the relationship of condenser reactance to frequency?
6. How is it possible for a condenser to conduct a.c. but completely block the flow of d.c.
7. *a.* How does a condenser charge? *b.* When is it fully charged?

CHAPTER 11
RESONANCE

1. The "natural frequency" that an object will begin to vibrate is said to be the _____ frequency of the object?
2. The resonator used to re-enforce a violin string's vibration; o a _____, and the resonator used with a pipe organ is a _____, while the resonator used in radio circuits is a _____ and _____ connected in either series or parallel.

3. At resonance the collapse of the coil's field, and the condenser's discharge (work together) (oppose each other).
4. The resonant frequency of a tank circuit is determined by the _____ of the coil, and _____ of the condenser.
5. To increase the resonant frequency you _____ inductance, capacity, or both.
6. When you switch frequency bands in a receiver, you connect in different sets of _____
7. When you tune a receiver, you adjust the _____ of the receiver to match the frequency of the transmission.

CHAPTER 12 THE VACUUM TUBE

1. Name the four principle parts of a diode vacuum tube.
2. When a filament is heated to red heat, _____ of the metal and form a _____ about the metal.
3. If a negative potential is placed on the plate of the diode the electrons will be _____ from the plate, but if a positive potential is placed on the plate the electrons will _____ the plate.
4. Increasing the positive potential on the plate of the diode, _____ the flow of electrons to the plate.
5. What happens to the flow of current through a diode, if a.c. is placed on the plate of the diode?
6. Why may a diode be considered a one-way street?
7. Where will you find diode vacuum tubes used in your radio equipment?

CHAPTER 13 AMPLIFIER TUBES

1. How does the physical structure of a triode vacuum tube differ from a diode?
2. How does the grid control the flow of current from the cathode to the plate?
3. The bias voltage is a _____ potential placed on the grid of a vacuum tube to _____ the flow of current.
4. The flow of current to the plate of the vacuum tube can be CONTROLLED by regulating the grid voltage or plate voltage. Which is the most effective? Why?
5. The ratio of the grid's ability to the plate's ability to control the flow of plate current is known as the _____ or _____ of the tube.

6. The ratio of the change in plate voltage to the change it will produce in plate current is the _____ of the tube.
7. The small condensers formed by the elements of a vacuum tube are referred to as _____
8. The small condensers in question 7 are responsible for causing _____ when amplifying r.f. voltages.
9. When triodes are used to amplify r.f. voltages, it is necessary to use _____ circuits.
10. The two chief disadvantages of a triode are _____ and _____

CHAPTER 14 MORE AMPLIFIER TUBES

1. The interelectrode capacitance of a triode was remedied by placing a _____ between the plate and control grid. The new tube is called a _____
2. In the new tube, the high velocity electrons arriving at the plate knocked other electrons off the plate to create _____. Many of these electrons flow to the _____ grid causing a serious distortion in the signal.
3. The defect of the tetrode was cured by placing a _____ between the plate and the screen grid. This new grid is called a _____, and the tube itself is called a _____
4. The suppressor grid usually operates at the same potential as the _____, and therefore cures the effect of secondary emission by forcing the electrons.
5. In a pentode, the screen grid corrects the _____ and the suppressor grid the _____.
6. The amplification factor of a pentode is (much higher) (much lower) (the same) than a triode.
7. The two chief advantages of a pentode are:
8. In a beam power tube, the suppressor grid is replaced by _____
9. The beam power tube has most of the advantages of the pentode, but has the additional advantage of being able to deliver large _____ with a small driving power.
10. Low frequency, high power transmitting tubes are usually (triodes) (pentodes).
11. The elements within a transmitting tube are usually (larger) (smaller) than in tubes used with receivers.
12. Why must you carefully watch a vacuum tube whose plate is operating at a dull cherry red?
13. What does a blue haze between the cathode and plate usually indicate?

14. Where can you find complete information about the operating characteristics of a vacuum tube?

CHAPTER 15

JOBS OF VACUUM TUBE

1. List the four major uses of a vacuum tube in radio equipment.
2. In rectifiers, the vacuum tube changes _____ to _____
3. The filter of a power supply has the duty of _____.
4. If 1 volt a.c. is placed on the grid of a vacuum tube and 40 volts a.c. appears in the plate circuit of the tube, the vacuum tube has amplified the voltage _____ times.
5. The principle difference between a r.f. amplifier and an a.f. amplifier is in the devices used to _____ the stages.
6. A voltage amplifier is designed to _____, while a power amplifier is designed to _____
7. The function of vacuum tube in an oscillator is to _____ to the oscillator circuit to keep the oscillations going.
8. In a detector circuit, the vacuum tube helps to separate the _____ from the _____ of the carrier wave.

CHAPTER 16

BACKGROUND TO MODERN RADIO

1. A message is carried from a transmitter to receiver by _____ waves.
2. Radio waves are vibrations in the _____
3. The radio frequency waves that are responsible for bringing a message to your transmitter are commonly called _____ waves.
4. Radio waves travel at the speed of _____
5. The frequency ranges for the seven Navy bands (VL, L, M, VH, UH, SH, and MICROWAVE) are: _____
6. The commercial broadcast band is included in the _____ band.

CHAPTER 17

INTRODUCTION TO TRANSMITTERS

1. a. The three stages of a typical Navy transmitter are _____ b. The duty of the second stage is to _____
2. Make a drawing that will show the nature of the wave formed by a C.W. transmitter.

3. The process of combining the r.f. and a.f. voltages in sending a voice message is called
4. A transmitter with low-level modulation has the a.f. voltages fed into one of the _____ stages.
5. In a modulated C.W. transmitter, an _____ is used to supply the audio signal to the C.W. transmission.

CHAPTER 18

INTRODUCTION TO RECEIVERS

1. The five tasks a receiver must do are: _____
2. The receiver's antenna, with the electromagnetic carrier waves act as a _____
3. The emf induced in a receiver's antenna has the (same) (different) frequency as sent out by the transmitter.
4. The field strength of a carrier wave is expressed in _____ per meter length of antenna.
5. The ability of a receiver to amplify a signal is referred to as the _____ of the receiver.
6. When you tune a receiver, you adjust the resonant frequency of the receiver to _____ the frequency of the transmitter.
7. The selectivity of a receiver refers to the ability of a receiver to _____
8. A receiver used to pick up C.W. messages may be (more) (less) selective than that one used to receive voice messages.
9. Verniers, band-spreaders, and tuning indicators are devices to aid you in _____ your receiver.
10. The _____ vacuum tube usually is used in the r.f. sections of a receiver.
11. In the detector stage, the _____ is separated from the _____ of the carrier wave.
12. Draw a block diagram of a tuned radio frequency receiver.
13. Draw a block diagram of a superheterodyne receiver.
14. What is a beat note?
15. The intermediate frequency stages of a superheterodyne receiver are tuned to a frequency of 465 kc. If the incoming signal is 17,100 kc., what must the frequency of the local oscillator be, if the beat note is equal to the difference in the two frequencies?
16. Receiver calibration cards are _____ of where to find a certain station.
17. The volume control on the Navy receivers is (similar) (entirely different) from the one on a home receiver.
- 18 The r.f. gain control is used to _____ in the r.f. stages of the receiver.

Automatic volume control and automatic sensitivity control are the (same) (different) systems.

18. Most Navy receivers have controls for _____ the A.V.C. systems.

19. Noise suppressors, silencers, and output limiters are devices designed to eliminate the effect of _____ and _____

20. Output meters are used to indicate when the set

21. When receiving a C.W. message, it is necessary to turn the B.F.O. (on) (off).

CHAPTER 19 REMOTE CONTROL SYSTEM

1. A key control panel has provisions for _____ and _____ the transmitter.

2. The six parts of a radiophone unit are:

3. Transfer panels are actually _____. Connections on the transfer panels are made with _____

4. Identify where each of the following relays are used: keying; control relays; sequency closing.

CHAPTER 20 THE ANTENNA

1. An antenna is a wire cut to the correct length so it will radiate _____ the energy from the transmitter.

2. A dipole is always equal to _____

3. In a center fed dipole, the impedance is the (greatest) (least) at the ends, and the current is (greatest) (least) at the center.

4. The electromagnetic field is (greatest) (least) at the center of the dipole.

5. Standing waves are _____ and _____ fields surrounding the dipole.

6. The actual length of a transmitter is approximately _____ percent _____ than a half wave length.

7. A Hertz antenna is any antenna equal to approximately a

8. A Marconi antenna is equal to approximately _____ wave length.

9. Antenna tuning circuits are used to correct the _____

10. Four common types of transmission lines are:

11. A resonant line (does) (does not) have standing waves distributed throughout its length.

12. A non-resonant transmission line is terminated by an impedance _____ to that of the line.

699198°-46-24

CHAPTER 21 WAVE PROPAGATION

1. The ground wave moves _____, while the sky wave moves _____
2. The ground wave is used for short range communication using low power with (high) (low) frequency, and long range communication with (high) (low) power, and (high) (low) frequency.
3. The skywave is used for long range (high) (low) frequency daylight communication.
4. Communication between airplanes in flight is an example of (direct) (ground) (surface) contact.
5. The tropospheric wave is the portion of the ground wave subject _____ conditions.
6. Long range communication with frequencies in the 18 to 300 kc. band is obtained by using (high) (low) power.
7. The ionosphere is an _____ layer of the atmosphere existing between the approximate limits of _____ miles above the earth.
8. The ionosphere is caused by _____ and _____ radiations from the sun _____
9. The ionosphere is (static) (constantly changing).
10. The layers of the ionosphere present during the daylight are:
11. Usually only the _____ layer is present at night with an occasional _____
12. The two general effects of the ionosphere on the skywave is to _____ and _____
13. The critical frequency is _____ and _____
14. Variations in the critical frequency are the cause of variations in the _____
15. The critical frequency (is) (is not) affected by the hour of the day.
16. The increased ionization during the day has three effects on the sky wave. They are _____
17. The presence of the _____ layer during the daylight hours makes long range, _____ frequency communications possible.
18. The area between the end of the ground wave, and the position the skywave returns to the earth is called the _____
19. Extremely long range communication is permitted by _____ refraction and reflection.
20. Fading is usually the result of two waves arriving at a receiver (in) (out) (varying) phase.

350

21. Frequency black-outs are the result of _____ or _____ storms.
22. The presence of ducts are responsible for _____ the normal range of V.H.F. and U.H.F. transmitters.
23. When can you expect increased ranges of V.H.F. and U.H.F. communications?
24. Nomograms are used to find the _____ for long range communication.

CHAPTER 22 NAVY TRANSMITTERS

1. You tune a transmitter to get maximum _____ from transmitter to antenna.
2. A straight-through transmitter is one where all stages are tuned to the frequency of _____
3. Resonating a stage is another name for _____ a stage.
4. What devices indicate when a stage is correctly tuned?

5. Resonance in a plate circuit is usually indicated by a _____ in the plate current meter.
6. Two indications of resonance in the antenna circuit are _____ antenna current, or a (increase) (decrease) in plate current of the power amplifier.
7. Frequency doubling, and frequency multiplying consists in tuning the amplifier stages to one of the being generated by the oscillator.
8. The frequency meter is a device used to _____ the frequency of the _____

CHAPTER 23 NAVY RECEIVERS

No questions on tuning of Navy receivers.

351

ANSWERS TO QUIZ

CHAPTER 1 WHAT IS ELECTRICITY?

1. Electrons-protons.
2. Losing electrons-gaining electrons.
3. Likes repel, unlikes attract.
4. An object that has gained or lost electrons.
5. Electrons will move through the wire and equalize the charges.
6. An electric current.
7. An ampere.
8. Potential.
9. *a.* -135, -20, -2, 0, 75, 425.
b. 560 volts.
10. Resistance.
11. Mica, bakelite, dry air.
12. Carbon, wire wound, variable.

CHAPTER 2 BATTERIES

1. An EMF.
2. Two dissimilar metals and an electrolyte.
3. Copper.
4. Chemical.
5. Primary-secondary.
6. Recharged.
7. Hydrometer.

8. Batteries.
9. Voltage, current.

CHAPTER 3 CIRCUITS

1. Complete path.
2. Flows through all parts-divide-smaller.
3. 600 ohms, 54.5 ohms.

352

CHAPTER 4 OHM'S LAW

1. The current flowing in a circuit is proportional to the voltage and inversely proportional to the resistance.
2. 0.005 amperes-5 milliamperes.
3. 246 volts.
4. 600 watts.

CHAPTER 5 MAGNETISM

1. Check your drawings with figures 35, 36.
2. The magnetic field.
3. From North to the South.
4. Permanent-temporary.
5. Permeability-retain its magnetism.

CHAPTER 6 ELECTROMAGNETISM

1. Clockwise.
2. Concentrates the field.
3. Wrap your left hand about the coil with the fingers pointing in the direction of the current. The thumb will point to the North pole.
4. Concentrate.
5. Low.
6. Relays.

CHAPTER 7 GENERATORS

1. A magnetic field, a conductor, and a relative motion between them.
2. Armature, field coils, slip rings, brushes.
3. Alternating.
4. Alternating current flows in two directions, direct current only one.
5. a. The current starts at zero, rises to maximum positive, falls to maximum negative and back to zero 60 times a second.
b. 60.
6. 20 to 20,000 cycle. 20 kc. to 30,000 mc.

353

7. Kilocycle is 1,000 cycles. Megacycle 1,000,000 cycles.
8. a. The slip rings are changed to commutator segments.
b. Cause the current to flow in one direction.
- 9- Check you; drawing with figure 66.

CHAPTER 8 MOTORS

1. The magnetic field of the armature is alternately attracted and repelled by the field of the stator causing the armature to rotate.
2. Armature, stator, commutator, brushes.
3. To drive the generators in a motor generator set, and to run ventilating fans to cool the transmitter.

CHAPTER 9 MORE ABOUT INDUCTION

1. The ability of a current flowing in a coil to induce a voltage in the coil itself.
2. The voltage of self induction.
3. The induced voltage opposes the voltage that created it.
4. Number of turns of wire per inch, diameter, number of layers of windings, kind of core.
5. a. Reactance is the opposition of a coil to the flow of an alternating current.
b. Inductance of the coil, frequency of the current.
6. 6.28 ohms, 62,800 ohms.
7. An a.f. choke coil has an iron core, while a r.f. choke coil has an air coil.
8. The ability of one coil to induce a voltage in another coil. Transformers.
9. An a.f. transformer will have an iron core, and a r.f. transformer will have an air coil.
10. Step up. One to three.

CHAPTER 10 THE CONDENSER

1. Two metal plates separated by an insulator.
2. Paper, mica, electrolytic, variable.
3. Variable.
4. The farad.
5. Higher the frequency the lower the reactance.

354

6. A conductor acts as an open circuit to d.c., but a solid conductor to a.c.
7. *a.* By electrons leaving one plate of the condenser, and entering the other. *b.* When the voltage across the condenser is equal to the applied voltage.

CHAPTER 11 RESONANCE

1. Resonant.
2. Wooden box, pipe, a coil and condenser.
3. Work together.
4. Inductance, capacity.
5. Decrease.
6. Coils.
7. Resonant frequency.

CHAPTER 12 THE VACUUM TUBE

1. Plate, cathode, glass envelope, and a vacuum.
2. Electrons boil out, cloud.
3. Repelled, move to.
4. Increases.
5. Current will flow from cathode to plate on positive half cycles, and not on negative half cycles.
6. Because current will flow from cathode to plate only.
7. In power supplies.

CHAPTER 13 AMPLIFIER TUBES

1. A grid is placed between the cathode and the plate.
2. A negative grid repels the electrons back to the cathode. The more negative the grid the stronger the repulsion.
3. Negative, reduce.
4. Varying the grid voltage. Because the grid is so much closer to the cathode.
5. Amplification factor, μ .

6. A.C. plate resistance.
7. Interelectrode capacitance.
8. Unwanted oscillations.

9. Neutralizing.
10. Low sensitivity, high interelectrode capacitance.

CHAPTER 14 MORE AMPLIFIER TUBES

1. Grid, tetrode.
2. Secondary emission. Screen grid.
3. Grid, suppressor, pentode.
4. Cathode, back to the plate.
5. Interelectrode capacitance, secondary emission.
6. Much higher.
7. High sensitivity, low interelectrode capacitance.
8. Beam forming plates.
9. Power.
10. Triodes.
11. Larger.
12. Because a slight addition of current will destroy the tube.
13. The tube is "gassy."
14. In a Vacuum Tube Manual.

CHAPTER 15 JOBS OF A VACUUM TUBE

1. Rectifiers, amplifiers, oscillators, detectors.
2. Alternating current to direct current.
3. Smooth out the ripples in the d.c.
4. 40.
5. Couple the stages.
6. Increase the voltage, increase the current.
7. Supply the energy.
8. Audio component, radio frequency portion.

CHAPTER 16 BACKGROUND TO MODERN RADIO

1. Electromagnetic.
2. Ether.
3. Carrier.
4. Light.
5. Check your answer with the table on page 162.
6. Medium frequency.

356

CHAPTER 17

INTRODUCTION TO TRANSMITTERS

1. *a.* Oscillator, buffer, power amplifier. *b.* Isolate the oscillator from power amplifier.
2. Check your drawing with figure 118.
3. Modulation.
4. Buffer.
5. Audio oscillator.

CHAPTER 18

INTRODUCTION TO RECEIVERS

1. Check your answer with page 172.
2. Generator.
3. Same.
4. Microvolts.
5. Sensitivity.
6. Match.
7. Tune in one transmitter and tune out another.
8. More.
9. Tuning.
10. Pentode.
11. Audio component, radio frequency component.
12. Check your drawing with figure 127.
13. Check your drawing with figure 128.
14. A note formed by beating two vibrations of different frequencies against each other.
15. 17,565 kc.
16. Accurate records.
17. Similar.
18. Control the gain.
19. Same.
20. Adjusting.
21. Noise and static.
22. Is properly tuned.

23. On.

CHAPTER 19 REMOTE CONTROL SYSTEM

1. Starting, stopping, and keying.
2. Handset, carrier off-on, earphone level, key circuit off-on, noise suppressor control, start-stop.

357

3. Switch boards. Patch cords.
4. To key the transmitter; used to start and stop transmitters; to turn on bias voltages and plate voltages in the correct order.

CHAPTER 20 THE ANTENNA

1. Efficiency.
2. A half wave length.
3. Greatest, greatest.
4. Greatest.
5. Electromagnetic, electrostatic.
6. 5% shorter.
7. One half wave length.
8. One quarter wave length.
9. Electrical length.
10. Open two wire, coaxial cables, twisted pair, shielded pair.
11. Does.
12. Equal.

CHAPTER 21 WAVE PROPAGATION

1. Along the surface of the earth-Upward and outward.
2. High, high, low.
3. High.
4. Direct.
5. Atmospheric.
6. High.
7. Ionized, 30-350.
8. Ultra violet, particle.
9. Constantly changing.
10. D , E , F_1 , F_2 .

11. *F*, Sporadic *E*.
12. Absorb, refract.
- 13 The highest frequency radiation that can be sent directly upward and still be returned to the earth.
14. Ionosphere.
15. Is effected.
16. *a*. Causes sky wave to return to the nearer point of transmission. *b*. Absorbs more energy from the sky wave. *c*. F_1 - F_2 layer makes long range, high frequency communication possible

358

-
17. F_2 , High.
 18. Skip zone.
 19. Multiple.
 20. Varying.
 21. Absorption by ionosphere, ionospheric storms.
 22. Increasing.
 23. Check your answer with list on page 231.
 24. Recommended frequency.

CHAPTER 22
NAVY TRANSMITTERS

1. Power.
2. The oscillator.
3. Tuning.
4. The meters.
5. Dip.
6. Maximum, increase.
7. Harmonics.
8. Check, oscillator.

359

INDEX

Alternating current	71	Charge, laws of	6
Ampere	9	Circuits	25-31
Amplifier tube	127-147, 151-154	Coil, magnetic field	58
Antenna	159, 201, 214	Coils, radio circuits	93
Antenna circuit, resonance	242	Communication, U.H.F.	227
Antenna, dipole	202	Communication, V.H.F.	227
current and voltage	203	Condenser	103-112
electromagnetic field	205	fixed	107
electrostatic field	206	reactance	110
impedance	202	size	109
Antenna, half wave	202	types	104-107, 112
Hertz	207	variable	106, 107
length	207, 210	Conductors	12
Marconi	208	Continuous wave transmission	165-168
tuning circuits	210	Control relay	198
Armature	75	Coulomb	8
Artificial magnets	43	Counter emf	89-92
Atom, arrangement of	2	Current	
Alternating current		electricity	8
generator	68	flow	56
motor	84	Ohm's Law	34-35
Audio frequency transformers	96	Cycles	73
Band switching	182	Detector stage	178
Band widths	175	Detector, vacuum tube	154
Batteries	17-24	Diode vacuum tube	121-126
Beam power tube	143-145	Dipole. See Antenna.	
Beat frequency oscillator	186	Direct current generator	75-78
Beat notes	180	Direct current motor	82
Bias voltage	130	Dry cell	19-20
Borrowing electrons, theory	4	Duct formation	228
Calibration	183	Earth, magnetism	48-49
Capacitance, inter-electrode	135, 142	Electromagnetic field, dipole	205
Capacitor	103	Electromagnetic stator	74
Cores, iron	60	Electromagnetism	53-63
Cathode	121, 128	Electromagnets, use	61

Cell		Electron flow, direction	11
battery	22	Electromotive force	17
dry	19-22	alternating	71
primary	17-20	counter	89-92
secondary	21-23	Fading	225
series and parallel	23-24	Field. magnetic	45-46

361

Fixed condenser	107	Magnetic field	45-46,54-60
Frequency		coil	58
audio	74	coil strength	59-60
band, Navy	230, 234	Magnetic materials	49-50
blackouts	226	Magnetism	41-51
general use	229	earth	48-49
intermediate	181	electricity from	65-66
meter	246	north	46-47
multiplying	224	south	46-47
radio	74-161	theory	43-45
Galvanometer	67	Magnets	
Generators		artificial	43
alternating current	68	natural	41-43
direct current	75-78	permanent	51
operation	69-71	Marconi antenna	208
Grid	120, 127	Mechanical energy from electricity	79
Grid control	129-132	Meter, frequency	246
Ground wave	216	Meter, output	184
Half wave antenna	202	Motor	79-86
Harmonica	244	alternating current	84
Helium atom	2	direct current	82
Hertz antenna	207	parts	82
Hydrogen atom	2	St. Louis	83
Impedance, dipole antenna	202	Mu	132
Inductance	90	Natural magnets	41-43
mutual	94	Navy frequency band	230-234

Induction	66, 87-102	Navy receivers	307-337
self	87	Navy transmitters	237-306
Insulators	12	Negative potentials	10
Interelectrode capacitance	135, 142	Neutron	3
Intermediate frequency	181	Noise suppressor	184
Ionosphere	218-224	Nomograms	232
IR drops	36-38	North magnetism	46-47
Jack boxes	194	Ohm	13
Key control panel	191	Ohm's Law	33-39
Kirchhoff's Laws	37-38	current	34-35
Left hand rule	56	voltage	36
Lenz's Law	90	Oscillator, beat frequency	186
Likes, law of	7, 47	vacuum tube	154
Lithium atom	3	Output limiter	184
Lodestones	42	Output meter	184
		Parallel circuits	27-29
		Pentode	140
		Permanent magnets	51

362

Permeability	50-51	Remote control system, parts	190
Potential		Resistance	12
energy	9-10	in parallel	29-31
negative	10	in series	29
Power	38-39	Ohm's Law	35-36
Primary cell	17-20	units of	13
Protective relay	198	Resistors for radio circuits	13-15
Radio		Resonance	113-118
background	157	Resonance, antenna circuit	242
circuits, coils	93	Resonator	114
resistors for	13-15	St. Louis motor	83
frequency	161	Self induction	87
transformer	100	Secondary cell	21-23
transmitter	163-169	Secondary emission	140

wave. <i>See</i> Wave.		Series circuits	27-28
Radiophone unit	192	Signal pick-up	172
RAK-RAL receiver	308-313	Simple circuits	26-27, 34
RAO-RBH receiver	313-322	Sine wave	71
RBB-RBC receiver	323-329	Spark, definition	6
RBK receiver	329-332	Spark gap transmitter	158
RCK receiver	332-337	Spreaders	176
Reactance	91	South magnetism	46-47
Reactance, condenser	110	Standing waves	206
Receiver	171-187	Static electricity	8
circuits	174, 178	Stator, electromagnetic	74
Navy	307-337	Superheterodyne receiver	180
RAK-RAL	308-313	Switching, band	182
RAO-RBH	313-318	TBK-TBM transmitter	247-260
RBA	318-322	TBL transmitter	260-271
RBB-RBC	323-329	TBS transmitter	284-291
RBK	329-332	TBY transmitter	298-306
RCK	332-337	TDE transmitter	272-283
selectivity	174	TDQ transmitter	292-298
sensitivity	173	Tetrode	139
superheterodyne	180	Transconductance	134
TBS	291-292	Transfer panels	194
uses	172	Transformer	95-102
Rectifier	124	audio frequency	96
vacuum tube	149	radio frequency	100
Relay	62, 196, 199	Transmission line	213
classification	197	Transmission, continuous wave	165-168
control	198		
keying	197		
protective	198		
Reluctance	50		

Triode amplifier tube	127-137	pentode	140
Navy	237-306	rectifier	149
radio	163	tetrode	139
Transmitters		transmitting	145
resonance	238-242	uses	149-155
spark gap	158	Variable condenser	106, 117
TBK-TBM	247-260	Verniers	176
TBL	260-271	V.H.F. communication	227
TBS	284-291	Volt	9
TBY	298-306	Voltage, bias	130
TDE	272-283	Voltage, Ohm's Law	36
TDQ	292-298	Volume control	184
tuning	168, 237	Wave	
Transmitting tube	145	carrier strength	172
Tube, Manual	146	continuous	165
Tubes. <i>See</i> Vacuum tube.		ground	216
Unlikes, law of	7, 47-48	modulated continuous	168
Vacuum tube	119-126	multiple refraction	225
amplifiers	127-147, 151-154	propagation	215-235
beam power	143-145	radio	160
detector	154	refraction	221
diode	121-126	sky	216, 218
oscillator	154	standing	206

* U. S GOVERNMENT PRINTING OFFICE: 1946-699198



[Previous Chapter](#)



[Radio Home](#)

[Page](#)

Copyright (C) 2005 [Historic Naval Ships Association](#)

All Rights Reserved

[Legal Notices and Privacy Policy](#)

Version 1.00, 12 Nov 05



Historic Naval Ships Association

Historic Naval Ship Visitors' Guide

[Historic Naval Ships Listed By Location](#)

[Historic Naval Ships Listed By Name](#)

[Historic Naval Ships Listed By Type](#)

[HNSA Ships with Overnight Programs](#)

[HNSA Associate Members](#)

[About HNSA](#)

[How To Join HNSA](#)

[Sources of Information](#)

[New-Historical Sound Online](#)

[New-WW II Destroyer Operating in 2006](#)

[New-Navy Documents and Manuals Online](#)

[HNSA Bulletin Board](#)

[Standards for Historic Vessel Preservation Projects](#)

[Job Postings in the Historic Fleet](#)

Join the next [HNSA Conference](#), 9 Oct 2006 at [HMS Belfast](#), London, U. K.

[Search hnsa.org](#)

Historic Naval Ships by Location:

AUSTRALIA

[HMAS Ovens](#), Fremantle, Western Australia

[HMAS Diamantina](#), South Brisbane, Queensland

[SS Forceful](#), South Brisbane, Queensland

[HMAS Advance](#), Sydney, New South Wales

[Commando Boat Krait](#), Sydney, New South Wales

[MB172 Epiclass](#), Sydney, New South Wales

[HMAS Onslow](#), Sydney, New South Wales

[HMAS Vampire](#), Sydney, New South Wales

[HMAS *Whyalla*](#), Whyalla, South Australia

CANADA

[RV *Ben Franklin*](#), Vancouver, British Columbia

[RCMPV *St. Roch*](#), Vancouver, British Columbia

[HMCS *Fraser*](#), Bridgewater, Nova Scotia

[HMCS *Sackville*](#), Halifax, Nova Scotia

[HMCS *Haida*](#), Hamilton, Ontario

ENGLAND

[HMS *Belfast*](#), London

[HMS *Cavalier*](#), Chatham

FRANCE

[FS *Colbert*](#), Bordeaux

GREECE

[B/S *Georgios Averoff*](#), Athens

ISRAEL

[INS *Af Al Pi Chen*](#), Haifa

[INS *Mivtach*](#), Haifa

NETHERLANDS

[HNLMS *Tonijn*](#), Den Helder

[HNLMS *Abraham Crijnsen*](#), Den Helder

[HNLMS *Schorpioen*](#), Den Helder

[Hr. Ms. *Buffel*](#), Rotterdam

[Hr. Ms. *Mercur*](#), Scheveningen

NORWAY

[M314 *Alta*](#), Oslo

PERU

[BAP *Abtao*](#), Callao

RUSSIA

[Cruiser *Aurora*](#), St. Petersburg

[Soviet *B-413*](#), Kaliningrad

[Icebreaker *Krasin*](#), St. Petersburg

SWEDEN

[T121 Spica](#), Stockholm

TURKEY

[TCG Uluçalireis](#), Istanbul

UNITED STATES OF AMERICA

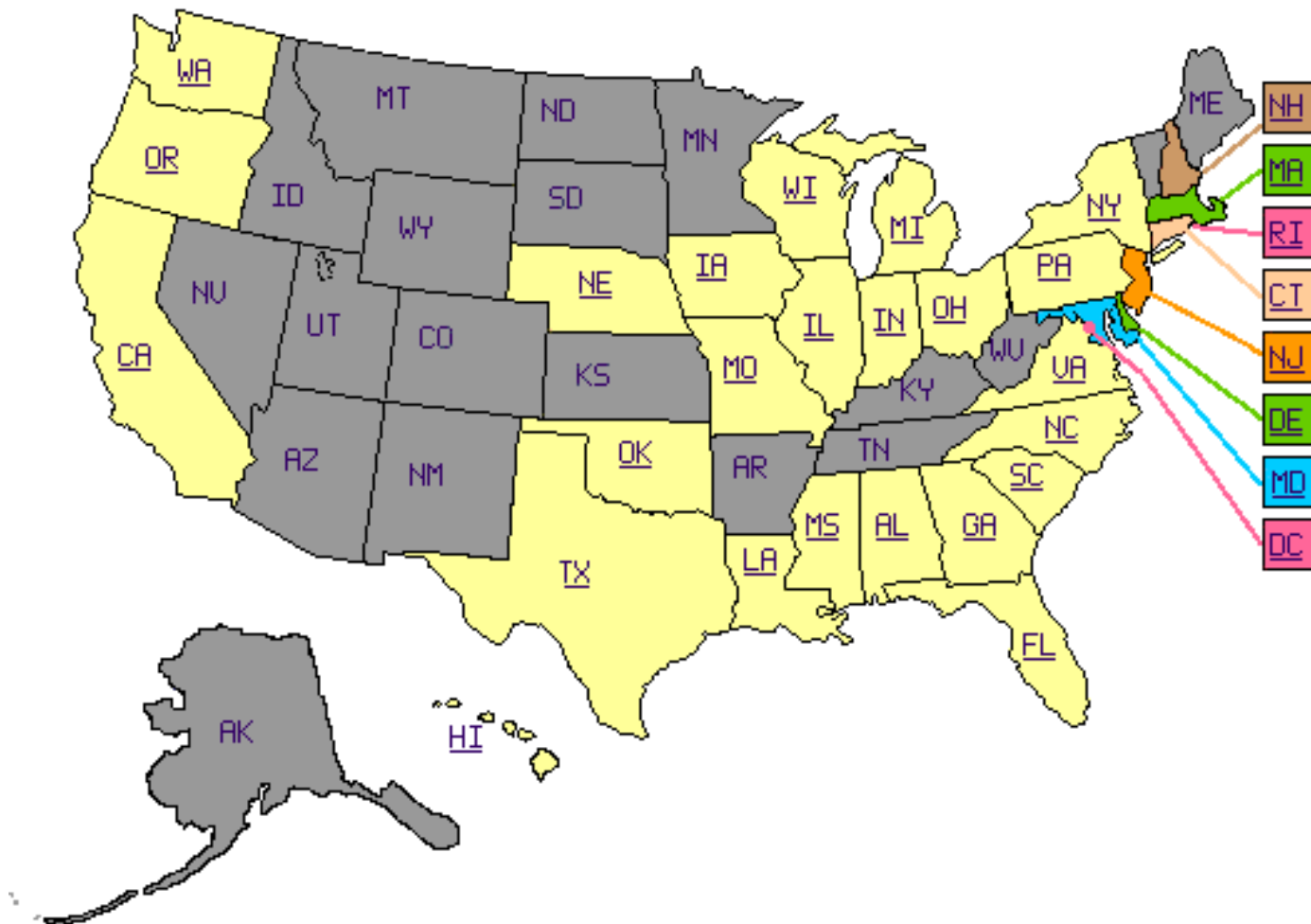

[[AL](#)] [[AR](#)] [[CA](#)] [[CT](#)] [[DC](#)] [[DE](#)] [[FL](#)] [[GA](#)] [[HI](#)] [[IL](#)] [[IN](#)] [[IA](#)] [[LA](#)] [[MD](#)] [[MA](#)] [[MI](#)] [[MS](#)]
[[MO](#)] [[NE](#)] [[NH](#)] [[NJ](#)] [[NY](#)] [[NC](#)] [[OH](#)] [[OK](#)] [[OR](#)] [[PA](#)] [[RI](#)] [[SC](#)] [[TX](#)] [[VA](#)] [[WA](#)] [[WI](#)]

Alabama

[USS Alabama](#), Mobile, Alabama

[USS Drum](#), Mobile, Alabama

[PBR Mark II](#), Mobile, Alabama

Arkansas

[USS Razorback](#), North Little Rock, Arkansas

California

[USS Hornet](#), Alameda, California

[USS *Potomac*](#), Oakland, California
[Lightship *Relief*](#), Oakland, California
[SS *Red Oak Victory*](#), Richmond, California
[USCGC *Fir*](#), Rio Vista, California
[PTF 26](#), Rio Vista, California
[USAT *LT-1967*](#), San Diego, California
[Steam Yacht *Medea*](#), San Diego, California
[USS *Midway*](#), San Diego, California
[SS *Jeremiah O'Brien*](#), San Francisco, California
[USS *Pampanito*](#), San Francisco, California
[SS *Lane Victory*](#), San Pedro, California
[PBR *Mark II*](#), Vallejo, California

Connecticut

[USCG Boat *Icebucket*](#), Bridgeport, Connecticut
[Japanese *HA-8*](#), Groton, Connecticut
[USS *Nautilus*](#), Groton, Connecticut
[Italian *Siluro a Lenta Corsa*](#), Groton, Connecticut, USA
[USS *X-1*](#), Groton, Connecticut
[Auxilliary Schooner *Brilliant*](#), Mystic, Connecticut
[USCGC *Eagle*](#), New London, Connecticut

Delaware

[Lightship *Overfalls*](#), Lewes, Delaware

District Of Columbia

[USS *Barry*](#), Washington, District of Columbia
[LCVP](#), Washington, District of Columbia
[Motor *Whaleboat*](#), Washington, District of Columbia
[PCF-1](#), Washington, District of Columbia
[RV *Trieste*](#), Washington, District of Columbia
[Continental Gunboat *Philadelphia*](#), Washington, District of Columbia

Florida

[PTF 3](#), Deland, Florida, USA
[PBR *Mark II*](#), Orlando, Florida, USA
[SS *American Victory*](#), Tampa, Florida

Georgia

[CSS *Chattahoochee*](#), Columbus, Georgia
[CSS *Jackson*](#), Columbus, Georgia

Hawaii

[USS Arizona](#), Honolulu, Hawaii
[USS Bowfin](#), Honolulu, Hawaii
[Japanese Kaiten](#), Honolulu, Hawaii
[USS Missouri](#), Honolulu, Hawaii
[USS Utah](#), Honolulu, Hawaii

Illinois

[German U-505](#), Chicago, Illinois

Indiana

[USS LST-325](#), Evansville, Indiana

Iowa

[USACOE Dredge William M. Black](#), Dubuque, Iowa

Louisiana

[USS Kidd](#), Baton Rouge, Louisiana

Maryland

[Lightship Chesapeake](#), Baltimore, Maryland
[USS Constellation](#), Baltimore, Maryland
[SS John W. Brown](#), Baltimore, Maryland
[USCGC Taney](#), Baltimore, Maryland
[USS Torsk](#), Baltimore, Maryland

Massachusetts

[USS Cassin Young](#), Boston, Massachusetts
[USS Constitution](#), Boston, Massachusetts
[Tug Luna](#), Boston, Massachusetts
[Demolition Boat](#), Fall River, Massachusetts
[Hiddensee](#), Fall River, Massachusetts
[USS Joseph P. Kennedy, Jr.](#), Fall River, Massachusetts
[LCM 56](#), Fall River, Massachusetts
[USS Lionfish](#), Fall River, Massachusetts
[USS Massachusetts](#), Fall River, Massachusetts
[PT 617](#), Fall River, Massachusetts
[PT 796](#), Fall River, Massachusetts
[USS Salem](#), Quincy, Massachusetts
[German Seehund](#), Quincy, Massachusetts

Michigan

[USCGC Bramble](#), Port Huron, Michigan

[SS City Of Milwaukee](#), Manistee, Michigan

[USCGC McLane](#), Muskegon, Michigan

[SS Milwaukee Clipper](#), Muskegon, Michigan

[USS Silversides](#), Muskegon, Michigan

Mississippi

[USS Cairo](#), Vicksburg, Mississippi

Missouri

[USS Ariès](#), Brunswick, Missouri

Nebraska

[USS Hazard](#), Omaha, Nebraska

[USS Marlin](#), Omaha, Nebraska

New Hampshire

[USS Albacore](#), Portsmouth, New Hampshire

New Jersey

[USS New Jersey](#), Camden, New Jersey

[Japanese Kaiten](#), Hackensack, New Jersey

[USS Ling](#), Hackensack, New Jersey

[PBR Mark II](#), Hackensack, New Jersey

[German Seehund](#), Hackensack, New Jersey

[Fenian Ram](#), Paterson, New Jersey

[Holland Boat #1](#), Paterson, New Jersey

[Intelligent Whale](#), Sea Girt, New Jersey

New York

[USS Slater](#), Albany, New York

[USS Croaker](#), Buffalo, New York

[USS Little Rock](#), Buffalo, New York

[PTF 17](#), Buffalo, New York

[USS The Sullivans](#), Buffalo, New York

[MV Commander](#), Cornwall-on-Hudson, New York

[USS Growler](#), New York, New York

[USS Intrepid](#), New York, New York

[USAT LT-5](#), Oswego, New York

[Admiral's Barge](#), Romulus, New York

North Carolina

[USS North Carolina](#), Wilmington, North Carolina

Ohio

[USS Cod](#), Cleveland, Ohio

[SS William G. Mather](#), Cleveland, Ohio

Oklahoma

[USS Batfish](#), Muskogee, Oklahoma

Oregon

[USS Blueback](#), Portland, Oregon

[PT-658](#), Portland, Oregon

Pennsylvania

[U.S. Brig Niagara](#), Erie, Pennsylvania

[USS Becuna](#), Philadelphia, Pennsylvania

[USS Olympia](#), Philadelphia, Pennsylvania

[USS Requin](#), Pittsburgh, Pennsylvania

Rhode Island

[Soviet Juliett 484](#), Providence, Rhode Island

South Carolina

[USCGC Ingham](#), Mount Pleasant, South Carolina

[USS Laffey](#), Mount Pleasant, South Carolina

[USS Yorktown](#), Mount Pleasant, South Carolina

[USS Clamagore](#), Mount Pleasant, South Carolina

[CSS H. L. Hunley](#), North Charleston, South Carolina

Texas

[USS Lexington](#), Corpus Christi, Texas

[Admiral's Barge](#), Fredericksburg, Texas

[Japanese HA-19](#), Fredericksburg, Texas

[PT 309](#), Fredericksburg, Texas

[USS Cavalla](#), Galveston, Texas

[USS Stewart](#), Galveston, Texas

[USS Texas](#), LaPorte, Texas

[USS Orleck](#), Orange, Texas

Virginia

[USS Monitor](#), Newport News, Virginia

[USS Wisconsin](#), Norfolk, Virginia

[RV Aluminaut](#), Richmond, Virginia

Washington

[USS Turner Joy](#), Bremerton, Washington

[RV Deep Quest](#), Keyport, Washington

[RV Trieste II](#), Keyport, Washington

[Tug Arthur Foss](#), Seattle, Washington

[Lightship Swiftsure](#), Seattle, Washington

[Schooner Wawona](#), Seattle, Washington

Wisconsin

[USS Cobia](#), Manitowoc, Wisconsin

[USCG Boat Icelander](#), Manitowoc, Wisconsin

Copyright (C) 1998-2006 Historic Naval Ships Association.

All Rights Reserved.

[Legal Notices and Privacy Policy](#)

Version 2.24, 28 Mar 06

HNSA Web Site Legal Notices

Liability:

The materials on this website are intended to be for informational purposes only.

This Website (excluding linked sites) is controlled by HNSA from its offices within the State of Virginia, United States of America. It can be accessed from all 50 states, as well as from other countries around the world. As each of these jurisdictions has laws and regulations that may differ from those of the State of Virginia, by accessing this Website both you and HNSA agree that the statutes and laws of the State of Virginia, without regard to conflicts of law principles thereof, will apply to all matters relating to use of this website. In the case of a dispute, you and HNSA agree to submit to the exclusive personal jurisdiction and venue of the Superior Court of the County of Isle of Wight, Virginia and the United States District Court for Virginia with respect to such dispute.

HNSA assumes no liability for the use or interpretation of information contained herein. This publication is provided "AS IS" WITHOUT WARRANTY OF ANY KIND, EITHER EXPRESSED OR IMPLIED, INCLUDING, BUT NOT LIMITED TO, THE IMPLIED WARRANTIES OF MERCHANTABILITY, FITNESS FOR A PARTICULAR PURPOSE, OR NON-INFRINGEMENT OF THIRD PARTY RIGHTS.

This website contains links to other resources on the Internet including our members, affiliates and others. These links are provided solely as aids to assist you in locating other Internet resources that may be of interest. They are not intended to state or imply that HNSA sponsors, endorses, is affiliated or associated with such linked sites. We do not control and cannot guaranty the relevance, timeliness, legality, cost, accuracy or any other properties of sites linked from our site.

Privacy:

Our computer system uses software programs to create summary statistics that are used for determining the volume of visitors, sources of referrals, determination of other system performance areas, errors in access, and assessing what information is of most or least interest. HNSA collects and stores the following information, The name of the domain from which you access the Internet; The date and time you access our web site; The pages you peruse and files you access; The Internet address of the web site from which you linked directly to our site.

If you choose to provide us with personal information, as in an email message or a web services request form, HNSA will use this information to respond to your request. There are times when your email may be forwarded to others both in and out of HNSA to better assist you. Except for the exceptions listed above and for authorized law enforcement activities, HNSA does not share email or other personal information with outside individuals or organizations without obtaining your permission.

Questions, comments and other communications that we receive may become part of the permanent record of HNSA.

You may send us e-mail. However you should not send us confidential or sensitive information via e-mail because the security of Internet-based e-mail is uncertain. By sending unencrypted e-mail messages containing sensitive or confidential information, you accept the risks of such uncertainty and possible lack of confidentiality over the Internet.

Copyright:

This web site is protected by copyright law and international treaties. Unauthorized reproduction or distribution of the content of this web site, or any portion thereof, may result in severe criminal or civil penalties and will be prosecuted to the maximum extent possible under the law.

Private Use: Contents of this web site may be used for personal and/or educational purposes without restriction

Commercial Use: Contents of this web site, or any portion thereof, including but not limited to non-public domain images, may not be used for any commercial purpose without specific authorization from HNSA.

The HNSA logo and HNSA crest are trademarks of HNSA.

Photos, drawings, and text in the ship pages may also be the intellectual property of others and is subject to their restrictions.

Disputes:

Should you have questions or disputes about these policies, please contact us with a detailed description of your question or dispute at contact below.

Contact Information:

Director
Historic Naval Ships Association
Post Office Box 401
Smithfield, VA 23431-0401
Tel: (757) 356-9422
Fax: (757) 356-9433
Email: info@hnsa.org

Return to the [HNSA Guide](#).

Copyright (C) 2004-2006, Historic Naval Ships Association.

All Rights Reserved.

Version 1.06, 10 Jan 06