

MHI
Copy 3

FM 57-21

DEPARTMENT OF THE ARMY FIELD MANUAL

600-40
310
6

COP 2

LIBRARY, U. S. MILITARY ACADEMY
WEST POINT, N. Y.

HEADQUARTERS AND HEADQUARTERS COMPANY AIRBORNE DIVISION BATTLE GROUP

~~GRADE S3~~



HEADQUARTERS, DEPARTMENT OF THE ARMY
JULY 1959

FIELD MANUAL

No. 57-21

HEADQUARTERS,
DEPARTMENT OF THE ARMY
WASHINGTON 25, D. C., 23 July 1959

HEADQUARTERS AND HEADQUARTERS COMPANY, AIRBORNE DIVISION BATTLE GROUP

| | | Paragraphs | Page |
|-------------------|--|------------|------|
| PART ONE. | OPERATIONS | | |
| CHAPTER 1. | ORGANIZATION AND DUTIES OF BATTLE GROUP HEADQUARTERS AND COMPANY HEADQUARTERS | | |
| Section I. | Introduction | 1-3 | 1 |
| II. | Battle group headquarters.... | 4-10 | 4 |
| III. | Company headquarters..... | 11, 12 | 7 |
| IV. | Preparation for the airborne assault | 13-15 | 9 |
| CHAPTER 2. | COMMUNICATION | | |
| Section I. | General | 16-40 | 11 |
| II. | Command posts..... | 41-48 | 47 |
| III. | Tactical employment..... | 49-57 | 57 |
| IV. | Electronic devices section..... | 58-64 | 74 |
| CHAPTER 3. | RECONNAISSANCE PLATOON | | |
| Section I. | General | 65-68 | 88 |
| II. | Operational techniques..... | 69-75 | 91 |
| III. | Missions | 76-82 | 96 |
| IV. | Reconnaissance techniques.... | 83-88 | 100 |
| V. | Security techniques..... | 89-93 | 104 |
| VI. | Actions on enemy contact..... | 94-96 | 107 |
| VII. | The airborne assault..... | 97-100 | 111 |

| | | |
|--|---------|-----|
| CHAPTER 4. ASSAULT GUN PLATOON | | |
| Section I. General | 101-104 | 116 |
| II. Offense | 105-115 | 121 |
| III. Defense and retrograde..... | 116-120 | 130 |
| IV. The airborne assault..... | 121-124 | 135 |
| PART TWO. LOGISTICS AND PERSONNEL | | |
| CHAPTER 5. SUPPLY AND TRANSPORTATION PLATOON | | |
| Section I. Mission, organization, duties, and installations..... | 125-131 | 140 |
| II. Combat supply operations..... | 132-138 | 146 |
| III. Repair, salvage, and miscellaneous activities..... | 139-144 | 171 |
| CHAPTER 6. MEDICAL PLATOON..... | 152-154 | 184 |
| 7. PERSONNEL SECTION..... | 145-151 | 174 |
| APPENDIX REFERENCES | | 187 |
| INDEX..... | | 189 |

PART ONE OPERATIONS

CHAPTER 1

ORGANIZATION AND DUTIES OF BATTLE GROUP HEADQUARTERS AND COM- PANY HEADQUARTERS

Section I. INTRODUCTION

1. Purpose and Scope

a. This text is a guide to the tactical employment of the headquarters and headquarters company of the airborne battle group. It covers the organization of the company and the organization and functioning of its elements.

b. The material presented herein is applicable to nuclear warfare. Where applicable, appropriate modifying guidance for nonnuclear warfare is integrated throughout the manual.

2. Mission

The headquarters and headquarters company provides command, staff, administration, communications, reconnaissance, supply, medical service, and assault gun functions for the airborne battle group.

3. Organization

The company consists of a battle group headquarters, battle group headquarters section, company headquarters, personnel section, assault gun platoon, reconnaissance platoon, communication platoon, medical platoon, and a supply and transportation platoon (fig. 1).

Section II. BATTLE GROUP HEADQUARTERS

4. Organization

a. The battle group headquarters consists of the battle group commander and his deputy, the executive officer, principal and special staff officers, and the sergeant major. The assistant staff officers and enlisted assistants are in the battle group headquarters section. For duties of the battle group commander and his staff, see FM 7-40 and FM 101-5.

b. The enlisted assistants consist of a sergeant major, intelligence sergeant and assistant, operation sergeant and assistants, supply sergeant, clerk-typists, radio operators, chaplain assistants, and a mail delivery clerk. The headquarters is organized to operate on a 24-hour basis.

5. Sergeant Major

The sergeant major is the principal enlisted assistant to the battle group commander. He supervises unit first sergeants in matters of administration and implementation of command

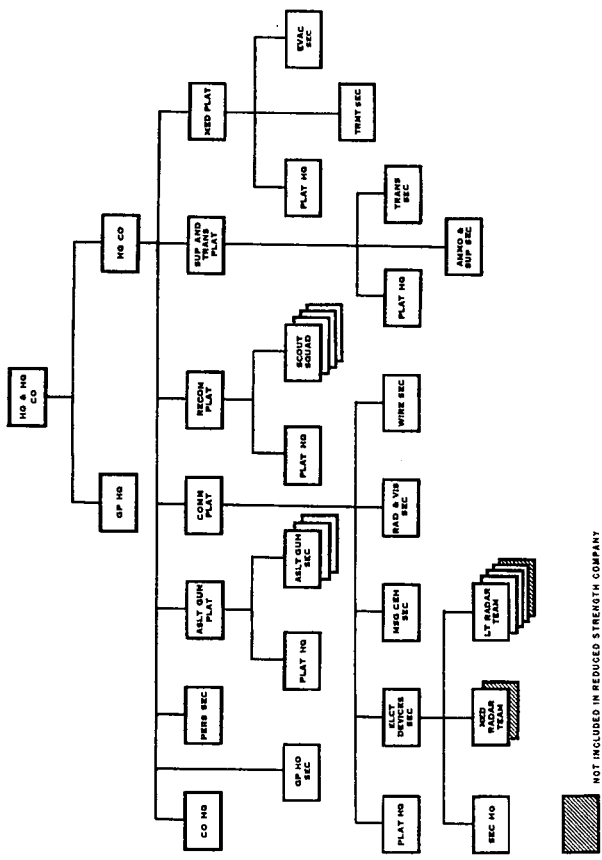

Figure 1. Headquarters and headquarters company, airborne division battle group.

policies; and advises the commander on assignments, transfers, promotions, granting of passes and leaves, punishments and awards for enlisted personnel. He conducts enlisted conferences on subjects such as unit drill, military courtesy and discipline, and customs of the service.

6. Intelligence Sergeant and Assistant

The intelligence sergeant and his assistant aid the intelligence officer (S2) by helping to supervise the collection of information, preparing the worksheet, and posting enemy and terrain information on the situation map. They assist in the preparation, reproduction, and distribution of intelligence plans and reports; in the dissemination of intelligence; and in the supervision and conduct of intelligence training.

7. Operations Sergeant and Assistants

These personnel assist the battle group operations and training officer (S3). They post friendly information on the situation map and help to prepare, reproduce, and distribute orders, sketches, overlays, training schedules, and reports.

8. Supply Sergeant

The supply sergeant is the principal enlisted assistant of the S4. His chief duties are to post the location of administrative installations on the administrative map, consolidate written and oral reports pertaining to supplies and status of main-

tenance, and assist the S4 in planning and expediting logistical support.

9. Clerical Assistants

The typists provide clerical assistance to the battle group commander and his staff. The chaplains' assistants also drive the $\frac{1}{4}$ -ton trucks assigned for the chaplains' use. The mail delivery clerk delivers incoming mail and collects and processes outgoing mail.

10. Radio Operators/Drivers

The radio operators/drivers in group headquarters section operate five of the $\frac{1}{4}$ -ton utility trucks and the radios mounted in these vehicles.

Section III. COMPANY HEADQUARTERS

11. General

The company headquarters provides necessary control and services for all personnel and units assigned or attached to the company. It consists of a company commander, a first sergeant, mess personnel, a company clerk, and a unit supply specialist.

12. Duties of Company Headquarters Personnel

a. The *company commander* is also the battle group headquarters commandant. He gives positive leadership to his command and maintains its discipline, welfare, and combat proficiency.

- (1) To accomplish his mission, he uses interior guards and all means at his command, and requests additional means whenever necessary. Without awaiting orders, he coordinates with other units and agencies.
- (2) In the battle area, he uses observation, patrols, liaison, and personal reconnaissance to maintain the security of the battle group command post and to prepare for future operations. He assigns definite missions to his subordinate leaders after coordinating with staff officers concerned and keeps informed of subordinate leaders' actions in order to give assistance when needed and to insure the success of his plan. He goes where he can best control and coordinate the actions of his company. He alone is responsible for all that his company does or fails to do.
- (3) He is responsible for individual training, personnel management functions, and for mess, supply, evacuation, transportation, and maintenance.
- (4) For his duties as battle group headquarters commandant, see FM 7-40.
- (5) Supervision of employment and technical and tactical training of all components of the company, except company

headquarters personnel, rest with the battle group commander and those respective members of his staff having primary interest.

b. The *first sergeant* assists the company commander. He advises and assists him on such matters as appointments, reductions, assignments, reassignments, and disciplinary matters as they pertain to the enlisted members of the company.

c. When the company mess is operational, the *mess steward and cooks* operate it as prescribed in TM 10-405.

d. The *company clerk*, under the supervision of the first sergeant, prepares, maintains, and files company records. He prepares, processes, and forwards reports, rosters, correspondence, and records received from or required by higher headquarters.

e. The *unit supply specialist* receives, stores, maintains, and turns in supplies and equipment for the company. He prepares and maintains organizational and individual supply records, and is also a light truck driver.

Section IV.

PREPARATION FOR THE AIRBORNE ASSAULT

13. General

The company prepares for an airborne assault in generally the same manner as a rifle com-

pany (FM 7-10), conforming to the principles and procedures prescribed in FM 7-40.

14. Rear Assembly Area Operations

The reconnaissance and assault gun platoons or any elements of them may be required to assemble, move, and land with task forces or rifle companies in the assault. The remainder of the company conducts rear assembly area operations in the same manner as a rifle company (FM 7-10).

15. Marshaling

a. Any element of the company that is attached to a task force or a rifle company in the rear assembly area marshals with that company. It is included in the air movement plan of the unit and moves to the loading site and loads with it.

b. The remainder of the headquarters company marshals, moves, and loads like a rifle company.

CHAPTER 2 COMMUNICATION

Section I. GENERAL

16. Responsibilities

a. The battle group commander is responsible for the installation, operation, and maintenance of all communication facilities of the battle group. He is responsible for battle group communications as part of the division signal system. All subordinate commanders are responsible for, and exercise tactical and technical control over, the communication systems within their commands. Tactical control of the systems insures that they are established and maintained properly to meet the operational requirements of the tactical situation. Technical control includes the supervision of the methods of installation, operation, maintenance, and supply of the signal equipment employed. A properly established system provides the commander with parallel means of communication for efficient command, control, and administration. It provides him with the capability to control the actions of his units, coordinate his supporting fires, receive and transmit orders and information, maintain contact with higher, lower, and adjacent units; and to coordinate adminis-

trative matters. The communication platoon of the battle group is under the operational control of the battle group signal officer.

b. Establishment and maintenance of communication between units is governed by the following rules:

- (1) The higher unit is responsible for establishing and maintaining communication with the subordinate (including attached) units.
- (2) A unit supporting another unit is responsible for establishing and maintaining communication with the supported unit. A unit supporting another unit other than by fire contacts the area communication center platoon nearest it and requests communications into the area system.
- (3) Lateral communications, except radio, between battle groups is established by the communication center platoon of the forward communication company. Lateral radio communication among battle groups within a division is undertaken, in the absence of other instructions, on the division command operations net (RTT) and division intelligence operations net. The rule for establishing lateral communication from left to right is applicable for the subordinate units of the battle group.

- (4) Restoration of disrupted communications is the joint responsibility of all units affected.

17. Communication Support for the Battle Group

a. The establishment of a division area communication system by the division signal battalion provides for the installation of area signal centers with or near the major divisional elements. These signal centers are operated by the area communication center platoons from the forward communication company of the division signal battalion. The area signal center provides the connecting link between the battle group headquarters and the division area communication system.

b. Each area signal center is organized and equipped to provide the following communication services to the battle group in its area of responsibility:

- (1) Message center (without messenger), cryptographic, and teletypewriter service on a 24-hour basis as a supplement to the organic capabilities of the battle group.
- (2) Installation and maintenance of the incoming wire lines from the area signal center to the battle group headquarters and to other divisional units in that area of signal responsibility.

- (3) Radio relay and carrier circuits between signal centers in the division area.
- (4) Establishment and operation of a forward switch during displacement if required.
- (5) Radio/wire integration station for connecting FM radio users in the battle group areas into the division area communication system, and for other services.

c. The division signal battalion furnishes a scheduled and special division messenger service down to and connecting battle groups and other major subordinate divisional units.

d. Air messenger service is incorporated into the division communication system to expedite the handling of documents over long distances. The aircraft for air message service are provided by the aviation company through coordination between the division signal officer and the division aviation officer.

18. Mission and Organization of the Communication Platoon

a. *Mission.* The battle group communication platoon installs, operates, and maintains all organic communication facilities within the battle group headquarters. In addition, it establishes and maintains communication to, but not within, subordinate companies and attached units.

b. *Organization.* The platoon is organized into

a headquarters and four sections. These sections can be further subdivided into teams of varying personnel strength, depending on each team's mission, the priority of its operation, and the type of terrain concerned.

- (1) The *platoon headquarters* consists of the communication chief and one light truck driver.
- (2) The *message center section* consists of the chief message clerk, message clerk, manual teletypewriter operators, and two motor messengers.
- (3) The *wire section* is composed of a section chief, four wire team chiefs, senior wiremen, switchboard operators, and wiremen.
- (4) The *radio and visual section* is composed of a section chief, radio-teletype team chiefs, radioteletype operators, and radiotelephone operators.
- (5) *Electronic devices section*. See section IV.

19. Duties of Platoon Headquarters Personnel

The *communication chief* supervises the operations of the radio mechanics, message center, wire, and radio sections, and assists the battle group signal officer. His duties include—

- a. Tactical and technical training of these sections.
- b. Supervising the installation, operation, and

maintenance of the signal equipment issued to the platoon.

c. Supervising the operation of communication installations.

d. Assisting the battle group signal officer and representing him in his absence.

e. Insuring that the battle group signal officer's instructions are carried out by the sections of the communication platoon.

f. Coordinating the work between the sections of the platoon.

g. Supervising the selection of locations for communication installations when necessary.

h. Supervising ground-to-air communication.

i. Seeing that records are properly kept.

j. Insuring that communication vehicles are maintained and dispatched correctly.

k. Keeping the battle group signal officer informed as to status and maintenance of signal equipment.

20. Duties of Message Center Section Personnel

a. The *chief message clerk* is responsible to the communication chief for the discipline, training, and operation of his section. His duties include—

- (1) Selecting the exact location for the message center and messenger station and establishing the message center facilities.

- (2) Processing, filing, servicing, and selecting the method of transmission for outgoing messages.
 - (3) Supervising the operation and maintenance of message center equipment.
 - (4) Checking the flow of message traffic to assure delivery.
 - (5) Supervising cryptography procedures of message clerks and manual teletypewriter operators.
 - (6) Maintaining a message center log on the effectiveness of each means of communication.
 - (7) Signing for messages delivered by scheduled or special messengers.
 - (8) Keeping the official time.
 - (9) Supervising messenger communication.
 - (10) Posting message center signs or guides.
 - (11) Maintaining a record of the locations of command posts of units with which the battle group maintains communication, including the best routes to them.
 - (12) Maintaining a supply of message center forms.
 - (13) Scheduling of message center personnel to provide operations on a 24-hour basis.
- b. The *message clerk's* duties include—
- (1) Assisting the chief message clerk in his duties.

- (2) Supervising one of the message center teams during displacement of the command post.
- (3) Encrypting and decrypting messages as required.
- (4) Receiving, recording, and dispatching incoming and outgoing messages and documents.
- (5) Maintaining a code file of processed messages.
- (6) Processing encrypted messages, to include insertion of call signs when messages are to be transmitted by electrical means.

c. The *manual teletypewriter operator's* duties include—

- (1) Transmitting and receiving messages on teletypewriter equipment in message center.
- (2) Correcting message errors and obtaining receipt for completed transmissions.
- (3) Receiving and processing incoming teletypewriter transmissions.
- (4) Encrypting and decrypting messages, employing message center cipher machine.
- (5) Establishing and posting the station log.
- (6) Maintaining teletypewriter equipment by cleaning and making minor adjustments and replacing minor parts, as authorized.

- (7) Keeping the chief message clerk informed of the status of teletypewriter communication.
- (8) Informing the chief message clerk of the status of parts supply for teletypewriter equipment.
- (9) Performing other communication duties as directed.

d. *Messengers'* duties include—

- (1) Carrying oral or written messages during all conditions of light, terrain, weather, and enemy activity.
- (2) Driving and performing required driver maintenance on the messenger vehicles.
- (3) Performing other communication duties as directed.

21. Duties of Wire Section Personnel

a. The *section chief* is responsible to the communication chief for the discipline, training, and operation of the wire section. His duties include—

- (1) Selecting the exact locations for wire installations.
- (2) Supervising the wire team chiefs in the installation, operation, and maintenance of the wire system within the command post and to all subordinate or attached units.
- (3) Selecting general routes for wire lines.
- (4) Preparing and recording line route

maps, circuit diagrams, and traffic diagrams.

- (5) Insuring that wire section personnel perform their duties correctly and efficiently.
- (6) Keeping the chief message clerk and the communication chief informed on the status of wire communication.
- (7) Maintaining a sufficient supply of wire and other necessary supplies to permit continuous wire operations.
- (8) Keeping records such as status of wire supply and maintenance forms on wire equipment.
- (9) Supervising the maintenance of the vehicles in the section.
- (10) Allocating wiremen to the wire teams based on the current mission of each team.

b. The *wire team chiefs'* duties include—

- (1) Assisting the section chief.
- (2) Selecting specific wire routes and assisting in the preparation of line route maps and circuit diagrams.
- (3) Supervising the wire teams in the correct techniques of laying and maintaining lines.
- (4) Assuring that lines are policed so as to minimize their damage by traffic and enemy fire.

- (5) Informing the section chief of the status of wire supply and the serviceability of wire circuits.
- c. *Wiremen's* duties include—
- (1) Installing, testing, tagging, and maintaining wire circuits and telephones.
 - (2) Locating and correcting trouble in lines.
 - (3) Operating switchboards.
 - (4) Keeping the wire team chief informed of the status of wire communication and wire supply.
 - (5) Driving and performing proper driver maintenance on wire section vehicles.
 - (6) Performing other communication duties as directed.
- d. The *switchboard operators'* duties include—
- (1) Installing, operating, and maintaining switchboards.
 - (2) Preparing and maintaining traffic diagrams.
 - (3) Routing traffic and rerouting calls when normal circuits fail.
 - (4) Supervising traffic to insure satisfactory service to the user.
 - (5) Performing such other communication duties as directed.

22. Duties of the Radio and Visual Section Personnel

- a. The *section chief* is responsible to the com-

munication chief for the discipline, training, and operation of his section. His duties include—

- (1) Selecting the exact locations for the radio, radioteletype, and visual installations, and insuring adequate dispersion of radio vehicles.
- (2) Supervising the installation, operation, and maintenance of radio and radioteletype equipment.
- (3) Insuring that visual signaling and message airdrop and pickup equipment is available and properly employed, and that sufficient personnel are fully trained in its use.
- (4) Preparing operating schedules for radio and radioteletype operators.
- (5) Supervising the maintenance of communication security, to include the use of authorized codes, ciphers, and authentication systems.
- (6) Insuring that all radio equipment is operated according to prescribed procedure and current communication orders.
- (7) Informing the chief message clerk and the communication chief of the status of radio and radioteletype communication.
- (8) Supervising the maintenance of station logs by operators of all radio nets.
- (9) Supervising the driver maintenance on the section's vehicles.

- (10) Informing the communication chief of the operating condition of all radio and radioteletype equipment and coordinating with the appropriate maintenance personnel for repairs when needed.
- (11) Maintaining records of the section, such as station logs, work schedules, equipment maintenance schedules, etc.
- (12) Supervising the training of radioteletype operators within the battle group.
- (13) Supervising first echelon maintenance of radios and other equipment issued to the section.

b. The *radioteletype team chiefs'* duties include—

- (1) Supervising the installation, operation, and maintenance of radio and teletypewriter equipment.
- (2) Assisting the section chief in establishing operators' work schedules to provide operations on a 24-hour basis.
- (3) Performing duties of radioteletype operator as required.
- (4) Supervising the operator maintenance of authorized teletypewriter equipment.
- (5) Informing the section chief of the current status of radioteletype communication.
- (6) Knowing joint radio and teletypewriter procedures.

- (7) Informing the section chief of the status of parts supply.
- c. The *radioteletype operators*' duties include—
- (1) Setting up and operating manual and radioteletype equipment.
 - (2) Transmitting messages, correcting message errors, and obtaining receipt for completed transmissions.
 - (3) Receiving and processing incoming teletypewriter messages and preparing such messages in proper format for delivery.
 - (4) Cleaning, making minor adjustments, and replacing minor parts of teletypewriter equipment as authorized.
 - (5) Establishing and posting station logs.
 - (6) Driving and performing driver maintenance on assigned vehicles.
 - (7) Performing other communication duties as directed, particularly when radio stations are under radio silence or on standby status.

d. *Radiotelephone operators* operate the FM voice radio sets in the radio and visual section. They are also trained in visual signaling and message drop and pickup techniques. In addition, two operators are light truck drivers for vehicles of the section.

23. Duties of Electronic Devices Section Personnel. See section IV.

24. The Battle Group Signal Officer. See FM 7-24 and FM 7-40.

25. Staff Responsibilities Affecting Communication. See FM 7-24 and FM 7-40.

26. Signal Supply

a. Authorized items of signal equipment are prescribed in tables of organization and equipment. Additional equipment may be authorized by higher commanders. Initial supply and resupply is made through normal supply channels. Requests for replacement are submitted through normal supply channels. The battle group S4 consolidates these requests and requisitions the equipment and supplies. The battle group signal officer assists in preparing these requests and requisitions. Signal supplies are delivered to the battle group supply area. The supply and transportation platoon leader then makes the distribution to the units. Unserviceable signal equipment that cannot be repaired or replaced by the forward repair sections of the division maintenance battalion is replaced by direct exchange for serviceable items from the reserve stock at the division supply and maintenance point. In an emergency, the battle group signal officer may obtain signal supplies directly from a supply point.

b. Repair parts consist of any parts, assemblies, or components required for maintenance of an end item. Allowances for repair parts are established by Sig 7 and 8 supply manuals or Repair Parts and Special Tools Lists of technical manuals. Authorized allowances of repair parts are carried by all echelons as a basic load. Mo-

ble signal repair teams normally issue and deliver repair parts for organizational maintenance. The requisition flows through maintenance channels as does the distribution of required repair parts.

27. Maintenance of Signal Equipment

Each unit maintains and repairs its signal equipment within the limits of its maintenance facilities, available parts, skills, and authorized level to perform maintenance. First echelon maintenance is performed by the using unit. Second and limited third echelon maintenance is performed by the airborne maintenance battalion.

28. Means of Communication

a. Signal communication includes all means of conveying information of any kind from one person or place to another except by personal conversation and mail. In this manual, the term *signal communication* is abbreviated to *communication* except where misunderstanding might result.

b. The means of communication available to the battle group are wire, radio, messenger, visual, and sound. The composition of the means in each unit is limited by the men, equipment, and transportation provided by the TOE and the unit or higher commander. The various means have different capabilities and limitations. They are used so that they supplement each other; entire dependence is not placed on any one means. The

reliability of communication systems is greatly increased by the use of all practical means. The means used most in a given situation is the one that provides the maximum reliability, flexibility, security, and speed with the minimum of effort and material.

29. Wire Communication

a. Wire communication includes the use of field wire, wire installation and recovery equipment, battery-operated and sound-powered telephones, switchboards, teletypewriters, and associated equipment. Except for the transmission of messages such as maps and documents, wire is a highly effective means of communication. It affords person-to-person conversation with break-in operation (capability of interrupting the conversation). Wire is more secure than radio communication, but security is never assured when transmitting in the clear. The decision to establish wire communication depends upon the need for it and the available time to install and use it. The supply of wire on hand, expected resupply, and the future needs also are considered. Wire communication can be used in most terrain and situations. Tables of organization and equipment provide the units with the equipment to install and maintain their wire systems. Figure 2 shows a typical system installed by the battle group communication platoon.

b. Using battery-operated telephones, the max-

imum operating range of field wire circuits is approximately 22 miles. Using the sound powered telephone TA-1/PT, the dependable range is from 4 to 10 miles. Wet weather, poor splices, and damaged insulation reduce the range appreciably. The wire operating range can be increased by using electrical repeaters or amplifying telephones. Cable is used to increase the telephone range and the available number of circuits, but it is only issued to the division signal battalion and higher echelons.

c. The installation of wire is primarily dependent upon the time available and the requirements of the tactical situation. It takes longer to install wire communication than any other means. The time for installation depends mainly upon the length of the line and the method of laying it (vehicle, aircraft, or man pack). Wire lines can be installed by men on foot at about $1\frac{1}{2}$ miles per hour and by vehicle at 3 to 5 miles per hour. In estimating the required time, it is also necessary to consider the number of men available, their training, the terrain, routes, weather, and visibility. The use of the dispenser for the installation of wire permits elements to move without disrupting communication. Wire lines usually are laid by wire teams of 3 to 5 men. One man can lay a line by using a wire dispenser or light reel. Besides the normal methods of installation, wire can be laid from dispensers attached to Army aircraft. Wire can be cast a short distance over

an obstacle (such as a stream) by attaching it to a rifle grenade or to a rocket fired from a launcher.

d. Lines are installed off roads with 15 to 20 percent slack. They are placed overhead in command posts or other areas where it is impracticable to bury them or to leave them lying on the ground. Wire crossing roads is buried, placed overhead, or run under bridges and culverts. Areas are avoided where wire is likely to be damaged by traffic or enemy fire. Part of a team lays the wire and the remainder of the team polices it (throws it off the road, makes road crossings, splices, etc.). The laying of a line is not delayed for policing it except at critical points.

e. Switchboards are used to increase the flexibility of wire systems and to reduce the number of lines needed. Party lines may be used to expand the subscriber capacity of the various switchboards in the battle group.

f. The number of telephone messages that can be transmitted simultaneously over a system is limited. Calls are kept brief. The telephone is reserved for occasions when there is a need for discussion, speed, and relative security. During critical periods, telephones may be restricted to designated personnel, except for emergency calls. They are not used for long reports or orders when some other means can be effectively used. To reduce the time the telephone is in use and to facilitate entry in the unit journal, messages are

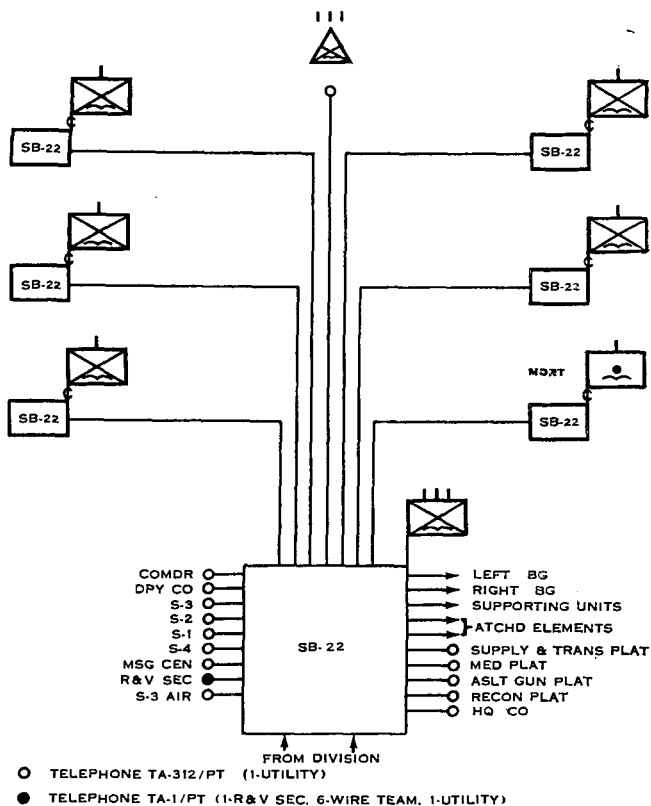

Figure 2. Type wire system, airborne battle group.

written or notes are prepared before a conversation begins.

g. Teletypewriter service is established as required. Teletypewriters provide both battle group and division headquarters with a written record of messages exchanged. Teletypewriter equipment in the battle group communication platoon substantially increases the volume of messages which can be handled by the battle group.

30. Radio Communication

a. Radio is a principal means of communication within the battle group. Radios are provided for all commanders, down to and including squad leaders. Additional radios are provided for command posts, fire control, and other uses. All radio sets issued within the battle group are capable of voice operation. This affords person-to-person communication between ground stations and between ground stations and aircraft. Radio communication, however, is subject to interference from static, jamming, and other radio stations. Its reliability is limited to the skill of the operators. Security requirements may restrict its use in certain operations since it reveals the location of the unit. Figure 3 shows a typical battle group command radio net in which the communication platoon operates.

b. Radio equipment issued to the battle group includes man packed and vehicular radio sets. One man can carry and operate a man packed set.

Since vehicular sets are normally operated from vehicular power sources, their use is limited to situations and terrain where vehicles can be utilized. Remote control equipment is used to permit siting of vehicular sets. Modification kits are available as auxiliary equipment to permit the use of certain vehicular set components in a ground role.

c. The tactical use of a radio set depends upon its characteristics. To be capable of operating together, radio sets must have a common or overlapping frequency range, transmit and receive the same type of signal, and be located within their operating ranges. The operating range given in technical manuals pertaining to an individual radio set is for average conditions; the range obtained may be more or less, depending upon the operator's skill, weather, terrain, interference, use of proper antenna, and the location from which the set is operated. Powerlines and steel structures near operating sites reduce operating ranges. The greatest ranges are obtained between sites affording line-of-sight operation.

d. Communication security is a constant consideration when using radios. It must be assumed that interception takes place every time a transmitter is placed in operation. The enemy obtains valuable intelligence information merely by knowing that friendly radios are operating, by analyzing the number of radios in operation, the volume of traffic, and by determining the locations of the

sets. For this reason, the use of radio may be restricted or prohibited. Important measures for defense against enemy radio intelligence are listening, silence and cryptography. Normally, messages are encrypted before being sent by radio. The decision to silence radios or to send messages in the clear is made after all factors have been carefully considered. For example, radios are not silenced when the need for radio communication outweighs the value of the information that the enemy might gain. Radios usually are not silenced within units in contact with the enemy. A message is sent in the clear when prompt action is called for and the urgency of sending the message in the clear outweighs the value of the information to the enemy.

e. Since only one station can transmit at a time, the message-handling capacity of a radio net is limited. The time required for a message transmission to its addressee is primarily dependent on whether it is encrypted or sent in clear text and on the volume of traffic of similar or higher precedence awaiting transmission. The speed and message-handling capacity of a radio net is increased by training all operating personnel in radio procedure, net discipline, and message writing. Messages usually are written before transmission.

f. The power supply is an important factor in radio communication. Dry batteries, when approaching the end of their service life, reduce the

range of the sets and may render them inoperative at a crucial moment. An adequate supply of serviceable batteries should be maintained for dry battery-operated sets. Every possible effort should be made to obtain maximum service from the batteries through operator training and supervision, and by maintaining a log of hours and conditions of use for each battery pack.

g. By the use of certain types of remote control equipment, a radio operator may be located at a distance from the set he operates. Other remote control units connect a radio set to a switchboard, which makes the radio available to commanders and staff officers through their telephones. Remote control facilities are normally established at the battle group CP. For further details on remote control equipment and the interconnection of radio and wire systems, see TM 11-488.

31. Messenger Communication

Messenger, the most secure means of communication, is flexible and reliable. But it is also slow, vulnerable to enemy action in forward areas, and does not permit conversation between the originator and the addressee. It is the only means available within the battle group for transmitting messages such as maps and documents. Messengers are used when security is required and when the time of delivery is less than that required for message preparation and transmission by other means. Messengers are the best means for transmitting long messages over short distances. They

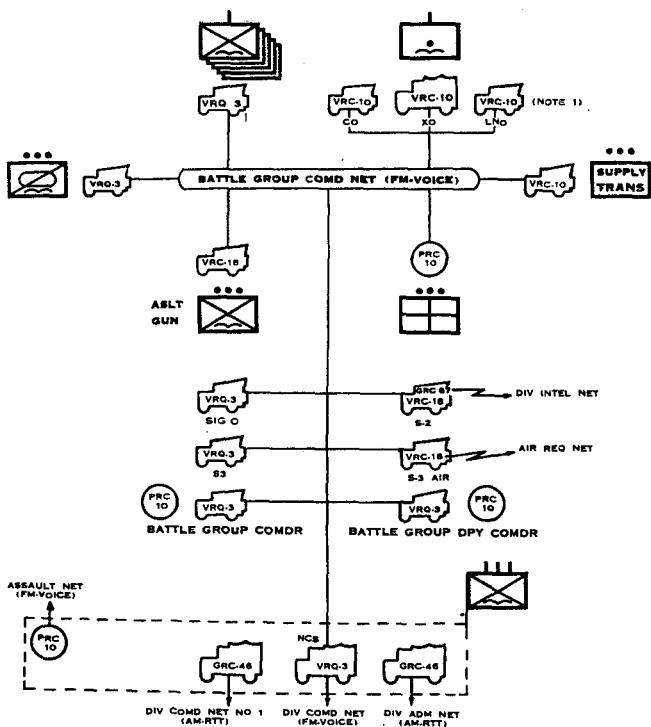

NOTE 1: THESE VEHICLES ALSO MOUNT THE RADIO SET AN/VRC-8

Figure 3. Type airborne battle group radio net.

may travel by foot, motor vehicle, or aircraft. In the combat zone, a vehicle driver is usually provided for a vehicle used for messenger service. The efficiency of messenger service is improved by the proper selection and training of the messengers. Routine periodic reports should be prepared in sufficient time to permit their transmittal by messenger. See FM 7-24 for further information on use of messengers.

32. Visual Communication

a. Visual signals supplement other means of communication. They are transmitted by flags, lights, pyrotechnics, panels, arm and hand signals, and other prearranged visual means. They are suitable for transmitting prearranged messages rapidly over short distances when their use is not prohibited for security reasons. The enemy may use similar signals for deception and confusion. Visual signals are easily misunderstood. They cannot be used during poor visibility or when line of sight locations are not available.

b. No special lights are issued to the battle group solely for communication purposes. Improvised signaling lights such as flashlights may be used to send prearranged messages. The meanings are given in the SOI. Messages may be transmitted by lights using the international Morse code.

c. Pyrotechnics, including smoke, are issued in

various colors and types. The meanings of certain signals are given in the SOI. Transmission and reception of pyrotechnic signals are preplanned. Signals are included for identifying units as friendly, for lifting or calling for fire, marking targets, and reporting an objective reached. Pyrotechnics can be used within and between ground units, between ground units and aircraft, and between ground units on shore and ships.

d. Two general types of panels are issued for communicating with aircraft—marking panels and signaling panels. Marking (identifying) panels are made in bright fluorescent colors. They can be used to mark positions and identify units as friendly. Black and white signaling panel sets are issued for use on light and dark backgrounds, respectively. They are used to transmit brief messages or to identify a particular unit. This is done by using the combined panel system and panel recognition code which is included in the SOI.

e. Infrared devices are used for signaling and as landing and assembly aids.

33. Sound Communication

Sound is a supplementary means of communication available to all units. Sound signals are transmitted by whistles, bugles, horns, gongs, sirens on tanks, weapons, and other noisemaking devices. They are used chiefly to attract attention, transmit prearranged messages, and spread

alarms when their use is not prohibited for security reasons. Sound codes are kept simple to prevent misunderstanding. The range and reliability are greatly reduced by battle noise. Sound signals and their meanings are prescribed in the SOI or are assigned by commanders. Three long blasts of a whistle, horn, or siren repeated several times or three equally spaced shots or short bursts of fire normally are used to warn of an air or mechanized attack. Rapid and continuous percussion sounds made with the standard gas alarm or improvised devices (iron rails and empty shell cases) normally are used to warn of gas attack.

34. Radio/Wire Integration System

a. An FM-voice radio/wire integration station is operated at each division forward signal center to connect mobile FM radio stations into the division area communication system on a push-to-talk basis. This system of stations is one of the more important features of the area system.

b. This system is used to establish communication between mobile FM radio stations and elements connected to the area communication system by telephone. It is also used in lieu of FM radio relay stations to establish communication between FM radio stations operating beyond their rated range. Typical uses of this system are as follows:

- (1) The division commander and his staff may use it when traveling, to contact

division elements connected to the area communication system by telephone; it may serve as a relay station in the division CG/Comd net (FM-voice).

- (2) It may be used to establish telephone service from the division area communication system to the using units, including battle group headquarters, until wire links are established.
- (3) It may provide voice communication between mobile combat elements in the division forward area and those supporting division logistics elements in the rear area who may be connected to the area communication system by wire or radio/wire integration links.
- (4) It may enable communication between low-flying Army aircraft operating in remote portions of the division area and the airstrips, or flight control elements connected to the area communication system, in the event direct FM radio contact is impossible.

35. Signal Operation Instructions (SOI) and Standing Signal Instructions (SSI)

a. The signal operation instructions are a type of *combat order* issued for the *technical* control and coordination of communication within a command. They include items covering codes and ciphers, radio call signs and frequencies, tele-

phone directory, and visual and sound signals. Current items are listed in the index to the SOI. The division SOI is prepared by the division signal officer and distributed to lower units. The battle group receives sufficient copies of the appropriate items of the division SOI for distribution of extracts to subordinate and attached units.

b. Standing signal instructions may be included in the SOI or issued in a separate publication. The SSI includes items of *operational data not subject to frequent change* and instructions for the use of the SOI. The SSI is prepared by the division signal officer and distributed to lower units. The battle group receives at least one copy of each item of the SSI.

36. Standing Operating Procedure (SOP)

An SOP is a set of instructions prescribing the manner in which routine tasks are done within a particular unit in the absence of other instructions. In the battle group the communication SOP is based on, and conforms to, the division SOP. The battle group signal officer prepares the signal SOP for the commander's approval. Periodic revision of the SOP is necessary for its effectiveness and conformance with the next higher unit's SOP. An SOP is particularly applicable to the communication platoon because many of its operations are the same regardless of the type of tactical operation. The platoon is not bound by its SOP to the extent that flexibility and individual initiative are destroyed.

37. Paragraph 5 of an Operation Order

a. Paragraph 5 of an operation order contains orders and instructions relative to communications and command posts. The battle group signal officer prepares recommendations for paragraph 5a. As a minimum, paragraph 5a contains the index of the SOI in effect for the operation. Command post locations appear in paragraph 5b.

b. Paragraph 5 can be oral or written. Applicable portions of the following instructions are covered in this sequence:

- (1) A reference to the signal annex or index to the SOI in effect; restrictions, if any, on the use of any means of communication; visual and sound signals; and other information not contained elsewhere in paragraph 5, such as lateral lines to be laid.
- (2) The command post location of the unit issuing the order, the reported locations of the command posts of the lower units, and the axes of signal communication. The time of opening the command posts also may be given. The information relative to command posts and axes may be shown on an operation map or overlay.

38. Oral Communication Orders

After his communication plan is approved, the battle group signal officer issues oral orders to the communication chief. The installation of the communication system may be expedited when

section chiefs also are present. The urgency of the situation may require that the signal officer issue orders directly to the section chiefs. In this case, the communication chief is informed of the situation as early as possible. The communication chief's oral orders to the section chiefs may be supplemented by an operation map. Detailed orders for routine operations governed by the SOP are not included. The communication chief's oral orders include—

a. Information of the enemy and friendly forces as required for the efficient operation and security of the communication system.

b. The platoon mission.

c. Instructions to each section chief, which may include any or all of the following:

(1) Instructions to the chief message clerk concerning the location of the message center and messenger station; schedules and routes; uses of codes and ciphers; and command post location of lower, attached, supporting, adjacent, and next higher headquarters (and routes to them).

(2) Instructions to the radio and visual section chief concerning the location of radio installations; operation instructions and schedules; use of voice radios; location of panel display, message drop and message pickup grounds; and restrictions, if any, on using radio and visual means.

- (3) Instructions to the wire section chief and team chiefs concerning the switchboard location; number and location of local telephones (including long locals such as the line to the observation post); number and routes of trunk lines; and other applicable special instructions.

d. Administrative details including locations of the motor park, bivouac area, and division signal supply point.

39. Communication Security

Communication security is the protection resulting from all measures designed to prevent or delay unauthorized persons from gaining information of military value from communication sources. It includes physical, cryptographic, and transmission security. Commanders insure that communication security orders and regulations are understood and constantly observed. Officers and enlisted men who personally transmit radio messages are concerned particularly with security measures. The commander establishes communication security measures by stating general principles in the unit SOP, by announcing before an operation the extent to which security is to be practiced in that operation, and by making security decisions during an operation. When prompt action is called for, he considers the time in which the enemy can act on the information contained in a clear-text message. He then decides whether the urgency of sending a message in the

clear outweighs its value to the enemy. Messages that compromise plans, operations, or crypto systems of other units are not transmitted in the clear. Messages to be transmitted in the clear by radio operators (including those sent through message center) are marked *send in clear* over the signature of the commander or his authorized representative.

a. *Physical security* protects the signal equipment and classified documents (including plain-language copies of messages and carbons) from capture, damage, or loss. Complete items such as SOI codes and ciphers are limited in distribution. Complete items of the SOI are not taken forward of the battle group command posts. Before a command post is vacated, it is inspected for messages, carbons, cipher machine tapes, and copies of maps or orders. Wire lines are patrolled to prevent the enemy from tapping them. When SOI, codes, or cryptographic equipment are lost or captured, the facts are reported promptly through signal and command channels to the next higher headquarters. Instructions are issued on how to destroy equipment and classified documents to prevent their capture or use by the enemy.

b. *Cryptographic security* means technically sound crypto systems and strict observance of instructions. These measures prevent or delay the enemy from reading messages. Time spent in encrypting gives a high return in security. The use of crypto systems other than those authorized by the unit SOI compromises security. Most un-

authorized systems are susceptible to easy solution and give the user a false sense of security. Security hazards may be minimized by being brief and avoiding stereotyped phraseology in preparing messages (particularly at the beginning and end of a message). Identical messages are not sent in both clear and encrypted text. When using clear text, landmarks that can be associated with encrypted map locations are avoided as references. When messages cannot be sent in the clear, individuals and small units that do not have cipher devices use codes found in the SOI. When using codes, clear and encrypted text (except coded map locations) are not mixed in the same message.

c. Transmission security limits the enemy's ability to intercept transmissions and prevents him from using our communication systems for deception. A message is transmitted by the most secure means available consistent with its precedence. Radio is particularly susceptible to interception, position-finding, traffic analysis, and deception. The radio operators are told about the dangers of giving information to the enemy through faulty operating procedures or techniques. Operators and men preparing radio messages must be aware of the enemy's ability to gain information from radio traffic. Those transmitting clear-text messages by voice radio use prescribed radio-telephone procedure and preplan the content and wording of each transmission. They use prescribed authentication systems and eliminate unnecessary transmissions. A high

standard of net discipline among operators is essential to communication security. Training in the correct procedure is continuous. For additional information on communication security, see AR 380-5 and ACP 122.

40. Communication Training

a. Communication training is conducted in three phases: individual, unit, and combined. During basic combat training and advanced individual training, personnel are trained in basic military subjects and in addition receive specialist (MOS) training in their primary duties. Unit specialist training is conducted best in division and lower unit schools (particularly applicable to radiotelephone). Certain specialists such as battle group signal officers and communication chiefs should receive their training at service schools.

b. During basic and advanced unit training, team and specialist training is completed, and communication personnel are trained in the communication technique for all types of tactical operations. Before participating in exercises involving entire units, command post exercises are conducted with commanders and staffs present. These develop skill in procedure for the installation, operation, and movement of command posts. Personnel are trained to install, operate, and maintain communication systems in fast-moving situations, in all kinds of weather, visibility, and terrain.

c. In the field exercise and maneuver phase (combined arms training), tactics and techniques of communication units working with higher, supporting, supported, attached, and adjacent units are perfected. As specialists become proficient in their primary duties, they are rotated to learn the duties of other selected key members of their unit.

Section II. COMMAND POSTS

41. General

The battle group command post is the battle group field headquarters. When the headquarters is divided into a forward and a rear echelon, the forward echelon is the command post. The command post group consists of the personnel and equipment needed to provide immediate assistance to the battle group commander. Although the commander frequently goes forward to observe and direct the action, he remains in communication with the CP. Contact with the commander can be secured at or through the command post. All communication facilities center there. Administrative activities not required at the CP are conducted at the rear echelon.

42. Location of CP

When the division commander does not designate the map location of the battle group command post, the battle group signal officer and the S1 consult with the S2 with respect to the vulnerability to nuclear weapons attack and make the

recommendations to the S3. The S3 makes the final recommendation to the battle group commander. Higher, lower, and adjacent units are kept informed of the location of the command post. When selecting the exact location, the S1 and the signal officer consider the following factors:

a. Type of Tactical Operation. During movement to contact, the command post moves by bounds along a designated route or is located at a designated place in the formation. In offensive operations, it is located well forward to avoid early displacement. In defensive operations, it is located so that local enemy penetrations will not cause displacement. In other types of tactical operations, it is located at the place from which the commander can control his battle group most effectively. The S1 and signal officer must consider its location with respect to other installations or units in order to avoid creating a remunerative nuclear target.

b. Signal Communication Requirements. Command posts are located to facilitate signal communication. An improperly located command post may delay the establishment of communication at a critical time or make effective maintenance of it impossible. The principal considerations for the command post location are—

- (1) Effect of distance and terrain on wire and messenger communications.
- (2) Necessity for wire routes to the front

and rear, permitting the prompt establishment of wire communication.

- (3) Effect of powerlines, electrical stations, hill masses, dense woods, and distance on radio communication.
- (4) Proximity to open terrain for use of air-drop and pickup of messages, and ground-to-air panel displays.
- (5) Necessity for line-of-sight locations, visible only to friendly troops, for use in visual communication.
- (6) Necessity for line-of-sight locations for area communication center platoon radio relay that extends the division communication system to the new battle group CP.

c. Routes of Communication and Traffic Conditions. Since all communication facilities center at the CP, roads into and out of the CP and the traffic to be expected on them influence the location. Messengers, wire teams, command vehicles, and other vehicles constantly use the communication routes from the command post forward to lower units and rearward to higher units. The absence of suitable communication routes causes delays and makes tactical control difficult. When practicable, messengers and wire teams use roads.

d. Space for Command Post Installations. The various installations within the command post are given enough space to operate efficiently and to avoid unnecessary casualties from enemy action.

Space is provided for other command posts that may be located in the vicinity and for liaison and agent personnel from other units.

e. Cover, Concealment, and Security. In selecting the command post location, the S1 and signal officer must consider the availability of natural concealment, cover, and defensive positions. They do not locate the CP near a landmark or terrain feature that is likely to attract hostile fire or air attack. A location that cannot be seen from main roads is preferable. For security reasons the command post may be located within an area occupied by a lower unit. The CP is dug in or located below the surface of the ground to reduce the effects of nuclear weapons.

43. Designation, Marking, and Time of Opening

The CP location is designated near a landmark that is easily identified on the map and on the ground, but which is not likely to be an enemy target. The exact site is located in the general area of the designated point. When shown on a map, the flag-staff base is placed at the designated location. The route leading from the designated location to the exact command post location is marked by signs or guides. For security reasons, only guides may be used. When signs are used, they are large enough to be seen and read from a rapidly moving vehicle. When the command post is in a town, the main roads leading into the town are marked, beginning at the entrance to the town. The headquarters commandant is respon-

sible for placing signs and guides leading to the command post. The message center places the signs or guides to direct incoming messengers to the message center. The CP is opened at the designated time. When no time is given, it is opened as soon as practicable after the order is issued.

44. Interior Arrangement

a. The (S1) is responsible for the command post's interior arrangement. He selects the locations for all activities except the communication installations. The battle group signal officer selects the locations for these. During training, an SOP for the command post arrangement is represented in schematic form to show the locations of command post installations and activities in their relationship to each other. This SOP is used as a guide; modifications are made as required by the terrain and the tactical situation.

b. *The commander and his staff* are situated for efficiency and convenience. The characteristics of the means of communication are considered in locating communication installations to serve the commander and staff in the best possible manner.

c. The *message center* is located at the natural entrance to the command post so that incoming messengers may find it easily and outgoing motor messengers can be dispatched quickly. A messenger station is selected nearby. Motor vehicles used by messengers are located conveniently with respect to the message center and messenger station.

d. The *radio station* is located to provide the maximum efficiency in transmission and reception. Considerations include convenience to the user (especially the message center); location of the panel display, message-drop and message pickup grounds; mutual interferences between radio sets; and the possibility of radios being located by enemy direction-finding equipment. Sets used with remote control equipment are located without regard to the user. Motor vehicles with radio sets installed usually are parked in the vicinity of the radio station.

e. The *panel display, message-drop, and message pickup grounds* should coincide, when possible, and be near the radio station whose personnel are used for their operation. Level, open ground that is free from high weeds and brush and removed from bodies of water is preferable. The panel display ground should be situated so that observers can read displays at side angles from the vertical. Shadows are avoided where possible. Unobstructed approaches to the message pickup ground are required. This field may also serve as an emergency landing strip for light aircraft.

f. The *switchboard* is installed convenient to incoming wire circuits. It should be as free from noise and interference as possible.

g. *Telephones* are installed as required, according to the priority established in the battle group SOP.

h. The *motor park* is established in a covered

location accessible to vehicles and at a distance from the command post. It is located so that its detection from the air will not disclose the location of the command post.

45. Operation and Conduct of Personnel

a. The command post is organized for 24-hour operation. During less active periods, the men take every opportunity to rest. The men on duty are rotated so they may have such an opportunity. Communication personnel are continuously prepared to establish new channels of communication and maintain existing channels. They promptly repair damaged wire lines. Sufficient means of communication must be available at all times to transmit and receive messages rapidly and efficiently.

b. All incoming messengers deliver their messages to the message center; the messages are signed for and delivered to the sergeant major by message center personnel. The sergeant major supervises the circulation of all incoming messages.

c. Outgoing written messages are usually sent through message center. The message center records include a message log (a recording of all outgoing messages, and messages incoming by messenger); a means chart (a record of the electrical means of communication available); a live file (duplicate of skeleton copies of outgoing messages for which receipt has not yet been obtained); a dead file (duplicate or skeleton copies of receipted outgoing messages); and a crypto

file (a clear text copy of all outgoing encrypted messages and the encrypted copy of all incoming messages). The dead file is turned over daily to the adjutant for disposition. Officers who send or receive messages that do not pass through message center see that a synopsis of each message is made available without delay for entry in the unit journal.

d. Vehicular traffic in and out of the command post is controlled. Visitors are stopped at a dismount point and directed to walk to their destination. Their vehicles are sent to the parking area. The communication vehicles required in the command post travel at reduced speed and use existing roads and trails. The troops wear the prescribed uniform and carry the required individual equipment. They work as quietly as possible and avoid unnecessary grouping. Individual and organizational equipment not in use is stored neatly or left packed so that the command post can move quickly. Sanitation and police are rigidly enforced. Latrines are set up near the command post with sufficient capacity to accommodate all personnel. All trash is buried since a fire might disclose the location of the command post to the enemy.

46. Local Security and Defense

a. The headquarters commandant is responsible for the command post security. Under the supervision of the S3, he prepares plans for the defense of the command post, using available elements of

headquarters and headquarters company or from the battle group reserve.

b. All command post personnel are prepared and trained to assist in defending the command post. They dig hasty entrenchments to provide individual protection and protection for the CP. Communication installations are dug in to protect the equipment and permit continuous operation. The maintenance of secrecy as to the command post location is important. The use of unshielded lights is prohibited. Camouflage is used where necessary.

47. Axis of Signal Communication

The axis of signal communication is the route along which future command posts are established. When displacement of the command post is anticipated, the division or battle group commander designates the axis of signal communication. The axis is designated by successive probable command post locations in the direction of movement or on a specific route such as a road or stream along which the command post will move. The axis extends to the final objective or at least far enough to provide a guide for displacing the CP until further orders can be issued. The battle group takes advantage of any situation that permits it to use the same axis that a company has used. This practice saves wire and labor and simplifies the communication system.

48. Displacement

a. Displacement of the CP is coordinated to

avoid disrupting communication and losing control. Before a location is changed, the minimum communication facilities required at the new command post are established. This requires that the signal officer be notified well in advance of the estimated time of displacement. Other units concerned are notified of the contemplated change. When the new CP location is not already prescribed, the S3 confers with the battle group signal officer and S2 and submits recommendations for the new location to the commander. A quartering party, including the S1, the battle group signal officer, communication center platoon leader, guides, and security and communication personnel, goes to the new location. The communication and the area communication center platoon's advance echelon may follow the quartering party. The exact site is selected and the locations for the different installations are designated. Communication is established and guides and security personnel are posted.

b. When the command post site is ready for occupancy, the commander is notified. The command group moves to the new location according to his instructions. Enough personnel, including communication personnel, remain at the old CP to operate and close it. On the commander's orders, the old CP is closed. The new CP is opened at the same time. Except for a guide who stays behind to direct messengers to the new location, all communication personnel go to the new command post.

c. Close coordination between the battle group

and the area signal center supporting the battle group must be maintained so that maximum communications are available during the displacement.

Section III. TACTICAL EMPLOYMENT

49. Movement to Contact

a. Communication in route column is limited to that necessary for transmitting orders. Communication within the column is regulated by the battle group SOP, SOI, and SSI, supplemented as necessary by special instructions. Motor messengers and messages delivered by organic Army aviation may also be used.

b. During movement in tactical column, communication is provided between the battle group march command post and the division commander, adjacent columns, reconnaissance and security elements, lower unit command posts within the column, and supply trains. Communication also is maintained within units in the column. The principal means are radio, motor and foot messengers, and aircraft. They are supplemented by visual and sound signals. When secrecy is necessary, the radios are restricted or silenced. Orders for the march cover the axis of signal communication, use of the means of communication, and command post locations.

- (1) *Radio* is an effective means for controlling units during a march. Command nets may be organized to include platoons. Some secrecy of movement is

achieved by using codes and by reporting positions in reference to phase lines and march objectives. Radio nets are organized so that the operating ranges are not exceeded. All commanders and operators familiarize themselves with the details of the net organization and codes. The radio ranges are reduced during movement and when line of sight locations cannot be selected. Army aircraft radios and radios with liaison officers are helpful in establishing radio communication with adjacent columns and between units in extended columns.

- (2) *Messengers* are used by all units during a march. Foot messengers are used from front to rear. Motor messengers are sent to the front or rear and are used between adjacent columns. Messages can be exchanged between moving vehicles. Army aircraft messengers facilitate communication between adjacent columns, to the distant command post of higher commanders, and within extended columns. Before the march begins, messengers are told the route, the information to be delivered, the locations of command posts, and special vehicular markings.
- (3) *Pyrotechnics* are used for prearranged messages. A common use is for reporting when units reach march objectives

or cross phase lines. They may also be used as messages between ground units and aircraft and as antiaircraft or anti-tank warnings. When prearranged pyrotechnic messages are to be used, lookouts are assigned areas of responsibility in which to watch for them.

- (4) *Panels* are kept ready for use to identify friendly columns, vehicles in a column, command posts, and message-drop and pickup fields to friendly aircraft. Panel teams may leave the column temporarily to communicate with aircraft.
- (5) *Wire* normally is not laid during a march. However, commercial wire systems and existing field wire circuits may be used after coordination with, and approval of, higher headquarters.
- (6) *Command posts* are located to facilitate column control. Their locations in the column are prescribed and announced in orders. During motor marches, the battle group command post normally travels near the head of the main body. Command posts of other units in the main body are located at the heads of their respective units. During foot marches, command posts may be motorized and move by bounds between units. A motorized command post consists only of essential command and communica-

tion vehicles. Communication vehicles include those for messengers, panel teams, radios used during the march, and additional radios for emergency use. A few wire vehicles required during or immediately after the march are also included. Communication personnel not required during the march travel in the headquarters company serial near the command group. Communication vehicles and transported personnel not required to maintain communication during the march move near the head of the battle group trains. Communication personnel who cannot be transported march with the headquarters company, which is usually at the head of the main body.

c. In the approach march, the means of communication used in tactical column are continued. Radio and messenger are the principal means. Light aircraft and visual and sound communication supplement these. Security measures are continued. Prearranged message and operations codes are used extensively except when clear-text messages can be transmitted without violating security restrictions. As units assume extended formations or move across country, messenger communication becomes more difficult. Cross-country marches reduce the speed of the messengers and make march command posts more difficult to locate. Instructions to messengers are more

explicit. The use of wire in the approach march depends upon the rate of advance, the distance to be covered, future plans, the speed at which wire can be laid, and the supply of wire. Premature establishment of the wire system results in the loss of wire and overextension of circuits. It delays the installation of communication for the next operation. March command posts are kept well forward and convenient to all command elements. They follow the best available communication routes. Communication personnel keep abreast of the situation, supervise the operation of the communication system, and plan continuously for future operations.

d. During halts a limited communication system is established. If it is a temporary halt, communication is the same as during the march. During prolonged halts, messengers are used extensively. The use of radio may be limited by security restrictions. Wire is installed, but is limited by the available wire supply and the duration of the halt. The battle group should have wire communication to lower units during overnight halts. When a quartering party precedes the march, communication personnel are included to establish communication in the bivouac or assembly area.

e. In the assembly area and temporary command posts, a limited communication system is established. The same means of communication are used as in prolonged halts during the march. The signal officer is given timely information of the commander's plan for the next operation. He

must have time to make his reconnaissance and submit recommendations for a communication system and CP locations for the next operation. Installing the system is easier when the first location for the battle group CP is in the assembly area. When the first CP is to be forward of the assembly area, the communication platoon's advance echelon moves to it early and installs the communication system before the next operation.

50. The Offense

a. The extent of communication required by the battle group during the offense depends on its assigned mission. The signal officer, in close coordination with the battle group commander and staff, insures that provisions for communication are complete, including that between maneuver and fire support units and between all combat and service elements involved. He considers adverse weather in the objective area that may affect communication.

b. As soon as the battle group signal officer is informed of the attack plan, he makes a map reconnaissance and a tentative plan. When possible, he discusses this plan with the S3. Then he makes a ground reconnaissance, accompanied by wire personnel and other platoon members. He submits his recommendations to the S3 for paragraph 5*a* of the operation order.

c. Following the issuance of the attack order, the signal officer completes the coordination of

his plans with the S1, S2, and S3, the mortar battery, and supporting artillery. He then proceeds to the designated CP area with the S1 to determine its exact location and interior arrangement. As soon as possible after the first location is approved, the signal officer contacts the communication chief and has the bulk of the communication platoon sent forward. He immediately contacts the platoon leader of the supporting area communication center platoon and notifies him of the exact location of the CP. The signal officer and his section chiefs may precede the platoon to the designated command post location to receive orders and to reconnoiter before the platoon arrives. The remainder of the platoon continues to provide communication in the assembly area until the CP for the attack is occupied.

d. Radio and messenger are the principal means of communication in the attack. An installation section from the division area communication center platoon installs trunklines from the area signal center into the battle group command posts. The communication platoon maintains only the observation post lines. Certain radio remote control units are connected to the operations tent. Lateral communication is made through the division forward signal centers.

e. Although radio is used to the maximum extent, its use may be restricted until a prescribed time in order to preserve secrecy and make surprise possible. Maneuvering and reserve units may be further restricted before committed to

action. Listening silence is not carried to the point of making it a handicap rather than a protection. When it is probable that the enemy knows the location or anticipates the movements of friendly units, or after contact is made, there is little to gain by imposing listening silence.

(1) Radio nets operated within the battle group are flexible and may be altered as required by the situation, but should remain as fixed in organization as is consistent with the mission of the organization and the units employed. The number of available frequencies varies. The battle group communicates with division in six different radio nets:

- (a) One amplitude modulated radio set (AM-voice-CW) in the division intelligence net.
- (b) One amplitude modulated radioteletypewriter (AM-RTT) in the division command net No. 1.
- (c) One frequency modulated (FM) radio in the division air request net.
- (d) One frequency modulated voice (FM-voice) radio in the division command net.
- (e) One frequency modulated (FM-voice) radio in the division assault net.
- (f) One amplitude modulated (AM-RTT) radio in the division administrative net.

- (2) The battle group command net includes the rifle companies, mortar battery, reconnaissance platoon, assault gun platoon, medical platoon, signal officer, S2, S3, S3 Air, battle group deputy commander, the net control station, and the battle group commander.
- (3) Radio sets are available for communication with the battle group observation post and for direct communication with Army aircraft, engineers, and reconnaissance units.
- (4) When the battle group commander leaves the command post, he maintains communications in the battle group command net and division command nets with organic radios.

51. Night Attack

a. Wire is the best means of communication during a night attack. It is laid to the attack echelon, to fire support units, and to the reserve. When possible, it is maintained throughout the attack and during the reorganization and consolidation.

b. When the attack is conducted with the aid of continuous fire support, radios may be used after the attack is discovered. When an attack is conducted by stealth, radio operators listen on assigned radio frequencies but do not transmit until told to do so by the net control station.

52. Defense

The communication system for a defense is more elaborate than for an attack. Two or more lines are laid over different routes between the battle group command post and subordinate units. Lateral communication between battle group units is obtained through the area signal centers. Lateral communication between battle group units is established. Lateral wire lines are also established between forward rifle companies. Wire communication is established to the battle group command post by the area signal center. Simplex and phantom circuits are used to provide additional channels of communication. Scheduled messenger service is established to relieve the traffic from the wire system. For security reasons, radio communication usually is restricted until the enemy makes contact. When wire communication is available, radio transmitters are not used; when wire communication is interrupted, radio nets are available for use. During the defense, the communication system is constantly improved to insure uninterrupted operation.

53. Retrograde

a. Communication during *withdrawals from action* is characterized by detailed planning in advance and close coordination during the withdrawal. Existing communication channels are maintained as long as available equipment and restrictions imposed by higher commanders permit.

b. When the battle group executes a *daylight withdrawal*, the communication platoon, when possible, establishes, operates, and maintains facilities similar to those required in a night withdrawal. However, a daylight withdrawal seldom permits as much detailed planning and preparation as a night withdrawal. All means of communications are used to the maximum extent.

c. A *night withdrawal* is characterized by detailed centralized planning, detailed reconnaissance, and decentralized execution. The communication plan is carefully prepared to support the tactical plan. During the movement to the rear, communication is necessary in the old position and within the new position or area to which the battle group is moving.

- (1) Reconnaissance of the withdrawal routes determines what existing wire circuits can be used. Communication is provided to assembly areas and march-control points and between forward and rear positions. An early reconnaissance of the rear position is necessary for timely completion of the communication system there. Limits on the size of reconnaissance parties usually permit only the communication platoon wire section personnel to reconnoiter the new position. Normally a radio relay team chief of the area communication center platoon will accompany the reconnaissance party.

- (2) Existing communication facilities are maintained in the old position by the detachments left in contact. Command posts close on order or when taken over by the detachments left in contact. The communication chief or his representative remains with the detachments left in contact. The minimum additional communication personnel remain in the old position to operate the communication system for the detachments left in contact. When time permits, unused wire lines are recovered or sections are moved to prevent their use by the enemy. Deceptive measures include using dummy radio stations and simulating normal radio activity in the old position.
- (3) Messengers and available wire circuits are the principal means of communication during a night withdrawal. The staff and liaison officers help the commander control the movement. Communication can be provided at march-control points by splicing telephones into existing wire circuits. Listening silence is ordered for the main body and radio operators continue to listen on assigned frequencies. If the enemy discovers the withdrawal and more control is needed, the higher commander may direct that radios be used.
- (4) The majority of the communication

platoon moves to the rear position as early as practicable to establish facilities at the new position before the main body arrives. When the defense is to be resumed on the new position, a complete defense wire system is installed. The forward signal center will initially displace sufficient wire and relay equipment to integrate the new battle group command post into the communication system, and will displace the entire platoon with the main body. The radios continue to listen on assigned frequencies, but remain silent until the battle group commander deems operation necessary. When the withdrawal is to be followed by some other type of operation, minimum essential communication is established within the battle group assembly area and to the outpost, until plans are made for the next operation. Reconnaissance and plans for communication for the next operation are completed as soon as possible.

54. Delaying Action

In a delaying action, emphasis is placed on speed and mobility in establishing communication. Existing wire lines along the axis of operations are used during movement to the rear. A minimum lateral wire system is installed on each delaying position to include one line to each rifle

company and the mortar battery. Visual signals and motor messengers are used. Communication to distant, detached, and motorized or mechanized units usually is limited to radio and messenger. Timely reconnaissance and planning are necessary for communication on successive delaying positions. New wire lines usually are not laid for communication between successive positions.

55. Retirement

Communication during a retirement is similar to communication during movement to contact. When the enemy attempts to pursue vigorously, a series of delaying actions may be necessary to assist the retiring force to disengage. In this case, communication is maintained in the same way as described for a delaying action.

56. Relief of a Battle Group in Contact

Before the relief occurs, the battle group signal officer and key men from the communication platoon accompany the battle group commander and his reconnaissance party. They familiarize themselves with the communication system already in operation. They make arrangements with the unit being relieved to exchange certain equipment and to take over the existing wire system in place. They exchange equipment requiring extensive installation. During the reconnaissance, the key wiremen familiarize themselves with all wire routes. The signal officer obtains a line-route map, circuit diagram, traffic diagram,

and radio net diagram. He gets as much information as possible about road conditions and routes for messengers. He evaluates the conditions that affect radio communication and the probable interruptions of wire communication. Strict secrecy measures are taken to prevent the enemy from discovering the relief. Such measures may include continuing the use of existing call signs, frequency codes, and ciphers of the unit being relieved. Some communication equipment may be exchanged to preclude any breakdown of the system.

57. Airborne Operations

a. Special communication problems arise during airborne operations. Because of the dispersion of the units on landing, security requirements, speed of action, and distances involved, communication is relatively difficult to establish. Detailed plans are prepared at battle group and higher levels so that facilities of each component of an airborne force may be integrated and coordinated. These provide for communication between the battle group and—

- (1) Transport aviation units, to include the marshaling phase, loading areas, as well as the objective area.
- (2) Artillery, naval, and tactical air fire support.
- (3) Reconnaissance, supply, and evacuation aviation.
- (4) Linkup forces with a coordinated mission.

- (5) Subordinate units during movement by air, at the landing area, and during breakout operations.

b. During the assembly and reorganization of a battle group after landing, radio is the principal means of communication. It is supplemented by messengers and other means. The installation of the wire system is started as soon as practicable. To facilitate and expedite the establishment of the wire system within the battle group, wire laying teams and their equipment from the communication platoon may be landed with the rifle companies. Command radio nets usually are opened immediately after landing to help control and speed the assembly. Man packed radios are habitually carried into the landing area to facilitate prompt opening of radio nets on landing. Radio communication to the next higher commander is established immediately after landing. Communication with cooperating aircraft and naval forces is provided through the air control teams and naval liaison personnel. When an airborne operation is near the seacoast, naval gunfire teams also may accompany the landing and provide communication with naval support craft.

c. The size, weight, and amount of equipment landed with the battle group during the assault are limited. Only equipment that is carried with the men in their transporting aircraft is available at first. This equipment includes man packed voice radios and batteries, field telephones, light wire, panels, and small switchboards. Larger

reserves of communication supplies and equipment are necessary to compensate for losses during the landing. Resupply plans include equipment and supplies to meet communication requirements.

d. Communication personnel are assigned throughout air serials. A radio operator assigned to a unit commander or staff officer accompanies the officer in the same aircraft. Communication vehicle drivers land with their vehicles.

e. To acquaint himself with the tactical situation and to receive additional information and orders, the signal officer assembles with the commander and staff. He makes his plans flexible to meet any requirement of a rapidly changing situation.

f. The communication chief assembles the communication platoon. The platoon, less radio operators, wire teams, and messengers on special assignments, normally assembles with the headquarters company. The communication chief reports the status of his men and equipment to the signal officer as early as possible. He directs the implementation of the communication plan. He maintains contact with the signal officer to execute orders. The battle group command post is established immediately after the landing. When possible, the CP is opened in its predetermined location. After units have assembled and established their command posts, they exchange messengers.

g. Reorganization is not complete until the

battle group assembles according to plan and establishes command and fire-control communication channels. After the initial units have been air-landed in the airborne assault, and subsequent buildup of troops and equipment is underway, communication in the battle group proceeds as in normal ground operations.

Section IV. ELECTRONIC DEVICES SECTION

58. General

This section deals with the organization, capabilities, duties of personnel, and tactical employment of the electronic devices section (fig. 4).

a. The primary mission of the section is to provide ground radar surveillance to the battle group. This section increases the battle group capability to perform combat surveillance. (Combat surveillance is defined as the 24-hour continuous watch over the battlefield. It is achieved by a combination of listening posts, observation posts, aerial surveillance, electronic devices, and other reconnaissance and surveillance means.)

b. A surveillance plan similar to that shown in figure 5 is prepared and coordinated by the battle group S2. This plan augments the battle group collection plan. Variations in its content and detail may be dictated by higher headquarters or by the weather, terrain, or tactical situation.

c. Medium range radars are normally employed under battle group control with the battle group S2 exercising primary staff supervision. Short

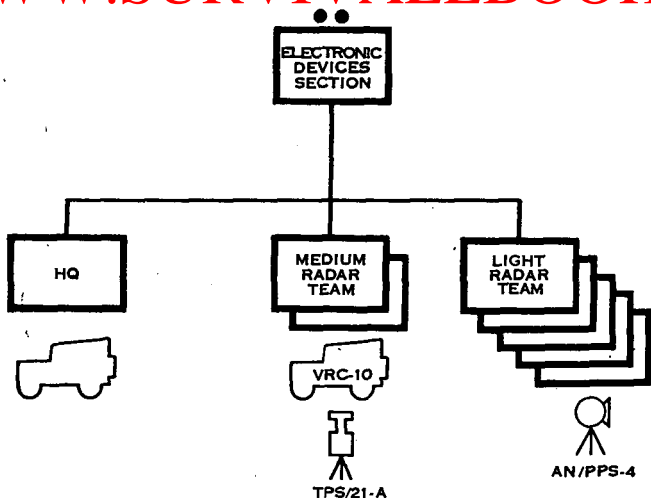

Figure 4. Electronic devices section.

range radars are normally attached to the rifle companies or other subordinate units for employment. Such employment insures effective utilization of these devices. Information collected from radars is correlated with that obtained from other intelligence sources.

59. Organization and Equipment

a. The electronic devices section consists of a headquarters, 2 medium range radar teams, and 5 short range radar teams. A lieutenant section leader and a sergeant section chief comprise the section headquarters. The medium range radar team consists of a senior radar operator and 2 radar operators. Each of the 5 short range radar

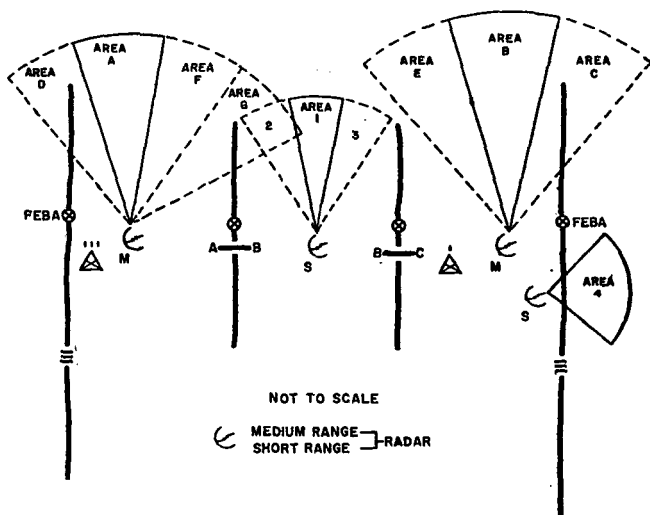

Figure 5. Surveillance plan.

teams have a senior radar operator and 1 radar operator.

b. Vehicular transportation within the section is as follows:

- (1) Section headquarters—one $\frac{1}{4}$ -ton truck with trailer.
- (2) Medium range radar team—one $\frac{1}{4}$ -ton truck with trailer.
- (3) Short range radar team—none.

c. Communication equipment in the section consists of one AN/VRC-10 radio set mounted in the $\frac{1}{4}$ -ton truck of each medium range radar team. When radio silence is in effect, the teams must tie in to the wire net of the nearest unit. The short

range teams must habitually utilize the existing wire net of the unit to which they are attached. Each of the short range and medium range teams has a telephone.

60. Capabilities

a. Radar surveillance is a method of detecting objects on or above the surface of the earth. Operators can determine the range azimuth, speed, and elevation of the detected object from an analysis of the audio return.

b. The section is capable of providing ground radar surveillance over assigned areas up to the maximum limits of terrain or equipment. Weather does not appreciably affect this capability. Dense undergrowth, trees, foliage and hill masks, however, clutter or block the radar signal to such an extent that no useful intelligence information or target data can be obtained. Limited communications equipment in the section, line of sight characteristics and other limitations of the radar equipment, and the inability of the section to provide its own local security, influence its employment and capabilities.

c. Ranges for planning purposes are—

Short range radar:

| | |
|-------------------------------|--------------|
| Detection of individuals..... | 3,500 meters |
| Vehicles | 6,000 |

Medium range radar:

| | |
|-------------------|--------|
| Individuals | 5,000 |
| Vehicles | 20,000 |

61. General Description of Radar Sets

a. Short Range Radar. This is a lightweight, portable set designed to detect moving targets such as vehicles and personnel. Targets are indicated by distinctive audio tones in the operator's headset. The operator is aided in the recognition of types of moving targets by superimposed audio tones resulting from the independent radial, velocity of the target's moving parts; e.g., tracks on tanks. Maximum tone signal indicates "on target." Manual operation allows a specific target to be tracked or "pin pointed" in range and azimuth. There are no provisions for remote control. Peep-sights mounted on the radar provide an optical axis for orientation and target identification. One man can place the radar in operation within 10 minutes. To attain desired efficiency of operation, operators should alternate every 30 minutes. This radar can be carried on two standard pack boards.

b. Medium Range Radar. This set functions very much like the short range radar, except it can be operated by remote control or set for automatic operation. For remote control operation, an interconnected cable up to 45 meters long is used. Automatic operation permits scanning of a pre-determined area. The set has a telescope mounted on it to aid the operator in orientation. This radar can be carried on five standard pack boards.

62. Duties of Personnel

a. Section Headquarters.

(1) *Section leader.* The section leader is

responsible for the section's training, control, operational employment, and supply. He recommends methods of employment of his section to the battle group commander and staff. Within the guidance of the S2 surveillance plan, he selects the primary positions and surveillance areas for the medium range radar teams. He insures that adequate orientation of the medium range radars is accomplished to provide electronic surveillance data to the degree of accuracy desired by the S2 and the fire support coordinator. He coordinates with the signal officer on such matters as call signs and other extracts of the SOI. He coordinates with the fire support coordinator to insure that fire support means are available to cover surveillance areas. He insures that radar surveillance cards for all devices retained under battle group control are prepared, utilized, and distributed to the battle group S2 and fire support agency. He coordinates with unit commanders in whose area his radar teams will operate on matters of communication, security, administration, and logistical support. He performs such other duties as the battle group commander may direct.

- (2) *Section chief.* The section chief is second in command of the section and assumes

command in the absence of the section leader. He is normally charged with the administrative and logistical functions of the section.

b. Medium Range Radar Team.

- (1) *Senior radar operator.* The senior radar operator's duties generally parallel those of a crew-served weapons squad leader. He is responsible for establishing and operating the radar site, and for preparing an appropriate radar surveillance card. He insures that specific areas are kept under surveillance as prescribed in the surveillance plan.
- (2) *Radar operators.* The radar operators of the team, assisted by the senior radar operator, operate the radar equipment on site. They also operate the communication equipment and vehicle.

c. Short Range Radar Team.

- (1) *Senior radar operator.* The senior radar operator's duties are similar to those of the senior operator of the medium range radar team. He is responsible for establishing and operating the radar site according to instructions from his section leader or the commander of the subordinate unit to which his team is attached. He insures that all information obtained is reported to the commander of the unit to which he is attached. This is accomplished by establishing wire

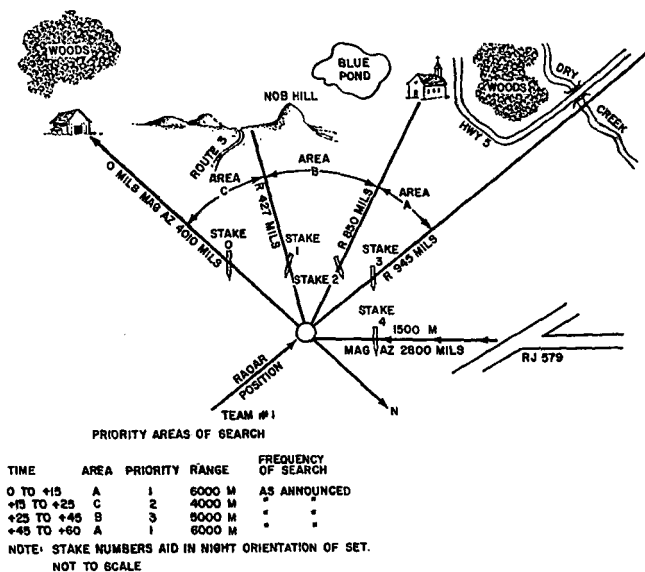

Figure 6. Radar surveillance card.

communication with unit to which the team is attached.

- (2) *Radar operators.* The radar operators, assisted by the senior radar operator, operate the radar and communication equipment on site.

63. Tactical Employment

a. General.

- (1) The medium range radars must be oriented. By proper orientation of the set and coordination with fire support elements, targets detected by the radars

can be taken under fire by fire support elements using preplanned concentrations. When feasible, orientation and coordination of surveillance areas for the short and medium range radars should be accomplished during daylight hours. Radar surveillance cards (fig. 6) are prepared and distributed to the fire support agency. Since these radars operate on a line of sight principle and require a background to detect movement, they are normally employed on dominating terrain similar to that required for a battle group or company observation post. The radar site may be located at the ground observation post. However, sound judgment must be exercised in establishing a joint radar/observation post so that troop density is reduced. Radar personnel should not act as ground observers except in emergencies.

- (2) Surveillance equipment having range capabilities greater than that normally required by the battle group is available at higher headquarters. When longer range equipment is required to support the battle group, such support is made available on a mission basis as required. When division ground surveillance devices are located in the battle group area, close coordination must be effected to insure maximum effectiveness of the

overall surveillance effort. Employment of this additional supporting equipment is similar to that of organic medium range radars.

- (3) The battle group S2 has primary staff supervision over the employment of the radar section. He recommends the method of employment (general support or attachment) to the commander. He designates general site locations and specific areas of surveillance. He specifies the frequency of coverage desired for the medium range radar teams, which are normally employed to add depth to the battle group's surveillance coverage.
- (4) The short range radar teams are normally attached to a rifle company or other subordinate unit of the battle group. The commander of the unit to which the team is attached selects the site for the radar, prescribes the area and method of surveillance, and arranges for security and logistical support of the team.
- (5) Each radar team is assigned a specific area of surveillance. In assigning sectors, consideration is given to terrain, enemy capabilities, equipment capabilities, and desired degree of sector overlap. Sector surveillance assignments and frequency of coverage must be included in the in-

structions to the radar team. The technique of scanning an area by radar is comparable to the scanning technique of a ground observer.

- (6) When short range radars are utilized, medium range radars are assigned surveillance ranges greater than those covered by the short range radars. The range of these radars increases the commander's knowledge of his area of interest during hours of poor visibility or darkness, thus permitting him greater reaction time within his area of influence.
- (7) Terrain, visibility, or the enemy situation may dictate the employment of the radars during daylight hours.

b. Offense. The tactical employment of the radar section is affected by the dispersion and rapidity of movement that characterizes the operations of the battle group under conditions of nuclear warfare. Radar teams may be used to provide surveillance forward of the line of contact as well as of an open or exposed flank. They may be used as a means of vectoring friendly attacking elements or patrols at night or when visibility is poor. They may be used to provide surveillance of critical areas or avenues of approach into the zone of attack of the battle group. At all times they are kept as far forward as the tactical situation and terrain will permit. The various tasks may be accomplished by the section in a general

support role or by elements of the section or individual radar teams attached to attacking companies.

c. Defense. Radars are employed to maintain surveillance over likely avenues of approach, gaps between units, and critical areas during periods of poor visibility or darkness. Subordinate unit commanders usually employ the short range radars to cover gaps between platoons and companies, and for surveillance of specific areas to the fronts. The medium range radars are normally employed in general support to add depth to the battle group surveillance coverage. In both defense and offense, the S2, in coordination with the radar section leader, prepares a battle group surveillance plan to insure adequate coverage and coordination with fire support units. A radar surveillance card is prepared for each radar site. It is desirable that the radar be oriented at the selected site and radar surveillance cards prepared during daylight. The radar is then moved to a defilade position. During periods of poor visibility or darkness, the radar is moved into the previously prepared site. When the medium range radar must be located in an exposed position, remote control operation is desirable. If enemy activity is detected in an area not included in the surveillance plan, a new mission may be prescribed redirecting the efforts of the radar. When such a mission is completed, the operator returns to the prescribed area of surveillance.

d. *Retrograde.*

- (1) *Medium range radar team.* Radar sites or positions are selected to which the medium range radar team will displace. The section leader and/or section chief and senior radar operator reconnoiter the area during daylight and insure that these positions are prepared. Tentative radar surveillance cards are made out.
- (2) *Short range radar team.* These teams operate under the control of the company or the subordinate unit to which they are attached. The team may operate with detachments left in contact or displace to new sites in a manner similar to the displacement of the medium range radar team.

64. Airborne Operations

a. The radar section can be delivered by parachute, assault aircraft, or transport helicopter. It should be delivered into the objective areas as early as practicable to provide maximum time for reconnaissance and preparation of radar sites. Usually it lands with the rest of the main body, but it may land in a separate area with security elements.

b. The section is employed in the airborne assault and subsequent operations in generally the same manner as discussed in paragraph 63. During the planning the section leader may be called on to make appropriate recommendations for the employment of his section. His recom-

recommendations may include initial and subsequent missions for the section, control (battle group control or attachment), a tentative time for teams to revert to section control if attached, and selection of probable initial sites and primary areas to be covered.

CHAPTER 3

RECONNAISSANCE PLATOON

Section I. GENERAL

65. Mission

The primary mission of the reconnaissance platoon is to perform reconnaissance and security missions for the battle group. It may operate under battle group control or, under certain conditions, it may be attached wholly or in part to task forces or rifle companies.

66. Organization

The platoon consists of a headquarters and four scout squads.

a. The platoon headquarters consists of a platoon leader, a platoon sergeant, and two scout drivers. Two AN/VRQ-3s and two AN/PRC-10s provide radio communication.

b. Each scout squad consists of a squad leader, an assistant squad leader, two scout drivers, a senior scout observer, and a scout observer. The scout squad normally functions as two teams:

Team 1
Squad Leader
Scout Observer
Scout Driver
¼-ton Truck-1
Machinegun-1.
Radio VRC-1-10-1
Radio PRC-10-1

Team 2
Assistant Squad Leader
Senior Scout Observer
Scout Driver
¼-ton Truck-1
Machinegun-1
Radio PRC-10-1

67. Communications

(fig. 7)

a. *Battle Group Command Net.* During mounted operation, the platoon leader enters the battle group command net with one-half of his AN/VRQ-3 radio.

Note. When the platoon leader is dismounted, he will have his PRC-10 on the platoon frequency.

b. *Platoon Net.* When mounted, the platoon leader communicates with squads and teams over one-half of his AN/VRQ-3. Dismounted, he utilizes the AN/PRC-10 in platoon headquarters.

c. *Squad Nets.* Squad AN/VRC-10s are all netted on the platoon frequency.

68. Training of the Reconnaissance Platoon

a. To perform their normally assigned missions, the scout squads should be trained to

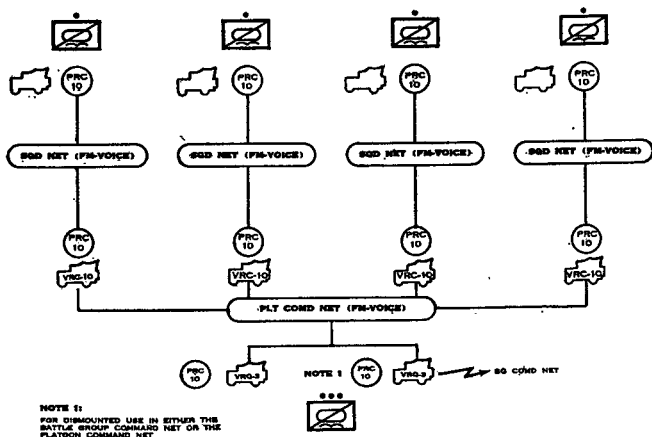

Figure 7. Type radio net, reconnaissance platoon.

operate independently as well as part of the platoon. The mission, enemy, and terrain may require dismounted action by the platoon or elements of it; thus, platoon members are trained in combat actions of the individual soldier and in dismounted patrolling techniques. See FM 21-75 for further information on combat training and patrolling.

b. All members of the platoon should be proficient in operating the radios, machineguns, $\frac{1}{4}$ -ton trucks, grenade launchers, individual weapons, compasses, radiacmeters, metascopes, and chemical agent detector kits organic to the platoon. They should know how to request and adjust supporting fires. They should also be familiar with surveillance and warning devices that may be available to them. All members should be trained to operate radiac instruments for radiation monitoring and survey.

c. Platoon members should be trained to remember and report the applicable elements of *who, what, when, where, and how many* regarding enemy and friendly activities and terrain.

d. The platoon should be trained in mounted and dismounted attack, defense and retrograde operations, as well as to perform the missions given in section III of this chapter.

e. The efficient functioning of the scout teams is facilitated by careful loading of the $\frac{1}{4}$ -ton truck. Weapons, radios, ammunition, personal equipment, rations, and other supplies should be placed so that they are secure, readily accessible

when needed, and allow maximum comfort and freedom of action for personnel.

f. The platoon must be trained to detect CW contamination and to recognize signs indicating BW agents have been used.

Section II. OPERATIONAL TECHNIQUES

69. Formations

The formation selected for movement of the mounted reconnaissance platoon is based on a consideration of mission, enemy, and terrain. The availability of suitable routes for movement of the vehicles is of particular importance in selecting formations.

70. Methods of Movement

a. *Continuous Movement.* When enemy contact is not likely or when speed is essential even at some risk, continuous movement is normal. The platoon (or separate squads) proceeds along its route, stopping only for investigation (often dismounted) of potentially dangerous areas. Platoon members maintain continuous all-round observation from the vehicles.

b. *Movement by Bounds.* When enemy contact is likely, one scout element (squad, if the platoon is together; team, if the squad is operating independently) remains stationary and covers the movement of another element by observation and, if necessary, by fire. The techniques for this method of movement are as follows:

- (1) Before moving, the scout element determines its next position and the most favorable route to it. During movement, the scout elements move as rapidly as the situation permits; they remain on the alert for cover, routes of withdrawal to cover and concealment, and enemy traps.
- (2) When approaching a position that will afford new areas of observation, the commander of the leading vehicle stops his vehicle and dismounts to assist in preventing detection. When observation has been established to front and flanks, the overwatching scout element moves forward.
- (3) Members must be trained not to be vehicle-bound. They must dismount frequently to provide security when the vehicle is stationary and to prevent enemy detection.
- (4) The distance of each bound is determined by the nature of the terrain and the range to which the covering element can effectively support the moving element. This distance usually should not exceed effective machinegun supporting range.
- (5) When covering elements have been signaled forward, they should take the shortest and fastest route to avoid delaying the movement.

c. Successive and Alternate Bounds. Techniques for executing these movements are explained in FM 21-75.

71. Utilization of Firepower

a. General. The reconnaissance platoon frequently must call for and adjust fires and fight with its organic weapons to accomplish its mission or protect itself. Scout squads should be skilled in rifle squad technique of fire for use in dismounted action.

b. Employment of Machineguns. Scout squads must be adept in placing their machineguns into action from either a vehicular or ground mount. Leaders must be able to decide quickly which mount is more suited to a particular situation. Machinegun fire is normally delivered from the truck pedestal mount during movement when effective fire must be delivered immediately. Or, fire can be delivered from the pedestal mount with the vehicle in chassis defilade or adequately concealed. Normally, reconnaissance by fire is made from the pedestal mount; movement by bounds is covered by pedestal-mounted machineguns. Machinegunners must keep their guns trained on the most likely enemy positions to facilitate immediate fire when contact with the enemy is imminent. When firing to the rear from the pedestal mount, the vehicle commander acts as gunner.

72. Observation

Careful, systematic observation is essential to

the proper performance of reconnaissance and security missions. Observation is a continuous process during reconnaissance operations. Techniques of effective observation include—

a. Selecting a concealed position affording good observation of the area of concern.

b. When possible, using two observers to watch the same sector. One observes the terrain in general for unnatural movement; the other systematically searches the terrain in strips.

c. Providing for all-round observation, when either mounted or stationary.

d. Changing observers frequently to insure alertness.

e. Making maximum use of binoculars, telescopes, and other surveillance devices.

73. Establishing Observation Posts

a. General. A reconnaissance platoon may establish up to eight observation posts. However, for extended periods of observation it is advisable to have at least two teams (six men) man an OP to provide for rotation of observers and security. The platoon leader usually selects the general location of the OPs and squad leaders select the specific location(s).

b. Mission. The OP maintains surveillance over an area to report enemy activities. OP personnel may also direct fires.

c. Selection of Position. An OP should provide a wide and deep field of observation, overlapping observation with other OPs, and concealment. The location should provide for good radio communication. Frequently, observers will be on or just forward of the topographical crest of high ground, while the radio(s), vehicle(s), and other personnel will remain on the reverse slope. Terrain conditions or a shortage of personnel may require that one of the observers operate the radio. Generally, two men observe, one man operates the radio, and the remainder, if any, rest and provide local security. Wire communication is used if practicable. Concealed routes of withdrawal are selected.

74. Establishing Listening Posts

a. During periods of low visibility, listening posts may be established along likely avenues of enemy approach. They may be in the vicinity of daylight OPs or considerably nearer the protected unit. Usually, ground mounted radios are used. Vehicles remain within a defensive position. The quiet operation provided by wire makes its use advisable if time and the situation permit.

b. Listening post personnel observe as well as listen. They use binoculars for night vision assistance. They may use such warning devices as trip flares.

75. Patrolling

Techniques for mounted and dismounted patrolling are given in FM 21-75.

76. General

Route, zone, or area reconnaissance missions may be assigned the platoon during any phase of battle group operations. When nuclear weapons are employed, the platoon performs radiological monitoring and survey work.

a. Radiological monitoring consists of detecting the presence and measuring the intensity of radiation by the use of radiation measuring (radiac) instruments. This simply means checking for radiation before it is encountered, measuring the intensity when it is encountered, and continuing to measure it after it is encountered.

b. Radiological surveying includes the organized process of measuring with radiac instruments the location, extent, and intensity of a radiation pattern on the ground. Radiological survey is the only means of determining the true pattern of fallout or induced radiation and the intensities within the pattern.

77. Movement to Contact

a. When the enemy situation is vague, the reconnaissance platoon may conduct security patrolling to the front. When the battle group advances in two or more adjacent columns, portions of the platoon usually operate forward of each column. Whenever possible, it is advisable to employ the scout squad as a unit, but teams may operate independently for short periods.

b. When one or both flanks are exposed, the platoon may provide flank security. At times, three squads may operate on the more dangerous flanks while one squad patrols the other flank. The squads may provide security by patrolling roads paralleling or approaching the axis of the main body, by establishing observation posts, or by a combination of these methods.

c. The platoon or any elements of it may be given the mission of maintaining contact between elements of the battle group (such as during an advance on two axes) or between the battle group and friendly units to front or flank.

d. When the battle group is not followed by other units, the platoon may patrol or observe likely enemy approaches into the rear of the battle group to provide warning.

78. Attack

During the attack, the platoon may provide flank security, maintain contact between elements of the battle group or between the battle group and other units, or establish and operate battle group OPs. Information included in paragraph 77 is also applicable to the attack.

79. Consolidation

After seizure of the battle group objective, the platoon may reconnoiter beyond the objective to maintain contact with the enemy, provide security to front, flank or rear, or contact adjacent units. If elements of the platoon are operating a battle

group OP(s), the OP(s) is displaced to the objective area and continues operation.

80. Pursuit

When the enemy situation is vague during a pursuit, the platoon operates as described for a movement to contact. When contact is made, the platoon operates as described for an attack. Also, the platoon may be employed to maintain contact with the withdrawing enemy.

81. Defense

a. The battle group normally defends as part of the division. It may, however, defend an isolated position beyond the division's supporting range. The battle group may participate in a defense where emphasis is placed on retention of terrain or mobile defense.

b. In either of the types of defense or when a general outpost is established, the reconnaissance platoon normally operates between the general outpost and the next security echelon to the rear. The platoon maintains contact with the general outpost. While accomplishing this, it reconnoiters the roads and trails in the area and establishes temporary observation posts to observe particular areas. It also reconnoiters for likely enemy approaches and possible locations of future enemy assembly areas and weapon positions. It recommends locations for concentrations as part of the long-range defensive fires. The platoon is capable of performing a combination of these missions

simultaneously. Upon the withdrawal of the GOPL, it may reinforce the GOPL or observe or patrol forward of it.

c. When security elements withdraw into the battle position, the reconnaissance platoon may operate battle group OPs within the position, maintain contact with adjacent units, conduct security patrolling on an exposed flank, or perform reconnaissance throughout the battle group rear. The ability of the platoon to perform more than one of these missions simultaneously is limited.

d. When there are no friendly forces operating forward of the battle group, the platoon may conduct a security mission to the front, maintaining visual contact with the enemy as he approaches.

e. The reconnaissance platoon of a reserve battle group normally performs reconnaissance and security missions throughout the battle group area of responsibility. When the reserve battle group is committed to the counterattack, the platoon functions as prescribed for the attack.

82. Retrograde

a. During the night withdrawal, the platoon is normally left as the reserve element of the detachments left in contact. It patrols and protects the command post of the detachments left in contact and blocks the most likely avenue of enemy approach into the battle group rear area. It acts as the security element to cover the withdrawal of the detachments left in contact. Also, it may

maintain contact with the enemy during the withdrawal of other forces.

b. During the daylight withdrawal, the platoon may be used under battle group control to protect the battle group's flanks or to maintain contact with the enemy forces and give warning of hostile movement. It may be attached to the battle group covering force to perform similar missions.

Section IV. RECONNAISSANCE TECHNIQUES

83. Purpose of Reconnaissance

a. The purpose of reconnaissance is to obtain combat information for the commander. Security missions, as well as the reconnaissance missions conducted by the reconnaissance platoon, frequently produce valuable combat information.

b. The platoon reports all information regardless of its apparent value. When considered in conjunction with information obtained from other sources, it might be extremely valuable to higher headquarters. Information must be accurate and timely.

c. The platoon obtains information without fighting when possible, but fights when necessary to accomplish its mission or to avoid destruction.

d. When the platoon establishes visual contact with the enemy, it makes every effort to maintain it. It breaks contact only if the mission or other orders necessitate it.

e. The platoon may encounter danger areas during any type of reconnaissance or security mis-

sion. Such areas are likely to be covered by enemy fire or obstacles and are frequently in or near woods, towns, defiles, or other areas providing concealment for the enemy. The platoon reconnoiters danger areas as carefully as time permits, frequently by sending forward dismounted personnel who are covered by other elements. Detailed observation with binoculars should precede movement toward the danger area.

84. Route Reconnaissance

A route reconnaissance is directed toward obtaining information of the enemy and terrain along a specific route. The leading element of the platoon (or squad, if operating independently) moves by bounds along the route while other elements reconnoiter laterally along roads, trails, or cross-country to investigate hills, woods, bridges, towns or other critical areas overlooking it. They conduct dismounted patrolling as necessary to insure complete coverage. The condition of roads and bridges and the presence of obstacles are included in the report.

85. Zone or Area Reconnaissance

Zone or area reconnaissance is performed by simultaneously conducting adjacent route reconnaissances, by increasing the lateral distance covered by scout elements branching off from a main route, or by crisscrossing a given area or zone. The technique selected depends on the size of the area, the road net, and the size of the unit conducting the reconnaissance. By assigning

boundaries or contact points, the platoon leader insures that no gaps exist between reconnoitered areas. A zone is usually a large area marked by generally parallel boundaries, whereas an area may be a specific locality such as a town or woods. See figure 8.

86. Reconnaissance by Fire

a. Reconnaissance by fire is an attempt to cause the enemy to disclose his presence by moving or returning fire. Certain elements deliver fire (usually machinegun) on suspected enemy positions, while others observe to locate enemy fire or movement. Surprise may be lost in this type of reconnaissance, but it increases the probability of disclosing the presence of enemy in well-concealed positions.

b. If the enemy returns fire, the unit either reports and bypasses the position or develops the situation further, depending on its mission. If fire is not returned, the unit usually continues on its mission. In any event, it must exercise caution since enemy troops may withhold fire as a deceptive measure.

87. Night Reconnaissance

Reconnaissance operations are slower and less effective at night. They are usually limited to dismounted patrolling, observation of enemy approaches, and listening posts. Only with exceptionally good visibility, favorable terrain and routes, and very light enemy resistance can vehicular movement be used in forward areas with-

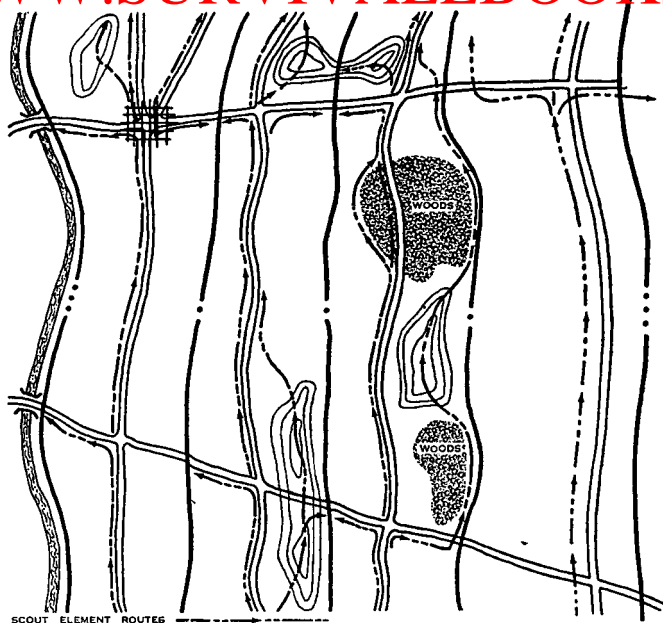

Figure 8. Zone reconnaissance.

out being preceded by dismounted patrols. Except for short cross-country movements, night vehicular reconnaissance should be confined to roads or trails.

88. Reconnaissance Instructions

Reconnaissance instructions should include—

- a. Pertinent information of enemy and friendly forces, to include appropriate portions of fire support plans.
- b. Specific information desired.

- c. Zone, area, or route to be reconnoitered.
- d. When, where, and how information is to be reported.
- e. Time of departure and return.
- f. Control measures such as phase lines, check points, and contact points.
- g. Action to be taken when mission is completed.

Section V. SECURITY TECHNIQUES

89. General

a. Security forces protect against surprise, ground observation, or annoyance by the enemy. A security force may be an advance guard, rear guard, flank guard, screening force, covering force or rear area security unit. It may accomplish its mission by offensive, defensive, or delaying action.

b. The reconnaissance platoon as a security force basis its position on that of the protected unit and stays between the protected unit and the enemy threat.

c. The platoon performs continuous reconnaissance to provide information of the enemy in its area of responsibility. It provides security from surprise by keeping the main body commander informed of enemy location and movements.

d. The platoon should operate far enough from the main body to insure adequate time and space for the main body to maneuver to meet enemy

threats. The main body should be protected from direct fire, surprise attack, and, if practicable, ground observation.

e. When the platoon makes contact, it retains it as long as the enemy remains in the area of responsibility. It may direct supporting fires against the enemy. If the enemy moves out of the area of responsibility of one security force into the area of another, action is taken to inform adjacent units of his presence.

90. Advance, Flank and Rear Guard

“Guarding” missions require forces strong enough to defeat, stop, or materially delay any enemy of considerable strength. Consequently, the reconnaissance platoon is not suitable for these missions, but may be attached to units performing them, as advance, flank, or rear guard to conduct reconnaissance or screening tasks.

91. Screening

a. Screening may be to the front, flank, or rear of a force engaged in offensive, defensive, or retrograde operations. The reconnaissance platoon frequently performs screening missions for the battle group.

b. Screening is designed to prevent surprise attack, direct fire, and ground observation (if practicable) from interfering with the main body. The commander assigning the mission designates the area of responsibility of the screening force. Screening is usually performed on the flank of a

moving unit or to front, flank, or rear of a stationary unit. It is accomplished by establishing OPs (a maximum of eight for the reconnaissance platoon) located to cover the assigned area. In some instances, these OPs must be augmented with patrols to observe areas unseen from the OPs (fig. 9). The flank of a moving unit is screened by leapfrogging the rearmost OP forward when the main body passes that area. When visibility is reduced, screening may be performed by listening posts and connecting patrols, often dismounted.

92. Security Patrolling

a. The reconnaissance platoon and squads often conduct security patrolling using the techniques of route, zone, and area reconnaissance (pars. 84 and 85). When patrolling on the flank of a moving unit, the platoon or squad travels a route generally parallel to the axis of the protected unit, investigating likely enemy approaches and periodically contacting the main body. When a suitable parallel route is not available, scout squads move laterally from the main body to reconnoiter dangerous approaches; they return, move forward, and prepare to investigate the next danger area.

b. The platoon may perform security patrolling in rear areas when the threat of guerillas, saboteurs, infiltrators, or bypassed enemy exists.

93. Establishing and Maintaining Contact

a. When contact with a friendly unit is to be

made, the platoon, squad or team leader, as appropriate, should determine who is to be contacted, where and when the contact is to be made, and what is to be accomplished on contact. Also, he should ascertain the frequency and call sign of the unit to be contacted, action desired if contact is not made, and method of reporting contact information. When contact is to be made by a squad at a particular point, one team may wait at the designated point while the other team overwatches from good vantage points to provide security and assist in locating the other party.

b. It maintains contact with friendly or enemy units by continuous observation of the designated force or by frequent visual contacts gained by moving to successive vantage points. It makes periodic reports to the controlling headquarters on the activity and location of the force.

c. The platoon frequently performs contact missions in conjunction with specific or implied reconnaissance and security missions. In any event, all personnel are alert to note and report all pertinent enemy, friendly, and terrain information.

Section VI. ACTIONS ON ENEMY CONTACT

94. General

The platoon avoids decisive combat and usually is not employed where strong enemy forces are known to be. However, emergencies may arise which require the use of the platoon to augment the combat power of the battle group rather than

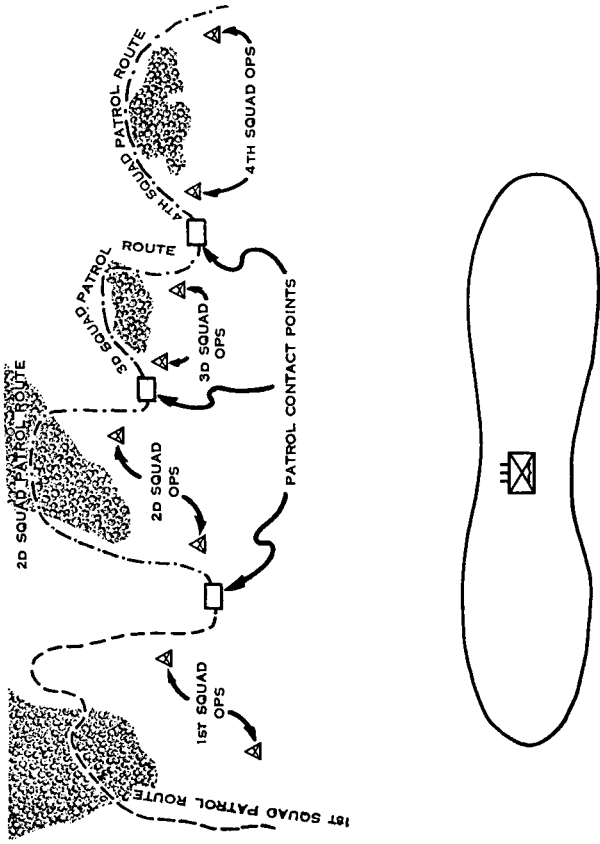

Figure 9. Screening by OP-patrol combination.

to perform its primary missions. Also, decisive combat may be necessary at times for survival. For these reasons, the platoon should be trained in rifle and machinegun squad tactics, rifle platoon tactics, and the application of fire and maneuver in motorized attack and retrograde operations.

95. Enemy Contact While on Reconnaissance

a. If the mission allows, reconnaissance elements retain under surveillance any enemy observed. The observers should remain undetected and report on the enemy's activity.

b. At times, the platoon or squad may leave a team to observe the enemy, while the remaining elements, avoiding detection, continue on their mission.

c. The platoon or squad may report and bypass stationary enemy such as troops in defensive positions or manning OPs.

d. If the mission requires or permits it, reconnaissance elements may destroy weak enemy groups such as small patrols or lightly protected roadblocks.

e. Where doubt exists as to the action desired by the higher commander, the platoon or squad leader reports the situation and requests instructions.

f. When fired upon or otherwise obviously detected by the enemy, reconnaissance elements seek cover (though some personnel are directed to observe the enemy from protected positions) and decide on a course of action. Depending on the

mission, enemy, terrain, and troops available, this course of action may be to retain visual contact with the enemy, bypass, withdraw, destroy the enemy element, or a combination of these actions.

96. Enemy Contact While on Security Missions

a. Security missions performed by the reconnaissance platoon usually require detection of the enemy rather than defense, attack, or delay. Consequently, the platoon or squad, upon observing the enemy, maintains contact by observation from fixed or moving OPs, reporting information as available and following any instructions given by the protected unit. If the enemy (or the protected force) moves out of the area of responsibility of the reconnaissance element concerned, the task of maintaining contact is passed to another unit, or the mission of the reconnaissance element is changed.

b. When the enemy comes under observation of a screening force, affected OPs maintain visual contact and withdraw by bounds as the enemy approaches. Often, OP personnel direct supporting fires to delay the enemy advance. Depending on the situation, the protected unit commander may specify that small enemy patrols be permitted to penetrate the screen and that OPs remain concealed and observe for larger enemy forces. At other times, OPs may be directed to stop or delay small enemy elements. After this is done, it is frequently advisable to move the OP to another position.

c. When discovered by the enemy, security patrols, OPs, and listening posts usually seek protection while still maintaining contact. This protection may be afforded by cover, movement, or friendly units. At times, organic and supporting fires must be used to protect their movement.

Section VII. THE AIRBORNE ASSAULT

97. General

The reconnaissance platoon is employed in the airborne assault in generally the same manner as it is in other offensive operations of the airborne battle group. It may remain under battle group control and be used in general support, or control may be decentralized initially by attachment of portions of the platoon to task forces or rifle companies. The platoon may be delivered in the airborne assault by parachute, assault transport, or transport helicopter.

98. Preparation for the Airborne Assault

a. The reconnaissance platoon follows the same general procedure as the headquarters company in preparing for the airborne assault.

b. During the planning for the assault, the platoon leader may be called upon to make appropriate recommendations for the employment of his platoon. His recommendations may include control (i.e., battle group control or attachment), initial and subsequent missions for the platoon, and a tentative time for the squads to revert to

platoon control, if attached. The recommendations, if accepted, are incorporated in the battle group order. Based on the battle group order, the platoon leader makes detailed plans for the following:

(1) When the platoon is operating under battle group control:

(a) The ground tactical plan.

1. Assembly in the airhead.

2. Assignment of specific missions to each squad.

(b) The aircraft loading plan.

(2) When control of the platoon is decentralized:

(a) Designation of elements of the platoon to be attached to companies or task forces.

(b) Tentative plans for squads to revert to platoon control.

c. The method of delivery and the mission of the platoon elements influence the platoon loading plan. When delivered by assault transport, scout squad personnel accompany their vehicles. When delivered by parachute, squad personnel should parachute in with their vehicles. A driver should accompany each vehicle. It is desirable to load squads in different aircraft to minimize the risk of losing the entire platoon. When elements are attached to subordinate units of the battle group, they may be attached in the marshaling phase and loaded with the unit to which attached.

The attachment may also be effective upon landing, in which case squad leaders report to the commanders of units to which they will be attached as soon as the battle group order is issued. The squad leaders participate in the planning of the units to which they are attached, and squad personnel are briefed with those units.

99. Air Movement, Landing, and Reorganization

a. Air Movement. The air movement from the departure airfield to the drop or landing zone is controlled by the commander of the transporting aviation unit.

b. Landing. The platoon lands as early as practicable so it can start ground reconnaissance promptly. When all scout squad personnel cannot accompany their vehicles in the heavy drop serial, they assemble at their vehicles on the drop zone or at other designated localities. Usually the platoon lands with the rest of the battle group, but some of its elements may be landed in a separate area, such as along the planned R&S line (RSL). If the platoon lands in advance of the battle group it will perform the required CBR monitoring of the intended landing areas.

c. Reorganization. During the reorganization after landing, the platoon leader regains control of the elements of his platoon under battle group control. The platoon may be assembled as a unit, or scout squads may move out directly on their missions after assembling on the drop or

landing zone. The platoon radio net is opened on landing and the platoon leader reports the status of his unit as prescribed in the battle group order or in the unit SOP. While the remainder of the battle group completes its reorganization, the reconnaissance platoon begins to reconnoiter the routes to objectives, establishes observation posts, and patrols likely routes of approach into the combat group assembly area. When all squads of the platoon are attached, the platoon headquarters lands with the battle group headquarters and the platoon leader prepares to resume control of the platoon on order of the battle group commander. The platoon leader keeps abreast of the tactical situation and makes appropriate recommendations concerning his platoon's employment.

100. The Attack and Subsequent Operations

a. When the battle group takes up a formation for movement to contact after the landing, the platoon is employed as described in paragraph 77.

b. The battle group commander returns the attached elements of the reconnaissance platoon to platoon control at the earliest practicable time.

c. The reconnaissance platoon is normally assigned missions on the RSL during the airborne assault. To accomplish its mission, the platoon may land on or move to the RSL under battle group control before the completion of the assault phase of the operation. When a suitable drop zone on or near the RSL exists and imme-

diate enemy resistance is not expected, it is desirable for the platoon to drop on or near the RSL to provide timely security. When the situation does not permit the establishment of the RSL during the assault, the platoon is used on other reconnaissance and security missions.

d. A battle group may be employed in a division airhead where the battle groups are not mutually supporting and where the size of the airhead does not permit the organization and defense of extensive portions of the airhead line. Under these conditions the battle group organizes critical terrain within its sector with emphasis on all-round defense. The battle group maintains surveillance over unoccupied portions of this sector of responsibility and takes timely action to eject, block, or destroy enemy forces. The reconnaissance platoon is usually employed by the battle group to provide security along the major routes of approach. As other units are assigned security missions within the battle group sector, the reconnaissance platoon is relieved of stationary posts so its mobility can be exploited by operating mobile patrols.

CHAPTER 4

ASSAULT GUN PLATOON

Section I. GENERAL

101. Mission and Employment

a. The mission of the assault gun platoon is to provide antitank protection and direct fire support for units of the battle group.

b. Depending on the tactical plan, the platoon or portions of it may be employed in general support or attached to the rifle companies. Normally, those elements of the platoon attached to the rifle companies are attached for *operational control* only, in order to relieve the rifle companies of providing logistical support.

102. Organization

a. General.

- (1) The platoon consists of a headquarters and three sections of two squads each. A platoon leader, a platoon sergeant, and a radio telephone operator comprise the platoon headquarters. Each section consists of a section leader (who also leads a squad), a squad leader, two gunners, two loaders, and two M56 drivers.

(2) Transportation within the platoon is assigned as follows:

(a) Platoon headquarters—one $\frac{1}{4}$ -ton truck for command and reconnaissance.

(b) Assault gun section—two 90-mm guns self-propelled, M56.

(3) The main armament of the platoon consists of six 90-mm guns self-propelled, assigned one per squad.

b. Capabilities. The platoon is capable of providing antitank protection and direct fire support for the battle group.

(1) *Mobility.* The mobility of the platoon (and its communications) enables it to maneuver throughout the zone of action of the battle group (terrain permitting) and to mass its fires. The excellent maneuverability of the M56 is an important means of protection. The platoon is air-transportable by C119, C123, and larger troop carrier aircraft. The platoon with its organic weapons and equipment can be dropped by parachute using heavy drop techniques.

(2) *Armament.* The 90-mm gun is a direct-fire breech-loaded weapon using fixed ammunition. The weight of the gun and its carrier is approximately 16,000 pounds. The weapon is fired only from its vehicular mount. The carrier holds 29 rounds of ammunition.

- (3) *Targets.* The platoon is normally employed by the battle group commander in its primary role of antitank protection. But it may be effectively employed against point targets such as bunkers, observation posts, vehicles, and grouped personnel. Under ideal conditions its weapons can be fired effectively at the maximum range of the direct fire sight (5,000 meters).

c. Limitations. The lack of protective armor on the M56 seriously limits the ability of this weapon to accompany rifle units in the **assault**. Normally the assault gun platoon is **limited to supporting** these units by fire.

103. Duties of Personnel

a. Platoon Headquarters.

- (1) The *platoon leader* is responsible for his platoon's training, tactical employment, and welfare. He recommends to the battle group commander methods of utilization of the platoon. He selects primary, alternate, and supplementary firing position areas for his sections; and plans and supervises displacement. In addition, he is the principal adviser to the commander on the employment of all antitank weapons assigned or attached to the battle group.
- (2) The *platoon sergeant* is second in command of the platoon and assumes com-

mand in the absence of the platoon leader. He assists the platoon leader as directed, primarily with ammunition resupply.

- (3) The *radiotelephone operator* drives and maintains the $\frac{1}{4}$ -ton truck in platoon headquarters and operates and maintains its radio equipment.

b. *Assault Gun Section.*

- (1) The *section leader* is responsible for the training and employment of his section and commands its first squad. He assigns primary, alternate, and supplementary position areas for his squads within the assigned section area. He controls the section's fires and its ammunition resupply and supervises the maintenance of its guns and carriers.
- (2) The *squad leader* selects the exact positions for the gun, usually choosing at least two within the position area assigned by the section leader. He supervises the preparation and occupation of the positions and specifies which position will be initially occupied. He controls his squad's fire in accordance with his section leader's orders, supervises the maintenance of his gun and carrier, and adjusts fire.
- (3) Each *gunner* lays his gun on the target with proper elevation and deflection and

fires the weapon on the squad leader's order. He assists in the maintenance of the gun.

- (4) Each *driver* operates his M56 vehicle and helps the gunner make major changes in deflection by maneuvering the vehicle. He normally performs the maintenance on the carrier assisted by other members of the crew.
- (5) Each *loader* inspects and stores the ammunition. He loads the gun and assists in maintenance of the gun and mount.

104. Communications

a. General. The platoon has one AN/VRC-18 and six AN/VRC-10 radios. One AN/VRC-10 radio is OVM to each carrier. The AN/VRC-18 is in platoon headquarters. It operates in the battle group command net and the platoon net.

b. Platoon Net. When the platoon is employed as a unit, a platoon net is established that includes the platoon headquarters and each squad. Net discipline must be strictly enforced, and communication between the squads of the section must be kept to an absolute minimum so the net is open for platoon leader-section leader communication (fig. 10).

c. Section Net. When a section is attached to a rifle company, one or both of the section's radios may operate in the company net.

Section II. OFFENSE

105. Movement to Contact

a. Approach March. One section is normally attached to the leading rifle company (ies). The platoon (—) remains in general support of the battle group and is disposed within the column to provide antitank protection and direct fire support.

b. Firing Positions. Throughout the movement to contact, the platoon, section, and squad leaders look for firing positions from which the most dangerous avenues of tank approach can be covered and from which the rifle companies can be given close and continuous fire support.

106. The Attack — General

a. Troop Leading. The platoon leader accomplishes certain troop leading steps before the attack. The time available determines the number of steps and the sequence; the following list is merely a guide:

- (1) Receives warning order.
- (2) Issues warning order.
- (3) Plans reconnaissance.
- (4) Executes reconnaissance.
- (5) Formulates and submits recommendations for the platoon's method(s) of utilization, firing position areas, and tentative plans of displacement.
- (6) Receives battle group order.

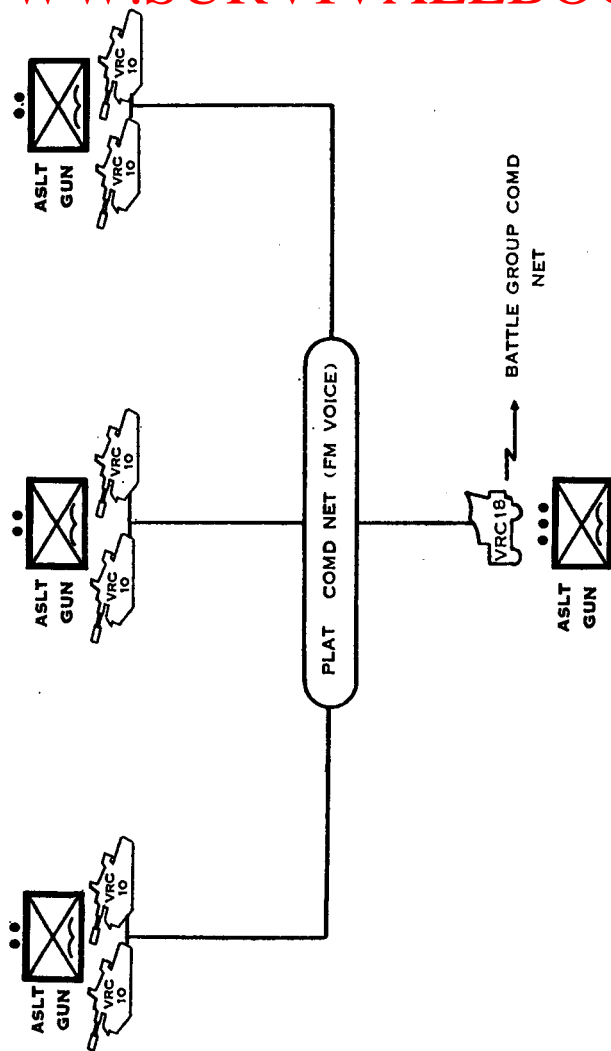

Figure 10. Type radio net, assault gun platoon.

- (7) Makes necessary arrangements for movement of the unit, reconnaissance, issuance of the platoon order, and coordination.
- (8) Completes reconnaissance (when necessary).
- (9) Completes and issues the platoon order.
- (10) Supervises execution of the order.

b. Methods of Utilization. The platoon, or elements of it, is employed in an antitank role, direct fire support role, or combination of the two. If the guns are positioned initially to provide direct fire support to attacking rifle companies and an enemy tank threat develops, the platoon immediately reverts to the role of providing antitank protection. The weapons are normally employed by section, each weapon providing support and protection for the other.

- (1) *General support.* In general support the platoon supports the effort of the entire battle group under the control of the battle group commander through the platoon leader.
- (2) *Attachment.* By attachment, the platoon (or portions of it) supports the effort of a specific portion of the battle group under the control of the supported unit commander. Attachment should be used when decentralization is imperative; for example, when task forces are organized within the battle group to op-

erate beyond supporting distance of 90-mm guns under control of the battle group. Usually, 90-mm guns are attached for *operational control* only.

- (3) *Combination of methods.* A combination of methods of utilization may be used; for example, one section may be attached while the platoon (—) is used in general support of the battle group. If tanks are attached to the battle group, they normally are used to support the attacking rifle companies while the assault gun platoon is employed to provide antitank protection to the flanks and rear of the battle group.

107. Selection of Firing Positions

a. The platoon leader assigns section firing position areas, the section leaders designate the general location for the guns, and each squad leader selects the exact locations (usually two or more) for his gun. Selection of multiple positions allows the squad to fire one or more rounds, move to another position, continue fire, then quickly return to the initial position or move to another. Positions should be selected from which the guns can perform both of their missions. When this is impossible, positions covering the most likely areas for the employment of enemy armor take priority. Alternate and supplementary positions are selected and prepared as time permits. These positions should permit

mutual support between the guns of the section. However, when the number of areas to be covered exceeds the number of sections, the guns may be employed individually.

b. When selecting positions, the mission, location of friendly units, enemy situation, and the terrain must be considered. With respect to the terrain, the primary considerations are—

- (1) Observation and fields of fire.
- (2) Cover (hull defilade for the gun in firing position) and concealment.
- (3) Routes into the position and for displacement.
- (4) Routes for ammunition resupply.

108. Occupation of Firing Positions

a. The unit leader (platoon or section) designates when and how the elements of the unit move into position. A major consideration is to move into position without being observed by the enemy. Positions which cannot be occupied except under enemy observation are entered rapidly and at the last possible moment.

b. If the positions are not to be immediately occupied, the squad leader and driver familiarize themselves with the exact position by dismounted reconnaissance so that, on order, they can place the guns in position without loss of time.

109. Security

The platoon, section, and squad leaders are responsible for providing their own local security.

Whenever possible, they use nearby riflemen for close-in protection. They make the maximum use of security measures such as camouflage, proper use of terrain, use of alternate positions, and the preparation of protective shelters.

110. Supporting Fires

During the attack, the guns deliver direct fire on known or suspected point targets. The primary target is enemy armor. Observed targets are fired on at the beginning of the supporting fires, before they are obscured by smoke and dust. Other fires are delivered against targets of opportunity and on call from the rifle unit commanders. The guns continue close fire support until their fires are masked by the assaulting rifle units.

111. Alternate and Supplementary Positions

a. Alternate position areas are occupied when hostile fire threatens to neutralize the guns. Authority to occupy alternate positions is normally delegated to the section leaders. This does not prevent the squad leader from using multiple positions within his primary position area. When a gun is operating independently, authority to move to an alternate position area rests with the squad leader. When alternate positions are occupied, the platoon leader is immediately notified.

b. When the platoon is in general support, movements to supplementary positions are made by the platoon leader with authority of the battle group commander. When it is attached, move-

ment is on order of the supported unit commander.

112. Ammunition Resupply

a. The 90-mm guns should move into firing position with a full load of ammunition on carrier. When feasible, additional ammunition may be placed on position for initial fires, allowing the carrier to displace with a full load.

b. Whenever possible, the headquarters and headquarters company commander provides the assault gun platoon with $\frac{3}{4}$ -ton trucks and trailers for ammunition resupply. These trucks come from the supply and transportation platoon. The trucks usually remain in a centrally located and covered position under the control of the platoon sergeant. When feasible, the trucks deliver ammunition to the guns. Otherwise, the carriers move to the platoon ammunition point and are resupplied directly from the trucks. Ammunition is taken from one truck at a time. When the supply becomes low, the remaining ammunition is placed on the other $\frac{3}{4}$ -ton truck and the empty truck is sent to the battle group ammunition supply point for more ammunition. When a section is heavily engaged and it is impractical for the M56 carriers to return to the platoon ammunition point, one of the trucks may be sent to the section firing position, resupply the section, and return to the platoon ammunition point. When a section is operating independently of the platoon and it is impractical to operate out of the

platoon ammunition point, one of the trucks may accompany the section.

c. When the headquarters and headquarters company cannot make additional transportation available for ammunition resupply, the platoon leader sends the M56 carriers directly to battle group. When it is necessary to use this system, the section leaders consolidate their ammunition on one of the M56 carriers and send the empty carrier to the ammunition supply point. Whenever this is done, the section leaders inform the platoon leader of the action taken. This is the least desirable method of ammunition resupply in that it greatly reduces the capability of the platoon to accomplish its mission. This method should be used only when additional transportation is not available to the platoon.

113. Displacement

a. To accomplish their mission, the 90-mm guns must be kept within supporting range of the rifle units. The platoon, section, or squad makes timely displacement to support these units during the attack and consolidation.

b. The 90-mm guns start displacing when their fires are about to be masked; when the rifle units are nearing the limits of effective supporting range; in time to support the consolidation on the objective; or in order to maintain continuous antitank protection and fire support for the attack.

c. When the platoon is in general support, the

battle group commander orders displacement or approves the platoon leader's request to displace. When attached to a unit, it displaces on order of the commander of the unit to which attached.

d. Units displace to position areas previously selected by a visual or map reconnaissance. Upon arrival at the new position areas, squad leaders select exact locations for the guns.

e. When the platoon is operating as a unit and the sections are operating as units, the platoon displaces by echelon. The most desirable method is to displace two sections in the first echelon and the remaining section in the second echelon. However, it may be necessary to displace one section at a time, or one section first, followed by two sections. When a section is operating independently, it displaces by squad echelon. The availability of new positions, routes forward, and the enemy armor threat influence the method of displacement.

114. Reorganization and Consolidation

Reorganization within the platoon is a continuous process. When the 90-mm gun unit has displaced to the objective, the leader reorganizes and coordinates with rifle unit and other supporting weapon leaders in organizing the ground for defense. The 90-mm guns are emplaced to cover the most dangerous avenues of enemy armor approach.

115. Pursuit

The airborne battle group may be employed in

the pursuit in the airborne role as the enveloping force. When it is engaged in a ground pursuit, the 90-mm guns are employed as in the approach march. Positions are sought from which effective fires can be delivered on the withdrawing enemy and on roads and defiles through which enemy troops and tanks may withdraw. If the battle group flanks are relatively secure, two or more assault gun sections may be employed with the leading company.

Section III. DEFENSE AND RETROGRADE

116. Tactical Employment

a. The employment of the assault gun platoon is essentially the same in the various types of defense (par. 81). In determining the best method of employment, the following factors must be considered:

- (1) The 90-mm guns are the battle group's principal organic antitank weapon.
- (2) Maximum advantage must be taken of the range, flat-trajectory, and mobility of the weapons.
- (3) The lack of armor protection must be compensated for as much as possible by proper use of the terrain and frequent movement of the gun.
- (4) Enough supplementary positions must be prepared to allow the guns to be moved immediately to engage a tank threat in any part of the sector.

(5) Maximum centralized control is exercised over the guns to make full use of the platoon's capabilities.

(6) Guns not engaging enemy armor are used to reinforce the fires of the forward rifle units. However, these guns immediately revert to their antitank role whenever enemy armor appears.

b. In developing the battle group fire support plan and the antitank defense plan, the battle group commander coordinates the employment of the assault gun platoon with other antitank measures. The entire platoon may be employed in the forward rifle company areas, or a portion of it may be employed in rear of the forward companies to provide depth to the antitank defense. Supplementary positions are prepared and occupied with authority of the battle group commander.

c. Platoon elements may be attached to units on the combat outpost line or the reconnaissance and security line.

d. When tanks are attached to the battle group, they may form the basis for the battle group antitank defense. The platoon then augments the protection afforded by these tanks, covers other armor approaches, and adds depth to the antitank defense of the battle group.

117. Selection of Firing Positions

The considerations governing the selection and occupation of firing positions are essentially the same as those discussed in paragraph 107. Em-

phasis is placed on covering likely armor approaches. Usually, alternate and supplementary positions are selected and prepared more carefully in the defense than in the attack. At night the guns may be moved to alternate positions to cover the armor approaches at closer range. Riflemen should provide close-in protection under conditions of reduced visibility.

118. Position of Leaders

a. The platoon leader occupies a position from which he can observe the avenues of armor approach into the battle area. If the terrain does not permit this, he places himself in a position from which he can observe the most dangerous approaches. He does not restrict himself to one location, however, but moves wherever he is needed most.

b. The section and squad leaders place themselves where they can best control the fires of their units.

119. Conduct of the Defense

a. The 90-mm guns attached to the security echelon engage hostile armored vehicles approaching the battle area. Terrain permitting, the guns are located near the topographical crest to facilitate long-range observation and fire. When the security echelon withdraws, the guns displace to previously selected positions within the battle area.

b. Unless instructed otherwise, 90-mm guns in

forward rifle company areas open fire when profitable targets come within effective range, frequently shifting within their primary position areas for security.

c. The senior squad leader in the vicinity of a gun makes the decision to move it from the primary to an alternate position area. When he moves a gun to an alternate position, he immediately reports this information to the platoon leader.

d. The guns occupy supplementary position areas with authority of the next higher commander only. Occupation of supplementary positions may necessitate a change in the operational control of one or more sections.

120. Retrograde

a. When the battle group is conducting a night withdrawal, all or a portion of the assault gun platoon may remain with the detachments left in contact. Any portion of the platoon not remaining withdraws with the main body to the new defensive positions. Plans for the movement of the platoon take into consideration the possible loss of secrecy and may include measures for early withdrawal by echelon, covering the movement by the use of fire or smoke.

b. When the battle group is conducting a daylight withdrawal, the 90-mm guns in the forward rifle unit areas support the units in contact. When the forward units pass through the battle group

covering force, the 90-mm guns drop off and support the covering force. At this point, the entire platoon is normally attached to the covering force. Guns that are not within the forward rifle company areas are attached to the covering force during the withdrawal of the forward companies.

c. When the battle group is conducting a delaying action, the platoon is used in essentially the same way as in the defense. As in defense, the 90-mm guns remain under battle group control whenever possible. However, the extended frontages frequently covered in a delaying action may necessitate attachment of portions of the platoon for control purposes.

d. When the battle group conducts a withdrawal from action by air, the platoon operates initially as in other withdrawals. After contact with the enemy is broken, elements of the platoon move to the loading area. Guns not employed to support forces in contact or the battle group reserve move directly to the loading area along previously selected routes. When preparing the loading plan, the commander must consider the length of time required to load the guns for the air movement. Early in the operation the commander must decide whether the guns will be withdrawn by air from the airhead or whether, because of the enemy situation, lack of aircraft, or time available, they will be destroyed after contact is broken and before the last elements of the force are withdrawn from the airhead.

Section IV. THE AIRBORNE ASSAULT**121. Employment**

The platoon is employed in the airborne assault in generally the same manner as in other offensive operations of the airborne battle group. Control of the 90-mm guns is more frequently decentralized to task force or rifle company level during the initial stages of the airborne assault than in other offensive operations of the battle group. Due to the absence of friendly armor in the airhead, the 90-mm guns assume greater importance as the principal antitank weapons of the battle group. The guns may be delivered either by parachute or by assault transport. However, compared to assault transport delivery, parachute delivery has the following disadvantages:

a. More time and specialized equipment are needed to prepare 90-mm guns for delivery and to load them in the aircraft.

b. Equipment is more susceptible to damage upon landing.

c. More time is needed to get the guns ready for action upon landing.

d. Landings are generally less accurate.

122. Preparation for the Airborne Assault

a. Preparations of the headquarters and headquarters company for the airborne assault are covered in chapter 1. In addition, preparation by the assault gun platoon includes—

- (1) Preparing the 90-mm guns for air landing or parachute delivery by heavy drop.
- (2) Moving to loading sites at departure airfields and loading.
- (3) Preparing for the tactical mission to be performed upon landing.

b. The method of delivery determines the nature and extent of preparations necessary to rig the 90-mm gun. When delivered by assault transport, preparation may be limited to fueling, stowing ammunition, and protecting sights and other equipment likely to be damaged during loading, air movement, and unloading. When delivered by parachute, the guns are loaded and lashed to a platform, the parachutes are rigged, and special measures are taken to protect equipment from damage during descent and landing. The extent to which these preparations can be made ahead of time depends on the availability of heavy drop platforms, parachutes, and on the mission of the unit while in a rear assembly area.

c. The guns may be moved to loading sites at the departure airfield under their own power or they may be transported by other means. Movement under their own power is usually limited to short distances in the immediate vicinity of the loading site. They must arrive at the loading site sufficiently ahead of the personnel serials to be loaded and ready for take off at the prescribed time. The gun crews accompany the guns to load

and lash them and other platoon equipment under the supervision of the aircraft pilot.

d. The battle group order assigns the platoon its mission for the airborne assault. As in other operations, the platoon leader may be required to prepare the battle group antitank defense plan. This plan covers one or more of the following phases of the operation: the landing and reorganization, the attack and seizure of the objectives, and the defense of the airhead. (See FM 7-40 for details on the preparation of the battle group antitank defense plan.) All or a part of the platoon may be attached to subordinate elements of the battle group. When the battle group lands on one drop or landing zone, the attachments are usually made effective upon landing. This simplifies preparations in the marshaling phase since the platoon leader can supervise the preparation and conduct of loading of his platoon as a unit. However, leaders of assault gun elements report to the commanders of units to which they will be attached as soon as the battle group order is issued. Leaders of 90-mm gun elements participate in the planning; their gun crews are briefed along with the units to which they are attached.

123. Air Movement, Landing, and Reorganization After Landing

a. Air Movement. The air movement from the departure airfield to the drop or landing zone

is controlled by the commander of the transporting aviation unit.

b. Landing. The platoon usually lands as a unit by either parachute or assault transport on a drop or landing zone with other assault elements. Gun crews parachute in with the heavy drop or land in the assault transport with the 90-mm guns. As soon as they are landed and prepared for action, the 90-mm guns move out on their assigned missions. When the enemy is engaged immediately upon landing, the gun crews give priority to the destruction of tanks and other armored vehicles capable of interfering with the landing and reorganization.

c. Reorganization. During the reorganization, the platoon leader regains control of those elements of his platoon under battle group control while the other elements join the units to which they are attached. The platoon may move directly from the drop or landing zone to assigned positions to cover likely avenues of tank approach into the battle group assembly area (if used), or move to positions from which it can support the attack by direct fire. The platoon radio net is opened upon landing and the platoon leader reports the status of his unit as prescribed in the battle group order or in the unit SOP. When control of the 90-mm guns has been decentralized, the platoon headquarters lands with the battle group headquarters and the platoon leader prepares to resume control of the platoon on order of the battle group commander. The platoon

leader keeps abreast of the tactical situation and makes appropriate recommendations concerning the employment of the weapons.

124. The Attack and Subsequent Operations

The platoon supports the battle group in the attack after an airborne assault in generally the same manner as in any other attack. In airborne operations, the platoon frequently has a larger number of tank approaches to cover than are common in other operations. As soon as the situation permits, elements of the platoon attached to task forces or rifle companies are returned to platoon control by the battle group commander. Since tanks will not be available to the battle group within the airhead, the assault gun platoon will form the basis for the antitank defense plan of the battle group.

PART TWO

LOGISTICS AND PERSONNEL

CHAPTER 5

SUPPLY AND TRANSPORTATION PLATOON

Section I. MISSION, ORGANIZATION, DUTIES, AND INSTALLATIONS

125. Mission

The supply and transportation platoon performs supply and transportation functions for the battle group.

126. Capabilities

The supply and transportation platoon is capable of—

a. Establishing and operating a battle group supply point.

b. Requesting, receiving, and distributing routine supplies for which it is responsible.

c. Maintaining records of all supply transactions.

d. Organizing, establishing, and operating a resupply drop zone for the battle group.

e. Recovering certain additional supplies dropped with the battle group in the assault.

f. Receiving and distributing followup supplies.

g. Providing pathfinder terminal guidance and control to Army aircraft.

h. Operating a battle group supply office when in garrison.

i. Organizing, establishing, and operating a battle group truck dispatch point.

j. Transporting supplies to and from the battle group supply point.

k. Conducting limited ground combat subject to the limitations imposed by numbers and type of weapons, communication equipment, and training of its personnel.

l. Controlling and supervising attached transportation.

m. Monitoring food and water if radiological fallout has been encountered.

127. Organization

a. The supply and transportation platoon is organized into a platoon headquarters, an ammunition and supply section, and a transportation section. It has a 24-hour operational capability.

b. The platoon headquarters establishes the battle group service area and supervises the operation of the battle group supply point(s) and the truck dispatch point.

c. The ammunition and supply section has the

primary responsibility of establishing and operating the battle group ammunition supply point. The section personnel are pathfinder trained and are prepared to perform terminal guidance duties and to assist in aerial resupply.

d. The transportation section has the primary responsibility of transporting the unit kitchens for the battle group, recovering supplies from the group drop zone, and moving supplies to and from the supply point. It establishes a truck dispatch point and routes traffic within the battle group service area.

e. In garrison operations, the platoon performs supply functions according to the procedures contained in AR 735-35.

128. Individual Duties

a. The *platoon leader* is responsible for the accomplishment of the platoon's mission. He coordinates continuously, in both planning and in operating, with the battle group S4 and the section leaders of the platoon. He is the chief agent of the S4 in requesting, receiving, storing, and distributing all supplies for which the S4 is responsible. The platoon leader's specific duties include—

- (1) Selecting the exact location for the battle group service area.
- (2) The security of the supply installations.

b. The *platoon sergeant* supervises the supply operations of the platoon and maintains liaison with the supported elements of the battle group.

c. The *ammunition chief* is the ammunition and supply section leader. He is responsible for the operation of the battle group ammunition supply points. He is assisted by an assistant ammunition chief and the platoon sergeant.

d. The *section chief* is the transportation section leader. He operates the truck dispatch point and controls the use of the platoon's vehicles according to the orders and policies of the platoon leader. He routes all traffic within the battle group supply and service area.

e. The *assistant section chief* supervises the distribution of class III supply. He is responsible for maintaining informal records of class III expenditures and providing information to the supply and transportation platoon headquarters to insure timely submission of requests for class III resupply.

129. Battle Group Service Area

The battle group service area is the focal point for the logistical operations within the battle group. It is operated by the supply and transportation platoon leader. The activities within the area are under the staff supervision of the battle group S4 (logistical officer). The platoon leader of the supply and transportation platoon operates in the battle group command net with the AN/VRC-10 radio set.

130. Characteristics of a Battle Group Area

The geographical location of the service area

is selected so the logistical installations within it can efficiently support the battle group. A suitable location includes the following characteristics:

a. It is convenient to units being served. This is the most important characteristic to be considered; if the area is not convenient to the units it supports, then it is not fulfilling its purpose. This means it should be centrally located to best serve all units of the battle group. It should be at or in rear of a point of divergence of routes to the units supported.

b. It does not interfere with the combat elements. The area must be far enough from the tactical units so that it does not occupy space needed by those units. Logistical support activities must not impede a tactical unit's freedom of movement.

c. It has sufficient space. The area should be large enough to permit adequate dispersion of vehicles and installations to avoid presenting a profitable target for enemy weapons.

d. It affords concealment from enemy ground and aerial observation.

e. It has firm ground for moving and parking vehicles.

f. There are no terrain features that are or may become a barrier to supply operations.

g. It has terrain features which favor defense against air attack and facilitates local security against ground attack.

- h.* It has water sources.
- i.* It is an adequate distance from other probable targets.
- j.* It is near airlanded or parachute resupply facilities.

131. Activities in the Battle Group Service Area

a. In the airhead during the assault phase, the supply and service area normally includes—

- (1) Supply and transportation platoon headquarters.
- (2) Battle group supply point.
- (3) Truck dispatch point.
- (4) Drop zone or aerial resupply point.
- (5) Collecting point for excess, salvage, and captured enemy materiel.

b. After linkup, or when an airborne battle group is employed in sustained operations, the supply and service area may include—

- (1) Supply and transportation platoon headquarters.
- (2) Truck dispatch point.
- (3) Class I supply point.
- (4) Class III supply point.
- (5) Class V supply point.
- (6) Kitchen area (when unit kitchens are under battle group control).
- (7) Collecting point for salvage, excess, and captured enemy materiel.
- (8) Drop zone or aerial resupply point.
- (9) Battle group support platoon (when at-

tached from the emergency repair company).

- (10) Recovery and disposition collecting point (when personnel and equipment are provided by a higher echelon for its operation).
- (11) Trains of attached or supporting units.

Section II. COMBAT SUPPLY OPERATIONS

132. Definitions and Abbreviations

a. Class I supplies consist of those items which are consumed by personnel or animals at an approximately uniform rate, irrespective of local changes in combat or terrain conditions. This uniform rate of consumption permits supply agencies to place balanced stocks in depots, supply points, and distributing points where they may be obtained by using units on the basis of personnel strength rather than itemized requisitions. See figure 11 for illustrations of the different classes of supply.

b. Class II supplies are supplies and equipment authorized in tables of organization and equipment, tables of allowance, equipment modification lists, letters of authorization, and other similar authority. They are the minimum essentials necessary to the accomplishment of the unit's mission.

c. Class III supplies consist of fuels and lubrication for all purposes except flamethrower fuel.

d. Class IV supplies are supplies and equipment

authorized a unit above the authorization established by the Department of the Army, or includes items other than those authorized by the Department of the Army. Class IV supplies are authorized a unit by intermediate commanders.

e. Class V supplies consist of ammunition, explosives, and chemical agents; e.g., flamethrower fuel, fuses, blasting caps, and pyrotechnics.

f. Miscellaneous supplies are those items of supply not included in any of the five classes described above.

g. Regulated items are those articles which are scarce, costly, or of a highly technical or hazardous nature which must be controlled closely during and after distribution.

h. Supply point distribution is a method of distributing supplies in which the receiving unit uses its organic transportation to obtain supplies at a supply point and moves those supplies to its own area. Example: a battle group, using its organic vehicles, travels to the rear and draws ammunition from the army ammunition supply point.

i. Unit distribution is a method of distributing supplies in which the issuing agency uses its own transportation to deliver supplies direct to the receiving unit. Example: rations for the battle group are delivered to the battle group class I distributing point by the division, in vehicles organic to the division.

j. The supply and transportation platoon headquarters is the organization that facilitates the

control and flow of supplies from the division technical service to the service area, or direct to the tactical units of the battle group. Personnel of the platoon operate throughout the service area, receiving and issuing supplies and equipment and dispatching vehicles. The supply and transportation platoon leader supervises and controls the service area under the staff supervision of the battle group S4.

k. The division logistical operations center (DLOC) is an agency established for coordination and supervision of those logistical operations that cannot be better handled on a preplanned or supply agency direct to user basis. The DLCC provides a single agency to which all units of the division, assigned or attached, may direct requests for other than routine support or medical supplies.

133. General Supply Procedures

a. Equipment and supplies to be carried by individuals and units of the battle group are listed in TOE's and in directives from commanders.

b. Requests for supplies are submitted through supply channels. Units submit informal requests (a written message, telephone call, radio message, etc.) to the supply and transportation platoon headquarters. Necessary consolidations, postings, annotations, and requisitions are prepared at the supply and transportation platoon headquarters. It forwards requisitions to division.

c. Unit distribution of all classes of supply is made from division to battle group when it is

CLASSES OF SUPPLY

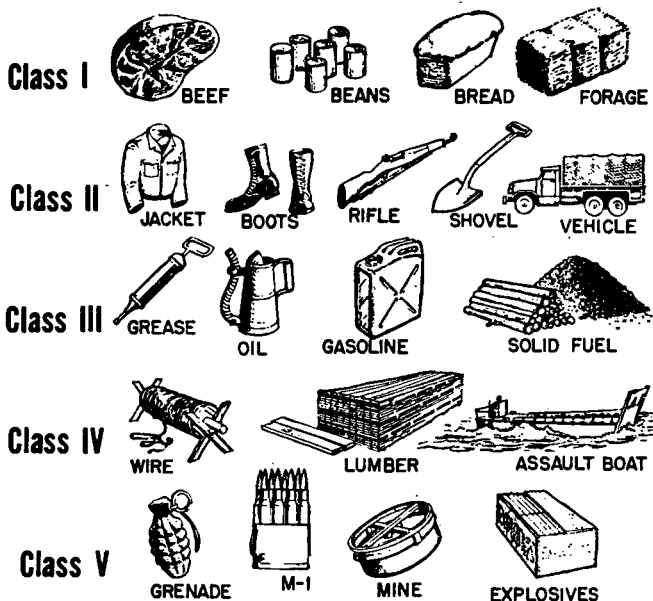

Figure 11. Classes of supply.

possible and practicable. The battle group does not have the capability to effect supply point distribution except for emergency, and then only in limited quantities.

d. The battle group collects salvage materiel for evacuation by the division supply and transportation company to the division salvage collecting point.

134. Systems of Supply

a. *General.* The systems for supply and resup-

ply within the battle group are planned, coordinated, and supervised by the S4. The operation of the systems is the responsibility of the supply and transportation platoon leader who utilizes the supply and transportation platoon headquarters as a primary means of exercising operational control and coordination. Supply of all classes, except medical supplies, maps and water, and quartermaster air-type equipment, is under the immediate jurisdiction of the ammunition chief, assisted by personnel of the ammunition and supply section.

b. Class I.

- (1) *Requests and requisitions.* All units of the battle group that are authorized a kitchen and mess personnel request rations by reporting the number and types of rations desired. The period covered by the report and the deadline for its submission are established in the battle group SOP or administrative order. The supply and transportation platoon headquarters consolidates the ration requests by number and type of rations and submits the report to division prior to a deadline established by division.
- (2) *Distribution.* Division delivers rations to the battle group supply point. Here they are broken down into unit lots in accordance with the requests originally submitted by the units to the supply and

transportation platoon headquarters. At a designated time, mess personnel from each kitchen draw their rations, take them to the unit kitchen location, divide the rations into three meals, and prepare the food.

Class II.

- (1) *Requests and requisitions.* All elements of the battle group enter combat with all authorized class II items. When a class II item is lost, damaged, destroyed, or worn out, the unit commander submits a request for a replacement to the supply and transportation platoon headquarters. The supply and transportation platoon headquarters posts, authenticates, and transmits class II requests to division.
- (2) *Distribution.* Division delivers class II items to the battle group supply point where they are further distributed to the requesting unit by any convenient means. A class II supply point is established and operated at battle group only when a major changeover of equipment is made; for example, turn-in of summer clothing and bed rolls and issue of winter equipment.

d. Class III.

- (1) *Requests and requisitions.* No formal requisitioning procedure is established for class III supplies. The supply and

transportation platoon headquarters transmits a status report to the supply and transportation company or the DLOC according to the schedule and procedure announced in the division SOP or administrative order. Formal requisitions are not required since class III supplies are issued on demand.

- (2) *Distribution.* The class III supply point operates under the direct supervision of the assistant section chief of the transportation section. During the assault phase and when operating in the objective area, fuel is normally delivered to the battle group in 5-gallon cans or 55-gallon drums. When facilities permit, however, class III supplies are delivered in bulk into the airhead. To reduce transportation requirements, supply points are located as near to combat units as feasible and bulk deliveries are made to these points. As units of the battle group require class III supply, it is distributed in 5-gallon cans. If the tactical situation does not permit delivery, the units send vehicles to the battle group supply point for refueling.

e. Class IV.

- (1) *Requests and requisitions.*

- (a) Requests for class IV supplies are handled essentially in the same man-

ner as for class II supplies, but the exact procedure depends on command policies regarding the item desired. For example, a requisition for a major item such as an extra $\frac{3}{4}$ -ton truck would have to be accompanied by a letter of justification signed by the requesting unit commander and approved by each commander intermediate to the issuing headquarters. In similar cases, requisitions are processed through command channels. When a commander has announced a policy, as in the case of minor items, class IV supplies are requisitioned through normal supply channels.

(b) Often, no requisition or request is required, particularly for fortification materials. Commanders at higher headquarters will determine requirements and inform the battle group when, where, and in what quantities the material will be available.

(2) *Distribution.* Class IV items are delivered to battle group in essentially the same manner as class II. However, it is frequently necessary to make special delivery trips from battle group to the units because of the size, bulk, quantity, and urgency.

f. Class V.

- (1) *Requests and requisitions.* Elements of the battle group submit requests for ammunition by type and amount to the supply and transportation platoon headquarters by written or verbal message. After the request is recorded at the supply and transportation platoon headquarters, it is sent to the battle group ammunition supply point for action. However, should supply point distribution be in effect, the requesting units submit requests direct to the battle group ammunition supply point, where immediate issue is made.
- (2) *Distribution.* Class V supplies are delivered to the units by the supply and transportation platoon or issued to the units at the battle group ammunition supply point. The ammunition chief supervises distribution of class V supplies and informs the supply and transportation platoon headquarters of all transactions. The supply and transportation platoon headquarters prepares all formal requisitions and submits them to the DLCC or to the class V section of the supply and transportation company.

135. Resupply for Subordinate Elements of the Headquarters and Headquarters Company

- a. *Requests and Requisitions.* Subordinate ele-

ments of the headquarters and headquarters company request all supplies in the same manner as the other units of the battle group. All requests are sent to the battle group supply and transportation platoon headquarters.

b. Distribution. Supply point distribution is normally used for elements of the headquarters and headquarters company. However, unit distribution may be made to certain elements, e.g., assault gun platoon, reconnaissance platoon.

136. Aerial Supply Procedures

a. General.

- (1) The quantity and types of supplies and equipment carried by assault airborne forces are dictated by the initial combat requirements. They are influenced by the availability and carrying capacity of aircraft, projected date of linkup or withdrawal, all-weather flight capability, anticipated weather, and enemy capabilities. Surface followup forces normally carry supplies for airborne forces within the objective area, within limitations of transportation available to them. Adequate and accurate airhead documentation of supplies is essential.
- (2) A minimum level of 2 days' supply should be maintained in the objective area at all times, with the exception of raid and relief operations. When feas-

ible, maintenance of a 3-day level may be desirable.

b. Phases of Supply. Phases of supply are *accompanying supply*, *followup supply*, and *routine supply*. Procedures employed vary with the category of supply being delivered.

(1) *Accompanying supplies* are those supplies of all classes that accompany the elements of airborne units into the objective area. Such supplies are issued to units prior to marshaling. With the exception of raid-type operations, the prescribed quantity of accompanying supplies is sufficient to sustain operations for 3 days. The tonnage is class III and V may be such as to require a second lift on D-day in order to have on hand the desired level. Accompanying supplies are carried as follows:

(a) *Unit prescribed load*—on individuals, in aerial delivery containers, and in unit vehicles.

(b) *Additional supplies*—in heavy drop load and/or bulk loaded in assault aircraft.

(2) *Followup supplies* consist of preassembled supplies delivered directly to forces in the objective area by air-landing, parachute, or free fall. Followup supplies are packed to correspond to anticipated daily requirements. Pro-

vision is made to permit flexibility in composition and delivery of daily requirements. Followup supplies are discontinued as soon as routine supply procedures can be reasonably implemented. Followup supplies are classed as automatic and on-call.

- (a) *Automatic.* Automatic followup supplies are delivered to units in the airhead(s) on a preplanned schedule. The quantities and times of delivery of automatic followup supplies depend on the specific situation. Automatic followup supplies continue until replaced by routine supply procedures.
- (b) *On-call.* On-call followup supplies are prepackaged and held in readiness in the departure area. They are delivered to units in the objective area on a specific request basis. Class I, III, and V, and selected class II and IV are prepackaged to correspond to anticipated daily requirements. Normally, a minimum 2-day requirement is so prepared. In addition, a small stock of specific critical items, normally class II and IV, are packaged on an individual basis to meet emergency requests for such items. In event on-call followup supplies are used, expended amounts are reconstituted immediately in the departure area. These on-call supplies

provide for emergencies throughout the operation.

- (3) *Routine supplies* consist of replacement and consumption supplies delivered to the objective area in bulk, based on actual needs, for distribution by normal supply procedures; and reserve supplies to build up to the desired level.

c. *Procedures.*

- (1) *Accompanying supplies.*

- (a) Unit prescribed loads are recovered, protected, and transported by the respective battle group units.
- (b) Additional supplies are recovered, protected, and transported by the respective units, except for the communication, reconnaissance, and assault gun platoons. Additional supplies for these platoons are recovered, protected, and transported by the supply and transportation platoon.

- (2) *Followup supplies.*

- (a) Prior to the availability of air-landing facilities in the objective area, follow-up supplies are delivered to the battle group service area by aerial delivery or air-landed on unprepared landing zones. These supplies are recovered by the battle group supply and transportation platoon, assembled in the battle group supply point, and further

distributed to the using units, either by supply point or unit distribution.

- (b) Because air-landing of followup supplies is the most economical method, the battle group supply point should be located as close to an air-landing facility as possible. Ideally, each battle group should have one such facility in or convenient to its sector. Supplies are distributed to the air-landing facility most convenient to the receiving unit. The supply and transportation platoon has the same functions and responsibilities for air-landed supplies as for aerial delivered supplies.
 - (c) High tonnage items (class I, III and V) are delivered forward (to the battle groups) ; those items of class II and IV supplies that are consumed at a less predictable rate are delivered to division supply points for subsequent distribution to using units.
- (3) Routine supply procedures usually are instituted only in independent operations, after linkup, or when the division is not committed to tactical operations. Such supply is handled in generally the same manner as in normal ground operations. Army type supply points are established as required. Delivery of supply by air should be as far forward as possible consistent with the situation.

This procedure shortens the surface communication distance, improves service to the consumer, and reduces security and service troop requirements. The supply level in the airhead(s) normally does not exceed 3 days. Units requisition in the normal manner and stock control records are maintained.

d. Special Supplies and Equipment. Airborne operations may necessitate additions, deletions, and substitutions in standard equipment and prescribed loads of units. Pallets and materials handling equipment may be employed to expedite the handling of cargo.

e. Type of Loading.

- (1) Assault airborne forces are combat loaded so that equipment and supplies essential to initiation of combat are readily accessible on landing. Combat loading distributes accompanying supplies among aircraft in such a manner that units are self-sustaining on landing. Particularly critical equipment may be duplicated to safeguard against loss or damage.
- (2) Followup and routine supplies may be loaded in delivering aircraft by classes to facilitate unloading, handling, and delivery in the airhead.

f. Method of Delivery.

- (1) Supplies may be landed by aircraft or dropped by parachute or free fall.

- (2) Landing supplies by aircraft is the most efficient method. Aircraft are capable of landing larger loads than can be delivered by parachute or free fall. In addition aircraft may be used for evacuation when returning from the objective area.
- (3) Delivery of supplies by parachute is the most economical method when aircraft cannot land. This procedure entails the use of a large amount of aerial delivery equipment and specially trained personnel. This method is used to supply assault airborne forces or isolated units when air-landing is impracticable or undesirable. In some situations, enemy action, weather, and distance may dictate the use of parachute delivery even though suitable landing areas exist.
- (4) The free fall delivery of supplies is the least efficient method of aerial supply. For certain items of supply there is a saving of delivery equipment but this is offset by the greater loss or damage to the supplies dropped.

g. Supply by Class:

(1) *Class I.*

- (a) Assault and individual combat rations are carried by all airborne units entering the objective area.

- (b) Combat rations are normally used for followup supply.
 - (c) All types of rations may be included in routine supply.
- (2) *Water.*
- (a) Airborne troops carry filled canteens and water purification tablets.
 - (b) Location of possible water supply points is predetermined.
 - (c) Water containers are carried filled, both for use en route and for consumption in the objective area.
 - (d) Water purification units are made available in the objective area as early as practicable.
- (3) *Class II.*
- (a) Limited amounts of essential class II items are included in followup supply.
 - (b) Minimum stocks of individual clothing and equipment are included in followup and routine supply.
- (4) *Class III.*
- (a) Powered vehicles and machinery are emplaned with fuel tanks filled to the safe level (generally $\frac{3}{4}$ full). Additional fuel and lubricants are carried on each vehicle.
 - (b) Followup supply includes fuel and lubricants for powered vehicles, machinery, and aircraft in the objective area.

- (c) Fuel and lubricants for vehicles normally are delivered in small containers. When facilities permit, fuel may be delivered to the objective area in bulk.
 - (d) Aviation gasoline is dispensed from 55-gallon or other large containers, utilizing a motor-driven fuel pump with a water segregator and micronic filter.
- (5) *Class IV.* The amount of class IV supply brought into the objective area is limited. Local resources must be exploited to the fullest extent.
- (6) *Class V.*
- (a) The amount and type of class V accompanying supplies vary with each operation. A prescribed load is designated for each operation and is based on—
 1. Degree of opposition anticipated during and after the landing.
 2. Number and type of weapons landed with the airborne force and requirements for bulk allotment items.
 3. Planned time followup supply becomes available.
 4. Number and types of aircraft to be used.
 5. Experience factors.
 - (b) Followup supply includes all types of class V supply and must be sufficient

to allow continuity of combat operations. Opposition encountered in the objective area frequently requires changes in the amounts and types planned for delivery. Such requirements are met by requesting delivery of on-call followup supply.

(7) *Captured supplies and salvage.*

(a) Within limitations prescribed by technical services, full utilization is made of captured or abandoned enemy materiel.

(b) Logistical considerations require recovery of salvageable equipment, especially parachutes and aerial delivery containers.

(c) Medical installations are sources of equipment salvaged from evacuated casualties.

(8) *Civilian supplies and equipment.* Local civilian supplies and equipment will be utilized as directed.

137. Functions of the Supply and Transportation Platoon Headquarters

a. General. The supply and transportation platoon headquarters operates primarily as a control and coordination center for the logistical activities of the battle group. Under the supervision of the battle group S4 and the operational jurisdiction of the supply and transportation platoon leader, the supply and transportation

platoon headquarters prepares and submits reports and estimates, consolidates requests for supplies, establishes priorities, disseminates logistical information, compiles experience data, supervises the receipt and distribution of supplies, exercises control over the supply and service area, controls battle group transportation, coordinates maintenance activities within the battle group, and maintains liaison with the DLOC.

b. Supply Operations by Class.

(1) *Class I.*

- (a) Prepares the battle group ration request and submits it to division.
- (b) Disseminates the battle group feeding plan.
- (c) Supervises kitchen and mess personnel when kitchens are under battle group control.
- (d) Coordinates ration issue to units.

(2) *Class II.*

- (a) Prepares requisitions to division.
- (b) Maintains records on regulated items.
- (c) Coordinates issue to requesting units.
- (d) Coordinates or performs delivery to requesting units.

(3) *Class III.*

- (a) Prepares and submits the class III status report to division.
- (b) Coordinates delivery to units.
- (c) Makes issue to units on demand.

(4) *Class IV.*

- (a) Prepares requisitions to division.

(b) Coordinates issue to requesting units.

(5) *Class V.*

(a) Audits unit requests and forwards them to battle group ASP.

(b) Prepares requisitions and forwards them to division.

(c) Maintains records of expenditures, available supply rate, etc.

(d) Coordinates issue or delivery to requesting units.

c. Transportation Operations.

(1) Supervises the activities of the transportation section.

(2) Establishes priorities for use of battle group supply vehicles.

(3) Coordinates use of unit vehicles when they are pooled at battle group.

(4) Coordinates operational use of all vehicles in the battle group to insure that scheduled maintenance is performed.

(5) Coordinates use of logistical vehicles attached to battle group.

(6) Establishes and disseminates traffic control plans within the battle group area.

d. Aerial Resupply Operations.

(1) Provides terminal guidance and navigational assistance to aircraft.

(2) Assists in the parking of aircraft.

(3) Reconnoiters landing sites and reports the practicability of landing troops and equipment.

- (4) Marks landing sites and drop zones with navigational aids.
- (5) Supervises the recovery and disposition of the battle group additional supply load and followup supplies from the drop zone.
- (6) Coordinates aerial resupply missions.

138. Control of Kitchens and Mess Personnel

a. General. Kitchen equipment and mess personnel are organic to the units of the battle group. However, the trucks used to transport the kitchen equipment are organic to the transportation section of the supply and transportation platoon. Since the control of kitchens involves the control of the cargo vehicles as well as supervision over the preparation of food, unit messes may be placed under battle group control and the vehicles released to unit control. All factors should be considered in determining the method of control to be adopted to insure that the requirements of a given situation are met. The method of control is recommended by the S4.

b. Battle Group Control of Kitchens.

- (1) In short duration operations, kitchens habitually remain in the departure area. Otherwise, kitchens may be phased into the airhead area with the followup echelon. In static situations, they are normally under battle group control. Kitchens are located in the service area.
- (2) Battle group control of kitchens provides maximum flexibility and efficiency in the

use of cargo vehicles and facilitates distribution of rations from battle group to unit messes. It locates the kitchens to permit close supervision by the supply and transportation platoon leader, thus relieving the unit commanders of an administrative burden. Battle group control, however, locates the kitchens farther from the troops, increasing the possibility that food will not be as hot or palatable as desired.

- (3) When kitchens are under battle group control, the supply and transportation platoon leader supervises meal preparation and delivery of food. He issues instructions, supervises loading of food and water, and controls vehicle movement.

c. Unit Control of Kitchens.

- (1) In static situations, unit kitchens may be controlled by parent units. The unit commander assumes responsibility for supervising the mess personnel in preparing and serving the food. The cargo vehicles may be released to the units or may remain under battle group control.
- (2) When vehicles are released to unit control, the commanders are responsible for transporting the rations from the battle group class I supply point to the unit mess location. If control of the vehicles is retained at battle group, then the

rations are delivered to unit mess locations.

d. Feeding Plans. The battle group S4 prepares a feeding plan. When the battle group commander approves it, the S4 transmits it to the unit commanders as early as possible. This allows mess personnel maximum time for preparing the food.

- (1) The feeding plan includes all or part of the following:
 - (a) Time and place of ration issue.
 - (b) Location of kitchens.
 - (c) Vehicles to be used for delivery.
 - (d) Instructions relative to type of ration and loading food containers.
 - (e) Additional items of supply to be sent forward with the food.
 - (f) Time vehicles will leave kitchen area.
 - (g) Location of battle group release point.
 - (h) Time vehicles and kitchen equipment are released to unit control and time they revert to battle group control.
 - (i) Any restrictions on vehicle movement.
- (2) The unit commanders prepare a unit feeding plan based upon the battle group plan. This plan includes—
 - (a) Type ration.
 - (b) Location of unit mess area.
 - (c) Instructions for unit guides and carrying parties.
 - (d) Time feeding is to begin and end.

- (e) Return of vehicles and mess equipment.
- (f) Supervision of vehicles while under unit control.
- (g) Arrangements for feeding attached personnel.

e. Water. Although water is a miscellaneous item of supply, it is generally delivered with food. The battle group obtains water at engineer water points in 5-gallon cans or water trailers. If engineer water points are not available, water should be purified by units using a tube of water purification powder, chlorine in the canvas water sterilizing bag (lyster bag), or by individuals using water purification tablets. For details concerning water purification, see FM 21-10.

f. Airborne Operations. All airborne units entering the objective area carry assault and individual combat rations. Individual combat rations are normally used for followup supply in airborne operations. Since there is no requirement for unit messes until linkup or until kitchens have been phased into the airhead, the unit mess personnel may perform other duties as desired by the battle group commander. They may be employed by their parent units as riflemen or to assist in handling the additional unit supply load. They may assist in casualty evacuation as litter bearers. They may be pooled in the supply and transportation platoon to assist in recovering the battle group additional supply load and followup sup-

plies, or they may be used in the departure area until linkup by land or airlift.

Section III. REPAIR, SALVAGE, AND MISCELLANEOUS ACTIVITIES

139. Repair

a. Timely repair of equipment within the battle group is essential. Individual users make minor repairs on unit equipment. Items requiring more extensive repairs are reported to the supply and transportation platoon headquarters. It coordinates with the battle group support platoon of the emergency repair company to accomplish the repairs at the site of the equipment.

b. Repairs are made as far forward as the situation permits, thus eliminating time-consuming evacuation. The equipment is returned to use as quickly as practicable.

140. Salvage

a. Unit commanders are responsible for salvage discipline, which includes collecting and moving salvage to collection points. Normally, they evacuate salvage to the battle group service area by any available vehicles making a trip to the rear.

b. The platoon sergeant at supply and transportation platoon headquarters establishes and operates the battle group salvage collecting point. Material brought to the collecting point is segregated when practicable into appropriate technical service lots and evacuated to division on partially loaded or empty vehicles and aircraft.

141. Excess

Items in excess to the needs of the battle group are collected and evacuated through supply channels in the same manner as salvage. Commanders are responsible for collecting excess items and returning them to supply agencies.

142. Captured Enemy Material

a. Captured enemy material is collected and evacuated in the same manner as salvage. The battle group commander controls the distribution and use of captured supplies. Destruction of captured material is prohibited except when specifically ordered. Subject to limitations of maintenance facilities and class III supplies, enemy vehicles may be used to supplement organic vehicles. Enemy material is a possible source of intelligence information. Its description and the circumstances leading to its capture are always reported to the next higher commander.

b. Captured enemy weapons are used only in emergencies. When they are used, friendly troops are notified. This prevents the characteristic sound of such weapons from attracting our own fire.

c. Captured enemy material that appears to be of new or unusual design is evacuated through intelligence channels.

143. Evacuation of the Dead

Identification and evacuation of the dead is performed by the recovery and disposition section of

the division supply and transportation company. Should the division or battle group suffer heavy casualties, additional support is rendered by an army recovery and disposition company.

144. Destruction of Vehicles and Equipment

When necessary, equipment is destroyed to deny its use to the enemy. The decision to destroy equipment (other than medical) is made on authority delegated by the division or corps commander. Plans for destruction of equipment are prepared in advance and executed on order of the battle group commander.

CHAPTER 6

MEDICAL PLATOON

145. Responsibilities and Duties of the Battle Group Surgeon

See FM 7-40.

146. Organization of the Medical Platoon

The medical platoon is organized into a platoon headquarters, a treatment section, and an evacuation section.

a. Platoon headquarters consists of—

- (1) *A medical service corps officer* (platoon leader) who performs the following duties:
 - (a) Supervises the discipline, organization, employment, and training of the medical platoon.
 - (b) Establishes and operates one or more aid stations.
 - (c) Personally supervises and performs treatment for the sick and wounded.
 - (d) Keeps the battle group surgeon informed of the medical situation at all times.
 - (e) Supervises the treatment given forward of the aid station.

- (j) With the platoon sergeant and general clerk, performs reconnaissance functions for relocation of aid station as directed.
 - (g) Supervises the recording and maintenance of casualty records.
 - (h) Controls the evacuation of casualties from units within the battle group to the battle group aid station.
 - (i) Supervises the expenditure of medical supplies.
 - (j) Makes timely requests for resupply to the battle group central supply point.
 - (k) Performs such necessary reconnaissance and liaison or other functions as the surgeon may direct.
- (2) A *platoon sergeant* who performs the administrative duties of his office in addition to assisting in treatment performed within the aid station.
 - (3) A *general clerk* who maintains all the records for the platoon as required.
- b. The *treatment section* consists of—
- (1) A *section sergeant* who supervises the establishment and operation of the section under the direction of the assistant platoon leader, who also functions as section leader.
 - (2) One *senior medical aid man*, one *aid man*, and an *aid station attendant* who operate the aid station(s).

- (3) One *ambulance driver*, also an aid man who drives the forward ambulance (a dual purpose administrative and evacuation vehicle) assigned to the section.
 - (4) Twenty *company aid men* who are routinely attached to the companies of the battle group on the basis of one per platoon during combat or training.
 - (5) Two *battery aid men* who are routinely attached to the mortar battery during combat or training.
- c. The *evacuation section* consists of—
- (1) A *section sergeant* who exercises control of the litter bearers and forward ambulance drivers under the direct supervision of the medical corps officer.
 - (2) Five *ambulance drivers*, also litter bearers, who drive the five forward ambulances assigned to the section.
 - (3) One *senior litter bearer* who assists the section sergeant in supervising the litter bearers and ambulance drivers.
 - (4) Four *litter bearers*, also aid men, who evacuate the wounded by litter with the assistance of ambulance drivers.

147. General Procedure

a. The employment of medical elements of the battle group is based on the requirements of each phase of an airborne operation.

b. In the marshaling phase prior to air drop,

the medical platoon is responsible for its planning to support each serial in which units of the battle group are involved.

c. Planning for the air drop includes proper apportionment of company aid men and medical supplies to each aircraft. In addition, in the assault serials litter bearers may be phased in with the company aid men to establish the forward terminus of the evacuation chain and to effect the contact of the followup aid station elements.

d. The aid station and evacuation section usually split into two elements to facilitate loading and to insure that at least one complete element will be functional when air-landed or dropped. Medical supplies are apportioned to each element, plus an additional increment to counteract losses during the air drop.

148. Company Aid Men

In combat and in certain field and training situations, after initial self aid or buddy aid, the sick and wounded of the battle group are first given emergency medical treatment by the attached company aid men. They treat emergencies on the battlefield and either direct the walking wounded toward the aid station(s) or place the litter casualty in marked protected places to await further evacuation by litter bearers or forward ambulances. The company aid men provide information of the medical and combat situation to the medical platoon leader by means of messages carried by litter bearers, ambulance drivers,

or walking wounded. When the time and tactical situation permit, company aid men initiate emergency medical tags for those who have been treated.

149. Evacuation

a. A company aid man treats a casualty and then moves along with his unit. The evacuation section of the medical platoon is responsible for removing the casualty to the battle group aid station(s).

b. When the time and tactical situation permit, forward ambulances and infantry carriers (when authorized) are used to evacuate from as far forward as possible to speed evacuation and to conserve the strength of the litter bearers.

c. Employment of evacuation personnel and means are as follows:

(1) Litter teams comprised of four litter bearers.

(2) Ambulance teams consisting of an ambulance driver and a litter bearer.

d. The principal duties of evacuation personnel include—

(1) Maintaining contact with combat elements.

(2) Moving to the battle group aid station(s) the wounded who are unable to walk.

(3) Directing or guiding walking wounded to the aid station(s).

(4) Administering additional emergency medical treatment as required.

- (5) Assisting in the displacement of the battle group aid station(s).
- (6) Acting as messengers.
- (7) Initiating emergency medical tags when necessary, time and tactical situation permitting.
- (8) Monitoring personnel, when indicated by the situation, for the presence of CBR contamination prior to medical treatment.
- (9) Performing medical resupply functions for the company aid men attached to the companies of the battle group.

150. Battle Group Aid Station(s)

a. The first medical installation in the normal system of evacuation is the battle group aid station. It is operated by the treatment section of the medical platoon. The station(s) is established as far forward within the battle group area as the tactical situation permits. It habitually locates farther forward in the attack than in the defense. The aid station must be capable of splitting for limited periods to meet tactical situations requiring the dispersal of elements of the battle group. Considerations governing the location of the aid station(s) include the following:

- (1) Tactical operation of the battle group.
- (2) Expected areas of casualty density.
- (3) Protection afforded by defilade.
- (4) Convergence lines of casualty drift.

- (5) Length of litter and ambulance haul.
- (6) Cover and concealment.
- (7) Security.
- (8) Accessibility of evacuation routes to the front and rear.
- (9) Proximity to likely enemy targets such as bridges, fords, important road junctions, firing positions, and supply installations.
- (10) Accessibility to helicopter or fixed-wing landing sites.
- (11) Communications.

b. At the aid station, casualties requiring further evacuation to the rear are given additional emergency treatment and prepared for evacuation. Constant efforts are made to prevent unnecessary evacuation and to return all casualties who are capable of performing a combat mission. Specific functions of the battle group aid station(s) include—

- (1) Receiving and recording casualties.
- (2) Examining and sorting casualties and returning the physically able to duty.
- (3) Giving emergency treatment necessary to preserve life and limb, and preparing casualties for further evacuation when necessary.
- (4) Preventing and treating shock.
- (5) Providing temporary shelter and protection for casualties.
- (6) Providing temporary treatment for combat exhaustion cases.

- (7) Maintaining a simple accurate roster of all patients treated in the aid station indicating those who are evacuated from the battle group area.
- (8) Initiating emergency medical tags for those casualties not previously tagged.
- (9) Verifying information contained on all emergency medical tags of casualties evacuated to the battle group aid station(s).
- (10) Evaluating prisoners of war covering evidence of medical implication and interrogating prisoners of war with the battle group S2.
- (11) Providing emergency treatment to civilian casualties.

c. If further evacuation and treatment are necessary after emergency treatment is completed, evacuation is the responsibility of the division medical service attached to or in support of the operation.

151. Supporting Medical Elements

a. In an air drop operation wherein linkup may be delayed for more than 24–48 hours, an appropriate supporting element from the division medical company is usually attached to a single battle group. It is in direct support if the operation involves two or more battle groups in a given task force.

b. In an operation involving three or less battle groups, at least one clearing platoon of the divi-

sion medical company (to include treatment, holding, and evacuation sections augmented by a surgical team plus indicated ambulance support from the evacuation platoon) is phased into the airhead following the assault serial.

c. Portions of the evacuation elements of the division medical company supporting within the airhead are phased into the area with the battle group medical platoon elements. Later they are established with the remainder of the division medical elements when they arrive in the airhead.

d. One division clearing platoon locates itself near available landing strips for fixed-wing **and** helicopter aircraft and provides emergency **surgery, further** emergency medical treatment, **and** limited holding within the airhead until evacuation is possible, either by transportation or medical helicopter ambulance or by fixed-wing aircraft, to designated hospital. The evacuation elements are responsible for the evacuation of casualties from aid stations.

e. After linkup, normal ground evacuation from battle group to division clearing station to field hospitals or evacuation hospitals is reestablished. Air evacuation then serves as augmentation of the usual ambulance evacuation provided by army.

f. The capability of aircraft to land within the airhead decides when evacuations can be made and the number of casualties that can be removed. Medical personnel as flight attendants on non-medical aircraft must be planned for and provided in advance.

WWW.SURVIVALBOOKS.
g. Enemy action, location of battle group aid stations, and the ability to deliver a helicopter to the airhead determine the possible aeromedical evacuation from the aid stations to the airhead landing strips or to other friendly positions.

CHAPTER 7

PERSONNEL SECTION

152. Organization

The personnel section of the headquarters and headquarters company consists of a warrant officer (personnel officer) and such enlisted assistants as are authorized in the unit TOE. The personnel section does not form a part of the assault echelon of the battle group. It normally operates from the division administration center located within the division trains area.

153. Duties

a. The personnel section performs the following duties under the supervision of the personnel officer :

- (1) Maintains custody of all individual personnel records.
- (2) Maintains and administers all individual personnel records.
- (3) Classifies and prepares assignment orders for enlisted personnel assigned to the battle group.
- (4) Assists the battle group commander and company commanders in determining personnel requirements, and requisitions personnel.

(5) Procures, stores, and distributes publications and blank forms.

(6) Administers the efficiency rating, army enlisted management program, and casualty reporting systems.

(7) Maintains the financial data records folder for all individuals within the battle groups.

(8) Prepares and submits monthly the military pay vouchers on all individuals.

b. Based on informal memorandums or worksheets received from the battle group commander and company commanders, the personnel section provides the following services:

(1) Prepares and forwards morning reports.

(2) Prepares and processes all requests for leaves, transfers, and discharges; applications for attendance at schools; military pay orders; and statements of charges.

(3) Publishes orders effecting reassignments, appointments, and reductions.

(4) Processes soldier deposits.

(5) Prepares formal personnel reports and correspondence, as necessary.

(6) Reports to the finance officer all changes in pay status of individuals within the battle group.

c. The personnel officer (designated as assistant adjutant) publishes special orders and prepares routine correspondence pertaining to battle group

personnel as individuals. He assumes custody of company funds when the companies go into combat or when, in the opinion of the battle group commander, the funds may be lost.

d. Processes manifests for pay purposes.

154. Personnel Administration

The personnel section relieves company commanders of as many administrative activities as possible. Routine administrative actions between the companies and the personnel section may be transacted directly by informal memorandums.

APPENDIX REFERENCES

- | | |
|-----------|--|
| AR 320-5 | Dictionary of United States Army Terms. |
| AR 320-50 | Authorized Abbreviations and Brevity Code. |
| AR 380-5 | Safeguarding Defense Information. |
| AR 711-16 | Installation Stock Control and Supply Procedures. |
| AR 735-35 | Supply Procedures for TOE Units. |
| AR 750-1 | Concept of Maintenance. |
| AR 750-5 | Maintenance Responsibilities and Shop Operations. |
| AR 750-8 | Command Maintenance Inspections. |
| FM 3-5 | Tactics and Techniques of CBR Warfare. |
| FM 5-15 | Field Fortifications. |
| FM 5-20 | Camouflage; Basic Principles and Field Camouflage. |
| FM 5-31 | Use and Installation of Boobytraps. |
| FM 7-10 | Rifle Company, Infantry and Airborne Division Battle Groups. |
| FM 7-24 | Communication in Infantry and Airborne Divisions. |

- FM 7-40 Infantry Regiment.
- FM 20-32 Land Mine Warfare.
- FM 21-5 Military Training.
- FM 21-6 Techniques of Military Instruction.
- FM 21-10 Military Sanitation.
- FM 21-30 Military Symbols.
- FM 21-75 Combat Training of the Individual Soldier and Patrolling.
- FM 27-10 Law of Land Warfare.
- FM 41-5 Joint Manual of Civil Affairs/
Military Government.
- FM 41-10 Civil Affairs/Military Government Operations.
- FM 57-30 Airborne Operations.
- FM 57-100 Airborne Division.
- FM 101-5 Staff Organization and Procedure.
- TM 5-260 Principles of Bridging.
- TM 10-405 Army Mess Operations.
- DA Pam 108-1 Index of Army Motion Pictures,
Film Strips, Slides, and Phonorecordings.
- ACP-122 Communications Instruction
Security.

INDEX

| | | |
|------------------------------------|----------|-----|
| Advance guard..... | 90 | 105 |
| Aerial supply procedures..... | 136 | 155 |
| Airborne assault: | | |
| Preparations for | 13-15 | 9 |
| Recon platoon in..... | 97-100 | 111 |
| Air movement | 99, 123 | 113 |
| Airborne operations | 64 | 86 |
| Ammunition chief | 128 | 142 |
| Approach march | 49 | 57 |
| Area reconnaissance | 85 | 101 |
| Assault gun platoon: | | |
| Communications | 104 | 120 |
| Displacement | 113 | 128 |
| Duties of personnel..... | 103 | 118 |
| In airborne assault..... | 121-124 | 135 |
| In attack | 106 | 121 |
| In defense | 116-120 | 130 |
| In offense | 105 | 121 |
| Mission and employment..... | 101 | 116 |
| Organization | 102 | 116 |
| Security | 109 | 125 |
| Selection of firing positions..... | 107 | 124 |
| Supply, ammunition | 112 | 127 |
| Battle group: | | |
| Aid station | 150 | 179 |
| Headquarters | 4 | 4 |
| Service area | 129, 130 | 143 |
| Signal officer | 24 | 24 |
| Surgeon | 145 | 174 |
| Captured enemy material..... | 142 | 172 |
| Classes of supplies..... | 142 | 146 |

| | Paragraph | Page |
|------------------------------------|-----------|----------|
| Clerks | 9 | 7 |
| Combat supply operations..... | 132-138 | 146 |
| Command post: | | |
| Designation of | 43 | 50 |
| Displacement of | 48 | 55 |
| Interior arrangement | 44 | 51 |
| Location of | 42 | 47 |
| Opening of | 43 | 50 |
| Operation | 45 | 53 |
| Personnel | 45 | 53 |
| Security of | 46 | 54 |
| Communication: | | |
| During tactical employment: | | |
| Defense | 52 | 66 |
| Delaying action | 54 | 69 |
| Night attack | 51 | 65 |
| Offense | 50 | 62 |
| Retirement | 55 | 70 |
| Retrograde | 53 | 66 |
| Means of | 28 | 26 |
| Messenger | 31 | 34 |
| Platoon, organization of..... | 18 | 14 |
| Radio | 30 | 31 |
| Security | 39 | 43 |
| Sound | 33 | 37 |
| Staff responsibilities for..... | 16, 25 | 11, 25 |
| Support for battle group..... | 17 | 13 |
| Training | 40 | 46 |
| Visual | 32 | 36 |
| Wire | 29 | 27 |
| Communication platoon | 18 | 14 |
| Company: | | |
| Aid men | 148, 149 | 177, 178 |
| Clerk | 12 | 7 |
| Commander | 12 | 7 |
| Mission | 1 | 3 |
| Organization | 1 | 3 |

| | Paragraph | Page |
|---------------------------------|-----------|--------|
| Company headquarters: | | |
| Mission | 11 | 7 |
| Personnel | 12 | 7 |
| Consolidation | 114 | 129 |
| Daylight withdrawal | 53 | 66 |
| Delaying action | 54 | 69 |
| Destruction of equipment..... | 144 | 173 |
| Displacement of CP..... | 48 | 55 |
| Electronic devices section..... | 18 | 14 |
| Capabilities | 60 | 77 |
| Mission | 58 | 74 |
| Organization and equipment..... | 59 | 75 |
| Personnel | 23, 62 | 24, 78 |
| Tactical employment | 63 | 81 |
| Evacuation of dead..... | 143 | 172 |
| Firepower, utilization of..... | 71 | 93 |
| Firing positions | 111 | 126 |
| First sergeant | 12 | 7 |
| Guarding missions | 90 | 105 |
| Headquarters, battle group..... | 4 | 4 |
| Headquarters personnel | 4-9 | 4 |
| Intelligence sergeant | 6 | 6 |
| Interior guards | 12 | 7 |
| Listening posts | 74 | 95 |
| Maintaining contact | 93 | 106 |
| Marshaling | 15 | 10 |
| Medical platoon: | | |
| Company aid men..... | 148 | 177 |
| Employment | 147 | 176 |
| Organization | 146 | 174 |
| Supporting elements | 151 | 181 |
| Medium range radar set..... | 61 | 78 |
| Message center | 18, 44 | 14, 51 |

| | Paragraph | Page |
|----------------------------------|-----------|---------|
| Message center personnel..... | 20 | 16 |
| Mess, control of..... | 138 | 167 |
| Messenger communication | 31 | 34 |
| Movement by bounds..... | 70 | 91 |
| Movement to contact..... | 77 | 96 |
| Night: | | |
| Attack | 51 | 65 |
| Reconnaissance | 87 | 102 |
| Withdrawal | 53 | 66 |
| Observation posts | 73 | 94 |
| Operation order | 37 | 41 |
| Operations sergeant | 7 | 6 |
| Oral communication orders..... | 38 | 41 |
| Organization of the company..... | 3 | 4 |
| Paragraph 5 | 37 | 41 |
| Patrolling | 75, 92 | 95, 106 |
| Personnel, duties of..... | 19 | 15 |
| Personnel section: | | |
| Duties of | 153 | 184 |
| Organization | 152 | 184 |
| Phases of supply..... | 136 | 155 |
| Platoon headquarters | 18, 19 | 14, 15 |
| Pursuit | 80 | 98 |
| Radar sets, description of..... | 61 | 78 |
| Radar surveillance card..... | 63 | 81 |
| Radio and visual section..... | 18, 22 | 14, 21 |
| Radio communication | 30 | 31 |
| Radioteletype operator | 22 | 21 |
| Radio/wire system | 34 | 38 |
| Rear assembly area..... | 14 | 10 |
| Reconnaissance by fire..... | 86 | 102 |
| Reconnaissance platoon: | | |
| Actions on enemy contact..... | 94-96 | 107 |
| Communications in | 67 | 89 |

| | Paragraph | Page |
|-------------------------------------|-------------|-------------|
| Missions: | | |
| Airborne assault | 97-100 | 111 |
| Attack | 78 | 97 |
| Consolidation | 79 | 97 |
| Defense | 81 | 98 |
| Movement to contact | 77 | 96 |
| Pursuit | 80 | 98 |
| Retrograde | 82 | 99 |
| Operational techniques | 69-75 | 91 |
| Organization of | 66 | 88 |
| Training of | 68 | 89 |
| Reconnaissance techniques: | | |
| Area reconnaissance | 85 | 101 |
| Night reconnaissance | 87 | 102 |
| Route reconnaissance | 84 | 101 |
| Zone reconnaissance | 85 | 101 |
| References | | 187 |
| Repair | 139 | 171 |
| Retirement | 55 | 70 |
| Retrograde | 53, 82, 120 | 66, 99, 133 |
| Route column | 49 | 57 |
| Salvage | 140 | 171 |
| Screening missions | 91 | 105 |
| Security techniques | 39, 109 | 43, 125 |
| Guarding missions | 90 | 105 |
| Maintaining contact | 93 | 106 |
| Patrolling | 92 | 106 |
| Screening | 91 | 105 |
| Send in clear..... | 39 | 43 |
| Sergeant major..... | 5 | 4 |
| Service area, battle group..... | 129, 130 | 143 |
| Short range radar set..... | 61 | 78 |
| Signal equipment, maintenance of... | 27 | 26 |
| Signal officer | 24 | 24 |
| Signal supply | 26 | 25 |
| SOI | 35, 49 | 39, 57 |
| SOP | 36, 49 | 40, 57 |

| | Paragraph | Page |
|------------------------------------|-----------|--------|
| Sound communication | 33 | 37 |
| SSI | 35, 49 | 39, 57 |
| Supply: | | |
| Procedures | 133 | 148 |
| Signal | 26 | 25 |
| Specialists | 12 | 7 |
| Systems | 134 | 149 |
| Supply and transportation platoon: | | |
| Capabilities | 126 | 140 |
| Headquarters functions..... | 137 | 164 |
| Mission | 125 | 140 |
| Organization | 127 | 141 |
| Supply sergeant | 8 | 6 |
| Supporting fires | 110 | 126 |
| Surgeon | 145 | 174 |
| Surveillance plan | 58 | 74 |
| Systems of supply..... | 132 | 146 |
| Tactical operation, type..... | 42 | 47 |
| Training, communication | 40 | 46 |
| Visual communication..... | 32 | 36 |
| Wire: | | |
| Communication | 29 | 27 |
| Section | 18, 21 | 14, 19 |
| Zone reconnaissance..... | 85 | 101 |

[AG 355 (24 June 59)]

By Order of *Wilber M. Brucker*, Secretary of the Army:

L. L. LEMNITZER,
General, United States Army,
Chief of Staff.

Official:

R. V. LEE,
Major General, United States Army,
The Adjutant General.

Distribution:

Active Army:

| | |
|-----------------------|------------------------|
| CNGB (1) | USAWC (5) |
| Tech Stf, DA (1) | USACGSC (2) |
| Tech Stf Bd (1) | Br Svc Sch (5) except |
| USCONARC (15) | US ARADSCH (150) |
| US ARADCOM (2) | USAARMS (125) |
| US ADADCOM Rgn (2) | USA Med Svc Sch (15) |
| OS Maj Comd (10) | USACMLSCH (5) |
| OS Base Comd (5) | USAES (60) |
| Log Comd (2) | USA Ord Sch (15) |
| Area Comd (2) | USA QM Sch (10) |
| MDW (5) | USASCS (25) |
| Armies (10) except | USATSCH (10) |
| First USA (12) | USACAMGSC (400) |
| Corps (2) | USAAVNS (8) |
| Div (5) except | USAINTC (12) |
| 82d Abn Div (70) | PMST Sr Div Units (2) |
| 101st Abn Div (70) | PMST Jr Div Units (2) |
| Brig (5) | PMST Mil Sch Div Units |
| Regt/Gp/bg (2) except | (2) |
| Abn bg (10) | Mil Dist (2) |
| Inf bg (5) | USA Corps (Res) (2) |
| Bn (2) | Sector Comd, USA Corps |
| Inf Co (2) | (Res) (2) |
| USATC (10) | Mil Msn (2) |
| USMA (38) | |

NG: State AG (3).

USAR: Same as Active Army except allowance is one copy to each unit.

For explanation of abbreviations used, see AR 320-50.

☆ U. S. GOVERNMENT PRINTING OFFICE: 1959—520525