

MHI  
Copy 3

copy

FM 54-1

DEPARTMENT OF THE ARMY FIELD MANUAL

S

(12/16)

# THE LOGISTICAL COMMAND

**RESTRICTED**  
PROPERTY OF  
THE QUARTERMASTER SCHOOL  
QUARTERMASTER COMMAND  
FORT LEE, VA.  
**FOR HISTORICAL USE ONLY**



HEADQUARTERS, DEPARTMENT OF THE ARMY  
JULY 1959

## FOREWORD

Field Manual 54-1, *The Logistical Command*, is published for the use of all concerned. This field manual reflects the missions, capabilities, and organization of logistical command headquarters. Although staff organizations of logistical commands are presented, it is emphasized that the commander has wide latitude in organizing his command and staff in the manner best suited to accomplish the assigned mission under the specific conditions, time, and place in which it is employed. The logistical command is designed as a flexible unit capable of being tailored to a wide variety of missions.

Developments in the tactical and technological fields, new concepts of operation, and organizational changes in the Army will make modifications of this manual necessary. Recommendations for changes should be forwarded to the Commandant, United States Army Command and General Staff College. (See AR 310-3 for desired format of recommendations for corrections and changes.) Recommendations for changes to the basic logistical command TOE's will be forwarded to Headquarters, United States Continental Army Command. They should be based on the anticipated wartime missions of the commands, and they should not be peculiar to a single theatre of operations.

FIELD MANUAL }  
No. 54-1

HEADQUARTERS  
DEPARTMENT OF THE ARMY  
WASHINGTON 25, D. C., 13 July 1959

LOGISTICAL COMMANDS

	Paragraphs	Page
CHAPTER 1. INTRODUCTION .....	1-5	2
2. MISSIONS, FUNCTIONS, AND EMPLOYMENT .....	6-17	7
3. ORGANIZATION .....	18-23	14
4. ADMINISTRATIVE SUPPORT AND BASE DEVELOPMENT PLANNING .....	24-25	29
SECTION I. Administrative support planning .....	24-28	29-33
II. Logistical planning .....	29-32	34-37
III. Troop requirements planning .....	33-39	37-42
IV. Base development .....	40-45	42-49
CHAPTER 5. ADMINISTRATIVE SUPPORT OPERATIONS .....	46-60	50
SECTION I. General .....	46, 47	50-51
II. Operational responsibilities .....	48-51	51-66
III. Administrative support functions .....	52-60	66-109
APPENDIX I. REFERENCES .....		110
II. STANDING OPERATING PROCEDURE .....		113
III. TYPICAL PLANNING SEQUENCE—JOINT OVERSEA OPERATION .....		112A
IV. INSTRUCTING AGENCIES AND AGENCIES FOR COORDINATION .....		118
V. BASE DEVELOPMENT PLAN .....		121
VI. TYPICAL TECHNICAL SERVICE TROOP UNITS NORMALLY ASSIGNED WITHIN THE THEATER COMMUNICATIONS ZONE .....		128

INDEX

\* This manual supersedes TC 54-1, 12 August 1957, including C 1, 30 December 1957.

## CHAPTER 1

### INTRODUCTION

---

#### 1. Purpose and Scope

a. This manual provides guidance on the organization, employment, and operation of logistical commands, and is intended for the commander and staff of all separate headquarters exercising command of a theatre army logistical command, a base or advance logistical command, or similar headquarters.

b. The manual is based on policies prescribed in AR 10-14, principles and procedures of administration as contained in FM 100-10, and the duties of staff officers in general and the principles of staff action as set forth in FM 101-5. Detailed data required by a staff officer of a logistical command are contained in FM 101-10. Techniques of operation for each technical service in the field, in sufficient detail for purposes of technical service staff officers of a logistical command or in units of these Services, are furnished in field manuals concerned with individual technical services. (See app. I)

c. The material presented herein is applicable to both nuclear and nonnuclear warfare.

#### 2. Definitions

a. *Logistical Command.* A logistical command is an administrative support organization composed of a TOE Headquarters Company and such service units as may be assigned or attached to execute specific administrative support missions. It may be augmented by tactical units for rear area security. There are three types of logistical command headquarters (types A, B, and C) each of which is designed to command and control an administrative support force of a given size. See chapter 2 for statements of the missions which may be assigned.

b. *Headquarters and Headquarters Company, Logistical Command.* Headquarters and Headquarters Company, Logistical Command, is an Army table of organization and equipment (TOE) organization designed to exercise command functions in the execution of the mission of a field army logistical command, a base logistical command, an advance logistical command, an area command, or, with suitable augmentation, a theatre army logistical command.

*c. Administrative Support.* This term embraces all assistance given to troops in the management and execution of all military matters not included in tactics and strategy. This assistance consists of appropriate staff planning, personnel management, interior management of units, provision of all types of supplies, and the provision of such services as transportation, maintenance, and communications.

*d. Theater Communications Zone.* The Theater Communications Zone is that portion of a theater of operations between the rear boundary of the theater of operations and the rear boundary of the combat zone. It provides the area for operation and defense of the supply, evacuation, transportation, service, and other administrative agencies required for rendering support to the combat zone.

### 3. Characteristics of the Logistical Command

The logistical command is a flexible organization formed by assigning or attaching required technical and administrative service units to a TOE headquarters which is designed to direct and control the assigned or attached units in various administrative support missions. Tactical units may be assigned for rear area security. The logistical command is a tailored grouping of service units and may operate in both the combat zone and the theater communications. The composition of a logistical command depends on its mission. The headquarters of a logistical command provides a nucleus for the command. It furnishes the organizational structure and a minimum number of trained logisticians and administrative personnel who can develop the standing operating procedures and plans upon which the organization is to be based. The logistical command is designed to have a capability of accomplishing missions which vary widely in scope, and it can be augmented with personnel necessary to insure the effective accomplishment of the assigned mission. This capability to expand, contract, or modify its organization to meet the requirements dictated by varying missions is a valuable characteristic of the logistical command.

### 4. Policies

(From AR 10-14)

*a.* The basis for the organization of logistical elements of major oversea commands is the operational mission of the command in the event of hostilities.

*b.* A TOE logistical command is the basic headquarters element of all appropriate logistical operations.

c. When the size of the operation requires that two or more subordinate Logistical Commands of a theater Army Logistical Command be established, separate TOE logistical commands are established as the nuclei thereof, as well as for the theater Army Logistical Command headquarters itself.

d. Missions occasioned by requirements peculiar to the area of operations, or the peacetime mission, are carried out by the establishment of augmenting subsections.

e. Augmentation of TOE logistical commands is normally accomplished on authority of the theater commander by provision of 500-series TOE teams, by allocation of theater bulk allotment spaces, or both.

f. Indigenous personnel may be employed at the discretion of the theater commander. In general, they do not occupy key TOE positions and are employed, where possible, on those missions that will not be vital in the event of hostilities.

## 5. Conditions of Conflict and Operational Environment

### a. *General.*

- (1) The mission, organization, and functions of the logistical command are applicable to both large and small theaters of operation. In addition, the logistical command has an inherent flexibility permitting expansion, contraction, or modification of its organizational structure in order to meet the requirements dictated by varying missions.
- (2) Although certain basic principles exist which govern the administrative support of land forces in the conduct of war, their application varies widely in the spectrum of modern conflict. It is essential, therefore, that the existing, probable, or possible wartime conditions be carefully scrutinized to determine their effect on the performance of administrative support of land force operations.
- (3) National agreement in regard to provision of indigenous resources for administrative support of a US force may be expected to vary widely depending upon the form of conflict pertaining to the deployed force. Similarly, the geographical locale, scale of use of nuclear weapons, and the many other factors which create the variables in operational environment become considerations which affect the administrative support of a force. Consequently, the commander must continuously analyze his mission in light of operational conditions. Basically, he must consider the condition of conflict as well as the operational environment visualized.

b. Impact of nuclear warfare upon administrative support operations.

- (1) The advent of nuclear weapons requires that particular emphasis be placed upon the protection of facilities and installations, and upon the flexibility and mobility in the administrative support system. The enemy can be expected to launch nuclear attacks against administrative support installations which constitute profitable targets. Proper planning and execution serve to minimize the effects of such attacks. In order to provide continuous and effective support, administrative support organizations and systems must be flexible. Maximum flexibility is dependent upon adequate communications and transportation means and upon adequate numbers of properly located and dispersed installations. Plans must include provisions for the use of alternate channels of service and supply, and emphasis must be placed upon the ability to maintain the flow of supplies rather than relying primarily upon a buildup of stocks. However, essential stocks may be dispersed or prepositioned close to the points of anticipated consumption in sufficient quantity to enable survival based on local resources during periods of isolation of an area or disruption of communications and/or transportation to the area.
- (2) The nuclear threat dictates that, in general, the location of administrative support installations and facilities in built-up areas be avoided. The administrative support effort must be divided into alternative channels for each type of support. Plans must include provisions for re-establishing the original channel after it is interrupted, or for rapidly diverting the logistical effort into alternate channels. As a general rule, supplies of any one type should not be concentrated in a few points, but should be as widely dispersed as the supply mission permits, both in storage and in movement.
- (3) Plans for the use of an area for the location of an administrative support installation or facility should be made only after an analysis of the vulnerability of the area has been completed. Camouflage and dummy positions (when dummy positions are authorized by appropriate headquarters) should be used whenever possible to reduced the probability of the actual installation being subjected to a nuclear attack. The effects of such attacks can be reduced through the proper arrangement of the material being stored; the attainment of maximum dis-

persion consistent with control; taking advantage of terrain features; utilizing such protection as barricades, revetments, and underground shelters; and adequate rear area damage control planning and operations.

- (4) There is an increasing requirement for the dispersion, duplication, and protection of storage facilities to provide passive defense against the effects of nuclear weapons. Dispersion and duplication of storage facilities should be accomplished to the degree required by enemy capabilities and within the limits permitted by the mission of the supply agency. The following factors must be considered in determining the degree of dispersion between, or the number of major administrative support installations in the theater communications zone:
  - (a) The yield and number of nuclear weapons which the enemy is capable of delivering.
  - (b) The nature of the terrain, to include manmade facilities (mines, caves, tunnels, etc.)
  - (c) The dispersion permitted by the capability of the organizational structures of the service units available to operate the administrative support installations, the number of service units available, the transportation net, and the availability of local civilian labor.
  - (d) The reduced efficiency resulting from dispersed administrative support operations.
  - (e) The calculated risk the commander is willing to accept.
  - (f) The disposition of other troops in the theater communications zone.
  - (g) The tactical situation of the supported force.
  - (h) The degree of protection provided by engineer or troop effort to personnel and supplies of the installation.



## CHAPTER 2

### MISSIONS, FUNCTIONS, AND EMPLOYMENT

---

#### 6. General

A logistical command is an administrative support organization composed of a TOE Headquarters and Headquarters Company and such technical and administrative service units as may be assigned or attached to execute specific administrative support missions. It may be augmented by tactical units for rear area security. A logistical command headquarters provides the nucleus for a tailored organization capable of accomplishing missions which vary widely in scope under diversified operational environments. The types and numbers of subordinate units in a logistical command depend on the mission of the logistical command.

#### 7. Mission

The primary mission of a logistical command is to provide administrative support to combat forces. The principal operators are the attached or assigned technical service units which actually provide administrative support. In a logistical command, the purpose of staff activities is to coordinate and supervise activities of the principal operators which in this case are the technical and administrative service units. The staff officers having primary directorate staff supervision over the administrative support operations of the technical service operators thus become the central figures for staff activities. The primary mission is administrative support and all other activities are either in support of the primary mission or secondary to it.

#### 8. Flexibility

The inherent flexibility of the logistical command organization, plus the availability of the three separate types (see ch. 3) permits the assignment of a trained, organizationally sound headquarters of appropriate size to administer technical and administrative type units required for the accomplishment of the administrative support mission. By adjustment of its troop list, the logistical command can proceed from one mission to another without varying its basic organic structure.

## 9. Objectives

Regardless of the type of logistical command employed, or the units comprising the technical and administrative service troop list, the primary consideration in developing an integrated organization is that it must be capable of providing responsive and effective support of the proposed operation. A corollary to the primary consideration is that continuous and uninterrupted support must be insured by providing alternate means. This becomes even more important under conditions of nuclear warfare. The organization must develop a high state of training in order to perform its duties with efficiency and economy; make maximum utilization of all resources, including specially trained and skilled personnel of the technical services; be able to provide commanders and staffs with accurate, up-to-date logistical and technical information at any time; be able to formulate accurate and authoritative supply requirements and to integrate the maintenance requirements with supply requirements; be administratively self-sufficient and capable of operating independently, when required; develop organizational and operational procedures which are capable of rapid transition from peacetime to wartime use, or from one situation or environment to another of vastly different scope and magnitude.

## 10 Security

The commander of the logistical command is responsible for the security of his area and will, within his capability, take appropriate action against all security threats. He must coordinate his plan with the rear area security and rear area damage control plans of adjacent commands.

## 11. Employment

A logistical command of the appropriate type (A, B, or C) and composition may be employed to provide administrative support to tactical forces in any type of war and in any operational environment. The type of logistical command headquarters required is determined by the size of the force it must control and the scope of the intended operation which it is required to support. Logistical commands will be utilized to execute specific administrative support missions. A logistical command may be assigned any of the missions discussed in the remainder of this chapter.

## 12. Theater Army Logistical Command (TALOG)

*a. Mission.* The mission of the theater army logistical command is to provide administrative support, except personnel

replacement and civil affairs, to all U.S. Army forces located in the theater, and to such theater navy, theater air force, allied, and other forces as directed.

*b. Functions.* The functions performed by the theater army logistical command include—

- (1) Provision of intersectional communications service.
- (2) Procurement, receipt, storage, maintenance, and distribution of supplies and equipment.
- (3) Provision of intersectional transportation service.
- (4) Operation of facilities for the maintenance, repair, and salvage of equipment.
- (5) Provision of intersectional pipeline service.
- (6) Construction, repair, and maintenance of roads, railroads, bridges, buildings, and other facilities essential to military operations.
- (7) Provision of medical service to include evacuation and hospitalization for the sick and wounded.
- (8) Evacuation, processing, and employment of prisoners of war within the provisions of existing agreements and treaties.
- (9) Training of troop units and individuals assigned or attached to the theater army logistical command.
- (10) Provision of military police services and traffic control within the theater communications.
- (11) Procurement of real estate.
- (12) Provision of rest camps, leave facilities, and welfare and recreational programs and facilities.
- (13) Chaplain services.
- (14) Army exchange service.
- (15) Army postal service.
- (16) Legal and judicial services.
- (17) Claims service.
- (18) Finance and accounting services.
- (19) Provision of Automatic Data Processing System (ADPS) services, as required.
- (20) Rear area security and rear area damage control within the theater communications zone.
- (21) Provision of graves registration services.
- (22) Territorial control of the theater communications zone.

### 13. Advance Logistical Command (ADLOG)

*a. Mission.* The mission of the advance logistical command is to furnish administrative support, except personnel replacements and civil affairs, to forces in the combat zone, including U. S. Army missile commands in support of allied ground forces. To accom-

plish this mission, advance logistical commands are provided as required to meet the support requirements of the combat forces to be supported in any given situation. A possible basis of allocation is one per U. S. field army and one per allied army authorized support from U. S. Army sources. The successful accomplishment of this mission requires that the advance logistical command normally be located contiguous to the rear boundary of the field army it supporting, and that it possess sufficient mobility to maintain this relative position as the supported field army displaces.

*b. Functions.* The commander, advance logistical command, is responsible for the performance of the following functions:

- (1) Acquisition, receipt, storage, and distribution of the supplies and equipment required to sustain the combat operations of the supported field army.
- (2) Provision of direct support and general support maintenance facilities.
- (3) Provision of transportation service, other than inter-sectional.
- (4) Construction, repair, and maintenance of highways, railroads, bridges, buildings, and other facilities essential to the conduct of military operations. However, repair and maintenance of railroads used for inter-sectional service is a responsibility of the inter-sectional service.
- (5) Provision of communications service, other than inter-sectional.
- (6) Provision of medical service, to include the evacuation of patients from the medical installations and facilities of the supported field army.
- (7) Evacuation from the combat zone, processing, and employment of prisoners of war within the provisions of existing agreements and treaties.
- (8) Rear area security and rear area damage control.
- (9) Provision of military police service and traffic control.
- (10) Acquisition of real estate essential to the conduct of military operations.
- (11) Training of troop units and individuals assigned or attached to the advance logistical command.
- (12) Chaplain services.
- (13) Army exchange service.
- (14) Army postal service.
- (15) Legal and judicial services.

- (16) Claims service.
- (17) Finance and accounting services.
- (18) Provision of ADPS service, as required.
- (19) Provision of administrative support to using units located in or passing through the advance logistical command area.
- (20) Such additional functions as may be assigned by the commander, theater army logistical command.

#### 14. Base Logistical Command (BALOG)

*a. Mission.* The principal mission of the base logistical command is to provide direct support to one or more advance logistical commands. It also supports units located in its zone of responsibility and furnishes materiel and services directly to a field army at the request of an advance logistical command, or as directed by TALOG. Since base logistical commands are established within *the theater communications zone* on an "as required" basis, their number is dictated in large measure by geographical and operational considerations and not necessarily on the basis of providing one base logistical command for each advance logistical command in the theater. To accomplish its mission of providing support, the base logistical command should be situated as dictated by geography and transportation nets so as to be in a position to continue this support for the maximum forward displacement of the supported commands. The establishment of logistical agencies between the base and advance logistical command is not contemplated. As the advance logistical commands displace forward to points beyond which the provision of direct support from existing base logistical commands is no longer feasible, these latter commands should be moved to more advantageous locations, and unnecessary installations should be promptly phased out of the logistical support system.

*b. Functions.* The commander, base logistical command, is responsible for the performance of the following functions within his area:

- (1) Acquisition, receipt, storage, and distribution of supplies and equipment required to provide direct support to the advance logistical commands operating in direct support of the combat zone.
- (2) Provision of direct and general support maintenance, except for such specialized maintenance facilities and operations as may be assigned to and under control of the intersectional services operated by the theater army logistical command.

- (3) Provision of *transportation service*, other than inter-sectional.
- (4) Construction, repair, and maintenance of highways, railroads, bridges, buildings, and other facilities essential to the conduct of military operations. However, repair and maintenance of railroads used for inter-sectional service is a responsibility of the inter-sectional service.
- (5) Provision of communications service, other than inter-sectional.
- (6) Provision of evacuation and hospitalization of sick and wounded in accordance with procedures established by theater army logistical command.
- (7) Provision of ADPS service, as required.
- (8) Evacuation, processing, and employment of prisoners of war within the provisions of existing agreements and treaties.
- (9) Rear area security and area damage control.
- (10) Provision of military police service and traffic control.
- (11) Acquisition of real estate essential to the conduct of military operations.
- (12) Training of troop units and individuals assigned or attached to the base logistical command.
- (13) Provision of rest camps, leave facilities, and welfare and recreational programs and facilities.
- (14) Chaplain services.
- (15) Army exchange service.
- (16) Army postal service.
- (17) Legal and judicial services.
- (18) Claims service.
- (19) Finance and accounting services.
- (20) Provision of administrative support to using units located in or passing through the base logistical command.
- (21) Such additional functions as may be assigned by the commander, theater army logistical command.

## 15. Area Commands

Areas may be created as commands directly subordinate to any designated headquarters. Even when the theater communications zone is divided into advance and base logistical commands, it may be desirable for the commander to retain direct control of certain activities not directly concerned with the support of the combat forces, especially in the case of small, geographically isolated areas for which he is responsible and which cannot satisfactorily receive direct control and supervision through a BALOG or

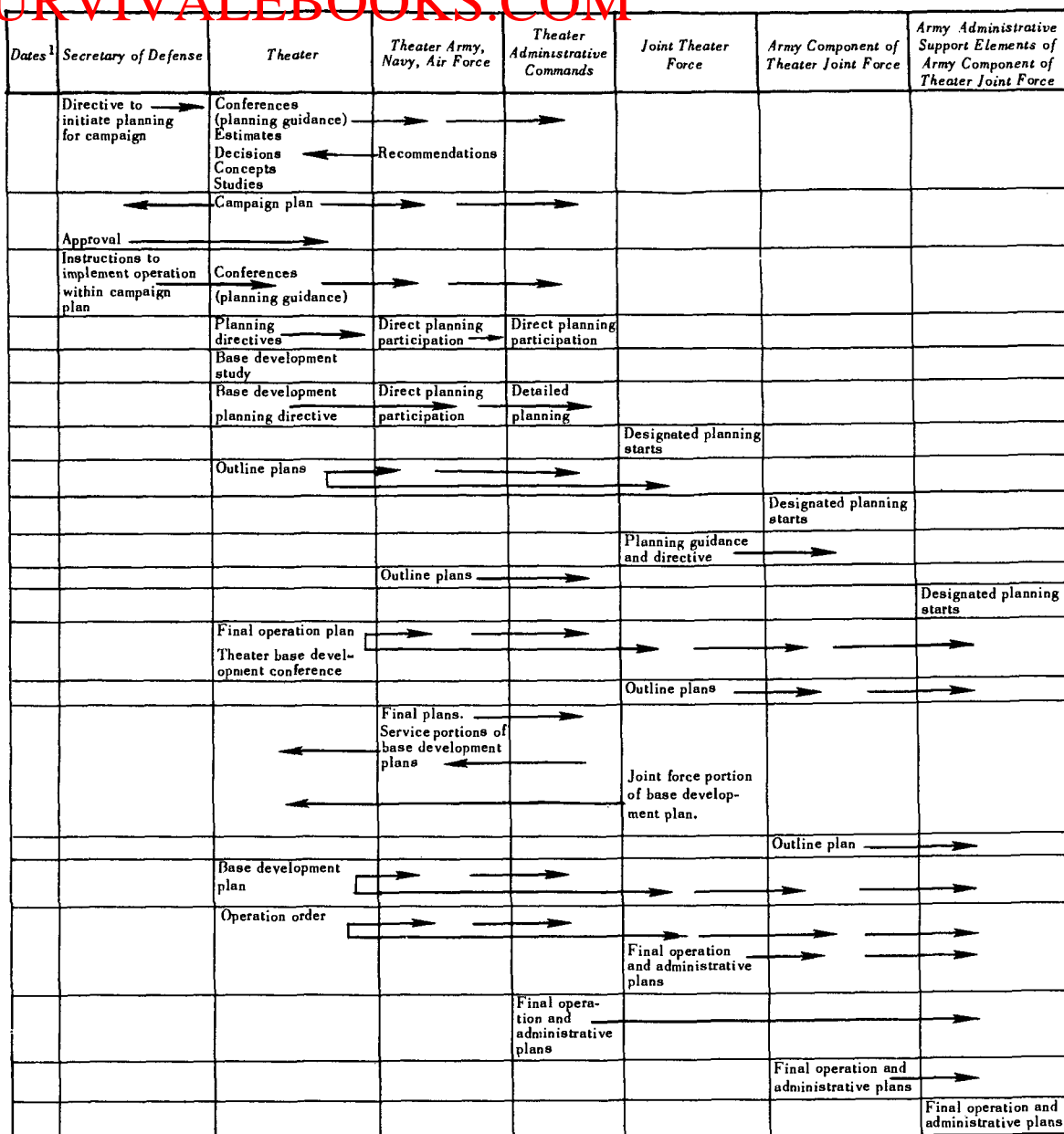

<sup>1</sup>Dates will vary.

Planning guidance as indicated in this sequence includes guidance given by the commander to his staff and that given to subordinate commanders as a basis for planning.

NOTE: This chart is simplified by omission of details of the Navy and Air Force planning in order that the overall planning sequence of primary interest to the army administrative support elements may be shown. It is important to note the extent of planning involved and the concurrent aspects of the cycle.

### APPENDIX III

## TYPICAL PLANNING SEQUENCE— JOINT OVERSEA OPERATION

ADLOG commander. When area commands are created, they will be controlled and administered by a suitable command headquarters. Normally, an area command provides only rear security, damage control and local administrative support necessary for the conduct of military operations within the area under its control. When a major administrative support mission is assigned to an area command, the composition of the logistical command headquarters and the area troop list must be appropriately augmented.

## 16. Area Rehabilitation

A logistical command headquarters may be assigned the mission of administering and rehabilitating an area in which civil means are inadequate because of natural disaster or military actions.

## 17. Separate Logistical Command

The field army or corps may be employed as a task force on an independent mission where the support normally provided by the theater army logistical command will not be present. A separate logistical command is employed when the field army or corps is operating on such an independent mission. The separate logistical command consists of a logistical command headquarters and such assigned and attached technical and administrative service units required to furnish administrative support which otherwise would be furnished by the supporting theater army logistical command. This command is normally attached to the field army or corps and performs administrative support functions otherwise furnished by theater army logistical command, theater army civil affairs, and theater army replacement command. The administrative support elements within field army or corps are not included in the separate logistical command, but are normally retained under the direct command of the field army or corps commander.



## CHAPTER 3

### ORGANIZATION

---

#### 18. General

The logistical command headquarters is organized and staffed to command, control, coordinate, and direct the administrative support operations performed in accordance with the mission assigned. Three types of logistical command headquarters, with similar organizational structures and capabilities, have been designed to perform the missions discussed in chapter 2, as follows:

*a. Headquarters, Logistical Command A*—to exercise command of an integrated organization ranging in size from 9,000 to 15,000 troops. When provided with these units, the command can furnish administrative support to a combat force of approximately 30,000 troops.

*b. Headquarters, Logistical Command B*—to exercise command of an integrated organization ranging in size from 35,000 to 60,000 troops. When provided with these units, the command can furnish administrative support to a combat force of approximately 100,000 troops.

*c. Headquarters, Logistical Command C*—to exercise command of an integrated organization ranging in size from 75,000 to 150,000 troops. When provided with these units, the command can furnish administrative support to a U. S. field army or an allied army group.

#### 19. Headquarters, and Headquarters Company, Logistical Command C

The commander, logistical command C, is provided with a deputy commander and personal, coordinating, technical, and administrative staff officers to assist him in discharging his responsibilities. As indicated in figure 1, the coordinating staff officers are divided into seven divisions, each of which is charged with staff responsibilities in one of the following areas: comptroller, personnel, security, plans and operations, services, supply and maintenance and civil affairs. The functions of these seven staff divisions are enumerated in *d* below.

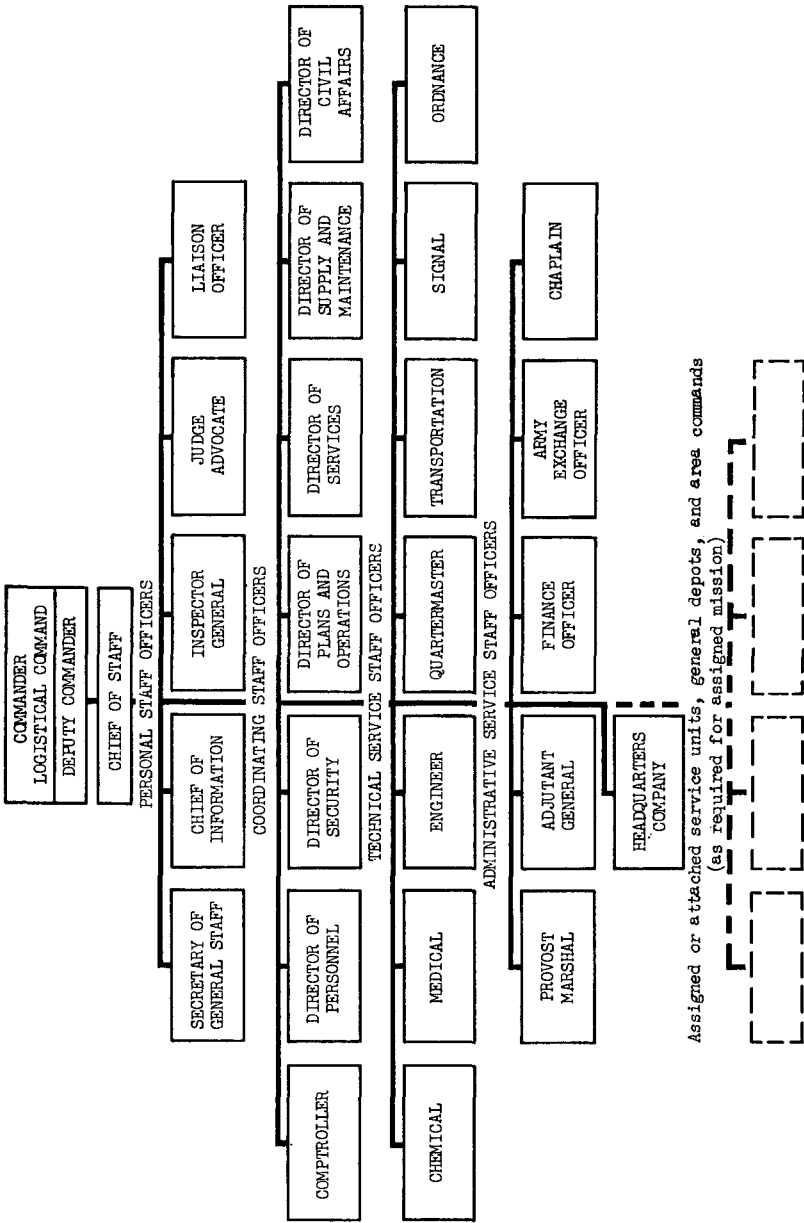

Assigned or attached service units, general depots, and area commands (as required for assigned mission)

Figure 1. Organization of headquarters, logistical command C.

*a. Functions of the Commander.* The functions of the commander include—

- (1) The command of all troops assigned or attached to the logistical command, except as otherwise specified. For example, troops assigned to an intersectional service command remain under the command of their parent headquarters.
- (2) Responsibility for the accomplishment of the administrative support and territorial control missions assigned to the logistical command, rear area security and area damage control, and for the operations of the forces required to accomplish these missions. He is concerned primarily with providing rapid, effective, and continuous support to the combat forces and to other supported elements as directed. The discharge of this responsibility involves—
  - (a) The anticipation and determination of the needs of the combat forces and other supported forces for administrative support in order that such support may be provided expeditiously.
  - (b) The preparation of plans, policies, and procedures, under the terms of guidance promulgated by higher headquarters, for the administrative support of forces supported.
  - (c) The furnishing of advice to the next higher headquarters with respect to the ability of the logistical command to sustain current and projected operations.

*b. The Functions of the Deputy Commander.* The functions of the deputy commander, logistical command, are—

- (1) To assist and advise the commander.
- (2) To represent the commander as authorized and required.
- (3) To supervise the planning and conduct of rear area security and rear area damage control and to coordinate these activities with the subordinate area commanders and their staffs.
- (4) To supervise the administrative support of the logistical command.

*c. Functions of the Chief of Staff.* The chief of staff of a logistical command is responsible for the normal chief of staff functions as provided for in FM 101-5. In addition, he exercises general supervision over the administrative support operations center.

*d. Functions of the Coordinating Staff Officers.*

- (1) *Common functions.* The directors perform the following common functions:
  - (a) Assist and advise the commander and the chief of staff.
  - (b) Formulate policies and prepare broad plans and procedures in consonance with the policies and directives received from higher headquarters.
  - (c) Coordinate and supervise the execution of plans and the implementation of plans by subordinate commanders to the extent necessary to insure compliance with the overall plans and policies of the logistical command commander.
  - (d) Coordinate and exercise staff supervision over the technical and administrative staff sections in activities pertaining to their respective areas of interest.
- (2) *Functions of the comptroller.* The comptroller exercises staff supervision over activities pertaining to—
  - (a) The employment of financial resources and the control of funds.
  - (b) Budgeting, to include the preparation and justification of estimates, and the distribution and application of funds.
  - (c) Accounting, to include fiscal, cost, and property accounting, as applicable.
  - (d) The performance of audits for which the command is responsible.
  - (e) The analysis of organizations and procedures, as required, and the provision of management engineering services to improve the command.
  - (f) The collection, analysis, summarization, and interpretation of statistical data; the preparation of statistical reports and publications; and the utilization of statistical standards.
  - (g) The control of reporting systems within the Command to include the administration of the reports control system and the preparation of standard reporting procedures.
  - (h) The establishment within the command of systems for the review, analysis, testing, and evaluation of command programs, and the integration of the review and analysis of such programs and activities.

- (3) *Functions of the director of personnel.* The director of personnel exercises staff supervision over activities pertaining to—
- (a) Management of personnel as individuals, both military and civilian; manpower control; personnel records and reports; and replacements for the command.
  - (b) Discipline, law, and order to include troop conduct and appearance, the control and disposition of stragglers, and the handling of prisoners of war.
  - (c) The administration of labor management policies with respect to non-U. S. civilian and prisoners of war labor to include the maximum effective utilization of available indigenous labor, the utilization of prisoners of war and non-U. S. civilian employees, and the execution of policies regarding working conditions, rations, wages, allowances, and similar matters for non-U. S. civilian labor.
  - (d) Graves registration service.
- (4) *Functions of the director of security.* The director of security exercises staff supervision over activities pertaining to—
- (a) Intelligence activities within the logistical command to include the collection, processing, and dissemination of information of intelligence value; the supervision of intelligence training; counter-intelligence operations; the conduct of security investigations; and the supervision of military and civil censorship activities.
  - (b) The preparation of standing operating procedures, directives, and plans for the provision of plant or industrial type security against pilferage, rear area security and area damage control within the area of responsibility for the command; and the coordination and supervision of area damage control operations.
- (5) *Functions of the director of plans and operations.* The director of plans and operations exercises staff supervision over activities pertaining to—
- (a) The preparation of current and long-range plans, procedures, policies, and programs pertaining to the operations and functions of the logistical command.

- (b) The organization of the logistical command, to include the compilation and submission of the phased troop basis for the logistical command to higher headquarters.
  - (c) The selection and allocation of service troops by types and numbers required to support the mission of the logistical command.
  - (d) The supervision and planning of movement of service units between the major subordinate commands of the logistical command.
  - (e) The recommendation of priorities to govern the allocation of weapons, munitions, and equipment in short supply within units of the logistical command.
  - (f) The conduct of inspections of units, installations, and activities within the logistical command.
  - (g) The supervision and planning for training of subordinate units.
- (6) *Functions of the director of services.* The director of services exercises staff supervision over activities pertaining to—
- (a) The acquisition, allocation, administration, and disposition of fixed installations and facilities and real estate.
  - (b) The construction, rehabilitation, maintenance and repair, and provision of utilities for facilities and installations within the logistical command's area of responsibility.
  - (c) The establishment of a medical support system to include hospitalization and evacuation of the sick and wounded.
  - (d) Communications operations.
  - (e) The control of movements to include the transportation of units, personnel, and supplies via water, rail, highway, air, and pipeline, as appropriate.
  - (f) The local procurement of services, to include the allocation of the means of production and local resources within established theater army policies.
- (7) *Functions of the director of supply and maintenance.* The director of supply and maintenance exercises staff supervision over activities pertaining to—
- (a) The determination of supply requirements for supported forces and the logistical command.

- (b) The requisitioning, receipt, storage, distribution, and documentation of supplies and equipment.
- (c) The allocation of weapons, munitions, and equipment in short supply within the logistical command in accordance with the priorities established by the director of plans and operations.
- (d) The collection and disposition of excess, surplus, and salvage, and captured enemy materiel.
- (e) The maintenance and repair of supplies and equipment.
- (f) The local procurement of supplies and equipment from local resources within established theater army policies.

(8) *Functions of the Director of Civil Affairs.*

The director of civil affairs exercises staff supervision over activities pertaining to—

- (a) Liaison with the Theater Army Civil Affairs Command.
- (b) Support of theater civil affairs command in providing U. S. Army goods and services to local population.
- (c) Logistic support of theater civil affairs units within the command.
- (d) Civil affairs activities within authority granted by higher headquarters.
- (e) The procurement of local goods, services, real estate, and labor to support the military effort, in accordance with policies and procedures established by the theater army commander.

e. *Functions of the Technical and Administrative Staff Officers.*

(1) *Common functions.* Technical and administrative staff officers of the logistical command perform the following common functions:

- (a) Serve as advisors to the commander and his staff in all matters pertaining to their respective services.
- (b) Exercise direct technical supervision over the activities of their respective services throughout the logistical command.
- (c) Prepare and promulgate plans, policies, and procedures for the performance of their assigned activities.

- (d) Assist in troop basis planning, the determination of requirements, the preparation of requisitions to cover the requirements of supported forces and the logistical command, and procurement within their respective areas of interest.
  - (e) Maintain centralized supply and stock control for all items supplied by their respective services.
  - (f) Conduct technical and administrative inspections of the units assigned or attached to the logistical command, and conduct similar inspections for supported units as directed by higher headquarters.
  - (g) Advise the logistical command commander as to the recommended allocation of controlled and regulated items of supply.
- (2) *Specific functions.* Technical and administrative staff officers of the logistical command perform the specific functions and duties enumerated in FM 101—5.

*f. The Administrative Support Operations Center (ADSOC).*

(1) *General.*

- (a) The ADSOC is a facility established within the headquarters of logistical commands and other appropriate headquarters to provide commanders and their staffs with timely and complete information upon which to base decisions and planning. It operates under the general supervision of the chief of staff.
- (b) The ADSOC is the logistical counterpart of the tactical operation center, providing an effective means for the assembly, collation and interpretation of logistical information needed for planning and command decisions. It does not perform any actual logistical operating but receives from operating agencies information which can be effectively utilized within the headquarters. Examples of data that might be included are—status of items in critical and short supply, special weapons information, status and location of reserves, location of logistical installations, and movement requirements and capabilities.
- (c) An ADSOC normally will be established at the headquarters of TALOG, BALOG, and ADLOG.



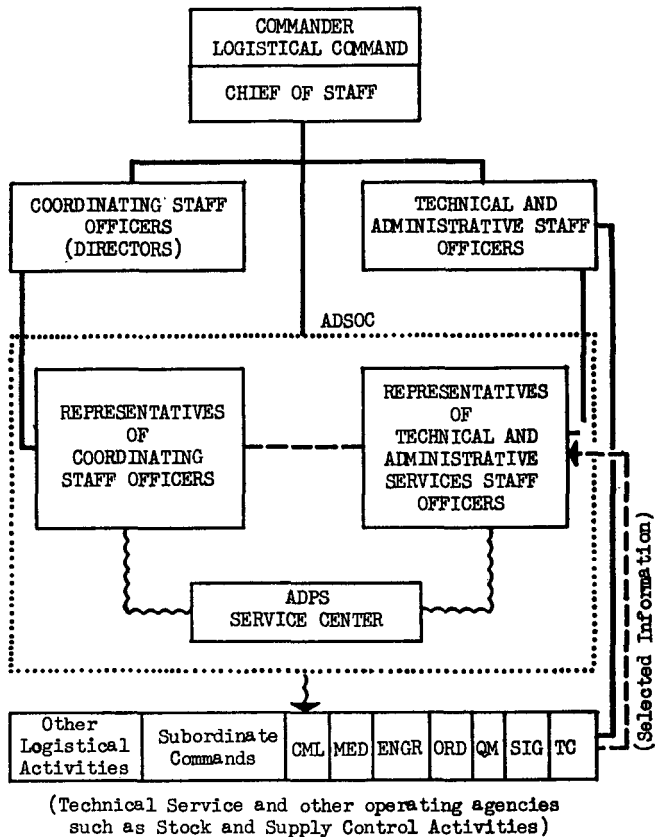

LEGEND

- ADSOC Control
- Service
- Coordination and
- Information

Figure 2. Administrative support operations center (ADSOC).

(2) Organization.

(a) The ADSOC usually consists of three distinct, but operationally interrelated, parts (see figure 4). The following description of the ADSOC of a logistical command can be related to any command utilizing an ADSOC.

1. Coordinating staff representatives.

Each of the coordinating staff sections of a logistical command, except the Comptroller and civil affairs, has full-time representation within the ADSOC. Further represen-

tation will be provided as required. The representatives are responsible to their respective directors within the logistical command.

2. *Technical and administrative services representations.*

Each of the technical services, as well as the provost marshal and adjutant general, has full-time representation within the ADSOC. Other administrative services will be represented as required. Although physically located within the ADSOC, these representatives are directly responsible to their respective chiefs of service within the logistical command.

3. *Automatic data processing system (ADPS) service center.*

a. This center is a service facility which provides central data processing facilities for the headquarters. It does not exercise command or operational control over other elements of the ADSOC. All ADPS equipment allocated to the headquarters is operated by this facility. Provision will be made for standby of alternate facilities.

b. The Center would also provide computer service to nearby operating agencies by means of local communication and simple input-output devices.

c. ADPS is not a prerequisite for the functioning of an ADSOC. It greatly facilitates operations and permits the processing of a great volume of information, but an adequate volume of statistics and data can be assembled and collated manually or with the aid of simple business machine devices if the scope of feeder information is carefully selected.

(3) *Functions and activities for staff operations.*

(a) *ADPS service center.*

1. Receives and transmits administrative support requirements and experience data.

2. Processes requirements and information as programmed by the headquarters staff sections.

3. Collates and disseminates supply control data, and retains such data for use in future planning.
4. Analyzes administrative support activities as required.
5. Provides to the representative of the Director of Security information required for the coordination of rear area security, rear area damage control and radiological activities, to include the computation of fallout patterns.
6. Stores a great variety of information which can be extracted rapidly upon demand.

(b) *Coordinating staff representatives.*

These representatives coordinate the activities of the technical and administrative services representatives and develop data and recommendations concerning operations and planning for their respective staff agencies. In addition, the representative of the Director of Security performs much of the planning, coordination, and direction of rear area security, rear area damage control, and radiological activities.

(c) *Technical and administrative services representatives.*

Each of these representatives processes and analyzes data concerning the current operations of the logistical command within his branch area of responsibility. They act as the representatives of the chief of technical service during planning and operating conferences. Chiefs of technical staff sections are advised of problem areas.

## 20. Headquarters, and Headquarters Company, Logistical Command B

Organization of the headquarters, logistical command B is shown in figure 3. It is the same as for headquarters, logistical command C, except as follows:

- a. The chief of staff is also the deputy commander.
- b. The comptroller is included only when required by the mission, and when specifically authorized by the Department of the Army.
- c. The director of security, plans and operations performs the functions listed previously for the director of security and the director of plans and operations.

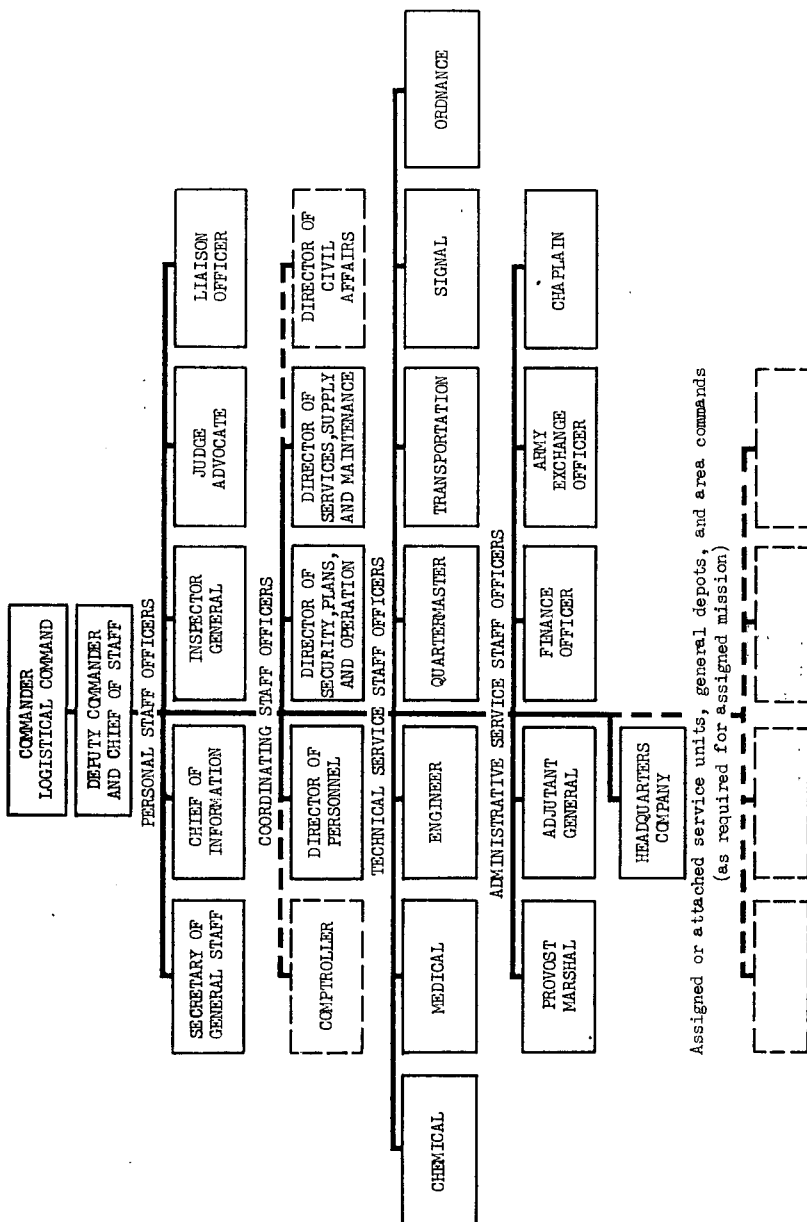
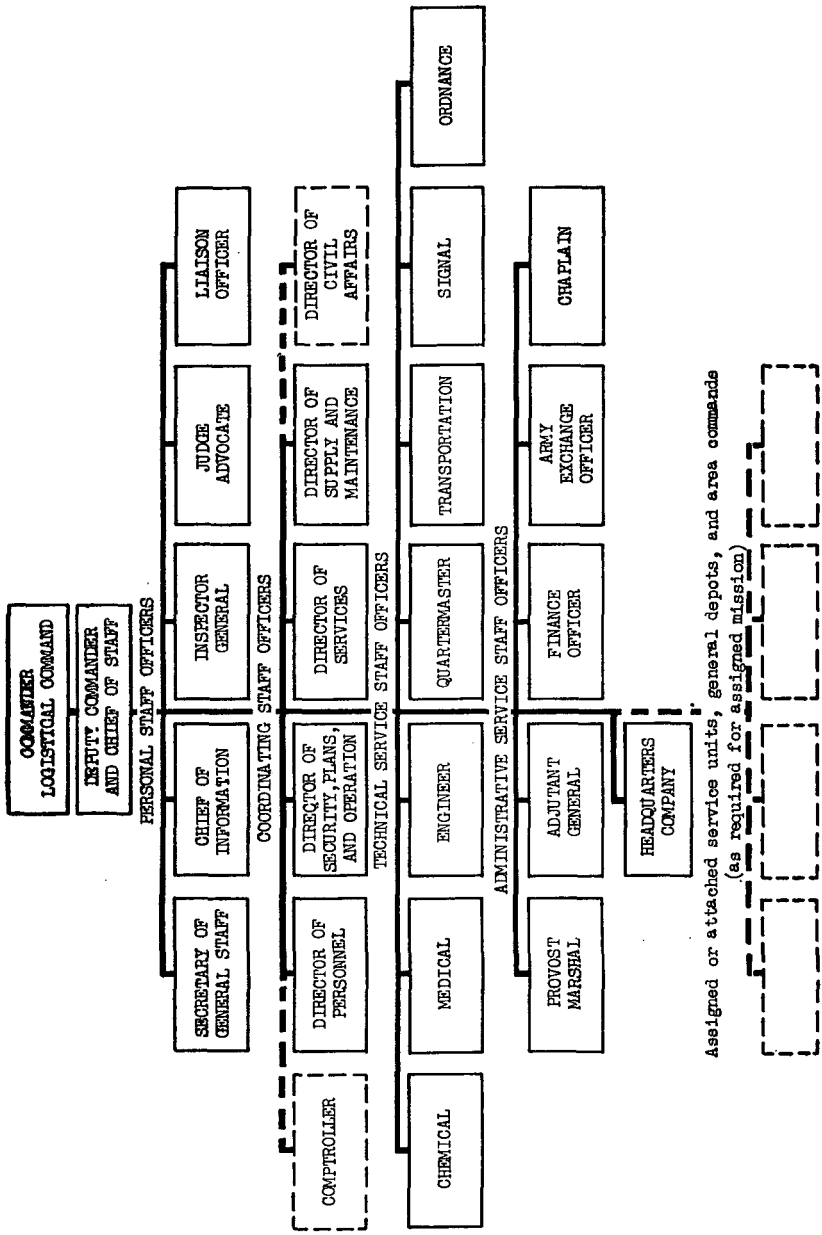

Figure 3. Organization of headquarters, logistical command B.



Assigned or attached service units, general depots, and area commands  
(as required for assigned mission)

Figure 4. Organization of headquarters, logistical command A.

*d.* The director of civil affairs will be provided on an augmentation basis as required. Normally, in peacetime, civil affairs activities will be handled by a civil affairs branch under the director of plans and operations.

## 21. Headquarters, Logistical Command A

Organization of the headquarters, logistical command A, is shown in figure 4. It is the same as for headquarters, logistical Command B, except that the director of services, supply and maintenance performs the functions listed for the director of services and the director of supply and maintenance.

## 22. Subordinate Units

*a.* The subordinate units of a logistical command may include any or all of the following:

- (1) Branch depots and general type field depots.
- (2) Area commands.
- (3) Intersectional service commands.
- (4) Other logistical commands.
- (5) Tactical units required for area security missions.
- (6) Technical and administrative service units.

*b.* Within the logistical command organization, technical and administrative service brigade, group, and battalion headquarters may be assigned or attached to command subordinate operating elements of a particular technical or administrative service (See app. VI). Integration of the operations of the various technical and administrative services is accomplished in the headquarters, logistical command. However, this does not preclude local coordination between units or delegation of authority for coordinated action. Integration of the operations of the various technical and administrative services may also be accomplished by subordinate headquarters.

*c.* Positive control of administrative support activities is vital under the dispersed conditions of nuclear warfare. However, the commander, while retaining control of his operations, must grant subordinate commanders maximum latitude and self-sufficiency in the accomplishment of their missions.

## 23. Variations from TOE Strength and Organization to Meet Special Conditions

*a.* Logistical commands are flexible organizations capable of performing, under varying circumstances, administrative support missions which vary widely in scope. This flexibility is based primarily on the fact that a balanced service force tailored to per-

form a specific mission is assigned or attached to the logistical command. As changes in the scope of the mission occur, changes are made in the service force. Three different size headquarters units are provided by TOE, depending on the mission and number of service troops involved. The commander has latitude in organizing his headquarters in a manner best suited to accomplish the assigned mission under the specific conditions, time, and place in which the command is employed. The staff is tailored as required within the environment in which it is to operate. It should be recognized that a single pattern of staff organization may not be effectively applied to all logistical command staffs for all situations. Augmentation of the headquarters of a logistical command in both numbers and rank may be required to meet a specific situation. This augmentation may consist of expanding the headquarters by adding personnel to one or more staff divisions to provide for an increased level of operations in established divisions, or by adding a completely new staff division to perform a function not provided for by any existing staff division. The source of these personnel may be a specially trained team from the 500-series TOE, from the theater bulk allotment as a table of distribution (TD) allowance, or from both. Missions occasioned by requirements peculiar to the area of operations or the peacetime mission are carried out by the establishment of augmenting subsections.

b. The cellular team of the 500 series TOE's are designed to provide small, trained teams capable of accomplishing a given mission. The types of team available are so varied that a team or combination of teams can be selected to accomplish virtually any augmentation task which is too small for a company size unit.

c. TD augmentation has been the traditional method of expanding a command headquarters to provide for an amplified mission, but this method requires a relatively long on-the-job training and indoctrination period to transform the TD augmentation into a well-trained, smoothly operating team. A TD augmentation is flexible, since any number of combinations of strength increases are possible because individuals are the basis of the augmentation.

d. If the proper type of logistical command headquarters is initially chosen for a mission, it should seldom be necessary to reduce the headquarters strength, since the principle of minimum strength was used in the development of each TOE. Reduced strength figures are provided to adapt the TOE to lesser requirements for personnel and equipment during prolonged noncombat periods and for a limited period of combat.

## CHAPTER 4

ADMINISTRATIVE SUPPORT AND  
BASE DEVELOPMENT PLANNING

## Section I. ADMINISTRATIVE SUPPORT PLANNING

## 24. General

The sequence of events for administrative support planning follows the pattern as described in FM 101-5. Administrative support planning must be carried on concurrently with, or in some cases prior to tactical planning at all echelons. Contingencies must be anticipated and adequate steps taken to ensure the uninterrupted flow of adequate supplies and services to supported units. Planning and execution are facilitated by close personal contact and coordination between corresponding staff officers of the headquarters logistical command and of the supported forces.

## 25. Theater Organization

a. For operations in a theater, it is frequently necessary to establish joint forces. A typical organization of theater of operations is shown in figure 5.

b. With the great amount of planning required in a theater, a planning organization in theater headquarters is highly desirable to insure that planning and current operations can be carried out concurrently. Each theater may have a different organization for this purpose as dictated by theater missions, allied participation, and numerous other factors.

## 26. Planning Documents

The more important planning documents used and the sequence in which they are prepared are shown in figure 6. Sample formats for documents used in planning are contained in the reference listed.

Standing Operating  
Procedure

See Appendix II

Logistical Estimate

See Form 4, appendix II to  
FM 101-5.

Operation Plan

See example 11, appendix III  
to FM 101-5.



- |  |   |
|--|---|
| <p>Administrative Order</p> <p>Administrative Order, Advance Section.</p> <p>Logistics Annex to Operation Plan or Order.</p> <p>Periodic Logistics Report</p> <p>Base Development Plan</p> | <p>See form 8, appendix IV to FM 101-5.</p> <p>See example 26, appendix IV to FM 101-5.</p> <p>See form 10, appendix IV to FM 101-5.</p> <p>See from 17, appendix V to FM 101-5.</p> <p>See appendix V.</p> |
|--|---|

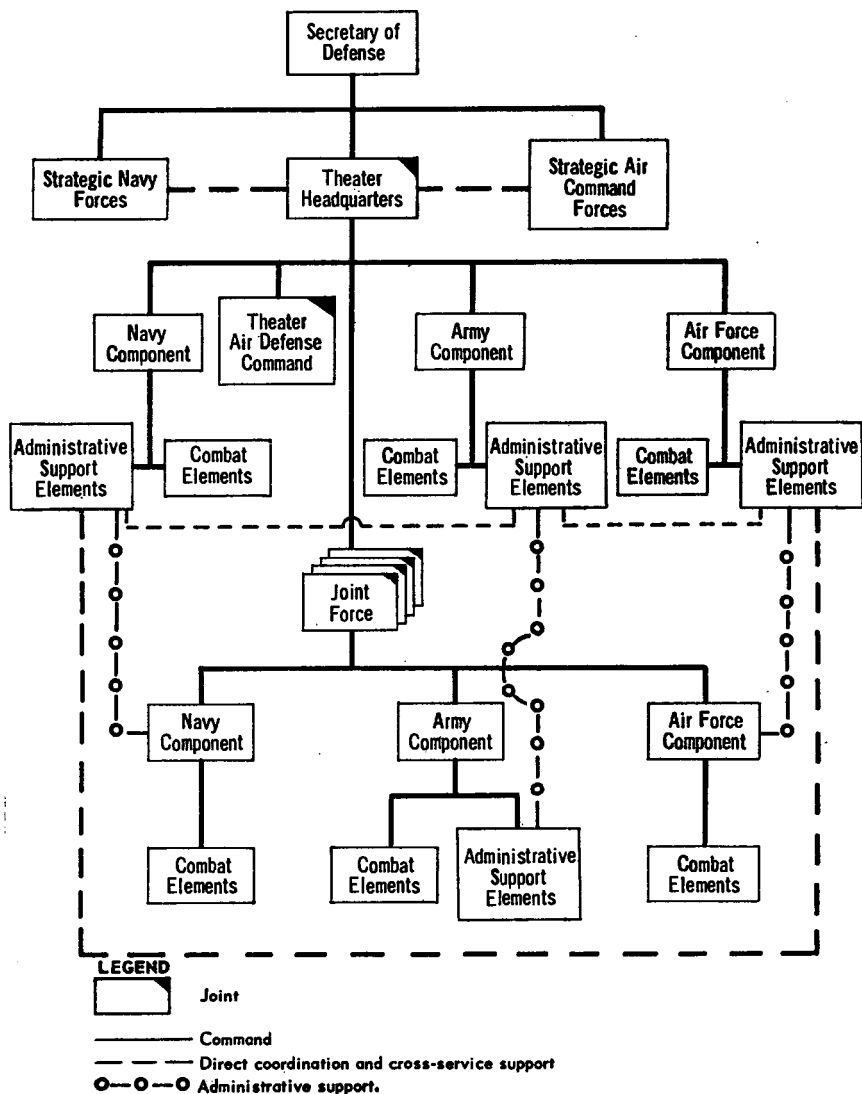

*Figure 5. Organization of a typical theater of operations.*

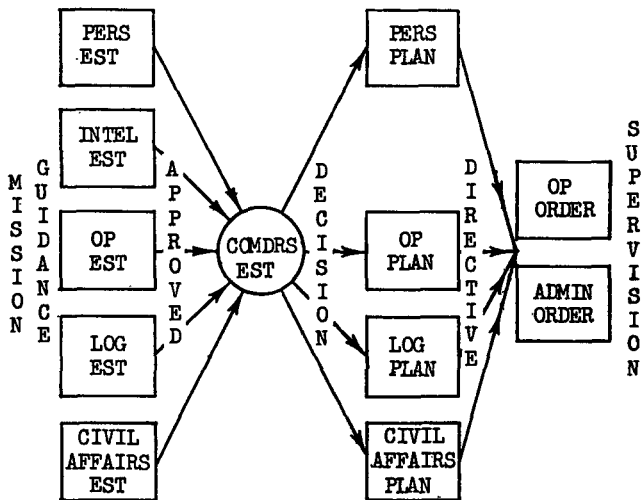

Figure 6. Sequence of planning documents.

## 27. Enemy Capabilities for Employment of Nuclear, Chemical and Biological Weapons

Enemy capabilities for employment of nuclear, chemical, and biological weapons must be evaluated in the light of the mission of the command. With the increased range of delivery systems and destructive power of mass destruction and mass casualty weapons, no area in the theater of operations will be free from the threat of attack.

a. Action to be taken by the commander of the logistical command to avoid or minimize the effects of these weapons is determined after considering the mission of the command, enemy capabilities, and the means available to accomplish this mission. This includes the establishment of clear lines of authority, communication and the preparation of detailed plans for rear area damage control, including careful target analysis of proposed sites for installations. The operation plan and layout of the administrative support areas will be greatly influenced by a study of these factors. The full art and skill of the administrative support commanders are required to arrive at a solution which minimizes risks without at the same time necessitating inefficient operations, wasteful use of manpower, and excessive use of stocks of supplies. A more detailed discussion of rear area security and rear area damage control planning is contained in paragraph 49.

b. Measures to be taken to minimize vulnerability to nuclear, chemical, and biological attacks are—

- (1) The establishment of clearly defined command lines and staff relationships.

- (2) Adequate dispersion of administrative support installations. Sufficient dispersion must be provided between each installation to prevent the loss or severe damage to more than one installation from a single nuclear weapon.
- (3) Adequate intelligence, warning, and reporting system.
- (4) Habitual practice of such passive measures as utilization of cover and concealment and deceptive measures. Underground facilities such as tunnels, caves, etc., should be used wherever available. Underground shelter should be constructed to provide cover for personnel and critical items of supply within the capability of the available engineer troops to construct. Also the shielding effect of natural terrain features must be utilized to the maximum.
- (5) Thorough vulnerability analysis of all installations is required during planning to insure minimum vulnerability.
- (6) Alternate plans for continuation of administrative support. These include—
  - (a) Alternate headquarters and communications facilities and an established succession of command.
  - (b) Duplicate supply and stock control records located at other stock control centers.
  - (c) Provision for standby facilities (water terminals and undeveloped ports, beaches, hospitals), or provision of installation capacity in excess of normal requirements, which will permit expansion of operations in the event of loss or damage of like installation.
  - (d) Duplication of supply and service installations, insofar as resources will permit, in order to avoid the total loss of any one type of supply or essential service. For example, provision for multiple general depots in the advance section.
  - (e) Utilization of beaches in the ADLOG and field army areas to insure continued support to the field army in the event of disruption to the water terminals and beaches in BALOG, or the line of communications from ADLOG to the combat zone.
  - (f) Development and utilization of *all* means of transportation and terminal facilities, including air, to insure flexibility and alternate means in the event of disruption to a water terminal of the transportation system.

- (7) Organize the area for area damage control and assurance that all units are trained and equipped to execute area damage control missions. Planning and the application of area damage control measures prior to enemy nuclear attacks will minimize the effects of those attacks. Prompt execution of area damage control operations will also facilitate the reestablishment of the administrative support functions which become disrupted by nuclear attacks.

c. Administrative support installations must not present remunerative targets. However, dispersion among installations cannot be permitted to such an extent as to jeopardize the accomplishment of the administrative support mission. Installations are dispersed based on the nuclear capability accorded the enemy.

- (1) Dispersion *between* major installations is based on—
- (a) Number, yield, and delivery systems of nuclear weapons available to the enemy.
  - (b) Nature of the terrain and size of the usable area.
  - (c) Availability of units and civilian labor.
  - (d) Possible resultant loss of control and inefficiency due to dispersion.
  - (e) Whether or not the loss of supplies or services of any *one* installation is within acceptable limits. There must be dispersion of balanced stocks.
  - (f) Avoiding a critical density of installations in any given area.
  - (g) Availability and capability of communication and transportation means.
- (2) Normal dispersion *within* installations should be the maximum consistent with efficient operations. It depends largely on the usable area, including facilities and working or storage space, and the availability of units, equipment, and civilian labor.

## 28. Relationship with Other Major Headquarters

The theater army logistical command bases its plans on those of the major forces supported and coordinates with every major headquarters in the theater which derives support from the theater army component or contributes support thereto. Its relations with theater, theater navy, theater air force, and theater joint air defense command headquarters on policy matters are conducted through theater army headquarters. The theater army logistical command headquarters works directly with the field army or other

supported force and the appropriate naval and Air Force administrative support agencies for routine support matters. It handles routine administrative support matters directly with the Army administrative support element of a joint force if one exists in the theater, but receives guidance from theater army headquarters on policy matters pertaining to the joint force. The theater army logistical command commander, functioning under the policies and procedures established by Department of the Army and theater army headquarters, conducts the routine operations of theater army administrative support with zone of interior (ZI) agencies. The theater army logistical command receives instructions from or coordinates with the major headquarters shown in appendix IV.

## Section II. LOGISTICAL PLANNING

### 29. General

All elements of administrative support planning (personnel, intelligence, operations, logistics, and civil affairs) are vital to the successful accomplishment of the assigned mission. However, because of its critical nature, logistical planning may be in many cases a determining factor as to whether or not a particular operation can be supported. The method and procedure involved in preparing the logistical estimate and plan will be discussed in the following paragraphs. The same sequence is applicable to any type of administrative support planning, be it personnel, intelligence, operations, logistics, or civil affairs.

### 30. Supply Planning

A key element of logistics planning is supply planning. A logistics officer must keep himself continuously informed of supply levels and major supply problems of other commands in order to insure maximum economy in utilization of supplies and to effect coordinated action that will further the operation as a whole. Particular emphasis must be placed upon—

- a. Efficient use of transportation.
- b. Reduction in the multiple handling of supplies.
- c. Reduction in order and shipping time.
- d. Elimination, or reduction to a minimum, of requirements that do not contribute directly to the progress of combat operations.
- e. Maximum and efficient utilization of manpower.
- f. Economy in the use of supplies and equipment.
- g. Reduction in nice-to-have and improbable contingency items.

- h. Simplification of work to include the latest mechanical methods for handling supplies and electronic devices for supply control.
- i. Establishment and maintenance of minimum supply levels.
- j. Establishment of alternate means to provide a support and to obtain flexibility.
- k. Increased mobility of installations.
- l. Rear area security and area damage control.
- m. Dispersion of units and installations.
- n. Placing supply installations in most favorable locations relative to the transportation net.

## 31. The Logistical Estimate

The planning activities in a logistical command parallel those of other theater army agencies and are covered in FM 100-10 and FM 101-5. Planning documents of particular interest to a logistical command are the logistical estimate, logistical plans, and the administrative order. The Logistical factors on the accomplishments of the mission or on the contemplated courses of action of the command, and it serves three broad purposes:

- a. It is used to determine whether the contemplated tactical operation can be supported.
- b. It serves as the basis for recommending one logistical course of action as the best for carrying out the mission.
- c. It brings to the commander's attention limiting features and those problem areas requiring command action.

## 32. Logistical Plans

Logistical plans are based on the logistical estimate, to include modifications resulting from the continuing aspects of the estimate, additional information received from other sources, and subsequent decisions made by the commander. They are used to announce these decisions for planning purposes and/or implementation on order. Information on the following is essential in the development of logistical plans:

- a. *The Overall Tactical Plan and Scheme of Maneuver.* Administrative support planners must be advised of the basic tactical concept of the operation early in the planning stages. After development of a planning schedule to meet the ultimate objective, plans are prepared to support the tactical units in accomplishing that objective. Logistical considerations have often altered or dictated tactical concepts of operations. Constant coordination between tactical and administrative support meets the requirements of the tactical plan.

b. *Supported Troop Strength and Equipment Density.* Supported troop strength and density of major items of equipment are governing factors in the preparation of the troop requirements for the technical services and administrative units necessary to support the operation. Supported troop strength and equipment density must be determined as early as practicable in planning support for combat operations, and thereafter must be subjected to minimum fluctuation. Without a reasonable idea of the number and types of troop units, armored and other vehicles, gun tubes, etc., to be supported, transportation requirements (water, land, air, pipeline, and terminal facilities), replacement and consumption materials, reserve tonnages, personnel replacements, hospitalization, and other service requirements cannot be computed.

c. *Transportation.* The logistical planner requires knowledge of transportation requirements and capabilities to plan the support for a contemplated operation. Rail, highway, inland waterway, pipeline and air capacities must be adequate for movement of supplies and equipment to supported troops in amounts needed, including replacement and consumption requirements and buildup of authorized reserves. Operational planning groups must make known their estimated requirements as early as possible and the logistical planner must match these requirements against known transportation capabilities. If reliable planning data are not available, estimates must be made based on all information available. Transportation planning data must include the following:

- (1) Lift requirements for military personnel, including medical evacuation equipment, and supplies, also for the comparative lift to meet the needs of allies, the indigenous economy, and relief.
- (2) Number, types, and characteristics of ships and a phased schedule of their availability.
- (3) Terminal capacities in both the mounting and objective areas.
- (4) Number, types, and characteristics of aircraft available.
- (5) Airfield capacities available in the mounting areas and in the objective area.
- (6) Highway, rail, pipeline and inland waterway capacities, including operating equipment.
- (7) Conditions of water terminals, beaches, railroads, highways, inland waterways, and airfields, and construction troops and materials available for rehabilitation.

d. *Use of Existing Facilities in the Objective Area.* Advance planning for administrative support includes consideration of available sites for depots and service installations in the objective

area. Existing facilities should be used when feasible. Factors which govern the location of these installations include ability to support the operation, defensibility, dispersion, and accessibility to the existing transportation net. The possibility of destruction of facilities selected for use must be considered and alternate plans prepared. All of these have an important bearing on requirements for engineer support. Plans must provide for construction troops and materials, barrier plans, acquisition of real estate, and repairs and utilities services. The plan will provide for the procurement of available civilian supplies, facilities, and services for use by our forces in consonance with national objectives.

*e. Labor.* Both local civilian and prisoner of war labor are valuable sources of manpower and plans should be made for their full utilization. Local attitude and expected reaction toward military occupation have a definite relationship to anticipated use of civilian and prisoner of war labor. In many instances, it may be necessary initially to depend primarily on military personnel for labor. Later, as the local attitude is properly developed, and as prisoners of war become available, maximum use of non-U. S. military personnel should be made in type B service units and civil labor units. Prisoner of war labor should be used to the maximum consistent with U. S. policies, ratified international treaties, conventions, and the rules of land warfare.

*f. Troop Basis Planning.* A balanced logistical support force must be provided and a sound command structure organized to exercise economy of force in accomplishing logistical support to combat forces. Considerable improvisation may be necessary.

### Section III. TROOP REQUIREMENTS PLANNING

#### 33. General

Logistical commands, except for the headquarters and headquarters company, have no fixed composition and there is no formula to apply nor table to consult that will show exactly how one should be organized, or exactly how many and what kind of units are necessary to perform the many missions with which it may be charged. There are several fundamentals which, if analyzed properly in light of the situation, will indicate proper methods of employing the data contained in FM 101-10 and appropriate TOE for developing satisfactory troop requirements for a logistical command.

#### 34. Factors Affecting Service Troop Planning

Many factors influence the number and type of service troops required to support any given operation. These factors must be



considered in determining to what extent the logistical command should be supplemented in order to carry out an administrative support mission. Principal factors are—

- a. Number and type of troops to be supported, their mission, and the extent of service support to be rendered them.
- b. Quantity, types, and distribution of equipment.
- c. Extent of construction required.
- d. Climate and terrain.
- e. Status of industrial development and local resources within the area of operations.
- f. Size of the geographical area of operations.
- g. Attitude, availability, and capabilities of local civilians and prisoners of war.
- h. Capability and limitations of technical service units.
- i. Enemy capabilities. The nuclear capability of the enemy is a major consideration in planning troop requirements since it is a controlling factor in determining the degree of dispersion required in the administrative support areas.

### 35. Fundamentals Affecting Troop Requirements Planning

Each of the factors listed in paragraph 38 is variable, and the troop planner must continuously analyze requirements to design the service force to fit conditions imposed by the situation. Whatever the conditions, the following three basic fundamentals must be intelligently applied.

- a. A force balanced against operational requirements.
- b. Sound command structure.
- c. Economy of force.

### 36. Troop Basis, Troop List, and Table of Distribution (TD) Definitions

a. *Troop Basis* A troop basis is a planning document which sets forth a major command's troop requirements by numbers and types of units, designations, organizations, strengths, locations, assignments, grades, and branches, within a personnel ceiling prescribed by higher headquarters. An approved troop basis constitutes a major commander's authorization for personnel and equipment (TOE and TD units).

b. *Troop List*. A troop list is any list of military units or individuals. Generally, a troop list will contain the designations of all the units in the command's area, or all units served by the command's machine records unit. Such a list may include units located

in the area but not assigned to the command, such as attached allied units. An approved troop list does not necessarily constitute a troop basis.

*c. Table of Distribution (TD) Unit.* A unit organized from personnel authorized by a table which prescribes a distribution of personnel for units and installations organized under a bulk allotment. TD units may be organized or discontinued within currently authorized bulk personnel allotments. The grades of individuals assigned to TD units are contained in the overall grade distribution authorized to the organizing authority. Equipment for TD units will be authorized by applicable tables of allowances (TA).

### **37. Basic Steps in Troop Requirements Planning**

*a.* The following general steps are essential to the accomplishment of sound troop requirements planning:

- (1) Determination of the functions of tasks to be performed.
- (2) Determination of quantitative workload.
- (3) Selection of type of operating units with the required capability.
- (4) Calculation of number of operating units required.
- (5) Provisions for command and control.

*b.* The accomplishment of the steps listed in *a* above requires a detailed study of the overall mission by each technical and administrative service in light of its responsibilities and the factors which affect the performance of support functions.

### **38. Troop Availability**

The determination of troop availability is based on several factors. These factors are the troop requirement of the command, the overall troop ceiling set by higher headquarters, and availability of specific type units. Technical service estimated requirements are submitted, consolidated, and revised as necessary by each agency to come within the prescribed ceiling. Troop requirements are coordinated to keep them within the overall ceiling and yet have a balanced force that can perform its mission. If the overall troop ceiling is definitely fixed, such as in an amphibious operation where shipping is limited, any change in the requirements of one agency must be balanced by the necessary changes in other agencies. However, the overall ceiling may be changed when, as a result of detailed planning, it is found that a change is justified.

### **39. Phases of Troop Requirements Planning**

Troop requirements planning passes through three phases—

estimation, calculation, and modification. The first step must be accomplished with few, if any, tangible figures. Each successive step is developed with more concrete and more accurate data than the preceding one until a balanced, sound troop list is evolved. It is important to note, however, that while the three phases are discussed separately below, the requirements of fast-moving warfare will often require that various aspects of several phases proceed concurrently.

*a. Phase I Planning—Estimation.* The initial step in the development of troop requirements must be accomplished with little specific data, often no more than a brief statement of the overall strength of the force to be employed or the number of divisions around which it is to be built. Each planner must employ broad experience factors such as division and wing slice, troop density, equipment density, replacement and consumption factors, and similar information. For example, when the total troop strength is unknown, it can be estimated by using appropriate division and wing slices. From this figure and from the basic vehicle density factors, the number of vehicles in the force can be estimated. Other data are derived in a similar fashion. The margin of error will depend on the accuracy of factors employed. Factors representing best available experience should be used, and the planner is cautioned against changing them unless he has the experience and background to make such changes valid.

*b. Phase II Planning—Calculation.*

- (1) Phase II planning begins when phase I estimates are received from all arms and services in the form of initial tentative troop lists. Troop strengths and equipment lists for the force can be derived from these initial lists, which should be more accurate than the estimates used to initiate planning in phase I. The margin of error between the initial tentative lists and those finally accepted depends not only upon the adequacy of the planning factors and guidance available to the troop requirement planners, but also upon the experience, aptitude, and judgment of the individual planner. Branch strengths in relation to the total force strength should be compared with currently accepted percentages and should be compatible with existing support requirements.
- (2) When the consolidated initial troop list is available, each planner should review the list and decide, based on the new information from the consolidated list, whether his next revision will increase or decrease and to what extent. The predictions of each planner should be appraised

for accuracy, and a recalculation of the first revised troop list should be made as a result of these predictions. This information should then be furnished all planners so that each will be aware of direction and limits of changes which are to be applied.

- (3) When this information is available, phase II planning continues with the preparation of revised estimates by each branch representative. The division slice and other factors suitable only for initial estimation are discarded in favor of actual (or adjusted) figures extracted from the initial lists. Several revisions may be necessary before all arms and services lists are brought into balance with each other. Intelligent adjustment and careful prediction at each successive planning stage will reduce the number of revisions necessary to arrive at a calculated balanced troop list to complete phase II.

*c. Phase III Planning—Modification.*

- (1) The consolidated troop list produced in phase II provides a balanced force, each element of which is capable of performing its mission without augmentation. Modifications, adaptations, or alterations dictated by policy, by command direction, or by conditions peculiar to the theater under consideration in phase I or phase II.
- (2) Substitution of civilian labor for military personnel should be made at this stage. At the same time, lists of class IV equipment to be issued for the use of the civilian labor forces must be prepared.
- (3) The substitution of civilian labor for military personnel immediately throws the troop list out of balance and it may require several revisions such as those made in phase II to restore it to balance. Various services will be affected differently. The impact on the ordnance troop list is relatively small since the equipment density does not change significantly, but the impact upon the medical troop list is great since medical service is provided primarily on the basis of military strength. Other services are affected to greater or less extent depending on the change in military strength and equipment required.
- (4) It may be argued that since substitution of auxiliary labor in phase III causes an imbalance and makes several additional revisions necessary, consideration should be given to effecting the substitution earlier in the planning. This would simplify matters for services, such as

medical, interested primarily in military strengths; but it complicates matters for those services which must prepare lists of class IV equipment for the labor force. If the labor force is planned concurrently with the military forces, the class IV equipment lists must be included in each step and revised accordingly. This unduly complicates and delays the steps in planning for all services, and may introduce greater degrees of error in each step. The decision as to which procedures to follow is made by the chief of the planning group, but the various technical service representatives should present to him the advantages and disadvantages of each method and make an appropriate recommendation in each case. It should also be observed that troop requirement planners are familiar with military troop lists habitually use them as the basis of comparison to evaluate specific plans. It is important that 100 percent military troop lists be established initially against which augmentations and comparisons may be made.

- (5) Frequently, arbitrary personnel ceilings are imposed upon the technical and administrative services. These should not be applied until phase III since the reduction in strength may not be proportional for all services or for all units within a service. Further, only if the full military strength required to accomplish a mission is known can the effects of a reduced strength be adequately appraised and reported to the head of the planning staff and force commander.
- (6) Final distribution of troops by area and determination and location of depots and other major installations is accomplished in phase III. If this is done tentatively for each troop list prepared in phases I and II, the final determination is simplified since each planner becomes increasingly aware of the deployment of the troops of other arms and services throughout the theater and progressively adjusts his own distribution to meet the probable load.

#### Section IV. BASE DEVELOPMENT

##### 40. General

*a.* Base development is the improvement and expansion of the resources and facilities of an area to support current and future operations of air, sea, or land forces, or combinations thereof.

It provides the framework for the administrative support of combat forces deployed in accordance with strategic war plans.

b. The most efficient development and operation of overseas bases in time of war requires the complete integration of theater strategic and administrative support planning and the exercise of coordination by the theater commander. It requires participation in planning by all elements of the command. Only by combining the skill and judgment of a large number of planners working together can the theater commander foresee the requirement for men, materiel, and equipment to construct, operate, and maintain the facilities supporting joint operations.

c. The base development plan is a detailed plan and serves the following purposes:

- (1) Informs all concerned as to the intent of the theater commander in the construction and operation of bases.
- (2) Is a basis for determining the number, kind, and dates of arrival of the necessary troops to construct and operate installations in the base.
- (3) Is the theater directive to the theater supply agencies to prepare requisitions and ship supplies, equipment, and troops in the proper amount and priority to build and equip the base.
- (4) Is the theater directive to undertake the construction of the base. It thus precludes the dissipation of effort on low priority areas.
- (5) Fixes dates by which commanders may expect to have certain facilities such as airfields, hospitals, harbors, and depots available for operation.
- (6) Allocates space on the ground to the various agencies and installations in a manner best suited to the plan of overall operation of the base.

#### 41. Responsibilities for and Purposes of Base Development Planning

a. The theater commander is responsible for all base development planning in the theater. The purpose of this planning is to achieve a broad development of theater resources in accordance with the theater strategic mission and operational plans, and to establish base facilities in objective areas to support combat or other operations. Planning by various echelons is carried on concurrently under the coordinating direction of the theater commander. The theater commander reconciles any conflicting requirements of the various agencies involved in the execution of

the plan and insures that adequate means are available to implement the plan.

b. The theater staff may be required to enter into details of base development planning. However, detailed planning is the responsibility of lower echelons of command.

c. Responsibility for the development of a base may be delegated by the theater commander to the theater army, navy, or air force commander in instances where the interest of one of these components is exclusive or predominant.

## 42. Planning Procedures

Three general phases, each culminating in the specific document, make up the sequence of base development planning. These include—

a. *Base Development Study.* During the early or strategic phase of the planning cycle, studies of potential areas for base development are undertaken by the theater headquarters. Normally, upon receipt of instructions to implement a specific operation, a base development study is prepared in more detail to cover that operation, including the feasibility of base development aspects. It includes the concept of the operation as it affects base development, the forces involved, target dates, and the broad administrative support requirements and implications of the proposed base development. The form for the study is not prescribed. It must be tailored to meet the requirements in each case.

b. *Base Development Planning Directive.* Following the base development study and when detailed planning for the operation is undertaken, the theater commander issues a base development planning directive. This directive may transmit to the Service commanders and commanders of joint forces copies of the base development study and includes other details, preliminary estimates, and instructions upon which specific planning can be based. There is no prescribed form, but the directive may—

- (1) Allocate responsibilities for specific projects and functions to the respective services.
- (2) Specify completion dates and priorities for projects.
- (3) Promulgate construction policy specifically applicable to the contemplated operation.
- (4) Designate areas allocated for specific purposes for inclusion in the general layout plan.
- (5) Indicate the command structure and designate major commanders charged with base development.



- (6) Indicate applicable standing operating procedures and directives which govern preparation of the plan.
- (7) Direct submission of data and recommendations by lower echelons for inclusion in the plan.

*c. The Base Development Plan.* The base development plan is the product of concurrent planning by Service commanders and commanders of joint forces accomplished in accordance with the planning directive. It sets forth clearly the base facilities to be provided and the operating and service functions to be performed. It is compiled and published by the theater headquarters and may be issued as an annex to the operation plan, as an appendix to the logistical plan, or it may be issued separately in parts to facilitate concurrent planning. (See app. V.)

### 43. Basic Planning Considerations

Base development planners should weigh carefully the following basic planning considerations:

*a. Mission.* The mission assigned a base serves as the basis for establishing the extent of development and the schedule of readiness for the facilities which are included in such development. Only those installations which are essential for fulfillment of the mission should be authorized.

*b. Degree of Permanency.* Plans should provide for only the minimum facilities necessary for fulfillment of the mission consistent with safety, health, and morale of the using forces, and protection against the elements. Bases located in primitive locales require most careful consideration in this respect. If permanent utilization of the base is anticipated, initial development is planned for later incorporation in permanent base development.

*c. Limitations on Personnel, Supplies, or Equipment.* The theater commander usually has at his disposal only limited resources in manpower, supplies, and equipment, and because unloading capacities in objective areas are limited, strict control of shipping is established. Base development planning should conform to those limitations which are established by overall tactical and administrative support considerations. In planning the most efficient prosecution of base development with the available resources, it should be appreciated that men, supplies, and equipment are closely related. Although all means at the disposal of planners should be exploited, the possible effect on future operations should not be overlooked.

*d. Estimated Phased Population.* To prepare the base development program, it is necessary to make estimates of troop popu-



lation at successive stages in the development of the base. These estimates should list the major units and accompanying special units, and include both combat and service troops of all services concerned. Initial estimates are revised to conform to troop lists as they become known, and the recapitulation of troops is stated in the final plan.

*e. Natural and Local Resources.* Every effort is made to develop natural and local resources of an area to provide maximum effective support of military operations. Any exploitation which conserves personnel, supplies, equipment, or time is given consideration. Estimates should, insofar as possible, be based on fact. Utilization of local civilian and prisoner of war labor is included in this consideration.

*f. Area Available for Development.*

- (1) Areas suitable for the various base installations in the objective area, particularly in the immediate landing area, and in the vicinity of water terminals and beaches, are usually restricted in size and number. If the base development involves more than one Service, consideration must be given to the allocation of areas to each Service for support of the activities for which it is responsible. If the requirements of the Services are in conflict, the theater commander evaluates the requirements of each Service and allocates areas so as to ensure the most effective overall development of the base area.
- (2) When information of the objective area is incomplete and the location of certain highest priority installations, such as airfields, cannot be indicated definitely, the base development plan and general layout plans should provide that all suitable sites found be reserved for the use of the Service concerned until released for other use. As a corollary, each Service makes early reconnaissance and releases all unsuitable sites at the earliest possible date.
- (3) The possibility of the need for future expansion should be considered in studying available areas and in selecting sites.

*g. Priority of Development.*

- (1) The determination of priorities for the development of bases is an intricate task which involves compromise and reconciliation between operational and administrative support considerations. After dates of operational readiness have been established, the base development plan-

ners insure that construction forces and supplies are provided in the objective area in accordance with requirements. Partial use of incomplete base facilities is usually necessary even though construction efficiency is thereby lowered and there is attendant delay in final completion. Priority for the development is established by balancing operational requirements against the construction program. While flexibility should be provided for contingencies, decision on major changes should be reserved to a command level which avoids hasty changes based on limited consideration of the factors concerned. The senior commander ashore must have authority to make necessary changes in the base development plan to reflect the tactical situation and physical conditions present in the objective area.

- (2) Factors which may govern development priorities include—
- (a) Urgency of meeting special operational requirements.
  - (b) Ease or difficulty of accomplishing individual construction tasks for reasons other than enemy opposition.
  - (c) Anticipated interference from enemy operations to certain construction efforts.

*h. Unloading of Base Development Personnel, Supplies, and Equipment.* Estimates of terminal capacity available for unloading base development personnel, supplies, and equipment are essential in determining the extent of the development possible in any given time. Further consideration must be given to the availability of facilities to accommodate these personnel, supplies, and equipment.

*i. Base Development Problems for any Future Operation.*

- (1) Those problems which are essentially geographical.
- (2) The problems posed by the development of new weapons.
- (3) The problems arising out of a new concept of time. The tempo of modern war demands a speedup of operations.
- (4) The development of new engineering techniques, new high speed construction methods, new materials, and improved design.
- (5) The development of new-type transportation and materials handling techniques.

- (6) The major problems related to the mobilization and training of manpower to insure the availability of technical abilities for base development.

#### 44. Essential Elements of Base Development Plans

Although it is not possible to prescribe universal items for all theater commanders to include in base development plans, listed below are essential elements which should be considered by the planners.

*a. Basic Planning Considerations.*

*b. Command and Administrative Organization, Assignment of Forces, and Command Relationships.* Preliminary organizational charts should be incorporated in the original base development plan. The commander of the base should maintain an up-to-date functional chart or functional manual for the base. Specific command authority lines and areas of coordination must be clearly delineated.

*c. General Layout Plans.*

- (1) The allocation of areas to Services by the theater commander is incorporated in general layout plans which accompany the theater base development planning directive. When modified to incorporate the recommendations of the separate Services, the general layout plans are issued as an annex to the base development plan.
- (2) Area boundaries should be defined clearly indicating the layout within the boundaries. Thus, local commanders have sufficient freedom of action to permit maximum exploitation of conditions found within the allotted areas. However, when known desirable features exist, tentative sites should be indicated.
- (3) Topographic maps including offshore hydrography are most desirable. Overlays to such maps and to ordinary topographic maps normally are adequate for general layout plans, and their use expedites preparation of the base development plan.

*d. General Supply and Maintenance Organization and Installations.*

*e. Ammunition, Guided Missile, and Nuclear Weapons Logistic Organizations and Installations.*

*f. Utilities, Roads, and Natural Resources.*

*g. Water Terminal and Beach Facilities.*

*h. Transportation.*

*i. Signal Communications.*

*j. Airfields.*

*k. Navy Installations.*

*l. Medical Facilities.*

*m. Miscellaneous Facilities.*

*n. Recapitulation of Troops by Phases.*

*o. Pertinent Directives and Publications.*

(1) Reference, in base development plans, to policy directives which cover such matters as general priorities, construction standards, responsibilities for control of construction, and prohibitions or restrictions on the use of critical resources, avoids repetitious matter and permits concentration on matters peculiar to the particular operation.

(2) If there is any likelihood that copies are not readily available to all units concerned, important basic directives should be reproduced as tabs to the base development plan.

*p. Instructions Relative to Reports to be Submitted.*

*q. Instructions Relative to Means for Accomplishing Change of Plans.*

*r. Construction Priority Schedule.*

#### **45. Forms of the Base Development Plan**

During World War II, there was no set form for the base development plan. The outline used by Army planners in the Pacific and in Europe differed considerably and both approached the problem differently than did the Navy. Yet the same essential elements were to be found in the base development plan of every assault operation. There is no prescribed form for a base development plan established at this time. However, a type form adaptable to use by logistical commands is given in appendix V.

## CHAPTER 5

ADMINISTRATIVE SUPPORT OPERATIONS

---

## Section I. GENERAL

**46. General**

The operations of the logistical command are as outlined in chapter 3, this FM, other pertinent FM's (see app. I), or as prescribed by proper authority. Whatever the roles, the closest liaison must be continuously maintained with the supported forces. The initiative for establishment of contact must be from the supporting to the supported force. Liaison officers are exchanged with the major supported commands to establish and maintain close contact with corresponding staff officers of those commands. This in no way reduces the necessity for frequent contact between supported and supporting commanders. The primary mission of the supporting commander is to provide the supported commander with adequate, continuous, and timely support. It is toward this aim that the supporting commander devotes his main effort. Since all military operations are dependent upon administrative support, the commander of the logistical command must be continually cognizant of the long-range and short-range plans of the supported commands. Therefore, it is essential that plans for the operation and for administrative support be prepared concurrently. The commander of the logistical command must ever guard against complacency and any tendency to permit operational arrangements to become static. He must be alert to the necessity for constant planning for future operations and the timely adjustment of facilities, stocks, and services for the adequate support of such operations.

**47. Functions of Administrative Support**

*a.* Administrative support functions performed by a logistical command in the accomplishment of its mission include supply, transportation, maintenance, construction, labor, medical evacuation and hospitalization, personnel, and local civil affairs. These functions are discussed in detail in section III.

*b.* In addition to the functions of administrative support performed by logistical commands, other areas of operational inter-

est include communications, rear area security, and area damage control. These are discussed in section II.

## Section II. OPERATIONAL RESPONSIBILITIES

### 48. General

Operational responsibilities of the logistical commands normally include rear area security and area damage control and communications. These are discussed in the succeeding paragraphs.

### 49. Rear Area Security and Area Damage Control

#### *a. General.*

- (1) The greater threat of attack by enemy saboteurs, infiltrators, guerillas, and airborne attacks, and longer range, more lethal weapons against the administrative installations and lines of communications poses a serious problem to the Theater Army Logistical Command commander or his major subordinate commander. Also, the avoidance and control of damage from nuclear attacks on rear area facilities is a problem new to warfare. In addition, commanders must be prepared to minimize the effects of enemy chemical and biological attacks.
- (2) The logistical command commander is responsible for the security of his assigned area and for area damage control operations. In the exercise of these functions, the commander utilizes the troops assigned to his command. This organic capability is supplemented by civilian personnel and facilities when available. In addition, when required by the situation, combat units must be available to reinforce the rear area security capability.
- (3) Although the troops assigned to the logistical command must be utilized in the execution of rear area security and area damage control operations, such utilization must be carefully coordinated and evaluated to insure minimum disruption of the primary mission of the command, i.e., the administration support of the combat forces.

*b. Command and Staff Control.* A single structure for control is established by making the deputy commander, logistical command, responsible for the general supervision of the planning and conduct of rear area security and area damage control. The Director of Security provides the necessary representation in the ADSOC to prepare the rear area security and area damage con-

trol plans to provide staff supervision over their execution. In addition, the ADSOC provides the necessary operations center, communications means and warning system.

*c. Rear Area Security.*

- (1) The objective of rear area security operations in the theater communication zone is to minimize the effect of enemy interference with administrative support operations in support of the combat forces. It is concerned primarily with enemy actions such as airborne raids, attacks by infiltrated units, attacks by guerilla forces, and sabotage.
- (2) In general, rear area security plans provide for the following:
  - (a) Coordination of local security of installations and units.
  - (b) Relief of attacked installations and units.
  - (c) Route patrolling and convoy escort.
  - (d) Surveillance of possible bases of operations for guerillas and infiltrators.
  - (e) Denial of possible drop and landing zones.
  - (f) Finding, fixing, and destroying enemy forces operating in the rear areas.
- (3) Normally, service units are responsible for plant or industrial type security against pilferage as well as providing the local security of their own installations. When required, additional forces must be made available to assist in the accomplishment of rear area security missions other than local security. Tactical units in the replacement stream or in theater army reserve may be assigned the emergency mission of rear area security in the *theater communication zone*, and should proceed on order to execute planned rear area security missions beyond the scope of the local actions which can be performed by troop units assigned to the theater army logistical command or its subordinate elements. When so ordered, these tactical units should be temporarily assigned to Theater Army Logistical Command or placed under the appropriate area commanders for the execution of their rear area security missions.

*d. Security of Lines of Communications.*

- (1) Within the combat zone, the security of lines of communications for intersectional service operations is the

responsibility of the field army commander having control of the area concerned. The security of these intersectional service lines of communications is coordinated between commanders of the field army and the theater army logistical command.

- (2) In the rear of the combat zone, the local security of the lines of communications for intersectional service operations is the responsibility of the commander of the theater army logistical command. The theater army logistical command commander coordinates and executes this responsibility through the commanders of his subordinate advance logistical commands, base logistical commands, and area commands, as appropriate. The threat of enemy airborne attacks, guerilla action, infiltration, and sabotage in the rear areas requires that all personnel be thoroughly trained and capable of engaging in effective, coordinated combat operations. Security plans should be based upon the employment of all military and appropriate indigenous forces located in the rear areas.

*e. Area Damage Control.*

- (1) Area damage control in military operations consists of those measures taken to minimize the immediate effects of mass destruction attacks or natural disaster as an aid to the reestablishment of administrative support. Each commander must be concerned and must insure that he is prepared to meet this threat. The use of ADPS to collect, compute, and transmit data and instructions will greatly facilitate the implementation of planned measures.
- (2) Area damage control measures may be considered in two phases. Phase I consists of those measures taken in advance of an enemy attack in order to avoid or minimize the effects of such incidents. Phase II action consists of those measures taken after an enemy attack or natural disaster occurs to restore control, save lives, isolate danger areas, and initiate salvage operations to prevent further loss. The action taken under Phase I will determine to a large degree the effectiveness of the operations conducted in Phase II. Phase I will provide for the following as a minimum:
  - (a) Clear lines of authority and responsibility down to the lowest unit.
  - (b) Adequate communications and warning systems to include fallout warning.



- (c) Proper dispersion within and between installations continuously planned and executed.
  - (d) Preparation of necessary plans and SOP, to include the reporting of information required for post-strike analysis.
  - (e) Organizing, equipping, and training of all personnel in rear area damage control operations.
  - (f) Appropriate use of cover and concealment.
  - (g) Allocation, control, and full utilization of available transportation net and equipment, to include alternate plans.
- (3) Phase II operations consist of the following:
- (a) Rapid assessment of the damage and its immediate action on operations.
  - (b) Control of personnel and traffic.
  - (c) Fire prevention and fire fighting.
  - (d) First aid and evacuation of casualties.
  - (e) Protection against chemical, biological, and radiological hazards.
  - (f) Emergency supply of food, clothing and water.
  - (g) Explosive Ordnance reconnaissance and disposal.
  - (h) Initiation of salvage operations.
- (4) Each unit and installation commander prepares to minimize and control damage within his own unit area. However, in the event of serious damage to his unit area he would be unable to cope with the situation and would require outside assistance. All units must be prepared to lend assistance to other units and installations which have suffered serious damage. Under general supervision of the deputy commander, the director of security will determine what units or elements of units will be prepared to render the required assistance after evaluation of the overall mission.
- (5) In area damage control operations the term incident is used to signify the occurrence of damage resulting from a single enemy weapon or from a natural disaster. Each scene of damage or each incident will be placed under the control of an "area damage control party" provided by the service units in the area to supervise the area damage control operations thereat. Area damage control parties are provided by the service units in the area, preferably by the various technical service battalion head-

quarters since they have only a supervisory mission to perform. However, the parties may be provided by a company-size unit. Area damage control parties will consist of an incident officer (commander), one or more officer assistants, and sufficient enlisted personnel to accomplish the following:

- (a) Establish and mark an incident post, or CP, at the scene of damage. (Incoming area damage control squads and other personnel reporting to the damaged area will be directed to report to the incident post.)
  - (b) Determine the extent of damage and the amount and type of assistance required. Command all area damage control squads dispatched to the damaged area and supervise all area damage control operations thereat.
  - (c) Provide such necessary administrative support as emergency food, water, and clothing.
  - (d) Coordinate with the medical personnel in treating and evacuating casualties.
- (6) The SOP will prescribe the composition of area damage control parties and designate the units which will provide them. When an incident occurs, the commander concerned will dispatch an area damage control party to the damaged area to assume responsibility for subsequent operations. Responsibility for probable target areas, such as a major installation, should be designated in advance so that the area damage control party commander can reconnoiter his area of responsibility and become familiar with the layout of the installation, location of critical areas, etc., before the damage occurs.

*f. Pre-Strike Analysis and Actions (see TC 101-1).*

- (1) In general vulnerability studies on the heat, blast, and radiation effects of nuclear weapons against friendly personnel and materiel will furnish the basis for damage control planning in the theater administrative zone.
- (2) In order to facilitate those measures which must be taken when nuclear explosion occurs in the *theater communications zone*, response time must be reduced to a minimum. Specifically, this can be accomplished to a large degree by a system of prestrike fallout predictions, which is based on observed meteorological data. Within

the communications zone, the provision of meteorological data for fallout prediction is a responsibility of the supporting Air Weather Service (AWS) organization.

- (3) Prestrike fallout predictions reduce response time by enabling staff agencies to plan alternate supply and evacuation routes, to select survey routes, to maintain adequate communications, and generally to give proper direction to Phase I control measures.
- (4) A prestrike fallout prediction should be prepared by the radiological center of each ADSOC as often as new wind data are received, since weather conditions may vary from place to place within the theater administrative zone. In addition to weather information, pre-strike prediction requires up-to-date intelligence of enemy capabilities.

*g. Post-Strike Analysis and Radiological Survey.*

- (1) As soon as a nuclear explosion occurs in the theater communications zone, or adjacent thereto, an immediate post-strike analysis must be made to determine whether or not fallout will occur and, if so, the predicted path of the fallout. The post-strike analysis consists of determining ground zero, time of burst, height of burst, yield of the weapon, and the meteorological conditions in the area. Post-strike analysis, fallout prediction, and fallout warning are accomplished in the radiological center (RADC), which is an element of ADSOC, and are considered a part of the overall area damage control function.
- (2) The predicted path of the fallout becomes the basis for warning the units and installations in the affected area so that they can take appropriate action either to take cover or evacuate the area. This information is also utilized by area damage control parties in selecting routes over which to move to the area of immediate damage. Incident officers must have this information so that they can select incident posts outside the predicted fallout area. The same information must be flashed to the military police so they can seal off the fallout area and prevent other personnel from entering. Many lives may depend upon accurate and timely fallout prediction and dissemination of the information as well as the rapid execution of damage control operations.
- (3) Although fallout prediction can serve as the immediate

basis for warning and for area damage control operations this prediction must be confirmed and refined by radiological survey. All units in rear areas must be equipped with radiological instruments so that they can monitor for radiological contamination and conduct radiological survey as required. Radiological survey is conducted by survey parties operating on foot or utilizing ground means of transportation, and survey parties utilizing fixed or rotary winged aircraft.

- (4) Radiological survey must be accomplished prior to the initiation of area damage control operations to determine whether the area is safe to enter or to determine the stay-time for limited entry to rescue and evacuate casualties. Decontamination of critical installations or parts of installations may be undertaken within the capabilities of available personnel to do so. However, decontamination operations are expensive even when attempted on a limited scale.

## 50. Communications

*a. General.* Responsibility for providing communications in the theater of operations is placed as follows:

- (1) The theater army commander is responsible for the provision of communications services for army elements and certain supporting USAF activities within the theater. He delegates executive responsibility for communication services within the combat zone to the various field army commanders and for such services within the area to the rear of the combat zone to the commander, theater army logistical command.
- (2) The theater army signal officer is charged with formulation and promulgation of plans, policies, procedures and guidance for the installation, operation and management of communications services within the theater.
- (3) The commander, theater army logistical command, in addition to responsibility for communications services in the area to the rear of the combat zone, is given executive responsibility for tying these services into those within the combat zone. He is also responsible for providing communications service from the theater to points external to the theater. The signal officer, theater army logistical command, as a technical staff officer, plans, supervises installation of, and manages the operation of these communications services.

(4) The communications services for which the commander, theater army logistical command, is responsible may be grouped functionally as follows:

(a) *Long lines services.* Communications services which are intra-theater in nature and transcend organization boundaries. These provide the long distance trunking service between all points in the theater communications zone and to the combat area.

(b) *Local communication services.* These provide local trunking and terminal communications facilities with which the user has immediate contact.

(c) *Special purpose communications services.* Communications services which are not general in nature but are established to meet specialized needs.

(d) *Nonelectronic communications services.* These are communications services which do not employ electronic equipment as transmitting agencies and will include—

1. Local and long distance signal messenger service for the transmission of documents and other communications (except mail) which are not suitable for transmission by electronic means.
2. Pictorial services, including photography and training film service.

(5) To achieve the objective of providing adequate, reliable, secure and responsive communications services, the signal officer, theater army logistical command, makes the following organizational and functional arrangements:

(a) To provide long lines services a communications intersectional service is organized. This agency, consisting of engineering, construction, operations and maintenance personnel and equipment, is charged with the installation, operation and maintenance of all communications trunking service between major communications switching centers within the zone and with connecting the trunking system to that of the field army in the rear of the combat zone. Because of the requirements for alternate routing, dispersion of facilities, and reliability of service, an area-type network must be established. This network, or

trunking system, will usually consist of an arrangement of radio-relay, cable, and open-wire system, both military and civilian, as may be appropriately engineered. The principal features of the system are—provision of alternate entrances for all principal groups of users, provision of sole-user as well as common-user facilities, high circuit capacity and reliability, and ability to withstand the shock of disruption of routes and switching facilities without serious curtailment of service. The Communications Intersectional Service is assigned to TALOG and operates under the direct supervision of the signal officer of that command.

- (b) To provide local communications services, responsibility for installation, operation, and maintenance of such service on a geographical basis is charged to ADLOG's, BALOG's, and to Area Commands. In those instances where area commands are not organized in BALOG their responsibility for provision of local communication services is absorbed by BALOG. In the event ADLOG and BALOG are not contiguous and an intervening area command is not established, the communications requirements for this area will be the responsibility of TALOG. Local service is provided by the responsible command to *all* users within the geographical limits of the command.
- (c) To provide special purpose communications services, personnel and equipment are placed at the disposal of the signal officer, TALOG. Since the areas covered by most of such services do not fall within geographical or organizational subdivisions of the zone, but are more intersectional in nature, supervision of these services by that individual is proper. In those cases when the quantity of special purpose communication services is large and varied, it may be necessary to establish an agency under the control of the signal officer, TALOG, to manage their installation and operation.
- (d) Nonelectronic communications services are provided as follows:
  - 1. Long-distance messenger service is provided by

the communications intersectional service between major communications centers and switching points operated by that agency. Local messenger service is provided within fixed geographical areas by the agency which provides other local communications services.

2. Pictorial service within the zone will be provided on a geographical basis by ADLOG's and area commands in a manner similar to local communications services.

*b. Communication Intersectional Service*

- (1) The communication intersectional service installs, operates and maintains the theater long-lines communications system. This system extends from the beach or air-head forward into the rear of the field army zones. It is made up of an integrated system of units operating signal centers, subcenters and switching centers, interconnected by multi-axis, multi-channel wire, radio and radio relay links and extension facilities.
- (2) The functions of the communications intersectional service are as follows:
  - (a) The provision of the theater long-lines communication system forward to interconnect into the field armies' communications systems.
  - (b) The provision of all trunk circuits between the theater communications system and the signal centers of major headquarters or area commands located to the rear of the field armies.
  - (c) The provision of terminal facilities required to integrate the U. S. theater army into the world-wide communication network emanating from the zone of interior.
  - (d) The provision of intersection circuits required for data transmission and all other intersectional communications requirements.
- (3) *Command relationships.* Units operating the intersectional communication service remain directly assigned to TALOG. The signal officer, TALOG, has operational control over all personnel, units, installations and facilities assigned or attached for the accomplishment of the intersectional communication service mission. He advises and submits recommendations to the TALOG commander regarding the most effective utilization of signal

communication facilities and resources. He is responsible to the TALOG commander for the execution of plans, policies and directive which pertain to intersectional communication service and operations as they are promulgated by the theater army logistical commander. He maintains close and continuous liaison with the armies, army groups, advanced logistical commands, and other supported forces within the theater.

- (4) *Concept of Operations.* Since the long-line communications service must provide commercial-grade trunking facilities for many types of service, their installation, operation, and maintenance must approximate best commercial standards.
  - (a) Installation of the network is accomplished on a carefully engineered basis. While radio-relay will be the most-employed method of transmission, full consideration must be given to the use of wire facilities. Maximum utilization of existing civil facilities must be made, even though they require some rehabilitation. Requirements for sole-user as well as common-user circuits must be included and the network must provide for multiple routes and multiple entrance and exits for all major centers and subcenters. The engineering of the system will be accomplished at the headquarters of the communications intersectional service. Installation and maintenance of the system will be performed by signal corps units assigned to the intersectional service and located strategically throughout the theater.
  - (b) Continuity of service is provided by employment of carefully drawn procedures for automatic or semiautomatic channel switching in case of circuit disruption. Operationally, the system will be made up of—
    1. Major centers located at intersections of the network. Here are provided facilities for entrance into and exit from the network, complete circuit and channel switching facilities, tape relay teletypewriter facilities, and dispatch stations for long-distance messenger service.
    2. Switching centers, located along routes of the network but not at an intersection. Here are provided network entrance and exit facilities and a



minor tape relay center. These may also be dispatch points for the theater long-distance messenger service.

3. Subcenters, located between intersections of the network and not on a route. These are located to serve as many installations and activities as possible, and provide network entrance and exit facilities, minor tape relay centers for teletypewriter service, and dispatch points for theater long-distance messenger service.

### c. *Local Communication Service*

#### (1) *Mission.*

Local communication services provide communications within areas, major headquarters and installations located to the rear of the combat zone.

#### (2) *Functions.*

- (a) The provision of terminal facilities required to integrate the area served into the theater communication system established by the communication intersectional service.
- (b) The provision of communication local trunk circuits to units located within the local area of responsibility.
- (c) The provision of communication facilities and service for the headquarters of the area of organization to which assigned.
- (d) The provision of communication circuits to units of intersectional services located within the local area.) Pipeline, highway, railway, etc.).

#### (3) *Command Relationships.*

The Signal Officer, Area Command, ADLOG, or BALOG is charged with provision of the local communication services and operates under the technical control of the Signal Officer, TALOG. The Area Command Signal Officer has operational control over all personnel, units, installations and facilities assigned or attached for the accomplishment of the local communication services mission.

#### (4) *Organization.*

The local communication service is organized along functional lines with units staffed and equipped to facilitate the accomplishment of their assigned missions.

(5) *Concept of Operations.*

- (a) Each subdivision of the administrative area to the rear of the field armies is assigned communications service units to provide the necessary interconnections between major commands and units of this subdivision and the communication system of the intersectional communication service.
- (b) When the subdivision consists of several depot complexes or other installations requiring signal facilities beyond their organic capability, signal units will be assigned to augment these facilities.
- (c) The local communication service will provide the required facilities to interconnect the users of special purpose communications systems, (such as highway, pipeline and railway) into the intersectional communication system to provide the long line facilities required.
- (d) Each major headquarters which does not have an organic communication facility to provide internal communications will be provided a signal unit to install, operate and maintain the facilities required.

*d. Special Purpose Communications Services.* In addition to normal long-distance and local communications services available to and used by all activities within theater communications zone, there exist requirements for special-purpose communication facilities, used by specific organizations in the conduct of their operations. In every case where these facilities can possibly be provided, in part or in full, through local or intersectional services, this should be done. However, engineering and other considerations may dictate the provision of separate facilities. The following give an indication of the types of services which may be required:

- (1) Point-to-point radio circuits provide direct voice and teletypewriter service between major headquarters and installations within the theater. These types of radio circuits may also be operated as emergency back-up to the communication intersectional service.
- (2) Communications services for press and morale services must be provided, but will rarely follow command or geographical lines.
  - (a) Depending upon the availability of commercial or other civilian facilities, communications services for press copy may have to be provided from the

combat zone and from each major headquarters in the area behind the combat zone to Theater Headquarters. Again, depending upon availability of commercial or other civil facilities, circuits may have to be provided from a Theater Press Center to the Zone of Interior. In cases when special circuits are required, separate operating units under direct supervision of the Signal Officer, Theater Army Logistical Command, will operate such circuits.

- (b) Morale communications services include those provided for Red Cross, entertainment broadcast service, and abbreviated (EMF) cable service for troops. The Signal Officer, Theater Army Logistical Command, is charged with providing such services as required.
- (3) Communication service for Army Aviation Air Traffic Control is required in the interest of flying safety and proper management of Army Aviation operations. The facilities required will be point-to-point voice and teletype service between army airfields not otherwise served, navigational aids en route and at army airfields, and in some instances, ground-air communication channels. To insure uniformity, the responsibility for installation and operation of such facilities is placed on the Signal Officer, Theater Army Logistical Command, who acts in coordination with appropriate Army Aviation Officers.
- (4) Installation and maintenance functions connected with specialized communication services for railway, highway and pipeline operations, being intersectional in nature, are the responsibility of the Signal Officer, TALOG. He carries out this responsibility in coordination with the Transportation Officer, Theater Army Logistical Command, for railway and highway service, and with the Quartermaster, TALOG, for pipeline service.
  - (a) Railway communications services are provided for each railway operating division and to connect the operating divisions. The requirements are for telephone service between the division dispatcher and each way station, teletypewriter service between adjacent division dispatchers, and voice radio between trains, sections of trains, and switching yards. At each division headquarters, facilities are provided to connect the railway

system into the intersectional service. Operation of the equipment for this service within the military railway system is by personnel organic to the transportation corps Railway Service.

- (b) Military highway communication services are provided for highway regulation and vehicular traffic control along principal military highways. The system is comprised of base radio stations located as necessary along the highway so as to permit continuous radio contact between highway regulation points, vehicles en route, isolated traffic control points, and base stations. Base stations are connected into local or intersectional communications systems as may be most convenient. Signal Corps personnel operate base radio stations.
- (c) Military pipeline communications services are provided for each pipeline district. Requirements exist for telephone service between each district dispatcher and all district pumping stations and teletypewriter service between adjacent districts.

## 51. Automatic Data Processing Systems (ADPS)

*a. General.* Major administrative headquarters, such as TALOG, BALOG, and ADLOG will be equipped with Automatic Data Processing Systems to meet the requirements for fast and accurate data processing. The hardware to perform this function initially will be of commercial design but will be replaced by items of the FIELDDATA family of equipment as these items become available. Those headquarters having a large data processing requirement will organize their data processing capability into an ADPS Service Center. The responsibility for the technical operation of this equipment will be charged to the Staff Signal Officer. Alternate methods must be provided to insure that operations will not be disrupted in the event that the ADPS Service Center becomes inoperative.

*b. Administrative Applications of ADPS.* Functional areas in which Automatic Data Processing Systems can be most effectively applied are supply, evacuation and hospitalization, transportation, and personnel. When applied to these functions Automatic Data Processing serves only as a management tool. Responsibility for the functions remains with the technical service concerned.

*c. FIELDDATA Equipment Family.* The FIELDDATA equipment family is built around mobile general purpose digital computers

and data processing equipment which will operate in a Theater of Operations environment. The equipment will have a high degree of reliability under severe field conditions and is adaptable to a wide variety of applications.

*d. Limitations of ADPS.* Commanders and their staff should be aware of the limitations of an Automatic Data Processing System. The system requires skilled operational and maintenance personnel. Shortage of these personnel will limit the usefulness of the system. Each application requires a thorough and detailed system analysis. The development of detailed operational instructions for the computer requires many manhours. Changes in the type of data to be extracted or changes in the method of processing require reprogramming of the computer and are time-consuming.

## Section III. ADMINISTRATIVE SUPPORT FUNCTIONS

### 52. General

Administrative support provided by the logistical commands will normally involve the functional areas discussed in the succeeding paragraphs.

### 53. Supply

#### *a. General.*

- (1) Supply operations in an oversea theater include all actions and activities involved in the determination of requirements, acquisition or procurement, storage, allocation among users, and distribution to users of all material.
- (2) Requisitions or requests are used to indicate unit needs or requirements. Requisitions may be submitted in the form of formal requisitions, strength reports, status reports, expenditure reports, or other similar means. Requests or reports may be transmitted by electrical or other means. The orderly flow of supplies and equipment through the distribution system is regulated and controlled principally by the proper and timely submission of requisitions and the preparation of supply movement programs.

#### *b. Responsibilities for Supply.*

- (1) The theater commander is responsible for insuring that all forces in the theater are adequately and properly supplied. Generally, each Service is responsible for fur-

nishing its own supply support except as otherwise provided in common and cross-servicing agreements. The theater commander allocates supplies among the Services, if such action is necessary to accomplish the theater mission.

- (2) The U. S. theater army commander is responsible for supplying all U. S. Army forces in the theater and supporting the U. S. Navy, U. S. Air Force, and other forces with Army items as directed by higher headquarters. He delegates responsibility for the operation of the theater army supply system to appropriate major subordinate commanders, retaining responsibility for the preparation of overall supply plans and policies for the guidance of all subordinate commands. His directives establish policies regarding priorities for the allocation of resources among the major subordinate commands of theater army. This is normally accomplished through the issuance of policy directives covering the several classes of supply. However, the allocation of specific items may be required when the nature or critical status of the item or items so dictates. The U. S. theater army commander also arbitrates differences which may arise between major subordinate commands with respect to the provision of supply support, and conducts inspections of the supply activities of these major subordinate commands as required.

- (3) *Theater army logistical command.*

- (a) The TALOG commander is responsible for the determination and submission of theater army material requirements. Forecasts are made in advance to ensure that supplies and equipment can be obtained when required to support planned operations and to maintain authorized supply levels. Responsibility for issuance of broad plans, policy and guidance to the commander, theater army logistical command, and the field armies or army groups regarding supply matters is retained by the U. S. theater army commander. Guidance furnished by theater army includes the phased troop basis to be supported, normal allowance authorizations, project and special authorizations, and reserve authorizations. Review and approval of project requirements is retained by the U. S. theater army commander. In addition,

- he reserves final approval of the balancing of material requirements with lift tonnages made available to him by the theater commander.
- (b) The TALOG commander, is responsible for the timely requisition of supplies from the zone of interior or other sources to support operation and to maintain balanced theater army supply levels. This is accomplished by the technical service staff officers of the theater army logistical command who maintain theater-wide inventory control over supplies of their respective services. The U. S. theater army commander furnishes the commander, theater army logistical command, with information on planned operations in sufficient time to permit acquisition of required supplies by requisition.
  - (c) The TALOG commander is responsible for providing logistical support to the field armies and other designated major commands and to his own command in accordance with the directives and policies of the U. S. theater army commander. He is responsible for establishment and maintenance of the theater army stocks and the operation of the theater army inventory control system. Necessary elements of the theater automatic data processing system are under his control for this purpose. In addition, the commander, theater army logistical command, suballocates supplies between his major subordinate commands, arbitrates differences between them, and provides command supervision over their supply activities.
  - (d) The receipt, storage, and distribution of all supplies, except receipt and distribution of bulk POL, are decentralized to the base and advance logistical command, and area commands operating directly under theater army logistical command. Receipt and distribution of bulk POL by pipeline throughout the theater is centralized in the POL intersectional service which operates under the direct control of the theater army logistical command quartermaster.
  - (e) Supply control and stock control responsibilities are assigned within theater army logistical command as indicated in figure 7.

## (4) *Base logistical command.*

- (a) Although the base logistical command is normally the initial point for the receipt of supplies from CONUS, supplies may be shipped direct from the zone of interior to aerial terminal elsewhere within the theater. Frequently, delivery will be direct to aerial terminals located in the forward areas which will permit by-passing of the base logistical command.
- (b) The ADLOG commander is responsible for supporting designated advance logistical commands. He may be directed to support field army supply installations and area commands operating directly under the theater army logistical command. He also provides supply support to all Army units and designated units of other Services located within the base section.
- (c) The receipt, storage, and issue of supplies within base logistical command is normally performed by technical service (branch) depots. The requirement for reducing vulnerability to enemy nuclear attack dictates maximum exploitation of all existing beaches and water terminals and may result in use of relatively remote or isolated beaches and water terminals. In this event, a small general-type field depot may be established as opposed to the normal use of branch depots. In such cases, the commander of the field depot will become responsible for the receipt, storage, and issue of the supplies entering his depot in the same manner as the commanders of field depots in advance logistical commands. Supply points and direct support technical service units may also be utilized as required for support of units within the base logistical command; these may be a part of a depot.
- (d) Each technical service staff officer in the base logistical command headquarters maintains stock control over the various classes of supply for which he has responsibility as illustrated in figure 7. These technical service staff officers also receive demands from the advance logistical commands, take supply action thereon, and submit stock status data to TALOG as required. Depots of the base logistical command receive, store and issue



supplies, maintain stock control (simple records of the amount and location of supplies on hand) of depot stocks and submit stock status reports to the technical service staff officers in BALOG headquarters as required. (The performance of the aforementioned functions is facilitated by the use of the ADPS equipment available in the ADSOC of BALOG headquarters and in the depot ADPS Service Center).

**(5) *Advance logistical command.***

- (a)** The commander of the advance logistical command is responsible for providing timely and effective support to a designated field army. This support is normally accomplished on a wholesale basis. The commander is also responsible for providing supply support to all Army units and designated units of other Services located in the advance section.
- (b)** The receipt, storage, and issue of supplies within the advance logistical command is normally performed by small general-type field depots. Medical supplies will be stored separately from non-medical supplies as necessary to qualify the medical supplies for protection under the Law of Land Warfare as set forth in FM 27-10. Technical service operating units assigned or attached to field depots provide general and direct supply support to using units within the advance logistical command for all supplies except those normally issued to users by direct support maintenance and supply units.
- (c)** Each technical service staff officer in the advance logistical command headquarters exercises supply for which he has responsibility as illustrated in figure 7. These technical service staff officers also take supply action on extract requisitions received from ADLOG field depots, submit replenishment requisitions to the appropriate technical service staff officer in BALOG headquarters, and submit stock-status data to TALOG as required. ADLOG normally relays demands from the combat zone for classes I, III (bulk), and V supplies in the manner shown in figure 7. The advance logistical command provides supply and maintenance sup-

port for the combat zone and for troops in the advance logistical command area through general-type field depots which are normally provided on a basis of three per supported corps of approximately four divisions. Each field depot consists of technical service supply and maintenance operating units and is responsible for receipt, storage and distribution or issue of all classes of supply. Field maintenance responsibilities of the field depot are described in paragraph 55d. The field depot commander is responsible to the commander, advance logistical command for the ~~supply and maintenance support of a specified segment of the combat zone.~~ The advance logistical command technical service staff exercises technical supervision over field depot operations. Field depots of ADLOG receive requisitions from supported elements, issue supplies in accordance with ADLOG plans and policies, maintain stock control (simple records of the amount and location of supplies on hand) of depot stocks and submit extract requisitions and stock-status data to the appropriate technical service staff officers in ADLOG headquarters as required. (The performance of the aforementioned functions is facilitated by the use of ADPS equipment available in the ADSOC of ADLOG headquarters and in the depot ADPS Service Center). Demands from the combat zone for tonnage supplies (classes I, III (bulk), and V) which have a reasonably predictable rate of consumption are relayed by the field depot through the ADLOG technical service staff to BALOG (classes I and V) and TALOG (class III (bulk) for through-put distribution to the combat zone.

*c. Levels of Supply.*

- (1) Supply levels for oversea commands currently are published in AR 11-8 and AR 710-26. These levels are expressed in "days of supply." After conversion into quantitative units, the supply levels prescribed by higher authority constitute the overall stockage objectives of the U. S. theater army command concerned. The U. S. theater army commander is responsible for the determination of supply levels for subordinate commands

- (theater army logistical command and field armies).
- (2) In establishing supply levels within oversea commands, consideration is given to the following factors:
- (a) The overall levels prescribed for the theater army command by higher authority (these levels are limiting primarily from the standpoint that they represent the maximum stockage authorized. However, stockage at levels lower than those authorized by higher authority would be warranted only when the reliability and promptness of resupply from CONUS are of a high order).
  - (b) The locations of subordinate commands.
  - (c) Applicable order and shipping times.
  - (d) Character and relative importance of the combat missions of the tactical units being supported.
  - (e) The vulnerability of supply installations.
  - (f) The estimated reliability of the resupply capability.
  - (g) Estimated wartime requirements for those types of materiel that receive little or no peacetime usage but which can be expected to experience increased demand under combat conditions.
  - (h) The requirement for mobility.
- (3) The stock level for the field army is set at a level sufficiently low to facilitate required mobility and, normally, it is restricted to items consumed at a reasonably predictable rate. Stocks maintained within field army supply installations include operating levels of class I, and fast-moving items of classes II, III (oils, greases and lubricants), IV, and V on a selective stockage basis to support daily consumption. Reserve stocks of class I and class III (packaged) are maintained for emergency issue only. Normally, major items of equipment other than those kept in maintenance floats are not stocked in field army depots but are obtained directly from depots in the advance logistical command, as required.
- (4) Advance logistical command normally maintains a 15 day level of all classes of supply for back-up stocks of fast-moving field army stockage list items, primary stocks of slow-moving and bulky field army stockage list items, and fringe items authorized in the system which relate to field army maintenance needs. The remainder

of the authorized theater army stocks are normally carried in branch depots of the base logistical commands.

- (5) The number of days of supply committed to a theater supply system can be reduced by increasing the speed with which requisitions are prepared and transmitted and by increasing the speed and reliability of replacement shipments. Similarly, supply levels at various echelons *within* the theater can be reduced by increasing the speed of transmission of requirements, by speeding up the flow of supplies, and by improving reliability of the distribution system. Optimum use of ADPS and modern communications equipment will enhance the attainment of these objectives.

*d. Local Procurement.*

- (1) Procurement from local resources within a theater is utilized to the fullest extent in order to save time and transportation and to conserve U. S. national resources. Whenever possible, supplies such as subsistence, POL, and construction materials should be procured locally. Local supply resources may be exploited through purchase, requisition, or confiscation.
- (2) The U. S. theater army commander retains only minimum functions with respect to local procurement. These functions are generally confined to the establishment of broad plans and policies and coordination with collateral commands and local governments. All other phases of local procurement are decentralized to the theater army logistical command.
- (3) Within the theater army logistical command, local procurement operations are performed by appropriate technical service staff officers. These operations include the determination of requirements, development of sources, preparation of specifications, preparation and dissemination of inspection procedures, and the actual procurement of supplies. Procurement operations of the various technical service staff officers are coordinated and supervised by the director of services, who is also responsible for the preparation of lists of items authorized for local procurement and for the allocation of local supply sources and production facilities among the technical services.

*e. Wholesale distribution.*

- (1) The POL intersectional service distributes bulk POL directly from tank farms in the base logistical command

area to storage tank in the ADLOG area or the field army area.

- (2) Field army requirements and schedules for all supplies, including bulk packaged POL, are transmitted to designated advance logistical command field depots. ADLOG field depots normally fill demands for stockage classes II and IV supplies. Field depots normally relay extract demands to the ADLOG staff for nonstockage classes II and IV items and for tonnage supplies (classes I, III (bulk), and V) for through-put distribution from BALOG. Although the ADLOG field depot at times will ship from their own stocks, they will, to the maximum extent practicable, arrange for the filling of class I, III (bulk), and V requirements of the field army by requesting through routings of these supplies from BALOG, by-passing ADLOG field depots. Requirements for replenishment of stocks in ADLOG field depots are transmitted by the ADLOG headquarters to BALOG headquarters as indicated in figure 7. Transportation for the forward movement of supplies to field army supply installations or divisions is the responsibility of the transportation intersectional service.
- (3) The threat of the administrative support system being subjected to nuclear attack necessitates that provisions be made for the incorporation of alternate supply control centers. These alternate centers are furnished the records and facilities required to enable the supply control system to be reestablished in the shortest possible time.

*f. Retail distribution.* Retail supply support of army and other designated units within the base section is provided by retail issue sections of the technical service depots, general depots, technical service supply points, and technical service direct support maintenance and supply units.

*g. Regulated and Command-Controlled Items.*

- (1) *Regulated items.* Department of the Army publishes lists of regulated items for all technical services which are applicable world-wide. Normally these lists are in the form of supply bulletins. Regulated items are usually scarce from a national standpoint, costly, or of a highly technical or hazardous nature. An item on the regulated items list can be deleted only through action by Department of the Army. The theater commander, through

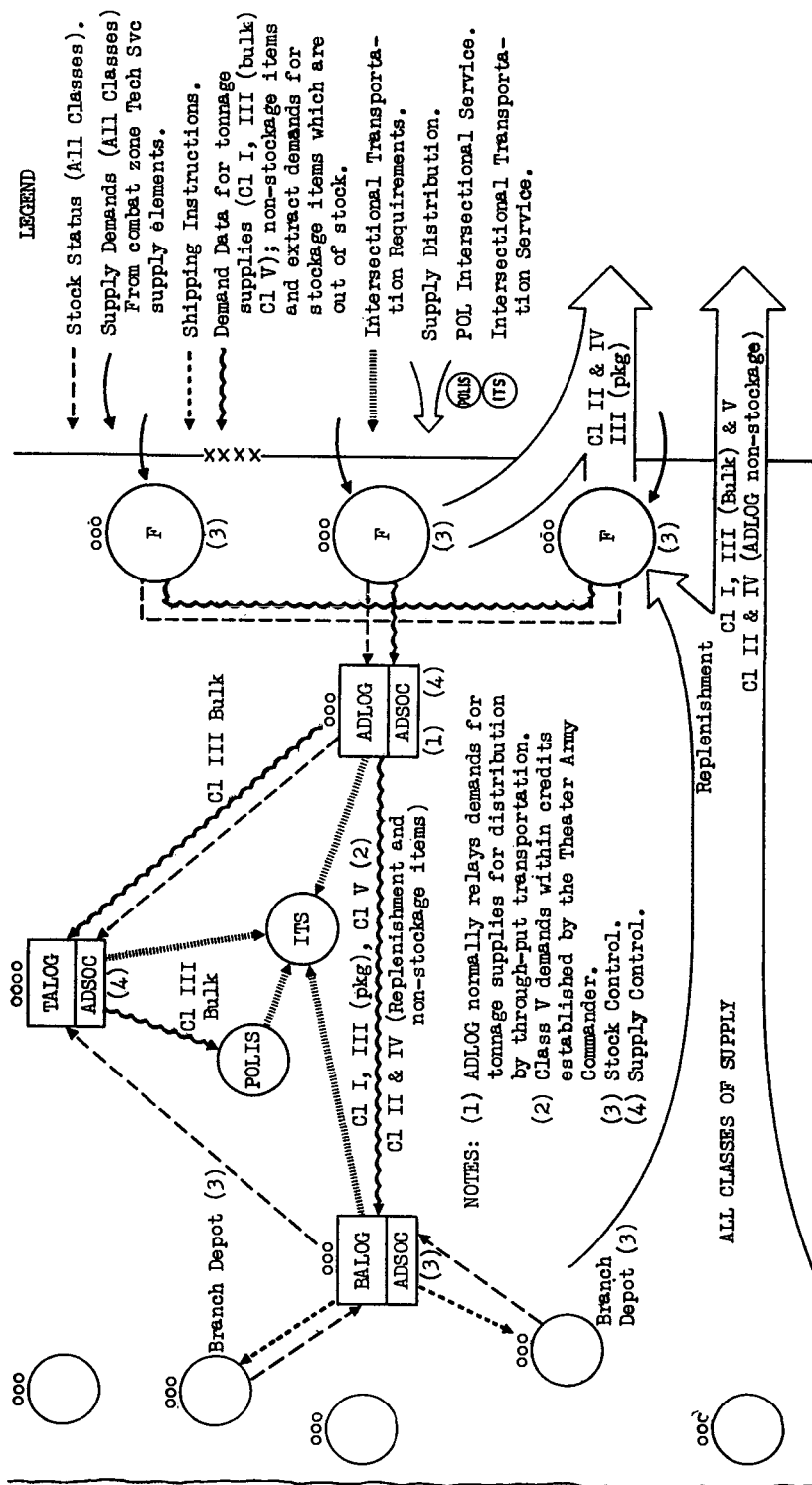

Figure 7. Supply operations in support of the combat zone.

command channels, must exercise close supervision of issues on individual requests to insure proper distribution in accordance with existing priorities. Requisitions for items on a regulated items list must be processed through command channels. Intervening headquarters may recommend the issue priority only for those units under their control. The theater commander will determine at what command levels various items can be approved for issue. For example: certain type regulated office machines could be approved for issue at the field army level while a highly costly, scarce, or technical piece of electronic equipment might require theater army approval before issue could be made.

- (2) *Command-controlled items.* In addition to regulated items, commanders at all echelons may control other items which are in short supply or critical in nature. In so doing they normally publish controlled items lists or directives which require the same general procedures for obtaining such supplies or equipment as for regulated items. Items are put on, or deleted from, locally controlled items lists only by the commander who published the lists. Normally recommendations for additions or deletions to the theater list will be made by TALOG to the theater commander.

#### 54. Transportation

*a. General.* It is normal for theater army to be charged with significant responsibilities for the provision of surface transportation support to air and naval components of the theater forces. The specific details of such responsibilities are subject to joint agreements and the directives of the theater commander. The creation of an efficient transportation system in a theater of operations requires the observance of the following basic principles:

- (1) The transportation service must be organized to accomplish the regulation and operation of the various modes of transportation must be capable of being integrated with each other to accomplish the movement mission. This precludes decentralization to the point where either the various modes of transportation or the transportation networks of separate area commands can be operated without regard for the intersectional transportation requirements.
- (2) The transportation service must serve the theater as a

whole. A high degree of flexibility is necessary in order that transportation capabilities may be diverted, concentrated, or allocated as the strategic and tactical situation demands. Furthermore, such flexibility is essential to insure the continuity of transportation support in the face of enemy attacks. The integration and flexibility required are achieved through centralized direction and means. It is important, however, that the transportation control of the system and decentralized operation of the service in the theater develop its own functional pattern of organization.

- (3) The requirement for centralized control and decentralized operations of a transportation system and the many factors that must be considered in making a decision dictate the utilization of automatic data processing. Each item or piece of data can be proposed, weighted, put into the system, and the system programmed to issue instructions to every element of the transportation network. If it is necessary to adjust an established movements program, the computer can indicate to management which item should not be shipped or which item has next highest priority and should be moved.
- (4) The transportation service must be organized to take full advantage of the modes available. Units operating each mode of transportation are organized into battalions and groups to facilitate operational command of the service. Centralized control and coordination of all modes of transportation and transportation movements are accomplished by the theater army logistical command transportation officer. The transportation activities normally organized in this manner are highway transport, military railway, inland waterway, and transportation movements. Collectively these are considered as the transportation intersectional service.
- (5) BALOG is normally provided with the necessary transportation capability to accomplish its responsibility for the movement of supplies from terminals to BALOG depots. Through-put transportation of supplies from terminals to ADLOG or the supported Field Army is accomplished by the TALOG transportation intersectional service. BALOG, ADLOG and area command requirements for local short-haul transportation is accomplished by transportation units assigned to these commands. Centralized control of this transportation is



accomplished by the staff transportation officer who normally exercises operational control over the transportation units.

*b. Movements.*

- (1) Movements must be controlled and fitted into an integrated overall movements plan to avoid congestion and confusion along the lines of communications, cross-hauls, back hauls, and unnecessarily long hauls, to attain the utilization of transportation equipment and facilities to their full capacity.
- (2) Control of movements is exercised only to the extent necessary to insure accomplishment of required movements.
- (3) The objective of transportation movements is the management of the movement capability to insure that personnel and supplies are moved when required, in the quantities required, and between the point of origin and destination required to support military operations. To accomplish this objective, movements plans must insure—
  - (a) Determination of movement requirements.
  - (b) Determination of capabilities of available transport.
  - (c) Determination of capabilities of actual and potential users to ship and receive traffic by all transportation modes or a combination of modes.
  - (d) The most effective use of all available means of transportation.
  - (e) The expeditious execution of movements authorized by competent authority.
  - (f) The allocation of workloads to transportation units in accordance with their respective capabilities.
  - (g) Close coordination among the various agencies operating the modes of transportation.
  - (h) Coordinated action by shippers, receivers, and air, highway, rail, water, and/or terminal service units.
  - (i) The supervision of movements en route.
  - (j) The use of maximum through-transportation to minimize handling en route to the consumer.

- (4) Following are the agencies involved and their responsibilities:
- (a) Shipping agencies prepare estimates of their future movement requirements; assemble personnel and equipment required to accomplish loading in advance of the arrival of transportation equipment; identify shipments to facilitate movement by transportation personnel; prepare required documentation; load transportation equipment rapidly and in accordance with the requirements of the shipments and of the transport services concerned; confine loading of a transportation unit whenever possible to one commodity consigned to a single destination; load transportation equipment to capacity consistent with operating conditions.
  - (b) Receiving agencies unload and release transportation equipment promptly; accomplish required transportation documentation; provide the personnel and equipment required for unloading upon the arrival of transportation equipment.
  - (c) Air, highway, railway, inland waterway, and terminal transportation units accept movement commitments from personnel authorized to allocate movements capacity; make available the greatest possible movement capacity and operate transportation equipment at the maximum speed compatible with the capacities and limitations of such equipment and consistent with operating limitations imposed by higher authority; conduct and maintain liaison with the appropriate military police organization authority to insure, with regard to highway movements, that highway regulation and military police traffic control are properly coordinated.
  - (d) The theater army logistical command transportation officer allocates movement workload to subordinate transport units in accordance with their capabilities and the types of personnel and supplies to be transported; provides the means for shippers to obtain an allocation of movement capacity by establishing necessary procedures; provides essential information regarding assigned workloads to the transport units; maintains con-

stant liaison with shippers, the transport services, and receiving agencies to insure coordination among these elements and to insure the accomplishment of the transportation mission; conducts continuous studies to develop sufficient movements capacity to meet movements requirements; insure that a continuous movement flow commensurate with movements requirements and capacities is attained; and provides means for the continuity of documentation while supplies and equipment are en route.

- (5) Responsibility for movements functions within the theater army logistical command is discharged by the TALOG Transportation Officer.
- (6) Within the theater army logistical command, the capabilities of all modes of transportation (except petroleum pipelines and terminal commands operating water terminals and beaches in the base or advance logistical command) are determined by the theater army logistical command transportation officer who has operational control over units providing the transportation inter-sectional service.
- (7) The theater army logistical command transportation officer is responsible for effecting movements into the combat zone and retains operations control of the inter-sectional transport services to their most forward point of delivery. Coordination of movements is effected as necessary with the transportation officer of the field army.
- (8) Requirements for transportation are furnished the theater logistical command transportation officer by all using agencies. These requirements are forecast as far in advance as practical in order that the transportation movements organization of TALOG transportation staff may prepare a movements plan. Through matching the movement requirements with transportation capabilities, a movement program is developed which will provide an efficient and effective transportation service. A movement program is an instrument by which shippers, receivers, and transport services are advised of the scheduled daily movements. To be practical, this movement program must be limited to a period of time sufficiently brief so that changes will be minor.

- (9) The movement program is a regulator of transportation. It is not self-implementing. Transportation equipment for each movement must be requested by the shipper through the transportation movements organization in the field. For those movements not contained in the movement program, a request must also be submitted through the transportation movements organization. In turn, the movements personnel will obtain an allocation of transportation capability. Such nonprogramed requests will be allocated transportation, if justified, and at that time will be handled in the same manner as a programed move.
- (10) Transportation movements personnel in the field exercise no command authority over any of the transport services. Their primary function is to act as agents for the users and operators of transport services and for the transportation movements services and for the transportation movements staff. They insure that the relationship between users and operators is so coordinated that the movement programs, directives, and policies of higher commands are complied with, and that maximum utilization of movement capability is obtained from available facilities and equipment. They may serve a single installation or they may serve a group of installations, depending on the workload generated and availability of communications. They are placed in the field to assist the transportation officer of the theater logistical command in his capacity as program director in discharging the following responsibilities:
- (a) Planning and programming transportation movements.
  - (b) Accomplishing movements.
  - (c) Establishing such regulatory measures as may be required in order to accomplish the mission.
- (11) Air, truck, rail, pipeline, and inland waterway transportation will be used as available in an integrated system of transportation.
- (12) Movement plans of the transportation officer, theater army logistical command, must anticipate serious dislocations of service by nuclear attack in one or more transportation systems, and must provide alternatives which integrate combinations of transportation capabilities to satisfy movement requirements. Movement plans

must provide a control system which will respond immediately to remedy the effects of breaks in the transportation systems. Regardless of the method of transportation employed, each shipment must be planned in such a manner that its loss will not create a critical shortage of any one item of supply.

- (13) The theater army logistical command transportation officer requests the director of services to establish priorities or allocate additional means when a shortage of transportation exists in the transportation intersectional service.
- (14) Procedures for preparation and use of transportation documentation for shipment and control of supplies and personnel en route should be uniform and contained in a command directive. Transportation documentation is prepared by the shipper at the point of origin. When a shipment is transferred from one mode to another, the shipment should proceed on its original documentation. However, when the transfer requires the splitting of a shipment, originally listed on one transportation document, new documentation will be required. New documentation must cross-reference the original document so that the shipment identity will be preserved. Distribution of transportation documentation is the responsibility of the transportation officer at the point of origin.

*c. Terminals.*

(1) *General.*

- (a) A terminal is essentially a transfer point, rather than a terminus, for traffic. Its operation must, therefore, be kept as fluid and flexible as possible. The terminal is a point at which cargo or personnel is transferred from one mode of transportation to another. The facilities through which these operations take place should not be used as warehouses except under the most exceptional circumstances.
- (b) The mission of a terminal is to—
  1. Control, operate, and maintain terminal facilities.
  2. Accomplish the physical handling of all cargo within the terminal, including the loading and unloading of vessels, rail cars, trucks, and other types of cargo conveyers.

- (c) Rail, highway and inland waterways terminals are operated by the transportation intersectional service units. Water and beach terminals are operated by the appropriate base logistical command or advance logistical command. Pipeline terminals are operated by the POL intersectional service.
- (2) *Water terminals and beaches.*
- (a) Water terminals and beaches are the means of entry into an oversea theater of operations for the bulk of materiel and personnel required in the conduct of a military operation. The base logistical commander (or advance logistical commander, if appropriate) is responsible for overall control and operation of all water terminals and beaches, to include anchorages, piers, wharves, aerial tramways, hardstands, and transient facilities and areas incidental thereto.
- (b) The theater army logistical command transportation officer in coordination with the base or advance logistical command(s), determines the specific water terminals and beaches to which vessels will be assigned for unloading. Whenever possible, vessels are berthed at the water terminal or beach which will minimize congestion of the transportation net and utilize the most direct means for shipment of the cargo to its destination.
- (c) The arrival of shipping at water terminals must be controlled to minimize ship concentrations and possible loss of shipping by enemy attack. The discharge and loading of ships at water terminals should take place at dispersed points within the area so as to minimize the loss of ships, personnel, and cargo as a result of enemy attack. Rapid terminal clearance must be emphasized, and depots and other installations not essential to actual terminal operations should not be established in these areas.
- (d) Terminal commands of the base or advance logistical command(s) actually operate the water terminals and beaches. The responsibility for discharging all shipping and clearance of this cargo from the terminal area is accomplished by these terminal commands.

- (e) Representatives of the BALOG transportation officer notify receiving BALOG depots of the movement of cargo from the water terminals and beaches.
  - (f) In the development and operation of the water terminals and beaches, the BALOG transportation officer effects coordination with the following agencies:
    - 1. Theater navy for transmission of berthing and vessel dispatch instructions.
    - 2. The engineer of the base logistical command for water terminal and beach construction and development and for the clearing of harbors.
    - 3. All technical service staff sections of base logistical commands for notification of the arrival of cargo and the evacuation of materiel from the theater.
    - 4. The surgeon of base logistical command for the evacuation of patients.
  - (g) Vessels loaded in the zone of interior are covered by manifests which document the entire cargo aboard. The port of embarkation dispatches the manifests to headquarters, theater army logistical command, to insure receipt in the theater prior to the arrival of the cargo. The transportation officer, theater army logistical command, in coordination with the operational staff divisions at headquarters, theater army logistical command, and with the base or advance logistical command, as appropriate, determines the location(s) where the cargo is to be discharged. The manifests are assembled into sections by technical service and class of supply for distribution to the agencies concerned.
- (3) *Air terminals.*
- (a) The theater army logistical command commander is responsible for the control and operation of Army functions at air terminals. These include facilities, army units, and equipment available or provided for the supply, transportation movements management, and loading and unloading aspects of Army air transport operations, and the submission of manifests to interested technical

service units of the advance and base logistical commands for cargo destination instructions based on previously established priorities. The Air Force is responsible for loading and unloading Army cargo transported by Air Force aircraft.

(b) Army functions discharged at air terminals by transportation movements personnel of the transportation intersectional service units include the following:

1. Calling personnel and cargo forward to meet regularly scheduled flights.
2. Clearing Army cargo from the air terminal.
3. Insuring that Army cargo moves in priorities assigned.
4. Providing means for continuity of transportation documentation.
5. Liaison with the Air Force.
6. Coordinating patient evacuation movement with appropriate command surgeon.

(c) Air terminals may be located within area commands intermediate between the base and advance sections. If the size of the operation warrants, a transportation terminal command may be established to handle this operation. Air terminals may also be located in the advance section.

(4) *Inland terminals.*

(a) Inland terminals are those inland intransit points where supplies are—

1. Transferred from one mode of transportation to another.
2. Held temporarily while tractor-trailer interchange and driver relief are effected.
3. Collected from other points to make up a transportation unit for reshipment.

(b) Responsibility for the operation of inland terminals is discharged by the transportation intersectional service units.

*d. Rail Service.*

(1) Operation of the theater army railway system is a responsibility of the military railway intersectional service under technical direction and operational control of the theater army logistical command transportation officer.



- (2) The operation of the system requires that the transportation intersectional service railway unit—
  - (a) Determine and coordinate schedules.
  - (b) Issue regulations for loading cars.
  - (c) Prescribe standards of maintenance for tracks and equipment.
  - (d) Maintain records of the various types of cars and motive power in order to insure its proper distribution to meet peak demands.
  - (e) Supervise or coordinate the functions of those railways operated and maintained by local civilians in the support of military operations.
- (3) The construction and major rehabilitation of military railway right of ways are responsibilities of the engineer units of the base and advance logistical commands and separate area commands. Operational maintenance of the military railway right-of-way is the responsibility of the transportation military railway intersectional service units.
- (4) The maintenance of railway operating equipment is a responsibility of the theater army logistical command and is discharged by units of the transportation military railway intersectional service. It includes—
  - (a) Motive power (locomotives).
  - (b) Rolling stock (passenger, tank, and freight cars).
  - (c) Special equipment, such as pile drivers, cranes, and railway maintenance equipment.
- (5) Rail transportation systems present profitable and vulnerable targets at materiel and personnel transfer points such as marshalling yards and large railroad terminals. the crowding of such facilities with rolling stock must be avoided. Tunnels, deep cuts and fills, and bridges are particularly vulnerable. Plans must be prepared for restoring, rerouting, or substituting alternate types of service in the event of successful enemy attacks against these critical points.

e. *Highway Service.*

- (1) The TALOG transportation highway intersectional service is responsible for controlling and operating a general hauling service comprising a pool of military motor vehicles. These vehicles are engaged in theater army-wide support and are not assigned to subordinate commands.

- (2) The transportation highway intersectional service command unit formulates and coordinates plans for the utilization of the services' motor transport resources and provides for the integration and supervision of the operation of indigenous highway transport facilities used in the administrative support of military operations.

*f. Inland Waterways.*

- (1) The transportation inland waterway intersectional service units are responsible for the operation of all military inland waterway systems throughout the theater, with the exception of those waterways which have both their point of origin and point of termination in the combat zone.
- (2) Terminals operated in support of the inland waterway system are the responsibility of the transportation intersectional service units.

*g. Air Transportation Service.*

- (1) Based upon the requirements stated by using agencies, the theater army logistical command requests the theater army commander to make necessary airlift available for administrative support operations. Allocation of lift capacity to the theater army logistical command is made by theater army headquarters.
- (2) Movement of army cargo and passengers, except medical evacuees, to and from airfields is the responsibility of the theater army logistical command transportation officer.
- (3) Relationships with users of air transportation service and the required coordination between elements of the theater army logistical command and field armies are the responsibility of the transportation officer, theater army logistical command.
- (4) Coordination with the Air Force on flight schedules, space at airfields, etc., is accomplished directly between the transportation intersectional service units and the designated Air Force representative.

*h. Pipelines.*

- (1) The operation of pipelines in the theater is a responsibility of theater army logistical command. This responsibility is discharged by the POL intersectional service under the operating control of the theater army logistical command quartermaster. Construction of pipelines

and related facilities is accomplished by the TALOG Engineer.

- (2) The POL intersectional service operates bulk petroleum dispensing equipment; operates off-vessel discharging and loading bases, including dock manifolds; and arranges for the transmission of bulk petroleum products through the pipeline system.
- (3) The theater army logistical command transportation officer, in coordination with the TALOG Quartermaster, provides for all movements, except by pipeline, of bulk petroleum products, including the scheduling of shipments where necessary with the Navy (Military Sea Transportation Service), the Air Force (Military Air Transport Service), and commercial agencies; and provides railroad, highway, and inland waterway operating services to implement approved plans for the supply and distribution of petroleum products. Packaged products are handled through the depot system.

## 55. Maintenance

*a. Definition.* Maintenance is the care taken and work done to keep any item of materiel or equipment in specified serviceable condition. Thus, maintenance of materiel includes inspection, testing, servicing, classification as to serviceability, repair, approved modification, and reclamation. Maintenance is a service provided to reduce requirements for new resupply items to a minimum. Thus the requirements of supply dictate the priority of the maintenance effort.

*b. Command Maintenance Responsibilities.* It is the responsibility of all commanders to enforce maintenance discipline and it is imperative that all maintenance procedures be guided by the principles of supply economy. Aggressive and positive actions will be taken to insure that combat effectiveness is retained without expensive and unnecessary over maintenance of equipment.

*c. Technical Service Responsibilities.* Within the army in the field each technical service having supply and maintenance responsibilities fulfills them with supply and maintenance units organized under appropriate Tables of Organization and Equipment. These units are so organized as to provide the supply support and the maintenance effort required by the army in the field. Within the command structure supply and maintenance battalions contain direct and general support Supply and Maintenance (S & M) companies for employment in the field army area. Depot companies and other specialized units, as well as direct

and general support S & M companies, are provided when the battalions are employed in the theater army communications zone. Direct and general support S & M companies carry specified levels of supply (end items, components and repair parts) and contain those maintenance skills required to accomplish assigned supply and maintenance mission. The technical service direct support supply and maintenance units are the using units' source contact for all supplies and for all maintenance support beyond that authorized to be accomplished by the using unit.

*d. Field depot responsibilities.* Within ADLOG, the field depot is responsible for furnishing both maintenance and supply support for a specified portion of the combat zone. Each field depot is provided maintenance and supply units of each technical service who receive, store and issue classes II and IV supplies, and perform field maintenance of their respective service supply items.

*e. Interrelationship of Maintenance and Supply.* Planning for supply and maintenance must be concurrent, closely integrated, and realistic with respect to current consumption rates. An inadequate maintenance organization imposes an increased requirement on the supply system. Conversely, the inability of the supply system to replace unserviceable items of equipment requires greater maintenance effort within the theater in order to return a larger portion of these items to the distribution system. The extensive damage and destruction of equipment which will result from enemy nuclear attack dictates the placing of special emphasis upon the interrelationship of maintenance and supply. Proper maintenance of equipment increases its period of economical usefulness, reduces supply requirements for new replacement equipment, and conserves funds and other resources for other purposes. Technical services with supply missions depend heavily upon maintenance to repair and recondition unserviceable material for return to user, return to stock, and (to a lesser extent) to fabricate parts.

*f. Categories of Maintenance.*

- (1) *Organizational maintenance.* Organizational maintenance is that maintenance which is authorized to be performed by, and is the direct responsibility of commanders of, organizations using the equipment. It includes preventive maintenance and minor repairs performed by individual users and crews and by specially trained personnel of the using organization.
- (2) *Field maintenance.* Field maintenance consists of direct support maintenance and general support maintenance.

(a) *Direct support maintenance.* Direct support maintenance is that maintenance performed by specialized technical service maintenance and supply units operating in close support of using organizations. Its principal function is the repair of equipment for return to users or the issue of a replacement item.

1. Direct support maintenance for theater army logistical command units and designated units and installations of other commands located in the theater administrative zone is provided by the respective technical service units of the base and advance logistical commands, or area commanders operating directly under the theater army logistical command.

2. When a direct support maintenance and supply unit cannot repair an item within a reasonable period of time, a replacement item is immediately issued to the using organization on a direct exchange basis. Direct support maintenance and supply units carry a small stock of replacement exchange items for this purpose. Items requiring maintenance beyond the capabilities of direct support units are evacuated to the nearest general support facility of the appropriate technical service units.

3. An additional, but important service, provided by direct support maintenance and supply units is technical assistance and the instruction of personnel of using units in the performance of organizational maintenance. This service, if aggressively carried out, enables unit commanders to maintain their equipment in acceptable standards of serviceability and materially reduces the workload of higher echelons of maintenance.

(b) *General support maintenance.* General support maintenance is that maintenance performed by specialized technical service maintenance units operating in support of direct support maintenance units. Its principal function is the repair of equipment for return to stock and distribution of equipment and repair parts to direct support units.

1. General support maintenance for theater army logistical command units and designated units and installations of other commands located in the theater communications zone is provided by the appropriate technical service units of the base and advance logistical commands.
  2. General support units of the advance logistical command receive unserviceable equipment which is beyond the repair capabilities of field army maintenance units. Equipment requiring echelons of repair assigned to general support units is assembled in collecting points, classified and shipped to general support maintenance units for repair. General support repair for return to user is performed only in special cases involving critical operational requirements.
- (3) *Depot maintenance.* Depot maintenance is that maintenance performed by specialized technical service maintenance units and consists principally of the complete reconditioning of equipment for return to depot stocks.
- (a) Because it requires relatively fixed installations, depot maintenance, if performed in the theater, is confined to the base logistical commands. This echelon of maintenance is the responsibility of the base logistical command technical service units. It is performed by depot maintenance units assigned to the base logistical commands, or by contractual arrangements with civilian concerns, or both. Materiel repaired in depot maintenance is returned to stock through technical service supply channels. Depot maintenance is curtailed in over-sea areas in time of war.
  - (b) Materiel of a highly technical nature, the repair of which requires skills and facilities not available in the theater, is evacuated to the zone of the interior, in accordance with policies established by Headquarters, Department of the Army.
- (4) The categories listed above are not synonymous with the echelons of maintenance described in appropriate maintenance allocation charts. Organizational maintenance for many items of equipment may encompass the first through the fourth echelon; direct support maintenance may perform second through fourth echelons; and

general support at times includes third through fifth echelons. The maintenance criteria developed by the chiefs of technical services for each item of equipment and contained in the maintenance allocation charts provide Department of the Army guidance for the Theater Army Maintenance Support Plan. This plan will assign echelons by item to organizational, direct, general support maintenance units as well as stipulate what specific repairs will be performed by units at depot maintenance level.

*g. Objectives of Maintenance.* The objectives of maintenance include the prevention of equipment failure by timely and adequate preventive maintenance service in using organizations; the early detection and correction of incipient or actual equipment failure at the lowest practical echelon of maintenance; and the maximum reduction of requirements for new equipment, consistent with the tactical situation and the economical use of manpower, supplies, and transportation.

*h. Principles of Maintenance.*

- (1) Direct support maintenance is performed as far forward as is consistent with the tactical situation, the time available, the capabilities of personnel, and the availability of repair parts and tools. It is often more desirable to move maintenance personnel to the equipment than it is to move the equipment to maintenance personnel. To satisfy this requirement, on-site repair service may be provided with repair parts and special equipment.
- (2) Each field maintenance unit is authorized a supply of maintenance exchange stocks (major items), repair parts, assemblies, and tools commensurate with its maintenance responsibilities. No echelon performs the work of a higher echelon to the neglect of its properly assigned functions.
- (3) Maintenance units are disposed laterally and in depth to offer the best possible service to the equipment being supported, consistent with the dispersion required by the threat of enemy attack. Maintenance units remain sufficiently close to the units being served to enable them to provide direct support.
- (4) General support maintenance units are dispersed laterally and in depth in close relationship with the direct support units which they support. This dispersion of general support units must be consistent with reduced



transportation requirements for the evacuation of un-serviceable equipment as well as the resupply of serviceable equipment. The displacement and dispersion of general support maintenance units must be consistent with the threat of enemy attack and their vulnerability to destruction by nuclear weapons.

- (5) Repair parts and supplies directly related to maintenance will be distributed through technical service maintenance and supply units from branch depots in the Base Logistical Command area. Issues of these items to using units will be made by maintenance units with direct support maintenance responsibilities.
- (6) Heavy maintenance shops and facilities, once established, remain in operation in the same locality as long as practicable without sacrificing service to supported units.
- (7) A system of recovery and evacuation is established for the equipment of each technical service. This system permits the evacuation of an item from the using unit to the echelon at which it may be repaired and returned to the user, repaired and returned to depot stocks, or salvaged. In the instance of items having high scrap value, the ultimate destination may be the zone of interior. The employment of mobile repair parties constitutes a departure from the evacuation procedure. When time is essential and personnel, tools, and equipment are available, these mobile repair crews may be sent forward to make on-the-spot repairs.
- (8) Organizations and DSU's must be expected to be the sole source of maintenance under certain conditions of nuclear or rear area attacks. What cannot be repaired without general support assistance will be made serviceable by cannibalization or evacuated.

*i. Plans, Policies, and Procedures.* The technical service staff officers of theater army, under the general staff supervision of the G4, recommend broad plans, policies, and procedures for the maintenance and repair of materiel in theater army. After approval by the theater army commander, these plans and policies are published in the form of theater army maintenance directives. Theater army technical service staff officers exercise staff supervision over the execution of theater army maintenance directives, and insure that these directives are followed.

*j. Maintenance Management.* Every technical service staff officer charged with a responsibility for maintenance must continuously balance requirements against resources. The decision



of when to evacuate an item and to whom it should be evacuated must be prescribed for every unit. The "who" and "when" can be determined on a recurring basis as equipment densities, maintenance support strength, parts availability and the tactical situation vary.

*k. Inspect and Repair Only as Necessary (IROAN).* The Inspect and Repair Only as Necessary (IROAN) concept which has recently been adopted for the overhaul of vehicles (AR 750-2300-8) will be the goal at all echelons of maintenance for all types of equipment. This requires the continued use of all functional parts, regardless of evidence of wear, to the maximum limits of their designed life. Likewise, equipment components and assemblies that perform effectively and satisfactorily will be retained in service and not disassembled in a search for defects that may not exist.

*l. Theater Army Maintenance Requirements.* Theater army technical service staff officers determine the maintenance support requirements of theater army, recommend the allocation of maintenance units to major subordinate commands, formulate broad plans for the provision of support, and provide staff supervision over the execution of these plans. Overall coordination and supervision are the responsibility of the theater army G4.

*m. Salvage and Cannibalization.* The salvage of recoverable items of mechanical equipment is accomplished only at the general support and depot maintenance levels. Determination is made in consonance with policies established by field army and TALOG and its subordinate commands. At direct support units and higher support levels nonstockage list items are obtained by recovery from unserviceable uneconomically repairable major items on hand to the maximum possible extent. Maintenance effort is not expended on disassembly of unserviceable major items and return of their serviceable components to stock unless there is a demonstrable need for the items in the supply system.

*n. Movement of Materiel.* Maintenance units are assigned responsibility to determine the need for evacuation, or movement of materiel throughout the maintenance system. The actual movement of materiel will be accomplished by any means available, including the transportation intersectional services and organic recovery and evacuation equipment.

*o. Command and Technical Maintenance Inspections.* Technical service units, under the ADLOG, BALOG, and area command technical service staff officers, perform technical maintenance inspections and assist in command maintenance inspections within the theater army logistical command.

## 56. Construction

*a. General.* The term construction embraces, but is not limited to, the following activities: construction, maintenance, repair, and rehabilitation of structures, roads, pipelines, inland waterways, railroads, airstrips, roadblocks, defensive works, and utilities.

*b. Impact of Construction upon Military Operations.*

- (1) Construction capability is a major factor in maintaining the mobility of field armies. The ability to concentrate construction means rapidly to overcome obstacles created by nature, or by enemy action, provides the U. S. armies in the field, including their administrative support, increased mobility.
- (2) Tactical and administrative support concepts for nuclear warfare include increased mobility and dispersion of forces and installations. These concepts have a direct influence on the type and scale of construction provided in the theater of operations. The following are some of the considerations imposed by nuclear warfare on construction support:
  - (a) The construction of shelters for the protection of critical installations, personnel, and supplies from the effects of nuclear weapons, including radioactive fallout.
  - (b) Extensive camouflage of critical administrative support installations.
  - (c) An increase in minimum essential static anti-aircraft and antimissile defense installations for essential areas.
  - (d) An increase in the construction of secondary and access roads to serve dispersed installations and facilities.
  - (e) An increase in requirements for the provision of minimum essential multiple transportation facilities to include airfields, beaches, and obstacle crossing sites.
  - (f) Increased demands for indigenous construction labor in dispersed areas.
  - (g) An increase in the requirements for MSR construction.
- (3) The nature of the conflict and the operational environment are the major factors in determining the theater construction policy.

*c. Responsibility for Construction.* Broad plans and policies for construction in the theater are established by the theater commander. They are based on coordinated planning by construction representatives of theater army, navy, and air forces. The theater army commander establishes policies, standards, priorities, and scales of construction in accordance with the base development plan for his subordinate echelons based upon recommendations of the theater army engineer. In turn, the theater army engineer furnishes staff supervision in the execution of theater army construction directives pertaining to all aspects of construction. The commander, theater army logistical command, is responsible for army construction throughout the theater communications zone. He exercises this responsibility through the commanders of the base and advance logistical commands and separate area commands.

*d. Planning and Supervision.*

- (1) Within U. S. theater army headquarters, planning and staff supervision of engineer construction is the responsibility of the theater army engineer. Major staff coordination is effected with the theater army G4, and liaison with the Air Force is also effected for requirements, acquisition, priorities, and materials. Plans for construction are based upon requirements generated at subordinate echelons. Only very broad planning guidance, theater army-wide in scope, is initiated by the theater army engineer. He exercises his staff responsibility through technical channels by the exchange of information, and through command channels in the form of orders and directives. Based upon current plans, the availability of both military and civilian construction supplies, the availability of civilian labor and construction capability, and the approved priorities for construction, the theater army commander allocates construction troops and materials to subordinate echelons.
- (2) The commander, theater army logistical command, is responsible for planning the construction required by army units located in the theater communications zone. He is assisted in this planning function by the commanders of the subordinate base and advance logistical commands and separate area commands. The theater army logistical command commander is responsible for utilizing the construction means available to him in accordance with the broad plans, policies, standards, and scales established by the theater army commander. He assists the field army construction effort, to the maxi-

mum extent possible, in accordance with policies and practices established by the theater army commander.

- (3) Interzonal construction requirements common to the accomplishment of the missions of both the combat forces and the theater army logistical command is normally accomplished by the theater army logistical command commander through the commander(s) of the appropriate supporting advance logistical command(s). The field army engineer coordinates directly with the engineer of the supporting advance logistical command.
- (4) Area commands operating directly under the theater army logistical command are responsible for construction within their area of responsibility on a basis similar to that of a base and advance logistical command commander within the base or advance section.

## 57. Labor

### a. General.

- (1) The labor function of administrative support includes the use of personnel resources within theaters of operations to further the military effort. The labor function is normally concerned with the procurement, management, and utilization of labor available from military service units, allied civilians, U. S. civilians, prisoners of war, enemy civilians, refugees, and displaced persons.
- (2) The need for manpower in modern warfare requires top level decisions to establish and maintain the proper balance between the Army Forces and the productive forces of a nation. Technological ability to wage war is exceeding the capacity to deliver the implements of war to the fighting front. Because of limited manpower resources and to assist in rehabilitation of occupied areas, commanders are responsible for mobilizing and utilizing civilians to the maximum extent feasible for the performance of tasks not concerned directly with combat operations.

### b. Current Policies and Considerations.

- (1) *Sources.* In a theater of operations, labor normally is available from quartermaster service units, allied civilians, U. S. civilians, prisoners of war, enemy civilians, refugees and displaced persons. Labor is both static and mobile and includes professional and skilled, as well as unskilled, personnel.
- (2) *Planning.* To release as many military personnel as

possible for combat duties, plans must make maximum use of all sources of labor consistent with operational and security requirements. Planning for administrative support of combat forces must provide for the maximum utilization of all categories of labor to effect manpower economy. Planning for operations in any geographical area must include an estimation of the available non-military manpower and its utilization for the support of the combat forces to reduce manpower requirements for service support operations.

- (3) *Type B units.* Type B units are quasimilitary organizations which conserve manpower and provide a uniform method of integrating non-U. S. military personnel into a work force. They utilize personnel other than military to fill noncritical spaces in the unit. Such units are composed of the necessary equipment and a qualified military cadre. They normally are provided administrative support by U. S. forces. The scale of pay and extent of support are determined by the theater commander.
- (4) *Impact of nuclear warfare on availability of local labor.* The civilian population of an area may be considered by the enemy as a possible target for mass destruction weapons. The employment of, or threat to employ, nuclear weapons may cause panic in the civilian population. The effect could well be to decrease the civilian support of military operations. Maintaining a local civilian labor force may be complicated by civilians avoiding probable target areas, such as troop concentrations and critical administrative support installations. It may become necessary to furnish limited U. S. engineer support to civilians. Mobile labor forces may be required to provide for emergency support of such critical military installations. However, local labor is employed to meet "on site" requirements insofar as practicable.
- (5) *Law of Land Warfare.* The United States is a party to the Geneva Conventions of 1949 relative to the treatment of prisoners of war and the protection of civilian persons in time of war. Provisions of these treaties pertaining to the employment of prisoner of war labor are contained in FM 27-10. Guidance on the employment of nonrepatriated persons is contained in FM 27-10.

*c. Responsibilities.*

- (1) The theater commander is responsible that combat effec-

tiveness and overall military efficiency are not diminished by employing military personnel for work which can be performed by other sources. Responsibilities related to local civilian labor include agreements with the national government concerned; procurement, transportation, contracts, accounts, and records; administrative support in in some areas; establishment of rates of pay and working conditions; medical arrangements; and the organization and administration of labor companies and pools. The theater army logistical command commander implements the established policies and applies them to Army operations. He may be required to provide the Air Force and the Navy with certain service in connection with the utilization of civilian employees.

- (2) The base logistical command commander arranges with local governments concerning procurement and distribution of labor, publication of detailed uniform wage scales, and conditions of employment. Initially these arrangements may be made by using services and units under announced theater policies, but should be centralized as early as practicable in the major areas concerned. Administration and supply are decentralized to using units under the guidance of an overall policy from the theater army commander. In any case, the responsible agency coordinates with the civil affairs authorities on the overall policies for procurement of civilian labor and makes the necessary contact with civil authorities for local procurement.
- (3) At base and advance logistical command headquarters the director of personnel is charged with the responsibility for the development of policy, organization, and procedures for the overall employment of all types of labor, to include the allocation of labor to subordinate units.
- (4) The directors of civil affairs at base and advance logistical command headquarters are responsible for the development of policy for the procurement of civilian personnel and coordinate with local officials in all matters pertaining to civilian labor.
- (5) The provost marshals of the base and advance logistical commands are responsible, through the M. P. POW Command, for organizing prisoners of war into labor units and for guarding them at all times, except when they are being employed as laborers outside the prisoner of war enclosure. The using units furnish necessary guard

augmentation for prisoners of war while they are employed as laborers.

- (6) When labor pools are organized, the Quartermaster Corps normally is responsible for their operation. However, any technical service may be given this responsibility. Labor pools can be employed efficiently at installations such as ports, depots, and rail terminals. When labor pools are utilized, all unskilled labor including military, civilian, and prisoners of war sources should be included in the total availability of labor.
- (7) Staff supervision of U. S. civilian personnel employed in oversea theaters is the responsibility of the personnel officer in the headquarters of the employing organization. Normally, such personnel are skilled laborers and are not included in a labor pool.

## 58. Medical Evacuation and Hospitalization

### a. *General*

- (1) The mission of the theater army medical service is to contribute to the maintenance of effectiveness of all supported forces. Its major effort is directed toward the evacuation and hospitalization of patients from the field armies, and the provision of medical supplies to that force. A second requirement is that of providing complete medical service to administrative support and other U. S. Army troops in rear of the battle area.
- (2) Medical service is continuous. It is interzonal and inter-sectional in character, interzonal in the respect that the efficiency of its operation depends upon the coordination established and maintained between the medical services of the combat and communications zones, and inter-sectional in that treatment of fixed hospitals and the evacuation of masses of casualties in the communications zone normally cannot be limited to sectional boundaries. Although it is normal in a large theater to decentralize operations to the section (ADLOG and BALOG) commanders, it is essential that adequate control of such operations be exercised by the commander, theater army logistical command. Decentralization of control of medical operations to ADLOG and BALOG commanders is normally limited to those activities which do not inhibit the operation of the medical service of the theater army logistical command as a whole. The commander, theater army logistical command, normally retains central control of construction standards for fixed hospitals; the



general location, relocation, opening and closing of fixed hospitals; and the mass evacuation of casualties without regard to sectional boundaries.

- (3) Normally, the surgeon, theater army logistical command, is authorized operational control of all medical units of the theater army logistical command which are not assigned or attached to an advance logistical command, a base logistical command, or other subordinate command.

*b. Evacuation and Hospitalization.* The evacuation of patients from the combat zone and their treatment within the theater communications zone is a responsibility of the commander, theater army logistical command. The system for evacuation and hospitalization must be designed as an integrated system to relieve combat units of their sick and wounded, and return such personnel to duty status as rapidly as possible.

- (1) *Evacuation.* Evacuation planning must anticipate and provide for utilization of alternate transportation means. Maximum use of aircraft should be made. The extent of reliance on air evacuation must be tempered by the susceptibility of this means to interruption by weather, enemy action, or reallocation. Ground means of evacuation must be available and medical facilities so disposed as to permit continuous medical service. Close coordination must be maintained between the surgeons of logistical commands and the surgeons of supported elements. This coordination normally is maintained through the establishment of medical regulating sections by the command surgeons concerned. (See FM 8-10.)
- (2) *Hospitalization.* The extent to which hospitalization is provided in the theater army logistical command is dependent, in large measure, upon the facility with which patients can be returned to duty status and upon the reliability of evacuation from the theater army logistical command. The period of time elapsing between the discharge of a patient from a hospital and his return in the combat zone is obviously greater when the hospitalization is provided in the zone of interior rather than in the theater of operations. If this time differential is substantial and the differential in the logistical cost to the theater is acceptable, a sufficient number of hospitals should be assigned to the theater army logistical command to permit the treatment and return to duty of a greater percentage of patients within the theater. This factor may have an effect, depending upon the intra-



theater transportation available, in echeloning general hospitals forward in the theater communications zone. If evacuation from the theater army logistical command is not reliable, sufficient hospital capacity must be provided to absorb the number of patients accumulated as the result of any interruption in the system. Medical units in direct support of the field armies must remain as mobile as the field armies they are supporting, and should therefore be limited to field (or evacuation) hospitals and holding companies. General hospitals should, as a rule, be disposed in the rear areas because of the time required for preparation and the relative permanence of their installations. Where lines of communications are extended, and ground evacuation is relied upon, general hospitals should be echeloned forward as soon as practicable. The geographical grouping of general hospitals as hospital centers promotes efficiency of operation. However, unless the commander has reasonable assurance that such centers will not be subject to attack, adequate dispersion between hospitals making up the center should be maintained to avoid presenting to the enemy a lucrative nuclear target.

- (3) *Flexibility.* The theater army logistical command must provide the requisite degree of flexibility for its own operations as well as for those of the field army medical service. While subject to great fluctuation in patient input, the latter can meet an increased influx of patients only by evacuating a greater portion of them to the theater army logistical command. The theater army logistical command is not able to acquire a similar flexibility at the expense of the zone of interior. It must, therefore, be provided with sufficient evacuation and hospitalization means to make it capable of handling an abnormal number of patients for a short period. This reserve must consist of evacuation units, supplies, and hospital facilities. It should be distributed throughout the theater communications zone, and is best maintained by permitting the facilities involved to operate normally at well below maximum capability, rather than by holding a number of units in an uncommitted status.
- (4) *Impact of nuclear warfare.* The problem of being prepared to cope with widely fluctuating numbers of patients is greatly increased under conditions of nuclear warfare. The employment of nuclear weapons against friendly troops may produce very large numbers of patients in

a given area in a very brief period of time. The rate at which these casualties are produced is of **particular** significance since it affects medical capabilities for providing treatment. This consideration is a major factor in determining the theater army evacuation policy. Medical installation and facilities must be so located that they are not susceptible to destruction by enemy nuclear attacks directed at other installations in the theater communications zone.

*c. Area Medical Service.* In addition to supporting the field armies, the theater army logistical command must provide medical service for its own assigned and attached units. This is accomplished through the medium of dispensaries and field or station hospitals, together with ambulance units to provide the necessary evacuation. The station hospital, because of the time required for its establishment and the relative permanence of its installation, is normally located in base logistical commands rather than in the advance logistical or separate area command. Since the theater communications zone is subject to recurrent damage from enemy action, the dispensaries and aid stations constitute the first echelon of medical support. It may be necessary, therefore, to sacrifice a certain amount of economy which might otherwise be gained through the consolidation of these facilities in the interest of providing a grid-like coverage of the areas of military population.

## 59. Personnel

### *a. General.*

- (1) The personnel function of administrative support includes personnel replacement, personnel services, and other activities related to personnel as individuals.
- (2) Personnel replacement is concerned with the procurement, reception, classification, distribution, training, and assignment of individual and unit replacements required in the maintenance of personnel strengths of combat and supporting forces within theaters of operations.
- (3) Personnel services are those administrative support activities concerning personnel as individuals provided primarily to assist the commander in attaining and maintaining good morale within the command. The term personnel services normally includes rest and leave, rotation, decorations and awards, army postal service, exchange service, finance service, chaplain services, special services, and welfare services.

- (4) Other administrative support included in the personnel function are such activities as prisoner of war operations, discipline, law, order, and graves registration.

*b. Personnel Replacement.*

- (1) Personnel replacements, both unit and individuals, are provided to logistical commands operating in the theater communications zone by the theater army replacement and training command. Requisitions for shortages are forwarded through command channels to theater army.
- (2) The logistical support of the units of the theater army replacement and training command is provided by the theater army logistical command. Sufficient transportation must be made available to the theater army replacement and training command to meet normal transportation requirements for the continuous, orderly movement of replacements to the forward areas.
- (3) When a logistical command operates the field army base or a small undivided theater communications zone, it may be assigned the additional mission of providing personnel replacements. In such circumstances, replacement units are assigned or attached to the logistical command.

*c. Personnel Activities and Services.*

- (1) *General.* The type and extent of personnel activities and services support provided within theaters of operation are dependent upon the operational environment, form of conflict, scale of employment of nuclear weapons, and the necessity and feasibility of furnishing the support. The activities and services listed in the following paragraphs normally are performed within theaters of operation on an area basis.
- (2) *Rotation.* The theater army logistical command units provide a base for rotation of personnel within a theater. The purpose of rotation is conservation of manpower. Individuals with the greatest combat exposure can be rotated, with minimum retraining, by assignment to positions in the theater communications zone before they become physically or mentally exhausted. The vacancies to which such personnel are assigned are created by casualties, administrative losses, and reassignment to combat units of personnel from theater army logistical command units.
- (3) *Recovery and disposition.* The theater army logistical command operates the office for the theater to maintain

data of the recovery and burial status of dead and missing, to coordinate search, recovery, identification, and burial operations; to supervise the establishment and maintenance of all temporary cemeteries; and to serve as a clearing point for recovery and disposition information for all field elements. The theater army effects depot is operated in the theater communications zone. Personal effects of all deceased personnel are forwarded to the depot for shipment to the personal effects depot in CONUS. The theater army logistical command assumes responsibility for cemeteries established by the field army when the army rear boundary is displaced forward of the location of the cemeteries.

- (4) *Prisoners of war.* The theater administrative zone is the final processing point for prisoners of war in the theater. The Military Police POW Command is the TOE unit utilized, within the theater army logistical command, for the purpose of evacuating, processing, custody, and handling of prisoners of war. The theater army logistical command relieves combat forces of custody of prisoners of war at the request of the combat units.
- (5) *Recreation and leave areas*
  - (a) Recreation centers usually are located in the theater administrative zone in cities or suitable area, a reasonable distance from areas of active combat. They are established to provide rest and relaxation for personnel on leave, pass, or temporary duty. The theater army logistical command commander establishes and supervises the operation of recreation centers. Allocations of quotas to army troops in the theater is the responsibility of the theater army commander.
  - (b) Leave areas are established for the purpose of accommodating large numbers of military personnel on leave or pass and offering numerous facilities for rest, recreation, and entertainment. Operating policies and responsibilities are the same as for recreation centers.
- (6) *Discipline, law, and order.*
  - (a) *U. S. military prisoners.* The theater Army Logistical command operates confinement facilities for U. S. military prisoners and relieves the combat forces of these prisoners at the request of the combat forces and within the prescribed policies

of the theater Army commander. The type of prisoners confined in these facilities normally include those who have been tried and whose sentence does not include a punitive discharge or who are potentially restorable to duty. The primary purpose of these facilities is the training of U. S. military prisoners for return to duty. All other U. S. military prisoners normally are evacuated to CONUS.

- (b) *Control of individuals.* Military police control the circulation of individuals and effect the return of stragglers to include deserters, and AWOL's to military control. In addition, military police enforce laws, regulations and orders and apprehend, within the scope of their authority, individual offenders. Crime prevention and suppression is an integral part of the military police effort.
- (c) *Security.* Military police service provides for the protection of personnel and property. Security is provided for installations and activities to include the prevention of pilferage of equipment and supplies in transit and storage.

(7) *Personnel services.*

- (a) *Postal service.* The mission of the Army-Air Force Postal Service is to extend the services of the Post Office Department to all units of the U. S. Army and U. S. Air Force, regardless of location. In the theater of operations, the Army and/or Air Force operate the entire system, depending upon which service has primary interest in the theater or which service has been delegated postal responsibility.
- (b) *Exchange service.* The mission of the Army and Air Force exchange service is to supply military personnel and other authorized persons with articles of necessity and convenience not provided by government issue, and to gain profits for distribution to welfare activities not covered by appropriated funds.
- (c) *Welfare services.* The American Red Cross provides service for members of the Armed Forces in theaters of operations in accordance with its Federal charter. The Army Emergency Relief

extends financial aid to personnel of the Army of the United States and their dependents. The Army Relief Society is a separate organization founded specifically to assist needy widows and orphans of Regular Army personnel. All of these agencies combine with organic means to provide welfare service in the theater.

- (8) *Finance service.* The finance service provides for the payment of military personnel and other persons and the maintenance of banking facilities and pay records throughout the theater of operations. The personnel services provided by the finance service are a component of the integrated accounting system which has been designed to integrate appropriations, expenditures, and financial accounting for all assets, liabilities, revenues, and costs of operation.

## 60. Civil Affairs

*a. General.* Civil affairs comprise those relationships between military forces and the local population and its government usually involving assumption by the military commander of authority or functions normally the responsibility of the civil government or other nonmilitary organizations. In occupied countries or areas, the military commander may be required to assume complete legislative, executive and judicial authority (military government). In friendly areas, the commander may assume lesser degrees of authority as provided for in treaty or agreement, express or implied.

### *b. Objectives.*

- (1) Support of military operations (primary mission during combat).
- (2) Fulfillment of obligations arising from treaty, agreement, or custom of warfare.
- (3) To further national policies.
- (4) Transfer of responsibility from the military commander to a civil agency.

*c. Mission of the Theater Civil Affairs Command.* The theater civil affairs command exercises, for the theater army commander, the required degree of control over the government, inhabitants, and the lands and properties which are placed under his jurisdiction and which he exempts from the control of field armies. The extent of civil affairs operations performed by each command and the degree of control required are governed by the type of civil affairs in effect.

*d. Civil Affairs Operations.* In order to carry out the functions detailed in the field manuals of the 41-series, civil affairs detachments of varying sizes are stationed in towns and cities throughout liberated and occupied territories, and in areas provided for in civil affairs agreements. Logistical commands will be required by the theater army commander to provide considerable troop labor and supply support to needy liberated or conquered foreign nationals. The logistical command director of civil affairs maintains liaison with the theater civil affairs command in all civil affairs matters, to include the expenditure of logistical command personnel and material resources in accordance with local command and theater army policies. The logistical command director of civil affairs conducts all necessary liaison with the theater civil affairs command concerning the procurement of supplies, real estate, and local labor to support the logistical command mission.

*e. Civil Affairs Support.*

- (1) Although the basic objectives of civil affairs in the theater communications zone are the same as in the combat zone, there is more emphasis on furthering national objectives in the war. The principal objectives normally are the political and economic rehabilitation of the area, with emphasis on the return of the country's government to the country's agencies as soon as possible. In addition, civil affairs supports economic rehabilitation to utilize local resources for military use and make the country self-sufficient at the earliest possible date.
- (2) The degree of control of the civilian population is less in rear of the combat zone. The populace must return to homes and jobs and be able to move about sufficiently to rehabilitate the local economy, to provide a labor force for reconstruction and for military needs, and to achieve a degree of political freedom which furthers U. S. national policies.
- (3) When the theater communications zone is located in a politically hostile area, the restrictions imposed approximate those imposed in the combat zone, except that the local economy must be rehabilitated to provide a degree of self-sufficiency. In areas where civilians are openly opposed to our efforts, precautions must be taken to insure that they do not interfere with support operations. At the same time, it is important that action be initiated to improve the attitude of the local populace.

- (4) As a matter of national policy in developing better relations with the people, military forces assist in the rehabilitation of the country to include feeding, clothing, and supplying the minimum essential needs of the population. Priorities are established for the rehabilitation of hospital, utilities, and other operations essential to the well being of both civilians and troops. Local resources are used to the maximum extent but may require supplementation with military and imported civil affairs supplies. The reindoctrination of the enemy civilian population is accomplished by such practices.



## APPENDIX I

## REFERENCES

## 1. Field Manuals

---

FM(0) 3-5	Tactics and Techniques of Chemical, Biological, and Radiological Warfare
FM 1-100	Army Aviation
FM 3-8	Chemical Corps Reference Handbook
FM 3-9	Staff Chemical Officer
FM 5-5	Engineer Troop Units
FM 5-6	Operations of Engineer Troop Units
FM 5-15	Field Fortifications
FM 5-20	Camouflage—Basic Principles and Field Camouflage
FM 5-21	Camouflage of Fixed Installations
FM 5-23	Field Decoy Installations
FM 5-25	Explosives and Demolitions
FM 5-30	Engineer Intelligence
FM 5-34	Engineer Field Data
FM 5-35	Engineers' Reference and Logistical Data
FM 5-36	Route Reconnaissance and Classification
FM 5-162	Engineer Construction Battalion and Group
FM 5-188	Engineer Topographical Units
FM 8-5	Medical Units, Theater of Operations
FM 8-10	Medical Service, Theater of Operations
FM 8-55	Medical Field Manual, Reference Data
FM 9-1	Ordnance Service in the Field
FM 9-2	Ordnance Corps Logistical Data
FM 9-3	Ordnance Direct Support Service
FM 9-4	Ordnance General and Depot Support Service
FM 9-5	Ordnance Service in the Field
FM 10-7	Quartermaster Organization and Operation in Divisions
FM 10-10	Quartermaster Service in Theater of Operations
FM 10-17	Quartermaster Organization and Service in Army and Corps
FM 10-60	Supply of Subsistence in a Theater of Operations

FM 10-63	Handling of Deceased Personnel in Theaters of Operation
FM 10-64	Quartermaster Class II and IV Supply in Theater of Operation
FM 19-5	Military Police
FM 19-10	Military Police Operations
FM 19-25	Military Police Traffic Control
FM 19-40	Handling of Prisoners of War
FM 19-90	The Provost Marshal
FM 21-5	Military Training
FM 21-30	Military Symbols
FM 27-10	The Law of Land Warfare
FM 30-5	Combat Intelligence
FM 41-5	Joint Manual of Civil Affairs and Military Government
FM 41-10	Civil Affairs/Military Government Operations
FM 55-6	Transportation Services in the Theater of Operations
FM 55-10	Movement Control in the Theaters of Operation
FM 100-5	Field Service Regulations; Operations
FM 100-10	Field Service Regulations; Administration
FM 101-1	The G1 Manual
FM 101-5	Staff Officers' Field Manual: Staff Organization and Procedure
FM 101-10	Staff Officers' Field Manual: Organization, Technical, and Logistical Data

## 2. Technical Manuals

TM 5-250	Roads and Airfields
TM 5-260	Principles of Bridging
TM 5-295	Military Water Supply
TM 5-310	Military Protective Construction
TM 5-350	Military Pipeline Systems
TM 5-360	Port Construction and Rehabilitation
TM 5-370	Railroad Construction
TM 11-486-2	Electrical Communication System Engineering: Traffic
TM 11-486-6	Electrical Communication System Engineering: Radio

## 3. Regulations

AR 10-14	Organization and Functions—Logistical Headquarters
----------	--

- AR 75-15 Responsibilities and Procedures for Explosive Ordnance Disposal
- AR 115-12 U. S. Army Requirements for Air Weather Service Support
- AR 115-10/  
AFR 105-3 Weather Service
- AR 320-5 Dictionary of United States Army Terms
- AR 320-50 Authorized Abbreviations and Brevity Codes

#### 4. Miscellaneous

- DA Pam 310 series Military Publications Indexes
- ATP 110-300 Army Training Program for Headquarters and Headquarters Company, Logistical Commands, Type A, B, C
- TC 9-2 Ordnance Class V System
- TC 101-1 Prediction of Fallout and Radiological Monitoring and Survey
- ST 55-175 Transportation Corps Reference Handbook
- TOE 54-1R Headquarters, Logistical Command A
- TOE 54-1 Headquarters Company, Logistical Command A
- TOE 54-2R Headquarters Company, Logistical Command A
- TOE 54-101R Headquarters, Logistical Command B
- TOE 54-102R Headquarters Company, Logistical Command B
- TOE 54-201R Headquarters, Logistical Command C
- TOE 54-202R Headquarters Company, Logistical Command C

APPENDIX II

STANDING OPERATING PROCEDURE

Type Standing Operating Procedure-Headquarters, Logistical Command

(Classification)

Logistical Command

Location

Date

PART ONE—ORGANIZATION AND FUNCTIONS

Section I. APPLICATION

In this section, give the purpose and scope of the standing operating procedure and applicability of procedures prescribed.

Section II. ORGANIZATION

By organizational charts show the organization of the logistical command and the headquarters logistical command.

Section III. FUNCTIONS

1. A general paragraph should explain the composition of the major elements of the headquarters, i.e., command and staff; the purpose of the headquarters; and the broad responsibilities and functions of commanders and staff officers.

2. By succeeding paragraphs, list the specific responsibilities and functions of each staff section and subordinate element of the command.

PART TWO—STAFF OPERATIONS

Section I. COMMAND AND STAFF RELATIONSHIPS

By separate paragraphs, outline the primary relationships between various elements of the logistical command and between the logistical command and higher headquarters, adjacent, and supported units. The following must be clearly delineated:

- 1. Command and technical channels.

(Classification)

---

(Classification)

(Short title identification)

2. Dual responsibilities such as one individual being both a commander and a staff officer.
3. Responsibility for liaison and coordination with higher, lower and adjacent commands.
4. Cooperation and coordination between staff sections.

## Section II. INTELLIGENCE

This section outlines the responsibilities for and describes the procedures for, all matters pertaining to intelligence operations in the command.

## Section III. ESTIMATE, PLANS, AND ORDERS

This section outlines the responsibilities for, and describes the procedures for, preparation of various estimates, plans, and orders.

## Section IV. SECURITY

This section outlines the responsibilities for rear area security and rear area damage control for all elements of the command. This may be done by reference to the appropriate annex of the SOP or operation plan.

## Section V. LOGISTICS

In this section, detailed procedures should be given covering supply, transportation, services, labor and medical evacuation and hospitalization. This section is closely related to the administrative order and many aspects covered in the SOP need not be repeated in the administrative order. However, appropriate reference to the SOP should be made. The details of logistical operations will normally be spelled out in the various technical services annexes and only the appropriate reference need be given in the main body of this paragraph.

## Section VI. PERSONNEL

In this section, detailed procedures should be given concerning all aspects of personnel management and operations. The following should be covered:

1. Strengths, records, and reports.
2. Replacements.
3. Discipline, law, and order.

---

(Classification)

---

(Classification)

(Short title identification)

4. Prisoners of war and civilian internees.
5. Graves registration.
6. Morale and personnel services.
7. Personnel procedures.
8. Civilian employees.

This section is closely related to the personnel paragraph in the administrative order. The more complete the SOP the less the detail required in the administrative order.

#### Section VII. CIVIL AFFAIRS

This section should give complete and detailed procedures pertaining to civil affairs activities to include civil supply, evacuation, transportation, real estate, labor, natural resources, control of civil population, travel, curfew and other restrictions, public health, law and order, public information, government administration, displaced persons and refugees, finances, price control, rationing and civil defense.

#### Section VIII. ADMINISTRATION

This section covers details pertaining to internal administrative matters not covered in other sections of the SOP. Activities such as the following may be included here: postal service, records management, correspondence, printing and publication, miscellaneous reports, staff procedures, staff records, maintenance of daily journals, policy files, command reports, uniform regulations, office hours, reports control, forms control, office services, courier and messenger service, handling of classified correspondence, fiscal and financial activities, inspections and investigations, and other miscellaneous administrative functions.

#### Section IX. COMMAND AND SIGNAL

This section covers such activities as the location of command post and special instructions and reports not covered in other parts of the SOP. Also included are special instructions concerning signal communications which are not contained in the signal annex, standing signal instructions, and signal operations instructions.

---

Commander

---

(Classification)

---

(Classification)

(Short title identification)

Annexes:

Annexes to an SOP facilitate the use of the SOP and preserve brevity, completeness, clarity, and simplicity within the main body of the SOP. By using annexes information that is limited in scope or technical in application can be excluded from the main body of the SOP. Subject matter in an annex need not be repeated in the main body of the SOP. However, appropriate reference should be made to the annex. The use of annexes also facilitates use of the SOP by permitting a larger printing and distribution of the annexes than of the main body plus all annexes. This technique is particularly appropriate in a logistical command wherein individuals of the technical and administrative services have need for the annex pertaining to their particular service but not for the full SOP. The following is a list of annexes that may be included in a logistical command SOP.

Organization charts

Administrative overlay

Intelligence

Psychological warfare

Chemical

Engineer

Medical

Ordnance (including support of special weapons when not published elsewhere).

Quartermaster

Signal

Transportation

Personnel

Civil affairs

Judge advocate

Finance

Procurement

Rear area security (when not published as a separate operation plan)

Rear area damage control (when not published as a separate operation plan)

---

(Classification)

---

(Classification)

(Short title identification)

Other emergency plans (when not published as a separate operation plan)

Other annexes as appropriate.

Distribution:

Authentication:

---

(Classification)



## APPENDIX IV

INSTRUCTING AGENCIES AND AGENCIES  
FOR COORDINATION

Theater Army Logistical Command receives instruction from or coordinates with the following major headquarters:

1. *Zone of Interior (ZI) agencies* for information from—
  - a. Oversea supply agencies (OSA) at ZI army terminals on supply matters.
  - b. ZI terminal commands on movement of supplies and personnel from the ZI to the theater.
  - c. Chiefs of technical and administrative services concerning unit availability, state of training, requirements for research and development, and modification of material. In addition, the Surgeon General (Armed Services Medical Regulating Office) for evacuation of casualties from the theater to the ZI.
2. *Theater headquarters (J4)* (either by direct coordination or through theater army headquarters) for—
  - a. Allocation of transportation capacities among the theater component forces.
  - b. Cross-procurement and cross-service missions among Army, Navy, and Air Force.
  - c. Administrative support to Navy, Air Force, joint forces, and Allies.
  - d. Territorial boundaries.
  - e. Petroleum requirements (area petroleum office).
  - f. Signal matters.
3. *Theater Army Headquarters* for—
  - a. Allotment of service troops.
  - b. Combat (security) troops.
  - c. Territorial boundaries.
  - d. Theater army tactical operations—priorities between army groups.
  - e. Stockage objectives and echelonment of theater stocks.
  - f. Special operational requirements.
  - g. Intelligence estimates and collection of information.

4. *Theater Army Civil Affairs command* for—

a. Governmental functions, which include governmental affairs, legal, public safety, public health, public welfare, public education, and labor.

b. Economic functions, which include economics, commerce and industry, food and agriculture, price control and rationing, property control, public finance, and civilian supply.

c. Public facilities, which include public works and utilities, public communications, and public transportation.

d. Special functions, which include displaced persons, civil information and arts, monuments, and archives.

e. The adoption and enforcement of measures designed to control and direct civilian activities affecting the military effort.

5. *Army group(s)* for—

a. Items *c*, *f*, and *g*, of paragraph 3 above, over which Theater Army Headquarters exercises final authority.

b. Tentative operation plans.

c. Priorities of allocation of administrative support to the various armies.

6. *Field armies* (detailed coordination effected between armies and advance logistical command) for—

a. Operational plans, operational requirements, boundaries, intelligence, and supplies required.

b. Location of administrative support installations.

c. Assumption of command of territory and installations left in place as army rear boundaries move forward.

d. Details of administrative support required within the priorities established by army group.

7. *Theater Navy Headquarters and Theater Air Force Headquarters* for—

a. Administrative support for campaign plans—basis for establishing common supply, transportation, and service requirements which theater army forces furnish the Navy and Air Force.

b. Forecast of theater army administrative support requirements provided by Navy and Air Force.

c. Utilization of allocated capacities of the Military Air Transport Service and Military Sea Transport Service.

8. *Allied Forces Headquarters*. Similar to paragraphs 5 and 6 conforming to basic agreements made at higher levels.

9. *Theater Air Defense Command*<sup>1</sup> for—

a. Requirements for administrative support to be provided by Theater Army Logistical Command.

b. Establishment of air defense priorities within the theater communications zone.

c. Establishment of restricted areas within the theater communications zone.

10. *Theater Army Replacement and Training Command* for—

a. Administrative support provided by Theater Army Logistical Command.

b. Service troop requirements.

11. *Theater Army Reserve Forces Headquarters* (if any) for—

a. Administrative support provided by Theater Army Logistical Command.

b. Availability and utilization of units to Theater Army Logistical Command for security and service support.

---

\* When control is retained by theater commander, otherwise included in appropriate Armed Forces requirement.

## APPENDIX V

## BASE DEVELOPMENT PLAN

---

 (Classification)

Annex_____ to Logistical	Copy Nr
Plan_____	Issuing headquarters
_____Base Development	Place of issue
Plan	Date and time of issue
Map reference	Message reference number

## BASE DEVELOPMENT PLAN

## 1. SITUATION

a. Enemy (enemy capability to influence or impede the execution of this base development plan).

b. Own (sufficient to provide a concept of the overall situation, plans of higher headquarters, and the operations of friendly troops which may influence the execution of this base development plan).

- (1) Objectives.
- (2) Strategic concept.
- (3) Tasks (include responsibilities for base development of theater army, navy, and air force).
- (4) Scheme of maneuver.
  - (a) Phases.
  - (b) Timing.
- (5) Static intelligence data.
  - (a) Natural resources.
  - (b) Existing facilities.

2. MISSION (A simple statement of the what, where, when, how, and why of the base to be developed—do not confuse this mission of the base with the overall mission of the entire command which should be set forth under paragraph 1, Situation).

## 3. OPERATIONS (of the base)

- a. Tasks (of the base).

---

 (Classification)

---

(Classification)

(Short title identification)

- (1) Breakdown of paragraph 2, Mission, into phases—if appropriate.
  - (2) Responsibility for base development planning including preparation, approval, and issuing of plans.
  - (3) Base security organization and installations.
    - (a) Command organization.
    - (b) Antiaircraft defense.
    - (c) Gas and other alarm systems.
    - (d) Ground defense.
    - (e) Coast defense.
    - (f) Local Navy defense.
    - (g) Harbor defense.
    - (h) Bomb mine disposal.
    - (i) Area Damage Control.
  - (4) Tactical air installations. Airfields and seaplane bases.
    - (a) Aircraft units assigned to fields and bases by phases.
    - (b) Airfield 1.
    - (c) Airfield 2.
    - (d) Seaplane base 3.
- b. General information.
- (1) Basic considerations.
  - (2) Degree of permanency of construction.
  - (3) General limitations.
  - (4) General layout plans. See Tab A (map).
  - (5) Priority of development.
    - (a) General priority.
    - (b) Echeloning of base forces and of base development material.
    - (c) Specific priority of development projects.
  - (6) Pertinent directives and publications.
  - (7) Instructions relative to changes in base development plans and to submission of reports.

---

(Classification)

---

 (Classification)

(Short title identification)—continued

- |                                  |           |
|----------------------------------|-----------|
| c. Force requirements—D+————days | Strengths |
| (1) Army.                        | _____     |
| (2) Navy.                        | _____     |
| (3) Air Force.                   | _____     |

(This is a statement of the forces which the base can expect to be supporting when it has been built up to its desired operating capacity. A base may be assigned succeeding tasks—for instance, to support a particular operation and subsequently to provide a base for further operations—in which case this paragraph should be broken down to show task A, task B, and the like. In some cases a simple statement of the strengths to be supported may not give the information desired; in such cases this paragraph should be expanded to show major types of forces and strengths.)

d. Force buildup tables. Phased deployment schedules.

- (1) Army.
- (2) Navy.
- (3) Air Force.

(This is the buildup of paragraph 3c, Force requirements, and shows the forces to be supported by critical phases. It does not show the buildup of base forces except that base forces are included in those forces requiring support. The buildup of base forces to accomplish base development is shown in paragraph 3b, General information, and in paragraph 4h, Requirements summary.)

e. Organization.

- (1) Headquarters and overhead. Location — Strengths. (Include higher and other headquarters and organizations which may be quartered or require facilities within the base section.)
- (2) Base organization.

#### 4. LOGISTICS

a. Supply and maintenance facilities.

- (1) General organization for supply and maintenance.
  - (a) Responsibilities for supply and maintenance.
  - (b) Procurement.

---

 (Classification)

---

(Classification)

(Short title identification)—continued

- (c) Levels of supply.
- (d) Distribution.
- (e) Requisitioning procedure.
- (f) Maintenance.
- (g) Salvage.
- (2) Army installations.
- (3) Air Force installations.
- (4) Navy and Marine air installations.
- (5) Navy installations other than air.
- (6) Marine installations other than air.
- b. Evacuation and hospitalization.
  - (1) General organization and information.
    - (a) Responsibility.
    - (b) Hospital construction and standards.
    - (c) Hospital summary.
  - (2) Army hospitals.
    - (a) Requirements.
    - (b) Location.
    - (c) Units assigned.
    - (d) Facilities and plant.
  - (3) Navy and Air Force medical facilities as required.
  - (4) Sanitary and epidemiological control.
  - (5) Miscellaneous—whole blood distribution center.
- c. Movements and transportation.
  - (1) General organization and information.
  - (2) Motor transport.
  - (3) Air transport.
  - (4) Water transport.
  - (5) Rail transport.
  - (6) Pipelines.
  - (7) Responsibilities of each service.
- d. Terminal facilities.
  - (1) Assault landing areas.

---

(Classification)

---

(Classification)

(Short title identification)—continued

- (2) General organization of water terminal facilities.
  - (3) Beaches.
  - (4) Port A.
    - (a) Harbor development.
    - (b) Port development.
  - (5) Port B.
  - (6) General organization of air terminal facilities.
- e. Roads, railroads, utilities, and natural resources.
- (1) Organization for development, maintenance and operation of utilities, roads, railroads, and natural resources.
  - (2) Roads.
  - (3) Railroads.
  - (4) Waterways.
  - (5) Utilities.
    - (a) Power.
    - (b) Water supply.
    - (c) Sewage.
    - (d) Waste disposal.
  - (6) Development of natural resources for utilization in base development.
  - (7) Development and reconstruction of industry.
- f. Communications.
- (1) Communications policies.
  - (2) Organization of signal staffs.
  - (3) General communications plan.
  - (4) Responsibilities.
  - (5) Units assigned.
  - (6) Facilities.
    - (a) Theater.
    - (b) Army.
    - (c) Navy and Marine.
    - (d) Air Force.
  - (7) Special projects.
- g. Construction requirements.
- (1) Responsibilities for construction.

---

(Classification)



---

(Classification)

(Short title identification)—continued

- (2) Site facilities—staging areas—tent camps.
- (3) Housing and associated facilities.
- (4) Storage facilities.
  - (a) Covered warehouses.
  - (b) Open.
  - (c) Bulk petroleum, oil, and lubricants (POL).
- (5) Maintenance and repair facilities.
- (6) Hospital construction requirements.
- (7) Communications and transportation facilities.
  - (a) Pole lines and cables.
  - (b) Roads.
  - (c) Bridges.
  - (d) Railroads—shops and yards.
  - (e) Pipelines.
  - (f) Port and beach construction.
    - 1. Intransit storage.
    - 2. Berths.
    - 3. Dolphins.
    - 4. POL unloading facilities.
    - 5. Ammunition unloading facilities.
    - 6. Dredging.
    - 7. Ship salvage facilities.
  - (g) Airfields and airbase facilities construction.
    - 1. Combat.
    - 2. Transport.
- (8) Utilities.
  - (a) Water supply.
  - (b) Power supply.
  - (c) Sewage and waste disposal.
- (9) Repairs and maintenance.
- (10) Mapping and map reproduction.
- (11) Camouflage.
- (12) Construction—manpower requirements. (After considering local labor.)
- (13) Construction materials requirements. (After considering local materials.)

---

(Classification)

---

(Classification)

(Short title identification)

(14) Final approved shipping schedule for all base development during entire development period.

h. Requirements summary.

(1) Supply requirements.

(a) Dry cargo.

(b) Bulk POL.

(2) Evacuation requirements.

(3) Transportation requirements.

(4) Construction requirements.

(5) Total strength requirements.

(6) Echelon schedule based on requirements for each base site consolidated into one proposed echeloning schedule for entire base development.

## 5. COMMAND AND COMMUNICATIONS

a. Command structure.

b. Command communications. (Reference to Communications Annex).

s/\_\_\_\_\_

Commanding

Appendixes: 1—Map of Base with Plan for Contemplated Development

2—Communications

3—Construction Plans

Distribution:

---

(Classification)

## APPENDIX VI

TYPICAL TECHNICAL SERVICE TROOP UNITS  
NORMALLY ASSIGNED WITHIN THE  
THEATER COMMUNICATIONS ZONE

---

The Technical Services have begun to reexamine their unit TOE's to determine the extent to which they should be combined or changed in order to provide maximum service support to supply and maintenance concepts such as those envisioned in this study. In the interim, the units listed below would be used to implement the recommended concepts.

1. *Chemical Corps*

- Chemical Group
- Chemical Smoke Generator Battalion
- Chemical Service Battalion
- Chemical Processing Company
- Chemical Maintenance Company
- Chemical Depot Company (ComZ)
- Chemical Decontamination Company

2. *Corps of Engineers*

- Engineer Group (Construction)
- Engineer Battalion (Construction)
- Engineer Dump Truck Company
- Engineer Heavy Equipment Company
- Engineer Group (M&S)
- Engineer Depot Battalion
- Engineer Heavy Maintenance Company
- Engineer Field Maintenance Company
- Engineer Forestry Company
- Engineer Water Supply Company
- Engineer Port Construction Company
- Engineer Group (Pipeline)
- Engineer Battalion (Pipeline)
- Engineer Battalion (Base Topographic)
- Engineer Base Map Depot Company
- Engineer Base Map Depot Company
- Engineer Base Survey Company
- Engineer Photomap Company

3. *Medical Corps*

Medical Group  
Medical Battalion, Separate  
Medical Collecting Company, Separate  
Medical Clearing Company, Separate  
Medical Holding Company  
Preventive Medicine Company  
Medical Depot, Communications Zone  
Medical Ambulance Company, Separate  
Field Hospital  
Ambulance Train, Rail  
General Hospital  
Station Hospital  
Convalescent Center  
Medical Laboratory

4. *Ordnance Corps*

Ordnance Ammunition Group  
Ordnance Maintenance and Supply Group  
Ordnance Ammunition Battalion  
Ordnance Maintenance and Supply Battalion  
Hq & Hq Det., Ordnance Special Weapons Depot Battalion  
Hq & Hq Det., Ordnance Special Weapons Support Battalion  
Ordnance Guided Missiles Direct Support Company  
Ordnance Guided Missile General Support Company  
Ordnance Supply Depot Company  
Ordnance Field Maintenance Company  
Ordnance Park Company  
Ordnance Special Weapons-Missile Company (Depot, Forward Depot, or Supply Point)  
Ordnance Collection and Classification Company  
Ordnance Tire Repair Company  
Ordnance General Support Company  
Ordnance General Automotive Support Company  
Ordnance Special Weapons and Missile General Support Company  
Ordnance Special Weapons and Missile Direct Support Company  
Ordnance Direct Support Company  
Ordnance Direct Automotive Support Company

5. *Quartermaster Corps*

Quartermaster Group  
Quartermaster Service Company  
Quartermaster Petroleum Supply Company  
Quartermaster Parts Company

Quartermaster Bakery Company  
Quartermaster Sales Company  
Quartermaster Laundry Company  
Quartermaster Salvage Company  
Quartermaster Subsistence Supply Company  
Quartermaster Clothing and General Supplies Depot Company  
Quartermaster Refrigeration Company  
Quartermaster Bath Company  
Quartermaster Recovery and Disposition Company  
Quartermaster Field Maintenance Company (Direct Support)  
Quartermaster Field Maintenance Company (General Support)  
Quartermaster Subsistence Depot Company  
Quartermaster Supply Depot Company  
Quartermaster Petroleum Depot Company  
Quartermaster Aerial Supply Company (and Team)  
Quartermaster Air Equipment Repair and Depot Company  
Quartermaster Mechanical and Metal Repair Company  
Quartermaster Clothing and Textile Repair Company  
Quartermaster Service Organization  
Quartermaster Depot  
Quartermaster Battalion  
Labor Supervision Organization

6. *Signal Corps*

Signal Group  
Signal Construction Battalion  
Signal Long Lines Battalion  
Signal Radio Relay Construction Battalion  
Signal Support Battalion  
Signal Support Company  
Signal Base Depot  
Signal Photo Service Platoon  
Signal Radio Relay Platoon  
Signal Repair Platoon  
Signal Base Maintenance Company

7. *Transportation Corps*

Transportation Truck Group  
Transportation Truck Battalion  
Transportation Light Truck Company  
Transportation Car Company  
Transportation Terminal Service Command A  
Transportation Terminal Battalion  
Transportation Highway Transport Command  
Transportation Medium Truck Company

Transportation Railway Command  
Transportation Railway Group  
Transportation Railway Operating Battalion  
Transportation Railway Shop Battalion  
Transportation Movements Group  
Transportation Movements Battalion  
Aviation Company, FW, Light Transport  
Transportation Aviation Battalion (Hcptr)  
Transportation Company (Light Hcptr)  
Transportation Company (Medium Hcptr)  
Transportation Aircraft Maintenance Supply Battalion  
Transportation Depot Company  
Transportation Boat Battalion  
Transportation Amphibious Tank Battalion  
Transportation Staging Area Company  
Transportation Floating Craft  
Depot Maintenance Company

## INDEX

	Paragraphs	Page
Administrative support:		
Control of activities .....	22c	27
Impact of nuclear warfare .....	5b	5
Operations .....	46-60	50-107
Center .....	19f, 49b	21, 51
Functions .....	47, 52-60	50, 66-107
Civil affairs .....	60	107
Construction .....	56	95
Hospitalization .....	58	101
Labor .....	57	97
Maintenance .....	55	88
Medical evacuation .....	58	103
Personnel .....	59	103
Supply .....	53	66
Transportation .....	54	76
Responsibilities, operational .....	48-51	51-65
Communications .....	50	57
Rear area damage control .....	49	51
Rear area security .....	49	51
Planning .....	24, 29, 32	29, 34, 35
Base development .....	40-45	39-49
Documents .....	26, 31	29, 35
Supply .....	30	34
Troop requirements .....	33-39	37-39
Advance logistical command .....	13	9
Responsibilities:		
Area damage control .....	49e	3
Area security .....	49d(2)	53
Construction .....	56d(3)	97
Labor .....	57c(3)-(5)	99
Medical evacuation .....	58a(2),b(1)	100, 101
Supply .....	53b(5)	70
Signal communications .....	50c(3)	62
Air:		
Evacuation of patients .....	58b(1)	101
Terminals .....	54c(3)	84
Traffic control system, communications .....	50d(3)	4
Transportation service .....	54g	87
Area command(s) .....	15	12
Responsibility:		
Area security .....	49d(2)	53
Construction .....	56d(4)	97
Signal communications .....	50c(3)	62
Augmentation of logistical command .....	23	27
Automatic Data Processing Systems (ADPS) .....	51	65
General .....	51a	65
Administrative applications .....	51b	65

	Paragraphs	Page
FIELDATA equipment family .....		
Limitations of ADPS .....	51d	66
Use		
Administrative Support Operations Center .....	19f(3)	23
Rear area damage control operation .....	49e	53
Supply operation .....	53h	75
<b>Base:</b>		
Development .....	40-45	42-49
Basic planning considerations .....	43	45
Essential elements .....	44	48
Forms .....	45	49
Plan .....	App V	121
Planning procedures .....	42	44
Responsibilities for planning .....	41	43
Logistical command .....	6	7
Responsibilities:		
Area security .....	49d(2)	53
Construction .....	56d(2)	96
Labor .....	57c	8
Supply .....	53b(3)	67, 69, 70
Signal communications .....	50a(5)	58-59
Beaches .....	54c(2)	83
Cannibalization .....	55m, 55h(9)	94, 92
<b>Capabilities:</b>		
Evaluation of enemy nuclear weapons employment	27	31
Headquarters, logistical command A .....	18a	14
Headquarters, logistical command B .....	18b	14
Headquarters, logistical command C .....	18c	14
Logistical command .....	3	3
<b>Characteristics of:</b>		
Headquarters, logistical command .....	3	3
Logistical command .....	3	3
<b>Civil affairs</b> .....	60	107
Functions of civil affairs .....	60d	108
General .....	60a	107
Mission .....	60b, c	107
Logistical command role .....	60e	108
Responsibility toward labor .....	57c(4)	99
<b>Communications</b> .....	50	57
General .....	50a	57
Responsibility for providing .....	50a(1)-(5)	57-58
Organization .....	50a(4)	58
Communication Intersectional Service .....	50b	60
Function .....	50b(2)	60
Command Relationships .....	50b(3)	60
Organization .....	50b(1)	60
Concept of Operations .....	50b(4)	61
Local Communication Service .....	50c	62
Mission .....	50c(1)	62
Function .....	50c(2)	62
Command Relationships .....	50c(3)	62
Organization .....	50c(4)	62
Concept of Operations .....	50c(5)	63



	Paragraphs	Page
Special Purpose Communications Services .....	50d	63
Point-to-Point Radio .....	50d(1)	63
Press and Morale Service .....	50d(2)	63
Army Aviation Air Traffic Control .....	50d(3)	64
Special communication service for railway ....	50d(4) (a)	64
Military Highway Communication service .....	50d(4) (b)	65
Military Pipeline Communication service .....	50d(4) (c)	65
Conditions of conflict .....	5a, b	4, 5
Construction .....	56	95
Impact on military operations .....	56b	95
Planning and supervision .....	56d	96
Requirements .....	56c, d	96
Responsibility .....		
Control:		
Administrative support activities .....	22c	27
Damage. (See Area damage control.)		
Movement. (See Transportation Movements.)		
Coordinating and instructing agencies .....	App IV	118
Damage control, area		
Location of units .....	49e	53
Measures .....	49e(2)	53
Mission .....	49e(1)	53
Objectives .....	49e	53
Organization .....	49e	53
Responsibility .....	10, 12b, 20	8, 9, 24
Standing operating procedures .....	49e(6)	55, 113
Troops .....	49e	53
Definitions:		
Administrative support .....	2c	3
Army Administrative Area .....	2a	2
Base development .....	40a	42
Logistical command .....	2a	2
Headquarters .....	2b	2
Headquarters company .....	2c	3
Types .....	2a	2
Theater Communications Zone .....	2d	3
Maintenance .....	55a, e	88
Tables of distribution .....	36c	39
Terminal .....	55e	88
Troop basis .....	36a	38
Troop list .....	36b	38
Type B units .....	57b(3)	98
Depot maintenance .....	55b(3)	91
Development, base .....	40-45	42-49
Basic planning considerations .....	43	45
Essential elements .....	44	48
Forms .....	45	49
Plan .....	App V	121
Planning procedures .....	42	44
Responsibilities for planning .....	41	43
Direct support maintenance .....	55e(2) (a)	90
Dispersion of administrative support facilities .....	5b, 27b(2)	5, 32, 83
Distribution of supplies:		

	Paragraphs	Page
Retail .....	53f	74
Wholesale .....	53e	73
<b>Employment:</b>		
Logistical command .....	11	8
Nuclear weapons by enemy .....	27, 57b(4)	31, 98
Estimate, logistical .....	31	35
Evacuation, maintenance .....	55h(8)	92
Evacuation, medical. (See medical evacuation.)		
Exchange stocks, maintenance .....	55g(2)	92
<b>Flexibility:</b>		
Logistical command .....	5a, 1	4
Medical service in theater army logistical command	58a, b(3)	100, 102
<b>Functions:</b>		
Administrative support .....	46-60	107
Civil affairs .....	60	107
Construction .....	56	95
Hospitalization .....	58	101
Labor .....	57	97
Maintenance .....	55	88
Medical evacuation .....	58	100
Operations center .....	19f(3)	23
Personnel .....	59	103
Supply .....	53	66
Transportation .....	54	76
Advance logistical command .....	13	9
Area command .....	15	13
Base logistical command .....	14	11
Headquarters, logistical command A .....	18a; 21	14, 27
Headquarters, logistical command B .....	18b; 20	14, 24
Headquarters, logistical command C:		
Chief of staff .....	19c	16
Commander .....	19a	16
Deputy commander .....	19b	16
Coordinating staff officers .....	19d	17
Comptroller .....	13d(2)	111
Director:		
Civil affairs .....	19d(8)	20
Personnel .....	19d(3)	18
Plans and operations .....	19d(5)	18
Security .....	19d(4); 49b	18; 16
Services .....	19d(6)	19
Supply and maintenance .....	19d(7)	19
Technical and administrative staff officers .....	19e	20
Theater army logistical command .....	12	8
General support maintenance .....	55e(2)(b)	89, 90
Headquarters company, logistical command, definition .....	2c	3
Headquarters logistical command:		
Capabilities .....	9	8
Characteristics .....	3	3
Definition .....	2a	2

	Paragraphs	Page
Employment .....	12-17	8-13
Flexibility .....	8	7
Integration of technical and administrative service operations .....	22b	27
Objectives .....	9	8
Organization:		
Type A .....	21	27
Type B .....	20	24
Type C .....	19	14
Variations .....	23	27
Size .....	8	7
Type standing operating procedure .....	App II	113-117
Highway transportation .....	54e	86
Communications systems .....	50d(4) (b)	65
Hospitalization .....	58	100
Inland:		
Terminals .....	54c(4)	85
Waterways .....	54f	87
Joint oversea operation—typical planning sequence ...	App III	
Labor ( <i>See also</i> Personnel.) .....	57	97
Current policies and considerations .....	57	97
Responsibilities .....	57c	98
Law of land warfare .....	57b(5)	98
Location:		
Administrative support installations .....	5b, 32d	5, 36
Advance logistical command .....	13	9
Air terminals .....	54c(3)	84
Area damage control units .....	49a	51
Base logistical command .....	14	11
Hospitals:		
General .....	58b(2)	101
Station .....	58c	103
Maintenance units .....	55h(1)-(9)	92, 93
Logistical command:		
Advance. ( <i>See also</i> Advance logistical command) ..	13	9
Base. ( <i>See also</i> Base logistical command.) .....	14	11
Capabilities .....	3, 18	3, 14
Characteristics .....	3	3
Civil affairs operations .....	60e	108
Army, independent .....	17	13
Definition .....	2a	2
Employment .....	11-17	8-13
Flexibility .....	5a, 8	4, 7
Mission, primary .....	7	7
Objectives .....	9	8
Organization, variations .....	23	27
Planning .....	24-45	29-49
Troop requirements .....	33-39	37-39
Security .....	10, 27	8, 31
Size of headquarters .....	8	7
Subordinate units .....	22	27
Theater army. ( <i>See also</i> Theater army logistical command.) .....	12	8

	Paragraphs	Page
Logistical planning .....	29-32	34, 35
Maintenance .....	55	88
Cannibalization .....	55 <i>f</i> (9), m	91, 94
Categories:		
Depot .....	55 <i>f</i> (3)	91
Direct support .....	55 <i>f</i> (2) (a)	90
General support .....	55 <i>f</i> (2) (b)	90
Organizational .....	55 <i>f</i> (1)	89
Command and technical inspections .....	55 <i>o</i>	94
Definition .....	55 <i>a</i>	88
Evacuation .....	55 <i>h</i> (8)	93
Exchange stocks .....	55 <i>h</i> (2)	92
Management .....	55 <i>j</i>	93
Objectives .....	55 <i>g</i>	92
Policies, plans, and procedures .....	55 <i>i</i>	93
Principles .....	55 <i>h</i>	92
Relationship with supply .....	55 <i>e</i>	89
Responsibilities, technical service .....	55 <i>b</i>	88
Repair parts .....	55 <i>h</i> (6)	93
Theater army requirements .....	55 <i>l</i>	94
Medical evacuation .....	58	100
Military prisoners, U.S. ....	59 <i>c</i> (6)	105
Mission:		
Advance logistical command .....	13	9
Area command .....	15	12
Area damage control .....	49 <i>e</i> (1)	53
Base logistical command .....	14	11
Civil affairs .....	60 <i>c</i>	107
Logistical command, primary .....	7	7
Terminals .....	54 <i>c</i>	82
Theater army:		
Logistical command .....	12	8
Medical service .....	58 <i>a</i>	100
Movement(s): (See Transportation movements.)		
Nuclear warfare:		
Construction problems .....	56 <i>b</i> (2)	95
Area damage control measures .....	49 <i>e</i> (2)	53
Impact:		
Administrative support operations .....	5 <i>b</i>	5
Availability of labor .....	57 <i>b</i> (4)	98
Medical service .....	58 <i>b</i> (4)	102
Nuclear weapons, employment by enemy .....	27	31
Objective(s):		
Area damage control .....	49 <i>e</i>	53
Logistical command .....	9	8
Maintenance .....	55 <i>g</i>	92
Rear area security .....	49 <i>c</i> (1)	52
Operational environment .....	5 <i>b</i>	5
Operations:		
Administrative support operations center .....	19 <i>f</i> (3)	23
Independent army .....	17	13
Signal communications .....	50 <i>a, b, c</i>	57, 60, 62

	Paragraphs	Page
Organization:		
Area damage control .....	49e	53
Flexibility .....	8	7
Headquarters, logistical command A .....	21	27
Headquarters, logistical command B .....	20	24
Headquarters, logistical command C .....	19	14
Administrative support operations center .....	19f(2)	22
Logistical commands, variations .....	23	27
Theater .....	25	29
Organizational maintenance .....	55e(1)	89
Parts, repair .....	55h(6)	93
Personnel. (See also Labor.)		
Activities and services .....	59c	104
Military prisoners, U.S. ....	59c(5)	105
Prisoners of war .....		
Recovery and disposition .....	59c(2)	104
Recreation and leave areas .....		
Rotation .....		
Services .....	59c(7)	106
Replacements .....	59b	104
Phases of troop requirements planning .....	39	39
Pipeline(s) .....	54h	87
Communications system .....	50d(4)	64
Planning .....	24-45	29-49
Administrative support .....	24	29
Documents .....	26, 31	29, 35
Base development .....	40-45	42-49
Construction .....	56d	96
Labor .....	57b(2)	97
Logistical .....	29-32	<b>34, 35</b>
Rear area security .....	49c	52
Supply .....	30	34
Theater:		
Level .....	25b	29
Troop requirements .....	33-39	37-39
Sequence, joint oversea operation .....	App III	
POL. (See also Pipelines.) .....	53e(1)	73
Policies .....	4	3
Labor .....	57b	97
Maintenance .....	55i	93
Prisoners of war, processing .....	59c(4)	105
Procurement, local .....	53d	73
Radiological survey .....	49g	56
Radio, new, point-to-point .....	50f(1)	63
Rail transportation .....	55d	89
Communications system .....	50d(4) (a)	4
Rear area security .....	48, 49	51
Responsibility .....	10, 27a, 49b	8, 31, 51
Standing operating procedures .....	App II	113
Recovery and disposition of personnel .....	59c(3)	104
Recreation and leave areas .....	59c(5)	105
References .....	App I	110
Regulated items of supply .....	53g	74

	Paragraphs	Page
Repair parts .....	55h(6)	92
Replacements, personnel .....	59b	104
Requirements:		
Construction .....	56b	104
Theater army:		
Maintenance .....	55l	94
Medical service .....	58a	100
Troop planning .....	33-39	37-39
Responsibilities:		
Commander:		
Advance logistical command .....	53b(5)(a)	70
Base logistical command .....	53b(4)(b)	69
Headquarters, logistical command C .....	18c, 19	14, 14
Security .....	10, 26, 49d	8, 29, 52
Base development planning .....	41	43
Construction .....	56c, d	96
Labor .....	57c	98
Maintenance:		
Depot .....	55f(3)	91
Direct support .....	55f(2)(a)	90
General support .....	55f(2)(b)	90
Organizational .....	55f(1)	89
Technical service .....	55b	90
Medical evacuation .....	58b(1)	101
Operational .....	48-50	51-57
Area damage control .....	49	51
Communications .....	50	57
Rear area security .....	49	51
Recovery and disposition of personnel .....	59c(3)	104
Supply .....	53b	66
Transportation .....	54a	76
Air terminals .....	54c(3)(a)	84
Highway .....	54e(1)	86
Inland:		
Terminals .....	54c(4)(b)	85
Waterways .....	54f	87
Pipelines .....	54h(1)	87
Rail service .....	54d(1)	85
Water terminals and beaches .....	54c(2)(a)	83
Rotation of personnel .....	59c(2)	104
Security, responsibility for. (See also Rear area security.) .....	10, 49d	8, 52
Services, personnel:		
Exchange .....	59c(7)(b)	106
Finance .....	59e(8)	107
Postal .....	59c(7)(a)	106
Welfare .....	59c(7)(c)	106
Signal communications. (See also Communications.) .....	50	57
Size of logistical command headquarters .....	8	7
Spare parts. (See Repair parts.)		
Standing operating procedure:		
Area damage control .....	49e(6)	55
Rear area security .....	App II	113

	Paragraphs	Page
Type, headquarters, logistical command .....	App II	113
Subordinate units of logistical command .....	22	27
Supply .....	53	66
Automatic data processing system, use in operations .....	53 <i>h</i>	75
Distribution .....	53 <i>e, f</i>	73-74
Levels .....	53 <i>c</i>	71
Local procurement .....	53 <i>d</i>	73
Planning .....	30	34
Regulated items .....	53 <i>g</i>	74
Relationship with maintenance .....	55 <i>e</i>	89
Responsibilities .....	53 <i>b</i>	66
Support. (See Administrative support.)		
Table of distribution, definition .....	36 <i>c</i>	39
Terminals, transportation .....	54 <i>c</i>	82
Air .....	54 <i>c</i> (3)	84
Beaches .....	54 <i>c</i> (2)	83
Definition .....	54 <i>c</i> (1)	82
Inland .....	54 <i>c</i> (4), <i>f</i> (2)	87
Mission .....	54 <i>c</i> (1) ( <i>b</i> )	82
Water terminals .....	54 <i>c</i> (2)	83
Theater:		
Theater communications system .....	50	57
Army:		
Commander:		
Responsibilities:		
Supply .....	53 <i>b</i>	66
Transportation .....	54 <i>a</i>	76
Logistical command:		
Commander, responsibilities:		
Construction .....	56 <i>c, d</i>	96
Evacuation and hospitalization .....	58 <i>a</i> (2), (3), <i>b</i>	100
Labor .....	57 <i>c</i> (1)	98
Personnel .....	59 <i>b, c</i>	104
Rear area security .....	49 <i>c</i> (3); <i>d</i> 54;	52, 53
Supply .....	53 <i>b</i> (3)	67
Water terminals .....	54 <i>c</i> (2) ( <i>a</i> )	83
Flexibility of medical service .....	58 <i>b</i> (3)	102
Instructing and coordinating agencies.....	App IV	118
Local procurement operations .....	53 <i>d</i>	73
Mission .....	7	7
Relationship with other headquarters.....	28	33
Maintenance requirements .....	55 <i>i</i>	93
Commander, responsibilities .....	53 <i>b</i> (1)	66
Organization .....	25	29
Transportation .....	54	76
Air .....	54 <i>g</i>	87
Basic principles .....	54 <i>a</i>	76
Highway .....	54 <i>e</i>	86
Inland waterways .....	54 <i>f</i>	87
Movements .....	54 <i>b</i>	78
Pipelines .....	54 <i>h</i>	87
Rail .....	54 <i>d</i>	85

	Paragraphs	Page
Responsibilities .....	54a	76
Terminals .....	54c	82
<b>Troops:</b>		
Availability .....	38	39
Area damage control .....	36a	38
Basis, definition .....	49e	53
<b>List:</b>		
Definition .....	36b	38
Evaluation .....	39	39
Requirements planning .....	33-39	37-39
Technical service, types of units .....	App. VI	128
Type B units, definition .....	57b(3)	98
Types of logistical command headquarters .....	2d, 13-16	9-13
Water terminals .....	54c(2)	83

[AG 322 (5 Jun 59)]

By Order of *Wilber M. Brucker*, Secretary of the Army:

**L. L. LEMNITZER,**  
*General, United States Army,*  
*Chief of Staff*

Official:

**R. V. LEE,**  
*Major General, United States Army,*  
*The Adjutant General.*

Distribution:

Active Army:

ASA (2)	Med Gp (2)
CofS (2)	Ord Gp (2)
Vice CofS (2)	QM Gp (2)
DCSPER (5)	Sig Gp (2)
ACSI (5)	Trans Gp (2)
DCSOPS (5)	CmlC Bn (2)
DCSLOG (10)	Engr Bn (2)
ACSRC (2)	Med Bn (2)
Chief, Civil Affairs, USA	Ord Bn (2)
(2)	QM Bn (2)
CoA (2)	Sig Bn (2)
CUSARROTC (2)	Trans Bn (2)
CofF (2)	CmlC Co (1)
CINFO (2)	Engr Co (1)
CNGB (2)	Med Co (1)
CLL (2)	Ord Co (1)
CRD (2)	QM CO (1)
TIG (2)	Sig Co. (1)
TJAG (2)	Trans Co (1)
TPMG (2)	USAINTC (300)
TAG (XO) (2)	USMA (5)
CofCh (2)	USAWC (50)
Tech Stf, DA (5)	USACGSC (3600)
Tech Stf Bd (2)	Br Svc Sch (5) except
	Ord Sch (15)
	TAGSUSA (15)



TAG Bd, USA (2)	USARADSCH (525)
USA MP Bd (2)	USAARMS (1000)
USA Ch Bd (2)	USACMLSCH (500)
USCONARC (20)	USAES (1560)
US ARADCOM (5)	FSUSA (100)
US ARADCOM Rgn (5)	USAIS (2102)
OS <sup>is</sup> Maj Comd (5)	AMSS (888)
OS Base Comd (5)	TPMGS (450)
Log Comd (10) except	USA QM Sch (800)
First Log Comd (Ft	USASCS (660)
Bragg) (70)	US ASA Sch (100)
MDW (2)	USATSCH (500)
Armies (10) except First	pecialist Sch (5) except
USA (12)	USASWS (500)
Corps (5)	USAAVNS (16)
Div 5 except Armd Div (11)	PMST (2)
(ea CC) (2)	GENDEP (2)
USATC (5)	AH (2)
Brig (2)	Mil Dist (2)
BG (2)	USA Corps (Res) (2)
CmlC Gp (2)	Sector Comd (USA Corps
Engr Gp (2)	Res) (2)

NG: State AG (3).

USAR: Same as Active Army except allowance is one copy per unit except Log Comd (10).

For explanation of abbreviations used, see AR 320-50.