

MASTER COPY

MHI  
Copy 3

**FM 9-65**

DEPARTMENT OF THE ARMY FIELD MANUAL

**RESCINDED**  
FOR HISTORICAL USE ONLY

**ARMORED  
ORDNANCE  
BATTALION**

PROPERTY OF  
QUARTERMASTER LIBRARY  
QM FIELD SUPPORT AGENCY, U. S. ARMY  
FORT LEE, VA.



HEADQUARTERS, DEPARTMENT OF THE ARMY  
DECEMBER 1960

FIELD MANUAL }  
 No. 9-65 }

HEADQUARTERS,  
 DEPARTMENT OF THE ARMY  
 WASHINGTON 25, D. C., 7 December 1960

ARMORED ORDNANCE BATTALION

	Paragraphs	Page
CHAPTER 1. GENERAL.....	1-4	2
2. BATTALION ORGANIZATION CAPABILITIES, AND EMPLOYMENT.	5-8	4
3. ORGANIZATION, FUNCTIONS, AND DUTIES OF PERSONNEL.		
Section I. Battalion headquarters.....	9-13	12
II. Support companies.....	14-16	20
CHAPTER 4. ORGANIZATIONAL MESS, ADMINISTRATION, AND SUPPLY.	17-22	30
5. DIVISION ORDNANCE OFFICE.....	23-31	41
6. MAINTENANCE		
Section I. General.....	32, 33	48
II. Main support company.....	34-40	49
III. Forward support companies.....	41-46	58
CHAPTER 7. SUPPLY		
Section I. Organization, functions, and responsibilities ..	47-51	63
II. Operations.....	52, 53	67
CHAPTER 8. RECOVERY AND EVACUATION.....	54-58	74
9. TECHNICAL ASSISTANCE.....	59-62	79
10. INSPECTIONS		
Section I. Inspection management.....	63-67	83
II. Organizational inspections.....	68-70	85
III. Command maintenance inspections.....	71-74	87
IV. Spot-check inspections.....	75, 76	90
CHAPTER 11. MOVEMENT AND DEFENSIVE OPERATIONS.		
Section I. General.....	77-81	93
II. Administrative movements.....	82-85	96
III. Tactical maneuvers.....	86-88	97
IV. Defensive operations.....	89, 90	100
CHAPTER 12. TRAINING.....	91-97	103
13. SAFETY.....	98-103	111
14. COMMUNICATIONS.....	104-111	118
APPENDIX. REFERENCES.....		129
INDEX.....		134

## CHAPTER 1 GENERAL

---

### 1. Purpose

This manual is a guide for personnel assigned to the Armored Ordnance Battalion, TOE 9-65. It is designed, primarily, to provide the battalion and company commanders and the key personnel of the battalion with the basic information needed to operate the unit in a manner that will permit efficient mission accomplishment.

### 2. Scope

*a.* This manual contains specific material on the organization, mission, employment, operational methods, training, administration, logistics, communication, and special problems of the armored ordnance battalion. It is based on TOE's 9-65, 9-66, and 9-67.

*b.* Users of this manual are encouraged to submit recommended changes or comments to improve the manual. Comments should be keyed to the specific page, paragraph, and line of the text in which change is recommended. Reasons should be provided for each comment to insure understanding and complete evaluation. Comments should be forwarded direct to the U.S. Army Ordnance School, Aberdeen Proving Ground, Maryland.

### 3. Application

*a.* The material presented herein is applicable, without modification, to nuclear or nonnuclear warfare. The provisions of this manual are applicable to the ordnance battalion of the armored division operating in the field, both in the continental United States (CONUS) and in oversea commands. During resident and unit training as well as field exercises it is essential that direct support ordnance service in the armored division be taught and conducted in accordance with these prescribed procedures to insure efficient training of ordnance personnel.

*b.* This manual supplements the basic information contained in FM's 9-1, 9-3, and 9-5, and should be used in conjunction with these basic manuals. FM 9-2 is also an invaluable aid to the ordnance officers in the battalion. Other references deemed appropriate are listed in the appendix.

## 4. Definitions

There is no section or glossary in this manual devoted to definitions of terms. The terms used throughout this manual may be found in AR 320-5, "Dictionary of United States Army Terms," except for those few not yet incorporated in this regulation. The latter are defined or explained in the text when first introduced, and can be located by referring to the index.

## CHAPTER 2

### BATTALION ORGANIZATION, CAPABILITIES, AND EMPLOYMENT

---

#### 5. General

*a.* The armored ordnance battalion is an organic part of the armored division, and provides ordnance direct support service for the division. In order to fully understand the factors governing the organizational structure and employment of the ordnance battalion, it is first necessary to have a general knowledge of the overall structure of the division and its employment. The location and grouping of the various elements of the division within the division area have a direct bearing on the structure and employment of the various elements of the ordnance battalion which provide the required ordnance support.

*b.* The armored division (fig. 1) is one of the basic large units of the combined arms and services. It may be employed in most types of ground combat in either nuclear or nonnuclear warfare. The division may operate as an element of a larger force in conjunction with infantry, airborne, and other armored divisions, or independently for a period of time, dependent on the logistical and other support afforded it.

*c.* The missions assigned to the armored division are those which capitalize upon its characteristics of mobility, maneuverability, and concentrated firepower. The division employs the combat command task force concept for the execution of the division's combat operations. Each combat command consists of combat, combat support, and required service support elements. Each element of the combat command task force, whether attached or in support, contributes its specific characteristics and capabilities to complement the combined effort of the whole. For detailed information on the organization (fig. 5) and employment of the armored division and its components, see FM 17-100.

*d.* Adequate ordnance support is necessary to maintain the mobility, maneuverability, and firepower of the division. Within the division this support is provided by the organic ordnance battalion (fig. 2). Each of the three combat commands of the division is provided ordnance direct support by one of the three forward support companies of the ordnance battalion. Direct support ordnance service for the support elements of the division is

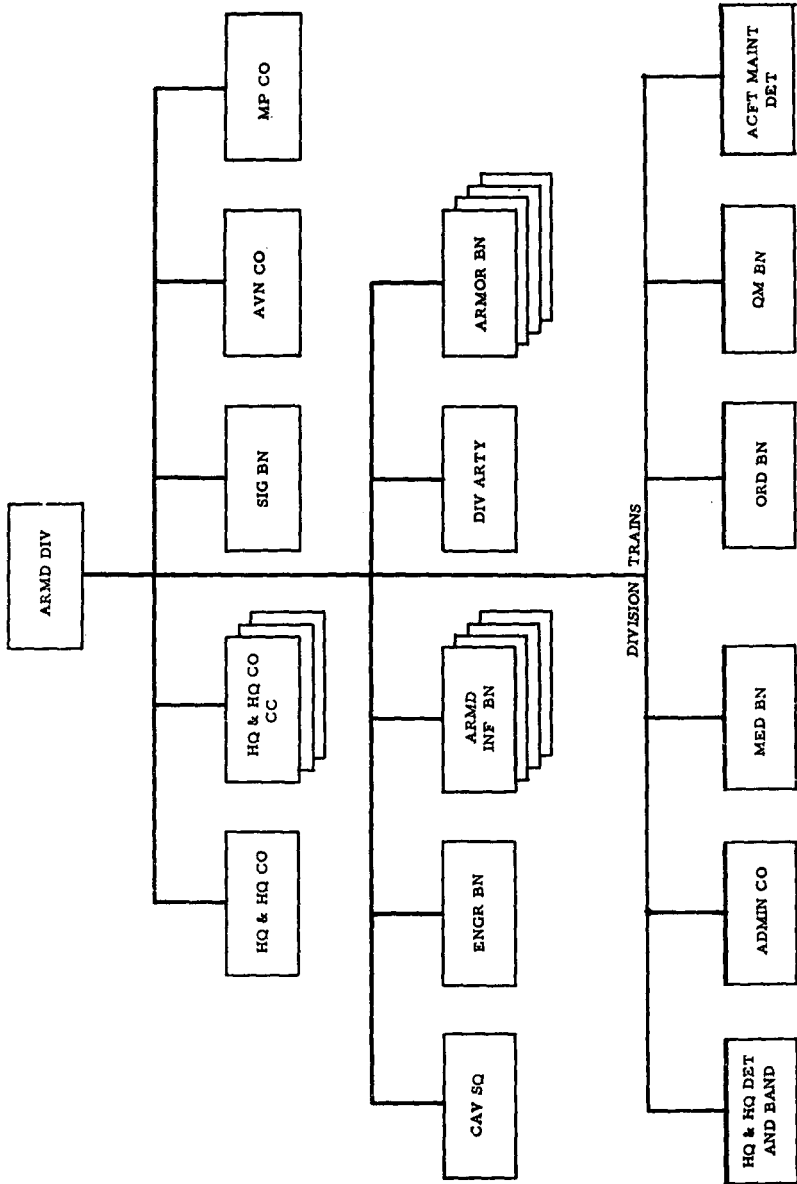

Figure 1. Armored division.

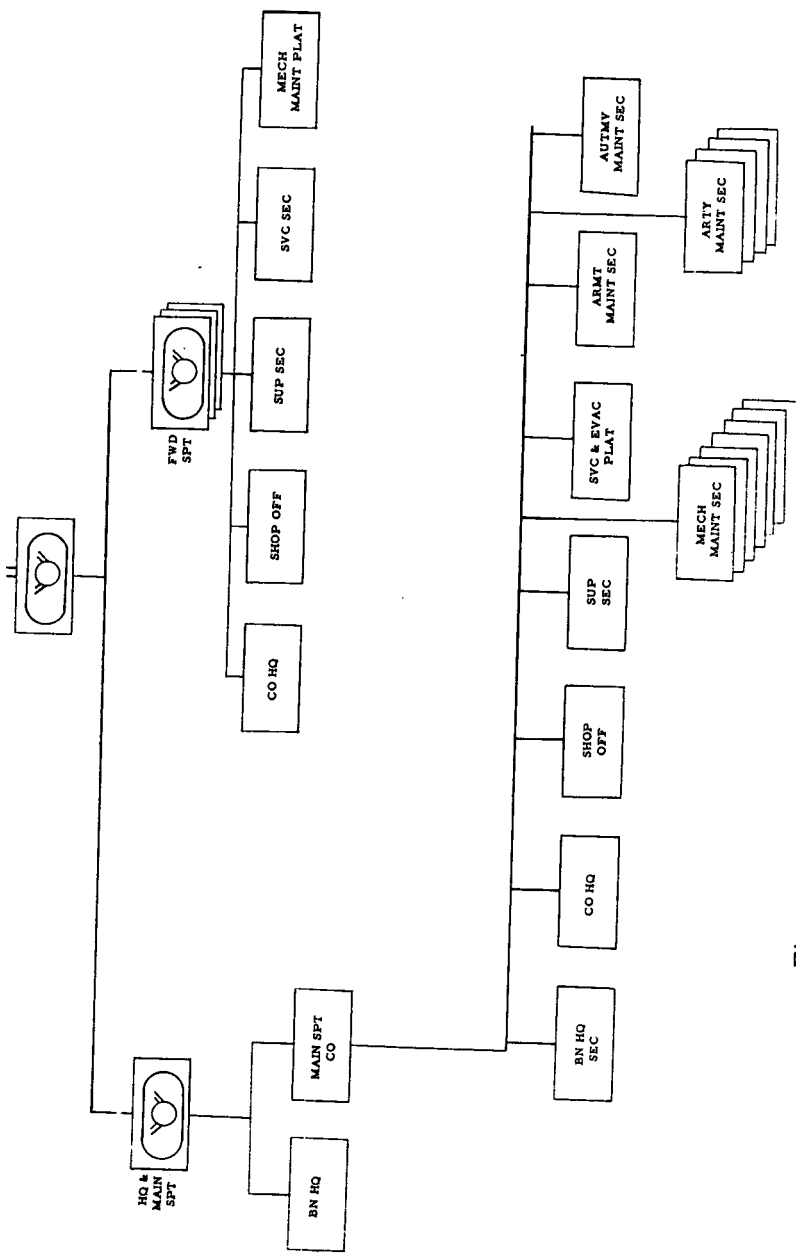

Figure 2. Organization of the armored ordnance battalion.

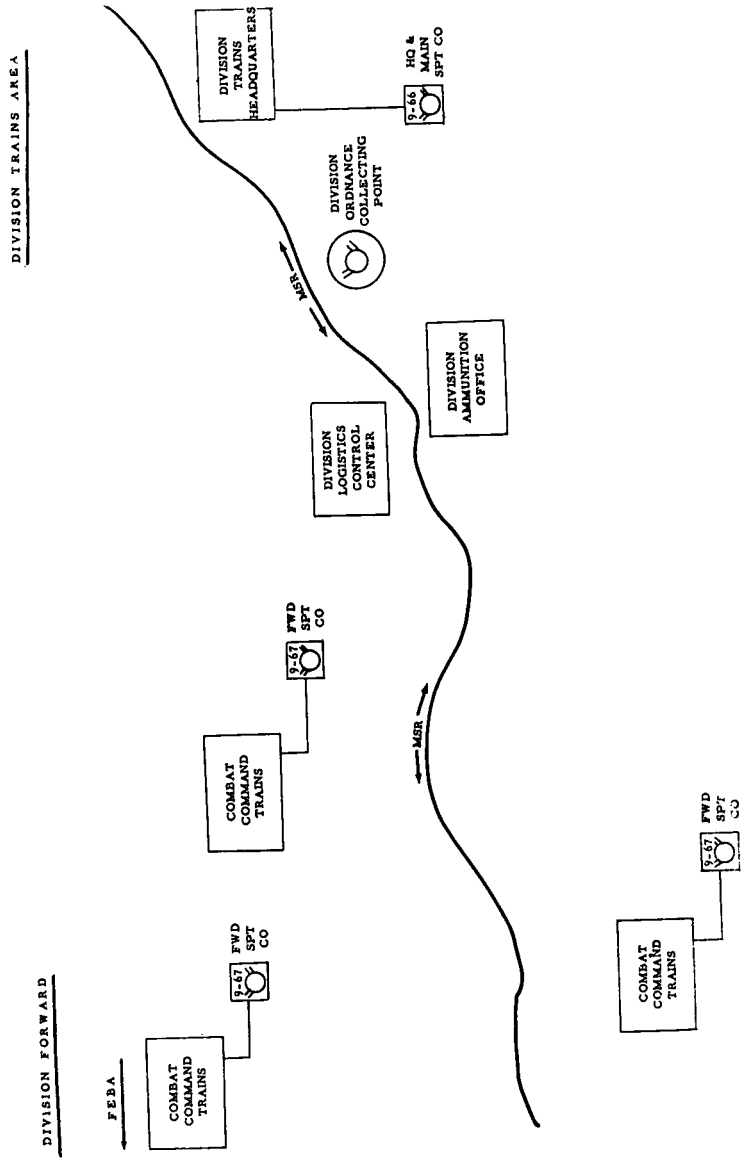

Figure 3. Type layout, Armored Ordnance Battalion, TOE 9-65.



provided by the main support company of the ordnance battalion. Figure 3 depicts a type layout of the armored ordnance battalion in the combat zone.

## 6. Organization and Mission of the Armored Ordnance Battalion (Fig. 2)

The armored ordnance battalion consists of a headquarters and main support company and three forward support companies. The support companies are also designated by letter, with the main support company being designated company "D" and the forward support companies being designated companies "A", "B", and "C." However, throughout the remainder of this manual the terms "main support company" and "forward support company" will be used.

### a. The headquarters and main support company—

- (1) Provides command, administration, and technical supervision of the armored ordnance battalion.
- (2) Provides direct support ordnance service for the support elements of the division, serves as a base of supply for the armored ordnance battalion, and provides supplementary support to the three forward support companies.

b. Each of the forward support companies provides direct support service for all ordnance equipment normally in a combat command of the armored division, and for one-third of the other ordnance equipment normally located in the forward portion of the division area.

## 7. Capabilities of the Armored Ordnance Battalion

a. *Support Capabilities.* At full strength this unit performs the following:

- (1) Provides ordnance technical assistance service for the division.
- (2) Performs third echelon maintenance on ordnance armament, wheeled and tracked vehicles, fire control equipment, and other instruments.
- (3) Assists in the performance of lower echelons of maintenance on any equipment enumerated above, the maintenance of which is beyond the capability of supported units.
- (4) Secures, stocks, and issues repairs parts, assemblies, certain components, and other secondary items of supply pertaining to the ordnance equipment supported for all organizational and field maintenance activities of the division.

- (5) Maintains and utilizes a stockage of selected fast-moving ordnance items for maintenance exchange.
- (6) Provides administrative control of ammunition supply to the division and attached units.
- (7) Provides recovery and evacuation support, within its capacity, for all supported equipment in the division area.
- (8) Operates the division ordnance collecting point.
- (9) Provides sufficient personnel to the division logistics control center (DLCC, fig. 3) to expedite the issue of ordnance supplies to combat elements and to coordinate evacuation and maintenance activities. For details on the mission, functions, and composition of the DLCC, see FM 17-50 and FM 17-100.

*b. Defense.* Individuals of this unit can fight as infantrymen when required. This unit has the capability of defending itself and its installations against hostile ground attack.

*c. Mobility.* Each of the companies of the battalion is 100 percent mobile with its organic transportation.

## 8. Employment

### *a. General.*

- (1) The armored ordnance battalion provides integrated ordnance maintenance and supply service to the armored division. The battalion is mobile and has a flexible organization to permit employment of elements at multiple locations. It is organized and equipped to accomplish the maximum repairs of equipment at a location near the using units, but its productivity is limited by the necessity for frequent displacement, interference by enemy action, and fluctuating workloads.
- (2) Battalion elements possessing appropriate capabilities are located to facilitate support of using units. The headquarters and main support company operates in the division trains area. The main support company provides ordnance direct support to the supporting elements of the division which operate in the division trains area, and provides supplementary support to the forward support companies. A forward support company is placed in support of each combat command and normally moves as a part of the combat command trains. In certain operations, as in exploitation or in a delaying action, forward support companies may be attached to the combat commands for more efficient control of movement and protection.

- (3) Ordnance support is, in general, provided on a task and area basis, with elements providing support to specified units and to a portion of the division area. Emergency maintenance support is provided to all transients upon request. Emergency supply support for all transients is limited to that necessary to permit the transient to reach his normal support base.

*b. Ordnance Support in Combat Operations.*

- (1) *Offense.* In the offense, an ordnance forward support company normally will be placed in direct support of each combat command. Forward support companies should be attached to the combat commands if the ordnance battalion is unable to control them due to distance, terrain, or enemy dispositions. The forward support companies move forward into the combat command areas and are located with combat command trains. The remainder of the battalion operates in the division trains area.
  - (a) It is essential that division ordnance maintenance service be within supporting distance of the combat elements. To accomplish this in a fast-moving offense, it may be necessary to move ordnance units in two or more echelons.
  - (b) When a movement is to be made, arrangements must be made for a higher echelon of maintenance to take over unfinished work. If this cannot be arranged, the main body of the battalion may have to move, and sufficient personnel and equipment left behind to complete the unfinished work. Necessary protection must be provided for personnel left behind.
- (2) *Defense.* In defensive operations, ordnance direct support service must be planned according to the type of defense contemplated.
  - (a) *Mobile defense.* In mobile defense, a forward support company will be placed in direct support of each combat command. The company will be located in the combat command trains area. Each forward support company must conduct its activities so as to be able to displace in not more than 1 hour after being warned. Work requiring extensive disassembly may have to be evacuated to the main support company, which will be located in the division trains area.
  - (b) *Position defense.* In position defense, the forward support companies may be located in the combat command trains areas, or may operate with the main sup-

port company in the division trains area. In the latter case, contact parties are used to support the combat elements. These contact parties carry stocks of repair parts and accomplish the maximum maintenance possible in the forward area. Only work that requires excessive repair time or the use of unavailable tools and equipment will be evacuated to the rear.

- (c) *Perimeter defense.* In perimeter defense, the entire ordnance battalion will normally operate in the division trains area and make maximum use of contact parties to support the combat elements.
- (3) *Retrograde operations.* Movement of elements of the ordnance battalion to the rear will be coordinated by the division ordnance officer. As the elements of the battalion move to the rear, they place the maximum number of contact parties in immediate support of the combat elements. These parties carry stocks of vehicle repair parts, small-arms parts, and such artillery parts that can be installed in a reasonable length of time.

## CHAPTER 3

### ORGANIZATION, FUNCTIONS, AND DUTIES OF PERSONNEL

---

#### Section I. BATTALION HEADQUARTERS

##### 9. General

Battalion headquarters is one of the two principal elements of the headquarters and main support company (fig. 2). The other element, the main support company, is discussed in section II. Battalion headquarters provides the personnel who command, control, and exercise supervision over the battalion and any attached units. It also provides the officer personnel to staff the division ordnance staff section (division ordnance office, fig. 4). The division ordnance office (ch. 5) is physically a part of the battalion headquarters, except for the division ammunition office, which usually operates near the division logistics control center (DLCC, fig. 3). The battalion sergeant major is also part of the battalion headquarters element of the headquarters and main support company, and is the only enlisted man so assigned. The remainder of the enlisted personnel utilized in battalion headquarters and the division ordnance office come from the battalion headquarters section of the main support company (fig. 2).

##### 10. Organization

*a.* The battalion commander is also the division ordnance officer. As battalion commander he commands, controls, and supervises the ordnance battalion and any attached ordnance units. As division ordnance officer he is responsible for supervising all aspects of ordnance service within the division; for making plans, policies, and recommendations relative to the supply and maintenance of ordnance materiel; for supervising the implementation of approved plans and policies throughout the division; for insuring the provision of timely and adequate ordnance support to the division; and for keeping the division commander and his staff informed on the ordnance situation.

*b.* The composition of the battalion headquarters is such that personnel are provided to assist the commander in the accomplishment of each of his major responsibilities. Like the battalion

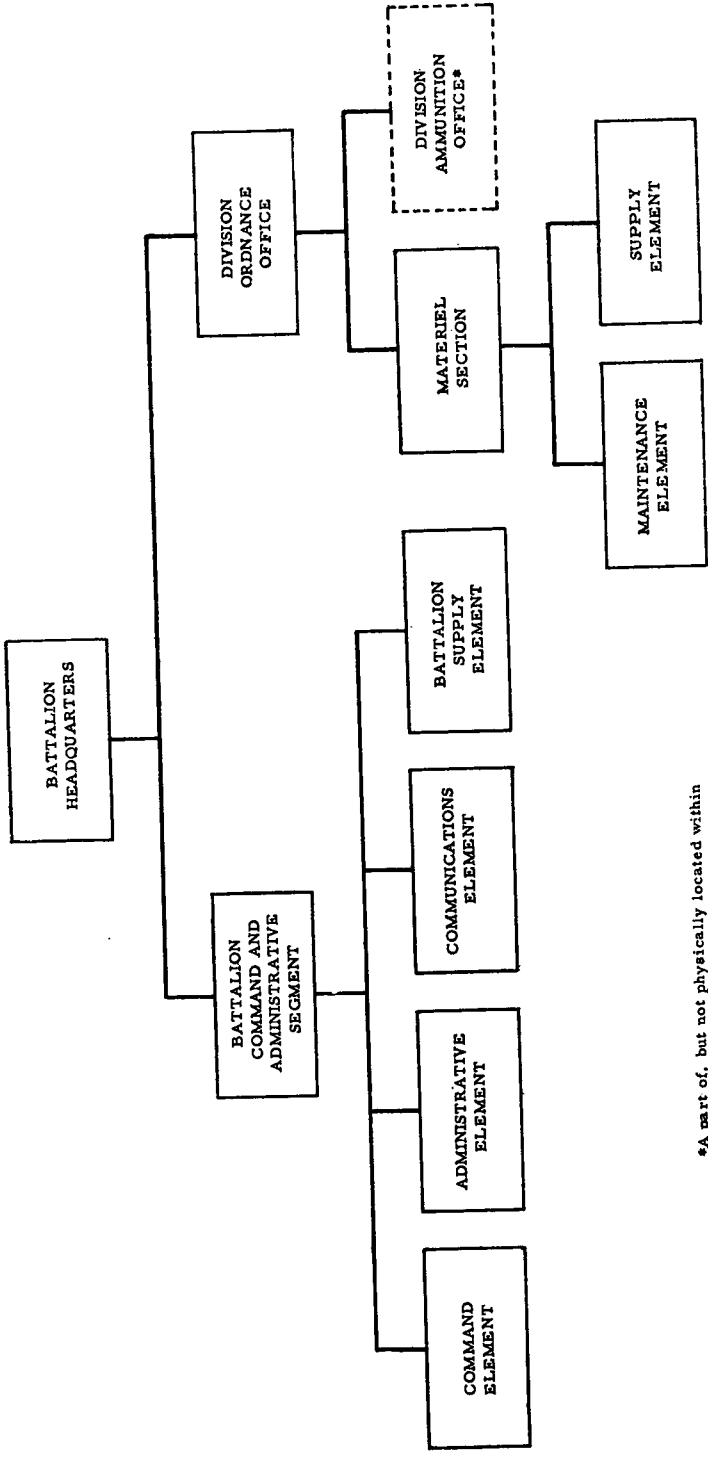

\*A part of, but not physically located within the division ordnance office proper; usually operates near the DLCC.

Figure 4. Functional organization of battalion headquarters.

commander, many of the battalion headquarters personnel also have dual responsibilities. The most significant exceptions are the ammunition personnel whose responsibilities consist solely of ammunition control in the division.

*c.* Functionally, the personnel comprising battalion headquarters may be classified into two groups: those whose primary responsibility is to the ordnance battalion, and those whose responsibilities encompass the division as a whole. Although such a distinction is necessary for purposes of explanation, it must be remembered that responsibilities overlap, and one group supplements and complements the other. Therefore, it is practical and desirable to have both groups operate from the same physical location (except for ammunition personnel). Included in the first grouping are those personnel who assist the commander in controlling and supervising battalion operations. This group may be referred to as the command and administrative segment of battalion headquarters (fig. 4). The personnel provided to assist the division ordnance officer in the accomplishment of his staff functions comprise the division ordnance office (fig. 4 and ch. 5). Administrative and communications support for the entire battalion headquarters, including the division ordnance office, is provided by personnel of the battalion headquarters section of the main support company. Personnel of battalion headquarters mess with the main support company.

*d.* The command and administrative segment of battalion headquarters consists of command, administrative, communications, and battalion supply elements. The battalion commander and the executive officer comprise the command element. The administrative element consists of the adjutant, sergeant major, and clerk typists. The battalion supply officer and supply sergeant make up the supply element. The radio-teletypewriter team chief, radio-teletypewriter and radio operators, and radio mechanics comprise the communications element. The operations of the communications element are controlled by a communications officer appointed by the battalion commander. Battalion communications are discussed in chapter 14.

*e.* The division ordnance office consists of an ammunition control section (division ammunition office) and a materiel section (fig. 4). The materiel section is further subdivided into a maintenance element and a supply element. Personnel of the division ordnance office include the division ordnance officer (battalion commander), assistant division ordnance officer (battalion executive officer), division ammunition officer (also nuclear weapons officer), materiel officer, maintenance officer, ordnance general supply officer, ammunition supply officer, operations sergeant, repair control supervisor,

chief ammunition clerk, and ammunition records clerks. Administrative and communications personnel are provided by the battalion headquarters section.

## 11. Functions

The battalion executive officer is charged with the responsibility of supervising the operations of the battalion headquarters so as to permit the battalion commander to devote more time to his staff functions. The functions of the battalion headquarters include:

a. Administering the headquarters.

b. Supervising the administration of ordnance units organic to the battalion. In certain situations it is possible that additional ordnance units will be attached to the battalion and it is conceivable that battalion headquarters may be required to administer these units.

c. Operating the battalion command post.

d. Operating the division ordnance office (ch. 5).

e. Maintaining the unit property books for the companies in the battalion and any attached ordnance units and assisting subordinate units in solving organizational supply problems.

f. Operating the battalion message center and the battalion communications facilities.

## 12. Staff Assistance

a. *Battalion Staff.* The battalion commander is provided a staff to assist in the administration, control, and technical direction of his command. The unit staff includes the executive officer, the adjutant, and the battalion supply officer. Operations and technical intelligence functions are handled by the materiel officer and the operations sergeant who function, primarily, as members of the division ordnance office. The capabilities of the unit staff are augmented, as necessary, by utilizing other personnel of the division ordnance office (except ammunition personnel).

b. *Division Ordnance Office.* This office assists the battalion commander in the performance of his duties as division ordnance staff officer. It prepares plans, supervises their implementation, makes recommendations on the conduct of ordnance technical operations in the division, recommends ordnance maintenance and supply policies and procedures for the division, and exercises technical supervision over all aspects of ordnance service within the division. The organization and functions of the division ordnance office and the specific duties of its key personnel are discussed in chapter 5.



### 13. Duties and Responsibilities of Key Personnel

a. *Battalion Commander.* He directs, controls, and supervises all ordnance units of the battalion, whether organic or attached. He is responsible for the preparation of plans, policies, and orders. He visits and inspects his troops and their activities. The battalion commander also serves as division ordnance officer, and in this capacity serves as adviser to the division commander and staff and keeps them informed on the ordnance situation in the division. (The duties of the division ordnance officer are listed in ch. 5.) Since the battalion commander has both command and staff responsibilities, either of which could take up all of his time, he must adopt a method of operation that will permit him to function effectively in his dual role. He has his executive officer and unit staff to assist him in his battalion functions, and the personnel of the division ordnance office to assist in the accomplishment of his division staff responsibilities.

b. *Executive Officer.* The principal assistant and adviser to the ordnance battalion commander is the executive officer. He too has a dual role in that he also serves as assistant division ordnance officer (ch. 5). In his capacity as executive officer he supervises the routine details of operations and administration, thereby enabling the battalion commander to devote maximum time to new or unusual problems. The executive officer keeps abreast of the logistical and tactical situations and future plans, and is constantly prepared to assume command in the absence of the commander. The responsibilities of the executive officer include:

- (1) Directing and coordinating the staff and headquarters personnel.
- (2) Representing the commander during his temporary absences.
- (3) Assigning tasks to members of the staff.
- (4) Reviewing all instructions issued by the staff to insure conformity to policy.
- (5) Supervising all plans and reviewing all periodic and special reports to be submitted to higher headquarters.
- (6) Keeping the battalion commander informed of the tactical situation and submitting recommendations on internal security and defense of the installations of the battalion.
- (7) Maintaining an up-to-date situation map and insuring that all staff officers and commanders of subordinate ordnance units are aware of the tactical situation.

- (8) Coordinating reconnaissance for new locations for subordinate ordnance units and selecting alternate areas to be occupied in case of heavy enemy attack.
- (9) Planning security measures during marches and displacement of the battalion.
- (10) Establishing training programs and supervising the training of battalion personnel. He is assisted in his training functions by the adjutant (for nonmission-type training) and the materiel officer (for mission-type training). Training is further discussed in chapter 12.

*c. Adjutant.* The adjutant is responsible for the administration of the headquarters and for coordinating the administration of the ordnance units organic or attached to the battalion. His responsibilities include:

- (1) Preparing instructions as to the time of submission, period covered, form, and channels for strength reports rendered by ordnance units of the battalion.
- (2) Receiving replacements consigned to the battalion and arranging for their delivery to appropriate subordinate units.
- (3) Submitting recommendations for citations, decorations, honors, and awards; supervising the distribution of mail; supervising the leave program; coordinating religious activities with the chaplain; and planning, coordinating, and supervising the athletic and recreation program.
- (4) Supervising personnel procedures including transfers, assignments, promotions, demotions, and classification of personnel. (The actual administrative details of these personnel actions are handled by the administrative company of the division.)
- (5) Supervising the internal arrangement and movement of the headquarters.
- (6) Keeping the unit journal and files of official correspondence for the staff and the division ordnance office including security files.
- (7) Assisting the executive officer in planning and supervising nonmission-type (military) training of battalion personnel.
- (8) Preparing training schedules.

*d. Supply Officer.* He is responsible for:

- (1) Consolidating the organizational supply requirements of organic and attached ordnance units.

- (2) Assuring that organic and attached units are provided rations, water, gasoline, lubricants, organizational and individual supplies and equipment, and ammunition.
- (3) Establishing a unit supply SOP for operating under the various conditions encountered in the field.
- (4) Advising the battalion commander on the status of organizational supply within the battalion.
- (5) Inspecting all activities under his supervision and assuring that all discrepancies are corrected.
- (6) Assuring that organizational supply operations are conducted according to the provisions of AR 735-35.
- (7) Maintaining the property books for organic and attached ordnance units. (For additional information on the responsibilities of property book officers see ch. 4.)

*e. Materiel Officer.* The materiel officer is in charge of the materiel section of the division ordnance office (ch. 5). In addition, he functions as operations officer (limited to operations incident to the battalion's technical mission) for the battalion and performs technical intelligence functions. In the performance of his functions, he is assisted by the operations sergeant. The duties of the materiel officer with respect to battalion operations include:

- (1) Establishing the battalion maintenance SOP.
- (2) Making a continuous study of the organization and equipment of the ordnance units in the battalion and preparing recommended changes to tables of organization and equipment.
- (3) Recommending the assignment of support missions to units of the battalion.
- (4) Providing policy guidance for the operations of the battalion maintenance shops.
- (5) Publishing support missions and notifications to supported units.
- (6) Supervising plans for the evacuation of installations and the destruction of ordnance materiel in the event of a general retrograde movement.
- (7) Preparing the operations order to show support missions of the battalion and attached ordnance units.
- (8) As necessary assisting the executive officer in planning and supervising mission-type training.

*f. Division Ammunition Officer.* See chapter 5.

*g. Ammunition Supply Officer.* See chapter 5.

*h. Maintenance Officer.* See chapter 5.

i. *Ordnance Supply Officer.* See chapter 5.

j. *Sergeant Major.* The sergeant major is the adjutant's principal assistant. He supervises and directs the administrative personnel of the headquarters in the preparation of orders, correspondence, records, forms, and reports. He is the liaison channel between battalion headquarters and the first sergeants of the companies in the battalion.

k. *Chief Ammunition Clerk.* The chief ammunition clerk is the principal enlisted assistant of the division ammunition officer. He controls and supervises the administrative personnel assigned to the division ammunition office in the preparation and maintenance of correspondence, records, forms, and reports.

l. *Operations Sergeant.* The operations sergeant assists in the performance of battalion operations functions. He assists in the preparation of plans, supervises the operations of the clerks assigned to perform the administrative work incident to operations functions, and performs other functions as directed.

m. *Repair Control Supervisor.* The repair control supervisor assists the maintenance officer in controlling and supervising the operations of the maintenance element of the division ordnance office (ch. 5). He keeps records and prepares reports on the status of maintenance within the division. These records include shop progress reports, deadline reports, etc. He also assists the maintenance officer in the conduct of ordnance inspections and performs such other duties as the maintenance officer may direct.

n. *Armament Repair Inspector.* This inspector is the principal assistant to the maintenance officer in maintaining high standards of maintenance within the division. He assists in the training of division ordnance inspection teams, assists in the performance of inspections of armament materiel throughout the division, and assists in the establishment of inspection procedures and SOP's.

o. *Radio-Teletypewriter Team Chiefs.* One of the team chiefs normally operates at battalion headquarters and the other with the division ammunition officer who may be displaced with the DLCC. They are the senior assigned communications specialists of the battalion, and they must be thoroughly familiar with the operation, application, capabilities, and limitations of all organic communications equipment. They supervise the installation, operation, and maintenance of battalion signal equipment; assist in the communications training of personnel and the procurement of necessary Signal Corps supplies; and advise the battalion communications officer on employment and maintenance of communications equipment, the utilization of personnel with primary communications

assignments, and the preparation of communications plans and documents. For additional information on communications within the battalion, see chapter 14.

*p. Battalion Supply Sergeant.* The supply sergeant is the principal assistant to the battalion supply officer. Like the supply officer, he is primarily concerned with organizational supply for elements of the battalion. He supervises the preparation and maintenance of transaction files for the property book officer, and assures that requests for issue and turn-in and associated supply records are prepared and maintained properly. He also conducts liaison with the supply personnel of the units in the battalion and assists the supply officer in the conduct of inspections of unit supply procedures.

## Section II. SUPPORT COMPANIES

### 14. Main Support Company—Organization and Function

The main support company provides direct support ordnance service for the rear elements of an armored division. It serves as a base of operations for ordnance service in the division, operates the division ordnance collecting point (ch. 8), is the base of supply for the ordnance battalion, and provides supplementary support to the three forward support companies. The main support company consists of:

*a. Battalion Headquarters Section.* This section (fig. 2) includes all the enlisted personnel who work in battalion headquarters. The duties and responsibilities of personnel of this section are discussed in section I.

*b. Company Headquarters.* The headquarters includes the company commander and all company overhead personnel. It performs command, administrative, and organizational supply functions for the company, provides communications and mess facilities, and controls and maintains organizational transportation.

*c. Shop Office.* The shop office contains the shop officer, automotive repair supervisor, and shop clerk. It carries and maintains a complete technical library for the company and controls the technical operations of the service, maintenance, and evacuation elements of the company. This office maintains shop production control on items processed through the shops, prepares records and reports on the maintenance activities of the company, and controls the dispatch of on-site maintenance teams.

*d. Supply Section.* This is the technical supply element of the

company (ch. 7). This section procures, stocks, and issues ordnance general supply items to other elements of the ordnance battalion, and issues organizational items of ordnance supply to elements of the division not supported by the forward support companies.

*e. Service and Evacuation Platoon.* This platoon provides metalworking, carpentry, packing and crating, canvas and leather repair, and similar services to all elements of the company; provides these same services in a backup role to the forward support companies; establishes and operates the division ordnance collecting point; and provides recovery and evacuation support within its capability to all organic and attached elements of the division.

*f. Automotive Maintenance Section.* This section provides third echelon maintenance for all vehicles of those elements of the division not being supported by the forward support companies. It also supplements the capabilities of the forward support companies when necessary.

*g. Armament Maintenance Section.* This section provides third echelon maintenance support for fire-control instruments and weapons for all elements of the division not supported by the forward support companies. It also supplements the capabilities of the forward support companies for third echelon maintenance of fire-control instruments and weapons.

*h. Mechanical Maintenance and Artillery Maintenance Sections.* The seven mechanical maintenance and four artillery maintenance sections are used to bolster the maintenance capabilities of the forward companies whenever a task force requires more support than that provided by one of the forward companies. These maintenance sections may be used separately to support combat elements which are placed at great distances from the main body of a combat command. They may also be used in rear areas as on-site maintenance teams. When their use is not required outside the main support company, these sections will be used in conjunction with the maintenance sections of the company shop. The attachment and employment of these sections are dependent upon the workload of the forward support companies.

## 15. Forward Support Companies—Organization and Functions

The armored ordnance battalion contains three forward support companies (fig. 2). All three are organized similarly, and each provides direct support service to a specific combat command and other units in the combat command area. Forward support companies are located in the field trains area of the combat command

they are supporting. The forward support companies also operate the vehicle collecting points which are established in the combat command areas. These collecting points are merely locations to which recovered vehicles and other items are brought for eventual repair and return to service by the appropriate forward support company or for further evacuation. Each forward support company is organized as follows:

*a. Company Headquarters.* Like its counterpart in the main support company, the headquarters performs command, administrative, communications, and organizational supply functions; provides mess facilities, and controls and maintains organizational transportation.

*b. Shop Office.* The shop office controls the technical operations of the service section and the mechanical maintenance platoon. It maintains a technical library, maintains shop production control on items processed through the company shops, controls the dispatch of on-site maintenance teams, and prepares and maintains records and reports. The shop office cooperates closely with the technical supply section to assure that the supplies required for maintenance are available on time and in sufficient quantity, and that excesses of serviceable items are turned in to supply.

*c. Supply Section.* This is the technical supply element of the company (ch. 7). This section obtains, stores, maintains in storage, and issues the repair parts and supplies needed to support maintenance operations of the company as well as those supplies needed to provide direct supply support to supported units in the combat command area.

*d. Service Section.* This section provides limited service (such as welding) and evacuation support within its capability. Its capabilities are not as varied and extensive as those of the service and evacuation platoon of the main support company. Disabled equipment and other heavy assemblies that cannot be repaired within the company are prepared for evacuation by the service section. The service section also provides the heavy equipment and personnel to move heavy items within the maintenance shops.

*e. Mechanical Maintenance Platoon.* This platoon provides direct support maintenance service for all ordnance equipment of supported units. It is normally augmented by one or more of the mechanical or artillery maintenance sections of the main support company.

## 16. Duties and Responsibilities of Key Personnel

*a. General.* The types of jobs performed and the duties of per-

sonnel are generally similar in all companies of the battalion, the significant differences being in the service and evacuation platoon of the main support company, which can provide more extensive and more varied allied trades support than the service sections of the forward support companies (e.g., the main support company has a blacksmith, while the forward support companies do not). Note also that the titles of supervisory personnel in the main support company differ, in some cases, from the job titles of personnel performing similar duties in the forward support companies, even though the MOS's are the same (e.g., the artillery repair officer in a forward support company has the same MOS as the armament maintenance officer of the main support company). Since the duties of clerks, switchboard operators, wiremen, and cooks are similar in all organizations, they will not be discussed.

*b. Company Commander.*

- (1) The company commander must have a sound basic knowledge of supply, maintenance, and administration. He manages the company and is responsible for all the company does or fails to do. He actually supervises all phases of the technical, tactical, and administrative operations conducted by the company. The commander cannot delegate responsibility for the general managership of the technical service mission to a subordinate.
- (2) The commander is responsible for planning, supervising, and directing the operations and training of his organization. He supervises company administrative functions; establishes policies; insures effective and efficient operation of all platoons and sections; takes all possible measures to assure the health, welfare, and morale of company personnel; plans technical and tactical operations; assures the proper assignment and training of personnel within the company; accomplishes or recommends promotions; and supervises all activities required for accomplishment of the company mission. The commander is assisted in these functions by other supervisory personnel who are assigned certain functions as primary duties or as extra duties. Company mess, supply, and administrative functions of the company commander are discussed in chapter 4.
- (3) Each forward support company commander also serves as ordnance officer on the special staff of the combat command that is supported by his company. His duties in this respect parallel those of the division ordnance officer (ch. 5).



*c. Shop Officer.* The shop officer is the principal assistant to the company commander in all matters pertaining to the direct support maintenance mission of the company. He supervises and directs the activities of the shop office and the maintenance shops, and coordinates the activities of the company's supply and maintenance elements to assure that each complements the other in the provision of direct support service to using units. His duties involve:

- (1) Supervising the quality and quantity of maintenance production.
- (2) Training and cross-training of personnel.
- (3) Supervising recovery and evacuation operations.
- (4) Knowing the status of equipment undergoing repairs and determining whether components or assemblies are to be repaired or replaced when performing maintenance on end items.
- (5) Devising means to assure continuity of maintenance support during each movement.
- (6) Coordinating the activities of all platoons and sections participating in maintenance, recovery, and evacuation functions.
- (7) Reviewing supported unit equipment status and deadline reports to determine the need for technical assistance.

*d. Maintenance Officers (Armament or Automotive).* Automotive and armament maintenance officers are provided in the main support company to supervise and direct the operations of the armament and automotive sections of the company shop. Each forward support company has an automotive maintenance officer who serves as platoon leader of the mechanical maintenance platoon. Each mechanical maintenance platoon also has an artillery repair officer who assists the platoon leader in the coordination and supervision of platoon activities. Maintenance officers will be concerned with:

- (1) Diagnosis of the mechanical or electrical difficulties of ordnance equipment, the use of test equipment, determining and identifying the condition of ordnance materiel, the conduct of technical inspections (technical inspection refers to that inspection performed on ordnance equipment by ordnance personnel in ordnance shops before repair is begun, and after repairs have been accomplished), and estimating the labor and time required for any maintenance operation.

- (2) Safety regulations to be observed in the performance of the maintenance operation.
- (3) Shop supply (the function of providing the repair parts, assemblies, components, and other supplies needed by company maintenance personnel in the performance of field maintenance, ch. 6).
- (4) Direct exchange (ch. 6).
- (5) Characteristics and limitations of ordnance equipment.
- (6) Preventive and organizational maintenance of organizational equipment.
- (7) Work supervision and simplification and methods of detecting poor working practices.
- (8) Preparation and preservation of ordnance materiel for storage or evacuation.
- (9) Organizing and conducting on-the-job technical training.

*e. Supply Officer.* Each of the companies of the battalion has a supply officer who serves as chief of the company's supply section (technical supply, ch. 7). The responsibilities of the supply officer include supervision of organizational supply operations and direction of the company's technical supply operations, and direction of the company's technical supply operations. The latter function will take up most of the supply officer's time. Organizational or unit supply encompasses those operations required to obtain and replenish individual clothing and equipment as well as organizational equipment and supplies authorized by TOE's, TA's, and other authorization documents (ch. 4). Technical supply includes all those operations required to obtain, account for, store, and issue ordnance class II and IV supplies needed by supported units and the company maintenance shops (ch. 7). The duties of these supply officers involve directing and supervising the requisitioning, receipt, storage, in-storage maintenance, and issue of repair parts and supplies and assuring that supply personnel are adequately trained. The main support company has an additional supply officer who is assigned to the service and evacuation platoon. He is usually given the responsibility for operating the division ordnance collecting point. The duties of the supply officer with respect to collecting point operation are enumerated in chapter 8. The supply officers of the supply sections of the battalion will be familiar with :

- (1) Procedures for ordering, receiving, accounting for, and issuing ordnance general supplies; the methods of storing, packing, preserving, and protecting ordnance supplies; and the identification of ordnance equipment, accessories, repair parts, tools, and supplies.

- (2) Safety precautions to be observed in handling ordnance supplies.
- (3) Requisitioning procedures and record keeping.
- (4) Supervision of personnel, including ways of detecting poor working practices.
- (5) Methods of conducting training.
- (6) Administration, management, and scope of ordnance support operation.
- (7) Maintenance of supplies in storage.

*f. Service Officer.* The service officer in each forward support company serves as chief of the company's service section. He directs and controls the activities of the section, and assigns and coordinates work according to the availability and capability of personnel and equipment. The service officer assures that a stock of supplies is available for operation of the service section, directs the inspection of repaired items to determine whether work was performed properly, supervises and directs recovery and evacuation operations, and instructs personnel on technical operations. In the main support company similar responsibilities are exercised by the platoon leader of the service and evacuation platoon who is a service officer by MOS.

*g. Recovery Officer.* This officer is assigned to the service and evacuation platoon of the main support company. There is no such duty position in the forward support companies. The recovery officer carries the MOS of an automotive maintenance officer. He plans, supervises, and directs recovery and evacuation operations; makes job assignments; and instructs personnel on technical operations. In the performance of his duties he must coordinate with the shop officer and the supply officer of the company to assure that the heavy equipment and operators under his control are used to best advantage in accomplishing the company technical mission.

*h. Platoon Leaders.* Platoon leaders supervise and direct the activities of their platoons. They are responsible for the training of the members of their platoons and must be thoroughly familiar with the skills, capabilities, and personalities of their men.

*i. Automotive Repair Supervisor.* In the main support company only, an automotive repair supervisor is provided to assist the shop officer. He is assigned to the shop office and is the principal assistant to the shop officer in matters pertaining to the maintenance mission of the company. He supervises the preparation of records and reports, makes job assignments to the shop sections, and assists the shop officer in implementing production control procedures.

*j. Repair Foreman (Automotive and Turret Artillery).* A chief repair foreman, automotive repair foremen, and a turret artillery repair foreman are assigned to the mechanical maintenance platoon of each forward support company. A turret artillery repair foreman is also assigned to the armament maintenance section of the main support company. When operating within the company maintenance shops these foremen supervise and direct the operations of small maintenance teams working on specific jobs, assist in the training of repairmen and repair helpers, perform inspections, and advise team members on proper maintenance procedures and techniques. The repair foremen of the forward support companies are also placed in charge of mobile teams used to provide technical assistance and on-site maintenance.

*k. Section Chiefs.* Section chiefs are responsible to their immediate supervisors for the efficiency of their sections, the condition and completeness of equipment, the training of specialists or technicians, and the overall operational readiness of their sections. They insure that equipment does not deteriorate due to neglect or misuse, and will take action to prevent the abuse of facilities or equipment. Section chiefs of maintenance sections should be qualified inspectors and should know the best way to repair the items for which their sections are responsible.

*l. Platoon Sergeants.* The platoon sergeant is the principal enlisted assistant to the platoon leader. He assists the platoon leader in controlling and directing platoon activities and performs the administrative functions incident to platoon administration.

*m. First Sergeant.* The first sergeant is the principal enlisted assistant of the company commander and assists him in the administration of the company. He exercises supervision over the overhead personnel of the company, operates the orderly room, and assists in the supervision of training. He prepares or supervises the preparation of rosters, schedules, reports, orders, records, correspondence, and the maintenance of correspondence files. The first sergeant assists the company commander in preparing defense plans and supervises the rehearsal of these plans. He assists in the selection of new sites for operations and advises on area defense, field sanitation, and general layout of the new area.

*n. Mess Steward.* The mess steward supervises the operations of the company mess, including the preparation and serving of food and the procurement of mess supplies and equipment. He is responsible for supervising the training of mess personnel, and prepares mess records and reports. For additional information on the operation of the company mess and the responsibilities of mess personnel, see chapter 4.

*o. Supply Sergeant.* The company supply sergeant supervises the storage, procurement, and issue of all TOE and TA equipment authorized the company and is responsible for assuring that in-storage maintenance is performed on stored items. For additional information, see chapter 4.

*p. Motor Sergeant.* The motor sergeant controls the dispatch of company vehicles and assures that organizational maintenance is performed thereon. He is responsible for general motor pool operation and for scheduling organizational maintenance services. He makes arrangements for the performance of maintenance in the company's maintenance shops when such maintenance is required. For more information on organizational maintenance, see chapter 4.

*q. Recovery Sergeant.* The recovery sergeant is assigned to the service and evacuation platoon of the main support company. He assists the recovery officer in planning and supervising the recovery and evacuation operations conducted by the platoon; exercises supervision over subordinate wrecker, recovery vehicle, and tank transporter drivers and crewmen; assists subordinates in carrying out the recovery and evacuation functions of the platoon; and instructs subordinate personnel in evacuation and recovery procedures and operations.

*r. Ordnance Supply Specialists.* These include ordnance supply specialists, stock records specialists, and requisition specialists. These specialists maintain stock records pertaining to receipt, storage, and issue of ordnance general supplies; prepare requisitions; examine requisitions and incoming shipments to verify the correctness of nomenclature, stock number, and classification; maintain stock control records and supply accounting systems. They also advise on the use, interchangeability, and identification of ordnance repair parts, inspect incoming shipments of parts, and establish locator card systems to show the physical location of parts in storage.

*s. Repairmen.* The repairmen perform third echelon maintenance on the ordnance equipment supported by the battalion. Each company of the battalion contains repairmen of various degrees of skill, and each of these repairmen is responsible to his immediate supervisor for proper job performance (e.g., automotive repair helpers are responsible to automotive repairmen, automotive repairmen to senior automotive repairmen, senior automotive repairmen to the automotive repair supervisor, etc.). In performing their tasks the repairmen will:

- (1) Perform routine repairs or adjustments in accordance with approved standards.

- (2) Work out solutions to problems where no specific instructions exist and get approval for these solutions prior to their implementation.
- (3) When feasible, try to develop improved jigs or fixtures to expedite and simplify repairs. (Such jigs and fixtures should not be too elaborate.)
- (4) Sign hand receipts and be responsible for tools and machines specifically assigned to them.
- (5) Clean, properly store, and care for all tools and equipment.
- (6) Make proper entries on job orders and technical inspection worksheets.
- (7) Report unserviceable shop equipment to foremen or section chiefs.
- (8) Be constantly on the alert to detect and report unsafe practices or conditions.

*t. Heavy Equipment Operators.* These include wrecker operators, recovery vehicle operators, and tank transporter drivers. They perform the recovery and evacuation functions in the companies to which they are assigned, haul supplies and equipment, and assist in the lifting and movement of heavy equipment. They drive, maintain, and operate the equipment for which they are responsible and perform any rigging necessary for the operation.

## CHAPTER 4

### ORGANIZATIONAL MESS, ADMINISTRATION, AND SUPPLY

---

#### 17. General

*a.* Organizational mess, administration, and supply operations in each of the companies of the battalion are generally the same; therefore, these aspects of battalion operations will be discussed in terms of one company. Where variations exist, they will be explained.

*b.* The company commander is responsible for all his company does or fails to do. In his absence, the responsibility for commanding, directing, and supervising the company falls upon the next senior officer in the company, unless higher authority decrees otherwise. The duties and responsibilities of the commander may be divided into two general areas: he must supervise, command, and direct the company in a manner that will most effectively and efficiently accomplish the technical mission and he must assure the accomplishment of all the functions necessary to properly clothe, equip, feed, house, assign, and train personnel, and to maintain their morale and health.

*c.* The company commander must devote a certain amount of attention to each of his functions, but he cannot personally direct every aspect of the company's mess, supply, and administrative operations. Moreover, he must not allow himself to become so enmeshed in administrative problems that he is forced to neglect the technical mission of the company. Therefore, he will assign personnel to accomplish some of the functions as extra duties. Company officers are appointed by company order to such positions as mess officer, voting officer, and postal officer.

*d.* Although the commander is concerned with all aspects of his company's operations, there are certain functions which require more of his attention than others, and certain ones which he cannot delegate. Those of most concern to the company commander are discussed in this chapter. Duties and responsibilities allied to the technical mission are covered elsewhere in this manual. The general duties of company commanders are listed in AR 220-70.

## 18. Mess Operations

*a. General.* The commander must assure that his personnel are properly fed, that food is prepared in a palatable and sanitary manner, and that the company mess is kept sanitary. Direct supervision of the company mess may be exercised by the company commander or by a mess officer appointed by him. The commander or mess officer must make daily inspections of the mess and must verify the accuracy and completeness of mess records and reports. Battalion headquarters personnel mess with the headquarters and main support company. For information on the conduct of mess operations and the detailed duties of personnel, see AR 30-41 and TM 10-405.

*b. Organization of Company Mess.* Operating personnel include the mess steward, cooks, and kitchen police. The operation of the mess is supervised by the company commander or mess officer. Duties of personnel include:

- (1) *Mess officer.* The mess officer supervises the operation of messing facilities; obtains the required subsistence, equipment, and supplies necessary for operation of the mess and feeding of troops; makes frequent inspections of the mess to insure proper storage, handling, preparation, and economical use of food and maintenance of equipment; assures that all phases of sanitation are enforced; supervises on-the-job training of mess personnel; and supervises the keeping of mess records and accounts.
- (2) *Mess steward.* The mess steward is responsible for the actual operation and control of the unit mess. He supervises the preparation, cooking, and serving of food; inspects mess personnel for cleanliness and assures that mess facilities and equipment are kept in sanitary condition; establishes operating and work procedures for mess personnel and assigns duties to individuals; prepares the cook's worksheet for the guidance of cooks in preparing and serving food; prepares estimates of the number of rations required; instructs and supervises the instruction of mess personnel and makes recommendations on promotions; and prepares and maintains accounts, records, and related reports.
- (3) *Cooks.* Cooks prepare, cook, and serve food and supervise and direct the work of kitchen police.

*c. Troop Train and Motor Convoy Messing.* When troops are being transported by rail they are either fed from kitchen cars or are issued meal tickets. Rail is generally used to transport units, as



a whole, on long moves. The companies may also be moved by motor convoy and may subsist on packaged lunches or operational rations. Packaged lunches are also used when units are airlifted and messing aboard aircraft is necessary. For further information on troop trains and motor convoy ration procedures see AR's 31-154, 31-157, and 31-310, and TM 10-206.

#### 19. Organizational (Unit) Supply Operations

*a. General.* Most of the functions incident to organizational supply will be performed by the company supply sergeant. The commander, however, must exercise control over these operations either personally or through the supply officer. Organizational supply encompasses all the operations required to obtain, account for, store, and replenish individual clothing and equipment as well as organizational equipment and supplies. Supplies and equipment in this category include individual equipment such as weapons and clothing, and organizational equipment such as desks, typewriters, tool sets, shop tools, vehicles, etc. Organizational supply operations are conducted in accordance with AR 735-35.

##### *b. Classes of Supply.*

- (1) *Class I.* These consist of items which are consumed by personnel at an approximately uniform rate. Rations are included in this class of supply. Rations are requested on a DA Form 10-163 (Ration Request) which is prepared by the mess steward and signed by the mess officer or company commander. These requests are presented to the class I supply point for issue action. Unit supply personnel are not directly concerned with this transaction.
- (2) *Class II.* These supplies are those authorized by the Department of the Army for issue to the unit and are prescribed in tables of equipment, tables of allowances, or similar authorization documents. These items are requested from supporting supply activities by means of a DA Form 1546, (Request for Issue or Turn-In), which is prepared by the property book officer after the companies make known their requirements to him. Personnel engaged in organizational supply operations will not be involved in the requisitioning, storage, and issue of class II end items and repair parts required for technical mission activities. This aspect of supply is handled by the technical supply element (supply section). Technical supply is discussed in chapter 7.
- (3) *Class III.* This class of supply consists of fuel and lubri-

cants drawn from a quartermaster supply point against an allocation established by G4.

- (4) *Class IV.* This class includes supplies or equipment for which allowances are not prescribed or which are not otherwise classified; e.g., construction and fortification materials. The ordnance battalion will have little dealing with this class of supply.
- (5) *Class V.* This class of supply includes ammunition, explosives, and chemical agents. Replenishment of ammunition in the ordnance battalion is accomplished as prescribed in FM 9-5. The supply sergeant of the company prepares transportation orders (ammunition requests) as necessary, and presents them to the division ammunition office for authentication and to the ammunition supply point for issue action. In the storage and accounting for class V items, the procedures in FM 9-5 must be followed.

*c. Organization for Supply Operations.*

- (1) *Company commander.* With respect to organizational supply, the company commander is responsible for:
  - (a) Having in his possession or on requisition all articles currently authorized for his unit.
  - (b) Conducting frequent inspections to insure that all supplies and equipment on hand are complete and serviceable.
  - (c) Insuring that unit personnel have adequate knowledge of the care and maintenance of property and that they understand the principles of supply economy.
  - (d) Making certain that no unauthorized property is on hand and that excesses are being turned in through appropriate channels.
  - (e) Insuring that individual clothing records are maintained. These records, for enlisted men, are maintained on DA Form 10-195 (Individual Clothing Record), and consolidated on DA Form 10-102 (Organizational Clothing and Equipment Record).
  - (f) Assuming responsibility for all Government property under his control, regardless of whether he receipts for it.
- (2) *Property book officer.*
  - (a) The company property book will be maintained at battalion headquarters by the property book officer (battalion supply officer). The property book officer

maintains informal accountability for supplies and equipment, employing the supply and accounting procedures contained in AR 735-35. He is responsible for conducting appropriate inventories upon change of individuals holding hand receipts, upon the change of property book officers, when adjusting discrepancies, or at least once every 6 months. Required adjustments and entries to records will be made following the inventories. At least once every 6 months and upon changes of property book officers an inspection of the property book officer's records will be made by the property book officer.

(b) He is also responsible for initiating action to adjust inventories and to fix responsibility for lost, damaged, or destroyed property. In so doing he will prepare the necessary documents in accordance with the provisions of AR 735-10 and AR 735-11, as applicable.

(c) The property book officer prepares the necessary Requests for Issue or Turn-In, DA Form 1546, upon being notified of requirements or turn-ins by the supply sergeants of the companies.

(3) *Company supply officer.* The supply officer exercises supervision over the functioning of the organizational supply operation. He assists in the training of personnel, supervises the preparation of correspondence and reports, assures that supply economy is practiced, and makes sure that supplies in storage are stored and maintained properly.

(4) *Supply sergeant.* The supply sergeant procures, stores, maintains in storage, and issues general supplies of all technical services which are authorized by TOE, TA, and other media and required for the internal functions of the company. He is also responsible for the secure storage and maintenance in storage of individual small arms for the company. The supply sergeant will not normally maintain a transaction register and file. These documents which support entries in the property book are kept by the same individual who maintains the company property book (AR 735-35). In the performance of the administrative functions associated with his job, the supply sergeant is assisted by the company clerk.

d. *Authorization Documents and References.*

(1) The equipment authorized for the companies of the battalion is listed in TOE 9-66 and TOE 9-67. TA 21 lists

organizational clothing and equipment for all Army personnel under all climatic conditions. TA 20-2 lists equipment for support of training. Special TA's are published to provide items not otherwise listed in TA's or other authorization media, and applicable to a particular over-sea area. TA 20-4 lists food service equipment. TA 20-8 lists allowances of office furniture and equipment. Other TA's list expendable supplies authorized the companies.

- (2) Organizational supply operations are conducted in accordance with AR 735-35. This and other regulations pertaining to supply operations are indexed in DA Pam 310-1. TOE's and TA's are indexed in DA Pam 310-7. These indexes should be checked frequently to determine whether any changes, supersessions, or rescissions exist.

## 20. Organizational Maintenance

a. The company commander is responsible for the proper operation and maintenance of organizational equipment. He, in turn, will hold the individual users, operators, and supervisory personnel responsible for the proper operation, care, and maintenance of organizational equipment.

b. In each of the companies, the motor sergeant has the greater part of company maintenance as a principal duty, since vehicles require the greatest portion of the total organizational maintenance effort. He keeps vehicle records, serves as dispatcher, performs as much of the second echelon vehicle maintenance as he can, and arranges with the company shops to perform that second echelon vehicle maintenance which exceeds his capacity as well as any required third echelon vehicular maintenance. Second and third echelon maintenance on the weapons of the company is also performed by the company maintenance shops. Senior communications personnel supervise and assist in the performance of organizational maintenance of signal equipment.

c. Maintenance is performed according to the procedures outlined in technical manuals dealing with the equipment. With respect to vehicles, the procedures relative to inspections and preventive and organizational maintenance as outlined in AR 750-5 and TM 9-2810 will apply.

## 21. Administration and Personnel Management

### a. *General.*

- (1) The bulk of the administration incident to company operations is handled by the first sergeant and the company

clerk. Some of the administrative operations, however, must be performed by the commander. Battalion headquarters provides assistance in administrative matters and coordinates the administration of all units of the battalion, both assigned and attached.

- (2) Within the company, the first sergeant personally supervises the keeping of records, files, and correspondence in the company headquarters. He maintains duty rosters and issues company orders when directed. (AR 310-110A shows the form used for company orders and discusses their use and authentication.) The first sergeant is responsible for the accuracy of reports made to higher headquarters. The performance of routine administration should require only a minimum of supervision on the part of the company commander.

*b. Correspondence and Reports—Preparation and Filing.* Correspondence and reports are prepared by the company clerk under the supervision of the first sergeant. AR 340-15 deals with the preparation of military letters and indorsements. The filing, maintenance, and disposition of records is covered in regulations of the 345-series. AR 345-292 is of particular significance.

*c. Personnel Administration.* Although personnel services are provided for the ordnance battalion by the administrative services company of the division, there are certain aspects of personnel administration which must be handled at company level.

- (1) *Promotions.* The promotion of individuals is an aspect of management that improves or disrupts morale, depending on how promotions are handled. Promotions should not be automatic, nor based on partiality. Each individual should be informed of the necessary qualifications and requirements for promotion to the next higher grade and encouraged to prepare himself for a more responsible position. The company commander's promotion authority is limited to certain grades (E3 and E4), but he can recommend personnel for promotion to higher grades. Promotions of enlisted men are covered in AR 624-200.
- (2) *Demotions.* Company commanders are also empowered to demote personnel from pay grades E3 and E4 and to recommend the demotion of personnel in higher grades. These demotions may be made because of misconduct, inefficiency, or conviction by a civil court. (See AR 624-200.)
- (3) *Assignments.* Commanders must assign personnel according to their qualifications and initiate action to effect

reassignment if the skills can be better utilized in another capacity, or if the individual is accident prone and for his safety should be placed in another assignment. The conditions under which enlisted personnel may be reassigned between units of the Army and the procedures to be followed are set forth in AR 614-240.

- (4) *Separations.* Company commanders are also responsible for initiating board action to effect the separation of personnel because of unsuitability for military duty, undesirable habits and traits of character, and misconduct. The general provisions for discharge and release and the procedures to be followed are contained in AR's 635-200, 635-204, 635-205, 635-206, 635-208, and 635-209.
- (5) *Awards.* Commanders may recommend the granting of awards and decorations to deserving individuals. Recommendations are made to battalion headquarters. The criteria for such awards and the procedures to be followed are set forth in AR 672-5-1.
- (6) *Military justice.* A commander must maintain discipline in his organization and must mete out punishment that is fair and impartial when an individual is guilty of misconduct. Punishment can range from company punishment administered by the company commander to court martial. For further information on the administration of military justice see the Manual for Courts-Martial, United States.
- (7) *Personnel records.* The DA Form 20 (Enlisted Qualification Record), should be used by commanders to determine training and assignments, including duty assignments within the company. The Form 20 reflects duties performed, skills acquired, etc. The DA Form 66 (Officer Qualification Record), is similar in nature. These forms are maintained by the administrative services company of the division. However, the company commander should periodically review these records so that he may be kept informed on the qualifications of his personnel. For information on the preparation and maintenance of these records, see AR's 140-138, 611-103, and 640-203.
- (8) *Efficiency ratings.* Company commanders are required to rate periodically the efficiency of the officers and enlisted men of their companies. The procedures to be followed in making these ratings are set forth in AR's 623-105 and 623-201.

*d. Morning Report.* The DA Form 1, (Morning Report), is the

form from which most of the information recorded on various personnel records is obtained. It is prepared by the company clerk and reflects the day-to-day strength of the company, transfers, assignments, and promotions, and is the basis for ordering rations and other items of supply issued on a troop strength basis. It is authenticated by the company commander or by an officer or warrant officer authorized by the company commander or higher authority to authenticate the report. It is prepared as indicated in AR 335-60.

*e. Duty Roster.* The DA Form 6, (Duty Roster), is prepared and maintained to establish a fair and equitable distribution of duty assignments such as guard, kitchen police, etc. It is maintained by the first sergeant. AR 220-45 covers the preparation and maintenance of duty rosters.

*f. Sick Slip.* The DD Form 689 (Individual Sick Slip), is used first to route men reporting for sick call to the dispensary and then to inform the commander as to the disposition of the reported sick cases. It constitutes a medium for the exchange of information between the medical officer concerned and the patient's company commander. The slip is normally initiated by the first sergeant or company clerk of the company and is completed by medical personnel at the medical facility. In case of emergency, it may be initiated at the medical facility. AR 40-207 governs the use and preparation of the sick slip.

*g. Welfare and Recreation.*

- (1) The commander, working through the first sergeant, can determine when personal problems of any of the men require his attention. Often the first sergeant can give valuable advice in the solving of such problems and the intercession of the company commander may not be necessary. However, a good commander will take a personal interest in his men and will help them to solve their problems if he can. If the problems cannot be handled locally, the commander may seek the assistance of battalion or may refer the individual to the chaplain, legal assistance officer, Army Emergency Relief, or the American Red Cross. (See AR's 600-103, 910-10, and 940-10.)
- (2) In addition, the commander should do his utmost to provide for off-duty recreation facilities. This can be accomplished by judicious use of the company fund (AR 230-21 covers accounting procedures for unit funds) and by utilizing the facilities and equipment provided by special services. (See AR 680-20.)

*h. Mail Service.* Mail is one of the most important factors contributing to morale of personnel in the company. Each company must have efficient mail service to assure that personnel receive mail promptly and to facilitate the dispatch of mail initiated by unit personnel. Each company commander will appoint a postal officer and a mail clerk to carry out these functions. The distribution of mail to and within the companies of the battalion is supervised by the battalion adjutant. The duties and responsibilities of the postal officer and the mail clerk are outlined in AR 65-75.

## 22. Standing Operating Procedures (SOP's)

*a. General.* Standing operating procedures are a set of instructions giving the methods to be followed by a particular unit for the performance of those features of operations, both tactical and administrative, which the commander desires to make routine. Routine procedures within the ordnance battalion are reduced to writing and published as SOP's in order to outline the procedures to be followed in the absence of instructions to the contrary. The units assigned or attached to the battalion will also prepare SOP's governing their operations and based on the battalion SOP's. Eventually, every routine operation should be covered by a published procedure and these SOP's should be made available to all concerned.

### *b. Advantages of SOP's.*

- (1) Simplify and shorten orders, expedite transmission of orders, and help insure their understanding.
- (2) Simplify the training of personnel, especially replacements.
- (3) Promote teamwork and understanding within the unit and higher headquarters.
- (4) Facilitate and expedite operations.
- (5) Minimize confusion and error.

*c. Company SOP's for Internal Operations.* An SOP prescribing the procedures and organization for the internal operations of the company should be prepared by each of the companies of the battalion. The following procedures should be covered by SOP:

- (1) *Administrative.* An SOP covering administrative procedures would cover such items as the orderly room, mess, organizational supply, etc.
- (2) *Technical.* Procedures such as admitting items to be repaired in the company shops, inspection, flow of work through shops, duties of shop sections, and release of work should be covered by this SOP.



- (3) *Tactical.* Procedures such as interior guard, outpost system, assignments, destruction plan, and air, chemical, biological, and radiological defense should be covered by SOP.
- (4) *Training.* Cross-training, training schools, combat training, etc., should be included in the SOP.
- (5) *Safety.* This SOP should include such items as fire prevention, designation of safety officer and committee, storage of ammunition and gasoline, reporting of accidents, etc.

*d. Company SOP's for External Operations.* In order to expedite ordnance service to supported units, each support company should have an SOP telling the supported units the procedures that will be followed in providing direct support. The following procedures should be covered by SOP :

- (1) *Supply.* The supported unit should be supplied with information as to requisitions, turn-ins, forms to be used, direct exchange, etc.
- (2) *Repair.* The SOP should cover the forms used, method of arranging for maintenance, vehicle abuse, whether on-equipment-materiel accompanies vehicles brought to the shop, etc.
- (3) *Technical assistance.* The SOP should give the scope of technical assistance service, responsibilities of technical assistance service, how this service will be provided, etc.
- (4) *Wrecker service.* The SOP should cover such items as assistance in battlefield recovery and availability of wreckers.

## CHAPTER 5

### DIVISION ORDNANCE OFFICE

---

#### 23. Organization and Operations

a. The division ordnance officer is on the division commander's special staff and works with the general staff in planning ordnance support and operations within the division. His responsibilities encompass ordnance general supply, maintenance, and ammunition control for the division and attached units. The division ordnance officer also plans the program for the organizational maintenance that is performed by division organizational maintenance personnel on ordnance equipment of the division. As a staff officer he advises the division commander and staff on the capabilities and limitations of U. S. ordnance equipment and that of the enemy. The division ordnance officer keeps the division commander informed on the progress being made in meeting ordnance task assignments, and reports problems that interfere with accomplishment of the ordnance mission.

b. The division ordnance office is staffed to assist the division ordnance officer in the accomplishment of his staff functions. It maintains status of equipment charts and maintenance summaries for all ordnance equipment of the division; prepares plans and makes recommendations relative to the supply, maintenance, and evacuation of ordnance materiel; supervises the implementation of approved plans and policies; and plans and conducts inspections of ordnance materiel within the division.

c. The division ordnance office (fig. 4) consists of two principal elements, a materiel section and the office of the division ammunition officer.

- (1) *Materiel section.* This section operates within battalion headquarters and is further subdivided into a maintenance element and a supply element. The materiel section includes the materiel officer, the maintenance officer, the ordnance supply officer, and sufficient enlisted personnel from the battalion headquarters section to assure continuity of operations. The materiel section is primarily concerned with maintenance and supply of ordnance class II and IV materiel within the division. It prepares plans and policies, determines requirements,

makes recommendations, maintains and prepares records and reports, and exercises supervision over all aspects of ordnance maintenance and supply within the division.

- (2) *Office of the division ammunition officer.* This office contains the division ammunition officer, an ammunition supply officer, and sufficient enlisted personnel and equipment to permit round-the-clock operation. It is physically separated from the materiel section of the division ordnance office, being located near the division logistics control center where it is easily accessible to unit trains en route to draw ammunition. The division ammunition office is responsible for ammunition control within the division. It also supervises the division class V mobile supply point, when established.

#### 24. Division Ordnance Officer

*a. Responsibilities.* The division ordnance officer is responsible for:

- (1) Commanding the division ordnance battalion and any attached ordnance units.
- (2) Advising the division commander and his staff on ordnance matters.
- (3) Supervising the determination of requirements for, and the requisitioning, procurement, storage, distribution, and documentation of, ordnance equipment, supplies, and munitions, including guided missiles, heavy rockets, and nuclear weapons.
- (4) Making plans and recommendations pertaining to requirements for, and employment of, ordnance troops.
- (5) Preparing and supervising training programs of ordnance units under his command or operational control and exercising technical supervision over ordnance activities throughout the command.
- (6) Operating the ordnance field maintenance activities within the division.
- (7) Providing the division commander with information on the current and projected availability of ordnance equipment and the logistical effect of deficiencies on current and proposed operations.
- (8) Inspection safety practices in the employment of ordnance equipment, investigating accidents involving the use and handling of ammunition, and making recom-

mendations on mechanical and safety engineering matters affecting ordnance equipment.

- (9) Investigating and making recommendations on instances of improper supply economy and abuse of ordnance equipment.
- (10) Making recommendations on the utilization of captured enemy ordnance equipment and cooperating with technical intelligence teams in locating and guarding new and unusual types of enemy ordnance equipment.
- (11) Planning and supervising the following ordnance operations:
  - (a) Recovery of ordnance materiel which is beyond the recovery capabilities of using units, and its repair or evacuation to higher maintenance echelons.
  - (b) Advice to appropriate commanders on all aspects of ordnance materiel and ordnance service, including the tactical characteristics, capabilities, and limitations of U. S. and foreign ordnance materiel; standards of serviceability of ordnance materiel; approved methods of operation and preventive maintenance for ordnance materiel; and the ordnance supply situation.
  - (c) Instruction of using unit personnel in organizational supply and maintenance of ordnance materiel.
  - (d) Spot-check inspections of ordnance supplies, equipment, and munitions including guided missiles and nuclear weapons, and the organizational maintenance of such supplies, equipment, and munitions.
  - (e) Collection and reclamation of captured or abandoned ordnance supplies and equipment.
  - (f) Making arrangements for explosive ordnance disposal service and ballistic and technical services, when necessary.
  - (g) Technical intelligence pertaining to ordnance activities.
  - (h) Supervision over the equipment status reporting system within his area of responsibility.

*b. Briefing the Division Commander.* Since the division ordnance officer cannot personally perform all of the functions listed above, he must rely on his staff to assist him in accomplishing his staff functions. Regardless of which member of the division ordnance office actually performs the work, the division ordnance officer must be kept fully informed on the ordnance situation at all times. He, in turn, must keep the division commander informed. This is done by frequent briefings of the division com-

mander. These briefings should be as brief as completeness and clarity will permit and should avoid details unless the commander desires them. The division ordnance officer must be prepared to present the ordnance situation, the problems affecting ordnance support, and proposed solutions. Much of this information can best be presented graphically, and the division ordnance officer should make maximum use of simple charts when briefing the division commander.

## **25. Assistant Division Ordnance Officer**

The executive officer of the battalion serves as assistant division ordnance officer. He assists the division ordnance officer in any manner the latter may direct, and provides positive direction and coordination for the office of the division ordnance officer. The assistant division ordnance officer may be charged with:

- a. Preparation of orders, directives, and periodic reports on the problems and progress of ordnance service.
- b. Liaison with the commanding officers of ordnance groups and battalions of field army ordnance service and the ordnance officers of corps and adjacent divisions.
- c. Representing the division ordnance officer during his absence.

## **26. Materiel Officer**

The materiel officer is responsible for the technical supervision of organizational maintenance and supply of ordnance equipment within the division. He supervises the training of organizational maintenance and supply personnel. He conducts spot-check inspections of ordnance materiel with the assistance of the maintenance officer. The ordnance supply officer and the ordnance maintenance officer work under the supervision of the materiel officer, and, with the materiel officer, form a maintenance supply team that schedules ordnance inspections and the rehabilitation of ordnance equipment of units after a period of combat. The materiel officer is specifically charged with:

- a. Directing the activities of the maintenance and supply sections of the division ordnance office.
- b. Preparing plans and policies for maintenance and supply support of the division.
- c. Advising the division ordnance officer on the status of ordnance class II and IV maintenance and supply in the division, the problems affecting ordnance support, maintenance and supply requirements, and proposed solutions to problem areas.

*d.* Performing limited operations functions for the battalion headquarters. (He is assisted in this function by the operations-intelligence sergeant.)

*e.* Assuring that priorities for supply and maintenance are carried out within the division.

*f.* Monitoring the operations of the battalion maintenance shops.

*g.* Coordinating technical intelligence matters and the collection and dissemination of information on the capabilities and limitations of enemy ordnance materiel.

*h.* Providing information on the characteristics, capabilities, and limitations of U. S. class II and IV ordnance materiel.

*i.* Assuring that ordnance maintenance and general supply service within the division supplement each other.

## 27. Maintenance Officer

The maintenance officer assists the materiel officer in carrying out his responsibilities. The maintenance officer coordinates and controls the quantity and quality of production of the field maintenance shops. He balances the capabilities of the forward support companies by attachment of augmentation sections from the headquarters and main support company. He may be specifically charged with:

*a.* Supervising organizational maintenance of ordnance equipment within the division to include inspection of organizational maintenance in using units, spot-check inspections of ordnance equipment in the hands of troops, supervision of the ordnance personnel performing command maintenance inspection of ordnance equipment in the hands of troops, supervising the reconditioning of ordnance equipment of units withdrawn from combat, and interpreting standards of serviceability for ordnance equipment.

*b.* Managing the maintenance effort of divisional ordnance units to include staff supervision of the quantity and quality of production of the ordnance battalion, supervision of the technical training and cross-training of ordnance repairmen, supervising the recovery and reclamation of ordnance equipment, advising the ordnance supply officer on requirements for replacement of ordnance equipment and on the anticipated needs for repair parts, and cooperating with the supply officer to insure that maintenance and general supply service supplement each other.

*c.* Making arrangements for backup support with the maintenance officers of supporting ordnance battalions and groups, to include balancing workloads between the divisional ordnance bat-

talion and the supporting ordnance service, turnover of division ordnance collecting points to field army ordnance service, assistance in the technical inspection and rehabilitation of ordnance equipment of units temporarily withdrawn from combat, and turnover of uncompleted repair work to field army ordnance service when the division ordnance battalion must displace.

## 28. Ordnance Supply Officer

The supply officer assists the materiel officer in carrying out his responsibilities with respect to ordnance general supply within the division. The ordnance supply officer may be specifically charged with :

*a.* Supervising ordnance general supply support in the division, including the procurement, storage, and issue of ordnance general supplies; investigating and making recommendations in all instances where ordnance general supplies are consumed at excessive rates and in all instances of alleged or suspected infractions of supply discipline; inspecting supply activities in the organizational maintenance sections of using units; and investigating the adequacy of ordnance general supply service to using units.

*b.* Cooperating with the maintenance officer to see that reclamation work is scheduled on the basis of anticipated requirements, that repair parts and assemblies are returned to supply channels, and that work is not initiated on ordnance equipment unless the necessary parts are readily available.

*c.* Advising the division ordnance officer of the effect of any anticipated shortages in ordnance general supplies and making recommendations on the exploitation of local resources and the utilization of captured enemy materiel.

*d.* Conducting liaison with ordnance general supply officers of supporting ordnance elements, and with supply officers of ordnance depot companies responsible for replenishment supply of the divisional ordnance unit.

*e.* Making arrangements with the ordnance general supply officers of supporting battalions and groups for mutual lateral supply to eliminate or reduce critical shortages that cannot be met in normal supply channels.

## 29. Division Ammunition Officer

The division ammunition officer is responsible for :

*a.* Operating the division ammunition office.

*b.* Advising the division ordnance officer on the supply and maintenance of all types of ammunition within the division.

*c.* Exercising technical supervision and administration of ammunition supply within the division.

*d.* Advising the division commander on the quantity and condition of nuclear weapons in the division and on the quantities of nuclear weapons allocated to the division and available for issue from SASP stocks.

*e.* Approving transportation orders presented by unit ammunition trains, and directing the trains to the ammunition supply points.

*f.* Inspecting the basic loads of units of the division to insure availability and serviceability.

*g.* Maintaining liaison with ammunition officers and commanding officers of ammunition battalions and companies operating ammunition supply points designated to support the division.

*h.* Maintaining ammunition records.

*i.* Evaluating and consolidating required supply rates.

*j.* Maintaining available supply rate records.

*k.* Conducting staff coordination with division G3 and G4.

### **30. Ammunition Supply Officer**

The ammunition supply officer assists the division ammunition officer in the performance of his duties and performs such functions as the division ammunition officer may direct. He may be specifically charged with the actual operation and administration of the division ammunition office, including the establishment and maintenance of records, preparation of reports, etc., or he may be located at the ammunition supply point to authenticate transportation orders and to keep the division ammunition officer informed on the status of class V supplies.

### **31. Enlisted Assistants**

The enlisted personnel included in the division ordnance office include a chief ammunition clerk, operations sergeant, repair control supervisor, armament repair inspector, and clerical personnel. The duties and responsibilities of these personnel are discussed in section I of chapter 3.



## CHAPTER 6

### MAINTENANCE

---

#### Section I. GENERAL

#### 32. Introduction

*a.* The missions of the main support company and the forward support companies are similar in that each provides direct support maintenance service to those divisional elements in its area of operations. Each of the forward support companies provides maintenance support to a combat command and any units attached to the combat command. The main support company performs a similar service for division supporting troops operating in the rear area of the division. The main support company, however, is also required to provide supplementary maintenance support to the forward support companies. For this reason, the main support company has been given a greater maintenance capability than any of the forward support companies. Basically, however, all companies of the ordnance battalion provide the same type of maintenance service to supported units, and the operations of each are generally similar. The variations that do exist are explained below and in the paragraphs which discuss the operations of the individual companies.

*b.* Most of the maintenance workload of the main support company is accomplished in the company's maintenance shops. In the forward support companies, a great deal of the work is performed on site. All companies, however, perform shop work and on-site maintenance and provide technical assistance. All adhere to the principles of direct support service which are explained in FM 9-3.

*c.* The main support company is specifically designed to facilitate the provision of supplementary maintenance support to the forward support companies. For example, the forward support companies have no blacksmiths. Such services, when required, must be provided by the main support company which has this capability. Moreover, the TOE of the main support company includes seven mechanical maintenance sections and four artillery maintenance sections which are used to augment the maintenance capacities of the forward support companies as required.

*d.* Production control is discussed in appendix IV to FM 9-3

and is a guide for implementing production control procedures in the maintenance shops of the companies of the ordnance battalion. The procedures described therein can be modified as required to suit the requirements of both the main and forward support companies, depending on shop organizations, operations and requirements for on-site maintenance.

e. Direct exchange procedures are discussed in FM 9-3 and should be used as a guide for developing procedures to be used by this battalion.

### 33. Maintenance Responsibilities and Functions

Divisional units are responsible for the performance of all organizational maintenance (first and second echelon, TM 9-2810) on ordnance equipment in their possession. When this maintenance is properly conducted, fewer breakdowns occur and fewer demands are made on supporting ordnance. But, the companies of the ordnance battalion should not refuse work because a lack of organizational maintenance is evident. Organizational maintenance deficiencies will be corrected by organizational mechanics at the repair site under ordnance supervision. Repeated offenders should be reported to battalion headquarters for appropriate action by the division commander. Ordnance inspection and technical assistance teams, in the performance of their normal functions, can assist the maintenance effort by emphasizing organizational maintenance. For further discussion of maintenance responsibilities and functions see FM 9-3.

## Section II. MAIN SUPPORT COMPANY

### 34. General

The main support company performs maintenance for the rear elements of the division on a return-to-user basis. The bulk of the maintenance workload will consist of wheeled vehicles. Supplementary support is also provided to the forward support companies. The work received from the forward companies will include all types of ordnance equipment. Although the main support company places emphasis on shop work, on-site maintenance is performed when necessary and practical. This company also provides maintenance teams to augment the maintenance capacities of the forward support companies. The attachment of these maintenance teams (artillery maintenance sections and mechanical maintenance sections of the augmentation platoon) is controlled by the maintenance officer of the division ordnance office. Those teams not required for attachment to the forward companies are

utilized to bolster the maintenance capacity of the main support company.

## 35. Organization for Maintenance Operations

### *a. Shop Work.*

- (1) The maintenance shop consists of a number of sections combined into an integrated operation and performing such functions as administering, planning, and controlling the maintenance effort; repairing unserviceable equipment brought to the company for repair; determining maintenance requirements and evaluating the quality of maintenance performed; and performing allied trades support (such as welding, body repair, fabrication of parts, etc.). Provision must also be made for the movement of heavy equipment within the shop area and the evacuation of items that cannot be repaired by the maintenance shops. To provide continuity to the maintenance effort, it is necessary to supplement the above sections with other sections to perform such functions as expediting the supply of repair parts and materials needed by the maintenance shops, consolidating the repair parts requirements of shop maintenance sections, and performing direct exchange to simplify and expedite the supply of certain fast-moving items needed by supported units and the maintenance shops. The TOE provides sections to perform most of the functions listed above. Direct exchange, shop supply, and inspection sections are manned by drawing personnel from other sections of the company.
- (2) The elements of the company directly involved in maintenance shop operations include:
  - (a) Shop office (also referred to as the control office).
  - (b) Inspection section.
  - (c) Shop supply section.
  - (d) Direct exchange section (usually a subsection of shop supply).
  - (e) Repair sections (armament maintenance and automotive maintenance, which may be further divided into automotive, instrument, artillery, and small arms sections when laying out the shop area).
- (3) The artillery and mechanical maintenance sections, when not utilized to augment the forward support companies, are pooled with personnel of the company maintenance shops to increase the maintenance capacity of the com-

pany's shops. These sections may also be utilized in the performance of on-site maintenance when necessary. When so used, individual sections should be kept intact, insofar as possible.

- (4) All of the sections involved in or supporting the maintenance operation should be located so as to provide for the logical and orderly movement of work from its receipt by the company to final inspection and return to the user. Moreover, the type of function performed will determine the location of specific sections of the company (e.g., the instrument repair section should be located in a relatively dust-free area, separated from sections where automotive maintenance is performed; the shop office and inspection section should be located near the entrance to the company area; the service and evacuation platoon should be located near the automotive repair section to facilitate allied trades support and movement of vehicles). Figure 5 shows how the company layout may be designed to facilitate technical mission operation.

*b. Work Outside the Shop.*

- (1) From the standpoint of practicality, as well as service to the user, it is better to perform some maintenance operations on site. Tanks and artillery, for example, should be repaired on site if possible, thereby saving the time and effort of transporting heavy equipment to the maintenance shop while at the same time providing the using unit with faster service. On the other hand, it is more practical to perform repairs on wheeled vehicles, small arms, and instruments within the maintenance shops of the main support company. The organization of the main support company does not provide a separate section to perform on-site maintenance. When such maintenance is required, a work party will be dispatched by the shop office. Such work parties may be dispatched as a result of requirements determined by liaison parties on visits to supported units (ch. 9), or as the result of a using unit's request for such assistance. This work party will consist of the required number of repairmen who possess the required skills, plus a supervisor. When not utilized to augment the forward support companies, the artillery and mechanical maintenance sections may be used to perform on-site maintenance; otherwise, necessary work parties must be organized by drawing personnel from the

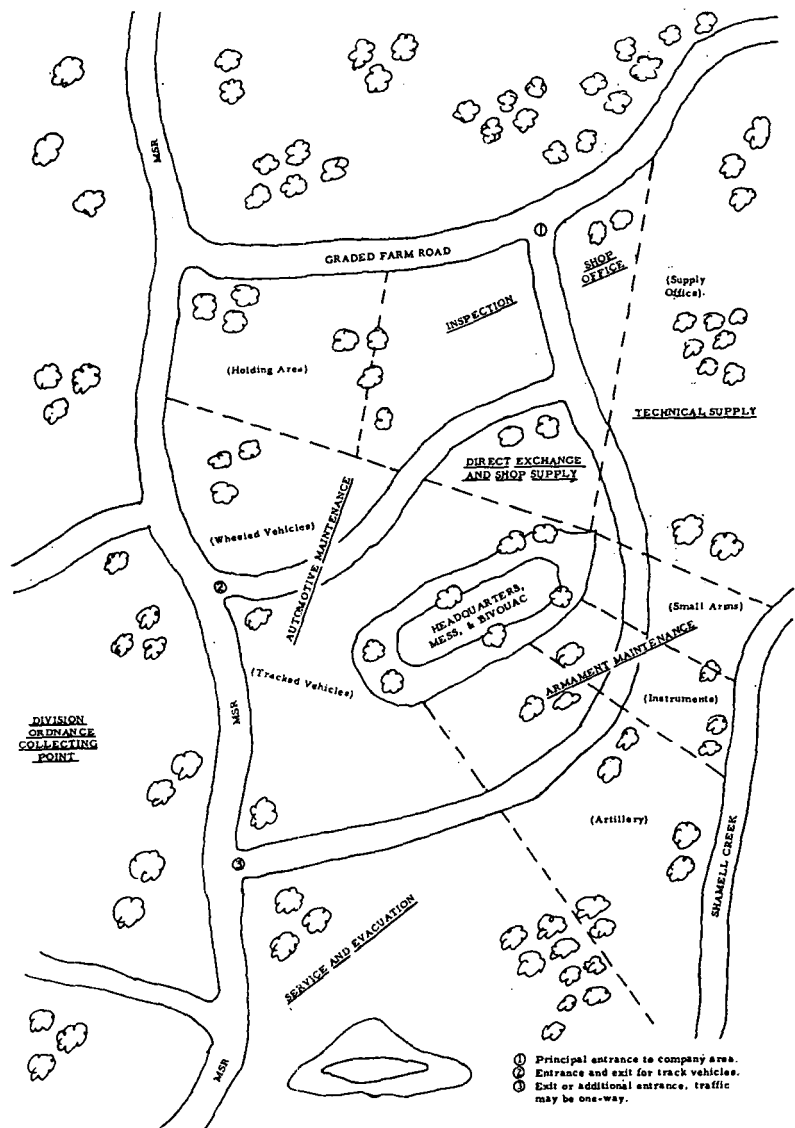

Figure 5. Type layout, main support company.

armament maintenance and automotive maintenance sections of the shop.

- (2) The work party will carry with it the repair parts necessary to perform the required maintenance. In this connection, the work party will attempt to ascertain the repair parts needed before departing for the site where on-site maintenance is to be performed. All supported units should be instructed to report, insofar as is known, the

nature of the malfunction and any known symptoms when requesting on-site maintenance. This is necessary to determine, with some degree of certainty, the parts that will be required. Any additional parts needed to perform maintenance, but not carried by the work party, may be called forward from the main support company. Work parties often use power packages assembled in the unit shop in advance. This system permits the work party to spend less time at the repair site and reduces to a minimum the time a vehicle is out of operation.

### 36. Shop Office

*a.* The shop office performs the administrative and control functions related to the operation of all sections of the maintenance shop; controls the operations and dispatch of work parties; assigns work to, and coordinates the activities of, the service and evacuation platoon; and exercises control over the operation of the division ordnance collecting point. Specific functions of the shop office include:

- (1) Receiving and receipting for all jobs entering the maintenance shops.
- (2) Determining whether jobs are to be repaired in the shop, on site, or evacuated, and making arrangements in each case.
- (3) Routing and controlling the flow of work through the maintenance shops by using the tools of production control.
- (4) Preparing parts requirements lists for jobs to be worked on in the shop (unless this is done by the inspection section in conjunction with the initial technical inspection).
- (5) Anticipating and trying to avoid bottlenecks within the shops by—
  - (a) Temporarily reassigning technicians and specialists among the shop sections, consistent with the demands of the workload.
  - (b) Taking action to expedite delivery of required repair parts and supplies to the repair sections.
  - (c) Rerouting work, when necessary, so that the capabilities of each shop section are fully utilized.
  - (d) Arranging for the evacuation of ordnance materiel, as required.
- (6) Keeping records on the location and status of each job.
- (7) Keeping files on the status of all active job orders.

- (8) Maintaining records of completed work.
- (9) Maintaining a record of service file for each supported unit.
- (10) Preparing all reports on shop operations.
- (11) Keeping an operations map current.
- (12) Maintaining the daily operations chart.
- (13) Maintaining the equipment chart which lists all ordnance equipment supported.
- (14) Reviewing equipment deadline and status reports submitted by supported units.

b. The records and reports used in shop operations are illustrated and explained in FM 9-3.

### 37. Inspection Section

a. Two very important functions performed by the inspection section are the technical inspections conducted before equipment is admitted into the shop and the technical inspections performed after repairs have been completed. The before-entry technical inspection is termed the "initial" inspection, while the inspection performed after repairs have been accomplished is called the "final" inspection. These inspections are performed by an inspection section which is organized, according to requirements, by utilizing qualified personnel from the repair sections of the company. Direct control over inspection activities is exercised by the company commander. Control by the commander is essential to preclude any undue influence being exercised on inspectors by other elements of the command.

b. The duties of inspectors include :

- (1) Making an initial inspection on equipment entering the shop to determine what deficiencies exist and the nature of repairs necessary.
- (2) Making an analysis of each deficiency to determine, when possible, the cause of each.
- (3) Determining the parts requirements for each job (unless local policy requires shop office personnel to do this).
- (4) Estimating the time required for repairs.
- (5) Performing in-process inspections, as directed by the commander, to assure that work is being performed properly and to identify areas in which maintenance operations can be improved.
- (6) Performing final inspections on equipment leaving the shop and, when necessary, returning the items for additional work.

- (7) Performing acceptance inspections on items turned in by using units to determine whether all components are present and to detect any deficiencies.

## 38. Shop Supply Section

*a.* This section operates within, or in proximity to, the maintenance shop. Although the technical supply section of the company is responsible for requesting, receiving, controlling, accounting for, and distributing ordnance general supplies to supported units and to the unit maintenance shops (ch. 7), the shop supply section is instrumental in insuring that the shops have sufficient supplies to sustain their operations.

*b.* The shop supply section acts as an intermediary between technical supply and the repairmen. It keeps a small stock of fast-moving repair parts, common hardware, and other material normally utilized in the maintenance operation, and obtains the other repair parts needed by the maintenance shops from the technical supply section. The shop supply section is operated by a stock record clerk and a supply clerk from the supply section. It maintains a tool check system on special tools issued to the shops, maintains a library of supply manuals, and keeps informal records of quantities of stock on hand.

## 39. Maintenance Shop

*a.* The armament and automotive maintenance sections perform the bulk of the field maintenance mission of the company. These sections, augmented as necessary by personnel of the service element of the service and evacuation platoon, comprise the maintenance shop of the company. The term "maintenance shop" is an all-inclusive term used to describe, collectively, all of the field maintenance facilities of the company which operate in the company area. It includes the automotive repair shop which is directly supervised by the automotive officer, and the armament repair shop, which is directly supervised by the armament maintenance officer. These shops are further sectionalized into a number of repair sections which include a small arms section, instrument section, artillery section, tracked vehicle section, and wheeled vehicle section. These repair sections, themselves, must be organized in such a way that the principles of management are properly implemented. In so doing it is necessary to—

- (1) Divide the sections into teams.
- (2) Maintain a proper balance of skills among teams so that each team will have the skills required for each operation it is called upon to perform.



- (3) Keep the span of control for each supervisor within bounds.
- (4) Provide sufficient space and equipment for each team in order properly employ all members of the team.

*b.* Jobs are assigned to the appropriate sections of the shop by the shop office. These assignments are based on work to be accomplished as listed on the DA Form 811, (Work Request and Job Order). Upon receipt of a job, the section chief assigns the job to a team having the manpower, skill, and space available to complete the job within allowable time limits. Thereafter, each section chief supervises each job being accomplished by his personnel. He must know the status of repair parts needed for each job and must be prepared to undertake another job if parts needed for a particular job are not available in supply and cannot be fabricated by the service element. He must be prepared, at all times, to shift personnel in a manner that will insure that all work progresses according to schedule and that manpower is not wasted.

*c.* Each maintenance section is responsible for the repair of items referred to it by the shop office. Items must be repaired as quickly and efficiently as possible, and quality control must be maintained. Within the shops, the respective section chiefs are responsible for the proper movement, control and performance of work. Section chiefs will perform, or supervise the performance of—

- (1) Allocating jobs to the various subsections or teams to equalize workloads.
- (2) Keeping the shop office informed on the progress of each job and any change in the status of each job.
- (3) Informing the shop office of any bottlenecks in shop production.
- (4) Conducting in-process inspections to assure that maintenance is being performed properly.
- (5) Ordering parts that are required for specific jobs when the requirement for such parts was not determined by initial inspection.
- (6) Reassigning personnel from one job to another to obtain the best productive effort, and maintaining a system of cross-training to facilitate such reassignment.
- (7) Coordinating the work of the various sections of the shops, including requirements placed on the service section for allied trades support.

- (8) Setting standards and making work measurement charts for the equipment repaired in the sections.

## 40. Service and Evacuation Platoon

This platoon consists of a service element and an evacuation element. The platoon functions, primarily, in support of the maintenance shops and the division ordnance collecting point.

### *a. Service Element.*

- (1) The service element includes specialists and special equipment that are pooled to do work common to all repair sections. It performs such functions as canvas and leather repair, fabrication of parts, welding, painting, and body repair. This element may operate as a subsection of a combined service and evacuation platoon, or it may be more advantageous to have it operate as a subsection of one of the repair sections. The services of this element (allied trades support) must be made available to all repair sections, and any specialists or equipment required on a full-time basis should be assigned to that section. (The service element also provides personnel to assist in the operation of the division ordnance collecting point. See ch. 8.)
- (2) Requirements placed on the service element are indicated on a DA Form 811 which is received from the shop office. These requests may be initiated by supported organizations, the repair sections of the company, the technical supply section, the company shop or supply officers, or battalion headquarters. Work for the repair sections of the company is accomplished by transferring the work to the area where the service element is operating, or by sending the necessary specialists and equipment to do the work in the area of the repair section which initiated the request. Work requests are channeled through the platoon leader. He coordinates with the appropriate shop section to decide how and where work will be performed.
- (3) The service element is frequently able to recondition worn parts, fabricate needed parts, or modify assemblies and parts. Fabrication of parts is attempted only when the part can be made easily and supply is unable to provide the part in a reasonable time. Machinists can refit some parts so that they may be used again (e.g., rethreading of bolts or removal of broken studs from engine blocks). Welding of sheet metal items such as

fenders will reclaim a large quantity of supplies. Welders can also cut metal pieces to size and can remove wornout tracks and similar parts in much less time than any other shop element.

- (4) The service element requires a varied stock of hardware and metal stock. These stocks may be obtained from supply channels, collecting points, or scrap generated by the company's shop sections.

*b. Evacuation Element.* This element provides the personnel and heavy equipment (recovery vehicles, tank transporter, and wreckers) needed to handle heavy equipment within the shop area and to perform recovery and evacuation functions for the company. This element is located in the vicinity of the automotive repair section. The evacuation element also assists the supply section in the transportation of heavy supplies and equipment (such as serviceable vehicles) which will be issued by the company to supported units; it supports the division ordnance collecting point; and it hauls heavy equipment when the company moves. The evacuation element may be given specific jobs or it may operate on an on-call basis. All orders and requests are channeled through the recovery officer.

### Section III. FORWARD SUPPORT COMPANIES

#### 41. General

*a.* The forward support companies provide third echelon maintenance support to all forward divisional elements on a return-to-user basis. Each forward support company provides direct support for all ordnance equipment normally in a combat command and one-third of the other ordnance equipment normally located in the forward portion of the division area. As much of the maintenance as possible is performed on site by work parties dispatched from the company. Work that cannot be performed on site is brought to the company maintenance shops, provided the maintenance shops have the required capability and capacity. Work that cannot be performed within the forward support company is evacuated either to the maintenance shops of the main support company, again depending on whether the shops have the required capability and capacity, or to the division ordnance collecting point for further evacuation or turnover to field army maintenance or collecting facilities. When necessary, the main support company assists in this evacuation.

*b.* The maintenance capacity of each forward support company is augmented, as necessary, by the attachment of one or more

maintenance sections from the augmentation sections of the main support company. Personnel of these maintenance sections may be pooled with the maintenance personnel of the forward support company's maintenance shops, or they may be utilized to perform on-site maintenance.

c. Ordnance maintenance operations should be coordinated with the maintenance operations of other technical services where concurrent work is feasible (e.g., coordination with signal forward repair sections will permit concurrent work on vehicles and vehicular communications equipment).

## 42. Organization for Maintenance Operations

The maintenance platoon, shop office, and a small portion of the supply section (specialists to operate shop supply and direct exchange) are organized into a maintenance shop, which serves as a base of operations for the maintenance activities of the company. Attached maintenance sections from the main support company, when not utilized in the performance of on-site maintenance, are also utilized within the shop. Limited allied trades support is provided by the service section. The maintenance shop of each forward support company is organized and operates in the same manner as the shop of the main support company, except that the shop is smaller in size; the maximum amount of maintenance is performed on site; there is no inspection section, as such; and direct exchange is handled in the using unit's area whenever practicable.

## 43. Maintenance Shop Operations

a. *General.* The shop functions in much the same manner as the shop of the main support company, except that its smaller size limits the amount of work it can perform and the time that can be spent on each job. The shop is set up in a central location in the field trains area of the combat command. It takes work only when the required space and repairmen are immediately available or will be available within a short time. The forward support company dispatches work parties to perform on-site maintenance when this procedure is more expedient (as in the case of emplaced artillery and disabled tracked vehicles). Jobs requiring extensive repairs or those that cannot be started within a short time are evacuated.

b. *Shop Organization and Operations.* Organizationally, the shop is composed of a number of sections, which perform the functions of management and control of maintenance operations,

repair, shop supply, and direct exchange. As in the case of the main support company, the shop supply and direct exchange sections are organized by utilizing personnel from the other sections of the company. Usually an inspection section is not organized within the shop, since a great proportion of the maintenance workload is performed on site. Necessary inspections are performed by supervisory maintenance personnel.

- (1) *Shop office.* This office is operated by the shop officer and a shop clerk. Radio operators are also included to provide communications between the shop office and other elements of the company, particularly on-site work parties and recovery teams, and between the shop office and the headquarters and main support company. The shop office manages and controls the activities of the maintenance shop, and dispatches work parties and recovery teams. The shop office maintains a system of production control within the maintenance shops similar to that used by the main support company but modified to suit the requirements of the forward support company.
- (2) *Repair sections.* The mechanical maintenance platoon includes small arms repairmen, automotive repairmen, instrument repairmen, and artillery repairmen. These repairmen are organized into sections or teams as in the main support company, and operate in the same manner. Initial, in-process, and final inspections are performed by designated supervisory maintenance personnel.
- (3) *Shop supply and direct exchange section.* A combined shop supply and direct exchange section is necessary to expedite the supply of repair parts to the shop and to provide supported units with certain items on a direct exchange basis. Personnel to operate the section are drawn from the supply section. (A repairman from the maintenance platoon who is thoroughly familiar with parts and parts supply may be cross-trained to perform these functions.) Shop supply and direct exchange procedures are similar to those established in the main support company, except that maximum use is made of direct exchange in the using unit's area by work parties during the normal course of visits to a using unit. The forward support companies and the main support companies utilize the same direct exchange list, but the quantities of each item carried by a forward support company are smaller.

#### 44. Service Section

The service section provides limited allied trades support to the maintenance shop. The services provided include welding, metal body repair, and parts fabrication. Jobs requiring the services of a blacksmith or canvas-leather repairmen must be evacuated to the main support company. The service section also provides heavy equipment and personnel to move heavy equipment within the company, to assist work parties in the performance of on-site maintenance, and to perform recovery and evacuation functions. All orders and requests for service section support are channeled through the service officer.

#### 45. On-Site Maintenance and Direct Exchange

a. Liaison parties (ch. 9) make frequent inspections of artillery in position to insure that all pieces are serviceable. When practical, these liaison parties will summon maintenance personnel to perform necessary artillery maintenance in the unit area. Similarly, liaison parties frequently visit the unit maintenance element of each armor unit to determine any need for the exchange or maintenance of weapons or instruments. Exchange items or maintenance personnel are called forward as necessary.

b. Upon notification of requirements by the liaison party, the shop office will arrange for the dispatch of the required support to the using unit's area, provided that on-site maintenance or direct exchange is the most practical way to handle the problem. Work parties are organized and equipped to provide the required support. The composition of the work party depends on the support required. The work party may consist of selected specialists to perform on-site maintenance, a direct exchange party, or a combination of both.

c. Each forward support company will usually have several work parties employed in various areas of the combat command at the same time. When possible, personnel are assigned to a work party on a permanent basis, and the supervisor heading the work party remains the same from job to job. This arrangement promotes better understanding of the job on the part of work party personnel, facilitates cooperation, and simplifies management of the maintenance effort.

#### 46. Records and Reports

The records and reports maintained by each forward support company are similar to those utilized by any direct support maintenance unit (FM 9-3, app. III). Some of the records may require

modification. For example, work parties performing on-site maintenance will record an entire day's production in one specific organization on one DA Form 811. In any case, certain records and reports are necessary to indicate status of equipment, to summarize maintenance operations, and to keep track of the maintenance performed.

## CHAPTER 7

## SUPPLY

## Section I. ORGANIZATION, FUNCTIONS, AND RESPONSIBILITIES

## 47. Introduction

a. *General.* With the exception of ammunition control, the ordnance battalion has no responsibilities for the supply of class V materiel within the armored division. Ammunition control is exercised by the division ammunition officer. Therefore, this chapter is devoted primarily to a discussion of the responsibilities, functions, and operations of the battalion with respect to the supply of class II and IV materiel.

b. *Class II and IV Supply.* The ordnance battalion obtains, stores, and issues the replacement ordnance class II and IV items needed by units of the armored division. Replacement items are issued during all phases of division operations. Supplies are issued based on requests or by direct exchange. Wherever practicable, supplies are delivered to divisional elements. However, supported units, particularly those operating in the division rear area, may be required to pick up ordnance supplies due to a lack of transportation facilities in the ordnance companies.

c. *Class V Supply.*

- (1) The normal source of conventional class V supplies for the division is the supporting field army ammunition supply point (ASP). When forward movement is so rapid that the army ASP will not be able to stay within supporting distance, the division G4 may request authority from army to establish a mobile ammunition distributing point. This point will contain a balanced stock of ammunition based on anticipated expenditures. The division ammunition officer exercises technical control over the distributing point. Trucks will be furnished by the division quartermaster battalion or by the field army. Ammunition will remain on the trucks and issues will be made by "tail-gate" transfers. Units will draw ammunition from the distributing point, or, if the required items are not on hand, from the supporting ASP.



- (2) Special ammunition is requested and distributed through special ammunition supply points (SASP).
- (3) Using units within the division, prepare transportation orders based on allocations. Transportation orders are authenticated by the DAO who informs the using units of the location of the class V supply point (ASP or SASP) that will supply the required ammunition. Units present authenticated transportation orders to the ASP or SASP and draw the ammunition. In some instances, under emergency conditions, special ammunition may be delivered to the using units.
- (4) For additional information on ammunition supply procedures, see FM 9-5 and FM 100-10.

#### 48. Types of Supply Operations Conducted by the Ordnance Battalion

The companies of the ordnance battalion perform three types of supply operations: organizational (unit) supply, shop supply, and technical supply.

*a.* Organizational supply encompasses the operations required to obtain and replenish individual clothing and equipment, as well as organizational equipment and supplies (desks, typewriters, individual weapons, etc.). Transaction files and company property books, with appropriate documents to support property book entries, are maintained by the property book officer at battalion headquarters. Each company has a supply sergeant who is responsible for acquisition, storage, in-storage maintenance, and issue of organizational supplies and equipment. For further information on organizational supply, see chapter 4 and AR 735-35.

*b.* Shop supply is the function of providing the repair parts, assemblies, components, and other supplies needed by the unit maintenance shops in the accomplishment of their maintenance missions. This is a function of the shop supply section which operates within, or in proximity to, the maintenance shops. Each of the companies utilizes a shop supply section to expedite the supply of repair parts to its maintenance shops (ch. 6).

*c.* Technical supply includes all those operations required to obtain, account for, store, and issue the ordnance class II and IV items needed by supported units and the maintenance shops of the battalion. Each of the companies of the battalion has a supply section to perform the technical supply mission. In the performance of technical supply functions, the basic procedures prescribed in AR 711-16 must be adhered to.

#### 49. Requirements for Direct Support Supply

a. The companies of the ordnance battalion will acquire and maintain sufficient stocks of ordnance supplies to satisfy the demands of their maintenance elements and the divisional units supported by the battalion.

b. The companies of the battalion should be able to reasonably anticipate any unusual supply requirements that might materialize due to changes in tactical operations or the environment.

c. The division ordnance officer will be kept advised on the probable effect any supply shortages will have on existing or future operations so that he, in turn, may keep the division commander and staff informed.

d. Within the companies, requirements for repair parts should be reduced by the quantity that can be realized from reclamation or repair operations. The companies, however, *will not* undertake extensive reclamation or repair merely to supplement unit stocks at the sacrifice of the maintenance support required by using units.

e. The companies of the battalion will order only that stock that experience dictates is necessary to insure continuity of supply. Only fast-moving items will be stocked. Slow-moving items will be requisitioned only as required.

#### 50. Conservation of Supplies

The provision of supplies carries with it the added responsibility of assuring that the materiel is used judiciously. In this respect supply economy, control, and conservation must be practiced throughout the division. Maximum service life must be obtained from each item and the accumulation of excess stocks must be avoided. Reclamation and repair of unserviceable items will be utilized as a source of supply whenever feasible. Policies and procedures for supply economy and control of ordnance supplies within the division are established under the direction of the materiel officer. The companies of the battalion assist in implementing these policies and procedures throughout the division by providing personnel for the conduct of ordnance inspections (ch. 10) and by furnishing technical assistance (ch. 9).

#### 51. Functions and Organization of Company Technical Supply Sections

a. *Functions.* Each of the companies of the battalion has an organic supply section (not to be confused with shop supply, ch. 6). The supply section (fig. 2) is, in reality, a small depot, whose operational and administrative procedures are similar to those of larger depots. All operate under the provisions of AR 711-16.

The functions of recordkeeping, stock control, requisitioning, storage, and distribution are generally similar in both instances, except that the supply sections of the ordnance battalion deal directly with the ultimate users of ordnance materiel. The functions of the supply section include:

- (1) Receiving, storing, and preserving ordnance general supplies.
- (2) Replenishing using units' organizational allowances of ordnance items.
- (3) Providing the supplies needed by the company maintenance shops and, in the case of the main support company, providing the supplies needed by the supply sections of the forward support companies.
- (4) Preparing those reports of supply operations required by battalion and higher headquarters.
- (5) Preparing and maintaining all records pertinent to the receipt, control, and issue of supplies.
- (6) Maintaining a system of controls to insure effective operation of the supply function.
- (7) Providing personnel for technical assistance teams.
- (8) Providing personnel to assist in the conduct of inspections of supply operations of using units.
- (9) Making arrangements for the supply of replacement end items not available within the battalion (e.g., vehicles to replace those destroyed in combat or evacuated to field army maintenance facilities).

*b. Organization.* The supply section is normally organized into a stock control unit and a storage unit.

- (1) *Stock control unit.* The stock control unit is the office of the technical supply officer, who is responsible for the operations of the supply section. The stock control unit maintains the registers and voucher files of ordnance property received, stocked, and issued; keeps records on the status and location of stocks; determines requisitioning objectives; and controls the distribution of supplies. This unit also keeps current references on all stock control procedures, keeps an up-to-date list of the amount and types of ordnance equipment held by supported organizations, and prepares requests for the replenishment of supplies.
- (2) *Storage unit.* The storage unit physically receives, stores, preserves, and issues all ordnance supplies.

## 52. Battalion Supply Operations—General

a. *Main Support Company.*

- (1) *Requirements.* The main support company consolidates all supply needs for the battalion. It maintains records of supplies on hand in the main support company and the demands for ordnance supplies throughout the division. Requirements for the division are based on the demands of all units supported by the battalion, as well as the requirements of the maintenance activities of all companies of the battalion. As each item is posted to the records of the main support company, it will be checked for balances and reorder point. The small stocks carried in the division make frequent ordering from field army supply facilities necessary.
- (2) *Bookkeeping.* The bookkeeping employed by the supply section of the main support company is explained, in detail, in AR 711-16. The issue of certain critical items within the division, however, is rigidly controlled by the division ordnance officer and all transactions pertaining to these items must be referred to the division ordnance office for authentication. None of these critical items may be ordered or issued without the approval of the division ordnance office.
- (3) *Receipt of supplies.* Most supplies received by the storage unit must be opened, inspected, and placed in proper storage immediately. Unit packs, however, should never be opened for inspection or to verify count. Information concerning the shipment will be passed on to the stock control unit without delay. Speed in handling supplies can compensate, to a great extent, for the low level of supplies maintained by the company.
- (4) *Issue.* The supply section of the main support company provides the supplies needed by the supply sections of the forward support companies, and the supplies needed by the main support company's maintenance activities. It also issues supplies to using units in the division rear area, and issues and arranges for the delivery of ordnance end items to the using units in the combat commands in response to consolidated requisitions submitted by armored battalion S4's through the division logistics control center (DLCC). The supply section makes every effort to fill requests as soon as they are received. When

a requested item is not in stock, a suitable substitute should be provided, if possible. When it is apparent that a requested item will not be readily available, the possibility and practicality of fabrication or reclamation within the company's maintenance shops should be explored. Transfer of an item from one divisional unit to another may be resorted to in emergencies. When a requested item cannot be supplied promptly, the supply facility supporting the division ordnance battalion should be made aware of the situation. Arrangements may be made for the aerial resupply of critically needed repair parts in emergencies.

*b. Forward Support Company.*

(1) *General.*

- (a) The supply sections of the forward companies function, primarily, to provide the repair parts needed by supported units for organizational maintenance functions, and the repair parts and supplies needed by the maintenance activities of the forward support companies. The forward support companies carry only a limited number of end items, and these are primarily small end items. Most of the large end items needed by supported units in the division forward area must be obtained through the main support company.
- (b) Each forward support company operates in a central location in the field trains area of the combat command it is supporting. The maintenance officer of the supported armored unit also uses this general area as his base of operations. Consequently, liaison between supported and supporting unit is facilitated, and the supply sections of the forward companies can be kept informed of the supply requirements of supported units.
- (c) Supported units may be provided supplies by work parties in the normal course of visits to using units; the supply section may arrange for the delivery of other supplies to satisfy requirements that are brought to the attention of, but cannot be filled by the work parties; or using units may be required to come to the supply section of the supporting ordnance company to obtain replenishment supply. The method in which supplies are provided at any particular time depends on the tactical situation and the transportation available to the supporting forward support company. Whenever practicable, supplies are delivered to using units and

paperwork is eliminated. Direct exchange is used to the maximum (ch. 6).

- (d) The supply sections of the forward support companies operate in much the same manner as the supply section of the main support company. They receive supply support from the supply section of the main support company.
- (2) *Supply by work parties (contact teams)*. Work parties (ch. 6) are organized according to requirements, and the composition of these teams will change frequently. The primary purpose of work parties is to provide on-site maintenance support; consequently, the party will be composed chiefly of maintenance personnel. However, these parties can also be utilized to provide on-the-spot replenishment of a using unit's stock or organizational repair parts, and may also carry a stock of direct exchange items. The composition of such a party should include a parts specialist or a repairman who is qualified to act in this capacity. In order to make maximum use of their supply capabilities, work parties will—
  - (a) Carry a supply of fast-moving, lightweight items.
  - (b) Provide direct exchange and on-the-spot replacement of supplies at the supported unit's area, with a minimum of paperwork.
  - (c) Arrange for the supply of those repair parts and direct exchange items needed by supported units and not carried by the work parties.

### 53. Supply Section Operations

For detailed information on specific procedures and forms involved in requisitioning, receipt, issue, and accounting for supplies, see AR 711-16. Briefly, the operations of the supply section include:

#### a. *Supply to Organizations.*

##### (1) *Repair parts supply.*

- (a) The replacement of organizational allowances of ordnance supplies within the division is accomplished by the supply section of the appropriate company of the ordnance battalion (unless it is a direct exchange item, in which case the direct exchange section effects replacement). Whenever practicable, the supply sections of the forward support companies make arrangements for delivery of repair parts to supported

units. In the division rear area, however, units supported by the main support company are usually required to come to the supply section of the company to obtain supplies, for the main support company will usually have to commit its available transportation to other uses.

- (b) For those units supported by the main support company, the supply officer, or his representative, presents a Request for Issue or Turn-In, (DA Form 1546) to the supply section of the company. Circumstances may dictate the use of improvised forms, or requisitions may be placed in the form of verbal requests in an emergency, in which case the supply records clerk prepares the necessary paperwork. Using units request repair parts whenever a stocked part which is not on the direct exchange list is expended, or when the authorized nonstocked part is needed for a current repair job.
- (c) In the forward area of the division, repair parts required for organizational maintenance are issued and delivered to using units, whenever practicable, by work parties from the appropriate forward support company. Issue is made in the following manner: the work party, as part of its visit to a unit, checks the maintenance parts on hand in the unit against those authorized; items that are in short supply are then issued from a parts load carried by the team. No formal paperwork is required from the using unit for this transaction. If the unit needs them, fringe (nonstocked) items are issued if carried by the team, provided the using unit is capable of making the replacement. Should the using unit require a part not carried by the work party, it may be brought to the using unit by the party on its next visit, or the using unit may go to the supply section of the supporting forward support company for it. At the time of its visit, the work party attempts to determine the reasons for any abnormal usage of parts by the unit, and gives corrective advice, if needed.
- (d) When it is not practicable for a work party to issue repair parts directly to a unit, the using unit may requisition needed parts by listing them as single line items on a DA Form 1546 (AR 711-16). This requisition is forwarded, without consolidation, to the supply

section of the supporting forward support company. Here supply action is taken as soon as possible.

(2) *End item supply.*

- (a) End items are supplied on a direct exchange basis, where no paperwork is required of a supported unit, or to fill requisitions presented by using units. End items on a direct exchange list are usually limited to small items such as small arms. The supply of a large end item usually requires the preparation of a requisition. Although the forward support companies will usually carry a limited stock of the smaller end items for issue on a direct exchange basis, most of the end items needed by divisional units are provided through the main support company.
- (b) Using units present informal requests for ordnance end items to their battalion S4's. The battalion S4's consolidate the requests of all units under their control and prepare formal requisitions.
- (c) Battalion S4's consolidate reports of losses submitted by all units under their control and prepare the daily battle loss report (FM 17-50). The unit reports are used as requisitions and are submitted through the DLCC to the supply section of the main support company. Formal requisitions for end items not appearing on the daily battle loss reports may be submitted with the reports.
- (d) The supply section of the main support company fills all the requisitions it can from stock carried by the company, and places demands on supporting supply facilities (park companies and field supply companies) for those items which it cannot supply.
- (e) The main support company makes arrangements for the delivery of requested items to the requesting units.

*b. Supply to Company Maintenance Shops.* In each of the companies, the parts required for accomplishment of the maintenance mission are also provided by the supply section of the company (ch. 6). The shop office and the maintenance shops list these requirements on a DA Form 9-79 (Parts Requisition) and submit them to the shop supply section. Shop supply may use the DA Form 9-79 to obtain the required parts from the supply section, or may transfer requirements to DA Forms 1546.

*c. Replacement of Supply Section Stocks.* The supply section of each company requests replenishment of its stocks at intervals



prescribed by its supply source. So as not to neglect its responsibilities to supported organizations, the supply section must always have sufficient quantities of materiel on hand and on order to sustain operations. To determine what is to be requested and in what quantity, the stock control unit chief reviews his stock accounting records and demand data cards as prescribed in AR 711-16 and prepares requisitions based on the information contained therein.

*d. Administration.*

- (1) *Files.* The supply section maintains all files of correspondence pertaining to supply for the technical service mission of the company. Normally, files of correspondence will be cut off at the end of each quarter, held 3 months in the current files area, and then destroyed.
- (2) *Voucher registers.* Voucher registers will be maintained on DA Form 272 (Register of Vouchers to Stock Record Account).
- (3) *Organizational folders.* A separate folder containing information on unfilled requisitions may be established for each supported organization. When a transfer in support responsibility occurs, this folder is forwarded to the new supporting unit. This folder will also indicate any special supply authorizations applicable to the unit.
- (4) *Reports.*
  - (a) The status of ordnance items and maintenance summary is a report of the status of the ordnance items in stock, both serviceable and unserviceable, and those in the shops for repair and return to organizations. The items to be included on this summary will be designated by battalion headquarters. This report is submitted to battalion headquarters each day. While this is a combined supply and maintenance summary, the technical supply officer has the dominant interest and is responsible for its preparation.
  - (b) The group labor record for the supply section is prepared by the stock control unit for submission to the unit shop office. Here it is consolidated with similar reports from other sections of the company for submission to battalion headquarters.
- (5) *Records.*
  - (a) The technical supply officer will make, or arrange to have made, periodic spot inventories. These records should be maintained for at least 90 days.

- (b) The stock records on all ordnance general supplies issued for use in the company shops and for use to using organizations are maintained by the stock control unit.

*e. Storage.*

- (1) Supplies that are correctly stored and maintained in storage can be issued safely, speedily, and in a serviceable condition. The storage unit chief is responsible for developing and executing a storage plan for all stocks. This plan must be in accord with policies established by the supply section of the division ordnance office and the policies established by the company commander. The storage plan will be based on these policies and the space available to the storage operation. Items will be stored under conditions best suited to each item. Size is another consideration. Storage space is of two types: covered and open. Covered storage is further divided into bulk and bin storage.
  - (a) *Open storage.* The first step in making a storage plan is to determine which of the items can be placed in open storage. The type of storage chosen for a particular item depends on the amount of protection it requires from the elements. The chief of the storage unit must bear in mind that when covered storage space is exhausted, new receipts must be stored in the open, regardless of their nature, unless time, labor, and equipment are available to rehandle items which originally could have been stored in the open.
  - (b) *Covered storage.* Certain items are always placed in bins because of their size and nature, type of packaging, or the small number stocked. Others are always placed in bulk storage on the basis of size alone. In many cases, items are placed in bulk as well as bin storage. Large issues of such items are made from bulk storage, while small issues are made from bin stock. Normally the only covered storage available will be the vans or trucks organic to the company.
- (2) Other factors to be given proper emphasis when storing materiel include space layout, proper storage methods, and the care, preservation, and protection of supplies. For a complete explanation of these and other aspects of the storage problem, see TM's 743-200 and 743-200-1.

## CHAPTER 8

### RECOVERY AND EVACUATION

---

#### 54. Introduction

*a. General.* During a combat operation, equipment is damaged at an accelerated rate, and many items of ordnance materiel, both enemy and friendly, may be abandoned on the battlefield. Many of these items can be repaired and returned to service, and others have a high salvage value. Enemy materiel abandoned on the battlefield may be extremely valuable for intelligence purposes. Therefore, unserviceable or abandoned enemy ordnance equipment found in the division area must be promptly recovered, classified, and evacuated to maintenance, supply, or intelligence facilities, depending on circumstances and the condition of equipment. Evacuation of U. S. ordnance materiel, however, should not be an automatic process. Recovered U. S. ordnance materiel should be repaired by the lowest echelon of maintenance having the capability and capacity. If using unit maintenance personnel or personnel of the armor battalion maintenance platoon have the time and capability of accomplishing the necessary repairs, recovered unserviceable items should not be evacuated to division ordnance. Likewise, the armored ordnance battalion does not evacuate any materiel which is within its repair capability and capacity.

#### *b. Definitions.*

- (1) *Battlefield recovery.* This term denotes the removal of disabled or abandoned materiel, either enemy or U. S., from the battlefield, and its movement to a collecting point or to a maintenance establishment. In the armored division, this materiel will consist predominantly of vehicular equipment. Consequently, this chapter stresses that aspect of recovery and evacuation.
- (2) *Evacuation.* This is the movement or transporting of damaged or abandoned materiel from axes of evacuation, collecting points, or maintenance establishments to higher categories of maintenance for repair and return to service or to supply channels for reissue.

#### 55. Responsibilities

Commanders at all echelons are responsible for the prompt re-

covery and evacuation of unserviceable or abandoned materiel, and for the prompt repair and return to service of damaged U. S. equipment. The primary responsibility for the recovery of unserviceable or abandoned materiel rests with the unit to which it belongs or in whose area it is found. The ordnance battalion makes arrangements for evacuation, and Transportation Corps facilities are utilized for the actual shipment of evacuated materiel from the division ordnance collecting point to installations or activities in the rear. When using units are unable to fulfill their obligations with respect to the recovery of unserviceable and abandoned materiel, the armored ordnance battalion will be called upon to assist in recovery operations. At times, because of the tactical situation, time available, and the workload of the ordnance battalion, it may be necessary for battalion to obtain assistance from field army ordnance maintenance units for the performance of recovery and evacuation functions.

## 56. Recovery and Evacuation of Vehicles Under Nonnuclear Conditions

*a.* In the armored division, instructions pertaining to battlefield recovery are covered in unit SOP's. In the forward area of the division, using unit maintenance sections and armor battalion maintenance platoons recover disabled vehicles from the battlefield, and repair that portion which is within the limitations of their capability and the time available. The remaining vehicles are moved to the axis of advance of the combat command or to established vehicle collecting points. In a fast-moving offense, armored battalion maintenance platoons evacuate disabled vehicles to the axis of advance; in a slow-moving offense or defense, these vehicles are evacuated to division vehicle collecting points. Axes of advance and the location of vehicle collecting points are designated prior to an operation. Vehicle collecting points are operated by the forward support companies of the ordnance battalion.

*b.* The supporting ordnance company assumes responsibility for disabled vehicles at the axis of advance or vehicle collecting point, as appropriate. The forward support companies repair those vehicles within their capability and capacity, and return them to service. Vehicles that cannot be repaired by the forward support companies are evacuated to the division ordnance collecting point operated by the main support company. When it is known that the main support company has the required capability and capacity, materiel may be evacuated directly to the shops of the main support company. The service and evacuation platoon of the main support company assists the forward support companies in evacuating disabled vehicles from vehicle collecting points to the main-

tenance shops of the forward support companies or to the main support company. Vehicles that are beyond the repair capability or capacity of the ordnance battalion are reported to the field army ordnance unit providing support to the division. Those vehicles that cannot be repaired within the division are normally evacuated to field army collecting points.

*c.* Vehicles that cannot be recovered because of combat conditions, and whose capture is imminent, are destroyed in accordance with existing instructions.

*d.* During fast-moving offensive operations, burned vehicles that obviously cannot be repaired within the division are not recovered by division personnel. However, their exact location and condition are reported through maintenance channels. Recovery and evacuation of such vehicles is the responsibility of field army ordnance service.

#### 57. Recovery and Evacuation of Vehicles Under Nuclear Conditions

*a.* Each echelon of maintenance follows the same sequence in determining the practicality of recovery, repair, or evacuation of vehicles disabled or rendered radioactive by a nuclear explosion. Vehicles are checked for the intensity of radioactivity to determine the practicality of recovery and evacuation. If practical, the vehicles are moved from the radioactive area, and repaired or evacuated. If the vehicles cannot be repaired by the armored ordnance battalion, they are evacuated to field army collecting points. If the intensity of radiation of the vehicle or the area is too great to permit recovery and evacuation, the locations of the vehicles are reported to the next higher echelon of maintenance.

*b.* Instructions pertaining to recovery of vehicles disabled by a nuclear explosion are issued in SOP's. The procedure for establishing axes or points for collection of disabled vehicles is essentially the same as under nonnuclear conditions. However, if designated collecting points are rendered radioactive, the echelon responsible for designating these collecting points will insure that new points are established and their locations disseminated to all supported units by the fastest means available.

#### 58. Division Ordnance Collecting Point

*a.* The division ordnance collecting point is a control point through which unserviceable or abandoned ordnance equipment, both U. S. and foreign, is evacuated for classification, segregation, reclamation, and further evacuation. It is located in the division trains area near the MSR (fig. 3) and is operated by the main

support company of the armored ordnance battalion. When necessary, assistance from ordnance units providing back-up support for the division ordnance battalion may be requested to facilitate operation of the collecting point. Some of the materiel processed through this collecting point will be repaired by the main support company. Anything clearly identifiable as scrap will be segregated and evacuated to the nearest quartermaster collecting point. The remainder will be evacuated to the ordnance collecting point designated in the evacuation instructions published by field army. This materiel may be turned over to field army ordnance service at the division collecting point, or arrangements may be made for its transportation to field army ordnance collecting points.

b. Materiel arriving at the division ordnance collecting point will include unserviceable end items, components, assemblies, and recoverable repair parts that are beyond the repair capability or capacity of the forward support companies or the main support company, as well as ordnance equipment retrieved from combat casualties and foreign ordnance materiel recovered on the battlefield.

c. The supply officer of the service and evacuation platoon, main support company, is charged with the responsibility for operating the division ordnance collecting point. Based on the capability and capacity of the main support company, he determines which items will be repaired within the company's maintenance shops and which will be evacuated. Based on the list of repair parts in critical supply in the division, he determines the types and quantities of components, assemblies, and repair parts that should be reclaimed locally from materiel arriving at the collecting point. The ordnance battalion will not attempt to reduce unserviceable equipment to component parts unless a serious shortage of parts exists in the division. The supply officer arranges for the evacuation or turnover to field army ordnance service of unserviceable (U. S.) materiel that will not be repaired by the armored ordnance battalion. Arrangements for the evacuation or turnover of foreign ordnance materiel are made through the division ordnance office. The supply officer keeps records and prepares reports on collecting point operations, and furnishes lists of evacuated items to the ordnance general supply officer of the division ordnance office so that supply planning for the entire division may be facilitated. He also supervises the identification of parts, assemblies, and components, as well as the packing, crating, handling, and other activities related to collection, classification, and evacuation. The supply officer is assisted in his collecting point duties by an ordnance supply specialist. If available, personnel from ordnance

maintenance units providing backup support to division ordnance may be utilized to perform any required disassembly. Service and evacuation platoon personnel are utilized to perform any required preservation, packaging, and crating. For additional information on the operation of division ordnance collecting points, see FM 9-3.

## CHAPTER 9

### TECHNICAL ASSISTANCE

---

#### 59. General

Technical assistance is the service of providing instruction and technical guidance to supported units to enable them to perform their missions in a more efficient manner. Ordnance technical assistance to supported units involves the dissemination of advice and assistance on the proper performance of those supply and maintenance functions with respect to ordnance materiel that are properly the responsibility of the supported units. In the armored division, the greatest need for technical assistance will be in the area of ordnance general supply. With respect to maintenance, technical assistance may be required to apprise supported units of new methods of performing maintenance, and the proper application of modification work orders. The objective of ordnance technical assistance is to insure correct interpretation and uniform application of supply and maintenance procedures in order to improve operations and conserve materiel.

#### 60. Benefits

a. An efficient technical assistance program benefits supported units and the ordnance battalion. It is imperative that the support companies of the battalion recognize the advantages of technical assistance and implement a vigorous and continuous program to provide efficient and effective technical assistance service to supported units. Moreover, supported units must be informed of the benefits of ordnance technical assistance and how it will be provided. Staff supervision, planning, and coordination of ordnance technical assistance within the division will be effected by the division ordnance office.

b. Supported units may request technical assistance whenever they are unable to cope with a problem because of the lack of equipment or facilities, the insufficient training of personnel, or unfamiliarity with equipment or procedures. Technical assistance, however, is not limited to that provided on the request of supported units. Provision should be made for frequent visits to supported units to determine requirements for technical assistance and to provide this assistance when necessary. These visits are



made as often as the situation permits, and should be used to determine the problems of the supported units and the remedial action that is necessary. Information derived during such visits is carefully analyzed to determine how organizational maintenance and supply operations can be improved and ordnance direct support made more effective.

*c.* Equipment status and deadline reports submitted by using units will often reveal the need for technical assistance. The nature of the technical assistance furnished is based on the information furnished in the reports.

*d.* Technical assistance benefits supported units by providing them with advice and assistance so that they may be able to properly perform their organizational maintenance and supply functions with respect to ordnance materiel. It should be used to provide information on new maintenance techniques, new supply procedures, the availability and use of publications, and the implementation of maintenance directives and orders such as modification work orders. When supported units are properly discharging their responsibilities with respect to organizational supply of ordnance items and organizational maintenance of ordnance equipment, the ordnance equipment in the hands of using units will remain combat ready for longer periods. More over, there will be less time lost due to awaiting repairs or replacement of equipment. From an ordnance standpoint, an effective technical assistance program will result in the quantitative maintenance workload of the ordnance battalion being reduced, thereby permitting it to function more efficiently, and the demands for repair parts and replacement items will be reduced.

*e.* The ordnance battalion, too, may occasionally require advice and assistance from ordnance units in a higher support level. In such instances, the assistance of the appropriate general support unit in the corps service area is requested. The division ordnance office will make arrangements for any ordnance to ordnance technical assistance needed within the division.

## 61. Organization, Functions, and Operations

*a.* Technical assistance service, when required, is provided to supported divisional units by the appropriate supporting company of the ordnance battalion. This service may be provided as a result of a specific request made by a supported unit, as a result of command direction, to satisfy requirements discovered by a liaison party, or in the normal course of direct support operations.

*b.* The liaison party is the normal method of contact between

the companies of the battalion and the units they support. As a minimum, this party should consist of an officer or noncommissioned officer who is thoroughly familiar with maintenance procedures and requirements, and a qualified supply specialist.

*c.* In most cases, the liaison party will be able to provide the supported unit with all the instruction and guidance necessary. However, there may be occasions when the provision of adequate technical assistance will require more time and effort than can be expended by the liaison party. In such cases the liaison party will determine requirements, and selected specialists will be dispatched by the supporting company to provide the required assistance. This permits the liaison party to maintain its schedule of visits to other supported units.

*d.* Visits by liaison parties are made as often as the situation permits, and in all cases at least once every 10 days. Emphasis is placed on visits to units receiving low ratings in spot-check or command maintenance inspections in order to assist unit commanders in improving their organizational maintenance and supply operations.

*e.* The functions of the liaison party include, but are not limited to:

- (1) Giving advice to the unit commander on accomplishing his organizational maintenance and supply functions.
- (2) Advising the unit commander on the efficient utilization of ordnance materiel.
- (3) Following up on ordnance supply requirements of the using unit to assure that the unit is provided all the tools, repair parts, and cleaning and preserving materials authorized and needed for organizational maintenance of ordnance equipment.
- (4) Determining the status of ordnance items in the using unit to determine whether the unit has all its authorized ordnance equipment and whether the equipment is in serviceable condition.
- (5) Determining what technical instruction and training assistance is needed by supported unit maintenance and supply personnel so that they may properly perform their organizational maintenance and supply functions. This instruction and assistance may be provided by the liaison party, or arrangements may be made with the supporting ordnance company to provide the required assistance if the liaison party is unable to do so. The liaison party

should assist supported units in obtaining needed technical publications when such assistance is necessary.

## 62. Records and Reports

Except when command direction decrees otherwise, no formal records or reports are made on technical assistance activities. Liaison parties may prepare informal reports on the status of organizational maintenance and supply operations in visited units and the technical assistance required. These reports are usually prepared in duplicate, with the original being given to the commander of the unit visited and the duplicate being retained in the files of the supporting unit. After the required technical assistance has been rendered and the organizational maintenance and supply operations of the visited unit are determined to be satisfactory, the informal records maintained by the supporting unit are disposed of. When technical assistance service discloses that supported units are unable to perform the required organizational maintenance due to weather conditions, the tactical situation, a shortage of personnel, or other conditions beyond their control, the division ordnance officer will be notified. He will take action to provide the additional assistance necessary.

## CHAPTER 10

### INSPECTIONS

---

#### Section I. INSPECTION MANAGEMENT

##### 63. General

*a.* The inspections with which the armored ordnance battalion will become involved include spot-check inspections, organizational inspections, command maintenance inspections, and ordnance technical inspections. Each of the companies of the battalion will be subject to all of the inspections noted above. They will perform technical inspections on ordnance materiel, and may be required to provide personnel for the conduct of ordnance spot-check and command maintenance inspections in divisional units.

*b.* The basic documents authorizing and prescribing inspections of ordnance supplies and equipment are AR's 750-5, 750-8, and 750-925. These regulations also list the forms and reports to be used, specify the frequency and scope of inspections, and give information relative to the determination of deficiencies and the methods of rating inspections. TM's 9-1100 and 9-2810 prescribe procedures to be used in conducting inspections of materiel in the hands of a using organization, and show examples of completed forms. Detailed technical information regarding the inspection of any particular item is contained in the ordnance technical manual for the item.

*c.* Command maintenance inspections of items of equipment of the other technical services are conducted as prescribed in AR 750-8. Spot-check inspection procedures for items that are the responsibility of other technical services are also set forth in Army Regulations. The companies of the ordnance battalion will be subject to command maintenance and spot-check inspections conducted by other technical service personnel.

*d.* The inspections of particular concern to the ordnance battalion are explained in subsequent sections of this chapter. Since the brunt of the inspection workload is borne by the individual companies of the battalion, both from a recipient's standpoint and because they provide personnel for the conduct of ordnance inspections throughout the division, inspections will be explained in terms of their impact on company operations. Technical inspec-

tions, as noted above, denote the initial and final inspections performed on an item of materiel prior to its entry into a maintenance shop and after repairs have been made in the shop. Technical inspections are performed by the companies of the battalion as part of their normal maintenance function, and are discussed in chapter 6.

#### 64. Purposes of Inspections

Inspections serve many purposes, the most important of which are:

- a. Assist commanders in determining the ability of units to perform their assigned functions.
- b. Inform commanders of the condition of materiel in the hands of using units.
- c. Inform commanders of the efficiency of mess, supply, administrative, and maintenance operations, and the ability of personnel performing these functions.
- d. Assist in predicting future maintenance and supply requirements.
- e. Aid in determining the need for improvement in training, procedures, organization, or equipment.

#### 65. Inspection Management

Any system that results in too many inspections harasses the inspected units and reduces their efficiency. Inspections should be scheduled to insure a minimum of interference with training or operations. The number of inspections that may be conducted by all the technical services, inspectors general, and any level of command could, if not properly controlled, result in units undergoing a continual inspection of some type. Coordination and scheduling at the highest level feasible can avoid duplication of inspections and the undue harassment of troops. Obviously, certain inspections, such as those that may be directed after a unit has withdrawn from action or returned from a maneuver, cannot be scheduled.

#### 66. Inspection Standards

Standards must be established commensurate with local situations, conditions, and missions of units. Standards must be low enough so that they can be achieved; yet high enough so that poor operation or other deficiencies which hamper performance can be detected. Borderline decisions, however, will favor the unit being inspected, and inconsequential deficiencies will not be reported

unless they establish a trend or by their accumulation represent an undesirable situation. This flexibility in standards must not be abused to the point that the inspection will fail to reflect a true picture of the conditions for which the inspection was conducted—to ascertain the true condition of the unit's equipment, the efficiency of its supply operations, the training of its personnel, etc. Certain prescribed standards, however, must be maintained regardless of conditions.

## 67. Followup

Thorough followup action on an inspection is a means of assuring that the deficiencies found in the inspection have been corrected and their causes eliminated. This can be done by on-the-job training of specific individuals or by reinspection. In the latter case, sufficient time should be allowed for the correction of deficiencies, and only those activities or items found deficient in the original inspection should be rechecked. Followup action induces personnel to correct deficiencies and to maintain the desired standards.

## Section II. ORGANIZATIONAL INSPECTIONS

### 68. Definition and Purpose

a. Organizational inspections are those performed by commanders, or their representatives, to determine whether the mess, supply, administrative, and maintenance procedures of the units under their control meet prescribed standards; to determine whether equipment is serviceable and whether it is being utilized properly; to reveal areas in which additional training is necessary; to evaluate the efficiency of operations; to determine whether directives and established procedures are being complied with; and to determine the operational readiness of personnel and equipment. In simple language, they are inspections conducted by or for commanders to determine whether units in the command are capable of performing their missions. In these inspections emphasis should be placed on examination of the areas of major deficiency noted in previous inspections.

b. This general category of inspections also includes those inspections of a company conducted by food service personnel of higher headquarters, inspections by inspectors general, or inspections of some aspect of training by representatives of major commanders or chiefs of technical services (e.g., inspections by Chemical Corps personnel or CBR officers to determine the proficiency of the unit in CBR detection and defense).

## 69. Frequency

The inspection may be formal, where prior notice is given to the unit to be inspected and a set procedure is established, or informal, where no advance notice is given and no set procedures are established beforehand. The latter method permits a commander to see his equipment in operation and to determine the proficiency of personnel while they are actually engaged in the performance of assigned duties. Formal inspections of a company by its commander should be conducted frequently. Ordnance battalion commanders should make formal inspections at least once a month. Informal inspections are made at the commander's discretion. The frequency of organizational inspections, however, will be determined by the commander concerned, who should take into consideration any other inspections to which his unit or units were subjected recently.

## 70. Types

*a. Inspection of a Company by the Company Commander.* These inspections normally cover all aspects of the company's operations, including unit mess and administration. Particular emphasis, however, is placed on: the condition of the company's TOE and TA equipment and the organizational maintenance performed thereon; the operation of the technical supply function, including the efficiency of personnel, maintenance of records, storage procedures, and cooperation with maintenance operations; the efficiency of the production control operation, including the proper use of the tools of control and the completeness and accuracy of records; the efficiency and methods of operation of the shop supply section; the thoroughness of the technical inspections and the ability of inspectors; the functioning of the repair shops, to include conformance to correct maintenance procedures, completeness and accuracy of records, adherence to safety regulations, compliance with the principles of supply economy, and the proper utilization and training of the workmen. In the inspection of his company, the commander may prepare a checklist according to his requirements, including thereon all the items or procedures he wishes to inspect.

*b. Inspection of a Company by the Battalion Commander.* The battalion commander will frequently conduct inspections of the companies of the battalion. These inspections may be formal or informal, scheduled or unscheduled, and are conducted in much the same manner and for the same purposes as the organizational inspection conducted by the company commander. In this case, however, the battalion commander is interested in determining the efficiency and operational readiness of all units in the battalion.

These inspections tend to be more formal than those conducted by company commanders, and because of the limitations on time and the number of personnel required, they may not be as extensive in coverage. Primary emphasis is usually placed on those aspects that most seriously affect accomplishment of the battalion mission, and the areas in which deficiencies were noted in previous inspections or in which deficiencies are known to exist or are suspected. They may be conducted while the inspected unit is conducting operations; formations may be held with equipment being displayed and personnel standing by the equipment for which they are responsible; or the inspections may be conducted while the companies are on the move, to see how rapidly and efficiently they can close out an old area, displace, set up a new area, and resume normal operations.

### Section III. COMMAND MAINTENANCE INSPECTIONS

#### 71. Definition and Purpose

a. The command maintenance inspection (CMI) is an inspection of a percentage of end items of Army materiel and related equipment in the hands of using units and activities, organizational and field maintenance operations, maintenance of individual equipment, and condition of ammunition. Materiel of all the technical services in the hands of inspected units and activities is included in this inspection.

b. This inspection is conducted for field army commanders or commanders of organizations of comparable size, and is intended to make available to major commanders and the heads of technical services, through a single inspection report, a means of determining—

- (1) The serviceability, proper usage, and operational readiness of a unit's end items of equipment, together with their applicable on equipment materiel.
- (2) The adequacy and effectiveness of organizational and field maintenance operations.
- (3) The efficiency of repair parts supply procedures directly supporting maintenance operations.
- (4) The proficiency of unit maintenance personnel.
- (5) Future maintenance and exchange requirements derived from deficiencies disclosed during the inspection.

c. Since the companies of the ordnance battalion are issued various items of equipment for which other technical services have logistical responsibility, the companies will be subject to command



maintenance inspections of this equipment by inspection teams of the appropriate technical services. Moreover, the ordnance equipment of the companies will be subject to command maintenance inspection by ordnance inspection teams. In addition, the ordnance battalion may be required to provide personnel for the conduct of the ordnance phase of a command maintenance inspection of the division. Command maintenance inspections are conducted as prescribed in AR 750-8.

## 72. Frequency

a. Army Regulation 750-8 requires that command maintenance inspections be conducted annually. These inspections may be performed simultaneously with other inspections normally conducted during the course of a calendar year. Consolidation of inspection teams to the maximum degree practicable is encouraged.

b. Command maintenance inspections are not intended to discontinue those inspections presently performed in the field maintenance shops of the ordnance battalion on equipment requiring repairs, or spot-check inspections prescribed by existing regulations.

## 73. Conduct of the Ordnance Phase of a Command Maintenance Inspection

### a. General.

- (1) The annual command maintenance inspection of ordnance equipment will be accomplished by ordnance technical personnel under the supervision of a qualified ordnance officer, and utilizing the procedures, checksheets, reports, and standards prescribed in AR 750-8. It requires an inspection of a minimum of 50 percent of end items of ordnance equipment and their supporting maintenance and repair parts supply operations.

*Note.* The percentage of ordnance items to be inspected should be greater as the density of the specific items assigned to a unit decreases. For example, a 50 percent inspection will reflect a fairly accurate picture when 20 or more like items are involved; however, if the number of items assigned to the unit is less than 20, the percentage to be inspected should be proportionately increased. In any case, the particular items to be inspected will be selected at random by the individual in charge of the inspection team.

The inspection should be scheduled in the master training directive. The unit to be inspected is informed in advance of the procedures to be used, how equipment should be prepared for inspection, and the standards desired.

- (2) The following will not be inspected during a command

maintenance inspection: supplies and equipment in storage, or in their original containers, or equipment assigned to schools and used exclusively for maintenance instructional purposes.

*b. Procedures.*

- (1) The ordnance phase of the command maintenance inspection will include inspection to: insure the adequacy and effectiveness of organizational maintenance and supply procedures; determine the condition of materiel; ascertain the availability and use of technical manuals, supply manuals, and lubrication orders; and determine the accuracy of records, authorized level of equipment and supplies, practice of supply economy, preservation and safekeeping of tools, and the availability of repair parts and supplies and followup thereon.
- (2) Commanders making command maintenance inspections and inspectors general will take full cognizance of and utilize spot-check inspections made within 30 days of the scheduled command maintenance inspection. In addition, evidence of a complete inspection made within the previous 90 days on a piece of equipment incident to its repair in a field maintenance shop may be accepted by an inspecting officer as meeting the requirement for the annual command maintenance inspection. When an item has been repaired in an ordnance shop and the inspection form incident to that repair indicates that the requirements of a pending preventive maintenance service have been met, this service may be considered as meeting the requirements of the preventive maintenance service.
- (3) Equipment will be inspected as prescribed in technical manuals and technical bulletins pertaining to the particular item and as prescribed in TM's 9-1100 and 9-2810.
- (4) During command maintenance inspections, deficiencies will be corrected on the spot when feasible.
- (5) The officer in charge of the command maintenance inspection of ordnance equipment will direct repair, evacuation, or replacement of ordnance equipment that is unsafe to operate or use, or which through continued use would result in additional damage to equipment.

## 74. Determination of Deficiencies and Rating of Inspections

*a. Deficiencies.*

- (1) Deficiencies found in the inspection of materiel are classi-

fied as "major" or "minor." A major deficiency is one that would cause the item to be unsafe to operate, to function improperly or not at all, or one which would cause further damage if the equipment were continued in operation. A minor deficiency is defined as any other deficiency that will not cause an immediate or subsequent breakdown, nor jeopardize the safe operation of the item.

- (2) A deficiency in shop operations, records, and supply is defined as a malpractice, error, or omission affecting the overall efficiency of the activity being inspected.

*b. Evaluation and Rating.* Inspections will be rated on the basis of deficiency averages of each group of materiel inspected, wherein deficiencies are given a numerical weight, and on an adjectival rating of each administrative operation. For information on how these deficiencies are evaluated, totaled, and averaged to determine an adjectival or numerical rating, see AR 750-8.

#### Section IV. SPOT-CHECK INSPECTIONS

##### 75. Definition and Purpose

*a. Definition.* This is a percentage-type inspection of materiel and related equipment. Also included is the inspection of related organizational maintenance and supply facilities. It is similar to the command maintenance inspection in most respects; however, the percentage of items inspected is smaller and the frequency of inspection is usually greater.

*b. Purpose and Scope.* Spot-check inspections are made to verify the adequacy and effectiveness of organizational maintenance and supply, and to detect incipient failures in equipment before unserviceability occurs. The items and procedures inspected are the same as those examined during the command maintenance inspection. Ordnance spot-check inspections are covered in AR 750-925.

##### 76. Conduct of an Ordnance Spot-Check Inspection

*a.* The division ordnance officer is responsible to the division commander for the conduct of spot-check inspections of ordnance materiel. He is also responsible for providing the personnel to conduct the inspection. Personnel to make up the inspection team are drawn from the companies of the ordnance battalion. All inspection teams will be under the direct supervision of a qualified officer.

*b. Types and Frequency.*

- (1) Since the division commander is responsible for main-

tenance and supply within the division, he will prescribe the frequency of ordnance spot-check inspections. This action, however, is based on recommendations of the division ordnance officer. As a minimum, all organizational maintenance and supply facilities and at least 10 percent of each type of ordnance equipment in the hands of each unit in the division will be inspected at least once annually. This inspection may be accomplished with or without prior warning to the unit to be inspected. In active theaters this inspection should be made more frequently. As in the case of the command maintenance inspection the percentage of items inspected depends on the number of items in the hands of the unit being inspected. The 10 percent sampling reflects a fairly accurate picture when the inspection involves 300 or more like items; however, as the number of items diminishes below 300, the percentage inspected should be proportionately increased. In any case, the equipment to be inspected will be selected at random by the officer in charge of the inspection team.

- (2) A variation of the spot-check inspection, and one which should be established within the division area, is the roadside or barrier inspection. In this inspection a team of qualified ordnance personnel is posted on a road carrying heavy traffic, at a gasoline supply point, a ration supply point, or any similar location where vehicles of various units will be found. Vehicles are selected at random by the team and are inspected on the spot. Ambulances, couriers, emergency vehicles, and combat vehicles will not be halted for this type of inspection, nor will unit convoys, labor details, or groups en route to or from instruction or recreation. No vehicle will be detained more than 30 minutes, and a backlog will not be allowed to build up. Inspections of this type provide a good indication of the adequacy of organizational maintenance being performed by using units.

*c. Procedures.* The spot-check inspection is conducted in much the same manner as the command maintenance inspection of ordnance equipment and supply and maintenance facilities.

- (1) Equipment is inspected as prescribed in technical manuals and technical bulletins pertaining to the particular item and TM's 9-1100 and 9-2810.
- (2) The inspection of shops includes inspection to determine the accuracy and completeness of records; the adequacy

and use of publications; the adequacy and efficiency of personnel; the adequacy of facilities; the care, handling, and adequacy of tools, equipment, and supplies; house-keeping; safety; and technical knowledge of personnel.

- (3) The inspection of supply operations includes: examination of records for completeness and accuracy; adequacy and use of supply publications; determination of excesses or shortages and whether appropriate action has been taken in each case; determination as to whether unserviceable, recoverable repair parts are being turned in by the unit; adequacy and technical knowledge of personnel; and efficiency and adequacy of repair parts storage, identification, and preservation procedures.
- (4) As in the command maintenance inspection, the officer in charge of the inspection team will direct repair, evacuation, or replacement of ordnance equipment whose continued use would jeopardize the safety of personnel or result in additional damage to equipment.
- (5) Deficiencies will be determined, evaluated, and the inspection will be rated in the same manner as with command maintenance inspections. See AR's 750-8 and 750-925.

## CHAPTER 11

### MOVEMENT AND DEFENSIVE OPERATIONS

---

#### Section I. GENERAL

##### 77. Introduction

a. Modern tactics of warfare, both offensive and defensive, stress greater dispersion of facilities and units to reduce the effects of enemy nuclear attack, more frequent and rapid movement of units to capitalize on enemy weaknesses and surprise and to deny the enemy the opportunity to observe and bring nuclear fire to bear on concentrations of troops, and greater emphasis on the proper selection and utilization of terrain to facilitate both the offense and defense. The modern armored division was expressly designed to meet the requirements of any combat situation, being capable of waging nuclear, nonnuclear, and limited warfare. It is a highly mobile organization capable of operating in one or several widely separately areas simultaneously.

b. The armored ordnance battalion, which is an integral part of the armored division, is also designed for mobility, rapid movement, and employment in several locations so that it may be able to render the required ordnance support under all conditions. Changes in the tactical situation and movements of the division and its combat commands will necessarily require movement on the part of the ordnance battalion, or specific elements thereof.

c. In addition to providing the required ordnance support for the division, the ordnance battalion must be capable of defending itself and its installations against all types of attack, and plans must be made therefor. In a rapidly moving situation it is quite possible that small pockets of enemy resistance will be bypassed by the combat commands of the division who may be seeking to exploit a breakthrough or attacking objectives deep within enemy lines. Such a situation would make rear areas of the division susceptible to attack by elements of the bypassed enemy unless adequate defensive measures were taken. Guerrilla action, infiltration, and airborne attack present additional threats to the ordnance battalion. It is probable that the division combat elements may not be able to provide assistance in meeting these threats, especially if the bulk of the division is actively committed in other areas.

Therefore, personnel of the ordnance battalion must be prepared to fight as infantrymen, waging defensive or limited offensive action to protect installations and to neutralize threats to supply routes and support activities.

#### 78. Types of Movement

Movements performed by the ordnance battalion include administrative movements and participation with the division in tactical movements.

*a. Administrative Movements.* An administrative movement is any movement of units or supplies other than a tactical movement against the enemy. This type of movement is made when no enemy activity or interference is anticipated; therefore, stress can be placed on expediting the movement and conserving the energy of troops. Movements from installations in CONUS to ports of embarkation, for example, are considered administrative movements. These movements are further explained in section II.

*b. Tactical Movements.* A tactical movement is a movement of troops and equipment made under combat conditions, whether or not in direct contact with the enemy. The ordnance battalion participates in tactical movements of the division as a whole, or elements of the ordnance battalion may be required to move when the division elements they support move. Tactical movements are discussed in section III.

#### 79. Area Selection, Preparation, and Layout

*a.* When the division moves, the ordnance battalion is assigned areas in which the companies of the battalion will conduct future operations. The division trains commander makes area assignments for the battalion headquarters and the main support company. Area assignments for the forward support companies are made by combat command S4's. The commanders of the forward support companies then inform the ordnance battalion commander of the location of their assigned areas.

*b.* The division trains commander and the combat command S4's should include their ordnance supporting elements in their initial reconnaissance and planning prior to the move. Specific area assignments for the ordnance elements within the trains areas are recommended by the ordnance commanders based on the factors listed in FM 9-3 concerning area selection.

*c.* Upon receipt of notification of an impending movement, the ordnance battalion and company commanders issue warning orders to alert all their personnel. Plans are then made for the movement.

Movement planning requires route reconnaissance; selection of specific areas to be occupied by companies of the battalion; detailed layout of areas in which the companies will conduct future operations; and march planning. Within the areas assigned to each company, sites will be selected that will facilitate both defense of the area and the conduct of mission operations. Advance parties must be dispatched to lay out the new area and prepare it for occupancy. The layout of the new area must be taken into consideration when planning march serials so that traffic congestion may be avoided upon arrival at the new area and the interruption of mission operations held to a minimum. Area preparation, layout, and march planning are discussed at length in FM 9-3.

## 80. Movement SOP's

Many of the aspects of movement into a new area become routine, either by their nature or because the commander wishes to make them so. Such things as composition of march serials; duties of reconnaissance, advance, and rear parties; convoy security; etc., become largely a matter of SOP once firm procedures are established. Minor changes may be required, but basically, the procedures vary little from movement to movement. Therefore, the preparation of SOP's to cover these aspects of operations relieves the commander of the necessity for repeated planning and issuance of directives for the conduct of operations that follow an established pattern. The commander, then, can concentrate on other operations which must be planned and directed as requirements develop. Chapter 4 points out those aspects of unit operations that should be covered by SOP.

## 81. Loading Plans

*a.* To facilitate movement of the battalion, plans for the loading of personnel and equipment must be made for every type of transport that will be utilized in the move. Plans must be made well in advance to provide time for any necessary packaging and preservation. Plans are based on the type transport to be used (truck, rail, or ship); the number of personnel involved; and the type, size, weight, and quantity of supplies and equipment to be moved.

*b.* Short moves, especially in oversea theaters, will probably be made by motor transport, and loading plans must be made for this type of move. Longer moves, especially in CONUS, are usually made by rail. A move may be made by more than one mode of transport, as in the case of a battalion moving from an installation in CONUS to a port of embarkation by rail, to an oversea theater by ship, and to its area of operations by motor transport. Loading plans must be made for all modes of transport to be used.



c. In the preparation of movement and loading plans, consideration must be given to priority of loading, safeguarding of equipment and supplies in transit, and the placing of personnel with or near their equipment. A logical embarking and debarking process must be included in the plan. All plans must be designed to permit rapid and orderly debarking and regrouping of personnel and equipment to facilitate speedy resumption of mission activities.

d. FM 101-10 contains valuable information on movement of personnel and equipment, including tonnages that can be handled by various modes of transport, loading procedures, the number of trucks required for motor movements, etc. SB 9-156 lists specifications, instructions, and related publications pertinent to packaging and processing ordnance general supplies for shipment. Detailed packing, boxing, and loading instructions for shipping ordnance items are contained in TB 9-OSSC-A through TB 9-OSSC-F, and SB 9-184/1.

## Section II. ADMINISTRATIVE MOVEMENTS

### 82. General

In administrative movements the ordnance battalion usually moves as a unit, forming an integral part of the division, except for those elements required to support the combat elements while on the move. In some cases it may be necessary to dispatch an advance party to precede the division in order to provide for maintenance and deprocessing of equipment when the division arrives at its destination. For long moves the battalion prepares its own equipment for shipment in accordance with current directives. For motor and rail movement it also loads its own equipment. For information on preparation for oversea movement and movement of units within CONUS, see AR 220-10 and SR 55-720-2.

### 83. Motor Marches

The ordnance battalion is completely mobile in its organic transportation. Routine motor marches will normally be covered by battalion SOP, implemented as required by company SOP's. Such items as routes, destinations, initial points, orders of march, and speed will be specified separately for each move. For additional information on motor marches, see FM 25-10.

### 84. Rail Movement

In training and preparation for movement by rail, the ordnance battalion must become familiar with packing, boxing, and crating

organic equipment, and loading equipment and personnel on railway cars. A battalion rail-movement table and rail-movement annex to the SOP are prepared and kept up to date. Detailed information on rail movements; types, characteristics, and capacities of railway cars; loading plans; and loading scales and tables is found in FM's 100-5, 100-10, and 101-10.

## **85. Water Movements**

Water movement requires special packing, crating, and marking of equipment and additional training of personnel. Destination, mission, anticipated employment on disembarking, available shipping space, and type of vessel are factors which must be considered. Moreover, if several vessels are used, elements of the battalion together with their equipment should be distributed among the vessels to minimize the effects of losses, especially if the division moves as a whole. The same data contained in the rail-movement table, but in slightly different form, can be used for the unit personnel and tonnage table in preparation for movement by water. For additional information see FM's 100-5, 100-10, 101-10, and AR 220-10.

## **Section III. TACTICAL MANEUVERS**

### **86. General**

A march in a combat zone is a tactical march when a column will be employed against the enemy upon making contact, or when interference from the enemy is a possibility. The mission of the column, proximity of hostile ground forces, terrain over which the column will travel, type of enemy resistance expected, and activity of hostile air forces are all factors which determine the organization and composition of the column. Division tactical march orders are prepared by G3 in coordination with other staff officers. Basic road spaces for motor elements should be maintained for all divisional elements (FM 101-10).

### **87. Battalion Participation**

In a tactical march involving the division as a whole, each forward support company marches as part of the trains serial of the combat command it is supporting. The headquarters and main support company marches with the division trains. The forward support companies do not accompany combat elements on movements to contact the enemy.

### **88. Battalion March Unit**

The ordnance battalion may be required to move as a separate

unit. When such a movement is made the following conditions apply:

*a. March Order.* A march order is issued by the battalion commander giving all pertinent details of the march.

*b. Initial Point.* An initial point is designated by the battalion commander, and a time is established for each march serial to reach and clear it.

*c. March Distances.* The march order will specify the normal distance between vehicles in the column during the hours of daylight. On night marches, the normal distance between vehicles is that which allows the driver to see the vehicle ahead of him. The normal time interval between march units in the column is 1 minute; between march serials, 3 minutes.

*d. Rate of March.* The rate of march is governed by the slowest vehicle in the column. This vehicle should be placed at or near the head of the column. During daylight on good roads the rate is 20 miles per hour for columns containing only wheeled vehicles. For night marches without lights, except in bright moonlight, the rate is reduced to 8 to 10 miles per hour on good roads.

*e. Formation for the March.* The march formation is governed by the situation. Each company normally forms a march unit. Heavy equipment such as recovery vehicles and tractors with semi-trailers are grouped to form a separate serial.

*f. Communication.* When radio silence is not imposed, radio is the principal means of communication while the battalion is on the march. Visual signals, however, are used extensively for column and vehicle control. Messengers are employed occasionally.

*g. Road Guides.* Whenever possible, road guides should be used at all points where there may be a question as to the correct route to be taken by a column. Arrangements must be made for personnel serving as guides to be picked up by the last vehicles of the column.

*h. Halts.* Halts should be prescribed in the SOP. Usually a halt will be made for the last 15 minutes of the first hour, and the last 10 minutes of every succeeding two hours, the time commencing when the leading element of the column crosses the initial point. March units assume proper distances during the halt periods. All drivers and vehicle crews perform their scheduled "at halt" maintenance operations. Since halts for refueling are scheduled in advance, commanders must know the rate of fuel consumption of their vehicles.

*i. Control and Supervision.*

- (1) Control of the battalion on the march can only be attained by a high degree of training and discipline. Detailed supervision by the battalion staff is necessary to insure that the column is formed according to plan. A staff officer is designated to check the column at the initial point, the arrival of subordinate units, and the order of march. A control vehicle is selected for each march unit of the battalion. A well-marked route and road guides also assist in control of the column and assure smooth movement. Radio is the primary means of control on the march. Factors affecting the use of radio are security, limitations of equipment, and terrain. Other means of control are hand signals, flags, phase lines, and control points.
- (2) Supervision of the march column is the responsibility of all battalion officers and noncommissioned officers. Items to check include: condition of vehicles, distance between march units, speed, and the general conduct of march units on the move. Necessary corrections are made at once.

*j. Security.* All movement in the combat zone is governed by strict security regulations, with special attention to the possibility of air attack. Distance between vehicles is greater than in rear areas. Panel sets are kept in readiness for instant use to avoid attack by friendly aircraft. The battalion must be well trained in passive defense against air attack. When there is a possibility of ground attack, as when guerrillas are operating in the region, tactical plans to meet an attack are made by the battalion and subordinate commanders. A system of observers and signals is established. Individual weapons and ammunition are kept in the hands of troops. Machineguns are manned and rocket launchers are dispersed throughout the column. Tactical considerations rather than administrative considerations govern the conduct of the march. CBR monitors should be located among lead vehicles and conduct continuous monitoring.

*k. Night Marches.* The battalion must be able to conduct night marches under all conditions. Practice offers the most valuable training, and this practice is conducted on unfamiliar roads of all types. Special attention is given to the planning and execution of night marches. The importance of route reconnaissance and the proper use of road guides and markers increases. Control of a night march is facilitated by decreased speed, decreased distance, and increased reconnaissance and security.

## Section IV. DEFENSIVE OPERATIONS

## 89. General

a. The responsibility for security and defense of the ordnance battalion rests with the battalion commander. Individual company commanders are responsible for the security and defense of their companies. Commanders must assure that all personnel know and properly implement the procedures for dispersal, concealment, and camouflage. They must be familiar with the defensive measures to be taken in the event of chemical, biological, radiological, guerrilla, or airborne attack; must assure that unit personnel are assigned specific duties with respect to unit defense and are familiar with the procedures to be followed; must assure that personnel have a practical knowledge of basic infantry tactics; and must prepare thorough and understandable plans for the defense and security of their units.

b. Commanders must be kept informed of the tactical situation and the enemy's capabilities in order to determine the degree of dispersion required in each area in which the companies of the battalion are conducting operations. The forward support companies are provided this information by the supported combat commands. Similar information is available to the main support company from the division G2 section.

c. Each of the companies of the battalion is responsible for defending its own area. Defense is accomplished by establishing an effective outpost and warning system, by making maximum use of natural terrain obstacles, by establishment and maintenance of an effective communications system, and by the utilization of exterior and interior guard systems. The defensive system is supplemented by defensive works and a mobile reserve which is centrally located so as to be able to rapidly converge on any sector of the company where an enemy breakthrough is likely. In the conduct of a defense, the companies of the ordnance battalion are virtually on their own, and defense plans must be made with this in mind. However, higher headquarters must be informed immediately of the type and strength of any attack so that assistance, if available and necessary, may be provided, and that other units may be alerted. Defense against airborne attack, guerrilla action, and infiltration is conducted in accordance with the principles contained in FM 31-15.

## 90. Security and Defense Measures

*a. General.*

(1) Defense plans must provide for the maximum use of all

personnel of the battalion and should provide for the evacuation or destruction of records and materiel to preclude capture by the enemy in the event of a breakthrough. Battalion headquarters prepares defense plans and SOP's for the battalion as a whole. The companies of the battalion prepare individual plans and SOP's according to local needs and in conformance with battalion plans. Defense plans should provide for a means of control and communication. When possible, alternate command and communications means should be established. Within each company a warning system should be established for the rapid dissemination, to all elements and to higher headquarters, of information concerning an impending or actual attack. Defense plans must include both active and passive measures. Within each company, SOP's will be prepared to standardize procedures that can be made routine and to assign specific functions and responsibilities to individuals and elements of the company. All personnel, including those engaged in shop work, must be thoroughly familiar with these SOP's.

- (2) Each company area must be selected with consideration given to tactical defense as well as accomplishment of the technical mission. Trenches or foxholes should be close to the working areas and in sufficient numbers to accommodate all personnel. An adequate defense plan must be established for each section of the company's area. Each section should constitute a defense area and should be placed so as to assist adjacent sections by supporting fire. Plans should include the use of any combat vehicles undergoing repairs in the shops or those awaiting other disposition, provided the weapons thereon are serviceable, ammunition is available, and fire can be brought to bear on the attackers. An armed firefighting crew must be provided. Within their areas, company commanders will establish such security measures as the use of internal and perimeter guards to check frequently all areas, shops, and storage sites and will fully utilize all features of terrain and construction to augment security and defense measures.

*b. CBR Defense.* Plans for defense against CBR attacks are a necessary and important part of the overall defense plans of the battalion. To insure adequate CBR discipline and training, certain officers and noncommissioned officers of the battalion staff and the companies of the battalion are trained in CBR protective tech-

niques. These personnel serve as CBR officers and noncommissioned officers for the units to which they are assigned, and are responsible for the establishment and implementation of adequate CBR defense measures, to include CBR defense plans, training, warning systems, CBR monitoring and surveys, etc. For additional information on CBR planning and training, see FM 9-3, FM 21-40, FM 21-41, FM 21-48, and TC 101-1.

*c. Camouflage.* The continued existence of ordnance support facilities in the combat zone will depend greatly on the quality of camouflage used. A greater need for camouflage will exist in barren and flat country. Wooded and hilly country will provide natural camouflage. The commander of the ordnance battalion will do well to insure that all personnel under his control are familiar with the provisions of FM 5-20. Each company should secure and use camouflage nets. When properly erected, nets are of great assistance in providing cover for the various elements of the company. Moreover, all personnel must be thoroughly instructed in the need for camouflage discipline, and commanders and supervisory personnel must exercise every means at their disposal to maintain effective camouflage discipline, both within and adjacent to the shops and supply areas.

## CHAPTER 12

### TRAINING

---

#### 91. General

a. The training objective of ordnance service is to train individuals to become proficient in their assigned tasks, to cross-train them in other related tasks, and to achieve the balance of skills and the cooperation necessary to achieve efficient individual, team, and unit performance. Training is continuous, and the battalion commander as well as the individual company commanders will always be concerned with some aspect of this important function.

b. Training is accomplished on an individual, group, or unit basis. It may consist of training in service schools, in unit schools, on-the-job, through correspondence courses, or any combination thereof. It is supplemented, as required, by refresher training to keep individuals and units informed of new methods, techniques, and equipment, and to review certain subjects which, although not directly associated with the technical mission, are considered essential for maintaining proficiency in general military subjects. Subjects which must be reviewed periodically include military justice, CBR warfare, qualification in arms, and the "Code of Conduct." To conserve training time, maximum use of concurrent and integrated training should be employed, particularly in the areas of CBR and signal communications.

c. Training must be programmed and conducted in such a manner that the efficiency and performance of the battalion mission, or the missions of any of the battalion elements, will not be materially interrupted.

#### 92. Responsibilities

The ordnance battalion headquarters is responsible for establishing training programs, for supervising the training and cross-training of personnel of the battalion, for the operation and supervision of battalion schools, for conducting training inspections, for recommending personnel to fill school quotas allotted by higher headquarters, and for coordinating the training activities of the units of the battalion. Battalion will also establish and operate



schools for the training of all elements of the division in organizational maintenance and supply with respect to ordnance materiel. The companies of the battalion are responsible for assuring that their personnel are trained; for conducting on-the-job, individual, and refresher training; for providing qualified instructors, as necessary, to staff battalion schools; for providing training materials support to schools established by battalion; and for selecting personnel to attend schools. The duties of personnel with respect to training include:

*a. Battalion Executive Officer.* The executive officer has overall responsibility for training of battalion personnel. He is assisted in his training functions by the adjutant and the materiel officer. The responsibilities of the executive officer with respect to training include:

- (1) Establishing training programs in the battalion and supervising the training and cross-training of personnel.
- (2) Preparing training directives, programs, orders, and field exercises based on plans approved by the battalion commander.
- (3) Selecting training areas and ranges.
- (4) Organizing and conducting schools for military and technical training and coordinating with other members of the battalion staff to determine the program of instruction, selection and training of instructors, and selection of students.
- (5) Recommending personnel to fill school quotas allotted by higher headquarters and coordinating with the commanders of assigned or attached units in the selection of these personnel.
- (6) Conducting training inspections and preparing and supervising the conduct of training tests.
- (7) Preparing training records and reports.
- (8) Coordinating and supervising troop information and education activities.

*b. Company Personnel.* Within each company of the battalion, varying responsibilities are exercised by the company commander and supervisory personnel.

- (1) *Company commander.* The company commander is responsible to see that all individuals of the company are trained. He establishes requirements, selects personnel to fill school quotas, selects instructor personnel, and supervises any training conducted within the company. These duties with respect to training may be performed

by the commander, himself, or may be delegated to other personnel of the company. The company commander is assisted in the planning and conduct of training by the shop and supply officers of the company.

- (2) *Other supervisory personnel.* Training conducted within the company requires the cooperative effort of all personnel. Personnel of higher skill levels are continually engaged in the training and the cross-training of personnel of lower skill levels. Section chiefs and platoon leaders supervise and assist in the training of personnel, determine training requirements of their personnel, and conduct on-the-job training.

### 93. Purposes of Training

Training is accomplished to:

- a. Assure the proficiency and efficiency of all battalion elements and the personnel thereof.
- b. As necessary, train organizational maintenance and supply personnel of other elements of the division to assure that they recognize and are able to perform their responsibilities with respect to ordnance materiel.
- c. Train replacements for the battalion who—
  - (1) Have had no training.
  - (2) Do not have the skills needed.
- d. Add versatility and flexibility to the units of the battalion by cross-training.
- e. Improve the proficiency of individuals.
- f. Acquaint personnel with latest equipment and techniques.
- g. Train personnel to accomplish their responsibilities commensurate with their grades and to be able to accomplish the duties of the next higher grade. (The duties and qualifications of enlisted personnel, according to military occupational specialty, are covered in AR 611-201. SR 605-105-5 contains the same information with respect to officers.)
- h. Comply with mandatory requirements for refresher training in certain subjects.
- i. Train personnel in the basic skills of a soldier so that they may be able to defend themselves and their installations if attacked.
- j. Train personnel in the importance and procedures of turning in articles of possible intelligence value, avoiding or neutralizing mines and booby traps, and avoiding capture.

#### 94. Methods

*a.* The Army provides an extensive system of service schools to teach officers and enlisted personnel the special skills required to effectively perform their duties. It is desirable that all personnel be school trained and that full advantage be taken of quotas authorized by these schools. Prospective students must be carefully screened to insure that they will be able to successfully complete the courses of instruction.

*b.* Unit training is conducted utilizing assigned personnel as instructors. This training supplements the service school system and in the armored ordnance battalion best results are obtained if this instruction is conducted at battalion level. This, however, does not prevent the individual company commander from establishing and conducting courses of instruction for his personnel. Unit training provides instruction to those persons who cannot attend school courses and provides special instruction not provided by service schools. The personnel to attend, subjects to be covered, facilities, and standards to be obtained are specified by the commander conducting the school. Items of equipment scheduled for maintenance or repair should be used for instructional purposes whenever practicable. Unit training may be necessitated by the contemplated receipt of new equipment; changes in procedures, mission, doctrine, or methods of operation; or special modifications to equipment.

*c.* On-the-job training is that portion of unit training received during the actual performance of duty. It is the most effective method available for the training of personnel in ordnance technical skills. Work, itself, is not training unless it is competently supervised in order that the proper method for correcting deficiencies and the application of approved methods and techniques can be effectively learned. The most effective method of on-the-job training is grouping experienced specialists with untrained personnel. Untrained personnel may be given the simpler jobs to perform until proficiency is obtained. Later, as experience is gained and skills are developed, these personnel may be permitted to undertake tasks that are progressively more complex.

*d.* Training conferences should be held periodically in which new techniques or information are discussed and new requirements outlined. Participants should be afforded the opportunity to present their problems and propose solutions. Conferences are effective only when they result in the acquisition of knowledge by the participants and mutual agreements on solutions to problems are reached. To be effective, these conferences must be held with both supervisory personnel and selected specialists.

## 95. Instructor Training

Proper training requires the selection of competent officer and enlisted instructor personnel. However, it must be remembered that a good specialist is not necessarily a good instructor. The principles outlined in FM's 21-5 and 21-6 for the selection and training of instructors should be followed. Personnel selected as instructors should be given special instruction in the following:

- a. Specialist training (this training should be the same course of instruction that students are to receive).
- b. Methods of instruction (supplemented by practice teaching so that errors may be corrected).
- c. Preparing, conducting, and scoring tests.

## 96. Officer Training

Additional training must be scheduled for officers from time to time to insure that they are familiar with their supervisory and managerial duties. Practical exercises are even more important for the officer as he seldom has the opportunity to actually operate, service, and maintain pieces of equipment for which he has supervisory maintenance responsibility.

## 97. Sources and Types of Training Materials

a. *Official Training Literature.* This category includes publications that contain approved Department of the Army doctrine, policy, and procedure and are designed to be used in the training of individuals and units. Publications in this category include:

- (1) *Field manuals (FM's).* Field manuals are textbooks and reference books primarily concerned with military training, especially with operations in the field. They cover general operating procedures principles, and techniques. Of particular significance to the armored ordnance battalion are FM's 9-1, 9-3, 9-5, 17-50, 17-70, and 17-100. FM's 21-5 and 21-6 should be used in the preparation of instruction and training of instructors. FM's are indexed in DA Pam 310-3.
- (2) *Technical manuals (TM's).* Technical manuals are instruction books or textbooks that present technical information pertaining to the care, use, and handling of a specific item or items of materiel. They are more detailed and contain special information not found in field manuals. TM's also include sections on repair parts allowances. Each company of the battalion will secure and utilize those TM's pertaining to the equipment utilized

or supported by the company. Battalion headquarters should maintain a similar library. DA Pam 310-4 contains an index to TM's.

- (3) *Training circulars (TC's)*. Training circulars are a rapid means of disseminating new and essential training information. They contain newly formulated doctrines and new developments in tactics and techniques which will later be incorporated in appropriate FM's. TC's are indexed in DA Pam 310-3.
- (4) *Technical bulletins (TB's)*. Technical bulletins contain new instructions and technical information on weapons and equipment or professional techniques. This information will usually be incorporated later in appropriate TM's. TB's are indexed in DA Pam 310-4.
- (5) *Supply bulletins (SB's)*. Supply bulletins contain instructions and information on the more technical aspects of supply matters. SB's are indexed in DA Pam 310-4.
- (6) *Army training programs (ATP's)*. Army training programs are documents published by the Department of the Army which provide guidance in the preparation of training programs and training schedules for specific types of troop units of the active Army and Reserve components. ATP 9-201 is applicable to ordnance units. ATP 20-5 contains information on field exercises and maneuver training. ATP's are indexed in DA Pam 310-3.
- (7) *Army subject schedules (ASubjScd's)*. Army subject schedules are used as guides in preparing lesson plans and practical exercises. Army subject schedules are listed in DA Pam 310-3. It should be noted that there are two basic types of subject schedules—unit subject schedules for unit training, and MOS subject schedules for the training of specific individual skills.
- (8) *Army training tests (ATT's)*. Army training tests are used to evaluate the ability of units, both tactically and technically. Test scores determine if the unit is sufficiently trained to accomplish its assigned mission and if the individuals of the unit are MOS-qualified and utilized correctly. ATT's are useful in determining areas in which training deficiencies exist so that emphasis may be placed on these areas in training. The index for ATT's can be found in DA Pam 310-3.
- (9) *Lubrication orders (LO's)*. Lubrication orders are illustrated, waterproofed, numbered, and dated cards, or decalcomania labels, that prescribe approved first and

second echelon lubrication instructions for mechanical equipment issued by the technical services. They are carried with, or attached to, the equipment to which they pertain. The instructions they set forth are mandatory. Company commanders are responsible for obtaining, installing, and complying with all current LO's that apply to the equipment in their company. LO's are indexed in DA Pam 310-4.

- (10) *Modification work orders (MWO's)*. These prescribe modifications to be made on materiel and the procedures to be followed in making the modifications. These modifications are designed to increase the operating efficiency of the item of equipment and to insure greater safety for the operator. They range from the simplest kind of alteration to a very complex change which can be done only at an arsenal. MWO's contain the following information: the type of materiel to be modified, the category of maintenance permitted to perform the modification (AR 750-5), the new parts and the number of man-hours required to perform the modification, and the date by which it must be completed. An MWO is a legitimate *authorization for requisitioning* any parts that may be needed to comply with the modification order. DA Pam 310-4 indexes MWO's.

b. *Visual Aids*.

- (1) *Graphic training aids (GTA's)*. These are instructional charts or posters (single or in series) and simple printed training devices reproduced and distributed as standard Department of the Army visual aids. GTA's are indexed in DA Pam 310-5.
- (2) *Motion pictures, television recordings, and film strips*. Many informative motion pictures, television recordings, and film strips are available for use through local Signal Corps film libraries and film equipment exchanges. These include Armed Forces information films, training films, film bulletins, film strips, and miscellaneous films. Films are indexed in DA Pam 108-1. This index also provides a summary on each film.

c. *Correspondence Courses*. DA Pam 20-4 lists courses offered by colleges and universities through the United States Armed Forces Institute (USAFI). DA Pam 350-1 is the USAFI catalog. DA Pam 350-60 announces Army extension courses. Personnel of the battalion should be informed of the provisions of these publications, the courses offered, and should be encouraged to improve

themselves by self-study. Evidence of such self-improvement should be recognized by company commanders when recommending their personnel for promotions.

*d. Department of the Army Pamphlets.* DA Pam 310-1 indexes many other DA Pam's which can be used as supplementary training references. These pamphlets cover a wide range of subjects and are useful in conducting training in military justice, discipline, conduct as prisoners of war, management, etc. DA Pam 20-21 is of particular importance since it lists courses of instruction offered by service schools. Others of importance are DA Pam's 20-300, 20-301, 21-52, 21-71, and 750-1.

*e. Unofficial Training Literature.* In addition to the assistance provided by official DA publications, the battalion and company commanders have a valuable source of information in the form of service school special texts, lesson plans, and subject schedules. A catalog of these materials may be obtained by writing to the commandant of the respective service school. In addition, each service school offers a self-education program in the form of extension courses which can be invaluable to every member of the Ordnance Corps.

## CHAPTER 13

SAFETY

---

**98. General**

*a.* In the accomplishment of their missions, the companies of the armored ordnance battalion will handle many items of bulky, heavy equipment, and will be required to store and use many potentially dangerous substances such as acids and other chemicals used in cleansing processes. In addition, normal maintenance operations entail the use of tools and equipment that can result in injury to personnel and damage to equipment if not utilized properly. Further, numerous items of Signal Corps equipment operated by personnel of the battalion employ high electrical potentials that constitute hazards. Misuse of any items of equipment or neglect of the safety precautions to be used in handling materiel can result in injuries and accidents that may seriously hamper operations. An effective safety program, therefore, must be established in each of the companies if the mission of the battalion is to be successful.

*b.* The safety program must encompass all phases of operations. All personnel must be thoroughly indoctrinated in the proper handling of materiel; the safety precautions to be exercised when using tools, machinery, electronic equipment, or vehicles; and the precautions necessary when handling or storing hazardous materials. In addition, personnel must be impressed with the importance of constant vigilance to detect potential hazards, encouraged to take remedial action to reduce or eliminate the danger, and required to report all accidents, near accidents, or safety hazards promptly.

**99. Safety Organization**

*a.* A safety program has but one objective—the prevention of accidents. The safety program in each of the companies of the battalion should be based on the provisions outlined in AR 385–10. Battalion headquarters will supervise the safety programs in the units assigned or attached to the battalion, and will implement a safety program of its own within the headquarters. The battalion adjutant is normally responsible for supervising the safety program within the battalion.



b. The implementation of the program necessitates the establishment of a safety organization in each of the companies. The safety organization will consist of a safety officer who is responsible for the supervision and coordination of all safety activities within the company, and a safety committee consisting of section chiefs and platoon leaders. Normally, the shop officer will be designated the safety officer for the company.

## 100. Safety Rules

a. An effective safety program will depend on the proper and continuous adherence to the following basic rules of accident prevention:

- (1) Creation and maintenance of active interest to assure that all personnel participate in the program.
- (2) Assembling all the information bearing on accident occurrence so that the causes may be determined.
- (3) Analyzing all facts bearing on accident occurrence and, on the basis of these facts, taking corrective action to prevent future accidents.

b. Active participation on the part of all personnel is the most important element of the safety program. Their interest in the program should be maintained by appealing to their pride and by pointing out their responsibilities to themselves and their unit. Suggestions for improving safety practices and eliminating hazards should be encouraged and the individuals making the suggestions should be given credit if their ideas are adopted or explanations if their suggestions prove impractical.

c. If accidents occur, despite precautions taken to avoid them, it is necessary to determine the cause and effect so that preventive measures can be taken to prevent future occurrences, so that operating procedures can be improved, and so that personnel can be made to realize the effect an accident has on operations and the malpractice or hazard that was responsible. In this regard, it is necessary to determine:

- (1) Who was injured or what was damaged.
- (2) The time and place the injury or accident occurred.
- (3) The severity and the cost (in manpower and materiel) of the accident.
- (4) The nature of the accident or injury.
- (5) The specific unsafe action committed, if any, and the reasons therefor.
- (6) The nature of any specific mechanical, electrical, or physical hazard, if one existed.

- (7) Whether any tools or equipment being used were defective or used improperly.

*d.* After the facts have been determined, the factors contributing to the accident should be eliminated by improving operations, removing hazards, and training personnel in the proper use of tools and equipment. Moreover, corrective action must be supplemented by constant vigilance on the part of supervisors to assure that familiarity with operations does not lead to contempt for the safety practices involved.

## 101. Safety Plan

Because of the differences in operations and employment existing between the main support company and a forward support company, their respective safety plans will differ as far as detailed procedures are concerned. The overall objectives, general procedures to be followed, and accident reporting procedures should be uniform, however. Moreover, the safety plans of the individual companies must conform to the SOP and directives established by battalion headquarters and other higher authority. The safety plans of each of the elements of the battalion will be submitted to battalion headquarters for coordination and approval. A few of the elements that should be included in the safety plans of each of the companies in the ordnance battalion are:

- a.* Designation of a safety officer and committee and their duties and responsibilities.
- b.* The procedure to be followed in reporting accidents or safety hazards. This procedure should emphasize promptness and completeness in reporting all accidents or injuries, no matter how slight, and the reporting of all possible hazards, no matter how insignificant they may seem.
- c.* The necessity for reporting any accidents resulting in equipment damage so that further injuries from continued use of the equipment may be avoided.
- d.* Investigation of all accidents or injuries to determine their cause and to take corrective action to prevent their recurrence.
- e.* Special precautions to be taken in the storage and handling of ammunition, gasoline, and other hazardous materials, including the designation and marking of storage areas and the location and use of first aid and firefighting equipment.
- f.* Designation of firefighting and first aid teams.
- g.* Location, care, and use of special equipment.
- h.* Procedures for the conduct of accident prevention inspections.

i. Procedures for submitting suggestions on the improvement of safety practices.

j. Procedures for disseminating information on new operations or equipment to all personnel of the company.

k. The need for observing safety practices off the job, and any special precautions to be taken.

l. Provision for regularly scheduled safety meetings to discuss safety practices, with emphasis on areas in which laxity has been evidenced.

## 102. Duties and Responsibilities of Personnel

a. *Commander.* It is the commander's responsibility to insure that all activities of his unit are conducted in accordance with established safety rules. He is also responsible for determining the cause of accidents and for seeing that corrective action is taken to prevent their recurrence. When no existing safety rules apply or when a deviation from an established rule is desired, it is his responsibility to submit a request, including full particulars and detailed plans and specifications, to the appropriate headquarters for decision. In the case of the individual companies of the battalion, this information is submitted to battalion headquarters for further action.

b. *Safety Officer.* The adjutant serves as safety officer for the battalion. In the individual companies of the battalion a safety officer will be designated by each company commander. Within the companies this duty is usually assigned to the shop officer. The safety officer is responsible to the commander for establishing and supervising the safety organization, for preparing the safety plan and establishing safety procedures, for investigating accidents and performing accident prevention investigations, and for establishing and maintaining continued interest in the safety program.

c. *Section Chiefs and Supervisors.* Section chiefs and supervisors exercise daily supervision over operating personnel. In their daily contacts with personnel on the job they are in a position to personally witness working conditions and the hazards to which operating personnel are exposed. The section chiefs and supervisors are the persons through whom the full force and effect of all accident prevention measures find application in daily operations. They should call frequent and regular meetings to brief all personnel on safety procedures, to elicit any suggestions on the improvement of safety practices, and to publicize any newly adopted safety procedures. Such meetings should be held at the

work location, and their objective should be to brief all personnel on safe job performance for new and unusual work or routine jobs, and to impress workers with the need for constant alertness and observation of safety measures so that familiarity with certain operations will not result in hazardous shortcuts or laxity in job performance which, in themselves, could result in increasing the accident rate.

*d. Individuals.* All personnel should be made to realize that safety rules have been established for their protection and welfare. It is their responsibility to follow all instructions and to use all the safeguards incident to the use of tools, machinery, equipment, and processes. Cooperation among workers in the development and practice of safe working habits is essential in order to prevent injuries to personnel and damage to materiel and facilities.

### 103. Special Precautions

*a.* Every tool and each piece of equipment is designed to do a certain job and is intended to be used in a specified way. Screwdrivers were not intended to be used as crowbars; wrenches were not meant to be used as hammers; and using the wrong size wrench on a nut will damage both the nut and the wrench, and possibly injure the offender. Unless personnel understand the proper use of tools and equipment, injuries, loss of efficiency, and damage to materiel or facilities are inevitable. All personnel should familiarize themselves with the tools and equipment they use, the care of these tools and pieces of equipment, and the purposes for which they were intended. In addition, prior to undertaking the disassembly or repair of items that are unfamiliar to the repairman, he should refer to the appropriate technical manuals or technical bulletins in order to determine any special precautions that should be taken. If necessary, the supervisor should be consulted on any points in question.

*b.* The properties and characteristics of gasoline make it one of the greatest potential hazards to the safety of any organization. The precautions to be taken in handling gasoline are covered in TM 10-1101. All personnel should be familiar with the provisions of this manual.

*c.* Although all electrical and electronic equipment used by the battalion is designed to furnish the optimum in safety to personnel, certain precautions must be observed, with particular emphasis on precautions to be taken during scheduled or emergency maintenance periods. Since many of the cords and cables interconnecting the various components of communications sets carry hazardous voltages, they should be replaced when insulation becomes cracked

or frozen, and should be repaired when couplings become worn to the extent that they may separate when subjected to vibration. Communication equipment should not be operated while removed from cabinets, or with access doors or ports open. Repairs or internal adjustments should never be attempted by untrained personnel. Interlock or safety switches should never be rendered inoperative.

*d.* Some of the items used by the companies of the battalion are potentially hazardous to personnel and equipment because of their chemical properties. Included in this group are items that produce toxic fumes that result in damage to body tissues when inhaled, ingested, or brought into contact with the skin (e.g., carbon tetrachloride) and those which have a corrosive effect on materiel and can seriously damage body tissues on contact (e.g., sulphuric acid). The precautions to be used depend on the hazards involved. In the case of substances producing dangerous vapors, adequate ventilation is mandatory. Moreover, care must be taken to avoid spillage of dangerous chemicals and they must be stored in tightly sealed containers. The use of chemicals also requires special handling techniques and may require special items of clothing and equipment. In addition, personnel must be able to recognize quickly symptoms of illness caused by chemicals, and should be able to render prompt and proper first aid. In the conduct of potentially dangerous operations, operating personnel should not work alone, for time is a big factor in the administration of first aid. For additional information on operational hazards and detailed information on the precautions to be exercised in each case, see the technical manual pertaining to the item of equipment or operation with which the hazardous item is associated.

*e.* Tanks or artillery brought to the division ordnance collecting point may contain items of ammunition lodged in gun tubes or lying loose in the hulls of vehicles. Regardless of the fact that ammunition personnel are usually available to render the special handling necessary (in the case of recovered items containing ammunition, the assistance of ammunition personnel from the nearest ammunition installation is requested), all personnel must be familiar with the precautions to be used in handling ammunition. These precautions are covered in FM 9-5, TM 9-1900, and TM 9-1903.

*f.* In the armored ordnance battalion, the safety aspects of the following operations must be stressed:

(1) *Vehicle operation.*

- (a) Drivers should be selected and trained in accordance with the provisions of TM 21-300. Vehicles should be

given a daily inspection by drivers. For the protection of personnel, speed limits should be established within company areas and vehicles should be prohibited from entering bivouac areas during hours of darkness.

- (b) Special care must be taken when backing vehicles. The backing of semitrailers and cargo trailers is particularly difficult and dangerous. The vehicle operator should be guided by an individual stationed in front of the vehicle and in full view of the operator. Extreme care must be taken to avoid jackknifing when backing semitrailers or cargo trailers.
  - (c) In the operation of wreckers, operators must also be sure that the wrecker boom, cables, and hooks are in serviceable condition. They should be inspected before each operation requiring their use. If engaged in a recovery operation, the operator must insure that the cable and wrecker boom have the required capacity and that the wrecker is anchored securely. This is not a one-man operation. All wrecker operators must be familiar with and practice the procedures outlined in TM 9-8028.
- (2) *Welding.* All welders must be familiar with the processes and procedures covered in TM 9-237 and the TM applicable to the equipment with which they are supplied. They must use the safety equipment provided, must consider the safety of other personnel when welding, and must not be allowed to operate welding equipment in areas where sparks might result in fires or explosions.
  - (3) *Storage and packaging.* Boxes and packages must be sturdily constructed. In storage operations, stacks must be stable. Heavy or bulky objects should not be lifted by one man.
  - (4) *Ropes, winches, and cables.* These should be inspected before each use to determine serviceability. Before using these items their capacity must be considered with respect to the load they will carry.

## CHAPTER 14

### COMMUNICATIONS

---

#### 104. Responsibilities

*a.* The division signal officer provides technical advice and assistance to the division commander and the general staff and is operationally responsible for the division signal communications system. This responsibility includes the detailed formulation of signal policies, plans, and procedures and the provision of supervision and guidance down to all subordinate echelons. The ordnance battalion commander and the commanders of the forward and main support companies have comparable responsibilities within their units.

*b.* At battalion headquarters, an officer will be appointed as communications officer. This assignment is given to one of the battalion officers by the battalion commander as an additional responsibility. The battalion communications officer is advised by the division signal officer on matters pertaining to integrated communications applications and assisted by appropriate battalion staff sections with respect to security, personnel, and administrative details incidental to signal communication activities. The communications officer is responsible for the installation and maintenance of communications materiel organic to the battalion, and for coordinating the battalion's entry into the division communications system. Specific responsibilities of the communications officer will usually include:

- (1) Insuring that personnel receive adequate training in the use and maintenance of communications equipment, and, when necessary, arranging for spaces at division or service level signal schools.
- (2) Preparing and disseminating signal communications documents such as signal operating instructions (SOI), standing signal instructions (SSI), and standing operating procedures (SOP) to facilitate installation and operation of the battalion communication system and to insure consonance between battalion communication activities and those of division and other headquarters.
- (3) Assuring continuous communications security.

(4) Assisting the battalion and company commanders in carrying out their communications responsibilities.

c. Within the battalion, personnel are provided by TOE to perform detailed functions and duties in the field of communications. Other personnel such as staff officers, company commanders, and truck drivers operate communications equipment in addition to or in conjunction with their primary duties.

d. Responsibility for establishing and enforcing effective, continuous communications discipline rests directly on the battalion commander and the company commanders. Command emphasis must be placed on the necessity for insuring that channels of communication are kept open and are not cluttered by nonessential traffic. To enable the elements of the battalion to respond quickly to the will of the commander, the flow of orders, reports, and essential information must be rapid and accurate.

e. Within the ordnance battalion, organizational maintenance of signal equipment is performed by the elements to which the equipment is organic. Field maintenance is performed by the division signal battalion.

## 105. Training

a. Communications specialists normally receive training at service school level or in troop schools established by the division. Arrangements may be made with the division signal officer for necessary training of specialists. Concurrently, officers and other communications users are given general training covering signal equipment operation, radio-telephone procedure, telephone procedures, message writing, and communications security. Training for equipment operators should include techniques of operation under unfavorable conditions, and procedures employed to avoid or to minimize the effects of enemy jamming.

b. Team training begins as soon as a point of minimum proficiency is reached in individual training. This training is best accomplished at battalion level and permits cross-training of individuals in the various duties of team members. Communications training is integrated with unit training at every opportunity.

## 106. Communications Instructions

a. Instructions for operating the division communications system are prepared and disseminated by the division signal officer. They apply to all units within the division and are published in two complementary publications entitled "signal operation instructions" (SOI) and "standing signal instructions" (SSI). The SOI



contains items for the technical control and coordination of signal communication. SOI items are for daily use and are subject to frequent change. The SSI contains items, regulatory in nature, which give instructions for the use of SOI items as well as other instructions. SSI items are not subject to frequent change.

b. SOI and SSI items are distributed in sufficient copies to be available to communications personnel down to battalion level. The ordnance battalion will make extracts of the division SOI for use by companies of the battalion. Extracts of the SOI will be prepared and issued on a need-to-know basis only. The number of such extracts should be kept to a minimum and items included in the SOI extract should cover a maximum period of 3 days so that minimum SOI material is subject to compromise in the event of loss of an extract. Extracts should be reproduced on pocket-size cards, which may be folded. The paper should be weather-resistant but capable of being destroyed in the event of capture. The loss of an extract will be reported immediately.

c. Within the companies of the battalion, communications procedures that can be standardized are made a part of the company SOP. SOP's must not violate instructions disseminated in other types of official publications from higher headquarters.

#### 107. Security

a. *General.* Communication security is the protection resulting from all measures designed to prevent or delay unauthorized persons from gaining information of military value from communication sources. It includes physical, cryptographic, and transmission security. Commanders insure that communication security orders and regulations are understood and observed by all concerned with communications. Officers and enlisted men who personally transmit radio messages are particularly concerned with security measures.

b. *Physical Security.* Physical security protects classified signal equipment and material, including plain-language copies of classified messages and carbons, from capture, damage, or loss. Before a command post is vacated it is inspected for messages, carbons, converter tapes, and copies of maps or orders which might be left behind. When SOI's or cryptomaterials are compromised by loss or capture, the facts must be reported immediately to the next higher commander. Personnel must be trained in the methods of destroying equipment and classified documents to prevent their falling into the hands of the enemy. Priorities are assigned to equipment and material to insure that classified items are destroyed prior to those bearing no security classification.

## *c. Cryptographic Security.*

- (1) Cryptographic security is obtained by the proper use of authorized cryptographic systems. Strict observance of cryptographic operating instructions is essential to reduce the effectiveness of the enemy's communications intelligence effort. The use of unauthorized cryptosystems is prohibited, for locally devised systems usually can easily be solved by the enemy and may give the user a false sense of security. The supply section of each company of the battalion is equipped with a cipher machine for use in encrypting and decrypting messages. The radio-teletypewriter shelters are also equipped with cipher machines.
- (2) Security hazards may be minimized by being brief and by avoiding stereotyped phraseology in the preparation of messages, especially at the beginning and end of a message. Identical texts will not be sent to both clear and encrypted messages or in more than one cryptographic system. When clear text is used, landmarks that can be associated with encrypted map locations are not given as references.
- (3) Codes and ciphers and instructions for their use will be found in the division SOI and SSI. Key lists for cipher devices may be found in the division SOI. Instructions for the use of cipher devices are distributed separately by the division cryptographic distribution authority.

## *d. Transmission Security.*

- (1) Transmission security makes it difficult for the enemy to intercept transmissions and prevents him from using friendly communication systems for deception purposes. A message is transmitted by the most secure means available, consistent with its precedence. Radio is particularly susceptible to interception, direction-finding, traffic analysis, and deception.
- (2) Personnel who operate radios must be trained in correct procedures so that they will not divulge information to the enemy through faulty operating procedures or techniques. Operators and personnel preparing messages for transmission by radio must be aware of the ability of the enemy to gain information from radio traffic. Those transmitting clear-text messages by voice radio must use prescribed radiotelephone procedures and must preplan the content and wording of each transmission, using prescribed authentication systems and eliminating

unnecessary transmissions. A high standard of net discipline is essential in maintaining communications security; therefore, training in correct operating procedures must be continual.

#### 108. Division Signal Communications

a. A division signal communication network facilitates control of the armored division. The basic concept is one of multiple alternate routing within the radio relay system. A series of mobile signal centers is used, each of which supports designated areas and units. These centers are tied together by radio relay links. Various configurations of signal centers within the division system can be employed to facilitate communications for every possible disposition of division forces. The actual engineering and construction of the most appropriate network are the responsibilities of the division signal officer. Since the division is seldom stationary, the signal system is never static. It is continually being changed to support not only the current disposition of units, but also the projected future movements of units. Figure 6 depicts a type layout of the division communication system.

b. The signal centers in the division communication system—

- (1) Provide points of entry into the system for supported headquarters, units, and installations for use of the trunk lines and channels in the system.
- (2) Provide terminal, testing, patching, and switching facilities for the radio relay and field cable trunks and the local lines in the system.

c. Signal centers in the system are generally located with or near the major divisional elements. The basic system is extended to other users by field-wire or by FM radio-wire integration links. The division communication system stresses maximum utilization of radio relay for telephone and telewriter service. As will be shown in succeeding paragraphs, such an area system is essential to facilitate communications within the ordnance battalion, since the elements thereof operate at considerable distances from battalion headquarters and from each other.

#### 109. Radio Communication Within the Ordnance Battalion

The radio nets utilized in the armored division are described in FM 17-70. The ordnance battalion has organic radio and radio-teletype (RATT) equipment which will normally operate in the following radio nets (fig. 7).

a. *Division Logistical Net (RATT)*. The logistical net is used

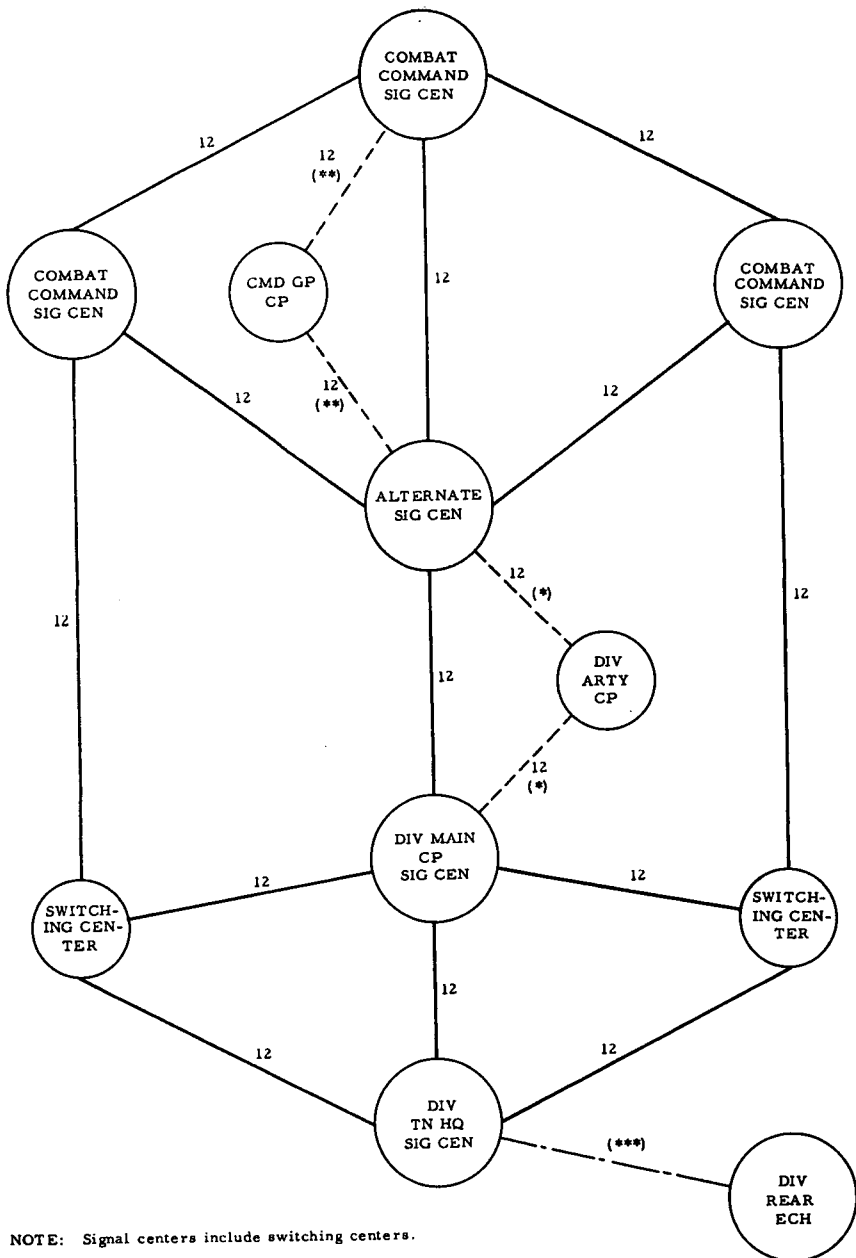

NOTE: Signal centers include switching centers.

Figures denote number of radio relay channels.

(\*) Either or both may be provided, depending on requirements.

(\*\*) Furnished only when required.

(\*\*\*) Cable of multifield wire.

Figure 6. Type division communication system.

for the transmission of administrative and logistical messages. Two vehicular-mounted radioteletype sets organic to the headquarters and main support company are operated in this net. One is used at the battalion command post while the other is used by the division ammunition officer, who is normally located at the division logistical control center (DLCC). The net connects the battalion with the division trains command post and with the forward support companies located in the combat command trains areas.

*b. Division Warning Broadcast Net (AM-Voice).* This net is used to broadcast air alerts, CBR attack warnings, radiological safety data, fallout warnings, and other similar information of an urgent operational nature applying to the division as a whole, or major segments thereof. No immediate reply is required on the part of the ordnance battalion upon receipt of a warning over this net. A ground radio receiver is provided the battalion command post expressly for monitoring this net.

*c. Division Trains Command Net (FM).* This net provides a direct channel of communication between the trains commander and units under his control. It is used for command operations. The materiel officer located at the battalion command post operates a station in this net.

*d. Ordnance Battalion Command Net (AM).* This is the principal command radio net for the battalion, and is capable of operating over the distances between the battalion command post and the forward support companies. This net connects the ordnance materiel officer with the shop office of each of the forward support companies.

*e. Ordnance Battalion Command Net (FM).* This net provides direct communications between key personnel of battalion headquarters, elements of headquarters and main support company and certain elements of the forward support companies of the battalion for command control and administration of the battalion (see fig. 7). The battalion commander, liaison officer, materiel officer and subordinate company commanders normally operate in this net. Though it serves a wide variety of purposes incidental to coordination of battalion activities, it is of particular value in coordinating the employment of recovery equipment as it permits direct transmission of information and orders to elements engaged in recovery missions without requiring that they report back to the service and evacuation platoon headquarters for each mission.

*f. Forward Support Company Command Net (FM).* This net provides the company commander with a means of communications

for command control of his company (see fig. 7). Provisions should also be made for the maintenance officers of supported units to enter this net as required to facilitate maintenance support. In addition, the shop office is equipped with an auxiliary receiver for monitoring the nets of supported units while operating in the company net. The company commander is equipped with a dual radio installation to enable him to operate simultaneously in the company command net and either the battalion command net or the logistic FM net of supported units as required. If frequency limitations preclude assignment of more than one FM operating frequency to the battalion, all stations in the battalion will operate in the battalion command net and no subordinate forward support company nets as such will be established. In this event special operating procedures will be required to allow joint use of the common battalion net so that the respective FM communications needs of the battalion and company commanders can be met with a minimum of mutual interference.

## 110. Wire Communication Within the Ordnance Battalion

*a.* The ordnance battalion can install, operate, and maintain a battalion wire net (fig. 8). Because of the distances involved, the elements of the ordnance battalion are not directly connected by wire lines. Instead, telephone and teletype communication is established through the division communication system. Elements of the battalion will arrange for entry into the wire system of supported units or a signal center in the division communication system. Installation of field-wire lines from the area signal center to using units is the responsibility of the using units.

*b.* The supply sections of the companies of the battalion are provided portable, lightweight teletypewriter sets. This equipment is used by battalion for teletypewriter communication with the forward support companies through the division communication system. Teletypewriters are used for lengthy supply traffic associated with ordnance logistical support.

## 111. Radio/Wire Integration Stations

*a.* An FM-voice radio/wire integration station is operated at each signal center (fig. 6) except the rear command post of the division. It is used to connect mobile FM radio stations into the division communications system on a push-to-talk basis. This system of stations is one of the more important features of the system.

*b.* The system of integration stations is used to establish communication between mobile FM radio stations and elements

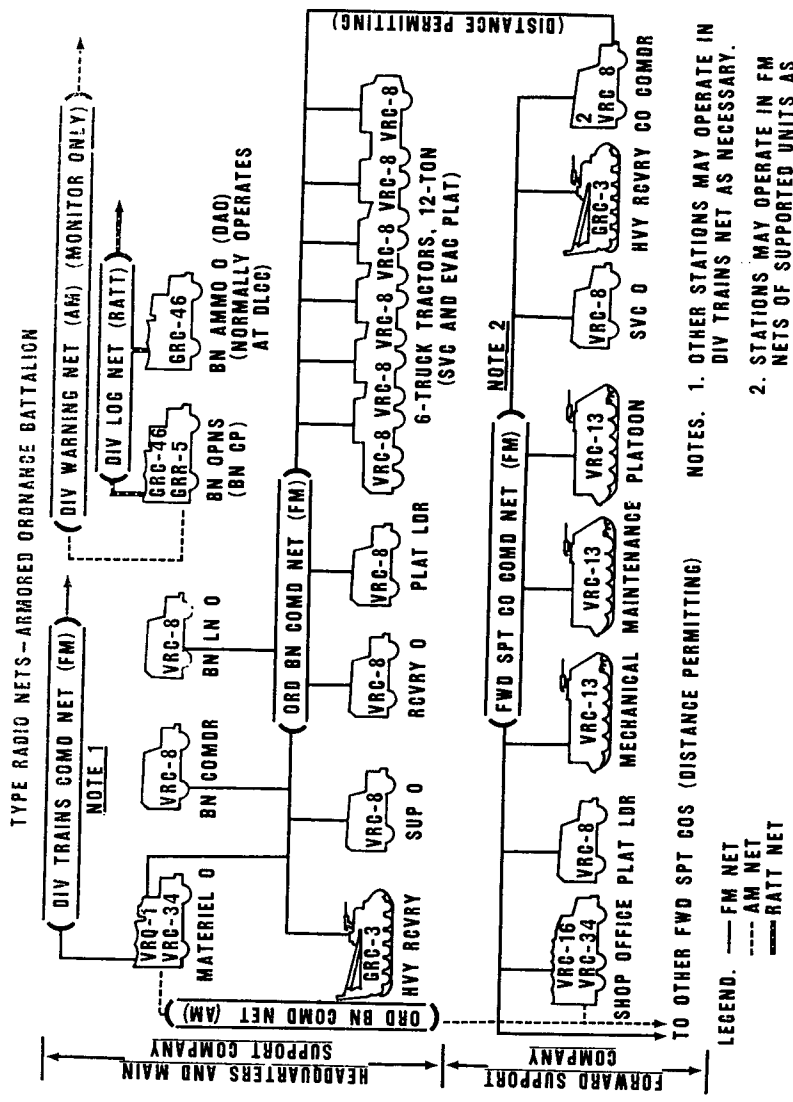

Figure 7. Type radio net, armored ordnance battalion.

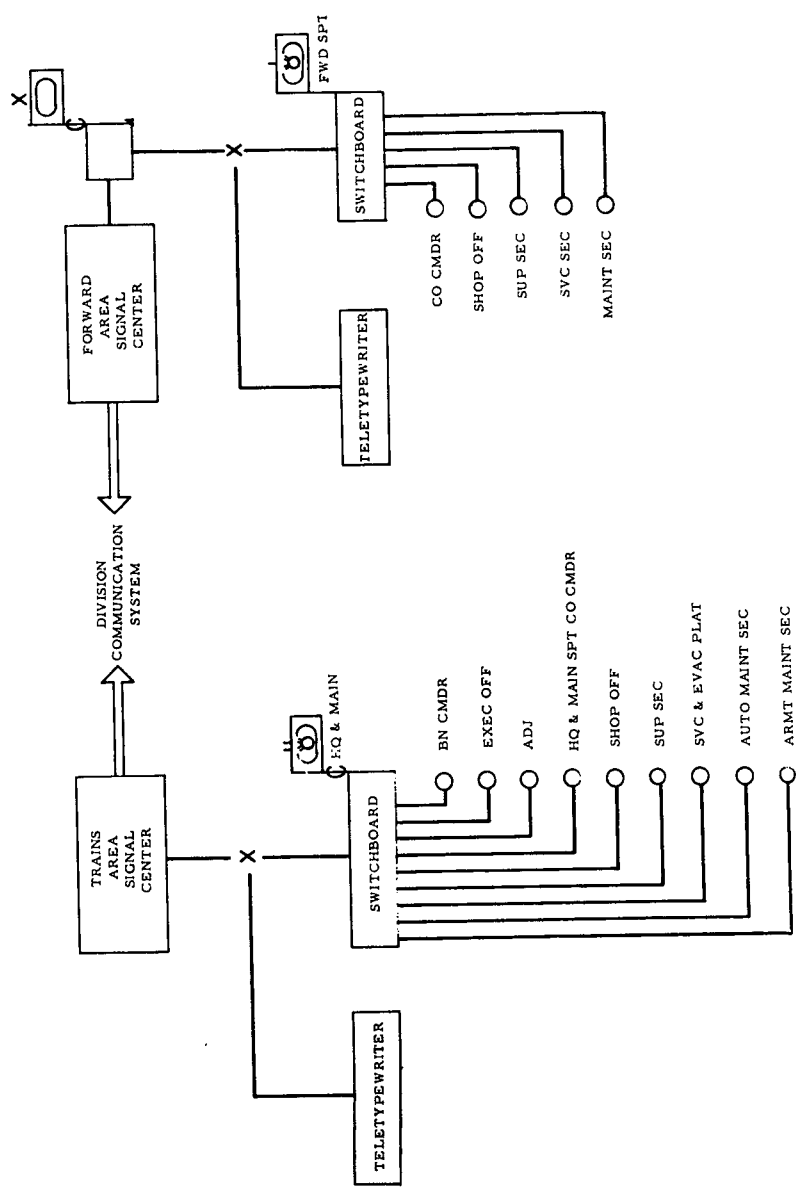

Figure 8. Type wire net, armored ordnance battalion.



connected to the division system by telephone. It is also used in lieu of FM radio relay stations to establish communications between FM radio stations operating beyond direct FM range. This system facilitates FM communication between battalion and the forward support companies. Instructions on the use of radio/wire integration stations are contained in the division SSI.

APPENDIX  
REFERENCES

The following references should be checked frequently for latest changes or revisions relating to material covered in this manual:

I. Army Regulations

- 30-41 Field Rations.
- 31-154 Commissaries; Troop Train and Motor Convoy Ration Procedures.
- 31-157 Troop Train and Motor Convoy Subsistence Accounts.
- 31-310 Commissaries; Purchase, Stockage, and Supply of Authorized Subsistence Supplies.
- 40-207 Individual Sick Slip.
- 65-75 Unit Mail Services.
- 140-138 Qualification Record; Officer, Warrant Officer, Enlisted Personnel.
- 220-10 Preparation for Oversea Movement of Units (POM).
- 220-45 Duty Rosters.
- 220-60 Battalions, Battle Groups, Squadrons; General Provisions.
- 220-70 Companies; General Provisions.
- 230-21 Accounting Procedures for Nonappropriated Unit Funds, Inmate's Welfare Funds, Stockade Welfare Funds, and Commandants' Welfare Funds.
- 310-110A Orders, Bulletins, Circulars, and Memorandums Issued from Headquarters of Field Commands.
- 320-5 Dictionary of United States Army Terms.
- 320-50 Authorized Abbreviations and Brevity Codes.
- 335-60 Morning Reports.
- 340-15 Correspondence.
- 345-292 Records Administration; Units of the Active Army and the Army Reserve.
- 385-10 Army Safety Program.
- 385-55 Prevention of Army Motor Vehicle Accidents.
- 600-103 Legal Assistance.
- 611-103 Officer Qualification and Classification.

- 611-201 Manual of Enlisted Military Occupational Specialties.
- 614-240 Reassignment of Enlisted Personnel.
- 623-105 Officer Efficiency Reports.
- 623-201 Enlisted Conduct and Efficiency Ratings.
- 624-200 Appointment and Reduction of Enlisted Personnel.
- 635-200 General Provisions for Discharge and Release.
- 635-204 Dishonorable and Bad Conduct Discharge.
- 635-205 Discharge and Release, Convenience of the Government.
- 635-206 Discharge; Misconduct (Fraudulent Entry, Conviction by Civil Court, AWOL, Desertion).
- 635-208 Discharge; Unfitness.
- 635-209 Discharge, Unsuitability.
- 640-203 Enlisted Qualification Record.
- 672-5-1 Decorations, Certificates, and Letters for Service.
- 680-20 Special Services.
- 711-16 Installation Stock Control and Supply Procedures.
- 735-10 Principles and Policies: Accounting for Lost, Damaged, and Destroyed Property.
- 735-11 Accounting for Lost, Damaged, or Destroyed Property.
- 735-35 Supply Procedures for TOE Units, Organizations, and Non-TOE Activities.
- 750-5 Maintenance Responsibilities and Shop Operation.
- 750-8 Command Maintenance Inspections.
- 750-925 Spot Check Inspection and Reports, Ordnance Corps Materiel.
- 910-10 Authorization, Organization, Operations, and Procedures.
- 940-10 National Red Cross Service Program and Army Utilization.

## 2. Special Regulations

- 55-720-2 Movement of Units Within Continental United States.
- 310-30-15 Organization and Equipment Authorization Tables; Personnel.
- 605-105-5 Commissioned and Warrant Officer Personnel Military Occupational Specialties.

## 3. Field Manuals

- 3-5 Tactics and Techniques of Chemical, Biological, and Radiological (CBR) Warfare.
- 5-20 Camouflage; Basic Principles and Field Camouflage.

- 9-1 Ordnance Service in the Field.
- 9-2 Ordnance Corps Logistical Data.
- 9-3 Ordnance Direct Support Service.
- 9-5 Ordnance Ammunition Service.
- 11-16 Signal Orders, Records, and Reports.
- 17-50 Armor Logistics.
- 17-70 Communication for Armored Units.
- 17-100 The Armored Division and Combat Command.
- 21-5 Military Training.
- 21-6 Techniques of Military Instruction.
- 21-30 Military Symbols.
- 21-40 Small Unit Procedures in Nuclear, Biological, and Chemical Warfare.
- 21-41 Soldier's Handbook for Nuclear, Biological, and Chemical Warfare.
- 21-48 Training Exercises and Integrated Training in Chemical, Biological, and Nuclear Warfare.
- 21-77 Evasion and Escape.
- 25-10 Motor Transportation, Operations.
- 31-15 Operations Against Airborne Attack, Guerrilla Action, and Infiltration.
- 100-5 Field Service Regulations; Operations.
- 100-10 Field Service Regulations; Administration.
- 101-10 Staff Officers' Field Manual: Organization, Technical, and Logistical Data—Part 1, Unclassified Data.

**4. Technical Manuals**

- 9-237 Welding Theory and Application.
- 9-1100 Inspection of Ordnance Materiel in Hands of Troops.
- 9-1900 Ammunition, General.
- 9-1903 Care, Handling, Preservation, and Destruction of Ammunition.
- 9-2810 Tactical Motor Vehicle Preventive Maintenance, Supply, Inspection, and Training Procedures.
- 9-8028 Operational and Organizational Maintenance: 5-ton, 6 x 6, Cargo Truck M41 and M54; Chassis Truck M40, M61, M139, and M139C; Dump Truck M51; Tractor Truck M52; Medium Wrecker Truck M62; and Tractor Wrecker Truck M246.
- 10-206 Kitchen Cars, Supplies, Equipment, and Rations.
- 10-405 Army Mess Operations.
- 10-1101 Petroleum-Handling Operations.
- 21-300 Driver Selection and Training (Wheeled Vehicles).

743-200 Storage and Materials Handling.

743-200-1 Storage and Materials Handling.

## 5. Training Circulars

101-1 Prediction of Fallout and Radiological Monitoring and Survey.

## 6. Supply Bulletins

9-156 Publications Packaging Ordnance General Supplies.

9-184/1 Ordnance Storage and Shipment Chart: FSC Group 23, Motor Vehicles, Trailers, and Cycles: FSC Group 24, Tractors: and FSC Group 25, Bulldozers.

## 7. Technical Bulletins

9-OSSC-A Ordnance Storage and Shipment Charts (Groups through A, B, C, D, and F).

9-OSSC-F

## 8. Army Training Programs

9-201 Army Training Program for Ordnance of the Field Army.

20-5 Army Training Program for Field Exercises and Maneuvers.

## 9. Department of the Army Pamphlets

20-4 Correspondence Course Offered by Colleges and Universities through the United States Armed Forces Institute.

20-21 The Army School Catalog.

20-300 Techniques of Work Simplification; More Effective Use of Manpower, Equipment, Materials, Space.

20-301 Work Simplification in Action through Use of Work Distribution Chart, Flow Process Chart, Work Count, Motion Economy, Layout Studies: Instructor's Guide.

21-52 Cold Facts for Keeping Warm.

21-71 The U. S. Fighting Man's Code.

27-1 Treaties Governing Land Warfare.

39-1 Nuclear Weapons Employment.

108-1 Index of Army Motion Pictures, Film Strips, Slides, and Phono-Recordings.

- 310-1 Index of Administrative Publications (Army Regulations, Special Regulations, Department of the Army Pamphlets, Commercial Traffic Bulletins, Military Traffic Management Bulletins, General Orders, Bulletins, and Circulars).
- 310-2 Index of Blank Forms.
- 310-3 Index of Training Publications (Field Manuals, Reserve Officers' Training Corps Manuals, Training Circulars, Army Training Programs, Army Subject Schedules, Army Training Tests, War Department and Department of the Army Posters, and Firing Tables and Trajectory Charts).
- 310-4 Index of Technical Manuals, Technical Bulletins, Supply Bulletins, Lubrication Orders, and Modification Work Orders.
- 310-5 Index of Graphic Training Aids and Devices.
- 310-7 Index of Tables of Organization and Equipment, Type Tables of Distribution, and Tables of Allowances.
- 310-29 Index of Supply Manuals—Ordnance Corps.
- 350-1 The United States Armed Forces Institute Catalog.
- 350-60 Announcement of Army Extension Courses.
- 750-1 Preventive Maintenance Guide for Commanders.

## 10. Manual for Courts-Martial, United States, 1951

## INDEX

	Paragraphs	Page
Administrative element, battalion headquarters.....	10 <i>d</i>	14
Administrative movements:		
Motor marches.....	83	96
Rail movement.....	84	96
Water movement.....	85	97
Administration and personnel management.....	21	35
Ammunition control section, division ordnance office.....	10 <i>e</i>	14
Ammunition officer, division.....	29, 47 <i>c</i>	46, 63
Ammunition supply officer, duties and responsibilities.....	30	47
Ammunition supply point (ASP).....	47 <i>c</i>	63
Area selection, preparation, and layout.....	79	94
Area signal communication network.....	108 <i>a</i>	122
Armament maintenance section, main support company....	14 <i>g</i>	21
Armament repair inspector, duties and responsibilities....	13 <i>n</i>	19
Armored division.....	5	4
Armored ordnance battalion:		
Capabilities.....	7	8
Employment.....	8	9
Layout.....	3	2
Mission.....	6	8
Mobility.....	7 <i>c</i>	9
Organization.....	6	8
Assignments.....	21 <i>c</i> (3)	36
Assistant division ordnance officer, duties and responsibilities.	25	44
Augmentation platoon, main support company.....	14 <i>h</i> , 34,	21, 49,
	35	50
Automotive maintenance section, main support company..	14 <i>f</i>	15
Automotive repair foremen, duties and responsibilities....	16 <i>j</i>	27
Automotive repair supervisor, duties and responsibilities..	16 <i>i</i>	26
Awards.....	21 <i>c</i> (5)	37
Barrier inspection.....	76 <i>b</i> (2)	91
Battalion, ordnance:		
Adjutant, duties and responsibilities.....	13 <i>c</i>	17
Commander, duties and responsibilities.....	10 <i>a</i> , 13 <i>a</i>	12, 16
Capabilities.....	7	8
Employment.....	8	9
Executive officer, duties and responsibilities.....	13 <i>b</i> , 25	16, 44
Headquarters:		
Command and administrative segment.....	10 <i>c</i> , <i>d</i>	14
Division ordnance office.....	10 <i>e</i> ; 23-31	14, 41
Functions.....	11	15
Organization.....	10	12
Layout.....	5 <i>d</i>	4
March unit.....	92	103

	Paragraphs	Page
Battalion, Ordnance—Continued		
Mission.....	6	8
Mobility.....	7c	9
Organization.....	6	8
Participation in division march.....	91	103
Sergeant major, duties and responsibilities.....	13j	19
Staff.....	12	15
Supply element.....	10d	14
Supply officer, duties and responsibilities.....	13d	17
Supply sergeant, duties and responsibilities.....	13p	20
Supply operations.....	48, 52, 53	64, 67, 69
Battle loss report.....	53a (2) (c)	71
Battlefield recovery, definition of.....	54b (1)	74
Briefing the division commander.....	24b	43
Camouflage.....	90c	102
Capabilities, armored ordnance battalion.....	7	8
CBR Defense.....	90b	101
Chief ammunition clerk, duties and responsibilities.....	13k	19
Codes and ciphers.....	107c (3)	121
Classes of supply, definitions of.....	19b	32
Class II and IV support mission.....	47b	63
Class V supply to the division.....	47c	63
Command and administrative segment, battalion headquarters.....	10c, d	14
Command element, battalion headquarters.....	10d	14
Command maintenance inspections.....	71-74	87
Communications:		
Element, battalion headquarters.....	10d	14
Division area system.....	108	122
Instructions.....	106	119
Nets, ordnance battalion.....	109, 110	122, 125
Radio communications, ordnance battalion.....	109	122
Radio/wire integration stations.....	111	125
Responsibilities.....	104	118
Security.....	107	120
Training.....	105	119
Wire communications, ordnance battalion.....	110	125
Company commander, duties and responsibilities.....	16b, 18, 19c, 20, 21	23, 31, 33, 35
Company headquarters:		
Forward support company.....	15a	22
Main support company.....	14b	20
Conservation of supplies.....	50	65
Contact parties.....	8b (2)	9
Control of a march.....	88	99
Correspondence and reports, preparation and filing.....	21b	36
Correspondence courses.....	97c	109
Covered storage.....	53e (1)	73
Cryptographic security.....	107c	121
Defense plans.....	90a	100
Defensive operations, provision of ordnance support.....	8b (2)	10



	Paragraphs	Page
Demotions.....	21c (2)	36
Department of the Army Pamphlets.....	97	110
Direct exchange:		
Operations.....	32e, 43b,	49, 59,
	45	61
Organization.....	43	59
Division:		
Ammunition office.....	9, 23c (2)	12, 41
Ammunition officer, duties and responsibilities.....	29	46
Characteristics of.....	5	4
Commander, ordnance briefing of.....	24b	43
Employment of.....	5c	4
Logistics control center.....	7a (9)	9
Maintenance responsibilities and functions.....	33a	49
Ordnance collecting point.....	58	76
Ordnance office, organization and operations.....	23	41
Ordnance officer, duties and responsibilities.....	10a, 24	12, 42
Ordnance support in combat operations.....	8b	10
Organization of.....	5	4
Recovery responsibilities.....	55, 56	74
Signal communications.....	108	122
Vehicle collecting points.....	56	75
DLCC.....	7a (9)	9
Duties and responsibilities, key personnel:		
Adjutant.....	13c, 92a,	17, 104,
	102b	114
Ammunition supply officer.....	30	47
Armament repair inspector.....	13n	19
Assistant division ordnance officer.....	25	44
Automotive repair foreman.....	16j	27
Automotive repair supervisor.....	16i	26
Battalion commander.....	13a	16
Battalion supply sergeant.....	13p	20
Chief ammunition clerk.....	13k	19
Company commander.....	16b, 18,	23, 35,
	19c, 21,	33, 35,
	92b, 107	104, 120
Division ammunition officer.....	29, 47c	46, 63
Division ordnance officer.....	24	42
Executive officer.....	13b	16
First sergeant.....	16m, 21	27, 35
Heavy equipment operators.....	16t	29
Maintenance officer, battalion.....	27	45
Maintenance officers, company.....	16d	24
Materiel officer.....	13e, 26	18, 44
Mess steward.....	16n, 18b (2)	27, 31
Motor sergeant.....	16p, 20b	28, 35
Operations sergeant.....	13l	19
Ordnance general supply officer, battalion.....	28	46
Ordnance supply specialist.....	16r	28
Platoon leader.....	16h	26
Platoon sergeant.....	16l	27
Radio—teletypewriter team chief.....	13o	19

	Paragraphs	Page
<b>Duties and responsibilities, key personnel—Continued</b>		
Recovery officer.....	16g	26
Recovery sergeant.....	16q	28
Repair control supervisor.....	13m	19
Repairmen.....	16s	28
Section chief.....	16k	27
Sergeant major.....	13j	19
Service officer.....	16f	26
Shop inspectors.....	37b	54
Shop officer, company.....	16c	24
Supply officer, battalion.....	13d	17
Supply officer, company.....	16e, 19c (3)	25, 34
Supply sergeant, company.....	16o, 19c (4)	28, 34
Duty roster.....	21e	38
Efficiency ratings.....	21c (8)	37
<b>Employment:</b>		
Armored division.....	5c	4
Armored ordnance battalion.....	8	9
End item supply to division.....	53a (2)	71
Equipment authorization documents.....	19d	34
<b>Evacuation:</b>		
Definition.....	54b	74
Element, main support company.....	40b	58
<b>Operations:</b>		
Nonnuclear conditions.....	56	75
Nuclear conditions.....	57	76
<b>Responsibilities.....</b>		
.....	55	74
Final inspections.....	37	54
First sergeant, duties and responsibilities.....	16m, 21	27, 35
Followup of inspections.....	67	85
Formal inspections.....	69	86
<b>Forward support company:</b>		
Functions.....	15, 41, 56, 57	21, 58, 75, 76
Maintenance operations.....	41-45	58
Mission.....	6b	8
Organization.....	15	21
Supply operations.....	52, 53	67, 69
<b>Functions:</b>		
Battalion headquarters.....	11	15
<b>Forward support company:</b>		
Company headquarters.....	15a	22
Mechanical maintenance platoon.....	15e, 43b (3)	22, 59
Service section.....	15d	22
Shop office.....	15b	22
Supply section.....	15c; 47-53	22, 63
Liaison party.....	61e	81
<b>Main support company:</b>		
Armament maintenance section.....	14g	21
Augmentation section.....	14h, 34, 35	21, 49, 50
Automotive maintenance section.....	14f	21

Functions—Continued

Main support company—Continued

Battalion headquarters section.....	14a	20
Company headquarters.....	14b	20
Service and evacuation platoon.....	14e, 40,	21, 57,
	56b	75
Shop office.....	14c, 36	20, 53
Supply section.....	14d; 47-53	20, 63
Group labor record.....	53d(4)	72
Heavy equipment operators, duties and responsibilities.....	16t	29
Informal inspections.....	69	86
Initial inspection.....	37a	54
Inspections:		
Command maintenance:		
Conduct.....	73	88
Definition and purpose.....	71	87
Determination of deficiencies and rating.....	74	89
Frequency.....	72	88
Followup.....	67	85
Management.....	65	84
Organizational:		
Definition and purpose.....	68	85
Frequency.....	69	86
Types.....	70	86
Purposes.....	64	84
Spot-check:		
Conduct.....	76	90
Definition and purpose.....	75	90
Standards.....	66	84
Technical.....	37, 63d	54, 83
Inspection section, maintenance shop:		
Forward support company.....	43b(2)	60
Main support company.....	37	54
Instructor training.....	95	107
Issue of supplies:		
Forward support company.....	52, 53	67, 69
Main support company.....	52, 53	67, 69
Liaison party.....	61	80
Loading plans.....	81	95
Mail service.....	21h	39
Main support company:		
Functions.....	14,33,	20, 49,
	34, 56-58	75
Maintenance operations.....	34-37,	49, 55,
	39, 40	57
Mission.....	6a	8
Organization.....	14	20
Organization for maintenance operations.....	35	50
Supply operations.....	52a, 53	67, 69
Type layout.....	35	50

	Paragraphs	Page
Maintenance:		
Exchange stock.....	39a (2)	55
Functions:		
Forward support company.....	41	58
Main support company.....	33, 34	49
In company shops:		
Forward support company.....	43	59
Main support company.....	35a	50
Officer, battalion—duties and responsibilities.....	27	45
Officers, company—duties and responsibilities.....	16d	24
Outside company shops:		
Forward support company.....	45	61
Main support company.....	35b	51
Records and reports.....	36b, 46	54, 61
Responsibilities and functions.....	33	49
Shop operations:		
Forward support company.....	43	59
Main support company.....	39	55
Management of inspections.....	65	84
March distances.....	88c	98
March formation.....	88e	98
March security.....	88j	99
Materiel officer, duties and responsibilities.....	13e, 26	18, 44
Materiel section, division ordnance office.....	10e	14
Mechanical maintenance platoon, forward support company.....	15e, 43b (3)	22, 60
Mess officer, duties and responsibilities.....	18b (1)	31
Mess operations.....	18	31
Mess steward, duties and responsibilities.....	16n, 18b (2)	27, 31
Methods of training:		
Communications.....	105	119
Officer.....	96	107
On-the-job.....	94c	106
Service schools.....	94a	106
Unit.....	94b	106
Military justice.....	21c (6)	37
Mission:		
Armored ordnance battalion.....	6	8
Forward support company.....	6b	8
Headquarters and main support company.....	6a	8
Mobile defense.....	8b (2) (a)	10
Mobile distribution point, ammunition.....	47c	63
Morning report.....	21d	37
Motor convoy messing.....	18c	31
Motor marches.....	83	96
Motor sergeant, duties and responsibilities.....	16p, 20b	20, 35
Movement:		
Administrative movements.....	78a, 82-85	94, 96
Area selection, preparation, and layout.....	79	94
Loading plans.....	81	95
SOP's.....	80, 83	95, 96
Tactical movements.....	78b, 86-88	94, 97
Types.....	78	94

	Paragraphs	Page
Night marches-----	88 <i>k</i>	99
Officer training-----	96	107
Official training literature:		
Army subject schedules-----	97 <i>a</i> (7)	108
Army training programs-----	97 <i>a</i> (6)	108
Army training tests-----	97 <i>a</i> (8)	108
Field manuals-----	97 <i>a</i> (1)	107
Lubrication orders-----	97 <i>a</i> (9)	108
Modification work orders-----	97 <i>a</i> (10)	109
Supply bulletins-----	97 <i>a</i> (5)	108
Technical bulletins-----	97 <i>a</i> (4)	108
Training circulars-----	97 <i>a</i> (3)	108
Technical manuals-----	97 <i>a</i> (2)	107
On-site maintenance-----	35 <i>b</i> , 45	51, 61
On-the-job training-----	94 <i>c</i>	106
Open storage-----	53 <i>e</i> (1)	73
Operations:		
Battalion headquarters-----	9, 10	12
Division ordnance collecting point-----	58	76
Division ordnance office-----	23	41
Forward support company:		
Direct exchange section-----	43 <i>b</i>	59
Inspection section-----	43 <i>b</i> (2)	60
Mechanical maintenance section-----	43 <i>b</i> (3)	60
Service section-----	44	61
Shop office-----	43 <i>b</i> (1)	60
Shop supply section-----	43 <i>b</i>	59
Technical supply section-----	51, 52 <i>b</i> ,	65, 68,
	53	69
Liaison parties-----	35 <i>b</i> , 45,	51, 61,
	61	80
Main support company:		
Armament maintenance section-----	14 <i>g</i> , 39	21, 55
Augmentation platoon-----	14 <i>h</i> , 34,	21, 49,
	41 <i>b</i>	58
Automotive maintenance section-----	14 <i>f</i> , 39	21, 55
Inspection section-----	37	54
Service and evacuation platoon-----	14 <i>e</i> , 40,	21, 57,
	56 <i>b</i> , 58 <i>c</i>	75, 77
Shop office-----	36	53
Shop supply section-----	38	55
Technical supply section-----	51-53	65
Work Parties-----	35 <i>b</i> , 45,	51, 61,
	61	81
Operations—intelligence sergeant, duties and responsibilities.	13 <i>l</i>	19
Ordnance battalion radio communications-----	109	122
Ordnance battalion, wire communications-----	110	125
Ordnance supply officer, duties and responsibilities-----	28	46
Ordnance supply specialists, duties and responsibilities-----	16 <i>r</i>	28
Ordnance support in combat operations:		
Defense-----	8 <i>b</i> (2)	10

	Paragraphs	Page
Ordnance support in combat operations—Continued		
Offense.....	8b(1)	10
Retrograde.....	8b(3)	11
Organization:		
Armored division.....	5c	4
Armored ordnance battalion:		
Battalion headquarters.....	9, 10	12
Division ordnance office.....	10, 23	12, 41
Forward support company.....	6, 15	8, 21
Main support company.....	6, 14	8, 20
Company maintenance.....	20	35
Company mess.....	18b	31
Company supply.....	19c	33
Maintenance shop:		
Forward support company.....	42, 43	59
Main support company.....	35a, 39	50, 55
Organizational administrative operations.....	21	35
Organizational inspections.....	68-70	85
Organizational maintenance.....	20	35
Organizational mess operations.....	18	31
Organizational supply, definitions of.....	48	64
Organizational supply operations.....	19	32
Parts Requisition, DA Form 9-79.....	53b	70
Perimeter defense.....	8b(2)(c)	11
Personnel administration.....	21c	36
Personnel records.....	21c(7)	37
Physical security, communications.....	107b	120
Platoon leaders, duties and responsibilities.....	16h	26
Platoon sergeants, duties and responsibilities.....	16l	27
Position defense.....	8b(2)(b)	10
Promotions.....	21c(1)	36
Property book officer, duties and responsibilities.....	19c(2)	33
Purposes of inspections.....	64	84
Radio nets:		
Division logistics net.....	109a	122
Division trains command net.....	109c	124
Division warning broadcast net.....	109b	124
Forward support company command net.....	109f	124
Ordnance battalion command net.....	109d, e	124
Radio-teletypewriter team chief, duties and responsibilities.	13o	19
Radio/wire integration stations.....	111	125
Rail movement.....	84	96
Rail movement annex.....	84	96
Rail movement table.....	84	96
Rate of march.....	88d	98
Receipt of supplies, main support company.....	52a	67
Records and reports, maintenance operations.....	36b, 46	54, 61
Recovery and evacuation:		
Definitions.....	54	74
Operations:		
Division ordnance collecting point.....	58	76

	Paragraphs	Page
Recovery and evacuation—Continued		
Operations—Continued		
Fast-moving offense.....	56	75
Nonnuclear conditions.....	56	75
Nuclear conditions.....	57	76
Responsibilities.....	55	74
Recovery officer, duties and responsibilities.....	16g	26
Repair control supervisor, duties and responsibilities.....	13m	19
Repairmen, duties and responsibilities.....	16s	28
Repair parts supply to the division.....	53a (1)	69
Replacement of supply section stocks.....	53c	71
Requirements for direct support supply.....	49	65
Responsibilities:		
Communication.....	104	118
Key personnel (See duties and responsibilities.)		
Maintenance.....	33	49
Recovery and evacuation.....	55	74
Safety.....	102	114
Supply.....	47, 52	63, 67
Training.....	92	103
Retrograde operations, provision of ordnance support.....	8b (3)	11
Road guides.....	88g	98
Roadside inspections.....	76b (2)	91
Ropes, winches, cables—safety aspects.....	103f (4)	117
Safety:		
Duties and responsibilities of personnel.....	102	114
Organization.....	99	111
Plan.....	101	113
Rules.....	100	112
Special precautions.....	103	115
Section chiefs, duties and responsibilities.....	16k	27
Security and defense measures.....	90	100
Security, communications.....	107	120
Separations.....	21c (4)	37
Service and evacuation platoon, main support company.....	14e, 40, 56b, 58c	21, 57, 75, 77
Service officer, duties and responsibilities.....	16f	26
Service school training.....	94a	106
Service section, forward support company.....	15d, 44	22, 61
Shop office:		
Organization and functions:		
Forward support company.....	15b, 43b (1)	22, 60
Main support company.....	14c, 36	20, 53
Shop officer, duties and responsibilities.....	16c	24
Shop supply:		
Definition.....	48b	64
Section:		
Forward support company.....	43b	59
Main support company.....	38	55
Sick Slip.....	21f	38
Signal centers.....	108	122
Signal operating instructions (SOI).....	106	119
Sources and types of training materials.....	97	107

	Paragraphs	Page
Special precautions, safety.....	103	115
Spot-check inspections.....	75, 76	90
Staff assistance, ordnance battalion:		
Battalion unit staff.....	12a	15
Division ordnance office.....	12b	15
Standing operating procedure (SOP).....	22, 106	39, 120
Standing signal instructions (SSI).....	106	119
Status of ordnance items and maintenance summary.....	53d (4)	72
Stock control unit.....	51b (1)	66
Storage and packaging, safety aspects.....	103f (3)	117
Storage plan.....	53e	73
Storage unit.....	51b (2)	66
Supervision of a march.....	88i	99
Supply:		
Administration, supply section.....	53d	72
Battalion supply operations.....	52, 53	67, 69
Bookkeeping.....	52a (2)	67
By work parties.....	52b	68
Classes, definition of.....	19b	32
Class II and IV responsibilities.....	47b	63
Class V responsibilities.....	47c	63
Conservation.....	50	65
End item supply.....	53a (2)	71
Functions of technical supply sections.....	51	65
Issue, main support company.....	52a (4)	67
Officer, battalion—duties and responsibilities.....	13d	17
Officers, company—duties and responsibilities.....	16e, 19c (3), 58c	25, 34, 77
Operations:		
Forward support company.....	52b, 53	68, 69
Main support company.....	52a, 53	68, 69
Organizational (unit) supply.....	19	32
Organization of technical supply sections:		
Stock control unit.....	51b (1)	66
Storage unit.....	51b (2)	66
Receipt, main support company.....	52a (3)	67
Repair parts, supply to organizations.....	53a (1)	67
Replacement of supply section stocks.....	53c	71
Requirements for direct support supply.....	49	65
Section:		
Forward support company.....	15c	22
Main support company.....	14d	20
Storage:		
Covered.....	53a (1) (b)	70
Open.....	53e (1) (a)	73
Supply sergeant, duties and responsibilities.....	16o, 19c (4)	28, 34
Supply to company maintenance shops.....	53b	71
Supply to organizations.....	53a	69
Types of operations:		
Organizational.....	48a	64
Shop supply.....	48b	64
Technical supply.....	48c, 53	64, 69
Unit supply (See organizational supply.)		



	Paragraphs	Page
Tactical marches.....	86-88	97
Tactical movements:		
Battalion march unit.....	88	97
Battalion participation.....	87	97
Technical assistance:		
Benefits.....	60	79
Definition.....	59	79
Organization, functions, and operations.....	61	80
Records and reports.....	62	82
Technical supply, definition of.....	48c	64
Technical supply sections, organization and functions.....	51	65
Training:		
Communications.....	105	119
Conferences.....	94d	106
Instructor training.....	95	107
Methods.....	94	106
Objective.....	91a	103
Officer training.....	96	107
On-the-job training.....	94c	106
Purposes.....	93	105
Responsibilities.....	92	103
Service school training.....	94a	106
Source and types of training materials.....	97	107
Unit training.....	94b	106
Transmission security.....	107d	121
Troop train messing.....	18c	31
Type layout, main support company.....	35	50
Types of organizational inspections.....	70	86
Types of supply operations.....	48	64
Unit supply (See organizational supply.)		
Unit training.....	94b	106
Unofficial training literature.....	97e	110
Vehicle collecting points.....	56	75
Vehicle operation, safety aspects.....	103f(1)	116
Visual training aids.....	97b	109
Voucher registers.....	53d(2)	72
Water movements.....	85	97
Welding, safety aspects.....	103f(2)	117
Welfare and recreation.....	21g	38
Work parties.....	61c	81

[AG 353 (22 Aug 60)]

By Order of *Wilber M. Brucker*, Secretary of the Army:

**G. H. DECKER,**  
*General, United States Army,*  
*Chief of Staff.*

Official:

**R. V. LEE,**  
*Major General, United States Army,*  
*The Adjutant General.*

Distribution:

*Active Army:*

To be distributed in accordance with DA Form 12-7 requirements for FM 9-series (uncl) plus the following formula:

DCSPER (5)	Seventh US Army (25)
ACSI (5)	EUSA (25)
DCSOPS (5)	Corps (10)
DCSLOG (5)	Div (8)
CNGB (2)	AFSC (5)
CUSARROTC (2)	USAOGMS (500)
CofCh (2)	Units org under fol TOE:
CMH (1)	9-65 (20)
Tech Stf, DA (5)	
except CofOrd (100)	

*NG*: State AG (3); units—same as Active Army except allowance is one copy to each unit.

*USAR*: Same as Active Army.

For explanation of abbreviations used, see AR 320-50.

★ U. S. GOVERNMENT PRINTING OFFICE: 1961 O - 610480 (2172 - B)