

MHI
Copy 3

FM 17-12

DEPARTMENT OF THE ARMY FIELD MANUAL

TANK GUNNERY



HEADQUARTERS, DEPARTMENT OF THE ARMY
NOVEMBER 1964

PREPARE TO FIRE

Instructional Card

(M41A3, M48, and M60 Tanks)

TANK COMMANDER	GUNNER	DRIVER	LOADER
<p>Command: PREPARE TO FIRE. Inspect coaxial machinegun and telescope ports to ensure gun shield cover is correctly positioned and clamps are secure. Clean exterior lenses and vision devices, and clean and inspect commander's direct-fire sight(s). Inspect cupola-stowed ammunition if applicable.</p>	<p>Observe loader's actions in making check of replenisher indicator tape. Clean and inspect gunner's direct-fire sights. Check operation of sight covers if applicable. Check instrument lights. Assist loader in opening breech.</p>	<p>Clean periscopes, lower seat, close hatch, and turn on master switch.</p>	<p>Check indicator tape for proper amount of recoil oil in replenisher. Check position of breechblock crank stop. Open breech (assisted by gunner); inspect chamber and tube, and close breech. Check coaxial machinegun and adjust head space if applicable. Check coaxial machinegun mount and adjust solenoid. Inspect turret-stowed ammunition.</p>
<p>Command: CHECK FIRING SWITCHES. If main gun has percussion mechanism, cock gun for each firing check if cocking mechanism is located on right side of gun. Check firing trigger when main gun switch is ON and when coaxial machinegun switch is ON.</p>	<p>Place main gun safety in FIRE position if located on right side of gun. Turn gun switch ON. Check firing triggers on power control handle if applicable. Check firing trigger on manual elevating handle. Check manual or auxiliary firing control. (If main gun has electric firing, announce FIRE each time a trigger is checked with the main gun switch ON.) Turn main gun switch OFF; turn coaxial machinegun switch ON. Check firing triggers on power control handle if applicable. Check firing trigger on manual elevating handle. Turn coaxial machinegun switch OFF.</p>	<p>Start auxiliary engine (main engine if tank has no auxiliary engine).</p>	<p>Place main gun safety in FIRE position if located on left side of gun. If main gun has percussion mechanism, cock gun for each firing check if cocking mechanism is located on left side of gun; watch action of linkage, and listen for action of percussion mechanism during each firing check. If main gun has electric firing, position circuit tester and watch indicator (light or scale). When the gunner announces FIRE, light should be illuminated or prescribed reading should be shown on scale; if not, announce NO FIRE. When the check is completed, remove circuit tester. Cock coaxial machinegun for each firing check, and listen for firing action.</p>
<p>Command: CHECK GUN CONTROLS. Check elevation and traverse with power control handle.</p>	<p>Check oil in power control system as applicable. Unlock turret if lock is located on right side of turret. Check manual elevation. Check manual traverse and ensure handle is returned to a latched position. Turn turret motor switch ON (and elevation power switch, if applicable). Check power control handle for power elevation and power traverse as applicable. Check magnetic brake if applicable. Recheck oil in gun control system on tanks with controlled pressure system. Check azimuth (deflection) indicator for accuracy and slippage. Turn turret motor switch OFF (and elevation power switch if applicable). Check accuracy of quadrants as applicable and adjust as required.</p>		<p>Check for obstruction to traverse and unlock turret if lock is located on left side of turret. Coordinate with gunner to check hull-stowed ammunition.</p>

TANK COMMANDER	GUNNER	DRIVER	LOADER
<p>Command: CHECK FIRE CONTROL.</p> <p>If tank has a range finder, check and place in operation. On tanks with a computer, check for binding by rotating ranging knob through entire range scale; turn computer ON; index various ranges on range finder and have gunner ensure that they are indexed on computer. Boresight direct-fire sight for main gun and apply established zero. Set prescribed battlesight range on range finder if applicable. Check caliber .50 machinegun and adjust head space and timing if applicable. Check caliber .50 machinegun mount and controls. Boresight caliber .50 machinegun if applicable.</p>	<p>On tanks with a computer, index zero on range correction knob. Check to ensure that inner pointer on computer indicates same ranges as indexed on range finder. Ensure circuit breaker switch is on and depress reset button. Check that outer and inner pointers on computer match at various ranges. Check that super-elevation scale on computer indicates proper super-elevation for the range and ammunition selected; check super-elevator action if applicable. On tanks without a computer, check operation of ballistic unit. Boresight and apply established zero. Index ammunition (and range if applicable) in fire control system for prescribed battlesight if applicable.</p>		<p>Assist in boresighting main gun and coaxial machinegun. Open breech (assisted by gunner). Assist tank commander in adjusting head space on caliber .50 machinegun if applicable.</p>

Note. When performing the prepare-to-fire checks in preparation for a combat mission, all weapons are loaded or half-loaded and placed on SAFE, as a last step before the report. When performed in conjunction with training exercises, weapons are loaded only on order.

TANK COMMANDER	GUNNER	DRIVER	LOADER
Command: REPORT.	Report: *GUNNER READY.	Report: *DRIVER READY.	Report: *LOADER READY.

*Or reports uncorrected deficiencies.

PREPARE TO FIRE CHECKLIST M 60 TANKS

AE GTA 17-010

- TANK COMDR** Command: **PREPARE TO FIRE.**
Clean exterior lens and vision devices on turret.
- GUNNER** Observe loader's action in checking replenisher indicator tape. Clean and inspect periscope and telescope (interior). Install batteries and check instruments lights and rheostats for proper operation.
- DRIVER** Clean periscopes, lower seat, close hatch, and turn on master switch.
- LOADER** Check recoil oil by feeling indicator tape, open breech; inspect tube and chamber for obstructions and cleanliness. Check coaxial machine gun mount. Inspect all turret-stowed ammunition for completeness of stowage, type, and serviceability. Check breech-block crank stop to insure it is in the rearward position.
- TANK COMDR** Command: **CHECK FIRING SWITCHES.**
Check firing trigger on power control handle when main gun switch is ON and again when coaxial machine gun switch is ON.
- GUNNER** Turn main gun switch on. Check firing triggers on power control handle and trigger on manual elevation control handle. Turn main gun switch to OFF position. Actuate handle of manual firing device. NOTE: Each time the handle is actuated the circuit tester light should come on. While actuating the handle announce FIRE. Turn main gun switch off, then turn coaxial machine gun switch. Check firing triggers on power control handle. Check firing triggers on power control handle. Check firing trigger on manual elevation control handle. Turn off coaxial machine gun switch.
- DRIVER** Start engine.
- LOADER** Turn safety to OFF. Position circuit tester between breech ring and breech block. Turn safety to FIRE position. During check of triggers and firing button with main gun switch on, observe for lighting of bulb in circuit tester. Light should be illuminated when gunner announces FIRE. If the light fails to illuminate announce NO FIRE. Close the cover, cock the coaxial machine gun, and listen for the action of the barrel and barrel extension going forward during firing trigger checks. Recock coaxial machine gun after each check.

- TANK COMDR** **Command: CHECK GUN CONTROLS.**
- Check power control handle for power elevation and power traverse. Check magnetic brake.
- GUNNER** Check oil in turret power control system. Check manual traverse to ensure free movement of turret. Insure that handle is returned to a latched position. Check manual elevation. Turn turret motor switch on. Check power control handle for power elevation and power traverse. Check magnetic brake. Re-check oil in turret control system. Check azimuth indicator for accuracy. Check turret ring for obstructions. Check elevating cylinder for leaks. Manually traverse turret a complete rotation, stopping to permit loader to check ammunition in hull stowage. Coordinate with crew members. Place turret in power and check azimuth indicator for slip-page. Turn off turret motor switch. Check for leaks.
- LOADER** Check for obstruction to traverse. Unlock turret. Check hull-stowed ammunition for completeness of stowage and serviceability; coordinate with gunner while checking ammunition. NOTE: Traverse manually for safety reasons.
- TANK COMDR** **Command: CHECK FIRE CONTROL.**
- Check and adjust head space and timing on cal. .50 machine gun (This check does not apply on tanks equipped with the M85, cal .50 machine gun). Turn on cupola power switch. Check operation of cal .50 machine gun mount and controls. Index various ranges on range finder. Calibrate and boresight range finder and apply established zero. NOTE: If an established zero has not been determined, apply the emergency zero. Set unit battlesight on range finder. Boresight the cal .50 machine gun on tanks equipped with the M85 machine gun. Half-load the cal .50 machine gun.
- GUNNER** Set range correction knob to reflect the number of rounds fired. Check manual operation of computer to ensure there is no bind in computer or linkage. Push RESET button on computer. Observe to see that pointers on computer synchronize at various indexed ranges. Index various types of ammunition and check for synchronization of pointers each time ammunition selector handle is released. Boresight periscope and telescope and apply established zero to these sights. NOTE: If an established zero has not been determined, apply the emergency zero. Index ammunition on computer for unit battlesight.
- LOADER** Assist tank commander in adjusting head space on cal .50 machine gun (This check does not apply on tanks equipped with the M85 cal .50 machine gun). Boresight coaxial machine gun and assist in boresighting main gun. Open breech of main gun; return operating handle to latched position. Load the coaxial machine gun.
- TANK COMDR** **Command: REPORT**
- GUNNER** Report: **GUNNER READY**
- DRIVER** Report: **DRIVER READY**
- LOADER** Report: **LOADER READY**

FIELD MANUAL }
No. 17-12 }

HEADQUARTERS
DEPARTMENT OF THE ARMY
WASHINGTON, D.C., 30 November 1964

TANK GUNNERY

	Paragraphs	Page
PART ONE. PURPOSE AND SCOPE		
CHAPTER 1. INTRODUCTION.....	1-2	3
PART TWO. TANK WEAPONS AND AMMUNITION		
CHAPTER 2. TANK WEAPONS AND USES.....	3-8	4
3. TANK GUN AMMUNITION AND TARGET DESTRUCTION		
Section I. Introduction.....	9-11	8
II. Projectiles and fuzes.....	12-14	10
III. Armor-defeating projectiles and uses.....	15-18	12
IV. Antipersonnel/antimateriel projectiles and uses.....	19-24	19
V. Special purpose projectiles and uses.....	25-28	23
VI. Identification of main gun ammunition.....	29-30	25
VII. Machinegun ammunition, identification and uses.....	31-35	27
PART THREE. FIRE CONTROL AND SIGHTING EQUIPMENT		
CHAPTER 4. DIRECT-FIRE CONTROL SYSTEM.....	36-45	30
5. AUXILIARY FIRE CONTROL INSTRUMENTS.....	46-49	38
6. TANK-MOUNTED SEARCHLIGHTS.....	50-52	42
7. BORESIGHTING AND ZEROING.....	53-60	48
PART FOUR. CONDUCT OF FIRE		
CHAPTER 8. INTRODUCTION.....	61-64	57
9. TARGET ACQUISITION.....	65-70	60
10. CREW FIRING DUTIES.....	71-75	65
11. DIRECT FIRE IN DAYLIGHT		
Section I. The initial fire command.....	76-86	67
II. Sensings.....	87-89	73
III. Direct-fire adjustment.....	90-93	78
IV. Special techniques for different ammunition.....	94-96	86
V. Battlesight.....	97-98	88
CHAPTER 12. FIRING AT NIGHT OR DURING REDUCED VISIBILITY		
Section I. The tank range card.....	99-100	90
II. Types of range cards.....	101-103	92
III. Preparation for and reoccupation of night firing positions.....	104-106	95
IV. Preparation for night firing.....	107-109	97
V. Tactical use of range cards.....	110-113	98
VI. Use of tank-mounted searchlights.....	114-116	102

* This manual supersedes FM 17-12, 3 April 1961, including C 1, 3 May 1961; and TC 17-8, 4 October 1962.

	Paragraphs	Page
CHAPTER 13. PLATOON FIRE DISTRIBUTION AND CONTROL		
Section I. Introduction.....	117-119	105
II. Distribution and volume of fire.....	120-122	106
III. Platoon leader's fire command.....	123-129	111
IV. Platoon fire planning offensive actions.....	130-132	116
V. Platoon fire planning, defensive actions.....	133-137	116
 PART FIVE. TANK GUNNERY TRAINING		
CHAPTER 14. GENERAL		
Section I. Introduction.....	138-140	122
II. Individual gunnery training.....	141-150	124
III. Crew gunnery training.....	151-152	130
CHAPTER 15. RANGE DETERMINATION		
Section I. Introduction.....	153-154	132
II. Methods of range determination.....	155-160	132
III. Range determination training.....	161-164	142
IV. Binocular.....	165-167	144
V. Range finder training and testing.....	168-175	147
CHAPTER 16. TARGET ACQUISITION TRAINING		
	176-179	153
 PART SIX. TANK GUNNERY TESTING		
CHAPTER 17. INTRODUCTION.....		
	180-185	156
18. TANK CREWMAN GUNNERY QUALIFICATION COURSE		
Section I. Introduction.....	186	160
II. Tank crewman preliminary gunnery examination.....	187-204	160
III. Tank crewman gunnery qualification—subcaliber firing.....	205-208	171
IV. Tank crewman gunnery qualification—service firing.....	209-213	179
CHAPTER 19. TANK CREW GUNNERY QUALIFICATION FIRING.....		
	214-221	187
20. FAMILIARIZATION AND PRACTICE FIRING		
Section I. Familiarization firing.....	222-224	206
II. Practice firing.....	225-226	208
 PART SEVEN. OPERATION OF TANK RANGES		
CHAPTER 21. ESTABLISHING TANK RANGES		
Section I. Introduction.....	227-228	210
II. Establishing tank firing ranges.....	229-233	210
CHAPTER 22. CONDUCT OF RANGE FIRING		
Section I. Preparation and duties of the officer in charge.....	234-238	213
II. Conduct of firing.....	239-243	217
III. Duties of the safety officer.....	244-245	218
IV. Duties of the tank instructor/examiner.....	246-247	220
V. Safety precautions and methods of controlling tank range firing.....	248-250	221
VI. Handling of main gun ammunition.....	251-253	222
VII. Targets.....	254-259	225
 APPENDIX I. REFERENCES.....		
		234
II. TANK IN THE ARTILLERY ROLE.....		
		236
 INDEX.....		
		246

PART ONE
PURPOSE AND SCOPE

CHAPTER I
INTRODUCTION

1. Purpose

This manual presents tank gunnery principles and techniques and training exercises and tests for crews of all standard tanks. Elements of tank gunnery are discussed in detail to promote uniformity and to maintain a high standard of proficiency. Proper application of these principles and techniques will insure the most effective use of the tank weapons system in training and in combat.

2. Scope

a. This manual is divided into seven parts. Part one outlines the purpose and scope of the manual. Part two presents the tank weapons, ammunition, and considerations used to place effective fire on various targets; part three, the tank fire control systems used to fire in daylight, at night, and with artificial illumination; part four, the principles and techniques of target acquisition and conduct of fire by the tank crew and platoon in daylight, at night, and with artificial illumination; part five, the types and means of tank gunnery training in the unit; part six, the tank gunnery testing program used to determine individual and crew proficiency; and part seven, guidance for the establishment and operation of tank ranges.

b. For detailed information on functioning, maintenance, and operation of specific items of equipment and weapons, refer to the appropriate field or technical manuals and training circulars.

c. Units equipped with tanks not considered in this manual may modify the methods of conduct of fire and firing exercises, when necessary, to conform with available equipment. When it is necessary to modify a qualification firing exercise, the number of rounds fired will not be changed and the modified exercise must be at least as challenging as the prescribed exercise.

d. The material presented herein is applicable without modification to both nuclear and nonnuclear warfare.

e. Users of this manual are encouraged to submit recommended changes or comments to improve the manual, direct to the Commandant, U.S. Army Armor School, Fort Knox, Kentucky. Comments should be keyed to the specific page, paragraph, and line of the text in which the change is recommended. Reasons should be provided for each comment to insure understanding and complete evaluation.

PART TWO

TANK WEAPONS AND AMMUNITION

CHAPTER 2

TANK WEAPONS AND USES

3. Introduction

United States tanks have a large caliber main gun, which is used for destruction of enemy armor and other hard targets, and those soft targets that are not within effective range of the tank mounted machineguns. They have a coaxially mounted machinegun (referred to hereafter as *coax* or *coax machinegun*) for engagement of soft targets (personnel, trucks, wooden structures, etc.) at close ranges and to provide suppressive fire while the tank is moving. The tank commander also has a machinegun, which can be used against soft targets and some lightly armored vehicles and may be fired at different targets when the main gun or coax machinegun is already employed. It can provide the tank commander with a means for reconnaissance by fire. Additionally, it provides the tank with an anti-aircraft capability against low performance aircraft.

4. Main Gun

The tank main gun with a variety of ammunition can be used effectively against all types of ground targets. The ballistic characteristics (flat trajectory) of the projectiles make the weapon very accurate. The tank commander's decision as to what type of ammunition to use against a target is based on his knowledge of the capabilities of the ammunition (ch. 3).

5. Coax Machinegun

Because of the large amount of coax ammunition that can be stowed in the tank and

the effectiveness of area fire with the gun from a stationary or moving tank, the coax machinegun is used against soft targets when they appear within its effective range. This conserves main gun ammunition for targets that cannot be destroyed with coax fire either because of range or type of target and reduces the supply requirements of main gun ammunition.

6. Coax Machinegun Fire

a. General. The coax machinegun is fired in bursts of 20–25 rounds both for adjustment on and destruction of targets. When the primary sight or an infinity sight is used, the gunner will index either range and ammunition in his ballistic unit (M41 tank) or the lowest muzzle velocity main gun ammunition in his computer (M48, M60 tanks) prior to firing. On a tank equipped with a range finder the tank commander does not have to range on a coax target, but he should index the approximate range to the target in his range finder prior to the gunner's firing. If the range to the target is about 500 meters he can rotate his ranging knob counterclockwise against the stop on the range finder, thereby indexing 500 meters (yards) in the fire control system.

b. Fire from a Moving Tank at Stationary Targets.

- (1) When the target is in front of the tank, fire is adjusted on the *near* edge of the target, and the movement of the tank combined with the gunner's manipulation will move the bursts through the target (fig. 1).

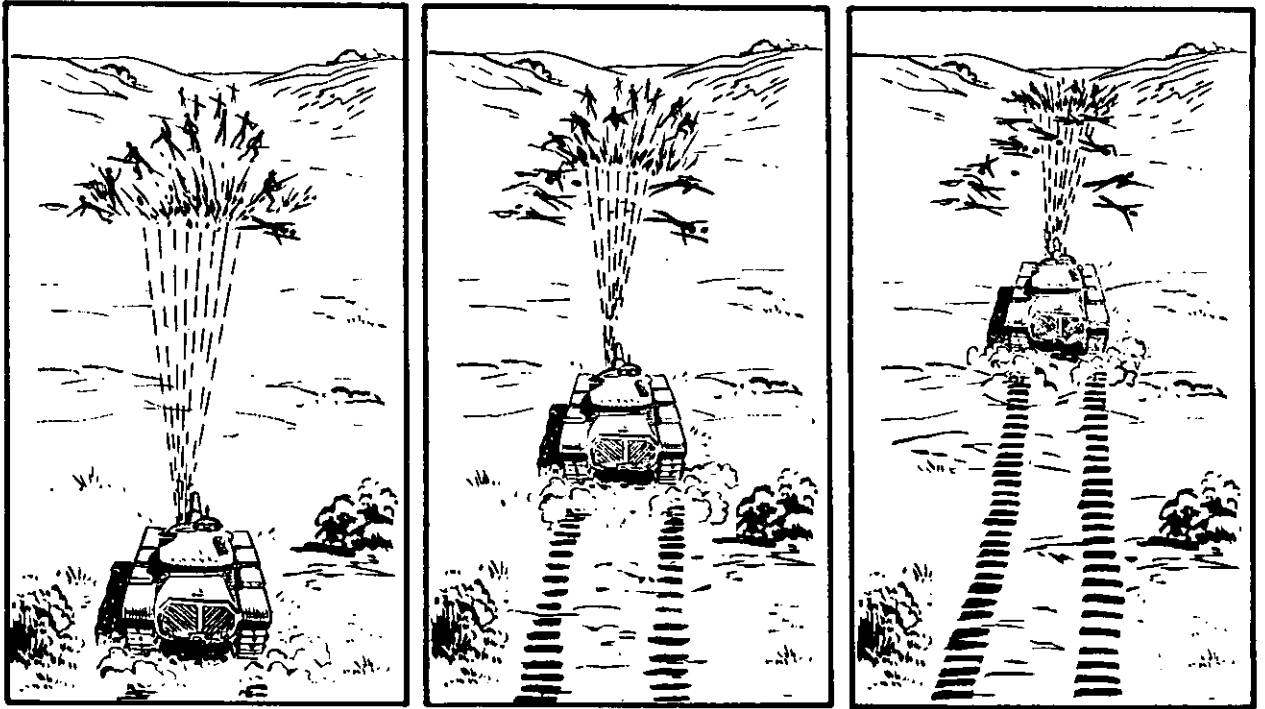

Figure 1. Coax fire—target direct front.

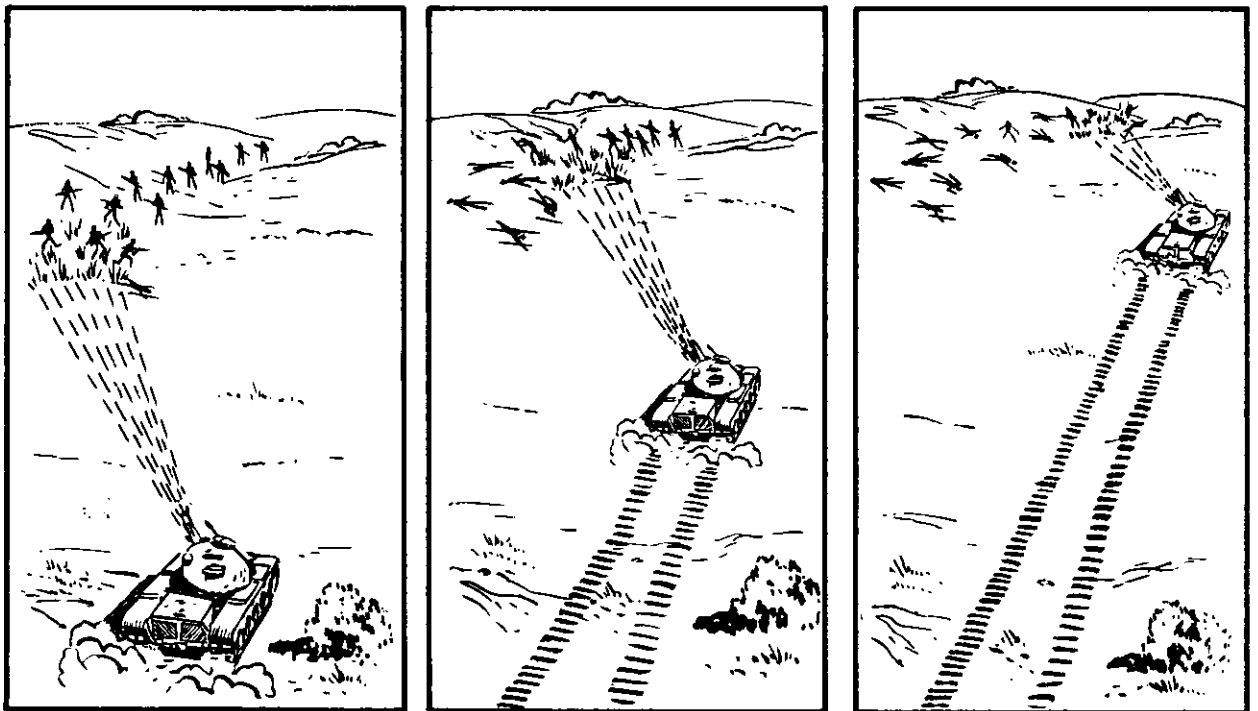

Figure 2. Coax fire—target to side and parallel.

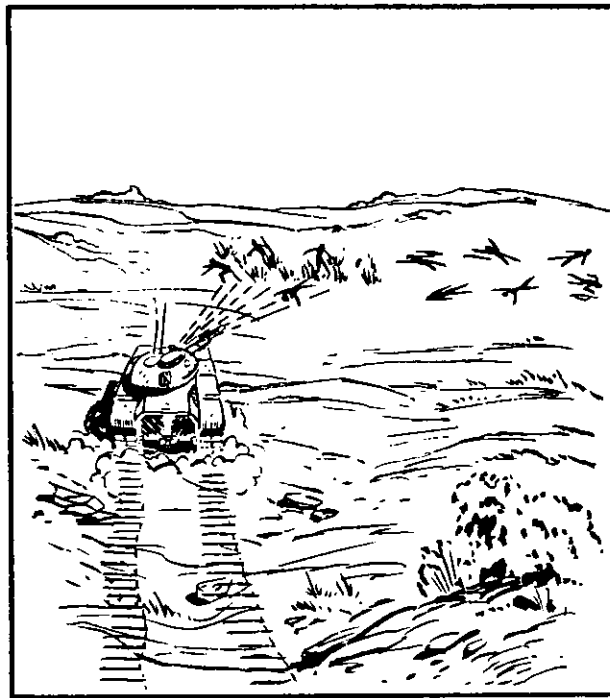
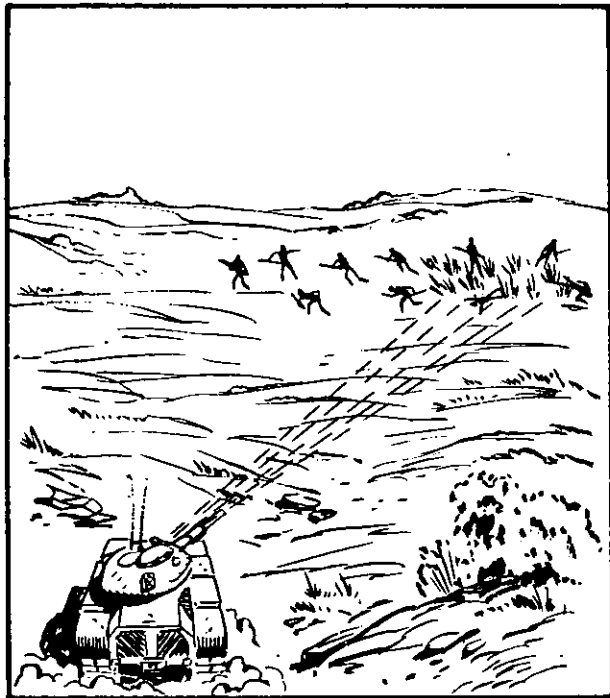

Figure 3. Coax fire—target to side and perpendicular.

- (2) When the target is to the side of the tank and parallel to the direction of movement, fire is adjusted on the *near* edge of the target, as the movement of the tank will move the bursts through the target (fig. 2).
- (3) When the target is to the side of the tank and perpendicular to the direction of movement, fire is adjusted on the *far* edge of the target so the movement of the tank will move the bursts through the target (fig. 3).

c. Fire at a Moving Vehicle. To destroy a moving vehicle, it is best to stop the tank momentarily for engagement, because a stable gun platform increases the hit probability. In a situation where enemy armor or antitank guns are suspected to be present, this halt should be made in a covered or deflade position. However, in a pursuit or unopposed situation the tank may halt momentarily in the open to engage a target of this type. If the situation requires, the target may be engaged

while on the move. If the target has apparent speed, a 5-mil lead should be used initially to engage the target, when not using the infinity sight.

7. Caliber .50 Machinegun

Because the tank commander's machinegun can be moved independently of the main gun and coax machinegun, it can be used to engage another target at the same time the gunner is firing. The tank commander loads, aims, and fires this weapon. The caliber .50 machinegun is used against the same type targets as the coax machinegun but is effective at greater ranges. It can be used to destroy some lightly armored vehicles, to engage air vehicles and for reconnaissance by fire on suspected enemy positions within its effective range. Another use of the caliber .50 machinegun is for its incendiary effect on wooden structures, gasoline or ammunition stores, and other inflammable targets. Conversely caution must be taken in its employment to preclude starting unwanted fires.

8. Caliber .50 Machinegun Fire

a. General. When the caliber .50 machinegun is mounted in a cupola, a sight is used that has a ballistic reticle (fig. 4). When the gun is mounted on top of the turret, a leaf sight on the gun or the tracer stream is used. The range to the target in either case must be determined prior to firing.

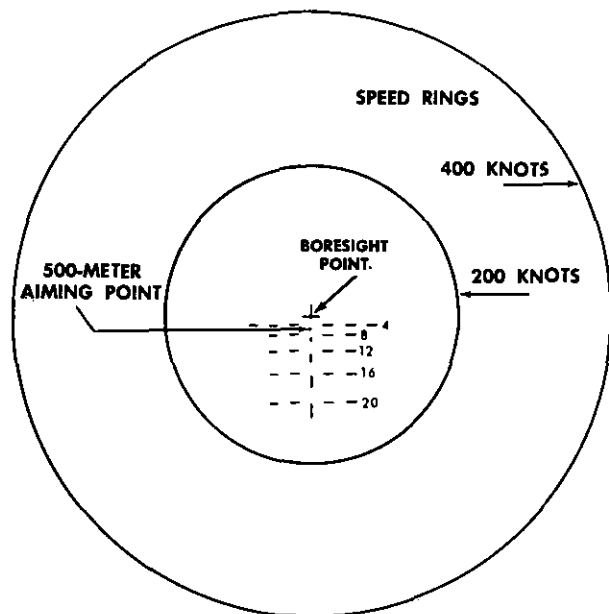

Figure 4. Cupola-mounted periscope reticle (ballistic).

b. Firing at Ground Targets. The caliber .50 machinegun is fired in bursts of 10–20 rounds for adjustment on and destruction of ground targets. The same procedures should be used to fire the caliber .50 machinegun against ground targets as are described for the coax machinegun in paragraph 6b and c. However, if speed and accuracy of target destruction are

the main considerations, the tank should be halted when firing the caliber .50 machinegun.

c. Fire Against Air Vehicles. Against air vehicles this gun is fired in one continuous burst until the target is destroyed or moves beyond effective range. When the target has apparent speed, the speed rings on the sight are used. The tank commander will estimate the apparent speed of the target and place either the 200- or 400-knot ring on the target, with the target pointing into the center of the sight (fig. 5). The tracer stream is then adjusted on the target. The leaf sight on turret-mounted machineguns cannot be used when engaging these targets; adjustment is made by observing the tracer stream.

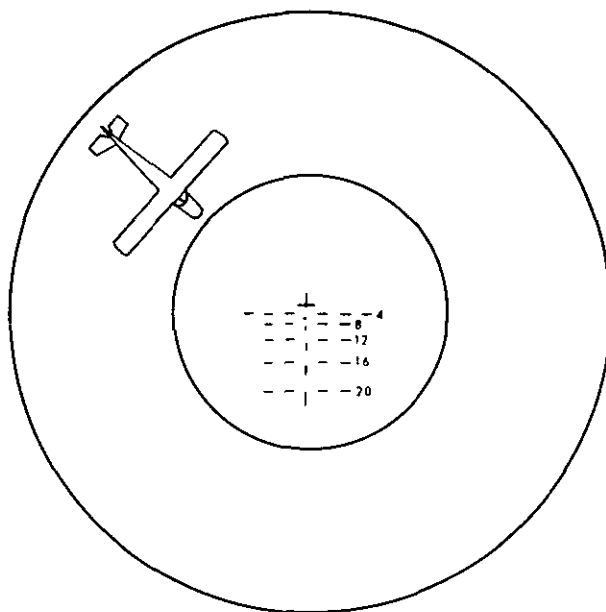

Figure 5. Engagement of air vehicles with caliber .50 machinegun.

CHAPTER 3

TANK GUN AMMUNITION AND TARGET DESTRUCTION

Section I. INTRODUCTION

9. General

The tank commander's decision regarding the type of ammunition to use against a target is based upon his knowledge of the capabilities and limitations of the ammunition. The commander must evaluate the vulnerability of a target to determine rapidly the ammunition to be employed. For the recommended employment of standard rounds of ammunition, see paragraph 78. For maintenance of ammunition, see appropriate operator's manual for the vehicle. For handling procedures of ammunition, see paragraph 253.

10. Complete Round of Tank Gun Ammunition

a. Components. A complete round of tank gun ammunition has all of the components necessary to fire the weapon once. These components are a—

- (1) *Projectile* which is fired to destroy the target.
- (2) *Propelling charge* to develop sufficient gas pressure when ignited to propel the projectile to the target.
- (3) *Primer* (electrical or percussion type) to ignite the propelling charge.
- (4) *Cartridge case* to contain the primer and propelling charge (fig. 6).

A projectile having a high explosive or chemical filler must be fitted with a fuze in order to explode it upon impact or at the desired time. Depending upon the manner in which these components are loaded into the gun a complete round is known as either *fixed* or *separated* (fig. 7).

b. Fixed Round. A fixed round has a cartridge case containing the primer and propelling

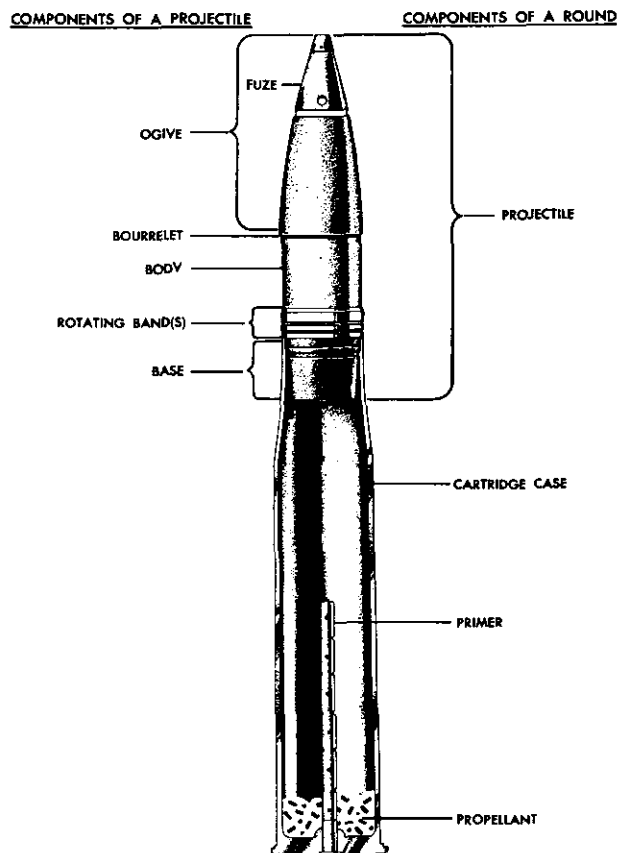

Figure 6. A complete round of tank gun ammunition.

charge attached to the projectile. The complete round is loaded into the weapon as a unit.

c. Separated Round. A separated round has a cartridge case containing a primer and propelling charge, which is sealed with a closing plug, and a separate projectile. The projectile and the cartridge case are loaded into the gun separately.

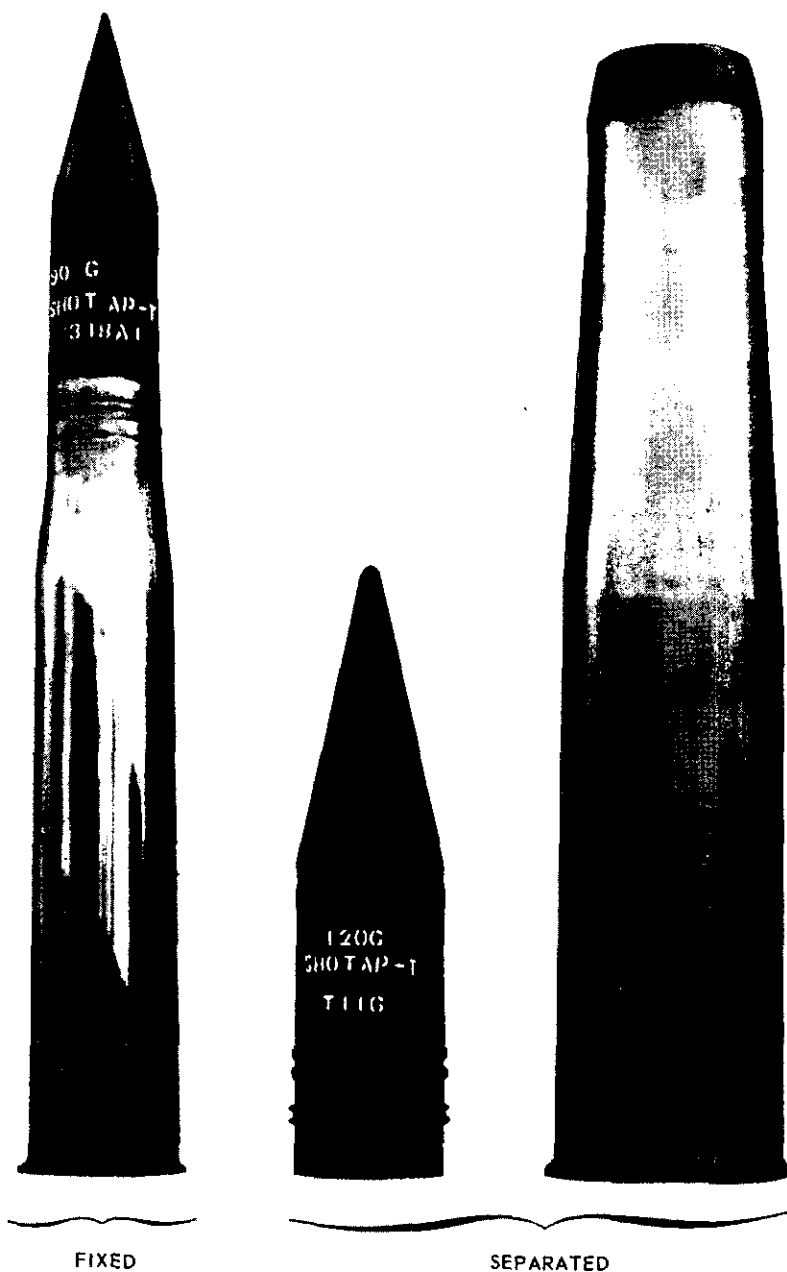

Figure 7. Fixed and separated complete rounds.

11. Classification of Tank Gun Ammunition

a. Tank gun ammunition is classified according to type and use. When classified according to type, the ammunition will be identified as service, target-practice, blank, drill, dummy, or inert.

Caution. All tank gun ammunition must be

handled with care. The explosive elements, particularly the primer, are sensitive to shock. Prescribed precautions for handling ammunition are stated in paragraph 253 and TM 9-1903.

b. When tank gun ammunition is classified according to use it will be identified as armor-defeating, antipersonnel/antimateriel, and special purpose.

Section II. PROJECTILES AND FUZES

12. General

Tank gun ammunition has two types of projectiles: inert (APDS, TP, AP) or filled (HE, HEP, HEAT, WP). Armor defeating inert projectiles, which do not contain an explosive, obtain their destructive effect by mass and velocity (kinetic energy). Target practice (TP) rounds are used in training to duplicate the in-flight ballistics of the more expensive combat round. Filled projectiles contain either an explosive or chemical filler and obtain their effect upon the target by blast, fragmentation, chemical energy (shaped charge), fire, or smoke. Filled projectiles will require a fuze to detonate the explosive filler or spread the chemical filler. In addition, canister projectiles which contain a number of subprojectiles are available for most tank guns.

13. Projectile Nomenclature

a. The forward portion of the projectile from the point to the widest portion is called the *ogive*, which may include a fuze (fig. 6). The length of the ogive influences the flight of the projectile by minimizing the effects of drag (air resistance) upon it. Because the "slug" of some inert projectiles are blunt to increase penetration, an aluminum windshield is added to streamline the ogive.

b. The *bourrelet* is the widest forward portion of the projectile and forms the rear of the ogive (fig. 6). The bourrelet is an accurately machined surface that is slightly larger in diameter than the body and by bearing upon the rifling of the gun tube, centers the forward portion of the projectile in its travel through the bore.

c. The *body* (fig. 6) is slightly smaller in diameter than the bourrelet and rotating bands and when manufactured must be accurately balanced in order for the projectile to maintain the required stability in flight. The body may consist of a "slug" or contain an explosive or chemical filler.

d. A common function of the *rotating band(s)* (fig. 6) of all projectiles is to seal the propellant gases behind the base of the

projectile. When spin-stabilized projectiles are fired, the rotating bands will also impart spin by being engraved by the rifling of the gun tube and simultaneously act as a rear bearing surface. When fin-stabilized projectiles are fired, the rotating band(s) do not cause spin to be imparted to the projectile and may act as a rear bearing surface; their primary function is to seal the propellant gases.

e. The *base* (fig. 6) is that portion of the projectile upon which the expanding propellant gases act, causing the projectile to move forward. With the exception of certain types of canister and some white phosphorus ammunition, the base of the projectile is equipped with a *tracer*. The tracer (-T) is used by the crew to sense the projectile (para. 87-89).

14. Fuze Operation and Nomenclature

a. Fuze. A fuze is a mechanical device used with a projectile to cause the projectile to function at the time and under the circumstances desired. Fuzes are classified by:

- (1) Position on the projectile.
 - (a) Base detonating.
 - (b) Point detonating.
 - (c) Point-initiating, base detonating.
- (2) Method of functioning.
 - (a) Impact.
 - (b) Timed (used with some types of antipersonnel/antimateriel ammunition).

b. Bore Safety and Methods of Arming. All fuzes for tank gun ammunition are bore safe. This means that the fuze will not be armed until such time as the projectile clears the muzzle of the gun tube. Sufficient centrifugal force must be obtained or inertia overcome to arm the fuze (methods of arming).

c. Fuze Settings. Normally, ammunition with a point detonating fuze (HE and WP) will be issued to function superquick (SQ). When the slot in the setting sleeve of the fuze is rotated one-quarter turn, in either direction, the fuze will be set for delay (fig. 8). With the fuze set for delay, the fuze will detonate the projectile a fraction of a second (.05) after impact.

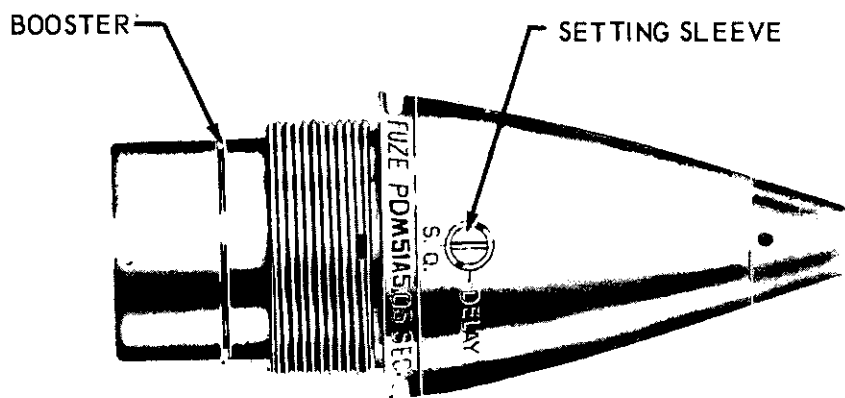

STANDARD SUPERQUICK-DELAY FUZE

NOTE. BOOSTERS ARE NOT INTERCHANGEABLE.

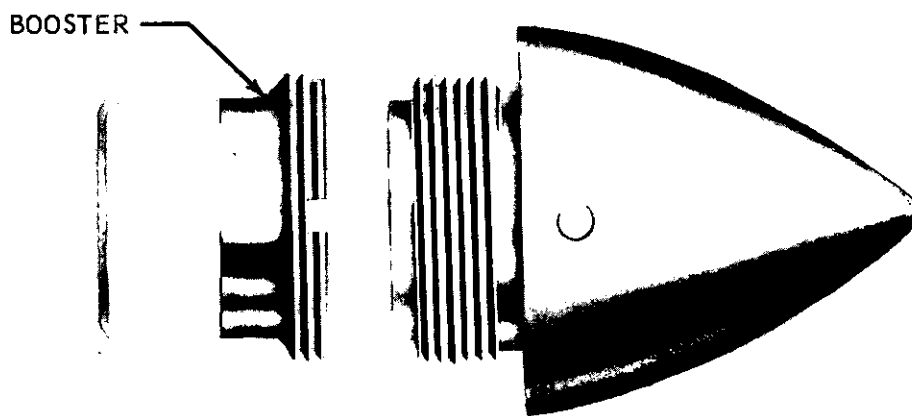

CONCRETE PIERCING FUZE

Figure 8. Point detonating fuzes—impact type.

The concrete-piercing fuze with booster has an established delay (.025), which cannot be adjusted by the crew (fig. 8). This fuze, when substituted by the crew for the standard point detonating fuze on the HE round, will provide

for better penetration of concrete.

Caution. When substituting a concrete-piercing fuze and booster, be sure to remove both the standard fuze and its booster.

Section III. ARMOR-DEFEATING PROJECTILES AND USES

15. General

Armor-defeating projectiles produce the desired effects against armor targets by the use of either kinetic or chemical energy.

16. Kinetic Energy Projectiles

Kinetic energy armor-defeating projectiles produce the desired target effects because of their mass (hardness, density, and weight), and the velocity of travel at the time of impact with the target (striking velocity). Range and angle of impact are two important factors that will affect the degree of penetration possible with these projectiles. As range to the target increases, air resistance or drag continuously reduces the velocity of the projectile. The angle of impact is determined by the slope or shape of the target and by the angle of target engagement. An inspection of figure 9 should aid in understanding that the thickness of armor to be penetrated will increase as the slope increases. The increase of armor protection is called equivalent thickness. To determine muzzle velocity, striking velocity, and angle of fall at various ranges, consult the firing table for the appropriate weapon. There are two kinetic energy armor-defeating projectiles: armor-piercing and armor-piercing discarding sabot.

a. Armor Piercing (AP-T). The armor-piercing projectile (fig. 10) consists of—

- (1) An *aluminum windshield* to improve its ballistic performance.
- (2) A *solid steel body (slug)* to destroy the target.
- (3) A *tracer element*.
- (4) A *copper rotating band* to cause the projectile to spin.

Upon impact, the windshield will shatter and neither hinder nor assist the slug in its target penetration. Armor-piercing projectiles are announced in the initial fire command as SHOT, and are used with the 76, 90, and 120-mm guns.

b. Armor-Piercing Discarding Sabot (APDS-T). The armor-piercing discarding sabot projectile (fig. 11) consists of—

- (1) A *tungsten carbide subprojectile* sheathed in aluminum with a tracer element attached.
- (2) Three *aluminum petals* to center the subprojectile with the *plastic bourrelet* around them.
- (3) An *aluminum alloy sabot (body)*, which houses the subprojectile and contains the *base friction plate*.
- (4) A *nylon-plastic rotating band*, which causes the projectile to spin.
- (5) A *rubber obturator* to help the rotating band seal off the propellant gases.

c. As a result of centrifugal force (spin) and friction, soon after the projectile clears the muzzle of the gun tube, the obturator, rotating band, and bourrelet will rupture and fall free. Air resistance and centrifugal force acting upon the three aluminum petals will cause them to break away simultaneously. This discarding will take place between 6–36 feet from the muzzle of the gun. The absence of these petals will allow air to pack into the open end of the sabot. This resistance and centrifugal force will overcome the grip of the friction plate and separation of the subprojectile from the sabot will take place. This separation will occur between 50–500 meters from the muzzle. From this point to the target, the subprojectile with tracer is not hindered by carrier components, which would unnecessarily reduce its velocity. Because the velocity of the projectile is greater than 3,500 fps, it is difficult for the crew to use the tracer for adjustment of fire up to a range of 2,500 meters. Upon impact with a metal target, the tungsten carbide subprojectile produces a distinctive bright orange flash. Because of its discarding of parts, this projectile should not be fired overhead of friendly troops without warning them. The danger area extends up to 1,000 meters from the gun along the trajectory and spreads out to 70 meters on each side of the trajectory at this range. Armor-piercing discarding sabot projectiles are announced in the initial fire command as SABOT, and used with the 105-mm gun.

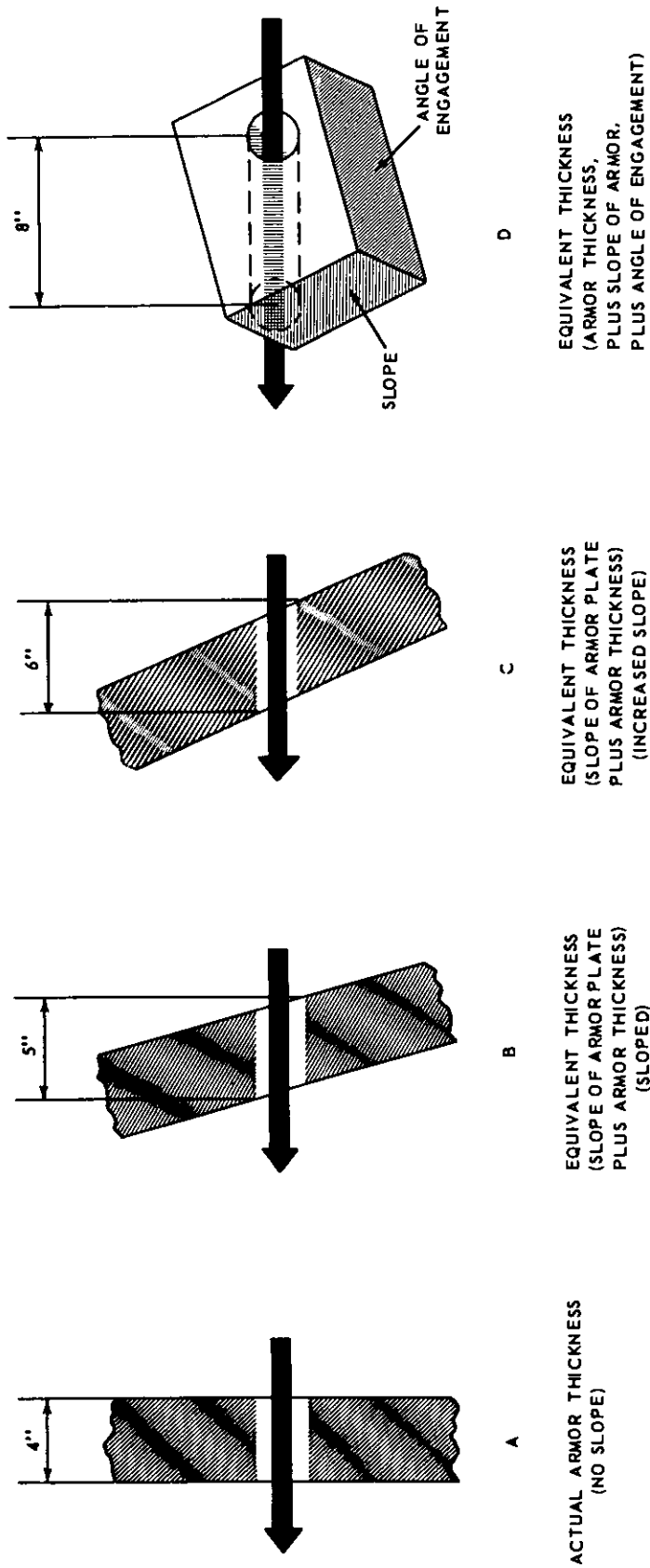
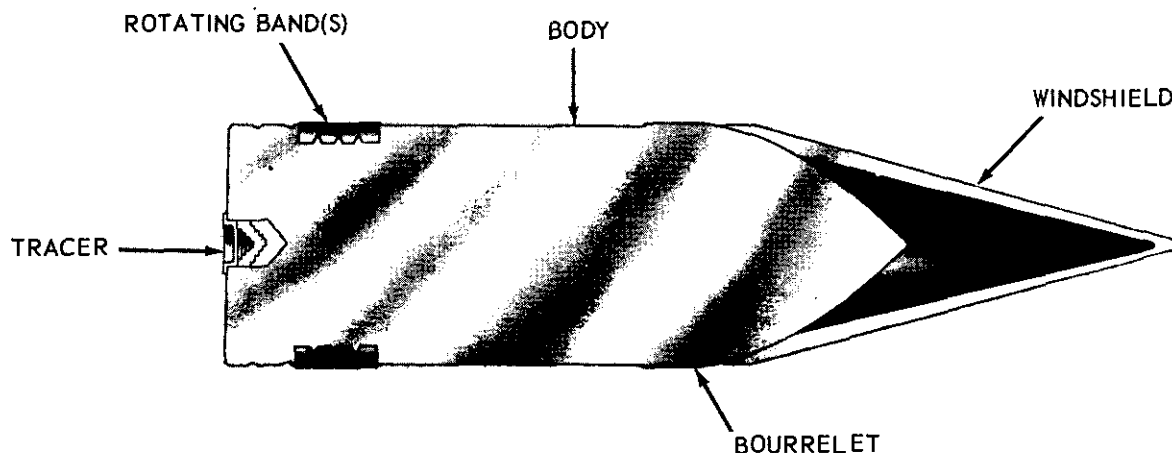

Figure 9. Equivalent thickness.



ARMOR-PIERCING

Figure 10. Armor-piercing projectile.

17. Chemical Energy Projectiles

a. Shaped charge projectiles cause their damaging effect by focusing the gases released as the high explosive detonates into a high pressure jet stream. The shaped charge must be held away from the target a certain distance to allow the jet stream to form. This distance is called standoff. Generally, the action of this jet stream can be likened to that of an acetylene cutting torch when cutting metal. Upon impact with the target, the jet stream will displace the armor plate. This in many cases will have an explosive effect upon the target or cause fires. An important thing to remember when using chemical energy armor-defeating projectiles is that their target defeating potential is not affected by range. The chemical energy armor-defeating projectile currently available is high explosive antitank (HEAT-T). This projectile (fig. 12) has a peculiar shape. It consists of a—

- (1) *Spike-like windshield* which provides standoff distance and contains the point initiator (ceramic disk) portion of the fuze.
- (2) *Steel body* which contains the high explosive shaped charge and the *bourrelet*.
- (3) *Nylon-plastic rotating band* which seals the propelling gases but *does not* impart spin.

- (4) *Steel fin assembly* which contains the tracer element.
- (5) *Base detonating fuze* actually contained within the body.

b. The complete fuze is called a point-initiating base detonating fuze (PIBD). The pointer-initiator is required to activate the fuze instantaneously upon impact to insure proper standoff. The PIBD fuze is armed by inertia (setback forces), as the projectile is fin-stabilized and it does not have any appreciable spin. The shape of this projectile is designed so that air passage will assist in stabilization (fig. 12). When the projectile strikes the target, the ceramic disk is deformed, and generates an electrical impulse that initiates the electrical detonator of the fuze. This results in detonation of the high explosive shaped charge. Because the energy produced by detonation of the shaped charge is restricted by the body of the projectile except toward the front, it will seek the path of least resistance (front). This energy (pressure) is refracted by the copper cone and at the point of intersection is focused, forming the reinforced high-pressure jet stream necessary to produce target effects (fig. 13).

c. The velocity of this projectile is greater than 3,500 pfs; therefore, the crew will have difficulty in using the tracer for adjustment of fire, although the strike of the round may

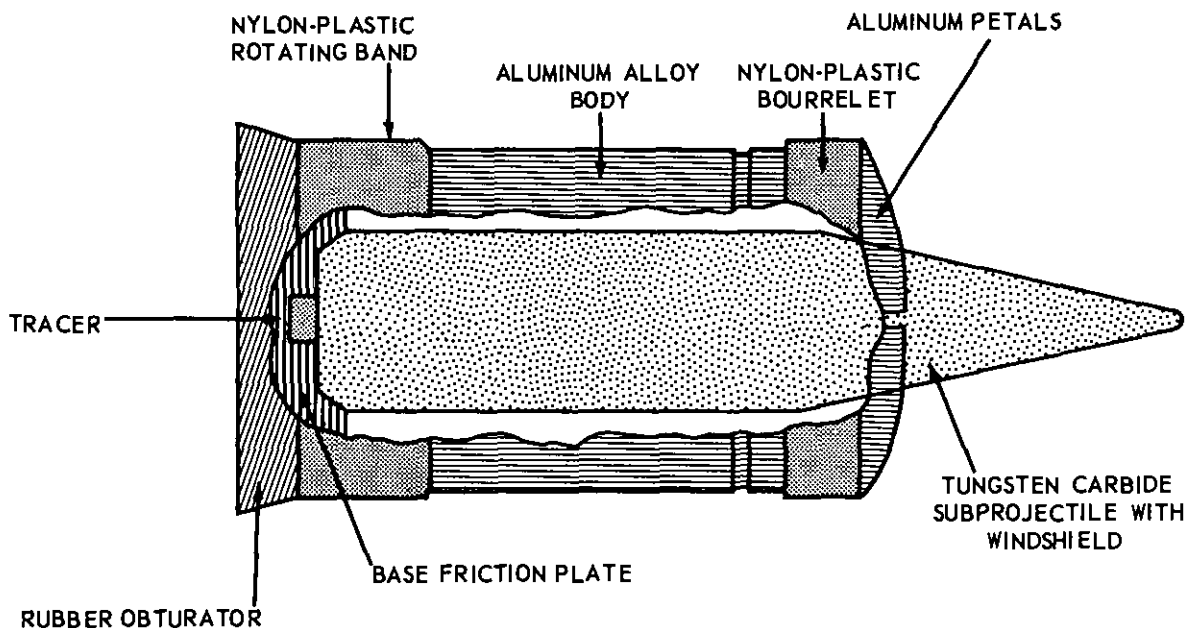

A. COMPONENTS

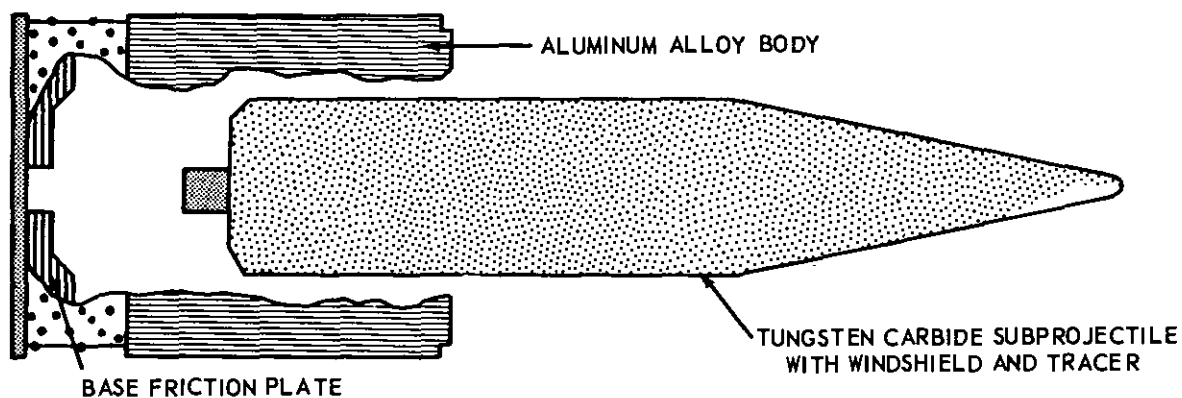

B. SEPARATION OF BODY AND SUBPROJECTILE

Figure 11. Armor-piercing discarding sabot projectile.

be very apparent. HEAT-T projectiles are available for the 76, 90, 105, and 120-mm guns and are announced in the initial fire command as HEAT.

18. Employment of Armor-Defeating Ammunition

a. Armor-defeating ammunition is used to destroy tanks and other armored vehicles. For target identification purposes a tank is any

self-propelled, track laying, armor protected vehicle that has a gun capable of destroying another tank. Other armored vehicles are wheeled or track laying vehicles, with armor protection, without major armament and used for combat security or cargo, e.g., armored personnel carrier, scout car, etc. Upon sighting a tank or other armored vehicle target, immediate attention must be given to its identification, range, and what part is exposed. This

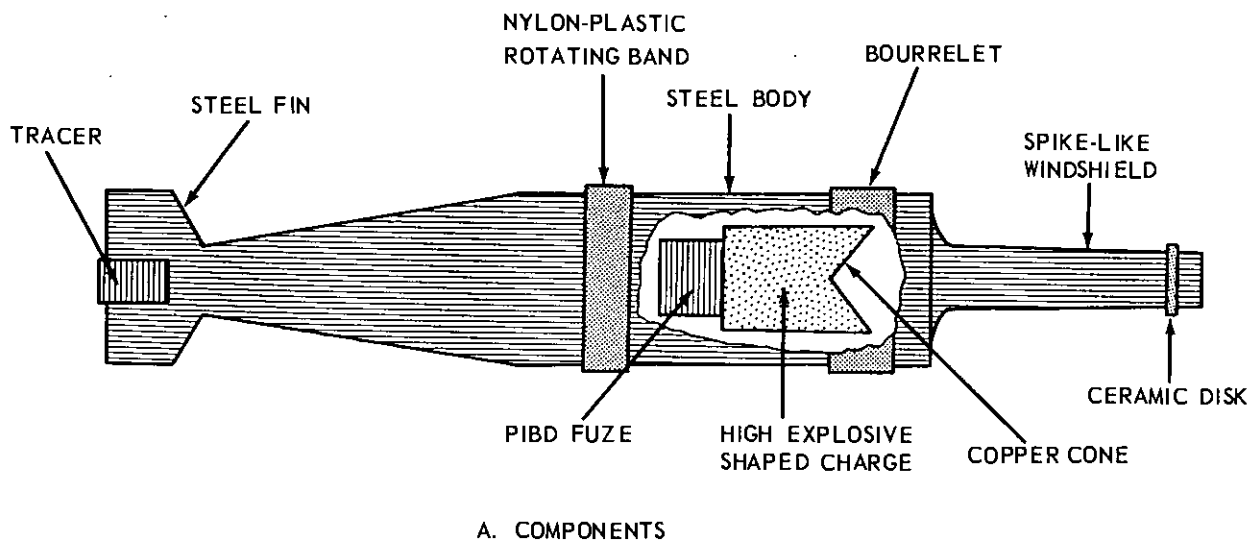

A. COMPONENTS

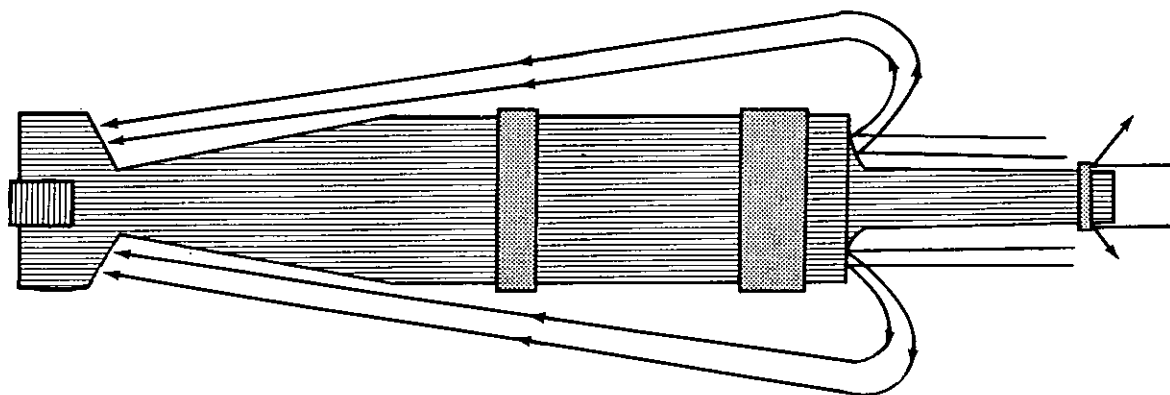

B. AIRFLOW PATTERN

Figure 12. High explosive antitank projectile.

information combined with a knowledge of the ammunition capabilities will assist in rapid destruction of the target. The vulnerability of an armored vehicle depends on the combination of actual armor thickness, slope of the armor plate (equivalent thickness), and angle of engagement. The slope of the armor plate is determined by the construction of the vehicle and its position in relation to the tank that is taking it under fire (angle of engagement). Equivalent thickness becomes greater as the amount of slope increases and the angle of engagement decreases, because there is more armor placed in the path of the projectile (fig. 9). Thus, a tank of given armor thickness with

flat surfaces perpendicular to the line of fire is more vulnerable than a tank of the same thickness with sloped surfaces oblique to the line of fire. Tanks have sloped surfaces whenever possible and have the heaviest armor on the front of the hull and turret. The sides and rear of the turret have less armor, and the sides and rear of the hull have the least amount. The sides and rear of the hull also have flatter surfaces and are the most vulnerable parts of a tank. The center of vulnerability varies with the amount of target exposed and the angle at which it is engaged. Figure 14 shows the vulnerability of a typical tank. If it is possible to get a flank or rear shot at a tank, the center

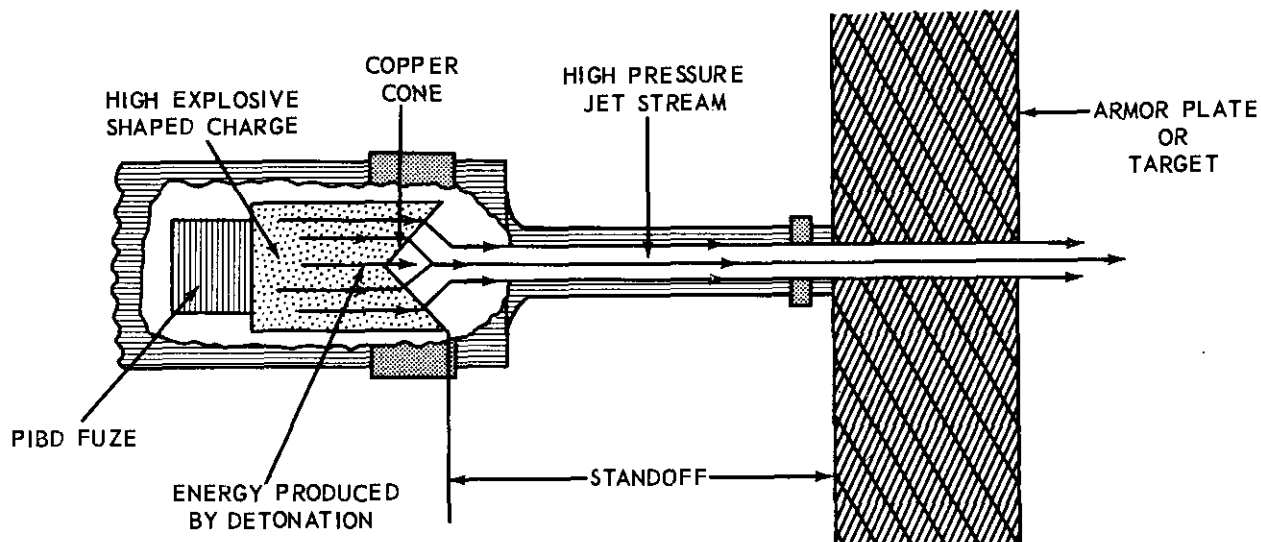
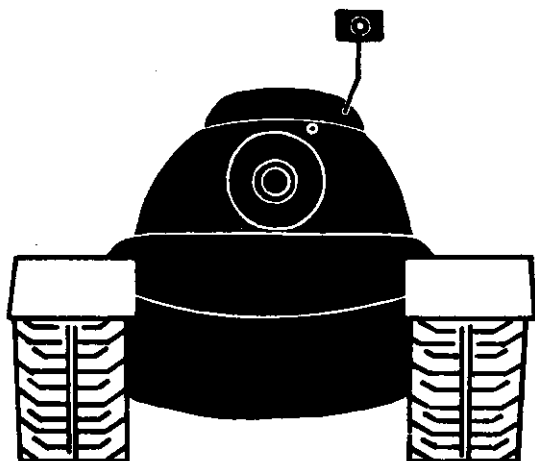

Figure 13. Jet stream action of HEAT projectile.



of vulnerability is the center of the hull. The center of vulnerability of a tank engaged head-on is the turret ring. Vulnerability decreases considerably when tanks are in hull defilade.

b. As a general rule, chemical energy armor-defeating projectiles have a greater target-defeating potential than the kinetic energy armor-defeating projectiles; therefore, they should be employed whenever the part of the tank target that possesses the greatest equivalent thickness of armor is exposed (frontal engagement). Kinetic energy projectiles should be employed when areas of lesser equivalent thickness are exposed (flank or rear engagement). With this general rule in mind, rapid and accurate target destruction within normal combat ranges (0-2,000 meters) should be accomplished without waste of ammunition. With the wide variety of armored vehicles known today, in many cases, experience will have to

dictate the best round to employ. With some armored vehicles, it may be found that destruction is possible by employing antipersonnel/antimateriel ammunition or by employing machinegun fire. In this case, the armor-defeating ammunition would be conserved for the engagement of heavier, more dangerous targets. Should the tank commander be in doubt regarding what round is necessary to destroy a particular armored vehicle, it should be considered as a tank and engaged with armor-defeating ammunition. Surprise type targets, e.g., tanks, other armored vehicles, and antitank guns, because of their mobility are of particular danger to the tank crew. HEAT, because of its blast and fragmentation, armor-defeating potential, and penetrating capability, will enable the tank crew to engage all types of surprise targets with the assurance of some degree of target destruction.



TYPICAL TANK
FRONT VIEW
HEAT IS THE PROPER
AMMUNITION TO USE

-  GREATEST EQUIVALENT THICKNESS; MOST DIFFICULT TO PENETRATE.
-  LESSER EQUIVALENT THICKNESS; NEXT MOST DIFFICULT TO PENETRATE.
-  LEAST EQUIVALENT THICKNESS; MOST EASILY PENETRATED.

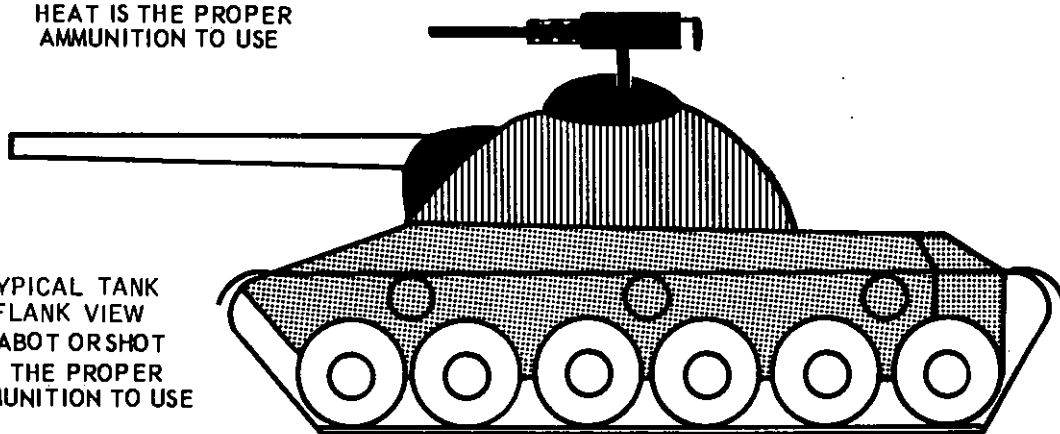

TYPICAL TANK
FLANK VIEW
SABOT OR SHOT
IS THE PROPER
AMMUNITION TO USE

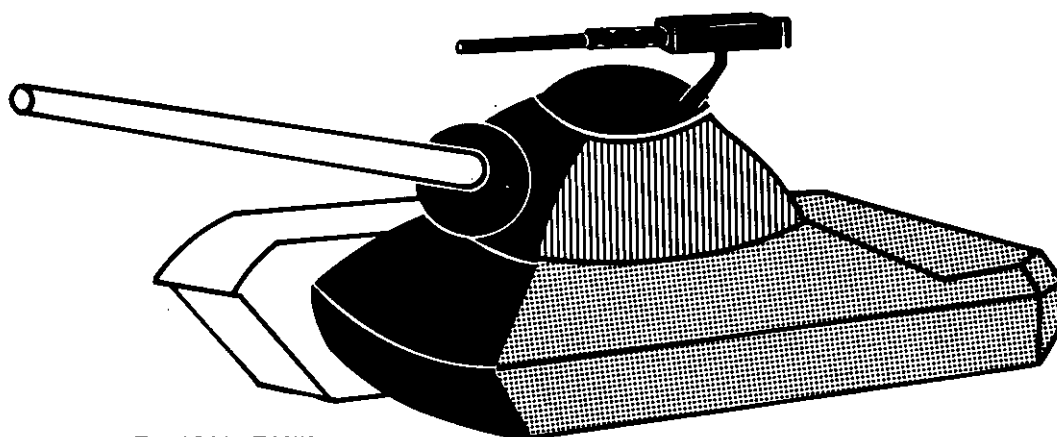

TYPICAL TANK
LEFT FRONT VIEW
60° ANGLE OF ENGAGEMENT
(LESS LEFT SUSPENSION)

Figure 14. Tank vulnerability.

Section IV. ANTIPERSONNEL/ANTIMATERIEL PROJECTILES AND USES

19. General

These projectiles are filled with either a high explosive filler with fuze, to cause them to act upon the target at the time and under the circumstances desired, or many subprojectiles. There are three projectiles available: high explosive, high explosive-plastic, and canister (antipersonnel use only).

20. High Explosive (HE-T)

a. High explosive projectiles (fig. 15) consist of a—

- (1) *Point detonating fuze* (para. 14), which is issued set to function immediately (superquick) upon impact. A fuze wrench or screwdriver is used to set the fuze to function in delay. The fuze wrench is also used to remove the point detonating fuze and to install the concrete-piercing fuze (para. 14).
- (2) *Steel body* which contains the high explosive filler.
- (3) *Copper rotating band(s)* which causes the projectile to spin.
- (4) *Tracer element* (for training, HE without tracer may be issued).

b. Because this is a spin-stabilized projectile, centrifugal force is used to arm the fuze. Upon impact, the fuze will function and detonate the high explosive filler. The primary target effects of this projectile are blast, fragmentation, and concussion. The bursting area is 5–8 meters deep and 35–45 meters wide (fig. 16). The HE-T projectile is available for the 76, 90, and 120-mm guns. It is announced in the initial fire command as HE, HE-DELAY, or HE-CONCRETE, depending upon the fuze and its setting.

21. High Explosive Plastic (HEP-T)

a. High explosive plastic projectiles (fig. 17) consist of a—

- (1) *Steel body* which contains the explosive-plastic filler.
- (2) *Copper rotating band* which causes the projectile to spin.
- (3) *Base detonating fuze* which functions immediately (superquick) upon impact.
- (4) *Tracer element*.

b. The fuze setting cannot be changed and will function upon impact, detonating the explosive plastic filler, producing blast, fragmentation, and concussion. The fragmentation effect pro-

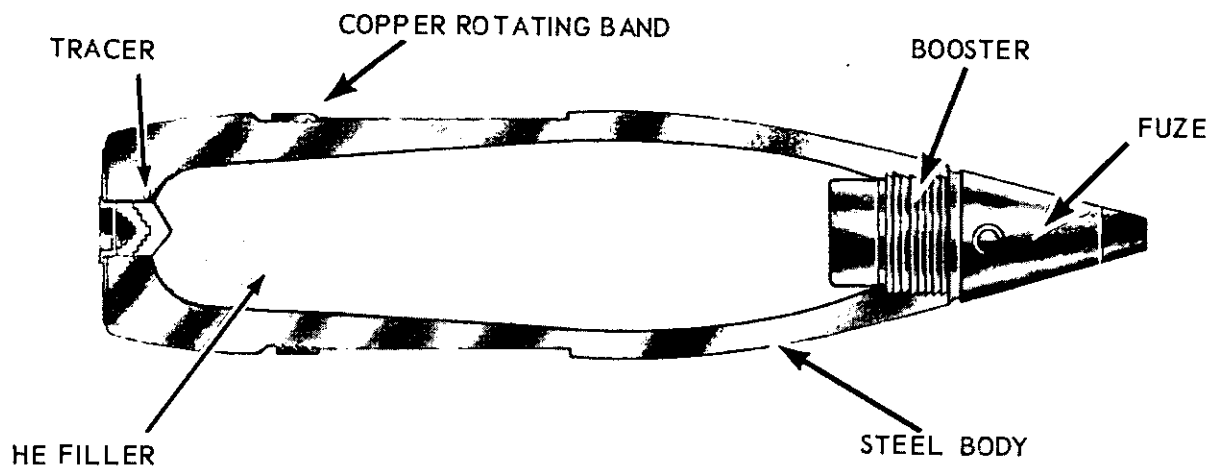

Figure 15. High explosive projectile.

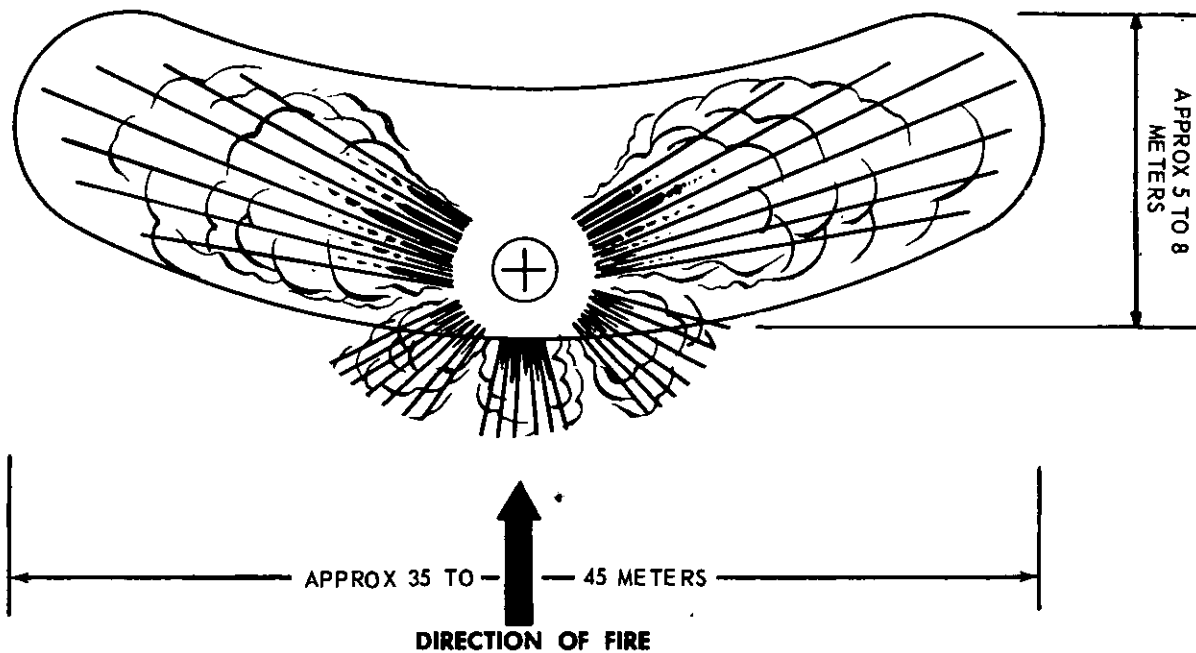
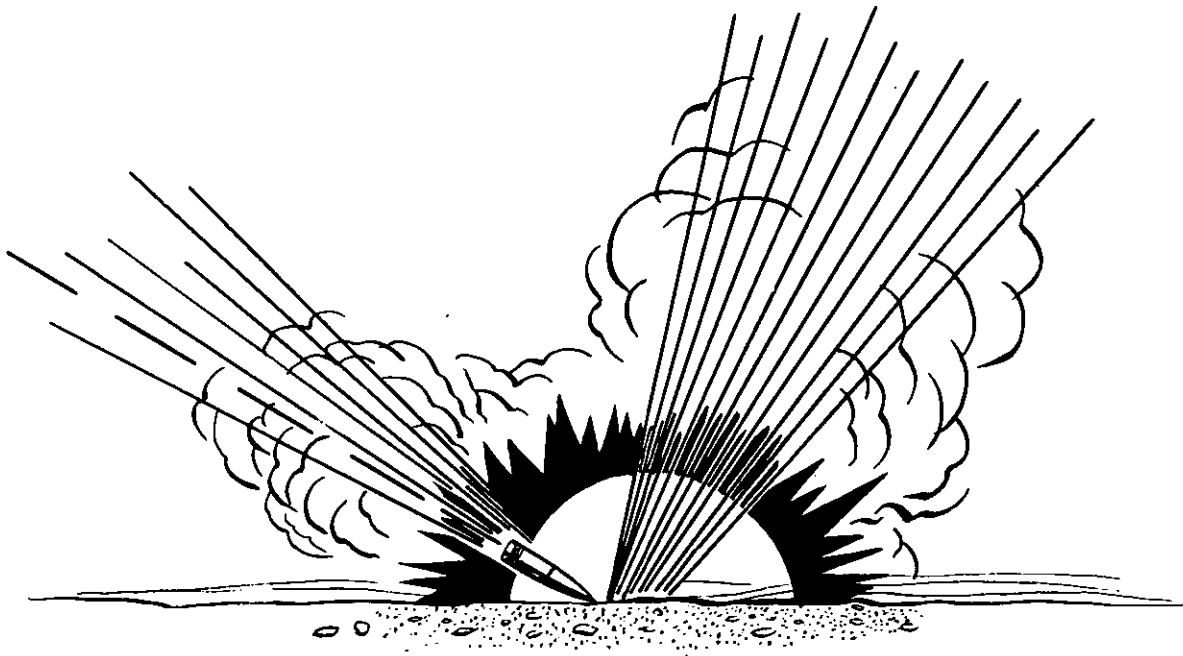

Figure 16. Approximate fragmentation pattern of HE burst.

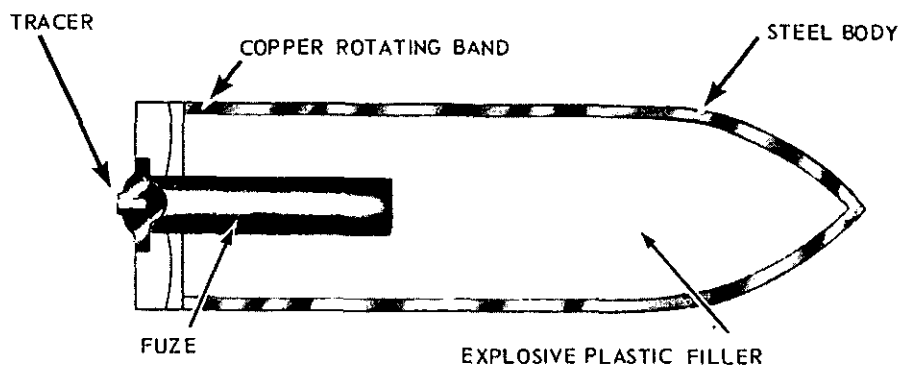

Figure 17. High explosive plastic projectile.

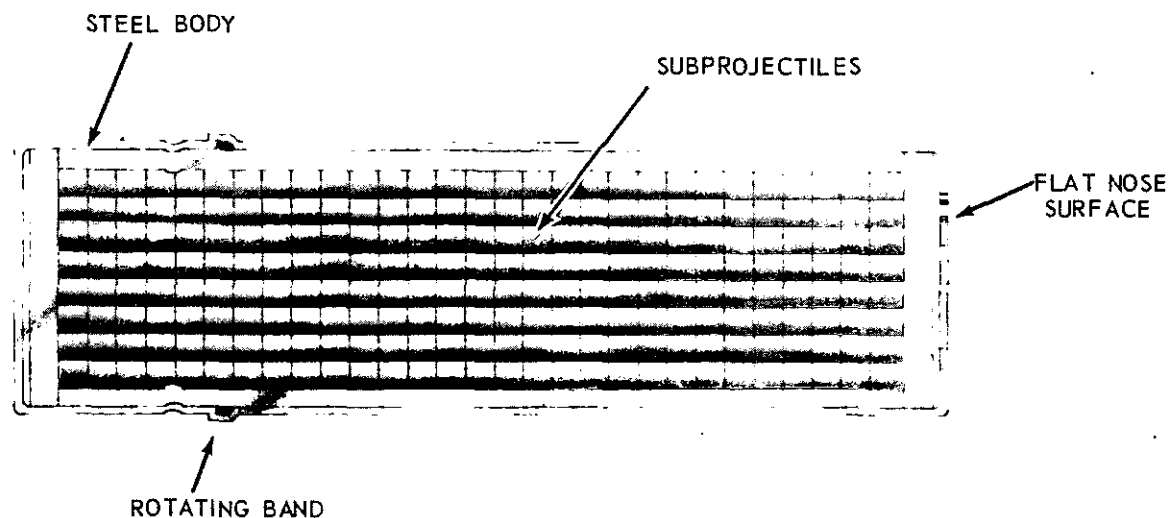

Figure 18. Canister projectile.

duced by the HEP projectile is similar to that produced by the HE projectile. It will vary however, depending upon the angle of impact. Because the ballistic characteristics of the HEP-T projectile allows it to be affected more readily than most other projectiles by wind, drift, and cant, a first round hit is more difficult when engaging distant stationary or moving targets. When engaging close-in targets, obscuration produced by firing presents a problem in adjustment of fire. Although these problems do exist, with the proper training (para. 95) tank crews can be trained to employ this projectile very effectively. HEP-T is available for the 105-mm gun only and is announced in the initial fire command as HEP.

22. Canister

Canister projectiles (antipersonnel use only) contain a large number of *subprojectiles*, a *slotted cylindrical body* with *rotating band*, no tracer element, and a flatnosed surface. As the projectile (fig. 18) leaves the muzzle of the gun, centrifugal force will rupture the projectile, discharging the subprojectiles. The maximum lethal effect of this round will take place between 150 and 200 meters. Canister is available for the 76- and 90-mm guns and is announced in the initial fire command as CANISTER.

Caution. Canister is not to be fired over vulnerable friendly troops.

23. Employment of Antipersonnel/ Antimateriel Ammunition

Antipersonnel/antimateriel ammunition (except canister), because of its blast, fragmentation, and concussion effect will be employed against field fortifications, bunkers, pill boxes, personnel, buildings, some armored and all unarmored vehicles, built-up areas, and crew served weapons. If experience proves that machinegun fire can be used to destroy any of these targets, it should be used within its effective range to conserve main gun ammunition.

a. Destruction of Unarmored and Lightly Armored Vehicles. Unarmored vehicles can be penetrated by coaxial machinegun fire. Lightly armored vehicles can be penetrated by caliber .50 machinegun fire or by the blast and fragmentation of antipersonnel/antimateriel ammunition. Unarmored vehicles include trucks and automobiles of all types; lightly armored vehicles include scout cars, some types of armored cars, and personnel carriers. Vehicles that cannot be penetrated by this fire should be engaged with armor-defeating ammunition. Unarmored vehicles are vulnerable to all types of fire, but their speed often makes them difficult to hit. HE or HEP ammunition should be used to destroy these targets when they are beyond the maximum effective range of machineguns (para. 32-34).

b. Firing at Dismounted Troops. Dismounted troops constitute an area target by varying depth, width, dispersion, and vulnerability. Attacking infantry should be engaged with machinegun fire whenever possible; however, the type weapon and ammunition employed depends primarily on the range and the actions of the enemy troops. Normally, HE or HEP is employed against troops beyond effective machinegun ranges. At lesser ranges, the fire of the machineguns is added to or substituted for that of the main gun. Depending on the terrain, ricochet fire may be effective against troops advancing under cover. At close ranges, (150-200 meters) canister is most effective against mass attacks, but consideration must be given to the location of vulnerable friendly troops before this type of ammunition is fired. Assaulting tanks employ the coaxial and caliber .50

machineguns while moving, firing into trenches and other vulnerable parts of the enemy defense. SMOKE (para. 27) also can be employed for its incendiary, screening, and casualty-producing effect.

c. Destruction of Crew-Served Weapons. Crew-served weapons include antitank guns, towed artillery, recoilless rifles, machineguns, and mortars. Crew-served weapons are sometimes encountered in hasty positions, but usually are placed in prepared positions with good cover and concealment. They present small targets with low silhouettes. Normally HE or HEP is employed to destroy these targets.

d. Destruction of Field Fortifications. Bunkers and pillboxes provide good protection against all types of fire, but they can be penetrated and defeated by employing the proper type of ammunition. A direct hit with HE or HEP at the aperture will result in part of the force of the explosion and fragmentation being directed inside the position. The possibilities of achieving a detonation inside the bunker are increased by employing HE delay. The HEP round or the concrete-piercing fuze with the HE round is most effective against concrete or masonry (pillboxes). Replacing the standard point detonating fuze with the concrete-piercing fuze should be accomplished prior to an operation and stowed in the tank. Should HE-CONCRETE or HEP prove to be ineffective, HEAT ammunition may be used to weaken the structure followed by an HE-CONCRETE or HEP round. The choice of ammunition for engagement of bunkers and pillboxes will depend primarily on the combat experience of the commander, ammunition availability, and target vulnerability. However, employment of HE or HEP has a greater casualty-producing effect and conserves armor-defeating ammunition.

24. Special Uses of Antipersonnel/ Antimateriel Ammunition

In addition to the specific techniques of target destruction previously mentioned, there are other special uses of main gun ammunition that have proved effective in battle. Combat situations may arise where the following fire techniques could be employed effectively.

a. Use of HE and HEP. HE and HEP are versatile types of ammunition as they can be employed in numerous ways against a wide variety of targets. The following special uses are in addition to those discussed previously:

- (1) They give excellent fragmentation effect when fired into treetops over the heads of enemy troops. With HE, superquick fuze normally is used; however, if the trees are exceptionally tall or the troops are deep in the woods, delay fuze should be used.
- (2) They may be employed in the reduction of certain obstacles such as roadblocks. They are ineffective for clearing minefields. Use of these rounds for this purpose will result in a waste of the limited amounts of ammunition available.
- (3) HE and HEP are effective for attacking troops occupying masonry buildings. When firing HE, fuze delay is usually the most effective for this purpose.

- (4) They may be used in reconnaissance by fire of probable enemy positions beyond the effective range of the caliber .50 machinegun.

b. Use of HEP Against Armor. HEP is primarily an antipersonnel/antimateriel round. It is the only such round of ammunition for use with the 105-mm tank gun; therefore, it should be reserved for destruction of personnel and materiel targets. However, in the event that armor-piercing ammunition is in short supply or has been expended during an operation, HEP ammunition may be used to engage an armored target. If used, and a direct hit is obtained, HEP will produce varying results, with concussion being the primary target effect. Depending upon the type and thickness of the armor, spalling (chipping of the armor plate opposite the point of impact) may occur simultaneously with concussion. These effects will kill or injure the crew, produce damage to the fire control instruments and other less rugged components, and damage the structure of the vehicle.

Section V. SPECIAL PURPOSE PROJECTILES AND USES

25. General

Special purpose projectiles include white phosphorus, which is used in combat and in training practice to train armor crewmen in the proper technique of tank gunnery.

26. White Phosphorus (WP) Projectiles

This projectile (fig. 19) is similar in construction to the HE projectile. It consists of a—

a. Point Detonating Fuze (para. 14) which is issued set to function immediately (superquick) upon impact. A fuze wrench or screwdriver is used to test the fuze to function in delay. This fuze cannot be replaced with the concrete-piercing fuze.

b. Steel Body which contains the white phosphorus filler and the burster tube.

c. Copper Rotating Band which causes the projectile to spin. This projectile may or may not have a tracer. The fuze is armed by cen-

trifugal force and functions on impact (superquick). The fuze action detonates the burster tube, which ruptures the body and disseminates the white phosphorus filler. When exposed to air, white phosphorus will burn and produce a dense white smoke. The white phosphorus round is available for the 76, 90, 105, and 120-mm guns and is announced in the initial fire command as SMOKE (hereafter referred to as SMOKE or WP).

Caution. When white phosphorus is stored or transported in temperature higher than 111° F. (melting point), it should be positioned on its base. If positioned otherwise the filler may become displaced, due to melting and consequently, cause either premature detonation after firing or erratic performance in flight (TM 9-1903).

27. Use of White Phosphorus Ammunition

SMOKE is employed for screening, incendiary, casualty-producing, and marking purposes. There are many combat situations where

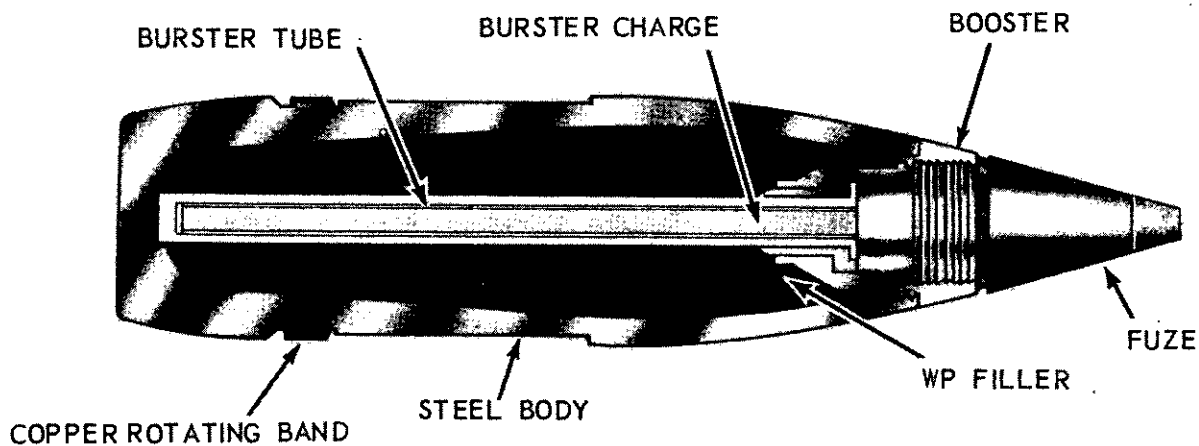

Figure 19. White phosphorus projectile.

use of this round, particularly in conjunction with other ammunition, will produce excellent results.

a. Screening blinds the enemy, allowing greater freedom of movement of friendly forces. SMOKE may be placed in front of the enemy to screen the maneuver of attacking tanks or to cover their withdrawal. Tanks are capable of temporarily screening short movements of the tank platoon or company. Due to the limited supply of this type of ammunition and the tendency of WP smoke to dissipate and rise rapidly, tank ammunition should be employed for screening purposes only when other sources are not available. The basic factors governing the employment of SMOKE are wind direction and velocity. With a wind from the flank, the screen is started upwind of the target so that it will drift into and in front of the enemy. With a tailwind, SMOKE should be placed just in front of the target; with a headwind, SMOKE should be placed on or behind the target. When the wind velocity is high, the rate of fire must be increased to maintain the screen. When firing into a strong headwind, consideration must be given to smoke drifting over friendly positions.

b. In addition to its incendiary effect on buildings and log fortifications, SMOKE is effective in burning out enemy positions in woods and brush. The factors of wind direction and velocity that govern the employment of SMOKE for screening apply also to its use

for burning purposes. HE, HEP, or machine-gun fire should be employed in conjunction with SMOKE to destroy and harass enemy troops driven from cover by fires.

c. The casualty-producing effect of SMOKE is a direct result of its incendiary nature. Best results are obtained when it is fired into an enclosure, such as a bunker or the ground floor of a building. It is also effective against troops in the open, because the burning phosphorus sticks to the skin and clothing. Although SMOKE does not have the destructive capability of HE or HEP, it has a much greater psychological effect on enemy troops.

d. SMOKE can be used also to mark targets; however, care must be taken so that the target is not obscured.

28. Target Practice Projectiles (TP-T)

These projectiles are used only for training purposes. They have the same shape and ballistic characteristics as the service (combat) round for which they are substituted. However, they do not contain an explosive filler nor cause the same target effects. The firing of these projectiles rather than service projectiles will cause less damage to range facilities; also, it is less expensive. They will be announced in the initial fire command the same as the service rounds they represent, e.g., target practice high explosive antitank (HEAT/TP-T) would be

announced as HEAT. If it becomes necessary to fire both service and target practice projectiles of the same type during training, then the

service projectile would be properly announced (HEAT) and the target practice projectile announced as TP-T.

Section VI. IDENTIFICATION OF MAIN GUN AMMUNITION

29. General

Ammunition can be identified by its shape, color code with markings, and by its location prescribed by the stowage plan. For shape or configuration, see figure 20.

a. *Color Code.* Ammunition is painted with a special paint to prevent rust and other corrosion. In addition it provides a color code for ease of identification, and to indicate primary uses (fig. 21).

b. *Markings.* Ammunition is identified by markings on the outside of its packing containers (fig. 22). Once removed from its packing, it may be identified by color and markings found on the rounds (fig. 23). The lot number of the ammunition is one of these markings. It is stenciled on the projectile and stamped on the base of the cartridge case and on its packing box. The lot number is information required for records, reports of condition, functioning, and accidents in which the ammunition is involved. To obtain the greatest accuracy in firing, successive rounds should be from the same ammunition lot whenever practicable.

30. Ammunition Stowage Plan

The ammunition stowage plan should be identical for all tanks in a battalion-size unit. This stowage plan should include location of all ammunition authorized for the basic load, by type and number of rounds. All ammunition loaded aboard the tank should be stowed in the racks according to the stowage plan. The stowage plan not only serves as a guide for the initial stowage of ammunition, but also serves as an aid to the crew, regarding supply of ammunition, by indicating the number of rounds by type that have been fired. During darkness, when the use of lights inside the turret would reduce the crew's night vision or give away the tank's position, the stowage plan assists the loader in locating rapidly that type of ammunition announced in the initial fire command. When preparing this plan, consideration must be given to the location of those ammunition racks that have been specified for only HEAT or SABOT.

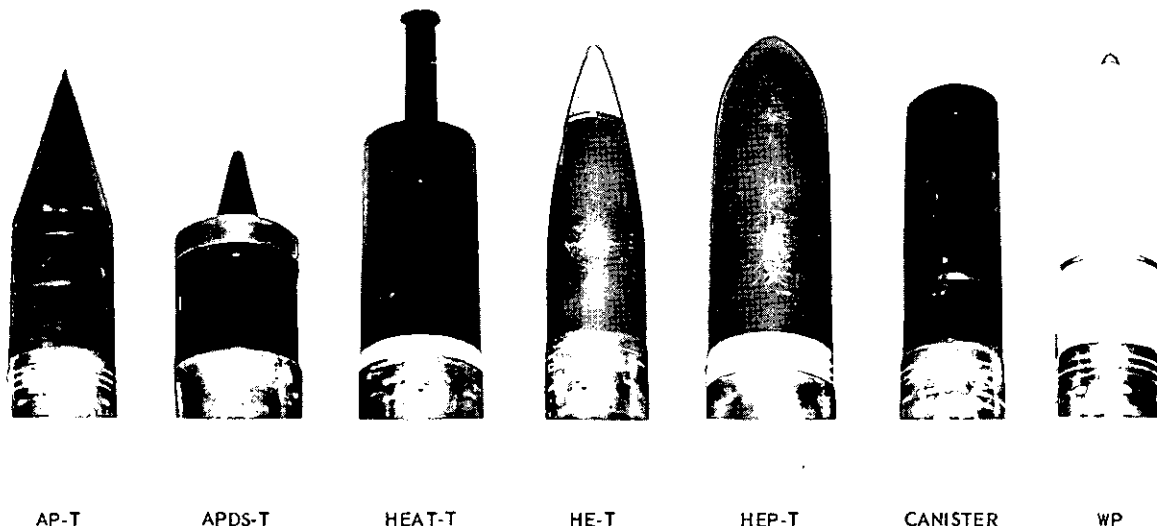

Figure 20. Configuration of tank gun ammunition.

TYPE OF AMMUNITION	BASIC COLOR WITH MARKINGS
Armor-Piercing Discarding Sabot (APDS-T)	Black with white markings
Armor-Piercing (AP-T)	Black with white markings
Armor-Piercing Target Practice (TP-T)	Blue with white markings
High Explosive Antitank (HEAT-T)	Black with yellow markings
High Explosive Antitank Inert (HEAT-INERT)	Black with yellow and blue band
High Explosive Antitank Target Practice (HEAT/TP-T)	Blue with white markings
Canister	Black with white markings
High Explosive, High Explosive Plastic (HE-T, HEP-T)	Olive drab with yellow markings
White Phosphorus (WP)	Light green with light red markings

COLORS INDICATING PRIMARY USES

- Yellow--High Explosive
- Light Green--White Phosphorus
- Black--Armor Piercing
- Blue--Target Practice, Inert and Drill
- Light Red--Incendiary
- Olive Drab--Antipersonnel
- White--Lettering and Marking Only

Figure 21. Ammunition color code.

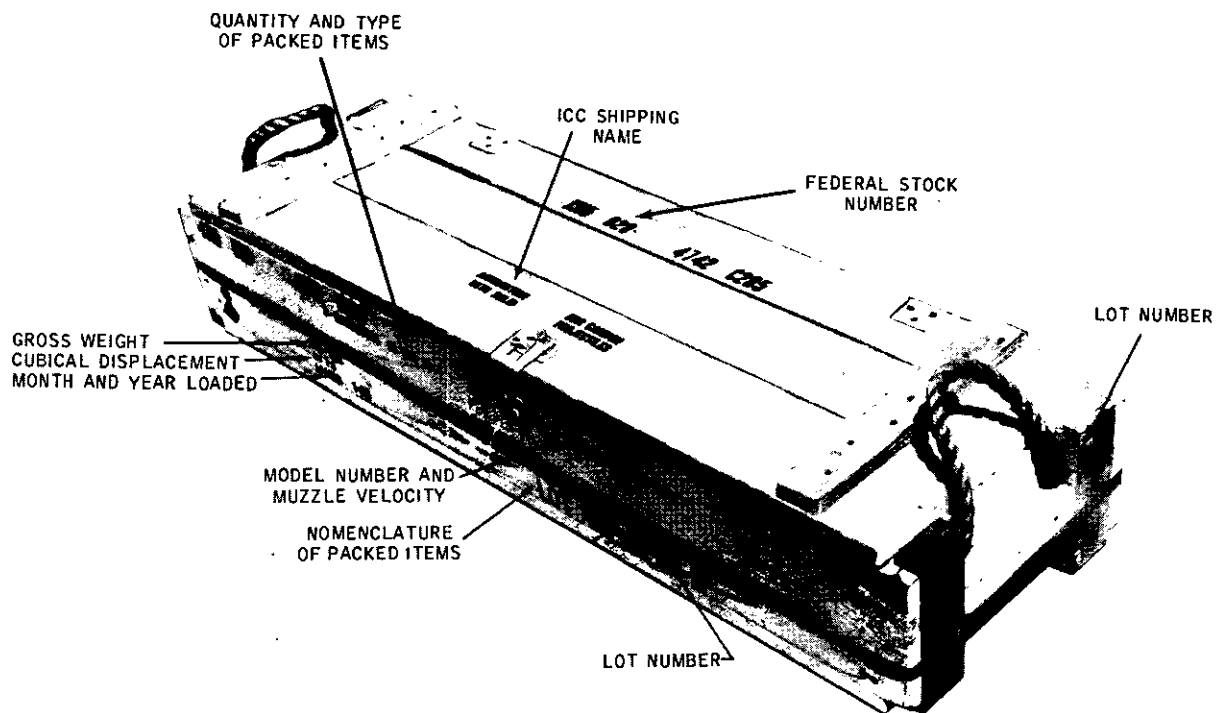

Figure 22. Typical two-round packing box.

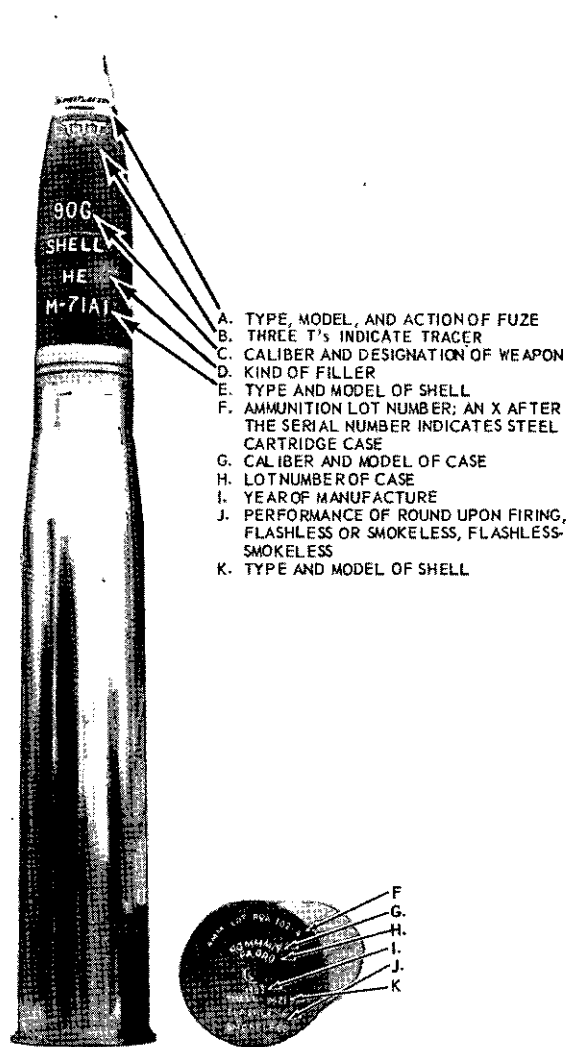

Figure 23. Typical markings on ammunition.

Section VII. MACHINEGUN AMMUNITION, IDENTIFICATION AND USES

31. General

Machinegun ammunition is belted in metallic link belts (MLB). In tank gunnery training and in combat, machinegun ammunition should be linked together in a ratio of 4 nontracer to 1 tracer (except for subcaliber exercises, which should be all ball or frangible). Tracer ammunition of some type is included in each belt to be used in automatic fire for observation and subsequent adjustment of fire. As machinegun fire normally cannot be adjusted beyond the range of tracer burnout, this determines

the maximum effective range of each type machinegun. Tracers of the same type do not burn out at exactly the same range. The figures used are averages and, therefore, approximate, but they are accurate enough to use in establishing a maximum effective range. Machinegun ammunition is identified by type, caliber, model, and lot number. A color code on the bullet tip is for identification by type. Markings are also located on the original packing containers (figs. 24 and 25). Units equipped with M85 machineguns must insure that the caliber .50 ammuni-

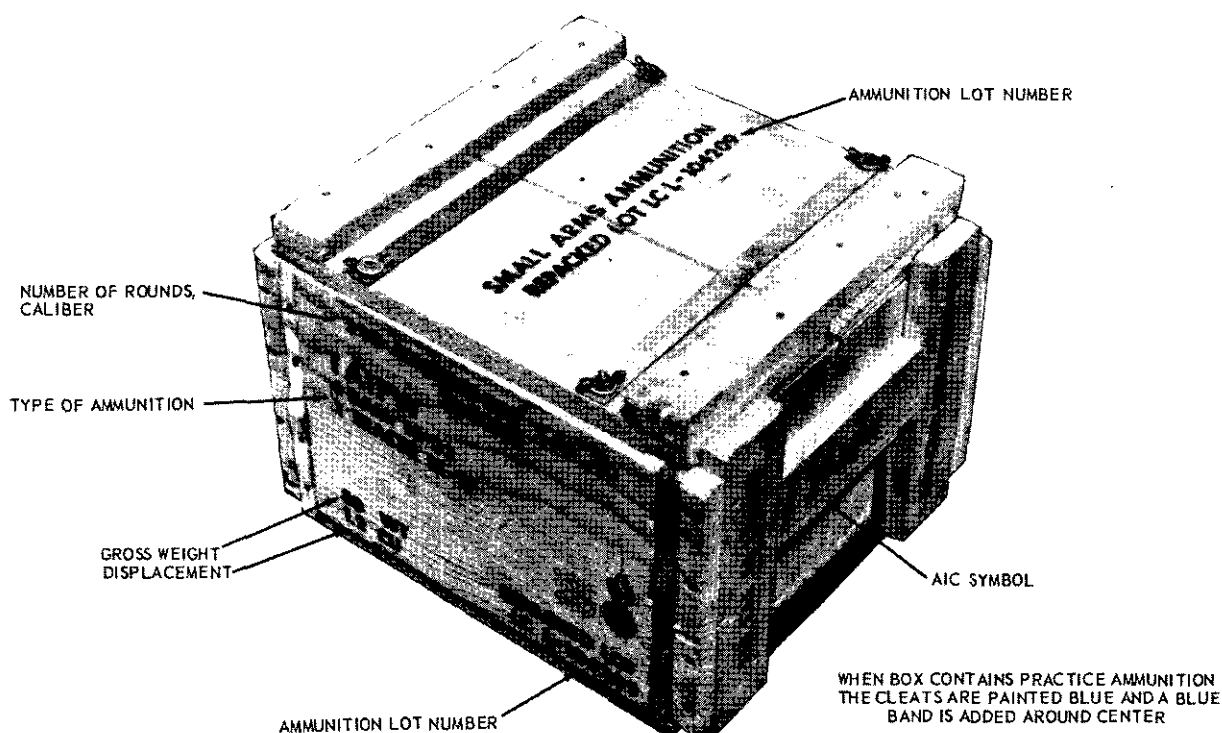

Figure 24. Typical wooden packing box for small arms ammunition.



Figure 25. Typical metal packing box for small arms ammunition.

tion is linked with the clip-type link rather than the closed loop link. For methods of employment of machineguns see paragraphs 5 through 8.

32. Cartridge Types, 7.62-MM Machinegun

a. *Armor-Piercing (AP) M61.* Belted with tracer, M62, is the standard combat ammuni-

tion used against personnel, unarmored vehicles, and equipment. The link M13 (clip-type) is used in belting.

b. *Tracer M62.* Burnout occurs at approximately 900 meters (1,000 yards).

c. *Ball M59.* Used in training.

33. Cartridge Types, Caliber .30 Machinegun

a. *Armor-Piercing Incendiary (API) M14.* When belted with tracer, M25, this is the standard combat ammunition used against personnel, unarmored vehicles, and equipment. The link M1 (closed-loop) is used in belting.

b. *Tracer, M25.* Burnout occurs at approximately 900 meters (1,000 yards).

c. *Ball, M2; Tracer, M25; Blank, M1909; and Frangible, M22.* Used in training.

Caution. Frangible ammunition will not be fired on indoor ranges without adequate ventilation because of the toxic hazard that may occur.

**34. Cartridge Types, Caliber .50
Machinings**

a. *Armor-Piercing Incendiary (API) M8.* When belted with armor-piercing incendiary tracer, M20, this is the standard combat ammunition used against personnel, unarmored vehicles, some lightly armored vehicles, equipment, and aircraft. Caliber .50 ammunition to be fired with the caliber .50, HB series of machineguns must be linked with either the M2 or M9 (closed-loop) link. The M15A2 (clip-type) link must be used for ammunition to be fired with the caliber .50, M85 machinegun.

b. *Armor-Piercing Incendiary Tracer (AP-IT) M20.* Burnout occurs at approximately 1,600 meters (1,750 yards).

c. *Ball, M33 or M2; Tracer, M17.* Used in training. Tracer (M17) burnout is approximately 2,250 meters (2,450 yards).

**35. Identification of Machinegun
Ammunition by Color Code**

<i>Type of cartridge</i>	<i>Color of tip of bullet</i>
Armor-Piercing	Black
Armor-Piercing Incendiary	Silver
Armor-Piercing Incendiary Tracer	Red and silver
Tracer (7.62-mm, caliber .30)	Red
Tracer (caliber .50)	Red
Ball	Not painted
Frangible	Green and white

Note. Dummy ammunition is identified by corrugated or perforated cartridge cases.

Blank ammunition is identified by its colored plug in place of a bullet (an exception is the 7.62-mm, which has an elongated case).

PART THREE

FIRE CONTROL AND SIGHTING EQUIPMENT

CHAPTER 4

DIRECT-FIRE CONTROL SYSTEM

36. General

This chapter discusses the components of the direct-fire control systems and their uses. When a target can be seen through the sights, the direct-fire control system is used. The components included in the direct-fire control system are—

a. For the tank commander—the range finder and/or periscope, supplemented by hand held binocular.

b. For the gunner—the computer or ballistic unit, periscope, superelevator in the hydraulic system, ballistic drive, and as the gunner's secondary sight, the telescope (fig. 26).

37. Binocular

The binocular is used by the tank commander to acquire targets, and to observe and adjust fire. By placing the center point of the horizontal mil scale on the target, he can measure deflection in mils that the round is to the left or right of the target. The measurement will form the basis of his deflection or lead correction (fig. 27). He can also measure vertical height in mils to aid in the determination of range (fig. 28). For adjustment and uses of the binocular see chapter 15.

38. Range Finder (M48 and M60 Tanks)

a. The range finder is used by the tank commander:

- (1) To determine accurate ranges.
- (2) As a direct-fire sight.
- (3) To sense rounds fired at night when

the target is illuminated by visible light.

- (4) To designate targets to the gunner.

b. Procedures for training range finder operators are contained in chapter 15. Because the range finder is linked to the computer, the tank commander can index range into the direct-fire control system on main battle tanks when the periscope sight is used by the gunner. Range finders have a nonballistic reticle graduated in mils (fig. 29).

39. Tank Commander's Sight (M41 Tank)

a. The tank commander's sight on the M41 tank moves with the gunner's primary sight and is used—

- (1) To designate targets to the gunner.
- (2) As a direct-fire sight.
- (3) To sense rounds fired at night when the target is illuminated.

b. It has a nonballistic reticle that is essentially the same as the gunner's periscope reticle (fig. 29).

40. Computer (M48 and M60 Tanks)

The computer receives ammunition information from the gunner and range information from either the tank commander's range finder or the gunner by means of the superelevation hand crank. The computer determines the superelevation (fig. 30) and transmits it to the fire control system based on the range and ammunition indexed. This data is transmitted to the ballistic drive and to the gunner's and

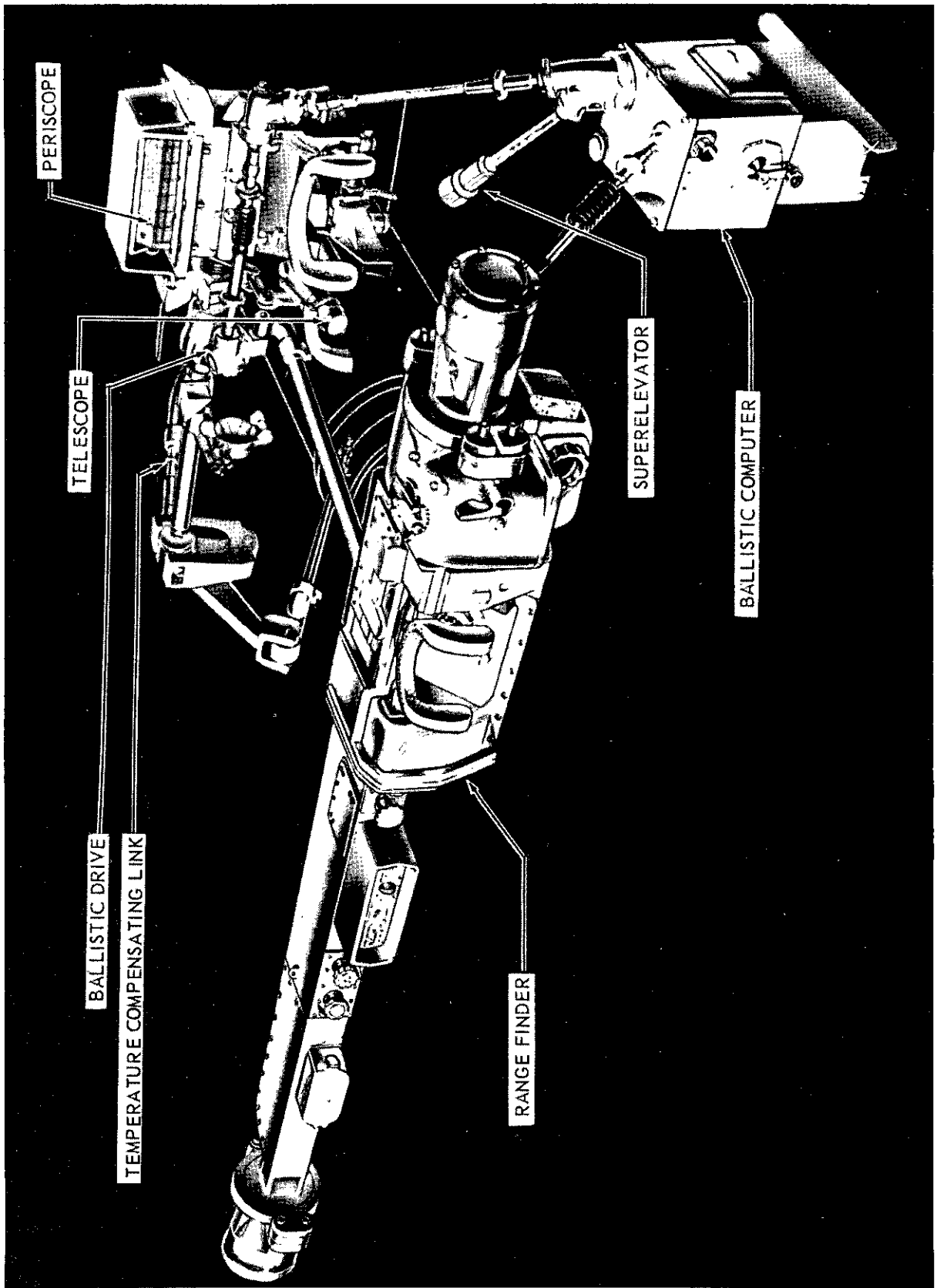
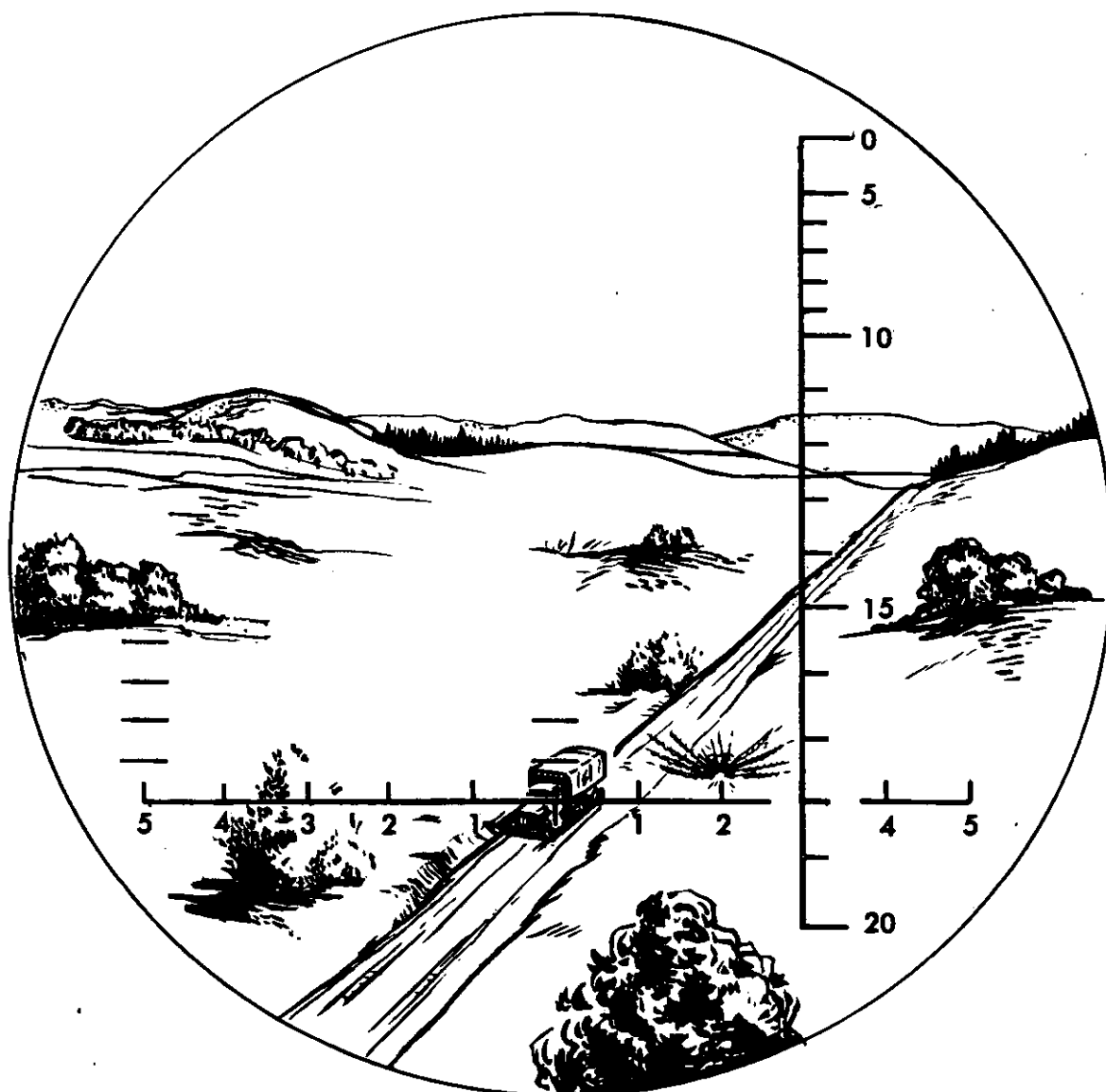

Figure 26. Representative direct-fire control system.



THE BURST IS 20 MILS RIGHT OF TRUCK.

Figure 27. Measuring a horizontal angle with the binocular.

tank commander's sights and, on the M48A2, M48A3, and M60 tanks, to the superelevator and the gun.

41. Ballistic Unit (M41 Tank)

The gunner must index both the range and ammunition, which are announced by the tank commander, in the ballistic unit. The ballistic unit then determines the superelevation data and transmits it to the ballistic drive and to

the tank commander's and gunner's primary sights, causing them to move while the gun remains stationary.

42. Gunner's Periscope

The gunner's periscope is his primary direct-fire sight because of its location and ease of use. It incorporates a nonballistic reticle (fig. 29) graduated in mils. In conjunction with the computer or ballistic unit, it can be used for

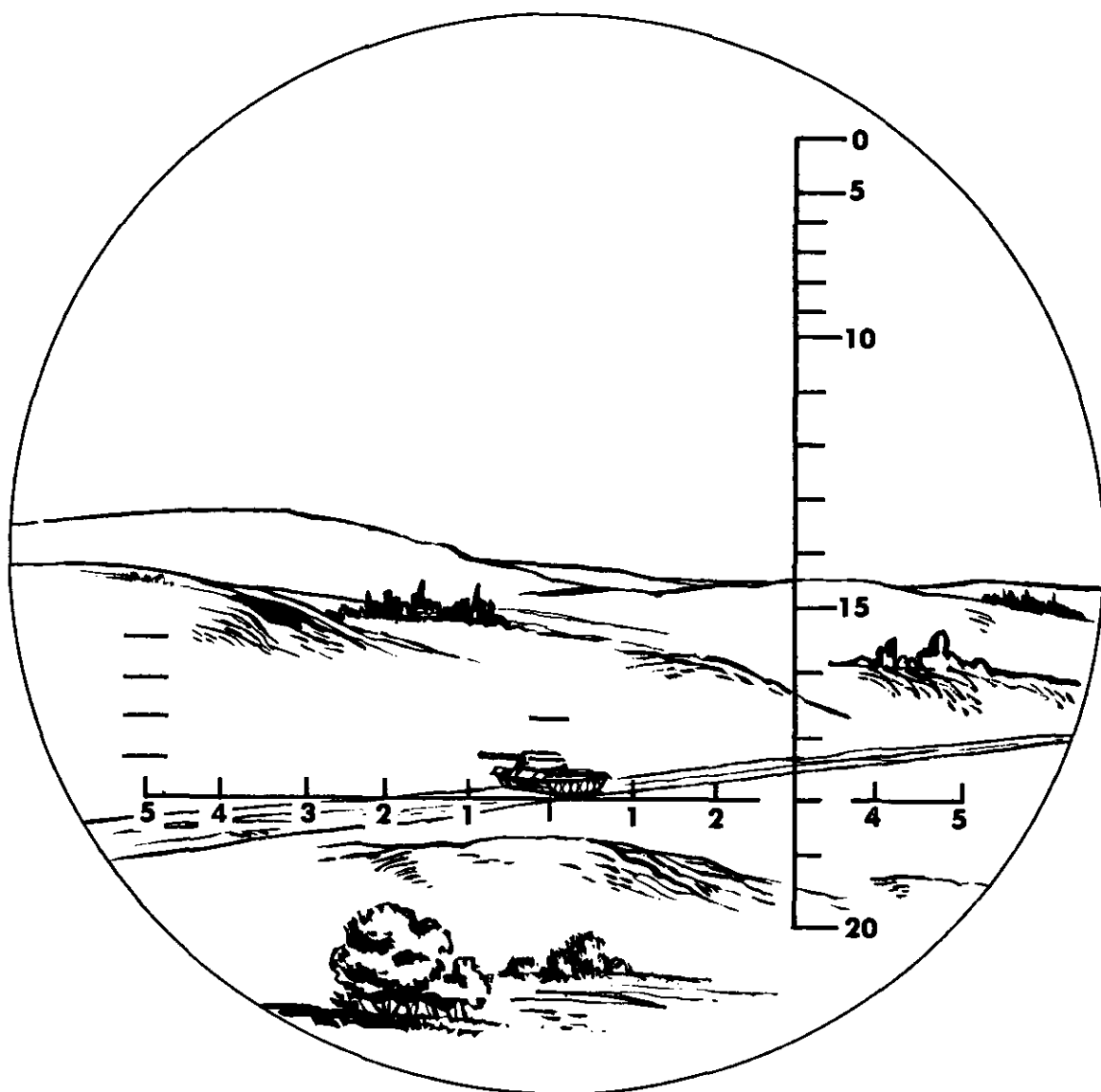

THE MIL ANGLE SUBTENDED BY THE HEIGHT OF THE TANK IS 6 MILS.

Figure 28. Measuring a vertical angle with the binocular.

all types of main gun ammunition and the coax machinegun. The viewing window has a unity (one power) field of view to provide a wider field of vision than that of the sight. In some viewing windows a projected infinity sight is provided as a coax machinegun sight (fig. 31).

43. Superelevator (M48A2, M48A3, and M60 Tanks)

The superelevator receives superelevation

data from the computer in the form of mechanical movement. The superelevator controls the flow of oil through the hydraulic lines to the elevation cylinder under the gun. With the turret power on, this causes the gun to move approximately the required amount above the line of sight for a given round to hit a target at a given range (superelevation angle).

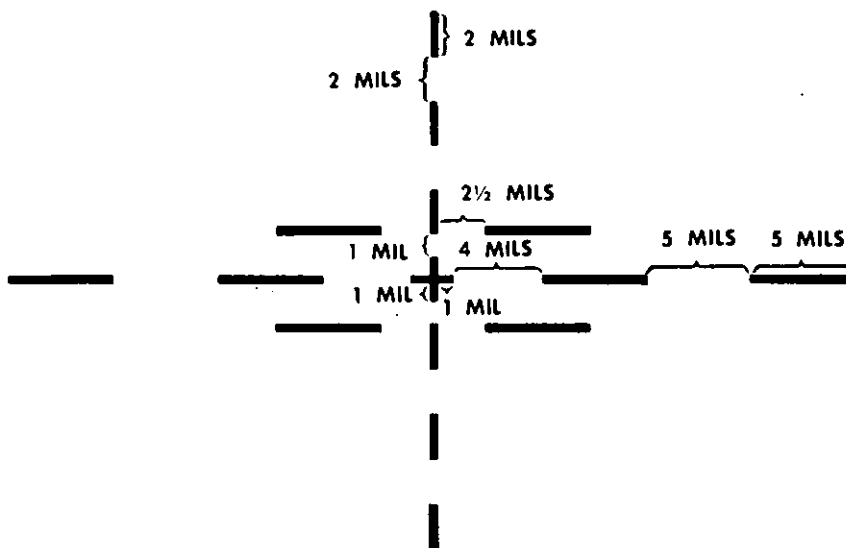

Figure 29. Nonballistic reticle.

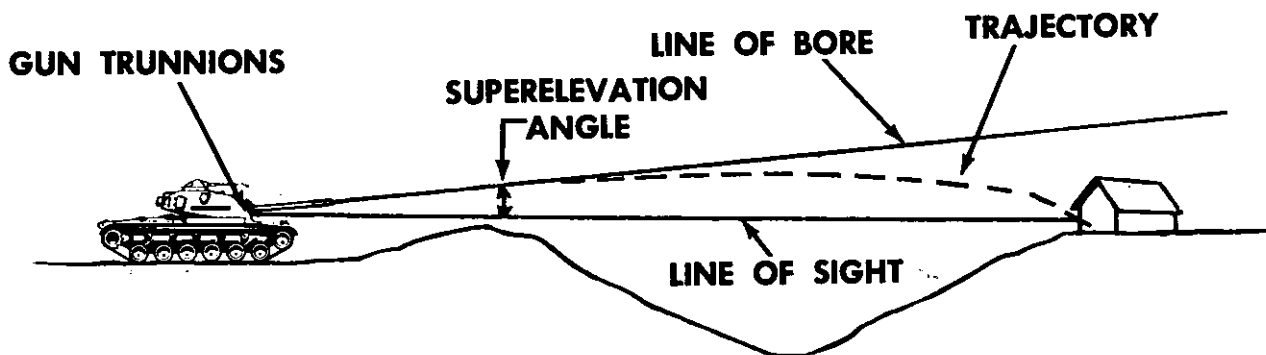

Figure 30. Super-elevation angle.

44. Ballistic Drive

The ballistic drive causes the gun and sights to move together when the gun controls are used. On those tanks equipped with a super-elevator it allows the sights and gun to move independently of each other to apply super-elevation to the gun while the sights remain within 1 mil of the aiming point. On those tanks without a super-elevator or on which the turret power is inoperative, it allows the sights to move independently of the gun to apply super-elevation.

45. Telescope

The telescope is mounted coaxially to the main gun and is used as the gunner's secondary

direct-fire sight. Telescopes that are articulated (jointed) have an eyepiece that remains in a fixed position for ease of the gunner's sighting. Because the telescope is not linked to the computer, the tank commander must announce the range to the gunner when the telescope is being used. However, the tank commander should determine range as accurately as possible, using the range finder if available.

a. Reticle. The telescope has a ballistic reticle, which means, it is graduated for a particular type of ammunition. The graduations are in yards or meters of range and in mils of deflection. The lead lines are either 2 1/2 or 5 mils wide, (figs. 32 and 33). Some telescopes have selectable reticles and some reticles themselves

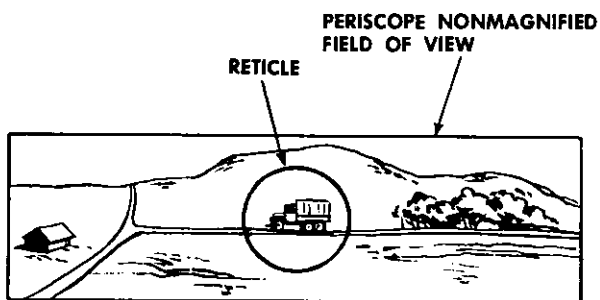

Figure 31. Infinity sight reticle (nonballistic).

combine the ballistics of two different types of ammunition (fig. 33). When the telescope is being used and there is no reticle for the ammu-

nition being fired, the gunner must either refer to an aiming data chart or use the computer (ballistic unit) as an aiming data chart (c below).

b. *Aiming Data Chart* (fig. 34). This chart is found in the tabular firing table issued to the tank unit or it may be issued separately. In either case it may be attached to the recoil guard of the main gun for ready reference. To use it the gunner reads—

- (1) Down the column of the announced ammunition to the announced range.
Example: SHOT (AP) 1300.
- (2) Across to the sight diagram to deter-

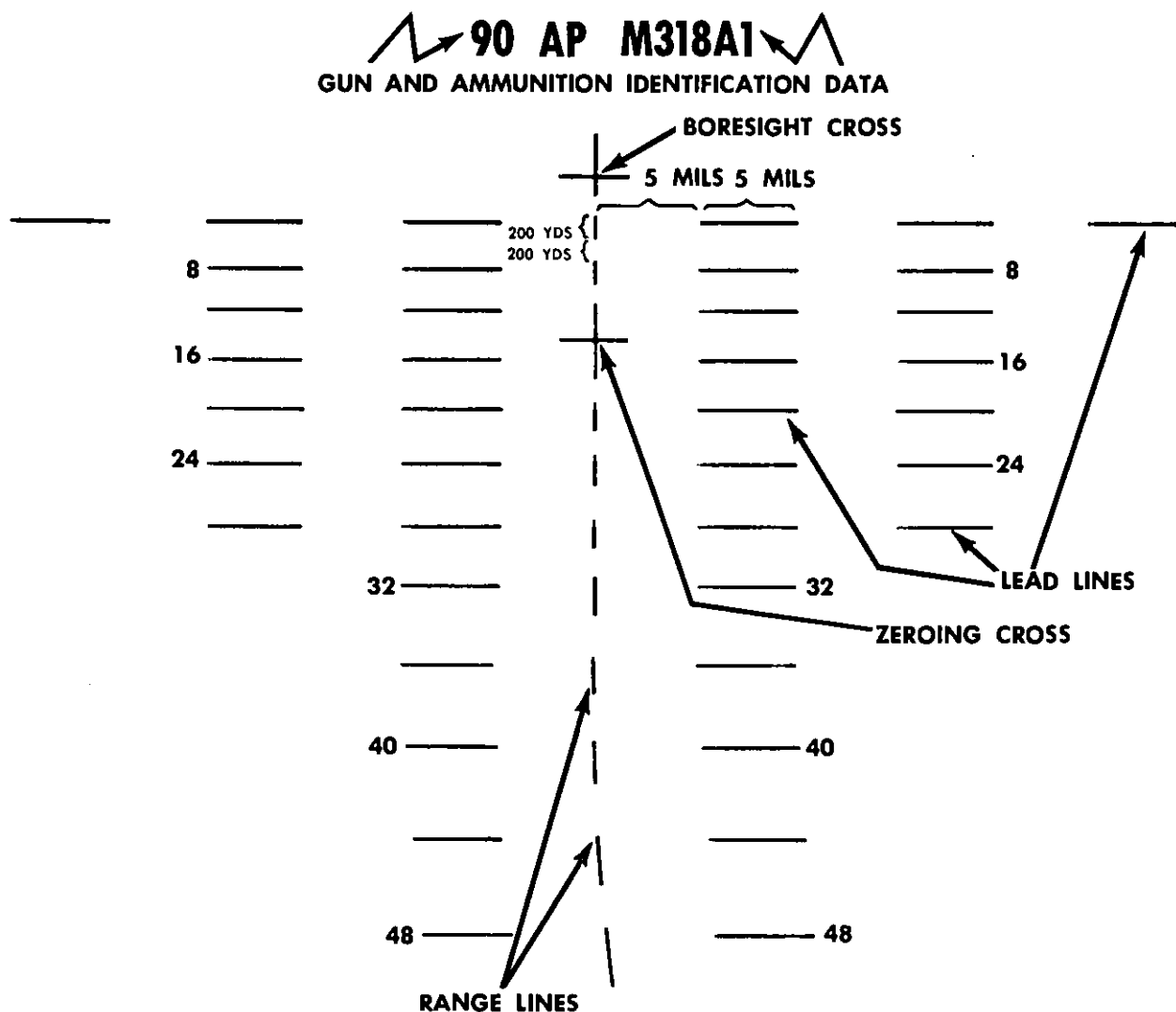

Figure 32. Ballistic reticle.

105-MM APDS-T M392

AND

HEP-T M393

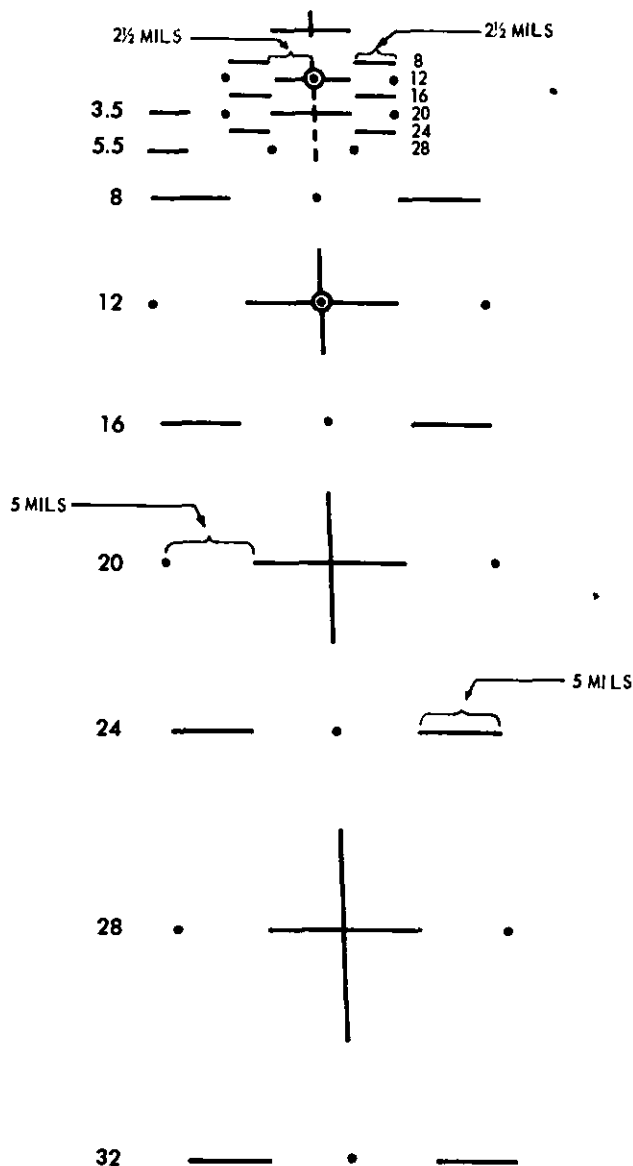

Figure 33. Ballistic combination reticle.

mine the range line to place on the target to fire. *Example: 1600.*

c. Computer as an Aiming Data Chart.

- (1) The gunner will index the announced ammunition in the computer.

- (2) The tank commander will range on the target and turn the computer off.
- (3) The gunner will then index the type of ammunition for which the reticle is graduated.
- (4) The gunner will note the range indi-

TANK, 90-MM GUN, M48-SERIES
W/CANNON, M41 AND TELESCOPE, M97G

HE, M71	T300E54 RETICLE PATTERN	HE-T, M71A1
WP, M313		WP, M313C
1		1
2		2
3		3
4	8	4
6		5
7		6
9		7
10	15	8
11	16	9
13		10
15		12
17		14
20	24	16
24		19
27		22
31		25
36	32	29
41		34
46		38
		43
	40	49

HEAT-T, T300E54 IN METERS
ON RETICLE ADC 90-X-1

AP-T, M318A1	T300E54 RETICLE PATTERN	CAL. 0.30 MACHINE GUN
TP-T, M353		
1		1
3		2
4		
5	8	3
7		4
9		5
11		
12	15	6
13	16	
15		7
18		
21		8
24	24	9
28		10
32		11
36		12
41	32	13
46		14
		15
		16
	40	18

Numbers and lines under the reticle column are those that appear on the reticle.

- To use chart:
1. Find the type of ammunition to be fired.
 2. Read down to the range at which you will fire.
 3. Move left (or right) and find the corresponding sight setting under the reticle column.
 4. Use this point in the telescope to lay and fire.

Figure 34. Aiming data chart.

cated by the outer pointer on the computer range dial and place this range line of the telescope reticle on the target.

d. Ballistic Unit as an Aiming Data Chart.

(1) The gunner indexes the announced

range and ammunition in the ballistic unit.

- (2) He then notes the indexed range for the ammunition for which the reticle is graduated.
- (3) He places this range line of the telescope reticle on the target.

CHAPTER 5

AUXILIARY FIRE CONTROL INSTRUMENTS

46. General

The auxiliary fire control instruments are designed to complement the direct-fire control system in providing the tank crew with a 24-hour capability of delivering effective fire. The instruments are primarily used to obtain and apply range card data for the tank's armament and searchlight. If the tank is used in the artillery role then the instruments are used to apply firing data from the fire direction center. The instruments used in this system consist of a gunner's quadrant or elevation quadrant and an azimuth indicator.

47. Gunner's Quadrant

This instrument (fig. 35) is OEM on all standard tanks. It is used to measure and apply angles of elevation on those tanks without mounted elevation quadrants. On main battle tanks this quadrant is used primarily to check and adjust the mounted elevation quadrant. In measuring and applying angles, it is possible to interpolate the reading of this quadrant to the nearest one-tenth of a mil. There are two scales on this quadrant: the elevation scale graduated in 10-mil increments, and the micrometer scale graduated in increments of two-tenths of a mil. Each scale has an index to designate readings. A level vial is mounted on the index arm. To measure or apply *plus* angles of elevation, the black line-of-fire arrow must be pointed to the muzzle end of the main gun. *Minus* angles are measured or applied with the black line-of-fire arrow pointing to the breech end of the gun. To use the quadrant to measure or apply angles of elevation, the quadrant shoes are placed on the seats or scribed marks provided on the breechring of the main gun. The index arm and micrometer knob or the gun controls are manipulated to obtain the proper reading. The quadrant must be checked

periodically for accuracy by the end-for-end test. If the correction is greater than 0.4 mil it must be turned in to Ordnance.

48. Elevation Quadrant

This instrument (fig. 36) is found only on the main battle tanks and is used to measure and apply gun elevation angles. Elevation angles can be measured and applied to the nearest 1 mil. It is mounted on the ballistic drive cross shaft or on the recoil guard of the main gun. The elevation quadrant has two scales: the elevation scale graduated in 100-mil increments and the micrometer scale graduated in 1-mil increments. Black figures indicate *plus* readings and red figures *minus* readings. Each scale has an index to designate readings. The quadrant has a level vial and a reflector to aid the gunners when centering the bubble. Elevations are applied or determined by rotation of the micrometer knob and use of the gun controls. The elevation quadrant is checked and adjusted by using the gunner's quadrant.

49. Azimuth Indicator

a. The azimuth indicator (fig. 37) is used to lay the gun for direction and to measure horizontal angles. It is mounted so that its gear meshes with the turret ring gear and is located on the right side of the turret where it can be viewed by the gunner. The azimuth indicator has three scales: an azimuth scale graduated in 100-mil increments, a micrometer scale graduated in 1-mil increments, and a gunner's aid scale graduated in 1-mil increments. There are three pointers: an azimuth pointer (middle) and a micrometer pointer (outer), both of which are adjustable, and a directional pointer (inner). The directional pointer indicates the amount of turret traverse measured from the front center of the tank and is non-

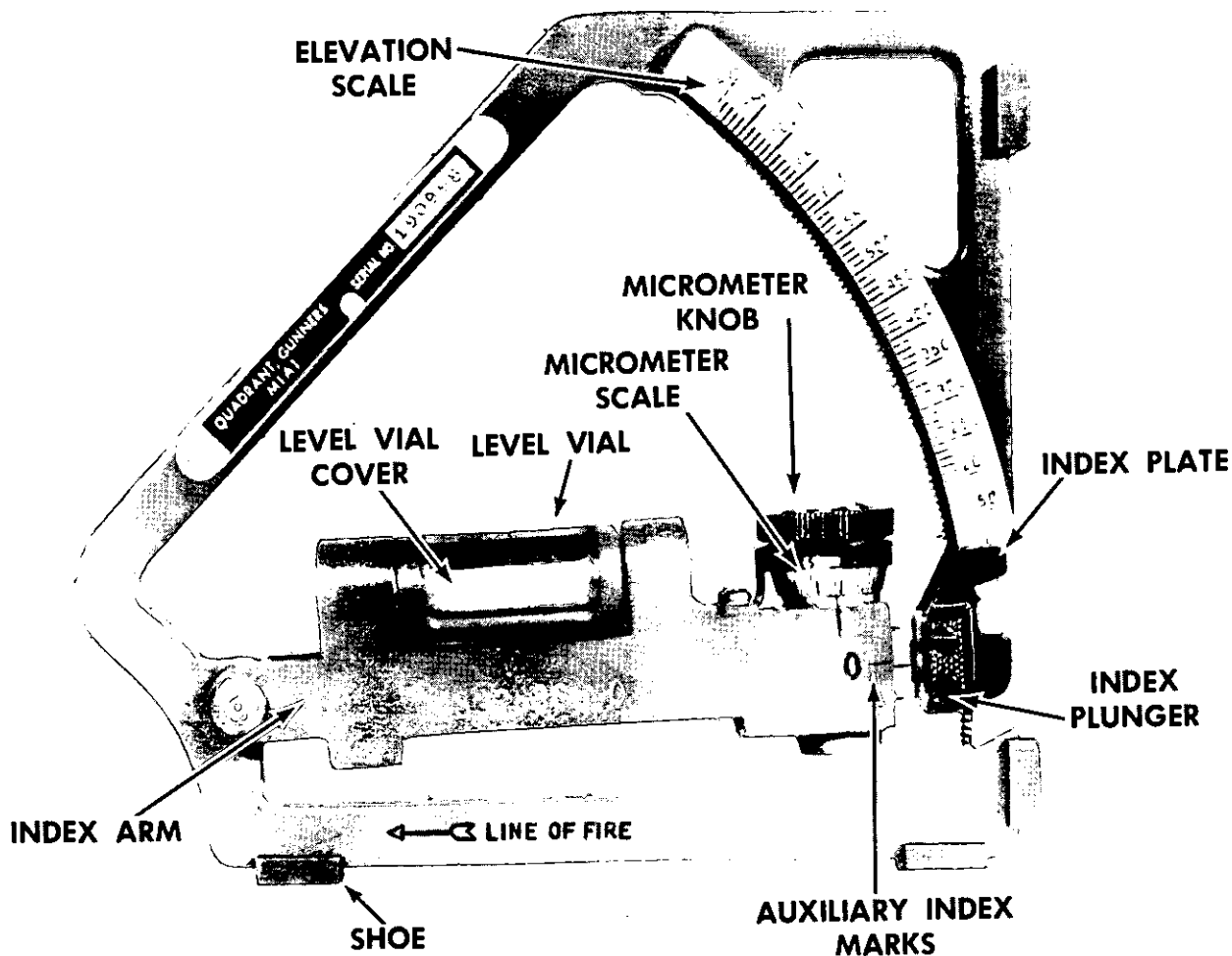

Figure 35. Gunner's quadrant.

adjustable. To use the azimuth indicator, the gun is laid on a reference point by use of the direct-fire sights. The resetter knob is pushed down and rotated to move the azimuth and micrometer pointers to zero, then released. Any subsequent turret rotation will be measured by the azimuth and micrometer scales. For small shifts (50 mils or less) in deflection, the gunner's aid is rotated to index the zero of its

scale opposite the micrometer pointer; then the turret is traversed in the desired direction until the micrometer pointer indicates the required deflection angle on the gunner's aid.

b. Azimuth indicators must be checked periodically for accuracy and slippage. As no error is allowable, inaccurate instruments must be repaired by Ordnance.

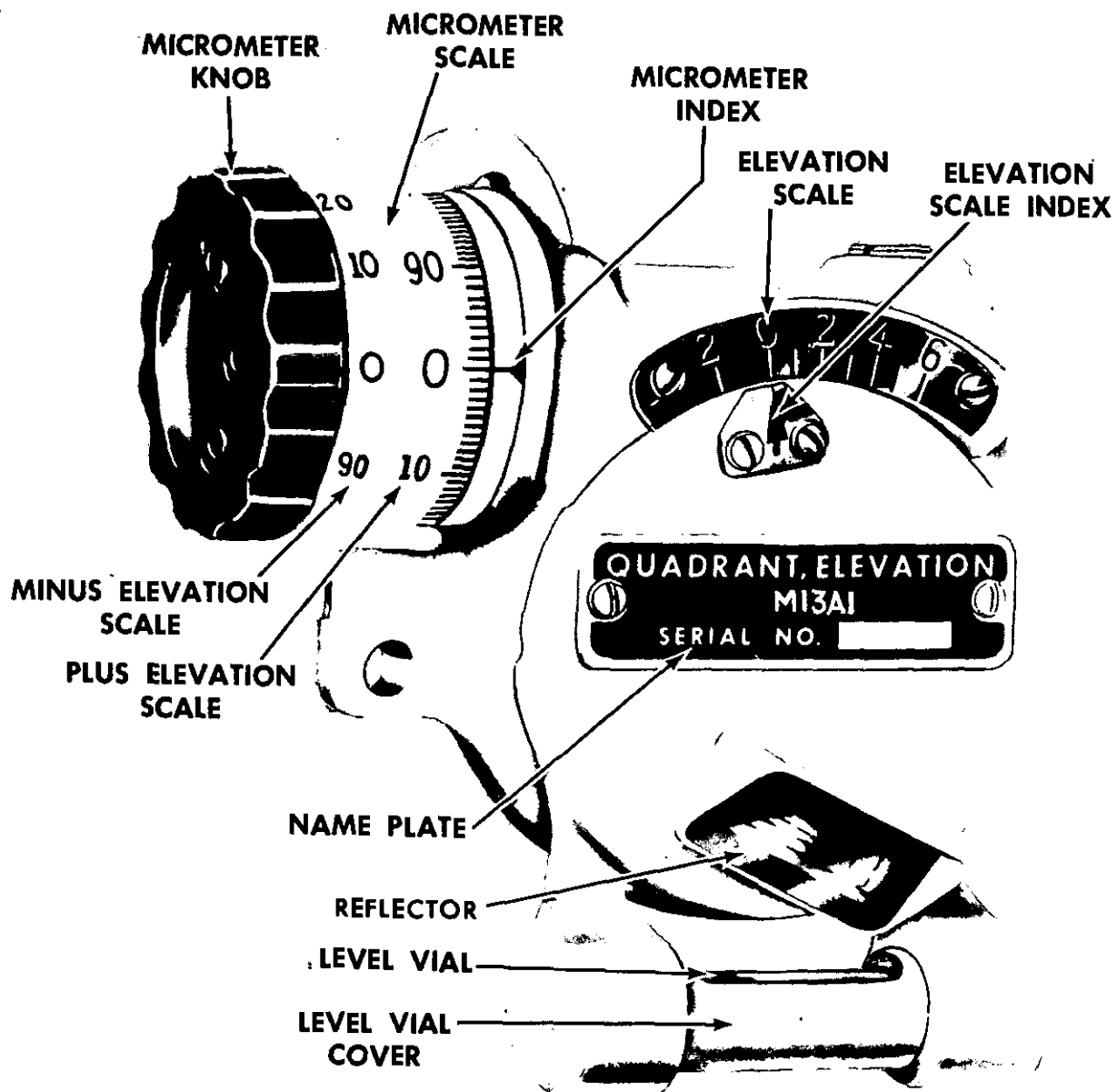

Figure 36. Elevation quadrant.

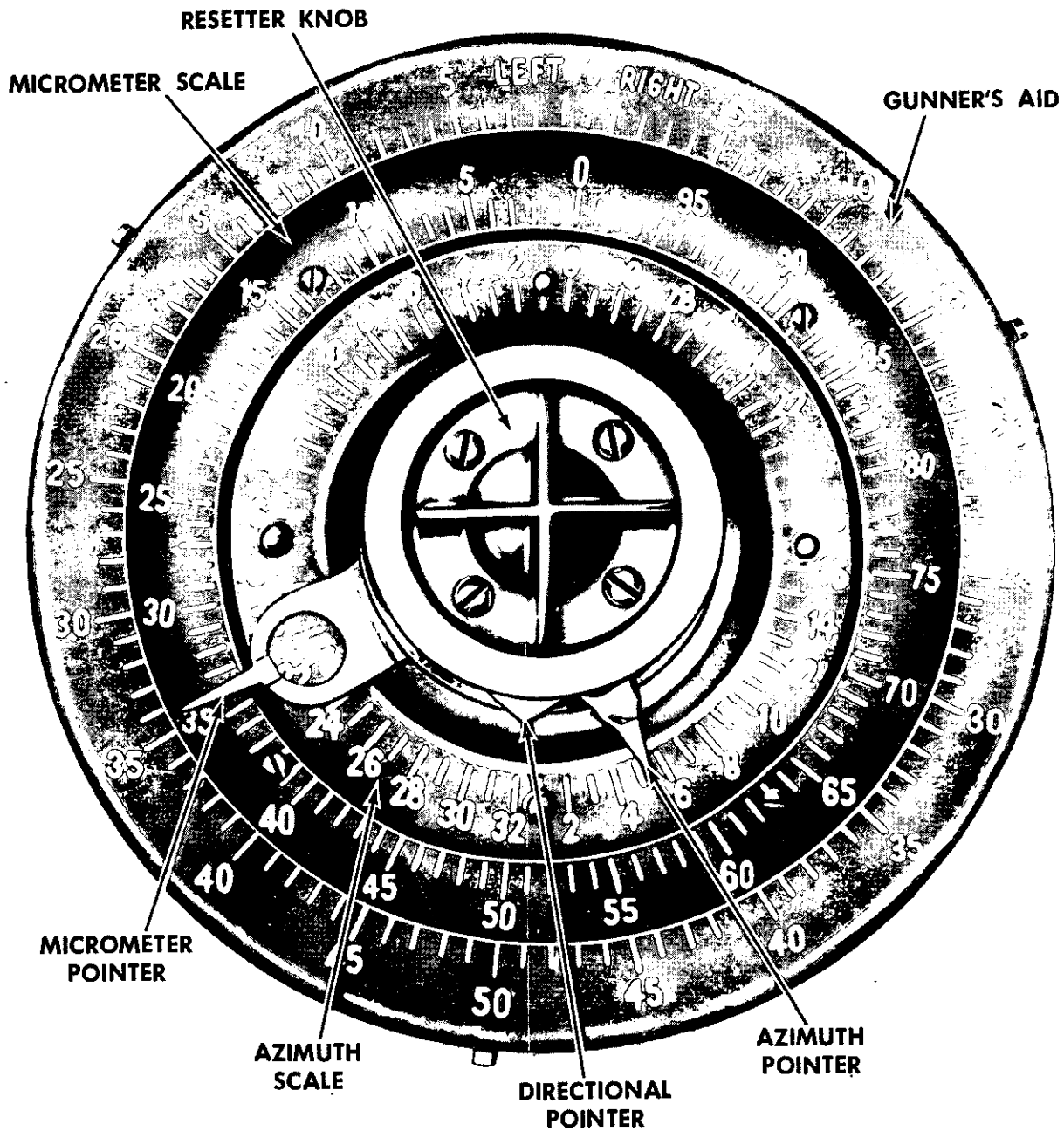

Figure 37. Azimuth indicator.

CHAPTER 6

TANK-MOUNTED SEARCHLIGHTS

50. General

All tank-mounted searchlights are mounted coaxially with the main gun. The tank crew can position the searchlight on a target area prior to illumination by use of the gun controls. When in a position for which a range card has been made, the tank crew can lay the searchlight on a specific point prior to illumination by using the auxiliary fire control instruments and the gun controls. If a tank has a stowage rack for the searchlight, then the light can be removed and stowed for daylight firing. This

makes the light less vulnerable to enemy fire and permits freer operation of the cupola machinegun. Some standard searchlights have a visible light capability only, while others have both visible and infrared capabilities. For employment of the searchlight and precautionary procedures see paragraphs 114 through 116 of this manual and appendix XV, FM 17-1.

51. Searchlight

The 18-inch searchlight (fig. 38) has a visible light capability, with a maximum effective



Figure 38. 18-inch searchlight.



Figure 39. Xenon searchlight.

range of approximately 1,000 meters on a clear night. If adverse weather conditions exist, i.e., rain, mist, fog, etc., the effective range would decrease proportionally. On tanks equipped with this searchlight, the light should be properly focused and boresighted (para. 54d). Once boresighted, the searchlight can be laid using the same controls that are used for the main gun. Instruction in the care and maintenance of the 18-inch searchlight is found in TM 5-6230-201-15.

52. Infrared Visible Light Kit for M60-Series Tanks

a. General. This light kit consists of a searchlight, a gunner's periscope, two periscopes for the tank commander, and a pair of infrared binoculars. The kit provides the crew with a visible light capability and an infrared light

viewing capability. The sights provide for direct fire with infrared light and can be used to detect the use of infrared light by the enemy.

b. Xenon Searchlight. The Xenon searchlight (fig. 39) has a dual capability of visible or infrared light. This searchlight has an increased maximum effective range with visible light in comparison with the 18-inch searchlight and provides a means of employing direct fire with infrared light. Either the visible or infrared light beam can be controlled in width from a minimum of 2 degrees to a maximum of 7 degrees (approximate figures). Either beam can be boosted in intensity by use of an *overdrive* capability. The overdrive can be selected by the tank commander on his control panel and once applied will operate for approximately 15 seconds, then automatically kick off. The

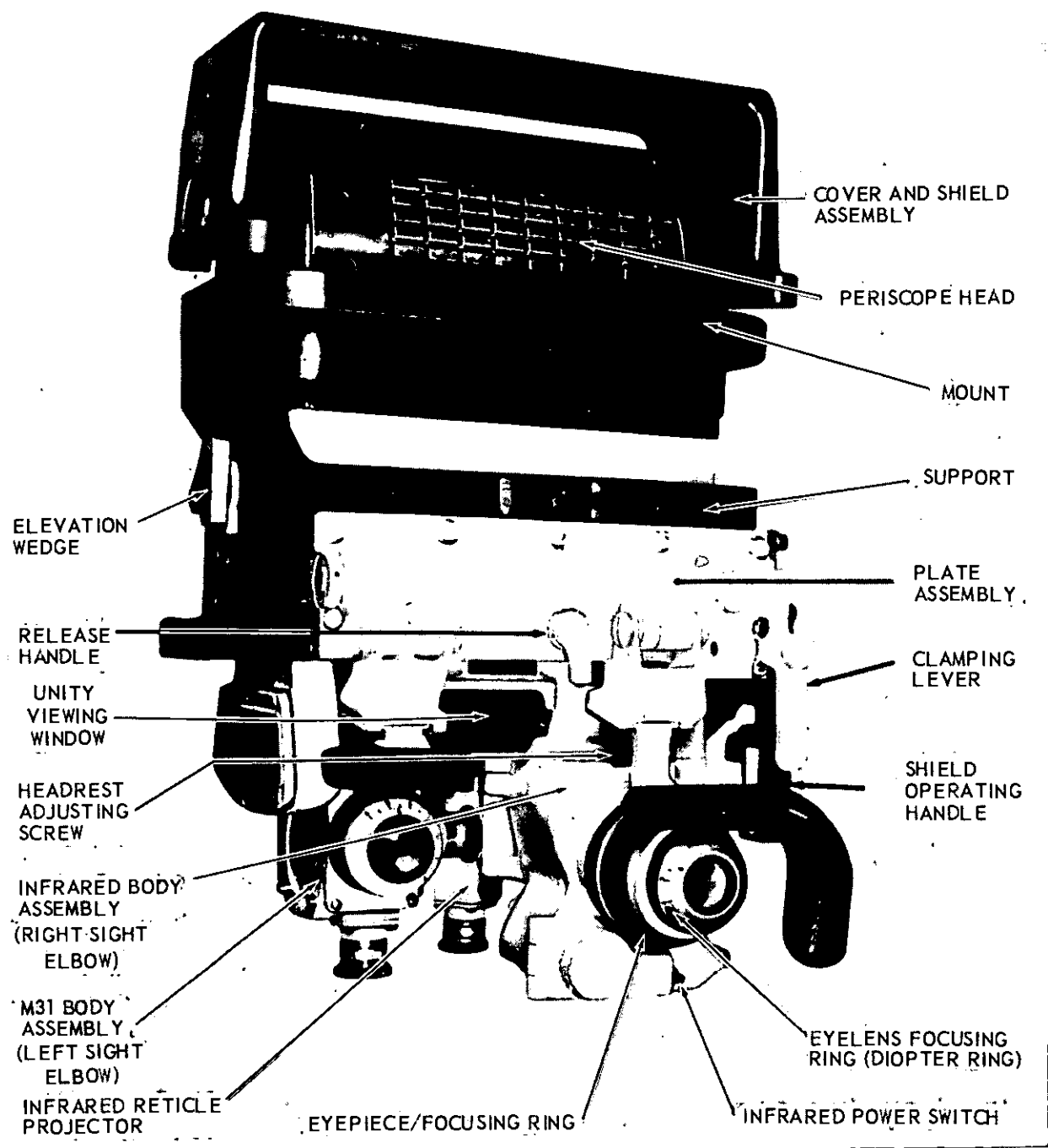

Figure 40. Gunner's periscope M22 (visible-infrared).

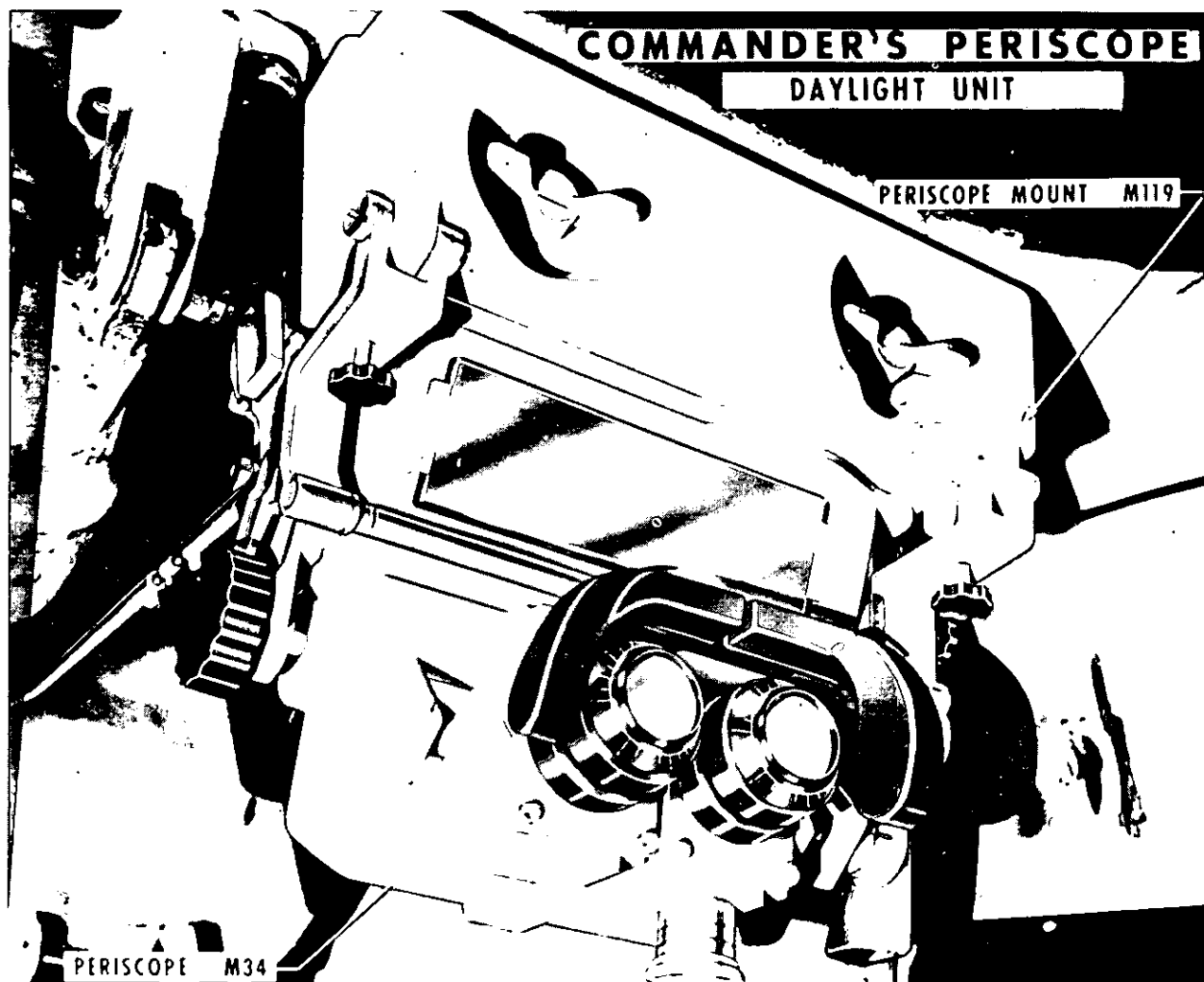

Figure 41. Tank commander's periscope M34 (visible light only).

control panel has a standby position, which will allow warmup of the light for instant illumination without leakage of light to the exterior. Conversely this standby position provides for instant cutoff of illumination without an "after-glow." If adverse weather conditions exist, the maximum effective range of either visible or infrared light would decrease proportionally. This searchlight is mounted coaxially to the main gun. A stowage rack is provided so that it can be placed in a less vulnerable position during daylight operations. The light must be focused and boresighted properly prior to operation. Once boresighted the searchlight can be laid using the same controls that are used for the main gun. Care and maintenance of

the Xenon searchlights are outlined in TM 5-6230-204-12.

c. Gunner's Periscope. The gunner's periscope (fig. 40) which is issued with the kit replaces the original periscope on the tank. It has two sight elbows. The left sight elbow for visible light has 8-power magnification and contains a nonballistic reticle. The right sight elbow for infrared light has 8-power magnification and contains a nonballistic reticle. A unity (1) power wide angle viewing window is also provided.

d. Tank Commander's Periscopes. The tank commander has two periscopes that use the same head assembly. They replace the periscope

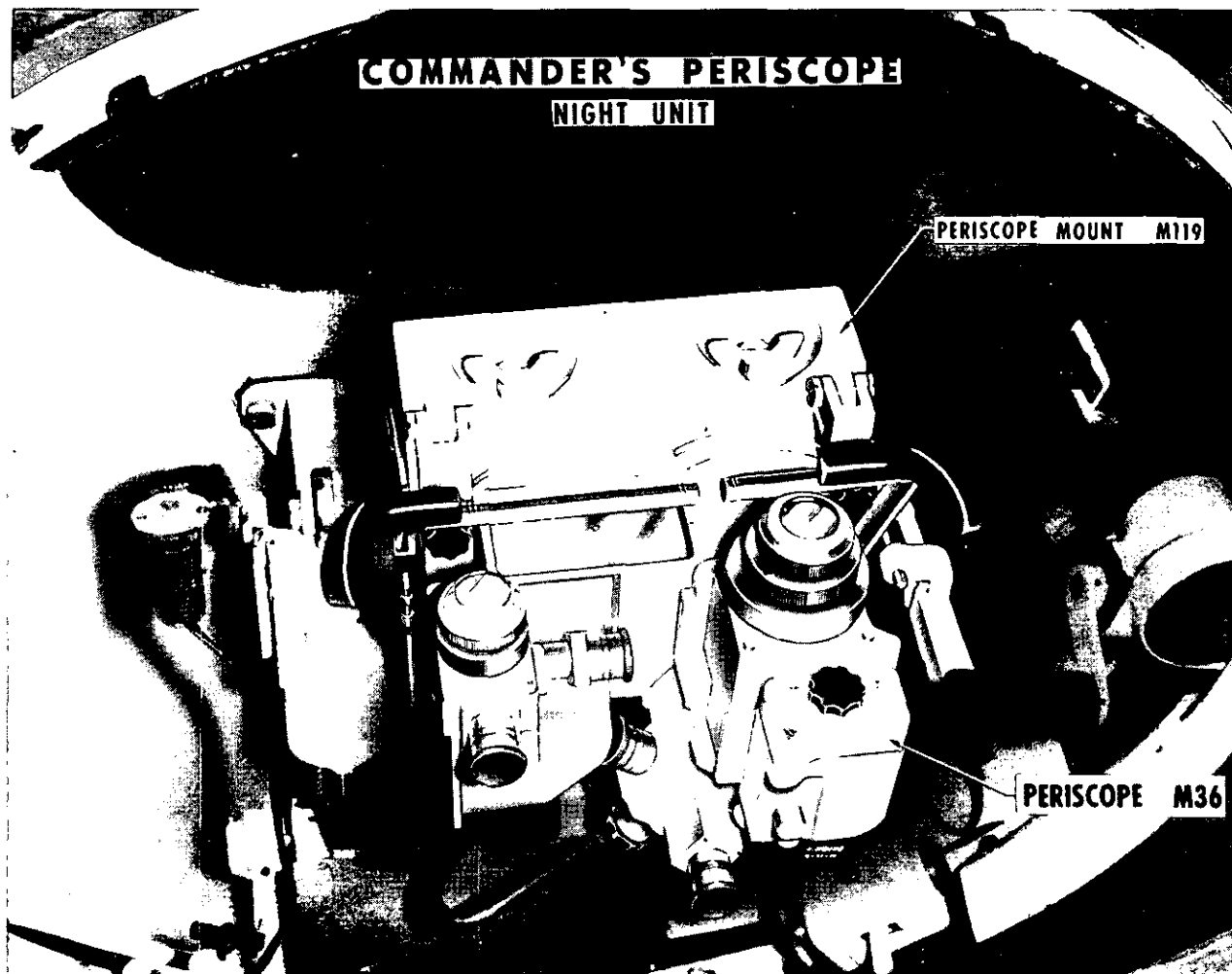

Figure 42. Tank commander's periscope M36 (visible-infrared).

for the cupola machinegun. One is a binocular periscope for visible light viewing only (fig. 41). It has 7-power magnification and contains a ballistic reticle in the left sight elbow for use with the cupola machinegun. The second periscope (fig. 42) is a combination visible-infrared sight similar to the gunner's periscope. It consists of two sight elbows. The left sight elbow is for viewing with visible light, has 7-power magnification, and contains a ballistic reticle for use with the cupola machinegun. The right sight elbow is for viewing with infrared light, has 8-power magnification, and contains

a nonballistic reticle. Each periscope has a unity (1) power wide angle viewing window.

e. Infrared Binocular. A pair of infrared binocular (fig. 43) is issued as part of the light kit. These binocular are for use with infrared light; they have 3.5-power magnification and do not contain a reticle. Their primary use is for target surveillance by the tank commander in conjunction with an infrared source. Once a target is acquired, the tank commander will use the infrared (right elbow) periscope for observing and adjusting fire.



Field of View(°)	12.0
Magnification	3.5X
Weight (pounds)	4.75

Tank Commander's Handheld Binocular, XM-18

Figure 43. Infrared binocular.

CHAPTER 7

BORESIGHTING AND ZEROING

53. General

Guns vary in their performance due to inherent differences such as wear, jump, and droop. The range scales used in fire control equipment are based on standard range table angles of elevation and make no allowance for the varying characteristics of individual weapons. To compensate for the variation in performance, sights must be adjusted. This adjustment must be accomplished periodically, as the movement of the tank and firing of the gun may cause the sights to move out of adjustment. Accurate sight adjustment is fundamental in tank gunnery; it is impossible to fire accurately without it. Sight adjustment includes boresighting, zeroing, and verification and refinement of the zero.

Note. Because of the extremely short ranges involved, boresighting and zeroing procedures for subcaliber firing are not the same as those discussed in this chapter. For boresighting and zeroing procedures for subcaliber firing, see paragraph 206b.

54. Boresighting

Boresighting provides the basis for all sight adjustment. It is performed to establish a definite relationship between the axes of the guns and the direct-fire sights, and is accomplished to facilitate zeroing or the indexing of an established zero. Complete boresighting, performed daily before firing, and as frequently as practicable in combat, includes boresighting the main gun, coaxial machinegun, cupola-mounted machinegun, and coaxially mounted searchlight. To boresight, position the tank as level as possible to eliminate or reduce cant error (para. 60b), charge manual accumulator on those tanks so equipped, and proceed as follows:

a Main Gun.

- (1) Select a target with a clearly defined right angle. Range to the target should

be as indicated in the technical manual for the tank.

- (2) Affix thread across the marks on the muzzle of the gun to form a cross. This cross is used as the front sight.
- (3) Open the breechblock and insert the breech boresight (if available). If no breech boresight is available, use the firing pin well as a rear sight.
- (4) Place the range finder (if tank is so equipped) in operation and index the range to the target on the range scale.
- (5) Remove all superelevation from the sights by use of the computer or ballistic unit.
- (6) Using the front and rear sights on the gun ((2) and (3) above), aline the axis of the bore on the target (aiming point) by *manually* elevating and traversing the gun. Use the right telescope of the binocular to sight through the gun tube (fig. 44).
- (7) Without disturbing the alinement of the gun, unlock the boresight knobs of all sights for the main gun and turn the knobs to move the aiming crosses or boresight crosses of all reticles to the aiming point (fig. 44). Relock the boresight knobs.
- (8) Slip the numbered scales on the boresight knobs in order to establish a known point from which to make corrections. The normal setting to which the scales are slipped is established for the standard boresight range in the technical manual for the tank. As a target may not be available at the standard boresighting range, some slip scales have reference marks for boresighting at other ranges. These alternate settings correspond to various

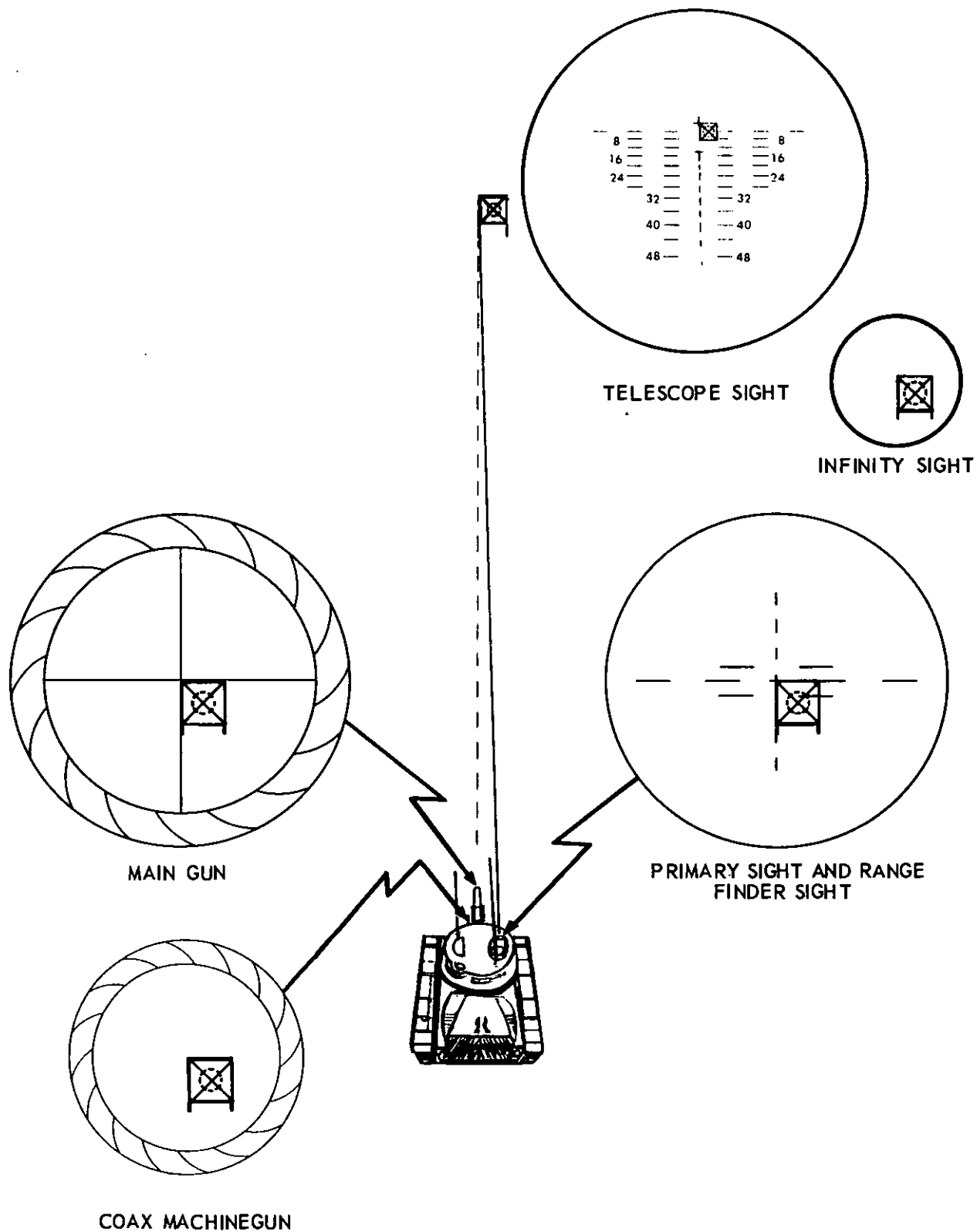

Figure 44. Boresighting the main gun and coaxial machinegun.

ranges and are etched in red on the slip scale. After boresighting at a range other than the standard boresight range, the scale should be slipped to the corresponding red number. For example, if a boresight range of 600 meters is used, the scales must be slipped to the red 6.

- (9) Recheck to insure that the gun and boresight point of all direct-fire sights are on the correct boresight point.
- (10) After slipping the scales to the appropriate numbers, index the established zero or emergency zero by unlocking the boresight knobs and turning them to the appropriate reading; then relock the knobs.

b. Coaxial Machinegun. Boresighting the coaxial machinegun takes place immediately after boresighting the main gun.

- (1) Select a target at the same range used for the main gun (normally the same target or aiming point).
- (2) With all superelevation removed from the fire control system, lay the aiming cross of the primary sight on the aiming point by use of the gun controls. Then if a separate sight is available for the coaxial machinegun, move this sight to the aiming point by use of its boresight knobs.
- (3) Remove the backplate and bolt or receiver group from the machinegun.
- (4) Looking through the barrel, move the axis of the barrel to the same aiming point by using the adjusting mechanisms on the machinegun mount.
- (5) Make a final check to insure that the sights and machinegun are on the aiming point and then replace the bolt and backplate or receiver group.

c. Cupola-Mounted Machinegun.

- (1) Select a target with a clearly defined right angle at a range of 500 meters (yards).
- (2) Remove the backplate group and the bolt from the machinegun.

Note. On the M85 caliber .50 machinegun, hold the feed cam lever to the left to allow a clear view through the barrel.

- (3) With the elevating and traversing controls, align the axis of the machinegun barrel on the aiming point. Engage the azimuth (travel) lock and use the vernier to make a precise adjustment.
- (4) Without moving the machinegun, refer the boresight point of the machinegun sight reticle to the same aiming point.
- (5) Replace the bolt and backplate group.

d. Tank-Mounted Searchlight. Boresighting the searchlight is aligning the axis of the searchlight parallel to the axis of the gun tube. Before such alinement is undertaken, the lamp must be properly focused. Boresighting is best accomplished during the hours of darkness or, if done in daylight, by placing the target in a shaded area. To boresight the searchlight, proceed as follows:

- (1) Project the beam on a smooth, light-colored, vertical surface, e.g., a 6 by 6-foot panel target. The target should be approximately 60 meters from the tank. Place two black dots approximately 2 inches in diameter on the target. Space the dots vertically with the same distance between them as distance between the axes of the gun tube and searchlight. With Xenon (visible light and infrared light capabilities) searchlights, either light can be used for boresighting.
- (2) Insert the breech boresight (if available) into the gun or remove the firing mechanism. Place black thread on the marks of the muzzle of the gun to form a cross.
- (3) Sight through the gun tube and, using the gun controls, lay the axis of the gun tube on the lower black dot. By moving the searchlight independently of the gun, place the center of the beam on the upper black dot. When this has been accomplished the searchlight is boresighted.

55. Emergency Zero

a. The emergency zero is used to compensate for the characteristics of the main gun and for

drift of the projectile in flight. This setting is applied to certain sights on the tank when no established zero has been determined. It is applied by unlocking the boresight knobs and turning them to move the reticle a specified number of mils in elevation and azimuth. The knobs are then relocked.

b. If any main gun sight has an established zero, all other main gun sights can be alined with this one without the need to zero.

c. If an established zero has not been determined for any sight and zeroing cannot be accomplished, firing will take place with the emergency zero.

d. If zeroing is to take place immediately after boresighting, the emergency zero need only be applied to the gunner's primary sight and the tank commander's sight.

e. If zeroing with HEAT or SABOT, no emergency zero is applied and zeroing is accomplished from boresight.

56. Zeroing

Both the tank commander and the gunner will go through the zeroing procedure together to insure accuracy. Zeroing is the firing of the gun to adjust the sights so that the point of aim and the point of strike of the projectile coincide at a given range, thereby increasing the accuracy of fire at all direct-fire ranges. When zeroing, all final lays of the main gun should be made in the same direction, against pressure, each time a round is fired to minimize slippage in the turret controls. All zeroing rounds should be of the same type and lot number and if the gun is cold, the first round fired is a warming round and is not part of the zeroing procedure.

a. *Main Gun* (fig. 45). To zero the main gun proceed as follows:

- (1) Boresight and apply emergency zero (if applicable).
- (2) Select a well-defined point in the target area at a range as indicated in the technical manual for the tank. The boresight target will normally be used.

Note. To give a high probability of all rounds in the shot group striking the target, this should be a 12- by 12-foot target. The

target used will have a dotted circle, 24 inches in diameter.

- (3) Determine the range to this target by the most accurate means available. Range finder is used on those tanks so equipped.
- (4) Index the range and type of ammunition to be fired in the fire control system and make a precise lay on the center of the target, using the *manual* controls.

Note. Normally the most accurate armor-defeating ammunition will be used to zero. If the type used cannot be sensed from the tank, position an observer (driver of tank) approximately 10 meters to the windward side of the tank to adjust fire if the first round misses. All zeroing rounds should be of the same type and lot number. Each final lay of the gun should be in the same direction, against pressure, during entire zeroing procedure.

- (5) Fire one round with the correct sight picture. If the gun is cold, the accuracy of this first round is doubtful; therefore, the first round fired through a cold gun is considered a warming round and is not used in the zeroing procedure. Re-lay on the aiming point and fire another round. (To obtain a correct sensing, re-lay immediately after firing each round.) If the first round fired (other than a warming round) fails to hit the target, note the point on the reticle where the strike of the round appeared in relation to the target and move this point to the center of the target by using the gun controls. Then unlock the boresight knobs; move the aiming cross to the center of the target, and lock the knobs. This procedure provides the gunner with a definite point on the reticle for firing subsequent rounds to establish a shot group. Continue to fire, re-laying on the center of the target by use of the gun controls for each round fired, until there is a three-round shot group. Again re-lay the gun with the sight on the center of the target.
- (6) Without disturbing the lay of the gun, move the aiming cross to the center of

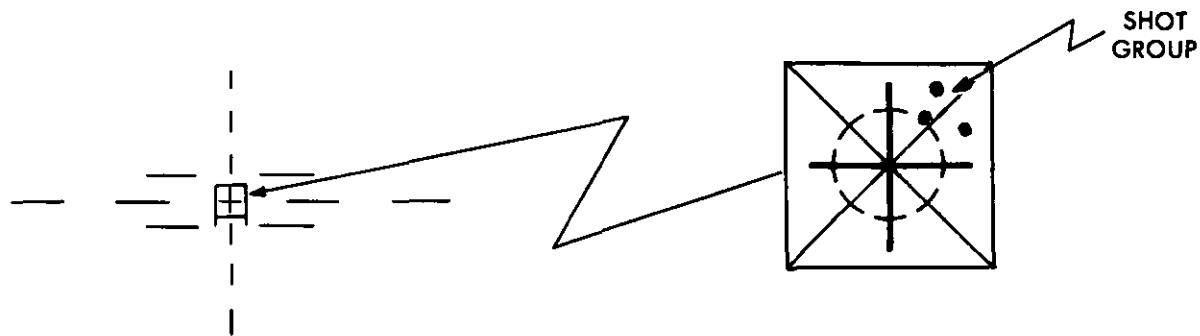

A. FIRE A THREE-ROUND SHOT GROUP, USING THE CENTER OF THE TARGET AS AN AIMING POINT.

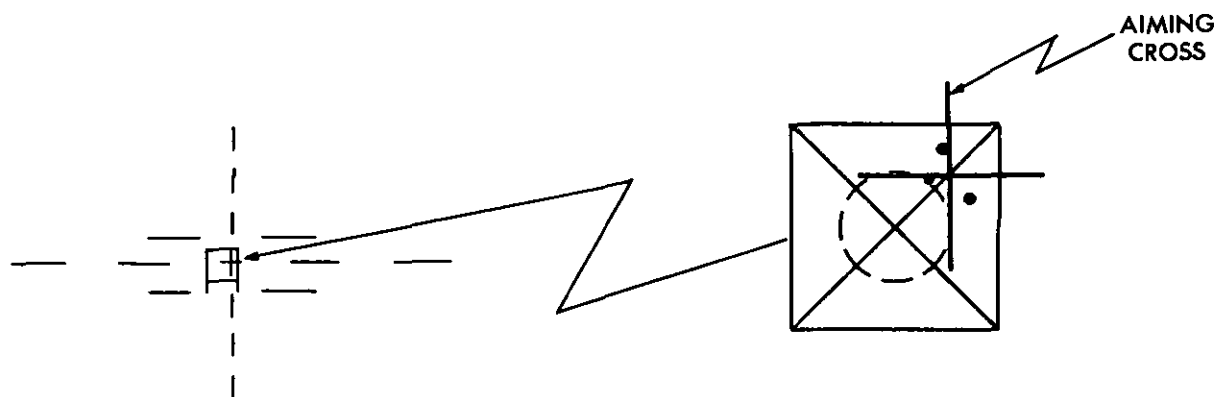

B. REFER THE AIMING CROSS TO THE CENTER OF THE SHOT GROUP USING THE BORESIGHT KNOBS.

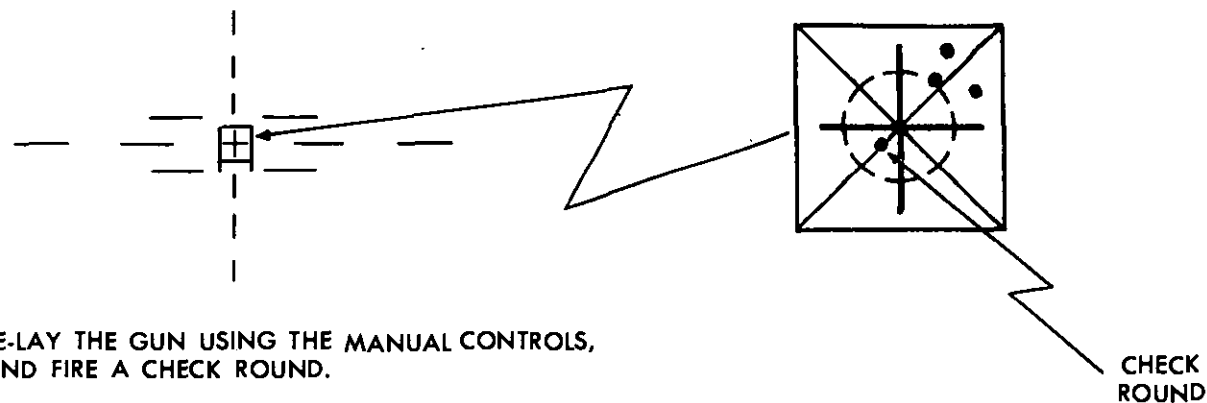

C. RE-LAY THE GUN USING THE MANUAL CONTROLS, AND FIRE A CHECK ROUND.

Figure 45. Zeroing the main gun.

the shot group, using the boresight knobs. Lock the boresight knobs.

- (7) Use the manual gun controls to lay the aiming cross back on the aiming point.
- (8) Fire a check round. The projectile should strike within *24 inches* of the aiming point. If it does not, fire a second check round. If either round strikes within the specified distance from the aiming point, the gun is zeroed. If not, re-lay on aiming point; unlock the boresight knob; move the aiming cross to the center of the two check rounds fired, and lock the knobs. Using the manual gun controls re-lay on the aiming point and fire a check round. If this round falls within the specified distance, the gun is zeroed. The aiming cross or appropriate range line of all sight reticles for the main gun are then referred to the aiming point. This is the established zero.
- (9) Record the zero settings and place them in some convenient part of the turret. In subsequent sight adjustment, this established zero is applied after boresighting to preclude repeating the zeroing procedure.

b. Zeroing the Coaxial Machinegun. Once boresighted, the coaxial machinegun is zeroed by firing to cause the center of the beaten zone (dispersion area of one burst of 20–25 rounds) to hit the target at a range of 800 meters (yards). To zero the coaxial machinegun, proceed as follows:

- (1) Index the known range to the target in the fire control system.
- (2) Index ammunition in the fire control system. If machinegun ammunition cannot be indexed, index the type of main gun ammunition with the lowest muzzle velocity.
- (3) Use the coaxial machinegun sight to lay on the aiming point and fire a burst of 20 to 25 rounds. If the coaxial machinegun sight is not available, use the main gun primary direct-fire sight.

- (4) If the main gun sight is to be used, use the adjusting mechanism on the coaxial mount and adjust the beaten zone to the main gun sight. Insure that the mounting block does not contact the gun port.
- (5) Fire another burst of 20 to 25 rounds. The beaten zone of the burst should bracket the target. If not, repeat adjustment in (4) above and again fire a burst of 20 to 25 rounds.
- (6) If a machinegun sight (infinity) is available, move the reticle with the boresight knobs to the beaten zone.

c. Cupola-Mounted Machinegun.

- (1) Select a target (normally the boresight target) with a clearly defined aiming point at a range of 500 meters (yards).
- (2) With the elevating and traversing controls, lay the 500-meter (yard) point of the periscope on the aiming point of the zeroing target. Engage the azimuth lock and make fine adjustments with azimuth adjusting knob (vernier).
- (3) Fire a burst of 10 to 20 rounds. Re-lay the gun if necessary after firing.
- (4) Without disturbing the lay of the gun, move the 500-meter (yard) point of the reticle to the center of the beaten zone.
- (5) Fire another 10 to 20 round burst to verify the zero. The weapon is zeroed when the center of this beaten zone is within 24 inches of the aiming point.

57. Verification of an Established Zero

Make periodic checks of the zero by boresighting and indexing the established zero setting. If the main gun is cold, fire a warmup round. Then fire a check round or burst from the machinegun at a definite aiming point at the zeroing range. If the projectile strikes within 24 inches of the aiming point, the zero is correct. If the projectile fails to strike within the prescribed distance, refine the zero (para. 58). Repetition of the complete zeroing exercise is necessary only on replacement of the gun tube.

58. Refinement of an Established Zero

As changes in wind, temperature, and humidity will affect an established zero, an accurate zero obtained on any day might not insure first round hits on following days or even later on the same day. As a result, the gunner should be aware of any constant error that exists in firing the main gun. When such an error is detected, first check the range finder and computer. If their adjustment is correct, refine the zero of the gun to obtain greater accuracy. To refine the zero, proceed as follows:

a. Boresight. This is done to insure that errors in firing are not being caused by loss of boresight.

b. If gun is cold, fire a warmup round.

c. Fire a two-round shot group at a zeroing target or any vertical surface at the zeroing range indicated in the technical manual for the tank. Final lay for each round should be in the same direction, against pressure.

d. With the same sight picture used to hit the target, unlock the boresight knobs and turn them until the aiming cross is in the center of the two-round group. This refinement results in a new established zero, which replaces the previously recorded established zero.

59. Combat Zeroing

In combat, if a zeroing panel is not available, a building or similar target may be selected and the tank gun zeroed by normal methods. When no target is available that would show a shot group, the following procedure is used:

a. Select a terrain feature as near the zeroing range for the tank as possible. Use the most accurate means available to determine this range.

b. Boresight and apply the established zero. If there is no established zero, use the emergency zero or the boresight setting (HEAT or SABOT).

c. If gun is cold fire a warmup round.

d. Lay on the center of the selected target and fire one round. re-laying immediately for proper sight picture when round is sensed.

e. Note the point on the reticle where this round strikes in relation to the target and, in using the gun controls, move that point to the center of the target.

f. Using the boresight knobs of the sight, move the aiming cross to the center of the target. This provides a definite point on the reticle for firing subsequent rounds.

g. Fire a check round using the same type round.

h. Continue to adjust the sights until the round strikes within approximately 24 inches of the aiming point.

60. Effect of Drift, Cant, Parallax, and Droop

Drift, cant, parallax, and droop cause a certain amount of error in firing. These errors are usually small at direct-fire ranges and can be corrected somewhat by zeroing and adjusting fire.

a. Drift is the deviation of the projectile from the plane of fire. It is the result of the effects of rotation and air resistance on the projectile. The rotation imparted to spin-stabilized projectiles by the rifling of the bore and the rotating bands cause the projectiles to drift in the direction of the rotation. This drift is to the right, since all tank gun bores are rifled with a right-hand twist. Ballistic reticles correct for drift by use of offset range lines; however, non-ballistic reticles do not. Proper zeroing results in full compensation for drift at the zeroing range and partial compensation at other direct-fire ranges. When firing at long ranges is conducted, as indirect fire, data from firing tables can be used to compensate for drift. The drift of the HEP round must be compensated for at direct-fire ranges (para. 95).

b. Cant is the inclination of the gun trunnions (trunnion tilt) from the horizontal when ground is not level. This is caused by one track of the tank being higher than the other. As the range to the target increases, cant causes increasing deflection and range error in the direction in which the tank is canted. Cant is avoided by the selection of as level a firing position as possible. When cant is unavoidable, error can be compensated for by taking a corrected sight picture (fig. 46) for the initial

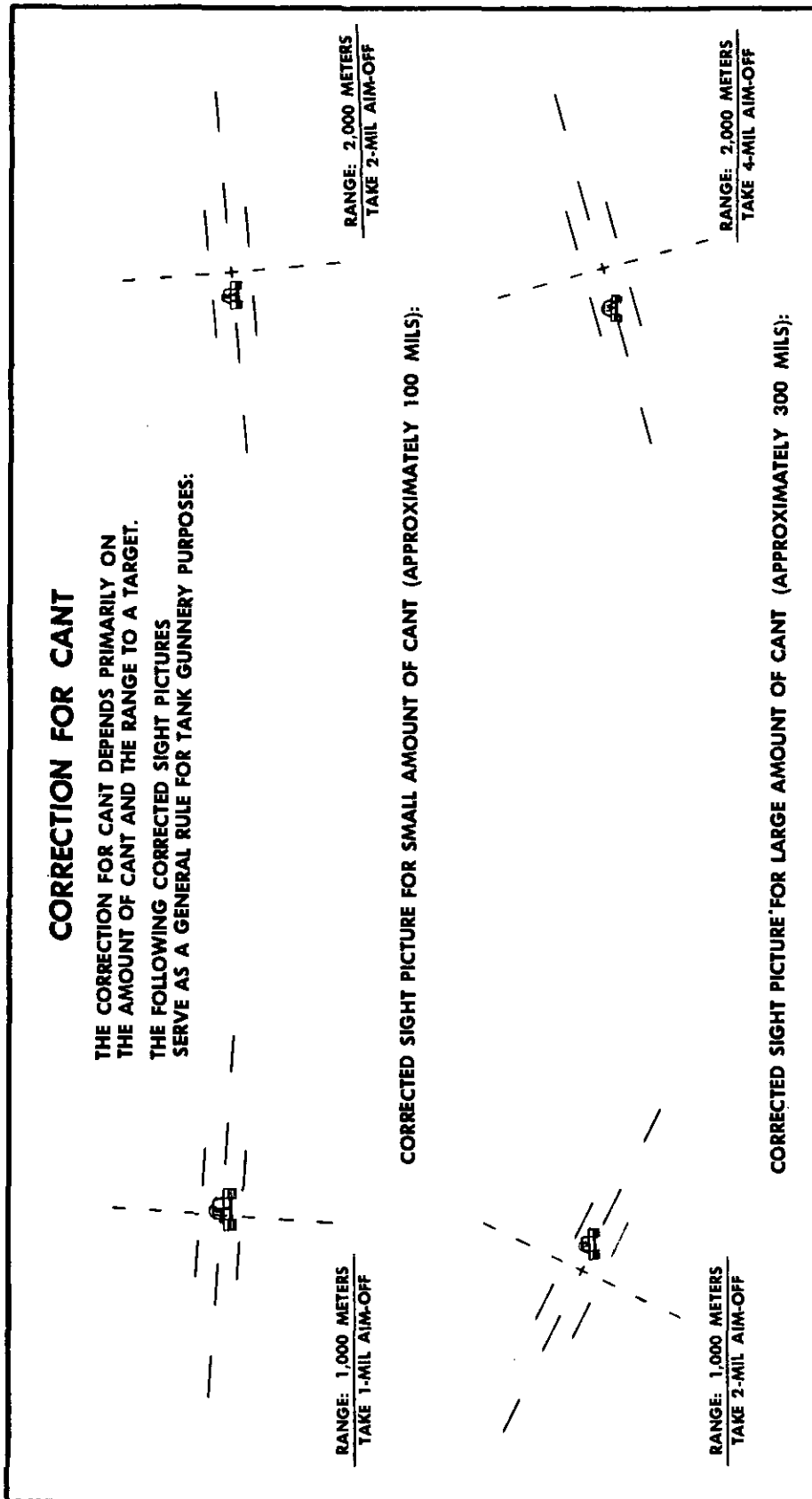

Figure 46. Corrected sight picture for cant.

round. The primary method of adjustment, burst-on-target, decreases in accuracy if the firing tank is canted.

c. Parallax is the apparent difference in the position of an object when it is viewed from two different points. A parallax error within the optics is caused by the sights being offset from the gun tube. This error is corrected at the zeroing range or by adjustments on some sights, and is of small consequence at any direct-fire range. A parallax error from physical sight displacement is caused by not positioning the eye to the sight in the same manner for each sight picture. This can be corrected through gunnery training or by proper adjustment of the headrest.

d. Droop is the bending of the gun tube as a result of uneven cooling of the outside surface. As rain or wind cools one portion of the tube and not another, the cooled surface will contract while the unaffected portion remains expanded. This will cause the tube to droop or bend slightly in the direction of the cooled surface. The tank commander should be aware of this problem because excessive droop can cause the rounds to completely miss the target. This condition can be compensated for by refining the established zero. By noting the climatic conditions when the gun is zeroed, the tank commander can best be prepared to compensate for changes in weather when they occur.

PART FOUR
CONDUCT OF FIRE
CHAPTER 8
INTRODUCTION

61. Scope

Part four explains conduct of tank fire by the tank crew and platoon. Conduct of fire consists of the methods and techniques used by the tank crew and tank platoon to detect, engage, and destroy enemy targets with minimum expenditure of time and ammunition.

62. General

a. The tank is an offensive weapon, possessing armor-protected fire-power and a high degree of mobility. The ability of armor to concentrate devastating fire on the enemy while aggressively advancing on his position produces the shock effect essential to success in battle.

b. The primary mission of tank units is to close with and destroy the enemy. Tank units perform this mission by assaulting the enemy position in mass; followed by exploitation and pursuit of the defeated enemy forces. Even in a defensive situation, every effort is made to use tanks offensively. The defense mission is accomplished by employing fire and maneuver.

63. Firepower

The most effective firepower is obtained by using direct fire, and concentrating the massed fire of the entire tank unit. Direct fire can be delivered by the tank crew on targets that can be observed through the direct-fire sights. The tank's firepower is not limited to a direct-fire capability. By proper preparation and use of range cards and platoon fire plans, the tank unit is able to deliver effective fire during darkness or other periods of poor visibility. Under exceptional conditions, the tank may be used

in the artillery role (app. II). This type of fire, however, is not as effective as direct fire, or fire using range cards, or supporting artillery fire.

64. Firing Positions

a. The ideal firing position is one that provides cover, concealment, and level hardstanding. When possible, hull defilade positions, where the hull is behind cover and the turret exposed, are employed for direct fire (fig. 47). When not in the act of engaging targets the tank commander may position his tank in turret defilade (fig. 48). This affords maximum cover from enemy direct fire yet allows the tank commander to observe for targets. Once a target is acquired the tank will be moved to a hull defilade position for engagement of the target. All firing positions must be as level as possible in order to eliminate or reduce cant (para. 60*b*). In a static situation, selection and occupation of positions are deliberate. However, in mobile situations ideal firing positions are not always available. Rapid selection and immediate occupation of a position is a crew effort, requiring close teamwork among crew members. Selection of the final position is the tank commander's responsibility, but a trained driver will constantly search for good positions so that he can move in immediately when ordered to do so. As rapid engagement of the target has priority over selection of a firing position, situations may arise when a dangerous target will be engaged from an exposed firing position.

b. When moving into hull defilade, the tank commander commands GUNNER TAKE OVER. With the gun level, the gunner looks

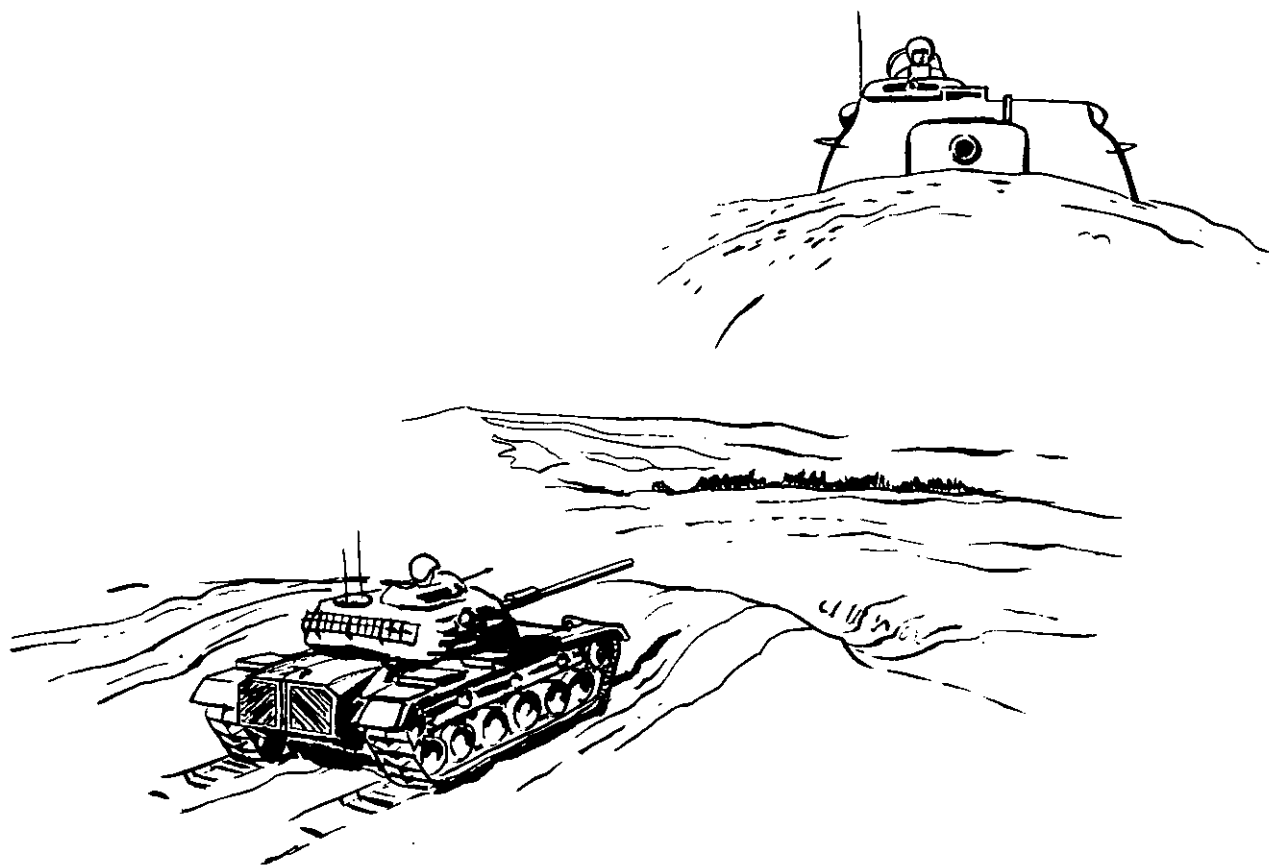

Figure 47. Hull defilade position.

through the telescope observing the designated target area and halts the driver when the mask of the defilade is cleared for firing. Any time it becomes doubtful as to whether or not the projectile will clear the mask, the loader will check by sighting along the bottom of the gun tube. If any of the mask is visible, the tank's position must be changed.

c. The tank commander directs the driver into turret defilade. The tank commander occupies his normal position for observing the target area and halts the driver when he can see the target area.

d. Although the machineguns can be fired effectively from a moving tank (para. 6-8), shooting on the move with the main gun is extremely inaccurate. The tank gun will normally be fired from stationary positions unless the tank gun is stabilized. In the event fleeting large area or personnel targets are presented and the terrain is *relatively flat*, an unstabilized tank main gun may be fired while the tank is moving. Accuracy will be secondary to psychological effect and HE, HEP, CANISTER or like ammunition will be used.

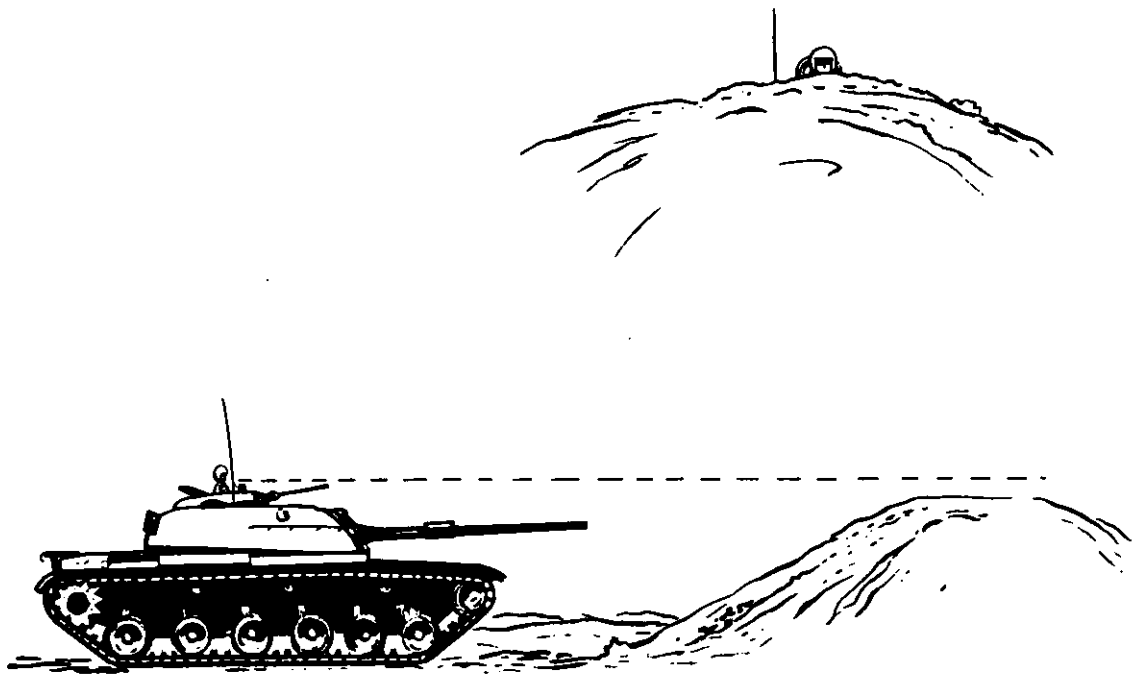

Figure 48. Turret deflade position.

CHAPTER 9

TARGET ACQUISITION

65. General

Target acquisition for a tank requires the combined efforts of all crewmen. It includes detection, location, and identification of targets by the crew. Subsequently, the target is analyzed by the tank commander to determine the most effective employment of weapons and ammunition. The tank crew that can fire the most accurate and quickest first round will emerge the victor from the battle. The speed of target engagement for a crew is directly proportional to their proficiency in target acquisition.

66. Responsibility and Duties of the Crew

Within the tank crew, target acquisition is the responsibility of the tank commander, but he is assisted by the other crew members. Acquisition must be rapid and accurate, so that the target can be engaged quickly with the correct weapon and type of ammunition. This is not an easy task, because enemy position and weapons will often be concealed and camouflaged. Even when an enemy gun opens fire, the haze and noise of battle make target acquisition difficult. Concealed and camouflaged targets are not only more difficult to detect, but they are also more difficult for the gunner to discern and consequently make a precise lay. To assist the tank commander in target acquisition, he will assign each crew member a specific sector for observation. In assigning sectors, provisions must be made for all-around security. The driver should be responsible to the front. The gunner is assigned a sector covering the most dangerous approach, because he must observe in the same direction the gun is laid. He will traverse the turret throughout his sector viewing through the observation window of his periscope. Upon observing a suspected enemy location, further detection will be made by using either the periscope or telescope. The loader

should be assigned the left flank and rear. The tank commander, at his discretion, will observe the remainder of the area. The driver, loader, and tank commander will be alert for aircraft. If one or more crewmen are dismounted or unable to observe sectors, sectors must be re-assigned accordingly.

67. Identification and Alert

The tank crewman who observes a target will alert the remainder of the crew to its presence. The tank commander does this by issuing an initial fire command. Other crewmen designate a target by announcing the target description and movement, direction, and range (estimated), in that order. For example, TANK, MOVING LEFT, DIRECT FRONT (12 O'CLOCK), 1,000. The use of the clock system by the crew in reporting direction, will enable the tank commander to engage targets more rapidly. The driver gives direction in relation to the tank hull. All other crewmen give direction in relation to the turret. Should the tank commander decide to engage a target designated by another crewman, he will issue an initial fire command. For the proper description of a target, see paragraph 79.

68. Classification of Targets by the Tank Commander

a. Targets are broadly classified as point or area, according to their nature. A point target is one that consists of a particular object or structure, e.g., tank, gun position, or bunker. An area target consists of a general location or area on which fire is to be delivered, e.g., defensive position, assembly area, or dispersed troops.

b. Targets are further classified as hard or soft. Hard targets are those that cannot be

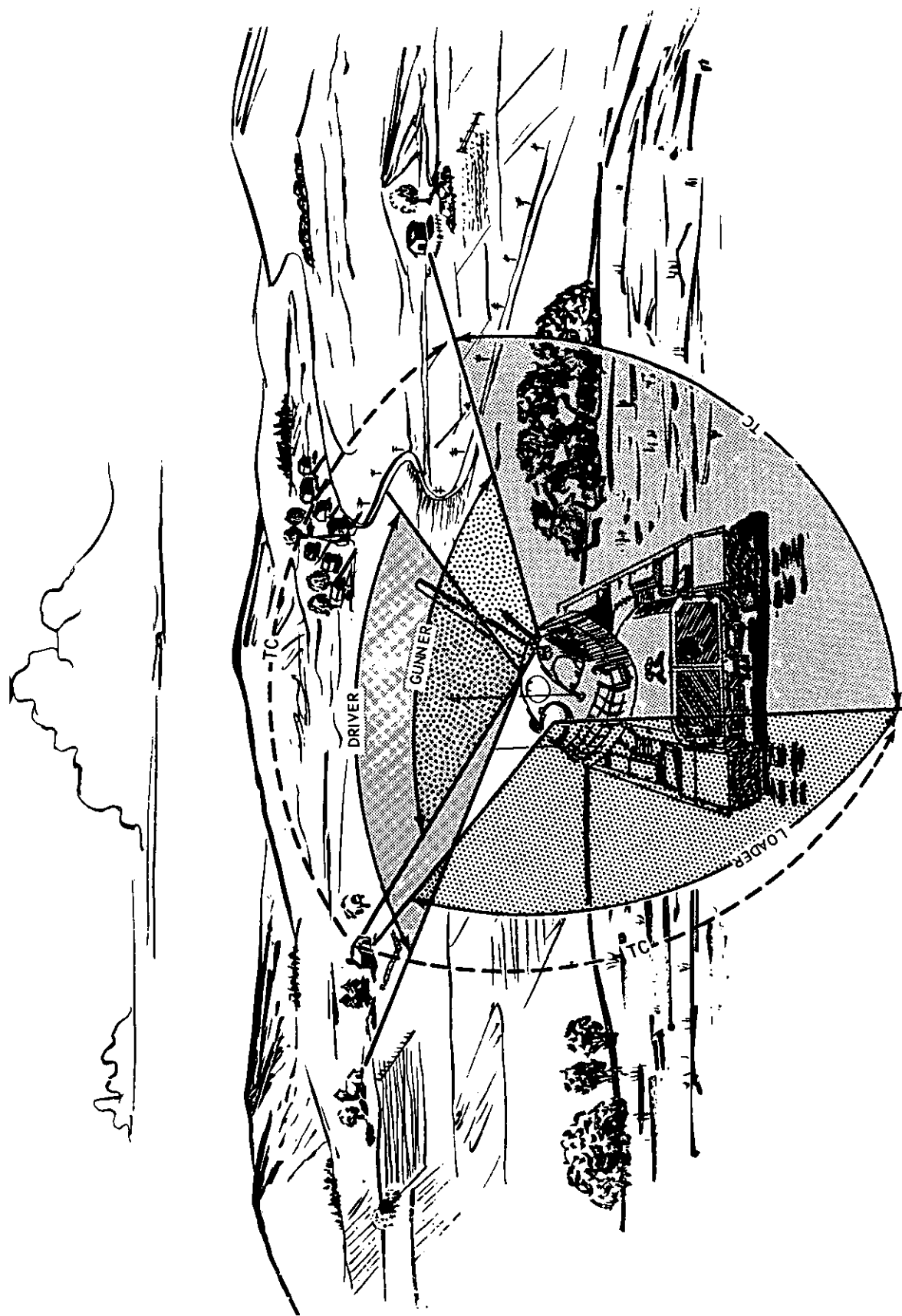

Figure 49. Crew sectors of observation.

penetrated by small arms fire (machineguns) or by the fragmentation effect of high explosive ammunition. The most common type of hard targets are armor protected vehicles, bunkers, and pillboxes. Soft targets are those that can be defeated by small arms fire and fragmentation. Common soft targets are personnel, unarmored vehicles, and gun positions.

69. Infantry Designation of Targets for Tank Fire

a. *General.* Fire coordination between tank and infantry units normally takes place at platoon level; however, situations may arise where this coordination can be best accomplished between tank commander and infantry squad leader or individual infantrymen. Infantry units assist tank units by locating targets. Tank units assist infantry units by engaging targets dangerous to dismounted troops and those that

cannot be destroyed by infantry weapons. To notify the tank commander of target locations or to request tank fire on particular targets, the infantryman contacts the tank commander by external interphone or radio. The action taken by the tank commander upon receipt of the information or request by the infantryman depends on the situation and delegation of firing control within the tank unit.

b. *Method of Requesting Fire and Designating Targets.* The following elements are required for an individual requesting fire or designating targets:

- (1) Identification of the individual.
- (2) Warning—fire mission or target.
- (3) Description of target—brief term consistent with clarity.
- (4) Location—direction and range.

Examples:

	<i>REQUEST FOR FIRE (RADIO)</i>	<i>REQUEST FOR FIRE (EXTERNAL TELEPHONE)</i>
Identification	PENROD 22 THIS IS APPLGATE 26A	THIS IS THE SQUAD LEADER OF SECOND SQUAD
Warning	FIRE MISSION	FIRE MISSION
Description	MACHINEGUN	MACHINEGUN
Location	LEFT FRONT (ELEVEN O'CLOCK) SIX HUNDRED	ONE O'CLOCK (RIGHT FRONT) ROAD JUNCTION
	<i>TARGET INFORMATION (RADIO)</i>	<i>TARGET INFORMATION (EXTERNAL TELEPHONE)</i>
Identification	PENROD 21 THIS IS APPLGATE 26A OPERATOR	THIS IS PFC SHAVERS, FIRST SQUAD, SECOND PLATOON
Warning	TARGET	TARGET
Description	ANTITANK	ANTITANK
Location	DIRECT FRONT (TWELVE O'CLOCK) ONE FIVE HUNDRED	ELEVEN O'CLOCK (LEFT FRONT) CHURCH

Note. The amount of detail required in the identification element depends on the length of time the infantry and tank units have been operating together; call words are used with the radio. Announcing FIRE MISSION indicates a request, and announcing TARGET indicates information on a target location. All tank commanders receiving a request for fire or information on a target location will acknowledge the call and maintain contact with the infantryman until the target is located. When a request for fire is received, the tank commander notifies the requester as to whether or not the target will be taken under fire.

70. Target Acquisition at Night

Target acquisition at night is accomplished in the same manner as for daylight. However, in the assignment of sectors of observation, the tank commander must insure that he has provided for adequate close-in protection against infantry and dismounted tank-hunter teams that may be operating under the cover of darkness. All crewmen must protect their night vision by blackening out the turret and by closing eyes when the enemy illuminates the area or when other weapons are firing (para.

107–109). But, if enemy illumination or friendly gun flashes appear frequently, crewmen should close one eye and take advantage of illumination to observe his assigned sector. Both the gunner and tank commander will find that a precise lay on the target will be difficult, because the target edges will blend into the background. In addition to protection of night vision, all crewmen must apply the following principles during night observation:

a. Use of Off-Center Vision. During periods of darkness, an individual must look out of the corner of his eyes rather than straight at an object. By experimentation, he can find the most sensitive area of his eyes, one side or the other, or, above or below normal view. For most individuals, 6 to 10 degrees from normal direction of vision is the most sensitive.

b. Scanning an Area. At night, observation should be performed by short, jerky, abrupt movement of the eyes until an object is located. Then off-center vision should be used to observe the object. While observing an object, short eye movement is frequently necessary to prevent object fadeout. Frequent periods of night training are necessary to produce confidence in night observation. Cupping the hand around the eyes will also increase night vision.

c. Use of Magnified Optics. Binoculars and the magnified sights are the most valuable aids to increase night observation without the use of artificial illumination. These instruments will allow the crew to detect targets at ranges four times greater than possible with the unaided eye. They gather the available light and magnify the target image. As a result of this, objects that cannot be observed because of distance or their contrast with the surrounding area, can be observed at greatly increased ranges by tank crewmen using the binoculars, telescope, periscopes, and range finder without the use of artificial illumination. When using binocular type (two eyepiece) instruments for night use, the necessity for accurate interpupillary distance adjustment is increased because the images must be in alignment with the pupils of each eye. Individuals may find that by using only 1 eye and 1 of the eyepieces they can increase their proficiency. Through training and experience each crewman will be able to

determine which method is better for him. When using the binoculars, the crewman must brace his arms in an effort to reduce unsteadiness, and cup the thumbs aside of the eyepieces to restrict all light from the eye except that seen through the binoculars. This problem does not exist when using the magnified sight on the tank. Regardless of the magnified instrument used, off-center vision, and scanning by moving the instrument must be employed.

d. Use of Gun Flash. The flash produced by a gun being fired at night will aid the crewman in target location. The flash will indicate the direction, and by counting the number of seconds that have lapsed from the flash to the bang (sound of weapons), the range can be estimated. Multiply the number of seconds flash to bang) by four to obtain the approximate range in hundreds of yards (meters) to the weapon position. Continued practice is necessary to maintain the degree of accuracy desired. Based on experience, the crew may be able to determine the nature of the target, i.e., rifle, antitankgun, or tank. For additional information see paragraph 159.

e. Use of Artificial Illumination. When an enemy is suspected to have occupied an area but determination is not possible (no patrols available nor listening posts in that area), artificial illumination may be used. The use of tank-mounted searchlights should be considered when mortar or artillery illumination is not available. By requesting mortar or artillery illumination, the tank's position will not be disclosed to enemy observation. Prior to the use of the tank-mounted searchlight for this purpose, permission must be granted by the platoon leader or company commander. The infrared (red light) searchlight is more desirable than the visible (white light) searchlight for this use; however, the use of infrared may also compromise the position because the enemy must be expected to have detection equipment. When employing mortar or artillery illumination the shell should be adjusted so that the maximum illumination is slightly in front of the enemy. Illumination in this manner will blind or dazzle the enemy so that he will not be able to effectively return fire to the tank's position, yet will provide sufficient target illu-

mination for the effective employment of the tank's weapons. The shell should burn out before it hits the ground, because the glare

produced by a grounded shell will produce smoke and haze, as well as blind or dazzle friendly personnel.

CHAPTER 10

CREW FIRING DUTIES

71. General

To insure target destruction with a minimum expenditure of time and ammunition, the tank crew must work together as a team. Each member of the tank crew must know his particular job so well that certain orders from the tank commander will stimulate automatic responses. In so much as possible the tank crewmen must be able to perform in all positions within the crew so the loss of one member will not destroy the effectiveness of the tank as a fighting vehicle. Each crew member must fire the tank crew qualification tables specified for his crew position at least once annually. This is essential in order to produce a tank crew capable of functioning as an integrated team and to insure a high degree of gunnery proficiency among all crew members to permit the assignment of any one of them as gunner in an emergency. Normal attrition and personnel turnover also make this an essential requirement during peacetime as well as combat. The specific firing duties of the crew will be discussed in the following paragraphs.

72. The Tank Commander

The tank commander controls the movement and fire of the tank. The effectiveness of the tank is dependent on the degree to which the tank commander has trained his crew. When a target appears he must decide whether or not to engage the target with his tank. If the tank is to engage the target the tank commander determines rapidly what type of weapon and ammunition will most effectively destroy the target. This decision is based on the type of target, the range to the target, and a thorough knowledge of the capabilities and limitations of the weapons and the type and quantity of ammunition available. The tank commander then

causes his tank to engage the target by issuing an initial fire command. At the same time he lays the gun to be fired near the target. If he uses the main gun or the coaxial machinegun, he either estimates the range during his lay for direction or, on main battle tanks, ranges on the target after the gunner has placed his sight on it. He tells the gunner to fire and observes the target with his binocular during daylight hours, and through the range finder during hours of darkness to adjust fire if the gunner cannot do so. After the target has been destroyed, he will order cease fire. If the gunner fails to identify the target or cannot properly adjust the rounds to bring accurate fire on the target, the tank commander can fire and adjust fire from his position, using his power control handle and direct-fire sight. If the range card is being used, the tank commander announces the data to be placed on the auxiliary fire control equipment by the gunner.

73. The Gunner

The gunner normally fires and adjusts the fire of the main gun and coaxial machinegun. He ensures that the necessary switches are turned on to cause the turret and weapon to function properly. He indexes the ammunition (and range if required) into the fire control system. He takes the correct sight picture (including lead and aimoff when applicable) and fires in the prescribed manner and continues to adjust fire, when possible, until the tank commander announces cease fire. When firing from range card data he applies the announced data on the auxiliary fire control equipment. Although observation from his position is limited, he assists the tank commander in acquiring targets.

74. The Loader

The loader aids the tank commander to acquire targets. He insures that all ammunition is in a serviceable condition and is ready to be loaded in all weapons. He loads the ammunition announced by the tank commander, ensures that the weapon is ready to be fired, and announces UP to the crew to signify the weapon is loaded. He continues to load until the tank commander announces cease fire. He must be prepared to rapidly reduce malfunctions in the tank weapons.

75. The Driver

The driver must constantly be looking for good firing positions that afford protection for the tank and are fairly level to reduce cant (para. 60). He must be prepared to stop the tank on the tank commander's order by bringing the vehicle to a gradual halt. He must be prepared to drive the vehicle forward as smoothly as possible when the machineguns are used against stationary targets. He aids the tank commander in acquiring targets.

CHAPTER 11

DIRECT FIRE IN DAYLIGHT

Section I. THE INITIAL FIRE COMMAND

76. General

The initial fire command is issued by a tank commander to his crew for each target engagement. Standard terminology and logical sequence are used to achieve effectiveness and speed in engagement. The tank commander will

include only those elements necessary to load, aim, and fire the tank weapons. This may be as few as 4 or as many as 6 elements, depending on the type of equipment on the tank and its serviceability. Given below is an example of sequence and terminology used in an initial fire command by the tank commander.

<i>Element</i>	<i>Example</i>	<i>Remarks</i>
<i>Alert</i>	GUNNER	
<i>Ammunition (weapon or searchlight)</i>	SHOT	Main gun AP-T ammunition
	COAX	Coaxial machinegun
	WHITE LIGHT	Visible searchlight
	RED LIGHT	Infrared searchlight
<i>Description</i>	TANK	
	MOVING TANK	To include word moving when target has apparent speed. Gunner will then apply appropriate lead for the type ammunition announced.
<i>Direction</i>	FIRST TRUCK	
	ANTITANK	
	TRAVERSE RIGHT— STEADY—ON	Omitted when tank commander can lay for direction.
<i>Range</i>	ONE TWO HUNDRED	Omitted when tank commander can index range into sighting system.
<i>Execution</i>	FIRE AT MY COMMAND —FIRE	

77. Alert Element

a. The alert is the first element of the initial fire command. It alerts the crew to the presence of a target to be engaged. This element is always included in initial fire commands.

b. The tank commander alerts the entire crew by the one word, GUNNER. The loader checks to see that the turret is free of obstructions. The gunner insures that turret power switch is on and the tank commander immediately lays the gun for direction.

78. Ammunition (Weapon, or Searchlight Element)

a. The tank commander must analyze the target rapidly and select the best type of main gun ammunition, machinegun, or illumination. This decision is based upon a thorough knowledge of the capabilities, limitations, and availability of the ammunitions, weapons, and searchlights, and the tactical consideration. If a target appears within the effective range and destructive capability of the machineguns, these weapons are used. This will conserve

main gun ammunition for those targets beyond effective machinegun range or those targets that cannot be destroyed with machinegun fire. In addition, the use of machineguns will reduce main gun supply requirements.

b. Listed below are the types of main gun ammunition and the targets normally engaged with each type. See also chapter 3.

<i>Ammunition</i>	<i>Term</i>	<i>Type targets</i>
High explosive, HE-T (super quick fuze setting) 76-, 90-, 120-mm.	HE (AITCH-EE)	Troops, crew-served weapons, and unarmored and lightly armored vehicles.
High explosive, HE-T (delay fuze setting) 76-, 90-, 120-mm.	HE-DELAY	Dug-in troops, sand bagged positions, and wooden structures.
High explosive, HE-T (concrete piercing fuze) 76-, 90-, 120-mm.	HE-CONCRETE	Bunkers and concrete fortifications.
Armor-piercing AP-T 76-, 90-, 120-mm.	SHOT	Flank engagement against tanks, other armored vehicles, flank or frontal.
Armor-piercing, discarding sabot, APDS-T, 105-mm.	SABOT (SAY-BO)	Flank engagement against tanks. Other armored vehicles flank or front.
High explosive anti-tank 76-, 90-, 105-, 120-mm.	HEAT-HEAT-T	Frontal engagement against tanks.
High explosive, plastic, HEP-T, 105-mm.	HEP	Troops, crew-served weapons; unarmored and lightly armored vehicles; bunkers, and concrete fortifications.
Canister, 76-, 90-mm.	CANISTER	Troops within 200 meters.
White phosphorus WP, 76-, 90-, 105-, 120-mm.	SMOKE	For casualty producing, incendiary, marking or screening effect.

c. Listed below are the tank machineguns, the types of targets normally engaged, and maximum effective range of each.

<i>Weapon</i>	<i>Term</i>	<i>Type targets and ranges</i>
Coaxial machinegun, cal. .30 and 7.62-mm.	COAX (KO-AXE)	Troops, crew-served weapons, and unarmored vehicles up to 900 meters.

<i>Weapon</i>	<i>Term</i>	<i>Type targets and ranges</i>
Caliber .50 machine-gun	CALIBER FIFTY	Same as coax up to 1,600 meters; limited capability against lightly armored vehicles.

d. Because the tank commander personally loads, aims, and fires the caliber .50 machinegun, he does not issue an initial fire command to use it. However, he announces CALIBER FIFTY before firing, to warn the crew and to indicate that they must assume responsibility for observation in his sector. Tank commander announces CEASE FIRE upon completion of firing.

e. Listed below are the tank searchlights and their uses, including their appropriate announcement in the fire command. Tank-mounted searchlights are effective at ranges up to 1,000 meters or more.

<i>Searchlight</i>	<i>Term</i>	<i>Use</i>
18-inch light	WHITE LIGHT	Visible light illumination of targets.
Xenon	WHITE LIGHT RED LIGHT	Visible or infrared illumination of targets.

f. The loader, upon hearing the ammunition element, sets the fuze if necessary, loads the announced type, checks to ensure the path of recoil is clear and the weapon safety is in the FIRE position, and announces UP. He continues to load this type of ammunition until the tank commander gives a command to change it or announces CEASE FIRE.

g. The gunner turns on the appropriate gun switch. If the tank has a computer he indexes the announced ammunition in the computer or a type of ammunition that ballistically matches the ammunition or weapon to be fired. On tanks with the main gun safety on the gunner's side, the gunner places the safety in the FIRE position. If the gunner is using the telescope, he selects the proper reticle or uses an aiming data chart. On tanks with a ballistic unit, the gunner notes the type of ammunition and awaits the range element. He then looks through the periscope or telescope to locate the target.

79. Description Element

a. The description element is always announced so that the gunner can rapidly identify and lay on the target. To avoid misunderstanding, the description must be clear and concise. Most of the targets encountered can be designated by using the following standard terminology:

- Any tank or tank-like vehicle* TANK.
- Any unarmored vehicle TRUCK.
- Any armored personnel carrier P.C. (PEE CEE).
- Any armored car without major armament P.C.
- Personnel TROOPS.
- Any type of machine-gun MACHINEGUN.
- Any antitank gun or towed artillery piece ANTITANK.
- Any moving target MOVING — followed by the appropriate description of target.
- Any other target Briefest term consistent with clarity.

* Armor-protected, full-track vehicles with a gun capable of destroying tanks, e.g., self-propelled artillery piece.

b. In some situations the tank commander must designate the specific target such as LAST TRUCK or specific part of the target such as HOUSETOP LEFT WINDOW TROOPS. When the target is concealed, it is described as it appears to the gunner such as GREEN BUSH —MACHINEGUN.

c. When the gunner has positively identified the target, he immediately announces IDENTIFIED, not waiting for the tank commander to finish the initial fire command. The tank commander releases control of the turret to the gunner. The gunner then, using the nonballistic reticle, places the aiming cross in the center of vulnerability of the target. If the tank commander is going to use the stereoscopic range finder, the gunner will position the reticle to

facilitate ranging (para. 172b). When the telescope is used, the gunner awaits the range element to make a precise lay.

d. If the tank commander has described a moving target in the initial fire command, the gunner upon making a positive identification, announces IDENTIFIED. If the tank commander is going to range on the target the gunner positions the reticle for ranging. Upon the command of execution the gunner applies the initial lead, using a standard lead element or a lead element based upon the experience of the crew. Lead is expressed in mils and is based upon the type of ammunition to be fired. The initial leads shown in this paragraph are those leads required by the ammunition being fired to hit a target moving perpendicular to the firing tank at a speed of 10 MPH. These initial leads should be used by tank crews until they have sufficient experience to dictate a change.

<i>Ammunition</i>	<i>Initial Lead</i>
HEP-T-----	7½ mils
HE-T, WP, AP-T-----	5 mils
APDS-T, HEAT-T-----	2½ mils

80. Direction Element

a. This element is omitted by the tank commander when he lays the gun for direction.

b. The tank commander uses his power control handle and sights through the cupola sight cover (vane sight) if available or over the gun tube to move the gun to the target. The gun must be at the approximate elevation to enable the gunner to see the target through the limited field of view of the sights. The tank commander can use one of the examples below to lay the gun for direction if for some reason he is unable to accomplish it with his power control handle.

- (1) *Traverse right (left)—steady—on.*
The tank commander commands TRAVERSE RIGHT (LEFT), and the gunner traverses rapidly in the announced direction. As the gun approaches the direction to the target, the command STEADY is given, and the gunner slows his traverse. When the gun is laid on the target, the tank commander commands ON; the gunner stops traversing, and the target should appear within the gunner's

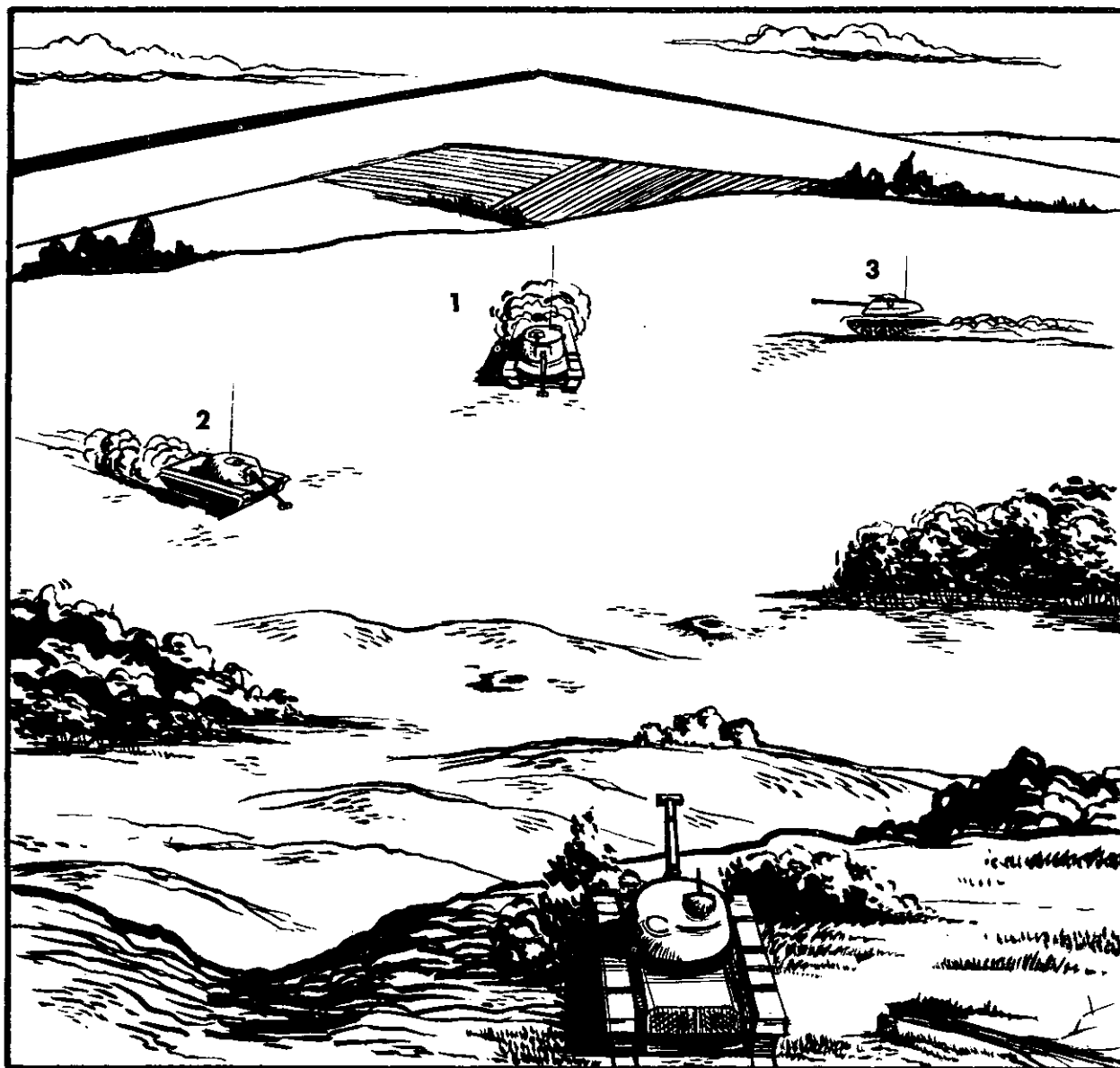

TANKS 1, 2, AND 3 ARE MOVING AT 10 M.P.H. TANK 1 HAS NO APPARENT SPEED. TANK 2 AND 3 BOTH HAVE APPARENT SPEED, WITH TANK 3 HAVING THE GREATER.

Figure 50. Apparent speed.

field of view. The tank commander may use his direct-fire sight to insure that the gun is laid on the selected target.

- (2) *Reference point and deflection.* To assist the gunner in identifying the target, the tank commander may use a reference point and a deflection shift in mils. The reference point must be one that the gunner can recognize

easily. The tank commander measures the deflection from the reference point with his binocular and announces the shift. For example, he commands REFERENCE POINT BRIDGE, RIGHT THREE ZERO. The gunner lays the aiming cross of his direct-fire sight on the reference point, zeroes his gunner's aid, traverses right 30 mils, and looks for his target. Small

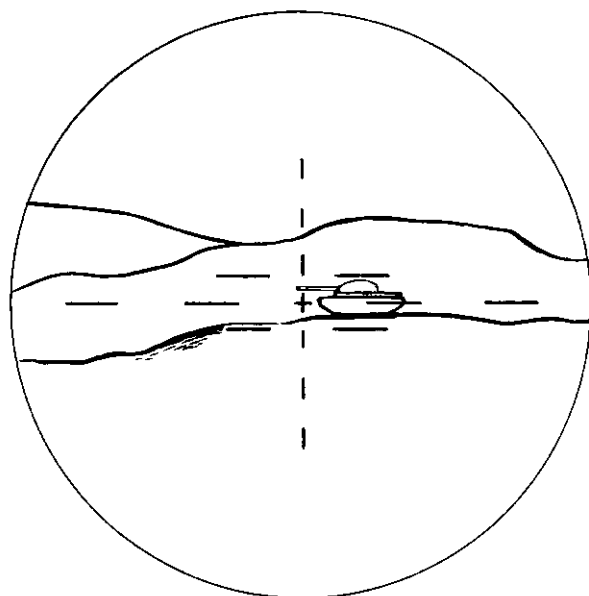

Moving target—range 1,000 meters (yards). Sight picture for lead of FIVE MILS.

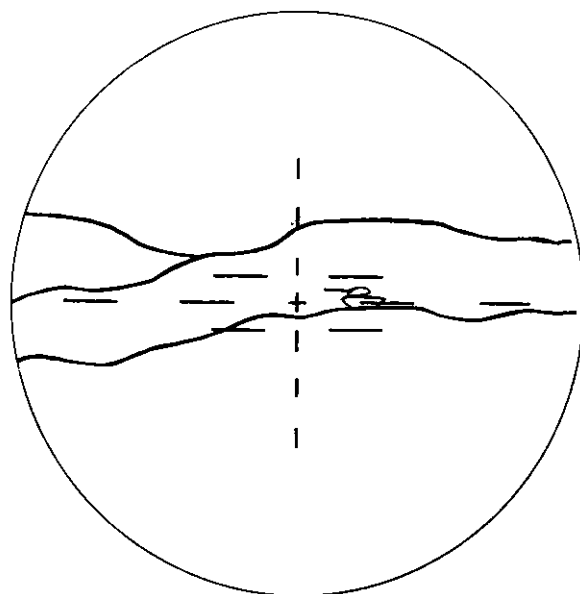

Same moving target—range 2,000 meters (yards). Sight picture of FIVE MILS LEAD. Target appears smaller due to greater range, but lead is the same.

Figure 51. Leading.

shifts may be made by using lead lines in the sight reticle.

81. Range Element

a. Because range is the greatest potential cause of error in direct fire, each tank commander will determine the range to the target as accurately as possible.

b. On tanks equipped with a range finder, the tank commander will range at this time and may announce the range even though it is mechanically transmitted to the computer (para. 95). On tanks without a range finder or when the gunner is using the telescope, the range must be announced by the tank commander.

c. When a ballistic unit is used, the gunner will index the range on the drum for the announced ammunition, or one that ballistically matches it. If the telescope is used, the gunner will place the announced range line on the center of vulnerability of the target.

d. If announced, range is given to the nearest 50 meters if accurately determined or to the

nearest 100 meters if estimated. Numbers are announced in even hundreds or thousands or digit by digit. Examples follow:

850_____EIGHT FIVE ZERO
 900_____NINE HUNDRED
 1,100_____ONE ONE HUNDRED
 2,000_____TWO THOUSAND
 3,050_____THREE ZERO FIVE ZERO

82. Aim-Off

Aim-off is not announced but should be automatically applied by the gunner when engaging stationary targets with ammunition that requires compensation for the drift of the projectile (para. 95). The tank commander must announce the range element when this ammunition is used. The gunner may then engage the target, using the ballistic reticle (preferred) or apply the appropriate aim-off to the nonballistic reticle. Aim-off is not considered when engaging a moving target.

83. Execution Element

a. After all preparations (crew duties) have been made and the tank commander is in a posi-

tion to observe the fire, the execution element is given.

b. Upon hearing the command FIRE, the gunner insures that he has the sight laid correctly (para. 86), announces ON THE WAY, pauses 1 second, and fires. The loader continues to load the type ammunition announced in the initial fire command and the gunner continues to fire, adjusting if necessary, without further command until the tank commander assumes control of firing or announces CEASE FIRE.

c. If the tank commander wishes to delay the fire he announces AT MY COMMAND and when he is ready, announces FIRE.

d. If the gunner has not announced IDENTIFIED, the tank commander will make a detail lay of the gun, using his direct-fire sight. If the gunner still fails to identify the target, the tank commander will announce FROM MY POSITION—ON THE WAY and fire, using his direct-fire sight and power control handle. The gunner should indicate his ability to adjust subsequent rounds by announcing IDENTIFIED. At this time the tank commander has the option of returning the adjustment of fire to the gunner or continuing the engagement from his position. Normally speed and accuracy are best assured by returning adjustment to the gunner.

84. Repeating Elements of the Initial Fire Command

When a crew member fails to hear or understand any element of an initial fire command, he announces such elements as a question. Only that element is repeated. For example, if the gunner or loader asks AMMO?, the tank commander repeats SHOT.

85. Correcting an Initial Fire Command

a. To correct an error in an initial fire command, the tank commander announces CORRECTION and corrects the element in error. He then completes the command by announcing all elements after the corrected element.

Examples:

GUNNER	GUNNER
HE	SHOT

TANK
CORRECTION
ANTITANK
FIRE.

TANK
ONE SIX HUNDRED
FIRE
CORRECTION
TWO SIX HUNDRED
FIRE.

b. The tank commander normally will not correct an error in the ammunition element after the gun has been loaded unless the supply of ammunition is critical; instead, he will allow the gunner to fire the chambered round, then will give a change in the ammunition as a subsequent fire command. In the following examples the tank commander announced SHOT in the initial fire command and the loader loaded shot before the tank commander realized his mistake.

Tank commander desires to unload chambered round:	Tank commander desires to have chambered shot round fired:
CORRECTION HE ANTITANK FIRE.	FIRE HE (loader announces HE, UP after second round is loaded)

c. It is not necessary to correct an error in sequence unless it prevents the crew from properly performing its duties; in this case, the announcement of CORRECTION will be made and a new fire command issued.

d. No attempt will be made to correct an element that has been unnecessarily included; e.g., direction element included when the tank commander has laid the gun for direction.

e. The omission of an element is corrected by the announcement of CORRECTION and the omitted element, and the command is completed.

Example:

GUNNER
TANK
CORRECTION
SHOT
TANK
FIRE.

f. For method of correcting subsequent fire commands see paragraph 93b.

86. Center of Vulnerability

Regardless of type of target engaged, the gunner places the aiming point on the center of vulnerability and adjusts fire to that point. This is the most vulnerable point of the exposed part of the target, which if hit will most likely destroy it. On many targets this will be the exact center, but this is not always true. The center of vulnerability varies with the type of target and the angle at which it is engaged. For example, the heaviest and most sloped armor of a tank is normally the front slope plate of the turret. The most vulnerable parts are the sides and rear. When possible, the gun-

ner should aim at these parts rather than the frontal armor. If only the front of a tank is exposed, the center of vulnerability is the turret ring. If the side is exposed, the aiming point becomes the hull just above the top of the track. The purpose of aiming at the center of vulnerability is to increase the probability of rapid target destruction. However, to increase the probability of target destruction at long ranges, the aiming point is the center of the target. The gunner should make his final precise lay on the target in the same direction each time against pressure. This will reduce error caused by slack in the linkage.

Section II. SENSINGS

87. General

Sensing is noting mentally where the round appears in relation to the target. The round and target must be seen at the same time; otherwise, the round or effects of the round only are observed. Every round fired is sensed, when possible, for deflection and range, by both the tank commander and the gunner. Tracer equipped rounds are sensed where the tracer strikes short of, passes, or hits the target; nontracer rounds are sensed at the point of burst. The strike or burst must be sensed immediately to avoid errors caused by drifting smoke or dust. When attempting to sense tracers, crewmen must concentrate on the target rather than the path of flight of the tracer. The gunner uses his direct-fire sight and the tank commander his binoculars except when buttoned up or at night when he uses his direct-fire sight. Some rounds cannot be sensed because of obscuration and velocity, which causes the round to pass the target before either the smoke and dust dissipate or the sights settle from the recoil of firing. The gunner must be cautioned that he can adjust fire *only* when he actually senses the round in relation to the target. At times, the gunner may be able to see the tracer through the haze of the obscuration but will not be able to see the target or he may be able to see the tracer only after it passes the target. In such cases he only has an *observation* and not a *sensing*. Also a residual

cloud of dust produced by a projectile striking the ground may indicate the general location of the strike and provide an *observation*.

88. Deflection Sensings

Deflection sensings are mental notations of whether the round is on line with or to the side of the target. There are three deflection sensings: *right*, *left*, or *line*. The gunner notes the point on his sight reticle and the tank commander measures the amount of error, using the horizontal mil scale of the binocular reticle. Deflection sensings are not announced but form the basis of deflection corrections in adjusting fire. With most ammunition there will be little or no error in deflection on stationary targets if boresighting and zeroing are performed properly.

89. Range Sensings and Observations

There are five range sensings: *target*, *over*, *short*, *doubtful*, and *lost*. Although these sensings are mental, they will be announced at times. There are two observations—*over* and *short*—which are made by the gunner or tank commander when he observes some evidence of the round being over or short, but cannot accurately sense the round. In adjustment if the gunner senses the round or burst, he will remain silent and apply the primary method of adjustment burst-on-target. If the gunner does not sense or observe either the tracer or burst

after firing, he announces LOST. However, if he observes evidence of the round being over or short he announces OVER or SHORT, allowing the tank commander to adjust fire. The tank commander announces *his* range sensings or observation when the gunner makes an announcement or anytime the tank commander takes over the adjustment of fire, using the alternate method of adjustment. The five range sensings are discussed in the following subparagraphs.

a. Target. A round is sensed as target (fig. 52) when the round or shell fragments strike any part of the target even though subsequent adjustments may be necessary toward the center of vulnerability to destroy the target. A hit

may cause the target to change shape, move, disappear, or burn. When a round strikes a metal target, a distinct bright orange flash is seen.

b. Over. A round is sensed as over (fig. 53) when the burst appears beyond or the tracer passes above the target. A tracer round is sensed at the point where it passes over the target; a nontracer round is sensed at the point of burst. Over sensings are also sensed for deflection; for example, *over, three right*.

c. Short. A round is sensed as short (fig. 54) when either the burst or the strike appears between the gun and the target. Both tracer and nontracer rounds are sensed at the point

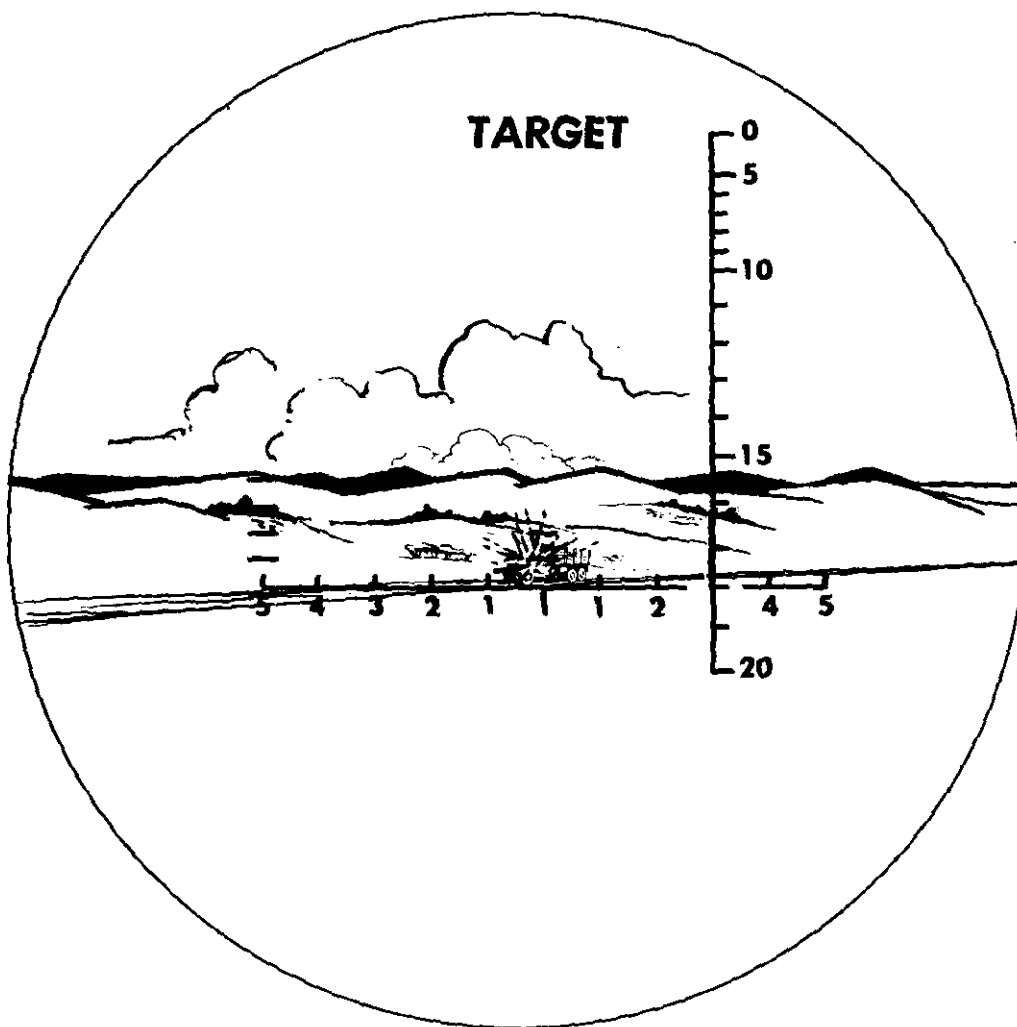

Figure 52. Sensing of target (as seen by tank commander).

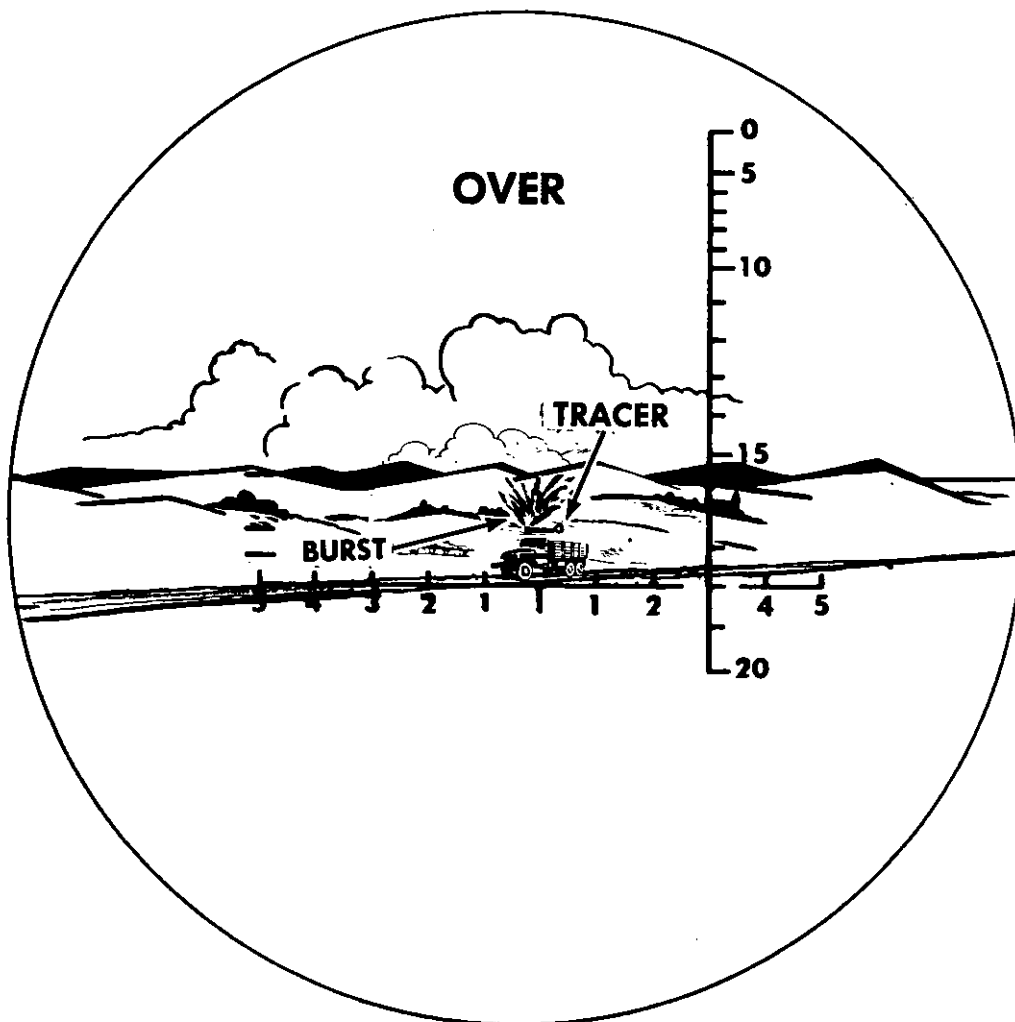

Figure 53. Sensing of over (as seen by tank commander).

of burst or strike. The strike must be observed carefully and sensed immediately, as the target, just after the strike, is sometimes temporarily obscured by smoke and dust. Short rounds are sensed also for deflection; for example, *short, line*.

d. Doubtful. A round is sensed as doubtful (fig. 55) when it appears to be correct for range but the tracer passes or the burst strikes left or right of the center of vulnerability. As a deflection correction is usually sufficient to obtain a hit on the center of vulnerability, no

range change is made on a doubtful sensing. An example of this sensing is *doubtful, two right*.

e. Lost. A round is sensed as lost (fig. 56) when the gunner or tank commander fails to see the point of strike, burst, or tracer. It may not be visible due to obscuration, terrain, failure of the tracer element to ignite, or failure of the round to detonate. Based on his knowledge of the terrain, the tank commander may make a range change if he feels that the round has been lost due to terrain (para. 92b(2)).

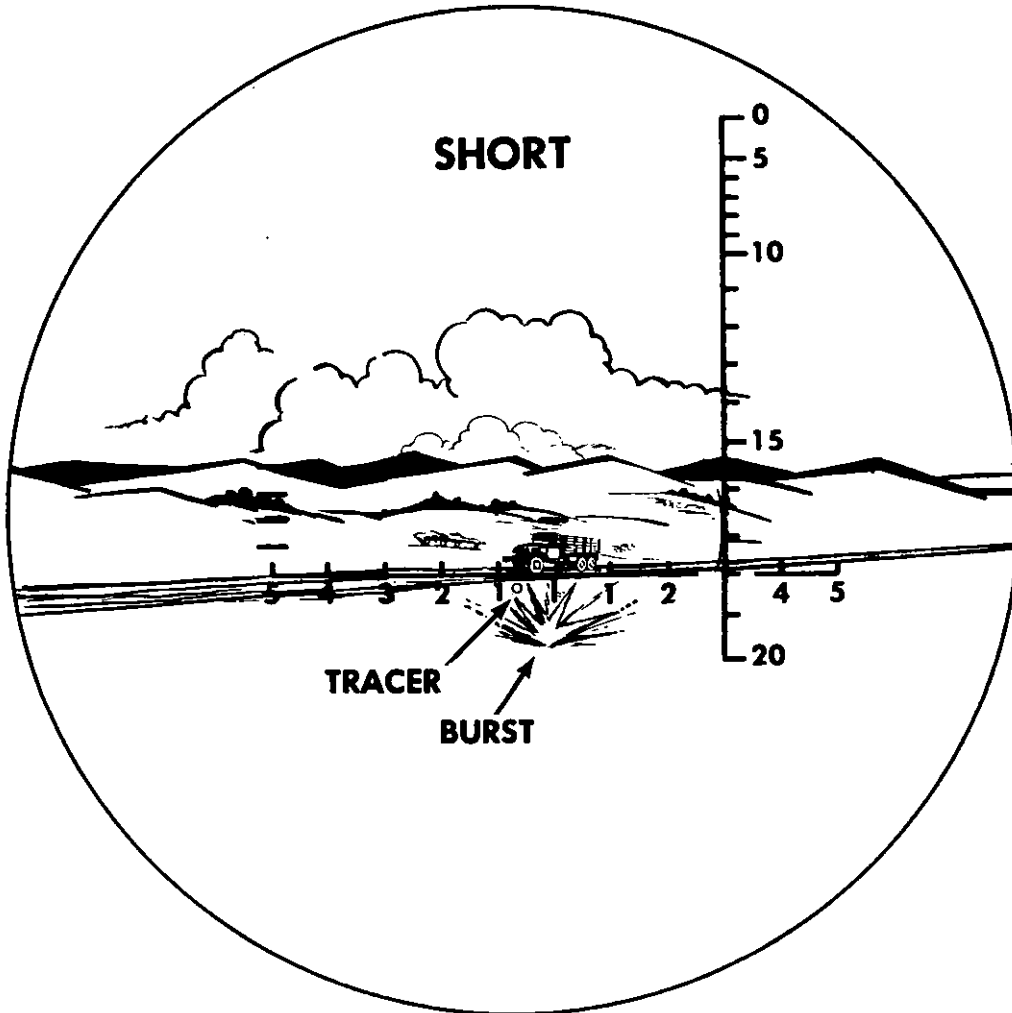

Figure 54. Sensing of short (as seen by tank commander).

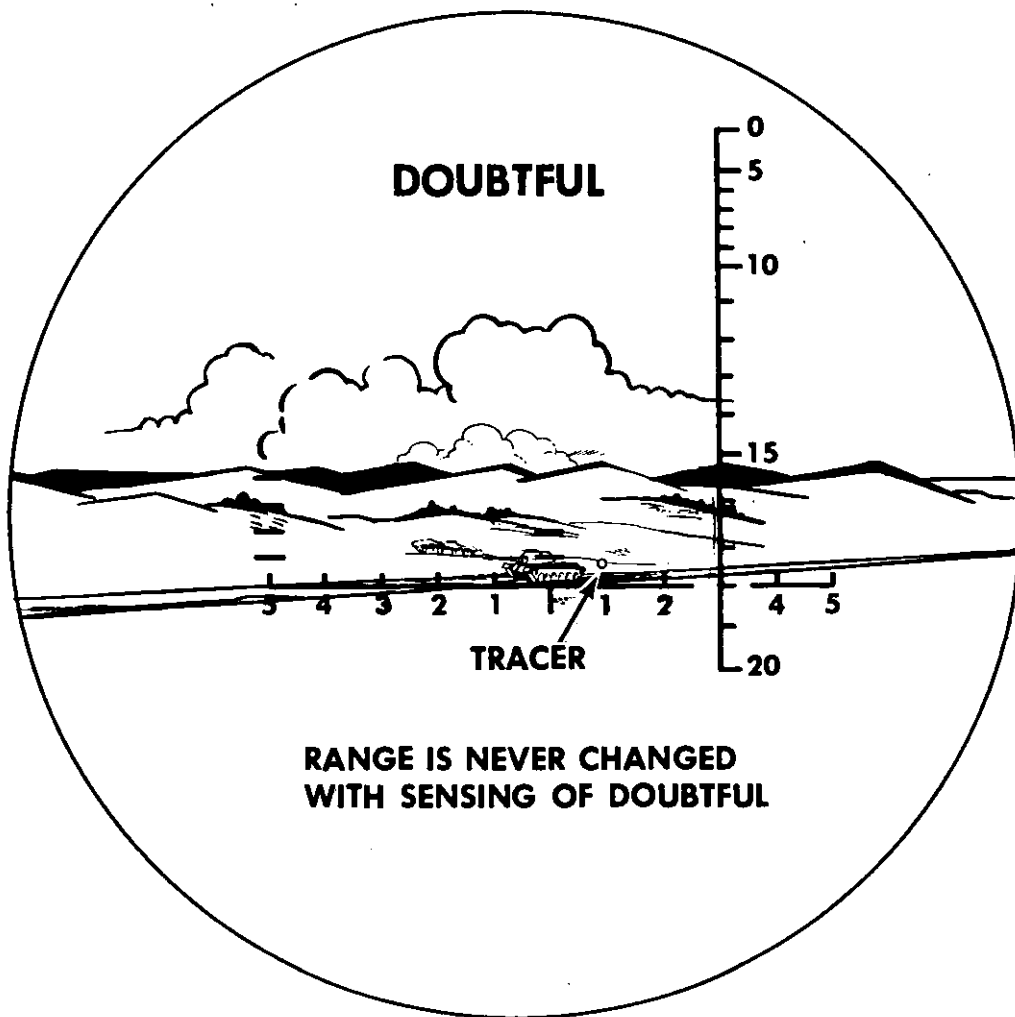

Figure 55. Sensing of doubtful (as seen by tank commander).

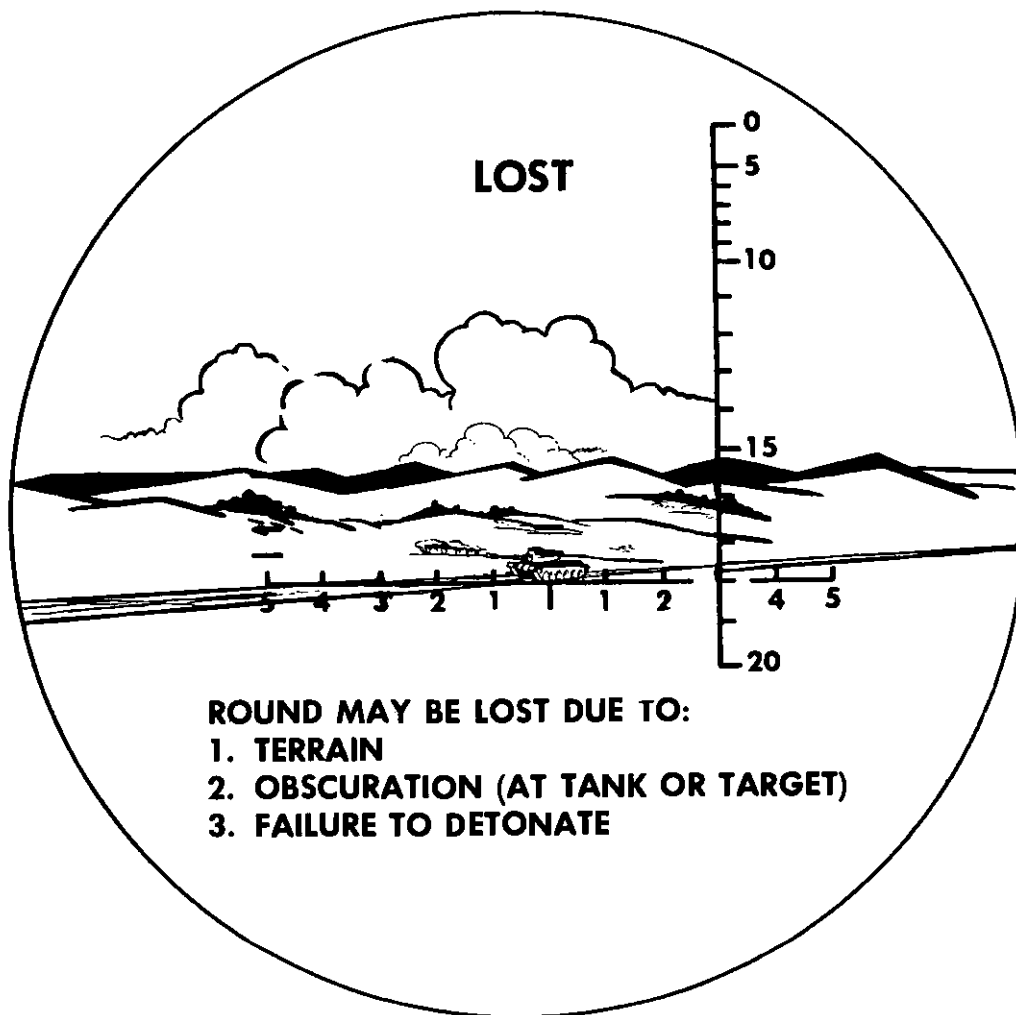

Figure 56. Sensing of lost (as seen by the tank commander).

Section III. DIRECT-FIRE ADJUSTMENT

90. General

a. The ultimate goal in tank gunnery is rapid target destruction with a first round hit, if possible. With the excellent fire control equipment and the relatively flat trajectory of tank gun projectiles, it is within the capabilities of a well-trained crew to achieve this goal consistently. This standard, however, must be approached realistically. Such factors as crew skill and target nature will obviously affect achievement of this goal. If the target is not hit or is not hit in a vulnerable spot, it is necessary to adjust fire to the center of vulner-

ability of the target rapidly to destroy it with the minimum number of rounds.

b. To obtain rapid destructive fire, accurate boresighting and zeroing are required. This becomes increasingly important as muzzle velocities of ammunitions increase and sensing becomes more difficult.

c. There are two basic methods of adjusting direct fire. The primary method, known as burst-on-target, is applied by the gunner. The alternate method involves the tank commander and the gunner. With both methods the gunner aims and fires the gun.

91. Primary Method of Adjustment

a. The primary method of adjustment, burst-on-target, is the gunner's means of adjusting fire without further command from the tank commander. This is the most rapid and accurate method of adjustment of direct fire and should be used whenever possible. To apply this method of adjustment, the gunner upon receiving the command FIRE takes the following actions: makes a final precise lay; announces ON THE WAY, pauses a second and fires; observes through his sight re-laying if necessary to maintain his correct sight picture, and concentrates on the target, noting the point of the sight reticle where the tracer or burst appears as it passes, strikes short of, or hits the target; if he senses the round he remains silent and immediately moves this point of the reticle to the center of vulnerability of the target by the shortest route, using his gun controls, announces ON THE WAY, and fires again; the gunner continues to fire, adjusting each subsequent round to the center of vulnerability until the tank commander announces CEASE FIRE or takes over the adjustment of fire.

b. Throughout the application of burst-on-target the gunner does not announce his sensing, but merely makes his adjustment and continues to fire. While the gunner makes these adjustments, the tank commander acts as a silent observer sensing each round fired for deflection and range. During daylight the tank commander will use his binocular and during the hours of darkness he will use the range finder or the tank commander's periscope. The tank commander is then prepared to take over adjustment of fire if the gunner fails to sense a round or if he is not satisfied with the gunner's adjustment of fire.

c. Accuracy of the burst-on-target method depends on the ability of the gunner to take correct sight pictures and make precise sensings. This method is applied in the same manner on ballistic and nonballistic reticles. Properly applied, burst-on-target provides a rapid and accurate means of obtaining second-round hits or adjusting target hits to the most vulnerable part of the target.

d. This method is applied in the same manner for both moving and stationary targets re-

gardless of the type of sight used. For moving targets, the gunner must track continuously before, during, and after firing in order to apply adjustments accurately. Figures 57-60 demonstrate burst-on-target with the ballistic and nonballistic reticles against stationary and moving targets.

92. Alternate Method of Adjustment

a. *General.* Although burst-on-target is the most rapid and accurate method of adjustment, there are conditions and rounds that preclude its use. When the gunner cannot observe the round he announces LOST. When he *observes* the round or its effects but cannot sense it, he announces OVER or SHORT depending on where it went. Under these conditions or at any other time he deems necessary, the tank commander will control the adjustment of fire by the alternate method of adjustment.

b. *Subsequent Fire Commands.* Subsequent fire commands are used to change an element in the initial or subsequent fire command, to cease fire, or in the alternate method of adjustment. They are used in the alternate method of adjustment to give directions to the gunner as to how he will move the sight and gun to adjust fire. Against stationary and moving targets the subsequent fire command may contain

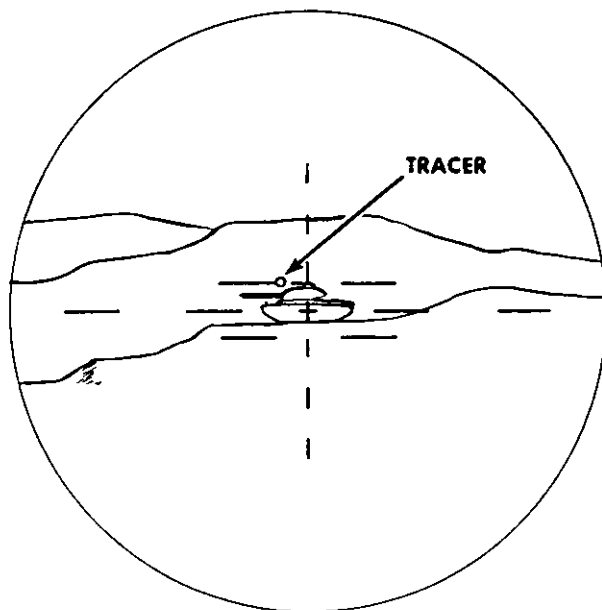

Figure 57. Situation 1, first round, stationary target.

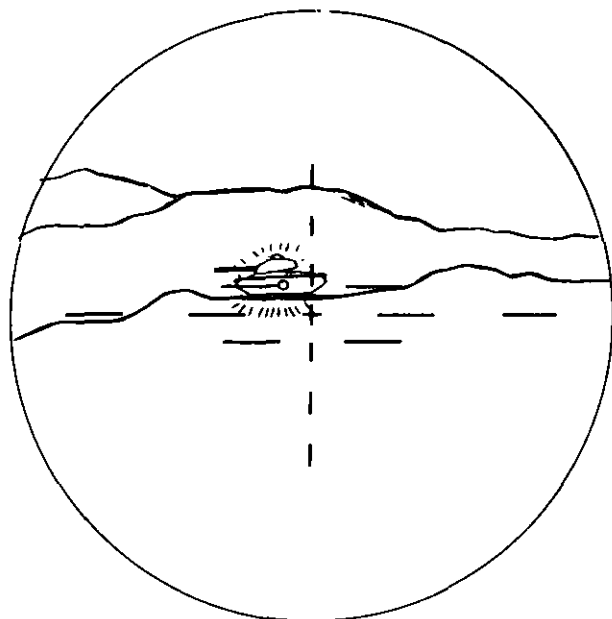

Figure 58. Situation 1, second round hit.

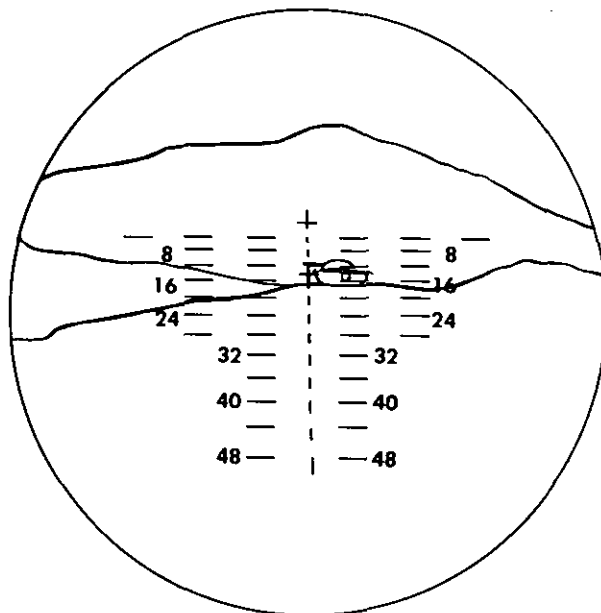

Figure 60. Situation 2, second-round hit.

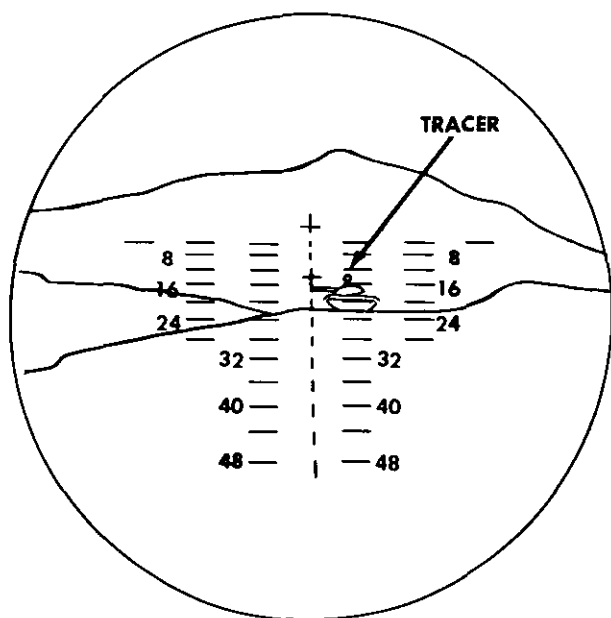

Figure 59. Situation 2, first round, moving target.

2, 3, or 4 elements. If all four elements are necessary, the following sequence will be used: *alert*, *deflection correction*, *range correction*, and *execution*. To alert the gunner that he is going to adjust fire and to prepare him to apply the issued corrections, the tank commander announces his range sensing or observation as the alert element of his subsequent fire command. The announced range sensing is based

upon the tank commander's mental sensing and the gunner's announcement. Deflection and range corrections are omitted if not required; the execution element, however, is always given.

- (1) *Deflection corrections.* The deflection element announced in the subsequent fire command is based on the tank commander's deflection sensing. The tank commander measures with his binoculars the number of mils that the round passed or struck to the left or right of the center of vulnerability of the target. He then commands the gunner to shift the measured number of mils in the opposite direction. For example, if the deflection sensing is *two left*, the announced deflection correction would be **RIGHT TWO**. If the round is sensed as *line*, the deflection element is omitted in the command. This procedure is used for stationary or moving targets. Because lateral dispersion is slight with tank guns, there should be little or no error in deflection. A deflection error of more than 3 mils indicates improper sight picture, improper boresighting and zeroing, cant error, or failure to correctly identify target.
- (2) *Range corrections.* The range element of the subsequent fire command is

based on the tank commander's range sensing or observation. If the round is short, the tank commander adds range; if the round is over, he drops range. Range is changed for the first round adjusted for range by use of the standard range change. The purpose of the standard range change is to obtain a target hit, to move the strike of the round closer to the target so the gunner can sense the round and apply burst-on-target, or to provide a mental yardstick on the ground if the tank commander must continue to adjust. The tank commander is bound by the standard range change only for the first round adjusted for range with a sensing or observation of *over* or *short*. Once an adjustment for range has been made (either by burst-on-target or the alternate method) the tank commander is no longer held to the standard range change, but may make any range change he feels is necessary to hit the center of vulnerability. Range changes are made in multiples of 50 meters (yards). The amount of the standard range change has been determined by experience and depends on the method initially used to determine the range.

Note. If the primary method of adjustment is employed first, then a range change is presumed to have been made.

- (a) *Accurate range determination.* When a range finder or other accurate means i.e., intersection (para. 160) has been used to determine the initial range to the target, the standard range change is made by adding or dropping 200 meters (yards) regardless of the tank-to-target range. If the gunner fails to sense or observe the first round, he announces LOST. If he only observes the first round as over or short, he announces OVER or SHORT. The tank commander then issues a subsequent fire command, making any necessary deflection change and adding or dropping 200 meters (yards) with a sensing or

observation of *over* or *short*. If the next round does not destroy the target, the gunner applies burst-on-target if possible. If this second round is also sensed as lost or observed as over or short by the gunner, the tank commander continues with the adjustment, making necessary deflection and range changes to destroy the target.

- (b) *Less accurate range determination.* When the initial range to the target is determined by a less accurate means (estimation, flash and sound), the standard range change depends on the determined range. If the range is 1,500 meters (yards) or less, the standard range change is 200 meters (yards); if the range is over 1,500 meters (yards), the standard range change is 400 meters (yards). Subsequent adjustment, if necessary, is accomplished as explained in (2) above.
- (c) *Announcement of range correction.* The tank commander announces all subsequent range corrections in meters (yards).
- (d) *Application of range correction.* In applying range corrections the gunner must consider the muzzle velocity of the ammunition and the type reticle (ballistic or nonballistic) he is using.
1. When the gunner is using the *ballistic* reticle, he merely adds or drops (so many) meters (yards) as announced by the tank commander. This is possible because the ballistic reticle is graduated in meters or yards and the correction can easily be made by the gunner.
 2. When the gunner is using the *non-ballistic* reticle, he must convert the announced yards or meters to mils before applying the correction because the reticle is graduated in mils. To convert mils the gunner uses a C factor. (The C factor for any type of ammunition is the num-

ber of mils of change in elevation necessary to move the strike of the projectile 100 meters or yards on the ground.) When ammunition with a muzzle velocity of 3,500 feet per second or less is fired, a 100-meter (yard) change is equivalent to a C factor of 1 mil for tank gunnery purposes. When ammunition with a muzzle velocity in excess of

3,500 feet per second is fired, a 100-meter (yard) change is equivalent to a C factor of 1/2 mil for tank gunnery purposes.

3. The application of the standard range change, therefore, depends on the method used to determine range, the type of sight used by the gunner, and the velocity of the ammunition fired.

Examples follow:

Muzzle velocity	Means to determine range	Tank commander's announced correction	Gunner's correction	
			Nonballistic reticle (mils after conversion)	Ballistic reticle (as announced) (meters/yards)
0-3,500 fps	Range finder	ADD 200	Adds 2	Adds 200
		DROP 200	Drops 2	Drops 200
over 3,500 fps	Range finder	ADD 200	Adds 1	Adds 200
		DROP 200	Drops 1	Drops 200
0-3,500 fps	Estimation (0-1,500 yd/m)	ADD 200	Adds 2	Adds 200
		DROP 200	Drops 2	Drops 200
over 3,500 fps	Estimation (0-1,500 yd/m)	ADD 200	Adds 1	Adds 200
		DROP 200	Drops 1	Drops 200
0-3,500 fps	Estimation (over 1,500 yds/m)	ADD 400	Adds 4	Adds 400
		DROP 400	Drops 4	Drops 400
over 3,500 fps	Estimation (over 1,500 yds/m)	ADD 400	Adds 2	Adds 400
		DROP 400	Drops 2	Drops 400

Note. Projectiles traveling faster than 4,500 feet per second may have as much as 200-meter (yard) change for 1/2 mil; however, vertical change is the primary consideration; therefore, the guide for conversion listed above is still applicable.

(e) *Large range error.* If an extremely large range error (more than 400 meters) is made in the initial range, the tank commander should announce CEASE FIRE, and then issue a new initial fire command to insure target identification as well as correct range.

(f) *Target, doubtful, and lost rounds.*

1. Regardless of the means of determining range, if the tank commander senses the round as *target*, *doubtful*, or *lost*, the tank commander can make any range change that he feels is necessary to destroy the target. With a sensing of *doubt-*

ful, no range change is made, merely a deflection correction.

2. When the gunner fails to sense or observe the round, he announces LOST. If the tank commander fails to sense or observe the round he also announces LOST and completes the subsequent fire command. Depending on the circumstances the tank commander has four alternatives. If the round is of such a high muzzle velocity that it is not normally sensed by the crew he will assume the round is over and announces LOST DROP 200 FIRE. If he thinks that the round was lost

because of obscuration or failure of the tracer to ignite or explosive to detonate, and that he has applied the proper range, he may command LOST FIRE. If he feels the round was lost due to terrain features in the vicinity of the target, he may issue a range change based on his knowledge of the terrain, i.e., LOST

DROP 400 FIRE, to bring the round close enough to the target to be observed. If none of these conditions apply, the tank commander may say LOST, CEASE FIRE and issue a new fire command, requiring a complete re-engagement of the target.

c. Examples of Subsequent Fire Commands.

<i>Alert</i>	OVER	SHORT	TARGET	DOUBTFUL	LOST
<i>Deflection Correction</i>	LEFT 2			LEFT 3	
<i>Range Correction</i>	DROP 200	ADD 200	ADD 50		
<i>Execution</i>	FIRE	FIRE	FIRE	FIRE	FIRE

Further examples of subsequent fire commands are shown in figures 61 and 62.

93. Repeating and Correcting Subsequent Fire Commands

a. Repeating Commands. The procedure for repeating elements of subsequent fire commands is the same as for initial fire commands (para. 84). The crewman requests a repetition by announcing the elements as a question, and

the tank commander repeats only the elements requested. For example, if the gunner announces RANGE?, the tank commander repeats ADD 200.

b. Correcting Commands. To correct an error in a subsequent fire command the tank commander announces CORRECTION and then issues an entire corrected command.

Examples.

OVER
RIGHT THREE
ADD 200
CORRECTION
OVER
RIGHT THREE
DROP 200
FIRE

DOUBTFUL
LEFT TWO
FIRE
CORRECTION
DOUBTFUL
RIGHT TWO
FIRE

SHORT
DROP 400
CORRECTION
OVER
DROP 400
FIRE

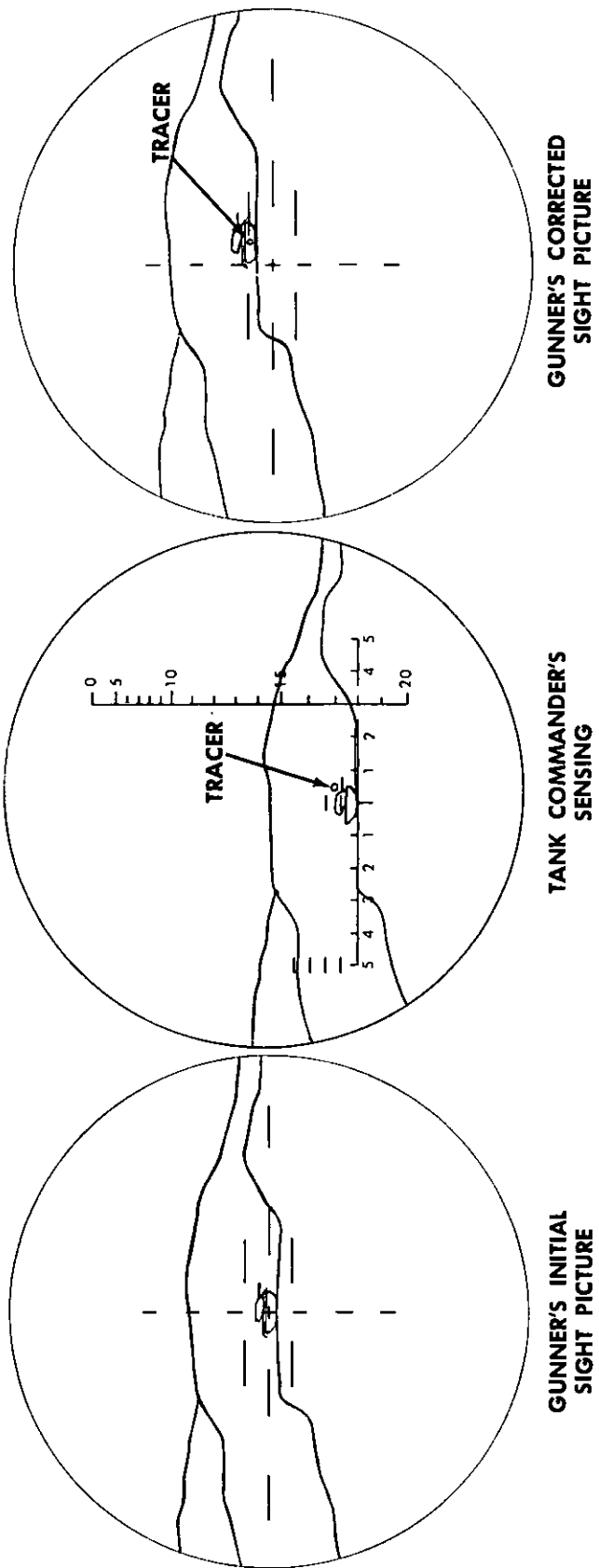

THE TANK COMMANDER MENTALLY SENSES THE FIRST ROUND AS OVER, TWO RIGHT; ANNOUNCES OVER, AND COMMANDS LEFT TWO, DROP TWO HUNDRED, FIRE. THE GUNNER APPLIES THE CORRECTION BY MOVING THE GUN 2 MILS LEFT AND 2 MILS DOWN WHEN FIRING AMMUNITION WITH A MUZZLE VELOCITY OF LESS THAN 3,500 FEET PER SECOND.

Figure 61. Application of the alternate method, stationary target.

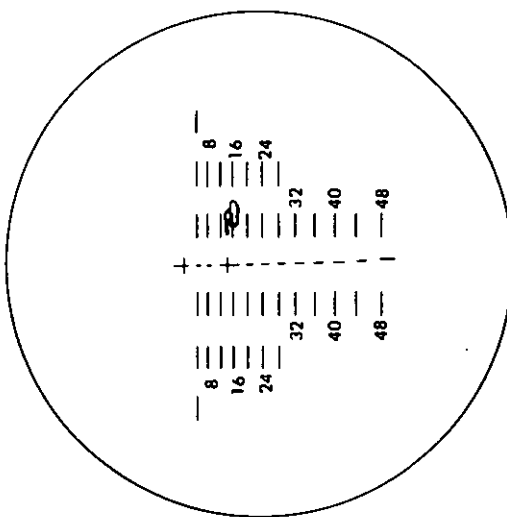

GUNNER'S CORRECTED
SIGHT PICTURE

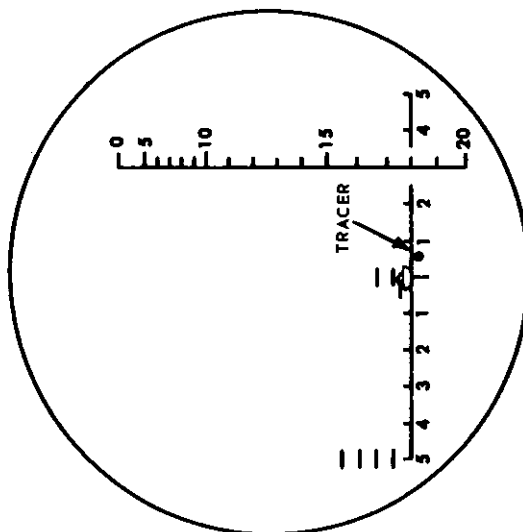

TANK COMMANDER'S
SENSING

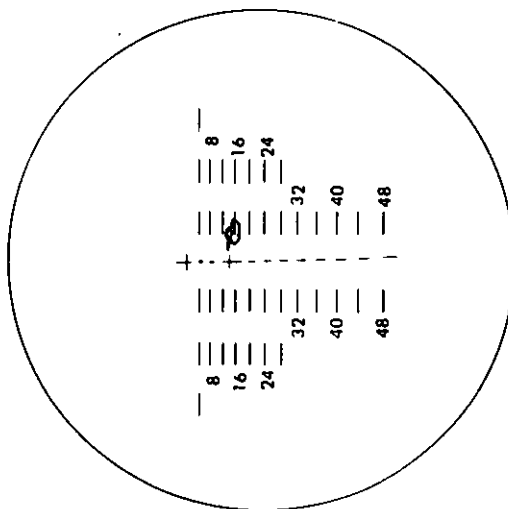

GUNNER'S INITIAL
SIGHT PICTURE

THE TANK COMMANDER MENTALLY SENSES THE ROUND AS SHORT, FIVE RIGHT; ANNOUNCES SHORT, AND COMMANDS LEFT FIVE, ADD TWO HUNDRED, FIRE. THE GUNNER APPLIES THE CORRECTION BY MOVING THE GUN 5 MILS LEFT AND 200 YARDS UP, WHEN FIRING AMMUNITION WITH A MUZZLE VELOCITY OF LESS THAN 3,500 FEET PER SECOND.

Figure 62. Application of the alternate method, moving target.

Section IV. SPECIAL TECHNIQUES FOR DIFFERENT AMMUNITION

94. General

Adjustment of fire and fire control equipment has been designed, based on firing rounds that have a muzzle velocity of approximately 3,000 feet per second. However, some ammunition has much slower (HEP) and some faster velocity (HEAT, SABOT), which require additional techniques to insure the most effective use of the ammunition.

95. HEP Gunnery

a. *General.* Because the combat zero on the M60 tank will be established with either SABOT or HEAT, an inherent error will be introduced when firing HEP from either of these zeroes when using the nonballistic reticle. This is because the SABOT and HEAT rounds have little or no drift, but HEP rounds drift considerably at ranges beyond 1,400 meters. If the gun is zeroed with HEP, the accuracy of the SABOT and HEAT rounds will decrease. As these rounds are rarely able to be sensed this greatly decreases the effectiveness of tank fire. Therefore periscopes on M60 tanks *should not* be zeroed with HEP.

b. *Aim-Off.* With drift inherent in the HEP round, the aiming cross of the *nonballistic reticle* cannot be placed on the center of vulnerability of a stationary target with the expectation of getting target hits beyond 1,400 meters. When firing HEP the tank commander glances at the range indexed in the range finder and announces it in the initial fire command. This allows the gunner to use his telescope, which has compensations for drift, or apply the necessary aim-off shown below if using the nonballistic reticle.

<i>Range</i>	<i>Aim-off</i>
500-1,400 -----	No aim-off
1,400-2,000 -----	LEFT ONE
2,000-2,500 -----	LEFT TWO
2,500-3,000 -----	LEFT THREE

c. *Telescope.* No aim-off is required when firing with the telescope as it is equipped with a ballistic reticle. For this reason the tank crew should use the telescope when engaging a target with HEP ammunition as it compensates for drift.

d. *Lead.* As the time of flight of the HEP round is considerable, the initial lead against a moving target should be 7½ mils. This will remain fairly constant regardless of range when the ballistic reticle is used. At ranges in excess of 1,400 meters moving targets should be engaged with HEAT ammunition in preference to HEP.

e. *Adjustment.* The propellant used with the HEP round causes much obscuration at the tank on windless days. As a result, the tank commander should be prepared to use the alternate method of adjustment when firing this round.

96. SABOT, Heat Gunnery

a. *General.* The SABOT and HEAT rounds have a very high muzzle velocity and, at ranges up to 1,500 meters for HEAT and 2,500 meters for SABOT, are almost impossible to sense; conversely because of their speed they are very accurate. As a result, if the target is not hit, it will be very close and in most cases if it is short, it can be observed. Most misses are due to range error.

b. *Lead.* Due to the short amount of time necessary for the round to travel to a moving target, an initial lead of 2½ mils should be given.

c. *Adjustment.*

- (1) Because these rounds are used primarily against tanks it is easy to sense target hits by the distinct bright flash of the round striking the metal target. When the gunner senses the round as *target* he remains silent and fires another round with the same sight picture unless the tank commander announces CEASE FIRE. If the gunner *senses* a miss he applies burst-on-target. If, however, the round misses and the gunner does not *sense* or *observe* it, he announces LOST. If he observes it he announces OVER or SHORT. The tank commander then announces his range sensing or observation and gives a subsequent fire command. If both the

gunner and tank commander fail to see any effects of the round, the tank commander announces LOST, DROP 200, FIRE. If either the tank commander or gunner observes the round as *over*, the tank commander announces OVER, DROP 200, FIRE. If either the tank commander or gunner observes the round as short, the tank commander announces SHORT, ADD 200, FIRE.

- (2) If the second round does not obtain a target hit and no sensing or observation is made by the crew, the tank commander re-ranges or re-estimates range to the target and the gunner places the aiming cross or appropriate range line on the center of vulnerability and fires. If however, an observation is made, another 200-meter range change is given by the tank commander.

d. Other Methods of Adjusting Fire. To increase the accuracy of firing ammunition that cannot be sensed from the firing tank in deliberate or static situations, a dismounted observer or a two-tank method of adjustment can be used. In sensing from any position farther than 10 meters from the firing tank, apparent errors in deflection for tracer rounds that are short, or for nontracer rounds that are over or short, must be ignored or an erroneous deflection sensing will be obtained.

- (1) *Dismounted observer method.* In the dismounted observer method, the driver or tank commander of the firing tank dismounts to sense and adjust the fire of his tank from a position approximately 10 meters to the flank (upwind side). The observer must be able to see the target area from this position and have cover and concealment. Communication between the tank and observer is by voice. After the initial round in the engagement is fired, the observer announces a subsequent fire command based on his sensing of the round. Rounds are sensed using the binoculars. Adjustment of fire is continued in this man-

ner until the target is destroyed. This method has the disadvantage of not having all crew members mounted for rapidly reverting to a mobile role.

- (2) *Two-tank methods.* When using a 2-tank method of adjusting fire, 2 tanks form a firing team. The tanks are positioned approximately 50 meters apart and 1 tank commander is designated the team leader for purposes of deciding target engagements, determining target destruction, and making other decisions. The team leader issues an initial fire command to initiate the engagement and insure that the location of the target is positively known by the other tank crew. Before employing a 2-tank method of adjustment in preference to the dismounted observer method, consideration must be given to the fact that 2 tanks are required for each target engagement with the firepower of only one tank being employed at a time. Commands and announcements when using two tanks for adjusting fire are usually transmitted by radio, and either of the following methods may be used:

- (a) *Two-tank burst-on-target (BOT).* Both tanks must have the range indexed as announced by the team leader. One tank crew (No. 1) commences firing as designated by the team leader. The other tank crew (No. 2) also lays its gun with the correct initial sight picture and senses the round fired from tank No. 1. If the target is not destroyed, the gunner of tank No. 2 applies the primary method of adjustment (burst-on-target) and fires a second round at the target. If properly applied, BOT should produce a second-round hit. The 2-tank method of BOT can be applied more rapidly than 1 tank applying BOT. It is simple to perform once the team leader has indicated that two-tank BOT will be used, as no further commands are necessary until target destruction has been obtained.

(b) *Firing tank and observing tank.* One tank is designated by the team leader as the firing tank and the other the observing tank. (These designations can be reversed for subsequent target engagements.) When the firing tank fires, the tank commander of the observing tank senses the round, using his binoculars and, based on this sensing, announces a subsequent fire command to the gunner of the firing tank. This procedure is continued until the target is destroyed. The gunner of the observing tank lays his sight on the center of vulnerability of

the target and senses each round fired, but remains silent unless his tank commander announces LOST. In this case, if the gunner of the observing tank has sensed the round, he will announce a subsequent fire command to the gunner of the firing tank. If he also failed to sense the round in this situation, he too would announce LOST and his tank commander would make corrections based on his judgement of the situation (para. 92b(2)(f)). This method is not as rapid as two-tank BOT, but does have the advantage of disclosing only one tank's position.

Section V. BATTLESIGHT

97. General

Battlesight is a combination of a predetermined range and ammunition setting (both indexed in the fire control system) with the specified ammunition loaded. It is employed against dangerous surprise targets and fleeing targets. The range and ammunition are determined by the unit commander (normally the company or troop commander, but can be designated by the platoon leader or even a tank commander when the situation dictates) as the most effective combination for destruction of the most dangerous target expected to be encountered in the immediate battle area. Battlesight is changed as necessary; it will vary according to available information of the enemy, terrain, and weather. The range is determined by previous experience of reconnaissance. The ammunition selected normally depends on the probability of tank or antitank opposition. An *example* of a battlesight setting could be range of 1,000 meters (yards) and HEAT ammunition. This range-ammunition combination will give a high hit probability on targets up to approximately 1,200 meters (yards). HEAT is the best battlesight ammunition in most situations as it will defeat armor and give good effect against materiel and personnel targets. The effective use of battlesight depends on rapid and accurate laying, with emphasis on speed. This means that both the main gun and machineguns are kept loaded. With

guns loaded and sights set, a tank crew should have an advantage on a dangerous target. The flat trajectory of projectiles fired from the tank gun gives a high probability of a first-round hit, even though the target is not exactly the range indexed in the fire control equipment. If a hit is not obtained, the appropriate method of adjustment is applied.

98. Action Upon Engagement

If the surprise target is one that is within the battlesight range, which is up to 200 meters beyond the indexed battlesight range, and the target is one that can best be defeated with the battlesight ammunition, the tank commander will issue a normal 4 or 5-element initial fire command except that he announces BATTLESIGHT as the ammunition element. The announcement of BATTLESIGHT will remind the loader of the type ammunition to be selected for additional firing. The following exceptions may be encountered:

a. If the range to the target is estimated to be more than 200 meters beyond the battlesight range, yet is best defeated by battlesight ammunition, accuracy of fire will take precedence over speed. Therefore, the tank commander will announce the type of ammunition loaded to indicate to the gunner that ranging must take place and either range (M48 and M60 tanks) on the target, or estimate and

announce the range element in his initial fire command.

b. If the target is dangerous and within battlesight range but not the type best destroyed with the chambered ammunition, the tank will fire the chambered round at the target and load a more suitable ammunition for subsequent fire. The tank commander will immediately follow the initial fire command with a subsequent fire command to have the ammunition changed.

Example.

GUNNER
BATTLESIGHT
TRUCK
FIRE
FIRE HEP

After the loader loads the new type of ammunition he will announce it as HEP UP to the gunner who will index HEP in the fire control system.

c. If the battlesight round will not defeat a target of opportunity and sufficient time is available, the tank commander, to conserve ammunition, may issue an initial fire command with the proper ammunition element.

Example.

GUNNER
HEP
TROOPS
FIRE

In this case the loader would be required to unload the chambered round and load the round announced in the initial fire command.

CHAPTER 12

FIRING AT NIGHT OR DURING REDUCED VISIBILITY

Section I. THE TANK RANGE CARD

99. General

The range card is a sketch or diagram of an area showing the tank's position, existing and probable target areas, and in some cases, prominent terrain features, plotted in relation to their actual location on the ground. Range cards are used to place effective fire on plotted targets and targets of opportunity during periods of good and poor visibility. The range card serves as the individual tank's fire plan and provides the basis for coordinating and concentrating the defensive fires of a unit.

100. Preparation of Range Cards

Range cards are prepared for all defensive positions (primary, alternate, supplementary, in order of priority) and all static positions when contact with the enemy is possible, e.g., after occupying an objective when the time for continuation of the attack is uncertain. Timeliness is an important factor in the preparation of range cards. Range cards must be made during the time targets are visible through the direct-fire sights; therefore, the preparation of these cards must be given a high priority when positions are occupied shortly before darkness, or when reduced visibility conditions are imminent. A range card must contain all information necessary to place fire on a target under all conditions of visibility, and it must be constructed so that it can be understood by all tank crewmen. The tank commander analyzes the terrain in his sector of responsibility and selects a firing position (preferably hull defilade) from which his tank can achieve maximum coverage of assigned or probable targets and target areas. In selecting the tank position, special consideration must be given to obscuration when firing at night with illumination.

Obscuration at the tank's position can be reduced by selecting a firing position that has a cover of vegetation. If this is not possible, the area around the firing position (especially the ground just below the muzzle of the gun) should be soaked with water or oil. Once the tank is in its firing position, the necessary data for a range card are obtained by use of the fire control equipment of the tank. Specific techniques for obtaining the data will vary for different type tanks, but generally the method is the same.

a. Reference Point. The tank commander selects a *reference point*—a prominent, easily located point on the terrain, fairly permanent, and readily seen through the direct-fire sights of the tank. The reference point serves as a starting point to determine data to targets. For each target plotted, including the reference point, the following information (*b-f* below) must be recorded.

b. Target Identification. Targets are recorded on the range card by using a military symbol, a brief word description, or both. In addition, specific targets selected by the company commander or platoon leader receive a designation in form of a number (company targets), or a letter (platoon targets). All company and platoon targets designated by the platoon leader must be plotted. Targets that cannot be engaged are plotted, but no data are recorded for such targets.

c. Deflection. The gunner obtains deflection by laying the aiming cross of the direct-fire sight on the reference point and zeroes the azimuth indicator with the reseter knob. The *deflection to the reference point* will always be 0. The gunner then traverses to the target to

be plotted. The gunner reads the deflection indicated by the azimuth and micrometer pointers of the azimuth indicator (fig. 63). The deflection thus obtained is recorded, including direction from the reference point, i.e., left or right.

Example. Deflection 2,840 right; plotted as DEFL 2,840 R.

d. Range. Range is obtained by use of the range finder or by the most accurate means available. If estimation is used initially, a more accurate range should be determined at the earliest opportunity. Range is recorded as RG 1,600, etc.

Example. Range 1,600; plotted as RG 1,600.

e. Quadrant Elevation. Quadrant elevation is a combination of angle of sight and superele-

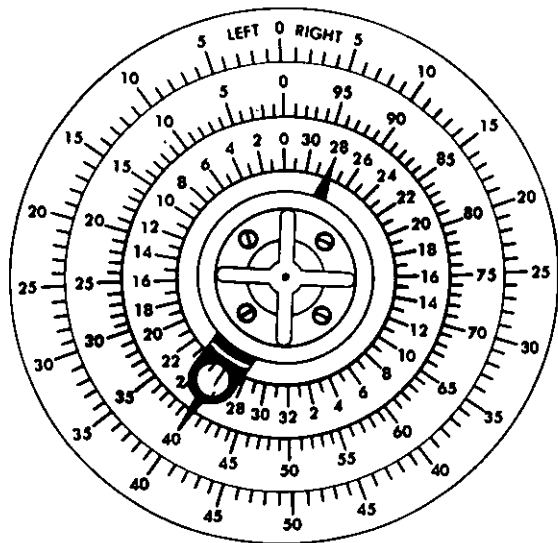
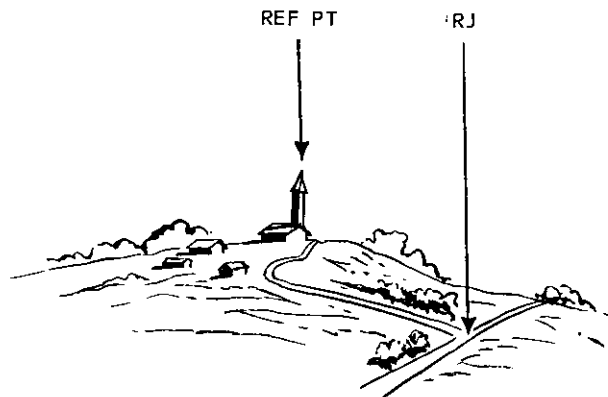

Figure 63. Azimuth indicator.

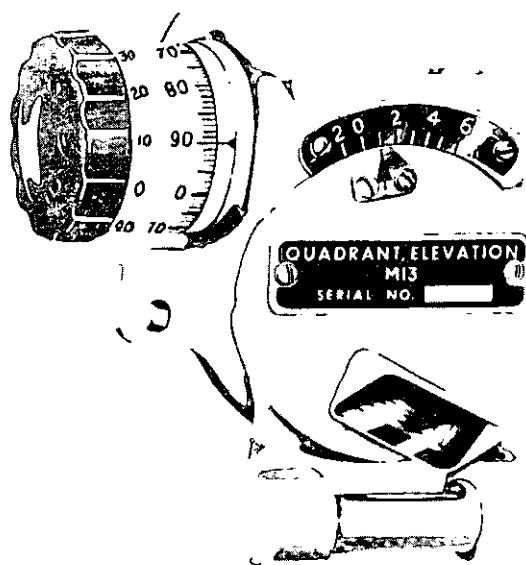

Figure 64. Mounted elevation quadrant.

vation. Simply, the number of mils the gun tube must be elevated, or depressed in relation to the horizontal to insure that a round will strike the target at a given range. HE or HEP ammunition is used during periods of poor visibility to take advantage of the bursting radius and fragmentation effect of the round. Quadrant elevation is obtained as follows:

- (1) *Main battle tanks.* With the computer on, the range to the target and either HE or HEP ammunition is indexed in the fire control system. The gunner lays the aiming cross of his direct-fire sight on the center of the target, centers the bubble in the elevation quadrant by using the micrometer knob, and reads the quadrant elevation from the elevation and micrometer scales.

Example. Quadrant Elevation + 90 mils. Recorded as QE + 90.

- (2) *Tank, M41.* The gunner indexes the range to the target on the HE scale of the ballistic unit and lays the aiming cross of his direct-fire sight on the target. He then places the gunner's quadrant on the quadrant seats of the breechring and centers the bubble, using the index arm and microm-

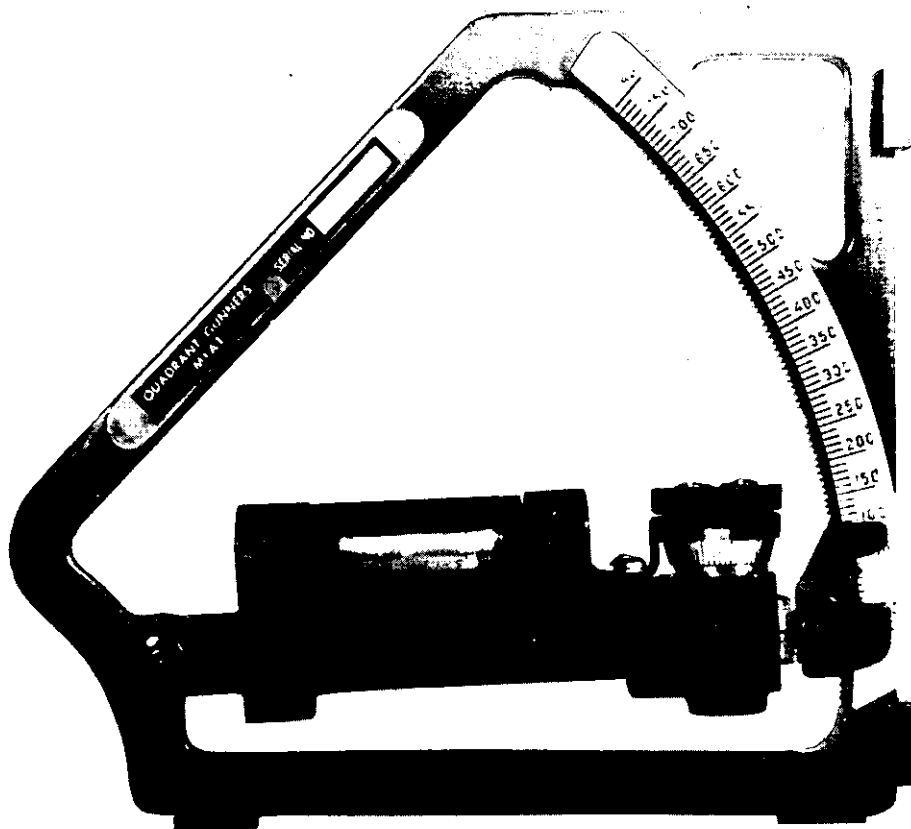

Figure 65. Gunner's quadrant.

eter knob. The existing quadrant elevation is now read from the elevation and micrometer scales.

Example. Quadrant Elevation + 55 mils. Recorded as QE + 55.

f. Range Card Identification. Each range card is marked in the upper right-hand corner with

a P, an A, or an S, or a combination of these letters, to indicate primary, alternate, or supplementary firing positions. If a combination of letters is used to indicate that the range card contains data for two firing positions (sketch-type range card only), then each position should be marked with the appropriate letter.

Section II. TYPES OF RANGE CARDS

101. General

The two types of range cards used in tank gunnery are the circular and the sketch range cards. The tank commander decides which type of range card will be used. He bases his decision upon the terrain and the distribution of targets within his sector of responsibility.

102. Circular Range Card

The circular range card (fig. 66), consists of five concentric circles, each circle represent-

ing a range designated by the tank commander. The outer range circle serves as a deflection scale; it is a reproduction of the azimuth scale; it is a reproduction of the azimuth (inner) scale of the azimuth indicator. Numbers in parentheses on the right side of the card have no application in tank gunnery. All targets are plotted for deflection and range in their relation to the tank's position. The tank's position is represented by the center of the card. Target data obtained as outlined in paragraph 100 are recorded on the range card adjacent to a line drawn from the center to

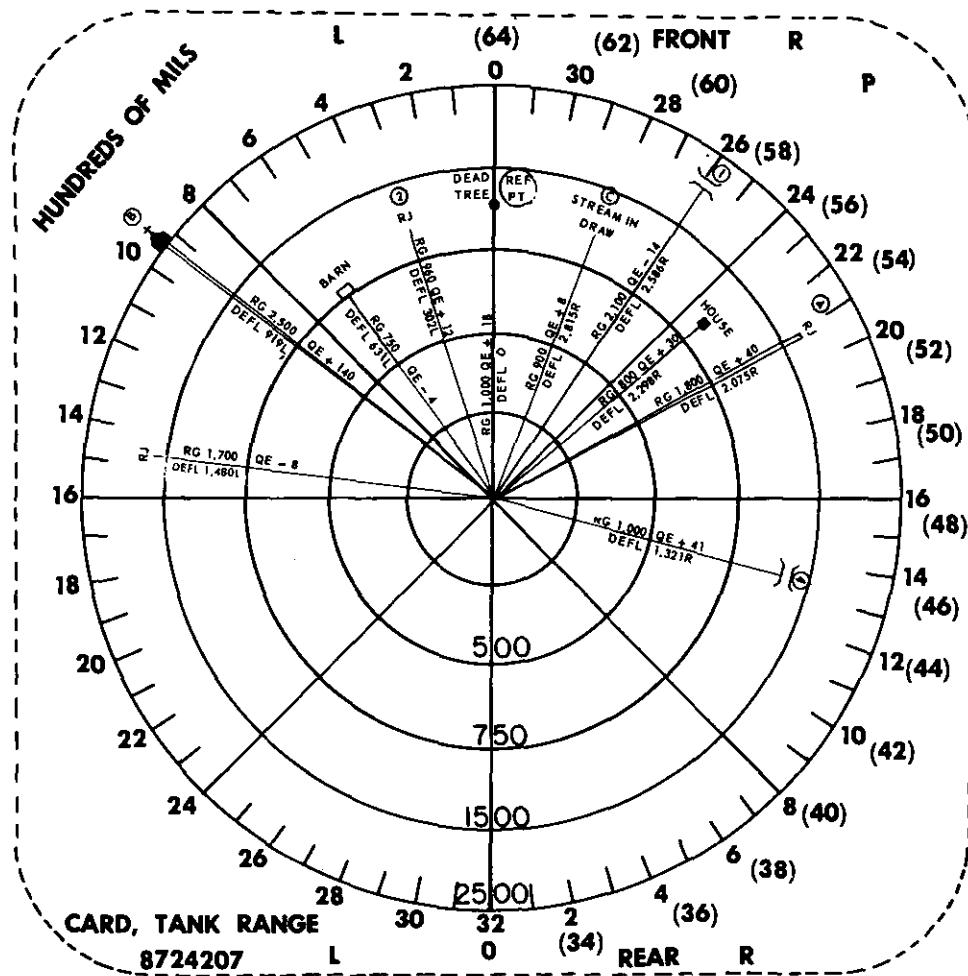

Figure 66. Circular range card.

a point corresponding to the range and deflection of the target. Double lines to targets represent the right and left boundaries of the sector of responsibility. The zero deflection line represents the direction to the reference point. Each target is positioned by interpolation for range and deflection. It is necessary to record the data even though it may coincide with a range circle or a graduation on the deflection scale. The value of this type of range card is the simplicity of preparation and ease of reading. If a tank has a narrow sector of fire it will be difficult to plot many targets and record data within the limits of the deflection scale. In this case, a sketch type range card should be used.

103. Sketch Range Card

The sketch range card (fig. 67) is a simple drawing of the sector of fire of the tank. The drawing shows the tank's position, reference point, key terrain features, and plotted target areas. A line is drawn from the tank's position to the plotted target and data obtained as outlined in paragraph 100 are recorded adjacent to this line. Double lines indicate sector of responsibility. Sketch range cards need not be drawn to scale and should provide ample space for plotting. The value of the sketch range card depends on the ability of tank crewmen to draw simple, legible diagrams. It can be used to plot data for more than one position.

Section III. PREPARATION FOR AND REOCCUPATION OF NIGHT FIRING POSITIONS

104. General

After the range card for a tank's firing position has been completed (para. 101-103), the position of the tank is marked to facilitate reoccupation of the position during reduced visibility conditions, or to permit a relieving unit to use prepared range cards. Depending upon the terrain and tactical situation, any one, or a combination, of the following techniques may be used.

105. Method 1

After the range card for the tank's firing position is completed, two reference stakes with filtered or shielded lights are placed out as shown in figure 68. One stake (high enough to be visible to the driver) is placed at the center, and flush with, the bow of the tank. The second stake is positioned approximately 20-25 meters to the front, and on line with, the first stake and the vehicle center. The gunner records the deflection reading to the far reference stake on the range card. When the firing position is to be reoccupied during darkness, or periods of poor visibility, the shielded lights on the reference stakes are turned on. As the tank moves into position, the driver, with the aid of a white tape or chalk mark on the front center of the tank hull, aligns the tank on the two lights. He stops when the front slope of the tank touches and is centered on the near reference stake. The tank is now positioned properly. The gunner lays his direct-fire sight on the far reference light, and using the resetter knob, indexes the deflection reading for the reference stake on the azimuth indicator. The gunner then traverses to zero deflection or any other deflection designated by the tank commander.

106. Method 2

a. After the range card for the tank's firing position is completed, and with the tank in position, a small stake is driven into the ground at the rear of the left or right track. Another small stake is positioned at the front of the same track at a point where the track touches the ground. Both stakes must be immediately adjacent to the outside edge of the track. Aiming stakes are set up in line at any angle from the firing position except within 100 mils of the direct front or rear, because placement of the aiming stakes in such a position will not facilitate accurate positioning of the tank. One stake is placed approximately 15-25 meters from the firing position and the other at twice that distance. The light on the far stake should be at a higher elevation than the light on the near stake. The gunner traverses from the reference point to the aiming stakes, and when both stakes appear in line, records the deflection reading to the aiming stakes.

b. When the firing position is to be reoccupied, a white tape stretched between the two ground stakes facilitates alinement of the tank. The shielded lights on the aiming stakes are turned on. The gun is traversed to the approximate angle of the aiming stakes and the tank is moved forward along the tape (fig. 69); the gunner controls the final positioning of the tank by giving instructions to the driver. When the far light appears to be above and in line with the near light in the sight reticle, the tank is positioned properly. Using the resetter knob, the gunner indexes the deflection to the aiming stakes on the azimuth indicator and *traverses* the gun to zero deflection or any other deflection designated by the tank commander.

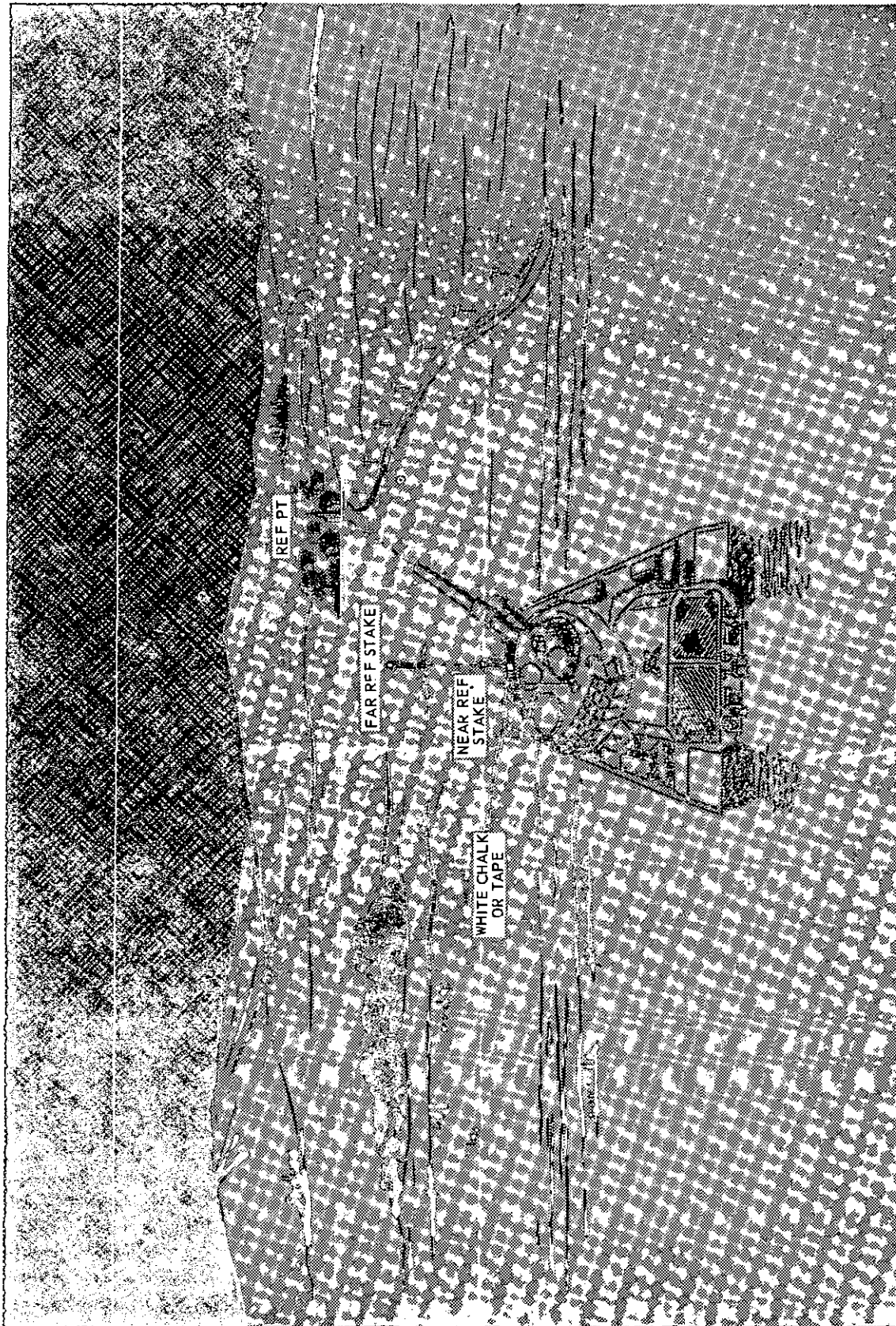

Figure 68. Method 1.

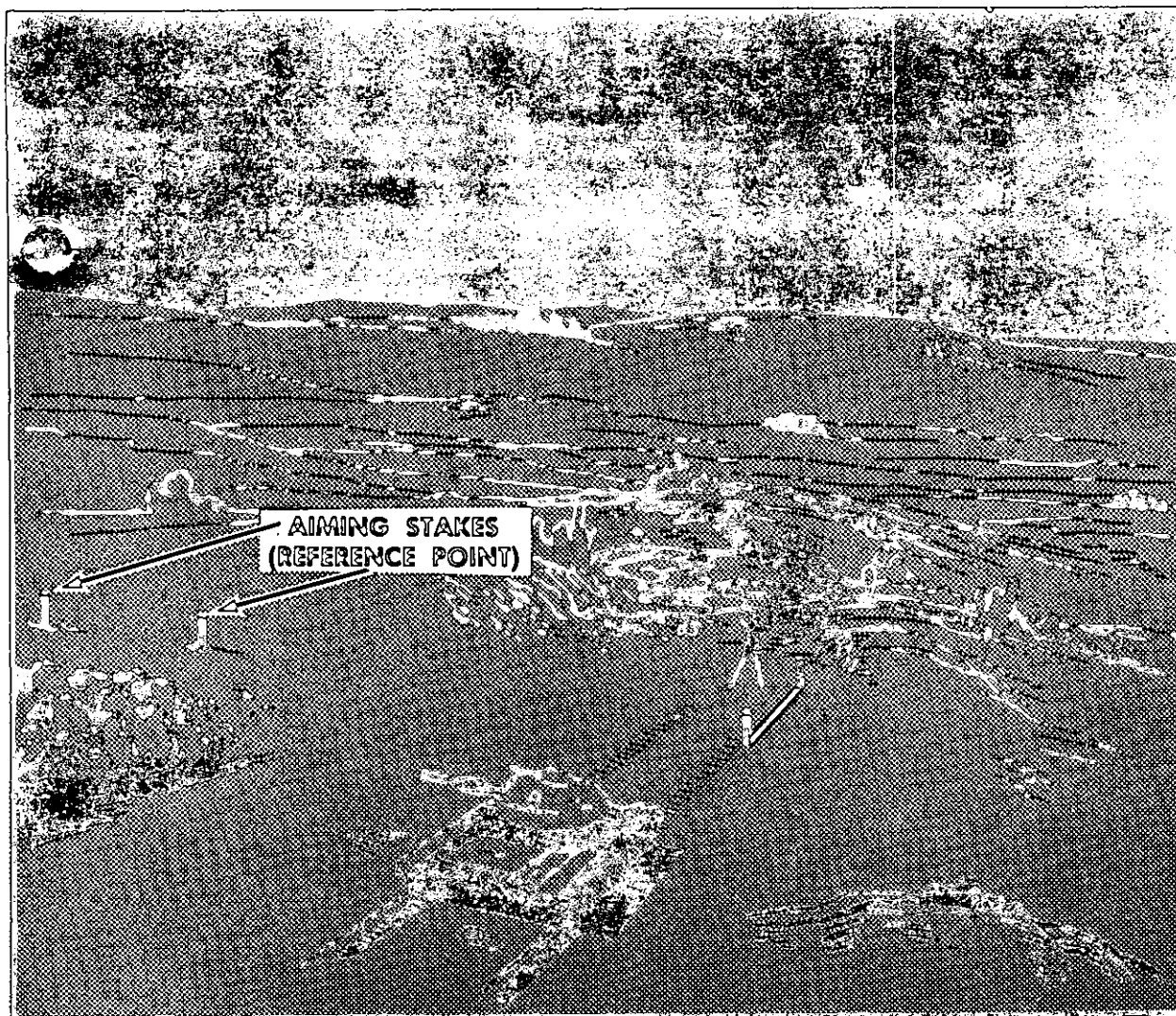

Figure 69. Method 2.

Section IV. PREPARATION FOR NIGHT FIRING

107. Blackout Turret

All unnecessary lights must be turned off. If lights cannot be independently turned off, they should be covered so no light shows, or the bulb should be removed. Intensity-controlled lights necessary for firing must be adjusted properly (dimmed as much as possible consistent with continued use). Necessary lights without intensity controls must be masked to reduce the amount of illumination. Shaded flashlights may be used to assist the crewman in reading scales.

108. Night Vision

To acquire night vision, tank crewmen should not be subjected to light for approximately 30 minutes before firing. Once night vision is obtained, it must not be destroyed by exposure to intense light. During firing, both the tank commander and gunner must close their eyes momentarily (from the announcement of ON THE WAY until approximately 1 second after the gun has fired) to avoid the blinding effect of muzzle flash. The head must not be moved away from the sight because repositioning of

the head may cause an incorrect sight picture and failure to sense the round. At night, the tank commander uses his direct-fire sight rather than his binocular to sense rounds. The direct-fire sight remains on the target. Between target engagements, the tank commander should position himself so he can observe his sector of responsibility.

Section V. TACTICAL USE OF RANGE CARDS

110. General

The range card is used by the tank crew. The platoon leader and company commander use a fire plan, based on their unit's range cards, to increase the effectiveness of tank gun fire during periods of both good and poor visibility. Good visibility implies daylight hours with no weather restrictions or the hours of darkness when illumination is used. Poor visibility implies daylight hours when weather conditions restrict vision or the hours of darkness when no illumination is used.

111. Firing During Poor Visibility

During periods of poor visibility, HE or HEP ammunition is employed to obtain the benefit of the blast and fragmentation effect in the target area. Firing during poor visibility discloses the tank's position and often requires a considerable expenditure of ammunition to achieve the desired results. The decision to fire is based on the importance of the target, the knowledge that the firing position may be disclosed, and the ammunition supply. In this last consideration, commanders at all echelons should exercise control over expenditure of ammunition when the effect of firing in the target area cannot be determined. To fire on a plotted target, range card data are applied to the auxiliary fire control instruments.

a. Initial Fire Command and Crew Duties.

<i>Command</i>	<i>Crew duties</i>
GUNNER	Gunner turns on turret power.
TWO ROUNDS	Loader loads a round of HE, checks path of recoil, positions safety in FIRE position, and announces UP. Gunner turns
HE	

109. Reticle Illumination

The reticle of a direct-fire sight usually must be illuminated during night firing because artificial illumination is not always of an intensity sufficient to provide contrast for viewing the etched reticle. When a reticle is illuminated for use, it must be kept as dim as possible by use of the rheostat to avoid glare.

<i>Command</i>	<i>Crew duties</i>
TROOPS DEFLECTION THREE TWO FIVE LEFT	on main gun switch and indexes HE in computer or waits on range element (M41 tank). Gunner traverses to announce deflection, then announces reading on azimuth indicator. Tank commander indexes recorded range on range finder (M48, M60 tanks) or announces it for the gunner to index (M41 tank).
QUADRANT PLUS ONE SIX	Gunner indexes announced QE on quadrant, elevates or depresses gun with <i>manual</i> controls until leveling bubble in quadrant is centered, and announces QE on quadrant.
FIRE	Gunner announces ON THE WAY and fires.

Note. Although turret power, range, and ammo are not necessary to lay the gun back on the target, they are used to return the sights to the target. In the event the target becomes illuminated, the direct-fire sights can be used.

The sequence of performing these steps is important because if the tank is canted, the gun may not be laid properly unless the leveling bubble in the quadrant is centered as the last step. Also, the leveling bubble must be recentered each time the weapon is fired. This is accomplished after the weapon is loaded to insure that the gun is laid correctly. When the gun is laid for deflection, the gunner's aid is zeroed for use in making subsequent deflection changes for firing at a particular target. Even when it is impossible to adjust fire by observa-

tion, target hits may be observed under certain conditions. For example, HE or HEP striking metal causes a bright flash, and has an incendiary effect on some targets. When HE or HEP rounds strike near a target, the target may be momentarily illuminated (short), or silhouetted by the detonation (over).

b. Area Fire. When target effect is not visible, area fire may be employed to increase the probability of damaging or destroying the target. Area fire is the firing of a prescribed number of rounds of HE or HEP in a prescribed pattern. The standard area fire pattern (fig. 70) is normally employed for all standard tanks. This pattern consists of five rounds. The initial round is fired from range card data; subsequent rounds are fired 1 mil over, 1 mil short, 10 mils right, and 10 mils left of the first round. This pattern gives an area coverage of approximately 200 meters (yards) in depth at all ranges and of a varying amount of width depending on range to the target. Other area fire patterns may be devised to increase the effectiveness of this type of fire against tar-

gets encountered in unusual terrain. If such additional patterns are used, they must be easily identifiable when announced in the fire command, e.g., pattern blue.

- (1) *Initial fire command for area fire:*
 GUNNER
 AREA FIRE
 TROOPS
 DEFLECTION ONE NINE TWO
 LEFT
 QUADRANT PLUS ONE ZERO
 FIRE
- (2) The gunner fires the first round, using range card data, and the remaining rounds in the prescribed pattern without further command.

112. Firing With Good Visibility

a. General. When a target is engaged that can be seen through the direct-fire sights, direct-fire methods are employed. At night, artificial light and sometimes moonlight provide sufficient visibility to allow target engagement

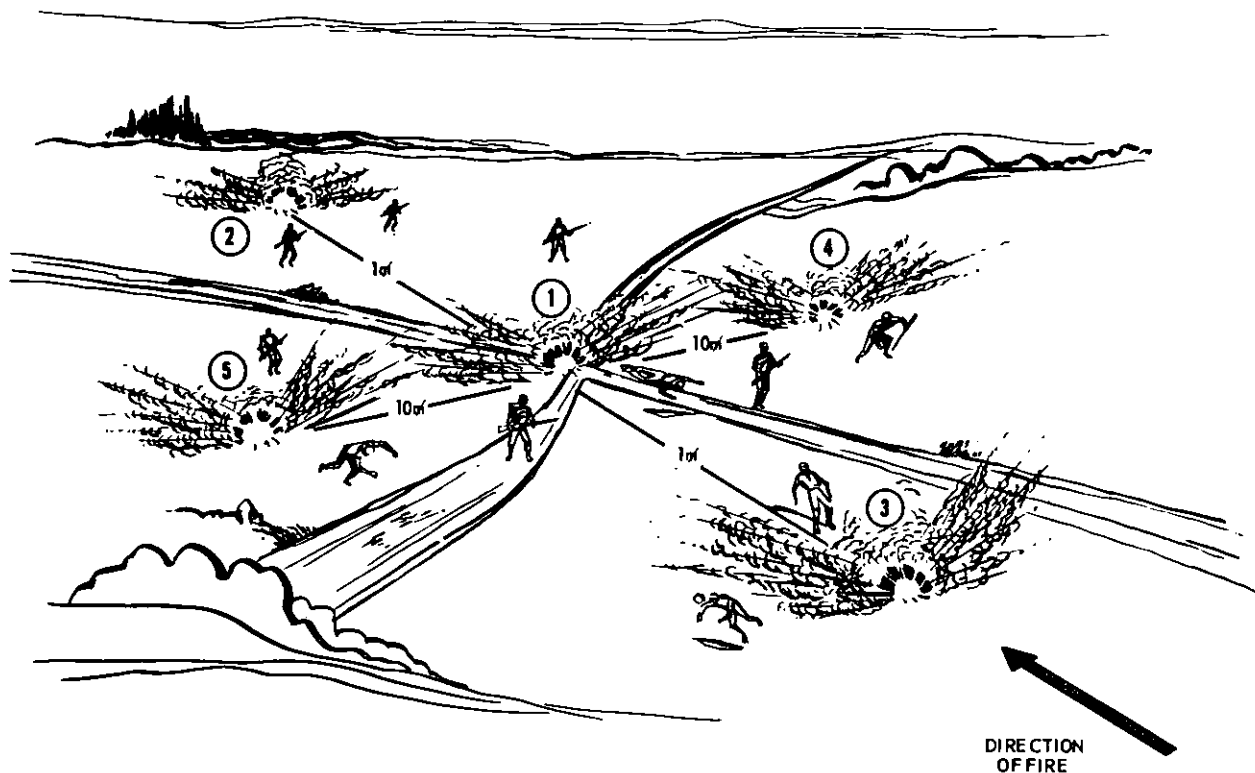

Figure 70. Standard area fire pattern.

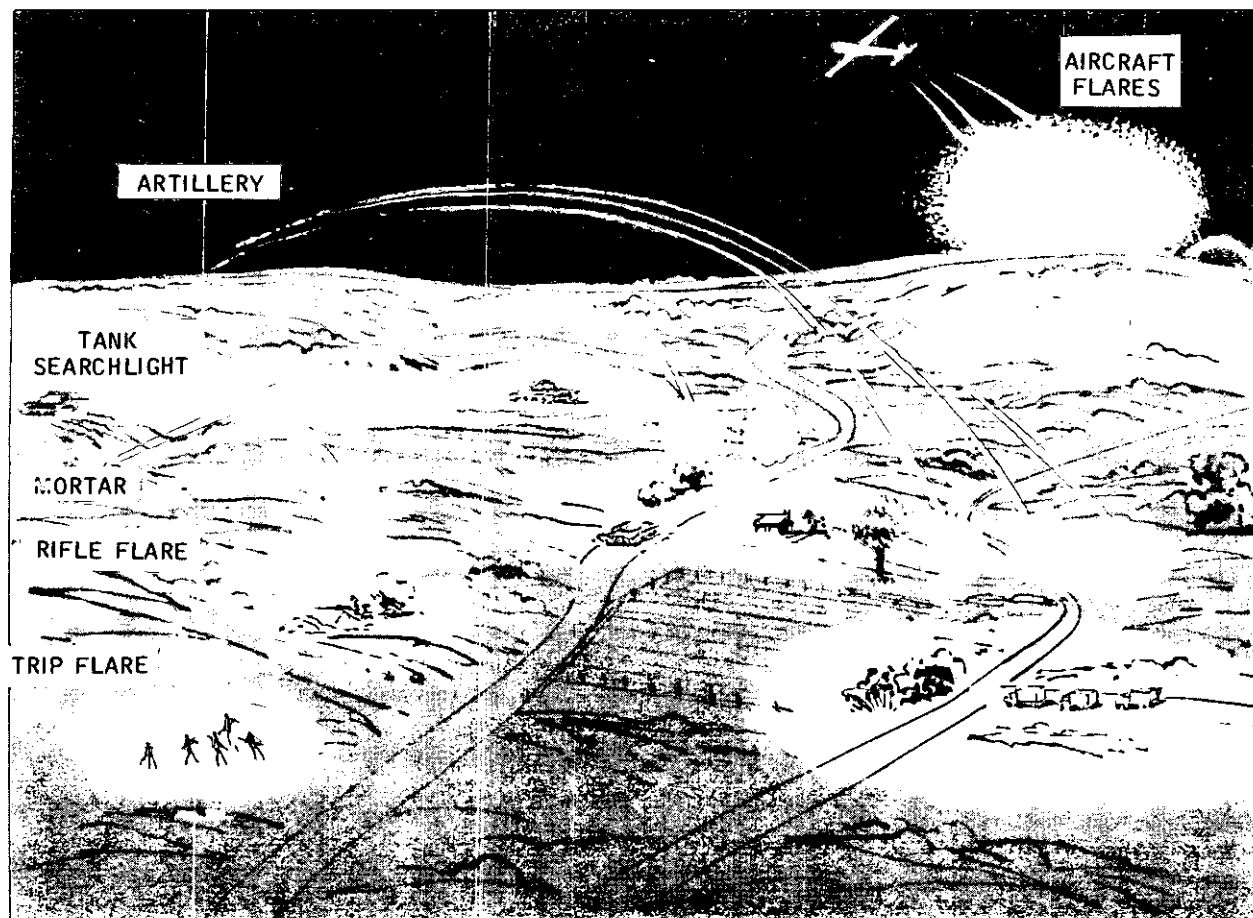

Figure 71. Types of artificial illumination.

by direct fire. Artificial illumination is provided by searchlights (tank-mounted, visible or infrared light, and artillery 60-inch searchlight), illumination shells (mortar and artillery), and flares (trip flares, rifle flares, hand-held flares, and those released from aircraft) (fig. 71). Fires may be started in the target area by firing smoke rounds, or machinegun incendiary or tracer ammunition at such flammable materiel as brush, trees, wooden buildings, or flammable materiel pre-positioned in the target area. Before any target or target area is illuminated, consideration must be given to the effects of this illumination on friendly troops.

b. Daylight. The tank commander can increase the speed of target engagement during daylight by using the recorded range to engage targets at or near a plotted target. The normal initial fire command is issued to engage the

target and the crew duties remain the same except that the tank commander eliminates the time normally required for ranging by indexing the recorded range. The recorded range to targets also serves as a yardstick on the ground, which will assist the tank commander in estimating the range to targets of opportunity that appear between plotted targets (M41 tank).

c. Artificial Illumination.

- (1) *Range card lay for direct fire.* When the decision is made to illuminate a target for engagement, the tanks to engage the target can lay their guns and sights on the target by use of range card data prior to illumination. This technique is *range card lay to direct fire*. Once illumination occurs, the gunner will see the target in his direct-fire sight and engage it immediately with direct fire. This will pre-

clude any time for evasive action by the enemy after illumination and prior to engagement. If the target to be engaged requires the same type ammunition for which the range card is prepared, the fire command and crew duties shown in example 1 below would be used. If the target required a type of ammunition other than that for which the range card was prepared, the fire command and crew duties shown in example 2 below would be used.

Example 1.

<i>Initial fire command</i>	<i>Crew duties</i>
GUNNER, DIRECT FIRE	Gunner insures that turret power is on. Tank commander turns computer on.
HE	Loader loads a round of HE, checks path of recoil, insures safety is in FIRE position, and announces UP. Gunner turns on main gun switch and indexes HE in computer. Tank commander indexes plotted range.
TROOPS DEFLECTION 217L	Gunner traverses to announced deflection and repeats the reading.
QUADRANT + 6	Gunner indexes quadrant reading, uses his manual gun controls to center bubble, and repeats the reading.
AT MY COM- MAND—	The tank commander calls or waits for illumination. When the target is illuminated the gunner announces IDENTIFIED when he sees it, makes a final precise lay, and upon the command FIRE from the tank commander engages the target.
FIRE	The tank commander announces FIRE after the gunner has identified the target. If the gunner fails to identify the target,

Initial fire command

Crew duties

the tank commander announces FROM MY POSITION and engages the target, using his direct-fire sight.

Example 2.

Initial fire command

Crew duties

GUNNER, DIRECT FIRE	Gunner insures that turret power is on. Tank commander turns the computer on.
INDEX HE FIRE SHOT	Loader loads a round of shot, checks path of recoil, insures safety is in FIRE position, and announces UP. Gunner turns on main gun switch and indexes HE in computer. Tank commander indexes plotted range.
TANK DEFLECTION 2895R	Gunner traverses to announced deflection and repeats the reading.
QUADRANT —18	Gunner indexes quadrant reading, uses his manual gun controls to center bubble, and repeats the reading. The gunner then indexes SHOT in the computer.
AT MY COM- MAND—	The tank commander calls or waits for illumination. When the target is illuminated, the gunner announces IDENTIFIED when he sees it, makes a final precise lay, and upon the command FIRE from the tank commander engages the target.
FIRE	The tank commander announces FIRE after the gunner has identified the target. If the gunner fails to identify the target, the tank commander announces FROM MY POSITION and engages the target, using his direct-fire sight.

The examples given are for tanks with range finders and superelevators. If the tank does not have a range finder (M41 tank) the tank commander announces the range just before quadrant elevation. In example 2, if the tank does not have a superelevator the gunner waits until after illumination of the target and then indexes SHOT prior to making his final precise lay. In both cases, the other crew duties remain the same as in examples.

- (2) *Targets of opportunity.* Unplotted targets may be illuminated when an area of enemy activity has been located or when accidental illumination is caused by some means. In either case, if these targets appear at or near plotted targets, the range can be obtained from the range card and indexed by the tank commander as he issues a normal direct-fire initial fire command. If the target is not located at or near a plotted target, the normal direct-fire initial fire command is issued and the

tank commander determines the range to the target.

113. Firing Machineguns at Night

Both tank machineguns are effective for firing at night with artificial illumination. During periods of poor visibility, the caliber .50 machinegun cannot be laid for elevation by indirect means; therefore, its use is limited unless the tank commander can determine the target area, i.e., by use of illumination or fire from one of the other tank weapons. The coaxial machinegun, however, can be laid indirectly by plotted range card data. When no illumination is available the gunner should search and traverse the target area to insure coverage. Tank machineguns are not laid on final protective lines as are ground-mounted machineguns. The reasons are clear. The elevation of the tank machinegun in relation to the ground prevents the delivery of effective grazing fire, which is an integral part of final protective fires, and the use of the machinegun in this manner would divert it and the tank main gun from their primary mission of engaging targets of opportunity.

Section VI. USE OF TANK-MOUNTED SEARCHLIGHTS

114. Quadrant Elevation

A tank equipped with a searchlight must prepare a range card that contains all of the data outlined in paragraph 100 to be used when the tank is engaged in the firing role. In addition to this information, the searchlight tank must obtain a separate quadrant elevation for the searchlight. This is necessary because the searchlight is a line of sight instrument. Quadrant elevation for the searchlight requires the angle of sight only. Quadrant elevation for the armament contains the line-of-sight angle and superelevation to compensate for the trajectory of the projectile. If the quadrant elevation for the armament were used, it would place the beam of the searchlight above the target to be illuminated. This would necessitate the gunner's depressing the searchlight when it is turned on. Quadrant elevation for the searchlight can be obtained by any of the following

methods, after the quadrant elevation for the main gun has been determined.

a. Main Battle Tanks. With the turret power on, the gunner uses the superelevation handcrank to index 0 mils in the superelevation counter of the computer. Superelevation has now been removed from the fire control system. The gunner centers the bubble in the elevation quadrant, using the micrometer knob, and reads the existing quadrant elevation from the elevation and micrometer scales.

b. Tanks Not Equipped with a Superelevator (M41 and M48 tanks). The gunner removes superelevation from the fire control system by indexing 0 mils on the ballistic unit (M41 tank), or indexing 0 mils in the superelevation counter of the computer (M48 tank). He lays the aiming cross of the direct-fire sight on the target and centers the bubble in the quadrant, using the micrometer knob. The gunner reads

the existing quadrant elevation from the elevation and micrometer scales.

c. Quadrant Elevation Conversion Method. This method can be applied on all tanks. It is used when existing conditions allow a tank crew only sufficient time to obtain range card data for the main gun. Quadrant elevation for the main gun can be converted to quadrant elevation for the searchlight as follows:

- (1) *Using the tabular firing table.* Obtain the elevation for range, (superelevation) in mils, from the tabular firing table and subtract it from the quadrant elevation for the main gun (fig. 72).

Example. Range = 1,000 yds., QE (main gun) = + 59 (mils)
 From main gun QE + 59
 Subtract 9
 —
 QE for searchlight = 50
 (Disregard tenths of a mil)

- (2) *Using the computer.* Index range and

ammunition in the computer; subtract the number of mils (nearest whole mil) shown in the superelevation counter window from the QE for the main gun (fig. 73).

Example. Range = 1,000 yds., QE (main gun) = + 59 (mils)
 From main gun QE + 59
 Subtract 9
 —
 QE for searchlight = 50

- (3) *Using the ballistic unit.* Use same procedure as discussed in (2) above with the exception that mils of superelevation is obtained by use of the mil scale on the ballistic unit.

d. Recording Searchlight QE. Crewmen must insure that a clear distinction is made between quadrant elevation for the main gun and quadrant elevation for the searchlight, when they are recorded on the range card.

Example. RG 1,000 QE + 59 SLT + 50
DEFL 2,859R

TABULAR FIRING TABLE				
Range	Elevation	Elevation Change For 100-yd Range Change	Vertical Change	Vertical Probable Error
Yds.	mils	mils	R.	R.
0	0.0	.8	0.0	0.0
100	0.8	.9	0.3	0.1
200	1.7	.9	0.5	0.1
300	2.6	.9	0.8	0.2
400	3.5	.9	1.1	0.2
500	4.4	.9	1.4	0.3
600	5.3	1.0	1.7	0.4
700	6.3	1.0	2.0	0.5
800	7.2	1.0	2.3	0.5
900	8.2	1.0	2.6	0.6
1,000	9.3	1.0	2.9	0.6
1,100	10.3	1.0	3.2	0.7

Figure 72. Tabular firing table.

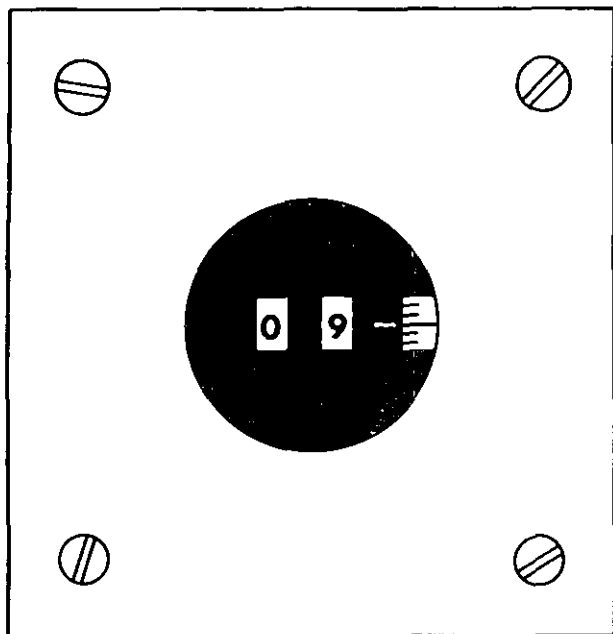

Figure 73. Superelevation—counter window.

115. Initial Searchlight Lay

A searchlight is laid on a target by indirect means, prior to lighting, in the same manner as a tank gun (para. 112c). The tank commander operates the ON-OFF switch for the searchlight, issues an initial fire command, and makes adjustments by subsequent fire commands.

Initial fire command

GUNNER
 WHITE LIGHT
 TROOPS
 DEFLECTION ONE ONE THREE LEFT
 QUADRANT PLUS ONE EIGHT

Note. When the gunner has completed laying the searchlight, he repeats the QE, and the tank commander then turns on the searchlight when ready or as ordered by the platoon leader.

Subsequent fire commands are issued by the tank commander of the tank providing illumination, or by the gunner of the firing tank, if the initial or subsequent lays are not satisfactory.

Subsequent fire command

ADD (DROP) _____STEADY _____ON
 RIGHT (LEFT) _____STEADY _____ON

Lights are turned off on the command CEASE FIRE. When the tank providing illumination has an Xenon searchlight, the searchlight would initially be laid on the target with the normal intensity of beam. When the gunner of the

firing tank is ready to make his final lay and fire, he can announce OVERDRIVE, thereby obtaining increased illumination for actual target engagement. For offensive operations, the light is turned on in the appropriate direction and adjusted on targets as required. Normally tanks mounting searchlights do not fire while illuminating, as obscuration from the firing reduces illumination of the target. In addition, the searchlight would not be centered on the target because it is a line of sight instrument and superelevation is required to fire the gun accurately. For maximum effectiveness, illuminating tanks should be positioned a minimum of 50 meters laterally from firing tanks. When a tank crew must illuminate for its own firing, it is advisable to use a dismounted observer, when possible, for adjusting fire because of the difficulty of sensing from the tank.

116. Techniques of Employment

Tank-mounted searchlights are used best against moving targets, point targets, and small area targets (50 meters or less in width). Tank-mounted searchlights must be properly focused (complete fusion of the light beam to obtain maximum efficiency of the light) and boresighted (para. 54d) before use by the crew. Normally, only direct illumination will be used for tank gunnery purposes and the tank-mounted searchlight will be quite vulnerable to enemy fire if not employed properly. The platoon leader coordinates the firing tanks and the searchlight tanks by fire commands. The flicker technique is employed to reduce the enemy's opportunity to fire accurately on the searchlight. One light is turned on for 15 seconds and then turned off as another searchlight is turned on for 15 seconds (if only one searchlight is used, the flicker time is 15 seconds on and 5 seconds off). To further reduce vulnerability of the searchlight to enemy fire, no more than two 15-second periods of illumination should be performed by any searchlight tank before moving to a new position. The tank-mounted searchlight has a limited capability with indirect illumination (bouncing light off of low clouds). When used for this purpose, the tank is behind a mask and not vulnerable to enemy direct fire, but conversely the tank's weapons cannot be used to place direct fire on the enemy.

CHAPTER 13

PLATOON FIRE DISTRIBUTION AND CONTROL

Section I. INTRODUCTION

117. General

This chapter provides guidance for the use of basic technique to control and coordinate the firepower of the tank platoon for target engagement with long and short range fires. The concentration or distribution of fires of the tank platoon at the proper time and place is essential to destroy, neutralize, or repel the enemy. It is the platoon leader's responsibility, and requires a high degree of fire discipline and responsiveness on the part of individual tank commanders and crews. The tank platoon leader must study techniques of fire control and coordination and practice them until he has the ability to take full advantage of his unit's firepower, regardless of the physical or mental strain imposed upon him by battle conditions. The guidance given in this chapter is basic and serves as fundamental techniques from which the platoon leader can derive his own methods as his training proficiency increases.

118. Firepower of the Tank Platoon

The tank's main gun, machineguns, and any supporting fires constitute the firepower of the tank platoon. Direct fire is the most effective type of fire delivered by the tank platoon. It should be used whenever possible in offensive or defensive action. Not only is it more readily placed on a target during daylight, but due to ever-increasing illumination capabilities, it can be equally effective during darkness or periods of reduced visibility. Range card fire is used during darkness or periods of poor visibility when illumination is not available or not desired. It is not as effective as direct fire but is vitally important in defensive actions. The tank in the artillery role (app. II) is used only in exceptional situations. It is slow and not very

effective, due to the flat trajectory and small bursting radius of tank gun projectiles.

119. Target Acquisition and Analysis

a. For destruction of targets, the platoon leader must first locate and then evaluate a target to form a sound basis for the employment of his weapons. The platoon leader, like the tank commander, must classify the target to insure that the proper weapon and ammunition are employed. He must determine the volume of fire required to destroy the target based on the mission and the number and type of weapons available.

b. Detection of targets is a platoon effort the same as it is a crew effort on the individual tank. The platoon leader assigns areas of observation and establishes a rapid reporting system within his platoon. This enables him to properly evaluate the acquired targets even if they are not in his field of view. The location, type, number, and action of the target(s) must be given in the report. The platoon leader must be careful to give guidance that will afford his tank commanders immediate independent action on targets within their capabilities. Subsequent reporting on the progress of engagement of independent targets is required.

c. The platoon leader has other means available for target detection and location. These may include infantry, observation and listening posts, the company radar sets, and air observers. The reports from these sources should contain the same general information that the platoon leader would receive from his tank commanders. If applicable, he should give specific guidance to those elements in support to insure that the information desired is contained

in their report. Spot report used for reporting observations and actions will include as a minimum, the following information:

- (1) **ALERT**—Callwords followed by word or words to alert person receiving the message of action taken by reporting station.

Example. PENROD TWO SIX, THIS IS PENROD TWO THREE, OBSERVING (ENGAGING OR DESTROYED).

- (2) **DESCRIPTION AND ACTION OF TARGET**—Use words that best de-

scribe the target(s). Include the type, number, and activity.

Example. TANK IN POSITION; THREE TRUCKS MOVING SOUTH; DEMOLITION SQUAD WORKING.

- (3) **LOCATION**—Use best means of locating targets (followed by the terminating proword).

Example. TARGET 4; FRONT OF CHURCH, COORDINATES 943785.

Section II. DISTRIBUTION AND VOLUME OF FIRE

120. General

a. Speed and accuracy are essential in the initial engagement of enemy targets. In many encounters, for reasons of urgency, the platoon leader will not be able to analyze the target fully prior to the engagement. Control over the fires of his platoon can be achieved rapidly through commands calling for the employment of a given fire pattern and a certain volume of fire. Once a target has been engaged, the platoon leader can issue subsequent commands to adjust or change the initial pattern or volume of fire.

b. Speed is essential in the initial engagement; for this reason, the platoon leader normally should not require the acknowledgement of his commands by individual tank commanders, nor should he attempt a time-consuming target description for those tanks that have not immediately identified the target.

121. Basic Platoon Fire Patterns

Sound guidelines in the distribution of fire must be established by the platoon leader to ensure complete coverage of target(s) or target area. Numerous patterns for distribution of fire can be developed to fit different situations; however, the possibility of confusion increases with each pattern that is established. Since the speed of effective initial engagement is critical, the development and constant practice of a few simple patterns that will fit most situations are more desirable. Examples of patterns and

their explanations shown in figures 74, 75, and 76 are sufficient for this purpose.

122. Volume of Fire

a. General. When engaging specific targets, i.e., tanks, trucks, or troops, the volume of fire will be dictated by the amount of fire necessary for destruction. In some situations specific targets will not be observed by a part or all of the tanks in the platoon. These situations occur when the platoon is fired upon from a well-concealed enemy position, when an enemy position is being attacked but the exact location of the target is not known, or when encountering suspected enemy positions. To insure that proper use of firepower is obtained in these situations, the platoon leader must provide basic guidelines for his tank commanders to use. Strength of the enemy, time required by the maneuvering force, availability and effectiveness of supporting fires, and ammunition supply are factors that will govern the volume of fire in these situations. The terms and explanations discussed in this paragraph will fit most situations that require the volume of fire to be controlled.

b. Reconnaissance by Fire. As dictated by the existing situation and mission, reconnaissance by fire is normally performed by individual tanks without specific orders from the platoon leader. It is used primarily in offensive or patrol actions. By placing machinegun fire, or a round of main gun ammunition, on sus-

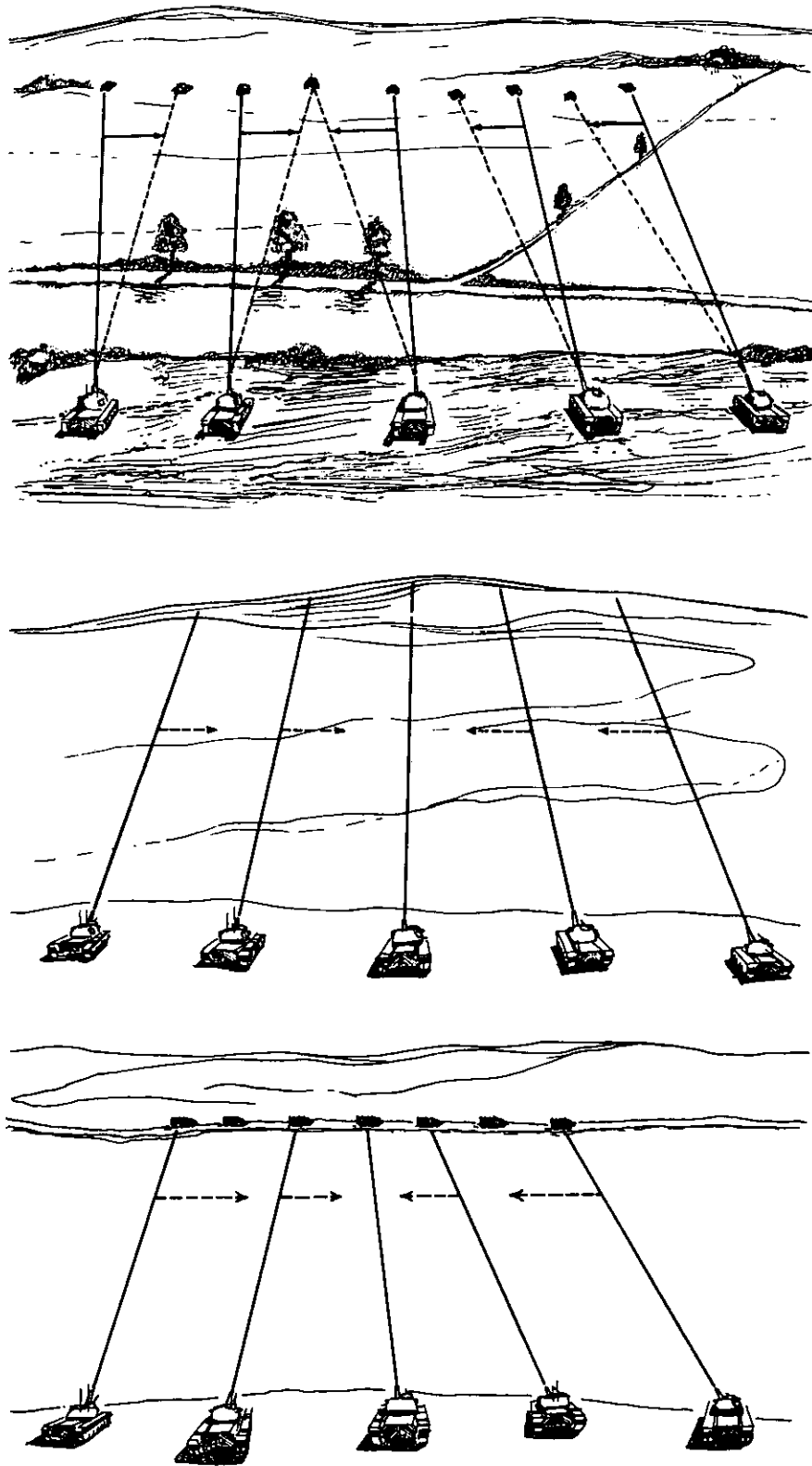

Figure 74. Frontal fire pattern.

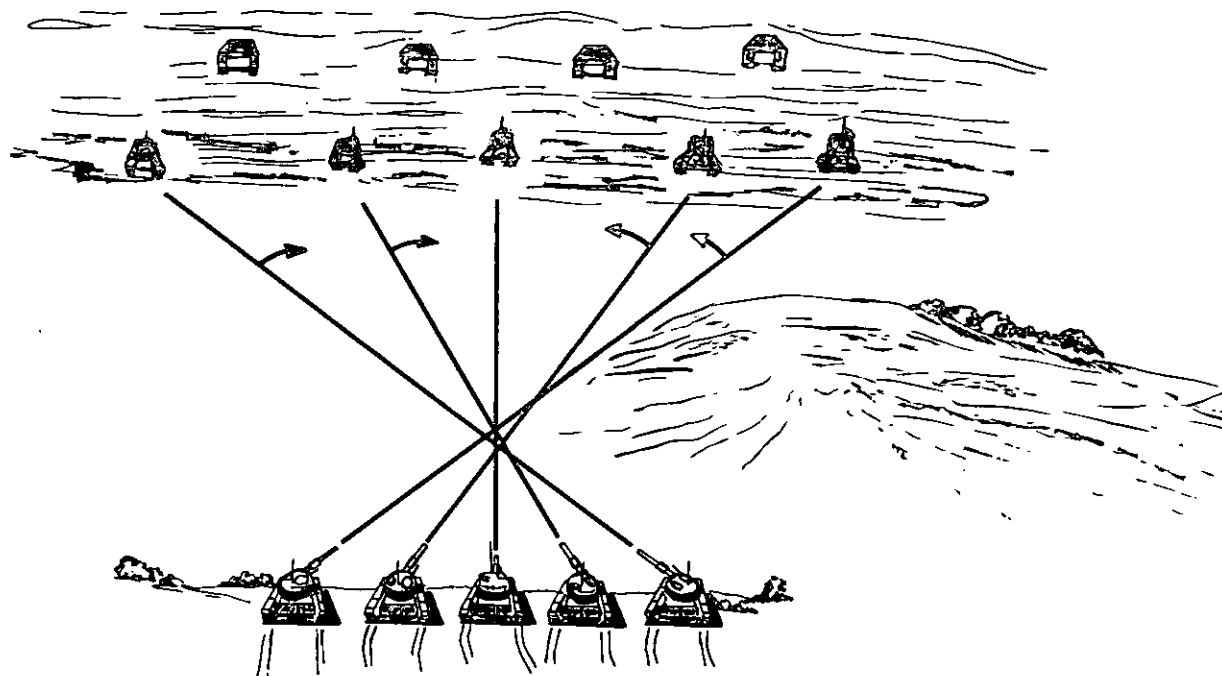

Figure 75. Cross fire pattern.

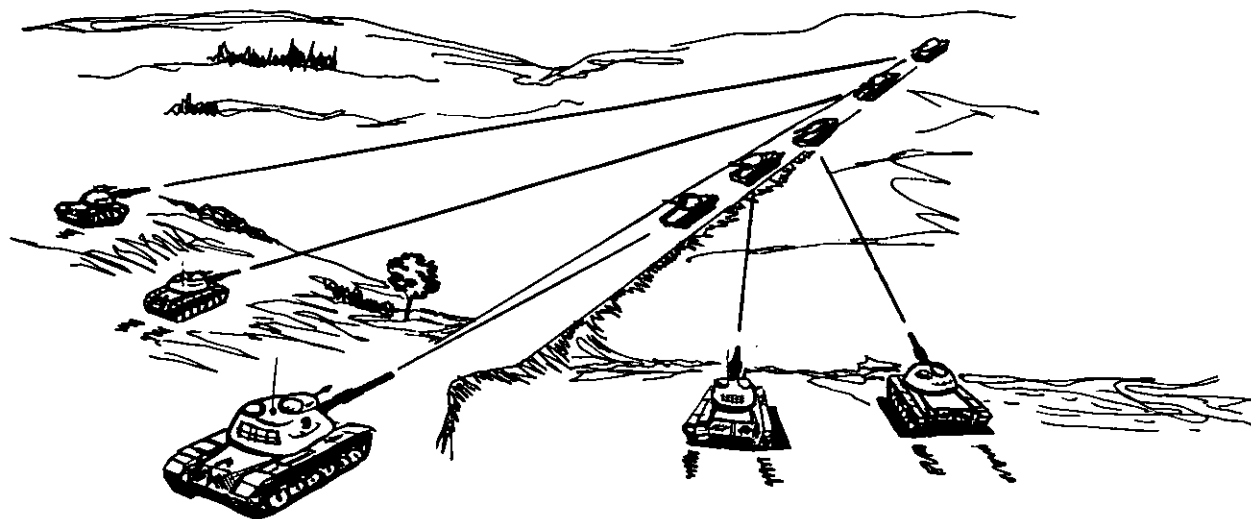

Figure 76. Depth fire pattern.

pected enemy positions it is anticipated that the enemy will return fire, thus revealing his location and approximate strength. Instructions to employ reconnaissance by fire are normally given prior to an operation, and individual tank commanders decide when to employ it on

suspected enemy positions (fig. 77). It must be considered that a well-trained enemy will not always react to reconnaissance by fire.

c. Support by Fire. Support by fire is used to pin down or neutralize an enemy position, permitting other elements to move, assault,

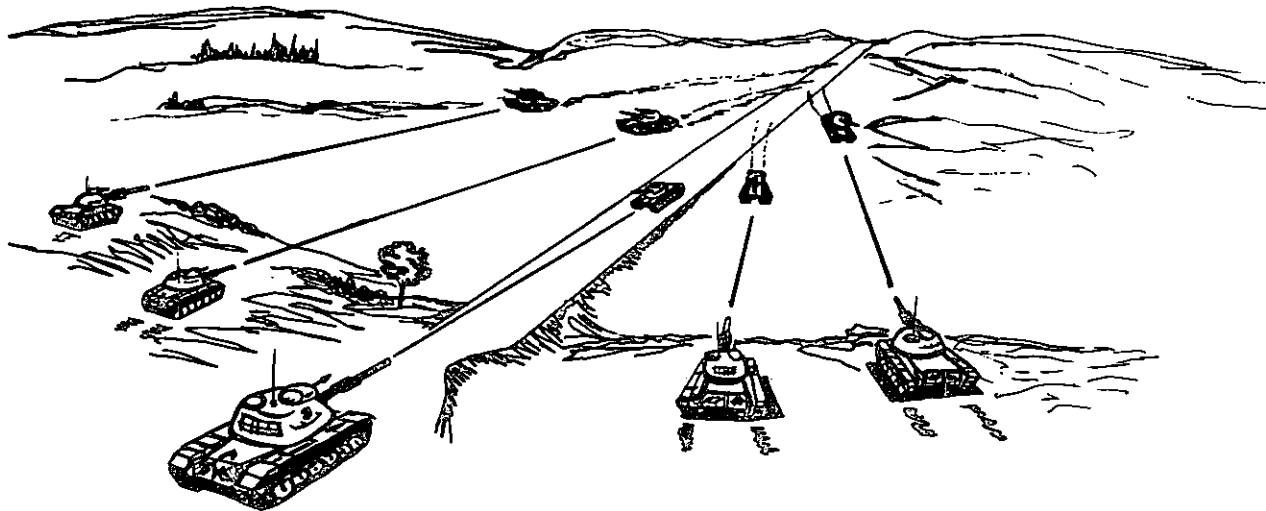

Figure 76—Continued.

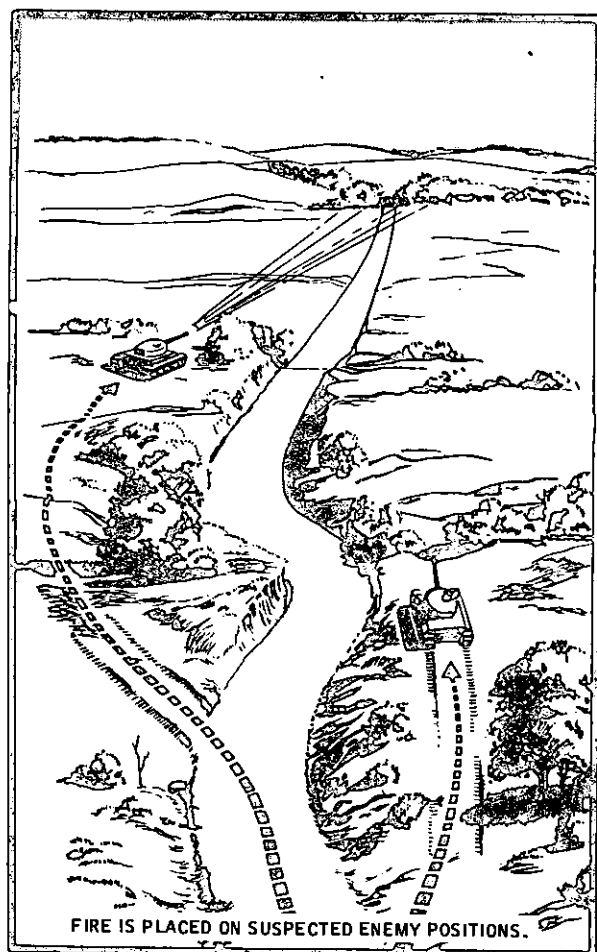

Figure 77. Reconnaissance by fire.

or withdraw (fig. 78). This type of fire will be employed when the tank platoon is performing one of the following roles:

- (1) Overwatching the infantry by fire.
- (2) Supporting by fire when fire and movement are employed.
- (3) Covering a withdrawal of another unit.

The intensity of fire desired is usually directed by the platoon leader in his oral order for an operation. Occasions may arise that require this type of fire during an operation. To direct this, the platoon leader announces SUPPORT and follows with the numerals designating the number of high explosive rounds from the main gun and bursts of machinegun fire per minute from each tank, e.g., SUPPORT TWO AND FOUR meaning 2 rounds main gun and 4 bursts from machinegun. When specific targets are acquired by a tank commander he engages them, using the type of ammunition and rate of fire required for destruction. The tank commander returns to the announced rate of support fire upon destruction of the target. Rate of fire can be changed by the platoon leader during engagement by issuing a subsequent fire command containing the change, e.g., REDUCE TO ONE AND TWO or INCREASE TO THREE AND FIVE. Anytime that the platoon leader desires that the maximum rate

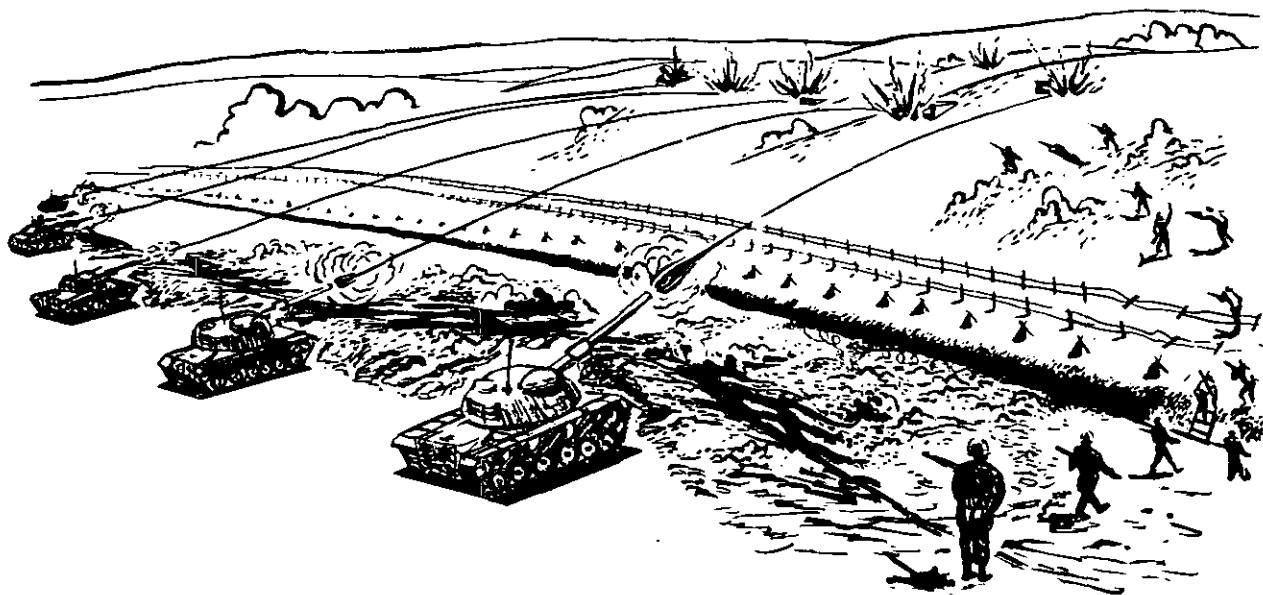

Figure 78. Support by fire.

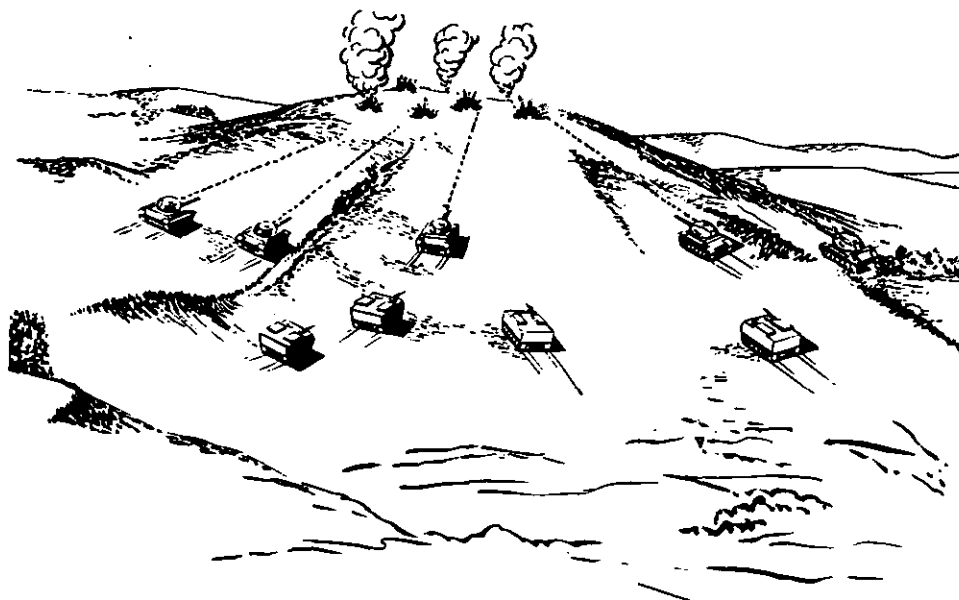

Figure 79. Assault fire.

possible is to be fired he would announce SUPPORT MAXIMUM or INCREASE TO MAXIMUM. When firing support fire, the platoon can expect to draw a heavy volume of enemy fire. For this reason hull defilade positions are highly desirable. If possible, tanks delivering this fire should have more than one firing position, alternating positions from time to time.

The termination of this fire can be controlled by the announcement of a time duration, a prearranged signal, or a subsequent command.

d. *Assault Fire.* The use of this fire is in the attack with the tank platoon as a part of the maneuver element (fig. 79). When assaulting an enemy position, the location of specific tar-

gets will not always be known. If they are known prior to movement, direct-fire support is planned to engage these targets. The movement to the enemy position must be fast and accomplished with the maximum effective firepower. For the assaulting tanks on the move this will be primarily machinegun fire. The main gun cannot be fired accurately on the move except when using special antipersonnel

ammunition; however, as individual targets appear that are dangerous and can best be destroyed with the main gun, the tank commander acquiring the target will stop and engage it. He should stop only long enough for the engagement and then move out again. The platoon leader must be especially alert to ensure that the momentum of the assault is maintained.

Section III. PLATOON LEADER'S FIRE COMMAND

123. General

In the stress of battle, a platoon leader must retain the ability to analyze a situation quickly, and issue concise and complete orders rapidly. The habitual use of standard format for a fire

command insures that all necessary information and control measures are given in a minimum of time, causing a positive reaction by the platoon leader even under the most adverse conditions. The elements of a platoon fire com-

BEARCAT ONE THIS IS BEARCAT ONE SIX
 MAIN GUN
 FIVE TANKS ADVANCING
 DIRECT FRONT, TWO THOUSAND
 FRONTAL
 FIRE

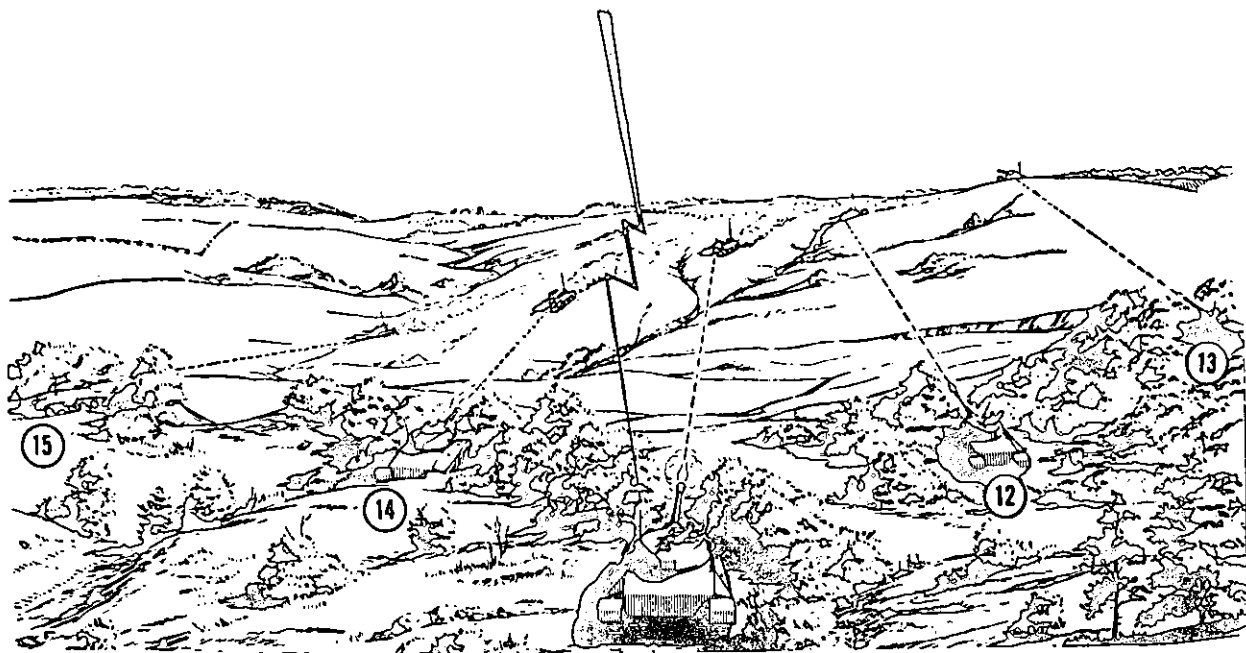

Figure 80. Platoon leader's fire command to engage assaulting tanks.

BEARCAT ONE THIS IS BEARCAT ONE SIX
 FIRE MISSION
 COLUMN OF TRUCKS
 RIGHT FRONT, ONE FIVE HUNDRED
 CROSS
 AT MY COMMAND -
 FIRE

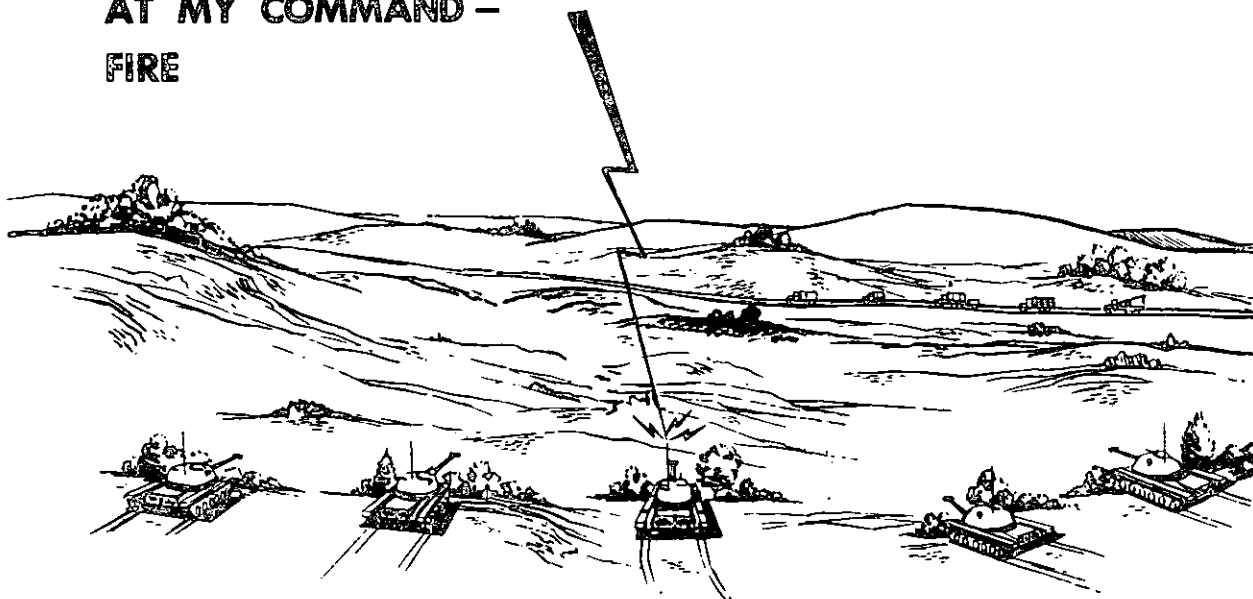

Figure 81. Platoon leader's fire command to ambush a truck column.

mand issued in sequence are: alert; weapon, ammunition, or searchlight; description; location; control; execution. Examples of the platoon leader's fire command are shown in figures 80-83. Correction of the platoon leader's initial fire command is the same as for the tank commander. Each element of the platoon fire command is discussed separately in the following paragraphs. Subsequent fire commands will consist of the necessary elements to alter the fire distribution or volume as the situation develops.

124. Alert

The alert should consist of the radio call signs of the tanks the platoon leader desires to employ.

Examples. 1. PENROD TWO, THIS IS PENROD TWO SIX.

2. PENROD TWO TWO AND TWO THREE, THIS IS PENROD TWO SIX.

125. Weapon, Ammunition, or Searchlight

a. This element directs the type weapon, ammunition, and illumination to be used. Whenever possible, the tank commander should be given the freedom of selecting the type of main gun ammunition or machinegun that he uses. This allows the tank commander to take full advantages of his armament capabilities, e.g., tank 22 has a frontal shot at a tank target and HEAT would be more effective; tank 25 has a flank shot at a tank target and SABOT would be more effective. Similar situations could arise when engaging a target with the machineguns e.g., tank 22 within coax range, but tank 25 is beyond coax range yet within

BEARCAT TWO THIS IS BEARCAT TWO SIX
 TWO THREE AND TWO FIVE WHITE LIGHT
 TWO TWO AND TWO FOUR MAIN GUN
 TANK
 TARGET NUMBER FOUR
 AT MY COMMAND
 FIRE

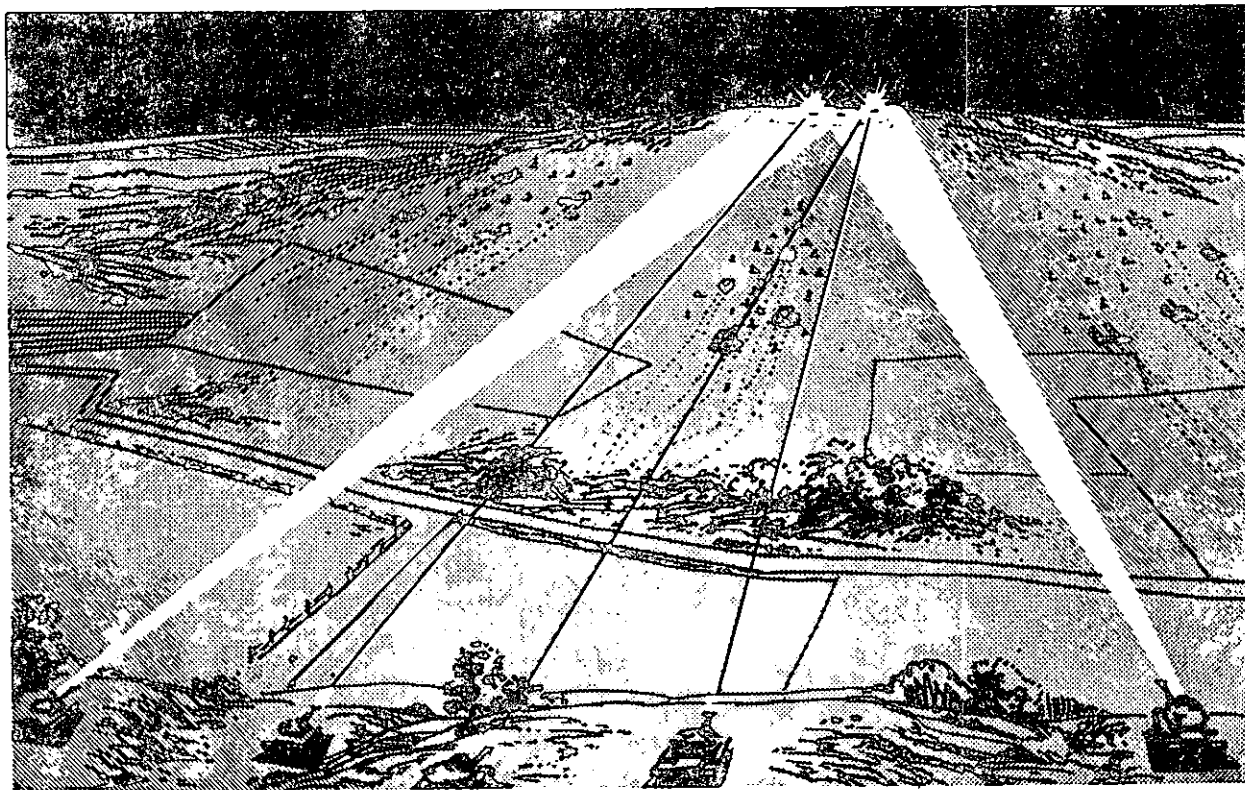

Figure 82. Platoon leader's fire command to engage and illuminate a target.

caliber .50 range. The platoon leader could indicate these options to the tank commanders as shown in examples below.

Examples. 1. MAIN GUN.
 2. MACHINEGUN.

b. If the tank commanders are well-trained and briefed on ammunition supply rates, the platoon leader could give a more general element that would allow them to select the weapon best suited for their tank positions.

Example. FIRE MISSION.

c. Occasions may arise that, because of supply availability, higher headquarters limita-

tions, platoon ammunition inventory during an operation, or poor visibility, the platoon leader must designate the type of machinegun, main gun ammunition, and the quantity. He would do so in this element of the fire command.

Examples. 1. HE.
 2. COAX.
 3. 2 ROUNDS HE.
 4. AREA FIRE.

d. The platoon will face situations that require the use of both the main gun and machinegun simultaneously. This situation will dictate whether all tanks employ both weapons or

**BEARCAT TWO THIS IS BEARCAT TWO SIX
DIRECT FIRE – FIRE MISSION
TANK AND TROOPS
TARGET BRAVO
FRONTAL
AT MY COMMAND –
FIRE**

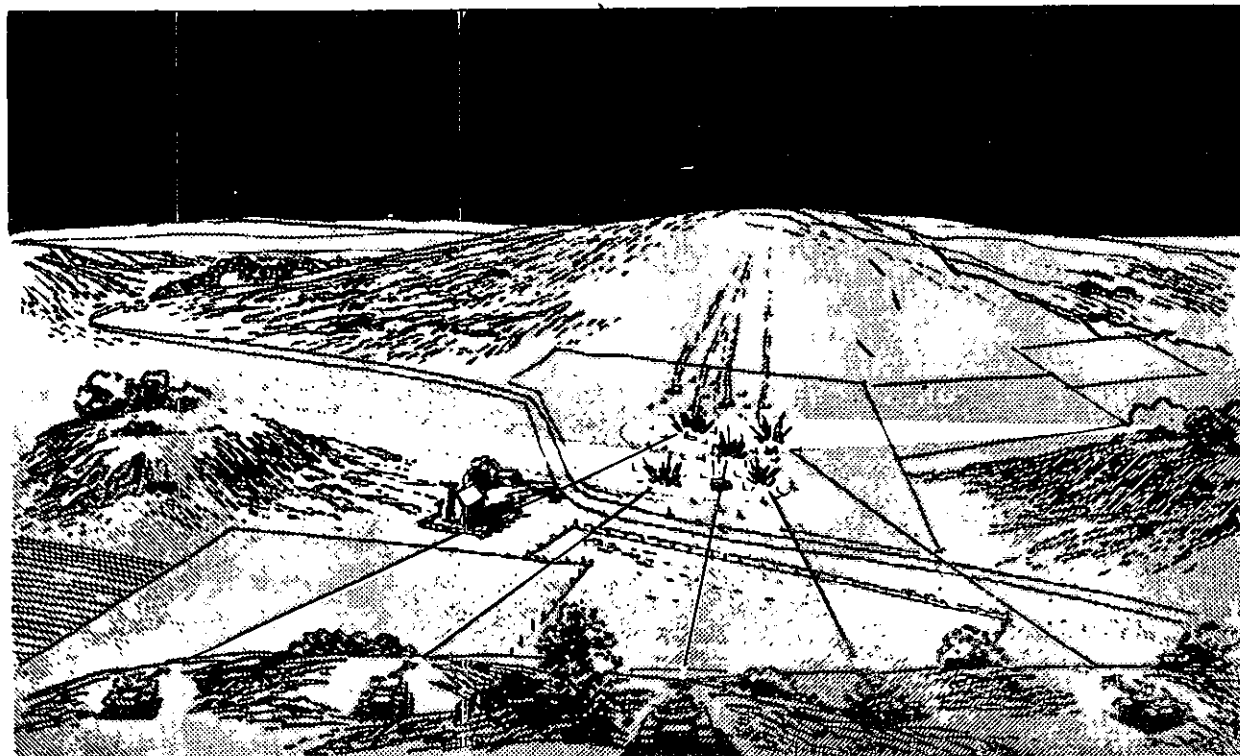

Figure 83. Platoon leader's fire command to engage targets illuminated by a source outside the platoon.

whether the platoon leader directs some to employ the main gun and others the machine-gun. Other situations will require illumination of the target area by the searchlights of some tanks and firing by the remaining tanks of the platoon. In either case this element is used to direct the desired employment.

e. Unless otherwise stated in this element, the announcement of WHITE (RED) LIGHT by the platoon leader means that the flicker illumination technique (para. 116) will be employed. Steady illumination is employed by the searchlight tank(s) only when specifically announced by the platoon leader, i.e., WHITE LIGHT-STEADY. If two tanks are used, the

tank call sign announced first begins the illumination.

- Examples.*
1. COAX AND HEP.
 2. TWO TWO AND TWO FOUR, COAX, TWO THREE AND TWO FIVE MAIN GUN.
 3. TWO THREE AND TWO FIVE RED LIGHT TWO TWO AND TWO FOUR MAIN GUN.

f. If a target is to be engaged at night and illumination is to be effected by a source outside the platoon, the platoon leader notifies his tank commanders in this element of the fire com-

mand so they will be ready to employ direct fire.
Example. DIRECT FIRE HE.

126. Description

The physical description of the target(s) should be the same as in the tank commanders initial fire command, i.e., tank, troops, etc. The platoon leader should include when appropriate the number and action of targets for clarity.

- Examples.*
1. TANKS.
 2. TWO TANKS MOVING SOUTH.
 3. TROOPS CRAWLING.

127. Location

In most cases, location can be given briefly and clearly by use of the platoon fire plan, prominent terrain features, or code names.

- Examples.*
1. TARGET NUMBER FOUR.
 2. STEEL BRIDGE.
 3. RIGHT SLOPE OBJECTIVE BANANA.

Direction and range or a combination of direction and a terrain feature can be used to locate the target. The announced range is accurate only for the platoon leader's tank, and would serve merely to locate the target for the other tanks.

- Examples.*
1. RIGHT FRONT, ONE SIX HUNDRED.
 2. RIGHT FRONT, ROAD JUNCTION.

Marking is a detailed method of locating the target. The platoon leader must realize that the element of surprise will be lost when locating a target in this manner.

- Examples.*
1. WATCH MY BURST.
 2. RIGHT FRONT WATCH MY TRACER.

128. Control

Rapid engagement of a target with effective distribution, intensity, and control of fire is essential to the tank platoon's success in combat. General patterns of engagement pertaining to distribution and intensity of fire should be taught by the platoon leader and practiced by

the platoon. These patterns were discussed in paragraphs 121 and 122. In training, the platoon should be thoroughly indoctrinated that this element, and specifically any of the patterns announced, serves primarily for an initial engagement and will be modified by the platoon leader as the situation demands. The control element may contain only the distribution desired if specific targets are to be engaged.

- Examples.*
1. FRONTAL.
 2. DEPTH TO CROSS WHEN DISPERSED.

When no specific targets are visible and a known enemy location or area is to be engaged, the platoon leader designates distribution and intensity.

- Examples.*
1. FRONTAL SUPPORT TWO AND THREE.
 2. CROSS ASSAULT.

If the platoon leader is issuing a fire command to 1 or 2 of his tanks he may omit this element. In these cases the tank commanders involved control their fire and the platoon leader monitors the engagement.

129. Execution

a. This element is used to designate when the firing will commence. When the element of surprise with the maximum tanks firing initially is not a consideration, the platoon leader simply announces FIRE. If the target(s) is desired to be hit with maximum firepower initially, the platoon leader announces AT MY COMMAND, pauses to allow time for the tanks to lay on the target, and then announces FIRE. In certain instances, such as an ambush, he may want to receive READY back from his tank commanders before he announces FIRE. If this situation exists, the platoon leader announces AT MY COMMAND—READY REPORT. He waits until all tank commanders have announced READY and then repeats the call sign and announces FIRE, e.g., PENROD TWO, THIS IS PENROD TWO SIX, FIRE.

b. If tank searchlights within the platoon are being employed, the word FIRE is the command of execution for both illuminating and firing tanks.

Section IV. PLATOON FIRE PLANNING OFFENSIVE ACTIONS

130. General

Offensive action requires the advance planning for the use of the platoon's firepower. Detailed fire planning will generally not be possible, but basic plans and techniques for distribution of fire (para. 121) will enable the platoon leader to quickly adapt them to most situations. These plans should be designed to be effective in both good and poor visibility. Most operations during periods of poor visibility will be supported in the assault phase by illumination, but the tank platoon should be prepared to complete its mission in case of an illumination failure or loss through enemy action.

131. Surprise Targets

a. In the offense, many targets appearing on the battlefield can be classified as surprise targets. The nature of many of these targets requires immediate engagement and destruction by individual tanks. To retain control under such circumstances, the platoon leader establishes basic guidelines for his tank commanders. Before giving his guidance, the platoon leader decides what instructions to give concerning the following questions.

What actions:

- (1) At various ranges.
- (2) On single targets—on two or more targets.
- (3) In good and poor visibility.
- (4) If terrain is favorable to enemy.

b. This guidance will not cover every conceivable situation, but it will provide for positive initial engagement on the part of each tank

commander when encountering surprise targets. An example of a part of a platoon leader's guidance might be as shown below.

Example. "In surprise engagement of enemy tanks, 22, and 23 will work as a team, and 24 and 25 as a team. If a tank appears within range of destruction, with the platoon in any formation, the first tank commander to see the tank will engage it. He will be joined immediately by the other tank in his team. I will monitor the action and, along with the remainder of the platoon, observe for other targets. If I am first to spot a target, the tank to my right, or to my rear if in column, will immediately join me in engaging the enemy. The platoon sergeant will then monitor the action and take control of the remaining tanks in the platoon for the duration of the engagement."

132. Known or Suspected Targets

More specific planning and training can be accomplished for the engagement of known or suspected targets. The presence or suspected presence of the enemy can be determined by surveillance sources within the unit or a supporting unit. The mission of the platoon dictates the employment of its firepower. The platoon leader controls this firepower, based on his knowledge of enemy situation and by employing patterns for distribution and intensity of fire as outlined in paragraphs 121 and 122.

Section V. PLATOON FIRE PLANNING, DEFENSIVE ACTIONS

133. General

In defensive situations, the fires of all available weapons are coordinated to obtain maximum effectiveness for the engagement of targets with long and short range fires. Sectors of responsibility are assigned and fire plans are developed for these sectors. The tank company fire plan is used to coordinate the fires of

the platoons. The platoon fire plan is used to coordinate the fire of tanks in the platoon. In addition to assigning sectors of responsibility to his platoons, the company commander assigns specific target areas to be plotted on range cards and designates them by number. In the selection of these target areas, the company commander considers those areas

within the company sector that he feels may require the massing of all available fires in the company, i.e., likely avenues of approach and key terrain features. He also considers those areas that lend themselves to offensive type actions to accomplish his defensive mission. The platoon leader insures that this information is disseminated to his tank commanders, and based upon a similar evaluation of his platoon sector, assigns specific target areas he desires to be plotted, designating each of them by a letter. The tank commander plots all the targets (numbered and lettered) assigned by the platoon leader even if he cannot determine data or the targets are not within his sector of responsibility. He selects additional target areas within and adjacent to his sector of responsibility that he feels are necessary to insure complete defense of his sector. This fire planning on the part of the tank unit provides them the capability of delivering effective coordinated fire during good or poor visibility.

134. Platoon Fire Plan

The platoon fire plan provides the platoon leader with the necessary information to distribute and control the fire of all available weapons. The basis of the platoon fire plan is the range cards of the tanks in the platoon. Supplementing this information is the recommendations of the tank commanders for additional fire coverage of attached or supporting weapons. The platoon leader combines this with the requirements established by the company commander and recommendations of attached elements. He considers all information and recommendations in regard to his own evaluation of the position and completes his direct-fire plan. This fire plan and recommendations for indirect-fire coverage for his sector are forwarded to the company commander. Indirect-fire concentrations approved for his sector will be added to his direct-fire plan upon receipt. The plan then is the coordinated platoon fire plan for all fires available.

135. Development of a Platoon Fire Plan

a. General. The fire plan when completed is a sketch or overlay of an area with reference data to provide for complete control of available fires. The development of this fire plan

requires many tasks to be performed by all members of the platoon; however, with a trained unit they can be performed with speed and efficiency. A platoon fire plan is developed each time the platoon moves into a position for a length of time that would allow deliberate planning for its defense.

b. Platoon Sector. Prior to occupation or immediately thereafter, the company commander assigns the platoon leaders their sectors of responsibility and specific targets he desires to have plotted. The platoon leader records this information as the outline of the sketch for his fire plan (fig. 84). He makes this as an overlay if the scale map being used is large enough for clarity; otherwise he uses a sketch showing prominent terrain features.

c. Individual Tank Sectors. After quickly evaluating his assigned sector, the platoon leader assigns each tank commander a primary sector of responsibility. He insures that these assignments provide coverage of the entire area assigned and that tanks in his platoon have overlapping fire if possible. He coordinates with the units on his flanks to provide overlapping fire between units. The targets assigned by the company commander and those selected by the platoon leader are designated to the tank commanders for plotting on their range cards. If alternate positions are to be planned, the platoon leader tells his tank commanders at this time. The company commander may assign a supplemental sector of responsibility for which plans are to be made. If so, the platoon leader begins a separate plan for this sector and assigns supplemental sectors of responsibility to his tank commanders.

d. Preparation of Range Cards. The initial effort of the platoon is to prepare their primary sector of responsibility range cards. Once work by any individual tank is complete on this, including alternate positions, work on a supplemental range card is begun. While work is being accomplished by the tank commanders on their range cards, the platoon leader analyzes his position and the surrounding terrain. He checks the positions and progress of his tanks and attached weapons, supplementing his original instructions as necessary.

1ST PLATOON FIRE PLAN

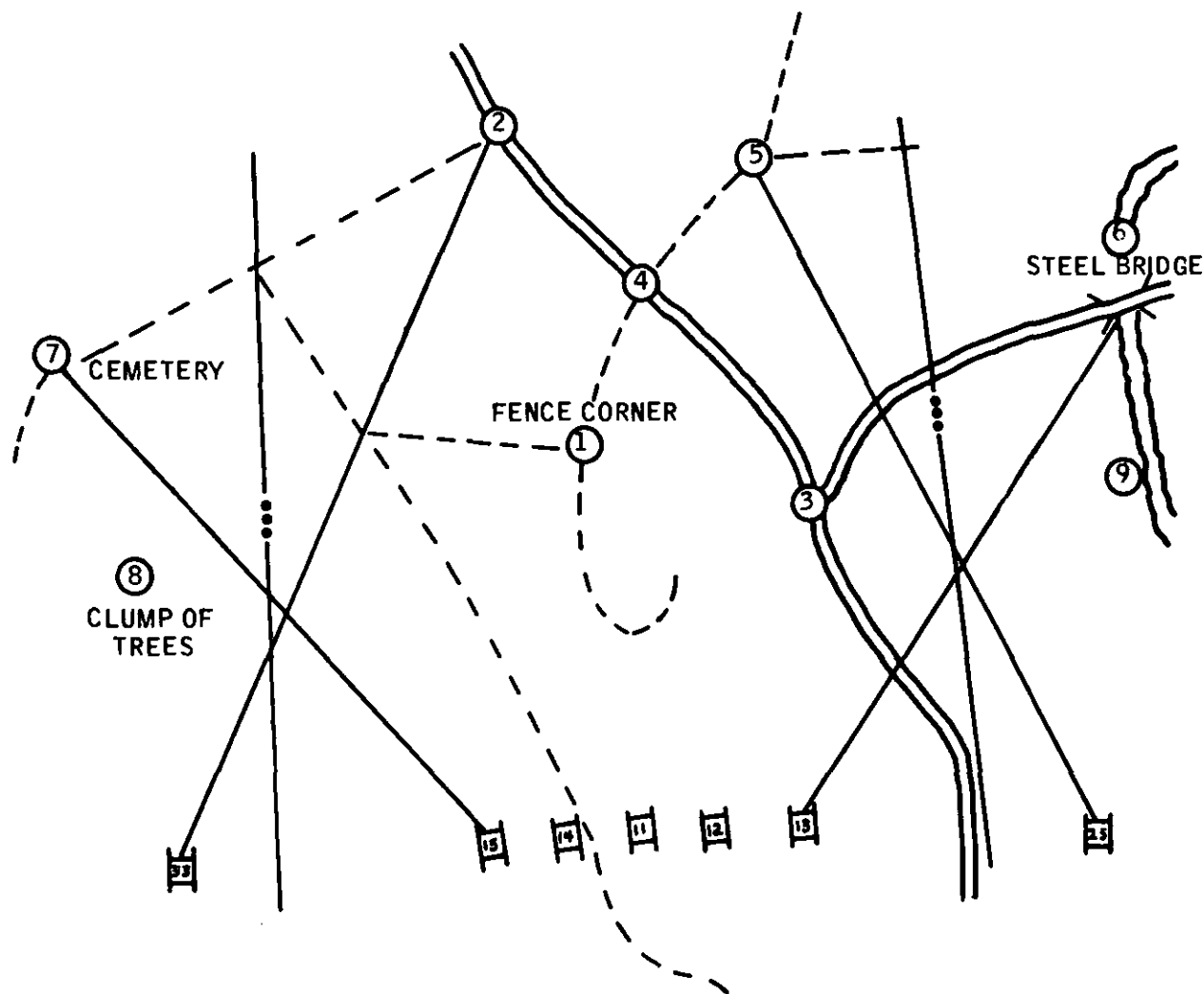

Figure 84. Initial sketch, platoon fire plan.

e. Completion of Direct-Fire Plan. When the tank commanders have completed their range cards, the platoon leader examines them and extracts the information necessary to complete his direct-fire plan. The fire plan to be submitted to the company commander will normally contain the information shown by the example in figure 85. Observation or listening posts and location of other attached elements are included if appropriate. Along with his direct-fire plan the platoon leader submits any recommendations (normally orally) for supporting fires.

f. Completed Fire Plan. Once the indirect-fire plan for the battalion is completed and ap-

proved, the concentrations and barrages planned for the platoon sector are placed in the platoon fire plan (fig. 86). If a supplemental sector of responsibility was assigned by the company commander, the fire plan for it would be similar to the primary fire plan.

136. Surprise Targets

If observation or listening posts and other surveillance means available are employed properly, very few surprise targets will be encountered in defensive operations. These acquisition sources will normally have reported the progress of enemy elements prior to their movement within engagement range. Despite

1ST PLATOON FIRE PLAN

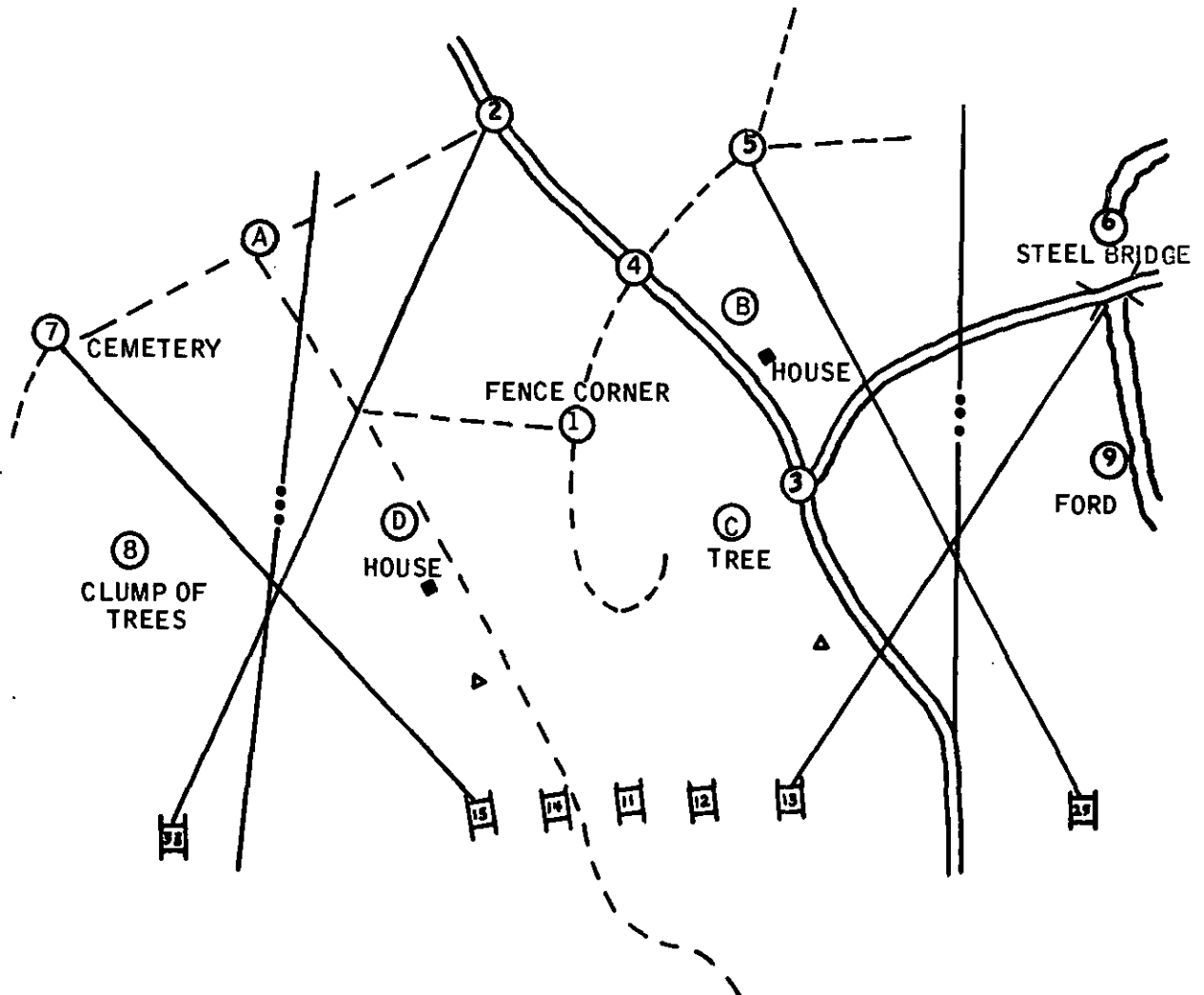

Target	Searchlight	Target	Tanks Able to Fire
1	13, 15	1	All
3	13	2	All
8	15	3	11, 12, 13, 14
C	13, 15	4	11, 12, 13
D	13, 15	5	All
		6	All
		7	All
		8	11, 12, 14, 15
		9	12, 13
		A	All
		B	All
		C	All
		D	11, 12, 13, 15

Figure 85. Sketch, platoon direct-fire plan.

1ST PLATOON FIRE PLAN

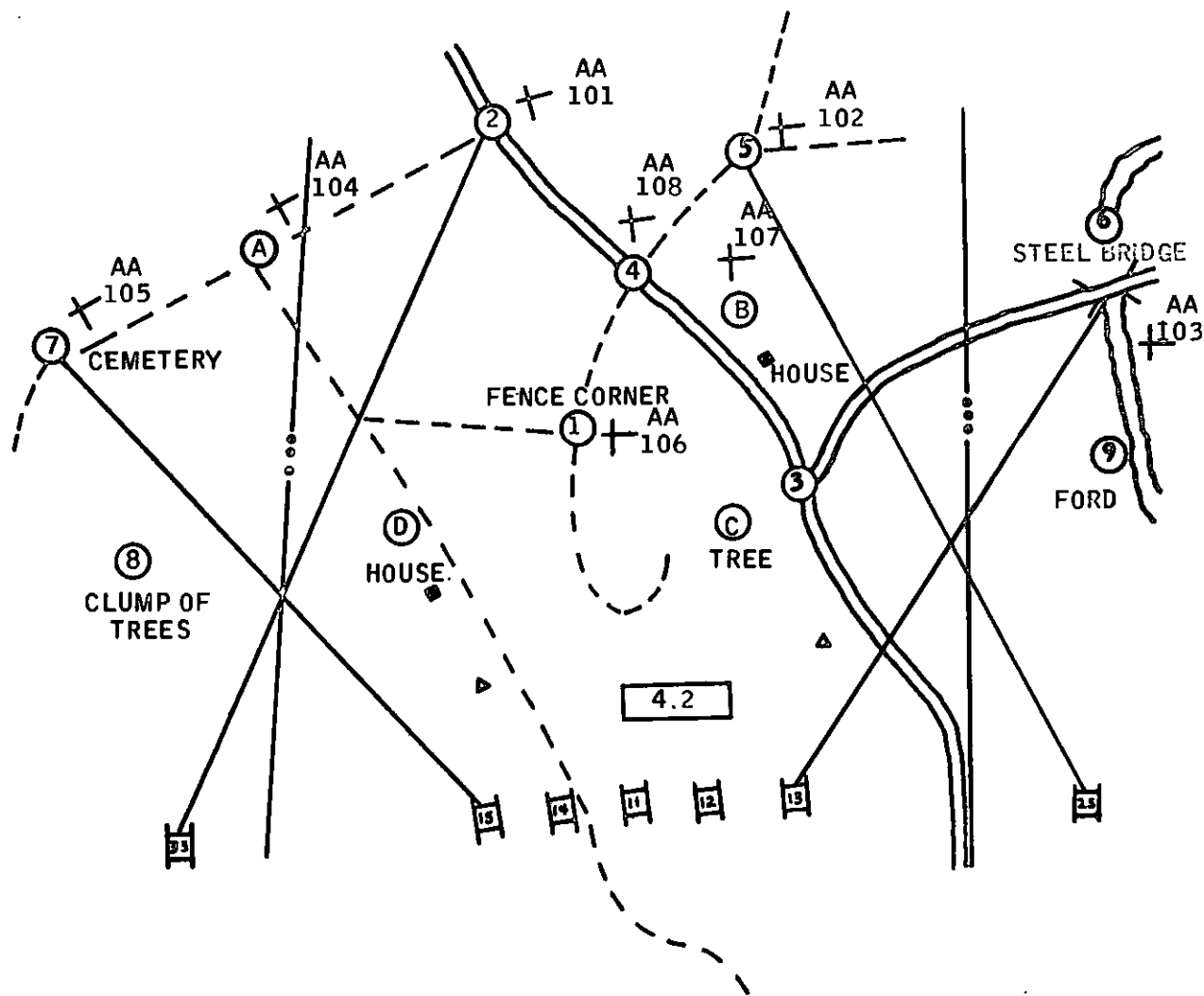

Target	Searchlight	Target	Tanks Able to Fire
1	13, 15	1	All
3	13	2	All
8	15	3	11, 12, 13, 14
C	13, 15	4	11, 12, 13
D	13, 15	5	All
		6	All
		7	All
		8	11, 12, 14, 15
		9	12, 13
		A	All
		B	All
		C	All
		D	11, 12, 13, 15

Figure 86. Completed sketch, platoon fire plan.

this fact, guidance for engagement of surprise targets must be established in case they are encountered. Unlike the engagement of surprise targets in offensive action, immediate, independent engagement by the individual tank commander acquiring surprise targets in the defense is not always desirable. In these cases the acquisition should be reported and the platoon leader decides whether immediate engagement is consistent with the mission assigned. For example, the platoon leader's primary concern may be to cause the enemy to deploy at maximum range consistent with the ammunition and weapons available, insuring that his platoon does not become decisively engaged. If he has continually studied the terrain around him, the platoon leader knows at what point he can best accomplish this and cause maximum confusion and damage to the enemy. In addition, coordinated massed fire rather than piecemeal engagement will be more effective. If a surprise target appears that threatens a part or all of the platoon's position, the target should be engaged by the tank commander who acquired it and he should immediately report actions taken. The platoon fire plan provides good initial distribution of fire without command in case of surprise attack all across the

front. If this occurs each tank commander has an assigned sector of responsibility in which to initially concentrate his fire. Subsequent changes in distribution can be made by the platoon leader as the situation develops.

137. Known or Suspected Targets

When normal security measures have been implemented by a unit in a defensive position, most every enemy activity that will effect that position will be reported by surveillance sources prior to direct contact. With this information, the platoon leader can begin formulating his plans for the engagement of the enemy. Mission, terrain, forces available, and weather (visibility conditions) will be the most decisive factors for him to consider. Once these have been considered the platoon leader can issue orders to his platoon, using his prepared fire plan to insure that the best use of available firepower is made. Use of the basic platoon fire patterns will provide definite control measures to be established prior to encountering known targets. This insures that the proper distribution of fire will be combined with surprise for destruction of targets with the minimum expenditure of time and ammunition.

PART FIVE
TANK GUNNERY TRAINING

CHAPTER 14
GENERAL

Section I. INTRODUCTION

138. General

a. The objectives of tank gunnery training are to develop tank crewmen capable of delivering rapid, accurate fire to destroy enemy personnel and equipment. The tank crew must be trained to function as a team. Each member of a crew must be trained to perform the duties of the other members, so that the loss of one member, while reducing, will not completely destroy the effectiveness of the tank as a fighting vehicle. In addition, personnel in other sections of the tank unit must be sufficiently trained to serve as replacements on the tanks. This replacement should take place at the earliest opportunity to restore the tank to its full effectiveness as a fighting vehicle.

b. To insure high standards of proficiency, prescribed tests and exercises must be conducted to measure the ability of tank crewmen and crews to apply the skills taught during the training cycle.

c. Parts five and six of this manual establish procedures and standards for training and testing tank crewmen and crews in all aspects of tank gunnery.

139. Sequence of Tank Gunnery Training

a. To develop proficient tank crews, tank gunnery training must be progressive. Crewmen receive training first in individual duties followed by crew exercises.

b. Gunnery skills and crew proficiency are

developed through instruction and practice in the following:

- (1) *Machineguns.* Characteristics, nomenclature, disassembly, assembly, functioning, malfunctions, immediate action, adjustments, and mounting.
- (2) *Tank armament, controls, and equipment.* Familiarization with the tank turret, gun and turret controls, vision devices, fire control equipment, and searchlight; sight adjustment; preventive maintenance services; and destruction of weapons and fire control equipment to prevent enemy use.
- (3) *Tank ammunition.* Identification, characteristics, capabilities, uses, and maintenance.
- (4) *Main gun.* Characteristics, nomenclature, disassembly, assembly, functioning, malfunctions, and adjustments; loading and unloading; and removal of stuck round or separated projectile.
- (5) *Range determination.* The mil relation, registration, intersection, maps, and estimation; practical work on range designation and range determination sites.
- (6) *Range finder.* Characteristics, nomenclature, adjustment, operation, ranging practice, determining target image coincidence (TIC), or internal correction system (ICS), and testing proficiency.

- (7) *Conduct of direct fire.* Initial fire command; crew composition and firing duties; use of the binoculars; sensings, observations, and adjustments; firing the main gun at stationary and moving targets; firing the tank-mounted machineguns; battle-sight and practical application on trainers or tanks.
- (8) *Preparation for firing.* Prepare-to-fire checks, safety precautions, flag signals for range firing; handling, loading, and stowing of ammunition; mounting and dismounting the crew; misfire and stoppage procedures; and procedure to clear and secure guns.
- (9) *Crew duties and target acquisition.* Crew nonfiring exercises in all phases of target acquisition and conduct of direct fire (also conducted at night in conjunction with range cards).
- (10) *Range cards and night firing techniques.* Types of range cards, determining data, plotting data, and use of range cards under conditions of good and poor visibility; practical exercises in constructing range cards and applying the data to the fire control equipment; use of the searchlight; and night firing techniques in conjunction with target acquisition.
- (11) *Tank crewman preliminary gunnery examination.*
- (12) *Subcaliber (coax machinegun) firing.* Zeroing the coax machinegun for subcaliber firing, correct sight picture and accurate laying exercises, range card exercises, primary method of adjustment exercises, alternate method of adjustment exercises, and moving target exercises.
- (13) *Service firing.* Zeroing tank weapons, firing at stationary and moving targets, adjustment of fire, and firing at night with illumination; firing from a moving tank with the coaxial machinegun; firing the cupola-mounted or external turret-mounted caliber .50 machinegun at ground and air targets; and individual crew exercises.

Note. Subcaliber and service exercises are fired in the qualification and familiarization courses and for practice.

- (14) *Platoon fire distribution and control.* Platoon target acquisition procedures, distribution and volume of fire, offensive and defensive fire planning, and conduct of fire by the entire platoon.
- (15) *Indirect-fire from deflade.* (Conducted after crews are proficient in all aspects of direct fire.) Laying tank guns parallel, determining minimum elevation, fire commands and crew duties, and duties of the observer.

140. Methods of Testing Gunnery Training

To evaluate training, commanders must have some means of measuring progress and proficiency of tank crews. Although individuals or crews may complete a training program, their level of proficiency cannot be determined without a method of testing. Methods of testing include:

a. Examination by Observation. Many aspects of gunnery training can be measured only by actual observation of the training or firing. For example, a tank commander who is able to write a correct fire command may not be able to give the command quickly and accurately during a live-firing exercise. Definite objectives must be sought when observing a phase of training.

b. Oral Examination. Normally used as an on-the-spot check of training, it can be used to check the effectiveness of the instructor and to determine whether the tank crewman understands the material being presented. Each oral question should have a specific purpose and emphasize one point.

c. Written Examination. This type of test indirectly measures an individual's knowledge to apply gunnery skills and is best used to determine the knowledge gained over a wide area of subject matter.

d. Performance Test. Proficiency in tank gunnery training can best be determined by the performance test. This type of test can be conducted in numerous phases of gunnery training by having the individual do what he has

been taught. A performance test includes and emphasizes such factors as correct procedure, accurate results, and performance within a pre-

scribed time limit. The tank crewman preliminary gunnery examination is an example of a performance test.

Section II. INDIVIDUAL GUNNERY TRAINING

141. General

Success in battle depends upon close coordination within the tank crew. Conduct of fire depends primarily upon the skills and actions of the loader, gunner, driver, and tank commander, who comprise the tank crew. The training of the crew is integrated after individual training; however, in all training, each crewman must master his individual duties before the crew can work together as a team.

142. Mechanical Training

As the first step in gunnery training, tank crewmen must learn the weapons, controls, ammunition, and associated equipment for their particular type tank. This is accomplished by classroom work and practical work on the tank or turret trainers. For specific information and procedures, see the technical manual for the tank.

143. Training in Use of Direct-Fire Sights

Use of direct-fire sights must be rapid and accurate when laying on a target and making adjustments. Each individual must know the graduations and use of the sight reticles. Initial training is conducted in the classroom by use of charts and slides. This instruction is followed by practical work on a trainer or tank.

144. Nonfiring Exercises

Nonfiring exercises are designed to prepare tank crewmen for firing exercises and as refresher training. They are directed toward developing firing skills of the gunner and tank commander and promoting team work of the entire crew. A thorough understanding of the operation and functioning of the tank turret and weapons is the first step in gunnery training. This is followed by classroom presentation and familiarization with crew duties and conduct-of-fire procedure for engaging targets.

a. Conduct-of-Fire Trainer. The conduct-of-fire trainer (fig. 87) is an excellent training aid to teach crewmen the correct sight picture for direct laying, set off lead, change lead, and to make adjustments when using the primary or secondary sight in conjunction with all methods of adjustment. The conduct-of-fire trainer is used also to teach crew firing duties. Each member performs (partially simulated) his assigned firing duties for each problem. Firing problems are conducted as follows:

- (1) Tank commander issues an appropriate initial fire command and begins laying for direction.
- (2) Upon hearing the ammunition element, the loader simulates loading and announces UP.
- (3) The gunner simulates indexing ammunition (and range when necessary) into the fire control system.
- (4) On identifying the target, the gunner announces IDENTIFIED and assumes control of the trainer.
- (5) The gunner takes the correct sight picture, announces ON THE WAY and simulates firing.
- (6) The instructor flashes a light to simulate a burst or tracer for sensing adjustment.
- (7) The gunner applies the appropriate method of adjustment, again announces ON THE WAY, and simulates firing.
- (8) The problem continues until the tank commander announces CEASE FIRE.
- (9) The instructor critiques each problem immediately after completion.

Note. The instructor should place the light so that it is off the target but within the reticle. Before beginning the problem, insure that the reticle can be traversed to the target. If the gunner fails to sense or observe the tracer, require the tank commander to issue a subsequent fire command.

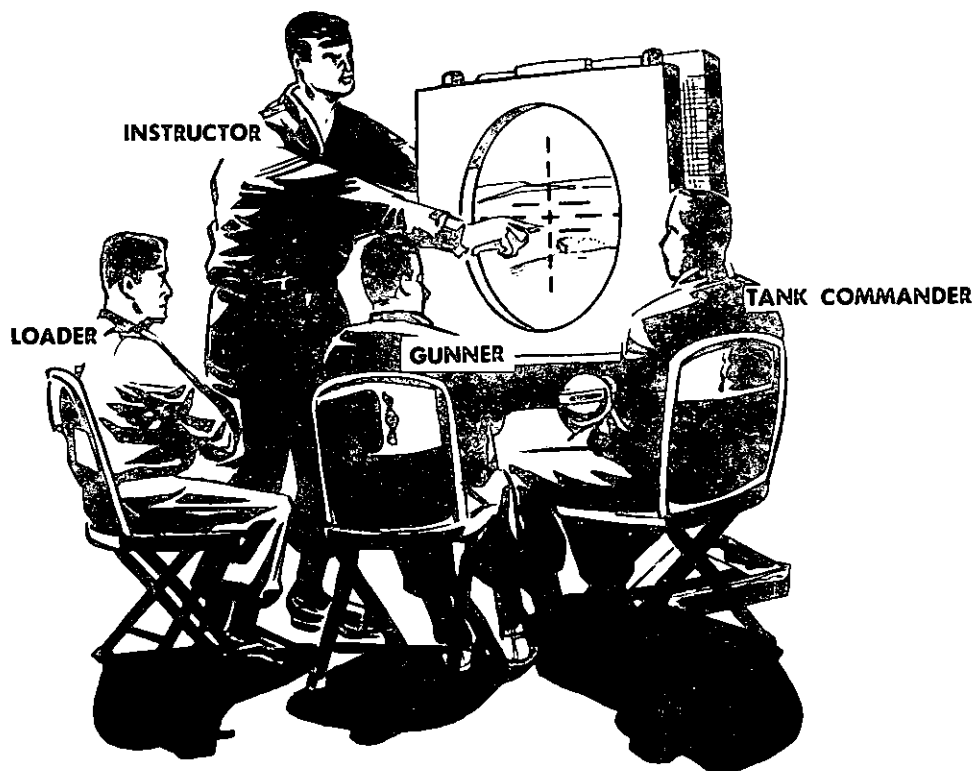

Figure 87. Conduct-of-fire trainer.

b. Target Board and Reticle.

- (1) Silhouette targets, such as tanks and antitank guns, are drawn or pasted on a target board representing terrain. A clear piece of acetate is cut and placed in a circular frame. A gun laying reticle is painted on the acetate to represent the gunner's sight reticle and field of view.
- (2) The crewman places the reticle on the target in the proper position to represent initial laying, relaying, applying burst on target, and making deflection and range changes. Following individual instructions, simulated crew exercises may be conducted.

c. Training on the Tank. Further practical application of direct laying is performed on the tank. The gunner simulates firing and adjusting on various targets, using both the primary and secondary sights in conjunction with the methods of adjustment. The instructor or tank commander supervises the gunner by observing through the direct-fire sight, which has

been boresighted on the same target as the gunner's. Accuracy is stressed and speed is developed as training progresses.

d. Aiming Data Charts. The gunner must learn to determine rapidly the correct aiming point to use with the ballistic reticle when firing a type of ammunition other than that for which the reticle is graduated. Aiming data charts are provided in tabular firing tables for this purpose and a computer or ballistic unit can be used to obtain the same information. As ballistic type reticles are calibrated for only one type ammunition, the gunner must compensate for the difference in trajectory when he uses any type of round other than the type for which the reticle is graduated. This correction can be determined by using an aiming data chart similar to the one shown in figure 34. This type of chart is issued to tank units and may be attached to the recoil guard of the main gun for ready reference. If an aiming data chart is not available, the computer or ballistic unit can be used as an aiming data chart (para. 45c and d).

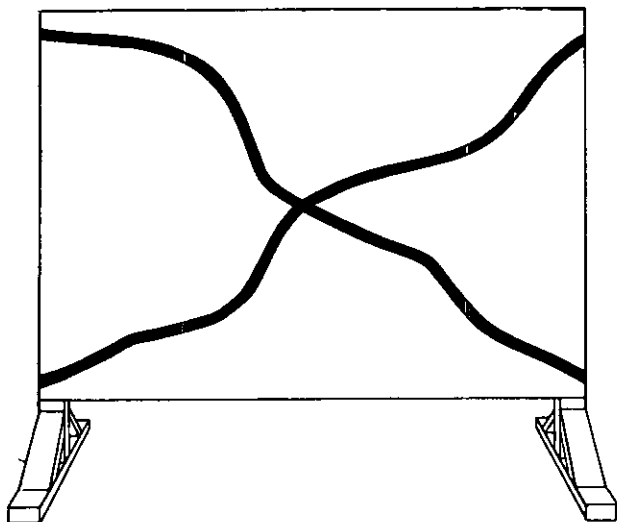

Figure 88. The snakeboard.

145. Manipulation Exercises

Any exercise that gives the gunner practice in traversing and elevating the gun is called manipulation. These exercises must be practiced by the gunner throughout his gunnery training.

a. The snakeboard (fig. 88) is an effective and easily fabricated aid to manipulation training. Lines, approximately 2 inches wide, are drawn on target cloth mounted between 2 standards or on any vertical surface. The gunner tracks accurately along the lines as rapidly as possible.

b. The next phase of manipulation training requires the gunner to lay rapidly on a series of stationary targets. This is a dry run of the manipulation part of subcaliber firing. The sub-caliber manipulation can take place on the actual firing range, using the standard targets or set up in another designated training area. The "dry run" type exercise does not give a "hit indication" to the gunner.

c. To offset this condition, a training device such as the LASER gun should be used. The simulator, weapon, firing LASER gun may be mounted on the tank. The power unit and control panel may be plugged into a 110-volt ac or the tank's 24-volt dc power supply. The LASER gun projects a light beam on a target covered with a reflective material. This light beam is an easily detectable hit indication, adding realism to manipulation exercises. The LASER gun will permit indoor or outdoor training in boresighting and zeroing procedures, burst-on-target exercises, range card firing exercises, and training in firing the subcaliber tables I, II, and III.

146. Tracking and Leading Exercises

a. *Towed-Card Exercises* (fig. 89). A line is stretched between two supports at different heights and a card is suspended from the line. The card is pulled along the line by a cord and the gunner tracks the card during its move-

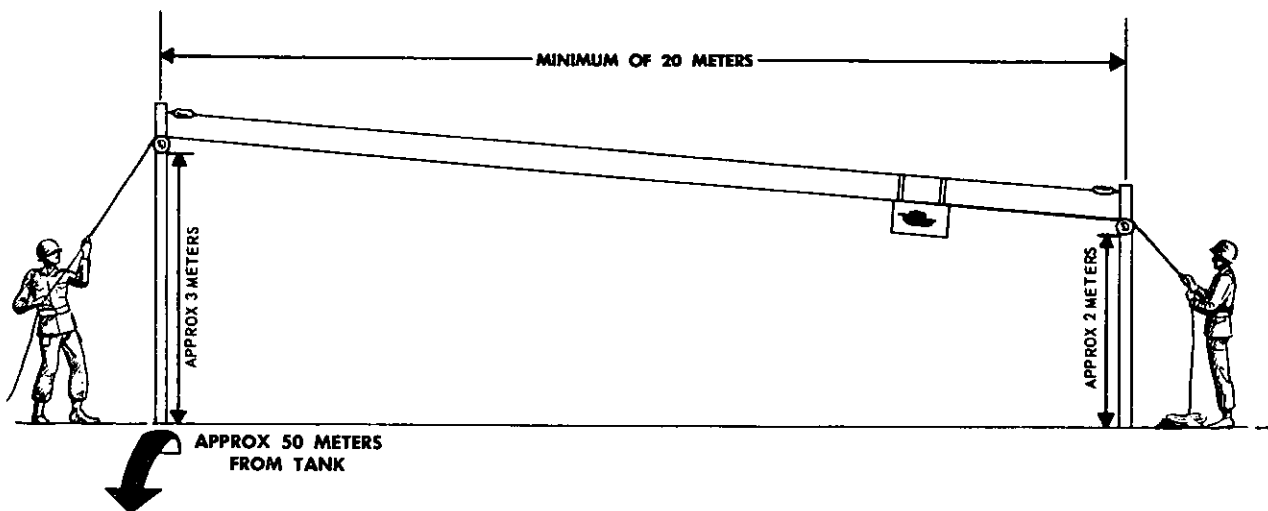

Figure 89. Towed card exercise.

ment. The speed of the moving card is alternately increased and decreased during its run.

b. Combat Tracking. Before firing at a moving target, the gunner performs dry run tracking. A vehicle, or the moving target on a subcaliber or service range, may be used for this purpose (fig. 90). The speed and direction of the target should be varied. The gunner tracks with proper lead. The gunner simulates firing and adjusting by changing the range and lead as directed by the tank commander, who observes the direct-fire sight. The gunner tracks with a smooth continuous motion, maintaining a constant sight picture before, during, and after firing. He does not stop traversing while he simulates firing. When the situation permits, gunners should practice in conjunction with their other training. Various other types of moving targets could be used for dry firing (fig. 91).

147. Boresighting Exercises

The prescribed steps for boresighting tank weapons should be followed closely and the exercises repeated until the crew is able to make precise adjustments. To check the crew's accuracy, the instructor selects a target with

well-defined intersecting horizontal and vertical lines. The crew aligns the sight and the weapons (main gun and coaxial machinegun) on the aiming point, locks the boresight knobs, and slips the scales to the prescribed setting. The instructor then traverses the gun off the target, and unlocks and rotates the knobs to disturb the reading. The crew then reboresights on the same target and readings are compared. This exercise is repeated until accuracy is obtained. This same general procedure is followed in boresighting the cupola-mounted machinegun; however, accuracy is checked as each step is performed.

148. Zeroing Exercises

The zeroing procedure for the main gun can be simulated by placing large targets at the zeroing range, with a shot group painted on each target (fig. 92). The gunner simulates firing a shot group, and simulates firing a check round. Each time the exercise is completed, the gunner records the azimuth and elevation knob readings. To check the accuracy of the gunner, his results are compared with previously determined zero readings on the same shot group. Any variations in the reading can be directly

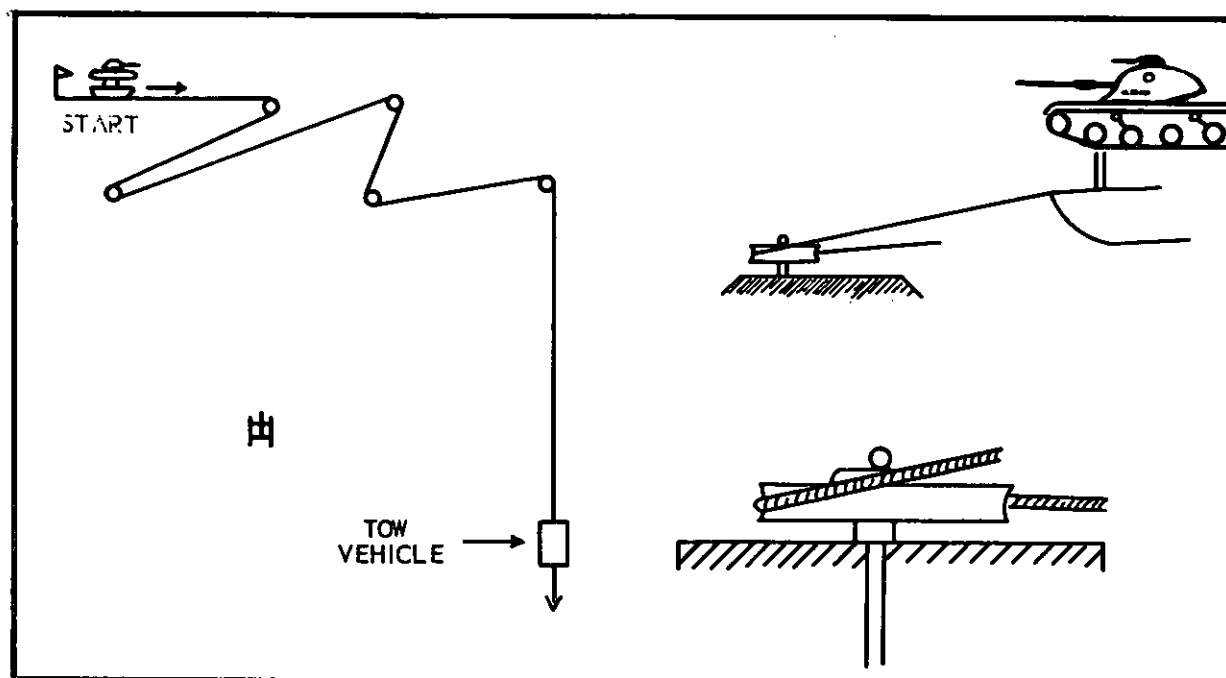

Figure 90. Manipulation and live fire moving target.

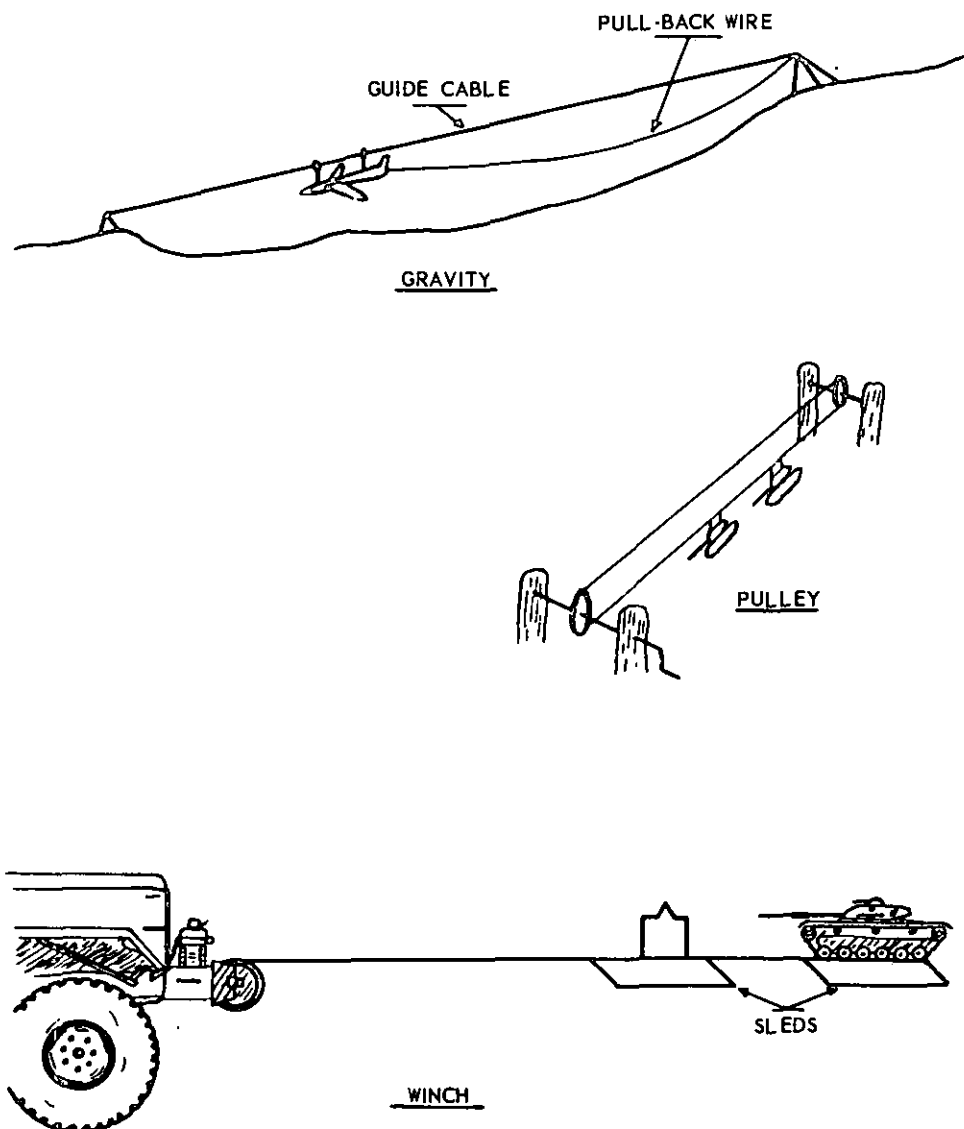

Figure 91. Various types of moving targets.

associated with the gunner's ability to make an accurate lay. This exercise is repeated until accuracy is obtained. The zeroing procedures for the coaxial machinegun and cupola-mounted machinegun are simulated in the same general manner, using target setups as shown in figures 93 and 94. Once crewmen have learned the zeroing procedures in simulated exercises, they are accomplished by actual firing.

149. Training in Use of Auxiliary Fire Control Equipment

a. Each crewman must have practice in obtaining range card data and in simulating firing

from these data. This practice can be obtained by integrating this instruction with target acquisition training (ch. 16), although any area with fields or fire up to at least 2,000 meters (yards) can be used. The instructor tests the accuracy of each crewman by first preparing a range card for the area, to be used in checking the crewman's data. This range card should have a minimum of six targets plotted, with approximately half the targets on each side of the referenced point. The crewman is then shown the reference point and each target to be plotted and is told the range to each target; with this information, the crewman (gunner)

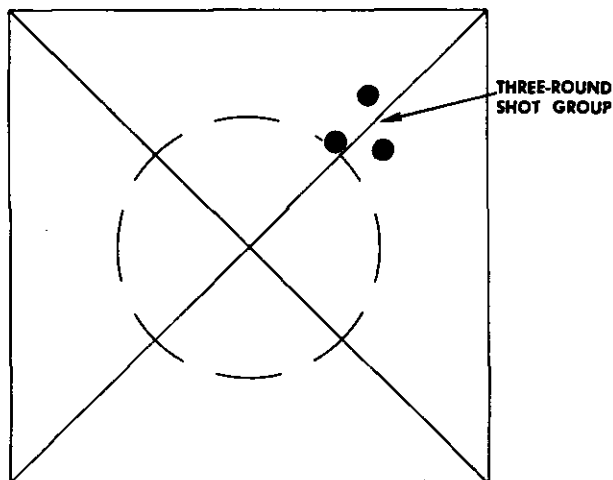

Figure 92. Target for dry practice—zeroing main gun.

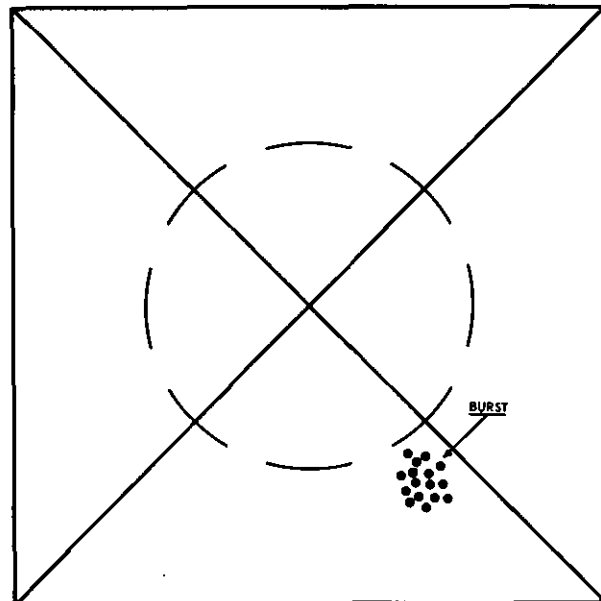

Figure 93. Target for dry practice—zeroing cupola machinegun.

prepares a range card. The data must be accurate and complete with a 1-mil tolerance allowed for both quadrant elevation and deflection. After the crewman has satisfactorily prepared a range card, he should be given practice in applying these data to the auxiliary fire control equipment by simulating firing from range card data. The instructor issues an initial fire command to engage each target. The crewman (gunner) is allowed 20 seconds to correctly apply these data to the auxiliary fire control equipment for each target, on tanks with an

elevation quadrant and 30 seconds when a gunner's quadrant must be used. Practice in simulating firing the standard area fire pattern can be accomplished in conjunction with this instruction. An additional minute should be allowed when this is performed. Accuracy and sequence of application are important. See paragraphs 100 and 110 through 112 for obtaining



E TARGET AT A RANGE OF 800 METERS (YARDS), ZEROING TARGET FOR COAX MACHINEGUN.



TARGET CLOTH REPRESENTING THE BEATEN ZONE OF THE INITIAL BURST OF THE COAX MACHINEGUN APPROXIMATELY 200 METERS (YARDS) SHORT (OVER) OF THE COAX MACHINEGUN ZEROING TARGET.



DIRECTION OF FIRE

Figure 94. Target for dry practice—zeroing coaxial machinegun.

and applying range card data and the area fire pattern.

b. Other appropriate exercises in the use of auxiliary fire control instruments are laying tank guns parallel, determining minimum elevation, and making deflection and range changes for indirect firing.

150. Preparation for Firing

Classroom and practical work are given on prepare-to-fire checks, safety precautions, and flag signals for range firing; handling, loading, and stowing ammunition; mounting and dismounting the tank crew; and misfire and stoppage procedures.

Section III. CREW GUNNERY TRAINING

151. General

The training of the crew will begin with the members in their assigned positions. Then the crewmen will rotate within the tank to attain proficiency in all gunnery skills.

152. Sequence of Crew Training

Crew gunnery training should follow the sequence list below.

a. *Recognition.* Crew exercises to train the crew in recognition of enemy equipment on the

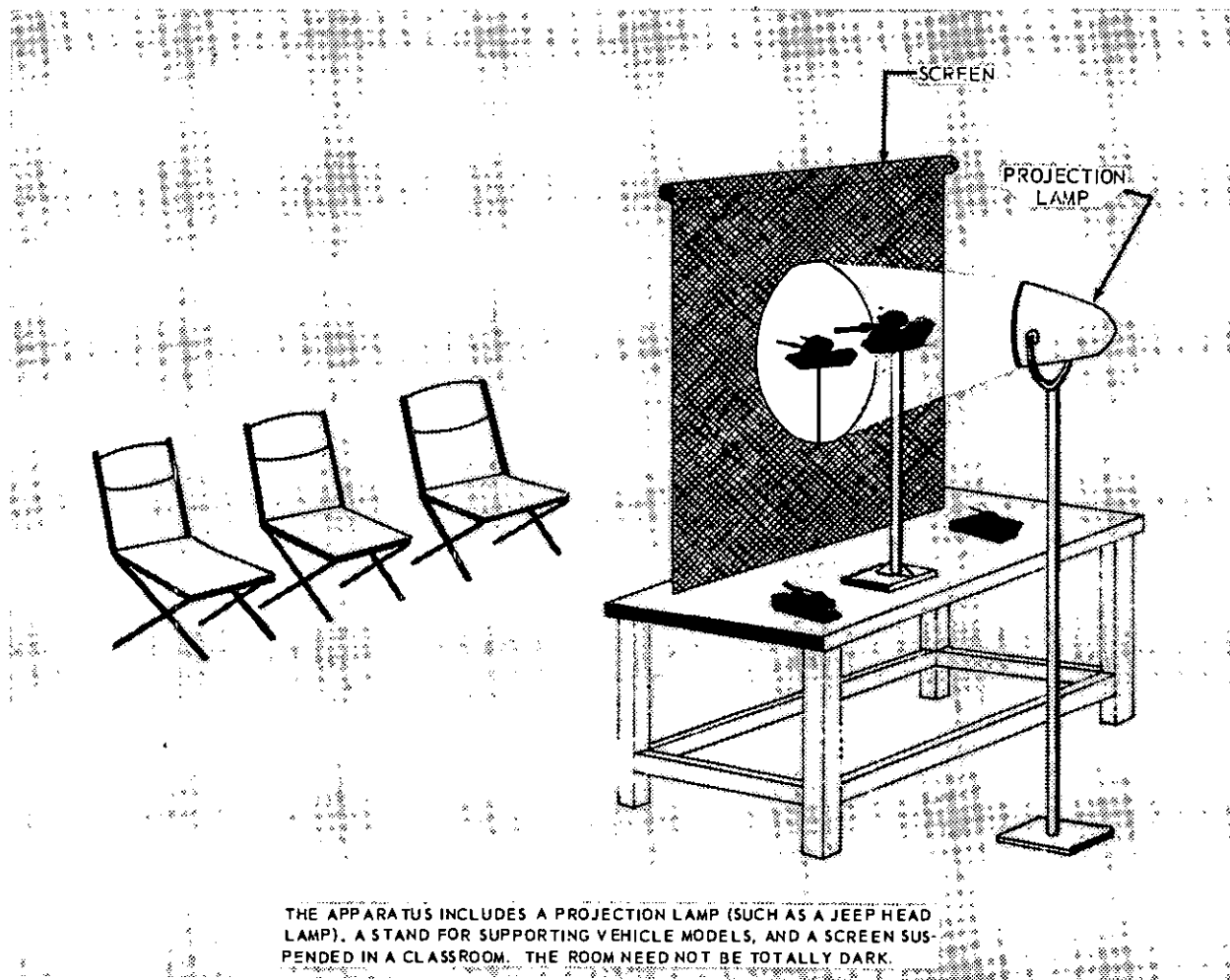

Figure 95. Shadowgraph recognition trainer.

battlefield, in periods of good and poor visibility, can be accomplished, by using flash card pictures, actual vehicles, and visual projectors (fig. 95).

b. Target Acquisition. This training includes crew nonfiring exercises in all phases of target acquisition and conduct of direct fire (also conducted at night in conjunction with range cards and with various types of illumination). The crew trains first in a static position, then from a moving tank (para. 178).

c. Machinegun Exercises. This training in-

cludes the firing of the cupola or externally mounted machinegun and the coaxial machinegun at stationary and moving targets from stationary and moving tanks in daylight and at night (ch. 19).

d. Crew Field Firing Exercise. This training includes firing all tank-mounted weapons at stationary and moving targets while moving the tank over a prescribed course in daylight and at night. The tank crew fires a practice and a record course and the proficiency of the tank crew is determined (ch. 19).

CHAPTER 15

RANGE DETERMINATION

Section I. INTRODUCTION

153. General

The greatest potential cause of error in tank gunnery is incorrect range determination. When a tank crewman can determine range accurately, the probability of obtaining a first-round target hit is greatly increased. The best methods of determining range for tank gunnery purposes are *range finders, binoculars and mil relation, maps, and estimation by eyesight or sound*. Another method of range determination is intersection; however, it is not used frequently by a tank crew. A source of range is information from friendly troops, but the range obtained is only as accurate as the method used to determine it. The best method in any given situation is the one that gives the most accurate range, consistent with the time and equipment available. When available, the range finder is the best means of determining range; however, as it is not mounted on all tanks or it may become inoperative, tank crewmen must become proficient in other methods of determining range.

154. Conversion Table

a. The following table will be of assistance in tank gunnery. The column of figures should

be used for quick conversion, and is accurate enough for tank gunnery purposes.

<i>To convert—</i>	<i>Multiply number by—</i>
meters to yards.....	1.1
yards to meters.....	.9
feet to meters.....	.3
meters to feet.....	3.3
mils to degrees.....	.06
degrees to mils.....	18

b. The following table provides a handy reference to those range commonly used by tank units:

<i>M</i>	<i>YD/M</i>	<i>YD</i>
458	500	547
549	600	656
732	800	875
914	1,000	1,094
1,097	1,200	1,312
1,372	1,500	1,640
1,646	1,800	1,968
1,829	2,000	2,187
2,286	2,500	2,734
2,743	3,000	3,281

Section II. METHODS OF RANGE DETERMINATION

155. Range Finder

On tanks so equipped, the use of the range finder is the primary method of range determination. The value of the range finder lies in the speed and accuracy of determining ranges beyond 1,000 meters (yards). A tank crew can expect a high percentage of first-round hits on targets when the range has been determined by a range finder.

a. Coincidence range finder ranging procedure (para. 171).

b. Stereoscopic range finder ranging procedure (para. 172).

156. Binoculars and Mil Relation

The binoculars and mil relation are useful in deliberate range determination. To use this method, the width or height of the target or

MIL ANGLE MEASUREMENT		1	2	3	4	5	6	7	8	9	10
Aggressor medium tank	Length: 6.5 meters	6500	3300	2200	1600	1300	1100	900	800	700	700
	Width: 3.5 meters	3500	1800	1200	900	700	600	500	400	400	400
Aggressor heavy tank	Length: 7.5 meters	7500	3800	2500	1900	1500	1300	1100	900	800	800
	Width: 3.5 meters	3500	1800	1200	900	700	600	500	400	400	400

- Notes.**
1. The above chart, which facilitates use of the mil relation as a means of determining range, is used as follows:
 - a. Measure mil angle of target with binocular.
 - b. Find length or width of target in the chart.
 - c. Find range to target by reading to the right to the range under the mil angle measured with binocular.
 2. This chart may be made readily available in a convenient location near the tank commander's position in the tank.
 3. Range figures on above chart are rounded off to the nearest hundred.

Figure 96. A range determination chart.

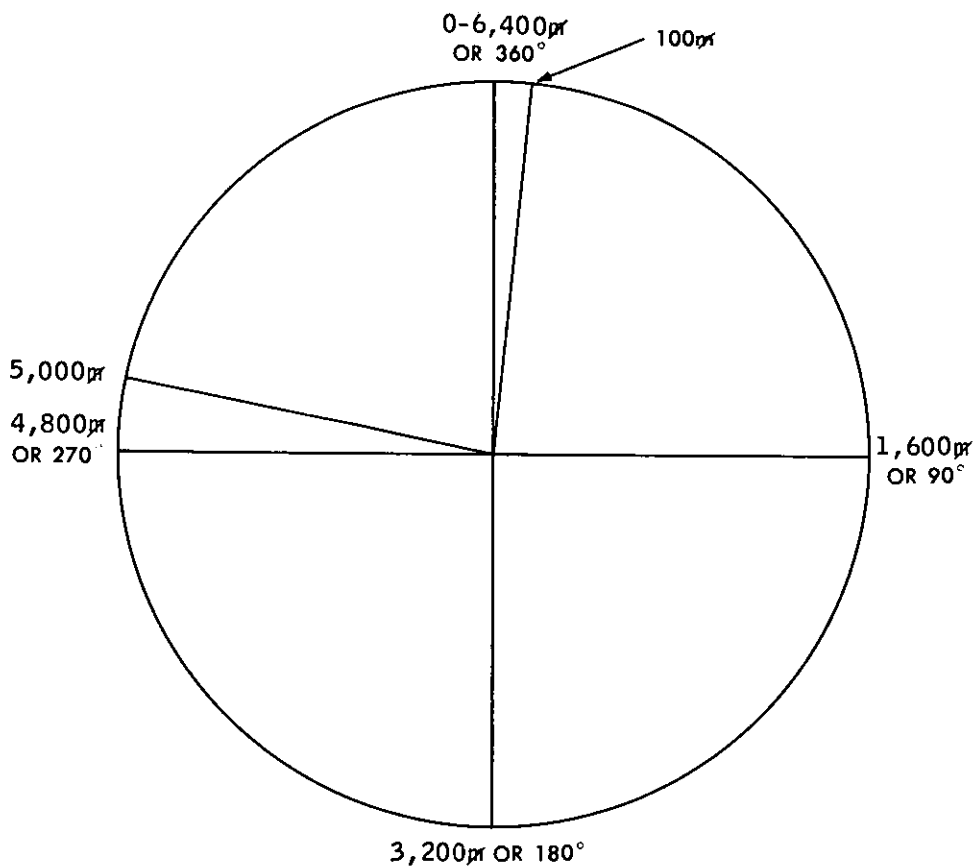

Figure 97. A comparison of mils and degrees.

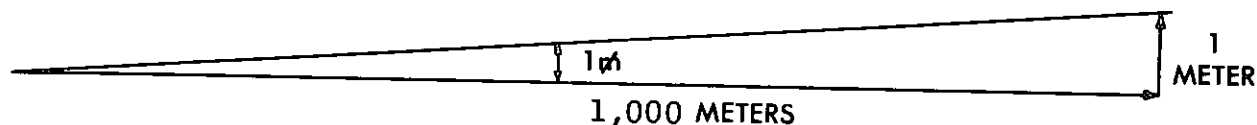
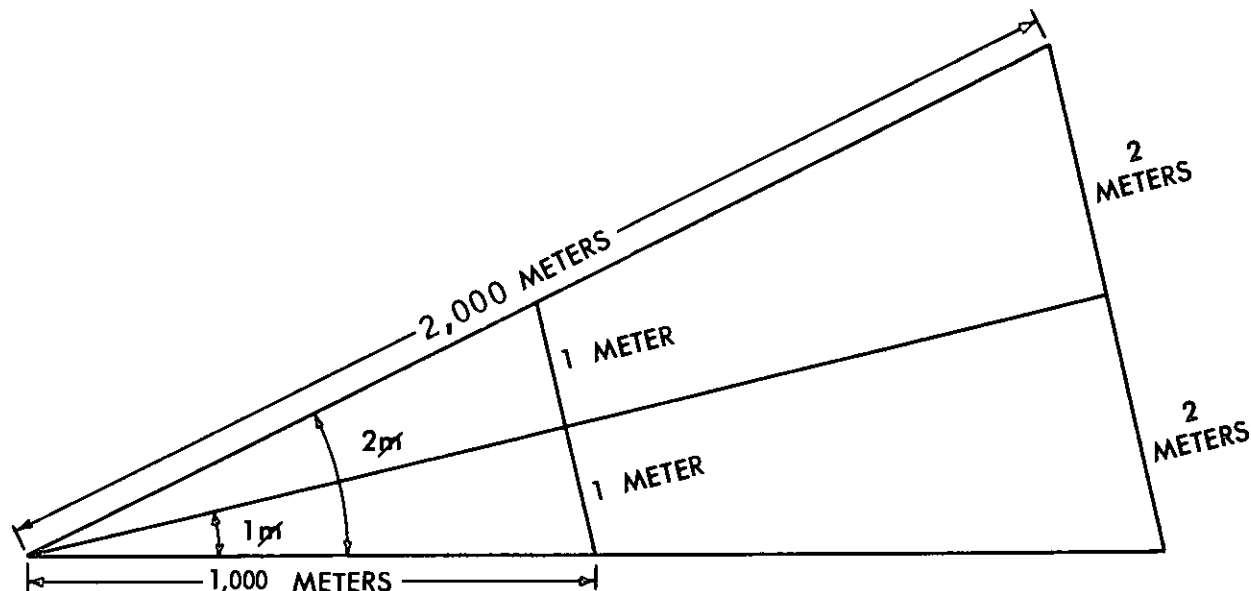

Figure 98. The mil relation at 1,000 meters.



1 MIL AT 1,000 METERS EQUALS 1 METER.
 1 MIL AT 2,000 METERS EQUALS 2 METERS.
 2 MILS AT 1,000 METERS EQUALS 2 METERS.
 2 MILS AT 2,000 METERS EQUALS 4 METERS.

Figure 99. The mil relation is constant.

objects in the vicinity of the target must be known. Measure the known width or height with the binocular mil scale or a nonballistic reticle; substitute the mil relation and compute the range. Accuracy of this method depends on knowledge of target dimensions and the ability of the individual to make precise measurements with the binoculars. The mil relation may be used in constructing a range determination chart as illustrated in figure 96.

a. *Mil.* The *mil* is the basic unit of angular measurement used in tank gunnery, because of the precise calculations and adjustments required. Tank weapons may be laid for deflection and elevation by moving the gun right (or left) and up (or down) a specified number of mils. Tank fire control equipment is graduated in mils to conform to the mil method of measure-

ment. There are approximately 18 mils in 1 degree (1° equals 17.777778 mils). The mil is a unit of angular measurement equal to $1/6400$ of a circle (fig. 97). One mil, for tank gunnery purposes, subtends a width (or height) of 1 meter at a range of 1,000 meters (fig. 98). When the sides of a 1-mil angle are extended until they are 2,000 meters long, the width between the ends of the lines is 2 meters. The relationship of the angle, the length of the sides of the angle, and the width (height) between the sides remains constant. Figure 99 demonstrates this constant relation as the angle increases from 1 mil to 2 mils and the range increases from 1,000 meters to 2,000 meters.

b. *The Mil Relation.*

- (1) The relationship of the size of the angle (μ), the length of the sides

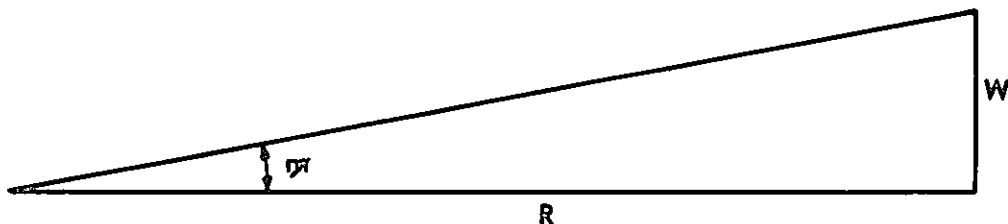

W = WIDTH (OR HEIGHT) IN METERS

R = RANGE IN THOUSANDS OF METERS

m = ANGLE IN MILS

Figure 100. The mil relation.

(R), and the width between the ends of the sides (W) is expressed as the mil relation or: $\frac{W}{R \times m}$ (fig. 100).

- (2) Because the mil relation is constant, other units of measure such as yards, feet, or inches may be substituted for meters in expressing width or range; however, the relation holds true only if both W and R are expressed in the same unit. For example, if the sides of a 1-mil angle are extended to 1,000

yards, the width between the ends of the sides is 1 yard.

- (3) The mil relation may be converted into a formula by removing the factor that is to be determined.

Thus $\frac{W}{R \times m}$ becomes $W = R \times m$

$$\text{or } R = \frac{W}{m}$$

$$\text{or } m = \frac{W}{R}$$

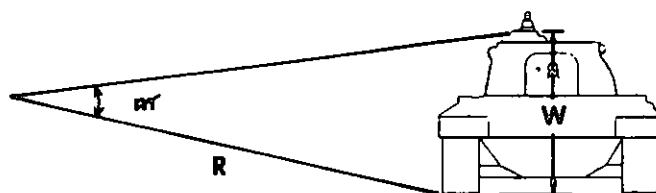
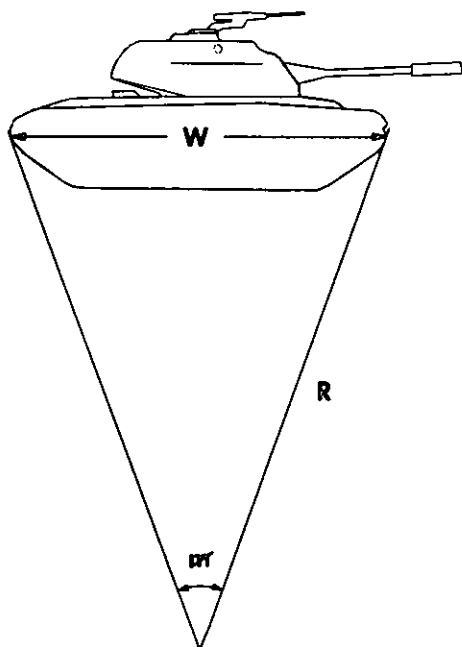

Figure 101. The mil relation is applicable in all planes.

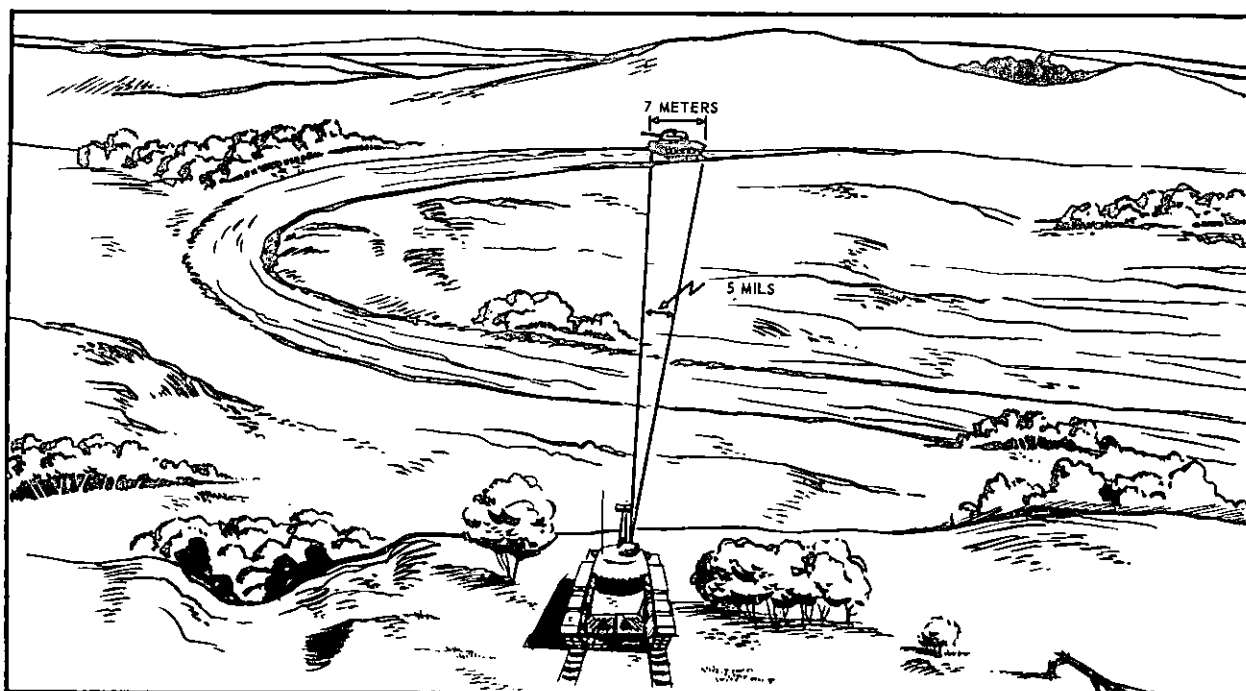

Figure 102. Determining the range to a target, using the mil relation.

As a memory aid, the word WORM may be used, meaning W over $R \times \mu$ or $\frac{W}{R \times \mu}$

- (4) The mil relation holds true whether the W factor is in a horizontal or vertical plane, if the mil angle is measured in the same plane (fig. 101).

c. Determining Range.

- (1) *General.* To determine range, the mil angle and the width (height) must be known. Figure 102 illustrates a situation in which the tank commander must determine the range to the target.

<i>Remember:</i>	<i>Remove unknown:</i>
$\frac{W}{R \times \mu}$	$\frac{W}{? \times \mu}$

(2) *Procedure.*

- (a) It is known that the enemy tank is approximately 7 meters long (W).
- (b) Using his binocular, the tank commander determines that the tank measures 5 mils (m) in length.

- (c) By removing the R factor from the mil relation,

$$\frac{W}{R \times \mu} \text{ becomes } R = \frac{W}{\mu}.$$

- (d) Substitute the two known values for W and m and solve for R :

$$R = \frac{W}{\mu} = \frac{7}{5} = 1.4.$$

- (e) Since R is in thousands of meters, multiply the answer (1.4) by 1,000; $1.4 \times 1,000 = 1,400$ meters, the range to the enemy tank.

d. Determining Mil Angle.

- (1) *General.* It may be necessary to solve for the mil angle (μ) when determining the safety factor for friendly troops (minimum elevation), when determining angle of site, or when the mil angle cannot be measured directly with instruments. To determine the mil angle, the range and width must be known. Figure 103 depicts a situation in which the tank commander must determine the mil angle neces-

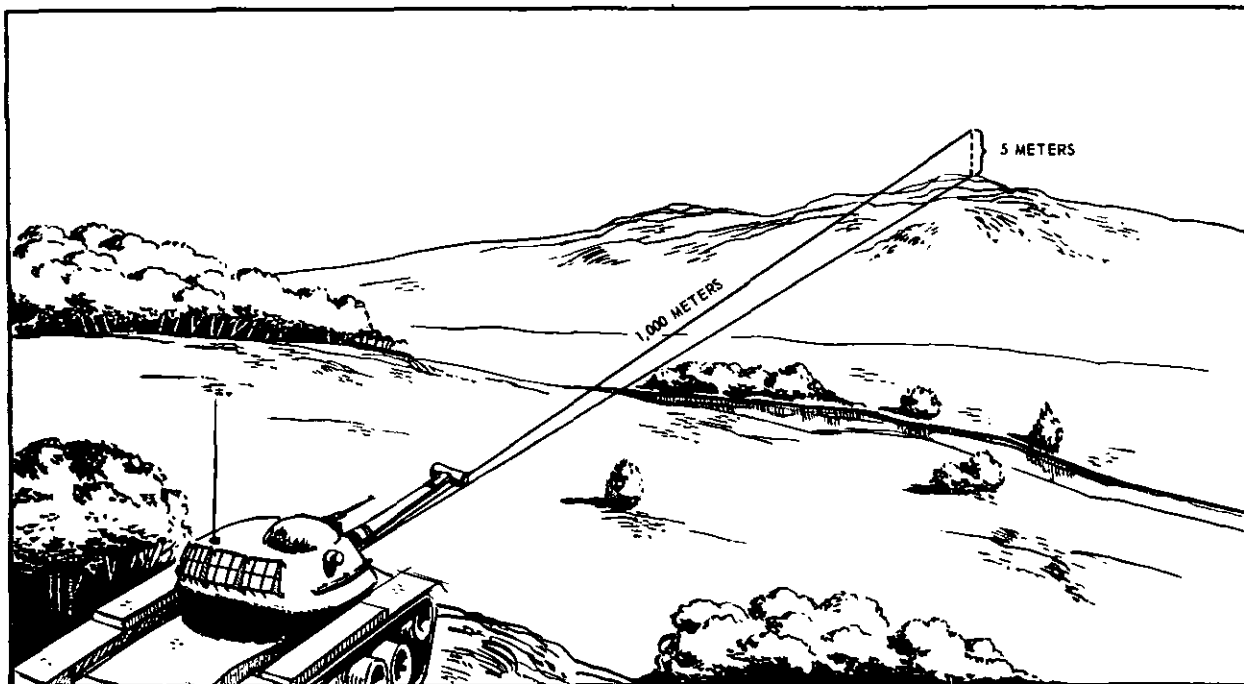

Figure 103. Determining the mil angle.

sary to add a 5-meter safety factor to the top of the mask.

Remember: Remove unknown:

$$\frac{W}{R \times \cancel{m}} \qquad \frac{W}{R \times ?}$$

(2) Procedure.

(a) Using the range finder or some other method of range determination, the tank commander determines that the range to the hill mask is 1,000 meters (R).

(b) The height above the mask for troop safety is 5 meters (W).

(c) By removing the m factor from the mil relation,

$$\frac{W}{R \times \cancel{m}} \text{ becomes } m = \frac{W}{R}$$

(d) Substitute the two known values for W and R and solve for m :

$$\cancel{m} = \frac{W}{R} = \frac{5}{1} = 5 \text{ mils.}$$

e. Determining Width.

(1) General. It is necessary to solve for width (W) when adjusting indirect fire, determining clearance for bridges

and underpasses, and determining the difference in elevation between gun and target. To determine width by using the mil relation, the mil angle (m) and the range (R) must be known. Figure 104 illustrates a situation in adjusting artillery fire. In order to correct for deviation, the observer must determine the width (W) between the volley and his observer-target (OT) line.

Remember: Remove unknown:

$$\frac{W}{R \times \cancel{m}} \qquad \frac{?}{R \times \cancel{m}}$$

(2) Procedure.

(a) The range (R) from the observer to the target is 3,000 meters.

(b) Using his binocular, the observer determines that the angle between the OT line and the volley measures 20 mils (m).

(c) By removing the W factor from the mil relation,

$$\frac{W}{R \times \cancel{m}} \text{ becomes } W = R \times \cancel{m}.$$

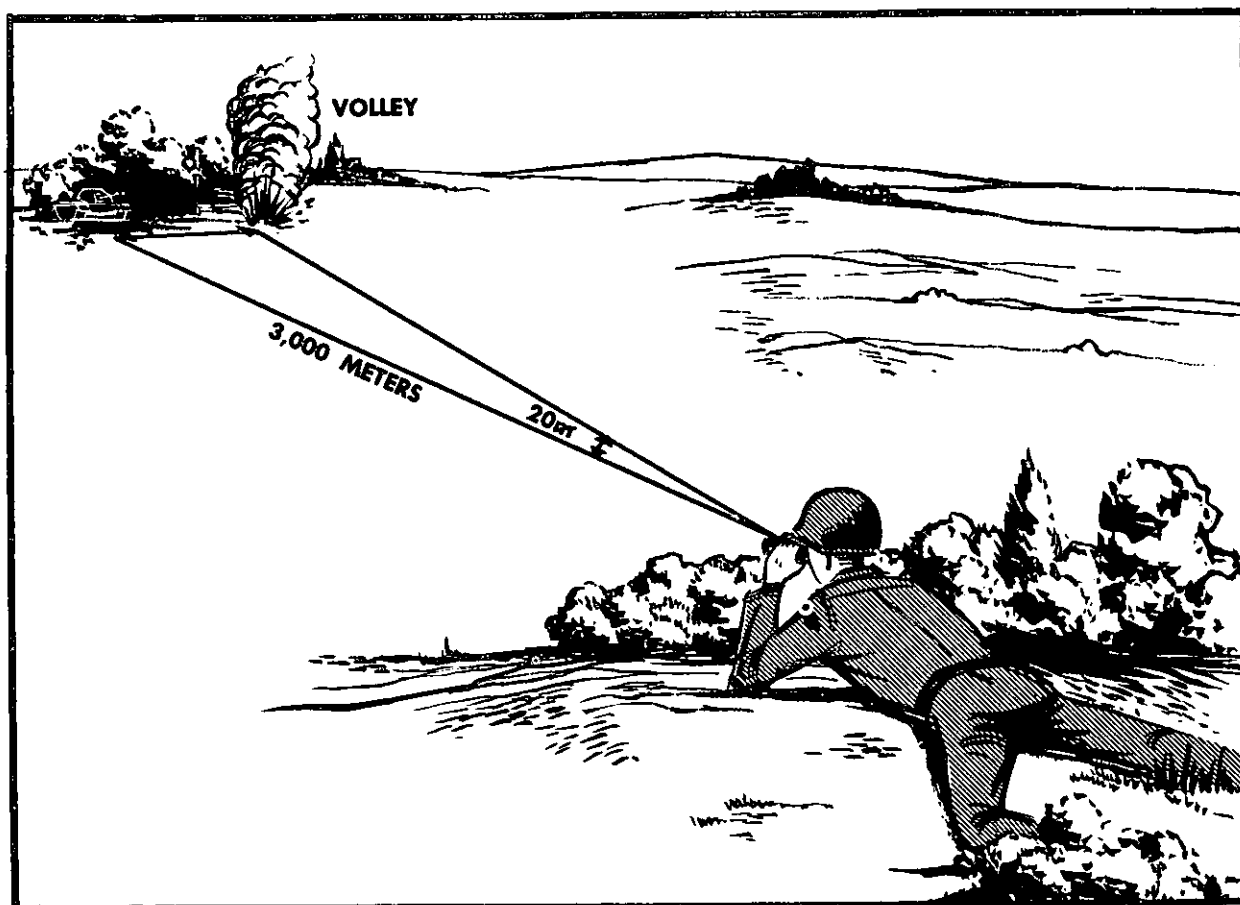

Figure 104. Determining the width.

- (d) Substitute the two known values for R and ϕ and solve for W .
 $W = R \times \phi = 3 \times 20 = 60$ meters,
 the width between the OT line and the volley.

157. Maps

When a tank commander has located the positions of both his tank and the target on a map, he can measure the distance between them. He then applies this measured distance to the graphic scale on his map and obtains the range. The accuracy of this method depends on the accuracy of the individual in locating the positions of both tank and target and the accuracy of the map.

158. Estimation by Eye

Estimation by eye is the most rapid but least accurate method of determining range. This

method requires a great deal of training. Training must be continuous to maintain the proficiency necessary to estimate range by eye with any degree of accuracy. Accuracy is also greatly influenced by the distance to the target. As the range increases, accuracy decreases at a rapid rate. In estimating range, the tank crewman employs some form of mental yardstick that can be practiced on a range determination site (para. 163). This yardstick is in multiples of hundreds of meters (yards) to correspond with the graduation on direct-fire sights. However, in order to apply this yardstick with maximum effectiveness, the crewman must be aware of certain factors that influence its application. These factors are nature of the target, nature of the terrain, and light conditions. As a general rule, the easier the target is to see, the closer it appears, and the harder a target is to see, the farther away it appears.

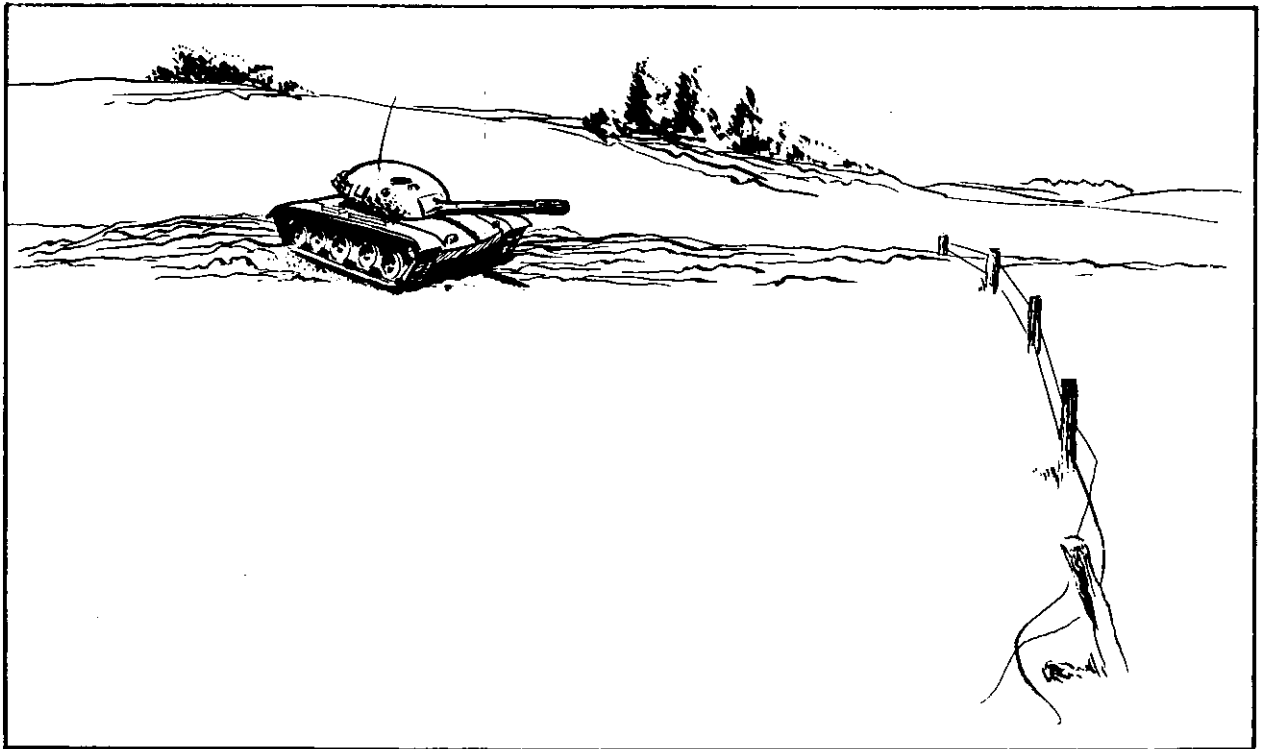
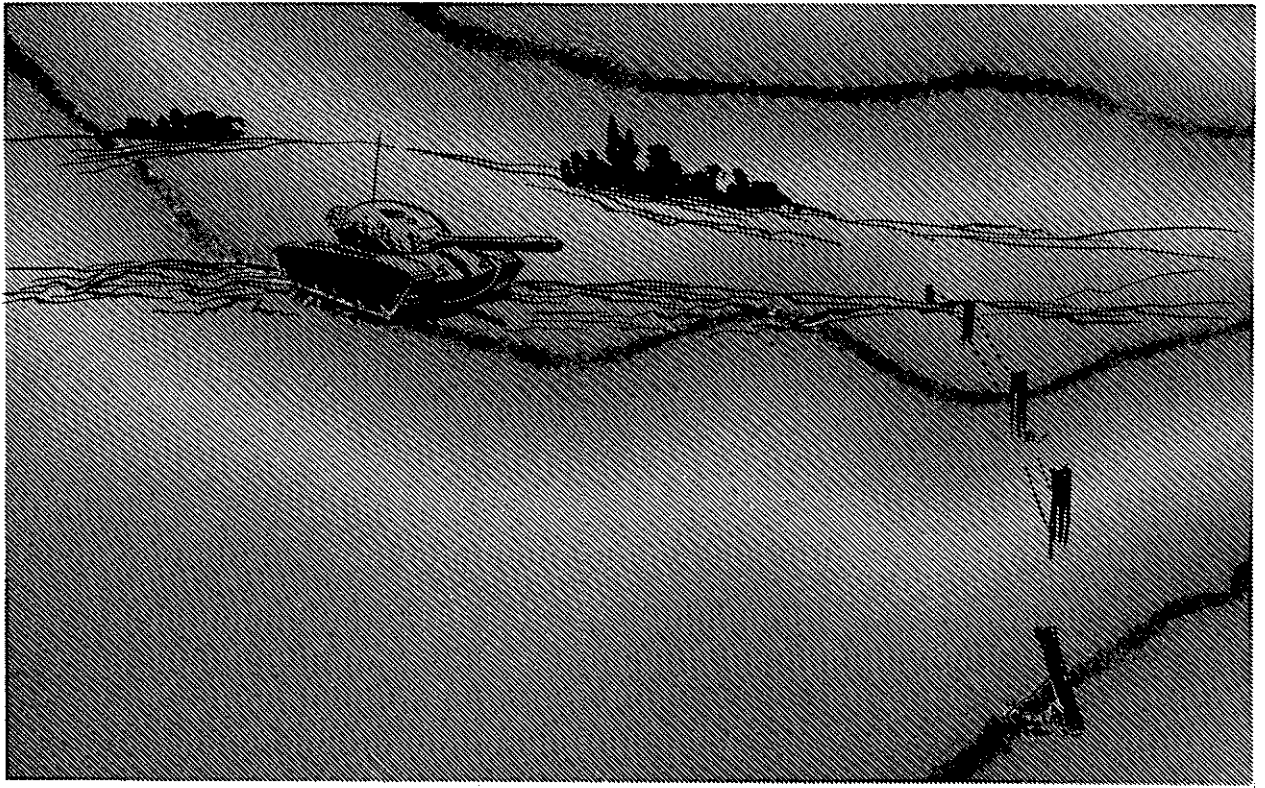

Figure 105. Clarity of outline affects estimation by eye.

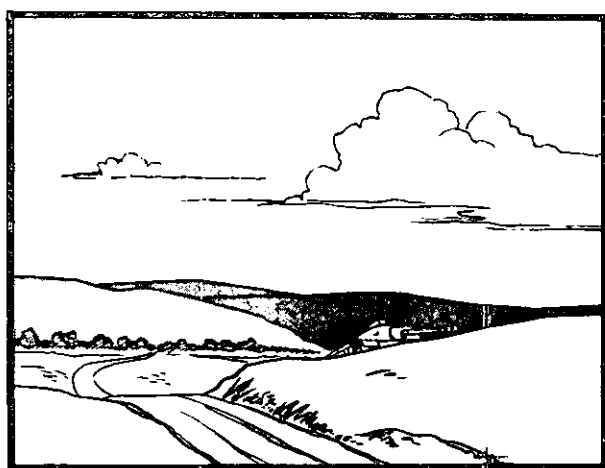
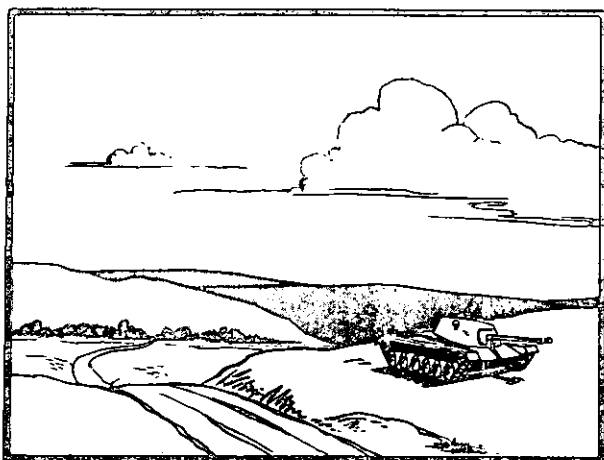

Figure 106. The amount of target visible affects estimation by eye.

a. Nature of the Target. A target of regular outline, such as a house or vehicle, appears to be closer than it actually is; a target of irregular outline, such as a clump of trees or a camouflaged position, appears to be more distant than it actually is. When the target is in contrast to the background, it appears nearer because the target outline is more clearly defined. If the target blends with the background, it appears farther away because it is more difficult to distinguish the target outline (fig. 105). The amount of target visible also affects the estimate. When the entire target is in view, it appears closer. When only part of the target is visible, it appears to be more distant (fig. 106).

b. Nature of the Terrain. Because projectiles travel through the air from gun to target, the

range to be estimated is the airline distance and not the ground distance. The eye, however, tends to measure the ground distance. In the field, the observer's eye unconsciously tends to follow the irregularities that vegetation and terrain conformation give to the ground line, thus resulting in over estimation of the range. Conversely, in observing over smooth terrain, such as desert, water, or snow, or in any other situation where there is little to distract the eye, the tendency is to under estimate the range.

c. Light Conditions. The more clearly a target can be seen, the closer it appears. A target seen in full light of the sun appears to be closer than the same target seen at dusk or dawn or through smoke, fog, or rain. The position of the sun with relation to the target also affects the apparent range. When the sun is behind the viewer, the target is in full light and easy to see and thus appears to be closer than it actually is. However, when the sun is behind the target and the viewer is looking into the sun, the target is more difficult to see and appears to be farther away.

159. Estimation by Flash and Sound

a. Sound travels through the air at a fairly constant speed, about 330 meters (1,100 feet) per second. This makes it easy to estimate range if you can see and hear the action. For example, when you see the flash or smoke of a weapon, or the dust it raises, immediately start counting at a rate of one count per second. When you hear the report of the weapon, stop; multiply the number you were counting when you heard the report by four; this will be the range to the weapon in hundreds of meters. If you stop on the number 3, the range is 1,200 meters. If you count to 8 before you hear the report, then the range is 3,200 meters.

b. Practice timing the speed of your count. The best way to do this is to practice with blank ammunition fired at known distances. If this is not possible, have someone time you while you count. When counting higher than 10, start over again; counting numbers such as 12 and 13 will throw your timing off. With practice, you can estimate range more accurately with this method than by eye alone.

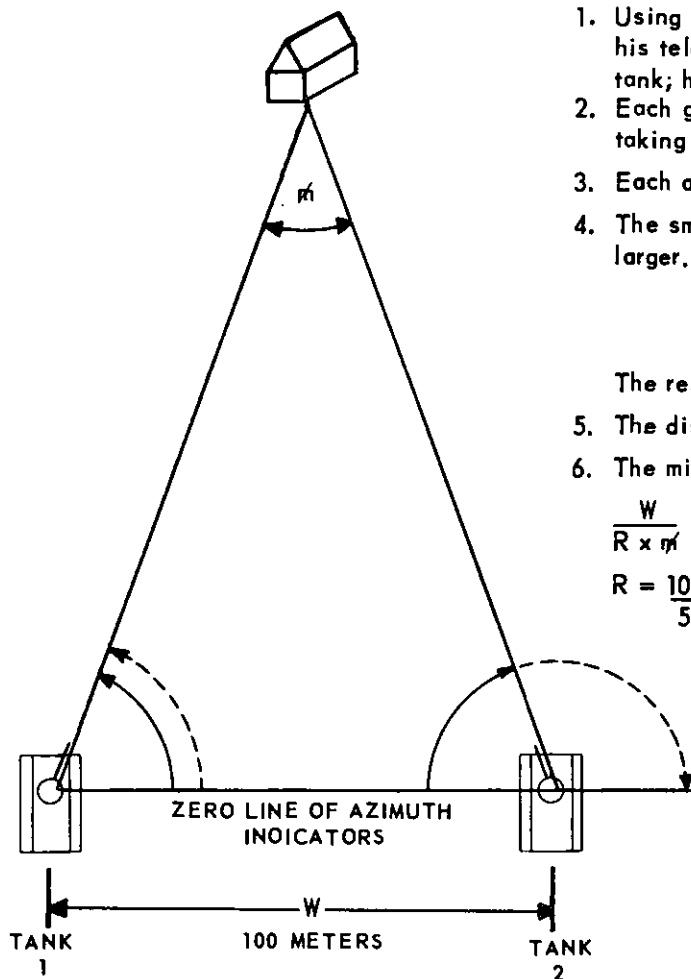

Note. The dotted lines indicate the angle measured.

AZIMUTH INDICATOR
READING: 1578 m

AZIMUTH INDICATOR
READING: 1628 m

Figure 107. Determining range by intersection—two-tank method.

160. Intersection

When time and equipment are available, intersection is an accurate method of determining range.

a. *Two-Tank Method (Primary)*. To use this method, establish a triangle, using the target as the apex. Place a tank at each end of the known base length of the triangle (fig. 107).

1. Using the boresight cross, each gunner aligns his telescope on the telescope port of the other tank; he then zeroes his azimuth indicator.
2. Each gunner traverses directly to the target, taking care to aim on the same point.
3. Each azimuth indicator reading is recorded.
4. The smaller reading is subtracted from the larger.

$$\begin{array}{r} 1628 \text{ m} \\ - 1578 \\ \hline 50 \end{array}$$

The result is the apex angle (m).

5. The distance (W) between the tanks is measured.
6. The mil relation is then used to solve for range.

$$\frac{W}{R \times \text{m}} \text{ or, removing the unknown, } R = \frac{W}{\text{m}}$$

$$R = \frac{100}{50} = 2 \text{ or range} = 2 \times 1000 = 2000 \text{ meters.}$$

b. *Summation of Angles (Alternate)*. To use this method, establish a triangle, using the target as the apex. Measure the angles at each end of the base of the triangle using any angle-measuring instrument (fig. 108). If only one instrument is available, mark both positions by stakes and move the instrument from one position to another.

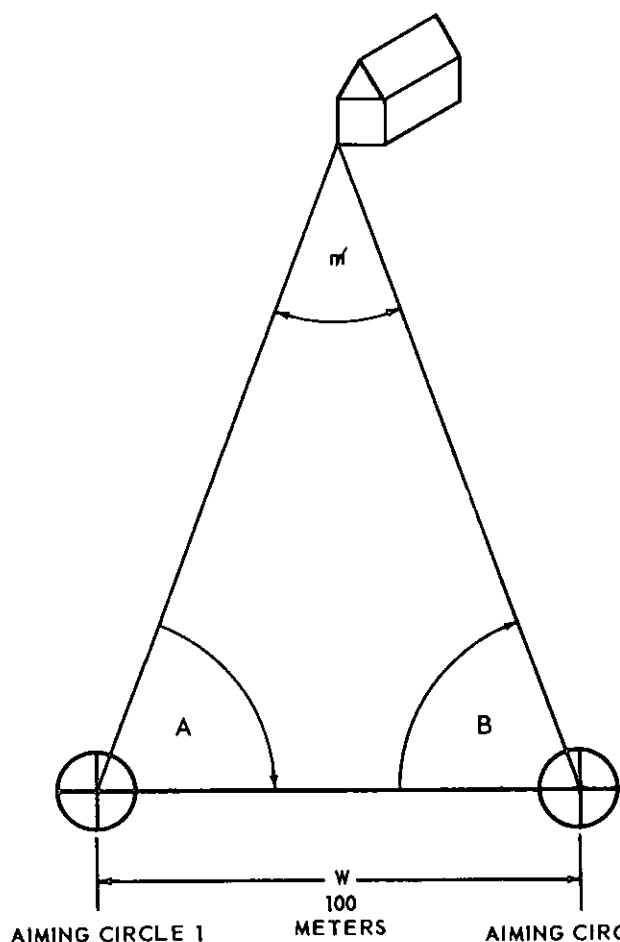

1. Aiming circle 1 measures angle A, which is the angle from the target to aiming circle 2.
2. Aiming circle 2 measures angle B, which is the angle from aiming circle 1 to the target.
3. These two base angles are added (angle A + angle B).
4. The sum of the base angles is subtracted from 3200 mils (the total number of mils in a triangle).
5. The result is the apex angle (m).
6. The distance (W) between aiming circles is measured.
7. The mil relation is then used to solve for the range to the target.

$$\text{Angle A} = 1578 \text{ m}$$

$$\text{Angle B} = 1572$$

$$\text{Total } \overline{3150}$$

$$\text{Apex angle (m)} = 3200 - 3150 = 50 \text{ m}$$

Using the mil relation:

$$\frac{W}{R \times m} \text{ or } R = \frac{W}{m}$$

$$R = \frac{100}{50} = 2$$

$$\text{Range} = 2 \times 1000 = 2000 \text{ meters}$$

Figure 108. Determining range by intersection—summation of angles method.

Section III. RANGE DETERMINATION TRAINING

161. General

Skill in the estimation of range can be attained only by constant practice. Initial training should be conducted, using *range designation* and *range determination* sites. As the crewman acquires proficiency in the estimation of ranges on these sites, training should be integrated or conducted concurrently with other field training. As individual ability increases, more difficult objects, such as camouflaged positions, are introduced.

162. Range Designation Site

a. The *range designation site* (fig. 109) is employed in the initial stage of range estimation

training to assist the crewmen in acquiring the mental yardstick necessary to estimate range by eye. The site should, if possible, allow the placement of targets to a range of 3,500 meters (yards). Signs marked 1, 2, 3, and 4 are placed at ranges of 100, 200, 300, and 400 meters (yards) from an observation point. Tanks, tank silhouettes to scale, or 6- by 6-foot panels are placed at 500-meter (yard) intervals from 500 to 3,500 meters (yards). Finally, the distance to prominent terrain features at greater ranges is determined. From the observation point, the crewman studies all of the marked ranges to get a mental picture of them. He then studies the tank silhouettes farther away, noting how the size tends to decrease as the range

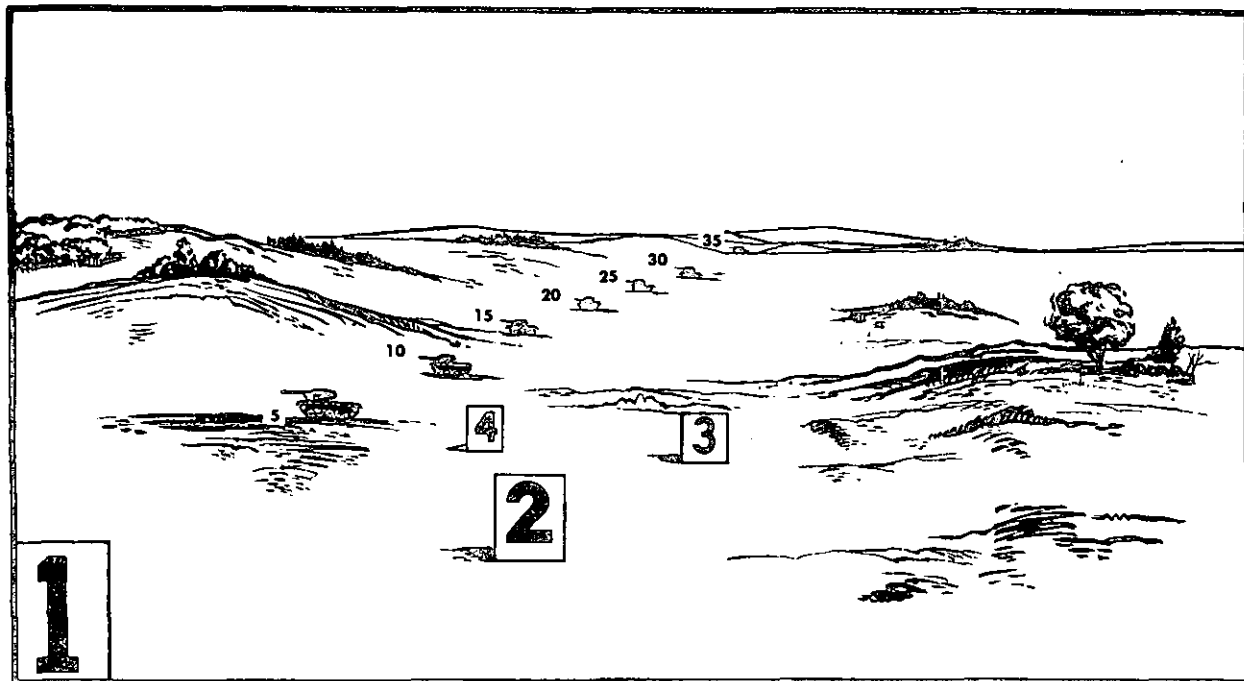

Figure 109. A range designation site.

increases and the relationship between sizes at specific ranges. If suitable additional terrain exists at the range designation site, practical work may be given by having the crewman estimate ranges to targets in a different direction, while estimating, he refers to the laid out site. After the range to a target has been estimated, the instructor announces the correct range.

b. As units receive tanks with fire control equipment graduated in meters, the unit commander should have a range designation site set up in both meters and yards. In this way, crewmen will have a comparison of these units of measure and can use this as a basis for establishing a mental yardstick in meters.

163. Range Determination Site

a. After the crewman has become accustomed to the measurement of range by use of a mental yardstick, his training should progress to the determination of ranges on a *range determination site* (fig. 110). On this site, he employs techniques of determining range by estimation. Determining range by intersection and use of the mil relation are integrated with this instruction. This site may

be established on any terrain having adequate fields of fire. The following steps are necessary to prepare the site:

- (1) Determine accurate ranges to prominent objects and terrain features. (Use a range finder or the intersection method.)
- (2) Measure the height or width of each object or terrain feature in meters (yards).
- (3) Determine the mil height or width of each object or terrain feature by means of an aiming circle or any other accurate method.

Note. If several similar objects exist in the target area, the azimuth to each target is measured as an aid to the instructor.

b. A method of instructing on the range determination site is as follows:

- (1) Have each crewman make the proper diopter and interpupillary settings on his binoculars.
- (2) Point out targets one at a time, giving sufficient time to estimate and record each range.

RANGE FINDER OPERATOR TESTING SITE

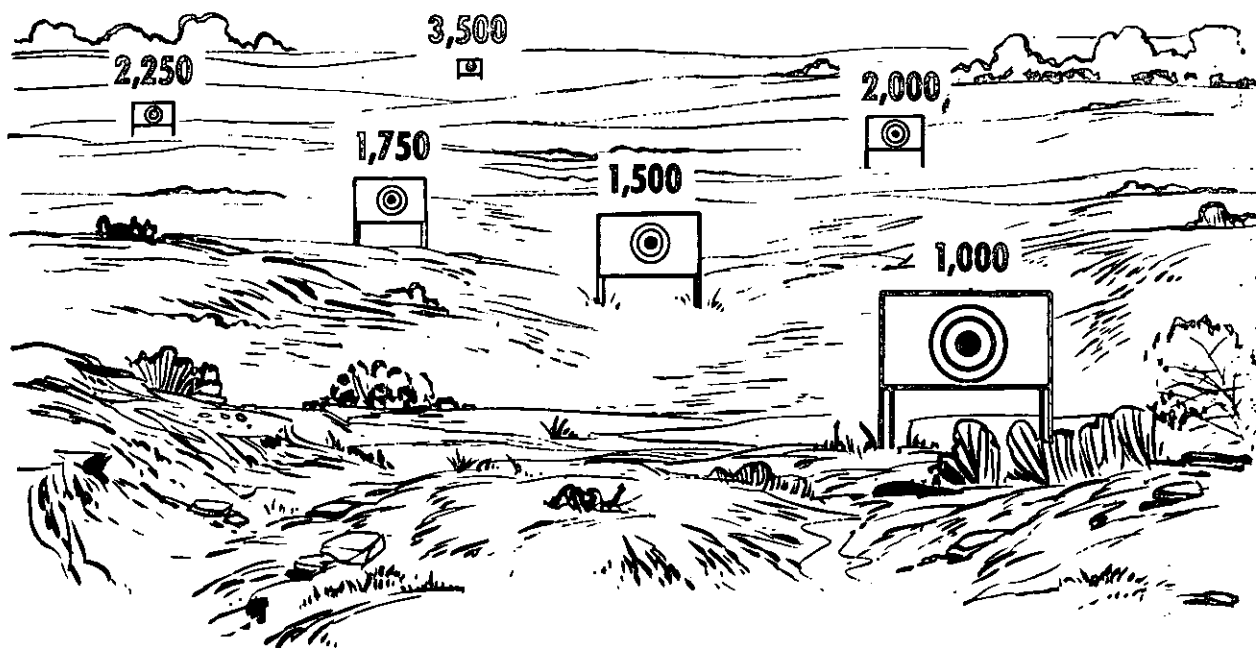

Figure 110. A range determination site.

- (3) Have each crewman measure the mil width or height of each target by use of his binoculars and give him the dimension of the part measured in meters (yards). Have him determine the range by use of the mil relation.
- (4) Announce the correct range for each target after estimation and mil relation computations have been made.
- (5) Have crewmen, working in groups of 3 or 4, determine the range to several targets, using the intersection method. (Tanks or aiming circles for this problem should be pre-positioned to check the crewman's computation.)

164. Advanced Range Determination Training

When individuals have attained reasonable proficiency in determining range on the range determination site, camouflaged targets should be added and used in determining range. Thereafter, training is integrated or concurrent with all field training. Tank crewmen should use every opportunity to practice determining range, first estimating the range and then checking their results against ranges obtained by more accurate means. This includes practice at night with the target area illuminated by tank-mounted searchlights and mortar or artillery illuminating shells.

Section IV. BINOCULAR

165. General

The binocular (fig. 111) is an optical instrument consisting of two telescopes hinged to-

gether for magnified vision from both eyes. The reticle (fig. 112) in the left telescope has both horizontal and vertical scales. The horizontal scale is 100 mils long graduated in 10-mil in-

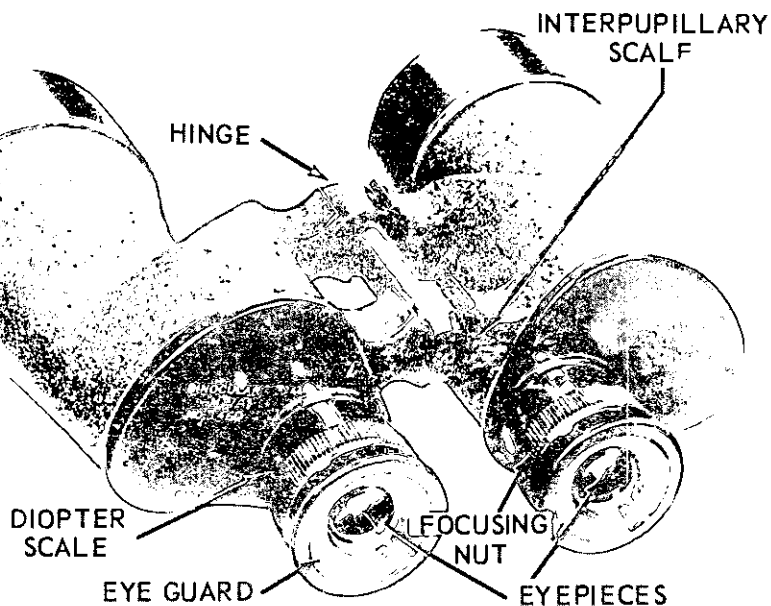

Figure 111. The binocular.

tervals, with 50 mils right and 50 mils left of the center of the field of view. There are three vertical scales. Infantrymen use the vertical scale in the right half of the field of view in adjusting indirect machinegun fire when using the auxiliary aiming point method. Tankers use it only to denote the 30-mil mark on the right side of the horizontal scale. The other vertical scales, one above the center and one above the left edge of the horizontal scale, consist of horizontal lines 5 mils long and spaced 5 mils apart vertically. These are for measurement of vertical angles.

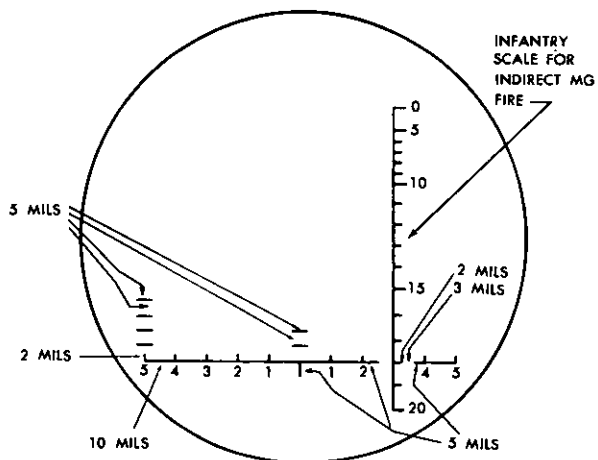

Figure 112. The binocular reticle.

166. Adjustment of the Binocular

a. Setting Interpupillary Distance. To set the binocular so that the eyepieces are the same distance apart as the eyes, open the binocular at the hinge and look through the eyepieces at the sky. Close the binocular until the 2 circles appear as 1 sharply defined circle. Note the reading on the interpupillary scale, for future use with the binocular or binocular type instruments. This reading remains constant for that particular individual.

Caution. Never look at the sun through the binocular. Permanent damage to eyesight will occur without warning symptoms as the magnified rays of sun burn the eyes. Uncorrectable blurring of vision is the most frequent result.

b. Focusing (Diopter Setting).

- (1) Set both diopter scales at plus 4 and, with both eyes open, look through the eyepieces at a distant object.
- (2) Cup the palm of 1 hand over the lens of 1 telescope and slowly turn the focusing nut of the other telescope until the object is clearly defined. Once the object becomes sharp, stop

turning the focusing nut and note the reading.

- (3) Reset the scale at plus 4 and repeat this procedure for the same telescope. Use the greater plus reading (or smaller minus reading) of the two trials.
- (4) Repeat the procedure in (2) and (3) above for the other telescope. It may be necessary to make a slight readjustment of the left focusing nut to define the reticle clearly.
- (5) Note the diopter scale reading for each eyepiece for further use with binocular-type instruments.

167. Use of Binoculars

a. Observing.

- (1) Holding the binocular with both hands, press the eyepieces lightly to the eyes (fig. 113).
- (2) Bend the thumbs and hold them at the side of the eyes to block out external light. Do not look through the binocular any longer than necessary at one time, as this may cause eye strain.
- (3) When observing, look at a specific area for a short period of time. To examine

a wide area, observe sections of the terrain at a time.

b. *Use of the Reticle.* The binocular should be held so that the reticle appears superimposed on the observed area. The reticle is used to measure horizontal and vertical angles. Measurement to the nearest mil is of primary importance.

- (1) *Measuring horizontal angles* (fig. 114). To measure the horizontal angle between two points, move the binocular so that both points are lined up along the horizontal scale. The number of mils between the two points is measured by the horizontal scale. If the points are less than 5 mils apart, place one end of a 5-mil horizontal line on one point of the object; then interpolate the number of mils to the other. If the points are more than 5 but less than 50 mils apart, place the zero graduation on one point; then read the number of mils to the other. If the points are between 50 and 100 mils apart, place one end graduation (numeral 5) on one point and read the number of mils

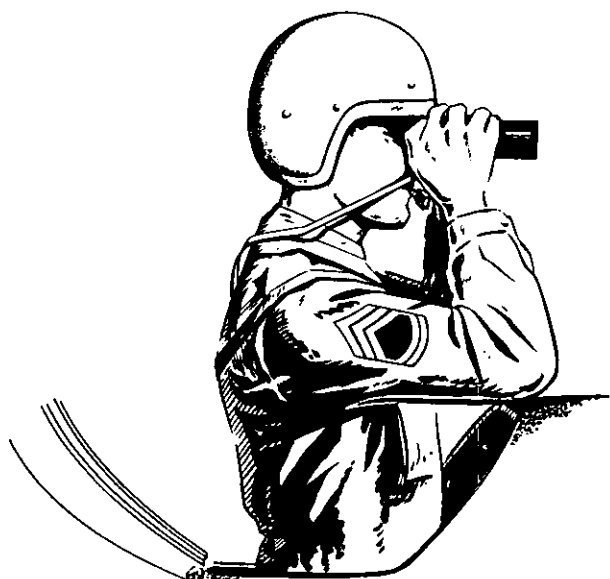

Figure 113. Proper method of observing with the binocular.

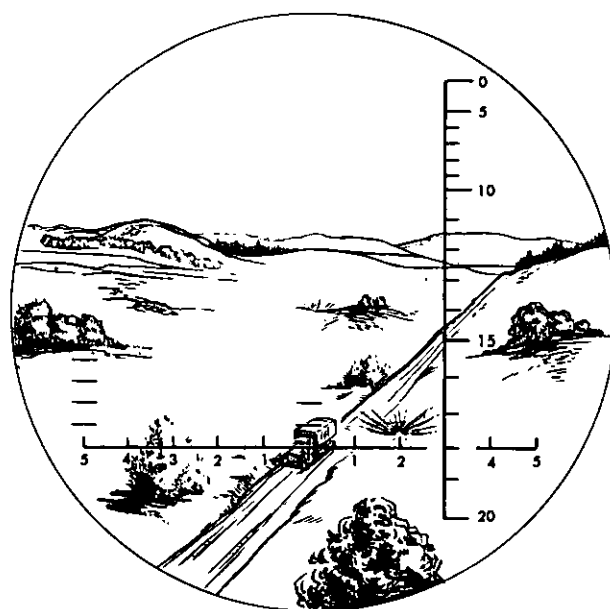
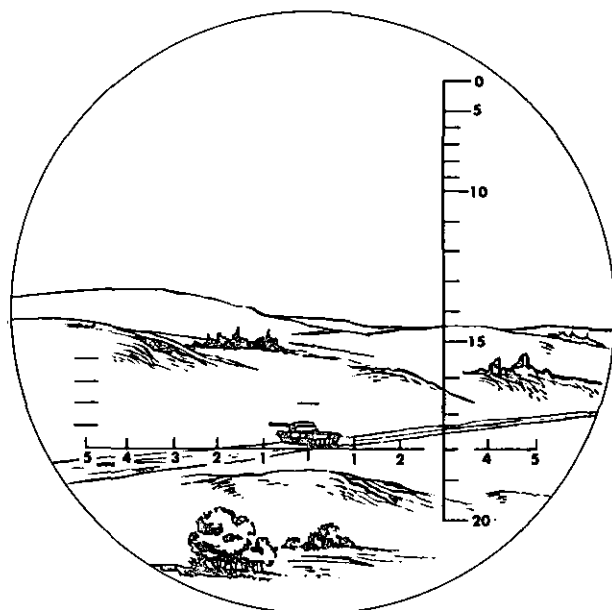

Figure 114. Measuring a horizontal angle with the binocular.



THE MIL ANGLE SUBTENDED BY THE HEIGHT OF THE TANK IS 6 MILS.

Figure 115. Measuring a vertical angle with the binocular.

to the other point (remember that there are 50 mils between each end graduation and the zero graduation). If the points are more than 100 mils apart, select 1 or more points between

them; make 2 or more measurements, and add them together. If one point does not appear exactly on a graduation, interpolate the number of mils less than 10.

- (2) *Measuring vertical angles* (fig. 115). To measure the vertical angle between two points, move the binocular so that the bottom point is on either the zero, or the left graduation (numeral 5) of the horizontal scale. The number of mils between the bottom and the upper points, as read on the vertical scale, is the vertical angle. Interpolate between the 5-mil graduations. To measure larger angles (over 20 mils), make two or more measurements and add them together or tilt the binocular sideways and use the horizontal scale.

Note. Do not use the numbered vertical scale (infantry) for these measurements.

c. *Position of the Binocular.* When using the binocular, adjust the carrying strap so that the binocular will rest high on the chest. In this position they are readily available and less likely to swing and strike against the turret or other parts of the tank. Keep the binocular in the carrying case when not in use.

Section V. RANGE FINDER TRAINING AND TESTING

168. General

In tank gunnery, the range finder can be the key to successful target engagement. A range finder combines accuracy with speed in determining range and is used for this task whenever possible. In range finder training, the standard is correct range within 5 seconds. This standard is achieved by the simultaneous development of speed and accuracy through frequent ranging practice. Training and testing methods for both coincidence and stereoscopic range finders are discussed in this section.

169. Training Areas and Equipment

a. Preliminary training in nomenclature, maintenance, adjustment, and operation is conducted in classrooms and motor parks. Ranging practice requires a target-ranging area acces-

sible to tanks, with targets placed at known ranges from 1,000 to 3,500 meters (yards) (fig. 110). Panel targets are desirable for initial training; however, as proficiency increases, natural terrain and partially camouflaged combat-type targets should be used. Targets should be placed in various locations, such as on forward slopes, partially visible on reverse slopes, on the skyline, against contrasting background, and in both thick and sparse vegetation.

b. Training aids include graphic charts, training films, slide projectors, depth perception trainers, stereovision trainers, and plastic or wooden reticle models. However, the best training aid is the range finder itself.

170. Steps in Range Finder Training

a. *Mechanical Training.* Nomenclature, main-

tenance, and operation of the instrument and its components are taught as preliminary training. Crew maintenance is limited to changing light bulbs and cleaning the instrument, including the outside lens. All other maintenance is restricted to higher echelon.

b. Adjustment. Inability to use the range finder can be traced usually to improper adjustment. Operators must master the step-by-step procedure of placing the instrument in operation.

c. Ranging Practice. Crewmen practice ranging on targets at varying ranges and locations. Each reading is recorded. This training continues until crewmen are obtaining consistent rangings on all targets. Crewmen should not range for more than 20 to 30 minutes per hour, or longer than 10 to 15 minutes at any one time. Ranging practice should be conducted in blocks of not more than 4 hours. Crewmen work in pairs; the second man records the range. Initially, the operator is allowed a maximum of 30 seconds for 1 ranging; this time is gradually reduced until he is ranging accurately within 5 seconds. Ranging practice should be conducted also during the hours of darkness with artificial illumination of the target area (tank-mounted searchlights and illuminating shells).

d. Miscellaneous.

- (1) The same range finder used to determine an individual's target image coincidence (TIC) adjustment or internal correction system (ICS) adjustment should be used for subsequent ranging. If a different range finder is used, a new adjustment is determined. In addition, the TIC adjustment is not permanent and must be adjusted as necessary (para. 171).
- (2) Range spread is the difference between the highest and the lowest readings for one target. (Use a minimum of 20 readings and subtract the lowest from the highest reading.)
- (3) Range bias is the average error in ranging. (Determine the average of a minimum of 20 readings and subtract

this average range from the known range to the target.)

e. Testing. When the crewman has obtained accuracy to the point that his range spread is 100 yards (meters) or less on targets up to 3,000 yards (meters) he is tested. The number of rangings required to achieve this degree of proficiency varies with the ability of the individual. Once proficiency in the use of the range finder is attained and initial testing is completed, periodic drills and tests should be conducted to insure that proficiency is maintained. Particular attention should be given to checking proficiency in the use of the range finder during the periods just before tank gunnery firing practice, tank gunnery annual qualification, and Army training tests.

171. Coincidence Range Finder Training Procedures and Techniques

a. During the first application phase of coincidence range finder training, crewmen must be checked individually to insure that they understand and can perform the correct method of placing the coincidence range finder in operation as outlined below.

- (1) *Diopter adjustment.* Place the occluder knob in the R position and rotate the diopter until the image is sharp and clear. The correct diopter setting will be indicated on the diopter scale.
- (2) *Light and filter check.*
 - (a) Place the occluder knob in the center position, the coincidence reticle (3-position) switch in the ON (12 o'clock position), and check the illumination of the coincidence reticle. Adjust intensity of illumination by use of the coincidence reticle (rheostat) knob. Place the coincidence reticle (3-position) switch in the AUX GUN-SIGHT (6 o'clock) position and check the illumination of the red illuminated reticle. Adjust intensity of illumination (if necessary) by use of the coincidence reticle knob.
 - (b) Turn on range scale lamp switch.
 - (c) Introduce filter (if necessary) by positioning the filter lever to the

left. In using the filter, be careful not to damage the range finder by slamming the lever into position.

(3) *Target image coincidence.*

- (a) With the occluder knob in the R (right) position and the 3-position switch in the OFF (center) position, and using the gun controls, lay the aiming cross of the black etched reticle on a target at a known range as near 1,200 meters as possible. Whenever possible this range should be surveyed. The measured range is always indexed on the range scale of the range finder. Place the occluder knob in the center position. If target images overlap with the ghost image to the left, use the vertical adjustment knob; adjust the double target images into coincidence vertically, and with the horizontal adjustment knob, bring the target images into coincidence, moving from left to right horizontally until a single target image appears in the field of view. Stop rotation of the knob the instant correct alinement is obtained. The target images need to be brought into coincidence only once in this manner for proper TIC adjustment.
- (b) If the images are wide apart or the ghost image is to the right of the more distinct image, use the horizontal adjustment knob to move the ghost image to the left of the distinct image. Then proceed as described in (a) above.

- (4) *Initial coincidence reticle alinement.* With the occluder knob in the center position, place the 3-position switch in the ON (12 o'clock) position; use knobs marked ICS and HALVING, and adjust the upper right half of the coincidence pattern until it is in alinement with the lower left half of the pattern, to form a cross. Turn the 3-position switch to the OFF (center) position. This completes placing the range finder in operation.

b. Because temperature changes may disturb optical alinement and cause separation of the coincidence reticle, frequent checks of the reticle will be made throughout the day. Subsequent adjustments of the reticle, when necessary, are made with the vertical and horizontal adjustment knobs only.

c. The range finder should be in the carry position: 500 or battlesight range indexed on the range scale, the occluder knob in the R position, and the 3-position switch in the OFF position. During periods of darkness, the occluder knob is in the L position and the 3-position switch is in the AUX GUN-SIGHT (6 o'clock) position.

d. With the range finder properly placed in operation the crewman practices ranging to develop proficiency. The proper ranging procedure is as follows:

- (1) After the gunner has announced IDENTIFIED and laid on the target (crewman lays on target in practice ranging) place the occluder knob in the center position.
- (2) Concentrating on a vertical or near vertical part of the target, rotate the range knob until the two target images merge. The range to the target has been determined.
- (3) The operator should habitually range out to the target (moving the ghost image from left to right) and stop rotation of the range knob the instant coincidence is obtained.
- (4) Upon completion of target engagement, return the range scale to 500 or the battlesight range setting.

When the crewman is familiar with the range finder controls and adjustments, knows how to place it in operation, and is ranging with an average range spread not greater than 100 meters, he is ready to be tested.

172. Stereoscopic Range Finder Training Procedures and Techniques

a. During the first application phase of stereoscopic range finder training, crewmen must be checked individually to insure they understand and can perform the correct meth-

od of placing the stereoscopic range finder in operation as outlined below.

- (1) *Diopter adjustment.* Rotate each diopter until the field of view is sharp and clear. Adjust each eyepiece separately.
- (2) *Interpupillary adjustment.*
 - (a) To determine interpupillary distance by the use of the binocular, note the setting on the binocular and place this setting on the interpupillary scale of the range finder. A finer adjustment may be necessary, as outlined in (b) below.
 - (b) To determine interpupillary distance when the binoculars are not used, one man stations himself beneath the range finder where he can observe the operator's eyes. With the filter off, he will note two beams of light from the eyepieces, shining on or near the operator's eyes. He then instructs the operator to narrow or widen the interpupillary distance with the adjusting knob until the beams are centered in the pupils of the operator's eyes.
- (3) *Light check.*
 - (a) Illuminate the stereopatterns (check each eyepiece separately) and then the red illuminated reticle. Adjust the degree of illumination with the brightness rheostat until the stereopatterns appear to have a pale yellow glow.
 - (b) Turn on range scale lamp switch.
 - (c) Introduce filter (if necessary) by positioning the filter lever to the left, being careful not to damage the range finder by slamming the lever into position.
- (4) *Halving adjustment.* To adjust for halving, rotate the range knob until maximum range is indexed on the range scale. Place the 3-position switch in the STEREO (12 o'clock) position. Lower the line of sight, without looking through the instrument, until the range finder is pointed at the ground directly in front of the tank. This will cause the ranging reticle

(fused stereopatterns) to separate. Using the halving knob, adjust the right stereopattern to the same elevation as the left stereopattern. It may be necessary to make a subsequent halving adjustment, after the gun is elevated. This adjustment will be very small and will cause the ranging reticle to appear clearer.

(5) *ICS adjustment.*

- (a) The operator will index his known ICS adjustment on the scale of the ICS knob. If the operator has to determine an ICS adjustment, follow the procedure in (b) below.

- (b) The instructor will place the lower vertical bar of the ranging reticle over a target to show the student the *proper relationship between the reticle and the target.*

1. Index the known range on the range scale of the range finder.
2. Using the ICS knob, move the ranging reticle until the lower vertical bar appears to be at the same range as the target. Record the reading now indexed on the ICS scale.

Note. Disturb the ICS knob in the same direction before each ranging, to eliminate being influenced by previous figures always ranging out (rotate from 50 toward 0).

3. Make a minimum of 10 ICS rangings in this manner. Total the column and divide by the number of ICS readings to obtain the ICS adjustment. This adjustment will then be indexed on the ICS scale.

b. With the ICS adjustment indexed into the range finder, the crewman will make practice rangings, using the proper technique outlined below.

- (1) The range finder should be in the carry position: 500 or battlesight range indexed on the range scale, the range scale switch in the ON position, and the 3-position switch in the STEREO (12 o'clock) position.
- (2) After the gunner has announced IDENTIFIED, he positions the reticle

for ranging by laying the gun so that the lower vertical bar is just above or to the side of the target. If practice ranging is being conducted, the crewman will position the ranging reticle, using the tank commander's power control handle.

- (3) Concentrating on the target, not on the ranging reticle, rotate the range knob to move the ranging reticle out toward the target until the lower vertical bar of the reticle appears to be at the same range as the target. The range to the target has been determined.
- (4) The operator should habitually range out to the target and stop rotation of the range knob the instant the lower vertical bar appears to be at the same range as the target.
- (5) Upon completion of target engagement, return range scale to 500 or the battlesight range setting.

When the crewman is familiar with the range finder controls and adjustments, knows how to place it in operation, and is ranging with an average range spread not greater than 100 yards, he is ready to be tested.

173. Testing Range Finder Operators

The testing site should be in a different location from the area for practice ranging; however, if this is not practicable, new targets may be erected in the practice ranging area. A minimum of six 6 by 6-foot panels are placed at varying known ranges from 1,000 to 3,500 meters (yards). Using the crewman's TIC or ICS adjustments, the operator makes 20 rangings on each of the targets. Each ranging starts from an indexed range of 500 meters (yards) in such a sequence that no 2 rangings on any 1 target are consecutive. The range scale on the range finder is covered so that the operator cannot read it and the operator is not informed of the range to any target. The examiner notes and records each reading from the computer, re-indexing 500 meters (yards) on the range finder for the next ranging. At the completion of the test, the readings for all targets are computed. The tested crewman is informed of his

spread, bias, and classification after computations are made. Operator proficiency is determined in the following manner:

a. The average range reading for each target is computed by adding all 20 readings for that target and dividing by 20.

b. Range bias for each target is obtained by determining the difference between the average range reading and the known range for that target.

c. Range spread for each target is obtained by subtracting the smallest reading from the largest.

d. Each crewman is classified as a *qualified* or *unqualified* range finder operator. The standard for qualification is a range bias not greater than plus or minus 50 meters (yards) on the coincidence or stereoscopic range finder, with a range spread not greater than 100 meters (yards) for each type range finder at each target. If this standard is not achieved, the individual is unqualified.

174. Improving Proficiency in Ranging

a. *Spread.* When an operator has a spread of more than 100 meters (yards), he is still making inconsistent rangings. The only way to develop consistency, or reduce spread, is through more ranging practice; however, additional practice is not a sure cure as all crewmen eventually reach the point of their maximum ability. Beyond this point, more ranging may not produce improvement, but it will enable the operator to maintain the proficiency that he has gained.

b. *Bias.* When an operator has a bias exceeding that for qualification, but a good spread, his lack of accuracy is probably due to an improper TIC or ICS adjustment. To verify this, his rangings should be checked for at least two successive days. If he continues to range with the same bias, his TIC or ICS adjustment should be corrected accordingly. However, if he is short one day and over the next, no correction is made.

Note. With a coincidence-type range finder, insure that the operator establishes his TIC adjustment and determines range by stopping rotation of the appropriate control the *instant* coincidence is obtained, always moving the ghost image from left to right.

c. Lack of Stereovision. A few persons do not have stereovision in the degree necessary to obtain acceptable results with a stereoscopic range finder, regardless of the amount of training and practice. When this condition exists (determined by medical examination) the individual can be taught to determine ranges rapidly and with greater accuracy than by estimation, using intersection with the range finder. This method is less accurate and slower than normal stereoscopic operation and should, therefore, be taught only to and employed by, individuals without stereovision. The method is as follows (use one eye at a time):

- (1) Using the gun controls, lay one edge (left or right) of the lower vertical bar of the fixed stereopattern in the left eyepiece on a definite point on the target.
- (2) Using the ranging knob, move the cor-

responding edge of the lower vertical bar of the movable stereopattern in the right eyepiece to the same point on the target. This completes ranging.

Note. When the ranging reticle (fused image of both stereopatterns) is viewed stereoscopically, it will appear to move in depth. When viewed separately, right stereopattern moves laterally. When lack of stereovision is due to one eye being much weaker than the other, the stronger eye should be used to lay both stereopatterns in the intersection method. Care must be taken to position head opposite each eyepiece in the same manner.

175. Retesting Range Finder Operators

Personnel who achieved a good spread on their initial test may be retested after their TIC or ICS adjustment is corrected. Those who had excessive spread should be retested after additional practice.

CHAPTER 16

TARGET ACQUISITION TRAINING

176. General

a. Training of the crew in the art of target acquisition is a training problem area that requires extensive emphasis at all echelons. The proficiency of the crew in the performance of target acquisition is of the utmost importance because armor combat demands rapidly attained first-round hits. This basic fundamental of modern warfare translates simply into "kill" or "be killed." Crew proficiency in target acquisition is directly related to proficiency in accuracy of fire. Target acquisition training therefore must be supervised closely to insure that all crewmen are participating and performing those duties required by their positions.

b. Combat realism must be emphasized during target acquisition training by employing realistic combat targets, e.g., tanks, antitank guns, personnel carriers, trucks, jeeps, and dismounted infantry. These targets should be concealed and camouflaged until their actions are required. Once exposed target movement should be tactically sound and typical of a well-trained enemy. Training with realistic targets will enable the crew to get the proper idea of a target in combat.

c. Target acquisition during periods of both good and poor visibility should receive equal emphasis. This will ensure a higher degree of combat readiness and will increase the number of crews that will attain a qualifying score on the crew proficiency exercises, tables VIIIA and VIIIB.

d. Duties and procedures during target acquisition are presented in chapter 9.

177. Target Acquisition Training Course Layout

a. Target acquisition training is most effectively accomplished in an area that has roll-

ing terrain, wooded and open areas, trails, or unimproved roads, hull defilade firing positions, and good fields of fire (fig. 116). Both stationary and moving combat-type targets should be placed in a camouflaged tactical position. These targets should be positioned at varied ranges out to 2,500 meters. The number of targets necessary will depend on the size of the area and the equipment available. Moving targets should be controlled by radio; stationary targets by telephone or radio. Targets should be equipped with gun simulators or fire blank ammunition to indicate enemy fire. If simulators or blank ammunition are not available for a particular target, then TNT charges should be emplaced. If this type of area or equipment is not available, target acquisition training can still be effective and realistic provided that the targets represent a well-trained enemy and that the actions of the crews are supervised and critiqued properly. To allow the crew to develop coordination and the basic skill of acquiring a target, initially, target acquisition should be simple with sufficient time between engagements for a thorough critique. As the crew becomes more proficient, training in target acquisition should be made more difficult and extensive by increasing the target activity, and by presenting multiple targets so that the tank commander must evaluate each target, select the most dangerous target, then engage it with the proper weapon and ammunition.

b. Another weapon may be used to engage the target(s) of lesser consequence, e.g., when a tank and a personnel target are presented, the main gun is employed to destroy the tank and simultaneously, the tank commander employs the caliber .50 to destroy the personnel target. After the crews have attained a high degree of proficiency in target acquisition from a stationary position, then they must be required to become proficient in target acquisi-

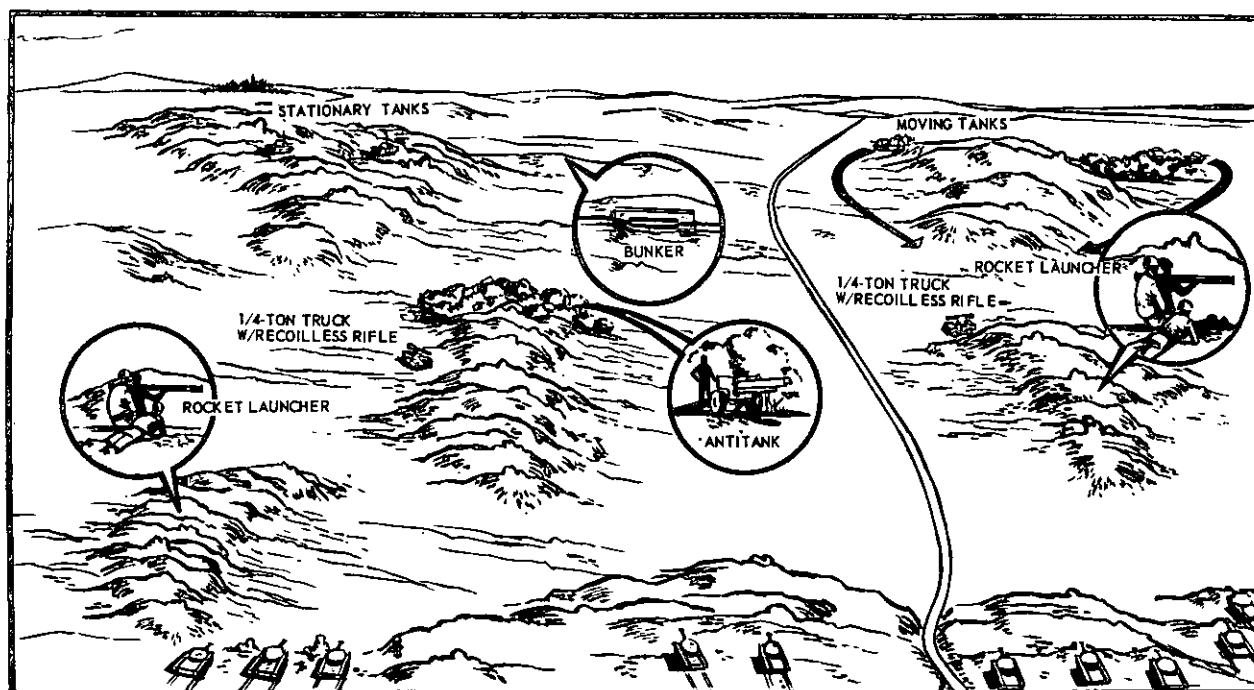

Figure 116. Stationary tank target acquisition course.

tion while moving their tank over unimproved terrain, employing all tank-mounted weapons against surprise combat targets. The same type live targets used for stationary tank target acquisition are positioned along the course. Some targets should be controlled, but others should be free to simulate fire on the crew as soon as they are visible and in range of the crew being trained. The crew must be required to react rapidly to this type of surprise enemy action. If the crew acquires and engages the target first, that target should not participate in its scheduled sequence during that particular run. Type and location of targets should be changed frequently. This training prepares the crew for the crew's part of the qualification course in addition to providing training in tactical operations.

178. Conduct of Target Acquisition Exercises

a. The targets should be positioned before the arrival of the crews. On stationary tank target acquisition, when the crews arrive they should move into a tactical position, prepare range cards, and organize the position. With both the targets and crews in their tactical posture, the conduct of the exercise is ready

to begin. All targets should be controlled by one individual who will order targets to move and fire in a random order. The crews must not be able to anticipate nor should they receive advanced notice of the next target to appear. They must be required to acquire the target without assistance. Additional combat realism is provided by having the targets respond with simulated fire, immediately after being exposed. The difficulty and rapidity of target engagements must be commensurate with the crew's proficiency in target acquisition.

b. To measure crew proficiency in this exercise, the following factors are considered:

- (1) Time elapsed before a target is located after it has fired or moved.
- (2) Identification of target.
- (3) Selection of the most dangerous target.
- (4) Selection of the correct weapon and ammunition.
- (5) Ranging time (when applicable).
- (6) Accuracy of determined range.
- (7) Speed and accuracy of lay.
- (8) Execution of crew firing duties.

179. Target Acquisition Training— Poor Visibility (Night)

Target acquisition training is continued during periods of poor visibility. Course layout, equipment, and target activity are generally the same as above. In addition, the tank-mounted searchlight and mortar or artillery illuminating shells may be employed to provide target illumination. A range card is prepared for the searchlight (para. 114) and indirect illumination is registered. During periods of poor visibility, more simulators, blanks, and TNT are required because the target should fire twice. The crew should acquire the target by the flash and bang of the first round (para. 159). They should then apply range card data and request illumination. Immediately upon illumination, the crew must engage the target. Any delay

in engagement will allow the target sufficient time to take evasive action. Once detected, the target will fire the second round. The crew should be required to engage several targets of opportunity, and targets that expose themselves by movement only. During the exercise, when appropriate, the controller will act as a listening post or patrol and announce the presence of a target to the crews who will then engage it. Training in target acquisition should require the crews to engage: illuminated targets of opportunity using daylight direct-fire techniques; illuminated targets for which they have plotted range card data and can engage with the ammunition used when preparing the range card; and illuminated targets for which they have plotted range card data requiring the use of a different round of ammunition (para. 112c).

PART SIX
TANK GUNNERY TESTING

CHAPTER 17
INTRODUCTION

180. General

The tank is an effective fighting machine only when the crew is capable of delivering fire with speed and accuracy. Firing exercises are designed to provide the tank crew with training in the destruction of targets under varied conditions so they will attain this proficiency. These exercises are the most important type of gunnery training. Range firing exercises afford opportunities to apply by individual and collective efforts, subject matter that was learned previously in the form of theoretical and nonfiring exercises. Tank firing should not be limited to annual qualification firing. To attain and maintain the proficiency of all tank crews in gunnery, unit commanders should schedule periods of practice firing and familiarization firing.

181. Types of Firing Exercises

- a. Tank crewman qualification firing (ch. 18).
- b. Tank crew qualification firing (ch. 19).
- c. Familiarization and practice firing (ch. 20).

182. Firing Skills

Individual and crew firing skills are developed by firing subcaliber and service exercises in a logical sequence.

a. *Subcaliber Firing.* The purpose of subcaliber firing is to develop speed and accuracy when engaging targets during good or poor visibility. Subcaliber firing also trains and tests crewmen in using the direct-fire sights, turret

controls, and fire control equipment without subjecting them to the blast and recoil of the main gun and without expending main gun ammunition.

b. *Service Firing.* The purpose of service firing is to test the crewman in firing the main gun at various targets and ranges and to develop skill, speed, and accuracy in applying gunnery techniques. At the same time, personnel are conditioned mentally to the blast and recoil of the main gun. In addition, these exercises provide training in gun and turret preventive maintenance services, handling and stowage of ammunition, and safety precautions connected with tank firing.

c. *Crew Field Firing and Crew Proficiency Exercises.* The purpose of these exercises is to train and test the speed and coordinated actions of the tank crew. The crew is required to move the tank over designated routes and rapidly engage different types of targets at varied ranges with the proper weapon and ammunition. These combat-type exercises provide the crew with the opportunity to achieve the high standards of training and efficiency necessary in combat.

d. *Night Firing.* The purpose of night firing is to train and test the tank crew in rapid engagement and destruction of both illuminated and nonilluminated targets. Furthermore, night firing exercises familiarize the crew with the various methods of illumination (including infrared if units are so equipped) and instill confidence in crew members by showing the effectiveness of tank weapons under these conditions.

183. Tank Gunnery Qualification Course

Chapters 18 and 19 contain the prescribed tank gunnery qualification course and gunnery qualification standards. All members of a tank crew (tank commander, gunner, loader, and driver) and other personnel as outlined in AR 370-5 will fire all or parts of the tank gunnery qualification course for qualification at least once annually.

a. The purpose of the tank gunnery qualification course is to provide a means of determining the proficiency of the tank crewman and the tank crew in gunnery. Tables I-III (sub-caliber) test each crewman as a gunner. Tables IVA and VA (service firing (day) course A) test three crewmen (tank commander, gunner, and one other as a gunner). Tables IVB and VB (service firing (night) course B) test the tank commander and gunner as a gunner. Tables VIA-VIIIB test the tank crew. All tables serve as an adjunct to training in the proper care and use of the weapons and their accessories. The complete tank gunnery qualification course is organized and conducted as follows:

- (1) *Tank crewman preliminary gunnery examination.* (All crew members.)
- (2) *Tank crewman gunnery qualification—subcaliber firing.* (All crew members fire for practice and record.)
Table I—zeroing and initial lay exercises.
Table II—adjustment of fire exercises.
Table III—moving target exercises.
- (3) *Tank crewman gunnery qualification—service firing (day)—course A.* (Fired by tank commander, gunner, and one other crew member.)
Table IVA—stationary target exercises (day).
Table VA—moving target exercises (day).
- (4) *Tank crewman gunnery qualification—service firing (night)—course B.* (Fired by tank commander and gunner only.)
Table IVB—stationary target exercises (night).
Table VB—moving target exercises (night).

- (5) *Tank crew gunnery qualification firing.*

Table VIA—crew machinegun exercises (day).

Table VIB—crew machinegun exercises (night).

Table VIIA—crew field firing exercises (day). (Fired twice.)

Table VIIB—crew field firing exercises (night). (Fired twice.)

Table VIIA—crew proficiency exercises (day).

Table VIIB—crew proficiency exercises (night).

b. Each tank crewman must satisfactorily complete the tank crewman preliminary gunnery examination before firing the subcaliber exercises. The crewman fires the subcaliber exercises once for practice and once for a record. He must qualify on the subcaliber exercises before firing the service exercises. The crewman fires the service exercises for record only. He must satisfactorily complete tables IVA-VB (service firing courses A and B) to qualify for the position of tank commander or gunner of a tank crew participating in the tank crew gunnery qualification exercises. Other members of the tank crew must have fired the subcaliber exercises (and tables IVA and VA (service firing course A, if applicable)) before participating as a member of a tank crew, other than tank commander or gunner, in the tank crew gunnery qualification exercises. An exception may be made to this requirement if crew members are assigned to a unit after the crewman's tables have been conducted, but before the crew tables are fired. In such cases, these persons may participate as crew members (other than tank commander or gunner) after satisfactorily completing the preliminary gunnery examination.

c. Classification of tank crewmen and tank crews is based on the score attained on the appropriate tables. Both crewmen and crew are classified as expert, sharpshooter, marksman, or unqualified.

- (1) There are three separate qualification categories for a crewman; one for subcaliber firing and two for service firing, but a qualification badge is

awarded for only one category at a time. These scores are not combined and a crewman who fires the service tables is not awarded a badge for sub-caliber firing; if such a badge has been previously awarded, it is automatically revoked. The indicated minimum satisfactory score must be attained on each table for a classification of marksman or higher to be awarded. These classifications are the basis for awarding arms qualification badges in conjunction with the following stipulations:

- (a) In active Army units, both sub-caliber and service tables must be fired annually unless a waiver of the service firing requirement is obtained from the appropriate theater commander. Such waivers are granted only when a unit does not have access to range facilities where service firing can be conducted.
- (b) In Army reserve component and national guard units, the type and amount of firing is based on annual training requirements; therefore, awards based on subcaliber firing only are authorized in years when service firing is not conducted.
- (c) *Individual classification—subcaliber firing.*

	<i>Score</i>
Total possible -----	300
Expert -----	280
Sharpshooter -----	240
Marksman -----	210
Unqualified -----	Below 210

Note. The second firing of each table scored for record.

- (d) *Individual classification — service firing (day)—course A.*

	<i>Score</i>
Total possible -----	200
Expert -----	185
Sharpshooter -----	160
Marksman -----	140
Unqualified -----	Below 140

- (e) *Individual classification — service firing (day and night)—courses A and B.*

	<i>Score</i>
Total possible -----	400
Expert -----	375
Sharpshooter -----	320
Marksman -----	280
Unqualified -----	Below 280

- (2) Classification of tank crews is based on the combined scores of tables VIIIA and VIIB (para. 221). The indicated minimum satisfactory score must be attained on each table or a combined score of 1,800 points if score on one table is below satisfactory, in order for a classification of marksman or better to be awarded. Arms qualification badges are not awarded for crew classifications; however, notations indicating crew position and crew classification will be entered on individual qualification records.

	<i>Crew classification</i>	<i>Score</i>
Total possible -----		2,400
Expert -----		2,000
Sharpshooter -----		1,800
Marksman -----		1,560
Unqualified -----		Below 1,560

184. Ammunition Required for Qualification Firing

a. The following chart lists the ammunition required for a crewman to fire the tank crewman's gunnery qualification tables applicable to his position in the crew:

Table	Coaxial MG 4-1 MLB	Main gun		Illum shell
		HE or HEP	TP-T	
*I a b c -----	22(176)			
*II b c -----	20(160)			
*III b c -----	10(80)			
**IVA d e -----		2(6)	6(23)	
**VA f -----			8(25)	
***IVB g -----		2(4)	6(12)	1(2)
***VB -----			8(16)	
Total practice per firing crewman -----	52	0	0	
Total record per firing crewman -----	52	4	28	
Total per crew	(416)	(10)	(76)	(2)

a—Includes five rounds for crewman who needs extra ammunition for zeroing, and to compensate for multiple-round bursts due to malfunction of the single-shot device.

b—The most recently packed standard coaxial machinegun tracer ammunition available will be used.

c—Frangible ammunition may be substituted when limited range facilities only are available.

d—Includes 5 rounds TP-T for zeroing weapon.

e—Includes 1 round TP-T for crewman to verify zero.

f—Includes 2 rounds TP-T for gunner to verify zero and 1 round each for other 2 crew members.

g—24 illuminating shells are used for 8 orders (3 shells per order) in a company size unit. 81-mm or 4.2-inch mortar or 105-mm howitzer can be used. Additional 10 rounds for settling and registration.

Figure in parentheses next to rounds per individual firing is rounds for one crew per table.

* Fired by all crew members.

** Fired by tank commander, gunner, and one other crew member.

*** Fired by tank commander and gunner only.

b. The following chart lists the ammunition required for one crew to fire the tank crew gunnery qualification tables:

Table	Coaxial MG 4-1 MLB g	Cal. 50 4-1, MLB g	Main gun		Illum shells e	Flare h
			HE or HEP	TP-T		
VIA a -----	345	150				
VIB -----	270	100				
VIIA b d -----	215	110	2	4		
VIIA c d -----	215	110	2	4		
VIIb b -----	200	100	2	4	3	
VIIb c -----	200	100	2	4	3	
VIIIA d f -----	315	110	4	6		
VIIb d f -----	315	110	4	6	3	1
Crew total	2,075	890	16	28	9	1

a—Includes 75 rounds coax and 50 rounds caliber .50 for zeroing machineguns.

b—First firing of table.

c—Second firing of table.

d—Includes 15 rounds coax and 10 rounds caliber .50 for operational check.

e—Twelve additional illuminating shells (mortar or artillery) are required daily for registration.

f—Includes 2 rounds of TP-T for crew to verify and refine the established zero.

g—Four nontracer to 1 tracer round.

h—Rifle or hand-held.

185. Rules for Record Firing

a. *General.* Before record firing, examining personnel must be thoroughly familiar with their duties, including correct firing and scoring procedures. If a malfunction occurs, the examiner notes the time and determines the nature of the malfunction. After the malfunction has been corrected, the crewman or crew is permitted to complete the exercise. If the malfunction was not due to negligence of the

gunner or crew being tested, the time required to correct the malfunction is *not* counted against the time allowed for that phase of the test. If the malfunction results from the crewman's or crew's failure to perform required duties, it is considered negligence, and no time credit will be allowed. All tank weapons to be used in firing tables IV-VIII B will have a zero established. On a tank with an infinity sight that has no scales on the boresight knobs, care must be taken not to move these knobs once the coaxial machinegun has been zeroed.

b. *Tank Crewman Gunnery Qualification Tables.* Examiners may be either commissioned or noncommissioned officers. Only the crewman being tested, loader(s), and examining personnel, will be on the tank during record firing. The examiner will take the tank commander's station. Before firing, the crewman is required to check the condition of the weapons, controls, sights, and ammunition. He is permitted a maximum of 30 minutes to make these checks; however, the time taken to correct any deficiencies discovered does not count against the crewman's time. During firing, the crewman, as gunner and without the benefit of coaching or assistance, performs all operations required by the test.

c. *Tank Crew Gunnery Qualification Tables.* Examiners may be either commissioned or noncommissioned officers. Only the examiner and the members of the crew in their assigned positions will be on the tank during firing. The examiner will be outside the tank where he can best control and score the tank crew and will use the intercommunication system for monitoring and control. The crew should use its assigned tank, if possible, but regardless of the tank used, the crew will be held responsible that the tank is fully operational and mechanically prepared to fire each exercise by performing the proper checks and reporting any deficiencies. The crew will be permitted a maximum of 30 minutes to make these checks; however, the time taken to correct any deficiencies discovered does not count against the crew's time. During firing, the crew will perform all the operations required by the test without benefit of coaching or assistance.

CHAPTER 18

TANK CREWMAN GUNNERY QUALIFICATION COURSE

Section I. INTRODUCTION

186. General

a. This chapter outlines the procedures to follow and standards required in the administration of the tank crewman preliminary gunnery examination and the firing of subcaliber and service exercises by the crewman.

b. The complete tank crewman qualification course is organized and conducted as follows:

(1) *Tank crewman preliminary gunnery examination.* (All crew members.)

(2) *Tank crew gunnery qualification—subcaliber firing.* (All crew members fire for practice and record.)

Table I—zeroing and initial lay exercises.

Table II—adjustment of fire exercises.

Table III—moving target exercises.

(3) *Tank crewman gunnery qualification—service firing (day)—course A.*

(Fired by tank commander, gunner, and one other crew member.)

Table IVA—stationary target exercises (day).

Table VA—moving target exercises (day).

(4) *Tank crewman gunnery qualification—service firing (night)—course B.*

(Fired by tank commander and gunner.)

Table IVB—stationary target exercises (night).

Table VB—moving target exercises (night).

Section II. TANK CREWMAN PRELIMINARY GUNNERY EXAMINATION

187. General

The tank crewman preliminary gunnery examination is designed to assist the commander in determining whether his tank crewmen are sufficiently trained to perform the functions necessary for firing the qualification tables. *Accordingly, each member of the tank crew is required to perform each test satisfactorily within the time allotted before he is permitted to fire the subcaliber tables or participate as a member of the crew, firing the tank crew gunnery qualification tables.* Failure of any part of a test means that the crewman fails the examination and, after any necessary training, must be reexamined on the test(s) he has failed. The examination is conducted under the direction of an officer, by examiners who may be officers or noncommissioned officers. Results are

recorded on an examination record (fig. 117). Crewmen on all tanks will complete the first 10 tests. Then, depending on the type of tank in the unit, additional tests will be required as shown. Detailed, locally produced guides may be used by the examiners.

188. Test on Field Disassembly and Assembly of Breech Mechanism

a. *Procedure.* The breech cover is removed; the gun travel lock is disengaged, and all devices necessary to remove the breechblock are present. The examiner assists when directed by the crewman being tested. The examiner commands **DISASSEMBLE BREECH MECHANISM (BLOCK)**. The crewman is required to field disassemble the breech mechanism and breechblock within 6 minutes, using the pre-

UNIT _____ NAME _____

DATE _____ GRADE _____ SN _____

TANK CREWMAN PRELIMINARY EXAMINATION RECORD

TEST NO.	TITLE	SAT	UNSAT	REMARKS*	EXAMINER'S INITIALS
1	Field disassembly and assembly of breech mechanisms				
2	Putting turret in power operation				
3	Use of replenisher indicator tape				
4	Identification and use of ammunition				
5	Boresighting and zeroing the main gun				
6	Boresighting and zeroing the coaxial machinegun				
7	Preparing and firing from a range card				
8	Misfire procedure				
9	Safety and control measures				
10	Direct laying and adjustment				
<u>M41A3</u>					
11	Disassembly, assembly and headspace adjustment on caliber .30 machinegun				
12	Adjusting head space and timing and mounting caliber .50 machinegun				
13	Checking and adjusting firing linkage				
<u>M48</u>					
11**	Disassembly, assembly and head space adjustment on caliber .30 machinegun				
12	Adjusting head space and timing and mounting caliber .50 machinegun				
13	Checking and adjusting machinegun solenoid and firing linkage				
14	Boresighting and zeroing caliber .50 machinegun				
15	Placing range finder in operation				
<u>M60</u>					
11	Disassembly and assembly on M73 machinegun				
12	Disassembly and assembly and mounting M85 machinegun				
13	Boresighting and zeroing M85 machinegun				
14	Placing range finder in operation				
<u>M103</u>					
11	Disassembly and assembly on M73 machinegun				
12	Adjusting head space and timing and mounting caliber .50 machinegun				
13	Checking and adjusting firing linkage				
14	Placing range finder in operation				

*P--Procedure incorrect

A--Accuracy not attained

T--Time limit exceeded

X--Requires much more training

**Test number II, M60 Tanks will be used by units equipped with M48A2C and M48A3 Tanks.

COMMENT _____

QUALIFIED YES NO

_____ OFFICER IN CHARGE

Figure 117. Tank crewman preliminary gunnery examination record.

scribed methods. The examiner then commands ASSEMBLE BREECH MECHANISM (BLOCK). The mechanism will be disassembled no further than to remove the breechblock (mechanism), extractors, and that portion of the firing train contained within the breechblock (mechanism). The crewman is required to assemble the breechblock and breech mechanism within the same time limits prescribed for disassembly.

b. Examiner's Guide.

- (1) Examiner: DISASSEMBLE BREECH MECHANISM (BLOCK). (Starts time.)
- (2) Crewman: Disassembles breech and announces COMPLETE.
- (3) Examiner: Stops time.
- (4) Time: 6 minutes.
- (5) Examiner: ASSEMBLE BREECH MECHANISM (BLOCK). (Starts time.)
- (6) Crewman: Assembles breech and announces COMPLETE.
- (7) Examiner: Stops time.
- (8) Time: 6 minutes.

189. Test on Putting Turret in Power Operation

a. Procedure. The crewman is required to put the turret in power operation within 2 minutes, performing all steps in the prescribed sequence.

b. Examiner's Guide.

- (1) Examiner: PUT TURRET IN POWER. (Starts time.)
- (2) Crewman: Alerts crew (announces POWER).
Checks oil. (Presence of oil or full before pumping according to type of tank.)
Unlocks turret. (Traverses manually to insure turret is unlocked.)
Turns on power.
Elevates and traverses.
(Again checks oil when applicable; full after pumping.)
Announces COMPLETE.

(3) Examiner: Stops time.

(4) Time: 2 minutes.

Note. Sequence is important.

190. Test on Use of Replenisher Indicator Tape

a. Procedure. The examiner hands an indicator tape or training aid to the crewman and directs him to identify the four sections of the indicator tape, to explain what each indicates, and to tell what action he would take when each section is exposed before firing and during firing. The crewman is required to do this within 2 minutes.

b. Examiner's Guide.

- (1) Examiner: IDENTIFY THE FOUR SECTIONS OF THE INDICATOR TAPE; EXPLAIN WHAT EACH INDICATES, AND TELL WHAT ACTION YOU WOULD TAKE WHEN EACH SECTION IS EXPOSED BEFORE FIRING AND DURING FIRING. (Starts time.)
- (2) Crewman: Identifies the different sections of the tape, explains their meaning, and states action required:
 - (a) Two rough edges. (Low—add oil.)
 - (b) One rough and 1 smooth edge. (Correct—no action.)
 - (c) Two smooth edges. (Before firing—excess—drain.)
During firing—OK—watch for change.)
 - (d) Two long notches (Excess oil—drain.)
- (3) Examiner: Stops time.
- (4) Time: 2 minutes.

191. Test on Identification and Use of Ammunition

a. Procedure. Three to five rounds of standard-type tank gun ammunition, with all nomenclature markings covered, are displayed before the crewman. The crewman is required to identify each round and state its primary use and how it is announced in a fire command. The crewman is required to do this within 20 seconds per round. (See chapters 3 and 11 for ammunition information.)

b. Examiner's Guide.

- (1) Examiner: IDENTIFY EACH ROUND OF TANK GUN AMMUNITION; STATE ITS PRIMARY USE AND HOW IT IS ANNOUNCED IN A FIRE COMMAND. (Starts time.)
- (2) Crewman: Identifies each round and states its primary use and how it is announced in a fire command.
- (3) Examiner: Stops time.
- (4) Time: 20 seconds per round.

192. Test on Boresighting and Zeroing Main Gun

a. Procedure. For this test, a 6-by-6-foot panel target with an 8-inch bull's-eye and the appropriate size circle is set as close as possible to the desired boresighting and zeroing range, as stated in the operator's technical manual. A 3-round shot group is shown by 3 holes (or dots) on the target. A sample target is shown in figure 118. To conduct the exercise, the

examiner places the computer or ballistic unit and the boresight knobs of the primary and the secondary direct-fire sights out of adjustment. The crewman is required to boresight and zero the gun with both these sights, using the prescribed procedure.

b. Examiner's Guide.

- (1) Examiner: BORESIGHT MAIN GUN (indicates target and range to target).
- (2) Crewman: Performs necessary steps to make boresight adjustment (including all main gun sights) and announces COMPLETE (examiner sights through tube while gunner lays on the target).
- (3) Time: No time limit.

Note. Correct procedure, including accuracy of lay, is mandatory.

- (4) Examiner: APPLY EMERGENCY ZERO TO THE PRIMARY SIGHT.

Note. Applicable only to certain type tanks.

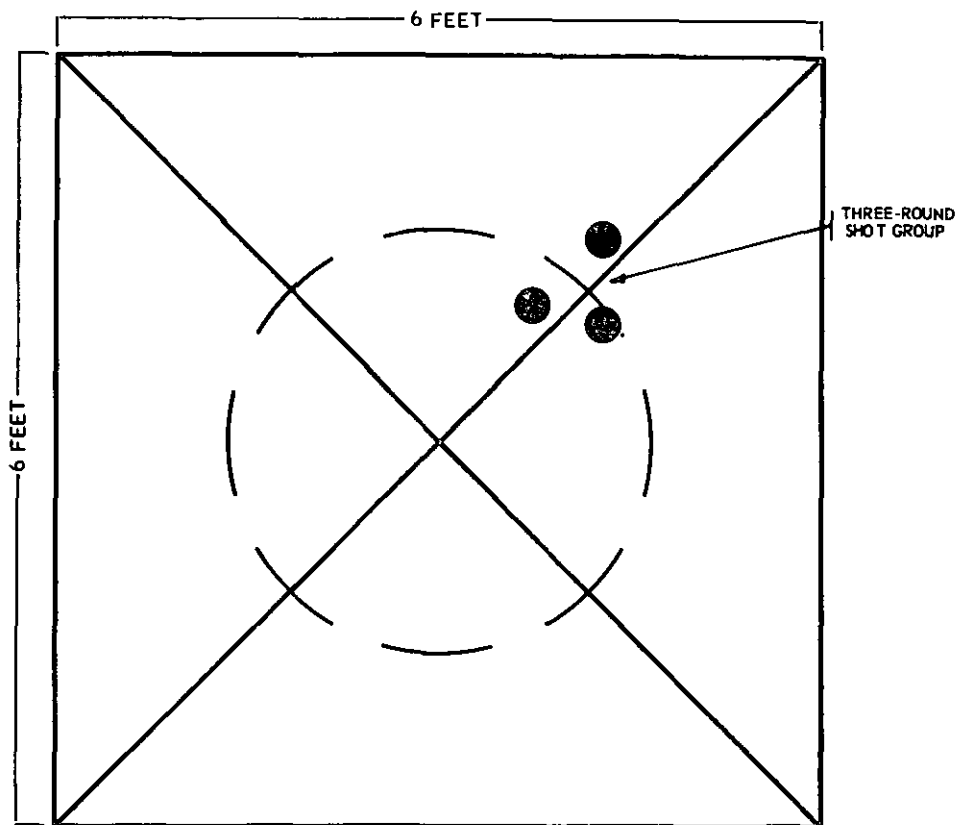

Figure 118. Target for test on boresighting and zeroing the main gun.

- (5) Crewman: Unlocks the boresight knobs and indexes the correct setting on all main gun sights; then locks knobs and announces COMPLETE.
- (6) Time: No time limit.
Note. Accuracy is required.
- (7) Examiner: SIMULATE ZEROING MAIN GUN.
- (8) Crewman: Indexes proper ammunition (and range if necessary), lays on the target, and simulates firing three rounds. Announces COMPLETE.
- (9) Time: No time limit.
Note. Proper procedure, including accuracy of lay and correct indexing of range and ammunition, is mandatory.
- (10) Examiner: THE LOCATION OF YOUR THREE-ROUND SHOT GROUP IS INDICATED BY THE THREE DOTS ON THE TARGET. COMPLETE THE ZEROING PROCEDURE, INCLUDING FIRING A CHECK ROUND AND ZEROING THE SECONDARY SIGHT.
- (11) Crewman: Lays on aiming point, unlocks boresight knobs of the primary sight, moves aiming cross to center of shot group, locks the knobs, re-lays on the aiming point by use of the gun controls, announces ON THE WAY, and simulates firing one round.
- (12) Examiner: YOUR CHECK ROUND HIT WITHIN THE PRESCRIBED DISTANCE OF THE AIMING POINT.
- (13) Crewman: Unlocks boresight knobs of secondary sight, moves the appropriate point of the reticle onto the aiming point, locks the boresight knobs, and announces COMPLETE.
- (14) Time: No time limit.
Note. Accuracy is required.

193. Test on Boresighting and Zeroing Coaxial Machinegun

a. Procedure. For this test an E-type target is set up 800 meters (yards) in front of the tank and a 6-by-3-foot piece of target cloth is laid out approximately 200 meters (yards) short of and on line with the target to repre-

sent a machinegun burst. For boresighting the coaxial machinegun, the main gun target is used. A sample setup is shown in figure 119. The coaxial machinegun is properly mounted and the examiner places the coaxial machinegun, and sight on tanks so equipped with a separate sight, out of adjustment.

b. Conduct. The crewman is required to boresight and zero the coaxial machinegun, using the prescribed procedure.

c. Examiner's Guide.

- (1) Examiner: BORESIGHT COAXIAL MACHINEGUN (indicates target).
- (2) Crewman: Performs necessary steps to make boresight adjustment and announces COMPLETE.
Note. The primary sight is laid on the same target used to boresight the main gun, by use of the gun controls. The coaxial machinegun is laid on the aiming point by use of the traversing and elevating controls on the mount. Then if a separate sight is available for the coaxial machinegun, the sight is moved to the aiming point by use of its boresight knobs.
- (3) Time: No time limit.
Note. Correct procedure, including accuracy of lay, is mandatory.
- (4) Examiner: ZERO COAXIAL MACHINEGUN (indicates target and range to target).
- (5) Crewman: Indexes proper ammunition and range, and simulates firing a burst.
- (6) Examiner: Points out simulated burst.
- (7) Crewman: Makes necessary adjustments.
Note. The gun is moved by using the controls on the mount so that the beaten zone will bracket the target. If the crewman moves the gun in the appropriate direction, he will be considered correct, as the exact amount of movement can be determined only by firing. The crewman simulates firing another burst to check the adjustment.

(8) Time: No time limit.
Note. Correct procedure is mandatory.

194. Test on Preparing and Firing From a Range Card

a. Procedure. For this test, 5 targets with 1-inch bull's-eyes are placed or drawn on a



BORESIGHTING AND ZEROING TARGET FOR THE MAIN GUN,
USED TO BORESIGHT COAX MACHINEGUN.



ZEROING TARGET AT A RANGE OF 800 METERS (YARDS), ZEROING
TARGET FOR COAX MACHINEGUN.



TARGET CLOTH REPRESENTING THE BEATEN ZONE OF THE
INITIAL BURST OF THE COAX MACHINEGUN APPROXIMATELY
200 METERS (YARDS) SHORT (OVER) OF THE COAX MACHINE-
GUN ZEROING TARGET.



DIRECTION OF FIRE

Figure 119. Setup for test on boresighting and zeroing the coaxial machinegun.

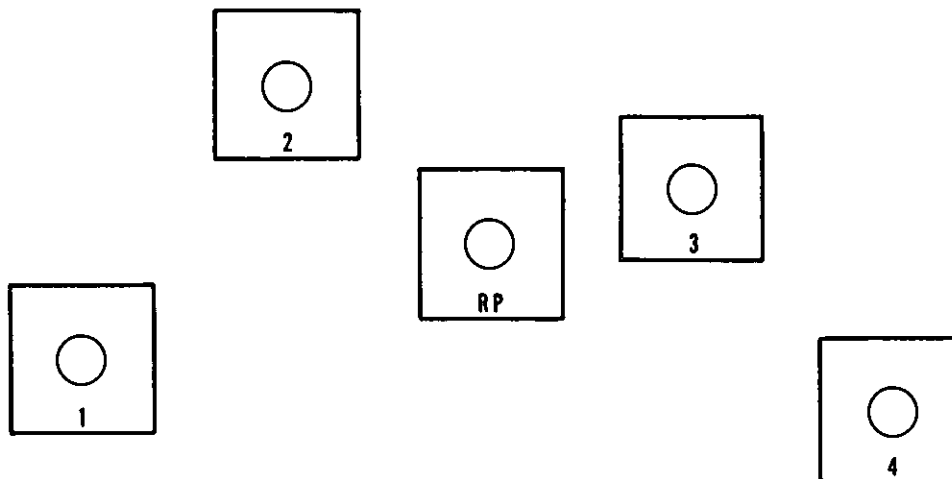

Figure 120. Target layout for range card test.

vertical surface about 25 meters in front of the tank; each target is set at a different elevation so as to provide plus and minus quadrant readings. A sample target layout is shown in figure 120. The center target is used as the reference point. The azimuth indicator is checked for accuracy. A range card, with data to all of the targets, is prepared.

b. Examiner's Guide.

- (1) Examiner: Indicates the reference point to the crewman.
- (2) Crewman: Lays on the reference point, zeroes the azimuth indicator and gunner's aid, and announces the quadrant elevation.
- (3) Examiner: Indicates two targets to the crewman.
- (4) Crewman: Lays on the targets designated and announces the quadrant elevation (plus or minus) and deflection (right or left).
- (5) Time limit: No time limit is placed on determination of this data.
- (6) Examiner: Covers the direct-fire sights and, using the range card data, issues a fire command to engage one of the remaining two targets.
- (7) Crewman: Lays the gun as directed by this fire command.
- (8) Time limit: 20 seconds are allowed for the engagement of this target on tanks with an elevation quadrant, and 30 seconds when a gunner's quadrant must be used.
- (9) Examiner: Issues a fire command for the remaining target.
- (10) Crewman: Repeats the procedure.

195. Test on Misfire Procedure

a. Procedure. The crewman assumes the gunner's position and the examiner is in the tank commander's position during the conduct of this test. When the crewman begins this test, the turret power and the main gun firing switch will be ON, with the breech closed.

b. Examiner's Guide.

- (1) Examiner: THE MAIN GUN HAS FAILED TO FIRE; PERFORM THE STEPS OF THE MISFIRE PROCEDURE.

DURE. (Starts time and cocks gun, if applicable, for each firing attempt.)

- (2) Crewman: Turns off the main gun switch and announces MISFIRE. Turns on the main gun switch and attempts to fire with the appropriate trigger; turns off the main gun switch and announces MISFIRE. Makes the last attempt to fire manually on tanks with a percussion mechanism and with the auxiliary unit on tanks that have electric firing; announces MISFIRE.
- (3) Examiner: Stops time.
- (4) Time: 30 seconds.

196. Test on Safety and Control Measures

a. Procedure. For this test, a tank, drill cartridge, tarpaulin, and a flag set are required. The tank gun is positioned to the front; the drill cartridge is placed on a tarpaulin laid adjacent to the tank, with the flags laid on top of the turret. The crewman is required to demonstrate and explain various safety precautions and control measures.

b. Examiner's Guide.

- (1) Examiner: DEMONSTRATE THE PROPER METHOD OF HANDLING AMMUNITION AND PASS IT TO ME. (Assists crewman by receiving round on tank.)
- (2) Crewman: Takes round from tarpaulin, carries it to tank, and hands it to examiner. Round must be handled properly.
- (3) Time: No time limit.
- (4) Examiner: DEMONSTRATE THE PROPER METHOD OF MOUNTING THE TANK (ON A STATIONARY TANK FIRING RANGE) (ON A MOVING TANK FIRING RANGE). (The examiner may specify either method.)
- (5) Crewman: Mounts the tank in the proper manner.
- (6) Time: No time limit.
- (7) Examiner: DEMONSTRATE THE PROPER METHOD OF STOWING A ROUND IN THE READY RACK. (Passes round to crewman.)

- (8) Crewman: Receives, stows, and locks round in ready rack.
- (9) Time: No time limit.
- (10) Examiner: DEMONSTRATE THE FLAG SIGNALS TO BE DISPLAYED (IN THE EVENT OF A MISFIRE) (WHEN FIRING) (WHEN PREPARING TO FIRE) (IN THE EVENT OF A MALFUNCTION WHEN ALL WEAPONS ARE CLEAR) (WHEN YOU ARE NOT FIRING).
- (11) Crewman: Displays the appropriate flag signals.
- (12) Time: No time limit.
- (13) Examiner: DEMONSTRATE THE PROPER METHOD OF DISMOUNTING THE TANK ON A (MOVING) (STATIONARY) TANK FIRING RANGE. (Requires method not used in (4) above.)
- (14) Crewman: Dismounts in the proper manner.
- (15) Time: No time limit.

197. Test on Direct Laying and Adjustment

a. Procedure.

- (1) *Preparation.* For this test, three 6- by 6-foot panels painted with tank targets about 4 feet long and 2 feet high are set up at a minimum distance of 300 meters in front of the exercise tank. Two of the panels are marked with a red dot, which represents a projectile that has missed the target. On the first panel, the red dot is located about 1 foot above the painted tank and near the left edge of the panel; on the second panel, a red dot is located 1 foot below the painted tank and near the right edge of the panel. A sample target layout is shown in figure 121.
- (2) *Engagements.* The crewman is required to engage the three targets twice in response to initial fire commands issued by the examiner. The crewman first engages the three targets, using the primary sight. He then engages the three targets, using the

secondary sight. When engaging the first two targets, with either sight the crewman will use the primary method of adjustment, assuming that the red dot on each panel is the first round fired. When engaging the third target, he will use the alternate method of adjustment.

(3) Conduct.

- (a) The examiner briefs the crewman on the series of engagements. When the crewman is ready, the examiner issues an initial fire command while laying the gun for direction and simulates ranging (on tanks not equipped with a range finder, a range element is included in the command). The crewman is required to—

1. Turn on the main gun switch.
Note. Turret power switch should be on before this exercise begins.
 2. Index the proper ammunition (and range if necessary).
 3. Announce IDENTIFIED.
 4. Position the reticle to facilitate ranging by the tank commander (when applicable).
 5. Make the final, precise lay (after command FIRE).
 6. Announce ON THE WAY.
 7. Simulate firing one round. (The red dot on the panel indicates a miss.)
 8. Apply the primary method of adjustment.
 9. Announce ON THE WAY, and simulate firing a second round.
- (b) This sequence is repeated for the second target. Twenty seconds are allowed for completion of each of the first two engagements.
 - (c) The sequence for engagement of the third target is identical; however, after simulating firing a round, the crewman announces LOST and receives a subsequent fire command. He then applies the corrections given by the examiner, announces ON THE WAY, and simulates firing a second round. Thirty seconds are allowed for the completion of the third engagement.

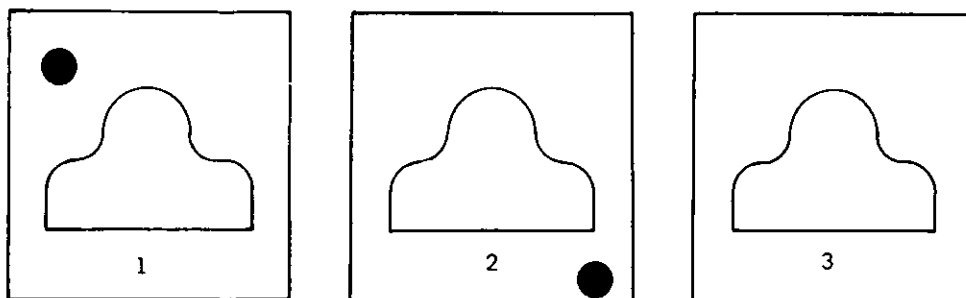

Figure 121. Target layout for direct laying and adjustment of fire.

(d) The series of three engagements is repeated with the secondary sight in the same manner; however, the examiner must include a range element in the fire command on all type tanks. The same time limits are allowed for each type of engagement.

b. Examiner's Guide.

- (1) Examiner: Issues appropriate fire command. (Starts time on announcing ammunition element.)
- (2) Crewman: Turns on main gun switch, indexes appropriate type of ammunition (and range, if necessary), announces IDENTIFIED, positions the reticle for ranging (on range finder equipped tanks), makes the final precise lay, announces ON THE WAY, and simulates firing the first round.
- (3) Examiner: Checks the initial lay and indicates tracer in relation to target.
- (4) Crewman: Applies primary method of adjustment, announces ON THE WAY, and simulates firing the second round.
- (5) Examiner: Stops time and checks for accuracy in applying the adjustment.
- (6) Time: 20 seconds for items (1) through (4).

Note. Proper procedure, including exact sequence and accuracy of lay, is mandatory. Procedures described in (1) through (6) above, are repeated for the engagement of the second target.

- (7) Examiner: Issues appropriate fire command. (Starts time on announcing ammunition element.)

- (8) Crewman: Turns on the main gun switch, indexes appropriate type of ammunition (and range, if necessary), announces IDENTIFIED, positions the reticle for ranging (on range finder equipped tanks), makes the final precise lay, announces ON THE WAY, simulates firing the first round, and announces LOST.
- (9) Examiner: Checks initial lay, announces an appropriate subsequent fire command (RIGHT) (LEFT) 3, (ADD) (DROP) 200 FIRE. (Starts time on command FIRE.)
- (10) Crewman: Applies correction, announces ON THE WAY, and simulates firing the second round.
- (11) Examiner: Stops time and checks for accuracy in applying adjustment.
- (12) Time: 30 seconds for items (1) through (10).

Note. Proper procedure, including exact sequence and accuracy of lay, is mandatory. Procedures described in (7) through (12) above, are repeated, using the secondary sight.

198. Test on Field Disassembly, Assembly, and Adjusting Head Space on Caliber .30 Machinegun (on Tanks So Equipped)

a. Procedure. The crewman is required to clear the caliber .30 machinegun, disassemble, assemble, and set head space on it within 4 minutes, performing all steps in the prescribed sequence.

b. Examiner's Guide.

- (1) Examiner: CLEAR, DISASSEMBLE,

ASSEMBLE, ADJUST HEAD SPACE COAX.

- (2) Crewman: Performs necessary steps to clear, field disassemble, assemble, and adjust head space on caliber .30 machinegun.
- (3) Time: 4 minutes.
Note. Proper procedure is important.

199. Test on Field Disassembly, Assembly of M73 Machinegun (on Tanks So Equipped)

a. Procedure. The crewman is required to clear the M73 machinegun, disassemble and assemble it within 4 minutes, performing all steps in the prescribed sequence.

b. Examiner's Guide.

- (1) Examiner: CLEAR, DISASSEMBLE, AND ASSEMBLE COAX.
- (2) Crewman: Performs necessary steps to clear, field disassemble, and assemble M73 machinegun.
- (3) Time: 4 minutes.
Note. Proper procedure is important.

200. Test on Adjusting Head Space, Timing, and Mounting of Caliber .50 M2 HB Machinegun (on Tanks So Equipped)

a. Procedure. The crewman is required to adjust head space and timing on the caliber .50 machinegun and mount it on the pedestal mount or in the cupola, performing all steps in the prescribed sequence.

b. Examiners' Guide.

- (1) Examiner: ADJUST HEAD SPACE AND TIMING AND MOUNT CALIBER .50 MACHINEGUN.
- (2) Crewman: Performs necessary steps to adjust head space and timing and mounts caliber .50 machinegun.
- (3) Time: No time limit.

Notes. 1. Examiner assists crewman in mounting cupola machinegun from outside of the cupola.
2. Proper procedure for adjustment is necessary.

201. Test on Field Disassembly, Assembly, and Mounting M85 Machinegun (on Tanks So Equipped)

a. Procedure. The crewman is required to perform all steps necessary to field disassemble, assemble, and mount the M85 machinegun.

b. Examiner's Guide.

- (1) Examiner: CLEAR, DISASSEMBLE, ASSEMBLE, AND MOUNT CUPOLA MACHINEGUN.
- (2) Crewman: Performs necessary steps to field disassemble and assemble, and mounts M85 machinegun in cupola.
- (3) Time: No time limit.

Notes. 1. Examiner assists crewman in mounting the M85 from outside of cupola.
2. Correct procedure for disassembly and assembly of M85 is necessary.

202. Test on Checking and Adjusting Machinegun Solenoid and Firing Linkage (on Tanks So Equipped)

a. Procedure. In preparation for the test, the coaxial (M41 and M48 tanks) and cupola (M48 tank) machinegun solenoids and main gun (M41, M48, M103 tanks) firing linkage are adjusted so that the guns will not fire. The examiner directs the crewman to turn on and actuate the firing switches and triggers and to adjust the solenoids and linkage so that the guns will fire. All necessary tools are present.

b. Examiner's Guide.

- (1) Examiner: CHECK AND ADJUST MACHINEGUN SOLENOIDS AND MAIN GUN FIRING LINKAGE.
- (2) Crewman: Performs the checks and adjustments and announces COMPLETE.
- (3) Time: No time limit.

Note. Correct adjustment is required.

203. Test on Boresighting and Zeroing Cupola Machinegun

a. Procedure. For this test a 6- by 6-foot panel is set up at 500 meters (yards) distance in front of the tank. The target must have a 10-inch bull's-eye and holes (or dots) representing the

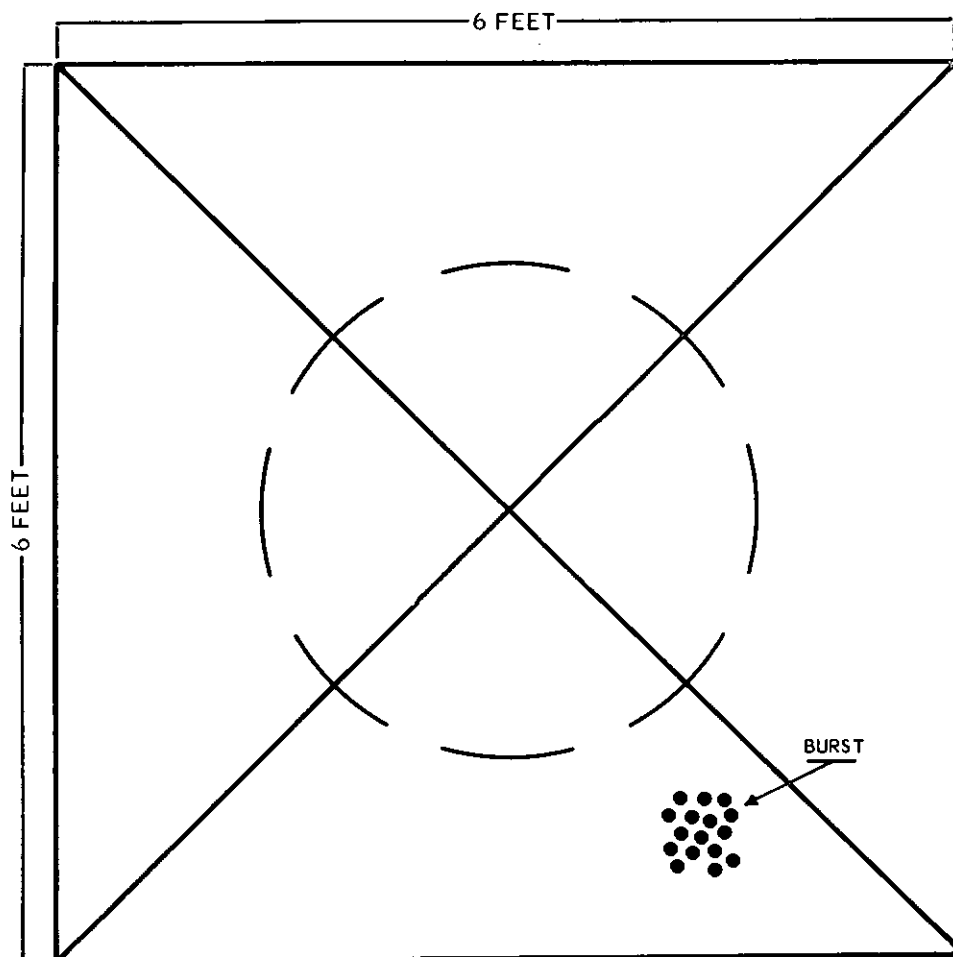

Figure 122. Target for test on boresighting and zeroing the cupola-mounted machinegun.

burst. A sample target is shown in figure 122. The caliber .50 machinegun is properly mounted and the examiner places the sight out of adjustment.

b. Conduct. The crewman is required to boresight and zero the cupola machinegun, using the prescribed procedure.

c. Examiner's Guide.

- (1) Examiner: BORESIGHT CUPOLA-MOUNTED MACHINEGUN (indicates target).
- (2) Crewman: Performs necessary steps to make boresight adjustment and announces COMPLETE.
- (3) Time: No time limit.
- (4) Examiner: ZERO CUPOLA-MOUNTED MACHINEGUN.
- (5) Crewman: Simulates firing burst.
- (6) Examiner: Points out burst.
- (7) Crewman: Refers sight to burst and simulates firing check rounds.
- (8) Time: No time limit.

Note. Correct procedure and accuracy of lay are mandatory.

204. Test on Placing the Range Finder in Operation

a. Procedure. The crewman is required to demonstrate the prescribed steps for placing the range finder in operation within 2 minutes. A target is used at a known range of approximately 1,200 meters for the coincidence range finder and at approximately 1,500 yards for the stereoscopic range finder.

b. Examiner's Guide.

- (1) Examiner: PLACE RANGE FINDER IN OPERATION. (Starts time).
- (2) Crewman: Places range finder in operation, announcing each step as it is performed. Announces COMPLETE.

(3) Examiner: Stops time.

(4) Time: 2 minutes.

Note. On all requirements in the preliminary gunnery examination with no time limit, the crewman will be informed to cease action if it becomes obvious that he does not know how to perform the requirement.

**Section III. TANK CREWMAN GUNNERY QUALIFICATION—
SUBCALIBER FIRING**

205. General

a. Subcaliber firing exercises are conducted with the coaxial machinegun to simulate main gun firing. They are fired before firing the main gun. Machineguns must be tightly secured to minimize dispersion. The exercises are fired single-shot throughout and ammunition must be loaded with alternate dummy cartridges or fired with a single-shot device. Targets are physically scored during all subcaliber record firing and the targets for tables I and II (except the zeroing target) should be pasted or replaced after each crewman fires. No credit is given for rounds fired after the time limit prescribed for the exercise.

b. A distance of 60 meters from weapon to target is prescribed for the subcaliber exercises. Range and ammunition requirements may be modified to enable units to use permanent range facilities now available. However, if the gun-target distance is changed, the size of the targets must be modified in proportion to the change.

206. Table I—Zeroing and Initial Lay Exercises

a. General. The purpose of these exercises is to test, with the coaxial machinegun, the crewman's ability to—

- (1) Zero the main gun.
- (2) Lay with the correct sight picture and fire during periods of good visibility.
- (3) Lay and fire during periods of poor visibility.
- (4) Lay and fire during periods of poor visibility with artificial illumination. (Figure 123 shows target layout for table I.)

b. Boresighting and Zeroing the Coax Machinegun for Subcaliber Firing.

(1) Sight adjustment for subcaliber firing with the coax machinegun is generally the same as for the main gun, except that superelevation is introduced into the fire control system for boresighting as well as zeroing. This procedure properly aligns the sights for short range firing with a service firing range indexed to provide a starting point for indexing range errors, when applicable, and to further simulate main gun firing. An emergency zero is not used on any type tank for subcaliber firing.

(2) To boresight the coax machinegun for subcaliber firing, use the following procedure.

- (a) The range from the tank to the target is 60 meters.
- (b) With the computer in electrical operation, and the turret power switch ON, index the appropriate range and ammunition combinations into the fire control system:
 1. M41A3 tank—1,500 yards and AP-T (M339) ammunition.

Note. The range and ammunition are indexed into the ballistic unit on the M41 tank.

2. M48A1 and M48A2 tanks—1,500 yards and HEAT (T300 or M431) ammunition.
3. M48A3 and M48A2C tanks—1,200 meters and HEAT (T300 or M431) ammunition.
4. M60 or M60A1 tanks—1,200 meters and HEAT (M456) ammunition.

Notes. 1. If a HEAT reticle is not available for the M105 telescope, index 1,200 meters and APDS.

2. If frangible ammunition is used it may be necessary to index HEP for exercises, although exercises will con-

tinue to simulate firing HEAT ammunition.

- (c) Move the receiver end of the coax machinegun as far left as possible.
 - (d) Sight through the barrel, and lay on any target of the zeroing silhouette. Using the boresight knobs, place the aiming cross of the nonballistic reticle on the boresight point.
 - (e) With the boresight knobs of the telescope, place the 1,500-yard (1,200 meter) range line or zeroing cross of the telescope on the boresight point.
- (3) To zero the coax machinegun for sub-caliber firing:
- (a) Lay on the aiming point (boresight point), using the gun controls, and fire a 3-round shot group. Take the same sight picture before firing each round.
 - (b) Unlock the boresight knobs of the primary sight and refer the aiming cross to the center of the shot group. Relock the boresight knobs.
 - (c) Lay on the designated aiming point, using the gun controls, and fire a check round. The check round must strike within the 4-inch circle. If it does not, repeat the above procedure.
 - (d) When zeroing has been accomplished, unlock the boresight knobs of the telescope and lay the 1,500-yard (1,200-meter) range line or zeroing cross on the aiming point. Relock the boresight knobs.

c. The exercises are conducted as follows:

- (1) *Exercise 1.* The examiner directs the crewman to zero the gun. The crewman boresights and zeroes the coax following the procedures outlined in *b* above. The examiner follows the crewman's procedure with the tank commander's sight.
- (2) *Exercise 2.* The examiner issues an initial fire command and indexes the correct range. The crewman lays on the top zeroing target. Using the primary sight, he fires 1 round at each target for a total of 10, alternating

between the 2 silhouettes for each round (i.e., target 1 on the left silhouette, then target 1 on the right). Either power or manual control can be used. The emphasis is on speed and accuracy. The exercise must be completed within 1 minute. Hits within the 4-inch circle are counted as 6 points; hits within the 8-inch circle are counted as 3 points.

- (3) *Exercises 3 and 4.* The examiner directs the crewman to lay his sight on the top zeroing target and to zero the azimuth indicator, using the resetter knob. From previously prepared data the examiner issues a range card initial fire command. The crewman uses the auxiliary fire control instruments to lay the gun. He will not use the direct-fire sights. On the command FIRE, the crewman fires 1 round at the target. A hit within the 4-inch circle is counted as 10 points; a hit within the 8-inch circle is counted as 5 points.
- (4) *Exercise 5.* The examiner issues an initial fire command for range card lay to direct fire, using ammunition other than that used to construct the range card. The crewman applies the data (indexing HEP), then indexes the ammunition (HEAT) to be fired (on tanks without superelevators the crewman will change the indexed ammunition after he identifies the target). The crewman then looks through his sight to identify the target and makes a precise lay. Upon the command FIRE the crewman fires one round at the target. A hit within the 4-inch circle is counted as 10 points; a hit within the 8-inch circle is counted as 5 points.

d. The exercises are scored as shown in table I. Points for each exercise are given as follows:

- (1) *Exercise 1.*
 - a. Correct procedure: 5.
 - b. Check round within zeroing circle: 5.
- (2) *Exercise 2.*
 - a. Hits within 4-inch circle: 6.

- b. Hits within 8-inch circle: 3.
- c. Hits after 1-minute time limit: 0.

(3) Exercises 3, 4, and 5.

- a. Hit within 4-inch circle: 10.
- b. Hit within 8-inch circle: 5.

e. An appropriate score card is shown in figure 124.

Table I

Possible score: 100
Minimum satisfactory score: 70

Exercise	Target	Type of exercise	Number of rounds	Sight	Scoring
1	Zeroing	Zeroing	4	Primary	10
2	Silhouette	Manipulation	10	Primary	60
3	Silhouette	Range card fire	1	None	10
4	Silhouette	Range card fire	1	None	10
5	Silhouette	Range card lay to direct fire.	1	Primary	10

207. Table II—Adjustment of Fire Exercises

a. The purpose of these exercises is to test, with the coaxial machinegun, the crewman's ability to:

- (1) Apply the primary method of adjustment (BOT) with the gunner's sights.
- (2) Apply the alternate method of adjustment with the gunner's sights. (Figure 125 shows the target layout for table II.)

b. The exercises are conducted as follows:

- (1) Exercises 1, 3, 6, and 8. The examiner issues an initial fire command and

indexes (announces on M41 tank) a plus or minus 200-meter error in the range finder. The crewman uses the primary sight to lay and fire the first round. The first round should miss the target. The crewman senses the round and immediately applies burst-on-target with the next round. Twenty seconds are given to complete each exercise from the command FIRE in the initial fire command.

- (2) Exercises 2 and 7. The examiner issues an initial fire command and indexes (announces on M41 tank) a plus or minus 200-meter error in the range finder. The crewman takes the correct sight picture with the primary sight, simulates firing, and announces LOST. The examiner issues a subsequent fire command to correct for the range error (OVER, DROP 200, FIRE). The crewman applies the range correction to his sight and fires the round. The round should hit the target. If not, the crewman applies burst-on-target and fires an additional round. Twenty seconds are given to complete the exercise from the command FIRE in the subsequent fire command.

- (3) Exercises 4 and 9. The examiner introduces a plus or minus 200-meter range error into the secondary sight system. He then issues an initial fire command, announcing 1,200 meters

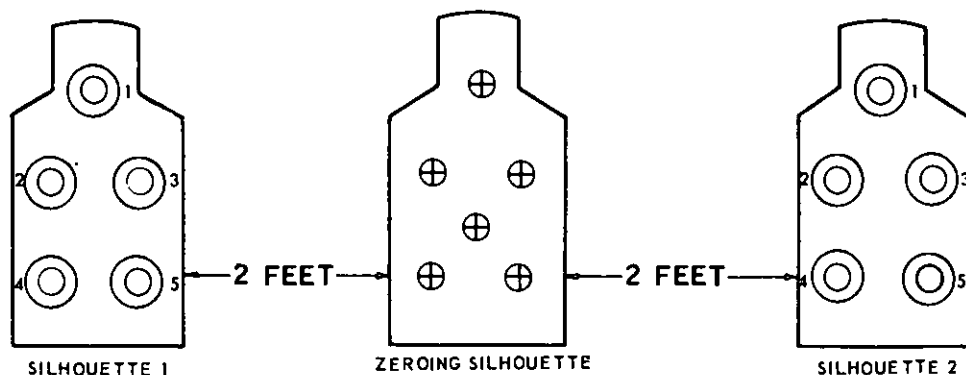

Figure 123. Target layout for table I.

UNIT _____ NAME _____

DATE _____ GRADE _____ SN _____

SCORE CARD: TABLE I--ZEROING AND INITIAL LAY

100 POINTS
POSSIBLE

EXERCISE	POSSIBLE	CORRECT PROCEDURE	HIT WITHIN 4-INCH CIRCLE	HIT WITHIN 8-INCH CIRCLE	SCORE
1	10				
2	60				
3	10				
4	10				
5	10				
TOTAL SCORE					

- Notes.
1. 5 points for correct procedure in exercise 1.
 2. 5 points for check round in zeroing circle in exercise 1.
 3. 6 points for hit in 4-inch circle in exercise 2.
 4. 3 points for hit in 8-inch circle in exercise 2.
 5. 10 points for hit in 4-inch circle in exercises 3-5.
 6. 5 points for hit in 8-inch circle in exercises 3-5.

Minimum satisfactory score70 points.

EXAMINER

OFFICER IN CHARGE

Figure 124. Score card for table I.

as the range element. The crewman uses his secondary sight, lays on the target, and fires. The first round should miss the target. The crewman senses the round and immediately applies burst-on-target with the next round. Twenty seconds are given to complete the exercise from the command FIRE in the initial fire command.

- (4) *Exercises 5 and 10.* The examiner introduces a plus or minus 200-meter range error into the secondary sight system. He then issues an initial fire

command, announcing 1,200 meters as the range element. The crewman uses his secondary sight, lays on the target, simulates firing, and announces LOST. The examiner issues a subsequent fire command to correct for range error (SHORT, ADD 200, FIRE). The crewman applies the range correction to his sight and fires the round. The round should hit the target. If not, the crewman applies burst-on-target and fires an additional round. Twenty seconds are given to complete the exercise from the com-

mand FIRE in the subsequent fire command.

c. The exercises are scored as shown in table II.

d. Points for each exercise are given as follows:

- (1) *Exercises 1, 3, 4, 6, 8, and 9.*
 - (a) Second round hit in 4-inch circle: 10.
 - (b) Second round hit in 8-inch circle: 5.
- (2) *Exercises 2, 5, 7, and 10.*
 - (a) First round hit in 4-inch circle: 10.
 - (b) Second round hit in 4-inch circle: 5.

Table II

Possible score: 100
Minimum satisfactory score: 70

Exercises	Number of rounds*	Sight	Method of adjustment	Scoring
1 and 6	2	Primary	Primary	a10
2 and 7	2	Primary	Alternate	a10
3 and 8	2	Primary	Primary	a10
4 and 9	2	Secondary	Primary	a10
5 and 10	2	Secondary	Alternate	a10

* Each exercise.
a—Ten points each exercise.

e. An appropriate score card is shown in figure 126.

208. Table III—Moving Target Exercises

a. The purpose of these exercises is to test, with the coaxial machinegun, the crewman's ability to—

- (1) Track, lead, and aim at moving targets.
- (2) Adjust fire on moving targets.

b. The moving target as shown in figure 127 is mounted on a 6- by 6-foot panel. The speed of the panels should be approximately 3 miles per hour so the crewman can track and engage it within the safety limits.

c. When the examiner issues the initial fire command, he announces the primary armor-defeating round in the ammunition element (HEAT). He announces MOVING TANK as the description and the gunner applies the appropriate lead. The 2½ mils that the crewman aims in front of the center of the target allows the round to strike the target moving in either

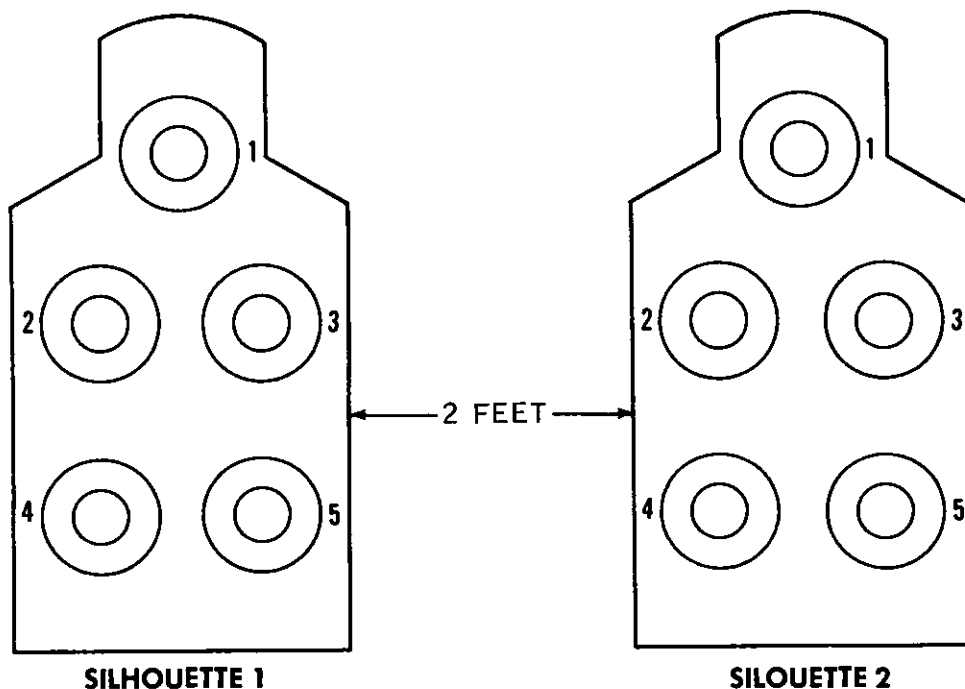

NOTE. THESE SILHOUETTES SHOULD BE PLACED TWO FEET TO THE RIGHT OF, AND ON LINE WITH, THE SILHOUETTES FOR TABLE I

Figure 125. Target layout for table II.

UNIT _____ NAME _____

DATE _____ GRADE _____ SN _____

SCORE CARD: TABLE II--ADJUSTMENT OF FIRE EXERCISES

100 POINTS
POSSIBLE

EXERCISE	POSSIBLE	FIRST ROUND 4-INCH CIRCLE	SECOND ROUND 4-INCH CIRCLE	SECOND ROUND 8-INCH CIRCLE	SCORE
1 and 6	20				
2 and 7	20				
3 and 8	20				
4 and 9	20				
5 and 10	20				
TOTAL SCORE					

- Notes.
1. 10 points for second round in 4-inch circle in exercises 1 and 6, 3 and 8, 4 and 9.
 2. 5 points for second round in 8-inch circle in exercises 1 and 6, 3 and 8, 4 and 9.
 3. 10 points for first round in 4-inch circle in exercises 2 and 7, 5 and 10.
 4. 5 points for second round in 4-inch circle in exercises 2 and 7, 5 and 10.

Minimum satisfactory score 70 points.

EXAMINER _____

OFFICER IN CHARGE _____

Figure 126. Score card for table II.

direction. The direction of movement of the target will be alternated so the crewman will engage the target from right to left and left to right. In the event that a lead other than 2½ mils is necessary because of target speed, the examiner will indicate this to the crewman and explain that it is due to the false subcaliber situation.

Note. Before firing table III the error introduced into the secondary sight system in table II must be removed by a referral of sights, using the gunner's periscope as the zeroed sight.

d. The exercises are conducted as follows:

- (1) *Exercise 1.* The examiner issues an initial fire command with the correct range indexed (announced on M41 tank) in the range finder and announcing moving tank as the description element. The crewman, using the primary sight, tracks, leads, and lays the sight on the target, using the power controls. He fires two rounds. The first round should hit the target. If it does not, the crewman applies burst-on-target before firing the sec-

ond round. To obtain maximum credit, the target must be hit with both rounds. Twenty seconds are given to complete the exercise from the command FIRE in the initial fire command.

- (2) *Exercise 2.* The examiner issues an initial fire command, announcing the correct range and moving tank as the description element. The crewman, using the secondary sight, tracks, leads, and lays the sight on the target, using the power controls. He fires two rounds. The first round should hit the target. If it does not, the crewman applies burst-on-target before firing second round. To obtain maximum credit, both rounds must hit the target. Twenty seconds are given to complete the exercise from the command FIRE in the initial fire command.
- (3) *Exercise 3.* The examiner issues an initial fire command with moving tank as the description element and an error of plus or minus 200 meters indexed (announced on M41 tank) in the range finder. The crewman, using the primary sight, tracks, leads, and lays the sight on the target, using the power controls. He simulates firing the round and announces LOST. The examiner issues a subsequent fire command to correct the range error. The crewman applies the correction and fires two rounds. The first round should hit the target. If it does not, the crewman applies burst-on-target before firing the second round. To obtain maximum credit, both rounds must hit the target. Twenty seconds are given to complete the exercise from the command FIRE in the subsequent fire command.
- (4) *Exercise 4.* The examiner issues an initial fire command announcing a range error of 200 meters. The crewman, using the secondary sight, tracks, leads, and lays the sight on the target, using the power controls. He simulates firing the round and announces LOST. The examiner issues a subse-

quent fire command to correct the range error. The crewman applies the correction and fires two rounds. The first round should hit the target. If it does not, the crewman applies burst-on-target before firing the second round. To obtain maximum credit, both rounds must hit the target. Twenty seconds are given to complete the exercise from the command FIRE in the subsequent fire command.

- (5) *Exercise 5.* The examiner issues an initial fire command with the correct range indexed (announced on M41 tank) and moving tank as the description element. The crewman, using the primary sight, tracks, leads, and lays the sight on the target, using the manual controls (power for assigned tank commander). He fires two rounds. The first round should hit the target. If it does not, the crewman applies burst-on-target before firing the second round. To obtain maximum credit, both rounds must hit the target. Twenty seconds are given to complete the exercise from the command FIRE in the initial fire command.

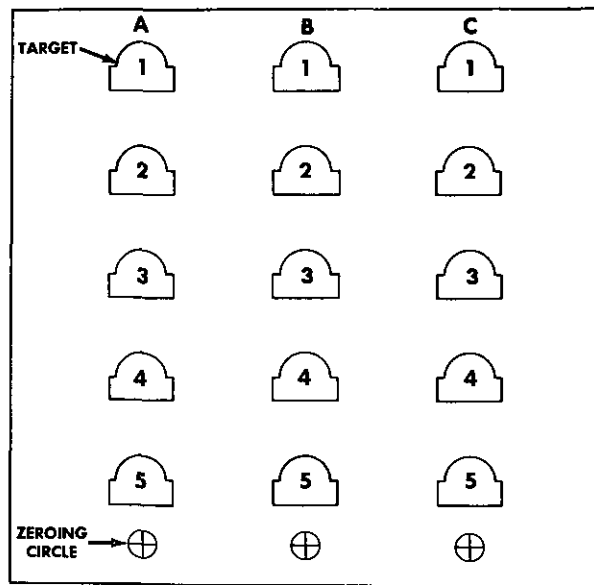

Figure 127. Moving target for table III.

Table III

Possible score: 100
Minimum satisfactory score: 70

Exercise	Number of rounds	Sight	Method of adjustment	Scoring
1	2	Primary-----	Primary-----	b20
2	2	Secondary-----	Primary-----	b20
3	2	Primary-----	Alternate-----	b20
4	2	Secondary-----	Alternate-----	b20
5	2	Primary a-----	Primary-----	b20

a—Manual controls are used.
b—Each exercise fired twice.

e. The exercises are scored as shown in table III.

f. Points for each exercise are given as follows in exercises 1-5.

- (1) Correct tracking: 5.
- (2) First round hit: 10.
- (3) Second round hit: 5.

g. An appropriate score card is shown in figure 128.

UNIT _____ NAME _____

DATE _____ GRADE _____ SN _____

SCORE CARD: TABLE III--MOVING TARGET EXERCISES

**100 POINTS
POSSIBLE**

EXERCISE	POSSIBLE	CORRECT TRACKING	1ST RD HIT	2D RD HIT	SCORE
1	20				
2	20				
3	20				
4	20				
5	20				
TOTAL SCORE					

- Notes.
1. 5 points for correct tracking in exercises 1-5.
 2. 10 points for first round hit in exercises 1-5.
 3. 5 points for second round hit in exercises 1-5.
 4. Each exercise fired twice.

Minimum satisfactory score 70 points.

EXAMINER

OFFICER IN CHARGE

Figure 128. Score card for table III.

Section IV—TANK CREWMAN GUNNERY QUALIFICATION— SERVICE FIRING

209. General

a. Service exercises are fired in order of IVA, IVB, VA and VB. The crewman should fire the applicable service tables on the same tank.

b. Targets will be scored by scorers observing from adjacent tanks or using battery commander scopes or similar instruments. Enough targets must be provided to preclude the possibility of erroneous scoring. The appropriate deduction will be made from the score when the time limit for an exercise is exceeded; however, all exercises will be completed.

c. In all exercises, if the crewman fails to sense the first round, the examiner issues a subsequent fire command for the second round. The crewman will be given credit for a second round hit, if obtained, or for correct application of adjustment given by the examiner.

d. In each of the tables, when the assigned tank commander is firing, one of the exercises must be fired from the tank commander's position.

e. When units are equipped with infrared-visible light kits at least one exercise on tables IVB and VB will be with infrared illumination.

210. Table IVA—Stationary Target Exercises (Day)

a. These exercises are designed to test the crewman's ability to fire the tank gun at stationary targets. Because of the problems cited in paragraphs 94–96, these exercises, at times, will necessitate both the examiner and crewman adjusting fire. The gunner will zero the main gun with the rounds allotted in the table if zero is not accomplished prior to range. Each firing crewman fires one round of ammunition as a check round, using tactical zeroing procedures (para. 59) before firing the scored exercises. The zeroing rounds or exercise rounds fired by the preceding firer are considered sufficient for warm-up. The crewman fires this round at a zeroing target set up at the range specified in the operator's manual. He then fires four exercises in any sequence. The range to the target in exercises 1 and 4, 1,600

meters or greater, should allow the crewman to sense the first round and apply burst-on-target. In exercise 2, when using HEAT (TP-T) ammunition he may not sense the round; however, it is a first round hit exercise with only one round allowed.

b. The exercises are conducted as follows:

- (1) *Exercise 1.* The examiner issues an initial fire command and indexes the correct range (announced on M41 tank). The crewman engages the target with two rounds, using the primary sight. The first round should hit the target. If it does not, the crewman applies burst-on-target or adjusts fire as directed by the examiner.
- (2) *Exercise 2.* The examiner issues an initial fire command and indexes the correct range (announced on M41 tank). The crewman engages the target with one round, using the primary sight. The first round should hit the target. If it does not, the crewman can receive credit only for the initial engagement within time limit specified.
- (3) *Exercise 3.* The examiner issues a fire command with the correct range element. The crewman engages the target with two rounds, using the secondary sight. The first round should hit the target. If it does not, the crewman applies burst-on-target or adjusts fire as directed by the examiner.
- (4) *Exercise 4.* The examiner issues an initial fire command and indexes the correct range. The crewman engages the target with two rounds, using the primary sight. The first round should hit the target. If it does not, the crewman applies burst-on-target or adjusts fire as directed by the examiner.

Note. Assigned tank commanders will fire this exercise from tank commander's position.

c. The exercises are scored as shown in table IVA.

d. Points for each exercise are given as follows:

- (1) *Exercises 1, 3, and 4.*
 - (a) Completing exercise within 20 seconds of the command FIRE: 10.
 - (b) Target hit with the first round: 15.
 - (c) Proper application of adjustment or hit of second round if first round misses: 5.

(2) *Exercise 2.*

- (a) Initial engagement within 5 seconds of the command FIRE: 15.
- (b) Target hit with first round: 10.

e. An appropriate score card is shown in figure 129.

f. An example of range layout for table IVA is shown in figure 145.

Table IVA

Possible score: 100
Minimum satisfactory score: 70

Exercise	Target	Range in meters	Number of rounds	Sight	Scoring
Zeroing	12x12-ft. panel	1,200	5 ^{a c}	Primary	Unscored
Tactical	12x12-ft. panel	1,200	1 ^a	Primary	Unscored
Zeroing					
1	6x6-ft. panel	1,600-1,800	2 ^a	Primary	25
2	6x6-ft. panel	900-1,100	1 ^a	Primary	25
3	6x6-ft. panel	1,000-1,400	2 ^b	Secondary	25
*4	6x6-ft. panel	1,600-2,000	2 ^a	Primary	25

a—TP-T ammunition.

b—HE or HEP ammunition.

c—Only assigned gunner fires zeroing exercise.

*Assigned tank commanders will fire exercise 4 from tank commander's position.

211. Table IVB—Stationary Target Exercise (Night)

a. The purpose of this table is to test the gunner's and tank commander's ability to fire the tank gun at night and hit illuminated stationary targets. Tank-mounted searchlights and mortar flares will provide the illumination. One exercise will be with infrared light if units are so equipped. All crewmen are initially briefed, after which the individual crewman fires the four exercises in any sequence.

b. The exercises are conducted as follows:

- (1) *Exercises 1 and 2.* The target is illuminated and the examiner issues an initial fire command, indexing the correct range (announces M41 tank). The crewman engages the target with two rounds. The first round should be a target hit. If it is not, the crewman applies burst-on-target, or adjusts fire as directed by the examiner.

Note. Assigned tank commander will fire exercise 2 from tank commander's position.

- (2) *Exercise 3.* The target is illuminated and the examiner issues an initial fire

command with the correct range element. The crewman engages the target with two rounds, employing the secondary sight. The first round should be a target hit. If it is not, the crewman applies burst-on-target or adjusts fire as directed by the examiner.

- (3) *Exercise 4.* This exercise will be executed using range card lay to direct-fire technique and flare illumination. The examiner issues an initial fire command, using prepared range card data for HE (HEP) ammunition. The firing crewman applies data and on tanks equipped with a superelevator changes to TP-T (HEAT, SHOT) on the computer. Upon illumination, the firer announces IDENTIFIED; immediately the examiner will announce FIRE. The crewman engages the target with two rounds. The first round should be a target hit; if it is not, the crewman applies burst-on-target or adjusts fire as directed by the examiner.

c. The exercises are scored as shown on table IVB.

d. Points for each exercise are given as follows:

- (1) Completing exercise within 30 seconds of initial command FIRE: 10.
- (2) First round hit: 15.
- (3) Proper application of adjustment or hit of second round if first round misses: 5.

e. An appropriate score card is shown in figure 130.

f. An example of range layout for table IVB is shown in figure 145.

g. Tanks mounting searchlights are placed on the firing line as is appropriate for the range.

If range safety will permit they may be placed on the flanks and forward of the firing line.

212. Table VA—Moving Target Exercises (Day)

a. These exercises are designed to test the ability of the crewman to lead, track, and adjust fire on moving targets with the tank gun. The gunner fires two rounds of ammunition, using tactical zeroing procedures (first round is for warm-up) at a target set up at the range specified in operator's manual. (Only TP-T ammunition is used in this exercise.) The other two crewmen are allowed one round each to check the zero prior to their firing exercises. Then each crewman fires four exercises, using an appropriate lead in any sequence, with the exception that exercise 3 should never be first.

UNIT _____ NAME _____
 DATE _____ GRADE _____ SN _____

SCORE CARD: TABLE IVB--STATIONARY TARGET EXERCISES (NIGHT) 100 POINTS POSSIBLE

EXERCISE	POSSIBLE	COMPLETED IN TIME LIMIT	1ST RD HIT	2D RD ADJUSTMENT OR HIT	SCORE
1	25				
2	25				
3	25				
4	25				
TOTAL SCORE					

- Notes.
1. 10 points for completing exercises within 30 seconds from the initial command FIRE until second round is fired.
 2. 15 points for first round hit in all exercises.
 3. 5 points for correct adjustment of second round if first round misses or if second round hits in all exercises.

Minimum satisfactory score 70 points.

 EXAMINER OFFICER IN CHARGE

Figure 130. Score card for table IVB.

In all cases except exercise 3, a second round will be fired even if a first round hit is obtained, to increase the training of the crewman in the engagement of moving targets.

b. The exercises are fired from a stationary tank at moving targets (6x6-ft. panels) at ranges of 700–2,000 meters. The targets are exposed for approximately 300 meters and travel at a constant speed between 8 and 15 MPH.

c. The exercises are conducted as follows:

- (1) *Exercise 1.* The examiner issues an initial fire command with the correct range indexed (announces on M41 tank). The crewman engages the target with two rounds, using the primary sight. Either manual or power controls may be used. The first round should hit the target. If it does not, the crewman applies burst-on-target or adjusts fire as directed by the examiner.
- (2) *Exercise 2.* The examiner issues an initial fire command with the correct range element. The crewman engages the target with two rounds, using the the secondary sight. Either manual or power controls may be used. The first round should hit the target. If it does not, the crewman applies burst-on-target or adjusts fire as directed by the examiner.
- (3) *Exercise 3.* The examiner issues an initial fire command and indexes the correct range (announced on M41 tank). The crew engages the target with one round, using the primary sight. Either manual or power controls may be used. A first round hit should be obtained; if not, the crewman can only receive credit for initial engagement and proper tracking procedures.
- (4) *Exercise 4.* The examiner issues an initial fire command and indexes the correct range (announced on M41 tank). The crewman engages the target with two rounds, using the primary sight. Either manual or power controls may be used. The first round should hit the target. If it does not,

the crewman applies burst-on-target or adjusts fire as directed by the tank commander.

Note. Assigned tank commanders will fire exercise 4 from the tank commander's position.

d. The exercises are scored as shown in table VA.

e. Points for each exercise are given as follows:

- (1) *Exercises 1, 2, and 4.*
 - (a) Completing exercise within 20 seconds of the initial command FIRE: 5.
 - (b) Correct tracking: 5.
 - (c) First-round target hits: 10.
 - (d) Correct adjustment or hit of second round if first round misses or hit with second round if first round hits: 5.
- (2) *Exercise 3.*
 - (a) Completing exercise within 15 seconds of initial command FIRE: 10.
 - (b) Correct tracking: 5.
 - (c) First round hit: 10.

f. An appropriate score card is shown in figure 131.

g. An example of range layout for table VA is shown in figure 146.

Table VA

Possible score: 100
Minimum satisfactory score: 70

Exercise	Range in meters	Number of rounds a	Sight b	Scoring
Tactical zeroing.	1,200	1 c	Primary	Unscored
1	700–1,400	2	Primary	25
2	700–1,400	2	Secondary	25
3	700–1,400	1	Primary	25
*4	1,500–2,000	2	Primary	25

a—All rounds TP-T.

b—Initial engagement will be with appropriate lead.

c—One additional round of TP-T is authorized for the first crewman checking zero.

*Assigned tank commanders will fire exercise 4 from tank commander's position.

213. Table VB—Moving Target Exercises (Night)

a. These exercises are designed to test the ability of the tank commander and gunner to

UNIT _____ NAME _____

DATE _____ GRADE _____ SN _____

SCORE CARD: TABLE VA--MOVING TARGET EXERCISES (DAY) 100 POINTS POSSIBLE

EXERCISE	POSSIBLE	COMPLETED IN TIME LIMIT	CORRECT TRACKING	1ST RD HIT	2D RD ADJUSTMENT OR HIT	SCORE
1	25					
2	25					
3	25				X	
4	25					
TOTAL SCORE						

- Notes.
1. 5 points for completing exercises 1, 2, and 4 within 20 seconds from the command FIRE in the initial fire command until second round is fired.
 2. 10 points for completing exercise 3 within 15 seconds of initial command FIRE.
 3. 5 points for correct tracking in all exercises.
 4. 10 points for first round hit in all exercises.
 5. 5 points for correct adjustment of second round if first round misses or if second round hits in exercises 1, 2, and 4.

Minimum satisfactory score 70 points.

EXAMINER

OFFICER IN CHARGE

Figure 131. Score card for table VA.

hit moving targets with the tank gun at night, using artificial illumination. The crewman indexes the zero obtained from tables IVA-VA to fire these exercises. He then fires four exercises in any sequence. The moving target in exercises are illuminated by tank-mounted searchlights. If unit firing is equipped with infrared-visible light kits a minimum of one exercise will be fired with infrared illumination. Both rounds must be fired to obtain maximum credit.

- b. The exercises are conducted as follows:
- (1) *Exercise 1.* The examiner issues an

initial fire command (range card lay to direct fire from previously plotted data, using a different type of ammunition) and indexes the correct range to the moving target. When the target is illuminated, the examiner gives the execution element and the crewman engages the target with two rounds, using the primary sight and the appropriate lead. The first round should hit the target. If it does not, the crewman applies burst-on-target or adjusts fire as directed by the examiner.

(2) *Exercises 2 and 4.* The searchlight illuminates the moving target and the examiner issues an initial fire command and indexes the correct range. The crewman engages the target with two rounds, using the primary sight and the appropriate lead. The first round should hit the target. If it does not, the crewman applies burst-on-target or adjusts fire as directed by the examiner.

Note. Assigned tank commanders will fire exercise 4 from tank commander's position.

(3) *Exercise 3.* The searchlight illuminates the moving target and the examiner issues an initial fire command, announcing the correct range element. The crewman engages the target with two rounds, using the secondary sight and the appropriate lead. The first round should hit the target. If it does

not, the crewman applies burst-on-target or adjusts fire as directed by the examiner.

d. The exercises are scored as shown in table VB.

e. Points for each exercise are given as follows for all exercises:

- (1) Completing exercise within 20 seconds of initial command FIRE: 5.
- (2) Correct tracking: 5.
- (3) First round hit: 10.
- (4) Correct adjustment of second round if first round misses or hit with second round if first round hits: 5.

f. An appropriate score card is shown in figure 132.

g. The range layout for table VB would be similar to that for table VA.

Table VB

Possible score: 100
Minimum satisfactory score: 70

Exercise	Range in meters	Number of Rounds a	Method of Illumination b	Sight	Scoring
1	700-1,400	2	Searchlight	Primary	25
1	700-1,400	2	Searchlight	Primary	25
3	700-1,400	2	Searchlight	Secondary	25
*4	700-1,400	2	Searchlight	Primary	25

a—All rounds TP-T.

b—At least one exercise will be with infrared illumination for units equipped with the infrared-visible light kits.

*Assigned tank commanders will fire exercise 4 from tank commander's position.

UNIT _____ NAME _____

DATE _____ GRADE _____ SN _____

SCORE CARD: TABLE VB--MOVING TARGET EXERCISES (NIGHT)

100 POINTS
POSSIBLE

EXERCISE	POSSIBLE	COMPLETED IN TIME LIMIT	CORRECT TRACKING	1ST RD	2D RD ADJUSTMENT OR HIT	SCORE
1	25					
2	25					
3	25					
4	25					
TOTAL SCORE						

- Notes.
1. 5 points for completing all exercises within 20 seconds from the command FIRE in the initial fire command until second round is fired.
 2. 5 points for correct tracking in all exercises.
 3. 10 points for first round hit in all exercises.
 4. 5 points for correct adjustment if first round misses or if second round hit in all exercises.

Minimum satisfactory score. 70 points.

EXAMINER _____

OFFICER IN CHARGE _____

Figure 132. Score card for table VB.

CHAPTER 19

TANK CREW GUNNERY QUALIFICATION FIRING

214. General

a. Purpose. The purpose of tank crew gunnery qualification firing is to determine the crew's ability to employ all tank weapons effectively during both daylight and darkness.

b. Sequence of Firing.

(1) Each crew fires tables VIA and VIB once and tables VIIA and VIIB twice. These tables are training exercises for developing crew proficiency and they afford the unit commander an opportunity to complete the organization and training of crews before firing tables VIIIA and VIIB. The firing of tables VIA, VIB, VIIA, and VIIB should be scored to provide motivation for the crews and to furnish the unit commander with an indication of crew progress. The minimum satisfactory scores for these tables are guides to progress and satisfactory performance. If a crew has not attained the minimum satisfactory score on these tables but, in the opinion of the unit commander, has shown progressive improvement, it may be allowed to fire tables VIIIA and VIIB.

(2) Tables VIIIA and VIIB are fired for qualification once by each crew.

c. Crew Composition.

(1) The firing crew should be the assigned crew. However, crew assignments may be varied during the firing of tables VIA, VIB, VIIA, and VIIB to provide an even distribution of skills among all crews in the unit.

(2) Crew composition should not be varied after the crew begins firing tables VIIIA and VIIB.

d. Conduct of Exercises. The tank crew gunnery qualification course should be conducted over designated routes providing as much realism of crosscountry firing as safety will permit. Combat realism should be emphasized consistent with targets and range facilities available. Demolitions and surprise targets should be used to add realism. The appropriate deduction will be made from the score when the time limit for an exercise is exceeded; however, all exercises will be completed.

e. Critique of Exercises. Examiners will critique each crew after it has fired each table, using the completed score card as the basis for the critique.

f. Corrective Training. As the firing progresses, commanders will make every effort to correct deficiencies noted so as to attain maximum performance when crews fire tables VIIIA and VIIB.

g. Range Facilities. Range facilities available to the unit may not permit firing the main gun from a series of firing positions as required in the crew field firing and crew proficiency tables. Under such conditions, unit commanders should make one of the following modifications, listed in order of desirability.

(1) Fire main gun exercises from a firing line in a manner similar to tables IVA and VA firing (figs. 145 and 146) and machinegun exercises from a series of positions as prescribed in the crew qualification tables.

(2) Fire machinegun exercises of all crew qualification tables as prescribed and simulate firing the main gun exercises.

Note. Scoring will be modified as appropriate and notations in individual records will indicate that modified main gun exercises or the machinegun exercises only were fired.

Table VIA or VIB

Possible score: 660

Minimum satisfactory score: 460

Exercise	Weapon	Range in meters	No. of rounds	Target description	Scoring
Zeroing	Coax MG -----	800	75 a	6x6-ft. panel -----	Unscored
Zeroing	Cal .50 MG -----	500	50 a	6x6-ft. panel -----	Unscored
1	Cal .50 MG -----	1,000-1,200	50	Truck (6x6 ft.) -----	110
2	Coax MG -----	200-400	75	Troops (14 E-type) -----	110
3	Coax MG -----	600-800	60	Machinegun (3x5 ft.) -----	110
4	Coax MG -----	600-800	60	Moving truck (6x6 ft.) -----	110
5	Coax MG -----	500-600	75	Troops (14 E-type) -----	110
6	Cal .50 MG -----	1,000-1,500	50	Suspected area -----	110

a--Zeroing rounds are only authorized for table VIA.

215. Table VIA—Crew Machinegun Exercises (Day)

a. The purpose of these exercises is to develop crew coordination and the ability to engage moving and stationary targets with tank machineguns from a moving and stationary tank in daylight. This table should be conducted on a range similar to the one used for crew field firing exercises (fig. 147).

b. Each crew makes a dry run of the exercises before its firing run. This can be done in conjunction with the firing run of another tank. On the dry run, the examiner indicates the location of the targets and what each target represents.

c. The tank crew inspects its vehicle and equipment, stows the ammunition, and establishes communication with the safety officer. An outline of the exercises is shown in table VIA. The sequence may be varied to suit the available range facilities. Zeroing is accomplished prior to moving out.

d. Points for each exercise are given as follows: (No partial credit is given except as indicated.)

- (1) *Zeroing exercises.* These are fired by the gunner and are not scored.
- (2) *Exercise 1.*
 - (a) Completed exercise within time limit: 10.
 - (b) Opened fire in 20 seconds: 15.
 - (c) Correct procedure and technique of fire (cut 5 points for each error): 15.

(d) Each hit on the target (up to a maximum of 7 hits): 10 (total 70).

(2) *Exercises 2 and 5.*

- (a) Completed exercise within time limit: 5.
- (b) Opened fire in 15 seconds: 15.
- (c) Correct fire commands, crew duties, and techniques of fire (cut 5 points for each error): 20.
- (d) Target effect (cut in 10-point increments for less than maximum): 70.

(3) *Exercises 3 and 4.*

- (a) Completed exercises within time limit: 5.
- (b) Opened fire within 15 seconds: 15.
- (c) Correct fire commands, crew duties, and techniques of fire (cut 5 points for each error): 20.
- (d) Target hits (10 points for each target hit, up to a maximum of 7 hits): 70.

(4) *Exercise 6.*

- (a) Completed exercise within time limit: 10.
- (b) Opened fire in 20 seconds: 15.
- (c) Correct procedure and technique of fire (cut 5 points for each error): 15.
- (d) Target effect (cut in 10-point increments for less than maximum): 70.

e. After zeroing is completed the tank crew is ordered to move out. Then exercises are conducted as follows:

- (1) *Exercise 1 (truck).* The tank is in a hull defilade position (can be simu-

UNIT _____

TANK CREW _____

COMMANDER _____

DATE _____

GUNNER _____

DRIVER _____

DAY NIGHT (Circle One)

LOADER _____

SCORE CARD: TABLE VIA OR VIB--CREW MACHINEGUN EXERCISE

 660 POINTS
POSSIBLE

EXERCISE	NUMBER OF ROUNDS	ITEM AND POSSIBLE POINTS	SCORE
1* Truck (6x6 ft)	50 Cal .50	Completing within 1 minute 10	_____
		Opened fire in 20 seconds 15	_____
		Correct procedure and technique of fire 15	_____
		Each hit on target (maximum 7 hits) 10	_____
		TOTAL POSSIBLE 110	EXERCISE TOTAL
2 Troops	75 Coax	Completing within 55 seconds 5	_____
		Opened fire in 15 seconds 15	_____
		Fire commands, crew duties, and technique of fire 20	_____
		Target effect (cut 10-point increments for less than maximum). 70	_____
		TOTAL POSSIBLE 110	EXERCISE TOTAL
3 Machinegun	60 Coax	Completing within 55 seconds 5	_____
		Opened fire within 15 seconds 15	_____
		Fire commands, crew duties, and technique of fire 20	_____
		Each hit on target (maximum 7 hits) 10	_____
		TOTAL POSSIBLE 110	EXERCISE TOTAL
4 Moving Truck	60 Coax	Completing within 55 seconds 5	_____
		Opened fire within 15 seconds 15	_____
		Fire commands, crew duties, and technique of fire 20	_____
		Each hit on the target (maximum 7 hits). 10	_____
		TOTAL POSSIBLE 110	EXERCISE TOTAL
5 Troops	75 Coax	Completing within 55 seconds 5	_____
		Opened fire in 15 seconds 15	_____
		Fire commands, crew duties, and technique of fire 20	_____
		Target effect (cut in 10-point increments for less than maximum). 70	_____
		TOTAL POSSIBLE 110	EXERCISE TOTAL
6 Suspected Area	50 Cal .50	Completing within 1 minute 10	_____
		Opened fire in 20 seconds 15	_____
		Correct procedure and technique of fire 15	_____
		Target effect (cut in 10-point increments for less than maximum) 70	_____
		TOTAL POSSIBLE 110	EXERCISE TOTAL

*Zeroing accomplished prior to firing exercise 1 on table VIA. TOTAL SCORE _____

Minimum Satisfactory Score 460 points.

EXAMINER _____ OFFICER IN CHARGE _____

Figure 133. Score card for table VIA and VIB.

lated but should be made known to crew). The target appears and is engaged with the caliber .50 machinegun. The exercise must be completed within 1 minute after target identification.

- (2) *Exercise 2 (troops)*. The targets appear and are engaged with the coaxial machinegun as the tank continues to move. The exercise must be completed within 55 seconds from target identification. When the exercise is completed, the tank continues to move.
- (3) *Exercise 3 (machinegun)*. The target appears and is engaged with the coaxial machinegun as the tank continues to move. The exercise must be completed within 55 seconds from target identification. When the exercise is completed, the tank continues to move.
- (4) *Exercise 4 (moving truck)*. The moving target appears. The tank halts and engages the target with the coaxial machinegun. The exercise must be completed within 55 seconds from the command to halt the tank. When the exercise is completed, the tank moves out.
- (5) *Exercise 5 (troops)*. The targets appear and are engaged with the coaxial machinegun as the tank continues to move. The exercise must be completed within 55 seconds from the time the tank commander identifies the target.
- (6) *Exercise 6 (suspected area)*. The caliber .50 machinegun is reloaded, if necessary, and the examiner designates a suspected area. The tank commander reconnoiters by fire, using the caliber .50 machinegun, while the tank is moving. The exercise must be completed within 1 minute. Time starts when the tank commander identifies the target area.

f. The following control measures are applied:

- (1) The safety officer follows the firing tanks in a radio equipped vehicle.

- (2) Radio communication is maintained between the safety officer and the firing tanks. An examiner rides each firing tank and has communication with the crew and the safety officer.
- (3) The firing tank should move at least 50 meters between exercises.
- (4) Upon completion of the last exercise, all weapons are cleared.

g. The examiner times and scores the tank crew, using the binocular to determine target effect. An appropriate score card is shown in figure 133.

216. Table VIB—Crew Machinegun Exercises (Night)

a. The purpose of these exercises is to develop crew coordination and the ability to engage moving and stationary targets with tank machineguns from a moving and stationary tank at night with artificial illumination. This table may be conducted on the same range used for table VIA, Crew Machinegun Exercises (Day).

b. Each crew makes a dry run of the exercises before its firing run. This can be done in conjunction with the firing run of another tank. On the dry run, the examiner indicates the location of the targets and what each target represents.

c. The tank crew inspects its vehicle and equipment, and establishes communication with the safety officer. Two searchlight tanks should be used on the flanks of the firing lanes to illuminate the targets. If possible, flicker illumination should be used. In those units equipped with infrared-visible light kits at least one coax machinegun exercise and one caliber .50 machinegun exercise will be with infrared illumination.

d. The same procedure, ammunition, scoring, and control outlined in table VIA is used except that no zeroing is authorized for table VIB.

217. Table VIIA—Crew Field Firing Exercises (Day)

a. The purpose of these exercises is to develop the crew's ability to engage moving and stationary targets during daylight with all tank

weapons and to prepare the crew for testing on table VIIIA.

b. The crew is required to move over a designated course and engage a series of targets. All firing crews are briefed on the conduct of the course. The briefing should include information on what each target represents and the designated battlesight should be announced. An outline of the exercises is shown in table VIIIA. The sequence may be varied to suit the available range facilities. The main gun targets should be alternated so that the gunner will be required to change ammunition settings on the computer, or refer to different range scale lines on the range drum. Time for each exercise begins when the tank commander can identify the target and his tank is in a position to fire safely, as determined by the examiner. In those instances when the crew has not identified the target before the opening fire time has elapsed, the examiner will point out the target and the crew will lose opening fire time. Communication will be established by the tank commander with the safety officer.

c. Each crew makes a dry run of the exercises before making the first firing run. This can be done in conjunction with a firing run of another tank. On the dry run the examiner indicates the location of the targets and what each represents, but he does not reveal the

range to the targets. If time and personnel permit the dry run may be scored by using indicated portion of each exercise of table VIIIA score card (fig. 134).

d. Points for each exercise are given as follows: (No partial credit is given except as indicated.)

- (1) *Exercises 1, 3, and 4.*
 - (a) First round fired within 15 seconds: 30.
 - (b) Completed within 45 seconds: 10.
 - (c) Fire commands and crew duties (cut 5 points for each error): 35.
 - (d) Target hit with either round: 50.
 - (e) Additional target hit: 30.
- (2) *Exercise 2.*
 - (a) Opened fire within 15 seconds: 20.
 - (b) Completed within 55 seconds: 5.
 - (c) Fire commands, crew duties, and technique of fire (cut 5 points for each error): 25.
 - (d) Target hits (10 points for each target hit, up to a maximum of 7 hits): 70.
- (3) *Exercise 5.*
 - (a) Opened fire within 15 seconds: 20.
 - (b) Completed within 75 seconds: 5.

Table VIIA

Possible score: 925
Minimum satisfactory score: 650

Exercise	Weapon	Range in meters	No. of rounds	Target description	Scoring
Verifying zero	Main gun ----	Zeroing range ----	*1 a	Zeroing panel -----	None
Operational Checks ----	Coax MG ----	200-400 -----	15	(12x12-ft. panel) -----	None
1	Cal .50 MG ---	200-400 -----	10	(3x5-ft. panel) -----	None
2	Main gun ----	900-1,100 -----	2 a	Moving tank (6x6-ft. panel).	155
3	Coax MG ----	600-800 -----	100	Moving truck (3x5-ft. panel).	120
4	Main gun ----	1,500-2,000 -----	2 b	Antitank (6x6-ft. panel) -	155
5	Main gun ----	1,500-1,800 -----	2 a	Stationary tank (6x6-ft. panel).	155
6	Coax MG ----	200-400 -----	100	Troops (14 E-type) ----	120
7	Cal .50 MG ---	1,200-1,400 -----	50	Truck ** (3x5-ft. panel) -	120
	Cal .50 MG ---	1,000-1,200 -----	50	Troops (10 E-type) ----	100

a—TP-T.

b—HE or HEP.

* A round not fired during exercises will be used to verify zero.

** 6x6-ft. panel for tanks using the flexible mounted cal .50 MG.

(c) Fire commands, crew duties, and technique of fire (cut 5 points for each error): 25.

(d) Target effect (cut in increments of 10 points for failure to get target effect on each of the 7 portions of the target area): 70.

(4) *Exercise 6.*

(a) Opened fire within 20 seconds: 20.

(b) Completed within 1 minute: 5.

(c) Procedure and technique of fire (cut 5 points for each error): 25.

(d) Target hits (10 points for each target hit, up to a maximum of 7 hits): 70.

(5) *Exercise 7.*

(a) Opened fire within 20 seconds: 20.

(b) Completed within 1 minute: 5.

(c) Procedure and technique of fire (cut 5 points for each error): 25.

(d) Target effect (cut in increments of 10 points for failure to get effect on each of 5 portions of the target area): 50.

e. Upon verifying zero and completing operational checks, the tank commander is directed to move the tank to the starting point. The exercises are conducted as follows:

(1) *Exercise 1 (moving tank).*

The moving target moves out. The tank commander observes the target, halts the tank, and the tank crew engages the target with the main gun. The target may be engaged using a locally established battlesight and lead, or by ranging on the target and using the appropriate lead. The first round must be fired within 15 seconds after the exercise begins. The second round is fired and points are awarded for an additional hit. The exercise must be completed within 45 seconds. After completing the exercise, the tank commander gives the order to move out.

(2) *Exercise 2 (moving truck).* The tank commander observes the target, halts the tank, and the tank crew engages the target with the coaxial machinegun. Firing must commence within 15 seconds after the exercise begins. The exercise must be completed within 55

seconds. After completing the exercise, the tank commander gives the order to move out.

(3) *Exercise 3 (antitank).* The tank commander observes the target, halts the tank, and the tank crew engages the target with the main gun. The first round must be fired within 15 seconds after the exercise begins. The second round is fired and points are awarded for an additional hit. The exercise must be completed within 45 seconds. After completing the exercise, the tank commander gives the order to move out.

(4) *Exercise 4 (tank).* The tank commander observes the target, halts the tank, and the tank crew engages the target with the main gun. The first round must be fired within 15 seconds after the exercise begins. The second round is fired and points are awarded for an additional hit. The exercise must be completed within 45 seconds. After completing the exercise the tank commander gives the order to move out.

(5) *Exercise 5 (troops).* The tank commander observes the targets. The tank crew engages the targets with the coaxial machinegun while moving. Firing must commence within 15 seconds after the exercise begins. The exercise must be completed within 1 minute.

(6) *Exercise 6 (truck).* The tank commander observes the target, halts the tank, and engages the target with the caliber .50 machinegun. Firing must commence within 20 seconds after the exercise begins. The exercise must be completed within 1 minute. After completing the exercise, the tank commander gives the order to move out.

(7) *Exercise 7 (troops).* The tank commander observes the targets. The tank commander engages the targets with the caliber .50 machinegun while the tank is moving. Firing must commence within 20 seconds after the exercise begins. The exercise must be completed within 1 minute.

UNIT _____ TANK CREW _____
 COMMANDER _____
 DATE _____ GUNNER _____
 DRIVER _____
 LOADER _____

925 POINTS
POSSIBLE

SCORE CARD: TABLE VIIA--CREW FIELD FIRING EXERCISES (DAY)

EXERCISE	NUMBER OF ROUNDS	ITEM AND POSSIBLE POINTS	SCORE
1* Moving Tank	2 Main Gun	#First round fired within 15 seconds	30
		#Fire commands and crew duties	35
		Completed within 45 seconds	10
		Target hit	50
		Additional target hit	30
		TOTAL POSSIBLE	155
			EXERCISE TOTAL
2 Moving Truck	100 Coax	#Opened fire in 15 seconds	20
		Completed within 55 seconds	5
		#Fire commands, crew duties, and technique of fire (maximum)	25
		Each hit on target, 10 points (maximum of 7 hits)	70
		TOTAL POSSIBLE	120
			EXERCISE TOTAL
3 Antitank	2 Main Gun	#First round fired within 15 seconds	30
		#Fire commands and crew duties	35
		Completed within 45 seconds	10
		Target hit	50
		Additional target hit	30
		TOTAL POSSIBLE	155
			EXERCISE TOTAL
4 Tank	2 Main Gun	#First round fired within 15 seconds	30
		#Fire commands and crew duties	35
		Completed within 45 seconds	10
		Target hit	50
		Additional target hit	30
		TOTAL POSSIBLE	155
			EXERCISE TOTAL
5 Troops	100 Coax	#Opened fire in 15 seconds	20
		Completed within 75 seconds	5
		#Fire commands, crew duties, and technique of fire (maximum)	25
		Target effect (maximum)	70
		TOTAL POSSIBLE	120
			EXERCISE TOTAL
6 Antitank	50 Cal .50	#Opened fire in 20 seconds	20
		Completed within 1 minute	5
		#Procedure and technique of fire (maximum)	25
		Each hit on target 10 points (maximum of 7 targets)	70
		TOTAL POSSIBLE	120
			EXERCISE TOTAL
7 Troops	50 Cal .50	#Opened fire in 20 seconds	20
		Completed within 1 minute	5
		#Procedure and technique of fire	25
		Target effect (maximum)	50
		TOTAL POSSIBLE	100
			EXERCISE TOTAL
TOTAL SCORE			

Minimum Satisfactory Score 650 points.

EXAMINER _____ OFFICER IN CHARGE _____

*Verifying zero and operational checks of machineguns are accomplished prior to firing exercise.
 #These parts of exercise can be used to score dry run for information only.
 Maximum possible (dry run)--375 points.
 Suggested minimum satisfactory--250 points.

Figure 134. Score card for table VIIA.

f. The following control measures are applied:

- (1) The safety officer follows the firing tank in a radio equipped vehicle and controls the speed of the firing tank between exercises.
- (2) Radio communications are maintained between the safety officer and the firing tank. An examiner rides on the firing tank and has communication with the tank crew and the safety officer.
- (3) The firing tank should move at least 150 meters between exercises at a speed of 10-12 MPH.
- (4) Upon completion of the last exercise, and before clearing the range fan, all weapons will be cleared by the tank crew and checked by the examiner.

g. Scoring will be as follows:

- (1) Scoring personnel will physically score exercises 1, 2, 3, 4, and 6. Exercises 5 and 7 will be scored by the examiner.

- (2) When tank hulls or other hard targets are used for the main gun exercises, the examiner will score the target hits.
- (3) The examiner determines time for each exercise.
- (4) The examiner scores firing procedures of the tank crew. An appropriate score card is shown in figure 134.

218. Table VIIB—Crew Field Firing Exercises (Night)

a. The purpose of these exercises is to develop the crew's ability to engage moving and stationary targets at night with all tank weapons, and to prepare the crew for the test on table VIIIB. The same range used for table VIIA may be used for table VIIB.

b. The crew is required to move over a designated course and engage a series of illuminated targets. A tank-mounted searchlight, hand-held or rifle flare, and mortar or artillery shells, are used for illumination. The searchlight equipped tank accompanies the firing tank. All firing crews are briefed on the conduct of the

Table VIIB

Possible score: 1,025

Minimum satisfactory score: 615

Exercise*	Weapon	Range in meters	No. of rounds	Target description	Method of illumination	Scoring
1	Main gun	1,500-2,000 (simulated for QE).	None	Troops (simulated) (range card).	None (range card)	100
2	Main gun	900-1,100	2 ^a	Moving tank (6x6-ft. panel).	Tank searchlight	155
3	Coax MG	600-800	100	Moving truck (3x5-ft. panel).	Tank searchlight	120
4	Coax MG	400-800	100	Troops (14 E-type).	Tank searchlight	120
5	Main gun	900-1,100	2 ^b	Antitank (6x6-ft. panel).	Tank searchlight	155
6	Cal .50 MG	1,000-1,200	50	Troops (10 E-type).	Tank searchlight	100
7	Main gun	1,500-2,000	2 ^a	Stationary tank (6x6-ft. panel).	3 illuminating shells.	155
8	Cal .50 MG	1,000-1,400	50	Truck (3x5-ft. panel)**.	Tank searchlight	120

a—TP-T.

b—HE or HEP.

*One main gun, one machinegun coax, and one caliber .50 machinegun exercise will be fired with infrared illumination in units equipped with infrared-visible light kits.

**6x6-ft. panel used in those units with flexible mounted caliber .50 machineguns.

course. The briefing should include information on what each target represents, illuminating procedures, and the designated battlesight should be announced. An outline of the exercises is shown in table VIIB. The sequence may be varied to suit the available range facilities. The main gun targets should be alternated so that the gunner will be required to change ammunition settings on the computer, or refer to different range scale lines on the range drum. The time for each exercise begins when the targets are illuminated effectively and the tank is in a position to fire safely as determined by the examiner. In those instances when the crew has not identified the target before the opening fire time has elapsed, the examiner will point out the target and the crew will lose opening fire time. Communication will be established by the tank commander with the safety officer.

c. Each crew will make a dry run of the exercises before making the first firing run. This can be done in conjunction with the firing run of another tank. On the dry run the examiner indicates the location of the targets and what each represents, but he does not reveal the range to the targets.

d. Points for each exercise are given as follows: (No partial credit is given except as indicated.)

(1) *Exercise 1.*

- (a) Completed within 90 seconds: 20.
- (b) Fire commands and crew duties (cut 5 points for each error): 30.
- (c) Accuracy of lay (25 points for elevation and 25 points for deflection; both within 1 mil): 50.

(2) *Exercises 2, 5, and 7.*

- (a) Opened fire within 25 seconds: 30.
- (b) Completed within 1 minute: 10.
- (c) Fire commands and crew duties (cut 5 points for each error): 35.
- (d) Target hit with either round: 50.
- (e) Additional target hit: 30.

(3) *Exercise 3.*

- (a) Opened fire within 25 seconds: 20.
- (b) Completed within 1 minute: 5.
- (c) Fire commands, crew duties, and

technique of fire (cut 5 points for each error): 25.

- (d) Target hits (10 points for each target hit, up to a maximum of 7 hits): 70.

(4) *Exercise 4.*

- (a) Opened fire within 25 seconds: 20.
- (b) Completed within 90 seconds: 5.
- (c) Fire commands, crew duties, and technique of fire (cut 5 points for each error): 25.
- (d) Target effect (cut in increments of 10 points for failure to get target effect on each of the 7 portions of the target area): 70.

(5) *Exercise 6.*

- (a) Opened fire within 30 seconds: 20.
- (b) Completed exercise within 75 seconds: 5.
- (c) Procedure and technique of fire (cut 5 points for each error): 25.
- (d) Target effect (cut in increments of 10 points for failure to get target effect on each of the 5 portions of the target area): 50.

(6) *Exercise 8.*

- (a) Opened fire within 30 seconds: 20.
- (b) Completed within 75 seconds: 5.
- (c) Procedure and technique of fire (cut 5 points for each error): 25.
- (d) Target hits (10 points for each target hit, up to a maximum of 7 hits): 70.

e. After the tank crew has been ordered to move out, the exercises are conducted as follows:

- (1) *Exercise 1 (range card).* The tank occupies a prepared position. A range card, prepared by examiner personnel, is given to the tank commander of the firing tank. The tank crew simulates engaging a target with one round of ammunition, using range card data as designated by the examiner. The exercise must be completed within 90 seconds. Time starts with the gun laid on the reference point, and the azimuth indicator and gunner's aid

zeroed. The exercise is completed when the gunner announces ON THE WAY. After completing the exercise, the tank commander gives the order to move out.

- (2) *Exercise 2 (moving tank)*. The target is illuminated by a searchlight tank employing continuous illumination. The tank commander halts the firing tank, and the crew engages the target with the main gun. The first round must be fired within 25 seconds after the exercise begins. The second round is fired and points are awarded for an additional hit. The exercise must be completed in 1 minute. After completing the exercise, the tank commander gives the order to move out.
- (3) *Exercise 3 (moving truck)*. The target is illuminated with a searchlight tank employing continuous illumination. The tank commander halts the firing tank and the crew engages the target with the coaxial machinegun. Firing must commence within 25 seconds. The exercise must be completed within 1 minute. After completing the exercise, the tank commander gives the order to move out.
- (4) *Exercise 4 (troops)*. The target area is illuminated by a flare or a searchlight tank employing flicker illumination. The firing tank crew engages the targets with the coaxial machinegun while moving. Firing must commence within 25 seconds after the exercise begins. The exercise must be completed within 90 seconds.
- (5) *Exercise 5 (antitank)*. The target is illuminated by a searchlight tank employing flicker illumination. The tank commander halts the firing tank and the crew engages the target with the main gun. The first round must be fired within 25 seconds after the exercise begins. The second round is fired and points are awarded for an additional hit. The exercise must be completed within 1 minute. After completing the exercise, the tank commander gives the order to move out.

- (6) *Exercise 6 (troops)*. The target area is illuminated with a searchlight tank employing flicker illumination. The tank commander halts the firing tank and engages the target with the caliber .50 machinegun. Firing must commence within 30 seconds after the exercise begins. The exercise must be completed within 75 seconds. After completing the exercise the tank commander gives the order to move out.
- (7) *Exercise 7 (tank)*. The target is illuminated by three illuminating shells. The tank commander halts the firing tank and the crew engages the target with the main gun. The first round must be fired within 25 seconds after the exercise begins. The second round is fired and points are awarded for an additional hit. The exercise must be completed within 1 minute. After completing the exercise the tank commander gives the order to move out.
- (8) *Exercise 8 (truck)*. The target is illuminated with a searchlight tank employing flicker illumination. The tank commander halts the firing tank and engages the target with the caliber .50 machinegun. Firing must commence within 30 seconds after the exercise begins. The exercise must be completed within 75 seconds. After completing the exercise the tank commander gives the order to move out.

f. Control Measures.

- (1) The safety officer follows the firing tank in a radio equipped vehicle and controls the speed of the firing tank between exercises.
- (2) Radio communications are maintained between the safety officer, searchlight tank, forward observer, and firing tank. An examiner rides on the firing tank and has communications with the firing tank crew and the safety officer.
- (3) The firing tank should move at least 150 meters between exercises at a speed of 10-12 MPH.

UNIT _____ TANK CREW _____
 DATE _____ COMMANDER _____
 GUNNER _____
 DRIVER _____
 LOADER _____

**1,025 POINTS
POSSIBLE**

SCORE CARD: TABLE VIIB--CREW FIELD FIRING EXERCISES (NIGHT)

EXERCISE	NUMBER OF ROUNDS	ITEM AND POSSIBLE POINTS	SCORE
1 Troops	None (range card)	#Completed within 1 minute and 30 seconds	20
		#Fire commands and crew duties	30
		#Correct elevation (within 1 mil)	25
		#Correct deflection (within 1 mil)	25
		TOTAL POSSIBLE	100
			EXERCISE TOTAL
2 Moving Tank	2 Main Gun	#Opened fire in 25 seconds	30
		#Fire commands and crew duties	35
		Completed exercise within 1 minute	10
		Target hit	50
		Additional target hit	30
			TOTAL POSSIBLE 155
			EXERCISE TOTAL
3 Moving Truck	100 Coax	#Opened fire in 25 seconds	20
		Completed in 1 minute	5
		#Fire commands, crew duties and technique of fire (maximum)	25
		Each hit on target 10 points (maximum of 7 hits)	70
			TOTAL POSSIBLE 120
			EXERCISE TOTAL
4 Troops	100 Coax	#Opened fire in 25 seconds	20
		Completed in 1 minute and 30 seconds	5
		#Fire commands, crew duties, and technique of fire (maximum)	25
		Target effect (maximum)	70
			TOTAL POSSIBLE 120
			EXERCISE TOTAL
5 Antitank	2 Main Gun	#Opened fire in 25 seconds	30
		#Fire commands and crew duties	35
		Completed exercise within 1 minute	10
		Target hit	50
		Additional target hit	30
			TOTAL POSSIBLE 155
			EXERCISE TOTAL
6 Troops	50 Cal .50	#Opened fire in 30 seconds	20
		Completed within 1 minute and 15 seconds	5
		#Procedure and technique of fire (maximum)	25
		Target effect (maximum)	50
			TOTAL POSSIBLE 100
			EXERCISE TOTAL
7 Tank	2 Main Gun	#Opened fire in 25 seconds	30
		#Fire commands and crew duties	35
		Completed exercise within 1 minute	10
		Target hit	50
		Additional target hit	30
			TOTAL POSSIBLE 155
			EXERCISE TOTAL
8 Truck	50 Cal .50	#Opened fire in 30 seconds	20
		Completed within 1 minute and 15 seconds	5
		#Procedure and technique of fire (maximum)	25
		Each hit on a target 10 points (maximum of 7 hits)	70
			TOTAL POSSIBLE 120
			EXERCISE TOTAL
TOTAL SCORE			

Minimum Satisfactory Score 615 points.

EXAMINER _____ OFFICER IN CHARGE _____

#These parts of exercises can be used to score dry run for information only.
 Maximum possible (dry run)--475 points.
 Suggested minimum satisfactory--340 points.

Figure 135. Score card for table VIIB.

g. The method of illumination may be varied to conform with local conditions and administrative requirements. However, at least one target must be illuminated by illuminating shells.

h. Scoring.

- (1) Scoring personnel will physically score exercises 2, 3, 5, 7, and 8. Exercises 1, 4, and 6 will be scored by the examiner. When tank hulls or other hard targets are used for the main gun exercises, the examiner will score target hits.
- (2) The examiner determines time for each exercise.
- (3) The examiner scores the firing procedures of the tank crew. An appropriate score card is shown in figure 135.

targets with all tank weapons during daylight. This table, in conjunction with table VIIIB, is the basis for the crew classification; therefore, there will be no dry or practice runs.

b. The crew is required to move over designated course and engage a series of targets. A sample range layout is shown in figure 148. The terrain should be different from that used in tables VIIA and VIIB; however, if range facilities are limited, the same terrain may be used with the route of movement and target locations varied. All firing crews are briefed on the conduct of the course and the tactical situation, including the mission of the tank crew. The briefing should include information on what each target represents and a designated battlesight should be announced. The sequence of the exercises may be varied to fit the available range facility. The main gun targets should be alternated so that the gunner will be required to change ammunition settings on the computer, or resort to different range scale lines on the range drum. An outline of the course is shown in table VIIIA. Time for each

219. Table VIIIA—Crew Proficiency Exercises (Day)

a. The purpose of this exercise is to test the crew's ability to engage moving and stationary

Table VIIIA

Possible score: 1,200
Minimum satisfactory score: 840

Exercise	Weapon	Range in meters	No. of rounds	Target description	Scoring
Verifying zero.	Main gun ----	Zeroing range ----	2 ^a	Zeroing panel ----	None
Operational check.	Coax MG ----	200-400 -----	15	3x5-ft. panel -----	None
Operational check.	Cal .50 MG --	500 -----	10	3x5-ft. panel -----	None
1	Coax MG ----	200-400 -----	100	Troops (14 E-type)	120
2	Main gun ----	1,500-2,000 -----	2 ^a	Tank (6x6-ft. panel).	155
3	Cal .50 MG ---	1,000-1,200 -----	50	Troops (10 E-type)	100
4	Coax MG ----	500-600 -----	100	Troops (14 E-type)	120
5	Main gun ----	900-1,100 -----	2 ^b	Antitank (3x5 ft. panel).	155
6	Main gun ----	900-1,100 -----	2 ^a	Moving tank (6x6-ft. panel).	155
7	Cal .50 MG ---	1,000-1,200 -----	50	Truck (3x5-ft. panel)*.	120
8	Coax MG ----	500-800 -----	100	Moving truck (6x6-ft. panel).	120
9	Main gun ----	1,500-2,000 -----	2 ^b	House (6x6-ft. panel).	155

a—TP-T.

b— HE or HEP.

*—6x6-ft. panel used in those units with flexible mounted cal .50 machineguns.

exercise begins when the target is marked by a blast or the tank commander can identify the target and his tank is in a position to fire safely, as determined by the examiner. In those instances when the crew has not identified the target before the opening fire time has elapsed, the examiner will point out the target and the crew will lose opening fire time.

c. Points for each exercise are as follows: (No partial credit is given except as indicated.)

- (1) *Exercises 1 and 4.*
 - (a) Opened fire within 15 seconds: 20.
 - (b) Completed within 75 seconds: 5.
 - (c) Fire commands, crew duties, and technique of fire (cut 5 points for each error): 25.
 - (d) Target effect (cut in increments of 10 points for failure to get target effect on each of the 7 portions of the target area): 70.
- (2) *Exercises 2, 5, 6, and 9.*
 - (a) First round fired within 15 seconds: 30.
 - (b) Completed within 45 seconds: 10.
 - (c) Fire commands and crew duties (cut 5 points for each error): 35.
 - (d) Target hit with either round: 50.
 - (e) Additional target hit: 30.
- (3) *Exercise 3.*
 - (a) Opened fire within 20 seconds: 20.
 - (b) Completed within 1 minute: 5.
 - (c) Procedure and technique of fire (cut 5 points for each error): 25.
 - (d) Target effect (cut in increments of 10 points for failure to get target effect on each of the 5 portions of the target area): 50.
- (4) *Exercise 7.*
 - (a) Opened fire within 20 seconds: 20.
 - (b) Completed within 1 minute: 5.
 - (c) Procedure and technique of fire (cut 5 points for each error): 25.
 - (d) Target hits (10 points for each target hit, up to a maximum of 7 hits): 70.
- (5) *Exercise 8.*
 - (a) Opened fire within 15 seconds: 20.
 - (b) Completed within 55 seconds: 5.

- (c) Fire commands, crew duties, and technique of fire (cut 5 points for each error): 25.
- (d) Target hits (10 points for each target hit, up to a maximum of 7 hits): 70.

d. The tank commander is directed to move the tank to the zeroing panel and halt. The crew fires two rounds with the main gun at a zeroing panel for verification of zero. The crew makes an operational check with the coaxial machinegun, by firing 15 rounds at a 3 by 5-ft. panel. The tank commander makes an operational check with the caliber .50 machinegun by firing 10 rounds at the same 3 by 5-ft. panel. Upon completion of the verification of zero and operational checks, the tank commander moves the tank to the starting point for the table. The exercises are conducted as follows:

- (1) *Exercise 1 (troops).* The tank commander observes the targets. The tank crew engages the targets with the coaxial machinegun while the tank is moving. Firing must commence within 15 seconds after the exercise begins. The exercise must be completed within 75 seconds.
- (2) *Exercise 2 (tank).* The tank commander observes the target, halts the tank, and the tank crew engages the target with the main gun. The first round must be fired within 15 seconds after the exercise begins. The second round is fired and points are awarded for an additional hit. The exercise must be completed within 45 seconds. After completing the exercise, the tank commander gives the order to move out.
- (3) *Exercise 3 (troops).* The tank commander observes the targets. The tank commander engages the targets with the caliber .50 machinegun while the tank is moving. Firing must commence within 20 seconds after the exercise begins. The exercise must be completed within 1 minute.
- (4) *Exercise 4 (troops).* The tank commander observes the targets. The tank

crew engages the targets with the coaxial machinegun while the tank is moving. Firing must commence within 15 seconds after the exercise begins. The exercise must be completed within 75 seconds.

- (5) *Exercise 5 (antitank)*. The tank commander observes the target, halts the tank, and the tank crew engages the target with the main gun. The first round must be fired within 15 seconds after the exercise begins. The second round is fired and points are awarded for an additional hit. The exercise must be completed within 45 seconds. After completing the exercise, the tank commander gives the order to move out.
- (6) *Exercise 6 (moving tank)*. The tank commander observes the target, halts the tank, and the tank crew engages the target with the main gun. The first round must be fired within 15 seconds after the exercise begins. The second round is fired and points are awarded for an additional hit. The exercise must be completed within 45 seconds. After completing the exercise, the tank commander gives the order to move out.
- (7) *Exercise 7 (truck)*. The tank commander observes the target, halts the tank, and engages the target with the caliber .50 machinegun. Firing must commence within 20 seconds after the exercise begins. The exercise must be completed within 1 minute. After completing the exercise, the tank commander gives the order to move out.
- (8) *Exercise 8 (moving truck)*. The tank commander observes the target, halts the tank, and the tank crew engages the target with the coaxial machinegun. Firing must commence within 15 seconds after the exercise begins. The exercise must be completed within 55 seconds. After completing the exercise, the tank commander gives the order to move out.

- (9) *Exercise 9 (house)*. The tank commander observes the target, halts the tank, and the tank crew engages the target with the main gun. The first round must be fired within 15 seconds after the exercise begins. The second round is fired and points are awarded for an additional hit. The exercise must be completed within 45 seconds. After completing the exercise, the tank commander gives the order to move out.

e. Control measures are the same as for table VIIA.

f. Where range safety requirements will allow, all targets should be surprise targets, i.e., their location is not known by the crew being tested and one target only is visible at a time. Depending on the materials available, targets should be activated by demolitions, by being moved into view, by pop-up techniques, by being hidden behind terrain features, until the firing tank reaches a certain position on the course, or by a combination of these methods.

g. Scoring will be as follows:

- (1) Scoring personnel will physically score exercises 2, 5, 6, 7, 8, and 9. Exercises 1, 3, and 4 will be scored by the examiner. When tank hulls or other hard targets are used for the main gun exercises, the examiner scores the target hits.
- (2) The examiner determines time for each exercise.
- (3) The examiner scores the firing procedures of the tank crew. An appropriate score card is shown in figure 136.

220. Table VIII B—Crew Proficiency Exercises (Night)

a. The purpose of these exercises is to test the crew's ability to engage moving and stationary targets with all tank weapons at night. This table, in conjunction with table VIIIA, is the basis for the crew classification; therefore, there is no dry or practice run. The same range used for table VIIIA may be used for table VIII B.

UNIT _____ TANK CREW _____
 COMMANDER _____
 DATE _____ GUNNER _____
 DRIVER _____
 LOADER _____

SCORE CARD: TABLE VIIIA--CREW PROFICIENCY EXERCISES (DAY)

1,200 POINTS
POSSIBLE

EXERCISE	NUMBER OF ROUNDS	ITEM AND POSSIBLE POINTS	SCORE
1*	Troops	100 Coax	Opened fire within 15 seconds 20
			Completed within 75 seconds 5
			Fire commands, crew duties, and technique of fire (maximum) 25
			Target effect (maximum) 70
			TOTAL POSSIBLE 120
			EXERCISE TOTAL
2	Tank	2 Main Gun	First round fired within 15 seconds 30
			Fire commands and crew duties 35
			Completed within 45 seconds 10
			Target hit 50
			Additional target hit 30
			EXERCISE TOTAL
3	Troops	50 Cal .50	Opened fire within 20 seconds 20
			Completed within 1 minute 5
			Procedure and technique of fire (maximum) 25
			Target effect (maximum) 50
			TOTAL POSSIBLE 100
			EXERCISE TOTAL
4	Troops	100 Coax	Opened fire within 15 seconds 20
			Completed within 75 seconds 5
			Fire commands, crew duties, and technique of fire (maximum) 25
			Target effect (maximum) 70
			TOTAL POSSIBLE 120
			EXERCISE TOTAL
5	Antitank	2 Main Gun	First round fired within 15 seconds 30
			Fire commands and crew duties 35
			Completed within 45 seconds 10
			Target hit 50
			Additional target hit 30
			EXERCISE TOTAL
6	Moving Tank	2 Main Gun	First round fired within 15 seconds 30
			Fire commands and crew duties 35
			Completed within 45 seconds 10
			Target hit 50
			Additional target hit 30
			EXERCISE TOTAL
7	Truck	50 Cal .50	Opened fire in 20 seconds 20
			Completed within 1 minute 5
			Procedure and technique of fire (maximum) 25
			Each hit on target 10 points (maximum of 7 hits) 70
			TOTAL POSSIBLE 120
			EXERCISE TOTAL
8	Moving Truck	100 Coax	Opened fire in 15 seconds 20
			Completed within 55 seconds 5
			Fire commands, crew duties, and technique of fire (maximum) 25
			Each hit on target 10 points (maximum of 7 hits) 70
			TOTAL POSSIBLE 120
			EXERCISE TOTAL
9	House	2 Main Gun	First round fired within 15 seconds 30
			Fire commands and crew duties 35
			Completed within 45 seconds 10
			Target hit 50
			Additional target hit 30
			EXERCISE TOTAL
TOTAL POSSIBLE 155			TOTAL SCORE

Minimum Satisfactory Score 840 points.

EXAMINER _____

OFFICER IN CHARGE _____

*Verifying zero of main gun and operational check of machineguns will be accomplished prior to first exercise.

Figure 136. Score card for table VIIIA.

Table VIII B

Possible score: 1,200
Minimum satisfactory score: 720

Exercise	Weapon	Range in meters	No. of rounds	Target description	Method of illumination	Scoring
Verifying zero.	Main gun ----	1,200 ----	2 ^a	Zeroing panel -----	Tank searchlight	None
Operational check.	Coax MG ----	200-400 -	15	3x5-ft. panel -----	Tank searchlight	None
Operational check.	Cal .50 MG --	500 ----	10	3x5-ft. panel -----	Tank searchlight	None
1	Coax MG ----	200-400 -	100	Troops (14 E-type) -	Flare -----	120
2	Main gun ----	900-1,000-	2 ^a	Tank (6x6-ft. panel) -	Tank searchlight	155
3	Cal .50 MG --	1,000-1,300-	50	Troops (10 E-type) -	Tank searchlight	100
4	Coax MG ----	400-600 -	100	Troops (14 E-type) -	Tank searchlight	120
5	Main gun ----	1,400-1,600-	2 ^b	Antitank (6x6-ft. panel).	3 illuminating shells.	155
6	Main gun ----	900-1,100-	2 ^a	Moving tank (6x6-ft. panel).	Tank searchlight	155
7	Cal .50 MG --	800-1,000-	50	Truck (3x5-ft. panel) ^{**} .	Tank searchlight	120
8	Coax MG ----	600-800 -	100	Moving truck (6x6-ft. panel).	Tank searchlight	120
9	Main gun ----	1,200-1,400-	2 ^b	Antitank (6x6-ft. panel).	Tank searchlight	155

^a—TP-T.

^b—HE or HEP.

* One main gun, one coax MG, and one caliber .50 MG exercise will be fired with infrared illumination in units equipped with infrared-visible light kits.

** 6x6-ft. panel used in those units with flexible mounted cal .50 machineguns.

b. The crew is required to move over a designated course and engage a series of illuminated targets. A tank-mounted searchlight, handheld or rifle flare, and mortar or artillery shells are used for illumination. All firing crews are briefed on the conduct of the course and the tactical situation, including the mission of the tank crew. The briefing should include information on what each type of target represents, on illuminating procedures, and the announcement of a battlesight should be made. The sequence of the exercise may be varied to fit existing range facilities. The main gun targets should be alternated so that the gunner will be required to change ammunition settings on the computer, or refer to different range scale lines on the range drum. An outline of the exercise is shown in table VIII B. The time for the exercise begins when the targets are effectively illuminated, as determined by the examiner. In those instances when the crew has not identified the target before the opening fire time has elapsed, the examiner will point out the target and the crew will lose opening fire time.

c. Points for each exercise are given as follows: (No partial credit is given except as indicated.)

- (1) Exercises 1 and 4.
 - (a) Opened fire within 25 seconds: 20.
 - (b) Completed within 90 seconds: 5.
 - (c) Fire commands, crew duties, and techniques of fire (cut 5 points for each error): 25.
 - (d) Target effect (cut in increments of 10 points for failure to get target effect on each of the 7 portions of the target area): 70.
- (2) Exercises 2, 5, 6, and 9.
 - (a) First round fired within 25 seconds: 30.
 - (b) Completed within 1 minute: 10.
 - (c) Fire commands and crew duties (cut 5 points for each error): 35.
 - (d) Target hit with either round: 50.
 - (e) Additional target hit: 30.
- (3) Exercise 3.
 - (a) Opened fire within 30 seconds: 20.

- (b) Completed exercises within 75 seconds: 5.
- (c) Procedure and technique of fire (cut 5 points for each error): 25.
- (d) Target effect (cut in increments of 10 points for failure to get target effect on each of the 5 portions of the target area): 50.

(4) *Exercise 7.*

- (a) Opened fire within 30 seconds: 20.
- (b) Completed within 75 seconds: 5.
- (c) Procedure and technique of fire (cut 5 points for each error): 25.
- (d) Target hits (10 points for each target hit, up to a maximum of 7 hits): 70.

(5) *Exercise 8.*

- (a) Opened fire within 25 seconds: 20.
- (b) Completed within 1 minute: 5.
- (c) Fire commands, crew duties, and technique of fire (cut 5 points for each error): 25.
- (d) Target hits (10 points for each target hit, up to a maximum of 7 hits): 70.

d. After the tank crew has been ordered to move out, the exercises are conducted as follows:

- (1) *Exercise 1 (troops).* The target area is illuminated by a flare or with a searchlight tank employing flicker illumination. The firing tank crew engages the targets with the coaxial machinegun while the tank is moving. Firing must commence within 25 seconds after the exercise begins. The exercise must be completed within 90 seconds.
- (2) *Exercise 2 (tank).* The target is illuminated with a searchlight tank employing flicker illumination. The tank commander halts the firing tank and the crew engages the target with the main gun. The first round must be fired within 25 seconds after the exercise begins. The second round is fired and points are awarded for an additional hit. The exercise must be completed within 1 minute. After com-

pleting the exercise the tank commander gives the order to move out.

- (3) *Exercise 3 (troops).* The target area is illuminated with a searchlight tank employing flicker illumination. The tank commander halts the firing tank and engages the target with the caliber .50 machinegun. Firing must commence within 30 seconds after the exercise begins. The exercise must be completed within 75 seconds. After completing the exercise the tank commander gives the order to move out.
- (4) *Exercise 4 (troops).* The target area is illuminated with a searchlight employing flicker illumination. The tank crew engages the targets with the coaxial machinegun while the tank is moving. Firing must commence within 25 seconds after the exercise begins. The exercise must be completed within 90 seconds.
- (5) *Exercise 5 (antitank).* The target is illuminated by three illuminating shells. The tank commander halts the firing tank and the crew engages the target with the main gun. The first round must be fired within 25 seconds after the exercise begins. The second round is fired and points are awarded for an additional hit. The exercise must be completed within 1 minute. After completing the exercise the tank commander gives the order to move out.
- (6) *Exercise 6 (moving tank).* The target is illuminated by a searchlight tank employing continuous illumination. The tank commander halts the firing tank, and the crew engages the target with the main gun. The first round must be fired within 25 seconds after the exercise begins. The second round is fired and points are awarded for an additional hit. The exercise must be completed within 1 minute. After completing the exercise the tank commander gives the order to move out.
- (7) *Exercise 7 (truck).* The target is illuminated with a searchlight tank employing flicker illumination. The tank

commander halts the firing tank and engages the target with the caliber .50 machinegun. Firing must commence within 30 seconds after the exercise begins. The exercise must be completed within 75 seconds. After completing the exercise the tank commander gives the order to move out.

- (8) *Exercise 8 (moving truck)*. The target is illuminated with a searchlight tank employing continuous illumination. The tank commander halts the firing tank and the crew engages the target with the coaxial machinegun. Firing must commence within 25 seconds after the exercise begins. The exercise must be completed within 1 minute. After completing the exercise, the tank commander gives the order to move out.
- (9) *Exercise 9 (antitank)*. The target is illuminated by a searchlight tank employing flicker illumination. The tank commander halts the firing tank and the crew engages the target with the main gun. The first round must be fired within 25 seconds after the exercise begins. The second round is fired and points are awarded for an additional hit. The exercise must be completed within 1 minute. After completing the exercise the tank commander gives the order to move out.

e. Control measures are the same as for table VIIB.

f. The method of illumination may be varied to conform with local conditions and admin-

istrative requirements. However, at least one target must be illuminated by illuminating shells.

g. Scoring will be as follows:

- (1) Scoring personnel will physically score exercises 2, 5, 6, 7, 8, and 9. Exercises 1, 3, and 4 will be scored by the examiner. When tank hulls or other hard targets are used for the main gun exercises, the examiner will score target hits.
- (2) The examiner determines the time for each exercise.
- (3) The examiner scores the firing procedures of the crew. An appropriate score card is shown in figure 137.

221. Crew Classification

Classification of tank crews is based on the combined scores of tables VIIIA and VIIB (para. 219 and 220). The indicated minimum satisfactory score must be attained on each table, or a combined score of 1,800 points if the score on one table is below satisfactory, in order for a classification of marksman or better to be awarded. Arms qualification badges are not awarded for crew classifications; however, notations indicating crew position and crew classification will be entered on individual qualification records.

<i>Crew classification</i>	<i>Score</i>
Total possible -----	2,400
Expert -----	2,000
Sharpshooter -----	1,800
Marksman -----	1,560
Unqualified -----	Below 1,560

UNIT _____ TANK CREW _____
 COMMANDER _____
 DATE _____ GUNNER _____
 DRIVER _____
 LOADER _____

SCORE CARD: TABLE VIII B--CREW PROFICIENCY EXERCISES (NIGHT)

1,200 POINTS
POSSIBLE

EXERCISE	NUMBER OF ROUNDS	ITEM AND POSSIBLE POINTS	SCORE
1*	Troops	100 Coax	Opened fire within 25 seconds 20
			Completed within 1 minute and 30 seconds 5
			Fire command, crew duties, and technique of fire (maximum) 25
			Target effect (maximum) 70
			TOTAL POSSIBLE 120
			EXERCISE TOTAL
2	Tank	2 Main Gun	First round fired within 25 seconds 30
			Fire commands and crew duties 35
			Completed within 1 minute 10
			Target hit 50
			Additional target hit 30
			EXERCISE TOTAL
3	Troops	50 Cal .50	Opened fire within 30 seconds 20
			Completed within 1 minute 5
			Procedure and technique of fire (maximum) 25
			Target effect (maximum) 50
			TOTAL POSSIBLE 100
			EXERCISE TOTAL
4	Troops	100 Coax	Opened fire within 25 seconds 20
			Completed within 1 minute and 30 seconds 5
			Fire commands, crew duties, and technique of fire (maximum) 25
			Target effect (maximum) 70
			TOTAL POSSIBLE 120
			EXERCISE TOTAL
5	Antitank	2 Main Gun	First round fired within 25 seconds 30
			Fire commands and crew duties 35
			Completed within 1 minute 10
			Target hit 50
			Additional target hit 30
			EXERCISE TOTAL
6	Moving Tank	2 Main Gun	First round fired within 25 seconds 30
			Fire commands and crew duties 35
			Completed within 1 minute 10
			Target hit 50
			Additional target hit 30
			EXERCISE TOTAL
7	Truck	50 Cal .50	Opened fire within 30 seconds 20
			Completed within 1 minute 5
			Procedure and technique of fire (maximum) 25
			Each hit on target 10 points (maximum of 7 hits) 70
			TOTAL POSSIBLE 120
			EXERCISE TOTAL
8	Moving Truck	100 Coax	Opened fire within 25 seconds 20
			Completed within 1 minute 5
			Fire commands, crew duties, and technique of fire (maximum) 25
			Each hit on target 10 points (maximum of 7 hits) 70
			TOTAL POSSIBLE 120
			EXERCISE TOTAL
9	Antitank	2 Main Gun	First round fired within 25 seconds 30
			Fire commands and crew duties 35
			Completed within 1 minute 10
			Target hit 50
			Additional target hit 30
			EXERCISE TOTAL
TOTAL POSSIBLE 155			TOTAL SCORE

Minimum Satisfactory Score 720 points

EXAMINER _____ OFFICER IN CHARGE _____

*Verifying zero for main gun and operational checks for machineguns are accomplished prior to firing exercise 1.

Figure 137. Score card for table VIII B.

CHAPTER 20

FAMILIARIZATION AND PRACTICE FIRING

Section I. FAMILIARIZATION FIRING

222. General

a. The objective of a familiarization course is to give required personnel training in the application of the fundamentals in the conduct of direct fire. A familiarization course does not qualify them as gunners and it does not replace qualification firing. For personnel to fire familiarization, see AR 370-5.

b. Before personnel are permitted to fire the familiarization course, a minimum of 28 hours of preliminary instruction should be given covering the following subjects:

- (1) Weapons mechanical training: 6 hours.
- (2) Turret familiarization: 8 hours.
- (3) Conduct of fire (direct fire only): 4 hours.
- (4) Range card preparation and use: 4 hours.
- (5) Nonfiring exercises, including sight adjustment, direct laying, adjustment of fire, crew drill, manipulation exercises, and tracking and leading exercises: 4 hours.
- (6) Tank crewman preliminary gunnery examination: 2 hours.

Note. The preliminary gunnery examination must be successfully completed by personnel before participating in firing exercises (para. 187-204).

c. Familiarization firing consists of firing tables I-III (subcaliber) and table IX (main gun and machinegun) one time only. Timing and scoring is maintained for instruction and information only.

d. Ammunition required to fire one individual through the familiarization tables is shown in the following chart.

Table	Ammunition				
	Coaxial machinegun		Cal .50	Main gun	
	Ball MLB	4-1, MLB	4-1, MLB	HE or HEP	TP-T
I-III a -----	52				
X b -----		50	50	2	2
Total --	52	50	50	2	2

a—Subcaliber firing is the same as tables I-III, section III, chapter 18 except that the tables are fired only once.

b—Five rounds of TP-T per tank will be required to establish the zero of the tank gun, if it has not previously been established. Seventy-five rounds of coaxial machinegun and 50 rounds of caliber .50 machinegun ammunition will be required per tank for zeroing if not accomplished previously.

223. Table I-III—Subcaliber Familiarization Exercises

a. The purpose of these exercises is to familiarize personnel with laying and firing the tank gun with a correct sight picture and adjusting fire before firing service ammunition.

b. In these exercises the individual, as gunner, will fire the subcaliber tables as prescribed in paragraphs 205 through 208 except that he will fire each table only one time.

224. Table IX—Service Familiarization Firing

a. These exercises are designed to familiarize the individual with the methods and procedures involved in firing tank weapons at stationary targets. Firing commences from the established zero for the main gun. Examiner personnel zero the machineguns before service familiarization exercises.

- b. The exercises are conducted as follows:
- (1) *First-round hit (primary sight).* The examiner issues an initial fire command and indexes (announces on tanks not equipped with a range finder) the correct range. The indi-

vidual as gunner, engages the target with one round. He should obtain a first-round hit and complete the exercise within 10 seconds after the command to fire.

- (2) *First-round hit exercise (secondary sight)*. This exercise is fired and timed in the same manner as in the first exercise except that the range is announced and the secondary sight is used.
- (3) *Primary method of adjustment exercise*. The examiner issues an initial fire command and induces a 200-meter (yard) range error into the range finder or announces an erroneous range on tanks not equipped with a range finder. The individual lays and fires two rounds, adjusting by the primary method of adjustment if possible. The exercise should be completed within 20 seconds after the command to fire.

Note. The second round is fired even though a first-round hit is obtained. If the individual is unable to sense the first round, he announces LOST, and the examiner issues a subsequent fire command. The individual then fires the second round, using the alternate method of adjustment. No additional time is allowed.

- (4) *Coaxial machinegun exercise*. The examiner issues an initial fire command and the individual engages the target with the coaxial machinegun and adjusts the fire by observation of the beaten zone. The exercise should be

completed within 1 minute after the command to fire.

- (5) *Caliber .50 machinegun exercise*. The examiner designates the target. The individual loads the caliber .50 machinegun and engages the target, adjusting fire by observation of the beaten zone. The exercise should be completed within 2 minutes after target identification.

c. The exercises are scored as shown in table IX.

d. Points for each exercise are given as follows:

- (1) *Exercises 1 and 2.*
 - (a) Completed exercise within 10 seconds of the initial command FIRE: 10.
 - (b) Target hit: 15.
- (2) *Exercise 3.*
 - (a) Completed exercise within 20 seconds of the initial command FIRE: 10.
 - (b) Target hit with second round: 15.
- (3) *Exercise 4.*
 - (a) Completed exercise within 1 minute of the initial command FIRE: 5.
 - (b) Correct technique of adjustment: 5.
 - (c) Effective target coverage: 15.
- (4) *Exercise 5.*
 - (a) Completed exercise within 2 minutes of target identification: 5.
 - (b) Correct technique of adjustment: 5.
 - (c) Effective target coverage: 15.

e. See figure 138 for illustration of appropriate score card.

Table IX

Possible score: 125

Exercise	Target	Range in meters (yards)	No. of rounds	Sight	Method of adjustment	Scoring
1	6x6-ft. panel -----	1,400-1,600-----	a 1	Primary ---	(First-round hit)-----	25
2	6x6-ft. panel -----	1,400-1,600-----	a 1	Secondary --	(First-round hit)-----	25
3	3x5-ft. panel -----	1,200-1,400-----	b 2	Primary ---	Primary -----	25
4	10 E-type -----	500-800 -----	c 50	Infinity e --	Primary -----	25
5	10 E-type -----	1,000-1,200-----	d 50	Cal. 50 ---	Primary -----	25

a—TP-T.

b—HE or HEP.

c—Coaxial machinegun, 4-1, MLB.

d—Caliber .50 machinegun, 4-1, MLB.

e—Primary sight is used on tanks not equipped with separate coaxial machinegun sight.

UNIT _____ NAME _____

DATE _____ GRADE _____ SN _____

SCORE CARD: TABLE IX--SERVICE FAMILIARIZATION FIRING 125 POINTS POSSIBLE

EXERCISE	POSSIBLE	COMPLETED IN TIME LIMIT	1ST RD HIT OR TGT EFFECT	2D RD HIT	CORRECT TECHNIQUE	SCORE
1				X	X	
2				X	X	
3			X		X	
4				X		
5				X		
TOTAL SCORE						

- Notes.
1. Ten points for completing in following time limits:
 Exercises 1 and 2: 10 seconds from initial command FIRE.
 Exercise 3: 20 seconds from initial command FIRE.
 Five points for completing in following time limits:
 Exercise 4: 1 minute from initial command FIRE.
 Exercise 5: 2 minutes from target identification.
 2. Fifteen points for first-round hit in exercises 1 and 2 and for effective target coverage in exercises 4 and 5.
 3. Fifteen points for second-round hit in exercise 3.
 4. Five points for correct technique of adjustment in exercises 4 and 5.

 EXAMINER

 OFFICER IN CHARGE

Figure 138. Score card for table IX.

Section II. PRACTICE FIRING

225. General

a. Tank gunnery practice firing is performed by personnel who have a current classification in tank gunnery as a result of firing the qualification course. The objective of a practice course is to maintain and improve the gun-course is conducted. Ammunition available for

practice firing can be found in TA 23-100. nery proficiency that has been attained. A practice course does not requalify an individual or take the place of qualification firing. Practice firing should be conducted at least once annually and, preferably, every training quarter except the quarter when the qualification

course is conducted. Ammunition available for practice firing can be found in TA 23-100.

b. Crewmen who are eligible to participate in practice firing may do so with no additional training except that considered necessary by the unit commander.

226. Practice Firing Exercises

Practice firing consists of firing any or all

of the tables in the qualification course either as written or as modified by the unit commander. A practice course is devised on the basis of the needs of the unit and range facilities, training time, and ammunition available. Scoring and timing are for instruction and information available. Scoring and timing are for instruction and information only. At least one-third of all practice firing should be conducted at night.

PART SEVEN

OPERATION OF TANK RANGES

CHAPTER 21

ESTABLISHING TANK RANGES

Section I. INTRODUCTION

227. General

a. Range firing is the type of training that most closely approximates the ultimate in combat—the destruction of the enemy. Realistic training is achieved by the use of live ammunition on organized ranges. Tank ranges are of various types. Some are permanent, such as those at armor training centers, while others are temporary. Range sites are designed for specific purposes, types of weapons, and particular firing exercises.

b. Commanders must understand and comply with the provisions of AR 385-63, technical

manuals, and field manuals concerning weapons and ammunition, local range regulations, and unit SOP's.

228. Purpose

The purpose of this chapter is to—

a. Provide procedures and guidance for establishing and conducting tank firing ranges.

b. Supplement other publications by providing additional information and safety measures to be used in the conduct of tank firing ranges.

Section II. ESTABLISHING TANK FIRING RANGES

229. General

The area required for establishing a range for firing tank guns is dependent upon the caliber of the weapons, the types of ammunition to be fired, and the exercises to be conducted.

230. Permanent Tank Firing Ranges

A permanently established tank firing range is one that has been designated a post facility, and for which there is a surface danger area diagram designating a firing line or area and safety limits, both on a map of the area and on the ground. Permanent ranges may exist in various stages of completeness. Normally, if the range is used frequently, the firing line and safety limits will be clearly marked. However, if the ranges are used infrequently, it may be

necessary for the using unit to establish the firing line and safety limits on the ground. Each range is designed for specific purposes, types of weapons and ammunition, and particular firing exercises; it cannot be used for other types of firing unless approved by competent authority. Requests to use such facilities must include the information required by post range regulations. Commanders or instructors in charge of firing must be familiar with the established surface danger area diagram for the range.

231. Temporary Tank Firing Ranges

A temporary tank firing range is one that has been approved for a particular tank firing exercise and, because of limited use or inter-

ference with other ranges, has not been established as a permanent range. These ranges are designed for specific purposes or specific types of weapons and ammunition. Normally a temporary range is established for firepower demonstrations, live fire exercises and combat ranges. Requests to establish and use a temporary tank firing range (unlike permanent ranges) normally must be accompanied by a surface danger area diagram to inform range personnel of the specific requirements and area desired. When the request has been approved, it is normally the using unit's responsibility to establish the firing line or area and safety limits on the ground. The procedure for conducting these type ranges is the same as for permanent range facilities, subject to any additional restrictions or requirements imposed by the approving authority.

232. Surface Danger Area Diagram

Requests for firing in any area for which there is no established range (or when the firing exercise to be conducted will not conform to the limitations of an established range) will be accompanied by a surface danger area diagram (fig. 139). This diagram is made in overlay form in accordance with AR 385-63, and illustrates the firing line or area and safety limits for firing a particular type weapon and ammunition for specific exercises in a given area. It should include the following information:

- a. Date and time of firing.
- b. Type of weapons and ammunition.
- c. Moving or stationary vehicles.
- d. Moving or stationary targets.
- e. Coordinates of firing points or lines.
- f. Azimuth of right and left firing limits.
- g. Location of safety markers (coordinates).
- h. Minimum range at which weapons will be fired.
- i. Maximum range at which weapons will be fired.
- j. Range of weapon at maximum prescribed elevation (considering the ammunition to be fired with the greatest range).

Note. The maximum prescribed elevation is normally 15° for direct fire. See AR 385-63 for exceptions and for indirect-fire limits.

- k. Date of preparation.
- l. Preparing agency.
- m. Maps, to be included with overlay.
- n. Miscellaneous information as required by local regulations.

233. Establishing a Temporary Range

a. Range control must approve the surface danger area diagram submitted by the officer in charge (OIC), before firing is conducted on a temporary range. In establishing a temporary range, the OIC must consider the following factors:

- (1) The firing line, or all main gun firing positions if the tank moves between target engagements, are surveyed to an accuracy of 1/1000.
- (2) Safety limit markers designate the firing limits of each range or firing position, and are placed on the azi-

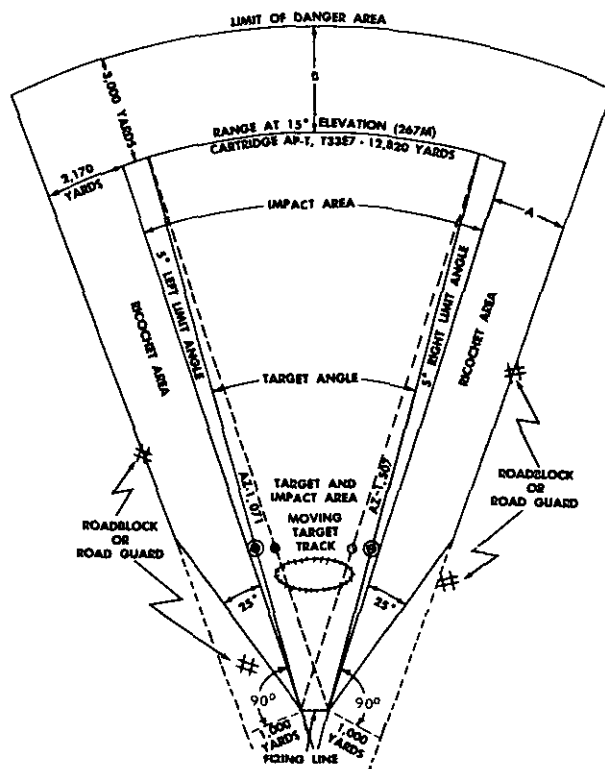

Figure 139. Surface danger area diagram.

OVERLAY: Tank Range No. 5.

MAPS: KENTUCKY, 1:25,000, FORT KNOX, PITTS POINT, COLESBURG, and VINE GROVE.

ORGANIZATION TO FIRE: 1/31 Armor.

DATE AND TIME OF FIRING: 0730 to 1630 hours, 2 June 1960.

TYPE OF WEAPON AND AMMUNITION: Caliber .30 and caliber .50 MG—ball and tracer; 90-mm gun—AP-T and HE-T.

Stationary tanks firing at field targets, stationary panels, and moving targets.

FIRING POINT COORDINATES:

Left end—596101. Right end—597191.

FIRING LIMITS:

Grid azimuth for left firing limit—1,071 mils.

Grid azimuth for right firing limit—1,507 mils.

Inner safety marker (common impact area).

Outer safety marker.

MINIMUM RANGE: 100 yards for MG, and 500 yards for tank gun.

MAXIMUM RANGE OF WEAPON: Range of weapon firing cartridge, AP-T, T33E7, at 15 degrees (267m)—12,800 yards.

MISCELLANEOUS:

Officer in charge of firing is responsible for raising and lowering range flag and manning roadblock as indicated.

PREPARED: 18 Aug, 1963, S3, 1/31 Armor

Signature _____

B.L. Smith

B. L. SMITH
Major, Armor
S3

Figure 139—Continued.

muth (line) limiting the target angle (fig. 139).

- (3) If survey equipment is not available, the firing line, (firing positions) and safety limit markers are marked as accurately as possible, using the largest scale map available and an aiming circle.
- (4) On ranges with a wide firing line, inner safety markers are used to keep the firing within the impact area. If two inner safety markers are used, tanks right of center on the firing line use the left inner marker and the right outer marker as their safety limits. Tanks left of center use the right inner marker and the left outer marker (fig. 139).
 - (a) To avoid confusion, inner and outer markers are painted a different color. Red and white poles are normally used for outer markers and black and yellow poles for inner markers. Safety markers are painted a design similar to that of barber poles and are of sufficient size to be visible to the naked eye from the firing line. (Solid color safety markers may also be used.)

- (b) When possible, safety markers are placed at the zeroing range for the tank so that they may be used for boresighting, and for adjustment of target image coincidence (TIC) or adjustment of internal correction system (ICS). Safety markers also are placed on the last terrain feature visible from the firing line.
- (c) To designate the limits of fire on combat ranges over rolling terrain, painted poles about 5 feet high can be used. These poles are placed approximately every 200 meters along the left and right limits of fire, from the start to the end of the maneuver area. These poles are in addition to the safety markers mentioned above.

- (5) When a range is first established, an airspace request must be forwarded through channels, to prevent aircraft from flying over the range. This normally is accomplished by post range personnel.
- (6) Targets must be positioned in the impact area in a manner so as to preclude tanks firing above the maximum allowable elevation when engaging the targets during all exercises.
- (7) Live fire exercises conducted on temporary ranges require the officer in charge, safety officer, and tank instructor examiners to exercise extreme care that weapons are pointed into the impact area at all times, and that all rounds land initially in the impact area.
 - (a) Mechanical stops can be used to restrict the movement of the cupola-mounted caliber .50 machinegun for elevation and deflection.
 - (b) Chalk marks placed on the tank turret will assist control personnel in restricting the movement of the turret in deflection.

b. Field firing exercises or live fire exercises must be strictly controlled by the OIC. The OIC must insure that all personnel are instructed on the problems involved in live fire exercises.

CHAPTER 22

CONDUCT OF RANGE FIRING

Section I. PREPARATION AND DUTIES OF THE OFFICER IN CHARGE

234. Preparation

An officer in charge (OIC) is designated for each firing range. When given the mission of conducting range firing, the officer in charge analyzes his mission and begins planning to conduct the firing exercise. The range firing mission may be simply stated by the commander to the OIC, or the commander may include detailed guidance. In either instance, the OIC must determine the answer to the questions who, what, when, where, and how.

a. Who Will Fire? The personnel to fire may be limited to the OIC's company, or it may be necessary for the OIC to conduct the firing exercises for personnel from other units in the battalion or squadron. Occasionally, armor units are required to sponsor and conduct firing for many units of battalion size.

b. What Type of Firing Will Be Conducted? Armor units conduct qualification, familiarization, and practice firing. The OIC determines the exercises, and types of weapons to be fired.

c. When Will the Firing Occur? Normally ranges are tightly scheduled and units are notified well in advance of the dates for range firing. The unit's training schedule and post range firing bulletin will indicate the dates for range firing.

d. Where Will the Firing Be Conducted? The specific range or ranges will be designated to the OIC. Firing is normally conducted from permanent ranges (para. 230). However, if a temporary range is to be established, the procedure outlined in paragraph 231 is followed. In addition to listing the dates for firing, the post range firing bulletin will specify the ranges to be used by the OIC, and the weapons and ammunition that may be fired on the assigned range.

e. How Will the Firing Be Conducted? The firing is conducted in accordance with a lesson plan prepared by the OIC. The OIC has many references available to assist him in preparing the lesson plan. The basic guidance for the preparation of a lesson plan is found in FM 21-6. The procedures for range safety and range firing are listed in AR 385-63, and this manual. For further assistance, the OIC refers to the post range regulations, unit SOP, and training directives. Finally the OIC refers to the technical manuals and field manuals pertaining to the weapons and ammunition to be fired.

235. Planning Requirements

After the OIC has determined who, what, when, and where, he prepares a tentative plan for the conduct of range firing. He considers the following requirements in his tentative planning:

a. Ammunition. The ammunition required for tank gunnery firing exercises is stated in paragraph 184. The OIC coordinates with the unit S3, to determine the availability of training ammunition as authorized by TA 23-100.

b. Tanks. The number of tanks required depends on the size of the firing line, and the number of personnel to fire. Each crew if possible, fires from their assigned tank.

c. Targets. Targets are described in detail for each exercise in paragraphs 254-256. Depending on local policy, the OIC may be able to obtain the targets from a central range supply facility. If not available, the targets must be constructed by unit personnel. Salvaged vehicles or equipment add realism to range firing and should be used if available. The OIC should designate a NCO to obtain the targets and supervise placing them in the impact area.

Finally, if a moving target is required, the OIC determines who is responsible for its operation.

d. Supplies. Special supplies and equipment should be requisitioned well in advance of the firing date. The unit supply NCO normally assists the OIC in requisitioning and maintaining the various items of range supplies. Special items to be considered by the OIC include stop watches, public address sets, battery commander scopes for scoring targets, and cleaning materials.

e. Transportation. Transportation requirements are coordinated with the unit S4. Personnel can move to the ranges on their tanks, trucks, or a combination of both. Detailed plans should be made for transporting ammunition to the range, and removing brass, wooden boxes, and trash from the range. The OIC works with the unit S4 or support platoon leader to insure that ammunition arrives on the range at the scheduled time. If necessary, the OIC organizes a detail to load and unload the ammunition vehicles of the support platoon.

f. Medical Support. A trained aidman must be present on all live firing ranges. In addition, a vehicle capable of transporting a litter patient must be present on the range. Normally, a frontline ambulance is used; however, other types of vehicles such as the $\frac{3}{4}$ -ton truck, or armored personnel carrier may be used. If the aidman or litter vehicle leaves the range, firing is halted until a replacement is obtained. Helicopter evacuation is available on many posts in the event a serious injury occurs. The procedure for requesting helicopter evacuation will be stated in the post range regulations. Medical support is arranged through the unit S4 or battalion/squadron medical section.

g. Assistants. The OIC will require several assistants to help him organize and conduct the range firing. The assistants must know their jobs and understand exactly what the OIC expects them to do. The assistants and their duties are listed below.

- (1) *Safety officer.* The safety officer, normally a platoon leader from the OIC's company, is responsible to assist the OIC in carrying out his safety

responsibilities. The duties of the safety officer are outlined in paragraph 245.

- (2) *Noncommissioned officer in charge.* The noncommissioned officer in charge (NCOIC) supervises the various details connected with range firing. The NCOIC may be the unit first sergeant or a platoon sergeant. Some of the duties normally assigned to the NCOIC are as follows: He insures that targets, supplies, and ammunition are obtained and properly placed on the range. Personnel are normally moved between the firing line and concurrent training under the supervision of the NCOIC. The NCOIC insures that maintenance personnel are readily available at all times, and he supervises the movement of spare tanks to the firing line on order of the OIC. After weapons have been cleared by the safety officer disabled tanks are moved off the firing line, under the supervision of the NCOIC. Personnel arriving after firing has begun, because of guard duty or fatigue duty report to the NCOIC. The NCOIC assigns them to firing tanks as directed by the OIC. Additionally, the NCOIC will insure that personnel required to leave before the end of firing for guard duty, etc., are released in sufficient time to report for the required formation.
- (3) *Ammunition NCO.* To insure that ammunition is obtained and properly placed on the range, the OIC designates an NCO to work with the ammunition. This NCO works closely with the members of the support platoon to insure that the correct type and amount of ammunition is placed on each range. A diagram should be given to the ammunition NCO by the OIC, illustrating the placement of ammunition on the range (figs. 140 and 141). The ammunition NCO insures that each tank to fire receives one lot number of main gun ammunition and that empty wooden boxes are properly

stamped and turned-in, in accordance with post supply procedures.

- (4) *Target NCO.* The OIC designates one noncommissioned officer to supervise the placement of targets in the impact area. The target NCO insures that the targets are the size specified by the OIC, and that they are placed at the correct range from the firing line. The OIC normally prepares a diagram showing the location of targets in the impact area to assist the target NCO in correctly placing the targets. The target NCO insures that the moving target is operable, if required, and that a trained operator is available. Before entering the impact area, the target NCO checks with range control to obtain permission. Upon leaving the impact area, he notifies range control.
- (5) *Tank instructors.* Tank instructors (examiners) are selected to control the firing on each tank and concurrent training. Tank instructors must be thoroughly trained in the procedure for firing each exercise and safety procedures. The tank instructors require extensive training to insure uniformity in the conduct of the firing. Their duties are outlined in paragraphs 246, 247.
- (6) *Scorers.* To insure uniform scoring of all targets, the OIC may form a scoring detail. This detail is responsible for scoring all firing as instructed by the OIC. When the firing is conducted for many company or battalion size units it may be necessary to appoint an officer as chief scorer. This officer supervises the scoring detail and certifies the posted scores.
- (7) *Mess personnel.* Based on the training schedule, the officer in charge arranges with the mess personnel to insure the troops are fed. The OIC may obtain and erect tents as temporary mess halls on the firing ranges.

236. Reconnaissance of the Range

- a. Based on his analysis of the mission, the

OIC prepares a tentative plan for the conduct of firing. Before the plan is finalized, however, he inspects the range to insure that the range facilities will support the firing. The following items are checked by the OIC during his reconnaissance.

- (1) The route and condition of roads and bridges between the motor park and the range are determined. Each post normally has designated a prescribed tank route that must be followed.
- (2) The OIC uses the surface danger area diagram to insure that the firing line is marked and that the safety markers or "barber poles" are positioned properly. On stationary tank ranges the firing line may consist of a concrete pad or an area covered with crushed gravel. Normally both ends of the firing line are marked with poles driven into the ground. On moving tank ranges the firing points are normally marked by painted poles placed in the ground alongside the firing lane or road. The limits of the impact area are defined by the safety markers or barber poles. If the safety markers are missing, range control must be notified. The OIC determines the number of tanks to be placed on the firing line. Sufficient space is left between tanks to prevent obscuration caused from firing to disturb the tanks on either side of the firing tank. Dust on the firing line can be reduced by soaking the area with water, oil, or calcium chloride. Additionally, adequate space between tanks will permit ammunition to be stacked as illustrated in figure 140. The control tower is checked by the OIC, or if a tower is not available the OIC may use an armored personnel carrier as a control point.
- (3) The communication facilities on the range are checked. The OIC insures that he can communicate with range control, either by telephone or radio, as stated in the range regulations, and personnel in the impact area, such as target operators, demolition men, or

scorers. If wire is layed into the impact area, the OIC insures that it is placed as far away from targets as possible, to avoid having it "shot out" during the range firing.

- (4) The OIC checks the pole from which the red streamer will be displayed to insure that a streamer can be flown.
- (5) A misfire bunker will be located near the firing line. The OIC checks the condition of the misfire bunker and notifies range control if it is in need of repair.
- (6) The OIC selects an area away from the noise of the firing line for concurrent training, and a mess area.
- (7) The OIC checks the target area and prepares a diagram showing the placement of targets in the impact area to be given to the target NCO.
- (8) The OIC or safety officer inspects each range barrier shown on the surface danger area diagram to insure that it is in serviceable condition, and can be placed across the road before firing. If a range guard is required, the OIC prepares a written list of instructions to be given to the range guard. It may be necessary for the range guards to be in contact with range control by either radio or telephone. If this is required the OIC provides the necessary communications equipment. During inclement weather a shelter tent is used by the range guard, if he is to remain in position for a considerable time. Additionally, the OIC arranges with the mess personnel to feed the range guards.

b. Upon his return from the range reconnaissance, the OIC notifies the unit S3 or range control of the deficiencies he noted on the range. The OIC insures that the deficiencies have been corrected before the scheduled date of firing.

237. Preparation of Lesson Plan

a. After completing his reconnaissance of the range the OIC finalizes his plan for the conduct of firing. He prepares a lesson plan

outlining in detail the procedure for operating the range. The lesson plan follows the format outlined in FM 21-6 and includes the following:

- (1) Objectives and standards of the range firing.
- (2) The exercises to be fired and the detailed procedure to be followed.
- (3) Plan for movement to and from the range.
- (4) Schedule for firing and concurrent training.
- (5) References.
- (6) List of necessary equipment and personnel.
- (7) Annexes that may be prepared for the following personnel:
 - (a) Tank instructor guide.
 - (b) Safety procedure or SOP.
 - (c) Diagram of placement of targets in impact area.
 - (d) Guide for concurrent training (if applicable).
 - (e) Diagram of organization of firing line, showing placement of ammo, tanks, etc.

b. The OIC gives a copy of the complete lesson plan to the safety officer and NCOIC. Other assistants receive copies of the annexes pertaining to their duties. A copy of the lesson plan is normally available on the range to brief inspectors, or visiting personnel. The lesson plan is used by the OIC to brief the firing personnel. Additionally, the lesson plan provides an excellent checklist that the OIC can use to insure that all supplies have been loaded and brought to the range.

238. Preparation of Range Facilities

a. After the OIC has inspected the range, completed his plans, and prepared his lesson plan, he insures that all deficiencies have been corrected. Before firing, the OIC checks the post range firing bulletin, to insure that he has authorization to fire the type of weapons and ammunition required by his firing exercise.

b. Before firing, the OIC conducts any necessary training for his assistants. Coordination is normally continuous with the S3 and S4, to in-

sure that ammunition and transportation is available.

c. Final planning before the day of firing is made with mess, supply, and maintenance personnel.

d. If possible the OIC has the targets placed

in the impact area the day before firing. This enables the target detail to work during daylight, and assists them in placing the targets in the proper position. Although it is often necessary for the target detail to install targets in the impact area during the hours of darkness it is not desirable.

Section II. CONDUCT OF FIRING

239. General

The duties of the OIC during range firing are presented in the following paragraphs. There is no set sequence in which the actions must occur, and they may be done simultaneously. The procedure depends on the orders of the OIC, and the type of firing being conducted.

240. Required Publications

The following publications are normally required on tank firing ranges:

a. AR 385-63.

b. Post range regulations.

c. Surface danger area diagram.

The OIC normally places the references, the lesson plan, and pertinent manuals in a briefcase to protect them from the elements.

241. Opening the Range

a. The OIC and his assistants may move to the range before the arrival of the firers, or the company may road march to the range as a unit. The NCOIC normally supervises the placement of the tanks on the firing line and concurrent training area. Any last minute details or problems are resolved by the OIC with his assistants on the range. The OIC normally conducts a briefing for his assistants upon their arrival on the range.

b. After the tanks have been positioned, and the assistants briefed by the OIC, the safety officer inspects all weapons to be fired, and the DA Form 2408-4, "Weapon Record Data," if the main gun is to be fired, (para. 245a(3)). If a basic load of ammunition is kept aboard the unit's tanks, a sufficient amount of the basic load must be off-loaded to provide room for ammunition to be fired. Care must be taken to avoid mixing the ammunition to be fired, with

the ammunition comprising the basic load. If ammunition to be fired is the same type as found in the basic load, approval should be requested to exchange with basic load. The OIC may assist the safety officer in checking the weapons. Tank crews will unbox the ammunition and perform a prepare-to-fire check on their tanks.

c. Range guards are posted in accordance with post range regulations and the surface danger area diagram.

d. All personnel to fire are given a detailed briefing by the OIC. The briefing is normally given at a vantage point from which the firer can see the firing line and the impact area. The briefing for field firing exercises tables VIIA and VIIB and VIIIA and VIIB may be given, using a sand table representation of the range. The OIC discusses the purpose, objectives, standards, and firing procedures to be followed. The OIC reviews the tank gunnery techniques applicable to the type of firing being conducted. He discusses:

- (1) Initial fire commands.
- (2) Crew duties.
- (3) Sensings.
- (4) Methods of adjusting fire.
 - (a) Burst on target.
 - (b) Alternate method.

Safety precautions are given to the firers. If the OIC desires, the safety officer may brief the firers on proper range safety procedures. The safety precautions should be stated in the lesson plan, possibly as an annex (para. 237). The OIC issues score cards to the firers at this time.

e. Before requesting permission to fire, the OIC checks the following:

- (1) That all road guards or range guards

have been posted, and the red streamer (blinking red light at night) is displayed.

- (2) That a trained aidman, with first aid kit, litter, and vehicle capable of transporting a litter patient is present on the range.
- (3) That all personnel are clear of the impact area.
- (4) That no obstructions exist between the firing line and impact area that may cause a detonation of a filled projectile (HE-T, HEP-T, HEAT-T).

f. The OIC obtains permission to fire from range control. The name of the individual at range control granting permission, and the time of the conversation, are recorded by the OIC. This will avoid difficulties later in the day if anyone questions the OIC's authority to fire.

242. Conducting the Firing Exercises

a. The OIC controls the firing, and conducts the exercises according to his lesson plan. Personnel move from the firing line to concurrent training on order of the OIC, under the supervision of the NCOIC.

b. All accidents are investigated by the OIC or safety officer and necessary reports submitted to higher headquarters. If it is necessary to evacuate an injured firer, using the litter vehicle, the OIC ceases firing until another litter vehicle is available on the range. If available, the OIC may request a helicopter to evacuate injured personnel.

c. Misfires on the main gun are removed by the OIC or safety officer after the proper misfire procedure has been followed. All personnel, except those necessary to remove the misfire dismount from the tank. The OIC or safety officer places the misfire in the misfire bunker, and records the lot number for future refer-

ence. The misfire is reported in accordance with the post range regulations. The OIC insures that the range is continuously policed during firing. Trash and empty cartridge cases are removed by the ammunition NCO as vehicles are made available.

d. If the firing cannot be completed within the time specified by the range firing bulletin, the OIC calls range control and requests permission to continue firing.

243. Closing the Range

a. Upon completion of firing the OIC insures that all weapons are clear, and that all live ammunition (except basic combat loads) has been removed from the firing tanks. Normally the safety officer clears the weapon, or he may be assisted by the OIC.

b. The OIC notifies range control that firing has been completed. The OIC notes the name of the individual at range control accepting the message, and the time of the conversation.

c. The OIC critiques the firers. The weapons are cleaned, after they have cooled, by the firers as outlined in the applicable technical manuals and lubrication orders.

d. During the firing, the ammunition NCO continuously separates the empty cartridge cases, trash, and boxes. If the range is policed during the firing the amount of time required to clear the range after firing will be shortened. The OIC insures that all trash, empty cartridge cases, etc., are removed from the range as expeditiously as possible. Prior planning with the S4 or support platoon leader will insure that the necessary vehicles are available. Ammunition is turned in as prescribed by local regulations.

e. The OIC prepares any reports required by local SOP. He insures that the number of rounds fired through the main gun are properly entered on the DA Form 2408-4.

Section III. DUTIES OF THE SAFETY OFFICER

244. General

A safety officer (SO) normally is detailed to assist the officer in charge in fulfilling his safety responsibilities. The safety officer's duty

is to prevent any normally safe condition or procedure from deteriorating into an unsafe act, whenever he sees such a possibility. The safety officer assists the OIC in planning and

conducting the firing. He may be from the same unit as the OIC.

245. Duties of the Safety Officer

Basic duties may vary, and are as stated by the OIC. To assist the OIC the safety officer may prepare the safety annex for the range firing lesson plan. During the range reconnaissance the safety officer may assist the OIC by checking the misfire bunker, control tower, pole for the red streamer, and any other items specified by the OIC. The safety officer may also conduct training in range safety for the tank instructors, and firers. During the conduct of range firing, the safety officer will not be assigned any duties that will interfere with his primary responsibility for range safety. Normally the OIC and safety officer work together checking weapons and handling misfires. The duties of the safety officer are outlined below:

a. Opening the Range.

- (1) After the tanks have been placed on the firing line, and the OIC has completed briefing his assistants the safety officer checks the weapons to be fired. The machineguns are checked by running a cleaning rod with a clean patch through the barrel. This procedure insures that the barrels are free of obstructions, and that any excess oil is removed.
- (2) The main gun is checked to insure that it is free of obstructions, and there are no visible defects in the gun tube. The bore evacuator and muzzle attachment (if present) are checked to insure that they are properly secured.
- (3) The safety officer insures that a DA Form 2408-9, "Proof Acceptance Record," is present in the equipment log book of each firing tank. He then checks the DA Form 2408-4 for the following:
 - (a) That there are sufficient rounds remaining to be fired from the main gun to enable the tank to be used throughout the firing exercise. If the number of EQUIVALENT FULL CHARGE (EFC) rounds to

be fired, exceeds the estimated remaining life of the gun tube, arrangements must be made to have Ordnance re-evaluate the remaining life of the gun tube.

- (b) That the recoil mechanism has been exercised within the past 6 months, either through firing or using a mechanical means as prescribed by TB ORD 303.
 - (4) After checking the weapons the safety officer insures that the tank instructors and firers know the safety limits and the maximum allowable elevation. He checks to insure that each firing tank has a green, red, and orange flag. The flag sets are an item of OEM, and must be available as an aid in controlling the firing.
- b. Conducting the Firing.*
- (1) The safety officer normally operates from the control tower on stationary tank ranges. From this position, he has excellent observation of the firing line and impact area. Additionally, at the control tower the safety officer has all the means of communication available to him. Hence, he can immediately correct personnel who may become careless on the firing line.
 - (2) On moving tank ranges the safety officer normally rides in the control jeep behind the firing tank. From the control vehicle the safety officer can best supervise the firing and insure that proper safety procedures are followed.
 - (3) The safety officer displays a green flag from the control tower or control vehicle, until the OIC gives permission to commence firing. At this time the safety officer then displays a red flag.
 - (4) During the conduct of the firing the safety officer insures that the following procedures are enforced:
 - (a) Ammunition is handled correctly (para. 253).
 - (b) Personnel mount and dismount from the tanks correctly.
 - (c) No smoking near the tanks or ammunition.

- (d) Misfires are handled as stated in AR 385-63.
- (e) Accidents are investigated promptly, as ordered by the OIC. Accidents are reported as directed by the OIC, or in accordance with the unit's SOP.
- (f) Weapons are pointed into the impact area at all times, and are not fired above maximum elevation.
- (g) Personnel are clear of the danger area, except as authorized in AR 385-63 (target operators, scorers, demolition personnel).
- (h) All range regulations are enforced.

c. Closing the Range.

- (1) Upon completion of firing the safety

officer checks the following:

- (a) That all weapons are clear, and all ammunition (except basic combat loads) has been removed from the firing tanks.
 - (b) That firing personnel do not have any live ammunition or ammunition components in their possession.
 - (c) That any rounds placed in the misfire bunker were reported in accordance with post range regulations.
- (2) The safety officer assists the OIC, in closing the range, and in addition to the above, he performs any other duties ordered by the OIC.

Section IV. DUTIES OF THE TANK INSTRUCTOR/EXAMINER

246. General

The tank instructor on each firing tank acts as a teacher or trainer during the practice part of the tank gunnery qualification course. For record firing the tank instructor serves as the examiner. The tank instructor conducts the firing as directed by the OIC. Normally the OIC prepares an annex to the range lesson plan, listing step by step the procedures to be followed by the tank instructor. In addition to training or examining the firers, the tank instructor insures compliance with all safety procedures.

247. Safety Procedures

a. General.

- (1) No smoking near tanks or ammunition.
- (2) No standing on top of the turret.
- (3) Personnel mount stationary tanks on a firing line from the right rear (right center on tanks with exposed mufflers).
- (4) The driver be alert when personnel are mounting the tank on moving tank ranges. Firers mount over the right front slope of the tank (opposite the coaxial machinegun).
- (5) All personnel keep clear of the path

of recoil and keep their bodies entirely inside the turret basket.

- (6) Misfires are reported promptly to the OIC.
- (7) DA Form 2408-4 is completed properly, and entries are correct for the day's firing.
- (8) All live ammunition (except basic combat loads) is removed from the tank upon completion of the firing.

b. Tank Commander's Position.

- (1) Keep fingers off the firing trigger unless firing.
- (2) Be prepared to override the gunner with power controls if he is committing an unsafe act (on tanks equipped with a tank commander's override).
- (3) Remain clear of the recoil of main gun.

c. Gunner's Position.

- (1) Keep fingers off the firing triggers until ready to fire.
- (2) Do not fire unless target is clearly identified.
- (3) Do not fire until after hearing the loader announce UP.
- (4) Select the proper firing switch.
- (5) Announce ON THE WAY and pause 1 second before firing.

- (6) In case of a misfire or stoppage, turn off the firing switch and announce MISFIRE (STOPPAGE).

d. Loader's Position.

- (1) Insure that ammunition is properly stowed and secured, and that the primer is protected at all times.
- (2) Use asbestos gloves to handle hot brass.
- (3) Do not throw empty brass out of the turret unless the area alongside the tank is clear.

- (4) Use the ramming and extracting tool to close the breech when a round is not being loaded, to remove a stuck round, and to chamber a round that has failed to chamber during loading of the weapon.

- (5) Remain clear of the recoil of the main gun.

- (6) Remain clear of empty cartridge cases as they are ejected from the breech-ring.

e. Driver's position. Insure driver's head remains clear of moving gun.

Section V. SAFETY PRECAUTIONS AND METHODS OF CONTROLLING TANK RANGE FIRING

248. General

This section lists the safety precautions that must be followed on all tank firing ranges. The safety requirements are given to the firers before the conduct of the range firing. The safety annex of the lesson plan can be prepared, using this section as a guide. The control methods presented in this section, are those used on all tank ranges.

249. Safety Precautions in Tank Range Firing

a. The commander of the unit or units that are firing is the officer in charge (OIC). He is responsible for the development of the maneuver and the firing phase to insure rigid compliance with range regulations and safety rules and practices, and for establishment of an overall safety program. The OIC procures from the range control officer the authorized and assigned position areas or firing lines, impact areas, and surface danger area. Additionally the OIC is responsible for ascertaining the competence and for final acceptance of safety officers. During Army training tests, the chief umpire is the OIC; at all other times the OIC is as previously described.

b. The safety officer is the direct representative of the officer in charge of firing and will not be assigned other duties while acting in this capacity. He must be competent and properly instructed in the performance of his duties. He is responsible for the final determination that, before firing, settings placed on

the weapons and ammunition represent data within prescribed safety limits.

c. The range must be scheduled for the type weapon and ammunition to be fired. This scheduling appears in the post range firing bulletin.

d. Range guards and barriers will be posted as directed by local regulations.

e. A red streamer or blinking red light at night, will be displayed during firing exercises.

f. No firing of nonstabilized tank main armament during movement of the tank.

g. Firing over the heads of personnel from moving vehicles is prohibited.

h. Weapons will not be loaded (or half-loaded) until a command to do so has been given.

i. Before machinegun firing, all bolts will be opened and a cleaning rod with a dry patch run through, and removed from the muzzle end of each machinegun barrel.

j. All trees or other obstructions in the line of fire that might cause an explosion of an HE, HEAT, or HEP round at close range, must be removed.

k. Care must be taken when firing the caliber .50 machinegun to preclude hitting the main gun.

l. In emergencies, anyone may give the command CEASE FIRE. Firing will cease immediately, regardless of the source of the command.

m. When CEASE FIRE is ordered, breech-blocks will be opened, and machineguns unloaded and the bolt held to the rear by locking or with T-blocks.

Caution: If a round has been in a hot weapon, and a cease fire is given, the tank instructor will not allow the round to be removed. Instead, he notifies the OIC and requests permission to fire the round. If firing of the weapon is inadvisable, it is kept pointed at the target area. If the main gun is involved, the crew evacuates the tank until the weapon is cool.

n. After machineguns are fired and before they are removed from the tank or dismounted, each gun will be inspected to insure that it is not loaded.

o. Tank weapons must always be elevated after firing, so that any accidental discharge of the guns resulting from a failure to clear the guns will go above personnel moving about in front of the tank. This procedure, however, does not eliminate the necessity for clearing the guns.

250. Communication and Control in Tank Range Firing

a. The post range officer normally controls all ranges by the use of wire or radio communication. The control system is for the purpose of obtaining clearance to fire, making reports, coordinating with other ranges, and ceasing fire. The range communication system allows for immediate shutdown of all ranges in the event of an emergency.

b. The OIC controls firing by the use of signal flags, radio, telephone, pyrotechnics, public address sets, flashlights, and hand and arm signals. Signal flags are displayed at the control point and on firing tanks during range firing. At night a series of predetermined flashlight signals can be used by the OIC or

safety officer in the control tower, and the tank instructors on the firing tanks.

c. Wire is preferred for communication with target operators, and demolition personnel in the impact area. Wire can also be used to control searchlight tanks, when illuminating from a stationary position. In all cases, the OIC plans for at least two means of communication with personnel in the impact area, to avoid a halt in the firing if one method of communication fails.

d. Within the tank, control is exercised by use of the tank interphone system.

e. The flag displayed at the control point indicates whether firing may be conducted. A red flag means firing may be conducted; a green flag means firing may not be conducted.

f. The flags displayed on a firing tank indicate the following:

- (1) *Red.* Tank is engaged in firing. The weapons must be pointed at the target area.
- (2) *Green.* All tank weapons are clear and elevated. Any live ammunition in the tank is properly stowed.
Note. Normally ammunition is loaded aboard the tank when the green flag is displayed; however, this will be at the discretion of the officer in charge.
- (3) *Orange.* Tank has a malfunction. This flag is used only in conjunction with either the red or green flag.
- (4) *Red and green.* Tank is preparing to fire. All weapons are clear, but not elevated; the crew is performing a nonfiring exercise.
- (5) *Red and orange.* Tank has a malfunction or misfire, but the weapons are not clear and they are pointed at the target area.
- (6) *Green and orange.* Tank has a malfunction. All weapons are clear.

Section VI. HANDLING OF MAIN GUN AMMUNITION

251. General

This section describes the handling of ammunition on tank ranges. Ammunition must be properly handled to prevent damage to the ammunition and injury to personnel. Detailed

information on ammunition is contained in TM 9-1903.

252. Arrangement of Ammunition and Containers on Tank Firing Ranges

a. Ammunition boxes and expended

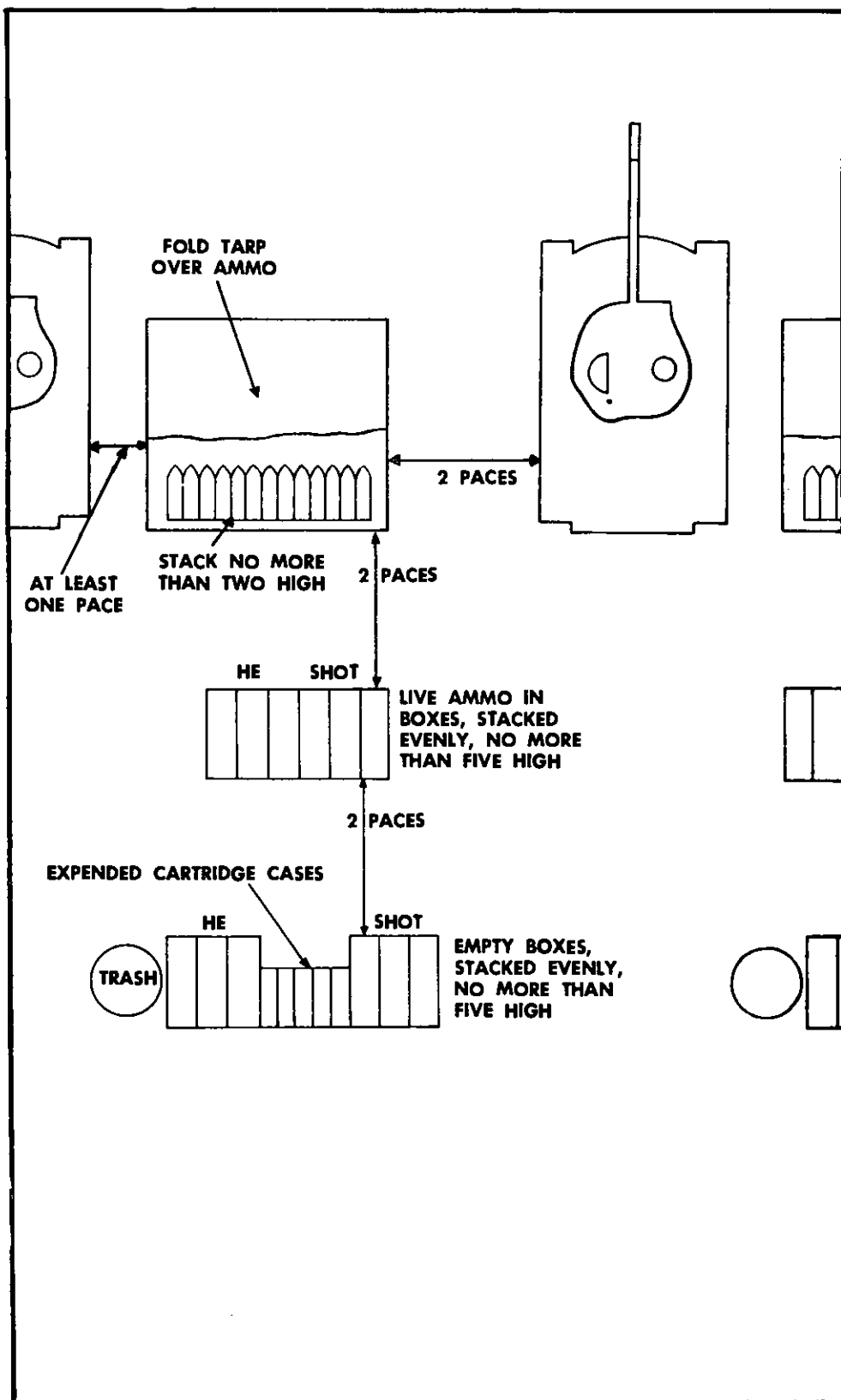
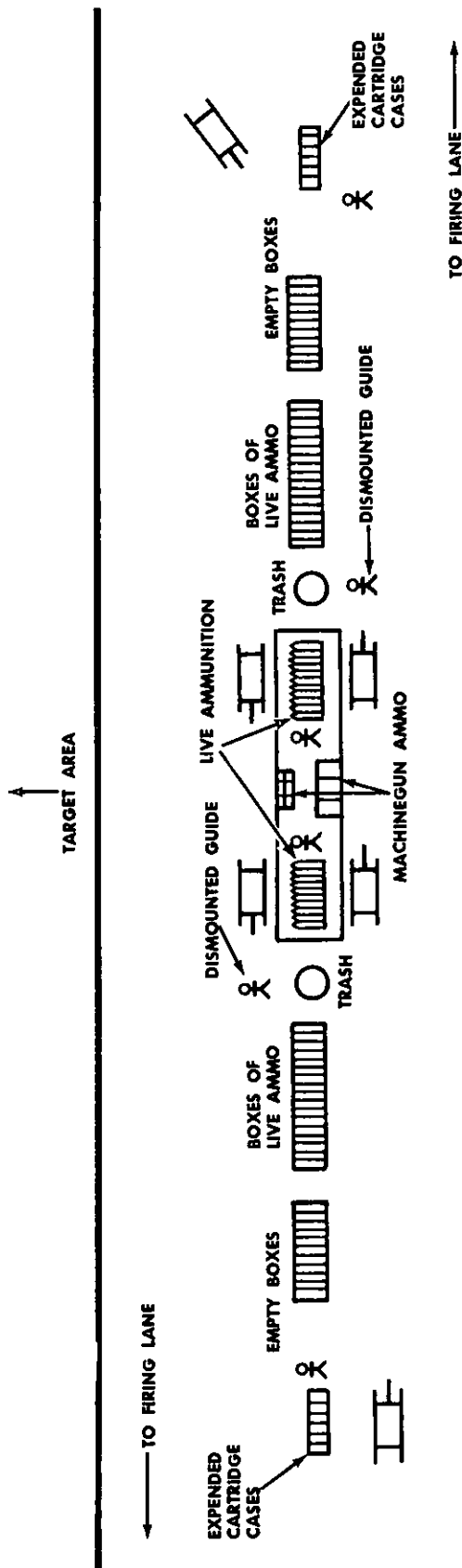

Figure 140. Arrangement of ammunition and containers for stationary firing.



- Notes.
- 1 Stack all main gun ammunition boxes evenly, no more than five high.
 - 2 Stack live ammunition on ramp no more than two high.
 - 3 Stress safety around the loading ramp. Use dismantled guides to bring tanks up to the loading ramp.
 - 4 After completing a firing run, have the expended cartridge cases for the main gun removed from the tank and placed in the designated area.
 - 5 Do not load the tank with ammunition after each firing run if a sufficient amount is loaded to complete more than one firing run.

Figure 141. Arrangement of ammunition and containers on moving tank ranges.

cartridge cases for stationary tank firing are stacked as shown in figure 140 and for moving tank ranges as shown in figure 141.

b. Ammunition is laid on a tarp, with the projectile pointing down range, and stacked no more than two layers high. On stationary tank ranges, the front edge (toward the muzzle) of the tarpaulin is kept free, so that it can be folded back over the ammunition, and the gun's muzzle blast will not uncover the ammunition.

253. Unpacking and Handling Ammunition

a. The proper method of unpacking and handling 90-mm and 76-mm ammunition is to remove the fiber containers from the wooden boxes, place cap end of container on the ground, and remove the tape. Pull up on the

large part of the container and remove it from the round, holding the round steady with the other hand. Place one hand around the projectile, pick up the round (primer end up), flip off the cap, and place the right hand over the primer. Then carry the round in this manner to the tarpaulin or the tank.

b. The proper method of unpacking and handling 105-mm ammunition packed in metal containers is to first remove the safety clip. Then turn the cap $\frac{1}{4}$ -turn counterclockwise and remove. Use the same unpacking method as stated for 90-mm and 76-mm ammunition for 105-mm ammunition packed in fiber containers and wooden boxes. The cartridge can now be removed from the container. Once the round of ammunition has been removed, handle it with the primer up and cover it in the same manner as 90-mm ammunition.

Section VII. TARGETS

254. General

There are two general categories of targets for tank gunnery ranges, those for subcaliber firing and those for service firing. Both types are discussed in this section.

255. Subcaliber Firing Targets

(fig. 142)

256. Service Firing Targets

(fig. 143)

For qualification firing, the size of the targets must conform to the dimensions outlined in each table. To add realism during service firing, tank hulls or other salvaged vehicles should be used as targets. Target panels may be constructed to look like some type of combat vehicle, or vehicle silhouettes may be painted on panel targets, but the scoring of hits on such targets must be limited to an area of a size specified in the qualification tables. When panel targets without marking are used in training, they should be designated as a specific type of combat target by the instructor or examiner, when appropriate, so that the tank commander will be required to make a decision as to the type of ammunition to use. In addition to cloth, panel targets may

be constructed of metal, plywood, or some similar type of material. Any of these items increase the permanency of the target and hits can be determined more accurately. Olive drab cloth instead of white cloth may be used to increase the difficulty of locating targets. When targets are placed close to each other, a number, letter, or color code (or combination of these) may be painted on the targets to facilitate target location and identification.

257. Scoring

Whenever possible, targets are physically scored in tank gunnery range firing. Marking the holes in each target will avoid confusion in scoring targets. Machinegun holes in silhouette targets can be covered with pasters, or simply marked with colored chalk or pencil. Main gun hits can be scored by marking each hole with paint, or recording on a diagram each target hit. Main gun hits may also be pasted over or patched.

258. Target Layout Subcaliber Firing

Subcaliber exercises are fired at a distance of 60 meters. A single range site can be established to facilitate the firing of all subcaliber tables at one location. A target layout for subcaliber firing is shown in figure 144.

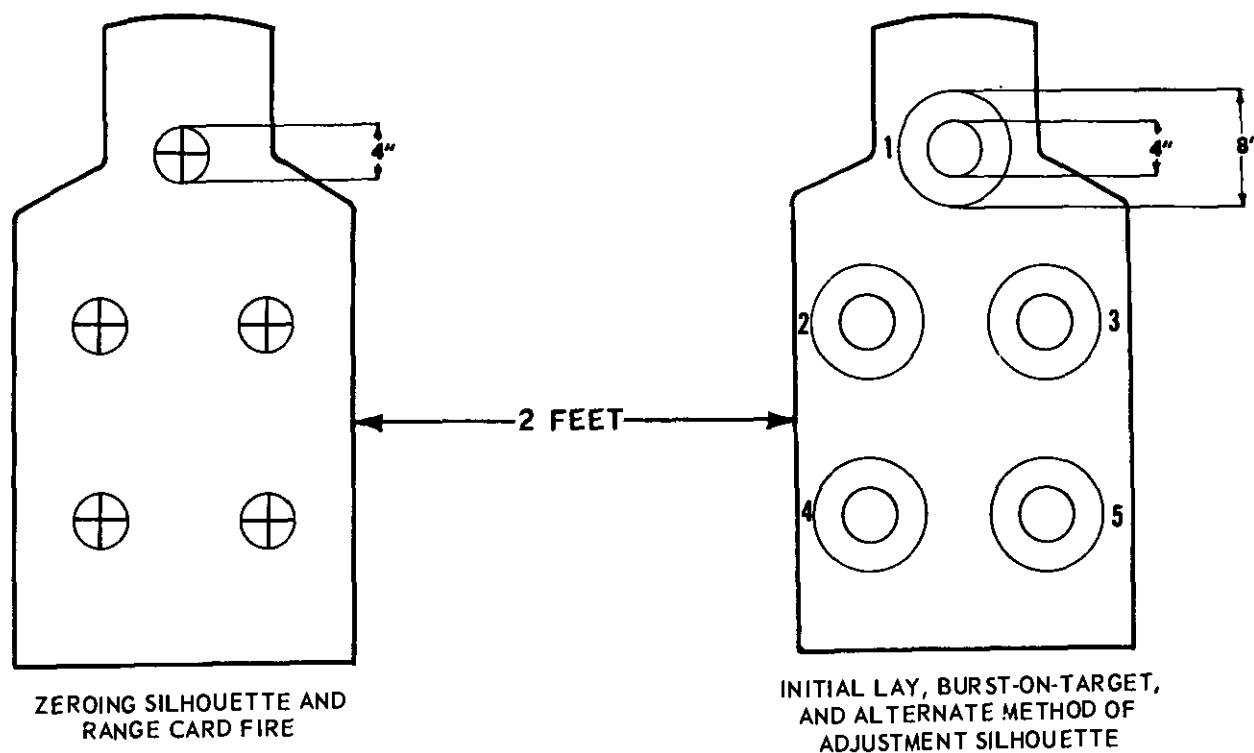

STATIONARY TARGETS

Figure 142. Targets for subcaliber firing.

259. Target Layout Service Firing

Service exercises are fired at distances up to 3,500 meters. To meet the requirements of tank gunnery training, service ranges must be of various types.

- a. Stationary target range (fig. 145).
- b. Moving target range (fig. 146).
- c. Crew field firing range (fig. 147).
- d. Crew proficiency range (fig. 148).

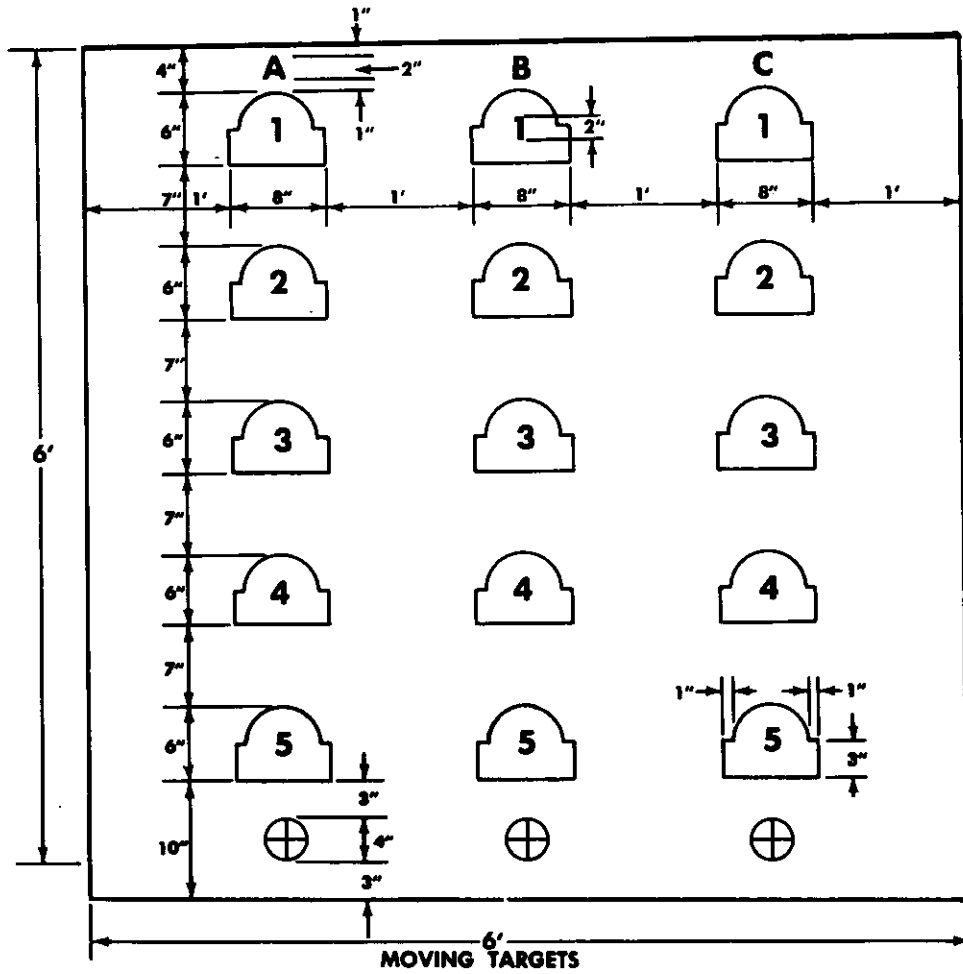
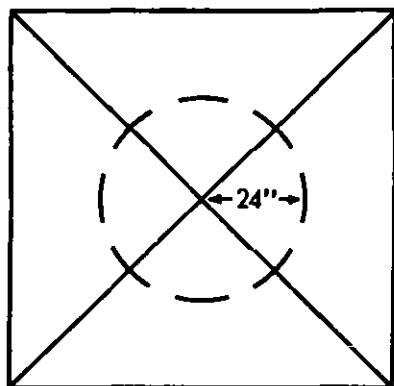
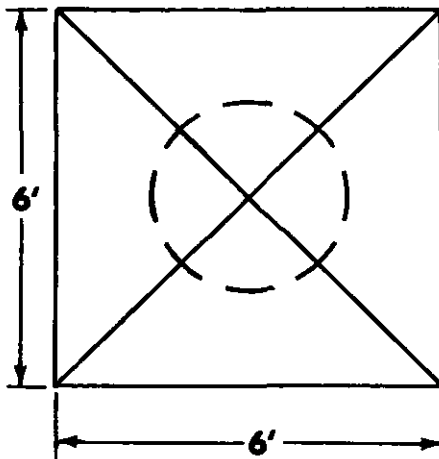

Figure 142—Continued.



BORESIGHTING AND ZEROING TARGET FOR THE MAIN GUN (USE 12 FEET X 12 FEET TARGET WHEN POSSIBLE) 48 INCH CIRCLE FOR ZEROING.



BORESIGHTING AND ZEROING TARGET FOR THE CUPOLA-MOUNTED MACHINEGUN.

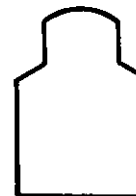

E-TYPE

ZEROING TARGET FOR THE COAX MACHINEGUN.

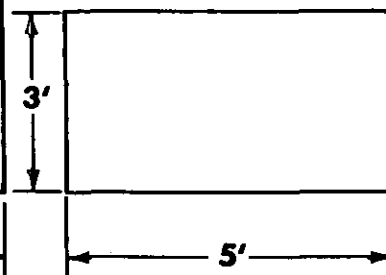
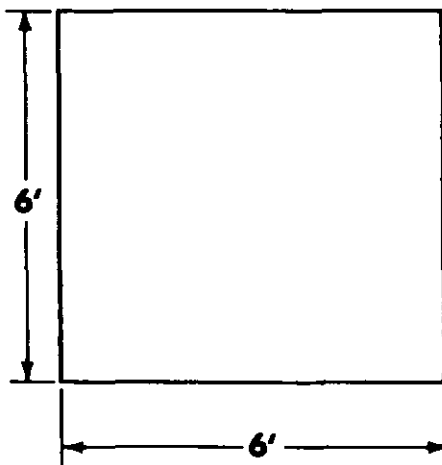

MAIN GUN TARGETS (CAN BE USED ALSO AS MACHINEGUN TARGETS)

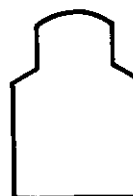

E-TYPE



F-TYPE

MACHINEGUN TARGETS

Figure 143. Targets for service firing.

TARGET LAYOUT FOR SUBCALIBER EXERCISES, TANK GUNNERY QUALIFICATION COURSE

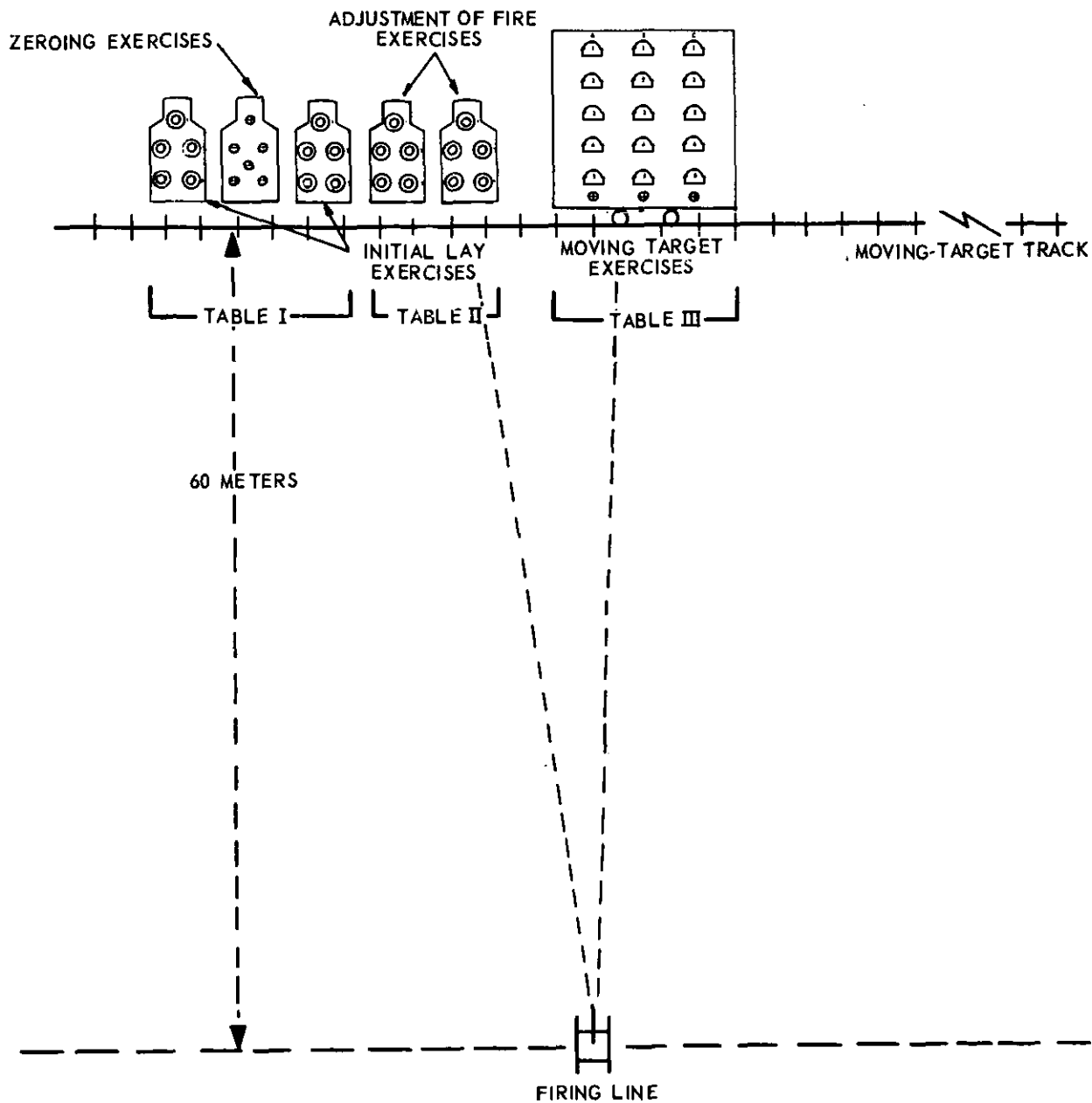

Figure 144. Subcaliber range layout.

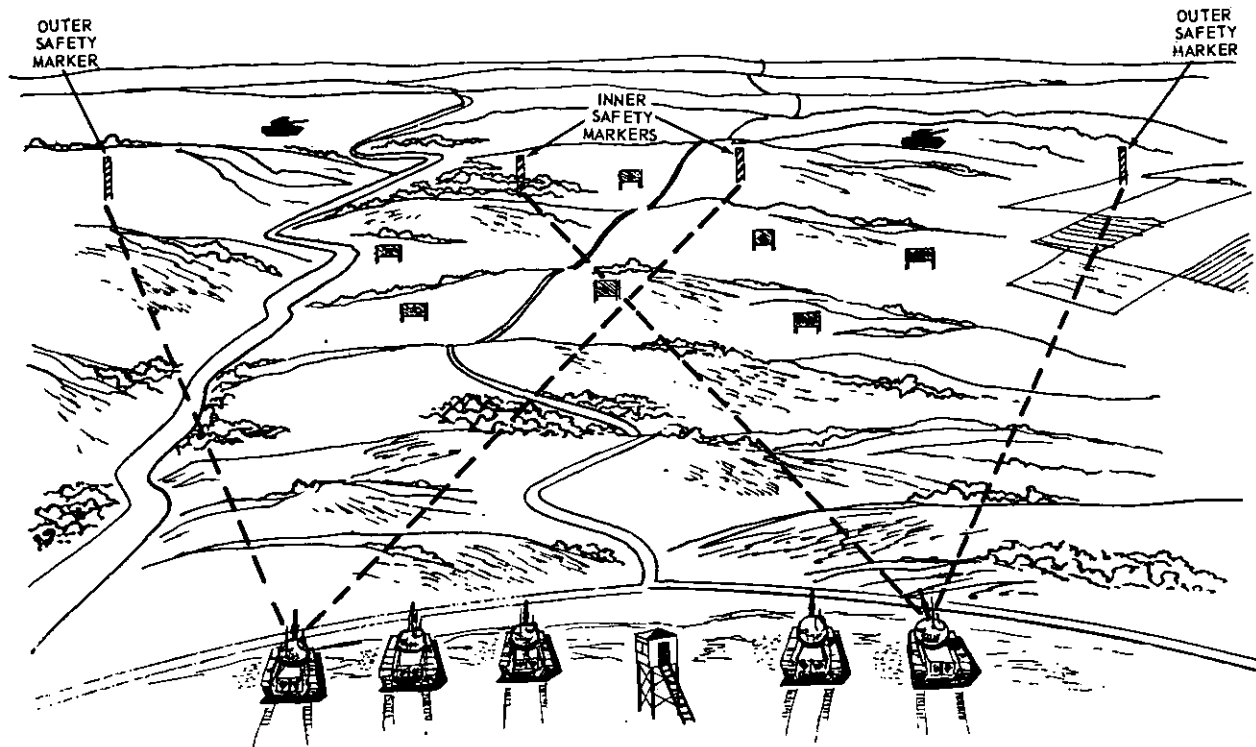
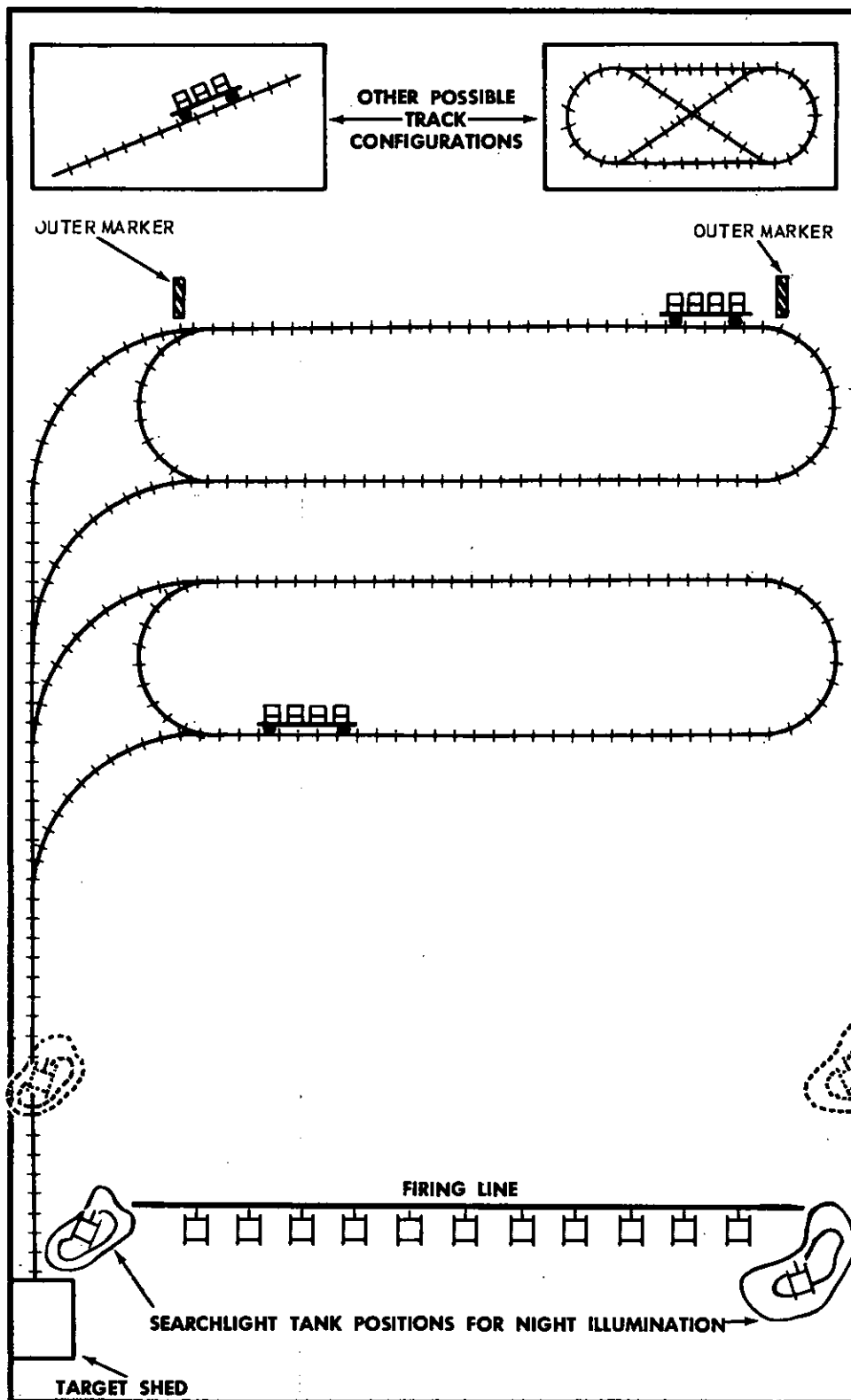

Figure 145. Stationary target range layout.



SAFETY PERMITTING, SEARCHLIGHT TANKS MAY BE PLACED TO THE SIDES AND DOWN RANGE TO PROVIDE EFFECTIVE ILLUMINATION.

Figure 146. Moving target range layout.

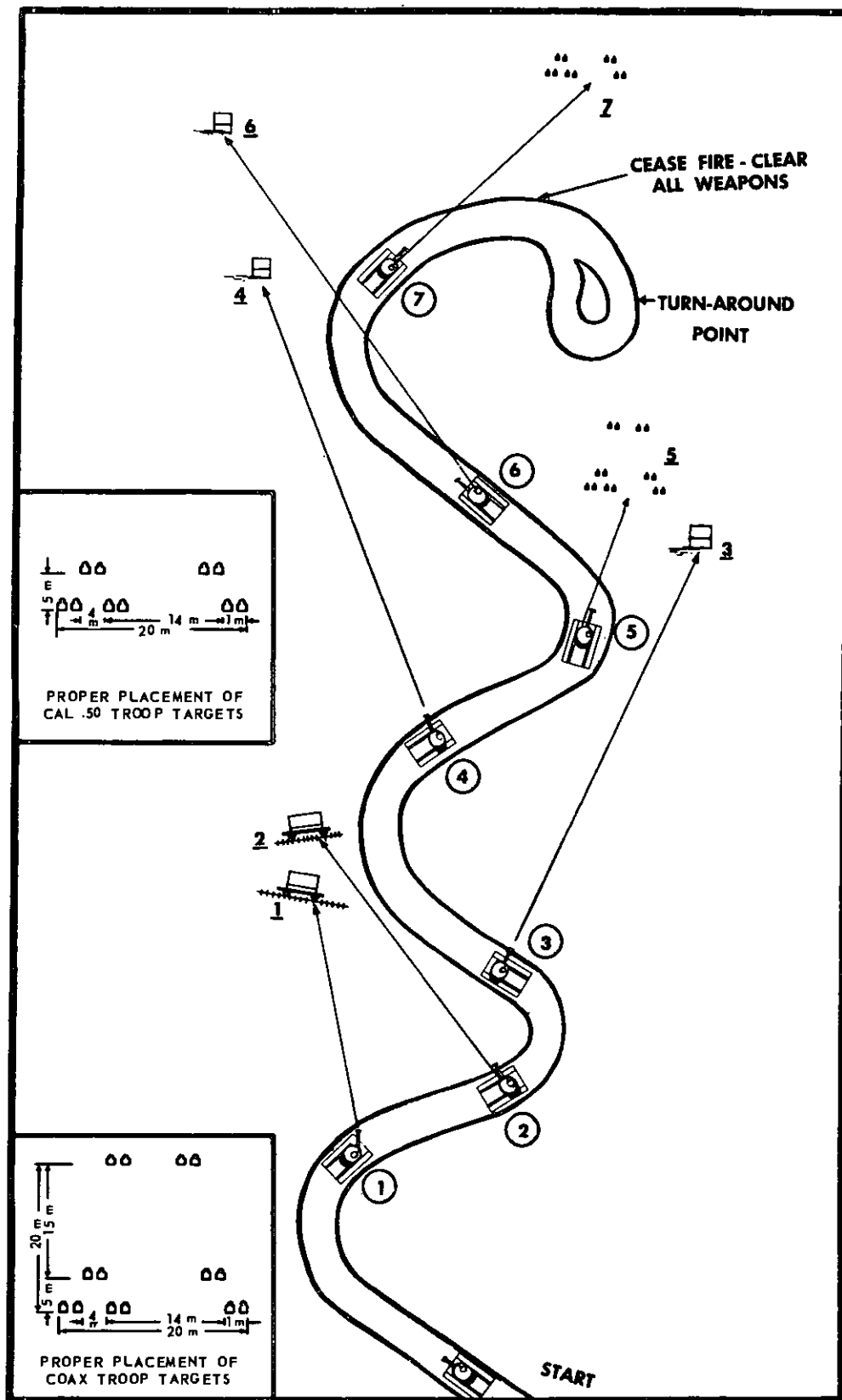

Figure 147. Crew field firing range layout.

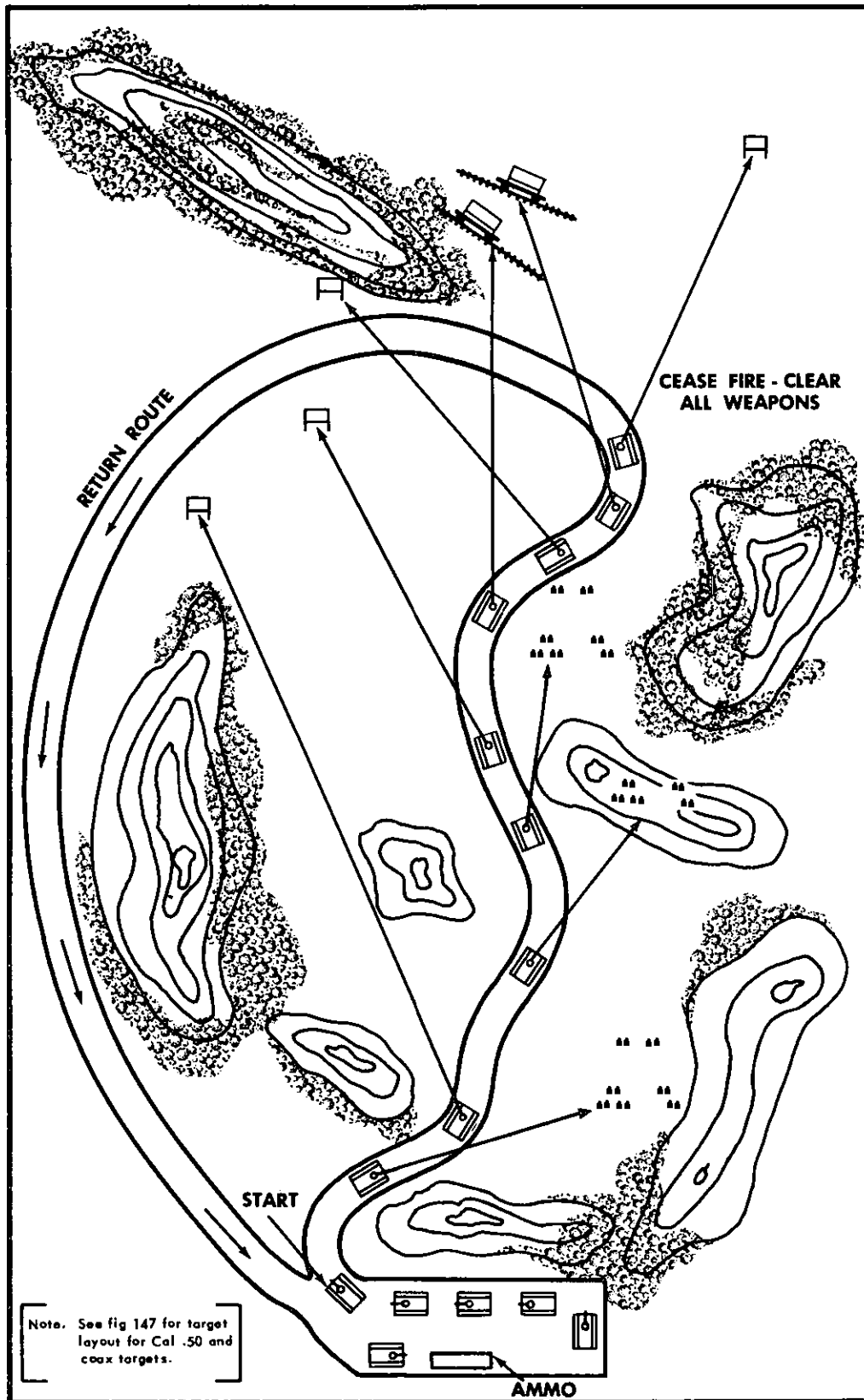

Figure 148. Crew proficiency range layout.

APPENDIX I

REFERENCES

1. Field Manuals

FM 6-40	Field Artillery Cannon Gunnery.
FM 6-135	Adjustment of Artillery Fire by the Combat Soldier.
FM 17-1	Armor Operations.
FM 17-15	Tank Units, Platoon, Company, and Battalion.
FM 17-30	The Armored Division Brigade.
FM 17-79	Tank, 90-MM Gun, M48.
FM 17-80	Tanks, 76-MM Gun, M41 and M41A1.
FM 17-95	The Armored Cavalry Regiment.
FM 20-60	Battlefield Illumination.
FM 21-5	Military Training.
FM 21-6	Techniques of Military Instruction.
FM 21-30	Military Symbols.
FM 23-55	Browning Machineguns, Caliber .30, M1917A1, M1919A4.
FM 23-65	Browning Machinegun, Caliber .50 HB, M2.

2. Technical Manuals

TM 9-1300-203	Ammunition for Antiaircraft, Tank, Antitank, and Field Artillery Weapons.
TM 9-1305-200	Small-Arms Ammunition.
TM 9-1900	Ammunition General.
TM 9-1903	Care, Handling, Preservation, and Destruction of Ammunition.
TM 9-2350-201-12	Operators and Organizational Maintenance Manual, Tank, Combat, Full-Tracked, 76-MM Gun, M41, M41A1, and Trainer, Tank Gunnery, 76-MM Gun, M17.
TM 9-2350-215-10	Operator's Manual, Tank, Combat, Full-Tracked: 105-MM Gun, M60 and M60A1 w/e; and Trainer, Tank Gunnery, Medium, XM30.
TM 9-2350-224-10	Operator's Manual, Tank, Combat, Full-Tracked, 90-MM Gun, M48A3.
TM 9-6166	Operation and Organizational Maintenance, Aiming Circle, M2.
TM 9-7012	Operational and Organization Maintenance, Tank Combat, Full-Tracked, 90-MM Gun, M48 and M48A1 and M48C, and Tank, Combat, Full-Tracked, Flamethrower, M67.
TM 9-7022	Operator and Organizational Maintenance Manual, Tank, Combat, Full-Tracked, 90-MM Gun, M48A2, and M48A2C; and Tank, Combat, Full-Tracked, Flamethrower, M67A1.
TM 38-750	Army Equipment Record Procedures.

3. Regulations

AR 320-5	Dictionary of United States Army Terms.
AR 320-50	Authorized Abbreviations and Brevity Codes.
AR 370-5	Qualification in Arms (Qualification and Familiarization).

AR 385-63 Safety (Safety Regulations for Firing Ammunition for Training, Target Practice, and Combat).
AR 672-5-1 Awards.

4. DA Pamphlets

DA Pam 108-1 Index of Army Motion Pictures, Film Strips, Slides, and Phono-Recordings.
DA Pam 310-Series Military Publications (Indexes).

APPENDIX II

TANK IN THE ARTILLERY ROLE

1. General

Tank guns are not normally used in the artillery (indirect fire) role. This is due to the high velocity, flat trajectory, and short tube life of tank guns and the small bursting radius of the ammunition. However, under exceptional circumstances, a command decision may be made to employ tanks in an indirect-fire role under the operational control of the supporting field artillery. The tank unit may either be attached, or given a reinforcing mission. The field artillery unit is responsible for fire control, communication, and survey. Whether attached or reinforcing, the tank unit must retain the capability of immediately reverting to its primary role of offensive combat. Therefore, the tank unit's basic load will not be used for indirect fire, and when such employment is contemplated, ammunition is stockpiled beforehand. The tank platoon is the basic fire unit in an artillery fire role. The tank platoon leader or company commander is normally responsible for selecting and occupying a firing position and for laying the tank guns parallel.

2. Selection and Occupation of Firing Positions

a. When selecting a position for artillery-type fire, the commander of the tank unit considers the immediate mission, future mobile missions, and the security of his command. The following are characteristics of a good firing position for tanks in the artillery role:

- (1) Located so fire can be placed on targets in the assigned sector. The position must be well forward, behind a mask providing cover, but not so near a hill mask that close-in targets cannot be engaged (fig. 149).
- (2) Located so tank units can revert rapidly to their primary role of offensive combat. Multiple access routes,

concealed if possible, are required to allow tanks to be moved without delay and to permit resupply.

- (3) Provide hardstanding with level ground.
- (4) Permit, 6,400-mil traverse, so that tank crews can fire in any direction.
- (5) Allow proper dispersion of tanks.

b. To occupy a firing position rapidly and smoothly, the platoon leader's tank moves in on the right with each succeeding tank taking position to the left. Tanks are positioned approximately 35 meters apart laterally, but not in a straight line; staggering the tanks provides fire coverage in depth, permits firing to the flanks, and provides passive defense against enemy fire (fig. 50).

3. Determining Minimum Elevation

a. General. Upon occupation of the position, the crew of each tank determines minimum elevation. Minimum elevation is the lowest elevation at which the gun can be fired with assurance that all projectiles will clear the mask to the front, including allowance for the safety of friendly troops occupying the mask, when appropriate. Tanks are not permitted to fire below minimum elevation.

b. Determining Minimum Elevation for the Tank. The crew determines minimum elevation for a tank gun by combining the following factors:

- (1) *Angle of site to mask.* This is the angle between the horizontal and the line of the bore when the gun is laid on the highest point of the mask (fig. 151). Determine it as follows:
 - (a) With the breech open, the loader sights along the bottom of the tube as the gunner elevates the gun until the loader's line of sight just clears the highest part of the mask.

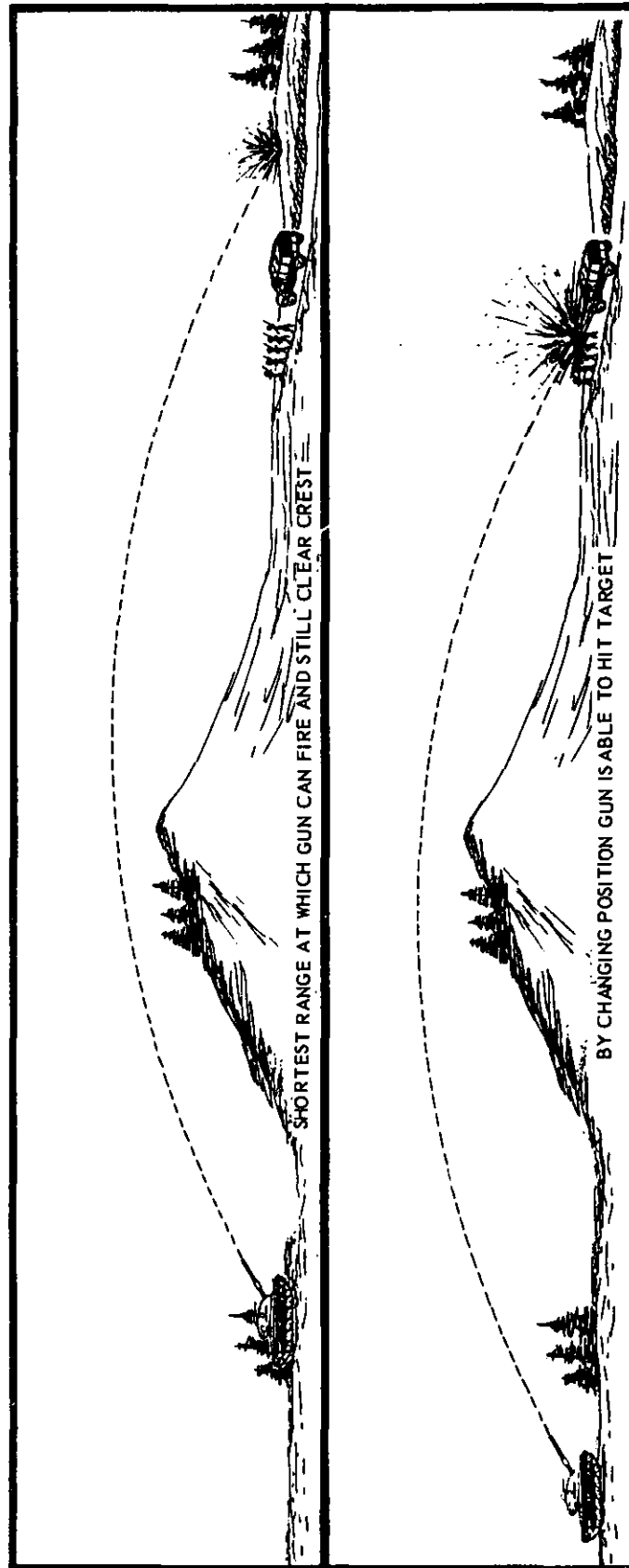

Figure 149. Positioning tank for indirect fire.

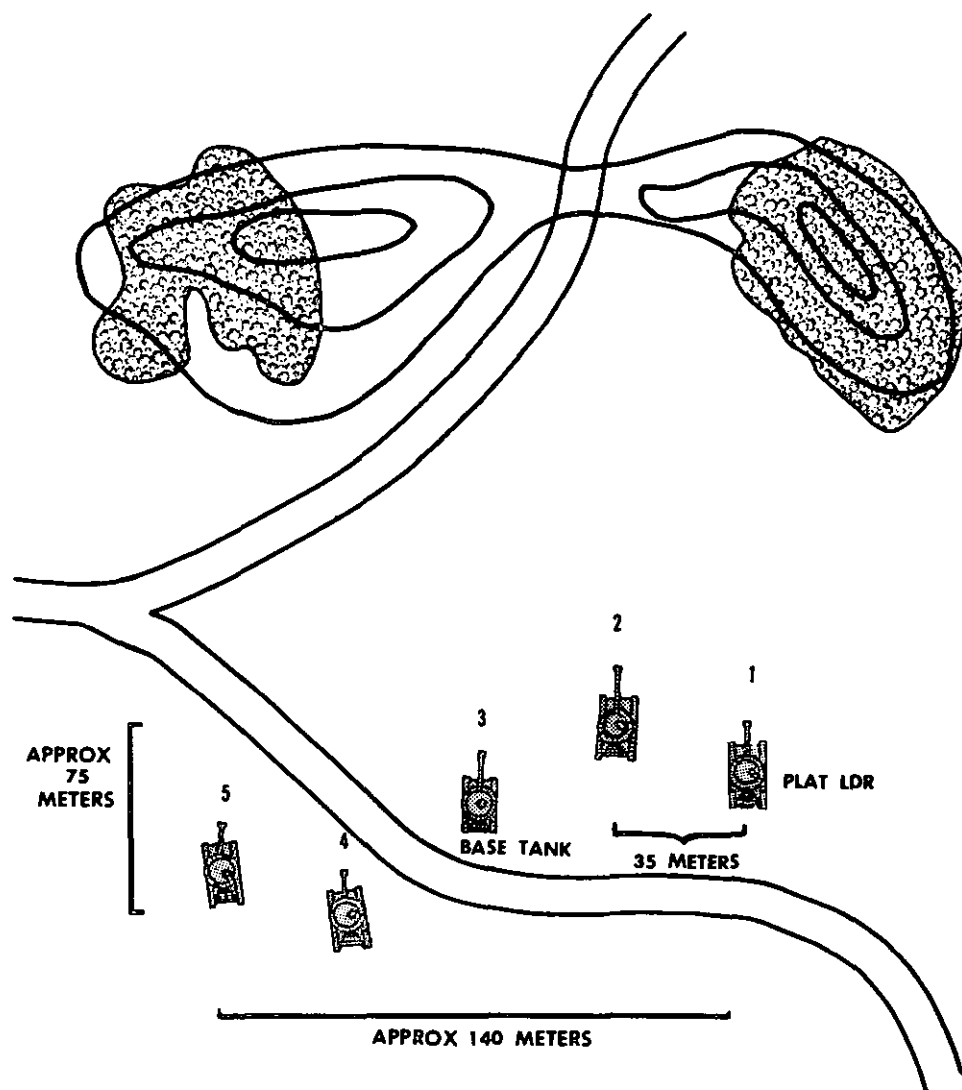

Figure 150. Positioning platoon for indirect fire.

The loader continues to sight along the bottom of the tube while the gunner traverses the gun between the limits of the firing sector to insure that the highest part of the mask has been selected.

- (b) With the gun laid on the highest point of the mask, the gunner measures the existing elevation of the gun by using the gunner's quadrant. This reading is recorded to the nearest tenth of a mil as the *angle of site to mask*.

- (2) *Elevation for range to mask.* Determine the elevation for range from the firing position to the top of the mask for HE or HEP ammunition as follows (fig. 151):

- (a) Determine the range to the mask by the most accurate means available.
- (b) Obtain the mil elevation for that range from the tabular firing table (or the ballistic computer), and record it to the nearest one-tenth of a mil as *elevation for range to mask*.

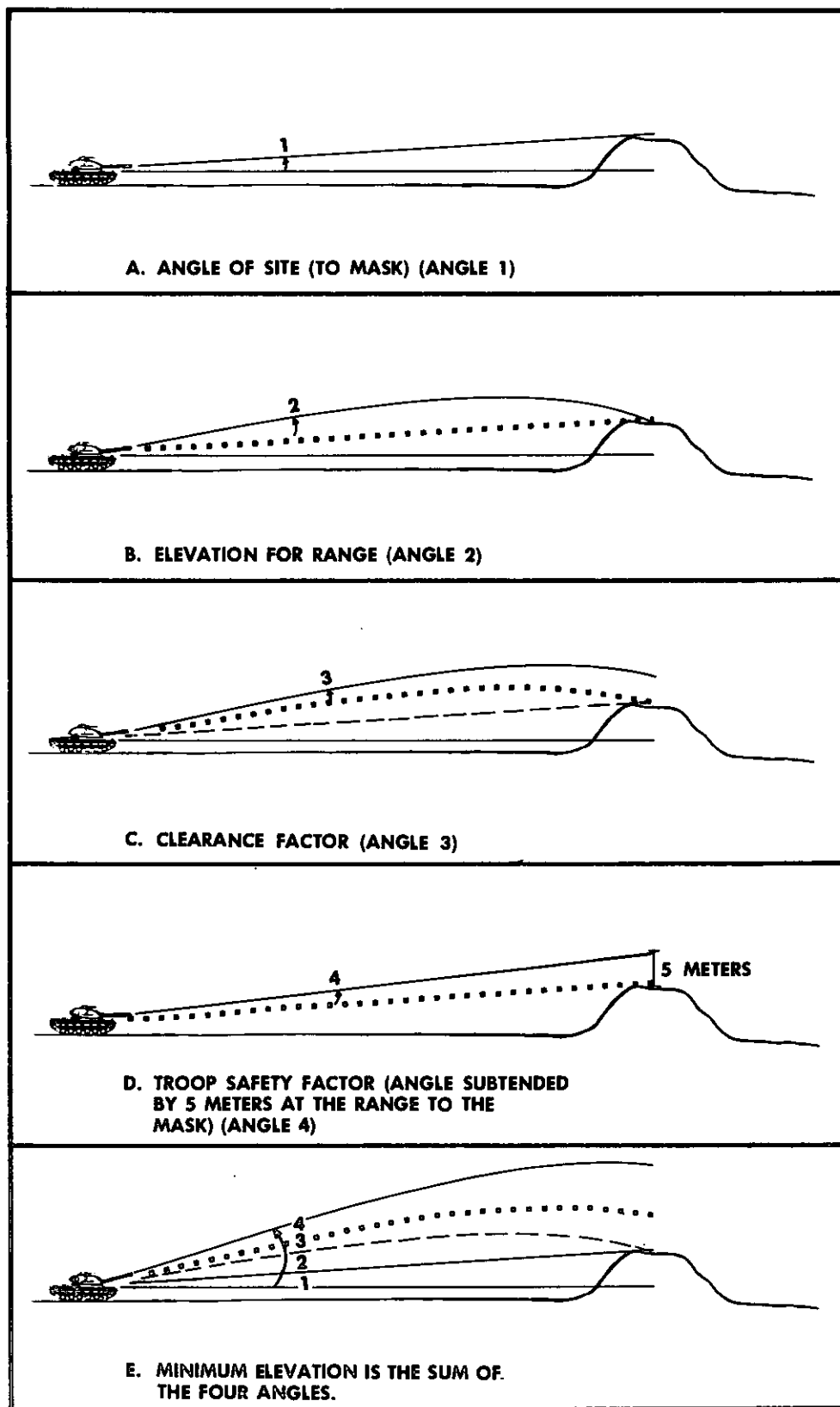

Figure 151. Determining minimum elevation.

- (3) *Clearance factor.* To insure positive clearance of the mask when firing, record a 2-mil clearance factor (fig. 151).
- (4) *Troop safety factor* (fig. 151). If the mask is occupied by friendly troops, include a safety factor in the minimum elevation. The safety factor consists of the value, expressed in mils, of a height of 5 meters at the range to the mask. Determine it by using the mil relation (para. 156).

c. *Computation of Minimum Elevation* (fig. 151). When the mask is not occupied by friendly troops, the minimum elevation consists of three elements:

- (1) *Angle of site.*
- (2) *Elevation for range to mask.*
- (3) *2-mil clearance factor.*

When the mask is occupied by friendly troops, the minimum elevation consists of four elements:

- (1) *Angle of site.*
- (2) *Elevation for range to mask.*
- (3) *2-mil clearance factor.*
- (4) *Troop safety factor.*

If the sum of the elements is fractional, round off the sum to the next higher whole mil.

d. *Platoon Minimum Elevation.* Each tank commander reports his minimum elevation to the platoon leader as soon as it is determined. The *highest* minimum elevation reported is established as the *minimum* elevation for the platoon and is recorded by each tank commander for reference. When a tank commander/gunner receives a quadrant elevation that falls below the established platoon minimum elevation, he ceases fire and announces BELOW MINIMUM ELEVATION.

4. Laying Tank Guns Parallel

a. *Aiming Circle Method.*

- (1) *Laying for direction by grid azimuth (aiming circle method).* When tanks are to be laid parallel on a grid azimuth and an aiming circle is used for this purpose, set up the instrument at a point that is sufficiently distant from all magnetic attractions.

Note. Minimum distances from objects presenting magnetic attraction:

High tension power lines	---	150 meters.
Tanks, armored vehicles	----	75 meters.
Trucks, or telegraph lines	---	40 meters.
Barbed wire, steel helmets, small arms, etc.	-----	10 meters.

Employ the following procedure to lay tank guns parallel on a grid azimuth:

- (a) The aiming circle operator subtracts the given grid azimuth from the declination constant of the instrument, adding 6,400 mils if necessary; for example:

$$\begin{array}{r}
 1. \text{ Declination constant is } 200. \\
 2. \text{ Announced azimuth is } 4,000. \\
 \quad 200 \text{ declination constant} \\
 \quad +6,400 \\
 \quad \hline
 \quad 6,600 \\
 -4,000 \text{ Grid azimuth} \\
 \quad \hline
 \quad 2,600 \text{ Clockwise angle between} \\
 \quad \text{the given grid azimuth} \\
 \quad \text{and magnetic north.}
 \end{array}$$

- (b) With the instrument level, the operator indexes the result on the azimuth and micrometer scales. Using the lower motion, he centers the compass needle. The 0-3,200 line of the aiming circle is now pointing along the given grid azimuth.

- (c) The operator then commands AIMING POINT THIS INSTRUMENT, DIRECTION OF FIRE . . . (points in the direction of fire). Subsequent procedure and commands are identical to those stated in (2) below. This procedure can also be used when tank guns are to be laid parallel on a *magnetic azimuth*, by first converting this azimuth to a *grid azimuth*, and then following the steps outlined in (2) below.

- (2) *Tanks and target (or reference point) visible.* When the tanks and the target area are both visible to the aiming circle operator, use the following procedure:

- (a) The operator levels the aiming circle and zeroes the azimuth and micrometer scales. Using the lower motion, he sights on the target (a

point in the target area or a reference point in line with the firing position and the target). He then commands AIMING POINT THIS INSTRUMENT, DIRECTION OF FIRE . . . (points out direction of fire).

- (b) Each gunner lays the boresight cross of his telescope on the telescope reflector or center of the aiming circle, using his gun controls. The azimuth indicator is then set at zero with the resetter knob. When this has been accomplished, the tank commander announces NUMBER (ONE), READY.

Note. The hand light can be used to illuminate the reflector on the aiming circle to aid gunners in laying at night.

- (c) Using the upper motion, the aiming circle operator lays the vertical line of the telescope reticle on the center of the telescope port of tank number one.
- (d) The aiming circle operator reads the existing deflection from the azimuth and micrometer scales and announces:

Example. NUMBER ONE, DEFLECTION ONE THREE FOUR ZERO.

Note. It may be necessary to take this reading from the lower scales of the aiming circle in order to obtain a deflection announcement of less than 3,200 mils.

The aiming circle operator repeats this process for each tank.

- (e) The tank commander repeats the deflection reading received from the aiming circle operator. The gunner traverses his turret until the azimuth indicator reading corresponds to the announced deflection.

Note. Repeating an announced deflection permits the aiming circle operator to detect errors and allows him to issue corrections immediately.

- (f) As each tank is laid the aiming circle operator commands AIMING POINT, AIMING POST, DEFLECTION ZERO, REFERRED. Upon this command, each gunner zeroes his azimuth indicator, using

the resetter knob. Aiming stakes may be placed out for each tank. When every tank has completed this procedure the tank guns are laid parallel in the direction of fire.

b. Reciprocal Laying. If an aiming circle is not available, tank guns can be laid parallel in the direction of fire by reciprocal laying. Reciprocal laying is a procedure by which the 0-3,200 line of an instrument (azimuth indicator, etc.) and the axis of the tube of a weapon are laid parallel, or the tube of one weapon is laid parallel to another and in the same direction, or the 0-3,200 line of one instrument is laid parallel to another.

- (1) The gunner of the base tank (number three tank) alines his telescope in the direction of the target by laying on a point that is in line with the target, or by laying on aiming stakes placed in line with the target. The gunner then zeroes his azimuth indicator.
- (2) The tank commander of the base tank commands NUMBER TWO, LAY ON ME, and the gunners of the center (base) tank and tank on the immediate right (number two) traverse until both telescopic sights are alined on each other.
- (3) The tank commander of the base tank points in the direction of fire and announces his existing azimuth indicator reading.

Example. NUMBER TWO, DEFLECTION ONE THREE FOUR ZERO.

- (4) The tank commander receiving the command repeats it so that the tank commander who originated the deflection can hear it and announce a correction if it was repeated erroneously. The tank commander of the tank being laid parallel adds the direction of fire (LEFT or RIGHT) to the command that he received. The gunner of the right tank (number two) indexes the announced reading on the azimuth indicator by using the resetter knob. He indexes the deflection reading on the scale opposite to the

direction of fire. For example, if the gun must be traversed right to move toward the desired direction of fire, then the left half of the azimuth scale is used. He then traverses the turret in the prescribed direction until zero is indicated on the azimuth indicator. The gun of the right tank is now parallel to the gun of the base tank and the direction of fire. The crew of the base tank repeats this procedure to lay the gun of the tank on the left (number four). Tanks 2 and 4 then lay tanks 1 and 5 in the same manner used by the base tank.

5. Initial Fire Command

The initial fire command for tanks employed in an artillery role is based on the initial fire

request of the observer. The initial fire command originates at the fire direction center and consists of six elements, issued in the same sequence as the initial fire command for direct fire.

a. Alert Element. This element alerts the unit for the fire mission and designates the unit or tanks to fire. The base tank fires alone when an adjustment is necessary; the remainder of the tanks follow the commands but do not fire. This is announced as PLATOON ADJUST, NUMBER THREE. If no adjustment is necessary, the command PLATOON is given, or the number designation of tanks to fire is announced, followed by FIRE MISSION. The alert element further indicates whether VOLLEY or SALVO fire will be employed.

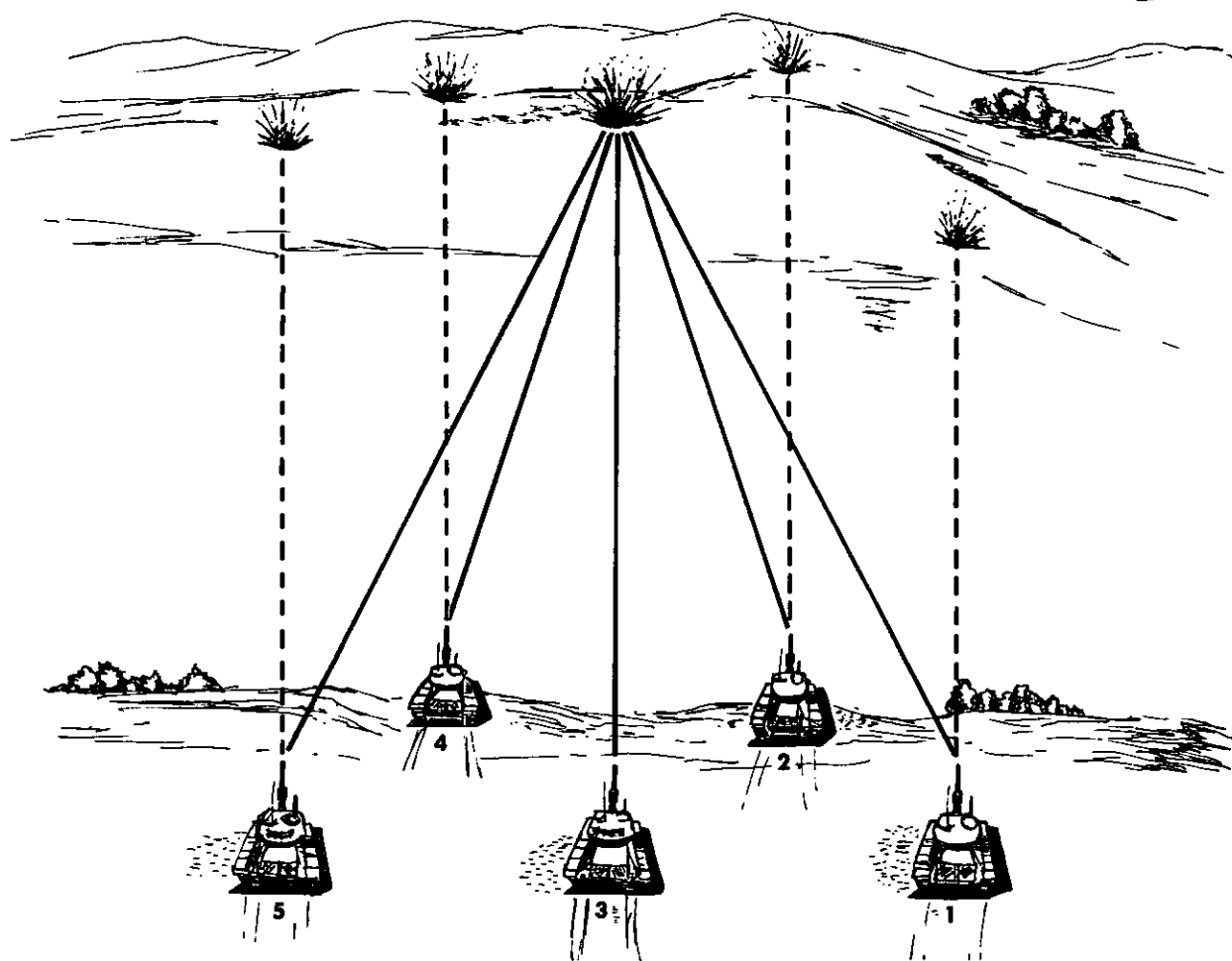

Figure 152. Sheaf—normal (dotted line) converged (solid line).

Note. In radio communications the callwords are used in place of unit designation or tank number.

- (1) *Volley fire.* This is the firing of a specified number of rounds by each firing tank. Once the initial command to fire has been issued, the number of rounds specified are fired rapidly without any further command. Normally, volley fire is employed if the type of fire is not specified.
- (2) *Salvo fire.* This is the successive firing by two or more tanks at a prescribed time interval. The command for salvo fire is SALVO RIGHT (LEFT). Upon receipt of the command FIRE, the right (left) flank tank of the unit fires, followed in 2-second intervals by each adjacent tank in succession. To vary the time interval it is necessary to specify the time. For example, PLATOON, SALVO RIGHT, FIVE-SECOND INTERVAL.

b. Ammunition Element. The ammunition element is announced in the standard terminology used for direct fire. In addition, when FIRE FOR EFFECT is ordered, the number of rounds to be fired is announced.

c. Description Element. This is announced for morale purposes and to maintain uniformity with the initial fire command for direct fire.

d. Direction Element.

- (1) To fire a normal (parallel) sheaf (a pattern where the lines of fire are parallel proportionately to the distance between firing tanks, normally 35 meters (fig. 152) the direction element is announced as a deflection (azimuth indicator reading) left or right of the registration point (zero deflection). Thus, when a target is 124 mils left of the registration point,

direction is announced as DEFLECTION 124 LEFT, or if 124 mils right of the registration point, as DEFLECTION 3076 RIGHT.

- (2) To fire a converged sheaf (a fire pattern where all bursts in the target area are planned to occur at a common point (fig. 152)) each tank is given a separate deflection.

Example. To fire at a target that is on a deflection of 3076 R for the base tank (number 3), the following command is given: CONVERGED SHEAF, NUMBER ONE, DEFLECTION 3090 RIGHT; NUMBER TWO, DEFLECTION 3083 RIGHT; NUMBER THREE, DEFLECTION 3076 RIGHT; NUMBER FOUR, DEFLECTION 3069 RIGHT; NUMBER FIVE, DEFLECTION 3062 RIGHT. This fire pattern is used only when firing for effect.

e. Range Element. When an elevation quadrant is used, range is announced as quadrant elevation to the nearest mil. If a gunner's quadrant is used, quadrant elevation may be announced in tenths of mils at the discretion of the fire control officer. Quadrant elevation is announced as QUADRANT PLUS (SO MUCH) if plus and QUADRANT MINUS (SO MUCH) if minus.

f. Execution Element. Tanks fire at the command of the fire control officer (FCO). The command to fire is preceded by the announcement AT MY COMMAND. When tank commanders of all firing tanks have signified readiness by giving the proper hand (flag) signal or by announcing READY, the FCO commands FIRE. The individual tank commander uses hand (flag) signal to signify when rounds are fired.

Examples of initial fire command — Tanks employed in the artillery role.

Alert	PLATOON ADJUST, NUMBER 3	PLATOON, FIRE MISSION
Ammunition	HEP	2 ROUNDS HE
Description	TROOPS	TRUCKS
Direction	DEFLECTION 2814 RIGHT	DEFLECTION 66 LEFT
Range	QUADRANT PLUS 116	QUADRANT PLUS 88
Execution	AT MY COMMAND . . . FIRE	AT MY COMMAND . . . FIRE

Alert	NUMBER 2, 3, AND 4, FIRE MISSION	PLATOON, SALVO RIGHT
Ammunition	3 ROUNDS HE	1 ROUND HEP
Description	ANTITANK	TROOPS
Direction	DEFLECTION 44 LEFT	DEFLECTION 1234 LEFT
Range	QUADRANT PLUS 52	QUADRANT PLUS 120
Execution	AT MY COMMAND . . . FIRE	AT MY COMMAND . . . FIRE

6. End of Mission

When a fire mission has been completed, the fire direction center announces **CEASE FIRE, END OF MISSION**, indicating that no further firing will be accomplished.

7. Subsequent Fire Commands

a. When the tank is used in the artillery role, subsequent fire commands are given for the adjustment of rounds. The subsequent fire command follows the same sequence as the initial fire command and, with the exception of range (QE) and execution (always given), includes only those elements that have changed from the initial or preceding subsequent fire command.

b. The following example outlines the various elements of a subsequent fire command and provides examples of their employment.

<i>Element</i>	<i>When announced</i>
Alert	Tanks to fire a given mission have been changed, i.e., tank number 3 fired for adjustment; all tanks in the platoon are now to fire for effect.
Ammunition	When a change in the type of ammunition or fuze is desired.
Description	Not repeated during the same fire mission.
Direction	When changed.
Range	Always announced.
Execution	Always announced.

8. Crew Firing Duties, Tank in the Artillery Role

To obtain speed in firing while retaining accuracy, tank crews perform firing duties in a logical sequence as the fire command is issued. Each element of the fire command requires specific actions by the crew.

a. Alert. All tank crews designated to fire or adjust are alerted for the fire mission. Crewmen assume their positions and prepare to follow commands. The tank commander repeats each element of the fire command to the crew.

b. Ammunition. All loaders select the designated ammunition and set the fuze, if necessary. Only the tanks designated to fire are loaded; commanders of nonfiring tanks announce **DO NOT LOAD** before repeating the ammunition element of the fire command. Loaders announce **UP** when the gun is loaded.

c. Description. Tank commanders repeat this element to the crew.

d. Direction. All gunners traverse in the appropriate direction until the announced deflection is indexed on the azimuth indicator. The gunner then repeats deflection.

e. Range. All gunners index the announced quadrant elevation and then center the bubble in the quadrant, using the manual elevation controls. The bubble must be centered after the gun has been loaded to insure an accurate lay of the weapon. The gunner now repeats quadrant reading. Tank commanders of firing tanks signify their readiness by announcing **READY** or by giving a prearranged signal to the fire control officer (FCO).

f. Execution. After announcing **AT MY COMMAND** and receiving the appropriate **READY** signal from all tank commanders, the FCO commands **FIRE**. Gunners announce **ON THE WAY** and fire; the FCO in turn, reports **ON THE WAY** to the observer. After firing the initial round, successive rounds are fired as specified in the fire command. When more than one volley has been ordered, the loader loads immediately after the gun is fired. The gunner checks his lay after the gun is loaded, re-lays if necessary, and announces **READY** to the tank commander. All subsequent com-

mands to fire are given by the tank commander; the crew continues to fire rapidly until the specified number of rounds are expended. After the last round is fired, the loader stands by, but does not load; the gunner

checks the lay of the gun, turns off the gun switch, and stands by. Tank commanders report, or signal ROUNDS COMPLETE to the FCO, or inform him of any malfunctions, such as misfires.

INDEX

	Paragraphs	Pages		Paragraphs	Pages
Accurate laying and firing -----	56, 86	51, 73	Ammunition—Continued		
Acquisition, target -----	65-70	60	Element (with weapon or		
Conduct of exercises -----	178	154	searchlight) in fire		
Course layout -----	177	153	commands:		
Platoon -----	119	105	Direct fire -----	78	67
Responsibilities and duties			Platoon -----	125	112
of crew -----	66	60	Range card lay -----	111	98
Training -----	176	153	Tanks in the artillery		
Actions of individual tanks in			role -----	App. II	236
massed fire -----	121, 122	106	For qualification firing ----	184	158
Adjustment of fire tank crew:			Machinegun:		
Direct fire:			Belting -----	31-34	27
Initial fire commands --	76	67	Cartridge types, cal .30_	33	28
Leading -----	79	69	Cartridge types, cal. 50_	34	29
Machineguns:			Cartridge types, 7.62-mm	32	28
Coaxial -----	6	4	Identification -----	35	29
Caliber .50 -----	7	6	Special uses -----	24, 94-96	22, 86
From a moving tank ----	6	4	Tank gun:		
Moving targets:			Classification -----	11	9
Alternate method -----	92	79	Fuzes -----	10, 12-14, 8, 10, 14,	
Primary method -----	91	79	17, 20-21 19, 22, 23		
Stationary targets:			23, 24, 26		
Alternate method -----	92	79	Lot numbers -----	29	25
Primary method -----	91	79	Painting and marking -----	29, 31, 35	25, 27, 29
Subsequent fire			Projectiles:		
command -----	92	79	Antipersonnel,		
Tracking -----	91	79	antimateriel -----	11, 19-24	9, 19
Adjustment, sight. (See Sight,			Armor-defeating -----	11, 15-18	9, 12
direct fire.) -----	54	48	Nomenclature -----	12, 13	10
Aerial observation -----	119	105	Special purpose -----	11, 25-28	9, 23
Aiming:			Stowage plan -----	30	25
Circle:			Antipersonnel, antimateriel		
Intersection -----	160	141	projectiles -----	11, 19-24	9, 19
Laying tank guns			Angle of site -----	App. II	236
parallel -----	App. II	236	Apparent speed -----	79	69
Data chart -----	45, 144	34	Application:		
Stakes -----	App. II	236	Alternate method of adjust-		
Aim-off -----	82	71	ment -----	92	79
Alert element in fire commands:			Primary method of adjust-		
Direct -----	77	67	ment -----	91	79
Platoon -----	124	112	Armament:		
Range card -----	111	98	Machineguns -----	3, 5, 7	4, 6
Tank in the artillery role --	App. II	236	Main -----	3, 4, 54, 56	4, 48, 51
Alternate method of adjustment.			Area fire -----	111	98
(See Adjustment of fire.)			Armor, equivalent thickness ---	16, 18	12, 15
Ammunition:			Armor-defeating projectiles ---	11, 15-18	9, 12
Arrangement, unpacking,			Armor-piercing discarding		
and handling tank firing -	251-253	222	sabot ammunition.		
Capabilities -----	15, 28,	12, 24	(See SABOT ammunition.)		
31-34		27	Armored vehicles:		
Changing -----	85, 97	72, 88	Classification for target		
Complete round -----	10	8	engagement -----	68	60
			Destruction. (See Destruc-		
			tion of targets.)		

	Paragraphs	Pages		Paragraphs	Pages
Arrangement and handling of ammunition for tank firing ---	251-253	222	Checklist:		
Artificial illumination -----	50, 125, 183	42, 112, 157	Officer in charge of tank range firing -----	234-243	213
Auxiliary fire control equipment:			Safety officer -----	245	219
Azimuth indicator -----	49	38	Safety precautions -----	249	221
Instruments -----	46-49	38	Tank instructor -----	247	220
Quadrants -----	47, 48	38	Chemical energy projectiles ----	17	14
Azimuth indicator -----	49	38	Circular range card -----	102	92
Background, tank -----	158	186	Classification:		
Ballistic:			Ammunition -----	11	9
Reticle -----	45	34	Target -----	68	60
Unit -----	41	32	Weapons qualification -----	183	157
Banks, rotating -----	13, 16, 17, 20, 22, 26	10, 12, 14, 19, 21, 23	Clearance factor -----	App. II	236
Base:			Coaxial machinegun -----	5	4
Tank -----	App. II	236	Employment -----	5, 6, 54, 78, 122	4, 48, 67, 106
Battlesight -----	97	88	Coincidence range finder -----	171	148
Bias, range -----	174	151	Training procedures and techniques -----	171	148
Binoculars:			Use -----	38	30
Description -----	165	144	Combat tracking -----	146	126
Focusing -----	166	145	Command:		
Observing -----	167	146	Fire. (See Fire commands.)		
Use -----	37, 156, 165, 167	30, 132, 144, 146	Light -----	78, 125	67, 112
Body, projectile -----	13, 16, 17, 20, 21, 22, 26	10, 12, 14, 19, 21, 23	Commander, tank. (See Crew.)		
Boresighting -----	53, 54	48	Communication and control for tank range firing -----	250	222
Coaxial machinegun -----	54	48	Components, ammunition -----	10, 12-14	8, 10
Cupola-mounted machinegun -----	54	48	Concentrations -----	134	117
Exercise -----	147, 192, 193	127, 163, 164	Conduct of:		
Main gun -----	54	48	Direct fire (daylight) -----	76-98	67
Searchlight -----	54	48	Direct fire (at night and with artificial illumination) -----	99-116	90
Subcaliber range -----	206	171	Fire trainer -----	144	124
Test -----	192, 193	163, 164	Platoon fire -----	117-137	105
Bourrelet, projectile -----	13, 16, 17	10, 12, 14	Tank in the artillery role --	App. II	236
Bunkers and pillboxes, engagement -----	18, 23	15, 22	Conducting:		
Burst-on-target -----	91	79	Tank range firing -----	239-247	217
C factor -----	92	79	Control and communication for tank range firing -----	250	222
Canister ammunition -----	22	21	Converged sheaf -----	App. II	236
Use -----	23	22	Conversion table -----	15	12
Cant -----	60	54	Correct sight picture -----	86	73
Capabilities of ammunition ---	15-28, 31-34	12, 27	Correcting fire commands -----	85, 93, 123	72, 83, 111
Cards, range -----	99-103	90	Correction:		
Care:			Deflection -----	92	79
Azimuth indicator -----	49	38	Range -----	92	79
Binocular -----	167	146	Course:		
Center of vulnerability -----	86	73	Familiarization firing -----	222-224	206
Changing ammunition (fuze) --	20, 85, 98	19, 72, 88	Practice firing -----	225-226	208
Characteristics:			Qualification firing -----	205-221	171
Range card firing positions --	100	90	Target acquisition -----	177	153
Tank firing positions -----	64	57	Coaxial machinegun. (See Machinegun.)		
Tank in the artillery role --	App. II	236	Crew:		
Chart, aiming data -----	45, 144	34, 124	Field firing -----	214-221	187
			Firing duties:		
			Direct fire -----	71	65
			Range card fire -----	111	98
			Exercises -----	215-220	188
			Nonfiring exercises ----	151, 152	130

	Paragraphs	Pages		Paragraphs	Pages
Crew—Continued			Direct fire—Continued		
Firing duties—Continued			Methods of adjustment:		
Proficiency firing -----	219-220	198	Alternate method -----	92	79
Qualification firing -----	219-221	198	Primary method -----	91	79
Sequence of training --	152	130	Sensings -----	87	73
Crewman qualification firing ---	209-213	179	Direction, element in fire		
Cupola-mounted machinegun ---	54	48	commands:		
Employment -----	8, 122	7, 106	Direct fire -----	80	69
Danger area diagram, surface ..	232	211	Platoon -----	127	115
Data chart, aiming -----	45, 144	34, 124	Range card fire -----	111	98
Defensive fire, massed -----	136, 137	118, 121	Directional pointer -----	49	38
Defilade:			Dismounted:		
Hull -----	64	57	Observer -----	96	86
Turret -----	64	57	Troops, destruction -----	5, 7, 23, 24, 32, 33,	4, 6, 22, 28, 29
Deflection:				34	
Corrections -----	92	79	Doubtful:		
Determination -----	100	90	Range sensing -----	89	73
Sensings -----	86	73	Drift -----	60, 95	54, 86
Descriptions:			Driver -----	75	66
Binocular -----	165	144	Droop -----	60	54
Element in fire commands:			Duties:		
Direct fire -----	79	69	Crew, firing:		
Platoon -----	126	115	Direct -----	71-75	65
Range card fire -----	111	98	Range card fire -----	111	98
Designation:			Tank in the artillery role	App. II	236
Range site -----	162	142	Officer in charge of range		
Target -----	67, 69	60, 62	firing -----	234-243	213
Destruction:			Safety officer -----	245	219
Armored vehicles -----	7, 15-18, 24, 32, 34	6, 12, 22, 28, 29	Tank instructor -----	246	220
Crew-served weapons -----	5, 7, 18, 23, 32, 33, 34	4, 6, 15, 22, 28, 29	Effects:		
Dismounted troops -----	5, 7, 23, 24, 32, 33, 34	4, 6, 22, 28, 29	Drift, cant, and parallax ---	60	54
Field fortifications -----	18, 33	15, 28	Range -----	16, 17	12, 14
Unarmored and lightly			Angle of site -----	App. II	236
armored vehicles -----	5, 7, 23, 32, 33, 34	4, 6, 22, 28, 29	Elements fire commands. (See		
Determination:			Fire commands.)		
Angle of site -----	App. II	236	Elevation quadrant -----	48, 100	38, 90
Deflection -----	100	90	Emergency zero -----	55	50
Factors in the mil relation ..	156	132	Employment. (See Use.)		
Initial data for tanks in the			Engagement:		
artillery role -----	App. II	236	Built-up areas -----	24	22
Minimum elevation -----	App. II	236	Bunkers and pillboxes -----	23	22
Quadrant elevation -----	100	90	Plotted targets -----	111, 137	98, 121
Range -----	81, 100, 153	71, 90, 132	Targets of opportunity ---	112, 131	99, 116
Range card data -----	100	90	Equipment, fire control. (See Fire		
Diagram, surface danger area --	232	211	control equipment.)		
Direct fire			Equivalent thickness of armor --	16, 18	12, 15
Commands for tank crew:			Establishing tank firing ranges -	227-233	210
Correcting -----	85	72	Estimation, range:		
Elements -----	76, 111	67, 98	By eye -----	158	138
Initial -----	76, 111	67, 98	By sound and flash -----	159	140
Repeating -----	84, 93	72, 83	Examination, preliminary		
Subsequent -----	92	79	gunnery -----	187-205	160
Commands for platoon -----	123-129	111	Execution element in fire		
Control systems -----	36-45	30	commands -----	83, 129	71, 115
			Exercises. (See also Training		
			and drill.):		
			Firing -----	205-221	171
			Familiarization -----	222-224	206
			Practice -----	225-226	208
			Qualification -----	209-221	179

	Paragraphs	Pages		Paragraphs	Pages
Exercises (See also Training and drill.)—Continued			Fire—Continued		
Nonfiring -----	144	124	Control equipment		
Boresighting -----	147	127	Auxiliary:		
Manipulation -----	145	126	Azimuth indicator _	49	38
Prepare to fire -----	150	130	Quadrants -----	47, 48	38
Target acquisition -----	178	154	Direct -----	36-45	30
Tracking and leading --	146	126	Miscellaneous:		
Zeroing -----	148	127	Aiming data chart _	45, 144	34
Use of auxiliary fire control equipment -----	46, 149	38, 128	Binocular -----	165	144
Use of direct-fire sights ----	143	124	Control officer -----	App. II	236
Familiarization firing -----	222-224	206	Cross -----	121	106
Field firing, crew:			Depth -----	121	106
Exercises -----	152, 214-221	130, 187	Direct. (See Direct fire.)		
Range -----	259	226	Direction center -----	App. II	236
Field fortifications, destruction. (See Destruction of targets.)			During poor visibility or at night with illumination --	99-116	90
Fire:			Frontal -----	121	106
Adjustment. (See Adjustment of fire.)			Machinegun. (See Machinegun fire.)		
Area -----	111	98	Planning -----	130-137	116
Assault -----	122	106	Reconnaissance by -----	122	106
Commands for tank crew:			Request -----	69	62
Direct, initial -----	76	67	Ricochet -----	23	22
Alert -----	77	67	Salvo -----	App. II	236
Ammunition, (weapon, or searchlight) -----	78	67	Supported by -----	122	106
Correcting -----	85	72	Volley -----	App. II	236
Description -----	79	69	Firing:		
Direction -----	80	69	By tank commander -----	83	71
Execution -----	83	71	Duties, crew:		
Lead -----	79	69	For direct fire -----	71-75	65
Range -----	81	71	For range card fire ----	111	98
Repeating -----	84	72	Exercises. (See Exercises.)		
Platoon, initial -----	123	111	Familiarization -----	222-224	206
Alert -----	124	112	From a moving tank -----	3, 6, 8, 64	4, 7, 57
Ammunition, (weapon, or searchlight) -----	125	112	Night, techniques -----	104-116	95
Control -----	128	115	Positions:		
Correcting -----	123	111	Direct -----	64	57
Description -----	126	115	Night -----	104	95
Execution -----	129	115	Practice -----	225-226	208
Location -----	127	115	Service -----	209-221	179
Range card, initial ----	111	98	Subcaliber -----	205-208	171
Alert -----	111	98	Tank machineguns -----	5, 7	4, 6
Ammunition -----	111	98	Tank range -----	227-231	210
Correcting -----	85	72	Techniques -----	94	86
Description -----	111	98	Firepower		
Deflection -----	100	90	Tank -----	63	57
Execution -----	111	98	Platoon -----	118	105
Range -----	100	90	Fixed round -----	10	8
Repeating -----	84	72	Flash and sound, range determination -----	159	140
Subsequent:			Focusing binocular -----	166	145
Correction -----	93	83	Fortification, field, destruction --	18, 33	15, 28
Direct -----	92	79	Friendly troops. (See Range determination.)		
Repeating -----	93	83	Frontal fire -----	121	106
Platoon -----	123	111	Fuzes:		
			Changing -----	14, 20, 23	10, 19, 22
			Impact:		
			Base detonating -----	14, 21, 26	10, 19, 23
			Point detonating -----	14, 20	10, 19

	Paragraphs	Pages		Paragraphs	Pages
Fuzes—Continued			Loader -----	74	66
Impact—Continued			Location, element -----	127	115
Point initiating, based			Lost, range sensing -----	89	73
detonating -----	14, 17	10, 14	Machinegun:		
Gun:			Ammunition. (See Ammunition.)		
Coaxial -----	3, 5, 6	4	Coaxial -----	3, 5-6, 122	4, 106
Cupola or external turret-			Cupola or external turret-		
mounted -----	5, 7	4, 6	mounted -----	3, 7, 8	4, 6, 7
Laying tanks gun parallel --	App. II	236	Firing:		
Main ammunition. (See			At night -----	113	102
Ammunition.)			From moving tank -----	6, 8	4, 7
Gunner -----	73	65	Tactical employment ---	5-8, 113	4, 102
Examination, preliminary --	187-204	160	Magnetic:		
Gunnery:			Azimuth -----	App. II	236
Testing -----	180-221	156	North -----	App. II	236
Training -----	138-179	122	Main gun:		
High explosive antitank (HEAT)			Ammunition. (See Ammunition.)		
ammunition -----	17	14	Firing:		
Special techniques -----	96	86	Direct -----	76-98	67
Use -----	18, 78	15, 67	Range card fire -----	99-116	90
High explosive (HE)			Tank in the artillery role	App. II	236
ammunition:			Manipulation exercises -----	145	126
Projectiles -----	20	19	Map, use of, in range deter-		
Ricochet fire -----	23	22	mination -----	157	138
Use -----	23, 24, 78	22, 67	Marking:		
High explosive plastic			And painting of ammunition	29, 31, 35	25, 27, 29
(HEP) -----	21	19	Targets -----	27	23
Special techniques -----	95	86	Massed fire -----	123	111
Use -----	23, 24, 78	22, 67	Defensive -----	133, 137	116, 121
Hull defilade position -----	64	57	Offensive -----	130-132	116
Identification, target -----	67, 100, 119	60, 90, 105	Measuring angle		
Illuminated reticle -----	171, 172	148, 149	Aiming circle -----	App. II	236
Illumination, artificial -----	50	42	Azimuth indicator -----	49	38
Infrared visible light kit			Binocular -----	167	146
Components -----	52	43	Method of adjustment, direct fire:		
Binocular, infrared -----	52	43	Alternate -----	92	79
Gunner's periscope -----	52	43	Dismounted observer -----	96	86
Tank commander's peri-			Exercises -----	143	124
scopes -----	52	43	Primary -----	91	79
Xenon searchlight -----	52	43	Two-tank method -----	96	86
Infantry designation of targets --	69, 119	62, 105	Method of testing tank gunnery		
Initial, fire command. (See			training -----	140	123
Fire command.)			Micrometer scale:		
Intersection -----	160	141	Azimuth indicator -----	49	38
Laying:			Quadrant -----	47, 48	38
Aiming circle -----	App. II	236	Mil:		
Direct -----	72	65	Conversion table -----	154	132
For direction -----	72	65	Definition -----	156	132
For range -----	111	98	Relation and use -----	156	132
Range card -----	111	98	Minimum elevation -----	App. II	236
Range card lay for direct fire	112	99	Mission:		
Reciprocal -----	App. II	236	Direct fire -----	76	67
Searchlight -----	50-52, 115	42, 104	Range card fire -----	99	90
Tank guns parallel -----	App. II	236	Light, white and red -----	114, 125	102, 112
Lead -----	79	69	Mortar illuminating shells -----	125	112
Leading -----	79	69	Moving:		
Light commands -----	78, 115, 125	67, 104, 112	Target exercises -----	146, 208, 212, 213	126, 175, 182, 183
Line, deflection sensing -----	88	73	Target range -----	259	226
			Tank exercises -----	214-221	187
			Tank range -----	259	226

	Paragraphs	Pages		Paragraphs	Pages
Night firing -----	99	90	Platoon--Continued		
Fire commands for firing			Target acquisition -----	119	105
during poor visibility ----	111	98	Volume of fire -----	122	106
Firing during poor visibility	111	98	Plotted targets, engagement ---	111, 112, 136, 137	98, 99, 118, 121
Firing with artificial illumination -----	112, 115, 116, 125	99, 104, 112	Point, reference -----	102	92
Preparation and occupation of positions -----	100, 104	90, 95	Pointers, azimuth indicator ----	49	38
Techniques -----	107-109, 113	97, 102	Positions:		
Night target acquisition -----	70	62	Defilade -----	64	57
Night vision -----	70, 108	62, 97	Firing -----	64, App. II	57, 236
Nonballistic reticle -----	42	32	Night firing, preparation and occupation -----	100, 104	90, 95
Nonfiring exercises. (See Exercises.) -----	114	124	Practice firing -----	225, 226	208, 209
Normal sheaf -----	App. II	236	Precautions, safety (tank firing)	249	221
North:			Preparation and occupation of night firing positions -----	100, 104	90, 95
Grid -----	App. II	236	Preparation for firing -----	150	130
Magnetic -----	App. II	236	Preparation of sights for firing -	53-59	48
Objects affecting operation of aiming circle -----	App. II	236	Preliminary gunnery examination	187-204	160
Observation and sensing -----	89	73	Primary method of adjustment --	91	79
Observation procedure, night ---	70	62	Procedures:		
Observer, report -----	69, 119	62, 105	Aiming circle, use -----	160, App. II	141, 236
Observing with binocular -----	70, 87	62, 73	Laying tank guns parallel --	App. II	236
Obtaining data (range card) ----	100	90	Mil relation -----	156	132
Occupation and preparation of night firing positions -----	100, 104	90, 95	Proficiency exercises, crew ----	219-221	198
Offensive fire, massed -----	130-132	116	Proficiency range, crew -----	259	226
Officer in charge:			Projectiles:		
Tank range firing:			Antipersonnel, antimateriel -	11, 19-24	9, 19
Checklist -----	241-243	217	Armor-defeating -----	11, 15-18	9, 12
Duties -----	235-238	213	Chemical energy -----	15, 17, 18	12, 14, 15
Officer, safety			Classification -----	11	9
Tank range firing duties ---	245	219	Kinetic energy -----	15, 16, 18	12, 12, 15
Ogive -----	13	10	Nomenclature -----	12-13	10
Operations:			Special purpose -----	11, 25-28	9, 23
Binocular -----	165-167	144	Types -----	11	9
Range finders -----	171, 172	148, 149	Quadrant:		
Organic fire control of the tank platoon -----	117-137	105	Gunner's -----	47	38
Over: range sensing -----	89	73	Elevation -----	48, 100	38, 90
Overlay, range surface danger area -----	232	211	Qualification course:		
Painting and marking of ammunition -----	29, 31, 35	25, 27, 29	Tank crew field firing exercises -----	214-218	187
Parallax -----	60	54	Tank crewman gunnery qualification firing:		
Parallel laying of tank guns ----	App. II	236	Service -----	209-213	179
Parallel sheaf -----	App. II	236	Subcaliber -----	205-208	171
Periscopes -----	39, 42, 52	30, 32, 43	Tank crew gunnery qualification firing -----	219-221	198
Permanent tank firing ranges ---	230	210	Tank crewman preliminary gunnery examination ----	187-204	160
Platoon:			Range:		
Distribution of fire (patterns) -----	121	106	Cards -----	102, 103	92, 93
Fire commands -----	123-129	111	Obtaining data (preparation) -----	100-102	90
Fire plan -----	134-135	117	Tactical use -----	110	98
Fire planning -----	130-137	116	Target designation ----	100	90
Minimum elevation -----	App. II, 3	236	Types -----	101	92
			When prepared -----	100	90
			Change, standard -----	92	79
			Corrections -----	92	79

	Paragraphs	Pages		Paragraphs	Pages
Range—Continued			Sabot, armor piercing discarding sabot (APDS)		
Crew field firing -----	214-221	187	Description -----	16	12
Designation site -----	162	142	Techniques -----	96	86
Determination -----	153	132	Use -----	18	15
Methods:			Safety:		
Binocular and mil relation -----	156	132	Officer, duties in tank range firing -----	245	219
Estimation by eye -----	158	138	Precautions for tank range firing -----	247-249	220
Flash and sound estimation -----	159	140	Salvo, fire -----	App. II	236
Intersection -----	160	141	Scale:		
Maps -----	157	138	Azimuth indicator -----	49	38
Range finders -----	155	132	Quadrant -----	47, 48	38
Site -----	163	143	Score card:		
Effects on ammunition -----	16, 17	12, 14	Tables I-III, subcaliber -----	206-208	171
Elements in fire commands. (See Fire commands.)			Tables IVA-VB -----	210-213	179
Finders -----	168	147	Tables VIA-VIIB -----	215-218	188
Improving proficiency --	174	151	Tables VIIIA and VIIIB -----	219-220	198
Retesting operators -----	175	152	Table IX -----	224	206
Testing -----	170, 173	147, 151	Searchlight:		
Training -----	155, 169, 170, 172	132, 147, 149	Boresighting -----	54	48
Firing -----	206-226	171	Element of fire command --	78, 115, 125	67, 104, 112
Mil relation -----	156	132	Tank-mounted:		
Sensings -----	89	73	18-inch -----	51	42
Surface danger area diagram	232	211	Laying and employment	114, 116	102, 104
Ranges, tank firing:			Xenon -----	52	43
Arrangement and handling of ammunition -----	252-253	222	Sensings:		
Checklist for OIC -----	249	221	Deflection -----	88	73
Communication and control --	250	222	Direct fire -----	87	73
Conducting -----	239-247	217	Range -----	89	73
Duties of OIC -----	234-243	213	Sensing and observation of tracer ammunition -----	87	73
Duties of safety officer -----	245	219	Separated round of ammunition --	10	8
Duties of tank instructors --	246	220	Sequence, tank gunnery training	186-221	160
Establishing -----	229	210	Service firing ranges -----	209-221	179
Safety precautions -----	247-249	220	Setting up aiming circle -----	App. II	236
Reciprocal laying -----	App. II	236	Sheaf:		
Recoil mechanism, test -----	190	162	Converged -----	App. II	236
Red illuminated reticle -----	171, 172	148, 149	Parallel -----	App. II	236
Reference point -----	49, 100	38, 90	Shells illuminating -----	125, 184	112, 158
References -----	App. I	236	Short, range sensings -----	89	73
Refinement of zero -----	58	54	Shot (AP-T) ammunition:		
Relation, mil -----	156	132	Description -----	16	12
Report by observer -----	69, 119	62, 105	Use -----	18	15
Request, fire -----	69	62	Sights, direct fire:		
Reticles:			Adjustment:		
Binocular -----	165	144	Boresighting -----	54	48
Infinity sight -----	42	32	Emergency zero -----	55	50
Illumination -----	109, 171, 172	98, 148, 149	Zeroing -----	56	51
Periscope -----	42, 52	32, 43	Description -----	38, 39, 42, 45, 52	30, 32, 34, 43
Telescope -----	45	34	Filters -----	171, 172	148, 149
Ricochet fire -----	23	22	Reticles -----	38, 39, 42, 45, 52	30, 32, 34, 43
Rotating bands -----	13, 16, 17, 20, 21, 22, 26	10, 12, 14, 19, 21, 23	Training in use -----	143, 171, 172	124, 148, 149
Round, marking -----	27	23	Site to mask, angle -----	App. II	236
Rules for record firing -----	185	159	Sketch range card -----	103	93

	Paragraphs	Pages		Paragraphs	Pages
Smoke (WP) ammunition:			Tank—Continued		
Description -----	26	23	Weapons employment -----	3-8, 62, 78, 110, 118, 120-137	4, 57, 67, 98, 105, 106
Use -----	27	23	Target:		
Snakeboard -----	145	126	Acquisition -----	65, 119	60, 105
Special equipment and personnel for indirect firing -----	App. II	236	Course layout -----	177	153
Special uses, tank ammunition --	24	22	Platoon -----	119	105
Special purpose projectiles ----	11, 25-28	9, 23	Training -----	180, 183	156, 157
Spread, range -----	174	151	As a range sensing -----	89	73
Stakes, aiming -----	App. II	236	Board and reticle -----	144	124
Standard range change -----	92	79	Classification -----	68	60
Stationary target range -----	259	226	Designation (range card). (See Range card.)		
Stereoscopic range finder -----	172	149	Crewman -----	67	60
Subcaliber firing:			Infantryman -----	69	62
Range -----	257	225	Location, platoon -----	127	115
Tables -----	206-208	171	Plotted engagement -----	112, 137	99, 121
Subsequent fire command. (See Fire command.)			Targets:		
Surface danger area diagram ---	232	211	Machinegun -----	259	226
Superelevation angle -----	40	30	Main gun -----	256	225
Systems, direct-fire control ----	36-45	30	Subcaliber -----	255	225
Tables, firing:			Teamwork, crew -----	71	65
Familiarization -----	222-224	206	Techniques:		
Practice -----	225, 226	208, 209	Firing -----	94-96, 116	86, 104
Qualification:			Night firing -----	107-109, 113	97, 102
Crew -----	209-213	179	Target destruction -----	18, 23, 24	15, 22
Crewman -----	214-221	187	Telescopes -----	45	34
Subcaliber -----	206-208	171	Temporary rank firing ranges --	233	211
Tactical employment, machinegun	6, 8, 113	4, 7, 102	Test. (See Examination.)		
Tactical zeroing -----	59	54	Thickness, equivalent (armor) --	16, 18	12, 15
Tank:			Tracking -----	91	79
Base -----	App. II	236	And leading exercises -----	146	126
Characteristics -----	3	4	Trainer, conduct of fire -----	144	124
Commander -----	72	65	Training. (See Exercises.)		
Crew. (See Crew and exercises.)			Gunnery -----	140, 186-221	123, 160
Field firing:			Methods of testing ----	140	123
Exercises -----	152, 186-218	130, 160	Sequence -----	139, 152	122, 130
Range -----	259	226	Individual, tank gun crew --	141	124
Proficiency firing:			Mechanical -----	142	124
Exercises -----	219-221	198	Range determination -----	153	132
Range -----	259	226	Range finder -----	168	147
Crewman:			Target acquisition -----	176	153
Familiarization firing --	222-224	206	Trajectory -----	40	30
Practice firing -----	225, 226	208, 209	Troop safety factor -----	App. II	236
Qualification firing ----	214-218	187	Towed-card exercise -----	146	126
Subcaliber -----	206-208	171	Turret deflade position -----	64	57
Gun. (See Main gun.)			Two-tank methods of adjustment	96	86
Gun ammunition. (See Ammunition.)			Unarmored and lightly armored vehicles, destruction -----	5, 7, 23, 32, 33, 34	4, 6, 22, 28, 29
Individual action in massed fire -----	130-132, 136, 137	116, 118, 121	Verification of zero -----	57	53
Mounted searchlights -----	50, 114	42, 102	Vision (optical) devices -----	70	62
Parallel laying -----	App. II	236	Volley fire -----	App. II	236
Platoon, organic fire control	117-137	105	Vulnerability, center -----	86	73
Range. (See Range.)					
Vulnerability -----	18	15			

	Paragraphs	Pages		Paragraphs	Pages
Weapon:			Zeroing:		
Element of fire command ---	78, 111,	67, 98,	Coaxial machinegun -----	56	51
	125	112	Cupola-mounted machinegun	56	51
Employment -----	3-8, 78	4, 67	Emergency -----	55	50
Familiarization firing -----	222-224	206	Exercise -----	148	127
Practice firing -----	225, 226	208, 209	Main Gun -----	56	51
Qualification firing. (<i>See</i>			Refinement -----	58	54
Tables, qualification firing.)			Tactical -----	59	54
White phosphorous. (<i>See</i>			Verification -----	57	53
Smoke ammunition.)					
Width, determining with mil					
relation -----	156	132			

By Order of the Secretary of the Army:

HAROLD K. JOHNSON,
General, United States Army,
Chief of Staff.

Official:

J. C. LAMBERT,
Major General, United States Army,
The Adjutant General.

Distribution:

Active Army:

- ACSFOR (2)
- DCSPER (2)
- DCSOPS (2)
- ACSI (2)
- CNGB (1)
- USCONARC (5)
- Armies (7) except
 - Armies (OS) (25)
- Corps (10)
- Div (2) except
 - Armd Div (10)
- USAC (3)
- Br Svc Sch (2) except
 - USAAMS (15)
 - USAIS (55)
 - USAES (7)
 - USAOC&S (10)
 - USATSCH (3)
 - USACMLCS (10)
- USACGSC (5)
- USMA (25)
- USAAMC (10)

Units org under fol TOE:

- 1-17 (1)
- 5-5 (5)
- 6-300 (3)
- 6-301 (1)
- 6-315 (5)
- 6-325 (5)
- 7-19 (2)
- 7-25 (2)
- 9-65 (5)
- 12-27 (1)
- 17-17 (22)
- 17-22 (2)
- 17-25 (71)
- 17-32 (5)
- 17-35 (71)
- 17-45 (33)
- 17-51 (26)
- 17-55 (33)
- 17-65 (71)
- 17-85 (33)
- 17-105 (33)
- 17-115 (5)

NG: State AG (3); units—same as Active Army.

USAR: Units—same as Active Army.

For explanation of abbreviations used, see AR 320-50.