

# TYPICAL FOREIGN UNCONVENTIONAL WARFARE WEAPONS

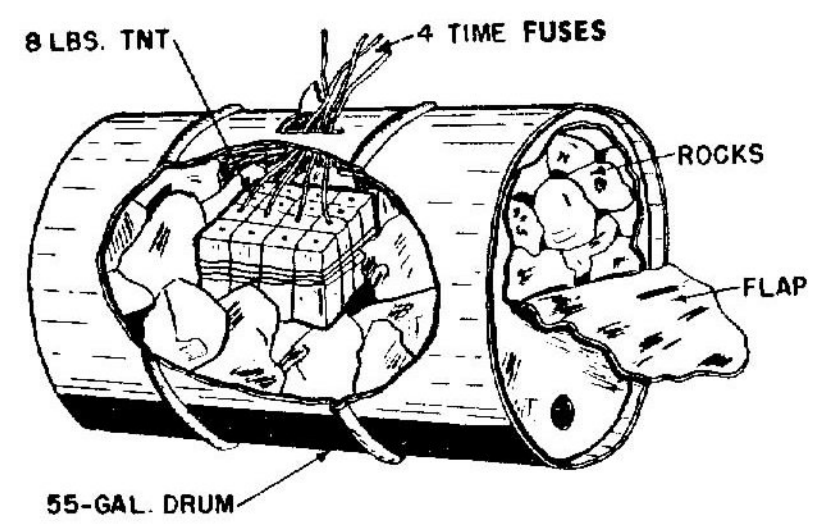

Project E1z-580

FSTC 381-5012

TYPICAL FOREIGN UNCONVENTIONAL  
WARFARE WEAPONS (U)

September 1964

Prepared by

U.S. Army Foreign Science and Technology Center  
Munitions Building  
Washington, D. C. 20315

APPROVED:

*Arthur E. McCabe,*  
for G. M. PAYNE Lt Col, Acty  
Colonel, Sig C  
Deputy Commander

A Category II Intelligence Document. This document was compiled and produced by the U.S. Army Foreign Science and Technology Center of the U. S. Army Materiel Command. It has been approved by the Assistant Chief of Staff for Intelligence, Department of the Army, and therefore contains agreed Department of the Army Intelligence.

UNCLASSIFIED

FSTC 381-5012

TYPICAL FOREIGN UNCONVENTIONAL  
WARFARE WEAPONS (U)

TABLE OF CONTENTS		<u>Page</u>
SECTION I. PURPOSE AND SCOPE -----		1
II. CONCLUSION -----		1
III. SMALL ARMS AMMUNITION -----		2
IV. SMALL ARMS -----		3
V. RECOILLESS AND ROCKET WEAPONS -----		12
VI. LAND MINES -----		14
VII. FIRING DEVICES -----		20
VIII. CALTROPS AND BOOBYTRAPS -----		35
IX. DISGUISED DEVICES -----		42
APPENDIX -----		53

UNCLASSIFIED

TYPICAL FOREIGN UNCONVENTIONAL WARFARE WEAPONS (U)

Section I. (U) PURPOSE AND SCOPE

1. (U) The purpose of this study is to present a description of typical foreign weapons which have been, or are being, used by insurgents or guerrillas involved in unconventional warfare. In this context, the term "unconventional warfare" means revolt or insurrection by predominantly indigenous personnel against a constituted government.
2. (U) This study is limited primarily to those weapons which have been improvised from materials at hand, or modified from standard military items. In addition, even though they do not fall within these limits, certain factory-made items have been included because their nature makes them especially useful to the insurgent. The latter class of equipment includes most of the incendiary devices and camouflaged explosives, as well as a few firing devices.
3. (U) The period of time covered by this study is from World War II to the present. The materiel described is a representative sample, rather than an exhaustive listing of such equipment. All of the items shown herein could be useful to the various guerrilla operations currently under way. Some of the factory-made pieces are no longer available because stocks are exhausted.
4. (U) This study is presented for its technical value; it does not analyze any guerrilla force's operational, tactical, or logistical strengths or weaknesses. The materiel described in this study represents, to a large extent, expedient solutions. The risks involved in manufacturing, storing, and handling equipment of the type covered in this study are relatively large, and must be accepted knowingly by both maker and user. In no case are any inferences warranted concerning its effectiveness by U. S. standards, or its availability in quantity, or the training status of the users. FSTC does not recommend any attempt by U. S. personnel to manufacture or use this materiel.

Section II. (U) CONCLUSION

5. (U) The guerrilla normally arms himself with standard, factory-made, military weapons, ammunition, explosives, incendiaries, and firing devices. He manufactures this materiel only when he must. When so driven, he often displays a considerable amount of ingenuity in design and in the adaptation of available materials to serve his purposes.

UNCLASSIFIED

6. (U) The complexity of the weaponry produced by a guerrilla munitions industry varies considerably. In the field of small arms, for instance, the range of complexity extends from a standard military rifle which has merely been lightened by shortening the barrel and removing excess wood, to a pistol or rifle made from scratch. The factors controlling the quality and complexity of an item appear to be the ingenuity of the people, the materials and tools available, and the presence or absence of outside support.

7. (U) The guerrilla normally obtains his weapons, ammunition, and explosives either by capturing them from an organized military force which opposes him, or by receiving them from friendly forces outside his operational area. In either case, this materiel almost always consists of standard, factory-made military equipment. A notable exception to this generality occurs when the supplier wishes to conceal his connection with the guerrilla. In this case, manufacturers' markings and serial numbers are often obliterated from weapons, and ammunition is manufactured either with nonsensical or with counterfeit headstamps, color codes, and other markings.

8. (U) When the total of the supplies captured from the enemy, plus those furnished by friends, is inadequate to satisfy the local need, a guerrilla munitions industry comes into being. This industry can flourish only when a secure area exists so that plants can be established on a more or less permanent basis, but, since the technical skills and facilities for such basic manufacturing techniques as turning, milling, and heat treating are generally lacking, the materiel produced is usually small and simple. The vast majority of these munitions exist only because they are the best available. Bows, arrows, and spears--the tools of life in a primitive society--are turned to warlike ends, but as soon as better or more effective weapons become available, the homemade ones either are abandoned or are returned to more peaceful uses.

#### Section III. (U) SMALL ARMS AMMUNITION

9. (U) By far the major portion--probably 99+%-of all small arms ammunition consumed by insurgent or guerrilla forces engaged in unconventional warfare is factory made, and thus falls outside the scope of this study. However, once in a great while a need arises for a cartridge which is not available. In this situation, the guerrilla will hand fabricate them.

10. (U) All known cases of field manufacture of small arms cartridges involve one of two basic processes--reloading a fired cartridge case of the appropriate caliber, or altering an existing cartridge to fit a weapon for which it was not originally intended. For instance, during World War II, resistance forces in the Philippine Islands reloaded fired caliber .30 cartridge cases, using kitchen match

heads for primers, grated nonsafety photographic film for propellant, and cast lead bullets. The Chinese Nationalists have converted caliber .30 carbine cartridges into .32 automatic pistol rounds on a relatively large scale by cutting the cartridge case to length, reducing the body diameter and propellant charge, cutting off the base of the bullet to reduce weight, and assembling these pieces.

11. (U) The 12-gauge shot shell shown in figure 1 was obtained in Vietnam. Originally it was a U.S. caliber .50 machinegun cartridge. The transformation of the one into the other, which is not too complicated a job, was accomplished by disassembling a loaded round, cutting the cartridge case to length, peening the extractor flange into a rim, and filing the rim to the correct diameter. The finished case was then loaded with propellant, wadding, shot (or miscellaneous scrap metal), more wadding, and lastly the end was sealed with some substance such as paraffin or candlewax.



Figure 1 (UNCLASSIFIED). Viet Cong 12-gauge shot shell (U).

#### Section IV. (C) SMALL ARMS

##### 12. (U) GENERAL

While probably over 90% of the small arms used by guerrilla forces are standard military as-issued items, including a small percentage of unaltered sporting weapons, the remaining 10% are of some interest. The latter group includes arms ranging from those which are completely homemade, with barrels and receivers made from gas pipe, to those adapted from standard military arms to meet the guerrilla's idea of a suitable weapon. This last category covers factory-made

UNCLASSIFIED

UNCLASSIFIED

FSTC 381-5012

barrels and actions fitted with homemade stocks of varying shapes and sizes. Because these homemade arms normally serve the guerrilla only until he obtains a better weapon, their short service life is not a great drawback.

### 13. (U) PISTOLS

a. The 9-mm pistol pictured in figure 2 is essentially a blowback-operated submachinegun minus the magazine. Its receiver, barrel, and chamber-reinforcing piece are made either of pipe or of thick-walled tubing, and fastened to the wooden grip assembly by means of two sheet-metal straps. To operate the pistol, retract the bolt by pulling back on the machine screw until the bolt latches to the rear; then drop a cartridge through the loading port in the right side of the receiver and into the chamber. The weapon fires from the open-bolt position. Since it has neither extractor nor ejector, extraction and ejection must be accomplished by retracting the bolt, and then shaking or prying the fired cartridge case out of the chamber and through the loading port.

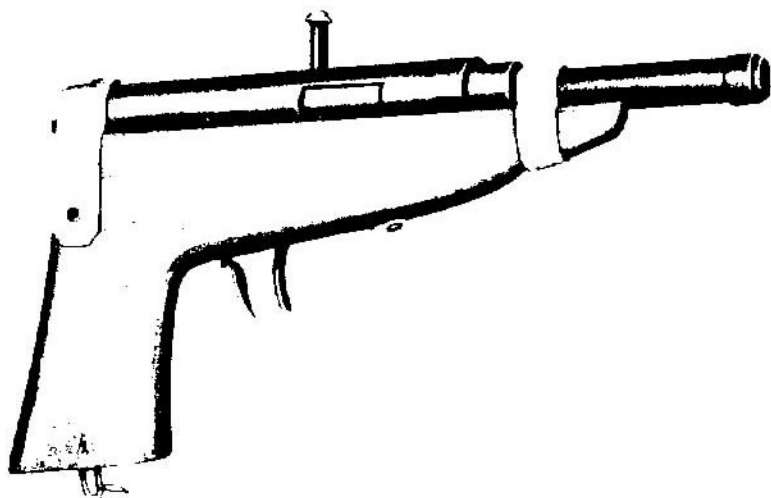

Figure 2 (UNCLASSIFIED). Viet Cong wooden-stock pistol (U).

b. The barrel and receiver of the homemade single-shot pistol shown in figure 3 are made of two pieces of pipe held together by pins, while the grip is a length of fairly heavy wire bent to shape and either welded or riveted to the receiver. The service life of this weapon is probably only a few rounds.

4

UNCLASSIFIED

UNCLASSIFIED

FSTC 381-5012

c. To load the pistol, retract the bolt handle and engage it in the small vertical slot at the right of the long horizontal slot; then drop a cartridge into the chamber through the loading port located in the right side of the receiver. To fire, point the weapon with the right hand and, disengaging the bolt handle from the small slot, allow the compressed driving spring to force the bolt forward until the fixed firing pin strikes the primer.



Figure 3 (UNCLASSIFIED). Viet Cong metal-stock pistol (U).

d. The weapons described up to this point display a relatively low level of ingenuity and effort in their structure and manufacture. The caliber .32 semiautomatic pistol shown in figure 4, however, although its design is conventional in all respects, exhibits considerable ingenuity on the part of its creator because of the difficulties overcome in bringing it into existence--it is completely handmade.

e. If he does not have design talent, the guerrilla artisan does not hesitate to produce a copy of a proven pattern, especially when a specimen is available.

f. During the time of the French War in Indochina (1945-1954), a number of underground factories produced weapons and allied materiel for the various irregular forces fighting there. The 9-mm Browning Hi-Power pistol illustrated by figure 5 was, according to the markings on the slide, manufactured at the Allied National Army Military Manufactory Number 5, which was located near Tay Ninh. A report states that this plant produced approximately 5,000 of these pistols. The workmanship exhibited in this weapon is surprising--the fits are reasonable, and the finish is quite good.

5

UNCLASSIFIED

UNCLASSIFIED

FSTC 381-5012

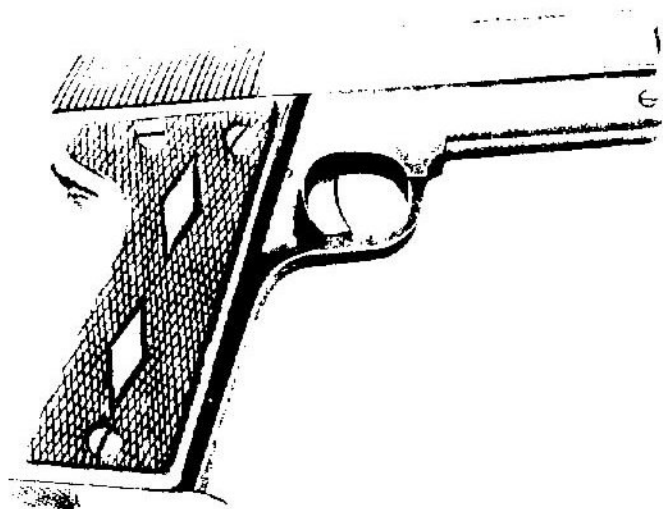

Figure 4 (UNCLASSIFIED). Viet Cong caliber .32 pistol (U).

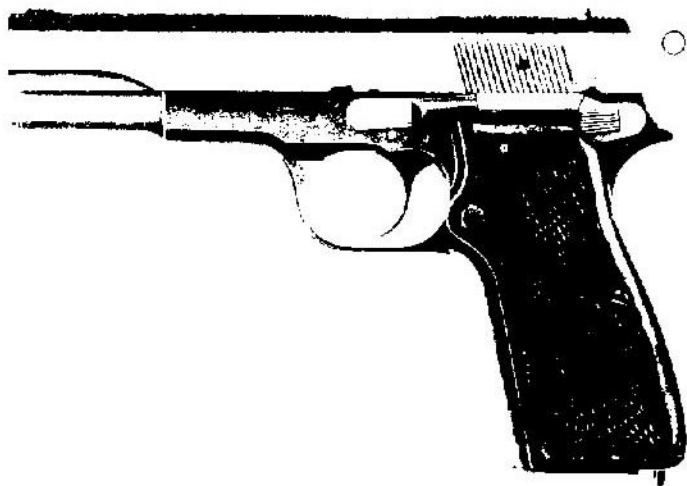

Figure 5 (UNCLASSIFIED). Vietnamese copy of 9-mm Browning pistol (U).

6

UNCLASSIFIED

UNCLASSIFIED

FSTC 381-5012

## 14. (U) RIFLES

a. Homemade rifles run the gamut of design sophistication and manufacturing complexities, from crude to well done. Oddly enough, the cruder the design, the more effort is required in manufacture. The reason for this apparent anomaly is that as the designs become more sophisticated, the likelihood increases that the rifle will incorporate major parts of a factory-made rifle.

b. The "rifle" shown in figure 6, actually a smoothbore weapon, has a barrel made from a piece of pipe. Its breechblock pivots transversely, and is articulated on a common door hinge. The hammer arrangement strongly suggests that the gun employs pinfire cartridges, and the absence of a trigger indicates that the user fires the piece by pressing down on the hammer spur with his thumb to compress the hammer spring, then releases the hammer spur to allow the hammer to fly forward to fire the cartridge.

c. The buttstock apparently has been made of two miscellaneous pieces of wood mitered together, but the forestock, as evidenced by the metal fitting at its front end, was salvaged from a factory-made weapon.

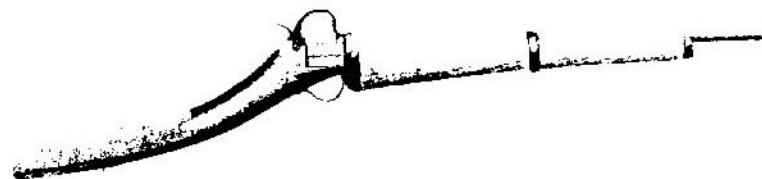

Figure 6 (UNCLASSIFIED). Vietnamese pinfire (?) shotgun (U).

d. The single-shot small arm seen in figure 7, although bearing some resemblance to a short-barrelled rifle, is actually a shotgun. Its method of operation is unknown. Both the barrel and the receiver are made from a piece of pipe, and are fastened to the stock at the rear by means of a metal strap, and at the front by a metal block which also serves as a recoil shoulder. The trigger pivots about a screw which passes transversely through the stock, and in this respect the trigger mechanism resembles that of the British Lee-Metford and Lee-Enfield rifles. The vertical finger-grip ribs on the cocking piece emphasize this resemblance.

e. The remaining small arms in this section illustrate some of the ways in which the guerrilla will modify standard military weapons, either to return them to useable condition or to adapt them to his individual ideas of the weapon he wishes to be armed with. A case in point is the modified French 8-mm Model 1907/15 Mannlicher-Berthier rifle shown in figure 8.

7

UNCLASSIFIED

UNCLASSIFIED

FSTC 381-5012

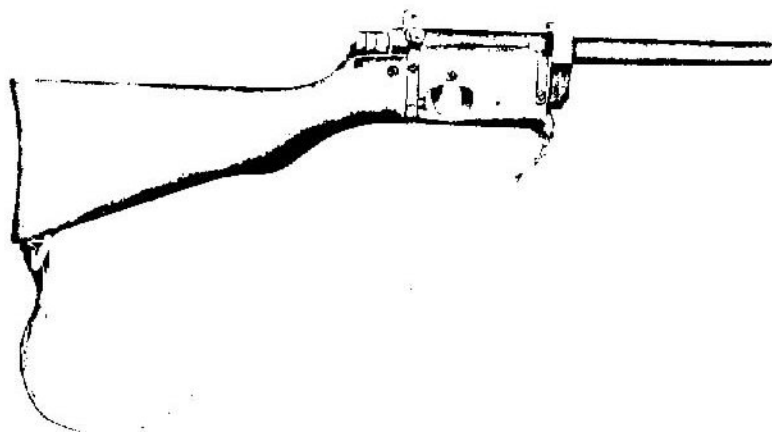

Figure 7 (UNCLASSIFIED). Viet Cong shotgun (U).



Figure 8 (UNCLASSIFIED). Viet Cong modified Mannlicher-Berthier rifle (U).

g. Another type of conversion has been performed on the weapon shown in figure 9, formerly a French 11-mm Model 1874 Gras rifle. In this case, since ammunition for this weapon is almost nonexistent, the barrel was cut off to make the weapon easier to handle, and the chamber was altered slightly so that 410-gauge shotgun shells could be fired. A homemade stock completes the picture.

8

UNCLASSIFIED

UNCLASSIFIED

FSTC 381-5012

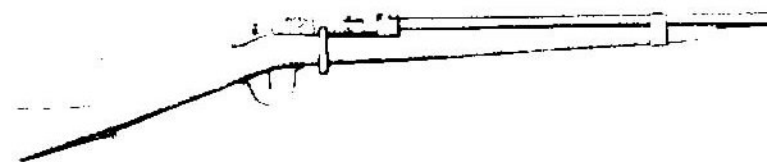

Figure 9 (UNCLASSIFIED). Viet Cong modified Gras rifle (U).

h. An even simpler modification is shown in figure 10. The barrel and stock of this U. S. caliber .30 M1917 Enfield rifle have been cut, and the front sight has been remounted. The object of such a conversion is to produce a lighter rifle which can be swung into firing position more rapidly, especially in the presence of the dense undergrowth found in Vietnam.



Figure 10 (UNCLASSIFIED). Viet Cong modified M1917 Enfield rifle (U).

#### 15. (C) SUBMACHINEGUNS

a. (U) The submachinegun, so long as the ammunition supply is adequate, is a popular guerrilla weapon, probably because of its compactness, light weight, and short-range effectiveness. Since the Vietnamese terrain lends itself to cover and concealment, it is not surprising to find the Viet Cong going to considerable lengths to supply themselves with this class of individual weapon. The four items shown in this study, all of which were used in Vietnam, illustrate various types of effort put into the manufacture of submachineguns.

b. (U) The weapon shown in figure 11, like some of the pistols and rifles discussed previously, has a barrel-and-receiver assembly made of pipe, with the various pieces held together by pins. The grip frame has been made from iron strap, and is welded to the receiver. The trigger-group and magazine-housing assemblies, also welded to the receiver, evidently have been salvaged from a standard submachinegun of unknown origin.

8

UNCLASSIFIED



UNCLASSIFIED

FSTC 381-5012

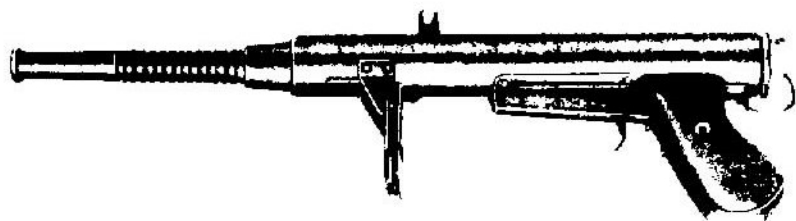

Figure 11 (UNCLASSIFIED). Viet Cong submachinegun (U).

c. (U) Geographically speaking, the United Kingdom's Sten-series submachinegun is one of the most widespread weapons of its type in the world, and it has been copied by a number of countries with varying degrees of fidelity to the original form. The two weapons shown in figures 12 and 13 were made in Vietnam, and are based on the Mk.II Sten gun. In fact, the pistol grips of each of them were probably modified from British-manufactured recoil spring car and buttstock assemblies. On the other hand, both receivers are definitely not Sten parts because the magazine housings are attached to the bottoms of the receivers, whereas this housing is fastened on the left side of a Sten receiver.

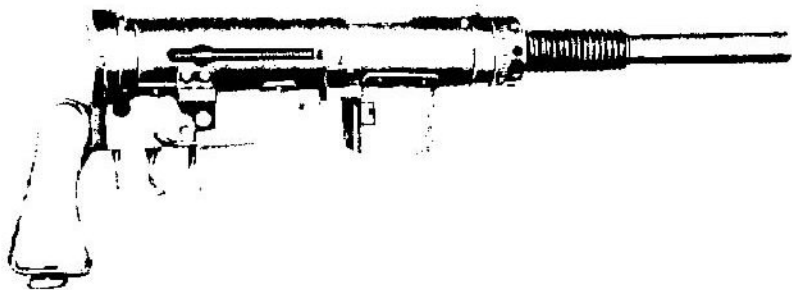

Figure 12 (UNCLASSIFIED). Viet Cong Sten-type submachinegun (variation 1) (U).

10

UNCLASSIFIED

FSTC 381-5012

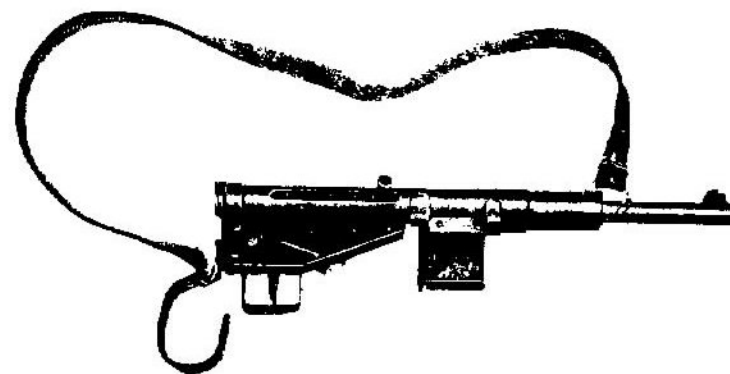

Figure 13 (UNCLASSIFIED). Viet Cong Sten-type submachinegun (variation 2) (U).

d. (C) The last of the submachineguns presented herein illustrates the result of a failing ammunition supply and outside aid to guerrilla forces. Basically the weapon, seen in figure 14, is a French 9-mm MAT-49 chambered for the 9-mm Parabellum cartridge. When the supply of 9-mm ammunition ran low, and prospects of resupply appeared dim, the North Vietnamese Army workshops, rather than scrap the weapon, rebarrelled it with a Chinese 7.62-mm submachinegun barrel and made new magazines so that the gun would fire the Soviet 7.62-mm Type P pistol and submachinegun cartridge and the various copies thereof. The only other modification involved was the salvaging of the MAT-49 original front sights and the mounting of them on the new barrel.

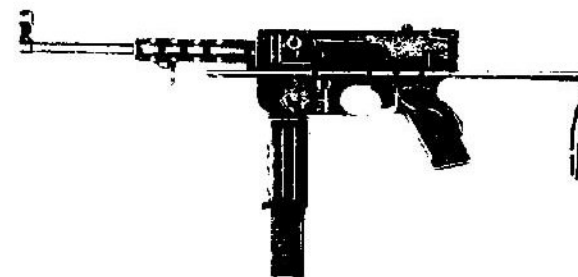

Figure 14 (UNCLASSIFIED). North Vietnamese modified MAT-49 (U).

11

UNCLASSIFIED

FSTC 381-5012

## 16 (U) MACHINEGUNS

Relatively few machineguns have appeared in guerrilla movements, and only one of them has been so modified as to merit inclusion in this study. The weapon pictured in figure 15 originally was a French 7.5-mm Model AV-34 flexible aircraft machinegun. The guerrilla who reworked the basic gun added a handguard, a shoulder stock salvaged from a French Chatellerault Model 24/29 automatic rifle, and a rear sight which appears to be a survivor of the Franco-Prussian War.



Figure 15 (UNCLASSIFIED). Modified AV-34 aircraft machinegun (U).

Section V. (U) RECOILLESS AND ROCKET WEAPONS

17 (U) Homemade recoilless and rocket weapons are almost as scarce among guerrilla forces as are machineguns. The Model S.S.A. recoilless gun shown in figure 16 was made either in North Vietnam or in a Viet Cong safe area, as it and its ammunition require fairly extensive shop facilities for manufacture.

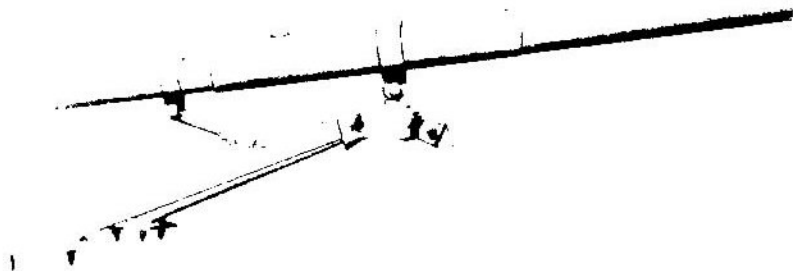

Figure 16 (UNCLASSIFIED). Model S.S.A. recoilless gun (U).

12

18. (U) The tube of the smoothbore Model S.S.A. is a piece of pipe approximately 4 1/2 feet long, having an extra section shrunk around its center for reinforcement. Two sighting devices are provided. One device consists of a blade front sight and a V-notch rear sight, both mounted on the reinforcing sleeve; the other consists of a tube sight containing an aperture and crosshair mounted on the left side of the tube. The tripod mount is made of pieces of angled metal joined to a hub which contains a tapered bushing. A circular clamp surrounding the barrel has a tapered pin pivoted to its bottom for attaching the tube to the tripod. The weapon traverses freely, but elevation is accomplished by means of a threaded shaft extending from a clamp around the rear of the tube to an arm attached to the mounting clamp.

19. (U) The total weight of the weapon is approximately 72 pounds. The specimen illustrated has a nominal bore diameter of 60 mm; a 66-mm version also exists.

20. (U) A variant of the last weapon is illustrated in figure 17. The variant differs in that it is a rocket launcher, and in that its mount embodies a sector plate and a wingnut to provide elevation adjustment. The latter weapon is breech loaded, whereas the former is muzzle loaded. Both weapons fire electrically initiated ammunition.

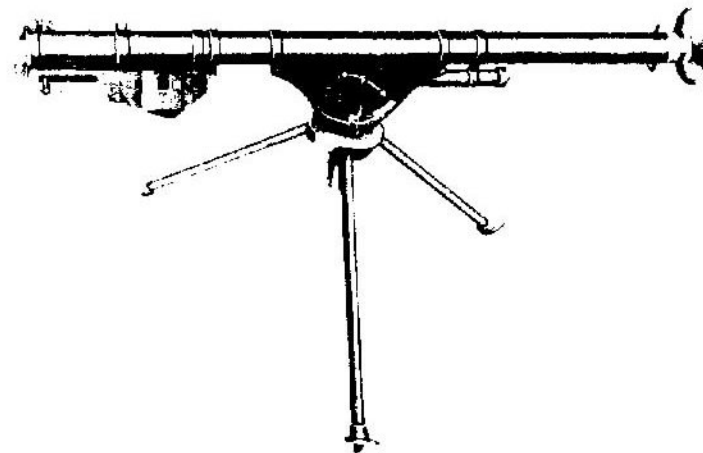

Figure 17 (UNCLASSIFIED). Viet Cong rocket launcher (U).

13

UNCLASSIFIED

UNCLASSIFIED

FSTC 381-5012

Section VI. (U) LAND MINES

21. (U) The guerrilla operation, being essentially a hit-and-run affair, lends itself especially well to the imaginative use of land mines as a means of creating an atmosphere of terror amongst the populace and of harassing opposing military and security forces. Since factory-made firing devices are often in short supply, one natural solution is to use an item which contains its own firing device--the hand grenade.

22. (U) There are many ways in which a hand grenade can be used as a mine--it can be tied in a bush and a wire can be led from the safety ring across a trail; or it can be inserted into a bag containing a charge of explosive, and thus serve as a fuze. The application shown in figure 18 was devised by the British during World War II and consists of a hand grenade, a tin can which is just large enough to fit over the grenade and its safety lever, and two lengths of string or wire. One length of wire is fastened to the can, and then tied to a stake, bush, or fence-post. The other length of wire is fastened to the grenade in such a way that it cannot interfere with the function of the fuze, and is then stretched across a road or pathway. The grenade is then inserted into the tin can, and the safety ring and pin are withdrawn. A pull on the wire stretched across the path will separate the grenade from the can, allowing the grenade fuze to function in the normal manner.

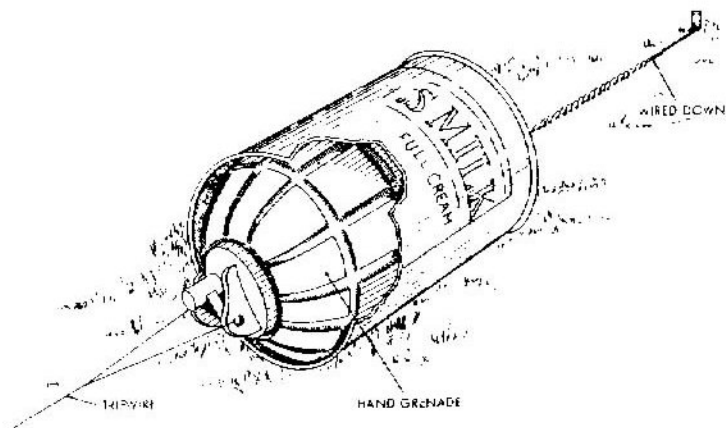

Figure 18 (UNCLASSIFIED). British grenade-in-can mine (U).

14

UNCLASSIFIED

UNCLASSIFIED

FSTC 381-5012

23. (U) During the Korean War, North Korean Forces occasionally made good use of the oil-drum mine which consists of a 55-gallon drum--a 100-pound wooden nail keg would serve just as well--filled with rock, a charge of explosive, and a number of time fuses. The user of this device places it uphill from the anticipated route of his target. At the appropriate moment he lights the fuses, and then rolls the drum down the hill where, if the fuses have been cut to the correct length, it explodes among the enemy. Multiple fuses should always be used with such devices to insure that at least one of them survives the downhill roll to initiate the explosive charge.

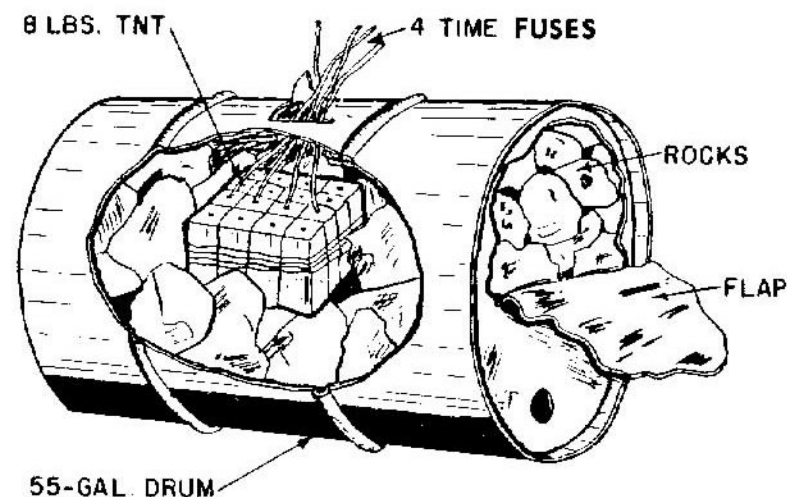

Figure 19 (UNCLASSIFIED). North Korean oil-drum mine (U).

24. (U) The advent of World War II found the Soviet Union unprepared to wage mine warfare on an extensive scale and, as a result, both infantry and engineer troops were trained to improvise mines in the field from available materials. Mines improvised by the infantry were generally much simpler than those improvised by the engineers, especially in terms of the facilities used in their fabrication. However, the former were by no means less ingenious in their structure.

25. (U) Probably the simplest of all these mines consists of a convenient charge of explosive wired to a stake, a pull-actuated fuze, and a tripwire anchored to a second stake (top panel of figure 20). When the wire is pulled, the fuze irritates the charge. If the terrain is suitable, this installation can be improved by

15

UNCLASSIFIED

UNCLASSIFIED

FSTC 381-5012

pling rocks around the charge. Although this device has the advantage of being made and installed very easily, it can be detected just as easily.

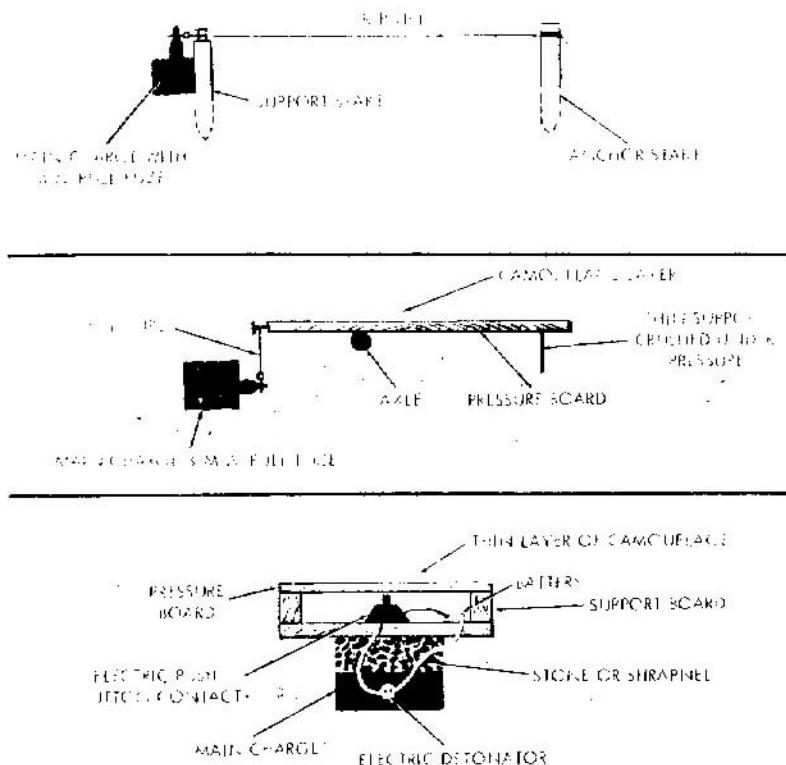

Figure 20 (UNCLASSIFIED). Soviet improvised infantry mines (U).

UNCLASSIFIED

UNCLASSIFIED

FSTC 381-5012

26. (U) A somewhat more complex mine, shown in figure 20 (center panel), consists of a charge of explosive, a pull-actuated fuze, and a pivoted pressure board. A wire connects the fuze's striker retaining pin with one end of the board, a flimsy support such as a large twig prevents the other end of the board from moving downward while the device is being laid and camouflaged. As with the last mine, rocks can be piled around the explosive charge to provide some fragmentation effect.

27. (U) The two mines just described are definitely infantry mines--simple in concept, manufacture, and installation. The third mine in this series, also pictured in figure 20 (bottom panel), is more complicated in that the ordinarily prudent person sent to install it would not do so until he had assured himself that the electric contact was in fact open by checking this point with a circuit tester--an equipment not normally included in infantry supplies. Except for this point, the mine is relatively simple in both manufacture and installation, consisting of a charge of explosive, some stones or miscellaneous metal scraps, a few boards, a battery, a doorbell-type contact, and an electric detonator. When either man or beast steps on the pressure board, the circuit is closed and the mine detonates.

28. (U) The three mines just described, primarily because of their simplicity of manufacture, have been categorized as infantry items. The next two are not so easy to make, and therefore are classified as engineer items.

29. (U) The device known as the lever tread mine, illustrated in figure 21, consists of a wooden box containing a charge of explosive, a pull-actuated fuze, and a tilting lid which is free to rotate about a fulcrum. A wire is attached to the striker retaining pin in the fuze, and to a screw or nail in one edge of the lid. This mine is normally laid below the surface of the ground. When the upper end of the lid is forced down, the wire attached to the lower end of the lid pulls the striker retaining pin out of the fuze to initiate the charge of explosive.

30. (U) The seesaw mine shown in figure 22 is a more complicated version of the lever tread mine just discussed. Although their structures are noticeably different, the principle of operation is the same--a wire attached to a pivoting board withdraws the striker retaining pin from a pull-actuated fuze. This design is somewhat wasteful of fuzes, as two are required for each mine, as compared to one for the lever tread mine. On the other hand, a foot placed on either end of the tilboard will actuate the seesaw mine whereas, with the lever tread mine, the foot must be placed on the upper end for actuation.

31. (U) In Algeria, the native Front de Liberation Nationale (National Liberation Front) (FLN) made their own special contribution to the lore of improvised mines. However, because the French forces were to a great extent mechanized, the FLN mines lean more heavily toward being antivehicular rather than antipersonnel items.

32. (U) A very common FLN antivehicle "mine" is shown in figure 23 in the section drawing of a road. The device is actually an uncased charge of explosive which fills a hole scooped from the center of the roadbed. The road surface is

UNCLASSIFIED

UNCLASSIFIED

FSTC 381-5012

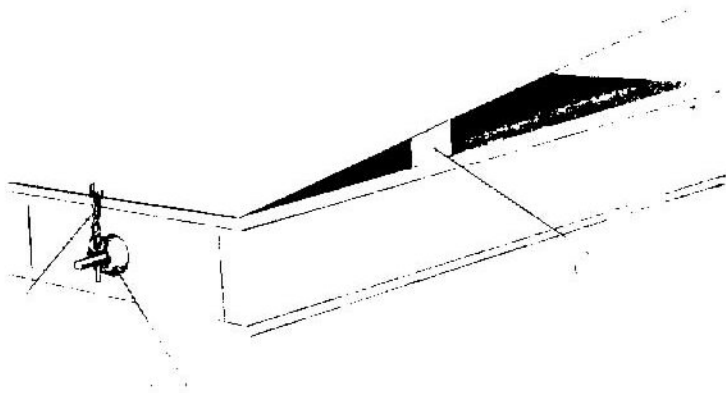

Figure 21 (UNCLASSIFIED). Soviet lever tread mine (U).

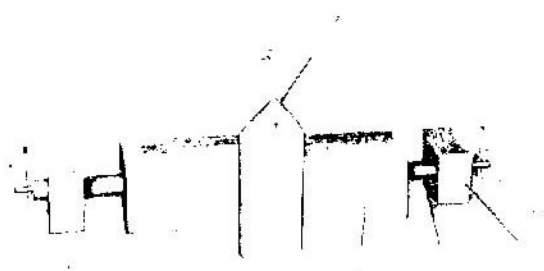

Figure 22 (UNCLASSIFIED). Soviet seesaw mine (U).

18

UNCLASSIFIED

UNCLASSIFIED

FSTC 381-5012

carefully cut, lifted, and then replaced to minimize the signs that it has been disturbed. The explosive is fired when the wheel of a vehicle passes over an electric firing device or contact placed on the edge of the road or in a wheel track. At first glance, the flat stones placed on top of the explosive charge might appear to have been put there to make this mine perform as a plate charge mine. However, since any reasonable explosive charge will shatter these stones, their true function more probably is to support the replaced road surface.

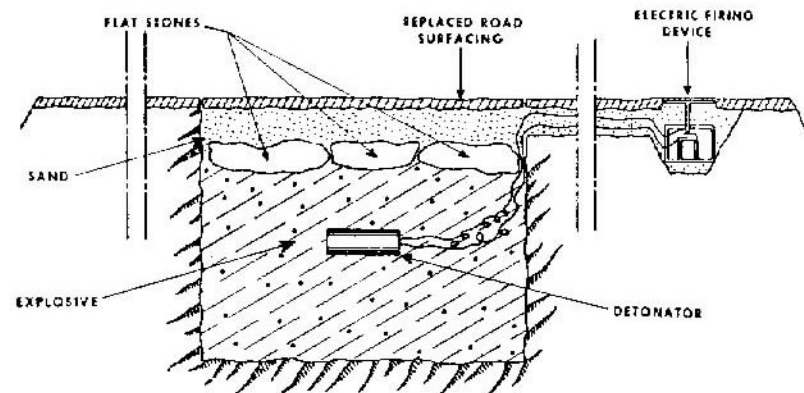

Figure 23 (UNCLASSIFIED). FLN antivehicle mine (U).

33. (U) An antilift mine can be made from an artillery shell, as figure 24 shows. The upper detonator is connected to a pressure-operated firing device which is not shown. The lower detonator is connected to batteries within the shell body, and to a contact box also within the shell body. The box consists of a tubular insulator having a metal end plate which is connected to the detonator. A sliding metal block within the insulator tube is connected to the batteries.

34. (U) If the external contact is closed, the mine detonates, destroying all possibility of determining its structure. On the other hand, if the mine is discovered, the person attempting to neutralize it will cut the external leads in the prescribed fashion--one at a time--thus disconnecting only the upper detonator. When the nose of the shell is lifted, the sliding block contacts the metal end plate, completing the circuit through the lower detonator, and the mine explodes.

19

UNCLASSIFIED

UNCLASSIFIED

FSTC 381-5012

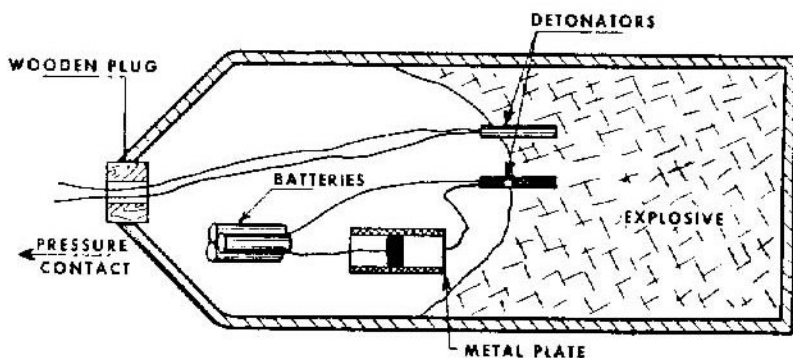

Figure 24 (UNCLASSIFIED). FN ontillift mine (U).

35. (U) The FLN in Algeria were also partial to the fougasse, an ancient device, which resembles nothing so much as an overgrown shotgun. The fougasse is most commonly aimed across a road, and, when properly loaded, will damage tin-skinned vehicles as well as kill troops. The top panel of figure 25 shows the entire installation, including the electric contact which is placed across the road from the exploding part, while the bottom panel shows in detail the structure of the charge portion of the fougasse emphasizing its resemblance to a shotgun. The maker of this device exercised his imagination when he chose to use the filament of a light bulb to initiate the propellant charge.

Section VII. (C) FIRING DEVICES

36. (U) GENERAL

a. A mine or boobytrap is essentially a concealed charge of explosive equipped with a device to initiate the explosive either at some predetermined time or upon the occurrence of some specific event. The guerrilla's capability to manufacture the explosive portion of these devices is generally limited, by the complexity of the processes involved, to packaging factory-made material. However, the manufacture of firing devices and fuzes is not nearly so difficult a task. As a result, considerable attention has been paid to the subject, resulting in the development of a variety of devices

UNCLASSIFIED

UNCLASSIFIED

FSTC 381-5012

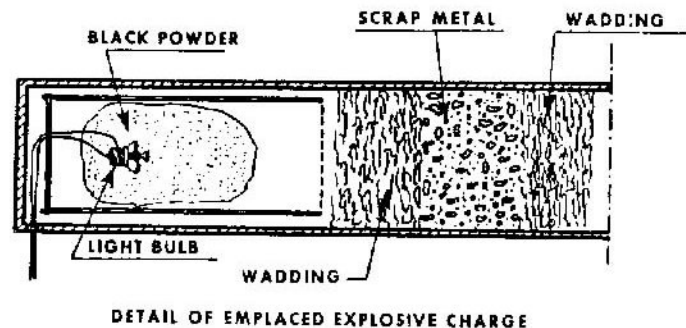
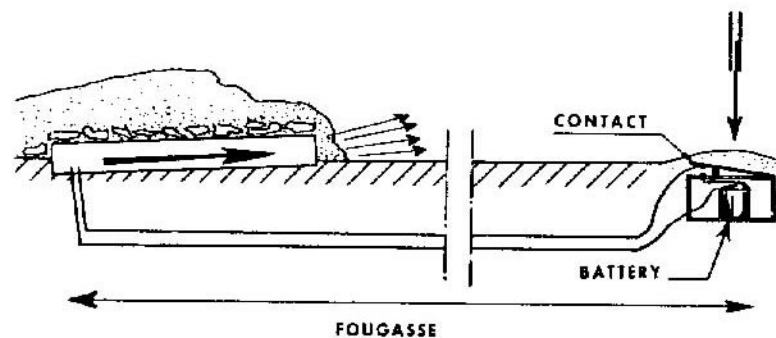

DETAIL OF EMPLACED EXPLOSIVE CHARGE

Figure 25 (UNCLASSIFIED). FN fougasse (U).

b. The distinction between a firing device and a fuze, although somewhat academic, is this--a firing device is a fuze without a detonator.

UNCLASSIFIED

UNCLASSIFIED

FSTC 381-5012

## 37. (U) NONDELAY DEVICES

a. Probably the most widely used type of firing device embodies a spring-loaded striker which is held in the cocked position by a retaining pin, and actuated by the pull of a wire attached to this pin. If the pin is formed in the shape of the letter T, the device also can be arranged to operate by pressure. Almost every country which manufactures these devices issues them with the T-shaped pins installed, thus eliminating a separate, pressure-operated device from its logistic system.

b. The fuze shown in figure 26 is a nondelay device, and was made in Algeria by rebel (FLN) personnel, probably in a basement workshop. The housing is a piece of thin-walled tubing, one end of which has been closed by hammering it over a mandrel. The striker has been turned from a piece of steel rod, and the spring was probably procured by midnight requisition from a junkyard. To complete the picture, the maker has pulled apart a round of small arms ammunition and fastened the empty cartridge case to the housing so that the striker can fire the primer, with the resulting flash initiating the detonator.

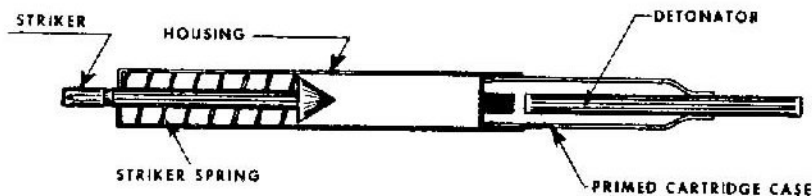

Figure 26 (UNCLASSIFIED). FLN improvised fuze (U).

c. Another variety of firing device operates either by tension (pull) or by tension release. These devices are, characteristically, installed with a taut tripwire, and the release of tension occurs when the wire either is unwittingly broken or is deliberately cut. In either case the device operates, and the charge of explosive to which it is connected explodes.

d. During World War II the British designed several devices of this type, and trained their troops to make them in the field.

e. One of the British devices employed a weighted can to keep the tripwire in tension as shown in figure 27. The frame which houses the can includes two pairs of electric contacts, one at the top of the frame and the other at the bottom, so

22

UNCLASSIFIED

UNCLASSIFIED

FSTC 381-5012

wired that when either pair is touched by the can, a circuit is completed. A battery then fires an electric detonator and the explosive charge. If the tripwire is pulled, the can rides up within the frame and closes the top pair of contacts; if the wire is cut or broken, gravity causes the can to drop and close the bottom pair of contacts.

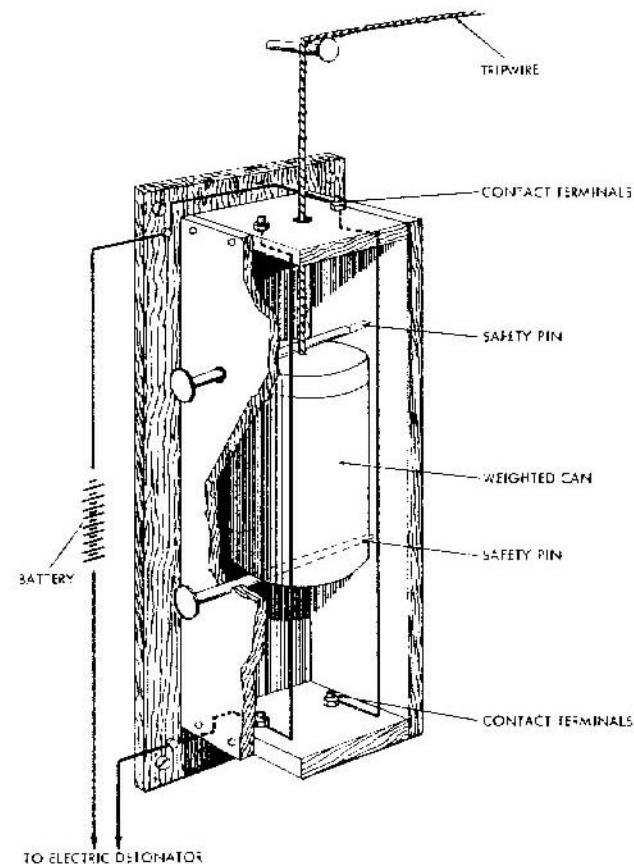

Figure 27 (UNCLASSIFIED). British weighted-can firing device (U).

23

UNCLASSIFIED

UNCLASSIFIED

FSTC 381-5012

f. A variation on the weighted-can device can be made with an ordinary knife arranged as shown in figure 28. Two pairs of nails driven into a board hold the knife in place by its handle, while a third pair is placed near the point of the knife and wired together, forming a double-pole electrical contact. The blade of the knife, lying between the two poles of this contact, is bent and held away from the far pole by a tripwire in tension. When the wire is pulled, the blade deflects further, and contacts the near pole; when the wire is cut or broken, the bent blade is released, and contacts the far pole. In either case the electric circuit is closed, and a detonator fires the explosive charge.

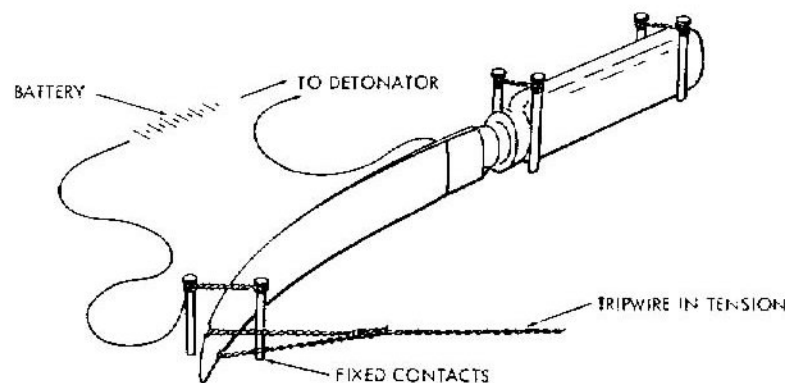

Figure 28 (UNCLASSIFIED). British knife switch (U).

g. A common spring-loaded clothespin can be made into a very good electric firing device by the wrapping of a small piece of sheet metal--that from a tin can will do--around each jaw. Small nails through each of these bits of metal will fasten them to the jaws of the clothespin, and will also function as binding posts. When the jaws of the pin are separated by an insulator such as a wooden wedge, an electric firing device is obtained.

h. The device shown in figure 29 was made by members of the the Algerian FLN rebel forces to be operated by a pull on the tripwire. This pull will dislodge the insulator from between the jaws of the clothespin, and the spring will bring the two metal contacts together and close the circuit to fire an electric detonator. Since the insulator stays in place because the jaws grip it, the trip wire is slack and can be cut as soon as it is discovered.

24

UNCLASSIFIED

UNCLASSIFIED

FSTC 381-5012

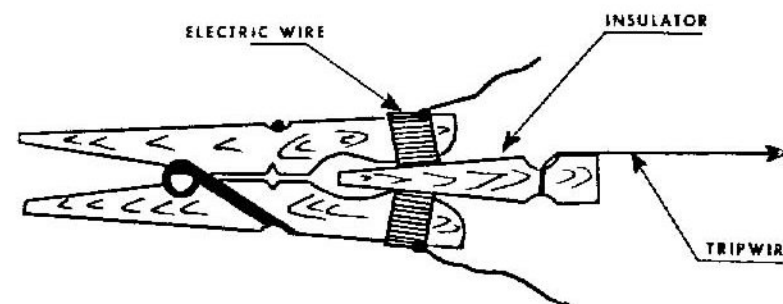

Figure 29 (UNCLASSIFIED). FLN clothespin firing device (pull-operated) (U).

i. If a sufficient number of firing devices are laid with slack tripwires, the guerrilla can reasonably hope that the persons responsible for clearing them may relax their vigilance somewhat, become a bit careless in examining individual installations, and possibly cut every tripwire they find. This provides a good psychological atmosphere for a change of tactics, which is now clearly indicated.

j. This change occurs when a clothespin is rigged so that the tripwires hold the jaws open, as shown in figure 30. The wedge is no longer needed, as the air-gap insulates the two contacts from each other. When the firing device is installed in this way, the unwary wirecutter succeeds only in exploding the charge connected to the device.

k. In addition to being made by the Algerian FLN, this type of device was also used by Soviet troops during World War II.

l. Another variety of British firing device consists of a metal tube and a ball bearing, arranged as shown in figure 31. So long as the left end of the tube is lower than the right end, the ball bearing does not contact the nail which passes through the center of the insulating cork to complete the electric circuit. However, when the tube is rotated clockwise until its left end is higher than its right, gravity rolls the bearing into contact with this nail, and the circuit is complete. Because of its particular adaptability to installation on doorknobs, this device is commonly known as the "doorknob device."

25

UNCLASSIFIED



UNCLASSIFIED

FSTC 381-5012

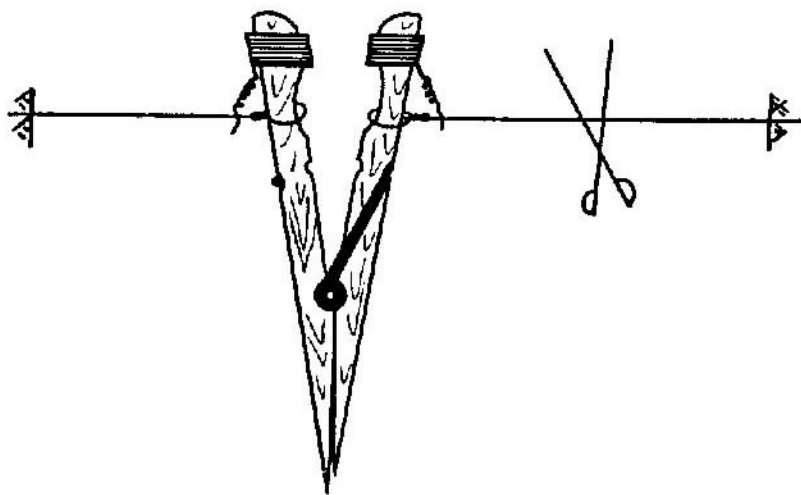

Figure 30 (UNCLASSIFIED). FLN clothespin firing device (tension-release-operated) (U).

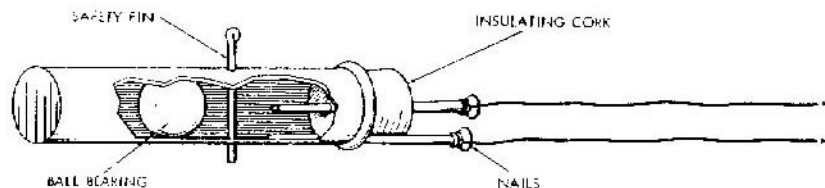

Figure 31 (UNCLASSIFIED). British ball bearing switch (doorknob device) (U).

UNCLASSIFIED

UNCLASSIFIED

FSTC 381-5012

m. Railroads and rolling stock are a prime target for the guerrilla. This is especially so if, as was the case in the U. S. S. R. during the Second World War, he is serving as an "advance guard" for regular troops. Whether he is performing this particular duty or not, a blow at a railroad is profitable because the rolling stock and the supplies it carries are often difficult to replace.

n. The Algerian device illustrated in figure 32 consists of a board with two flexible electric contacts attached to it. It is laid with the contacts on the inside of a rail so that the flange of a locomotive wheel can bring them together to close the circuit through an electric detonator. This device is relatively sturdy and resistant to displacement by shock, but, because it is placed above ground, it can be detected relatively easily, even when camouflaged with a small bush or leaves.

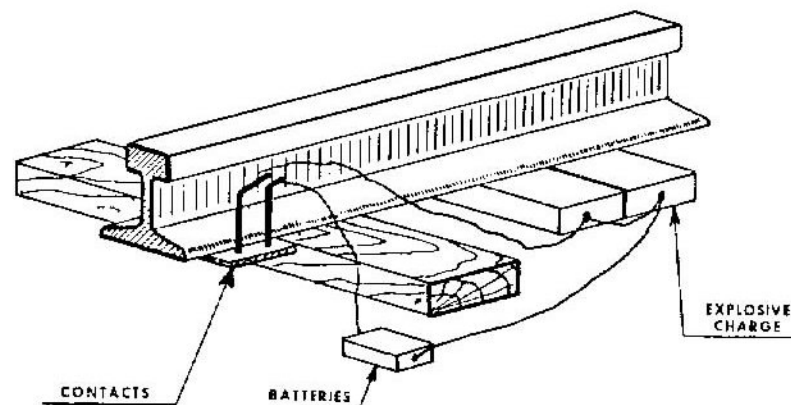

Figure 32 (UNCLASSIFIED). FLN wheel-flange firing device (U).

o. A variation of the Algerian railroad firing device is the item seen in figure 33, made from two lengths of insulated wire and used by the Germans during World War II. The insulation has been stripped from one end of one wire for a distance of about 3 inches, and this bare end has been formed into a coil. About 1 inch of insulation has been stripped from the same end of the other wire, and this bare section has been placed inside the coil so that the two bare sections do not touch. The coil end is then laid on top of a railroad track, and, when crushed by a passing wheel, completes an electric circuit to fire an electric detonator.

UNCLASSIFIED

UNCLASSIFIED

FSTC 381-5012

p. Although the manufacturing of this device is extremely simple, to conceal the en-placed device is very difficult. Furthermore, it is easily displaced by natural forces.

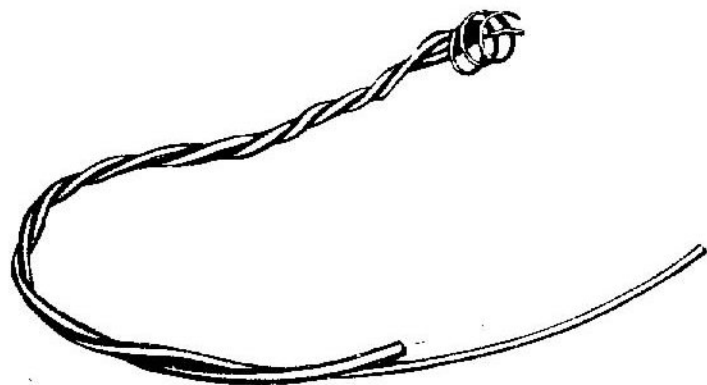

Figure 33 (UNCLASSIFIED). German wire-coil firing device (U).

q. All of the devices described so far act instantaneously; that is, they make no provision for a delay in time between the application of an actuating force and the explosion of the charge to which they are connected. Before passing on to the discussion of devices which do incorporate a time delay, a short backward look to consider the preponderance of electric firing devices over mechanical ones seems appropriate. This pattern holds in practically every country in which batteries are readily obtainable. This is a very reasonable trend, because electric firing devices require a minimum of tools and materials to make them.

r. Electric firing devices require more than batteries, however. They require electric detonators which, although quite readily available in mining camps, are almost invariably kept under lock and key. If the illicit demand for electric detonators reaches major proportions, the supplying of them can be strictly rationed or, better yet, blasting at the mining site can be converted to the use of time fuses and nonelectric detonators. Whatever the situation in Algeria was in actuality, the rebel FLN forces devised an ingenious means of circumventing the shortage of electric detonators by converting nonelectric detonators to electrical ones.

28

UNCLASSIFIED

UNCLASSIFIED

FSTC 381-5012

s. The device pictured in figure 34 consists of a small light bulb with two electric wires soldered to the filament contacts. A small portion of the glass envelope has been cut away, and the empty envelope has been filled with black powder. A nonelectric detonator taped to the envelope completes the assembly. This item is also being used by the Viet Cong.

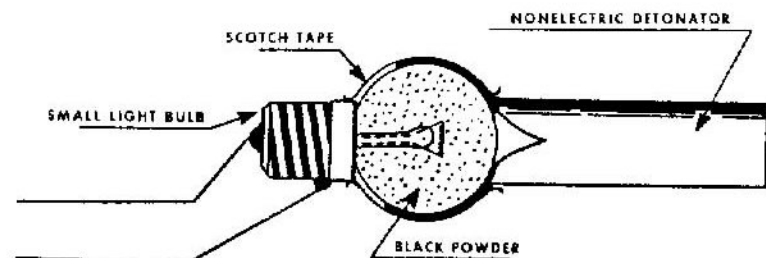

Figure 34 (UNCLASSIFIED). FLN electric detonator (U)

### 38. (C) DELAY DEVICES

a. (U) From time to time the guerrilla desires to place a charge which will detonate after a fixed period of time has elapsed. A current example of this type of activity occurred in February 1964 when a Viet Cong bomb actuated by a delay firing device exploded in the bleacher section of Pershing Field at Saigon, South Vietnam, during a softball game. Although most countries include delay firing devices among their families of standard demolition materiel, these devices are not normally accessible to guerrillas, and the latter's efforts to imitate their function lead to some clever contraptions.

b. (U) A case in point is the German can-and-cork delay shown in figure 35. This consists of a can having a small hole in its bottom, a cork, and two insulated wires which lead to a battery and an electric detonator. The insulation has been stripped from a portion of one wire, and this bared section has been bent into a loop. Similarly, insulation has been stripped from a portion of the other wire, but in this case the bared section has been bent into a zigzag shape. The first wire is passed through two holes in the upper sides of the can, and the lower, insulated portion of the second wire is passed through the loop. The bottom end of the second wire is now fixed to the cork. When water is placed into the can, the cork floats, and only the insulated portion of the second wire is in contact with the uninsulated portion of the first wire. As the water drips out of the hole in the

29

UNCLASSIFIED

UNCLASSIFIED

FSTC 381-5012

Bottom of the can, the cork sinks lower and lower, carrying with it the wire with the zigzag bend. Eventually the uninsulated wire forming this bend contacts the uninsulated loop in the other wire, the electric circuit is complete, and the detonator fires a charge of explosive.

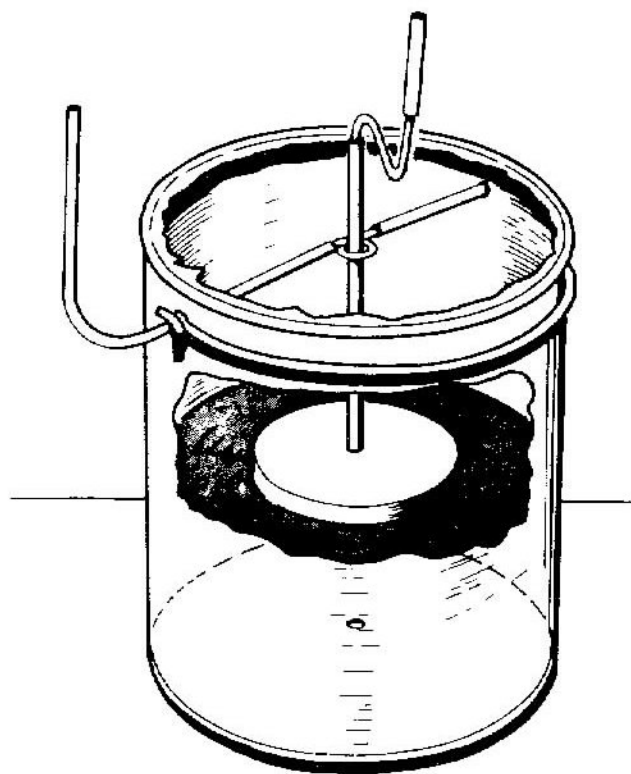

Figure 35 (UNCLASSIFIED). German can-and-cork delay (U).

30

UNCLASSIFIED

UNCLASSIFIED

FSTC 381-5012

c (U) A German variation of the can-and-cork item is the keyring delay, shown in figure 36. It consists of a spring-type keyring having its adjacent coils held apart by a small lump of some water-soluble substance such as a lump of sugar or a salt tablet. Electric leads are connected to these coils. One lead contacts a coil directly, while the other lead is insulated from the coil. This assembly is then suspended from a hook or a nail, and a glass is placed around it. When sufficient water is added to the glass to cover the soluble lump but not the bare ends of the wires, the water begins to dissolve the lump which eventually loses its ability to hold the two coils apart. At this time the coils resume their normal or unseparated position, bringing the two bare wires into contact with each other. The circuit is thus closed, and the detonator is fired.

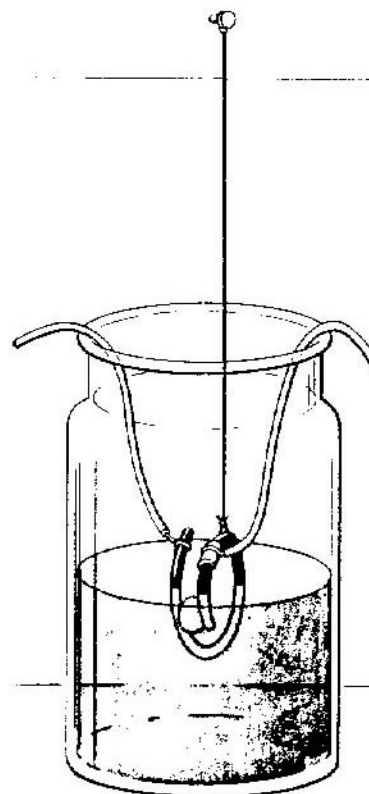

Figure 36 (UNCLASSIFIED). German keyring delay (U).

31

UNCLASSIFIED

UNCLASSIFIED

FSTC 381-5012

d. (U) Although not so clever or ingenious as the two preceding items, the most obvious delay-producing mechanism is a common pocket watch arranged as shown in figure 37. A lead from the battery is connected to the winding stem, and a lead to an electric detonator is connected to a screw through the glass crystal. For delays from one to twelve hours, the minute hand is removed. When the hand contacts the screw, the detonator is fired.

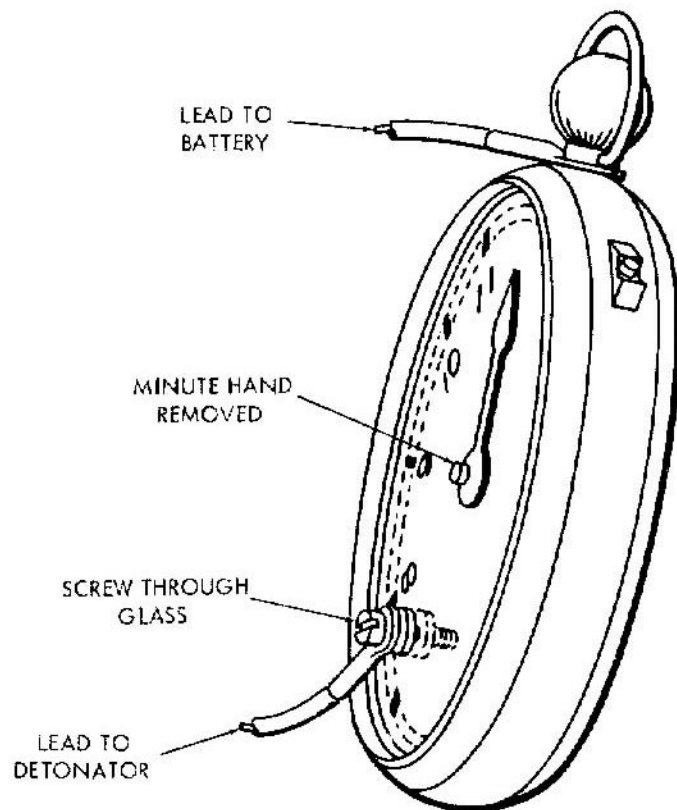

Figure 37 (UNCLASSIFIED). German pocket watch delay (U).

32

UNCLASSIFIED

FSTC 381-5012

e. (C) Figure 38 shows a similar device made from a wrist watch. The delay device used in the Pershing Field bomb in South Vietnam, mentioned earlier, was a watch of this type. Watches so altered were used also by German forces during World War II.

f. (U) A survey of standard demolition materiel reveals many delay firing devices which would or could be useful to a guerrilla. This class includes mechanical, chemical, and mechanical-electrical items with delay times ranging from 3 or 4 minutes to approximately 2 months.

g. (U) The mechanical and the chemical devices are usually simple. Their function is generally dependent on temperature, and their delay times range up to approximately 3 weeks.

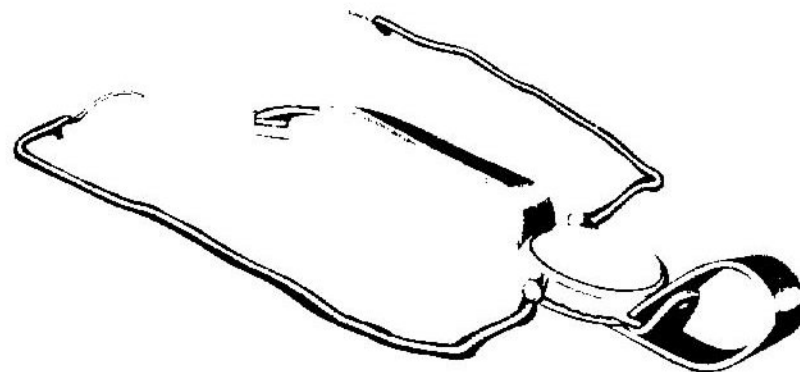

Figure 38 (UNCLASSIFIED). Viet Cong wrist watch delay (U).

33

FSTC 381-5012

l. (U) A typical mechanical device is the British No. 9, Mark 1 delay fuze which contains a spring-loaded striker restrained by a lead rod. When the safety pin is removed, the rod comes into tension and stretches slowly until it breaks. The breaking of the rod allows the striker spring to drive the striker into a percussion cap which starts the firing chain.

i. (U) The British No. 10, Mark 1 delay fuze typifies the chemical devices. Its operation is quite similar to that of the No. 9, Mark 1, except that the spring-loaded striker is restrained by a wire which is weakened by a corrosive fluid.

j. (U) Long-delay devices (over 2 weeks) are generally built around a clock-work mechanism. Although their function is practically the same as that of the pocket and the wrist watch devices described previously, their mechanisms are usually more complicated because they must count days as well as hours.

k. (U) The Italian 50-day clock shown in figure 39 typifies this class of device.

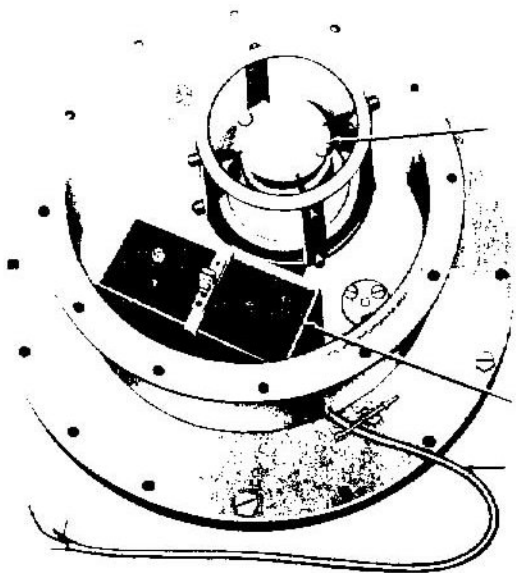

Figure 39 (UNCLASSIFIED). Italian 50-day clock delay (U)

FSTC 381-5012

### Section VIII. (C) CALTROPS AND BOOBYTRAPS

#### 39. (C) CALTROPS

a. (U) Webster's International Dictionary (2d edition) defines a caltrop as "an instrument with four iron points so disposed that any three of them being on the ground, the other projects upward, used to impede the progress of an enemy's cavalry, etc." This definition is outdated now, as caltrops are no longer restricted to having four points, the points are not necessarily made of iron, and cavalry has become scarce. Nevertheless, the idea of an upward-projecting point upon which the victim impales himself is still very much alive.

b. (C) The caltrop collection having the largest number of variations comes from Vietnam where they are used as antipersonnel weapons. In addition, a conventional four-point item has been received from Brazil where it had been placed on a street to puncture an automobile tire.

c. (U) Figure 40 depicts a "new look" caltrop from Vietnam which follows the spirit, if not the intent, of Webster's definition. The device consists of a piece of board with two large nails driven through it, and if the number of points projecting upward have anything to do with it, it should be twice as effective as its conventional predecessor. To compound the problem of disengaging the victim from these points, the maker has supplied them with barbs. The Viet Cong, who operate in South Vietnam, have made these devices with anywhere from one to seven points, each of which ranges from 2 to 12 inches long. To complicate matters further, they occasionally smear the points with fecal matter or any other filth which happens to be at hand.



Figure 40 (UNCLASSIFIED). Viet Cong double-spike caltrop (U).

FSTC 381-5012

d. (U) An improvement on the previous item, shown in figure 41, is the spike portion of a caltrop minus the support board. The improvement consists of a second barb pointed in the opposite direction from that of the first barb, and so located that both barbs will lodge within the victim's foot. This arrangement increases the attending doctor's problem in removing the barb by preventing him from cutting the nonbarbed end and pulling the spike out with a pair of pliers, not to mention the effect on the patient.

Figure 41 (UNCLASSIFIED). Viet Cong double-barbed spike (U).

#### 10. (U) BOOBYTRAPS

a. The boobytrap is another ancient device, the function of which is to lure the unwary into performing an apparently safe act that injures or destroys him by means of a concealed explosive charge. In the context of guerrilla use, the boobytrap is as much an instrument of psychological warfare as anything else. Used judiciously, it serves to emphasize the idea that the guerrilla is the man who wields power, and that he will not hesitate to use it. This is especially effective if an incident is backed up by the suggestion that future incidents can be avoided by cooperation with guerrilla forces.

b. At one time or another during World War II, practically everything found on the battlefield had been boobytrapped, not excluding the dead. The Japanese radio shown in figure 42 has a charge connected to the off-on switch so that its curious but incautious captor may destroy himself.

c. Another Japanese boobytrap uses the ringing handle of a telephone to set off a charge of explosive. In this installation, seen in figure 43, a pull-operated fuze installed in a demolition block is connected to the handle by a wire so that, when the handle is turned, the wire is pulled taut to initiate the fuze.

d. Both of these devices were used by regular troops during overt combat operations. However, their translation to the guerrilla warfare situation requires only the smallest stretch of the imagination.

UNCLASSIFIED

FSTC 381-5012

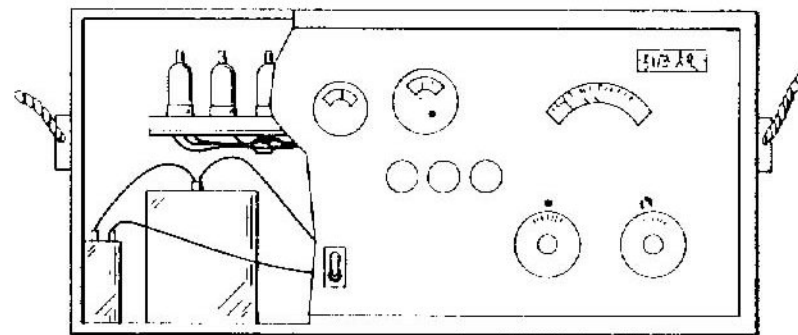

Figure 42 (UNCLASSIFIED). Japanese boobytrapped radio (U).

e. Although there have been very few true boobytraps found in Vietnam, an otherwise prolific source of improvised weapons, the same has not been true for Algeria, a relatively sterile source of improvised weapons. During the Algerian rebellion, the native FLN forces spent a good deal of time and effort inventing harmless-looking devices to make life difficult for their French opponents. A case in point is the relatively straightforward book boobytrap shown in figure 44. Depending on the circumstances, this book could be lying on the ground, on top of a specially constructed bookcase, or even on top of other books placed upright in an ordinary bookcase. When the book is displaced either by lifting or by sliding, the wire attached to the cover moves, carrying with it one of the battery leads. The other battery lead is connected to an electric detonator which is in turn attached to the metal tube housing the first battery lead. When the first lead contacts the metal tube the circuit is complete, and the detonator initiates an explosive charge.

f. In the section dealing with firing devices, two variations of the Algerian clothespin were illustrated. The four parts of figure 45 show four different ways in which this device is used to boobytrap a bangalore torpedo. Needless to say, any charge of explosive will serve the purpose as well as will the torpedo.

g. Parts one and two show two ways of installing the pull-operated version, and part four shows the tension-release installation. Part three shows a new variation in which the clothespin has been placed so that the weight of the bangalore torpedo holds the contacts apart. When the torpedo is lifted, the spring closes the contacts, and the electric detonator explodes the torpedo.

h. Flag mines have been used for quite a while; the Soviets occasionally attached explosive charges to mine field marker flags during World War II.

UNCLASSIFIED

UNCLASSIFIED

FSTC 381-5012

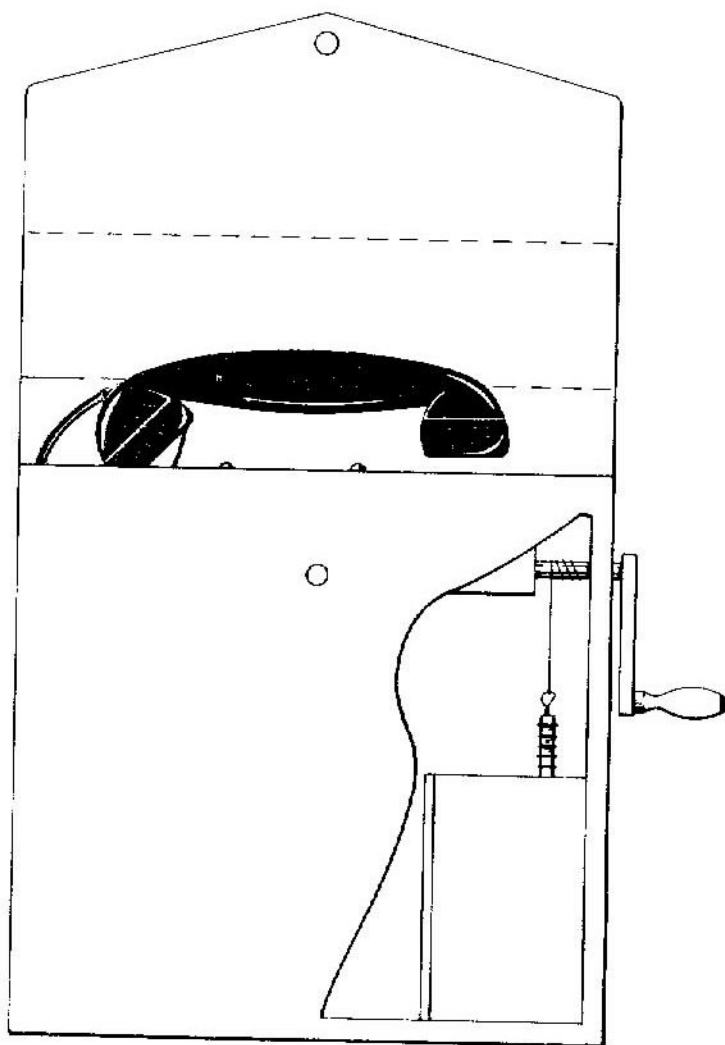

Figure 43 (UNCLASSIFIED). Japanese boobytrapped telephone (U).

38

UNCLASSIFIED

UNCLASSIFIED

FSTC 381-5012

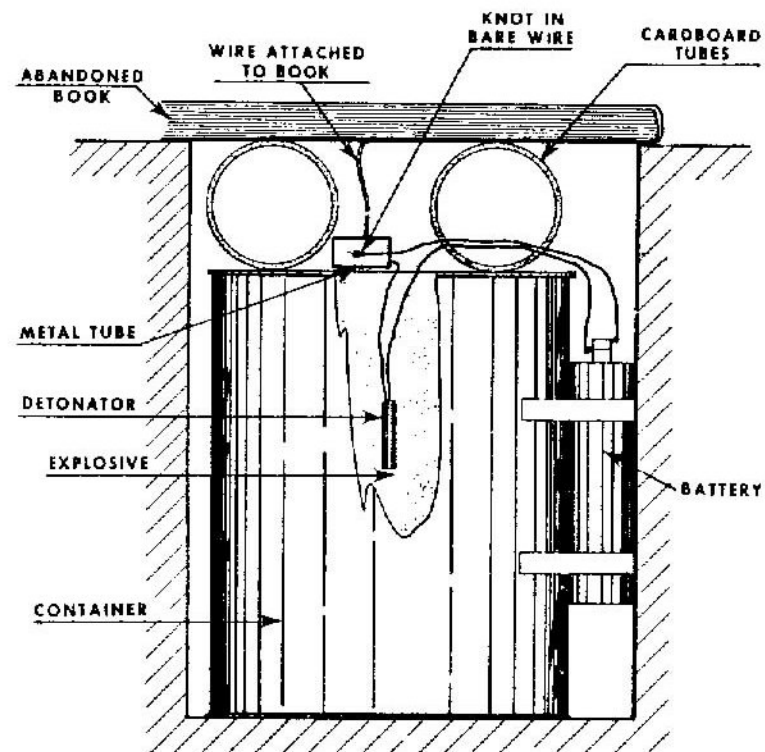

Figure 44 (UNCLASSIFIED). FLN book boobytrap (U).

39

UNCLASSIFIED

UNCLASSIFIED

FSTC 381-5012

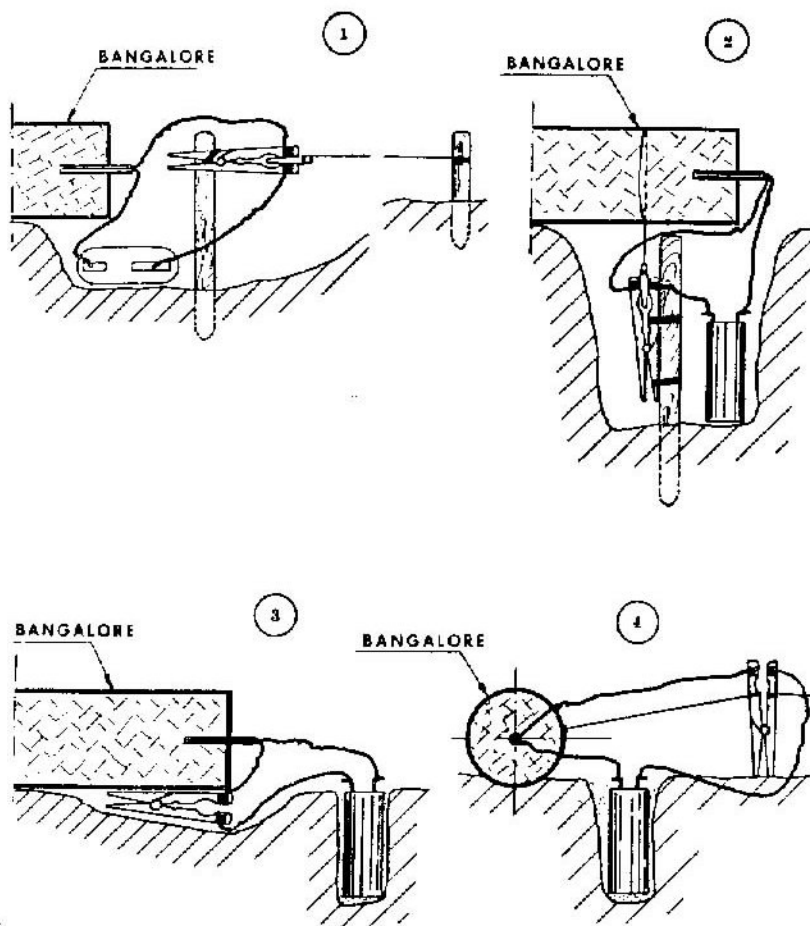

Figure 45 (UNCLASSIFIED). FLN bangalore torpedo boobytraps (U).

UNCLASSIFIED

UNCLASSIFIED

FSTC 381-5012

i. The device shown in figure 46 is a box containing a battery and two contacts arranged so that the circuit can be closed by raising the flagstaff. This device was used by members of the FLN in Algeria where it is customary for land owners to display a flag on their property. The explosive charge can be placed in any convenient place within a reasonable distance of the flag, and can be actuated at an opportune moment.

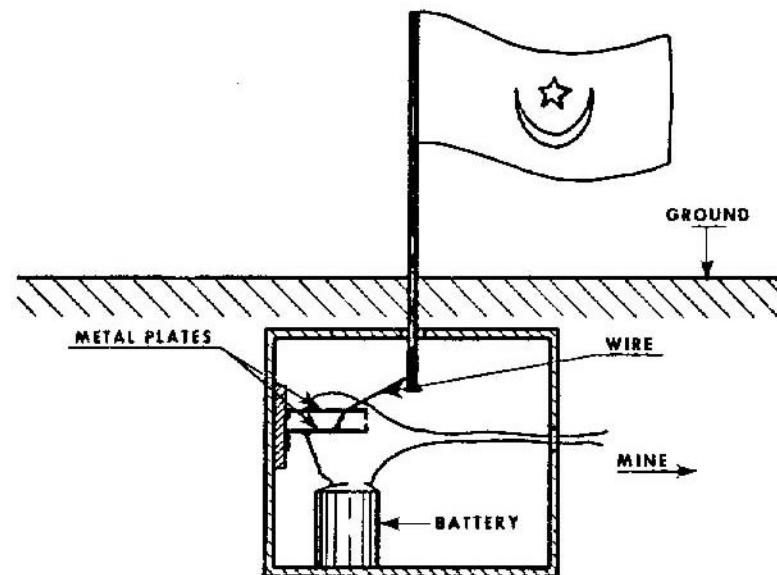

Figure 46 (UNCLASSIFIED). Flag mine (U)

j. A second version of the flag mine exists which would be more appropriately called the flag boobytrap. It differs only in that the explosive charge is placed inside the box. If the emblem of the flag was that of the FLN, displaying it publicly was akin to waving a red flag in front of a bull, at least until the time the French withdrew. The gendarme or poilu who attempted to remove the flag succeeded only in destroying himself.

UNCLASSIFIED



UNCLASSIFIED

FSTC 381-5012

Section IX. (U) DISGUISED DEVICES

41. (U) All of the materiel items discussed in the preceding sections of this study, despite their diversity of form and function, have a common trait; that is, they are what they seem to be. This section is devoted to another group of devices--those which are not what they appear to be; they are, in the words of the title of this section, disguised devices.

42. (U) Previous sections have laid considerable emphasis on items which were either made in toto or extensively modified from factory-made materiel by the guerrilla in the field or in a basement-style workshop. In this context the major problem in design and fabrication is to obtain a product which will function with reasonable reliability without regard to its form and appearance. The disguised device, on the other hand, has as one of its major points its appearance, because it is intended to look like something which it is not. This requirement almost precludes the manufacturing of disguised devices in the field where the necessary equipment and skills are usually lacking.

43. (U) The first of these devices to be described here is, to all external appearances, a cigarette lighter bearing a modest resemblance to those made by Ronson. It is shown in figures 47 and 48. In actuality it is a firearm that was probably made for an assassination mission. The body of the lighter houses a tube containing the functional parts. Reading from left to right in the exploded view these are a bullet, a tube containing a charge of propellant and a primer, a firing pin, and a firing pin spring. A stud which projects through one wall of the lighter body holds the firing pin against its compressed spring. When this stud is pressed, the weapon fires. It is patently a short-range device--the user could probably not hit a man-sized target beyond 8 to 10 feet--and it is undoubtedly capable of killing at close range.



Figure 47 (UNCLASSIFIED). Vietnamese cigarette lighter (external view) (U).

42

UNCLASSIFIED

UNCLASSIFIED

FSTC 381-5012

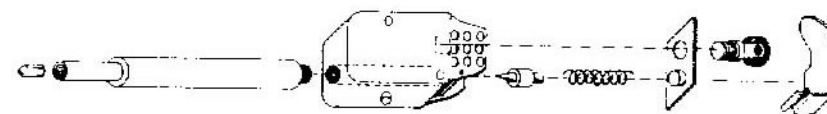

Figure 48 (UNCLASSIFIED). Vietnamese cigarette lighter (exploded view) (U).

44. (U) The pen-and-pencil set shown in the exploded view seen in figure 49 is a delay fuze which operates by requiring sulphuric acid to eat its way through a celluloid disk before coming into contact with a mixture of potassium chlorate and sugar. The latter action causes a flash which fires a detonator. The flash, in turn, initiates an explosive charge.

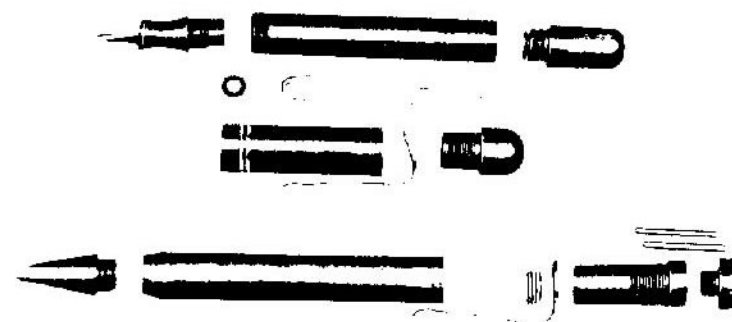

Figure 49 (UNCLASSIFIED). German pen-and-pencil delay fuze (U).

45. (U) A glass ampoule of acid, the celluloid disk, and a plunger for crushing the ampoule are housed in the body of the pen. The potassium chlorate and sugar mixture and the detonator are contained in the pencil. The device is readied for use by removing and discarding the pencil point and the pen cap. The pen body is then screwed into the pencil body, and the detonator is screwed into the hole formerly occupied by the pencil point. Twisting the upper end of the pen body forces a plunger to crush the glass ampoule, and the sulphuric acid can then begin to react with the celluloid disk. When the acid has eaten its way through the disk it then drips down through the nib of the pen and onto the mixture of potassium chlorate and sugar.

43

UNCLASSIFIED

UNCLASSIFIED

FSTC 381-5012

46. (U) A variation of the pen-and-pencil delay fuze is the pen which conceals an incendiary device, shown in figure 50. The pen consists of a magnesium casing containing a cocked striker, a primer pellet, a delay element, an igniting charge, and a quantity of thermitite. When the barrel of the pen is rotated 180°, the striker spring drives the striker into the primer, igniting the delay element, the igniting charge, and finally the thermitite.

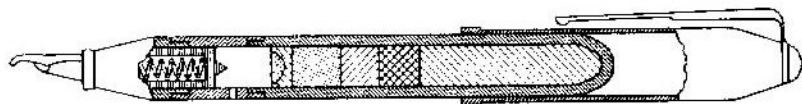

Figure 50 (UNCLASSIFIED). German incendiary pen (U).

47. (U) The incendiary cigar shown in figure 51 consists of a lead casing containing a glass ampoule of sulphuric acid, a cardboard barrier, and a mixture of potassium chlorate and sugar. A strong squeeze by the fingers on the blunt end of the casing breaks the ampoule from which the acid leaks to contact the barrier. Eventually the acid eats its way through the barrier and, on contacting the potassium chlorate and sugar mixture, causes a chemical reaction accompanied by a strong flash which ignites any nearby combustible material.

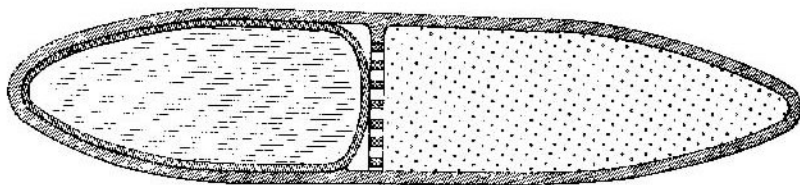

Figure 51 (UNCLASSIFIED). German incendiary cigar (U).

48. (U) The range of common containers which can be, or have been, used to house the larger incendiary devices covers almost every conceivable innocent item--oil cans, mess tins, paint buckets, and even thermos flasks. As mechanisms, they have little or nothing about them of interest because the major part of each is devoted to housing a quantity of incendiary material, although they

44

UNCLASSIFIED

UNCLASSIFIED

FSTC 381-5012

may occasionally contain an amount of explosive which is just large enough to rupture the container and scatter the burning contents.

49. (U) Although the specific mechanism of the German World War II incendiary thermos flask pictured in figure 52 is not known, it may be taken as representative of its entire class.



Figure 52 (UNCLASSIFIED). German incendiary thermos flask (U).

45

UNCLASSIFIED

UNCLASSIFIED

FSTC 381-5012

50. (U) All incendiary materials do not come housed in innocent-looking cans. Both the "brick" and the bar of "soap", respectively shown in figures 53 and 54, are incendiary mixtures compounded to closely resemble their pseudomorphs.

51. (U) The "brick" is composed of potassium chlorate, sulphur, ground coal or sugar, iron filings, wax, and red coloring matter. Its surface has been waxed to imitate the glaze of a common brick. This item has no hole for the insertion of an igniter. However, either the fountain pen or the cigar discussed previously will ignite the brick if placed in contact with it. The absence of an igniter pocket suggests that this item is intended to be fuel for a blaze established by other means, rather than as a primary fire-starter.

52. (U) The "soap" bar is composed of barium nitrate, paraffin, magnesium, aluminum, rosin, and ferrosiferrous oxide. Unlike the incendiary brick, the "soap" bar has an igniter pocket in one side, and is thus probably intended as a primary starter of fires.

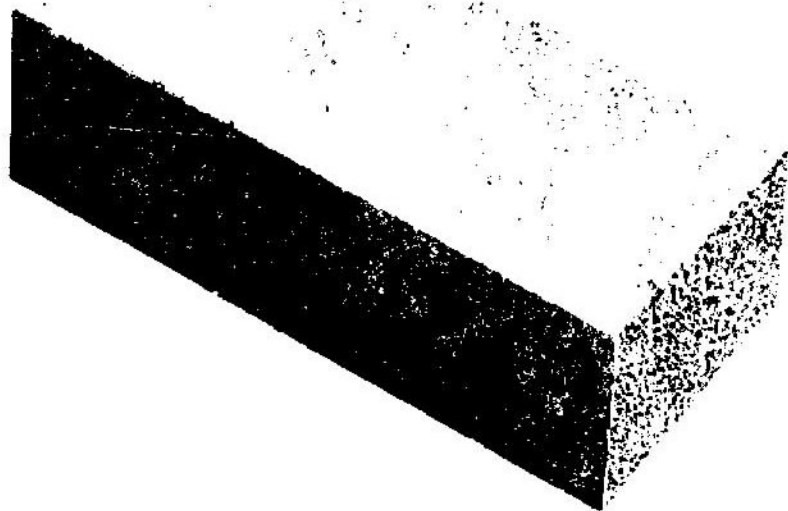

Figure 53 (UNCLASSIFIED). Japanese incendiary brick (U).

46

UNCLASSIFIED

UNCLASSIFIED

FSTC 381-5012

Figure 54 (UNCLASSIFIED). Japanese incendiary soap (U).

53. (U) The German incendiary capsule shown in figures 55 and 56 is a factory-made item which, although not a disguised device, has been included here because its function parallels that of other materiel in this section. The capsule, which is approximately 5 inches long by 1-1/4 inches in diameter, consists of a flammable casing filled with a mixture of gasoline and paraffin. The left-hand end of the casing has been coated with a matchhead composition so that it can be lit on a safety-match box.

54. (U) There are numerous varieties of disguised explosives, including those in toothpaste tubes, paint or oil cans, wooden shoes, and food containers. Any of the larger disguised incendiaries can be converted by merely substituting an explosive substance for the incendiary mixture.

55. (U) One of the less obvious ways of camouflaging an explosive is to make it resemble a lump of coal which can be planted at power generating stations, in railroad coal bins, or in other strategic locations. While the damage-producing potential of this item is open to some question, its harassment potential is undeniable.

47

UNCLASSIFIED

UNCLASSIFIED

FSTC 381-5012



Figure 55 (UNCLASSIFIED). German unburned incendiary capsule (U).



Figure 56 (UNCLASSIFIED). German burned incendiary capsule (U).

56. (U) Two varieties of explosive coal have been found. The first, shown in figure 57, consists of a lump of RDX containing a detonator, the whole encased in a thin earthenware shell. The shell has been coated with a bitumen paint to give it the appearance of a lump of anthracite coal. Although close examination of one of these lumps will reveal the deception, they are virtually impossible to detect when mixed with real coal. When such a disguised explosive is exposed to fire, the heat eventually initiates the detonator which in turn sets off the RDX.

57. (U) If a more realistic appearance is necessary, such can be obtained, but at the expense of a reduced amount of explosive per lump. Figure 58 shows a lump of genuine coal, while figure 59 shows the alterations to it. The holes drilled in the lump are filled with explosive and a detonator. The holes are then sealed with modeling clay or putty that is then blackened with shoe polish.

UNCLASSIFIED

UNCLASSIFIED

FSTC 381-5012



Figure 57 (UNCLASSIFIED). Japanese explosive coal (U).



Figure 58 (UNCLASSIFIED). German explosive coal (external view) (U).

UNCLASSIFIED

UNCLASSIFIED

FSTC 381-5012

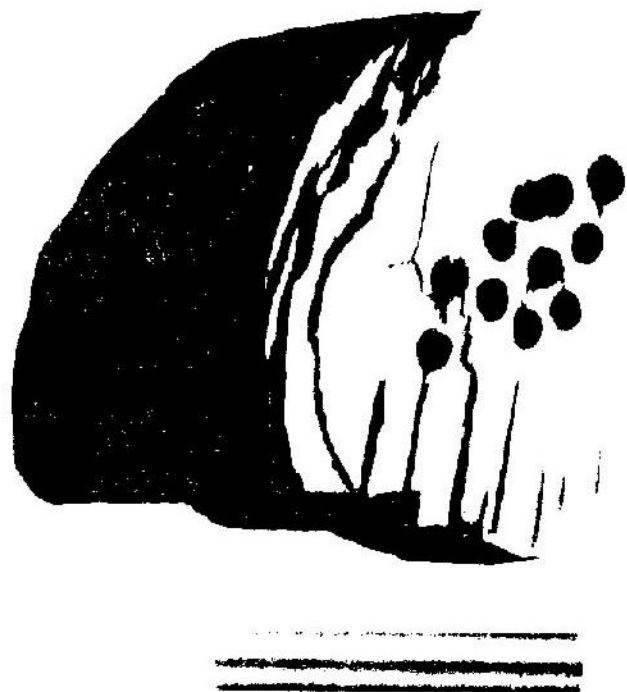

Figure 59 (UNCLASSIFIED). German explosive coal (section view) (U).

58. (U) A cake of Japanese "soap," which is in fact an incendiary, is shown in figure 54. On the other side of the world, the Germans devised the cake of soap, shown in figure 60, which is actually a block of explosive covered with a thin layer of real soap.

UNCLASSIFIED

UNCLASSIFIED

FSTC 381-5012



Figure 60 (UNCLASSIFIED). German explosive soap (U).

UNCLASSIFIED