

WWW.SURVIVALEBOOKS.COM

YOUR LAST LINE IN DEFENSE AND SURVIVAL

CHECK OUT OUR WEBSITE SOME TIME FOR PLENTY OF ARTICES ABOUT SELF DEFENSE,
SURVIVAL, FIREARMS AND MILITARY MANUALS.

<http://www.survivalebooks.com/>

Thank you for purchasing our ebook package.

FM 23-23

DEPARTMENT OF THE ARMY FIELD MANUAL

ANTIPERSONNEL MINE M18A1 AND M18 (CLAYMORE)

This copy is a reprint which includes
current pages from Changes 1 and 2.

HEADQUARTERS, DEPARTMENT OF THE ARMY
JANUARY 1966

CHANGE }
N O . 2 }

HEADQUARTERS
DEPARTMENT OF THE ARMY
WASHINGTON, D.C. 30 March 1973

ANTIPERSONNEL MINE, M18A1 and M18 (CLAYMORE)

FM 23-23, 6 January 1966, is changed as follows:

Page 2, para 3, line 13. The words “(knife-edge sight on later model)” is added after “slit/type sight,”.

Page 2, para 3, line 15. The last sentence of paragraph 3 is changed to read: An instruction sheet for the M18A1 mine is attached to the inside cover of the bandoleer. The instruction sheet which accompanies the M18A1 mine having the knife-edge sight is shown in figure 3.

Page 3. Figure 1 is superseded.

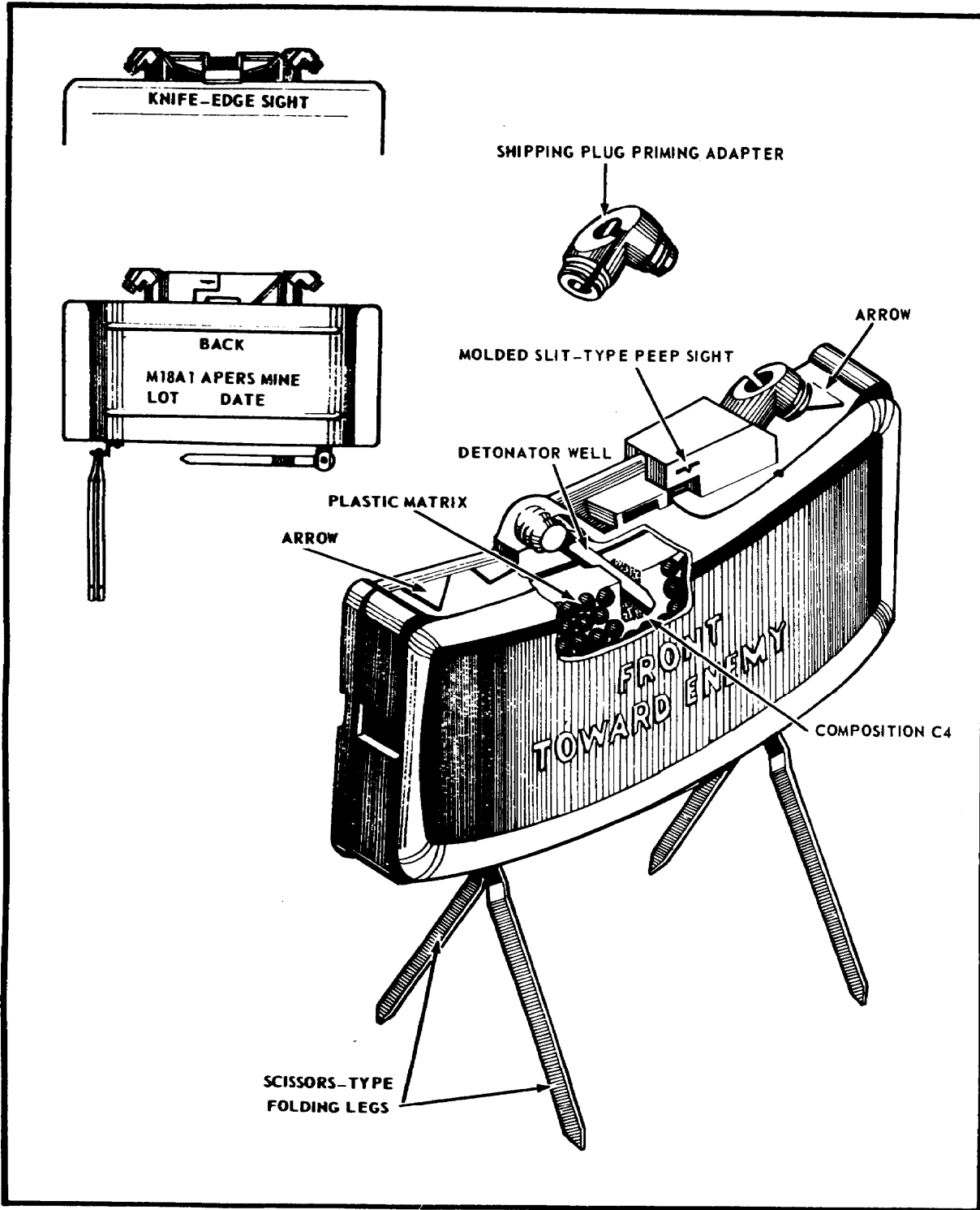

Figure 1. The M18A1 antipersonnel mine (CLAYMORE)

Page 6. Figure 3 is superseded.

INSTRUCTION SHEET
M16A1 ANTI-PERSONNEL MINE

1. WHERE TO POSITION MINE

WITHIN 300 FT. (132 PACES), TO REAR & SIDES OF MINE
ALL FRIENDLY PERSONNEL MUST TAKE COVER

50 FT. (22 PACES)
MINIMUM SAFE DISTANCE

FRAGMENT SPRAY
60 FT.
150 FT.
7 FT.
DIRECTION OF ENEMY APPROACH
AIMING POINT

WARNING TAKE COVER

STONES OR MINE DEBRIS MAY BE THROWN TO THE REAR OR SIDE WITHIN 300 FT. (132 PACES), TO REAR & SIDES OF MINE ALL FRIENDLY TROOPS MUST TAKE COVER. THE MINE MAY BE SAFELY FIRED ONLY FROM PROTECTED OR SHIELDED POSITIONS NO CLOSER THAN 50 FT FROM THE MINE.

2. HOW TO AIM MINE

1. TURN LEGS OF MINE DOWNWARD AND SPREAD APART. TWIST THE SPREAD LEGS TO LIE TO THE FRONT AND BACK AS SHOWN. ARROWS POINT TO ENEMY.

2. AIM MINE BY ALIGNING THE TWO EDGES OF SIGHT WITH THE AIMING POINT. EYES SHOULD BE SIX TO NINE INCHES TO THE REAR OF SIGHT. AIMING POINT SHOULD BE AT GROUND LEVEL 150 FEET IN FRONT OF MINE. PRESS LEGS FIRMLY INTO GROUND RECHECKING AIM.

SIGHT
AIMING POINT
SIGHT EDGES (FRONT & REAR)

3. HOW TO ARM MINE

1. REMOVE BLASTING CAP ASSEMBLY FROM BANDOLEER.
2. LAY WIRE BETWEEN MINE AND FIRING POSITION. UNROLL WIRE FROM FIRING POSITION TOWARDS MINE. WRAP WIRE AROUND STAKE AS SHOWN AND BURY WIRE IF POSSIBLE.

3. INSERT BLASTING CAP IN EITHER DETOMATOR WELL AND LOCK WITH SHIPPING PLUG-PRIMING ADAPTER.
4. RECHECK AIM OF MINE AFTER ABOVE ARMING.

EMEMY
SHIPPING PLUG - PRIMING ADAPTER
BLASTING CAP
DETONATOR WELL
BACK
M16A1 APERS MINE
SIGHT

4. HOW TO TEST CIRCUIT

(TAKE COVER AT FIRING POSITION):

1. REMOVE SHORTING PLUG FROM BLASTING CAP WIRE.
2. INSERT PLUG OF BLASTING CAP WIRE INTO TEST SET
3. INSERT PLUG OF TEST SET INTO FIRING DEVICE.
4. SWING SAFETY BAIL TO FIRE POSITION AND FROM COVERED POSITION DEPRESS FIRING HANDLE. LIGHT IN WINDOW OF TEST SET INDICATES GOOD CIRCUIT. IF NO LIGHT, WIRE OR CAP MAY BE DEFECTIVE. CHECK AND REPAIR WIRE BY TWISTING LEADS TOGETHER OR REPLACE CAP. IF AVAILABLE, TAPE OVER REPAIRED WIRE.

TO TEST CIRCUIT
FIRING DEVICE
TEST SET
SHORTING PLUG
UNROLLED BLASTING CAP ASSEMBLY
BURY WIRE IF POSSIBLE

5. HOW TO FIRE MINE

(TAKE COVER AT FIRING POSITION):

1. INSERT PLUG OF BLASTING CAP WIRE DIRECTLY INTO FIRING DEVICE - SAFETY ON.
2. WHEN READY TO FIRE SWING SAFETY BAIL TO ARMED POSITION.
3. FIRE BY DEPRESSING HANDLE SMARTLY.

NOTE: IF TWO OR MORE FIRING DEVICES ARE LOCATED AT ONE POSITION, THE LOOPS ON FLAP OF BANDOLEER MAY BE USED TO IDENTIFY THE FIRING WIRES BY SLIPPING WIRES THRU LOOPS BEFORE CONNECTING TO FIRING DEVICE.

TO INDICATE DIRECTION THE MINE IS FACING, PHOSPHORESCENT TAPE, FSM 970-22 (M7), MAY BE APPLIED TO "BACK" COVER. CROSS SLICING THE TAPE WITH A KNIFE AFTER APPLICATION WILL PREVENT UNIFORM REMOVAL. WARNING TAPE AND MINE MAY BE TURNED. CHECK PERIODICALLY TO ASSURE CORRECT DIRECTION.

TO FIRE
FIRING DEVICE
SAFE
ARMED

Figure 3. The instruction sheet attached to the M7 bandoleer.

C2, FM 23-23

Page 8, para 7c(9), line 1. The words "Peepsight and arrows." are changed to read "Sight and arrows."

Page 8, para 7a(9), line 2. The words "(or knife-edge sight)" are added after the word "peepsight".

Page 9, para 7b(2), line 2. The word "assembly" is added after the word "cap".

Page 9, para 7b(2). The following note is added:

Note. With mines of later manufacture, the M4 electrical blasting cap assembly is wound on a spool.

Page 11, paragraph 12 is superseded as follows:

12. Installation for Electrical Firing

a. Laying and Aiming.

(1) Laying.

(a) Check to see that the mine and all accessories (fig. 2) are in the bandoleer. Read the instruction sheet (fig. 3) attached inside the bandoleer cover before installing the mine.

(b) Remove the electrical firing wire leaving the mine and other accessories in the bandoleer.

Warning: During installation the M57 firing device must be kept in the possession of the man installing the mine to prevent accidental firing by a second man.

(c) Secure the shorting plug end of the firing wire at the firing position. Place the bandoleer on your shoulder and unroll the firing wire to the position selected for emplacing the mine.

Note. The instructor sheet which accompanies the M18A1 mine with slit-type peepsight indicates that the firing wire can be unrolled from the mine or from the firing position; however, the firing wire should always be laid from the firing position to the mine emplacement.

(d) Remove the mine from the bandoleer; turn the legs rearward and then downward. Spread each pair of legs about 45 degrees. One leg should protrude to the front and one to the rear of the mine. Position the mine with the surface marked "FRONT TOWARD ENEMY" and the arrows on top of the mine pointing in the direction of the enemy or the desired area of fire. On snow or extremely soft ground the bandoleer may be spread beneath the mine for support.

(e) To prevent tipping in windy areas or when the legs cannot be pressed into the ground, spread the legs to the maximum (about 180° so that the legs are to the front and rear of the mine. A top view of the M18A1 antipersonnel mine is shown in figure 10.

(2) Aiming.

(a) Mines with slit-type peepsight.

1. Select an aiming point which is about 50 meters (150 feet) to the front of the mine and about 2½ meters (8 feet) above the ground (fig. 11).

2. Position the eye about 15 centimeters (6 inches) to the rear of the sight. Aim the mine by sighting through the peepsight. The groove of the sight should be in line with the aiming point. The aiming point should be in the center of the desired area of coverage, and the bottom edge of the peepsight should be parallel to the ground that is to be covered with the fragment spray.

(b) Mines with knife-edge sight.

1. Select an aiming point at ground level that is about 50 meters (150 feet) in front of the mine.

2. Position the eye about 15 centimeters (6 inches) to the rear of the sight. Aim the mine by aligning the two edges of the sight with the aiming point (fig. 11.1).

b. Arming and Electrical Firing.

(1) Secure the firing wire about 1 meter behind the mine so it will not become misaligned should the firing wire be disturbed.

(2) Test the firing device, test set, and blasting cap assembly as described in paragraph 15.

Warning. Make certain that the combination shorting plug and dust cover is assembled to the connector of the firing wire before proceeding with installation of the mine.

(3) Unscrew one of the shipping plug priming adapters from the mine. Slide the slotted end of the shipping plug priming adapter (fig. 12) onto the firing wires of the blasting cap between the crimped connections and the blasting cap. Pull the excess wire through the slotted end of the adapter until the top of the blasting cap is firmly seated in the bottom portion of the shipping plug priming adapter. Screw the adapter with blasting cap into the detonator.

Warning. Make certain that the face of the mine marked “Front Toward Enemy” and the arrows on top of the mine point in the direction of the enemy.

(4) Recheck the aim of the mine. Camouflage the mine and, if possible, bury the firing wire to protect it from fire and enemy detection. Make certain you have the bandoleer and other accessories and then move back to the firing position.

Warning. The mine firing position should be in a foxhole or covered position at least 16 meters to the rear or the side of the emplaced mine.

(5) Before connecting the M57 firing device (fig. 5) to the firing wire, make certain that the safety bail is in the SAFE position and that all friendly troops within 250 meters of the front and sides and 100 meters of the rear of the mine are under cover. Do not connect the firing device to the firing wire until the actual time of firing.

(6) To fire the mine, remove the dust cover on the firing device, remove the combination shorting plug and dust cover from the end of the firing wire, and connect the firing device to the firing wire. Fire the mine by positioning the firing device safety bail in the FIRE position and actuating the firing device handle with a firm, quick squeeze.

By Order of the Secretary of the Army:

Official:

VERNE L. BOWERS
Major General, United States Army
The Adjutant General

CREIGHTON W. ABRAMS
General, United States Army
Chief of Staff

Distribution:

To be distributed in accordance with DA Form 12–11 requirements for Antipersonnel Mine, M18, and M18A1.

HEADQUARTERS
DEPARTMENT OF THE ARMY
WASHINGTON, D.C., 17 December 1968**ANTIPERSONNEL MINE M18A1 AND M18 (CLAYMORE)**

FM 23-23, 6 January 1966, is changed as follows:
Page 12, paragraph 12 a. Subparagraph 12 a (5) is added as follows:

(5) When using the mine with the knife-edge sight, select an aiming point at ground level that

is approximately 150 feet in front of the mine. Position the eye approximately 6 inches (15 cm.) to the rear of the sight. Aim the mine by alining the two edges of the sight with the aiming point (fig. 11.1).

Page 13, figure 11.1 is added as follows:

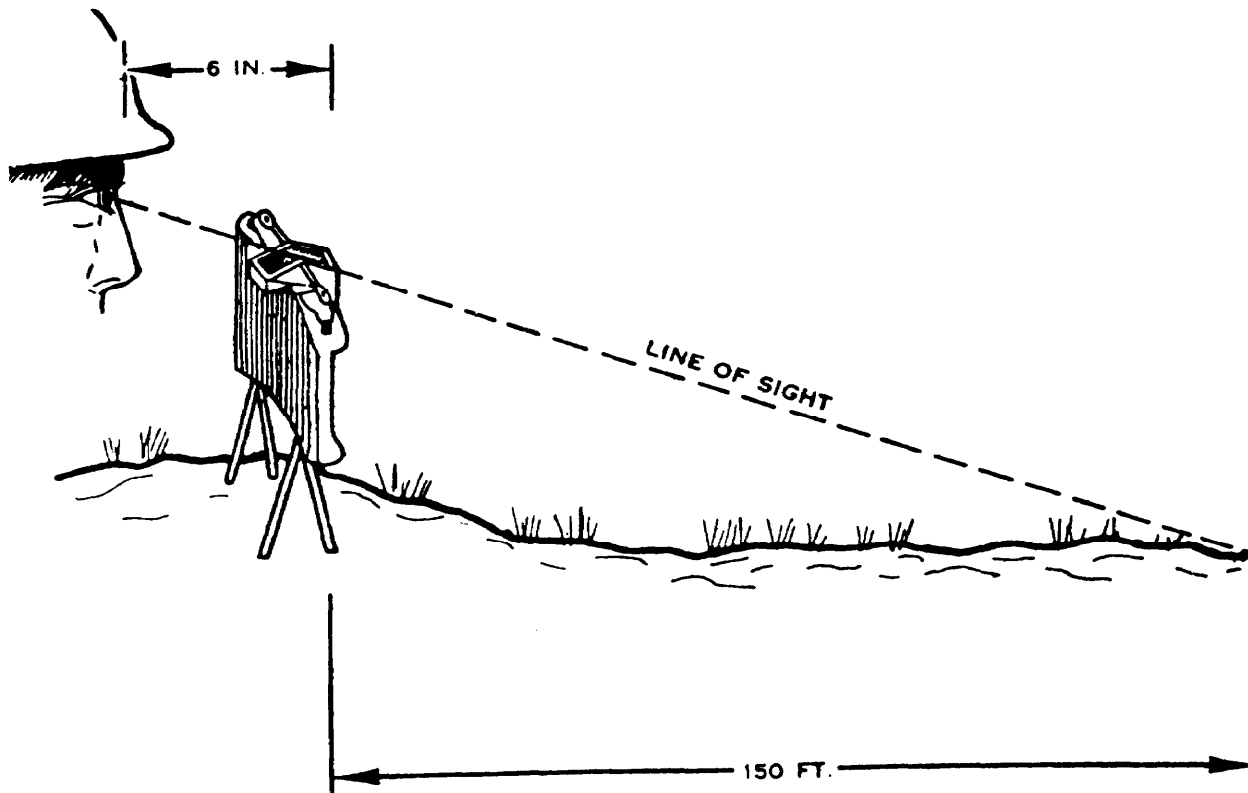

Figure 11.1 Aiming the M18A1 antipersonnel mine equipped with the knife-edge sight.

Page 33, appendix IV, paragraph 2 b is superseded as follows:

b. Graphic training aid (GTA) 7-1-15, "Anti-

personnel Mine, M18A1 (Claymore)" illustrates the mine and its methods of employment.

C 1, FM 23-23

By Order of the Secretary of the Army:

Official:

KENNETH G. WICKHAM,
*Major General, United States Army,
The Adjutant General.*

W. C. WESTMORELAND,
*General, United States Army,
Chief of Staff.*

Distribution:

To be distributed in accordance with DA Form 12-11 requirements for Antipersonnel Mine, M18 and M18A1 (CLAYMORE).

TAGO 713A

FIELD MANUAL }
No. 23-23 }

HEADQUARTERS
DEPARTMENT OF THE ARMY
WASHINGTON, D. C. 6 January 1966

ANTIPERSONNEL MINE M18A1 AND M18 (CLAYMORE)

	Paragraph	Page
CHAPTER 1. INTRODUCTION		
Section I. General		
Purpose and scope.....	1	2
Roles of the antipersonnel mine, CLAYMORE.....	2	2
II. Description		
General.....	3	2
Casualty effects.....	4	2
Danger areas.....	5	4
CHAPTER 2. MECHANICAL TRAINING		
Section I. Introduction		
General.....	6	8
Detailed description.....	7	8
II. Coverage and methods of fire		
Fire discipline.....	8	10
Controlled frontal coverage.....	9	10
Methods of fire.....	10	10
III. Functioning and installation		
Functioning.....	11	11
Installation for electrical firing.....	12	11
Installation for nonelectrical firing.....	13	14
Camouflage.....	14	17
Testing.....	15	17
Disarming and destruction.....	16	20
CHAPTER 3. TRAINING		
General.....	17	21
Phase I training.....	18	21
Phase II training.....	19	21
CHAPTER 4. TACTICAL EMPLOYMENT		
General.....	20	22
Defense.....	21	22
Offense.....	22	24
APPENDIX I. REFERENCES	---	26
II. M18 ANTIPERSONNEL MINE	---	27
III. SAFETY	---	31
IV. TRAINING AIDS	---	33

* This manual supersedes TC 7-3, 5 October 1962.

DISTRIBUTION RESTRICTION: Approved for public release; distribution is unlimited.

1

CHAPTER 1

INTRODUCTION

Section I. GENERAL

1. Purpose and Scope

a. This manual provides guidance for commanders and instructors presenting instruction and training on the functioning, installation, and employment of the antipersonnel mine, CLAYMORE.

b. This manual describes the M18A1 antipersonnel mine, CLAYMORE, its functioning, and installation. It provides a basis for conducting training utilizing the electric firing system issued with the mine. It also gives guidance for tactical employment and safety requirements. An earlier model of the CLAYMORE antipersonnel mine, the M18, is covered in appendix II.

c. The material contained herein is applicable without modification to both nuclear and nonnuclear warfare.

d. Users of this manual are encouraged to submit recommended changes or comments to

improve the publication. Comments should be keyed to the specific page, paragraph, and line of the text in which the change is recommended. Reasons should be provided for each comment to insure understanding and complete evaluation. Comments should be forwarded direct to the Commandant, United States Army Infantry School, Fort Benning, Ga. 31905.

2. Roles of the Antipersonnel Mine, CLAYMORE

The number of ways in which the CLAYMORE may be employed is limited only by the imagination of the user. The CLAYMORE is used primarily as a defensive weapon, but has its application in the offensive role. It must be emphasized that when the CLAYMORE is referred to as a weapon, this implies that it is employed in the controlled role. In the uncontrolled role, the CLAYMORE is considered a mine or boobytrap (FM 20-32).

Section II. DESCRIPTION

3. General

The M18A1 antipersonnel mine was standardized in 1960, and replaced the M18 antipersonnel mine (app. II). Both mines are similar in appearance and functioning. The M18A1 (fig. 1) is a directional, fixed-fragmentation mine. When employed in the controlled role, it is treated as a one-shot weapon. It is primarily designed for use against massed infantry attacks; however, its fragments are also effective against light vehicles. The M18A1 mine is equipped with a fixer plastic slit-type sight, adjustable legs, and two detonator wells.

The mine and all its accessories are carried in the M7 bandoleer (fig. 2). The instruction sheet for the M18A1 is shown in figure 3.

4. Casualty Effects

When detonated, the M18A1 mine will deliver spherical steel fragments over a 60° fan-shaped pattern that is 2 meters high and 50 meters wide at a range of 50 meters (fig. 4). These fragments are moderately effective up to a range of 100 meters and can travel up to 250 meters forward of the mine. The optimum effective range (the range at which the

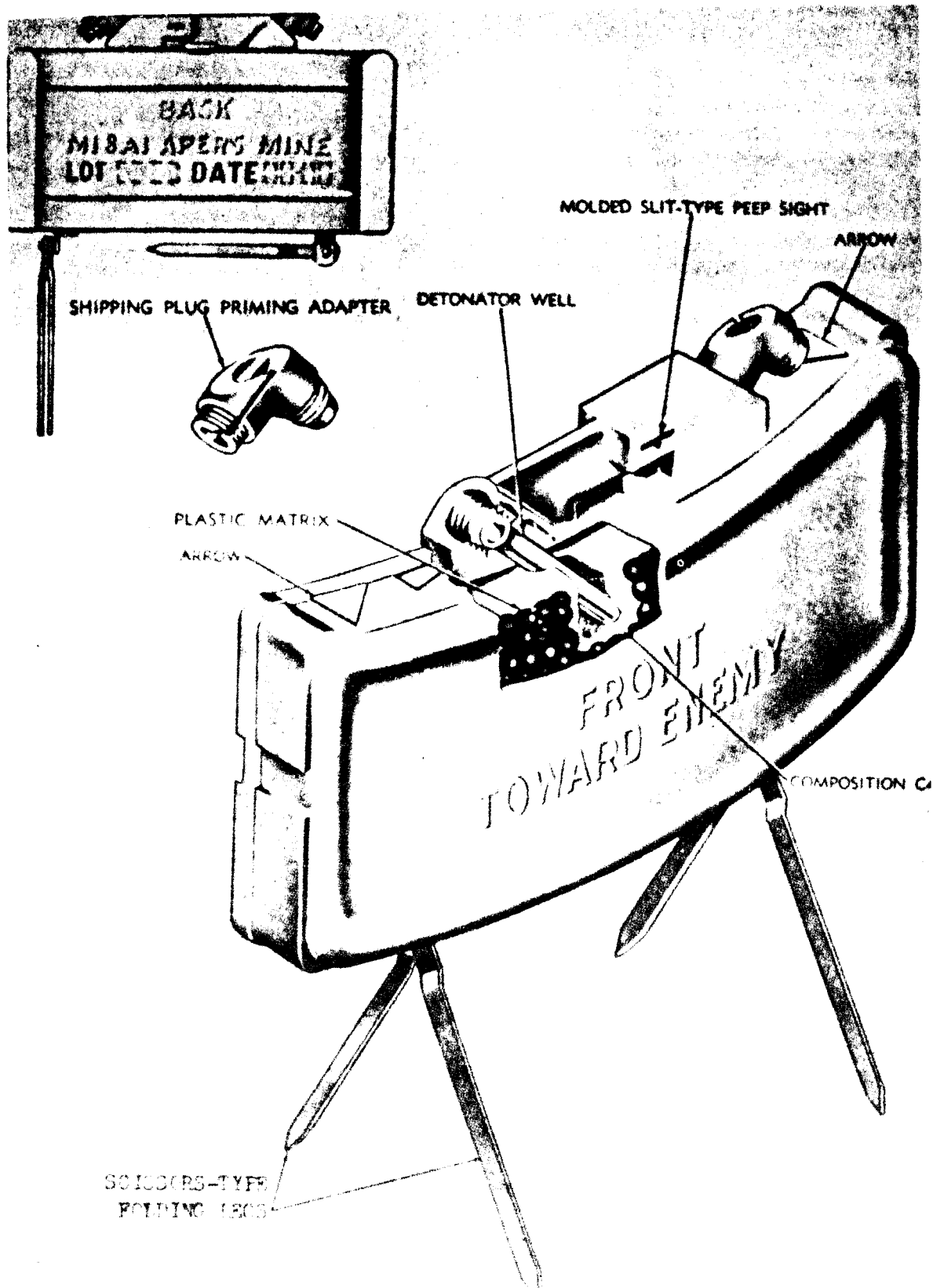

Figure 1. The M18A1 antipersonnel mine (CLAYMORE).

most desirable balance is achieved between lethality and area coverage) is 50 meters.

5. Danger Area

a. Danger From Fragments (fig. 4). The danger area consists of a 180° fan with a radius of 250 meters centered in the direction of aim.

b. Danger Area of Backblast and Secondary Missiles (figs. 4 and 24). Within an area of 16 meters to the rear and sides of the mine, backblast can cause injury by concussion (ruptured eardrums) and create a secondary missile hazard.

- (1) Friendly troops are prohibited to the rear and sides of the mine within a radius of 16 meters.
- (2) The minimum safe operating distance from the mine is 16 meters. At this distance, and regardless of how the mine is employed, the operator should be in a foxhole, behind cover, or lying prone in a depression. The operator and all friendly troops within 100 meters of the mine must take cover to prevent being injured by flying secondary objects such as sticks, stones, and pebbles.

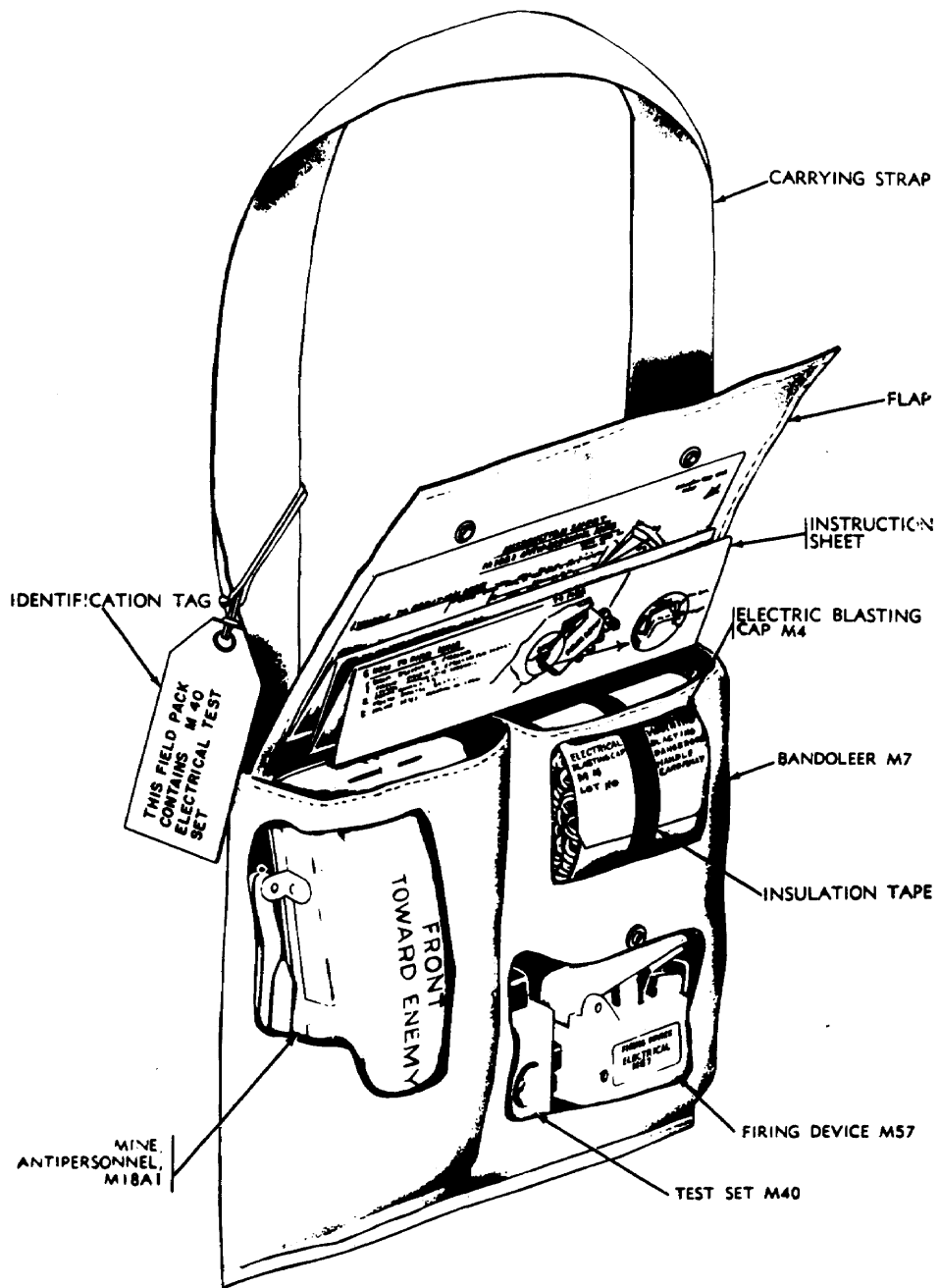

Figure 2. The M18A1 antipersonnel mine and accessories packed in the M7 bandoleer.

INSTRUCTION SHEET
M18A1 ANTIPERSONNEL

DIRECTION OF ENEMY

1. WHERE TO POSITION MINE



WARNING: TAKE COVER

STONES OR MINE DEBRIS
300 FT. (132 PAGES) TO
TAKE COVER. THE MINE
SHIELDED POSITIONS NO CLOSER THAN 50 FT. FROM THE MINE.

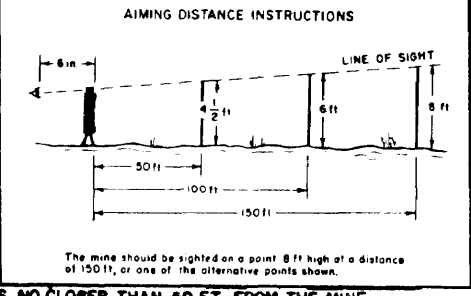

2. HOW TO AIM MINE :

1. TURN LEGS OF MINE DOWNWARD AND SPREAD APART. TWIST THE SPREAD LEGS TO LIE TO THE FRONT AND BACK AS SHOWN. ARROWS POINT TO ENEMY.

2. AIM MINE BY SIGHTING THROUGH SLIT SIGHT. SHIFT MINE TO PUT GROOVE IN LINE WITH AIMING POINT. PRESS LEGS FIRMLY INTO GROUND RECHECKING AIM.

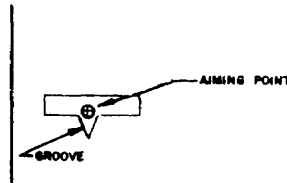
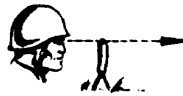
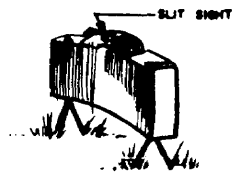

3. HOW TO ARM MINE :

1. UNROLL PAPER FROM BLASTING CAP ASSEMBLY BY PULLING INSULATING TAPE TAB (SAVE TAPE FOR POSSIBLE REPAIR OF WIRE.)
2. LAY WIRE BETWEEN MINE AND FIRING POSITION (CAN UNROLL WIRE FROM MINE OR FIRING POSITION) WRAP WIRE AROUND LEG OF MINE AS SHOWN AND BURY WIRE IF POSSIBLE.
3. INSERT BLASTING CAP IN EITHER DETONATOR WELL AND LOCK WITH SHIPPING PLUG-PRIMING ADAPTER.
4. RECHECK AIM OF MINE AFTER ABOVE ARMING.

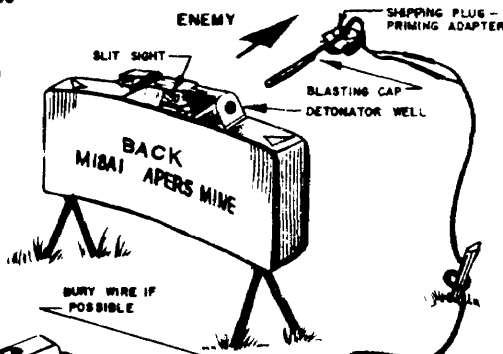

4. HOW TO TEST CIRCUIT :

- (TAKE COVER AT FIRING POSITION)
1. REMOVE SHORTING PLUG FROM BLASTING CAP WIRE.
 2. INSERT PLUG OF BLASTING CAP WIRE INTO TEST SET
 3. INSERT PLUG OF TEST SET INTO FIRING DEVICE.
 4. SWING SAFETY BAIL TO FIRE POSITION AND FROM COVERED POSITION DEPRESS FIRING HANDLE. LIGHT IN WINDOW OF TEST SET INDICATES GOOD CIRCUIT. IF NO LIGHT, WIRE OR CAP MAY BE DEFECTIVE. CHECK AND REPAIR WIRE WITH TAPE SAVED FROM WRAPPER OR REPLACE CAP.

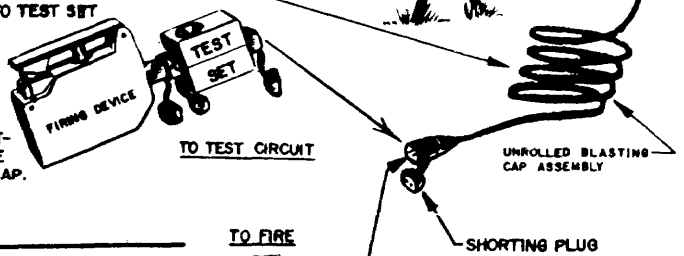

5. HOW TO FIRE MINE :

- (TAKE COVER AT FIRING POSITION)
1. INSERT PLUG OF BLASTING CAP WIRE DIRECTLY INTO FIRING DEVICE (SAFETY ON)
 2. WHEN READY TO FIRE, SWING SAFETY BAIL TO ARMED POSITION.
 3. FIRE BY DEPRESSING HANDLE SMARTLY.

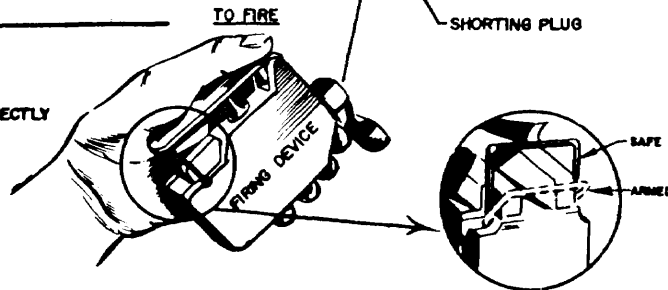

Figure 3. The instruction sheet attached to the M7 bandoleer.

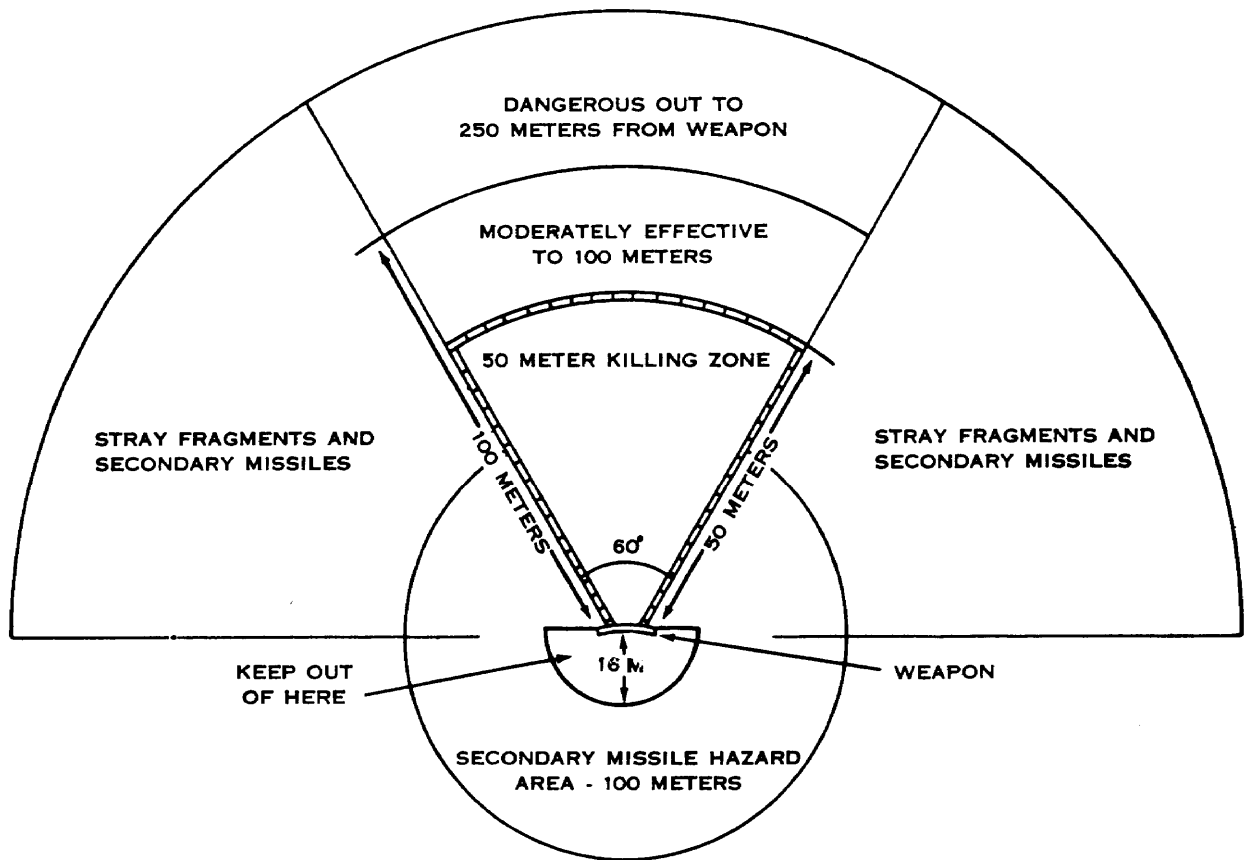

Figure 4. Danger radius and effects of the M18A1.

CHAPTER 2
MECHANICAL TRAINING

Section I. INTRODUCTION

6. General

This section describes and illustrates the M18A1 antipersonnel mine and the electric and nonelectric firing systems that can be used to detonate the mine.

7. Detailed Description

a. Mine.

(1) *Nomenclature* --Mine, antipersonnel, M18A1.

(2) *Common name* _CLAYMORE.

(3) *Type* -----Antipersonnel.

(4) *Weight* -----3½ pounds.

(5) *Dimensions* ----8½ inches long; 1 3/8 inches wide; 3¼ inches high (legs folded); 6¾ inches high (legs unfolded).

(6) *Firing unit construction.* The outer surface of the mine is a curved, rectangular, olive-drab, molded case of fiberglass-filled polystyrene (plastic). In the front portion of the case is a fragmentation face containing steel spheres embedded in a plastic matrix. The back portion of the case behind the matrix contains a layer of explosive.

(7) *Explosive* -----1 ½ pounds of composition C4.

(8) *Detonator wells.* Two detonator wells are located on the top of the mine which allows for single or dual priming. These wells are sealed by the plug ends of the shipping plug priming-adapters which prevent entry of foreign materials into the detonator wells. The slotted end of the shipping plug priming-adapters is used to hold an electric blasting cap in place when the mine is armed. The shipping plug priming-adapters is merely reversed when the mine is to be armed.

(9) *Peepsight and arrows.* The molded slit-type peepsight and arrows (fig. 10) located on top of the mine are used to aim the mine.

(10) *Legs.* Two pairs of scissors-type folding legs located on the bottom of the mine enable it to be emplaced on the ground. The mine can also be tied to posts, trees, etc.

b. Accessories.

(1) *M57 firing device.*

(a) One M57 electrical firing device is issued with each M18A1. This device is a hand-held pulse generator. A squeeze of the handle produces a double (one positive, one negative) 3-volt electric pulse of sufficient energy to fire the electric blasting cap through the 100 feet of firing wire which is issued with the mine. The M57 device is 4 inches long, approximately 1½ inches wide, 3¼ inches high, and weighs three-fourths of a pound. On one end of the firing device is a rubber connecting plug with a dust cover.

The M57 firing device is shown in figure 5.

- (b) The safety bail on the M57 electrical firing device (fig. 6) has two positions. In the upper SAFE position, it acts as a block between the firing handle and the pulse generator. In the lower FIRE position, it is clear of the firing handle and allows the pulse generator to be activated. The M18A1 antipersonnel mine with the M57 firing device connected is shown in figure 7.
- (c) The M57 electrical firing device and firing wire should not be discarded after initial use. Another electric blasting cap can be attached to the firing wire and the M57 device can be used to fire other devices, such as fougasse bombs and demolition charges, provided no more than 100 feet of firing wire and one M6 blasting cap are used.

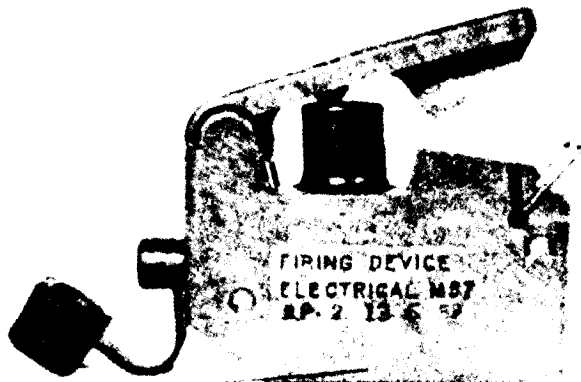

Figure 5. The M57 firing device.

- (2) *M4 electric blasting cap.* The M4 electric blasting cap (fig. 7) consists of an M6 electric blasting cap attached to 100 feet of firing wire. Attached to the firing wire connection is a combination shorting plug and dust cover. The shorting plug prevents accidental functioning of the blasting cap by static electricity; the dust cover prevents dirt and moisture from enter-

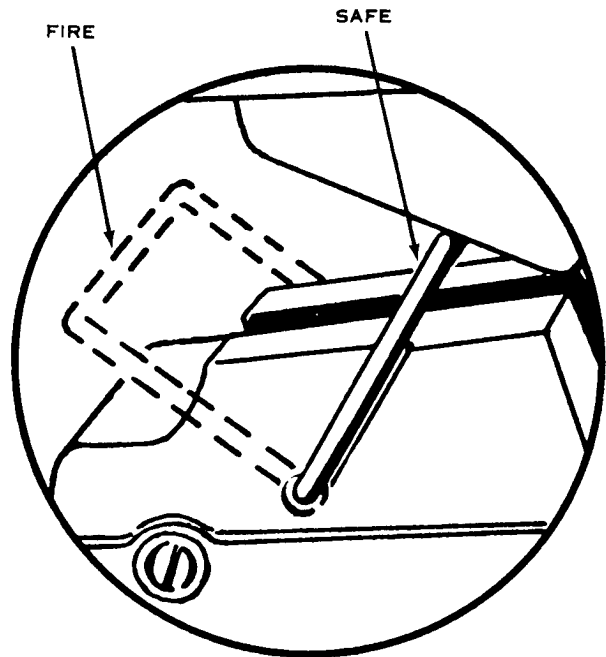

Figure 6. The M57 firing device safety bail.

ing the connector. The firing wire is wrapped around a flat paper and then rolled to form a package 6 inches long, 4 inches wide, and 2 inches high. A piece of insulating tape is used to hold the package together.

- (3) *M40 test set.* The M40 test set (figs. 17 and 18) is an instrument used for checking the continuity of the initiating circuit of the mine. (For further details on the M40 test set, see para 15.)

Note. Only one of the six bandoleers in each packing box contains a test set. The bandoleer containing the test set is marked by an identification tag on the carrying strap (fig. 2).

c. M7 Bandoleer. The M7 bandoleer (fig. 2) is constructed of water resistant canvas (olive-drab color) and has snap fasteners which secure the flap. The bandoleer has two pockets; one pocket contains the mine and the other contains a firing device, a test set, and an electric blasting cap assembly. A 2-inch wide web strap, which is used as a shoulder carrying strap, is sewn to the bag. An instruction sheet is sewn to the inside flap (fig. 3).

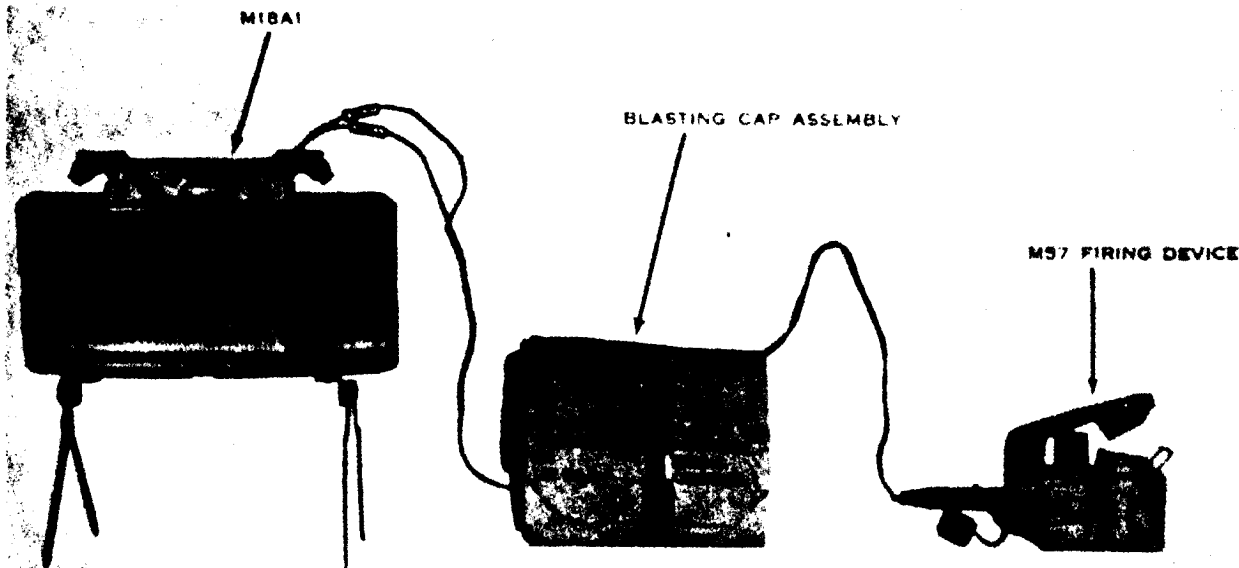

Figure 7. The M18A1 antipersonnel mine with the M57 firing device connected.

Section II. COVERAGE AND METHODS OF FIRE

8. Fire Discipline

Since the M18A1 mine can be fired only once, fire discipline is of paramount importance. The mine should not be used against single personnel targets; rather, it should be used for its intended purpose—massed personnel. When lead elements of an enemy formation approach within 20 to 30 meters of the mine, it should be detonated. If practicable, and to insure fire discipline, actual authority and responsibility for target selection and timely detonation should rest with squad leaders or their superiors.

9. Controlled Frontal Coverage

a. For effective coverage of the entire front of a position, mines can be placed in a line no closer than 5 meters and no farther apart than 45 meters. Preferred lateral and rearward separation distance is 25 meters (fig. 8).

b. If mines are placed in depth (from front to rear), the minimum rearward separation distance is 5 meters, provided secondary missiles are removed. This distance is sufficient

to prevent possible disturbance or damage to the rearward mines.

10. Methods of Fire

The M18A1 mine can be employed in either the controlled or uncontrolled role.

a. Controlled Role. The mine is detonated by the operator as the forward edge of the enemy approaches a point within the killing zone (20 to 30 meters) where maximum casualties can be inflicted. Controlled detonation may be accomplished by use of either an electrical or nonelectrical firing system (fig. 9). When mines are employed in the controlled role, they are treated the same as individual weapons and are reported for inclusion in the unit fire plan. They are not reported as mines; however, the emplacing unit must insure that the mines are either removed, detonated, or turned over to a relieving unit.

b. Uncontrolled Role. Uncontrolled firing is accomplished when the mine is installed in such a manner as to cause an unsuspecting enemy to detonate the mine. Mines employed in this manner must be reported and recorded as land mines.

Section III. FUNCTIONING AND INSTALLATION

11. Functioning

a. Electrical Firing. When the M18A1 is armed, actuating the M57 firing device handle (fig. 5) with the safety bail in the FIRE position provides sufficient electrical energy to detonate the M6 electric blasting cap. The detonation of the blasting cap, in turn, sets off the high explosive charge (composition C4). Detonation of the high explosive charge causes fragmentation of the plastic matrix and projects spherical steel fragments outward in a fan-shaped pattern (fig. 4). This mine is sufficiently waterproof to function satisfactorily after having been submerged in salt or fresh water for 2 hours.

b. Nonelectrical Firing. The M18A1 mine is deliberately detonated by the operator pulling or cutting a trip wire attached to a nonelectrical firing device (fig. 9). A nonelectric blasting cap attached to the firing device and crimped to a length of detonating cord sets off the detonating cord. At the other end of the detonating cord,

a second crimped nonelectric blasting cap, which is inserted in one of the detonator wells, detonates the mine.

12. Installation for Electrical Firing

a. Laying and Aiming.

- (1) Remove the mine and accessories (fig. 2) from the bandoleer. Read the instruction sheet (fig. 3) attached to the flap of the bandoleer before proceeding with the installation of the mine.
- (2) *The M57 firing device must be in the possession of the individual installing the mine. This prevents accidental firing by a second individual.*
- (3) Turn the legs downward and spread them about 45° apart. Twist both pairs of legs so that one leg protrudes ahead and one behind the mine, and position the mine so that the surface marked FRONT TOWARD ENEMY

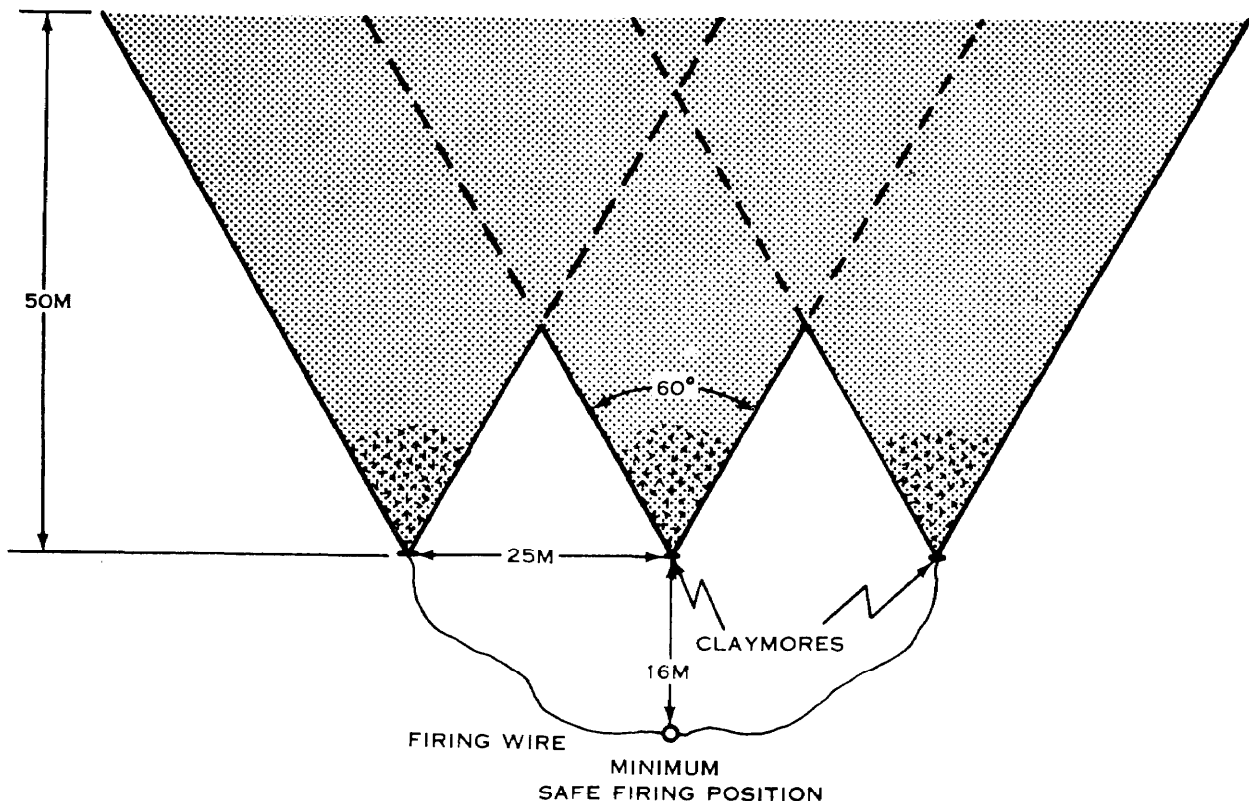

Figure 8. Diagram of lateral separation pattern of (CLAYMORES).

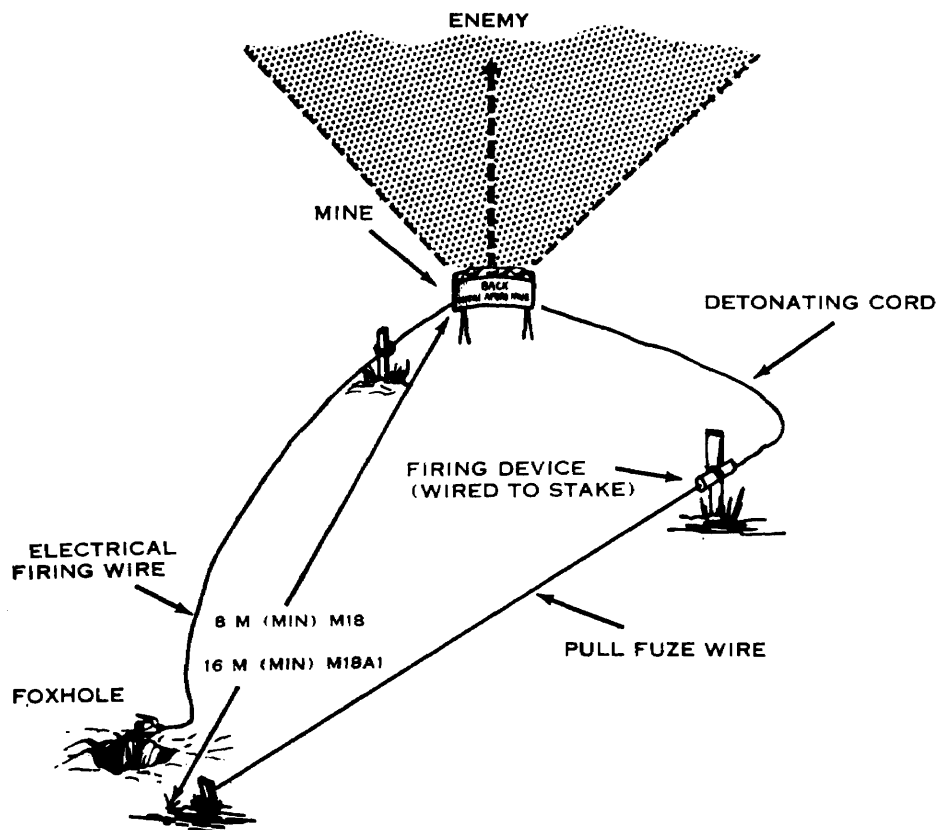

Figure 9. Diagram of the M18A1 antipersonnel mine installed for controlled nonelectrical and electrical detonation.

and the arrows on top of the case point in the direction of the enemy or the desired area of fire. On snow or extremely soft ground (mud), the bandoleer may be spread beneath the mine for support. To prevent the mine from tipping in windy areas, or when the legs cannot be pressed into the ground, carefully spread the legs to the maximum width (approximately 180°) so that the legs will be to the front and rear of the mine. A top view of the M18A1 antipersonnel mine is shown in figure 10.

- (4) Select an aiming point (tree, bush, etc.) that is approximately 150 feet from the mine and which projects approximately 8 feet above the ground (fig. 11). This approximates 2½ meters at a distance of 50 meters. Position the eye approximately 6 inches (15 cm.) away from the mine and aim the mine by sighting through the peepsight. The groove of the sight

should be in line with the aiming point. The aiming point should be in the center of the desired area of coverage, and the bottom edge of the peepsight should be parallel to the ground that is to be covered with the fragment spray.

b. Arming and Electrical Firing.

- (1) Unscrew either the right or left shipping plug priming-adapter, and reverse it to allow the firing wire to be placed into the slot provided in the priming-adapter portion (fig. 12). Remove the insulation tape and unroll the paper form from the firing wire. Make sure that the firing wire is uncoiled without tangling or kinking. Retain the paper form and the tape for possible future use. Hold the blasting cap while unwinding approximately 3 meters of the firing wire. Make certain that the combination shorting plug and dust cover are

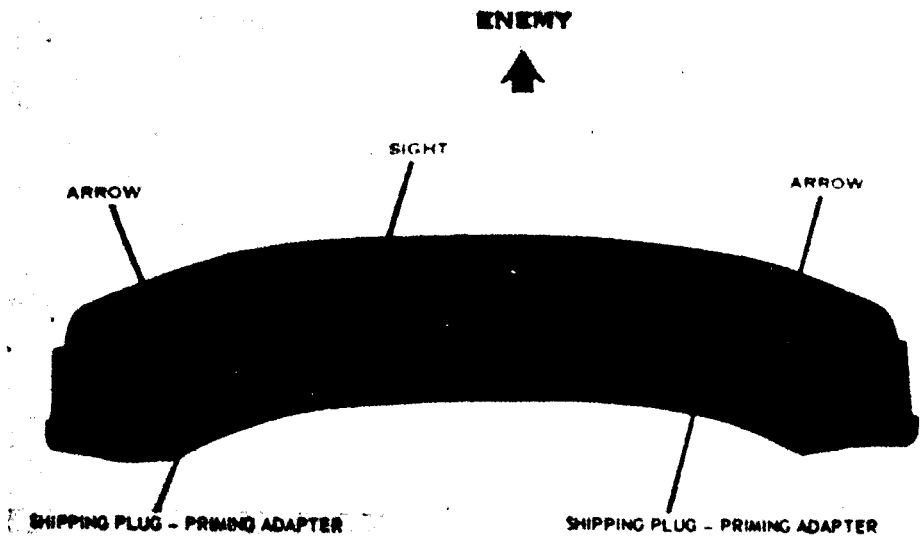
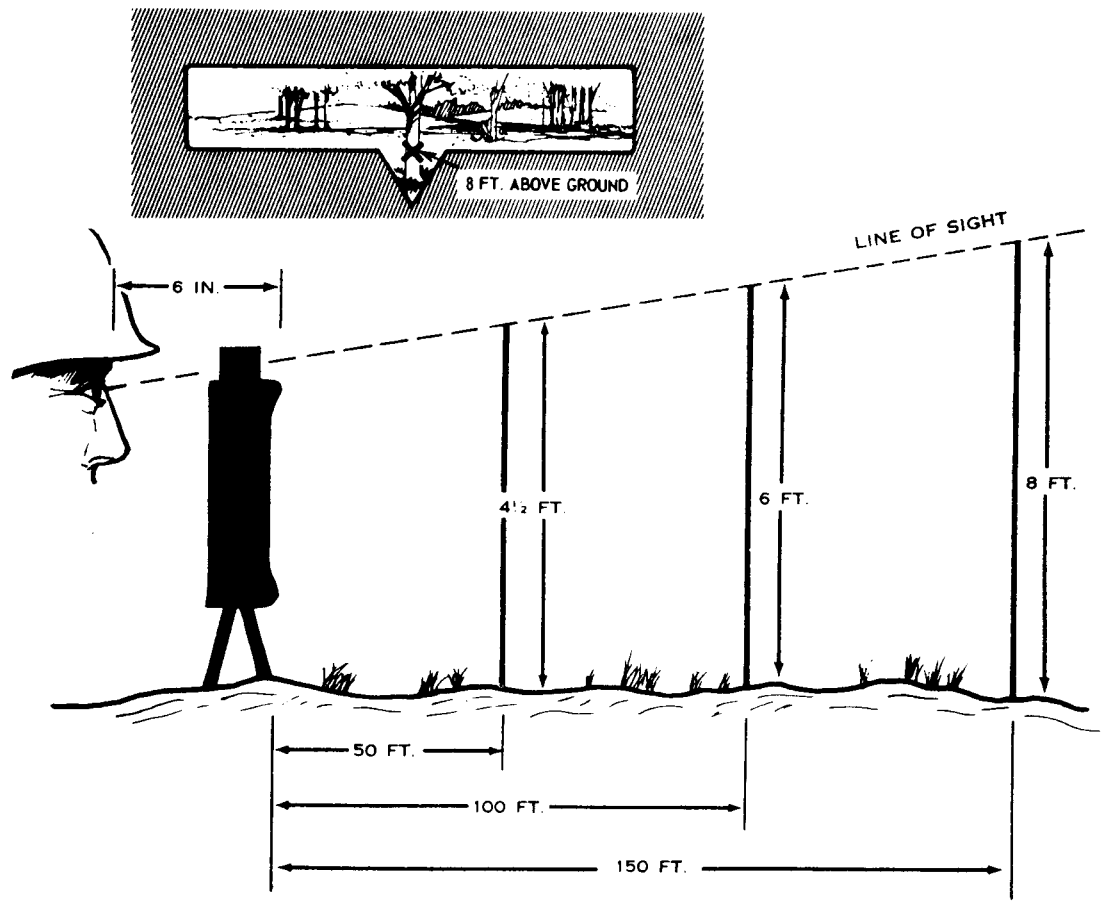

Figure 10. Top view of the M18A1 antipersonnel mine.



THE MINE SHOULD BE SIGHTED ON A POINT 8 FT. HIGH AT A DISTANCE OF 150 FT. OR ONE OF THE ALTERNATIVE POINTS SHOWN.

Figure 11. Aiming the M18A1 antipersonnel mine.

assembled to the connector of the firing wire before placing the blasting cap into the detonator well. Wrap the firing wire around a stake located approximately 1 meter from the mine to prevent the mine from becoming misaligned if the firing wire is disturbed.

- (2) A firing circuit test (para 15) should be conducted before the blasting cap is placed into the detonator well. This test checks the continuity of the firing circuit.
- (3) Slide the slotted end of the shipping plug priming-adapter on the firing wires of the blasting cap between the crimped connections and the blasting cap. Pull the excess wire through the slotted end of the shipping plug priming-adapter until the top of the blasting cap is firmly seated in the bottom portion of the shipping plug priming-adapter. Screw the shipping plug priming-adapter and the blasting cap into the detonator well.
Warning: Make certain that the face of the mine marked "front toward enemy" and the arrows on top of the mine point in the direction of the enemy.
- (4) Recheck the aim of the mine. Camouflage the mine and unwind the remaining firing wire to the firing position. If possible, bury the firing wire to protect it from artillery fire and detection. The operator should be in a foxhole, or in a covered position at least 16 meters behind or to the side of the emplaced mine. If possible, perform the tests in paragraph 15 before arming the M18A1. If the area is subjected to mortar or artillery bombardment, retest the circuit.
- (5) Remove the dust cover from the connector on the firing device; also, remove the combination shorting plug and dust cover from the end of the firing wire. Plug in the two connectors. Before connecting the firing wire to the M57 firing device (fig. 5),

the safety bail must be in the SAFE position. Before attaching the firing device, insure that personnel are under cover at least 250 meters away from the front and sides of the mine and at least 100 meters to the rear of the mine. The firing device should not be connected to the firing wire until the actual time of firing.

- (6) After testing (para 15), the mine is ready for firing. To fire the mine, position the firing device bail in the FIRE position.
- (7) Fire with a firm, quick squeeze of the firing device handle.

13. Installation for Nonelectrical Firing

A nonelectric firing system utilizing a ring main is shown in figure 13. Instructions for laying, aiming, and arming the mine using two nonelectric M7 blasting caps, a piece of detonating cord approximately 25 feet long, a pull wire, and a pull-type or pull release-type firing device, such as the M1 or the M3 is discussed in *a* and *b* below. Instructions for laying, aiming, and arming the mine using a dual firing system and a ring main is discussed in *c* below. To arm the mine by the methods described below, a thorough knowledge of explosives and demolition materials and the use and installation of land mines and boobytraps is required. Material on these subjects and techniques is contained in FM 3-5, FM 5-25, FM 5-31, FM 20-32, FM 31-10, TM 9-1375-200 and TM 9-1345-200.

a. Pull Wire Initiation of the Mine (controlled).

- (1) Laying and aiming the mine are performed in the same manner as for electrical firing. For details on laying and aiming, see paragraph 12 *a*.
- (2) Crimp a nonelectric blasting cap to a firing device. With the nonelectric blasting cap attached, fasten the firing device to the detonating cord with tape. Using tape, wire, twine or cord, fasten the firing device securely to a firmly emplaced stake (fig. 13). Insert the detonating cord into a second nonelectric blasting cap and crimp the cap to the detonating cord. Carefully insert the cap into the

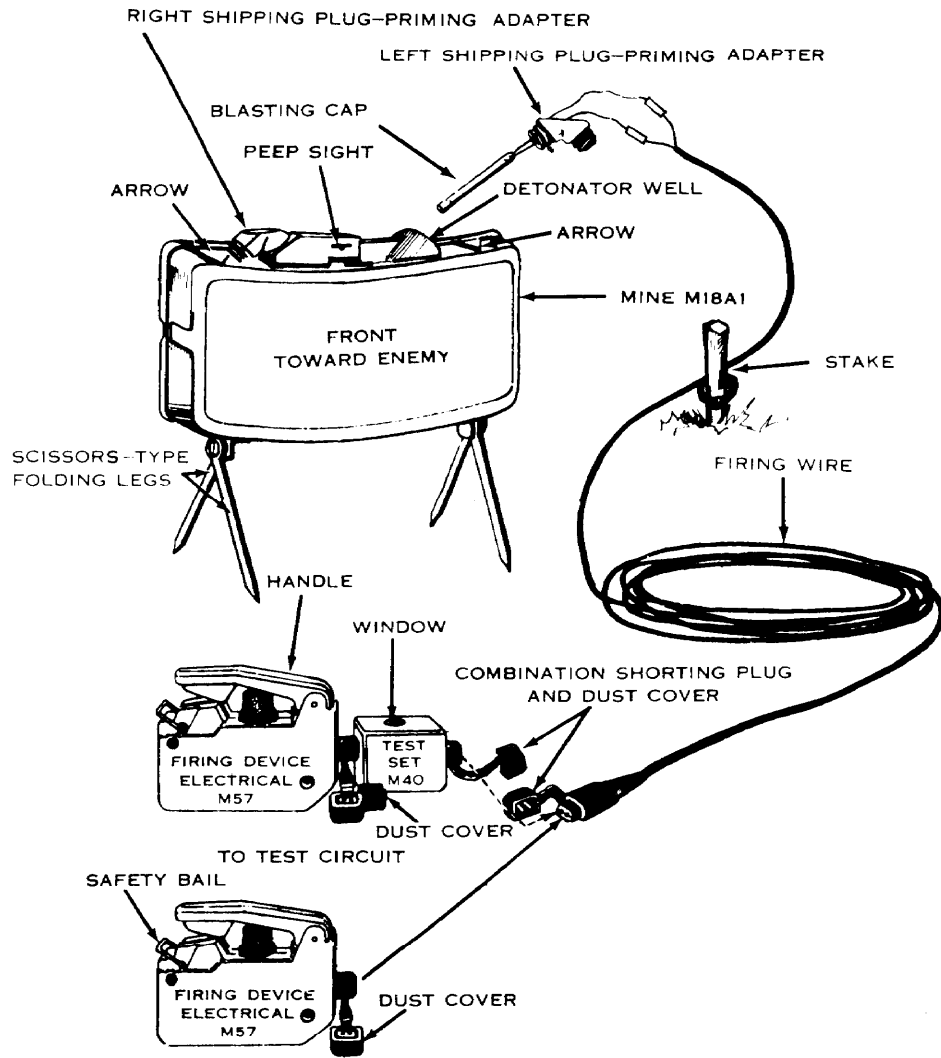

Figure 12. Arming and testing the M18A1 mine.

detonator well. Secure the cap in the detonator well by carefully taping or tying the detonating cord to the mine. A method of taping detonating cord to a nonelectric blasting cap is shown in figure 14.

- (3) Attach a pull wire securely to the pull ring of the firing device. The pull wire should be sufficiently long to allow actuation of the firing device from a protected position at least 16 meters to the rear of the mine. Care must be taken during emplacement to secure the firing device so that the mine will not be dislodged by a pull of the detonating cord of the tripwire.

b. Tripwire Initiation of the Mine (uncontrolled).

- (1) Laying and aiming the mine are performed in the same manner as for electrical firing. For details on laying and aiming, see paragraph 12 *a*.
- (2) The preliminary steps used to arm the mine are the same as those described in *a* (1) through (3) above.
- (3) The tripwire and the firing device, which are stretched across a trail or other avenues of approach, must be securely attached to two stakes firmly emplaced in the ground at a distance of 20 to 30 meters forward of the mine (fig. 15).

CONNECTION USED FOR
RING MAIN AND BRANCH LINES

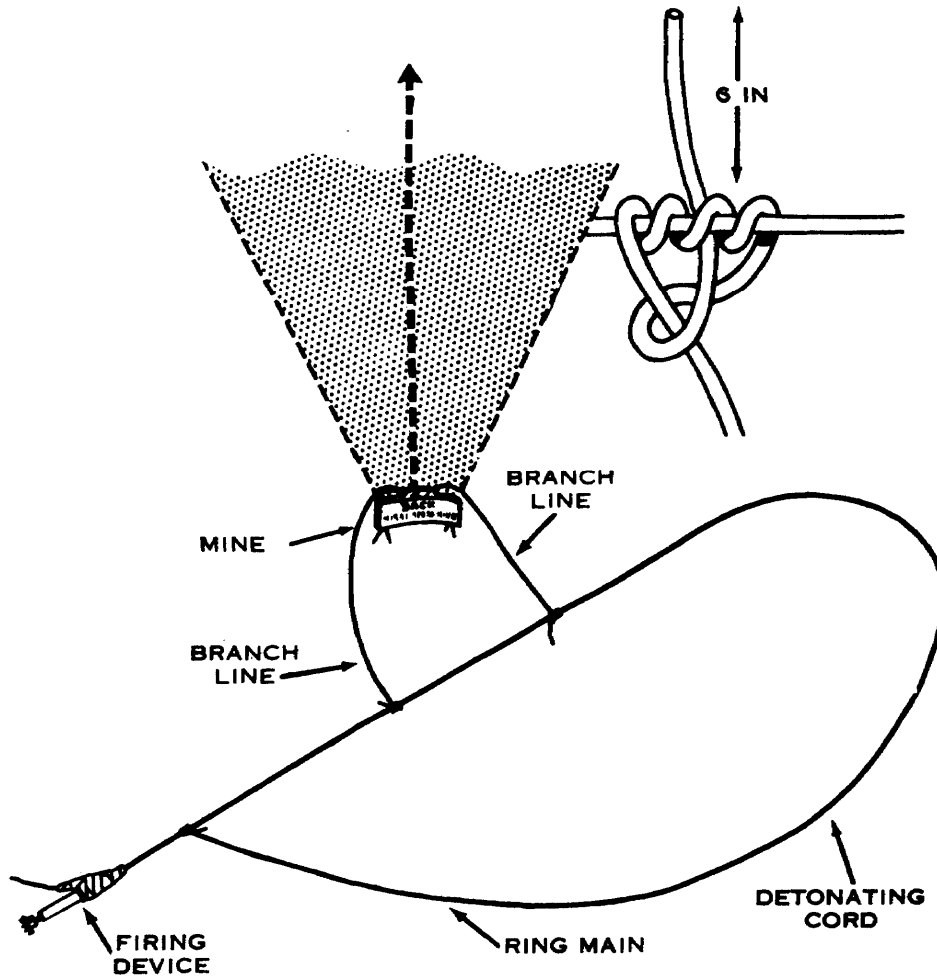

Figure 13. Nonelectric firing system.

c. Nonelectric Method Using Dual Firing or Ring Main.

(1) Dual firing.

- (a) Obtain two 10-meter lengths of detonating cord, four M7 nonelectric blasting caps, and two pull-type firing devices. Details for using dual firing or ring main systems are contained in FM 5-25.
- (b) Remove both shipping plug priming-adapters from the mine.
- (c) Crimp an M7 nonelectric blasting cap to the end of each piece of detonating cord. Insert the caps into the detonator wells, and carefully tape or tie the detonating cord to

the mine. While moving back to a safe firing position, unwind the detonating cord.

- (d) Emplace the mine and the detonating cord as described in a (1) through (3) above.
 - (e) Attach a pull-type firing device and a tripwire (or pull wire) to the free end of each piece of detonating cord (fig. 13). Use the procedures described in a or b above.
- (2) Ring Main.
- (a) Follow the instructions in (1) (a) through (d) above.
 - (b) Make a ring main as described in FM 5-25 (fig. 13).

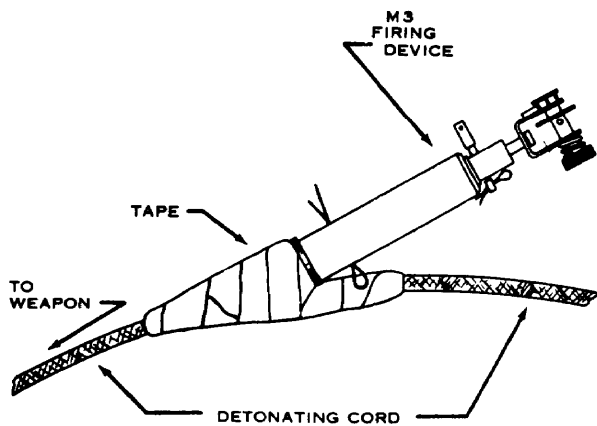

Figure 14. Method of taping M3 firing device to detonating cord.

- (c) When mines are emplaced one behind the other, the one nearest the enemy is generally fired first. Mines emplaced laterally may be fired in any order or simultaneously.
- (d) The mine and the danger area around the mine must be visible from the firing position so that friendly personnel in the vicinity of the mine may be seen.

14. Camouflage

a. Although the M18A1 is painted olive-drab to facilitate camouflaging, it is necessary to blend the mine into its surroundings to prevent its detection.

b. Only lightweight foliage, such as leaves and grass should be used to avoid increasing the secondary missile hazard to the rear of the mine.

c. Both the front and rear of the mine should be camouflaged with foliage. The firing wire should also be camouflaged or buried underground. If used, detonating cord should not be buried; however, it may be covered with light foliage. For the principles and methods of camouflage, see FM 5-20.

15. Testing

a. *M40 Test Set.* One M40 test set is provided with each case of six M18A1's. The test set is an instrument used for checking the continuity of the electrical firing circuit. A shipping tag on the carrying strap marks the bandoleer which contains the test set. The test

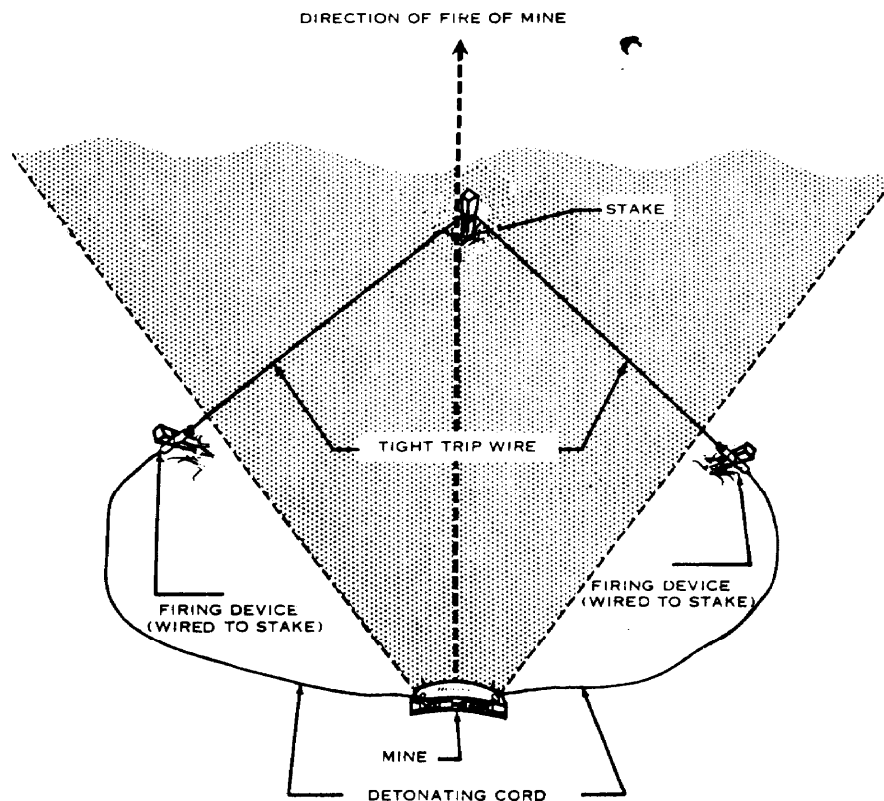

Figure 15. Diagram of the M18A1 antipersonnel mine installed for uncontrolled firing.

set is 2 inches long, 1½ inches high, and weighs 8 ounces. A small window is located on top of the test set and is used for observing the flashes of the indicating lamp (figs. 17 and 18). The M18A1 antipersonnel mine set up for circuit testing is shown in figure 16.

b. Detailed Circuit Testing Procedure. The firing circuit test should be conducted before the blasting cap is placed into the detonator well. This precaution will prevent the destruction of the mine if the testing set malfunctions and detonates the electric blasting cap. If the blasting cap is detonated during testing, it can be replaced by a standard electric blasting cap attached to the remaining firing wire. Before and after completion of the firing device and blasting cap continuity tests, ascertain that the firing device safety bail is in the SAFE position.

(1) *Testing the M57 firing device and the M40 test set.*

- (a) Remove the dust cover from the connector of the firing device and from the female connector of the test set. Plug the test set into the firing device (fig. 5). Leave the combination shorting plug and dust cover assembly on the other end of the test set. Position the firing device bail to the FIRE position and actuate the handle of the firing device with a firm, quick squeeze and observe the flashing of the lamp

through the window of the test set. The window of the test set should be held near the eye when checking the firing device and blasting cap circuitry. This minimizes the risk of enemy observation in the dark and enables the operator to see the lamp flashing, even in bright sunlight.

- (b) Flashing of the lamp indicates that the firing device is functioning properly. If the lamp does not flash (on and off), it could be caused by corrosion on the electric connectors of the test set. The firer can overcome this by connecting and disconnecting the shorting plug dust cover on the M40 test set. If the test set indicates that several firing devices are faulty, retest with another set since the first one may be defective. Side and top views of the M40 test set are shown in figures 17 and 18.

(2) *Testing the blasting cap.*

- (a) After determining that the firing device and test set are operative, remove the shorting plug dust cover from the connector of the firing wire and from the end of the test set. Plug the connector of the firing wire into the test set. Position the M57 firing device bail to the FIRE

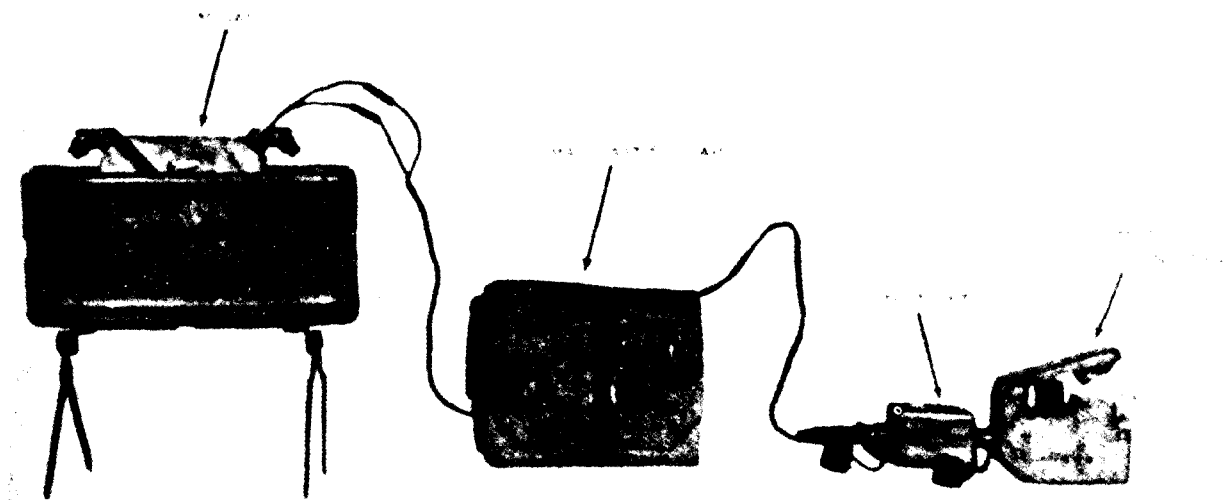

Figure 16. The M18A1 antipersonnel mine set up for circuit testing.

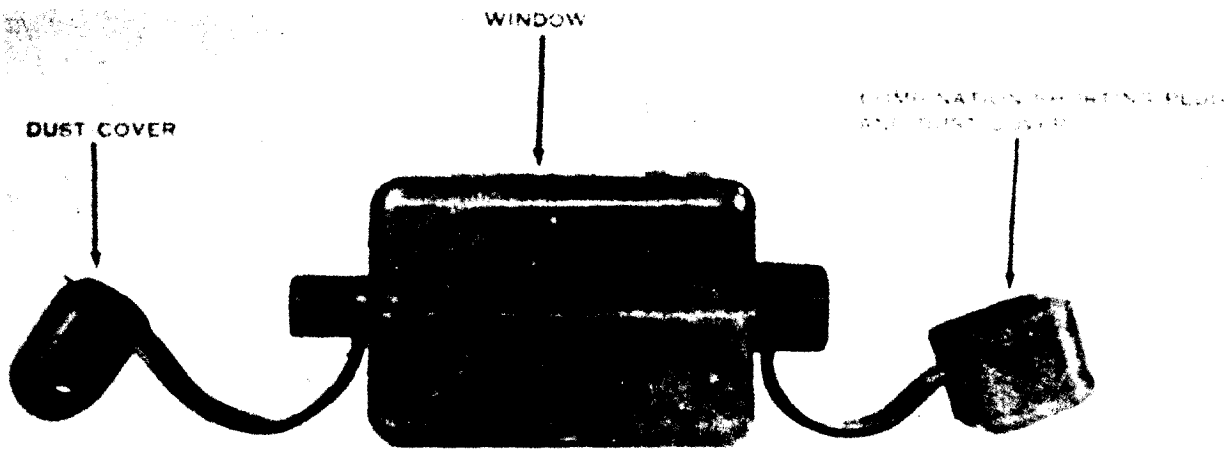

Figure 17. Side view of the M40 test set.

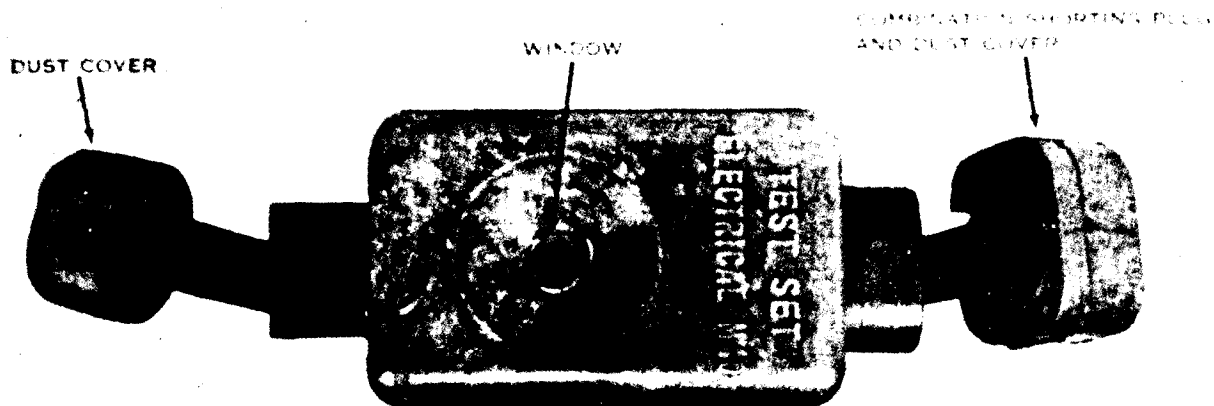

Figure 18. Top view of the M40 test set.

position. Insure that no friendly personnel are near the blasting cap, as it may detonate.

DETAILED CIRCUIT TESTING IS CONDUCTED WITHOUT THE BLASTING CAP INSERTED INTO THE DETONATOR WELL.

- (b) When the handle of the firing device is actuated, a lamp in the window of the test set will flash. This flash indicates that the blasting cap circuitry is satisfactory. If there is no flash, replace the blasting cap and retest.
- (c) Immediately after the circuit test, the firing device is disconnected from the firing wire and the shorting plug dust cover is connected

to the firing wire. The operator returns to the mine WITH THE FIRING DEVICE IN HIS POSSESSION and inserts the blasting cap into the detonator well. The operator then rechecks the aim of the mine and returns to his firing position.

- (d) If an extended period of time lapses between the circuit test and the insertion of the blasting cap into the detonator well, or if the area is subjected to artillery or mortar fire, another test should be conducted.

Note. If time available precludes the conduct of a circuit test with the blasting cap removed from the mine, then an abbreviated test may be conducted with the blasting cap inserted into the detonator

well. If an abbreviated test is conducted, all personnel must be under cover at least 250 meters away from the front and sides of the mine and 100 meters to the rear of the mine.

16. Disarming and Destruction

a. Disarming a Mine with an Electrical Firing System.

- (1) Prior to disarming the mine, the firing device safety bail must be in the SAFE position.
- (2) Disconnect the firing wire from the firing device. Replace the combination shorting plug dust cover on the firing wire connector and the dust cover on the firing device connector.
- (3) Unscrew and remove the shipping plug priming-adapter containing the blasting cap from the mine. Remove the blasting cap and firing wire from the shipping plug priming-adapter. Reverse the shipping plug priming-adapter, and screw the plug end of the adapter into the detonator well.
- (4) Remove the firing wire from the stake. Reroll the blasting cap and firing wire and place it in its cardboard container.
- (5) Remove the mine from its emplace-

ment. Repack the mine and its accessories into their respective pockets in the bandoleer.

b. Disarming a Mine with a Nonelectrical Firing System.

- (1) Prior to performing (2) through (6) below, render the firing device safe by replacing all safety pins.
- (2) Disconnect the pull wire or tripwire from the nonelectric firing device.
- (3) Remove the detonating cord and blasting cap from the detonator well.
- (4) Using crimpers, cut the blasting cap free of the detonating cord. Non-electric blasting caps and detonating cord crimped together can be separated only by cutting the blasting cap free of the detonating cord.
- (5) Replace the shipping plug priming-adapter and screw it into the detonator well, plug end down.
- (6) Remove the mine from its emplaced position and repack. Store accessory items in appropriate containers.

c. Destruction of Mine to Prevent Enemy Use. CLAYMORES can be most quickly destroyed by detonation or burning. For proper destruction procedures, see TM 9-1345-200.

CHAPTER 3

TRAINING

17. General

Training is divided into two phases—phase I and phase II. Phase I training is designed to familiarize the soldier with the characteristics, capabilities, and installation of the M18A1 using its electrical firing system. In phase II training, the soldier receives further instruction in nonelectrical firing systems, tactical employment, and other advanced training. This training is designed to fully prepare the soldier to employ the mine effectively in combat.

18. Phase I Training

a. Purpose. To provide the minimum amount of training required to employ the M18A1 with the electrical firing system in the controlled role, using the components found within the M7 bandoleer.

b. Elements of Phase I Training. The soldier receives training in the following areas:

- (1) Characteristics, mechanical training, and capabilities of the M18A1 (para 3-10).
- (2) Aiming, sequence of installation, circuit testing, and disarming (para 12, 15, and 16 *a*).
- (3) Safety procedures (app. III).
- (4) Camouflage techniques (para 14).

c. Practical Exercises. Emphasis should be placed on practical exercises using inert or simulated mines.

19. Phase II Training

a. Purpose. To provide the soldier with the necessary skills and tactical knowledge to effectively employ the CLAYMORE, utilizing both electrical and nonelectrical firing systems.

b. Elements of Phase II Training. In addition to phase I training, the soldier is further trained in the following areas:

- (1) Controlled and uncontrolled nonelectric firing systems (para 13).
- (2) Dual firing systems (para 13).
- (3) Ring main systems (para 13).
- (4) Tactical employment (ch 4).

c. Practical Exercises. Initially, practical exercises should be conducted in installing inert or practice mines using pull wire and tripwire actuation of the mine and in dual firing and ring main systems. Inert or simulated items, such as detonating cord, nonelectrical firing devices, and caps should be substituted for live explosives. Practical exercises should emphasize employment of the CLAYMORE in various tactical situations.

d. Use of Live Explosives. As the soldier becomes more proficient in inert installation, training progresses to the use of live explosives. He is trained in firing systems and demolition equipment as described in FM 5-25.

e. Proficiency. To maintain proficiency after the completion of phase II training, the soldier should employ inert mines during field training in both the controlled and uncontrolled roles.

CHAPTER 4

TACTICAL EMPLOYMENT

20. General

The M18A1 mine is primarily a defensive weapon. It may be employed to a limited extent in certain phases of offensive operations. The M18A1 has the same basic capabilities as antipersonnel mines and can be used in most situations where other types of antipersonnel mines are employed. In addition, the M18A1 has the capability of being sighted directionally to provide fragmentation over a specific area and does not necessarily rely upon chance detonation by the enemy. The M18A1 is adaptable for covering the ranges between maximum hand grenade throwing distance and the minimum safe distance of mortar and artillery supporting fires.

21. Defense

a. General. The M18A1 normally is employed in the controlled role as an antipersonnel mine. When used in conjunction with other types of antipersonnel and antitank mines, the employment of the M18A1 will be governed by the procedures described in FM 20-32.

b. Minefields.

- (1) Ease of transportation, installation, and removal facilitates the use of the M18A1 in protective, defensive, and nuisance minefield.
- (2) The M18A1, with its controlled dispersion pattern, is designed to cover areas where enemy personnel attacks in force are anticipated. They may be located singly, or in multiples (fig. 8).
- (3) CLAYMORES may be mixed with antipersonnel and antitank mines in conjunction with nuisance minefield and arranged for detonation by tripwire.

(4) The M18A1 can supplement other mines within a protective minefield, and can be installed and employed in either the controlled or uncontrolled roles. The configuration and composition of the minefield pattern varies with the terrain and tactical situation.

(5) The M18A1 can be used to cover portions of defensive minefield by emplacing it on the minefield perimeter, or within the field to cover lanes between mines. The controlled method of employment is desirable. Care should be taken to insure that the mine is properly aimed to provide fragmentation effect over and not into the minefield. This can be accomplished by securing the mine to trees or other elevated objects which are at least 2 meters above ground level.

c. Find Protective Fires. The M18A1 can be employed to fill the dead space of the final protective fires of automatic weapons in defensive positions. Depending on the importance of the area being protected, CLAYMORE mines may be emplaced behind each other in relatively close proximity. To avoid the risk of sympathetic detonation, mines should be placed no closer than 5 meters apart. Normally, mines closest to the enemy will be detonated first. If the enemy continues to approach a defender's position, he will successively detonate rearward mines as he comes within their range. In determining positions for emplacing CLAYMORE mines, consideration must be given to the effects of backblast on friendly positions.

d. Security of Outposts. CLAYMORE mines are easily transported and rapidly emplaced for security of outposts. The mines can be in-

stalled for complete perimeter coverage of a position. Time permitting, several rows can be employed. The mine can also be emplaced to assist in covering withdrawals from outposts.

e. Defense of Command, Combat Support, Combat Service Support Installations, and Reserve Forces.

- (1) CLAYMORE mines can be utilized to assist in the local security of command posts and support installations; and they can be carried in vehicles located within these areas. In addition to providing local protection for these installations, the mines also provide protection for the vehicles.
- (2) CLAYMORE mines so emplaced should be employed in the electrically controlled role as a protective measure against inflicting casualties on friendly personnel.
- (3) It is necessary to mark, record, and report all such positions as described in FM 20-32. The shorting plug dust cover must be attached to the firing wire and the firing device should not be attached until actual firing, particularly in rear areas where friendly personnel move about extensively.
- (4) Reserve forces in blocking positions or assembly areas can use CLAYMORES to augment their local security forces.

f. Local Security of Halted Columns. CLAYMORES may be carried on tanks and other types of vehicles and emplaced for perimeter defense of such vehicles when they are halted. As soon as they are halted, personnel will emplace the CLAYMORES for close-in protection of the vehicles. Controlled electrical firing should be employed for simplicity, speed, and safety.

g. Roadblocks and Obstacles.

- (1) In conjunction with roadblocks, CLAYMORES should have a clear field of fire to cover the avenue of approach. Additional CLAYMORES should be placed on the friendly side of a roadblock. When used to cover obstacles, the CLAYMORE should be

placed 20 to 30 meters on the friendly side of the obstacle. This distance also applies to barbed wire obstacles.

- (2) Controlled detonation is most desirable, since the firer can best judge the exact moment of detonation. However, uncontrolled detonation may be employed allowing the enemy to activate the mine when he attempts to breach the obstacle (para 10).

h. Boobytraps. Using standard firing devices, CLAYMORE mines can be employed as boobytraps (para 13). Concealment of the mine and a positive detonation system is essential. The mine must be emplaced and sighted to cover the desired area. In order to allow for the full effects of the dispersion pattern of the mine, it is best to locate it away from the boobytrap actuation device. The mine is adaptable to many varied situations of boobytrapping, limited only by the ingenuity of the individual emplacing the mine. Authority to emplace boobytraps requires approval by the field army commander (FM 5-31).

i. Retrograde Operations.

- (1) During a *delay* while on position, CLAYMORES will be employed in the same manner as they are when employed in the defense. During movement between positions, CLAYMORES will be employed in the same manner as a withdrawal.
- (2) During a *night-type withdrawal*, which is conducted without enemy pressure, CLAYMORES may be emplaced for use by the detachments left in contact, using both controlled and uncontrolled methods of employment. CLAYMORES may be used to assist in covering the gaps left by the main force. They may be used singly or in conjunction with other mines to mine routes of withdrawal.
- (3) If used, the rear guard can also employ M18A1's using the uncontrolled means of firing to assist in covering its withdrawal to the rear. Utilization of the M18A1 in this manner provides added security for the detachments left in contact, or the rear guard, and can delay the enemy's advance. How-

ever, since the M18A1 is employed in the uncontrolled role, it must be reported and recorded as a mine.

- (4) If a covering force is used during a *daylight-type withdrawal*, CLAYMORES can be employed by the covering force in a manner similar to that used in any blocking position and also employed using the same techniques as used during a night-type withdrawal.

22. Offense

a. General. The M18A1 can be employed in certain phases of offensive combat, and provisions for its use should be considered in planning offensive operations. The mine easily can be transported by attacking troops for defense of assembly areas, to provide security during the conduct of the attack, and for protection during the reorganization and consolidation of the objective. The M18A1 also provides an economical means for establishing effective ambushes.

b. Offensive Combat.

- (1) *Preparation for the attack.* When a unit is approaching the enemy and occupies an assembly area prior to an attack, it is particularly vulnerable to surprise enemy attacks. CLAYMORE mines can be quickly emplaced around the perimeter of the assembly area to cover the unit during its preparation for the attack.
- (2) *Conduct of the attack.* During the conduct of the attack, CLAYMORES can be employed by the flank security forces. The ease of employment and disarmament of the M18A1 facilitates its use in this manner.
- (3) *Reorganization and consolidation.* During the conduct of the attack, assaulting troops may carry CLAYMORES for employment during reorganization and consolidation. After a unit has overrun an enemy position and pursued him by fire, it must immediately begin consolidation of the objective. The prompt emplacement of CLAYMORES will provide the base for an immediate defense against

possible counterattack, while leaders reorganize their units and prepare to continue the attack. When the final objective is captured, mines should be immediately emplaced. The emplaced CLAYMORES can be integrated into the defensive plans as they are developed.

- (4) *Defense of supporting elements during the attack.*

(a) CLAYMORE mines can be utilized in command posts or in the defense of supporting units, such as mortar and artillery batteries. Immediately after displacement, and as the first echelon of these supporting units moves into new positions, adequate defense measures will be established. CLAYMORES should be emplaced initially to cover likely avenues of enemy approach; eventually, they should be integrated with the fully developed defensive position. When displacements occur, the mines will be disarmed, collected, and moved to the next position. If the area is to be occupied by other units, the mines may be left in position by mutual arrangement with the relieving unit.

(b) When CLAYMORE mines are employed in the defense of command posts, supporting unit installations, or reserve forces in the rear of the battle positions, they must be well-marked and personnel should be familiarized with their location.

c. Ambush. CLAYMORE mines provide an excellent, economical means for establishing effective ambushes deep in enemy territory with a minimum use of friendly personnel. Small groups can easily transport a large number of CLAYMORES; for example, one man can carry six CLAYMORES, enough to cover a frontage up to 300 meters. CLAYMORES may be employed in any or all of the following ways:

- (1) *Laterally along the killing zone of the ambush, between the ambush element and the killing zone.* This method inflicts maximum damage on dismounted

troops and is particularly useful in countering enemy immediate action drills that include assault into the ambush element.

- (2) *At the front and rear of the killing zone* (fig. 19). This method provides enfilade fire into the killing zones, greater economy of employment, and is particularly useful when the route through the killing zone is restricted in width. It also provides a good counter in enemy immediate action drills that include withdrawal or forward movement out of the killing zone along the original route.
- (3) *Laterally or at the front and rear of the killing zone, on the far side of the killing zone from the ambush element* (fig. 19). This method of employment is particularly effective in countering enemy immediate action drills that include maneuver or with-

drawal out of the killing zone by moving away from the ambush element. Care must be taken to insure the ambush element is protected from the fragmentation of the M18A1.

- (4) *Defiles.* CLAYMORES are particularly effective in covering areas that might afford the enemy cover from small-arms fire, such as defiles. CLAYMORES used in ambushes may be emplaced on the ground, in trees, or on other upright objects which insure a clear, unobstructed, sighted field of fire. Controlled detonation is desirable, since this permits the firing to be delayed until that portion of the enemy which the commander desires to catch in the ambush is in the killing zone. Mines should be carefully camouflaged to prevent their detection.

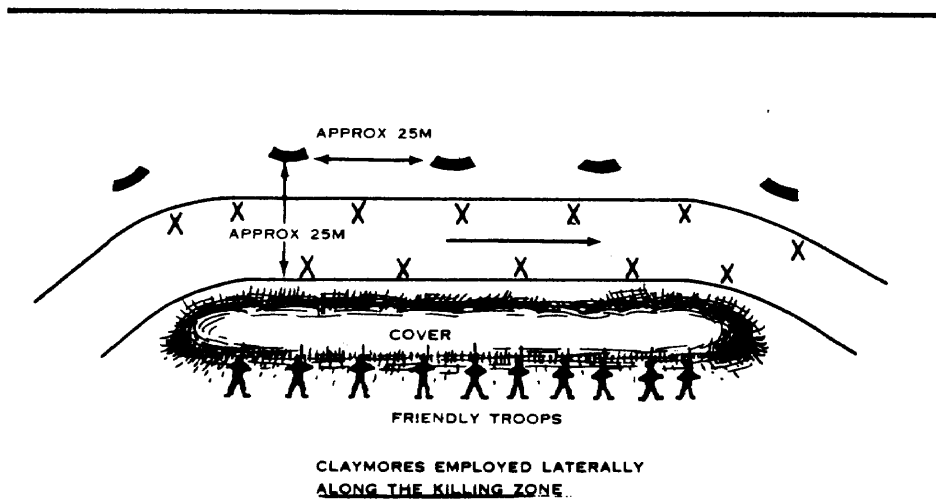
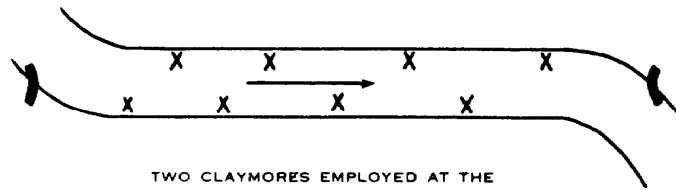

Figure 19. CLAYMORES employed in ambush.

APPENDIX I

REFERENCES

AR 320-5	Dictionary of United States Army Terms.
AR 320-50	Authorized Abbreviations and Brevity Codes.
AR 385-63	Regulations for Firing Ammunition for Training, Target Practice and Combat.
AR 385-65	Identification of Inert Ammunition and Ammunition Components.
AR 700-1300-8	Malfunctions Involving Ammunition and Explosives.
AR 710-1300-1	Distribution of Ammunition for Training.
DA Pam 108-1	Index of Army Motion Pictures, Filmstrips, Slides, Tapes, and Phono-Recordings.
DA Pam 310-3	Military Publications: Index of Doctrinal, Training, and Organizational Publications.
DA Pam 310-5	Military Publications: Index of Graphic Training Aids and Devices.
FM 3-5	Chemical, Biological, and Radiological (CBR) Operations.
FM 5-15	Field Fortifications.
FM 5-20	Camouflage, Basic Principles and Field Camouflage.
FM 5-25	Explosives and Demolitions.
FM 5-31	Use and Installation of Boobytraps.
FM 20-32	Land Mine Warfare.
FM 21-6	Techniques of Military Instruction.
FM 21-30	Military Symbols.
FM 31-10	Barriers and Denial Operations.
FM 100-5	Field Service Regulations—Operations.
FM 101-10-2	Staff Officers' Field Manual—Organizational, Technical, and Logistical Data—Extracts of Tables of Organization and Equipment.
SM 9-2-1	Stock List of All Items, Price List.
SM 9-4-1375-R03	Demolition Equipment Set, Explosive Initiating, Electric and Nonelectric.
SM 9-5-1345	Ammunition and Explosives, Land Mines.
SR 385-10	Army Safety Program.
SR 755-140-1	Ammunition.
TA 23-100	Ammunition, Rockets, and Missiles for Training.
TA 23-103	Dummy, Drill, and Inert Ammunition.
TF 7-3180	Technique of Employment, M18 and M18A1 Antipersonnel Weapons (CLAYMORE).
TM 9-1300-206	Care, Handling, Preservation, and Destruction of Ammunition.
TM 9-1345-200	Land Mines.
TM 9-1375-200	Demolition Materials.
TM 9-1900	Ammunition, General.
TM 9-1910	Military Explosives.

APPENDIX II

M18 ANTIPERSONNEL MINE

1. General

The M18 antipersonnel mine is an earlier model of the M18A1 antipersonnel mine, which is described in chapters 1 and 2. The difference between the two models may be seen by comparing figure 20 with figures 1 and 7. The M18 and the M18A1 are similar in use and functioning. The M18 antipersonnel mine is now limited standard.

2. Description

a. General. The M18 antipersonnel mine comes in two versions—with or without a peep-sight; otherwise, both versions are identical (fig. 20). The mine is a curved, rectangular, plastic case and contains a layer of composition C3 explosive. It has a fragmentation face of rectangular steel fragments. The front face containing the steel fragments is designed to produce a fan-shaped spray which can be aimed at a prescribed target area. The arrow marked on top of each mine indicates the direction of aiming. The mine has three folding-type legs and cloth tabs on each side of the mine. The legs of the mine are used to emplace it above

the ground; the cloth tabs are used to tie or nail the mine to trees or posts. There is a horizontal cap well on each side of the mine. To reduce detection, the mine is covered in a camouflage pattern of green and brown fleck.

b. Detailed Description.

- (1) *Weight* --2½ pounds.
- (2) *Detonator* -Electric blasting cap.
- (3) *Explosive* - ¾ pound C-3 explosive.
- (4) *Firing wire.* 50 feet (2-strand).

- (5) *Firing device.* Plastic frame with metal flashlight-type electric switch. Frame holds two 1.5-volt BA-30 dry batteries.

Warning: The electrical firing device issued with the M18 CLAYMORE is not safe. Due to its construction, it may cause premature detonation of the mine. Whenever possible, the battery holder (firing device) issued with the M18 mine should be replaced by a standard M57 firing device if the battery holder is used, both firing wires should be connected to one

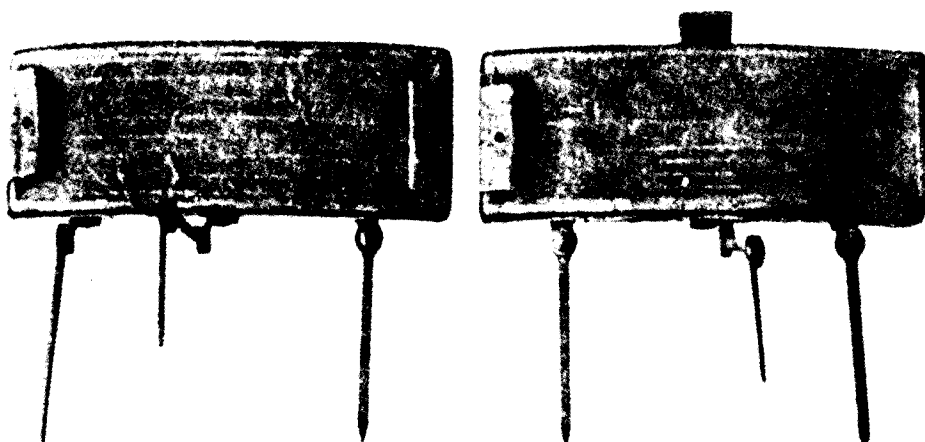

Figure 20. The M18 antipersonnel mine without sight on left; with sight on right.

terminal until the desired moment of detonation. Then the wires should be connected to both terminals before the batteries are inserted into the battery holder (fig. 21).

3. Effects of the M 18 Mine

a. *Casualty Effects* (fig. 22). The M18 delivers a large number of highly effective steel fragments in a fan-shaped beaten zone approximately 2 meters high and 30 meters wide at a range of 30 meters. These fragments are moderately effective out to 40 meters.

b. *Danger Area* (fig. 22).

- (1) *Danger from fragments.* The danger area consists of an 80° fan with a distance of 205 meters centered in the direction of aim of the mine.
- (2) *Danger from backblast and secondary missiles to the rear and sides of the mine.*
 - (a) Distance of 0 to 8 meters from the mine. Friendly troops are prohibited in this area.
 - (b) Distance of 8 to 16 meters from the mine. Friendly troops must lie prone or be in foxholes.

- (c) Distance of 16 to 50 meters from the mine. If all potential secondary missiles have been removed within a 1-meter radius to the rear and sides of the mine, friendly troops need only shut their eyes when the mine is detonated.

4. Installation and Disarming

a. *Arming and Laying* (fig. 23).

- (1) Using the point of a 7.62-mm cartridge or a similar shaped object, puncture the tape at either end of the mine and form a hole in the explosive for insertion of the blasting cap.
- (2) Carefully remove the special electric blasting cap from the cardboard tube and insert the cap into the hole of the explosive. Insure that firm or positive contact between the explosive charge and the blasting cap has been achieved.
- (3) For emplacement above the ground, unfold the legs of the mine and press them firmly into the ground. The center leg must be placed forward

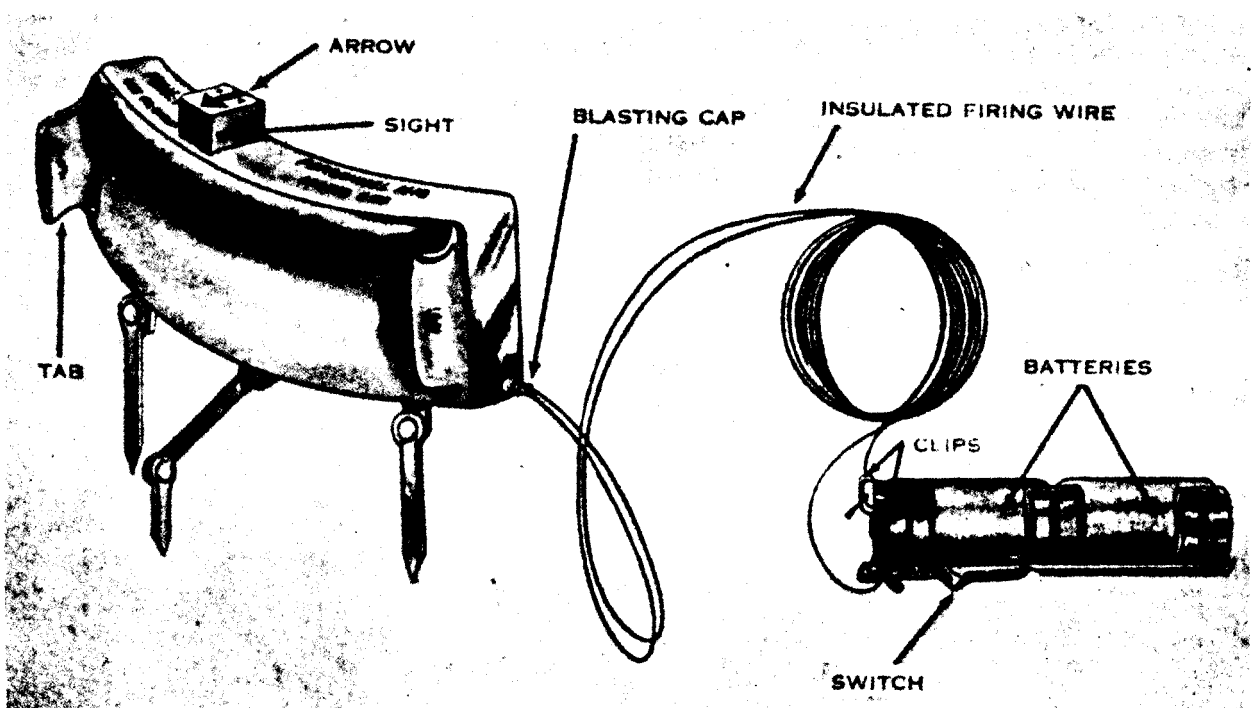

Figure 21. The M18 antipersonnel mine with electric blasting cap and lead wires, batteries, and battery holder.

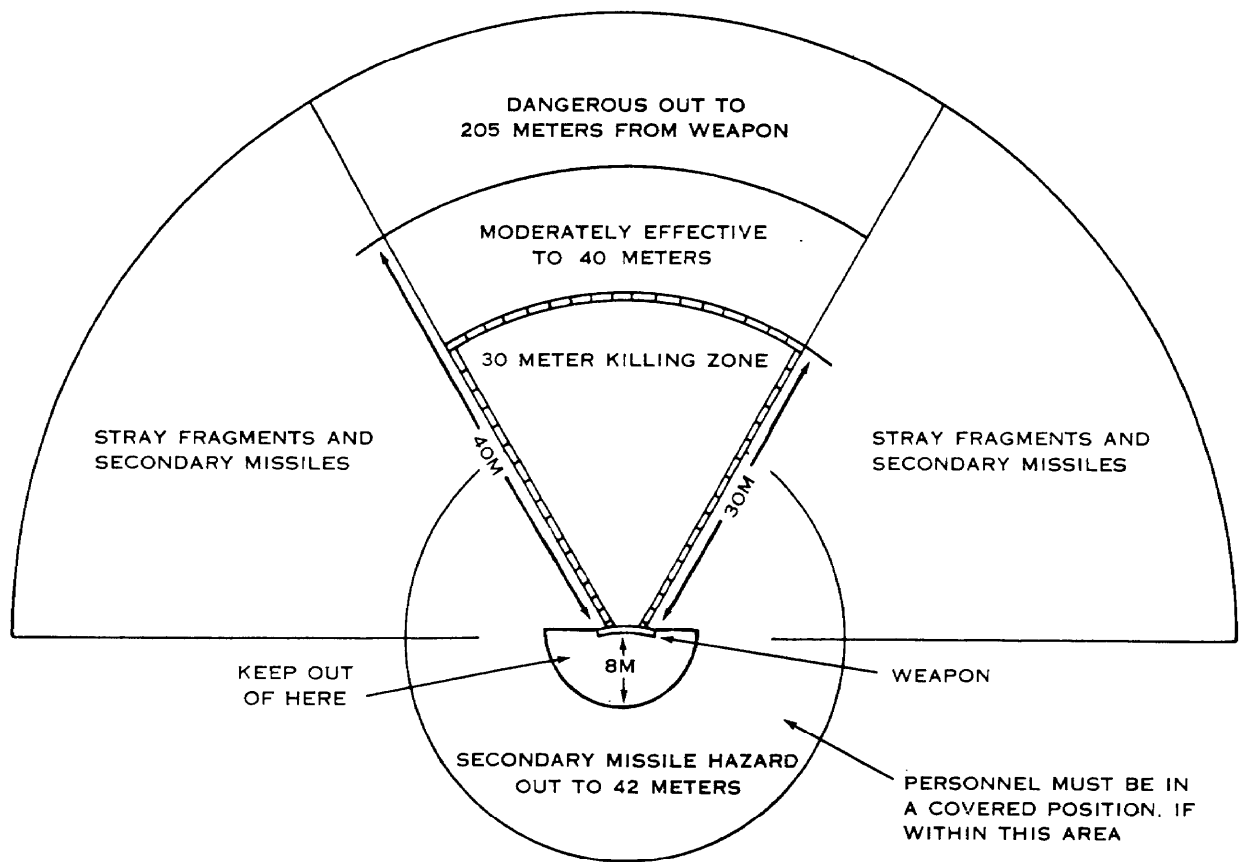

Figure 22. Danger radius and effects of the M18.

- of the mine to provide maximum stability.
- (4) For installation on a tree or post, the mine legs should remain folded. Utilizing the holes in the cloth tabs of the mine, secure it to the tree or post by tying or nailing. For either method of installation, the arrow on the top of the mine must point at the center of the fragmentation pattern.
 - (5) After placement of the mine, completely unwind the 50 feet of lead wires and run them to the firing position. Camouflage the mine and wire. The lead wires may be laid on top of the ground; however, if time permits they should be buried underground. This will reduce the possibility of artillery fragments dislodging the mine and cutting the wires. Lead wires of M18 mines that are tactically employed must be twisted together and taped at two or more equidistant

places. Leads must also be shunted. This can be accomplished by attaching both leads to the clip on the battery holder nearest the switch. The shunt must then be removed by detaching one of the leads and attaching it to the other clip on the battery holder before installing batteries and firing.

b. Preparation and Firing.

- (1) *M18 mine with M68 carrying kit.*
 - (a) Remove the protective wood blocks from the battery holder.
 - (b) Carefully attach the lead wires to the clips of the battery holder. The mine is now armed.
 - (c) Insert two 1.5-volt flashlight batteries (BA-30) into the battery holder, insuring that the forward end of each battery is facing the clip of the holder. The switch of the battery holder must be in the OFF position. Batteries are not provided with the kit. Keep batteries dry and

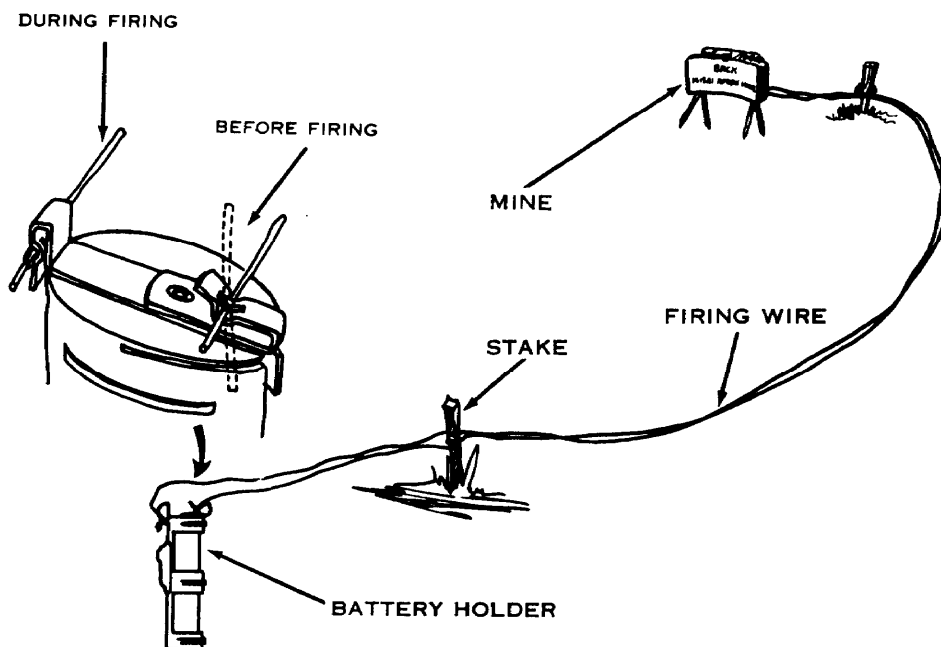

Figure 23. Diagram of the M18 antipersonnel mine installed for electrical detonation.

warm in cold weather. Use only fresh or fully charged batteries.

- (d) Fire by firmly pushing the switch to ON position.
 - (e) If additional lead wire is required, add 3 volts of power for each 50 feet (16 meters) of wire used, utilizing additional batteries and battery holders.
- (2) *M18 mine with M69 carrying kit and other firing devices.*
- (a) The M18 mine packed in the M69 carrying kit is designed for armor use. The mine is fired by connecting the lead wires to the battery of a tank or other types of vehicles.
 - (b) This mine may also be fired using pull-type firing devices, nonelectric blasting caps, and a sufficient length of detonating cord to bridge the

distance between the mine and the firing devices. (See para 13, chapter 3 for a detailed description.)

c. Disarming.

- (1) If dry cell batteries and battery holder(s) are utilized, insure that the switches are in the OFF position, and remove lead wires from the clips of the holder.
- (2) Short the lead wires by twisting the bare ends together.
- (3) Carefully remove the blasting cap from the mine.
- (4) Rewind lead wires and return the blasting cap and wire to the cardboard tube.
- (5) Remove the mine from its installed position, fold the legs (if required), and place the mine into its original packing.

APPENDIX III

SAFETY

1. General

This appendix covers the safety precautions to be observed when firing the M18A1 and M18 antipersonnel mines for training purposes. These safety precautions will assist the instructor in conducting CLAYMORE training. They are intended as a guide only and must be used in conjunction with appropriate safety measures prescribed in Army and/or local installation regulations.

2. Safety Precautions

a. Before firing, the *officer in charge* (OIC) will check all mines to insure that—

- (1) Mines are installed correctly.
- (2) The fragmentation face of the mine is pointed into the impact area and away from friendly troops.

b. CLAYMORES will be installed only on command of the OIC.

c. All mines will be kept under guard until the OIC directs their issue.

d. Once a mine has been emplaced for firing it will not be disarmed, except by order of the OIC.

e. The firing wire will not be connected to the firing device until ordered by the OIC.

f. When more than one mine is to be fired, the OIC will insure that a previous firing has not dislodged other mines in the impact area.

g. No one will enter the impact area without the approval of the OIC.

h. After firing, the impact area will be inspected to insure that all mines have detonated.

3. Operational Safety Factors

a. An individual installing a mine will carry the firing device on his person.

b. Mines must be installed in a manner that will prevent them from becoming disoriented.

c. Blasting caps will not be inserted into the detonator wells until the mine has been emplaced in its firing position and aimed.

d. The safety bail on the firing device must be in the SAFE position after the completion of the firing circuit test.

e. The shunt will not be removed from the firing wire of the M18 until the operator is ready to connect it to the firing device. Before installing batteries and firing, leads can be shunted by attaching both leads to the clip on the battery holder.

f. Firing wire leads of the M18 mines that are tactically employed must be twisted together and taped at two or more equidistant places.

4. Misfires

a. *Electrical Firing System.* A misfire of an electrically employed M18A1 must be investigated immediately. If the mine is dual-primed with both electric and nonelectric caps, it will then be necessary to wait 30 minutes before investigating the cause of the misfire. When handling electrical misfires, the following steps will be taken:

- (1) Shout MISFIRE (nontactical).
- (2) Check the firing device connection to the firing wire connector; make two attempts to fire the mine.
- (3) Using the M40 test set, check the continuity of the electric firing circuit.

Note. Only one man at a time will investigate the cause of an electric misfire.

b. *Nonelectrical Firing System.* If the nonelectric blasting cap initiator attached to the detonating cord fails to function, delay investigation for at least 30 minutes. Then cut the detonating cord between the firing device and the mine and fasten a new firing device to the detonating cord. If the detonating cord leading

to the mine detonates, but the mine fails to detonate, delay investigation until it is certain that the mine is not burning. If the mine is not damaged, insert a new blasting cap with detonating cord. In training, if the mine appears to be damaged, it should be treated as a dud and destroyed as instructed in TM 9-1300-206.

5. Surface Danger Area for the CLAYMORE Antipersonnel Mine

(fig. 24)

a. When employing the antipersonnel mines, careful consideration must be given to the safety of friendly troops. Emphasis must be placed on the danger areas to the rear and sides of the mine, as well as the killing zone to the

front. Care must be exercised when installing mines to prevent the creation of secondary missile hazards.

b. No personnel will be allowed within 16 meters of the rear of the mine. Personnel from 16 to 100 meters in a 180° arc to the rear of the mine will be in a covered position, lying prone in a depression, or behind some form of protection.

c. When a mine is installed on a tree or some other object, the secondary missile hazard cannot be eliminated. When mines are used in this manner, friendly troops in a 16- to 100-meter radius in a 180° arc must be in a covered position.

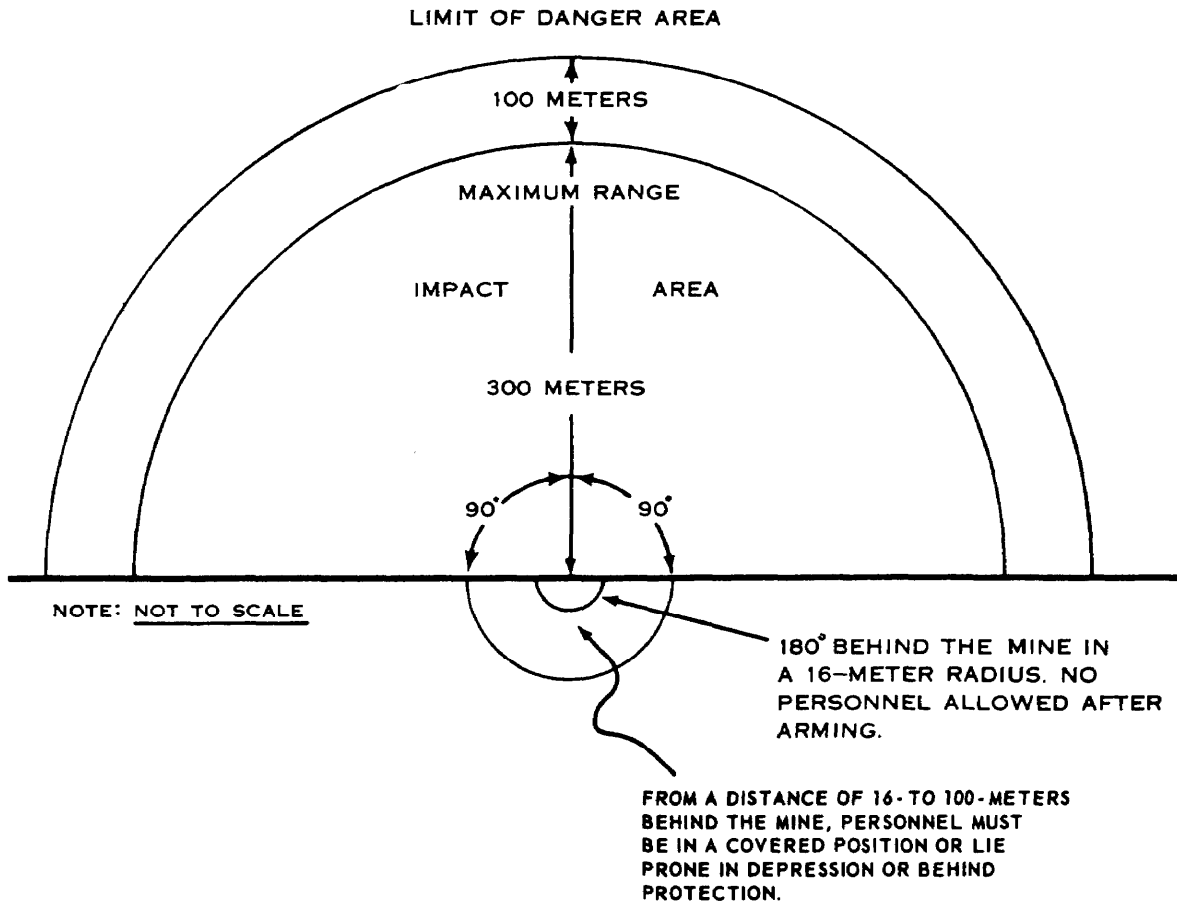

NOTE: WHEN THE MINE IS TIED TO A TREE OR FIRED IN SOME OTHER AREA WHERE THE SECONDARY MISSILE HAZARD CANNOT BE REMOVED, FRIENDLY TROOPS IN A 16-TO 50-METER RADIUS BEHIND THE MINE MUST BE IN A COVERED POSITION.

Figure 24. Surface danger area for CLAYMORE.

APPENDIX IV

TRAINING AIDS

1. General

Training aids should be used to the maximum during phase I and phase II training. A model, picture, or chart can be used to explain how the mine functions or is installed. Effective training aids improve instruction and increase understanding.

2. Training Aids

a. Training film 7-3180, "Technique of Employment, M18 and M18A1 Antipersonnel Weapons (CLAYMORE)," 27 minutes.

b. Graphic training aid (GTA) 7-1-1, "M18A1 Antipersonnel Mine, (CLAYMORE)"

illustrates the mine and its methods of employment.

c. When the training film and GTA are not available, figures 3, 10, 11, and 24 illustrate the type of training aids that can be used to conduct phase I training. These training aids should not limit the instructor's imagination or replace any other aids which may be available or listed in training aids catalogs. Wherever possible, local training aids centers should be utilized to obtain desired training aids and devices. These centers will loan and/or fabricate the required aids and devices.

By Order of the Secretary of the Army:

HAROLD K. JOHNSON,
*General, United States Army,
Chief of Staff.*

Official:

J. C. LAMBERT,
*Major General, United States Army,
The Adjutant General.*

Distribution:

Active Army:

DCSPER (2)	LOGCOMD (1)
ACSI (2)	MDW (5)
DCSLOG (2)	Armies (5)
DCSOPS (2)	Corps (3)
ACSFOR (2)	USAC (2)
CORC (2)	Div (2)
CRD (1)	Div Arty (1)
COA (1)	Bde (1)
CINFO (1)	Regt/Gp/Bat Gp (1)
TIG (1)	Bn (5)
CNGB (2)	Co/Btry (5)
USAIB (5)	USMA (2)
USCONARC (5)	Svc Colleges (2)
USACDC (5)	Br Svc Sch (5)
ARADCOM (2)	Mil Msn (1)
ARADCOM Rgn (1)	Units org under fol TOE:
OS Maj Comds (5)	17-22 (1)

NG: State AG (3) Units same as Active Army except allowance is one copy each unit.

USAR: Same as active Army except allowance is one copy each unit.

For explanation of abbreviations used, see AR 320-50.

PIN: 023702-002