

MIRL
COPY

FM 17-1

DEPARTMENT OF THE ARMY FIELD MANUAL

ARMOR OPERATIONS



HEADQUARTERS, DEPARTMENT OF THE ARMY
OCTOBER 1966

FIELD MANUAL }
 No. 17-1 }

HEADQUARTERS
 DEPARTMENT OF THE ARMY
 WASHINGTON, D.C., 14 October 1966

ARMOR OPERATIONS

		Paragraphs	Page
CHAPTER	1. GENERAL		
Section	I. Purpose and scope -----	1-4	4
	II. The role of armor units -----	5-9	4
	III. Armor mission and capabilities -----	10, 11	6
	IV. Conduct of armor operations -----	12, 13	7
CHAPTER	2. FUNDAMENTALS OF ARMOR		
Section	I. Principles of war -----	14, 15	8
	II. Active and nonactive nuclear warfare -----	16-18	9
	III. Considerations of employment -----	19-29	10
	IV. Factors affecting employment -----	30-34	12
	V. Organization for combat -----	35-41	14
	VI. Planning armor operations -----	42-46	16
	VII. Control -----	47-51	20
CHAPTER	3. COMMAND		
Section	I. Command and leadership -----	52-57	22
	II. Troop leading procedure -----	58-60	24
CHAPTER	4. THE COMMANDER AND HIS STAFF		
Section	I. The Commander -----	61, 62	29
	II. The unit staff -----	63-68	29
CHAPTER	5. RECONNAISSANCE, SURVEILLANCE, AND SECURITY OPERATIONS		
Section	I. Reconnaissance operations -----	69-84	44
	II. Surveillance operations -----	85-89	48
	III. Security operations -----	90-109	49
CHAPTER	6. THE OFFENSE		
Section	I. Considerations of the offense -----	110-112	63
	II. Planning for the attack -----	113-119	64
	III. Conduct of the attack -----	120-124	69
	IV. Forms of maneuver and offensive operations -----	125-132	73
	V. Passage of lines -----	133-135	77
	VI. Reconnaissance in force -----	136-138	79
	VII. Meeting engagement -----	139-141	80
	VIII. Procedures and techniques of the bypass -----	142-144	81
	IX. Night attacks -----	145-150	82
CHAPTER	7. DEFENSIVE OPERATIONS		
Section	I. General -----	151-156	88
	II. Organization of the defense -----	157-166	90
	III. Mobile defense -----	167-173	94
	IV. Area defense -----	174-183	99
	V. Relief in place -----	184-192	101
CHAPTER	8. RETROGRADE OPERATIONS		
Section	I. General -----	193, 194	106
	II. Considerations of the retrograde -----	195-199	106
	III. Delaying action -----	200-203	109

* This manual supersedes FM 17-1, June 1963, including C 1, 30 November 1964.

CHAPTER		Paragraphs	Page
	8. RETROGRADE OPERATIONS—Continued		
Section	IV. Withdrawal -----	204-208	116
	V. Retirement -----	209, 210	118
	VI. Withdrawal through a rearward position -----	211, 212	119
CHAPTER	9. COMBAT SUPPORT		
Section	I. General -----	213, 214	121
	II. Field artillery support -----	215-219	121
	III. Air defense artillery -----	220, 221	125
	IV. Army aviation -----	222-224	126
	V. Chemical -----	225, 226	127
	VI. Engineer -----	227, 228	128
	VII. Communications -----	229-234	130
	VIII. Tactical air support -----	235-240	133
	IX. Intelligence -----	241-246	136
CHAPTER	10. COMBAT SERVICE SUPPORT		
Section	I. General -----	247-249	138
	II. Combat service support personnel -----	250-254	139
	III. Brigade trains -----	255-258	140
	IV. Battalion or squadron combat service support elements and trains -----	259-263	141
	V. Company and troop combat service support ele- ments and trains -----	264-267	142
	VI. Employment of trains -----	268-272	144
	VII. Battalion combat service support operations ----	273-284	146
	VIII. Supply -----	285-292	151
	IX. Maintenance -----	293-300	154
	X. Medical service -----	301-305	158
	XI. Area damage control -----	306-317	159
CHAPTER	11. OTHER OPERATIONS—ENVIRONMENT		
Section	I. General -----	318, 319	168
	II. Jungle operations -----	320-323	168
	III. Desert operations -----	324-326	170
	IV. Operations in deep snow and extreme cold -----	327-329	171
	V. Mountain operations -----	330-333	171
CHAPTER	12. OTHER OPERATIONS—MISSION TYPE		
Section	I. General -----	334, 335	173
	II. Airmobile operations -----	336, 337	173
	III. Linkup operations -----	338-342	173
	IV. Raids -----	343-345	175
	V. Tank sweeps -----	346-349	176
	VI. Operations in forests or wooded areas -----	350-354	177
	VII. Operations at defiles -----	355-358	180
	VIII. Operations at inland waterways -----	359-370	183
	IX. Operations in fortified positions -----	371, 372	198
	X. Operations in built-up areas -----	373-382	201
	XI. Amphibious operations -----	383-400	208
	XII. Shore-to-shore movements -----	401-406	216
	XIII. Internal defense operations -----	407-414	218
	XIV. Division rear area security -----	415-419	243
	XV. Psychological operations (PSYOP) -----	420-424	247
APPENDIX	I. REFERENCES -----		251
	II. COMMAND FACILITIES -----		255
	III. STAFF RELATIONS IN SELECTED OPERATIONS ACTIVITIES -----		260
	IV. STAFF RECORDS -----		265
	V. REPORTS AND WARNINGS -----		268
	VI. MOVEMENTS -----		275
	VII. ESTIMATE OF THE SITUATION -----		295

	Paragraphs	Page
APPENDIX VIII. COMMANDER'S APPLICATION OF PRINCIPLES OF WAR -----	-----	300
IX. OPERATION ORDER AND PLANS -----	-----	308
X. CONTROL MEASURES AND OVERLAY TECHNIQUES -----	-----	319
XI. EXAMPLE OPERATION ORDERS AND GUIDE FOR THE PREPARATION OF FIRE PLANS -----	-----	329
XII. HANDLING PRISONERS OF WAR -----	-----	330
XIII. TANK UNITS, CONDUCT OF FIRE AND MOVEMENT BY A MANEUVER FORCE --	-----	332
XIV. ORGANIC FIRE SUPPORT -----	-----	337
XV. NIGHT COMBAT TECHNIQUES -----	-----	345
XVI. TASK ORGANIZATION -----	-----	363
XVII. EMPLOYMENT OF THE ARMORED VEHICLE LAUNCHED BRIDGE (ALVB) AND THE COMBAT ENGINEER VEHICLE (CEV) -----	-----	365
XVIII. MINE WARFARE -----	-----	369
XIX. OBSTACLE PLANNING AND EMPLOYMENT -----	-----	379
XX. TACTICAL EMPLOYMENT AND COMMAND CONTROL OF ATOMIC DEMOLITION MUNITIONS -----	-----	386
XXI. EMPLOYMENT OF GROUND SURVEILLANCE RADAR -----	-----	390
XXII. PREDICTION OF FALLOUT, CHEMICAL DETECTION AND IDENTIFICATION, AND RADIOLOGICAL MONITORING AND SURVEY -----	-----	397
XXIII. PROTECTIVE MEASURES UNDER CONDITIONS OF CHEMICAL AND BIOLOGICAL OPERATIONS AND NUCLEAR WARFARE -----	-----	402
XXIV. ASSEMBLY AREAS -----	-----	409
XXV. STANAG NO. 2113, DESTRUCTION OF MILITARY TECHNICAL EQUIPMENT --	-----	413

CHAPTER 1

GENERAL

Section I. PURPOSE AND SCOPE

1. Purpose

This manual is a guide for armor commanders and staffs in the employment, command, and control of armor units.

2. Scope

a. This manual provides basic doctrine, tactics, techniques, and procedures of employment; exercise of command, reconnaissance and security; combat service support; control; movements; and offensive, defensive, retrograde, and special operations appropriate to all armor units. Unless otherwise specified, the material presented herein is applicable without modification to both nuclear and nonnuclear warfare.

b. This manual is for use in conjunction with other manuals and training texts (app I). It presents doctrine that is common to all areas of operations. Special operations (northern, jungle, desert) are covered in detail in other manuals and are discussed only in general terms as they apply to armor.

c. Users of this manual are encouraged to submit comments or recommendations for changes to improve the manual. Comments should be keyed to the specific page, para-

graph, and line of the text in which the change is recommended. Reasons should be provided for each comment to insure understanding and proper evaluation. Comments should be forwarded directly to the Commanding Officer, U.S. Army Combat Developments Command Armor Agency, Fort Knox, Kentucky 40121.

3. Armor

Armor is a combined arms force designed to conduct mounted combat employing armor-protected vehicles and armed aircraft as a principal means of accomplishing a land force combat mission. Armor operates normally within a force structure that includes tanks, mechanized infantry, artillery, engineers, armored cavalry, air cavalry, and Army aviation, supported on the battlefield by a flexible and rapid communication system, and a mobile combat service support system.

4. The Role of Armor

Armor conducts decisive, highly mobile, land-environment warfare, primarily offensive in nature and characterized by a predominance of mounted combat, through the use of both ground vehicles and aircraft.

Section II. THE ROLE OF ARMOR UNITS

5. General

Armor units fight normally as combined arms forces of two or more arms. Each arm complements the other and aids the forward movement or defensive posture of the force by employing its own special capabilities. The organization of these combined arms forces is

tailored by cross-attachment to use the favorable characteristics of each type unit and to complement the strengths and compensate for the weaknesses of other units. Commensurate with its intended employment, the resulting force varies in degree of armor protection, mobility, and ability to deliver fire.

6. The Brigade

The armored division brigade and the separate armor brigade command and control attached combat maneuver, combat support, and combat service support units in training and combat operations. (Hereafter, the armored division brigade and the separate armor brigade will be referred to as the brigade.) The brigade is capable of conducting operations with either a preponderance of tank battalions or mechanized infantry battalions, or a balanced force made up equally of tank and mechanized infantry battalions. Tactical doctrine concerning the brigade is set forth in FM 17-30. The brigade is capable of conducting semi-independent and independent armor operations when appropriate combat support and combat service support elements are attached.

main battle tank may be attached to airborne divisions for conventional ground operations that do not require airlift.

b. Tank Companies of Armored Cavalry Regiments and Separate Airborne Brigades.

- (1) The tank company of the armored cavalry squadron, armored cavalry regiment, is the basic unit used to increase the capability for sustained, mounted combat of the regiment.
- (2) When a tank company is attached to the separate airborne brigade, it may be equipped with the M56 airborne self-propelled 90mm AT gun or AR/AAV (*a*(2) above).

7. Tank Units

a. Tank Battalions of Divisions and Brigades.

- (1) The tank battalion of the armored, mechanized infantry, and infantry divisions and separate brigades is the source of the tank elements for combined arms forces.
- (2) Although the airborne division does not have an organic tank battalion, airborne operations may require the attachment of a tank battalion. For airborne operations, the attached tank battalion may be equipped with the M56 airborne self-propelled 90mm AT gun or the armored reconnaissance/airborne assault vehicle (AR/AAV). If the attached tank battalion is equipped with the M56 AT gun, it is used primarily to deliver heavy caliber direct fire to support dismounted airborne units in ground operations because of limited armor protection. When the attached tank battalion is equipped with the AR/AAV, it may be used to provide heavy caliber fires to support dismounted airborne units or to form combined arms forces due to the added armor protection of the AR/AAV. Tank battalions equipped with the

8. Mechanized Infantry Battalion

The mechanized infantry battalion of the armored division and separate armor brigade provides the combined arms forces of armor with a force capable of fighting dismounted. It possesses high cross-country mobility, light armor, and multiple means of communication, and complements and enhances the inherent capability of tank elements when employed as a part of a tank-infantry team.

9. Armored and Air Cavalry Units

a. The armored cavalry squadron of the armored, mechanized infantry, infantry, and airborne divisions and of the armored cavalry regiment is the basic unit used for reconnaissance, security, and economy of force missions. Cavalry combat elements are capable of fighting with organic aircraft, ground vehicles, or dismounted.

b. The mobility of air cavalry units greatly extends and improves the capability for reconnaissance, security, and surveillance and permits the rapid transport of lightly armed elements with little regard for terrain restrictions. Air cavalry, operating in conjunction with ground cavalry elements equipped with lightly armored, amphibious vehicles, provides a unique capability for operations in underdeveloped areas. Because of its varied capabilities, air cavalry is an important information gathering means. The command

and control facilities found in air cavalry units make them a sound structure around which to tailor other airmobile forces.

c. The armored cavalry troop of the separate brigade is the basic unit used to perform reconnaissance and security for the brigade.

Section III. ARMOR MISSION AND CAPABILITIES

10. Missions

a. Tank units close with and destroy enemy forces, using fire, maneuver, and shock effect in coordination with other arms.

b. Armored cavalry units perform reconnaissance and provide security for the unit to which organic, assigned, or attached, and engage in offensive, defensive, and delaying actions as an economy of force unit.

c. Mechanized infantry units close with the enemy by means of fire and maneuver to destroy or capture him or to repel his assault by fire, close combat, and counterattack.

11. Capabilities

a. *General.* Armor is capable of operating throughout the spectrum of warfare, from cold war to general war. Armored vehicles are particularly suited to a nuclear environment because their armor protection reduces significantly the effects on personnel of blast and radiation from a nuclear burst and have the capability of dispersing and concentrating rapidly over great distances. Armor's inherent characteristics of firepower, mobility, armor protection, shock effect, and responsiveness to command provide an optimum force for sustained operations against any type of opposing ground force.

b. *Deep Penetration and Wide Envelopment.* Large armor formations with inherent mobility and flexibility, controlling nuclear and non-nuclear fire support, provide forces with power and momentum for deep penetrations and wide envelopments. In the enemy's rear areas, these forces attain great freedom of action as they maneuver to seize terrain; disrupt communication; destroy command posts, missile sites, artillery, and troop reserves; and capture or destroy supplies.

c. *Exploitation.* Armor has the combat power to create its own opportunities for exploitation. It also provides the higher commander with a destructive force to exploit rapidly the successes of other formations. For

example, the armored division, as a part of the corps, may be used by the corps commander to expand the successes of other forces or the effects of nuclear fires.

d. *Mobile Defense.* Armor is well suited to the conduct of a mobile defense. Since it is designed primarily for offensive action, it is employed best in defensive operations as the mobile counterattack force of a higher command. The armored division, with or without the use of nuclear weapons, provides the corps and army commander with a powerful reserve for destroying enemy attacking forces. The armor unit's capability to move, live, and fight on the nuclear battlefield permits its employment in compressing or canalizing enemy forces for destruction by nuclear weapons.

e. *Destruction of Enemy Armor Formations.* Defeat of enemy armor is essential to successful ground combat and is a continuing requirement in offensive and defensive operations. The tank is the primary armor-defeating weapon of armored formations.

f. *Reconnaissance and Security.* As the range of weapons is extended, as the battlefield becomes less densely populated, and as units are more widely dispersed, the need for reconnaissance and security becomes more acute. Armored cavalry units provide reconnaissance for the higher commander by ground and air means. Reconnaissance and security missions demand highly mobile forces with a ground combat capability. These forces detect enemy forces, warn of them, and destroy them within their capabilities. Armored cavalry units are well suited to conduct covering, guarding, screening, and rear area security operations and to conduct limited probing attacks. The capability of armor units for rapidly maneuvering great firepower makes them well suited for reconnaissance-in-force operations.

g. *Counter guerrilla Operations in Rear Areas.* Armor units can be employed in operations against forces conducting guerrilla operations in defined rear areas in limited and gen-

eral war field army-type operations. Forces conducting guerrilla operations may vary from irregular to enemy airborne and airmobile regular armed forces. Terrain may require armor units to be tailored for antiguerrilla operations.

h. Close Support of Infantry. This task is fulfilled most frequently by the tank battalions of the mechanized infantry and infantry divisions and tank battalions attached to airborne divisions. Tank battalions increase greatly the firepower and mobility of the infantry attack and defense and provide a powerful armor-defeating capability.

i. Economy of Force. Armored cavalry units are particularly suited to perform economy of force missions, thus permitting a commander to maneuver the preponderance of his other forces to another area for a decisive blow.

j. Stability and Internal Defense Assistance (IDA) Operations. The armor-protected firepower, shock effect, mobility, and mass of ar-

mor produce psychological effects which make armor well suited for conducting stability operations such as a show of force. In IDA operations, these characteristics similarly enable armor to conduct successful tactical operations against insurgency tactical forces, especially during insurgency phase II and phase III. Air cavalry units are particularly well suited for IDA operations in terrain that does not provide trafficability for ground armored units. Armor units, as part of stability and IDA operations, also may be employed to support internal security operations, conduct or support military civic action, provide advisory assistance to host country (HC) units, and engage in psychological and intelligence operations (para 404-414). In stability and IDA operations, armor units may be attached or assigned to independent task forces, MAAG, Missions, or Military Assistance Commands (MAC), and may be employed to support host country and US divisions, brigades, battalions, or specific political and/or military areas.

Section IV. CONDUCT OF ARMOR OPERATIONS

12. General

Armor operations are conducted by fire and maneuver and are combined and controlled to create a preponderance of combat power that culminates in a powerful and violent action at the decisive time and place. Commanders must avoid rigid adherence to the original plan in the face of significant changes in the situation that provide opportunities to destroy the enemy. The cross-country mobility, firepower, and communications of armor units allow the armor commander to rapidly mass or disperse his combat power for the accomplishment of any given task. The armor commander seeks every opportunity to employ his combined arms force in mass and thus bring maxi-

mum combat power to bear against the enemy. Every effort is made to gain knowledge of the enemy before, during, and after engagement. Commanders and leaders at all levels must make continuous estimates and react rapidly to changes in the situation. Armor operations are mobile in nature, violent in action, and calculated to obtain decisive results.

13. Type Operations

The basic doctrine discussed in paragraph 12 is employed by the armor commander at every opportunity regardless of the type operation he may be conducting. The techniques used in the conduct of offensive, defensive, retrograde, reconnaissance, security, and other operations are discussed in specific chapters.

CHAPTER 2

FUNDAMENTALS OF ARMOR

Section 1. PRINCIPLES OF WAR

14. General

a. The *principles of war* govern the conduct of all military operations. They represent the major factors essential to the successful conduct of war.

b. A successful commander applies the principles to specific situations. He knows when to emphasize one at the expense of others. In some instances a commander may elect not to apply a given principle. If he does so with the knowledge that he is doing it and if the failure to apply the principle works to his ultimate advantage, he has not violated the principle. The commander uses the principles of war during his estimate of the situation. In formulating courses of action, he must consider and compare each course developed in light of the principles. Thus, the commander's decision is a result of the direct application of the principles of war. Appendix VIII provides an example of the commander's application of the principles of war in a specific situation.

15. Application

a. The Objective. The objective of a military force is to accomplish the goal or aim for which the force was constituted. This principle is overriding and is always applicable to any operation, at any level of command. The objective of a force can be stated in broad or precise terms depending upon the nature of the goal. Each element of an armor unit contributes to the attainment of the objective of the larger unit of which it is a part. For example, when the objective of a division has been defined, all elements of the division must be assigned objectives that assist in the attainment of the di-

vision objective. The objective or goal of a military force is expressed, in general terms, as a mission. Success in combat operations is measured by the accomplishment of the mission.

b. The Offensive. By the offensive the commander can impose his will on the enemy, set the pace and course of battle, exploit enemy weaknesses, and meet unexpected contingencies. Even in the defense the commander must be alert to regain the initiative by offensive counteractions. Aggressiveness, flexibility of mind, and the ability to make rapid, reasoned decisions are required to apply fully the principle of the offensive. In defense, the armor commander can often best accomplish his mission by offensive action.

c. Simplicity. Simplicity demands that detailed, simple plans be adopted in every military operation. It is, of course, a relative term because all actions in war are essentially complex. Simplicity is especially important on the nuclear battlefield, where the full use of available means will require close control and coordination and where plans must be as simple as the situation will permit. Detailed, simple plans lead to coordinated, timely execution.

d. Unity of Command. Unity of command is the establishment of a single authority. This is the best means to insure unity of effort, which implies a singleness of purpose and cooperation by all elements of the command.

e. Mass. Mass demands that superiority of combat power be attained at the critical time and place for a decisive purpose. This superiority is both qualitative and quantitative. Combat power is primarily a combination of firepower and maneuver, which is applied at the right place and time for a decisive purpose.

Mass does not require continued concentration of forces; it does require that forces be so disposed that maximum combat power can be concentrated at the decisive time and place. The use of nuclear weapons by enemy forces will require greater dispersion for passive defense; therefore, greater stress must be placed on the application of mass from the point of view of time rather than space. Whenever possible, tanks are employed in mass. The speed, maneuverability, and communication of armor permit the rapid massing of mobile firepower. The armor leader seeks to concentrate his mobile firepower at one decisive point, overcome that point, then shift to another decisive point. Violation of this principle exposes the commander to the risk of piecemeal defeat by even an inferior enemy.

f. Economy of Force. Economy of force requires that sufficient force be applied at other than the decisive time and place to permit mass to be applied at the point of decision. These two principles are so closely related that they cannot be considered singly. Application of the two principles requires a sound estimate of what is sufficient elsewhere to permit the attainment of decisive superiority at the decisive time and place. "Sufficient" is the key. It connotes the application of the force necessary to accomplish the purpose and not the application of as little force as possible.

g. Maneuver. Maneuver requires that all military resources be brought to bear in the accomplishment of the objective. Correct applica-

tion of the principle of maneuver requires not only the full use of combat power at the decisive time and place but includes the movement of elements of combat power (including combat service support) to the area of operations. Application of this principle is a function of command at all levels. At the highest level it usually means the movement of men, means, and supplies to an area of operations, and at the lowest level it means the positioning of troop units and fires to destroy the enemy.

h. Surprise. Surprise connotes striking the enemy when, where, or in a manner that he is unable to counter effectively. The achievement of surprise is not necessarily dependent upon misleading the enemy as to intentions, such as, for example, concealing from him an intention of attacking. He may know from the situation that he will be attacked, yet the attacker may achieve surprise by the time, place, direction, size or composition of forces, or tactics employed.

i. Security. Security provides readiness for action or counteraction and is enhanced greatly by flexibility. Flexibility in mind, organization, and means contributes to security. Its attainment embraces all measures designed to avoid being surprised or interfered with seriously, and the retention of freedom of action. Security does not imply undue caution and avoidance of all risks, for bold action is essential to success in war. When security is provided, unexpected developments will not interfere seriously with the pursuit of vigorous operations.

Section II. ACTIVE AND NONACTIVE NUCLEAR WARFARE

16. General

a. Basic armor doctrine is generally applicable under conditions of both active and nonactive nuclear war and major changes in tactics and techniques are not required. The impact of nuclear weapons on the battlefield is considered to require, primarily, increased emphasis on dispersion and the armor protection and mobility of armor units. The employment of armor units in nuclear war will not vary significantly from that of the nonactive nuclear environment. Armor missions will remain essentially unchanged and will continue the employment of armor units in wide envelopments or deep penetrations to seize objectives.

b. A primary distinction between the nuclear and nonactive nuclear battlefield may be the dispersion of forces. On the nuclear battlefield, greater dispersion between principal elements or battalion-sized elements will be required. The requirements for dispersion are not new to armor elements, and massing for the attack or assault can be accomplished in space and time by reason of inherent armor unit mobility.

17. Active Nuclear Warfare

a. Employment of armor on the nuclear battlefield in the offense will be based primarily on the basic forms of maneuver: the pene-

tration and the envelopment. The frontal attack is a variation of the penetration; a double envelopment and a turning movement are variations of the envelopment. Each form will assign objectives deep in the enemy rear and the adoption of any one form will depend in varying degrees upon the mission, the terrain, the enemy situation, and the troops available. In a nuclear war, the penetration as a form of offensive operation may be used more frequently than was previously considered normal for armor units. When time, space, and an assailable flank are available, the envelopment may be used in preference to the penetration. After achieving success through the penetration or envelopment, the attack progresses into an exploitation and pursuit. The preferred use of armor units in the defense is as a counterattack force wherein their inherent mobile characteristics are exploited fully. Organization for combat in the mobile defense will stress the provision of a reserve weighted heavily with tanks. The commander dispersing his forces as a passive defense measure against enemy nuclear weapons must recognize that he may afford the enemy opportunity to infiltrate in force. To prevent infiltration, the commander must insure thorough surveillance of the areas between the dispersed formations 24 hours a day in all weather.

b. Greater use of night or other limited visibility conditions will be a result of a nuclear

battlefield environment. Although the techniques of night operations will include the use of night viewing devices, the principles of movement and combat will not change markedly. Frequency of limited-visibility operations will increase in the conduct of troop movements, realignment of forces on the battlefield, movement to attack positions, movement to lines of departure, and attack of limited objectives.

18. Nonactive Nuclear Warfare

Nonactive nuclear war is a condition that requires the conduct of operations without using nuclear weapons although the threat of their use may be present. The firepower available under conditions of nonactive nuclear war is reduced materially. The tactics of the nonactive nuclear battlefield and the forces employed may be similar to those employed in past wars. The armored division will continue to be a powerful striking or exploiting force for the corps. Within the division, the brigade will be assigned missions involving wide envelopments or penetrations to seize deep objectives. Brigade commanders and staffs can expect to receive mission-type orders and substantial tactical freedom in carrying out assigned missions. Great reliance is placed on the initiative of brigade and subordinate unit commanders. Normally, brigades will be able to rely on each other for a degree of mutual support.

Section III. CONSIDERATIONS OF EMPLOYMENT

19. General

The successful employment of armor forces is dependent upon certain fundamentals. The degree of success obtained in the use of these fundamentals depends largely on imaginative, resourceful, audacious, prudent, progressive, and flexible thinking commanders and staffs. The commander must be willing to take calculated risks.

20. Fire and Maneuver

Armor units fight by combining fire and maneuver. This is a tactic used by the commander, of establishing a base of fire and a maneuvering force. These two distinct forces

have separate missions. The mission of the maneuvering force is to close with and destroy the enemy by fire and shock effect. It will consist of all available tank and infantry units. The mission of the base of fire is to minimize the enemy's capability to interfere with the movement of the maneuver force and, within its capabilities, to destroy the enemy. The base of fire normally does not join the maneuvering force in the assault. The base of fire may consist of mortars, attached antitank weapons, supporting artillery, tactical air, and naval gunfire. Tanks and air cavalry are not normally included in the base of fire because this role does not take maximum advantage of their

characteristics. However, when necessary, tanks and air cavalry may temporarily support by fire the other elements of the maneuvering force.

21. Gaining and retaining the Initiative

a. The initiative is a condition in which a commander retains the capability to apply his resources at will to influence the action. The commander possessing the initiative is able to take actions that so threaten his opponent that the actions must be countered.

b. Armor commanders seek every opportunity to gain the initiative. Bold and aggressive employment of overwhelming combat power, the achievement of surprise, or the exploitation of enemy errors or weaknesses all serve to gain the initiative.

c. Once the initiative is gained, every effort is expended to retain it. Once lost, the initiative is difficult and costly to regain. The continuous application of force against those parts of enemy units least capable of withstanding attack, the neutralization or destruction of the enemy's means of influencing the situation, and the prompt exploitation of successful actions at all levels all serve to retain the initiative. The initiative is retained by commanders who conduct actions rapidly and decisively and who have alternate plans ready to be implemented.

22. Exploiting Enemy Weakness

Because combat power is relative, armor commanders actively seek to take advantage of any enemy weakness to enhance success (weaknesses from faulty dispositions, poor morale, insufficient support or troop strength). Nuclear weapons are used to create enemy weakness.

23. Mobility

The mobility of armor units must be exploited to maneuver firepower into position to destroy the enemy. Mobility makes possible the achievement of surprise. It permits the rapid concentration and prompt dispersal of combat forces required by nuclear warfare. It makes feasible the assignment of multiple missions and permits the rapid disengagement of committed forces. It permits the concentration of converging forces on a single objective from several directions. Commanders at all levels

must anticipate, and plan to overcome or avoid, conditions that inhibit mobility. These conditions are not just terrain obstacles but all restrictions to movement, from enemy fires to the state of maintenance which affects material readiness.

24. Flexibility

a. The interaction and reaction of events and conditions in mobile warfare make it necessary for combatants to adapt their actions to significant circumstances that may develop.

b. Armor units, by virtue of their organization, extensive communication, mobility, and variety of weapons, are capable of rapid and frequent changes in organization for combat and direction of movement.

c. Armor commanders at all levels must keep themselves and their superiors abreast of fast-moving situations and be willing to modify their plans to meet significant changes.

25. Combined Arms Forces

a. The versatility of armor operations is realized when combined arms forces are used. The special characteristics of each type unit, tank, infantry, artillery, or engineer, are used to contribute to the success of the force.

b. The proper combination of tanks and infantry supported by engineers, artillery, and aviation normally makes the most effective force. In this combination, tanks engage in mounted combat while infantrymen fight dismounted or mounted. Tank and infantry units are sometimes, by necessity, employed separately. Tank and infantry may be separated providing time or distance will permit mutual support.

26. Deliberate Planning—Violent Execution

Successful armor operations are characterized by careful planning followed by violent execution. Once plans are put into effect, the degree of aggressiveness with which the attack is executed will determine the measure of success. Shock effect cannot be obtained without violent execution. Armor operations involve large spaces, careful timing, and detailed plans for logistical support. They involve careful coordination and teamwork by all units. They require

carefully thought-out communication plans. It is desirable that each armor commander be given information as to the intentions of the next higher commander. With this knowledge, he can rapidly direct successive efforts toward furtherance of the overall plan as he finds opportunity to exploit local successes. The commander must plan ahead to anticipate actions that may be required during the conduct of operations.

27. Orders

Armor commanders make maximum use of mission type orders which tell the subordinate commanders what to do but not how to do it, and thereafter, depend on fragmentary orders for issuing changes or additions as the situation dictates. The speed of armor operations and the rapidly changing tactical situation during mobile warfare make it necessary that commanders be allowed as much freedom of ac-

tion as possible. Only under these conditions can commanders take immediate advantage of favorable changes in the situation.

28. Use of Environment to Best Advantage

a. Armor commanders must seek to use every advantage offered by the terrain, air-space, weather, and time.

b. The cross-country capability of armor units reduces dependence on roads. Armor units seek to capitalize on this capability.

29. Adequate Combat Service Support

Adequate and timely combat service support is essential to the successful accomplishment of the tactical mission. Detailed planning for adequate supply, evacuation, and maintenance must precede the operation. During operations, logistical estimates are continuous, and plans are implemented to maintain the fighting capabilities of combat forces.

Section IV. FACTORS AFFECTING EMPLOYMENT (METT)

30. General

a. To be successful, commanders must employ armor in a manner calculated to make maximum use of its favorable characteristics. This calculation is based on a reasoned analysis of certain factors affecting the employment of armor units.

b. These factors are considered within the four paramount groupings of mission, enemy, terrain and weather, and troops available (METT). The tactical environment in which armor units are employed is described under these four groupings. The commander must keep the following factors constantly in mind to make maximum use of his combat power.

31. Mission

a. The mission assigned by higher headquarters guides the employment of armor units. The success of tactical operations is measured by accomplishment of the mission.

b. A mission is a statement of a task and its purpose, which clearly indicates the action to be taken and the reason therefor. Missions will prescribe *what* is to be done but leave *how* it is to be done to the judgment of the subordinate commander.

c. The commander studies the mission to insure that he understands it and to determine tasks that are specifically stated. He must analyze the mission in relation to the other factors affecting employment to deduce requirements and tasks that are not stated specifically but that must be done to accomplish the mission. Other implied tasks may be determined during the commander's estimate of the situation.

32. Enemy Information

a. General. All possible information of the enemy location, strength, disposition, composition, and activity is obtained before the commitment of armor units. The collection of information is continued throughout the operation. All means and sources are exploited to furnish the commander with accurate and timely information so that he may make a continuing estimate of enemy capabilities.

b. Nuclear Capability. An enemy capability to employ nuclear weapons must be given serious consideration. This will result in increased attention to passive defense measures such as dispersion, concealment, movement during darkness, cover, stringent traffic control, radio discipline, and individual protective measures.

c. Air. An armor unit will be a high-priority

target for enemy tactical air forces. Although armored vehicles are relatively invulnerable to all but direct hits by conventional weapons, unarmored vehicles organic to armor units are vulnerable to all types of air to ground fires. Therefore the employment of organic weapons; attached air defense artillery (ADA); all forms of deception, cover, dispersion, concealment; and, particularly, movement is of importance. An enemy capability of employing airborne or airmobile forces must be considered by the commander.

d. Firepower Capability. The enemy capability to counter the employment of armor units is of vital concern and must be considered in the preparation of plans. Factors to be considered in determining his firepower capabilities are—

- (1) Location and disposition of his weapons and their fires.
- (2) Characteristics of his weapons, such as range, rate of fire, mobility, and effectiveness against the various type vehicles being used in the operation.
- (3) Vulnerability of the enemy weapons to the combat power available to the friendly commander.
- (4) Number and type of weapons in possession of and available to the enemy.

e. In addition to the aforementioned enemy capabilities which are of special concern to the armor unit, see FM 30-5 for discussion of others that may be considered by the commander.

33. Terrain and Weather

a. General. The terrain and the weather are important factors in armor operations. The commander makes a thorough analysis of the terrain to determine the advantages it offers and to evaluate the advantages it may afford the enemy. Weather affects virtually all operations, both combat and combat service support.

b. Terrain.

- (1) *Observation and fields of fire.* The effect of observation on both friendly and enemy operations is considered. High ground that affords line-of-sight observation is of particular importance. The commander employs all ob-

servations means, including visual and electronic, ground and air, to keep the enemy under constant surveillance. Good fields of fire are essential for the effective employment of direct-fire weapons. Fields of fire are analyzed in connection with the nature of the weapons and the nature of the targets.

(2) *Obstacles.*

- (a) The effect of obstacles, either in hindrance or support of operations, is considered.
 - (b) Obstacles may be natural terrain features; manmade obstructions, obstructions created by nuclear fire, or restrictions imposed by chemical fires. Minefields, roadblocks, anti-tank ditches, and other antitank obstacles are constructed to restrict the maneuver of armor units and slow their operation. The commander needs to know the location, extent, and strength of obstacles if he is to calculate accurately the measures needed to overcome or avoid them.
 - (c) Obstacles may be used by both friendly and enemy forces to strengthen a defense, or deny use of key terrain for observation and defensive positions, to assist in economy-of-force measures, and to protect the flank of a moving force.
 - (d) Nuclear weapons can create the following obstacles: induced and fallout radiation, cratering, rubble, fires, or tree blowdown. The obstacle-creating effect must be considered when nuclear weapons are used.
- (3) *Concealment and cover.* Concealment is protection from observation. Cover is protection from fire. Every advantage afforded to friendly forces by the terrain and conditions of visibility to provide concealment and cover must be exploited. Concealment and cover are essential in masking assembly of troops, for protection against all types of fires, and in aiding in tactical

cover and deception measures. Natural and artificial camouflage, smoke screening, and natural and manmade areas may be used to conceal and cover forces. Measures to counter advantages afforded the enemy by cover and concealment must be considered.

(4) *Key terrain.* Key terrain is any locality or area the control of which affords a marked advantage to either combatant. Key terrain must be seized, neutralized, or otherwise controlled to deny its use by the enemy or permit its use by friendly forces.

(5) *Avenues of approach.*

(a) Possible avenues of approach are analyzed based upon the availability of observation, concealment and cover, fields of fire, space for dispersion and maneuver, and trafficability. The obstacle-producing effects on avenues of approach by nuclear weapons must be considered.

(b) In analyzing approach routes for airmobile operations, the major concern is achieving or avoiding tactical surprise. Favorable routes provide defilade and ease of navigation. Heavily forested and swampy areas provide good routes, as ground troops have less opportunity to see or fire at low-flying aircraft. Ridges reduce the possibility of detection by radar. If steep defiles or canyons are used as routes, careful reconnaissance must be made due to possible enemy ground fires and the effect of down-drafts on control of aircraft.

(c) All avenues of approach are considered; use of less obvious or desirable avenues of approach may achieve a degree of surprise that offsets disadvantages.

c. *Weather.* Weather conditions have an important bearing on any decision and should be a primary consideration in operational planning. The primary effects are on visibility and trafficability. The basic meteorological elements affecting operations are wind (speed and direction), temperature, humidity, cloud cover, precipitation, and atmospheric stability (inversion, lapse, and neutral conditions). The forecast, which includes such items as sunrise, sunset, moonrise, and moonset should be considered. Weather conditions may prohibit or limit some phases of an operation. In the planning of operations, adverse weather conditions should be considered; often the success gained during unfavorable weather offsets the limitations and difficulties imposed by soil trafficability and slow rate of movement. Weather factors are of special importance in the conduct of offensive or defensive operations that include nuclear, chemical, or biological employment. Fallout and chemical and biological cloud travel are greatly influenced by weather conditions. Detailed information is contained in FM 3-10, FM 3-12, FM 5-26, and TM 3-240.

34. Troops Available

a. No realistic plans can be made or actions taken that do not consider the capabilities of the forces available.

b. The capabilities of a force are dependent on—

- (1) Number of units.
- (2) Type of units.
- (3) State of training.
- (4) Morale.
- (5) Strength in men and equipment.
- (6) Previous, present, and contemplated employment.
- (7) Location and disposition.
- (8) State of maintenance and supply.
- (9) Adequacy of combat support and combat service support.
- (10) Personalities of commanders.

Section V. ORGANIZATION FOR COMBAT

35. General

Organization for combat is a concept of forming an appropriate combination of various types of combat and combat support units for

a specific mission or task. This serves as a basis for the task organization which is the grouping of specifically designed elements to accomplish a specific mission or task in imple-

menting the commander's organization for combat. For a discussion of how the factors of METT apply to organization for combat, see paragraph 30. Tank and mechanized infantry battalions are normally attached to brigades. The brigade commander may employ the attached battalions without attachment, or he may organize them for combat by cross-attachment. Similarly, tank and rifle companies normally operate directly under control of one of the battalions. The battalion commander may employ his companies without attachment, or he may organize them for combat by cross-attachment. The armored cavalry squadron normally operates under the control of division or its parent armored cavalry regiment.

36. Battalion Task Force

a. A battalion task force is a temporary grouping of combat units, formed to provide the battalion commander with the number and type of units necessary to accomplish a specific mission or task. A battalion task force normally consists of a tank or mechanized infantry battalion headquarters and headquarters company and one or more organic and attached companies. Combat support units are attached or placed in support of the battalion task force as required.

b. There is no definite rule to determine the size and composition of a battalion task force; it is based on a consideration of the factors of METT. In this regard, the battalion task force is similar to the brigade. Units required are attached, or placed in support, in sufficient numbers to carry out the assigned missions. The composition of a battalion task force can be readily changed to meet varying tactical situations.

c. A task force organized around a mechanized infantry battalion headquarters is normally infantry-heavy or balanced. Likewise, a task force using a tank battalion headquarters is normally tank-heavy or balanced. (A battalion task force is balanced when it contains rifle companies and tank companies in equal number, infantry-heavy when it contains a preponderance of infantry companies, and tank-heavy when it contains a preponderance of tank companies.)

37. Company Team

a. A company team is a tactical grouping of combat units under one company commander formed for a specific operation or mission. The company team normally consists of a complete company with one or more nonorganic combat units attached, or a company with one or more organic units detached, and one or more nonorganic combat units attached.

b. In the battalion task force, the task force commander may organize company teams. The ratio of tanks to infantry in a company team varies with the factors of METT. Tank and infantry units are usually employed together. If they are separated, they should be mutually supporting by fire or maneuver.

c. Platoons normally are employed as a part of the company team. Typical exceptions would be combat or reconnaissance patrols or direct-fire support missions. The platoon is the smallest armor unit to be attached to another organization.

d. The tank and rifle platoons normally are commanded directly by the team commander. Normally, a platoon leader will not command any platoon other than his own. Coordinated action between platoons of a company team is attained by orders to each platoon leader from the team commander and by coordination between the platoons. If it is deemed necessary to place two platoons under a single commander, the company executive officer or the senior platoon leader may be designated to command them.

38. Heavy Mortar Platoon and Davy Crockett Section

a. The heavy mortar platoon normally is employed under battalion control (general support). The platoon or its mortar squads may be given a mission in which control is retained at battalion, but the platoon or its squads are positioned to fire in support of a particular company team (direct support). The platoon or its squads are rarely attached to company teams.

b. When authorized by Department of the Army, Davy Crockett sections are provided by modified TOE to mechanized infantry battalions, airborne infantry battalions, and armored cavalry squadrons of the armored cavalry regiment. The section is normally employed in gen-

eral support under battalion control. On occasion, the section or its squads are positioned to fire in support of a particular team, but control is still retained at battalion.

39. Scout and Reconnaissance Platoons

The scout platoon organic to armor or mechanized infantry battalions and the reconnaissance platoon organic to the infantry and airborne infantry battalions are normally employed under battalion control. In special situations, these platoons or their elements may be attached to company teams.

40. Armored Cavalry

The attachment of combat or combat support units to armored cavalry units is referred to as reinforcement. The type and amount of reinforcement are based on an analysis of the factors of METT.

41. Factors of METT in Relation to Organization for Combat

a. Mission.

- (1) Missions requiring wide ranging or rapid maneuver favor tank-heavy forces.
- (2) Missions requiring close and detailed organization of terrain favor infantry-heavy forces.
- (3) Missions requiring semi-independent operations of a subordinate unit favor an organization for combat that provides for an organization which is self-sustaining.
- (4) Counterattack missions favor tank-heavy forces.

- (5) Missions requiring defense against modern mechanized forces favor balanced forces.

b. Enemy. Action against—

- (1) An enemy protected by strongly organized antitank defenses or by obstacles favors infantry-heavy forces.
- (2) The anticipation of encountering enemy forces in meeting engagement favors tank-heavy forces.
- (3) An enemy conducting a hasty defense or a retrograde action favors a tank-heavy force.
- (4) An abundance of enemy automatic weapons and massed indirect fires favors tank-heavy forces.
- (5) A vague enemy situation favors tank-heavy or balanced forces.
- (6) An enemy capability for using strong tank forces favors tank-heavy or pure tank forces.

c. Terrain and Weather.

- (1) Conditions that provide good observation and long range fields of fire favor tank-heavy forces.
- (2) The presence of obstacles, other than chemical or radiation obstacles, favors infantry-heavy forces.
- (3) Tank-heavy forces require trafficable terrain.

d. Troops Available. The discussion of troops available in paragraph 34 is a consideration primarily of those factors that determine the feasibility of different organizations for combat.

Section VI. PLANNING ARMOR OPERATIONS

42. General

The tempo of events in mobile warfare and the rapid fluctuations in tactical situations place a premium on time. The successful commander makes sound and timely decisions. He is assisted by his staff in developing a plan to implement the decision and an order to disseminate the plan to subordinates.

43. The Decision

a. The decision is the result of a reasoned analysis of all factors affecting the employment of units in combat. The steps to be considered and their sequence are contained in the estimate of the situation (app VII). Because of rapidly changing situations, estimates normally are accomplished mentally.

b. The decision encompasses the following as a minimum. Some items may be fixed by order of higher headquarters.

- (1) WHO (the unit to take some action, the command as a whole).
- (2) WHAT (the type action to be taken; attack, occupy, delay on successive positions).
- (3) WHEN (time the operation is to start or end).
- (4) WHERE (the area from which, through which, or to which the action will be accomplished).
- (5) HOW (statement of the scheme of maneuver, organization for combat, and plan of fire support).
- (6) WHY (statement of the purpose, which includes details necessary to insure intelligent preparation and execution of the plan).

44. The Concept

a. The concept is an elaboration of the decision and is used for two purposes—

- (1) To announce the concept to individuals who will prepare the plan to execute the decision. It will be as detailed as necessary to insure that plans are developed in accordance with the commander's desires.
- (2) To form the basis of the concept of the operation stated in paragraph 3a of the operation order. For a discussion of the concept in this form, see appendix IX.

b. The commander's concept may include, among other things—

- (1) *Type of operation* (penetration, envelopment, delay on successive positions, mobile defense, reconnaissance in force, screen, and covering force).
- (2) *Area of operation* (avenue of approach, sector of defense, flank to be secured).
- (3) *Scheme of maneuver* (formation for the attack, disposition of forces for defense and delaying action, organization for combat).

(4) *Purpose of the operation* (to destroy the enemy in position to be able to continue the attack, to block enemy movement, to determine enemy strength and dispositions).

(5) *Purpose of the reserve* (number of units and their organization for combat, general location, and anticipated employment).

(6) *Preparation for future operation* (changes in organization for combat, positioning of units, or order of march; special efforts to support future operations).

(7) *Special instructions* (security measures, employment of combat and combat support units, use of aircraft).

(8) *Control measures* (objectives, phase lines, boundaries, axis of advance, delay lines, blocking positions).

(9) *Nuclear weapons* (use in scheme of maneuver, restrictions on use, allocations).

(10) *Troop safety*. This is expressed as the degree of risk to troops that the commander is willing to accept to accomplish the mission.

(11) *Priorities* (priorities of fire, combat service support priority).

(12) *Any departure from standing operating procedure* (a change in the amount of combat rations carried, a change in the employment of the trains).

45. The Plan

a. A plan is a method or scheme for a military action. It is a proposal to carry out a decision or project of a commander. As discussed in this section, it is a part of the planning process in preparation for an armor operation.

b. A good plan should—

(1) Be capable of accomplishing the mission.

(2) Be based on facts. The facts influencing planning are discussed in paragraphs 30 through 35, under METT.

- (3) Use existing resources. All means of applying or supporting combat power must be included. The use of these means is planned so that all resources contribute to the accomplishing of the unit's mission.
- (4) Provide the necessary task organization. The organization for combat decided upon by the commander must be translated into the specific terms of task organization. For example, a decision to attack with a tank-heavy unit must be converted into the specifics as they will appear under "task organization" in the order. This will be a determination of what unit will be the nucleus, how many subordinate elements should remain under the unit's control, how many elements will be attached, what unit or units will these elements be detached from, and when the attachments will be effective. Command relationships and responsibilities must be indicated in the organization for combat.
- (5) Provide continuity. The plan must make all necessary arrangements for the full period of the operation. Arrangements should be made in detail as far in advance as the events of the operation can be foreseen. This includes such items as displacement of supporting weapons, command post facilities, and trains.
- (6) Provide decentralization. Subordinates should be allowed maximum freedom in the discharge of their responsibilities consistent with the necessity for coordinating their efforts. As a planning technique, the planner normally visualizes the action of units *two* levels below his own. This technique must not be carried over into the order. Adherence to the fundamental of using mission-type orders will require that the planning develop *what* subordinates are to do without specifying *how* they are to do it.
- (7) Provide control. All actions and efforts must contribute to the accomplishment of the mission. Even though the armor commander desires to permit maximum freedom of action of his subordinates, he must still plan to control and direct their efforts toward a common goal, the accomplishment of the mission. For overlay techniques used to express the commander's desires concerning controls, see appendix X.
- (8) Be simple. Plans may, of necessity, be detailed but should avoid complexities. The planner strives for simplicity of execution. As an example, committing a following unit around a leading unit is normally simpler than committing it through the leading unit.
- (9) Be flexible. Planners strive for flexibility in plans. One reason why unnecessary restrictions are not imposed on subordinates is that the exercise of initiative at all levels adapts the conduct of operations to circumstances. Other parts of the plan that may contribute to flexibility are the composition and location of a reserve, the use of balanced task organizations, and the preparation of alternate plans.
- (10) Be coordinated. All aspects of the plan that affect units or support agencies not under control of the unit must be coordinated to prevent conflict of action.
 - c. The two basic elements of the plan are the scheme of maneuver and the plan of fire support. They are developed together and are so interrelated that they normally are referred to by a single name—plan of attack or plan of defense.
 - d. The overall plan is made up of many parts of supporting plans. To insure that this overall plan is complete and that each part contributes to it, a basis for planning must be used. The basis is the scheme of maneuver—the employment of the basic maneuver units, and the plan of fire support—the employment of fire support units. Specific plans developed to support the scheme of maneuver and plan of fire support may include—

- (1) Employment of organic or attached indirect-fire weapons. These plans are usually integrated into the plan of fire support.
- (2) Employment of attached air defense artillery. This plan insures proper allocation and employment of resources to defend the priority elements during the operation.
- (3) Employment of organic or attached reconnaissance and security units. These plans are based on the reconnaissance or security unit's capabilities and tactical requirements.
- (4) A communication plan. This plan is prepared to support the commander's concept and to overcome difficulties that might interrupt communication. All means are considered and alternate plans are developed. The movement of any command facility is a major factor in the communication plan.
- (5) A plan to insure adequate logistical support for sustained operations. All organic, attached, and supporting logistical means are integrated into a single effort aimed at maintaining the combat power of the unit. This logistical plan encompasses supply; transportation; maintenance; battlefield recovery, evacuation, and salvage; and services.
- (6) A plan for maintenance of unit strength; morale and personal services; medical service; graves registration; discipline, law, and order; handling of enemy prisoners of war, and control over circulation of personnel.
- (7) Control of civilians. The presence of civilians in the area of operations will require plans for their control.
- (8) Area damage control. These plans are made to minimize the effects of massive damage or contamination of the unit.
- (9) Rear area security. Plans are made to secure the unit against hostile infiltrators, guerrillas, airborne or airlanded forces, and waterborne forces (if applicable).
- (10) Attached or supporting engineers. Plans for use of engineers are made; however, engineer support is more effective when control of the engineer work effort is under central control.
- (11) Standing operating procedures. SOP specify many routine procedures and actions to be taken within the unit during operations. Any departure from such procedure or actions will require a stated change to the SOP. Newly assigned personnel must immediately become familiar with the SOP.
- (12) Intelligence plans. These plans are required in order to make maximum use of means and to insure that no sources of information are overlooked. The employment of all surveillance means must be integrated into a single overall effort that best contributes to the accomplishment of the unit mission.
- (13) Employment of nuclear and chemical weapons. These plans must be carefully coordinated with other plans. The commander must weigh carefully the degree of risk he will accept in order to accomplish his mission without undue exposure of his men.
- (14) Weapons such as mechanized flamethrowing vehicles or special transportation means such as helicopters. Use of these units are normally integrated into the scheme of maneuver; however, their employment may require other supplementary plans, such as an airlanding plan or a loading plan.
- (15) Illumination means other than those delivered from weapons. The use of this illumination is integrated into the scheme of maneuver and coordinated with the plan of fire support.
- (16) Movement plans in preparation for an operation. The specific movement plans required will depend upon the type of transportation available and must include considerations for neces-

sary traffic control in view of the nature of mounted operations.

- (17) Operations that require special training or rehearsals. Plans to accomplish necessary training must make best use of the time available.

Section VII. CONTROL

47. General

Success in mobile warfare demands effective control of the combat power available to armor commanders. Control as discussed in this section concerns all means available and used by the commander to enhance unit responsiveness. It also involves attitudes of the commander and his staff as to freedom of action of subordinate commanders in combat operations. Cooperation on the part of subordinate commanders also increases control. Control involves—

- a. Effective orders and coordination.
- b. Adequate control facilities.
- c. Proper organization for combat and use of formations and terrain.
- d. Responsive, informed subordinates.

48. Orders

a. Orders contribute to control of a unit by their clarity and timeliness. To be effective, orders must clearly express the wishes and intentions of the commander.

b. For a detailed discussion of orders, see appendix IX.

49. Control Facilities

a. Keeping abreast of the situation assists the commander in maintaining control of the unit. To do this he must receive reports from subordinates (subordinate commanders and staff officers), higher headquarters, and adjacent units. He must be aware of the situation and condition of his subordinate units, and be cognizant of the mission and general situation of his superior headquarters.

b. The primary means employed by the commander are—

- (1) *Communication.* All forms of signal communication must be used to the best advantage. Great reliance is placed upon radio. Maximum use is

46. The Order

The plan usually is presented to subordinates by means of an order. The order may be verbal or written. For format and techniques used in preparing the order, see appendixes IX and XI.

made of ground and air radio relay. Wire is used to supplement radio when practical.

- (2) *The command post.* The command post is the principal facility from which the commander and his staff perform their duties. For further details, see appendix II.
- (3) *The command group.* When the situation requires, the commander accompanied by selected staff officers may locate himself away from the command post (CP) to better control operations. This group is small and mobile and normally operates for relatively short periods. For further discussion of the command group, see appendix II.
- (4) *Alternate control means.* Normally, alternate CP's are not established at brigade level or lower. Subordinate headquarters are designated as successor headquarters. However, in certain situations, a requirement for an alternate command post at brigade and battalion level may exist. In this event, additional equipment, particularly communication equipment, may be required.
- (5) *Movement of the command post.* Movement of the command post should be planned so as to cause minimum interference with normal operation. A quartering party with communication facilities may move to the new command post location and establish communication and conduct operations while the command post displaces.
- (6) *Liaison.* The commander must make maximum use of their liaison officers

to establish contact with higher, lower, adjacent, or supporting headquarters and subordinate units to insure mutual understanding and unity of action. See paragraph 69*m* for liaison officer's duties.

50. Control Through Organization for Combat and Formations

a. The commander exercises control of his unit through proper organization for combat. Combat, combat support, and combat service support units are grouped to best accomplish the mission. Organization for combat has two necessary functions—it combines resources to accomplish each part of the mission, and it provides the means to insure adequate command and control of these groupments by the commander. Organization for combat is discussed in paragraph 35.

b. Formations used by the commander to aid control of his units are based on an analysis of METT. He must insure that the formation selected for an operation provides necessary control to facilitate maneuver and rapid shifting

of subordinate units to counter terrain variations and enemy activity. For a detailed discussion of formations in various types of operations, see FM 17-15, FM 17-30, FM 17-36, and FM 17-95.

51. Subordinates

a. For control, subordinates must be responsive to the will of the commander. This means prompt reaction to orders or to changes in the situation. Mobile warfare demands the utmost in commanders or other persons in responsible positions. The flexibility of armor operations depends on the mental flexibility of all soldiers in the operation.

b. To encourage this mental flexibility and to foster the sense of teamwork that contributes to his control of the unit, the commander will keep his subordinates fully informed of his concept of the operation and the situation as it develops.

c. In turn, subordinates must keep the commander informed. Control of the unit depends on the timeliness and accuracy of information provided to the commander.

CHAPTER 3

COMMAND

Section I. COMMAND AND LEADERSHIP

52. General

a. The primary objective of armor units is success in combat. This requires the development, integration, and employment of the unit's ability to move, shoot, and communicate. In preparing for operations, the armor leader must understand thoroughly the tactical and technical employment of his unit, and the operations and employment of normal supporting or attached units. In combat operations, the armor commander normally commands a combined-arms force.

b. In cold war operations, particularly those involving deployment in oversea areas, the commander must have a thorough understanding of the people with whom he deals, and the ability to adapt his concepts and thinking to the limitations that may be imposed on the use of his force, political or otherwise.

53. The Armor Commander

a. Responsibilities. The armor commander is responsible for the training of his unit, its actions in combat, the health and well-being of its personnel, its supply, and the maintenance of its equipment. In short, he is responsible for all that his unit does or fails to do. To discharge these responsibilities efficiently, he must train and use his subordinate commanders and staff officers to the fullest. To encourage ingenuity, initiative, self-reliance, and aggressiveness, he should indicate his policies to his subordinates and then allow them maximum freedom of action.

b. Command. The armor commander makes decisions, which are transmitted as orders. To insure that they are understood and executed satisfactorily, he continually supervises and

checks on the execution of all orders issued. The armor commander will normally receive his orders from the next higher headquarters. In the absence of such orders, he must be prepared to take action on his own.

c. Relations with Subordinates. The armor commander's relationship with his subordinates should be direct and personal. He must keep them informed of the situation and of his desires. He should encourage them to deal directly with him whenever they feel that such action is desirable. However, the chain of command must be emphasized to insure rapid reaction to orders and to facilitate control. He should frequently visit subordinate units to obtain firsthand information and to foster esprit de corps; this is particularly desirable in the case of newly attached units. Attached or supporting unit commanders advise and assist the armor commander in technical matters pertaining to the employment of their units.

d. Command Supervision. Supervision is the most difficult part of the order-execution pattern. The commander must use his subordinates to the fullest extent during supervision. Supervision includes but is not limited to—

- (1) Questioning subordinates and assistants to determine understanding of tasks to be accomplished.
- (2) Insuring that policies and orders be carried out in the highest military tradition.
- (3) Making personal visits to subordinates to observe, offer advice, and make corrections when necessary.
- (4) Encouraging initiative and creative thinking by recognizing efficient exe-

cution of orders and prompt provision of services.

54. Succession of Command

a. The nature of armor operations requires a clearly understood procedure for succession of command upon the sudden loss of the commander. The succession of command should be defined clearly, either through orders or in the unit SOP. As a fundamental of leadership, each commander must train and use his subordinates so that a smooth and efficient transition of command is insured. With few exceptions, succession of command should be vested in the next senior in rank. Under exceptional circumstances, a subordinate other than the next senior in rank may assume temporary command.

b. The designation of authority is a function of command. This is especially important during periods in combat when contact with the commander is temporarily lost. The armor commander should provide adequate guidance as to his concept of operations and should delegate sufficient authority to permit his key subordinates to exercise command in his name during periods of temporary loss of communication. Responsibility cannot be delegated.

55. Responsiveness to Command

Armor commanders are responsive to command. They are capable of accepting a mission-type order, understanding it clearly, and taking immediate action to execute the order. Responsiveness to command is achieved by fully understanding and exploiting the extensive and flexible communication systems of armor units. It is also accomplished through a combination of the mental mobility of the commander and the mobility and flexibility of the unit. Mental mobility is the mental state of a commander which permits him to respond rapidly, aggressively, and boldly to any battlefield situation with a maximum utilization of his force. Responsiveness enables the armor unit commander to direct the employment of organic, attached, and supporting units with speed, accuracy, and efficiency.

56. Leadership

a. The primary responsibility of the leader is the accomplishment of his assigned mission.

Everything else is subordinate to the mission. The leader briefs, instructs, and trains his men so that the mission is accomplished. The welfare of his men is the leader's second most important responsibility. See FM 22-100 for a detailed discussion of leadership.

b. Command of armor units presents unique leadership problems. For example, the armor leader must convince his unit that being completely separated from other friendly units and operating well within enemy-held terrain, is a normal armor operation. Problems of maintenance and supply for both personnel and equipment assume major proportions in armor warfare.

c. Welfare is concerned with the physical and moral needs of the command. The commander avoids coddling his men for the same reason that he avoids pampering himself. Coddling soon blinds a unit to the distinction between real needs and luxuries. As a result, when the demands of a mission require the sacrifice of luxuries, morale and esprit de corps suffer needlessly. Techniques used by the commander to improve the welfare of his men are—

- (1) Being approachable.
- (2) Developing an intimate knowledge and understanding of subordinates.
- (3) Maintaining an interest in living conditions of members of the command, including their families.
- (4) Providing for recreation, personnel services, and religious services.
- (5) Protecting the health of the command by insuring an efficient preventive medicine program.
- (6) Administering justice impartially.
- (7) Insuring a fair leave and pass policy.
- (8) Sharing the hardships imposed upon the command.
- (9) Developing a sincere interest and appreciation of the duties performed by subordinates.

57. The Human Factor

a. Although the most striking features of armor forces are their powerful weapons and fighting machines, the successful employment of these material assets in combat depends ultimately on the courage, intelligence, profession-

al competence, and endurance of the soldier. The individual soldier of an armor unit must be indoctrinated with the spirit of the offensive. His thinking must be geared to the speed and violence of armor warfare. He must be trained to operate deep in hostile territory, and to recognize that the presence of the enemy to his front, flanks, and rear is a condition to be expected.

b. Armor leaders operate with their forward elements. They must possess mental mobility and be responsive to command. They must know and follow sound troop leading procedures and techniques. They must be alert, aggressive, and decisive in the selection and pursuit of a suitable course of action to overcome the varied and complicated problems that will confront them.

Section II. TROOP LEADING PROCEDURE

58. General

a. Troop leading procedure describes the sequence of actions and thought process a leader follows while preparing for and executing assigned missions. He must make the best use of time, equipment, and personnel.

b. The sequence of troop leading procedure may vary depending on the size and type of unit, nature of the mission, and time available. Certain procedures may be undertaken concurrently, and some are considered continuously, throughout an operation. Regardless of the technique used in troop leading procedures, the commander must make an estimate of the situation.

c. Time is one of the leader's most important considerations. Leaders must allow their subordinates maximum time for planning. If subordinates do not have enough time to make adequate preparations, even the most brilliant plan cannot be executed properly. On the other hand, a plan conceived in undue haste places a great burden on the combat soldier. Therefore, the armor leader allocates the time available for troop leading procedure, consistent with the situation, to prepare and execute his mission.

59. Sequence of Troop Leading Procedure

a. The sequence of troop leading procedure is—

- (1) Receipt of mission.
- (2) Warning order.
- (3) Estimate of the situation.
- (4) Tentative plan.
- (5) Reconnaissance.
- (6) Decision and completion of plan.
- (7) Order.
- (8) Supervision.

b. Upon receipt of a mission, the commander analyzes this mission to determine tasks necessary to accomplish it. He issues a *warning order* to his force including as much information as is available. He then begins his *estimate of the situation* based upon all information available at the time. He arrives at a *tentative plan* and, based upon this plan, conducts his *reconnaissance*. He may at this point revise his plan or continue with his *completed plan* or *decision*. He then issues his *order* and *supervises* to insure that it is carried to a successful conclusion.

60. Techniques of Troop Leading Procedure

a. *Receipt of Mission.*

- (1) Analyze the mission to insure a complete understanding of the assigned mission and to determine what tasks must be performed to accomplish it. Ask questions of the commander for any points not understood.
- (2) Plan the use of available time. Allocate enough time to subordinates to perform their troop leading procedures.

b. *Warning Order.* Subordinates are alerted that some action will be required. The warning order allows units to make such preparations that do not depend on specific orders, such as performing maintenance; boresighting weapons; checking radios and individual equipment; and distributing ammunition, fuel, rations and other supplies. These tasks are supervised by the platoon sergeant, platoon leader, and vehicle commanders. The desirable minimum elements of a warning order are—

- (1) *Addressee.* The warning order is relayed down the chain of command to every soldier.
- (2) *Nature of operation.* If security conditions permit, at least the general nature of the operation should be disseminated.
- (3) *Time of action.* If known or if it can be estimated, knowledge of this element will assist subordinates in their preparations.
- (4) *Time and place of the issuance of the complete order.* This element, if known or anticipated, should be disseminated.

c. Estimate of the Situation. The purpose of the estimate is to arrive at a decision through a logical and orderly examination of all factors affecting the accomplishment of the mission. The estimate of the situation is opened by the initial evaluation of information available. As an example, information of the terrain may be gathered from a map reconnaissance as a minimum. The estimate is progressively refined as more information becomes available. The estimate is a continuous process of evaluation before and throughout the operation. For a further discussion of the estimate, see appendix VII.

d. Tentative Plan. Based on the decision as a result of the initial estimate, the leader makes a tentative plan, which guides his actions and the actions of his subordinates and, at the appropriate levels, serves as guidance for staff planning. The tentative plan may be modified after coordination and reconnaissance and before the final decision. At this point in troop leading procedures, the tentative plan serves as a basis for the following:

- (1) *Coordination.* Information is exchanged and coordination is made with all units or agencies that might be affected by the impending operation. If other leaders are present when the order is issued, coordination based on the tentative plan should be initiated at that time. Coordination is continued as the plan is put into final form.
- (2) *Movement of the unit.* Arrangements for movement of the unit are made, if

required. The tentative plan will contain at least initial plans for a task organization to implement the organization for combat decided upon. The movement and "marrying up" of the units affected by the planned cross-attachment should be planned at this time. Movement plans are as detailed as necessary to accomplish the purpose, and normally include who is to move, where they are to go, and when the move is to be made.

- (3) *Planning the reconnaissance.* The reconnaissance must be planned to make the best use of time. The plan must include where to go, the sequence of areas or places to be reconnoitered, such as routes to the attack position; attack position; routes to line of departure; line of departure; location of friendly elements and enemy positions, and transportation to be used; persons to accompany the leader; and coordination to be effected during the reconnaissance. Certain persons, such as a weapons platoon leader, scout platoon leader, or other subordinates, may be directed to make a specific reconnaissance.
- (4) *Plan for time and location for issuance of order.* A plan for issuance of the order must be made. Armor leaders normally issue orders to subordinates at a terrain vantage point. If subordinates cannot be assembled at a single place to receive the order, the plan to issue the order may be a combination of the following techniques:
 - (a) *Radio.* Leader to subordinates.
 - (b) *Personal contact.* Leader to individual subordinate or designated staff officers.
 - (c) *Messenger or other means of communication.*

e. Reconnaissance. On his ground reconnaissance, the leader continues the estimate process, adjusting his courses of action accordingly, and selects the best course of action. He then selects or confirms; as appropriate, such items as objectives, phase line, line of departure, defense areas, routes, weapons position

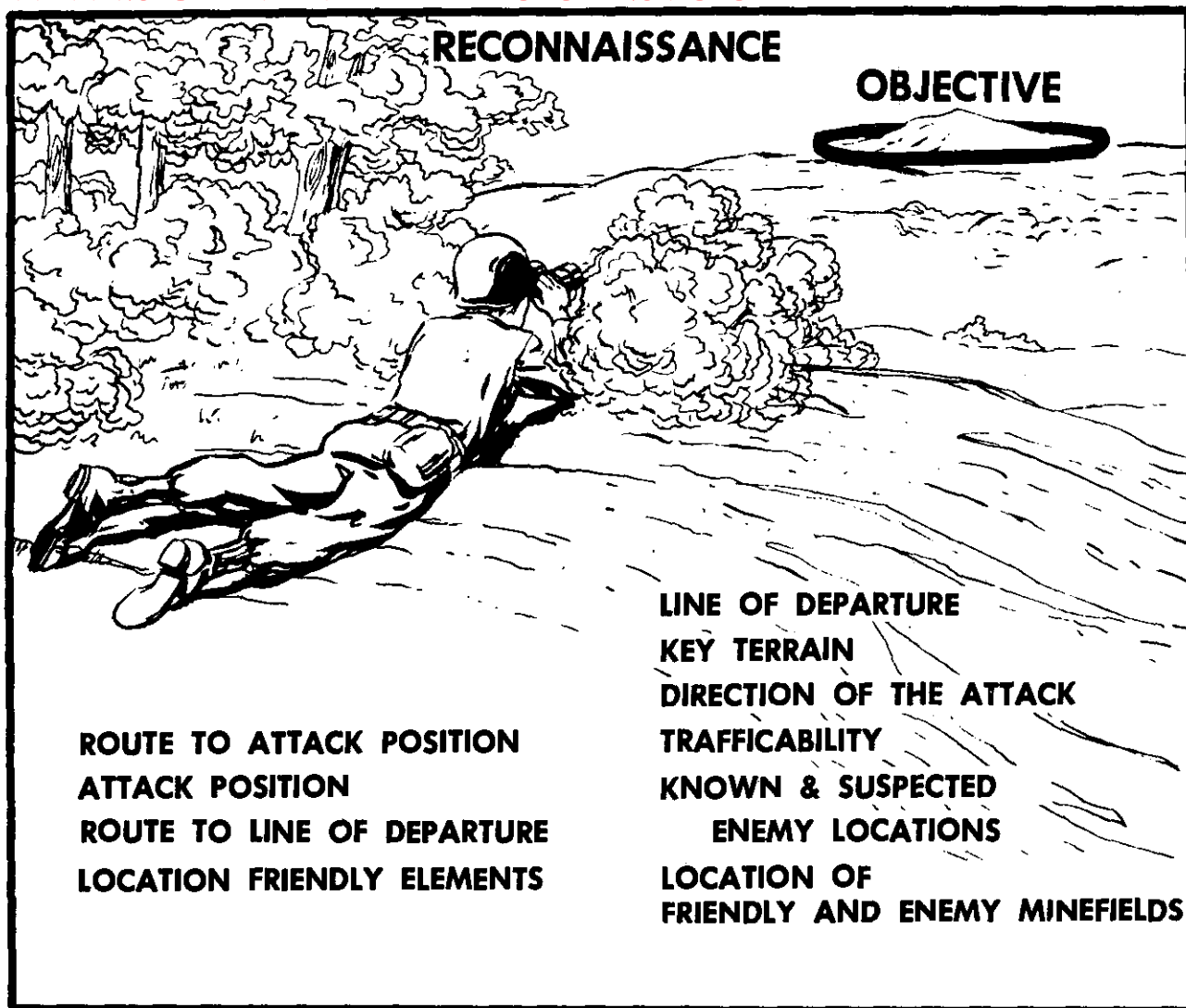

Figure 1. Reconnaissance, completing the plan and issuing the order.

areas, sectors of fire, and targets (fig. 1). He notes the effects of the terrain on his tentative plan, and he rejects, alters, or adopts appropriate parts of this plan accordingly. During his reconnaissance, he coordinates with adjacent and supporting unit leaders as planned. To expedite his reconnaissance, the leader will use an aircraft if appropriate and available.

f. Decision and Completion of Plan. The completed plan is a result of refinements made of the tentative plan (fig. 1). Recommendations from attached or combat support unit representatives (infantry, artillery, engineers, or air force), and the results of the reconnais-

sance serve to give the leader the elements necessary to complete the plan.

g. Order. Orders must be clear, concise, and as complete as required to insure that the order is understood (fig. 1). It must be delivered in a manner that insures complete understanding of the leader's concept. Subordinates ask questions after the order has been issued.

h. Supervision. The leader, with the assistance of his subordinates, actively supervises his unit to insure that the order is carried out satisfactorily. If he notes a deficiency or a misunderstanding, he takes immediate corrective action.

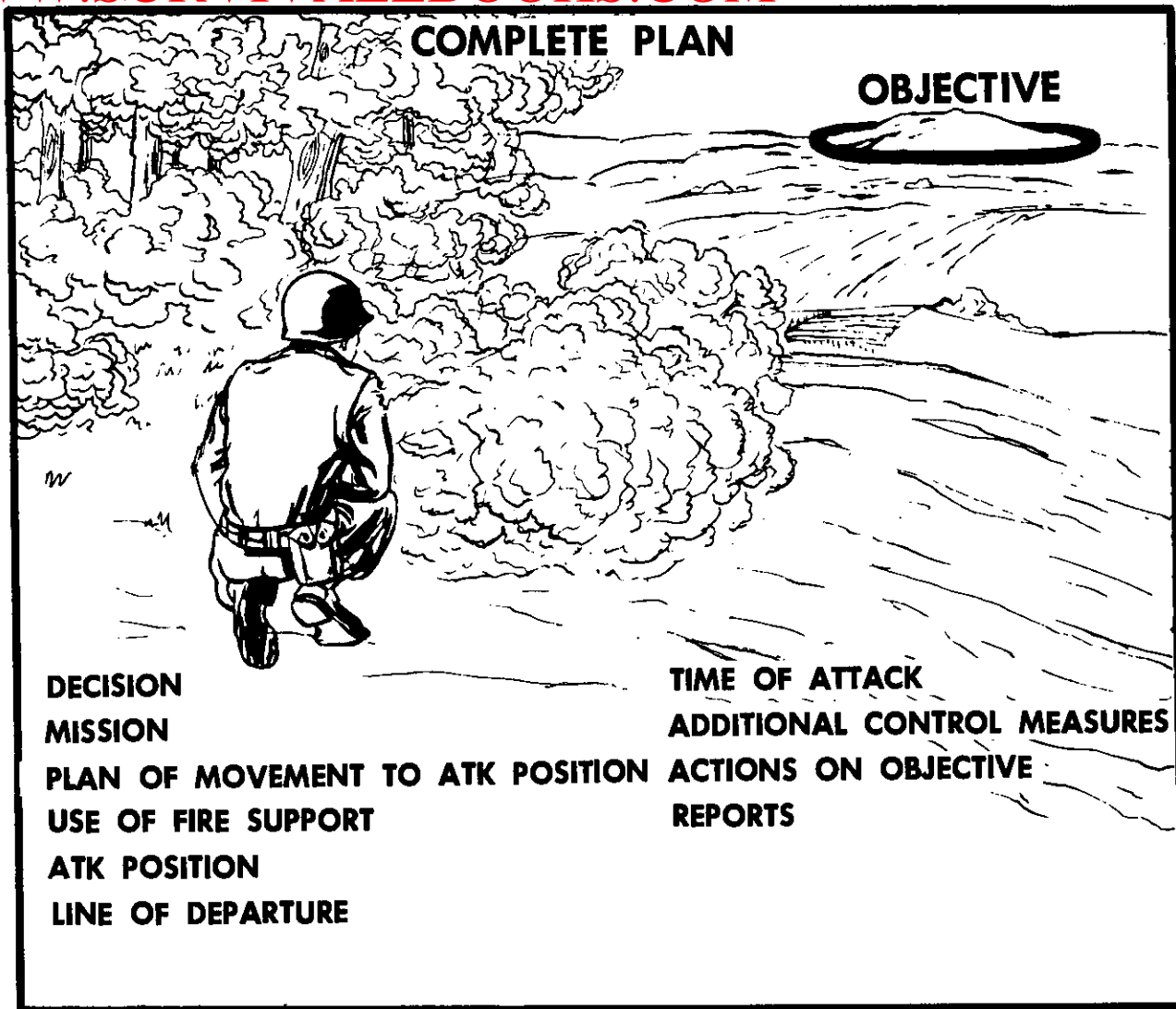

Figure 1—Continued.

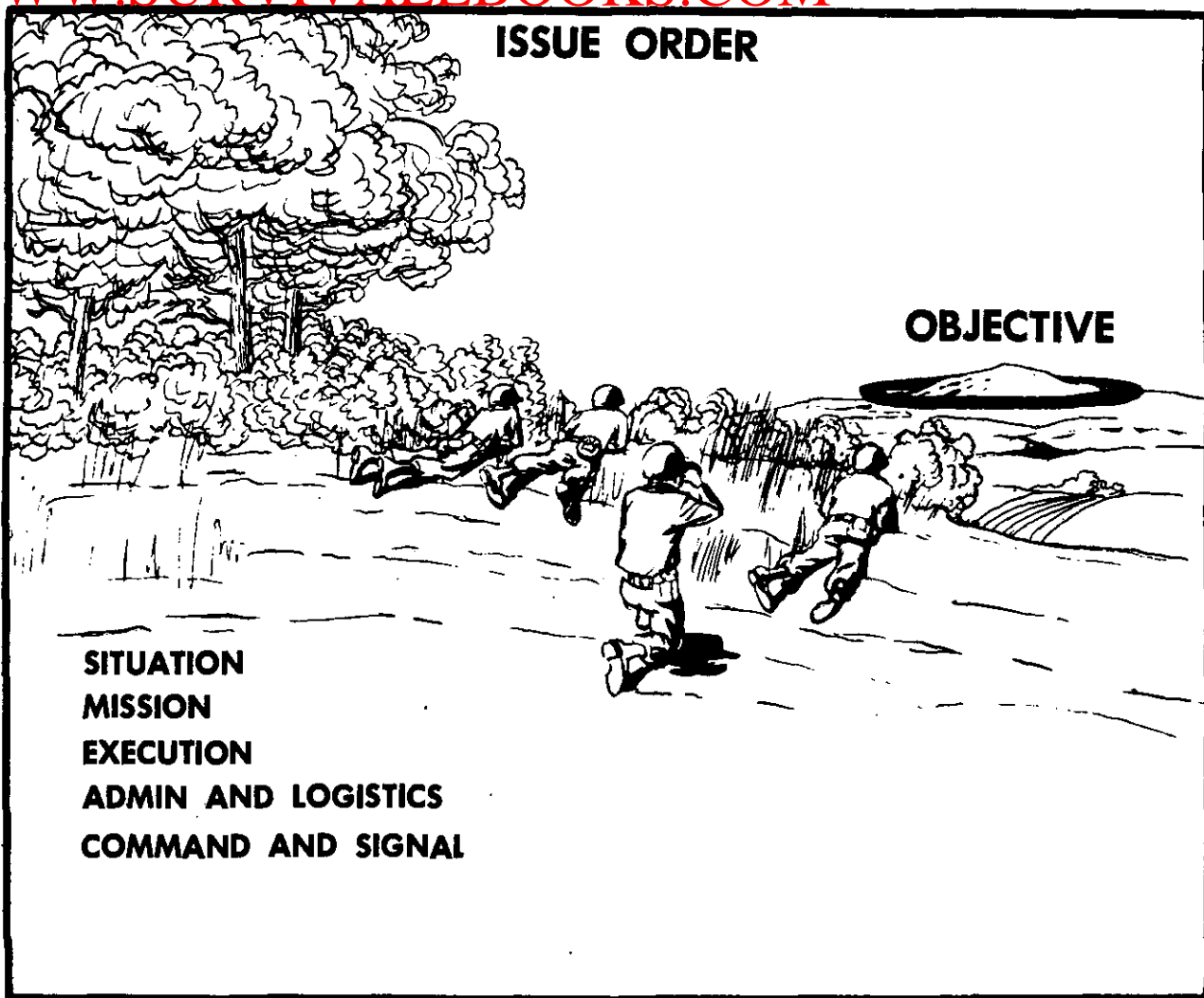

Figure 1—Continued.

CHAPTER 4

THE COMMANDER AND HIS STAFF

Section I. THE COMMANDER

61. General

The commander and his staff are a military entity with one purpose: successful accomplishment of the commander's mission. The commander's mission involves varied and complex problems as reflected in chapter 3. The purpose of this chapter is to discuss the specific duties of the staff to include its actions and relationship with the commander to insure the successful accomplishment of the mission.

62. The Commander's Conduct in Combat

a. The commander uses all available means to accomplish his mission. His plans, orders, and supervision insure that the actions of all units contribute effectively toward that end. When additional units, weapons, or other support is required to accomplish the mission, the commander takes action to obtain it. He coordinates the activities of his command with

those of adjacent and supporting units.

b. The commander goes where he can best direct, control, and influence the operation. He may be with the command group element, at his command post, or anywhere else in his area of operations where his presence is required. Before he leaves the command post, he informs his staff on plans to be made or actions to be taken if the situation changes. When he is away, he insures that he can communicate with his command post and subordinate commanders. If, while away from his command post, he issues orders or obtains pertinent information of the situation that has not been made available to the staff, he informs them without delay.

c. The commander influences the conduct of battle by employing supporting fires, shifting maneuver elements, and making his presence felt at critical points.

Section II. THE UNIT STAFF

63. General

a. A staff officer is an assistant to the unit commander in the exercise of command. The five broad functions of the staff officer are providing information, making estimates, making recommendations, preparing plans and orders, and supervising the execution of orders. He transmits his commander's orders to unit commanders or conveys his commander's instructions or desires. Staff officers may, when so authorized, issue orders based upon the policies of the commander. Whenever a staff officer issues an order, he informs the commander as soon as possible. The staff assists the com-

mander by relieving him of time-consuming details. The staff keeps its information and estimates current on the strength, location, and action of lower units; enemy capabilities, strength, location, and composition; and the status of combat service support. On the basis of this information, the staff makes recommendations to the commander. When a decision is made, the staff members assist in translating the decision into orders and in supervising their execution.

b. The unit staff is a closely knit team. The successful functioning of this team depends primarily upon close coordination among its

members and between the staff and elements of the unit. This coordination includes teamwork with the staffs of higher and adjacent units. Coordination is developed through understanding, training, and practice. Prompt dissemination of all pertinent information, decisions, and orders promotes the efficiency and teamwork of the unit. Conferences and personal contact promote coordination and cooperation. There is some overlapping of duties in the battalion staff sections, and only by coordination and cooperation will contradictions and duplication of effort be avoided. It is essential that staff officers know the duties and responsibilities of other members of the staff so that they may take over such duties in case of emergency. The staff sections should be organized to operate on a 24-hour basis.

c. The staff officer organizes and trains his assistants to function in his absence. Before leaving the command post, he acquaints himself with the general situation, announces his destination and probable hour^s of return, and determines what assistance he may give to other staff officers.

d. The staff cultivates friendly relationships with the commanders of lower and attached units. A staff officer must remember that he is not the commander but acts only in the commander's name. Commanders of lower and attached units are consulted to determine their needs and problems. Staff officers visit lower units to get firsthand knowledge of the tactical situation and combat service support conditions. Commanders or their representatives are contacted personally as the first and last steps of each visit. When conditions are observed that are contrary to announced policies, they are called to the attention of the appropriate commander. Details that do not require a command decision may be settled with the unit commander at the time of the visit. Concise reports of facts are provided the battalion commander following such staff visits.

64. Unit Staff Organization

a. General. The unit staff consists of the primary staff and the special staff. Their functions are similar to those outlined for small unit staffs in FM 101-5.

b. Unit Staff. The unit staff is composed of the executive officer, adjutant (S1), intelli-

gence officer (S2), operations and training officer (S3), logistics officer (S4), and the sergeant major.

c. Special Staff, Brigade and Regiment. The special staff of the division armor brigade and the armored cavalry regiment consists of the aviation officer, chaplain, chemical officer, fire support coordinator, liaison officers, signal officer, surgeon, headquarters commandant, and other staff positions as may be established by the commander. For the unit special staff of the separate armor brigade, see FM 17-30.

d. Special Staff, Battalion and Squadron. The tank battalion or armored cavalry squadron unit special staff is composed of the communications officer, fire support coordinator, headquarters commandant (headquarters and headquarters company or troop commander), liaison officers, maintenance officer, surgeon, and other staff positions as may be established by the commander.

e. Other Special Staff Officers. When combat support and combat service support units are attached to or placed in support of the battalion, the commanders of these units function as special staff officers for their field of interest. For example, the commanding officer of an attached or supporting engineer company also functions as the battalion staff engineer. Tables of organization do not provide separate special staff officers for such functions as safety, claims, postal officers, or others. The commander may appoint one of his staff or other officers to serve in a special staff capacity in addition to his other duties.

65. Unit Staff Intrarelations

Figure 2 shows the general relationship between the unit primary and special staffs. Though not indicated in the diagram, special staff officers have direct access to all members of the primary staff on matters within their primary responsibilities. During staff functioning—

a. The primary staff insures that the special staff is informed of the plans, policies, and decisions of the commander. It obtains information, estimates, and recommendations from the special staff and uses this data in preparing integrated reports, estimates, recommendations, and plans for the commander. Staff officers, both primary and special, must keep

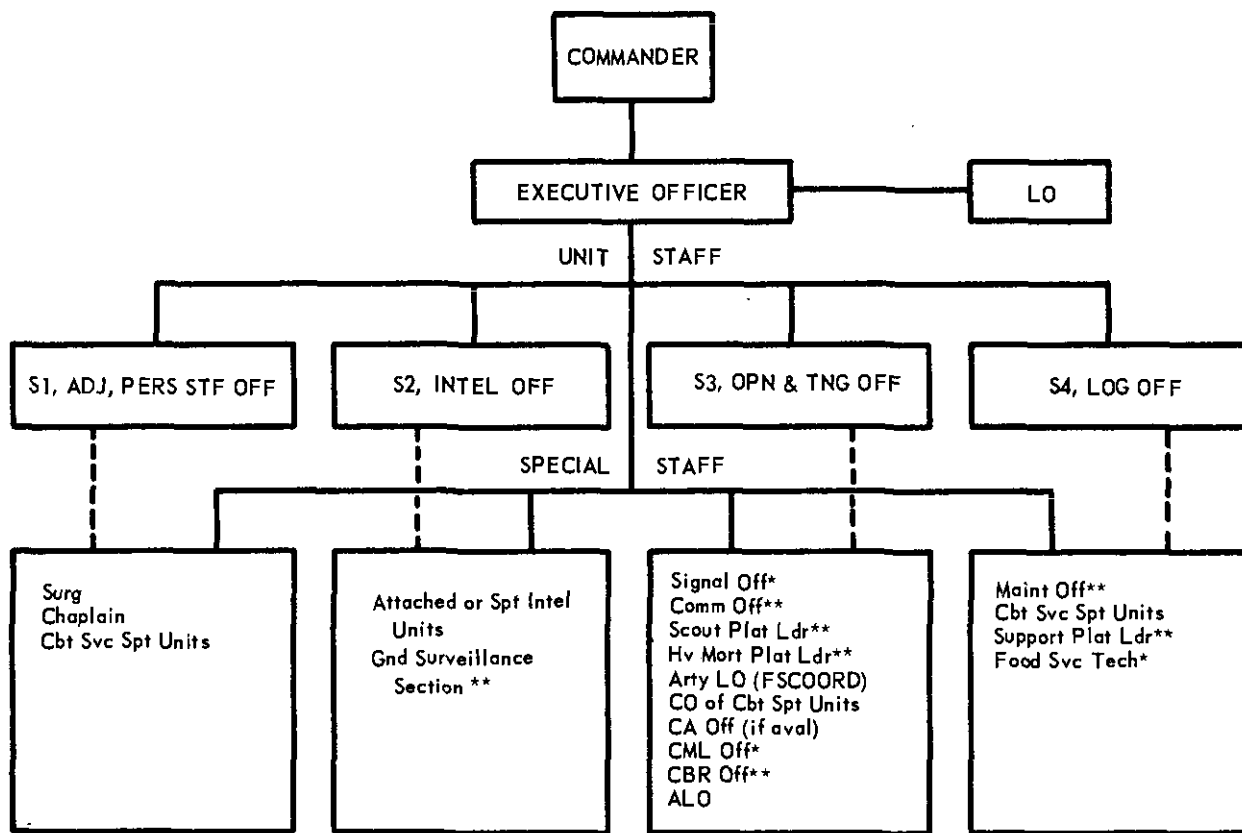

Note. The dotted line indicates primary unit staff responsibility for staff coordination of the personnel or activity. This is an example and the commander will base his decisions on his desires and the best arrangement to achieve his objectives.

*Bde or Regt only.
**Bn or Sqdn only.

Figure 2. Relationship between unit primary and special staffs.

each other informed on matters of common interest.

b. A special staff officer usually deals with the commander through the appropriate primary staff officer; however, technical considerations of a particular problem may make it desirable for him to present information and recommendations directly to the commander. Whenever a special staff officer has direct contact with the commander, he should inform the appropriate staff officer or officers of the information exchanged and the recommendations made, when appropriate.

66. The Armor Brigade and Armored Cavalry Regimental Unit Staff and Principal Staff Assistants

a. *General.* The functions, procedures, authority, and responsibilities of the staff are contained in FM 101-5. The responsibilities and functions of the unit staff are comparable to those of the division general staff.

b. *The Brigade or Regimental Executive Officer.*

- (1) The executive officer is the principal assistant and adviser to the com-

mander. His functions and responsibilities are similar to those of a chief of staff. He supervises the staff, and represents and acts for the commander during the temporary absence of the latter when directed to do so. He normally is the materiel readiness officer. As required, he assigns tasks to the members of the staff in addition to their primary duties. He is prepared to assume command at any time.

- (2) The executive officer is responsible for the overall functioning of the command post. He is assisted by the headquarters commandant. He and the commander should not be absent from the command post at the same time.
- (3) The executive officer establishes and supervises liaison with adjacent, higher, subordinate, and supporting units. For details of liaison activities, see FM 101-5.

c. The Brigade or Regimental Adjutant (S1). The duties of the adjutant correspond to those of the G1 (FM 101-5). He has unit staff responsibility for personnel activities and other administrative matters not assigned to other staff officers. He may, when the need arises, advise the commander in those areas of S1 interest which would normally concern, at higher staff level, the inspector general, staff judge advocate, provost marshal, special service officer, and finance officer. The divisional brigade S1 does not enter the personnel and administrative channels between the division administrative company and attached units except for policy matters, to develop training and operational plans, as directed by division, and to insure effectiveness of the brigade. The extent of operation in the personnel and administrative fields by the separate armor brigade or the armored cavalry regimental S1 will depend on the policy and procedures of the corps or field army to which attached. The unit S1 exercises staff supervision of the activities of the surgeon. He has staff responsibility for the movement, initial arrangement, organization, and operation of the headquarters and the allocation of shelter within the headquarters. His

principal assistant for this function is the headquarters commandant.

d. The Brigade or Regimental Intelligence Officer (S2). The duties of the unit intelligence officer correspond to those of the G2 (FM 101-5). He has staff responsibility for matters pertaining to combat intelligence and counter-intelligence. He coordinates surveillance and reconnaissance activities of organic or attached units and is a nuclear weapons employment officer. It is his duty to keep the commander, staff, subordinate units, and all other interested agencies fully informed of enemy capabilities and terrain and weather. He is authorized a captain as assistant S2.

e. The Brigade or Regimental Operations and Training Officer (S3). The duties of the unit operations and training officer correspond to those of the G3 (FM 101-5). He has staff responsibility for all matters pertaining to the organization, training, and combat operations, and works closely with the fire support coordinator (FSCoord) to insure the adequacy and effectiveness of supporting fires. He is a nuclear weapons employment officer. He exercises staff supervision over organic and attached aviation units and over CBR, civil affairs, psychological warfare, and signal activities. He has staff responsibility for the overall security of the command, including the rear area when applicable. He is authorized two captains as assistant S3 and S3 air. In the combined intelligence operation section, the S2-S3 work as a team with each being qualified and prepared to take full charge of both activities during the absence of the other.

f. The Brigade or Regimental Logistics Officer (S4). The S4 has staff responsibility for logistics, except medical service. His duties correspond to those of the G4 (FM 101-5). He is primarily a planner and an advisor to the brigade or regimental commander; he operates in the logistical support system only when necessary to insure proper support to organic, attached, and supporting units. The S4 does not become involved directly in preparing or processing supply requisitions or the distribution of supplies except when the unit is on an independent mission, a class IV item is requested by a subordinate unit, or when aerial delivery of supplies is required. He selects the

location of the brigade trains area and has staff responsibility for the operations, security, and displacement of the trains as required to support tactical operations. He also is responsible for area damage control planning and for the integration of the area damage control plan with that of the next higher unit. He is authorized an assistant S4 and a food service technician, who normally are located in the brigade trains area during tactical operations.

g. The Brigade or Regimental Sergeant Major. The sergeant major is the senior noncommissioned officer assigned the armored brigade or armored cavalry regiment. He functions under the direction of the unit commander. He may assist the S1 in administrative matters. He exercises no command prerogative except in the absence of all commissioned officers assigned or attached. However, he is expected to make on-the-spot corrections and decisions. Specifically, the sergeant major is concerned with soldierly appearance, conduct, and discipline within the unit and its attachments with emphasis on these qualities in the noncommissioned officers. He utilizes a direct channel to all attached battalion or squadron sergeant majors and attached companies first sergeants. He evaluates and makes recommendations in the areas of appearance, conduct, and discipline or administrative matters. He actively assists in the investigation of any charges involving noncommissioned officers and functions as a member of any board pertaining to noncommissioned officers. The sergeant major monitors training in drill and ceremonies. He instructs noncommissioned officers assigned to brigade or regiment in their duties and orients all newly assigned personnel (officer, noncommissioned officer, and enlisted) in the history and traditions of the brigade or regiment. He supervises the unit's noncommissioned officers' mess and should be a member of the fund and character guidance councils.

h. The Brigade or Regimental Aviation Officer. The duties of the brigade or regimental aviation officer correspond to those of the division aviation officer in FM 101-5. The aviation officer is the staff advisor to the commander on army aviation employment. He assists the S3 in planning airmobile operations, the S2 and S3 in planning reconnaissance and surveillance operations, the S4 in aerial resupply

operations, and the chemical officer in aerial radiological surveys. He coordinates constantly with the assistant S3 air on the employment of organic and supporting army aircraft in the brigade or regimental area, to include air traffic control and coordination with air defense agencies.

i. The Brigade or Regimental Chaplain. The brigade or regimental chaplain will operate in accordance with command staff relationships and doctrine outlined in FM 101-5. He is the senior chaplain assigned to the brigade or regimental headquarters and headquarters company or troop. He functions under the staff supervision of the S1. The brigade or regimental chaplain supervises the activities of all assigned chaplains. He insures that religious services and pastoral care are provided for all units or elements assigned or attached to the brigade or regiment.

j. The Brigade or Regimental Chemical Officer. The chemical officer is the advisor to the commander in all aspects of chemical, biological, and radiological (CBR) operations. In coordination with appropriate staff officers, the chemical officer supervises the CBR operation and training of subordinate units. The chemical officer is responsible for the accomplishment of certain CBR functions in the brigade or regimental headquarters. He is a nuclear weapons employment officer. The members of the staff coordinate with the chemical officer those aspects of CBR operations and training which fall within their purview.

- (1) In coordination with the S1, the chemical officer—
 - (a) Assists with records and reports regarding CBR casualties.
 - (b) Maintains records of radiation dosage status of units.
- (2) In coordination with the S2, the chemical officer—
 - (a) Prepares fallout predictions.
 - (b) Disseminates the fallout prediction message to units.
 - (c) Disseminates the effective wind message to units.
 - (d) Plans and supervises ground radiological surveys.
 - (e) Consolidates radiological monitoring and chemical detection reports

received from units, and forwards them to division.

- (f) Plans aerial radiological surveys. He also coordinates with the brigade aviation officer in this role.
 - (g) Maintains contamination maps.
 - (h) Recommends CBR reconnaissance.
 - (i) Assists the S2 to estimate enemy CBR capabilities.
- (3) In coordination with the S3, the chemical officer—
- (a) Prepares the brigade CBR training program.
 - (b) Supervises, and when appropriate, conducts CBR training within the brigade.
 - (c) Prepares the brigade CBR SOP.
 - (d) Prepares plans for the integration of chemical fires with the scheme of maneuver.
 - (e) Assists the FSCOORD in the preparation of the fire support plan by preparing chemical target analyses and recommending integration of chemical fires. He calculates troop safety requirements when toxic chemical agents are to be used.
 - (f) Prepares recommendations to integrate chemical mines into minefield and barrier plans.
 - (g) Assists in planning the employment of flame weapons, flame field expedients, and smoke in support of operations.
 - (h) Advises on the employment of attached or supporting chemical units.
 - (i) Advises the CBR officers of attached and supporting units on technical matters.
- (4) In coordination with the S4, the chemical officer—
- (a) Inspects chemical equipment of subordinate units.
 - (b) Monitors the requisition and distribution of chemical equipment and supplies.
 - (c) Plans for and supervises the installation of collective protection facilities, when appropriate.

(d) Supervises CBR decontamination activities.

k. The Brigade or Regimental Fire Support Coordinator. The armor brigade or armored cavalry regimental fire support coordinator is normally the commander of the supporting artillery battalion or his designated representative. He operates under the staff supervision of the S3 and advises and assists the commander and his staff on all fire support matters concerning the delivery of fires on surface targets. The fire support coordinator's duties include—

- (1) Advising the commander and staff on all fire support matters.
- (2) Preparing the fire support part of the unit SOP.
- (3) Preparing plans of fire support.
- (4) Coordinating all supporting fires, including certain aspects of close air support and air-delivered nuclear weapons (in conjunction with S3).
- (5) Keeping supporting artillery units informed of the situation.
- (6) Planning and coordinating air defense artillery fires employed in the ground support role according to the policy established by higher headquarters and the commander's directives.

l. The Brigade or Regimental Headquarters Commandant. The duties of the headquarters commandant (headquarters and headquarters company commander, armor brigade, and headquarters and headquarters troop commander, armored cavalry regiment) are similar to those listed in FM 101-5. His principal duties are performed under the staff supervision of the S1. In coordination with the unit staff, he supervises—

- (1) The custody and evacuation of prisoners of war and civilian internees in coordination with supporting military police.
- (2) The custody and return of stragglers to units in coordination with supporting military police.
- (3) Establishment of command post facilities.
- (4) Operation of a brigade forward prisoner of war holding point if military

police collecting points are not available.

- (5) Implementing command post security plans.
- (6) The quartering party in the absence of the S1.

m. The Brigade or Regimental Liaison Officers. The armor brigade and armored cavalry regimental liaison officers function under the staff supervision of the executive officer. They are normally given duties as assistants to specific staff sections when not engaged in liaison activities. Liaison officers must insure dissemination of information to all interested staff officers. Their general duties are as outlined in FM 101-5 and as listed below.

- (1) Before departing on their liaison mission, they thoroughly familiarize themselves as to the situation, future plans, and new policies of their unit.
- (2) They coordinate with the staff to determine areas for coordination.
- (3) On arrival at the headquarters to which sent, they report to the commander or appropriate staff officer; pass on information and orders as required; and become familiar with that unit's situation and plans that they are to transmit to their own unit.
- (4) While moving between headquarters, liaison officers should observe all locations of troops and command posts and other actions of interest to their commander not otherwise obtained by liaison visits.

n. The Brigade or Regimental Surgeon. The duties of the brigade or regimental surgeon correspond to those of the division surgeon (FM 101-5). He plans, advises, supervises, and coordinates medical matters for the brigade's or regiment's attached and supporting units. The surgeon monitors requests for air evacuation originated by battalion or squadron surgeons and establishes priorities for support when requirements conflict; he coordinates air ambulance flight requirements with the staff as required. He keeps the commander informed concerning the health of the command as a whole. He maintains direct liaison with the surgeons of attached and supporting units. The

surgeon operates under the staff supervision of the S1.

o. The Brigade or Regimental Signal Officer. The armor brigade or armored cavalry regimental signal officer is the principal adviser to the commander and staff on all communication matters. His duties are generally the same as those performed by the division signal officer outlined in FM 101-5. He coordinates and exercises technical supervision over the training and activities of the communication personnel in the brigade or regimental headquarters and headquarters company or troop and organic and attached units. He keeps informed of current and planned activities of the unit. Under the staff supervision of the S3, the signal officer plans and recommends the employment of all communications-electronics means in the unit. He is normally a member of the quartering party.

p. The Brigade or Regimental Assistant S2, Intelligence and Assistant S3, Operations and Training. The duties of the assistant S2, intelligence and assistant S3, operations and training are as prescribed by the S2 and S3 respectively. Their normal place of duty is the command post unless otherwise directed. They must be prepared to assume the duties of the S2 or S3 as appropriate and to act in their absence.

q. The Brigade or Regimental Assistant S3 Air. The assistant S3 air assists the S3 and fire support coordinator (FSCOORD) in Army or Air Force air support and fire support coordination. He performs other duties as specified by the S3. He submits request for tactical air support and air strikes. He coordinates such activities with the FSCOORD and the air liaison officer of the tactical air control party. Other duties of the S3 air include—

- (1) Preparing SOP for ground/air operations.
- (2) Preparing the air support portion of the fire support plan.
- (3) Preparing or processing request for immediate and preplanned close air support.
- (4) Assisting the S2 by forwarding request for tactical air reconnaissance.
- (5) Supervising air/ground recognition

and identification procedures within the unit.

- (6) Coordinating air-to-surface fires.
- (7) Assisting the fire support coordinator and S3 in the preparation of fire plans.

r. The Brigade or Regimental Assistant S4, Logistics. The assistant armor brigade or armored cavalry regimental S4 assists the S4 in all logistical matters. His specific duties include—

- (1) Establishing a brigade or regimental logistics control point which serves as the trains headquarters and is located in the brigade or regimental trains area.
- (2) Keeping informed of the status of vehicles, equipment, personnel, and supplies in the trains area.
- (3) Recommending to the S4 the internal arrangement of the trains—including locations of battalion or squadron field trains and supporting logistical elements.
- (4) Functioning as the logistical representative on the brigade or regimental area damage control and assessment team.
- (5) Implementing the security plan for the trains.
- (6) Keeping abreast of the tactical and logistical situation, posting the logistical situation map, and maintaining the journal.
- (7) Maintaining communication with, and disseminating information to, subordinate units and commanders of logistical activities in the trains area as directed by the S4.
- (8) Keeping higher headquarters informed of the location of brigade or regimental trains and supporting logistical elements.
- (9) Maintenance officer duties (armored cavalry regiment).

s. The Brigade or Regimental Food Service Technician. The armor brigade or armored cavalry regimental food service technician is the S4's principal assistant in planning for and managing class I supplies. He exercises techni-

cal supervision over food service activities. His primary duties include—

- (1) Insuring that units are issued the rations to which they are entitled and that the rations are received in proper condition.
- (2) Recommending to the S4 location of the forward class I distributing point in the trains area.
- (3) Inspecting kitchens for proper handling, storage, preparation and serving of food, maintenance of sanitary standards, and adequacy of mess equipment.
- (4) Supervising the training of the mess stewards and cooks.
- (5) Assisting in the continuous operation of the trains headquarters.

67. The Armor Battalion and Armored Cavalry Squadron Unit Staff and Special Staff Officers

a. General. The functions, procedures, authority, and responsibilities of the armor battalion and the armored cavalry squadron unit staffs correspond to those of the division staff contained in FM 101-5 and to those of the armor brigade and armored cavalry regiment contained in paragraph 66.

b. The Battalion or Squadron Executive Officer. For duties of the executive officer, see paragraph 66b. In addition to the duties listed in paragraph 66b, he is the unit information officer and the unit materiel readiness officer.

c. The Battalion or Squadron Adjutant (S1). The adjutant performs the functions of the personnel officer of the general-staff-type organization, the functions of the secretary of the general staff, and the functions of the commander's personal staff. He may, when the need arises, advise the commander on those areas within the S1 interest which would normally at higher staff levels concern the adjutant general, inspector general, staff judge advocate, provost marshal, and special services officer. He has primary staff supervision over the unit surgeon. His major areas of responsibility for staff supervision are—

- (1) *Maintenance of unit strength* to include but not limited to—
 - (a) Preparation of loss estimates.

- (b) Maintenance of personnel records and reports reflecting the status of personnel matters in the command.
 - (c) Obtaining replacements (unit and individual) and arranging for their reception, processing, assignment, and quartering.
 - (d) Maintaining records of remaining radiation service of organic and attached units.
- (2) *Personnel Management* to include but not limited to—
- (a) Classification, including promotion, demotion, and awarding and changing of MOS's.
 - (b) Assignment, including reassignment, transfer, reporting and requisitioning of personnel.
 - (c) Reenlistment.
 - (d) Preparation and processing of reports on casualties and prisoners of war.
 - (e) Administration of civilian employees operating with the unit or in the unit area.
 - (f) Arrangements for the collection and evacuation of prisoners of war in coordination with the S2 and S4.
- (3) *Development and maintenance of morale* to include but not limited to—
- (a) Personnel services, including leaves of absence, awards, and decorations.
 - (b) Medical services, including preventive medicine, dental service, and treatment and evacuation of sick and wounded.
 - (c) Evaluation of the morale aspects of health services in the unit, personal hygiene, sanitation, and in coordination with the unit surgeon, selection of the medically fit and disposition of the medically unfit.
 - (d) Operation of the unit postal service.
 - (e) Recovery and disposition of the dead.
 - (f) Coordination of recreation for unit personnel and evaluation of morale.
- (4) *Maintenance of discipline, law and order* to include but not limited to—
- (a) Recommendations to the commander of measures that will maintain or improve discipline within the battalion.
 - (b) Maintenance of records on military justice procedures and assistance in the review of courts-martial proceedings from an administrative viewpoint.
- (5) *Headquarters management* to include but not limited to—
- (a) Operation of the headquarters communication control, distribution centers, and messenger service.
 - (b) Internal arrangement of the command post and establishment of a standing operating procedure to guide its operation and security.
 - (c) Assignment of shelter and quartering areas.
 - (d) Command and supervise the activities of the quartering party to include selection of the exact CP location.
- (6) *Miscellaneous*. The S1 is responsible for all administrative matters not assigned another staff officer.
- d. *The Battalion or Squadron Sergeant Major*.
- (1) The sergeant major is the senior non-commissioned officer in the battalion or squadron. He acts as the commander's representative in dealing with other noncommissioned officers, and is his noncommissioned officer adviser in enlisted personnel matters. He establishes direct contact with the first sergeants, personnel staff non-commissioned officer of organic units, and first sergeants of attached units. He holds periodic meetings with them to disseminate information and instructions from the commander. He assists in inspections of activities as prescribed by the commander. He accompanies the commander on visits and at ceremonies.

- (2) Other duties and functions of the sergeant major are discussed in paragraph 66g.

e. The Battalion or Squadron Intelligence Officer (S2). The S2 has staff responsibility for intelligence and counterintelligence matters. His duties are similar to those of the G2 (FM 101-5). He keeps the commander, staff, subordinate units, and all other interested agencies fully informed of the enemy situation and capabilities, and terrain and weather. Among his duties, he—

- (1) Plans and supervises (in conjunction with S3) the intelligence and counterintelligence training of the battalion.
- (2) Plans and supervises troop counterintelligence measures in the battalion.
- (3) Prepares and presents the intelligence estimate.
- (4) Prepares the intelligence plan, including the collection plan and orders and requests to collecting agencies, and coordinates subordinate collecting agencies (coordinating with S3).
- (5) Records all pertinent enemy information on the situation map.
- (6) Evaluates and interprets enemy information, and disseminates intelligence information to his commander, the staff, and higher, lower, and adjacent units.
- (7) Supervises the questioning of enemy personnel, including civilians (hostile or friendly) who may possess information of immediate tactical value. Examines captured documents and materiel if of immediate tactical value, and expedites the sending of captured materiel, documents, and personnel to higher headquarters.
- (8) Requests and supervises distribution of maps, airphotos, imagery-interpretation reports, defense overprints, annotated airphotos and photomaps for the battalion.
- (9) Plans and supervises the operations of the ground surveillance section (coordinating with the S3).
- (10) Supervision and coordinating of prediction of fallout from enemy em-

ployed nuclear weapons and coordination of radiological survey.

f. The Battalion or Squadron Operations and Training Officer (S3).

(1) The S3—

- (a) Has staff responsibility for all matters pertaining to organization, training, and tactical operations. His duties correspond to those prescribed for the G3 (FM 101-5).
- (b) Is the commander's principal adviser on organization for combat.
- (c) Has staff responsibility for civil affairs and psychological functions, and staff supervision over civil affairs or psychological elements or personnel that may be attached.
- (d) Has staff responsibility for fire support planning and coordination.
- (e) Is responsible for overall planning and supervision of tactical security for the unit.
- (f) Is a qualified nuclear weapons employment officer and will normally prepare the detailed target analysis when required.

(2) Among his specific training duties, the operations and training officer—

- (a) Prepares and has staff supervisory responsibility for the execution of training directives, programs, orders, field exercises, and maneuvers, based on plans approved by the commander.
- (b) Selects training areas and ranges, and allocates training aids, ammunition, and equipment.
- (c) Organizes and conducts battalion or squadron schools. Based upon the commander's directives, he prepares the program of instruction, selects and trains instructors, and recommends the selection of units or personnel to attend schools.
- (d) Makes training inspections, and prepares and supervises training tests based on Army training tests.
- (e) Prepares training records and reports.

(3) His operations duties include the following:

- (a) Informs his commander and other staff officers of the tactical situation and is prepared to recommend to the commander actions to be taken by the unit.
- (b) Studies the situation as affected by the enemy, orders from higher headquarters, actions of adjacent and supporting units, and location and capabilities of the battalion or squadron. He studies the effects of casualties and replacements, terrain and weather, and the status of supply and equipment, as they apply to the mission.
- (c) Maintains up-to-date information on the battalion or squadron and friendly units; supervises the posting of friendly and enemy information on the situation map.
- (d) Recommends the general location of command post sites.
- (e) Plans troop movements, including units involved, formation, and type of transportation required (coordinating with S4). He prepares the march order after the plan of movement is approved.
- (f) Recommends the tactical employment of units after a study of the factors of METT and after conference with other staff officers and unit commanders.
- (g) Recommends tactical and counter-intelligence measures to attain secrecy and effect surprise (coordinating with S2).
- (h) Coordinates with the communication officer in the preparation of the signal communication plan to maintain communication between the commander, battalion or squadron headquarters, and subordinate units.
- (i) Prepares the operation order for the commander's approval. Material for inclusion in the order is obtained from other staff officers (S1, S2, S4, FSCOORD, and communi-

cation officer). Although the commander normally issues the operation order verbally, a complete order, often in pencil form only, should be written and filed for record. Frequently this done during lulls in combat after the action involved has been completed.

- (j) Transmits the commander's orders and instructions to organic, attached and supporting units.
- (k) Prepares for future operations, guided by information obtained from the commander and S2 and by knowledge of the present situation.
- (l) Prepares operational and after-action reports, and recommends training to correct combat deficiencies.

g. The Battalion or Squadron Logistics Officer (S4). The logistics officer (S4) is responsible to the commander for the formulation of logistical policy and for planning, coordinating, and supervising the logistical effort. The S4 is a logistical operator at battalion or squadron level. His duties are generally as described for the G4 in FM 101-5 and include—

- (1) Advising and keeping the commander informed on logistical matters.
- (2) Planning, coordinating, and supervising supply, maintenance, and evacuation.
- (3) Coordinating with the higher headquarters on logistical matters.
- (4) Assisting subordinate commanders with logistical matters.
- (5) Controlling the battalion or squadron combat trains.
- (6) Submitting logistical reports as directed.
- (7) Accomplishing area damage control planning.
- (8) Preparing paragraph 4 of the operation order.
- (9) Exercising staff supervision over receiving, storing, and issuing supplies.

h. The Battalion or Squadron CBR Officer. The armor battalion or armored cavalry squadron CBR officer is appointed by the battalion or squadron commander from his staff. His

principal assistant is the chemical NCO. He advises and assists the staff on chemical, biological, and nuclear defense matters. Duties of the CBR officer and the chemical NCO are—

- (1) To assist the S2 in the collection, processing, and dissemination of CBR intelligence information to include radiological survey control party duties (FM 3-12), use of the effective wind messages, fallout prediction messages, nuclear biological chemical reports as appropriate, CBR contamination messages, enemy CBR materiel, and the plotting of CBR contamination data.
- (2) To assist the S3 on chemical, biological, and nuclear defense plans and operations including preparation of CBR and nuclear defense annexes to the unit SOP, the training of unit CBR teams, determination of radiological time of entry, time of stay calculations, computation of the battalion radiation dose, preparation of the CBR portion of the master training schedule, the inspection of all CBR training, and the selection of individuals for CBR school training.
- (3) To assist the S4 in the issuance, maintenance, inspection, and repair of chemical materiel and equipment in the battalion or squadron.

i. The Battalion or Squadron Communication Officer. The armor battalion or armored cavalry squadron communication officer is both a special staff officer and the commander of the battalion or squadron communication platoon. His place of duty is the command post. His duties correspond to those of the signal officer as outlined in FM 101-5 and paragraph 66o. The communication officer's duties include—

- (1) Advising the battalion or squadron commander on all communication matters.
- (2) Supervising the communication training conducted in the battalion or squadron.
- (3) Supervising the communication activities of attached units.
- (4) Working under the staff supervision of the executive officer or S3 depend-

ing on the desires of the commander and coordinating with other staff officers as appropriate.

- (5) Keeping the commander and the S4 informed of the status of signal maintenance and evacuation.
- (6) Maintaining contact with subordinate elements and supporting signal elements to insure that signal maintenance supply activities are coordinated.
- (7) Procuring and maintaining repair parts and components.

j. The Battalion or Squadron Fire Support Coordinator (FSCOORD). The armor battalion or armored cavalry squadron fire support coordinator is normally an artillery liaison officer from the supporting artillery battalion. When an artillery liaison officer has not been provided, the commander normally designates the heavy mortar platoon leader or S3 air as FSCOORD. For duties of the FSCOORD, see paragraph 66k.

k. The Battalion or Squadron Headquarters Commandant. For duties of the tank battalion and armored cavalry squadron headquarters commandant, see paragraph 66l; however, those duties concerning prisoner of war, stragglers, and civilian internees are accomplished with battalion resources. Military police may assist in evacuation of prisoner of war or internees from battalion.

l. The Battalion or Squadron Liaison Officers. For duties of the tank battalion and armored cavalry squadron liaison officers, see paragraph 66m.

m. The Battalion or Squadron Maintenance Officer. The armor battalion or armored cavalry squadron maintenance officer is both a special staff officer and the commander of the battalion or squadron maintenance platoon. He works under the staff supervision of the executive officer or S4 depending on the desires of the commander. His duties include—

- (1) Supervising and coordinating the maintenance activities of the battalion or squadron, except medical or signal.
- (2) Keeping the commander and S4 informed of the status of maintenance

and evacuation of equipment, except signal and medical.

- (3) Recommending to the commander and coordinating with the S4 the composition and employment of maintenance elements.
- (4) Preparing a vehicle evacuation plan, based on the tactical situation and the plans of the commander, and coordinating this plan with the S4 to insure that it is in consonance with the overall logistical plan.
- (5) Efficient operation of the maintenance facilities of the unit to keep equipment in the most efficient operating condition.
- (6) Maintaining liaison with the subordinate elements of the units to insure that maintenance activities are coordinated.
- (7) Coordinating with higher maintenance category.
- (8) Supervising the recovery and evacuation of vehicles from the battlefield.
- (9) Supervising the tactical training of the maintenance platoon.
- (10) Supervising the technical training of all maintenance personnel, except communication and medical personnel, and monitoring training in vehicle operation and maintenance for drivers and crews of the battalion or squadron.
- (11) Procuring repair parts and maintenance supplies, except signal and medical.

n. The Battalion or Squadron Surgeon. The armor battalion or armored cavalry squadron surgeon is both a special staff officer and commander of the battalion or squadron medical platoon. His duties correspond to those outlined in FM 101-5 for the division surgeon and as outlined in FM 8-15. He works under the staff supervision of the S1. The surgeon duties include—

- (1) Advising the commander on all medical matters, including sanitation, first aid, and health of the command.
- (2) Keeping the commander and interest-

ed staff officers informed of the medical situation.

- (3) Recommending locations for the aid station, and controlling its operations.
- (4) Preparing a medical plan, based on the tactical situation and the plans of the commander, and coordinating this plan with the S4 to insure that it is in consonance with the overall logistical plan.
- (5) Planning for and supervising the provision of all medical services including acquisition of patients, treatment, and evacuation to supporting medical units as required.
- (6) Procuring medical supplies.
- (7) Supervising preparation of reports on and maintaining records of the sick and wounded.
- (8) Technical and tactical training of the medical platoon.

o. The Battalion or Squadron S3 Air. The armor battalion or armored cavalry squadron S3 air is the principal assistant of the S3 and performs duties assigned him by the S3. He assists in planning and relieves the S3 of some of his administrative workload by assembling data and preparing reports. He is prepared to assume duties of the S3 and act in his absence. He coordinates the employment of close air support with ground operations and has staff responsibility for coordinating the activities of the REDEYE teams. These two activities are coordinated with the FSCoord and the air liaison officer or forward air controller with the tactical air control party. For other duties of the S3 air, see paragraph 66g.

p. The Battalion or Squadron Support Platoon Leader. The armor battalion or armored cavalry squadron support platoon leader commands the battalion or squadron support platoon and functions as the assistant S4. His duties include—

- (1) Controlling the field trains.
- (2) Insuring that the organic cargo transportation is loaded with fuel and lubricants, ammunition, and rations in accordance with instructions from the S4.

- (3) Functioning as the ammunition officer.
- (4) Organizing the internal security of the field trains.
- (5) Training the support platoon.
- (6) Maintaining communication with the higher headquarters logistical control facility.
- (7) Coordinating employment and locations of the mess teams.

68. Command and Staff

a. General. The command and staff sequence presented in this section is included as a training vehicle for development training of the commander and his staff. Becoming thoroughly familiar with the steps in the command and staff sequence develops the ability to use abbreviated estimates discussed in appendix VII. In highly mobile, fast-moving situations, the sequence described in *b* below will be compressed or curtailed frequently due to time limitations. Trained and experienced commanders and staffs continually keep abreast of the situation and constantly make or revise estimates. The commander makes rapid decisions and, for the most part, issues oral and fragmentary orders. Once an operation begins, subordinate commanders will seldom be called to the rear to receive an order. The techniques of application of the command and staff sequence will vary with the personalities of the commander and staff, the time available, and the professional abilities of the commander and his staff.

b. Command and Staff Sequence.

- (1) Upon receipt of a mission from higher headquarters, the commander and his staff study the mission to insure that they thoroughly understand its implications regarding specified and implied missions and tasks. The commander assembles his staff and receives the latest information from their respective fields of activity. Based on this information, his knowledge of the situation (including a study of the map), knowledge of the next higher commander's future plans and intentions, and his professional experience and judgment, he formulates and disseminates his planning guidance. This guidance provides the necessary direction for concurrent planning by the staff and a framework for making studies and estimates. It should include an analysis of the mission, any special aspects of the situation, any courses of action the commander desires the staff to consider in their estimates, restrictions placed on the operation, and an indication as to allocations of means (combat power). Planning guidance from the commander is essential and eliminates needless exploratory work by the staff. The planning guidance may be brief or exceedingly detailed, depending upon the relations of the commander with his staff and the length of the time they have functioned as an entity.
- (2) The staff, having received the commander's planning guidance, begin their individual staff estimates. Formulation of the operation estimate requires certain detailed information from other staff officers. The S2 furnishes the S3 the results of his analysis of the weather, terrain, enemy situation, and enemy capabilities. The S1 and S4 furnish the S3 details pertaining to their respective fields. The S3 then determines the possible courses of action that will accomplish the mission and announces them to the other staff officers. The S2 evaluates his own estimate in the light of the courses of action to determine if additional detailed intelligence is required. The S1 and S4 evaluate their estimates, from their respective viewpoints, to determine what limitations exist as to their support and which course is favored. During the preparation or revision of staff estimates, planning for the employment of supporting fires, including nuclear weapons, is accomplished by the fire support coordinator.
- (3) Each unit staff officer completes his estimate, arriving at recommendations to be made to the commander. A meeting is then conducted during

which the S3 presents one or more courses of action and recommends priority. Each of the other staff officers comments in turn on significant aspects in his respective field and recommends the best course of action from his standpoint. The commander may question his staff to ascertain any additional information he requires to complete his own estimate (commander's estimate).

- (4) The commander completes his estimate and announces his decision. The decision is a statement of the general course of action that the unit will adopt to accomplish the mission. So that the staff may prepare detailed plans to execute the decision, the commander must elaborate upon the decision by issuing the concept. This concept is presented to the staff at the time of the announcement of his decision, in enough detail to permit preparation of orders. This concept in refined form becomes the basis for paragraph 3a of the operation order (app IX). For a discussion of what may be included in the commander's concept, see paragraph 44.
- (5) Based on the decision and the concept, the staff will complete their planning and prepare necessary orders. The S3 has primary staff responsibility for the preparation of the plan. Additional details for the operation are furnished the S3 by unit and special staff officers as a result of their planning. The plan will then be presented to the commander for his approval. After approval, the plan may be issued to subordinate units to facilitate their planning or it may be converted into an order and issued to subordinate units.
- (6) After the order is issued, the commander, assisted by his staff, supervises its execution. The staff coordinates with and assists the subordinate units where possible.
- (7) The executive officer supervises the staff through the entire planning sequence to insure that the proper coordination takes place between staff officers, and that the commander's desires are being followed. By keeping abreast of the situation, the executive officer is prepared to assume command if necessary.

CHAPTER 5

RECONNAISSANCE, SURVEILLANCE, AND SECURITY OPERATIONS

Section I. RECONNAISSANCE OPERATIONS

69. General

a. Reconnaissance is the directed effort in the field to collect information of the enemy and the area of operations by ground and air activities. This information is classified under the headings of enemy, terrain, weather, and enemy's resources.

b. The purpose of reconnaissance is to obtain combat information of the enemy and the area of operations for the production of combat intelligence. The combat intelligence produced is used by the commander in planning and conducting combat operations. Reconnaissance information and the resulting combat intelligence seek to reduce the unknown aspects of the enemy and the area of operations and contribute to the accuracy of evaluating risks involved and the successful application of combat power.

c. Reconnaissance and security complement each other and cannot be readily separated. Effective ground and air reconnaissance provides a certain amount of security, and a security force provides information of the enemy and the area of operations.

d. Reconnaissance is a continuing responsibility of each commander and each soldier. Unit training, SOP's, and the commander's instructions to subordinates must emphasize the importance of timely and accurate reports of both positive and negative information of the enemy and the area of operations. Reports should contain facts not opinions. Information is reported as it is obtained.

e. The use, or the threat of use, of nuclear weapons and chemical agents necessitates the employment of techniques to determine the ab-

sence of contamination or the degree of contamination in specific areas.

70. Reconnaissance Agencies

a. Ground reconnaissance agencies include personnel and units specifically organized, designed, or designated to perform reconnaissance. Armor units specifically designed for reconnaissance are the armored cavalry regiment, the divisional armored cavalry squadrons, and the scout platoon organic to each combat maneuver battalion. Armored cavalry regiments and divisional armored cavalry squadrons are equipped to conduct air and ground reconnaissance. Other units not organized and equipped essentially for conducting reconnaissance may be considered reconnaissance agencies when their missions involve the performance of reconnaissance to a considerable degree.

b. Army aviation units provide air observation, photography, and electronic surveillance and are excellent agencies to supplement ground reconnaissance efforts.

c. Air Force tactical air provides an air reconnaissance and photography capability.

d. FM 17-36 contains the detailed procedures and techniques for conducting reconnaissance missions.

71. Fundamentals of Reconnaissance Operations

Reconnaissance operations vary with the situation and conditions in the area and with the assigned missions, size, type, and composition of the reconnaissance units. Ground combat reconnaissance operations are performed in conformance with the following five fundamentals.

a. *Orient on the Location or Movement of the Intelligence Objectives.* Units performing reconnaissance must maneuver according to the location or movement of the intelligence objective rather than the location or movement of friendly forces. The objective may be enemy troops, a terrain feature, or a locality. To effectively perform the operation, commanders of units conducting reconnaissance must be allowed maximum freedom of action.

b. *Report all Information Accurately.* Reconnaissance is conducted to obtain information to be used in the production of combat intelligence. To be of value to the commander, this information must be received in time to be of use and must be accurate in answering the questions *what* (including how many), *when*, *where*, and *doing what*. All members of units conducting reconnaissance missions must report all positive or negative information rapidly and accurately to the next higher headquarters. When considered in conjunction with information from other sources, information that appears unimportant to one level of command may be extremely valuable to the next higher commander. The development and use of brief reconnaissance spot report forms (app V) will facilitate the rapid transmission of essential information. A unit performing reconnaissance has not fully accomplished its mission until it has reported all information gathered to the next higher headquarters.

c. *Avoid Decisive Engagement.* Units performing reconnaissance obtain information by stealth whenever possible, but fight when necessary to gain the desired information. The reconnaissance mission must not be jeopardized by combat with the enemy when combat is not essential to obtain the information desired.

d. *Maintain Contact with the Enemy.* In the performance of a reconnaissance mission to obtain information of an enemy force, contact with the enemy is gained as soon as possible. Once contact has been made, it is maintained and is not voluntarily broken without authority from higher headquarters. Contact can be maintained by ground or air observation.

e. *Develop the Situation.* When contact with the enemy is made, or an obstacle is encountered, the situation must be developed quickly and a decision made regarding subsequent

operations. In the case of enemy contact, the following actions, known as Actions on Contact, are taken:

- (1) *Deploy and report.* Units move immediately to positions from which they can fire, observe, or be employed against the enemy. The commander immediately reports the enemy contact to higher headquarters in as much detail as is available.
- (2) *Reconnoiter.* The enemy's location, strength, composition, and disposition are determined, with a special effort being made to determine the flanks of his position. When terrain permits, the enemy position is reconnoitered by mounted elements. Reconnaissance by fire may be employed when time is critical. If terrain restricts vehicular movement, the enemy position is reconnoitered with dismounted patrols. Patrols, whether mounted or dismounted, are supported by other elements of the unit.
- (3) *Choose a course of action.* After reconnoitering the enemy position to gain as much information as he can, the commander must choose a course of action appropriate to the immediate situation as well as to the accomplishment of the assigned mission. A decision to attack, bypass, or contain the enemy must be made as quickly as the reconnaissance will permit.
- (4) *Report.* The commander then reports to his higher headquarters. This report includes the additional enemy information gained by the reconnaissance and the decision as to what course of action the commander plans to follow.

72. Types of Reconnaissance Missions

There are three types of reconnaissance missions: route, zone, and area. The type to be employed is determined after considering the information desired, where the information is to be sought, the known enemy situation, terrain, size of the reconnaissance force, and the time available for obtaining the information. FM

17-36 contains detailed procedures and techniques for conducting reconnaissance operations.

73. Route Reconnaissance

a. Route reconnaissance is the directed effort to obtain information of the route, obstacles, and enemy along a specific route, and the terrain adjacent to the route, which, if occupied by the enemy, would affect movement along the route.

b. Route reconnaissance may be assigned to obtain information of a specific route (see FM 5-36 for discussion and report format) or of an enemy force moving generally along a specific route. When intelligence indicates that the enemy is moving on one or more routes, or when terrain features canalize his advance, these routes may be reconnoitered to obtain enemy information. Routes of advance of friendly forces may be reconnoitered when specific information of a route or series of routes is required.

c. The technique employed and the requirements of a route reconnaissance are less time consuming and can normally be performed more rapidly than zone or area reconnaissance.

74. Zone Reconnaissance

a. Zone reconnaissance is the directed effort to obtain detailed information of all routes, terrain, and enemy forces in a zone defined by boundaries. Zone reconnaissance is more thorough and time consuming than other reconnaissance missions.

b. When the enemy's location is in doubt, or when it is desired to locate suitable routes or determine cross-country trafficability in a zone, a zone reconnaissance may be directed. The width of the zone assigned to subordinate units is determined by the pattern of the road net, terrain features, type of information desired, anticipated enemy action, troops available, weather, visibility, and time available to accomplish the mission.

75. Area Reconnaissance

a. Area reconnaissance is the directed effort to obtain detailed information of all routes, terrain, and enemy forces within a clearly defined area.

b. Area reconnaissance is performed to gain information of a definite locality such as towns, woods, or crossing sites over a river. The area may be reconnoitered for possible enemy or to determine its suitability as an assembly area or for other uses by friendly forces. The area to be reconnoitered must be clearly delineated. The unit assigned the mission moves directly to the area and conducts the reconnaissance employing the same techniques as a zone reconnaissance.

76. Reconnaissance by Fire

a. Reconnaissance by fire is accomplished by firing on likely or suspected enemy positions in an attempt to cause the enemy to disclose his presence by movement or firing. During reconnaissance by fire, positions being reconnoitered must be observed continuously, so that any enemy movement or return fire will be definitely located.

b. Reconnaissance by fire is used when time is critical. It is made at the risk of losing surprise, but it tends to lessen the probability of moving into a well-concealed enemy position without being aware of its presence.

c. If the enemy returns the fire, the unit proceeds to develop the situation. If the fire is not returned, the unit continues on its mission. However, caution should be exercised, because reconnaissance by fire may fail to draw the fire of seasoned enemy troops.

77. Reconnaissance of a Town, Obstacle, or Enemy Position

a. In reconnoitering a town, obstacle, or enemy position, it should be approached from the flanks or rear if possible. If time is available, the reconnaissance is made dismounted; however, if time is short, the unit remains mounted. In either case, detailed observation should precede the actual reconnaissance and reconnaissance by fire made depending on the tactical situation.

b. When time is available, dismounted patrols move forward, covered by the remaining elements of the unit. The number of patrols depends upon the size of the objective and upon available approaches, cover, and concealment. If the patrols find that the near edge of the area is clear, the remainder of the unit moves

forward. The dismounted patrols then continue the reconnaissance, overwatched and followed closely by the rest of the unit.

c. In conducting a mounted reconnaissance, part of the unit moves forward rapidly, overwatched by the remaining elements. If the near edge of the area is clear, the overwatching elements move forward and the advance continues. Vehicles move through a town by bounds in staggered formation, covering the buildings on the opposite side of the street by observation and fire. It is desirable for dismounted troops to precede the vehicles.

78. Reconnaissance of a Bridge or Defile

Visual reconnaissance is made for enemy positions that dominate the bridge or defile before leading elements of the unit cross the bridge or enter the defile. When mines, boobytraps, or ambushes are suspected, patrols, accompanied by supporting engineers, reconnoiter the approaches of the bridge or defile. Reconnaissance of a bridge includes checking underneath as well as on top for mines, boobytraps, demolition charges, or weakened construction. Any demolitions located should be removed or neutralized. The class of a bridge should be determined and a sign placed on the bridge to indicate the class to troops using it later.

79. Reconnaissance at Night

Reconnaissance operations are slower and less effective at night. Night reconnaissance is limited usually to dismounted patrolling, observation of routes, and the use of listening posts. Ground radar is used in coordination with observation and listening posts. Only against light enemy resistance and with favorable terrain and routes of advance can vehicular reconnaissance be used without being preceded by dismounted patrols. Cross-country movement is more difficult. Engines and tracked vehicle movements can be heard for considerable distances. Observation is limited, making vehicles highly susceptible to ambush. For further discussion of night reconnaissance, see FM 17-36.

80. Reconnaissance in Force

a. A reconnaissance in force differs from a route, zone, or area reconnaissance in that it is

a limited-objective offensive operation by a considerable force to discover and test the enemy's dispositions and strengths, or to develop other intelligence. Although its primary aim is reconnaissance, it may discover weaknesses in the enemy dispositions which, if exploited promptly, may enhance tactical success.

b. The reconnaissance in force normally develops information more rapidly and in more detail than other reconnaissance methods.

c. For a detailed discussion, see chapter 6.

81. Reconnaissance by Aircraft

a. Army aircraft extend, supplement, or, in some instances replace ground reconnaissance means. Commanders not having organic aircraft should request them to support their reconnaissance efforts.

b. Army aircraft are normally employed in conjunction with, and in close support of, ground reconnaissance forces. Aircraft are used to extend the reconnaissance effort by air observation, air photography, and electronic surveillance.

c. Army aircraft may be used to conduct radiological surveys and to locate routes through or around contaminated areas.

82. Reconnaissance Frontages

There is no established frontage for a given size of force conducting a reconnaissance mission. The visibility, terrain, road net, enemy situation, nature of the information sought, and time available are factors that influence reconnaissance frontages that are assigned to a unit. If detailed rather than general information is desired, the operation will be more time-consuming; therefore, the frontage should be narrower than that for general information. Wider frontages may be assigned when aircraft or air cavalry units are available.

83. Coordination and Control During Reconnaissance Operations

a. Reconnaissance must be coordinated at all levels of command. This will insure maximum results from the intelligence effort, prevent duplication of effort, and provide for economical use of reconnaissance forces. Coordination is accomplished primarily by assigning a specific mission to each unit conducting the reconnaissance.

b. The commander conducting the reconnaissance uses radio as the primary means of control. Phase lines, checkpoints, contact points, boundaries, routes, objectives, and time limitations are used by the commander in controlling his unit. Liaison personnel, staff officers, messengers, and aircraft are used to assist in the rapid transmission of reconnaissance instructions and reports.

84. Reconnaissance Instructions

Reconnaissance instructions must be complete and include exactly what combat information is to be obtained, the time by which the information must be reported, where the infor-

mation is to be sought, and when the mission is to be executed. Essential details may include—

- a. Pertinent information of the enemy and friendly troops.
- b. Plans of the higher commander.
- c. Specific information desired.
- d. Zone, area, or route to be reconnoitered.
- e. When, where, and how information is to be reported to the higher commander.
- f. Time of departure.
- g. Appropriate control measures.
- h. Action to be taken when mission is completed.

Section II. SURVEILLANCE OPERATIONS

85. General

a. Battlefield surveillance involves the systematic and continuous observation of selected areas, routes, or static locations such as crossroads, bridges, aircraft landing areas, or other specific type installations. Factors influencing surveillance are visibility, terrain, natural or manmade concealment, enemy air defense capabilities (aerial surveillance), and types of surveillance equipment. Units performing surveillance missions provide commanders with current information by keeping a systematic watch over the assigned surveillance area for the purpose of detecting, locating, identifying, and reporting information of military value.

b. Although surveillance as part of unit security is conducted in each combat operation by all combat units, surveillance as discussed in this section is an assigned mission to be conducted by an armor unit.

86. Types of Surveillance

a. *Visual.* Visual surveillance is accomplished by air cavalry or ground armor units. Reports of an immediate nature are relayed by radio through intelligence or command channels, depending on the channel established by the surveillance mission order.

b. *Electronic.* Electronic surveillance is performed through the use of ground and airborne radar and infrared equipment. Information secured by use of ground mounted radar and infrared equipment is reported in the same man-

ner as that used for reporting information gained visually. Aircraft equipped with infrared and radar provide a simultaneous transmission of imagery data from the aircraft to a ground station (data link) where the imagery is recorded for processing and subsequent evaluation. The data link equipment normally is located near the force headquarters to facilitate the immediate passage of information (FM 30-20).

c. *Photographic.* Photo coverage by armor units performing a surveillance mission usually is limited to hand-held or special mounted cameras operated from organic aircraft. Other type aerial photo coverage is provided by Army aviation or Air Force units.

87. Surveillance Agencies

a. Armor units capable of performing surveillance missions are the armored cavalry regiment, the divisional armored cavalry squadron, and the reconnaissance or scout platoon organic to each combat maneuver battalion. Armored cavalry regiments and divisional cavalry squadrons are capable of performing both air and ground surveillance. Tank units may perform surveillance missions; however, it is not considered an appropriate mission since the firepower of these units can be better utilized in other combat missions.

b. Army aviation units provide air observation, photography, and electronic surveillance. They are excellent units to supplement the

ground and air surveillance efforts of armor units.

c. Tactical Air Force units may provide air reconnaissance and surveillance support to assist armor units performing surveillance missions.

88. Surveillance Operations

When planning surveillance operations, the factors of METT will govern the organization and disposition of forces. Since surveillance usually consists of systematic and continuous observation of large areas, long routes, or several specific locations, armor units normally commit the bulk of their forces to performing observation while retaining a small reserve to assist elements that may be attacked by enemy forces. Ground armored units performing a surveillance mission will usually operate in rear areas, areas adjacent to the FEBA, or provide dismounted elements which will be airlifted into areas forward of the FEBA. Surveillance missions are conducted in a manner similar to that of a screening force or a rear area security operation. Observation posts, lis-

tening posts, and patrols are established to provide continuous and systematic observation. A surveillance force is not usually capable of offering strong resistance to the enemy; however, it must be capable of protecting itself. Air cavalry units are integrated into and extend the surveillance capabilities of ground units. When air cavalry units are performing surveillance missions forward of the FEBA, commanders must give careful consideration to enemy antiaircraft capabilities, due to the continuous operation of the aircraft in enemy territory.

89. Night Surveillance

Surveillance by armor units normally is less effective at night. Observation is limited to the range of organic radar and infrared equipment. Use of patrols and listening posts is increased. Air cavalry is limited to photography unless other night vision equipment is mounted on the aircraft. Support from Army aviation or Air Force units whose aircraft mount infrared and radar equipment is usually required.

Section III. SECURITY OPERATIONS

90. General

a. Security includes all measures taken by a command to protect itself from espionage, observation, sabotage, annoyance, or surprise. Its purpose is to preserve secrecy and to gain and maintain freedom of action.

b. Security is achieved by effectively providing for the detection of a threat; for sufficient time and maneuver space to react to the threat; and for the avoidance, neutralization, or destruction of the threat. Security is improved by timely and accurate intelligence and rapid, aggressive movement. All units are responsible for their own security, regardless of the security provided by other units. A security force for a larger formation must be strong enough, and properly located, to provide adequate time for the force being secured to react. Within their capabilities, security forces will engage the enemy as necessary to accomplish their mission. However, security measures must not unnecessarily divert forces or effort

from the accomplishment of the mission of the force being secured.

c. FM 17-36 contains the detailed procedures and techniques for conducting security operations.

91. Security Against Ground Action

Ground threats to the security of a command include reconnaissance, fire, attack by ground forces, infiltration, guerrilla forces, partisans, and airmobile and airborne forces. Security forces must use terrain and obstacles to augment their security efforts. Security against ground attack is provided by air and ground reconnaissance; covering, guard, and screening force; and local security elements. Covering, guard, and screening missions may be performed to the front, flank, or rear of a friendly force. Size and composition of security forces are dependent upon the factors of METT. Against a highly mobile enemy, strong in armor, security forces must possess equal or greater mobility and have adequate antitank

capabilities. In any case, security forces must be afforded the capability of effective operations under the same conditions as the enemy force that poses the threat.

92. Fundamentals of Security Operations

Although the fundamentals of security are closely related, the provision of timely and accurate warning and space for maneuver is paramount. The actions of security forces should be guided by the practical application of these fundamentals through the effective use of available resources.

a. Provide Timely and Accurate Warning. The security force must provide the commander of the force being secured early warning of the location and movement of enemy forces that constitute a threat to his mission. Only by timely warning and accurate information can the commander of the force being secured choose the forces, time, and place to engage the enemy, and maneuver his forces to gain tactical surprise and advantage.

b. Provide Space for Maneuver. Security forces operate far enough from the force being secured to insure that this force has enough time and space to maneuver to meet or avoid the enemy threat. The distance between a security force and the force being secured varies according to the factors of METT.

c. Orient on the Location or Movement of the Force Being Secured. A security force maneuvers according to the location and movement of the force being secured, and positions itself between the friendly force and the known or suspected enemy threat.

d. Perform Continuous Reconnaissance. All security forces must perform continuous and aggressive reconnaissance. The reconnaissance provides the security force commander with information of enemy forces in his area of responsibility and enables him to properly position the security force in relation to the force being secured and the enemy threat. Reconnaissance provides security from surprise by keeping the commander of the force being secured informed of enemy locations and movements, and by maintaining contact with enemy forces that constitute a threat.

e. Maintain Enemy Contact. Once contact with the enemy has been gained, it must be

maintained until the enemy ceases to be a threat to the force being secured or moves out of the assigned area of responsibility. For discussion for actions on contact, see paragraph 71. Contact is not voluntarily broken unless ordered by higher headquarters. Enemy forces must not be permitted to surprise the force being secured. If the enemy force moves out of the area of responsibility, action must be taken to inform the adjacent unit and to assist in establishing contact with the enemy force.

93. Frontages in Security Operations

The extent of the frontage assigned in security operations depends on several factors, including the degree of security desired, the length of time the security is required, the enemy capabilities, the terrain (with emphasis on avenues of enemy approach), and the weather. Wider frontages may be assigned when aircraft or air cavalry units are available.

94. Degrees of Security

a. Cover. To cover is to operate as a force apart from the main force and oriented in the direction of the enemy for the purpose of intercepting, engaging, delaying, disorganizing, and deceiving the enemy before he can attack the force being covered.

b. Protect. To protect is to operate to the flank, front, or rear of a larger moving or stationary force in a manner that precludes enemy ground observation, direct fire, and surprise attack. This is done by defeating, destroying, or delaying the enemy within the protecting force's capabilities.

c. Screen. To screen is to maintain surveillance to the front, flank, or rear of a moving or stationary force, and to provide early warning to this force by observing, reporting, and maintaining contact with enemy forces encountered. The screening force will, within its capability, impede and harass the enemy by organic and supporting fires and destroy or repel enemy patrols.

95. Security Forces

A security force may be a covering force, guard force, screening force, or a rear area security force, according to the degree of security required and to its location in relation to the force being secured (fig. 3). It may engage in

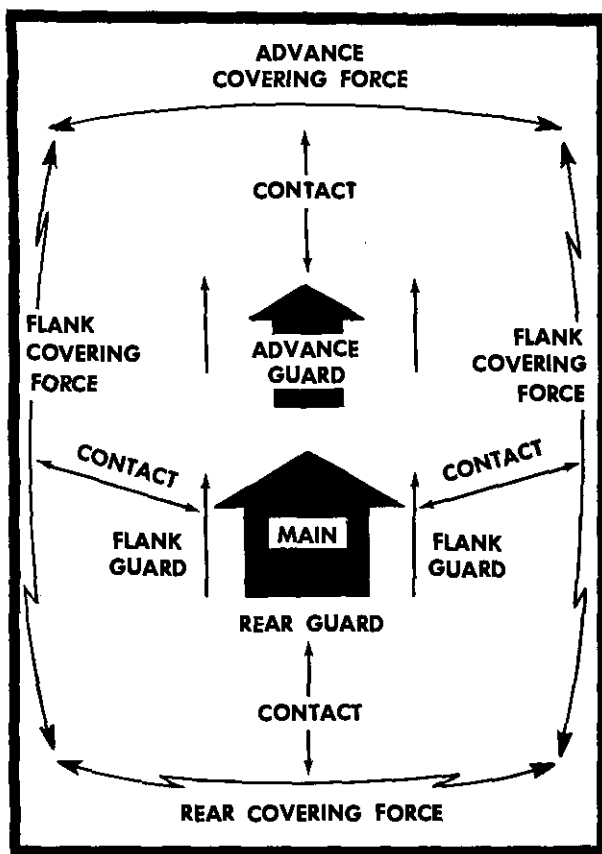

Figure 3. Relationship of advance, flank, and rear guards to covering forces.

offensive, defensive, or delaying actions as required to accomplish the mission.

96. Covering Force

A covering force is a tactically self-contained security force that operates at a considerable distance to the front, flank, or rear of a moving or stationary force. Its mission is to develop the situation early, defeat hostile forces if possible, and to deceive, delay, and disorganize enemy forces until the main force can cope with the situation. This mission is not normally assigned to a unit smaller than a battalion task force or reinforced armored cavalry squadron. A covering force engages in any action necessary for the success of its mission and may be employed when the main force is engaged in offensive, defensive, or retrograde actions. The commander of the force being covered specifies the area to be protected. The covering force must not become engaged decisively,

bypassed, or enveloped. The covering force should be completely mobile, tank heavy, and reinforced with infantry, artillery, engineers, aircraft, and air cavalry as required. These forces should be placed under one commander who operates under the direct control of the commander of the forces being covered.

97. Advance Covering Force—Offense

An advance covering force mission for a force engaged in offensive operations is conducted employing techniques that are similar to those used in a route or zone reconnaissance operation. The covering force advances with companies or troops abreast to insure complete coverage of the area and to find enemy forces. Enough forces should be retained in reserve to influence local actions. The reserve is located to permit immediate employment to assist in the accomplishment of the mission. When contact with the enemy is made, the advance covering force attacks and destroys or disperses the enemy. An enemy force may be bypassed if authority to do so has been stated in the unit's mission or on order of the next higher commander.

98. Advance Covering Force—Defense

A covering force may be employed by a larger unit conducting a defensive or retrograde operation. The distance which the covering force operates forward of the FEBA is normally prescribed by the commander of the force being covered. The covering force sector is divided into company or troop sectors, and these units occupy blocking positions within their assigned sectors. Observation posts and mobile patrols are established forward of the blocking positions. The blocking positions are located on key terrain that dominates likely avenues of enemy approach. Normally, a company or troop size reserve should be retained. Tanks, infantry, artillery, engineers, and air cavalry should be attached to the covering force. When forced to displace, the covering force conducts a delaying action to the FEBA, avoiding decisive engagement with the enemy. Every effort must be made to deceive the enemy as to the true location of the friendly dispositions and the FEBA.

99. Flank Covering Force

A flank covering force employs techniques similar to those of a flank guard except that the covering force operates at a greater distance from the force being covered. It is beyond the flank guard of the force being covered and is usually out of range of fire support of the force being covered.

100. Rear Covering Force

A rear covering force may be designated by a higher commander to cover a withdrawal or a retirement. When employed in this manner, the covering force uses the friendly front line, or a position near it, as its initial position. The techniques used in performing this mission are the same as those described for the Advance Covering Force—Defense in paragraph 98.

101. Guard Force

A guard force is a security force that operates to the front, flank, or rear of a moving or stationary force to protect that force from enemy ground observation, direct fire, and surprise attack. It defeats, destroys, or delays enemy threats within its capabilities. A guard force is normally composed of units assigned or attached to the force being protected.

102. Advance Guard

a. An advance guard is a security force, primarily offensive in nature, that operates to the front of a moving force to insure its uninterrupted advance and to protect it from surprise attack by defeating, destroying, or delaying the enemy. The advance guard may protect the deployment of the protected force if it is committed to action and may facilitate the advance by removing obstacles, repairing roads and bridges, or locating bypasses.

b. The advance guard moves as fast as the situation will allow but should remain within supporting distance from the protected force. It performs continuous reconnaissance to the front and flanks and pushes back or destroys small enemy groups before they can hinder the advance of the protected force. When the advance guard encounters large enemy forces or heavily defended areas, it takes prompt and aggressive action to develop the situation and, within its capability, employs offensive action

to defeat the enemy. It employs every means available to determine the location, strength, disposition, and composition of the enemy. It may then be required to join in the attack of the protected force. The advance guard must be far enough in front of the protected force to insure that the commander of the protected force has freedom of action in the employment of his forces. However, it must not be so far in front that it can be destroyed by enemy attack before assistance can reach it. The protected force commander usually specifies how far in front of his force the advance guard is to operate. Distances are reduced at night, in close terrain, and under conditions of low visibility.

c. The advance guard normally advances in column until contact is made. It may move continuously or by bounds. It moves by bounds when contact with the enemy is imminent and the terrain is favorable. For additional information, see FM 17-36.

103. Flank Guard

a. General.

- (1) A flank guard is a security force that operates to the flank of a moving or stationary force to protect it from enemy ground observation, direct fire, and surprise attack by defeating, destroying, or delaying the enemy within its capabilities. It may employ offensive, defensive, or delaying action as necessary to accomplish the mission. During offensive or retrograde operations, the flank guard is mobile when the force being secured is moving. This is known as a mobile flank guard. When the force being secured is conducting defensive operations, the flank guard is normally stationary but is prepared to conduct a mobile flank guard action should the need arise.
- (2) The protected force commander specifies the units to be protected or the zone of responsibility. Normally, the flank guard responsibility begins at the rear of the leading battalion (TF) and ends at the rear of the other combat elements of the protected force (exclusive of the rear

guard), unless otherwise specified. The route of advance generally parallels the axis of the protected force and provides rapid access to pre-planned blocking positions on key terrain dominating likely avenues of enemy approach into the flank of the protected force.

b. Flank Guard Methods of Movement.

There are three basic methods of movement that are employed by the mobile flank guard—alternate bounds, successive bounds, and continuous marching. The method selected depends upon the rate of advance of the protected force and the enemy situation.

- (1) *Alternate bounds.* This method may be used when the protected force is advancing slowly and strong enemy action is anticipated against the flank guard. In this method of movement, designated elements of the flank guard occupy blocking positions while other elements leapfrog forward to occupy new blocking positions as required by the movement of the protected force. This method of movement is the most secure but is the slowest.
- (2) *Successive bounds.* This method is used when the movement of the protected force is characterized by frequent short halts, and enemy action against the flank guard is light. Each subordinate unit occupies designated blocking positions. When forward movement resumes, subordinate units move simultaneously, retaining their relative position in the flank guard formation as they move forward to occupy new blocking positions.
- (3) *Continuous marching.* This method is used when the protected force is advancing rapidly at a constant rate and there is no enemy action on the flank. The flank guard uses a column formation and moves without halting, adjusting its rate of advance to the movement of the protected force. Air and ground elements reconnoiter to the flank as the remainder of the unit moves along the route of advance.

c. Flank Guard Planning and Conduct

- (1) The commander plans a flank guard mission in the following sequence (fig. 4):

- (a) Initially he makes a map reconnaissance of the area of operations and selects the most likely avenues of enemy approach from the flank. He selects a series of blocking positions on the flank that generally parallel the axis of advance of the force being protected. These blocking positions should be located on defensible terrain that dominate likely avenues of enemy approach. The blocking positions should be far enough from the flank of the force being protected to give it timely warning of enemy approach and to provide it with sufficient time and maneuver space to react to an enemy threat. The blocking positions should be located in such a manner as to deny the enemy ground observation and direct fire on the protected force. These positions should be within the supporting range of the artillery of the protected force. If the flank guard force encounters a superior enemy force, the positions should be far enough to provide sufficient terrain for the conduct of a delaying action toward the force being protected. However, the distance between the axis of advance or flank of the force being protected and the line of blocking positions should not be so great that one armored cavalry troop or company team cannot secure this frontage.
- (b) The flank guard commander selects the route of advance unless it has been prescribed by higher headquarters. The route of advance should be far enough from the axis of advance of the force being protected to prevent the flank guard from interfering with the maneuver of the protected force. The route should permit rapid access to the line of blocking positions.

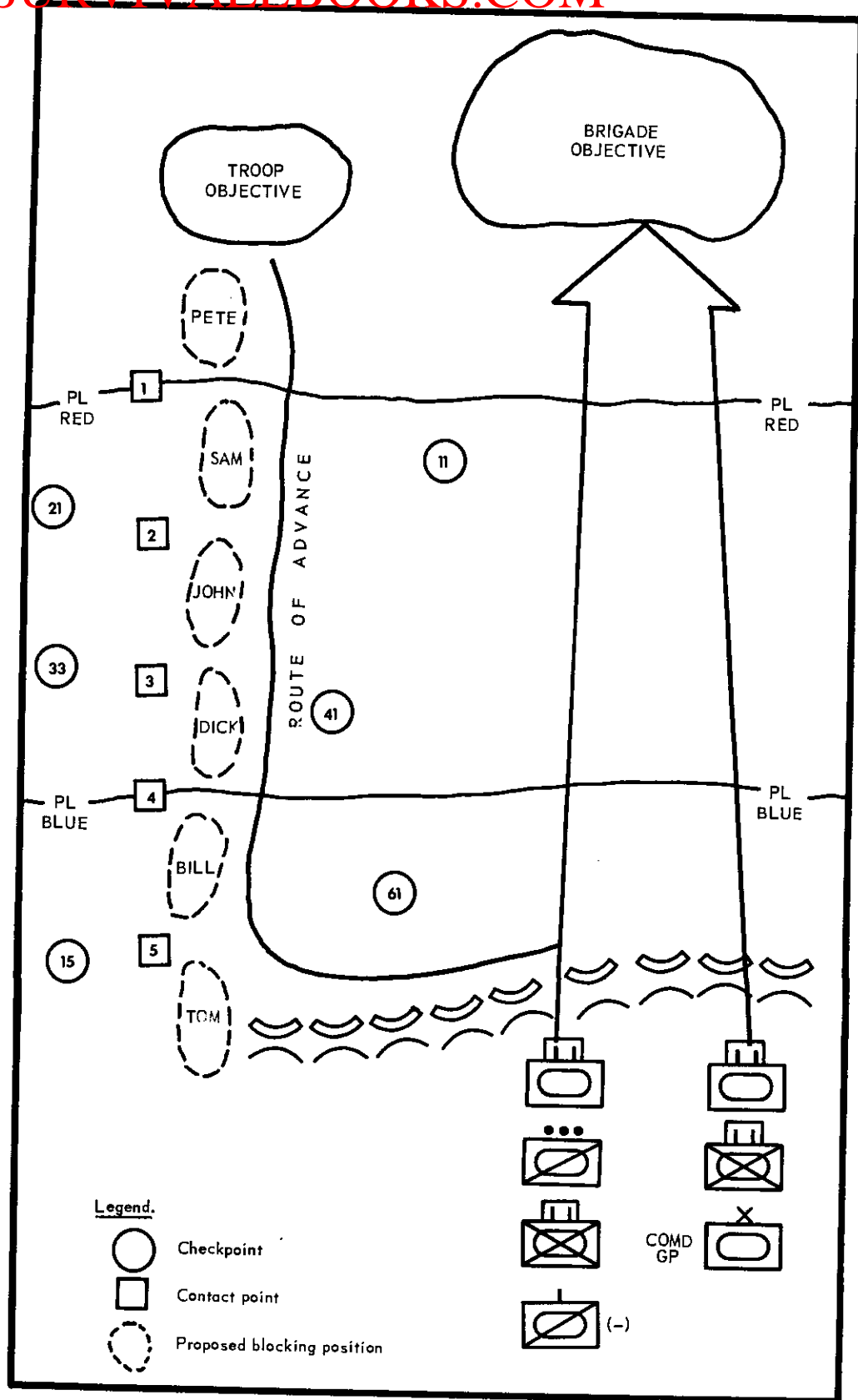

Figure 4. Planning for a flank guard operation.

- (c) The flank guard commander next develops a scheme of maneuver that will enable him to seize and hold selected blocking positions and secure the area between the axis of advance of the leading task force of the protected force and the route or axis of advance of the flank guard force. The scheme of maneuver provides for seizing the blocking positions either by individual units or by the entire flank guard force.
 - (d) Contact points are selected between blocking positions to delineate the area of responsibility for the unit holding each position. Contact points should be easily identifiable on the ground, located forward of the line of blocking positions, and centered between blocking positions. When a unit is ordered to occupy a blocking position, it is responsible for the area between the contact points on each flank. The unit is required to make physical contact with adjacent units at the contact points.
 - (e) The commander selects a formation that will permit rapid employment against an enemy threat. The formation must be flexible to meet any change in the situation. The column formation provides the best control and flexibility. The flank guard force provides its own security. Aircraft or air cavalry elements may be used to secure the flank guard force and extend reconnaissance.
- (2) During a mobile flank guard operation, the lead unit of the flank guard force acts as the advance guard. It secures the area between the force being secured and the flank guard route of advance and maintains contact with the rear of the leading battalion or task force of the force being protected. It may be necessary to reinforce the leading unit to enable it to accomplish its threefold mission. The remainder of the flank guard moves

in column, prepared to secure blocking positions on order. The decision to occupy these positions will depend on the speed with which the protected force is advancing and the enemy situation on the exposed flank. The method of movement selected depends on the rate of advance of the force being protected and the enemy situation. If the flank guard becomes overextended, the flank guard commander should ask for permission to screen the area (observing and reporting) or to be relieved of responsibility for the rear part of the area. This request will be in the form of a recommendation to the protected force commander.

d. Flank Guard for an Attacking Force.

- (1) The area of responsibility of a flank guard for an enveloping or exploiting force of larger than battalion size normally starts at the rear of the leading battalion task force and extends to the rear of the last combat element of the protected force. The responsibility of a flank guard for a battalion task force normally begins at the rear of the leading company team and ends at the rear of the combat elements of the battalion task force.
- (2) There are special considerations in planning for the use of the flank guard in a penetration or when conducting a passage of lines. These considerations are the relatively narrow front on which a penetration is normally conducted and the limited maneuver room associated with a passage of lines. In the performance of a flank guard mission under these conditions—
 - (a) The blocking positions normally are selected by the protected force commander.
 - (b) Initially, when a penetration is made through friendly frontlines, a division or brigade flank guard's

area of responsibility starts at the shoulder of the penetration (which is held by friendly forces) and extends forward to the rear of the leading battalion task force or company team of the protected force. When the last combat element of the protected force moves through the gap, the flank guard's area of responsibility is normally changed to that of an enveloping or exploiting force as discussed in (1) above.

- (c) The movement through the gap of the penetration by the force conducting the penetration and the flank guard unit must be closely coordinated. The leading element of the flank guard normally follows the leading major command of the protected force through the gap until the situation permits its movement to the flank. The lead flank guard unit acts as the advance guard for the main flank guard force and secures the area between the rear of the leading battalion task force and the flank guard route of advance. When the remainder of the flank guard unit moves through the gap, it moves to the flank and is prepared to seize and occupy blocking positions or to meet a counterattack by the enemy. The initial phase of the operation will usually be slow-moving; therefore, the flank guard normally employs the alternate bound method of movement. When the flank guard is attacked by a superior enemy force, it conducts a delay action, providing time and space for the protected force to react to the enemy threat.

e. Flank Guard for a Defensive Force. The flank guard for a defensive force occupies a series of blocking positions on the flank. The blocking positions are located on key terrain features that dominate likely avenues of enemy approach into the sector. The flank guard normally is given a sector of responsibility which is tied in to specific terrain features. In the accomplishment of the mission, the flank guard

employs defensive or delaying tactics. If forced from its positions, it conducts a delaying action, providing time and space for the commander conducting the defense to react to the threat.

f. Flank Guard for a Retrograde Movement. The operations of a flank guard for a unit performing a retrograde movement are similar to those of a flank guard for an advancing force. The major difference is that the area of responsibility for the flank guard must be specified by the protected force commander.

104. Rear Guard

a. A rear guard is a security force that operates to the rear of an advancing or withdrawing force to protect it from enemy surprise attack or annoyance by defeating, destroying, or delaying the enemy within its capabilities. The rear guard follows the protected force at a distance prescribed by the protected force commander and usually moves over the same route or routes. It is prepared to intercept and engage enemy forces that attempt to attack the rear of the protected force. If attacked by superior forces, the rear guard conducts a delaying action. It must not permit itself to be bypassed or driven into the protected force until the protected force can react to the threat.

b. When planning a rear guard operation, the commander considers the following:

- (1) *Terrain.* The commander analyzes the terrain in the area of operations and selects a series of delaying positions along the prescribed route of advance or withdrawal. With respect to terrain, the ideal procedure is for the rear guard to withdraw over routes used by the forces being protected.
- (2) *Organization of the rear guard.* The commander must determine the size force to be employed on the initial delaying position. If the situation permits, he may position subordinate units in depth. He assigns a route or routes of withdrawal and designates measures to insure effective control, which may include delay lines, delay positions, phase lines, checkpoints,

contact points, coordinating points, and routes of withdrawal.

- (3) *Security.* The commander plans for flank security and reconnaissance to the front and flanks of occupied delaying positions. The enemy must not be permitted to bypass the rear guard and attack the rear of the force being protected. One or more subordinate units may be assigned to reconnoiter an area to the front or flanks of a position. Normally, however, rear guard units are assigned the additional mission of protecting the flanks and extending reconnaissance forward of the delaying position. Aircraft and air cavalry improve control and communication and extend observation to the front and flanks. The organic ground radar sets may be used to augment security to the front or flanks. Air cavalry elements may be employed to maintain contact with the protected force and to prevent the enemy from bypassing the rear guard and attacking the rear of the force being protected. Air cavalry elements may establish an air screen to the front and flanks of the rear guard to warn of enemy approach.
- (4) *Supporting elements.* The rear guard commander, in coordination with the artillery representative, develops the plan of fire support for the operation. The plan of fire support includes planned artillery fires (nuclear and nonnuclear), tactical air, and the fires of organic weapons. Frequently, engineers are attached to or placed in support of the rear guard. The rear guard commander, together with the engineer unit commander, plans to construct obstacles to delay the enemy.
- (5) *Coordination with the force being protected.* Liaison must be maintained with the force being protected to regulate withdrawal of the rear guard. The rear guard commander must be thoroughly familiar with the plan of the force being protected.

Communication between the protected force commander and the rear guard commander must be continuous so that both commanders are informed of any situations that affect the withdrawal of the rear guard.

c. The rear guard follows the force being protected, occupying successive delay positions at a prescribed time interval or distance. When contact with the enemy has been made or is imminent, the rear guard occupies each delaying position until the protected force has cleared the next delaying position. If the protected force is moving rapidly and no contact is made with the enemy, the rear guard may move at a given rate behind the force being protected, regulating its speed to maintain the prescribed interval.

d. The rear guard engages enemy forces that threaten the rear of the force being protected. It fights to insure that the enemy does not impede the movement of the protected force. The rear guard fights a delaying action, trading space for time until the protected force has moved beyond the range of effective enemy action. When contact with the enemy has been made, it is maintained until the enemy is no longer a threat to the force being protected or has moved out of the area of responsibility.

105. Screening Force

a. A screening force provides early warning by surveillance over an extended frontage to the front, flank, or rear of a moving or stationary force. The missions of the screening force are to—

- (1) Provide timely warning of enemy approach.
- (2) Gain and maintain visual contact with, and report the movement of enemy forces.
- (3) Destroy or repel enemy patrols.
- (4) Impede the advance of enemy forces by employing long range organic and supporting fires.

b. A screening mission is assigned when economy of force requires that an extended area must be kept under surveillance and there are few troops available to perform the mission. The mission is accomplished by manning a series of observation posts that cover

avenues of enemy approach into the sector. Foot, motor, and air patrols reconnoiter those areas that cannot be observed from the observation posts.

c. The commander of the force being screened designates the general trace of the screen, the unit to be screened, and the responsibility for the area between the screening force and the screened units. In determining the units to be screened the commander considers the factors of METT and the capability of the screening force to—

- (1) Maintain contact with the screened force.
- (2) Reach and man the line of screening positions (OP's).

d. In planning a screening force operation, the screening force commander selects the general location for establishing a series of OP's and designates contact points between and forward of the line of OP's. When selecting the location of OP's, the following should be considered:

- (1) Overlapping fields of observation with other OP's.
- (2) Concealment of OP's and access routes.
- (3) Ease of installation.
- (4) Maintenance of communication.
- (5) Avoidance of landmarks.

e. Observation posts are positioned to provide for maximum observation and concealment. Mounted or dismounted patrolling is conducted between contact points consistent with the need for security. To be effective, a screening force must have good radio communication between OP's and enough personnel to man the OP's for sustained periods and to patrol between the OP's and contact points. Ground radar should be used to cover major avenues of enemy approach. Aircraft and air cavalry elements may be used to extend reconnaissance and materially increase the effectiveness of the security screen. It is desirable that each OP have one automatic weapon. Once visual contact has been made with the enemy, it is maintained. OP's make accurate and timely reports and may direct the fires of supporting elements to harass advancing enemy forces. If permitted to withdraw, the screening force moves by bounds, maintaining visual con-

tact with the enemy and continuing to adjust supporting fires. Under some circumstances small enemy patrols may be permitted to infiltrate the security screen so that larger enemy forces may be observed. Precaution must be taken to insure that infiltrators do not join with other infiltrated forces and threaten the screened force.

f. When the flank of a moving force is to be screened, the mission is conducted in the same manner as is a mobile flank guard operation except that—

- (1) The screening force normally does not have responsibility for the area between the screened force and the screening force as does a flank guard.
- (2) The screening force may not always be within range of support from the screened force.
- (3) The screening force occupies observation posts in succession along the flank instead of blocking positions.

106. Rear Area Security

a. *General.* A rear area security force protects rear area units, installations, and routes of communication (all routes, land, sea, and air, along which supplies and replacements move) from attack by enemy airborne and air-landed forces, guerrilla forces, and infiltrators. The rear area security force commander must coordinate with combat and other type units in the area. He should avoid stereotyped operation of patrols, observation posts, and listening posts in regard to time, areas, and patrol routes. See chapter 12 for the conduct of rear area security operations.

b. *Securing Lines of Communication.* The techniques of guarding lines of communication vary with the terrain, road net, length of the lines of communication, and the type of enemy activity expected. The following techniques form the basis for plans to secure lines of communication.

- (1) If the lines of communication to be secured extend a short distance, subordinate units of the rear area security force may be assigned areas of responsibility. Small security forces are placed on dominating terrain features overlooking likely avenues of enemy

approach along the route. The commander maintains a centrally located and highly mobile reserve to counter enemy threats that develop.

- (2) If the lines of communication are long and must be guarded over a great distance, both flanks of the route are covered by a series of observation posts. These observation posts warn of enemy approach. Aircraft or air cavalry elements may be employed to provide early warnings. The remainder of the rear area security force may be employed to patrol the line of communication and escort vehicles moving through the area, or it may be positioned as small reserves at locations along the route of communication. The security force commander must control reserve groupings so that he can employ them singly or in mass. Plans are prepared to commit the reserve in likely areas of enemy activity. Aircraft may be employed to increase the mobility of dismounted elements of the reserve.

c. Protecting an Installation. An installation in the rear area may be of such importance as to warrant protection beyond the capability of the local commander operating the installation. Additional forces should be attached to the local commander for this purpose. As an alternative, the commander of the rear area security force may be charged with the responsibility of the installation defense. In this case, the local installation commander would be relieved of this responsibility.

d. Security Against Airborne, Airmobile, and Guerrilla Force Attack.

- (1) When protecting a rear area against enemy airborne, airmobile, or guerrilla forces, the commander deploys his troops to best counter the enemy threat. The commander reconnoiters the area and selects likely drop zones for airborne forces, landing areas for airmobile forces, and potential assembly areas for guerrilla forces. He establishes observation posts to view likely drop zones, landing areas, and areas where guerrilla forces may as-

semble. These areas are patrolled. Whenever possible, a small reserve is retained in a central location, prepared to move rapidly to any part of the area. When the size of the area and lack of troops preclude the holding of a reserve, threatened areas are reinforced by security forces located in adjacent areas and which are not actively engaged with the enemy.

- (2) The key to success against airborne or airlanded forces is rapid deployment and the placing of maximum fires on the airborne or airmobile forces during the early phases of the landing. Consequently, movement to attack enemy forces is of paramount importance and piecemeal commitment may be required.
- (3) Action against guerrilla forces includes defensive actions to prevent or minimize their effectiveness, and offensive actions to destroy them. Guerrilla forces must be detected early, taken under fire, and attacked rapidly to destroy them.

e. Army Air or Air Cavalry Elements. These units may be employed to perform air reconnaissance of rear areas and reconnoiter likely landing areas for airborne and airmobile forces. The capability of air cavalry units to move at relatively high speeds without regard to terrain obstacles should be used to the maximum to locate, destroy within their capability, and maintain contact with enemy forces.

107. Air Defense Security Measures

a. General. Armor units are vulnerable to air attacks during all phases of operations. Active air defense means available include tactical aircraft, Army air defense artillery weapons, and organic weapons. Passive air defense means include air warning systems, concealment, and dispersion.

b. Air Warning System. Air attack alerts are given by hand signals, radio, a continuous series of short blasts on a vehicle horn, bugles, whistles, or other available wind instruments, depending on the situation. Air alert sentries are on duty in every vehicle during a march. Air alert observation posts are established in

bivouacs and assembly areas. Sectors of observation are usually assigned. A small armor unit acting alone must observe in all directions. Personnel are trained in the recognition of both friendly and enemy aircraft.

c. Concealment. Natural concealment is used whenever possible; camouflage is used to supplement it when necessary. The entire unit must not be crowded into a limited area of natural concealment, such as a small isolated woods, that merely provides the enemy with an easily defined target. Groves, orchards, hedgerows, and shadows of buildings should be used for protection against observation. Every effort is made to fit vehicles into the natural lines of the terrain. Vehicles parked in shadows must be moved as the shadows shift. Tracks made by vehicles moving into a new area must be brushed out or camouflaged.

d. Dispersion. Dispersion is achieved by increasing the distances and intervals between individual vehicles and by distributing the unit in small groups. Dispersion is employed on the march, during halts, in bivouacs, in assembly areas, and in attack positions. If possible, dispersion is increased when the unit actually is under air attack. An armor unit that is attacked by enemy aircraft while advancing on a road should disperse off the road and continue its advance, the individual vehicles taking evasive action. Such action requires expert driving and complete control. If vehicles cannot leave the road, they continue to advance on the road while firing at the attacking aircraft.

e. Defense Consideration, Organic Machineguns and Small Arms. Machineguns and small arms provide armor units with a limited self-defense capability against hostile low-flying aircraft. These weapons are employed as part of the unit's local defense with a dual mission of ground and air defense. They are not components of an integrated and coordinated air defense system.

- (1) During a march, all vehicular-mounted machineguns are kept manned, uncovered, and ready for instant action. Platoons or separate vehicles are assigned air defense zones of fire (app VI, para 20c). In assembly areas, attack positions, or at halts, certain guns are trained on points where

low-flying aircraft are likely to appear such as the top of a nearby tree line.

- (2) "Rules for engagement" for the attack of hostile aircraft will be established by the appropriate commander. Unit commanders may establish their own SOP for hostile aircraft engagement within the confines of the "rules for engagement." Normally, aircraft will not be engaged unless they are committing a hostile act.
- (3) When hostile aircraft are attacked, all weapons which can be effectively employed will engage the aircraft.
- (4) Against fast-flying aircraft, it is best to have all weapons fire at maximum elevation in the direction from which the aircraft are approaching. This method forces the aircraft to fly through a curtain of fire and results in a greater probability of hits than does aimed fire. Against slow-flying aircraft, gunners may obtain the best results by employing aimed fire techniques. For specific guidelines for employment, defense design, and engagement techniques of the caliber .50 machinegun, see FM 44-1 and FM 23-65.

f. Defense Considerations, REDEYE.

- (1) *General.* The REDEYE weapon system provides armor units with a limited self-defense capability against hostile, low-performance, low-flying aircraft within range and engagement capability. The REDEYE weapon system is not a component of an integrated and coordinated air defense system but may be augmented with the fires of organic crew served weapons. Site selection for crew served weapons should, when possible, be made so as to complement the fires of the REDEYE weapons systems. Tank battalions and cavalry squadrons are provided REDEYE teams for each organic company, troop, or battery. These teams are organic to the headquarters and headquarters company or troop and are

placed in support of or attached to subordinate elements depending on the tactical situation. A REDEYE team consists of two men, one $\frac{1}{4}$ -ton truck with trailer, and other necessary equipment. Normally the rules for engagement for the REDEYE weapons system are—

- (a) Engage aircraft identified as hostile.
 - (b) Attack aircraft committing a hostile act.
- (2) *Defense of the unit in position.* REDEYE positions are selected to provide for maximum observation and unobstructed fields of fire. In selecting these positions, consideration is given to likely avenues of aircraft approach, the desire to engage an enemy aircraft before it can strike the defended unit, and local ground security. Surveillance is maintained in all directions with emphasis on the expected or most likely direction of attack. REDEYE team members may be separated short distances when observation is limited. During periods of intense enemy air activity, both REDEYE team members may act as gunners, thereby increasing the rate of fire or covering additional avenues of approach.
- (3) *Defense during unit movement.*
- (a) When a company or troop is moving in column, the commander may place one REDEYE team member near the front and one near the rear, each with a portion of the available missiles. This will necessitate transporting one member of the team in a company or troop vehicle other than the one authorized the REDEYE team. It will also require a driver for the REDEYE team vehicle in order for the other team member to perform his duties.
 - (b) During movements when the company or troop is tactically deployed, the REDEYE team is usually employed as a team and is placed

where it can best protect the company or troop as a whole.

- (c) During movements in which more than one REDEYE team is involved (battalion or brigade) teams should be placed throughout the column with emphasis on the front and rear. Route coverage may be improved by directing certain teams to occupy critical points along the route; however, road condition or column speed may prevent leap-frogging.
 - (d) In all movements, appropriate primary and secondary zones of responsibility are assigned to REDEYE teams. If possible, all-round observation is maintained and necessary missiles are prepared for immediate use.
- (4) *Control.* The gunner normally attacks the targets on his own initiative since time and engagement range do not permit the gunner to request permission to fire on any particular target. Unit commanders may impose further weapons control of REDEYE fires to prevent compromising the unit location, but under no circumstances will the unit commander allow freedom to fire beyond that established by higher authority. The gunner has no authority to deviate from the established action status, rules of engagement, identification criteria, and rules for target selection.

g. Unit SOP. Units should prepare detailed SOP's for air defense based on Army and theater guidance. These SOP's should incorporate provisions for early warning, rules of engagement, personnel to fire, techniques of fire, and the control measures to be exercised. For other items to be covered in the SOP, see sample shown in FM 44-1.

108. Security Against Nuclear, Chemical, Biological Attack

Armor units obtain security from nuclear, chemical, and biological attack by dispersion, consistent with *efficient conduct* of operations, active use of their inherent mobility, construc-

tion and use of protective shelters and field fortifications, individual protective clothing and equipment, marking and avoiding contaminated areas, training in individual and collective protective measures, and decontamination. For details, see appendix XXIII.

109. Security Against Covert Threats

Security against hostile threats of espionage, sabotage, and subversion is best provided by effective counterintelligence operations (FM

30-7). Because the principal covert threats to security are espionage and sabotage, security measures to counter these activities must be emphasized. These measures include training of all individuals in the safeguarding of information and other aspects of personnel control and security; the control of personnel movement and communication; physical protection of sensitive areas, installations, and individuals; and the fostering of friendly relations with the civil population.

CHAPTER 6

THE OFFENSE

Section I. CONSIDERATION OF THE OFFENSE

110. Doctrine of the Offense

a. Armor units employ firepower and maneuver in the attack to dominate, neutralize, or destroy enemy forces; to control terrain; or to disrupt enemy rear areas. Armor plans boldly and thoroughly and attacks aggressively and violently to gain maximum shock effect in destroying the enemy, including his materiel and will to resist. This violence contributes to success by weakening the enemy to the point where he can no longer resist effectively.

b. Current trends in military tactics tend to move more and more into the tridimensional battlefield. In modern warfare, the airspace over the combat zone must be considered another dimension of the ground commander's sphere of action. The armor commander must employ air cavalry, Army aviation, Air Force tactical aircraft, and Army air artillery defense not only to seize the objective and further extend his sphere of influence but also to protect his attacking force from the effects of an aerial counterattack.

c. Friendly guerrilla forces directed by U.S. Army Special Forces may be encountered during offensive operations. These lightly armed units normally will have detailed knowledge of the terrain and enemy dispositions in their areas. While not organized or equipped for sustained infantry combat, they may be utilized to produce immediate effects against enemy combat forces and reinforcement capabilities, and to occupy key terrain for short periods of time. An understanding of their capabilities and limitations is necessary to achieve maximum benefit from the employment of guerrilla forces in conjunction with armor operations.

For a detailed discussion of guerrilla warfare operations, see FM 31-21 and FM 31-20.

111. Fundamentals of Offensive Action

a. Armor units participate in offensive operations by attacking with fire and maneuver. Fire and maneuver are accomplished by a base of fire and a maneuver force.

(1) *Base of fire.*

(*a*) *Mission.* The base of fire pins the enemy to the ground and neutralizes his weapons, thereby permitting freedom of action by the maneuver force. The base of fire normally does not close on the objective.

(*b*) *Composition.* The base of fire may consist of mortars, attached anti-tank weapons, supporting artillery, tactical air, and naval gunfire. Tanks and air cavalry normally are not included in the base of fire because this role does not take maximum advantage of their characteristics. However, when necessary, tanks and air cavalry may temporarily support by fire the other elements of the maneuvering force.

(*c*) *Employment.*

1. The base of fire should be assigned specific targets and target areas on which to fire during the advance of the maneuver force, during the assault, and during continuation of the attack or the consolidation of the objective. Signals for lifting or shifting

these fires must be prearranged and should include visual signals. The base of fire must be prepared to deliver fires on targets of opportunity.

2. The base of fire is located in a position or is prepared to move to positions from which it can continuously deliver fire to support the maneuver force. Alternate positions are selected for all weapons.

(2) *The maneuver force.*

- (a) *Mission.* The maneuver force closes with and destroys the enemy.
- (b) *Composition.* The maximum possible strength should be placed in the maneuver force. When possible, it should be a combined arms force of tanks and mechanized infantry.
- (c) *Employment.* The maneuver force closes with the enemy as quickly and directly as possible to exploit the effects of the base of fire. Usually it is committed so that it has mass and depth, and when possible, it seeks to attack one or both flanks of the enemy. Once the maneuver force is committed, it should proceed with all the speed and violence at its command. The advance

should be timed so that the elements of the maneuver force arrive on the objective simultaneously, so that the tanks and mechanized infantry can provide mutual support. As the objective is reached and overrun, the base of fire is shifted to the flanks and rear of the objective and the assault fires of all weapons of the maneuver force are intensified.

- b. The attack is planned thoroughly and executed violently. The commander must take maximum advantage of the inherent characteristics of his combined arms force to insure a concentration of superior combat power at the proper time and place. Planning should take advantage of terrain and be sufficiently flexible to permit enemy weaknesses to be exploited rapidly.

112. Factors Affecting the Planning and Conduct of the Offense

Throughout the planning and conduct of offensive operations, commanders and staff officers must consider the factors of METT. Regardless of the situation or level of command, these factors are considered continuously and simultaneously to insure maximum use of all available combat power. For a detailed discussion, see paragraphs 30 through 34.

Section II. PLANNING FOR THE ATTACK

113. General

In planning the attack, the commander and his subordinates (including his staff) follow the procedures described in chapters 3 and 4 as regards estimates, troop leading procedures, orders, and supervision. In offensive operations, the plan normally includes those general planning items discussed in paragraphs 42 through 46.

114. Plan of Attack

a. *General.* When the commander arrives at his decision, he completes his plan of attack. The plan is simply a detailed elaboration of the fifth step of the estimate—the decision. It must be simple, but cover all essential details. The

plan of attack includes the scheme of maneuver and the plan of fire support.

b. *Scheme of Maneuver.* The scheme of maneuver is the detailed plan for the placement and movement of the maneuvering force into advantageous positions with respect to the enemy or the objective. In developing the scheme of maneuver, consideration is given to its possible effects on future operations. The scheme of maneuver includes but is not limited to—

- (1) Task organization.
- (2) Formations.
- (3) Control measures.
 - (a) Objectives.
 - (b) Direction of movement.

(c) Line of departure.

(d) Time of attack.

c. *Plan of Fire Support.* This plan must provide for the coordination of all available fires of organic, attached or supporting fire support agencies to include tactical air and naval gunfire. The plan of fire support includes but is not limited to—

- (1) Location of fires.
- (2) Schedule of fires.
- (3) Type of fires.
- (4) Assignment of missions and tasks to fire support units.
- (5) Priority of fires.

d. *Air Defense.* The need for air defense during offensive operations is considered in the initial stages of planning. When air defense units are provided, their mission is included in the operations order as an annex.

115. Organization for Combat

Organization for combat is the commander's visualization of an appropriate force to meet the varying requirements of the battlefield (para 35-41). For a discussion on the employment of combat support units, see chapter 9 and appendix XIV. Armored cavalry units, organic or attached, are employed in accordance with FM 17-36 and FM 17-95.

116. Formations

a. *General.*

- (1) The initial formation for the attack, and subsequent changes to it, are based upon the factors of METT.
- (2) It is desirable to attack in depth because this formation permits greater flexibility in the employment of the attacking force, and assists in maintaining the momentum of the attack.
- (3) An attack in depth is favored—
 - (a) Against deep objectives.
 - (b) When the enemy situation is vague, and major enemy strongpoints or troop locations are not known.
 - (c) When there is a requirement for security against a counterattack.
 - (d) During periods of poor visibility when maximum control is desired.

(4) A formation with less depth is favored—

- (a) Against limited objectives.
- (b) When major enemy strongpoints and troop concentrations are known.
- (c) When the objective is strongly held by the enemy, and there is a requirement to place maximum fire upon the objective.
- (d) When the situation requires maximum freedom of action by subordinate units.

b. *Column.*

(1) The column formation (fig. 5) provides depth to the attack since units are in position to move through or around a leading unit. This capability contributes to—

- (a) *Flexibility.* The commander using a column will normally have several courses of action open to permit him to retain the initiative, maintain momentum of the attack, and provide the response required to meet varying situations.
- (b) *Retention of the initiative.* The commander using a column will have significant uncommitted combat power in the form of reserve units to introduce into the situation at a time and place of his choosing.
- (c) *Maintaining the momentum of the attack.* The commander using a column has forces available to assume the mission of the leading unit should its combat power decrease and to commit significant combat power to exploit success.

(2) The column formation provides a high degree of security to the flanks since units are in position to counter threats to either flank.

(3) The column formation facilitates control of the unit.

(4) Considerations that favor adoption of the column formation are—

- (a) Restricted maneuver room.
- (b) Enemy defenses that must be attacked on a narrow front.

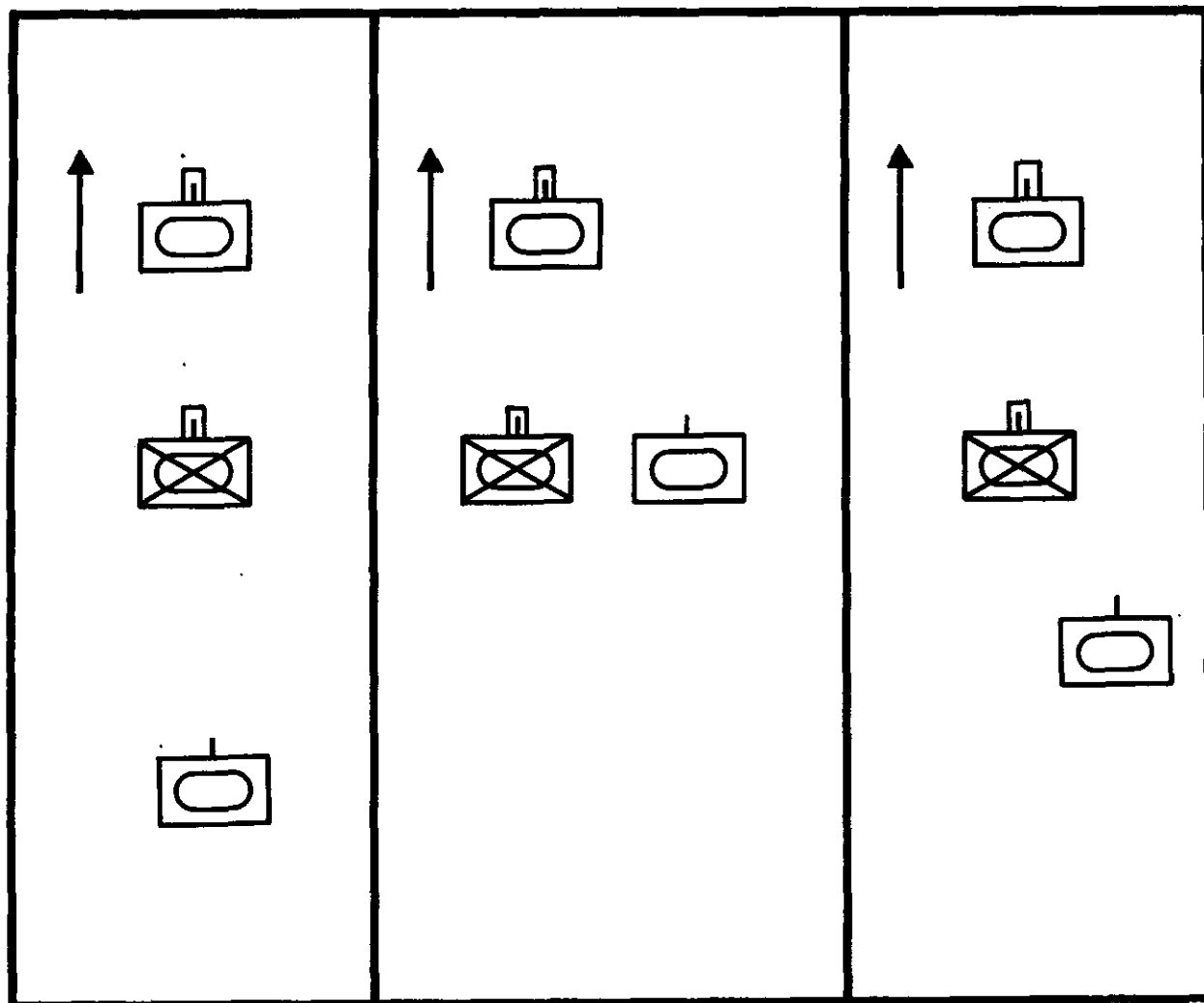

Figure 5. Variations of the column.

(c) Enemy reserves in such strength and location that a sustained attack or a meeting engagement is anticipated.

(5) When forced by terrain and the enemy situation, the commander may use a column formation. However, care must be taken that the use of a column does not unduly emphasize security and flexibility at the expense of speed and the placement of maximum firepower forward.

c. Line.

(1) The line is formed by placing two or more units abreast to lead the formation (fig. 6). The line formation pro-

vides combat power forward over a relatively wide front. This deployment contributes to—

- (a) *Coordinated attacks and assaults.* A commander using a line formation can employ leading units so that their attacks are mutually supporting. He can converge the combat power of leading units into one, massive, coordinated assault.
- (b) *Rapid development of the situation.* The commander using a line formation gains information from a broader front than if he were using a column. Gaps, weak points, or flanks of the enemy's dispositions are more rapidly discovered.

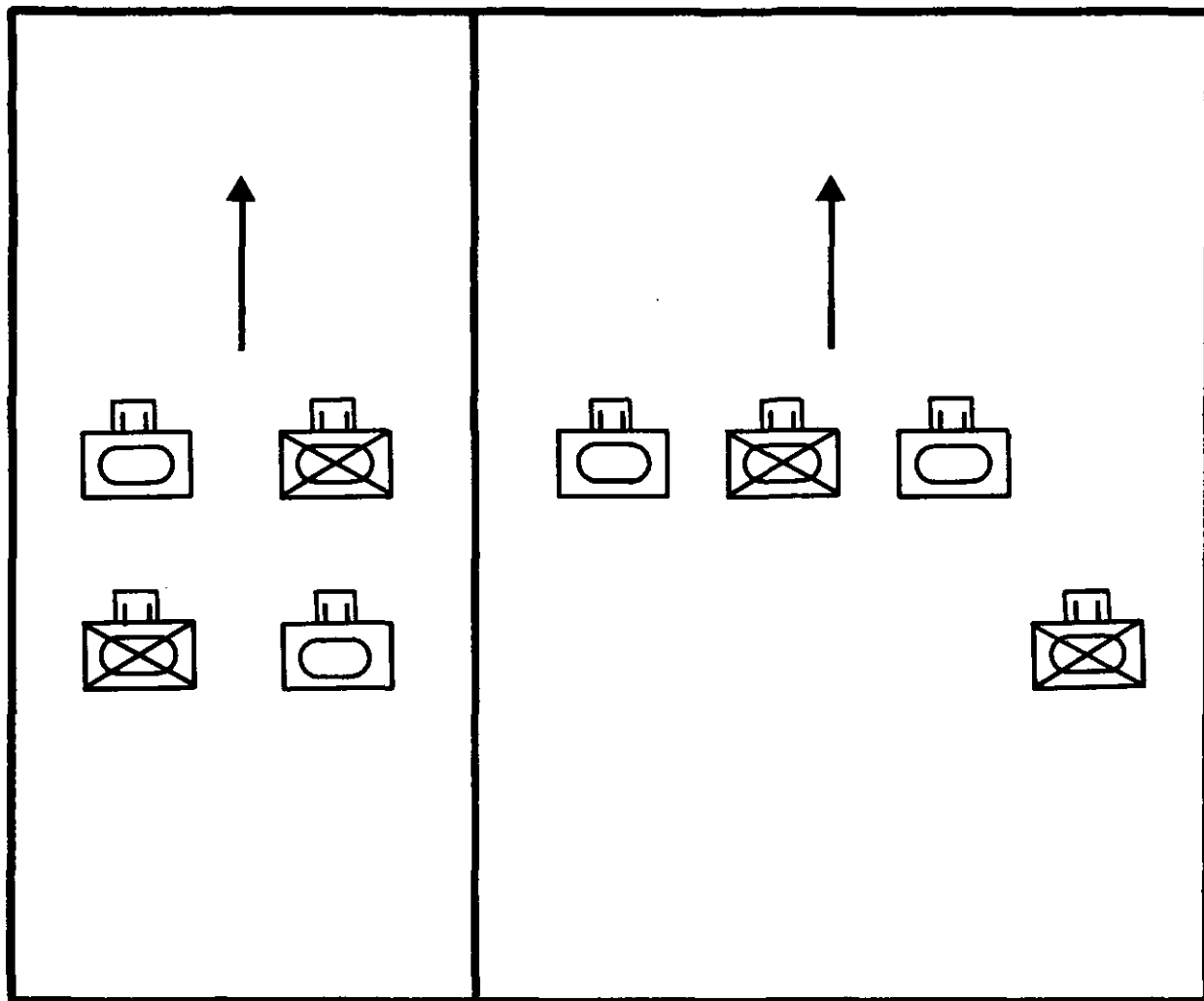

Figure 6. Variations of a line.

- (2) The line is more difficult to control than the column.
- (3) Considerations that favor the adoption of the line are—
 - (a) Adequate maneuver space.
 - (b) Shallow enemy defenses.
 - (c) A requirement for more combat power than one subordinate unit.
 - (d) A requirement for a rapid advance on a broad front.
 - (e) A requirement to develop the situation.

troops that is kept to the rear of the formation, or withheld from action at the beginning of an engagement so as to be available for decisive employment. In armor operations, reserve forces are kept well forward in the formation to be readily available for the commander's immediate use.

- (2) Reserves, when so designated, are employed to—
 - (a) Exploit success or friendly nuclear fires.
 - (b) Maintain the momentum of the attack.
 - (c) Defeat enemy counterattacks.

117. Reserves in the Offensive

a. General.

- (1) A reserve is a part of a body of

(d) Provide security by protecting the flanks and rear of a force.

(e) Reinforce the attack.

(3) A tank company is an assault unit and does not normally constitute or designate a reserve. Every effort is made by the tank company to destroy the enemy by employing all available combat power.

(4) Committing the reserve is a matter of reasoned judgment by the commander, based on his analysis of the factors of METT.

b. Size of the Reserve. A deep objective, limited knowledge of the enemy situation, available friendly combat power, or inability to visualize the attack or its conclusion requires the retention of a stronger reserve than when these conditions do not exist.

c. Location and Movement of the Reserve. In attacks by armor units, the reserve, when designated, is part of the maneuver force. It moves in the formation of the overall unit. In the formation, the reserve is positioned to—

(1) Permit rapid movement to points of probable employment.

(2) Provide security by its presence.

d. Nuclear Weapons. The commander normally holds a part of his nuclear weapons in reserve.

e. Establishment or Reconstitution of the Reserve. When the commander has all maneuver units actively engaged, he should provide for means by which he may influence the action. He may either—

(1) Constitute forces for a reserve from other elements of the command.

(2) Determine which unit may be most profitably disengaged if an urgent requirement for a reserve arises, or

(3) Request additional means from higher headquarters.

118. Control Measures

In the attack, armor commanders impose upon subordinates only the controls necessary to coordinate maneuver and fires. For a discussion of control measures, see appendix X.

119. Methods of Attack

a. General. The maneuver force, composed of tanks and mechanized infantry, accomplishes its mission by closing with and destroying the enemy. There are three general methods of attack employed by the maneuver force.

(1) The maneuver force attacks in a single direction.

(2) The maneuver force attacks in two or more converging directions.

(3) Tanks of the maneuver force support by fire only.

b. Maneuver Force Attack in a Single Direction. Using this method, the entire maneuver force closes on the enemy in a single direction.

(1) *Coordination.* Because the force attacks in the same direction, coordination and control of elements is less difficult.

(2) *Mutual support.* Since all elements of the force are together throughout the attack, mutual support within the maneuver force is simplified.

c. Maneuver Force Attacks in Two or More Converging Directions. Using this method, the maneuver force closes on the enemy from more than one direction.

(1) *Surprise.* An attack that converges on the enemy from more than one direction forces him to fight in more than one direction simultaneously and may achieve surprise.

(2) *Coordination.* When elements of the maneuver force are attacking over different terrain with varying enemy resistance, the coordination and control necessary to insure a coordinated attack and simultaneous assault may be difficult to achieve. Measures must be taken to prevent elements from firing into each other.

(3) *Mutual support.* The separate directions used by the maneuver force make mutual support between elements of the force more difficult than in the single-direction attack.

d. Tanks of the Maneuver Force Support by Fire Only. The only justification for this method of attack is under conditions where terrain or enemy-emplaced obstacles prevent tanks

from moving with the maneuver force. This method does not take maximum advantage of the mobility, shock effect, and combat power of tanks.

e. Selection of a Method of Attack. During

an attack, any one or more of the three methods of attack may be used. As the situation changes, the commander is alert to vary his method of attack. The factors of METT are analyzed in selecting a method of attack.

Section III. CONDUCT OF THE ATTACK

120. The Advance to the Assault

a. The advance to the assault is initiated from a line of departure and is conducted in a manner which minimizes casualties to the maneuver force while placing combat power in position to impose maximum destruction on the enemy.

b. The maneuver force conducts the advance to the assault as a continuous rapid movement, to insure that it passes through the enemy's defensive fires in minimum time.

c. Where possible the assault is always conducted in mass. However, enemy action may require the maneuver force to employ fire and movement. For a discussion of fire and movement, see appendix XIII.

d. Throughout the advance to the assault, the commander supervises the execution of his plan and continues his estimate. He keeps abreast of the situation as it develops to determine if changes must be made in the scheme of maneuver or plan of fire support.

121. Tank and Infantry Teamwork During the Advance to the Assault

a. General. Armor operations are based on the combined arms concept in which each arm contributes its capabilities to the combat power of the overall force. To weld the capabilities of infantry and tank units into one effort, the commander considers the following relationships between tanks and infantry in the advance to the assault.

- (1) Whenever possible, tanks lead the attacking formation in order to take maximum advantage of their capability for mounted combat.
- (2) It is desirable that the infantry remain mounted as long as possible so that—
 - (a) Movements can be conducted at the speed of the tanks to rapidly close with and destroy the enemy.

- (b) The battlefield mobility of both elements of the tank and infantry team will be retained.
 - (c) Casualties will be minimized in areas covered by small arms, mortar, and artillery fire.
 - (d) Artillery airbursts can be employed over the attacking force.
 - (e) Some protection will be afforded against nuclear weapons.
 - (f) The infantry can conserve energy to be better able to fight dismounted when needed.
- (3) Infantry normally dismount when it is necessary for them to—
 - (a) Breach or remove obstacles that are preventing the forward movement of the tanks.
 - (b) Assist in the neutralization or destruction of antitank weapons that are holding up the forward movement of the tanks and armored personnel carriers.
 - (c) Lead an attack through heavily wooded areas or over very rough or broken terrain.
 - (d) Lead an attack across defended rivers that cannot be crossed by armored personnel carriers or forded by tanks.
 - (e) Take part in an attack through fortified areas or defended towns and villages that cannot be bypassed.
 - (f) Assist the tanks forward movement during certain conditions of low visibility and restricted fields of fire (darkness, fog, smoke, heavy woods, broken terrain, or other similar conditions).

b. Mounted Infantry.

- (1) Tank and mounted infantry elements

are coordinated by combining them into one mutually supporting formation. Mounted infantry must be prepared to fight from the carrier. They are positioned in the formation according to the tactical situation. In determining the location of the carriers in the formation, the commander must consider the primary requirement for having the mechanized infantry readily available. He must also consider the vulnerability of the carrier to enemy fire. The armored personnel carriers can provide additional flank and rear security to the maneuvering force during the attack by employing their vehicular-mounted machineguns.

- (a) When undue enemy interference is not anticipated, the carriers will follow more closely behind the tanks.
 - (b) Where hostile antitank fires are encountered, the location of the carriers with relation to the tanks will depend partially on the type and caliber of the hostile antitank weapons. If the enemy is equipped with only short range antitank weapons, such as rocket launchers, the carriers may follow the tanks more closely than if the enemy were using long range, high velocity antitank weapons.
 - (c) The distance between the tanks and carriers must not become so great that mutual support between the tanks and mechanized infantry is lost.
 - (d) In terrain affording numerous defilade positions, the mechanized infantry may follow the tanks closely.
 - (e) The carriers can follow the tanks closely during darkness or periods of limited visibility.
- (2) The rate of advance of mounted infantry is based on the actions of the leading tank units.
- (a) When the tanks are advancing in mass, the following mounted in-

fantry may advance in mass or by bounds. Mounted infantry moving by bounds stays behind the tanks and moves forward rapidly from cover to cover as the advance of the tanks uncovers successive defilade positions.

- (b) When the tanks are employing fire and movement, mounted infantry advances by bounds as described above.

c. Dismounted Infantry.

- (1) When mechanized infantry is required to dismount, tanks and infantry operate sufficiently close together to provide mutual support. The infantry may move between tanks, or immediately in rear of them. As the advance progresses, the relative positions of tanks and infantry are adjusted according to the enemy resistance and the terrain. This permits close coordination and maximum mutual support but sacrifices speed, making the tanks more vulnerable to antitank fire.
- (2) When terrain, obstacles, or enemy antitank weapons restrict or stop the movement of the tanks but permit infantry to move forward, tanks may support by fire while the infantry advances. As conditions permit, the tanks should move forward, pass through the infantry, and lead the assault on the objective.
- (3) The armored personnel carriers should follow close enough behind infantry to be readily available when needed to continue the attack mounted or to assist in the consolidation of the objective. They may move forward by bounds, or follow closely the attacking force and augment the fires of the tanks and infantry with their vehicular weapons.

122. The Assault

The desired goal in the assault is to bring the maximum combat power of tanks, mechanized infantry, and the base of fire to bear upon the enemy simultaneously and to destroy

him as rapidly as possible with minimum casualties to friendly forces. The assault of a defended position by tanks and mechanized infantry in coordination with the base of fire may take one of three forms—

a. Tanks and Dismounted Infantry Assault in Coordination.

(1) Regardless of the method of attack used to bring the force into the assault position, the assault is conducted as a coordinated effort. As the force approaches the objective, the objective is under heavy fire from the base of fire. The tanks maintain their rate of advance and increase the volume of fire on the objective. As the tanks approach the objective, the mechanized infantry moves quickly to dismount positions to support the tanks. Fire from the base of fire is lifted as the tanks move onto the objective. Mortar and artillery overhead time fires are shifted to the flanks and far side of the objective. The local commander determines when and where the mechanized infantry will dismount taking maximum advantage of defilade for the armored personnel carriers.

(2) As the tanks continue their assault to the far side of the objective, the infantry follows and protects them by engaging infantry-type targets, including individual antitank weapons and tank killer teams. Coordination should be accomplished before the attack to maximize infantry support of tank elements during the assault. Whenever possible, the machineguns of the armored personnel carriers are used to support the assault until their fires are masked by advancing riflemen. The riflemen use assault fire to close with the enemy. The shock effect of assaulting tanks and infantry is multiplied by rapid movement and heavy volume of fire. As the tanks arrive at the far edge of the objective, fire is directed on the enemy positions beyond the objective area. During the assault of an objective lo-

cated on high ground, care must be taken to acquire and destroy any enemy antitank and automatic weapons sited on the reverse slope. These weapons are normally positioned so as to engage tanks and dismounted infantry as they crest the hill.

(3) Once the assault has cleared the objective, the carriers are moved forward to remount their squads for continuation of the attack. They should be moved forward under control to avoid "cruising" the objective searching for their squads. The following techniques may be employed to move carriers forward under control.

(a) *Radio.* Armored personnel carriers are provided with radios that net with those carried by the dismounted infantry. The range of the transmitting station must be considered with respect to the position of the carrier and the driver must constantly monitor the radio.

(b) *Messenger.* A dismounted messenger may be sent to the position occupied by the carriers to guide them to their respective units. This is the slowest method and depends on a route clear of the enemy.

(c) *Pyrotechnic devices.* A pyrotechnic signal may be fired to indicate to drivers the time to move and the approximate location of the unit. This technique requires constant scanning of an area by the driver, good visibility, and availability of pyrotechnics.

b. Tanks and Mechanized Infantry in the Mounted Assault. In some situations, because of the nature of the terrain or of limited enemy resistance, it may be unnecessary to dismount the mechanized infantry. The decision to keep the infantry mounted is up to the local commander at the time and can rarely be preplanned. The mounted assault differs from the dismounted assault in the employment of supporting fires. In the mounted assault, integrated forces may assault the objective under cover of overhead artillery and mortar fire. Tanks

and mounted mechanized infantry overrun the objective. If necessary, supporting fires may be shifted to isolate the objective, and mechanized infantry, as required, dismounts to mop up.

c. Tanks Support by Fire. Terrain or obstacles may make it impossible for tracked vehicles to join in the assault. In this situation, dismounted mechanized infantry will conduct the assault. Tanks support by fire, with full consideration given to the long range and rapid rate of fire of the tank weapons and the precision and control with which these fires can be delivered. As soon as the situation permits, tanks will rejoin the mechanized infantry and, if appropriate, again lead in the attack.

123. Continuation of the Attack

a. General. Armor units seek to conduct the attack as a single advance and assault that continues until the assigned objective is seized. The momentum of the attack must be maintained. When intermediate objectives must be seized, armor units strive to avoid halting. If there is no requirement to hold the objective, the tanks and mechanized infantry continue the attack, reorganizing on the move. If the objective is to be held, the unit will consolidate, reorganize, prepare to repel enemy counterattack, and continue the attack on order.

b. Intentions of the Higher Commander. The overall plan of attack contained in the "concept of operation" is an expression of the commander's intentions. Subordinate commanders require a full understanding of the purpose of the operations so that they may exercise initiative in continuing the attack without waiting for further orders.

c. Continuous Reorganization. All steps are taken to maintain the combat effectiveness of the unit. Whenever possible, this is done while on the move. To save time, actions that cannot be accomplished on the move are preplanned.

d. Supporting Elements.

- (1) Combat support elements are kept well forward in order to provide immediate assistance to the combat elements.
- (2) If contact with the enemy is lost, reconnaissance and security units, especially those with aircraft, are employed to regain contact.

- (3) Combat service support elements seek every opportunity to supply the combat and combat support units with the means required to continue the attack.

124. Consolidation and Reorganization

a. General. The actual occupation of the objective is the critical stage of the attack. Control is most difficult and it is the time when an aggressive enemy delivers a carefully planned and coordinated counterattack, supported by all available fires. When possible, the seizure of the objective should be followed by an immediate continuation of the attack. In nuclear warfare, a rapid move to dispersed locations from which the unit can dominate the objective will avoid presenting a lucrative nuclear target. In many situations, small armor units will be required to hold an objective. In these cases, consolidation of the objective is required and the unit should be reorganized.

b. Consolidation. Consolidation pertains to all measures taken to use a newly captured position or terrain feature against possible enemy counterattack. The action may vary from a rapid redistribution of forces and security elements on the objective to the organization and detailed improvement of the position for defense. When consolidation is anticipated, many of the actions can be preplanned and announced initially in the attack order. These instructions may be changed or supplemented by fragmentary orders as the attack progresses. Actions to be taken include—

- (1) *Security.* Observation or listening posts are established; and, if required, patrolling is initiated.
- (2) *Reconnaissance.* In addition to the reconnaissance efforts to effect security, commanders take steps to reconnoiter in anticipation of immediate and future missions.
- (3) *Positioning.* Tanks are positioned on armor avenues of approach and mechanized infantry cover infantry avenues of approach. Combat support and combat service support elements are relocated if necessary.
- (4) *Fire planning.* While fire planning is continuous in an operation, specific

actions may be preplanned and executed for a consolidation. Registration is completed when possible, and integrated fire plans are prepared to support the consolidation. If the time for the continuation of the attack is not known, tank commanders begin preparation of individual range cards.

c. Reorganization. Reorganization includes all measures taken to maintain the combat effectiveness of the unit. Reorganization is continuous throughout the attack, but halts for consolidation offer opportunities to accomplish those activities that are difficult to do on the move. Actions to be taken include—

- (1) *Reports.* Units report their location and status to assist the next higher commander in his planning for subsequent operations.

- (2) *Casualties.* Casualties are replaced as soon as possible or men are reassigned within the unit to cover the loss of key personnel.
- (3) *Evacuation.* Plans made before the attack for the evacuation of casualties, prisoners of war, and damaged equipment are implemented.
- (4) *Supply.* Ammunition and equipment are redistributed within the unit if necessary. Basic and prescribed loads of supply are reconstituted as time permits.
- (5) *Control.* New communication plans are made or old ones revised as required. Command and control facilities are located to control the consolidation and anticipated future actions.

Section IV. FORMS OF MANEUVER AND OFFENSIVE OPERATIONS

125. General

Offensive maneuvers and operations that armor units conduct, or in which they participate, are the penetration, envelopment, turning movement, and exploitation (including pursuit). The basic forms of offensive maneuver are the penetration and envelopment. The frontal attack is a variation of the penetration; a double envelopment and a turning movement are variations of envelopment. Infiltration is a technique of movement used in conjunction with the several forms of maneuver. The exploitation is an offensive operation which may follow a successful penetration or envelopment. The pursuit is an extension of a successful exploitation. The choice of a specific form of maneuver or a specific type of operation is influenced by the mission, enemy, terrain and weather, and troops available.

126. Penetration

a. General. In the penetration, the attacking force passes through the enemy defensive position, ruptures it, and neutralizes or destroys objectives to break up the continuity of the defense. The penetration is accomplished by means of three tasks: rupturing the enemy defensive position; holding or widening the gap;

and overrunning or seizing objectives that destroy the continuity of the enemy defense and create an opportunity for exploiting the breakthrough. If the rupture is not made sharply and the seizure of the objectives accomplished quickly, the penetration becomes a frontal attack. This may result in high casualties and affords the enemy an opportunity to adopt other defensive measures. Armor units participate in the penetration by accomplishing one or more of the three tasks by maneuver forces or, under some circumstances, by fire alone.

b. Rupture of the Position.

- (1) The rupture of the enemy defensive position is made by a violent attack on a relatively narrow front. The forces involved must be strong enough to overwhelm the defenses and open a gap to permit highly mobile forces to pass rapidly through to exploit the enemy's rear. The employment of nuclear weapons may allow attack of the defense positions on a broader front.
- (2) The attack is planned and coordinated carefully to insure that the assault has sufficient force and momentum to overcome the enemy's defenses.

- (3) Preparatory fires are used in the rupture to weaken the enemy defense and neutralize his reserves. Enemy forces isolated during the rupture may be neutralized by fire.
- (4) The rupture must be completed and widened as rapidly as possible to preclude reinforcement or blocking actions by enemy reserves, or to prevent engaged enemy forces from adopting delaying tactics.

c. Holding or Widening the Gap. Holding or widening the gap may be accomplished by maneuver forces, by fires, or by both. Actions are aimed at preventing the movement of enemy forces into or out of the area of operations. Enemy counterattacks are engaged rapidly with reserve units or by fire. Desirably, it is performed by fire or by other forces to avoid dissipating the maneuver forces.

d. Destroying the Continuity of the Defense.

- (1) Armor units participating in a penetration expend every effort to maintain the violence and momentum of the attack. Overrunning the enemy or an attack deep in the enemy rear that disrupts the continuity of his defenses requires friendly forces to have relatively greater battlefield mobility than that of the enemy.
- (2) As the rupture is completed, the tempo of the attack is increased to create an opportunity to exploit deep into the enemy rear.

e. Exploiting the Penetration. The force given the mission of exploiting the penetration is not normally committed until the rupture is completed but may be committed to hasten the penetration. In the latter event, it executes a passage of lines through the force making the rupture to continue the attack with unrelenting pressure on the enemy.

127. Envelopment

a. General. In the envelopment, the attacking force avoids the enemy's main defensive strength by going around it on the ground or over it by air to seize an objective in his rear. Its purpose is to disrupt his communication and support, to cut his escape routes, and to subject him to destruction in position.

b. Considerations of the Envelopment.

- (1) A successful envelopment requires that the enemy have an assailable flank. An assailable flank may be created by nuclear weapons or by a successful penetration.
- (2) An envelopment of both enemy flanks simultaneously usually requires greater superiority in combat power than that normally available to the units considered in this manual.
- (3) Fixing the enemy in position is accomplished by fires or, if required, by a supporting attack. Although favored as the enveloping force, armor units may participate in the envelopment as a supporting attack force.
 - (a) A supporting attack fixes the enemy by striking him with enough combat power to seriously threaten the enemy forward defensive positions and to force premature commitment of enemy reserves.
 - (b) Fixing the enemy is accomplished by fires to allow the maximum number of maneuver elements to be placed in the enveloping force.
- (4) Maneuvering around the assailable flank is accomplished by the enveloping force.
 - (a) The enveloping force seizes terrain that dominates enemy supply lines and avenues of escape or reinforcement.
 - (b) The enveloping force may make a close or wide maneuver. In a close maneuver, fire support elements are usually capable of easily supporting both the enveloping force and the supporting attack forces from a central location. In a wide maneuver, fire support elements are usually not capable of supporting both the enveloping and supporting attack forces from a central location. Enveloping forces conducting a wide maneuver may be accompanied by fire support elements.
 - (c) The seizure of the objective by the enveloping force may be followed by an exploitation if the opportunity occurs.

- (5) The success of the envelopment depends largely upon surprise and mobility of the enveloping force, and the ability of the supporting fires or supporting attacks to fix the enemy in position.
- (6) Rapid movement of the enveloping force and application of a supporting attack, if required, are essential to prevent the enemy's movement of reserves to occupy previously prepared positions.

c. Conduct of the Envelopment.

- (1) A supporting attack may be launched at the same time as the attack of the enveloping force, or earlier, to increase deception.
- (2) Preparatory fires for the attack of the enveloping force may be omitted in the interest of secrecy. If used, these fires may be intense but of short duration.
- (3) A supporting attack that is conducted aggressively and violently may lead to an opportunity to convert the supporting attack into a successful penetration.
- (4) The enveloping force moves rapidly and directly to the objective, bypassing enemy forces that cannot interfere with the accomplishment of the mission. If the enemy attempts a frontal attack against a supporting attack, the enveloping force continues to the objective while the supporting attack force blocks or delays.
- (5) Enemy counterattacks that threaten the accomplishment of the mission by the enveloping force are engaged in a manner similar to the meeting engagement (para 139-141).

128. Frontal Attack

The frontal attack is a variation of the penetration. It normally consists of a series of small operations that strike the enemy all along his front. It is used to overrun and destroy a weaker enemy.

129. Turning Movement

The turning movement is a variation of the envelopment. The attacking force avoids an en-

emy force and seizes an objective deep in the enemy rear to force him to abandon his position or divert major forces to meet the threat. The enemy is then destroyed on ground of the attacker's choosing. Normally, brigade and lower units participate in the turning movement as part of a larger force. For details of turning movements, see FM 61-100.

130. Exploitation and Pursuit

a. Exploitation. In the exploitation, the attacker seeks to follow up the gains of a successful penetration or envelopment. The attacker drives deep into the enemy's rear to destroy his means to reconstitute an organized defense or to initiate an orderly withdrawal.

b. The Pursuit. The pursuit is the final phase of the exploitation. Its goal is annihilation of the enemy force. It is accomplished by maintaining direct pressure on the withdrawing enemy and by intercepting and destroying the main enemy force.

c. Consideration of the Exploitation.

- (1) Opportunities for major exploitations are indicated by an increase in prisoners captured, in abandoned equipment, and the overrunning of artillery, command facilities, signal installations, and supply dumps. The transition from the attack to the exploitation may be abrupt or so gradual as to be hardly distinguishable.
- (2) Speed and combat power are required in exploiting forces.
- (3) In the exploitation, class III consumption rates are high, and provisions for rapid supply by ground or air are essential. Security of ground or air supply columns must be considered since forward elements may be behind enemy forces.
- (4) Minimum necessary control measures are used. The decentralized execution characteristic of the exploitation requires the exercise of great initiative on the part of all leaders.
- (5) In the exploitation, nuclear, conventional, and chemical weapons may be used principally on targets of opportunity. Fire support units march with

or immediately in rear of exploiting forces.

- (6) Reconnaissance efforts are intensified. The rapid gathering of information on enemy activities and strength coupled with information of the terrain assist the commander in making decisions involving the bypass or changes in the scheme of maneuver.

d. Conduct of the Exploitation.

- (1) Exploiting forces advance rapidly on a broad front. Only the reserves necessary to insure flexibility, and essential security are retained.
- (2) Once the exploitation is begun, it is carried relentlessly to the objective deep in the enemy rear to cut his lines of communication and disrupt his command and control.
- (3) Maximum use should be made of air cavalry to increase the reconnaissance and security of the exploiting force. Airmobile fires may be used to assist in seizing terrain that becomes key to the tactical success of the exploiting force.
- (4) Enemy forces encountered are not engaged unless they can interfere with the accomplishment of the mission. Based on the factors of METT, information gained from efforts to develop the enemy situation and the determination of suitable bypass routes, the commander may attack, block, or bypass the enemy. If his decision is to bypass, he must determine the possible impact the bypassed enemy force may have on his mission and the mission of the larger force. If the enemy force can hinder movement during the bypass, a force may be employed to block the enemy. Armored or air cavalry elements or other aircraft may be used to facilitate movement around an enemy force. For techniques of the bypass, see paragraphs 142 through 144.
- (5) Commanders use all means and weapons to overrun enemy forces that cannot be bypassed.

- (6) Meeting engagements may occur frequently in the exploitation. For a discussion of the considerations and conduct of meeting engagements, see paragraphs 139 through 141.

- (7) Following and supporting units normally follow armor units in the exploitation to relieve them of time-consuming tasks that dissipate the combat power of exploiting forces.

- (8) As enemy demoralization begins and enemy forces disintegrate under pressure, exploitation may develop into pursuit.

e. Considerations of the Pursuit.

- (1) Armor units participate in the pursuit by—

- (a) Maintaining direct pressure on the withdrawing enemy by a maneuver force that seeks to engage the withdrawing enemy's main body. This direct pressure force attacks constantly to overcome or bypass the enemy's rear guard.

- (b) Intercepting and destroying the main enemy force by a highly mobile encircling force that seeks to get in rear of the enemy force to block his withdrawal. Once this is accomplished, the enemy is destroyed between the direct pressure force and the encircling force. If the encircling force cannot outdistance the enemy, it attacks the flank of the enemy main body.

- (2) Successful pursuit requires unrelenting pressure against the enemy to prevent reorganization and preparation of defenses. Commanders may take greater risks to achieve decisive results. In the interest of the tremendous gains at stake, troops and equipment are pushed to the limit of their endurance.
- (3) Destruction of the enemy force is the primary objective of the pursuit.
- (4) Adequate preparation is made for logistical support. Class III consumption is particularly high. Air transportation may be used for rapid

delivery of supplies to forward units. Maximum use is made of captured enemy materiel.

f. Conduct of the Pursuit.

- (1) The direct pressure force attacks on as broad a front as possible. The attacks continue day and night. When conditions permit, elements of the enemy force are enveloped or cut off. If the enemy main force establishes itself on a position, the direct pressure force attacks in an effort to dislodge it.
- (2) The encircling force attacks along an avenue of approach that facilitates early engagement or interception of the withdrawing enemy force. Formations are used that contribute to control and speed of movement.

131. Infiltration

a. Infiltration is a technique of movement used in conjunction with several types of offensive actions. In the attack, its purpose is to deploy strong forces in the enemy rear while exposing only small forces to enemy defensive fires.

b. The movement and assembly of forces by stealth among enemy positions is a slow operation. While dismounted mechanized infantry or armored cavalry units are most suitable for infiltration, tank units can be carefully infiltrated by taking advantage of faulty enemy dispositions, gaps created in obstacles without enemy knowledge, or by diversionary attacks by fires or maneuver forces.

c. Planning for infiltration must be detailed and coordinated closely into the overall plan of

attack. Deviation from plans is difficult to coordinate once movement has begun. Linkup plans or plans to extricate the force must be prepared.

d. Infiltration lanes, assembly areas, attack positions, and objectives are the control measures used primarily; phase lines and checkpoints assist in control while rallying points or areas are required for units that become scattered and disorganized.

e. The infiltrating elements in small groups pass through, over, or around enemy forward defensive positions. They avoid detection, and if detected, avoid decisive engagement. They normally move over multiple lanes, to assembly areas adjacent to their objectives. Closely coordinated demonstrations and fires in areas not included in the infiltration may be used to assist their movement. Fires in the area of infiltration may serve to reduce the enemy's surveillance capability.

f. Upon arrival at the assembly area, the infiltrating unit prepares for action, deploys, and at the appropriate time, performs its mission. Consolidation includes preparations for linkup or withdrawal.

132. Movement to Contact

Movement to contact is a means of gaining contact or of reestablishing lost contact with the enemy. Its purpose is the early development of the situation to provide an advantage prior to decisive engagement. During a movement to contact armor units may be given missions of a covering force, advance guard, flank guard, rear guard, or moving as part of the main body. For a detailed discussion, see FM 17-30 and FM 61-100.

Section V. PASSAGE OF LINES

133. General

The commitment of a unit through one which is in contact with the enemy constitutes a passage of lines. A passage of lines may be required to continue the momentum of the attack or to exploit a weakness in the enemy position. A passage of lines requires careful planning and close coordination between the units. Due to differences in organization and techniques of operation, the passage of armor

through infantry is more difficult than is its passage through another armor unit.

134. Planning for Passage of Lines

a. Scheme of Maneuver. The scheme of maneuver is based on the factors of METT. The scheme of maneuver normally determines the location at which the passage of lines will take place.

b. Reconnaissance. A thorough reconnais-

sance should be made by commanders and key members of the unit making the passage. This reconnaissance should cover routes to the area of the passage, the area itself, existing troop locations, proposed positions, and, if necessary, proposed locations of individual combat vehicles. A visual reconnaissance should be made of the area forward of the frontline position; aircraft may be used in this reconnaissance. In reconnoitering, care must be taken not to alert the enemy by offering indications that a passage of lines is to take place. It may be necessary to limit the number and size of reconnaissance parties, or it may be advisable to use ground vehicles and aircraft of the units in contact.

c. Intelligence. The units in contact should provide all possible information of the enemy and the terrain to their front to the unit making the passage. This information should include strength, disposition, composition of enemy forces, and location of enemy armor, antitank weapons, and obstacles.

d. Fire Support. The fire support agencies of the units in contact are normally integrated into the fire support plan of the unit making the passage. Artillery liaison officers, forward observers, air liaison officers, and mortar platoon leaders of the unit making the passage should contact their counterparts in the unit in position to exchange information and develop the details of the fire support plan.

e. Priorities of Routes and Areas. The higher headquarters directing the passage normally establishes an overall priority on routes and areas. If it does not, a priority must be established between the commanders concerned. Complete information on routes to be used and areas to be occupied should be disseminated as early as possible to avoid confusion and delay.

f. Movement Through the Area. The routes established for movement into the forward areas must be well marked and controlled. Ideally, the passing unit and the unit in contact provide guides down to platoon level. As a minimum, the units in contact provide guides. Guides lead elements of the passing unit through the unit in contact along prearranged routes. For increased security, the movement into the forward areas may be conducted at night; this requires stringent control and thor-

ough planning and reconnaissance. Artillery fire may be employed during the movement to cover the noise of the vehicles. If the movement is conducted during daylight, smoke may be placed on known enemy observation posts and forward positions. While the passing unit is moving through the area of the unit in contact, the resulting concentration presents an excellent target for nuclear attack. Therefore, the passage should be completed as quickly as possible. During the period of concentration, maximum passive defense measures against nuclear attack should be taken.

g. Control Measures. The type and number of control measures will depend upon the experience of the commanders involved but will normally be more restrictive than those used in other operations. For a discussion of control measures, see appendix X.

135. Liaison and Coordination in Passage of Lines

a. Liaison. As soon as it is determined that a passage of lines will be made, liaison must be established between the passing unit and the unit in contact. At brigade and battalion level, liaison officers are exchanged until completion of the operation.

b. Coordination. Thorough coordination is essential to the success of a passage of lines. Normally, the unit in contact is given the definite mission of "assisting in the passage." Special emphasis must be placed on the following coordination measures—

- (1) Refueling areas and routes into and out of these areas are reconnoitered by personnel from the passing unit, assisted by guides furnished by the unit being passed through. It may be necessary for the unit being passed through to adjust its positions to permit a satisfactory passage, but such adjustments should be held to a minimum.
- (2) Clearing and marking the lanes through friendly minefields and obstacles to permit rapid passage are accomplished by the unit being passed through. Passing units should provide their own control personnel at difficult gaps or defiles to check through each subunit.

- (3) Details of fire support are furnished by the unit through which the passage is being made.
- (4) Details of communication nets and channels required by the passing unit are coordinated between the units and with their higher headquarters.
- (5) Within its capabilities, the unit being passed through furnishes combat service support to the passing unit during and immediately after the passage. This support may include medical services, handling PW's, traffic control, straggler control, clearing roads of refugees, and assisting in

handling the dead, but normally will not include supply of Class III and V.

c. Passage of Command. The time or circumstance when responsibility for the zone of action is transferred to the commander of the unit executing the passage of lines must be mutually agreed upon by the two commanders concerned. Normally, the commander of the unit making the passage of lines assumes responsibility for the zone of action at or before the time of passage. The responsibility for the zone may shift at the time of the firing of preparatory fires or earlier at the direction of the headquarters ordering the passage.

Section VI. RECONNAISSANCE IN FORCE

136. General

A reconnaissance in force is an attack to discover and test the enemy disposition, composition, and strength. Although its primary aim is reconnaissance, it may discover weaknesses in the enemy dispositions that, if promptly exploited, may permit tactical success. Terrain objectives are selected that, if threatened or seized, will force the enemy to react to the threat.

137. Considerations

a. In deciding to reconnoiter in force, the commander considers the—

- (1) Knowledge of the enemy situation that he has and the urgency and importance of the information sought.
- (2) Efficiency, speed, and availability of other collection agencies.
- (3) Extent to which future plans may be revealed to the enemy by the reconnaissance in force.
- (4) Possibility that the reconnaissance may lead to a general engagement under unfavorable conditions.

b. The size of the reconnoitering force varies in accordance with the factors of METT. The force must be of sufficient size and composition to cause the enemy to react strongly and definitely to the attack, thus disclosing his forward troop locations, dispositions, and strength in addition to the location

of his reserves. The force is normally not less than a reinforced squadron or a battalion task force with artillery, engineer, and air cavalry or Army aviation support.

138. Conduct

a. Restrictions may be placed upon the commander of the force to avoid actions that might cause a general engagement. The higher commander is alert to exploit success gained by the reconnaissance in force, including continuation of the attack or retention of terrain seized. Suitable targets discovered by the force may be attacked by nuclear weapons, and their destruction completed by local exploitation by the reconnoitering force. The higher commander prepares to assist in the extrication of the force if it becomes decisively engaged. Nuclear weapons may provide a means of doing this. Upon completion of its reconnaissance, the force may remain in contact with the enemy or withdraw. If the reconnaissance is to be followed by further attack, other units pass through the reconnoitering force in the attack or it may itself continue the attack.

b. When information is sought of a particular area, the reconnaissance in force is planned and executed as an attack with a limited objective. If the enemy situation along a front is to be developed, the reconnaissance in force is an advance employing strong aggressive probes to determine the enemy situation at key points.

139. General

a. A meeting engagement is the combat action that occurs when a moving force, incompletely deployed for battle, engages a moving or static enemy force about which it has little or no intelligence. The action ceases to be a meeting engagement when the enemy situation has been developed and subsequent operations are undertaken for the specific situation at hand.

b. Meeting engagements are characterized by—

- (1) Limited knowledge of the enemy.
- (2) Minimum time available to the commander to develop the situation, formulate plans, and execute them.
- (3) Rapidly changing situations.

c. Under the conditions of highly mobile warfare, with combat units dispersed laterally and in depth, meeting engagements may occur frequently at brigade and lower echelons of command. In the attack, armor forces may encounter enemy units in depth either in blocking positions or on the move.

140. Considerations

a. In each meeting engagement, the commander of the advancing force is normally confronted with three possible courses of action—

- (1) Attack directly from march formation as rapidly as his units are available for employment.
- (2) Reconnoiter and block the enemy with forces in contact until other units can be committed in a coordinated effort, either offensively or defensively, as they become available.
- (3) Attempt to break contact and bypass the enemy force.

b. The paramount objective of the commander fighting a meeting engagement is to gain and retain the initiative. In so doing he may adopt one or a combination of the aforementioned courses of action that will contribute most effectively to the accomplishment of his mission. Without the initiative, he can only react to the enemy's actions.

c. The character of the battle is such that the commander must use bold initiative to quickly develop the situation. Frequently, aggressive action must be initiated despite the vagueness and uncertainty of the situation. Mobile forces are required to develop the situation rapidly and aggressively to seize an initial tactical advantage.

d. Success in the meeting engagement requires that the enemy be kept off balance by offensive actions. Proper balance must be retained by the attacker to rapidly follow up the gains of initial actions. Accomplishment of this complex goal depends largely upon aggressive reconnaissance and rapid commitment of forces from the march formation in a coordinated effort.

e. The tempo and speed of this fight dictates that the commander take personal control with minimum reliance on written or formal instructions through normal staff channels. His decision should be based on firsthand knowledge and, if practicable, on personal reconnaissance. He should move quickly to the scene of action, make a rapid estimate of the situation, formulate a simple plan, and issue fragmentary orders.

f. Speed and combat power are required in this uncertain and vague situation. When friendly and enemy forces attack simultaneously from the march formation, fighting may develop wherein the initiative of the engaged commanders; the experience of the troops; and the fire and striking power, particularly of tanks, will be decisive.

g. Minimum control measures are used. However, commanders at all levels must retain a firm hand on their units and not allow coordination to be impaired by the necessity of committing units rapidly or piecemeal. Lack of coordination may cause subordinate units to become engaged in actions that do not assist the force mission.

141. Conduct of the Meeting Engagement

a. The desired goal in the meeting engagement is to strike the enemy force continuously until he ceases to exist as a fighting entity. The armor commander must orient his forces

against the enemy and strike violently and relentlessly. The terrain may offer such an advantage that it will be best to defend, inflict losses on the enemy, and then counterattack with all available forces. This is particularly true when the enemy has superior tank strength.

b. The security elements will normally be the first to contact the enemy. The initial fighting by security elements is particularly important to the successful continuation of the engagement and is of great concern to the commander. These forces must make a rapid reconnaissance as accurate information is required by the commander from the outset. They may attack or block the enemy, making it possible to occupy important terrain.

c. Forces in the march column deploy rapidly and are normally committed to the fight while on the move to achieve tactical surprise. Certain forces may be deployed adjacent to the route of march and constitute the commander's reserve.

d. Artillery supports the security forces and forces committed to the action from the march formation. Artillery units quickly move as far forward as possible to provide the required fire support. This maneuver is essential because the confines of the fight cannot be predetermined

and may evolve only as the engagement continues.

e. Maneuver units direct their attacks against the flanks of a fixed enemy to produce decisive results. Frontal attacks are avoided.

f. If the enemy force is moving when contact is made, a rapid flank attack may hinder seriously his ability to deploy and maneuver his main body.

g. It is of utmost importance that the commander recognize changes in the situation in time to act accordingly. He may be required to change plans rapidly, and assign new tasks to his units already in motion to support the initial plan.

h. Units committed from the march column often encounter enemy forces in unreported locations. The action taken against them must always assist in the accomplishment of the overall mission. Adjacent and higher headquarters must be advised of this enemy contact and the commander's plan of action.

i. Commanders may be directed to bypass an enemy force. Minimum forces are employed to block the enemy and allow the uninterrupted advance of the main force. Blocking forces will initially be security elements and should be relieved of this mission as rapidly as possible by units that have a follow and support role.

Section VIII. PROCEDURES AND TECHNIQUES OF THE BYPASS

142. General

a. In a bypass operation the commander deliberately avoids offensive combat with an enemy force, position, or installation. This action is designed to avoid dissipation or diversion of combat power to efforts other than accomplishment of the mission. Bypass operations are particularly applicable during the exploitation, pursuit, or other offensive action when the enemy force encountered is of insufficient strength to jeopardize the accomplishment of the unit's mission.

b. Authority to bypass is delegated by higher headquarters but is not normally delegated below task force level. Because of the extended front over which the armored cavalry squadron normally operates, authority to bypass may be delegated down to troop level.

c. Regardless of the level to which authority has been granted, the commander conducting the bypass immediately notifies the next higher commander of his intention and reports on the enemy force to be bypassed.

143. Considerations

a. The first consideration in the decision to bypass an enemy force is an analysis of the factors of METT.

b. Initially, limited information of the enemy may be available. Aggressive action must be initiated to develop the situation to obtain accurate detailed knowledge of the enemy.

c. Minimum time is available to develop the situation and formulate plans to hasten execution of the bypass.

d. Mobile forces are required to develop the situation rapidly and aggressively and to locate possible bypass routes.

e. The availability of follow-and-support forces may influence the commander's decision to bypass an enemy force.

144. Conduct

a. *Developing the Situation.* When enemy contact is made, engaged friendly forces deploy, develop the enemy situation (location, strength, composition, and disposition), choose a course of action, and report to higher headquarters. Concurrently with actions to develop the situation, reconnaissance is conducted to locate possible bypass routes. If available, armored cavalry, air cavalry, or other aircraft may be employed to facilitate the reconnaissance of enemy positions and possible bypass routes.

b. *Techniques of the Bypass.* One or both of the following techniques may be employed:

- (1) Block the enemy by fire and bypass with the maneuver elements.
- (2) Block the enemy with part of the maneuver elements and bypass with the balance of the force (fig. 7).

c. *Actions of the Blocking Force.*

- (1) Normally the blocking force will engage the enemy until the maneuvering elements have completed their bypass and then disengages from the enemy to rejoin the maneuver units. The blocking force normally employs defensive, delaying, and limited offensive actions in this type operation.
- (2) The commander conducting the bypass may direct the blocking force to block and maintain contact with the enemy until relieved by follow-and-support forces. This may require the blocking force to be reinforced with combat support elements since a combination of offensive, defensive, and delaying actions are employed to accomplish this mission. The blocking force commander coordinates with the follow-and-support force commander as early as possible and provides him with all available information about the enemy and terrain. Concurrently with this action, the blocking force commander plans to rejoin the main force.

Section IX. NIGHT ATTACKS

145. General

a. Night combat is an integral part of all armor operations. Night attacks and night operations offer excellent opportunities for achieving deception and surprise.

b. Night combat that achieves surprise may offer opportunities for success when daylight operations are impractical. This is especially true when friendly forces lack air superiority. Continuous pressure applied day and night, particularly against a weakening enemy, hastens decision. Relentless exploitation around the clock denies the enemy time for regaining his composure and speeds his destruction.

c. Troop movements, concentration of forces before the attack, and the conduct of the attack may result in minimum risk to friendly forces and fewer casualties.

d. Operations in smoke, fog, haze, falling snow, and other conditions of reduced visibility

require the use of special techniques of night attack operations. These periods of reduced visibility should be taken advantage of to conduct offensive operations.

e. The fundamentals involved in night operations are the same as those in daylight operations; however, techniques may vary. For example, more control measures may be placed upon units during night operations than during daylight operations.

f. Battlefield illumination and surveillance equipment increase the efficiency of units operating at night and facilitate the employment of supporting fires.

146. Basic Considerations of Night Attack

a. Night combat is characterized by a decrease in the range of aimed fires and a corresponding increase in area type fires and close supporting fires by direct fire weapons.

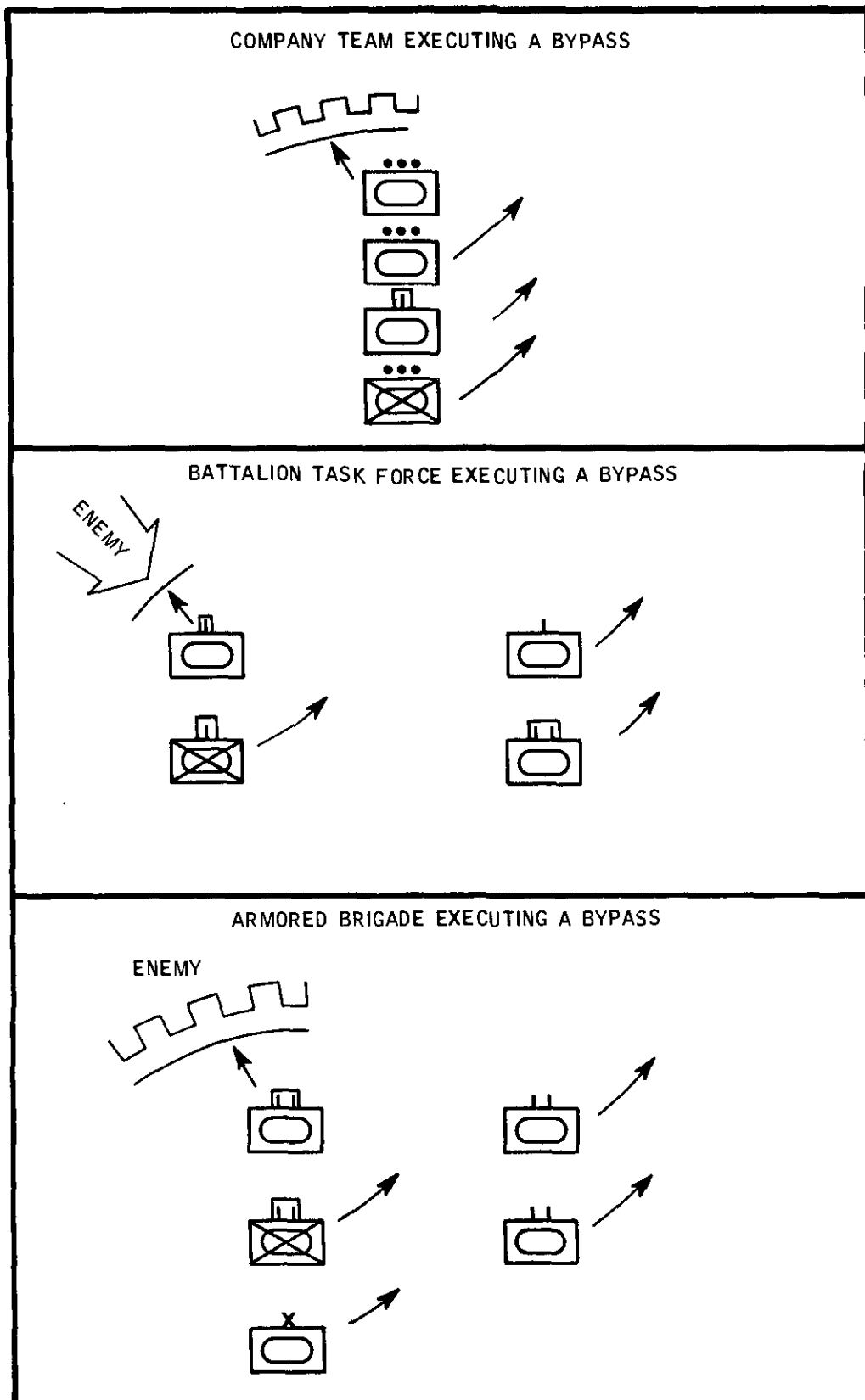

Figure 7. Examples of the bypass.

b. Morale of troops, both friendly and enemy, is highly sensitive to physical and psychological factors. Troops trained and conditioned in night operations can use these psychological factors to their advantage.

c. Darkness increases difficulty of movement, maintenance of direction, and control. The time required to execute movement and emplace weapons is greater at night than in daylight. Simple schemes of maneuver with well-defined objectives and routes simplify control. Leaders must be well forward in attacking echelons. Full use is made of navigational aids to assist in the maintenance of direction.

d. Subordinate commanders should have adequate time for reconnaissance. They should be able to observe, during daylight, terrain over which their units will move in order to fix terrain features which will aid maintenance of direction.

e. Coordination of nuclear fires with maneuver at night is difficult. Darkness increases troop safety considerations because of degradation of night vision. Obstacles created by nuclear fires are difficult to traverse at night and these fires may destroy landmarks which were to be used as control measures.

f. Enemy use of nuclear weapons may affect the vision of attacking or defending troops, causing them to be temporarily less effective. Fires created by nuclear or conventional weapons may assist in identification of objectives and maintaining direction but may also silhouette forces of either side.

g. The paramount consideration is that the attacking troops be as familiar as possible with the terrain over which they will attack. It is desirable to employ troops in night operations that have not been engaged in fighting all day. Troops become fatigued more easily in night combat due to the added physical and psychological stress and strain.

h. During night operations, the effectiveness of armor is increased by the use of illumination, including tank-mounted infrared devices and searchlights. Illumination also aids the adjustment of artillery fire.

i. Illumination by diffuse lighting in rear areas assists in troop movements, logistical operations, and the operation of supporting weapons.

147. Planning the Night Attack

In general, planning for the night attack is similar to that of a daylight attack. However, plans for the night attack are in greater detail with stringent control measures to insure coordination within and between attacking and supporting elements. Subsequent paragraphs will discuss areas that require emphasis in planning offensive operations at night or under conditions of reduced visibility. Appendix XV contains techniques for night operations.

a. *General.* The commander's decision to conduct a night attack must be disseminated to subordinate leaders in time to provide them an opportunity for reconnaissance, detailed planning, and coordination. The amount of planning will depend on the time available, especially when armor units are continuing a daylight attack into the night. The commander must consider the inherent risks in such an attack. Nevertheless, attacks in progress are not discontinued merely because of nightfall. Brigades and subordinate units in the attacking echelon plan to continue the attack through the night unless ordered otherwise.

b. *Reconnaissance.* A detailed day and night reconnaissance should be made of the route of march, attack position, positions for searchlights, and platoon points of departure. Daylight reconnaissance of terrain not held by friendly troops may be accomplished from aircraft and from vantage points controlled by friendly units. Reconnaissance should be conducted to platoon level as a minimum and lower if time permits. When a passage of lines is required, the reconnaissance should be conducted jointly with the units in contact. It should include as a minimum location and identification of guides from units in contact, routes through friendly positions, and known minefields and obstacles. Air photographs of the area over which the attack is to be conducted should be obtained and distributed at least down to company level. It may be necessary to send out patrols to obtain detailed information of the terrain and of the location and strength of enemy security elements. Every effort is made to locate enemy minefields and plans are made to breach these and other obstacles before the attack.

c. *Surprise and Security.* In a night attack, surprise is obtained mainly through secrecy. Measures to obtain secrecy include—

- (1) Restricting the size and time of parties engaged in reconnaissance and other preparations.
- (2) Using artillery and mortar fire to cover the sound of tanks and armored personnel carriers.
- (3) Conducting local attacks in areas not designated for the night attack.
- (4) Attacking at a time and from a direction heretofore not used against the enemy. Set patterns, including methods of attack, are avoided.
- (5) Illuminating areas other than the attack area to mislead the enemy.
- (6) Imposing radio listening silence, at least until reaching platoon points of departure and preferably to the probable line of deployment.
- (7) Conducting the attack nonilluminated until the attacking force is exposed by the enemy or until it reaches the probable line of deployment.

d. *Control Measures.* The following control measures are normally used in the night attack—

- (1) *General.* Attack positions, line of departure, contact points, boundaries, direction of attack, and objectives are night attack principal control measures and are discussed in Appendix X.
- (2) *Limit of advance.* To retain control and prevent the assault echelon from being endangered by friendly fires, the commander establishes a limit of advance. This limit should be easily recognizable under conditions of reduced visibility. It should be far enough beyond and to the flanks of the objective to allow space for security elements to perform their mission. Fire support agencies can engage enemy forces beyond this line without clearance from the supported unit.
- (3) *Point of departure.* This point is where the attacking platoons cross

the line of departure. Platoons will normally cross in column formation. The point of departure should be readily identifiable and if necessary, guides should be posted to facilitate control.

- (4) *Probable line of deployment.* The probable line of deployment should be an easily identifiable terrain feature (road, trail, or other feature). This line is where the unit will assume its assault formation if enemy contact has not been made. Illumination is normally initiated at this time if it is to be used and radio listening silence lifted.
- (5) *Special control means.* For special control means, see Appendix X.

e. *Illumination*

- (1) If there is little or no chance of surprising the enemy, artificial illumination may be used as soon as the attack is launched. If surprise can be gained, illumination may be withheld until the enemy places effective fires upon the attacker. In any event, illumination must be planned for and performed when the enemy fires become effective or if he chooses to illuminate the battlefield himself.
- (2) Battlefield illumination facilitates control and coordination within the attacking elements, permits delivery of aimed fire, and allows rapid minefield removal and evacuation of casualties. For a discussion of battlefield illumination, see Appendix XV.

f. *Fire Support.*

- (1) In a night attack, supporting fires are planned and controlled in the same manner as in a daylight attack. They may be employed before, during, and after the attack. To assist in gaining surprise, the attacking force may advance within assaulting distance of the objective without supporting fires. Once the assault on the objective begins, fires are delivered to isolate the objective, prevent or limit counterattacks, and support the assaulting force.

- (2) Nuclear fires may be used just before the attack to neutralize known hard targets. The employment of on-call nuclear fires should be avoided. The exact location and protective measures afforded the attacking troops may be difficult to determine. Special precautions must be taken to increase troops safety considerations because of dazzle effect at night. The creation of obstacles is to be avoided as they are more difficult to negotiate at night. Nuclear fires may obliterate landmarks that were to be used as control measures.
- (3) Normal fires are maintained before and during an unsupported attack. They do not alert the enemy to an impending attack but assist in maintaining secrecy by muffling the noise of advancing tanks and armored personnel carriers.
- (4) Positions for supporting weapons are reconnoitered and marked, and firing data is prepared during daylight. Weapons are moved under cover of darkness. In a night attack by a battalion task force, it may be desirable to provide all supporting fires from units not in the task force. When this is done, all the battalion's supporting weapons can follow the attacking echelon to the objective by bounds.

g. Communication. Radio is the primary means of communication in the mounted attack. Listening silence may be imposed on the attacking force to mislead the enemy as to the intentions of the moving tracked vehicles. When the enemy discovers the attack, listening silence is lifted. Dismounted mechanized infantry given the mission of breaching minefields and securing the probable line of deployment should use wire communication until the attack is disclosed. In any event, supplemental means such as pyrotechnic signals, infrared searchlights, and electronic devices are planned and employed.

148. Scheme of Maneuver

The amount of maneuver possible during a night attack depends mainly on the nature of

the objective and the visibility. It is difficult to change direction. Complicated maneuvers are avoided to decrease the danger of firing on friendly troops. Attacks normally are made in one direction and in a relatively close formation to facilitate control. Nevertheless, simple maneuvers may be used by tank and mechanized infantry units employing vehicular mounted navigational aids and infrared equipment.

a. Formations. In an attack that is not illuminated initially, tank companies cross the line of departure in line formation with platoons in column. Attached mechanized infantry may be in column behind a tank platoon. Intervals between company teams are such that units can deploy when necessary. Deployment by platoons to the line formation is made when forced by enemy action or at the probable line of deployment to attain maximum firepower and shock effect. In an illuminated attack with supporting fires or when visibility permits, platoons may employ the line formation from the attack position to the objective. In any event, the rate of advance is timed to permit a simultaneous assault on the objective by the leading units. For a discussion of formations in a dismounted attack with tanks, see FM 7-20 and FM 7-11.

b. Time of Attack. Time patterns are avoided to facilitate surprise. Consideration must be given to the mission and enemy situation. If the attack is to seize favorable terrain for a succeeding daylight attack, it may be launched during the final hours of darkness to give the enemy minimum time in which to interfere with the subsequent attack. However, attacks launched during early darkness permit the attacker to take maximum advantage of a long period of darkness and exploit the enemy's confusion and loss of control. Attacks may be initiated during darkness and continued without pause during daylight.

149. Conduct of the Night Attack

a. The attacking forces cross the line of departure at the time prescribed by the operation order. Commanders are well forward to insure aggressive movement of their units, maintenance of direction, and coordination with other units and the base of fire. All leaders must ex-

ercise close control over their elements to prevent a premature assault. The ideal is to conduct the attack nonilluminated as far forward as possible then conduct the action from the point of discovery to the consolidation of the objective in a manner similar to a daylight attack with maximum illumination.

b. Enemy security forces encountered during the advance are disposed of by the leading elements. This action may require engaged elements to deploy before the planned time. Adjacent units may continue to advance during this action. Following units may be committed around the flank of the engaged unit and assume its mission. After the resistance has been reduced, engaged units may reform and follow the main force. This technique is effectively used in an attack of a deep objective. In any event, the entire attack should not be halted because of engagement by leading elements with enemy security forces. If the resistance is such that commanders may lose control or receive effective enemy fire during the attack, visible illumination may be employed and the advance continued as a daylight attack.

c. The ideal to be achieved in the night assault is the same as in a daylight assault. Deployment by platoons to line formation is completed without halting; any prolonged halt at

this stage of the operation increases the chance of detection and allows the enemy time to re-dispose his force on the objective. Mechanized infantry remain mounted until dismounted action is required. When further surprise cannot be achieved, visible illumination is initiated or increased. Mechanized infantry is dismounted to allow the force to place its maximum aimed and concentrated firepower on the enemy. The key to firepower in the assault is volume. The key to shock effect is moving tracked vehicles. Every effort is made to maintain the line formation and prevent it from breaking into isolated groups.

150. Actions on the Objective

Security elements are sent out far enough to warn of enemy forces forming for counterattack within assaulting distance of the captured position. If they are required to go beyond the established limit of advance, their movements are carefully coordinated with the base of fire. Consideration must be given to the use of infrared during the consolidation and reorganization of the objective. This is necessary because the attacking unit will suffer from night blindness for 15 to 30 minutes after extinguishing visible lights. Before daylight, all elements should be in position, prepared to continue the attack or defend the position.

CHAPTER 7

DEFENSIVE OPERATIONS

Section I. GENERAL

151. Purpose of Defense

In the defense armor units prevent, resist, repulse, or destroy an enemy attack. The purpose of the defense is to gain time pending the development of more favorable conditions for undertaking the offensive; economize forces in one area to concentrate superior forces for decisive offensive action elsewhere; destroy or trap a hostile force; reduce the enemy capacity for offensive action; or deny an enemy entry into an area.

152. Doctrine of Defense

The doctrine of defense envisions the use of security forces to provide early warning to detect, delay, deceive, and disorganize the enemy attack; forward defense forces to organize the forward defense area to repel the attacker and develop the situation; and a reserve force to eject or destroy the attack by offensive action. This doctrine also envisions capitalizing on mobility, firepower, and offensive action to establish a defense to retain the initiative, denying the attacker his decisive objectives without the defender becoming fixed and destroyed; and destroying the enemy by fire and maneuver. When the enemy possesses a modern mechanized force, the forward defense force must contain sufficient tanks and other antitank weapons that will enable them to repel the attacker or develop the situation whichever is desired. The nature of the operation demands adequate space for maneuver and a high degree of mobility.

153. Basic Consideration of Defensive Operations

The planning, organization, and conduct of the defense are based on the following considerations:

a. Proper Use of Terrain. Terrain is a major factor in the selection of the defensive area and the location and distribution of defending forces. The defender seeks to control key terrain features essential to observation, communication, and maneuver of reserves. He seeks to deny the enemy the use of terrain which might jeopardize success of the defense. Advantage is taken of obstacles to strengthen the position or to divert the enemy into areas suitable for counterattack. Obstacles in the area have a strong bearing on the general defensive scheme, including the distribution of forces and positioning of the reserves. An evaluation of the enemy avenues of approach in conjunction with key terrain features serves as the basis for positioning troops, surveillance means, and fire. In an analysis of terrain, the following factors should be considered:

- (1) Key terrain features.
- (2) Observation and fields of fire.
- (3) Cover and concealment.
- (4) Obstacles.
- (5) Enemy avenues of approach.

b. Security. Precautions must be taken to avoid tactical surprise by the enemy since the attacker normally retains the initiative as to the time, place, direction, and strength of the attack. Commanders provide for all-round security to insure early warning and reliable information of approaching enemy forces. All

units, regardless of their size, are responsible for their own security.

c. All-Round Defense. Although the defense is designed primarily to combat an enemy attack along the most probable avenues of approach, the enemy may attack from a direction other than expected or considered likely. Also, the enemy may attack the rear by envelopment or large-scale guerrilla action. The defending unit must be capable of meeting an attack from any direction. It must not permit the enemy to gain a decisive advantage by surprise as to the direction or location of the attack. The defender prepares for all-round defense by the careful initial disposition of forces and by the planned redistribution of troops and shifting of fires to meet contingencies.

d. Defense in Depth. Adequate depth to the defense is essential. It must be expected that a strong attack, particularly if supported by nuclear weapons, will permit the enemy to advance some distance in the defense area. There must be sufficient depth to the defense to contain or canalize the enemy and to permit execution of counterattacks. Shallow defenses are inherently vulnerable because the enemy may breach them before he can be contained or effective counteraction taken. Depth to the defense is achieved by proper deployment of forces, selection and preparation of blocking positions in depth, maneuver of forward elements to supplementary positions as necessary, and use of mobile reserves in any part of the defensive area.

e. Responsiveness. The success of the defensive battle will, as in the offense, depend upon the application of superior combat power at the decisive time and place. Both maneuver units and fire support elements must be responsive to the commander's needs if this superiority is to be gained at the proper time and place.

f. Dispersion. In a nuclear situation, dispersion is an important consideration in organizing the defense to limit or minimize vulnerability to nuclear attack. The need for maximum dispersion must be balanced against certain operational requirements for concentration that may be necessary to accomplish the mission. For example, the retention of specific terrain may oppose maximum dispersion. In such cases the mission is paramount, and the degree

of risk in accepting a lesser dispersion is secondary. A force that disperses laterally rather than in depth, risks isolation of its separate forward combat units, subsequent penetration by frontal attack, and defeat in detail. Dispersion in depth is preferable to purely lateral formations since it avoids frontages that overextend the defender, provides a larger percentage of a given force as a reserve, avoids lateral movements in the face of an enemy attack, permits detection and destruction of infiltrators, and provides a better posture from which to launch offensive operations.

g. Maximum Use of Offensive Action. In the defense, every opportunity is taken to wrest the initiative from the enemy and to destroy him. The defender must be prepared to take offensive action whenever the opportunity presents itself. The counterattack or spoiling attack is often the key to success in the defense.

h. Integration and Coordination of Defensive Measures. The overall defense plan involves the careful integration and coordination of all defensive measures. Special attention must be given to antitank defenses when the enemy possesses modern mechanized forces.

- (1) Fire planning is conducted and coordinated at all levels. Fire planning must provide for continuous fire support to the forces in the security area, forward defense area, and reserve area. Fires are also planned to control gaps and cover barriers.
- (2) When time permits, natural obstacles are supplemented by minefields and other artificial obstacles to form effective barriers. Such barriers are designed to restrict the movement of the enemy without restricting the planned maneuver of our own forces. For a detailed discussion on barrier planning, see appendixes XVIII and XIX.
- (3) Mutual support is provided between units by fire or movement, or both, and coordinated and incorporated into the overall plan of defense.
- (4) All surveillance means are coordinated closely and incorporated into the overall plan of defense. See appendix XXI for employment of radar.

i. Time. Time available for planning, preparation, and occupation of defensive positions is of major importance and will often determine the defensive posture of a unit.

154. Basic Forms of Defense

There are two basic forms of defense, the mobile defense and the area defense.

a. The mobile defense employs a combination of offensive, defensive, and delaying actions with the ultimate success of the defense depending upon offensive action. The primary objective of the mobile defense is the destruction of the attacking enemy force. In the mobile defense, minimum forces are deployed as fixing forces in the forward defensive area to detect, disorganize, delay, and destroy the attacking enemy and to provide time and space for action by the reserve. The bulk of the combat power of the command is deployed as a counterattack force which employs the principles of offensive combat to destroy the enemy at the most favorable time and place.

b. In the area defense, emphasis is placed on retention of specific terrain. Offensive and defensive actions are directed at stopping the enemy forward of the forward defensive area or ejecting him if he penetrates this area. The bulk of the combat power of the command is committed to defense of the forward defensive area. Reserves are employed to add depth to the defense, to block or destroy enemy penetrations, to counterattack and restore the defensive position, or to reinforce threatened forces.

155. Selection of the Type Defense

a. Selection of the type defense to be used depends on the mission, terrain, mobility, nuclear weapons, air situation, time, and enemy capabilities. See FM 61-100 for detailed discussion.

b. Mobile defense is the preferred type of defense for armor. Its adoption is favored when—

- (1) The mission and the area of operation permit the defense to be organized and fought in sufficient depth.
- (2) Terrain permits relatively free movement by the defending force.
- (3) The mobility of the defending forces compares favorably with that of the enemy.
- (4) The enemy has the capability of employing nuclear weapons and the defender must employ maximum dispersion and mobility to decrease vulnerability to nuclear attack.
- (5) The air situation permits relatively free movement of the defending forces.
- (6) Minimum time is available for deployment of forces and organization of the ground and defensive positions.

c. Area defense is less desirable for armor units because it does not make maximum use of the mobility of the tank. Its adoption is favored when—

- (1) There is a lack of depth in the defensive area.
- (2) There is a requirement to retain specific terrain.
- (3) Terrain restricts maneuver by the defending force.
- (4) The attacker possesses a mobility differential over the defender.
- (5) The attacker possesses air superiority.
- (6) Time is available for the construction of defensive positions to include the preparation of barriers.

156. Factors Affecting Employment

The commander must employ armor in a manner calculated to make maximum use of its favorable characteristics. Regardless of the type defense that may be employed, this calculation is based on a reasoned analysis of the factors of METT (para 30-34).

Section II. ORGANIZATION OF THE DEFENSE

157. General

In either the mobile or the area defense, armor units may be required to organize the defense of specific terrain in accordance with the

overall plan of defense of the higher commander. In mobile defense, a small armor unit may be required to organize a sector of the forward edge of the battle area (FEBA) or one or

more blocking positions. In the area defense, the unit may be assigned a sector to defend as part of the forces in the forward defense area. Techniques in organizing the defense of the ground in these cases are basically the same and are discussed in this section. They include reconnaissance, planning, organization of the ground, command and control, fire planning, surveillance, and employment of supporting troops.

158. Reconnaissance for Defensive Action

Upon receipt of an order to assume the defensive, the commander makes a map study and formulates tentative plans. As soon as possible, he reconnoiters his assigned sector as completely as time and the situation will permit. While on reconnaissance he determines—

- (1) The probable avenues of enemy armor and dismounted approach.
- (2) The terrain that is to be occupied by security forces.
- (3) Key terrain that is to be retained or denied the enemy.
- (4) Natural obstacles forward of and in the area that can be used to strengthen the defensive area.
- (5) Location of reserves.
- (6) Location of command posts.
- (7) Location of logistical support installations.

159. Planning for Defense

Normally, the defender has an advantage in that he can select the terrain and has time for organization of the ground and opportunity to improve natural obstacles. Initially, the commander develops a tentative plan from his reconnaissance and issues a warning order. This is followed by more detailed plans, including plans for—

- (1) Organization of the ground.
- (2) Organization for combat.
- (3) Command and control.
- (4) Fire support.
- (5) Security and surveillance.
- (6) Employment of supporting troops.
- (7) Logistics.

160. Priority of Work in Organization of the Ground for Defense

In the defense, measures for increasing the effects of fire and movement take precedence over all other work. The goal is to insure that accurate fire can be delivered on the attacker, to make his fires ineffective, and to impede his movements while improving the movement of defending forces. The normal tasks associated with organization of the ground include—

a. Preparation of Counterattack Routes. A reconnaissance is conducted for each counter-attack plan to determine the best routes for movement of forces. This task also includes the reconnaissance and improvement of routes from primary to supplementary positions.

b. Preparation of Defensive Position.

- (1) As soon as defensive positions are occupied, units organize the ground for defense to include air defense weapons. Fields of fire are cleared, tanks are placed in hull defilade, emplacements are dug for crew-served weapons, and foxholes are dug for personnel. Alternate and supplementary positions are planned and prepared as time permits.
- (2) Armored personnel carriers and air defense artillery automatic weapons may be integrated into the forward defense positions. These vehicular weapons can be assigned fire missions to augment the long range, close-in, and final protective fires of other automatic weapons. Due to the high silhouette and vulnerability to certain types of enemy fire, armored personnel carriers are usually placed to the rear in defilade. However, provisions are made to move the carriers, as the situation requires, to previously selected firing positions from which they can augment protective fires. When in defilade, they can provide flank and rear protection.
- (3) Range cards are prepared for all crew-served weapons. All vehicles, weapons, and emplacements are camouflaged. Every effort is made to deceive the enemy as to the true location of the defensive positions. Move-

ment of individuals and vehicles within the defensive areas is kept to a minimum.

c. Strengthening the Defensive Position. Obstacles are improved and mines are used to provide close-in protection for each blocking position. Protective, defensive, and dummy minefields may be installed. Protective minefields may be installed, upon authority of the company commander, to the front and flanks of the blocking positions to provide security. Dummy minefields may be used as gaps by the reserve. Time permitting, and upon authority of the brigade commander, defensive minefields may be installed to add strength to each blocking position. Each minefield must be marked and recorded properly.

d. Preparation of Routes for Supply. Supply routes are established for each battalion task force. Supply routes must be coordinated with the plan of defense to insure that they do not conflict with the maneuver of forces conducting the defense. Alternate supply routes may be required. Supply routes should be marked and traffic entering the forward defensive area should be controlled.

e. Establishment of Early Warning System. Emphasis will be placed on early detection and warning of enemy approach. This is accomplished by establishing OP's, LP's, and by employing air and ground surveillance and security forces. See chapter 5 for employment of surveillance and security forces.

161. Organization for Combat

Organization for combat is the method by which a commander organizes his forces to meet the varying requirements of the battlefield in terms of the factors of METT. These factors are of such importance and sufficiently different in the two basic types of defense that a detailed discussion of each is set forth in paragraphs 167 through 173 (Mobile Defense) and paragraphs 174 through 183 (Area Defense).

162. Command and Control

a. General. The defense commander must insure effective control and coordination of the defensive action. However, this control must permit maximum flexibility of employment of the forces conducting the defense and allow

freedom of action by subordinate commanders. The commander initiates control and coordination by announcing his concept of the operation and the plan of defense, by insuring adequate communication, and by employing necessary control measures, together with priorities of effort and sequence of action.

b. Control Measures.

- (1) Objectives are normally established for the coordination of each counter-attack plan. In addition, fire control measures, lines of departure, axes of advance, zones of action, or directions of attack are established for each counterattack plan.
- (2) Phase lines may be used to control the rearward movements of the security force, to delineate areas for surveillance, and to coordinate the movement of the reserve.
- (3) Boundaries are used to delineate lateral responsibilities in the forward defensive area. Boundaries normally extend forward to the extent of the area of influence which is normally the range of organic, attached, or direct support weapons and rearward to the depth of the blocking positions.
- (4) Coordinating points are used in the forward defensive area for the coordination between adjacent units.
- (5) Contact points may be designated to insure coordination of units performing surveillance missions and of units operating observation posts or combat outposts.

c. Communication. Although radio is the means of communication most often used in armor units, all forms of signal communication must be utilized to the best advantage. Maximum use must be made of both ground and air relay. In the defense when time and the situation permit, more reliance is placed on wire communications. A discussion of communication is contained in paragraphs 229-233.

163. Fire Planning in Defense

a. Mission. The fires of organic and supporting weapons are coordinated to—

- (1) Bring the enemy under effective fire as early as possible.

- (2) Subject the enemy to progressively heavier fire as he approaches the defensive area.
- (3) Destroy the enemy by fire if he attacks the defensive positions.
- (4) Support the counterattack and movement of other units to support the plan of defense.

b. The Plan of Fire Support. The plan of fire support is the coordinated and integrated plan for all fires, nuclear and nonnuclear, available to the commander at each echelon. Components of the plan of fire support include detailed plans for fires of automatic weapons, tanks, mortars, and all available fire support agencies. Planning for fires is continuous and is as detailed as the situation and the time permit. Fires are planned on all targets and areas on which a need for fire might arise. This permits prompt and effective delivery of fires under all conditions of visibility. Provision must be made to allow departures from the plans to permit prompt attack of targets of opportunity.

- (1) Each unit develops plans for employment of its organic weapons. Requests for supporting fires are included in the plan of fire support which is submitted to the next higher headquarters. Subordinate fire support plans are incorporated into the next higher echelon's plan of fire support.
- (2) Planned fires for the defense fall into four categories—long range fires, close defensive fires, final protective fires, and fires within the defensive area.

c. Long Range Fires.

- (1) Long range fires are planned to engage the enemy as early as possible to inflict casualties, to delay his advance, and to disrupt his organization.
- (2) Long range fires are employed initially in support of the security force.
- (3) As the enemy continues his advance and comes within range of additional weapons, he is brought under an increasingly heavy volume of fire.
- (4) Long range fires should also support counterattacks and spoiling attacks

conducted forward of the defended area.

d. Close Defensive Fires. Close defensive fires are planned to disorganize the attacking force before the enemy can assault defensive positions. These fires are planned to inflict the greatest possible number of casualties; to disrupt command, control, and communication; to deny observation; and to neutralize his supporting fires. Close defensive fires also support counterattacks or spoiling attacks made immediately forward of the battle area.

e. Final Protective Fires. Final protective fires are designed to break up the enemy assault on the forward defended positions under all conditions of visibility. Such fires consist of a first priority, prearranged, barrier of fire laid down just in front of forward blocking positions. They consist of mortar and artillery barrages and final protective line fires of machineguns. Tanks in the blocking position engage targets of opportunity.

f. Fires Within the Forward Defensive Area. Fires within the position are planned to limit possible penetrations of the forward defensive areas or support counterattacks. Fires are planned to seal off the penetrating force and to prevent movement of enemy reinforcements. Plans should be made for fires of adjacent units to support the penetrated units by firing on the flanks and rear of the penetration force. In addition, fires should be planned to cover gaps between blocking positions.

g. Air Support. When available, air cavalry and close air support fires are integrated into the plan of fire support. If possible, ground alert or air alert aircraft should engage targets of opportunity. Preplanned on-call missions should be planned on locations where enemy troop concentrations are likely to occur during an enemy attack. Preplanned missions should be requested to support counterattack plans.

h. Additional Information. See chapter 9 and appendix XIV for additional information on fire support planning.

164. Security and Surveillance in Defense

Gaps throughout the defensive area must be secured against infiltration, guerrilla action, or airborne and airmobile attacks. The commander plans for the employment of all availa-

ble means in providing adequate surveillance of the defensive area. See appendix XXI for employment of ground surveillance radar.

165. Combat Support Units in Defense

a. Field Artillery.

- (1) The massed fires of supporting artillery are essential to the success of the defense. Every effort is made to meet enemy attacks with massed artillery fires. If the frontage is so extensive that artillery fires cannot be massed across the entire front, plans must be developed for concentrating fires on likely avenues of enemy approach and on areas to be denied to the enemy.
- (2) Artillery normally is placed in direct support of each brigade conducting the defense. Artillery liaison officers are provided to each battalion of the brigade, and forward observers are provided to each company-size combat unit.
- (3) Fires of general support artillery may be made available by request through direct support artillery channels.
- (4) Artillery elements are attached normally to the security force during the initial conduct of the defense. When the security force is forced to withdraw, the artillery withdraws to preselected positions to support the defensive action.

b. *Air Defense Artillery.* The static nature of units and installations in a defensive posture increases the probability of detection and attack by enemy aircraft. Use of ADA must be considered in defensive plans and appropriate action taken to defend priority areas. Air defense artillery units must also be considered in plans for counterattack to provide protection of displacing units, particularly when in march column. Natural and manmade features essential to success of a counterattack such as defiles, river crossing sites, and bridges must be protected from air attack (para 220-221).

c. *Engineers.* Engineer support during defensive operations is discussed in chapter 9.

d. *Air Cavalry.* Air cavalry is used to augment the ground reconnaissance and security effort. Initially, maximum support is provided to the security force. After the security force has withdrawn through the forward defensive area, air cavalry may provide surveillance of the flanks and the areas between blocking positions. They may support the movement of forces in the defensive area, particularly counterattacking forces.

166. Defensive Areas

Defensive areas include the security area, the forward defensive area, and the reserve area. Each of these areas is allocated forces and fires as part of the overall plan of defense.

Section III. MOBILE DEFENSE

167. General

a. The mobile defense employs a combination of offensive, defensive, and delaying actions. The ultimate success of the mobile defense depends upon the offensive action of the reserve. The primary objective of the mobile defense is the destruction of the attacking enemy force.

b. Although armor units may employ some of the techniques of the mobile defense, the division is normally the smallest unit to conduct such an operation. Armor units participate normally in a mobile defense as the security force, the fixing force, or the reserve.

168. The Security Forces

a. *General.* Security forces consist of the covering force, observation posts, listening posts, patrols, and rear area security forces.

b. *Covering Force.*

- (1) The covering force detects and reports the approach of the enemy; delays and disorganizes his advance; and deceives him as to the location of the main force. The division covering force seeks to destroy the enemy within its capabilities employing supporting fires, including nuclear weapons when authorized, and ground action.

- (2) The size and composition of the covering force depend upon the front to be covered and the amount of delay required. The covering force for a division may be a brigade, the armored cavalry squadron, or a battalion task force. In some situations, the armored cavalry regiment may be attached from corps to perform this mission. The covering force is reinforced normally with combat and combat support units necessary to accomplish the mission.
- (3) When the armored division is executing the mobile defense as a part of the corps, the covering force will coordinate its actions with the security forces of adjacent divisions.
- (4) When the armored division executes the mobile defense independently, the covering force may be located from 8 to 25 kilometers forward of the FEBA.
- (5) When engaged heavily with the enemy, the establishment of a covering force may not be possible.

c. Observation Posts and Listening Posts. In the mobile defense, sizable gaps will often exist between elements of the fixing forces. Observation or listening posts are established forward of, between, and to the rear of blocking positions. Observation posts provide early warnings of the enemy approach and adjust long range supporting fires on the enemy. They are located on dominant terrain generally from 800 to 2,000 meters forward of the FEBA. Troops required to man the observation posts are provided from the fixing forces. The location of observation posts is coordinated by the brigade commander with adjacent units and must insure complete surveillance of the defensive area. Listening posts and ground radar are employed during darkness and other periods of reduced visibility. Communication must be provided each observation post or listening post to permit accomplishment of their mission.

d. Patrols. Foot and motorized patrols are employed between blocking positions and observation posts. These patrols are used to prevent or detect infiltration and to maintain surveillance over assigned areas. Patrols may be

used at night to check listening posts, to maintain liaison with adjacent units, to seize PW's, and to gain information of the enemy.

e. Rear Area Security. The increased dispersion required by nuclear warfare, together with the enemy's capability of employing airborne, airmobile, and guerrilla forces in rear areas, requires that units provide their own local security. However, combat units may be assigned missions to assist in rear area security. The armored cavalry squadron may be assigned such missions. See chapter 12 for rear area security operations.

169. Fixing Forces

a. General. Fixing forces, consisting of minimum forces and heavy in mechanized infantry, are employed in the forward defensive area. However, adequate tank strength must be provided for antitank defense when the enemy possess modern mechanized forces. The mission and the area to be defended should be stated with minimum restrictions. This permits fixing force commanders to use their means to maximum advantage within the framework of the overall plan of defense. The holding of specific terrain by the fixing force may restrict the execution of the mobile defense. However, fixing forces may be required to hold terrain on the flanks of other defending units that are conducting an area defense.

b. Mission. Missions suitable for units assigned to fixing forces are—

- (1) Warn of impending attack and provide information on the progress of the attack.
- (2) Defend.
- (3) Delay, deceive, and disorganize the attacker.
- (4) Canalize the attacker into an area suitable for attack by the reserve or by nuclear fires.
- (5) Force the attacker to mass.

c. Actions of the Fixing Forces. Fixing forces accomplish the mission assigned by a combination of the following actions:

- (1) Establishment of observation or listening posts and other surveillance means.
- (2) Patrolling.

- (3) Occupation and defense of blocking positions.
- (4) Delaying action.
- (5) Offensive action within their capabilities.

170. The Reserve

a. General. The reserve is the decisive element in the mobile defense. It consists of the bulk of the combat power of the command and is strong in tanks.

b. Mission. The reserve destroys the enemy by offensive action.

c. Actions of the Reserve. The reserve accomplishes its mission by attacking within, to the flanks, or forward of the FEBA.

171. Considerations of the Mobile Defense

a. Organization of the Ground. Organization of the ground consists of use and optimum improvement of the natural defensive features of the terrain with the men, materials, and time available. The specific location of the units in the defensive area is determined from the following:

- (1) Unit missions to be assigned and the maneuver room required to accomplish them.
- (2) Enemy capabilities, known and assumed.
- (3) Military characteristics of the terrain, particularly the defensive strength of obstacles, all possible enemy avenues of approach, and the area trafficability.
- (4) The capabilities of friendly forces, including all available combat support units. In this connection, the relative mobility of all units and their responsiveness have considerable bearing on the positioning of units.

b. Organization for Combat.

- (1) *Security forces.*
 - (a) The covering force is organized as a highly mobile, self-contained force in keeping with the fundamentals of security discussed in chapter 5.
 - (b) The observation and listening posts established by the fixing forces are

coordinated by the brigade commanders. Artillery or mortar observers are employed with elements that provide the best observation of the area.

(2) *Fixing forces.*

(a) Brigades in the fixing force receive the attachment of combat maneuver battalions in the number and type best suited for the accomplishment of the mission. Balanced forces (infantry-tank) may be required to provide adequate antitank defenses when the enemy possesses modern mechanized forces. However, when possible, such brigades will normally be mechanized infantry heavy. The reserve of the brigade, if established, is usually tank heavy.

(b) Battalion task forces and company teams are organized in accordance with an analysis of the factors of METT. The anticipated mission of the task force or team is a major consideration in determining the size and composition of the force. Normally, frontages occupied by task forces in the fixing force preclude their withholding a reserve.

(3) *Reserves.* The reserve is organized with as much combat power as possible, is tank heavy for maximum offensive power, and is employed under a single commander.

172. Planning for the Mobile Defense

a. Covering Force. The plan for the covering force is prepared as outlined in chapter 5.

b. Fixing Forces. The plan for the fixing forces makes the most effective use of the forces available to develop the situation. Commanders at all levels express clearly their intentions to their subordinates.

- (1) *Brigade.* Based on the division order, brigade commanders assign defensive sectors to battalion task forces. In assigning sectors, the commanders consider the forces available and the enemy avenues of approach into the brigade sector. Boundaries, coordi-

nating points, and the general trace of the FEBA are designated according to the definitions and purposes outlined in appendix VII. Based on an analysis of key terrain, certain brigade blocking positions may be designated for occupation by task forces. If an analysis of the situation indicates, a small, tank-heavy reserve may be held at brigade level. Normally, elements of the fixing forces are initially deployed in their blocking positions. However, the brigade commander may determine that his forces should be initially disposed in assembly areas. He designates the appropriate assembly areas and issues the orders for the occupation of the defended localities (FM 17-30).

- (2) *Battalion.* Battalion task force commanders normally assign sectors to company teams based on the brigade order, the forces available, and the enemy avenues of approach into the battalion task force sector. Boundaries, coordinating points, and further refinements of the trace of the FEBA are designated. See appendix X for a discussion of appropriate control measures. Frontages occupied by battalion task forces rarely permit holding a reserve.
 - (a) Based on an analysis of terrain, the battalion task force commander may designate a specific terrain feature as a blocking position. He must specify when or under what circumstances the position(s) is to be occupied and the priority.
 - (b) If the battalion task force commander determines that his forces should be disposed initially in assembly areas, rather than in defended localities, he designates the appropriate assembly areas. Orders for the occupation of the defended localities are issued by the task force commander.
 - (c) When the battalion task force commander determines that he will conduct a delaying action or offen-

sive action, he employs the techniques outlined in chapters 8 and 6 respectively. Combinations of these actions may be used. Such combinations add to the complexity of the plan and must be expressed clearly to subordinates.

- (3) *Company.* Company team commanders assign positions and sectors of fire to platoons based on the task force order, forces available, and enemy avenues of approach into the company team sector. The company team normally does not hold a reserve.
 - (a) Blocking positions are organized as outlined in FM 17-15 and FM 17-36.
 - (b) A delaying action is planned in accordance with the techniques outlined in FM 17-15, and FM 17-36.
 - (c) Offensive action is planned in accordance with the techniques outlined in FM 17-15, and FM 17-36.

c. Counterattack Planning.

- (1) Counterattack plans are prepared, as a minimum, to attack an assumed major penetration on each principal enemy avenue of approach into the division area. First priority in counterattack planning is for assumed penetrations. Planning priorities may shift as intelligence of the enemy develops.
 - (a) Counterattack plans permit, to the extent possible, the reduction of the time required to commit the reserve if the penetration develops as envisioned. These plans also assign priorities for reconnaissance, engineer efforts, and coordination. If the enemy penetration does not conform to the assumed penetrations, modification can be made without excessive loss of time.
 - (b) Assumed penetrations will normally conform only generally to actual enemy actions. Although useful for planning, assumed penetrations are not to be construed as preselected

areas into which the enemy must be canalized before being attacked by the reserve or nuclear fires.

- (2) When disseminated to the commander of the reserve, the division counterattack plans will include—
 - (a) Assumptions of the status and location of both friendly and enemy forces.
 - (b) Control measures.
 - (c) Organization for combat.
 - (d) Missions for brigades and other units subordinate to the division.
 - (e) Plans for fire support.
- (3) Based on the division counterattack plan, the commander of the reserve prepares and disseminates detailed plans to subordinates. The sequence of work is in accordance with the priority established by the commander conducting the mobile defense. Depending upon the time available, detailed reconnaissance is accomplished by all commanders, and rehearsals are conducted. Fire plans are prepared to support each counterattack plan.
- (4) Counterattack plans employ the principles of the offense (chap 6) and are designed to strike the enemy forward of, within, or in the rear of the forward defensive area.
- (5) Counterattack plans must be flexible to meet the actual situation. The actual counterattack will probably be a variation of one of the counterattack plans. Particular consideration must be given to multiple penetrations to avoid piecemeal commitment of the reserve. See FM 17-30.

173. Conduct of the Mobile Defense

a. The mobile defense is conducted as a resilient opposition to enemy attack. Minimum forces are used within their capabilities to gain information, delay, disorganize, divert, and otherwise weaken the attack in preparation for a counterattack by the bulk of the command to destroy the enemy.

b. Unless surprise offers a great opportunity for success, the enemy is taken under fire as early as possible. As the enemy advances, he is

taken under fire by the security forces who warn, deceive, and execute maximum delay, within their capabilities, without becoming engaged decisively. They attempt to inflict maximum casualties on the advancing enemy and force him to deploy. As a means of collecting information, elements of the security force may remain in the area after passage of the enemy.

c. The attacker's strength and dispositions during the engagement with the security forces may favor action by the reserve forward of the FEBA to destroy him. The commander must weigh carefully the risks in terms of their effects on the accomplishment of the mission.

d. A tank sweep to disrupt the enemy attack during its formative stages should be considered. The decision to commit such a force must be carefully considered against the possible piecemeal loss of the strength of the command to the detriment of the overall mission.

e. As the security forces withdraw through the fixing forces, the attacker is taken under fire by all weapons within effective range. The fixing forces accomplish their mission by a combination of holding ground and a delaying action extending over considerable depth. As the attack develops, commanders are able to judge the degree to which specific terrain features must be held. Forces and fires not affected by the attack may be shifted to concentrate against the enemy. Forces may occupy blocking positions in company team to battalion task force strength to force the enemy to mass or become canalized. Normally these positions are held only long enough to contribute to the overall plan. When required, elements of the fixing forces may be given the mission of occupying blocking positions to be defended at all costs. This action should be taken only when specific terrain must be held to permit success of the overall plan of defense. Forces in the fixing force may be employed in limited offensive action when opportunities occur to inflict damage on the enemy.

f. The decision as to when and where to launch the counterattack by the reserve is made by the commander of the overall defense (normally the division or higher commander). It is advantageous to launch the counterattack when the enemy attack has been slowed,

stopped, or disorganized. However, these are not essential prerequisites for the counterattack. Criteria for determining where and when the counterattack should be launched are primarily those for assessing offensive maneuver. For considerations on the launching of the counterattack, see FM 61-100.

g. The reserve is committed normally as a unit to destroy the enemy. The counterattack plan may include terrain objectives for control purposes, but the goal of the reserve is destruction of the enemy, not seizure of terrain to restore the position. The reserve seeks to employ the principles of the offense to destroy enemy units, reserves, command facilities, fire

support elements, and combat services support. Many techniques of the meeting engagement (para 133-135) are used to seize the initiative from the enemy.

h. In the event of multiple enemy penetrations, they may be dealt with simultaneously or individually in the order of the seriousness of their threat. The reserve may be committed to destroy the major threat, while sufficient force is applied to contain the other threats. It may be necessary to detach part of the reserve and attach it to the fixing force to assist in containing secondary threats. Simultaneous counterattacks by elements of the reserve divide combat power and should be avoided.

Section IV. AREA DEFENSE

174. General

a. The area defense requires the retention of terrain for a period of time. In this type of defense, forward positions are strongly held and emphasis is placed on stopping the enemy forward of the FEBA. The bulk of the combat power is committed to this task. It may not be possible or advisable to physically occupy all key terrain in the defended area, but sufficient combat power must be available to dominate the area. If the enemy penetrates the defense, he is destroyed or ejected by counterattack of the reserves with the principal objective of regaining control of the forward defense area. Reserves are also employed to block enemy advances and to reinforce threatened areas.

b. Although armor units prefer to employ the techniques of the mobile defense for defensive operations, they may establish an area defense when the terrain or the mission requires it.

175. Distribution of Forces in the Area Defense

In the area defense, forces are distributed to accomplish three functions—to provide security and prevent surprise attacks; to stop and repel the enemy's attack; and to destroy or eject penetrations of the forward defensive area. To accomplish these functions, three tactical groupings are organized—the security force, forces in the forward defense area, and the reserve.

176. Selection of the Forward Defensive Area and Reserve Positions

a. The Forward Defense Area. Higher headquarters will normally designate the forward edge of the battle area (FEBA) by establishing boundaries and coordinating points.

b. The Reserve Position. The reserve should be located where it can best accomplish prepared plans for its employment. Consideration must be given the probable direction of the enemy's main effort, terrain, route of communication, concealment, and security. The characteristics of a good reserve position include—

- (1) *Accessibility.* It should have good routes for rapid movement to the anticipated sectors of employment.
- (2) *Concealment.* It should not be under enemy ground observation, and should offer the best possible concealment from air observation.
- (3) *Dispersion.* It must permit dispersion of units and vehicles.
- (4) *Firm standing.* It must offer standing that permits free movement of all vehicles in the reserve force.

177. Organization and Function of the Security Force

The size and composition of the security forces depend upon the time required for the defending forces to prepare defensive positions, the terrain, and the troops available. In

the area defense, the security force at brigade level is normally deployed as a combat outpost (COP). For a discussion of the COP, see FM 7-20.

178. Organization and Functions of Forces in the Forward Defense Area

The commander selects the terrain that must be held to accomplish the defense mission and determines the enemy avenues of approach leading to them. Based on this, he then designates defensive sectors to subordinate units. Where possible, avenues of approach or key terrain features are not divided between units. Boundaries and coordinating points are established between battalion task forces and company teams. Boundaries are extended forward of the FEBA to designate areas of responsibility and are limited to the maximum effective range of organic, attached, or direct support weapons and to the rear to include the subordinate reserve location. The gaps between defensive areas are covered by fire, obstacles, and surveillance. Fires are coordinated between adjacent units. For a discussion of the armored brigade, tank battalion, and tank company, see FM 17-30 and FM 17-15, and for armored cavalry units, see FM 17-36 and FM 17-95.

179. Organization and Functions of the Reserve

Normally, armor units are cross-attached with infantry for the conduct of the area defense. In the area defense, terrain and frontages may permit such units to hold a reserve at task force and team level. Armor units may also be designated as an element of either a division or brigade reserve. The reserve is constituted from forces not required in the forward defense area. The reserve is located to protect key terrain and is positioned to block penetrations from both the front and the flanks. Counterattack plans are developed for possible penetrations by the enemy; in addition, counterattack plans are developed to strike the enemy in front of the FEBA or to the flanks. Objectives, routes, lines of departure, and direction of attack are selected for each counterattack plan. Key personnel should reconnoiter the route for each counterattack plan. The reserve plans to reinforce or cover the withdrawal of frontline units. The reserve

should be heavy in tanks; however, the exact composition of the reserve is determined after a study of the factors of METT. For a discussion of the armored brigade, tank battalion, and tank company, see FM 17-30 and FM 17-15.

180. Conduct of Area Defense

The success of the area defense depends upon the solidity of the defense, maximum application of firepower in front of the FEBA, and timely execution of counterattacks to destroy or eject enemy penetrations. The commander conducts the defense aggressively. He maintains continuous surveillance, using aircraft, air cavalry, and other agencies to locate enemy formations and attack positions and to adjust supporting fires. Once contact has been established, he makes every effort to obtain detailed and timely information about the enemy. The defense progressively disrupts and weakens the enemy from the time he comes within long range fires of the security forces. Emphasis is placed on blocking avenues of approach at the FEBA. Forward defensive forces exert every effort to halt the enemy. However, if the enemy penetrates the area, forward defensive forces attempt to force him into areas favorable for counterattack. When launched, counterattacks are aimed at eliminating the penetration and restoring the integrity of the battle area.

181. Actions of Security Forces in Area Defense

The security force accomplishes its mission in the same manner as discussed in paragraph 168. The security force maintains contact with the enemy until it withdraws through the FEBA.

182. Action of Forces in the Forward Defensive Area

Forces in the forward defense area engage the enemy at maximum effective range of their weapons. Initially, long range fires are delivered on the enemy. As he continues to advance within range of other weapons, the volume of fires is increased. If the attack is not disrupted by the close defensive fires and the enemy prepares to assault the position, final protective fires are delivered. Adjacent units may be

moved to positions from which they can deliver additional fires upon the flanks of the enemy.

183. Actions of the Reserve in the Area Defense

a. If the enemy penetrates the forward defense area, the commander uses his reserve or other forces to limit the penetration. Once the penetration has been slowed or stopped, the commander launches a counterattack to destroy forces in the area and to restore the FE-BA.

b. All available combat and combat support forces are used to support the counterattack.

c. Once the enemy force has been destroyed

or ejected, the reserve may return to its original positions or may occupy and defend the regained ground.

d. The reserve may be used to conduct limited-objective attacks to the front of the FE-BA to destroy or disrupt the enemy as he forms for the attack.

e. The reserve may be used to reinforce a unit in the forward defense area.

f. If a strong enemy attack penetrates the battle area and counterattacks are unsuccessful, the reserve may be used to block the penetration or to cover the withdrawal of forces from the forward defense area.

Section V. RELIEF IN PLACE

184. General

a. When tactical operations continue over a prolonged period, conservation of fighting power, maintenance of effectiveness, and the tactical plan may require the periodic relief of committed units. Such reliefs are accomplished by a relief in place or a passage of lines. See paragraphs 133–135 for passage of lines.

b. Armor units prefer to conduct relief operations by a passage of lines due to the inherent difficulty of concealing armor vehicle movement. However, armor units may be required to participate in a relief in place as part of a larger unit or it may direct and control reliefs in place of subordinate units.

185. Definition

A relief in place is an operation in which all or part of a unit is replaced in a combat area by an incoming unit. The combat mission and area of operation responsibilities of the outgoing unit are assumed by the incoming unit. The relief in place is accomplished when the outgoing unit is in the defense. The incoming unit may have the mission of continuing the defense or preparing for a subsequent attack. In either case, the outgoing unit or elements thereof are withdrawn.

186. Basic Considerations

a. Relief operations must be executed in an expeditious and orderly manner.

b. Units in forward combat areas are normally relieved at night or during periods of reduced visibility.

c. Very close cooperation and coordination of plans is necessary between the commanders and subordinates of both the incoming and outgoing units.

d. Detailed prior reconnaissance by the incoming unit is essential.

e. The incoming unit must fit into and accept the general defense plan of the outgoing unit until passage of command.

f. During the relief, to preserve secrecy, normal patterns of activity in a defense sector should be maintained.

g. Every effort must be made to effect the relief without weakening the tactical security of the position and by offering the least profitable target for attack by nuclear weapons.

h. Units of the supporting arms normally should not be relieved at the same time as the units they support.

187. Planning Procedures

a. General. When an armor unit relieves another unit in place, the warning order to the incoming unit must specify, as a minimum, the time for commencing and completing the relief and the priorities for use of routes involved. The warning order normally will direct that the relief be carried out under cover of darkness or other conditions of reduced visibility. Upon receipt of the warning order, the unit

commander and staff analyze the mission, issue warning orders, establish liaison, and visit the unit to be relieved. The unit will normally establish its command post in the vicinity of the command post of the unit being relieved. Conferences are held between the commanders and staffs of the two units concerned to work out the details of the relief.

b. Details To Be Coordinated. Procedures for the accomplishment of the following must be agreed upon:

- (1) Exchange of plans and liaison personnel. The incoming unit commanders and staffs must be briefed and become thoroughly familiar with the existing defensive plans to include fire plans, barrier plans, and counterattack plans. To make the most efficient transfer of information concerning the plans, dispositions and area of operation, the outgoing unit leaves liaison personnel with the incoming unit. The number of these personnel and the duration of their stay with the incoming unit vary with the situation. Normally, they will remain with each combat and combat support headquarters of the incoming unit from company level up. These personnel usually remain until the incoming units become familiar with the situation.
- (2) Sequence of relief (if not specified by the headquarters ordering the relief). To establish the strongest defense during relief, the relief in place is executed by stages, either rear to front or front to rear. In determining the sequence of the relief, both commanders should consider—

- (a) The subsequent mission of the unit that is conducting the relief.
- (b) The strength and combat efficiency of the unit presently in the forward defense area.
- (c) The capability of the enemy to detect and react against the relief.
- (d) The characteristics of the area of operations.
- (e) The need to vary the pattern of relief.

- (f) Size and type of elements involved in the relief.
- (3) When "command is to pass." The time or circumstances under which the incoming unit commander will assume responsibility for the area must be clearly established. Until command passes, the outgoing unit commander retains responsibility for the area and mission and exercises operational control over all subordinate elements of the incoming units which have completed their portion of the relief. During this period, the incoming units must fit into and accept the general defense plans of the outgoing unit. Normally, command passes to the incoming commander when the units in the forward defense area have been relieved by his subordinate units and when adequate communications means have been established. When command passes, the incoming commander assumes operational control of all units of the outgoing unit which have not been relieved.
 - (4) Reconnaissance. Arrangements must be made for a thorough daylight reconnaissance by commanders and staff officers of all echelons of the incoming unit. Reconnaissance should include an inspection of terrain to the front, defensive installations, relief routes, assembly areas, weapon positions, and combat service support installations.
 - (5) Security. Every effort must be made by all echelons of the incoming and the outgoing units to prevent the enemy from learning that a relief is taking place. In addition to conducting the relief during periods of reduced visibility, the following security measures should be taken:
 - (a) Every form of normal activity in the area of operations must be maintained during the relief. The incoming unit should assume the normal pattern of harassing and interdicting fires, patrols, communications traffic, and movement

- previously employed by the outgoing unit.
- (b) Restrictions on the size of advance parties and reconnaissance parties must be enforced. These parties should move to the area of operations by infiltration.
 - (c) If applicable, aerial reconnaissance by members of the incoming unit should be made in aircraft of the outgoing unit.
 - (d) Radio nets of the incoming unit should not be used in the new area until after the relief is complete.
 - (e) Registration of fires of the incoming unit should be coordinated by the outgoing unit until command passes.
 - (f) An integrated tactical cover and deception plan should be executed by both the incoming and outgoing units.
- (6) Movement control. Arrangements between the incoming and outgoing units must be made for the control of units moving into and out of the area. Coordination must include—
- (a) Routes to be used and priorities for their use.
 - (b) Responsibility for traffic control.
 - (c) Location of assembly areas.
 - (d) Provision of guides for incoming units.
 - (e) Common use of transportation, if necessary.
- (7) Intelligence. The outgoing unit transfers to the incoming unit all information and intelligence concerning the enemy and the area of operations. Additional intelligence information required by the incoming unit should be obtained by the outgoing unit.
- (8) Fire support.
- (a) The method of relieving fire support units must be clearly established. Normally, the fire support units of the outgoing unit remain in position until the units in the forward defense have been relieved.

By using this procedure, fire support units which are familiar with the fire support plans and the area are in position to fire during the critical period of the relief of forward units. For a discussion of artillery units relief in place, see FM 61-100.

- (b) Battalion or squadron organic fire support elements may elect not to take over the firing positions of outgoing units if sufficient firing positions are available from which the same fire missions can be accomplished. In this case, the incoming fire support units move into position by platoons or sections. When the lack of firing positions so dictates, fire support units may be relieved in place. In this case, it may be necessary to relieve by squad or section to avoid congestion.
- (c) Concurrent planning. The relieving unit and the unit being relieved will issue operation orders directing the conduct of the relief in accordance with procedures agreed upon between the two units. Prior to the issuance of the operation orders, fragmentary orders are disseminated to subordinate units to allow concurrent planning by these units.

188. Sequence of Relief

A relief in place is executed in stages to insure the most effective defense during the relief. Reserves may be relieved first, followed by relief of forward elements, or vice versa. Normally when minimum forces are employed on the FEBA, the relief is conducted from rear to front, and when maximum forces are employed on the FEBA, the relief is conducted from front to rear. In determining the sequence of the relief, commanders should also consider:

- a. Strength and condition of elements involved in the relief.
- b. The subsequent mission of the relieved and relieving units.
- c. The enemy situation and the capability of

the enemy to detect and react against the relief.

- d. Characteristics of the area of operations.
- e. The need to vary the pattern of relief.

189. Methods of Relief

a. When the determination as to sequence of relief has been made, the commander then selects the method of relief for forward units. Choices are:

- (1) Relief of the first of two forward companies to be completed before relief of the second company begins when two companies are employed forward.
- (2) Relief of the two flank companies simultaneously followed by the center company when three companies are employed forward.
- (3) Relief of the center company followed by simultaneous relief of the flank companies when three companies are employed forward.
- (4) Relief of all forward companies simultaneously.

b. In analyzing these four methods, the commander should consider:

- (1) The enemy situation and capability of the enemy to detect and react against the relief.
- (2) Characteristics of the area of operation.
- (3) The time available for accomplishing the relief.
- (4) The degree of concentration of forces acceptable.

190. Transfer of Responsibility for Minefields

A report of transfer is a written report which transfers the responsibility for a minefield from one command to another. The report of transfer must be signed by both the relieved and relieving commanders and must include a certificate stating that the relieving unit commander has been shown, on the ground, or otherwise informed of all mines within his zone of responsibility and that he assumes full responsibility for such mines. The report of transfer is forwarded to the next

higher commander having authority over both the relieved and relieving unit commanders. This transfer includes local protective minefields as well as minefields directed by higher headquarters.

191. Exchange of Equipment

Because of the difficulty in accurately laying weapons at night, commanders of the incoming and outgoing units arrange for the mutual exchange of crew-served weapons which cannot be easily moved, or when necessary to insure the effective delivery of fires. As an alternative, machinegun tripods and mortar baseplates should be exchanged. The exchange is on a weapon-for-weapon basis. The authority for this exchange is included in the relief order of the next higher commander. Outgoing units leave on position bulky and excessive supplies such as ammunition, field fortification materials, and other supplies and equipment which are difficult to move.

192. Conduct of the Relief

a. Defending forces are vulnerable to an enemy conventional or nuclear attack during the conduct of a relief. Appropriate counterintelligence measures are employed to avoid disclosure of relief operations to include continuation of normal activities such as supporting fires, radio traffic, vehicular traffic, radar employment and other activity. Maximum fire support from outgoing and incoming units should be available to insure the success of the operation and neutralize enemy reaction in the event the operation is discovered. The tactical situation usually dictates whether the relief is made during daylight or periods of limited visibility. In some instances, the relief may be conducted over a period of more than one day. Reliefs at battalion level in daytime are avoided if possible; however, smoke may be used locally or on enemy observation to conceal visible stages in a daylight operation. The relief is conducted as rapidly as possible, consistent with secrecy and control. The outgoing battalion furnishes security and surveillance during the conduct of the relief. The incoming commander must insure that coordination is made with adjacent and supporting units.

b. Mechanized infantry will dismount far enough to the rear to avoid compromising the

relief and move forward to effect the relief on foot. The carriers will move forward after completion of the relief by dismounted troops. Outgoing mechanized units will exfiltrate carriers prior to relief providing such action will not compromise the relief; otherwise, the carriers of the outgoing units will not move until the relief is completed.

c. Time permitting, tank units may be relieved by individual tanks (usually, company teams with only one tank platoon), platoon, or company to fit maintenance or resupply periods. See FM 17-12 for preparation for and occupation of night firing positions.

d. To limit confusion inherent in a relief and to avoid excessive massing, adjacent companies of the battalion are not normally relieved at the same time. Elements of the outgoing battalion leave the area as soon as they are relieved and control is established.

e. Battalions do not designate assembly areas for units larger than a company. Company assembly areas are separated as much as possible to minimize vulnerability to enemy

fires. Delays within assembly areas are avoided by precise planning, timing, and execution.

f. During the relief, commanders at each echelon are together at the command post or observation post of the outgoing unit. The incoming unit commander assumes responsibility for the defense when the majority of his unit is in position and communication and control are established, or at a time previously designated by the next higher commander. In the absence of orders from the next higher commander, the exact time of exchange of responsibility is agreed upon by the commanders concerned. When command passes, the incoming commander assumes control of all units of the outgoing unit which have not been relieved. If an attack occurs before the incoming commander assumes responsibility for the defense, he assists the outgoing commander with all means available to him. In this event, elements of the incoming unit in the battalion area are under the operational control of the outgoing unit. Changes in organization of the defense desired by the incoming unit commander are initiated after the change of responsibility.

CHAPTER 8

RETROGRADE OPERATIONS

Section I. GENERAL

193. General

A retrograde operation is an organized movement to the rear or away from the enemy. The operation may be made voluntarily or forced by enemy action. Retrograde movements are conducted for one or more of the following reasons:

- a. To harass, exhaust, resist, delay, and inflict punishment on the enemy.
- b. To draw the enemy into an unfavorable situation.
- c. To permit the use of elements of the force elsewhere.
- d. To avoid combat under undesirable conditions.
- e. To gain time and avoid a decisive engagement.
- f. To disengage from combat.
- g. To place the forces involved in a desired position in relationship to other friendly forces.
- h. To shorten lines of communication.

194. Types of Retrograde Operations

a. *Delaying Action.* A delaying action is a retrograde operation in which maximum delay and damage are inflicted on an advancing enemy without the delaying force becoming decisively engaged or outflanked. In a delaying action, minimum space is traded for maximum time.

b. *Withdrawal.* A withdrawal is a retrograde operation in which all or part of a deployed force disengages from the enemy. It may be executed during daylight or darkness and may be forced or voluntary. Regardless of the type withdrawal being conducted, contact is maintained with the enemy forces to provide security and deception.

c. *Retirement.* A retirement is a retrograde operation in which a force not in contact marches away from the enemy to avoid combat under existing conditions. It may be made following a withdrawal. Normally, a retirement is performed to allow future combat operations to be conducted under more favorable conditions or in a more decisive place or at a more decisive time.

Section II. CONSIDERATIONS OF THE RETROGRADE

195. General

Armor units are capable of inflicting heavy damage to enemy units during retrograde operations, particularly in the delaying action. Under these conditions, success depends upon planning and conducting operations so as to capitalize on the capabilities of the unit. The following are considerations that affect the employment of armor units in the retrograde.

196. Weather and Terrain

a. Weather and terrain have a major influence on the planning and conduct of retrograde actions. Clear weather provides good observation and assists in attaining maximum results from fires. Unfavorable weather conditions may limit observation, reduce the effects of nuclear weapons, limit cross-country movement, and increase the problem of control.

b. Terrain is selected that provides long range observation and fields of fire, concealment from enemy observation, and protection. This allows the commander to engage the enemy at maximum effective range and to maintain this fire as the enemy maneuvers toward the position.

c. Obstacles are used extensively to impede the advance of enemy units, to protect exposed flanks, and to force the enemy to mass. Mines and demolitions aid in slowing and canalizing the enemy advance. Nuclear weapons, as well as other fires, are employed to destroy the enemy when he attempts to breach or bypass the obstacle.

d. Good road nets and trafficable terrain facilitate the movement of units and the commitment of counterattacking forces. Terrain affording good cross-country trafficability permits wide dispersion and thus reduced vulnerability to enemy air and nuclear attack.

e. Effective use of existing cover and concealment assists armor units in destroying the enemy by achieving surprise and reducing the enemy's ability to locate friendly forces.

197. Control and Coordination

a. Armor units conducting retrograde operations will be deployed frequently on an extended front. Subordinate units may be dispersed widely, especially during rearward displacements. Retrograde operations normally consist of decentralized actions within the framework of the overall detailed plan. Effective control and coordination of such operations require centralized planning and control and decentralized execution. Subordinate commanders must be aware of the overall concept of operation to insure effective and intelligent execution.

b. Radio is the primary means of communication at all echelons to exercise control and coordination. It may be used by security forces to simulate normal traffic during a retirement or withdrawal operation.

c. Displacement of units in contact is controlled primarily by establishing boundaries between units. Boundaries are not used between platoons except in armored cavalry actions. For units not in contact, routes of withdrawal are designated together with time of movement. Phase lines, checkpoints, and other

control measures appropriate to tactical marches for coordinating and controlling movement may be used. When units must share routes, road priorities are assigned.

d. Civilian control policies must be simple to execute, easily understood, and capable of enforcement with minimum employment of tactical troops. Refugees must not be permitted to interfere with military operations.

198. Security and Deception

a. Employment of nuclear and nonnuclear fires, coupled with limited offensive action, assists in providing security during retrograde operations. Knowledge of the intent to execute a withdrawal or to displace is denied the enemy as long as possible. Maximum passive security and deception measures are adopted to deprive the enemy of knowledge of the move. These measures may include radio listening silence for units displacing; maintenance of a normal radio pattern in the forward area; maintenance of normal artillery and other supporting fires; displacement of units during darkness or under conditions of reduced visibility; and retention of sufficient troops in position to indicate the presence of the entire force.

b. Security against nuclear attack is provided by operations on a broad front, and by denying the enemy observation and information.

c. Positive measures must be taken to provide security to the front, flanks, and rear of forces. Security detachments are employed to hold defiles that must be traversed during the operation. Security precautions taken must include measures against air attack.

d. Deception measures are employed to assist in withdrawing with minimum enemy interference.

199. Combat Support

a. Air Support.

- (1) Tactical Air Force aircraft are employed against hostile aircraft and to delay the enemy advance by harassing and interdicting hostile ground forces at critical localities. Maximum use is made of Tactical Air Force offensive aircraft to support ground actions.

(2) Air cavalry is used to perform reconnaissance and security missions. Their fires are used to assist ground units in delaying enemy forces, disengaging from enemy forces, and the extrication of friendly forces that have become decisively engaged.

(3) Army aircraft are employed in reconnaissance and to assist the commander in the execution of his plan. Aviation units can be used in shifting troops rapidly, in supplying units, and in evacuation.

b. Field Artillery.

(1) Artillery is employed in retrograde operations to take the enemy under fire at maximum ranges, to interdict enemy avenues of approach, deliver harassing fires, destroy enemy concentrations, and provide continuous close support of maneuver units.

(2) Retrograde operations conducted on a wide front will often require the attachment of artillery units to committed brigades.

(3) For details, see FM 6-20-1 and FM 6-20-2.

c. Air Defense Artillery.

(1) When provided, air defense artillery is employed in retrograde operations to defend priority installations and units. Typical vital installations that need defending during retrograde operations will be bridges, road intersections and defiles.

(2) Retrograde operations conducted on a wide front may require the attachment of air defense artillery units to committed brigades.

d. Engineer.

(1) The requirements for engineers by units in contact with the enemy may require attachment.

(2) Engineers provide advice and assistance in the formulation and implementation of obstacles which are used to delay the enemy or to canalize him into areas where he can be destroyed

with fires. Obstacles must be coordinated with higher headquarters to prevent interference with future operations.

(3) Under favorable conditions, subsurface or surface nuclear detonations may be employed to create obstacles that will slow or impede the enemy's advance. The employment of such atomic demolition munition (ADM) must be authorized (app XX).

(4) Detailed plans are prepared for the use of demolitions along enemy avenues of approach. Demolitions are placed in defiles and on routes traversing natural and artificial obstacles. Demolition plans include—

(a) Provisions for placing and firing the necessary demolitions.

(b) Adequate guards to prevent premature firing of charges or seizure by enemy infiltrators.

(c) Fixed responsibility for the destruction of bridges.

(d) Schedule for the destruction of bridges when no longer needed by friendly forces.

(e) Covering by fire those obstacles that are created by demolition.

(5) The destruction of bridges is of major importance to the retrograde force commander. Care must be exercised to insure that bridges are not blown prematurely or that they are not seized intact by the enemy. Responsibility for blowing bridges in a zone is delegated to the tactical commander. A demolitions firing party and a demolition guard are designated for each bridge. The guard commander has the authority to destroy the bridge, subject to conditions established by the higher commander. A list of all units that are to use the bridge is furnished the guard commander. Each unit commander notifies the guard commander when his unit has cleared. After the main body has crossed, the majority of the bridges in the zone are destroyed. Certain predesignated

bridges are left for use by security elements. When capture of the bridge is imminent, the demolition guard

commander will destroy it even though all security elements have not crossed.

Section III. DELAYING ACTION

200. General

a. A successful delaying action gains maximum time while surrendering minimum space without the delaying force becoming decisively engaged or outflanked.

b. A unit withdraws from one delay line or position to another only with specific authority of the commander, designating the delay line or position.

c. A unit is decisively engaged when it loses freedom of action to accomplish its mission and no longer has the resources available to regain freedom of action.

d. A unit is outflanked when enemy forces with a capability of adversely affecting the mission of the delaying force are on the flank or in the rear of the delaying force.

e. Offensive action is taken whenever opportunities arise to inflict serious damage on the enemy, disengage a unit decisively engaged, seize dominating terrain, or deceive the enemy.

f. Delaying actions are accomplished by—

(1) *Delay on successive positions.* In the delay on successive positions, the initial delaying position is organized and occupied by the unit. When withdrawal becomes necessary, the unit displaces to the next rearward delaying position providing certain elements to remain in contact with the enemy. This procedure is repeated through successive delay positions. Since wide frontages are common in the delay, armor units will normally delay on successive positions.

(2) *Delay on alternate positions.* The force is divided into two elements. The first element occupies the initial delaying position while the second element occupies and improves the next rearward delay position. When the first element is forced to withdraw, it displaces through or around the sec-

ond element. It occupies and improves the subsequent delay position to the rear. Before displacing, the first element provides forces to remain in contact with the enemy. As the enemy continues to advance, the second element repeats the procedure used by the first element. Armor units will seldom operate on a front narrow enough to permit delay on alternate positions.

Note. A combination of (1) and (2) above may be employed.

g. Regardless of how the delay is accomplished, continuous delay must be achieved in each action. Continuous delay is accomplished by maintaining constant contact with the enemy with at least a portion of the delaying force during the entire delay period. Armor units will use all available forces to inflict maximum damage upon the enemy as he attempts to close on the delay position.

201. Basic Considerations of Delaying Actions

Delaying actions vary with the situation, terrain, and weather conditions in the area and with the size, type, and composition of the delaying force. Considerations which must be applied in developing plans and conducting a delaying action are—

a. *Centralized Control and Decentralized Action.* A delaying action is characterized by operations on a wide front with maximum forces in contact and minimum forces in reserve. This results in a series of independent unit actions across the front in which each commander must be permitted freedom of action in engaging the enemy. In the conduct of the delay, the rearward movement of all units must be closely coordinated. This will insure that the enemy does not bypass or envelop elements of the delaying force or achieve a penetration that would prevent the successful accomplishment of the delaying mission.

b. Maximum Use of Terrain. Delaying forces must make maximum use of all terrain from which delay of the enemy can be obtained. Maximum delay must be achieved and the enemy must not be allowed to advance great distances unopposed. Delaying positions should be located on terrain features that dominate the likely avenues of enemy approach.

c. Force the Enemy to Deploy and Maneuver. Maximum use must be made of the terrain in order to exploit the firepower of the delaying force. The enemy should be engaged at maximum ranges of all weapons. This action should cause the enemy to take time-consuming measures in deploying, in developing the situation, and in maneuvering to drive the delaying force from its position. Repeated use of this technique will slow the forward progress of the enemy and will exchange space for time.

d. Maximum Use of Obstacles. The use of demolitions, mines, and artificial and natural obstacles is exploited to the maximum to delay the enemy. They are used to canalize and slow his forward progress and to provide security to the flanks of the delaying force. To obtain maximum effectiveness, obstacles should be covered by fire.

e. Maintain Contact With the Enemy. Continuous reconnaissance must be conducted to establish and maintain contact with the enemy. Enemy forces possessing freedom of maneuver and mobility will attempt to bypass or envelop the flanks or penetrate between units conducting the delay. To prevent penetration or envelopment, contact must be maintained with all enemy forces encountered.

f. Avoid Decisive Engagement. In a delaying action, positions are occupied for sufficient periods of time to cause the enemy to deploy, develop the situation, and maneuver to attack each position. The delaying force withdraws to the next delaying position before becoming decisively engaged with the enemy. If units conducting the delay become decisively engaged, they may fail in their mission and jeopardize the entire operation.

202. Planning

a. General. Planning the delaying action is centralized but execution is decentralized. Orders to armor units will state the mission

normally in general terms and specify, as a minimum, the following:

- (1) *The general location of the initial delaying position (IDP).* This general location is refined at each level of command until, finally, positions are selected for men, weapons, and combat vehicles. If the unit is in contact when the order to initiate the delay is received, the present friendly positions may become the IDP.
- (2) *Area for delay.* The area assigned to each unit down to company team level is indicated by lateral boundaries. Company team commanders normally assign areas to their platoons by orientation on the ground.
- (3) *Period of delay.* Commanders guide their subordinate's planning by announcing the time the enemy is to be held forward of a specified line. The primary purpose of this measure is to assist coordinated action among adjacent forces and establish a planned time phasing of the operation. The stated time does not imply authority for withdrawal or displacement. The delaying force holds the enemy forward of designated areas for the longest time possible.
- (4) *Contemplated future action.* Any future plans, such as a withdrawal through or around a rearward position, must be announced if they affect the planning of subordinates.
- (5) *Limitations imposed upon the operation.* If the commander visualizes any conditions that might limit the planning of his subordinates, he must announce the limitations. For example, the unrestricted demolition of bridges might interfere with subsequent offensive plans.

b. Selection of Proposed Delaying Positions.

- (1) Proposed delaying positions are selected that will afford the greatest opportunity for inflicting maximum damage on the advancing enemy as well as insuring continuous delay. Proposed positions are selected where

minimum forces can, whenever possible—

- (a) Stop or repel the attack of enemy security forces so as to force the enemy main body to deploy, develop the situation, and attack.
 - (b) Cause the enemy main body to mass and thus present a profitable nuclear target.
- (2) Terrain offering advantages to the delaying force incorporates the following characteristics:
- (a) A series of parallel ridges perpendicular to the lines of hostile advance.
 - (b) Obstacles to the front and flanks.
 - (c) High ground with good observation and long range fields of fire.
 - (d) Concealed routes of displacement.
 - (e) An area road net providing good trafficability.
- (3) Phase lines, checkpoints, and contact points may be used to coordinate actions in the delay. Commanders may use phase lines and a stated time to express their concept of the time phasing of the delaying action. These phase lines may later be designated as delaying positions.
- (4) Delaying positions are determined in the following sequence:
- (a) Based on the division order (fig. 8), the brigade commander may select additional delay positions as part of the brigade scheme of maneuver (fig. 9).
 - (b) The battalion task force commander, in developing his scheme of maneuver, also may select additional delay positions (fig. 10).
 - (c) The company team commander, guided by the delay positions directed in the battalion task force order, selects terrain to be used in the delaying action. These terrain features will be organized as blocking positions on and between delay positions to control avenues of enemy approach. Blocking positions in the vicinity of the IDP are occu-

pied while others, in depth, may be reconnoitered and prepared as time permits (fig. 11).

c. Organization of Ground.

- (1) In planning for a delaying action, definite zones of responsibility are assigned to each committed unit down through company level (platoon level in armored cavalry operations). The limits of each zone are delineated by boundaries. These boundaries may extend through the depth of the zone and, as a minimum, must extend through the next rearward delay line as described in appendix X.
- (2) In assigning sectors to subordinate units, each likely enemy avenue of approach is assigned, in its entirety, to one unit. Boundaries are assigned so that terrain features which control fire and observation into a zone are assigned to the unit having responsibility for the sector. Coordinating points are designated for coordination and to insure continuity of the delay.
- (3) Natural obstacles are improved and artificial obstacles are built within the limitations of available materials, time, and manpower. Obstacles alone must not be relied upon to halt the enemy's progress.
- (4) Blocking positions are organized in the delay similarly to those used in defense. However, more emphasis is placed on reconnaissance and preparation of routes of withdrawal. Each mechanized infantry squad and each tank crew should be familiar with the routes of withdrawal from their primary and alternate positions as well as their supplementary positions. Less emphasis is placed on the installation of tactical and protective wire, final protective fires, and stockpiling of ammunition. The position is organized in width with little depth.

d. Disposition of Forces, Delaying Action.

Forces in the delaying action are disposed in three echelons. These echelons are the security forces, delaying forces, and reserves.

- (1) *Security forces.* A covering force or

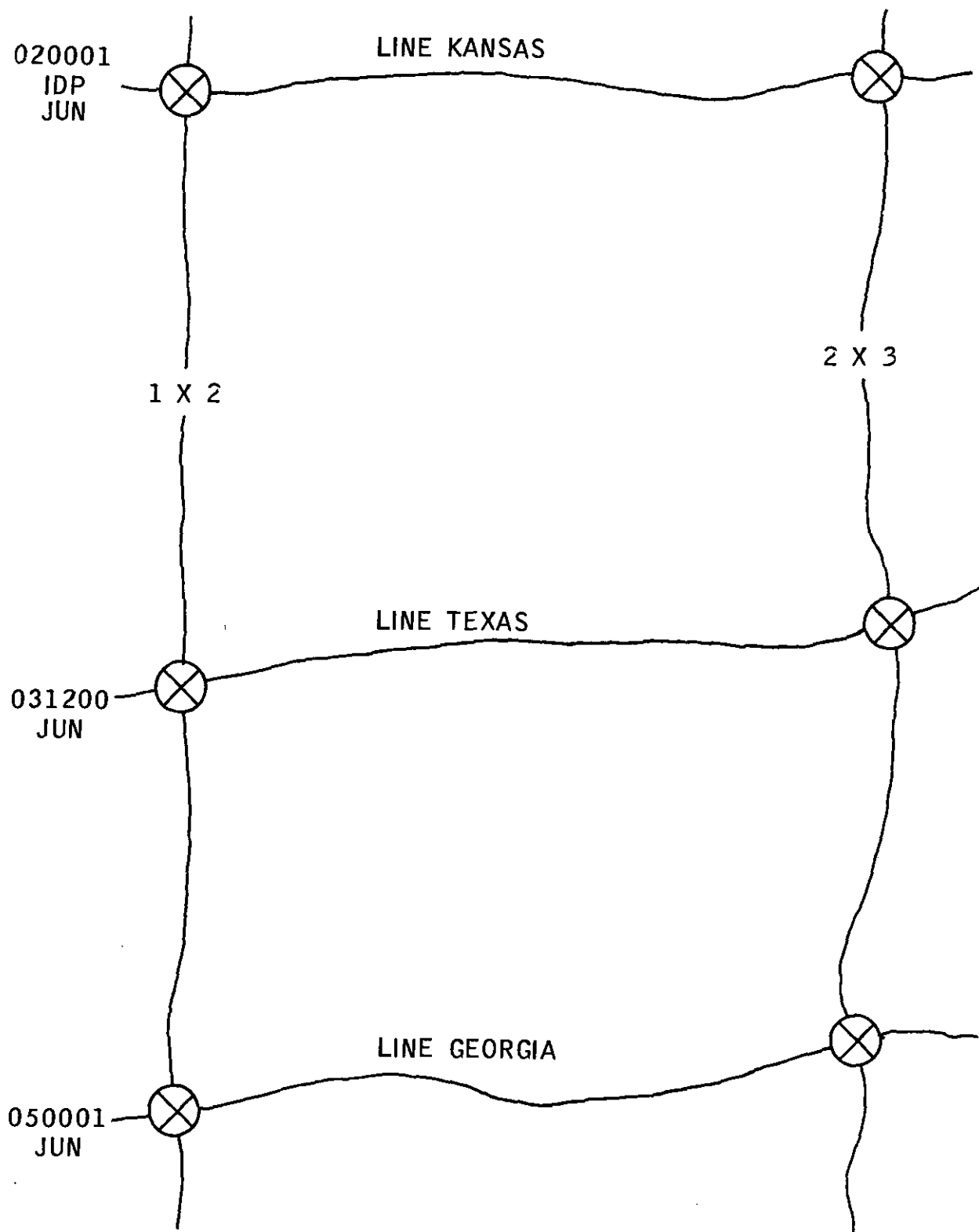

Figure 8. Initial and subsequent delaying positions depicted on division order.

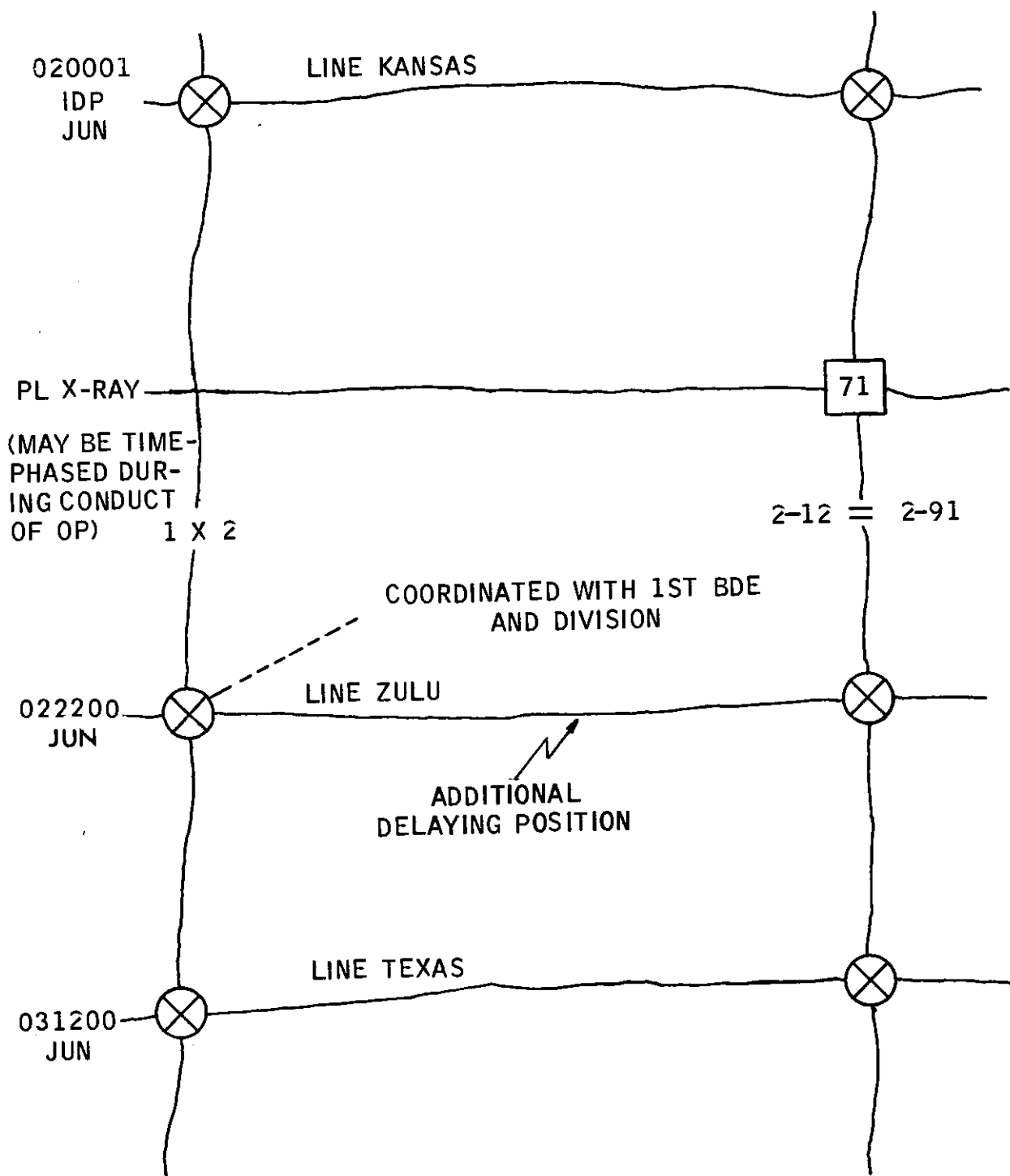

Figure 9. Additional delay positions and phase lines depicted on brigade order.

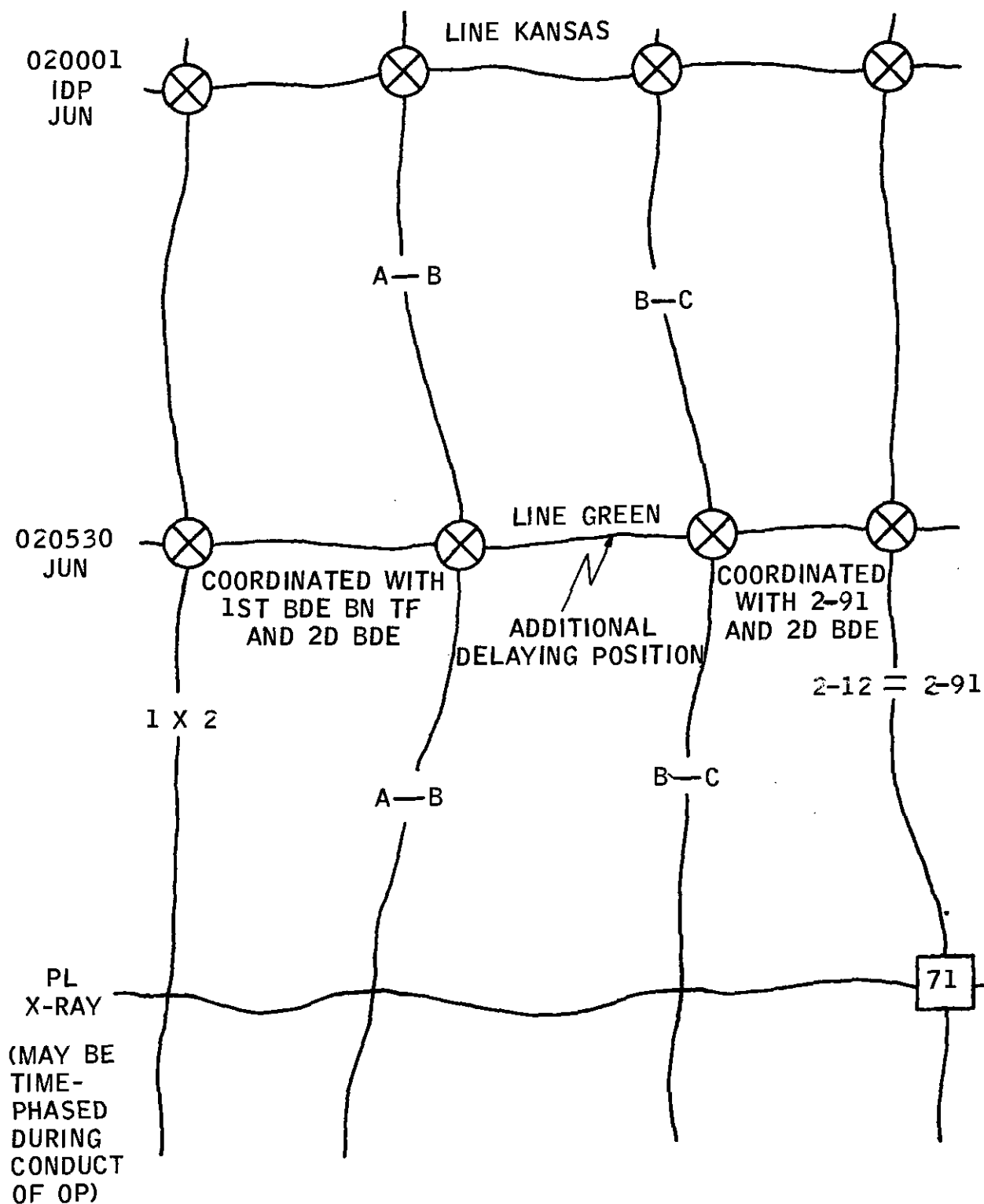

Figure 10. Battalion task force scheme of maneuver showing additional delaying positions selected by task force commander.

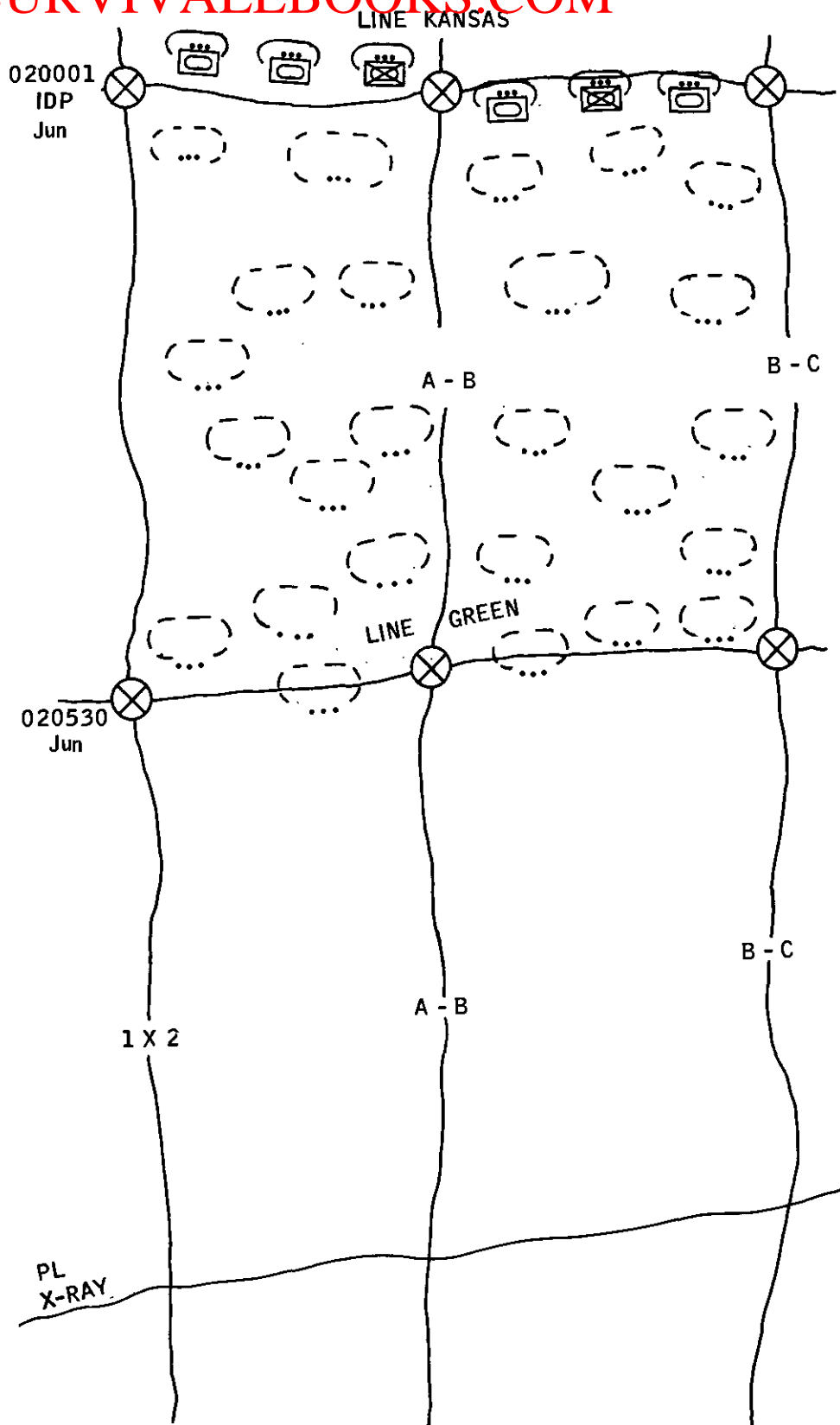

Figure 11. Company team commander's selection of blocking positions.

other security forces may be employed forward of the IDP when the situation permits. The highest headquarters conducting the delaying action prescribes the force to execute the security mission.

- (2) *Delaying forces.* The bulk of the unit's combat power is normally in the delaying force.
 - (a) Maximum firepower is forward with the bulk of the forces concentrated on likely avenues of approach.
 - (b) The delaying force is deployed in width with little depth.
- (3) *Reserves.* The brigade is normally the lowest level that designates a reserve. However, frontages, terrain, or weather may allow the retention of a small reserve by task forces or teams. In the delay on alternate positions, elements not in contact can perform the functions of a reserve.

e. Organization for Combat. Forces are organized for combat based on an analysis of METT.

- (1) Security forces are organized for combat as discussed in chapter 5.
- (2) Delaying forces are organized to capitalize on the long range fires and mobility of tank units. Combat support and combat service support elements are often attached to better accomplish their mission in support of combat troops.
- (3) The reserves are small tank-heavy forces and nuclear weapons.

f. Routes of Withdrawal. Routes of withdrawal are selected to provide good trafficability and cover or concealment. Although withdrawal during the delaying action is normally decentralized, specific routes, together with priorities, may be assigned.

g. Logistical Plans. See chapter 10.

203. Conduct of Delaying Action

a. The enemy is taken under fire as soon as he is within effective range of available weapons. As he nears the position, fires are increased to inflict casualties, cause him to deploy early, and require him to take time-consuming maneuvers to close with the position.

b. Each position is defended until the enemy actions threaten decisive engagement. Commanders are alert to detect significant events that may require modification of the basic plan. Rigid adherence to plans conceived before the enemy situation develops may prevent the accomplishment of the mission. The original concept of time-phasing may be adjusted to the situation as it develops. This allows delaying units to seize opportunities to gain greater delay than anticipated or to preserve the delaying force against an attack in overwhelming strength.

c. When the maximum possible delay has been achieved and it becomes apparent that further occupation of the position will result in the units becoming decisively engaged, withdrawal is begun. Withdrawals may be initiated in accordance with prearranged plans or on order of the higher commander. Withdrawing forces must coordinate their action with adjacent units.

d. When a unit withdraws to the next delay position, elements of the unit maintain contact with the enemy. These elements provide security for the withdrawing units and continue to provide maximum delay between delaying positions. They utilize maneuver, available terrain, long range fires, air cavalry, tactical air, mines and demolitions.

e. The opportunity to inflict heavy casualties on the enemy by offensive action should be exploited. Limited objective counterattacks and tank sweeps should be employed to gain additional time or to extricate units which have become decisively engaged.

Section IV. WITHDRAWAL

204. General

a. A withdrawal is a retrograde operation in which all or part of a deployed force disen-

gages from the enemy. It may be executed during daylight or under cover of darkness and may be involuntary or voluntary. Preferably a

withdrawal is made while a unit is not under heavy pressure from the enemy. To deceive the enemy, armor units move with as much secrecy as possible, applying techniques that keep the withdrawal hidden from enemy observation. When a unit under heavy pressure from the enemy is forced to conduct a withdrawal, it disengages by fighting a delaying action and then a rear guard action until it regains complete freedom of action. When these techniques are used, it is called an involuntary withdrawal.

b. Until a withdrawal is completed, contact is maintained to provide deception, security, and to prevent a rapid enemy advance.

205. Considerations

a. Plans and orders for a withdrawal are prepared in detail.

b. Sufficient information should be provided subordinates in time to permit their making a daylight reconnaissance.

c. The withdrawal may be facilitated by the conduct of limited-objective attacks or the employment of nuclear weapons.

d. Withdrawals conducted at night or under conditions of reduced visibility are preferred over daylight withdrawals. However, the protection, mobility, and long range firepower of armor units enable them to conduct daylight withdrawals with greater success than units that do not have these characteristics.

206. Plans and Orders

Plans and orders include—

a. New location to be occupied and missions of units upon arrival.

b. Organization for combat and time phasing of attachments and support.

c. Zones or routes of withdrawal to be used. Existing boundaries are used when possible.

d. Provision for security forces and other security measures.

e. Provision for fire support.

f. Provision for breaking contact in an involuntary withdrawal and action to be initiated in the event the enemy attacks to follow up a voluntary operation.

g. Deception measures.

h. Time and priority of withdrawal of units.

i. Traffic control measures.

j. Provision for evacuation or destruction of excess supplies.

k. Evacuation of casualties.

l. Communication plan.

m. Provision for combat service support.

207. Voluntary Withdrawal

Armor units in a voluntary withdrawal may begin the operation as forces in contact or the reserve.

a. *Forces in Contact.*

(1) A unit withdrawing designates a part of its force, both maneuver and support, to remain in contact with the enemy. These forces are called "detachments left in contact" (DLIC). These forces provide security and cover the withdrawal of the major elements of the unit. The size and composition of the DLIC force are based on an analysis of the factors of METT. The DLIC is normally commanded by the task force and team executive officer at their respective levels. In any event, the DLIC must have a single commander. The DLIC performs the following functions:

(a) Delays and deceives the enemy and prevents interference with the withdrawal.

(b) Simulates normal radio traffic, fires, and other activities.

(c) Is prepared to act as rear guard for the main force, on order.

(2) The main elements of the withdrawing forces initiate movement to the rear in the following sequence:

(a) Elements to reconnoiter and prepare new locations.

(b) Combat service support elements.

(c) Combat support units less elements essential to the support of the security force left in contact.

(d) Units in contact less then DLIC.

(3) The withdrawal of forward units, less the DLIC is executed simultaneously on a broad front. Units move directly to the rear, form march columns, and

proceed to the designated location. To facilitate control, assembly areas may be designated for subordinate units before march columns are formed. These assembly areas are dispersed and are occupied for a minimum time.

- (4) When the withdrawing units, less the DLIC, have formed march columns, further movement is conducted in a manner similar to that of a retirement (para 209 and 210).
- (5) The DLIC withdraws at a prescribed time.

b. Reserve or Part of a Reserve.

- (1) Units in reserve may be committed in offensive actions to assist in the withdrawal of units. See chapter 6 for a discussion of the offense.
- (2) The brigade or battalion task force, as division reserve, may form a covering force through which forces in contact will withdraw. See chapter 5 for a discussion of the covering force.

c. For employment of mechanized infantry and infantry units in a voluntary withdrawal, see FM 7-11 and FM 7-20.

208. Involuntary Withdrawal

As in the voluntary withdrawal, armor units in an involuntary withdrawal may begin the operation as forces in contact or the reserve.

a. Forces in Contact.

- (1) A unit in contact provides and controls its own security force (detachments left in contact) (DLIC). Close coordination of these forces is required, but control normally is not centralized above battalion. The size and composition of this DLIC are

based on an analysis of the factors of METT. The DLIC—

- (a) Delay the enemy and prevent interference with the withdrawal.
 - (b) Are prepared to act as rear guard for the main force, on order.
- (2) The movement of the main force is decentralized consistent with the requirements for control. Assembly areas are not used. Units move directly to the rear, form march columns, and continue movement without halting.
 - (3) Though no particular sequence is followed, normally command and support facilities and less heavily engaged units are withdrawn first.
 - (4) If a subordinate unit becomes decisively engaged, the next higher commander may use unengaged units or units that can be easily withdrawn, and fires to assist in the withdrawal of engaged elements.

b. Reserve or Part of a Reserve.

- (1) The division reserve normally will form a covering force to assist forward units to break contact and to conduct a delaying action after withdrawal of the forward forces. See chapter 5 for a discussion of the covering force.
- (2) Brigade reserves may be used to support by fire the withdrawal of forward units, conduct limited objective counterattacks, or other offensive action.

c. For employment of mechanized infantry and infantry units in a voluntary withdrawal, see FM 7-11 and FM 7-20.

Section V. RETIREMENT

209. Planning

a. In a retirement, the force is organized into a main force and security forces in a manner inverse to that employed in the movement to contact.

b. In the initial stage of a retirement, control may be decentralized. However, plans pro-

vide for centralized control as soon as the situation permits. Normally centralized control is achieved very early in this operation as compared to the delay or withdrawal.

c. Appropriate control measures are used to insure that the retirement is conducted as a coordinated operation.

210. Conduct of the Retirement

a. When the retirement is preceded by a withdrawal, the rear guard is formed from the security force left in contact.

b. For the conduct of a tactical march, see appendix VI.

c. For the conduct of the advance, flank, and rear guards, see chapter 5.

Section VI. WITHDRAWAL THROUGH A REARWARD POSITION

211. General

Armor operations may involve many actions that require men or units to withdraw through a rearward position. The following general considerations pertain to such actions as withdrawing an outpost; return of patrols or armored cavalry units to friendly positions; termination of a covering force mission; or during a delaying action on alternate positions.

212. Considerations

a. Commanders and troops involved must be familiar with the details of the plan. Fires must be coordinated. Direct and indirect fires may be required to assist the withdrawal.

b. The commanders of the withdrawing force and the forces on position are concerned with—

- (1) *Mutual cooperation and coordination.* Neither commander exercises command over the other but each force may support the other by fire and maneuver.
- (2) *Responsibility for control of the sector.* Responsibility must be passed from the withdrawing force to the forces on position at a time and place mutually agreed upon.
- (3) *Troop density.* Withdrawing units use multiple routes through the depth of the positions and avoid the use of assembly areas or other halts within the position. Withdrawing forces normally have priority on roads. Fueling areas may be selected in rear of the friendly frontline units to provide emergency fueling if required.
- (4) *Traffic control.* Withdrawing commander is responsible for traffic control forward of the main defensive position. Commanders of forces organizing the main defense are responsible for providing traffic control to

units passing to the rear through their areas.

(5) *Control measures.* Stringent control is necessary for a smooth withdrawal through a rearward position. Measures by which the operation will be controlled are prescribed by the higher commander or agreed upon between the commanders concerned. Deviations from preplanned control measures must be coordinated between the effected units and made known to all interested agencies. Control measures normally include—

- (a) *Contact points.* A point on the ground is designated where two or more units are required to make physical contact. To insure detailed coordination between the two units, a primary and alternate contact point is designated by the commander in each company sector. These points are coordinated by liaison personnel and are located on easily identifiable terrain features beyond the direct-fire range of weapons on the FEBA. Elements along the FEBA which have designated contact points will send a contact party, equipped with a radio and guides, forward to the contact point.
- (b) *Passage points.* These are points on the FEBA through which friendly forces will withdraw. They must be easily recognized by withdrawing forces. These points are also used to provide a means of reporting specific locations and information relative to the control of units. Guides from the friendly units occupying the FEBA will normally meet the withdrawing elements at the contact point and guide them

through the passage point on the FEBA. These actions are coordinated by the liaison personnel of the two units.

- (c) *Routes of withdrawal.* These are designated through a rearward position and facilitate a smooth and continuous withdrawal. Adherence to the prescribed routes within the position is mandatory.
- (d) *Time of passage.* The overall time of passage is prescribed by the commander ordering the operation. At each subordinate level, specific times are designated for each unit by the commanders concerned. In addition, a representative of the unit with a radio will precede each march unit to the passage point. This representative provides the friendly unit being passed through with the number of vehicles to pass and a positive identification of the last vehicle.
- (e) *Recognition signals.* These are included in the order and should be

based upon the signal operation instructions (SOI) and unit SOP's. Positive recognition signals must be used and mutually agreed upon by the two units. Normally, recognition signals will cover both daylight and night withdrawals.

- (6) *Liaison officers.* Units exchange liaison officers at all levels of command. These officers exchange information and keep their respective commanders informed of the situation. They are normally located at critical points during the actual passage and render assistance to both the withdrawing force and the defensive force when required.
- (7) *Exchange of SOI information.* This will be accomplished during the liaison visit between the two units.
- (8) *Designation of units to move through respective withdrawal points.* This will be accomplished between the two liaison officers in their coordination of the withdrawal.

CHAPTER 9

COMBAT SUPPORT

Section I. GENERAL

213. Combat Support Elements

The armor unit commander can expect to receive combat support elements from higher headquarters to the extent necessary to accomplish assigned missions. These elements may be placed in support or attached and may include field artillery, air defense artillery, engineers, signal, chemical, or aviation units. The commander must make plans for the employment of these elements in accordance with their capabilities and the mission of his unit. Discussion of combat support in this chapter refers

to the brigade, battalion, and company. Unless otherwise specified, it is also applicable to the armored cavalry regiment, squadron, and troop.

214. Organic Combat Support Element

The organic combat support elements available to armor unit commanders at brigade and below are the fire support, communication, and aviation elements authorized by the TOE. For additional discussion, see FM 17-30, FM 17-95, and appendix XIV.

Section II. FIELD ARTILLERY SUPPORT

215. General

Artillery support provides the supported commander with a powerful means of influencing the course of combat. To make effective use of artillery support, the supported commander must be familiar with artillery organization, tactical employment of artillery, and the means by which artillery fires are obtained.

216. Tactical Employment of Artillery

a. Tactical employment of artillery is accomplished by the assignment of an artillery tactical mission to each artillery unit, by attachment to another artillery unit, or by attachment to a supported unit. Generally, missions are not assigned to batteries within a battalion or to battalions within a field artillery group. Tactical missions for artillery units are assigned by the force commander on the recommendation of the force artillery commander.

b. An artillery tactical mission defines the fire support responsibilities that are inherent with the mission assigned. Tactical missions are general support, general support-reinforcing, reinforcing, and direct support (FM 6-20-1).

217. Armored Division Field Artillery

a. General. The armored division artillery consists of a headquarters and headquarters battery; three 155-mm battalions, self-propelled; a 155-mm/8-inch battalion, which contains three 155-mm howitzer batteries, self-propelled and one 8-inch howitzer battery, self-propelled; and an Honest John battalion.

b. Organization for Combat. Field artillery units organic or attached to the division are normally employed under the centralized control of division artillery headquarters. Subordinate artillery units are controlled by the assignment of appropriate tactical missions. When the tactical situation, distance between

units, communication, or other factors prevent centralized control of artillery units by the division artillery commander, artillery units may be attached to subordinate elements of the division.

- (1) Each of the three 155-mm howitzer battalions is normally employed in direct support of one of the three brigades. An artillery unit with the mission of direct support remains under the command of the higher artillery commander assigning the mission. If one brigade is in reserve initially, the 155-mm howitzer battalion that normally supports that brigade may be assigned a general support, general support-reinforcing, or a reinforcing mission by the division. This artillery battalion must be prepared for direct support of the reserve brigade when committed.
- (2) The 155-mm/8-inch howitzer battalion is normally employed under division artillery control in a general support or general support-reinforcing role. When it is desirable to detach one or two howitzer sections to execute a special mission, part of the battery fire direction center must accompany these sections. The detached sections may operate under control of the battery, battalion, or they may be attached to another artillery headquarters.
- (3) The Honest John battalion will normally function under division artillery control in a general support or general support-reinforcing role. However, elements of the battalion may be assigned a reinforcing mission or, when necessary, be attached to another artillery unit. The firing batteries are so organized and equipped that they are capable of operating by platoon for limited periods of time. The platoons may be attached to another artillery headquarters for special missions.

218. Fire Planning and Coordination

a. Coordination of fire support is a command responsibility. The senior artillery officer

at each echelon (battalion and above) is the fire support coordinator and principal adviser to the commander on fire support matters. At company level, the company commander is the fire support coordinator, advised by the artillery forward observer.

b. The plans of fire support at company, battalion, and brigade are coordinated and fully integrated to assure success of the plan of attack or defense. The plan of fire support includes fires of organic, attached, and supporting weapons. Fire planning is continuous and as detailed as time will permit. The following definitions must be understood to establish a common basis in planning.

- (1) *Fire plan.* A tactical plan for using the weapons of a unit or formation so their fire will be coordinated.
- (2) *Planned fires.* Fires (concentrations) planned on areas and targets for which a need can be anticipated. This includes known enemy locations, avenues of approach, observation posts, suspect weapons locations, and similar-type targets.
- (3) *Prearranged fire.* Fire that is formally planned and conducted against targets or target areas of known location. Such fires are usually planned well in advance and are conducted at a predetermined time or during a predetermined period of time.
- (4) *Scheduled fires.* Prearranged fires that are to be delivered at a specific time or upon occurrence of a specific event.
- (5) *On-call fires.* Prearranged fires that are to be fired as requested.
- (6) *Concentration.* A volume of fire placed on an area within a limited time or an area designated and numbered for future references as a possible target.
- (7) *Barrage.* A prearranged barrier of fire, except that delivered by small arms, designed to protect friendly troops and installations by impeding enemy movement across defensive lines or areas. It is fired as part of the final protective fires.
- (8) *Preparation.* A heavy volume of prearranged ground, air, and naval

fire delivered to destroy, disrupt, disorganize, and neutralize the enemy's positions, materiel, observation, communications, and command. These fires demoralize and destroy enemy defending forces prior to the initiation of the friendly attack by the assault echelon.

- (9) *Group of fires.* Two or more concentrations to be fired simultaneously; groups may be fired individually, consecutively, or concurrently.
- (10) *Series of fires.* Number of concentrations or groups of fires planned to support a maneuver phase such as the fires planned on an objective area just before the final assault.
- (11) *Targets of opportunity.* A target visible to a surface or aircraft observer which is within range of available weapons and against which fires have not been scheduled or requested.
- (12) *Final protective fires.* Planned defensive fires designed to break up the enemy's assault on the battle position under any conditions of visibility. It is a first priority, prearranged, barrier of fire laid down just in front of the forward edge of the battle area. It consists of mortar and artillery barrages and final protective lines of fire of machineguns.

c. Fire planning and fire support coordination are accomplished at all combat echelons. At brigade level and below, fire planning and fire support coordination functions are carried out informally. Each supported unit commander has an artillery officer as his fire support coordinator who will assist in planning fire support.

- (1) *Company (team).* Normally, a forward observer from direct support artillery units and organic mortar units will operate with each company team. They are the principal assistants to the commander on matters of fire support. The company commander and the platoon leaders should solicit the forward observers' advice as to how the supporting artillery can best help the company in any particular situation. The commander

is responsible for providing an armor protected vehicle with communication facilities to the forward observers when required. Radio is the primary means of communication for requesting and controlling fire support.

- (a) In the initial planning phase of an operation, the company commander must discuss the company's mission and his concept of operation with the platoon leaders and the forward observers. The platoon leaders in planning the employment of their platoon may submit requirements or recommendations for supporting fires to either the commander or the forward observers. Based on the commander's concept of the operation, his plan of fire support, and requirements submitted by the platoon leaders, the company commander and the artillery forward observer formulate a plan of fire support. They select targets that must be engaged to support the operation and decide the best method of attacking them. Targets suitable for attack by the company's organic weapons are assigned to those weapons so far as their capabilities and available ammunition permit. In addition, the commander and artillery forward observers prepare a fire plan to support the company's scheme of maneuver. Included in this plan are the targets not susceptible to profitable attack by organic weapons. This fire plan is normally only a target list showing location and description of targets. This plan or target list is sent to battalion headquarters where the artillery liaison officer incorporates it into the battalion fire plan.
- (b) During the conduct of the operation, requests for artillery and mortar fires are processed through the artillery and mortar forward observers respectively. They transmit these requests to the supporting fire direction center and adjust fire

upon the designated target. The forward observers may call for fire on their own initiative on targets that affect the actions of the company. They locate themselves where they can best observe and adjust fire. They must maintain communication with both the supported company and the supporting fire direction center. When the commander desires supporting fire, he will normally request the fire through the forward observers who will transmit the request direct to the supporting fire direction center. If the company commander cannot contact the forward observers, he may send his request to the battalion fire support coordinator (FSCOORD) by using the battalion task force command communication net. The FSCOORD will then transmit the request to the supporting fire direction center. A platoon leader should send his request for supporting fire direct to the forward observers with the company. If a platoon leader cannot contact the forward observers, he should send his request to his company commander. In either case, the company commander and the forward observers, if practical, will discuss all requests for fire before sending them to the appropriate headquarters.

(c) For details of field artillery employment, see FM 6-20-1 and FM 6-20-2.

(2) *Battalion (task force)*. The artillery liaison officer at battalion task force is the fire support coordinator. As such, he is the principal adviser to the task force commander on all fire support means.

(a) Based on the supported commander's concept of the operation and the fire plans or request received from the artillery forward observers with the companies, he prepares the artillery fire plan to support the actions of the battalion

task force. Additionally, he supervises the preparation of all other fire plans and formulates the fire support plan.

- (b) The fire support plan normally includes the fire plans for the employment of the supporting artillery, tactical air support, and organic weapons.
- (c) As the fire support coordinator, the liaison officer insures that targets that would affect the accomplishment of the mission are attacked as rapidly as possible with the best fire support means. If sufficient means are not available, he will request additional support through artillery channels.
- (d) When the fire support plan and all supporting fire plans are completed, they are sent to the artillery liaison officer at brigade if time permits; otherwise, they may be sent direct to the supporting artillery fire direction center.
- (e) The artillery liaison officer is assisted by representatives of other fire support agencies available to the battalion.
 1. When tactical air support is available, a tactical air control part (TACP) is furnished the unit by the Air Force (para 235-240).
 2. The battalion task force S3 air represents the battalion staff on this fire support coordination team. He formulates and prepares the air fire plan.
 3. The tank battalion heavy mortar platoon leader advises on the employment of the heavy mortars. In conjunction with the artillery liaison officer and battalion commander, he prepares the heavy mortar fire plan for the battalion.
- (f) In a battalion-size task force, the fire support coordination personnel will be present at the command post or at a designated location

during the planning phase of an operation. These officers resolve any problems of fire support that arise.

(3) *Brigade.* At brigade level, the supporting artillery battalion commander is the fire support coordinator. He makes recommendations on the employment of his battalion, and on the basis of the commander's decision, coordinates and integrates the various fire plans.

(a) In the absence of the supporting artillery commander, the artillery liaison officer at brigade acts as the fire support coordinator. In actual practice, a large portion of the detailed work of coordination will be performed by this officer and his section.

(b) When the fire support coordinator receives the fire plans from the battalion task forces, he integrates them into the fire plans to support the brigade. Based on the fire plans received from the battalion task forces and on the commander's guidance for employment of all available fire support, the liaison officer formulates and prepares the fire support plan and the artillery

fire plan. He is assisted by the air liaison officer and the brigade S3 air. Their duties are the same as outlined at battalion task force level.

(c) When the fire support plan is completed, it is sent to the S3 of the supporting artillery battalion, who makes final changes and additions. After completion, it must be approved by the brigade or regimental commander. The brigade fire support plan is then sent to the division artillery S3 who integrates it into the division fire support plan, which is issued as an annex to the division operation order. The regimental fire support plan is published as an annex to the regimental operations order and forwarded to the higher headquarters for review and to be included in their fire support plan if approved.

219. Fire Support Control Measures

Certain control measures must be established to protect the safety of friendly troops and to permit maximum support with minimum restrictions. All of the control measures are established in coordination with the supported commander (app X).

Section III. AIR DEFENSE ARTILLERY

220. Air Defense Artillery

a. Overall army air defense of the field army is the responsibility of, and is provided by, the air defense artillery brigade at field army level. ADA units in the field army include Nike Hercules, Hawk, and automatic weapon units. Nike Hercules units and some Hawk units will normally be retained at field army level under the control of the ADA brigade commander. These units provide area air defense of the field army. The balance of Hawk units will normally be assigned or attached to corps under control of ADA groups. The ADA missile units are integrated with Air Force interceptors to provide a coordinated, integrated air defense system responsive to a single commander.

b. Forward area ADA automatic weapon battalions are attached to divisions as required. Further organization and assignments are the prerogative of the division commander. Although the ADA AW battalion may be employed directly under division control or further attached to division artillery, direct division control is to be preferred from the air defense viewpoint. Battalion elements may be further attached to, or placed under, operational control of maneuver units. These elements may be of battery, platoon, or section size, depending upon the size of a defended installation, its priority, and the number of weapons available. For independent division operations, increased air defense capability may be provid-

ed by attachment of Hawk or additional automatic weapon units. For further discussion on employment of Hawk, see FM 44-1 and FM 44-96.

c. The nuclear surface-to-surface fire support missions by ADA units are planned and coordinated by the fire support coordination element (FSCE) with the Air Defense Element (ADE). Weapons allocated to the field army air defense commander for use in the air defense role are not employed in the surface-to-surface role without special authorization of the commander making the allocation. When employed in the surface role, ADA automatic weapon units do not require this special authorization and coordination and planning is not required by the FSCE. Employment in this role is inherent in the mission assigned by the maneuver force commander. ADA automatic weapon units employed in the division area may, as part of their assigned mission, be required to integrate their fires in local security plans, and defend against airmobile and airborne attacks or air-landed troops in or near their positions. This part of the mission should be carefully integrated with the battalion or squadron plan for countering these enemy forces.

221. ADA Automatic Weapon Battalions

a. *Mission.* The mission of ADA automatic weapons is to attack and destroy hostile airborne and surface targets. This mission encompasses a primary air defense role and a secondary ground support role. Commanders whose forces include ADA AW units assign the role, air defense or ground support, which best

counters the greatest threat to the accomplishment of the overall force mission. Weapons should be positioned to best accomplish the assigned role, with secondary consideration being given to the other role. Commanders must keep in mind that the primary role and justification for ADA automatic weapon units is defense against air attack. This is the role for which they are best trained, organized, and equipped.

b. *Assignment.* Air defense artillery units attached to the division are controlled by the division commander to the extent specified by the field army or corps commander and within control measures established at theater level. These ADA units may be retained under division control or attached to subordinate maneuver elements as appropriate.

c. *Employment.* The battalion is the basic tactical and administrative organization for ADA automatic weapon units. It consists of a headquarters and headquarters battery and four firing batteries. Firing batteries each consist of two platoons of eight automatic weapons each. As required by the tactical situation, these units are tailored to best accomplish the assigned mission. Individual defenses are designed to provide all around coverage, defense in depth, and when terrain dictates, weighting along low altitude avenues of approach. The number of weapons required for a specific defense is determined by the priority of the defended installation, its size and shape, terrain, and the anticipated air threat. ADA units must be capable of moving with, and providing continuous air defense of division elements.

d. For details of ADA employment, see FM 44-1, FM 44-2, and FM 61-100.

Section IV. ARMY AVIATION

222. General

Army aviation increases the mobility, versatility, and combat efficiency of ground combat units. It is integrated into combat, combat support, and combat service support units when the employment of Army aircraft will benefit operations. Aircraft provide the commander with a capability to move rapidly throughout the area of operations to influence critical ac-

tions by his personal presence. In addition to the armored divisions and armored cavalry regiments organic aircraft, army and corps aviation units provide information of the enemy and area of operations by both visual and electronic means. This timely information enables the armor commander to fully exploit the capabilities of armor units at the time and place of his choosing. Aviation units provide on a continuing basis such valuable services as

expanding lines of communications, barrier crossing capabilities, providing aircraft for airmobile operations, aerial fire support, and limited resupply for fast moving situations. For discussion of the capabilities and limitations of Army aviation, see FM 1-5, FM 1-15, FM 1-100, FM 17-36, and FM 57-35.

223. Organic Aircraft, Armored Division and Armored Cavalry Regiment

a. Command, Control, and Observation Aircraft. The armored cavalry regimental headquarters, the armored cavalry regimental squadrons, division headquarters, division artillery, and divisional brigades are provided helicopters by TOE for command and control and to provide visual aerial observation, reconnaissance, and liaison. These helicopters are normally employed under unit control and operate from heliports in the vicinity of unit command posts. Brigades and regimental air elements provide aircraft to attached maneuver battalions on priorities established by the brigade or regimental commander. These aviation units may be augmented by corps or army aviation units for specific operations. When armor brigades conduct airmobile operations, corps or army aviation units are placed under operational control of the brigade or attached, depending on the type and length of the operation.

b. Air Cavalry Troop. Each armored cavalry regiment and each divisional armored cavalry

squadron has an organic air cavalry troop. For the basic employment of this troop, see FM 17-36 and FM 17-95.

c. Logistical Support Aircraft. The transport section of the armored cavalry regiment's aviation platoon provides a capability for limited aerial movement of troops, supplies, and equipment for units of the regiment. The helicopters in the aircraft maintenance company in the division support command are used for maintenance support. Other organic aircraft may be diverted for logistical support missions on a priority basis.

224. Army and Corps Aviation Support

Army and corps aviation units consist of light and medium airmobile companies for troop and cargo lifts, heavy helicopter companies for heavy equipment and cargo lifts, fixed wing surveillance companies for visual and electronic surveillance, separate air cavalry troops, escort helicopter companies (armed), and air ambulance companies. Aircraft requirements for airmobile operations either tactical or logistical aerial electronic surveillance, and other type operations requiring additional aircraft over those provided armor units by TOE will be allocated by army or corps as required. These aviation units may be attached to, placed in support of, or under the operational control of an armored unit. Armor commanders at all levels must consider the availability and capability of corps and army aircraft during the planning and conduct of operations.

Section V. CHEMICAL

225. General

Guidance relative to the employment of toxic agents by armor units will be received through command channels. There are no restrictions on the initial employment of nontoxic chemical agents such as flame and smoke. After use of toxic chemical agents is authorized, their employment will be planned and executed subject to policy restrictions of higher headquarters. Operations involving the use of toxic biological agents will normally be planned and executed by corps or higher units. Chemical employment planning parallels fire planning and plans are

forwarded to division for inclusion in division plans.

226. Chemical Support Units

Certain chemical units may be attached or in support of brigade or battalion operations or may be operating in the brigade zone of action. Such a unit is the chemical company, smoke generator. This unit provides concealment of troops or installations under all operating conditions by the use of smoke. It is equipped to defend itself against hostile ground attack and is 100 percent mobile.

227. Division Engineer Battalion

a. General. The primary mission of the division engineer battalion is to increase the combat effectiveness of the division by means of engineer combat support. A secondary mission is to undertake and conduct infantry combat missions when required.

b. Capabilities. The division engineer battalion is specially organized, equipped, and trained to perform tasks that assist division units. These tasks include—

- (1) Providing engineer staff planning and supervision of organic and attached engineer troops.
- (2) Performing construction, repair, and the maintenance of roads, bridges, fords, and culverts.
- (3) Providing support to hasty river crossing operations with boats, rafts, and bridges; preparation of deep-fording or vehicle swim sites; coordinating of organic, attached, and supporting engineer troops in the conduct of deliberate river crossing operations.
- (4) Providing fixed bridging for passage of short gaps.
- (5) Assisting in the removal of obstacles, including mines.
- (6) Assisting in the emplacement of obstacles, including minefields and booby-traps.
- (7) Preparing and executing demolitions, including employment of nuclear demolitions (ADM).
- (8) Technical assistance to other troops in the preparation of field fortifications, camouflage, and deception devices.
- (9) Performing engineer reconnaissance and intelligence missions.
- (10) Accomplishing general construction, including construction of airlanding facilities.
- (11) Producing a supply of potable water.
- (12) Providing assistance in the assault of fortified positions.

- (13) Conducting infantry combat missions, when required.

228. Employment of Engineers

a. General. The division engineer battalion is designed to provide an optimum combination of engineer equipment and individual skills for combat engineer tasks. Some of these tasks are performed by the battalion operating as a unit. However, most of them are accomplished by the combat engineer companies and platoons that support the brigades, battalion task forces, or company teams. These engineer units may be reinforced with engineer construction equipment from headquarters and headquarters company and stream crossing equipment and assault bridging from the bridge company (FM 5-135).

b. Fundamentals of Employment.

- (1) Combat engineer support is allocated on the basis of anticipated engineer work as determined by the factors of METT. The amount of engineer support given to a tactical unit is based on the anticipated engineer work, as determined by the mission of the tactical unit, capabilities of the enemy, scheme of maneuver, type of terrain, expected weather conditions, and capabilities and amount of engineer effort available.
- (2) Combat engineer units are used most effectively and efficiently in a direct support status. Greater flexibility and efficiency in the overall engineer effort are realized by retaining the subordinate engineer elements under the control of its parent engineer unit. However, engineers are attached when distance, terrain, or mission make operation under the control of the parent unit impractical and undesirable. Engineer units will often be attached to armor units in operations such as the offense, exploitation, and pursuit, or if one brigade or battalion task force is conducting an independent mission.
- (3) In an offensive action, engineer ele-

ments must be positioned to assist in the movement of the maneuver forces. To provide effective support to the attacking force, it is essential that combat engineer units be located well forward. This forward location promotes rapid river crossing and the removal or breaching of obstacles that cannot be bypassed. This technique enables the engineer commander to maintain constant liaison, to anticipate the needs of the attacking troops, and to have maximum engineer effort available for meeting those needs promptly.

- (4) In a defensive situation, the location of the engineer units is dictated by the assigned task priorities. In a defensive operation, the senior commander specifies the form of defense, and the priorities of engineer tasks. These engineer tasks are normally accomplished by attaching a reinforced engineer unit to the security force, placing a reinforced engineer unit in support of each brigade occupying the forward defensive area, and retaining the remainder of the available engineer effort in support of the division. An engineer unit reinforced with assault bridging is normally attached to the reserve when committed. This engineer commander establishes early liaison with the commander of the reserve and functions as his engineer staff officer during all planning. This engineer unit also assists in the preparation of blocking positions, improvement of counterattack routes, and coordination and rehearsals of counterattack plans.
- (5) In a retrograde operation, engineers play a vital role in delaying the advance of the enemy and in providing adequate withdrawal routes. Proper coordination and accomplishment of engineer tasks in retrograde operations normally require the attachment of engineer elements to the delay force in a delaying action, the rear guard in a retirement, or the detach-

ments left in contact in a withdrawal. The leading elements of the friendly troops must be kept moving to their destination, therefore, routes to these destinations must be kept open and clear to provide for the continuous flow of traffic. The obstacle plan is prepared so as not to interfere with future operations. Engineers may destroy bridges and culverts, block roads, lay mines, destroy supplies, and demolish railways and rolling stock in carrying out the obstacle plan. The engineers in coordination with combat and other combat support units prepare successive delaying positions and maintain routes of withdrawal.

- (6) The senior engineer representative functions as the tactical unit's engineer staff officer. Nondivisional engineer units in support of the division are attached when their missions necessitate close command control. All engineer combat support provided to the division is coordinated by the division engineer (FM 5-135).
- (7) Considerations for commitment of engineers to an infantry combat mission.
- (a) *Mission of tactical force.*
1. Will the enemy force be able to seriously affect the tactical force if the engineer unit is not committed?
 2. Can the tactical force afford the temporary loss of the engineer unit and the possible degradation of the future engineer capability?
- (b) *Capabilities of the engineer unit.*
1. Is the combat strength of the engineer unit sufficient to significantly influence the action if committed?
 2. What combat support will the engineer unit need to perform the combat mission?
 3. Could the available engineer unit be committed piecemeal as rein-

forcement for existing combat units thereby achieving a better tactical posture?

4. How quickly can the engineer unit be modified to assume a combat mission?
5. Does the equipment of the engineer unit lend itself to commitment in the current tactical situation?

(8) *Conduct.* Commitment of an engineer unit to an infantry combat mission is

not instantaneous. It requires time for the engineer unit to prepare for such a mission. Normal organization of the engineer platoon or company is modified to provide effective use and control of crew-served weapons; security of equipment not needed for combat; and the special requirements of command, communication, and supply in combat. The extent of modification varies with the size of the engineer unit, the time available, and the mission. See FM 5-135.

Section VII. COMMUNICATIONS

229. General

Communication is a function of command. Each armor unit commander is responsible for the establishment, operation, and maintenance, within his capabilities, of the communication system of his command and its operation in the system of the next higher headquarters. He must adhere to the following principles in establishing and operating his communication system:

a. The communication system must be organized to fit the unit task organization. The communication systems of subordinate and supporting elements must be integrated into the unit communication system.

b. Planning for the maximum use of all available means of communication will prevent the overloading of any one means and will minimize the effect of a disruption of one or more means.

230. Communication means

Radio is the means of communication used most in armor units. Wire, messenger, visual, and sound communication are supplemental means employed extensively under certain circumstances. Instructions for the use of these means are contained in SSI's, SOI's and other pertinent directives.

a. *Radio.* The flexibility of radio communication affords the commander the ability to control and coordinate subordinate elements, yet does not restrict maneuver of these elements. Radio communication may be affected

adversely by enemy jamming, unfavorable terrain, and weather. Armor leaders habitually operate their own voice radios to insure the direct and personal contact characteristics of armor command. Armor units generally employ three types of radio equipment in the basic configurations discussed below—

(1) *FM radios.*

(a) *Mounted FM radios.* These radio sets, mounted in ground and air vehicles, consist of combinations of components which are configured to satisfy the communications requirements of various users. The components used include—short-range transceivers with a planning distance of 24-32 kilometers; auxiliary receivers; and short-range, low-power transceivers with a planning distance of 8 kilometers.

(b) *Portable FM radios.* These are radio sets which are back-packed or hand-carried and have planning distances of 500 meters to 8 kilometers, depending on the radio set and type of antenna used.

(2) *AM radios.*

(a) *AM radios (voice or CW).* These are medium range, HF radio sets both portable and vehicular mounted, which provide for transmission and reception of voice or CW signals. Depending on equipment and

antenna used, these sets have the following planning distances: voice, 16–80 kilometers; and CW, 32–120 kilometers.

- (b) *AM radio teletypewriter (RATT) sets.* These are vehicular mounted, medium range, HF radio sets which can provide either separate or simultaneous transmission and reception of voice and RATT signals. Additionally, these sets can transmit and receive CW signals. Planning distances for these sets are from 80–120 kilometers dependent on mode of transmission and antenna used.
- (c) For additional details concerning these radios, see FM 24–19.

- (3) *UHF radios.* These are vehicular mounted radio sets which are voice operated and are used for ground-to-air communications. Planning distances are dependent on altitude of the aircraft and vary from 48 kilometers (at 1,000 ft air elevation) to 160 kilometers (at 10,000 ft air elevation).

b. Wire. Wire communication supplements radio and is used whenever practicable. The installation of wire is dependent on the situation and the time available. It is used mainly in defensive situations and in assembly areas.

c. Messengers. Messengers are used to supplement radio and wire. Messenger communication is more secure and dependable generally than other means but lacks the speed inherent in radio or wire communication. Use of air messenger service will speed delivery time.

d. Visual. Visual communication is a means available to all units. Visual signals are transmitted by flags, lights, pyrotechnics, panels, arm and hand signals, and aircraft maneuvers. (See ACP 126 and FM 21–60.) They are suitable for transmitting simple prearranged messages rapidly over short distances as well as for recognition and identification of friendly forces. Their use is restricted by distance, visibility, security, and the nature of the signal.

e. Sound. Sound communication is typified by such devices as sirens, shots, horns, and alarms. The chief value of sound signals is to

attract attention, transmit simple prearranged messages, and to spread alarms. Sound signals are satisfactory only for short distances, and their effectiveness is greatly reduced by battle noise.

231. Employment of the Battalion or Squadron Communication Platoon

It is the function of the communication platoon to insure the efficient operation of the battalion or squadron communication system and to perform organizational maintenance on communication and electronic equipment organic to the battalion or squadron headquarters and headquarters company or troop. The communication platoon provides the following services:

- a.* Operates the message center and provides messenger service.
- b.* Installs wire lines to subordinate units and staff sections when required.
- c.* Operates the battalion or squadron switchboard, panel displays, and message pickup facilities.
- d.* Provides facilities for encrypting and decrypting messages.
- e.* In coordination with the S4 section, procures communication and electronic repair parts for the battalion or squadron (less cryptographic) and evacuates all communication and electronic equipment that requires repair beyond organizational maintenance level.

232. Liaison

a. Liaison is a means of establishing communication. Each commander maintains liaison with higher headquarters, supported units, and adjacent units by any means available.

b. Liaison may be accomplished by personal conference between commanders or by means of a liaison agent or officer who represents the commander. Usually both methods are employed concurrently.

233. Communication Security

The armor unit commander is responsible for the security of his communication system, which includes all measures taken to prevent or delay the enemy from gaining information from friendly communication systems. The

commander must determine the maximum degree of communication security that he can employ consistent with his mission and the reaction time of the enemy. For a detailed discussion of radio security measures, see FM 24-1, FM 24-18 and (CM)FM 32-5.

234. Electronic Counter-Countermeasures (Antijamming)

a. General. The possibility of electronic interference to command and control communications must be carefully considered in planning operations. Electronic counter-countermeasures include but are not limited to—

- (1) Siting of communications and surveillance equipment to reduce its vulnerability to jamming. Such measures include dispersion, adoption of reverse slope positions for other than line of sight antennas or radiating and receiving devices, and frequent displacement when practicable.
- (2) Minimizing the use of radiating communication and surveillance equipment (including such measures as periods of radio listening silence) to hamper the enemy's signal intercept and intelligence acquisition systems.
- (3) Providing alternate means in both the communication and surveillance fields with the alternate means operating on different transmitting frequencies and from different locations.
- (4) Training operators in antijamming techniques and in detecting enemy deceptive action taken against our surveillance devices.
- (5) Use of decoys and simulating devices.
- (6) Use of radar-homing missiles.

b. Radio Jamming Checklists. Enemy forces usually have the capability to jam all radio circuits. Until jam-proof equipment and techniques are developed, all possible steps must be taken to minimize the effects of enemy jamming.

- (1) *Commanders and staff.*
 - (a) Reduce use of radio messages to absolute minimum.
 - (b) Preplan all operations possible; use brevity codes to implement plans and directives.

- (c) Keep messages as short as possible.
- (d) Stress radio discipline and security.
- (e) Destroy enemy jamming stations where possible and if deemed advisable by the tactical commander.
- (f) Always inform the next higher headquarters of jamming.

(2) *Communications officer.*

- (a) Use the radio only when necessary.
- (b) Train radio operators to readjust equipment and continue operating through jamming.
- (c) Enforce radio discipline and security to maximum.
- (d) Require authentication of all transmissions.
- (e) Site radio stations and antennas to evade enemy jamming.
- (f) Always include alternate call signs and frequencies in signal operation instructions (SOI) and include prearranged plans for their use.
- (g) Always report jamming to the commanding officer and staff.

(3) *Radio operators.*

- (a) Site station and antenna to evade enemy jamming.
- (b) Learn to recognize enemy jamming and report details to officer in charge.
- (c) Learn to readjust the set to minimize effect of jamming.
- (d) Operate with minimum power until jammed—then increase the power.
- (e) Shift to alternate frequencies and call signs as directed.
- (f) Authenticate all transmissions.
- (g) Use dummy antenna, when one is provided, on tuneup of transmitter.
- (h) KEEP OFF THE AIR, except as absolutely necessary.
- (i) Observe radio discipline at all times.
- (j) Keep transmission as short as possible.
- (k) When jammed, keep calm, keep trying, keep operating.

235. General

a. Tactical air support consists of close air support and tactical air reconnaissance in areas of concern to the ground commander.

b. The Air Force provides tactical air control parties (TACP's) to Army units down to battalion level. The TACP's are composed of selected Air Force officers who are tactical fighter pilots. They are responsible for advising the ground commander on Air Force capabilities and limitations, transmitting immediate air requests to the direct air support center (DASC) over the Air Force air request net, controlling air strikes, and keeping the S3 air informed on status of air request.

c. All equipment and personnel for TACP's are provided by the Air Force. When the situation dictates, full-tracked Army vehicles are provided the TACP's by the supported unit.

d. The battalion level TACP is composed of two officers (an air liaison officer (ALO) and a forward air controller (FAC)), vehicular and portable communications equipment, and sufficient enlisted personnel to operate and maintain the equipment. The TACP's above battalion level have a senior air liaison officer (ALO), specialized assistants according to echelon (e.g., at division, tactical air reconnaissance and tactical airlift operation's officers) vehicle mounted communications, and enlisted communications personnel to operate and maintain the equipment.

e. The TACP should be collocated with the fire support coordinator (FSCoord). This will assure timely coordination with ground support elements to determine the most appropriate weapon system to be used.

f. Targets for supporting tactical air include enemy armor, enemy columns, targets out of range of artillery, enemy strongpoints, and enemy communications centers. Tactical air may perform visual, photographic, weather, or electronic reconnaissance missions and make a 24-hour a day all-weather light bombardment attack.

g. Close air support provided by navy and marine elements is controlled by attached ANGLICO personnel as described in FM 31-12 or by TACP's provided by USAF.

236. Tactical Close-Air Support Requests

There are two types of request for close support air missions—

a. *Preplanned.* A preplanned mission is one that is decided upon early enough to allow complete planning and thorough preparation. The deadline for submission is outlined by orders (SOP). Preplanned air requests are submitted thru army channels moving progressively up and through each level of command, until they reach the senior TOC (TASE). (Field army is the highest army command echelon considered to be involved in preplanned air request). If the request is approved at this level by the to be involved in preplanned air request.) If is then submitted to the TACC as a requirement to the appropriate close air support unit. A preplanned air request should include the following information:

- (1) *Target location.* Coordinates; speed and direction, if moving; location with regard to prominent landmarks.
- (2) *Target description.* Guns: size, hasty or fortified positions, camouflage. Strongpoints: size and type of construction.
- (3) *Time on target (TOT).* Specify limits, if any.
- (4) *Troops.* Bivouac, marching, type of dugouts, and their depth. Supply areas: size, dispersed or concentrated, revetted or in the open, and class of supply.
- (5) *Results desired.* Destruction, neutralization, harassment limitations.
- (6) *Tactical significance.* How attack will aid mission of requesting unit.
- (7) *Target distance and direction from troops.* Distance and azimuth or limiting coordinates of troop positions, landmarks if possible.
- (8) *Special control information.* Special bomblines; marking of frontlines, whether marked on call of pilot or otherwise; facilities available for marking targets; desired direction of attack.

- (9) *Other pertinent information.* Flak suppression if provided; artillery and naval gunfire maximum ordinate; forward air controller (FAC) identification and location.

Note. Photo requests should contain information as to type of photography, scale, information desired, and quantity of prints. Visual reconnaissance should include specific area or route to be covered.

b. Immediate. Requests for immediate close air support are passed over the Air Force air request net directly from the TACP at the originating headquarters to the DASC at corps (fig. 12). Every request is acknowledged by each echelon having approval authority. If any intervening headquarters wishes to disapprove a request, it so indicates and informs the requesting agency of the type support to be used. In the absence of acknowledgment following a length of time specified by the appropriate commander, the request will be processed as though an acknowledgment had been received.

237. Control Measurer

To insure the safety of friendly troops and installations, a fire support coordination line (FSCL) is established on the ground by the ground forces, generally by the corps commander, and it must be coordinated with the supporting Air Force commander. This is a line beyond which the Air Force or other agencies may attack targets without danger to, or approval from, the ground forces. The movement of the FSCL must be anticipated and appropriate recommendations must be submitted enough in advance to insure dissemination to tactical air force. The FSCL must be easily identifiable by terrain features from the air and ground to prevent confusion and accidental air attacks on friendly ground forces. Tactical aircraft may attack targets short of the FSCL when ground forces request or give clearance for such an attack.

238. Close Air Support

The following types of missions are employed normally in close air support operations:

a. Column-Cover. These missions are performed usually by tactical fighter aircraft and are accomplished by positioning the aircraft

over the ground formation to perform visual reconnaissance to the front, rear, and flanks, and to attack enemy air or ground elements that impede or threaten the progress of the ground force. A FAC is located usually in one of the forward armored vehicles and directs aircraft onto targets. The column cover mission is of great assistance to armor in the exploitation of enemy disorganization and weakened resistance following a breakthrough. Aircraft on column cover missions can often neutralize elements of impending enemy resistance before these elements have been contacted by friendly ground forces.

b. Air Escort. When heliborne forces are employed, air escort may be used to defend the force against enemy air and ground attack in addition to eliminating enemy resistance in the objective or landing area.

c. Air Strike. These missions are the backbone of close air support. Heavily armed tactical fighters perform their missions by attacking weapons positions, tanks, troops, vehicles, and other equipment.

d. Special Missions. These may include such missions as electronic countermeasures performed by specially equipped aircraft to neutralize enemy electronic equipment.

239. Armament

a. Bombs. Bombs are used to destroy or neutralize a selected target. This is achieved usually by blast, shock, fragmentation, or fire effect. Varied fuse arrangements are used to control bomb bursts as desired. Types of bombs that may be used by tactical air support aircraft are—

- (1) Fragmentation (against personnel and aircraft on the ground).
- (2) General purpose (same as HE shell).
- (3) Special purpose:
 - (a) Penetrating.
 - (b) Demolition.
 - (c) Chemical.
 - (d) Mining.
 - (e) Fire bombs (thickened fuel).
- (4) Nuclear.

b. Rockets. Air-to-air and air-to-ground rockets are used to destroy small targets such

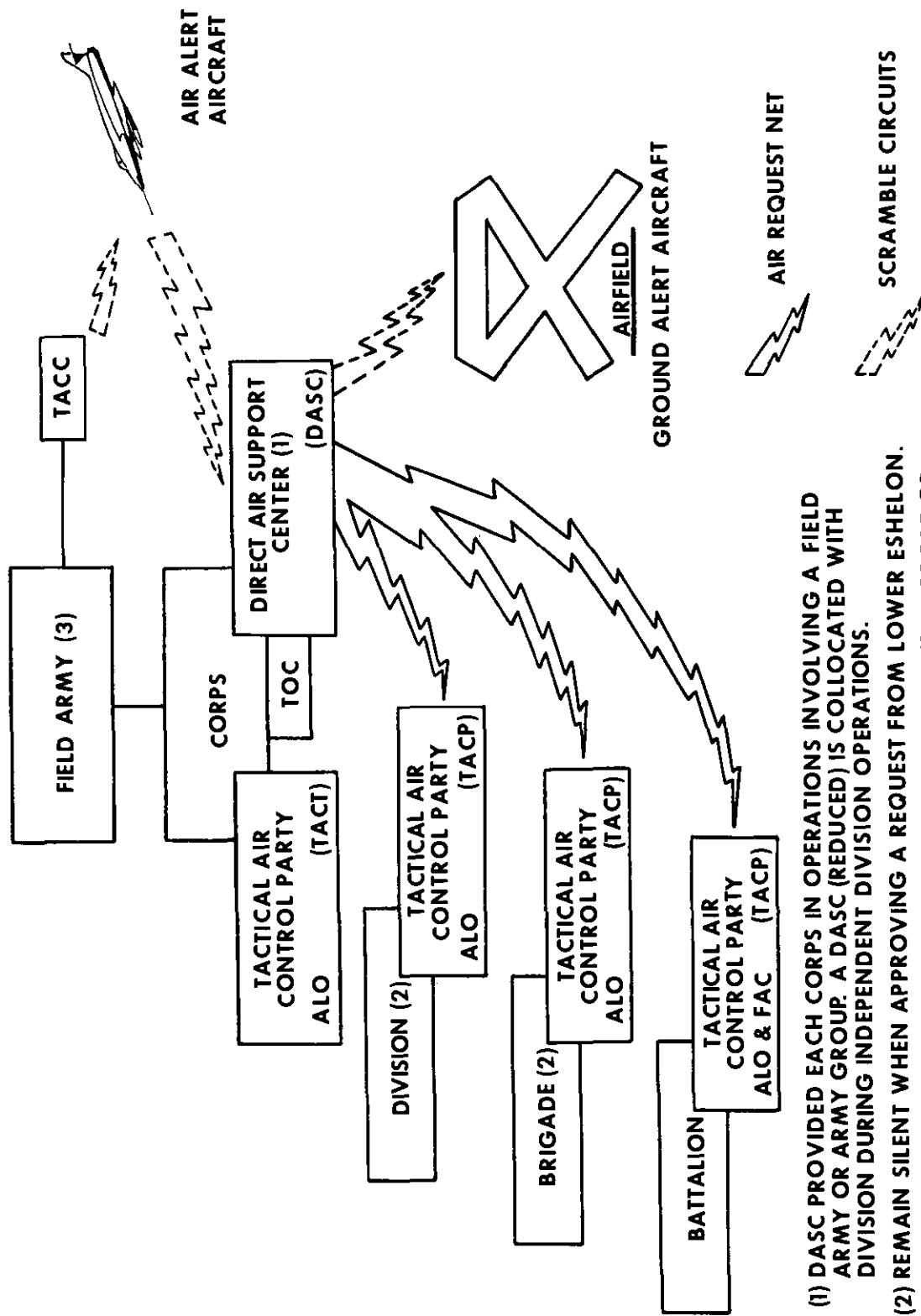

- (1) DASC PROVIDED EACH CORPS IN OPERATIONS INVOLVING A FIELD ARMY OR ARMY GROUP. A DASC (REDUCED) IS COLLOCATED WITH DIVISION DURING INDEPENDENT DIVISION OPERATIONS.
- (2) REMAIN SILENT WHEN APPROVING A REQUEST FROM LOWER ESHELON.
- (3) FIELD ARMY REQUIREMENTS FOR IMMEDIATE CLOSE AIR SUPPORT OR TACTICAL RECONNAISSANCE ARE SUBMITTED TO A CTOC OR TO THE TACC AS THE SITUATION DICTATES.

Figure 18. Immediate tactical air request.

as tanks, armored vehicles, trucks, gun emplacements, strongpoints, and aircraft.

c. Machineguns and Cannons. These weapons are an integral part of armament of tactical fighters and feature:

- (1) High cyclic rate of fire.
- (2) High muzzle velocity.

d. Missiles. These weapons may be employed air-to-air or air-to-surface. There are two general types—guided and nonguided.

e. Chemical Spray. Tactical air support aircraft may be fitted with spray tanks filled with

smoke agent to provide smoke screens or filled with chemical agent to deliver spray attacks.

240. Typical Targets for Close Air Support

- a. Weapon positions.
- b. Vehicles and armor.
- c. Command posts.
- d. Troop concentrations.
- e. Strongly defended positions.
- f. Missile launch sites.
- g. Defended roadblocks.

Section IX. INTELLIGENCE

241. General

Combat intelligence is intelligence for use in a combat area, whether based upon information collected locally or provided by higher headquarters. An armor commander uses the three elements of combat intelligence—information of the terrain, weather, and the enemy—in the performance of any combat mission (app XII). In internal defense operations, information of the civil populace becomes another intelligence element. Information of the enemy situation is normally the most critical intelligence requirement because this information is difficult to obtain. The S2 must be certain that routine intelligence production activities are undertaken in order of urgency to insure that the commander is provided with answers to his intelligence questions in time to be of use. Forward armor units constitute a major source of combat information. The S3 must support the intelligence effort by understanding and accepting conclusions concerning the effects of the weather, the terrain, and the enemy situation on the operation plan. An effective collection effort must be made to determine the existing enemy situation. This permits the commander to develop plans that take advantage of weather and terrain and exploit known enemy weaknesses. The actions of the unit generate combat information for its own use and for use of higher headquarters in the production of combat intelligence (FM 30-5 and FM 30-7).

242. Agencies

Maximum use must be made of combat intelligence collection and production agencies. The

agencies and organizations that will most frequently be in support or attached are—

a. Divisional Agencies.

- (1) Artillery forward observers.
- (2) PW interrogation teams.
- (3) Armored cavalry squadron.

b. *Nondivisional Agencies* (normally not under brigade or battalion task force control, but frequently in the area of operations).

- (1) *U.S. Army Security Agency division support company.* This company supports the division and its units by assisting in the maintenance of communication security and providing communication intelligence. Elements of this company usually are located in the brigade and battalion areas. They can be of great assistance to the commander if informed of the brigade and battalion intelligence requirements.
- (2) *Combat electronic warfare company.* This company may be attached or in support of the division. It provides the division G2 information regarding enemy electronic equipment, organization, and locations by detecting and studying enemy electromagnetic transmissions. Information gathered by this unit can be obtained through intelligence channels.
- (3) *Technical intelligence company.* This company, organic to the military intelligence battalion, field army, provides centralized performance of technical intelligence functions in the field

army. The company, which is located in the army rear service area, operates under the direct control of the military intelligence battalion commander. The technical intelligence field team organic to the military intelligence unit of corps is responsible for the collection of technical materiel within the division areas to include immediate combat evaluation and to make arrangements for the evacuation of captured enemy equipment to the technical intelligence company, field army. Technical intelligence information required by brigades or battalions can be obtained through intelligence channels.

- (4) *Military intelligence detachment.* This detachment performs specialized intelligence and counterintelligence functions that require the employment of special or foreign language skills in support of the armored cavalry regiment or separate armored or infantry brigades. The detachment provides the cavalry regiment, or separate armored or infantry brigade S2, assistance in the specialized fields of order of battle, imagery interpretation, interrogation of prisoners of war, document translation, and counterintelligence activities.
- (5) *Armored cavalry regiment.* Armored cavalry regiments are equipped to collect information of the enemy and the area of operations by ground and air activities. See chapter 5 and FM 17-95.

243. Reconnaissance

Effective reconnaissance provides much of the information necessary for the conduct of operations (ch 5).

244. Target Acquisition

Targets result from study or interpretation of the data supplied by many sources and agencies. Speed and accuracy in reporting are vital for successful engagement and destruction of targets. Soldiers must be trained to report all enemy activity or lack of enemy activity.

245. Surveillance

Surveillance involves the systematic observation of the battlefield by visual, electronic, photographic, and other means. It must be conducted on an all-weather, day-and-night basis to provide timely information to support combat operations. Appendix XXI provides guidance on the employment of ground radar.

246. Counterintelligence

Counterintelligence consists of means to deceive the enemy, deny the enemy information, and detect and expose, or neutralize, the enemy intelligence effort. Active counterintelligence measures block the enemy's attempts to gain information or to engage in sabotage or subversion. Among these measures are counterespionage, countersabotage, countersubversion, and the use of smoke to deny observation. Security of a unit can be so effective that it can deny the enemy any information and thus aid in achieving surprise. Passive counterintelligence measures conceal information from the enemy; they include censorship, security of classified documents and materiel, signal communication security, concealment, camouflage, electronic countermeasures, and control of civil population. A part of the counterintelligence section of the military intelligence detachment which is attached to division may be attached to brigade to advise the commander on counterintelligence measures. The S2 assists in planning and supervising unit counterintelligence training.

CHAPTER 10

COMBAT SERVICE SUPPORT

Section I. GENERAL

247. Purpose and Scope

a. This chapter provides guidance to commanders and staffs of armor units below division level in combat service support operations, including supply, combat service support aspects of medical treatment and evacuation, transportation, maintenance, and services in an active theater of operations. It also outlines command and staff combat service support responsibilities.

b. Discussion of combat service support in this chapter refers to the brigade, battalion, and company, unless otherwise specified, it is also applicable to the armored cavalry regiment, squadron, or troop.

248. Principles of Combat Service Support

Combat service support is the part of administration that provides for and manages supply, evacuation and hospitalization, transportation, and maintenance and service. Although procedures may vary at different echelons, the principles of combat service support remain constant and are applicable to all forms of warfare. However, the mass destruction of personnel, supplies, and equipment that may result from nuclear attack, and the mass casualties and contamination of supplies and equipment that may result from chemical and biological attacks requires that additional consideration be given to applying these principles. For discussion of combat service support operations under conditions of chemical, biological, and nuclear warfare, see FM 54-2. All echelons in the combat service support structure adhere to four basic principles.

a. *Combat Service Support is a Function of Command.* Commanders at all echelons are re-

sponsible for the combat service support of organic and attached elements of their commands. From the tank commander or squad leader upward, each commander assures himself that combat service support is adequate by anticipating his requirements, making his wants known, and employing properly the combat service support elements available to him. The logistics officer (S4) assists the commander in performing his combat service support responsibility. To insure an active, well-coordinated effort, the commander makes his policies and decisions known to his logistics officer.

b. *The Impetus of Combat Service Support is From Rear to Front.* All combat service support echelons must be impressed with the necessity for constantly pushing the combat service support forward to the user to provide him the means to accomplish his missions. At all echelons, combat service support agencies must be in reasonable reach of the organic transportation of lower units. This is especially important in armor operations, which normally extend over great distances.

c. *Advance Planning is Essential to Successful Combat Service Support.* The logistical plan is based upon and provides adequate and timely support to the tactical operation. It is complete, simple, and flexible. It must be prepared with foresight and coordinated with all appropriate staff officers. Combat service support and tactical planning are concurrent. The logistics officer advises the commander on all combat service support matters pertaining to anticipated operations.

d. *Reserves of Supplies are Maintained at All Echelons.* Certain reserve supplies, includ-

ing rations, ammunition, fuel and lubricants, and repair parts, are carried by all echelons. These reserves insure that the combat units can continue to operate if the supply chain should be broken temporarily; they must be replenished when supplies become available.

249. Logistical Characteristics of Armor Units

a. Battalions, squadrons, and separate companies and troops are logistically capable of operating independently for limited periods of time. Companies of tank battalions and troops of armored cavalry squadrons are dependent upon the parent unit for combat service support.

b. Headquarters and headquarters companies or troops of the division brigade or armored cavalry regiment contain only the personnel and equipment required to establish and maintain the headquarters and the company lo-

gistically. These units do not have organic combat service support elements required to support attached combat battalions or combat support units.

c. Armored cavalry regiments and separate armored brigades receive combat service support from direct support units of the field army support command.

d. Logistically, armor units are characterized by their large consumption of fuels, heavy expenditures of ammunition, and support requirements. The success of the armor unit depends on how well these requirements are satisfied.

e. Armor units may be logistically supported by air for limited periods. Supplies and equipment are delivered by parachute, by low-level extraction, and by utility or cargo helicopter. Terrain and tactical situation permitting, low-level extraction is preferred due to accuracy of delivery.

Section II. COMBAT SERVICE SUPPORT PERSONNEL

250. General

a. At brigade and battalion level, the commander is provided a logistical staff officer (S4) and other key combat service support personnel to assist him. At company level, the commander is provided warrant officers or trained enlisted men whose primary duties are concerned with combat service support matters.

b. For discussion of the commander's combat service support responsibilities, see FM 54-2.

251. Brigade Combat Service Support Personnel

The divisional brigade headquarters is primarily a tactical headquarters and normally enters combat service support channels only to coordinate and establish priorities for critical items of supply. However, the commander must insure adequate combat service support for the subordinate elements. Higher headquarters attaches or places in support the combat service support means to support operations. The commander is provided a staff to monitor the combat service support situation, control and coordinate combat service support

elements, and recommend adjustment of combat service support means, as necessary. Separate brigades have an organic combat service support battalion. For duties of brigade and regimental combat service support staff personnel, see paragraph 66.

252. Battalion or Squadron Combat Service Support Personnel

a. General. Within the division the normal chain of combat service support is direct from divisional support command elements to the battalion or squadron. The armored cavalry squadron of the armored cavalry regiment's normal chain of combat service support is from direct support units of the field army support command. The battalion commander is provided with a logistics staff officer (S4) and other key combat service support personnel to assist him. For logistical duties of the S4, communications officer, maintenance officer, support platoon leader, and surgeon, see paragraph 67.

b. Transportation Section Commander. The transportation section commander (lieutenant) commands the transportation section in the battalion support platoon. His duties include—

- (1) Supervising the hauling of cargo and movement of personnel in vehicles of the transportation section.
- (2) Supervising the selection and training of personnel in his section in the operation, maintenance, and employment of cargo vehicles.
- (3) Instructing and supervising in the proper loading of cargo.
- (4) Directing the movement of supply vehicles in convoy.
- (5) Conducting inspections to determine vehicle and load conditions and insuring compliance with prescribed procedures.
- (6) Advising the support platoon leader on motor transport problems.
- (7) Assisting the S4 in the control, security, and displacement of the combat trains.

c. Supply Section Leader. The battalion supply section leader (warrant officer) commands the supply section of the support platoon. His duties include—

- (1) Maintaining records to reflect the current logistical situation.
- (2) Preparing requisitions and other logistics documents.
- (3) Preparing logistical reports.
- (4) Assisting the support platoon leader in the operation of the field trains.

253. Company Combat Service Support Personnel

a. The key combat service support personnel at the company level include supply, communication, and maintenance warrant officers or noncommissioned officers who perform or supervise the functions of supply or maintenance.

b. Normally the company executive officer is responsible to the commander for the supervision of all combat service support matters of the unit. This does not preclude the assignment of other unit officers as assistant supply or maintenance officers.

c. In the air cavalry troop, a support platoon commander (lieutenant) supervises all troop maintenance and supply activities.

d. For additional discussion of company or troop combat service support personnel, see FM 17-15 and FM 17-36.

254. Separate Company or Troop Combat Service Support Personnel

The separate company-level armor units are organized to operate without battalion-level support. These units have organic mess teams. In addition to the personnel discussed in paragraph 253, the separate unit has an automotive maintenance technician (warrant officer) who performs the duties of unit motor officer.

Section III. BRIGADE TRAINS

255. General

The brigade trains consist of a control group, elements and units of the division support command attached to or in support of the brigade, and the field trains of units attached or organic to the brigade. These trains are established to provide adequate combat service support to the tactical elements of the brigade and to control, coordinate movement, and protect the supporting elements and unit field trains.

256. Organization for Control

The brigade trains are organized under the tactical control (movement, security, and location) of the brigade S4. The S4 section estab-

lishes the control element of the trains, which is known as the brigade logistical control point. Movement of all combat service support elements is coordinated at this point.

257. Composition and Employment

The composition of the brigade trains varies, depending upon the tactical situation and the type and number of units attached or in support. For a discussion of the composition and employment of brigade trains, see FM 54-2, and for regimental trains, see FM 17-95.

258. Brigade Trains Under Division Control

In certain situations, when route space is at a premium, it may be advantageous to place the brigade trains under the division support

command commander, who then becomes responsible for their movement and protection. However, brigade trains, when so attached, should be kept as a unit positioned together

and moved as a serial. The retention of brigade trains as a unit greatly improves their logistical efficiency, particularly when they are released to brigade control.

Section IV. BATTALION OR SQUADRON COMBAT SERVICE SUPPORT ELEMENTS AND TRAINS

259. Battalion (Squadron) Combat Service Support Elements

There are three basic combat service support elements organic to the tank battalion and armored cavalry squadron—the support platoon, maintenance platoon, and medical platoon. The size and composition of these elements vary depending on whether the parent unit is a tank battalion or armored cavalry squadron and depending on the major command to which the unit is assigned (division, regiment, or separate brigade). The functions performed by the combat service support elements are identical regardless of the unit to which organic.

a. Support Platoon. The support platoon of division and separate brigade armor units is organized with a platoon headquarters, transportation section, mess section, and supply section. In the armored cavalry regiment, mess elements are organic to each troop and battery.

- (1) *Transportation section.* The transportation section is organized and equipped with the personnel and trucks to transport supplies from supporting supply or distributing points to the companies of the battalion. The section normally transports a part of the unit basic load of ammunition and prescribed loads of fuels and lubricants.
- (2) *Mess section.* The mess section is organized and equipped to receive class I supplies and prepare and deliver meals or rations to all units of the battalion. The cellular organization of the mess section permits the attachment of a mess team to each company or troop when required.
- (3) *Supply section.* The supply section is organized and equipped to receive supply requests, except for repair parts, from the companies and prepare and forward battalion requisitions

or requests to the appropriate agency. Upon receipt of supplies, this section stores (if required) and distributes the supplies in the battalion.

b. Maintenance Platoon. The maintenance platoon is equipped and trained to perform organizational maintenance, as outlined in the 20-series technical manuals, which cannot be accomplished by company or troop maintenance sections. It provides repair parts and evacuation of all equipment for repair (except signal and medical) and accomplishes battlefield recovery of repairable tank-automotive equipment.

c. Medical Platoon. The medical platoon is composed of the battalion surgeon, noncommissioned officers, aidmen, ambulance drivers, and aid station personnel, together with their equipment and transportation. The battalion surgeon is on the special staff of the battalion commander and commands the medical platoon, and operates under the staff supervision of the S1. The platoon is organized to provide emergency medical treatment within its capabilities. It provides for patient acquisition, emergency medical treatment, and evacuation to the battalion aid station. At the battalion aid station, the patient receives treatment and is returned to duty or evacuated to the rear. In combat operations, the battalion medical platoon will habitually attach a medical aid-evacuation team to each company.

d. Communication Platoon. The communication platoon is normally located in the command post area. It provides organizational maintenance as outlined in the 20-series technical manuals for the headquarters and headquarters company's communication and other electronic equipment (less cryptographic). It also provides limited backup and organizational maintenance for the line companies. The platoon procures signal repair parts for the battalion (less cryptographic) and provides for the evacuation of all signal equipment that re-

quires repair beyond organizational maintenance level.

260. Battalion Trains Organization

The organization of trains varies with the mission, tactical and administrative situations, and such other factors as terrain, weather, and time and space. The trains may be organized as unit trains, with all combat service support elements grouped directly under the S4, or as combat and field trains (para 268-272).

a. Combat trains are organized to provide immediate combat service support for the combat operation and consist of supply, medical, and maintenance vehicles, personnel, and equipment.

b. Field trains consist of administrative, supply, and maintenance vehicles, personnel, and equipment not included in the combat trains and not required for the immediate support of combat operations.

261. Composition of Battalion (Task Force) Combat Trains

The composition of the battalion combat trains is variable, depending on the tactical and administrative situations and such other factors as terrain, climate, road nets, and location of field trains. In slow-moving operations, the bulk of maintenance and medical facilities and a minimum number of supply vehicles are normally located in the combat trains. In such situations, the field trains are positioned close enough to the combat elements to supply them daily. In fast-moving operations such as an exploitation, it is desirable to place the bulk of organic combat service support elements in the combat trains since the location and disposition of the field trains will normally preclude their issuance of supply on a daily basis to the com-

bat elements. Regardless of the trains area from which supplies will be issued to the combat units, the supply vehicles must be organized to be responsive to the demand of the supported units. When road space is limited, higher headquarters may restrict the size of battalion combat trains.

262. Composition of Battalion (Task Force) Field Trains

The factors used in determining the composition of the battalion combat trains also apply to the battalion field trains. Battalion field trains consist of those combat service support elements not included in the combat trains and not required for the immediate support of combat operations. Generally, field trains include kitchen, ration, administrative, fuel and lubricant, and ammunition vehicles. Elements of the maintenance platoon may be part of the field trains to perform scheduled maintenance and to provide maintenance for other field trains elements. For specific operations, the maintenance section of the headquarters company of the tank battalion may be located in the field trains to provide maintenance for the field trains elements and thus allow the maintenance platoon to operate as an entity away from the field trains area.

263. Control of Battalion (Task Force) Trains

Control of the battalion trains, when employed either as a unit or as combat and field trains, is the responsibility of the battalion S4. The battalion combat trains are located in the general area of the battalion command post and are under the direct control of the battalion S4. The battalion support platoon leader, as the assistant S4, directly controls the battalion field trains, which are normally located in the trains area of the next higher command.

Section V. COMPANY AND TROOP COMBAT SERVICE SUPPORT ELEMENTS AND TRAINS

264. Organization of Company and Troop Combat Service Support Elements

The organization and equipment of combat service support elements organic to the different armor company-size units are not standard but vary in each TOE according to the mission of the unit.

a. Tank Company and Armored Cavalry Troop. Tank companies and armored cavalry troops organic to divisional battalions or squadrons have two basic combat service support elements—a maintenance section and a supply element. The organic elements provide organizational maintenance and company-level supply support to the company and any at-

tached units. Mess support, backup organizational maintenance, medical, and supply and transportation support are provided by the parent battalion or unit to which attached. In the airborne division, the armored cavalry troop combat service support elements have limited ground mobility means and, during sustained ground operations, require an augmentation of cargo vehicles to attain full mobility.

b. Air Cavalry Troop. The air cavalry troop has an organic service platoon. The service platoon is organized with a maintenance section to provide organizational maintenance and a supply section to provide troop-level supply, including transport of ammunition, fuels, and lubricants. The air cavalry troop is dependent on the parent squadron for mess support except for the air cavalry troop of the armored cavalry regiment which has its own organic mess team. In the airborne and airmobile division, the troop service platoon is provided limited transport means and requires an augmentation of cargo vehicles or aircraft during sustained operations.

c. Headquarters and Headquarters Company or Troop.

- (1) The battalion headquarters and headquarters company and the squadron headquarters and headquarters troop contain organic combat service support elements to provide combat service support for the unit as a whole. See paragraphs 259 through 263 for a discussion of battalion or squadron logistical elements.
- (2) Brigade headquarters and headquarters company contains organic maintenance, medical, mess, and supply elements required for normal company operations. The maintenance element of the headquarters contains the personnel and equipment necessary to perform organizational repair and maintenance on all equipment except aircraft. The crew chiefs of the aviation section perform organizational maintenance on aircraft under the supervision of the maintenance supervisor. The brigade surgeon and medical aidman provide limited medical treatment for the headquarters and headquarters company. The head-

quarters and headquarters company does not contain the combat service support units to support the brigade as a whole.

265. Company Train

a. The company train consists of organic and attached combat service support elements. The company train may be employed as a unit train or organized into a combat train and a field train. The factors considered in determining the composition of trains are discussed in paragraphs 259 through 263.

b. A company detached from the parent battalion will have attached to it a proportionate share of the battalion combat service support. The attachments will normally include ammunition, fuel, and lubricant supply vehicles, a company mess team, and a medical aid-evacuation team. Additional medical aidmen and equipment and a supply of fast-moving repair parts may accompany a detached unit. Upon joining the unit to which attached, the company commander will organize the company train to support the combat operation. The organic and attached combat service elements not required for immediate support of the combat operation become a part of the trains of the higher headquarters.

c. An important consideration in company-level logistics is that each vehicle in the unit carries its prescribed load of rations, fuels, lubricants, authorized repair parts, and its part of the basic load of ammunition, as appropriate.

266. Composition and Employment of the Company Train

a. The company normally organizes a combat train and a field train. In some situations, dispersed operations preclude the echelonment of the train and require the employment of a unit train.

- (1) *Company combat train.* The company combat train consists of the maintenance section, the attached medical aid-evacuation team, and supply vehicles that may be required from the support platoon for the immediate support of the combat operation.
- (2) *Company field train.* The company field train consists of the personnel

and equipment not located in the combat train.

b. The combat train remains with the company under the control of the executive officer. In fast-moving situations, the combat train normally moves as a part of the combat formation to gain security from its proximity to combat elements. In a slow-moving situation, the combat train follows the combat elements by bounds, taking advantage of cover and concealment.

c. The company field train normally moves with the field trains of the next higher headquarters.

267. Composition and Employment of Air Cavalry Troop Train

a. *General.* The air cavalry troop train consists of the personnel and equipment of the troop service platoon together with any attached combat service support elements. The air cavalry troop organizes an air train and a ground train to support troop combat elements. The size and composition of the air train and ground train will normally depend upon the size of the combat element to be supported, the extent of operations, and the distance of the combat elements from the troop train areas.

b. *Air Echelon.* The air cavalry troop may employ an air train to provide responsive combat service support to the troop combat elements. The air train consists of the two utility helicopters organic to the service platoon to-

gether with their assigned crews and designated loads. The designated loads may consist of maintenance personnel and repair parts, attached medical personnel, ammunition, or externally carried fuel containers. Actual loads are based on estimated requirements to support specific missions. The air train may be located with the ground train or at a predetermined area from which it moves to rendezvous with the combat elements to accomplish supply, maintenance, or evacuation functions. Rendezvous points and times may be predetermined or the air train may stand by to rendezvous with the troop combat elements on an on-call basis.

c. *Ground Echelon.* The air cavalry ground train consists of the organic and attached ground logistical vehicles and the combat service support personnel, equipment, and supplies not included in the air train. The ground train may be organized and employed as a unit train or echeloned into a combat train and field train as discussed for the company train in paragraph 265. The air cavalry troop unit or combat train is normally employed under the control of the service platoon and is located where it can best support the combat elements of the troop, such as the air cavalry troop assembly area, squadron combat trains area, or a ground troop combat train area. The field train, when organized, normally becomes part of the squadron field trains. Helicopters may return to the train areas for fuel and ammunition supply, or ground vehicles may be dispatched to rendezvous points for supply functions.

Section VI. EMPLOYMENT OF TRAINS

268. General

The major considerations in the employment of trains are—

a. *Combat Service Support to the Combat Units.* In all situations, the trains are organized and positioned to provide adequate and timely supplies, medical evacuation, and maintenance support to the combat unit. The trains of the higher echelons are oriented on and convenient to the location of subordinate units. The movements of trains are based on the movements of the combat units to insure continuous and responsive support.

b. *Minimum Interference With Tactical*

Operations. The location and movement of logistical support vehicles must be integrated with the planned location and movement of combat units. Combat service support activities and vehicular traffic must not impede a combat unit's freedom of action.

c. *Security and Protection to Elements of the Trains.* Trains should be employed in areas and on routes that have been cleared of enemy by the combat units. Ideally, the area should provide natural passive protective means such as barriers, cover, and concealment. Trains should be located to take advantage of the protection afforded by the disposition of combat units. In certain situations, it may be neces-

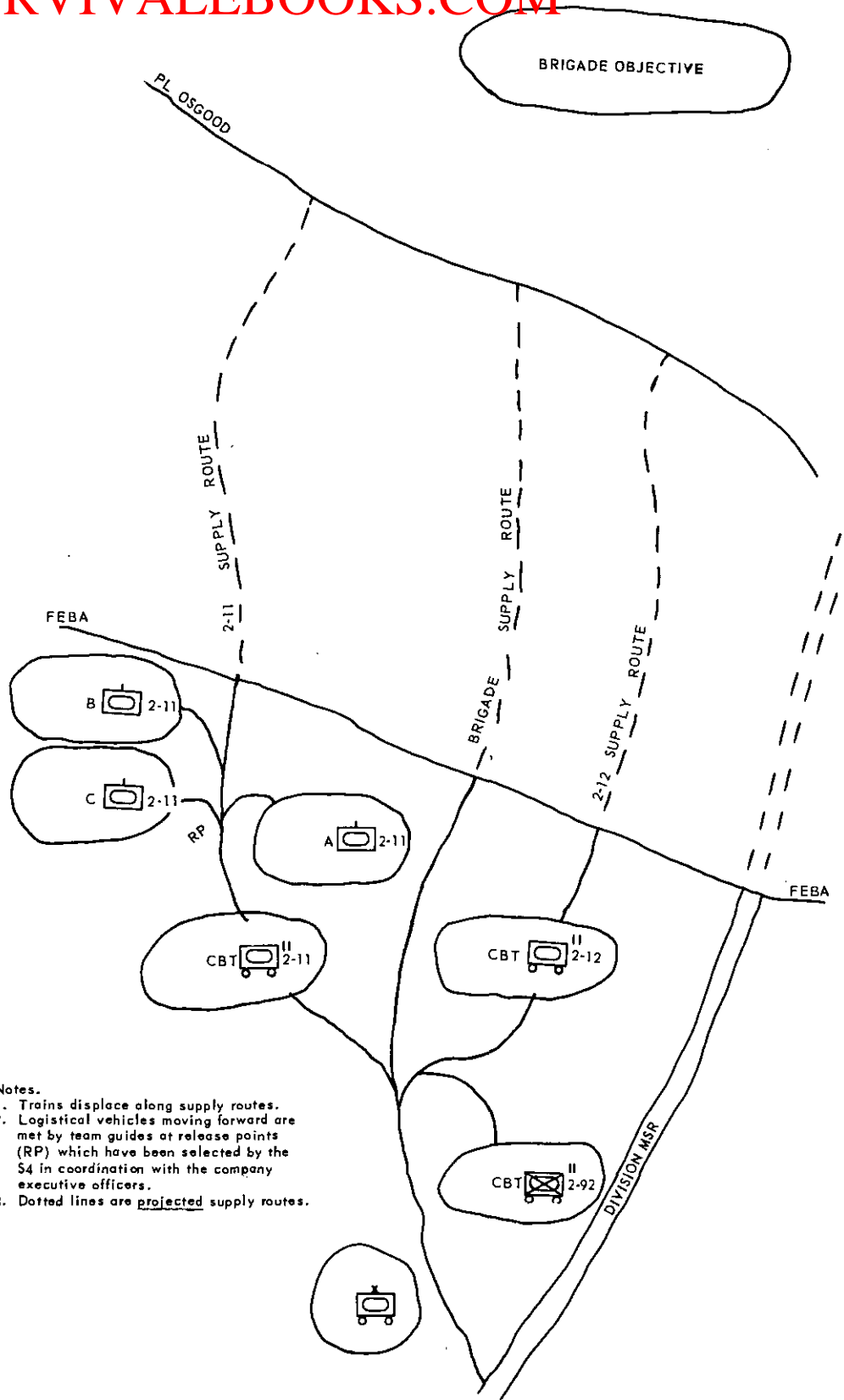

Notes.

1. Trains displace along supply routes.
2. Logistical vehicles moving forward are met by team guides at release points (RP) which have been selected by the S4 in coordination with the company executive officers.
3. Dotted lines are projected supply routes.

Figure 13. Supply routes.

sary to assign combat elements to protect the trains.

269. Characteristics of Trains Areas

The desirable characteristics of an assembly area discussed in appendix XXIV are applicable to trains area. Additionally, the trains area should be convenient to suitable routes to the combat units, subordinate headquarters trains, and the trains of the higher echelon.

270. The Supply Route

a. The supply route is a specified direction or route in relation to an axis of advance, zone of operations, or area of operations to be established for the supply, evacuation, and transportation of personnel and materiel.

b. The supply route extends from a logical juncture with the main supply route (MSR) of the next higher headquarters to a location convenient to subordinate elements. In offensive operations, the supply route may be projected forward as far as practical (fig. 13). The supply route may be announced in the operation order or other appropriate means and will be changed by fragmentary order as necessary.

c. The headquarters designating the supply route is responsible for its security.

d. In defensive and retrograde operations, the supply route should be parallel to the expected or planned movement of subordinate combat elements.

271. Employment of Battalion (Task Force) Combat Trains

a. In fast-moving tactical situations, continuous movement of the combat trains is required for responsive combat service support. In this type operation, the combat elements

will soon pass beyond supporting distance of the combat trains if the trains are kept stationary. The continuous movement of the combat trains to keep up with the combat elements limits the performance of combat service support, particularly in maintenance, because of the lack of time and optimum operational conditions.

b. In a slow-moving tactical situation, the combat trains can remain stationary for longer periods, moving by bounds when the distance between combat elements and the trains becomes too great for timely support.

c. The combat trains are under the direct control of the battalion S4 for operations, movement, and security. The combat trains provide their own local security. Normally, overall security is provided by locating the combat trains near the combat elements; however, in a fast-moving situation, it may often be necessary for combat elements to provide protection for the combat trains or make the trains part of the combat formation.

272. Employment of Battalion (Task Force) Field Trains

The field trains normally operate in the trains of the next higher echelon. This assists in providing adequate combat service support to the combat elements and provides control and coordinated movement of and protection to the field trains. It further disperses and echelons combat service support elements. The field trains are under the control of the battalion support platoon leader. In some situations, time and space may require that the field trains be located between the combat trains and the trains area of the higher echelon. In this case, the parent unit has full responsibility for security and movement of the field trains.

Section VII. BATTALION COMBAT SERVICE SUPPORT OPERATIONS

273. Combat Service Support During Marches

a. *Position of Battalion Trains on the March.* On the march, the trains normally march as a unit near the rear of the formation.

b. *Supply or Class III on the March.*

(1) On the march, fueling is normally ac-

complished during scheduled halts by fueling from bulk fuel tankers. One or more fuel and lubricant vehicles from the support platoon may be placed in support of each company. At halts, trucks move down the column, dropping off the required lubricants at each vehicle and bulk tank

trucks will transfer fuel directly to vehicular fuel tanks.

- (2) During halts when units coil up, fuel trucks may move from one vehicle to another in the area or may form the basis of a gas-station method of refueling.
- (3) On extended marches in rear areas, empty fuel and lubricant vehicles replenish their loads at class III supply and distributing points often established by higher headquarters along the route of march. It is frequently possible for empty fuel vehicles to precede the column to these points to be refilled before the arrival of the main body.

c. Messing on the March. Halts for feeding should, if possible, coincide with scheduled halts. The tactical situation permitting, the kitchens may move with the quartering party so that meals can be prepared before the arrival of the unit as a predetermined location. Kitchens may march with the unit, cooking en route so that hot meals can be served at prescribed halts or at the end of the march. If the tactical situation does not permit serving hot meals en route, small detachment rations or combat rations are used.

d. Medical Service and Evacuation on the March. The battalion aid station usually marches near the rear of the formation. However, if the situation warrants, it may march with the headquarters. The surgeon places an aid-evacuation team in support of each company. The medical aid-evacuation team, mounted in a frontline ambulance, marches near the rear of the company column and is available for the evacuation of casualties to the battalion aid station. If necessary, ambulances evacuate casualties from the aid station to the nearest medical installation. Maximum use of available aero medical evacuation capabilities must be planned and utilized during the march since medical support from organic medical facilities is limited.

e. Maintenance and Evacuation on the March.

- (1) When a warning order for a march is received, vehicles that cannot be repaired before the movement are evacuated

to the supporting maintenance unit. If time does not permit evacuation or if the vehicles cannot be moved, their location and condition are reported to the supporting maintenance unit.

- (2) The maintenance platoon marches near the rear of the battalion formation. Company maintenance sections march with their respective units.
- (3) Disabled vehicles are moved to the side of the road so they do not interfere with the passage of the rest of the column. Personnel of the company maintenance section will first attempt to repair inoperative vehicles. If repair cannot be made, they will tow the vehicles to the destination. Vehicles that cannot be repaired or towed are left to be repaired or evacuated by the maintenance platoon. If maintenance or evacuation cannot be accomplished by the maintenance platoon, vehicles are left with their drivers or members of their crews. The vehicle's condition and location are reported to the supporting maintenance unit.

274. Combat Service Support in Assembly Areas

In an assembly area, combat service support operations are accomplished in accordance with available time and the tactical situation.

a. Supply. In an assembly area, first priority is given to the supply of ammunition, fuels and lubricants, rations, and water. If time is available—

- (1) All classes of supply will be issued. Requests for supplies are submitted to the appropriate agency; items to fill shortages are drawn and issued.
- (2) Supplies and equipment are checked to determine that prescribed and basic loads are on hand in proper condition.

b. Medical Service and Evaluation. Normally, personnel receive only first aid medical treatment in the assembly area. Persons requiring further treatment are evacuated by

supporting ambulances to the nearest higher medical facility.

c. Maintenance. Maximum advantage must be taken of the time available in assembly areas to accomplish as much maintenance as possible. Drivers and maintenance personnel must realize that after they leave the assembly area, opportunities to perform maintenance will be limited. All commanders, vehicle crews, and maintenance personnel do everything possible to insure efficient operation of equipment. Maximum effort should be devoted to maintenance checks and repairs that cannot be accomplished properly during periods of combat. Equipment should be inspected, cleaned, and put in the best possible condition. The commander may request assistance from supporting maintenance units. Materiel that the battalion cannot repair is evacuated or turned over, in place, to the supporting maintenance unit.

275. Combat Service Support in Fast-Moving Offensive Operations

a. In an exploitation or pursuit, the battalion combat trains move with the battalion and are usually near the end of the formation, where they gain security from their location between the forward combat elements and the rear guard. When the battalion becomes engaged, the combat trains move into an area that affords them cover and concealment and a degree of security by their proximity to combat elements.

b. In the exploitation, supply lines become much longer. Overcoming the problems of supply over greater distances requires detailed combat service support planning. The accomplishment of this supply may require attachment of additional cargo transportation to the battalion from the higher combat service support echelon and the use of aerial resupply. Increased protection for trains and supply convoys may be required. Some situations may require all of the battalion combat service support elements to operate as unit trains.

c. Ammunition expenditures during an exploitation are usually light, while consumption of fuels and lubricants is heavy. To meet this increased need for hauling fuel and lubricants, kitchen equipment may be unloaded or consoli-

dated into a few trucks and the empty kitchen trucks used to transport fuel and lubricants.

d. Each vehicle should carry a minimum 5-day supply of either small-detachment or individual combat rations rather than the normally prescribed 3-day supply.

e. The number of casualties from combat normally decreases, but the distance for their evacuation increases. When possible, aircraft are used for evacuation of casualties.

f. During an exploitation, the percentage of vehicles lost to combat decreases with respect to other operations; however, the percentage lost through mechanical failure increases. The maintenance platoon thus directs its efforts toward making minor repairs on the maximum number of vehicles, rather than major repairs on a few. Vehicles that cannot be repaired by the maintenance platoon are towed to the supply route of the next higher headquarters and their location and condition reported to the supporting maintenance element.

276. Combat Service Support in Slow-Moving Offensive Operations

a. During a slow-moving offensive situation, the battalion combat trains move forward by bounds behind the combat elements. Movement should be screened from enemy observation. If the road net is limited, location of the combat trains at a point from which adequate combat service support is insured assumes increased importance.

b. Ammunition expenditures in a slow-moving offensive situation are high, contrasted with consumption of fuel and lubricants. Supply and transportation of ammunition must be emphasized.

c. Patients are normally high during this type of offensive action, necessitating rapid evacuation by the supporting medical aid-evacuation team from the companies to the battalion aid station. When attacking through a friendly unit, coordination should be made with the friendly unit surgeon to receive patients from the attacking companies. This will speed evacuation from the battlefield to a medical facility and assist the attacking unit medical aid station to retain mobility.

d. Vehicular losses are likely to be high, therefore, close and continuous maintenance

support is essential. The techniques used in providing this support are discussed in paragraphs 296 through 300.

277. Combat Service Support in Defensive Operations, General

The combat service support of an armor unit must be flexible enough to support a defensive operation and to permit immediate change to the support of an offensive operation. This flexibility is especially important in the mobile defense. Defensive operations are normally characterized by relatively heavy expenditures of ammunition and light expenditures of fuel and lubricants. However, in the mobile defense, the expenditure of fuel and lubricants may become heavy due to the offensive characteristics of the operation.

278. Combat Service Support in the Mobile Defense

The combat service support plan for the mobile defense must provide for alternate methods of supply and medical evacuation, multiple routes of supply and medical evacuation to insure adequate support and avoid interference with the tactical maneuver, and rapid maintenance and evacuation of equipment. The combat service support of the security force, the fixing force, and the reserve must be adaptable to either the offense or the defense. Supply and medical evacuation by air are employed to supplement the normal ground means. Alternate locations are planned from which the combat trains can support the battalion in either an offensive or defensive maneuver.

a. Combat Service Support for Security Force. Combat service support for the security force is similar to that for a unit in a delaying action (para 71). The battalion trains may be augmented so that additional supplies are available should the unit be cut off by enemy action. Plans must be prepared for supply by air. Casualties are normally evacuated by air. Maintenance is necessarily confined to minor repairs. Frequently, time will not allow repair of disabled vehicles, and they must be evacuated quickly. To support vehicular evacuation for units in the security force, as well as in the fixing force and the reserve, it will often be necessary to designate or establish mainte-

nance collecting points in depth along the supply route. When capture of inoperative equipment located in maintenance collecting points is imminent, it must be destroyed.

b. Combat Service Support for Fixing Forces. Detailed plans must be made for the combat service support of each blocking position, including multiple routes and alternate means of supply and medical evacuation. Combat service support for elements of the fixing force is essentially the same as for a unit conducting an area defense (para 279). The combat trains are reduced to essential maintenance and medical elements; class III and V vehicles are placed in the field trains out of range of the enemy's light artillery.

c. Combat Service Support for the Reserve. In the event a task force is part of the reserve, plans are made to hold all trains elements except the armored recovery vehicles and medical armored personnel carriers in place during the initial stages of the counterattack. Once the situation has stabilized, other elements of the combat trains may be moved forward. Since a counterattack is made at rapid speed, but to a relatively limited distance, the action is often completed before the bulk of the counterattacking force trains move. The S4 must have detailed plans formulated and sufficient supply vehicles organized for resupply of the teams.

d. Requirements of Combat Service Support Personnel. In the mobile defense, supply and maintenance personnel, often having to work in unsecured areas, are extremely vulnerable to attack and must be responsive to rapidly changing situations.

279. Combat Service Support in the Area Defense

a. Battalion combat trains normally contain only the medical platoon (minus the medical aid-evacuation teams with the companies) and all or the bulk of the maintenance platoon. The outer perimeter of the combat trains area is in close proximity to the battalion command post, generally between 200 to 1,200 meters. Supply vehicles, when not required, are located in the field trains. Fuel and lubricant trucks normally are not needed forward because of the light expenditures of these supplies. If necessary, additional ammunition is stockpiled during hours

of darkness (upon approval from higher headquarters) in the forward areas.

b. When mess trucks are used to transport rations to forward defense elements, they move from the field trains area under cover of darkness and normally return to the field trains before daylight.

c. The medical platoon aid-evacuation teams, equipped with frontline ambulances, evacuate patients from the companies to the battalion aid station. In some cases, dismounted litter bearers are required. Patients are evacuated from the aid station by elements of the supporting medical unit.

d. Personnel of the company maintenance sections recover and evacuate disabled vehicles to the established maintenance collecting point, using organic recovery vehicles. Disabled vehicles that cannot be repaired by the battalion maintenance platoon are evacuated to the supporting maintenance collection point.

280. Combat Service Support in Retrograde Operations

Retrograde operations are characterized by heavy expenditures of fuel and lubricants. The nature of the operation may involve comparable expenditures of ammunition. All classes of supply are often prepositioned to insure continuous support for the combat elements since the supply route is extremely vulnerable to enemy attack. Movement of supply vehicles is normally accomplished during periods of reduced visibility because of the enemy's superiority in combat power. Maintenance and recovery of damaged materiel is difficult since it is often performed in the face of enemy fire.

281. Combat Service Support in the Delaying Action

a. In the delaying action, control and security of the logistical elements are vitally important. The plan for the operation must provide for adequate support during movement to and occupation of each delaying position. The size of the battalion combat trains is held to a minimum.

b. Supply of the combat elements is accomplished immediately upon their arrival at selected delaying positions. As soon as practical, the S4 or his representative directs the move-

ment of battalion combat trains to the immediate rear of the next delaying position where they can effectively support the operation.

c. The battalion commander must give special consideration to demolitions and engineer class IV supply requirements. Transportation must be provided for these items, and they must be so located that they are readily available to the combat elements. It may be expedient to stockpile these items on successive delaying positions. This permits the early withdrawal of supply vehicles and provides additional time for the supply vehicles to replenish loads at supporting supply or distributing points.

d. The evacuation of casualties is generally the same as that in offensive or defensive operations. The aid station operates in the battalion combat trains area. If the medical aid-evacuation teams attached to the companies cannot evacuate all casualties, it may be necessary to use company vehicles and the armored ambulances from the medical platoon. Plans should be made for air evacuation of seriously wounded personnel.

e. During delay operations, four courses of action exist for the disposition of disabled vehicles. One course of action may be emphasized while two or more are employed simultaneously. These courses of action are—

- (1) Normal evacuation to higher categories of maintenance (teams evacuate disabled vehicles to task force maintenance collecting points by use of their recovery vehicles).
- (2) Maximum on-site maintenance using work parties from organic, attached, and supporting elements.
- (3) Towing disabled vehicles with other than the recovery vehicles.
- (4) As a last resort, destruction of disabled vehicles.

282. Combat Service Support in the Withdrawal

a. Combat service support plans in the withdrawal provide for the support of the main body and for security forces remaining in contact with the enemy. Combat service support for the main body is similar to that for a unit

conducting a march (app VI). Combat service support for the security force in the withdrawal is similar to that of the security force in the mobile defense (para 278).

b. The combat service support plan provides for evacuation or destruction of excess supplies and equipment, except medical, in a manner not to compromise the plan of withdrawal. Medical supplies and equipment are not intentionally destroyed (FM 27-10).

Section VIII. SUPPLY

285. General

a. In the division, supplies are distributed to battalion and separate companies using a combination of supply point and unit distribution. The division support command delivers all classes of supply, except class V, down to the brigade trains and, whenever possible, directly to the using unit. Supplies delivered to the division by direct and general support units are delivered directly to the using units without transloading whenever possible. See FM 10-50 and FM 54-2 for a discussion of division supply procedures.

b. In the battalion, all supplies are delivered directly to the companies.

c. The prescribed loads of fuel, lubricants, and repair parts carried by armor units are established by the field army commander. Basic loads of ammunition are established by the Department of the Army based on recommendations of theater commanders.

d. A request or requisition may be a formal requisition on a specified form, an informal request in a message form, or an oral request. Although the terms are used interchangeably, each constitutes a demand on a supply activity for supplies or equipment. Throughout this section, the term requisition generally refers to the written formal requisition.

286. Class I

a. *Definition.* Class I supplies are items consumed at a uniform and predictable rate, irrespective of combat or terrain conditions, and require no adaptation to individual requirements. Class I supplies consist primarily of ra-

283. Combat Service Support in the Retirement

The combat service support of units conducting a retirement is as discussed for a unit conducting a march (app VI).

284. Combat Service Support in Special Operations

See chapter 12 for logistical support in special operations.

tions. Post exchange supplies issued on a gratuitous basis are also included in class I.

b. *Requests and Requisitions.* In the division, a formal requisition for class I supplies is not required. The division supply and transport battalion requests rations for the division, based on estimated strength figures provided by the adjutant general, 72 hours before the time rations are to be delivered. Upon receipt, rations are broken down into battalion and separate unit lots based on personnel daily summaries submitted by each unit. In rapidly changing situations, it may be necessary for units to submit daily informal request for the number of rations required. These requisitions compensate for cross attachments and casualties. When a unit requires a specific type ration, requisitions must be submitted in advance.

c. *Distribution.*

(1) In the division, battalions and separate units use organic transportation to pick up rations at the division class I distributing point in the division support area or at the division forward distributing point in the brigade trains area. Rations are then broken down into company-size lots and delivered to the kitchens.

(2) Mess personnel prepare rations in the trains area or on the move to serve hot meals whenever possible.

287. Class II

a. *Definition.* Class II supplies consist of supplies and equipment for which allowances are prescribed by such documents as tables of

organization and equipment (TOE), tables of allowances (TA), prescribed load lists (PLL), or special lists or letters. Class II (A) supplies are aviation supplies and equipment authorized by tables of allowance lists. Examples are clothing, weapons, vehicles, and repair parts.

b. Requests and Requisitions. Armor units normally enter combat with all authorized class II items. When a class II (except repair parts) item is lost, destroyed, or worn out, the unit commander requests a replacement by message through the S4 or his representative. The supply section of the battalion support platoon consolidates class II requests for all units of the battalion and forwards the consolidated request to the division supply office in accordance with the division SOP or administrative order. Requests or requisitions may be transmitted electronically or by messenger. Requisitions for regulated or command-controlled class II items must be forwarded through command channels.

c. Distribution.

- (1) Whenever possible, class II supplies are delivered by the supporting army supply unit or facility directly to the requesting unit. When this is not feasible, they may be delivered by the division supply and transport battalion to the field trains area of the requesting unit. They may also be delivered to the forward class I distributing point operating in the brigade trains area where the items are issued to the requesting unit.
- (2) Distribution in the battalion is made directly to the requesting unit. Distribution of class II items is normally accomplished at the same time ammunition, rations, or fuels are delivered. A large issue, such as changes from cotton to woolen clothing, is usually distributed when the unit is out of contact with the enemy. Requesting units may be required to furnish drivers for delivery of vehicles.

288. Class III

a. Definition. Class III supplies consist of fuel and lubricants for all purposes, except for operating aircraft or for use as ammunition in

weapons such as flamethrowers. Class III supplies include gasoline, kerosene, diesel fuel, lubricating oil, grease, and solid fuels such as coal, coke, and wood. Fuel for aircraft is classified as class IIIA.

b. Requests and Requisitions. No formal requisition is required for class III supplies. Empty class III containers presented at designated class III supply points or distributing points constitute a requisition. A daily POL status report is forwarded to the next higher headquarters. This report provides the status of class III supply within a battalion-size unit and gives a forecast of requirements.

c. Distribution.

- (1) Class III supplies are distributed to battalions and separate units at division distributing points in the division support area, division forward class III distributing points in brigade trains areas, or designated rendezvous points. Units use organic cargo trucks and bulk fuel tankers or pods to obtain fuels and lubricants from these supply points.
- (2) Battalion fuel and lubricant trucks are dispatched to companies where the supplies are delivered to individual vehicles. If it is not practical to deliver directly to the individual vehicles in position, supplies are hand-carried by the vehicle crews or vehicles are withdrawn from their positions and moved to the location of the refueling vehicle. The class III trucks return to the battalion field trains area where loads are redistributed. The empty vehicles are then dispatched to the appropriate supply or distributing point to be refilled.
- (3) The air cavalry troop uses organic vehicles to obtain class IIIA supplies from division or corps support brigade distributing points and to deliver supplies to individual aircraft.

289. Class IV

a. Definition. Class IV and class IV(A) (aviation) supplies consist of items for which allowances are not prescribed. Examples of this class are construction, roadbuilding,

camouflage, and fortification materials; water-proofing supplies; and flamethrower, cold-weather, and deep water fording kits. All classes of supply may be subject to class IV issue, or class IV control, when issued in excess of prescribed allowances.

b. Requisition and Distribution. Class IV requisitions normally require command approval. Battalions submit requests for regulated items and items appearing on the command-controlled lists through command channels. Requests for class IV items not on these lists are submitted directly to the supporting supply unit who in turn refers the requests for approval by the appropriate commander. Once command approval is given, class IV supply is accomplished generally in the same manner as class II.

290. Class V

a. Definition. Class V supplies consist of items containing explosives, propellants, initiating composition, or nuclear, biological, or chemical material for use in connection with defense or offense including demolitions. Ammunition is categorized as either conventional or special. Personnel concerned with the supply of ammunition should be familiar with these terms and with required supply rate, available supply rate, basic load, and special ammunition load (SAL) (AR 320-5). Personnel concerned should also refer to FM 3-8, FM 3-10, FM 9-6, FM 101-10-3, and FM 101-31-1.

b. Requisitions. Requisitions (transportation orders) are prepared by battalions and separate units to replenish their basic load. Replenishment of the basic load in an active situation may be made concurrent with, in anticipation of, or after expenditure. Transportation orders must be validated by the division ammunition officer before they are presented at any army supply point or mobile class V distributing point. In the armored cavalry regiment, they are validated by the regimental S4 or his designated representative.

c. Distribution.

- (1) The normal source of class V supply is the supporting army ammunition supply point (ASP) and special ammunition supply point (SASP). When the tactical situation indicates that

movement will be so rapid that the supporting ASP will not continually be within supporting distance, the division G4 may request a mobile ammunition distributing point to operate in the division area.

- (2) Supply of class V items is accomplished within combat units at every opportunity. The battalion S4 sends ammunition trucks, containing mixed loads of ammunition, from the combat trains directly to the combat vehicles of the companies, tactical situation permitting. After supplying the combat vehicles, the trucks return to the combat trains area. Here, remainders of loads are adjusted, and empty trucks are dispatched to the battalion field trains. Empty ammunition trucks are normally dispatched through brigade logistical control points, where they are formed into convoys for movement to the army ASP, SASP, or mobile class V distributing point (if one is established). After resupply, the unit ammunition trucks return to the battalion field trains area. They either remain in the field trains or are sent forward to join the combat trains.

291. Water

Water purification and production is a function of supporting engineer units. Water points are established in the most convenient locations available consistent with security requirements. Units using organic transportation draw water from the nearest water point.

292. Repair Parts

a. Definition. Repair parts are any parts, assemblies, or components required for the maintenance of an end item.

b. Stockage.

- (1) Fast-moving repair parts are carried in each battalion and separate unit on the basis of a prescribed load list (PLL). The prescribed load must be kept on hand or on requisition and is used in day-to-day maintenance. Slow-moving repair parts are not

stocked in the combat area but farther to the rear.

- (2) The division maintenance battalion obtains (or provides requisitioning facilities for), stores, and issues repair parts and maintenance supplies authorized and required by armor units for the performance of organizational maintenance. Except for those items provided by the transportation aircraft maintenance company, the main support company serves as a base of supply for repair parts and maintenance supplies. It obtains and distributes repair parts and maintenance supplies required by the forward support companies and issues repair parts and maintenance supplies to divisional units. Each forward support company keeps a stock of supplies to support its maintenance activities and carries a stock of fast-moving repair parts and maintenance supplies for issue to the supported unit. The transportation aircraft maintenance company keeps a stock of transportation air items that are required and used primarily in support of its own maintenance operations. Repair parts and supplies from the transportation aircraft maintenance stocks are issued to supported units only in emergencies and only when authorized to be used at organizational level.

c. Requests and Requisitions. Repair parts and other maintenance supplies are issued on the basis of requests or by direct exchange. Separate company maintenance sections and

battalion maintenance platoons request repair parts whenever a stocked part that is not on the direct exchange list is expended, or when the authorized nonstocked part is needed for a current repair job. Repair parts are provided in several ways—

- (1) Certain fast-moving items as well as direct exchange items may be provided by maintenance teams from the forward support companies during the course of their visits to supported units. No formal paperwork is required for this transaction, but items issued should be shown on the unit record of demand cards so that demand data is recorded accurately.
- (2) Direct exchange items may be obtained from the direct exchange section of the forward support company or main support company. The supported maintenance elements are required to take the unserviceable item, properly tagged in exchange for a like serviceable item.
- (3) Direct exchange for air items is provided by the transportation aircraft maintenance company.
- (4) For routine replenishment supply of organizational repair parts and maintenance supplies, supported units prepare requisitions and submit them to the supporting forward support company or transportation aircraft maintenance company, as appropriate.

d. Distribution. Repair parts may be picked up by the requesting unit at the supporting maintenance activity or delivered to the requesting unit by the maintenance battalion. For details, see FM 9-30.

Section IX. MAINTENANCE

293. Maintenance Responsibility

Maintenance is a command responsibility. The commander is responsible for the proper maintenance of all equipment under his control. When the requirements for maintenance exceed a unit's capabilities, the commander must insure that the next higher category of maintenance is notified promptly.

294. Organizational Maintenance

a. Organizational maintenance is that maintenance normally authorized for, performed by, and the responsibility of a using organization on equipment in its possession. Organizational maintenance incorporates operator or crew maintenance and organizational maintenance.

nance performed by specially trained personnel.

- (1) *Operator or crew maintenance.* Operator or crew maintenance is outlined in the 10-series technical manuals. It consists of inspecting, cleaning, servicing, lubricating, repairing, testing, and replacing parts as prescribed by applicable technical publications and parts lists.
- (2) *Organizational maintenance.* Organizational maintenance is outlined in the 20-series, technical manuals and is performed by specially trained personnel. It includes all elements of organizational maintenance not prescribed as operator or crew maintenance, such as scheduled preventive maintenance, minor adjustments, repair, tests, technical assistance, supervision, and inspections. Operator or crew personnel normally participate in organizational maintenance by performing tasks within their capability.

b. Each company of an armor unit has a maintenance section which is manned and equipped to perform organizational maintenance and evacuation. Maintenance and evacuation that are beyond the capability of the company are reported to the supporting maintenance elements.

c. The battalion contains a maintenance platoon that is responsible for backup organizational maintenance performed in the company. It is manned and equipped to provide recovery, maintenance, and evacuation support to organic and attached companies. The maintenance platoon is provided specialists and tools to perform maintenance over and above that of company maintenance sections. Maintenance and evacuation that are beyond the scope of capability of the maintenance platoon are reported to supporting maintenance elements.

295. Direct and General Support and Depot Maintenance

a. Direct support maintenance is provided armor units by the division maintenance battalion for all items except cryptographic, electronic accounting machines, quartermaster air, and medical items. These units are authorized

a larger assortment of repair parts and subassemblies, and more precise tools and test equipment than are authorized supported units. These units repair assemblies and subassemblies and repair the overflow from supported units within limits of authorized skills, tools, equipment, and repair parts. They provide technical advice, mobile repair crews, and repair parts supply to supported units. Employment of the maintenance battalion is described in FM 9-30 and FM 54-2. Maintenance support for cryptographic and medical equipment is provided by the division signal and medical battalions.

b. General support maintenance is that maintenance authorized and performed by designated TOE and TD organizations in support of the Army supply system. Normally TOE and TD general support maintenance organizations will repair or overhaul materiel to required maintenance standards in a ready to issue condition based upon applicable supported Army area supply requirements. Although armor equipment goes to general support maintenance shops, armor units do not normally deal directly with these units. Depot maintenance is performed at fixed installations. For details, see FM 29-22.

296. Recovery and Evacuation of Vehicles

a. Commanders at all echelons are responsible for the prompt recovery and evacuation of damaged vehicles and their return to service. When combat units are unable to recover disabled vehicles, direct support maintenance units are requested to assist in recovery operations.

b. Supply routes and the location of maintenance collecting points are designated before an operation. Company maintenance sections and battalion maintenance platoons recover disabled vehicles from the battlefield and move them to the supply route or to maintenance collecting points designated by the next higher category of maintenance. Division maintenance units assume responsibility at these locations and repair and return the vehicles to service. If the direct support unit cannot repair a vehicle immediately, a replacement vehicle may be issued from a maintenance float.

c. Battlefield recovery is accomplished by company recovery vehicles, augmented if necessary by recovery vehicles from the battal-

ion maintenance platoon. Company recovery vehicles follow in close support of the unit; disabled vehicles are towed into defiladed positions and repaired if possible. In a fast-moving offense, if company maintenance personnel cannot repair a vehicle, they tow it to the battalion supply route and report its location and condition to the battalion maintenance platoon. In a slow-moving offense or defensive operation, if company maintenance personnel cannot repair a vehicle, they tow it to the battalion maintenance collecting point (fig. 14 and 15). Unit SOP will specify what personnel will accompany vehicles being evacuated.

finding disabled vehicles along the route of supply or receiving disabled vehicles at the battalion maintenance collecting points repair them if possible. Repaired vehicles rejoin their units as soon as practicable. Vehicles beyond the immediate repair capability of the maintenance platoon are evacuated by the platoon to the maintenance collecting point established by the supporting forward support company. In a fast-moving situation, it may not be practicable to evacuate to the established maintenance collecting point, in which case the battalion maintenance platoon evacuates disabled vehicles to the brigade supply route.

d. The battalion maintenance platoon

e. Vehicle crews and maintenance personnel

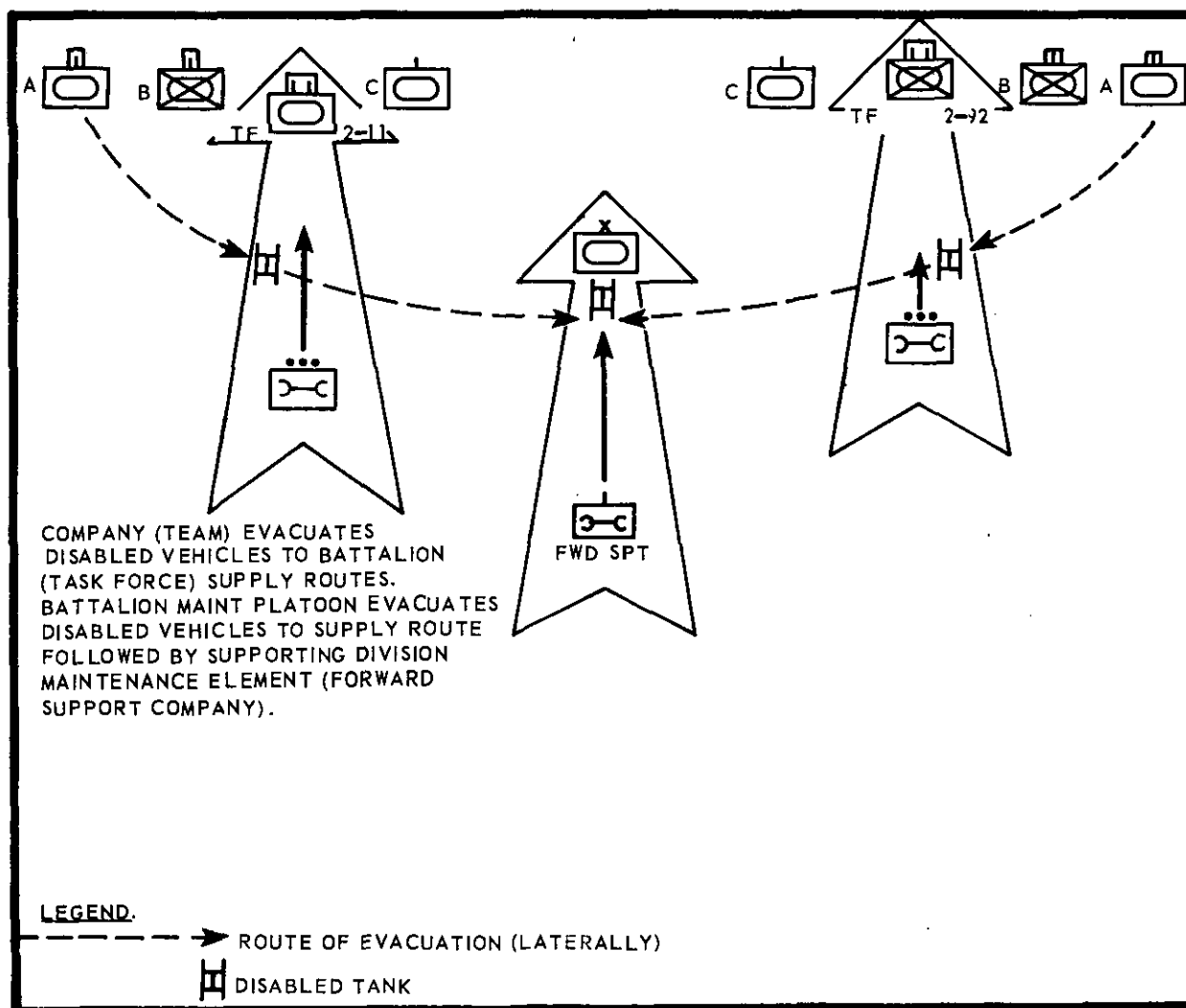

Figure 14. Evacuation of disabled vehicles in fast-moving offensive situations.

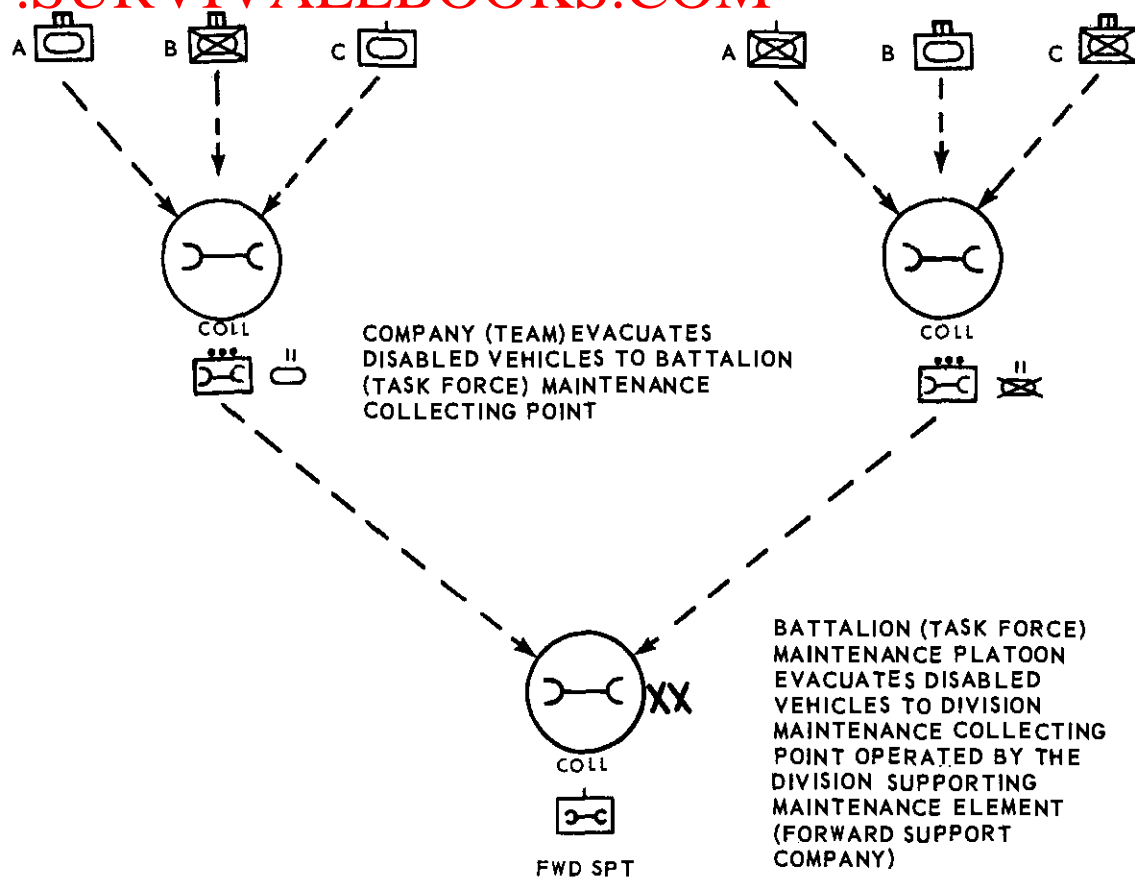

Figure 15. Evacuation of disabled vehicles in the defense or slow-moving offense.

must take security precautions when recovering or repairing disabled vehicles. Maintenance personnel who are fired on when performing battlefield recovery employ their individual and vehicular weapons to the maximum. Combat units in the vicinity provide supporting fires to permit recovery. Vehicles that cannot be recovered because of combat conditions, and whose capture is imminent, are destroyed in accordance with existing instructions (app XXV).

f. During fast-moving offensive operations, vehicles that obviously cannot be repaired are not recovered by combat and direct support units. However, their exact location and condition are reported through maintenance channels. Recovery and evacuation of such vehicles are a responsibility of army.

297. Recovery and Evacuation of Aircraft

a. Whenever possible, aircraft that cannot be flown are repaired in place. This repair may consist of only that necessary for a one time

flight to more suitable repair facilities. The structural characteristics of an aircraft do not adapt it to extensive movement by ground transportation. Normally, the dismantling and special rigging required for evacuation of an aircraft require more personnel and time than if the aircraft were repaired and flown out. However, the extent of repairs, or the aircraft site, may leave no alternative to evacuation.

b. Armor units having organic aircraft are not responsible for their recovery or evacuation, other than to assist as appropriate. However, the armor unit is responsible for requesting assistance from the supporting direct support maintenance unit. If recovery operations are required, it will be indicated in the initial request for assistance. The request will include location, type, and identification of aircraft, identification of individual and unit making the request, parent unit of the aircraft, and description of damage. See appendix XXV for destruction of aircraft if capture is imminent.

298. Recovery, Repair, and Evacuation of Communication and Electronic Equipment

a. Companies recover and repair communication and electronic equipment within their capabilities. Such equipment requiring repair beyond the capability of company is evacuated as follows:

- (1) Equipment installed in disabled vehicles is evacuated with the vehicle in accordance with procedures in paragraph 296.
- (2) Separate items may be evacuated directly to the battalion communication platoon or maintenance collecting point. Companies normally use available transportation moving to the rear to evacuate equipment.

b. The battalion communication platoon repairs, within its capabilities, communication and electronic equipment organic to headquarters and headquarters company. It also provides limited backup repair services for organic or attached companies. The communication platoon works closely with the maintenance platoon to repair communication and electronic equipment in vehicles undergoing maintenance. The communication platoon evacuates all communication and electronic equipment that requires repair beyond organizational maintenance level.

c. If capture of communication or electronic equipment is imminent, see appendix XXV for recommended priority of destruction.

299. Recovery and Evacuation of Medical Equipment

Combat units normally recover or evacuate

medical equipment requiring maintenance above organizational level through medical channels. However, when authorized, medical equipment may be evacuated to maintenance collecting points established by supporting maintenance units.

300. Recovery, Repair, or Evacuation Under Nuclear Conditions

a. In nuclear warfare, maintenance elements will have two main factors to contend with that are not present in conventional warfare—contamination of the maintenance area by nuclear fallout, and the handling of contaminated equipment. Whenever radioactivity is suspected, maintenance personnel use radiacmeters to determine dose rate so that protective and decontamination measures may be taken.

b. If radioactivity in the maintenance area exceeds the dose rate specified by the unit commander, the maintenance element should move to an area of less intensity. Maintenance personnel monitor radiation levels en route to equipment requiring recovery to avoid heavily contaminated areas. If the equipment is located in an area that exceeds the specified dose rate, recovery should be delayed until the radioactivity has decayed to a safe level.

c. Contaminated equipment should be decontaminated before it is repaired. Decontamination procedures are discussed in paragraph 317 and appendix XXIII.

d. The techniques of evacuation and the procedure for establishing maintenance collecting points or supply routes are essentially the same as under nonnuclear conditions.

Section X. MEDICAL SERVICE

301. General

Commanders at all levels are responsible for providing proper medical service to the members of their commands. The objectives of such medical service are the conservation of manpower and the preservation of unit efficiency and morale. These objectives are attained by strict adherence to the principles and procedures of preventive medicine, sanitation, treatment, and by rapid evacuation if needed.

Medical service must be planned and conducted to conform to and support the tactical plan.

302. Unit Medical Service

a. Unit medical service includes battlefield acquisition of the wounded, injured, or sick; emergency medical treatment by company aidmen; evacuation to the unit aid station; and further emergency or definitive treatment at the aid station as required. Unit medical serv-

ice includes advising the commander on military field sanitation, disease prevention, and the health of the command.

b. Unit medical service is provided to armor units by organic medical platoons.

303. Division Medical Service

Division medical service is provided by the division medical battalion and includes the evacuation of patients from the battalion aid stations, the operation of division clearing stations, and the furnishing of medical supply and emergency dental service. Division medical service is discussed in FM 8-10, FM 8-15, and FM 54-2.

304. Medical Treatment and Evacuation

a. Each battalion medical platoon establishes a medical aid station and provides a medical aid-evacuation team for each organic company. The medical aid-evacuation teams move with company combat trains following closely behind the combat elements. Patients are given first aid or emergency medical treatment by the medical aid evacuation team. If further treatment is required, patients are evacuated to the battalion aid station by the medical aid-evacuation team.

b. At the aid station, patients are sorted as to type and degree of injury or illness. If the tactical situation permits, patients who will be able to return to duty in a short time are retained in or near the aid station and are returned to duty from there. Patients who must be evacuated for further medical treatment are prepared for evacuation.

c. The supporting medical unit is responsible for evacuation from the battalion aid station. Field ambulances from the supporting

medical unit evacuate patients from the battalion aid station to the clearing station located in the brigade trains area.

d. Request for air evacuation is processed through medical channels, utilizing logistical radio nets. Command radio nets are used as required.

305. Medical Support of the Air Cavalry Troop

a. The air cavalry troop receives medical support from the squadron medical section as described for the company in paragraph 304. However, during operations involving extensive use of the organic air-ground elements, one aidman may be provided for each tactical grouping (one per platoon or platoon team) commensurate with the availability of medical personnel.

b. When the air cavalry troop is conducting operations in conjunction with ground combat units, patients requiring medical treatment beyond the capability of the troop aidman will normally be turned over to the ground unit for evacuation.

c. When the air cavalry troop is operating in enemy controlled territory, normal evacuation means will be by air. Air ambulances of the field army medical service provide evacuation support on an on-call basis. If the army unit cannot provide the required support, aircraft organic to the division or the air cavalry troop may be used to evacuate patients requiring immediate medical or surgical treatment. Patients not requiring immediate medical attention will be evacuated when the troop or troop elements withdraw to friendly territory. In all cases, the tactical mission is given priority on the use of organic aircraft.

Section XI. AREA DAMAGE CONTROL

306. General

Definite measures must be taken before, during, and after a mass destruction or mass casualty attack or natural disaster to minimize the effects. The measures considered in this section, when appropriately modified, are applicable to the separate armored brigade and the armored cavalry regiment as well as units of the division.

a. In rear areas, damage control is directed primarily toward minimizing the impairment

of combat service support and aiding in reestablishing such support.

b. In forward areas, area damage control operations are directed toward minimizing interference with tactical operations and the loss of combat power.

c. Area damage control activities are a command responsibility, and the commander of each echelon is responsible for damage control training and implementation of damage control plans. The commander must direct all meas-

ures and means at his disposal toward accomplishing the tactical mission, and at the same time minimizing the possibility of losses of personnel and materiel to a mass destruction attack or natural disaster.

307. Staff Responsibilities

The S4 has staff responsibility for area damage control planning. When the decision has been made to implement the plan, staff responsibility for control of the operation passes to the S3. The S2 exercises staff supervision over the collection, processing, reporting, and dissemination of radiological monitoring information and meteorological data. The S1 will exercise staff responsibility over the maintenance of records and reports which reflect the strength of the command as a result of radiation exposure.

308. Area Damage Control Measures Before an Operation

a. Damage control organizations and procedures must be established in workable damage control SOP.

b. Units and individuals must be trained thoroughly in passive, protective measures against an enemy nuclear attack. These measures are discussed in appendix XXIII.

c. Area damage control training in conformance with established SOP must be integrated with all phases of tactical training.

d. During the planning of an operation, the commander and his staff must provide for area damage control measures that can be taken if the unit or its elements are subjected to an enemy mass destruction attack or a natural disaster. Rallying points are designated for each company and battalion and higher level unit for each operation. These points are used to collect survivors of units subjected to mass destruction attacks. They are designated in offensive or defensive operations approximately 1,000 meters to the rear of each unit or major headquarters. When possible, rallying points are designated on clearly defined terrain features.

309. Area Damage Control Measures Taken During an Operation

a. The massing of troops and units should be avoided except when essential to accomplishing

the mission and then only for a minimum period.

b. Adequate dispersion between units and in units is maintained.

c. When units are on the move, every effort is exerted to keep them moving.

d. When units are not on the move, individual vehicle movement is minimized. Essential movement is restricted to periods of poor visibility preferably during hours of darkness.

e. Units do not remain stationary for prolonged periods.

f. Effective use of air and ground reconnaissance means is practiced.

g. Maximum use is made of cover and concealment.

h. The commander and his staff continually review their dispositions and actions to be taken if the unit is subjected to a mass destruction attack.

310. Area Damage Control Measures Taken After an Enemy Mass Destruction Attack

a. Units Subjected to Attack.

- (1) Individuals and units immediately adopt protective measures, such as taking the best available cover and donning protective clothing and equipment to minimize the residual effects of the weapon.
- (2) Report expeditiously the situation and condition of the unit to the next higher effective headquarters.

b. Units Observing the Mass Destruction Attack.

- (1) Every effort is directed toward continuance of the assigned mission. A report of the observation of the attack should be submitted to the next higher effective headquarters.
- (2) Commanders of units not subjected to the attack should anticipate a possible change in mission to counter the attack's effects on the plan of the next higher headquarters. This reduces reaction time when a change of mission is received.

c. Next Higher Headquarters of Unit Subjected to a Mass Destruction Attack.

- (1) Receives, plots, and relays reports from subordinate units concerning the enemy attack; determines the extent of damage as early as possible; and issues necessary orders to continue the assigned mission.
- (2) As early as feasible, acts to restore the effectiveness of the unit subjected to the attack. If necessary, an area damage control organization will be employed. Appropriate functions for the organization performing area damage control operations are—
 - (a) Determine and report the condition of elements of the unit subjected to the attack.
 - (b) Assume control of disorganized personnel and elements of the attacked unit.

- (c) Release combat capable elements to the control of the next higher headquarters.
- (d) Restore communications between the attacked unit and its next higher headquarters.
- (e) Evacuate casualties to appropriate medical installations.
- (f) Evacuate vehicles and major items of equipment to appropriate vehicle and equipment collecting points.
- (g) Perform limited decontamination.
- (h) Conduct monitoring.

d. Control and location of area damage control elements. To facilitate control and to expedite rescue and aid missions, the control and assessment team (CAT) must utilize certain control measures (fig. 16).

- (1) *Assembly point.* This point is designated by the CAT commander and is

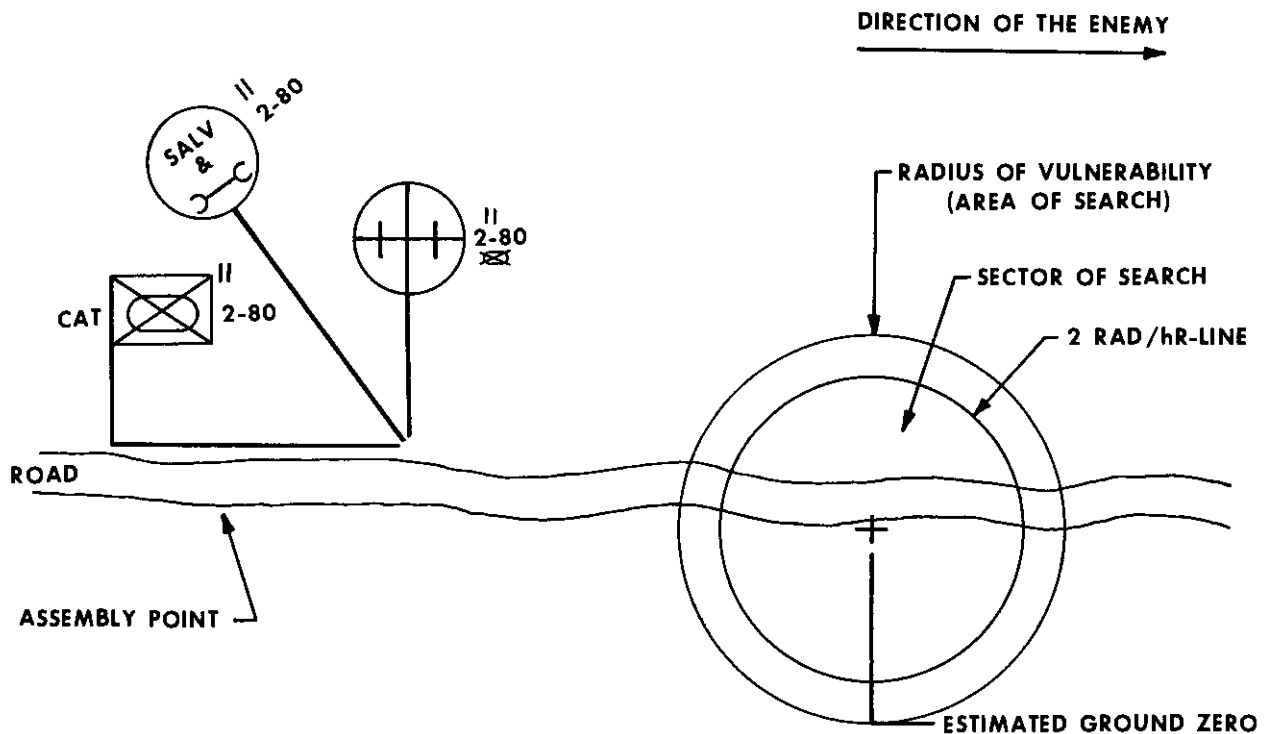

CONTROL MEASURES: 2D BN 80th MECH INF IN AN AREA DAMAGE CONTROL OPERATION. IN THIS SITUATION THE BN IS EMPLOYING A CAT, BN RESCUE SQUAD AND THE RESCUE SQUADS OF TWO COMPANIES.

Figure 16. Control measures, area damage control operations.

utilized to assemble the various provisional units and issue necessary instructions to commence the operation. The point selected should be centrally located and sufficient distance from the estimated ground zero (GZ).

- (2) *Area of search.* As a starting point for the operation, the CAT commander will designate the area of search. The size of the search area is based on the radius of vulnerability to the troops in the area of attack which is based on the assumed postures of the troops at the time of burst (protected or unprotected) and the estimated size of the enemy nuclear weapon employed.
- (3) *Two rads per hour contour.* Because of the significance of any movement within the two rads per hour contour, this radius must also be estimated and disseminated. All movement and operations within this contour must be controlled by the CAT commander who will estimate allowable stay time for the troops involved. Units which must pass through the affected area coordinate with the CAT in order to receive information relative to conditions within the area.
- (4) *Sectors of search.* Sectors of search are subdivisions of the area of search. Boundaries should be reflected along easily distinguished terrain features whenever possible.

311. Provisional Area Damage Control Teams

Units subjected to a mass destruction attack or natural disaster use all means necessary to reestablish unit combat readiness as rapidly as possible. In circumstances where assistance is required from sources outside the unit, other units may be directed to assist. Armored cavalry units are well suited for conducting area damage control operations. Where it is not feasible to employ TOE units, provisional area damage control units can be organized and employed. Provisional damage control teams are established usually by unit SOP. These teams must be capable of taking decisive and coordi-

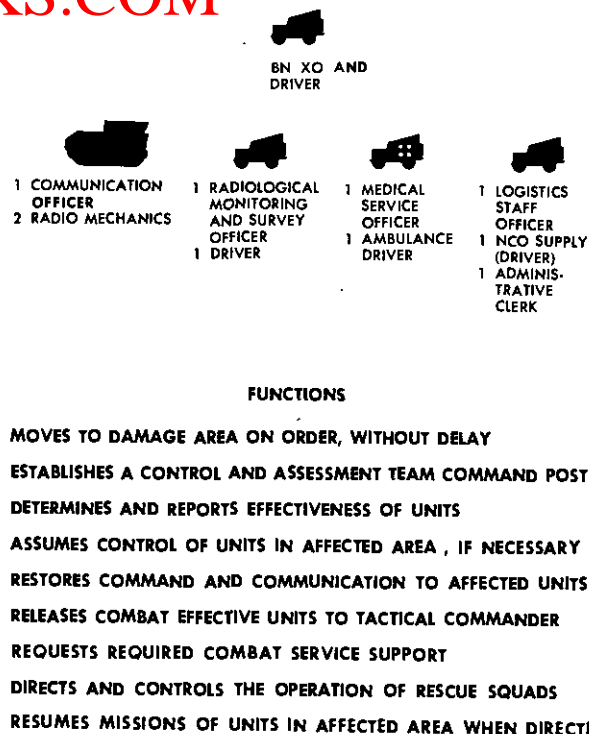

Figure 17. Type combat battalion control and assessment team.

nated action in area damage control operations when TOE units cannot be employed.

a. *Control and Assessment (CAT).* Each battalion headquarters establishes a control and assessment team. A type battalion control and assessment team with personnel, major items of equipment, and a statement of functions is shown in figure 17.

b. *Battalion Rescue Squad.* Each battalion headquarters establishes a battalion rescue squad. This squad will be assembled on order and attached to a control and assessment team for area damage control operations. A type battalion rescue squad with personnel, major items of equipment, and statement of functions is shown in figure 18.

c. *Company Rescue Squad.* Each combat company-size unit establishes a company rescue squad which will be assembled on order and attached to a control and assessment team for area damage control operations. A type company rescue squad with personnel, major items of equipment, and statement of functions is shown in figure 19. Other organizations as desired by the commander can be established



FUNCTIONS

- OPERATES CASUALTY AND EQUIPMENT COLLECTING POINTS
- PROVIDES LIMITED EMERGENCY MEDICAL TREATMENT
- CONDUCTS RADIOLOGICAL MONITORING
- PROVIDES ASSISTANCE TO COMPANY RESCUE SQUADS

Figure 18. Type combat maneuver battalion rescue squad.

by SOP in conformance with his organizational structure and concept of performing area damage control operations.

312. Method of Employment

To control an operation, the CAT must have a starting point and a means of controlling the actions within the concerned area. The starting

point should be the assumed or known GZ. The CAT will have to depend to a large degree on reports from observing units and initial assessment reports from aerial survey teams (normally operating from the brigade aviation section). From reports and the assumed posture of the involved unit at the time of the burst, the CBR officer will determine or estimate the

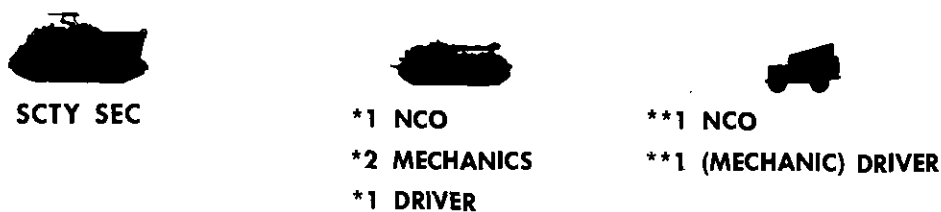

FUNCTIONS

- ADMINISTERS FIRST AID
- RESCUES AND REMOVES CASUALTIES
- EVACUATES VEHICLES AND MAJOR ITEMS OF EQUIPMENT
- CONDUCTS RADIOLOGICAL MONITORING
- PERFORMS LIMITED HASTY DECONTAMINATION
- * PERSONNEL AND RECOVERY VEHICLE PROVIDED BY MAINTENANCE SECTION
- ** PERSONNEL AND 1/4-TON TRUCK PROVIDED BY CO HQ

Figure 19. Type company rescue squad.

GZ, type of burst (low or high air, or surface burst), the destructive power of the weapon (example 20 KT), and the induced pattern or fallout pattern. Based on this information, the CAT commander (assuming the decision has been made to employ the CAT) will be able to establish an assembly point, area of search, sectors of search, and establish the proposed CAT command post, salvage and maintenance points, and casualty collecting points. These sectors and locations are all tentative and, if required, must be adjusted once actual conditions are determined in the area.

313. Employment of Provisional Area Damage Control Units

a. Provisional area damage control units, established by SOP, are employed for area damage control when it is not practical to employ TOE units. If it is necessary to employ provisional area damage control units, brigade or division will determine which unit or units will participate in the operation. Normally, uncommitted forces will provide the provisional teams and squads. When more than one battalion-size unit provides provisional elements, the brigade will establish control of these elements through the brigade CAT. If the operation requires means in excess of those of the provisional units, division will provide division-level squads for heavy duty rescue and labor work. See division SOP, FM 61-100, for division-level squads and teams.

b. Since the employment of provisional area damage control units reduces the parent unit's capability for sustained combat, it is imperative that provisional units rejoin the parent unit as soon as possible. Control of units and areas subjected to mass destruction attacks should pass to follow or support units as soon as practical. In the absence of relief, provisional area damage control units will terminate their operations when the personnel and equipment are required by the parent unit to accomplish its mission. It is also terminated when further efforts by the CAT and the rescue squads are no longer practical.

314. Conduct of Operation

A method of conducting battalion-level area damage control operations after an enemy nuclear attack using a provisional area damage

control organization is described in the following illustrative example:

a. Task Force 2-11 Armor has been advancing on two axes (fig. 20). Team B was struck by an enemy nuclear airburst. In the absence of assistance from sources outside the task force, the task force commander ordered Team A to bypass the area and to assume the mission of Team B. Other units continued their assigned missions.

b. The initial reports from units not involved in the attack indicated that the weapon was a 20 KT low airburst. As the reports are received, they are plotted and forwarded to the next higher headquarters. The task force executive officer is the CAT commander and as soon as possible he conducts an aerial reconnaissance survey over the affected unit. During the flight, he attempts to determine the extent of damage, number and location of survivors, and the condition of the terrain (tree blow down), roads, and bridges. Concurrently, the commander and his staff are making estimates of the effect that the weapon has had on the accomplishment of their mission and what course of action must be followed. When the commander arrives at a decision, necessary orders are issued. In this situation, the battalion CAT and rescue squads are to be used to give assistance to Team B. A message is sent to subordinate elements informing them of the employment of the CAT and the rescue squads. The message includes the location of the assembly point and what radio net is to be used. The radio net may have a specific frequency set aside by SOP or the frequency of Team B may be used. During the preparation for the operation, continuing attempts are made to establish communications with Team B. Participating elements are assembled at the assembly point and issued necessary instructions by the CAT commander, such as the location of the CAT command post, collecting points, area of search, two rads per hour line, and sectors of search (fig. 21 and 22).

c. During the conduct of the area damage control operation, the CAT commander will keep the battalion operations center informed of the progress of the operation and will direct all requests for assistance to the operations center.

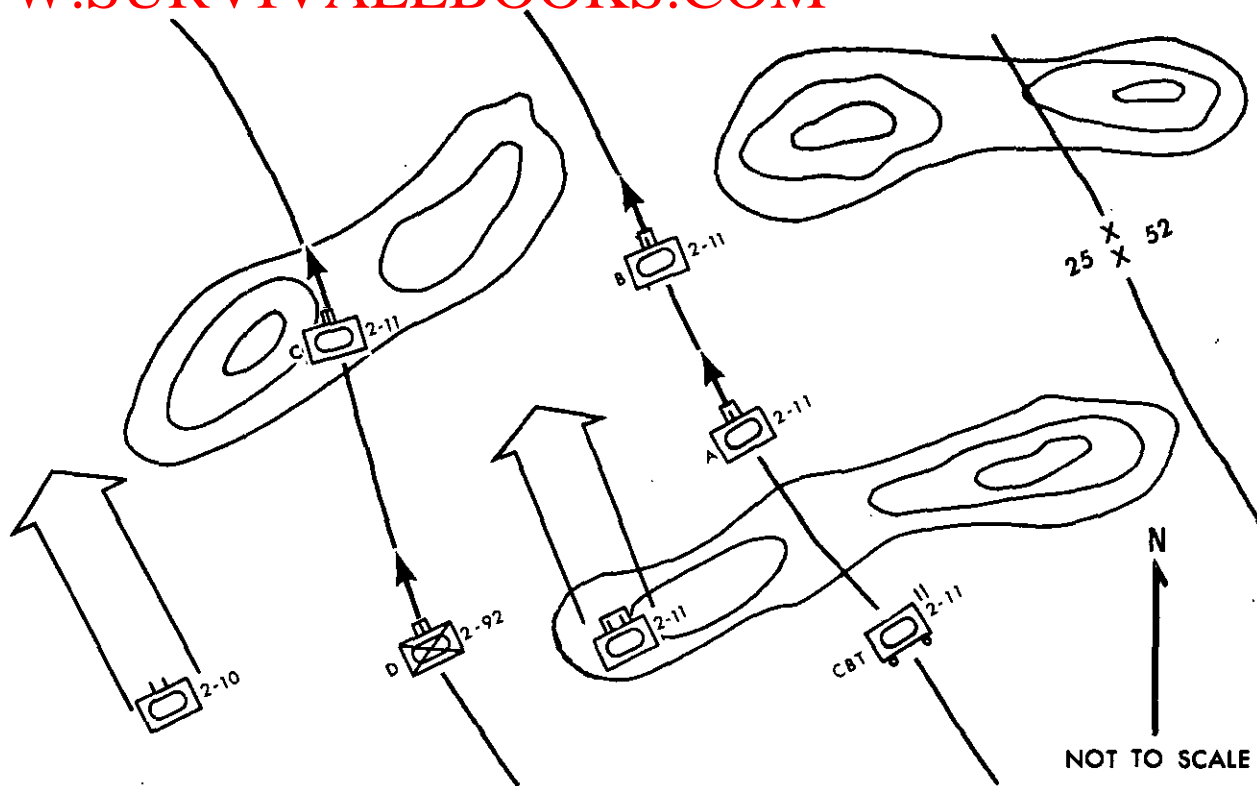

Figure 20. Task force situation before enemy nuclear attack.

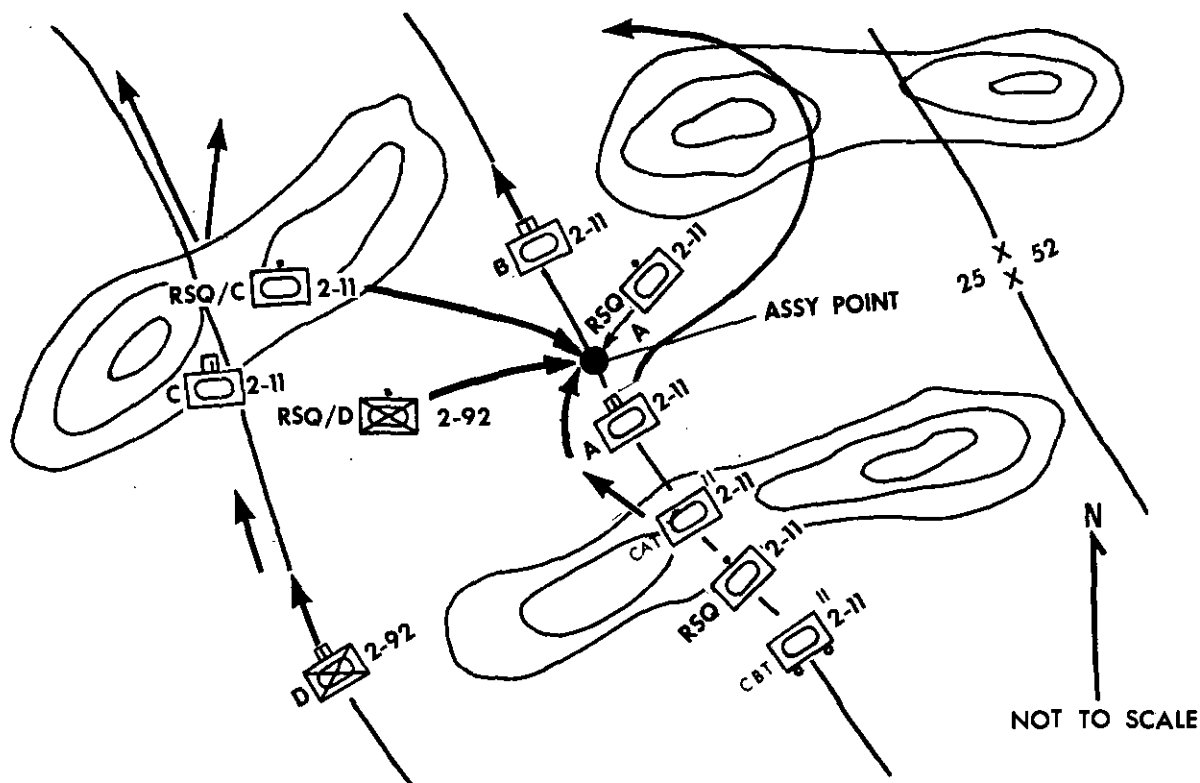

Figure 21. Provisional area damage control elements committed to render assistance to Team B.

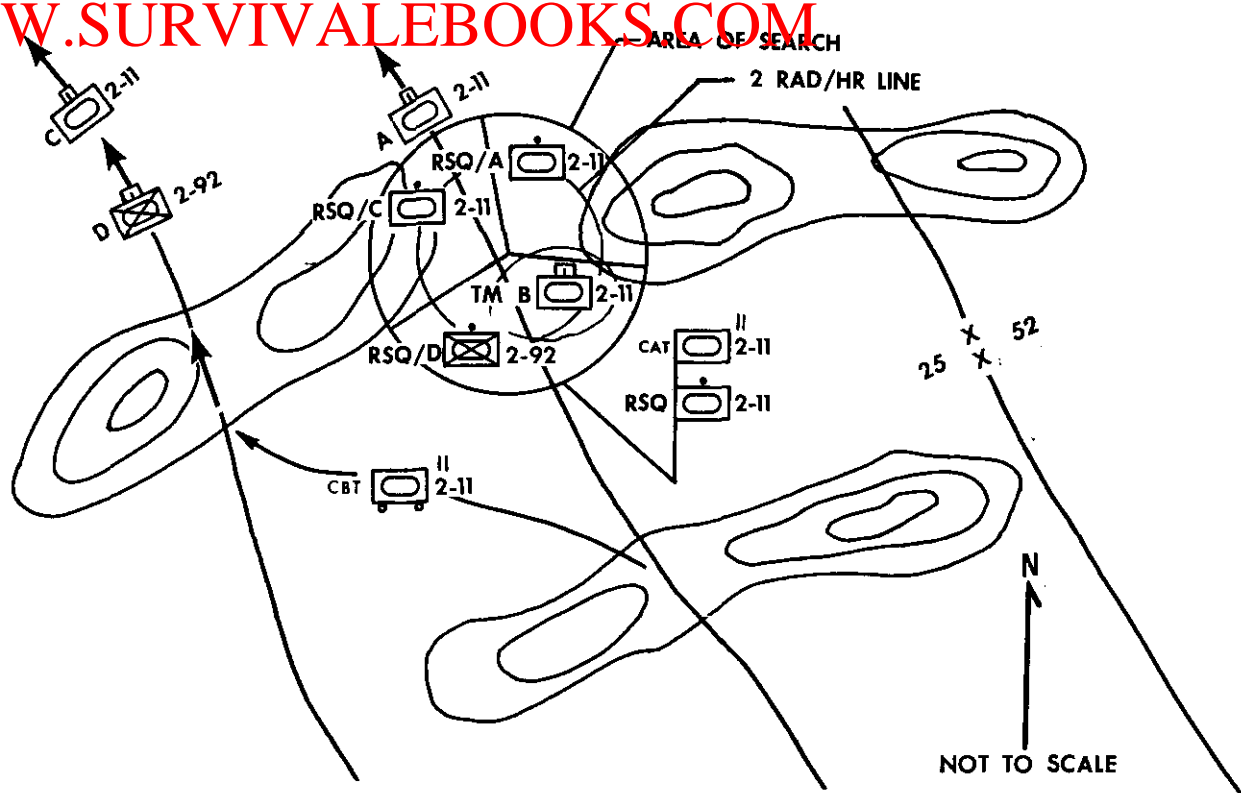

Figure 22. Task force continuation of tactical mission and damage control areas of responsibility.

315. Brigade and Division Level Operations

The brigade headquarters is a tactical headquarters and will not usually establish rescue squads but will be required to establish a CAT. This team will only operate when division has directed the brigade to conduct area damage control operations that will entail the use of control and assessment teams and rescue squads from more than one battalion. Otherwise, the brigade S4 will monitor a battalion level operation and keep the brigade commander informed of the progress of the operation. Other division units may be required to assist during a battalion or brigade-level operation. Such units consist of medical mass evacuation and heavy labor teams that are established by the medical and engineer battalions or other divisional units as established by SOP. Assistance from these teams is requested from the division G4. Brigade commanders have operational control of these division teams when they are provided.

316. Natural Disasters

Although not specifically described herein, measures taken and the procedures in employ-

ment of area damage control provisional organizations are the same for natural disasters such as floods, typhoons, or tornados as for nuclear attack.

317. Decontamination Measures

a. Radiological Decontaminations. Radiological decontamination measures are unit and individual measures taken to reduce the dose rate resulting from fallout. They include—

- (1) Brushing or sweeping off clothing and equipment. If possible, a complete change of clothing should be issued and the old laundered.
- (2) Bathing as soon as possible.
- (3) Turning over the soil in the immediate area of foxholes, vehicles, and occupied installations. This buries the fine fallout particles and reduces intensity.
- (4) Hosing or washing equipment and vehicles with soap or other detergents at the earliest opportunity.

b. Decontamination of Vehicles after Toxic

Attack. A contaminated armored vehicle will continue its mission until the tactical situation permits decontamination by the crew. For very light contamination, exposure to the weather may be sufficient for decontamination. Decontamination of the interior of the vehicle may be accomplished by the use of forced hot air or wiping with rags. Other expedients are protective ointment on small critical areas and solvents such as kerosene, fuel oil, and diesel oil on large critical areas. When such expedients are used, they must be washed off or otherwise removed before damage occurs to sensitive materiel. To decontaminate the outside of a vehi-

cle, the crew will spray the vehicle with a decontaminating apparatus. Should this prove insufficient, specially trained personnel may scrub the entire vehicle with hot soapy water or apply the bleach slurry or DANC method. Decontamination is performed at decontamination points in maintenance areas by vehicle crews and special units.

c. Maintenance personnel should exercise care when disassembling or servicing previously contaminated equipment. For additional information on decontamination and further explanation of the above methods, see FM 21-40, FM 21-41, and TM 3-220.

CHAPTER 11

OTHER OPERATIONS—ENVIRONMENT

Section I. GENERAL

318. General

a. Armor units may have to be augmented with additional equipment or special equipment as required by the geographical area, nature of operations, or a combination of these factors. Tank units may require a lighter vehicle, such as the AR/AAV, to replace the main battle tank. The organization of a tank unit may require adjustment as to the number of platoons in a company or the number of companies in a battalion. Combined arms forces, to include infantry, engineer, artillery, and other supporting troops, may be organized prior to or subsequent to arrival in the theater of operations. Cavalry units may require vehicle and personnel changes or a different ratio of air cavalry troops to armored cavalry troops. This generally requires special considerations in training, techniques of operation, tactics, maintenance, and logistical support.

b. Tactics. The fundamentals of employment and conduct of tactical operations for armor units discussed elsewhere in this text are appli-

cable, when modified, to meet the conditions of environment.

c. Maintenance. Under conditions of extreme environment, maintenance is emphasized more than in normal operations. Special care is required for metal surfaces to prevent rusting, icing or frosting, or accumulating sand. Communication equipment is waterproofed, fungusproofed, or given other preventive maintenance. Special lubricants are required generally for vehicles.

319. Logistics

Careful planning is essential to support operations conducted in extreme environments. The lack of supply routes will in many instances place great reliance on aircraft to supply units. The quantities of all classes of supply will vary greatly depending upon the environment. For example, in jungle operations, greater quantities of class V are needed, while in cold weather operations and desert operations, class III supplies are in greater demand.

Section II. JUNGLE OPERATIONS

320. General

Jungle combat involves operations in tropical areas, largely overgrown with dense vegetation, that may contain deep valleys, steep ridges, and swamps. The conduct of combat operations requires a high degree of leadership and individual initiative to meet the problems imposed by climatic conditions, land forms, and vegetation. In tropical areas, knowledge of terrain is of vital importance. Armor unit

leaders must strive to obtain information relative to the terrain by prior reconnaissance. This information must be current and complement the frequent climatic and seasonal changes peculiar to the operational area. These problems may be overcome by proper acclimatization, training, and careful planning. See FM 31-30 for details in jungle operations. Also see paragraphs 350-354 for operations in forest or wooded areas.

321. Effects of Jungle

a. The jungle affects operations by restricting observation, fields of fire, movement, and communication, and by providing concealment from air and ground observation. These factors make control difficult and continuous contact virtually impossible. In jungle operations, the leader is normally faced with situations that at best are vague. Narrower frontages than normal are assigned to attacking forces, and distances between units and individuals are reduced. The use of supporting fires is restricted.

b. Jungle areas seldom have good roads. The road net consists usually of a few roads on the edge of the jungle and narrow winding trails in the interior. Often movement of armor units is limited to roads, beaches, grass or brush covered fields (secondary growth); however, armor vehicles can move through difficult terrain and at times they will be able to pass through even primary jungle. When the jungle vegetation is coupled with either steep slopes or swamps, it will be necessary to work with dismounted personnel or select routes based on careful reconnaissance. When the terrain cannot accommodate cross-country movement, armor must utilize the existing roads and trails. Administrative type column formations must not be selected because of the terrain restrictions. Movement by successive bounds should be given consideration to preclude ambush of the entire element. In these situations, it must be recognized that time will be lost and plans made accordingly. In jungle terrain, surprise may be gained by the appearance of armor from an unexpected direction rather than through speed of movement.

c. Radio range is reduced greatly because of the screening effect of dense vegetation and steep slopes. The effectiveness of radio depends upon the radio's location and the atmospheric conditions; the use of aircraft for radio retransmission may prove advantageous. In a slow-moving attack, wire is the most satisfactory means of communication. Wire teams move with the assault echelon to provide communication to the rear. Increased reliance is placed on dismounted messengers and prearranged visual signals.

d. The jungle gives excellent concealment for offensive operations. This permits dismounted infantry to advance close to the enemy before launching their attack. However, concealing foliage also permits ambush and infiltration attacks and requires increased security.

e. Certain effects of particular interest to armor should be considered in nuclear warfare in jungles—shielding by thick vegetation, severe obstacles created by blowdown, and difficulty in accurately locating suitable nuclear targets.

322. Offensive Operations in Jungle

a. The fundamentals of employment and considerations of the offense for armor forces apply to offensive combat in jungles. Roads, trails, and rivers are key terrain in jungle operations. Use of mechanized flamethrowers and the increased use of the cannister round should be considered since jungle conditions often require a variety of munitions.

b. Jungle combat is essentially a fight by small dismounted infantry units operating extremely close to the enemy. A tank platoon may be attached to an assault rifle company to reduce enemy automatic weapons by close-range fires. In close terrain, dismounted troops and tanks move together at the same rate of speed. On trails, dismounted troops generally precede the tanks at about 25 to 50 meters, depending on the terrain and enemy resistance. At times the terrain may restrict deployment to the vicinity of the trail and may limit operations to a one-tank front. Tanks must be protected closely by dismounted patrols that reconnoiter for routes of advance, antitank guns, and antitank obstacles. Riflemen are designated to protect the flanks and rear of each tank. When the tanks are engaged, riflemen use the tanks as a shield while determining the location of the enemy firing position. When the enemy is located, the tank-infantry team attacks and destroys him. At times, close terrain makes it necessary for a tank commander to expose himself from the turret to locate targets and maintain contact with nearby tanks.

c. Sometimes the terrain makes it impossible for tanks to take part in the assault. In this case, the tanks may support the attack with

overhead and flanking fire. A tank forward observer may go with the assault rifle company to call for supporting fires.

323. Defense in Jungles

a. In light jungles, the principles of defense in woods generally apply. Thorough and continuous ground reconnaissance is necessary because the observation of security elements is restricted and air reconnaissance is often ineffective. Long range fires can seldom be employed.

b. In a dense jungle, troops are disposed along the forward edge of the battle area with minimum intervals between foxholes and no gaps between units. Security elements consist

of small groups, dug in for all-round defense, to cover trails and other approaches to the position. Security should be out to a distance that will insure detection of the enemy before he is within range to effectively employ his handheld antitank weapons. Frequently units are isolated in this type of terrain. In this event, the need for all-round defense takes on added significance. Every effort should be made to establish a perimeter as soon after halting as possible. Particular care must be taken to guard against enemy infiltration and dismounted infantry attacks.

c. Effective passive air defense is possible for armor units in jungle operations, thereby reducing the number of air defense units required.

Section III. DESERT OPERATIONS

324. General

All deserts have certain characteristics—lack of water, absence of vegetation, large areas of sand, extreme temperature ranges, and brilliant sunlight. The terrain is not necessarily flat and level. There are hills, depressions, sand dunes, rocks, shale, and salt marshes, as well as great expanses of sand. However, these terrain features usually present, at most, only local obstacles to movement.

325. Effects of Desert

a. *Camouflage.* The lack of vegetation in the desert makes concealment of men and equipment difficult. Artificial means of camouflage are employed extensively, including protective painting for all vehicles. Maximum use is made of shadows in broken ground, dried-out stream beds, and sand dunes.

b. *Mobility.* As a rule, it is easy to move in desert areas; therefore, the force that has the greater mobility is the more effective. Movements are made normally for long distances, and speed is essential. Maintaining direction during movements is difficult because of the absence of roads, trails, and landmarks. Navigational aids and dead reckoning are used to maintain direction.

c. *Surprise.* Visibility is often poor because of the absence of high ground for observation

and the presence of blowing dust. Surprise is improved by the use of aggressive reconnaissance and security forces, speed of movement, and deception. Dummy positions, decoy movements, and the operation of false radio nets aid in deception. In open areas, a force can conceal its movements by moving at night or during dust storms. The glare of the sun, especially when it is low on the horizon, reduces visibility toward the sun. An attacker may gain surprise by moving with the sun at his back.

d. *Security.* Because of the lack of natural obstacles in the desert, all-round protection is necessary at all times. Units must be prepared to fight in any direction. Reconnaissance must extend for greater distances than normal. The lack of natural concealment increases the difficulty of security against enemy air action. Dispersion and camouflage are used as passive means of defense against air attack, and active defensive measures are employed fully. Since it is virtually impossible to conceal logistical installations from either ground or air observation, their security is best obtained through dispersion and through deception as to the nature of the installation. A larger than normal number of air defense units may be required to support an armored unit in a desert operation due to a lack of concealment. Increased emphasis must be placed on active defense of supply columns and logistical installations from ground attack.

326. Conduct of Desert Operations

a. Offensive Operations. In desert combat, emphasis is placed on maneuver because flanks are most accessible. Terrain favors envelopments and deep turning movements. Wide movements around an enemy flank can often be made without deception. See chapter 6 for discussion of offensive operations.

b. Defensive and Retrograde Operations. Defensive and retrograde operations are carried out as discussed in chapters 3, 7, and 8, taking into consideration the effects of the desert described in this section.

c. For additional information, see FM 31-25.

Section IV. OPERATIONS IN DEEP SNOW AND EXTREME COLD**327. General**

a. Deep snow and extreme cold weather present many problems for armor operations. Special training must be conducted for individuals and units, including small unit and battalion training.

b. Leaders must supervise all activities and always set the example. In no other part of the world is the necessity for leadership more apparent than it is in that of deep snow and extreme cold.

c. For detailed discussion of operations in extreme cold, see FM 31-70 and FM 31-71.

328. Effects of Deep Snow and Extreme Cold

a. Troops require special clothing and heated shelters. Equipment and supplies that would be damaged by freezing are protected against the cold. Weapons and vehicles are winterized with special lubricants. Wheeled vehicles may be used on established roads in rear areas. Full-track vehicles with low ground pressures are used for movement over snow-covered or muddy terrain. Movement on icy slopes often requires special grousers fitted on the tracks.

b. All movement is slow. This frequently limits the depth of combat missions. Careful reconnaissance by patrols on skis, snowshoes,

or light oversnow vehicles precedes movement of units. Reconnaissance reports include information on snow depth and ice thickness. Short range weather forecasts are important in planning movement.

c. Armor units advancing cross country avoid heavy forests and deep drifts, taking advantage of windswept ridges where snow cover is thinnest. Thickly frozen lakes and rivers, instead of being obstacles, are good routes for movement.

d. In winter, the short periods of daylight and the difficulty of concealing movement in snow-covered terrain cause an increase in night movements which are frequently aided by clear atmosphere and bright moonlight. Deep snow provides concealment but increases the difficulty of orientation on the terrain. Long movements require the use of navigational aids.

329. Conduct of Operations in Deep Snow and Extreme Cold

a. Offensive Operations. Offensive operations are conducted as described in chapter 6.

b. Defensive and Retrograde Operations. Defensive and retrograde operations are conducted as described in chapters 7 and 8.

Section V. MOUNTAIN OPERATIONS**330. General**

Mountain combat may involve operations in areas of high altitudes subject to extreme changes in weather. These areas usually have snow-covered slopes much of the year, few roads most of which are narrow and twisting, and few, if any, communication centers. In general, operations in mountainous terrain re-

tards and restricts maneuver, reduces the effect of fire, and makes communication and supply difficult. Mountain terrain and weather can be either a dangerous obstacle to operations or a valuable aid, depending on how well it is understood and to what extent advantage is taken of its peculiar characteristics. See FM 31-72 for detailed discussion of mountain operations.

331. Effect of Mountains

a. The nature of the terrain normally limits the use of armored vehicles to roads and trails. Tactical surprise may be achieved by employing varying degrees of engineer effort to permit tanks to move to advantageous firing positions in the roughest types of terrain.

b. Consideration should be given to obtaining information from local inhabitants of the area about trails and natural obstacles that often do not appear on military maps.

c. Adequate logistical support for armor units engaged in mountain operations is extremely difficult. Roads are usually few in number and require extensive maintenance. Helicopters may be used for supply operations.

d. Mountainous terrain presents many communication problems. Radio communication, particularly FM sets, may be affected by high ground between stations. See FM 24-1 for details on communications in mountain operations.

332. Offensive Operations

a. In mountainous terrain, an armor attack must be planned in detail and the troops briefed thoroughly. The terrain may permit tanks to support attacking infantry with relatively long range direct fire. This requires excellent radio communication and thorough coordination between the infantry and tank units.

b. Key terrain features are primary objectives. Attacks along low ground are usually costly because the defender has excellent observation. The route of an attacking force will normally be along ridge lines or on other ele-

vated terrain. On such terrain, the attacking force will often gain tactical surprise. Extensive engineer work may be required to place tanks on high ground where they can closely support the attack. It may be necessary to build a trail from low ground to the attack position. When mountainous terrain contains corridors that are favorable to the attack and permit employment of armor, armor units may attack down the corridors while infantry units attack along the ridge lines.

c. Available roads and trails must be kept in good repair to permit the movement of armor. Tank dozers, armored vehicle launched bridges, and bridging material must be kept well forward.

d. No more armored vehicles should be taken forward than are required for immediate operation. Having uncommitted armored vehicles in forward areas causes unnecessary damage to roads and may create traffic hazards for supply vehicles.

e. If decisive armor action becomes possible, armor forces are committed in mass, supported closely by artillery and engineers. Objectives are usually critical points on hostile supply routes and withdrawal, the capture of which would isolate the enemy forward position.

333. Defensive and Retrograde Operations

The fundamentals of defensive and retrograde operations discussed in chapters 7 and 8 are applicable to the conduct of the defense in mountain warfare. The use of armored vehicles may be limited; however, wherever possible, full advantage is made of tanks in their anti-tank role and in offensive actions.

CHAPTER 12

OTHER OPERATIONS—MISSION TYPE

Section I. GENERAL

334. Description

The operations described in the following sections are normally conducted in conjunction with major operations—attack, defense, or retrograde. These operations evolve as a part of the overall mission of a unit; for example, an airmobile operation conducted in conjunction

with an attack to seize crossing sites over a river.

335. Scope

These mission-type operations are only discussed as they affect armor operations. References are made to other field manuals, where appropriate, for detailed information.

Section II. AIRMOBILE OPERATIONS

336. General

When provided with aviation units from corps, army, or USAF the armored division has a capability to conduct airmobile operations to assist in the seizure of objectives. This capability increases the speed and flexibility of armor operations. Airmobile operations are not limited to any particular type combat unit. However, mechanized infantry battalions and armored cavalry units of the armored division will participate most frequently in airmobile operations.

337. Airmobile Operations

a. The operations of airmobile forces may include—

- (1) Economy of force missions.

- (2) Raids.
- (3) Antiairborne and antiguerrilla operations.
- (4) Overobstacle assault operations.
- (5) Assist in the exploitation of the effects of nuclear weapons.
- (6) Seizure and limited retention of key terrain.
- (7) Feints and demonstrations.
- (8) Reconnaissance and security missions designed to block or screen enemy avenues of approach.
- (9) Counterattack of enemy penetrations.
- (10) Ship-to-shore operations.

b. For planning and conducting airmobile operations, see FM 57-35.

Section III. LINKUP OPERATIONS

338. Definition

A linkup operation is the convergence of two separate ground units and usually occurs in joint airborne, amphibious, shore-to-shore, air-

mobile, and infiltration operations; during the relief of an isolated unit; the breakout of an encircled force; or an attack to join a friendly guerrilla force. See FM 31-21, Special Forces Operations, for a detailed discussion of linkup

operations between field army forces and guerilla forces.

339. Conduct of Linkup Operations

The initial phase of a linkup operation is conducted as any other offensive operation. As the linkup forces come closer together, coordination and control are intensified and restrictions are placed on the forces involved.

a. Planning. Plans for a linkup are coordinated in advance and must be timely. It is extremely important that the forces involved have an early and continuing exchange of information.

b. Command Relationship and Responsibilities. The headquarters directing the linkup operation must establish the command relationships and responsibilities of the forces involved. Both the linkup force and the force with which linkup is to be made can remain under control of the directing headquarters, or either force may be attached to the other.

c. Command and Staff Liaison. Liaison is normally established during planning and continues throughout the operation. As the distance closes between the forces, additional liaison personnel are exchanged. Aircraft improve and expedite this exchange.

d. Communication. The communication plan includes the channels for radio communication between the two forces. It must prescribe day and night identification procedures, including primary and alternate means. Aircraft can be used to give signals or to otherwise extend communication. Visual signals such as flares or panels may be used during daylight, and flashlights or infrared devices may be employed during darkness.

e. Mutual Recognition System. To preclude the possibility of friendly troops exchanging fires, recognition signals must be established. They may be pyrotechnics, armbands, vehicle markings, panels, colored smoke, distinctive light patterns, infrared signals, and passwords.

340. Linkup of a Moving Force with Stationary Force

a. General. In an operation where one force is moving to linkup with a stationary force, the following procedures are necessary.

b. Coordination of Ground Linkup Points. To insure that the forces join without doing

battle against each other, linkup points are selected at which physical contact between the forces will occur. These points must be readily recognizable to both forces. Alternate points are selected in the event enemy activities cause linkup at places other than those planned. The number of linkup points selected depends upon the terrain and the number of routes used by the linkup force. All personnel involved in the linkup force must be thoroughly familiar with procedures for mutual identification and plans for the rapid passage of lines.

c. Fire Coordination Line. To prevent losses from fire by friendly forces, the fire coordination line is established to coordinate the fires delivered by both the linkup force and the stationary force. As linkup becomes imminent, one force may deliver fire outside the line only after coordinating with the friendly force.

d. Air Defense Artillery Considerations. During linkup operations, particularly with airmobile or airborne units, the rules for engagement become extremely important. It is important that ADA units do not engage friendly aircraft that may be supporting the airborne or airmobile units.

e. Actions Following Linkup. When the linkup is made, the linkup force may join the stationary force or may pass through or around and continue the attack. If the linkup force is to continue operations in conjunction with the stationary force, a single commander for the overall force must be designated. Plans for these operations must be made in advance. If linkup is to be made under conditions of nuclear warfare, objectives for the linkup force must provide for dispersion in relation to the stationary force. The linkup force may immediately pass through the perimeter of the stationary forces, be assigned objectives within the perimeter, or be assigned objectives outside the perimeter, depending upon its mission. If the mission and terrain will permit, it is desirable that the linkup force pass around the stationary force and be assigned objectives outside the perimeter of the stationary force.

341. Linkup of Two Moving Forces

When two moving forces linkup, normally only suitable control measures such as boundaries, fire coordination lines, and contact points where juncture is to be made are prescribed.

When the linkup is accomplished, the units continue on their assigned missions.

342. Logistical Support in Linkup Operations

a. Logistical support reinforcements may be greater in linkup operations than those for other offensive actions. Additional considerations for planning logistical support in linkup operations include the distance to the objective area, time the objective area is to be held, planned operations or movement out of the objective area, and the movement of the land tails of units participating in the airborne or airmobile assault.

b. The supply requirements for a linkup operation may exceed the transportation capability of the battalion support platoon. The battalion may have to request additional vehicles or supply by air. If additional vehicles are not available, kitchen trucks and company supply trucks may have to be used to transport ammunition and fuels.

c. In airborne and airmobile operations,

priority for supply by air is given to the units assaulting the objective area. Supplies for the linkup forces normally move by land transportation. However, when the objective area is to be defended jointly by the linkup and airborne or airmobile force, supplies for the linkup force may be flown into the objective area and stockpiled.

d. Evacuation of equipment and patients may create major problems for the linkup force. If supply routes are open, the normal evacuation procedures apply. When ground routes are insecure, helicopters may be used for evacuation of patients while damaged equipment may be carried forward with the linkup forces until a suitable opportunity for evacuation is available.

e. The land tails of airborne or airmobile assault units will normally move with the linkup forces. These elements move with the trains of the headquarters of the linkup force. When moving with a battalion, these elements march with the field trains.

Section IV. RAIDS

343. General

A raid is an attack to accomplish a specific purpose in enemy territory with no intention of gaining or holding terrain. Raids are made normally to capture prisoners; to capture or destroy specific enemy materiel; to obtain information of enemy units, locations, dispositions, strength, intentions, or methods of operation; or to disrupt his plans. Usually, raids are designed for tactical deception, inflicting loss or damage to specific enemy materiel, securing information, or supporting or coordinating with unconventional forces. Raids may be conducted within or beyond supporting distance of the parent unit in either daylight or darkness. When the area to be raided is beyond supporting distance, the raiding party operates as a separate force. The raiding force always withdraws after it accomplishes its mission. Unless planned and conducted carefully, the withdrawal is the most difficult part of the operation. Security is vital because normally the raiding force penetrates the enemy position and is vulnerable to attack from all directions. Raids are planned and executed much

like other attacks, but surprise and speed of execution are of greater importance (ch 6). Raids may be conducted dismounted, motorized, mechanized, or by air or waterborne means. The tank sweep is suited ideally for raids (para 346-349). See FM 57-35 for raids conducted by airmobile units and FM 17-36 for tactics and techniques that may be used in conducting raids by air cavalry units.

344. Conduct of Raids

a. *Selection of Raid Objectives.* The raid objective may be prescribed by the higher commander, or it may be left to the discretion of the commander of the raiding force. Where possible, the area selected for the raid is lightly defended. The raid objective accomplishes the mission of the raiding force.

b. *Time of Raid.* Before a raid, time should be allowed for reconnaissance, planning, registration of supporting fires, and rehearsals. Preferably, raids are carried out so that the raiding force will arrive at the objective area at dawn or twilight, or other conditions of low

visibility, to limit enemy observation and yet give enough light for close combat.

c. Route of Advance and Withdrawal for Raid.

- (1) In daylight raids, covered routes of approach should be used. The raid begins when the raiding force departs the last area or terrain feature held by friendly forces. Under conditions of reduced visibility when surprise through stealth is possible, advance and flank security detachments precede the raiding force. They prevent premature discovery of the raid by the early destruction of enemy security detachments.
- (2) The withdrawal usually is made over another route. Road intersections and other prominent landmarks are avoided. Security detachments and protective fires are used to keep the routes of withdrawal open.

d. Rallying Points for Raids. Rallying points are locations at which units assemble when they have become separated during a raid or

have completed their missions and are ready to withdraw. A rallying point is designated near the objective, and a series of rallying points may be prescribed along the routes of advance and withdrawal. A rallying point in an area controlled by friendly forces is usually prescribed to assemble materiel, prisoners, and information gathered in the raid.

345. Logistical Considerations in Raids

In planning logistical support of a raiding party, it must be realized that the raiding party may be isolated or required to fight its way back to friendly lines. Factors governing the amount of logistical support accompanying a raiding party include the type and number of vehicles and weapons, movement distance, length of time the raiding party will operate in enemy territory, and expected enemy resistance. Usually the raiding force carries everything required to sustain itself during the operation. Plans are made to supply a raiding unit, if required, by use of aircraft as the primary means and by ground vehicles as an alternate means.

Section V. TANK SWEEPS

346. General

The tank sweep is an offensive operation designed to deliver a rapid, violent attack against an enemy force to inflict maximum casualties, disrupt control, and destroy equipment. It may be employed to achieve objectives of a reconnaissance in force that are compatible with the conduct of the sweep.

347. Planning the Tank Sweep

a. The tank sweep is planned as a mounted assault through enemy-controlled territory. Planning is essentially the same as for any offensive operation except that no attempt is made to seize an objective. The tank sweep passes through the enemy and returns to friendly positions in a single move.

b. The tank sweep may be controlled more closely than other offensive operations. The extent of control may vary from a direction of attack to an axis of advance, depending upon the purpose of the sweep and factors of METT. Control measures are used to preclude

friendly units firing into each other and to coordinate supporting fires.

c. The force conducting the tank sweep should be predominately a tank unit. Small mechanized infantry units may be attached for specific tasks, such as guarding and evacuating enemy prisoners or demolishing specific material during the sweep.

d. The selection of the area through which the sweep is to be conducted depends upon the purpose of the sweep.

- (1) When the tank sweep is used to extricate a heavily engaged unit, it is planned in an area that enables the attacking force to strike the enemy flank immediately in rear of the line of contact.
- (2) When the tank sweep is used to achieve certain objectives usually associated with a reconnaissance in force, it is planned in an area that will satisfy the need for information.

e. Combat support is provided where necessary. Indirect fires from units already in position are planned in and along the flanks of the area to be swept. If weather conditions permit, smoke may be planned to add to enemy confusion and to assist in concealing the strength of the force conducting the sweep. Engineer tasks that can be accomplished rapidly, such as demolition of roadblocks or the expeditious breaching of a minefield, may require the attachment of engineer forces. Such tasks are planned carefully and coordinated closely to avoid slowing the sweep.

348. Conduct of the Tank Sweep

a. The commander of the attacking force employs a formation that permits the rapid delivery of heavy volumes of fire in the direction of the sweep. While the commander is alert to adapt the formation to the situation, he avoids changes that require any part of the force to halt. He adopts as wide a formation as the analysis of the factors of METT indicates to accomplish the following:

- (1) Gain information of the enemy from as wide an area as possible.
- (2) Inflict casualties and damage on as many enemy units and installations as possible.
- (3) Insure that the force conducting the sweep has a time-length that permits passage of dangerous areas as rapidly as possible.

b. Units keep moving and fire on enemy units and installations as they appear. Enemy

tanks and armored vehicles are taken under fire with appropriate armor defeating ammunition. Light vehicles, CP's, and supplies are destroyed by machinegun and HE fire. Enemy infantry forces and weapons with exposed crews are machinegunned and physically overrun. Enemy forces discovered in march formation or only partially deployed are assaulted immediately. The combination of heavy fire and rapid maneuvering into and through enemy units generates the necessary shock effect to maintain the momentum of the tank sweep.

c. If immediate evacuation is impossible, tanks that become damaged or otherwise immobilized are destroyed to avoid their capture. Crews of destroyed vehicles are evacuated. Armored personnel carriers from attached mechanized infantry units may accompany each tank platoon to evacuate crews and casualties from destroyed tanks.

d. Supporting fires are primarily preplanned and on call. Fire support units, when not firing, relay their weapons to keep pace with the sweep.

349. The Return to Friendly Positions

The return to friendly positions is a critical part of the tank sweep. As the sweeping force closes into friendly positions, close control and coordination are required to identify units, avoid obstacles, and prevent firing on friendly forces. These details are planned before the conduct of the sweep. See paragraphs 211 and 212 for techniques in planning and conducting a withdrawal through friendly positions.

Section VI. OPERATIONS IN FORESTS OR WOODED AREAS

350. General

a. The attack of a forested area is best suited for an infantry-heavy force. Heavily wooded areas, like builtup areas, restrict mobility, limit visibility and fields of fire, and increase problems of control. Fighting in forests is characterized by many small unit actions. As a result, attacks in forests require detailed planning and control measures, decentralized control, and thorough briefing of subordinate commanders. Whenever possible, tanks avoid combat in forested areas. They are better employed to bring direct fire on positions located

on the outer edges and to encircle the defended wooded area. Whenever combat in woods is unavoidable, dismounted infantry are essential for the protection of armored vehicles. The attack in forest is divided into three phases—

- (1) Attack and occupation of the near edge.
- (2) Advance through the forests.
- (3) Exits from the forests.

b. Detailed planning and careful coordination of all the arms and services involved extend down to every member of the tank crews and of the rifle squads supporting them. Com-

munication and target designation are especially important. It is necessary to plan supporting fires from artillery and infantry weapons as well as from the organic battalion support weapons, and to arrange with the engineers for route clearance or improvements. Tank dozers may be used to advantage. In nuclear warfare, consideration must be given to tree blowdown and fires that may occur in the attack area as a result of friendly nuclear strikes. Similar consideration must be given to enemy nuclear capabilities and the resultant obstacles to tank movement that could result.

351. Attack of the Near Edge of the Forests

a. The attack of a defended area near the edge of the forests is similar to the attack of any organized area. The near edge, or a terrain feature in which the near edge is included, is designated as the objective. When the attack

must cover ground entirely exposed to enemy observation and fire, it may be made under the concealment of smoke or darkness. The methods of attack used are the same as in the attack of an organized position.

b. When a foothold has been established in the forests, the assault echelon consolidates and reorganizes. Distances and intervals between smaller units and supporting weapons are reduced so that contact can be maintained during the advance through the forests. Since the edge of the forest is a good target for hostile artillery and aviation, the consolidation and reorganization must be rapid.

352. Advance Through the Forests

a. The actual tactics employed must be designed to overcome the weapons and tactics of the enemy. Tanks move slowly, at short intervals and distances, to improve control and to insure mutual support. In heavily forested

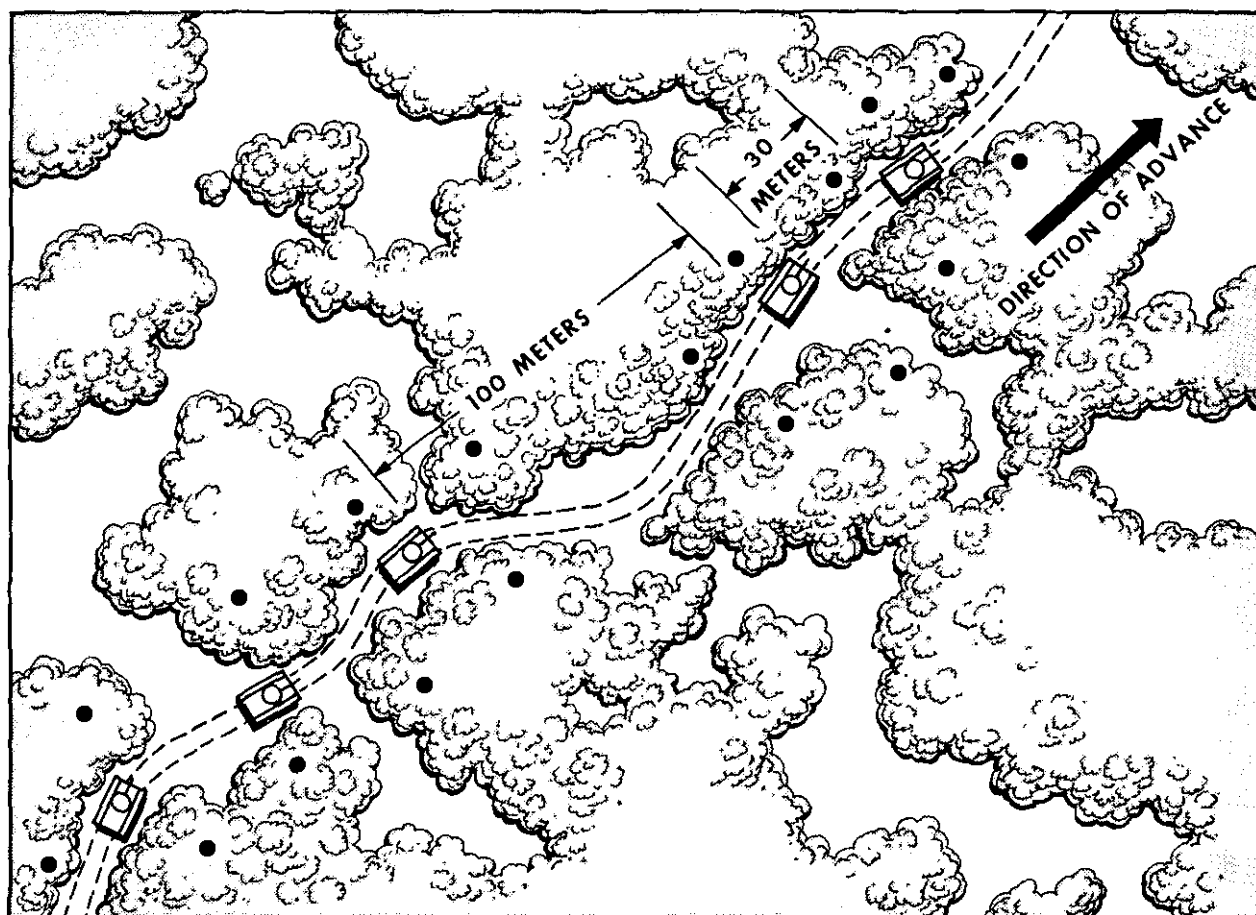

Figure 23. Tank-mechanized infantry formation in sparsely forested area.



Figure 24. Tank-infantry formation in wooded areas.

areas, there are frequent halts for reorganization, supply, and orientation. Consumption of fuel and ammunition is heavy.

b. Figure 23 shows a typical formation of a tank platoon advancing with dismounted infantry along a trail in a forested area. The two leading tanks are echeloned to the right and left of the trail. Dismounted infantry accompany each tank. This formation presents a smaller target to the enemy and provides mutual fire support for each tank. The following three tanks proceed along the trail ready to support the leading tanks. The team of combined arms advances together, infantry maintaining close visual contact with the leading tanks; locating targets for the tanks; and providing security for the tanks by destroying infantry type targets.

c. Though forested areas often severely limit

maneuver, the possibility of flanking action or flanking fire by the tanks is always considered. The more difficult the terrain, the greater the surprise obtained if a tank attack can be launched successfully across it. The infantry must never let the leading tanks advance out of sight. If this happens, the tanks may be knocked out by tank killer teams and antitank guns and the infantry subsequently stopped by machinegun fire. Proper coordination of effort will prevent the enemy from separating tanks and infantry (fig. 24).

d. The infantry indicate targets by using tracer ammunition, the external tank interphone, or prearranged signals.

e. Supply is a serious problem because of the large quantities of fuel and ammunition consumed and the difficulty of getting supplies forward. Consequently, maintenance and supply

personnel must operate immediately behind the attacking elements. It may be necessary to establish an advance supply point at company level.

353. Security

Security is of the utmost importance in operations in forested areas where surprise, ambush, sniping, and infiltration tactics are employed constantly. Whenever an attacking tank-infantry element halts, immediate provision must be made for all-round security. When time permits, an all-round defense system is established behind mines, boobytraps, and barbed wire and is covered by an outer ring of dismounted infantrymen. Logistical elements should be located in the center of the perimeter defense for maximum protection.

354. Exit

The continuation of the attack from the far edge of the forest is conducted like any other attack. Plans are usually made to reorganize the assault echelon before it reaches the far edge, especially when strong enemy resistance is expected after the forests are cleared. Units and supporting weapons are redispersed, and frontages, zones of action, and the formation of the unit are rearranged as necessary. New objectives are assigned; if possible, they are terrain features whose capture will mask the far edge of the forests from hostile ground observation and direct fire. When practicable, supporting weapons are given general support missions. Artillery and mortar fires and smoke are planned to assist the exit.

Section VII. OPERATIONS AT DEFILES

355. General

a. Although armor units prefer to attack and maneuver on as broad a front as is tactically feasible, there are occasions when deployment may be constricted to negotiate a defile. In these instances, commanders and staffs must be alert to foresee areas where defiles may interfere with operations or constrict maneuver. When defiles are detected, plans must insure that troops are not compressed; traffic is rigidly controlled; areas for dispersion of vehicles, equipment, and personnel are selected; and the passage of the defile is accomplished in minimal time. Every effort must be made to secure the flanks of a defile before attempting to pass the main body through the defile. When provided, ADA units are used to protect the defile from enemy air attack. Air cavalry and organic or attached aircraft are employed to perform reconnaissance and surveillance of critical areas and to transport light elements in the air-landed seizure of such areas.

b. The following definitions are necessary to the understanding of this section:

- (1) A *defile* is any terrain feature, natural or artificial, that tends to constrict the passage of troops. Examples are mountain passes, gaps through minefields, river-crossing sites, or bridges.
- (2) A *target zone* is a generally circular

area centered on and encompassing a defile within which personnel would become casualties and equipment would be destroyed or severely damaged by the effects of a selected enemy nuclear weapon.

- (3) A *defile target zone coordinator* is an individual designated by the commander to plan and regulate traffic flow through the defile target zone. This individual is normally the S3 when the traffic passing through the defile target zone consists primarily of combat and combat support units and the S4 when the traffic is predominantly combat service support. The defile target zone coordinator exercises absolute control of traffic moving through the target zone.
- (4) *Holding areas* are waiting spaces for vehicles located on both the near and far side of the target zone. These areas are far enough from the defile to insure against loss of vehicles and personnel from blast and thermal effects of an expected enemy nuclear weapon directed at the defile site. The areas may be large enough to accommodate battalion-size units but are preferably company-size and should be occupied for a minimal time to avoid creating a lucrative target.

- (5) *Traffic control points* are critical locations at which traffic is controlled, either by military police or other personnel. Traffic control points operate under direct control of the defile target zone coordinator.
- (6) *Equipment parks* are small, well-camouflaged areas located near the defile for the central assembly of vehicles, equipment, and material for engineers' use during the defile operation.

356. Planning

a. *Control.* Control measures are planned in advance and employed to insure successful passage of a defile. The following control measures and techniques are essential:

- (1) Establish the limits of the target zone. This is actually a "vulnerability circle" encompassing a defile within which forces may be subjected to the maximum effects of an enemy nuclear strike.
- (2) Designate defile target zone coordinator.

- (3) Designate routes, including alternate routes for movement.
- (4) Establish traffic control points.
- (5) Select and establish well-dispersed holding areas.
- (6) Select and establish equipment parks.
- (7) Establish and maintain all feasible means of communication among the defile target zone coordinator, the traffic control points, stationed wreckers, and the engineers at the points of construction, such as bridge site, mountain pass.
- (8) Provide the defile target zone coordinator with adequate military police traffic control personnel, communication equipment and personnel, engineers and engineer equipment, wreckers, and security units.
- (9) Figure 25 depicts the control measures described in (1) through (8) above.

b. *Conduct of the Passage.*

- (1) Forces must move into, through, and disperse beyond the target zone with

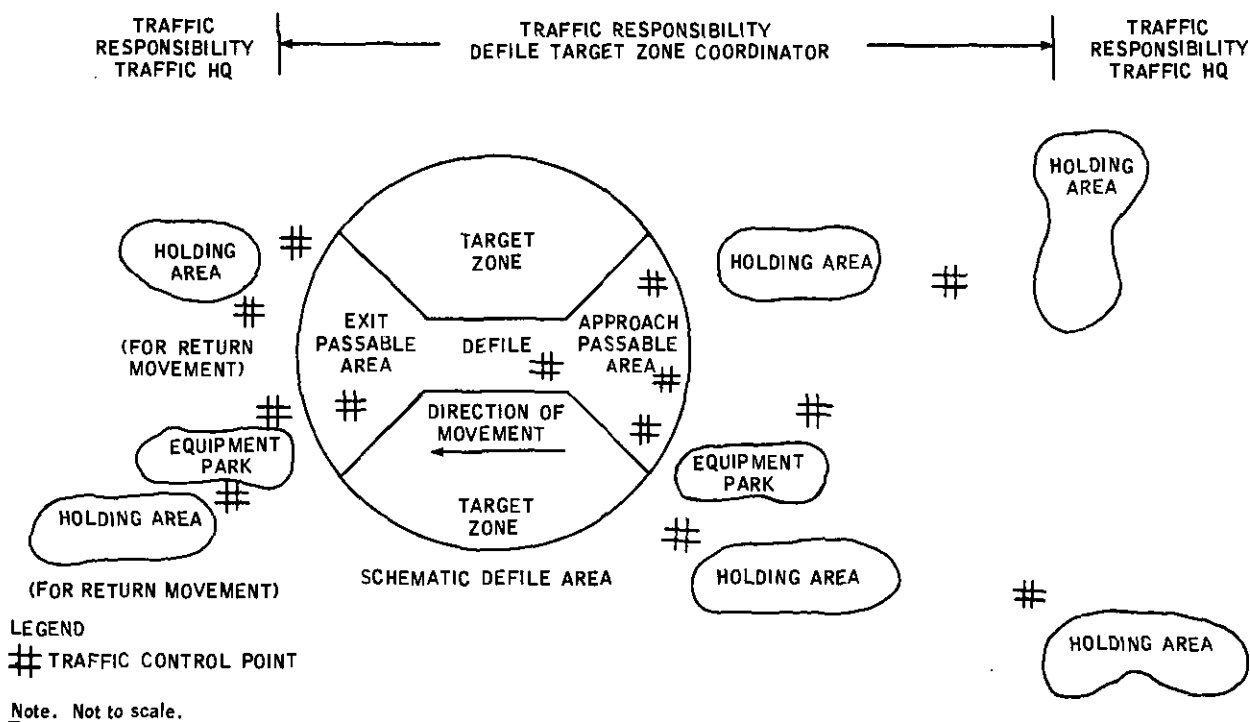

Figure 25. Control measures in defile operations.

great speed. Responsibilities for traffic regulation and control must be defined clearly. Engineer support required to prepare the defile site for passage should be accomplished under conditions of reduced visibility or at night, when practicable. The defile target zone coordinator is completely responsible for planning, regulating, and controlling traffic into, through, and beyond the target zone. He establishes priorities for movement, schedule of movement, rates of march, size of march units, and input of traffic into the target zone. Traffic regulation must be enforced rigidly to insure smooth, constant flow and prevent disruption.

- (2) To assist the defile target coordinator, a traffic control headquarters is established and controls—
 - (a) Movement of traffic into holding areas on the near side of the target zone.
 - (b) Movement from holding areas (if used) on the far side of the target zone.
 - (c) Normal movement beyond holding areas on the far side of the target zone.
- (3) To insure rapid movement of traffic through the target zone, the defile target zone coordinator establishes traffic control points between the holding areas and the perimeter of the target zone, within the target zone, and beyond the target zone up to holding areas on the far side. Wreckers should be stationed at critical points along all routes, preferably near traffic control points, to be immediately available. The engineer must have at his immediate disposal equipment and materiel, located in equipment parks, necessary to reduce obstructions to free-moving traffic. Communication must be maintained among the defile target zone coordinator, wreckers, the traffic control

points, the engineer at the defile site, the military police or other traffic control personnel, the traffic headquarters (at division level), and holding areas.

c. Alternate Routes. In the planning for a passage of a defile, alternate routes must be designated. Alternate routes should take advantage of concealed approaches to and through the target zone if possible. The negotiation of the defile by combat units should not be dependent exclusively on roads. All routes must be reconnoitered and made suitable for the anticipated volume of traffic.

d. Deception. Adequate deception measures must be planned to further the success of the main defile passage operation. Dummy equipment should be placed at selected defile sites to deceive the enemy and cause him to expend nuclear weapons on this site.

e. Retrograde Passages. The procedures established for the passage of a defile during the advance are equally applicable to retrograde movements. In fact, plans for a passage of a defile during the offense should encompass plans for a retrograde movement.

f. Use of Aircraft. Aircraft may be used for airlifting certain troops, supplies, and equipment over or around the defile to reduce substantially the number of ground elements required to negotiate the target zone.

g. Security. Security units should be provided the defile target zone coordinator as a ready force to eliminate enemy countermeasures. Security outside the target zone remains the responsibility of the commander concerned. However, security plans must be coordinated.

h. Ground and Air Reconnaissance and Surveillance. In operations at a defile, reconnaissance and area surveillance are of utmost importance. It is imperative that the command be warned of the presence or approach of the enemy at the earliest possible moment and at the longest ranges possible.

357. Brigade-Level Passages

Tactical considerations are shown in *a* and *b* below.

a. Offense. When the brigade must pass through a defile, armored and air cavalry ele-

ments should precede the main body and reconnoiter the entire surrounding area. If the immediate area is clear, tanks and mechanized infantry are dispatched rapidly through the defile and establish a defense, securing enough maneuver room to permit the main body to emerge from the defile unhampered. If the area is defended, enough space must be seized for the main body to maneuver.

b. Defense. The defense of a defile by the brigade may be conducted using several methods:

- (1) Positioned with flanks refused and protected by the obstacles forming the defile with the bulk of the force held in reserve behind the defile.

- (2) Delaying action, with leading elements well forward of the defile to gain time and space for the main body to pass the defile and deploy for any action required.
- (3) Mobile defense, with all major elements of the division forward of the defile.

358. Battalion or Task Force Passages

The procedures for battalion or task force passages are the same as described for the brigade (para 357). Normally, battalion-size forces can readily bypass a defile if it is other than a mountain pass or a similar type terrain obstacle.

Section VIII. OPERATIONS AT INLAND WATERWAYS

359. General

In an inland water crossing, the actual crossing is a means to extend the operation. The approach to the water obstacle is made rapidly on a broad front whenever possible. Mobile assault forces push forward quickly to catch the enemy astride the obstacle and to seize and secure crossing sites where the opposition appears weakest. Crossings of opportunity, such as captured bridges or fords, are the product of rapid offensive action. Once these crossing means are captured, they are checked for the presence of demolitions immediately after the lead elements have crossed. Air defense units should be immediately employed to protect the crossing means from enemy air attack. A crossing, however, is not predicated on the seizure of bridges or fords intact. In any case, assault units cross first to establish a bridgehead on the far bank to protect the crossing of the remainder of the command. Whenever possible, the plans for the crossing of every water obstacle which cannot be bypassed should be prepared well in advance by appropriate command echelons. Prior planning affords a greater opportunity to conduct a crossing with speed, surprise, less vulnerability to nuclear attack, and usually less risk. The material contained in this section may be applied to operations across canals, lakes, and rivers bridgeable by tactical bridging or passable with swimming or fording vehicles. See FM 31-60. For

the passage of inland water obstacles unbridgeable by tactical bridging or impassable by swimming or fording vehicles, see paragraphs 401 through 406 and FM 31-12.

360. Types of Crossings

The types of crossings discussed in this paragraph are those special operations required when crossings of opportunity fail to materialize.

a. The hasty crossing is the crossing of an inland waterway using crossing means at hand or readily available without significant delay when the waterway is reached. It is a pre-planned operation which is conducted as a continuation of the operation which is underway (normally an attack). Although the crossing is termed hasty, detailed prior planning assures that fire support and crossing means are available to force commanders on arrival at the water obstacle. A hasty crossing is characterized by minimum loss of momentum at the water line, speed, surprise, minimum concentration of forces, and decentralization of control of specific crossing times for subordinate crossing forces. This type crossing is preferred by armor units. Hasty crossings are feasible when the crossing areas are lightly held by the enemy or are undefended and when mobile task forces are available to advance rapidly to the water line.

b. A deliberate crossing is the crossing of a waterway that requires extensive planning and detailed preparations. It is characterized by detailed planning to support a selected course of action, deliberate preparation, the employment of specialized equipment, delay at the water line to mass for breaching enemy defenses, and the clearance of the near shore of enemy. The deliberate crossing is conducted when a unit is moving from a defense of the water obstacle to an offensive posture, a hasty crossing is not feasible, or a hasty crossing is unsuccessful. Overall planning and coordination are performed at corps or higher levels. Tank units that are not involved in the initial assault are normally kept in reserve and pass through the crossing area after the far shore has been neutralized.

361. Nature of a Crossing Operation

Inland water crossing operations are different in many ways from other types of ground maneuvers. The primary differences are—

a. There is a greater requirement for special equipment and specially trained personnel.

b. Command and control of units are more difficult because of space, traffic, communication restrictions, and the involvement of units of many arms and services.

c. Ability to maneuver and deliver effective supporting fires may be restricted, particularly if amphibious vehicles and close support aircraft are not available or nuclear weapons are not employed.

d. Once forces and equipment are committed to the assault, withdrawal or deviation from the plan of action for the initial assault is extremely difficult.

e. The operation is more vulnerable to enemy air attack than most other ground maneuvers.

362. Crossing Means

All available means are used to cross the maximum number of troops and items of equipment in the shortest possible time. The means organic to armor units are the armored personnel carrier, the armored command and reconnaissance carrier, the armored reconnaissance/airborne assault vehicle, and the 155mm self-propelled howitzer, all of which

have a swimming capability; the main battle tank with appropriate kit has a deep fording capability; and aircraft. In addition, supporting engineers may furnish or construct such additional crossing means as rafts, ferries, bridges, mobile assault bridges, and assault boats. Amphibious vehicles and aircraft may supplement the carrying capacity of rafts and bridges by transporting high priority items.

363. Timing of the Crossing

The decision to cross in daylight or darkness depends on the need for concealment, state of training of troops, nature of the terrain, characteristics of the water obstacle, enemy disposition and capabilities (use of minefields on far bank, capability to mount air and/or tank attacks) and the need for speed. Specific actions that must be timed carefully to insure the success of the crossing are—

a. Movement of assaulting troops into attack positions as required.

b. Movement of reserve elements into assembly areas.

c. Movement of engineer assault crossing craft and bridging equipment into equipment parks.

d. Establishment of forward dumps of ammunition, gasoline, and high priority supplies.

e. Use of smoke (if required).

f. Feints, demonstrations, and other deceptive measures.

g. Preparatory fires.

h. Artificial illumination (if required).

i. Loading and departure of transport aircraft.

364. Desirable Crossing Site Characteristics

In the selection of crossing fronts, crossing areas, and crossing sites, both the technical and tactical requirements must be considered and evaluated. The crossing should be planned on a wide front with several attacks at separated localities to deny the defender the capability of massing his fires or his counterattack on more than one of these localities. The following desirable site characteristics are sought in river-crossing operations:

a. Assault crossing site should include—

(1) A shoreline held lightly or undefended by the enemy.

- (2) Ready access to a good avenue of approach to objectives on the far shore.
- (3) Dominating ground on near shore for artillery observation and for support by direct fire.
- (4) In nonnuclear war, a bend in the water toward the attacker (reentrant) of such size and configuration that it favors the concentration of the crossing (assaulting) force and denies the enemy effective direct fire on the crossing site. Such configuration assists in denial of the far bank to the enemy by conventional direct and indirect supporting fires.
- (5) Covered approaches to the river.
- (6) Existing routes leading to sites capable of handling vehicular traffic or easily constructed access routes from existing road net to the site.
- (7) Moderate current.
- (8) Unobstructed water area.
- (9) Suitable banks requiring minimum preparation for entry and exit of amphibious and fording vehicles.
- (10) Straight stretch of river avoiding sharp bends where current is accelerated (if situation described in (4) above is not available).
- (11) An area suitable for a raft site.
- (12) Bed composition and water depth that will permit deep water fording.
- (13) Landing zones on near and far bank adequate for airmobile operations if required.

b. In addition to the above characteristics, the following characteristics are also desired for the type site indicated:

- (1) Amphibious vehicle crossing site.
 - (a) Stream current less than the water speed of the vehicle (0 to 1.5 meters per second).
 - (b) Gentle gradient with a firm bottom for entering and leaving the water.
 - (c) Landing places wide enough to allow vehicles to land even though subjected to the lateral force of the stream current.

- (2) Raft or ferry sites.
 - (a) Short, easily constructed, access and egress roads from existing road net to and from the site.
 - (b) A gentle current near each bank.
 - (c) Streambed free from ledges, rocks, shoals, islands, sandbars, and other obstructions that would prevent or hinder crossings.
 - (d) Banks not so high or steep as to require excessive grading for approach. The water close to the bank should be deep enough to float a loaded raft or ferry without grounding.
 - (e) Cover and concealment on both shores for vehicles or personnel waiting to be loaded or unloaded.
- (3) *Floating bridge.*
 - (a) Short, easily constructed approach roads to existing road nets on both shores.
 - (b) Firm stream banks.
 - (c) Moderate stream current generally parallel to the banks (0 to 1.5 meters per second).
 - (d) Stream bottoms in which anchors will hold but not foul.

365. Preliminary Selection of Crossing Areas

Unless a quickly repairable or intact bridge is opportunely seized, crossing areas must be reconnoitered and selected. During the advance, it is usually not feasible to determine the exact location of each crossing site. Nevertheless, during planning stages, information pertinent to the general crossing areas is collected and analyzed to determine likely crossing sites and to guide further reconnaissance. Available sources of information include—

- a. Maps, charts, and hydrographic information developed at division and higher headquarters.
- b. Prisoners of war, line crossers, and captured documents.
- c. Local inhabitants and friendly irregular forces.
- d. Long range reconnaissance patrols and aerial reconnaissance.
- e. Terrain studies (both civil and military).

366. Reconnaissance of Crossing Sites

a. General. In general, the purpose of on-site reconnaissance is to locate, report, and mark suitable crossing sites. This includes determining the amount and type of enemy resistance; determining information concerning those items appropriate to the site as enumerated in paragraph 364; accomplishing the marking of approaches and crossing sites with flags, engineer tape, ropes, and buoys; and the inspection of captured bridges and abutments for immediate use and for mines or demolitions. On-site reconnaissance may be conducted under enemy observation and fire; therefore, speed is essential to avert casualties and to avoid divulgence of the operational plan to the enemy. Information obtained by reconnaissance parties is reported to the commander as quickly as possible. Based on the information received, crossing plans are changed as required. Final selection of the actual crossing sites is based on the desired characteristics of crossing sites as listed in paragraph 364, the tactical situation, and the analysis of information collected by all reconnaissance means.

b. Reconnaissance Means. A map reconnaissance reveals only the superficial character of the water obstacle. Up-to-date aerial reconnaissance and photography, radar observations, and infrared imagery provide armor unit commanders with information of shorelines and crossing conditions. The photogrammetry method of interpretation of aerial and infrared photography may reveal soil type in banks, approaches, and streambed; approximate current velocity and depth; possible shallow fording sites and submerged obstacles; and areas where favorable bank gradients are to be found. Most important to the armor unit commander, however, is the result of on-site physical reconnaissance with respect to entrances and exits, stream velocities, streambed conditions, and depths for vehicle swimming and fording operations.

c. Reconnaissance Personnel.

- (1) Personnel conducting on-site reconnaissance missions will be briefed by intelligence staff members and guided by the essential elements of information (EEI) which is a part of the operation order.

- (2) Reconnaissance will be performed by organic scout sections of armor units. Because of the complex nature of water crossings, it will be normal for engineers to supplement armor unit reconnaissance teams. If insufficient reconnaissance personnel are present in the crossing area, additional teams should be immediately requested and transported to the area by the fastest available means.

- (3) When underwater reconnaissance is necessary to reconnoiter routes for fording armored vehicles, qualified personnel, trained in underwater techniques to include the determination of stream bottom characteristics and the recognition and marking of water obstacles, should be requested if not provided.

d. Reconnaissance at the Crossing Site. Reconnaissance at the crossing site determines the presence or conditions of the following:

- (1) *Obstacles.* Obstacles include—

- (a) Vertical banks.
- (b) Mines and boobytraps at entrance and exit sites. Mines in the channel attached to submerged and floating obstacles.
- (c) Debris and floating obstacles such as large quantities of logs and brush, floating poles with heavy wire attached for fouling propellers and suspension systems, and ice which may cause major damage to the conning towers of deep fording vehicles and may interfere with the track or trim vanes of an amphibious vehicle.

- (2) *Current.*

- (a) The maximum current in which amphibious vehicles can be operated safely depends on such factors as the choppiness of the water, the amount of debris or ice in the water, and the maximum acceptable drift distance. When the current is greater than 6.5 kilometers per hour, particular attention must be given to drift distance, balance

of load, entry into the water, and ability of drivers. A simple way to determine the speed of current is to use a floating device over a measured distance. Measure a distance of at least 30 meters along the near bank; designate the upper end as point A and the lower end point B. At point A throw any object that will float, such as a piece of wood or cork, into the fastest part of the current. Determine the time it takes the floating object to move from point A to point B (fig. 26). Dividing the distance in meters by the time in seconds gives the current speed in meters per second. For example, if it takes 20 seconds for the object to float 30 meters, the speed of the current is 1.5 meters per second. This must then be converted to kilometers per hour by multiplying meters per second by 3.6. At least two tests should be made, the average time being used to determine

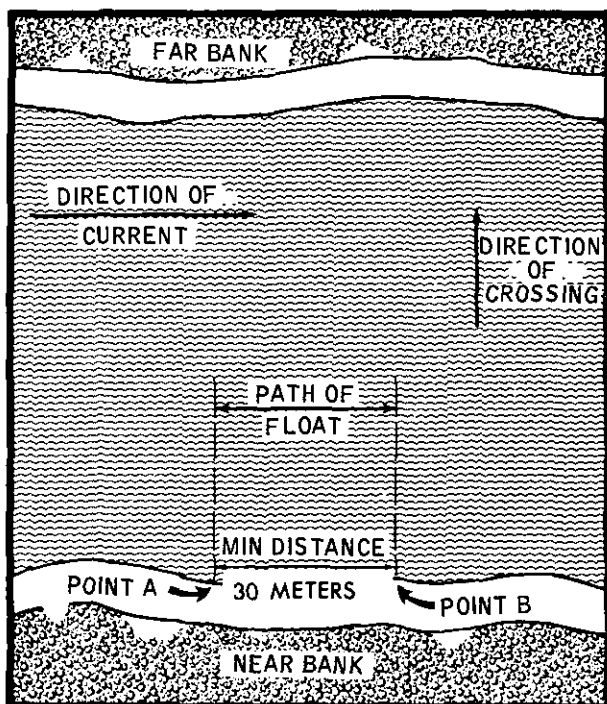

Figure 26. Float timing device over a measured distance.

the speed of the current in meters per second.

- (b) A sluggish stream or river may become a torrent in a few hours or even minutes as a result of sudden heavy rainfall. This is more likely to happen in tropical and arid regions. Currents must be checked at frequent intervals to provide warning of such changes.
 - (c) Currents may vary in different parts of a stream. The current is usually slowest near the shore and fastest in the main channel, slower where the stream widens, and faster where it narrows.
- (3) *Entrances and exits.*

- (a) Gently sloping entrances and exits are desirable for inland water crossing. The most common way to express slope is in percent (fig. 27). Thus, a 1 percent slope rises or descends 1 unit in a horizontal distance of 100 units; a 10 percent slope rises or descends 10 feet in 100 feet, or 10 meters in 100 meters. The formula for percent slope is—

$$\frac{\text{Vertical Distance}}{\text{Horizontal Distance}}$$

$$\times 100 = \text{Slope in Percent}$$

(Note: Distances must be in same units of measure.)

- (b) Vehicle characteristics must be considered during the reconnaissance to select entrances and exits that may be negotiated. Characteristics of the M113, armored personnel carrier, and the M114, armored command and reconnaissance vehicle, are as follows:

1. For known gradual slopes, the

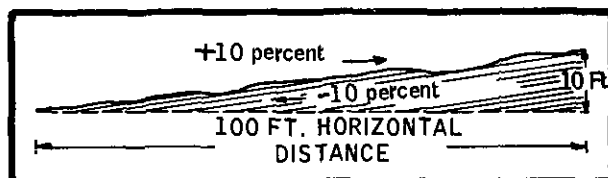

Figure 27. Expression of percent of slope.

- M113 enters the water slowly (approximately three kilometers per hour). When the slope is steep (over 20 percent), the underwater slope is not known, or the river is bordered by *low* vertical banks, the M113 makes safe entries up to 18 KMPH. Vertical banks must be approached rapidly enough to permit jumping the vehicle overboard. The water must be deep enough to float the vehicle (to prevent damage to suspension system), and it must be surveyed for obstacles both above and below the water line. For entries where there is doubt as to the configuration of the underwater slope, the rapid entry is safest to prevent possible swamping of the vehicle. When the M113 enters it may go under completely, but it will come up immediately (provided the trim vane is secure and all other conditions for swimming have been checked) whereas slow entry off a similar slope may cause the vehicle to take too much water through the engine compartment grills.
2. The M113 can leave the water or banks with average traction up a slope of 30 percent. Under better tractive conditions, higher slopes are negotiable. The number of vehicles that can go up the 30 percent bank at the same location depends on vegetation, gravel content of soil, and whether track pads have been removed.
 3. The M114 can make safe entries up to 32 kilometers per hour. A rapid entry is the safest way to

enter deep water when the bank slopes steeply below the water line. This vehicle normally does not submerge completely when entering the water, although water may splash over all of it. The best entry speed is about 12 kilometers per hour.

4. The M114 leaves the water in the same manner as the M113; however, it will not negotiate as steep a slope as the M113. It does not have as an efficient angle of approach.
 5. Vehicle maximum grade capabilities are found in TM 9-500; however, the composition and condition of the soil at the entrances and exits may reduce these capabilities.
- (4) *Determining landing point on the far bank for armored amphibious vehicles.*
- (a) For stream flow velocities less than three kilometers per hour, the swimming vehicles may go straight across. For water flow velocities exceeding three kilometers per hour and less than six kilometers per hour, the vehicle will drift downstream with the current.
 - (b) When the speed of the current and the water speed of the vehicle are the same, the vehicle drifts downstream one meter for each meter it moves forward. When the speed of the current is twice that of the vehicle, the carrier moves two meters downstream for each meter it moves forward.
 - (c) A simple formula for estimating the landing point on the far bank is—

$$\frac{\text{STREAM VELOCITY (KMPH)}}{\text{WATER SPEED OF VEHICLE (KMPH)}} \times \text{DISTANCE ACROSS THE WATER (METERS)} = \text{DISTANCE OF DOWNSTREAM DRIFT (METERS)}$$

For example, in theory a vehicle traveling at six kilometers per hour in a stream that has a current speed of six kilometers per hour and is 100 meters across will land 100 meters downstream from the point where it entered the water. Since there is an unknown component of the vehicle speed moving the vehicle, the landing point will be *more* than 100 meters downstream (fig. 28). This formula gives a rough estimate of the landing point. An additional distance downstream will always be required because of the downstream component of the vehicle's speed (in addition to stream speed), consequently, the only satisfactory means to determine the exact landing point is a trial crossing.

- (d) Maximum water speeds of vehicles are found in appropriate operator and technical manuals.

(5) *Streambed and depth.* For fording operations, the depth of the water obstacle and the bottom conditions must be determined. Field expedients are used for determining depths since there are no mechanical devices organic to armor units. These include measured poles, weighted measured ropes, and similar devices. Depth readings should be taken every nine feet. Bottom conditions are determined by getting into the water and checking the stability and composition of the bed. If the water is shallow, this can be accomplished by wading across the obstacle. In deeper water, underwater reconnaissance personnel or other means will have to be used to determine bottom conditions.

e. *Underwater Reconnaissance.*

- (1) If underwater reconnaissance personnel are provided, they are utilized to

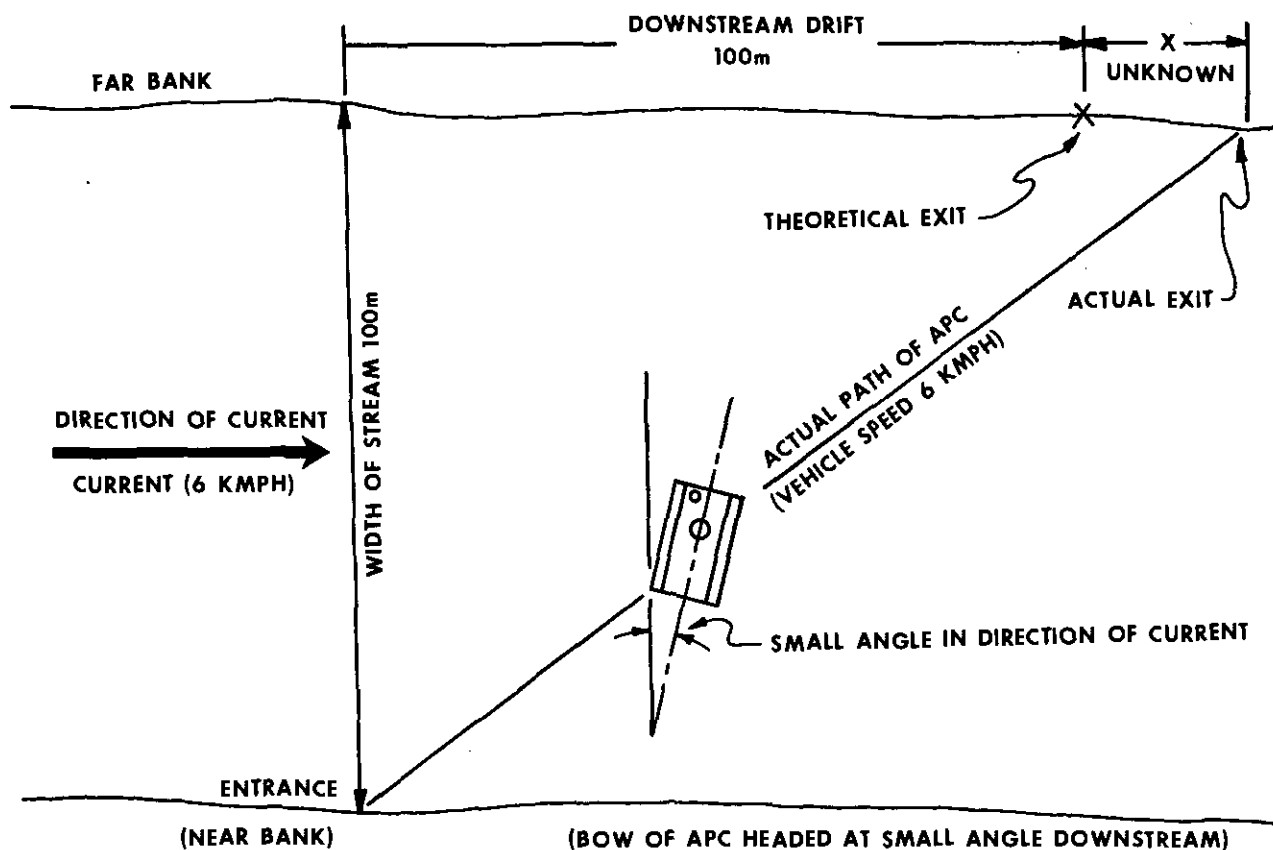

Figure 28. Downstream drift in a stream crossing.

select, reconnoiter, mark, and assist in the improvement of fording sites for deep fording operations. Underwater reconnaissance teams are usually formed and may include organic personnel and those from supporting engineer units. Subsequent paragraphs provide guidance for the employment of underwater reconnaissance personnel when they are provided.

- (2) When the water obstacle is narrow, underwater reconnaissance personnel may enter from the near bank and conduct their reconnaissance by swimming to the far bank. When the distance between banks will not permit this, M114's M113's will enter the water when an entrance has been selected and drop teams off at regular intervals. Vehicles will remain in the water during reconnaissance and pick up swimmers when the operation is completed unless the area is under enemy fire. If the area is under heavy fire, divers will swim to the friendly shore or, if on the far side of a wide obstacle, they will signal when ready to be picked up. To reduce the possibility of injury, swimmers are remounted over the front slope with the vehicle tracks locked.
- (3) To assist the underwater reconnaissance team in maintaining direction, weighted ropes can be placed across the bottom of the water obstacle. Buoys or other floating obstacles are attached to these ropes to indicate the area of responsibility of each team. Where the current is in excess of about 1.3 meters per second, underwater reconnaissance personnel will have difficulty maintaining a position along the line selected. Another weighted rope, parallel to the directional rope, is placed upstream with lines connecting these ropes to assist the swimmer.
- (4) During periods of good visibility and when the water is clear, bottom conditions can be easily determined. Arti-

ficial light may be used to reconnoiter the bottom. Searchlights and flares can be used in addition to waterproof lights used by the swimmers. In absolute darkness, or when the water is murky, reconnaissance is much slower since swimmers must swim to the bottom, feeling their way across.

- (5) The length of time that underwater reconnaissance personnel can remain in the water will depend on the current, water temperature, and equipment. When conducting a reconnaissance in any current, the swimmer will expend more energy, tire more easily, and use his air supply quicker than when working in calm water. In water temperatures between 70 and 85° F, divers can work comfortably in their underwear but will chill in one to two hours while resting in water. In temperatures above 85° F, the diver will overheat and the maximum temperature that can be endured, even at rest, is 96° F. Protection is usually needed when the water temperature is below 70° F, and in cold water, sense of touch and ability to use the hands are affected. Air tanks vary in size. The size used and the working conditions will govern how long a person can operate on a set of air tanks. Extra tanks should be readily available to the underwater reconnaissance teams; and when tanks are emptied, they should be immediately recharged. Recharging equipment should be located so as to be responsive to team requirements.

367. Conduct of Inland Water Crossings

a. General. During the movement to the water obstacle, the armor unit commander deploys his force with the necessary means readily available for the anticipated crossing. He advances on a broad front as rapidly as possible in an attempt to seize bridges intact before the enemy can destroy them. This is the most economical means of crossing a water obstacle and should be attempted whenever possible.

The advance guard will clear the near bank of defending or delaying enemy elements. Additionally, as a part of the advance guard, armor reconnaissance personnel and, when available, engineer reconnaissance personnel will immediately commence reconnaissance of the crossing area. Air cavalry units may be used in conjunction with surface operations to great advantage. Simultaneously, air landed units on the far shore may neutralize enemy defenses. Supporting engineers and river crossing equipment (to include AVLB's) as well as supporting fires should be so located in the column to provide rapid response to assist in bridge repair or crossings. Often, a partly demolished bridge can be repaired quickly by supporting engineers or by the emplacement of AVLB's across demolished spans.

b. Conduct of Physical Reconnaissance.

- (1) The physical reconnaissance and selection of crossing sites begin as soon as the near bank has been secured. Air cavalry, artillery and tank fires, and smoke are employed to prevent the enemy on the far bank from firing on friendly troops in the crossing area.
- (2) If the situation permits and there are sufficient personnel, entrance, underwater, and exit reconnaissance are conducted simultaneously. Reconnaissance teams report applicable items shown in paragraphs 364 and 366. In addition, an estimate of work required to improve the water obstacle banks is reported. Water obstacle banks can often be improved by use of pioneer tools, bulldozers, combat engineer vehicles, and tank dozers. Small underwater obstacles can also be removed by tank dozers or combat engineer vehicles. Corduroying (laying logs) can improve entrances and exits. When engineer reconnaissance personnel have determined that they cannot remove or destroy obstacles or minefields, or if the banks require improvement, supporting engineer personnel may be airlifted into the area to assist them. If supporting personnel are not immediately available, it

may be necessary to change the order of crossing or select a different crossing site.

- (3) Based on the information obtained from reconnaissance, the officer in charge selects entrances, lanes, and exits and has them marked in accordance with the unit SOP. Entrances and exits can be marked with flags, engineer tape, poles, or luminous markers. Crossing lanes can be marked with any floating object that is moored and easily identifiable. These include buoys, plastic inflatable markers, painted canteens, and wooden blocks.

c. Precrossing Considerations. While reconnaissance is being conducted, the crossing units prepare equipment for crossing. The armor unit commander selects an assembly area where equipment is checked before entering the water. This area should afford protection from observation from the far bank. Where deep fording is possible, consideration must be given to routes from this area to the crossing site for tanks that have the underwater fording kit installed. These routes must be free of obstacles that will restrict movement or damage fording kits. The commander must determine the position of the gun tube during deep fording. This will be based on the urgency of delivering fire upon emerging from the water. When the gun tube is to the rear, there is less chance of damage by collision and the driver can more easily escape through the turret and conning tower in the event the tank is completely immobilized under water.

d. Movement to the Water. The movement to the water obstacle is so timed that the crossing unit does not pause on the friendly side but moves directly into the water. The total elapsed time between approach to the water obstacle and the crossing must be held to a minimum to insure success. Once started, the crossing is completed as rapidly as possible.

e. Formation and Priority of Crossing.

- (1) The mission, number of entrances and exits, and the number of vehicles to cross are the most important factors in determining the formation and priority for crossings. When the

water is shallow and has no obstacles, and when the banks permit, tanks will ford in a line formation. When deep fording is feasible, tanks will cross in platoon column formation—where possible, one platoon to a crossing site.

- (2) Crossing of amphibious vehicles should be accomplished in waves, preferably formed by platoon, each in line formation; echelon formation should be used where there is a current. In an echelon formation, the vehicles move out in successive order starting with the vehicle farthest downstream proceeding to the vehicle farthest upstream. This formation insures that upstream vehicles do not drift into downstream vehicles. When tanks and amphibious vehicles cross simultaneously, extreme caution must be taken to prevent collision. To avoid

collision, amphibious vehicles should cross downstream from tanks (fig. 29).

- (3) If the commander has been unable to place troops on the far bank during the reconnaissance phase, it may be necessary to move M114's and M113's to the far bank while the tanks provide direct fire support. Vehicular mounted weapons can be fired while swimming. If the M114's and M113's cannot exit because of steep banks, personnel can exit from the top hatch while the vehicle is held close to the bank. If conditions require that the driver operate the vehicle with his hatch closed, one man will remain with the vehicle to assist the driver in returning to the near shore. Dismounted personnel then continue the reconnaissance and improvement of exits. Additional personnel and equip-

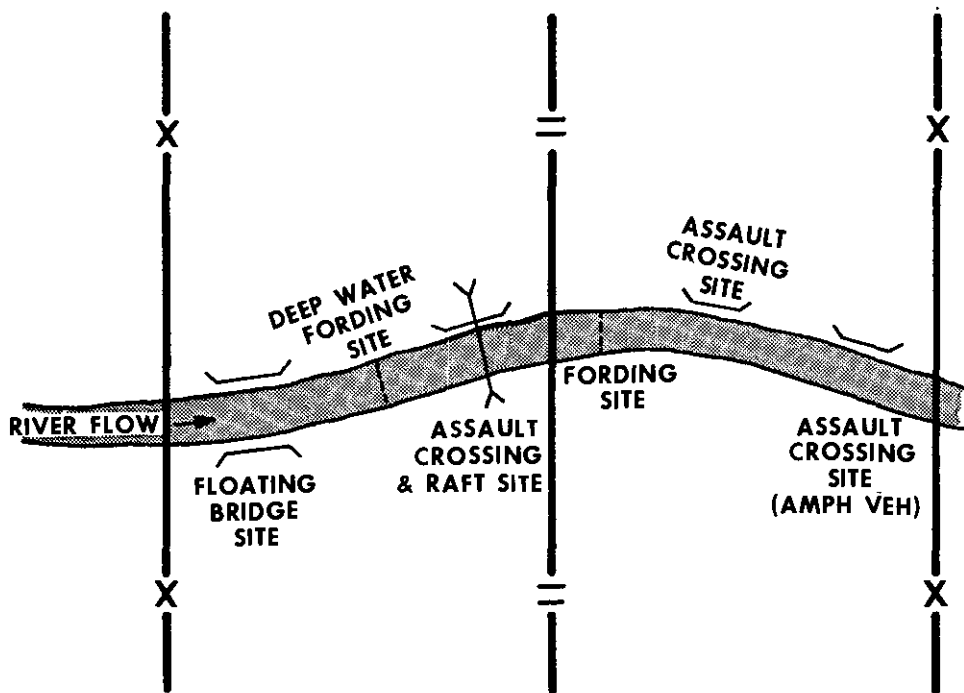

NOTE: SYMBOLS MAY BE USED IN COMBINATION TO DENOTE TYPE CROSSING SITE; SUCH AS  FOR AN ASSAULT CROSSING, A RAFT AND FLOATING BRIDGE SITE, OR  FOR AN ASSAULT CROSSING AND RAFT SITE.

Figure 29. Schematic of a brigade in a river crossing.

ment may be ferried by M113's to secure and expand the bridgehead. Air cavalry units and other aviation and airmobile units are utilized to assist in securing and expanding the bridgehead and ferrying personnel and equipment. When fording is not possible and when the necessary tactical amphibious vehicles of the unit cross the obstacle and the far shore is cleared of enemy small arms fire, bridges or rafts are erected and the remaining personnel and vehicles cross. Priority is given to tanks. Air defense weapons are moved across early in the operation to protect the expanding bridgehead from air attack.

- (4) Ferrying operations and amphibious vehicles that have to recross the water obstacle by swimming, as in the case of ambulances, messenger vehicles, and supply vehicles, will require entrances and exits for one-way passage. This will avoid traffic congestion and confusion created by oncoming vehicles at the original crossing sites. For traffic procedures that govern traffic of amphibious vehicles while waterborne, see paragraph 370.
- (5) Forces securing the near bank should be relieved as soon as possible and join their unit.
- (6) In nuclear warfare, overconcentration of troops in the bridgehead area must be avoided to avoid presenting a lucrative target.

f. Fire Support. Maximum fire support is brought to bear against known and suspected enemy positions on the far shore. Smoke is often employed, particularly on the flanks, to screen the reconnaissance and crossing. When tanks support by direct fire, arrangements must be made for control of fires. Extra ammunition must be made available to units to insure that they have a complete load when they cross. To increase and to extend the range of the firepower in the bridgehead, amphibious self-propelled mortars and artillery are crossed as soon as possible.

g. Expansion and Exploitation of a Bridgehead.

- (1) When units reach the far shore, the supporting fires should either be lifted or shifted to deeper targets.
- (2) Any bridgehead must be quickly expanded and secured to protect the crossing site and permit assembly of forces in the bridgehead area. The initial security and expansion of the bridgehead will be accomplished by units that have the capability of crossing rapidly with little or no preparation. Armored cavalry, air cavalry, airmobile forces, and mechanized infantry units have this capability. When planning crossing operations, commanders must consider the placement of these units in the formation.
- (3) The tactical situation will decide how far the units on the far shore will advance. Units must be prepared for enemy counterattacks or to continue the mission on order.

h. Limited visibility.

- (1) To achieve surprise or deception, it may be desirable to conduct crossings under blackout conditions. Such crossings differ from daylight crossings in that more stringent control and coordination are required to prevent overconcentration of vehicles at entrances and exits and to prevent accidents while crossing. The amount of natural light and availability of night vision devices must be considered when planning a blackout crossing.
- (2) During crossings at night or periods of limited visibility, entrances and exits must be marked by lights or other means that permit detection by the driver or vehicle commander. Reference points on the far shore must be readily identifiable or illuminated in some manner to assist in maintaining direction. Illumination aids may be vehicle lights, tank-mounted searchlights, flashlights, aiming post night lights, chemiluminescent compounds, and weapons fires. The devices used

will depend on the equipment available and the tactical situation. As an additional navigational aid, lighted or illuminated floating markers may be used to mark lanes. These markers may be locally fabricated or may be those described in FM 55-15. Aids used during night crossings must not affect the vision of the driver or vehicle commander.

i. Attachments. Armor units take advantage of their speed, mobility, and amphibious and deep fording capabilities to seize bridges intact or to force hasty crossings against light or poorly organized defenses, with or without the assistance of mechanized infantry and engineers. When attached, mechanized infantry and engineers closely follow the leading tanks. Engineers remove or neutralize any demolitions or mines found on bridges, on abutments or approaches, or at the crossing sites; and the mechanized infantry assist in seizing and defending the bridges or sites. Organic personnel, augmented by engineers when required, conduct the crossing reconnaissance. When a crossing site must be improved before tanks can cross, mechanized infantry may have to establish a bridgehead on the far bank to protect crossing operations.

j. Capabilities of Supporting Engineers.

- (1) Engineers can support the crossing operation by—
 - (a) Improving entrances and exits.
 - (b) Removing mines and obstacles.
 - (c) Conducting or assisting in underwater reconnaissance.
 - (d) Providing assault boats, rafts, ferries, and bridging.
- (2) In crossing operations, additional engineer support may be furnished by corps and army engineer units. This applies particularly in deliberate crossing operations.
- (3) The mobile assault bridge can be employed rapidly and will provide rafts or a floating bridge as required.
- (4) Bridging equipment may be fabricated in the rear area and delivered by aircraft to the work parties at the shoreline.

k. Crossings During Cold Weather.

- (1) Crossings during cold weather, especially under freezing conditions, are hazardous and time consuming. Conning towers, antennas, and waterproofing equipment are vulnerable to damage by heavy drifting ice; also bilge pumps and linkage systems may freeze. Rescue and recovery operations are more difficult. Safety of underwater reconnaissance personnel, when provided, receives additional attention during these crossings.
- (2) When ice thickness permits crossings of tanks and heavy vehicles, the river or lake is not an obstacle. However, a reconnaissance is necessary to determine that the ice will support vehicles that are to cross. The banks may require improvement to permit entrance and exit. Ice may be reinforced by adding timber treads or other load distributing devices. Data on carrying capacity of ice and intervals and distances between vehicles are found in TM's 21-306 and 5-349. Entrances, exits, and lanes are marked in accordance with unit SOP.
- (3) When ice conditions do not permit crossing by vehicles and there are no bridges or rafts available, clearing the ice may be quicker and more economical than reinforcing it. Personnel are placed on the far bank, by walking across the ice if thickness permits or by air vehicle, to secure the area and to reconnoiter and prepare exit sites. Reconnaissance personnel on the near bank select and prepare entrances and determine where to place explosives to clear lanes through the ice. When more than one lane is to be cleared, the distances between lanes must be sufficient to prevent the ice between lanes from drifting and closing other lanes or damaging vehicles. After blasting, M114's and M113's will move into the water to clear the lanes of loose and drifting ice. Amphibious vehicles should not be used to break ice as swamping may occur.

- (4) Warming tents must be provided for personnel, and if possible, for the waterproofing equipment. The equipment is more manageable when handled in a warming tent.
- (5) During the crossing, ruts will develop at entrances and exits and may require bulldozing. Consideration must be given to placing tank mounted dozers and combat engineer vehicles in the formation so that they will be available for this task. Upon exiting, waterproofing equipment and kits must be immediately removed to prevent their freezing in place and seriously hampering the operation of the vehicle. Ice will form on optical devices if they are not immediately cleaned. Steering linkage and engine compartments must be checked to insure that controls do not freeze.

l. Recovery.

- (1) During all water crossing operations that involve swimming or fording of vehicles, maintenance personnel and equipment should be located near the crossing site to assist in the recovery of stalled or sunken vehicles. This applies especially during crossings in cold weather. If a tank is completely immobilized and flooded while deep water fording, the crew will evacuate immediately. M113's and M114's can be used to pick up crews which have abandoned immobilized vehicles. The controls of the stalled tank will be placed in neutral before the driver evacuates. Recovery operations begin as soon as the tactical situation permits. When provided, underwater reconnaissance personnel may be used to attach cables to the stalled tank after which it is pulled or winched from the water. In all fording operations, preparation of fording vehicles for possible recovery is essential.
- (2) When available and the situation permits, engineer personnel in boats may be used during crossings to recover personnel and assist in the recovery

of vehicles. Helicopters also may be used to recover personnel.

- (3) If a swimming vehicle misses the landing area, the driver will attempt to bring it to shore as quickly as possible. If the vehicle cannot be landed, it should be evacuated. Helicopters can evacuate personnel while the vehicle is moving. Care must be exercised when using M113's or M114's as recovery vehicles. Control of the recovery vehicle is difficult and serious injuries or accidents may occur. It may be safer for personnel to get into the water before being picked up. Personnel should evacuate a vehicle from the upstream side to prevent the vehicle from drifting into them.

m. Control. To assist in the control of units during a crossing, crossing control officers are designated. They assist the commander in maintaining an uninterrupted, orderly movement into the water. Congestion must be avoided at entrances and exits. Should an exit become blocked or unusable, vehicles in the water will form a circle and continue to swim if stream velocity and water traffic conditions permit. Tanks will halt with engines running and brakes set. Each crossing unit will maintain contact with the crossing control officer.

n. Use of Radar. Radars placed on the near bank may determine the progress of friendly units on the far bank. During periods of limited visibility, or when smoke is used by friendly forces engaged in a crossing, radar may be used to detect enemy troop activity on the far bank including withdrawal, reinforcement, or shifting of units.

368. Employment of Tanks in Inland Water Crossing

a. General. In seizing a bridgehead and crossing a water obstacle, tanks participate usually as part of a combined arms team. The team advances with speed and violence, attempting to seize bridges intact and make a rapid crossing. The lack of bridges will not prevent tanks and attached infantry from making a crossing. With the inherent swim capability of M113's and the deep fording capability of tanks, armor and mechanized infantry

units need not wait for bridges or rafts to be constructed to cross water obstacles where suitable streambed, depth, current, and entry and exit conditions are available. As opposed to the bridging method for crossing, the swimming and fording methods have definite advantages of less time to prepare for the crossing and considerably less accompanying equipment to install or erect.

b. Movement to the Water Obstacle. The commander will determine the number of crossing sites required once a crossing area has been selected. The advance guard should be far enough in front of the main body so that it can report to the commander in sufficient time for him to determine whether the main body will be able to cross without stopping or if preparations are required which will necessitate moving into a precrossing assembly area.

c. Reconnaissance. When the tactical situation permits or as soon as the near bank is secure, entrance and water reconnaissance begin. The number of crossing sites desired or the difficulty of the area may require attachment of additional personnel to augment the underwater reconnaissance capability of the unit that is designated to secure the near bank and conduct the reconnaissance. Personnel are placed on the far bank as soon as possible to secure it and conduct the exit reconnaissance. Tank elements of the advance guard support the operation by direct fire. Entrances, lanes, and exits are marked in accordance with the unit SOP.

d. Crossing.

- (1) When reconnaissance has determined that tanks can cross the water without preparation, units will not halt but will move into and across the water, secure the bridgehead, and be prepared to continue the mission.
- (2) When deep water fording preparations are required, the units will move into a preparation assembly area. Once preparations have been completed, units move from the area to the crossing site without stopping. The crossing is completed as quickly as possible. Fording equipment that will hamper operations of vehicles is re-

moved immediately. The first units crossing will jettison conning towers and continue their mission. This equipment will be recovered, disassembled, and stored in the bridgehead by designated supporting personnel and returned to the unit on the first available transportation. Subsequent units will remove and disassemble fording equipment and secure it to the vehicles. Once the bridgehead is secured, units that supported the operation by direct fire begin preparations for crossing and cross as soon as possible. The assault unit then continues its mission. Forces left to secure the bridgehead area must be relieved as soon as possible and join their units.

e. Fire Support. All available fire support is used against known and suspected enemy positions on the far shore. Fires are lifted or shifted as the bridgehead is expanded. This includes direct fires provided by tanks. When tanks are employed in a direct fire role, they must be supplied with ammunition in excess of their normal load so that when they cross the water obstacle they will have a full load of ammunition. Supporting artillery and mortars that are capable of being airlifted or swimming displace to the far bank as soon as the bridgehead has been expanded and the crossing unit is capable of continuing the mission. Air defense artillery units will support the crossing operation by protecting the crossing site from air attack and by providing continuous air defense to the expanding bridgehead. ADA units attached to armor units must be prepared to continue the attack beyond the bridgehead when ordered.

f. Other Support. Air cavalry units will support the crossing operation by placing personnel on the far shore to reconnoiter and secure crossing sites. They will also provide fire support against positions on the far shore or against deeper targets that can affect the crossing. During the securing and expansion of the bridgehead, they extend the reconnaissance means of the ground unit and take under fire enemy units forming for a counterattack.

369. Employment of Armored Cavalry in Inland Water Crossing

a. Armored cavalry units are well suited for inland water crossing operations since all organic combat vehicles are capable of swimming or fording, and the units have an organic air capability of rapidly placing ground troops on the far bank. However, to assist the swimming and fording capabilities of these units, underwater reconnaissance personnel should be made available.

b. Once a crossing area has been selected, the commander will determine the number of crossing sites. Leading units in the approach to the water obstacle determine enemy strength and dispositions and locate crossing sites. The initial objective is to eliminate enemy emplacements which are defending the near bank. When available, underwater reconnaissance personnel will be part of the force used in the approach to the water obstacle.

c. Against lightly or poorly defended water obstacles, rifle squads and air cavalry units will move across the obstacle and secure the far shore. Air cavalry units will first concentrate on the enemy on the far shore and then shift to deeper targets which might affect the bridgehead. Tanks and AR/AAV's will support the reconnaissance and bridgehead operations by direct fire. If tanks require fording kits, installation will be accomplished in an area that affords protection from observation on the far bank. Routes from this area to the crossing sites must be free of obstacles that will damage the fording kits. Organic and supporting artillery will support the operations by indirect fire engaging targets on the far shore and shifting to deeper targets as the bridgehead is secured and expanded. Artillery positions are located as far forward as possible to exploit the range of the weapons; however, they must not interfere with the movement of units conducting the crossing. Direct support artillery will begin to displace to the far bank as soon as the assault units have eliminated resistance in the bridgehead and have occupied positions that will deny the enemy direct fire on the crossing area. Displacement will be by echelon to insure continuous support. The size of the supporting unit and number of crossing sites will determine the size unit that will displace. Once

crossed, direct support artillery will occupy positions that provide the assault force with maximum fire support for continuing the mission.

d. When the water obstacle is not defended and is capable of being crossed with little or no site or vehicular preparation, the formation need not be changed and the unit can move rapidly into the water, cross the obstacle, and continue the mission without loss of momentum. Armored cavalry units with organic or attached main battle tank units leading the formation need not halt at a water obstacle that requires installation of kits before fording. Armored cavalry troops should pass through the tank units, cross the water obstacle, secure the bridgehead and continue the forward movement while tanks are preparing for deep water fording. If, after crossing, enemy resistance prevents the armored cavalry units from advancing, the cavalry elements secure the bridgehead and wait for the tank units to complete their crossing, move forward, reduce the resistance, and continue the advance. While waiting for the tanks to complete their crossing, every effort must be made to destroy the enemy and continue the advance. This includes using organic and supporting mortar and artillery fires and air cavalry units.

370. Waterborne Driving Procedures for Armored Amphibious Vehicles

a. When armored amphibious vehicles have to be driven slowly into the water (less than 8 KMPH) because of obstacles, the driver must be prepared to accelerate the engine rapidly if the front end of the vehicle should suddenly enter deep water.

b. When exiting from the water, the vehicle should start up the bank at a constant speed never allowing excessive track slippage. Once traction is lost, the tracks will dig in and the vehicle will stall or the vehicle will slide in the water.

c. All swimming vehicles should avoid obstacles in the water where possible. When encountering an obstruction, the engine speed should be reduced quickly and both steering brakes applied. The driver should back off the obstacle rather than attempt to cross over it. When clear, the vehicle is allowed to drift below the

obstacle, forward power is applied, and the vehicle continues to cross.

d. To minimize the danger of capsizing when a vehicle encounters an obstacle broadside while drifting, the driver should turn the nose of the vehicle slightly in the direction that the water flows (fig. 28). This will cause the vehicle to slide by such obstacles or strike the obstacle with the front of the vehicle.

e. When it is evident that an M113 or M114 is sinking, all hatches should be opened and the crew *should move to the top of the vehicle*. The driver should attempt to complete the crossing since a vehicle underway may complete the crossing or be close enough to the bank to easily recover. The crew should abandon the vehicle prior to its sinking since the vehicle *does not* provide an air pocket to breathe in after it sinks. Escape by an entire rifle squad from an M113 under these conditions is unlikely.

f. To avoid collisions, the following procedures will govern amphibious vehicles while waterborne.

- (1) When two vehicles approach each other head on, each should turn to the right and pass the other vehicle on its left side. The turn should be started soon enough for each driver to be sure of what the other intends to do.
- (2) When one vehicle overtakes another (this is not normal, but may happen when one vehicle is having trouble), it may pass the slower vehicle on either side, provided there is ample space. However, the vehicle being overtaken has the right of way. The passing vehicle should cross the wake of the overtaken vehicle at any angle of at least 45 degrees and should be sure to provide ample passing space.

Section IX. OPERATIONS IN FORTIFIED POSITIONS

371. Attack Against Fortified Positions

a. *General.* The attack of a fortified area is made by a combined-arms assault force consisting of tanks, mechanized infantry, field artillery, engineers, air cavalry, and tactical air when available. Special items of equipment and ammunition may be required. FM 31-50 covers in detail the attack of fortifications.

b. *Planning of Attack.*

(1) *Reconnaissance of fortified positions.*

A thorough estimate of the situation and detailed plans and orders are essential in an attack against a fortified position. The estimate is based on an extensive reconnaissance. The reconnaissance starts with a preliminary map and airphoto study, after which all commanders make extensive personal reconnaissance. Observation posts, patrols, interrogation of civilians, tactical air, and army aircraft are used to gain information. The reconnaissance seeks information on—

- (a) Location of fortifications, such as pillboxes.
- (b) Location of obstacles, such as minefields, wire, and trenches.

(c) Details of fortifications—embrasures, thickness of concrete and steel, entrances and exits, and underground organization.

(d) Location and type of enemy weapons.

(e) Defiladed approaches to the position.

(f) Positions from which direct-fire support can be furnished to the assaulting force.

(2) *Organization of the assault teams.*

The assault teams are normally built around mechanized rifle platoons with tanks supporting each team. The assault team is divided normally into one or two flank groups as needed, an assault group, and a support group. Each group may have tanks in support. Each man and each vehicle on the team is given a special mission to perform. The teams must be allowed as much time as possible for rehearsals and reconnaissance. Normally, each team is assigned only one pillbox, bunker, or similar fortification at a time.

(3) *Employment of tanks against fortifications.* The tanks normally provide direct-fire support to the assault teams. They fire at embrasure openings and attempt to destroy the fortification. Tanks usually follow other elements of the team but must be close enough to give direct support at all times. Tanks not attached to an assault team may give additional fire support from hull-defilade positions.

(4) *Employment of flamethrowers against fortifications.* Both portable and mechanized flamethrowers may be used in the assault teams. The flamethrower is an effective weapon for the last-minute, close-in protection of men placing breaching charges and for mopping up the fortification after it has been breached.

(5) *Use of smoke against fortifications.* Smoke may be used to screen the entire front, to cover the movement of troops into position, to screen one or both flanks of a gap created by unequal advance of units, to screen an area outside of the immediate action, or to obscure observation posts and fortifications that cannot be neutralized by other weapons. Though the attack may be made during darkness, smoke may be valuable to counter the possible enemy use of illuminating flares and shells. The use of smoke must be coordinated to insure that it will not interfere with the need for direct fire on fortifications and for ground observation by the assault teams. If conditions are at all favorable, every effort should be made to observe fortifications that can support those being attacked.

(6) *Orders for attack on fortifications.* Orders for an attack on a fortified position normally are issued in great detail. The attack on each bunker and defensive work is planned individually and is coordinated with attacks on adjacent fortifications. The order includes detailed instructions to each assault team, including positions,

routes to be followed, time to open fire, types of fire to be used, areas in which teams may fire, and the general conduct and action of each team.

(7) *Use of tank dozers and combat engineer vehicles (CEV's).* In the initial phase of the attack, the tank dozer or CEV may be used to assist in reducing obstacles. As soon as the assault team closes on the fortification, the tank dozers or CEV's are moved forward to be available to cover the openings of the fortification with dirt. This is an effective way of immobilizing any enemy troops who refuse to surrender.

(8) *Artillery assault fire.* When the usual direct-fire means and supporting fires cannot neutralize an enemy fortification, self-propelled medium or heavy artillery may be used in an assault fire role.

(9) *Use of nuclear weapons.* Extensively fortified areas present a difficult target for destruction by nuclear weapons. By careful selection of weapons and height of burst, however, severe damage can be created to permit exploitation by armor units without causing an unacceptable hazard from radioactive fallout.

c. Conduct of the Attack of Fortifications.

(1) The attack usually starts with intense artillery fire and with the laying of a smoke screen if conditions are favorable. Air bombardment of the fortifications is also desirable. While the artillery is firing, routes are cleared of antipersonnel mines by use of grapnels or other means. Demolition snakes may be used to clear antitank mines. When paths have been cleared, the assault teams move forward as rapidly as possible (fig. 30) under the cover of supporting fires.

(2) The flank groups direct their fire at any open emplacement on the flanks of the fortification. The tanks and machineguns of all groups fire at embrasures to keep them closed. If the

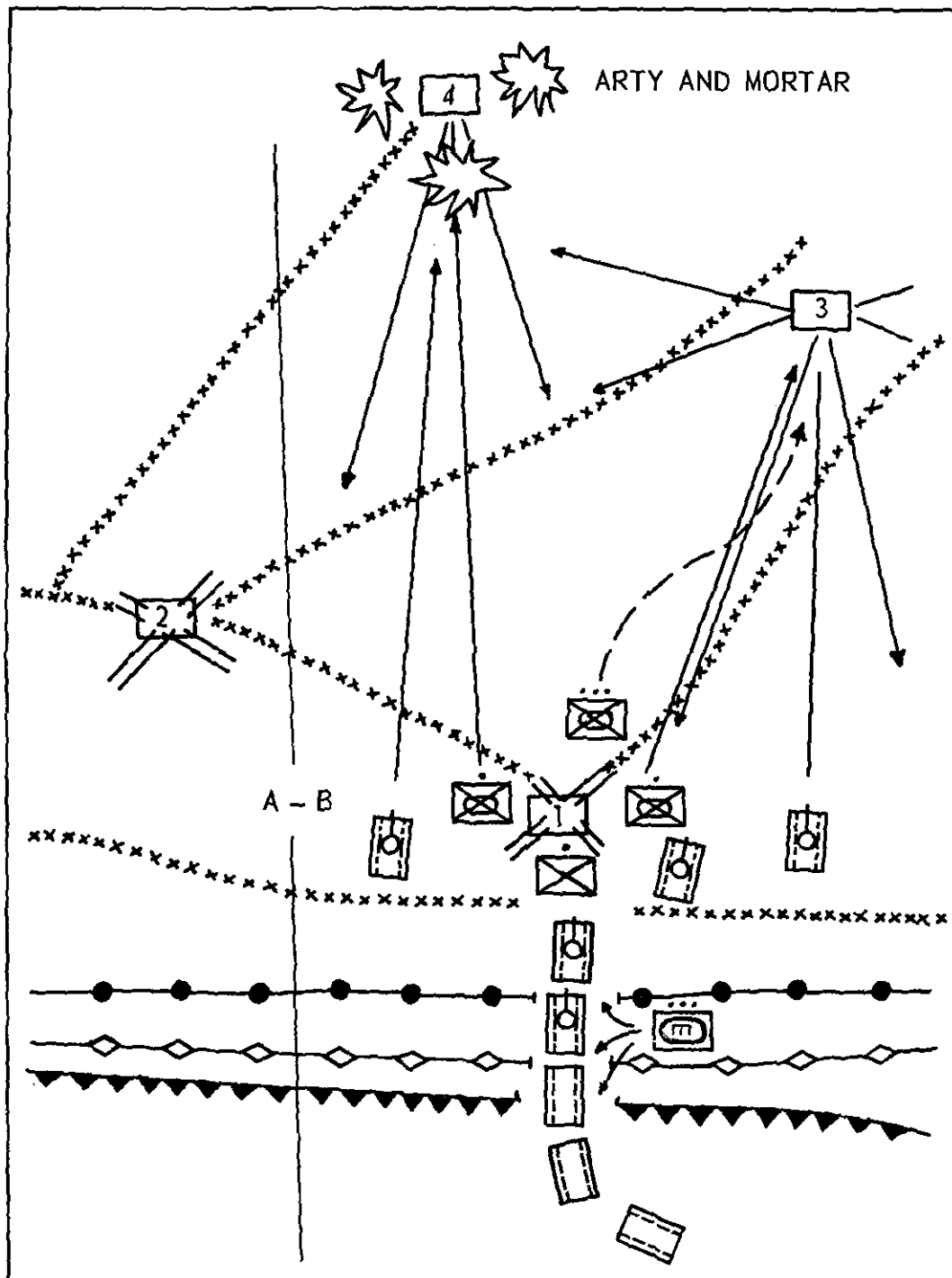

Figure 30. Assault of the objective.

fortification is protected by wire, a path through the wire must be made by wire-cutting parties, by tanks, or by bangalore torpedoes. If possible, the assault group advances over

ground not covered by fire from the embrasures. The tank guns cease fire on signal of the assault team commander; and the machineguns, both tank and ground, cease fire when

masked. Fire from the antitank rockets and flamethrowers, directed against embrasures, may be used by the assault group to assist in covering the advance of a demolition party at close range. Upon breaching the fortification, the assault group rushes the emplacement and, with hand grenades and portable flamethrowers, overcomes all enemy resistance. Flank and support groups move up and cover the reorganization of the team.

- (3) During the mopup stage, tanks are prepared to fire on probable avenues of enemy counterattacks. Tanks that

have been supporting the attack by fire are moved forward to assist. Fresh teams are moved forward quickly to continue the attack without delay, and the process of deepening and widening the breach is continued.

372. Defense of a Fortified Position

Tanks are normally a part of the reserve for employment in counterattacks. However, when numerous armor approaches exist, tanks may be attached to forward defense units to cover critical avenues of approach from defilade positions. See FM 31-50 for details of the defense of fortified positions.

Section X. OPERATIONS IN BUILT-UP AREAS

373. General

Armor units normally bypass built-up areas because combat operations are characterized by house-to-house fighting, restricted observation and fields of fire, restricted maneuver space for armored vehicles, and extreme difficulty of control and coordination. As a result, combat in such areas consists of a series of small, predominantly mechanized infantry-heavy actions (FM 31-50).

374. Tactical Considerations

Basic tactical doctrine and fundamentals for operations in built-up areas are essentially the same as those prescribed in previous chapters, in FM 31-50, and in FM 100-5. The nature of the environment reduces the speed with which armor units normally conduct operations. Planning must be in great detail and troops must be briefed carefully. The following factors must be considered in establishing the tactical procedures and techniques for this type of operation.

a. Characteristics of City Fighting Favorable to the Defender.

- (1) A well-organized and determined force located in the confines of a built-up area can hold off a superior attacking force for long periods of time. Strongly constructed cities give the defender a decided advantage over the attacker in that each building or group of buildings is a poten-

tial strongpoint. By additional construction, use of barricades, booby-trapping of areas in the buildings, and other means available to the defender, the buildings selected for defense become potential fortresses.

- (2) The defender can select positions that maintain observation and fires on the approaches into the city.
- (3) The defender has a choice of buildings to defend. These buildings also provide cover and concealment. The attacker must determine which buildings are being defended and which are not. Adequate underground cover is usually available to the defender and gives him some protection against air and artillery bombardment.
- (4) Streets and alleys allow movement and constitute ready-made fire lanes and killing zones. Streets and alleys can be blocked easily by mines, booby-traps, barricades, and other obstacles. The attacking troops, by the nature of the area through which the attack must be conducted, will find their movement restricted and canalized.
- (5) The attacker will be limited in the employment of indirect-fire weapons because of restricted observation in the area and the nearness of his own troops to enemy targets. Employment

of direct-fire weapons is subjected to limited fields of fire.

b. Characteristics of City Fighting Favorable to the Attacker.

- (1) The attacker has the advantage of maneuver in isolating the city to be seized. Once the isolation of the city has been completed, the attacker is in a position either to press the attack on the city or to contain it and force the defender eventually to capitulate.
- (2) Once the city has been isolated, the attacker may select his point of entry into the city. The attack may be conducted from any direction(s).
- (3) The attacker may be able to bypass strongly defended buildings in the city by going under them, using cellars, sewers, subways, or other underground passages. Other strongly held defensive positions may be bypassed by attacking over the roofs of the buildings.

c. Building Arrangement in Built-up Areas. The construction patterns or building arrangements of a typical city are classified usually into three different categories.

- (1) On the outskirts or suburbs are found normally isolated houses or small groups of houses surrounded by small plots of land, gardens, farms, fields, or vacant lots. When this part of the city is attacked, the houses should be treated as inferior pillboxes or individual emplacements, and the plan of attack may be no different from that used in an attack over normal terrain where an occasional fortification is encountered.
- (2) The second type of building arrangement is usually found in the residential district. This is an intermediate area where buildings are closely spaced, detached, or semidetached and are usually flanked by streets on one side and by gardens or grassy plots on the other. The general layout may or may not follow some geometrical pattern. The type of attack to be used in this area will depend upon the density of the buildings. A modified form

of street fighting will probably be used, but basic techniques will remain the same.

- (3) The center of the built-up area is usually the business section and will almost always consist of buildings of block-type construction, with little or no space between buildings, except for an occasional park, street, or alley. This type of construction will require fighting from building to building and block to block. This is the part of the built-up area where basic differences in techniques are required.

375. Plan of Attack

Plans for the attack and seizure of a well-defended city must be based on a detailed study of the city as well as the enemy dispositions in and around it. As in any other attack, planning must provide for a plan of maneuver and a plan of fire support. The attacking force may be composed of a mechanized infantry-heavy *direct-assault force* and a tank-heavy *enveloping force* (fig. 31). Both forces are supported by coordinated fires. The enveloping force has the mission of preventing the escape of the enemy, preventing reinforcements from entering the city, providing direct-fire support for the direct-assault force, and protecting the direct-assault force from counterattack. The direct-assault force has the mission of clearing the city of enemy resistance and linking up with the enveloping force. The attack is planned normally in three phases: in the first phase the city is isolated; in the second phase, a foothold is gained on the near edge of the city; and in the third phase, the area is systematically reduced.

376. Conduct of the Attack

a. Phase I. Phase I is the isolation of the city and the seizure of terrain features that dominate the approaches into it. The attacker secures positions outside the built-up area from which to support the entrance into the city itself. The tactics and techniques for this phase of the operation do not differ from those employed in an attack against other well-organized enemy positions.

b. Phase II. Phase II is an advance of the attacking forces to the edge of the built-up

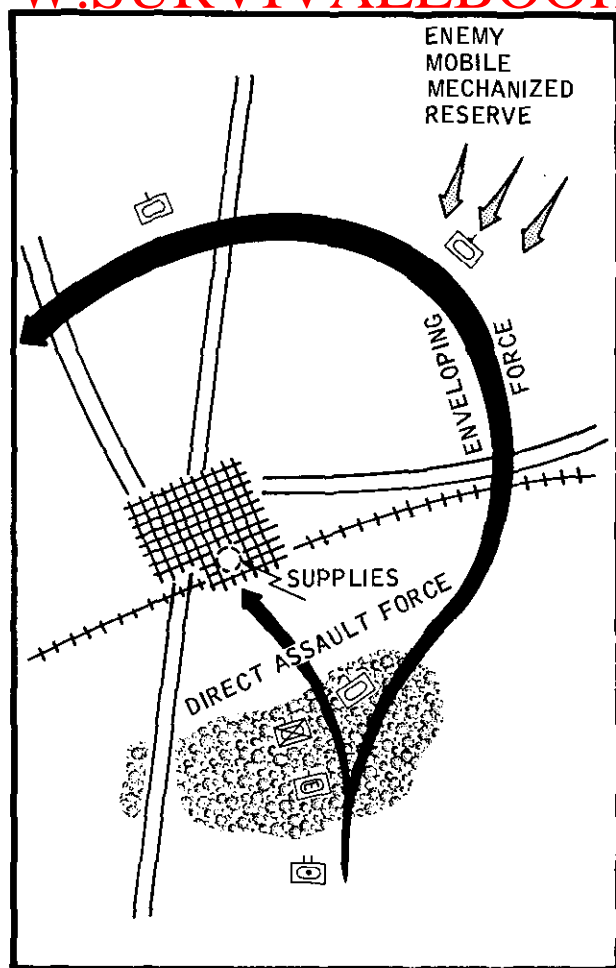

Figure 31. Coordinated attack against a town.

area and seizure of a foothold. It should insure the elimination of the defender's ground observation and direct fires on the approaches into the built-up area. The attacker uses the foothold area to reorganize, decentralize control, and displace weapons to firing positions from which the continuation of the attack can be supported. The initial penetration is made on a narrow front with tanks leading. All available supporting fires are concentrated at the point selected for entry. Assaulting forces can expect to encounter barricades, antitank mines and obstacles, and effective antitank fire. The probabilities of success are increased if the assault is launched from an unexpected direction and preferably in the early morning just before first light, during other periods of limited visibility, or under the cover of smoke. To achieve the penetration on a narrow front, a column

formation is employed normally in the initial assault. The use of a column formation does not mean that all elements of the assaulting force should be in column. Several column formations may be employed by a commander conducting the assault. For example, a battalion task force may use a column with each of its company teams in line, wedge, or echelon. These formations tend to shorten the length of the task force column reducing the time necessary to move into the built-up area. Regardless of the formation employed, the leading elements of the assaulting force should use a formation that facilitates the delivery of maximum fire on the point of penetration. Engineers, mechanized flamethrowers, and mine-detection or mine-detonating tanks or vehicles (if available) should be included in the assaulting force. Artillery airbursts are placed over the point selected for entry to prevent the enemy from manning crew-served or individual antitank weapons. The mechanized infantry remain mounted and are carried as close to the objective as possible. In the attack of a strongly defended area, the mechanized infantry will have to dismount to assist in the assault of the outer defense and to provide close-in protection for the tanks. Designated fire teams or squads may be assigned to work with a particular tank. Direct communication between the rifle squad or fire team leader and tank commander is maintained by visual signals and external interphone. When operating dismounted, the mechanized infantry should remain to the rear of their assigned tanks to avoid masking their fires and to protect themselves from fires directed at the tanks. When it is necessary for the dismounted mechanized infantry to maneuver to engage or destroy resistance holding up the advance, the tanks support by fire, moving forward as soon as possible. The armored personnel carriers follow as closely as the situation permits behind the advance of the tanks and dismounted mechanized infantry. When possible, the fires of the armored personnel carriers' machineguns augment the other fires of the assault or cover critical areas on the flanks of the assaulting force. When the buildings on the periphery of a town are fortified heavily, the techniques for

the attack of a fortified area may have to be employed (para 371).

c. Phase III. Phase III varies from a systematic block by block, house to house reduction of the built-up area to a rapid advance through the town with clearance of specific critical areas and strategic buildings. Phase III begins without pause after the completion of phase II. Clearance and seizure techniques are dependent upon the mission, size of the town, construction and building arrangement, and enemy dispositions and strength. Factors governing the selection and conduct of the techniques are—

- (1) When the built-up area is exceedingly large and heavily fortified, or when the mission requires a complete clearance of enemy forces, a methodical house by house, block by block clearance operation is performed. The area is divided into company team zones of responsibility. Each subordinate unit must clear its zone completely, leaving no enemy in its rear. The procedure of street fighting is conducted in the same manner as described in FM 31-50.
- (2) When the built-up area is small or defended lightly, the attacking force should attempt to drive through or into the town as rapidly as possible. Tanks lead the column, closely followed and supported by mechanized infantry. Except when an advance is made on a wide street, it will rarely be possible to effectively employ more than three tanks at the head of the column. The leading tanks are followed by the other two tanks of the tank platoon. The automatic weapons of the tanks and the vehicular machineguns of the carriers are fired continuously and are concentrated on the windows and rooftops of buildings. The mechanized infantry remain mounted in their carriers until forced to dismount to protect the tanks from individual or longer range antitank weapons. The mechanized infantry may dismount to assist in the removal of obstacles or barricades that have

halted the advance of the tanks. When required to dismount to secure the tanks from fire being received from buildings, a rifle squad moves along each side of the street, keeping approximately abreast of the lead tanks. Depending upon the resistance being encountered, the squad may challenge every doorway or ground floor window by throwing in hand grenades and spraying the interior with small arms fire. Selected men in each squad should be assigned the mission of locating and engaging targets in the upper floor windows and rooftops of the building on the *opposite* side of the street. The leading tanks meanwhile continue to fire at suspected enemy locations farther down the street. When resistance is heavy, each alley or side street presents an excellent fire lane for enemy high-velocity tank or antitank fire and should be crossed with caution. The mechanized infantry observe down alleys and side streets before the tanks cross and emplace light machineguns on each corner covering or firing in both directions. When a serious antitank threat to the column's flank exists, one or two tanks and a rifle squad with its carrier from the lead company team may be dropped off at each intersection along the route. If these forces are to remain in position until the entire force has passed, the following company team assumes the lead in the advance when the original lead company team has been depleted; otherwise the following company teams may relieve these forces, permitting them to continue the advance with their company team.

377. Control Measures

The conduct of combat in built-up areas requires specific control measures with which all troops must be familiar. Such measures include—

a. Boundaries. In order to provide easy and definite identification in denser portions of

block-type areas, boundaries are placed along one side of the street with the street inclusive to one unit. In areas of semidetached construction where observation and movement are less restrictive, the boundaries may be placed in the alleys or within the blocks so that both sides of the street are included in one unit zone.

b. Objectives. Objectives are specific and limited. The assignment as objectives of major street intersections, principal buildings, or other readily identifiable physical features improves control. The numbering of the buildings along the route of attack simplifies the assignment of objectives and reporting. When assigning a street as an objective, always designate the near side as the objective. If the far side of the street is assigned, it will be necessary to hold buildings on both sides of the street to secure the objective. Units promptly report their seizure of objectives and continue the attack on order of the next higher commander.

c. Frontages, Formations, and Zones of Action.

(1) Attacking battalions will normally be assigned relatively narrow zones of action. The frontages assigned will be dependent on enemy strength, size of the buildings, and resistance anticipated. Normally, a battalion task force will be assigned a frontage of from three to six blocks which in turn will permit the assignment of a frontage to the attacking company teams of one to two blocks. Frontages assigned subordinate units must be commensurate with their capabilities.

(2) Formations, although influenced by frontages and zone of action, must provide for reserves. These forces should be well forward to add momentum to the attack, exploit success, repel counterattacks, and protect the flanks and rear against enemy action.

d. Phase Lines. Phase lines may be employed to further control by regulating the advance of attacking forces and delineating where, in the visualization of the commander, the command is expected to pass from one phase of the assault to another. Since phase lines are less restrictive than objectives, they

provide for the rapid exploitation of success without halting. Principal streets, rivers, trolley lines, and railroad lines are appropriate for use as phase lines.

e. Checkpoints and Contact Points. Street corners, buildings, railway crossings, bridges, or any easily identifiable feature may be designated as check or contact points. These points, respectively, improve the reporting of locations and serve as specific points where the commander desires units to make physical contact.

378. Mission of Mechanized Infantry in Street Fighting

a. Location of targets for engagement by tank weapons.

b. Neutralization and destruction of enemy antitank weapons.

c. Assault and reduction of positions and clearance of buildings under the covering fire of tanks.

d. Protection of tanks against individual antitank measures.

e. Security and defense of the area once cleared.

379. Mission of Tanks in Street Fighting

a. Neutralization of enemy positions by machinegun fire to allow the mechanized infantry to close with and destroy the enemy.

b. Destruction of enemy strongpoints by appropriate tank fire.

c. Destruction of barricades across streets.

d. Forcing of entry for infantry into buildings when doorways are blocked by debris, obstacles, or enemy fire.

e. Taking under fire any other targets indicated by the mechanized infantry (fig. 32).

f. Establishment of roadblocks and barricades.

380. Employment of Attached and Supporting Units

a. Tanks.

(1) Streets and alleys constitute ready-made fire lanes and fixing zones. Vehicular traffic is greatly restricted and canalized and is subject to ambush and close-range fire. Tanks are at a further disadvantage because

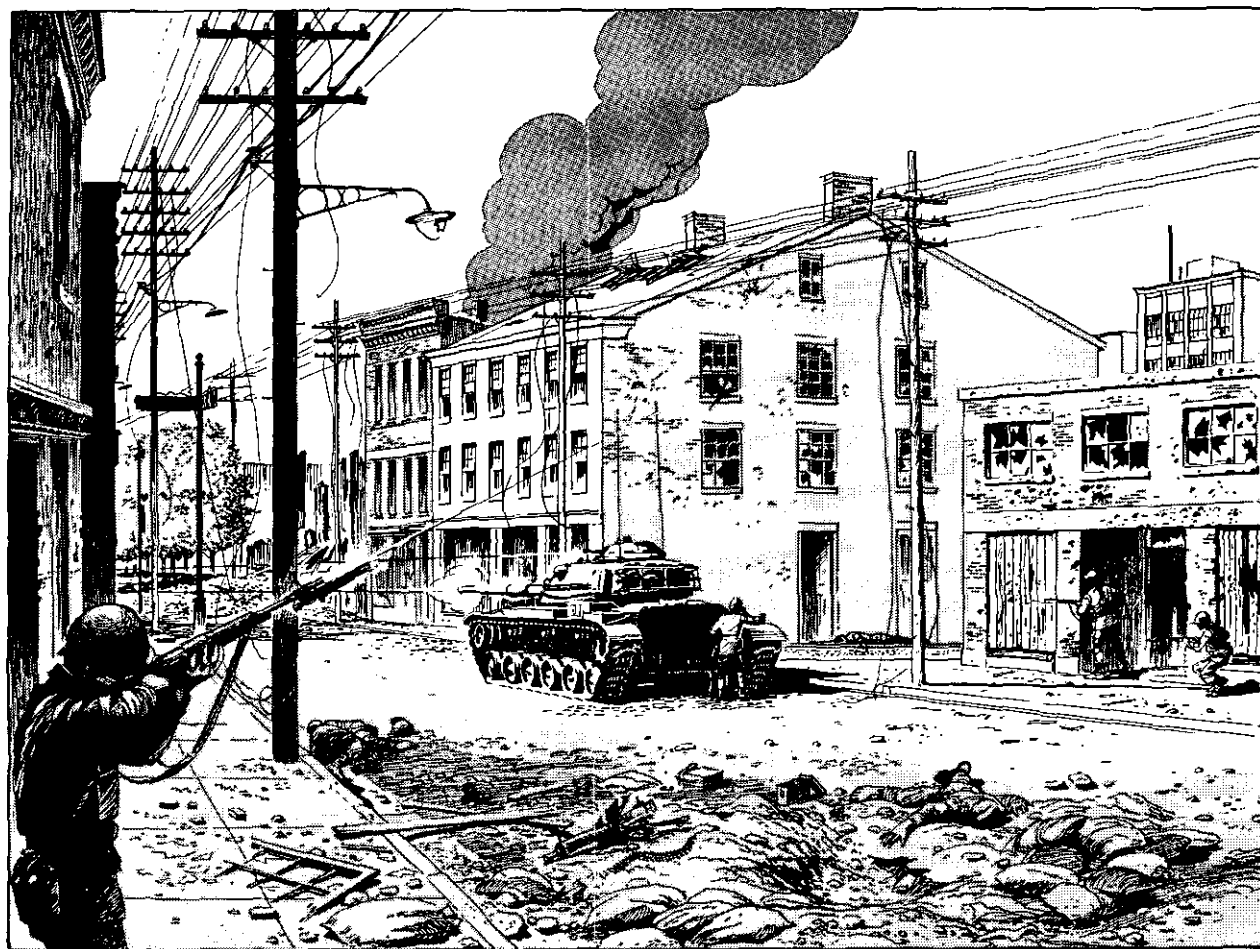

Figure 32. Tanks take under fire targets indicated by dismounted mechanized infantry.

their main guns cannot be depressed or elevated enough to fire into the basements or upper floors of buildings at close range.

- (2) When a platoon of tanks forms part of a company team, two tanks advance with the leading mechanized infantry. The remaining tanks support by overhead and flank main gun and machinegun fire. At least a squad of mechanized infantry should remain

with these tanks to furnish local security.

- (3) Tanks employ high explosive ammunition against street barricades. Steeples, tall chimneys, and other structures likely to contain enemy artillery observers are destroyed promptly. Crewmembers must be alert to detect pillboxes built into houses along the street. Tanks should not halt or move slowly close to build-

ings not held by friendly troops since enemy troops may drop explosives or flammables on them. All bridges and overpasses should be checked for mines and for weight-carrying capacity. Boobytraps of all varieties should be expected. Tanks should not move singly, and specific riflemen should be charged with protection of specific tanks.

- (4) Moving tanks keep fairly close to buildings on either side of the street

held by friendly troops, covering the opposite side and firing at anything suspicious (fig. 33). All tank crewmembers are alert to detect signals from the infantry in the houses to each flank. Tank commanders keep their personal weapons and hand grenades ready for close-in defense.

b. Artillery. The artillery is employed under centralized control in its normal role of close support. During phase III, the effectiveness of artillery fires will be reduced because of re-

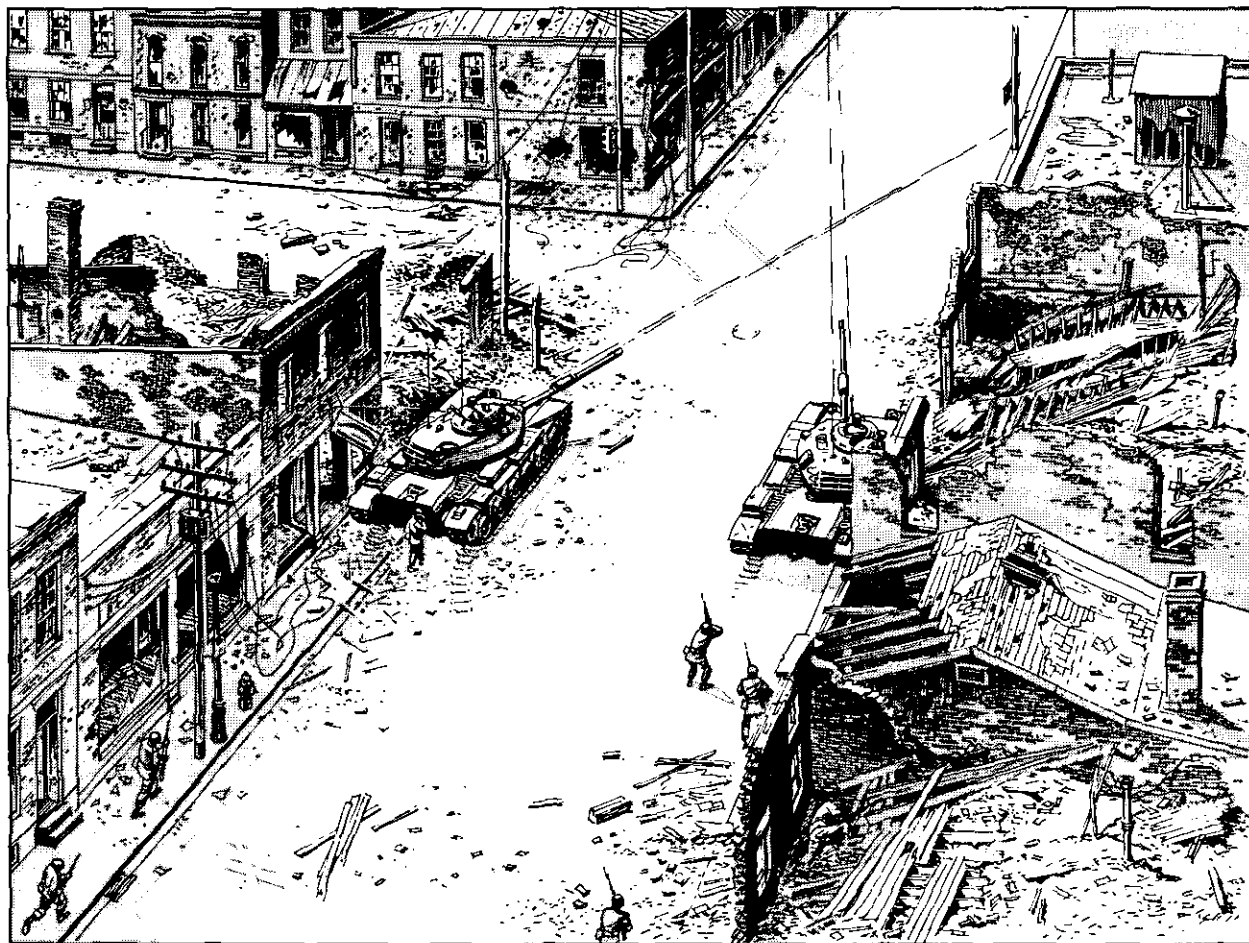

Figure 33. Movement of tanks.

stricted observation and proximity of friendly and enemy troops. The artillery employed during this phase should be capable of firing high-angle fire so that it will clear the taller buildings. Time fire and proximity-fuze fire may be used effectively against enemy on rooftops and behind barricades. The 155mm and 8-inch self-propelled howitzers may be used effectively as direct-fire weapons in support of the attacking troops but are vulnerable to enemy antitank fire.

c. Mortars. 4.2-inch mortars and 81mm mortars are usually employed in general support of their parent unit. Mortars firing high explosive shells with point detonating fuzes are useful against rooftop targets. Use of delay fuze settings will permit projectiles to penetrate roofs and destroy the enemy inside buildings. These weapons may be used to provide smoke screens to cover the advance of assault elements across streets, parks, yards, and other open areas as well as being used in their normal role.

d. Engineers. Attached or supporting engineers should be well forward and will frequently operate under the control of the attacking battalion task force. When used as part of an assault team, they are attached to the team. The normal mission of the engineers is to remove mines, clear barricades and debris, and execute demolitions.

e. Nuclear Weapons. Nuclear weapons are not likely to be used in conjunction with a ground attack on a built-up area, except possi-

bly on a large city. The progress of the ground attack would be seriously hampered by the effects of a nuclear explosion.

381. Communication

Although radio communication during phase III may be affected adversely by conditions peculiar to the built-up area, radio is still the primary means of communication. Wire communication will assume greater importance than in other types of operations. Foot messengers will frequently be the most reliable means of communication. Visual and pyrotechnic signals may be used by smaller units to indicate the need for fire, the shifting and lifting of fires, and to announce the seizure of a building or group of buildings. Armored personnel carriers may be used to provide mobile, protected communication centers.

382. Logistics

a. Evacuation of Wounded. Evacuation of wounded from rooftops and upper stories of buildings may require additional litter bearers and the use of special evacuation equipment. Plans should include marking buildings that contain wounded personnel.

b. Supply of Ammunition. Large quantities of ammunition are consumed in this type of operation. Therefore, ammunition supply points should be well forward, and mobile supply points may be required down to team level. Consideration should be given to the use of armored personnel carriers to resupply the assault echelons.

Section XI. AMPHIBIOUS OPERATIONS

383. General

a. Amphibious doctrine is set forth in FM 5-144, FM 31-11, FM 31-12, FM 31-13, and pertinent Department of the Navy publications. For explanation of Navy and special terms used in amphibious warfare, see AR 320-5. Detailed guidance on embarkation and ship loading is contained in FM 60-30. General guidelines for planning communications in amphibious operations are contained in FM 24-1.

b. An amphibious operation consists of an attack launched from the sea by naval and landing forces on a hostile shore. It includes the following phases: planning, embarkation,

rehearsal, movement, and assault. It is a joint operation when the assigned forces are composed of elements of more than one service.

384. Armor Units in Amphibious Operations

a. The tank battalion of the infantry division participates in the assault in support of the division mission. The armored or mechanized division, because of its heavy vehicles and equipment, is not normally used in the assault phase of an amphibious assault. However, in certain situations the early landing of armor units (brigade, regiment, or smaller) may be desirable for early linkup with airborne or air-

mobile forces or to seize key terrain dominating the landing area. Once ashore, the tactical employment of armor units is as in land warfare.

b. In large-scale amphibious operations, a beachhead may be secured by infantry; then an armored division or a brigade may be landed to add its firepower, mobility, and shock effect in further operations.

c. A mechanized infantry battalion, less carriers, may be used in the assault landing. Its employment is similar to that of a battalion landing team of an infantry division. When a landing is supported by engineer amphibious units equipped with vehicles of the LVT family, the mechanized infantry can continue their mission utilizing these armored vehicles until their organic carriers can join them. These vehicles, the landing vehicle tracked personnel (LVTP), a personnel and cargo transport; the landing vehicle tracked (LVTC), a command communication vehicle; the landing vehicle tracked engineer (LVTE), a combat engineer vehicle; and the landing vehicle tracked recovery (LVTR) can be effectively organized to form a mechanized (LVT) task force. If possible, tanks should be landed in landing crafts, medium (LCM's) in the early scheduled waves to provide fire support for this type of task force (FM 5-144).

d. Cavalry units may be employed on reconnaissance and security missions before, during, or after the assault landing. Air cavalry units are capable of performing reconnaissance and security missions prior to, during, and after the assault landing. Armored cavalry unit operations are usually conducted during and after assault landings. These operations usually consist of maintaining contact between widely separated landing forces or to seize lightly defended objectives.

385. Planning

a. Planning for the employment of armor units in amphibious operations is conducted and coordinated concurrently, with other elements of the amphibious task force. Planning begins on receipt of the initiating directive and continues for the duration of the operation. Basic factors influencing planning for tank employment are—

- (1) Mission and concept of operations of the landing force.

- (2) Enemy disposition and capabilities, with particular attention to antitank defenses and enemy armor.
- (3) Terrain, weather, and hydrography of the landing area.
- (4) Troops, tanks, and ships and landing craft available.

b. These factors must be considered throughout the planning cycle. Following the commander's concept and the issuance of his planning guidance, a decision is made as to armor employment. The armor unit commander then becomes a special staff officer of the unit to which he is assigned.

c. The directive from higher echelon for an amphibious operation, intelligence, and information of available shipping are the basic tools with which to start planning for the employment of armor units. The continuous receipt of intelligence and timely requests for additional intelligence pertinent to tank employment are essential to planning.

386. Preparation of Tentative Plan

a. The armor adviser participates in the preparation of the tentative plans at division and higher landing force headquarters. Information is exchanged between this officer and other staff officers. Specifically, the armor adviser considers the detailed employment of armor units and makes recommendations on the following:

- (1) Total number and type of armor units to be employed.
- (2) Task organization.
- (3) Missions and objectives.
- (4) Command relationships, by phases if appropriate.
- (5) Place and manner of landing.
- (6) Time of landings.
- (7) Coordination with naval gunfire, air, artillery, infantry, and engineers.
- (8) Antitank protection.
- (9) Special measures to be taken for communication, supply, and maintenance.
- (10) Requirements for special vehicles, such as mechanized flamethrowers.
- (11) Requirements for assault shipping and landing craft to support the tentative a morale factor in early stages of the

b. Upon completion of the tentative plan by higher headquarters, staffs of the armor units enter into the planning. Based on the plans of the higher headquarters, these units begin preparation of their own operation and administrative plans. At the same time, the armor adviser assists supported units in preparing the supported unit's plans. Close coordination is required with the air defense elements. Attainment of air superiority is a requirement for the successful conduct of amphibious operations.

387. Organization for Combat

a. Tank battalions may be employed under division control or attached to a brigade. In either event, they may be employed as a unit, may attach one or more tank companies to infantry battalions, or be employed as the nucleus of a tank-heavy task force.

b. Requirements of concentration of means and separation of tactical units on the one hand and centralization or distribution of support elements on the other must be resolved by the landing force commander. They are specified in his plans for organization for combat and reviewed continuously during the operation.

c. Attachments may be in effect before embarkation or upon landing, depending on the landing plan.

388. Landing Plans

a. The landing plan must support the scheme of maneuver of the landing force ashore. Basic considerations of the amphibious assault with regard to use of armor units are the following:

- (1) Armor units are required ashore early to assist the infantry in rapidly seizing initial objectives or to perform reconnaissance and security missions.
- (2) They are a valuable weapon in protecting the landing forces from early attack by enemy mechanized forces.
- (3) If landed early, they tend to reduce casualties among the infantry and are a morale factor in early stages of the amphibious assault.
- (4) Armor units should be landed early

when the mission demands tanks as a part of a mechanized task force.

- (5) They must be landed without excessive vehicular losses.

b. Methods of timing the landing of armor units or vehicles are—

- (1) They may be landed in a scheduled wave. This method is suitable when it is practicable or desirable to land tanks or armored cavalry early.
- (2) The on-call method is used when conditions ashore are unsatisfactory for the landing of vehicles and the beach must be prepared for landing.

c. The method selected should best suit the situation and be the most efficient ship-to-shore movement. Armor units may be organized by either of two methods for the landing—

- (1) Units may be attached to a brigade or battalion landing team for the landing and assault of the beach.
- (2) Units may remain under command of the armor unit commander until they have landed. Attachments to accomplish task organization may become effective upon landing or as stated in orders.

389. Embarkation Plans

a. The need for large-capacity landing craft and ships and the time required in loading and unloading tanks demand detailed planning for the embarkation and subsequent landing. The type and number of tank-landing craft and landing ships required are determined by the anticipated tactical employment of the unit. The selection of tank shipping and landing craft, therefore, is governed by several factors, including the scheme of maneuver, characteristics of the beaches, and presence or absence of offshore obstacles. When possible, tactical considerations govern the planned use of shipping. However, the shipping available will seldom support the desired tactical plan without adjustment.

b. When shipping assignments have been made, tentative ship loading plans (forms) are prepared by unit embarkation officers and are submitted to the commanding officer of the ship for approval. When approved, they constitute the final loading plans and govern the loading of the ship. Changes are made only

with approval of the commanding officer of the ship and the commanding officer of troops concerned. Disagreements are referred to the next higher level of command for resolution.

c. Detailed information of embarkation planning is contained in FM 60-30.

390. Administrative and Logistics Plans

a. The logistics plan for armor units in an amphibious operation is based on each unit's tactical plan and the logistics plans of higher echelons. There is no steadfast rule by which planners can decide the supplies units will carry and the supplies that higher echelons will provide. Decisions as to the equipment and supplies each echelon will carry are issued in directives from higher headquarters. The directives are based on the overall plans for the operation and previous usage factors. Examples of planning considerations that must be studied carefully to determine the means of logistic support for armor units are—

- (1) Duration of the operation.
- (2) Shipping available.
- (3) Type of operation.
- (4) Estimated date of arrival of supply shipping.
- (5) Method and means of unloading.
- (6) Size of the objective.

b. During the planning phase, decisions are made that permit the S4 to procure supplies and equipment required for the training period, embarkation phase, and initial phases of the actual operation.

c. Fuel, ammunition, rations, repair parts, and special supplies and equipment are obtained. This includes waterproofing equipment, cold weather equipment and clothing, special type munitions, and tank accessories or attachments. Units carry repair parts based on replenishment rates. It is important that minimum supplies to fill basic requirements be carried.

d. Regardless of the landing plan, plans must provide for placement of supplies where they will be available when required. Floating dumps and beach dumps are methods of providing supplies. Liaison with appropriate logistic agencies afloat and ashore should be effected early to insure availability of supplies ashore.

391. Shipping

The type of shipping to which armor units are assigned affects their availability for landing to support the tactical plan. Shipping suitable for landing tanks consists of two general categories, landing ships and landing craft. Each type of landing ship has several classes of construction, and ships differ in their capabilities, cargo, and troop capacity. Final embarkation loading plans can be developed only after a study of the characteristics of the ships being used. The characteristics are provided in ships' characteristics pamphlets and amplified through direct liaison with ships' officers.

392. Preparation for Embarkation

a. Loading and embarkation plans for units are prepared before the arrival of assault shipping at the embarkation point. Armor unit embarkation officers prepare these plans in conjunction with embarkation officers and Navy commanders concerned. Vehicle crews and maintenance men should always be embarked with their vehicles.

b. The commanding officer of troops and the ship's representative arrange other details of embarkation which may include—

- (1) Assignment of personnel to billets and working parties.
- (2) Stowage of fuel, lubricants, and maintenance material so that appropriate items are available for servicing vehicles and weapons while embarked.
- (3) Organization of security details and messing procedures aboard ship.
- (4) Use of ship's equipment and personnel to assist in servicing equipment en route.
- (5) Provisions for en route training as may be feasible.

c. The unit commander and his subordinates supervise and control preparation, marking, and protection of the unit supplies and equipment. Before arrival of assault shipping in the embarkation area, all supplies and equipment are prepared for loading. A final inspection is made to insure that tanks and other vehicles and equipment are ready for combat. Tanks are always prepared for deepwater fording before embarkation.

393. Embarkation

In the embarkation of armor units, it is important to retain, so far as possible, the integrity of the unit as organized for combat. The landing ship, docks (LSD's) and landing ship, tanks (LST's)—because of their greater capacity—generally assist in the maintenance of unit integrity. To expedite the loading operation, personnel must be familiar with different methods of ship loading.

394. Movement to the Objective Area

a. Security regulations usually preclude detailed briefing of all personnel before embarkation. Therefore, they are informed of details of the operation during movement to the objective area. All personnel must understand their duties and be thoroughly familiar with the overall plan. Each commander or leader should know the relationship of his mission to the plan of the units in the amphibious troops. Briefings for personnel should emphasize the following:

- (1) Mission.
- (2) Scheme of maneuver.
- (3) Details of the beach assault.
- (4) Procedure for the ship-to-shore movement.
- (5) Location and methods of communication with command posts, liaison personnel, and the naval control organization.
- (6) Condition of the beaches, nature of obstacles, beach exits, terrain inland, and terrain trafficability.
- (7) Plans for breaching beach obstacles.
- (8) Tentative location of initial assembly areas and instructions for waterproofing.
- (9) Plans for location of maintenance and supply facilities ashore.
- (10) Enemy situation, with particular attention to antitank defense.

b. Intelligence information received during movement to the objective area should be disseminated to all personnel. This information is obtained from air observers, submarine periscope photographs, and reports of underwater demolition teams and reconnaissance units. Provision must be made for disseminating per-

inent information to each separately embarked unit.

c. The commanding officer of the troops and embarkation team commander are responsible for shipboard routine and training.

d. Vehicles should be loaded so that they are accessible for servicing during the voyage. Daily servicing and final preparation for combat must be planned, scheduled, and performed including—

- (1) Prestarting checks.
- (2) Daily running of engines for approximately ten minutes.
- (3) Checking batteries.
- (4) Checking controls and linkage to insure free movement.
- (5) Final application of waterproof sealing compound on D-day minus one.
- (6) Constant preventive maintenance on communication equipment.
- (7) Constant preventive maintenance on armament.

e. Vehicles must be well secured aboard ship. Tank landing ships are equipped with securing chains. During extremely heavy seas, chains alone may not prevent heavy vehicles from slipping on the ship's steel decks. Therefore, heavy shoring timber is placed on deck between the vehicles and flush with the tracks. Shoring is used in conjunction with securing chains. Dunnage must be placed under vehicles having steel tracks. In heavy seas, a continuous watch is maintained to insure that securing chains and shoring remain in place.

f. All removable vehicular weapons are test fired during the voyage. Fire control equipment should also be tested.

g. The following precautions are observed during the voyage:

- (1) Engines are not run or fueled without permission of the ship's commanding officer.
- (2) Vehicles in LST's are neither started nor fueled below decks unless enough blowers are operating.
- (3) Vehicles are fueled one at a time.
- (4) Fire extinguishers are kept on hand and fire precautions observed when fueling.

- (5) Tank shift levers are in park position while the ship is underway.
- (6) Personnel move cautiously between vehicles when the ship is underway, particularly in rough seas.
- (7) Tarpaulins used to cover tanks are checked continuously to insure that the vehicles are protected from salt spray.
- (8) Radio transmitters are not tested until radio silence is lifted.

h. Final preparations for unloading and operations ashore are started in sufficient time before landing to allow personnel to—

- (1) Top off oil and fuel tanks.
- (2) Secure oil and water cans to be carried on vehicles.
- (3) Check and place vehicular maintenance equipment in vehicles.
- (4) Check turret fire control mechanisms.
- (5) Install final waterproof sealing.
- (6) Mount and check weapons and bore-sight where practical.
- (7) Check oil reservoir, power traverse, and elevation systems.
- (8) Test radio equipment—after radio silence is lifted.

395. Ship-to-Shore Movement

a. The ship-to-shore movement of armor units is influenced by the landing craft and landing ships to be used. In turn, the ship and craft requirements are based on the mission, scheme of maneuver, beach characteristics, and offshore obstacles. These factors determine in part the method of landing. One other important consideration is whether or not the beach is defended.

b. Against defended beaches it is necessary to conduct a waterborne deployment of combat units. However, the threat of nuclear attack precludes massing large quantities of shipping, troops, and equipment. Therefore, assault troops are landed from dispersed shipping in controlled waves of small craft and amphibian vehicles over widely separated beaches with long intervals between waves. To reduce casualties during such landings, vehicles are landed from less vulnerable small craft, such as a landing craft, utility (LCU) and a landing

craft, medium (LCM). Effort should be made to land tanks early so that they may expedite the infantry's passage of the beach and seizure of initial objectives.

(1) When shipping availability permits, units to be landed on defended beaches should be preloaded in LCU's or LCM's and launched from LSD's in the unloading area. Once debarked, the landing craft will assemble and proceed as a group to the line of departure. Here they will either deploy and cross in scheduled waves, or layoff in a designated area awaiting the order to land in on-call waves. Landing craft must be disembarked to reach the line of departure or landing beach at the time designated in the assault schedule. Upon crossing the line of departure, they continue directly to the beach.

(2) Because of the shallow draft of the LCU and LCM, vehicles should make a relatively dry landing. However, if they must emerge from the ramp into uncertain waters, they should have guides—individuals, markers, buoys, or LVT's—to insure that they reach shore without striking mines or other obstacles or being drowned out in underwater potholes. Once ashore, armor units join the infantry units to which attached, and assault and execute the beach passage, seizing at least enough ground to protect the beach from aimed small arms fire. Armored cavalry units proceed to accomplish assigned missions.

c. When assured that the landing beaches are lightly defended, and that terrain and hydrography conditions permit, tanks and armored personnel carriers or landing vehicles, tracked, personnel (LVTP) are embarked on LST's for debarkation directly onto the beach. The armor assault landing team should be loaded aboard the LST with the vehicles positioned to land tanks first. When the LST's beach, tanks debark and proceed immediately to points of egress from the beach.

d. Task organization and loading may provide for contingency landing plans. When pre-

paring for landing on a beach where the probability of defense is low, tanks should be embarked to permit an assault landing against the defended beach, while still possessing a subsequent exploitation potential. This may be accomplished when the armor unit is sufficiently large, by placing some of the tank units aboard LSD's preloaded with LCU's or LCM's, while the remainder of the armor unit is aboard LST's. The enemy situation in the landing area will decide the mission and units that will land first. If the beach is undefended they may all land at the same time.

396. Time and Place of Landing

a. In an amphibious operation tanks are needed as soon as the initial wave of assault troops land; therefore, they should be landed at the earliest possible time. Against a beach undefended by antitank weapons and obstacles, tanks may be landed in advance of, or with, the infantry; however, a beach strongly defended by antitank weapons and obstacles prevents the early landing of tanks.

b. The scheme of maneuver is designed to accomplish the mission in the most expedient manner. Therefore, a place and time of landing for armor units should be selected that will support the scheme of maneuver.

c. The type and number of ships and crafts available to transport tanks may determine where the unit must land and will determine the rate of buildup of tank strength ashore.

d. The beach gradient, offshore reefs or sandbars, navigability of the approach lanes, and the waters surrounding the objective area influence the choice of the landing site. A beach should be selected where the soil is trafficable and the gradient not too steep. It should have routes of egress ample to sustain the momentum of the attack, and so located that they support the scheme of maneuver. The landing of tanks will be delayed where offshore reefs bar passage of tank-laden craft, the gradient is poor for beaching, soil trafficability is poor, or where it is necessary to emplace causeways.

e. Beach minefields and obstacles must be breached or overcome before the main tank landings is losses are to be minimized and the momentum of the attack sustained. Obstacles

offshore, on the beach, or inland from the place of landing, whether natural or manmade, should be avoided. If avoidance is impossible, a site should be selected where they can be breached most easily.

f. Tanks in tank landing craft present a profitable target for well-placed antiboat weapons. These weapons may influence the place of landing or cause delay, as they must be avoided or neutralized.

g. In the selecting of a landing site for tanks, trafficability inland from the beach must be considered. The terrain inland should provide ample maneuver area, a suitable road net, and cover and concealment.

h. The enemy disposition, particularly the strength, location, capabilities of his armored formations, and antitank defenses are important in the selection of a place and time to land. Enemy antitank defenses should be avoided.

397. Obstacle Clearance and Breaching

a. Beach and underwater mines and obstacles must be cleared rapidly to permit landing and effective employment of tanks. Clearance of underwater obstacles seaward of the high-water mark is accomplished by Navy underwater demolition teams, usually during the preassault phase. Mines and obstacles inland from the highwater mark are cleared by the landing force. Time seldom permits removal of all mines and obstacles. Only certain routes across the beaches will be cleared for passage early in the landing. It is often necessary to alter the prescribed landing formation and submit to a degree of canalization during the beach passage. To reduce lateral movement necessary to reach the cleared lanes after the units have reached the beach, information received from armor unit officers on the beach must be relayed immediately to commanders of LST's and appropriate control vessels, so that the units can be beached as close as practicable to the lanes cleared by the shore party. The lanes selected should be located so as to insure—

- (1) Sufficient breadth to accommodate the width of the tank.
- (2) Sufficient number to permit rapid egress from the beaches.

- (3) Access to a road net or area that is trafficable.
- (4) They correspond to the planned landing points of the units.
- (5) Minimum of lateral movement after units have landed.
- (6) Landing points leading to cleared lanes are identifiable from seaward.

b. Because these lanes are of primary importance to armor units, armor personnel and equipment should assist in their clearing. Armor reconnaissance personnel are integrated with engineers into teams. They assist in demolition and removal, selection and marking of the lanes, and the guidance of vehicles through the lanes. Other supporting equipment are the tank-mounted dozer, landing vehicle, tracked, engineer (LVTE), or combat engineer vehicle for obstacle removal, and the gun tanks for obstacle destruction and team protection. When landed with the breaching teams, the tanks can serve as logistics vehicles, carrying bulky items ashore. Organization of mine and obstacle breaching teams is based on an analysis of the specific obstacles to be encountered.

c. Breaching teams should be organized to land with the leading scheduled waves, often with the first wave of assault troops. Each team clears at least 1 vehicle lane 18 to 24 feet wide. The scope of breaching teams' mission must be delineated distinctly during planning and provide for the return of its components to parent control as early as possible. Armor unit commanders must insure that the dissolution of the teams includes disposition of the breaching equipment.

398. Guiding Vehicles Ashore

a. Landing conditions may require units to cross reefs, tidal flats, or other areas covered by shallow water. Vehicles must be guided around obstacles that might cause them to hang up or engines to drown out. An amphibian tractor may be employed to guide vehicles ashore after debarkation. If this method is used, guide vehicles must be designated well in advance of the landing to allow for briefing and communication planning.

b. A crewman may dismount and guide by wading ahead of the vehicle. This method is slow, especially if the water is deep or the bot-

tom is rough. Guides are vulnerable to hostile fire. This method is satisfactory for short distances only.

c. Reconnaissance personnel may mark lanes to the beach. However, marking devices such as buoys are moved or destroyed easily by enemy action or by natural causes.

399. Passage of the Beach

a. To avoid congestion and tank losses at the waterline and on the beach, passage of a defended beach area is planned and coordinated carefully and conducted aggressively. Liaison, reconnaissance, and breaching teams must perform their tasks quickly and thoroughly if armor units are to provide timely and effective support of the beach assault. Landing sites that support the scheme of maneuver are selected and lanes through them cleared and recognizably marked. The location of lanes, targets, missions assigned by supported infantry, and other pertinent information are transmitted promptly to the attached tank unit commander during the ship-to-shore movement. As the tanks emerge from their landing craft, they are met by guides and directed through the cleared lanes to the points from which they support the attack. Tank units may support the beach assault in the following manner:

- (1) Gun tanks lay down a blanket of small arms fire with machineguns while engaging hard targets with their main guns.
- (2) Dozer tanks or combat engineer vehicles cover apertures and entrances to emplacements, assist in preparing antitank ditch crossings, and aid in mine breaching operations inland. They assist in the immediate improvement of the newly seized beaches if the tactical situation ashore permits.
- (3) Mechanized flamethrowers reduce enemy positions not susceptible to other weapons available ashore during the early period of the landing and assault.

b. Against undefended beaches, mass landings can be made by integrated assault teams transported in vehicles. Teams will debark

from the landing ships directly onto the beach and attack inland.

c. During the ship-to-shore movement, armor unit commanders receive information by radio from their reconnaissance and liaison personnel ashore. The information includes the condition of the beaches, progress of beach clearance efforts, recommendation of the best beaches for vehicles to land on, and other pertinent information. After landing, vehicles are met at the edge of the water, and commanders are informed of the best routes across the beach. They are then led through the cleared lanes by guides. The cleared lanes are marked to be clearly visible from within the tank, usually by strips of tape placed along the edge of each lane.

d. If intelligence is complete and indications are that mines will not be encountered on the beach, and hydrographic conditions are favorable, tank units may be landed as the first wave. They should land from 2 to 5 minutes ahead of the initial wave of infantry. The landing and the initial wave of troop-carrying craft or vehicles must be timed precisely to obtain maximum effect from shock and firepower, and to

provide infantry support early in the assault. If heavy enemy resistance at the waterline is expected, the tank units landing in the initial wave will land usually in a line formation to bring the maximum firepower to bear on the hostile defenses.

400. Rehearsals and Training

a. *Rehearsal.* The rehearsal is that part of the amphibious operation in which one or more exercises are conducted by the participating forces under conditions approximating those anticipated for the actual operation. Rehearsals are conducted in accordance with a plan which approximates the plan for the specific operation. Units that participate in the rehearsals will depend on the tactical plan. Responsibility for the preparation of rehearsal plans is same as for the preparation of the actual operation plan. Rehearsal plans should be issued separately.

b. *Training.* Amphibious training for Army units is outlined in FM 31-12. This training is normally supported by Naval amphibious training command and may be conducted at the armor unit's base station by landing force training units.

Section XII. SHORE-TO-SHORE MOVEMENTS

401. General

This section provides general guidance for armor commanders and staff officers in the execution of shore-to-shore movements by armor units. FM 31-12 provides general guidance for commanders, staff officers, and other interested personnel for the planning and execution of shore-to-shore operations and movements. AR 320-5 defines shore-to-shore operations and shore-to-shore movements.

a. Shore-to-shore movements include some of the techniques of amphibious operations and inland waterway operations, and involve procedures and considerations related to each of them. Shore-to-shore movements, although similar to, are not amphibious operations because they do not involve embarkation in Naval ships; however, both operations involve assault landings on a hostile shore. The shore-to-shore movement is conducted normally by Army forces alone, employing primarily Army trans-

portation of the waterborne movement of the force.

b. As is the case with amphibious operations, armor units may be employed in several types of shore-to-shore movements:

- (1) Attack.
- (2) Withdrawal.
- (3) Raid.
- (4) Deceptive operation (demonstration or feint).
- (5) Reconnaissance.

c. Shore-to-shore movements may be conducted across large lakes, inland seas, along coast lines, across bays, or against offshore islands.

402. Considerations

a. The participation of armor units with their vehicles in shore-to-shore movements will be dependent on the types and load-carrying

characteristics of the assault craft available for the operation.

b. The extent of participation by armor units in the assault is limited by the number of landing craft available since the assault elements must be contained in a single lift.

c. The relatively heavy requirements for logistical support of armor units must be considered in light of landing craft available for this support on the far shore. Aircraft may be required to augment surface craft.

403. Planning Guidance

a. The general considerations in planning for employment of armor units in a shore-to-shore movement are the same as those in planning an amphibious operation and the near shore actions in a deliberate river crossing.

b. The control of the waterborne movement in a shore-to-shore movement is an Army function; in amphibious operations, it is a Navy function. This responsibility will usually rest with the engineer amphibious units (brigade, group, or battalion) as augmented by transportation corps units under the direction of the overall tactical commander responsible for the operation.

c. Critical factors such as terrain, weather, and hydrography of the far shore must be emphasized when planning the employment of armor units in the assault landing.

d. The armor commander must include all aspects of the deliberate river-crossing operation in determining his concept of armor employment. He must plan for the assembly of armor units and their means of waterborne transportation on the near shore. The arrival of armor units in the embarkation area on the near shore must be phased so that those units participating in the assault of the far shore arrive first and are loaded first. Unnecessary massing of units in the embarkation area must be avoided.

e. Armored cavalry units, less their tracked vehicles, and mechanized infantry units, less their personnel carriers, may participate in shore-to-shore movements when landing craft are not available for their vehicles. In this event, the shore-to-shore movement will be conducted as infantry in an amphibious operation or deliberate river crossing with vehicles either

shuttled across after the assault or moved around the shore for a linkup.

404. Preliminary Planning

a. An armor commander begins to plan for a shore-to-shore movement in response to directive from a higher echelon or as an operational requirement in his own command.

b. The availability of landing craft capable of lifting vehicles will determine armor's participation; therefore, the first step in planning is to determine the numbers of landing craft that will be available.

c. During preliminary planning the armor commander must determine—

- (1) The overall concept of the operation.
- (2) Any Navy or Air Force support in the form of ships, landing craft, or aircraft that may be available.
- (3) The objective area.
- (4) The amphibious area and specific embarkation points suitable for armor units on the near shore.
- (5) The terrain and hydrography of the objective area.
- (6) The task organization for support of the assault landing and subsequent operations in the objective area.

d. Dependent on the determinations made (b and c above), the armor commander recommends—

- (1) Embarkation points on the near shore and landing points on the far shore for armor units.
- (2) Task organization of armor units in support of operations on the far shore.

405. Conduct of the Assault

The assault on the far shore is conducted in the same manner as in an amphibious operation with subsequent operation ashore being as in normal land warfare.

406. Training

a. Preliminary training for shore-to-shore assaults can be conducted as an adjunct to amphibious and deliberate river-crossing training. Advance training must be conducted in a waterborne training area and include training

with the type landing craft that can normally be expected to be used for a shore-to-shore movement.

b. The attainment of a high state of training

in shore-to-shore movements will reduce the supplementary shore-based and ship-based training required for participation in an amphibious attack.

Section XIII. INTERNAL DEFENSE OPERATIONS

407. General

a. Internal defense operations are conducted by a host country or its allies directly against armed insurgents, their underground organization, support system, external sanctuary, or outside supporting power. The ultimate objective in combating armed insurgency is to eliminate the causes behind the insurgency and to prevent its recurrence. Tactical operations by armor units against insurgent forces may be conducted over vast areas. The operational plans must anticipate the difficulties of control and combat service support. Most important will be the complete integration of armor into the overall operation being conducted in a particular area, for example, region, province, and district. This may entail support of U.S. or host country tactical units in tactical operations, support of receiving state police agencies in internal security operations, assisting host country forces in military civic action, or conducting these operations independently as part of the overall clear, hold, and consolidation operation in a particular area.

b. The concepts, tactics, techniques, and procedures for the tactical employment of armor units contained in this field manual basically apply to internal defense operations. However, they must be adjusted to fit the particular operational environment. The organization and characteristics of the insurgent battlefield does not resemble that found in limited or general war situations. The area between insurgent forces or their principal sources of supply do not usually present lucrative military targets. Insurgent supply installations are small, dispersed, and difficult to locate and destroy. Caches, insurgent safe areas, and sympathetic or dominated populations may be so universally dispersed that insurgent units are not dependent on a few critical logistical bases. Under these conditions, a turning movement, for example, launched by friendly forces intended to cause the insurgent force to react

to protect a base, may produce movement in entirely different directions than those anticipated. Having developed multiple base areas, insurgent forces may move in any direction to an offensive maneuver and still not sacrifice its logistical support capabilities. Insurgent tactical forces will not normally be committed to limited and general battlefield arrangements until a defeat of friendly force is a certainty and their defeat will affect the entire internal defense effort.

c. The insurgent tactical forces' missions are aimed at subversion and the overthrow of an established government. The rear area guerrilla in a limited or general war environment is mainly concerned with the harassment of friendly forces. Operations of armor units in internal defense may include the following major areas of activity:

- (1) Tactical operations against insurgent irregular, paramilitary, and armed forces which are employing guerrilla warfare. This type of warfare is conducted predominantly by irregular and paramilitary organizations in phases II and III of insurgency. Guerrilla warfare constitutes sustained combat operations which are conducted and supported within hostile territory and utilize tactics characterized by surprise, brief violent action, and elusiveness. These operations may also be supported, in varying degrees, by an external source. Communist led insurgent movements employing guerrilla warfare are not merely uncoordinated, hostile bands of poorly equipped insurgents. Rather, in the modern sense, guerrilla warfare is a well developed form of war where the guerrilla, when conditions are favorable, can fight a conventional type battle using regular formations supported by heavy weapons.

- (2) *Military civic actions.* Military civic actions are the use of U.S. and host country (HC) armed and paramilitary forces on projects useful to the local population at all levels in such fields as education, training, public works, agriculture, transportation, communications, health, sanitation, and others. These actions contribute to the economic and social development of the host country. They also serve to improve the standing of the armed and paramilitary forces with the population. These operations include extending projects of the United States Agency for Internal Development (USAID), United States Information Service (USIS), and other U.S. civilian programs in host countries.
- (3) *Internal security operations.* These operations include supporting host country police and other essentially civilian organizations in their responsibilities to maintain a state of lawfulness; the prevention of action against HC resources, industries, and institutions; and the protection of life and property in the event of a domestic emergency by the employment of all measures, in peace or war, other than military defense. They also include taking actions to control human and material resources and to deny insurgent access to those resources.
- (4) *Advisory assistance.* This assistance consists of furnishing specialized mobile training teams (MTT) for training regular or paramilitary forces in branch or branch immaterial subjects. These operations include extending USAID, USIS, and other U.S. civilian programs in host countries.
- (5) *Psychological operations.* These operations include extending host country civilian-military information and psychological operations programs.
- (6) *Intelligence operations.* Intelligence operations not only include normal combat intelligence but also extend into the civil-military sociological,

economic, political, psychological operations, and other intelligence activities of a host country.

d. FM 100-5, FM 100-20, FM 31-16, and FM 31-22 contain the basic doctrine for operations against insurgent tactical forces to include military civic action, internal security operations, advisory assistance, and psychological and intelligence operations. To prevent duplication, the discussion in this section applies only to doctrine, tactics, techniques, and procedures as they affect armor units in tactical internal defense operations. Where brigade, battalion, and company are discussed in this section, it is equally applicable to the armored cavalry regiment, squadron, and troop unless otherwise specified.

408. Planning Internal Defense Operations

a. Tactical operations against insurgent forces conducting guerrilla warfare are planned according to these basic considerations:

- (1) The majority of guerrilla operations consist of small unit actions. However, when conditions are favorable to the insurgent tactical force (insurgency intensified to late phase II and phase III levels), they may conduct tactical operations of battalion and regimental size to seize and hold, temporarily, objectives using coordinated fire and maneuver to retain the initiative.
- (2) Tactical operations are generally offensive in nature and continuous once initiated.
- (3) Tactical operations are designed to minimize the strength of tactical insurgent forces and to exploit their weakness.
- (4) The close relationship between the population and the tactical insurgent force may demand enforcement of stringent internal security operations such as—
 - (a) Securing key installations such as airfields, water and food supplies, hospitals, host country government installations, and defended village

complexes, thereby releasing host country troops for other requirements.

- (b) Operating mobile and static checkpoints to assist in controlling populations and movement of materiel and supplies along authorized routes. Personnel must be trained in detailed search procedures, and their activities must be closely coordinated with local officials.
- (c) Controlling civil disturbances which must be accomplished with utmost caution and discretion to prohibit undue injury or loss of life to the populace.
- (d) Securing routes of communication, convoy escort duty, and other constabulary-type missions.
- (e) Mounting armor patrols between villages and hamlets to make the presence of internal defense forces felt, to have positive psychological effects on the population, and to discourage contact between villages and insurgent tactical forces.
- (f) Operating along the host country border to assist host country forces in interdicting, denying, or keeping under surveillance adjacent power(s) supporting the insurgents, and to prevent the use of an adjacent country as a sanctuary. Border operations will utilize armor units in terrain where their mobility and communications capabilities can be employed to advantage.

b. The following specific factors are considered in the commander's estimate:

- (1) Motivation and loyalties of segments of the population, identification of hostile and friendly elements, vulnerability of friendly elements to coercion by terror tactics, and susceptibility to insurgent and friendly propaganda.
- (2) Existing policies and directives regarding status and treatment of population and insurgent force members.

(3) Terrain and weather.

(4) Resources available to the insurgent force.

(5) Extent of the insurgency as a whole and specifically the insurgent force operation.

(6) Size and composition of forces available for tactical operations against insurgent forces.

(7) Communication facilities available to allow effective control of tactical operations against insurgent forces.

c. Armor units may be involved in combined operations with host country forces; therefore, commanders must be prepared to cope with problems of force interrelationships, communications, coordinated intelligence operations, and proper psychological approach to the counterpart force in conducting combined operations. These problems, which in limited and general war have been handled customarily by commanders of higher headquarters, may become problems of subordinate unit commanders. Maximum use should be made of liaison personnel from host country forces to assist U.S. forces in all types of operations involving contact with host country civilians.

d. Armor units contain equipment and personnel with specialized skills that may be used to improve the environment of the populace through military civic action. Such projects may include the use of armored vehicles to clear trees during local construction programs, and communications to augment or provide emergency communications systems for civil use in remote areas. An important aspect of military civic action is the discriminate movement of armored vehicles to avoid destroying crops, irrigation systems, or damaging other items or facilities that affect the well being of the local people. For armor to accomplish its mission, a certain amount of damage is inevitable; however, with thoughtful care and a common sense approach, the local population will usually accept these damages. See FM 31-22 for examples of military civic actions and FM 41-10 for additional civic action doctrine.

e. Commanders must consider carefully the application of weapons fires so that civilians and property are not unnecessarily destroyed,

thereby alienating the population. Minimum combat power must be used to accomplish the mission as contrasted to limited and general war employment of massed firepower, mobility, and shock effect against enemy forces.

409. Missions

There are two general categories of operations which will be conducted in an insurgency operational environment—strike operations and clear, hold, and consolidation operations.

a. Strike operations, usually conducted in remote or contested areas, variously called search and clear, search and destroy, and others, are primarily tactical operations. Other activities, such as psychological operations, military civic action, advisory assistance, and internal security operations, are minimized during the period of the strike. Because strike operations are of relatively short duration, one day to several weeks, these latter activities are pursued only to the extent that they can assist the force while it is in the strike area. Strike operations are conducted primarily to find, fix, and destroy insurgent tactical forces, and they also may be used to harass insurgent forces. Generally, they are conducted against located insurgent tactical forces and bases or in areas suspected of containing these. Additionally, they serve to keep the insurgent forces on-the-move and off balance. The operation entails no intent to remain permanently in the area of operations. Ground or water means of entry may be used. Airmobile or air drop means are most adaptable in some areas to this type of operation. Usually a combination of means is required. Strike operations are comprised of raids, reconnaissance in force, coordinated attacks, relief operations, or combinations of these.

b. Clear, hold, and consolidation operations, strategic hamlet operations, province rehabilitation, and others, are, in essence, the application of all aspects of the HC national internal development program to specific regions, provinces, districts, or other political subdivisions. The internal development operation restores HC governmental control to the population and the area. It provides an environment within which the normal economic, political, social, and civic activities of the population may be

pursued. It is improved through the implementation of civilian national economic, political, social, psychological, and civic development programs supported by military resources. Units committed to these operations support the overall effort by the application of their resources in the following methods.

- (1) In the offensive phase, tactical offensive operations of the strike variety are stressed, other activities being subordinated to the tactical mission.
- (2) In the defensive phase, tactical defensive operations, to include extensive patrolling and defense of the area, will be the primary missions. During this phase, advisory assistance in training HC paramilitary and irregular forces for tactical defensive, internal security, or other civilian activities are initiated. Intelligence and psychological operations and military civic action programs are conducted concurrently.
- (3) In the consolidation phase, defensive phase activities are continued, and planning for supporting subsequent internal development operations is stressed.

c. In the conduct of these two types of operations (strike operations and clear, hold, and consolidation operations), the six operational modes or activities (i.e., tactical operations against insurgent tactical forces, military civic action, internal security operations, advisory assistance, psychological operations, and intelligence operations) may be conducted to varying degrees. The following specific tactical missions, which fall under one of the above six operational modes or activities, may be accomplished by armor units. Tank units usually will require attachment of infantry or mechanized infantry for these specific missions. These missions are accomplished primarily through offensive operations. No attempt is made to designate missions most suitable for armor units since suitable missions in one geographic area may be unsuitable in another.

- (1) Search and seizure of areas.
- (2) Search and clearance of areas.
- (3) Reaction force (reserve).

- (4) Installation and community security.
- (5) Security of surface lines of communication.
- (6) Reconnaissance.
- (7) Surveillance.
- (8) Apprehension of insurgent force members.
- (9) Harassing and elimination of insurgent tactical forces.
- (10) Convoy escort.
- (11) Border control.

410. Combined Arms Forces

a. General.

- (1) Operations against insurgent forces may have to be conducted in any geographical area in the world. Therefore, armored units must be area oriented to cope with the varying terrain conditions and special techniques required to combat insurgent forces. The particular environment in which operations are being conducted will dictate the most effective armor force to employ against insurgent forces. Generally, these operations make maximum use of highly mobile, combined-arms task forces or teams that can find, fix, fight, and destroy elusive enemy forces. In addition, armored vehicles provide protected communication, mobile checkpoints, protected supply and evacuation, protected artillery, and convoy escort.
- (2) Airmobile forces may be used to advantage to deploy rapidly ground forces for attack of located insurgent tactical forces, to permit encircling movements that might not be possible by ground forces, to cut off routes of escape, and to relieve besieged friendly forces.
- (3) Psychologically, the introduction of tanks and other armored vehicles is demoralizing to insurgent forces.
- (4) Armored cavalry units are particularly suited for sustained operations against tactical insurgent forces to include internal security operations

because of their extensive means of communication, mobility, flexibility of organization and equipment, and the insurgent's usual lack of armor. Air cavalry units greatly extend the range and capabilities of ground units in conduct of operations against insurgent forces in difficult terrain.

- (5) Aviation units are a principal means for collection of information concerning insurgent forces. In particular, aerial surveillance units can rapidly identify suspect areas, which can then be reconnoitered, if required, by ground elements. Aircraft can be used for movement of troops and supplies.

b. Compositions of Combined Arms Forces.

- (1) Composition of combined arms forces will vary with the geographic area in which they must operate. Since insurgent forces usually operate in terrain which best reduces the ground mobility of vehicles, tank units will normally operate with infantry-heavy teams or task forces. However, in areas that permit mounted operations by infantry in armored personnel carriers, tank-heavy teams or task forces should be employed to take advantage of the tank's firepower, mobility, protection, and shock effect. Tanks should be employed in the greatest possible number in each situation and environment.
- (2) Armored cavalry units have combined arms capabilities inherent in organization and are well suited for employment without attachments in internal defense operations.
- (3) As part of a combined arms force, air cavalry units are used in internal defense operations as separate maneuver units and to support ground tactical units, including airmobile operations.
- (4) Artillery, engineers, medical, psychological warfare, military intelligence, signal, military police, and civil affairs units are included in combined arms forces as required.

411. Employment of Tanks, Armored Wheeled Vehicles, and Armored Personnel Carriers

a. Tanks. Terrain and limited road nets in most internal defense environments may often restrict the large-scale employment of tanks. The movement of tanks will normally be limited to roads, trails, beaches, grass or brush covered fields, hills, plantations, and water areas with hard bottoms and water level permitting. Light armored vehicles, however, such as the armored reconnaissance/airborne assault vehicle, possess low ground pressure, are amphibious, and can greatly extend the areas of operation for armored units. Careful selection of routes and axes of advance is necessary. In favorable terrain, tanks can be of great value when used as offensive or blocking forces operating as a part of a combined arms team with mechanized infantry or infantry units. Tanks should be used in every operation where possible. Frequent use will lead to development of special techniques which will permit their successful employment.

b. Armored Wheeled Vehicles. Armored wheeled vehicles may be used by units assigned missions of route security and convoy escort. These vehicles possess limited cross-country mobility but are well suited for road operations by virtue of their speed, durability, cruising range, firepower, and communications capabilities. Normally units equipped with armored wheeled vehicles must be provided motorized infantry and engineer support to be effective.

c. Armored Personnel Carriers. Use of armored personnel carriers, where possible, will frequently result in achieving a significant ground mobility advantage over insurgency forces. If the insurgency forces have limited antiarmor capabilities, the armored personnel carrier is considered to be a fighting vehicle when used against insurgency forces in the open. Only after the maximum possible casualties have been inflicted on the enemy should riflemen be dismounted from the carriers. Premature dismounting from armored personnel carriers may cause unnecessary casualties and the loss of the carriers' speed, armor protection, and shock effect. Riflemen are usually dismounted as follows:

- (1) When securing an objective after an

assault, when prisoners must be secured, and when the area must be searched for hidden enemy. This task is most efficiently accomplished by carriers and dismounted riflemen working as a team.

- (2) When terrain obstacles preclude closing with insurgent forces. In this situation, a dismounted attack is immediately launched. If possible, the carriers' weapons are used to fix the enemy by fire while the dismounted elements maneuver to close with the insurgent force.
- (3) When the unit is unavoidably halted in an unsecured area. OP's, LP's, patrols, and local security are provided by dismounted riflemen.
- (4) When missions are assigned, such as encirclement and search of a village. These type missions require the use of dismounted elements. However, the speed and protection of the carrier should be used whenever possible. In the search of a village, for example, encirclement may be accomplished mounted with the dismounted search following.

412. Combat Operations by Ground Armor Units

a. General. Employment of armor units in internal defense operations may take many forms depending upon the mission assigned, upon enemy actions and reactions to friendly operations, and upon terrain and weather conditions prevalent in the area of operations. The operations, tactics, and techniques discussed may be employed in varying degrees by armor units in both strike and clear, hold, and consolidation operations.

- (1) *Organization for combat.* Combined arms teams are basically formed by cross-attachment between infantry and armor units. Other elements such as artillery, engineers, and signal units are included as necessary. Each team or task force should be composed of complementing elements which best fit the task at hand. For example, a team whose assigned mis-

sion will include an assault on an area impassable to armor vehicles should be provided with elements of mounted infantry in sufficient strength for a dismounted attack. Conversely, where the mission is to cover areas of good trafficability against enemy forces likely to be engaged in the open, a team which is preponderantly armor equipped is appropriate. Except in special situations, platoons within teams are not further broken down for interplatoon cross-attachment. However, when required, the armored cavalry troop may be subdivided into mortar, scout, tank or infantry platoons.

- (2) *Combat formations.* Where terrain permits, conventional formations should be used, such as column for maximum control, echelon to guard a vulnerable flank, line for maximum firepower to the front, or wedge for a combination of control and firepower. In certain situations, terrain restrictions must be overcome to maintain required formations. For example, where the enemy occupies a prepared defensive position, every effort must be made to engage him with several tanks or carriers simultaneously, despite terrain obstacles which tend to force a column formation and thus piecemeal engagement. In the face of an organized enemy position, a column formation is permissible only after fire superiority has been established, either by elements of the attacking team or by other units or fire support means.
- (3) *Prior reconnaissance.* Although the armored personnel carrier, and the carrier, command and reconnaissance to a lesser degree, can operate effectively in most insurgency areas, their mobility is restricted by certain terrain obstacles, such as canals or streams with banks too steep for the vehicle to negotiate, jungle, forest, or mountains. Movement of the main battle tank is normally even more re-

stricted. The limiting effect of these obstacles can be significantly reduced by a careful selection of routes based on accurate information. This knowledge will permit crossing of each barrier at the most practical point.

- (a) In most situations, a map reconnaissance serves as the starting point from which plans for direct reconnaissance of the terrain are developed. However, maps that are based upon even the most recent survey data may not provide the details needed to select the most advantageous points for passage of obstacles. Thus, movements (especially cross-country) should not be based on map information alone. Requests for aerial photo coverage should be made where considerations of time and security permit.
- (b) Air cavalry or other observation aircraft are the primary means for reconnaissance prior to an operation. These flights should be made by the unit commander, when possible, or an observer and a pilot with experience in supporting armor units. Persons unfamiliar with the capabilities of armored vehicles and without some experience in judging trafficability from the air cannot provide the required information. These reconnaissance flights may disclose the planned action unless they are tailored to fit the existing patterns of aircraft activity. Unusual air activity over an area alerts the enemy and may cause him to leave the area temporarily. This disadvantage can be overcome if reconnaissance flights are made sufficiently in advance of the operation to permit the enemy to return to the area and drop their alert status. In areas of little aircraft activity, the required information should be obtained by other means, such as records of previous operations or use of local guides.

When security is of paramount importance, aerial reconnaissance should not be used or, if essential, should be disguised by an appropriate cover plan.

- (c) Prior reconnaissance on the ground is usually limited to the route of approach to the area of operations. In order to achieve surprise, the approach march often covers a long distance over secondary roads. The requirement for accurate timing of the march makes a route reconnaissance of some type essential. The physical risks of ground travel must be weighed against the detailed information required, and often aerial observation must suffice. These risks, combined with the difficult terrain and the requirement for surprise, usually make a ground reconnaissance impractical.
 - (d) During each operation, detailed records should be kept of pertinent terrain information. In internal defense operations, many areas are fought over several times. Recorded information can reduce or eliminate the need for future aerial or ground reconnaissance with its risk of disclosing the planned operation. Care must be taken to avoid use of identical routes each time the same area is attacked, otherwise the enemy can concentrate his antiarmor weapons to best advantage.
 - (e) The knowledge required of vehicle capabilities and limitations and the experience necessary for accurate estimates of trafficability support the habitual assignment of air cavalry to ground armor units during internal defense operations.
- (4) *Control measures.* Within an area of operation, phase lines, boundaries, and axes of advance may be used in the normal manner. Assignment of objectives must be qualified to allow immediate reorientation of the armor maneuver element to counter unforeseen enemy threats. If the mission of the operation is seizure of a terrain

feature or the destruction of an enemy installation, then firm objectives are assigned. However, the normal internal defense operation seeks to defeat the insurgent rather than to occupy a specific terrain feature.

- (5) *Security against antiarmor means.* Insurgent tactical forces will have weapons which can disable or destroy armored vehicles. Although the capability may be limited, normal antiarmor security measures should be taken. The threat to armor units is two fold—first, antiarmor weapons may be already positioned in an area of operations, or, second, the insurgent tactical force may be given enough time to bring the weapons into the area of operations. These two possibilities are minimized by exploiting the mobility of the unit. An armor unit should not be habitually employed using the same pattern of operations or routes in a particular area. Its mobility should be used to gain surprise by frequent movement in previously occupied areas and by penetration of new areas in which the insurgent tactical forces are unprepared for armor attack.

b. Area Organization.

- (1) An armor unit engaged in supporting a clear, hold, and consolidation operation may be assigned a specific area of operation. Whenever military considerations permit, this area encompasses a political subdivision. Such an assignment is to—
 - (a) Make maximum use of existing civil administrative agencies.
 - (b) Make maximum use of existing police and paramilitary forces.
- (2) However, it must be realized that political subdivisions will seldom provide optimum military areas of operation. In some cases, such as in strike operations, area boundaries may be dictated by military considerations; however, as soon as possible, boundaries should be readjusted to insure

unity of command of areas. Rarely will clear, hold, and consolidation operational boundaries not conform to political boundaries.

- (3) The brigade is normally assigned a specific area of responsibility. The brigade commander assigns specific areas of responsibility (sectors) to subordinate battalions, and these commanders normally do the same (subsectors) to subordinate companies. The company commander does not normally assign specific areas to his platoons, but rather assigns tasks or missions to accomplish the company missions. Within the assigned sector or subsectors, commanders at all echelons down to and including company level will normally establish one or more combat bases from which to conduct offensive operations, and static security posts as needed to secure troops, installations, and lines of communication. However, this does not imply that these combat bases are fixed installations since they should be moved frequently to minimize insurgent planning time for attacks and to keep insurgent forces off balance. Each armor unit assigned an area of responsibility will normally maintain a reaction force (reserve) of appropriate strength at its base to be used in local reaction to any contact made with insurgent forces.

- (4) The size of the area assigned to a unit depends on the mission, the terrain, the nature of the insurgent force, and the troops available. The size of the area assigned to a unit may be too large to be cleared concurrently by the subordinate units. In this case, the commander must establish a priority for the clearance of the sectors or subsectors, and assign areas of responsibility to the subordinate units accordingly.

- (5) Figure 34 shows a schematic armored cavalry regimental area of operations. Note that one squadron has more area than can be cleared concurrently by

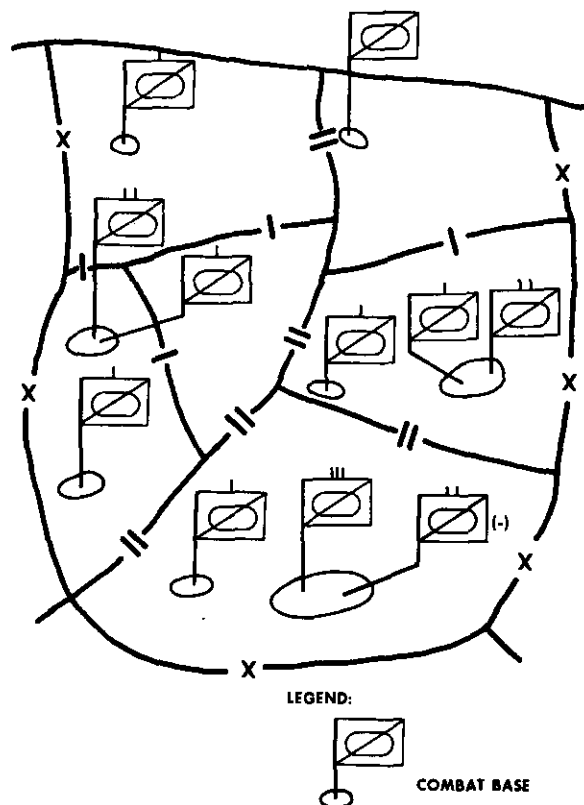

Figure 34. Schematic armored cavalry regimental area of operations.

its subordinate units. Consequently, one subsector in its area is not occupied initially. This subsector will be placed under surveillance and patrolled under squadron control until it can be assigned to a subordinate unit for clearance.

- (6) To indicate the flexibility possible in the organization of an area of operations, figure 35 shows a schematic armor brigade area of operations. Because of the existing terrain and enemy situation, the company teams have been assigned areas which are not contiguous in all cases. The gaps between the companies are kept under surveillance utilizing Army aircraft and forces such as the scout platoon or civilian paramilitary patrol units.
- (7) In any case, the subsector assigned a company or troop should be no larger than the unit can clear or control

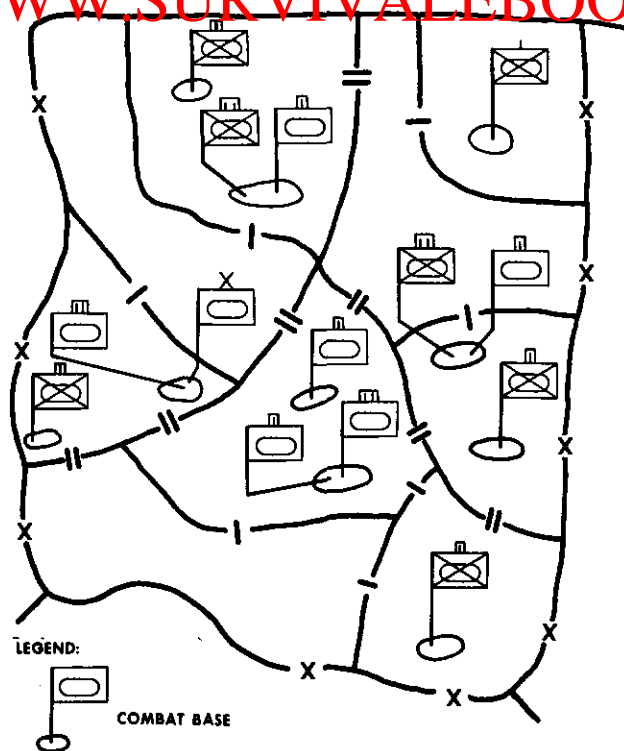

Figure 35. Schematic armor brigade area of operations.

without large groups of the enemy circumventing its forces and regrouping elsewhere in the subsector. Constant movement of forces will usually permit the enlargement of the area due to the "spoiling" effect movement has on insurgent activities.

- (8) A company or troop normally retains a platoon (\pm) as a local reaction force. Likewise, a battalion or squadron normally retains a reaction force of at least one company or troop. The brigade normally retains a very strong reaction force of battalion (\pm) size to counter and destroy large consolidations of insurgent forces in the area. In difficult terrain, the reaction forces should have the capability of operating as an airmobile force.

c. Mobile Combat Bases.

- (1) Units conducting tactical operations against insurgent forces establish combat bases from which to operate. However, it is not normal for a battalion or a higher unit to be assigned

an area small enough for it to operate entirely from one combat base. It is more normal for the battalion or squadron to assign specific areas of responsibility to subordinate companies or troops and require that they establish combat bases in their respective areas. Depending on the size of the unit's subsector, one or more combat bases may be established. Whenever possible, the entire company or troop operates from one base to facilitate security and control.

- (2) A combat base is the contact point for all tactical operations against insurgent forces in the area of the unit concerned. It will include the essential command, control, and administrative elements of the unit. It may also include certain support elements from higher units.
- (3) The combat base is located to facilitate future tactical operations in the area and for security. Whenever possible, combat bases are established on highly defensible terrain. The majority of the unit will conduct operations away from the combat base, leaving only the local force or the reaction force to secure the base depending on plans for employing the reaction force.
- (4) The size of the base will vary with the size of the friendly units occupying it, the defensibility of the terrain, and the probability of insurgent attack. In any case, the combat base is as small as practicable to facilitate its security.
- (5) A combat base is organized with encircling positions prepared from which it can be defended against insurgent attack. Protective obstacles are prepared to support the defensive positions. Outposts and listening posts are established well forward of the defensive positions and occupied at all times. All possible avenues of approach leading into the area are mined.

- (6) The provision of troop facilities is a consideration in the organization of a combat base. Whenever possible, temporary overhead shelter is provided. An adequate water supply should be within the base. Some means of physical recreation such as volleyball or wrestling must be provided. A good base will assist in maintaining high morale in the unit.
- (7) The highest standards of discipline and sanitation must be maintained in the combat base. Normally, a commander will seldom see his men during operations against guerrilla forces, except for the brief periods they are in the combat base. Most of the time, members of the unit will be operating on patrols, raids, ambushes, outposts, or other operations.
- (8) Combat bases must be completely mobile. These bases must be moved fre-

quently within the area of responsibility to prevent the insurgent force from receiving detailed information about their location and disposition. This capability must take priority when in conflict with needs listed in (6) and (7) above.

- (9) When the insurgent force has reached the state of development where its operations approach those of conventional forces, the use of widely separated bases will normally be tactically unsound.

d. Static Security Posts (fig. 36).

- (1) A static security post is any organized security system for the protection of fixed critical military or civil installations, or critical points along lines of communication such as terminals, tunnels, bridges, and road or railway junctions. Although armor units secure areas through the use of

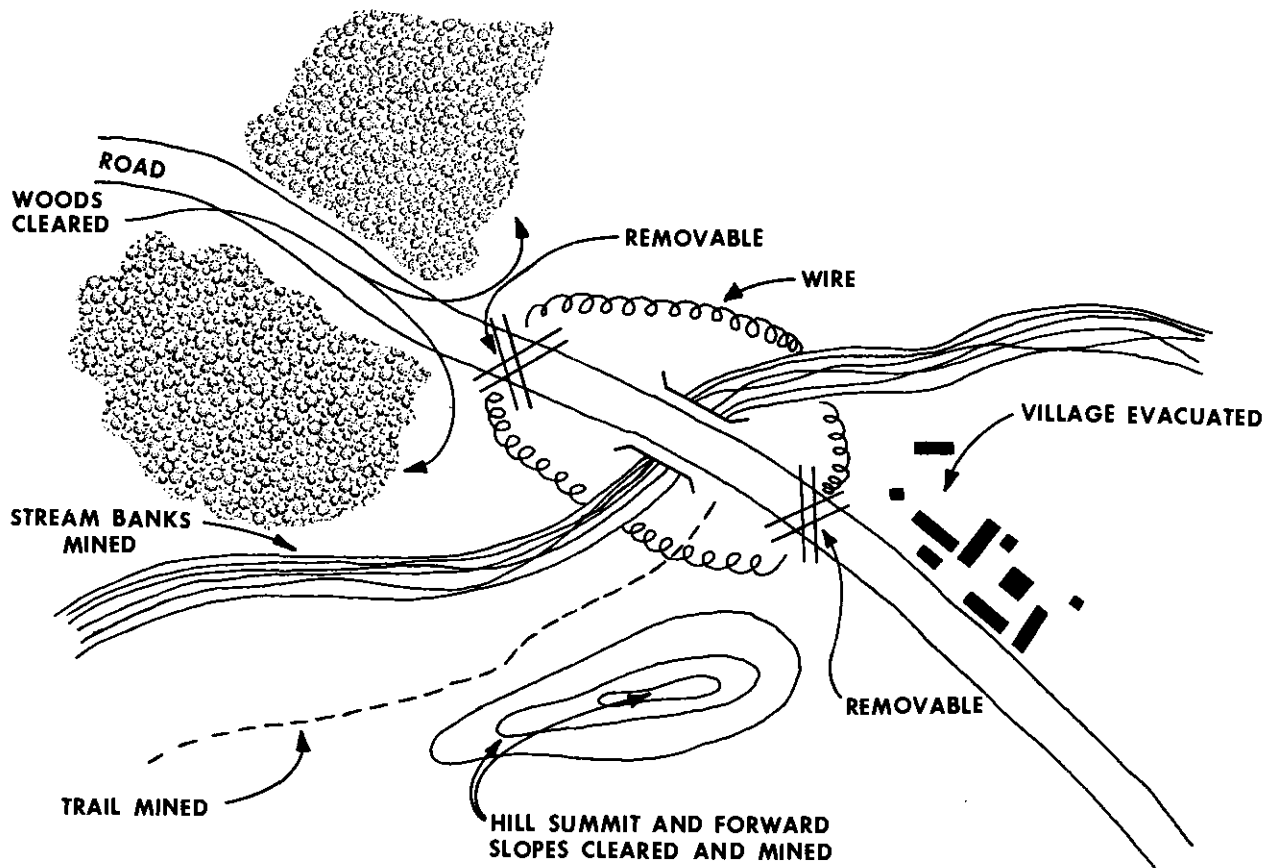

Figure 36. Typical static security post (guarding bridge).

their mobility, a static security post may be required to adequately secure the assigned area of operations against insurgent attack. The size of the post depends on the mission, the size and characteristics of the hostile force, the attitude of the civil populace, and the importance of the area being secured. It may vary from a two-man bridge guard to a reinforced company securing a key communication center or civilian community. Static security posts in remote areas will necessarily be larger than those nearer supporting forces.

- (2) The organization of a static security post will vary with its size, mission, and distance from reinforcing units. In any case, the outpost is organized for the security of both the installation and the security force. Reliable communications must be established between static security posts and the parent unit base. The parent unit must be prepared to counterattack with its reserves or reaction force to assist the outpost.
- (3) Static security posts are organized and prepared for all-round defense. Adequate guards and patrols must be used to prevent surprise. Precautions are necessary to prevent guards being surprised and overpowered before they can give an alarm. Concealed approaches to the security posts are mined. Areas from which short-range fire can be placed on the position are cleared and mined. Areas of poor visibility are improved or covered with automatic weapons. The immediate area of the outpost is dug-in and reinforced with earth and sandbags. Personnel are provided auxiliary exits and covered routes from their shelters to the combat positions. Buildings used for shelter should be selected with care. Generally, wooden or other lightweight constructions are avoided. If they must be used, the walls should be reinforced for protection against small arms fire. If the

post consists of more than one position, consideration is given to the use of connecting trenches. Supplies are stored in dispersed and protected caches. Adequate security must be provided for communication installations and equipment. Combat efficiency is maintained by training and periodic alert drills.

- (4) Indigenous personnel, other than paramilitary personnel, are not allowed to enter the defensive positions, and those living in the immediate vicinity are screened and evacuated, if necessary. Friendly civilians may be helpful in warning of the approach of insurgent forces.
- (5) All consideration possible is given to troop comfort during the organization and preparation of the security post. At best, morale will suffer among troops who must operate for prolonged periods of time in small groups away from their parent organization.
- (6) If a static security post is far removed from other organic units and there is a possibility of isolation of the post by insurgent action, sufficient sustaining supplies are prestocked within the post. A static security post should never have to depend solely on the local populace for supplies.
- (7) The defense of an installation should be varied often to counter information the enemy may have received concerning the disposition and routine operations of the security force. This may be accomplished by varying—
 - (a) Patrol and sentinel routes.
 - (b) Fixed posts and listening post locations.
 - (c) Schedule of changing guard.
 - (d) Password.
 - (e) Positions of tanks, scout vehicles, mortars, and automatic weapons.

e. Movement to Contact. In order to achieve surprise, armor units normally enter an area of operations from an approach march origi-

nating outside the area of operation. This practice makes accurate timing of the attack difficult and places responsibility on the unit commander for an accurate estimate of the time required for the approach march. Maximum prior reconnaissance and ample time allowances for unforeseeable delays are necessary in planning. Where limited reconnaissance or terrain difficulties make an accurate time questionable, it may be necessary to base the maneuver of other elements, such as airmobile forces, on the actual arrival time of the armor unit. The mobility, speed, and communications of armor units assist materially in attaining the necessary punctuality, but the commander must provide the leadership, foresight, and planning required.

f. Encirclement. The encirclement is the best method of fixing insurgent forces in position. It must be accomplished with great speed, with sufficient forces to close the area completely, and—especially when small forces are being used—with utmost secrecy. Surprise is essential; the least warning is enough to scatter the insurgent forces. Normally only when a major supply base is threatened will insurgents defend an area. Even then, if it becomes apparent they are outnumbered, they will attempt to infiltrate or attack to break out and escape. Since nearly all insurgent groups are based in nearly inaccessible areas, most encirclements are accomplished by infantry that can march into the area or be airlifted. Even airlifted troops may not prove too successful since the noise of the helicopters serves to warn the enemy. Therefore, the following pertains to operations conducted in open areas or areas where some roads or trails permit vehicular movement.

- (1) Tank units reinforced with infantry and armored cavalry units possess the mobility and speed to accomplish an encirclement. Vehicular noise may preclude surprise. This may necessitate dismounting part of the troops some distance away, moving the vehicles into predesignated positions on order after the dismounted troops are in position.
- (2) The majority of operations of this nature, conducted by armored units,

will usually require a force large enough to encircle and destroy the insurgent tactical force. The initial encirclement will have to be large enough to insure that the entire insurgent force is contained within the boundaries. This usually requires a high proportion of infantry in the armored unit. The limited road nets usually found in an insurgency environment normally preclude parallel movement on roads of mounted units. This requires elements to follow one another and thereby seriously hampers effort at surprise. However, with detailed planning and reconnaissance, multiple columns can be used in cross-country movements.

- (3) Since air cavalry and airmobile troops are capable of fast movement, can suddenly appear and interdict an area with accurate automatic weapons fire, and can land riflemen to flush insurgents out into killing zones, they are particularly suited for encirclement operations. If the foliage is not too dense, air cavalry can observe, pursue, and kill fleeing individuals. The noise of approaching helicopters is an unavoidable complication and partially detracts from the advantage of speed and surprise.
- (4) Encircling movements are executed rapidly. Defensive positions are occupied simultaneously in order to block escape and prevent evasion. If simultaneous occupation of these positions is not possible, escape routes most likely to be used are covered first. Initial occupation is the most critical period of the operation. If large insurgent formations realize, during this period, that they are being encircled, they can be expected to react immediately to probe for gaps or attack weak points to force a gap.
 - (a) Units occupying the positions along the encirclement provide strong combat patrols well to their front so early warning of attempted breakouts may be received and es-

cape routes ambushed. If strong combat patrols cannot be employed, the minimum security required is an outpost line with multiple listening posts. Mobile reserves are positioned for immediate movement to counter any threat of a breakout and to reinforce difficult areas, such as deep ravines, caves, or tunnels.

- (b) Indirect fire support can serve to cloak an impending encirclement by gaining and maintaining the insurgent's attention through interdiction and harassing fires while encircling units move into position. Control and coordination of fires should be planned in detail to support the encirclement after it is discovered.
- (c) Following the initial encirclement, the capture or destruction of the insurgent tactical force is conducted methodically and thoroughly by use of fire and maneuver in simultaneous, controlled contractions of the encirclement. As the line of encirclement is progressively contracted, units may be removed from the line and added to the reserve. Against small insurgent tactical forces, the entire encircled area may be cleared by progressive contraction; however, against larger insurgent armed forces, it is probable that, at some point, some action other than further contraction will be required (fig. 37).

1. One technique consists of driving a wedge through the insurgent force to divide it, permitting the destruction of insurgent tactical forces in each subarea. This technique also may be used in conjunction with contraction of the line of encirclement (fig. 38).
2. Another technique, employed after some degree of contraction, is to employ a holding force on one or more sides of the perimeter while part of the line of encirclement forces the insurgent tactical

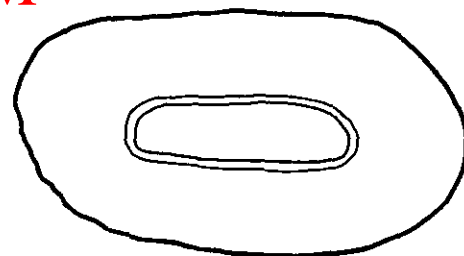

A. ENCIRCLEMENT COMPLETED

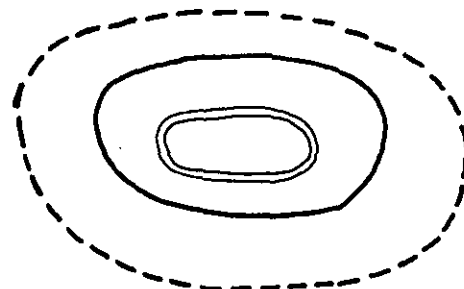

B. MOVEMENT TO FIRST PHASE LINE

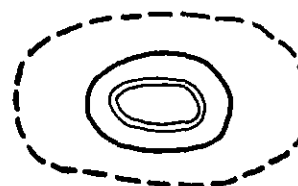

C. MOVEMENT TO SECOND PHASE LINE



Figure 37. Tightening of the encirclement.

forces against the holding force by offensive action. Either element may accomplish the actual destruction, but it usually will be accomplished by the attacking element (fig. 39). This technique is most effective when the holding force is located on, or immediately in the rear of, a natural terrain obstacle (fig. 40).

3. Another technique is the use of blocking or ambush forces to encircle an area approximately 1,000 meters square. After the

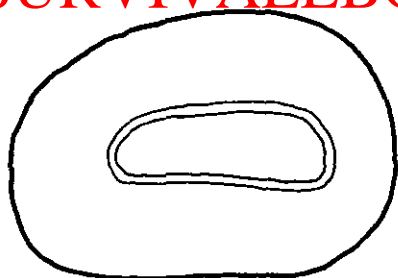

A. ENCIRCLEMENT COMPLETE

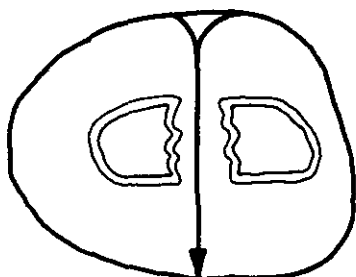

B. FIRST BISECTION

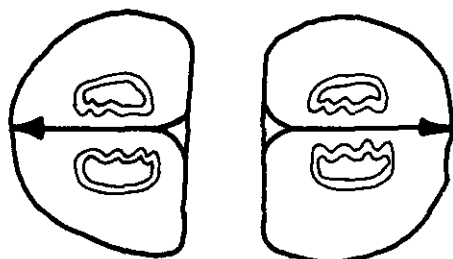

C. SECOND BISECTION



Figure 38. Fragmenting the encirclement.

positions are established, the area is subjected to intense saturation-type indirect fire and aerial attack. As the tactical insurgent forces try to exit the area, they are either destroyed or captured. This type operation requires accurate information of the location of insurgent forces to preclude casualties to civilians (fig. 41).

g. *Attack and Pursuit.* The primary role of armor units in operations against insurgent

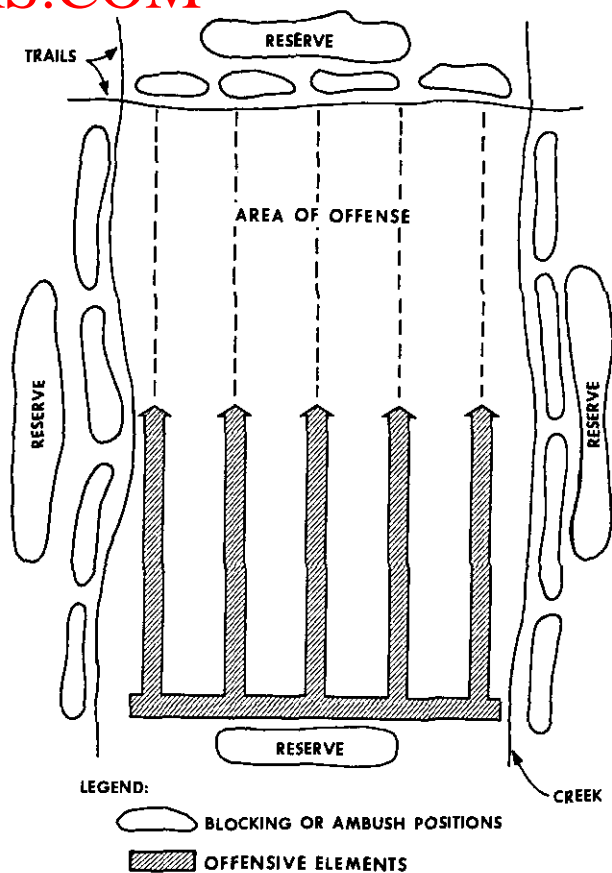

Figure 39. Use of a blocking force and an offensive force.

tactical forces is to attack and pursue. To accomplish these missions, the commander must be prepared to meet two situations—first, contact with tactical insurgent forces who are in the open and attempting to break contact; second, encounter with prepared defensive positions from which the insurgent intends to conduct a sustained defense.

- (1) *Enemy in the open.* In this situation the attack and pursuit phases of the operation may merge. If the tactical insurgent force is attempting to refuse contact, he must be pursued before he can be attacked. The essential requirement is to establish contact in order to fix the enemy and halt his flight. For this reason, armored personnel carriers may be used as fighting vehicles, and riflemen not dismounted until required for mopping up. Unit integrity is desirable but not

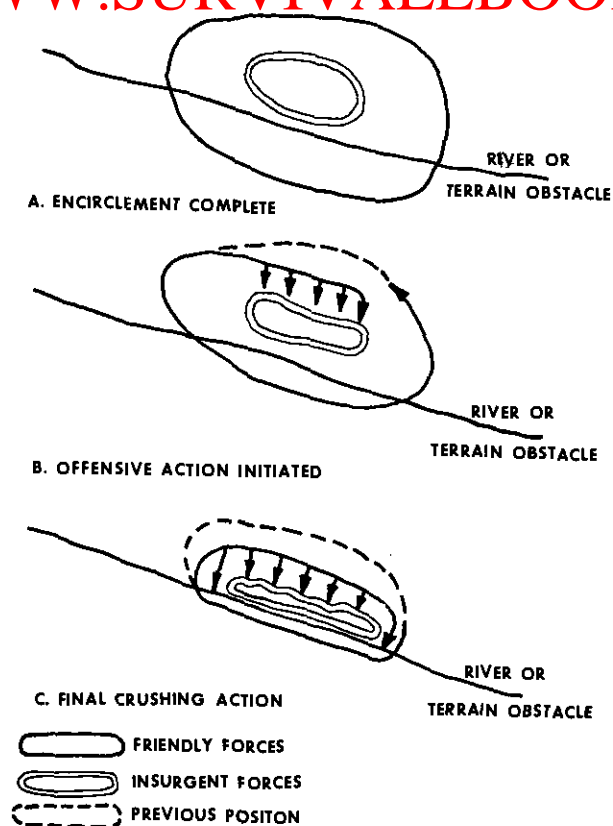

Figure 40. Encircling force's use of a terrain obstacle.

essential. Two or three available armored vehicles must move forward aggressively to fix the insurgent, even if the remainder of the team is held up by terrain or darkness. Judgment must be exercised, however, to avoid being led into a prepared ambush by simulated enemy flight. If the leading vehicles are caught in an ambush situation, they should withdraw to overwatching positions and maintain contact by observation and fire until the remainder of the force arrives.

- (2) *Tactical insurgent forces in prepared position.* When insurgent tactical forces are defending from prepared positions, the armor commander must initiate the normal troop leading procedures of reconnaissance, estimate of the situation, and orders. He is assisted in this sequence by his mobility, armor protection, and com-

munications—all of which should be exploited to permit attack in the shortest possible time. The insurgent tactical force will usually be organized to prevent overrunning of his position by the armored vehicles. If tanks are not available, the commander must then plan his attack making maximum use of his remaining resources. He may establish a base of fire while riflemen are carried in the assault by armored personnel carriers using their mobility to take the most advantageous approach to the enemy position. Use of smoke and riot control munitions should be considered as well as a grenade barrage from the assault carriers just prior to dismounting. As the riflemen dismount and begin their assault, the armored vehicles in the base of fire and the assaulting personnel carriers join the attack with the dismounted riflemen. When the insurgent position includes antiarmor weapons, these should normally be neutralized or destroyed before a mounted attack is made. If this cannot be accomplished and time permits, the armored vehicles are moved as far forward as possible and a dismounted attack is launched from that point. Time limitations may require a mounted assault without neutralization of the antiarmor weapons. In establishment of fire superiority, maximum use is made of available air cavalry, artillery, and close air support. All units must be prepared to continue the mounted attack and pursue the enemy.

- (3) *Pursuit.* In every possible instance, fleeing insurgent forces should be relentlessly pursued and killed or captured. Since dispersing insurgent tactical forces usually use preplanned routes of withdrawal or simply scatter to predesignated rallying points, pursuit must be undertaken immediately both on the ground and in the air. Riflemen are necessary to conduct the ground pursuit. Armored vehicles

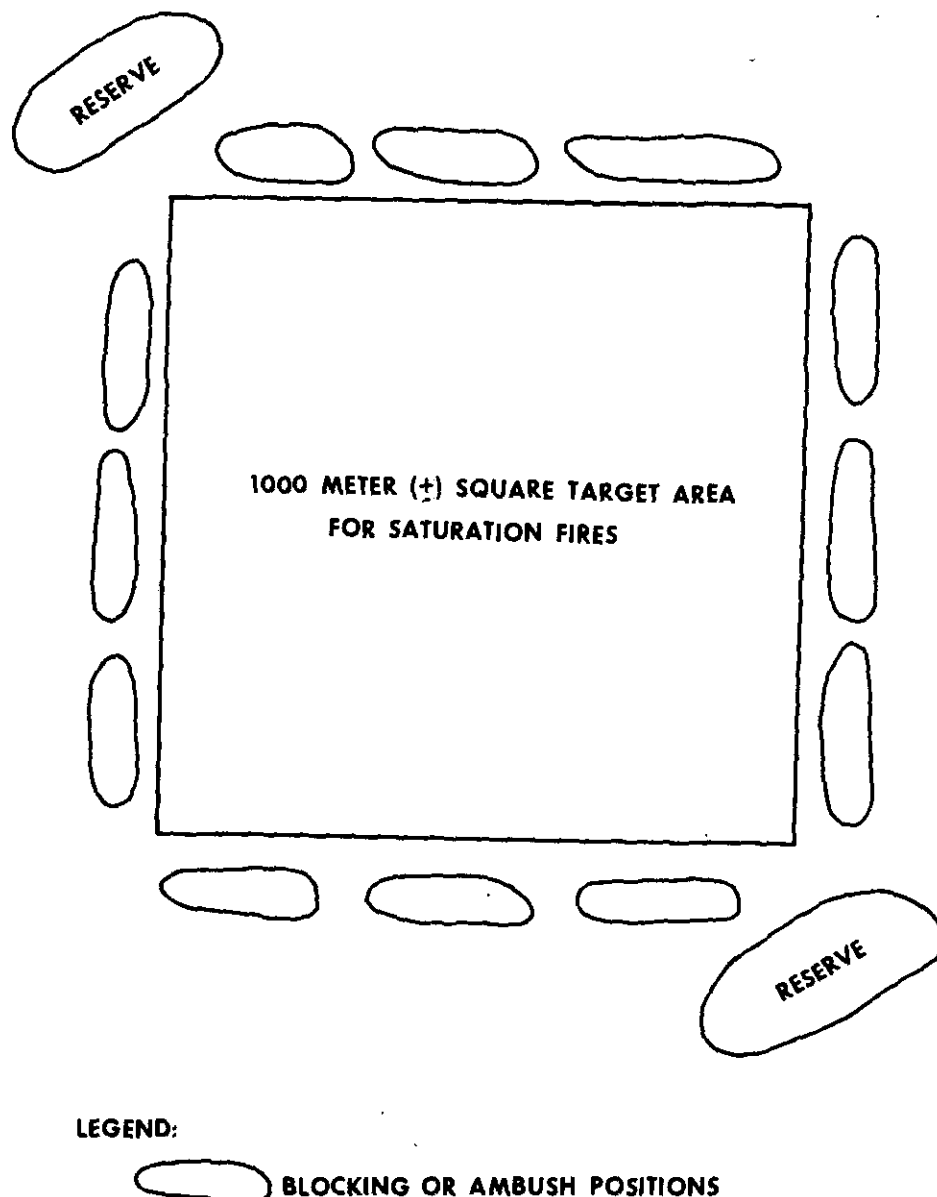

Figure 41. Use of saturation fires.

are usually ineffective against individuals running through brush or hiding; however, in terrain such as rice paddies where insurgent movement may be impeded, faster-moving, light armored vehicles, such as armored personnel carriers, can be used effectively to pursue and destroy insurgent tactical forces. Air cavalry is particularly well suited for the pursuit role when operations are conducted during daylight and in partially open terrain.

Air cavalry elements can observe the movement of insurgent tactical forces, interdict them by fire, and land riflemen to seek out enemy that attempts to hide. Because acclimatization and familiarity with the terrain are necessary, ground pursuit will normally be undertaken by or with the assistance of indigenous forces. Forces conducting pursuits normally are organized into direct pressure forces and encircling forces. Direct

pressure forces use all action other than encirclements in order to deny the insurgent the opportunity to reorganize his forces or reconstitute his defenses. Encircling forces, employing all available means of mobility, conduct local encirclements to cut off and destroy insurgent tactical force elements.

h. Search and Clear. This type of operation combines the movement to contact with attack and search techniques to cover an assigned zone in which all insurgent forces must be captured or destroyed by offensive action. Armor teams or task forces for this mission should be provided with sufficient infantry to permit effective dismounted search of villages, woods, and other likely enemy hiding places in the area of operation. Tank and scout elements of the team or task force are normally used to move through or around suspected insurgent areas and to establish blocking positions while a detailed search of the area is conducted by dismounted riflemen. During the search, tanks and armored personnel carriers are used to overwatch the riflemen and to complete the encirclement of the area. Techniques for village search and seize are as follows:

- (1) The first step is to isolate the village to prevent the enemy from leaving by various escape routes prior to the seizure of the village. The isolation phase is in the form of an encirclement. Characteristics of the isolation phase are—
 - (a) The operation is launched from a clandestine base or assembly area, by a quick thrust from an operational base, from an approach march, or from helicopters.
 - (b) Surprise is absolutely essential.
 - (c) Release points are used for control and no movement is made into the link of encirclement until all encircling units are in position at their release points.
- (2) The second step is to complete the encirclement. Under certain situations and in coordination with search activities, the encirclement may be contracted or subdivided as discussed in

f(4) above. Village search teams should be supported by PSYOP, military civic action, and intelligence interrogation teams. Figure 42 illustrates a technique of encirclement that may be used when sections of a village are dispersed. If the village is defended from prepared positions, see *g(2)* above and *n* below.

- (3) The third step is to search the village.
 - (a) Once the village has been seized, unit search of assigned areas is immediately initiated.
 - (b) One system of search is the fire team (half squad) concept. This system provides for a systematic search of each house and the entire area. Points in the village are not seized but the search begins at one end of the village and moves completely through it.
 - (c) The village is divided in lanes or sectors. The size of the lane or sector depends upon the capability of one rifle squad. The larger the village, the more rifle squads required. Rifle squads operate in the following manner:
 1. One fire team takes up a fire position while the other fire team is dispatched to search house number 1. The fire team in firing position is prepared to fire on house number 1 or other houses if necessary. The fire team conducting the search makes use of any cover available so as to be masked from insurgent fire that may come from other houses.
 2. When house number 1 has been searched, the fire team providing cover moves to search house number 2 while the other fire team provides support. After the second house has been searched, each house is searched in turn. One fire team does the searching while the other fire team provides necessary support.
 3. During the search, it is essential that one squad does not get for-

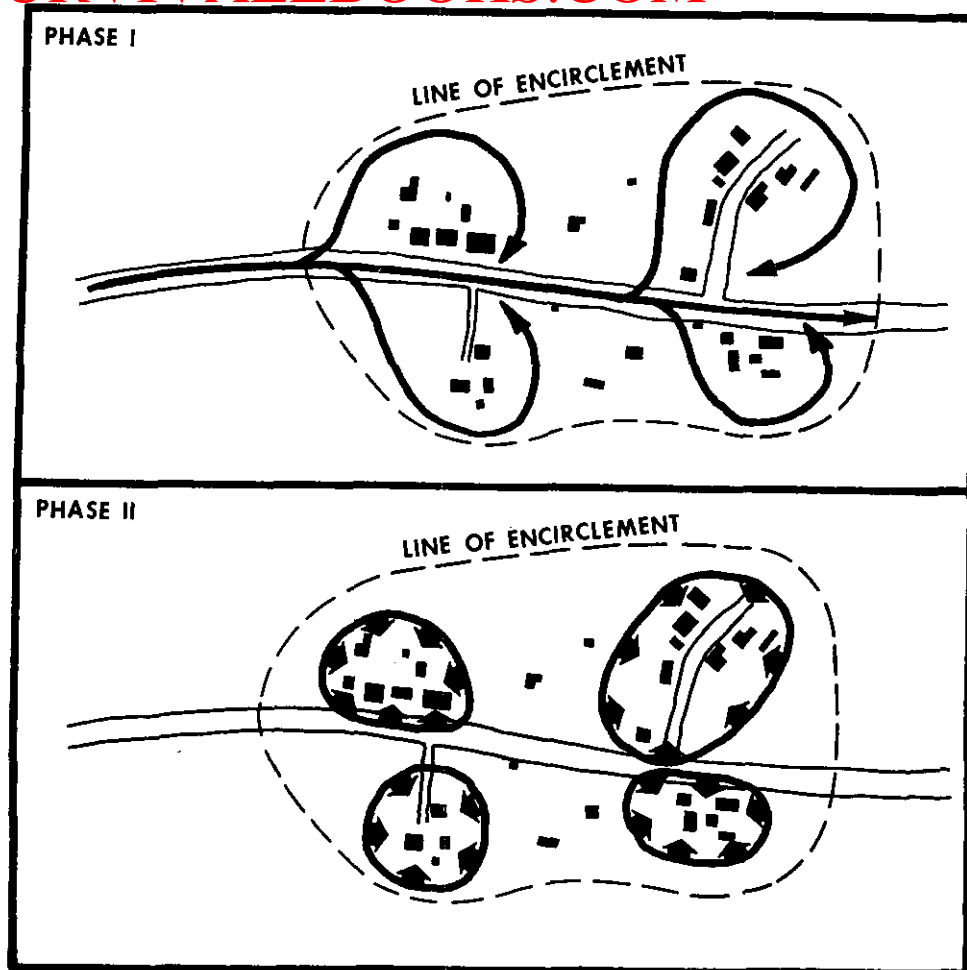

Figure 42. Village search.

ward of the other. Control is essential, and each squad must know the relative position of the other to prevent a firefight between the squads.

- (d) Two methods are available to the commander to control the civilian population in a village—the collection of personnel into one central location when they appear to be hostile and the restriction of personnel to their homes. Regardless of the method used, all personnel should be searched, questioned immediately, and held until the search of the village is completed. The necessity of the search should be explained to the villagers.
- (e) Searches must be thorough and de-

signed to detect insurgent personnel, equipment, tunnels of escape, and other items of value to the insurgent. All likely areas, for example, cattle pens, wells, haystacks, gardens, fence lines, and cemeteries should be investigated. The search teams must be constantly on the alert for boobytraps and mines.

i. Counterattack. Counterattacks are normally conducted against insurgent ambushes, raids, and coordinated attacks by forces either under attack or from reserve elements.

- (1) To be effective, the counterattacking force (reserve force) must be able to move without delay to the battle area, assault the enemy in the face of a large volume of automatic weapons fire, and drive them away from the battle

area, disperse, and pursue them. Since insurgent raids are normally accomplished in open populated areas and ambushes along usable routes of communications, counterattacking forces can usually expect access to the battle area. Proper security measures, such as aerial surveillance and reconnaissance by fire, must be exercised in the approach, march by the counterattack force. The insurgent's initial attack may have been a diversion with their main force deployed in ambush to destroy the counterattack force. Although time is critical, cross-country movement may be required. A mobile, indirect fire support capability should be available to the counterattacking force. The counterattacking force must be provided with adequate infantry strength for closing with the enemy and for search of areas for concealed insurgent troops.

- (2) Once the insurgent is identified, minimum reaction time is of greatest importance. The counterattacking force must arrive at the attack site before the friendly defenders are defeated. Ground armor, air cavalry and airmobile units are well suited for these missions. Air cavalry provides the suppressive and interdiction fires. The air cavalry squads and airmobile troops fix or assault the insurgent force, and the armor team or task force or armored cavalry unit moves to the attack area for the final destruction of the insurgent force. Air cavalry can also observe the action, interdict fleeing insurgents, and land riflemen to cut off and ambush escapees.
- (3) The most responsive use of attached helicopter transport is to locate the helicopters and the troops to be airlifted centrally within the supported organization. Where response time is not critical, the helicopters can go to a designated armored unit, pick up dismounted elements, and lift them to their objective.

j. Ambush. Use of armor in ambush operations requires careful planning, violent action, and aggressive leadership.

- (1) In ambush operations, the noise made by moving armored vehicles can be heard over a considerable distance and is easily identified by the insurgent. In order to overcome this difficulty, the "stay behind" technique can be employed. Using this technique, a number of vehicles are moved through a planned ambush location and a few predesignated vehicles drop out to hide and cut engines. This technique can be applied at dusk when the enemy returns to the scene of earlier engagements to access damage and to evacuate dead and wounded.
- (2) The speed of armored vehicles may be used in some ambushes. The ambush force will (by the technique of the preceding paragraph or by an extremely slow and disciplined approach) hide itself in a position from which it can observe the ambush site and from which good routes are available to the site. When the enemy enters the observed area, a concerted, top speed attack is made on the ambush site.
- (3) Because armored vehicles are large and difficult to hide from close observation, careful control of casual civilian traffic through and near the point of concealment will be necessary.
- (4) During the period in which the armored vehicles are static in a concealed position, maximum local security must be provided. For this reason, the ambush force must be well reinforced with riflemen.
- (5) Night viewing devices on armored vehicles can be used effectively for night ambushes.
- (6) Air cavalry can be successful in establishing impromptu ambushes with rifle squads, especially if the site can be approached without warning to the insurgent force.
- (7) See FM 31-16 for detailed discussion of ambushes.

k. Counterambush. Armor units may expect to encounter insurgent ambushes in the course of normal operations. The extent to which an armor unit is involved in an insurgent ambush can vary greatly. Vehicle movement may be obstructed, or the unit may only be subjected to intense fire. Only a small portion of the column may be within the area of fire, or for smaller columns, most of the unit may be immediately under fire. The ambush may have been planned for an armor unit, or the insurgent force may be surprised to find armored vehicles in the ambush. Most, if not all, of these conditions will not be immediately apparent to the ambushed troops; therefore, a predetermined procedure for instant and instinctive application of counterambush techniques is required.

- (1) Each vehicle must at all times have crew or squad members clearly designated for all-round observation and immediate warning.
- (2) Vehicles caught in the area of fire should attempt to drive through to a safe distance.
- (3) Vehicles which have not yet entered the area of fire or which have successfully driven through should halt. The senior commander should immediately organize and launch a counterattack, mounted if possible but dismounted if necessary.
- (4) All vehicles actually engaged by insurgent fire must return fire immediately with all available weapons. This fire is particularly essential during development of the counterattack by forces not engaged.
- (5) Armored vehicles trapped in the area of fire should face the insurgent positions and move as close to them as practicable. Riflemen should dismount only if ordered to do so, for example, when the insurgent force is using antiarmor weapons.
- (6) Fire support, based on a prearranged plan, should be called for immediately.

l. Blocking Positions. Armor teams should not be used to establish blocking positions unless their speed, armor protection, or firepower can be used to particular advantage, outweigh-

ing the disadvantages of possible loss of surprise (due to noise) and the vulnerability of a static position. In order to use their weapons and vehicles to full advantage in this role, armor teams require good fields of observation and fire. Blocking positions should either be occupied slowly and quietly, or they should be occupied swiftly at the last minute after the insurgent force is fully committed to his route of withdrawal. In either case, the armor unit will be static during development of the attack, and local security will be required. Armor units are also particularly suited for establishment of hasty blocking positions in situations where enemy routes of withdrawal have not been foreseen and rapid redeployment is required. In all blocking situations, the team should assume the offensive as soon as the enemy force is firmly committed to the route being blocked.

m. Raids.

- (1) Raids are limited-objective surprise attacks from which a prompt and carefully planned withdrawal is made prior to any coordinated enemy countermove. In internal defense operations, raids are limited to insurgent strongholds or "safe areas." Friendly strength is usually limited in these areas by remoteness or difficult terrain and, if given sufficient time, the insurgent is likely to launch a counterattack. Armor units are well adapted for raiding with good communications for necessary coordination and timing and good mobility for penetrating enemy strongholds. Routes of withdrawal must be carefully planned so that unforeseen obstacles do not trap the unit in unfriendly territory and subject it to defeat. If terrain is particularly difficult, withdrawal should be over the route of entry despite the risks involved rather than over new terrain in which the unit might bog down and be attacked. In these situations, a portion of the armor unit or air cavalry should be used to patrol and secure the route of entry to avoid ambushes during withdrawal.

- (2) Raids will usually be conducted by small, mobile elements. Targets will seldom require a major force. Time available for a raid will usually preclude the organization of a large force due to the fleeting type targets presented by the insurgent forces.
- (3) Armored cavalry platoons and air cavalry elements are especially suitable for raid type operations. The combination of sudden, simultaneous attack by ground armored troops and helicopter-borne riflemen landed under aerial suppressive fires will be successful over most insurgent forces encountered and seriously disrupt insurgent operations.
- (4) Major mounted raids may be conducted against known or suspected centers of insurgent activity or supply bases when these bases are located in accessible areas. Since relatively large forces are used in major raids and must usually move over extended distances, complete surprise can seldom be achieved. Some surprise may be gained by rapidity of movement. Consequently, raiding forces of this nature require speed, heavy firepower, armor protection, and air support. While large insurgent organizations can seldom be trapped or annihilated by a raiding force, large amounts of critical supplies and equipment may be captured. An effective force for a major raid is the armored cavalry squadron and, when necessary, reinforced with infantry and artillery. The air cavalry troop provides security along the route and participates in the attack on the objective.

n. Offense in Cities and Built-up Areas. There are two general types of built-up areas—villages and towns or cities. Villages usually consist of poorly fabricated huts clustered in a disorderly arrangement convenient to the local industry. The houses provide no cover to weapons crews but are often used as insurgent supply caches especially for food and ammunition. This type area offers little resistance to an ar-

mored attack. On the other hand, there are many permanent structures in towns and cities, such as factories, major stores, warehouses, temples, schools, and government facilities. During the last phase of an insurrection, the insurgents must attempt to overthrow and seize governmental control, and this necessitates attacks on the towns. Conversely, the insurgents may hold a town and government forces must attack it. Combat against insurgents in such built-up areas will be conducted in the same manner as against any hostile troops. This type of fighting is most easily accomplished by using a combined armor-infantry-air team.

o. Security Force in Cities and Villages. One of the first steps in internal defense operations is to convince and show the people that the established government will and can protect them. The best persuasion is useless if the insurgents can enter populated areas at will, assassinate officials, terrorize the people, and appropriate whatever supplies they need. It is necessary, therefore, to outpost villages with small powerful elements which can be promptly reinforced by highly mobile armor or airmobile reaction forces from the larger cities. If a village is known to be sympathetic to the insurgents or perhaps wavering, a fairly strong force is required. The defense of a village is organized in a perimeter or strongpoint type defense. The piecemealing of units in this role must be carefully considered. Once a village has organized a self-defense unit and has participated in actions against the insurgents, the village can be outposted by an indigenous infantry element or left with only its own self-defense forces which permit better utilization of the regular forces. A defensive technique for a village security force under attack is to organize a mobile striking force which breaks out of the built-up area under covering fire. The mobile reaction (reserve) force moves rapidly into the concealment of the countryside, flanks the insurgent position, and counterattacks. This technique is accomplished primarily by dismounted troops and must be practiced until it is automatic.

p. Security of Routes of Communications. This mission involves keeping the roads, passable trails, and waterways open for traffic and

is usually accomplished as an integral part of area security. Securing land routes requires constant surveillance to discover and eliminate mines, roadblocks, and ambushes. This mission is best accomplished by a combination of air and armored cavalry units. Scouts are used to patrol the routes with the tanks, rifle squads, and support squads positioned at intervals along the route as reaction forces. Routes may be divided into squadron, troop, or in some cases platoon sectors. The extensive use of herbicides to clear permanent wide swaths along roadsides will assist in eliminating ambushes since it deprives insurgents of most of their concealment and exposes them more readily to air observers. Insurgents often use mines to block roads and trails in preparing ambushes. Waterways are normally assigned to the Navy; however, armored cavalry units may be given this type of mission. Air cavalry can patrol a waterway, observing, reporting, and interdicting enemy moving on or in the vicinity of the water route. The use of the swimming vehicles of armored cavalry units is limited in this type operation because of their slow water speed. Also see paragraph 106.

q. Convoy Escort. This mission, like the preceding one, is suitable for armored cavalry elements. Convoy escort is usually required only after area and route security measures have failed to keep routes open. Convoy escort elements must be able to survive and destroy ambushes, inflicting greater casualties than those received. Normally, a platoon is sufficient for this purpose. In situations of unusual insurgent activity, critical cargo or troop convoys, or extra long convoys, a troop or larger force may be required (fig. 43). Long convoys will normally be broken up into march units, each with its own escort elements, and dispatched at irregular intervals. All units will remain in constant radio contact so that an attack on any element will permit prompt reinforcement. Escorts will usually be organized with armored elements at both ends of a march unit and occasionally within it. Escorts may be varied depending on existing conditions and the commander's experience. Rehearsal of individual vehicle counterambush actions is essential (*k* above). Air cavalry should be used to support the ground escort by aerial fires and provide

security as required. Convoy escort missions are not necessarily limited to military convoys. Military units may be required to provide protection for civilian transportation carrying goods from cities to outlying districts and vice versa. When the insurgent activities become so pronounced that they effectively curtail economic transactions, local governments are in imminent danger of collapse.

r. Reconnaissance and Surveillance.

- (1) Reconnaissance, other than route reconnaissance, is restricted by terrain to primarily aerial and dismounted elements. Finding specific insurgency bases or camps is extremely difficult because of the lack of adequate intelligence. In the event information is available, reconnaissance should normally be made by aircraft since speed is essential. To avoid operational intentions, reconnaissance aircraft should not hover over or appear to show unusual interest in any particular area. Periodic flights over suspected area will accustom the insurgents to such reconnaissance. This will tend to make them less wary when a specific objective is searched and will also permit continuous photograph coverage for comparative analysis. Dense forests or other type cover and concealment usually found in areas of insurgency operations will preclude effective aerial reconnaissance in most instances, but every effort must be made to secure accurate information.
- (2) Armored cavalry dismounted elements will not ordinarily conduct zone reconnaissance but will often patrol selected areas. This area reconnaissance mission has a threefold purpose: it permits the troops to become familiar with the terrain and habitations; it threatens the insurgents with the loss of supply caches and hidden cultivated food plots; and it forces the insurgents to keep constantly on the move or to stay dispersed. The scheduling, size, and route of reconnaissance patrols must

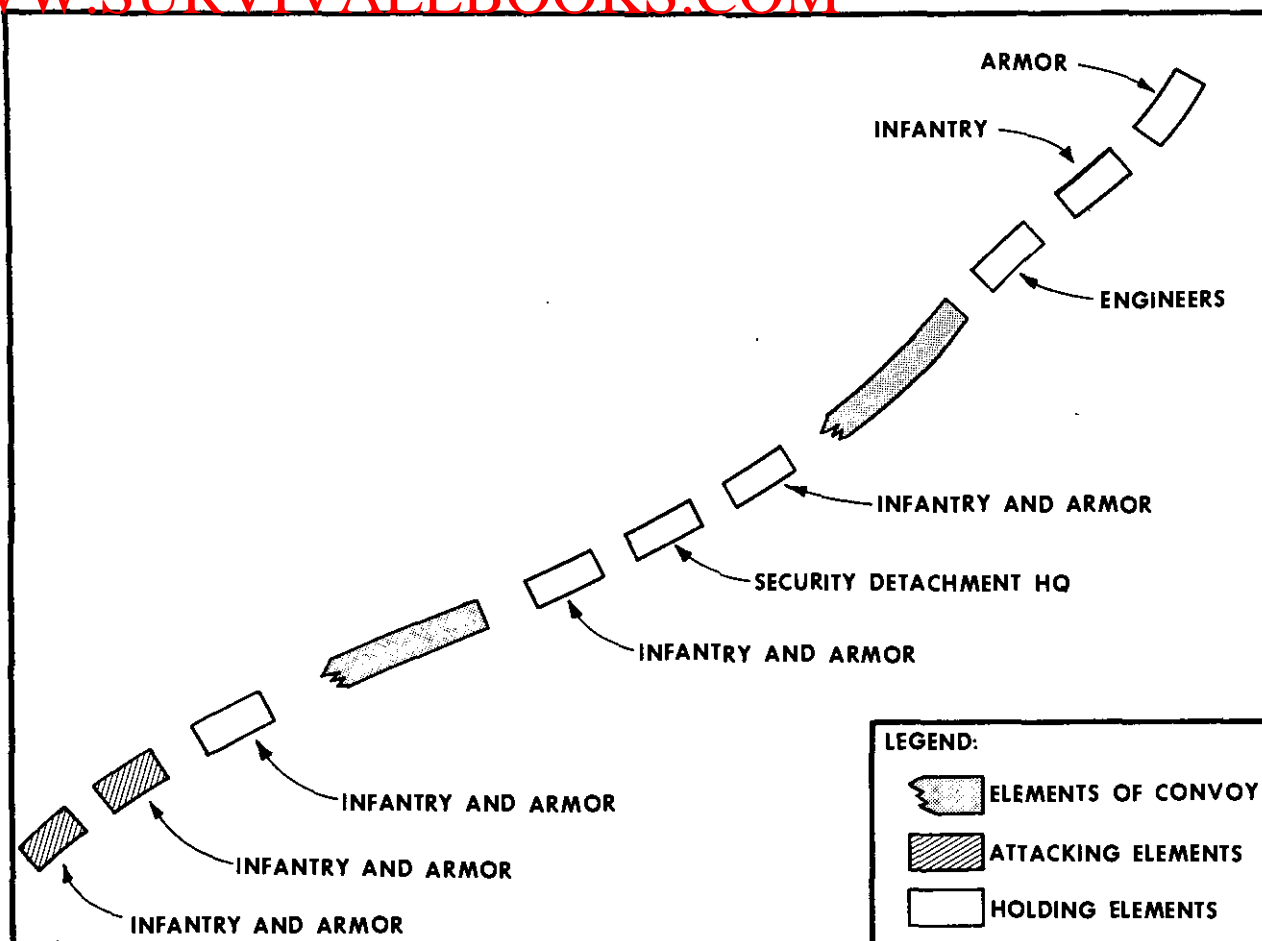

Figure 43. Convoy with a strong security force.

be varied since they are vulnerable to ambush.

- (3) Complex, sophisticated surveillance means are of limited value in counter-insurgency operations. Neither human eye, infrared, nor radar sensors can penetrate the dense forest canopy that conceals many insurgent groups, and no means available can differentiate between the armed insurgent and the loyal civilian. Photographic coverage or other electronic devices may reveal an area of unusual activity that can be useful in determining what trails are in constant use. However, insurgents are efficient in the art of camouflage and are rarely discovered by a surveillance means.

s. Inland Water Crossings. Inland waterways are not normally used as routes of ap-

proach or withdrawal except in heavily inundated areas where other routes are not available. The use of inland waterways as routes of approach or withdrawal subjects armor units to easy ambush or other offensive actions by insurgency forces. Amphibious armored vehicles are not normally used for protracted water movements due to their slow water speed. In heavily inundated areas, amphibious armored vehicles may be used to assault enemy elements when water movements are for relatively short distances. Armor units conducting tactical river crossings should follow doctrine outlined in paragraphs 359 through 370 and FM 31-60.

t. Border Control Operations. In conjunction with the host countries National Border Control Agency, armor units may support indigenous forces or operate as separate units in border control operations. This mission will

usually conform to a screening-type operation as discussed in FM 17-36. The size of the reserve or reaction force in these operations will depend on the local tactical situation. In addition to the tactical requirements of a screening force, armor units may support or perform the following missions:

- (1) Construction of barriers, minefields, CBR barriers, and development of restricted zones.
- (2) Control of buffer areas.
- (3) Provide airmobile and mechanized reaction (reserve) forces.
- (4) Organization and training of paramilitary forces and trail watchers.
- (5) Assist in psychological operations, radio and loudspeaker broadcasts, leaflet dissemination, and radio jamming.
- (6) Tunneling detection.
- (7) Protection of the population by offensive and defensive combat.

u. Psychological Operations. For detailed discussion of psychological operations in internal defense operations, see FM 31-16, FM 31-22, FM 33-1, FM 33-5, and paragraphs 420 through 424.

v. Combat Service Support. During internal defense operations, armor units are usually employed at a considerable distance from support elements. The strength of accompanying combat trains may be increased considerably, including the attachment of combat service support elements. Because of the frequency of independent and semi-independent operations, the provision of supplies and evacuation of casualties may pose serious problems. Protected convoys are usually required for supply trains and medical evacuation. Emphasis will be placed on air supply and air medical evacuation. Conditions may require frequent use of Landcarrying parties for some supply operations. When practicable, local civilian labor is used. Armor units, employed in insurgency operational environments, may not receive combat service support as in limited or general war field army operations from a field army support command, but rather, combat service support in excess of organic unit capabilities may be provided directly from U.S. or HC lo-

gistical commands or installations. See chapter 10 for organization of trains.

w. Where possible, maximum use of vehicular and heliborne searchlights should be made in internal defense operations.

- (1) Appendix XV contains the tactics and techniques for employment of tank mounted searchlights. These tactics and techniques are also applicable to other type armored vehicles mounting searchlights.
- (2) Heliborne visible searchlights may be used at night for performing aerial surveillance, target identification and engagement, illuminating landing areas, and providing visible illumination to assist ground operations.

(a) *Surveillance.* Surveillance by searchlight helicopters of relatively small areas, troop formations, weapons emplacements, fortifications, and similar size targets usually requires an accompanying observer helicopter. This is necessary due to the feedback of illumination that prevents the crew of the searchlight helicopter from observing small targets. The observer helicopter flies at a lower altitude outside the searchlight beam. However, for surveillance of traffic on canals, rivers, roadways, or other large targets, the observer helicopter is usually not required. Protection is provided the searchlight helicopter and the observer helicopter (if used) by an armed helicopter fire team that trails to the rear and at an appropriate altitude. The fire team also provides the firepower for target engagement. The searchlight helicopter, observer helicopter, and helicopter fire teams are commanded by a flight team leader.

(b) *Target identification and engagement.* The tactics and techniques used in night target identification and engagement are generally the same as those used in night surveillance. Target location and tentative identification are usually reported

by other aircraft or ground troops. The searchlight helicopter and helicopter fire team are then vectored to the target location. After the target is identified, the searchlight helicopter establishes an orbital flight pattern, maintaining illumination on the target for the fire team helicopters throughout the engagement. If an observer helicopter is employed, the helicopter is immediately turned away from the searchlight beam once the target is identified. The observation helicopter's rotating beacon is turned on so that it can be seen by the fire team helicopters. When the observer helicopter is armed, it joins the fire team helicopter in engaging the target. If unarmed, the observer helicopter orbits well out of the target area and at an altitude above the searchlight helicopter.

- (c) *Illumination of landing zones.* Searchlight helicopters provide illumination of landing zones by using flight paths parallel to the landing helicopters and by linear or orbital flight paths above the landing zone. Of the three techniques, the orbital flight path above the landing zone usually provides the best illumination. This technique allows the searchlight helicopter crew to maintain the light on a single point and thus produce a more even intensity of light in the landing zone.
- (d) *Illumination in support of ground operations.* Searchlight helicopters

may be used to provide illumination to support ground operations either by preplanned request or by immediate request. Areas to be illuminated are specified by the ground commander. The tactical situation will determine the organization of the helicopter flight team as to the number of searchlight and armed helicopters. These teams provide a responsive force for assisting in the relief of units, convoys, or installations that are under insurgent night attack.

413. Internal Defense Operations by Air Cavalry Units

Air cavalry units are used in counterinsurgency operations as separate maneuver units to support ground operations of armor and infantry units, including airmobile operations. Since air cavalry units are not confronted by terrain obstacles encountered by ground maneuver units, the tactics, techniques, and procedures contained in FM 17-36 are readily adaptable to counterinsurgency operations.

414. Stability Operations

Stability operations are internal defense operations to restore order in the face of irregular forces of violence, to protect vital areas, and to permit host or receiving country to function from a position of strength. It is characterized by brevity, restrained use of force, and dependence on psychological impact of a display of force. In stability operations, armor units use tactics, techniques, and procedures discussed in this section as necessary and as permitted.

Section XIV. DIVISION REAR AREA SECURITY

415. General

a. The term *rear area security* refers to measures, except for active air defense, taken to neutralize or destroy localized enemy forces which constitute threats to units, activities, and installations in rear areas. Enemy operations and threats that endanger a command as a whole become operational matters and are

beyond the scope of rear area security operations.

b. In forward areas, each combat unit is responsible for its own local security. Unit, activity, and installation commanders (tenants) in rear areas are responsible for their own local security. However, armor units may be designated as rear area security forces to conduct

operations in the rear areas that are beyond the capabilities of tenant units, activities, and installations.

416. Guerrilla Operations in Rear Areas

a. In rear areas guerrillas may operate as independent or semi-independent groups. These groups may be composed of dissident civilian irregulars, paramilitary type forces, bypassed armed forces evading capture, or stay-behind armed forces units designed to organize and conduct resistance activities against friendly forces. The use of the term "guerrilla" in the remainder of this section does not limit the operations and activities described to irregular bands roaming the countryside, but includes, as appropriate, paramilitary and regular armed forces units which may be using guerrilla tactics. The extent of organized guerrilla activities is normally dependent on guerrilla force organization, leadership, and logistical support available.

b. Guerrilla operations are characterized by surprise, mobility, and rapid dispersion of forces following any operation. As a general rule, guerrilla forces converge on a target over multiple, concealed routes, moving either singly or in small 2 to 3-man groups. Immediately following an attack, the guerrilla force will disperse and move to secure bases or mingle with the local population. Surprise is the most important single element in guerrilla operations. A guerrilla force will normally attack friendly forces where they are weakest and when least expected.

c. The primary objectives of organized guerrilla operations are to restrict or stop the flow of supplies, troops, and equipment, to and within the combat zone; to disrupt communications; and to interfere to the maximum extent possible with friendly force operations with the aim of forcing commanders to divert combat forces to mobile and static security operations.

d. Operations of hostile guerrillas can affect armor units by:

- (1) Delaying the movement of armor units by interdiction operations against critical bridges and defiles.
- (2) Forcing commanders to divert armor elements to mobile and static security operations.

417. Rear Area Security Operations

a. *Concept.* Rear area security operations, by armor units designated as rear area security forces, include the location, engagement, and destruction of guerrilla, infiltrator, sabotage, and conventional forces whether ground, airborne, or airlanded. Tenant unit, activity, or installation commanders conduct defensive operations primarily and limited offensive operations within their capabilities. The primary function of the rear area security force is to fix and destroy the enemy or to keep the hostile elements sufficiently off balance to preclude their launching successful offensive operations. In the event hostile attacks occur, rear area security forces are deployed rapidly to defeat the enemy elements or to contain the attack until additional forces are committed.

b. *Missions.* An armor unit designated as a rear area security force is assigned the mission of protecting the entire rear area or specific territorial areas in the rear area, by the appropriate commander. The protection of the designated territorial areas includes—

- (1) Relief of attacked installations and units.
- (2) Protection of lines of communication.
- (3) Denial of drop or landing zones.
- (4) Surveillance of possible bases of operations for guerrilla forces.
- (5) Finding, fixing, and destroying enemy conventional forces and enemy guerrilla forces operating in rear areas (fig. 44).

c. *Planning.*

- (1) The commander responsible for security of an area reconnoiters his assigned area to determine key terrain to defend, the location of installations, and likely enemy drop zones, landing areas, or assembly areas. Based on intelligence and other information furnished by higher headquarters, the commander and subordinate commanders familiarize themselves with capabilities of enemy forces and enemy airborne and airlanded assault capabilities. Based on his reconnaissance and study of the enemy capabilities, together with a

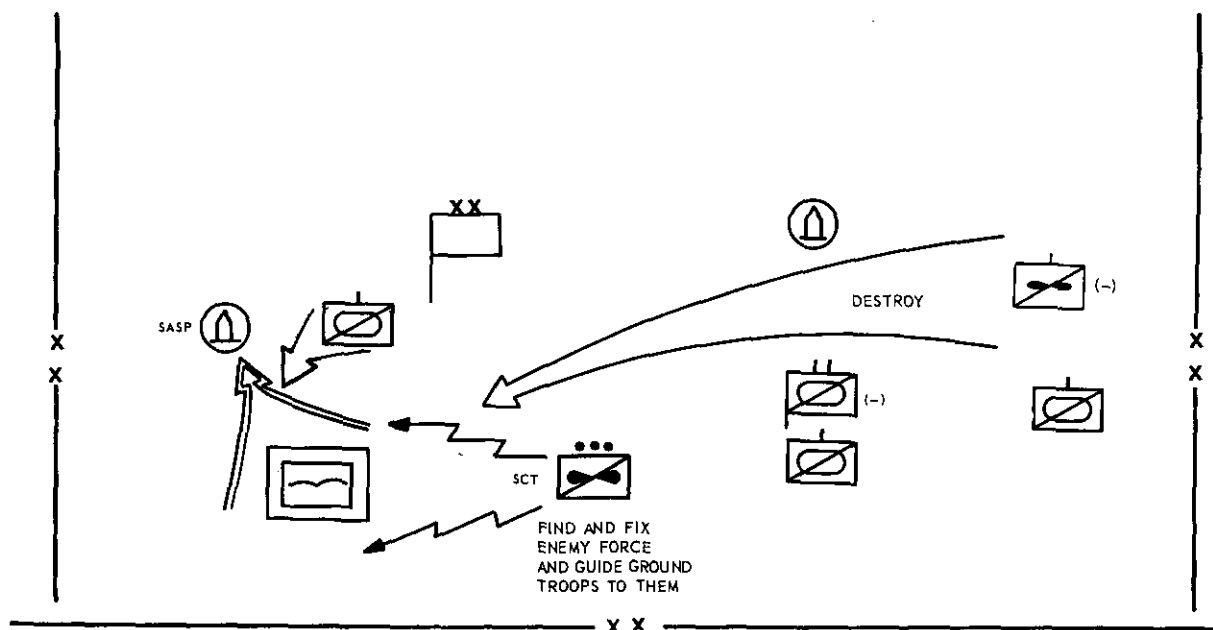

Figure 44. Finding, fixing, and destroying enemy conventional forces.

consideration of troops available and the mission, the commander develops his plan.

(2) Major components of the commander's plans includes—

- (a) Surveillance of the entire area of responsibility.
- (b) Counterattack of airborne or air-landed forces.
- (c) Operations against guerrilla forces.
- (d) Control of civil populace in conjunction with civil affairs agencies.
- (e) Protection of critical rear installations and lines of communication.
- (f) Alert and warning systems, including periodic checks of all communication facilities and alert procedures of units, activities, and installations in the area.
- (g) Contingency plans for all operations.

(3) Plans should include maximum use of aircraft to maintain air patrols between OP's, roadblocks, or other defensive positions and to airlift elements of the reserve to engage enemy elements detected by screening forces or to reinforce units in contact.

d. Coordination.

- (1) With tenant units. The rear area security force commander is responsible for coordinating rear area security operations in his assigned sector with all tenant unit, activity, and installation commanders. While tenants are responsible for their own local security, the rear area security force commander must coordinate with them and assist them in defense planning. Liaison must be maintained to advise the tenants of the situation and to obtain information concerning activity in the tenant area.
- (2) With intelligence and civil affairs activities. The rear area security force commander maintains close coordination with intelligence and civil affairs activities to obtain information concerning enemy forces operating in the area.
- (3) With Air Force units and Army air defense units in the area for early warning.
- (4) With military police units. Because military police units have area-oriented missions, their mobility and com-

munications system combine to afford the rear area security commander an important source of information and control for rear area security.

e. The successful accomplishment of a rear area security mission is contingent upon the establishment of an adequate warning system, which in turn is dependent on effective communication means. All organic, primary, and alternate means of communication, including those of rear area units and installations, must

be incorporated in the system. Procedures for reporting are established that provide for communication checks at frequent intervals at an established time employing both primary and alternate means of communication. Provisions include a means of immediately contacting those stations that do not report at the prescribed time, such as OP's, patrols, and other subordinate elements. Standby air and ground elements should be provided and dispatched immediately when a station fails to report.

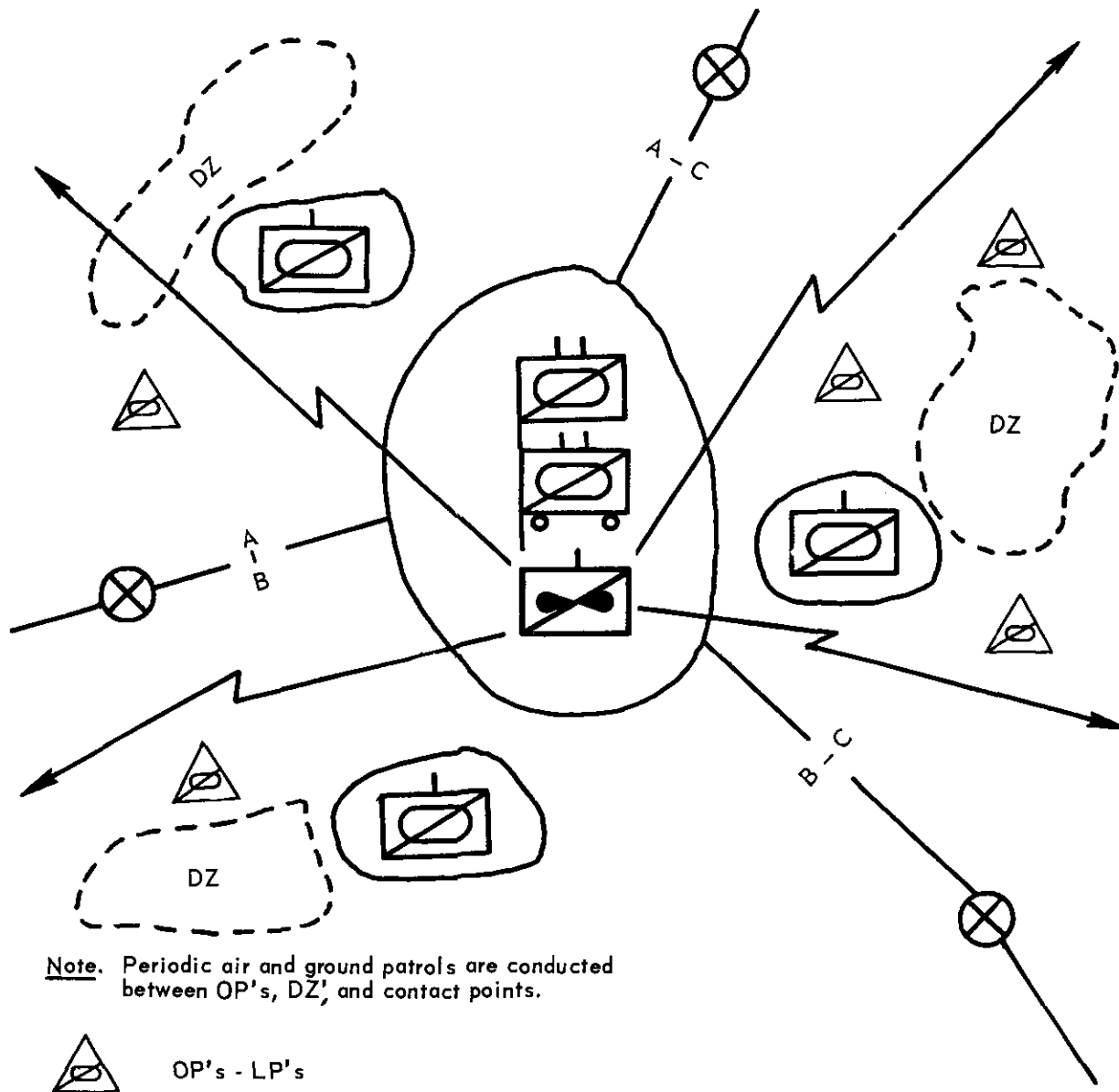

Figure 45. Armored cavalry squadron employed in rear area security mission.

418. Deployment of Rear Area Security Forces

The rear area security force may establish a defensive position. If the area to be secured is too large for employment of this method, the area is covered by observation posts and patrols with a large, highly mobile reserve prepared for immediate movement to any part of the area (fig. 45). Observation posts are sited to maintain observation over routes and installations to be secured and usable drop or landing zones identified in the initial reconnaissance. Reserves are centrally located with regard to the vulnerable areas that are subject to airborne or ground attack. If the area is large, it may become necessary to locate the reserve in small groups throughout the area; however, the security force commander must retain control of all reserve groupings so that he can employ them separately or in mass. Aircraft are used to maintain contact between OP's or defense positions and to conduct systematic air reconnaissance missions over the area to be secured. Ground elements establish a similar patrol system between OP's and major concentration of forces. The unit escorting convoys through threatened areas usually employs its main strength in the forward part of the formation and establishes security to the front, flanks, and rear. Air patrolling of routes will normally assist in more rapid movement of convoys.

419. Conduct of Rear Area Defense

a. Successful defense of the rear area is contingent upon the early warning furnished by observation posts, air and ground patrols, and other security dispositions throughout the area (fig. 46). Care should be taken to operate air and ground patrols, and OP's or LP's on irregular time schedules, in varying directions and locations. Security elements, after promptly reporting the imminence of an enemy action, maintain contact with the enemy. The main force or elements thereof are moved, as necessary, to counter the enemy activity.

b. Successful defense against an airborne or airlanded assault is based upon prompt engagement of the hostile elements by all available means. Every effort is made to attack and reduce the airborne or airlanded assault in the earliest stages of the drop or landing operations when the enemy forces are most vulnerable. This immediate reaction to an airborne or airlanded attack may require the piecemeal commitment of forces, depending upon the overall disposition of the security forces at the time of the enemy attack.

c. Information pertaining to an enemy threat may be received from intelligence agencies or other sources. On receipt of such information, the commander in whose area the threat occurs takes action to reduce the threat.

d. Tactics, techniques, and procedures discussed in preceding section XIII for internal defense operations are also applicable for rear area security operations.

Section XV. PSYCHOLOGICAL OPERATIONS (PSYOP)**420. Psychological Support to Armor Units**

a. General. The nature of armored warfare, particularly in offensive situations, has a profound psychological effect on enemy forces. This effect can be maximized by the employment of PSYOP units in armor operations. FM 33-1 contains the basic doctrine for psychological operations. PSYOP integration must be complete, continuous, and in accordance with each specific mission assigned. PSYOP units provide combat support by engaging in propaganda operations which attempt to—

(1) Depress enemy morale.

(2) Diminish enemy combat effectiveness.

(3) Encourage defections.

(4) Stabilize the population and prevent refugee movements from interfering in combat operations.

b. Employment. PSYOP loudspeaker teams are employed in an armored unit's area of operations under the staff supervision of the unit's S3. Additional printed media and radio broadcast support may be requested from higher headquarters as necessary. Limited interpreter and translator service may be provided through the linguistical capabilities inher-

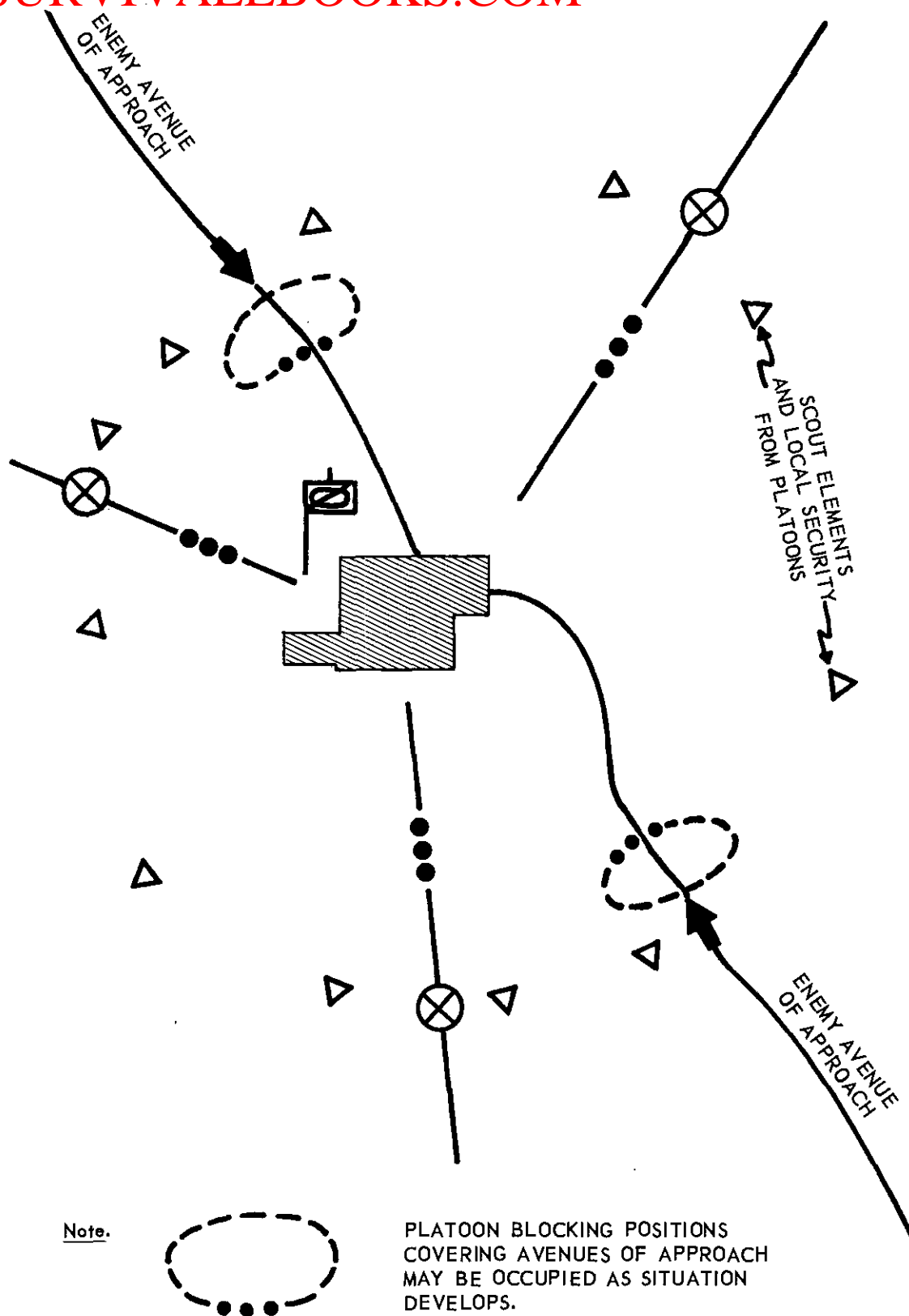

Figure 46. Armored cavalry troop protecting an installation as a part of a squadron rear area security force.

ent in the loudspeaker teams. Some of the potential target audiences are—

- (1) Isolated enemy units. These are excellent target audiences for psychological operations.
- (2) Individual enemy soldiers, particularly after prolonged exposure to armored assaults.
- (3) Civil populace. The actions of a confused populace and refugee movements in the area of operations will hamper the movements and combat operations of the unit. Loudspeaker teams may be attached to the lead march elements to assist in removing or redirecting refugees from roads and highways. Radio appeals and leaflet drops should be requested to assist in stabilizing the civil populace.

c. For a more complete discussion of PSYOP, see FM 33-1 and FM 33-5.

421. PSYOP in Support of Offensive Operations

a. *Loudspeaker Operations.* Loudspeaker teams may hasten the surrender of enemy soldiers, thus reducing the fighting potential of enemy units. While mass surrenders are not likely, this possibility is always present and should not be overlooked. Loudspeaker appeals should be directed at isolated units (or those that think they are). A propaganda address is made, sufficient time allotted for the acceptance of surrender, and then an attack is launched. Air cavalry or other aircraft may participate in airborne loudspeaker operations if compatible with the tactical situation. Propaganda appeals must be in consonance with previously disseminated printed media messages.

- (1) Loudspeakers must be properly situated. The equipment should be located on the forward slope of hills and ridges, or the topmost floors of buildings to insure maximum broadcast range and coverage.
- (2) Where possible, loudspeakers should be attached to units operating in areas free of dense foliage, buildings, or other obstructions which might

distort propaganda messages and thus reduce target audience coverage.

- (3) Loudspeaker teams must be provided the degree of mobility and armor protection equal to that of the unit they are supporting.
- (4) The timing of loudspeaker appeals should receive the same considerations as would the employment of supporting weapons. It is useless to schedule a propaganda address during artillery fire with its competing noise and confusion, where petitions made before and after the artillery action may produce worthwhile results.
- (5) Inclement weather will adversely affect the audibility and range of broadcasts.
- (6) Loudspeakers draw fire and may be considered a hazard by the supported units.

b. *Printed Media Operations.* Preplanned printed media missions in support of armor units should be requested well in advance and provision must be made for continuous PSYOP support before, during, and after the operation. The armored cavalry regiment has organic printed media dissemination capabilities in its field artillery battery, 155mm SP, and its air cavalry troop. Armored cavalry units and other armor units with organic aircraft should keep contingency type leaflets readily available to engage targets of psychological opportunity which might appear during the conduct of an operation.

c. *Radio.* Radio broadcasts eliciting the cooperation of civilians encountered, or to be encountered, in an armored units area of operation may be requested from higher headquarters.

422. PSYOP in Support of Defensive Operations

PSYOP loudspeaker teams may be deployed with the security forces, the forward defense forces, or with the mobile reserve when committed. PSYOP loudspeaker teams attached to defensive forces carry out their primary mission of conducting loudspeaker appeals to opposing enemy forces and, in addition, may be

deployed by the commander in appropriate deception roles. Ruses may be profitable such as using tape recordings at night to simulate large tank movements, or by massing all available loudspeakers at full amplification to conceal the sounds of friendly maneuvers. Care must be taken to avoid patterns of activity that are subject to enemy discovery, and so become worthless with use.

423. PSYOP in Support of Retrograde Operations (Delay)

PSYOP loudspeaker teams should initially be attached to those units conducting the delaying action, and so employed to further the deception plans of the supported commander. Messages that imply impending aggressive action by the delaying unit may be used to aid in deceiving enemy intelligence gathering agencies.

424. PSYOP in Support of Security Operations

a. Psychological Actions. PSYOP support to an armored unit's tactical plans during security operations is similar to that described in paragraphs 421 and 422. In addition, the armor unit commander must consider certain nontactical missions his unit is capable of performing when committed in a rear area securi-

ty role or in counterinsurgency operations. The following examples apply:

- (1) If appropriate, parades, displays, and other activities may be conducted to demonstrate the combat power inherent in the armor unit.
- (2) When enemy air strength is impotent, organic and supporting aircraft may make massed flyovers thus causing a desirable psychological impact on the populace. If insurgents are active, a further purpose is served by placing them on false alert.
- (3) Organic aircraft may be used to make airborne loudspeaker appeals and to disseminate leaflets.

b. PSYOP in Support of Military Civic Action.

- (1) Insurgent influence can be reduced, and rapport with the populace increased, if personnel of armor units participate in appropriate military civic action projects. For detailed discussion see FM 31-16, FM 31-22, and FM 41-10.
- (2) All military civic actions projects should receive full PSYOP support to exploit and maximize their effect on the populace. See FM 33-1 and FM 33-5.

APPENDIX I
REFERENCES

FM 1-5	Army Aviation, Organizations and Employment.
FM 1-10	Army Aviation, Organizational Aircraft Maintenance and Supply.
FM 1-15	Aviation Battalion, Infantry, Airborne, Mechanized and Armored Divisions.
FM 1-60	Army Aviation, Air Traffic Operations—Tactical.
FM 1-100	Army Aviation.
FM 3-5	Chemical, Biological, and Radiological (CBR) Operations.
FM 3-8	Chemical Corps Reference Handbook.
FM 3-10	Chemical and Biological Weapons Employment.
(S)FM 3-10A	Employment of Biological Agents (U).
(C)FM 3-10B	Employment of Chemical Agents (U).
FM 3-12	Operational Aspects of Radiological Defense.
FM 5-1	Engineer Troop Organizations and Operations.
FM 5-15	Field Fortifications.
FM 5-20	Camouflage, Basic Principles and Field Camouflage.
FM 5-25	Explosives and Demolitions.
FM 5-26	Employment of Atomic Demolition Munitions.
FM 5-34	Engineer Field Data.
FM 5-36	Route Reconnaissance and Classification.
FM 5-135	Engineer Battalion, Armored, Mechanized, and Infantry Divisions.
FM 5-136	Engineer Battalion, Airborne Division.
FM 5-144	Engineer Shore Assault Units.
FM 6-20-1	Field Artillery Tactics.
FM 6-20-2	Field Artillery Techniques.
FM 6-121	Field Artillery Target Acquisition.
FM 6-135	Adjustment of Artillery Fire by the Combat Soldier.
FM 7-11	Rifle Company, Infantry, Airborne Infantry, and Mechanized Infantry.
FM 7-15	Rifle Platoon and Squads—Infantry, Airborne, and Mechanized.
FM 7-20	Infantry, Airborne Infantry, and Mechanized Infantry Battalions.
FM 17-30	Infantry, Airborne, and Mechanized Division Brigades.
FM 8-15	Division Medical Service, Infantry, Airborne, Mechanized and Armored Divisions.
FM 8-16	Medical Service, Field Army.
FM 8-35	Transportation of the Sick and Wounded.
FM 8-55	Army Medical Service Planning Guide.
FM 9-1	Ordnance Service in the Field.
FM 9-6	Ammunition Service in the Theater of Operations.
FM 9-30	Maintenance Battalion, Division Support Command.
FM 10-50	Supply and Transportation Battalion, Division Support Command.
FM 10-63	Handling of Deceased Personnel in Theaters of Operations.

FM 11-50	Signal Battalion, Armored, Mechanized, and Infantry Divisions.
FM 11-57	Signal Battalion, Airborne Division.
FM 12-11	Administration Company, Airborne, Armored, Infantry, and Mechanized Divisions.
FM 14-8	Class A Agent Officer.
FM 17-12	Tank Gunnery.
FM 17-15	Tank Units, Platoon, Company, and Battalion.
FM 17-30	The Armored Division Brigade.
FM 17-36	Divisional Armored and Air Cavalry Units.
FM 17-95	The Armored Cavalry Regiment.
FM 19-15	Civil Disturbances and Disasters.
FM 19-25	Military Police Traffic Control.
FM 19-40	Enemy Prisoners of War and Civilian Internees.
FM 20-22	Vehicle Recovery Operations.
FM 20-32	Land Mine Warfare.
FM 20-33	Combat Flame Operations.
FM 20-60	Battlefield Illumination.
FM 21-5	Military Training Management.
FM 21-6	Techniques of Military Instruction.
FM 21-10	Military Sanitation.
FM 21-11	First Aid for Soldiers.
FM 21-26	Map Reading.
FM 21-30	Military Symbols.
FM 21-40	Small Unit Procedures in Chemical, Biological, and Radiological (CBR) Operations.
FM 21-41	Soldier Handbook for Chemical and Biological Operations and Nuclear Warfare.
FM 21-48	Chemical, Biological, and Radiological (CBR) Defense Training Exercises.
FM 21-50	Ranger Training and Ranger Operations.
FM 21-60	Visual Signals.
FM 21-75	Combat Training of the Individual Soldier and Patrolling.
FM 21-77	Evasion and Escape.
FM 21-150	Combatives.
FM 22-5	Drill and Ceremonies.
FM 22-100	Military Leadership.
FM 23-8	U.S. Rifle 7.62-mm, M14.
FM 23-20	Davy Crockett Weapons System.
FM 23-30	Grenades and Pyrotechnics.
FM 23-65	Browning Machinegun, Caliber, .50, HB, M2.
FM 23-67	Machinegun, 7.62-mm, M60.
FM 23-71	Rifle Marksmanship.
FM 23-92	4.2-Inch Mortar, M30.
FM 24-1	Tactical Communications Doctrine.
FM 24-16	Signal Orders, Records, and Reports.
FM 24-18	Field Radio Techniques.
FM 24-19	Communication-Electronics Reference Data.
FM 26-5	Interior Guard.
FM 27-10	The Law of Land Warfare.
FM 29-22	Maintenance Operations in the Field Army.
FM 30-5	Combat Intelligence.
FM 30-7	Combat Intelligence, Battle Group, Combat Command, and Smaller Units.

FM 30-10	Terrain Intelligence.
FM 30-28	Armed Forces Censorship.
FM 30-30	Aircraft Recognition Manual.
FM 30-102	Handbook on Aggressor Military Forces.
FM 30-103	Aggressor Order of Battle.
FM 31-10	Barriers and Denial Operations.
FM 31-12	Army Forces in Amphibious Operations (The Army Landing Force).
FM 31-15	Operations Against Irregular Forces.
FM 31-16	Counter guerrilla Operations.
FM 31-21	Special Forces Operations.
(S)FM 31-21A	Special Forces Operations (U).
FM 31-22	U.S. Army Counterinsurgency Forces.
(S)FM 31-22A	U.S. Army Counterinsurgency Forces (U).
FM 31-25	Desert Operations.
FM 31-30	Jungle Training and Operations.
(C)FM 31-40	Tactical Cover and Deception (U).
FM 31-50	Combat in Fortified and Built-up Areas.
FM 31-60	River-Crossing Operations.
FM 31-70	Basic Cold Weather Manual.
FM 31-71	Northern Operations.
FM 31-72	Mountain Operations.
(CM)FM 32-5	Communications Security (U).
FM 33-1	Psychological Operations—U.S. Army Doctrine.
FM 33-5	Psychological Operations.
FM 41-5	Joint Manual of Civil Affairs/Military Government.
FM 41-10	Civil Affairs Operations.
FM 44-1	US Army Air Defense Employment.
FM 44-2	Light Antiaircraft Artillery (Automatic Weapons).
FM 54-2	Division Logistics and the Support Command.
FM 55-15	Transportation Reference Data.
FM 55-30	Motor Transportation Operations.
FM 55-45	Aircraft Maintenance Operations.
FM 57-10	Army Forces in Joint Airborne Operations.
FM 57-35	Airmobile Operations.
FM 60-30	Embarkation and Loading, Amphibious.
FM 61-100	The Division.
FM 100-5	Field Service Regulations; Operations.
FM 100-10	Field Service Regulations; Administration.
(C)FM 100-20	Field Service Regulations; Counterinsurgency (U).
FM 101-5	Staff Officers Field Manual; Staff Organization and Procedure.
FM 101-10-1	Organizational Technical and Logistical Data Part I—Unclassified Data.
FM 101-10-2	Staff Officers Field Manual—Organizational, Technical and Logistical Data—Extracts of Tables of Organization and Equipment.
(S)FM 101-10-3	Organizational, Technical, and Logistical Data—Classified Data (U).
FM 101-31-1	Staff Officers Field Manual; Nuclear Weapons Employment.
(S)FM 101-31-2	Staff Officers Field Manual; Nuclear Weapons Employment (U).
FM 101-31-3	Staff Officers Field Manual; Nuclear Weapons Employment.
FM 101-40	Armed Forces Doctrine for Chemical and Biological Weapons Employment and Defense.
(S)TC 3-7	Capabilities and Employment of Biological Agents (U).
TC 31-35	Control of Gaps.

TM 3-210	Fallout Prediction.
TM 3-220	Chemical, Biological, and Radiological Decontamination.
TM 3-240	Field Behavior of Chemical, Biological, Radiological Agents.
TM 5-210	Military Floating Bridge Equipment.
TM 9-1345-200	Land Mines.
TM 11-666	Antennas.
TM 21-306	Manual for the Tracked Vehicle Driver.
TM 57-210	Air Movement of Troops and Equipment.
AR 220-10	Preparation for Oversea Movement of Units (POM).
AR 220-58	Organization and Training for Chemical, Biological, and Radiological Operations.
AR 320-5	Dictionary of United States Army Terms.
AR 320-50	Authorized Abbreviations and Brevity Codes.
AR 380-5	Safeguarding Defense Information.
AR 600-20	Army Command Policy and Procedures.
AR 750-1	Maintenance Concepts.
DA Pam 108-1	Index of Army Motion Pictures, Film Strips, Slides, and Phono-Recordings.
DA Pam 310-Series	Military Publications Indexes.
JCS Pub 1	Dictionary of United States Military Terms for Joint Usage.
ACP 121	Communications.
ACP 124	Radio Teletypewriter Procedures.
ACP 125	Radio Telephone Procedures.
ACP 129	Visual Communications Procedures.
ACP 136	Panel Signaling.
ACP 168	Pyrotechnic Signaling.

APPENDIX II

COMMAND FACILITIES

1. General

Command facilities include the command post and the command group.

2. Command Post

a. Purpose. The command post provides personnel and facilities for the operational control of the unit. The command post maintains communication with higher, adjacent, supporting, and lower units. It forwards reports to the command group on new developments in the situation, plans continuously for current and future operations, provides for liaison with adjacent and higher units, and supervises liaison with supporting and lower units. The command post consists of the commander, the staff, liaison personnel from attached and supporting units, and the necessary supporting enlisted personnel, vehicles, and equipment. The command post revolves around the combined operations-intelligence section. This section uses both S2 and S3 personnel. It must be capable of continuous operations over extended periods. The executive officer supervises the command post operations and insures that sufficient officer and enlisted assistants, familiar with the situation and the operation of the headquarters, are on duty at all times. The brigade or regimental S4 operates from the brigade or regimental trains area. Depending on the desires of the commander, the brigade or regimental S1 may also operate from the trains area. At battalion or squadron, the S1 and S4 may operate from the combat trains rather than the command post area. The combined operations of these sections in the trains areas provide a combat service support center that facilitates control, communications, and continuous operations. However, "operates" should not be construed to mean a fixed loca-

tion. The S1 and S4 will frequently be away from the trains area supervising the combat service support effort.

b. Selection of Command Post Locations. Considerations in the selection of command post locations are—

- (1) *Communication.* The command post must be in communication with all subordinate elements and higher headquarters, preferably by voice radio. For this reason, the command post will usually be located to take advantage of high ground for communication purposes. High ground other than the actual hilltop will usually provide adequate communication sites. Use of radio relay stations or available remote control equipment may allow the command post to be located on low ground with the radio facilities on high ground.
- (2) *Accessibility.* Command posts should be accessible to a road net that permits travel to subordinate elements and to higher headquarters. Generally, the command post should be near the supply route. It should not be too close to crossroads, landing strips, heliports, or other prominent landmarks that might permit easy disclosure of the position by observation.
- (3) *Security.* Local security is obtained by positioning the armored vehicles on the perimeter, by assigning sectors of fire to vehicular weapons, and by establishing outposts with drivers and other available personnel. The headquarters commandant (headquarters company commander), assisted by the first sergeant, supervises local securi-

ty and prepares a plan of defense using all personnel normally located in the command post. Additional security is gained when the command post is positioned close to combat units. The use of combat troops primarily for command post security is to be avoided whenever possible.

- (4) *Cover and concealment.* The command post location should offer the best available concealment from air observation and cover from direct and indirect fires.
- (5) *Hardstanding and drainage.* The command post area must have sufficient hardstanding to support vehicular traffic and facility operations. Drainage must be considered since inclement weather may change radically an otherwise satisfactory area.
- (6) *Space.* The command post must provide sufficient space for adequate dispersion of vehicles and facilities.
- (7) *Displacement.* In offensive action, the command post should be located close to the forward elements, primarily to insure good communication and preclude immediate displacement. In retrograde movements, the command post is located rearward to the limit of communication to avoid involvement with the advancing enemy and to preclude frequent displacements as friendly elements move back.

c. Arrangement of the Command Post. The command post is arranged to facilitate work, foster security, permit concealment, and permit rapid and orderly exit. Units normally establish an SOP for the interior arrangement of the command post. The message center, located near the entrance, provides an information center and is convenient to messengers. A dismount point with parking area near the entrance prevents vehicles from moving through the command post. The operations center is located a short distance from the dismount point. The commanding officer, executive officer, and liaison officers are located near the operations center. When the S1 and S4 operate in the command post area, they are located adjacent to the operations center. Mess and maintenance

facilities are grouped together, away from the operations center, so that vehicle movement is kept away from the main part of the command post. Figure 47 is a schematic diagram of the command post.

d. Movement of the Command Post. Movement of the command post should be planned to cause minimum interference with normal operations. The command post is capable of operation on the move; however, its efficiency is reduced. Often when the command group is operating, it can maintain communication and control while the main part of the command post moves. When the command group is not operating, a quartering party consisting of S1, S2, and S3 representatives with communication facilities move to the new command post location. The quartering party establishes communication and conducts operations while the command post moves. In any event, the command post does not close down.

3. Command Group

a. A command group is a command and control facility, consisting of the commander and selected staff officers, signal means, and a security detachment. This group enables the commander to operate away from his command post to obtain personal knowledge of the situation, exercise personal leadership, and closely control the operation during critical periods.

b. There is no prescribed location for the command group. The situation and the commander's personal desires affect the location. However, communication must be maintained with subordinate commanders and the command post at all times.

c. Whether the commander uses the command group will depend upon his personality and the situation. His means of transportation will vary with the situation and his personal desires. The brigade commander has a choice of helicopter, $\frac{1}{4}$ -ton truck, armored reconnaissance vehicle, and, if the need arises, tanks, which can be obtained from a subordinate armor unit. The battalion commander has a choice of $\frac{1}{4}$ -ton truck, tank, or helicopter (if provided).

d. The command groups depicted in figures 48 and 49 are examples only of command groups and possible locations.

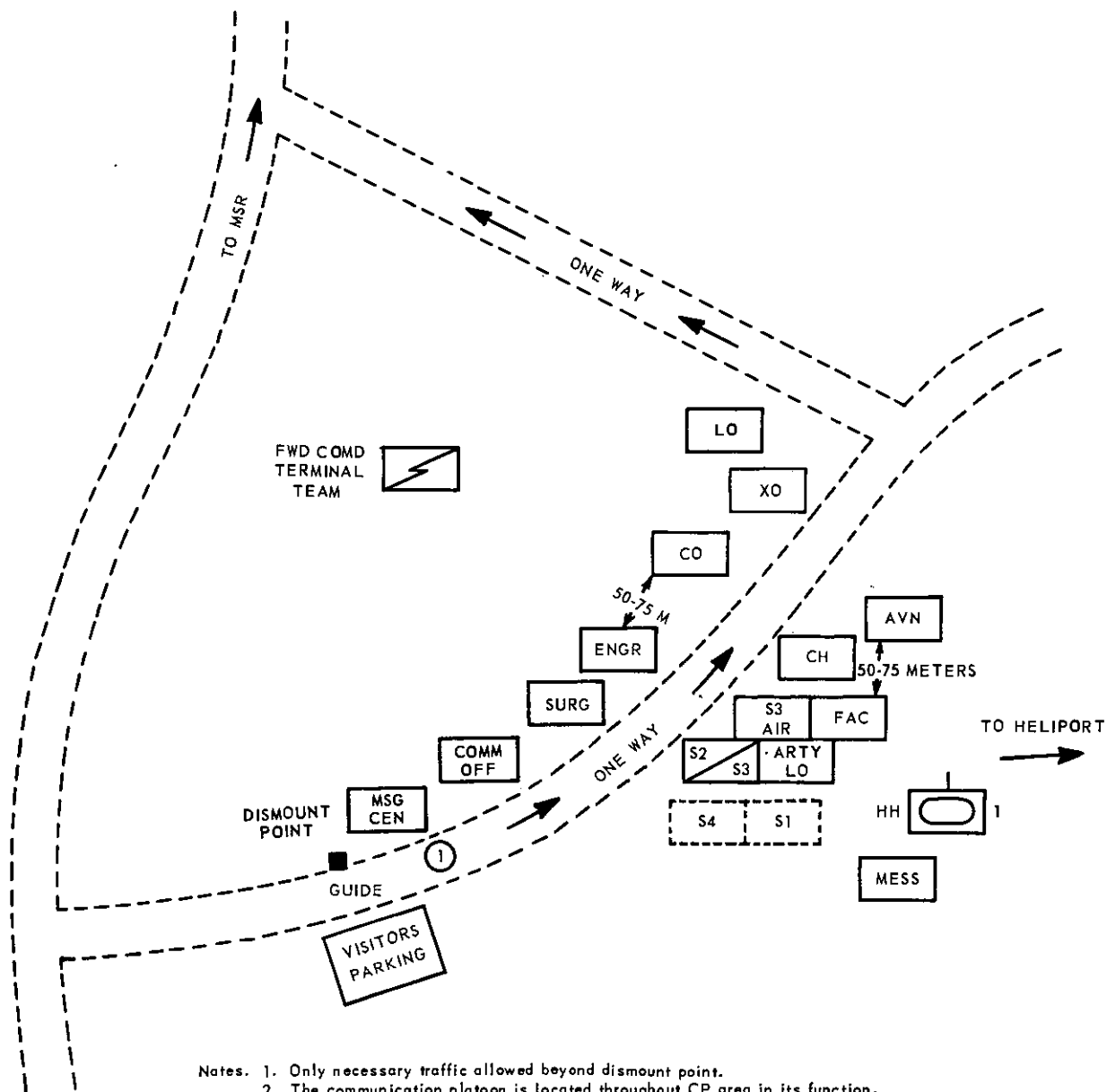

- Notes.
1. Only necessary traffic allowed beyond dismount point.
 2. The communication platoon is located throughout CP area in its function.
 3. The signal forward command terminal team is normally located contiguous to the CP and provides VHF links to higher and adjacent headquarters.
 4. Distances between elements, i.e., engineer, CO, comm off, at least 50-75 meters.
 5. Location of S1 and S4 when operating in CP area.
 6. Security elements are not shown.

Figure 47. Schematic diagram of a brigade CP.
A battalion CP would be disposed in a similar manner.

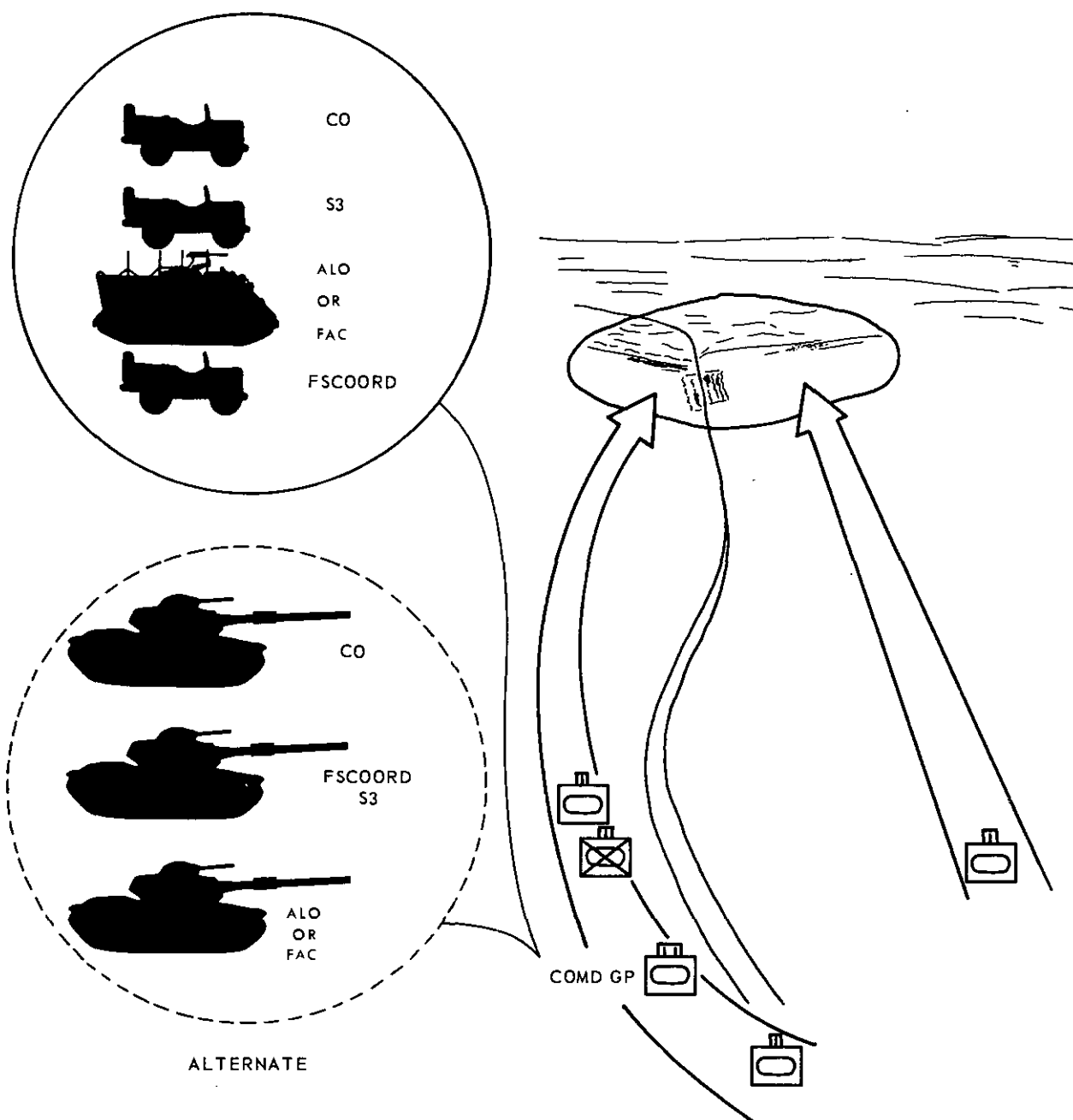

In fluid situations, a battalion-size armor unit may attack on several axes of advance. The commander during a critical period can use the command group to control and supervise the operation closely.

Figure 48. Task force command group.

ALTERNATE

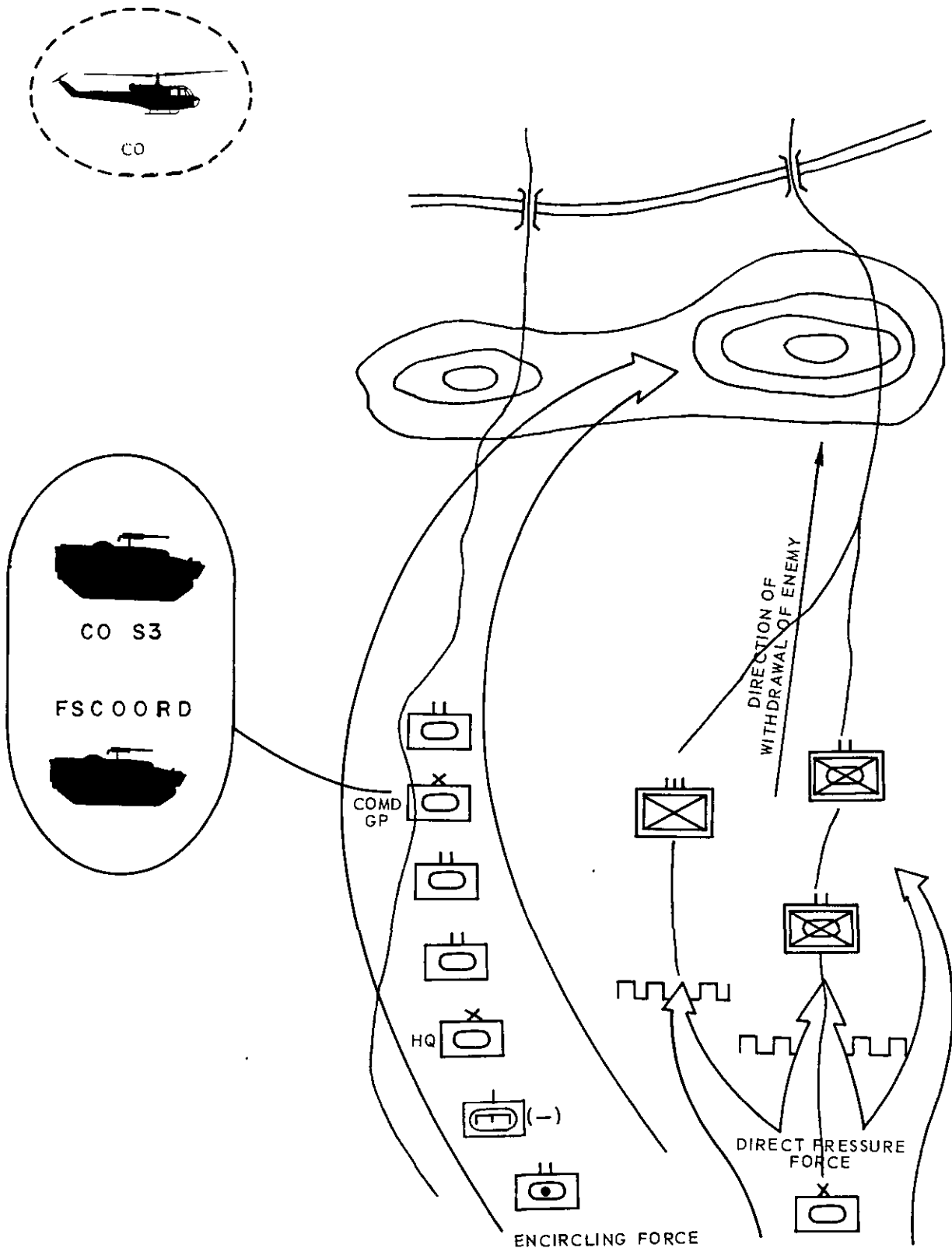

Figure 49. Type command group, armored division brigade in pursuit.

APPENDIX III

STAFF RELATIONS IN SELECTED OPERATIONS ACTIVITIES

Activity	S3	S2	S1	S4	Special staff officers (attached or organic)
1. Operations, general --	<p>Advises the commander on combat and combat support matters, and on organization and training.</p>	<p>Provides commander and staff with the current intelligence situation. Exercises coordinating staff supervision over all intelligence and counterintelligence activities of the command.</p>	<p>Advise (commander and S3) on ability to support operations, and on the impact of current and planned operations in their respective fields. Supervise combat service support operations and adjust to meet changing tactical situation as provided by S3.</p>		<p>All—advise appropriate staff officers on ability to support operations in their respective fields.</p>
2. Organization -----	<p>Maintains the troop list, including continual review and revision to insure the number and type of units attached or supporting are those that can best accomplish and support the mission.</p> <p>Requests attachment of combat, combat support, combat service support units or teams; attaches such units in the command in accordance with the task organization consistent with the commander's concept and the situation.</p> <p>Receives and processes assigned or allocated units or teams, including orientation, training, and reorganization as required.</p>		<p>Submit requirements to S3 for combat service support units required to support operations.</p> <p>Requests assignment of individuals and unit replacements.</p>		<p>All—submit requirements for combat and combat support units to S3.</p> <p>All—submit requirements for combat service support units to appropriate staff officer.</p> <p>All—recommend to appropriate staff officers priority and allocation of assignment of units and personnel and issue of equipment in area of interest.</p>

<p>3. Training -----</p>	<p>Prepares and supervises training programs, directives, and orders; supervises the planning and conduct of field exercises. Determines requirements for, procures, and distributes, or assigns training aids and facilities. Plans, conducts, and coordinates training inspections and tests. Organizes and conducts schools. Compiles training records and reports.</p>	<p>In conjunction with S3, is responsible for intelligence training and counterintelligence training of the command. Provides S3 with requirements for training aids and areas.</p>	<p>In conjunction with S3 are responsible for supervision of training of the command in their respective areas of interest. Provide S3 with recommendations concerning training requirements, including type and amount. Conduct training inspections as coordinated by S3. Submit requirements for training aids and areas to S3.</p>	<p>All—responsible to S3 for supervision of technical training of the command in their respective fields. Provide recommendations to S3 concerning need for training, including type and amount. Conduct training inspections as coordinated by S3. All—submit requirements for training aids and areas to S3. All—coordinate with S3 to insure training required to maintain technical proficiency of their respective units is included in the training program of the command.</p>
<p>4. Operations a. Operation estimate.</p>	<p>Based on the commander's guidance and information received from other staff officers, prepares the operation estimate, which culminates in a recommended course of action.</p>	<p>Provides S3 with intelligence estimate and analysis of area of operations.</p>	<p>Inform S3 of capability to support the mission, and limitations that exist in the personnel management field, and may recommend course of action favored from a personnel management viewpoint.</p>	<p>All—provide S3 or other staff officer most concerned with advice regarding availability and capability of combat or combat service support means, and make general recommendations for employment.</p>

Activity	S3	S2	S1	S4	Special staff officers (attached or organic)
<p>b. Tactical plans. (1) General.</p>	<p>Conducts tactical planning, including supervision and coordination of annexes to the tactical plan; after command approval, publishes the operation plan or operation order. Prepares alternate operation plans as required. Insures that all plans consider the security of the command, including tactical reconnaissance, tactical cover, and deception. Establishes allocations and priorities for personnel, and supplies and equipment for combat and combat support units. Establishes the prescribed load for combat and combat support units.</p>	<p>Based upon commander's decision, develops EEI and after approval by commander, submits to S3 for inclusion in operation plan. Exercises coordinating staff supervision over the preparation of surveillance and daily patrol plans. Provides S3 with continuing intelligence and makes recommendations concerning the plan as affected by the changing intelligence situation.</p>	<p>Based on tactical plan being developed by S3, evaluate capabilities to provide combat service support; advise S3 of limitations in combat service support that may affect the tactical plan; develop plans to provide required combat service support; recommend to S3 allocations and priorities for tactical units. Provides S4 with personnel entries of the operation for paragraph 4 of operation order.</p>	<p>All—provide advice and recommendations concerning employment of combat or combat service support means in their respective fields. All—recommend to appropriate staff officer allocation and priorities of personnel, supplies, and equipment to combat and combat support units of the command. All combat support commanders assist the S3 in planning to include preparation of specific plans for employment of their respective combat support means and preparation of parts of the overall plan.</p>	
<p>(2) Fire support.</p>	<p>Supervises fire support planning. Receives the plan of fire support from the artillery officer; reviews to insure it is in consonance with command guidance and is compatible with the planned scheme of maneuver or plan of defense; integrates the plan of fire support into the operation plan.</p>	<p>Provides S3 with enemy capabilities and vulnerabilities; recommends targets for attack by fire support means. Approves plan for monitoring fallout resulting from employment of nuclear weapons and survey of fallout areas when directed by higher headquarters. Develops potential nuclear targets and disseminates to S3 and FSCCOORD.</p>	<p>Provides S3 and FSCCOORD with specific areas that should be spared from attack by fire support means if tactical situation permits. Advises S3 on current available supply rates (ASR). Insures approved plan of fire support can be supported, or notifies S3 of inability to support the plan, and makes recommendations.</p>	<p>Artillery—In conjunction with the ALO, prepares the plan of fire support; reviews artillery, air, and other fire plans to insure coordination; submits to S3 for review and approval. Recommends to S3 required supply rate and ASR as pertains to fire support units. Makes detailed target analyses for attacks by friendly nuclear weapons and submits to S3. Advises S3 and makes recommendations concerning employment of fire support means. Recommends to S3 organization for combat for artillery. Engineer—advises S3 of requirements for support of engineer operations.</p>	

<p>(3) Tactical cover and deception, barrier and denial, electronic warfare, and tactical reconnaissance.</p>	<p>In coordination with S2 and other staff officers, reviews tactical cover and deception, barrier and denial, electronic warfare, and tactical reconnaissance plans and integrates these plans into the operation plan.</p>	<p>Provides S3 with advice and recommendations concerning counterintelligence aspects. Develops counterintelligence part of plans; supervises execution. Estimates effectiveness of operations and makes appropriate recommendations to S3. Provides S3 with an estimate of enemy capabilities and activities of partisans and guerrillas.</p>	<p>Review impact of plans on combat service support operations; adjust to insure compatibility if possible; otherwise inform S3 of conflict and provide recommendation. Provide combat service support as directed.</p>	<p>All—provide S3 and S2 with advice and recommendations concerning capabilities of combat or combat service support units to support the plans. Develop detailed plans for their particular part of the overall plan.</p>
<p>(4) Civil affairs and psychological operations.</p>	<p>Is the commander's principal adviser on matters pertaining to the civil population in the area of operations. Submits requests for civil affairs and psychological support units to higher headquarters.</p>	<p>Provides information of weather, terrain, and enemy situation.</p>	<p>Coordinates with S3 for priority of movement of CP.</p>	<p>Engineer — provides S3 with road and bridge capabilities; recommends routes. Aviation and ALO—plans for providing air reconnaissance and surveillance as required. Signal—plans for providing signal communications during movement. Military police—plans for traffic control.</p>
<p>c. Tactical troop movement (ground).</p>	<p>Plans and supervises tactical troop movement, including the selection and designation of tactical units, establishment of priorities, selection of destinations, times of movement, selection of routes, security of the movement, quartering, and, as appropriate, staging, and preparation of the movement order.</p>	<p>Coordinates with S3 for requirements for transport means from S3.</p>	<p>Provides transportation section leader with allocation of transportation. Determines priority for movement of combat service support units. Insures required logistical support is provided.</p>	<p>Engineer — provides S3 with road and bridge capabilities; recommends routes. Aviation and ALO—plans for providing air reconnaissance and surveillance as required. Signal—plans for providing signal communications during movement. Military police—plans for traffic control.</p>

Activity	S3	S2	S1	S4	Special staff officers (attached or organic)
<p>d. Airmobile operations.</p>	<p>In coordination with the commanders of supporting transportation aircraft unit and the unit to be lifted, plans and supervises the air movement. Prepares and publishes the air movement plan, including landing zones, flight routes, loading areas, and the air movement table.</p>	<p>Provides S3 with weather and terrain information and enemy dispositions (including air defense) for the selection of flight routes and landing zones.</p>	<p>-----</p>	<p>Coordinates with S3 for required security while in movement.</p> <p>Provides S3 with data concerning status and availability of supply for unit to be airlifted.</p>	<p>Aviation—provides assistance and technical advice to S3.</p> <p>Engineer—assist in preparation of landing zones.</p> <p>Artillery—In conjunction with the ALO, prepares fire support plans.</p>
<p>e. General location of CP.</p>	<p>In coordination with the communication officer, selects the general location of the command post and affiliated command installations.</p>	<p>Advises on intelligence aspects.</p>	<p>Selects exact locations; supervises its interior arrangement and establishment.</p>	<p>-----</p>	<p>Communication officer—advises S3 on signal communication aspects of location. Recommends site.</p>

APPENDIX IV

STAFF RECORDS

1. Staff Journal

The staff journal is the official, permanent, chronological record of events, information, and operations of the staff section during a stated period, normally 24 hours. It is an index of reports and messages that have been received and transmitted and of important events that have occurred. It serves as a chronological file, enabling all interested parties to locate a message or data on an event quickly and easily. Journals are permanent records and will be disposed of in accordance with AR 345-210. The journal is normally closed at 2400 hours and opened at 0001 hours daily during combat; however, it can be opened and closed at the beginning and end of periods of combat (fig. 50).

2. Staff Section Worksheet

a. A staff section worksheet is a temporary record (fig. 51) consisting of a pad or looseleaf notebook in which the staff officer enters information classified according to subjects in which he has a staff interest. When so arranged, it serves as a checklist or reminder of the types of information that should be recorded as well as providing a place to record it.

b. As the worksheet is a temporary record, when action is completed on an item, the entry can be lined out. When a worksheet is filled, it may be destroyed.

3. Sources of Information

Sources of information for the worksheet may be messages, telephone conversations, journal entries, conferences with the commander and staff officers, and information developed by the staff officers' conclusions, opinions, ideas, and inspections. When information is obtained from the journal, the journal item number of the item is entered in the worksheet preceded by the letter J to indicate that the information has been recorded in the journal.

4. Uses

The worksheet provides the staff officer with a ready reference for information to assist in preparation of estimates, plans, orders, and reports. Constant review of the worksheet may reveal problems that require further evaluation and coordination. It provides a source of information for the policy file. There is no prescribed form for a worksheet.

DAILY STAFF JOURNAL OR DUTY OFFICER'S LOG <small>(AR 220-346 & FM 101-5)</small>				PAGE NO. 1		NO. OF PAGES 10		
ORGANIZATION OR INSTALLATION			LOCATION		PERIOD COVERED			
S2, TF 1-68 Armor			Kirchheim, Germany 405 324		FROM		TO	
					HOUR	DATE	HOUR	DATE
					0001	13 Oct	2400	13 Oct
ITEM NO.	TIME		INCIDENTS, MESSAGES, ORDERS, ETC.	ACTION TAKEN	INL			
	IN	OUT						
1	0030		S2, 1st Bde, rpt, 11 en tks heading east on Autobahn approx 5 km east of Bad Hersfeld at 0005 hrs	M-S-F-T				
2	0410		TMB, 1-68: 6 en tks atk our position at 0400 hrs vic coord 479334. Atk repulsed, 2 en tks destroyed	M-S-T-Bde				
3		0422m	Msg, item 2, dispatched to 1st Bde					
*	*	*	* * * * *	* * * *				
55			Journal closed 2400 hours					
			LEGEND:					
			M -- Situation Map					
			S -- Staff Distribution					
			T -- Distribution to Teams					
			F -- File					
TYPED NAME AND GRADE OF OFFICER OR OFFICIAL ON DUTY					SIGNATURE			
JOHN C. PALMER, Captain, Duty Officer					<i>John C. Palmer</i>			

DA FORM 1594
NOV 62

PREVIOUS EDITION OF THIS FORM IS OBSOLETE. * U.S. GOVERNMENT PRINTING OFFICE: 1962 O-864154

Figure 50. Sample journal.

(Classification)²

S1 WORKSHEET

From: _____
hour and date

To: _____
hour and date

Headquarters: _____

Place: _____

(Classification)²

1. Strengths
2. Replacements
3. Military Personnel Procedures
4. Civilian Personnel
5. Prisoners of War
6. Morale and Personnel Services
7. Graves Registration
8. Discipline, Law and Order
9. Headquarters Management
10. Miscellaneous

- Notes.**
1. The example illustrated is one used by the S1. Worksheets used by other staff officers will be indexed to fit the needs of the particular officer.
 2. The classification will be stamped at the top and bottom of each page.

Figure 51. Staff worksheet.

APPENDIX V

REPORTS AND WARNINGS

1. General

a. This appendix prescribes the reports and warnings commonly used in armor units, illustrates forms with examples where appropriate, and outlines procedures that may facilitate the transmission of information.

b. The forms illustrated provide an integrated system for use from the lowest echelon through brigade or regiment level and include the majority of recurring information requirements under tactical conditions.

2. Reports

Reports are the primary source of information upon which plans and decisions are based. They must be accurate, timely, and complete. Negative information ("There is no enemy at checkpoint 40") is frequently as important as positive information. Prearranged outlines save time and contribute to completeness. Requirements for reports must be kept to a minimum consistent with requirements for information. The types of reports considered include—

a. Recurring reports, which are normally directed in the unit SOP include—

- (1) Periodic reports conveying the same information at prescribed intervals (hourly, daily, etc.), such as the personnel daily summary (PDS).
- (2) As-required reports submitted upon the occurrence of a specified event or situation, such as shelling reports (SHELREP).

b. One-time reports, which are submitted once only as directed.

3. Intelligence, Counterfire, and NBC Reports

a. *Spot Report (SPOTREP)*. This report is used as required for reporting by radio infor-

mation of the enemy and the area of operations. It is designed for use by any element that can report or relay such information. Examples of a spot report are shown at figure 52. The basic items of the report normally include—

- (1) Alfa—Who is reporting
- (2) Bravo—What is being reported
- (3) Charlies—Where and when
- (4) Delta—Doing what or condition of Bravo
- (5) Echo—What you are doing

b. *Road, Bridge, Tunnel, Ford, or Ferry Report (DD Form 173 and DA Form 11-170)*. These forms are completed as required at battalion level or higher headquarters from information received in SPOTREP's or route information supplemented from other sources as necessary. They are forwarded by messenger through channels and are suitable for exchanging information with other NATO nations (FM 5-36).

c. *Shelling, Mortar, Bombing, and NBC Reports (SHELREP, MORTREP, BOMREP, NBC 1 (Nuclear), NBC 1 (Toxic), and NBC 1 (Biological))*. These reports are used for reporting the indicated information. They are initiated by the observer and transmitted through the designated channels. The reports have been standardized for use within NATO. The basic format and examples of these reports are contained in FM 30-5, FM 3-12, FM 21-40, and figure 53.

d. *Report of Radiation Dose-Rate Measurement*. These reports are used by radiological monitoring or survey parties to report, electrically, data collected. Radiological monitoring information, (NBC 4 report) is normally reported through command channels to division.

ENEMY INFORMATION

ALFA--Who is observer or source?*

BRAVO--What?
How many?
How equipped?

CHARLIE--Where and when?*

DELTA--Doing what (if moving; direction, speed, and altitude)?

ECHO--What are you doing?

HIGHWAY, ROAD, TRAIL, OR CROSSCOUNTRY TRACE

ALFA--Who is observer or source?*

BRAVO--What?
Distance?
Width?
Surface material?
Alinement (bad curves or grades)?
Foundation (stable or unstable)?

CHARLIE--Where and when?*

DELTA--Condition (of surface, shoulders, and drainage)?

ECHO--What are you doing?

BRIDGE, OVERPASS, CULVERT, OR CAUSEWAY

ALFA--Who is observer or source?*

BRAVO--What?
Overall length?
Width of roadway?
Type and material?
Spans (number and length)?
Class (compute)?
Clearances (overhead and horizontal)?

CHARLIE--Where and when?*

DELTA--Condition?
Bypass (add complete report if required)?

ECHO--What are you doing?

FORD, FERRY, OR OTHER CROSSING SITE

ALFA--Who is observer or source?*

BRAVO--What?
Length of crossing?
Width (usable)?
Bottom material?
Depth or water level (present, maximum and minimum)?
Speed of current?
Banks or approaches (material, height, and slope)?
Vessels and facilities (capacity, etc.)?

CHARLIE--Where and when?*

DELTA--Condition (of bottom, banks, etc.)?
Bypass (add complete report if required)?

ECHO--What are you doing?

*Source: the actual origin from which information is obtained, such as prisoners of war, local civilians, documents, etc.
**Where: include from-to for route or trace of area; enemy locations sent in grid coordinates in the clear except behind friendly lines, information locating friendly units or activities in code.

When: state either time (date-time group) of observation or duration (from-to) of activity.

(TANK COMPANY COMMANDER) THIS IS (ARTILLERY FORWARD OBSERVER)	(PLATOON LEADER) THIS IS (SECOND SCOUT SQUAD)	(ENGINEER BATTALION S2) THIS IS (ENGINEER RECONNAISSANCE TEAM ONE)	(SQUADRON S2) THIS IS (ALFA TROOP COMMANDER)
(SPOTREP) ALFA--(ARTILLERY FORWARD OBSERVER) BRAVO--FIVE AGGRESSORS WITH MACHINEGUN	(SPOTREP) ALFA--(SECOND SCOUT SQUAD) BRAVO--ROAD/FIVE METERS WIDE/CONCRETE SURFACE	(SPOTREP) ALFA--(ENGINEER RECONNAISSANCE TEAM ONE) BRAVO--BRIDGE/ONE-EIGHT METERS LONG/SIX METERS WIDE/CONCRETE SLAB/CLASS SEVEN-TWO/THREE SIX METER SPANS/CLEARANCES UNLIMITED	(SPOTREP) ALFA--(ADJACENT UNIT CONTACT PARTY) BRAVO--FORD/SIX-FIVE METERS LONG/ONE-TWO METERS WIDE/ROCK BOTTOM/ ONE-HALF METER DEEP/ CURRENT SLOW/APPROACHES TWO-ZERO PERCENT GRAVEL BOTH SIDES
CHARLIE--COORDINATES MIKE-BRAVO-NINER-EIGHT-FIVE-FIVE-NINER-ONE/TIME TWO-FIVE-ONE-SEVEN-FOUR-TWO DELTA--DUG IN/FIRING	CHARLIE--FROM CHECKPOINT ONE-NINER TO CHECKPOINT SIX-ONE/TIME TWO-FIVE-ZERO-NINER-FIVE-ZERO DELTA--GOOD CONDITION/SUITABLE FOR USE BY (FIRST BRIGADE)/NO ENEMY CONTACT	CHARLIE--COORDINATES (MIKE-ALFA-EIGHT-SIX-SIX-NINER-SIX-FIVE)/TIME TWO-FIVE-ONE-ZERO-ZERO-ZERO DELTA--GOOD CONDITION/NO BYPASS WITHIN FIVE-HUNDRED METERS/NO ENEMY	CHARLIE--FROM CHECKPOINT TWO-NINER DOWN THREE-HUNDRED RIGHT ONE-FIVE-ZERO/TIME TWO-FIVE-ZERO-SIX-ZERO-ZERO DELTA--GOOD CONDITION/NO ENEMY
ECHO--CAN FIRE IF YOU DESIRE	ECHO--CONTINUING TOWARD CHECKPOINT EIGHT-EIGHT	ECHO--RETURNING TO YOUR LOCATION WITH MORE INFORMATION	ECHO--CONTINUING MISSION
OVER	OVER	OVER	OVER

Figure 52. SPOTREP originating or used at company/troop/battery level and below.

Radiological survey data (NBC 5 report) is reported as directed. DA Form 1971-1-R (Route Technique or Course Leg Technique (Ground and Aerial Survey)) is locally reproduced and is used for recording information collected. These reports are used for exchanging information with NATO forces. For discussion of these reports see FM 3-12.

e. Intelligence Summary (INTSUM). This is a periodic summary of the significant information developed from all sources by a batta-

lion-level or higher unit for a period specified by SOP. It is prepared by the S2 and distributed electrically or by messenger through intelligence channels to higher, lower, and adjacent units. An example is shown in figure 54. See FM 30-5 for a detailed discussion.

f. Patrol Report. Patrol report form ((2), fig. 54) is used to guide patrol leaders and interrogating officers in preparing a final patrol report. The paragraph headings of the form are lettered and not numbered. This is to pre-

ITEM MEANING

(Omit items not applicable; state units of measure used, such as meters, mils, etc.)

ALFA--FROM (unit call sign) and type report (SHELREP, BOMBREP, NBC 1-(NUCLEAR) (TOXIC) (BIOLOGICAL))

BRAVO--POSITION OF OBSERVER (in grid coordinates in code)

CHARLIE--AZIMUTH OF FLASH (or SOUND or GROOVE OF SHELL - state which) (or ORIGIN OF FLIGHT PATH of missile)

DELTA--TIME FROM/DATE-TIME OF ATTACK

ECHO--TIME TO (or ILLUMINATION TIME)

FOXTROT--AREA ATTACKED (either azimuth and distance from observer in code or grid coordinates in the clear)

GOLF--NUMBER AND NATURE OF GUNS, MORTARS, AIRCRAFT, OR OTHER MEANS OF DELIVERY IF KNOWN

HOTEL--NATURE OF FIRE (barrage, registration, etc.) (or TYPE OF BURST - air or surface - NUCREP only) (or TYPE OF TOXIC AGENT)

INDIA--NUMBER AND TYPE OF BOMBS, SHELLS, ROCKETS, ETC.

JULIETT--TIME FLASH-TO-BANG IN SECONDS (of weapon)

KILO--DAMAGE (in code) (or CRATER DIAMETER--NUCREP only)

LIMA--FIREBALL WIDTH (immediately after shock wave passage) NUCREP only

MIKE--CLOUD HEIGHT (top or bottom--state which) (10 minutes after burst) NUCREP only

NOVEMBER--CLOUD WIDTH (10 minutes after burst) NUCREP only

(BATTALION S2) THIS IS (BRAVO COMPANY COMMANDER) (SHELREP) ALFA--(FIRST PLATOON BRAVO COMPANY)

BRAVO--(MIKE-BRAVO-TWO-ONE-SIX-EIGHT-FIVE-EIGHT)

CHARLIE--MAGNETIC AZIMUTH GROOVE OF SHELLS NINER-SIX DEGREES APPROXIMATE

DELTA--ZERO-NINER-ONE-SIX-TWO-FIVE

ECHO--ONE-SIX-FOUR-FIVE

FOXTROT--SAME AS BRAVO

GOLF--ESTIMATE FOUR ONE-FIVE-TWO MILLIMETER HOWITZERS

HOTEL--HARASSMENT

INDIA--TWO-FOUR ROUNDS HIGH EXPLOSIVE

KILO--NEGLIGIBLE

OVER

(BRIGADE S2) THIS IS (TANK BATTALION S2) NBC 1 (NUCLEAR) ALFA--(ALFA COMPANY)

BRAVO--VICINITY (MIKE-BRAVO-TWO-NINER-SIX-THREE)

DELTA--ZERO-TWO-ZERO-FOUR-FIVE-ZERO

ECHO--ILLUMINATION TIME FOUR SECONDS

FOXTROT--VICINITY MIKE-BRAVO-TWO-ZERO-SIX-TWO

HOTEL--AIR BURST

INDIA--ONE ROUND TYPE UNKNOWN SMALL YIELD

KILO--(SEVERE FLASH BLINDNESS THROUGHOUT AREA OTHER DAMAGE UNKNOWN AT THIS TIME)

LIMA--TWO-FIVE-ZERO METERS ESTIMATED

MIKE--TOP TWO-SEVEN-HUNDRED METERS ESTIMATED

NOVEMBER--ONE-THOUSAND METERS ESTIMATED

OVER

Figure 53. Forms originating or used at company/troop/battery level and below.

clude any confusion between the headings and the contents of paragraphs, many of which will be in numerical form. When transmitting reports, it may be convenient to designate paragraphs by letters only and not by their full titles. Patrol reports are forwarded as directed by the next higher headquarters or as prescribed in the unit SOP.

4. Operations Reports

a. *Unit Situation/Status Report (STAT-REP.)* This report covers the tactical situation and status of units below battalion level (fig. 55). It is submitted to the battalion operations center. The complete report is normally rendered by radio or messenger upon seizure of an objective, closing in an assembly area, immediately after a nuclear strike, and in other similar instances or as required by SOP

(at least daily). A fragmentary report is submitted by radio periodically (usually every hour) during tactical operations. The complete report may be required whenever a company, troop, or platoon is newly attached to another headquarters. Information is collected and transcribed from this report at battalion or comparable level for inclusion in required reports.

b. *Operational Situation Report (SITREP.)* This is a periodic report forwarded electrically or by messenger by battalion-level and higher units summarizing the tactical situation for a period specified in the SOP. See FM 101-5.

c. *Command Report.* This is a detailed formal report submitted usually monthly by battalion-level and higher headquarters. It covers all aspects of a unit's activities for historical purposes. See FM 101-5.

FORMAT

(Omit items not applicable unless otherwise indicated)

1. Issuing unit.
2. Time and date of issue.
3. Summary of enemy activity for period:
 - a. Ground activity.
 - b. Trace of forward elements.
 - c. Potential targets for nuclear weapons.
 - d. Air activity.
 - e. Nuclear activity.
 - f. Other (new tactics, counterintelligence, etc.)
4. Personnel and equipment losses:
 - a. Personnel (KIA, WIA).
 - b. Prisoners of war.
 - c. Equipment destroyed or captured.
5. New obstacles and barriers.
6. Administrative activities.
7. New identifications:
 - a. Units.
 - b. Personalities.
8. Enemy movements.
9. Estimates number and types of vehicles.
10. Weather and terrain conditions.
11. Brief discussion of capabilities and vulnerabilities (always included).
12. Conclusions (always included).

EXAMPLE

(FIRST BRIGADE S2) THIS IS (TASK FORCE TWO-SLASH-NINER-ONE MECHANIZED) (ISUM) ONE--(TASK FORCE TWO-SLASH-NINER-ONE MECHANIZED) TWO--ZERO-TWO-ONE-SIX-ZERO-ZERO-ALFA THREE ALFA--PLATOON STRENGTH PROBING ATTACKS AT MIKE-BRAVO-TWO-ONE-SEVEN-NINER-NINER-TWO TIME ONE-FOUR-FIVE-ZERO AND AT MIKE-BRAVO-TWO-TWO-ONE-NINER-NINER-THREE TIME ONE-FIVE-ONE-FIVE THREE BRAVO--NO CHANGE THREE DELTA--TWO JET FIGHTER-BOMBER AIRCRAFT ATTACKED (TEAM CHARLIE) AT MIKE BRAVO-TWO-ONE-ZERO-NINER-NINER-FIVE TIME ONE-FOUR-FIVE-FIVE WITH CANNON AND ROCKETS FOUR ALFA--ESTIMATE ONE-ZERO KILLED AND TWO-ZERO WOUNDED FOUR CHARLIE--TWO PERSONNEL CARRIERS AND ONE MEDIUM TANK DESTROYED SIX--SUSPECTED BATTALION LEVEL SUPPLY POINT AT MIKE-BRAVO-TWO-SIX-EIGHT-NINER-NINER-TWO EIGHT--ESTIMATED REINFORCED TANK COMPANY MOVING NORTH ON ROAD FROM VICINITY MIKE-BRAVO-TWO-SEVEN-TWO-NINER-NINER-EIGHT AT ONE-TWO KILOMETERS PER HOUR ESTIMATED TIME ONE-FIVE-TWO-FIVE NINER--NO CHANGE ONE-ZERO--NO CHANGE ONE-ONE--ENEMY CAPABLE OF ATTACKING IN REINFORCED COMPANY STRENGTH IN SECTOR PRIOR TO ONE-NINER-ZERO-ZERO ONE-TWO--EXPECT REINFORCED COMPANY STRENGTH ATTACK IN SECTOR PRIOR TO ONE-NINER-ZERO-ZERO AND INCREASING PRESSURE THROUGHOUT NIGHT OVER

(1)

Figure 54. INTSUM originating or used at battalion or squadron level and above.

PATROL REPORT

(Omit Heading(s) Not Applicable)

(DESIGNATION OF PATROL)

(DATE)

TO:

MAPS:

A. SIZE AND COMPOSITION OF PATROL

B. TASK

C. TIME OF DEPARTURE

D. TIME OF RETURN

E. ROUTES (OUT AND BACK)

F. TERRAIN

(Description of the terrain--dry, swampy, jungle, thickly wooded, high brush, rocky, deepness of ravines and draws; condition of bridges as to type, size and strength, effect on armour and wheeled vehicles).

G. ENEMY

(Strength, disposition, condition of defenses, equipment, weapons, attitude, morale, exact location, movements and any shift in dispositions). Time activity was observed; coordinates where activity occurred.

H. ANY MAP CORRECTIONS

J. MISCELLANEOUS INFORMATION

(Including aspects of nuclear, biological and chemical warfare).

K. RESULTS OF ENCOUNTERS WITH ENEMY

(Enemy prisoners and dispositions; identification; enemy casualties; captured documents and equipment).

L. CONDITION OF PATROL, INCLUDING DISPOSITION OF ANY DEAD OR WOUNDED

M. CONCLUSIONS AND RECOMMENDATIONS

(Including to what extent the mission was accomplished and recommendations as to patrol equipment and tactics).

Signature

Grade/Rank

Organization/Unit of Patrol Leader

N. ADDITIONAL REMARKS BY INTERROGATOR

Signature

Grade/Rank

Organization/Unit of Interrogator

Time

O. DISTRIBUTION

(SECURITY CLASSIFICATION)

(2) Patrol report form.

Figure 54—Continued.

ITEM MEANING	FRAGMENTARY	COMPLETE
<p>Report as of (DTG)</p> <p>ALFA--REPORTING UNIT (call sign)</p> <p>BRAVO*--LOCATIONS/ Company/ Troop report locations of immediate subordinate elements, command post, airstrip/heliport, trains, and observation post and radar site location and primary sector.</p> <p>Platoons report only center of mass or front line trace and observation post locations.</p>	<p>(COMPANY COMMANDER) THIS IS (FIRST PLATOON LEADER)</p> <p>(STATREP) TWO-SEVEN-ONE-FOUR-ZERO-ZERO</p> <p>ALFA--(FIRST PLATOON)</p> <p>BRAVO--COORDINATES (MIKE-BRAVO-SIX-SEVEN-FIVE-TWO-TWO-THREE)</p>	<p>(BATTALION OPERATIONS) THIS IS (CHARLIE COMPANY COMMANDER)</p> <p>(STATREP) ONE-FOUR-ZERO-FOUR-ZERO-ZERO</p> <p>ALFA--(CHARLIE COMPANY)</p> <p>BRAVO--(FIRST PLATOON) COORDINATES (MIKE-ALFA-ONE-EIGHT-TWO-FIVE-SIX-EIGHT) TO (ONE-EIGHT-SEVEN-FIVE-SIX-SEVEN)/(SECOND PLATOON) (ONE-EIGHT-SEVEN-FIVE-SIX-FIVE) TO (ONE-EIGHT-NINER-FIVE-SIX-TWO)/(THIRD PLATOON) (ONE-NINER-ZERO-FIVE-FIVE-NINER) TO (ONE-NINER-TWO-FIVE-FIVE-FIVE)/(COMMAND POST) (ONE-EIGHT-FOUR-FIVE-SIX-TWO)/(TRAINS) (ONE-EIGHT-ZERO-FIVE-SIX-ONE)/(OBSERVATION POST ONE) (ONE-EIGHT-NINER-FIVE-SIX-NINER)/(OBSERVATION POST TWO) (TWO-ZERO-EIGHT-FIVE-FIVE-NINER)/(RADAR) (ONE-EIGHT-EIGHT-FIVE-SIX-THREE PRIMARY SECTOR AZIMUTH ONE-ONE-EIGHT-ZERO MILS)</p>
<p>CHARLIE*--ACTIVITY Brief summary of activity since last report.</p> <p>DELTA--PERSONNEL*** Losses since (DTG) (in code):</p> <p>DELTA ONE--Killed in action.</p> <p>DELTA TWO--Wounded in action.</p> <p>DELTA THREE--Missing in action.</p> <p>DELTA FOUR--Captured.</p> <p>DELTA FIVE--Nonbattle casualties.</p> <p>DELTA SIX--Administrative losses.</p> <p>ECHO--AMMUNITION Total ammunition required to replenish basic load (in code).</p>	<p>CHARLIE--CONTINUING ATTACK</p>	<p>CHARLIE--ALL ELEMENTS CLOSED IN POSITION</p> <p>ONE-FOUR-ZERO-FOUR-FOUR-EIGHT RECEIVING SPORADIC ARTILLERY FIRE</p> <p>DELTA TWO--(ONE)</p> <p>DELTA FIVE--(ONE)</p>
<p>FOXTROT--FUEL Total fuel required in gallons by type (in code).</p> <p>GOLF--EQUIPMENT Total vehicles and designated major items short; include all items not immediately available for action ** (in code).</p>	<p>HOTEL--TWO PAPA WHISKEY LEFT GUARDED AT CHECKPOINT TWO-TWO OVER</p>	<p>ECHO--NEGATIVE</p> <p>FOXTROT--(ONE-TWO-HUNDRED DIESEL FIVE-HUNDRED MORGAN)</p> <p>GOLF--(ONE ONE-QUARTER-TON TRUCK)</p>
<p>HOTEL--REMARKS Any additional information required to complete the situation/status picture. Omit if not required.</p> <p>*Indicates items of fragmentary report.</p> <p>**See unit SOP for detailed method of reporting.</p> <p>***For initial report upon attachment <u>only</u> send complete PDS.</p>	<p>HOTEL--IN CONTACT WITH (BRAVO COMPANY) AT CONTACT POINT FIVE-NINER (SHELREP) FOLLOWS WAIT</p>	

Figure 55. Situation-status report originating or used at company, troop or battery level and below.

d. Minefield Reports. Reports of initiation, completion of laying, transfer, change, and removal are forwarded as appropriate by units laying minefields. DA Form 1355 (Minefield Record) will be completed and forwarded in addition to these reports. See FM 20-32.

5. Administrative Reports

a. General. Administrative reports are submitted from battalion or squadron in the format and at times specified by the higher headquarters SOP or as directed. At battalion or squadron level, administrative items are included in the STATREP (fig. 55) which provides most of the information required from subordinate units to prepare these reports.

b. Personnel Daily Summary (PDS) (FM 101-5). This report provides a detailed summary of an organization's personnel status as of the time of submission and is forwarded daily by battalion-level units as directed. The PDS is prepared from information received in STATREP's from subordinate units and from other sources (S3 for task organization, etc.).

c. Morning Report (DA Form 1) (AR 335-60). The morning report is normally prepared under tactical conditions by personnel services elements of the division, separate brigade, or regiment. Information for the morning report is obtained from a feeder report submitted daily by each company-size unit.

d. Casualty Report (DA Form 1154) (AR 600-65). The casualty report is prepared by personnel services elements from data furnished on DA Form 1156 (Casualty Report Feeder Report) substantiated as required by DA Form 1155 (Witness Statement). Forms 1155 and 1156 are completed as soon as possible after the incident. They are normally prepared by the squad leader or tank commander and witnesses.

e. Special Logistic Report. This report is prepared by the S4 at battalion or comparable level using information from STATREP's of subordinate elements and from the supply, maintenance, and communication officers. It is submitted as directed and reports status of major or critical items of equipment minus vehicles.

f. Special Strength Report. This report is a one-time personnel strength report that is submitted as directed by higher headquarters.

g. Combat Vehicle Status Report (FM 101-5). This report is submitted by battalion-level units daily and reflects the detailed status of combat vehicles. It is normally prepared by the S4 from information received in lower unit's STATREP's and from the maintenance officer.

h. Periodic Logistics Report (FM 101-5). This report is submitted as required by battalion and higher-level units covering in detail the status of all categories of logistics in the unit. It is normally required of a unit upon attachment to a new headquarters.

i. POL Status Report. This report is submitted daily. It is prepared by the S4 from information received in lower unit's STATREP's and from the S3 when future operations are involved.

6. Warnings

Warnings are messages giving information of an impending threat or dangerous condition. They must be disseminated rapidly to higher, lower, and adjacent elements. Prearranged warning messages giving only essential information provide the most rapid means of dissemination and contribute to complete understanding. The SPOTREP report and some of the NBC reports (para 3) are suitable for use as warnings in appropriate situations.

APPENDIX VI MOVEMENTS

Section I. GENERAL

1. Purpose

The purpose of a movement is to relocate a unit to arrive at the appointed time and place with all personnel and equipment ready to accomplish the mission. This appendix outlines the techniques and methods employed in moving armor units.

2. Classification

Movements are classified as either tactical or administrative. They may be classified further by the method used to move the unit. Of these methods, armor units are concerned with movements by motor, rail, air, and water.

a. Administrative. An administrative move is conducted with primary consideration on the rapid transit of units and vehicles. This type of movement is made when contact with the enemy is remote. The integrity of units is maintained whenever practicable.

b. Tactical. A tactical move is one conducted with primary emphasis on movement in combat-ready formations. In a tactical move, units, vehicles, and equipment are arranged to facilitate their employment upon contact with, or interference from, the enemy. The main factors influencing dispositions for the tactical move are the composition and nearness of hostile forces, and the plan of action upon arrival at the destination. Under these conditions, tactical considerations often preclude the most efficient use of transportation means.

3. Control and Coordination

Control requires proper organization of the force for movement, staff agencies to plan and

supervise the movement, use of control measures, and communication. Proper organization for movement requires that the force be subdivided into manageable echelons and unit integrity be maintained consistent with the tactical situation. A movement group when composed of troops from more than one unit should have a single commander designated. Subgroups should be composed of units under their own commanders.

4. Planning

Movement planning consists of three steps which may be accomplished jointly and continuously. These steps are determination of requirements for the move, analysis of organic and nonorganic movement capabilities, and establishment of priorities for units in the movement. The following factors are considered in movement planning:

a. Organization of units and their equipment.

b. Assembly of units and transportation means.

c. Packing and marking of equipment and loading personnel and equipment.

d. Control, coordination, and combat service support for the movement and at the destination.

e. Assembly of units and equipment at the destination.

f. Security measures before and during movement, and at destination.

g. Enemy situation, geographic conditions, and weather.

5. Orders

Movement orders are usually preceded by a warning order. The information given in the warning order includes the destination, time

and date of departure, and other essential information. Movement orders follow the general format of the operation orders. They are based on the movement plan and unit SOP.

Section II. MARCHES

6. Movement Terms

a. Arrival Time. The time at which the head of the column arrives at a designated point.

b. Clearance Time. The time at which the tail of a column passes a designated point.

c. Close Column. A column in which each vehicle is closed to safe driving distance behind the preceding vehicle. Armor units in close column normally use a density of approximately 30 vehicles per kilometer, with an intervehicular distance of 25 meters per vehicle.

d. Control Vehicle. The vehicle traveling at the head of a column and setting the speed of the column to maintain the prescribed rate of march.

e. Critical Point. Point on a route of march where difficulties in executing a march are anticipated.

f. Density. The average number of vehicles or persons occupying one kilometer of road space.

g. Distance. The space between units, measured from the rear of one unit to the front of the following unit in the column, expressed in meters or kilometers.

h. Gaps. Distance between march columns having different serial numbers.

i. Guide. A person who leads a unit or vehicle over a predetermined route or to a selected area, or a person posted along the route of march to direct traffic.

j. Infiltration. Movement of vehicles, singly or in small groups.

k. Intervehicular Distance. The space between vehicles measured from the rear of one vehicle (including towed load if any) to the front of the following vehicle in the column. It is expressed in meters.

l. Start Point (SP). Point (a crossroads or other prominent terrain feature) at which a foot march or motor movement is formed,

without halting, by the successive arrival of the units that make up the column.

m. Light Line. A theoretical line on the ground beyond which vehicles moving to the front at night are required to use blackout markers, or beyond which vehicles moving to the rear are required to operate with driving lights on.

n. March Column. The elements using the same route for a single movement.

o. March Discipline. Observance and enforcement of the rules governing a unit on the march.

p. Road Movement Graph. Time-spaced diagram used in planning and controlling marches, both road and foot, and in preparing or checking road movement tables.

q. March Order. An operation order issued by a commander to give instructions for a march.

r. Road Movement Table. A composite list showing the general organization and time-space schedule for a march movement. It is generally published as an annex to an operation order.

s. March Unit. A unit or group of units that moves or halts at the order of a single commander. A platoon, company, or similar organization normally forms the march unit. A serial is made up of one or more march units.

t. Open Column. A column in which distances between vehicles are increased to accomplish greater dispersion. Armor units in open column normally use a density of approximately 15 vehicles per kilometer or greater if conditions require when marching at an intervehicular distance of 50 meters per vehicle.

u. Quartering Party. A variable group of persons representing each unit in the march column. It is dispatched before the main body to reconnoiter and plan for the occupation of the new area. It may post guides to direct or lead elements of the main body.

v. Rate of March. Rate of march is the average distance traveled in any given period of time, including periodic halts and other short delays. It is expressed in miles or kilometers in the hour.

w. Release Point (RP). A location at which the units of a march column revert to control of their respective commanders.

x. Road Space. The length of roadway, in kilometers, occupied by an element of the march column.

y. Serial. One or more march units, preferably with the same march characteristics, placed under one commander for march column. A battalion normally forms a march serial.

z. Strip Map. Sketch of a route of march. It may or may not be drawn to scale but should include identifying landmarks such as towns, bridges, or crossroads with the distance between them expressed in kilometers.

aa. Time Distance. The time required to move from one point to another at a given rate of march.

ab. Time Interval. It is applied in the amount of time between march units, serials, or columns as they move past a given point. The time is measured from the instance the tail of one unit clears the point to the instant the head of the following unit reaches the same point.

ac. Time Length. The time required for a column or elements thereof to pass a given point.

7. Types of March Columns

a. Open Column. The open column is normally used in tactical marches made during daylight. It may be used when the unit moves at night with infrared or visible driving lights or moves on moonlit nights on good routes with blackout lights on. The open column provides the best compromise between the conflicting requirements for a short time-length and for dispersion.

b. Close Column. The close column is normally used in tactical and administrative marches during hours of darkness under blackout driving conditions. This method of marching takes maximum advantage of the traffic capacity of the routes. However, it does not

provide dispersion. In daylight, a distance of approximately 25 meters between vehicles is prescribed. At night, the distance between vehicles is such as will enable the driver to see two lights in the blackout marker of the preceding vehicle.

c. Infiltration. Infiltration may be used on tactical marches when sufficient time and road space are available and maximum secrecy, deception, and dispersion are desired. Because of extended distance between vehicles, column control is extremely difficult, and routes must be marked carefully in advance to prevent drivers from becoming lost.

8. Planning the March

Factors to consider in planning are—

- a.* Enemy situation.
- b.* Routes of march.
- c.* Reconnaissance.
- d.* Quarters party.
- e.* Organization of the march column.
- f.* Determination of critical points (SP, RP, defiles).
- g.* March distances.
- h.* Control and supervision of the march.
- i.* Halts.
- j.* Security measures.
- k.* Logistical support.
- l.* Establishment of necessary liaison.
- m.* Issuance of maps and orders.

9. Organization of the March Column

a. The organization of the march column for the tactical march is governed primarily by the tactical situation and the order in which it is desired that subordinate units arrive at a given location. Other considerations are the time of the move and the march characteristics of the marching units. When the tactical situation demands that a column be composed of vehicles of different characteristics, the rate of march is based on the slowest vehicle.

b. The number of columns that a unit employs depends on the availability of routes and the situation. The use of one march column facilitates control but increases the time length of the unit. The use of multiple march columns makes control more difficult but decreases the amount of time required for the movement.

10. Road Movement Table

The road movement table includes the route, rate of march, and times of arrival and clearance at the destination and at critical points along the route. Determination of these times is based on the route space occupied by each unit and the time required for the unit to pass a given point at a uniform rate of march (time length) and the distance (time interval) between march units and serials (fig. 56). The road movement table ((2), fig. 56) may be issued as an annex to the operation order. See FM 101-5, FM 101-10, FM 55-30, and annex XI.

11. March Routes

Higher headquarters usually designates march routes for both road and cross-country marches. Higher headquarters may establish a route priority and schedule for the march.

12. Reconnaissance of March Route

The reconnaissance should provide information about critical points and route characteristics, specifically—

- a. The type, condition, and width of routes.
- b. The capacity and location of bridges and bypasses.
- c. The location of fords, depth of water, and condition of bottom, banks, and approaches.
- d. Defiles, congested areas, or obstacles that may result in excessive concentration of marching elements and creation of a possible nuclear target.
- e. Location of "coil up," feeding, or fueling areas if their use is contemplated.

13. Quartering Party

a. A quartering party should precede the main body whenever possible. The quartering party is composed of representatives of all subordinate units. Its mission is to thoroughly reconnoiter the new area and to make necessary improvements on entrances to, and routes in the area. The commander of the quartering party should be informed of the route, order of march, and estimated time of arrival of the main body.

b. It is desirable that the same individuals be employed regularly on quartering party assignments and be trained in mine detection and

removal. The quartering party may be furnished with guides and markers and with pioneer tools to make improvements in the area.

14. Start Point

a. The start point (SP) is a common point from which all units start their march according to a predetermined timetable. Each unit must be traveling at the prescribed speed, time and ground distances when it reaches this point.

b. Each march unit or serial commander is responsible for a reconnaissance of the route to the SP. Commanders using the same route must coordinate their actions to insure an uninterrupted advance to and across the SP.

15. Release Point

The release point (RP) is the point at which an incoming serial or march unit is released from column control. The serial or march unit separates from the column and is led by guides from the quartering party into its assigned area. Serials and march units must clear the RP at the designated rate of march.

16. Rate of March

a. The rates of march for mixed columns of tanks, armored personnel carriers, and wheeled vehicles for sustained periods vary as follows:

- (1) During daylight—10 to 30 kilometers per hour (6–20 miles per hour).
- (2) During darkness—7 to 15 kilometers per hour (4–10 miles per hour).

b. The factors to consider in determining the exact rate of march are—

- (1) Grades, sharp turns, cities, towns, and other restrictions along the route.
- (2) Surface conditions such as dust, ice, mud, and snow.
- (3) Condition of vehicles.
- (4) Condition of drivers and crews.
- (5) State of march training and degree of experience of individuals and units.
- (6) Weather conditions that affect visibility.
- (7) Light conditions that affect visibility.
- (8) The maximum sustained speed of the slowest vehicle.

EXAMPLE: TANK BATTALION OF 180 VEHICLES IS MOVING IN OPEN COLUMN (DENSITY--15 VEH) AT A RATE OF MARCH OF 20 KPH. THE BATTALION IS MOVING IN 4 MARCH UNITS WITH 3 MINUTES BETWEEN MARCH UNITS. WHAT IS THE TOTAL TIME LENGTH OF THE BATTALION?

RATE OF MARCH--20 KPH.

Hq Co

Co C

Co B

Co A

TIME INTERVAL--3 MINUTES

ROAD SPACE

TO DETERMINE ROAD SPACE:

$$\frac{\text{NO. OF VEHICLES}}{\text{DENSITY}} + \frac{\text{TIME INTERVAL (MIN.)} \times \text{RATE (KPH.)}}{60} = \text{ROAD SPACE}$$

$$\frac{180}{15} + \frac{9 \times 20}{60} = \text{ROAD SPACE}$$

$$12 + 3 = \text{ROAD SPACE}$$

$$\text{ROAD SPACE} = 15 \text{ KILOMETERS}$$

TO DETERMINE TIME LENGTH:

$$\frac{\text{ROAD SPACE (KILOMETERS)} \times 60}{\text{RATE (KPH.)}} = \text{TIME LENGTH}$$

$$\frac{15 \times 60}{20} = \text{TIME LENGTH}$$

$$\text{TIME LENGTH} = 45 \text{ MINUTES}$$

- Notes.
1. March computations, always round up to the next whole number.
 2. Road space (RS) for a single march unit = $\frac{\text{No. of vehicles}}{\text{Density}}$.
A march unit has no time interval.
 3. These formulars apply to computations expressed either in miles per hour (mph) or kilometers per hour (kpm).

(1)

Figure 56. Procedure for computing road space and time length of column.

EXAMPLE ROAD MOVEMENT TABLE
(A guide only, will need adjustment to suit individual cases)

(SECURITY CLASSIFICATION)

Copy No. 4

21st Armored Div
YREVA, GERMANY
OL1030Z, January, 1966
OPS 27

Annex 'B' - "Movement Table" to Operation Order 14
Map: GERMANY, 1/250,000

General Data:

1. Average Speed
2. Traffic Density
3. Halts

4. Routes (i.e. between Start Points and Release Points)
5. Critical Points (See NOTE 4)
 - (a) Start Points
 - (b) Release Points
 - (c) Other Critical Points
6. Mai: Routes to Start Points
7. Main Routes from Release Points

Routes and points are here described by grid references, codewords, etc., and, if necessary, numbered or lettered for ease of reference in the column below.

Movement Number or Identification Serial Number (a)	Date (b)	Unit/Formation (c)	No. of Vehicles (d)	Load Class of Heaviest Vehicles (e)	From (f)	To (g)	Route (h)	Route to Start Point (j)	Critical Points		Route from Release Point (n)	Remarks (o)
									Ref. (k)	Due (hrs) (l)		
See NOTE 5												

Acknowledge

Distribution :-

Authentication:-

(SECURITY CLASSIFICATION)

- NOTES:-
1. Only the minimum number of headings above should be used. Any information which is common to two or more movement numbers or identification serial numbers should be included under the 'data' paragraphs.
 2. As the table may be issued to personnel concerned with control of traffic, the security aspect must be remembered. It may not be desirable to include dates or locations.
 3. If the table is issued by itself, and not as an annex to a more detailed order, the table must be signed or authenticated in the normal way.
 4. 'Critical Point' is defined as 'a selected point along a route used for reference in giving instructions. It includes start points, release points and other points along a route where interference with movement may occur or where timings are critical'.
 5. This will be the number which is used to identify a column (or element of column) during the whole of the movement.
 6. In the case of an annex having the same distribution as an operation order it will not be necessary to include the headings and ending as shown on this page.

(2) Example road movement table

Figure 56—Continued.

17. March Distance

a. The intervehicular distance in a march column is determined by the selection of the type column to be employed.

b. The distance between elements of the column expressed as a time interval is announced usually by the commander. For planning purposes, the time interval is generally three minutes between march units and five minutes between serials. A company or team usually composes a march unit and a battalion task force usually composes a serial.

c. Gap (time or distance) between columns having different identification numbers is specified by the commander ordering the march.

18. Control and Coordination*a. General.*

- (1) A high degree of march training and discipline is the greatest factor in successful control of the unit on the march. March orders must be clear and complete. Commanders and staff officers must supervise the march to insure strict compliance with the control measures announced in the march order. They may use ground vehicles, aircraft, radio, route markings guides and military police to assist them in control and coordination of the march.
- (2) When radio silence is in effect, or to supplement radios, visual signals are used extensively for column and vehicle control. Messengers are used between units in the column, and guides may be used to pass messages to following units. Aircraft may be used to supplement organic means of communication during the march.
- (3) Each unit marching as part of a larger unit maintains liaison with the preceding unit. A liaison officer or agent travels with the preceding unit and keeps his commander informed of the preceding unit's location and gives him early warning of any unscheduled halt and the reason for it as soon as it is determined.

b. Traffic Control of the March.

- (1) When an armor battalion size unit is marching as a part of a larger unit, traffic control is provided normally by the headquarters controlling the march (FM 19-25). Military police traffic control posts are located at critical points along the route to direct all elements and to minimize delays caused by other columns, civilian or refugee traffic, congested areas, or difficult terrain. Efficient use of military police must be planned. Movements on multiple routes during periods of poor visibility and the existence of major intersections, defiles, and detours along routes increase traffic control problems. Minimum essential traffic control posts should be used. Additional military police support from higher headquarters is requested when attached or supporting military police are incapable of rendering proper support.
- (2) Road guides may be used to augment and support the military police effort. Road guides may be posted in pairs, one to direct traffic while the other provides security. Their equipment should provide for identification during hours of darkness. Guides are normally provided by the moving unit.
- (3) Battalion size units performing marches alone or when military police support is not provided, the above functions are performed by organic and attached elements.

c. Control of Speeds in the Column.

- (1) Elements in a column of any length encounter simultaneously many different types of routes and obstacles, resulting in different parts of the column moving at different speeds at the same time. This produces an undesirable accordion-like action or whip.
- (2) To reduce whip the leading vehicle must not exceed the authorized maximum speed of the slowest vehicle in the column, especially after negotiat-

ing an obstacle. To minimize vehicle congestion on the near side of an obstacle, vehicle commanders and drivers must be alert and maintain the prescribed minimum distance between vehicles. To further reduce whip and to maintain proper march distance, each vehicle when reducing or increasing speed to maintain the prescribed rate of march must do so gradually (FM 25-10).

d. Individual Vehicle Control on the March.

- (1) The march order should prescribe a maximum allowable speed applicable to all vehicles. This speed must be based on the maximum sustained speed of the slowest vehicle in the column. It will not be exceeded even when closing gaps or making up for lost time. Normally, march orders should specify that vehicles that have dropped out of the column for any reason regain their position in column have halted.
 - (a) Insuring that the vehicle maintains proper intervehicular distance in the column.
 - (b) Designating crewmembers to control traffic and to assist passing traffic when his vehicle is halted.
 - (c) Supervising maintenance and service of the vehicle at halts.
 - (d) Repeating signals passed back along the column.
 - (e) Furnishing local security.
 - (f) Observing prescribed blackout driving measures as required.
- (3) The following rules will assist drivers and vehicle commanders to insure proper procedure on a march.
 - (a) Start engine on signal from the unit commander and keep alert for the command to move out.
 - (b) Move out slowly and allow the vehicle ahead to gain its proper intervehicular distance as normal speed is reached.

- (c) Keep in the lane of the column unless required to give way to or pass other traffic.
- (d) Maintain an even driving pace, increasing and decreasing speed gradually. Do not speed to catch up; do not lag behind.
- (e) Regain proper distance from the vehicle ahead by gradual changes in speed.
- (f) Watch the vehicle ahead for changes in direction, traffic hazards, or column signals.
- (g) Keep position in the column unless ordered or signaled to pass other elements.
- (h) Shift into proper gear when approaching a hill.
- (i) Obey traffic signals, signs, and markers except when instructed otherwise (for example, when guides have cleared the way for the column to pass intersections).
- (j) If possible, move a disabled vehicle off the route to the right and signal the succeeding vehicle to pass.
- (k) Insure that your vehicle has cleared the route or is as far as possible to the right side of the route.
- (l) Stop the engine on proper signal or if the vehicle is to stand longer than a few minutes.
- (m) Wait for the command before dismounting at halts.
- (n) Keep to the off-route side of the vehicle and off the traveled part of the route, when dismounted.

19. Halts

a. Units on the march normally make scheduled halts of 10 minutes duration after each 1 hour and 50 minutes of marching. At scheduled halts, all march units and serials halt *simultaneously* at the specified time; they make no attempt to close up gaps in the column. Vehicular crews perform their during-operation maintenance services at the scheduled halts.

b. At halts, march unit and serial commanders make sure that—

- (1) Road guides are posted at the front and rear of each march unit.
- (2) Correct intervehicular distance is maintained.
- (3) All vehicles and personnel remain well on the right side of the route and keep the traveled part of the route clear.
- (4) Ground and air security is maintained.
- (5) Crew maintenance is performed by the crew of each vehicle.
- (6) Vehicle personnel are alert to receive and relay signals for the resumption of the march. This is particularly important at night when personal contact should be maintained with the vehicle in front.
- (7) Maintenance personnel check the mechanical condition of vehicles as appropriate.
- (8) All vehicles move out at the same time after the halt.

c. Unit SOP must prescribe the actions to be taken when unscheduled halts occur. As a minimum, vehicle commanders make contact with the vehicle to their front and commanders take appropriate action to determine and eliminate the cause of the halt.

d. Halts for refueling should be scheduled in *advance*; this enables march unit commanders to make definite plans for refueling.

e. It may be desirable to clear the route of march temporarily to shorten the column. When the terrain permits, units do this by coiling up on each side of the route. In an administrative march, the units are placed so they can easily move back onto the road. If tactical considerations govern, the units are placed to facilitate movement in the direction of the expected action.

20. Security

a. General.

- (1) *Secrecy*. Secrecy makes a major contribution to the security of a unit on a march. All measures are employed to keep the enemy from learning of the intention to march or detecting a march once it has begun.

- (2) *Security forces*. Security may be provided by a covering force; advance, flank, and rear guards; or by the relative position of other friendly forces. For details of security forces, see chapter 5.

b. Security Before the March.

- (1) *Secrecy*. Routine operations should be maintained up to the time of movement, with no apparent increase or decrease in activity. Movement of vehicles or units should be kept to a minimum and the number and size of reconnaissance parties may have to be restricted. Concealment offered by darkness is used for unavoidable major movements.
- (2) *Communication*. Radio transmissions continue at average rates before the move. Plans may be made to continue dummy radio traffic after the march is begun as a deceptive measure.

c. Security During the March.

- (1) *Secrecy*. Marches may be conducted at night or during periods of reduced visibility. Routes may be selected that offer maximum concealment. Marches should be accomplished in as short a time as possible.
- (2) *Aircraft*. In addition to reconnoitering routes and supervising the execution of the march, aircraft are used to provide security by reporting the approach of enemy aircraft. Air cavalry units may be used to provide column cover.
- (3) *Communication*. Listening silence may be prescribed during the march. If listening silence is not in effect, low power and minimum transmissions assist in preserving secrecy.
- (4) *Sectors of observation*. While on the march and at halts, each vehicle commander is assigned a primary sector of responsibility for observation (fig. 57). These sectors are assigned in a pattern to provide all-round observation.
- (5) *Security against air attack*. During the march and at the halt, the unit

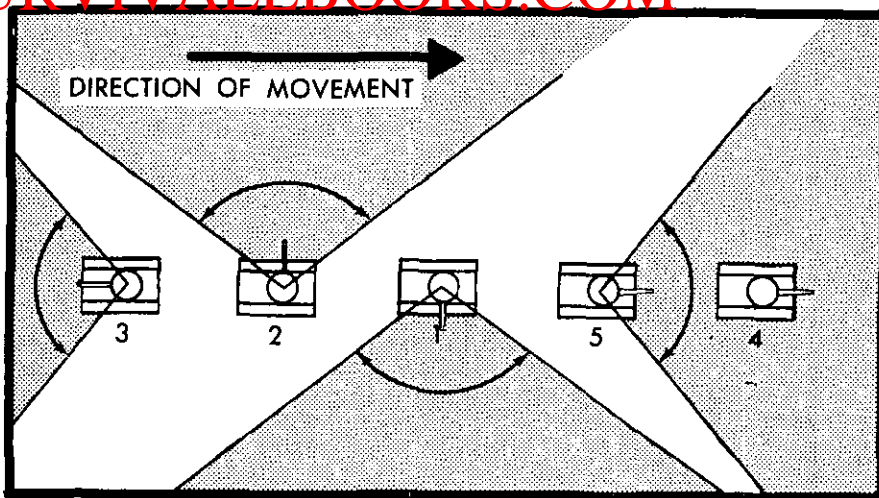

Figure 57. Vehicles assigned primary sectors of responsibility for observation.

must provide its own security against air attack. This is done by designating an air sentry on each vehicle. Proper distances must be maintained between vehicles. See paragraph 107 for further discussion.

- (6) *Defense against nuclear attack.* Moving march formations normally present poor targets for enemy nuclear weapons. Increased emphasis is placed on avoiding congestion at obstacles.
- (7) *Local security.* At halts, each vehicle crew posts a sentry in the turret or at a nearby vantage point. Tanks may be posted to cover any suspicious areas or avenues of approach during long halts (fig. 58).

21. March Logistics

See chapter 10, paragraphs 268 through 271.

22. Movement Orders

a. The movement order is an operation order. As an operation order, it is prepared and issued in accordance with the principles discussed in appendix IX. Items appropriate for inclusion in the march order are—

- (1) Destination.
- (2) Route.
- (3) Rate of march (may be SOP).
- (4) Order of march.

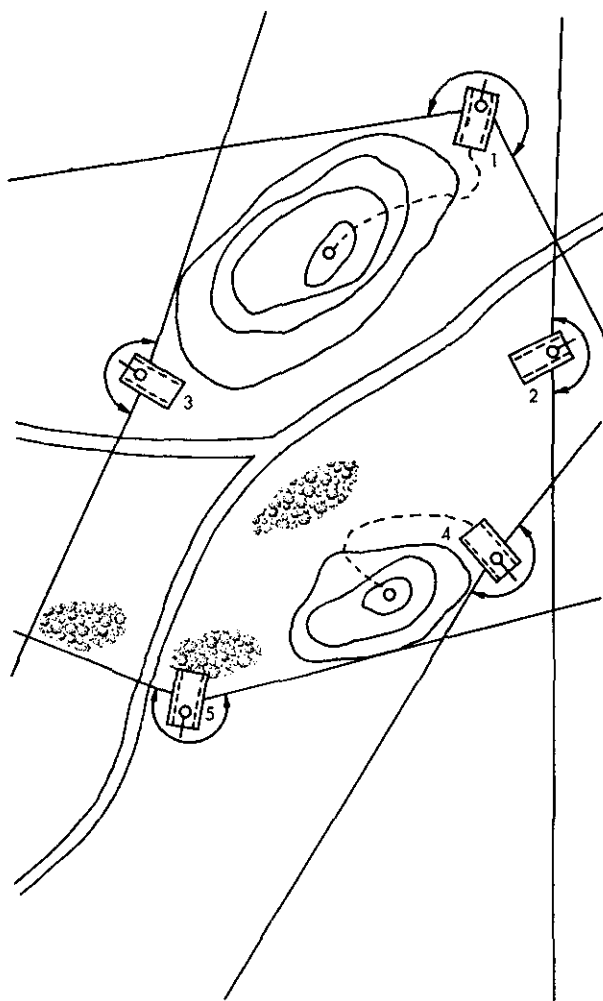

Figure 58. At halts, all avenues of approach are covered.

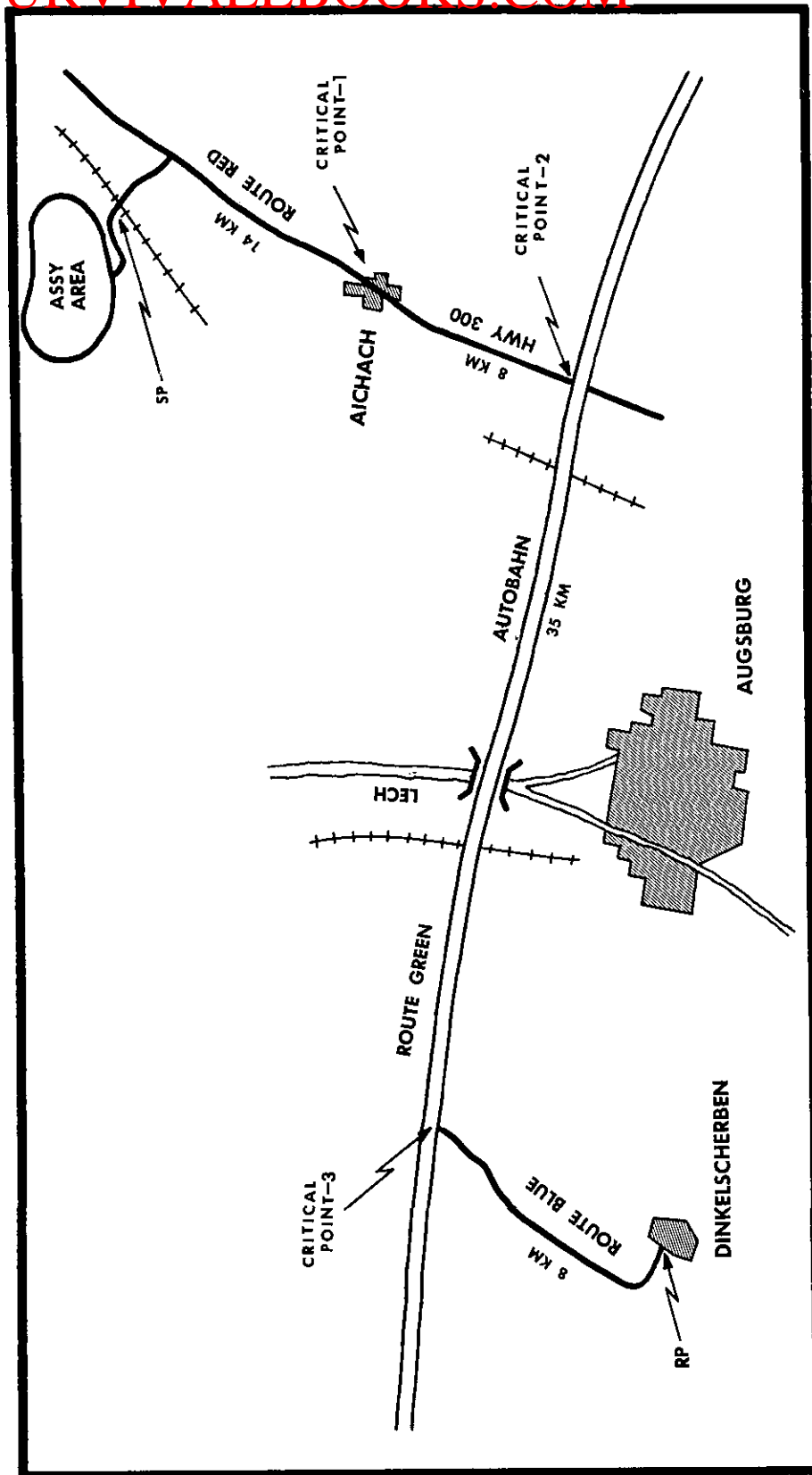

Figure 59. Strip map.

- (5) Location of the start point.
- (6) Time of arrival at the start point.
- (7) Security (may be SOP).
- (8) Scheduled halts (may be SOP).
- (9) Intervehicular distance and time interval between march units (may be SOP).
- (10) Communication.
- (11) Location of the command post during the march (may be SOP).
- (12) Traffic control measures (may be SOP).
- (13) Critical points.
- (14) Location of the release point.
- (15) Time each march unit is to clear the release point and any other critical points along the route of march.

b. Strip maps may be supplied to all key personnel, including vehicle commanders and guides. The strip map is a sketch of a route of march. The amount of detail, for example, distances or location of critical points, is dependent on the intended purpose and unit level of use of the strip map (fig. 59).

c. Road movement tables may be issued as annexes to movement orders. See paragraph 10, this annex. Also see annex XI for example road movement order.

Section III. MOVEMENT BY RAIL

23. General

When rail facilities are limited, tracked vehicles may be moved by rail and other vehicles marched by road. Calculations and figures shown herein are based on American railway equipment, personnel, and procedure. Use of foreign railway equipment and personnel, and the location of the enemy will dictate changes in the details of these troop and equipment movement and loading plans.

24. Planning the Movement

a. *Responsibilities.* Troop and equipment movements by rail are the joint responsibility of the unit being moved and the transportation agency. The local transportation agency establishes the facilities necessary to accommodate the unit during movement. It furnishes administrative support, technical guidance and supervision, and security during movement except when the responsibility is charged to other agencies. The moving unit is responsible for preparing and implementing plans in accordance with directives and in cooperation with the transportation agency. It provides housekeeping and local security details of troops to the transportation agency and is charged with its own internal administration and control.

b. *Orders.* The order directing the movement of a unit by rail will designate the point or points at which it will entrain, desired clos-

ing time, and destination. The sequence in which elements are moved is determined by the availability of transportation, the mission, and the situation that will confront the unit at its destination. The assignment of units to entraining points is determined by availability of suitable loading facilities, materiel to be loaded, and closeness of units to the entraining points.

25. Functions of Key Personnel

a. *General.* The details incident to the movement of a unit are handled by the unit logistics staff officer (S4) so far as transportation is concerned. He must work closely with the local transportation officer in planning, preparing for movement, and entraining. He collects and compiles all information necessary for the preparation of the movement and gives it to the local transportation officer. The local transportation officer requires the following information:

- (1) *Number of persons to be moved.* This will be broken down by classes, that is, the number of officers, enlisted men, stretcher cases, medical attendants, dependents (if any), and evacuees; further, the number of males and females in each category must be indicated.
- (2) *Equipment desired.* The number and kind of cars required to handle mili-

tary impedimenta and organizational equipment are specified. Specific information must be furnished when special type cars are necessary.

- (3) *Date desired.* This is a date for placement of cars, date to depart, or date due at destination—whichever is applicable.
 - (4) *Authority for the move.*
 - (5) *Amount of baggage and impedimenta.*
 - (6) *Mixed train, if desired.* A mixed train is a combination of passenger and freight cars.
 - (7) *Destination.*
 - (8) *Entraining points desired.*
 - (9) *Reference to oversea requisition number.* If troops are going to a port of embarkation for shipment overseas, this number is needed.
- b. General Functions of Unit Officers.*
- (1) *Unit commander.* The unit commander is responsible for the entraining and detraining of personnel and equipment in accordance with the movement order.
 - (2) *Unit staff.* The staff is responsible for planning, supervising, and coordinating all movement activities in accordance with the directives of the unit commander.
 - (3) *Train commander.* The designated train commander supervises all matters pertaining to the safety of personnel and freight en route. He supervises intermediate services required by personnel and freight from the time the train is accepted for movement by the railroad until the train is delivered at the destination.

26. Unit Movement Operations

The principal operations involved in the movement of a unit are divided into three phases—training, alert, and movement.

a. Training Phase. This phase is the period before receipt of the warning order. During this period, a standing operating procedure is developed, key personnel are trained for the jobs they will perform, and equipment estimates are prepared.

b. Alert Phase. During this phase—the period between receipt of the warning order and receipt of the movement order—personnel, baggage, organizational equipment, vehicles, and other property are prepared for shipment. Training is intensified.

c. Movement Phase. During this phase—the period between receipt of the movement order and final detraining at destination—troops entrain, impedimenta is loaded, and the movement is accomplished.

27. Principles of Rail Movements

a. Different types of equipment have different freight rates and should be loaded separately. For example, baggage of personnel (having a higher freight rate) should not be loaded in vehicles transported on flat cars.

b. In loading equipment and supplies, the minimum freight weight of a railroad car should be met whenever possible.

c. The towed piece of equipment should be with the towing vehicle to facilitate loading and unloading.

d. A 6-inch brake wheel clearance per car (American) must be allowed for *all* freight.

28. Rail Movement Table

a. The rail movement table shows actual strength of the unit, type and amount of equipment, number and type of cars (for planning purposes), and other pertinent information. It is kept current, and following receipt of movement orders, it is used to prepare the train consist table. The rail movement table is prepared during the training phase of movement operations and, in accordance with Army regulations, must be maintained current. The unit S4 prepares the initial rail movement table. He revises it to conform with current strength, impedimenta, and equipment to be moved, and maintains an up-to-date table through all phases of the movement. *Final revision of the movement table is made upon receipt of orders directing the movement.*

b. To be ready for movement, each troop unit will prepare and maintain up-to-date rail movement tables under guidance of the unit S4. See (1), figure 60 for an example of a rail movement table.

29. Loading Plans

a. General. Loading plans are essential to the preparation of a rail movement table. A loading plan provides the type and amount of railway equipment required by a unit as well as that required by each subordinate organization (2), fig. 60).

b. Space Requirements for Troop Loading. For planning purposes and staff training, the following assumptions may be made.

- (1) *Sleeping cars.* Standard and tourist Pullmans will ordinarily accommodate 26 troops with individual equipment.
 - (a) Officers and warrant officers will normally be moved in standard Pullman, two per section.
 - (b) Enlisted men move in either standard or tourist Pullmans, or coaches.
- (2) *Coaches.* A coach can accommodate 55 troops with individual equipment.
- (3) *Passenger trains.* Passenger trains consist normally of 11 sleeping cars, 2 kitchen-baggage cars, and 1 or 2 baggage cars. A train of this size will normally accommodate two companies.
- (4) *Freight trains.* For troop unit moves, including heavy equipment such as tanks, artillery, and engineer equipment, each train does not normally exceed 65 cars for infantry divisions and 55 cars for armored divisions.
- (5) *Mixed trains.* Mixed trains, which carry personnel with their vehicles and equipment are desirable from a tactical and organizational standpoint.

c. Loading Organizational Equipment.

- (1) The amount of headquarters, kitchen, and maintenance equipment varies in units. For planning purposes, 20 short tons (2,000 pounds per ton) are allowed per company or equivalent unit.
- (2) Organizational equipment moves normally in baggage or box cars.

d. Flat Cars. Flat car requirements are computed on the basis of maximum use of each car, regardless of length. Do not restrict com-

putation to cars of one length. Six inches at one end of each car must be left for brake-wheel clearance. Length, width, height, and weight must be considered in loading vehicles and equipment. Final approval of loads will be made by the local transportation officer.

30. Train Consist Table

a. General. The train consist table is prepared after the rail movement table has been revised following receipt of the movement order. The unit S4, as directed by the commander, prepares the train consist table from data appearing on the completed rail movement table. The commanding officer of a unit must designate the order in which the various organizations of his unit are to move to insure their arrival at the destination in the sequence he desires.

b. Making Up Trains and Train Sections.

- (1) *Size.* Trains of moderate size that are capable of making good speed are preferable to long trains of slow speed.
- (2) *Makeup.* The carrier is responsible for organizing the trains and is governed by the operating rules of the railroad. When the size of the train is fixed, the organization (relative positions of cars) of the train will be determined by the railroad representatives, who comply with the wishes of the military as far as possible.
 - (a) *Personnel.* Organizational units will not be divided by assignment to more than one train when it can be avoided. When organizational units must be divided, the commanding officers should be notified as soon as possible so adequate arrangements can be made for care of the troops.
 - (b) *Baggage.* Troops and their baggage normally will not move on different trains. When there are two or more trains, the proper baggage cars should accompany each train.
 - (c) *Freight.* In movements of large bodies of troops, freight normally moves by separate trains. When

TO&E	RAIL CARS		Military Equipment on Each Car	Total Length Required (Inches)	Total Length Available (Inches)	
	No.	Length (Feet)				
17-36E	2	40	One bridge (AVLB)	384	468	
	1	40	One APC (M577); one mortar carrier (M106)	442	468	
	3	40	One tank (M60)	320	468	
	3	40	Two APC (M113-(3), M577-(3))	441	468	
	2	40	One 5-ton medium wrecker (M62)	310	468	
	2	40	One 3/4-ton truck (M37) w/wn; One 1 1/2-ton trailer (M106, water trailer)	356	468	
	2	40	One 5-ton truck LWB (M54)	299	468	
	1	40	One 5-ton truck LWB (M54); One comd recon vehicle (M114)	465	468	
	1	46	Three 1/4-ton truck amb (M170)	465	540	
	7	46	One 5-ton LWB (M54) w/wn; one 1/4-ton truck (M151)	436	540	
	2	46	One recovery vehicle (M88); one 3/4-ton truck (M37) w/wn	516	540	
	2	46	One AVLB (launcher only)	468	540	
	1	46	One 5-ton truck LWB (M54); one 3/4-ton truck (M37)	484	540	
	6	46	One 2 1/2-ton truck (M135); one 1 1/2-ton trailer (M104)	464	540	
	8	46	One 2 1/2-ton truck (M135) w/wn; one 1 1/2-ton trailer (M104)	469	540	
	3	46	One 5-ton truck LWB (M54); one 1 1/2-ton trailer (M104-(1), M106-(2))	465	540	
	1	46	Three comd recon vehicle (M114)	498	540	
	1	50	Two tanks M41A3	554	588	
	6	50	Two APC (M106-(3), M113-(6), M577-(3)); one 1/4-ton truck (M151)	574	588	
	1	50	One 2 1/2-ton fuel tank truck; one 1/4-ton truck (M151); one 1/4-ton trailer (M100)	551	588	
	6	50	One 5-ton truck LWB (M54); one 1/4-ton truck (M151); one 1/4-ton trailer (M100)	540	588	
	1	50	One 3/4-ton truck (M37); one 3/4-ton trailer (M101); one 1/4-ton truck (M151); one 1/4-ton trailer (M100)	573	588	
	1	50	One comd recon vehicle (M114); one recov vehicle light (M578)	583	588	
	17-37E	17	40	One tank (M60)	320	468
		1	46	One 2 1/2-ton truck (M135) w/wn; one 1 1/2-ton trailer (M104)	469	540
		1	46	One 3/4-ton truck (M37) w/wn; one 3/4-ton trailer (M101); one 1/4-ton truck (M151)	469	540
		1	46	One APC (M113); one 1/4-ton truck (M151); one 1/4-ton trailer (M100)	462	540
		1	46	One recovery vehicle (M88); one 1/4-ton truck (M151)	458	540

SUMMARY OF FREIGHT CARS

TO&E	No. Cars Per Bn	Railway Flat Cars			Total Flat Cars
		40'	46'	50'	
17-36E	1	16	31	16	63
17-37E	3	18	3	0	21
17-35E	Totals	71	40	15	126

(2)

Vehicle and equipment loading plan.
Figure 60—Continued.

there is not enough freight for a separate train, the cars containing the freight are attached to the appropriate train.

c. Preparation of the Train Consist Table (fig. 61).

- (1) *Train number.* When a movement to one destination consists of more than one train, the trains are designated by Army numbers. These numbers will be put in the train number column of the table in the order in which they will depart; for example: train 1, train 2.
- (2) *Transportation groupings.* In this column will be shown the units or organizations moving on each train.
- (3) *Railway equipment.* The number of cars to be carried in each train, under

the proper designations, will be shown in this column. Under the total column will be shown the sum of these cars for each train.

- (4) *Train officers.* In this column are shown the key officers assigned to each train. They are responsible for the conduct and welfare of the troops.

31. The Individual Train Loading Plan

a. This plan is prepared by the unit S4 after the rail movement table has been revised and the train consist table has been prepared. The plan consists of assignment of specific personnel and equipment to each car in the train.

b. When the individual train loading plan has been completed, copies will be furnished to—

- (1) Unit commanders.

TRAIN CONSIST TABLE
2D TANK BATTALION, 11TH ARMOR

Train Number	Transportation Grouping	Railway Car Requirements							Train Officers
		Coach	Pullman Troop	Ki	Box or Bag	Flat	Caboose	Total	
1	Hq & Hq Co (Freight)	0	0	0	1	63	1*	65	Capt Hensen
		1 officer, 8 EM freight train guards, 2 EM medics							
2	Co A (Freight) Co B (Freight) Co C (Freight)	0	0	0	3	63	1*	67	Capt Gilmore
		1 officer (Co A), 4 EM (Co B), 4 EM (Co C), and 2 EM medics (Hq Co)							
3	Hq & Hq Co	0	11**	1	1	0	0	13	Capt Baxter Capt Jacobs, MC
		Hq & Hq Co: 22 officers, 283 EM (less 3 off and 19 EM for advance party, freight train guards, and medics for train 1, 2, and 4.) TOTALS: 19 officers, 259 EM							
4	Co A, Co B, Co C	0	11**	1	3	0	0	15	Capt Haley Lt Brewster, Mess Officer
		Co A: 5 officers, 85 EM (less 1 off for train 2) Co B: 5 off, 85 EM (less 4 EM for train 2) Co C: 5 off, 85 EM (less 4 EM for train 2) Attachment: 2 medics, 5 mess EM from Hq Co TOTAL: 14 Officers, 254 EM							

* Freight train guard (10 officers, 10 EM)

** 13 sections or 26 persons per car.

Figure 61. Train consist table.

- (2) Entraining officers.
- (3) Train commanders.
- (4) Motor park dispatcher (so that vehicles will arrive at the entraining point in the order in which they will be loaded on railway cars).
- (5) Local transportation officer.

- (2) Each train will depart from the entraining point.
- (3) Each train will arrive at its destination; this, of necessity, will be an expected time of arrival.

b. Preparation of the Entraining Table (fig. 62). Preparation of this form requires the following actions:

- (1) Train number will be as indicated on the train consist form.
- (2) The local transportation officer will obtain the MAIN and MI number, which authorized the movement of each train.
- (3) The entraining officers are designated by name on the entraining table. They are detailed by the commanding

32. The Entraining Table

a. *General.* The entraining table is prepared by the unit S4 after the train consist table and the individual train loading plan have been completed. This form is dependent upon receipt from the carrier of the time schedule for the move. This table will indicate the time—

- (1) Each organization must be at the entraining point.

**ENTRAINING TABLE
2D TANK BATTALION, 11TH ARMOR**

Train No.	Main or MI No.	Order of Depart	Loading			Departure		Arrival		Entraining Officer
			Point	Date	Hour	Date	Hour	Date	Hour	
1	47301	1	EP1 (A)	3Jun	1300	4Jun	1400	8Jun	0520	Capt Hastings HQ & HQ Co
2	47302	2	EP2 (B)	3Jun	1330	4Jun	1500	8Jun	0630	Lt Kirk Co A
3	53631	3	EP1 (A)	5Jun	0400	5Jun	0700	7Jun	1800	Capt Haley HQ & HQ Co
4	53632	4	EP2 (B)	5Jun	0430	5Jun	0730	7Jun	1845	Capt Martin Co B

Loading Points

- (A) Hayshed ramp, Fort Knox, Kentucky.
- (B) New siding ramp, Fort Knox, Kentucky.

Figure 62. Entraining table.

officer of the troops. The entraining officer—

- (a) Supervises the loading of both personnel and property that will move in the train.
- (b) Precedes the command to the entraining point and acts as guide for the unit.

33. Trains En Route

a. Problems and details involving troops, military freight, and the carrier railroad en route are solved, if possible, by the train commander and the railroad representative. If solution on the spot is not possible, the problem will be referred to a designated authority.

b. The responsibility of troop train commanders starts at the home station and terminates upon arrival at the destination. The train commander does not control railroad personnel, operation of the train, or train schedule.

34. Detraining

a. Detraining must be planned carefully. The requirements parallel those of entraining.

b. It is desirable to send advance parties, when possible, to prepare the following:

- (1) Arrangements for the arrival of the trains.
- (2) Unloading facilities.
- (3) Traffic control.
- (4) Assembly areas for personnel and equipment.
- (5) Routes of departure from detraining
- (6) Barracks or bivouac areas.
- (7) Transportation and equipment necessary for detraining of troops, unloading of equipment, and movement of troops and equipment to assigned areas.

Section IV. MOVEMENTS BY AIR

35. General

Movements by air involve the transportation of troops, supplies, or equipment into an objective area, or into an area inaccessible to other means of transport. Air movements may be either tactical or administrative, or a combination of the two. The air movement may be for the execution of a tactical or strategic mission. Movement by air exploits the capability of aircraft to overcome distance and geographical barriers and is characterized by flexibility and speed. Transport aircraft are limited in their cargo carrying capability by size and weight restrictions. Adverse weather, inadequate landing facilities, and enemy counterair activities may restrict further the suitability of aircraft as a means of transportation for armor units.

36. Responsibilities

a. The Military Airlift Command (MAC) and the U.S. Air Force are designated the agencies for intertheater movements by air. Air movements using Army aviation are limited normally to a theater of operation.

b. For considerations governing the employment of air transportation, see FM 57-10, FM 57-35, FM 61-100, and FM 100-5. Staff procedures and details regarding planning, use, and stowage of air transport are contained in FM 57-10, FM 57-35, FM 57-100, FM 101-10, and TM 57-210. The responsibilities of the unit being moved are the same as set forth in paragraph 24, this Appendix.

Section V. MOVEMENTS BY WATER

37. General

a. Water transport is the primary means used to establish and maintain oversea operations. It is characterized by large capacity for

personnel and equipment, long range operations, relatively slow speed compared to air movements, and a high rate of movement.

b. Movements by water are especially vul-

nerable to attack by nuclear weapons and by enemy surface, subsurface, and air forces. When there is danger of attack by hostile forces, vessels will be assembled usually in convoy under command of the Navy and provided with naval escort. Air cover by land or carrier based aircraft will normally be provided convoys determined critical to the overseas operation. Convoys of lesser importance will be provided air cover consistent with existing capabilities and priorities.

38. Responsibilities

a. The Military Sea Transport Services (MSTS) and the U.S. Navy are designated the agencies for oversea movements by water. The responsibilities of the moving agency are set forth in JCS Pub 3.

b. The responsibilities of the unit being moved are the same as set forth in paragraph 24, this appendix. For details regarding planning, use, and stowage for water transport, see FM 31-12, FM 31-13, FM 61-100, FM 100-5, and FM 101-10.

APPENDIX VII

ESTIMATE OF THE SITUATION

1. General

The purpose of the estimate is to arrive at a decision through a logical and orderly examination of all factors affecting the accomplishment of the mission. It involves reason and judgment and should not be a mechanical process (example below). Estimates made are usually mental and may not be written.

Example. Sequence of the leader's estimate of the situation.

1. MISSION

2. THE SITUATION AND COURSES OF ACTION

a. Considerations affecting the possible courses of action.

(1) Characteristics of the area of operations.

(2) Enemy situations.

(3) Own situation.

(4) Relative combat power.

b. Enemy capabilities.

c. Own courses of action.

3. ANALYSIS OF OPPOSING COURSES OF ACTION

(Analysis of effect of each enemy capability on each of own courses of action.)

4. COMPARISON OF OWN COURSES OF ACTION

(Summary of advantages and disadvantages of own course of action.)

5. DECISION

(Who, what, when, where, how, and why.)

2. Explanation

a. *Mission (step 1).* The mission is a clear, concise, and simple statement of the task to be

accomplished and its purpose. The analysis of the mission is the beginning of the estimate.

Note. The italicized parts in the following paragraphs are the platoon leader's mental estimate of the situation (fig. 63).

1st Platoon, Team A, attacks at 1430 hours to seize Hill A and continues the attack to the north on order.

b. *The Situation and Courses of Action (step 2).* The purpose of this part of the estimate is to think through all significant facts pertaining to the situation to examine what influence they will have on the employment of the unit. Considering the factors of METT (mission, enemy, terrain and weather, troops available) various ways to accomplish the mission are determined. These are conceived in general terms and involve the employment of the unit as a whole. All possible ways are considered; those that are feasible and vary significantly are retained for further examination. They are called courses of action. In arriving at a decision, the commander must answer the questions; *who, what, when, where, how* and, if required, *why?* The *who, what, when, and where,* are normally prescribed in the mission. *1st Platoon, Team A (who) will attack (what) at 1430 hours (when) to seize Hill A (where) and continue the attack to the north on order.* This leaves the *how* to be solved. The elements of *how* are the possible formations of the unit; the firepower that may be employed; and the direction the attack will move. The result of this examination will be the development of feasible courses of action.

(1) *Terrain.* All aspects of the terrain in the area of operations are studied to gain familiarity with observation and fields of fire, cover and concealment,

ENEMY MECHANIZED
RIFLE PLATOON IN
TRENCHES WITH ONE
ANTITANK GUN (TOWED)

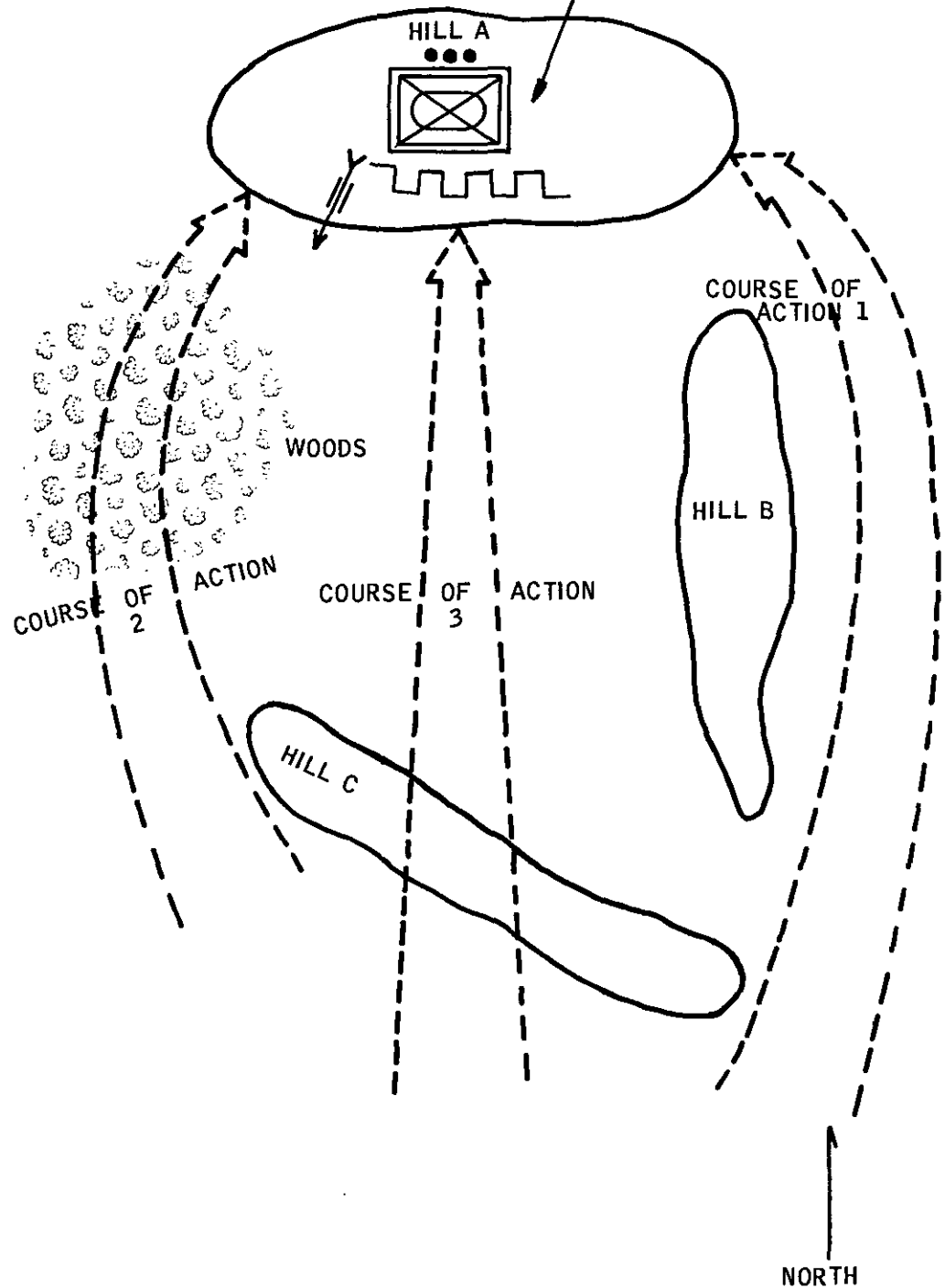

Figure 63. Situation and courses of action.

obstacles, key terrain, and avenues of approach.

Hills A, B, and C are key terrain features because control of these features will offer me or the enemy a marked advantage in that the hills offer good observation and fields of fire. From these hills I can control the surrounding terrain to the limit of my tank gun range. The wooded low ground will restrict my observation and fields of fire and hinder my movement and may require the supporting infantry to dismount and clear the woods, but it offers good concealment and forces the enemy to shift his fires to his flank. Hill B will offer me a covered approach and forces the enemy to shift his fires to the flank. I can attack on a straight line from Hill C to Hill A, which is the fastest approach and has unlimited fields of fire and observation; however, I would be under direct fire from the enemy all the way to Hill A, and my flanks are exposed to woods on the left and high ground on the right.

- (2) *Weather.* Past, existing, and predicted weather conditions must be considered.

There are 6 hours of daylight left. No rain has fallen for the past week. No rain is expected.

- (3) *Relative combat power.* All factors of troops available are judged and weighed to determine their effect on the combat power of the unit, such as strength, composition, disposition, reinforcements, logistics, training, and morale. Since combat power is relative, the same considerations are applied to the enemy situation to determine enemy capabilities.

Enemy situation. Enemy action and reports, indicate that he has organized a platoon-size blocking position on Hill A. He has a towed antitank gun on the west of his position. Own situation. My platoon is up to strength, and supply and equipment

are adequate for this mission. The mobile firepower of my tank platoon and the capabilities of the supporting infantry and other combat support provide the platoon with a combat power advantage (firepower, equipment, and mobility) over the enemy.

- (4) *Enemy capabilities.* The significant enemy capabilities are actions of which the enemy is capable physically and which, if adopted, will affect the accomplishment of the friendly unit's mission.

Defend in place.

Withdraw north of Hill A.

Attack.

Enemy intentions are not considered, as this leads to "guessing."

- (5) *Own courses of action.* Courses of action, to be useful and manageable, should vary significantly. One of the courses of action will become the decision; therefore, the courses of action must be complete and as accurate as possible. Those considered are—

- (a) *Course of action 1 is the use of the right (east) approach with my platoon in line formation.*
- (b) *Course of action 2 is the use of wooded left (west) approach with my platoon in line formation.*
- (c) *Course of action 3 is the use of the center approach with my platoon in wedge formation.*

c. Analysis of Opposing Courses of Action (step 3).

- (1) Each of the enemy capabilities is studied (considered in step 2) to determine its broad impact on each course of action. Enemy capabilities that have little or no influence on the courses of action are not considered further. *Each* course of action is then analyzed against *all* of the remaining enemy capabilities. The technique used in the analysis is to picture the action by both sides in logical sequence throughout the operations. This mental study (war game) includes consideration of the factors of

METT and their effect on the action to determine the probable outcome of the course of action under consideration. This analysis serves to refine the *where* and *how* and to identify some of the advantages and disadvantages of each course of action. The enemy's ability to oppose the course of action and the effectiveness of this opposition are determined from this mental war gaming.

- (2) This process is repeated for each of the other courses of action.
- (3) During the analysis, the estimator may make major changes in courses of action; eliminate one or more from further consideration; or form a new one.
- (4) No attempt should be made to compare own courses of action during this war gaming. It is neither possible nor practicable to reach a conclusion at this point since only one basis of comparison, the enemy, has been used.

The enemy can defend in place on Hill A with long range antitank fires. The defense can be overcome with my superior firepower and mobility. The enemy can withdraw to the north, which will affect my chosen courses of action equally, so I will not consider this capability any further. If the enemy attacks, a new situation is presented which requires a new estimate, so I will not consider this capability any further. Course of action 1 versus enemy capability to defend avoids his best defenses (to his front) and requires him to move his antitank gun and other fires to his left flank. Course of action 2 versus enemy capability to defend moves in an approach concealed from his observation, but the woods will slow down my movement, and his antitank gun is on this flank. Course of action 3 versus enemy capability to defend puts my platoon in the open directly in front of the enemy's best defenses; however, it

will place me on the objective in the shortest time.

d. Comparison of Own Courses of Action (step 4). In paragraph 4 of the commander's estimate, the commander compares courses of action developed in paragraph 3 and reaches a conclusion as to the best course of action.

- (1) In making the comparison, the commander first analyzes each course of action in light of such major considerations as terrain, enemy and friendly dispositions, enemy capabilities, time, or other factors as a result of this analysis, certain advantages and disadvantages will emerge.
- (2) The commander then lists the advantages and disadvantages of each course of action of the subparagraphs.
- (3) The commander then determines the significance of each advantage and disadvantage in the light of the accomplishment of the mission. The mental weighing of these advantages and disadvantages demands sound professional judgment, military experience, and an analytical mind. No arbitrary formula or rule of element can substitute for these qualities.

Analyzing the three courses of action, the following advantages and disadvantages emerged:

(a) *Course of action 1.*

Advantages

1. *Provides a covered approach to the objective.*
2. *I can hit the enemy on his weakest flank.*

Disadvantages

It is the longest route to the objective.

(b) *Course of action 2.*

Advantages

1. *Wooded area will afford some concealment.*
2. *Hits the enemy from his flank.*

Disadvantages

1. *Wooded areas will hinder movement.*
2. *I will have to engage enemy flank with the strongest antitank defense.*

(c) *Course of action 3.*

Advantage

It provides shortest route to the objective.

Disadvantages

1. *Provides limited cover and concealment.*
2. *Strikes the enemy at position of greatest strength.*

(d) *My conclusion is that in this situation, I can strike the enemy at his weakest point and have a greater chance of success by using course of action 1.*

e. *Decision (step 5).*

(1) The decision is the course of action offering the best chance of success. The leader is responsible for his decision. It is translated into a concise statement of what the unit will do. It answers the following questions:

(a) WHO: the unit to take some action, the command as a whole.

(b) WHAT: the type action to be taken—attack, occupy, delay on successive positions, or defend.

(c) WHEN: time the operation is to start or end.

(d) WHERE: area from which (defensive sector or delay lines), through which (avenue of approach), or to which (objective) the action will be accomplished.

(e) HOW: a statement of the formation and organization for combat for the offense and the disposition of forces and their organization for combat in the defense and retrograde as well as the use of available fire support.

(f) WHY: statement of the purpose; includes those details necessary to insure intelligent preparation and execution of the plan.

(2) *My decision is for the platoon to attack in a line formation at 1430 hours along Hill B to seize Hill A.*

APPENDIX VIII

COMMANDER'S APPLICATION OF PRINCIPLES OF WAR

1. General

The commander, in analyzing courses of action during his estimate of the situation, should evaluate the relative merits of each selected course of action in light of the principles of war. Violation of principles should be avoided if possible. If a principle is violated, the commander must be aware of the implications and be willing to accept the resultant risks. To illustrate application and use of the principles of war, the following situation and courses of action are discussed. No attempt has been made to discuss the enemy capabilities as they affect each course of action.

a. Situation.

- (1) Task Force 1 (1st Tank Battalion), 11th Armor, has been temporarily halted in the vicinity of Hill A prior to continuing the offensive. At 162000 Jun—the battalion task force commander received the following message, "Attack 171400 to seize Hill D: be prepared to continue the attack on order."
- (2) The enemy has been conducting a series of delaying actions. The enemy situation as to troop disposition and location is indicated on sketch map at figures 64, 65, and 66.
- (3) Battalion Task Force 1st Tk Bn, 11th Armor, has 3 tank companies and 1 mechanized infantry company.
- (4) Light data:

	BMNT	EENT
16 Jun -----	0440	2045
17 Jun -----	0430	2048
18 Jun -----	0425	2051

b. Courses of Action (CA).

- (1) Course of action 1. Attack to seize Hill D with 2 teams abreast, 1 tank-

heavy on the north axis, 1 tank-heavy on the south axis, with remainder of the task force following and supporting on south axis. The scout platoon screens the northern flank of the south axis from Hill B initially (fig. 64).

- (2) Course of action 2. Attack in column, seize Hill C; on order, seize Hill D. Leading task force tank-heavy attacks down Federal Road 7, seizes Hill C. After Hill C has been secured, continue attack on order on two axes to seize Hill D. Scout platoon initially screens the south flank of Hill C from Hill B (fig. 65).
- (3) Course of action 3. Task force attacks, to seize Hill D, on south axis with two tank-heavy teams abreast. Remaining teams follow and support. Scout platoon screens northern flank initially from Hill B (fig. 66).
- (4) Other courses of action. There are other feasible courses of action in this situation. However, for explanation purposes only, the three courses of action selected above will be analyzed and discussed.

c. Principles of the Objective. The accomplishment of the mission is paramount; all other considerations must contribute to this end. The objective assigned to the commander in this situation facilitates the accomplishment of the brigade and division mission. The task force commander must in turn consider missions and means that he will allocate to his subordinates to accomplish his mission.

- (1) In CA 1 the commander plans to seize the objective assigned to him, thereby accomplishing his mission and con-

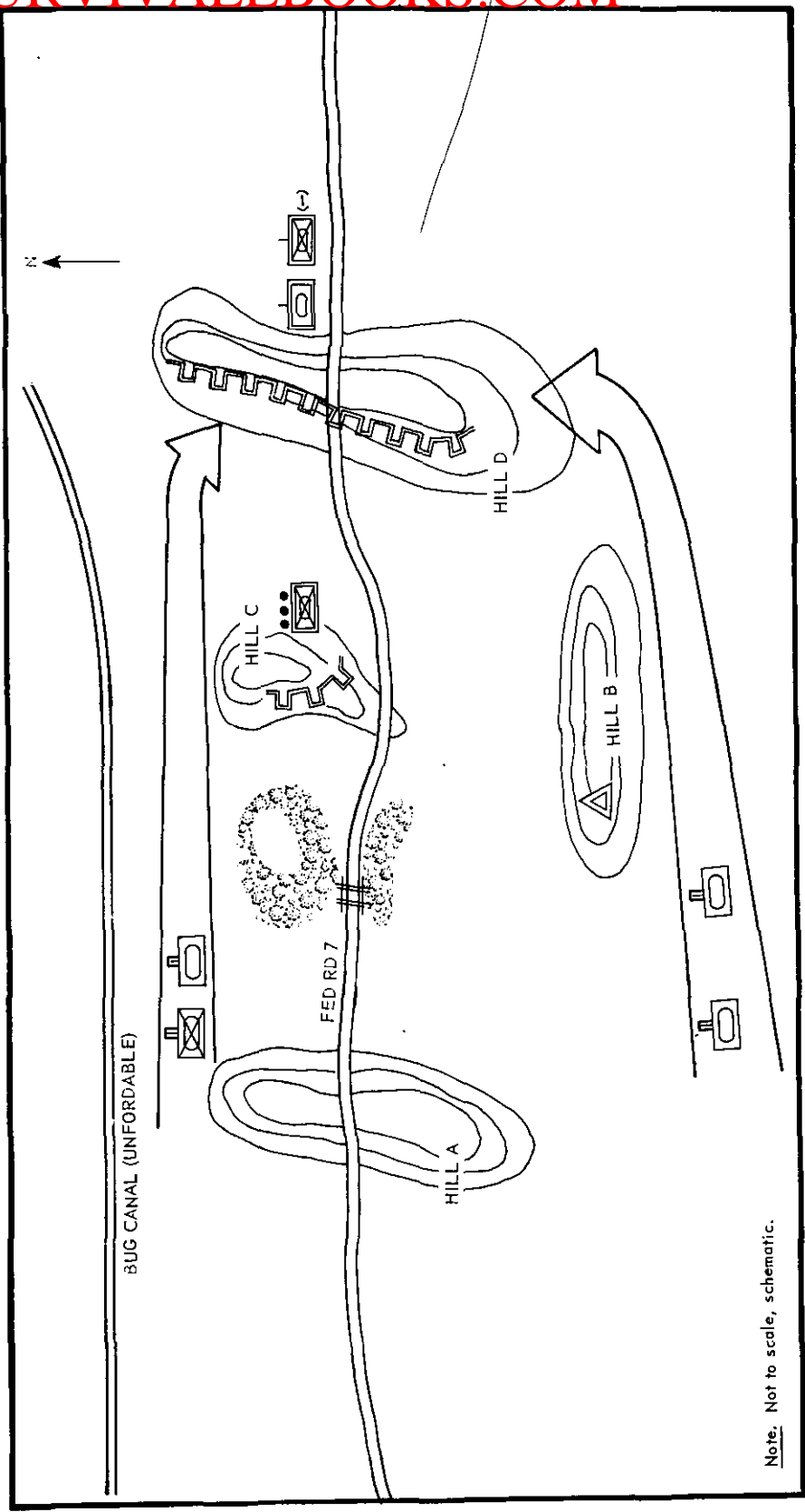

Figure 64. Course of action I.

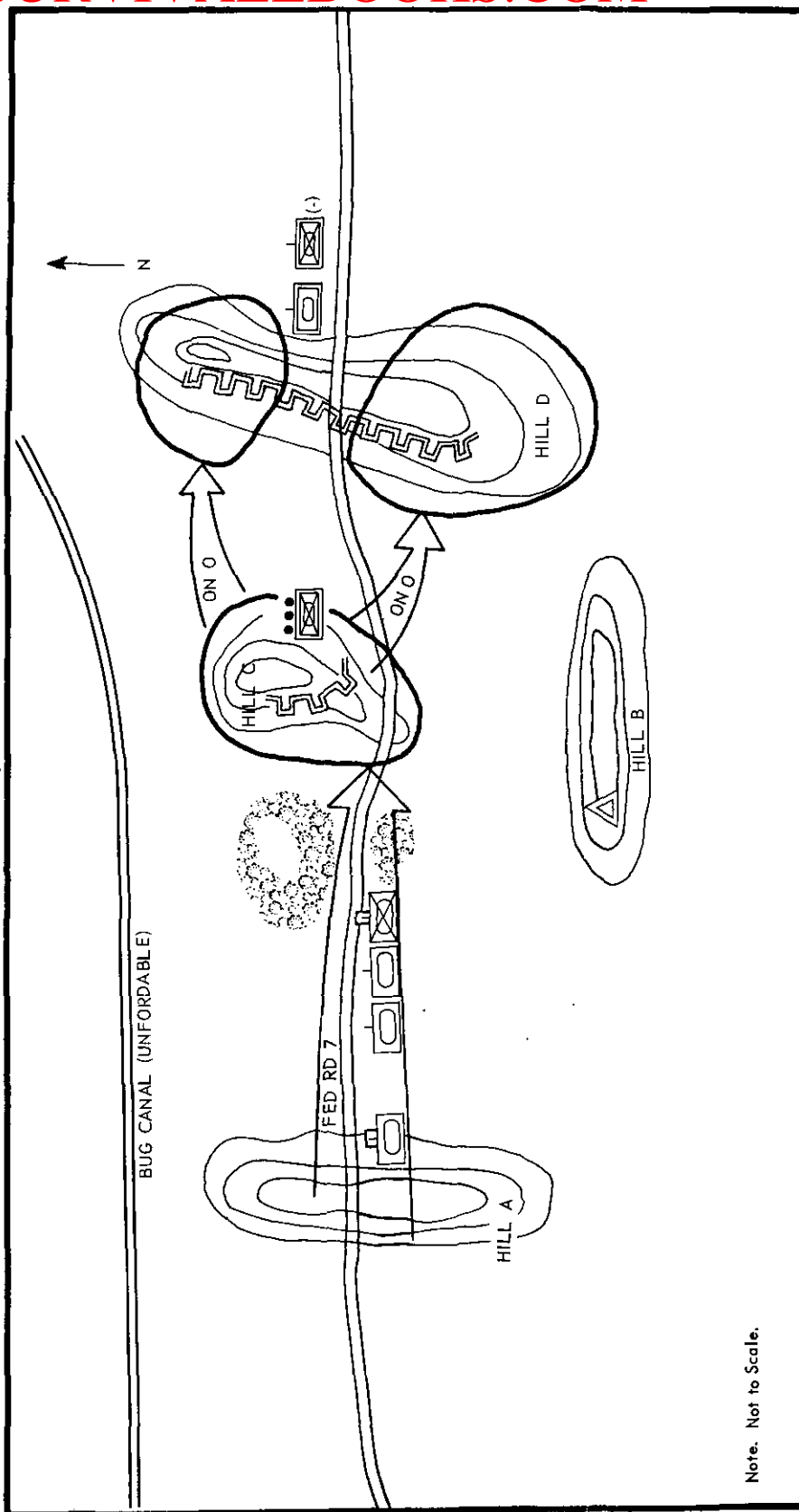
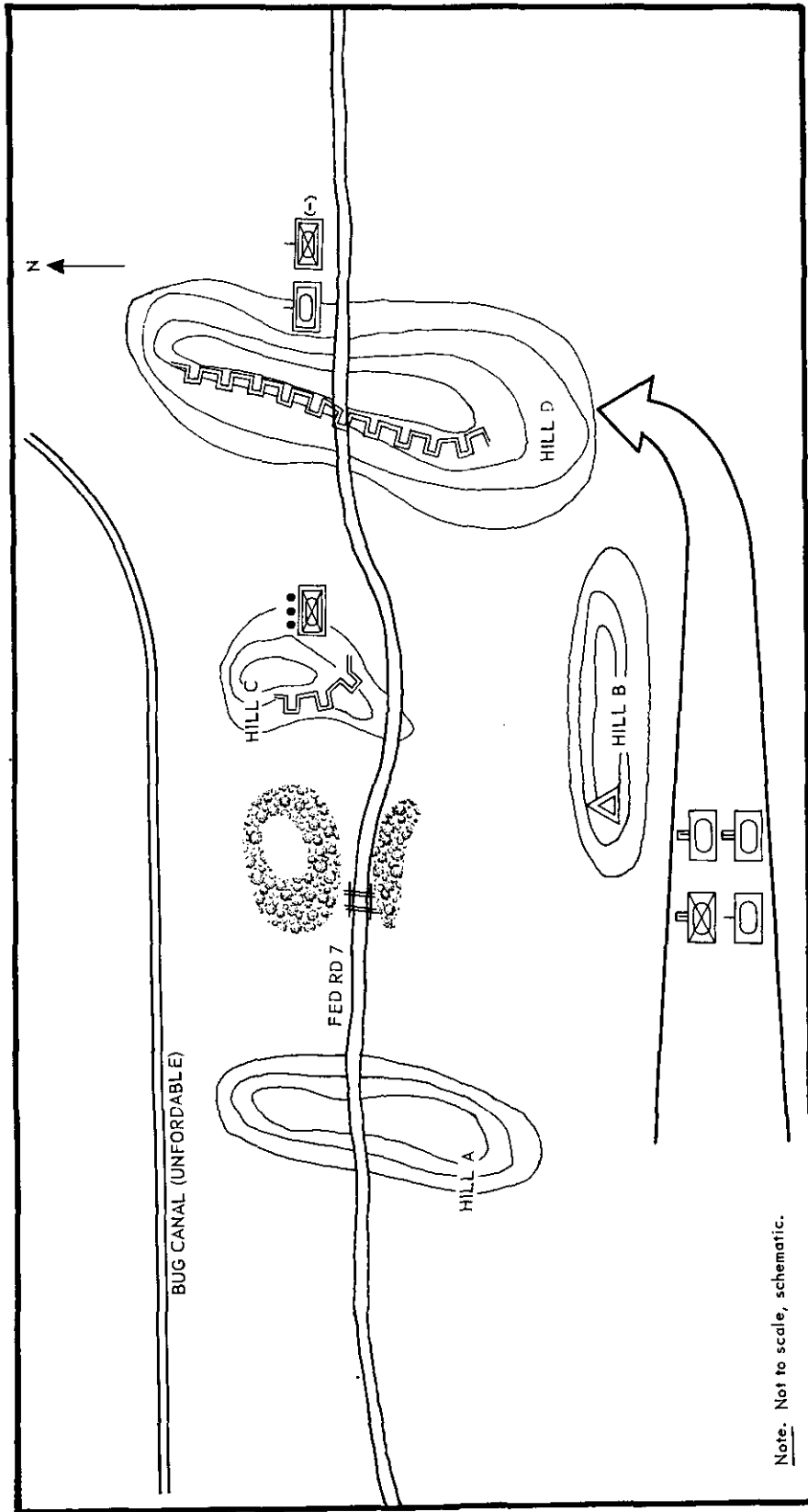

Figure 65. Course of action 2.



Note. Not to scale, schematic.

Figure 66. Course of action 3.

tributing to the overall mission of the brigade.

- (2) CA 2 fails to provide for the timely seizure of the objective. Seizure of Hill C subjects his force to unnecessary contact with the enemy and could ultimately preclude seizure of Hill B. Failure to accomplish a timely seizure of the objective in this situation fails to contribute to the overall mission of the force and is a violation of the principle of the objective.
- (3) In CA 3 the objective is seized and the mission accomplished as in CA 1.
- (4) CA 1 or CA 3 is favored based on this principle.

d. Principle of the Offensive. The correct application of this principle requires that the commander impose his will upon the enemy to set the pace and course of battle; maintaining an aggressive attitude and the initiative, exploiting enemy weaknesses, and meeting unforeseen contingencies are an integral part of applying this principle.

- (1) In CA 1, the commander reasons that he can exploit and take advantage of the enemy's dispositions. By attacking on two axes of advance, he causes the enemy on Hill C to react against either the north or south axis or both simultaneously, thus creating favorable conditions for defeat or containment of the enemy. Under these conditions the commander can succeed in imposing his will upon the enemy.
- (2) In CA 2, the commander fails to maintain the offensive by stopping unnecessarily on Hill C and in so doing also fails to—
 - (a) Maintain the momentum of the attack.
 - (b) Retain the initiative.
 - (c) Maintain an aggressive attitude (in terms of (a) and (b) above).
- (3) In CA 3, the commander outflanks the enemy by an attack on Hill D from the south, and exploits an open flank while attacking in mass. The commander envisions that he will outflank the enemy positions on Hill C and cause the enemy to abandon

this position. The enemy is now obliged to fight according to the commander's plan; thus he succeeds in imposing his will upon the enemy in this situation. The depth of the formation provides for maintenance of the momentum of the attack and will provide for unforeseen contingencies.

- (4) Based on this principle, CA 3 is favored.

e. Surprise. Striking the enemy when, where, or in a manner that he does not anticipate, will help the commander to attain surprise. The commander must consider under this principle, time of attack, direction, combat power to be employed, deception measures, secrecy, and rapid movement. Night attacks, although more difficult to execute, should be employed frequently and considered as normal operations. Continuation of the attack during darkness is also effective and serves to gain surprise. Attacking at generally the same time each day, such as BMNT or BMNT -30, should be avoided. Deception measures are employed to mislead the enemy as to the true status or purpose of friendly activities. The deception measures are a part of the commander's counterintelligence measures which include denial measures. Communication security is an important denial measure. Camouflage is used as a denial and deception measure. Rapid movement is associated not only with surprise, but it affords some security. Factors that contribute to the possible attainment of surprise in each course of action are—

- (1) CA 1.
 - (a) *The time of attack.* The unusual hour at which the attack commences could certainly cause surprise.
 - (b) *The direction of attack.* The enemy must decide whether to divide his forces and engage friendly forces on both axes or engage either one, and which one.
 - (c) *The resultant application of all combat power from both directions of attack.* Once the enemy on Hill C discovers the strength of the attack and the directions of attack, he is forced to decide whether to remain

and be cut off or withdraw to Hill D.

- (d) *The speed of the attack.* The southern avenue of approach offers a fast unopposed route to Hill D; however, enemy interference could slow the forces on the northern axis.

(2) CA 2.

- (a) *Time of attack.* The same reasoning applies here as in CA 1.
- (b) *Directions of attack.* Not selecting the most obvious concealed routes of approach could possibly gain surprise from a deceptive viewpoint.

(3) CA 3.

- (a) *Time of attack.* This is the same as in CA 1 and CA 2.
- (b) *The direction of attack.* Although the initial movement of the main force may be detected by the hostile OP or Hill B before the SP can be seized by the tank platoon, the subsequent direction of attack and assault by the main force remains unknown to the enemy.
- (c) *The strength of the attack.* The overwhelming application of combat power on the flank of the enemy position on Hill D creates mass at the decisive time and place to insure success.
- (d) *Speed of attack.* The anticipated speed on the unopposed southern route will insure rapid closing on the objective and may prevent the reaction of the enemy on Hill C to reinforce Hill D and the redispotion of enemy forces on Hill D.

- (4) Selection. CA 3 is favored by application of this principle. CA 1 facilitates surprise but not to the degree as does CA 3.

f. *Security.* Security encompasses all measures taken by a command to protect itself from the enemy. The commander achieves this by early cognizance of the enemy, by the formation used in the operation, and by the allocation of forces for front, flank, and rear protection, and through rapid movement.

- (1) In course of action 1, the commander's northern flank rests upon an unfordable canal and is relatively secure. However, he must concern himself with the security of the southern flank of the northern axis, which is relatively insecure, and the area between the northern and southern axes. The possible lack of mutual support between the forces on two axes contributes to a lack of security. The depth of his formation on the southern flank provides flexibility with which to meet unforeseen contingencies and provide security. The disposition of the scout platoon on Hill B affords security to both flanks of the southern axis through observation and can be used as a delaying position in the event of an attack from the south. To a limited extent it provides security to the southern flank of the northern axis.

- (2) In CA 2, the commander must plan for the protection of both flanks. However, the northern flank is more secure than the southern flank because of the unfordable canal on the north. The column formation will provide for sufficient reaction time in the event of unforeseen developments from the south. In addition, the positioning of the scout platoon on Hill B will provide security by observation on the south flank and by delaying in the event of an attack from the south.

- (3) In CA 3, the commander can protect his north flank by disposition of the scout platoon on Hill B. This terrain feature will provide observation to the north and south and can be used as a delay position in the event the enemy on Hill C attacks the formation. The depth of the formation will provide the flexibility to cope with unforeseen contingencies on the south flank.

- (4) Although all three courses of action provide for security, priority based on this principle is CA 2, CA 3, and CA 1.

g. Mass. The application of mass at the decisive time and place can achieve a superiority of combat power that will insure success. Even under conditions of a disparity of opposing forces, a local superiority of combat power can be attained against a numerically superior enemy by the proper and decisive application of mass against detected enemy weaknesses. The commander achieves mass by avoiding the dissipation of his combat power through piecemeal commitment, by maneuvering his forces simultaneously from more than one direction, and by maintaining depth to the formation to influence the action.

- (1) CA 1 may achieve mass through the application of simultaneous combat power from multiple directions. However, the force attacking on the northern axis of advance could become engaged by enemy elements on Hill C.
- (2) In CA 2, mass cannot be applied initially by attacking in column. Depth is achieved initially and there is maximum provision for contingent action, particularly to the flanks. However, the formation provides only for the piecemeal commitment of forces forward against Hill C, thus forfeiting the application of mass. In the continuation of the attack from Hill C, mass is achieved through application of all combat power from multiple directions.
- (3) CA 3 meets all of the criteria for mass except for the application of combat power from multiple directions initially. Even this criteria can be met partly by changing the direction of attack of one team just before the assault.
- (4) CA 3 is favored based on this principle. CA 1 is a strong second choice.

h. Economy of Force. The application of mass may necessitate the economy of combat power in other areas to gain superior combat power at the critical time and place. Nevertheless, the economy of force unit must be sufficiently strong to accomplish its mission. Skillful and prudent use of combat power to accomplish the mission with the minimum expenditure of resources is also within the mean-

ing of economy of force. This means that a battalion is not employed to attack an enemy platoon. Only the combat power necessary is employed to do the job. The application of this principle in this situation is not readily apparent since the commander in all courses of action applies all of his combat power in the furtherance of the mission. A marginal application of this principle, however, is in the use of the scout platoon in its security role. The commander has not allocated additional combat power for security, and accepts the security, and any resultant risks that accrue, that can be provided by the scout platoon. This is especially noticeable in CA 1 where security of the southern flank of the northern axis of advance is marginal.

i. Maneuver. Maneuver means the movement to place combat power of troops (units) at a more advantageous position with regard to the enemy. It means that all military resources—combat power, combat support, and combat service support—be positioned and maneuverable to accomplish the mission. It requires relatively rapid movement and also, that the commander remain alert to anticipate probable future actions and plan for contingencies.

- (1) CA 1 envisages the maneuver of 2 teams of the task force to apply combat power at the proper time and place from more than one direction. The open avenues of approach afford rapid movement.
- (2) In CA 2, the commander does not take advantage of the terrain or his combat power to achieve maneuver. The mere movement of the task force in column toward Hill C does not constitute maneuver. If the commander would plan to assault Hill C from more than one direction or from the rear or flank, rather than the column formation, he would succeed in maneuvering his combat power. The continuation of the attack from Hill C on converging axes applies the principle of maneuver.
- (3) The rapidity of movement afforded by the covered avenue of approach to the south of Hill B and the attack of Hill

D from the exposed flank applies properly the principle of maneuver.

- (4) Application of this principle favors CA 1 or CA 3.

j. Unity of Command. Unity of command must provide for single command authority. Attachments to subordinate units establish a single command authority at that level. The commander at each level must have command or control of all resources required to accomplish the mission. Unity of command insures coordination of maneuver, adequate maneuver space and control measures, prevention of mutual interference by attacking teams converging on the objective from different directions, and unity of effort.

- (1) CA 1, CA 2, and CA 3 achieve unity of command through singleness of command at each level and centralized coordination of the final assault.
- (2) Unity of effort results from unity of command. Unity of effort can fail if subordinates do not carry out the commander's orders in the manner prescribed or in the spirit and with the intent desired by the commander.

k. Simplicity. Simplicity embodies simple plans and execution. A simple plan with only such detail to insure understanding by subordinates generally precludes a cumbersome, uncoordinated, complex, and time-consuming execution.

- (1) CA 1 is more complex in planning and execution than CA 3. Maneuver on two axes requires plans for fire support of each maneuver force as well as the coordination of the assault.

(2) CA 2, although appearing relatively simple, is the most complex plan. This is brought about by the seizing of an intermediate objective that will require a temporary defensive posture, and the coordination required to continue the attack on converging axes. Fire support coordination will be more difficult if constant changes are made in the actual operation.

- (3) CA 3 is the simplest way the commander can conceive to accomplish his mission. Centralized control, the use of one axis, and the ease of fire support lend to the simplicity of the plan.
- (4) CA 3 is selected based on this principle.

l. Conclusion. As a result of the commander's analysis of the three courses of action, based solely on the principles of war, CA 3 was favored.

2. Summary

Although the application of the principles of war is more apparent at higher levels, they can and must be applied as illustrated above at all levels. The platoon leader as well as the field army commander, must apply the principles of war to every situation. The seasoned commander, in arriving at a course of action, will normally consider the factors of METT and the principles of war concurrently. A less experienced commander may find it helpful to arrive at courses of action by initially considering the factors of METT. He then applies each of the principles of war to each course of action before final selection.

APPENDIX IX

OPERATION ORDERS AND PLANS

Section I. COMBAT ORDERS

1. General

a. Classes of Orders. Orders are of three general classes—routine, court-martial, and combat.

- (1) Routine orders cover normal administrative operations in garrison or the field and include general, special and letter orders, bulletins, circulars, and memorandums. For details see AR 310-10.
- (2) Court-martial orders are published promulgating the result of trials by special or general court-martial.
- (3) Combat orders pertain to operations and attendant combat service support in the field. They are classified as directives, letters of instruction, operation orders, administrative orders, and standing operating procedures.

b. Definitions.

- (1) *Directive.* A directive is any communication that initiates or governs action, conduct, or procedure. It is a general term, including all forms of orders and instructions. It is used most often to indicate broad aims, policies, or strategic plans promulgated by commanders of theater or higher commands.
- (2) *Letter of instruction.* A letter of instruction is intended for guidance and control of the operations of a large command. It may consist of one or more paragraphs dealing with the broad phases of operations. When issued, it follows the sequence of the 5-paragraph operation order to the extent possible. Letters of instruction are issued normally by army and

higher commanders and have the same authority as operation orders.

- (3) *Operation order.* An operation order is given by a commander setting forth the situation, the mission, his decision and plan of action, and such details of method of execution as will insure coordinated action by the whole command.
- (4) *Administrative order.* An administrative order is given by a commander, announcing to elements of the command the plan to provide combat service support for operations.
- (5) *Standing operating procedure.* A standing operating procedure (SOP) is a set of instructions to be followed by a particular unit for the performance of the features of operations, both tactical and administrative, that the commander desires to make routine.
- (6) *Fragmentary order.* A fragmentary order, normal to armor operations, is a combat order containing information of immediate concern to certain subordinate units. It may omit elements normally found in a complete combat order that (1) have not changed since issuance of the last complete order; (2) are not essential to the performance of the mission; (3) might delay or complicate transmission; and (4) are unavailable or incomplete at the time of issue. The advantage of fragmentary orders is *timeliness*. In a rapidly moving situation, there may not be time to publish

and distribute a complete order to all subordinate units. In such an instance, fragmentary orders are issued. With this type of order, separate instructions are sent to one or more subordinate elements, prescribing to each element its part in the operation. They are concise, but not at the expense of clarity or omission of essential information. In armor operations these instructions are usually oral. The content follows the same sequence as the complete order.

- (7) *Warning order.* A warning order contains advance information to enable subordinate units to prepare for operations to be initiated by later orders. They are issued usually as brief, oral or written messages with the content following the same sequence as the complete order. Information or instructions contained in warning orders are usually repeated in the order that follows.

2. Operation Orders

Operation orders may be issued verbally or in writing. A verbal order may be recorded verbatim or in note form by the receiver. A complete copy of all orders is kept by the staff of the issuing commander. They may be prepared on an operation overlay or operation map accompanying the order as an annex, with the order written on the overlay (overlay-type operation order); with no overlay, in which case items normally presented graphically on an overlay or map are described in the body of the order; or by annotating a map or sketch. They may be issued directly to the subordinate commanders or their representatives, or may be transmitted by signal communication facilities, liaison officer, or messenger.

3. Form

Regardless of the manner in which the operation order is issued, it always follows a prescribed format which facilitates completeness and note-taking. This format contains a heading, body, and ending as follows:

(Classification)

(Changes from verbal orders)

Copy No. _____
 Issuing headquarters
 Location of CP
 Date-time group
 Message reference number

OPORD _____
 (Numbered serially)

References: (Maps, airphotos, or relevant documents.)

Time zone: Used, throughout the order, when execution will take place in a different time zone from place of issue. If not necessary, omit.

Task organization: The task subdivisions or tactical components that will comprise the entire command, together with the name and grade of the commanders, when necessary.

1. SITUATION

Such information of the general overall situation as may be essential for subordinates to understand the current situation.

- a. Enemy forces: Composition, disposition, location, movements, identification, capabilities, and estimated strengths.

b. **Friendly forces:** Information of friendly forces, other than those organic or attached, which may directly affect the action of subordinate commanders.

c. **Attachments and detachments:** Units attached to or detached from the issuing unit for this operation, including the effective time. Reference to "task organization" is usually sufficient.

2. MISSION

A clear, concise statement of the task to be accomplished by the issuing unit and its purpose.

3. EXECUTION

a. The first subparagraph is entitled "concept of operation" and provides a brief summary of the commander's tactical plan to accomplish his mission.

b. In subsequent lettered subparagraphs, the specific tasks are given for each element of the command charged with the execution of tactical duties.

c. The last subparagraph is entitled "coordinating instruction" and will contain the details of coordination and control measures applicable to two or more units of the command. For example, "Illumination plan will be implemented only on order of commander, Task Force 2-1, or, in emergency, by commanders of Teams A and B." If the order is not effective upon receipt, the effective time will be indicated in this subparagraph.

4. ADMINISTRATION AND LOGISTICS

Specific instructions concerning administration and logistics for the conduct of the operation.

5. COMMAND AND SIGNAL

a. **Signal:** A reference to the index of signal operation instructions in effect. Special instructions relating to the use of signal communication, for example: Emergency signal to call for illumination: Green star cluster.

b. **Command:** Location of command posts; location of commander.

c. **Axis of command posts displacement:** One or more future CP locations.

Acknowledge: _____
(Commander and grade)

Annexes:

Distribution:

Authentication.

(Classification)

4. Discussion of the Form

a. Classification. Operation orders are assigned the lowest classification consistent with their proper protection. The classification will be as prescribed in appropriate regulations. The classification is shown at the top and bottom of each page. For instructional purposes in teaching the preparation of operation orders, the word "classification" is used to simulate an actual classification.

b. Heading. The heading contains the following 9 items, if applicable.

- (1) *Changes from verbal orders.* This space will be used only if verbal orders regarding this operation have been issued previously and if this order either confirms or changes them. If there were no verbal orders, this space will remain blank. All entries made will be inclosed in parentheses. In the case of no change, the statement will appear as "(No change from verbal orders)." If there is a change, a statement such as "(Change from verbal orders, para 3b, c, and d)" will be used.
- (2) *Copy number.* The issuing headquarters will allot a copy number to each copy of an order and maintain a record showing the specific copy issued to each addressee. The copy number will be entered in the following manner, "Copy No. 3."
- (3) *Issuing headquarters.* The official designation of the command issuing the order. When secrecy requires, a code name may be used.
- (4) *Location of CP.* The physical location of the headquarters issuing the order. The map coordinates will always be included. The name of the town or place will normally be included. The name of the country will be included if appropriate.
- (5) *Date-time group.* The date and time are shown by a group of six digits, followed by the month and year, for example, 061030 Sep 1965. The date-time group means the date and time at which the order is signed. It is also

the date and time the order is effective, unless stated to the contrary in "coordinating instructions."

- (6) *Message reference number.* The message reference number consists of letters or numbers, or a combination of letters and numbers, which in no way refer to the fact that the reference number is connected with an operation order. The reference number is assigned from the SOI by the operations officer.
- (7) *Title and number of order.* Operation orders of a command are numbered successively during a calendar year. If two or more are issued on the same day, they are given consecutive numbers.
- (8) *References.* The reference designates the map, sketch, or air photograph required, giving the country or geographical area, the scale, and the name or number of sheets in sufficient detail to identify the exact references used in the preparation of the order, for example, Reference: Map, GERMANY, 1:50,000, NURNBERG sheet.
- (9) *Time zone.* This item will be omitted unless the unit will execute the order in a different time zone from the time zone in which the order was issued. If used, it will appear with the time wherever it appears in the order.

c. Body. The body will consist of the task organization (when used) and five main paragraphs. Each paragraph will be given a heading in capital letters. All major subparagraphs will be given headings. The initial letter of the first word and proper nouns in the headings of the major subparagraphs will be capitalized. No headings will be underlined.

- (1) *Task organization.* This listing will include the title of each subordinate element, the name and grade of each element commander when necessary, and the subordinate units of each element. If the task organization is listed in this manner, the titles of the forces only are used in paragraph 3. Missions are assigned to subordinates in paragraph 3 and the composition

of the elements need not be listed again. If the task organization is lengthy, it may be included in an annex to the order, and reference made to the annex. Units in a support status may be shown under task organization if followed by "(SPT)" or "(DS)" as appropriate.

(2) *Situation.* Paragraph 1 will have three major subparagraphs and under each subparagraph, will be given a brief description of the situation. This paragraph is devoted exclusively to information and contains no instructions of the commander. The three subparagraphs are as follows:

(a) *Enemy forces.* Paragraph 1a contains information of the enemy that is likely to affect the accomplishment of the mission. This subparagraph should contain factual information. Information contained may be supplemented by reference to a published intelligence annex, a periodic intelligence report, or an intelligence summary. The paragraph may consist of such reference only, if practical. In small units, the enemy situation may be shown on the operation overlay if it does not detract from the graphic portrayal of the scheme of maneuver.

(b) *Friendly forces.* Paragraph 1b will include information of the next higher unit, adjacent units, and units supporting the operation that are *not* organic or attached, that may affect the accomplishment of the mission. Listing of friendly forces is in a definite sequence, as follows:

1. Higher units (minimum, next higher unit).
2. Adjacent units.
3. Supporting units.
4. Artillery units in numerical or alphabetical order.
5. Remainder in any order. Much of this information is obtained from the orders of the next higher commander.

(c) *Attachments and detachments.* Listed in paragraph 1c are units attached to or detached from the issuing unit for this particular operation. Any other existing detachment or attachment may be shown as "remains detached (attached)." The effective time of attachment or detachment is stated if it differs from the effective time of the order. When attached units are shown under the task organization, a remark in paragraph 1c such as "task organization" will be substituted for the listing of the attached unit.

(3) *Mission.* There will be no subparagraphs in paragraph 2. This paragraph will contain a clear, concise statement of the task to be accomplished by the commander and its purpose. The mission will normally include the *who, what, when, and why* of the commander's decision. It is always stated in full even though it is shown graphically on an operation overlay or map.

(4) *Execution.* Paragraph 3 gives the concept of operation and assigns definite tactical tasks or missions to each element of the command (organic, attached, or under operational control). A separate lettered subparagraph is assigned to each element.

(a) The first subparagraph is entitled "concept of operation" and contains a brief summary of the concept of operation announced by the commander. The concept includes as a minimum the scheme of maneuver and the plan of fire support. Planned use of nuclear fires is described. Although brief, this subparagraph is stated in sufficient detail to insure appropriate action by subordinates in the absence of specific instructions. General terms are used. If required, this subparagraph may be divided into two subparagraphs—the first describing the scheme of maneuver entitled

- "maneuver," and the second covering the plan of fire support entitled "fires".
- (b) Subsequent subparagraphs give specific tasks assigned to subordinate elements. Units are listed in the following order:
1. Task forces or company teams in alphabetical or numerical order.
 2. Infantry units in alphabetical or numerical order.
 3. Tank units in alphabetical or numerical order.
 4. Scout platoon.
 5. Heavy mortar platoon.
 6. Surveillance section.
 7. Other combat and combat support units, if attached or under operational control, in alphabetical order.
- (c) Units in *support* of the operation will *not* be given instructions in this paragraph.
- (d) A reserve paragraph is not used unless nuclear weapons are held in reserve.
- (e) The final subparagraph of paragraph 3 is always entitled "Coordinating instructions" and contains tactical instructions and details of coordination applicable to two or more elements of the command. Essential elements of information (EEI) are shown, unless an intelligence annex is issued with the order. If, however, the commander wishes to emphasize this information, it may be stated in this subparagraph and repeated in the intelligence annex. If the order is not effective upon receipt, the effective time will be indicated. If there are no coordinating instructions, the word "none" will be placed after the heading. Concise movement instructions, not elaborate enough to require a separate movement order, may be placed in this subparagraph.
- (f) Instructions contained in the issuing unit's SOP normally are not repeated in the order.
- (g) If all the instructions to a unit are shown on an operation map or overlay, the unit title only is listed after the proper subparagraph letter. This indicates that the assigned mission is shown on the overlay or map, the omission of further written instructions is intentional. If most of the instructions to a unit are shown graphically on the operation map or overlay, but one or more of the items cannot be shown, they are written under the subparagraph of the unit in the written part of the order. If the instructions are multiple, they should be itemized for clarity and given a priority of accomplishment.
- (h) To properly use organic or attached units, the commander may attach some of his subordinate units to others. The commander receiving the attachment commands the attachment as if it were one of his own units. He can further attach it to one of his own subordinate units if he desires. In the preparation of operation orders, these attachments are shown by indention in the task organization. For example:
- A/301st Engr Bn
1/E/301st Engr Bn
- This is done so that subordinate units may clearly understand how the command is organized. Release from the attachment is *implied* when a new operation order is issued assigning the attached unit a new mission or showing it attached to another unit. Attachments in armor units are normally shown under task organization rather than in paragraph 3.
- (5) *Administration and logistics.* At brigade, battalion, and company level, paragraph 4 normally contains necessary information or instructions pertaining to trains, messing, supply, and maintenance. At division level

and for special operations below division level, this information may be included in an administrative order or an annex to the operations order (see FM 101-5). When an administrative order or an annex is used, paragraph 4 of the operation order may consist of only a reference to the administrative order or annex. Special administrative details not presented in the administrative order or annex but which affects the operation may also be included. Subjects appearing in this paragraph are arranged in definite sequence, as follows:

- (a) General (including traffic circulation plan).
 - (b) Supply, beginning with class I, through class V, and miscellaneous supplies, including critical items such as allocation of nuclear weapons and prescribed nuclear loads.
 - (c) Transportation.
 - (d) Services.
 - (e) Evacuation.
 - (f) Personnel.
 - (g) Civil affairs.
 - (h) Miscellaneous.
- (6) *Command and signal.* Paragraph 5a contains signal matters and 5b command matters.
- (a) Paragraph 5a, "Signal," should contain, as a minimum, a reference to the index of the signal operation instructions (SOI) to be in effect. Any special instructions relating to signal communication, such as instructions on radio or pyrotechnics or restrictions on the employment of any means of communication, should be placed in this subparagraph.
 - (b) Paragraph 5b, "Command," may contain the location of the command post of the issuing unit and the next higher unit and may include instructions to select and report locations of command posts of subordinate units. The initial location of the commander is indicated.

d. *Ending.* The ending of the order consists of the acknowledgement instructions, signature of commander, list of annexes (if any), distribution, and authentication.

- (1) *Acknowledge.* Instructions will be placed under the final subparagraph of the body of the order and will not be given a heading paragraph number or subparagraph letter. Instructions may be acknowledgement instructions or simply the word "acknowledge." The receiver acknowledges, using the message reference number given in the heading of the order, unless directed otherwise. The acknowledgement of an order means that the order has been *received* and *understood*.
- (2) *Signature of commander.* The original copy of the order will bear the actual signature of the *last name* of the commander or his designated representative and will be filed as a matter of record. All other copies will be authenticated by the S3 and, in this case, the commander's last name will appear above the commander's grade.
- (3) *Annexes.* Annexes are supporting documents attached to the order to amplify and supplement the instructions in the order. They are listed by letter and title as they appear in the order. Annexes will have the same heading and ending as the operation order except for the title of the annex, the message reference number (if not issued with the basic order), and the authentication. If there is one annex listed, the word "annex" is used. If there are no annexes, this term may be omitted. In order of units with organic or attached artillery units, the fire support annex is referred to in paragraph 3.
- (4) *Distribution.* This indicates to whom the order is distributed. If the distribution includes any allied unit, the entire distribution list will be written out. If the distribution list does not include allied units, or if the order does not involve interallied use, the

distribution code as established by the unit SOP may be used. In the latter case this may be some statement such as "Distribution: A."

(5) *Authentication.* All operation orders,

other than the original (copy no. 1), will bear the signature of the unit S3. The word "OFFICIAL," and the signature, last name, and title of the S3 will appear.

Section II. TECHNIQUES OF PREPARATION

5. General

The purpose of uniform techniques in the preparation of operation orders is to employ a system familiar to all military personnel and to avoid inadvertent omissions. By consistent application of these techniques the confusion of order writing will disappear.

a. The military profession, like other professions, has developed a technical vocabulary. It is convenient and aids in the clear and rapid transfer of ideas. The use of this vocabulary in texts and instructions is natural. However, in an operation order it is essential that there be no possibility for misunderstanding by any subordinate of the exact intended meaning of each term used. With partially trained troops and staffs, the use of technical military language or unfamiliar abbreviations may cause misunderstandings. Therefore, the use of technical expressions in operation orders should be avoided if there is any danger of misunderstanding. Words of common understanding should be used even at the sacrifice of brevity. *Clarity is the first essential.*

b. Abbreviations save space and time. Except for abbreviations in common international use, for example, *mm* for millimeters, abbreviations will not normally be used in any operation order or operation plan circulated for interallied use. In operation plans or orders not involving interallied use, common abbreviations are used. Common abbreviations may include unit designations, such as 25 Armd Div, the month and year of the date-time group, and items such as OP, CP, FEBA, SOI, and OBJ. Persons who write orders and those who read them should not be required to memorize a list of abbreviations, nor be compelled to look up any that are unfamiliar. The author of the order when determining whether or not to use abbreviations should consider the recipients' familiarity with them. There is no hard and fast rule regarding their use. It is a matter of judgment.

c. Orders must be *clear, concise, and timely.* Clarity must not be sacrificed for brevity. The correct use of plain English is essential in operation orders, and rules for punctuation and grammar hold throughout. An order is faulty if it does not convey the exact meaning and intention of the commander. Subordinates must be told in unmistakable terms exactly what their commander wants them to do.

d. In the interest of simplicity and clarity, the positive form of expression is used throughout operation orders. Such wordings as "The trains will not accompany the task force" is defective because the gist of the order depends upon the single word "not." The proper form is "Trains remain in present area." No doubt arises in the positive expression. Expressions similar to "attack vigorously" are avoided. Vigorously is not only meaningless and verbose but weakens the force of subsequent orders in which the expression does not appear.

e. The numerical designation of army group, army, corps, and division is written in Arabic numbers, as "10." Smaller units with numerical designations also use Arabic numbers. Some smaller units are designated by capital letter and some by functional title, as "scout platoon."

f. When a date and hour are determined and are to be published, they are expressed in a group of six digits. The first 2 digits indicate the day of the month, the next 2 the hour, and the last 2 the minutes past the hour. Where the day, hour, or minutes can be expressed by single digits, each is preceded by a zero, for example, 07 for the seventh day of the month and 0625 for 25 minutes past 6 o'clock in the morning. The month and year follow the 6-digit date-time group; thus 25 minutes past 6 o'clock on the morning of 7 December 1965 is written 070625 Dec 1965 or 070625 December 1965. The date-time group will always include the year in the heading; in the remainder of the

order, the year may be omitted. Terms such as "p.m.," "a.m.," "dawn," "daylight," "dusk," "EENT," and "BMNT" are not used in place of specific times. For example, in an order the term "Attack 030600 Nov" is used rather than "Attack at dawn, 03 Nov." When the date and hour are undetermined or are not to be published at the time of issuance of the order in the interest of secrecy, the terms "D-day" and "H-hour" are used, and the selected date and hour are communicated later to those concerned.

g. All subparagraph headings will be followed by a colon. If there is only one item of instructions following the heading, it may be on the same line as the heading. If there is more than one, the instructions should be itemized and placed below the heading.

h. Second and succeeding pages of orders and annexes will show short-title headings, including number (or letter), designation, and headquarters.

i. Compass points are used in place of the terms "right" and "left." If the situation indicates the advisability of including the terms "right" and "left," they are placed in parentheses immediately following the appropriate compass point, for example, "north (right)."

j. Areas are designated by northernmost point first and the remaining points in clockwise order.

k. Directions are given as from true, magnetic, or grid north.

l. Riverbanks are described as "left" or "right" from the point of view of an observer facing downstream.

m. Roads are identified by name, number, or by sequence of points on the road, named in the direction of movement.

n. Boundaries indicate zones or sectors of action or movement and areas of responsibility. They are designated by easily distinguishable terrain features in the sequence in which they occur on the ground. This sequence is given from rear to front in an advance, and from front to rear in defense and retrograde.

o. Geographical names of definite areas, cities, towns, rivers, mountains, and places that are named specifically on a map are written or printed in capital letters. When referring to a hill by number, the word "HILL" will be writ-

ten in capital letters for prominence in the order. The spelling in the order must be the same as on the map.

p. The first time a place or feature is mentioned in the order, the grid coordinates will be added in parentheses after the name of the place or feature. Thereafter where the place or feature is mentioned, the grid coordinates are not required unless there is a possibility of misunderstanding. When grid coordinates are used by themselves, and not in opposition to a place or feature, they will *not* be inclosed in parentheses.

q. Orders giving missions for subordinate units should prescribe only those details that are necessary to insure that the actions of the subordinate unit will conform to the overall plan of operation. A commander does not charge subordinate commanders with decisions that are his responsibility, nor does he trespass on their initiative by prescribing details of execution that lie within their province. See Chapter 2, paragraphs 42 through 46 for a discussion of this guidance.

6. Operation Overlays and Overlay-Type Orders

a. An operation map or operation overlay complements the oral or written order. It promotes clarity, accuracy, and brevity by conveying information and instructions graphically. It contains instructions for coordination, assembly areas, location of command posts, lines of departure, time of attack, axes of advance, boundaries, nuclear safety lines, phase lines, objectives, and bomblines. Other instructions and information that can be shown graphically may be included. See appendix XI for sample orders.

b. An operation overlay is prepared to portray graphically those instructions that can be represented pictorially by the use of conventional symbols. If the written part of the order is brief, it is preferable to write it on the overlay (overlay-type operation order). If the written part of the order is long, it may be written on separate paper, and instructions that can be portrayed graphically may be placed on an overlay issued as an annex to the operation order. Regardless of which type operation

order is used, the techniques of preparation of the written part of the order and the overlay part are similar.

c. Military symbols (FM 21-30) are used on overlays to portray information and instructions graphically. To prevent the overlay from becoming cluttered with details, it should contain only the graphic information necessary for a clear understanding of the order.

7. Annexes and Appendixes to Operation Orders

a. *Annexes.* Material of a plan or order may be put into annexes to preserve brevity, clarity, and simplicity in the body of an order.

- (1) When information that is used to amplify a plan or order is limited in application to the command as a whole or is primarily technical in nature, it may be included in an annex.
- (2) Annexes are separate documents attached to and forming a part of complete plans and orders. Information given already in a plan or order need not be repeated in an annex. Forms or *checklists for most types* of annexes are found in FM 101-5.
- (3) Annexes are issued to all units or agencies whose actions are affected by the annexes. Unless there is good reason to the contrary, such as security, each copy of a plan or order is issued complete with all annexes.
- (4) Even when accompanied by annexes, the order itself should contain all information essential to the effective employment of the elements of the command. Staff officers and subordinate commanders should not have to read and digest an entire annex to determine the basic organization and employment of a single arm.
- (5) Maps, sketches, or overlays are used frequently as annexes. When the written part of a plan or order is placed directly on a map or overlay, the map or overlay then becomes the plan or order and is not an annex.
- (6) Annexes are prepared by appropriate staff officers and submitted to the commander for approval before issue.

Annexes are lettered alphabetically in the sequence in which they are mentioned in the basic order, for example, Annex A, "Intelligence," or Annex B, "Operation Overlay." The operations officer, who is responsible for the preparation of the operation order, will assign letters to the annexes of an operation order. Headings and endings of annexes are similar to those of the basic operation order. The title of the annex identifies it with the basic operation order, such as "Annex B (Operation Overlay) to Operation Order 6." The original of an annex to an operation order is signed by the commander or his designated representative. Copies of the annex are authenticated by the unit staff officer having primary interest in the field of the annex; thus the operations officer would authenticate a signal annex to an operation order, and the intelligence officer would authenticate an intelligence annex.

b. *Appendixes.* Appendixes contain additions that are necessary to amplify an annex. They are numbered serially with Arabic numbers, for example, "Appendix 1 (Illumination Plan) to Annex C (Fire Support Plan) to Operation Order 6."

c. *References to Annexes and Appendixes.* References to annexes and appendixes are used in operation orders as follows:

- (1) In operation orders, reference to an annex is made at the place in the order at which it first is desired to direct the reader's attention to the annex. References to annexes are made in subsequent paragraphs and subparagraphs wherever necessary. Reference to each annex must be made at least once in the body of the order and in the ending.
- (2) In the body of an operation order, an annex or appendix is referred to by giving both its letter or number and its subject.

Example. Annex C, Fire Supply Plan.
Appendix 1, Illumination Plan.

8. General

Plans for future or anticipated operations are issued as operation plans. The standard form for the operation plan is identical to that of the operation order, with the exception that operation plans have an additional paragraph, 1d, titled "Assumptions." The techniques of preparation, the rules governing attachments, and the like, are the same as for the operation order.

9. Assumptions

There must be a basic reason or reasons for each operation plan. The unit will make plans for future operations, basing these plans on certain changes in the friendly or enemy situation that will take place between the time the plan is prepared and the time it is ordered into execution. Therefore, the operation plan will contain a listing of changes that must occur before the plan will be executed. These changes are called assumptions and are listed in paragraph 1d of the operation plan. They tell the subordinate commanders the circumstances under which the plan will be ordered into effect as an operation order.

10. Techniques of Preparation

a. Operation plans follow the same format as operation orders. When an operation plan is ordered executed, the subordinate commanders will treat the plan as an order. Therefore, *the operation plan must be written as if it were a current order just prepared for this operation.*

b. An operation plan becomes an operation order when the issuing headquarters notifies the units concerned.

Example. Operation Plan ALFA is effective 190600 Oct 65 as Operation Order 15. (Operation plans are usually given code names so as not to confuse them with operation orders.)

c. Once an operation plan has been issued, subordinate units are free to plan for the contemplated operation and issue operation plans to their subordinates. However, the operation in effect at the time the operation plan is issued will continue. Once the plan is converted into an order, it will supersede the previous order in the same manner as any operation order. Operation plans must be complete enough to give instructions to all subordinate units.

APPENDIX X

CONTROL MEASURES AND OVERLAY TECHNIQUES

1. General

The armor commander is guided by the control measures specified in orders from higher headquarters; he may specify additional control measures if they are essential to the operation. In armor operations, the commander uses the minimum number to insure that the operation progresses according to his concepts. He uses the least restrictive control measures possible, thus permitting subordinate commanders maximum freedom of action in executing their assigned missions.

2. Objectives

a. Purpose. Objectives are used to provide unity of effort, to designate area responsibility during reorganization, or to assist change in direction. The assignment of an objective normally requires that the unit seize and control that objective until the mission is accomplished. Exceptions should be specified in orders.

b. Characteristics. An objective may be a terrain feature, a locality, or a hostile force.

- (1) Its seizure must be essential to the accomplishment of the unit's mission and should contribute to future operations.
- (2) Its seizure must be possible within the time and space limits imposed by the assigned mission and within the capabilities of the force to which assigned.
- (3) It must be identified easily.
- (4) It must produce a convergence of effort.
- (5) Its seizure must compel the enemy to evacuate his position or risk destruction on it.

c. Assignment. The objective is normally specified by the next higher commander.

d. Control. The assignment of an objective indicates that control over it is to be gained and maintained until the mission is accomplished; the degree of control will normally be specified by the terms "seize" or "secure."

- (1) *Seize.* The act of seizure is inherent in the assignment of an objective.
- (2) *Secure.* The attacking unit must physically clear the enemy from the objective area.

e. Overlay Technique. Each objective is encircled by a line and identified by the abbreviation "OBJ" and a number, letter, code name, or unit designation.

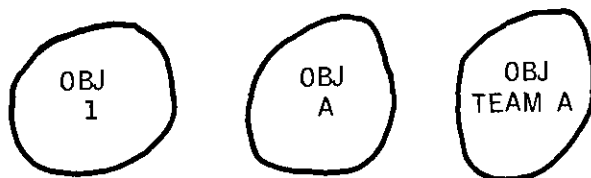

Example A. Objectives.

3. Intermediate Objective

An intermediate objective is assigned by any commander when its seizure is essential to the accomplishment of the mission. When an enemy cannot be bypassed, the assignment of intermediate objectives may be required. For characteristics, control, and overlay technique for intermediate objectives, see paragraph 2 above.

4. Assembly Area

a. Purpose. This is an area in which the command is assembled in preparation for

Further action. Normally the following is accomplished in the assembly area:

- (1) Issuance of orders.
- (2) Organization for combat.
- (3) Maintenance.
- (4) Supply.

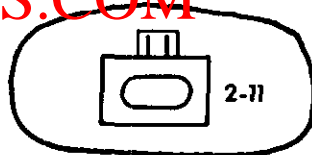

Example B. Assembly areas.

b. *Characteristics.* Desirable characteristics include the following:

- (1) Provides passive protection from enemy nuclear attack by being—
 - (a) Located in broken terrain (to reduce blast effect).
 - (b) Elongated in shape to present a less lucrative target.
 - (c) Large enough to disperse battalion-size units a minimum of 4,000 meters, perimeter to perimeter, or 6,000 meters between centers of mass.
- (2) Located beyond the range of enemy light artillery.
- (3) Provides adequate area for dispersion of units for passive protection from nuclear weapons.
- (4) Provides cover from direct-fire weapons.
- (5) Provides concealment from ground and air observation.
- (6) Contributes to the security of the unit through the use of natural or artificial obstacles.
- (7) Avoids interference with other units operating in the area.
- (8) The terrain allows movement into, through, and out of the area.
- (9) Provides adequate and hardstand drainage.
- (10) Facilitates communication.

c. *Assignment.* Commanders assign assembly areas to their subordinate units, who subdivide them to their subordinate units. Desirably, battalion-size units require an assembly area 2,000 by 2,000 meters or a comparable area.

d. *Control.* Units will adhere to the assigned limits of the assembly area to prevent interfering with other units.

e. *Overlay Technique.* Inclosed by a line, the unit symbol is placed in the center. Proposed assembly areas are shown with broken lines.

5. Attack Position

a. *Purpose.* This designates to units leading the attack, the area in which they are to deploy into attack formation.

b. *Desirable Characteristics.*

- (1) Covered from direct fire.
- (2) Adequate space to deploy the unit.
- (3) Close enough to the line of departure so that units can maintain attack formations without becoming disorganized before crossing.

c. *Assignment.* Attack positions are not normally designated for units larger than company or team. The battalion task force commander will normally designate the general area of the attack position for each of his leading companies and teams. The company and team commanders will select the exact position within this general area.

d. *Control.*

- (1) To minimize vulnerability to enemy nuclear fires, armor units using attack positions halt only as required to deploy assault elements; where possible, they will move into the attack position, deploy into the prescribed formation, and move out, all without stopping.
- (2) Units using an attack position will adhere to the prescribed limits of the attack position to prevent interference with other units.

e. *Overlay Technique.* Inclosed by a line, with the abbreviation "ATK" placed in the center.



Example C. Attack position.

6. Routes of March

a. Purpose. They provide for the control and coordination of the movement of units from one point to another during a tactical march. In armor operations, multiple routes of march are used from the assembly area to the attack position. This allows rapid clearing of the assembly area and rapid movement to and exit from the attack position. This rapid and continuous movement provides passive protection against enemy nuclear or air attack. The commander assigning the routes of march will normally specify start and release points.

b. Characteristics.

- (1) Be trafficable.
- (2) Contribute to security of the force while en route.

c. Assignment. The next higher commander normally designates routes of march and priorities.

d. Control. Units will adhere to the prescribed routes of march and observe priorities to prevent interference with other units.

e. Overlay Technique. Lines drawn on the route and labeled with their purpose and code name or unit designation.

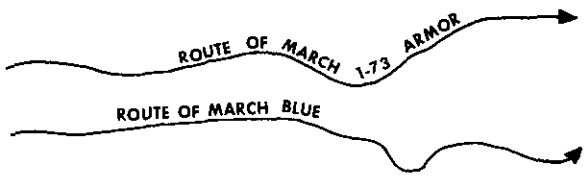

Example D. Route of march.

7. Line of Departure

a. Purpose. This coordinates the commitment of units to the attack at a specified place and time. The line of departure (LD) may be the existing line of contact or it may be a readily identifiable terrain feature.

b. Desirable Characteristics.

- (1) Clearly defined on the ground.
- (2) Approximately perpendicular to the direction of attack.
- (3) As far forward as the unit can advance without fighting.
- (4) Requires minimum coordination with other friendly forces in the area.

(5) Minimizes exposure to enemy direct-fire weapons.

(6) If nuclear weapons are used, its location should conform to the commander's guidance on troop safety.

c. Assignment. The next higher commander normally assigns the line of departure.

d. Control. Units must cross the line of departure at the time specified.

e. Overlay Technique. Line of contact (LC) is to be the line of departure (LD).



Example E. Line of contact is line of departure.

Present positions (PPOs) of the attacking force are to be the line of departure.

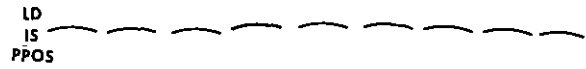

Example F. Line of departure is present position.

When the LD is other than the LC or PPOs, it is designated by a line drawn according to characteristics in *b* above and labeled LD.

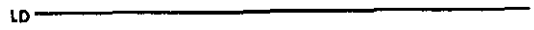

Example G. Line of departure.

8. Boundaries

a. Purpose. Boundaries designate areas of responsibility, coordinate movement and fires. To prevent confusion, boundaries may be used in conjunction with other directional control measures, such as axes of advance or direction of attack.

b. Characteristics.

- (1) *Location.* Boundaries are drawn along easily discernible terrain features such as railroads or streams.
- (2) *Control.* Boundaries must not divide responsibility for key terrain features, or avenues of approach.
- (3) *Forward extension.* In the defense, boundaries are extended to indicate

foremost territorial responsibility of the unit to which applicable, based on the extent of the area of influence, normally the range of organic, attached, or direct support weapons. When used in the offense, they are extended forward beyond the objective(s) at least to the depth necessary for coordination of fires in the seizure and consolidation of the objective(s).

(4) *Rearward extension.* To—

- (a) Assign roads, avenues of approach, and routes of withdrawal for use by units.
- (b) Provide subordinate units adequate maneuver space for placement of forces.
- (c) Coordinate fires and lateral movements.

c. Assignment. Boundaries are designated by the next higher commander. Subordinate commanders may designate additional boundaries to their subordinate units as required. Boundaries are normally not assigned within a company-size unit between its platoons except in reconnaissance, surveillance, and security operations.

d. Degree of Control. Units (both organic ground and air) may fire or maneuver over a boundary with authority of the commander assigning the boundary or with approval of the adjacent unit commander.

e. Overlay Technique. Line drawn on selected terrain with unit designation on both sides of a break, into which is inserted the symbol of the larger unit. Boundaries that are effective on order are shown with broken lines and labeled with the headquarters establishing the boundary.

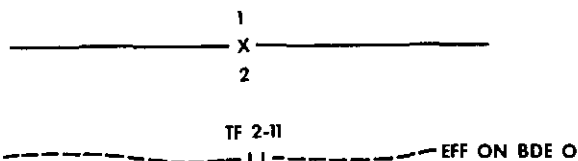

Example H. Boundaries.

axis of advance, zone of action, and the direction of attack that are used to direct the attack toward an objective. However, in security operations, routes of advance are used for directional control and infiltration lanes are used in penetrations by infiltration.

a. Axis of Advance.

- (1) *Purpose.* The axis indicates the general direction of movement of an attacking unit.
- (2) *Characteristics.* Normally it follows a well-defined terrain feature.
- (3) *Assignment.* The next higher commander normally assigns the axis of advance. One is assigned for each leading major unit. Subordinate commanders may assign additional axis or axes of advance for their subordinate units. Boundaries may be used with axes of advance. Axes of advance are not normally assigned to platoons.
- (4) *Control.* A commander assigned an axis of advance may maneuver his troops and supporting fire freely to either side of the axis of advance. He must insure, however, that a deviation in movement or fires from the assigned axis of advance will not interfere with maneuver of adjacent units. If it does, prior approval must be obtained from higher headquarters. Units are not required to clear enemy forces from the axis of advance unless ordered.
- (5) *Overlay technique.* Open arrow extending in the direction of attack to the objective. The axis of advance is normally labeled with a code name or unit designation. It is drawn with dashed lines if effective on order. The width of the arrow is of no significance. The point of the arrow touches the objective.

b. Zone of Action.

- (1) *Purpose.* This delineates an area and direction of movement when close coordination and cooperation is required between adjacent units. A wide zone permits maximum freedom of fire and maneuver. As a zone de-

9. Control of the Direction of the Attack

There are three basic control measures, the

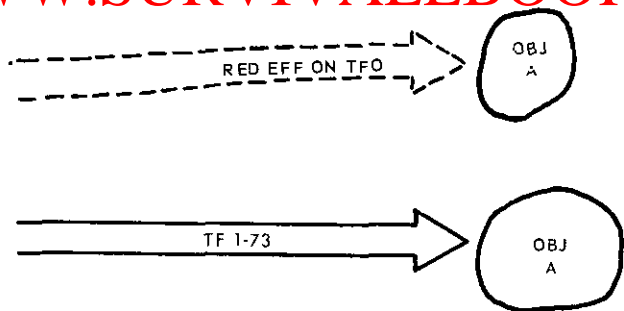

Example I. Axis of advance.

creases in width, its restrictiveness increases proportionately. Narrow zones may be required however by—

- (a) A requirement for a concentration of combat power.
- (b) Terrain limitations.
- (c) A requirement for close coordination between adjacent units. Units may be oriented in direction in a wide zone by the additional control of an axis of advance.

(2) Characteristics.

- (a) Is defined by the establishment of lateral boundaries and the line of departure.
- (b) Should provide maneuver space for subordinate units commensurate with their mission and capabilities.
- (c) Should include entire key terrain features and avenues of approach to them.
- (d) Should extend as a minimum beyond the objective to the depth necessary for the coordination of fire support.

(3) *Assignment.* The next higher commander assigns the zone of action. Subordinate commanders may subdivide the zone for their units. Zones of action are not normally assigned to platoons except in reconnaissance, surveillance, security and night operations.

(4) Control.

- (a) When assigned a zone of action, units cannot fire or maneuver into an adjacent zone without coordination with the adjacent unit com-

mander or the next higher commander. Zones are prescribed to avoid interference with the adjacent unit and unwarranted massing of units.

- (b) Boundaries do not require a subordinate unit to clear the zone of enemy forces. However, the unit must destroy or contain those enemy forces in zone which pose a threat to the continued operations of the unit. If clearance of the zone is desired, the operation order must clearly specify.

(5) *Overlay Technique.* Designated by boundaries drawn on either flank of the zone.

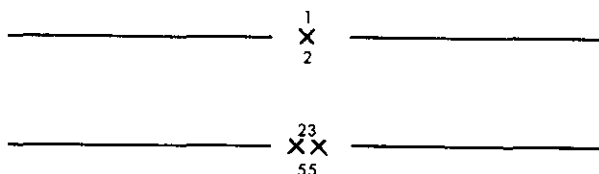

Example J. Zone of action.

c. Direction of Attack.

- (1) *Purpose.* A direction of attack is used when the commander considers it essential to designate a specific direction of attack or to coordinate closely a plan of attack. The direction of attack is used principally in armor operations in the conduct of night attacks or in counterattacks.

(2) Characteristics.

- (a) Follows well-defined terrain features such as a road or ridgeline.
- (b) An azimuth may be used as the direction of attack.
- (c) Is the most restrictive means of controlling the direction of an attack.

(3) *Assignment.* The next higher commander assigns the direction of attack.

(4) *Control.* The direction of attack is a highly restrictive control measure. A unit assigned a direction of attack must employ the bulk of its combat

power along the direction of attack and cannot deviate from it except to maneuver against enemy forces interfering with the advance. Because of its restrictive nature, a direction of attack should begin and extend where only this form of control is essential to the overall plan.

- (5) *Overlay technique.* Arrow drawn to indicate the direction of attack.

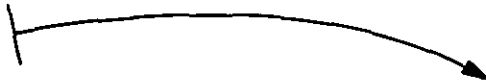

Example K. Direction of attack.

d. *Route of Advance.*

- (1) *Purpose.* A route of advance is selected for a flank guard to delineate the specific route to be followed in the security mission. The route of advance is used in flank guard missions.
- (2) *Characteristics.*
 - (a) Follows well-defined terrain features such as a road or ridgeline.
 - (b) Should be interior to, and permit rapid access to, proposed blocking positions.
 - (c) Be located far enough from the force being secured to avoid interference with the movement of the force, but close enough to permit the flank guard to secure the area between the main force and the route of advance.
- (3) *Assignment.* The commander assigning the flank guard mission or the commander of the flank guard assigns the route of advance.
- (4) *Control.* A flank guard assigned a route of advance moves along that route. The flank guard clears the route enough to permit its own movement.
- (5) *Overlay technique.*

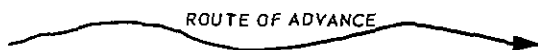

Example L. Route of advance.

e. *Infiltration Lane.*

- (1) *Purpose.* The infiltration lane is used to prescribe routes to be used by infiltrating forces and to coordinate fires and movement during the infiltration.
- (2) *Characteristics.*
 - (a) Delineated by boundaries.
 - (b) Of sufficient width to permit the infiltrating force to move by stealth.
 - (c) Avoids enemy locations.
- (3) *Assignment.* The commander ordering the infiltration assigns infiltration lane.
- (4) *Control.* Infiltrating units stay in the infiltration lane unless ordered out of it. During the infiltration, units must coordinate fires into the infiltration lane with the commander conducting the infiltration.
- (5) *Overlay technique.*

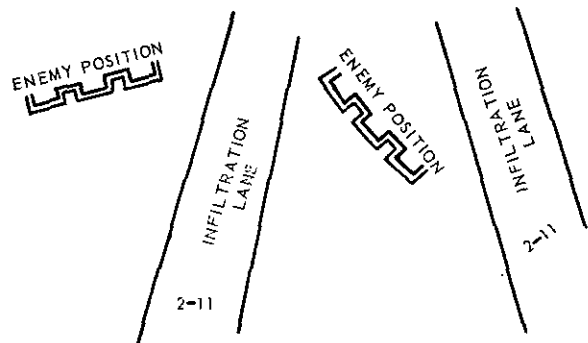

Example M. Infiltration.

10. *Phase Line*

a. *Purpose.* Phase lines are used by the commander as a reference when he issues orders or receives reports, to delineate an area, to facilitate maintaining or changing a formation, and when regaining control of temporarily separated units. Phase lines are employed wherever the commander desires to orient and control his forces, such as—

- (1) Where it is visualized a penetration will be concluded.
- (2) On a difficult obstacle.

- (3) In conjunction with an axis of advance or zone of action covering great distances when units may require reorientation.
- (4) Immediately before a coordinated assault of the objective.
- (5) To indicate the distance from the main force that a flank guard will operate.

b. Characteristics.

- (1) Follows terrain easily identified from the ground and air.
- (2) May be oriented in any direction with regard to the movement or location of the force involved, depending upon the requirement for control.

c. Assignment. Each echelon of command may assign a phase line.

d. Control. Unless directed otherwise, units will report their arrival and clearance of phase lines without halting. The commander may enforce any other control and require any other unit activity at or within phase lines as necessary.

e. Overlay Technique. Line drawn on selected terrain, labeled with the abbreviation "PL", and identified by a code name.

PL
GREEN

Example N. Phase line.

11. Checkpoints

a. Purpose. They provide a means of reporting rapidly specific locations and information relative to the location or control of units. Checkpoints may be disseminated as a list of checkpoint numbers together with their map coordinates, or they may be indicated on an overlay. They should not be used as reference points in reporting enemy locations; enemy locations should be reported in the clear unless otherwise directed.

b. Characteristics. They are designated on conspicuous terrain features such as road junctions, stream junctions, bridges, and conspicuous buildings or groups of buildings.

c. Assignment. Each echelon of command may assign checkpoints.

d. Control. They are not restrictive unless so specified by the commander.

e. Overlay Technique. Circle inclosing a selected terrain feature with a number inside the circle.



Example O. Checkpoints.

12. Contact Points

a. Purpose. They designate a point on the ground where two or more units are required to make physical contact.

b. Characteristics. They are indicated on easily identified terrain features.

c. Assignment. Each echelon of command may assign contact points.

d. Control. Units are required to establish physical contact at these points as directed by the commander. Contact is usually made by liaison personnel or patrols.

e. Overlay Technique. Square placed on a selected terrain feature with a number inside.



Example P. Contact points.

13. No-Fire Line

a. Purpose. The no-fire line is a line beyond which artillery units may fire without prior clearance from the direct support artillery of the supported unit.

b. Characteristics. It is located to avoid firing on friendly forces by friendly artillery.

c. Assignment. The location of the no-fire line is recommended by the supporting artillery commander and approved by the supported unit commander.

d. Control. Direct support artillery is authorized to fire short of the no-fire line in its own sector; other artillery units must obtain clearance from the direct support artillery before doing so.

e. Overlay Technique. Line with the abbreviation "NFL." It may or may not appear on

the operation overlay but must appear on the artillery fire plan, artillery situation maps, and firing charts of all supporting artillery.



Example Q. No-fire line.

14. Coordinating Points

a. *Purpose.* Coordinating points are designated points at which adjacent units or formations must make contact for purposes of control and coordination.

b. *Characteristics.* They are located on easily identifiable and accessible terrain features.

c. *Assignment.* Coordinating points are assigned by the higher headquarters of the adjacent units or as agreed upon by the commanders of the adjacent units.

d. *Control.* Commanders or their representatives coordinate at coordinating points to determine whether the area between their units should be covered by fires, barriers, physical occupation, or a combination of these means.

e. *Overlay Technique.* Circle drawn on the selected terrain feature with an X placed in the center.

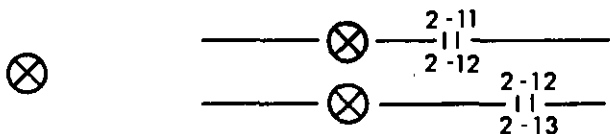

Example R. Coordinating points.

15. Sector

a. *Purpose.* This designates the defense area in which the unit will operate and for which it has defensive responsibilities.

b. *Characteristics.* Assignment, characteristics, and control are the same as for a zone of action in offensive operations. See paragraph 9b, this appendix.

c. *Overlay Techniques.* Designated by boundaries, similar to a zone, with the coordinating points drawn on the boundaries to indicate the forward edge of the battle area (FEBA). These coordinating points may be connected by

a line to indicate the general trace of the FEB.

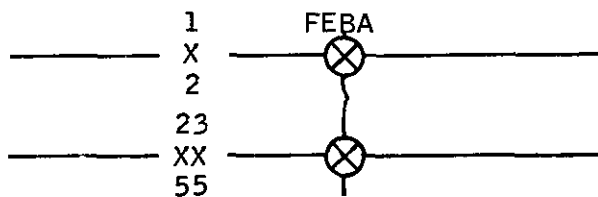

Example S. Sector.

16. Delaying Position

a. *Purpose.* This is a location or series of locations from which friendly forces can affect maximum delay and attrition on an advancing enemy force.

b. *Characteristics.* Delaying positions are sought that incorporate—

- (1) A series of cross compartments perpendicular to the enemy avenue of approach.
- (2) Natural obstacles to strengthen the position.
- (3) Good observation and long range fields of fire.
- (4) Concealed and covered routes of withdrawal.
- (5) A road net and areas providing good cross-country trafficability.

c. *Assignment.* The next higher commander designates delay positions. Intermediate commanders select additional delay positions to meet the delay requirements of the higher command.

d. *Control.* A delaying force must delay the enemy forward of a specific line until a stated time as a minimum. The period of time a delay position is to be held is normally stated opposite each position on the graphic portrayal of the operation order.

e. *Overlay Technique.*

17. Routes of Withdrawal

a. *Purpose.* This provides for the control and coordination of the movement of units from one point to another during a retrograde operation.

b. *Characteristics.*

- (1) Be trafficable.

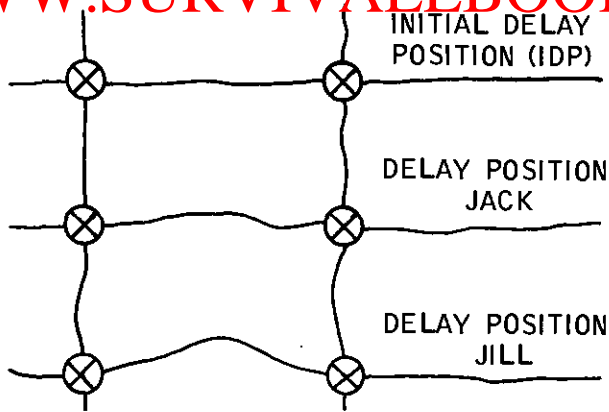

Example T. Delay positions.

- (2) Contribute to security of the force while en route.
- (3) Avoid passage through friendly forces if possible.

c. *Assignment.* The next higher commander assigns routes of withdrawal.

d. *Control.* To prevent interference with other units, units must adhere to the prescribed routes of withdrawal and observe priorities if established.

e. *Overlay Technique.* Drawn on the route and labeled "Route of withdrawal" and a letter, number, code word, or unit designation.

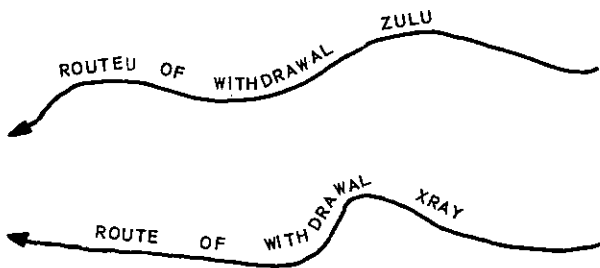

Example U. Routes of withdrawal.

18. Blocking Positions (Initial and Supplementary)

a. *Purpose.* Initial and supplementary blocking positions are locations from which units plan to conduct fixing force or security missions. Forces occupying these blocking positions do not necessarily hold their position but will fight offensive and delaying action to accomplish the mission. Supplementary blocking positions are occupied when initial blocking positions become untenable or when occupation is ordered by the next higher commander to support the overall scheme of defense.

b. *Characteristics.* Initial and supplementary blocking positions are located on terrain providing the best available observation and fields of fire into enemy avenues of approach.

c. *Assignment.* Any commander charged with a fixing force or security mission may assign initial and supplementary blocking positions.

d. *Control.* Units assigned initial and supplementary blocking positions occupy them as directed by the higher commander. For ease of reference and identification, each supplementary blocking position is numbered. In operations where multiple supplementary blocking positions are designated, the commander will normally assign "be prepared" missions to his subordinates for preparation and occupation of each position.

e. *Overlay Technique.* The area of the initial blocking position is inclosed by a line with a break where the size symbol of the occupying unit is placed. If desired, the military symbol of the occupying unit may be entered in the center of the inclosed area. The configuration of the line is dictated by the terrain with closed end towards the avenue of approach to be blocked. Supplementary positions are depicted in the same manner except the symbols are drawn with broken lines.

Example: INITIAL BLOCKING POSITION

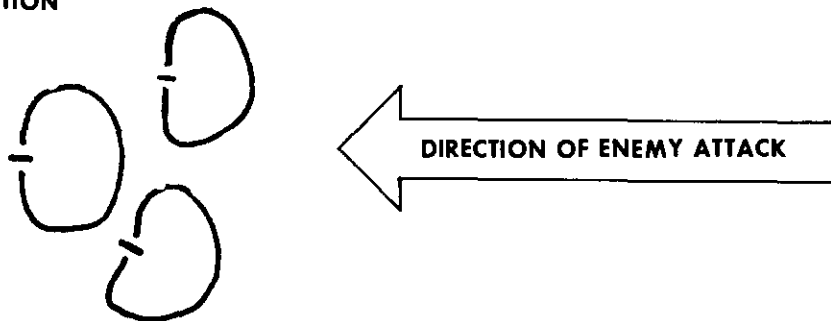

Example V. Blocking positions.

Example: SUPPLEMENTAL BLOCKING POSITION

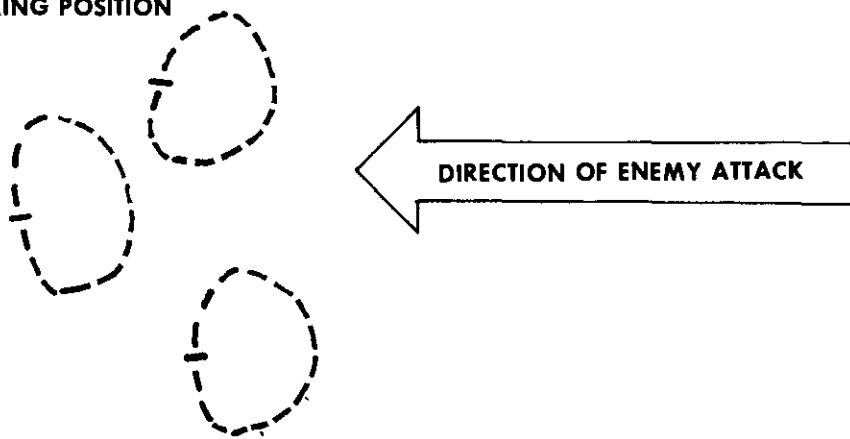

Example W. Proposed blocking positions.

APPENDIX XI
EXAMPLE OPERATION ORDERS AND GUIDE FOR THE
PREPARATION OF FIRE PLANS

(The following are located in back of manual)

- Figure 67. Brigade attack order.*
- Figure 68. Brigade defense order.*
- Figure 69. Brigade counterattack order. (Reserve Brigade for the division in the mobile defense.)*
- Figure 70. Task force attack order.*
- Figure 71. Task force defense order. (Fixing force for the mobile defense.)*
- Figure 72. Task force delay order.*
- Figure 73. Task force movement order.*
- Figure 74. Task force surveillance annex.*
- Figure 75. Team attack order.*
- Figure 76. Guide for preparation of fire plans.*

APPENDIX XII

HANDLING PRISONERS OF WAR

1. General

The S1 prepares and supervises the execution of plans for the collection and evacuation of enemy prisoners of war (PW's). At brigade level, the S1 coordinates with the supporting military police unit. He must insure that these plans conform to the directives of higher headquarters, and that they are clear, complete, and understandable. He coordinates with the S2 for estimates on prisoners anticipated and facilities for any interrogation desired, and with the headquarters commandant for the operation of the PW collecting point. He coordinates with the S4 for transportation to evacuate prisoners and with the battalion surgeon for evacuation of wounded prisoners. Emphasis is placed on the proper conditioning of prisoners of war for interrogation. For additional information, see FM 19-40 and FM 61-100.

2. Capturing Troops

a. Capturing troops disarm, segregate, tag, and search PW's for documents of military value. Documents are tagged to identify them with the PW's from whom taken and evacuated with PW's. Personal effects will not be taken except on orders of an officer for reasons of security. In this event, a property register is maintained and signed receipts are given each PW for personal items taken.

b. Capturing troops segregate PW's according to rank, sex, nationality, and other appropriate category, and tag each PW to show time, place, circumstances of capture, and capturing unit. Selective interrogation by PW interrogation teams for immediate information may be undertaken in the forward area.

3. Fast Moving Operations

Because of the continuous movement of the command post in fast moving operations, the

evacuation of prisoners of war and establishment of collecting points pose a problem at brigade and battalion task force level. To offset this problem, two procedures are employed—

a. The division MP company will normally establish a collecting point on the supply route or in the trains area of each committed brigade. This facilitates evacuation from battalion or squadron collecting points.

b. PW interrogation teams with armored divisions are mobile and operate with minimum facilities. At brigade and battalion task force level, interrogation of prisoners is limited to immediate information required, such as location and deployment of antitank weapons and defenses, enemy roadblocks, and presence of enemy tank units. In fast-moving offensive operations, interrogators may be employed with forward elements of the battalion task force. Facilities for interrogation at brigade and battalion task force level are kept to a minimum, because PW's are questioned briefly on the spot and evacuated to the division PW collecting point or turned over to nearby infantry units for evacuation. Selected PW's may be evacuated from battalion task force to brigade for further interrogation.

4. Defense

In defensive operations, evacuation of PW's is normally from the point of capture to the battalion task force PW collecting point and then to the brigade PW collecting point. Preliminary interrogation attempts to develop information of immediate tactical value to the battalion task force and brigade commanders. Following the preliminary interrogation, PW's are evacuated to the division PW collecting point for a more detailed interrogation concerning tactical information.

5. Evacuation Techniques

a. The evacuation of PW's from the forward areas presents problems to the company (team) or troop commander. In fast moving situations, the team or troop commander must rely on attached or nearby infantry, returning vehicles, aircraft, slightly wounded, or headquarters personnel and vehicles for the evacuation of PW's to the collecting points. The company or troop commander must use every possible resource to assist in the evacuation without reducing his combat strength.

b. The battalion or squadron S1, in conjunction with the S4, normally has greater resources at his disposal for evacuation of PW's than does the company or troop commander. Necessary assistance is given the company or

troop as required. Assistance from brigade or regiment is requested when requirements for evacuation of PW's are beyond the capabilities of the battalion or squadron.

c. When large numbers of PW's are collected during an operation, combat units may be required to furnish assistance in their evacuation. When planning operations where large numbers of PW's are anticipated, such as the exploitation or pursuit, combat units may be assigned a "be prepared mission" to assist in the evacuation of PW's. This type mission is usually assigned units that are in reserve or in a follow and support role.

d. Wounded PW's are evacuated through medical channels.

APPENDIX XIII

TANK UNITS, CONDUCT OF FIRE AND MOVEMENT BY A MANEUVER FORCE

1. General

a. Armor units fight with fire and maneuver. Fire and maneuver consist of—

- (1) The base of fire, which may be composed of artillery and mortar units, TAC air, and naval gunfire, has the mission of providing fire support for the advance of the maneuver force. These fires are designed to pin the enemy to the ground in the forward defensive area, reduce the effectiveness of his fires, hinder the movement of enemy reserve forces, and limit his capability for command and control. See chapter 6, paragraph 111, for a detailed discussion of the base of fire.
- (2) The maneuver force, which is composed of tank and mechanized infantry units, has the mission of closing with and destroying the enemy.

b. Ideally, the maneuver force moves continuously in mass. The entire force advances on the enemy without halting, while the base of fire neutralizes the enemy's capability for interfering with the advance of the maneuver force. This advance in mass is conducted at top speed. The combination of speed and the multiplicity of targets reduces the time the maneuver force is exposed to enemy fire, thus reducing its vulnerability and producing tremendous shock effect.

c. Under some circumstances, the base of fire or machinegun fire from moving tanks may be unable to neutralize enemy weapons that prevent continuous movement in mass. The maneuver force may be forced to engage the enemy with direct tank gun fire from defilade positions by designated elements while other elements continue the advance. This technique is called fire and movement.

d. Fire and movement is accomplished by the maneuver force. A distinction is made between fire and maneuver and fire and movement to emphasize the point that tanks close with the enemy and are not normally used in a base of fire. The distinction between fire and maneuver and fire and movement is shown graphically in figure 77.

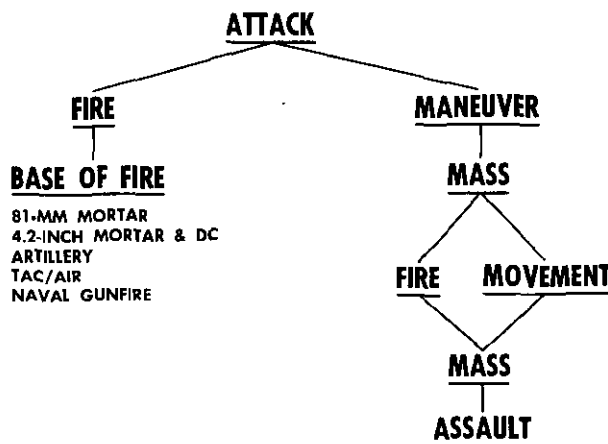

Figure 77. Relationship between fire and maneuver and fire and movement.

2. Fire Delivered by the Maneuver Force

a. General. In the fire fight, the armor unit commander seeks to capitalize on the armor protection, firepower, and mobility of the tank to close with and destroy the enemy. Normally, this is best accomplished by advancing continuously in mass.

- (1) All measures are taken to make fires as effective as possible. The commander is alert to order any action that will improve the volume and accuracy of fire or to deliver fire from a direction or location that will provide an advantage over the enemy.

- (2) All measures are taken to reduce the effectiveness of the enemy fire. The commander uses cover and concealment to the maximum both for firing positions and for movement. Movements are made rapidly to avoid presenting a stationary target. Smoke may be used to reduce enemy observation.

b. Fires During Continuous Movement in Mass.

- (1) The unit continues to move without halting.
- (2) Tanks with stabilized guns can be employed effectively while the tank is moving, but the accuracy of the unstabilized tank gun is reduced seriously.
- (3) Fires of unstabilized tank guns during continuous movement in mass are effective only within the relatively short range of the machinegun and against an enemy vulnerable to small arms fire.
- (4) Continuous movement in mass with tank gun fire is used in the assault of defended positions.

c. Fire and Movement. Fire and movement is used so that the force as a whole may continue to advance while elements of it halt temporarily to fire 1 or 2 rounds from the tank gun at known targets that prohibit continuous movement in mass. Fire and movement is conducted by two methods—movement by individual tanks and coordinated movement by bounds.

(1) *Movement by individual tanks* (fig. 78).

- (a) Each tank commander determines whether to fire while moving or to halt and fire the machinegun or tank gun. If the decision is made to halt, the tank commander selects the firing position, the target, the time of fire, and the route between firing positions. In making these determinations, he must maintain, in general, his relative position in the platoon formation. The platoon leader insures that the platoon con-

tinues to move and may direct individual tanks to fire less and move more if necessary to insure that all tanks participate aggressively in the fight. The platoon leader may direct the fire of individual tanks when necessary.

- (b) The accuracy capabilities of both the machinegun and the tank gun are best realized when fired from a stationary position.
 - (c) Movement by individual tanks is employed against any type target except those requiring the concentrated fires of more than one tank.
 - (d) Considerations when movement by individual tanks might be used are as follows:
 1. In the advance to or in the assault when enemy tanks or other point targets threaten the accomplishment of the mission and cannot be neutralized by the base of fire or by machinegun fire while moving.
 2. When a force is caught in the open by effective enemy fire and must move and neutralize the fire to prevent unacceptable losses.
 - (e) The advance by continuous movement in mass is resumed as soon as possible.
- (2) *Coordinated movement by bounds.* The unit commander selects the firing positions, designates who is to occupy the positions, and gives the order to displace from one position to another. The unit commander may designate targets, the time to fire, and the route between firing positions.
- (a) *Alternate bounds* (fig. 79).
1. A part of the tank unit is ordered forward to a predesignated limit while the remainder of the unit fires on the enemy. When the leading element is in position, it fires on the enemy while the remainder of the unit advances past its position to a second predesignated limit. This alterna-

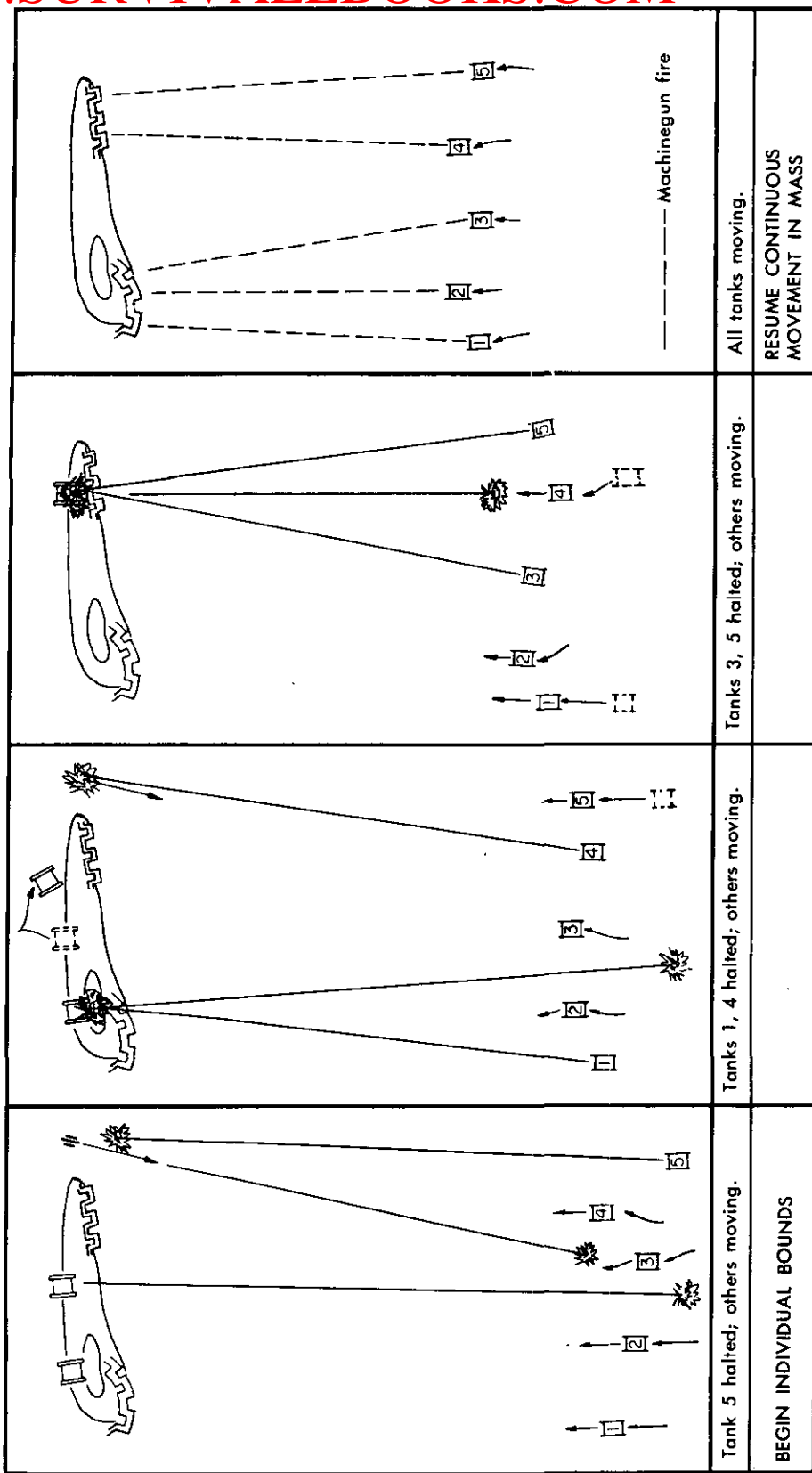

Figure 78. Movement by individual tanks.

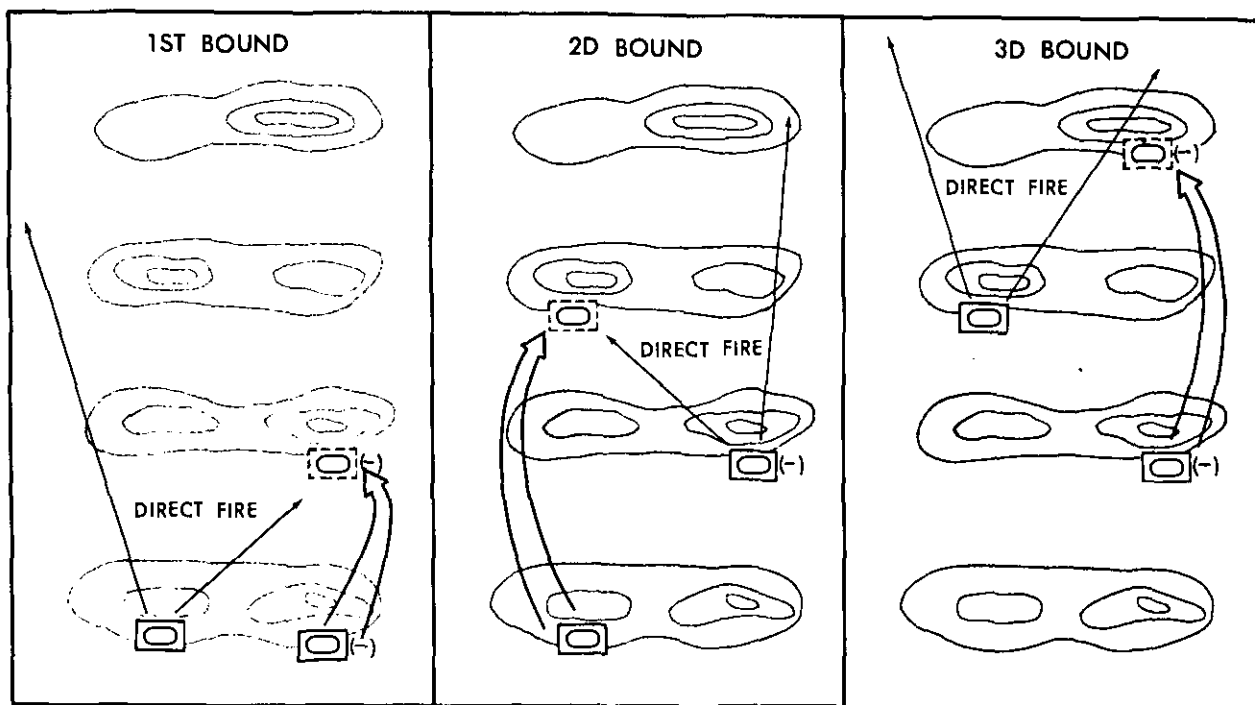

Figure 79. Movement by alternate bounds.

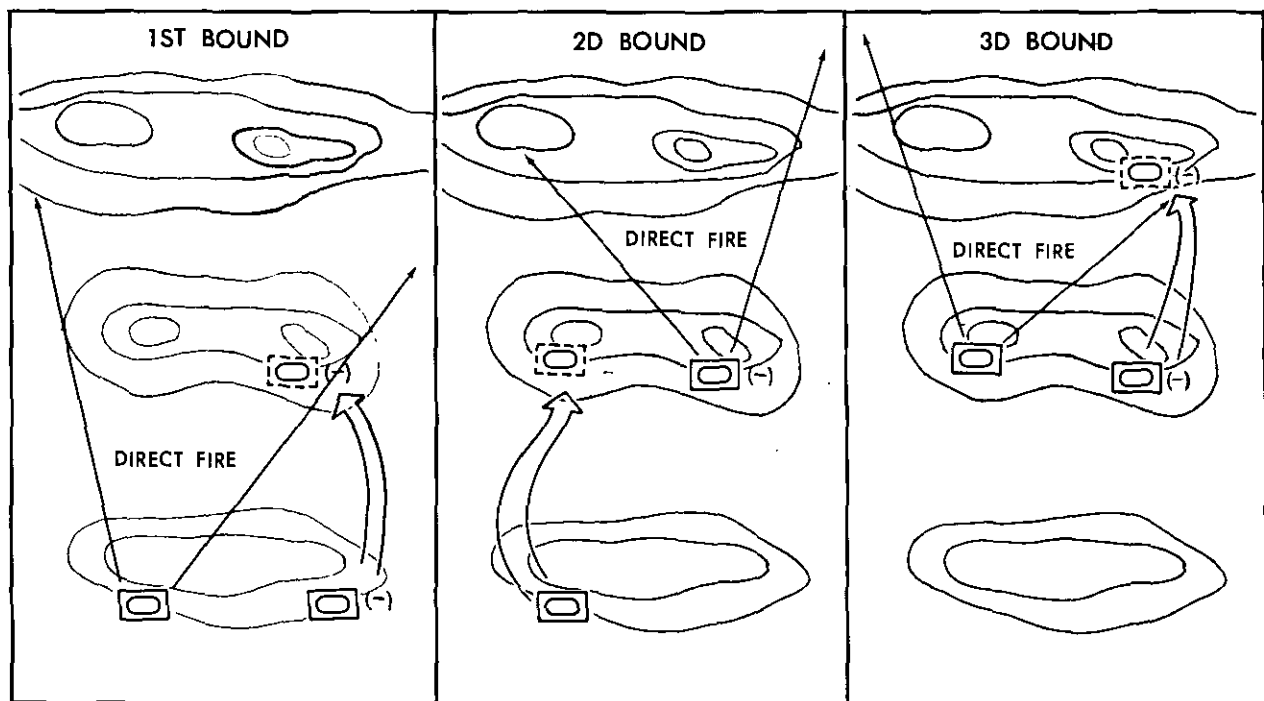

Figure 80. Movement by successive bounds.

tion of movement is repeated as often as necessary. The tank company executes alternate bounds by platoons. When platoons are forced to execute alternate bounds, the platoon leader decides where and when a tank or tanks will move. The movement of all tanks is coordinated.

2. The fires of tanks in firing positions may be concentrated against those elements of the enemy that constitute the greatest threat to the unit.
 3. The advance by continuous movement in mass is resumed as soon as possible.
- (b) *Successive bounds* (fig. 80).

1. A part of the tank unit is ordered to a predesignated limit while the remainder of the unit fires on the enemy. Once the leading element is in position and firing on the enemy, the remainder of the unit

advances to join the leading element. While the unit is together, the commander may halt all movement long enough to increase fires on the enemy. The bounds are repeated as often as necessary. The tank company commander executes successive bounds by platoons. When platoons are forced to execute successive bounds, the platoon leader decides which tank or tanks will move.

2. Movement by successive bounds is the only method that offers an opportunity to concentrate the fires of the entire friendly unit. This occurs when all elements of the unit are on the same terrain feature before continuing to the next bound.
3. The advance by continuous movement in mass is resumed as soon as possible.

APPENDIX XIV

ORGANIC FIRE SUPPORT

Section I. GENERAL

1. General

The armored division combat maneuver battalions support the scheme of maneuver with fires from organic weapons. The organic weapons considered are—

<i>Weapon</i>	<i>Unit</i>
Heavy mortar -----	Tank Bn, Mech Inf Bn, and Armd Cav Plat.
Davy Crockett -----	Mech Inf Bn and Armd Cav Sqdn (Armd Cav Regt).
81mm mortar -----	Mech Rifle Co.
Antitank guided missile (ATGM) -----	Mech Inf Bn.
106mm recoilless rifle ---	Mech Rifle Co.

For information concerning weapons organic to the armored cavalry squadron, see FM 17-36 and for information concerning the employment of the heavy mortar platoon, see FM 17-15.

2. Tactical Missions for Organic Weapons

Tactical missions must be assigned organic fire support weapons of armor units in the same manner as tactical missions are assigned to artillery units. Tactical missions for fire support weapons organic to armor units are general support and direct support.

3. General Support (GS)

General support is the mission of supporting the entire parent unit. The parent unit commander retains control of fires, movement, and supplies. A variation of this mission is the assignment of general support with a priority of fire for a specific subordinate element.

4. Direct Support (DS)

a. Direct support is the mission of supporting a subordinate element of the parent unit and answering directly the supported element's requests for fires.

b. When observers are not a part of the organic fire support unit TOE, the weapons leader must position his weapons to provide the most effective support.

5. Attachment

The organic fire support means of a combat maneuver battalion may be attached to a subordinate unit. Attachment is a status, not a tactical mission. Once attached, the receiving commander may assign the tactical mission of general support or direct support.

Section II. THE DAVY CROCKETT SECTION

6. General

The mechanized infantry battalion and the armored cavalry squadron of the armored cavalry regiment are authorized a Davy Crockett section by modified TOE. When a Davy Crockett section is authorized by Department of the Army, it is employed to provide nuclear fire

support for its parent organization in all types of combat operations. Its flexible communication system and mobility foster its responsiveness to command, and the destructive effects of its fires provide commanders with an effective means of influencing the outcome of battle. The Davy Crockett section is capable of pro-

viding ground elements with low-yield nuclear direct or indirect fire support.

7. Factors Governing Employment

The following factors must be considered in planning for the employment of the Davy Crockett section:

- a. Maximum and minimum ranges of the weapon system.
- b. Slow rate of fire of the weapon.
- c. Requirements for registration or adjustment to deliver accurate indirect fire.
- d. The bulk, weight, and security requirement characteristics of the ammunition.
- e. The coordination, including minimum safe safe distances and warning of troops, necessary for the employment of nuclear fires.
- f. The time required to dismount and lay the weapon.
- g. The requirement for frequent displacement of the section and its teams to minimize detection by the enemy.
- h. Firing positions must be selected near other friendly units to assist in the security of the weapons system.
- i. Ammunition allocations and availability.
- j. Relatively low maximum ordinate of projectile trajectory.

8. Fundamentals of Employment

The following principles govern the employment of the Davy Crockett section.

- a. The Davy Crockett weapons system supplements the firepower available to armor units. It must be employed in coordination with other fire support elements.
- b. The Davy Crockett should be employed against the more dangerous enemy targets of opportunity because of its responsiveness to task force requirements.
- c. Authority to fire a Davy Crockett weapon is retained by the battalion commander.
- d. Davy Crockett weapons must be employed well forward to maximize the range characteristics of the system.

9. Method of Employment

The Davy Crockett section is employed in general support. Control of the section is retained by the battalion commander. Calls for fire will be answered from all subordinate elements; however, delivery of fires is subject to the guidance announced by the commander. The battalion commander normally designates the priority of fires.

10. Fire Planning

a. The battalion commander is responsible for the planning and coordination of Davy Crockett fires. The Davy Crockett section leader, however, in coordination with the battalion fire support coordinator and battalion heavy mortar platoon leader, performs tasks incident to planning Davy Crockett fire support.

b. Based on the concept and other guidance announced by the battalion commander, the section leader, in coordination with the fire support coordinator and the heavy mortar platoon leader, plans the fires of his section. At section level, the fire plan is usually an overlay that is issued, time permitting, as an appendix to the battalion fire support plan. At team level, the fire plan will usually consist of concentrations plotted on the team leader's map.

c. Fires are categorized either as scheduled or on call. Scheduled fires are planned on known or suspected enemy positions and are fixed in accordance with a prearranged time schedule, usually expressed in terms of H-hour. On-call fires are planned on known or suspected enemy targets and are fired as requested by supported unit commanders. In addition to scheduled and on-call fires, targets of opportunity may be engaged.

d. There are no specific rules as to the type of target to be engaged with Davy Crockett weapons. In general, targets should be selected which are vulnerable to the effects of the weapon and whose destruction is essential to the accomplishment of the commander's mission. Suitable targets are as follows:

- (1) Personnel targets of platoon and company size. Fires should be planned into areas likely to be occupied by units of this size, such as assembly

areas, attack positions, or avenues of approach.

- (2) Enemy mortar, artillery, and missile launching positions.
- (3) Vehicular targets, mechanized or lightly armored vehicles.
- (4) Command posts of battalion size or larger.
- (5) Trains areas and supply installations.

11. Conduct of the Attack

a. Davy Crockett fires are delivered in accordance with the battalion fire support plan. Scheduled fires are delivered at the time and on targets prescribed. Upon completion of scheduled concentrations, the section prepares to engage targets of opportunity or deliver on-call fires as requested by supported elements.

b. The section leader keeps informed of the situation and continues his estimate. Davy Crockett squads are shifted to alternate firing positions before hostile fire threatens their primary positions. Supplementary positions are occupied if it becomes necessary to meet enemy counterattacks.

c. Davy Crockett squads displace before the supported elements move beyond effective range of the weapon. Generally, they should begin displacement when supported units reach distances approximately one-half the range of the weapon. The section may displace in whole or by squads as the requirement for fire support and the tempo of the operation dictate. The section leader strives to have at least one weapon in position and ready to fire at all times. In fast-moving attacks and movement to contact, the Davy Crockett section or one or more squads will have to deploy from march column as requests for fire are received.

12. Defense

a. General. Davy Crockett weapons are employed in support of defensive operations by applying the same general principles as for offensive operations.

b. Employment. Certain techniques that apply to the support of defensive operations are as follows:

- (1) The commander employs the Davy Crockett in general support.

- (2) Fire planning in the defense is similar to that for offensive situations.

- (3) When the parent organization is part of the striking force, Davy Crockett fires are planned as described for offensive operations.

- (4) During conduct of the defense, Davy Crockett fires are delivered on prearranged concentrations and targets of opportunity as requested by supported commanders. Because of troop safety considerations associated with nuclear fires, the majority of concentrations are usually placed on targets in the midranges. Troops are warned in accordance with the unit SOP.

- (5) Alternate and supplementary positions are designated by the Davy Crockett section leader. Squads move to alternate positions when hostile fire threatens primary positions; supplementary positions are occupied as necessary.

13. Retrograde

a. General. The Davy Crockett section is employed in retrograde operations applying techniques similar to those used in the defense.

b. Retirement. The Davy Crockett section will move as part of its parent organization when it participates in a retirement. Davy Crockett squads are interspersed in the column to permit rapid deployment into firing positions and to provide fire support to all elements of the battalion.

c. Withdrawal. The Davy Crockett section provides fire support for its parent battalion throughout all phases of the withdrawal. As the main body withdraws, one or more Davy Crockett squads are attached to the security elements. Security measures must be taken to prevent weapons left with the security elements from falling into enemy hands.

d. Delaying Action. In support of delaying actions, Davy Crockett fires are planned to subject the enemy to attack at maximum ranges. Targets of opportunity are engaged as they are detected. Use of air observers permits full use of the range characteristics of the system.

14. General

The basic principles set forth in this appendix for the employment of the Davy Crockett and in FM 17-15 for the employment of the heavy mortar are applicable to armored cavalry units. This section prescribes techniques peculiar to armored cavalry operations.

15. Davy Crockett

a. General. The Davy Crockett section is employed in general support. However, squads are normally placed in support of troops of the squadron because of the extended operational distances.

b. Support of Different Operations. Paragraphs 9 through 13, this appendix, are applicable to the Davy Crockett section in support of economy of force offensive, defensive, and retrograde operations by an armored cavalry squadron.

c. Reconnaissance Operations. Davy Crockett weapons are used in reconnaissance operations when fires from artillery, mortars, and tank guns are not sufficient. When firepower of the magnitude inherent in Davy Crockett weapons is required in the accomplishment of the squadron or troop missions, fires are delivered employing techniques described for the engagement of targets of opportunity (para 13 and 14, this appendix).

d. Security Operations.

- (1) The Davy Crockett section supports its parent squadron in the conduct of security operations by applying the principles and techniques prescribed in paragraphs 9 through 13, this appendix, and in FM 23-20.
- (2) Davy Crockett squads will usually be placed in support of armored cavalry troops. Fires are planned to support defense of blocking positions and limited offensive action of the security forces. Targets of opportunity are engaged as they are detected to prevent the enemy from reaching positions so close to friendly elements that troop safety considerations preclude firing of concentrations. Air observers

should be used to extend observation out to ranges commensurate with those of the weapons system.

16. Support Squad*a. Offense General.*

- (1) The support squad, armored cavalry platoon, can be employed in two basic ways—
 - (a) Normally in support of the parent platoon.
 - (b) Infrequently, as a provisional platoon.
- (2) When employed as a provisional platoon, it is under control of the troop commander and supports the entire troop.
- (3) Regardless of the method used, the squad must be constantly ready to provide timely and accurate fire support.

b. General Support of the Parent Platoon.

- (1) The platoon leader will control the support squad by designating its initial position or its place in formation, target areas, and displacement instructions in his operation order. After the operation begins, he will control the squad by radio. The squad leader must monitor the platoon net constantly to stay abreast of the situation. From these information reports, he must be able to anticipate the fire requests he will receive and position his squad to support the platoon. This will relieve the platoon leader of constant supervision of the squad, but the squad does not fire a mission without the knowledge of the platoon leader. The support squad leader must keep the platoon leader informed of the squad situation to include position, displacement requirements, ammunition status, POL requirement, and capability to support the platoon.
- (2) The two primary techniques of selec-

tion of firing position and displacement are as follows:

- (a) In a fast-moving situation, where the enemy resistance is light, the support squad will move at the rear of the platoon formation. It must be far enough to the rear of the formation so that the minimum range of the weapon will not create a problem when it moves into firing position.
- (b) When the enemy situation is such that the squad will be in position to fire, selection of the position will follow the characteristics outlined in FM 17-15. In selecting these firing positions and in planning for displacement, consideration should be given to keeping the squad positioned so that the majority of fire missions will not be beyond the mid-range of the mortar.
- (3) The support squad does not have the capability of providing for its own local security and firing in support of the platoon. Security is gained as follows:
 - (a) The area the squad is to occupy will have been cleared of the enemy by leading elements of the platoon as it advances.
 - (b) When the platoon is the advance guard for the troop, security is gained by the close proximity of following troop elements as well as (a) above.

c. Provisional Platoon.

- (1) *General.* When the area of operations for the armored cavalry troop is such that the support squads can be brought together into a provisional platoon, they will follow the tactics and techniques outlined in FM 17-15 and FM 23-92.
- (2) *Control.* Although the troop commander will control the provisional platoon, a control headquarters is provided in the platoon. Following are techniques that may be employed:

- (a) One of the armored cavalry platoon leaders is designated as platoon leader. He uses one of the squad leaders as platoon sergeant, one as computer, and the third as gunnery sergeant.
- (b) The senior, or best qualified, squad leader is designated to command the platoon. He uses one squad leader as computer and the other as gunnery sergeant.
- (3) *Observation.* The forward observers will normally be the scouts and other individuals in the troop who can observe suitable targets.
- (4) *Communication.* Radio is the primary means of communication. The provisional platoon is on the troop command net for fire control.

d. Defense and Retrograde.

- (1) *General.* During defensive and retrograde operations, the support squad is employed in a manner similar to offensive operations. The squad is in general support of its parent platoon or is formed into a provisional platoon under troop control, along with the support squads from the other platoons. The factors of METT determine which method best accomplishes the fire support mission.
- (2) *Defense.*
 - (a) *General support of parent platoon.* When the squad is employed in general support of its parent platoon, it occupies a firing position as close to its platoon as minimum range and the enemy situation permit. Concentrations are planned to cover the known and suspected areas, and a barrage is planned for an area that cannot be covered by flat-trajectory fire. The firing position—
 1. Must provide maximum coverage of the front and flanks of the platoon position.
 2. Should be in defilade and allow for mask and overhead clearance.

3. Should have good routes of supply.

Note. Alternate and supplemental positions should be prepared.

(b) *Support squad as part of provisional platoon.* The troop commander employs the support squads as a provisional platoon when the situation permits, applying the tactics and techniques outlined in FM 17-15 and FM 23-92.

(3) *Delaying actions.* In a delaying ac-

tion, the support squad is employed using the techniques outlined in FM 17-15. Firing positions selected should—

- (a) Provide for taking the enemy under fire at maximum range.
- (b) Have a good route of withdrawal for rapid displacement to the rear.
- (c) Be in rear of the squad's parent platoon.

Section IV. MECHANIZED INFANTRY WEAPONS

17. General

Armor operations envisage the employment of combined arms forces at brigade, task force, and team level. Armor commanders at the task force and team level can expect the attachment of mechanized infantry. Thus, the tank battalion commander and the tank company commander must have a general understanding and appreciation of the organic fire support weapons of the mechanized infantry battalion and company. The primary fire support weapons organic to the mechanized infantry battalion are found in the heavy mortar platoon, Davy Crockett section, and the antitank platoon. At company level, the 81mm mortars and the 106mm recoilless rifles of the weapons platoon are the primary fire support means.

18. Antitank Platoon

a. The primary mission of the platoon is to provide antitank support for the battalion. Its secondary mission is to provide fire support for the rifle companies of the battalion.

b. The platoon is capable of providing antitank support and fire support for the battalion in several tactical roles. Depending on the operation plan, the platoon may be employed in a general support, direct support, or attached role. The platoon's mobility and communication enable it to respond rapidly to tank threats throughout the battalion area.

c. The platoon's primary target is enemy armor. Provided it does not interfere with its antitank role, it may engage bunkers, observation posts, vehicles, crew-served weapons, grouped enemy personnel, and other similar targets. The antitank platoon is the commander's primary organic antitank means.

d. In the attack, antitank weapons may be employed well forward or in depth to add to the battalion antitank capability. The battalion commander considers the factors of METT in determining where and how the weapons will be employed. He may attach one or more squads to one or more units and retain the remainder of the platoon in general support. He may hold the entire platoon in general support to be available for use where armor threats develop.

e. In movements to contact or when the enemy situation is vague, the commander retains the major part of the platoon in general support for flexibility in employment. Security elements of the battalion, such as flank or rear guards or screening forces, may have one or more antitank squads attached.

f. In the defense and retrograde, squads of the antitank platoon are located generally where they can destroy enemy armor forward of the battle area and provide antitank defense in depth. If possible, squads are mutually supporting. When antitank weapons are employed in the area of a forward rifle company to cover a tank approach of primary concern to that company, they are usually attached. The employment of other antitank weapons is integrated to provide the best possible antitank defense.

g. For detailed organization and employment of the antitank platoon, see FM 7-20.

19. The Battalion Heavy Mortar Platoon and Davy Crockett Section

For the employment of the heavy mortar platoon, see FM 23-92 and FM 17-15. For the

employment of the Davy Crockett section, see section II, this appendix.

20. The Weapons Platoon, Mechanized Rifle Company

a. *Offense.*

- (1) The company commander employs the 81mm mortar section in general support whenever centralized control will permit delivery of fires in support of all or the major part of the company. Forward observers of the weapons platoon are positioned as directed by the company commanders.
- (2) He employs the antitank section in general support whenever centralized control will permit the squads to provide antitank protection for the company or, if appropriate, close fire support for the attacking platoons. Considerations in determining the method of employment include the company commander's ability to control the section throughout the attack and the section's ability to move rapidly throughout the area of operations to meet an armor threat.
- (3) For detailed discussion of the employment of the weapons platoon in the offense, see FM 7-11 and FM 7-20.

b. *Defense.*

- (1) 81mm mortar section.
 - (a) Whenever possible, the 81mm mortars are employed in general support. It is desirable that they be able to support all forward rifle platoons from one position area. In some situations, the forward rifle platoons may be too widely separated for the mortars to be used in general support. In this case, one or more squads may be attached to forward platoons while the rest are used in general support.
 - (b) When the company is responsible for the combat outpost, the mortars may frequently be positioned well forward to provide adequate support for the combat outpost. If this

does not give adequate support, one or more squads may be attached to the combat outpost.

- (c) When the mortars are employed in general support, the company commander designates a general position area, based on the recommendation of the weapons platoon leader.
- (2) Antitank section.
 - (a) Whenever possible, the antitank section is employed in general support. When the terrain does not permit free movement, one or both squads may be attached to rifle elements.
 - (b) One or both squads may be attached to the combat outposts.
 - (c) When the antitank section is employed in general support, the company commander assigns each squad a general position area and a principal direction of fire, based on the recommendation of the weapons platoon leader.
 - (d) For a detailed discussion of employment of the weapons platoon in defense, see FM 7-11.

c. *Retrograde.*

- (1) *81mm mortar section.* The 81mm mortars are normally employed in general support to cover the front and are placed well forward to obtain maximum range. If the mortars cannot cover the company sector adequately from a centralized location, they may be attached to the rifle platoons. One or more of the mortars may be employed as part of units left in contact.
- (2) *Antitank section.* The antitank squads are normally attached to the rifle platoon in whose area they are located. If attached to units left in contact, they withdraw based on the plans of the rifle platoon.
- (3) *General.* For a detailed discussion of the weapons platoon in retrograde operations, see FM 7-11.

Section V. FIRE PLANNING AT PLATOON AND COMPANY LEVEL

21. General

The planning of organic and supporting fires to support an operation is accomplished at all levels. The plan of fire support at company, battalion, and brigade must be coordinated and fully integrated to insure success of the plan of attack or defense. The plan of fire support includes fires of organic, attached, and supporting weapons. Fire planning at platoon and company level must be continuous and as detailed as time will permit.

22. Fire Planning in Defense

a. Company Level. As soon as the battalion commander has determined his plan of defense, he assigns each company a sector of responsibility, which the company commander is required to cover by fire. The battalion commander will designate critical target areas to the companies. He may also assign a mortar barrage to the company. The company commander assigns areas of responsibility to each platoon. Upon receipt of the platoon plan of fire support, he integrates these plans along with the target areas, concentrations, barrages, and other organic and supporting fires available. The artillery forward observer and the mortar observer supporting the company are the commander's principal advisers in the preparation of the company plan of fire support. When the consolidated company plan of fire has been completed, the platoon leaders annotate their maps to reflect all planned fires. The targets and target areas are identified by numbers and letters so that any member of the company can call for fires on a target using a common identification system.

b. Platoon Level. The company commander assigns each platoon a sector of responsibility and specific targets or target areas. The platoon leader assigns a sector of responsibility to each tank along with specific targets or target areas. The sectors of responsibility assigned each tank must be overlapping to insure complete coverage of the platoon sector. Tank commanders prepare a range card, which includes the specific targets and areas assigned by the platoon leader, and select additional targets to

insure complete coverage by fire of the tank sector of responsibility. The platoon leader selects suspect target and target areas in addition to those assigned by the company commander. The fire plan submitted by the platoon leader to the company commander is an integration of the tank range cards, the targets assigned by the company commander, and targets selected by the platoon leader.

23. Fire Planning in Offense

a. Company Level. The company commander, assisted by the artillery forward observer, develops a plan of supporting fires to support the company's scheme of maneuver. The company commander, platoon leaders, and artillery forward observers must be alert to detect targets of opportunity during the attack, and request fires on these targets to prevent interference by the enemy. In developing the plan, the company commander must consider—

- (1) The mission and scheme of maneuver.
- (2) Information of the enemy.
- (3) Possible enemy avenues of approach.
- (4) Fires requested by the platoon leaders.
- (5) Protective fires required along the flanks and during consolidation on the objective.
- (6) Smoke required to facilitate maneuver.
- (7) Illumination required to support a night attack.
- (8) Other supporting fires available such as attached mortars, artillery, close air support, or naval gunfire.

b. Platoon Level. Upon receipt of the attack order, the platoon leader issues a warning order and begins planning for the employment of his platoon. He is concerned primarily with fires on known or suspected targets and fires en route to and on the objective. The company commander will designate target areas and the platoon leader should select targets and report these to the company commander or forward observers for integration into the company fire plan.

APPENDIX XV

NIGHT COMBAT TECHNIQUES

1. General

This appendix is a guide for commanders and staffs at all echelons for the employment of night combat techniques. Basically, night operations are conducted in the same manner as daylight operations. However, in night operations the problem of identification, control, coordination, and maintenance of direction are greater; dispersion is less; maneuver is restricted; movement is slower; and surprise and simplicity become major considerations. The following paragraphs discuss the techniques that may be employed in night operations to overcome these problems. For a detailed discussion of illuminating the battlefield with visible light see FM 20-60.

2. Identification

a. General. Night procedures are based on the use of night vision equipment and visual, audio, and electronic identification means. Audio identification measures are prescribed in FM 21-75.

b. Personnel Identification. Individuals may be identified through use of the challenge and password as discussed in FM 21-75 and by the use of visual identification. Personnel should wear identification of some type in night operations. Luminous or reflective strips on the rear of the helmet may be used to designate officers and noncommissioned officers. Luminous or reflective armbands may be used to identify guides. Other members of the unit may place a white band on either arm or both arms, on their packs, or on the rear part of their web belts. Standardized outer uniforms are also helpful. At platoon level, identification may be made by using filtered flashlights, metascopes, infrared (IR) weapons sights, IR

driving lights, IR searchlights, and IR periscopes or telescopes.

c. Unit and Vehicle Identification. Units may be identified at night through radio communication used in conjunction with audio or visual signals. Preplanned IR, radar, or other electronic signals may be used to identify units. Luminous panels or markers may be displayed on vehicles according to a preplanned procedure. Visible or infrared lights may be flashed according to a prearranged pattern as identification. Positive identification should normally be insured by dismounting a representative of the unit or vehicle and requiring him to identify all elements of the unit being identified. It is extremely important that adequate security is posted to prevent enemy infiltration.

3. Control

Since control of a unit during operations under conditions of limited visibility is difficult, techniques to aid in controlling the unit must be developed. Before adopting control techniques, the commander must consider the enemy's night vision capabilities and the effect which these capabilities may have on his plan.

4. Formation

Control is facilitated by proper use of formations. By retaining the column formation as long as possible, control of movement is aided. Individuals and units may move with less dispersion in order to take advantage of the increased concealment provided by darkness and on visual contact with each other for maintenance of unit integrity. A decrease in dispersion must be balanced against the enemy's limited visibility equipment. Control is aided

further by designating guide vehicles and units responsible for rate and direction of movement.

5. Preparation

a. General. Control over a unit is facilitated by adequate prior training in the use of night vision equipment. Commanders insure familiarity of all personnel with the plan and insure maximum reconnaissance by leaders down to tank or squad level. Detailed orders, simple plans, and adequate SOP's are also vital to control.

b. Attack. In the attack, emphasis must be placed on selected control measures such as objectives, boundaries, phase lines, and checkpoints that are easily identifiable at night. IR equipment, radar, and guides may be used to assist in the movement of individuals and vehicles. Illumination may be used to mark boundaries. Techniques that can be employed to provide orientation and to maintain direction are—

- (1) Flares dropped beyond and on line with the objective.
- (2) Artillery concentrations fired on a time schedule so that the friendly force can orient on them.
- (3) Tracers from cal. .50 weapons, fired at irregular intervals can delineate boundaries, routes, and objectives.
- (4) Guides equipped with infrared lights may be posted on routes, points of departure, and the probable line of deployment.
- (5) Surveillance radar may be used to monitor the movement of advancing units to report and correct any deviation from the prescribed route. See appendix XXI, paragraph 14.
- (6) Easily identifiable terrain features, such as hills, unusual terrain formations, trees, or manmade objects can be used in conjunction with the above for orientation.

c. Defense and Retrograde. In defensive and retrograde situations, range cards are prepared for use during periods of limited visibility or at night. The preparation of range cards is explained in FM 17-12. Commanders through company level will actively supervise

and insure their prompt and accurate preparation. At platoon level they are consolidated into sketch form as a supplement to the platoon fire plan. The platoon fire plan submitted to company should include data from this sketch range card, location of platoon observation posts and listening posts, and location of platoon surveillance equipment with their fields of survey. At company level these sketches are consolidated into the company fire surveillance plan for submission to battalion. Examples of a tank range card, platoon fire plan, and company fire plan are shown in figures 81 through 83. The company surveillance plan may be consolidated with or attached to the fire plan. See annex XI for an example task force surveillance plan. Details included in these plans will include as a minimum the primary position and sector of fire for crew-served weapons and tanks and the primary position and area of surveillance coverage for surveillance means. Units given a support by fire mission for a night attack may use range card techniques for employing fires. For information regarding surveillance cards, see appendix XXI.

d. Supporting Fires. Control of supporting weapons and their fires, when illumination is used, is identical to that in daylight operations. When no illumination, partial illumination, or infrared illumination are employed, the movement of weapons and shifting of fires must be restricted. Protective fires for flanks of units and to isolate the objective in the attack must be planned. Once visible illumination is provided, restriction on supporting fires may be lifted.

e. Communications. Communications take on added significance during night operations. Plans must include alternate means of communication. Additionally commanders should consider—

- (1) *Offense.* The use of radio listening silence from the initial position to the probable line of deployment or until such time as the enemy has detected the attack. Once the attack has been discovered, radio becomes the primary means of communication, supplemented by pyrotechnics as appropriate.

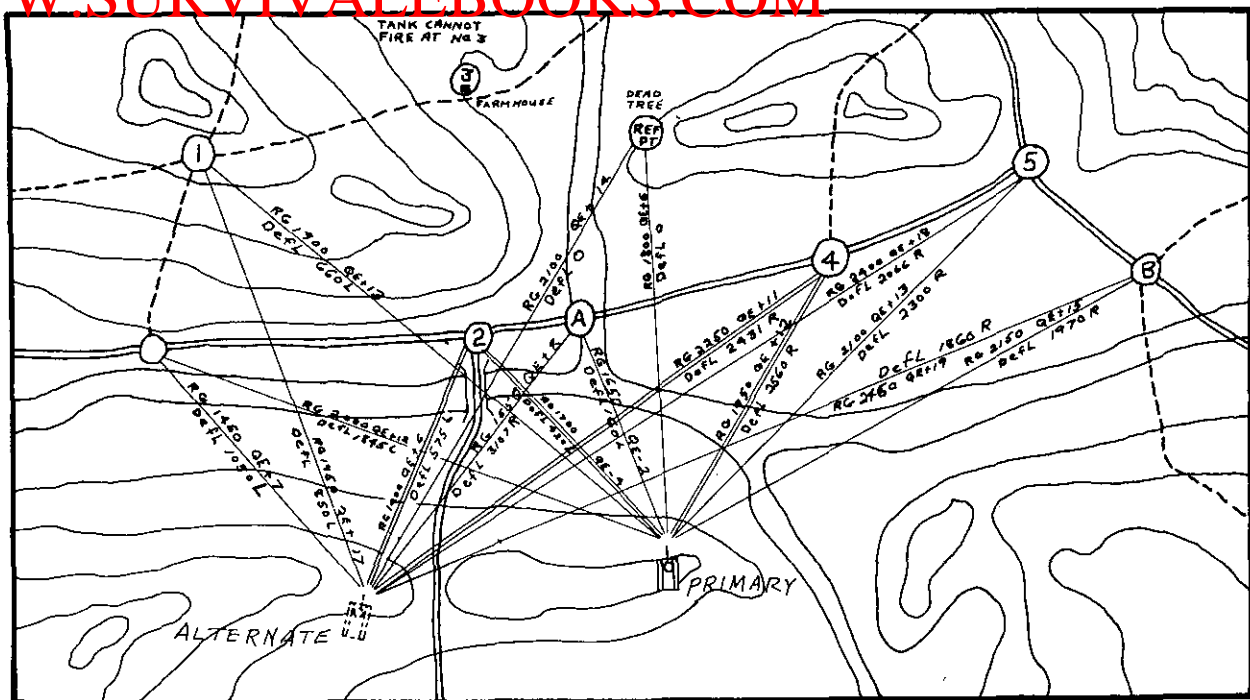

Figure 81. Sketch range card.

(2) *Defense.* Radio listening silence and more reliance on wire communications, messengers, and signaling devices.

6. Artificial Lighting of the Battlefield

a. General. Battlefield lighting consists of active lighting systems that use visible light and nonvisible (infrared) light from manmade sources. The efficiency of these systems is greatly reduced by fog, haze, rain, dust, smoke, and snow.

b. Visible Illumination. The employment of visible light has been the most common means of increasing the range of vision during darkness to date. Examples of visible battlefield illumination are ground signals, illuminating grenades, trip flares, artillery, mortar, and rocket-delivered illumination flare, aircraft-delivered flares, searchlights, and improvised means. The observer needs no special equipment to use this system. The chief disadvantage of the use of visible light is its inherent lack of security. Enemy forces are immediately alerted and often times the light can be of considerable benefit to the enemy if the illumination is not carefully planned. Searchlights

often become targets and while the fire they draw may be ineffective from the standpoint of destroying the searchlight, the light does provide a focal point for the fire into friendly elements in the vicinity.

c. Near Infrared Illumination. Near infrared is an active illumination system that uses near infrared radiations that are invisible to the naked eye. This system uses near infrared radiation that is projected toward the scene by an illuminator. Examples of equipment that use near infrared illumination are metasopes, infrared weapons sights, infrared driving lights, infrared searchlights, and infrared periscopes and telescopes. These devices have greater inherent security than systems using visible light since infrared radiation cannot be detected by the naked eye. Although simple devices can be used to detect active near infrared at ranges of several miles, their field of view is restricted, and therefore the observer must not only be using the proper equipment but also be looking in the right direction to detect the infrared source. These factors, in addition to the technique of employing the active sources intermittently, greatly reduce the probability of detecting active near

COPY NO. 2
1/C/2-11 ARMOR
(COORDINATES)
111530 JUN

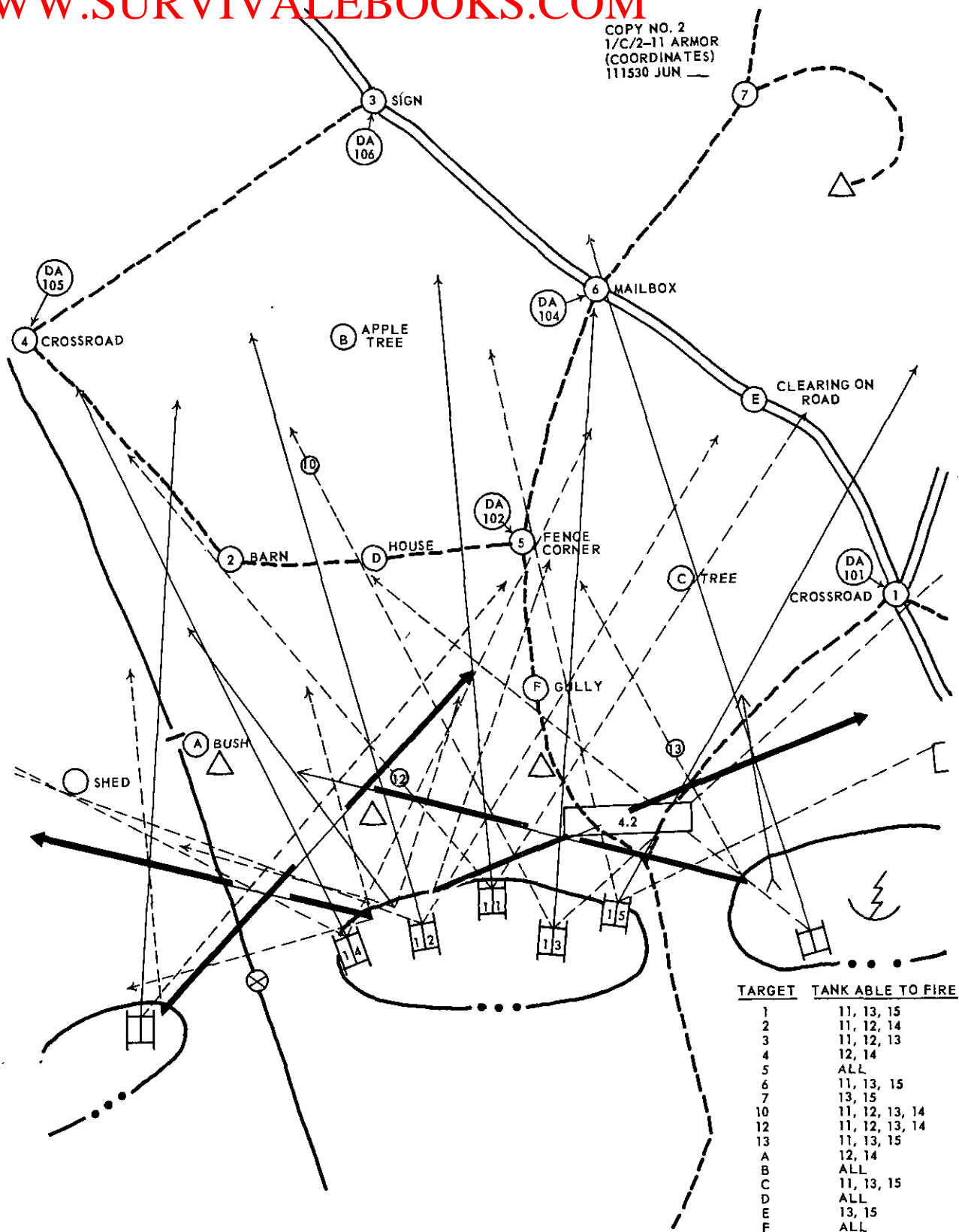

Figure 82. Platoon fire plan.

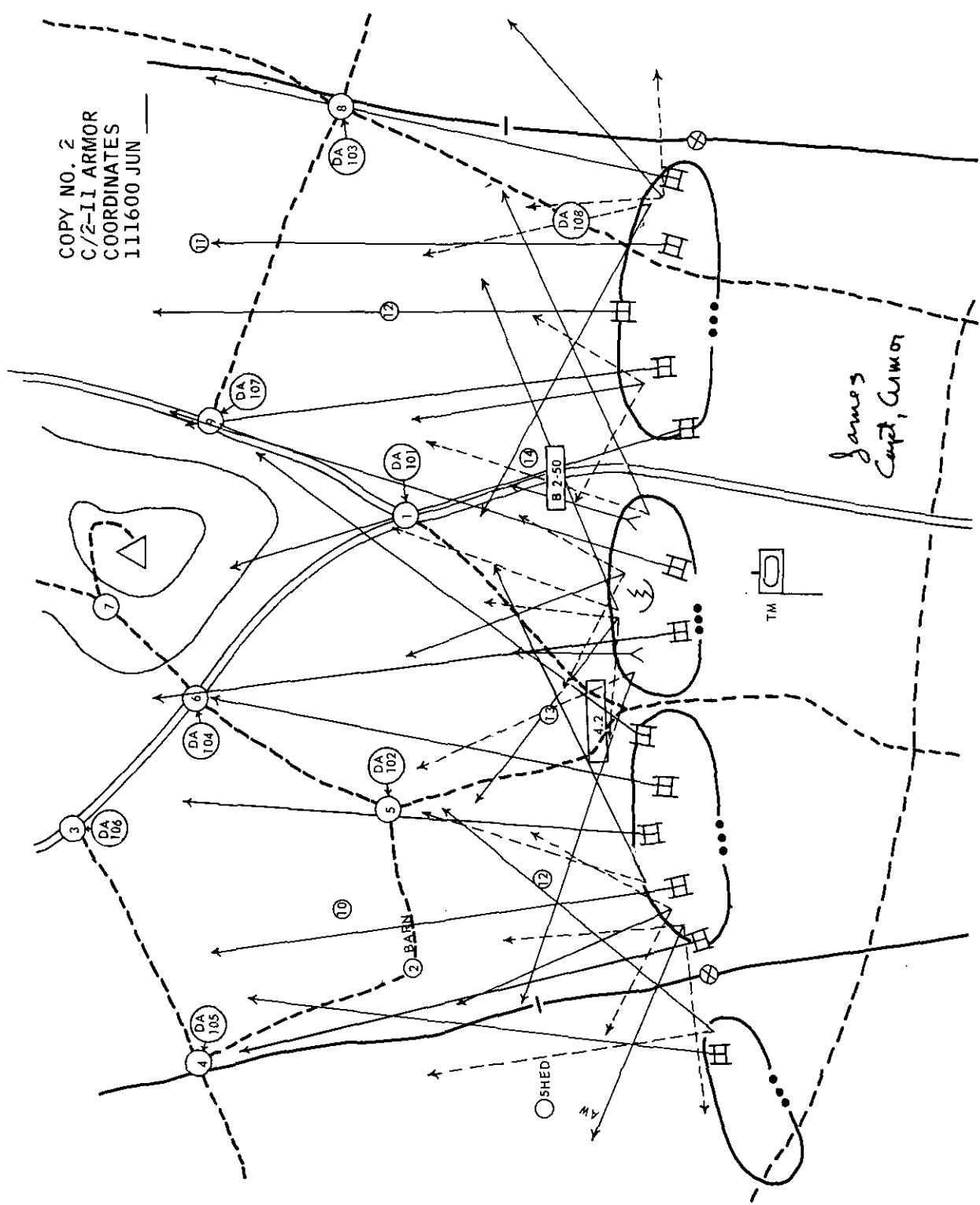

Figure 88. Company or team fire plan.

infrared devices. The infrared viewing component of this system may be used to detect enemy infrared illuminators. Infrared illuminators cannot be used effectively in the indirect (reflected) mode.

d. Employment of Active Lighting System (Visible and Near-Infrared).

- (1) *General.* Active lighting systems in operation can be detected by the enemy; therefore, active systems are controlled and coordinated closely by the commander directing the operation.
- (2) *Planning.* In addition to normal planning for combat operations, commanders must—
 - (a) Prepare an illumination plan and insure its integration into the plan of fire support if artillery or mortar illumination means are employed (fig. 84).
 - (b) Prepare a surveillance plan for the employment of visual, infrared, and audio devices and techniques.
 - (c) Consider the use of all appropriate night vision equipment in the illumination and surveillance plans and, consistent with other tactical considerations, insure that the most efficient use is made of their capabilities.
 - (d) Insure the provision of an adequate communication network.
 - (e) Provide, where possible, for daylight reconnaissance in the selection of primary and alternate positions.
 - (f) Consider the obscuration that may be caused by the effects of supporting fires since dust and smoke may diffuse illumination and act to the disadvantage of friendly forces.
 - (g) Assure that control of illumination means will be vested in the commander having overall control of the operation. The use of all illuminating devices should be covered by unit SOP's with special instructions being issued in operations orders.
 - (h) Consider the time of illumination in relation to the factors of security and surprise.

- (i) Provide for adequate logistical support when large amounts of illuminating munitions may be required.
- (3) *Indirect illumination.* Indirect illumination may be obtained by visible light through diffusion or reflection. In this technique, the light source is a searchlight positioned behind a terrain mask with the light directed over the crest of the mask. It is directed in such a manner that the light is reflected from low clouds or diffused by particles within the air so as to illuminate the selected area. The location of the light source is difficult to detect and, therefore, the position need not be changed frequently. Tank searchlights will be used rarely for indirect illumination as this use limits the use of the tank weapons. The primary source of indirect illumination is the artillery searchlight. See FM 20-60.
- (4) *Direct illumination.* In planning for the use of direct illumination, the commander should insure that the illumination means illuminates the enemy position or formation, so that effective fire may be placed on him, while the friendly force remains illuminated. Techniques to be used in direct illumination are dependent upon the characteristics of the area to be illuminated, atmospheric conditions, illumination means available, and the tactical situation.
 - (a) *Pyrotechnics.* The employment of pyrotechnics, in addition to the considerations affecting all illumination systems, is based on a further consideration of—
 1. Range of weapon or aircraft.
 2. Duration and area of effective light.
 3. Temporary loss of supporting fires during illumination firing.
 - (b) *Searchlights.*
 1. *Visible searchlights.* Searchlights used in direct visible illumination give more intense illumination on a target area than when used in-

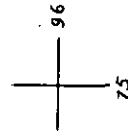
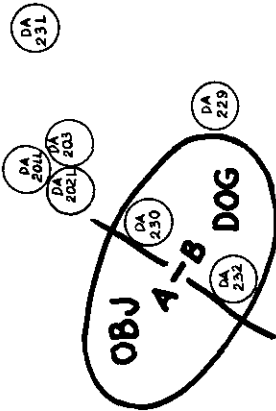
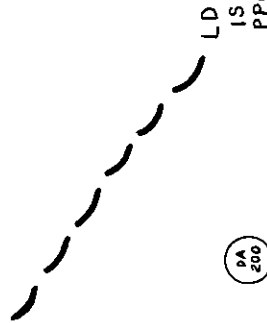
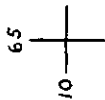

(Classification)

Copy No. 2
2d Inf Bn, 91st Inf (Mech) (TF 2-91)
GAUBUTTELRUNN (6399), GERMANY
071800 June 19

Appendix 1 (Illumination Plan) to Annex A (Fire Support Plan) to OPORD 31.

Reference: Map, GERMANY, 1:25,000, GEBELSTADT sheet.

1. TF 2-91 Inf will conduct a mounted, illuminated attack 080100 June 19 to seize designated objectives with two teams; Team A on the north and Team B on the south. Illumination will begin and cease on task force order.
2. Execution of illumination plan will be controlled by Arty LO with TF 2-91 Inf.
3. Code word to call for Illumination FIDDLE.
4. Code word to extinguish illumination. AGONY.

Table of Description

Conc	Description	Coordinates	Altitude	Area	Remarks
DA 200	Mechanized Co	69620310	280	680 m	Illuminating shell, 155-mm H diamond, or 4.2 in diamond, on call.
DA 201L	Road Junction	68580190	300		SLT, 1/2, Diffused, H-hour.
DA 202L	Road Junction	68500120	294		SLT, 1/2, Diffused, H-hour.
DA 203	Entrenchment	68840110	300	400 m	SLT, 1/4, Direct or 4.2 in diamond, on call.
DA 20F	1 June	6709	77	460 m	155-mm H diamond.
L8	Area 1	0102770	300		
DA 229	Road Junction	69939872	291		SLT, 1/2, Diffused, or 4.2 in diamond, on call.
DA 230	Objective	67209924	300	600	SLT, 1/4, Direct, or 155-mm or 4.2 in diamond, on call.
DA 231	Road Junction	70500243	280		SLT, 1/2, Diffused, or 4.2 in diamond, on call.
DA 232	Road Junction	67019818	305		SLT, 1/2, Diffused, or 4.2 in diamond, on call.

Acknowledge.

Jones
Lt Col

Distribution: A
TF 2-92 Inf
2-22 Armd Cav

OFFICIAL:
/s/ Redlegs
REDLEGS
SS

(Classification)

Figure 84. Visible illumination plan.

directly (fig. 85). The intensity of illumination on the ground decreases gradually as the range from the searchlight increases. Minute atmospheric particles reflect the beam and reduce the ability of the observer to see the target area. This effect may be reduced by positioning the observer to the flank of the light. Objects silhouetted between an observer and the light beam are clearly visible to a range of several hundred meters. The efficiency of direct illumination is affected by atmospheric conditions, natural night light, the reflectivity of the illuminated surfaces, and shadows. Visible searchlights used in direct illumination should be operated intermittently and moved often to alternate or supplementary positions. This not only decreases the ability of the enemy to bring effective fire on the position but also provides greater surprise illumination. The tank-mounted searchlight is the searchlight most commonly available to armor commanders. A detailed discussion of the employment of tank-mounted searchlights is discussed in paragraphs 7 through 9, this appendix.

2. *Near infrared searchlights.* This type searchlight is used in direct near IR illumination and is employed similarly to the visible searchlight. It is best employed to checkpoints or areas which have been previously plotted on a range card. With the narrow beam, the amount of terrain illuminated is too small for systematic and complete coverage of an assigned angular sector. Use of the beam spreader further reduces the range which prevents the proper coverage of an assign-

ed sector. Employment of the system in the "spot check" manner has the additional advantage of brief periodic operation. This reduces the vulnerability to attack from an infrared-equipped enemy and achieves better results at the illuminated point because of the surprise illumination.

e. *Selection of the Means of Illumination.*

(1) *Factors involved.*

- (a) No one means of illumination is suitable under all circumstances.
- (b) In planning for illumination, all means must be considered. The use of only one type of illumination may be negated by such factors as enemy action, changing weather, the necessity for employing all organic weapons on missions other than illumination, failure of the illumination device itself, or lack of logistical support.

(2) *Influences of the enemy and friendly situation.*

- (a) Enemy and friendly dispositions may affect the allocation of illumination means. For example, priority may be assigned to the weaker sectors of a defended front.
- (b) Enemy mass attacks at night justify extensive provision for large area illumination to enable friendly forces to destroy all or part of the enemy at longer ranges.
- (c) The enemy's illumination capability may require use of our illumination resources as a countermeasure.
- (d) The illumination means selected should be in a position and be capable of accomplishing the mission without disclosing the actions or positions of friendly forces.
- (e) The enemy's retaliatory action must be considered. For example, enemy fire at a searchlight may not damage the searchlight itself but may inflict extensive damage on

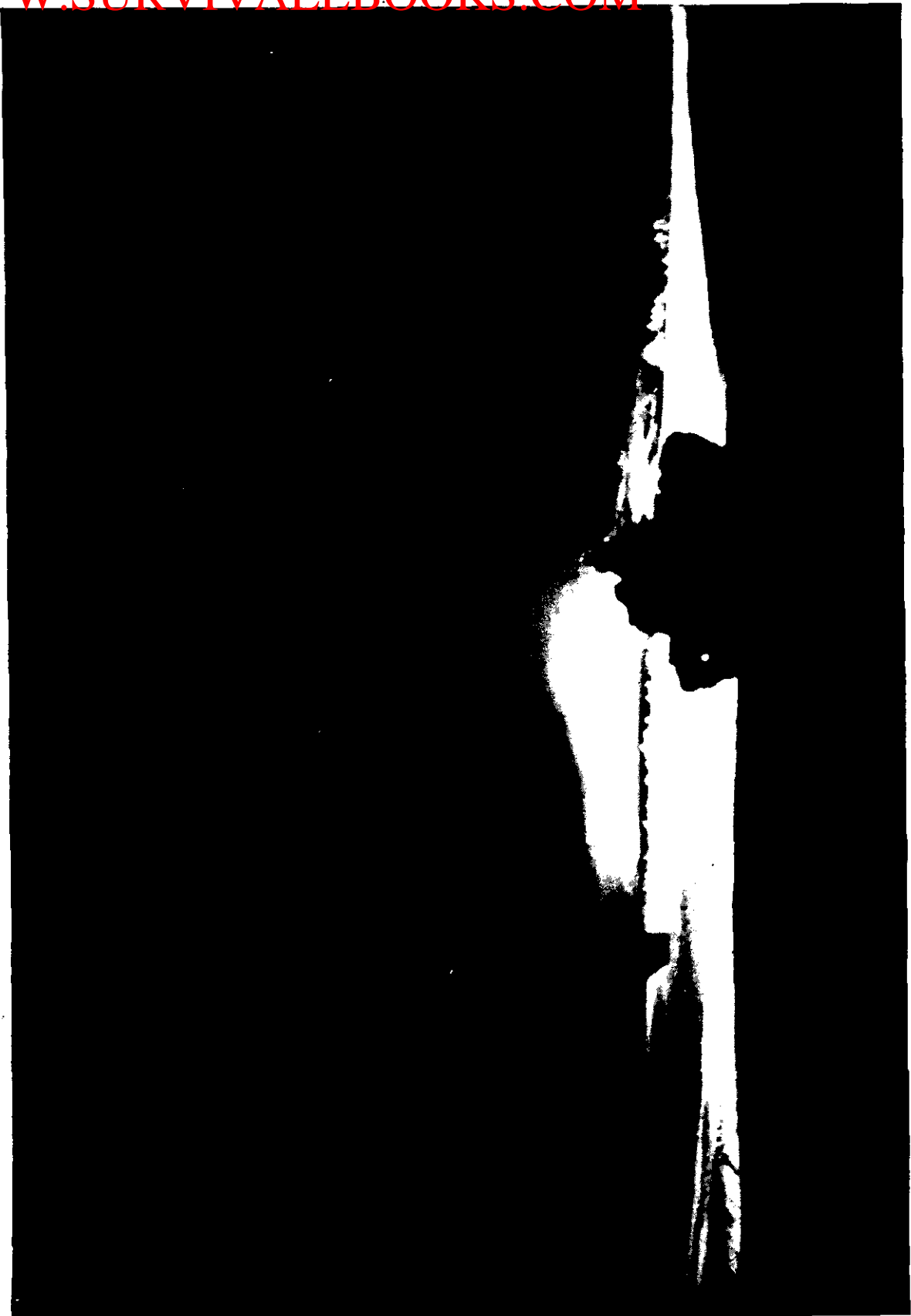

Figure 85. Visible direct illumination.

other friendly equipment or installations. In such a case, it might be preferable to use an alternate, though less effective, means of illumination.

(3) *Availability of illumination means.* In determining the availability of means, factors which should be considered are the types of illumination means on hand or obtainable in time for use, the quantities on hand, and the logistical situation.

(a) Since it is normally more difficult to supply ammunition to mortars than to artillery, it is often better to employ artillery in the illumination role. However, the maneuver force may be required to use organic mortars to establish illumination in the event that the direct support artillery has other priorities of fire. Similarly, even though 30-inch searchlights or aircraft flares may be a more effective or more economical illumination means than illumination shells, it is often necessary to use illumination shells until searchlights can be moved to suitable positions or until aircraft become available. The availability of illumination means frequently dictates which will be used even though other means may be preferable.

(b) Use of supporting artillery and mortars in an illumination role may interfere with their primary role of delivering supporting fires. This use may reduce the number of weapons firing regular support missions; and may saturate the communications to an extent that the overall efficiency of indirect fires is reduced.

(c) Since no one means is entirely reliable or suitable in all circumstances and since the enemy may neutralize the first choice of illumination means, plans should be made for alternate means of illumination.

7. The Employment of Tank-Mounted Searchlights

The infrared-visible night vision kit for the main battle tank operates in both the visible and infrared modes. The range is less in the infrared mode. The employment is based on certain techniques of positioning lights, combining lights, and turning on lights. Lights must be controlled and their effect on the enemy must be considered. For fire commands used to control searchlights and for technique of target engagement see FM 17-12.

a. Single or Intersecting Beams. A single beam or an intersection of two or more beams may be used to—

- (1) Mark targets or objectives (fig. 86).
- (2) Aid in deception by illuminating an area or point outside of the area of action.
- (3) Orient aircraft and illuminate landing areas. (Aircraft must have IR viewing device to operate in the infrared mode.)

b. Flicker Illumination. Tank-mounted searchlights should be operated in groups of two or more using flicker illumination techniques. The duration of each flicker should be approximately 15 seconds. A sequence of illumination among the tanks should be used. Once illumination of a target area has begun, keep the target area illuminated by turning the operating searchlight off only after the next searchlight in sequence has been turned on. This will preclude times of insufficient illumination for firing.

c. Positions. The tactical employment of tank-mounted searchlights is facilitated by daylight reconnaissance and selection of positions. The reconnaissance should include azimuths and elevations to prominent points and target areas. Positions should be located as accurately as time and facilities permit. Final selection of positions should consider the location of vital friendly installations that could be damaged by enemy action directed at the searchlight. The position should use maximum defilade compatible with the direct illumination mission. Ideally, the position should be on high ground to afford maximum range and flexibility and to avoid silhouetting friendly troops located along or near the axis of the beam.

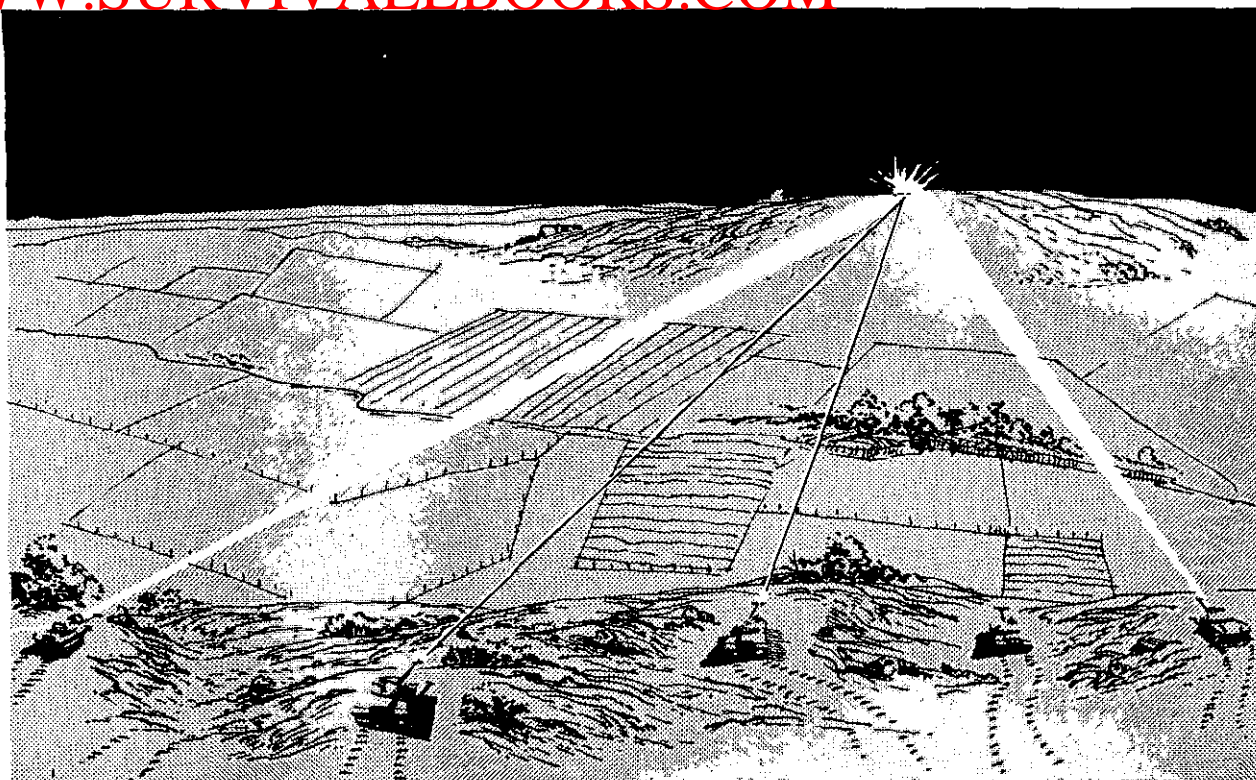

Figure 86. Intersecting searchlight beams marking a target (visible or infrared mode).

d. Control of Searchlights. The unit commander may retain central control of the searchlights to be used in an operation or he may utilize normal command channel, depending on which method best contributes to the accomplishment of the mission.

e. Effects on Enemy Observers. In using the searchlight for direct illumination, the following effects on enemy observers should be considered:

- (1) Direct observation into the visible light source with the naked eye will cause a loss of night vision varying from loss of night adaptation to night blindness depending on the nearness of the light source. If the eyes are protected by an IR or passive vision device, only loss of night adaptation will occur and the device itself will be only temporarily inoperative. Since the night viewing devices do not require the use of night adapted eyes for operation, they are effective again

as soon as direct observation into the light source is ended.

- (2) An observer located in the light beam will find it difficult to estimate the range to the searchlight.
- (3) Objects silhouetted between an observer and the light beam are visible for several hundred meters.

8. Tank-Mounted Searchlights in the Offense

a. Direct Illumination. In using tank-mounted searchlights for direct illumination, the following basic considerations are applicable:

- (1) Vehicles or troops advancing toward an enemy position should remain along the outside edge of the searchlight beam so as to use the stray light along the edge of the beam without being in the beam itself.
- (2) Assuming that the enemy position is known, a moving tank unit may reduce the probability of detection by the following use of searchlights:

- (a) If the enemy observer is some distance (1,500 meters) from the friendly visible light source, position the light so that the observer is generally in the center of the beam; the friendly approaching elements should then remain on either side, outside the beam's edge.
- (b) If the enemy observer is relatively close to the friendly visible light source (700 meters), then position the light beam so that he must look through or across it. The friendly approaching element should remain beyond the far edge of the beam away from the enemy (fig. 87).
- (3) It is difficult to maintain searchlights on targets while searchlight tanks are moving over rough terrain. At the same time, tank-mounted searchlights accompanying a maneuvering force may disclose the direction of attack if searchlights are left on continuously. Therefore, whenever the terrain and

enemy situation permit, searchlight tanks should advance by bounds. Illumination should be accomplished while tanks are stationary; searchlights should be extinguished when tanks are moving.

b. *Employment in the Offense.* Tank-mounted searchlights are best employed in the infrared mode for security and visible illumination should be used only when necessary. They are employed in the following roles:

- (1) In the initiation and the continuation of an exploitation or pursuit.
- (2) In a night attack against a hastily organized position.
- (3) In a night penetration, as part of the assault force, to conceal the movement of accompanying tanks and infantry in the cloak of darkness between the visible light beam and the objective. The IR mode provides concealment only against observers using IR viewing devices (fig. 87).

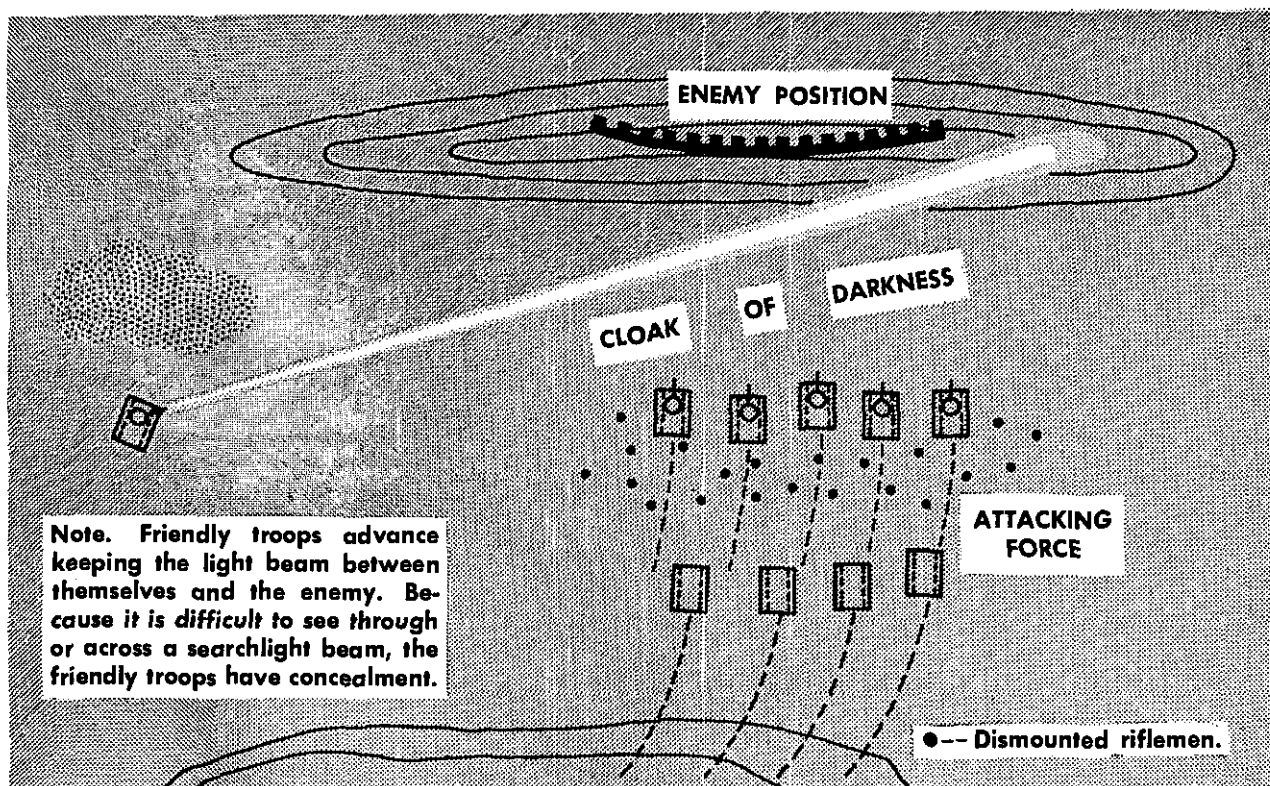

Figure 87. The cloak of darkness behind the vehicle searchlight beam.

- (4) In a night envelopment, as part of the base of fire, to illuminate the objective.
- (5) In orientation of friendly troops. This can be accomplished by illuminating a part of the objective, terrain features leading to the objective, or terrain features between the line of departure and the objective. The light beam itself may be used as a guideline, boundary, or line of departure. Friendly troops should avoid moving in the brightest part of the beam but should skirt the edge of the beam to obtain maximum concealment.

c. Methods of Employment. Tank-mounted searchlights may be employed in one or a combination of the three following methods of attack. Where possible, the illuminating tanks should be provided by units other than the maneuvering force.

- (1) *Illuminating tanks support by fire and illumination.* Tanks should be dispersed 50–100 meters apart through-

out the supporting position (fig. 88). The commander should be located to control the lights and should enter the maneuver force command net. Illumination should not take place until called for by the commander of the maneuvering forces, but it should be employed in sufficient time to allow friendly fires to neutralize enemy fires and obtain fire superiority before the assault on the objective. While illuminating, the searchlight tank commanders must be alert not to silhouette elements of the maneuver force. Flicker illumination techniques should be employed, with each searchlight laid on its target before illumination is initiated. During flicker illumination those tanks that have extinguished their lights should search out and engage enemy point targets illuminated by the other tanks. Plans for reorganization on the objective must include plans for alter-

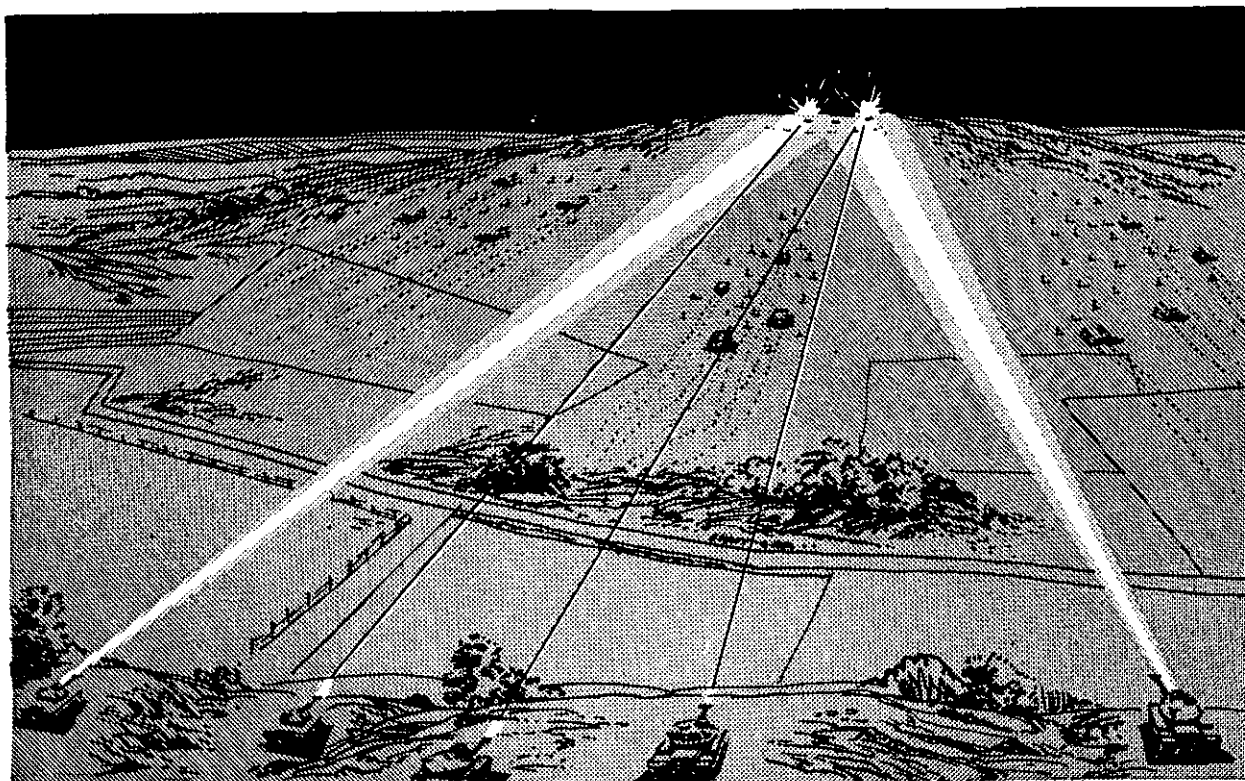

Figure 88. Use of tanks with searchlights in the "support of fire only" role (visible or infrared mode).

nate means of illumination, shifting of lights, and illumination in event of counterattack. Plans also should be made to illuminate the flanks of the new position to aid in covering avenues of approach and areas used by enemy counterattacking forces attempting to outflank the new positions. Care must be taken to avoid creating shadow areas favorable to enemy counterattacking forces.

- (2) *Illuminating tanks incorporated into the maneuver force* (fig. 89). This method is used for deep objectives. The illumination unit should follow the maneuver force closely so that it will not hamper maneuver of the attacking force but will be located so that it can move into illuminating positions when required. The maneuver force commander will control the illumination through the illuminating unit commander. Searchlight tanks should approach to within 1500

meters or less of the target or objective before illuminating. Flicker illumination should be used. Even though the enemy may expect an infantry attack from some other direction than that of the attacking tanks, the blinding condition of the visible lights may effectively prevent enemy observation. Friendly infantry may attack from any direction outside the searchlight beam and still benefit from the darkness. The infantry must close rapidly with the enemy, securing the positions as quickly as possible, to reduce the illumination time. Normally, tank-mounted searchlights will maintain illumination until the objective is taken. Extinguishing of visible lights will cause night blindness unless an alternate light source is provided as a flicker illumination or by using artificial moonlight or parachute flares. Plans for reorganization of the position will include the order to ex-



Figure 89. Use of searchlights when tanks and infantry are used in the maneuver force.

tinguish or shift lights, provision for illumination in event of counterattack by the enemy and the mode of illumination. Positions for searchlights on the objective must be reconnoitered and occupied rapidly.

- (3) *Illuminating tanks provide boundary illumination.* Tank searchlights may be used to mark boundaries after illumination has been initiated. When employed in this manner, they operate in pairs and use flicker illumination. They move by bounds in the same direction as the attacking force and lay the searchlight beam on predetermined terrain features or on a given azimuth.

9. Tank-Mounted Searchlights in Defense

a. General. The searchlight is used to cover likely avenues of approach and provide illumination for night counterattacks. Proper use of searchlights in coordination with listening posts, passive viewing devices, and ground surveillance radar provide an additional aid to surveillance and assists in gaining tactical surprise over approaching enemy troops. The reverse of the tactics for offense (para 8) will apply when an enemy is using a searchlight in direct illumination on the offense. Friendly forces should give special attention to the dimly illuminated area *outside* the edge of the enemy light beam. The defender should try to silhouette an advancing enemy against the beam's light.

b. Planning. Preparation for the defense always include the employment of tank searchlights. Use of tank searchlight requires the same planning and coordination that precede any other defensive action. Planning will include these additional considerations—

- (1) Tank searchlights must be coordinated with other illumination means and tied into the team and task force fire plans.
- (2) Primary, alternate, and supplementary positions should be selected.
- (3) Illumination must be strictly controlled to prevent premature illumination and to minimize the time required to engage and destroy a target.

- (4) Alternate means of communication should be provided.

c. Employment.

- (1) Requirements for clear fields of illumination are similar to requirements of direct-fire weapons for clear lines of sight to the target area. The commander will select areas and assign priorities for illumination. He will designate the type of illumination to be used (visible or IR). Searchlights will be laid on selected areas to provide instantaneous illumination, either sweep or fixed, on order. Selected areas will be given code designations. Illumination will be requested by code designations, thus reducing the time required to put the lights in action. Illumination data will be incorporated into the range card for each tank in the defense area positions.
- (2) Coordination and control of the initiation of illumination by tank searchlights will be retained at brigade or task force level as the situation warrants. (Exterior teams of the task force may need brigade approval to illuminate if such action can affect an adjacent task force.) However, the employment of the searchlights will be the responsibility of the team commander.
- (3) Searchlights may be extinguished when in imminent danger of being destroyed or extinguished by close-in small arms fire, or when the final protective fires have been penetrated by the enemy. In either case, the decision to extinguish lights will normally remain with the commander of the defending unit.
- (4) Efforts will be made, by using deception and fires, to direct the enemy to areas where searchlights can be used to illuminate him for his destruction by aimed fire of infantry and tanks. By engaging the enemy at maximum effective ranges, his attack may be retarded. Special attention should be given to fringe areas of

fixed beams since the enemy, while avoiding direct illumination, may attempt to use the low-level illumination on the edge of the beam to assist his advance. The enemy, attempting to avoid illumination, may be canalized into selected areas best suited to defense by our forces or into ambushes or minefields.

- (5) Effective fire may be obtained by having one tank engage the target with its searchlight while another tank engages the target with the main gun or machinegun. The firing and illuminating roles will be exchanged frequently to decrease exposure of the illuminating tanks to counterfire.
- (6) Tank-mounted searchlights, as part of the illumination plan, are integrated into the coordinated fire plan to obtain maximum effectiveness of fires.
- (7) Steady illumination is to be avoided since it permits the enemy to adjust fires against the tank positions. The

alternating periods of light and darkness obtained by flicker illumination serve to confuse the enemy.

- (8) Areas or points of illumination will be picked at the maximum range of the light, and guns and lights will be pre-laid on these target areas. When blocking positions are within illumination range of each other, coordination in the use of tank-mounted searchlights will be established. The searchlights of one position can assist adjacent blocking positions by illuminating areas between positions of the flank of an attacking force (fig. 90).
- (9) Until the entire defensive position is committed to action, the minimum number of lights necessary to accomplish the defense mission will be used to prevent disclosure of the size of the defensive force.
- (10) Flexibility in the defense is assisted by placing tank-mounted searchlights in position to support friendly coun-

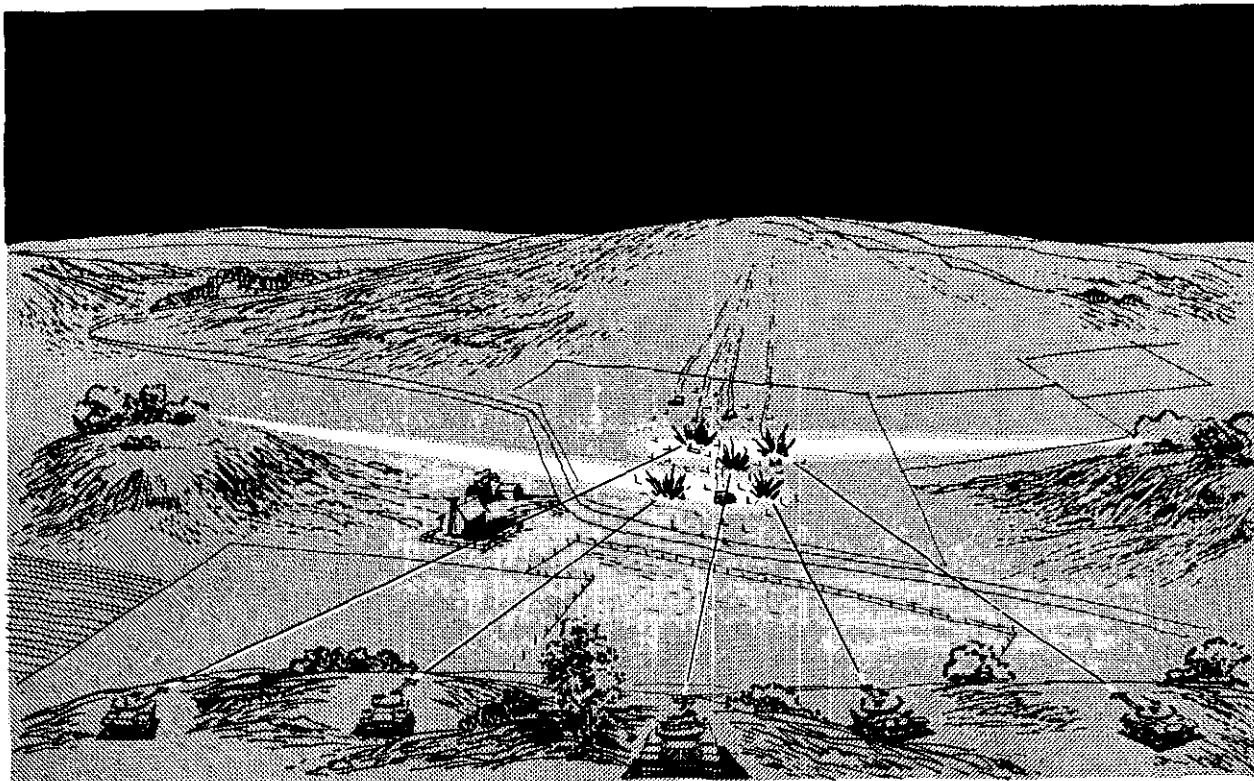

Figure 90. Tank searchlights illuminating area between blocking positions.

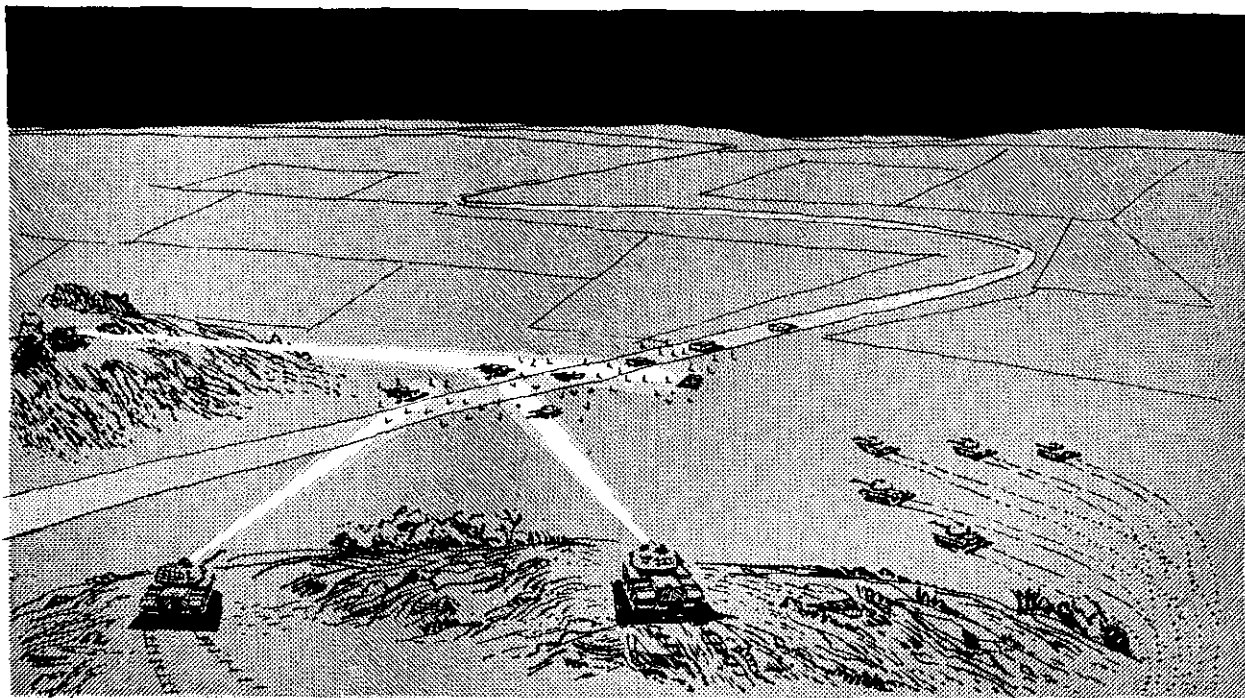

Figure 91. Tank searchlights supporting friendly forces in the counterattack (visible or infrared mode).

terattacking forces (fig. 91). In the event a unit must support a counter-attack, illumination will be provided based on the three methods of illumination designated for the attack. The counterattacking force commander will control the initiation and termination of illumination through the command net of the unit responsible for the conduct of the counterattack.

10. Night Occupation of Position

Normal daylight occupation techniques are followed at night supplemented by additional control techniques. At night or during periods of limited visibility, the guide for subordinate units should be equipped with markers so that he can physically mark the location for each vehicle on the ground. Ideally, these markers should be luminous and positioned in a manner not detectable by the enemy. The route to each vehicle location may be marked with white tape or other light reflective material. If tactical considerations permit, a unit may coil in the open before entering the area. While vehicles are being fueled, the commanders can complete a reconnaissance of the route into the

area and actual location for the vehicles. Vehicle locations may be adjusted by the commander during this reconnaissance. This period allows vehicle crews time to gain or regain night vision. Normal night security will be posted at all times.

11. Guide Signals

For signals used by guides at night, see FM 21-60.

12. Countermeasures Against Visible and Nonvisible Lights

a. Visible Light. The most effective countermeasure against visible illumination, other than destruction, is counterillumination. This reduces or sometimes nullifies the effectiveness of the initial illumination. Other measures are the use of smoke to diffuse the light, direct or indirect fires placed on the light source, and assault of the light source position by infiltration.

b. Nonvisible Light (IR). Nonvisible illumination of the battlefield must be detected before effective countermeasures may be taken. After the illumination device has been detected and the range of its location determined, the following courses of action may be taken—

- (1) The device may be kept under observation for possible elimination later.
- (2) The device may be fired on by direct or indirect weapons.
- (3) Counterillumination may be used.
- (4) Smoke may be used to diffuse the light.

13. Passive Night Vision Equipment

a. General. Passive equipment used to survey the battlefield are dependent upon the amplification of natural night light or IR radiations. The use of passive equipment should be considered by each commander in planning fields of fire, the operations plan, and the surveillance plan. Passive night vision equipment is ideally suited to operations requiring stealth and secrecy. Because of the passive nature of this equipment, authority to use it is generally given with its issuance to the unit. Normal observation techniques are followed with appropriate changes.

b. Types of Passive Night Vision Systems.

- (1) *Image intensification system.* This system uses natural light from the night sky reflected by the target. It produces a useful visible image in a viewing scope that is essentially the same as a near IR viewing scope. Fog, haze, smoke, dust, and snow reduce the effectiveness of the system.
- (2) *Far infrared system.* This night vision system uses a scope that receives and amplifies far infrared radiations present in the natural radiation or heat emitted by all objects and present an image or an indication of a target. For this reason, it is a passive system and is independent of natural or artificial light. Since most military targets are warmer than

their background, they may be detected with far infrared equipment even though lightly camouflaged. This equipment performs better under poor night visibility conditions than other types of night vision equipment but it does not have an all-weather capability.

c. Employment of Passive Night Vision System. Passive night vision equipment is used for surveillance or for fire control with individual, crew served, and armored vehicle weapons. This system should be integrated into the unit's surveillance, security, and fire plans. Passive and active night vision measures are used in a complementary role. Both systems are capable of independent use. Upon detection of a suspected target, it may be possible to identify and engage the target by using only passive vision devices. If identification is not possible, active night vision equipment may be employed to positively identify the suspected target. An example would be the passive use of a metascope or IR binocular to survey an area for IR emission. Upon detecting IR emissions, an attempt may be made to identify the target, range and place, fire on it by using the metascope in conjunction with the rangefinder. If unsuccessful due to low light level, the searchlight may be used in the IR mode and if more illumination is necessary, in the visible mode. The control of active illumination equipment is vested in the commander having direct control of the operation.

d. Passive System Countermeasures. The use of passive surveillance systems may be countered by using the same techniques employed during daylight to prevent observation by the enemy except that sparse concealment is ineffective against far IR detectors. Movements or operations in areas under observation should be restricted.

APPENDIX XVI

TASK ORGANIZATION

1. General

Task organization is the cross attachment of units to implement the commander's concept of organization for combat. It is the determination of number and type of units to be placed temporarily under a single commander. In determining organization for combat in his estimate of the situation, the commander is concerned with the advantages and disadvantages of leading an attack or defending with tank-heavy, infantry-heavy, balanced, or pure units. Once he has decided to lead an attack or defend with a tank-heavy unit, the task organization must be determined since "tank-heavy" may mean 3 tank and 1 infantry units, 3 tank and 2 infantry units, or 2 tank and 1 infantry units. Examples of task organizations are contained in FM 17-15 and FM 17-30. For organization of logistical support, see chapter 10.

2. Organization

Task organization is determined from an analysis of the factors of METT and the commander's decision. Although the factors of METT are discussed separately below, it must be remembered that they are interrelated in terms of the mission. For a detailed discussion of the factors of METT, see chapter 2.

a. Decision. The task organization must satisfy the commander's needs as expressed in his decision on organization for combat.

b. Mission. The anticipated mission and tasks of the unit to be organized must be considered. The subordinate commander will be assigned sufficient combat power to accomplish his mission. A useful technique is to visualize the employment of elements in accomplishing the mission, which should allow a fair estimate of the number of elements required.

c. Enemy. The effectiveness of the enemy is based on his strength, composition, disposition, and location. An analysis of these conditions assist in determining the number and type of forces to be assigned to a subordinate commander.

d. Terrain and Weather. Terrain and weather affect the combat power of units. An analysis of these factors is important in determining the type of forces to be assigned to a subordinate commander.

e. Troops Available. The greatest limiting factor to task organization is the restriction imposed by the number, type, and combat effectiveness of units available. All aspects must be analyzed, including the number and type of units and their capabilities, their state of training, maintenance, status of supply, present locations and missions, recent activities, and contemplated future requirements. When defending against modern mechanized forces, particular attention must be given to distribution of tank and antitank forces between the forward defense forces and the reserves to insure that both have adequate combat power to accomplish their mission. The personalities of commanders are also a consideration.

3. Source of Units

As a technique, task organization (including unit designations) will be stated in the operation order (app IX). However, whenever possible, subordinate commanders should be asked to furnish the designation of their elements to be detached. For example, the battalion S3 determines that Company A will furnish one platoon to another company. The S3 should, if time permits, ask the commander of Company A which platoon he desires to detach. The com-

mander of Company A will furnish the platoon best suited for the task.

4. Changes to Task Organization

Task organization, if changed during the conduct of operations, is more strongly influenced by time and space factors and current activities of the unit. Many actions may be initiated with a task organization that is less than ideal in the interest of timeliness and troops available.

5. Use of Battalion Headquarters

a. Situations can be expected to develop that will require one battalion to be attached to another battalion or all companies of a battalion to be attached to other battalions. This leaves a control headquarters without subordinate elements which is undesirable and should be avoided if possible.

b. When a battalion is attached to another, the battalion attached becomes subordinate to the battalion to which attached. Missions for an attached battalion may include functioning as the reserve, functioning as one of the attacking elements or assuming responsibility for a part of a defensive sector.

c. Missions for a battalion headquarters without subordinate elements created as a result of brigades attaching all of the companies to other battalion task forces may include—

- (1) Use as an alternate brigade command post.
- (2) Use as a planning group for future

operations, or for developing counter-attack plans in the defense.

- (3) Augmentation of the brigade staff to permit both staffs some rest.
- (4) Use as a control headquarters for rear area security and damaged control operations.

6. Use of Company Headquarters

a. Situations may arise requiring a company to be attached to another company or all platoons of a company to be attached to other companies leaving a control headquarters without subordinate elements. Either situation is undesirable and should be avoided if possible.

b. When it is necessary to attach a company to another, the company attached becomes subordinate to the company to which attached. Appropriate missions for the company headquarters in this status are to—

- (1) Assist in planning.
- (2) Supervise organic or attached fire support elements.
- (3) Supervise the logistical effort.

c. Missions appropriate for a company headquarters without subordinate elements created as a result of battalion task force's attaching all of the platoons to other companies may include—

- (1) To assist in planning or reconnaissance.
- (2) To assist the battalion staff in the technical aspects of the employment of the attached platoons.

APPENDIX XVII

EMPLOYMENT OF THE ARMORED VEHICLE LAUNCHED BRIDGE (AVLB)
AND THE COMBAT ENGINEER VEHICLE (CEV)

Section I. EMPLOYMENT OF THE ARMORED VEHICLE LAUNCHED BRIDGE (AVLB)

1. General

a. An armored vehicle launched bridge section is organic to each tank battalion. Each section has two assault bridge launchers, each launcher mounting a 60-foot, class 60, assault bridge (fig. 92).

b. The armored vehicle launched bridge platoon of the bridge company, division engineer battalion, has two organic armored vehicle launched bridge sections. Each section has two assault bridge launchers with each launcher mounting a 60-foot, class 60, assault bridge. In addition, each section has one heavy tractor-trailer that transports one assembled spare assault bridge. These AVLB's provide assault bridging to the armored cavalry squadron, task forces built about the nucleus of the mechanized or infantry battalions, or supplements the assault bridging of the tank battalions.

2. Uses

The armored vehicle launched bridge (AVLB) is employed primarily in assault crossings, but because of its mobility and minimum constructing personnel requirements, it may be used effectively in other ways. It is particularly suitable for spanning streams, antitank ditches, craters, canals, partially blown bridges, and similar obstacles that normally would slow the momentum of attack. Where the flank of friendly forces is on a narrow stream or defile, the assault bridge may be used in supporting a flanking movement. Similarly, where a task force reserve is to be shifted across a front in a minimum of time, assault bridging can be emplaced rapidly, using only a

few operating personnel, compared to other type bridging. In retrograde movements, an AVLB can be used in place of conventional bridging that has been destroyed or removed. If time permits, special preparation and stabilization of the launching site will facilitate rapid recovery of the emplaced bridge, thus the launch crew will be exposed to enemy fires for a minimal time. If the bridging cannot be recovered, it must be destroyed.

3. Normal Sequence for Employing the Organic or Attached AVLB

a. A gap is encountered by the leading elements of the task force, or its existence has been determined from intelligence.

b. The proposed crossing site is reconnoitered quickly by the scout elements or by the supporting engineers, or both, to determine the width of the gap, bank conditions, locate access routes, and mark and determine the launching site. The task force commander will normally commit attached assault bridges, if any, from the division engineer battalion before commitment of his organic bridging.

c. On approval for emplacement, an AVLB is brought forward under the overwatching fire of the leading tactical elements and emplaced quickly. The successful emplacement of an assault bridge is reported immediately to brigade. This report should include—

- (1) Bridge location.
- (2) Estimated time task force elements will complete crossing.
- (3) Mechanical condition of bridge.

d. The tactical elements of the task force



Figure 92. Armored vehicle launched bridge.

then cross the assault bridge and resume the attack.

e. When the last tactical element of the task force has crossed and in the absence of orders from the brigade commander to *leave the assault bridge in place*, the task force commander will direct recovery of the emplaced bridge. On recovery of the assault bridge, the AVLB should be afforded route priority in moving it forward to position with the leading tactical elements. The recovery of the bridge must be reported to the next higher headquarters.

4. Other Than Normal Recovery of the Assault Bridge

a. When the brigade commander directs that an assault bridge remain in place, he takes the following actions:

- (1) Reports his decision immediately to division G3.
- (2) Requests a replacement bridge.
- (3) Establishes a rendezvous for transshipment of the replacement bridge to the organic launcher.

b. Working within established policies, the division engineer supply officer may coordinate the delivery to and transfer of a spare assault bridge from the division engineer battalion to a task force. The division engineer battalion may be in the best position for the most rapid replacement from within its reserve during a fast-moving situation. If the division engineer battalion has expended its supply, or if priorities prevent such support, the replacement

bridge will be made through normal logistic channels. Resupply to both the tank and engineer battalions is the responsibility of the division support command.

c. Recovery of emplaced AVLB for reconstitution of the engineer battalion capability or

for return to supply channels will be accomplished by engineer elements. Authority for recovery and responsibility for ultimate recovery of an emplaced AVLB remains with the commander who employed the bridge unless control by a higher echelon has been assumed.

Section II. EMPLOYMENT OF THE COMBAT ENGINEER VEHICLE (CEV)

5. General

The combat engineer vehicle is basically a main battle tank which has been modified to provide a dozing, winching, lifting, and demolition gun capability for combat engineers operating in the forward battle area (fig. 93). It is organic to combat engineer companies. The turret is provided with a hydraulically-operated A-frame type of boom and with a winch in addition to the main armament, automatic weapons, and other required equipment. The main armament is the demolition gun (165mm). Secondary armament consists of a

coaxially mounted 7.62 machinegun and a .50 caliber machinegun mounted in the cupola.

6. Capabilities

The CEV provides engineer troops an armor-protected means of accomplishing pioneer tasks under hostile fire in support of teams and task forces. In combat operations involving movement, armor commanders position CEV's in formations to provide quick response. This is necessary to maintain the momentum of the operation. Typical tasks which may be assigned to the CEV are—

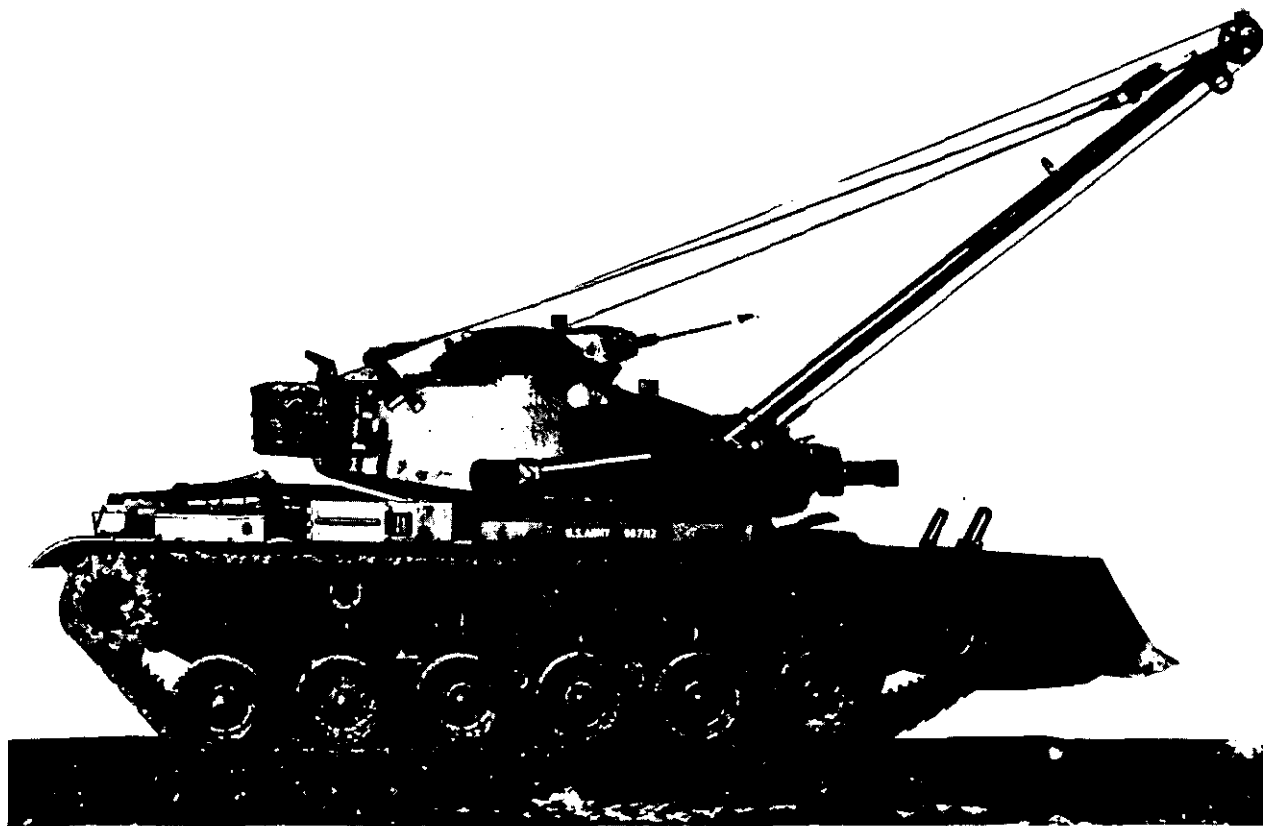

Figure 93. Combat engineer vehicle.

a. Destruction or removal of obstacles by use of the demolition gun, bulldozer, winch, or boom.

b. Construction of roadblocks and other obstacles by use of the bulldozer, winch, or boom.

c. Passage of short dry gaps, antitank ditches, and craters by earthfilling using the bulldozer.

d. Placement of fixed span assault bridging or fascines for passage of short gaps.

e. Preparation of abutments for the armored vehicle launched bridge (AVLB).

f. Removal of barbed wire entanglement by dozing or running over the wire obstacle.

g. Construction of approaches and entry and exit points for fording and amphibious vehicles.

h. Construction of combat roads and trails.

i. Destruction of strongpoints in the assault of fortified areas or in combat in built-up areas.

j. Clearance of rubble and debris in built-up areas to permit passage of other combat vehicles.

k. Construction of tank and gun emplacements.

l. Launching explosive mine clearing devices in the assault breaching of minefields.

7. Limitations

Although the CEV is a heavily armored vehicle and carries a 165mm demolition gun, it is designed for use as a combat support vehicle, not as a tank. When employed in forward areas subject to enemy tank or antitank fire, it requires protection by tanks or other antitank weapons. The crew of the CEV is trained to utilize the vehicle in combat construction and demolition tasks, not in armor tactics. The CEV should be used only for those combat engineer tasks required to support assault elements.

APPENDIX XVIII

MINE WARFARE

1. Minefield

Mines are among the best of artificial obstacles—they are portable, installed and camouflaged easily and constitute a great hazard to the enemy; however, large scale employment of mines requires considerable time, manpower, and logistical effort. They delay and canalize enemy movement and can lower the will of enemy soldiers to fight by the fear of casualties they produce. They can be used to support all types of combat operations. Once laid, mines remain a hazard to both the enemy and to friendly forces until neutralized. The mine warfare policy at each echelon must be consistent with the overall concept of operations, including future plans. Commanders may restrict the employment of mines by controlling or revoking authority to employ and prohibiting certain types or use in specified areas. Restrictions on authority and the delegation of authority are mandatory so that smaller units do not engage in mine warfare without the knowledge of a commander responsible for maneuver in the area. Subordinate commanders should be permitted to use mine warfare to achieve economy of force, strengthen the battle position, and delay or disrupt the enemy unless cogent reasons for restrictions exist. Unduly restricting a subordinate commander's use of mines against an enemy who employs mines effectively may adversely affect the unit's ability to perform its mission. Conversely, failure to impose proper restrictions may jeopardize future operations. In internal defense operations, the effect that minefields will have on the local population and the overall mission of winning the support of the people must be considered. For information on the employment of land mines, see FM 20-32 and FM 31-10.

2. Minefield Employment Planning

A commander desiring to use mines evaluates their employment by considering the factors of METT—

a. Mission. The tactical plan of operations will determine the type of minefield used, its size, mine density, location, and extent of safe gaps and lanes.

- (1) *Size.* When plans envision early attack, a minimum effective field is installed. If a prolonged defense is contemplated, the minefield should be planned with increased densities and depth to provide maximum effectiveness.
- (2) *Location.* To be most effective, a minefield should be anchored to natural or artificial obstacles. On a short-term basis, minefields should be sited in likely avenues of enemy approach. For prolonged defense, fields should be located to permit later expansion. They must require more time and be more hazardous to breach than to flank. Minefields may be skillfully used to mass targets for artillery and antitank weapons and to canalize an attacking force into a small area covered by massed fires. On a larger scale, minefields may be laid in patterns, so that a penetration of the foremost field will be contained by subsequent fields. Carefully concealed gaps can then be used as counterattack routes.
- (3) *Lanes and gaps.* Minefield lanes and gaps must be left to allow the unit protecting the field, and adjacent

units, to execute operational plans such as patrolling, attacking, and counterattacking. Lanes and gaps must be located skillfully to prevent easy detection by the enemy. Their trace should be irregular and not follow established roads or paths. Every effort should be made to deceive the enemy of their location. When laying minefields, wheeled and tracked vehicles can be used to establish paths through the field, which can later be mined, thus prompting the enemy to think these tracks indicate the trace of safe lanes. The location of lanes and gaps must be changed frequently to prevent detection and subsequent ambush of patrols. In minefields having a high density of small, nonmetallic mines, locations for future lanes and gaps should be determined before the field is installed and more easily detectable mines laid in such areas.

b. Enemy. Enemy capabilities will influence the size, composition, and type of minefield to be laid. The following should be considered:

- (1) The strength and tactics of enemy forces.
- (2) The quantity and quality of enemy breaching equipment and the technique and effectiveness of enemy breaching methods.
- (3) The capability of the enemy to harass or otherwise interfere with the progress of the laying force. To hinder enemy ground and air observation of mining operations, mines should be sited in folds in the ground, and around blind curves in roads, yet be in a position where they can be covered with fire.
- (4) The capability of enemy intelligence to locate friendly minefields, thereby weakening or nullifying the minefields intended purpose.

c. Terrain and Weather.

- (1) *Terrain.* Careful analysis of the terrain, for tying in the minefield with natural obstacles, will materially increase the overall effectiveness of the

position. The type and bearing capacity of soil must be considered. This is essential to the laying of individual mines ((2) below).

- (2) *Camouflage and concealment.* When analyzing the terrain for employing mines, the weather and the season are considered so the individual mines may be properly concealed to surprise the enemy.

- (a) When a minefield is to be retained for a long period of time during the spring and summer months, it should not be laid in grassy pasture areas unless absolutely necessary. Differences in the rate of growth between the grass over the mine and adjacent grass will indicate the location of mines.

- (b) In the fall and winter, minefields are placed where excessive snowdrifts are unlikely to build up. Excessive snow may interfere with the functioning of the mines.

- (c) The concealment afforded by the vegetation in the area should be exploited to increase deception and difficulty in clearance. The type of mines that can be easily camouflaged should be used.

- (d) Minefields should be under friendly observation and fire and so sited as to deny the enemy knowledge of their location.

d. Troops and Mines Available.

- (1) The experience, training, and number of troops and material available will determine the extensiveness and effectiveness of a minefield laid within a specified time limit. The availability of mines in basic loads and supply dumps and restrictions on the use of certain types are important considerations in planning and siting a minefield. When the supply is limited, priorities and controls must be established. In critical areas, mine uses must be specified and quantities allocated carefully.

- (2) Minefields to be effective must be covered by fire. Artillery and antitank fire will destroy damaged or immobilized enemy vehicles, and small-arms fire will prevent enemy troops from breaching the minefields.

3. Employment of Minefields

a. General. Effective employment of mines is dependent upon a thorough knowledge of their function and the tactical use to which they can be applied. Minefields may consist of antitank or antipersonnel mines, or both. Minefields are classified functionally as protective, defensive, barrier, nuisance, or phoney (FM 20-32). Armor units will normally employ the protective or defensive type minefield.

b. Protective Minefield. Protective minefields supplement offensive and defensive fires by providing close-in protection and warning to small units. They may be used to block gaps and lanes through existing obstacles, containing as few as five or six mines.

- (1) They should contain easily detectable mines that are laid (no pattern) just beyond hand grenade range of the units positions. The mines are laid initially on the surface of the ground and then, time permitting, buried and camouflaged. The mines in this field are normally removed and returned to the unit's basic load for reuse in future operations unless the field is absorbed into a defensive or barrier minefield.
- (2) Battalion task force commanders have the authority to employ protective minefields and may delegate this authority to company team commanders. They are usually laid on short notice for short duration and should be positioned where they can be covered adequately by small arms and antitank fires. Properly positioned, they may be effectively employed during short halts, about refueling points, overnight assemblies, as flank security to block roads in defiles, and as counterattack obstructions after an objective is taken. The latter use provides an effective obsta-

cle when the enemy has limited maneuver room.

c. Nuisance Minefield. Nuisance minefield may be employed as required, however, authority for laying is usually not lower than the division CG. When approval for laying is granted, these minefields may consist of the following:

- (1) *Roadblocks.* Antipersonnel mines should be laid around and adjacent to roadblocks to hinder their breaching by the enemy. Antitank mines may also be laid forward of a roadblock; it is desirable also to lay them on the friendly side to add depth to the obstacle. The latter is a deceptive measure since the enemy will move forward quickly once the obstacle is overcome only to encounter mines a few meters beyond.
- (2) *Approaches to bridges.* Mines placed on the approaches to bridges and near the abutments is added assurance of delaying the enemy in case of a misfire in blowing the bridge. Mines near the abutment may, in addition to destroying or disabling a vehicle, render the bridge unusable until repaired. Also, it will hinder the enemy in using this location for a hasty crossing site.
- (3) *Ferry sites.* The near and far approaches to ferry sites should be mined to delay the enemy. In the event the enemy breaches the mines on the far approach, the mines laid on the friendly side will restrict his movement out of the water.
- (4) *Fords.* Fords should be mined on the friendly side extending the mines into the water. This method makes it more difficult for the enemy to utilize the ford since vehicles disabled by a mine will block the ford.

d. Laying of Individual Mines.

- (1) *General.* Mines may be laid on top of the ground and concealed by covering them with leaves, brush, grass, or other materials natural to the sur-

roundings. Mines may also be buried and camouflaged. If they are placed under sod, the turf should be carefully cut, rolled back, then replaced over the mine after it is positioned in the ground. In soft snow up to four inches in depth, mines may be placed in the snow resting upon the ground. On ice or hard-packed snow, mines may be painted white and placed on the surface. Pull-type firing devices only should be used to boobytrap mines when employed in snow; other types will collect moisture, freeze, and become inoperative, or melting snow or ice may cause the device to set off the mine. Tripwires should be 45 centimeters above snow because a taut tripwire or one close to the surface of snow is easily seen. Regardless of the season, camouflage is important in the laying of mines. All spoil, mine containers, tape, and other working materials must be removed from the mined area. Deceptive measures, such as making tracks in grassed areas and snow before the mines are laid, may also be used.

- (2) *Antitank mines.* Antitank mines are placed in holes dug two or three inches larger than the mine at the bottom and sloped outward at an angle of about 45 degrees toward the surface. The depth of the hole should be such that the pressure plate of the mine is flush with the ground but not more than $\frac{1}{2}$ -inch above the ground (fig. 94). If the soil is soft or spongy, a piece of board or a stone is placed under the mine to provide a solid foundation. The earth removed from the hole is used to fill in around the mine and to provide a $1\frac{1}{2}$ -inch covering over the mine. Excess soil is removed from the minefield. If mines are laid in grassed areas, the sod may be folded over the top of the mine, providing the proper depth of cover. The fuzing and arming of antitank mines are described in TM 9-1345-200.

- (3) *Antipersonnel mines.* The methods for laying, fuzing, and arming of antipersonnel mines vary considerably, depending upon the type of mine (TM 9-1345-200). In general, antipersonnel mines are buried with the fuze extending above the ground because they are set off by stepping on the fuze or by pulling or cutting a tripwire attached to the fuze. When tripwires are used, the far end of the wire must be anchored firmly. Care in camouflage is essential; this includes the removal of excess soil from the mined area.

e. Battle Drill. The following battle drill is designed for tank crews and infantry fire teams in the rapid laying of protective minefields.

- (1) *Tank crew.* The tank commander and the loader dismount, each carrying two antitank mines. The gunner assumes the position of the tank commander, mans the tank weapons providing covering fire and directs the driver to maneuver the tank when required. The tank commander positions the mines on the surface of the ground. The loader fuzes, arms, and camouflages each mine; time permitting they may be buried. If more mines are required, either or both crewmembers return to the tank for the mines, which are normally carried in the basket on the back of the tank. Each man returns to the tank as soon as his duties are completed. The safety clips from the fuzes are retained for reuse if the mines are recovered. The tank commander reports the mines in position. He prepares a simple minefield location report giving the pattern, number of mines, and location for the platoon leader who forwards it to the company team commander. If later actions prevent neutralization of the protective minefield, the company team commander forwards the record to the battalion task force commander for appropriate action.

- (2) *Mechanized rifle squad.* The driver of

the armored personnel carrier (APC) remains with the vehicle; other persons dismount carrying two mines each, except the squad leader who carries the mine fuzes. The driver moves the APC to a covered position and mans the vehicle machinegun. The squad or fire team leader points out where each man is to position a mine on the ground, leaving the fuzes near the first mine. The first man to lay his mines takes the fuzes and proceeds to fuze and arm each mine. The second man, following immediately behind the man fuzing and arming the mines, checks each mine to see if it is armed, then camouflages each mine; time permitting they may be buried. Each man returns to the APC as soon as his duties are completed. The squad leader reports the mines in position. He prepares a simple minefield location record giving the pattern, number of mines, and location for the platoon leader who forwards it to the company team commander. If later actions prevent neutralization of the protective minefield, the company team commander forwards the record to the battalion task force commander for appropriate action.

f. Defensive Minefields. Defensive minefields are laid in accordance with the tactical plan. They are laid between, in front of, or on the flanks of positions occupied to delay and disorganize enemy attacks and to defeat or limit enemy penetration into the tactical positions. All types of mines, flares, warning devices, and antihandling devices are used. Defensive minefields should be integrated with the plan of fire support and covered by artillery, mortar, machinegun, and antitank fire. Barrages should not be laid on the minefields but sited on their outer edges. Defensive minefield records should be prepared simultaneously with the laying, using DA Form 1355, and will normally be forwarded at least to division headquarters. For details of records and reports, see FM 20-32. Defensive minefields are laid to a standard pattern, consisting of the following elements (fig. 95).

- (1) *Mine cluster.* A mine cluster is the basic unit of the standard pattern minefield. It may contain from one to five mines. When more than one mine is used, the additional mines are placed within a 2-pace radius of the base mine. The base mine is usually an antitank mine. Each cluster will contain no more than one antitank mine. In an antipersonnel minefield, a readily detectable type antipersonnel mine will be the base mine. When chemical mines are to be integrated in a composite minefield, they can be employed best at a rate of one for every four clusters, the chemical mine being substituted for an antipersonnel mine. Clusters are placed in rows with 6-pace intervals between the base mines.
- (2) *Mine strip.* Two rows of clusters constitute a mine strip. The rows are six paces apart, being three paces on either side from the centerline, thus leaving a 6-pace safety lane between the two rows of the strip. The clusters in the two rows are staggered so that they are located at 3-pace intervals, alternating right and left of the centerline. The open sides of the clusters in both rows are toward the centerline of the strip. If tripwires are used, they are placed on antipersonnel mines in the front row (enemy side of strip centerline), not more than one tripwire-activated mine to a cluster, and no closer than every third cluster. Tripwires should be employed in pairs forming a vee with the open ends towards the enemy, and must not be closer than two paces at the closest point. The length of the tripwire should not exceed the casualty radius of the mine to which it is attached. Mine strips are lettered alphabetically (A, B, C, D), from the front to the rear, and must be at least 18 paces apart. The strips need not be parallel; a centerline may have as many turning points as desired. A standard pattern minefield contains a

minimum of three regular strips and an irregular outer edge (IOE). The IOE contains approximately one-third the number of clusters as does the regular strips. For details for the laying of this type mine strip, see FM 20-32.

4. Reporting and Marking of Enemy Minefields

a. Any knowledge or suspicion of enemy minefields must be reported immediately to the next higher headquarters, using the fastest means available. This report is forwarded in the following format:

Explanation	Letter Designation	(1) a	(2) b	(3) b	(4) b
Map Sheet(s) Designation	ALPHA				
Date and Time of Collection of Information	BRAVO				
Type of Minefield (AT, Apers)	CHARLIE				
Coordinates of Minefield Extremities	DELTA				
Depth of Minefield	ECHO				
Enemy Weapons or Surveillance	FOXTROT				
Coordinates of Lanes or Gaps and Width in Meters	GOLF				
	HOTEL				
	INDIA				
Other, Such as Type of Mines, New Mines or Boobytraps	ZEBRA				

- a. First minefield in report.
- b. Additional minefields in report.
- c. Additional lanes and/or gaps may be reported under an extended alphabetical listing.

b. The unit that encounters an enemy minefield or mined area is responsible for posting warning signs on approaches to the field. These signs may be of the standard type or constructed expediently, such as a ration box nailed to a tree reading: "Mines Ahead," or "Mined Area."

5. Detecting Mines

a. One method of detecting mines is to use an electronic mine detector. However, all personnel must be trained to detect mines by visual means and by probing since mine detectors may not be available when needed.

b. Visual inspection combined with experience pertaining to the habits of the enemy will often be a great aid in detecting mines. In general, the following are likely locations for mines:

- (1) Near any unusual object that may have been placed by the enemy, such as a mine marker or a large stone along the side of a road.
- (2) Near souvenir items or materials such as a helmet, field glasses, pistol, or a bottle of liquor.
- (3) Buildings or areas that would be ideal locations for a CP or assembly area. A careless or hurried enemy may leave evidence of laying mines; such indications may be disturbed soil, debris of mine packages, field markings to warn his own troops, such as piles of stones, flags, or fences.
- (4) Pot holes, soft spots, broken areas, and freshly repaired patches in surfaced roads.

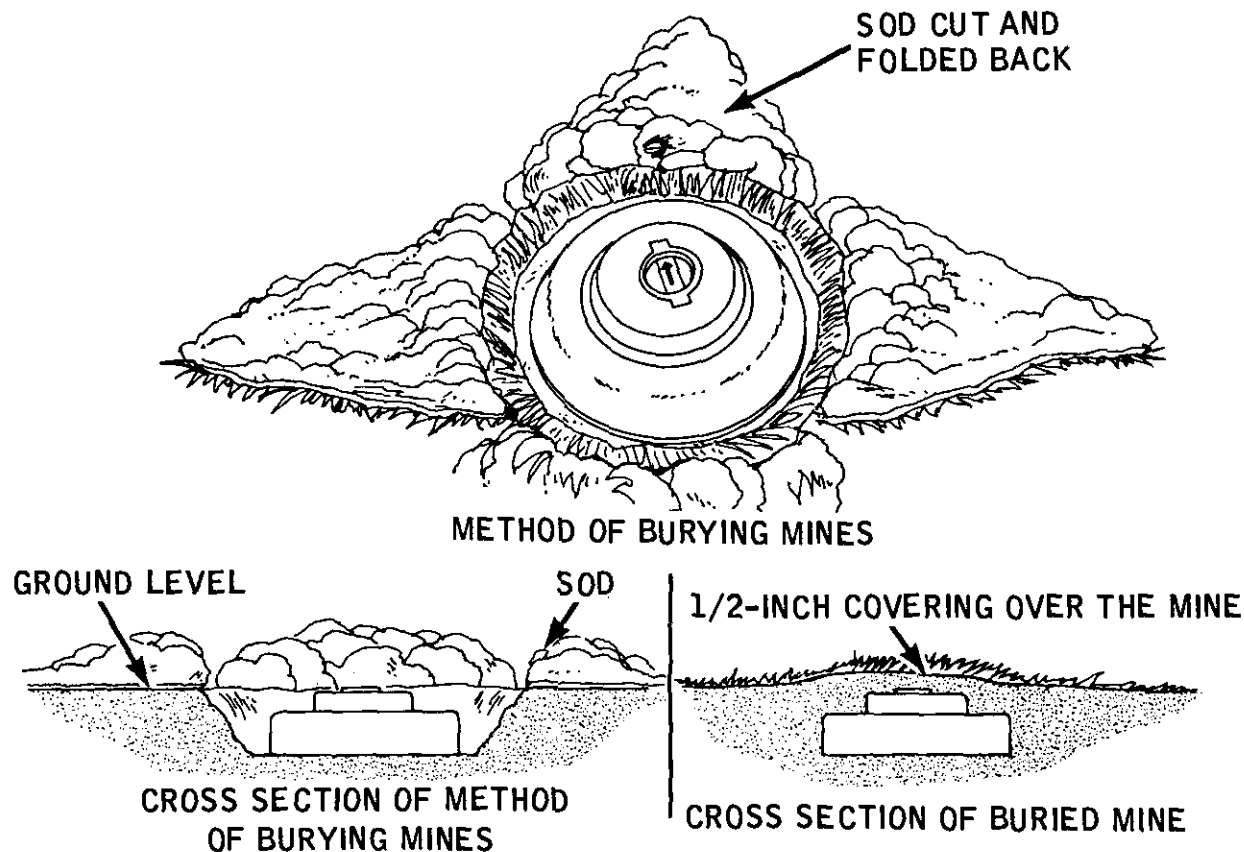

Figure 94. Burying of mines.

- (5) Along the shoulders, turnoffs, and under the edges of the road surfaces.
- (6) In logical bypasses around an existing obstacle and just beyond an obstacle that is not difficult to overcome.
- (7) The edges of road craters and approaches to bridges, ferries, and fords.
- (8) In barbed wire entanglements, along fencelines, or among fallen trees and limbs extending across roads or trails.
- (9) Narrow defiles and other places where it is natural to drive a vehicle or walk.

c. Probing is a positive means of locating mines by penetrating the surface of the earth with any sharp instrument. Such items as a screwdriver, section of an antenna, ammunition box bolt, mess kit knife, and a cleaning rod may be used when probes or bayonets are not available. Probing requires very little

training and may be accomplished during darkness as well as daylight. A disadvantage is that it is slow and close controls are necessary to insure that no mines are overlooked in the path being cleared.

d. To prepare for probing, the soldier rolls up his sleeves to increase the sensitivity to contact with tripwires. Watches and rings are removed to preclude entanglement. The prober then moves on hands and knees, looking and feeling forward for tripwires and pressure prongs of mines before he probes. After looking and feeling forward, the prober probes either from his left or right, inserting the probe into the ground six to eight inches at an angle of less than 45 degrees. After he has probed across his front, a width of about three feet, he moves forward about six inches, observes, feels for tripwires, and probes. He repeats this procedure until a solid object is touched beneath the surface of the ground; he will then probe around it to determine its ap-

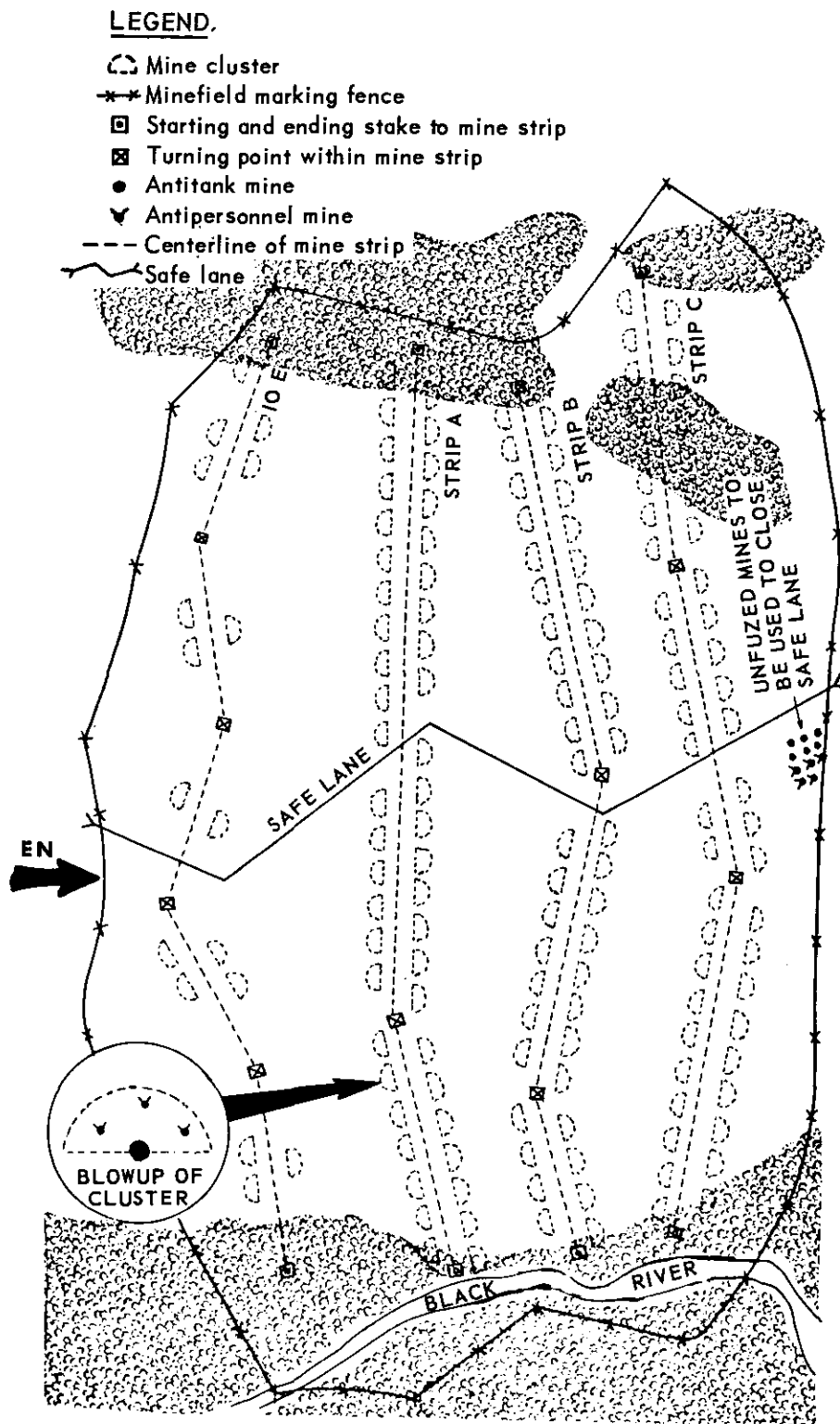

Figure 95. Standard pattern minefield.

proximate location and size. He must be careful to insert his probe gently in the ground at an angle of less than 45 degrees each time; because if the probe is pushed straight down with considerable force, it may detonate a mine. He then carefully uncovers the object; if it is a mine, it is neutralized.

6. Hasty Breaching of Minefields

Armor units are concerned primarily with hasty breaching of enemy minefields. To maintain the momentum of the attack, this method will be the rule rather than the exception in fast-moving armor operations. Hasty breaching requires speed with little time and minimum reconnaissance or planning. The leading elements must accomplish breaching by any and all means available to create rapidly a mine-free lane through the mined area. This may be accomplished by special mechanical or explosive means as described in FM 20-32 and FM 5-25. Herds of animals may be driven through the field; barrels or large stones rolled down hills; a damaged tank may be pushed through the field; a tank dozer or CEV may doze a path of earth over the top of existing mines. If no other means is immediately available, a mine-free lane wide enough for a tank may be provided by probing. If this method is used and materials are not available to guide individual probers in a staggered formation, a minimum of seven men may be placed side by side to probe the necessary width, each prober following the procedures described in paragraph 5c and d (fig. 96). In armor operations, hasty breaching methods will be initiated when minefields are encountered and cannot be bypassed. The procedure and techniques for deliberate breaching of minefields are explained in FM 20-32.

7. Removal of Mines

a. The safest method for disposing of enemy mines is to blow them in place. An explosive charge is placed on each mine and detonated from a safe distance. If explosives are not available or if the explosions may alert the enemy, damage bridges, block passage, or damage useful installations, other methods described (b and c below) must be used. Handlifting should be avoided when unfamiliar mines are encountered. If lifting is necessary



Figure 96. Probing to locate mines.

the man who is handlifting the mine is equipped with a sound-power phone or small radio, and he relays back, step by step, what he is doing. This is recorded to train others. If this person becomes a casualty, the record provides valuable information for the next time this type of mine must be handlifted.

b. A rope or wire may be attached to the mine to pull the mine from the ground. It should be long enough for a person to take cover. A grapnel attached to a length of communication wire or rope may be used to clear an area of tripwires before individuals probe for mines. It may also be used to hook onto a mine to pull it out of the ground. A grapnel may be made of ammunition box bolts or similar materials. To clear an area of tripwires, the grapnel is thrown out over the area concerned; the loose end of the rope or wire is tied to the individual's wrist to avoid losing the complete assembly when it is tossed. It is then pulled back and as this is accomplished, it will set off tripwire-activated mines. The person throwing the grapnel must drop to the ground in a deflated position before the rope or wire and grapnel hits the ground, because this may provide the necessary force to actuate a mine. When used to pull out mines, the grapnel is hooked gently into the side fuze well or carrying handle of the mine. The rope attached to the grapnel is laid out with care so as not to place tension on the rope until the person pulling out the mine is in a safe place.

c. When neither of the above methods may be used, the mines are handlifted. This is the least desirable method and is resorted to only when absolutely necessary. It is used when secrecy of removal is required or if destruction in place will damage some usable facility or create an undesirable obstacle. This method is time consuming and very dangerous. Instructions for disarming U.S. Army mines are presented in TM 9-1345-200 and instructions on known foreign army mines in TM 5-280. Some of the precautions for handlifting of mines are—

- (1) Always work alone on a mine.
- (2) First examine carefully the ground around the mine for other mines, tripwires, and boobytraps before starting to work.
- (3) Never pull or cut a tripwire—locate the device to which it is attached;

render the device safe; then disconnect the wire.

- (4) Next, remove the earth slowly from the top of the mine; locate and remove very carefully all the fuzes to the mine.
- (5) Never apply force, shift, tilt, or move a mine until it is believed to be neutralized.
- (6) Then, remove the earth slowly from around the sides of the mine; inspect for antilift devices, and if any are found, render them safe. Others may be located underneath the mine which must also be made safe.
- (7) A mine is safe when the firing chain is broken; always look for more than one firing chain.

APPENDIX XIX

OBSTACLE PLANNING AND EMPLOYMENT

1. General

A well-constructed obstacle is designed to impede the enemy. A coordinated series of obstacles are positioned and constructed to halt, canalize, restrict, or delay an advancing force. This coordinated series of obstacles may constitute a barrier. A barrier plan is normally a part of an operations order at brigade or higher. It may be initiated by fragmentary orders or sketches and implemented at battalion task force level, or below, whenever the tactical situation warrants. Front line companies may automatically lay protective minefields using their basic load of mines. This is not to be construed as being the sole obstacle effort of these companies as there are many types of obstacles that a company team or platoon can employ. Employment of all types of obstacles, both natural and artificial, must be considered in any tactical situation. For a detailed discussion of obstacles and barrier planning, see FM 31-10. See example obstacle plan at the end of this appendix.

2. Obstacles

a. An obstacle is any obstruction that restricts, delays, diverts, or stops movement. Obstacles are of two general categories—natural and artificial.

- (1) Natural obstacles are natural terrain features such as steep slopes, rivers, gulches, or soil conditions. They may be manmade objects such as canals, embankments, and built-up areas not originally erected to serve as obstacles.
- (2) Artificial obstacles such as demolished bridges, roadblocks, minefields, or dam destruction to cause flooding are

constructed to stop or impede military movement. Under conditions of chemical operations, artificial obstacles may include roadblocks that have been contaminated with chemical agents and minefields that contain chemical mines.

b. Commanders use natural obstacles, usually strengthened by artificial obstacles, in the organization of the ground. The authority to supplement natural obstacles with artificial ones is delegated to the lowest level consistent with the need for the obstacles being employed. For example, the company team must have the authority to construct obstacles that will augment their close-in protection against armor and personnel. The type of obstacles that may be employed are antipersonnel mines to cover avenues of approach, placement of explosive charges on trees to be felled as roadblocks, protective minefields using easy-to-detect antitank and antipersonnel mines, and wire entanglements. Flares should be used in conjunction with obstacles to warn of enemy activity forward of the obstacles during darkness. The development of an extensive system of coordinated obstacles of major tactical significance will be as directed by brigade or higher.

c. The following reports pertaining to obstacles are required:

- (1) *Report of intention.* When a commander intends to install an obstacle, the type, location, and estimated time of completion are reported to the next higher headquarters. Work may start immediately following the submitting of this report. The higher commander's silence in response indicates his approval for installation.

- (2) *Report of initiation of laying.* In that a minefield is an obstacle, a report of initiation of laying is also required. This report is forwarded by the most secure means to the commander authorizing the field at such time as the laying unit is ready to begin operations. The report indicates the location and extent of the minefield, estimated completion time, and the number and types of mines to be laid.
- (3) *Report of completion.* The report of completion confirms the installation of the obstacle.

d. The S3 has the staff responsibility for the tactical employment of obstacles and the integration of natural and artificial obstacles with the overall tactical plan. To accomplish this, he considers the commander's plan of action, recommendations and advice from the S2, logistical data from the S4, and technical advice from the supporting engineer commander as follows:

- (1) Based upon the terrain study and reconnaissance, the S2 evaluates the terrain in relation to the tactical plan. He provides the S3 with an analysis of the natural obstacle value of the terrain together with the weather and the enemy situation and capabilities.
- (2) The S4 has the staff responsibility for the logistical aspects of obstacle employment. This includes the priorities for allocation of obstacle materials and labor and the coordination of the transportation.
- (3) The attached or supporting engineer commander will conduct reconnaissance of the area; prepare estimates on time, labor, and materials required to augment natural obstacles; and make recommendations on the use of artificial obstacles. The engineer commander will provide technical advice, furnish special equipment, and prepare obstacles designated by the supported unit.

3. Tactical Employment

a. Obstacles are used in the offense and defense to supplement fires. When a position is established, first priority should go to the fires

covering the existing obstacles. Priority is then given to the construction of obstacles to strengthen existing ones. Covering fire receives the highest priority since an obstacle is of little value unless covered by fire. Artillery and main tank gun fires can destroy enemy vehicles entrapped by an obstacle and small arms fire can prevent dismounted persons from breaching obstacles.

b. A good obstacle site is inconspicuous to the enemy and can be protected with friendly fires to prevent its easy neutralization. A system of obstacles should be placed on likely or favorable enemy avenues of approach. They should allow for the withdrawal of defending troops and the maneuver of counterattacking and other maneuvering forces.

c. Obstacles may be used effectively in offensive operations. For example, protective minefields, roadblocks, or felled trees may be used on likely enemy avenues of approach for counterattacks following the seizure of an objective. These obstacles will supplement protective fires and assist in the consolidation and reorganization phase. They become more important when the enemy has limited maneuver room.

d. To provide the necessary forces for use elsewhere, a brigade commander may extend a company team or task force frontage. Obstacles assist in flank security, filling gaps between strongpoints, or counterattack obstructions.

e. Obstacles employed on flanks of any attacking force have proved successful. However, the availability of forces to install and protect flank obstacles must be considered. Roadblocks and minefields are examples of obstacles used to assist in flank security.

f. Obstacles employed by helicopterborne and airborne forces to entrap or block the enemy's routes of withdrawal can be of great assistance in any offensive operation. These forces can block defiles in rough terrain, demolish bridges, or use destroyed equipment to create obstacles.

g. Obstacles are important in defensive operations and retrograde movements. An effective way to impede an enemy advance is to employ a mixed minefield that will separate the enemy armor elements from infantry. The de-

velopment of a tank obstacle system will limit lateral movement by the enemy, thereby permitting defeat in detail. Obstacles may be employed to canalize the enemy into an area for his destruction or used to deny him key terrain.

4. Construction Responsibilities

Each tactical unit is responsible for the construction of obstacles for close-in protection. Tactical units use organic pioneer tools, including those from vehicles, demolition sets, basic load of mines, and tank dozers. The effort of the engineer unit should be used primarily in constructing obstacles requiring special skills and equipment and obstacles that add depth to the battle position. Once the engineers have completed an obstacle or prepared a demolition for execution, the responsibility of security and execution should be assigned to the unit responsible for the battle position. This releases engineer units to accomplish other obstacles or missions.

5. Execution of Obstacles

a. The commander responsible for ordering the execution of an obstacle that is important to the tactical plan such as blowing a tank crater, key bridge, or a dam will—

- (1) Establish a clearcut command channel whereby the order to fire the demolition is transmitted from himself to the commander of the demolition firing party.
- (2) Insure that this channel is known and understood by all concerned.
- (3) Insure that a positive, secure means for transmitting the order to fire is established.
- (4) Determine the requirements and designate responsibility for a demolition guard.

b. Obstacles of which the tactical commander controls the time of execution are called reserve demolitions. Orders to the commander of the demolition firing party of these reserved demolitions are written whenever time and conditions permit, using DA Form 2050-R. The tactical commander will complete parts I, II, and III of this form before it is issued to the commander of the demolition

firing party, who will retain the form until the demolition is fired.

c. A demolition order should specify whether the demolition guard commander (or if there is no demolition guard, the commander of the demolition firing party) is authorized to fire the demolition if the enemy is in the act of capturing it. The consequence of premature or ill-advised execution could be disastrous to the operation. A tactical commander must choose carefully the technique of command control for execution of a reserved demolition. The following techniques may be used:

- (1) *Direct order of a specific commander.* A direct order from a commander who has, or has been delegated, the authority to execute a reserve demolition is the most frequent control used. For example, during a delaying action, this commander will instruct the demolition guard commander to blow the bridge after a specific unit has cleared the bridge and its commander has stated words to the effect "all clear, blow the bridge."
- (2) *At a definite time and date.* When the tactical situation is such that unforeseen events are not probable, the appropriate commander may specify a time for execution of the obstacle. This method is seldom used except when the obstacle plan is such that a part of it can be accomplished by a timetable.
- (3) *On receipt of a preassigned code word.* On receipt and authentication of a preassigned code word, the commander of the demolition firing party would execute the obstacle.
- (4) *As soon as prepared.* In a pressing situation, the commander may direct the obstacle be executed as soon as it can be prepared.
- (5) *To prevent capture.* For example, a commander may plan to use a specific route or bridge in the near future and there is a possibility it may fall into enemy hands. Orders to the demolition guard would be to destroy only to prevent capture by the enemy. This

method is used frequently in connection with one of the other methods ((1)-(4) above).

d. The tactical commander responsible for the execution of obstacles should designate a staff officer or a subordinate commander who is familiar with the tactical situation to be at the

obstacle site and control the activities of the demolition crew. The execution must *not* be at the discretion of the demolition party. Obstacle planning and construction requires much effort, time, and logistical support. Strict coordination is necessary for both construction and execution.

Example of Obstacle Plan

(Classification)

Copy No. 6
 1st Bde, 25th Armd Div
 HEIDENHEIM (NU857926),
 GERMANY
 071630 Jun 19__
 XB 127

Annex C (Barrier Plan) to OPORD 42

Ref: Map, GERMANY, 1:100,000, HEIDENHEIM, ANSBACH, NURNBERG sheets.

1. SITUATION

- a. Enemy forces: Annex A (Intelligence) to OPORD 42.
- b. Friendly forces: OPORD 42.

2. MISSION

1st Bde executes barrier in sector to deny enemy control of sector and support striking force.

3. EXECUTION

- a. Concept of operation:
 - (1) OPORD 42, para. 3a.
 - (2) Barrier system on FEBA designed to impede enemy advance and to compel him to concentrate; barrier system west of FEBA is to deny enemy penetrations.
 - (3) Directed targets.
 - (a) TF 2-91 Mech.

Barrier or Target	Priority	Completion Date	Location Description	Remarks
ABC	1	091800 Jun	-----	Improve natural obstacles to impede armor movement.
25-XX-1	1	072200 Jun	NB986083 Bridge	See attached material efforts list.
1-X (25 Armd) 2	1	080100 Jun	NA841926 Road junction	See atomic demolition plan.

(Classification)

(b) TF 2-95 Mech.

Barrier or Target	Priority	Completion Date	Location Description	Remarks
CD	1	091800 Jun	-----	Improve natural obstacles to impede armor movement.
25-XX-5	1	081630 Jun	NA877765 Bridge	Execute on bde order.
1-X(25 Armd)3	2	091200 Jun	NA896790 Abatis	Execute on bde order.

(c) TF 2-10 Armor.

Barrier or Target	Priority	Completion Date	Location Description	Remarks
1-XXX-21	1	081200 Jun	-----	See atomic demolition plan.
25-XX-6	1	090001 Jun	NU877926 Bridge	Execute on bde order.

b. Coordinating instructions.

- (1) TF's prep additional obstacles along forward barrier.
- (2) TF's coordinate extent of gaps. Direct liaison authorized.
- (3) Lanes and gaps closed on bde order.
- (4) Use of CBR contaminants prohibited.
- (5) Barriers EFG and DG to be accomplished by Co's A and B, 590th Engr Bn. Direct liaison authorized.

4. ADMINISTRATION AND LOGISTICS

- a. Annex F (Admin.), Div OPORD 7.
- b. AT and APers mines, dml, at ASP.
- c. C1 II and IV fortification materials, 25th Spt Comd.

5. COMMAND AND SIGNAL

- a. Signal: SOI, index 1-19 in effect.
- b. Reports:
 - (1) Minefields, SOP.
 - (2) Other obstacles and dml, report location, type, extent, and estimated time of completion.

Acknowledge.

WOODS
Col

Appendixes:

- 1—Demolition Plan (to be issued)
- 2—Atomic Demolition Plan (to be issued)
- 3—Barrier Trace (See fig. 97)

Distribution: A

OFFICIAL:

s/Reeder

t/REEDER

S3

(Classification)

Appendix 3 (Barrier Trace)
to Annex C (Barrier Plan)
to OPORD 42

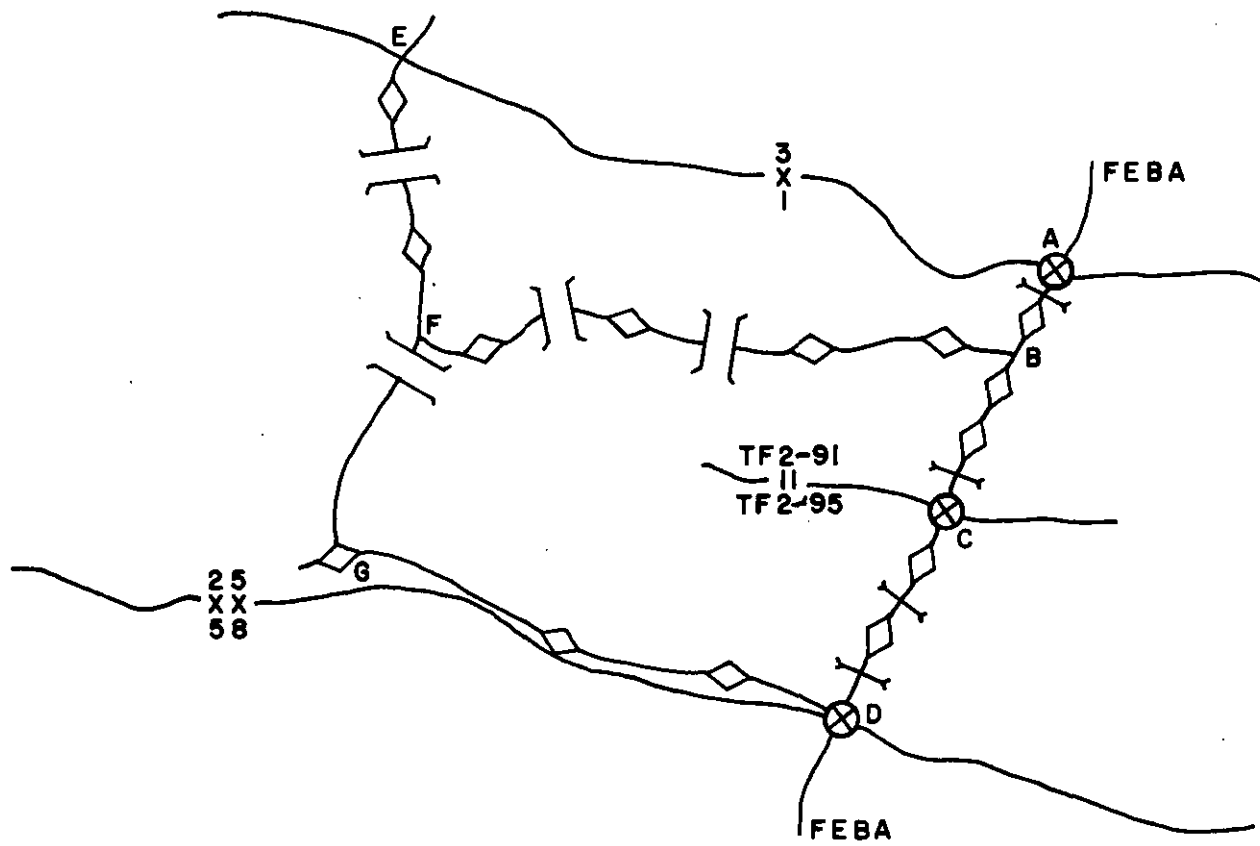
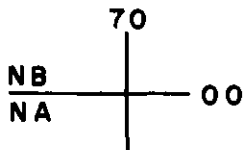

LEGEND:

—◇—◇— Barrier containing tank obstacles, type unspecified.

↔ Lane through barrier.

—◇} {< Gap in barrier.

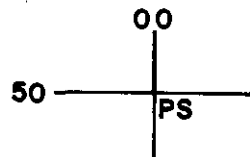

(Classification)

Figure 97. Example of a barrier trace.

APPENDIX XX

TACTICAL EMPLOYMENT AND COMMAND CONTROL OF ATOMIC DEMOLITION MUNITIONS

Section I. TACTICAL CHARACTERISTICS OF ATOMIC DEMOLITION MUNITIONS

1. General

The atomic demolition munition (ADM) provides armor with an explosive capability contained in a relatively small package, but the equal of many tons of conventional explosives. This capability may be used to demolish natural or manmade features or create obstacles. Positioning of ADM's other than on the surface may make use of existing structures or require preparation of platforms or excavations.

2. Employment

a. General. Instructions governing the employment of atomic demolition munitions will be published separately by the theater commander in accordance with national policies and instructions from higher headquarters. ADM's may be employed to create barriers in certain situations and are particularly useful in denying the enemy large strategic installations such as a communications center. The atomic demolition plan may appear as an appendix to the barrier plan, denial plan, or as a part of the fire plan appendix to the fire support annex to the operations plan.

b. Uses. Atomic demolition munitions have application to most armor operations as a nuclear weapon or as a demolition charge.

(1) *Offense.*

(a) Protect a flank (create a landslide, crater, or an obstacle in the form of tree blowdown or rubble that would preclude enemy penetrations).

(b) Demolition in a heavily fortified area.

(c) Obstruct a withdrawing enemy force.

(2) *Defense and delay.*

(a) Block constricted avenues of approach.

(b) Sever lateral routes of communication in front of friendly positions by clandestine emplacement.

(c) Canalize the enemy.

(d) Inhibit enemy movement.

(e) Demolish key tactical targets.

3. Tactical Characteristics

a. No Delivery Error. The ADM, with its extreme accuracy (that is, zero CEP), can be emplaced exactly where desired. This accuracy allows use of minimum yields to accomplish the mission.

b. Simplified Target Acquisition. Target acquisition for the ADM presents no problem. Targets, such as prominent terrain features or manmade installations, are determined easily and do not move. The emplacement site may be selected as part of the plan of maneuver.

c. Flexibility of Delivery. The method of ADM delivery is flexible. Depending on the type ADM used and location of the target, transport can be accomplished in any of several ways—armored personnel carrier, helicopter (either internally or externally), truck, or man. Helicopter external carry is authorized only in war time.

d. Massive Destruction. The ADM can do jobs not practicable with conventional explosives. Less time and logistical effort are re-

quired. The ADM has the capability of moving quantities of earth not previously possible. Missions such as blocking major passes and destroying complete major installations may be accomplished in the time available in a tactical situation. Further, it can destroy targets or items that cannot be attacked by any other nuclear delivery means such as underground emplacements.

e. Emplacement Site Control and Security. The employment of the ADM requires that the immediate area of ADM emplacement must be under friendly control or occupancy for the period of the time required to emplace and assemble the munition. Furthermore, provisions must be made to protect an emplaced ADM from the time the emplacement site is evacuated

until the time of detonation. An ADM normally requires a maximum of two hours to emplace and prepare for firing if the emplacement site requires no preparation. After attainment of this armed condition, the munition may be fired within five minutes after the tactical commander makes the decision to fire. The number of successive rounds that may be fired is limited only by the available engineer effort. An engineer squad supplemented with other technically trained engineer personnel is the smallest size engineer unit capable of an ADM mission.

f. Time Saver. The demolition of targets can be accomplished quickly and efficiently with an ADM, whereas use of conventional explosives is a tremendous manpower and time-consuming task.

Section II. TACTICAL EMPLOYMENT AND COMMAND CONTROL

4. Command and Staff Responsibilities

a. General. The tactical use of an ADM does not alter command and staff relationships or procedures as specified in FM 101-5. Planning phases and staff actions for ADM missions are essentially the same as for the employment of other nuclear weapons. Detailed planning for the tactical employment of ADM's will seldom be accomplished below brigade level. However, staff planning at all echelons must consider formulating and promulgating directives, policies, and SOP's containing ADM information and guidance for subordinate units. Furthermore, authority for ordering an ADM mission, such as a surface or subsurface nuclear detonation, will not be fixed at any echelon of command except as directed by the senior tactical commander in the area of operations. Normally, this authority will be delegated to the lowest commander exercising control over the area of militarily significant fallout resulting from the burst, which for an ALFA (0.5 KT) weapon could be at battalion task force level.

b. Command Responsibilities.

- (1) An allocation of ADM's usually is made by a commander to subordinate commanders for planning purposes for a specific phase of an operation or period of time. This allocation is expressed as a number of specific type and yield ADM's.

- (2) Authority to fire is provided by an assignment of the ADM's. However, this authority is subject to normal requirements for troop warning, coordination, and other specific instructions.
- (3) Commanders having physical control of ADM's are responsible for their security.

c. Staff Responsibilities.

- (1) *General.* Nuclear weapons employment officers (NWEEO) are provided in the staff organizations down to battalion task force level. These staff officers are specially trained in the technical aspects of the tactical employment of ADM. They make the necessary target analysis and staff recommendations inherent to their use.
- (2) *Special staff.* Certain special staff officers furnish the commander information and intelligence as pertains to their related fields. The engineer staff officer performs the following:
 - (a) Participates in the target analysis for employment of the ADM in coordination with the operations officer, chemical officer, and the artillery officer. The elements of an ADM target analysis are discussed in FM 5-26.

- (b) Based on the target analysis and the commander's guidance prepares the ADM plan in coordination with the operations officer. (Contents of a classified ADM plan are contained in FM 5-26.)
- (c) Coordinates with the appropriate staff officers pertaining to availability of ADM's; location of special ammunition supply points; and issue, transport, communications, and security of ADM's.
- (d) Advises the tactical commander relative to designation of the engineer delivery unit to execute the technical requirements of the ADM mission.
- (e) Maintains close contact with the intelligence officer and chemical officer relative to current meteorological conditions and probable residual radiation effects resulting from the ADM detonation.

5. Actions of the Immediate Tactical Commander

a. The tactical commander, after deciding to employ an ADM, has the following responsibilities:

- (1) Selects the desired yield.
- (2) Selects the location of the emplacement site.
- (3) Prepares the "reserved demolition" orders.
- (4) Coordinates the movement of the ADM from the special ammunition supply point (SASP) to emplacement site.
- (5) Coordinates the detonation of the ADM with the overall plan of maneuver.
- (6) Designates the tactical unit that will provide security of the ADM.
- (7) Establishes positive command control for communications, including remote command firing of the munition.
- (8) Selects method and time of firing (that is, timer or remote command).
- (9) Establishes liaison with the engineer delivery unit at emplacement site or

rendezvous point and operationally controls it until the mission is accomplished.

- (10) Establishes percent of damage desired and designates a nuclear safety line.
- (11) Evacuates friendly civilians, if necessary.
- (12) Informs higher, lower, and adjacent units of the proposed detonation.

b. Throughout the above actions, the commander reports to his immediate commander on mission progress.

6. Actions of the Engineer Delivery Unit

a. The engineer delivery unit has the following responsibilities:

- (1) Picks up, on order, the desired ADM from the special ammunition supply point.
- (2) Transports and provides movement security for the ADM.
- (3) Prepares the emplacement site and remote command sites.
- (4) Installs obstacles, including protective minefields, around the emplacement site and remote command sites.
- (5) Installs the ADM at emplacement site.
- (6) Installs remote command equipment at remote command site.
- (7) Camouflages sites.
- (8) Prepares the ADM for detonation.
- (9) Provides immediate security of emplacement site and remote control site.
- (10) Fires (detonates) the munition, when ordered, by procedures established in the "reserved demolition" orders.
- (11) Establishes and maintains communications as directed.
- (12) Recovers the munition, if so ordered.

b. Throughout the entire operation, the senior engineer representative reports technical progress to the tactical commander assigned the mission.

7. Orders for Firing

a. General. There are normally three commanders involved in the execution of an ADM. They are—

- (1) The military authority (authorized commander) who has overall responsibility and is empowered to order the firing of the ADM.
- (2) The commander of the demolition (ADM) guard.
- (3) The commander of the demolition (ADM) firing party.

Note. To assist the commanders in the execution of their responsibilities, two demolition orders are used. They are the orders to the demolition guard commander and the orders to the commander of the demolition firing party.

b. Procedures. Each authorized commander, the military authority referred to above, will—

- (1) Establish the requirement and allot the responsibility for a demolition (ADM) guard and a demolition (ADM) firing party.
- (2) Establish a clear-cut channel whereby the order to fire the ADM is transmitted from himself to the commander of the demolition (ADM) guard and

thereby to the commander of the demolition (ADM) firing party.

- (3) Insure that this channel is known and understood by all concerned and that positive secure means for transmitting the order to fire are established.
- (4) Specify the conditions for executing the demolition by completing part V of "Orders to the Commander, Demolition (ADM) Firing Party," and part IV of the "Orders to the Demolition (ADM) Guard Commander."

c. Orders to the Demolition (ADM) Guard Commander. The authorized commander completes and signs this order. The order is written in seven parts, each of which is self-explanatory. See FM 5-25 for a sample order.

d. Orders to the Commander, Demolition (ADM) Firing Party. This order provides the officer in charge of the demolition (ADM) firing party, who would normally be the senior engineer, with explicit instructions relative to pickup, transport, security, emplacement, and firing of the ADM. It is similar to the demolition order (DA Form 2050-R) issued for a "reserved demolition" amended for use with nuclear munitions. Samples of the classified version of these orders are contained in (S) FM 5-26.

APPENDIX XXI

EMPLOYMENT OF GROUND SURVEILLANCE RADAR

1. General

a. Ground surveillance radar equipment provides the armor unit with a mobile, all-weather capability for battlefield surveillance. This equipment can be either vehicular or ground mounted and complements other combat surveillance and target acquisition means in the battalion. Its employment is coordinated closely with the employment of patrols, listening posts, observation posts, and with infrared and other sensory devices. Ground surveillance radar can provide observation from a given vantage point 24 hours a day and can detect targets and provide a much more accurate range and azimuth reading than is possible in eye estimation. By using this all-weather, 24-hour capability inherent in ground surveillance radar equipment, the unit commander can increase appreciably the effective use of fire support means.

b. Although the radar equipment is an excellent means of obtaining information, it does not replace other surveillance means. Its primary advantage is its ability to complement other means and to detect objects with accuracy when other surveillance means cannot. Radar is used primarily for operations at night or under conditions of poor visibility (haze, fog, or smoke); radar equipment may be used effectively during periods of good visibility. The employment of this equipment should not be restricted to a certain type of terrain, a rigid set of conditions, or to a few functional operations.

2. Types of Radar Equipment

The two general types of ground surveillance radar equipment found in an armor ground unit are—

a. Short range radar organic to armored

cavalry troops and to ground surveillance sections of combat maneuver battalions.

b. Medium range radar organic to ground surveillance sections of cavalry squadrons and combat maneuver battalions.

3. Capabilities and Limitations

a. Radar energy produced by ground surveillance equipment can penetrate light camouflage, smoke, haze, light rain, light snow, darkness and light foliage to detect targets; it will not penetrate dense undergrowth, trees, and heavy foliage. Heavy rain or snow seriously restrict radar detection capabilities; however, a well trained operator can minimize these effects. Radar sets have a *line-of-sight* capability.

b. Ground surveillance radar is generally ineffective against air targets unless the air target is flying close to the ground as it is designed to only detect moving targets in the presence of a background. The radar is vulnerable to jamming by electronic and other deception means.

4. Definitions

a. Search. To systematically inspect an area by range scan, azimuth scan, elevation scan, or a combination of the three.

b. Range Scan. A method of search in which a specific area (fixed by width of beam) is inspected in range by the range gate.

c. Azimuth Scan. A method of search in which a specific area is inspected in azimuth by moving the radar set in azimuth throughout the area to be searched.

d. Elevation Scan. A method of search in which a specific area is inspected in elevation by moving the radar set in elevation through the area to be searched.

e. Strobing. The automatic scanning of a given range segment by a range gate.

f. Range Gate. An increment of distance in which targets can be detected.

g. Monitor. To maintain surveillance of a specific point of interest or, a number of points, for a given length of time.

5. Training

a. In the training of radar operators, practical work performed by the operator must be emphasized. Through practice under all conditions of weather, terrain, and visibility, the operator can reach peak proficiency in the identification of moving objects as military targets versus other moving objects such as animals. Guidance for the training of ground surveillance radar operations is contained in ASubjScd 30-11F20.

b. All commanders and other key personnel should be familiar with the capabilities, limitations, and methods of employment of ground surveillance radars. Periodic refresher training of these personnel should be conducted to insure a high level of knowledge of the radar equipment. Whenever possible, employment of radar equipment should be integrated into field exercises and other tactical training.

6. Tactical Employment

Ground surveillance radar may be employed in all types of tactical operations. Types of surveillance employed by radar personnel are search and monitor. It is capable of performing a variety of tasks, including—

a. Searching avenues of approach, possible enemy attack positions, assembly areas, or other sectors or areas on a time schedule, at random, or continuously to report location, size, compositions, and nature of enemy activity.

b. Monitoring point targets such as bridges, defiles, or road junctions and reporting quantity, type, and direction of movement of targets through the point.

c. Monitoring and searching final protective fire areas or barrage locations to permit timely firing.

d. Searching areas of nuclear and conventional fires to detect enemy activity immediately after firing as an indication of firing effect.

e. Extending the observation capabilities of patrols by enabling them to survey distant points or areas of special interest.

f. Assisting the visual observation of units during daylight hours by making initial detection of partially obscured (haze) targets at long ranges.

g. Assisting in the control of units during limited visibility operations.

h. Increasing the effectiveness of fire support. When targets have been detected with reasonable certainty by radar, the fire support means may immediately take the target under fire. If the type of target cannot be established definitely, the radar team can furnish location information of the target so that illumination may then be employed accurately to establish which type of fire can be used best. Since well-trained radar operators can estimate the density of enemy activity in a given area and the rate of enemy movement, radar equipment may be used to assist in determining the optimum weapons system for employment.

i. Determining rate of movement of a target by plotting the location of the target at two known points and the time it took the target to move from one point to the other.

7. Radar Surveillance Cards

To insure proper surveillance coverage of the battalion area, in relatively static situations, subordinate units will normally submit overlays to battalion indicating the area of coverage of organic or attached surveillance means. Radar surveillance cards (fig. 98) will assist commanders in preparation of these overlays. Cards will normally be prepared by the senior radar operator immediately after the equipment is placed in position. Information from these cards will be distributed to appropriate fire support agencies. Radar surveillance cards are prepared for primary (P), alternate (A), and supplementary (S) positions. Coordinates for the radar positions are noted as accurately as possible. The type radar employed is also designated on the radar surveillance card.

8. Selection of Radar Sites

The specific location of the radar equipment site is normally selected by the ground surveillance section or team leader. The specific loca-

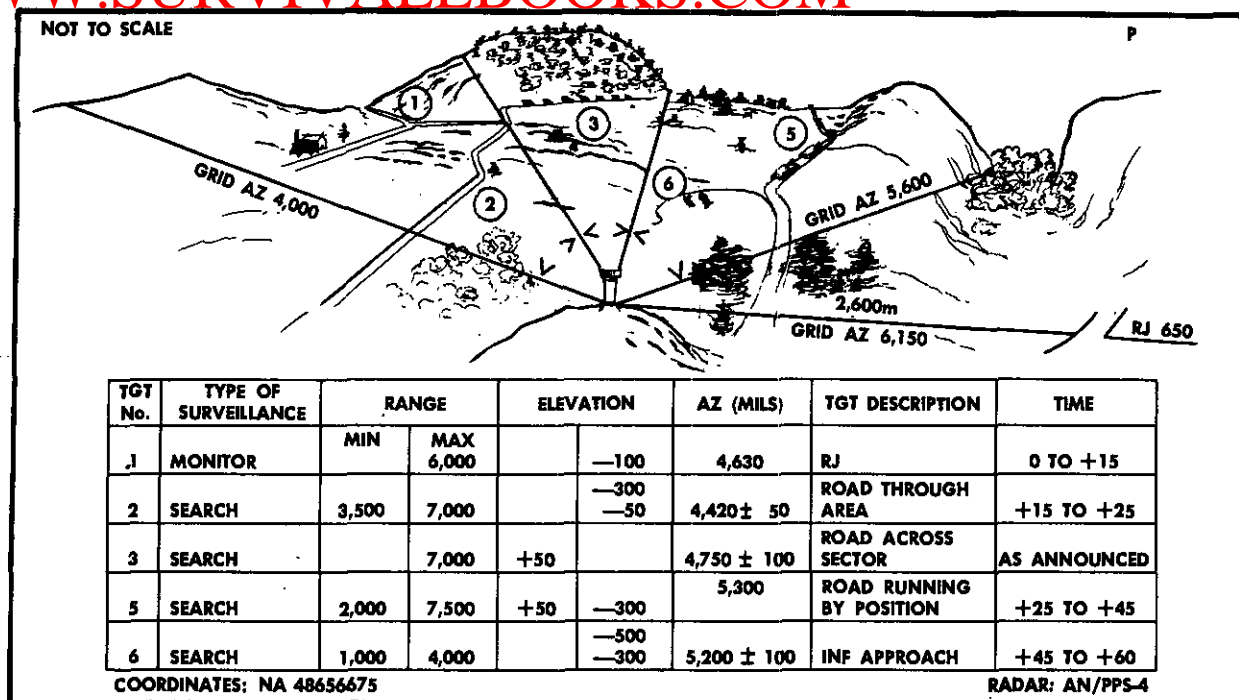

Figure 98. Radar surveillance card (AN/PPS-4).

tion must be in the general location designated by the unit commander and meet the criteria of a position for a crew-served weapon. Primary, alternate, and supplemental positions should be selected and prepared if time permits. The radar site should have as many of the following characteristics as possible:

a. Permit maximum radar coverage of the assigned area.

b. Provide concealment for the team vehicle and equipment.

c. Facilitate communications.

d. Take advantage of routes for displacement.

e. Located in areas relatively free of close ground clutter, such as trees, bushes, or buildings. If these objects are directly in the radar beam, the resulting clutter tends to distort the radar beam resulting in inaccurate range, azimuth, and elevation data.

f. The factors of METT must be considered in positioning radar equipment. Advantage should be taken of security provided by combat elements while avoiding interference with their operations. If possible, a position should be selected within a well-defended area. Since the

enemy may be capable of detecting radar signals and firing in that area, locating radar equipment in the immediate vicinity of troop dispositions or key installations may be undesirable.

9. Positioning of Equipment

Radars are normally positioned on the forward slopes of dominating terrain (military crest). A radar site and an observation post may be located together; however, radar personnel should not be detailed as ground observers except in emergencies. To take advantage of the maximum range of the set, radars are employed as far forward as possible. As with a crew-served weapon, radar equipment is dug in and camouflaged, consistent with the requirements for operating the equipment. It is positioned so that its employment is coordinated closely with the disposition and employment of other surveillance means.

10. Orientation of the Radar Site

a. After the site is occupied, the radar set is oriented immediately and placed in operation. A radar surveillance card is then prepared and the site is improved. The set must be oriented

in azimuth and range and its position must be accurately plotted on a map before the operator can pinpoint targets geographically. Location of the radar site may be accomplished by survey, resection, or intersection.

b. If the set is properly oriented and coordination with fire support elements is made, targets detected by radar can be taken under fire using preplanned concentrations. Orientation and coordination of surveillance areas should be accomplished during daylight hours. In some instances, it may be more desirable to move radars into previously prepared positions under cover of darkness or poor visibility.

11. Operation of Equipment

a. Each radar team is assigned specific surveillance missions. In assigning missions, consideration is given to terrain, enemy capabilities, equipment capabilities, and desired degree of surveillance overlap. Sector surveillance assignments, type of surveillance to be conducted (search or monitor), *how and when* information is to be reported, and frequency of coverage must be included in instructions to the radar team.

b. If enemy activity is detected in an area not included in the surveillance plan, new missions may be prescribed redirecting the efforts of the radars to meet changes in the tactical situation. The radar should be operated at irregular intervals to provide some security from detection and subsequent enemy jamming.

12. Reporting Information

Ground radar surveillance reporting procedures should be incorporated in the unit SOP. Depending upon the specific requirements, positive and negative information obtained by the radar will be reported by the team immediately or at prescribed intervals. The team will transmit the information in spot report format by using range and azimuth, coordinates, or distance from a known reference point of the activity located. For security reasons, the use of coordinates is preferred. They will also state what the target appears to be, for example, dismounted personnel or wheeled or tracked vehicles. The specific reporting details will be prescribed by the commander when assigning

surveillance missions to the radar team. The requirement for immediate reporting of enemy activity or cessation of activity must be stressed at all echelons. Reporting is through command channels unless specified otherwise.

13. Alternate and Supplementary Positions

Alternate and supplementary positions are selected and prepared as time permits. When the mission cannot be accomplished from the primary position, the team leader or senior radar operator may *displace* the equipment to an alternate position. Before moving to an alternate position, the section leader or unit commander is notified. Moving to supplementary positions is accomplished only on order of the section leader or unit commander.

14. The Offense

a. *General.* There will be many opportunities for the employment of radar in offensive action. Commanders should be alert to these situations and capitalize on the capabilities of the ground radar. Highly mobile, fast-moving operations may preclude the continuous and effective use of radar.

b. *Movement to Contact.* During the movement to contact, radar may be employed with reconnaissance and security elements on an exposed flank or to provide additional observation and security. To provide continuous flank surveillance, it may become necessary to employ radar in pairs and move them by bounds.

c. *Penetration.*

(1) Radar may be employed profitably in a penetration. It may locate enemy defenses before the attack. This information is used by the commander to avoid enemy strengths and capitalize on enemy defensive weaknesses. Radar teams may locate enemy activity to facilitate use of preparatory fires and may survey enemy positions to establish whether there is any reinforcement, shifting, or withdrawal of enemy units just before the attack. To accomplish this the normal movement pattern of the enemy position must be established.

(2) Once enemy contact has been established, radar may be used to provide surveillance forward of the line of

contact or on an exposed flank. It may be positioned to provide surveillance over critical areas or on avenues of approach during the attack.

- (3) During darkness or poor visibility, radar *may be employed* to vector or guide friendly attacking elements. It may be used in tracing the movement of forward friendly units to establish and confirm their specific location at any given time and to coordinate supporting fires with the advance of friendly elements. To facilitate location of friendly elements, conventional communication means and a pattern of signals may be established to assist the operator in identification. These signals may consist of swinging a canteen or helmet in rotary fashion, using a reflector or using any pattern of movement that can be identified readily by the operator of the radar equipment.

d. Infiltration.

- (1) Infiltration may be used in the penetration. When gaps in enemy defenses have been located, attacking elements may infiltrate through the enemy position. Radar teams may be employed effectively in conjunction with infiltration by surveying infiltration lanes for enemy activity and determining the progress of infiltrating units.
- (2) Short range radar teams may be employed with infiltrating units in the enemy rear area. Use of a team by infiltrating elements may enable these elements to locate enemy activity and avoid discovery. Conversely, radar emissions may compromise the location of friendly units. The determination of whether radar teams should be employed by an infiltrating element will generally depend upon the urgency of obtaining information of the enemy in the area as opposed to the need for avoiding discovery. If radar is employed with infiltrating elements, it may be used also to assist linkup with attacking forces.

e. Envelopment. In the envelopment, radar may be able to detect large gaps or assailable flanks that can help to hasten the operations. It may be possible to employ the radar with security elements of the enveloping force to provide early warning of enemy activity.

f. Displacement.

- (1) Radars should be kept as far forward as the tactical situation and terrain will permit. Teams displace to support a continuation of the attack or when they can no longer provide effective support for a unit making the attack. Displacement may be required also to support the consolidation on the objective. For this reason, displacement should not be delayed arbitrarily until the radar teams can no longer provide effective support. The commander must weigh the immediate loss of a surveillance capability against the requirement for immediate surveillance during the consolidation.

- (2) Displacement should be accomplished so that teams are in position on the objective immediately following its seizure. Timely displacement will enable forward units to continue destructive fire on withdrawing enemy units or to detect enemy activity indicating a counterattack. When feasible, teams displace by bounds.

g. Consolidation and Reorganization. Radar teams displace on order to positions selected previously by a visual or map reconnaissance. During the consolidation and reorganization, primary emphasis is placed on immediately placing the equipment in operation to obtain information of the enemy. Thereafter, positions are improved and equipment is dug in and camouflaged as the situation permits. Since the radar teams on the objective will be surveying the area beyond the objective, they must be informed fully of friendly patrols and other elements sent forward to maintain contact with the enemy.

h. Exploitation or Pursuit.

- (1) In the exploitation or pursuit, radar teams are employed essentially as they are in the movement to contact.

They may be employed with security elements to provide surveillance on an exposed flank or may provide observation and security. Radar teams may be moved by bounds with rapidly advancing elements to provide information of enemy activity. By detecting the presence or lack of enemy activity in an area, the ground surveillance may speed up exploitation operations.

- (2) Radar teams attached to an enveloping force may be sited to locate withdrawing enemy elements. Radar may be used in conjunction with other communication means to identify friendly units during linkups.

i. River Crossing Operations. Radars are used in a river crossing as in normal offensive operations. Radars placed on dominating terrain on the near bank may determine the progress of friendly units on the far bank. When smoke is used by friendly forces engaged in a river crossing, radar may be used to detect enemy troop activity on the far bank including withdrawal, reinforcement, or shifting of units.

15. The Defense

a. General. In the defense, the radars are employed to maintain surveillance over avenues of approach, possible enemy attack positions, and assembly areas. The surveillance effort is directed not only forward of the FE-BA but also used by units throughout the battle area. Particular attention is given to gaps between units, exposed flanks, possible helicopter or parachute landing zones in the battle area, and other critical areas. Alternate and supplementary positions for radar teams are established to provide complete surveillance coverage of the battle area.

b. Employment in the Defense.

- (1) Radar may support one or any combination of the three defense areas. It may be employed with the security forces to extend their surveillance capability. Teams employed with the security force normally revert to their primary mission when the security force is withdrawn.
- (2) The uses of radar in the defense are

limited only by the capabilities of the equipment and the imagination and ingenuity of the tactical commander. Radar teams may be employed in conjunction with barrages and final protective fires by determining when the enemy approaches or is located in these areas. Radars may be used in conjunction with emplaced antipersonnel weapons in determining when such weapons can be employed best. They may be used to determine the optimum time for detonation of explosives, chemicals, or atomic demolition munitions.

- (3) Since the enemy may often attack at night, during poor visibility, or with use of heavy smoke screens, radar will be of great use in defensive operations. When an enemy attacks on a broad front, the amount of enemy activity in a given area may indicate the possible location of the enemy main effort. When radar sightings are used in conjunction with knowledge of enemy tactics, specific enemy maneuvers may be anticipated. Radar sightings may be used to establish the depth of the enemy offensive effort and to indicate whether a feint or demonstration is being conducted in the area.

c. Ambushes. Radar teams may locate enemy patrols moving toward friendly defensive positions and thereby allow friendly units to ambush such patrols and take prisoners.

d. Action During a Counterattack. During a counterattack, radar teams will continue to report information of enemy activity. In the counterattack, radars may be used to gain information for the commander of the strength and depth of the enemy penetration. Teams employed with forward companies in or adjacent to an enemy penetration may shift their area of surveillance on order to the area of penetration to provide the commander with this information.

16. Retrograde Operations

a. General. In retrograde operations, radar is used primarily for early warning. It is em-

ployed with security elements to cover avenues of approach, flanks, and the rear of a unit.

b. Employment in Retrograde Operations.

(1) By use of ground surveillance radar, the commander may obtain additional information of the enemy strength in the area. Based upon this information and information obtained from other sources, he is in a better position to plan the conduct of his operations.

(2) *Movement to subsequent positions.*

(a) The decision when to displace radar equipment involves many factors. In most retrograde operations, secrecy will be a primary consideration. Since radar emissions may be detected by the enemy, any premature displacement of radar equipment may compromise this secrecy. If the equipment is not vehicular mounted, the commander must consider also the amount of time required to take the equipment out of action.

(b) With these and other considerations, the commander must weigh the requirement for maintaining surveillance equipment on position as long as practicable. Radars may aid in the effective delay of the enemy by providing early warning of the direction and size of his movement. Premature displacement of radar teams should be avoided.

(c) Radar may be employed with security elements to overwatch movement of friendly units to the rear. Radar may be employed to assist in maintaining contact with the enemy and to determine the extent of aggressiveness of the enemy pursuit.

17. Unit Operations

See FM 17-15, FM 17-36, and FM 7-20 for unit type operations with ground surveillance radar.

Section II. FIELD EXPEDIENT METHODS FOR ESTIMATION OF NUCLEAR BURST YIELD

3. General

After a nuclear burst, certain measurements must be observed and reported to provide a means of determining location of ground zero and estimating the yield. Units in the vicinity of the burst will measure and report burst observations to their next higher headquarters.

4. Description of Terms

a. Flash-to-Bang Time. This is the time interval in seconds between the "chalkwhite flash" of the detonation and the arrival of the sound of the explosion at the position of the observer. This measurement establishes the distance from the observer to ground zero. The shock wave (sound of the explosion) travels at an average velocity of 350 meters per second. To determine the distance in meters from the observer to ground zero (GZ), multiply the flash-to-bang time in seconds by 350 meters.

b. Width of the Fireball. This is the angle in mils subtended by the fireball and measured by an observer immediately after the passage of the shock wave.

(1) In the field, this measurement is made by the observer taking cover on noting the flash, and counting the seconds until the explosion is heard (flash-to-bang time). As soon as the shock wave has passed, he then measures the fireball width by available means. At this time there is no danger to the eyes from the fireball luminescence. It is important that the measurement be made immediately after the passage of the shock wave, because the rapid expansion of the fireball would cause a late reading to be in error.

(2) The fireball will vary in appearance, depending on the yield and the distance of the observer from GZ. The appearance may vary from a hot, radiant ball of fire at early times to a barely luminous, generally spherical cloud at later times.

c. Azimuth Measurement. Azimuth from the observer to the mushroom stem is measured

and reported to the next higher headquarters. By receiving several reports, these headquarters are able to locate ground zero of the burst by means of several intersecting azimuths.

d. Cloud Angles.

(1) Cloudbottom angle is the vertical angle in mils or degrees subtended by horizontal plane and the top of the mushroom cloud, measured at approximately 10 minutes after the burst. At this time, the cloud has stabilized in height (fig. 100).

(2) Cloudbottom angle is the vertical angle in mils or degrees subtended by a horizontal plane and the point of intersection of the mushroom cloud and the stem, measured at approximately 10 minutes after the burst (fig. 100).

e. Height of Burst. This is the position of the explosion relative to the surface (earth or water). The exact height of burst of enemy-delivered weapons is desirable to know but may be virtually impossible to ascertain with present observational techniques. The trained observer can, however, discriminate between the obvious airburst and the contact surface burst, leaving the transition zone as an area of doubt to be resolved by other means, such as the presence or the absence of a crater.

f. Cloud Diameter. There may be instances where it is not possible to distinguish clearly the cloudbottom height or cloudbottom height. In such cases, if a clear measurement of cloud diameter is possible at time of stabilization (H+10 minutes), this measurement, in mils or degrees and the observer location should be reported through command channels to the CBRE for use in yield determination (fig. 100).

g. Ground Zero. This is the point on the ground at or above which the nuclear explosion occurs. The location of GZ can be determined either by intersecting azimuths (*c* above), or by flash-to-bang time (*a* above).

5. Nuclear Burst Information

a. There are certain requirements for observed data on nuclear bursts.

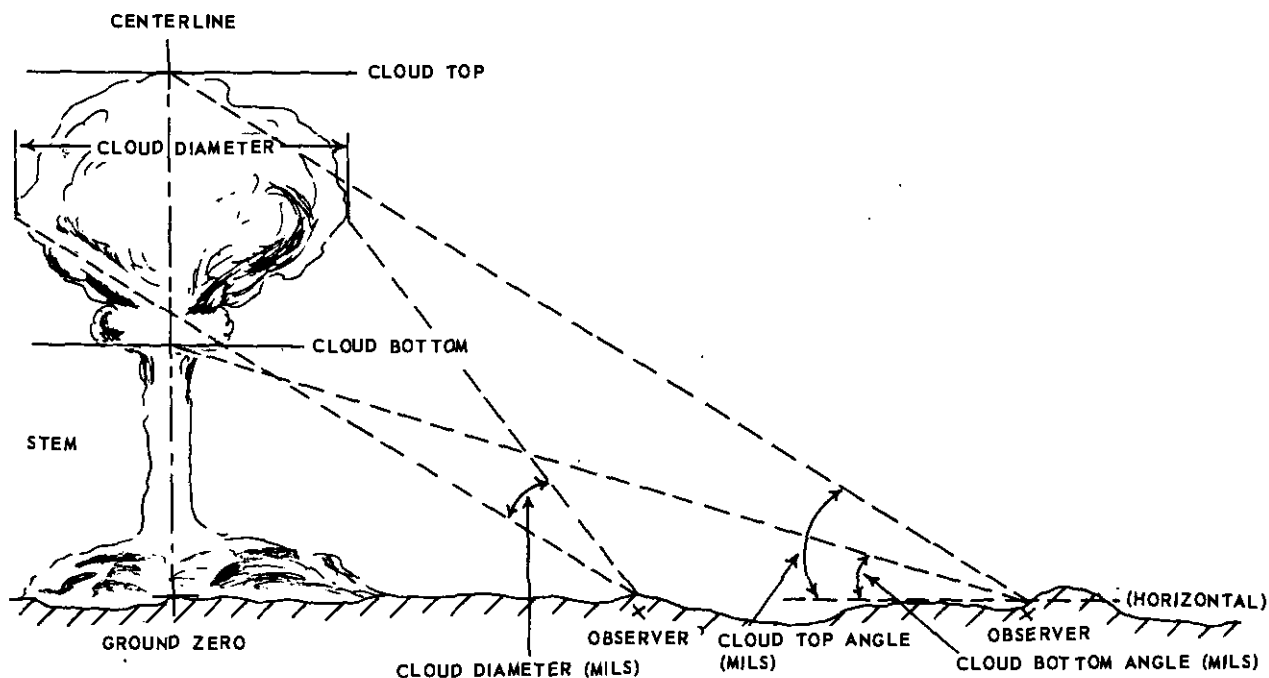

Figure 100. Cloud measurements.

(1) *Primary.* Every effort should be made to obtain the following:

- (a) Height of the bottom of the cloud (intersection of the stem and bottom of the cloud) at the time it reaches its maximum altitude (approximately 10 minutes after detonation) (fig. 100).
- (b) Ground zero location (by intersecting azimuths, flash-bang-time, sound ranging, or radar).

(2) *Secondary.* Efforts should be directed toward measuring the following parameters in addition to the height of the bottom of the cloud:

- (a) Height of the top of cloud at the time it reaches its maximum altitude (approximately 10 minutes after detonation) (fig. 100).
- (b) Cloud diameter at 10 minutes after detonation (fig. 100).
- (c) Height of burst—whether an obvious airburst or surface burst.

b. All units with optical equipment will orient their instruments on the site of the burst. A reading to the center of the stem is taken as soon as feasible after detonation to

determine ground zero. Readings of elevation to the intersection of the stem and cloud bottom, elevation to the top of the cloud, and the azimuths to the edges of the cloud at its widest points are taken at 10 minutes after detonation. In the absence of instruments, individuals will use field expedient methods for determining these measurements. Information outlined is submitted to the next higher headquarters by the most expeditious means.

6. Field Expedient Measurement of Angles

When optical instruments are not available for measurement of angles required for the determination of burst parameters, these angles can be estimated in mils through field expedients. This is accomplished by the observer holding his arm fully extended and measuring the angle in terms of a number of fingers (30 mils each), or fist (180 mils), or fingers spread (300 mils), as described in FM 3-12.

7. Nuclear Burst Sighting Report

The format for transmission of nuclear burst measurements is contained in appendix V.

8. Yield Estimation

a. If any of the following combinations of burst measurements are known, a nuclear yield can be estimated:

- (1) Flash-to-bang time and width of fire-ball.
- (2) Flash-to-bang time and cloud-top angle.

(3) Flash-to-bang time and cloud-bottom angle.

b. Values of any of the measurements (a above) can be indexed on the M4 nuclear yield calculator and a corresponding weapon yield determined. In the absence of the M4 calculator, the yield can be determined by using nomograms contained in TM 3-210.

Section III. CHEMICAL DETECTION AND IDENTIFICATION, AND RADIOLOGICAL MONITORING AND SURVEY

9. General

a. The armor unit is trained and equipped to conduct radiological monitoring and survey. Chemical detection and identification are routine activities. Air radiological monitoring and survey missions will be performed primarily by the air cavalry troop. This section discusses the conduct of these operations in general terms, as applicable to armor units, and explains the terminology used.

b. Armor units are trained and equipped to perform chemical detection and identification and radiological monitoring as a part of their routine activities. Radiological survey missions may be assigned to armor units. Aircraft of the air cavalry troop perform radiological monitoring and survey operations and should be used to facilitate the accomplishment of radiological survey missions.

c. For additional information concerning chemical detection and identification, and radiological monitoring and survey operations, see FM 3-12 and FM 21-40.

10. Definitions

a. *Radiological Monitoring.* Actions taken to detect and measure the dose rate of radioactive contamination by use of radiac instruments on areas, structures, personnel, equipment, and supplies.

b. *Radiological Survey.* The directed effort to determine the distribution and dose rates of radiation in an area.

c. *Chemical Detecting.* Actions taken to detect and identify the presence and give warning of toxic chemical agents by use of detection paper, detection crayon, chemical agent detection kits, or alarm devices.

d. *Radiological Survey Party.* A radiological survey party normally consists of a monitor and an assistant. The survey party may be mounted in a ground vehicle, an aircraft, or dismounted as required by the type of contamination. The assistant may drive the vehicle, fly the aircraft, and operate the radio. A ground survey party may be augmented by additional persons for security or other reasons.

e. *Radiological Control Party.* A radiological control party is a group of individuals that coordinates the efforts of two or more survey parties and reports radiological data to higher echelon.

f. *Radiological Survey Team.* A radiological survey team consists of a control party and two or more survey parties.

11. Radiological Monitoring and Chemical Detection Operations

a. Chemical detection and identification and radiological monitoring are command responsibilities. It is a protective measure to detect and warn all personnel of the presence of chemical or radioactive contamination.

b. All armor and air cavalry units are equipped with radiac instruments and chemical agent detection and identification equipment to perform radiological monitoring and chemical detection and identification. As a minimum, one primary operator and one assistant operator are trained for each piece of equipment.

c. Radiological monitoring and chemical detection and identification activities may be conducted on a periodic or continuous basis. While a unit is moving, it is advisable for designated persons to perform continuous monitoring and detection to prevent movement into an area of

dangerous contamination without warning. When the unit has occupied a position or an area, periodic monitoring and detection may suffice.

d. The objective of radiological monitoring and chemical detection and identification is to determine the presence or absence of significant levels of radiation or chemical contamination and when possible, to determine accurate ground dose rates or concentrations.

12. Survey Operations

a. When an armor unit is assigned a radiological survey mission, the size, number, and composition of the survey team is based on a consideration of the persons available, equipment on hand, the size of the area to be surveyed, the road net in the area, and the information desired. Survey personnel must be protected from contamination. The cumulative dose of radiation acquired by a person must be

considered. No one must be permitted to exceed dosages specified by command guidance.

b. Radiological survey by air is employed in areas that have dose rates that are too dangerous for ground survey parties. These areas may include lines of communication, areas under consideration for relocation of units and installations when speed is important, and areas that are not readily accessible to ground troops.

13. Reporting Data

a. Information obtained while conducting chemical detection and identification and radiological monitoring operations should be forwarded through command channels.

b. Radiological data gathered during a survey operation is reported directly to the division chemical, biological, and radiological elements (CBRE) or through command channels, depending on the type of survey being conducted.

APPENDIX XXIII

PROTECTIVE MEASURES UNDER CONDITIONS OF CHEMICAL AND BIOLOGICAL OPERATIONS AND NUCLEAR WARFARE

1. General

This appendix presents individual and unit protective measures under conditions of chemical and biological operations and nuclear warfare. Included are measures employed to reduce the probability of detection, to minimize the effects of enemy CBR attacks, and for decontamination operations in the event the enemy uses nuclear, biological, or chemical weapons. Many of these measures apply when nuclear weapons are employed in close support of friendly armor units.

2. Definitions

a. Active Protective Measures. Active protective measures include all positive means taken to engage, destroy, or neutralize the enemy forces, his weapons, and his intelligence efforts.

b. Passive Protective Measures. Passive protective measures are means taken before, during, and after an action to prevent detection or to minimize the effect of enemy attack.

c. Chemical Weapons. An item of materiel which projects, disperses, or disseminates a chemical agent.

d. Nuclear Weapons. An instrument of combat which utilizes nuclear energy as a principal means for producing blast, thermal, and nuclear radiation damage.

e. Chemical Detection and Identification, and Radiological Monitoring and Survey. See appendix XXII.

f. Area Damage Control. The measures taken before, during, or after hostile action or natural or manmade disaster, to reduce the probability of damage and minimize its effects.

3. Protective Measures in Nuclear Warfare

a. General. Nuclear detonations have three primary effects—blast, thermal radiation (heat), and nuclear radiation. Blast injuries are caused by collapsing buildings and flying debris. Blast damage to materiel is due primarily to the violent displacement of the materiel by the shock wave. Thermal radiation casualties are caused by burns resulting from flash heat. Nuclear radiation casualties result from damage to or destruction of living body tissue. For information of the effects of nuclear explosions, see FM 101-31-1. For information on residual radiation, see FM 3-12 and TM 3-210.

b. General Protective Measures.

- (1) *Training.* The nuclear weapon, although a tremendously destructive military device, is not a weapon against which there is no defense. This fact must be firmly established early in the training of any unit. The more each soldier knows about what the weapon can and cannot do, the more effective he will be on the nuclear battlefield and the greater will be his chances for survival. Training must stress the interrelated importance of discipline, camouflage, cover, concealment, dispersion, and immediate reaction for battlefield survival. (See FM 21-40 for small unit procedures, and FM 21-41 for individual protective measures.) Field exercises should always include application of unit and individual protective measures. The fact must be emphasized that armor units, because of their equipment and method of operation,

are much better suited for the nuclear battlefield than any other combat unit. Personnel must be fully aware that the immediate effects of a nuclear explosion may last for 90 seconds, while the residual or delayed effects may last for several days.

- (2) *Unit Standing Operating Procedure.* Conditions on the nuclear battlefield will require that many individual protective measures be performed without detailed direction. The SOP of each armor unit must include procedures to be followed in connection with friendly and enemy employment of nuclear weapons. The SOP should provide—a warning system of friendly or enemy weapons employment, routine procedures for protection of equipment and personnel, use of radios, and certain specified reports. The measures prescribed by the SOP should be rehearsed at every opportunity.

c. Concealment as a Protective Measure.

- (1) *General.* Concealment consists of any measure that prevents personnel or equipment from being seen by the enemy, but which provides little or no protection.
- (2) *Camouflage.* Camouflage includes all measures taken to mislead the enemy by concealment and deception. Successful camouflage depends on the selection of position, the discipline of the personnel involved, and the use of natural material and artificial construction. FM 5-20 contains procedures and techniques of camouflage.
- (3) *Night operations.* An effective way to obtain concealment is to conduct movements and tactical operations during hours of darkness or very limited visibility. Difficulties encountered in night operations can be minimized through adequate training, planning, and supervision.

d. Mobility as a Protective Measure. The mobility of armor units provides an extremely effective means of passive protection. The armor unit can be a fleeting target that is capa-

ble of rapid movement from widely dispersed areas, brief concentration, and subsequent rapid dispersal. Mobility permits armor units to move quickly through or out of an area of radioactive or chemical contamination. Retention of mobility is essential to successful armor operations. Other protective measures should be employed that do not restrict the movement of armor units.

e. Protection Afforded by Armored Vehicles.

- (1) *General.* Armored vehicles provide protection to troops against the effects of a nuclear explosion.
- (2) *Tanks.* A tank provides excellent protection for persons in it. This protection is roughly equivalent to that provided by a 4-foot-deep foxhole with overhead cover. The SOP must require that all unnecessary items, such as empty shell casings or ration boxes, be removed from the vehicle and all necessary items be secured in the vehicle. In an active nuclear war, tank crews may have to operate with hatches closed for maximum protection. The decision to accept a greater risk and to operate with hatches open is taken by the commander concerned.
- (3) *Armored personnel carriers.* Armored personnel carriers provide protection against the effects of nuclear explosions for persons in the vehicle, though not as much as a tank. There should be no loose material or equipment in the vehicle that might fly around and cause injuries, and occupants should wear helmets. The protection against nuclear effects is generally the same as that afforded by the tank ((2) above), except for a lesser degree of nuclear radiation, and the same considerations apply.

f. Protective Measures for Dismounted Personnel. Personnel of an armor unit will not have the protection of an armored vehicle at all times. It is essential that members be well trained in protective measures to use if they are dismounted. For a detailed discussion of unit and individual protective measures, see FM 21-40, FM 21-41, and TM 3-220.

- (1) *Protection against blast.* The imme-

mediate reflex action of a person caught in the open at the time of a nuclear explosion should be to hit the ground. Shallow ditches or even slight folds in the ground provide some protection against flying debris. Individual emplacements, such as foxholes or prone shelters, offer better protection. If time and the tactical situation permit, the most effective individual shelter to use, with the exception of a tank, is a well-constructed 2-man foxhole with overhead cover. This shelter should be dug in firm ground, revetted, and kept free of loose objects. The overhead cover should be as substantial as possible.

- (2) *Protection against thermal radiation (heat).* The thermal effects of a nuclear explosion are emitted instantaneously in all directions at the speed of light. Thermal casualties result from burns on bare skin and to a lesser extent through clothing. Persons caught in the open at the time of the explosion will be exposed immediately to this effect and will be unable to react rapidly enough to avoid it. However, any shadow-producing object or terrain feature provides protection against thermal radiation. Unit SOP's must require that troops reduce to the minimum the amount of bare skin exposed when in the open. Shirts and jackets should be worn with sleeves rolled down, and gloves should be worn whenever practical. To avoid injury to their eyes, personnel must be trained never to look at the fireball of an explosion. Armored vehicles and shelters having overhead cover afford excellent protection from thermal effects. Placing a shelter half over an otherwise open trench or foxhole gives protection. The use of combustible items for overhead cover must be avoided.
- (3) *Protection against nuclear radiation.* Nuclear radiation is the effect least understood by the average soldier. Protection from nuclear radiation may be obtained by placing dense ma-

terial between the radiation source and the individual. One and one-half inches of steel or seven and one-half inches of earth will reduce initial nuclear radiation by 50 percent. To be effective, shielding must be on all sides. Thus, 3 inches of steel in the hull and turret of a tank, or 15 inches of earth, will reduce the initial nuclear radiation by one-fourth. Initial nuclear radiation is emitted at the same time and velocity as thermal radiation, but to a shorter range. Initial nuclear radiation is emitted from the fireball at the time of the explosion. Its duration is about one minute after the burst or until the cloud is too high for the radiation to reach the ground. Initial nuclear radiation must not be confused with residual radiation, which is fallout in areas downwind from the target area or neutron-induced radiation in the immediate vicinity of ground zero. Persons in the open within range of this effect at the time of explosion cannot act quickly enough to avoid all of the initial nuclear radiation. A tank or a 4-foot-deep foxhole with adequate overhead cover provides the best available protection. The armored personnel carrier and other shelters discussed above provide partial protection against this hazard.

- (4) *Protection against fallout.* A surface or subsurface nuclear explosion causes the radioactive hazard of fallout. The explosion lifts tremendous quantities of earth particles into the nuclear cloud formed at the time of detonation. This material is highly radioactive and particles are carried downwind and eventually fall back to earth. The particles are known as fallout. The lingering hazards from fallout may cover many square miles. The presence and intensity of residual radiation is determined by radiological monitoring and survey. Procedures for radiological monitoring and survey must be specified in unit SOP's and are based on FM 3-12 and

TM 3-210. If the tactical situation permits, the first protective measure is prompt movement out of the area before fallout begins or as soon as possible after it has been detected. However, in some situations it may be better to remain in the area and take maximum individual and unit protective measures. Once residual radiation has been detected, the unit continues its mission, relocating in its assigned sector to minimize radiation exposure, if required, and reports the presence of radioactivity to the next higher headquarters. If it is necessary to remain in the fallout area, the protective measures against the other effects discussed previously will be used against fallout. Armored vehicles must be buttoned up completely with the crews remaining inside. Shelters should have overhead cover. The period of time a unit may remain in a contaminated area depends on the total dose of radiation the troops can receive and still remain effective, the intensity of the radiation, and the protection available. The amount of time spent away from cover should be kept to a minimum. The radioactive dust that collects on top of shelters and vehicles should be brushed away at intervals, and complete decontamination should be accomplished at the first opportunity. The protective mask prevents breathing and swallowing of radioactive particles and is used when dust concentration makes breathing difficult.

g. Unit Protection Against Nuclear Weapons.

- (1) *General.* A unit's protection depends on the collective protective measures taken by its individuals. The fundamental purpose of both individual and unit protective measures is to maintain the combat efficiency of the unit. The number of protective measures an armor unit can take depends on the tactical situation. There are certain measures that can be taken in almost any situation.

- (2) *Smoke.* The use of smoke decreases materially the thermal effects of either a friendly close support weapon or an enemy nuclear attack. Dense fog, heavy snow, or rain provide similar protection.

- (3) *Dispersion.* Dispersion is an excellent protective measure, primarily because it makes target acquisition more difficult and the target less attractive. If the tactical situation and the size and characteristics of the available area permit, approximately 4,000 meters should be maintained between perimeters of adjacent battalions or 6,000 meters between their centers of mass. These desirable dispersal distances should be considered in the assignment of assembly areas, axes of attack, objectives, and defensive positions. Armor units cannot disperse to the point that it affects their tactical employment. The terrain or the enemy capability or willingness to mass and maintain a certain force in a given area may require more concentrated dispositions to accomplish the mission.

- (4) *Position selection.* Within the restrictions imposed by the tactical situation, unit positions should be selected on terrain that provides natural shielding from nuclear weapons. Casualties resulting from secondary blast effects (flying debris) are more likely in built-up areas than in open country.

h. Unit Protective Procedures Against Nuclear Weapons. The unit protective procedures described below should be routine in armor units. Procedures employed to protect against possible friendly nuclear attack should not be so obvious that the enemy will be warned.

- (1) Whenever the direction can be determined from the unit's position to a point where either a friendly or enemy nuclear explosion may occur, vehicles should be positioned to take advantage of cover offered by the terrain.
- (2) Whenever possible, just before the

friendly employment of a nuclear weapon, tank turrets are rotated so that the main gun is facing away from the blast. This is to prevent damage to the fire control equipment.

- (3) Tools and light equipment, such as those used by kitchen and maintenance personnel, should be secured to reduce the missile hazard in the area.
- (4) Radiac instruments for determining the dose rate of residual radiation should be maintained in an operative condition and ready for use. During periods when the unit is subject to fallout, the dose-rate meters are used to determine the presence of radioactivity and to take readings of intensities. Unit SOP's must establish frequency and reporting procedures.
- (5) Such activities as feeding, supply, maintenance, training, and recreation should be staggered so that a minimum number of troops are out of cover.

4. Protection Against Chemical and Biological Attack

a. General. Armor units must train their personnel to apply protective measures against toxic chemical and biological attack. Unit SOP's should include actions to be taken in the event of such attacks. Protective measures should provide for an adequate warning system; use of individual and unit protective equipment; facilities for prompt decontamination of individuals, equipment, and supplies; and prompt treatment of casualties. For additional information, see FM 21-40, FM 21-41, and TM 3-220.

b. Protective Equipment and Shelters Against Chemical Attack.

- (1) The individual's primary protection against toxic chemical attack is his protective mask. The mask protects against inhalation of toxic chemical agents, biological agents, and radioactive material.
- (2) Armored vehicles are provided with a gas particulate filter unit. This filter unit consists of an air purifier which supplies purified air to hose connec-

tions to which individual tank protective masks are attached. These individual masks, which may be detached from the air purifier when crewmembers leave the tank, give the same protection as the individual protective mask. Each individual (tank) mask is equipped with a built-in microphone that connects to the vehicle intercom system.

- (3) Armor units rarely construct or use protective shelters. Instead, they take advantage of their mobility to avoid or rapidly pass through contaminated areas. Personnel decontamination stations are established as required to provide showers, an exchange of individual equipment, and the issue of new or laundered clothing.

c. Biological Attack. Definite information on the employment of biological agents by the enemy is disseminated from higher headquarters. Each armor unit must be alert to the danger and report promptly the unusual occurrence of diseases. The best local defense against biological warfare is strict enforcement of all preventive medical and sanitation measures and high standards of personal hygiene.

5. Decontamination

a. Effects of CBR Contamination. Chemical, biological, or radiological contamination may cause casualties; restrict the effective use of terrain, buildings, or material; or hinder operations. CBR contamination, particularly chemical, may slow down or hinder tactical operations because of the following:

- (1) Casualties or the threat of casualties.
- (2) Loss of efficiency of troops who must wear protective clothing and equipment.
- (3) Time lost in decontamination operations.
- (4) Time lost in bypassing or avoiding the contamination hazard.

b. Estimate of the Situation To Determine the Need for a Decontamination Operation.

- (1) *Purpose.* A decontamination operation is conducted to reduce the hazard from CBR contamination sufficiently

to allow the overall mission to be accomplished.

- (2) *Effect on unit mission.* A decision of a unit commander to carry out a decontamination operation will be based on the effect it will have on the unit mission. The expense in materials, time, and labor involved in the decontamination operation must be considered and compared with the time lost to the unit mission in avoiding or bypassing the contamination. (For information on unit procedures, see FM 21-40.)
- (3) *Conditions.* Conditions which must exist before decontamination is undertaken include the following:
 - (a) The area or object must actually be contaminated with toxic chemical agents or radioactive material or evidence must indicate that a biological hazard exists.
 - (b) There must be a necessity for decontamination.
 - (c) Suitable and practical means of decontamination must be available.
- (4) *Time factors.* Time factors which should be considered before decontamination is undertaken are as follows:
 - (a) The time which the contamination would remain if left alone.
 - (b) The time which the contamination may be allowed to remain without interfering with the unit mission.
 - (c) The time which would be required to conduct a decontamination operation.

c. Echelons of Decontamination.

- (1) *First echelon decontamination* is that decontamination performed by the individual on himself, his personal equipment, and possibly on his assigned equipment. First echelon decontamination will be accomplished sufficiently to allow the individual to continue his assigned mission.
- (2) *Second echelon decontamination* is that decontamination performed by unit personnel under the supervision

of specially trained individuals in the unit and with the unit's decontamination equipment. Second echelon decontamination will be accomplished sufficiently to allow the unit to accomplish the assigned mission.

- (3) *Third echelon decontamination* is that decontamination which is beyond the capabilities of the using unit. Third echelon decontamination will be accomplished by specially trained, specially equipped units. Third echelon decontamination will reduce the hazard to as low a level as possible.

d. General Types of Decontaminants.

- (1) *General.* There are three general types of decontaminants that are available in the field for use in a decontamination operation: natural, standard, and miscellaneous. Any of the three types of decontaminants may be employed either jointly or independently to accomplish a decontamination mission.
 - (2) *Natural decontaminants.* The common or natural decontaminants are normally available for use in decontamination. These are weather, fire, earth, and water.
 - (3) *Standard decontaminants.* Standard decontaminants are those chemicals that have been especially designed and are issued for decontamination, to include GI soap. Six chemicals are presently issued for the purpose of decontamination. The standard nomenclature is given below, along with the common name, for each of these decontaminants.
 - (a) Decontaminating Agent, STB (supertropical bleach, bleach, or STB).
 - (b) Decontaminating Agent, DS2 (DS2).
 - (c) Decontaminating Agent, Biological, BPL (beta-propiolactone or BPL).
 - (d) DANC Solution, M4 (DANC).
 - (e) Vesicant Agent Protective Ointment, M5 (M5 protective ointment).
 - (f) Soap, Ordinary (GI soap).

(4) *Miscellaneous decontaminants.* Miscellaneous decontaminants include certain common chemicals and organic solvents, absorbents, and explosives. The chemicals include caustic soda, washing soda, household bleach, and others. These chemicals act to destroy or lessen the toxicity of chemical agents and to destroy biological

agents. Solvents, as a general rule, aid in removing chemical agents but do not destroy them. Absorbents and explosives may be used to remove CBR contamination.

e. Decontamination Measures. FM 21-40 and TM 3-220 contain detailed procedures for the decontamination of individuals, equipment, and vehicles.

APPENDIX XXIV

ASSEMBLY AREAS

1. General

An assembly area is an area in which a unit is assembled preparatory to future action. In this area orders are issued, the unit services and repairs vehicles, receives and issues supplies, and feeds troops. The assembly area, when used to prepare for an attack, is usually well forward. If possible, it should be out of range of enemy light artillery.

2. Characteristics

a. Desirable characteristics of assembly areas include—

- (1) Concealment from air and ground observation.
- (2) Cover from direct fire.
- (3) Good drainage and a surface that will support vehicles.
- (4) Good exits and entrances, and adequate internal roads or trails.
- (5) Ample space for dispersion of vehicles, personnel, and equipment for a battalion task force will vary with the number of company teams assigned and attached (approximately 2,000 x 2,000 meters is required as a minimum for a three company team battalion task force).
- (6) Adequate communication sites.
- (7) Be far enough away from other installations that together they do not present a lucrative nuclear target.
- (8) Offer, if appropriate, a suitable landing site for organic, attached, or supporting aircraft.

b. Overhead concealment is important if the unit is to remain in the area for any length of time. Vehicles, equipment, entrances, and exits

are camouflaged to keep the enemy from detecting the location of the unit. Maximum use should be made of available aircraft to inspect overhead camouflage.

3. Organization

a. The individual in charge of a quartering party divides the area among the subordinate units, the command post, and the trains, as appropriate. It is desirable to have the trains centrally located in the area and near the main road or trail through the area.

b. If the individual in charge of a subordinate quartering party determines from his reconnaissance that the assigned area is unsatisfactory, he immediately notifies the individual in charge of the higher headquarters quartering party and requests a change of area. If a change cannot be made in the time available, the unit is located under the best available cover and concealment as soon as it arrives, and necessary adjustments are made later.

4. Occupation

Upon the arrival of a unit at an assembly area, all elements move off the road and clear the route of march without slowing or halting. The posting of guides, selection of routes, and the allocation of areas by the quartering party are done with this objective in mind. This requires aggressive action on the part of guides and close supervision by commanders and staff officers. In designating locations in the area, the quartering party considers the unit's positions in the march column. The march route is not blocked while precise adjustments are made. After the march serial has cleared the route, any desired adjustments of vehicles can be made easily without holding up the flow of traffic (fig. 101, 102, and 103).

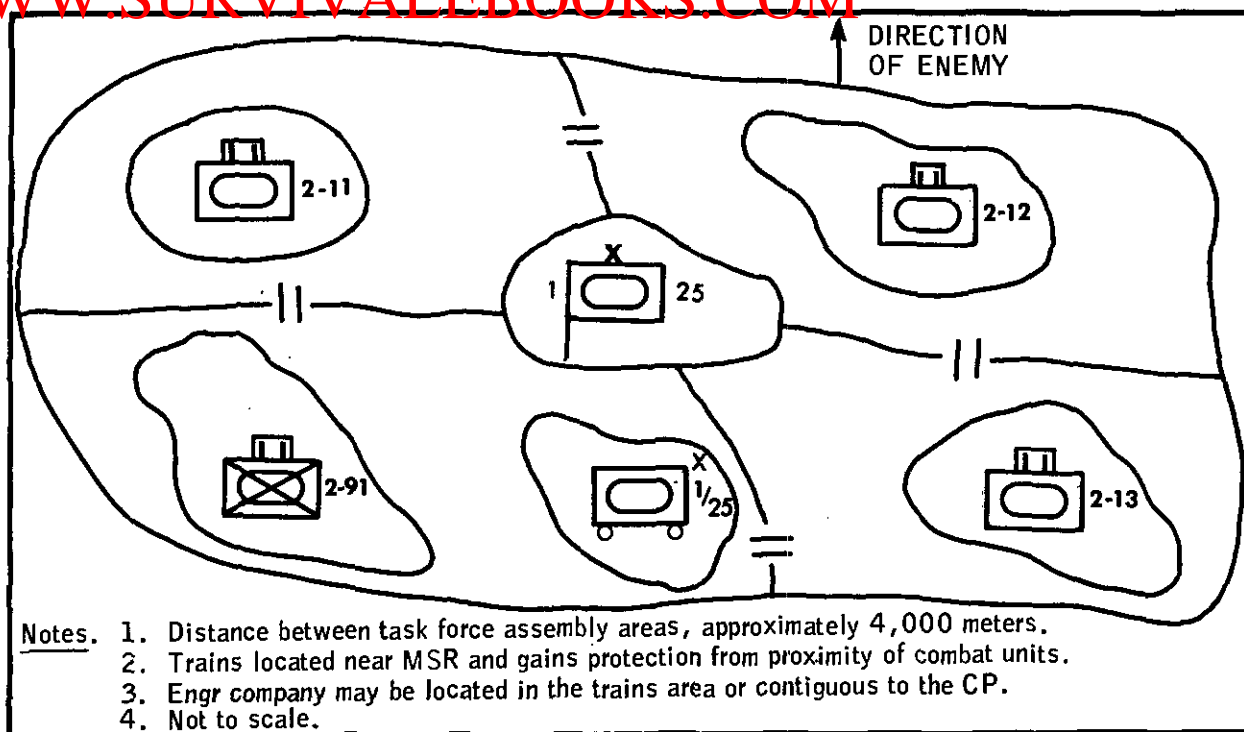

Figure 101. Diagram of a brigade assembly area.

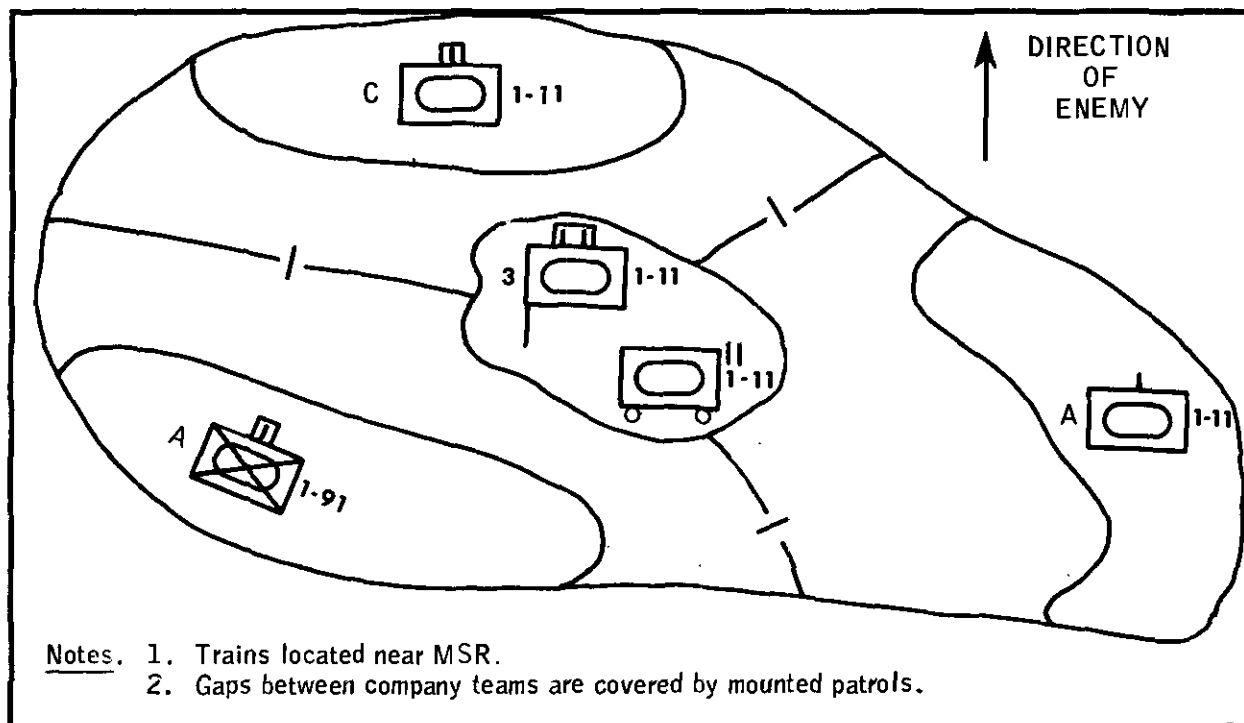

Figure 102. Diagram of a battalion assembly area.

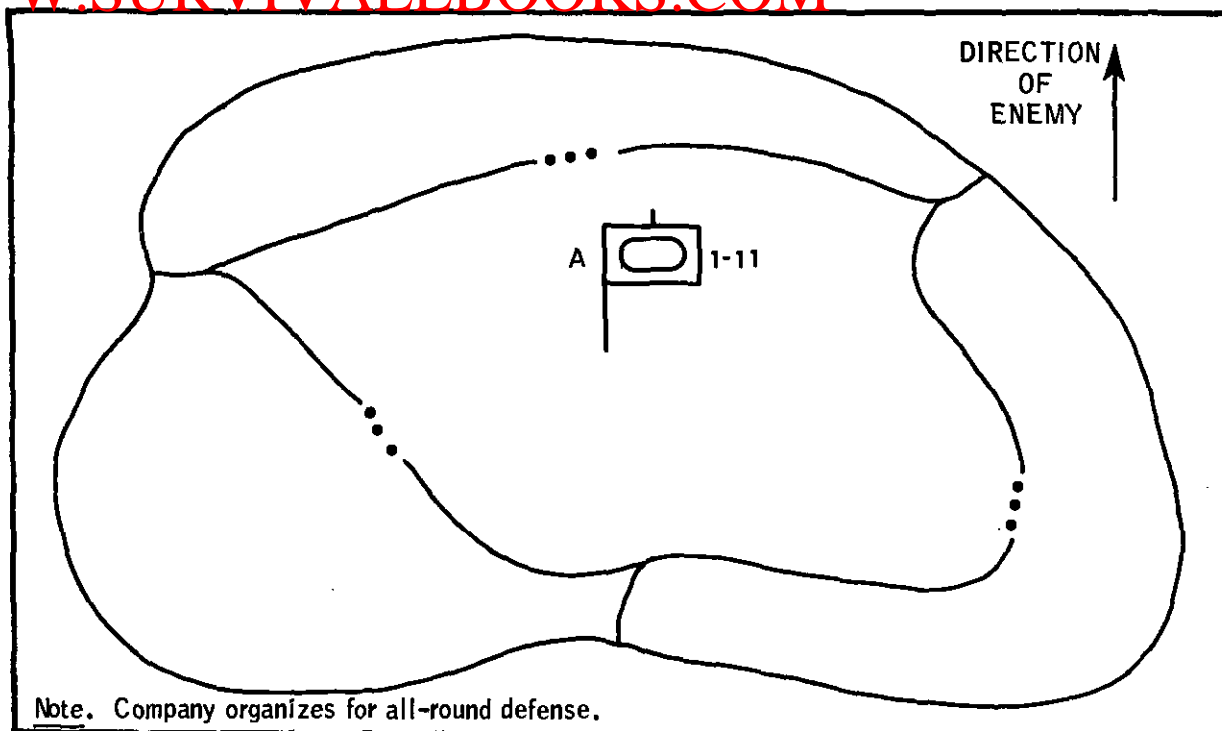

Figure 103. Diagram of a company assembly area.

5. Security

a. Security in assembly areas is obtained by tactical disposition of troops, concealment, use of natural and artificial obstacles, reconnaissance, and the establishment of blocking positions and local security. Local security measures, including observation or listening posts, cover all key terrain features and likely avenues of enemy approach.

b. The size and disposition of security elements depend upon the anticipated enemy activity and the nature of the terrain. Blocking positions and observation and listening posts will be strong enough to provide security. Since such duty is tiring and reduces the subsequent combat efficiency of troops, the combat power of the main body should not be dissipated on unnecessarily large security detachments. The basic consideration is that the command must not be surprised.

c. When dividing the area among units of the force, the commander assigns boundaries between adjacent units and designates contact points at which liaison is to be established and maintained.

d. Protective minefields, when authorized,

are placed to provide close-in protection and warning of enemy approach. For discussion on the employment of mines, see appendix XVIII.

e. Assembly areas, regardless of location, must have adequate security against hostile air and ground attack, patrol activities, and guerrilla forces.

6. Communication and Liaison

a. The signal communication system of an armor unit in a bivouac or assembly area consists of messenger, wire, radio, and visual means. Normally for security purposes, radio operation is minimized. Radio silence or listening silence may be directed.

b. Wire lines are laid to units as necessary.

c. Each company sends a liaison agent (messenger) to the battalion command post. The battalion sends a liaison officer to the next higher headquarters.

7. Logistics

a. As a minimum, ammunition and fuel and lubricants are supplied. This supply must be supervised closely to insure that all vehicles have prescribed and basic loads prior to com-

bat operations. When an assembly area is occupied for an extended period of time, additional supply is accomplished in accordance with the situation. Replenishment of all classes of supply is accomplished if time permits.

b. In the assembly area, vehicular, weapons, and signal inspections and maintenance are

among the primary considerations of the unit commander. Vehicle crews and maintenance personnel must insure that equipment operates efficiently. Maximum effort should be devoted to completing those maintenance checks and repairs that cannot be accomplished properly during combat.

APPENDIX XXV
STANAG NO. 2113
DESTRUCTION OF MILITARY TECHNICAL EQUIPMENT

NATO UNCLASSIFIED

STANAG 2113

Agreed English/French Texts.

DETAILS OF AGREEMENT (DofA)
DESTRUCTION OF MILITARY TECHNICAL EQUIPMENT

Annex: A (DofA) Priorities for Destruction of Parts of Military
 Technical Equipment.

* * * * *

PRINCIPLES AND PRIORITIES

2. *Detailed Methods.* Detailed methods of destroying individual items of equipment are to be included in the applicable technical publications, user handbooks and drill manuals.
3. *Means of Destruction.* Nations are to provide for the means of destruction for their own equipment.
4. *Degree of Damage.*
 - a. *General.* Methods of destruction should achieve such damage to equipment and essential spare parts that it will not be possible to restore the equipment to a usable condition in the combat zone either by repair or cannibalization.
 - b. *Classified Equipment.* Classified equipment must be destroyed in such degree as to prevent duplication by, or revealing means of operation or function, whenever possible, to the enemy.
 - c. *Associated Classified Documents.* Any classified documents, notes, instructions, or other written material pertaining to function, operation, maintenance, or employment, including drawings, or part lists, must be destroyed in a manner to render them useless to the enemy.
5. *Priorities for Destruction.*
 - a. Priority must always be given to the destruction of classified equipment and associated documents.
 - b. When lack of time and/or stores prevents complete destruction of equipment, priority is to be given to the destruction of essential parts, and the same parts are to be destroyed on all like equipment.
 - c. A guide to priorities for destruction of parts for various groups of equipment is contained in Annex A (DofA) to this STANAG.

NATO UNCLASSIFIED

413

6. *Equipment Installed in Vehicles.* Equipment installed in vehicles should be destroyed in accordance with the priorities for the equipment itself, taking into account the relative importance of the installed equipment and the vehicle itself.
7. *Spare Parts.* The same priority, for destruction of component parts of a major item necessary to render that item inoperable, must be given to the destruction of similar components in spare parts storage areas.
8. *Cryptographic Equipment and Material.* The detailed destruction procedure to be followed in order to ensure the rapid and effective destruction of all types of cryptographic equipment and material is to be specified in instructions issued by the appropriate communication security authority.
9. *Authorization.* The authority for ordering the destruction of equipment is to be vested in the divisional and higher commanders, who may delegate authority to subordinate commanders when the situation requires.
10. *Reporting.* The reporting of the destruction of equipment is to be done through command channels.

* * * * *

ANNEX A (DofA) TO
 STANAG 2113

PRIORITIES FOR DESTRUCTION OF PARTS OF MILITARY
 TECHNICAL EQUIPMENT

<i>EQUIPMENT</i>	<i>PRIORITY</i>	<i>PARTS</i>
1. <i>VEHICLES (INCLUDING TANKS AND ENGINEER EQUIPMENT)</i>	1	Carburetor/fuel pump/injector/distributor.
	2	Engine block and cooling system.
	3	Tires/tracks and suspensions.
	4	Mechanical or hydraulic systems (where applicable).
	5	Differentials.
	6	Frame.
2. <i>GUNS</i>	1	Breech, breech mechanism, and spares.
	2	Recoil mechanism.
	3	Tube.
	4	Sighting and fire control equipment (Priority 1 for Anti-Aircraft guns).
	5	Carriage and tires.
3. <i>SMALL ARMS</i>	1	Breech mechanism.
	2	Barrel.
	3	Sighting equipment (including Infrared).
	4	Mounts.
4. <i>OPTICAL EQUIPMENT</i>	1	Optical parts.
	2	Mechanical components.
5. <i>RADIO</i>	1	Transmitter (oscillators and frequency generators).
	2	Receiver.
	3	Remote control units or switchboards (exchanges) and operating terminals.

<i>EQUIPMENT</i>	<i>PRIORITY</i>	<i>PARTS</i>
	4	Power supply and/or generator set.
	5	Antennae.
	6	Tuning heads.
6. <i>RADAR AND OTHER ELECTRONIC EQUIPMENT</i>	1	Frequency determining components, records, operating instructions, which are subject to security regulations, and identification material (Identification Friend or Foe (IFF)).
	2	Antennae and associated components such as radiators, reflectors and optics.
	3	Transmission lines and waveguides.
	4	Transmitter high voltage components.
	5	Control consoles, displays, plotting boards.
	6	Cable systems.
	7	Automatic devices.
	8	Other control panels and generators.
	9	Carriage and tires.
7. <i>GUIDED MISSILE SYSTEMS</i>	1	Battery control centers.
	2	Missile guidance equipment (including homing systems).
	3	Launchers including control circuits.
	4	Missiles.
	5	Measuring and test equipment.
	6	Generators and cable systems.
8. <i>AIRCRAFT AND SURVEILLANCE DRONES</i>	1	Identification (IFF) equipment, other classified electronic equipment, publications and documents pertaining thereto, and other materiel as defined by the national government concerned.
	2	Installed armament (Use subpriorities for Group 2, Guns, or Group 3, Small Arms, as appropriate).
	3	Engine Assembly (Priorities for destruction of magnetos, carburetors, compressors, turbines and other engine sub-assemblies to be determined by national governments, depending on type of aircraft involved and time available for destruction).
	4	Airframe/control surfaces/undercarriage (Priorities for destruction of propellers, hub-rotor blades, gear boxes, drive shafts, transmissions, and other sub-assemblies (not already destroyed in priority 3) to be determined by national governments, depending on type of aircraft involved and time available for destruction).
	5	Instruments, radios, and electronic equipment (not included in priority 1).

<i>EQUIPMENT</i>	<i>PRIORITY</i>	<i>PARTS</i>
	6	Electrical, fuel, and hydraulic systems.
9. <i>ROCKETS</i>	1	Launcher.
	2	Rocket.
	3	Sights and fire control equipment.

INDEX

	Paragraphs	Pages
Administrative orders -----	App IX	308
Administrative reports (<i>see</i> reports and warnings)		
Advance guard (<i>see</i> security operations)		
Air cavalry (<i>also see</i> type of operation) -----	9	5
Air defense:		
Air defense artillery -----	220-221	125
Offensive planning -----	114	64
Security measures -----	107	59
Air movements -----	App VI	275
Air support, tactical -----	235-240	133
Airmobile operations -----	336-337	173
Amphibious operations:		
Administration and logistics -----	390	211
Armor units -----	384	208
Embarkation -----	393	212
Embarkation plan -----	389	210
General -----	383	208
Guiding vehicles ashore -----	398	215
Landing plan -----	388	210
Movement to objective area -----	394	212
Obstacle clearance and breaching -----	397	214
Organization for combat -----	387	210
Passage of the beach -----	399	215
Planning -----	385	209
Preparation for embarkation -----	392	211
Preparation of tentative plans -----	386	209
Rehearsals -----	400	216
Ship to shore movement -----	395	213
Shipping -----	391	211
Time and place of landing -----	396	214
Area damage control -----	306-317	159
Area defense (<i>see</i> defense)		
Area reconnaissance (<i>see</i> reconnaissance operations)		
Armor, general:		
Capabilities -----	11	6
Conduct of operations -----	12	7
Consideration for employment -----	19-29	10
Control -----	47-51	20
Definition -----	3	4
Factors affecting employment (METT) -----	30-34	12
Missions -----	10	6
Planning -----	42-46	16
Role -----	4	4
Role of units -----	6-9	5
Armored and air cavalry units -----	9	5
Brigade -----	6	5
Mechanized infantry units -----	8	5
Tank units -----	7	5
Armored cavalry (<i>also see</i> type of operation) -----	9, 40, App XIV	5, 16, 337
Army aviation -----	222-224	126
Artillery, field -----	215-219	121

	Paragraphs	Pages
Assembly areas (<i>also see</i> control measures and overlay technique) -----	App XXIV	409
Assault (<i>see</i> offense)		
Atomic demolitions munitions:		
Tactical characteristics -----	App XX	386
Tactical employment and command and control -----	App XX	386
Attachments (<i>see</i> type of operation)		
Attack (<i>see</i> offense)		
Attack, control of direction (<i>also see</i> offense) -----	App X	319
Attack position (<i>also see</i> offense)	App X	319
Base of fire (<i>see</i> fire and maneuver and fire and movement)		
Battalion operations (<i>see</i> type of operation)		
Battalion staff (<i>see</i> unit staff)		
Biological (<i>see</i> protective measures)		
Blocking positions (<i>also see</i> type of operation) -----	App X	319
Boundaries (<i>also see</i> type of operation) -----	App X	319
Bridge, armored vehicle launched (AVLB) -----	App XVII	365
Bridge, reconnaissance -----	78	47
Brigade operations (<i>see</i> type of operation)		
Brigade staff (<i>see</i> unit staff)		
Built-up area operations -----	373-382	201
Bypass, procedures and techniques -----	142-144	81
Capabilities, armor (<i>see</i> Armor, general)		
Checkpoints (<i>also see</i> type or operation) -----	App X	319
Chemical (<i>see</i> combat support, protective measures, or type operation)		
Chemical detection and identification -----	App XXII	397
Combat service support:		
Battalion and squadron elements and trains:		
Combat service support elements -----	259	141
Combat trains -----	261	142
Control of the trains -----	263	142
Field trains -----	262	142
Trains organization -----	260	142
Battalion and squadron combat service support operations:		
Area defense -----	279	149
Assembly areas -----	274	147
Defense, general -----	277	149
Delaying actions -----	281	150
Fast moving offensive operations -----	275	148
Marches -----	273	146
Mobile defense -----	278	149
Offensive operations -----	276	148
Retirements -----	283	151
Retrograde actions -----	280	150
Slow moving offensive operations -----	276	148
Withdrawal -----	282	150
Brigade trains:		
Composition and employment -----	257	140
General -----	255	140
Organization for control -----	256	140
Under division control -----	258	140
Characteristics of armor units -----	249	139
Classes of supply -----	285-292	151
Company and troop combat service support elements -----	264-267	142
Employment of trains:		
Battalion combat trains -----	271	146
Battalion field trains -----	272	146
General -----	268	144
Supply routes -----	270	146
Trains areas -----	269	146

Combat service support—Continued

Maintenance:		
Direct and general support -----	295	155
Organizational -----	294	154
Recovery and evacuation -----	296-297, 299-300	155, 158
Recovery and evacuation of aircraft -----	298	158
Responsibilities -----	298	154
Medical service:		
Division -----	303	158
General -----	301	158
Support of the air cavalry troop -----	305	158
Treatment and evacuation -----	304	158
Unit -----	302	158
Personnel:		
Battalion and squadron -----	252	139
Brigade -----	251	139
Company and troop -----	253	140
General -----	250	139
Separate company and troop -----	254	140
Principles -----	248	138
Repair parts -----	292	153
Water -----	291	153
Combat support (<i>also see</i> type of operation):		
Air defense artillery -----	220, 221	125
Air support, tactical:		
Armament -----	239	134
Close air support -----	238	134
Control measures -----	237	134
General -----	235	133
Request for close air support -----	236	133
Typical targets for close air support -----	240	136
Army aviation:		
Army and corps aviation support -----	224	127
General -----	222	126
Organic aircraft, armored division and armored cavalry regiment -----	223	127
Chemical support -----	225-226	127
Communications:		
Battalion or squadron communication platoon -----	231	131
Communications means -----	230	130
Communications security -----	233	131
Electronic counter-countermeasures -----	234	132
General -----	229	130
Liaison -----	232	131
Engineers -----	227-228	128
Field artillery:		
Armored division artillery -----	217	121
Fire planning and coordination -----	218	122
Fire support control measures -----	219	125
General -----	215	121
Tactical employment -----	216	121
Intelligence:		
Agencies -----	242	136
Counterintelligence -----	246	137
General -----	241	136
Reconnaissance -----	243	137
Surveillance -----	245	137
Target acquisition -----	244	137
Combined arms (<i>see</i> Armor, general and type of operation)		
Command:		
Armor commander -----	53, 61-62	22, 29
General -----	52	22

	Paragraphs	Pages
Command—Continued		
Human factor -----	57	23
Leadership -----	56	23
Responsiveness to command -----	55	23
Succession of command -----	54	23
Command and staff -----	68	42
Command facilities -----	App II	255
Communications (<i>also see</i> type of operation) -----	229-234	130
Conduct of operations (<i>see</i> Armor, general and type of operation)		
Company (<i>see</i> type of operation)		
Contact points -----	App X	319
Control (<i>see</i> Armor, general and type of operation)		
Control measures and overlay techniques -----	App X	319
Consideration for employment of armor (<i>see</i> Armor, general)		
Coordinating points -----	App X	319
Covering force (<i>see</i> security and defensive operations)		
Defense:		
Area defense:		
Action of the forward defense force -----	182	100
Action of the reserve -----	183	101
Action of the security force -----	181	100
Conduct of the area defense -----	180	100
Distribution of forces -----	175	99
General -----	174	99
Organization and function of forces in the forward defensive area -----	178	100
Organization and function of the reserve -----	179	100
Organization and function of the security force -----	177	99
Selection of forward defense areas and reserve positions -----	176	99
Defensive operations, general:		
Basic forms -----	154	90
Considerations -----	153	88
Doctrine -----	152	88
Factors affecting employment of forces -----	156	90
Organization of the defense:		
Combat support units -----	165	94
Command and control -----	162	92
Defensive areas -----	166	94
Fire planning -----	163, App XI, App XIV	92, 329, 337
General -----	157	90
Organization for combat -----	161	92
Planning -----	159	91
Priority of work -----	160	91
Reconnaissance -----	158	91
Security and surveillance -----	164	93
Purpose -----	151	88
Selection of type defense -----	155	90
Mobile defense:		
Conduct -----	173	98
Considerations -----	171	96
Fixing forces -----	169	95
General -----	167	94
Planning -----	172	96
Reserves -----	170	96
Security forces -----	168	94
Mines (<i>see</i> Mine warfare)		
Night defense combat techniques -----	App XV	345
Obstacles (<i>see</i> Obstacle planning and employment)		
Orders -----	App IX, App XI	308, 329
Relief in place -----	184-192	101
Sector -----	App X	319
Defile operations -----	334, 355-359	173, 180

	Paragraphs	Pages
Delaying actions (<i>see</i> Retrograde and defense)		
Delaying positions (<i>also see</i> Retrograde and defense) -----	App X	319
Desert operations -----	318-319, 324-329	168, 170
Destruction of technical military equipment -----	App XXV	418
Electronic counter-countermeasures -----	234	132
Engineer combat vehicle -----	App XVII	369
Engineer support (<i>also see</i> type of operation) -----	227-228	128
Estimate of the situation -----	App VII	295
Factors affecting armor employment (METT) -----	30-34	12
Field artillery support (<i>also see</i> type of operation) -----	215-219	121
Fire and maneuver -----	111, App XIII	68, 332
Fire and movement, tank units -----	App XIII	332
Fire planning (<i>also see</i> type of operation) -----	218, App XIV	122, 337
Fire plans, example for preparation -----	App XI	329
Fire support organic -----	App XIV	337
Fixing force (<i>see</i> Defense)		
Flank guard (<i>see</i> Security operations)		
Forest and wooded area operations -----	350-354	177
Formations (<i>see</i> type of operation)		
Forms of maneuver and offensive operations (<i>see</i> Offense) -----		
Fortified positions -----	371-372	198
Forward defense area (<i>see</i> Defense)		
Inland water crossings:		
Conduct of crossings -----	367	190
Crossing means -----	362	184
Crossing site characteristics -----	364	184
Employment of armored cavalry -----	369	197
Employment of tanks -----	368	195
General -----	359	183
Nature of a crossing operation -----	361	184
Preliminary selection of crossing areas -----	365	185
Reconnaissance of crossing sites -----	366	186
Timing of the crossing -----	363	184
Types of crossing -----	360	183
Waterborne vehicle driving procedures -----	370	197
Intelligence (<i>also see</i> type of operation) -----	241-246	136
Internal defense operations:		
Combat operations by ground armor units -----	412	223
Combined arms forces -----	410	222
Employment of tanks, armored wheel vehicles, and armored personnel carriers --	411	223
General -----	407	218
Missions -----	409	221
Planning -----	408	219
Jungle operations -----	318-323	168
Line of departure -----	App X	319
Linkup operations -----	338-342	173
Maintenance -----	298-300	154
Marches (<i>see</i> Movements)		
Mechanized infantry (<i>see</i> type of operation)		
Medical service -----	301-305	158
Meeting engagements (<i>see</i> Offense)		
METT -----	30-34	12
Mine warfare -----	App XVIII	369
Missions (<i>see</i> Armor, general and type of operation)		
Mobile defense (<i>see</i> Defense)		
Mortar platoon, heavy (<i>see</i> Organization for combat; fire support, organic; and type of operation)		

	Paragraphs	Pages
Movements -----	App VI	275
Mountain operations -----	318-319, 330-333	168, 171
Night attacks (<i>see</i> offense)		
Night combat techniques -----	App XV	345
No fire line -----	App X	319
Nuclear burst yield estimation -----	App XXII	397
Nuclear fallout prediction -----	App XXII	397
Nuclear protective measures (<i>see</i> protective measures)		
Nuclear warfare, active and nonactive -----	16-18	9
Obstacle planning and employment -----	App XIX	379
Offense:		
Advance to the assault -----	120-121	69
Assault -----	122	70
Bypass, procedures and technique -----	142-144	81
Considerations -----	111-112	63
Consolidation and reorganization on the objective -----	124	72
Continuation of the attack -----	123	72
Control measures -----	118	68
Doctrine -----	110	63
Formations -----	116	65
Forms of maneuver and offensive operations:		
Envelopment -----	127	74
Exploitation and pursuit -----	130	75
Frontal attack -----	128	75
General -----	125	73
Infiltration -----	131	77
Movement to contact -----	132	77
Penetration -----	126	73
Turning movement -----	129	75
Meeting engagement -----	139-141	80
Methods of attack -----	119	68
Night attacks -----	145-150, App XV	82, 345
Orders -----	App IX & XI	308, 329
Organization for combat -----	115	65
Passage of lines -----	133-135	77
Planning -----	113-114	64
Reconnaissance in force -----	136-138	79
Reserves -----	117	67
Operations orders and plans:		
Combat orders -----	App IX	308
Examples of operations orders -----	App XI	329
Operations plans -----	App IX	308
Technique of preparation -----	App IX	308
Organization for combat (<i>also see</i> type of operation):		
Armored cavalry -----	40	16
Battalion task forces -----	36, App XVI	15, 363
Company teams -----	37, App XVI	15, 363
Factors of METT -----	41	16
General -----	35	14
Heavy mortar platoon and Davy Crockett section -----	38	15
Scout and reconnaissance platoons -----	39	16
Passage of lines -----	133-135	77
Phase lines (<i>also see</i> type of operation) -----	App X	319
Principles of war -----	14-15	8
Principles of war, commander's application -----	App VIII	300
Prisoner of war, handling -----	App XII	330
Protective measures under conditions of chemical and biological operations and nuclear warfare.	App XXIII	332

	Paragraphs	Pages
Psychological operations:		
Armor units -----	405	217
Defense operations -----	407	218
Offense operations -----	406	217
Retrograde operations -----	408	219
Security operations -----	409	221
 Quartering party (see movements and unit staff, S1)		
Radar, ground employment -----	App XXI	390
Radiological monitoring and survey -----	App XXII	397
Raids -----	343-345	175
Rail movements (see movements)		
Rear area security operations, division -----	415-419	248
Rear guard (see Security operations)		
Reconnaissance in force (also see Offense and reconnaissance operations) -----	136-138	79
Reconnaissance operations (also see type of operation) :		
Agencies -----	70	44
Aircraft, by -----	81	47
Area -----	75	46
Bridges and defiles -----	78	47
Coordination and control -----	83	47
Fire, by -----	76	46
Frontages -----	82	47
Fundamentals -----	71	44
In force -----	80	47
Instructions -----	84	48
Night -----	79	47
Operations, general -----	69	44
Route -----	73	46
Town, obstacle or enemy positions -----	77	46
Types -----	72	45
Zone -----	74	46
Relief in place -----	184-192	101
Reports and warnings -----	App V	268
Reserves (see type of operation)		
Retirements (see Retrograde operations)		
Retrograde operations:		
Considerations -----	195-199	106
Delaying action -----	200-203	109
General -----	193	106
Retirement -----	209-210	118
Types -----	194	106
Withdrawal -----	204-208	116
Withdrawal through a rearward position -----	211-212	119
River crossings (see inland water crossings)		
Route of withdrawal (also see Retrograde operations) -----	App X	319
Route of march (also see movements) -----	App X	319
Screening force (see Security operations)		
Scout and reconnaissance platoons (see Organization for combat and type of operation)		
Searchlights, tank mounted (see Night combat techniques)		
Sector (also see Defense) -----	15, App X	8, 319
Security operations:		
Actions on contact -----	94	50
Advanced guard -----	96	51
Against covert threats -----	109	62
Against ground attack -----	91	49
Against nuclear and chemical attack -----	108	61
Air defense security measures -----	107	59
Covering force -----	104	56
Flank guard -----	97-102	51

	Paragraphs	Pages
Security operations—Continued		
Frontages -----	93	50
Fundamentals -----	92	50
General -----	90	49
Rear guard -----	105-106	57
Screening force -----	103	52
Security forces -----	95	50
Shore to shore movements -----	401-406	216
Staff (<i>see</i> Unit staff)		
Staff records -----	App IV	265
Staff relations, selected operations activities -----	App III	260
Surveillance operations -----	85-89	48
Supply (<i>see</i> logistics)		
Tank sweeps -----	346-349	176
Tanks (<i>see</i> type of operation)		
Troop leading procedures -----	58-60	24
Task organization (<i>also see</i> organization for combat) -----	App XVI	363
Unit staff and principal assistants:		
Battalion and armored cavalry squadron -----	66	31
Brigade and armored cavalry regiment -----	67	36
General -----	63	29
Intrarelations -----	64	30
Organization -----	65	30
Water movements (<i>see</i> movements)		
Withdrawals (<i>see</i> Retrograde operations)		
Zone reconnaissance (<i>see</i> Reconnaissance operations)		

By Order of the Secretary of the Army:

HAROLD K. JOHNSON,
*General, United States Army,
 Chief of Staff.*

Official:

KENNETH G. WICKHAM,
*Major General, United States Army,
 The Adjutant General.*

Distribution:

To be distributed in accordance with DA Form 12-11 requirements for Armor Operations.

(Classification)

- c. Bde supply route: NA020301, KLINGSTADT (NA025353), Route 292, PHERDEBURG (NA425450).
- d. Maint coll pts: NA021305, NA028317.
- e. PW coll pt: NA017320 init; move on order.

5. COMMAND AND SIGNAL

- a. Signal:
 - (1) SOI, index I-17.
 - (2) Listening silence until crossing LD.
- b. Command:
 - (1) Comd Gp follow TF 2-13 Armor init.
 - (2) CP remains present loc; move on order.

Arnold
ARNOLD
Col

- Annexes: A--Intel (to be issued)
 - B--Fire Spt (to be issued)
 - C--Check Point
- Distribution: A 21st Inf Div

Note. In this example, the commander signed the original copy of the order, which was then reproduced.

(Classification)

Copy No. 15
2d Bde, 25th Armored Div
GIEBELSTADT (NA010325), GERMANY
261300 Nov 19
RS 24

OPORD 9
Ref: Map, GERMANY, 1:100,000, WUERZBURG and BAMBERG sheets.
Task org:

- TF 2-13 Armor
- 2-13 Armor (-1 co)
- C/2-92 Mech
- 1/B/25 Engr (DS)
- 1/1/E/25 Engr (MAB)
- 1 LOH (OPCON)
- TF 2-14 Armor
- 2-14 Armor
- B/2-92 Mech
- 2/B/25 Engr (DS)
- 2/1/E/25 Engr (MAB)
- 1 LOH (OPCON)
- Bde Con
- 2-51 Arty (DS)
- B/25 Engr
- 1/E/25 Engr (MAB) (-)
- 1/3/E/25 Engr (-)
- 1/25 MP

1. SITUATION

- a. En forces: Annex A, Intel.
- b. Friendly forces:
 - (1) 25th Armored Div atks 270600 Nov 19 through 21st Inf Div and 54th Inf Div (M) with two bde's abreast; seizes and secures crossings over the MAIN River; cont atk to northeast on order.
 - (2) 54th Div (M) follow and splts atk 25th Armored Div.
 - (3) 2-22 Cav (-) follows 2d Bde init; thereafter, protects div north flank.
- c. Atch and det: Task org.

2. MISSION

2d Bde atk 270600 Nov 19 through elements 21st Inf Div; seize crossings over MAIN River vic ERLANGEN (PV4594); cont atk to northeast on order.

3. EXECUTION

- a. Concept of operation:
 - (1) Maneuver: Op consist of passage of lines through elements 1st and 3d Bde, 21st Inf Div; atk with two TF's abreast to penetrate en def followed by an exploitation to seize crossings over MAIN River; TF 2-14 Armor on the north to seize obj 1; TF 2-13 Armor on the south to seize obj 2; TF 2-92 Mech follow TF 2-14 Armor. Be prepared to cont atk to northeast on order.
 - (2) Fires: Arty-Nonnuc prep H-15 until lifted by leading TF's. Pri fires TF 2-13 Armor. Annex A, Fire Spt.
- b. Nuc-1 HJ/FOXTROT/20KT at H-15
- c. TF 2-13 Armor.
- d. TF 2-14 Armor:
 - Spt or assume mission of either leading TF on order.
- e. B/25 Engr: GS.
- f. 1/25 MP: Est PW coll pt; est TCP's on order.
- g. Coordinating instructions:
 - (1) Coord passage of line before 270200 Nov 19.
 - (2) EEI; Will en defend MAIN River vic ERLANGEN?

4. ADMINISTRATION AND LOGISTICS

- a. Annex F, Div OPORD 7.
- b. Bde tm loc vic NA015330.

(Classification)

(Classification)

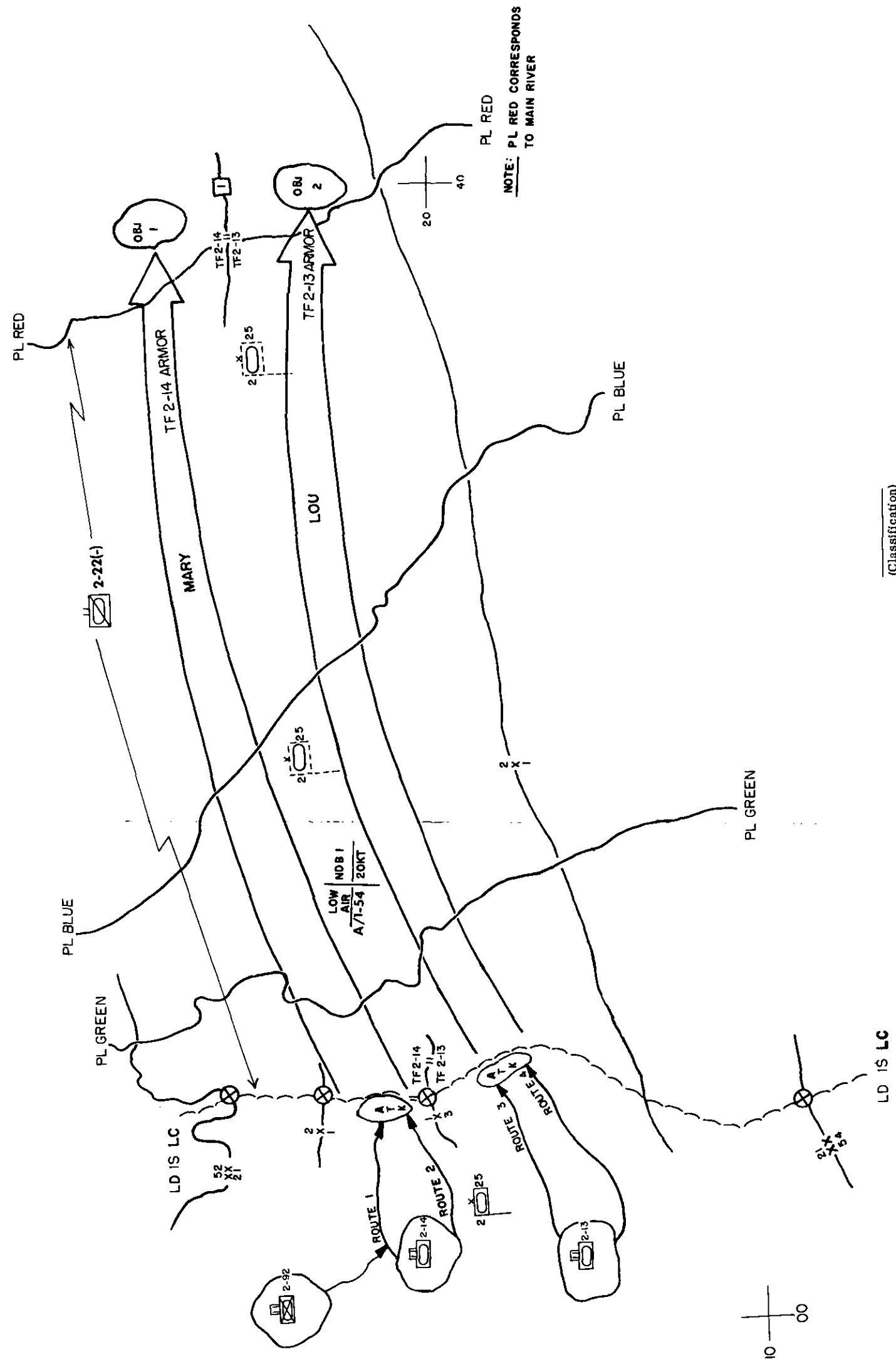

(Classification)

Figure 67. Brigade attack order.

(Classification)

(Classification)

(Classification)

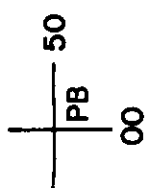
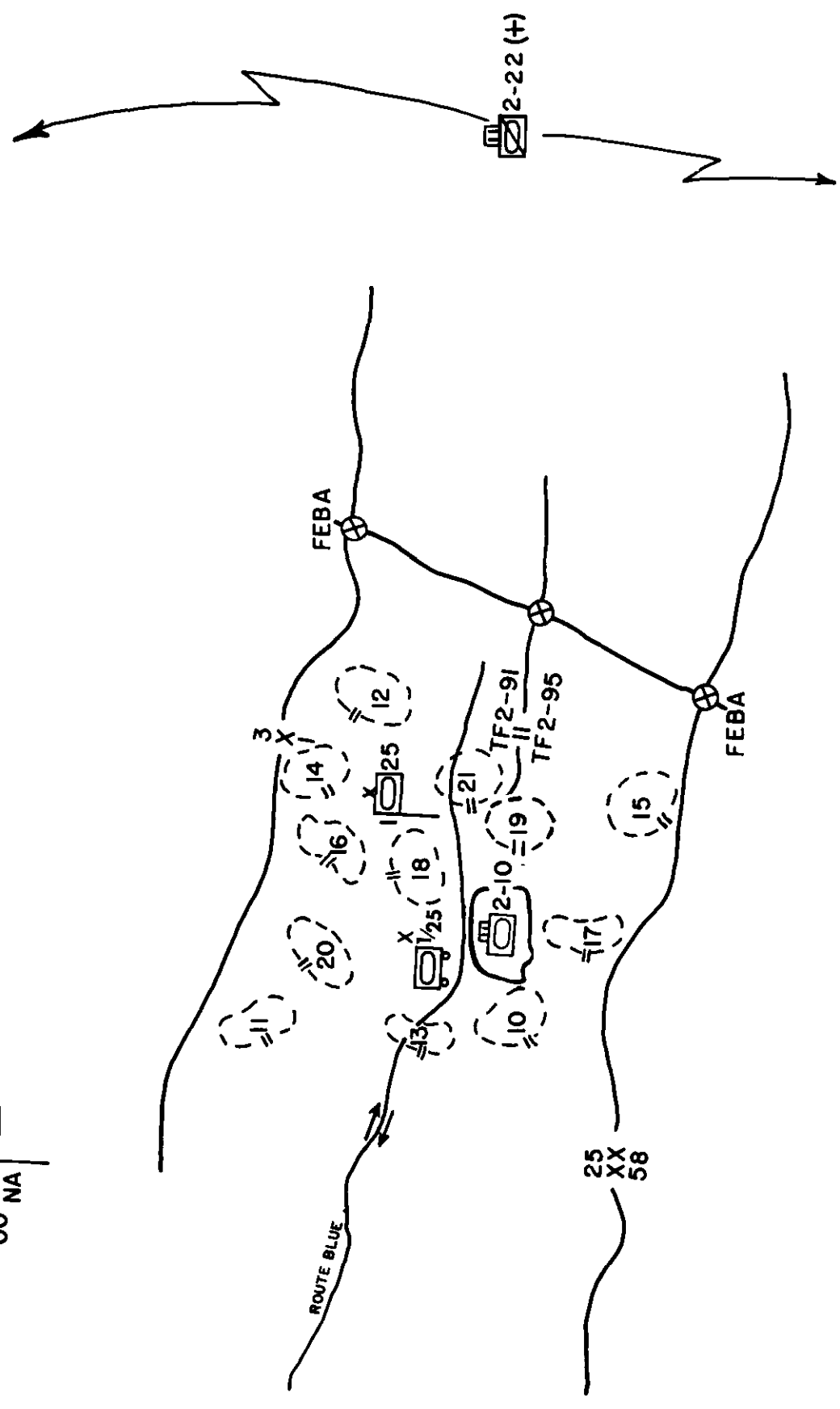
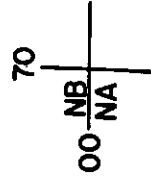

(Classification)

e. Reserve: 2 DC/ALFA/.5KT
3 155-mm/BRAVO/1KT

f. Coordinating instructions:

- (1) Assist withdrawal elm TF 2-22 Cav through fwd def area and report time elm 2-22 Cav clear fwd def area.
- (2) TF prep to occ suppl blocking pos in bde sector, on order.
- (3) All units complete org and prep for assigned missions by 072100 Sep 19__.
- (4) Catk plans effective for planning on receipt, for execution on order.
- (5) Road priority, covering force; upon withdrawal; 2d Bde on commitment.
- (6) EEI: Will en atk? If so, when, where, and in what strength?
- (7) Annex D, Rd Mov Table.

4. ADMINISTRATION AND LOGISTICS

- a. Annex F (Admin), Div OPOD 7.
- b. Bde supply route: Route Blue.
- c. Maint coll pt vic BASTHEIM (NA856842).
- d. PW coll pt: NA855861.

5. COMMAND AND SIGNAL

- a. Signal: SOI, index 1-19 in effect.
- b. Command: CP opens 071500 Jun 19__.

Annexes: A--Intel (to be issued)
B--Fire Spt (to be issued)
C--Barrier (to be issued)
D--Rd Mov Table (to be issued)

Distribution: A
OFFICIAL:

WOODS
Col

REEDER
S3

Note: In this example, the division commander has elected to place the engineer company in direct support of the brigade. This does not mean that the engineer company will always be placed in direct support of a brigade in the mobile defense. It is done this way in this example in order to show how the direct support engineer platoons are carried in the task organization of the task forces. This reflects a meeting of the minds between the brigade commander and the engineer company commander on the employment of the engineer company. The engineer company commander still controls the platoons.

Copy No. 6

1st Bde, 25th Armored Div
HEIDENHEIM (NU857926), GERMANY
071130 Jun 19__
UZ 27

OPOD 42
Ref: Map, GERMANY, 1:100,000, HEIDENHEIM, ANSBACH, NEUBURG, and NURNBERG sheets.

Task org:

- TF 2-10 Armor
- 2-10 Armor (-2 co's)
- B/2-95 Mech
- 1/A/25 Engr (DS)
- 1 LOH (OPCON)
- TF 2-91 Mech
- 2-91 Mech
- C/2-10 Armor
- 2/A/25 Engr (DS)
- 1 LOH (OPCON)
- TF 2-95 Mech
- 2-95 Mech (-1 co)
- B/2-10 Armor
- 3/A/25 Engr (DS)
- 1 LOH (OPCON)

Bde Con

- 2-60 Arty (DS)
- A/25 Engr (DS)
- 1/1/E/25 Engr

1. SITUATION

a. En forces: Annex A, Intel.

b. Friendly forces:

- (1) 25th Armored Div conducts mobile def in sector.
- (2) 2d Bde, div reserve.
- (3) 3d Bde, def in sector; spt div catk.
- (4) TF 2-22 Cav, init div covering force; after withdrawal through fwd def area, protect div north flank.
- (5) 2-50 Arty, DS 1st Bde.
- (6) 2-631 Arty, reinf fires 2-50 Arty.
- (7) A/25 Engr: Pri of tasks; prep of obs in fwd def area, catk routes, and obstacles, in that order. Prep suppl blocking pos's 13, 20, 10, and 11 in that order.
- (8) TAF spt 25th Armored Div with 126 Sorties.

c. Atch and det: Task org eff 071630 Jun 19__.

2. MISSION

1st Bde defends 072100 Jun 19__ from NA925852 to NA853628; prep to spt catk of div reserve.

3. EXECUTION

a. Concept of operation:

- (1) Maneuver: 1st Bde, def in sector employing two TF's abreast, TF 2-91 Mech on the north and TF 2-95 on the south; TF 2-10 Armor in res. Def of fwd area conducted init from pos along FEBA. TF prep to spt by fire catk of bde or div res.
- (2) Fires: Arty--Pri of fire TF 2-95 Mech init, TF 2-10 Armor when committed. Annex B, Fire Spt.

Nuclear--Nuc fires aval on call for target of opportunity.

Asg: TF 2-91 Mech: 1 DC/ALFA/.5KT
TF 2-95 Mech: 1 DC/ALFA/.5KT

b. TF 2-10 Armor: Bde res.

Prep catk plans bde sector, pri to TF 2-95 Mech and TF 2-91 Mech zone, in that order.

c. TF 2-91 Mech: Pri of planning to occ suppl blocking pos's 12, 21, 14, and 18 in that order.

d. TF 2-95 Mech: Pri of planning to occ suppl blocking pos's 15, 19, and 17 in that order.

(Classification)

Figure 68. Brigade defense order.

(Classification)

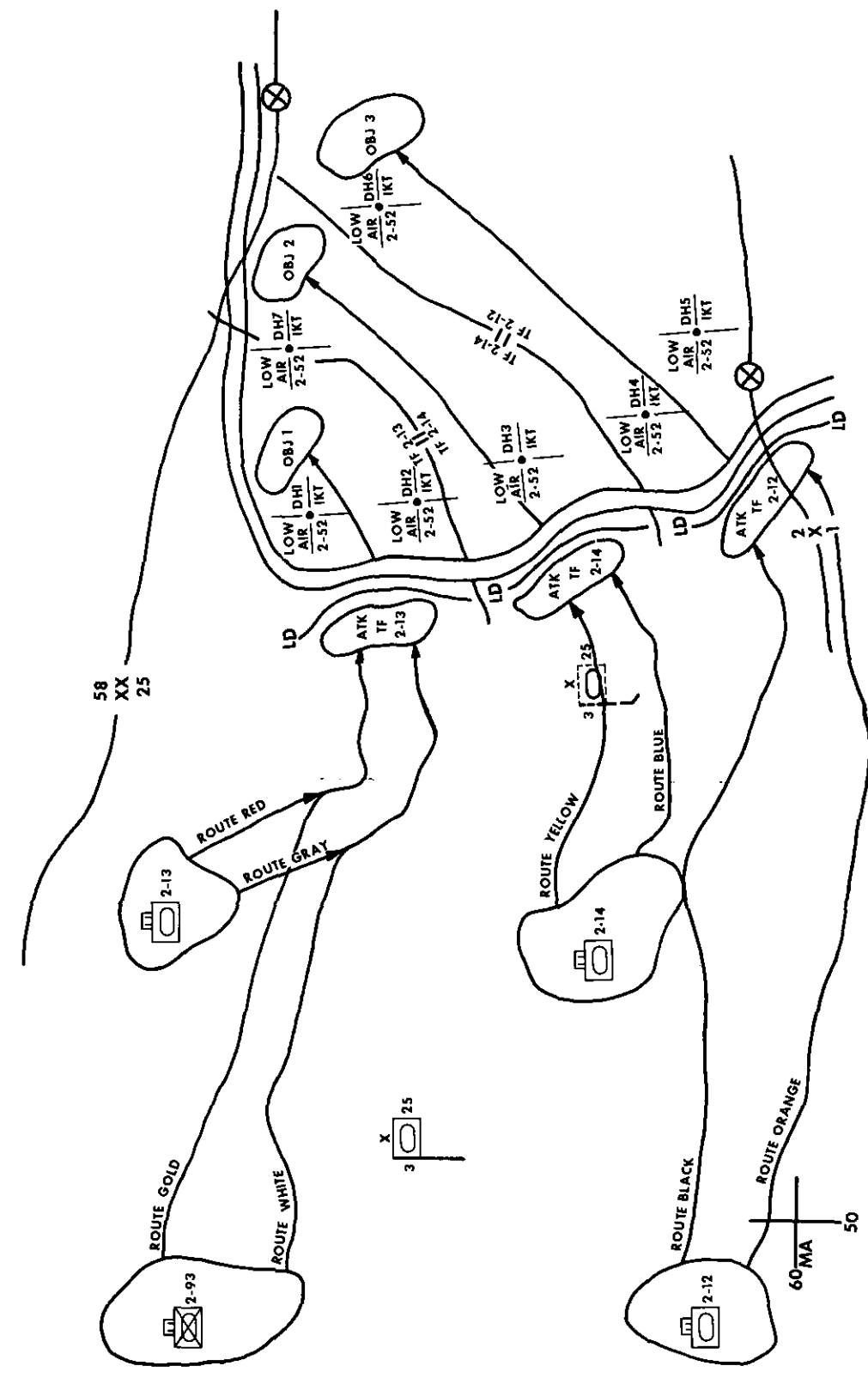

(Classification)

(Classification)

(No change from verbal orders)

Copy No. 10
3d Bde, 25th Armd Div
MA501731, GERMANY
071400 Jun 19
BA 5

OPLAN 9 (Catk Plan RED)
Ref: Map, GERMANY, 1:100,000, BRESLAU--LIEGNITZ sheets.
Task org:

- 2-12 Armor
- 2-12 Armor (-1 co)
- 3/C/25 Engr (DS)
- 1 LOH (OPCON)
- TF 2-13 Armor
- 2-13 Armor
- A/2-93 Mech
- 1/C/25 Engr (DS)
- 1 LOH (OPCON)
- TF 2-14 Armor
- 2-14 ATmor
- B/2-93 Mech
- 2/C/25 Engr, DS
- 1 LOH (OPCON)
- TF 2-93 Mech
- 2-93 Mech (-2 co's)
- A/2-12 Armor
- 1/3/E/25 Engr
- 1 LOH (OPCON)
- Bde Con
- 2-52 Arty (DS)
- C/25 Engr
- 3/E/25 Engr (-)
- 3/25 MP

1. SITUATION

- a. En forces: Para. d below; current INTSUM.
- b. Friendly forces: OPORD 7.
- c. Atch and det: Task org.
- d. Assumptions:
 - (1) Penetration made in sector 2d Bde with major part mtz rifle div (est 2 reinf mtz rifle regt).
 - (2) Main en atk slowed or stopped.
 - (3) Nuc wpns OPORD 7 aval to spt catk.
 - (4) US forces have local air control.
 - (5) One mech tm, 2d Bde, atch 3d Bde upon passage of lines.
 - (6) 58th Inf Div (M) cont to hold in sector.
 - (7) Task organization effective on division order.

2. MISSION

3d Bde atk on order to destroy en in area of penetration. Prep for relief by 2d Bde. Reassemble as div res present assy area on order.

3. EXECUTION

- a. Concept of operations:
 - (1) Maneuver: Catk with 3 tk-hv TF's abreast. TF 2-13 Armor on west, TF 2-14 Armor in the center, TF 2-12 Armor on the east to seize obj's 1, 2, and 3 respectively; TF 2-93 Mech follow TF 2-13 Armor, destroy en in area of penetration.
 - (2) Fires: Arty; Prep H-15 until lifted by leading TF; pri of fires TF 2-12 Armor; annex A, Fire Spt.
 - Nuclear; Nuc prep H-15
 - Nuc available for tgt of opportunity
- b. TF 2-13 Armor:
- c. TF 2-14 Armor:
- d. TF 2-93 Mech: Assume mission TF 2-13 Armor on order.
- e. 2-12 Armor:
- f. C/25 Engr Bn: GS.
- g. Reserve: 2-155/BRAVO/1KT.
- h. Coordinating instructions:

(Classification)

(Classification)

- (1) Plan eff for planning upon receipt; for execution on order.
- (2) All units coordinate passage.
- (3) H-hour, D-day to be announced.

4. ADMINISTRATION AND LOGISTICS

- a. Div ADMINO 2 in effect.
- b. Bde to remain present pos, move on order.
- c. Bde supply route: MA500725 to route WHITE to PU108542.
- d. Maint coll pt: PU084931.
- e. Med aid and evac: on order to 2d Bde.
- f. PW coll pt: on order, to 2d Bde.

5. COMMAND AND SIGNAL

- a. Signal: SOL, index 1-19, in effect.
- b. Command:
 - (1) CP vic MA501731 071200 Sep 19; move on order.
 - (2) Comd Gp fol TF 2/14 Armor init.

Acknowledge.

Wilson
WILSON
Col

Annex A--Fire Spt (to be issued)
Distribution: A
58th Mech Div

(Classification)

Figure 69. Brigade counterattack order.
(Reserve brigade for the division in the mobile defense.)

(Classification)

- Route 3--Tm A.
- Route 4--Tm B, Comd Gp, Tm C.
- Start point.
- (3) Route 3--NA011501.
- Route 4--NA011165.
- 261600 Nov 19__.
- (4) Start point time--270327 Nov 19__.

4. ADMINISTRATION AND LOGISTICS

- a. Fid Tm: Remain present loc; revert bde to 270500 Nov 19__.
- b. Cbt Tm: Move on order.
- c. TF supply route: KUSEL, BAD RITTENBERG, RJ (NA235243), Route 3, SULZBERG.
- d. Main coll pts NA243252; NA250253; NA250252.
- e. Aid station: Init TF 1-72 Inf (NA122247); TF cbt tns on order.
- f. PW coll pt init TF 1-72 Inf (NA123250); TF cbt tns on order.

5. COMMAND AND SIGNAL

- a. Signal:
 - (1) SOI, index 1-5.
 - (2) Listening silence until crossing LD.
- b. Command:
 - (1) Comd gp follow Tm B init.
 - (2) CP remain present loc; move on order.

Acknowledge.

Annexes: A--Fire Spt (to be issued)
B--Surv (to be issued)

Distribution: A
TF 1-72 Inf

OFFICIAL:

Sharpe
SHARPE
S3

(Classification)

Note. In this example, the commander signed the original copy of the order and the S3 signed the remaining copies. (Note that this is copy no. 4.)

(Classification)

(No change from verbal orders except para. 3e)

Copy No. 4
TF 2-13 Armor
NA045194, GERMANY
261600 Nov 19__
JP 143

OPORD 15

Ref: Map, GERMANY, 1:50,000, GRUNSTADT, ELLENBURG, and LUDWIGSBURG sheets.

Task org:

- Tm A
A/2-13 Armor (-1 plat)
1/C/2-94 Mech
- Tm B
B/2-13 Armor (-1 plat)
2/C/2-94 Mech
- Tm C
C/2-94 Mech (-2 plates)
3/A/2-13 Armor
3/B/2-13 Armor
- TF Con
1/A/25 Engr (DS)
1 LOH (OPCON)

1. SITUATION

- a. En forces: Current INTSUM.
- b. Friendly forces:
 - (1) 2d Bde atk 270600 Nov 19__ through elm 21st Inf Div with TF 2-14 Armor on north, TF 2-13 Armor on south, and TF 2-92 Mech following TF 2-14 Armor; seize and secure crossings over MAIN River and cont atk on order to northeast.
 - (2) 3d Bde: 21 Inf Div follow and spt.
 - (3) 2-81st Arty: DS 2d Bde, pri fires TF 2-13 Armor.
 - (4) 1/A/25 Engr, DS.
- c. Atch: Task org. Det: C/2-13 Armor atch 2-92 Mech.

2. MISSION

TF 2-13 Armor atk 270600 Nov 19__, seize crossings over MAIN River vic ERLANGEN (PV4594); cont atk to the northeast on order.

3. EXECUTION

- a. Concept of operations:
 - (1) Maneuver: TF conducts passage of lines through TF 1-72 Inf; atk with two tm's abreast to penetrate en def followed by exploitation to seize obj's 1 and 2; Tm A on the north to seize obj 1; Tm B on the south to seize obj 2; Tm C follow Tm B. Cont atk to the northeast on order.
 - (2) Fires: Arty: Prep H-15 until H-hour; pri of fire init Tm B; annex A, Fire Spt.
- b. Tm A: Nuclear: Nuc prep H-15.
- c. Tm B: d. Tm C: Spt or assume mission of either leading tm on order.
- e. Scout Plat: Maintain contact TF 2-14 Armor on north flank.
- f. Hv Mortar Plat: GS; pri fires init Tm B.
- g. Surv Sec: Conduct surv forward leading tm's; annex B, Surv.
- h. Coordinating instructions:
 - (1) Coord passage of lines before 270100 Nov 19__.
 - (2) Order march atk pos:

(Classification)

50 03

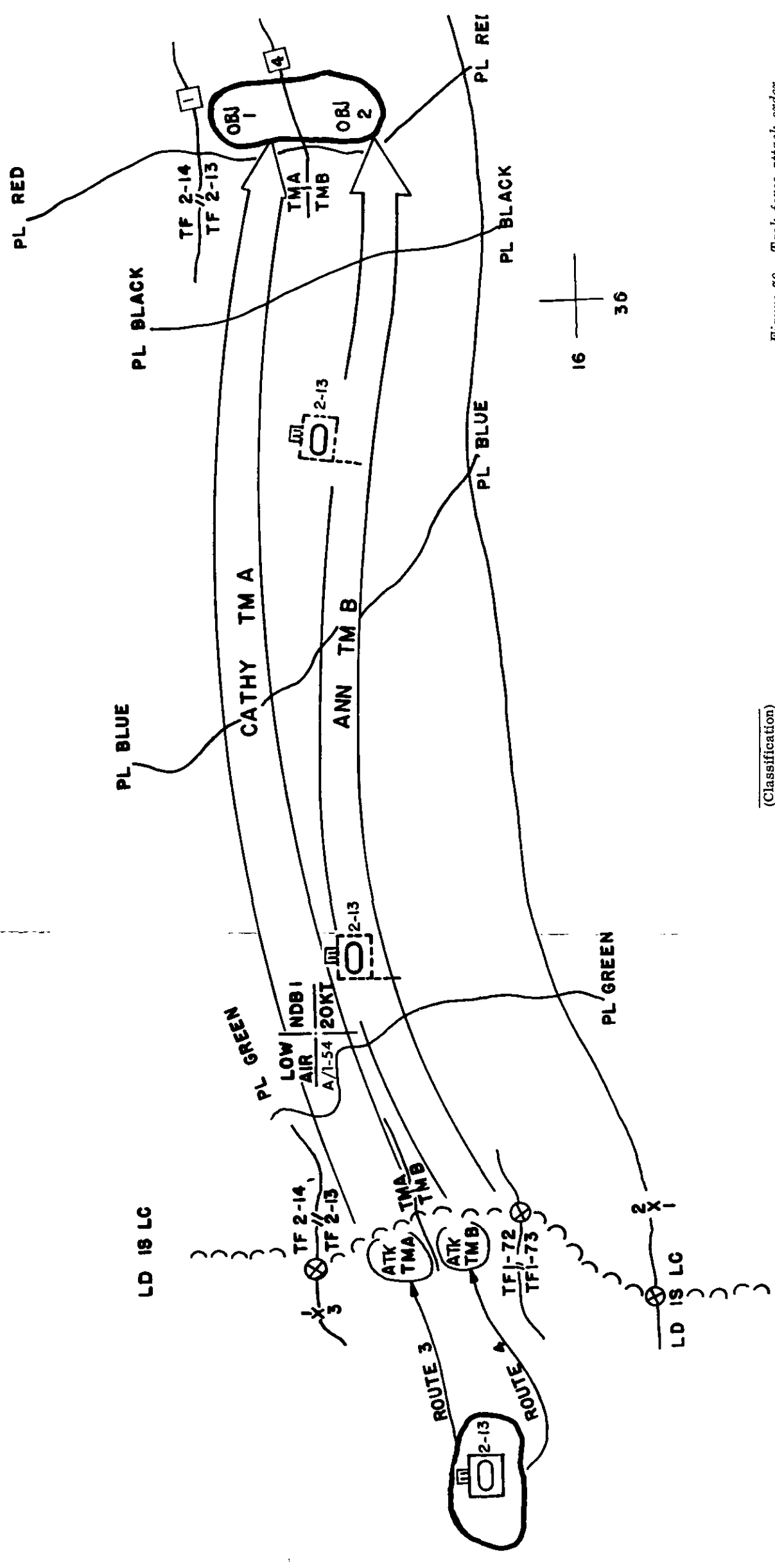

(Classification)

Figure 70. Task force attack order.

(Classification)

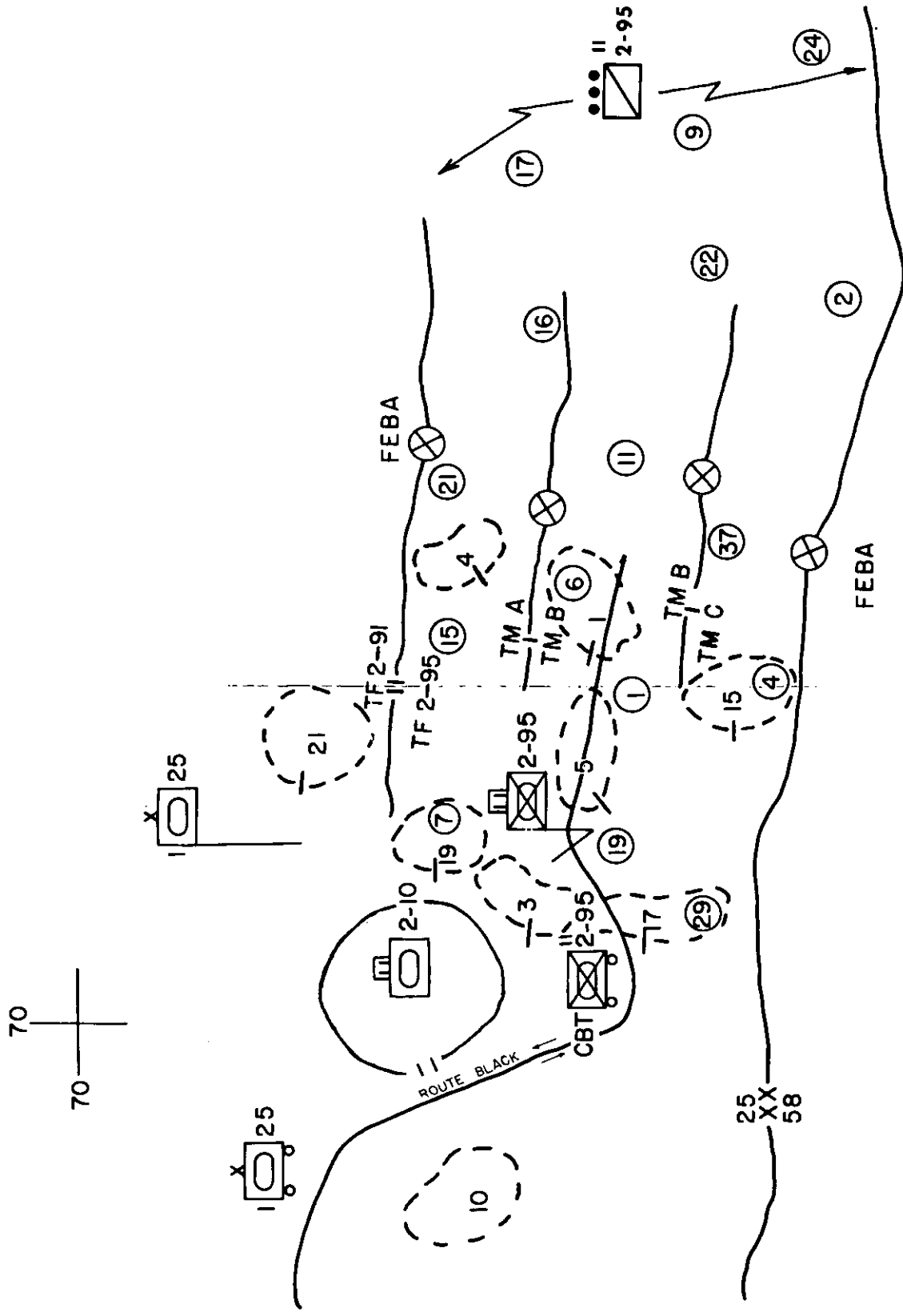

(Classification)

Copy No. 2
 TF 2-95 Mech
 NAY58767, GERMANY
 071600 Jun 19__
 RA 41

OPORD 51
 Ref: Map, GERMANY, 1:50,000, HEIDENHEIM, NEUMARKT, KALTENBRUNN,
 and ANSBACH sheets.
 Task org:

- Tm A
 A/2-95 Mech (-1 plat)
 1/B/2-10 Armor
 1 sqd, AT Plat
 1 AN/PPS-4
- Tm B
 B/2-10 Armor (-1 plat)
 2/A/2-95 Mech
- TF Con
 3/A/25 Engr (DS)
 1 LOH (OPCON)
 Scout Plat
 2 AN/PPS-4
- Co C
 C/2-95 Mech
 AT Plat (-1 sqd)
 1 AN/PPS-4

1. SITUATION
- a. En forces: 2 en tk-hv bn's moving rapidly NW on multiple routes. Lead elm loc POPPENHOF (PA1873) and NEUBERG (PA1684).
 - b. Friendly forces:
 - (1) 1st Bde, def in sector, spt catk div res.
 - (2) 2d Bde, div res.
 - (3) TF 2-10 Armor, bde res, pri catk in TF 2-95 Mech zone.
 - (4) TF 2-91 Mech, def in sector.
 - (5) 2-22 Cav, init div covering force, after withdrawal protect div north flank.
 - (6) 58th Inf Div (M), def in sector.
 - (7) 2-50 Arty, DS 1st Bde, pri fires TF 2-95 Mech init, TF 2-10 Armor when committed.
 - (8) 3/A/25 Engr (DS) pri of tasks, prep of def pos in fwd def area, block-ing pos's 1, 4, 15, 5, 17, 19, and 3 in that order.
 - (9) TAF spt 25th Armd Div with 126 sorties.
 - c. Aitch: Task org eff 071630 Jun 19__. Det: B/2-95 Mech atch to 2-10 Armor 071630 Jun 19__.

2. MISSION
 TF 2-95 Mech def in sec from NA850663 to NA800621, as of 072100 Jun 19__;
 Spt or reinf bde or div catk, on order.

3. EXECUTION
- a. Concept of operations:
 - (1) Maneuver: Def in sec with three tm's abreast, Tm's A, B, C, from north to south. Def init from blocking pos along FEBA. Spt catk by div or bde res on order.
 - (2) Fire: Arty; Pri of fire to Tm B; annex A, Fire Spt. Nuclear; Nuc fires aval on call

(Classification)

Figure 71. Task force defense order. (Firing force for the mobile defense.)

(Classification)

- b. Tm A: Prep suppl blocking pos's 4 and 19 in that order.
- c. Tm B: Prep suppl blocking pos's 1, 5, and 3 in that order.
- d. Co C: Prep suppl blocking pos's 15 and 17 in that order.
- e. Scout Plat:
 - (1) Est OP's and patrols fwd FEBA init.
 - (2) Screen TF south flank after withdrawal through FEBA.
- f. Hv Mort Plat: GS; pri of fire Co C.
- g. DC Sec: GS.
- h. Survl Sec: GS, conduct survl to front. Annex B, Survl.
- i. Reserve: 1-DC/ALFA/.SKT.
- j. Coordinating instructions:
 - (1) Delay to suppl blocking pos on order.
 - (2) Prep to asst withdrawal elm 2-22 Cav.

4. ADMINISTRATION AND LOGISTICS

Note. In this example, the TF S4 had distributed the necessary logistical information to subordinates before the publication of the order. The S4 does not need to show any information in para. 4 if the subordinates have already received all the necessary information.

5. COMMAND AND SIGNAL

- a. Signal: SOI, index 1-19 in effect.
 - b. Command: CP opens 072000 Jun 19__.
- Acknowledge.

DAVIDSON
 Lt Col

Annexes: A--Fire Spt (to be issued)
 B--Survl

Distribution: A
 TF 2-93 Mech

OFFICIAL:

JAMES
 JAMES
 S3

(Classification)

(Classification)

4. ADMINISTRATION AND LOGISTICS

- a. Cbt lns loc init vic MU101210; move on order.
- b. ASB: (09-12 Aug).
 - (1) 105-mm (APDS): 8.
 - (2) 4.2-in. (HE): 35.
 - (3) Other; no restrict.
- c. TF supply route: Route WHITE.

5. COMMAND AND SIGNAL

- a. Signal.
 - (1) SOI, index 2-5.
 - (2) Recognition sig:
 - (a) Green flare or two-star cluster.
 - (b) One-half cerise panel on surface lead veh facing IDP.
 - (c) Switch to emerg freq for unexpected passage of line CHICAGO.
- b. Command: CP open 092100 Aug 19; move on order.

FOR THE COMMANDER

Scott
SCOTT
XO

Annex A--Fire Spt (to be issued)
Distribution: A

Note. In this example, the commander designated the task force executive officer as an authorized individual to sign the order for the commander. The executive officer signed the original copy of the order and his signature was reproduced on all copies.

(Classification)

Note. If time does not permit designating unit, then size of unit is shown.

Copy No. 2
TF 2-13 Armor
MU102215, GERMANY
091800 Aug 19
Y 251

OPORD 7
Ref: Map, GERMANY, 1:50,000, SULZHEIM, VIET, and FREUDENHEIM sheets.
Task org:

- Tm A
A/2-13 Armor (-1 plat)
1 plat C/2-94 Mech
1 AN/PPS-4
- Co B
B/2-13 Armor
- Tm C
C/2-94 Mech (-2 plat's)
1 plat A/2-13 Armor
1 plat C/2-13 Armor
- Tm D
TF Con
1/A/25 Engr
1 LOH (OPCON)
Scout Plat
3 AN/PPS-4

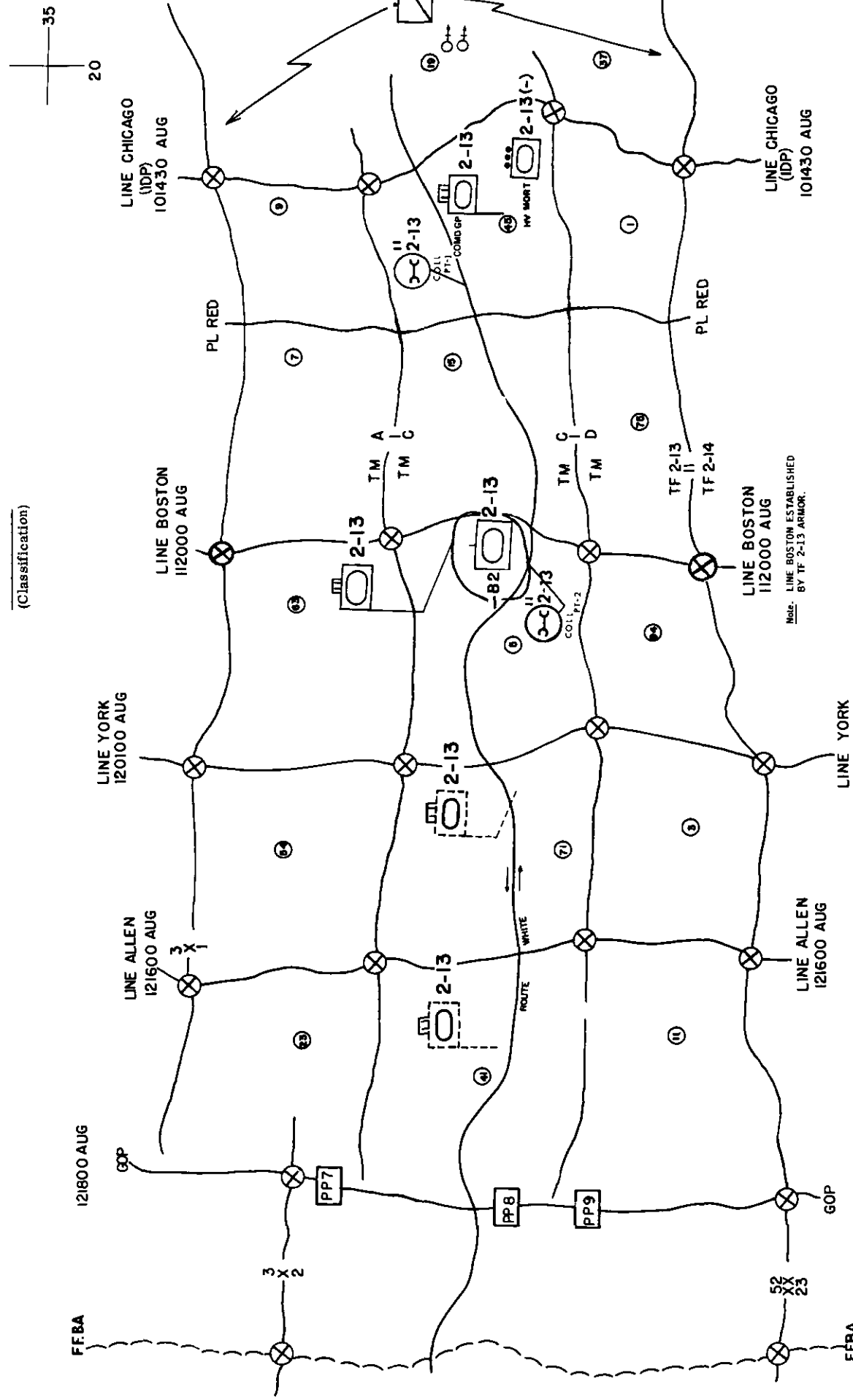

Note: 1. TRACE OF DELAY LINES COORDINATED WITH ADJACENT UNITS BEFORE ESTABLISHED BY COMMAND CONCERNED.
2. COORDINATION POINTS ON BRIGADE OR TASK FORCE SCALE MUST BE COORDINATED WITH ADJACENT COMMANDERS.

Note: LINE BOSTON ESTABLISHED BY TF 2-13 ARMOR.

Note: LINE YOR ESTABLISHED BY 1ST BRIGADE.

(Classification)

(Classification)

(Classification)

(Classification)

(Classification)

Figure 72. Task force delay order.

(Classification)

(Classification)

(Classification)

(No change from verbal orders except annex A)

Copy No. 2
 2-12 Armored
 EICHSTATT (PV655540), GERMANY
 211100 Dec 19
 NXP 47

OPORD 21
 Ref: Map, GERMANY, 1:100,000, NURNBERG, NORDLINGEN, and BAMBERG sheets.
 Task org: Appendix 1 to Annex A, Road Movement Table.

1. SITUATION
 a. En forces: Elements of Aggressor 20th Combined Arms Army continue to defend along line HOLLFELD (PA6434), WAISCHENFELD (PA6824), POTZENSTEIN (PA7317), VELDON (PV8299), SULZBACH (PV8987).
 b. Friendly forces: 1st Bde assembles vic GRAFFENBERG (PA6802), prepares to attack to seize CREUZZEN (PA8823).

2. MISSION
 2-12 Armored moves night of 21-22 Dec 19 to fwd assy area vic GRAFFENBERG; prep to attack on order with 1st Bde.

3. EXECUTION
 Concept of operation: On a tactical road march to a fwd assy area; prep for subsequent attack as part of 1st Bde.
 a. March unit 1:
 b. March unit 2:
 c. March unit 3:
 d. March unit 4:
 e. March unit 5:
 f. March unit 6:
 g. Coordinating instructions:
 (1) Annex A, Road Movement Table, w/app. 1.
 (2) Annex B, Route Overlay.
 (3) Quartermaster party assemble on dismount point, 211400 Dec.
 (4) Formation: Close column.
 (5) Time interval SOP.

4. ADMINISTRATION AND LOGISTICS
 a. Annex A to OPOD 21.
 b. Troop loc given to co's at RP.

5. COMMAND AND SIGNAL
 a. Signal:
 (1) SOI, index 1-16.
 (2) Listening silence effective 211300 Dec.
 b. Command:
 (1) March CP (Comd Gp) at head of march unit 2.
 (2) CP opening, closing times and location TBA.

Acknowledge.
 Annexes: A--Road Movement Table, w/app. 1
 B--Route Overlay
 Distribution: A
 OFFICIAL:
 SPEEDY
 SS

(Classification)

(No change from verbal orders except annex A)

Copy No. 2
 2-12 Armored
 EICHSTATT (PV655540), GERMANY
 211100 Dec 19
 NXP 47

Annex A (Road Movement Table) to Annex A (Road Movement Table) to OPOD 21, 2-12 Armored.
 Ref: Map, GERMANY, 1:100,000, NURNBERG, NORDLINGEN, and BAMBERG sheets.
 Task org: Appendix 1 to Annex A, Road Movement Table.

1. General data: Average speed 16 KPH (maximum catch up speed: 20 KPH).
 2. Traffic density: 30 VPK.
 3. Halts: SOP.
 4. Route:
 RJ of Hwy 2035 and Hwy 13 at PV633145 (Start Point).
 Hwy 13 to WEISZENBURG (PV4433).
 Hwy 2 to junction with E-6 Autobahn (PV466654) vic SACHWABACH (PV4766).
 E-6 Autobahn to junction E-5 Autobahn (PV626810).
 E-5 Autobahn to junction with Hwy 2 (PV547872).
 Hwy 2 to GRAFFENBURG to RP (PA628015).
 5. Critical points:
 a. Start point: PV633145. Time 211900 Dec.
 b. Release point: PA628015.
 c. Other critical points:
 CP 1--EICHSTATT (PV590190)
 CP 2--WEISZENBURG (PV440330)
 CP 3--ROTH (PV520570)
 CP 4--RJ at PV466654
 CP 5--RJ at PV590740
 CP 6--RJ at PV626810
 CP 7--RJ at PV547852

6. Main routes to start point.
 a. March units 1 and 2: Unnumbered road from MORTZERTHURN (PV589001) to Hwy 2035 to SP.
 b. March units 3, 4, 5 and 6: Unnumbered road from PRIETHUF (PV581004) to WITTENFELD (PV586101) to Hwy 2035 to SP.
 7. Route from RP: Highway 2187.

Acknowledge.
 Distribution: A
 OFFICIAL:
 SPEEDY
 SS

(Classification)

(No change from verbal orders)

Copy No. 2
 2-12 Armored
 EICHSTATT (PV655540), GERMANY
 211100 Dec 19
 NXP 47

Annex B (Route Overlay) to OPOD 21
 Ref: Map, GERMANY, 1:100,000, NURNBERG, NORDLINGEN, and BAMBERG sheets.

Serial	Date	Unit	No. of Vehicles	Load Class of Heaviest Vehicle	Critical Points		Remarks
					Ref.	Time (hrs)	
1	21 Dec 19	Co A	10	58	SP	1900	Move by infiltration
	21 Dec 19	Co A	1	58	SP	1900	
2	21 Dec 19	Bn HQ Sec	12	12	CP 1	1931	Attached: 1 class I truck 1 class II truck 1 alt/eng veh
	21 Dec 19	Co HQ	2	12	CP 1	1931	
3	21 Dec 19	Med Plat	9	56	CP 1	1931	Attached: 1 class I truck 2 class II trucks 1 alt/eng veh
	21 Dec 19	Bn Med Plat	4	56	CP 1	1931	
4	21 Dec 19	Co B	27	58	SP	1919	Attached: 1 class I truck 2 class II trucks 1 alt/eng veh
	21 Dec 19	Co B	1	58	SP	1919	
5	21 Dec 19	Bn Sp Plat (-)	18	10	CP 1	1950	Detached: Sp Plat 9 class I trucks 7 class II trucks
	21 Dec 19	Bn Med Plat	4	10	CP 1	1950	
6	21 Dec 19	Co C	26	58	SP	0220	Attached: 1 class I truck 2 class II trucks
	21 Dec 19	Co C	1	58	SP	0220	
Bn Tail Party	21 Dec 19	Bn Maint Plat	12	58	SP	0300	Attached: 1 class III truck 1 alt/eng veh
	21 Dec 19	Bn Maint Plat	1	58	SP	0300	

Acknowledge.
 Distribution: A
 OFFICIAL:
 SPEEDY
 SS

(Classification)

(No change from verbal orders)

Copy No. 2
 2-12 Armored
 EICHSTATT (PV655540), GERMANY
 211100 Dec 19
 NXP 47 B

Annex B (Route Overlay) to OPOD 21
 Ref: Map, GERMANY, 1:100,000, NURNBERG, NORDLINGEN, and BAMBERG sheets.

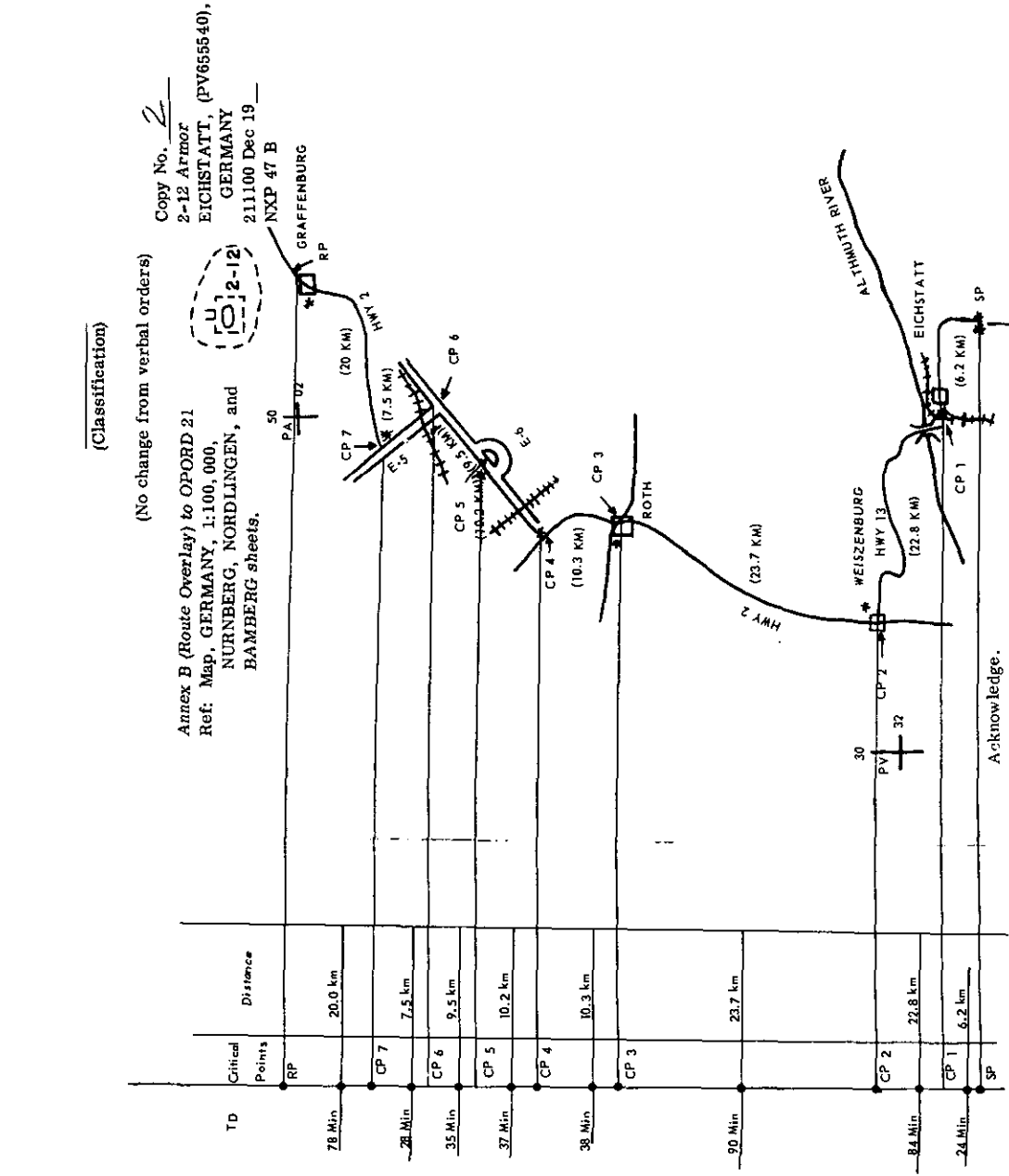

Acknowledge.
 Distribution: A
 OFFICIAL:
 SPEEDY
 SS

Figure 78. Task force movement order.

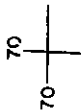

(Classification)

Copy No. _____
TF 2-95 Mech
NA758767, GERMANY
071600 Jun 19 ____
RA 41

Annex B (Surv) to OPOD 51
Ref: Map, GERMANY, 1:50,000, HEIDENHEIM, NEUMARKT, KALTENBRUNN,
and ANSBACH sheets.

EXECUTION

1. Tm A: Prep 6-man dismounted recon patrol to depart 072200 Jun 19 ____.
Patrol leader to S2 for briefing and specific mission by 072000 Jun 19 ____.
2. SurvI section: Occupy each medium radar site with one AN/TPS-33 radar. Site 1, monitor road intersection the second 30 minutes of each hour. Site 2, monitor crossroads first 20 minutes of each hour, search road from ANSBACH second 30 minutes each hour.
Acknowledge.

DAVIDSON
Lt Col

Distribution: A
OFFICIAL:

Mcroy
SHOUP
S2

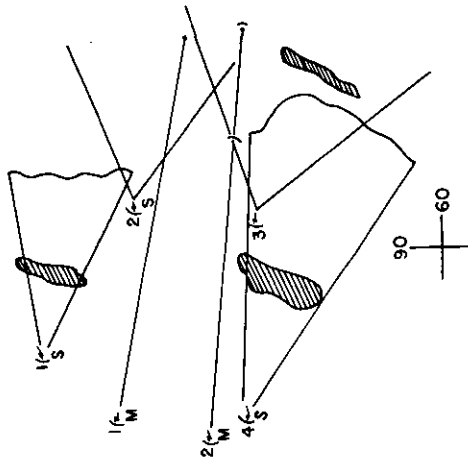

Note. The Ground Surveillance Radar Plan is prepared by the Bn S2. Each company or team commander will select the site location and area of surveillance of the attached AN/PPS-4. This information will be forwarded to the Bn S2 for consolidation into the overall bn surveillance plan. S2 will determine the general site and mission of the bn AN/TPS-33 radars and any AN/PPS-4 under TF control. One copy of the bn surveillance plan will be retained by the Bn S2 and 1 copy will be forwarded to the S2 of the next higher headquarters. The amount of detail information that will be included in the surveillance plan will be governed by the unit SOP; as a minimum, the surveillance plan should include the site location and area of surveillance of each ground surveillance radar.

(Classification)

Figure 74. Task force surveillance annex.

VERBAL ORDER ISSUED BY TEAM B, TF 2-13 ARMOR COMMANDER
(Based on task organization established by OPORD 15)

Note. The following order would be issued orally to platoon leaders, artillery and heavy mortar platoon forward observers, team executive officer, and desirable, a representative of A/1-72 Inf. The order should be issued from an OP of the A/1-72 Inf. Once all the recipients have arrived for the order, the team commander allows sufficient time for the subordinates to copy the overlay, phase lines, check points, and concentrations. The overlay indicates those graphics that the team commander would have inscribed on his acetate covered map. The commander then orients all personnel to the terrain before issuing the order.

1. SITUATION

a. En forces: There is an estimated enemy motorized rifle company defending in the team zone (here). The enemy has used nuclear weapons and is capable of gaining air superiority for short periods of time.

b. Friendly forces:

- (1) TF 2-13 Armor atks at 0600 hours tomorrow with 2 teams abreast to seize and secure crossings over the MAIN River; cont the atk to the northeast on order.
- (2) Tm A, 2-13 Armor, atks on our north to secure obj 1; cont the atk to northeast on order.
- (3) Tmp B, 2-22 Cav, follows our team ipit, then screens the bde south flank.
- (4) 2-51 Arty is DS 2d Bde, with pri of fires to our task force. Lt Jones, our FO, will ride in the FO tank. We have pri of fires from the mortar plat; Sgt White will call our fires.

c. Atch and det:

- (1) Our 3d Plat is attached to C/2-94 Mech.
- (2) 2d Plat, C/2-94 Mech, is atch.

2. MISSION

We atk at 0600 hours tomorrow to seize obj 2 (HILL 348) and cont the atk to the northeast on order.

3. EXECUTION

a. Concept of operations:

- (1) Maneuver: Our team makes a passage of lines through A/1-72 Inf with 2 platoons abreast; 1st Plat on the left, 2d Plat on the right, followed by the mech plat on the right to seize obj 2. We cont the atk to the northeast on order.

(2) Fires: There will be a nuclear prep at H-15 here, followed by arty prep until H-hour. Lt Jones has planned concentrations. Pick them up from him.

b. Mech Rifle Platoon: Follow the 2d Platoon. Dismount on my order to seize obj 2 in conjunction with the 2d Platoon.

c. 1st Tank Platoon: Move from the atk pos to pass through the inf here. Upon crossing the LD, guide init on the 2d Platoon; seize the north half of the obj B; protect team's north flank.

d. 2d Tank Platoon: Move from the atk position to pass through the infantry here. Upon crossing the LD, guide init on this road. Seize the south half of obj B; protect the team's south flank.

e. Coordinating instructions:

- (1) We must complete our coordination and recon by 1600 hours.
- (2) SP: Here.
- (3) SP time: 0530 hours tomorrow.
- (4) Order of march: 1st Tank Platoon, 2d Tank Platoon, 3d Mech Platoon, CP, and combat trains.
- (5) Route of march: Route 4.

(6) Release point: Here.

(7) Blackout markers to the RP; no lights beyond that point.

(8) XO will be with Co, A/1-72 Inf, during passage; 1st Sgt move the CP and train.

(9) Platoon leaders pick up your guide from the infantry for passage at the RP.

(10) All troops protect eyes from nuclear detonation at 0543 hours. We lager to right and left of the route of march and return to the route on my order.

4. ADMINISTRATION AND LOGISTICS

a. Breakfast: 0300 hours present assembly area. feed 50 percent; 3 days C rations issued with breakfast.

b. POL refueling: Start 1900 hours, completed NLT 2200 hours.

c. Ammo supply: Start 2200 hours, completed NLT 2400 hours.

d. TF supply route: Highway 1729.

e. Aid station: XO evacuate to TF 1-72 Inf init (NA122247); same is true for graves registration and PW's.

5. COMMAND AND SIGNAL

a. Signal:

(1) The commo sgt will give you freq call signs when we return to the assembly area.

(2) Friendly air panel for next 24 hours--orange.

(3) Listening silence until crossing LD or upon enemy contact.

(4) Challenge and password effective for the next 24 hours--HOT-WORD.

b. Command: I will follow the 2d Tank Platoon in the atk.

Are there any questions?

When I say time, the time will be _____ hours.
5-4-3-2-1 Time. The time is now _____ hours.

(Classification)

(Classification)

(Classification)

(Classification)

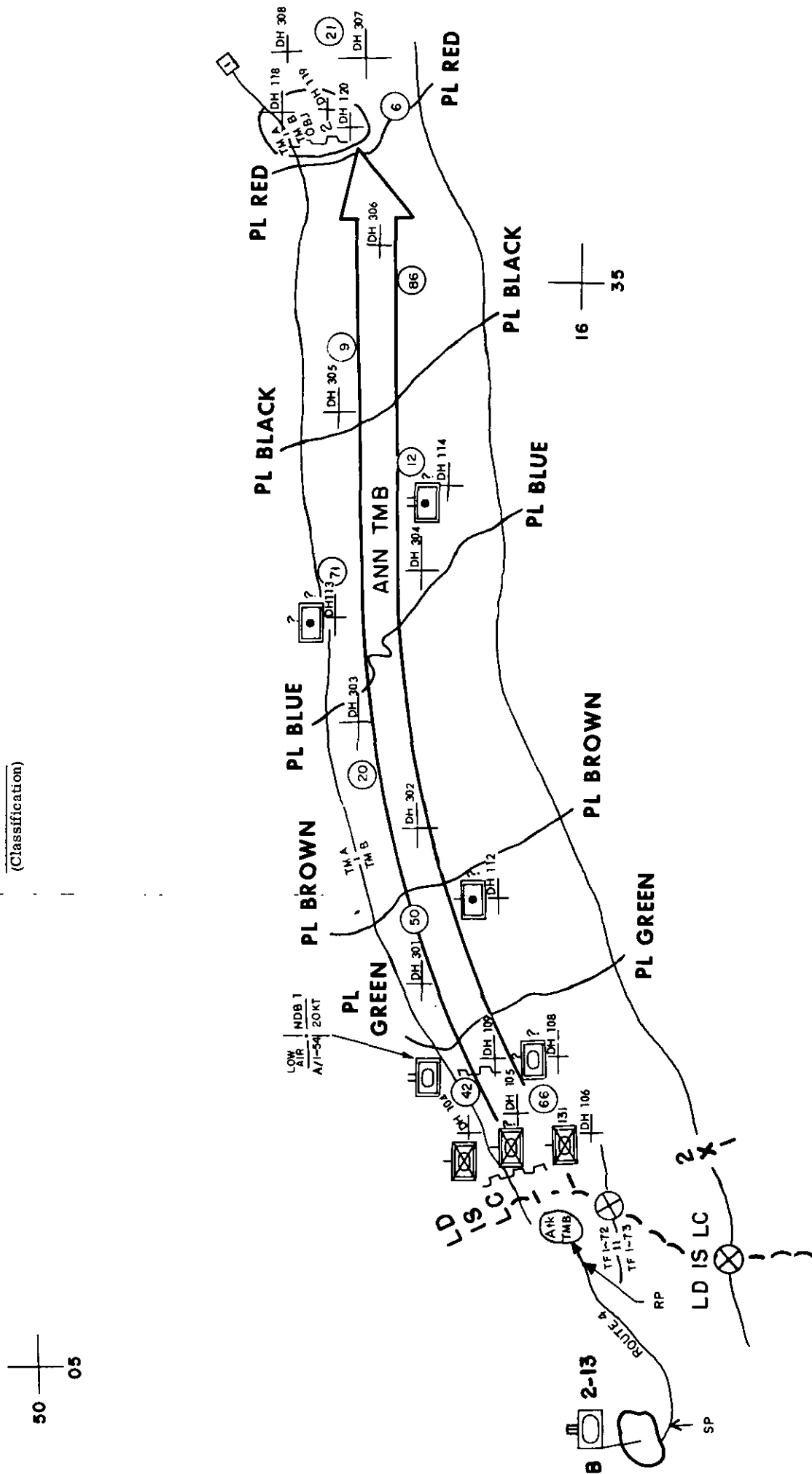

Figure 75. Team attack order.

MARGINAL INFORMATION

Unit
Location and coordinates
Time
Date

TITLE:
MAP (Reference-Scale):

1. Plan of maneuver of supported unit.
2. Priority of fires.
3. Requests to higher headquarters for additional fire support.
4. Requests for clearance of smoke missions and fires outside zone of supported unit.
5. Davy Crockett and 4.2-inch mortar employment.
6. Requests for groups and series of fires. (No standard number of paragraphs or sequence of information is prescribed. The purpose of this section is to convey information not shown graphically.)

Signature
Title

Target List

No.	Description	Location	(Alt Meters)	Remarks
DA101	Machinegun	40731308	412	Dug-in petrol
DA102	Entrenchment	40891286	398	Pl 25 meters
DA103	Suspect OP	40861258	426	Mop
DA121	Mortar	42031310	354	Radar 50 meters
DA201	Machinegun	41231158	340	Dug in
DA202	Recallless rifle	41251136	358	
DA211	Road junction	42611191	337	
...

1. All concentrations shown in graphical parts will be listed in this section.
2. All concentrations listed are available to be fired on call.
3. Description column and remarks column must be in sufficient detail to assist the S3 to evaluate the target.
4. Table filled out concurrently with graphical section.
5. Remarks will be added in a remarks column or the body of the table where necessary.

Groups of Fires

Unit (Btry of Bn)	Group Identification				
	D1A	D2A	D3A	D4A	D5A
A	DA101	DA112	DA110		
B	DA102	DA203	DA111		
C	DA103	DA204			

1. Groups of fires are planned to cover a single tactical locality too large to be covered by a single concentration.
2. Each concentration in a group of fires is assigned to a separate fire unit (battery or battalion).
3. Concentrations may be made into groups of fire without regard to the agency planning the concentrations.
4. Groups of fires are fired on call.
5. The artillery battalion S3 will plan groups of fires based on recommendations of the task force liaison officers and will assign the number-letter-number designation for each group of fires.

GUIDE FOR THE PREPARATION OF FIRE PLANS

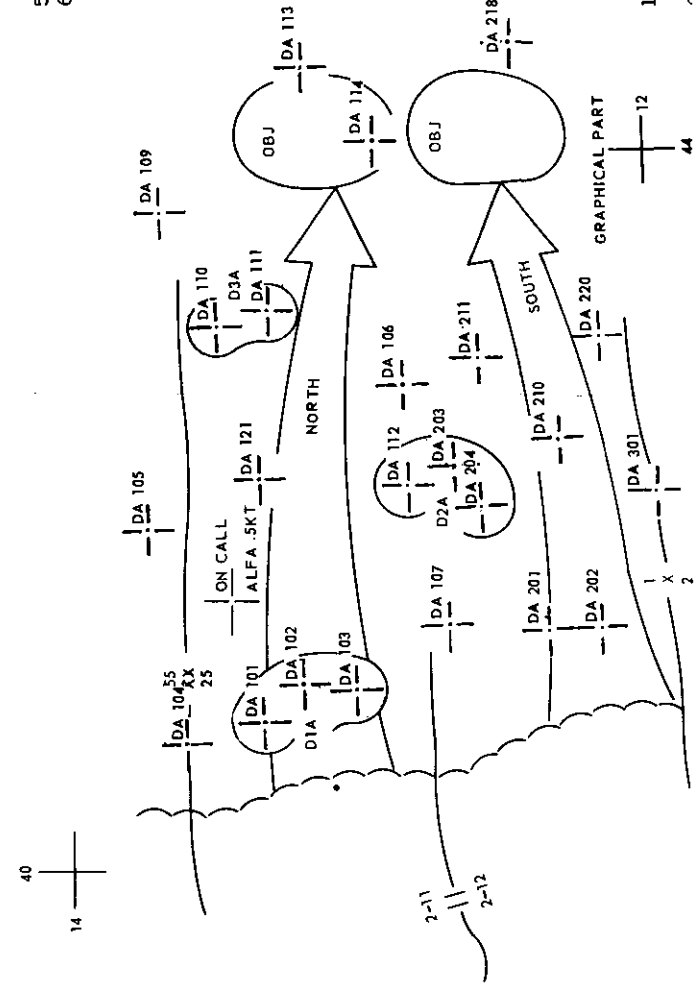

1. Show concentrations by tick mark, identified by the appropriate number and letter prefix, except any target larger than 100 meters must be outlined in size and shape.
2. Friendly information such as boundaries, line of departure, and objectives may be shown.
3. Where appropriate, make groups of fires to cover single tactical localities too large to be covered by one concentration.
4. Show two "tick" marks for orientation of overlay.
5. This section is prepared by consolidating the various artillery fire plans for the battalion task forces and eliminating any duplications. Additional concentrations are planned based on the fire support part of the commander's concept and information received from the artillery S2.
6. Concentrations are planned on known enemy locations, suspected enemy locations, and terrain features including likely avenues of approach, likely assembly areas, terrain adaptable for weapons locations, and terrain features suitable for shifting of fire and orientation of observers or the maneuvering elements. Concentrations are planned on any target that can affect the supported unit and are not restricted by boundaries. However, these targets are not fired on without coordination with and authority of the unit in whose zone they are located.

Schedule of Fires

BN	BTRY	-20	-18	-16	-14	-12	-10	-8	-6	-4	-2	H
2-50	A	DA121 36	DA110 36	DA111 54	DA101 54	DA103 36	DA102 36					
	B	DA121 36	DA112 54	DA107 36	DA101 54	DA103 36	DA102 36					
	C	DA121 36	DA114 36	DA210 54	DA101 54	DA103 36	DA102 36					
2-12	Mortar Plat			DA107 54	DA202 36					DA201 54		
Armer	B											

1. Schedule is blocked out for the appropriate time in 2-minute time blocks for each unit.
2. Show the following in each block:
 - a. The concentration to be fired.
 - b. A horizontal bar showing the starting time of the concentration, and the time firing must be completed.
 - c. Below the horizontal bar, the amount of ammunition to be expended per unit.
3. An appropriate time interval for shifting to next target and control will be left between concentrations depending on the unit SOP. (An SOP might be 2 minutes for light artillery and mortars and 3 minutes for medium artillery.)
4. The force commander will determine the length of the preparation. Fires of direct support battalions will normally be scheduled to include a short period after H-hour.
5. Additional schedules may be prepared to be fired on call or upon the happening of a certain event during the operation.
6. Scheduled fires may be interrupted for on-call missions of decisive importance.
7. Fires directed by higher headquarters will be scheduled first. Fires requested by the supported unit and finally other appropriate artillery targets will then be scheduled.
8. Scheduling of fires will be coordinated with the fires of armor and infantry supporting weapons, close air support, and naval gunfire.
9. The time allotted for firing each concentration will be determined by the ammunition to be expended and the maximum rate of fire of the weapons.

DISTRIBUTION

Distribution of this plan, or parts thereof, will be made to supported units, heavy mortar platoons, mortar or Davy Crockett sections, division artillery, all liaison officers and forward observers, and to artillery battalions that have a mission of reinforcing this direct support battalion.

Figure 76. Guide for preparation of fire plans.