

9 JUNE 1966

By Order of the Secretary of the Army:

**JOHN A. WICKHAM, JR.**  
*General, United States Army*  
*Chief of Staff*

Official:

**R. L. DILWORTH**  
*Brigadier General, United States Army*  
*The Adjutant General*

DISTRIBUTION:

*Active Army, USAR, and ARNG:* To be distributed in accordance with DA Form 12-11A, Requirements for Transportation Reference Data (Qty rqr block no. 390).

**TABLE OF CONTENTS**

	Page
<b>PREFACE</b> .....	i
<b>CHAPTER 1. TRANSPORTATION PLANNING AND MOVEMENT CONTROL</b> .....	1-1
<b>CHAPTER 2. AIR TRANSPORT</b> .....	2-1
<b>Section I.</b> Organization and Operations .....	2-1
<b>Section II.</b> Landing Site Selection and Preparation .....	2-6
<b>Section III.</b> Cargo Carrying Aircraft .....	2-11
<b>Section IV.</b> Restraint Criteria .....	2-41
<b>Section V.</b> Airdrop .....	2-44
<b>CHAPTER 3. MOTOR TRANSPORT</b> .....	3-1
<b>Section I.</b> Organization and Operations .....	3-1
<b>Section II.</b> Motor Transport Data .....	3-69
<b>CHAPTER 4. RAIL TRANSPORT</b> .....	4-1
<b>Section I.</b> Organization and Operations .....	4-2
<b>Section II.</b> Rail Transport Data .....	4-21
<b>CHAPTER 5. WATER TRANSPORT AND TERMINAL OPERATION</b> .	5-1
<b>Section I.</b> Organization and Planning .....	5-1
<b>Section II.</b> Vessel Data .....	5-32
<b>Section III.</b> Terminal Equipment, Cargo Containers, Pallets, and Markings .....	5-42
<b>APPENDIX A. ORDERS, PLANS, AND SOP FORMATS</b> .....	A-1
<b>APPENDIX B. TRANSPORTATION-RELATED DATA</b> .....	B-1
<b>GLOSSARY</b>	
<b>Section I.</b> Abbreviations and Acronyms .....	Glossary-1
<b>Section II.</b> Terms .....	Glossary-5
<b>REFERENCES</b> .....	References-1
<b>INDEX</b> .....	Index-1

FIELD MANUAL  
NO 55-15

HEADQUARTERS  
DEPARTMENT OF THE ARMY  
Washington, DC, 9 June 1986

## TRANSPORTATION REFERENCE DATA

### PREFACE

This manual is both a planning guide for staff and unit officers and a digest of operational data for use as a reference by operators and users of transportation.

It includes characteristics of typical transportation equipment and facilities and methods for estimating capabilities and requirements for transportation equipment, facilities, and troop units. Personnel and equipment data for the modes of transportation and for transportation terminals are presented, as well as data for computing requirements for staff, supervisor, and control activities. Factors concerning administrative support requirements are discussed.

The manual also contains report formats and examples of orders and standing operating procedures. Loading data for water, rail, motor, and air movements; tables on weights, measures, and conversion factors; and miscellaneous data of general usefulness are included. Planning data contained herein may be modified as necessary to meet known conditions and requirements.

The proponent of this publication is HQ TRADOC. Submit changes for improving this publication on DA Form 2028 (Recommended Changes to Publications and Blank Forms) and forward it to **Commandant, US Army Transportation School, ATTN: ATSP-TDL, Fort Eustis, VA 23604-5399**.

Unless otherwise stated, whenever the masculine gender is used, both men and women are included.

---

\*This publication supersedes FM 55-15, 28 February 1968.

## CHAPTER 1

## TRANSPORTATION PLANNING AND MOVEMENT CONTROL

## CONTENTS

	<b>Page</b>
Transportation Planning .....	1-1
Movement Control .....	1-5

**TRANSPORTATION PLANNING**

Transportation planning is determining what must be moved, where and when it must be moved, and the best way to move it. The planner must pay attention to detail. He must realize that while working with a system that calculates detailed computations in minimal time, with the aid of a computer, the computer output must be in a form that is easy to use by transportation management personnel.

**Overview**

Transportation planning that supports a unified commander's operations plan covers both intertheater and intratheater movement and reception of personnel, materiel, and equipment into the theater and onward to their final destinations. In addition, the competing requirements for limited strategic lift resources, mobility support facilities, and intratheater transportation assets must be assessed in terms of impact on mission accomplishment. Priorities must be established to resolve conflicts. A movement program is prepared in light of both movement constraints and the

concept of operations. The movement program is the basis for development of detailed transportation tables and schedules used in the execution phase of the plan.

The payoff in transportation planning lies in the timely delivery to planned destinations of both effective combat forces and the means for their sustained support. Effective combat forces include both unit personnel and unit-related supplies and equipment. Sustained support includes support forces, replacement and filler personnel, resupply and buildup, and construction personnel, materiel, and equipment.

Only the total force and resource requirement for movement need be covered in the movement program. At the outset of transportation planning, all requirements data are assessed in terms of point of origin and destination. After it is determined what is to be moved, requirements (force increments, personnel increments, and cargo increments) are sequenced in order of desired arrival at the destination and the mode of transportation is selected. A port of debarkation (POD) and intermediate PODs are selected at the ship's

destination meeting. Time-distance factors are applied, a departure date is reckoned, conflicting requirements for limited transportation assets and mobility support facilities are reconciled, and the movement program is tested for feasibility.

### Process

The transportation planning process must be followed regardless of the type of transportation planning being done. First, determine what must be moved. Second, determine what transportation resources are available. Third, balance requirements against resources. Fourth, determine shortfalls and critical points and apply priorities. Fifth and most important, coordinate the plan with all units affected. The transportation planner must determine what the unit needs and then attempt to develop a transportation network to satisfy these needs.

**Determine requirements.** Each requirement for movement of troops or supplies generates at least one requirement for transportation. Initial transportation requirements can be expressed in terms of tonnage (or numbers of personnel) and distance. In the later stages of planning, the tonnages become classes of supply or even distinct items. Distances become routes between specific origins and destinations are determined.

The responsibility for providing adequate transportation support for the operation rests with the transportation planner. He estimates total requirements based on the supplies required for the supported forces and the distances involved in the phases of the operation. This estimate serves as a point of departure. It functions as a general check on whether the requirements submitted by users are realistic. It also serves to recognize every supply or personnel action as a transportation requirement and to refine those requirements as early as possible.

Some requirements may be within the capability of transport organic to the requesting unit. The planner must determine the extent of such capabilities and urge their use.

Special requirements will be generated when the corps includes an airborne or air assault division. These divisions have limited organic transport capabilities. Therefore, when committed to sustained ground combat operations, they will require significant, dedicated transportation from the corps.

**Determine resources.** Resources are determined by assessing transportation resources and considering —

- What types of transportation units are available.
- Characteristics and capabilities of each mode of transport.
- Capabilities of available civilian transport, based on a survey of facilities, inspection of equipment, and agreements negotiated with civilian transportation operators.
- Capabilities of host-nation transport, both civil and military, based on a survey of facilities, inspection of equipment, and agreements negotiated with the host-nation.

**Balance requirements and resources.** Balancing requirements and resources is a process which determines if the transportation capability is adequate to support the operation. It also establishes the work load for each segment of the transportation service. This is the most time-consuming portion of the planning process.

To provide complete transportation support, the planner considers factors other than the necessary operating units. The planner provides for adequate command and control by organizing units according to their mission, proposed locations, and area of coverage. He coordinates with planners of other services to make certain that their plans include the necessary capability for support to the transportation units. He makes recommendations on location of supply and service installations according to their requirements for transportation.

A composite statement of total requirements for transportation speeds up the planning process. Each planner selects the format that he finds most usable. One may use a chart listing

all requirements and showing origin, destination, required delivery date, weight, quantity, and class of supply for each shipment.

The process of establishing work loads for each transport mode varies according to the phase of operation. In the usual situation, the plan for the initial phase should provide sufficient motor transport for all cargo and personnel movements. Though some priority items will move by air, this quantity will normally be only a small percentage of the total supplies.

Work loads are computed individually for each transport mode, according to the characteristics and capabilities of the operating units of that mode. The final plan, however, must combine the units and operations of all modes into a single, integrated transportation system.

During actual operations, the theater commander allocates a portion of the available airlift to the theater army for its requirements. For planning purposes, however, air movement capacity is an assumption based on coordination with Army aviation and Air Force planners. This assumed capacity seldom exceeds the requirement for movement of priority cargo. If there is an excess, planners should use it for nonprogrammed priority movements. Army transport aircraft capacity seldom exceeds the amount required for direct support of combat operations. Therefore, plans should not provide for routine movements by air of other than priority cargo.

Rarely will a transportation plan indicate extensive use of inland waterways. In only a few areas of the world are there extensive inland waterway systems compatible with the requirements for transportation. Inland waterway systems are relatively vulnerable to

enemy action and sabotage and are difficult to restore to usefulness.

The planner must be certain to include all types of work loads, such as the following successive, direct, and retrograde shipments of some cargo; documentation for rehandling; requirements for rewarehousing; augmentation of unit's transportation; assistance to medical evacuation plan; and requirements to support allied and civilian organizations.

**Determine critical points.** Determining critical points along the proposed transportation system is done early in the planning process to identify points such as supply facilities, aerial and water ports, terminal transfer locations, and other points which may create bottlenecks. Accompanying this critical point determination is an analysis of which alternative plans would alleviate possible bottlenecks. This builds flexibility into the system.

**Coordinate with other planners.** Complete coordination among all planners is mandatory to ensure integrated support. Since the original guidance is seldom valid throughout the planning period, constant coordination with the other staff planners on changes to the mission, commander's concepts, assumptions, intelligence, policies, priorities, allocations, locations of facilities, and other elements necessary to keep planning current is an absolute necessity.

### Tables of Organization and Equipment

For a detailed breakdown of the transportation headquarters, by TOE, mission, assignment, and capabilities, refer to Table 1-1. These are not mode oriented, will be used where appropriate, and are provided for general planning information.

*Table 1-1. Tables of organization and equipment — transportation headquarters*

UNIT	TOE	MISSION/ASSIGNMENT/CAPABILITY
Transportation command	55-002H	<p><b>MISSION:</b> To command and control units employed in the transportation service supporting an independent corps force, to coordinate transportation service support matters with other US, host nation, and allied nations as directed, and to control indigenous transportation resources allocated to the transportation service.</p> <p><b>ASSIGNMENT:</b> To a COSCOM.</p> <p><b>CAPABILITIES:</b> The TRANSCOM is one of the functional commands of the theater Army. It is the principal transportation headquarters in the theater and, although located in the COMMZ, provides theater-wide mode operations. The TRANSCOM may be the direct higher headquarters for the brigades or groups located in the COMMZ. At level 1, this unit —</p> <ul style="list-style-type: none"> <li>• Commands and supervises the activities of all transportation and other assigned or attached units operating the transportation service in support of an independent corps force.</li> <li>• Provides staff planning and coordination of transportation CSS activities by the COSCOM headquarters.</li> <li>• Provides liaison with US, host, and allied nations as directed by COSCOM headquarters.</li> <li>• Controls, as required, indigenous transportation resources allocated to the COSCOM transportation service.</li> </ul>
Transportation composite group	55-028H	<p><b>MISSION:</b> To command units employed in the transportation service supporting an independent division-size force or a two-division separate corps force.</p> <p><b>ASSIGNMENT:</b> To a support brigade employed in support of an independent division-size force or a two-division separate corps force.</p> <p><b>CAPABILITIES:</b> At level 1, this unit —</p> <ul style="list-style-type: none"> <li>• Provides command of attached units (air, motor, terminal, and rail transport) required for operation of a transportation service in support of an independent division-size force.</li> <li>• Provides a nucleus organization for development of a transportation brigade or command during the initial stages of a logistical base buildup.</li> <li>• Develops plans and policies for employment of attached units.</li> <li>• Coordinates rear battle and ADC activities of subordinate units with the designated commander.</li> </ul>
Transportation service organization headquarters teams:	55-500H	<p><b>MISSION:</b> To provide command, control, and supervision of a transportation separate platoon, company, or battalion organized by attachment of operational teams.</p>
AA, platoon headquarters (component)		<p><b>ASSIGNMENT:</b> Normally assigned to a transportation company.</p>

*Table 1-1. Tables of organization and equipment — transportation headquarters (cont)*

UNIT	TOE	MISSION/ASSIGNMENT/CAPABILITIES
AB, platoon headquarters (separate)		<p><b>CAPABILITIES:</b> This team provides command and control for a platoon which will normally be composed of more than one team with an aggregate strength of not less than 40 individuals and to which a commissioned officer is not organically assigned.</p> <p><b>ASSIGNMENT:</b> Normally assigned to a transportation company.</p> <p><b>CAPABILITIES:</b> In separate operations, this team provides command and administrative control for a platoon normally composed of more than one team with an aggregate strength of not less than 40 individuals and to which a commissioned officer is not organically assigned.</p>
AC, company headquarters		<p><b>ASSIGNMENT:</b> Normally assigned to a transportation battalion or group or may operate separately.</p> <p><b>CAPABILITIES:</b> This team provides command and administrative control for the equivalent of two or more platoons.</p>
AD, battalion headquarters		<p><b>ASSIGNMENT:</b> Normally assigned/attached to a transportation group or brigade or may operate separately.</p> <p><b>CAPABILITIES:</b> This team provides command and administrative control of three to seven transportation companies, detachments, or teams of equivalent size.</p>

## MOVEMENT CONTROL

For a detailed breakdown of movement control units by TOE, mission, assignment, and capabilities, refer to Table 1-2.

*Table 1-2. Tables of organization and equipment—movement control units*

UNIT	TOE	MISSION/ASSIGNMENT/CAPABILITIES
Transportation movement control agency	55-004H	<p><b>MISSION:</b> To operate under the direction of the TRANSCOM ACoS Movements, the theater army movement control center, highway traffic headquarters, transportation movement offices, and highway regulating points.</p> <p><b>ASSIGNMENT:</b> To the TRANSCOM.</p> <p><b>CAPABILITIES:</b> At level 1, this unit —</p> <ul style="list-style-type: none"> <li>• When augmented by teams from TOE 55-580, provides the personnel and equipment to control movement of personnel and materiel, except bulk POL by pipeline, within the COMMZ.</li> <li>• When augmented by teams from TOE 55-580, provides the personnel and equipment to perform highway traffic headquarters functions within the COMMZ.</li> </ul>



Table 1-2. Tables of organization and equipment — movement control units (cont)

UNIT	TOE	MISSION/ASSIGNMENT/CAPABILITIES
Transportation movement control center (COSCOM)	55-006H	<ul style="list-style-type: none"> <li>• Maintains liaison with transportation elements of other US Forces and allied or host nations.</li> <li>• Provides command and nontechnical supervision and training of the enlisted component and provides limited unit level administrative supply and communications support to the technical movement control elements.</li> </ul> <p>Mission: To command and supervise attached or assigned units and teams engaged in movement control and highway regulation; to provide movement management for movement of personnel and materiel, except bulk POL moved by pipeline, within or out of the corps area; and to provide highway regulation services within the corps area.</p> <p>ASSIGNMENT: To a COSCOM.</p> <p>CAPABILITIES: At level 1, this unit —</p> <ul style="list-style-type: none"> <li>• Provides command and control of assigned or attached units or teams.</li> <li>• When augmented by teams from TOE 55-580, provides a central organization and field office necessary to perform movement control services in support of a corps.</li> <li>• When augmented by teams from TOE 55-580, provides personnel and equipment to perform highway traffic headquarters functions within the COMM2.</li> <li>• Maintains liaison with transportation elements of other US forces and allied and host-nation transportation agencies.</li> </ul>
Transportation movement control teams: LA, movement control	55-580H	<p>ASSIGNMENT: To an MCA or MCC.</p> <p>MISSION: To perform movement control functions for movement of personnel and materiel, except bulk POL by pipeline.</p> <p>CAPABILITIES: This team is capable of providing single-shift movement control functions at intermediate transfer points, small army air terminals, or specialized supply installations and may also be used to augment a larger movement control team when the size of the operation warrants.</p>
LB, movement control		<p>MISSION: To perform movement control functions for movement of personnel and materiel, except bulk POL by pipeline.</p> <p>CAPABILITIES: This team is capable of providing single-shift movement control functions at a two-ship LOTS terminal, a one- or two-ship fixed water terminal, or an inland transfer point.</p>
LC, movement control		<p>MISSION: To perform movement control functions for movement of personnel and materiel, except bulk POL by pipeline.</p> <p>CAPABILITIES: This unit is capable of providing single-shift movement control functions to support GS supply and/or maintenance activities, a four-ship fixed water terminal operation, or a rail or motor terminal.</p>

**Table 1-2. Tables of organization and equipment — movement control units (cont)**

UNIT	TOE	MISSION/ASSIGNMENT/CAPABILITIES
LD, movement control (region)		<p><b>MISSION:</b> To perform movement control functions for movement of personnel and materiel, except bulk POL by pipeline.</p> <p><b>CAPABILITIES:</b> This team is capable of coordinating the activities of up to 10 subordinate movement control teams on a 24-hour basis and may be employed as a central movement control element to support a tactical force where employment of an MCC is not warranted.</p>
LE, movement control (region)		<p><b>MISSION:</b> To perform movement control functions for movement of personnel and materiel, except bulk POL by pipeline.</p> <p><b>CAPABILITIES:</b> This team is capable of coordinating the activities of up to 10 subordinate MCTs on a single-shift basis and providing a central movement element to support a small tactical force where the employment of an MCC is not warranted.</p>
LF, movement control (air terminal)		<p><b>MISSION:</b> To coordinate the expeditious clearance of Army cargo and personnel from US Air Force air terminals and to coordinate the arrival of retrograde or resupply of cargo and personnel.</p> <p><b>CAPABILITIES:</b> This team is capable of performing the following movement control functions on a 24-hour basis.</p> <ul style="list-style-type: none"> <li>• Expediting the clearance of Army cargo and personnel arriving at a US Air Force terminal.</li> <li>• Coordinating local movement of retrograde or resupply of cargo or personnel.</li> <li>• Providing technical expertise in the functional areas of transportation, medical services, adjutant general, and supply and coordinating with functional counterparts in the COMMZ and/or corps.</li> <li>• Providing liaison with the US Air Force air terminal commander.</li> </ul>
LG, movement control (air terminal)		<p><b>MISSION:</b> To coordinate the expeditious clearance of Army cargo and personnel from US Air Force air terminals and to coordinate the arrival of retrograde or resupply of cargo and personnel.</p> <p><b>CAPABILITIES:</b> This team is capable of performing the following movement control functions during a 12-hour shift:</p> <ul style="list-style-type: none"> <li>• Expediting the clearance of Army cargo and personnel arriving by US Air Force aircraft.</li> <li>• Coordinating local movement of retrograde or resupply of cargo and personnel.</li> <li>• Providing technical expertise in the functional areas of transportation, medical services, adjutant general, and supply and coordinating with functional counterparts in TA and corps.</li> <li>• Providing liaison with the US Air Force air terminal commander.</li> </ul>

Table 1-2. Tables of organization and equipment — movement control units (cont)

UNIT	TOE	MISSION/ASSIGNMENT/CAPABILITIES
LH, highway regulation point team		<p><b>MISSION:</b> To operate a highway regulation point, to coordinate the movement of authorized traffic, and to effect changes in truck or convoy routings.</p> <p><b>CAPABILITIES:</b> This team is capable of observing, following, and reporting the progress of vehicles along routes and adjusting movement schedules as necessary on a single-shift basis.</p>

**Movement in the Communications Zone**

The TA MCA or MCA provides theater-wide movement control services for all US forces and coordinates with allied and host-nation forces as applicable and necessary. As the central US movement management organization (see Figure 1-1), the MCA prepares movement and port clearance plans and programs. It conducts liaison with higher and lower movement

control elements, including host-nation movement control elements, and supervises the activities of subordinate movement control teams (MCTs). It provides technical supervision to the corps movement control center (MCC) and ensures proper use of available host-nation and military-transport assets. For a detailed discussion of the mission and functions of the MCA, see FM 55-10.

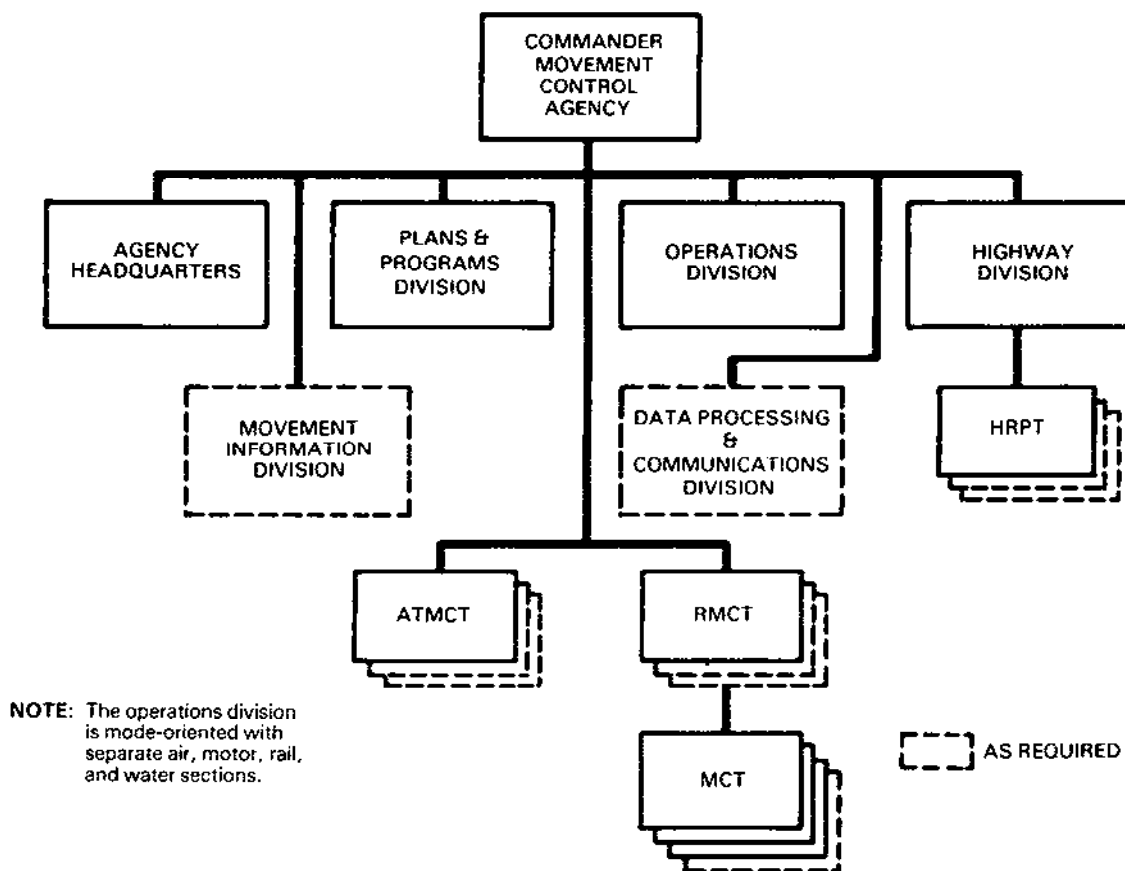

Figure 1-1. Movement control agency

**Movement Through the COMMZ**

During the early stages of transition to a wartime environment, all available transportation (US Army, allied, and host-nation) will be used to move personnel, equipment, and supplies forward in the theater. As the theater matures and CONUS-based transportation units begin arriving in the theater, US Army transportation units will perform a greater share of the US transport requirements. However, the theater will continue to use available host-nation transportation assets as required.

As cargo and equipment move through the COMMZ, a change in transportation mode

may be necessary. This is particularly true for rail movements. At each location where the mode of transportation is changed, a terminal transfer unit or host-nation equivalent is needed to make the transfer.

The operation of terminal transfer points is a transportation function. It provides for the continuous movement and positive control of personnel, equipment, and supplies through the transportation net. These terminal transfer units or teams are also responsible for transferring retrograde cargo and transportation equipment (such as containers and trailers). The principal Army transportation mode operator for the theater is the transportation command (TRANSCOM).

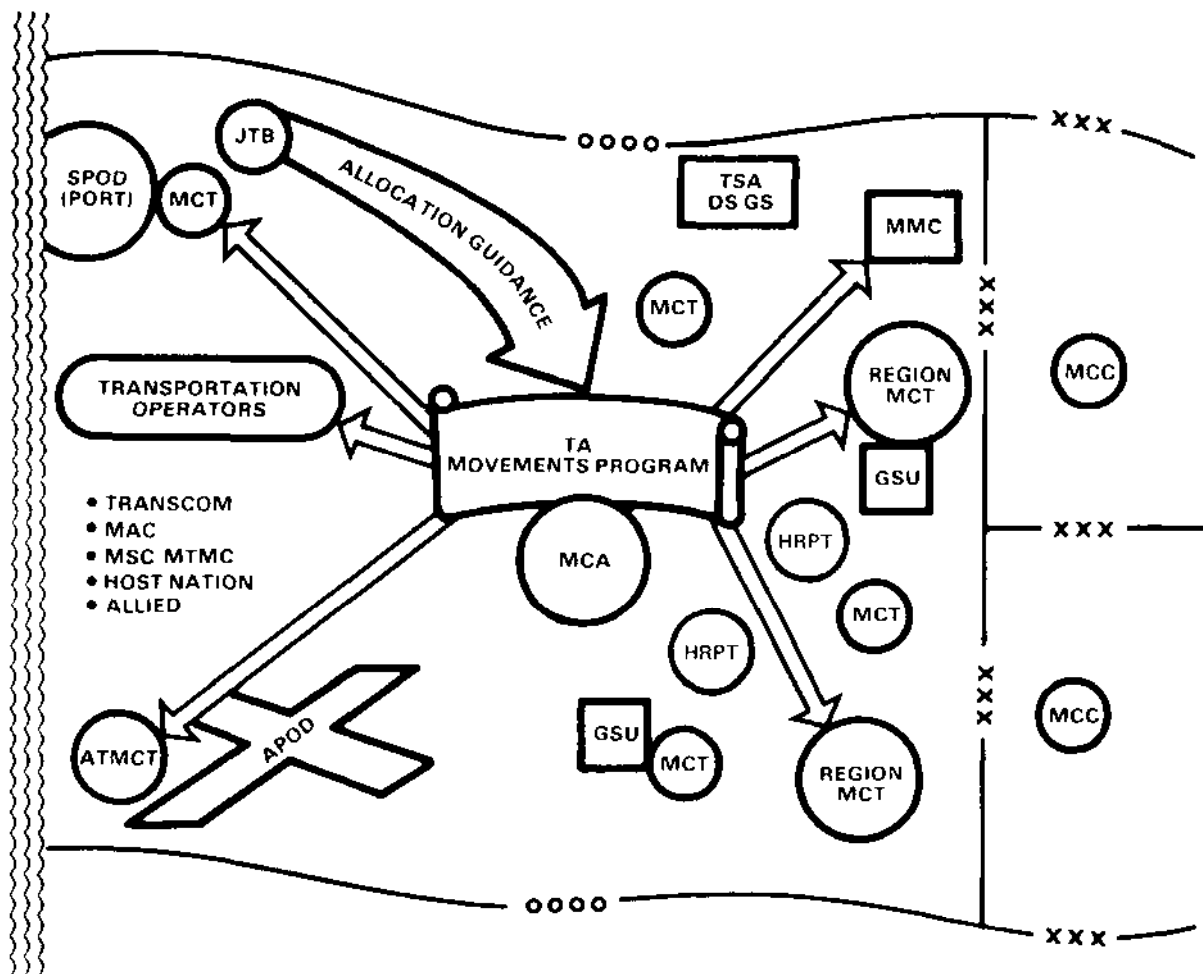

Figure 1-2. Communications zone

### Movement in the Corps

Centralized movement management and highway regulation are provided by the MCC. Movement control functions in the corps are similar to those provided by the MCA in the COMMZ. The MCC is under the staff supervision of the COSCOM assistant chief of staff (ACofS) for transportation. The MCC provides transportation control throughout the corps

and plans for both logistical and tactical transportation requirements.

All movements from the COMMZ into the corps area must be coordinated by the MCA with the MCC to obtain clearance to enter the corps. Movements from the corps to the COMMZ must also be coordinated by the MCC with the MCA. This coordination is designed to prevent overloading of any segment of the transportation system (see Figure 1-3).

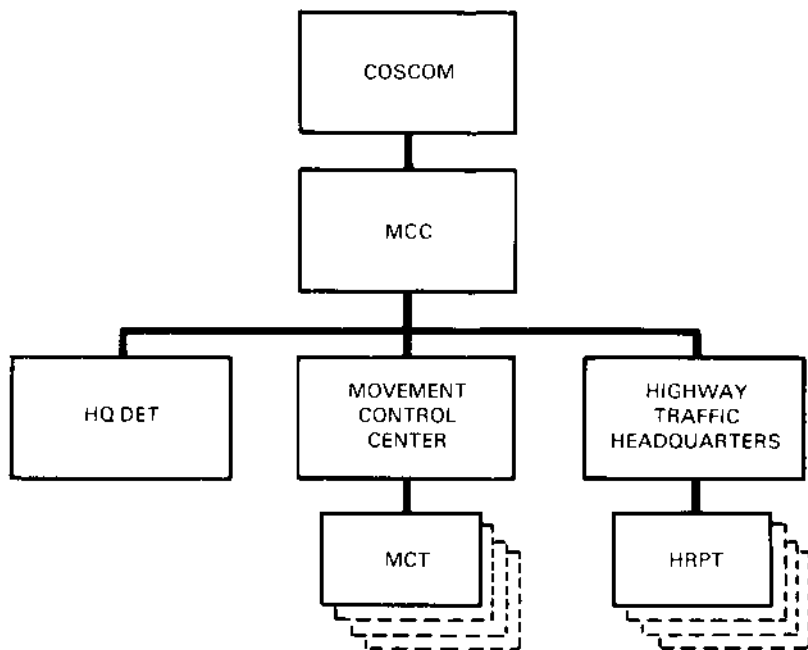

*Figure 1-3. Transportation movement control center*

### Movement Through the Corps

As personnel, equipment, and supplies enter the corps, transportation will be provided by a combination of modes and operators as coordinated between the MCA and MCC.

Throughput of supplies and equipment will be used in the corps as in the COMMZ. Throughput is the direct delivery of cargo to the ultimate consignee, bypassing one or more intermediate supply points. The amount and type of throughput cargo will depend on the tactical situation and the ability of the receiving unit or agency to unload the vehicles and containers with assigned materials-handling equipment (MHE). Containerized cargo will be

delivered into the corps support area (CSA). However, since some containers may move into the division support area (DSA), the receiving and unloading capability for container handling must be assured before the division is burdened with them. Containers will not be grounded where there is no container-handling capability.

The corps support command provides combat service support (CSS) to the corps. A transportation brigade is the principal transportation operating headquarters in the corps. A transportation composite group will perform that function in contingency operations (see Figure 1-4).

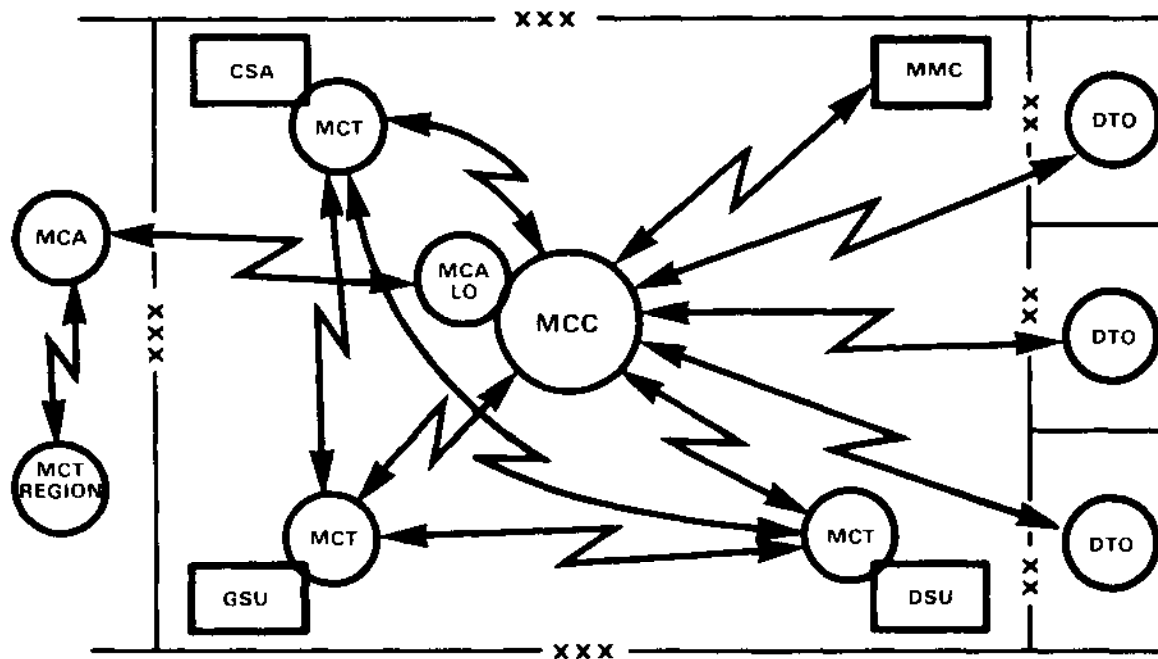

Figure 1-4. Corps area with its MCC

### Movement in the Division

The division transportation officer (DTO) and the division support command (DISCOM) movement control officer (MCO) manage the division transportation system.

Transportation organic to the division is limited in number. Therefore, the division gets

transportation assets beyond its own capability from the corps, by request from the MCO, through the DTO, to the MCC. For a detailed discussion of the role of transportation movement management within the division, see FM 55-2.

## CHAPTER 2

## AIR TRANSPORT

## CONTENTS

	Page
<b>Section I. ORGANIZATION AND OPERATIONS</b>	
Aviation Transport Units .....	2-1
Airlift of Materiel .....	2-3
<b>II. LANDING SITE SELECTION AND PREPARATION</b>	
Selection .....	2-6
Preparation .....	2-9
<b>III. CARGO-CARRYING AIRCRAFT</b>	
External Transport Helicopters .....	2-11
Internal Transport Helicopters .....	2-16
Military Airlift Command Aircraft .....	2-22
Civil Reserve Air Fleet Aircraft .....	2-25
Characteristics of Standard Army Aircraft .....	2-33
<b>IV. RESTRAINT CRITERIA</b>	
Determining the Center of Gravity .....	2-41
Securing Cargo .....	2-41
<b>V. AIRDROP</b>	
Delivery Operations .....	2-44
Types of Airdrop .....	2-44
Release Methods .....	2-45
Low Altitude Parachute Extraction System .....	2-45
Ground-Air Emergency Codes .....	2-46

**Section I. ORGANIZATION AND OPERATIONS****AVIATION TRANSPORT UNITS**

The evolution of warfare has generated a need for greater mobility in support of the Army. Army aviation is an integral part of the

transportation system designed to provide efficient and effective movement of personnel and cargo. Army aviation units provide airlift in support of requirements of the theater army,

corps, and division. In addition, Army aviation units are capable of providing airlift to support a unified or specified command, a military assistance advisory group or mission operating detachment, or a separate brigade operation. Because of the high mobility requirements of today's Army, considerable reliance is placed on the air mode of transportation provided by Army aviation units.

**Categories**

These units are separated into two categories, divisional and nondivisional.

**Divisional.** Aviation elements which are organic to a division are authorized on the basis of each type division's requirement for constantly available aviation support. An air assault division which has a constant requirement for large numbers of aircraft is authorized an aviation group. Each armored, infantry (mechanized), motorized, and light infantry division is authorized a combat aviation brigade.

**Nondivisional.** To meet the varying requirements of subordinate divisions for aviation support and to augment the organic aviation assets of other theater army and corps elements, separate aviation organizations are included in the Army field force structure. These separate aviation units are referred to as nondivisional aviation units. They normally include helicopter elements which are capable of performing airlift missions and providing

direct aerial fire support to subordinate divisions. Special-purpose airplanes, such as reconnaissance and surveillance, are also included.

**Mission**

The mission of Army aviation units is to provide airlift of personnel and cargo for combat service support and combat support operations as required. Missions assigned to an aviation unit are usually similar to the normal mission as stated in the TOE.

**Objective**

The aviation company is assigned missions with the objective of assisting in the accomplishment of the mission of the land force.

**Authority**

When the aviation company is assigned to support a ground unit, the ground unit commander assigns tasks to the aviation commander. The aviation commander retains authority to issue orders to elements under his command as necessary to accomplish these tasks.

**Tables of organization and equipment**

The table of organization and equipment (TOE) of each military unit prescribes its normal mission, organizational structure, and personnel and equipment authorization. Users who need detailed information on any specific aviation unit should use the TOE of that unit. A breakdown of the aviation companies according to TOE, task aircraft, mission, and assignment is outlined in Table 2-1.

*Table 2-1. Army aviation units providing combat service support*

UNIT	TOE	TASK AIRCRAFT	MISSION/ASSIGNMENT
Combat aviation company	1-258JA	15 UH-60	<b>MISSION:</b> To provide tactical mobility of combat supplies and equipment of the support unit within the combat zone. <b>ASSIGNMENT:</b> Organic to the combat aviation brigade (TOE 1-105J400).
Combat aviation company	55-167J1	16 CH-47	<b>MISSION:</b> To provide air transport of personnel and cargo for combat service and combat support. <b>ASSIGNMENT:</b> Organic to the medium helicopter battalion (TOE 55-165), either in the air assault division or to the corps transportation group; organic to the support battalion, air cavalry combat brigade (TOE 29-155); may be attached to a composite transportation battalion/group in the



**Table 2-1. Army aviation units providing combat service support (cont)**

UNIT	TOE	TASK AIRCRAFT	MISSION/ASSIGNMENT
			corps support command or theater army area command.
Combat aviation company	1-257J410	23 UH-1	<b>MISSION:</b> To provide tactical mobility of troops, supplies, and equipment within the combat zone. <b>ASSIGNMENT:</b> To the combat aviation brigade.
Combat aviation company	1-257J420	15 UH-60	<b>MISSION:</b> To provide tactical mobility of troops, supplies, and equipment within the combat zone. <b>ASSIGNMENT:</b> To the combat support aviation battalion of the combat aviation brigade.
Combat aviation troop	1-257J430	15 UH-60	<b>MISSION:</b> To provide tactical mobility of troops, supplies, and equipment within the combat zone. <b>ASSIGNMENT:</b> To the armored cavalry regiment.
Combat aviation company	7-269J	15 UH-60	<b>MISSION:</b> To provide tactical mobility of troops, supplies, and equipment within the combat zone. <b>ASSIGNMENT:</b> Organic to the combat aviation battalion, air assault division (TOE 7-255).
Combat aviation company	1-259J4	15 UH-60	<b>MISSION:</b> To provide tactical mobility of combat troops, supplies, and equipment of the supported unit within the combat zone and aerial surveillance of the combat zone. <b>ASSIGNMENT:</b> Organic to the combat aviation brigade (TOE 1-105J400).
Heavy helicopter company	55-259H	9 CH-54	<b>MISSION:</b> To provide combat service support airlift for movement of heavy supplies, vehicles, aircraft, and equipment and, as directed, to provide combat support airlift of combat units and air supply of units engaged in combat operations. <b>ASSIGNMENT:</b> To a combat aviation group (TOE 1-252). Normally, attached to an aviation battalion (TOE 1-258).

## AIRLIFT OF MATERIEL

The Army air transport service was not designed to compete with the Air Force. Its purpose is to provide rapid-response transport for high-priority personnel, supplies, and equipment to locations inaccessible by other transportation modes and to supplement the lift capability of other Army transportation modes.

### Area of Operations

**Communications Zone.** In the COMMZ, Army air transport is furnished by the TRANSCOM's aviation battalions, which are composed of up to six Army medium- and heavy-lift helicopter companies. These aircraft are used for the movement of high-priority cargo and personnel to and from Air Force terminals and for rapid deployment of rear area protection forces. Based on the theater move-

ment program, these heavy- and medium-lift units are located where they can best fulfill the programmed requirements. Army helicopters complement other Army transportation modes when speed is essential and if other transportation modes cannot be used because of their inherent limiting factors.

**Theater of Operations.** Army air transport in the theater can be designed to provide the connecting link between theater air and ocean terminals and the receiving supply activities, the receiving units, or terminal transfer points. This air movement may be programmed or nonprogrammed. For example, the MCA may task the COMMZ aviation battalion to transport high-priority cargo daily from theater air terminals forward to the supply activity who will issue the cargo, or the MCA may pull the programmed commitment and

issue a higher-priority nonprogrammed commitment. There are both advantages and limitations to Army air transport in a theater of operations.

**Advantages.** Army transport helicopters offer the following advantages:

- A high degree of flexibility.
- Speed of transport.
- Internal or external transport of cargo or equipment.
- Immunity to surface or terrain conditions.

**Limitations.** Army transport helicopters have the following limitations:

- Vulnerability to enemy air action.
- Vulnerability to air defense weapons and other ground fire.
- Susceptibility to adverse weather conditions.
- Inherent decrease in lift capability as air density decreases due to altitude, temperature, or humidity changes.
- Higher maintenance per operating hour than other modes.
- Dependence on logistics support.

**Corps.** Army air transport originating in the corps is managed by the corps movement control center. The MCC obtains its combat service support medium-lift helicopters from the corps aviation brigade/group and its other transportation assets from the corps support command transportation brigade. The MCC controls and directs which logistical support missions the CH-47 helicopters will fly. MCC control of all modes of corps logistics transportation assets is essential to make sure that the best mode is selected to accomplish the mission.

Medium-lift cargo helicopter companies of the aviation brigade/group (corps) provide a highly mobile and responsive means for logistics movement of supplies and equipment. To support these operations, medium-lift helicopter units provide logistics movement of ammunition, repair parts, POL, engineer material, artillery, special weapons, troops, disabled aircraft and vehicles, and other large or heavy items. The helicopters augment surface transportation systems to meet increased transportation demands in surge operations, to

overcome terrain obstacles, and to meet time-sensitive requirements.

The logistics mission for the helicopters is characterized by single-ship, independent operations. The helicopters will not routinely operate forward of the brigade support area. However, the trend to position more units forward and to dedicate aircraft for weapon system resupply will require more forward employment of the medium-lift helicopters. This may require aircraft to operate as close as 5 to 7 kilometers from the forward edge of the battle area.

Aircraft may also be required to operate beyond the forward line of own troops (FLOT), to support air-land-battle-deep operations. Logistics support of the covering force justifies additional cargo helicopter commitments in the forward area to support these maneuver units. Both external loads at high altitudes and internal loads, coupled with nap-of-the-earth flying, are used, depending on the situation. The division's utility helicopters will provide most of the intradivision air transport support.

### **Programmed and Nonprogrammed Movements**

Programmed and nonprogrammed Army air transport will be performed in the COMMZ, corps, and division.

**Programmed** Programmed air transport permits matching movement requirements against airlift capability. It also allows for the maximum ton-mile capability of the aircraft and is the most economical method of air transport. Programmed air movements are generally (but not necessarily) carried out over established routes.

**Nonprogrammed.** Nonprogrammed air transport results from changing requirements which directly or indirectly affect the transportation pipeline supporting the battlefield. Some of these are shown below:

- Unplanned requirements for resupply or repositioning of existing supplies.
- Emergency movement of personnel and equipment.
- Assistance to aeromedical air ambulance units.

- Prevention of congestion at an air or ocean terminal.

Nonprogrammed air transport is an integral part of the ALOC; it may or may not be carried out over the established air lines of communications.

### Employment Considerations

Although optimum utilization of airlift would be attained by use of Air Force transport aircraft to move materiel from a COMMZ depot directly to the user, this is often impracticable in a tactical situation. There normally must be a point at which wholesale airlift is terminated and retail deliveries to the user are undertaken by Army aviation elements.

**Wholesale airlift.** Factors to be considered in determining the point at which wholesale airlift is terminated include the following

**Airfields.** Suitable airfields must be available at points where materiel is to be airlanded by Air Force transport aircraft.

**Enemy action.** The enemy may be capable of limiting or denying the use of forward areas for airlanding by transport aircraft.

**Receiving unit capability.** Combat units in forward areas have a limited capability to receive, store, protect, and redistribute materiel airlanded in wholesale lots by transport aircraft.

**User requirements.** The user may be a unit of company size or smaller that requires resupply in retail quantities only.

**Efficiency.** The efficient employment of Army aviation is based upon the following considerations:

**Economy of use.** Aircraft should not be used to transport cargo when surface transportation is equally effective. Since there are seldom enough aviation assets to satisfy all requirements of commanders, most aviation support is allocated on a priority basis.

**Ready availability.** The ability to respond rapidly to demands for aviation support increases the value of air transport to supported commanders. Ready availability is obtained by locating aviation units as close as practicable

to the supported units. Also, the inherent mobility of aircraft permits support to be made available to units located throughout a wide area. Ready availability is enhanced by intelligent scheduling of operational aircraft and by programming of required maintenance.

### Operational Considerations

**Air density.** Unlike surface transportation, where the payload of a particular vehicle is relatively fixed, aircraft payloads are affected by air density. Denser air provides greater lift to an aircraft's wing or rotor blade, thus increasing the weight-lifting performance of the aircraft. Air density is affected by temperature, altitude, and humidity.

**Temperature.** An increase in temperature causes a decrease in air density. The amount of air that occupies 1 cubic inch at low temperature will expand and occupy 2 or 3 cubic inches as the temperature rises. It is important to recognize that the payload of a particular aircraft can change, depending on the time of day a flight is scheduled. Usually early morning temperatures favor operations, and noonday heat causes a decrease in the efficiency of the aircraft.

**Altitude.** An increase in altitude causes a decrease in air density. This factor is particularly important when operations are conducted from areas high above sea level. It is necessary either to decrease the aircraft weight or to increase the length of takeoff and the landing strip.

**Humidity.** An increase in humidity causes a decrease in air density. Air always contains some moisture in the form of water vapor, but the amount varies from almost 0 to 100 percent. This water vapor is known as humidity. As humidity increases, water particles displace the air, causing a decrease in air density and reducing the performance efficiency of the aircraft.

**Distance.** The distance to be flown is particularly important when using Army transport aircraft, because the allowable load is computed after the amount of fuel, plus reserve, is determined. Aircraft must carry less fuel with a relative reduction in distance flown when the maximum payload is desired, and the

payload must be reduced when the maximum distance is the important factor.

**Weather.** Weather conditions influence the operations of Army aviation elements. While low ceilings and limited visibility may restrict operations, such conditions may be used as an advantage to shield the aircraft from enemy observation. However, adverse weather generally reduces the efficiency of Army air transport operations. Although Army transport aircraft can operate under instrument flight conditions, commanders should establish weather minimums to preclude scheduling flights that jeopardize the safety of aircraft and personnel. Weather minimums should be established commensurate with the experience of the pilots, type of aircraft employed, urgency of mission, navigational aids available, terrain along the flight route, and time of operation.

**Enemy situation.** Consider the location and capabilities of enemy forces before finalizing flight routes for Army air transport operations. Avoid areas where suspected enemy anti-aircraft weapons or known enemy ground fire exist. Prepare prearranged evasive-action flight plans for aviation units in case enemy aircraft are encountered.

**Terrain.** Consider terrain features with regard to their possible effects on each operation. Terrain influences the following:

- Location of takeoff and landing sites.
- Flight routes.
- Identification of prominent landmarks for navigational purposes.
- Location of navigational aids.
- Location of emergency landing sites.

**Flight routes.** Combat operations generate many demands for the use of airspace. Employment of US military aircraft, artillery, drones, and missiles must be coordinated to ensure adequate safety, proper identification, and

operational efficiency. Army aviation units must ensure that flight routes are properly coordinated and approved by the appropriate air traffic control facility before beginning combat service support or combat support operations.

**Communications.** Combat service support and combat support airlift operations require that adequate communications be established before the beginning of a mission. Voice communication is necessary among Army airlift and command units, supported organizations, inflight aircraft, and takeoff and landing sites.

### Support Requirements

Primary support requirements are the availability of petroleum, oils and lubricants (POL); ammunition; and aircraft maintenance support.

**Petroleum, oils, and lubricants.** Aircraft consume large quantities of fuel. POL items require special handling. Refueling facilities should be readily available.

**Ammunition.** The ammunition used in Army aircraft may be expended rapidly. This necessitates locating resupply facilities near the area of operations to avoid the time penalty involved in lengthy flights to obtain supplies.

**Aircraft maintenance.** Performance of aircraft operations on a sustained basis is dependent upon efficient aircraft maintenance. Maintenance of aircraft begins with that performed by aviation unit maintenance (AVUM) and extends through aviation intermediate maintenance (AVIM) to depot maintenance. To assure continuing availability of aircraft, close coordination is required between the aviation unit commander, the ground combat commander, and the supporting maintenance unit commander. Proper scheduling of aircraft is mandatory to prevent maintenance overload which can result in excessive downtime for aircraft.

## Section II. LANDING SITE SELECTION AND PREPARATION

### SELECTION

The selection of a usable pickup zone (PZ) or landing zone (LZ) is extremely important.

Logistical and tactical considerations must be analyzed and taken into account to assure that the PZ/LZ is correctly placed to support the

mission. The area must be accessible to the aircraft that will use the site. The supported/receiving unit commander, in coordination with the aviation unit liaison officer, if available, will select and prepare the PZ. The aviation unit liaison officer will make the final decision concerning minimum landing requirements.

**Dimensions**

The size of the landing site will depend on the number of landing points within it, the size of the landing points, and the dispersion required between the landing points as the tactical situation dictates (see Figure 2-1.) The minimum size of a landing point for each size helicopter is shown in Table 2-2.

Many considerations such as helicopter type, unit proficiency, nature of loads, climatic conditions, and day or night operations may apply to the size of the landing points used. If such information is not available from the aviation unit, a size 5 landing point should be prepared. The minimum recommended distance between landing points within the landing zone, where no consideration is given to dispersion, is the same as that size helicopter's minimum diameter; only measure from the center of one landing point to the center of the other. (See Figure 2-2.)

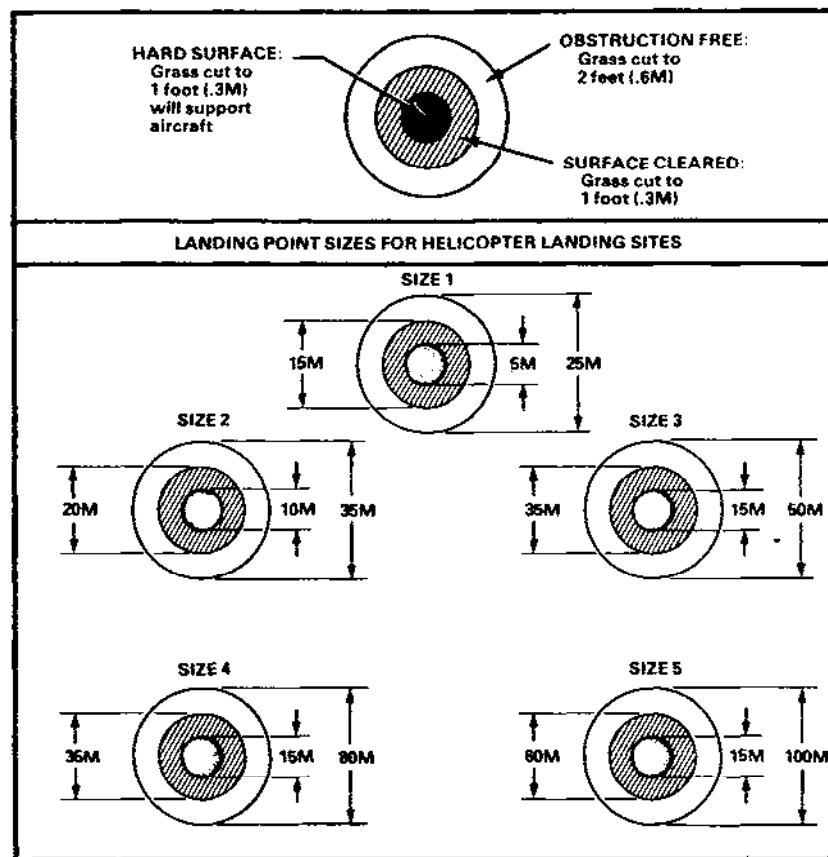

Figure 2-1. Helicopter landing sites

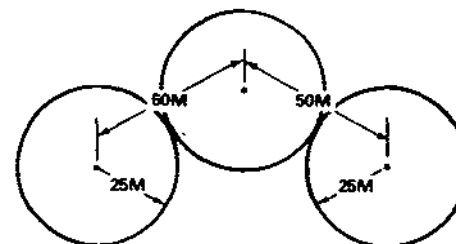

Figure 2-2. Size 3 aircraft landing zone for V-formation

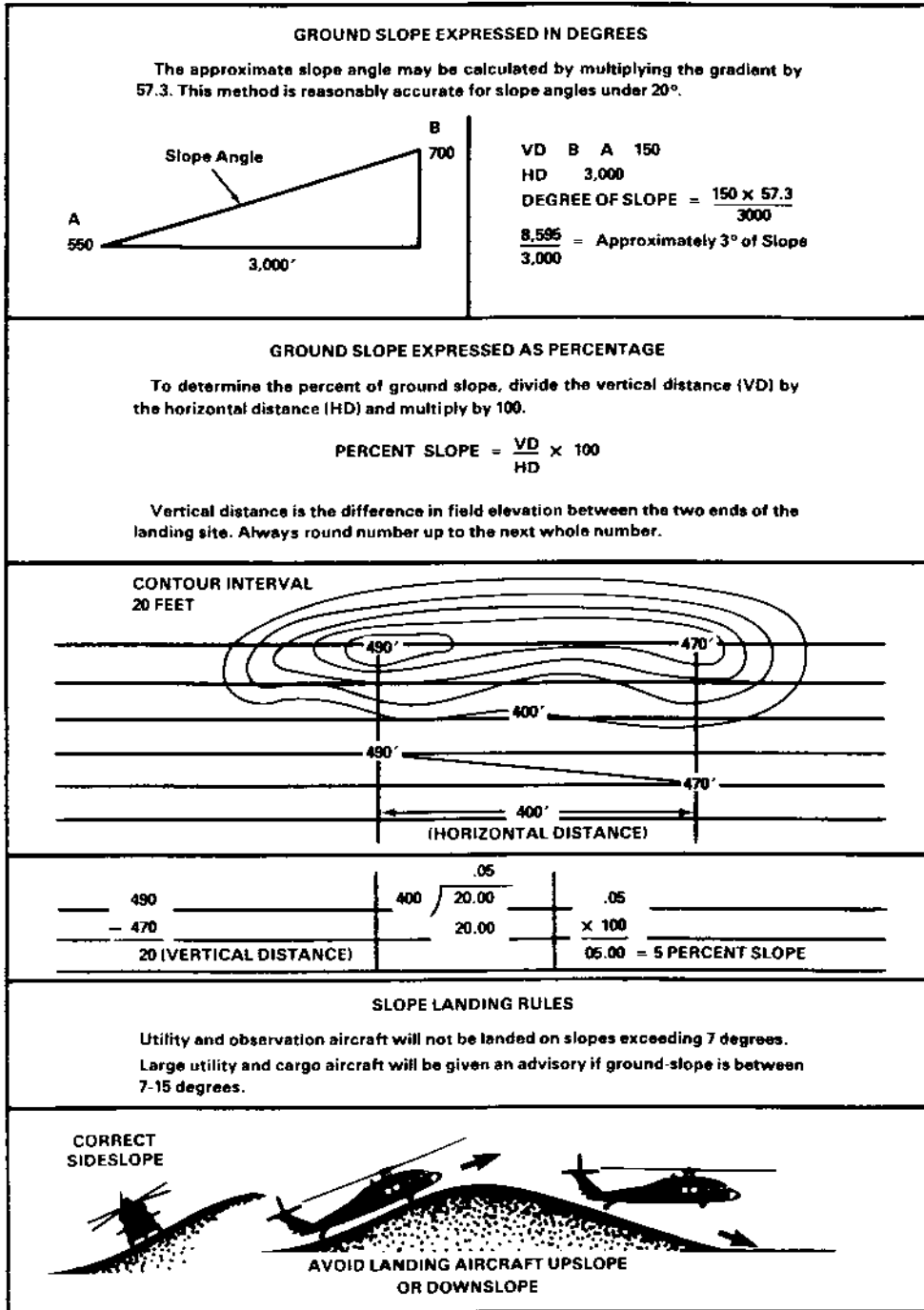

Figure 2-3. Determining ground slope

Table 2-2. Size helicopter for landing point

Helicopter size	Minimum diameter of landing point	Type helicopter
1	80 feet (25 meters)	OH-6, OH-58
2	125 feet (35 meters)	UH-1
3	160 feet (50 meters)	UH-60
4	264 feet (80 meters)	CH-47, CH-53, CH-54
5	328 feet (100 meters)	To be developed

### Surface

The surface of the center of the landing point must be level and sufficiently firm to allow a fully loaded vehicle (1/4-ton truck for size 1 or 2 helicopters and a 3- to 5-ton truck for size 3 to 5 helicopters) to stop and start without sinking. The entire landing point must be cleared of any loose material, piles of dust, or sand which could be blown up by the aircraft's rotor blades. Landing points with sandy or dusty surfaces should be stabilized if possible. All trees, brush, stumps, or other obstacles that could cause damage to the main or tail rotor blades or to the underside of the aircraft must be cleared around the landing points. Any snow on a landing point should be packed or removed to reveal any obstacles and to reduce the amount of loose snow blown over the area. A marker panel is essential to provide a visual reference for the pilot's depth perception in a snow-covered landing zone and also to reduce the effect of whiteout.

### Slope

Ideally, the ground at the landing point should be level. Where a slope is present, it should be uniform. During a daylight approach, the slope should not exceed 7 degrees (1 in 8) if the helicopter is to land. A greater slope may be acceptable for hover operations. During a night approach, a reverse slope as viewed from the approach path, is not normally acceptable. Forward and/or lateral slope should not exceed 3 degrees (1 in 19). If these criteria cannot be met, use of the landing point must be confirmed by the aviation unit. (See Figure 2-3.)

## Approaches

Ideally, there should be an obstruction-free approach and exit path into the wind. Approaches which do not meet the following minimum requirements may be acceptable depending on the nature of the operation. However, when these criteria cannot be met, the aviation unit must be consulted.

**Daytime.** Within the selected approach and exit paths, the normal maximum obstruction angle to obstacles during daylight hours should not exceed 6 degrees, as measured from the center of the landing point to a distance of 1,640 feet (500 meters). The maximum obstacle height at the 1,640-foot mark is 171 feet (52 meters). (See Figure 2-4.)

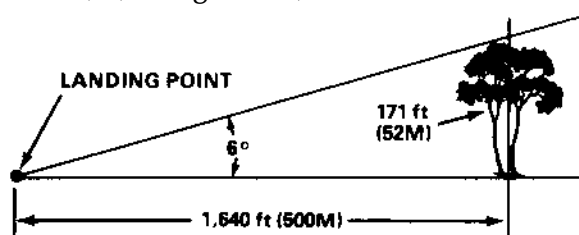

Figure 2-4. Maximum angle of approach (daylight)

**Nighttime.** The selected approach and exit paths should contain a sector of not less than 16 degrees in azimuth measured from the center of the landing point. The width of the approach and exit paths should not be less than the width of the area in the landing point cleared to 2 feet (.6 meters) in height. Less than 164 feet (50 meters) will not be acceptable; more than 328 feet (100 meters) is not necessary. Within the selected approach and exit path, the maximum obstruction angle should not exceed 4 degrees as measured from the center of the landing point to a distance of 9,843 feet (3,000 meters). The maximum obstacle height at the 9,843-foot mark is 689 feet (210 meters). (See Figure 2-5.)

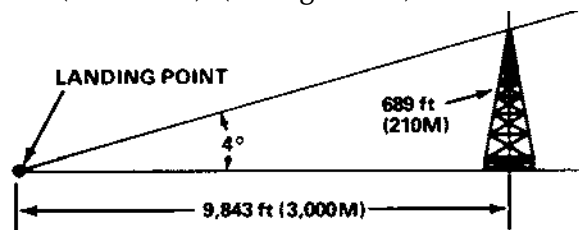

Figure 2-5. Maximum angle of approach (night)

## Density Altitude

Density altitude is determined by altitude, temperature, and humidity. For planning, as density altitude increases, the size of the landing zone must be increased proportionately. Generally, hot and humid conditions at a landing site will decrease the lift capabilities of helicopters using that site. Therefore, a large area and better approach and/or departure routes are required more for fully loaded helicopters than for empty or lightly loaded ones, since most helicopters cannot climb or descend vertically when fully loaded.

## Concealment

A pickup zone/landing zone near the forward line of own troops should be masked whenever possible. The selection of the approach and exit routes should be based on the availability of good masking features.

## PREPARATION

### Receiving Flight Formations

In large tactical relocations or resupply missions, the helicopters will normally fly in formations. The PZ/LZ and the ground crew will have to be prepared to receive them. When possible, helicopters should land in the same formation in which they are flying. However, planned formations may require modification for helicopters to land in restrictive areas. If a modification in flight formation is required for landing, the change requiring the least shift of helicopters should be used and the flight leader notified as soon as radio contact is made. (See Figure 2-6.)

Many times, size 4 helicopters will not fly in standard flight formations and will be received one or two at a time. In such cases, each aircraft initially approaches and hovers at the Y and is then guided to its cargo pickup point by the signalman.

### Marking the Landing Site

The landing site, during daylight hours, can be marked with signal panels but, because of the possibility of the rotor wash from the helicopter tearing them from the ground and causing a hazard, they are seldom used. During daylight operations the landing sight is usually marked with colored smoke.

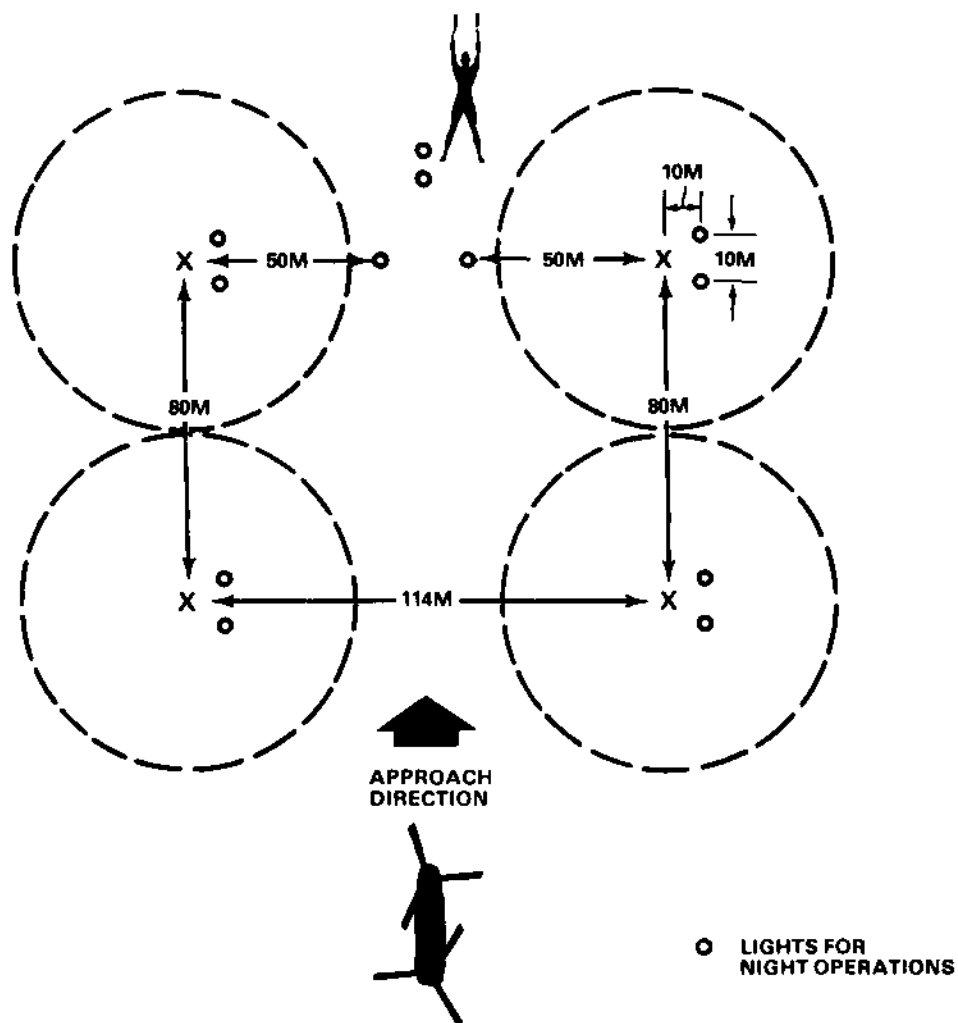

*Figure 2-6. Landing zone/pickup zone landing formation for size 4 helicopters*

The landing site is also marked by the ground guide, who holds both arms straight up over his head or holds a folded VS-17 signal panel chest-high.

**CAUTION**

When using colored smoke to mark the PZ/PL, be sure the canister is far enough away from the landing point so the rotor wash does not pick up the smoke and obstruct the pilot's vision.

During night operations, the landing point for the lead aircraft is marked by amber beacon lights. The single point landing site or the landing point for the lead aircraft, if aircraft are in formation, is marked with either an inverted Y or T (see Figure 2-7). The aircraft will touch down or hover on the midpoint of the legs of the Y and to the left of the stem if the T is used. The landing points for the other aircraft in the formation are also marked with lights. For size 1 through size 3 helicopters, a single light is used to mark the landing point; size 4 and 5 helicopters have two lights spaced 10 meters apart to mark the landing point. The aircraft lands to the left of the lights.



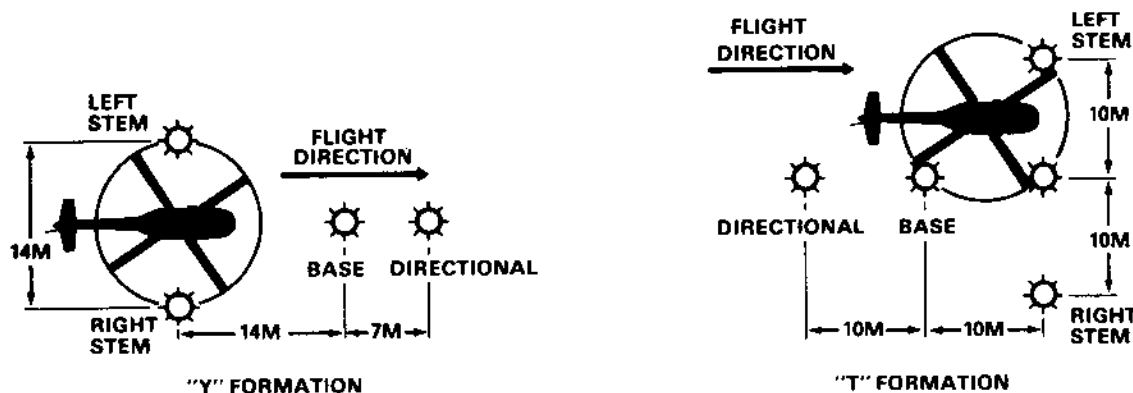

Figure 2-7. The Y- and T-formations for single-point formation landing sites

Whenever the size of the LZ/PZ permits, the size of the landing points should be increased to the next largest size for the helicopters involved to provide an extra margin of safety for night operations.

### Marking Obstacles

During daylight operations, obstacles that may be difficult to detect or impossible to remove, such as wires, holes, stumps, and rocks, are marked with red panels or by any other easily identifiable means. Devices used to mark obstacles must be colored red.

During night operations, red lights are used to mark all obstacles that cannot be easily eliminated. In most combat situations, the need for security will prohibit the use of red lights to mark the tops of trees on the approach and departure ends of the landing zone. In training, however, or in a rear area landing site, red lights should be used whenever possible. If obstacles or hazards cannot be marked, aviators should be fully advised of existing conditions by radio.

## Section III. CARGO-CARRYING AIRCRAFT

### EXTERNAL TRANSPORT HELICOPTERS

The helicopter method of transport can overcome many obstacles that prevent other methods of transportation from completing the mission.

#### Advantages

One major advantage of transporting loads externally by helicopter is that it rapidly moves heavy, outsized, or "needed now" items directly to their destinations. Another advantage is that damaged or congested highways, destroyed bridges, and most en route terrain obstacles have little impact on cargo transport. The helicopter may use different flight routes to provide a diversion and maintain security of the unit on the ground.

Another advantage of external transport is that cargo may be rapidly moved into or taken

out of an area, which helps the ground unit obtain items of equipment when and where it needs them. The helicopter can also place fire power where it is needed and then relocate it in a rapidly changing battlefield situation. A PZ/LZ can be relocated rapidly to avoid detection and thus aid in ground security.

#### Disadvantages

The disadvantages of transporting cargo externally by helicopter appear when the size, weight, and flight characteristics of the cargo fall outside of the design limits of the aircraft. If cargo is too light or bulky, it will not fly right when suspended beneath the aircraft. If it is too heavy, the aircraft will not be able to lift it.

Generally, any restrictions which apply to helicopters also apply to sling load operations or routine training flights. Limited aviation

assets, maintenance downtime, and mission priority must be taken into account to assure that aircraft are used wisely. Weather conditions and the PZ/LZ terrain can present natural obstacles to the use of aircraft and become particularly critical factors during external sling load missions. When operations are planned during the hours of darkness or under reduced visibility, the size of the PZ/LZ must be increased to give the pilot more room to maneuver.

### Responsibilities

There are normally three different elements involved in a sling load mission: the supported unit (requests the mission), the aviation unit (provides the aircraft), and the receiving unit (receives the cargo). Sometimes, such as during a unit relocation, the supported and receiving units are the same. The responsibilities and functions of each are discussed below.

**Supported unit.** The supported unit is responsible for—

- Selecting, preparing, and controlling the PZ. (Pathfinders can be of great assistance in this area if available.)
- Requisitioning all the equipment needed for sling load operations, including slings, A-22 cargo bags, cargo nets, and containers.
- Storing, inspecting, and maintaining all sling load equipment.
- Providing a sufficient number of trained ground crews for rigging and inspecting all the loads, guiding the helicopters, hooking up the loads, and clearing the aircraft for departure.
- Securing and protecting sensitive items of supply and equipment.
- Providing load derigging and disposition instructions to the receiving unit.
- Providing disposition instructions to the receiving and aviation units for the slings, A-22 cargo bags, cargo nets, and containers.

**Aviation unit.** The aviation unit is responsible for—

- Establishing coordination with the supported and receiving units and appointing a liaison officer who is thoroughly familiar with

the capabilities and limitations of the unit's assigned aircraft.

- Advising the supported unit on the limitations of the size and weight of the loads which may be rigged.
- Advising the supported and receiving units on the suitability of the selected PZ/LZ.
- Providing assistance for the recovery and return to the PZ of the slings, A-22 cargo bags, cargo nets, and containers, as required by the supported unit. (The supported unit is still responsible for packaging and providing disposition instructions to the aviation unit.)
- Arranging for the aircraft to be at the PZ/LZ on schedule.
- Establishing safety procedures that will ensure uniformity and understanding of duties and responsibilities between the ground crew and flight crew. For example, determining which direction the ground crew (below the helicopter) departs from after hookup. If the ground crew moved from the aircraft in the same direction as the aircraft, injury could result. Each PZ has a different shape and obstacle. In an emergency, the pilot must know in which direction to go to set the aircraft down to avoid hitting the ground crew. (While the supported unit is responsible for ensuring that the load is properly rigged, the pilot has the prerogative to refuse the load if he notices a rigging error while approaching the load or if the load does not ride properly when first picked up to a hover.)

**Receiving unit.** The receiving unit is responsible for—

- Selecting, preparing, and controlling the LZ.
- Providing trained ground crews to guide the aircraft in and derig the load.
- Coordinating with the supported (sending) unit for the control and return of the slings, A-22 cargo bags, or any other items that belong to the supported unit, and returning them as soon as possible.
- Preparing, coordinating, and inspecting backloads, such as slings, A-22 cargo bags, and so forth, and having them ready for hookup or loading.

**Methods**

**Slings.** Figure 2-8 shows the three types of slings used in external air transport opera-

tions. They are the 10,000- and 25,000-pound-capacity slings, multi-leg slings, and aerial-delivery slings.

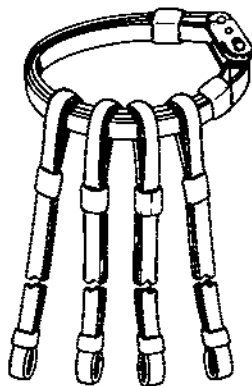

**\*AERIAL DELIVERY SLINGS  
10,000-POUND**

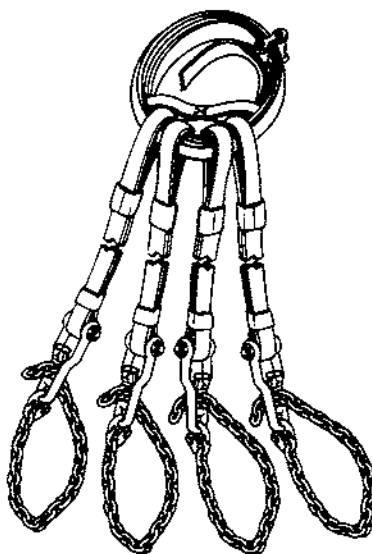

**\*NYLON AND CHAIN MULTI-  
LEG SLINGS,  
15,000-POUND**

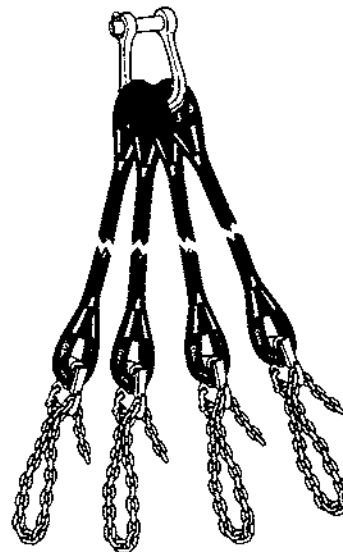

**10,000- AND 25,000-POUND-  
CAPACITY SLING SETS**

**\*BEING PHASED OUT OF THE INVENTORY.**

**Figure 2-8. External air transport slings**

**Cargo nets.** Figure 2-9 shows the three types of cargo nets used in external air transport operations. They are the 5,000-, 8930-, and 10,000-pound-capacity nets.

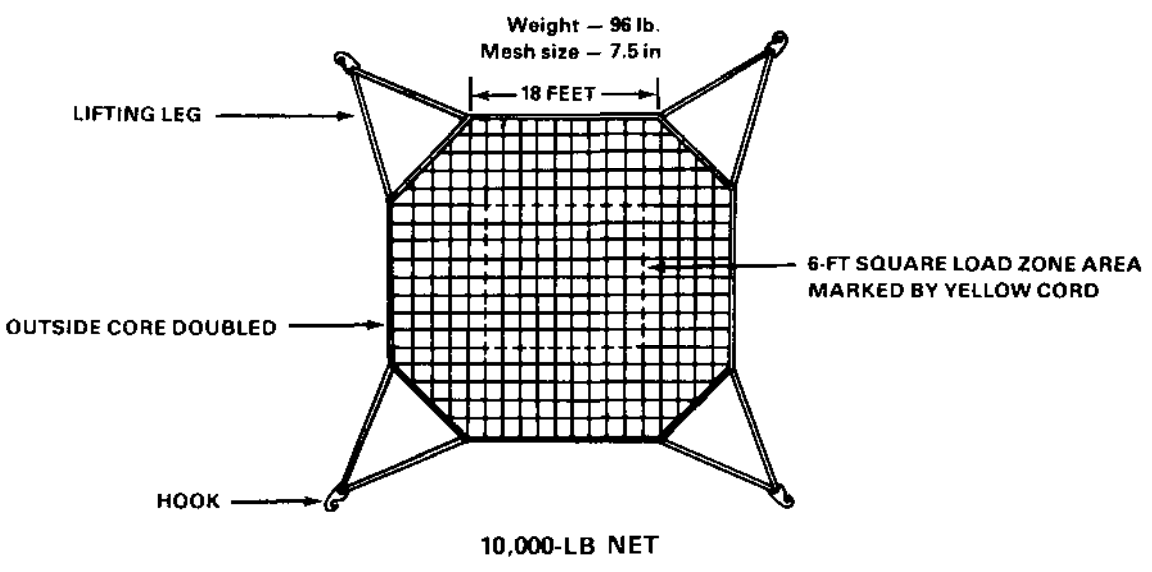
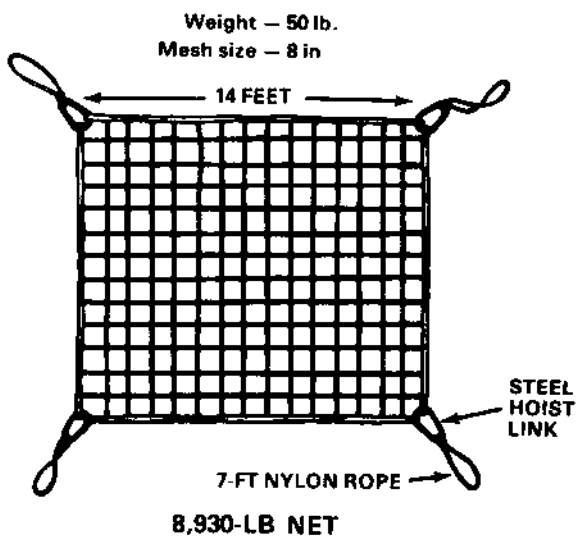
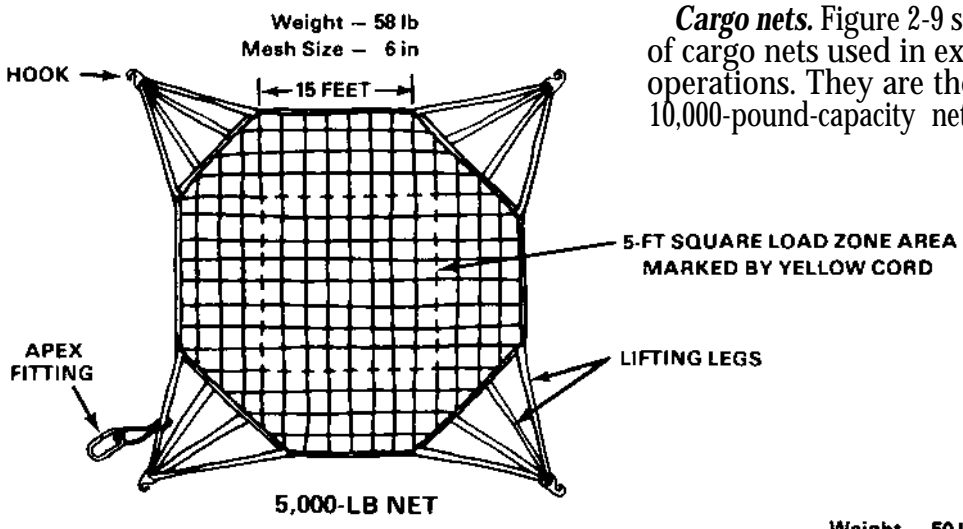

Figure 2-9. Cargo nets

**Cargo bags.** The A-22 cargo bag is an adjustable cotton duck cloth and webbing container consisting of a sling assembly, cover, and four suspension webs. This external carrying device can be used to transport any standard palletized load, loose cargo, and oil drums. The bag can transport up to 2,000 pounds of cargo. You may rig the cargo in the bag with or without the cover. Figure 2-10 shows the parts of the bag.

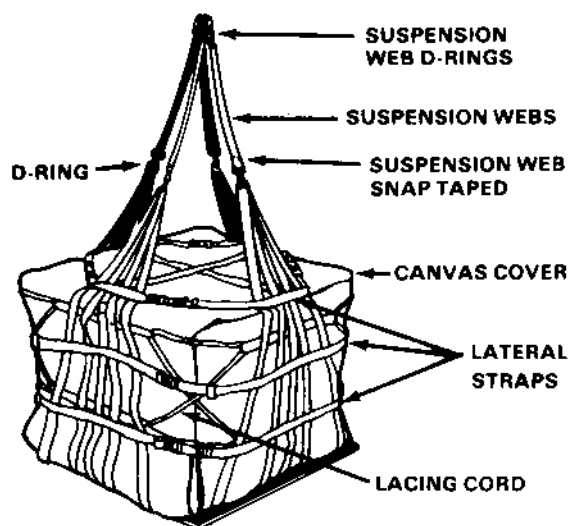

Figure 2-10. A-22 cargo bag

### Personnel

The number of personnel in a ground crew may vary depending on the situation, type of cargo, and the size of the pickup zones. The unit commander determines how many crews need to be trained. Generally, three people make up the ground crew: the signalman, the hookup man, and an assistant hookup man. The commander must also provide local security for the operation. (This task is not a responsibility of the ground crew.)

Large items of equipment may require more than three people to prepare them for sling loading. For example, bridge sections or towers may need as many as eight people to manhandle them into place for aerial pickup. Although each member of the crew has specific duties during the operation, each person should be trained in how to perform all duties.

### Equipment

**Rigging and hookup.** Each ground crew needs a separate and complete issue of rigging and hookup equipment in addition to weapons, radios, and operational equipment. This is because there might be several pickup or landing zones, and they may be spread out over a large area. Refer to FM 55-450-1 to obtain the proper method to rig loads for external air transport.

**Protective.** The ground crew members involved in helicopter operations are exposed to the hazards of noise and rotor downwash caused by the helicopter. Therefore, protective equipment must be worn by the ground crew members when they are performing their duties.

**Pickup zone/landing zone.** The following list of minimum equipment is needed to operate the PZ/LZ:

- Helmet.
- Goggles (or protective mask).
- Snap-ring pliers.
- Ear plugs.
- Gloves.
- Smoke grenades.
- Tool kit T33 (pliers and pocket knife).

**Static electricity discharge.** In flight, a helicopter generates and stores a charge of static electricity. When the helicopter lands, this charge is grounded out. While the helicopter is in flight, however, this charge remains stored unless a path is provided for it to be channeled into the earth. A ground crew member provides this path by contacting the helicopter cargo hook when it is positioned over a cargo hookup point. Although this charge may not cause an electrical burn, it can cause a muscular reaction which may, if the individual concerned is on unsure footing, result in injury from a fall. An individual shocked by the electricity may also suffer delayed discomfort from muscular cramps or spasms.

To avoid the possibility of a ground crew member being shocked by the static electricity, a discharge probe is used to ground the cargo hook. Since this probe channels the electricity

from the helicopter directly into the ground, the ground crew member is assured of receiving no shock when he touches the cargo hook during hookup operations.

The static electricity discharge probe is currently being procured and may not be an item of issue when this manual is published. If it is not available, one will have to be made locally. It consists basically of an insulated plastic tube with a metal hook and one end with a wire attached leading to a ground rod. The entire length of wire must be insulated, as contact with personnel will cause a severe shock. In use, the ground rod is driven into the earth and the contact rod is held by a ground crew member. As the helicopter hovers over the load, the assistant hookup man holds the contact rod against the cargo hook, thus ground-

ing out the stored electrical charge. Meanwhile, the hookup man places the clevis on the hook.

#### WARNING

**Contact between the discharge probe and the cargo hook must be maintained until the clevis is placed on the hook. If contact between the probe and the hook is not maintained, the ground crew member may receive a serious shock. This does not mean the ground crew should rig a spring clip to hook directly to the aircraft. If contact between the probe and hook is broken, then contact must again be made before touching the hook.**

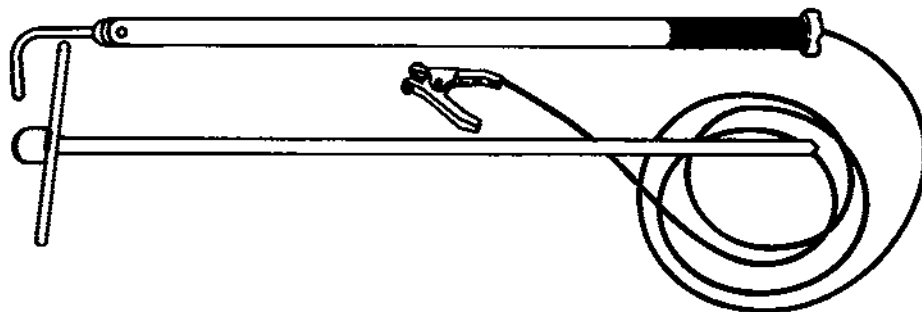

*Figure 2-11. Static electricity discharge probe*

## INTERNAL TRANSPORT HELICOPTERS

### Advantages

The helicopter method of transport can overcome many obstacles that prevent other methods of transportation from completing the mission. One major advantage of transporting the load internally is that the helicopter rapidly moves items directly to their destinations. Another advantage is that damaged or congested highways, destroyed bridges, and most en route terrain obstacles have little impact on cargo transport. The helicopter may use different flight routes to provide a diversion and to maintain security of the unit on the ground. Another advantage of internal transport is that cargo may be rapidly

moved into or out of an area, which helps the ground unit obtain items of equipment when and where it needs them. The helicopter can move combat troops and weapons where they are needed and relocate them in a rapidly changing battlefield situation. A landing zone can be relocated rapidly to avoid detection and on-ground security.

### Disadvantages

The disadvantages of transporting cargo internally by helicopter appear when the size and weight of the cargo may exceed the design limits of the aircraft. Any restrictions which apply to helicopters in general also apply here, whether for internal load operation or a routine training flight. In addition, aviation assets are

limited and maintenance downtime and priority of missions must be taken into account to assure that aircraft are used wisely.

Bad weather may adversely affect the operation and the LZ terrain can present natural obstacles to the use of aircraft which become particularly critical factors during internal load missions.

### Responsibilities

There are normally three different elements involved in an internal load mission: the supported unit (requests the mission), the aviation unit (provides the aircraft), and the receiving unit (receives the cargo).

**Supported unit.** The supported unit is responsible for—

- Selecting and controlling the pickup zone. Pathfinders can be a great help in both of these.
- Assuring that advanced coordination is effected with the aviation unit.
- Assuring that before equipment is prepared all loading, tie-down, and unloading procedures; tie-down diagrams; and tiedown data tables are carefully reviewed.
- Preparing supplies and/or equipment for air transport with technical supervision and assistance as required from appropriate field support units.
- Assuring that if vehicles are loaded with cargo, the cargo is restrained in the vehicle and all other loose equipment in the vehicle is secured.
- Loading the vehicle into the helicopter, tying it down, and unloading it from the helicopter, once the helicopter commander, flight engineer, or crew chief gives approval.
- Assuring that loads are properly prepared and do not exceed any weight or size limitations imposed by the transporting helicopter.
- Providing appropriate safety equipment to all unit personnel who will be around the loading operations.
- Policing the pickup zone.

**Aviation unit.** The aviation unit is responsible for—

- Establishing coordination with the supported and receiving units and appointing a liaison officer who is thoroughly familiar with the capabilities and limitations of the unit's assigned aircraft.
- Advising the supported unit on size and weight limitations of the loads which may be hauled.
- Advising the supported unit and the receiving unit on the suitability of the selected PZ/LZ.
- Becoming familiar with the security, safety, and technical peculiarities of the loads which may adversely affect air transport.
- Providing all components of the 5,000- and 10,000-pound tie-down assemblies used for internal transport in helicopters. (The supported unit is still responsible for packaging and providing disposition instructions to the aviation unit.)
- Arranging for the aircraft to be at the PZ on schedule.
- Establishing safety procedures that will ensure uniformity and understanding of duties and responsibilities between the ground crew and flight crew.

**Receiving unit.** The receiving unit is responsible for—

- Selecting and controlling the LZ.
- Providing trained ground crews to guide the aircraft in.
- Coordinating with the supported (sending) unit for retrograde of items that belong to the supporting unit.
- Preparing, coordinating, and inspecting back loads and having them ready for loading when the aircraft arrives.

### Tie-Down Rings

Several types of cargo restraint devices can be used to tie down cargo. Tie-downs must be correctly attached to prevent cargo from shifting. Each tie-down has a rated strength to prevent cargo from shifting.

**UH-1 Iroquois.** The tie-down rings in the floor of the UH-1 have a rated holding capacity of 1,350 pounds in the vertical direction and 500 pounds in the horizontal direction. The restraint criteria are 4 g's forward, 2 g's aft, 2

g's vertical, and 1.5 g's lateral. Table 2-3 shows the dimensions of the cargo compartments by mode. Figure 2-12 shows the tie-down fittings for a UH-1 H helicopter.

**Table 2-3. Dimensions of cargo compartments by model**

	UH-1C/M	UH-1D/H
Height of Floor above Ground	26"	32"
Cargo Compartment		
Length	60"	92"
Width	80.5"	96"
Height	56"	52"
Cargo Door		
Width	48"	92"
Height	48"	49"

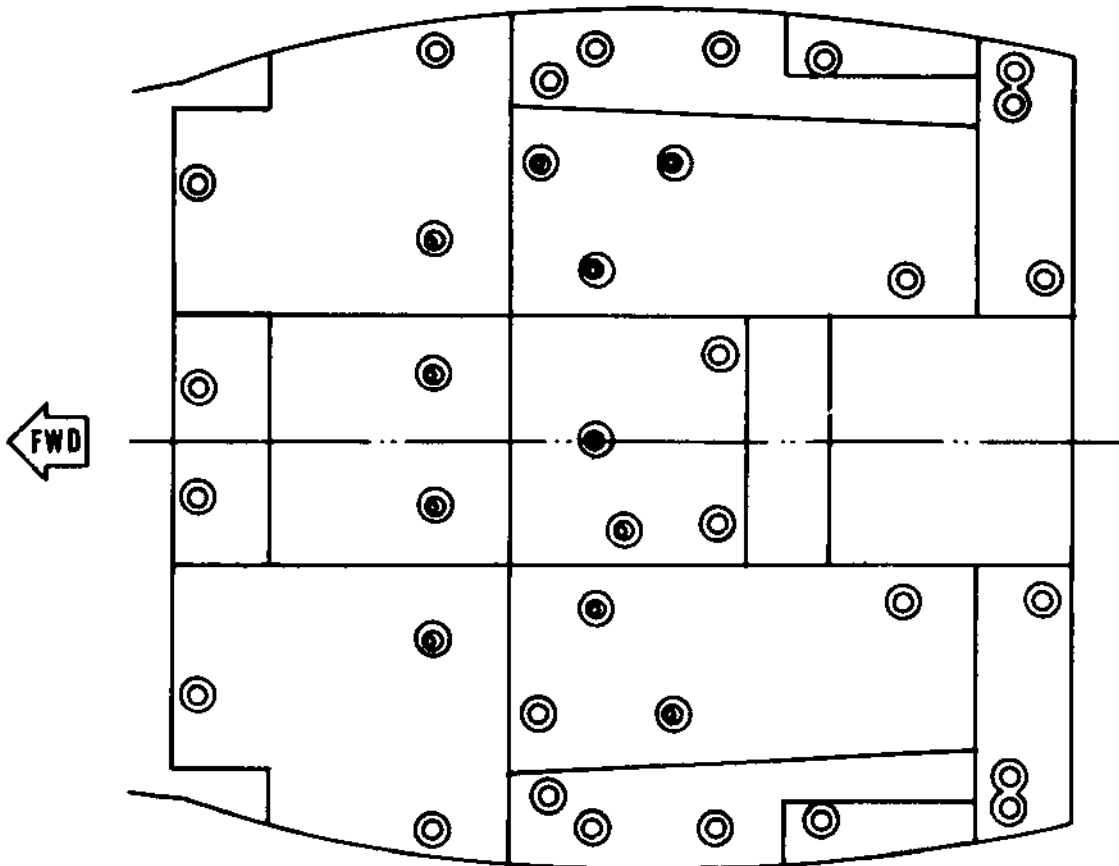

**Figure 2-12. UH-1H tie-down rings**



**UH-60 Blackhawk.** The tie-down fittings in the floor have a rated capacity of 5,000 pounds in any direction. The cargo restraint net rings on the walls and ceiling are rated at 3,500 pounds. The restraint criteria are 12 g's forward, 3 g's aft, 3 g's vertical, and 8 g's lateral with troops

and cargo; 2 g's is the lateral criterion with cargo only. Table 2-4 shows internal cargo loading specifications. Figure 2-13 shows the locations of the tie-down fittings for a UH-60 helicopter.

**Table 2-4. UH-60A internal cargo loading specifications**

SECTION	MAXIMUM CAP (LB)	MAXIMUM LB/SQ FT	SQUARE FEET
FORWARD CABIN	5,460	300	18.2
CENTER CABIN	8,370	300	27.9
AFT CABIN	8,370	300	27.9

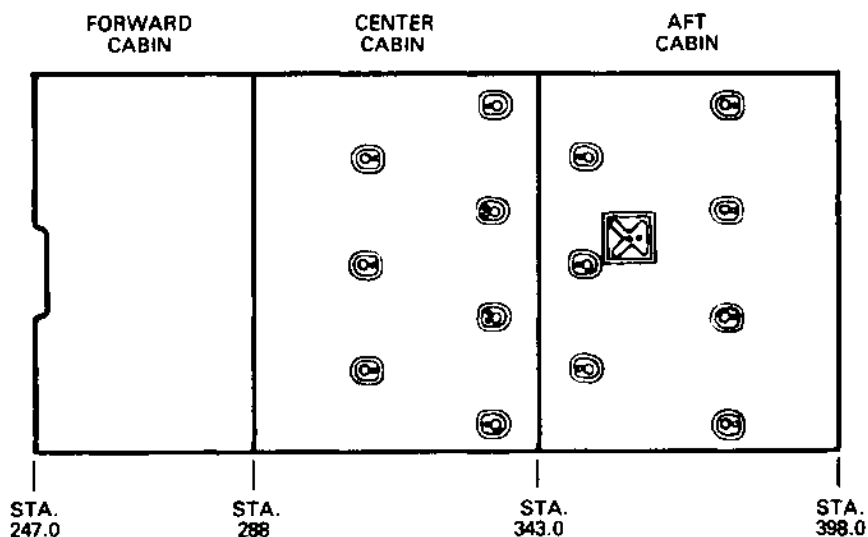

**Figure 2-13. UH-60A tie-down rings**

**CH-47 Chinook.** There are eighty-seven 5,000-pound-capacity tie-down rings (83 in the fuselage and 4 on the ramp) and eight 10,000-pound-capacity tie-down rings in the cargo compartment. The restraint criteria are 4 g's forward, 2 g's aft, 4 g's down, 2 g's up, and 1.5 g's lateral. Figure 2-14 shows the locations of the tie-down rings for a CH-47 helicopter.

328 inches long. There are ninety-six 5,000-pound-capacity tie-down rings in the floor of the pod. Pod limitation is 20,000 pounds. Restraint criteria for the pod are 2 g's forward (4 g's forward when personnel are not protected by aircraft structure and/or other barriers), 2 g's aft, 2 g's vertical, and 1.5 g's lateral. Figure 2-15 shows the locations of the tie-down rings for a CH-54 helicopter.

**CH-54 Tarhe.** Interior dimensions of the pod are 106 inches wide, 78 inches high, and

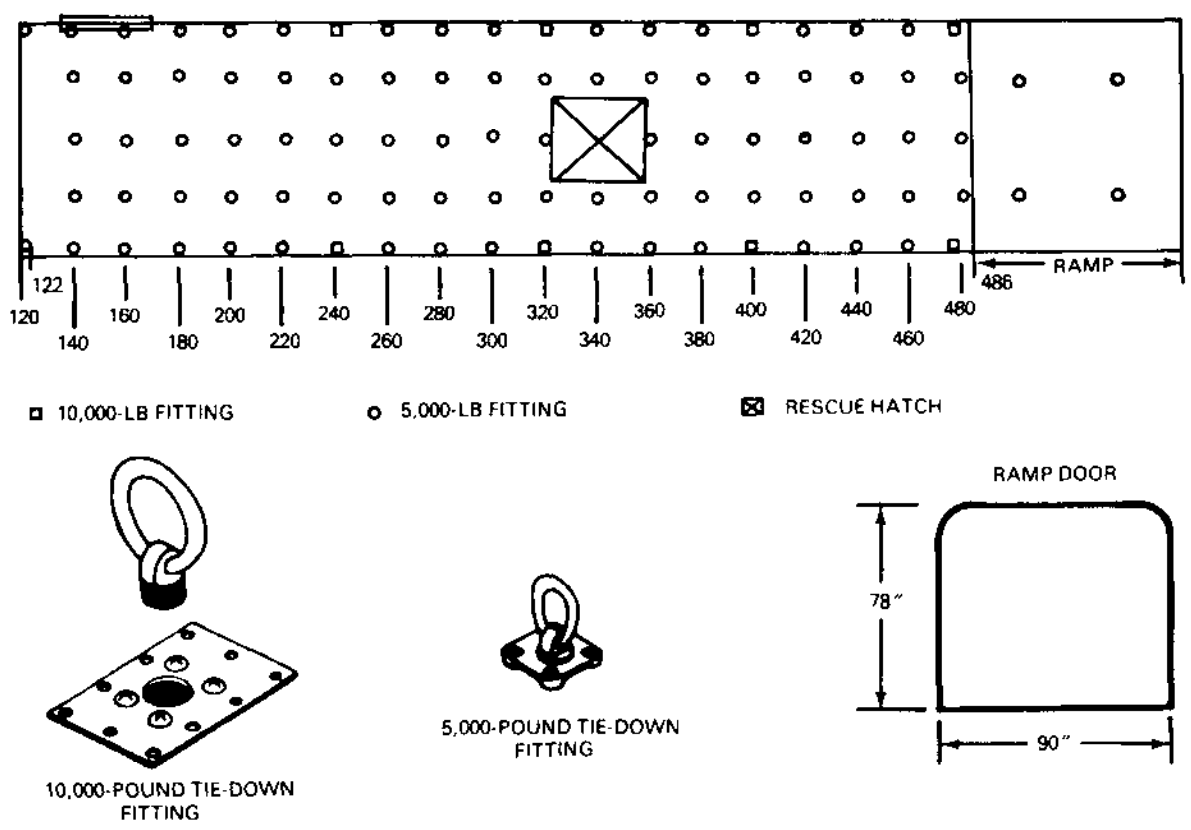

Figure 2-14. CH-47 tie-down rings

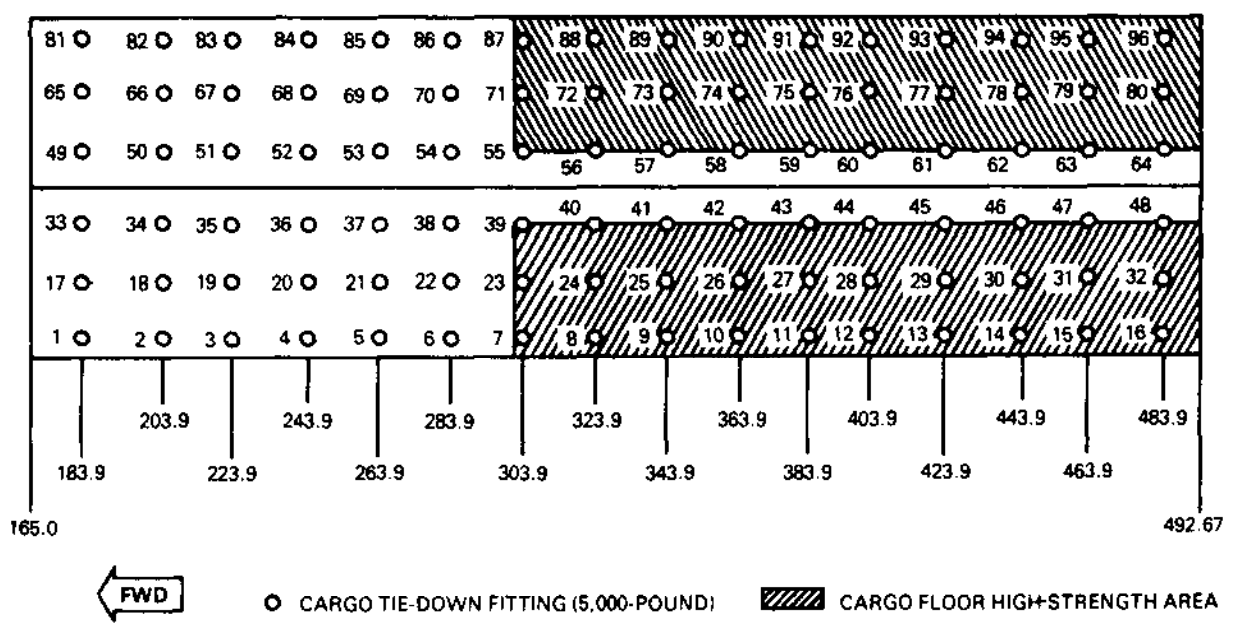

Figure 2-15. CH-54 tie-down rings

### Loading/Unloading System

The Helicopter Internal Cargo Handling System (HICHS) is a roller system designed for the CH-47 helicopter and is used to expedite the loading and unloading of 463L Air Force pallets and other modularized cargo.

With the HICHS installed, a CH-47 can

carry three (88 x 108-inch) 463L pallets or 12 (40 x 48-inch) standard warehouse pallets. The height of all loads is restricted to 54 inches. The HICHS can be installed in the aircraft by four men in 45 minutes and removed in 20 minutes. Figure 2-16 illustrates a CH-47 with a HICHS installed.

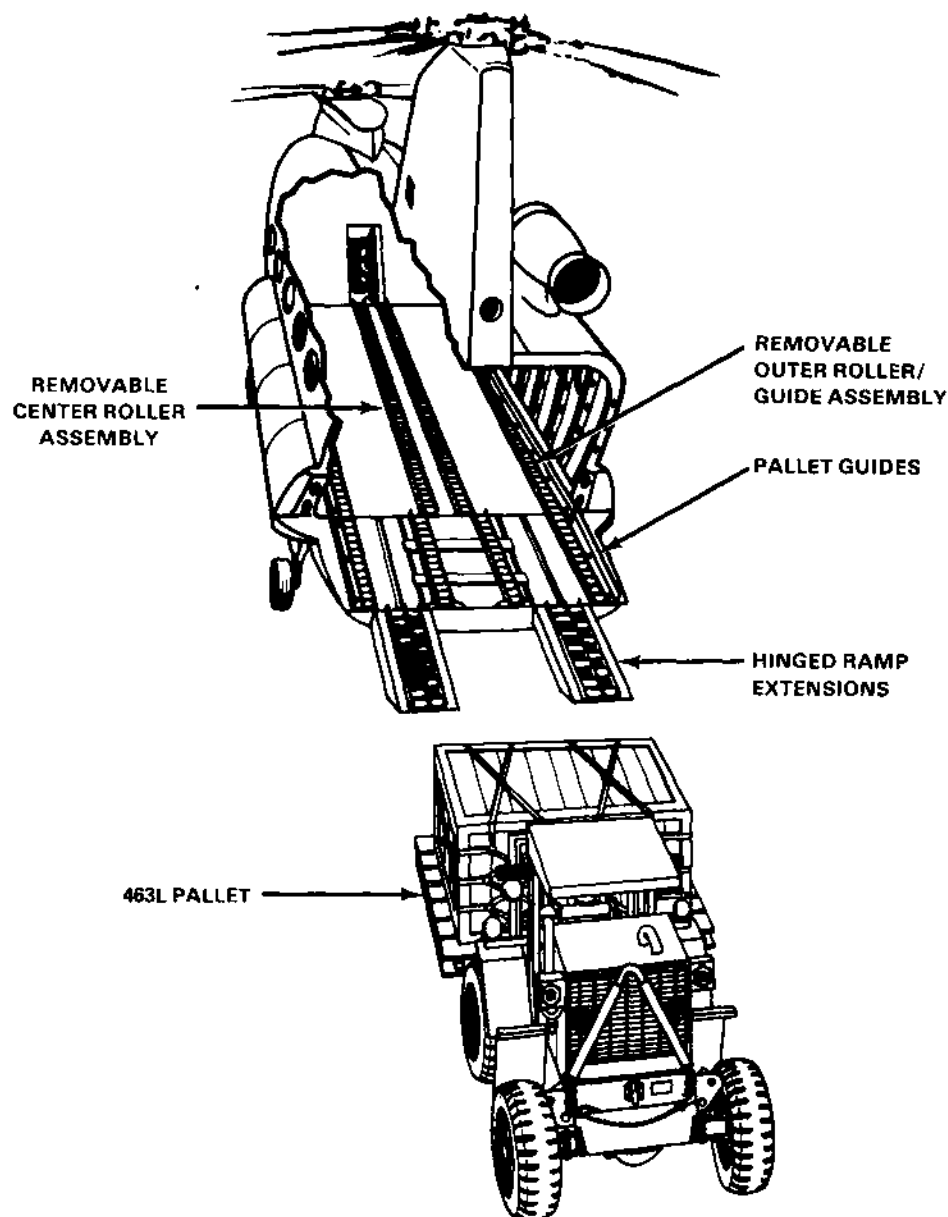

*Figure 2-16. HICHS installed in a CH-47 helicopter*

**MILITARY AIRLIFT COMMAND  
AIRCRAFT**

Personnel who prepare load plans must be familiar with the types of available aircraft and their characteristics. As mentioned before, the aircraft we are primarily concerned with are the C-130, C-141B, C-5, and KC-10. All four aircraft are designed primarily as transport aircraft. Their cargo compartments can be configured to accommodate general bulk or palletized cargo, vehicles, troops, paratroopers, and cargo rigged for airdrop. The wide range of cargo carried by these aircraft, along with the many combinations of loads,

provides great flexibility in moving troops and equipment. All four aircraft have long-range mission capability, possess roller-conveyor systems for utilization of the 463L pallet system, and have hydraulically activated ramp systems for ease of loading and offloading.

**C-130E/H Hercules**

The C-130E/H series Lockheed aircraft is a high-winged, turbo-prop airplane designed for tactical/intratheater-type missions (see Figure 2-17). It is the primary aircraft used by MAC for tactical missions. See Table 2-5 for characteristics of C-130E/H aircraft.

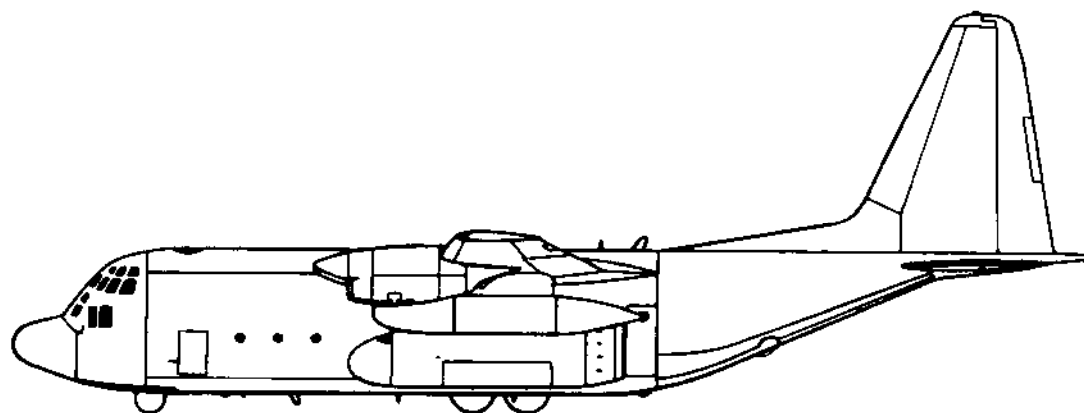

*Figure 2-17. C-130E/H aircraft*

*Table 2-5. Characteristics of C-130 aircraft*

Dimensions	Cargo Compartment	Troop Door	Aircraft Ramp	Palletized Cargo Restrictions		
				Pallet Position	Maximum Weight	Maximum Height
Length	492 in	--	120 in	1-4	10,354 lb	96 in
Height	108 in	72 in	--	5	8,500 lb	96 in
Width	123 in	36 in	--	6	4,664 lb	76 in

NOTE: C-130E/H aircraft can carry six 463L pallets.

Restraint Factors	
Forward	3.0 g's
Aft	1.5 g's
Vertical	2.0 g's
Lateral	1.5 g's

- Maximum passenger load: 90
- Usable loading space: 580 in
- Floor height above ground: 40 in
- Center of balance: Station 520 + 10 in
- Allowable cabin load: 25,000 lb

### C-141 Starlifter

The C-141 series aircraft by Lockheed is a high-swept-wing, turbo-fan-jet airplane designed for strategic, intertheater-type missions (see Figure 2-18). The C-141 should be considered the primary aircraft for deployment to another theater of operations. See Table 2-6 for characteristics of C-141 aircraft.

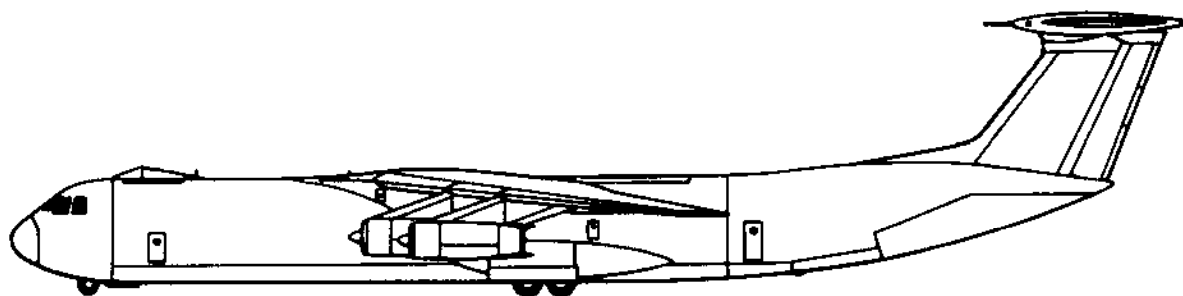

Figure 2-18. C-141 aircraft

Table 2-6. Characteristics of C-141 aircraft

Dimensions	Cargo Compartment	Troop Door	Aircraft Ramp	Palletized Cargo Restrictions		
				Pallet Position	Maximum Weight	Maximum Height
Length	1,120 in	--	133 in	1	10,354 lb	76 in
Height	109 in	72 in	--	2-12	10,354 lb	96 in
Width	123 in	36 in	--	13	7,500 lb	76 in

NOTE: C-141 aircraft can carry thirteen 463L pallets.

Restraint Factors	
Forward	3.0 g's
Aft	1.5 g's
Vertical	2.0 g's
Lateral	1.5 g's

- Maximum passenger load: 208
- Usable loading space: 1,220 in
- Floor height above ground: 50 in
- Center of balance: Station 960 + 20 in
- Allowable cabin load: 72,000 lb

**C-5 Galaxy**

The Lockheed-manufactured C-5 is a high-swept-wing, turbo-fan-jet aircraft used for strategic, intertheater missions (see Figure 2-19). It is primarily designed to transport cargo that is outsized or overweight for the C-130 or C-141 aircraft. Special features of the C-5 are its ability to load and unload from

either end of the cargo compartment and its capability to “kneel” which lowers the aircraft to facilitate loading and unloading. The C-5 is also unique in that its floor does not have treadways. The “floor-bearing pressure” is the same over the entire floor. However, there are some weight restrictions that must be adhered to as shown in Table 2-7.

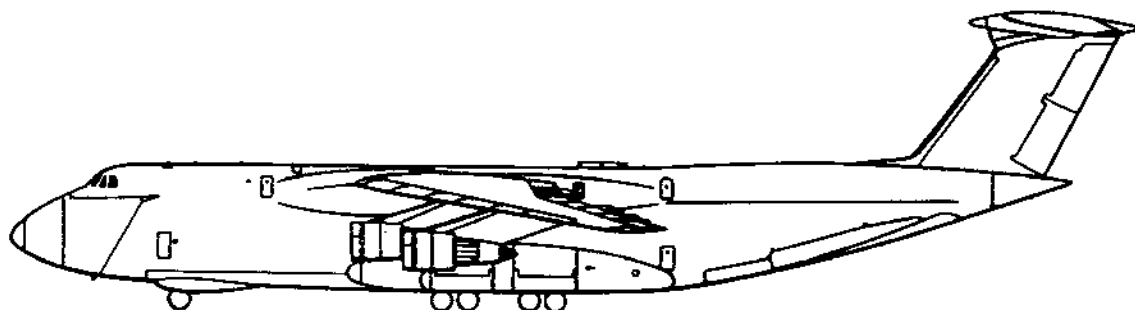

*Figure 2-19. C-5 aircraft*

*Table 2-7. Characteristics of C-5 aircraft*

Dimensions	Cargo Compartment	Troop Door	Aircraft Ramp
Length	1,465 in	--	116 in (fwd) 155 in (aft)
Height	108 in	72 in	
Width	123 in	36 in	--

Restraint Factors	
Forward	3. g's
Aft	1.5 g's
Vertical	2.3 g's
Lateral	1.5 g's

Palletized Cargo Restrictions		
Pallet Position	Maximum Weight	Maximum Height
1-2	7,500 lb	96 in
3-34	10,354 lb	96 in
35-36	7,500 lb	70 in

NOTE: C-5 aircraft can carry up to thirty-six 463L pallets.

- Maximum passenger load:  
73 normal contingency;  
267 cargo compartment
- Usable loading space: 1,650 in
- Floor height above ground: (variable):  
Aft: 73 to 105 in  
Forward: 36 to 70 in
- Center of balance: Station 1300 + 50 in
- Allowable cabin load:  
Peacetime - 100,000 lb  
Wartime - 205,000 lb

Weight Restrictions

- Maximum axle load: 36,000 lb
- Maximum tracked vehicle weight: 129,000 lb
- Floor limitations: per 40-in area between stations--  
517 and 724: 20,000 lb  
724 and 1884: 36,000 lb  
1884 and 1971: 20,000 lb

## KC-10A

The KC-10A series aircraft is a swept-wing tri-jet designed to air-refuel military airplanes and airlift cargo and support personnel (see Figure 2-20). In addition to being equipped to air-refuel military airplanes requiring either a

boom or hose drogue, the KC-10A may be refueled from another KC-10A or KC-135 tanker. The unobstructed cargo compartment will accept combinations of palletized cargo, vehicles, and logistics equipment and mixed cargo and support personnel. See Table 2-8 for characteristics of KC-10A aircraft.

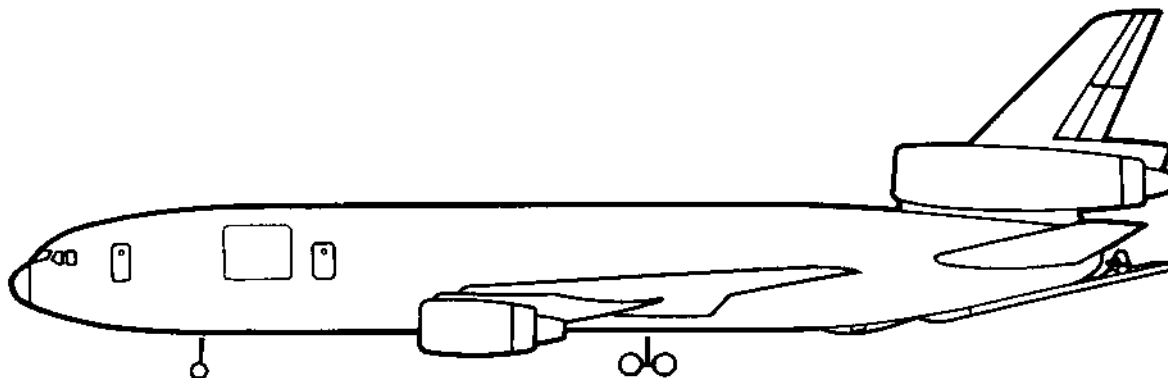

Figure 2-20. KC-10A aircraft

Table 2-8. Characteristics of KC-10A aircraft

Dimensions	Cargo Compartment	Troop Door	Aircraft Ramp	
Length	118 ft	--	--	<ul style="list-style-type: none"> <li>• Usable loading space: 118 ft</li> <li>• Floor height above ground: 15 ft 10 in</li> <li>• Center of balance: Station 1325 + 50 in</li> <li>• Allowable cabin load: Because of the many types of load configurations (troops, cargo, and fuel) possible, the ACL varies significantly. Contact your local ALCE to get the ACL for the load you wish to transport.</li> </ul>
Height	110 in	76 in	102 in	
Width	144 in	42 in	140 in	
<ul style="list-style-type: none"> <li>• Maximum passenger load:               <ul style="list-style-type: none"> <li>w/o seat kit 20</li> <li>w/seat kit 75</li> </ul> </li> </ul>				

## CIVIL RESERVE AIR FLEET AIRCRAFT

The Civil Reserve Air Fleet (CRAF) is composed of US civil air carriers who contractually commit themselves to provide operating and support personnel for the Department of Defense. The CRAF concept is designed to quickly mobilize the nation's resources to meet DOD requirements.

### Airlift Services

CRAF airlift services are divided into four operational segments:

- Long-range international—strategic inter-theater operations.
- Short-range international-intratheater

operations.

- Domestic CONUS—DOD supply distribution.
- Alaskan—Aerospace Defense Command support.

### Capability

The CRAF airlift capability can be activated in three stages:

**Stage I.** Stage I may be activated by the Commander in Chief, MAC, to perform airlift services when the MAC airlift force cannot meet simultaneously both deployment and other traffic requirements.

**Stage II.** Stage II is an additional airlift expansion identified for an airlift emergency

which does not warrant national mobilization but may be activated by authority of the secretary of defense.

**Stage III.** Stage III makes available the total CRAF airlift capability when required for DOD operations during major military emergencies involving US forces. The secretary of defense issues the order to activate CRAF stage III only after a national emergency has been declared by the president or Congress.

## Description

Table 2-9 gives dimensions and capabilities for Boeing B747 series aircraft, Table 2-10 gives the same data for the Douglas DC-10 and Lockheed L-1011 series aircraft, and Table 2-11 gives the same data for the Douglas DC-8 and Boeing B707 series aircraft. Figure 2-21 shows profiles of CRAF aircraft, while Figure 2-22 shows profiles of CRAF pallets.

**Boeing B747** The Boeing B747 is a wide-body aircraft. The cargo-carrying capacity versions have an average planning cargo weight of about 180,000 pounds. The main deck can hold either 32 to 36 military or 28 commercial pallets. The passenger version can carry about 364 passengers (but only 266 on the B747SP).

**Douglas DC-10.** The Douglas DC-10 and Lockheed L-1011 are both wide-body aircraft. The cargo-carrying version of the DC-10 has an average cargo weight of about 120,000 pounds, and the main deck can hold either 30 military or 22 commercial pallets. The passenger version of the DC-10 can carry about 242 passengers. The L-1011 is currently available in a passenger version with a capacity of 238 to 270 seats.

**Douglas DC-8 and Boeing B707.** The Douglas DC-8 and Boeing B707 are narrow-body aircraft. The cargo-carrying version of the DC-8 has a planning cargo weight varying from 52,000 to 82,000 pounds; the main deck can accommodate 13 to 18 pallets, depending on the aircraft series. The cargo version of the B707 has a planning cargo weight of about 60,000 pounds, and the main deck can carry 13 military or commercial pallets. The passenger DC-8 carries 165 to 219 passengers and the B707, approximately 165 passengers. CRAF

aircraft are not designed for nor intended to carry litter patients.

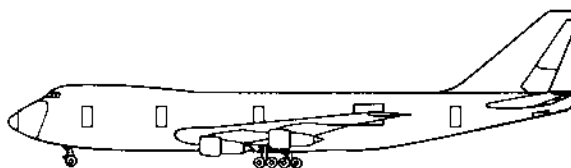

BOEING: B747

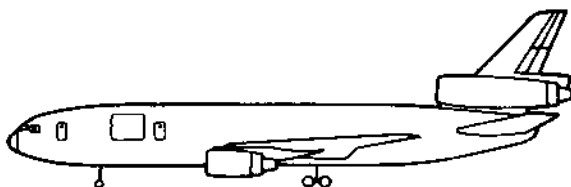

DOUGLAS: DC-10

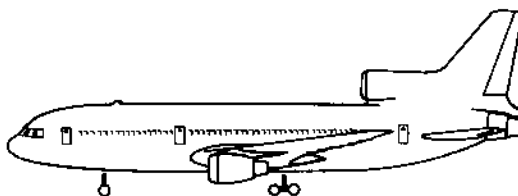

LOCKHEED: L-1011

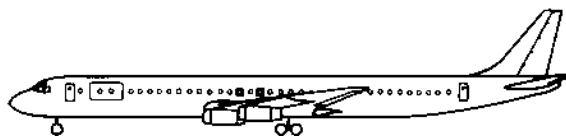

DOUGLAS: DC-8

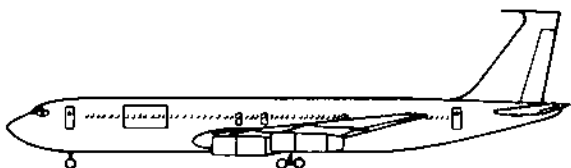

BOEING: B707

Figure 2-21. CRAF aircraft profiles



**B-747-100F/200C/200F (ALL MAIN DECK POSITIONS)**

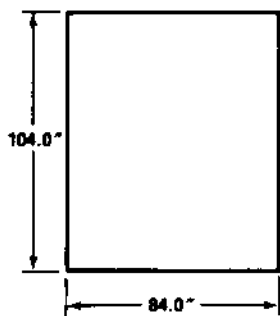

PALLETS CAN BE LOADED LENGTHWISE (104.0") OR CROSSWISE (84.0")

**DC-10 POSITIONS 1, 13, 14**

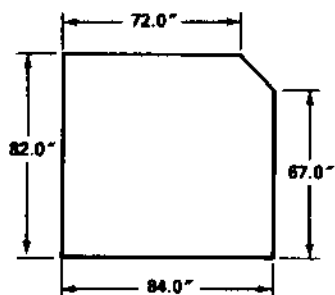

**DC-10 POSITIONS 2 THRU 12**

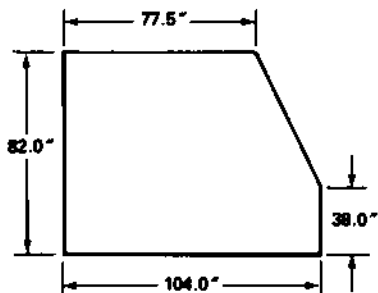

**DC-10 POSITION 15**

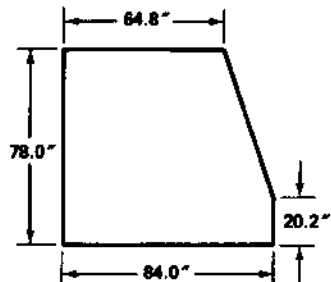

(Loaded lengthwise 104.0")

NOTE: Pallet profiles are shown for left side of aircraft. Rightside pallets will be a mirror image.

**DC-8 MAIN DECK POSITIONS:**  
 DC-8-33F/50F/CF 1 THRU 11  
 DC-8-62CF 1 THRU 12  
 DC-8-81/63CF 1 THRU 16

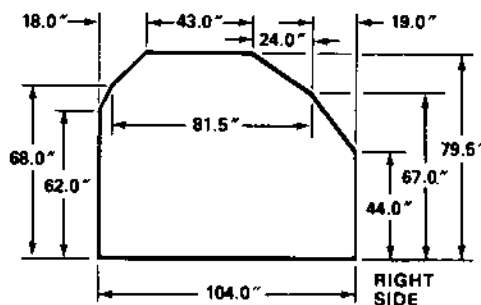

**DC-8 MAIN DECK POSITION:**  
 DC-8-33F/50F/CF 12  
 DC-8-62CF 13  
 DC-8-81/63CF 17

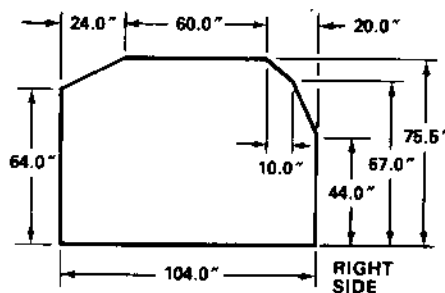

**DC-8 MAIN DECK POSITION:**  
 DC-8-33F/50F/CF 13  
 DC-8-62CF 14  
 DC-8-81/63CF 18

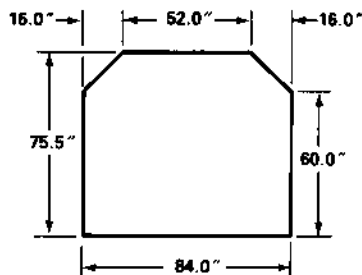

**B-707/F A POSITIONS 1 THRU 12**

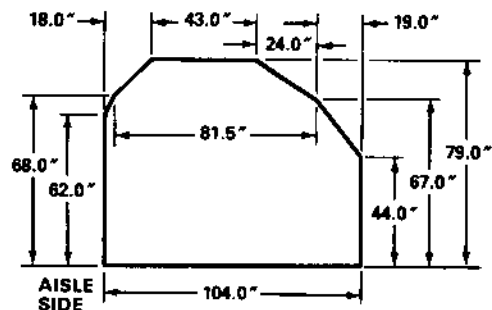
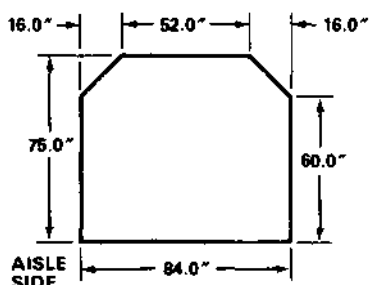

Figure 2-22. CRAF pallet profiles (measurement of pallet surface)

B-707/F B POSITION 13



B-707/F C POSITIONS 1 THRU 12

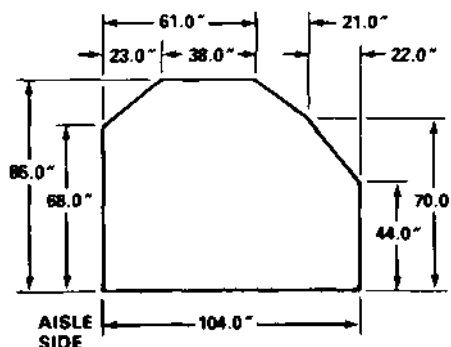

Figure 2-22. CRAF pallet profiles (measurement of pallet surface) (cont)

Table 2-9a. Dimensions of B747 series aircraft

Dimensions	Aircraft Designation				
	B747SP	B747-100/200B	B747-100F	B747-200C	B747-200F
<b>Floor height (ACL)</b>					
Main deck	188-196 in	193-201 in	193-201 in	186-204 in	186-204 in
Lower deck	108-122 in	109-121 in	109-121 in	109-121 in	109-121 in
<b>Main deck cargo compartment</b>					
Length	NA	NA	NA	NA	NA
Width	NA	NA	NA	NA	NA
Height	NA	NA	NA	NA	NA
<b>Lower lobe (fwd)</b>					
Length	315 in	315 in <sup>1,5</sup> 504 in <sup>6</sup>	504 in	504 in	504 in
Width	125 in <sup>2</sup>	125 in <sup>2</sup>	125 in <sup>2</sup>	125 in <sup>2</sup>	125 in <sup>2</sup>
Height	66 in <sup>3</sup>	66 in <sup>3</sup>	66 in <sup>3</sup>	66 in <sup>3</sup>	66 in <sup>3</sup>
<b>Lower lobe (aft)</b>					
Length	315 in	251 in <sup>4,5</sup> 436 in <sup>6</sup>	436 in	436 in	436 in
Width	125 in <sup>2</sup>	125 in <sup>2</sup>	125 in <sup>2</sup>	125 in <sup>2</sup>	125 in <sup>2</sup>
Height	66 in <sup>3</sup>	66 in <sup>3</sup>	66 in <sup>3</sup>	66 in <sup>3</sup>	66 in <sup>3</sup>
<b>Door sizes</b>					
Visor door	104 in w × 98 in h				
Main cargo door	122 in w × 120 in h				

<sup>1</sup>Pallets will not be planned for use in the lower lobe forward compartment of American/United Airlines B747-100 passenger aircraft.

<sup>2</sup>Floor width, 125 inches or 190 inches wall to wall; all cargo, however, must be on pallets or shoring.

<sup>3</sup>Measured from top of rollers to ceiling.

<sup>4</sup>Use 251 inches for American/United Airlines B747-100.

<sup>5</sup>With galley installed in lower lobe.

<sup>6</sup>Without galley installed in lower lobe.

**Table 2-9b. Capabilities of B747 series aircraft**

Capabilities	Aircraft Designation				
	B747SP	B747-100/200B	B747-100F	B747-200C	B747-200F
<b>Max auth gross weight</b>					
Takeoff	690,000 lb	733,000/775,000 lb	750,000 lb	775,000 lb	820,000 lb
Landing	450,000 lb	564,000/564,000 lb	585,000 lb	630,000 lb	630,000 lb
Operating	318,000 lb	322,800/369,820 lb	322,000 lb	344,040 lb	348,100 lb
Zero fuel	410,000 lb	508,900/526,500 lb	545,000 lb	590,000 lb	590,000 lb
<b>Optimum load CG at fuselage station</b>	NA	NA	1,280 ± 30 in	1,280 ± 30 in	2,280 ± 30 in
<b>Restraining factors</b>					
Forward	1.5 g's	1.5 g's	1.5 g's	1.5 g's	1.5 g's
Aft	1.5 g's	1.5 g's	1.5 g's	1.5 g's	1.5 g's
Vertical	2.0 g's	2.0 g's	2.0 g's	2.0 g's	2.0 g's
Lateral	1.5 g's	1.5 g's	1.5 g's	1.5 g's	1.5 g's
<b>Passenger capacity</b>	266 <sup>1</sup>	364 <sup>1</sup>	2	364 <sup>1</sup>	2
<b>Planning ACL</b>	NA	NA	89.9 STONs	96.9 STONs <sup>2</sup>	99.1 STONs
<b>463L pallet capacity</b>	NA	NA	32 <sup>3</sup>	32 <sup>3</sup>	32 <sup>3</sup>
<b>Max pallet height</b>	NA	NA	118 in	94 in <sup>5</sup>	118 in <sup>4</sup> 94 in <sup>5</sup>

<sup>1</sup>Maximum passenger capability will vary according to carrier configuration.

<sup>2</sup>Since this is a convertible aircraft, figures are based on cargo or passenger loads.

<sup>3</sup>Some aircraft may be configured to a 36-pallet configuration.

<sup>4</sup>Side door.

<sup>5</sup>Visor door.

**Table 2-10a. Dimensions of DC-10 and L-1011 series aircraft**

Dimensions	Aircraft Designation				
	DC-10-10 CF	DC-10-30 CF	DC-10-40	L-1011-100	L-1011-500
Floor height (ACL)					
Main deck	189 in	189 in	189 in	182-186 in	182-186 in
Lower deck	103-118 in	103-118 in	103-118 in	105-112 in	105-112 in
Main deck cargo compartment					
Length	1414 in <sup>1</sup>	1414 in <sup>1</sup>	NA	NA	NA
Width	218 in	218 in	NA	NA	NA
Height	84-95 in <sup>2</sup>	84-95 in <sup>2</sup>	NA	NA	NA
Lower lobe (fwd)					
Length	491 in <sup>3</sup>	216 in <sup>4</sup>	491 in <sup>3</sup>	500 in <sup>5</sup> 250 in <sup>6</sup>	370 in
Width	125 in <sup>7</sup>	125 in <sup>7</sup>	125 in <sup>7</sup>	125 in	
Height	66 in <sup>8</sup>	66 in <sup>8</sup>	66 in <sup>8</sup>	64 in	64 in
Lower lobe (aft)					
Length	241.5 in	241.5 in	241.5 in	250 in	190 in
Width	125 in <sup>7</sup>	125 in <sup>7</sup>	125 in <sup>7</sup>	125 in	125 in
Height	66 in <sup>8</sup>	66 in <sup>8</sup>	66 in <sup>8</sup>	64 in	64 in
Lower lobe (aft, bulk compartment)					
Length	179 in	179 in <sup>9</sup>	179 in <sup>9</sup>	170 in	170 in
Width	125 in <sup>10</sup>	125 in <sup>10</sup>	125 in <sup>10</sup>	125 in	125 in
Height	66 in <sup>10</sup>	66 in <sup>10</sup>	66 in <sup>10</sup>	64 in <sup>10</sup>	64 in <sup>10</sup>
Door sizes					
Main cargo door	140 in w × 102 in h				
Forward and center door				70 in w × 68 in h	
Aft door				44 in w × 48 in h	

<sup>1</sup>Length from FS 523 to 1937. A barrier net is located at FS 495. Usable cargo space is based on pallet surface.

<sup>2</sup>Max height of 84 inches at pallet positions 1 and 15; 88 inches at positions 2 through 14; 95 inches at the forward half of the cargo door.

<sup>3</sup>Length from FS 604.5 to FS 1095.5.

<sup>4</sup>Length from FS 879.5 to FS 1095.5.

<sup>5</sup>Without galley installed in lower lobe.

<sup>6</sup>With galley installed in lower lobe.

<sup>7</sup>Wall-to-wall distance is 164 inches.

<sup>8</sup>Measured from top of rollers to ceiling.

<sup>9</sup>Aircraft with an extended aft cargo compartment will have a 126-inch aft bulk cargo area and a cargo door 30 inches wide by 36 inches high.

<sup>10</sup>Dimensions decrease toward aft of cargo compartment.

**Table 2-10b. Capabilities of DC-10 and L-1011 series aircraft**

Capabilities	Aircraft Designation				
	DC-10-10CF	DC-10-30CF	DC-10-40	L-1011-100	L-1011-500
<b>Max auth gross weight</b>					
Takeoff	440,000 lb	555,000 lb	530,000 lb	466,000 lb	496,000 lb
Landing	363,500 lb	411,000 lb	403,000 lb	368,000 lb	368,000 lb
Operating	209,346 lb	234,591 lb	266,689 lb	253,720 lb	241,946 lb
Zero fuel	335,000 lb	391,000 lb	391,000 lb	320,000 lb	338,000 lb
<b>Optimum load CG at fuselage station</b>	1,323	1,323	1,323	NA	NA
<b>Restraining factors</b>					
Forward	1.5 g's	1.5 g's	1.5 g's	1.5 g's	1.5 g's
Aft	1.5 g's	1.5 g's	1.5 g's	1.5 g's	1.5 g's
Vertical	2.0 g's	2.0 g's	2.0 g's	2.0 g's	2.0 g's
Lateral	1.5 g's	1.5 g's	1.5 g's	1.5 g's	1.5 g's
<b>Passenger capacity</b>	242 <sup>1</sup>	242 <sup>1</sup>	242	273	238
<b>Planning ACL</b>	55.2 STONs <sup>1</sup>	69 STONs <sup>1</sup>	NA	NA	NA
<b>463L pallet capacity</b>	30	30	NA	NA	NA
<b>Max pallet height</b>	78-82 in	78-82 in	NA	NA	NA

<sup>1</sup>Figures on CFs are for eight ACLs or passengers, depending on the mode of aircraft use.

**Table 2-11a. Dimensions of DC-8 and B707 series aircraft**

Dimensions	Aircraft Designation					
	DC-8-33F	DC-8-50C F	DC-8-61C F	DC-8-62F	DC-8-63F/ CF	B707-300C/F
<b>Floor height (ACL)</b>						
Main deck	126-135 in	126-135 in	128-132 in	126-130 in	126-131 in	119-126 in
Lower deck	68-92 in	68-97 in	75-98 in	73-100 in	76-98 in	54-63 in
<b>Main deck cargo compartment</b>						
Length	1,176 in <sup>1</sup>	1,176 in <sup>1</sup>	1,622 in <sup>2</sup>	1,265 in <sup>3</sup>	1,622 in <sup>2</sup>	1,176 in <sup>4</sup>
Width	127.2 in	127.2 in	127.2 in	127.2 in	127.2 in	126 in
Height	86 in <sup>5</sup>	86 in <sup>5</sup>	86 in <sup>5</sup>	86 in <sup>5</sup>	86 in <sup>5</sup>	87 in <sup>6</sup>
<b>Lower lobe (fwd)</b>						
Length	330 in <sup>7</sup>	330 in <sup>7</sup>	437 in	370 in	437 in	298 in
Width	100 in	100 in	100 in	100 in	100 in	100 in
Height	51 in <sup>8</sup>	51 in <sup>8</sup>	51 in <sup>8</sup>	51 in <sup>8</sup>	51 in <sup>8</sup>	54 in <sup>9</sup>
<b>Lower lobe (aft)</b>						
Length	357 in <sup>10</sup>	357 in <sup>10</sup>	407 in	400 in	407 in	378 in
Width	100 in	100 in	100 in	400 in	100 in	100 in
Height	51 in <sup>8</sup>	51 in <sup>8</sup>	51 in <sup>8</sup>	51 in <sup>8</sup>	51 in <sup>8</sup>	54 in <sup>9</sup>
<b>Door sizes</b>						
Main cargo door	140 in w × 85 in h					134 in w × 91 in h

<sup>1</sup>Length from FS 302 to FS 1478.

<sup>2</sup>Length from FS 62 to FS 1684.

<sup>3</sup>Length from FS 262 to FS 1527.

<sup>4</sup>Length from FS 242 to FS 1418.

<sup>5</sup>Measured from floor to ceiling.

<sup>6</sup>Measured on centerline to ceiling.

<sup>7</sup>Measurement for entire fwd cargo compartment.

<sup>8</sup>Lowest point in cargo compartment to ceiling.

<sup>9</sup>Height of aft cargo compartment 54.5 in for the first 80 in, then tapering down.

<sup>10</sup>Measurement for entire aft cargo compartment.

**Table 2-11b. Capabilities of DC-8 and B707 series aircraft**

Capabilities	Aircraft Designation					
	DC-8-33F	DC-8-50CF	DC-8-61CF	DC-8-62F	DC-8-63F/CF	B707-300C/F
Max auth gross weight						
Takeoff	315,000 lb	315,000 lb	328,000 lb	335,000 lb	355,000 lb	331,600/ 333,100 lb
Landing	207,000 lb	240,000 lb	258,000 lb	250,000 lb	275,000 lb	247,000/ 247,000 lb
Operating	128,000 lb	131,600 lb	145,506 lb	146,000 lb	141,330 lb	146,400/ 132,174 lb
Zero fuel	192,140 lb	224,000 lb	234,000 lb	230,000 lb	261,000 lb	230,000/ 230,000 lb
Optimum load CG at fuselage station	860.0	860.0	828.0-889.0	836.1-883.8	833.9-883.8	838.3-843.7
Restraining factors						
Forward	1.5 g's	1.5 g's	1.5 g's	1.5 g's	1.5 g's	1.5 g's
Aft	1.5 g's	1.5 g's	1.5 g's	1.5 g's	1.5 g's	1.5 g's
Vertical	2.0 g's	2.0 g's	2.0 g's	2.0 g's	2.0 g's	2.0 g's
Lateral	1.5 g's	1.5 g's	1.5 g's	1.5 g's	1.5 g's	1.5 g's
Passenger capacity	2	165 <sup>1</sup>	219 <sup>1</sup>	170 <sup>1</sup>	219 <sup>1</sup>	165
Planning ACL	26.0 STONs	29.9 STONs <sup>1</sup>	47.3 STONs <sup>1</sup>	32.1 STONs <sup>1</sup>	41.4 STONs <sup>1</sup>	29.9 STONs <sup>1</sup>
463L pallet capacity	13	13	18	14	18	13
Max pallet height	62-80 in <sup>2</sup>	62-80 in <sup>2</sup>	62-80 in <sup>2</sup>	62-80 in <sup>2</sup>	62-80 in <sup>2</sup>	74-80 in <sup>2</sup>

<sup>1</sup>Figures on CF are for eight ACLs or passengers, depending on the mode of aircraft use.

<sup>2</sup>For actual max height, see GRAF pallet profiles (Figure 2-22); a general planning height of 76 inches can be used.

**CHARACTERISTICS OF STANDARD ARMY AIRCRAFT**

Tables 2-12 through 2-16 give data on standard Army aircraft. Table 2-12 gives capabilities and dimensions for fixed-wing air-

craft. Table 2-13 gives the same data for rotary-wing aircraft. Tables 2-14 through 2-16 list speed and range factors, preparation times, and sortie capacities. Figure 2-23 shows profiles of Army aircraft.

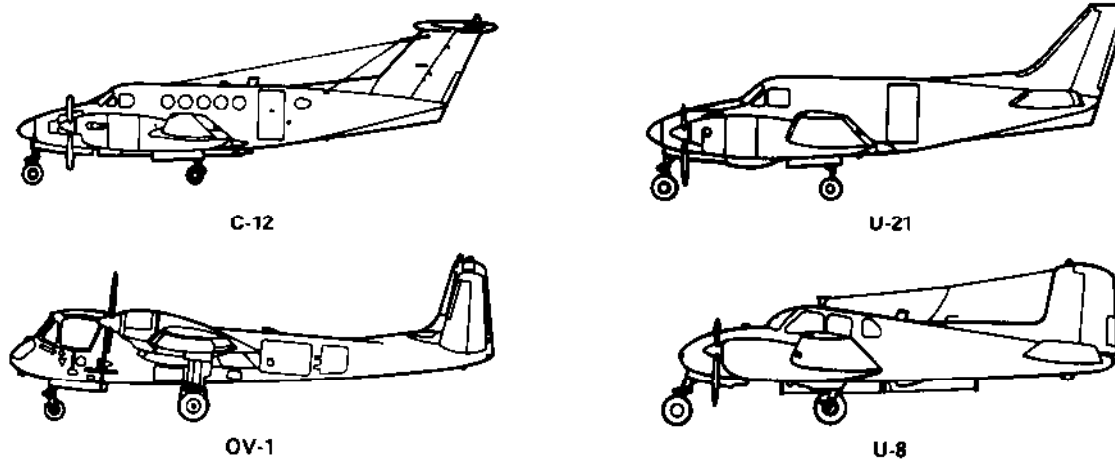

**Figure 2-23. Profiles of Army aircraft**

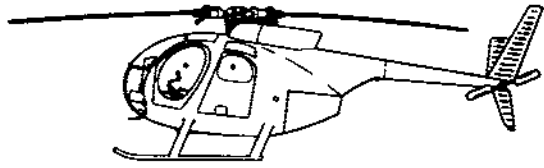

OH-6

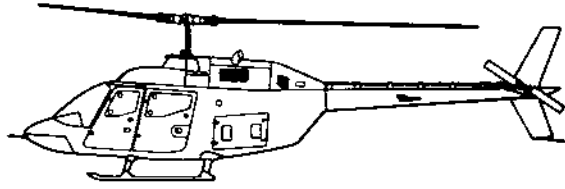

OH-58

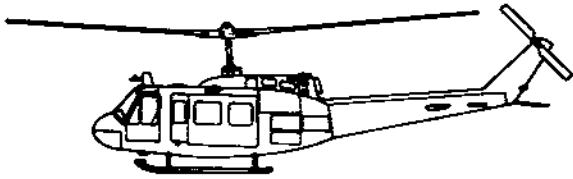

UH-1

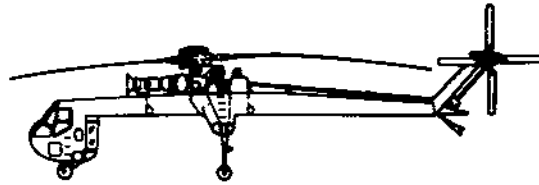

CH-54

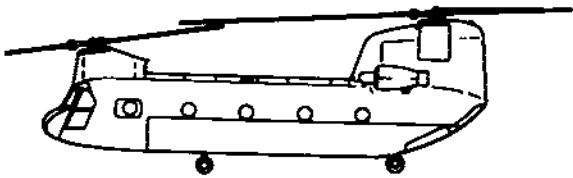

CH-47

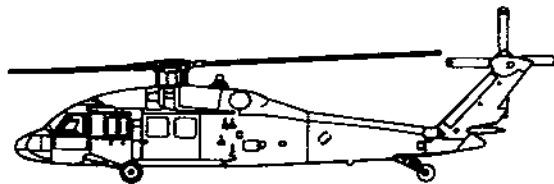

UH-60

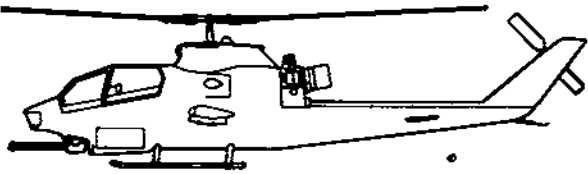

AH-15

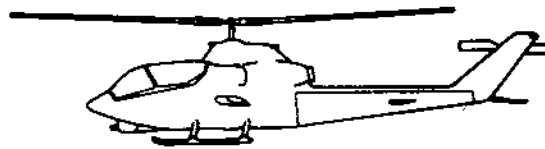

AH-1G

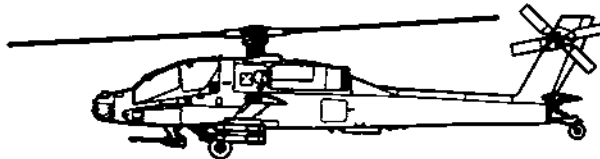

AH-64

Figure 2-23. Profiles of Army aircraft (cont)



Table 2-12a. Characteristics of Army fixed-wing aircraft (U-1A, U-10A, and T-41B are not included due to their low density)

Dimensions	Unit	C-12A	C-12C	C-12D	OY-1B	OY-1C	OY-1D	RC-120	RV-1C	RV-1D	T-42A	U-8F	U-21A	U-21D	U-21F	U-21G	U-21H	RU-21A	RU-21B	RU-21C	RU-21D	RU-21H	RU-21J
Fuselage length <sup>1</sup>	ft-in	43'10"	43'10"	43'10"	41'9"	41'1"	41'9"	43'10"	41'9"	41'9"	27'3"	33'4"	35'10"	35'10"	39'11"	35'10"	35'10"	35'10"	35'10"	35'10"	35'10"	35'10"	35'10"
Blades																							
Length unfolded	ft-in					NA									NA								NA
Length folded	ft-in					NA									NA								NA
Width folded	ft-in					NA									NA								NA
Tread width	ft-in	17'2"	17'2"	17'2"	9'2"	9'2"	9'2"	17'2"	9'2"	9'2"	9'7"	12'9"	12'9"	12'9"	13'0"	12'9"	12'9"	12'9"	12'9"	12'9"	12'9"	12'9"	12'9"
Extreme height	ft-in	15'5"	15'5"	14'9"	13'0"	13'0"	13'0"	15'5"	13'0"	13'0"	9'7"	14'2"	14'2"	14'2"	15'4"	14'2"	14'2"	14'2"	14'2"	14'2"	14'2"	14'2"	14'2"
Rotor diameter																							
Main or fwd	ft-in					NA									NA								NA
Tail or rear	ft-in					NA									NA								NA
Wing span	ft-in	54'6"	54'6"	55'6.5"	48'0"	42'0"	48'0"	54'6"	42'0"	45'11"	37'10"	45'11"	45'11"	45'11"	45'11"	45'11"	50'11"	50'11"	45'11"	45'11"	45'11"	50'11"	55'6"
Cargo door																							
Width x height	in	27.7x51.5	27.7x51.5	52.0x52.0		NA		27.7x51.5	NA	NA	13.5x22.3	50.5x26.5	50.5x53.0	50.5x53.0	17.0x51.7	50.5x53.0	50.5x53.0	50.5x53.0	50.5x53.0	33.0x51.5	50.5x53.0	50.5x53.0	50.5x53.0
Location vs fuselage	(left/right front/rear)	left rear	left rear	left rear		NA		left rear		NA		left	left	left	left	left	left	left	left	left	left	left	left
Cargo floor																							
Hgt from ground	in	47"	47"	42"		NA		47"		NA		48"	48"	48"	45"	48"	48"	48"	48"	48"	48"	48"	42"
Usable length	in	128"	128"	128"		NA		128"		NA		110.5"	110.5"	110.5"	11"	110.5"	110.5"	110.5"	110.5"	110.5"	110.5"	110.5"	128"
Usable width	in	54"	43"	54"		NA		54"		NA		55"	55"	55"	54"	55"	55"	55"	55"	55"	55"	55"	54"
Unobstructed hgt	in	57"	57"	57"		NA		57"		NA		55"	55"	55"	57"	55"	55"	55"	55"	55"	55"	55"	57"
Max cgo space	cu ft	306.5	306.5	306.5		NA		306.5		NA		158	230	230	306	230	158	158	158	158	158	158	306.5

<sup>1</sup>Dimension from nose to end of tail

FM 55-15

Table 2-12b. Characteristics of Army fixed-wing aircraft (U-1A, U-10A, and T-41B are not included due to their low density)

Capabilities	Unit	C-12A	C-12C	C-12D	OY-1B	OY-1C	OY-1D	RV-12D	RV-1C	RV-1D	T-47A	U-8F	U-21A	U-21D	U-21F	U-21G	U-21H	RU-21A	RU-21B	RU-21C	RU-21D	RU-21H	RU-21J
Normal crew	per acft	2	2	2	2 (pilot & radar)	2 (pilot & IR op)	2 (pilot & op)	2	2 (pilot & IR op)	2 (pilot & op)	1 (2 for IFR)	1 (2 for IFR)	2	2	2	2	2	4 (2 pilots & 2 op)	4 (2 pilots & 2 op)	4 (2 pilots & 2 op)	4 (2 pilots & 2 op)	4 (2 pilots & 2 op)	4 (2 pilots & 2 op)
Passenger cap																							
Troop seats	na	8	8	8	1	1		8	1	1	3	5	10	10	10	10	10						
Normal cap	na	8	8	8	1	1	1	8	1	1	3	5	6	6	7	6	6						
Total w/crow	ea	10	10	10	2	2	2	10	2	2	4	6	12	12	12	12	12	4	5	4	4	4	4
Liters/ambt	na					NA							3/3	3/3	3/3	3/3	3/3						
Operational cap <sup>1</sup>																							
Max auth gross wt	lb	12,500	12,500	12,500	15,795	14,823	18,109	14,200	14,823	18,109	5,100	7,700	9,500	9,500	11,568	9,650	9,650	10,200	10,900	10,900	9,650	10,200	12,500
Basic wt	lb	7,869	8,084	8,084	10,983	10,011	12,054	8,143	10,011	12,054	3,480	5,490	5,383	5,383	7,012	5,434	5,434	5,450	5,945	5,945	7,170	6,814	8,084
Useful load	lb	2,131	4,416	4,416	4,812	4,812	6,055	2,078	4,812	6,055	1,620	2,210	4,117	4,117	2,756	4,216	4,216	4,750	4,945	4,945	2,480	3,386	4,416
Normal payload	lb	2,000	2,000	2,000		NA		2,000	NA	NA	1,115	590	2,000	2,000	1,800	2,000	2,000	1,845	1,845	1,845	0	962	2,000
Fuel cap <sup>2</sup>																							
Internal	lb/gal	2,470/386	2,470/386	2,470/386	1,930/297	1,930/297	1,790/276	2,470/386	1,930/297	1,790/276	852/142	1,380/230	2,457/378	2,457/378	2,405/370	2,457/378	2,457/378	2,405/370	2,574/396	2,574/396	2,405/370	2,405/370	2,470/386
External	lb/gal		NA		1,950/300	1,950/300	1,950/300	NA	1,950/300	1,950/300					NA								
Fuel usage <sup>2</sup>	lb/gal per hr	350/538	456/70	456/70	826/126.9	826/126.9	900/130	456/70	826/126.9	900/130	154.8/25.8	204.5/35	450/72	450/72	450/72	450/72	450/72	580/89.2	580/89.2	580/89.2	580/89.2	580/89.2	456/70
Normal cruise speed	knots	240	260	260	225	225	220	260	225	220	177	160	210	210	220	210	210	205	205	205	205	205	260
Endurance at cruise (+30 min reserve)	hr + min	5 + 30	5 + 15	5 + 15	1 + 55 <sup>4</sup>	1 + 55 <sup>4</sup>	1 + 40 <sup>4</sup>	5 + 15	1 + 55 <sup>4</sup>	1 + 40 <sup>4</sup>	5 + 00	5 + 30	5 + 00	5 + 00	4 + 45	5 + 00	5 + 00	3 + 45	5 + 00	4 + 15	3 + 45	3 + 45	5 + 15
Fuel grade	octane	JP4/5	JP4/5	FP4/5	JP4	JP4	JP4	JP4/5	JP4	JP4	115/145	115/145	JP4	JP4	JP4	JP4	JP4	JP4/5	JP4/5	FP4/5	JP4/5	JP4/5	JP4/5
External cargo																							
Max auth load <sup>3</sup>			NA		2,000 ea wing	2,000 ea wing	2,000 ea wing	NA	2,000 ea wing	2,000 ea wing					NA								
Rescue hoist	lb					NA									NA								
Cgo winch cap	lb					NA									NA								
Weapons type						NA									NA								

<sup>1</sup>All data was computed at standard conditions at sea level but is subject to change with developmental testing.

Detailed weight computations and characteristics were taken from current 55-series TMs.

<sup>2</sup>Aviation gas was figured on 6 lb/gal JP4 computed on 6.5 lb/gal.

<sup>3</sup>The maximum load the aircraft is able to lift.

<sup>4</sup>Without external fuel.

<sup>5</sup>With external fuel.

Table 2-13a. Characteristics of Army rotary-wing aircraft

Dimensions	Unit	OH-6A	OH-58A	OH-58C	CH-47B	CH-47C	CH-47D	CH-54A	CH-54B	UH-1B	UH-1C/M	UH-1D/H/V	UH-60	TH/AH-1G	AH-1S	AH-64 <sup>2</sup>	TH-55A	
Fuselage length <sup>1</sup>	ft-in	23'0"	32'3.5"	32'8.8"	51'0"	51'0"	51'0"	70'0"	70'0"	38'5"	42'7"	40'7"	50'7.5"	44'5.2"	44'7"	49'3"	21'11"	
Blades																		
Length unfolded	ft-in	30'4"	40'11.8"	40'11.8"	99'0"	99'0"	99'0"	88'5"	88'5"	52'10.8"	52'10"	57'1"	64'10"	52'11.7"	53'1"	57'1"	28'10"	
Length folded	ft-in	23'0"	NA	NA	51'0"	51'0"	51'0"	NA	NA	NA	NA	NA	40'4"	NA	NA	NA	NA	
Width folded	ft-in	5'6"	NA	NA	12'5"	12'5"	12'5"	NA	NA	NA	NA	8'7"	9'8.1"	10'4"	10'9"	16'3"	NA	
Tread width	ft-in	6'9"	6'3.5"	6'5.4"	11'11"	11'11"	11'11"	19'9"	19'9"	8'4"	8'7"	8'7"	8'10.2"	7'0"	7'0"	6'6"	6'3"	
Extreme height	ft-in	9'6.5"	12'0"	18'6"	18'8"	18'8"	24'5"	24'5"	24'5"	12'8"	12'8"	14'6"	17'6"	11'7"	13'9"	12'6"	8'3"	
Rotor diameter																		
Main or fwd	ft-in	26'4"	35'4"	35'4"	60'0"	60'0"	60'0"	72'0"	72'0"	44'0"	44'0"	48'0"	44'0"	44'0"	44'0"	48'0"	25'3"	
Tail or rear	ft-in	4'3"	5'2"	5'2"	60'0"	60'0"	60'0"	16'0"	16'0"	8'6"	8'6"	8'6"	11'0"	8'6"	8'6"	9'3"	3'4"	
Wing span	ft-in	NA					NA					NA		10'4"	10'4"	16'3"	NA	
Cargo door																		
Width × height	in	41 × 34.5	40 × 35	40 × 35	90 × 78	90 × 78	90 × 78	104.5" (pod)	104.5" (pod)	48 × 48	48 × 48	74 × 48	68 × 54			NA	NA	
Location vs fuselage	(left/right front/rear)	left and right	left and right	left and right	rear	rear	rear	rear	rear	left and right	left and right	left and right	left and right			NA	NA	
Cargo floor																		
Hgt from ground	in	14"	14"	24"	19"	NA					14.5"	22.5"	22.5"	31.2"	31.2"	31.2"	27" (pod)	27" (pod)
Usable length	in	60"	60"	92"	110"	NA					69"	39"	39"	360"	362"	362"	329"	329"
Usable width	in	80.5"	80.5"	96"	72"	NA					38"	50"	50"	90"	78"	78"	104.5"	104.5"
Unobstructed hgt	in	54"	54"	49"	54"	NA					38"	50"	50"	78"	78"	78"	78"	78"
Max cargo space	cu ft	140	140	220	246.8	NA					40	20	20	1,474	1,474	1,474	1,552	1,522

<sup>1</sup>Dimension from nose to end of tail.

<sup>2</sup>Height is restricted to 54 inches with HCHS installed.

**Table 2-13b. Characteristics of Army rotary-wing aircraft**

Capabilities	Unit	OH-5A	OH-58A	OH-58C	CH-47B	CH-47C	CH-47D	CH-54A	CH-54B	UH-1B	UH-1C/M	UH-1D/H/V	UH-60	TH/AH-1G	AH-1S	AH-64 <sup>2</sup>	TH-55A
Normal crew	per acft	1 + (obs)	1 + (obs)	1 + (obs)	4	4	4	4	4	2	2	2	3	2	2	2	1
Passenger cap																	
Troop seats	ea	3	4	4	33	33	33	1 (w/pod 45)	1 (w/pod 45)	7	7	11	14	0	0	0	1
Normal cap	ea	3	4	4	33	33	33	1	1	7	7	7	14	0	0	0	1
Total w/crew	ea	4	4	4	37	37	37	5	5	9	9	13	17	0	0	0	2
Litters/ambt	ea	NA	2/4	2	24	24	24	0 (w/pod 24)	0 (w/pod 24)	3	3	6	4/6	0	0	0	NA
Operational cap <sup>1</sup>																	
Max auth gross wt	lb	2,400	3,000	3,200	40,000	46,000	50,000	42,000	47,000	8,500	9,500	9,500	20,250	9,500	10,000	17,400	1,600
Basic wt	lb	1,163	1,586	1,898	19,591	20,481	22,499	20,800	21,200	4,523	4,827	5,132	10,500	5,560	6,598	10,505	1,010
Useful load	lb	1,237	1,417	1,302	20,445	23,380	27,501	21,200	25,800	3,977	4,673	4,368	6,195	3,940	3,402	6,895	590
Normal payload	lb	650 <sup>5</sup>	760 <sup>5</sup>	837 <sup>5</sup>	15,000	18,200	20,206	11,650 <sup>5</sup>	16,250 <sup>5</sup>	2,490	2,685	2,900	3,360 <sup>7</sup>	1,785 <sup>8</sup>	1,293 <sup>8</sup>	4,090 <sup>8</sup>	590 <sup>5</sup>
Fuel cap <sup>2</sup>	lb/gal	400/61.5	475/73	465/71.5	4,036/621	7,351/1,131	6,695/1,030	8,794/1,353	8,794/1,353	1,072/165	1,573/242	1,358/209	2,360/362	1,755/270	1,703/262	2,405/370	150/25
Fuel usage <sup>2</sup>	lb/gal	143/22	189/29	175/27	2,780/427	3,038/467	2,600/400	3,614/556	4,230/651	488/75	500/77 <sup>5</sup>	550/84	960/148	546/83.6	640/98	810/124	60/10
Normal cruise speed	knots	121	120	120	150	155	145	95	110	75-95	92-140	90-120	145	0-190 <sup>9</sup>	0-190 <sup>9</sup>	0-161 <sup>9</sup>	65
Endurance at cruise (+30 min reserve)	hrs + min	3 + 15	3 + 30	3 + 00	1 + 00	2 + 00	2 + 30	2 + 00	1 + 30	1 + 45	3 + 00	2 + 15	2 + 15	2 + 00 <sup>10</sup>	2 + 30	1 + 45	2 + 00
Fuel grade	octane	JP4	JP4	JP4	JP4	JP4	JP4	JP4/5	JP4/5	JP4	JP4/5	JP4/5	JP4/5/8	JP4	JP4	JP4/5/8	115/145
External cargo																	
Max auth load <sup>3</sup>	lb	.....	NA	.....	20,000	20,000	28,000	20,000	25,000	3,000	3,787	4,000	8,000	NA	1,380 <sup>13</sup>	6,200 <sup>13</sup>	NA
Rescue hoist cap	lb	.....	NA	.....	600	600	600	.....	NA	.....	300 <sup>7, 15</sup>	300 <sup>7, 15</sup>	600	NA	.....	NA	.....
Cgo winch cap	lb	.....	NA	.....	3,000	3,000	3,000	15,000	25,000	.....	.....	.....	.....	NA	.....	.....	.....
Weapons type <sup>4</sup>		XM27E1	XM27E1	NA	M24	M24	M24	NA	NA	XM3	XM3	M23	M23	M18	M65	HELLFIRE	NA
										M5	M5	M56		M28	M97	M200 <sup>12</sup>	
										M6	M6	M59		M35	M158	M260	
										XM16	XM16			M157 <sup>11</sup>	M200 <sup>12</sup>	M230	
										M22	M22			M159 <sup>12</sup>	M261		
										XM156	XM156			X200 <sup>12</sup>			

<sup>1</sup>All data was computed at standard conditions at sea level, but is subject to change with developmental testing. Detailed weight computations and characteristics were taken from current 55-series TMs.

<sup>2</sup>Aviation gas was figured on 6 lb/gal JP4 computed on 6.5 lb/gal.

<sup>3</sup>The maximum load the aircraft is able to lift.

<sup>4</sup>Type of weapons the aircraft can carry; specific armament is based on unit assignment.

<sup>5</sup>Does not meet 200 NM range requirement of normal mission definition.

<sup>6</sup>Fuel consumption at 92 knots, 77 gallons per hour; at 140 knots, 84 gallons per hour.

<sup>7</sup>Normal mission, internal load-probability exists to cube-out before weigh-out. Maximum load on the floor is 300 lb/sq ft.

<sup>8</sup>Gross weight minus basic weight minus 400 lb for crew and total fuel weight.

<sup>9</sup>Due to armament configurations and flight profiles.

<sup>10</sup>Varies with load; figure given is for normal mission profile.

<sup>11</sup>Has 7-round, 2.75-inch rocket pod.

<sup>12</sup>Has 19-round, 2.75-inch rocket pod.

<sup>13</sup>Has external wing stores.

<sup>14</sup>Subject to final development configuration.

<sup>15</sup>UH-1 is restricted to a hoist capacity of 300 lb because of CG conditions.

**Table 2-14. Aircraft speed and range factors<sup>1</sup>**

Aircraft Type	Average Cruise Speed (kn) <sup>2</sup>	Ferry Range (NMs)
AH-1	141	381
AH-1S	130	338
CH-47B	114	1,090
CH-47C	111	1,226
CH-47D	136	1,070
CH-54B	100	226
OH-6A	102	330
OH-58	102	260
UH-1C/M	92	300
UH-1H/V,	111	276
EH-1H/X	111	276
UH-60A	143	960
C-12A	222	1,177
U-8F	127	1,220
U-21A	180	1,249
OV-1C	200	1,081 <sup>3</sup>

<sup>1</sup>Source is FM 101-20; factors are for ferry mission configuration.

<sup>2</sup>True airspeed under no-wind conditions.

<sup>3</sup>With two 150-gallon external fuel tanks.

**Table 2-15. Aircraft preparation times and sortie capacities for airlift<sup>1</sup>**

Type Aircraft Loaded	AF Aircraft Required	Disassembly Time Per Aircraft		Reassembly Time Per Aircraft		Airlifted Aircraft Per Sortie
		Man-Hours	Elapsed Hours	Man-Hours	Elapsed Hours	
AH-1G	C-5	8	2	12	3	12
AH-1S <sup>2</sup>	C-5	8	2	12	2	6
CH-47	C-5	174	32	225	36	3
CH-54	C-5	180	16	225	36	3
OH-6A	C-5	6	3	6	3	26
	C-141A	6	3	6	3	6
	C-130	6	3	6	3	3
OH-58	C-5	1.5	0.5	2	1	13
	C-141A	7.5	1.5	10	3	4
UH-1C/D/H/M/V	C-5	12	3	18	5	8
EH-1H/X	C-5	12	3	18	5	8
UH-60A <sup>3</sup>	C-5	9	1.5	9	1.5	6
	C-141A	9	1.5	9	1.5	2
UX-8/RU-8	C-5	16	4	32	8	4
U-21	C-5	16	4	32	8	4
OV-1B/C/D	C-5	305	38	750	94	3

<sup>1</sup>Data taken from FM 101-20 for minimum disassembly required for air shipment.

<sup>2</sup>AH-1S Cobras are usually shipped with stub wings on, due to excessive reassembly time and boresighting of the TOW system.

<sup>3</sup>UH-60A data taken from TM 55-1520-237-23-4.

**Table 2-16. Aircraft preparation times and barge capacities for sealift<sup>1</sup>**

Aircraft Type	Man-Hours	Crew Size	Elapsed Hours	Airlifted Aircraft <sup>2</sup>	
				SEABEE Barge	LASH Lighter
AH-1G <sup>3</sup>	6.0	3	2.0	14 <sup>4</sup>	8
AH-1S	6.0	3	2.0	6	5
CH-47 <sup>3</sup>	18.0	6	3.0	Note <sup>4</sup>	-
OH-6A <sup>5</sup>	6.0	3	2.0	27	15
OH-58 <sup>3</sup>	4.0	3	1.5	14	8
UH-1	5.0	3	2.0	94	6
UH-60A <sup>6</sup>	9.0	6	1.5	6	4
U-21A <sup>7</sup>	16.0	4	4.0	4	

<sup>1</sup>Based upon minimum disassembly. Preparation times include disassembly, preservation, and crating, as required. Times are rounded off to the next higher 0.5 hours (MTMC Report 74-19).

<sup>2</sup>TM 55-1520-400-14.

<sup>3</sup>MTMC Report 74-19.

<sup>4</sup>SEABEE has capability of loading the following numbers of aircraft on the lower deck if 12 barges are displaced: 48 CH-47s, 3 AH-1Gs, 19 UH-1Hs.

<sup>5</sup>Estimated by MTMC Transportation Engineering Agency (MTMCTEA) from TM 55-1520-214-5 and FM 101-20.

<sup>6</sup>Estimate based on information in TM 55-1520-237-23-2 and TM 55-1520-237-23-4.

<sup>7</sup>Estimated by MTMCTEA from TM 55-1500-200-5 and FM 101-20.

## Section IV. RESTRAINT CRITERIA

### DETERMINING THE CENTER OF GRAVITY

To determine the center of gravity (CG) location of a loaded aircraft, you must first know the weight of the aircraft ready for loading, then calculate the weight times the arm to determine the moment.

**Arm** = the horizontal distance in inches from the reference datum line to the center of gravity of an object.

**Moment** = the product of the weight of an item multiplied by its arm. Moment may be expressed in pound-inches; for example, 2 pounds (weight) X 10 inches (arm) = 20 pound-inches (moment).

The procedures for computing the center of gravity of a loaded aircraft areas follows:

- Calculate for moment. Weight times arm = moment.
- List aircraft ready-for-loading weight times the ready-for-loading CG = moment.
- List weight times the arm of each cargo item = moment.
- Add all the weights and enter the total.
- Add all the moments and enter the total.
- Divide the total moments by the total weight; round off any decimals.

This number is the station number at which the aircraft is balanced. If the number does not fall within the safe flight limits, the load or a part of it must be relocated and aircraft balance recomputed.

#### Sample problem (C-141 aircraft)

The C-141 aircraft is loaded with three M35, 2 1/2-ton trucks, each weighing 13,700 pounds, and six passengers (1,800 pounds). All trucks are positioned facing the rear of the aircraft with the center of gravity of truck 1 at station 630; the CG of truck 2 at station 920; the CG of truck 3 at station 1200; and the CG of the six

passengers at station 930. The weight of the aircraft ready for loading is 271,000 pounds, with its CG at station 915.

- Weight X arm = moment
- Weight of aircraft ready for loading X CG of aircraft ready for loading
- Weight of one truck X station 630
- Weight of one truck X station 920
- Weight of one truck X station 1200
- Weight of passengers X station 930

271,000	×	915	=	247,965,000
13,700	×	630	=	8,631,000
13,700	×	920	=	12,604,000
13,700	×	1200	=	16,440,000
1,800	×	930	=	1,674,000
313,900				287,314,000
(total weight)				(total moment)

$$\frac{\text{Total moment}}{\text{Total weight}} = \frac{287,314,000}{313,900} = 915.3 \text{ or } 915$$

Station 915 is the CG of the loaded aircraft. The CG limits safe flight for the C-141 are 906.7 to 948. The aircraft balanced at station 915 is safe for flight.

### SECURING CARGO

Tie-down devices secure cargo against forward, rearward, lateral, and vertical movement during takeoff, flight, and landing. To determine the number of devices needed to safely secure any given item of cargo, it is necessary to know the—

- Weight of the cargo.
- Restraint criteria for the aircraft.
- Strength of the tie-down devices and fittings.
- Angles of tie to be used.

#### Restraint Factors

These vary for different aircraft and are influenced by acceleration during takeoff, stability during flight, deceleration during landing, and type of landing field (improved or unimproved) for which the aircraft is designed. Restraint criteria for each aircraft are computed to counter the maximum amount of force

or thrust that cargo can be expected to exert against tie-downs under operating conditions.

**Tie-Downs**

The effective holding strength of a device (or fitting) is determined by the rated strength of the item and the manner in which it is employed. All tie-downs must be anchored to a tie-down fitting. The strongest tie-down is no stronger than the fitting to which it is attached. If a tie-down is stressed to its breaking point, the fitting is stressed an equal amount up to the full rated strength of the tie-down. Figure 2-24 shows a typical tie-down correct pull-off.

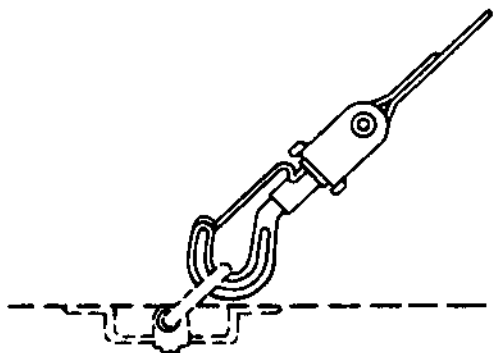

Figure 2-24. Correct pull-off

**Number required** There is one basic formula for figuring the restraint for an item of cargo:

- WT = Weight of cargo
- R(g's) = Restraint required (g's)
- RSD = Rated strength of device
- % of = Percent of angle of tie-down
- FTBR = Force to be restrained
- EHSD = Effective holding strength of device

$$\frac{WT \times R (g's)}{RSD \times \% \text{ of}} = \frac{FTBR}{EHSD} = \text{Total number of devices required}$$

**Example:**

- WT = 1,000 pounds
- R (g's) = 4
- RSD = 5,000 pounds
- % of = 74.9
- FTBR = 4,000 pounds
- EHSD = 3,745

$$\frac{1,000 \times 4}{5,000 \times 74.9} = \frac{4,000}{3,745} = 2 \text{ devices}$$

The weight of the cargo times the restraint forces of g's equals the force to be restrained. The rated strength of the tie-down device times the percent of angle of tie equals the effective holding strength of the tie-down. When the force to be restrained is divided by the effective holding strength of the tie-down, the total number of tie-downs needed is obtained. Tie-down devices should be used in pairs, so if the total number of tie-downs is an uneven number of a decimal, it should be rounded off to the next higher even number.

If the weight of the cargo is not marked on a particular item of cargo, refer to TB 55-46-1 for its weight and dimensions. The g forces for each direction are found in the applicable aircraft -10 manual. The rated strength of each device is given in Chapter 3 of this manual.

**Angle.** The percent of angle of tie-down is in relation to where the load is tied in the aircraft. See Figures 2-25 and 2-26 for examples of where to figure the angles. For a 30/30 angle of tie, measure from B to C (Figure 2-25) and go one and two-thirds of CB to A; then split the corner angle of DE. For a 45-degree angle, measure one length from B to C, one length to A, then right or left one length.

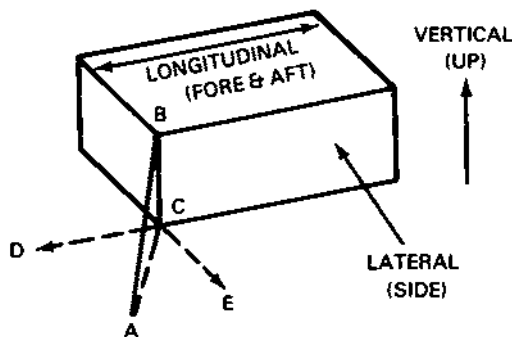

Figure 2-25. Longitudinal angle of tie-down

The recommended angle of tie is the 30/30 angle, as this is the best compromise of tie-down device-holding strength and angle. This tie-down is effective up to 75 percent of its rated strength forward (or aft) to 50 percent vertically and to about 43 percent sideward. Tie-downs secured at a 45-degree angle to the cargo floor and in line with the expected thrust will hold approximately 70 percent of their rated strength against forward, aft, or vertical



movements. Tie-downs secured in this manner will hold against movement in two directions. Tie-downs Secured at a 45-degree angle to the cargo floor and a 45-degree angle to the longitudinal axis of the aircraft prevent cargo movement in three directions, forward (or aft), vertical, and lateral.

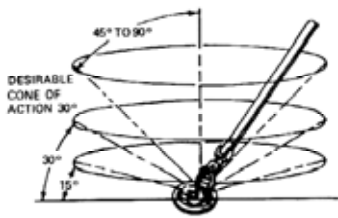

Figure 2-26. Vertical angle of tie-down

These tie-downs will hold about 50 percent of their rated strength against forward (or aft) and lateral movements and 70 percent of their rated strength against vertical movements. To calculate the percentage of angle of tie-down, see Figure 2-27.

Angles across the top are those formed between the tie-down device and the cabin floor. Angles down the side are those formed between the tie-down device and the longitudinal axis of the aircraft. Vertical restraint is related only to the angle between the tie-down device and the cabin floor. The lateral angle has no bearing on it. The unshaded area indicates the "best compromise" position.

		5°	10°	15°	20°	25°	30°	35°	40°	45°	50°	55°	60°	65°	70°	75°	80°
5°	VERTICAL	8.7	17.4	25.9	34.2	42.3	50.0	57.4	64.3	70.7	76.6	81.9	86.6	90.6	93.9	96.6	98.5
	LONG	99.2	98.1	96.2	93.6	90.2	86.3	81.6	76.3	70.4	64.0	57.2	49.8	42.1	34.1	25.8	17.3
10°	LAT	8.7	8.6	8.4	8.2	7.9	7.5	7.1	6.7	6.2	5.6	4.9	4.4	3.7	2.9	2.3	1.9
	LONG	98.1	97.0	95.2	92.6	89.2	85.3	80.7	75.5	69.9	63.8	56.5	49.3	41.7	33.7	25.5	17.1
15°	LAT	17.3	17.1	16.8	16.6	16.6	15.8	14.3	13.3	12.3	11.2	9.9	8.7	7.4	5.9	4.5	3.0
	LONG	96.2	95.2	93.3	90.8	87.5	83.7	79.1	73.9	68.3	62.1	55.4	48.3	40.9	33.0	25.0	16.8
20°	LAT	25.8	25.5	25.0	24.3	23.5	22.4	21.2	19.8	18.3	16.7	14.9	12.9	10.9	8.9	6.7	4.5
	LONG	93.6	92.6	90.8	88.4	85.2	81.4	76.9	72.0	66.5	60.4	53.9	47.0	39.8	32.1	24.3	16.6
25°	LAT	34.1	33.7	33.0	32.1	30.9	29.6	28.0	26.2	24.2	21.9	19.6	17.1	14.5	11.7	8.9	5.9
	LONG	90.2	89.2	87.5	85.2	82.1	78.5	74.2	69.4	64.1	58.3	52.0	45.3	38.3	30.9	23.5	15.8
30°	LAT	42.1	41.7	40.9	39.8	38.3	36.6	34.6	32.4	29.9	27.2	24.3	21.2	17.8	14.5	10.9	7.4
	LONG	86.7	85.7	84.1	81.4	78.5	74.9	70.9	66.3	61.2	55.7	49.7	43.3	36.6	29.6	22.4	15.1
35°	LAT	49.8	49.3	48.3	47.0	45.3	43.3	40.9	38.3	35.4	32.2	28.7	25.0	21.2	17.1	12.9	8.7
	LONG	81.4	80.7	79.1	76.9	74.2	70.9	67.1	62.7	57.5	52.7	47.0	40.9	34.6	28.0	21.2	14.3
40°	LAT	57.2	56.5	55.4	53.9	52.0	49.7	47.0	43.9	40.6	36.9	32.9	28.7	24.3	19.6	14.9	9.9
	LONG	76.3	75.5	73.9	72.0	69.4	66.3	62.7	58.7	54.2	49.3	43.9	38.3	32.4	26.2	19.8	13.3
45°	LAT	64.0	63.3	62.1	60.4	58.3	55.7	52.7	49.3	45.5	41.3	36.9	32.2	27.2	21.9	16.7	11.2
	LONG	70.4	69.6	68.3	66.5	64.1	61.2	57.9	54.2	49.9	45.5	40.6	35.4	29.9	24.2	18.3	12.3
50°	LAT	70.4	69.6	68.3	66.5	64.1	61.2	57.9	54.2	49.9	45.5	40.6	35.4	29.9	24.2	18.3	12.3
	LONG	64.0	63.3	62.1	60.4	58.3	55.7	52.7	49.3	45.5	41.3	36.9	32.2	27.2	21.9	16.7	11.2
55°	LAT	76.3	75.5	73.9	72.0	69.4	66.3	62.7	58.7	54.2	49.3	43.9	38.3	32.4	26.2	19.8	13.3
	LONG	57.2	56.5	55.4	53.9	52.0	49.7	47.0	43.9	40.6	36.9	32.9	28.7	24.3	19.6	14.9	9.9
60°	LAT	81.4	80.7	79.1	76.9	74.2	70.9	67.1	62.7	57.9	52.7	47.0	40.9	34.6	28.0	21.2	14.3
	LONG	49.8	49.3	48.3	47.0	45.3	43.3	40.9	38.3	35.4	32.2	28.7	25.0	21.2	17.1	12.9	8.7
65°	LAT	86.7	85.7	84.1	81.4	78.5	74.9	70.9	66.3	61.2	55.7	49.7	43.3	36.6	29.6	22.4	15.1
	LONG	42.1	41.7	40.9	39.8	38.3	36.6	34.6	32.4	29.9	27.2	24.3	21.2	17.8	14.5	10.9	7.4
70°	LAT	90.2	89.2	87.5	85.2	82.1	78.5	74.2	69.4	64.1	58.3	52.0	45.3	38.3	30.9	23.5	15.8
	LONG	34.1	33.7	33.0	32.1	30.9	29.6	28.0	26.2	24.2	21.9	19.6	17.1	14.5	11.7	8.9	5.9
75°	LAT	93.6	92.6	90.8	88.4	85.2	81.4	76.9	72.0	66.5	60.4	53.9	47.0	39.8	32.1	24.3	16.6
	LONG	25.8	25.5	25.0	24.3	23.5	22.4	21.2	19.8	18.3	16.7	14.9	12.9	10.9	8.9	6.7	4.5
80°	LAT	96.2	95.2	93.3	90.8	87.5	83.7	79.1	73.9	68.3	62.1	55.4	48.3	40.9	33.0	25.0	16.8
	LONG	17.3	17.1	16.8	16.6	15.8	15.1	14.3	13.3	12.3	11.2	9.9	8.7	7.4	5.9	4.5	3.0
85°	LAT	98.1	97.0	95.2	92.6	89.2	85.3	80.7	75.5	69.9	63.8	56.5	49.3	41.7	33.7	25.5	17.1

Figure 2-27. Percentage restraint chart

## Section V. AIRDROP

### DELIVERY OPERATIONS

Airdrop is a method of delivering supplies and equipment from aircraft to ground elements. As a rule, airdrop is a joint effort between Army and Air Force elements. Air Force airlift aircraft carry the airdrop items to the target area and effect delivery. Both Air Force and Army personnel support the operation on the ground.

The Army is responsible for providing airdropped supplies and equipment and airdrop equipment and ground vehicles used in recovering the items. Army divisions and separate brigades possess varying capabilities to support airdrop operations. Normally, airborne or air assault divisions have organic airdrop equipment support elements. Armored, infantry, mechanized divisions, and separate brigades require support from corps or theater air delivery units (see FM 29-51).

#### Advantages

Many advantages result when supplies and equipment are delivered by the airdrop method. Supplies and equipment can be airdropped directly to units, to otherwise unreachable areas, behind enemy lines, or to special operation units. Airdropping supplies and equipment takes less handling and shipping time. Emergency items can be prerigged and stored, and flight time and exposure of the aircraft to enemy fire is reduced.

Airdrop reduces the need for forward airfields or landing zones, reduces congestion during airfield off-loading, and reduces materials handling equipment requirements. It also increases aircraft availability and allows greater dispersion of forces.

#### Disadvantages

There are some disadvantages to the airdrop method of delivery, such as the need for specially trained personnel and appropriate airlift aircraft. The amount of cargo and troops aircraft can deliver depends on capacity and range of the aircraft. Airlift aircraft are affected by bad weather and high winds and are also vulnerable to enemy aircraft and ground fire.

Drop zones must be secured to keep items from falling into enemy hands. They also require special preparation for LAPES. In addition, the bulkiness of equipment rigged for airdrop and aircraft weight restrictions reduces the amount of the supplies aircraft can carry. There is also the possibility of loss or damage to equipment.

### TYPES OF AIRDROP

#### Freedrop

No parachute or retarding device is used for freedrop. Energy-dissipating material may be used around the load to lessen the shock when the load hits the ground. The load descends at a rate of 130 to 150 feet per second. Fortification or barrier material, clothing in bales, and other such items may be freedropped.

#### High-Velocity

Ring-slot cargo, cargo-extraction, and pilot parachutes are used to stabilize loads for high-velocity airdrop. The parachute has enough drag to hold the load upright during the descent at 70 to 90 feet per second. Items to be airdropped are placed on energy-dissipating material and rigged in an airdrop container. Subsistence, packaged POL products, ammunition, and other such items may be high-velocity airdropped.

#### Low-Velocity

Cargo parachutes are used for low-velocity airdrop. Items are rigged on an airdrop platform or in an airdrop container. Energy-dissipating material is put beneath the load to lessen the shock when the load hits the ground. Cargo parachutes attached to the load reduce the rate of descent to no more than 28 feet per second. Fragile material, vehicles, and artillery may be low-velocity airdropped.

#### Halo

Halo is used to airdrop supplies and equipment at high altitudes when aircraft must fly above the threat umbrella. The rigged load is pulled from the aircraft by a stabilizing parachute and free falls to a low altitude where

a cargo parachute opens to allow a low-velocity landing.

**RELEASE METHODS**

Loads to be airdropped may be released by one of the following methods:

**Extraction**

The load and the platform on which it is rigged are pulled from the cargo compartment by an extraction parachute.

**Door Load**

The load is pushed or skidded out through the paratroop door.

**Gravity**

The aircraft is flown in a nose-up attitude. The restraint holding the load inside the aircraft is released, and the load rolls out of the cargo compartment.

**LOW ALTITUDE PARACHUTE EXTRACTION SYSTEM**

LAPES is a method of delivery which uses ring-slotted extraction chutes to extract palletized loads from low-flying airlift aircraft. It is used to airdrop supplies and equipment from an aircraft flying about 5 to 10 feet above the ground. Energy-dissipating material is put under the load, and the load is rigged on a LAPES airdrop platform. Webbing and load binders hold the load to the platform. The rigged load is pulled from the aircraft by extraction parachutes, which also help to slow the platform and load as it slides across the DZ. An airfield or DZ may require special preparation for a LAPES delivery. Vehicles, artillery, ammunition, supplies, equipment, and water may be delivered by LAPES.

**Concept of Employment**

The LAPES may be the preferred method of delivering supplies or equipment under certain conditions.

**Adverse weather conditions.** Use LAPES when—

- Surface or altitude winds exceed drop limitations.
- Ceilings are low and preclude airdrop of equipment in visual meteorological conditions.

**Surface conditions.** Use LAPES—

- In restricted terrain where accuracy is required because of cliffs, mountains, ravines, or other obstacles.
- When an airfield or assault LZ has been cratered and adequate repair equipment is not available.

**Tactical conditions.** Use LAPES—

- When enemy air defense capabilities pose an unacceptable threat to airlift aircraft at normal drop altitudes.
- When hostile ground fire would pose a threat to an aircraft on the ground.
- When reduced aircraft radar signature is required.

During clandestine resupply operations, where large loads and increased accuracy are required.

**Extraction Zone (EZ)**

The proper site selection for an EZ depends on a variety of conditions. Specific standards must be used in physically locating and marking an EZ to ensure safe operation. MAC Regulation 3-3 describes appropriate criteria.

**Table 2-17. Weight limitations for cargo parachute and aerial delivery container**

Parachute	*Suspended weight in pounds	
	Minimum	Maximum
G-11A	2,270	4,250
G-11B	2,270	5,000
G-12C	501	2,200
G-12D	501	2,200
G-12E	501	2,200
G-13	200	500
T-7A	100	500

Container	Maximum weight (16)
A-7A	500
A-21	500
A-22	2,200

\*Suspended weight is the total rigged weight less the weight of the cargo parachutes and their riser extensions.

**GROUND-AIR EMERGENCY CODES**

The symbols shown in Figure 2-28 may be made by using strips of fabric or parachute,

pieces of wood, stones, or by tracking in the snow. The symbols should contrast with the background as much as possible and be 8 feet or more in length and 10 feet apart.

GROUND SIGNALS			
1. Require doctor	I	10. Will attempt takeoff	▷
2. Require medical supplies	II	11. Aircraft seriously damaged	◻
3. Unable to proceed	X	12. Probably safe to land here	△
4. Require food and water	F	13. Require fuel and oil	L
5. Require firearms and ammunition	∇	14. All well	LL
6. Require map and compass	◻	15. No	N
7. Require signal lamp with battery and radio	I	16. Yes	Y
8. Indicate direction to proceed	K	17. Not understood	JL
9. Am proceeding this direction	↑	18. Require engineer	W

ACKNOWLEDGEMENT BY AIRCRAFT	
Message received and understood	{ 1. Rocking from side to side 2. Green flashes from signal lamp
Message not understood	{ 1. Aircraft will make complete right-hand circuit 2. Red flashes from signal lamp

Figure 2-28. Ground-air emergency symbols

## CHAPTER 3

## MOTOR TRANSPORT

## CONTENTS

	Page
<b>Section I. ORGANIZATION AND OPERATIONS</b>	
Motor Transport Units .....	3-1
Administration .....	3-11
Planning .....	3-22
Transport Operations .....	3-29
<b>II. MOTOR TRANSPORT DATA</b>	
Vehicle Characteristics .....	3-69
Planning Statistics .....	3-90

## Section I. ORGANIZATION AND OPERATIONS

## MOTOR TRANSPORT UNITS

A break down of Army motor transport units according to TOE, mission, assignment, and capability is outlined in Table 3-1.

*Table 3-1. Tables of organization and equipment — motor transport units*

UNIT	TOE	MISSION/ASSIGNMENT/CAPABILITY
Headquarters and headquarters company, transportation motor transport brigade	55-11H	<p><b>MISSION:</b> To command and provide planning, supervision, coordination, and control of transport groups and other assigned or attached units. Units are those required in the movement of cargo or personnel by highway transport, particularly in a continuous intersectional or other line-haul operation.</p> <p><b>ASSIGNMENT:</b> To a theater army. Normally attached to a transportation command (TRANSCOM).</p> <p><b>CAPABILITY:</b> This unit commands and supervises three to eight motor transport groups and supporting units of another administrative or logistical service.</p>

Table 3-1. Tables of organization and equipment — motor transport units (cont)

UNIT	TOE	MISSION/ASSIGNMENT/CAPABILITY
Headquarters and headquarters detachment, transportation motor transport group	55-12H	<p><b>MISSION:</b> To provide command, control, and staff planning and attached transportation motor transport battalions.</p> <p><b>ASSIGNMENT:</b> To a TRANSCOM or brigade. Normally attached to a motor transport brigade or may operate separately.</p> <p><b>CAPABILITY:</b> This unit commands, plans, and supervises three to eight transportation motor transport battalions and attached supporting services.</p>
Headquarters and headquarters detachment, transportation motor transport battalion	55-16H	<p><b>MISSION:</b> To provide command and supervision of units engaged in motor transport operations.</p> <p><b>ASSIGNMENT:</b> To a corps support command (COSCOM) or theater army command. Normally attached to a transportation motor transport group, transportation brigade, or transportation composite group.</p> <p><b>CAPABILITY:</b> This unit -</p> <ul style="list-style-type: none"> <li>• Provides command and supervision for three to eight transportation companies and attached supporting services as required.</li> <li>• Operates a truck terminal and/or trailer relay system when required. These operations require assignment of teams from TOE 55-540.</li> <li>• Provides unit maintenance on field radios for attached units.</li> </ul>
Transportation light truck company	55-17H	<p><b>MISSION:</b> To provide truck transportation for movement of general cargo and personnel.</p> <p><b>ASSIGNMENT:</b> To a theater army or COSCOM. Normally attached to a motor transport battalion.</p> <p><b>CAPABILITY</b> (at level 1, with 75 percent vehicle availability):</p> <ul style="list-style-type: none"> <li>• SRC 55-17H510 — operates in two shifts, makes four round-trip local hauls per day (two per operating shift) and two round-trip line-hauls per day (one per operating shift). This unit transports — <ul style="list-style-type: none"> <li>– Local hauls — 720 STONs of cargo (4 STONs per truck on road), (2 1/2 STONs per truck off road), or 3,600 passengers (20 passengers per truck) on/off road.</li> <li>– Line-hauls — 360 STONs of cargo (4 STONs per truck) on road or 1,440 passengers (16 passengers per truck) on/off road.</li> </ul> </li> <li>• SRC 55-17H520 — operates in two shifts, makes four round-trip local hauls per day (two per shift) and two round-trip line-hauls per day (one per shift). This unit transports — <ul style="list-style-type: none"> <li>– Local hauls — 1,080 STONs of cargo (6 STONs per truck) on road or 900 STONs of cargo (5 STONs per truck) off road, or 3,600 passengers (20 passengers per truck) on/off road.</li> <li>– Line-hauls — 540 STONs of cargo (6 STONs per truck) on road, or 1,620 passengers (18 passengers per truck) on/off road.</li> </ul> </li> <li>• SRC 55-17H530 — operates in a single shift, makes two round-trip local hauls per day and one round-trip line-haul per day. This unit transports —</li> </ul>

Table 3-1. Tables of organization and equipment — motor transport units (cont)

UNIT	TOE	MISSION/ASSIGNMENT/CAPABILITY
Transportation medium truck company	55-18H	<ul style="list-style-type: none"> <li>– Local hauls — 360 STONs of cargo (4 STONs per truck) on road, 225 STONs of cargo (2 1/2 STONs per truck) off road, or 1,800 passengers (20 passengers per truck) on/off road.</li> <li>– Line-hauls — 180 STONs of cargo (4 STONs per truck) on road or 720 passengers (16 passengers per truck) on/off road.</li> <li>• SRC 55-17H540 — operates in a single shift, makes two round-trip local hauls per day and one round-trip line-haul per day. This unit transports — <ul style="list-style-type: none"> <li>– Local hauls — 540 STONs of cargo (6 STONs per truck) on road or 450 STONs of cargo (5 STONs per truck) off road or 1,800 passengers (20 passengers per truck) on/off road.</li> <li>– Line-hauls — 270 STONs of cargo (6 STONs per truck) on road or 810 passengers (18 passengers per truck) on/off road.</li> </ul> </li> </ul> <p><b>MISSION:</b> To provide transportation for the movement of containerized or general cargo, bulk petroleum products, and refrigerated cargo by motor transport.</p> <p><b>ASSIGNMENT:</b> To an area support group or COSCOM. Normally attached to a motor transport battalion.</p> <p><b>CAPABILITY:</b> This unit operates at full strength with 45 semitrailer combinations available, makes four round-trip local hauls per day or two round-trip line-hauls per day (one per 10-hour shift).</p> <ul style="list-style-type: none"> <li>• When equipped with 12-ton cargo semitrailers, this unit transports — <ul style="list-style-type: none"> <li>– Local hauls — 2,160 STONs of cargo (12 STONs per semitrailer) or, in an emergency only, 9,000 passengers (50 passengers per semitrailer).</li> <li>– Line-hauls — 1,080 STONs of cargo (12 STONs per semitrailer) or, in an emergency only, 4,500 passengers (50 passengers per semitrailer).</li> </ul> </li> <li>• When equipped with 34-ton semitrailers, this unit transports — <ul style="list-style-type: none"> <li>– Local hauls — 3,960 STONs of cargo (22 STONs per semitrailer) or 360 20-ft containers or, in an emergency only, 6,300 passengers (35 per semitrailer).</li> </ul> </li> <li>• When equipped with 5,000-gallon petroleum semitrailers, this unit transports — <ul style="list-style-type: none"> <li>– Local hauls — 900,000 gal</li> <li>– Line-hauls — 450,000 gal</li> </ul> </li> <li>• When equipped with 7 1/2-ton refrigerator semitrailer carrying 6 tons per vehicle, this unit transports: <ul style="list-style-type: none"> <li>– Local hauls — 1,080 STONs</li> <li>– Line-hauls — 540 STONs</li> </ul> </li> <li>• With a minor modification, (military desert-design tires), this unit can provide logistical and combat support in desert areas.</li> </ul>

*Table 3-1. Tables of organization and equipment — motor transport units (cont)*

UNIT	TOE	MISSION/ASSIGNMENT/CAPABILITY
Transportation medium truck company (container/cargo, 40-foot)	5518J4	<p><b>MISSION:</b> To provide transportation for both dry and refrigerated containerized cargo, general noncontainerized cargo, and bulk water by motor transport.</p> <p><b>ASSIGNMENT:</b> When employed in the COMMZ, to a TRANSCOM. Normally further attached to a motor transport battalion. May be attached to an area support group (ASG). When employed in the corps, normally attached to a transportation brigade with further attachment to a motor transport battalion.</p> <p><b>CAPABILITY</b> (at strength level 1 with a 75 percent task vehicle (M915 14-ton tractor and M872 3/4-ton semitrailer) availability): This unit operates in two shifts, makes four round-trip local hauls (two per shift) or two round-trip line-hauls (one per shift) per day. This unit transports —</p> <ul style="list-style-type: none"> <li>• Containerized (dry or refrigerated) cargo.                     <ul style="list-style-type: none"> <li>— Local hauls — 180 40-foot containers or 360 20-foot containers (total weight of 20-foot containers per transporter load not to exceed 34 STONs).</li> <li>— Line-hauls — 90 40-foot containers or 180 20-foot containers.</li> </ul> </li> <li>• Noncontainerized cargo (palletized or package).                     <ul style="list-style-type: none"> <li>— Local hauls — 3,960 STONs of cargo (22 STONs per semitrailer load).</li> <li>— Line-hauls — 1,980 STONs of cargo (22 STONs per semitrailer load).</li> </ul> </li> <li>• Water.                     <ul style="list-style-type: none"> <li>— Local hauls — 180 collapsible 4,750-gal-capacity water containers (855,000 gal of potable water).</li> <li>— Line-hauls — 90 collapsible 4,750-gal-capacity water containers (427,000 gal of potable water).</li> </ul> </li> <li>• Passengers — 50 seated per 34-ton break-bulk/container semitrailer (in emergencies).</li> </ul>
Transportation command transport company	55-19J3	<p><b>MISSION:</b> To provide transportation for the movement of personnel and/or light cargo by motor transport.</p> <p><b>ASSIGNMENT:</b></p> <ul style="list-style-type: none"> <li>• When organized under TOE 55-19J310, assigned to a theater army, a corps headquarters, or a COSCOM. Normally attached to a motor transport battalion.</li> <li>• When organized under TOE 55-19J320, assigned to an airborne corps headquarters. Normally attached to a motor transport battalion.</li> </ul> <p><b>CAPABILITY:</b> At level 1, operating in a single shift, this unit provides daily motor transport support for personnel and light cargo.</p>
Transportation medium truck company (container/cargo, 20-foot)	55-23J4	<p><b>MISSION:</b> To provide transportation for the movement of both dry and refrigerated containerized cargo, general noncontainerized cargo, and bulk water by motor transport.</p>



Table 3-1. Tables of organization and equipment — motor transport units (cont)

UNIT	TOE	MISSION/ASSIGNMENT/CAPABILITY
Transportation cargo carrier company (tracked)	55-27H	<p><b>ASSIGNMENT:</b> When employed in the corps, normally attached to a transportation brigade, with further attachment to a motor transport battalion. When employed in the COMMZ, to a TRANSCOM; normally further attached to a motor transport battalion. May be attached to an ASG.</p> <p><b>CAPABILITY</b> (at level 1 with a 75 percent task vehicle (M818 5-ton tractor and M871 22 1/2-ton semitrailer) availability): This unit operates in two shifts, makes four round-trip local hauls (two per shift) or two round-trip line-hauls (one per shift) per day. This unit transports —</p> <ul style="list-style-type: none"> <li>• Containerized cargo (dry refrigerated). <ul style="list-style-type: none"> <li>— Local hauls — 180 20-foot containers.</li> <li>— Line-hauls — 90 20-foot containers.</li> </ul> </li> <li>• Noncontainerized cargo (palletized/packaged). <ul style="list-style-type: none"> <li>— Local hauls — 2,700 STONs of cargo (15 STONs per semitrailer).</li> <li>— Line-hauls — 1,350 STONs of cargo (15 STONs per semitrailer).</li> </ul> </li> <li>• Water. <ul style="list-style-type: none"> <li>— Local hauls — 180 collapsible 3,000-gal-capacity water containers (540,000 gal of potable water).</li> <li>— Line-hauls — 90 collapsible 3,000-gal water containers (270,000 gal of potable water).</li> </ul> </li> </ul>
Transportation heavy truck company	55-28H	<p><b>MISSION:</b> To provide transportation for supply distribution in regions where wheeled vehicles cannot operate effectively.</p> <p><b>ASSIGNMENT:</b> To a theater army command, COSCOM, or FORSCOM.</p> <p><b>CAPABILITY:</b> In sustained operations with 75 percent vehicle availability, this unit transports 228 STONs of cargo. When equipped with tank units, the unit transports 43,200 gal of fuel 50 miles forward daily.</p> <p><b>MISSION:</b> To provide truck transportation for tanks, heavy or bulky vehicles, and heavy, bulky, and outsize cargo.</p> <p><b>ASSIGNMENT:</b> To a theater army command or COSCOM. Normally attached to a motor transport battalion.</p> <p><b>CAPABILITY</b> (at level 1 with 75 percent task vehicle availability):</p> <ul style="list-style-type: none"> <li>• TOE 55-28H510 — operates in two shifts, makes four round-trip local hauls (two per shift) or two round-trip line-hauls (one per shift) per day: <ul style="list-style-type: none"> <li>— Local hauls — 72 tanks or similar vehicles (one per transporter) or 2,880 STONs of cargo (40 STONs per transporter).</li> <li>— Line-hauls — 36 tanks or similar vehicles or 1,440 STONs (40 STONs per transporter).</li> </ul> </li> <li>• TOE 55-28H520 — operates a single shift, makes two round-trip local hauls or one round-trip linehaul per day:</li> </ul>

Table 3-1. Tables of organization and equipment — motor transport units (cont)

UNIT	TOE	MISSION/ASSIGNMENT/CAPABILITY																				
Transportation company light-medium truck	55-67H	<p>— Local hauls — 36 tanks or similar vehicles (one per transporter) or 1,440 STONs of cargo (40 STONs per transporter).</p> <p>— Line-hauls — 18 tanks or similar vehicles (one per transporter) or 720 STONs of cargo (40 STONs per transporter).</p> <p><b>MISSION:</b> To provide transportation for the movement of general cargo and personnel by motor transport.</p> <p><b>ASSIGNMENT:</b> To a theater army command, COSCOM, or separate force. Normally attached to motor transport battalion.</p> <p><b>CAPABILITY:</b> When operating at full strength, this unit transports —</p> <ul style="list-style-type: none"> <li>• One-time lift with all vehicles available — 360 STONs of cargo or 1,700 passengers.</li> <li>• One-time lift with 75 percent of vehicles available — 276 STONs of cargo or 1,300 passengers.</li> </ul> <p>— Local haul, 15 miles forward, two-shift operations, 75 percent of vehicles available, four trips cargo and six trips personnel—1,104 STONs of cargo or 7,800 passengers.</p> <p>— Line-haul, 75 miles forward, two-shift operations, 75 percent of vehicles available, two trips daily — 552 STONs of cargo or 2,600 passengers.</p>																				
Transportation company light-medium truck	55-67J4	<p><b>MISSION:</b> To provide for movement of general noncontainerized cargo and personnel by motor transport.</p> <p><b>ASSIGNMENT:</b> To a TRANSCOM or COSCOM. Normally further attached to a motor transport battalion.</p> <p><b>CAPABILITY:</b> (at level 1 with 75 percent vehicle availability): This unit operates in two shifts, makes four round-trip local hauls (two per shift) or two round-trip line/long hauls (one per shift) per day. This unit transports-</p> <ul style="list-style-type: none"> <li>• Bulk cargo (5 tons per 5-ton cargo truck, 15 tons per 22 1/2-ton semitrailer): <table data-bbox="750 1370 1268 1668"> <tr> <td>— Local Haul</td> <td style="text-align: right;">STONs</td> </tr> <tr> <td>5-ton cargo truck</td> <td style="text-align: right;">750</td> </tr> <tr> <td>5-ton tractor (M818) and 22 1/2-ton semitrailer (M871)</td> <td style="text-align: right;">450</td> </tr> <tr> <td></td> <td style="text-align: right; border-top: 1px solid black;">1,200</td> </tr> <tr> <td>— Line-Haul</td> <td style="text-align: right;">STONs</td> </tr> <tr> <td>5-ton cargo truck</td> <td style="text-align: right;">375</td> </tr> <tr> <td>5-ton tractor (M818) and 22 1/2-ton semitrailer (M871)</td> <td style="text-align: right;">225</td> </tr> <tr> <td></td> <td style="text-align: right; border-top: 1px solid black;">600</td> </tr> </table> </li> <li>• Personnel (20 per 5-ton cargo truck, local; 16 per 5-ton cargo truck, line-haul; 35 per 22 1/2-ton semitrailer (emergency only): <table data-bbox="750 1753 1268 1808"> <tr> <td>— Local Haul</td> <td style="text-align: right;">Troops</td> </tr> <tr> <td>5-ton cargo truck</td> <td style="text-align: right;">3,000</td> </tr> </table> </li> </ul>	— Local Haul	STONs	5-ton cargo truck	750	5-ton tractor (M818) and 22 1/2-ton semitrailer (M871)	450		1,200	— Line-Haul	STONs	5-ton cargo truck	375	5-ton tractor (M818) and 22 1/2-ton semitrailer (M871)	225		600	— Local Haul	Troops	5-ton cargo truck	3,000
— Local Haul	STONs																					
5-ton cargo truck	750																					
5-ton tractor (M818) and 22 1/2-ton semitrailer (M871)	450																					
	1,200																					
— Line-Haul	STONs																					
5-ton cargo truck	375																					
5-ton tractor (M818) and 22 1/2-ton semitrailer (M871)	225																					
	600																					
— Local Haul	Troops																					
5-ton cargo truck	3,000																					

*Table 3-1. Tables of organization and equipment — motor transport units (cont)*

UNIT	TOE	MISSION/ASSIGNMENT/CAPABILITY														
		5-ton tractor (M818) and 22 1/2-ton semitrailer (M871) <span style="float:right">1,050</span> <span style="float:right">4,050</span> — Line-Haul <span style="float:right">Troops</span> 5-ton cargo truck <span style="float:right">1,200</span> 5-ton tractor (M818) and 22 1/2-ton semitrailer (M871) <span style="float:right">525</span> <span style="float:right">1,725</span>														
Transportation motor transport company, air assault division	55-69JO	MISSION: To provide organic motor transport to supplement division air transport of all classes of supply for the supply and transport battalion. ASSIGNMENT: Organic to supply and transport battalion, air assault division. CAPABILITY (at level 1, with 75 percent vehicle availability): This unit operates on a single shift and provides the following task vehicles daily to support division transport requirements: <table border="0" style="margin-left: 40px;"> <thead> <tr> <th>Task Vehicles</th> <th>Each</th> </tr> </thead> <tbody> <tr> <td>5-ton cargo truck with 1 1/2-ton cargo trailer</td> <td style="text-align: right;">13</td> </tr> <tr> <td>5-ton tractor with 5,000-gal fuel semitrailer</td> <td style="text-align: right;">7</td> </tr> <tr> <td>5-ton tractor with 22 1/2-ton break-bulk container semitrailer or 5-ton tractor with 12-ton stake and platform semitrailer</td> <td style="text-align: right;">6</td> </tr> <tr> <td>5-ton cargo truck with liquid-dispensing tank and pump unit and 1 1/2-ton cargo trailer with liquid tank unit</td> <td style="text-align: right;">1</td> </tr> <tr> <td>10-ton tractor with 25-ton low-lid semitrailer</td> <td style="text-align: right;">1</td> </tr> <tr> <td></td> <td style="text-align: right; border-top: 1px solid black;">28</td> </tr> </tbody> </table>	Task Vehicles	Each	5-ton cargo truck with 1 1/2-ton cargo trailer	13	5-ton tractor with 5,000-gal fuel semitrailer	7	5-ton tractor with 22 1/2-ton break-bulk container semitrailer or 5-ton tractor with 12-ton stake and platform semitrailer	6	5-ton cargo truck with liquid-dispensing tank and pump unit and 1 1/2-ton cargo trailer with liquid tank unit	1	10-ton tractor with 25-ton low-lid semitrailer	1		28
Task Vehicles	Each															
5-ton cargo truck with 1 1/2-ton cargo trailer	13															
5-ton tractor with 5,000-gal fuel semitrailer	7															
5-ton tractor with 22 1/2-ton break-bulk container semitrailer or 5-ton tractor with 12-ton stake and platform semitrailer	6															
5-ton cargo truck with liquid-dispensing tank and pump unit and 1 1/2-ton cargo trailer with liquid tank unit	1															
10-ton tractor with 25-ton low-lid semitrailer	1															
	28															
Transportation motor transport company, supply and transport battalion, infantry division (mechanized)	55-84H	MISSION: <ul style="list-style-type: none"> <li>• To provide transportation for unit distribution of all classes of supply except Class V.</li> <li>• To transport division reserve supplies for which the unit is responsible.</li> <li>• To furnish vehicles required for displacing division headquarters and division administration company and to supplement transport means available to other elements of the division.</li> </ul> ASSIGNMENT: Organic to supply and transport battalion, infantry division (mechanized). CAPABILITY (at level 1 with a 75 percent vehicle availability): This unit transports 270 STONs of cargo or 99,150 gal POL.														
Transportation motor transport company, supply and transport battalion, armored division	55-87H	MISSION: <ul style="list-style-type: none"> <li>• To provide transportation for unit distribution of all classes of supply except Class V.</li> <li>• To transport division reserve supplies for which the unit is responsible.</li> </ul>														

Table 3-1. Tables of organization and equipment — motor transport units (cont)

UNIT	TOE	MISSION/ASSIGNMENT/CAPABILITY																								
		<ul style="list-style-type: none"> <li>To furnish vehicles required for displacing division headquarters and the division administration company and to supplement transport means available to other elements of the division.</li> </ul> <p><b>ASSIGNMENT:</b> Organic to supply and transport battalion, armored division.</p> <p><b>CAPABILITY</b> (at level 1 with 75 percent vehicle availability): This unit transports:</p> <table border="0" style="width: 100%;"> <tr> <td style="text-align: center;">General Cargo</td> <td style="text-align: right;">STONs</td> </tr> <tr> <td>45 trucks, cgo, 5-ton (6 STONs per vehicle)</td> <td style="text-align: right;">270</td> </tr> <tr> <td>7 trucks, tractor, 5-ton with 12-ton S&amp;P semitrailer</td> <td style="text-align: right;">84</td> </tr> <tr> <td></td> <td style="text-align: right;"><u>354</u></td> </tr> <tr> <td colspan="2" style="text-align: center;">or</td> </tr> <tr> <td>45 trucks, cgo, 5-ton (6 STONs per vehicle)</td> <td style="text-align: right;">270</td> </tr> <tr> <td>7 trucks, tractor, 5-ton with 22 1/2-ton break-bulk/container transporter (15 STONs per vehicle)</td> <td style="text-align: right;">105</td> </tr> <tr> <td></td> <td style="text-align: right;"><u>375</u></td> </tr> <tr> <td colspan="2" style="text-align: center;">POL</td> </tr> <tr> <td>25 trucks, tractor, 5-ton with 5,000-gal fuel semitrailer (5,000 gal per semitrailer)</td> <td style="text-align: right;">125,000</td> </tr> <tr> <td>4 trucks, cgo, 5-ton and 1 1/2-ton trailer with fuel pods (1,800 gal per trailer)</td> <td style="text-align: right;">7,200</td> </tr> <tr> <td></td> <td style="text-align: right;"><u>132,200</u></td> </tr> </table>	General Cargo	STONs	45 trucks, cgo, 5-ton (6 STONs per vehicle)	270	7 trucks, tractor, 5-ton with 12-ton S&P semitrailer	84		<u>354</u>	or		45 trucks, cgo, 5-ton (6 STONs per vehicle)	270	7 trucks, tractor, 5-ton with 22 1/2-ton break-bulk/container transporter (15 STONs per vehicle)	105		<u>375</u>	POL		25 trucks, tractor, 5-ton with 5,000-gal fuel semitrailer (5,000 gal per semitrailer)	125,000	4 trucks, cgo, 5-ton and 1 1/2-ton trailer with fuel pods (1,800 gal per trailer)	7,200		<u>132,200</u>
General Cargo	STONs																									
45 trucks, cgo, 5-ton (6 STONs per vehicle)	270																									
7 trucks, tractor, 5-ton with 12-ton S&P semitrailer	84																									
	<u>354</u>																									
or																										
45 trucks, cgo, 5-ton (6 STONs per vehicle)	270																									
7 trucks, tractor, 5-ton with 22 1/2-ton break-bulk/container transporter (15 STONs per vehicle)	105																									
	<u>375</u>																									
POL																										
25 trucks, tractor, 5-ton with 5,000-gal fuel semitrailer (5,000 gal per semitrailer)	125,000																									
4 trucks, cgo, 5-ton and 1 1/2-ton trailer with fuel pods (1,800 gal per trailer)	7,200																									
	<u>132,200</u>																									
Transportation motor transport company, heavy division	55-87J4	<p><b>MISSION:</b></p> <ul style="list-style-type: none"> <li>To provide truck transportation for unit distribution of Class I, II, IV, and VII supplies.</li> <li>To transport division reserve supplies for which the main support battalion is responsible.</li> <li>To furnish vehicles to assist division elements with a requirement for supplemental transportation, including unit distribution of Class V supplies.</li> <li>To provide truck transportation for the movement of heavy, outsize vehicles and cargo.</li> </ul> <p><b>ASSIGNMENT:</b> Organic to the main support battalion of the heavy division.</p> <p><b>CAPABILITY</b> (at level 1, with 75 percent availability): This unit —</p> <ul style="list-style-type: none"> <li>Provides the following task vehicles daily for dispatch:</li> </ul> <table border="0" style="width: 100%;"> <tr> <td style="text-align: center;">Task Vehicles</td> <td style="text-align: right;">Each</td> </tr> <tr> <td>5-ton cargo truck</td> <td style="text-align: right;">27</td> </tr> <tr> <td>5-ton tractor (M818) with 22 1/2-ton semitrailer (M871)</td> <td style="text-align: right;">24</td> </tr> <tr> <td>Heavy equipment transporter (HET) (M911 tractor with M747 semitrailer)</td> <td style="text-align: right;">18</td> </tr> <tr> <td></td> <td style="text-align: right;"><u>69</u></td> </tr> </table>	Task Vehicles	Each	5-ton cargo truck	27	5-ton tractor (M818) with 22 1/2-ton semitrailer (M871)	24	Heavy equipment transporter (HET) (M911 tractor with M747 semitrailer)	18		<u>69</u>														
Task Vehicles	Each																									
5-ton cargo truck	27																									
5-ton tractor (M818) with 22 1/2-ton semitrailer (M871)	24																									
Heavy equipment transporter (HET) (M911 tractor with M747 semitrailer)	18																									
	<u>69</u>																									

Table 3-1. Tables of organization and equipment — motor transport units (cont)

UNIT	TOE	MISSION/ASSIGNMENT/CAPABILITY										
Transportation motor transport company, supply and transport battalion, infantry division	55-88H	<ul style="list-style-type: none"> <li>• Makes a one-time lift of noncontainerized cargo as follows:               <table style="margin-left: 40px; border-collapse: collapse;"> <thead> <tr> <th style="text-align: left;">Noncontainerized cargo</th> <th style="text-align: right;">STONs</th> </tr> </thead> <tbody> <tr> <td>5-ton cargo truck</td> <td style="text-align: right;">135</td> </tr> <tr> <td>5-ton tractor (M818) with 22 1/2-ton semitrailer (M871)</td> <td style="text-align: right;">360</td> </tr> <tr> <td>HET or 18 tanks or equivalent vehicles.</td> <td style="text-align: right;"><u>720</u></td> </tr> <tr> <td></td> <td style="text-align: right;">1,215</td> </tr> </tbody> </table> </li> </ul>	Noncontainerized cargo	STONs	5-ton cargo truck	135	5-ton tractor (M818) with 22 1/2-ton semitrailer (M871)	360	HET or 18 tanks or equivalent vehicles.	<u>720</u>		1,215
		Noncontainerized cargo	STONs									
5-ton cargo truck	135											
5-ton tractor (M818) with 22 1/2-ton semitrailer (M871)	360											
HET or 18 tanks or equivalent vehicles.	<u>720</u>											
	1,215											
<p><b>MISSION:</b></p> <ul style="list-style-type: none"> <li>• To provide transportation for unit distribution of all classes of supply except Class V.</li> <li>• To transport the division reserve supplies for which the unit is responsible.</li> <li>• To furnish vehicles required for displacing division headquarters and the division administration company and to supplement vehicles available to other elements of the division.</li> </ul> <p><b>ASSIGNMENT:</b> Organic to supply and transport battalion, armored division.</p> <p><b>CAPABILITY</b> (at level 1 with 75 percent vehicle availability): This unit transports 270 STONs of cargo or 51,750 gal POL in a single lift.</p>												
Transportation motor transport company, infantry division (light)	55-88J8	<p><b>MISSION:</b></p> <ul style="list-style-type: none"> <li>• To provide truck transportation for unit distribution of Class II, IV, and IX supplies.</li> <li>• To transport troops in support of division operations.</li> <li>• To transport the division reserve supplies for which the supply and transport battalion is responsible.</li> <li>• To provide supplemental transportation for division elements, including emergency unit distribution of Class V supplies and water.</li> </ul> <p><b>ASSIGNMENT:</b> Organic to supply and transport battalion, infantry division, light.</p> <p><b>CAPABILITY:</b> At level 1, this unit provides enough drivers and control personnel for 24-hour operation of unit task vehicles. For planning purposes, based on 75 percent task vehicle availability, this unit —</p>										
		<ul style="list-style-type: none"> <li>• Provides the following task vehicles daily:           <table style="margin-left: 40px; border-collapse: collapse;"> <thead> <tr> <th style="text-align: left;">Task Vehicles</th> <th style="text-align: right;">Each</th> </tr> </thead> <tbody> <tr> <td>5-ton cargo truck</td> <td style="text-align: right;">24</td> </tr> <tr> <td>5-ton tractor (M818) with 22 1/2-ton semitrailer (M871)</td> <td style="text-align: right;">6</td> </tr> <tr> <td></td> <td style="text-align: right;"><u>30</u></td> </tr> </tbody> </table> <p style="text-align: center;">or</p> <ul style="list-style-type: none"> <li>• Makes a one-time break-bulk cargo lift as follows:           <table style="margin-left: 40px; border-collapse: collapse;"> <thead> <tr> <th style="text-align: left;">Break-bulk cargo</th> <th style="text-align: right;">STONs</th> </tr> </thead> <tbody> <tr> <td>5-ton cargo truck</td> <td style="text-align: right;">120</td> </tr> </tbody> </table> </li> </ul> </li></ul>	Task Vehicles	Each	5-ton cargo truck	24	5-ton tractor (M818) with 22 1/2-ton semitrailer (M871)	6		<u>30</u>	Break-bulk cargo	STONs
Task Vehicles	Each											
5-ton cargo truck	24											
5-ton tractor (M818) with 22 1/2-ton semitrailer (M871)	6											
	<u>30</u>											
Break-bulk cargo	STONs											
5-ton cargo truck	120											

Table 3-1. Tables of organization and equipment — motor transport units (cont)

UNIT	TOE	MISSION/ASSIGNMENT/CAPABILITY
		5-ton tractor (M818) with 22 1/2-ton semitrailer (M871)
		72
		192
		or
		• Makes a one-time troop lift as follows:
		One-time troop lift
		Troops
		5-ton cargo truck
		480
		5-ton tractor (M818) with 22 1/2-ton semitrailer (M871)
		210
		690
Transportation motor transport teams:	55-540H	
GA, car		<p><b>MISSION:</b> To transport passengers, messengers, and a limited amount of cargo by 1/4-ton utility truck, 1 1/4-ton cargo truck, or sedan.</p> <p><b>ASSIGNMENT:</b> To a theater army or COSCOM. Normally attached to a motor transport battalion or may operate separately under the supervision of the appropriate staff transportation officer.</p> <p><b>CAPABILITY</b> (with a 75 percent task vehicle availability (7 vehicles)): This team transports —</p> <ul style="list-style-type: none"> <li>• When equipped with 1/4-ton utility trucks, 21 passengers (3 per vehicle) and 1 3/4 STONs of cargo (1/4 STON per trailer) per lift.</li> <li>• When equipped with 1 1/4-ton cargo trucks, 49 passengers (7 per truck) or 8 3/4 STONs of cargo (1 1/4 STONs per truck).</li> <li>• When equipped with sedans, 35 passengers (5 per sedan) per lift.</li> </ul>
GB, light truck		<p><b>MISSION:</b> To transport personnel or cargo by light truck.</p> <p><b>ASSIGNMENT:</b> To a theater army or COSCOM. Normally attached to a motor transport company or may operate separately under supervision of the appropriate staff transportation officer.</p> <p><b>CAPABILITY</b> (with 75 percent vehicle availability (7 trucks)): This team transports —</p> <ul style="list-style-type: none"> <li>• When equipped with 2 1/2-ton cargo trucks, 28 STONs of cargo (4 STONs per truck) on road, 17 1/2 STONs of cargo (2 1/2 STONs per truck) off road, or 140 passengers (20 per truck) per lift.</li> <li>• When equipped with 5-ton cargo trucks, 42 STONs of cargo (6 STONs per truck) on road, 35 STONs of cargo (5 STONs per truck) off road, or 140 passengers (20 per truck) per lift.</li> <li>• When equipped with 44 passenger buses, 308 passengers, or 112 litter patients.</li> </ul>
GC, medium truck		<p><b>MISSION:</b> To transport general cargo, containers, bulk petroleum products, or refrigerated cargo by truck tractor with semitrailer combinations.</p> <p><b>ASSIGNMENT:</b> To a theater army or COSCOM. Normally attached to a motor transport company or may operate separately under supervision of the appropriate staff transportation officer.</p> <p><b>CAPABILITY</b> (with a 75 percent vehicle availability (7 trucks)): This team transports —</p>

*Table 3-1. Tables of organization and equipment — motor transport units (cont)*

UNIT	TOE	MISSION/ASSIGNMENT/CAPABILITY
GD, heavy truck		<ul style="list-style-type: none"> <li>• When equipped with 40-foot combination container/cargo semitrailers, seven 40-foot containers, fourteen 20-foot containers, or 175 STONs of noncontainerized cargo.</li> <li>• When equipped with 20-foot combination container/cargo semitrailers, seven 20-foot containers, or 105 STONs of noncontainerized cargo.</li> <li>• When equipped with 12-ton stake and platform semitrailers, 84 STONs per lift or, in an emergency, 350 passengers.</li> <li>• When equipped with 5,000-gal-tank semitrailers, 35,000 gal of bulk petroleum products per lift.</li> <li>• When equipped with 7 1/4-ton refrigerator semitrailers, 42 STONs of refrigerated cargo per lift.</li> </ul> <p><b>MISSION:</b> To transport heavy or outsize cargo by heavy truck tractor-semi-trailer combinations</p> <p><b>CAPABILITY</b> (with a 75 percent vehicle availability (three trucks)): This team transports three tanks or similar vehicles (one per semi-trailer) or 120 STONs of outsize or heavy-lift cargo per lift.</p>
GE, trailer transfer point		<p><b>MISSION:</b> To operate a trailer transfer point in conjunction with a line-haul operation.</p> <p><b>ASSIGNMENT:</b> To a transportation motor transport headquarters responsible for line of communications motor transport operations.</p> <p><b>CAPABILITY:</b> Operates on a single shift, in conjunction with a line-haul operation, a trailer transfer point with a maximum capacity of 125 semi-trailer units in and out. The operation includes —</p> <ul style="list-style-type: none"> <li>• Receiving, segregating, assembling, and dispatching loaded or empty semi-trailers for convoys.</li> <li>• Maintaining POL-dispensing facilities to refuel operating equipment.</li> <li>• Servicing, inspecting, and, if required, making emergency repairs to incoming vehicles.</li> <li>• Preparing and maintaining required operational records and reports.</li> </ul>

## ADMINISTRATION

### Standing Operating Procedures

See Figure 3-1 for sample SOP format for motor transport movements within divisions, logistical commands, and higher echelons. See Figure 3-2 for sample SOP format for motor transport service.

### STANDING OPERATING PROCEDURE

1. GENERAL. *Policies and factors involved in movements.*
  - a. Highway regulation. *Purpose, application/scope, responsibilities, methods and procedures.*
  - b. Convoy clearance. *Minimum vehicle requirements; convoy symbols; procedures; format for requesting and furnishing clearance; routing; halts; convoy composition; restrictions on tracked, overweight, or outsize vehicles.*
  - c. Highway regulation points. *Purpose, basis for, responsibilities and procedures, required records.*
  - d. Traffic control. *Responsibilities, relationship to highway regulation, coordination with provost marshal.*
  - e. Return loads. *Policies, methods, and procedures for securing and reporting.*
  - f. Convoy commanders. *Appointment, responsibilities, and functions; relationships with transportation personnel; instructions to be furnished.*
  - g. Halts. *Types; policies, procedures, and responsibilities; area policing.*
  - h. Security. *Responsibilities; defensive measures.*
  - i. Records and reports. *Responsibilities, methods, required reports.*
  - j. Communications. *Responsibilities, means of communication.*
2. SUPPLY MOVEMENTS
  - a. Releases. *When required, methods of obtaining, formats, dissemination, actions required.*
  - b. Diversions and reconsignments. *Authority, request procedures.*
  - c. Records and reports. *Types of required records and reports.*

**Figure 3-1. Sample format for motor transport movements SOP**

### STANDING OPERATING PROCEDURE

1. GENERAL. *Policies for control, operation, and maintenance of facilities, equipment, and installation; command responsibility; technical supervision required and agencies involved.*
2. MISSION. *Service provided, extent of operation.*
3. ORGANIZATION. *Available operating units, location, and operating limits.*
4. FUNCTIONS. *Scheduled and nonscheduled operations; maintenance of equipment, including responsibilities, procedures, facilities, and inspection practices.*
5. PLANNING. *Troop and equipment requirements, capability estimates, communication procedure and requirements, rehabilitation requirements.*
6. OPERATIONS. *Operational procedures and controls, pooling, and equipment use.*
7. MAINTENANCE. *Responsibilities and procedures for maintenance, regulations, and reports.*
8. SUPPLY. *Responsibilities for supplies, authorized levels, requisitioning procedures, accounting methods, disposal of excesses.*

**Figure 3-2. Sample format for motor transport service SQP**



9. INTELLIGENCE AND RECONNAISSANCE. Responsibilities for collection, collation, evaluation, and dissemination of highway transportation intelligence and reconnaissance information.
10. SECURITY. Responsibilities for disaster and defense plans, convoy and cargo security, equipment and facilities.
11. RECORDS AND REPORTS. Responsibilities for operational and personnel status reports, technical reports, and miscellaneous records/reports.
12. TRAINING. Responsibilities for unit and technical training.

Figure 3-2. Sample format for motor transport service SOP (cont)

### Vehicle Commitment Format

Use a locally reproduced format to furnish routine vehicle commitments to subordinate units. See Figure 3-3 for a sample.

20th Transportation Battalion (Truck) APO 0000	
Date <u>24 Sep '85</u>	
Subject: Vehicle Commitment	
To: <u>CO 86th Iron Co. Mym (Cgo)</u>	Commitment No <u>9-108</u>
1. Vehicles w/drivers <u>7-12T 5&amp;P</u>	
Report to: <u>Major Eason</u>	
Location: <u>Q200, Warehouse 19</u>	
Time: <u>0730</u>	Date <u>25 Sep '85</u>
To transport: <u>77 tons dry rations</u>	
Destination: <u>Q166, Ludwig's Bldg - Iron Off.</u> <u>Bldg. A8</u>	
2. Remarks: <u>No return load scheduled; POL</u> <u>available at Q166 for refueling.</u>	
<u>C. H. Mitchell</u> (Signature) <u>Major S-3</u> (Rank & Title)	

Figure 3-3. Type vehicle commitment work sheet

## Convoy Procedures

**Briefing.** Before a convoy departs on a mission, the commander briefs all convoy members. The following areas should be covered, with adjustments to suit local conditions:

1. Situation:
  - Friendly forces.
  - Support units.
  - Enemy situation.
2. Mission:
  - Type of cargo.
  - Origin.
  - Destination.
3. Execution:
  - General organization.
  - Time schedule.
  - Routes.
  - Speed.
  - Catch-up speed.
  - Vehicle distance.
  - Emergency measures (for accidents, breakdowns, and separation from convoy).
    - Action of convoy and security personnel if ambushed.
    - Medical support.
4. Administration and logistics:
  - Personnel control.
  - Billeting.
  - Messing.
5. Command and signal:
  - Convoy commander's location.
  - Assistant convoy commander designation.
  - Security forces commander's action.
  - Serial commanders' responsibilities.
  - Arm and hand signals.
  - Other prearranged signals.
  - Radio frequencies and call signs (for control personnel, security force commanders, fire support elements, reserve security elements, medical evacuation support).
6. Safety:
  - Hazards of route.
  - Weather conditions.
  - Defensive driving.

## Convoy Commander's Checklist

Before departure time, convoy commanders should use the following list of questions to make sure arrangements are complete:

- Where is start point? Release point?
- What route is to be used?
- Has reconnaissance been made and condition of route determined?
  - Can bridges, tunnels, underpasses, and defiles safely accommodate all loaded and tracked vehicles?
  - Are critical points known and listed on strip maps?
  - What is the size of serials?
  - What is the size of march units?
  - What is the rate of march?
  - What is the vehicle interval on an open road? In built-up areas? At halt?
  - What type of column will be used?
  - Has provision been made for refueling if required?
  - Has a suitable bivouac site been selected if required?
  - Have suitable rest and mess halt areas been selected if required?
  - Is road movement table needed? Prepared? Submitted?
  - Have convoy clearances been obtained? What date?
  - Is escort required and has it been requested?
  - Are spare trucks available for emergencies?
  - Are vehicles fully serviced, clean, and ready for loading?
  - Is load proper, neat, and balanced?
  - Are drivers properly briefed? By whom? When? Strip maps furnished?
  - Is convoy marked front and rear of each march unit? With convoy number when required?
  - Are guides in place? Have arrangements been made to post guides?
  - Are blackout lights functioning?
  - Are maintenance services alerted?
  - Is maintenance truck in rear? Are medics in rear? Is there a plan for casualties?
  - Are all interested parties advised of estimated time of arrival (ETA)?

- Is officer at rear of convoy ready to take necessary corrective action, such as investigating accidents and unusual incidents and changing loads? Who is trail officer?
- Is there a truck load plan? Who is responsible?
- Is there a truck unload plan? Who is responsible?
- Has a plan been made for feeding personnel?
- Have times been established for loading trucks?
- Has time been established for formation of convoy?
- Have times been established for unloading trucks?
- Has time been established for releasing trucks? Who is responsible?

- Is there a carefully conceived plan known to all convoy personnel that can be used in case of attack?
- Is a written operation order on hand if required?
- Will a log of road movement be required at end of trip? Are necessary forms on hand?
- Has a weather forecast been obtained?
- Do all personnel have proper clothing and equipment?
- Is there a communications plan?

**Convoy commander's report.** After a move has been completed, the convoy commander prepares a report to submit to his immediate superior officer. Use the sample report in Figure 3-4 as a guide. The report may also be submitted in the form of a strip map with an appropriate legend attached.

FORWARD LOAD		
420 Trans Bn (Trk)		4401 Trans Co (Lt Trk)
28FE01C (Convoy No)	Twelve 2 1/2-Ton Trucks (No and type of task vehicles)	16 Feb XX (Date)
<b>TIME</b>		
Departed starting point . . . . .		0621 hr
Departed 1st loading point . . . . .		0800 hr
Arrived 1st loading point . . . . .		0630 hr
Time at 1st loading point . . . . .		1 hr 30 min
Arrived highway regulating point (HRP) . . . . .		1200 hr
Departed HRP . . . . .		1205 hr
Time at 1st unloading point . . . . .		33 min
<b>SUPPLIES AND PERSONNEL</b>		
Cargo (STONs) . . . . .		50.2
Class of supplies . . . . .		I
Number of personnel . . . . .		0
<b>DISTANCE</b>		
Odometer reading of lead vehicle (at 1st loading point) . . . . .		21,324 mi
Odometer reading of lead vehicle (at starting point) . . . . .		21,322 mi
Total forward (no load) . . . . .		2 mi
Odometer reading of lead vehicle (at 1st unloading point) . . . . .		21,381 mi
Total forward (loaded) . . . . .		57 mi

*Figure 3-4. Sample convoy commander's report*

**REMARKS**

Starting point — company area, RJ 124/167

Weak bridge 6.4 mi east of 1st loading point. Road generally in poor condition between starting point and 1st unloading point.

**RETURN LOAD**

**TIME**

Departed 2d loading point . . . . .	1300 hr
Arrived 2d loading point (same as 1st unloading point) . . . . .	1245 hr
Time at 2d loading point . . . . .	15 min
Departed 2d unloading point . . . . .	1415 hr
Arrived 2d unloading point . . . . .	1400 hr
Time at 2d unloading point . . . . .	15 min

**SUPPLIES AND PERSONNEL**

Cargo (STONs) . . . . .	10.0
Class of supplies . . . . .	II and IV
Number of personnel . . . . .	120

**DISTANCE**

Odometer reading of lead vehicle (at 2d unloading point) . . . . .	21,396 mi
Odometer reading of lead vehicle (at 2d loading point) . . . . .	21,381 mi
Total return (loaded) . . . . .	15 mi
Odometer reading of lead vehicle (at starting point) . . . . .	12,346 mi
Total return (no load) . . . . .	40 mi

**REMARKS**

Road in excellent condition between 2d loading point and starting point .

**ROUND-TRIP DATA**

**TIME**

Returned to starting point . . . . .	1,654 mi
Total round-trip time . . . . .	10 hr 33 min
Total travel time (including halts) . . . . .	8 hr
Total loading time . . . . .	1 hr 45 min
Total unloading time . . . . .	48 min

**SUPPLIES AND PERSONNEL**

Cargo (STONs of class I) . . . . .	50.2
(STONs of class II and IV) . . . . .	10.0
Number of personnel . . . . .	120

*Figure 3-4. Sample convoy commander's report (cont)*

<b>DISTANCE</b>	
Total distance (loaded) . . . . .	72 mi
Total distance (unloaded) . . . . .	42 mi
Total round-trip distance . . . . .	114 mi
<b>REMARKS</b>	
Average rate of march = 14.2 MIH.	
Ton-miles forward = 2,861; return = 150.	
Passenger-miles forward = 0; return = 1,800.	
/s/	
/t/ Thomas A. Young	
(Convoy commander)	
2d Lt, 4401 Trans Co (Lt Trk)	
(Rank/grade and organization)	

*Figure 3-4. Sample convoy commander's report (cont)*

**Convoy clearance.** A convoy clearance request is usually required from a unit or organization planning a move by convoy. The information required varies according to regulations and local SOP. See Figure 3-5 for a sample DD Form 1265. See FM 55-312 for detailed instructions on preparing the form.

*In a theater of operations.* Before beginning a road movement over a route requiring a movement credit, the unit submits a request for clearance on DD Form 1265 (Request For Convoy Clearance). Submit the request through movement channels to the highway traffic headquarters (HTH) controlling the area where the movement starts. DD Form 1265 is a dual-purpose document. It can serve either as a request or as an authorization for movement, or both. The requesting agency uses DD Form 1265 to initiate a movement via highway; the HTH uses the form to grant clearance and to issue instructions for the road movement. Information to complete this form is supplied by the unit requesting movement. Depending on the urgency of the requirement, the information on the form may be transmitted orally, electrically, or in writing. After

receiving the request, the HTH schedules the movement at the time and over the route requested by the unit, if possible. When the move cannot be scheduled at the requested time or on the requested route, the HTH notifies the requester. Alternate times and routes are then arranged. After final coordination and approval, the HTH issues the necessary movement credit, convoy movement number, and any other required information. The authorization is returned to the requesting agency. In NATO operations, STANAG 2155 governs movement credits.

*In CONUS.* A military convoy needs permission from appropriate state and city officials to travel on public highways. Obtain permission by submitting DD Form 1265 through the installation transportation officer (ITO). Submit the DD Form 1265, a copy of the operations order, and four copies of a strip map of the proposed convoy route with one additional copy of each document for each state to be crossed and one copy for the local ITO at point of origin. The request must reach the approving authority (in most cases, the local ITO) at least 10 days before the planned move.

REQUEST FOR CONVOY CLEARANCE				DATE	
				1 Jan XX	
SECTION I - GENERAL					
1. ORGANIZATION		2. STATION		3. CONVOY COMMANDER	
100th Trans Co (Lt Mdn Trk)		Fort Eustis, Virginia 23604		John J. Jones 1LT, TC	
4. PERSONNEL STRENGTH		5. POINT OF ORIGIN		6. DESTINATION	
7. OFFICER	8. ENLISTED	Fort Eustis, Virginia		Camp A. P. Hill, Virginia	
1	47				
7. DATE AND TIME		7a. DEPARTURE	7b. ARRIVAL	8. RATE OF MARCH	
		15 0700 Jan XX	15 1002 Jan XX	40 MPH	
SECTION II - CONVOY COMPOSITION					
9. NUMBER OF EACH TYPE OF VEHICLE AND DESCRIPTION (Include towed equipment)					
1 1/4-ton Truck, Utility					
20 5-ton Tractor W/19 Stake and Platform Semitrailers (1 Bobtail)					
1 5-ton Wrecker					
<b>SAMPLE</b>					
10. TOTAL NUMBER OF VEHICLES	11. NUMBER OF OVERSIZE/ OVERWEIGHT VEHICLES	12a. NO. OF SERIALS	12b. TIME INTERVAL	13a. NO. OF MARCH UNITS	13b. TIME INTERVAL
22	21	1	NA	2	2 min.
SECTION III - ROUTE DATA					
14. PROPOSED ROUTING (Indicate US Routes, State Routes, etc)					
Interstate 64, State Route 168, State Route 33, Interstate 64, Interstate 95, State Route 207, U. S. 301 to Camp A. P. Hill					
15. ETA AND ETD AT STATE LINES, MAJOR ROAD JUNCTIONS, MAJOR BRIDGES AND TUNNELS, METROPOLITAN AREAS AND OVERNIGHT HALT SITES (Continue on a separate sheet if additional space is required)					
LOCATION		ETA	DATE	ETD	DATE
I-64		0700		0705	15 Jan XX
Rt # 168		0732		0737	
15 min-Rest Halt. Rt # 33		0754		0814	
I-64		0835		0840	
I-95		0859		0904	
207-301		0957		1002	
SECTION IV - LOGISTICAL DATA					
16. BRIEF GENERAL DESCRIPTION OF CARGO (Brief general description; i. e., organizational impediments, etc.) (Within security limitations)					
Class I (packaged rations)					

DD FORM 1265 JAN 65

Figure 3-5. DD Form 1265 (Request for Convoy Clearance) (sample)

17. ARE EXPLOSIVES TO BE TRANSPORTED? <input type="checkbox"/> YES <input type="checkbox"/> NO (If YES, describe below)						
CLASS	AMOUNT	DESCRIPTION	VEHICLES TO BE USED			
			NO.	TYPE		
		NA				
18. STATEMENT WHY EXPLOSIVES CANNOT BE TRANSPORTED COMMERCIALY (Movements involving explosives and/or other dangerous articles are required to comply with all applicable regulations or directives)						
NA						
19. LOGISTICAL SUPPORT REQUIRED AT OVERNIGHT HALT SITES? <input type="checkbox"/> YES <input type="checkbox"/> NO (If YES, complete the following) (Use separate sheet if additional space is required)						
DATE	INSTALLATION	GAS (gals)	OIL (gals)	RATIONS	BILLETS	OTHER
	NA					
20. REMARKS						
<p><u>ETA</u> is the time the first vehicle clears the referenced point.</p> <p><u>ETD</u> is the time the last vehicle clears the referenced point.</p> <p style="text-align: center; font-size: 2em; font-weight: bold; transform: rotate(-15deg);">SAMPLE</p>						
21. REQUESTING AGENCY			22. APPROVING AGENCY			
100th Trans Co (Lt Mdn Trk)						
23. REQUESTED BY (Typed name, grade and title)			24. APPROVED BY (Typed name, grade and title)			
CHARLES C. CHESTNUT						
25. DATE	26. SIGNATURE	27. DATE	28. SIGNATURE			
1 Jan XX	<i>Charles C. Chestnut</i>					
INSTRUCTIONS: In cases where bona-fide emergencies exist, the information contained on DD Form 1265 and DD Form 1266 may be transmitted to the appropriate headquarters by telephone or electric transmission. In this event, reference will be made to item numbers in the sequence in which they appear on the form. Items which do not apply will be so indicated.						

Figure 3-5. DD Form 1265 (Request for Convoy Clearance) (sample) (cont)

**Special Hauling Permit.** In CONUS, use DD Form 1266 (Request for Special Hauling Permit) to request permission to move oversize or overweight vehicles over public roads. Prepare

the form in four copies with an additional copy for each state to be crossed. The request must reach the approving authority at least 15 days before the planned move. Only identical

REQUEST FOR SPECIAL HAULING PERMIT							DATE
							15 Jan XX
SECTION I - GENERAL							
1. ORGANIZATION		2. STATION		3. DATE OF MOVEMENT			
100th Trans Co (Lt Mdn Trk)		Fort Eustis, Virginia 23604		a. STARTING 0700 15 Jan XX		b. COMPLETION 1830 16 Jan XX	
4. POINT OF ORIGIN				5. DESTINATION			
Fort Eustis, Virginia				Fort Drum, New York			
6. ARRIVAL AT STATE LINES			7. ROUTING (Specify US Route, State Route, etc.)				
DATE	TIME	STATE LINE	IS 64, Va 168, Va 33, IS 64, IS 95, IS 495E, US 1, IS 695, IS 83, IS 81, US 11				
15 Jan XX	1308	Va/Md					
15 Jan XX	1440	Md/Pa					
16 Jan XX	1145	Pa/NY					
8. ESCORT REQUIREMENTS							
None							
SECTION II - VEHICLE AND LOAD DATA							
DESCRIPTION (a)	TYPE (2-ton etc) (b)	NO. OF VEHICLES (c)	REGISTRATION NUMBER (d)	HEIGHT (e)	WIDTH (f)	LENGTH (g)	WEIGHT (h)
9. VEHICLE							
A. TRUCK							(Empty)
B. TRUCK-TRACTOR	5-ton	8	See Item 12	103.5	98.3	158.3	18,560
C. TRAILER							(Empty)
D. SEMI-TRAILER	12-ton	8	See Item 12	108.3	97.3	348.5	14,240
E. OTHER (Specify)							(Empty)
10. LOAD							
Orgn Impedimenta							
11. OVERALL (Vehicle and load)							5,000
				108.3	98.3	526	37,800
12. DESCRIPTION OF LOAD (Brief general description: Organization impedimenta, etc.) (Within security limitations)							
Organization impedimenta.							
Registration Numbers							
Trac		Trc		Trac		Trc	
SE5551 - 5T9991		SE5555 - 5T9995		SE5555 - 5T9995		SE5555 - 5T9995	
SE5552 - 5T9992		SE5556 - 5T9996		SE5556 - 5T9996		SE5556 - 5T9996	
SE5553 - 5T9993		SE5557 - 5T9997		SE5557 - 5T9997		SE5557 - 5T9997	
SE5554 - 5T9994		SE5558 - 5T9998		SE5558 - 5T9998		SE5558 - 5T9998	
<b>SAMPLE</b>							
13. LOAD OVERHANG		a. FRONT		b. REAR		c. LEFT SIDE	
		NA		NA		NA	
						d. RIGHT SIDE	
						NA	

DD FORM 1266 1 JAN 66

Figure 3-6. DD Form 1266 (Request for Special Hauling Permit) (sample)



vehicles with loads of uniform weight and dimensions may be listed on the same DD Form 1266. See Figure 3-6 for a sample re-

quest. See FM 55-312 for detailed preparation instructions.

14. NUMBER OF AXLES									
	(1)	(2)	( )	( )	( )	( )	( )	( )	( )
	A	B	C	D	E	F	G	H	I
	AXLE 1	AXLE 2	AXLE 3	AXLE 4	AXLE 5	AXLE 6	AXLE 7	AXLE 8	TOTAL
15. NUMBER OF TIRES	2	4	4	4	4				18
16. TIRE WIDTH (Inches)	11	11	11	11	11				
17. TIRE SIZE	1100x20	1100x20	1100x20	1100x20	1100x20				
18. AXLE LOAD (Empty)	8,244	6,958	6,958	5,320	5,320	<b>SAMPLE</b>			32,800
19. AXLE LOAD (Loaded)	9,044	8,058	8,058	6,320	6,320				37,800
20. AXLE SPACING (See item 24 for identification)	A SPACING	B SPACING	C SPACING	D SPACING	E SPACING	F SPACING	G SPACING	H SPACING	
	140	54	162	52					
21. REMARKS									
22. MOVEMENT BY HIGHWAY IS <input type="checkbox"/> ESSENTIAL TO NATIONAL DEFENSE <input checked="" type="checkbox"/> IN THE INTEREST OF NATIONAL DEFENSE									
23. REQUESTING AGENCY					24. APPROVING AGENCY				
100th Trans Co (Lt Mdn Trk)									
25. REQUESTED BY (Typed name, grade and title)					26. APPROVED BY (Typed name, grade and title)				
Charles C. Chestnut, Opt, TC, Commanding									
27. DATE	28. SIGNATURE				29. DATE	30. SIGNATURE			
1 Jan XX	<i>Charles C. Chestnut</i>								
<b>INSTRUCTIONS</b>									
<p><b>GENERAL:</b></p> <p>DD Form 1266 "Request for Special Hauling Permit" will be used to obtain special hauling permits for the movement of oversize/overweight vehicles over public highways when accompanying a convoy or when traveling separately.</p> <p>This form, in duplicate and accompanied by letter of transmittal, will be forwarded through the local transportation officer as soon as possible to the appropriate headquarters not less than ten (10) working days prior to the starting date of the movement. Letters of transmittal will contain complete itinerary and explanation of the movement. One (1) letter of transmittal is sufficient when several DD Forms 1265 and 1266 involving one (1) movement are forwarded to the appropriate headquarters.</p> <p>In cases where bona-fide emergencies exist, the information contained in this form and DD Form 1265 may be transmitted to the appropriate headquarters by telephone or electric transmission. In this event, reference will be made</p>					<p>to item numbers in the sequence in which they appear on the forms. Items which do not apply will be so indicated.</p> <p><b>SPECIFIC:</b></p> <p>Item 9A, B, C, and D - Complete nomenclature of vehicles involved. More than one unit may be included, provided units are identical in equipment, load characteristics, routing and movement date. Total number of units shall be indicated prominently.</p> <p>Item 9E - Note all units other than standard highway vehicles, road equipment, guns, etc.</p> <p>Item 9 (d) - Indicate the registration number for each unit or combination of units. Use additional page if required.</p> <p>Item 14 - Indicate appropriate number of axles by inserting number in proper circles. Block out circles not applicable.</p> <p>Item 21 - For movement through the District of Columbia, include name of manufacturer of equipment.</p>				

Figure 3-6. DD Form 1266 (Request for Special Hauling Permit) (sample) (cont)

## PLANNING

### Unit/Vehicle Capabilities

**General factors.** Motor transport planning, particularly in its earliest stages, must often be based on broad planning factors and assumptions. However, because of the varied services performed, loads carried, and terrain crossed, use general planning factors with caution and only in the absence of specific data on the local situation. When specific data is not available, use the following estimates to compute vehicle and truck company requirements:

- Average number of assigned task vehicles not in maintenance and available for daily operations — 83 percent (short-range), 75 percent (long-range).

**NOTE:** Short-range figure is for maximum sustained effort only. It is not to be used for periods of more than 30 days.

- Anticipated payload per vehicle — rated cargo capacity of vehicle (but 3,000-gal capacity for 5,000-gal-tank semitrailers).
- Average daily round-trips per vehicle (will vary with running time and delay times) — two per day (one per operating shift) (line-hauls), four per day (two per operating shift) (local hauls).
- One-way hauling distance — 90 miles/144 kilometers one way per operating shift (line-hauls), 15 miles/24 kilometers one way per trip (local hauls).
- Average number of miles covered in an hour (including short halts) — 10 MIH/16 KIH (poor roads), 20 MIH/32 KIH (good roads).

**NOTE:** Under actual road conditions, consider not only the road's surface, but also terrain, weather, and hostile activity, all of which may affect rate of march.

- Turnaround time — time consumed for round-trip movement, including delays.
- Delay time (includes loading, unloading, and line-haul relay time; also includes halts and delays en route, such as mess halts or ferrying

operations, which can be anticipated but are not included in the rate of march).

– 2.5 hours loading/unloading time per round-trip (cargo trucks).

– 2.5 hours loading/unloading time per round-trip (semitrailers).

– 1 hour per relay round-trip per line-haul leg (tractor trucks in semitrailer relay operations).

- Use per day of vehicles with drivers — 10 hours (one shift), 20 hours (round-the-clock, two shifts).

**NOTE:** The remaining 4 hours of the 24-hour day is scheduled for maintenance.

- Unit lift and daily lift — the amount of cargo a truck company can move at one time (unit lift); the amount it can move in a day, making a number of trips (daily lift).
- Ton- or passenger-miles — the product of the number of tons or passengers times the number of miles moved.

**TOE capabilities.** For planning purposes, in the absence of other specific operational data, see Section II for motor transport unit tonnage and passenger capabilities estimated from TOE capabilities. Also refer to Section II for estimated vehicle payload capacities.

**Fuel Requirements.** NATO uses the fuel consumption unit (FCU) method to calculate fuel requirements (STANAG 2115). This is an easy method which uses current data. The FCU is the quantity of fuel required for operation by a given piece of equipment under average operating conditions, based on —

- 100 kilometers of movement per day for wheeled and tracked vehicles over solid, level, dry roads.
- 3 hours of flying time per day for aircraft.
- 12 hours of normal operating time for stationary equipment.

Use the FCU method to compute fuel consumption requirements for a brigade, division, or corps:

- List each type of equipment on the organization TOE by nomenclature and quantity on hand.
- Multiply the number of pieces of each type of equipment by the rate of consumption for the equipment. (See appropriate technical manual for rate.)
- Add the gallons of each type of fuel used to obtain estimated fuel requirement for each type of fuel.
- Under combat conditions, the total number of gallons consumed is multiplied by factors representing the type of combat, terrain, and climate present. See Table 3-2 for a list of these factors. Use them *only* in combat situations.

**Table 3-2. FCU factors (combat conditions)\***

Situation	Multiplication Factor
<b>Combat:</b>	
Attack	2.5
Delay/Withdrawal	2.0
Defense	1.5
<b>Terrain:</b>	
Flat	1.0
Hilly	1.2
Mountain	1.5
Cross-Country	1.5
<b>Climate:</b>	
Hot	0.9
Temperate	1.0
Cold	1.3

\*Use these factors *only* if unit is involved in combat.

For example: An organization's total diesel fuel requirement under average conditions is 109,784 gallons per day. During combat, additional calculations are required for combat (delay), terrain (hilly), and climate (hot). Compute the fuel consumption rate for the organization using the following formula:

$$\text{Combat (delay) X terrain (hilly) X climate (hot) X total gallons diesel fuel per day (average operating conditions) = diesel fuel consumption for the organization}$$

$$2.0 \times 1.2 \times 0.9 \times 109,784 = 237,132 \text{ gal/day total diesel fuel consumption}$$

**Movement Requirements**

Use the following formulas to compute unit and vehicle requirements on the basis of planning estimates, actual operational data, or a combination of both. If the load you are computing is not in tons, substitute the particular unit (gallons, persons, other) for tons in the formulas.

**One-time lifts.** To determine the number of truck companies or vehicles required to move a given number of tons in one lift, substitute appropriate values in the following formulas:

$$\text{companies required} = \frac{\text{tons to be lifted}}{\text{tons per veh} \times \text{veh aval per company}}$$

$$\text{vehicles required} = \frac{\text{tons to be lifted}}{\text{tons per veh}}$$

**Turnaround time.** To determine turnaround time, use the following formula:

$$\text{turnaround time} = \frac{2 \times \text{distance}}{\text{rate of march (MIH)}} + \text{delays}$$

The delay factor must be accurate. Round off turnaround time to the nearest tenth.

**Line-haul leg.** Use the following formula to determine the distance to allow between trailer, transfer points (TTPs) (that is, the length of a line-haul leg):

$$\text{distance} = \frac{(\text{hr per operating shift} - \text{hr of delay}) \times \text{rate (MIH)}}{2}$$

The numerator in the formula equals the total distance a driver can travel in one round-trip shift. Division by 2, therefore, results in a driver's one-way distance. One-way distance equals the length of a line-haul leg.

**Sustained operations.** Use the following formula to determine the number of truck companies required to move a given daily tonnage in sustained operations. The formula applies to both local and line-haul operations.

$$\text{companies required} = \frac{\text{daily tonnage} \times \text{turnaround time}}{\text{tons per veh} \times \text{veh aval per company} \times \text{operational day}}$$

The number of vehicles required can be determined by omitting vehicles available per company from the formula.

$$\text{vehicles required} = \frac{\text{daily tonnage} \times \text{turnaround time}}{\text{tons per veh} \times \text{operational day}}$$

**Specific loads.** A transport mission may require movement of specific loads which, because of their peculiarities, involve a variation in the normal planning process. The loads may be one or more items, packaged or not packaged, with unusual size, shape, cube, or weight. Examples are aircraft engines and missile components. In such cases, determine vehicle requirements by test loading or by using operational data available from previous similar operations. If test loading is not feasible or operational data is unavailable, use the method described here.

First, determine the number of items that can be transported by one vehicle. This can be computed from the cargo weight or cube. If circumstances warrant, calculate the load both ways to arrive at the lesser figure:

$$\frac{\text{veh payload capacity}}{\text{weight of item}} = \text{number of items, by weight, in a single-vehicle load}$$

$$\frac{\text{veh cargo compartment cube}}{\text{cube of item}} = \text{number of items, by cube, in a single-vehicle load}$$

If the value using cargo weight is the lesser value, the weight of the computed load will exceed the vehicle payload capacity before all available cargo space is filled. If the value using cargo cube is the lesser, the computer cargo load will "cube out" (exceed the cubic cargo space available in the vehicle) before it "weighs out" (exceeds the vehicle payload capacity).

Obtain the vehicle payload capacity and the cargo compartment cubic capacity from the vehicle data plate, vehicle technical manual, or Section II of this chapter. The weight and cubic volume of a specific item or load can be obtained from the shipper, the service representative, or the applicable technical manual.

Knowing the single-vehicle load, compute the number of vehicles required:

$$\frac{\text{number of items to be transported}}{\text{number of items in single-veh load}} = \text{vehicles required}$$

The calculation may be for a one-time lift or a day-to-day lift, depending on the mission.

### Line-Haul Operational Planning Exercise

The following procedure demonstrates how to plan and set up a motor transport line-haul move involving trailer transfer operations. See Figure 3-7 for a diagram of the route including length of line-haul, locations of support facilities, and tonnages to be moved.

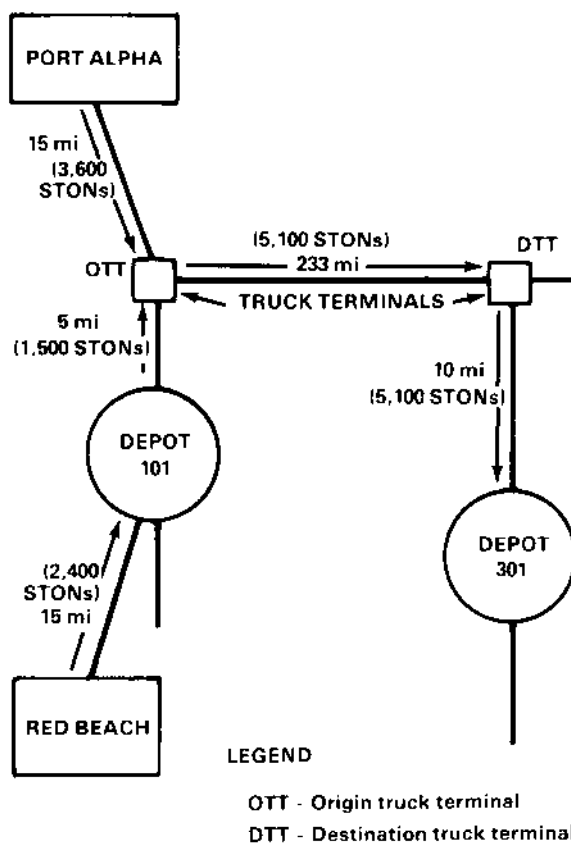

Figure 3-7. Route and location of facilities

**Tonnages.** Information provided by the staff movements officer establishes tonnages to be moved by highway:

- 13,600 STONs daily from Port Alpha to Depot 301.

- 2,400 STONs daily from Red Beach to Depot 101.
- 1,500 STONs daily from Depot 101 to Depot 301.

The daily forward movement of 3,600 STONs from Port Alpha and 1,500 STONs from Depot 101 have been combined at the point on the route where these forward movements coincide. Figure 3-7 provides a realistic picture of the tonnage flow over the road and a working aid in planning this type of operation.

**Planning factors.** For purposes of this exercise, assume cargo is a type that can be loaded to rated weight capacities of vehicles without exceeding cube capacities of cargo compartments. Use the following operational planning factors:

- Round-the-clock operation — two 10-hour shifts.
- Vehicles available per unit — 45 (at 75 percent availability rate).
- Load per 2 1/2-ton truck — 2.5 tons (off-road weight only).
- Load per 34-ton M872 semitrailer — 22 tons.
- Load per 22 1/2-ton M871 semitrailer — 15 tons.
- Load per 12-ton cargo semitrailer — 10 tons.
- Rate of march:
  - 20 MIH/32 KIH — main supply route between origin and destination terminals.
  - 15 MIH/24 KIH — Port Alpha to origin terminal, Depot 101 to origin terminal, destination terminal to Depot 301.
  - 10 MIH/16 KIH — Red Beach to Depot 101.
- Delay times:
  - 2.5 hours per round-trip (1.25 hours for loading, 1.25 hours for unloading).
  - 1 hour per relay (round-trip per leg) for truck tractors.

**Truck terminals.** Truck terminals are normally located in or near centers of concentrated trucking activities at both ends of a line-haul.

They form the connecting link between local pickup and delivery service (local haul) agencies and the line-haul operations. They provide assembly points and dispatch centers for line-haul motor transport equipment. Truck terminals may be used for in-transit storage or freight sorting, but this use should be held to an absolute minimum.

Figure 3-8 shows a typical origin truck terminal. Arrangement of facilities may deviate from the diagram, but consider the facilities indicated to be the minimum necessary for effective terminal operation.

In this line-haul exercise, distances and operating factors require short-haul/shuttle tractor operations in conjunction with a trailer relay operation. Therefore, the approximate locations of the origin and destination truck terminals must be found for the line-haul task. This is needed to separate the line-haul from local operations and to identify specific work loads and tasks.

The origin truck terminal should be centrally located near the road intersection between Port Alpha and Depot 101, provided a suitable site is available. The destination truck terminal should be located near the intersection above Depot 301. This would place the destination terminal on the main route near the cargo's destination and would allow for expansion forward without relocation. Refer back to Figure 3-7. Note that there is no requirement for an intermediate truck terminal.

**Trailer transfer points.** Trailer transfer points are located at predetermined locations along the route of a line-haul operation. They form the connecting links between various operating units' areas of responsibility. Trailer transfer points tie the overall operation into one continuous, efficient movement procedure.

Before determining and computing the type and number of truck units required for each task for the line-haul, locate the trailer transfer points to divide the line-haul into legs. Then compute total delays and total turnaround time for the entire line-haul. To determine the distance of each leg for a turnaround time of 10 hours in around-the-clock operation, allow a 1-hour relay time per line-haul leg.

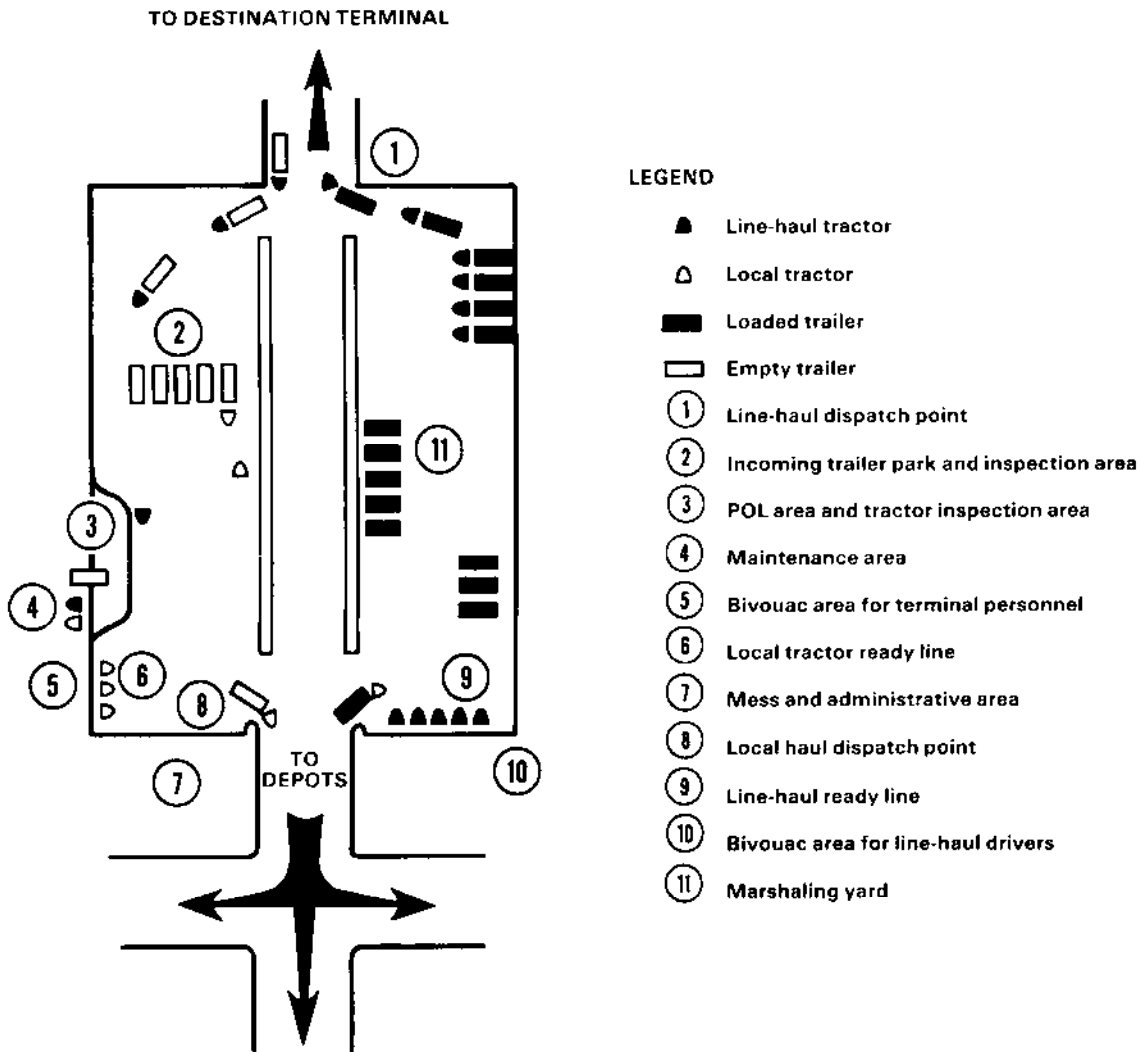

Figure 3-8. Typical origin truck terminal layout

$$\begin{aligned}
 \text{distance} &= \frac{(10 \text{ hr per operating shift} - 1 \text{ hr delay}) \times 20 \text{ MIH}}{2} \\
 &= \frac{(10-1) \times 20}{2} \\
 &= 90 \text{ miles between trailer transfer points}
 \end{aligned}$$

Trailer transfer points are then located as shown in Figure 3-9. In addition to allowing the most desirable turnaround time, the planner must consider suitable sites for locating these facilities. Note also that the short leg (53 miles) has been placed forward. This is to avoid

relocating any but the most forward trailer transfer point if the operation is expanded.

**Types of units.** Specific tasks, work loads, and types of units required for the exercise can not be determined from the preceding information. A study of the overall operation is needed, including types of hauls, operating areas, and daily tonnage requirements, to indicate the kinds of units most suitable for the various transport missions. For this exercise, the units required are medium truck companies (34-ton semitrailer) and light truck companies (2 1/2-ton truck) (see Figure 3-10).

**Number of units.** Medium truck companies were selected for the line-haul and three local hauls:

- Origin truck terminal to destination truck terminal.
- Port Alpha to origin truck terminal.
- Depot 101 to origin truck terminal.
- Destination truck terminal to Depot 301.

The medium truck companies may be equipped with the 12-ton M127A2 semitrailer, the 22 1/2-ton M871 semitrailer, or the 34-ton M872 semitrailer. The M872 is used primarily by theater army units. A light truck company was selected for the local haul from Red Beach to Depot 101.

The planner now calculates the number of medium and light truck companies needed for the operation.

1. Line-haul, origin to destination truck terminal, 5,100 STONs by medium truck company:

- Vehicles per company — 45 tractors with semitrailers (stlr) (at 75 percent vehicle availability).
- Average payload per vehicle — 22 STONs (34-ton stlr).
- Given 1 hour delay for each of three relays, 233 miles distance from OTT to DTT —

$$\text{turnaround time} = \frac{(2 \times 233 \text{ mi})}{20 \text{ MIH}} + 3 \text{ hr} = 26.3 \text{ hr}$$

- Operational day — 20 hours.
- Number of companies required —

$$\frac{5,100 \text{ STONs} \times 26.3 \text{ hr}}{22 \text{ STONs} \times 45 \text{ veh} \times 20 \text{ hr}}$$

$$= \frac{134,130}{19,800}$$

$$= 6.77 \text{ medium truck companies}$$

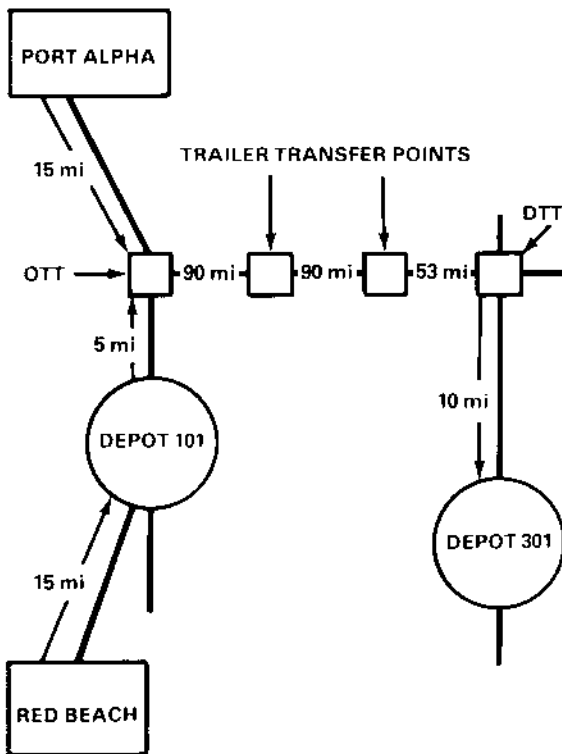

Figure 3-9. Location of trailer transfer points

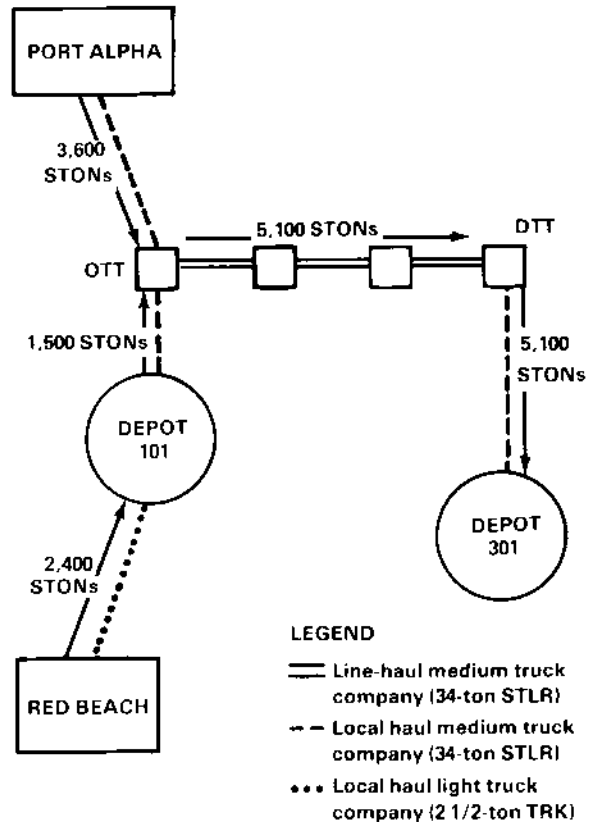

Figure 3-10. Types of units

2. Local haul, Port Alpha to origin truck terminal, 3,600 STONs by medium truck company:

- Vehicles per company — 45
- Average payload per vehicle — 22 STONs (34-ton stlr).
- Given 1 hour delay time, 15 miles distance—

$$\text{turnaround time} = \frac{(2 \times 5 \text{ miles})}{15 \text{ MIH}} + 1 \text{ hour} = 1.67 \text{ hours}$$

- Operational day — 20 hours.
- Number of companies required —

$$\frac{3,600 \text{ STONs} \times 3 \text{ hr}}{22 \text{ STONs} \times 45 \text{ veh} \times 20 \text{ hr}} = \frac{10,800}{19,800}$$

= .55 medium truck company

3. Local haul, Depot 101 to origin truck terminal, 1,500 STONs by medium truck company:

- Vehicles per company — 45.
- Average payload per vehicle — 22 STONs (34-ton stlr).
- Given 1 hour delay time, 5 miles distance—

$$\text{turnaround time} = \frac{(2 \times 5 \text{ miles})}{15 \text{ MIH}} + 1 \text{ hr} = 1.67 \text{ hr}$$

- Operational day — 20 hours.
- Number of companies required —

$$\frac{1,500 \text{ STONs} \times 1.67 \text{ hr}}{22 \text{ STONs} \times 45 \text{ veh} \times 20 \text{ hr}} = \frac{2,505}{19,800}$$

= .13 medium truck company

4. Local haul, destination truck terminal to Depot 301, 5,100 STONs by medium truck company:

- Vehicles per company — 45.
- Average payload per vehicle— 22 STONs (34-ton stlr).
- Given 1 hour delay time, 10 miles distance—

$$\text{turnaround time} = \frac{(2 \times 10 \text{ mi})}{15 \text{ MIH}} + 1 \text{ hr} = 2.33 \text{ hr}$$

- Operational day—20 hours.
- Number of companies required—

$$= \frac{5,100 \text{ STONs} \times 2.33 \text{ hr}}{22 \text{ STONs} \times 45 \text{ veh} \times 20 \text{ hr}} = \frac{11,883}{19,800}$$

= .60 medium truck company

5. Local haul, Red Beach to Depot 101, 2,400 STONs by light truck company:

- Vehicles per company — 45.
- Payload per vehicle — 2.5 STONs.
- Given 2.5 hours per round-trip for loading/unloading, 15 miles distance —

$$\text{turnaround time} = \frac{(2 \times 15 \text{ mi})}{10 \text{ MIH}} + 2.5 \text{ hr} = 5.5 \text{ hr}$$

- Operational day — 20 hours.
- Number of companies required —

$$\frac{2,400 \text{ STONs} \times 5.5 \text{ hr}}{2.5 \text{ STONs} \times 45 \text{ veh} \times 20 \text{ hr}} = \frac{13,200}{2,250}$$

= 5.87 light truck companies

A total of six light truck companies is needed for the local haul from Red Beach to Depot 101. When less than a full company is required, teams from TOE 55-540 may be used for augmentation.

Determine the total number of medium truck companies by adding the numbers for each haul.

6.77	line-haul, origin to destination truck terminal
.55	local haul, port Alpha to origin truck terminal
.13	local haul, Depot 101 to origin truck terminal
.60	local haul, destination truck terminal to Depot 301
<hr/>	
8.05	or 9 total number of medium truck companies

In this operation all medium truck companies share the work load since all are connected with the semitrailer relay operation. Therefore, the fractional part of the unit requirement for each task is retained and included in the total. The total is then rounded



off to the next higher whole number. However, where the work load cannot be shared among units doing varied tasks, the unit requirement for each task must be rounded off to the next higher whole number.

**Control units.** Based on the preceding computations, nine medium truck companies and six light truck companies are required for the operation. In addition, four teams (Team GE, TOE 55-540) are required to operate the two trailer transfer points and the transfer operations in the truck terminals. Three motor transport battalions and one motor transport group are required for command and control. (See FM 101-10-2 for basis of allocation.) The group commander has overall responsibility for the operation and assigns a specific geographic area to each battalion. The group commander assigns responsibility for operating each truck terminal to a specific battalion.

## TRANSPORT OPERATIONS

### Motor Pool Facility

The basic layout of motor pools varies, depending on space and conditions. For new construction, a single structure should be built to economize on construction costs and operating expenses. The typical motor pool should include these facilities:

- **Motorpool office.** This office should be in the motor pool operations area.
- **Dispatch office.** All vehicular operations are controlled through this office. If at all possible, it should be at the exit of the motor pool. This allows the dispatcher to visibly check vehicles leaving the parking area.
- **Drivers' room.** For convenience and orderly operation, the drivers' room should be near, but separate from, the dispatch office.
- **Emergency repair facility.** This facility performs minor and emergency repairs not serious enough to warrant removing the vehicle from operation. The repair facility is usually in a section of the general repair shop or at the POL point.
- **Vehicle-washing facilities.** These facilities should be available under all weather conditions. Facilities should be located so that

drainage flows away from parking areas and buildings. Automatic washing facilities should be considered when feasible.

- **Preventive maintenance and general repair shop.** The number of vehicles to be serviced is a deciding factor in the type of shop used. Primary functions of the shop are to carry out regularly scheduled preventive maintenance, lubrication, and general repair activities.

- **Allied trade shops.** These are shops for spot painting, minor body work, carpentry, and welding. Fire hazards in some trade shops require that these shops not be collocated. For example, painting and welding activities must be in separate areas.

- **Supply and parts room.** This facility is centrally located within the main shop building to provide easy access to parts and tools. Parts, bins, tool racks, and an appropriate issue counter should be provided.

- **Public address system.** A public address system helps to control the motor pool and parking area. Interoffice communication between the dispatch office and key locations within the pool area eliminates many unnecessary, time-consuming trips and promotes orderly operation.

### Vehicle Loading

The driver is responsible for his vehicle being loaded properly. Follow these loading rules:

- Place heavy supplies at the bottom of the load and distribute them evenly over cargo floor.
- Place the load so that it will not shift; distribute the weight equally.
- Do not distribute load loosely or build it up too high. High, loosely distributed loads cause swaying. This makes the vehicle difficult to handle and increases the danger of losing the cargo or overturning the vehicle.
- If the truck has an open body, put a tarpaulin over the cargo when practicable to protect against sun, dust, rain, and pilferage.
- If possible, place barrels and drums on their sides parallel with the length of the truck. Brace and pyramid them. If the possibility of leakage prohibits this placement, set the

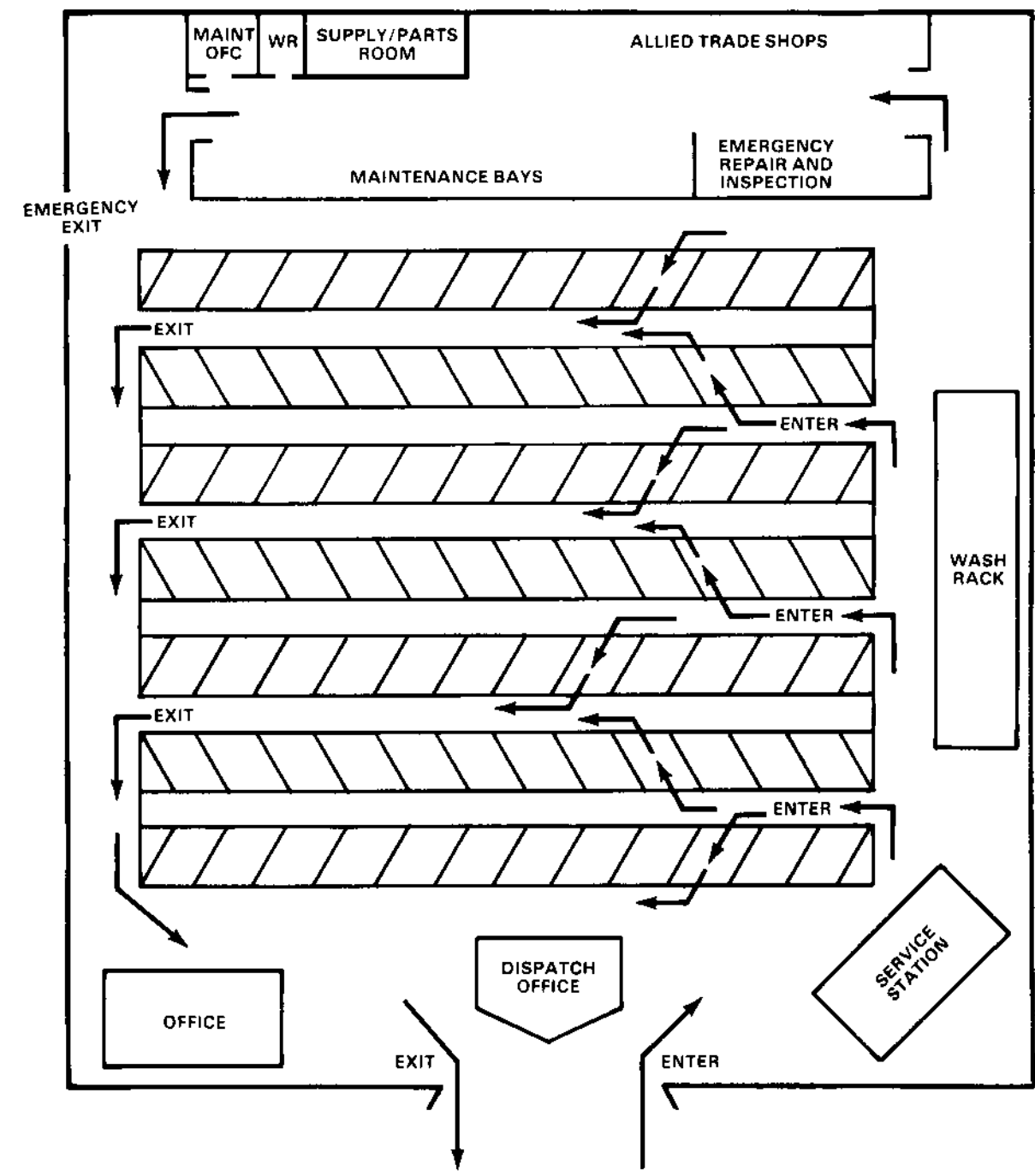

Figure 3-11. Motor pool facility layout

drums upright. Not as many drums can be loaded in the same space with the upright arrangement.

- Combine boxed, crated, and packaged cargo as much as possible with like items or items of compatible shapes.

- Load sacked cargo separately or so it will not be punctured by odd-shaped items; stack it in overlapping layers to prevent shifting.

See Figure 3-12 for correct placement of load in truck.



WRONG



RIGHT

Select the right vehicle for the right job.

CAB-OVER-ENGINE (COE) TRUCK

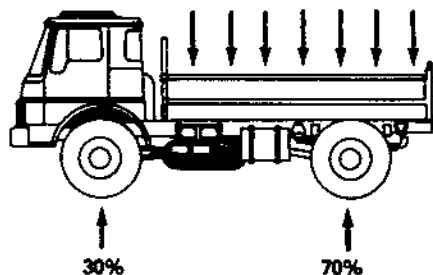

CONVENTIONAL TRUCK

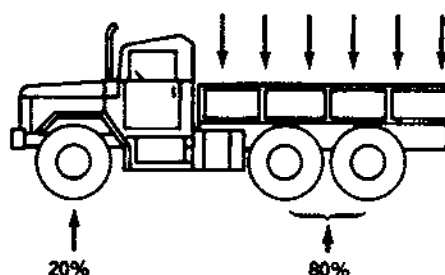

Tires, axles, and frame are designed to carry a load distributed as shown.

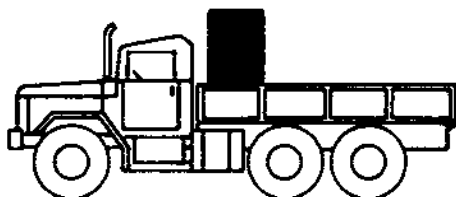

WRONG

This load bends the frame, overloads front tires, and makes steering harder.

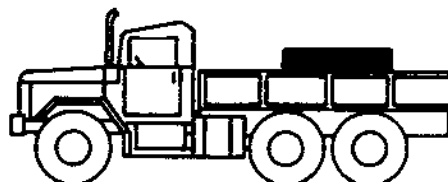

RIGHT

Place heavy part of load near rear axle for proper tire loading and to keep frame from bending.

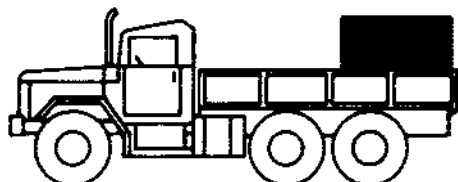

WRONG

This load bends the frame, overloads rear tires, and makes steering almost impossible.

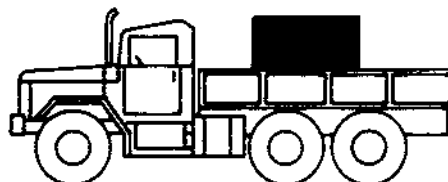

RIGHT

Set a concentrated load just ahead of the rear axle with the longest side on the floor, if possible.

Figure 3-12. Load placement in trucks and semitrailers

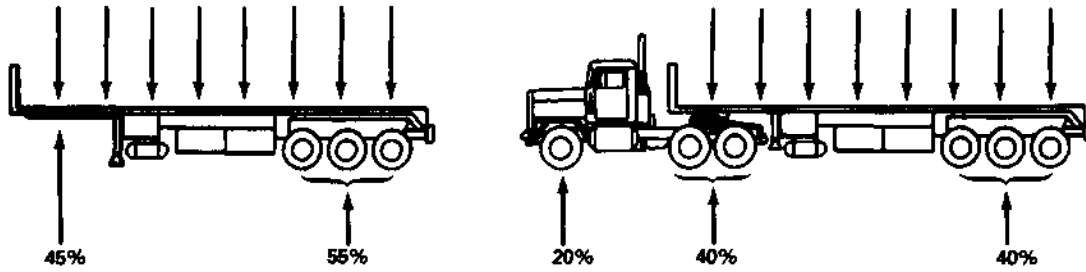

Distribute trailer loads equally between the rear tires and the fifth wheel. This placement transfers the load to the tractor.



WRONG

This placement overloads one spring and set of tires. Brakes lock on the light side, causing skids.



RIGHT

Nothing is overloaded; frame will not twist and loosen cross-member rivets.



WRONG

This placement shortens tire life and bends the truck rear-axle housing. Applying the trailer brakes may lock the wheels and cause flat spots and skidding.



WRONG

This placement overloads trailer rear wheels so that brakes will not function properly and rubber scuffs away.



RIGHT

Distribute the load over the full trailer floor.

Figure 3-12. Load placement in trucks and semitrailers (cont)

**Road Movement Table**

A road movement table is a convenient way to let subordinates know about schedules and other essential details. The table is particularly useful if including these details in the body of the operation order would complicate it or make it unduly long. Road movement tables frequently require a wider distribution than normal operation orders. Copies are issued to convoy operating personnel, traffic-regulating personnel, and traffic control posts. For security reasons, it may not be desirable to include dates or locations. A security classification is assigned according to the contents of

the road movement table. This classification is not necessarily the same as the operation order's. The road movement table may be issued as an annex to the operation order. If issued alone, the table must be signed and authenticated in the same way as other orders.

As illustrated in Figure 3-13, the road movement table shows the date of the move, units involved, number of vehicles, and load class of the heaviest vehicle. It also shows the routes and the times when serials will arrive at and clear critical points.

(CLASSIFICATION)													
Annex B - "Movement Table" to Operation Order for Movement No										Copy No			
Map:										Issuing HQ			
General Data:										Place of Issue			
1. Average speed:										Date-Time Group of Signature			
2. Traffic density:										Message Reference No			
3. Halts:													
4. Routes (between start points and release points):													
5. Critical points:													
(a) Start points.													
(b) Release points.													
(c) Other critical points.													
6. Main routes to start points:													
7. Main routes from release points:													
Serial or Movement Number	Date	Unit/Formation	Number of Vehicles	Load Class of Heaviest Vehicles	From	To	Route	Route to Start Point	Critical Points			Route from Release Point	Remarks
									Ref	Due (hr)	Clear (hr)		
(a)	(b)	(c)	(d)	(e)	(f)	(g)	(h)	(i)	(j)	(k)	(l)	(m)	(n)

Authentication:  
 Appendixes:  
 Distribution:

(CLASSIFICATION)

**Figure 3-13. Suggested format for road movement table.**

A strip-map may also be published as an annex to an operation order. When a strip map is used, its details should correspond to the data in the road movement table, and it should be distributed to the lowest practical level. Where practical and appropriate, a strip map may include —

- Start point.
- Release point.

- Route numbers.
- Town names.
- Critical points.
- Distance.
- Total distance.
- North orientation.

See Figure 3-14 for a sample strip map.

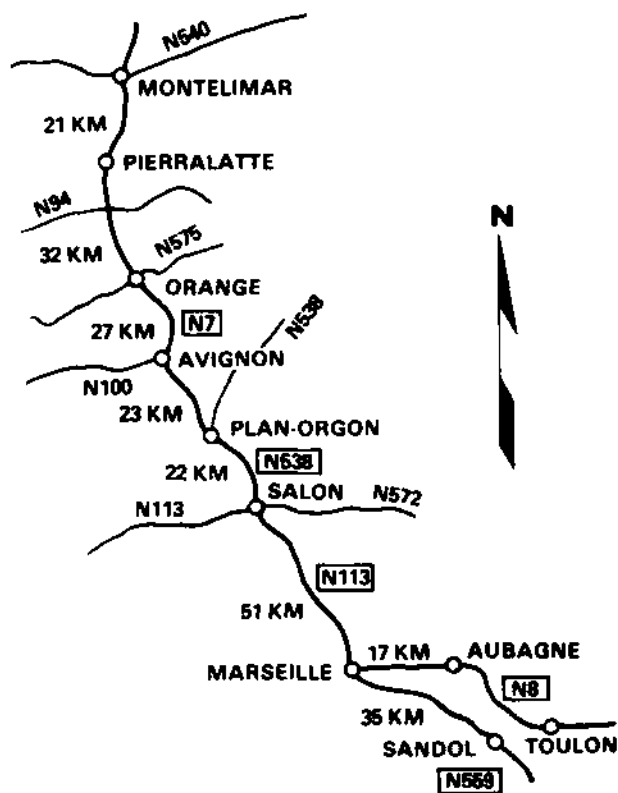

Figure 3-14. Sample strip map

**Route Reconnaissance**

A route reconnaissance overlay is an accurate and concise report of the conditions affecting traffic flow along a specified route and is the preferred method of preparing a route reconnaissance report. An overlay normally satisfies the requirements of hasty route reconnaissance. If, however, more detail is required to support the reconnaissance, the overlay is supplemented with written reports describing critical route characteristics in more detail. For additional information, see FM 5-36. See Figure 3-15 for an example of a route reconnaissance overlay. See Figure 3-16 for an explanation of route reconnaissance symbols.

Consider the following checklist when preparing reconnaissance reports:

- Identification and location of the reconnoitered route.
- Distance between points, which should be easily recognized both on the ground and on the map.

- Percent of slope and length of grades which have a 7 percent slope or greater.
- Sharp curves with a radius of 100 feet or less.
- Bridge military load classifications, limiting dimensions, and suitable bypasses.
- Locations and limiting data for fords and ferries.
- Route restrictions, such as underpasses, which are below minimum standard and any additional distances caused by these restrictions.
- Locations and limiting dimensions of tunnels and suitable bypasses.
- Suitable areas for short halts and bivouacs which offer drive-off facilities, adequate dispersion, cover, and concealment.
- Areas of rockfalls and rockslides which may present a traffic hazard.

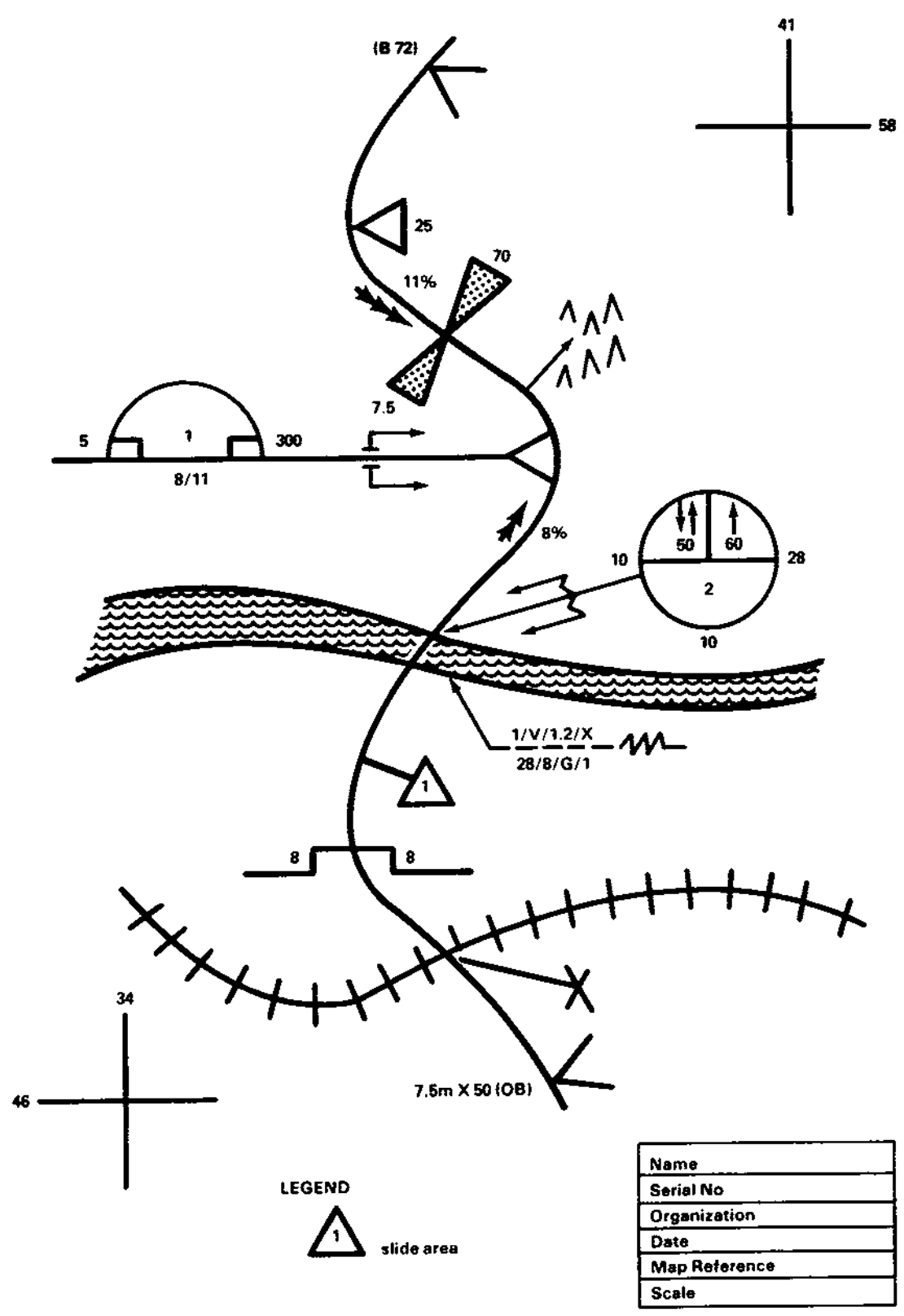



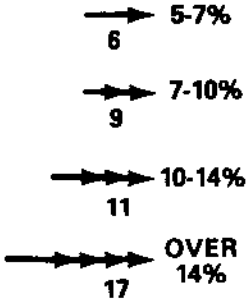



Figure 3-15. Sample route reconnaissance overlay

Explanation	Symbol	Remarks/Reference*
Civil or military route designation		Designation written in parentheses along route.
Critical point		Critical points are numbered and described in legend. They may be used to point out features not adequately covered in other reconnaissance symbols.
Limits of sector		Limits of reconnoitered sector of route.
Route classification formula	<p>10.5m X 120 6m Z 8 (OB) 9m Y 20 (OB)(W)</p>	<p>Formula designates, in order, width, type, military load classification, obstructions, and regular flooding or snow blockage.</p> <p>Legend:</p> <ul style="list-style-type: none"> <li>X—All-weather route</li> <li>Y—all-weather route (limited traffic)</li> <li>Z—fair-weather route</li> <li>T—regular snow blockage</li> <li>W—regular flooding</li> </ul>
Grades		Arrows point uphill; actual percentage of slope is shown to the right of symbol. Length of arrow represents length of grade if map scale permits.
Sharp curve		Vertex of triangle points to map location of curve; number indicates radius.
Series of sharp curves		Left figure indicates number of curves. Right figure indicates radius of the sharpest curve.

\*All dimensions are in meters.

Figure 3-16. Route reconnaissance symbols





Explanation	Symbol	Remarks/Reference
Ferry		<p>Arrow extends to ferry location on map. Data above symbol indicates, in order, ferry serial number and type. Data inside symbol indicates, in order, military load class of deck and dead weight capacity in tons. Data below symbol is turnaround time in minutes.</p> <p>Question mark indicates unknown information. Difficult approaches are represented by zigzag lines corresponding in position to shore approach.</p> <p>Ferry type:  V—vehicular  P—pedestrian</p>
Width constriction		<p>Figure to the left indicates the width of the route constriction; figure to the right, the total constricted length.</p>
Arch underpass constriction		<p>Figure to left indicates width of constriction; figure to right, overhead clearance. If different, both minimum and maximum overhead clearances are given.</p>
Rectangular underpass constriction with sidewalks		<p>Numbers indicate width of traveled way followed by total width, including sidewalk, to left of symbol. Overhead clearance appears on right.</p>
Tunnel with sidewalks		<p>Arrow extends to tunnel location on map. Serial number is placed inside symbol; width of traveled way, followed by total width including sidewalks, is placed below symbol. Overhead clearance is placed to the left of symbol, total tunnel length to the right. A question mark represents unknown information. Bypasses are shown by standard symbol notations.</p>
Railroad grade crossing		<p>Grade crossing is level; passing trains will interrupt traffic flow. Number indicates height of power line (if present) above the ground.</p>
Concealment		<p>Road lined with trees, deciduous on left, evergreen on right.</p>

Figure 3-16. Route reconnaissance symbols (cont) .







Explanation	Symbol	Remarks/Reference
Concealment		Woods bordering road, deciduous trees on left, evergreen trees on right.
Side road turnoff Additional information: •Wheeled vehicle •Tracked vehicle •Dead-end road over 1 km		Arrow indicates direction of turnoff.  Number indicates length of turnoff.
Roadblock, craters, and blown bridges  •Proposed •Prepared but passable •Completed		Center of the symbol indicates position of block.
Lateral route		Broken lines indicate lateral route identified by even number.
Axial route		Solid line indicates axial route identified by odd number.
Unknown or doubtful information		
Parking area		
Traffic control point		

Figure 3-16. Route reconnaissance symbols (cont)

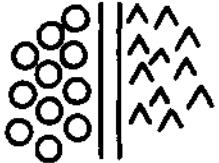
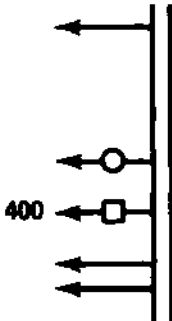
**Traffic Circulation Plan**

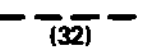
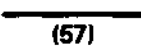
A traffic circulation plan is a map that shows a roadnet and gives necessary information and traffic restrictions. The circulation plan establishes one-way, two-way, and alternating routes of traffic flow. Routes must be available for a circular flow in the required directions. A one-way route normally requires a return route in the opposite direction. Adequate access and egress routes must be provided to prevent congestion of main supply routes.

Normally, the traffic circulation plan contains—

- Route designations and the most restrictive route features.
- Direction of movement.
- Location of boundaries, unit highway regulation points, traffic control posts, and principal supply activities.
- Major geographic features.
- Light lines, if applicable.

Circulation plans frequently combine a standard map with an overlay to give the needed information. If the necessary information is too much to put on one overlay, use separate overlays for different types of information. See Figure 3-17 for a sample traffic circulation plan.

Tonnage capacities of roads and bridges are important considerations when selecting routes. The gross weight of the heaviest loaded vehicle should not exceed the rated tonnage capacity of the weakest bridge. It is difficult to

determine exact tonnage capabilities of highways for sustained operations because conditions will vary. Also, the volume of tactical, administrative, and local traffic using supply routes may exceed that of cargo-hauling vehicles. This traffic further restricts highway transport capabilities.

In the absence of more accurate data, use Table 3-3 as a guide for highway tonnage capabilities. The table provides estimates of supply support tonnage capabilities for various conditions. Sustained operations, adequate road maintenance, and two-way traffic are assumed. When more than one limiting condition is involved, apply the reduction factors in the same order as they appear in the table (left to right):

- First, narrow roadway.
- Second, terrain (rolling, hills, or mountains).
- Third, weather (if conditions are sustained).

Size and weight limits change periodically as a result of road and bridge construction. Planners must verify local limits and clearance and exemption methods with local military or civilian agencies before putting vehicles on the road.

**Military Load Classification System**

The military load classification system is a load-capacity rating system based on the vehicle's weight and its effect on routes and bridges. In this classification system, whole numbers are assigned to vehicles, bridges, and

**Table 3-3. Highway tonnage capabilities**

Highway Type	Daily Tonnage Forward (STONs)			Reduction Factors for Various Conditions (%)				
	Optimum Dispatch (Rear Area)	Supply Traffic (COMMZ)	Supply Traffic (CZ)	Narrow Roadway (Less than 24 ft or 7.20 m)	Rolling Terrain	Hills With Curves	Mountains	Seasonal Bad Weather
Concrete	60,000	36,000	8,400	25	10	30	60	20
Bituminous	45,000	27,000	7,300	25	10	30	60	30
Bituminous-treated	30,000	18,000	5,800	25	20	40	65	40
Gravel	10,150	6,090	3,400	25	20	50	70	60
Dirt	4,900	2,940	1,600	25	25	60	80	90

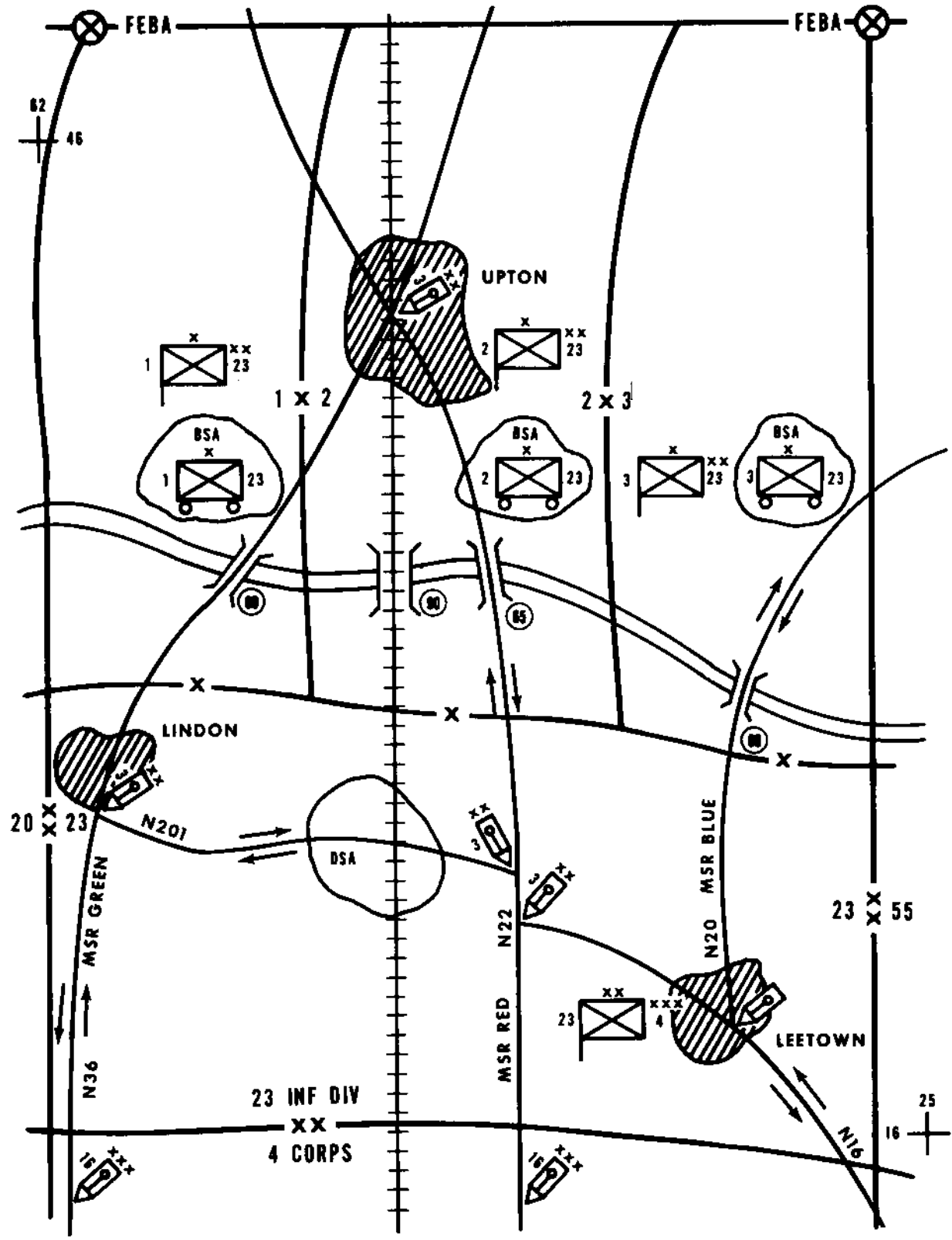

Figure 3-17. Sample traffic circulation plan

routes. Most allied military vehicles are externally marked with their respective classification number. Military load classifications are assigned to bridges and routes based on their safe-load capacity and physical dimensions. For a detailed discussion of the military load classification system, see FM 5-36.

**Vehicles.** Except for prime movers, self-propelled vehicles in Class 3 or higher and towed vehicles in Class 1 or higher are marked to

indicate their class. Prime movers are marked either with their own class or the class of the normal combination of prime mover with trailer or semitrailer. Markings on trucks should be on the right front, on or above the bumper, and below the driver's vision. Markings are lusterless black numerals on a lusterless forest green background. See Figure 3-18 for examples. For weight classification listings of specific vehicles, see FM 5-36.

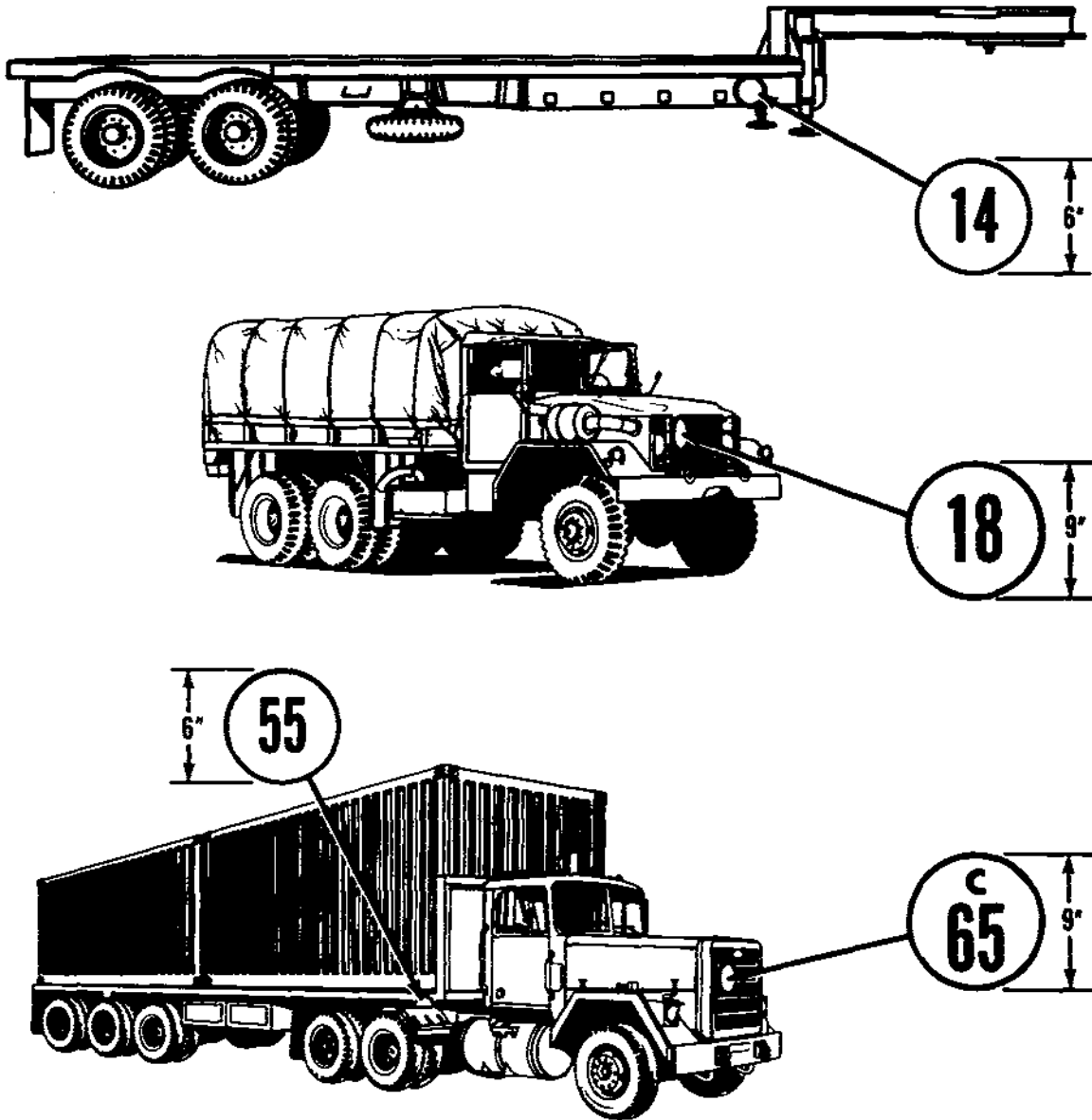

Figure 3-18. Vehicle classification markings

**Bridges.** Every military bridge is posted with a number capacity to indicate the highest weight-class vehicle that can safely cross. Heavier vehicles are barred except in special cases; for example, crossing at reduced speed or in limited numbers. Fixed bridges may also be marked with the length in feet of the span which corresponds to the posted capacity.

There are two types of bridge signs: classification (circular) signs and information (rectangular) signs. In both types, symbols or letters appear in black on a yellow background. See Figures 3-19 and 3-20 for examples.

**Routes.** Routes are classified according to the route classification formula. The formula is a brief description of the route, which is used with a route reconnaissance overlay. The route classification formula reflects a route's—

- Minimum traveled-way width.
- Weather resistance type.
- Lowest military load classification.
- Obstructions (if any).

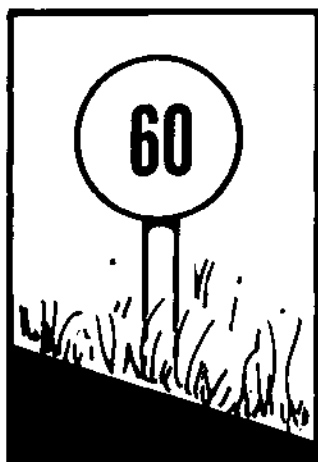

SINGLE-LANE  
FIXED BRIDGE

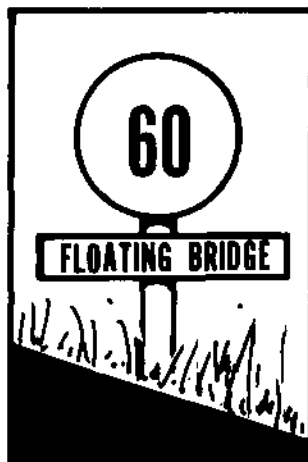

SINGLE-LANE  
FLOATING BRIDGE



TWO-LANE BRIDGE  
USED FOR EITHER  
SINGLE - OR TWO-  
LANE TRAFFIC

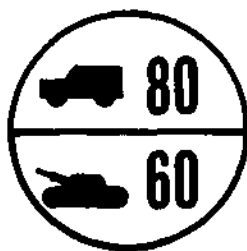

DUEL-CLASS BRIDGE

Figure 3-19. Typical bridge signs

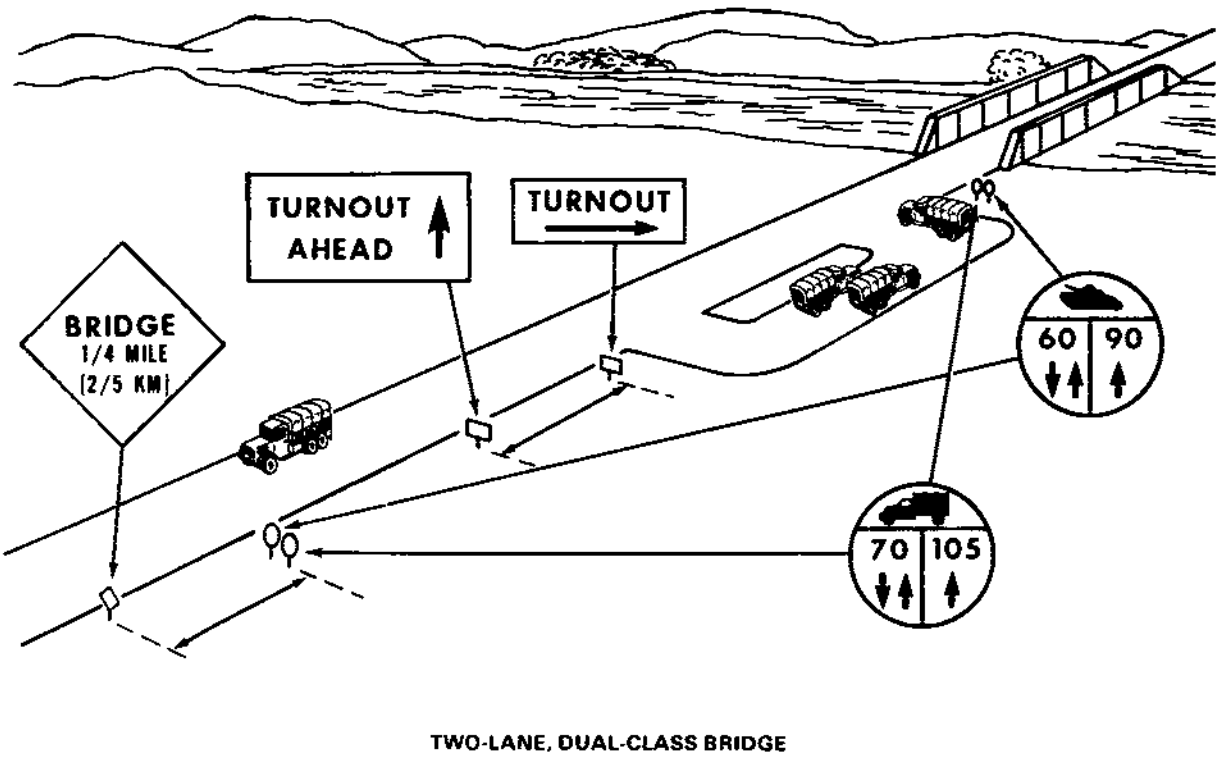
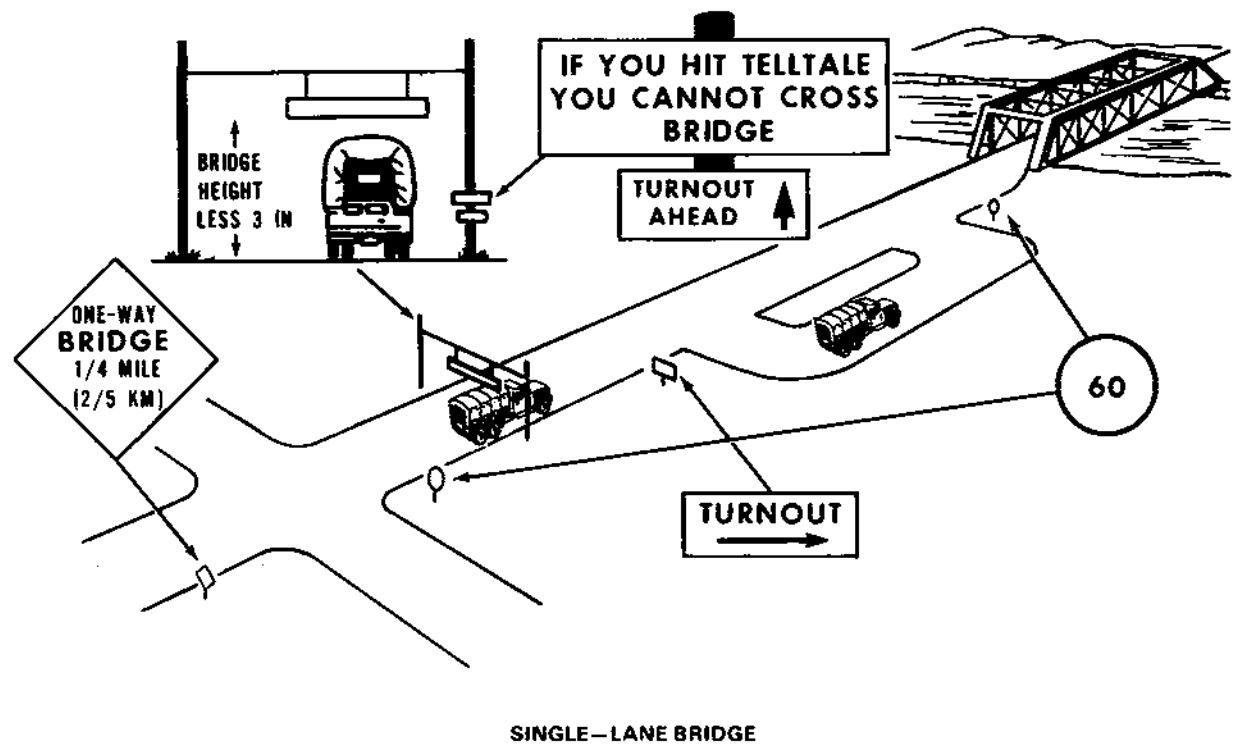

Figure 3-20. Typical placement of bridge signs



Width. Minimum route widths for wheeled and tracked vehicles in single- and double-flow traffic are:

Traffic Flow	Widths	
	Wheeled Vehicles	Tracked Vehicles
Single	18 to 23 ft (5.5 to 7 m)	19.5 to 26 ft (6 to 8 m)
Double	Over 23 ft (7 m)	Over 26 ft (8 m)

**Type.** For classification purposes, the type of route is based on its resistance to the effects of weather. The worst section of the route determines its type:

- Type X — an all-weather route which, with reasonable maintenance, is passable throughout the year to traffic that is never appreciably less than the maximum capacity of the route. Roads on a Type X route normally have waterproof surfaces and are only slightly affected by precipitation and temperature fluctuations. At no time is the route closed to traffic due to weather except for temporary snow or flood blockage.

- Type Y — an all-weather route which, with reasonable maintenance, can be kept open in all weather but may limit traffic in some kinds of weather. Roads on a Type Y route usually do not have waterproof surfaces and are considerably affected by precipitation and temperature fluctuations. Traffic may be completely halted for short periods. Heavy, unrestricted use during adverse weather may cause complete collapse of the surface.

- Type Z — a fair-weather route which quickly becomes impassable in adverse weather and can then be kept open only by major repairs. A Type Z route is so seriously affected by weather that traffic maybe brought to a halt for long periods.

**Load.** Route load classification is determined by the lowest bridge classification number,

regardless of vehicle type or traffic conditions. Using the lowest bridge classification number ensures that the route will not be overloaded. When a proposed route has a lower military load classification than that of the vehicles which must cross it, this fact is shown on the route reconnaissance overlay. A special reconnaissance determines if a change in traffic control procedures, such as a single-flow crossing, would make the route safe for these vehicles. If there is no bridge on the route, the worst section of road governs the route's classification.

**Obstructions.** Obstructions affect the type, amount, and speed of traffic flow. Route obstructions are indicated in the route classification formula by the letters "OB". (An exception is bridge capacities reported separately as a military load classification.) Reconnaissance symbols are used on the route reconnaissance overlay to describe each obstruction. Obstructions that must be included in the route classification formula are —

- Overhead obstructions, such as bridges, tunnels, underpasses, wires, and overhanging buildings, which have an overhead clearance under 14 feet (4.25 m).

- Reductions in traveled-way widths which are below the standard minimums prescribed in FM 5-36 for the type of traffic flow. Examples are width reduction due to bridges, tunnels, craters, mines, and projecting buildings or rubble.

- Gradients of 7 percent or greater.

- Curves with radii of curvature of less than 100 feet (30 m).

- Ferries.

- Fords.

If an obstruction appears in the route classification formula, refer to the route reconnaissance overlay to determine the exact type and location of the obstruction.

**Formulas.** Following are examples of typical route classification formulas:

Formula	Minimum Width of Traveled Way	Route Type	Military Load Classification	Remarks
20 ft Z 10	20 ft	fair weather	10	Based on 20-ft min width of traveled way, accommodates wheeled and tracked, single-flow traffic. No obstruction.
20 ft Z 10 (OB)	20 ft	fair weather	10	If used for double-flow traffic, min width of traveled way (20 ft) is considered an obstruction.
7 M Y 50 (OB)	7 m	limited all-weather	50	If used for wheeled or tracked vehicles in double-flow traffic, min width of traveled way (7 m) is considered an obstruction.
10.5 M X 120 (OB)	10.5 m	all-weather	120	Based on 10.5-m min width of traveled way, accommodates wheeled and tracked vehicles in double-flow traffic

**NATO Military Vehicle Markings**

NATO armed forces have agreed to use standard markings for vehicles. These markings are not necessarily used at all times but, when used, should conform to the guidelines below. The rear of a trailer is marked in the same manner as its prime mover; there is no need to mark the front of a trailer. If necessary for security reasons, vehicle markings may be covered or removed when directed by the field commander or his superior authority. Standard NATO markings include:

- Registration numbers — numbers or a combination of letters and numbers, as required by the nation concerned.
- National symbols — shown, at a minimum, front and rear to identify each country's vehicles. Service symbols may be superimposed on national symbols or appear separately.
- Speed limits — placed on vehicles as directed by the nation concerned.
- Tactical markings — stripes and geometrical figures, sometimes with a name, for identification within units. Markings

should be large enough to make ground-to-ground identification of vehicles possible; colors may be used. The design and position of these markings are prescribed by the field commander for easy battlefield recognition. They are removed when vehicles are permanently released from the jurisdiction of the same commander.

- Ground-to-air recognition markings — red and yellow fluorescent panels, approximately 6 feet by 2 feet 3 inches (1.80 meters by 0.68 meters), equipped with tie cords. Panels are draped on vehicles in a standard, unchanging pattern that differs from displays prescribed for other recognition purposes (frontlines, targets, and so forth). Theater commanders prescribe the arrangement of panels and conditions under which they will be used.
- Special-purpose vehicle identification:
  - Military police and other traffic control vehicles — prescribed markings placed front and rear.
  - Ambulances and other vehicles used exclusively for medical purposes — marked according to Geneva convention rules with a red cross or crescent on a square white background

painted on side body panels, body roof, cab roof, and rear doors or panel.

– Bomb disposal unit vehicles – all fenders painted red.

- Red flag — indicates danger.
- Priority-vehicle markings — equilateral triangles with red borders and symbols on white backgrounds placed on the front and rear of a vehicle. The commander may mark any vehicle which has priority over all other vehicles. Examples of priority vehicles are those carrying special liaison officers, priority dispatches, and damage-assessment personnel. A single priority sign may be used if visible from both front and rear. The sign should be as large as the vehicle's dimensions permit. The symbol inside the triangle identifies the authorizing commander. Priority signs must be removable to avoid misuse. They are used only on direct orders of the commander concerned. See Figure 3-21 for an example of a vehicle priority sign.

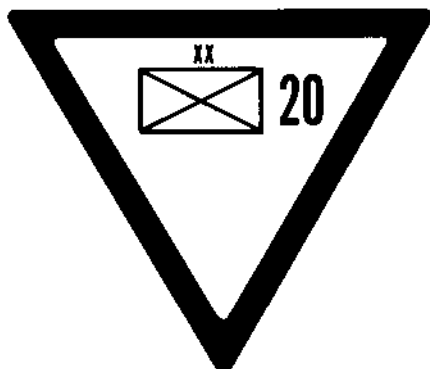

**Figure 3-21. NATO vehicle priority sign**

### Geneva Convention Road Signs

The Geneva convention road signs discussed here were agreed to at the United States Conference on Road and Motor Transport in 1949.

Although not military, these signs should be familiar to Army personnel, who will encounter them overseas.

Dimensions of the signs are standardized in each country for uniformity. In general, there are two sizes for each type of sign — standard and reduced. The reduced size is used where conditions preclude, or safety does not require, the standard size. In exceptional cases, a small sign may be used in built-up areas or to repeat the main sign.

**Danger signs (Class I).** Danger signs are red-bordered equilateral triangles with black or dark-colored symbols on white or yellow backgrounds. The triangles point upward except the “priority road ahead” sign, which points downward. The length of each standard side is not less than 0.9 meters (35.4 inches); of each reduced side, not less than 0.6 meters (23.6 inches). Overall height of signs is not more than 2.2 meters (86.6 inches) above ground. Away from built-up areas, signs are placed not less than 0.6 meters (23.6 inches) above ground. Signs are placed to be clearly visible without impeding pedestrians. See Figure 3-22 for examples of Class I signs.

**Instructional signs (Class II).** There are two types of instructional signs — prohibitory (Class II A) and mandatory (Class II B). Class II A signs are red-bordered circles with black or dark-colored symbols on a white or yellow background. Class II B signs are blue circles with white symbols. Standard size is at least 0.6 meters (23.6 inches) in diameter; reduced size, 0.4 meters (15.7 inches). Bottom of sign must be at least 0.6 meters (23.6 inches) above ground; top of sign must not be more than 2.2 meters (86.6 inches) above ground. Signs are placed close to the point where the requirement starts and at intervals along the route. See Figure 3-23 for examples of Class II signs.



















			
Rough Road	Dangerous Bends	Road Bends to Right	Road Bends to Left
			
Double Curve (Right then Left)	Double Curve (Left then Right)	Crossroads	Danger
			
Drawbridge Ahead	Construction Site	Slippery Road	Pedestrian Crosswalk Ahead
			
Children Crossing	Domestic Animal Crossing	Right of Way	Yield Right of Way
			
Guarded R.R. Crossing	Unguarded R.R. Crossing	Dangerous Downgrade	Road Narrows

Figure 3-22. Class I (danger) signs — Geneva convention



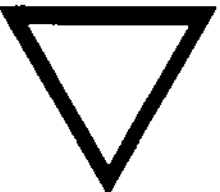















 <p>Stop at Intersection</p>	 <p>No Right Turn</p>	 <p>Customs Control</p>	 <p>No Stopping or Waiting</p>
 <p>Bicycles Prohibited</p>	 <p>Maximum Width Allowed</p>	 <p>Maximum Height Allowed</p>	 <p>Maximum Weight Allowed</p>
 <p>Maximum Axle Weight Allowed</p>	 <p>No Entry for Motorcycles w/o Sidecars</p>	 <p>No Entry for All Motor Vehicles</p>	 <p>Maximum Loaded Weight Allowed</p>
 <p>No Passing</p>	 <p>Motor Vehicles Prohibited</p>	 <p>Prohibited for all Vehicles</p>	 <p>Entry Prohibited</p>
 <p>Oncoming Traffic has Right of Way</p>	 <p>No Passing for Trucks</p>	 <p>Maximum Speed Limit</p>	 <p>No Parking</p>

Figure 3-23. Class II (instructional) signs — Geneva convention

**Informational signs (Class III).** There are three types of informational signs — indication (Class III A), direction and advance direction (Class III B), and place identification (Class III C). Signs are usually rectangular. Colors may or may not be specified. If they are not specified, red may be used but is not the dominant color. See Figure 3-24 for examples of Class III signs.

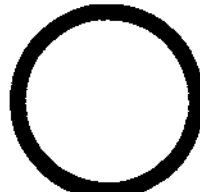
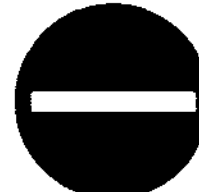
**Class III A.** These signs are blue rectangles with variously colored symbols, except for priority-road signs. Priority-road signs are diamond-shaped, either white with black rims or yellow with dark rims. Standard size is at least 0.6 meters (23.6 inches) square; reduced size, 0.4 meters (15.7 inches). If signs are repeated within built-up areas, square size is 0.25 meters (9.8 inches). Class III A signs indicate parking, hospitals, first aid stations, telephones, service stations, and priority roads.

**Class III B.** These rectangular signs have either light backgrounds with dark symbols or

dark backgrounds with light symbols. They are large enough to be easily understood by drivers in time for them to comply. Advance direction signs are placed from 100 to 250 meters (328 to 820 feet) from the intersection on normal roads. On special roads, such as concrete multilane roads, the distance is increased to 500 meters (1,640 feet). Direction signs are rectangular; the longer side is horizontal and ends in an arrowhead. Names of places lying in the direction of the arrow may be added to the sign. Figures indicating distances, if given, are inscribed between the name of the place and the arrowhead.

**Class III C.** These rectangular signs have light backgrounds with dark symbols or dark backgrounds with light symbols. The signs are placed with the long side horizontal. Their size and location are adequate for nighttime visibility. Class III C signs are placed before the beginning of built-up areas and at other points necessary to indicate place locations.

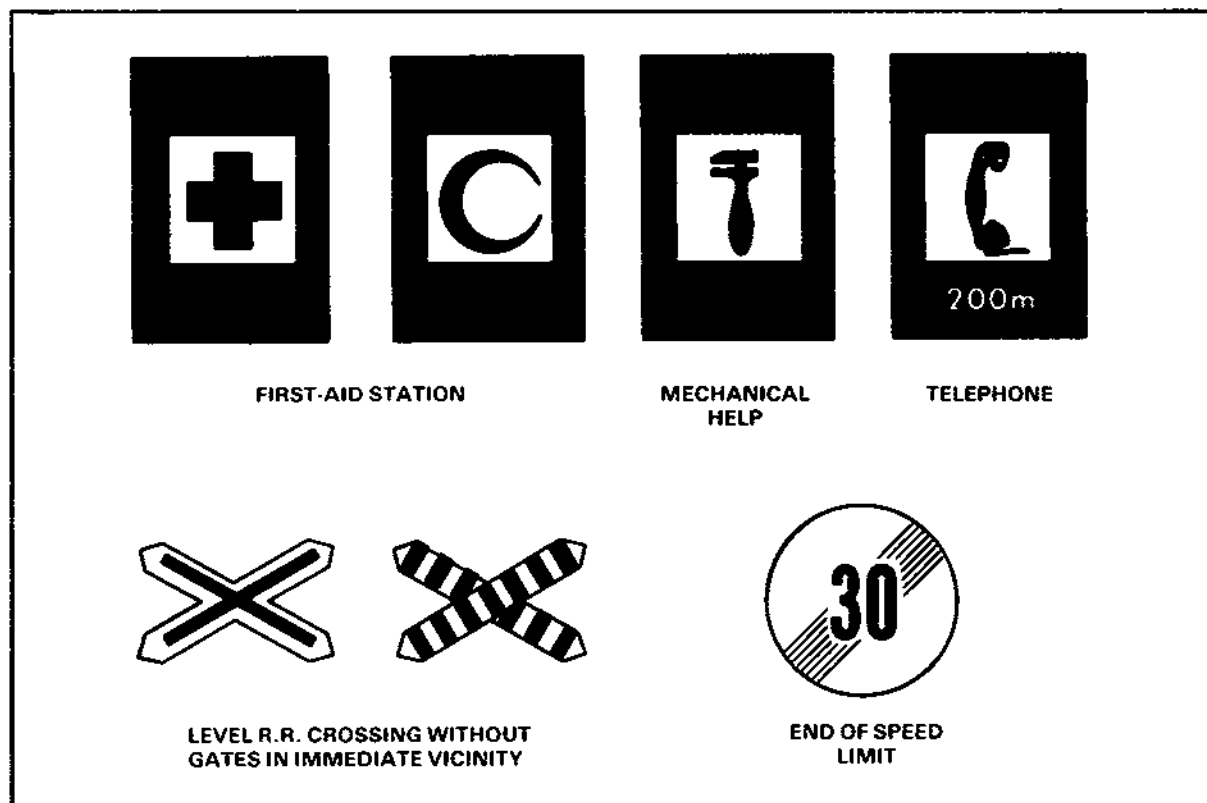

Figure 3-24. Class III (informational signs) — Geneva convention

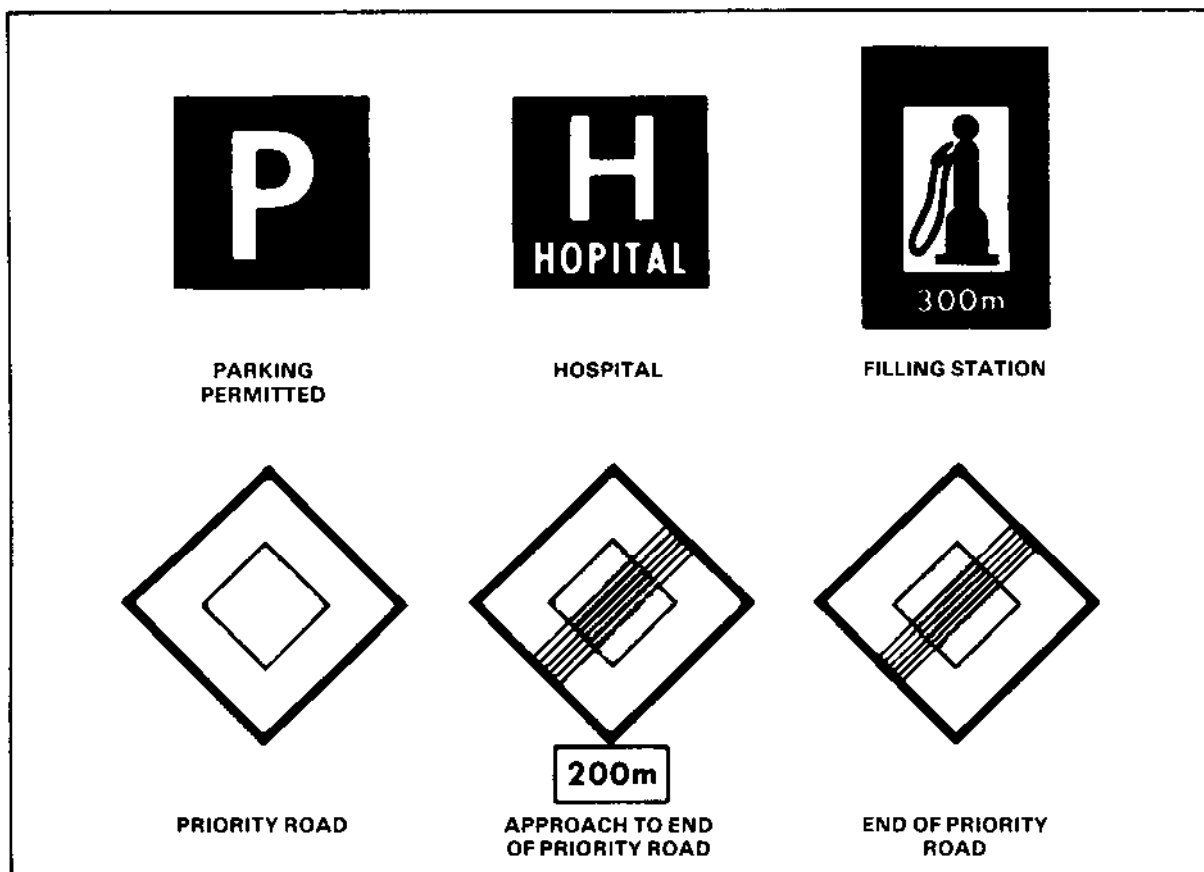

Figure 3-24. Class III (informational signs) — Geneva convention (cont)

### NATO Road Signs

To aid movement of NATO forces in any territory controlled by operational military command or national authority, member governments have adopted a standard system of military route signs. This system includes the signs prescribed by the Geneva convention as well as others not included in that group. There are three standard types of NATO road signs – hazard signs, regulatory signs, and guide signs. See Figure 3-25 for examples of standard NATO road signs.

**Hazard signs.** These diamond-shaped signs are yellow with black symbols. Hazard signs indicate traffic hazards and are used only in areas under military authority. A purely military sign not included in the international (Geneva convention) system or host country's system has a yellow background with the legend or symbol in black. If the sign is included in the international system or host

country's system, the international or host country's sign is used on the same yellow background instead of the black symbol or legend.

**Regulator signs.** These square-shaped signs are black with white symbols except for bridge classification, stop signs, and signs of various shapes, used by the military to control civilians under specified conditions. Regulator signs are used to regulate and control traffic and to define the light line. See STANAG 2010 for descriptions of regulatory signs.

**Guide signs.** These signs indicate locations, distances, directions, routes, and similar information:

- Route guide signs are rectangular with white symbols on black backgrounds. Signs are placed with the long side vertical. Odd numbers indicate axial routes; even numbers, lateral routes.

- Casualty evacuation route guide signs are either rectangular or cross-shaped with red symbols on white backgrounds.
- Detour signs are diamond-shaped with a white arrow (barred or not) on a blue background.
- Directional disks are circular, less than 0.41 meters (16 inches) in diameter, with a

black arrow (barred or not) on a white background. Eight equally spaced holes around its circumference allow the disk to be nailed with the arrow pointing in any direction. Directional disks supplement other guide signs or major unit signs to indicate route direction. Battalions and lower units are not permitted to install directional disks.

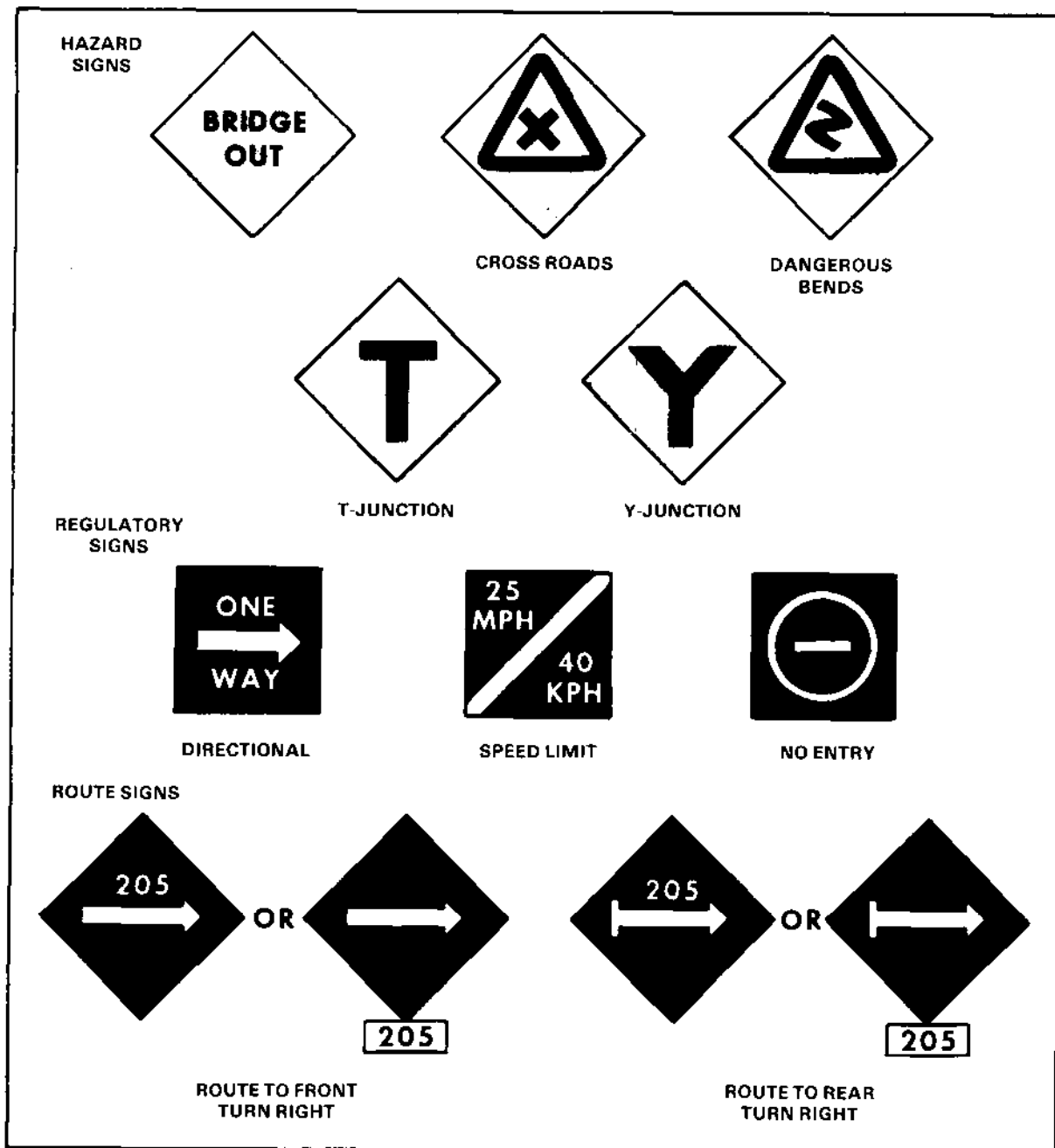

Figure 3-25. Standard NATO road signs



## NATO Warning Signs

Roads and areas within NATO nations containing contamination, minefield, booby traps, or unexploded bombs are marked with triangular signs according to STANAG 2002. See Figure 3-26 for examples.

traps, or unexploded bombs are marked with triangular signs according to STANAG 2002. See Figure 3-26 for examples.

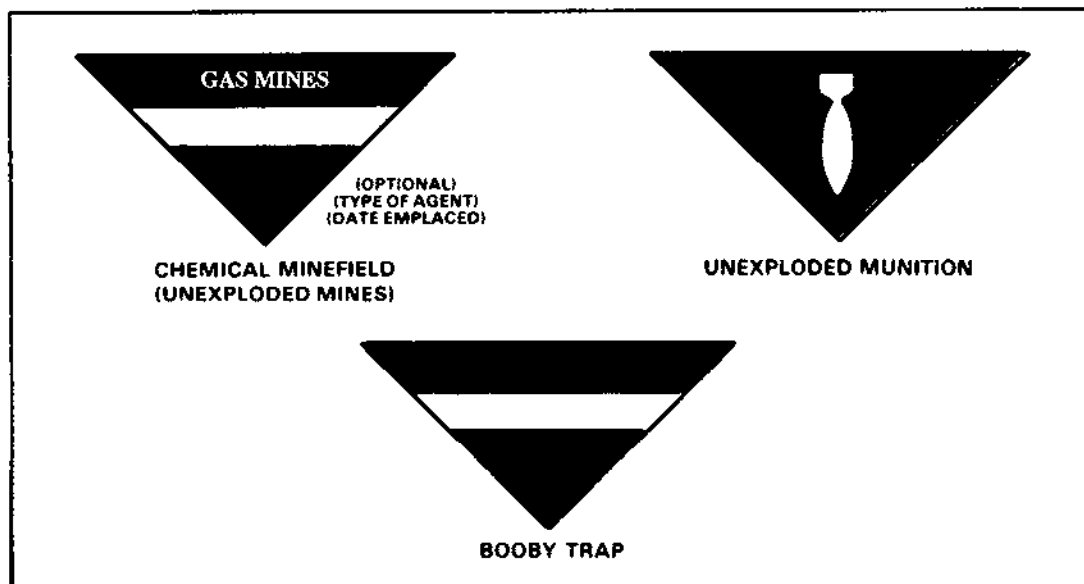

*Figure 3-26. NATO contaminated dangerous land area signs*

## Convoy Movement

A convoy is a group of at least 6 vehicles moving at the same time, or 10 vehicles moving within a 1-hour period, under a single commander over the same route in the same direction. To aid in control, large columns may be broken down into serials; serials may be further broken down into march units. Each column and each organized element must include a —

- Commander, whose place in the column varies.
- Pacesetter in the first vehicle in the first element to lead the column and regulate its speed.
- Trail officer in the last vehicle of the last element to deal with problems that occur at the tail of the column.

**Column identification.** Each column is identified according to STANAG 2027 guidance; for example, a blue flag on leading vehicle, a green flag on last vehicle. When moving at night, the leading vehicle also shows a blue

light and the last vehicle a green light. The column commander's vehicle displays a flag bisected by a diagonal line to form two triangles. The upper triangle is white; the lower is black. In areas where vehicles drive on the left side of the highway, the flags are mounted on the right side of the vehicle; otherwise, they are mounted on the left side.

Each column is identified by a number known as a "movement number," or "identification serial number," which is assigned at the same time as the movement credit by the authority organizing the movement. This number identifies the column during the entire movement. The number is placed on both sides and, if possible, on the front of all vehicles in the column to be clearly visible. The movement number is broken down into three parts:

- Two digits indicating the day of the month when movement is scheduled.
- Three or four letters indicating the organizing authority. First two letters are the national symbols shown in STANAG 1059.
- Two digits indicating the serial number assigned by the responsible authority.

For example, movement number 03-JSV-08 identifies column number 8, composed of V Corps vehicles, which will be moved by United States authority on the third day of the current month. The elements of a column may be identified by adding a letter behind the movement number.

**Movement credit.** A movement credit is the time allotted to one or more vehicles to move over a supervised, dispatch, or reserved route. Besides the allocation of a movement number or identification serial number, a movement credit indicates times at which the first and last vehicle of a column are scheduled to pass the entry and exit points. These are the points where the column enters and leaves the controlled route.

### Movement Calculations

The three basic factors involved in march calculations are distance (D), rate (R), and time (T). When values are known for two factors, the unknown factor can be computed:

$$D = R \times T$$

$$R = \frac{D}{T}$$

$$T = \frac{D}{R}$$

Corresponding units of measure must be used throughout each calculation.

See Figure 3-27 for space and time factors used in the formulas. The length of any column or element of a column is the length of roadway which is occupied, measured from front to rear, inclusive. For planning purposes, the average length of one motor transport vehicle is 10 yards (about 9 meters).

March rate (R) can be calculated in yards per minute, meters per minute, miles in the hour, or kilometers in the hour.

$$R = \frac{D \text{ (length in yd)}}{T \text{ (pass time in min)}} = \text{yd/min}$$

$$= \frac{D \text{ (length in m)}}{T \text{ (pass time in min)}} = \text{m/min}$$

$$= \frac{D \text{ (road distance in mi)}}{T \text{ (time distance in hr)}} = \text{MIH}$$

$$= \frac{D \text{ (road distance in km)}}{T \text{ (time distance in hr)}} = \text{KIH}$$

Pass time, time lead, time gap, or time space (T) can be calculated in minutes or hours.

$$T = \frac{D \text{ (length in yd)}}{R \text{ (yd/min)}} = \text{pass time in min}$$

$$= \frac{D \text{ (length in m)}}{R \text{ (m/min)}} = \text{pass time in min}$$

$$= \frac{D \text{ (lead in yd)}}{R \text{ (yd/min)}} = \text{time lead in min}$$

$$= \frac{D \text{ (lead in m)}}{R \text{ (m/min)}} = \text{time lead in min}$$

$$= \frac{D \text{ (gap in yd)}}{R \text{ (yd/min)}} = \text{time gap in min}$$

$$= \frac{D \text{ (gap in m)}}{R \text{ (m/min)}} = \text{time gap in min}$$

$$= \frac{D \text{ (road space in mi)}}{R \text{ (MIH)}} = \text{time space in hr}$$

$$= \frac{D \text{ (road space in km)}}{R \text{ (KIH)}} = \text{time space in hr}$$

$$= \frac{D \text{ (road distance in mi)}}{R \text{ (MIH)}} = \text{pass time in h}$$

$$= \frac{D \text{ (road distance in km)}}{R \text{ (KIH)}} = \text{pass time in h}$$

Distance (D) (length, lead, gap, road space, or road distance), can be calculated in yards, meters, miles, or kilometers.

$$D = R \text{ (yd/min)} \times T \text{ (pass time in min)} = \text{length in yd}$$

$$= R \text{ (m/min)} \times T \text{ (pass time in min)} = \text{length in m}$$

$$= R \text{ (yd/min)} \times T \text{ (time lead in min)} = \text{lead in yd}$$

$$= R \text{ (m/min)} \times T \text{ (time lead in min)} = \text{lead in m}$$

$$= R \text{ (yd/min)} \times T \text{ (time gap in min)} = \text{gap in yd}$$

$$= R \text{ (m/min)} \times T \text{ (time gap in min)} = \text{gap in m}$$

$$= R \text{ (MIH)} \times T \text{ (time space in hr)} = \text{road space in mi}$$

$$= R \text{ (KIH)} \times T \text{ (time space in hr)} = \text{road space in km}$$

$$= R \text{ (MIH)} \times T \text{ (time distance in hr)} = \text{road distance in mi}$$

$$= R \text{ (KIH)} \times T \text{ (time distance in hr)} = \text{road distance in km}$$

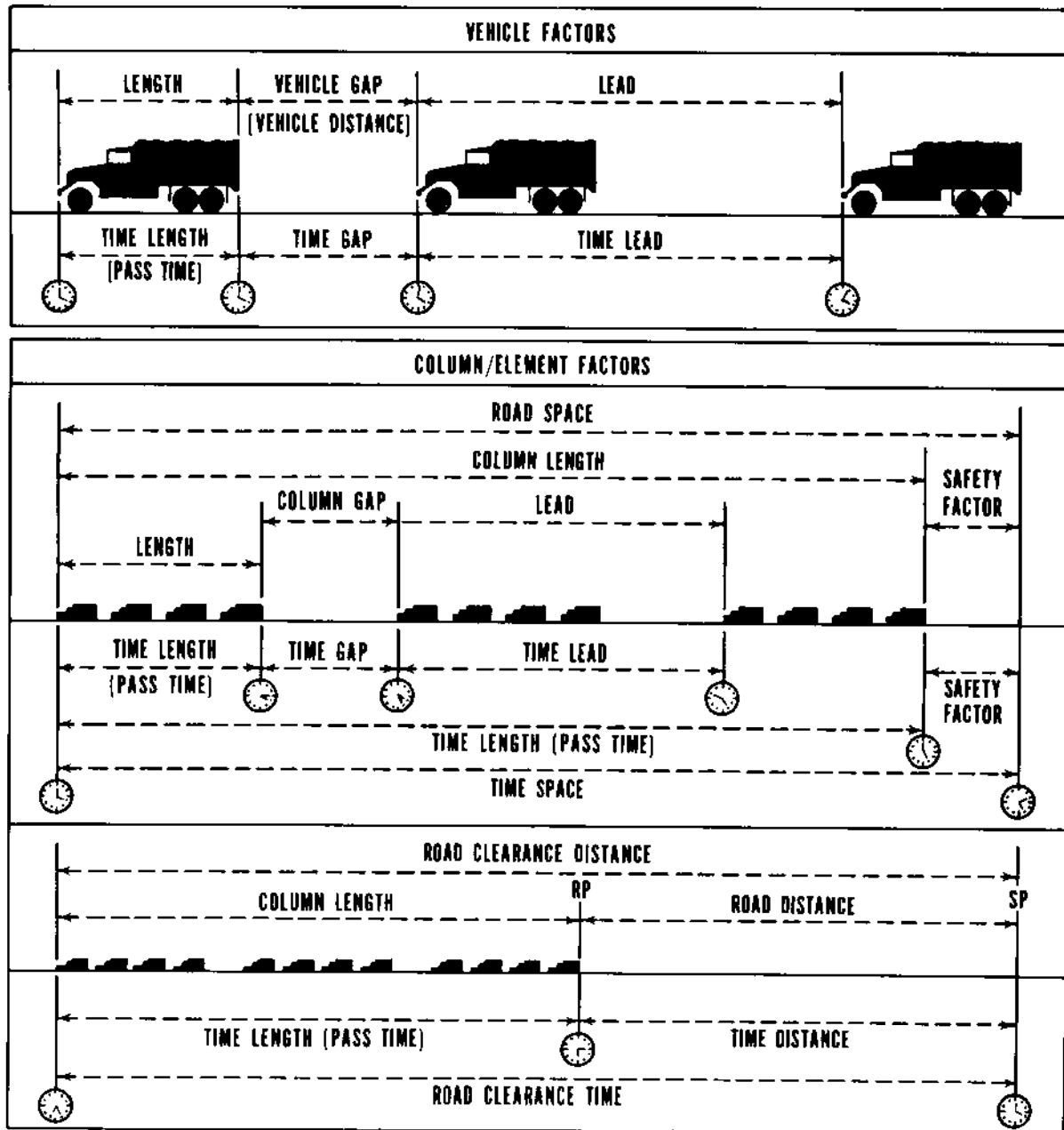

Figure 3-27. Space and time factors

Calculations for D, R, and T are plotted graphically in Figure 3-28. When the rate (MIH or KIH) is known, the time in minutes or the distance in miles or kilometers traveled can be quickly determined from the time-distance graph. For example, if a convoy moves at a rate of 15 MIH for 2 hours, the distance traveled can be determined by —

- Locating the oblique line marked 15 MIH.

• Locating the horizontal coordinate representing the 2 hours traveled.

• Determining the point at which these two lines intersect and reading the distance in miles from the bottom scale or kilometers from the top scale. For this example, the distance traveled would be 30 miles (48 km).

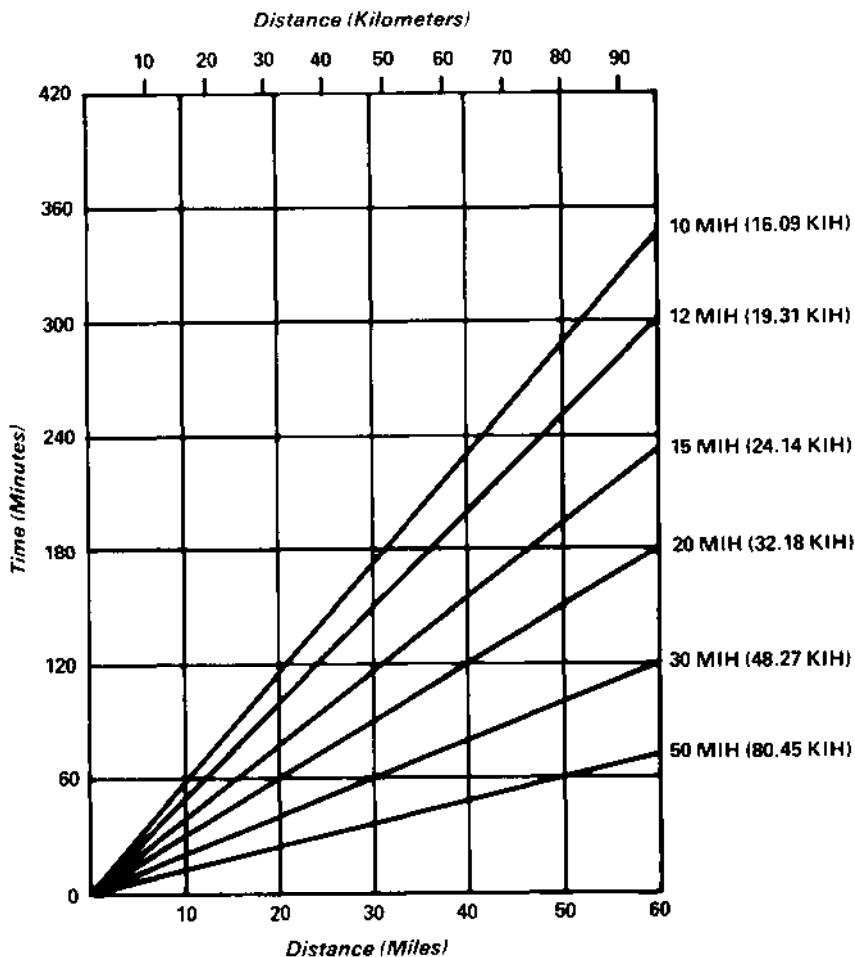

Figure 3-28. Time-distance graph

According to circumstances, the following conversion factors may be required:

Length + gap = lead

Pass time (time length) + time gap = time lead

Distance (mi) X 1,760 = distance (yards)

Distance (km) X 1,000 = distance (m)

Time (hr) X 60 = time (min)

Rate (MIH) X 30 = approximate yards per min

Rate (KIH) X 17 = approximate meters per min

These factors are substituted in the basic formulas in these examples:

$$T (\text{pass time in min}) = \frac{D (\text{mi} \times 1,760)}{R (\text{MIH} \times 30)} = \frac{D (\text{yd})}{R (\text{yd/min})}$$

$$R \text{ (speed in yd/min)} = \frac{D \text{ (km} \times 1,000)}{R \text{ (KI/H} \times 17)} = \frac{D \text{ (m)}}{T \text{ (m/min)}}$$

$$R \text{ (speed in m/min)} = \frac{D \text{ (mi} \times 1,760)}{T \text{ (hr} \times 60)} = \frac{D \text{ (yd)}}{T \text{ (min)}}$$

$$R \text{ (speed in m/min)} = \frac{D \text{ (km} \times 1,000)}{T \text{ (hr} \times 60)} = \frac{D \text{ (m)}}{T \text{ (min)}}$$

**Road Movement Graph**

A road movement graph is a time-space diagram used to control foot and road marches and to prepare or check road movement tables. The graph helps the planner foresee possible conflicts and discrepancies in planning.

Road movement graphs may be used to indicate -

Position of mixed traffic on a route at a particular time.

Passing schedule of traffic elements at a particular time.

Conflicts between traffic elements at junctions, intersections, bridges, and defiles.

Deviations of columns from prescribed schedule.

Reverse directions of march, either by simultaneous turn of all column elements or by circling.

- Two-way traffic over a route and alternating traffic through defiles.
- Variations in actual running speeds.
- Changes in a route's traffic flow and traffic density.

**Preparation.** Preparation of a road movement graph begins with an analysis of the route on the map. Note important items, such as cities, towns, road junctions, and distances between major points. Select graph paper with enough squares to plot distance and time factors. Across the bottom coordinate, mark off time increments; on the vertical coordinate, distance increments.

If the origin, destination, march rate, and departure time of a movement are known, the head of the column can be plotted on the road movement graph. See Figure 3-29, Serial B, for an example. Assume that a unit is marching

from Mount Royal (at the 25-mile mark on the vertical scale). The unit will leave at 0700 hours and proceed at 15 MIH to a point 5 miles beyond Tavistock, a distance of 60 miles. At 15 MIH, the trip will take 4 hours. Place a point at the intersection of the 25-mile coordinate and the 0700-hour coordinate. This point represents the place and hour of departure: Mount Royal at 0700 hours. Place a second point at the intersection of the 85-mile coordinate and the 1100-hour coordinate. This second point represents the destination and scheduled arrival time: location 5 miles past Tavistock at 1100 hours (0700 plus 4 hours).

Unless the unit is very small, it is usually desirable to show the schedule for the column tail as well as the head. After charting the schedule of the head, schedule the tail if the time length of the column is known or can be computed. Use the following formulas:

$$\text{road space (length)} = \frac{\text{number of vehicles}}{\text{density}} + \frac{\text{time gaps} \times \text{rate}}{60}$$

$$\text{pass time (time length)} = \frac{\text{road space} \times 60}{\text{rate}} + \text{EXTAL}$$

or

$$\text{time length} = \frac{\text{number of vehicles} \times 60}{\text{density} \times \text{rate}} + \text{time gaps} + \text{EXTAL}$$

where EXTAL (extra time allowance) is calculated as an additional 1-minute allowance for each 25 vehicles in a serial:

Number of Vehicles	EXTAL (min)
24 or less	0
25 - 37	1
38 - 62	2
63 - 87	3

Assume that the time length of Serial B, including extra time allowance, is 30 minutes. Draw a line from point representing the column's clearance at origin (0730 hours) to its arrival at destination (1130 hours) to represent the column tail's schedule past all points en route.

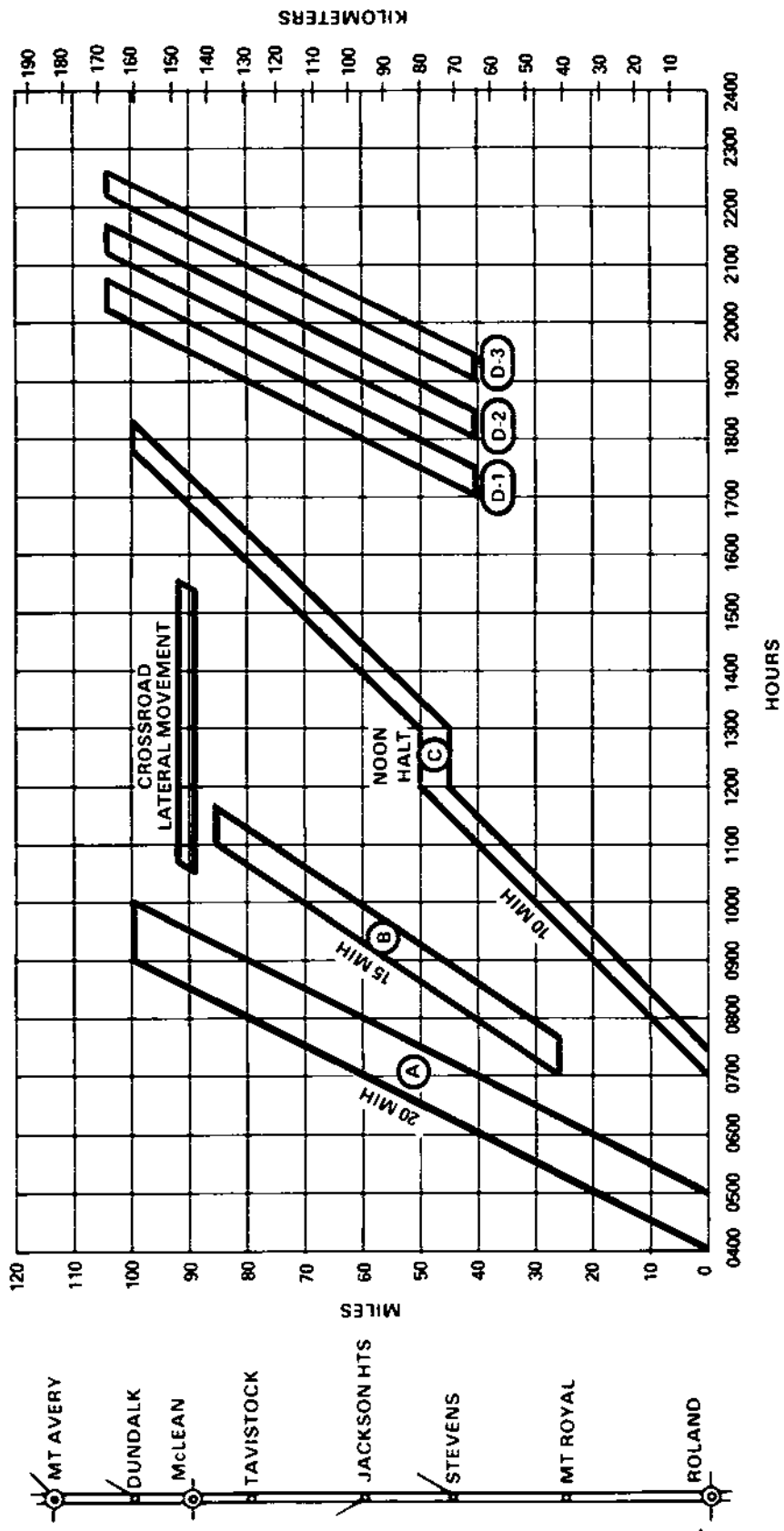

Figure 3-29. Road movement graph

To determine what time the column must start to complete the movement and arrive at the destination at a certain hour, reverse the above procedure.

**Use.** Use the road movement graph to find length of column, pass time (time length), rate of march, and other factors:

- **Length of column** — a vertical line connecting the head and tail lines, measured on the mile or kilometer scale. This line shows the planned length of the column at the prescribed rate of march at any hour during the movement, provided any extra time allowance is converted to distance and subtracted from the measurement.

**Example:** When the head of the column (Serial B, Figure 3-29) is at Stevens (the 45-mile mark of the vertical scale), the tail will be approximately at the 38-mile mark.

- **Pass time (time length)** — a horizontal line connecting the head and tail lines, measured on the hour scale. This line shows the planned pass time of the column as it passes any point on the road.

**Example:** If the head of Serial B arrives at Tavistock at 1040 hours, the tail will not clear that point until half an hour later at 1110 hours.

- **Rate of march** — a diagonal line intersecting any two vertical lines spanning a 1-hour period. This line indicates the distance in that hour (rate of march).

**Example:** For Serial B, the diagonal line from 0700 to 0800 on the time scale spans a 15-mile distance on the mile scale. The rate of march, therefore, is 15 MIH. For Serial A, the rate is 20 MIH; for Serial C, 10 MIH.

- **Halt time** — halts are graphed to show if they are on or off the road. For graphing purposes a halt beside the road is classed as an on-road halt if it impedes the forward movement of other traffic.

**Example:** In Figure 3-30, Serial A is an on-road halt; Serial B, an off-road halt.

**Multiple movements.** A number of serials or columns over the same route can be plotted on the road movement graph. The commander of a large unit or the highway regulation officer

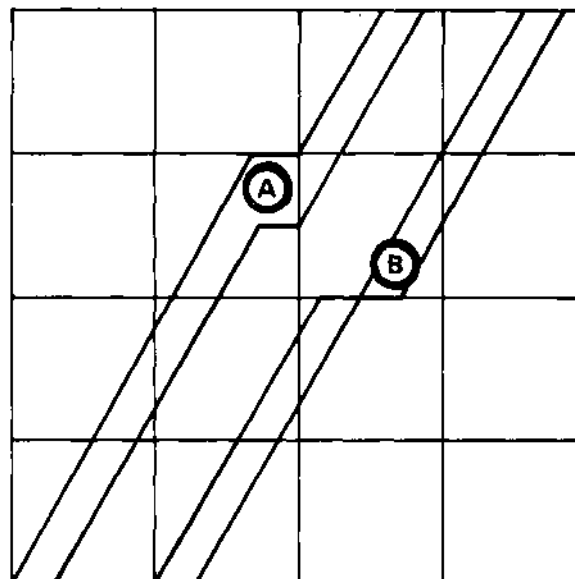

*Figure 3-30. On- and off-road halts*

should be notified as each serial reaches or clears HRP's along the route of march. The commander can keep an accurate record on the road movement graph of each serial's location. Filling in the space between the lines representing the scheduled head and tail of each column with color or tape enables the headquarters to see each serial's location at a glance. This method is used to follow the progress of each movement and to correct situations which may cause congestion and delay. The method is especially useful should it be necessary to issue new orders.

Pencils, crayons, ink, or adhesive tape in different colors may be used to indicate various schedules, plot movements in progress, and show relative priority. For example, use black to outline the head and tail schedule. Fill in green for each serial's progress and red for failure to adhere to schedules.

See Figure 3-31 for the progress of serials which were shown scheduled in Figure 3-29. Note the changes and adjustments in schedules. This is what happened:

- Serial A — element went through as scheduled.

- Serial B — change in orders required that Serial B continue to Dundalk. The column head arrived at its new destination on schedule at noon.

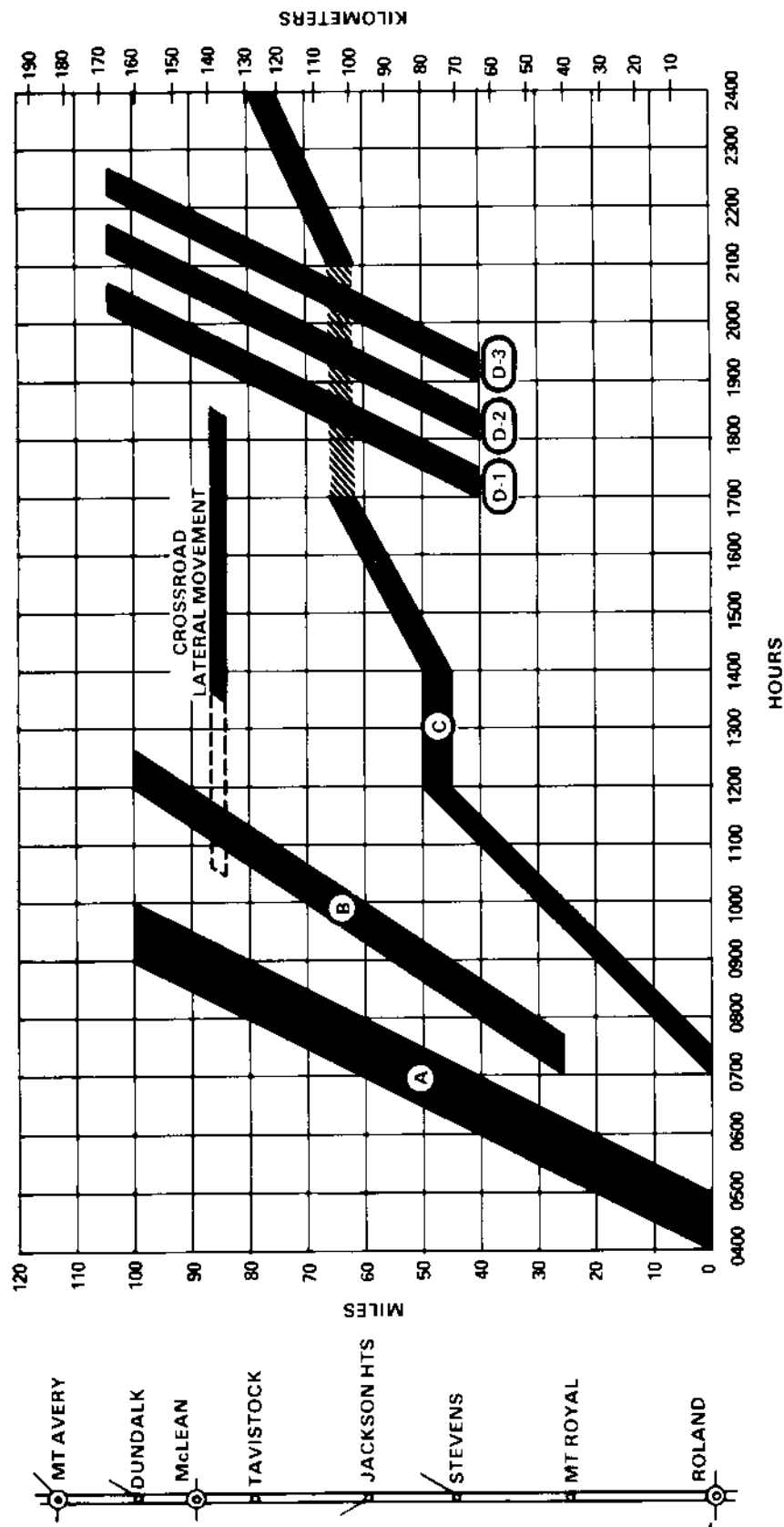

Figure 3-31. Adjusted road movement graph



- Lateral movement — because of a change in orders for Serial B, the lateral movement was delayed outside McLean. After a noon halt, the movement crossed the route 3 hours behind its original schedule, not clearing until 1830 hours.

- Serial C — at 1200 hours it became obvious that if Serial C continued on schedule, it would conflict with the delayed lateral movement at about 1730 hours. Also, Serial C had lost priority because of Serial B's arrival at Dundalk with critically needed supplies. Therefore, Serial C was halted from 1200 to 1400 hours before continuing at a slower rate of march. At 1700 hours, Serial C halted again to let Serial D pass.

- Serial D (D-1, D-2, D-3) — all elements went through on schedule.

### Traffic Density and Flow

Traffic density — vehicles per mile/kilometer (VPM/KPM) — is the average number of vehicles that occupy 1 mile or 1 kilometer of road space. VPM/VPK is based on an average vehicle length and a constant vehicle gap.

Traffic flow — vehicles per hour (VPH) — is the total vehicles which will pass a designated point in a given time, normally an hour. VPH is based on a constant operating speed, an average vehicle length, and a constant vehicle gap. With a constant vehicle gap, traffic flow increases as speed increases and decreases as speed decreases.

To find vehicle gap in yards, multiply the speedometer reading by the speedometer multiplier (SM). The speedometer multiplier is a whole number (1, 2, 3, or higher) determined by the commander, which signifies whether the distance between vehicles will be one, two, three, or more times the rate of speed. The choice of an SM is based on conditions (of the driver, the vehicle, the road, or combat). For example, with an SM of 2, vehicles traveling at 25 MPH would maintain a vehicle gap of 50 yards between them. Vehicle gap changes with speed. The column will close (gap decreases) as speed is reduced and will open (gap increases) as speed is increased.

**Formulas.** Determine any traffic density desired for dispersion or for maintaining maximum capacity of a route by selecting an appropriate vehicle gap and using the following formulas:

$$\frac{1 \text{ mi (1,760 yd)}}{\text{veh gap (yd) + avg veh length (yd)}} = \text{VPM}$$

or

$$\frac{1 \text{ km (1,000 m)}}{\text{veh gap (m) + avg veh length (m)}} = \text{VPK}$$

Example: If vehicles are dispersed every 100 yards (91 meters) and the average vehicle length is 10 yards (9 meters), then the traffic density is —

$$\frac{1,760}{100 + 10} = 16 \text{ VPM} \quad \text{or} \quad \frac{1,000}{91 + 9} = 10 \text{ VPK}$$

When the speed and SM are known, use the following formulas to find traffic density:

$$\frac{1 \text{ mi (1,760 yd)}}{(\text{MPH} \times \text{SM}) + \text{avg veh length (yd)}} = \text{VPM}$$

or

$$\frac{1 \text{ km (1,000 yd)}}{(\text{KPH} \times \text{SM}) + \text{avg veh length (m)}} = \text{VPK}$$

Example: If the speed of a column is 20 MPH (32 KPH) with an SM of 2, the traffic density is —

$$\frac{1,760}{(20 \times 2) + 10} = 35.2 = 35 \text{ VPM}$$

or

$$\frac{1,000}{(32 \times 2) + 9} = 13.69 = 14 \text{ VPK}$$

At a constant speed, traffic density can also be determined by counting the number of vehicles passing a given point in a period of time. Use the following formulas:

$$\frac{\text{VPH passing point}}{\text{MPH}} = \text{VPM}$$

or

$$\frac{\text{VPH passing point}}{\text{KPH}} = \text{VPK}$$

MPH	KPH (approx)	10	15	20	25	30	35	40	45	50	55	60	65	70	75	80	85	90	95	100
50	80	10	15	20	25	30	35	40	45	50	55	60	65	70	75	80	85	90	95	100
45	72	9	14	18	23	27	32	37	41	46	50	55	59	64	69	73	78	82	87	91
40	64																			
35	56																			
30	48																			
25	40																			
20	32																			
15	24																			
10	16																			
5	8																			
		70	58	50	44	39	35	32	29	27	25	23	22	21	20	19	18	17	16	16
		2100	1740	1500	1320	1170	1050	960	870	810	750	690	660	630	600	570	540	510	480	460
		88	70	58	44	39	35	32	29	27	25	23	22	21	20	19	18	17	16	16
		2200	1750	1450	1250	1100	975	875	800	725	675	625	575	550	525	500	475	450	425	400
		88	70	58	44	39	35	32	29	27	25	23	22	21	20	19	18	17	16	16
		1760	1400	1160	1000	880	780	700	640	580	540	500	460	440	420	400	380	360	340	320
		88	70	58	44	39	35	32	29	27	25	23	22	21	20	19	18	17	16	16
		1320	1050	870	750	660	585	525	480	435	405	375	345	330	315	300	285	270	255	240
		88	70	58	44	39	35	32	29	27	25	23	22	21	20	19	18	17	16	16
		880	700	580	500	440	390	350	320	290	270	250	230	220	210	200	190	180	170	160
		88	70	58	44	39	35	32	29	27	25	23	22	21	20	19	18	17	16	16
		440	350	290	250	220	195	175	160	145	135	125	115	110	105	100	95	90	85	80

NOTE: VPM x 0.62 = VPK

\*VPM (Traffic density)  
 \*\*VPH (Traffic flow)



LEGEND

VEHICLE GAP

Example: If 500 vehicles pass a given point in 1/2 hour at 20 MPH (32 KPH), traffic density is -

$$500 \text{ vehicles per } 1/2 \text{ hour} = 1,000 \text{ VPH}$$

$$\frac{1,000}{20} = 50 \text{ VPM}$$

or

$$\frac{1,000}{32} = 31.25 = 31 \text{ VPK}$$

Use the following formula to find traffic flow:

$$\frac{\text{MPH} \times 1,760 \text{ yd}}{\text{veh lead (yd)}} = \frac{\text{yd per hr}}{\text{veh lead (yd)}} = \text{VPH}$$

where veh lead = distance in yards of vehicle gap and vehicle

Example: For a convoy moving at 30 MPH, the individual vehicle length is 10 yards and the vehicle gap is 20 yards.

$$\frac{30 \times 1,760}{10 + 20} = 1,760 \text{ VPH}$$

**Density-flow graph.** Use the graph in Figure 3-32 as a convenient means to determine traffic density and traffic flow for movements at various speeds and gaps. The planner must know the vehicle gap and operating speed for the particular operation. The planner should then -

- Read across the bottom scale to the column indicating the appropriate vehicle gap.
- Read up the vehicle gap column to the block opposite the appropriate speed. The block at the intersection of these coordinates contains two figures separated by a diagonal line. The upper figure is the traffic density for the operation in VPM; the lower figure, the traffic flow in VPH.

The following examples illustrate how to use the traffic density and flow graph.

Example 1: Assume that a convoy is to move over a road with a vehicle gap of 40 yards at a speed of 25 MPH. Read across the bottom scale (vehicle gap) to the 40-yard column. Then read up the column to where it intersects the

horizontal coordinate for 25 MPH. The box at that point reads -



Traffic density (VPM of roadway) for this operation is 35; traffic flow (VPH past a given point) is 875.

When vehicle gap and speed are in meters and kilometers, the traffic density figure on the chart must be converted from VPM to VPK. To convert to VPK, multiply the figure shown on the chart by 0.62. No adjustment is needed for traffic flow since it is based on a constant factor of 1 hour at a given point along the route.

Example 2: Assume that a convoy is to move over a road at 32 KPH with a vehicle gap of 32 meters. Read across the bottom scale (vehicle gap) to the 32-meter column. Then read up the column until it intersects the horizontal coordinate of 32 KMH. The box at that point reads -



Traffic density for this move is 39 VPM. To convert to VPK, multiply VPM by 0.62:

$$39 \times 0.62 = 24.18 \text{ or } 24 \text{ VPK. VPH is } 780.$$

No adjustment is needed for this figure.

The traffic density and flow graph in Figure 3-32 has other applications. For example, the planner/operator can use the graph to determine vehicle gaps and operating speeds compatible with restrictions imposed on an operation. Instructions from higher headquarters or operating conditions may limit the number of VPH arriving at a designated point (a critical road junction, a river crossing point, or a loading/unloading point). Or the VPM on a certain route may be restricted. Correlate these restrictive figures with the values in the graph to determine suitable operating gaps and speeds.

Example 3: Assume that higher headquarters has ordered that forward-moving traffic passing a critical point on a route be kept to no more than 400 VPH. This traffic flow must

be maintained as nearly as possible. Scan the traffic flow figures on the graph. There are several speed-gap combinations which will meet the restriction:

- 10 MPH at a 35-yard vehicle gap — 390 VPH.
- 15 MPH at a 60-yard vehicle gap — 375 VPH.
- 20 MPH at an 80-yard vehicle gap — 400 VPH.
- 25 MPH at a 100-yard vehicle gap — 400 VPH.

**Example 4:** Assume that higher headquarters orders traffic density over a given route be kept to no more than 30 VPM and no less than 25 VPM. This density must be maintained as nearly as possible. Scan the traffic density figures on the table. There are a number of vehicle gaps which will meet this restriction:

- At 50 yards — 29 VPM.
- At 5 yards — 27 VPM.
- At 60 yards — 25 VPM.

Although the density flow graph is set up in speed increments of 5 MPH (8 KPH), traffic flows for intermediate speeds may be inferred. Divide the difference in traffic flow between two consecutive speeds by either 4 for MPH or 8 for KPH. Multiply the result by the difference in speed. Then add that result to the lesser traffic flow figure used. Round off any fraction of a vehicle to the next whole number.

**Example 5:** Assume that a planner/operator must determine traffic flow for a motor move at 23 MPH with a 50-yard vehicle gap. First, determine the difference between traffic flow at 20 MPH and 25 MPH for a vehicle gap of 50 yards:

$$\begin{array}{r} 725 \text{ (VPH at 25 MPH)} \\ - 580 \text{ (VPH at 20 MPH)} \\ \hline 145 \end{array}$$

Divide 145 by 5 (the numerical difference between 20 and 25 MPH) to determine the traffic flow for 1-MPH increments between these speeds:

$$\frac{145}{5} = 29$$

Multiply 29 by 3 (the numerical difference between 20 and 23 MPH):

$$\begin{array}{r} 29 \\ \times 3 \\ \hline 87 \end{array}$$

Finally, add 87 to the traffic flow at 20 MPH to determine the traffic flow at 23 MPH:

$$\begin{array}{r} 580 \\ + 87 \\ \hline 667 \text{ VPH at 23 MPH} \end{array}$$

**Example 6:** Assume that a planner/operator must determine the traffic flow for a motor move at 45 KPH with a 64-meter vehicle gap. First, determine the difference between traffic flow at 40 KPH and 48 KPH for a vehicle gap of 64 meters:

$$\begin{array}{r} 660 \text{ (VPH at 48 KPH)} \\ - 550 \text{ (VPH at 40 KPH)} \\ \hline 110 \end{array}$$

Divide 110 by 8 (the numerical difference between 40 and 48 KPH) to determine the traffic flow for 1-KPH increments between these speeds:

$$\frac{110}{8} = 13.75$$

Multiply 13.75 by 5 (the numerical difference between 40 and 45 KPH):

$$\begin{array}{r} 13.75 \\ \times 5 \\ \hline 68.75 = 69 \end{array}$$

Finally, add 69 to the traffic flow at 40 KPH to determine the traffic flow at 45 KPH:

$$\begin{array}{r} 550 \\ + 69 \\ \hline 619 \text{ VPH at 45 KPH} \end{array}$$

## Preparing for Vehicle Air Movement

Units which must be ready for immediate air movement should make preparations well in advance to avoid delays in loading vehicles on transporting aircraft. Essential items of information which should be known beforehand for each vehicle are -

- Weight with load.

- Dimensions.
- Center of balance (CB).

**Weight and dimensions.** TB 55-46-1 includes the weight and dimensions of almost all Army equipment. If TB 55-46-1 is not available but a scale is, weigh the item. If an item of equipment is too big to manhandle onto a scale, load it on a vehicle and weigh it on a vehicle scale. Make sure that scales are calibrated.

**Center of balance.** The center of balance of cargo items must be determined before the weight and balance of a loaded aircraft can be computed. The shipping agency is responsible for marking each item of cargo with the correct gross weight and a CB point. Mark all items measuring 10 feet or longer and those having a balance point other than at center. Mark vehicles with load-carrying capability to show an empty or loaded CB, whichever is appropriate. Items not marked according to these guidelines will not be accepted for airlift.

Determine weight and CB of a vehicle after all secondary loads are secured. Secondary loads are items of baggage or cargo transported in truck beds and trailers, which must be included in total vehicle weight. Nothing can be added to or removed from a vehicle that has been weighed without afterwards reweighing the vehicle.

To compute CB of a vehicle, multiply the weight of each axle by its distance from the reference datum line (RDL). This result is called the moment. Then divide the moment by the gross weight of the vehicle. The resulting CB figure is the number of inches measured aft from the RDL to the point where the vehicle will balance. See Figure 3-33 for an explanation of terms used in measuring and weighing vehicles. Compute CB to the nearest whole inch.

$$\frac{(W_1 \times D_1) + (W_2 \times D_2)}{\text{gross weight}} = \text{CB}$$

where  $W_1$  = front axle weight

$W_2$  = rear axle weight

$D_1$  = distance from RDL to front axle

$D_2$  = distance from RDL to rear axle

- RDL (reference datum line) — predetermined point from which all measurements are taken.
- FOH (front overhang) — distance in inches from front bumper to center of front axle.
- WB (wheelbase) — distance in inches from center of front axle to center of rear axle or center of tandem axles.
- ROH (rear overhang) — distance from rear or center of tandem axles to rear bumper.
- FAW (front axle weight in pounds).
- RAW (rear axle weight in pounds).
- MOMENT — the product obtained by multiplying the weight at a given point by its distance in inches from the RDL.

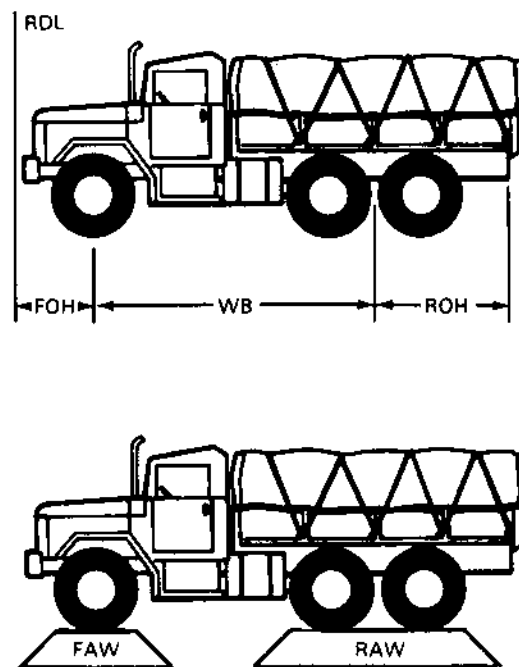

Figure 3-33. Weight and measurement points

After computing CB, mark both sides of the vehicle with masking tape to form a "T" shape. Use a grease pencil or magic marker to write the gross weight in the crossbar of the "T." Write the letters "CB" in the vertical bar to mark exact CB position. Mark axle weights above each axle.

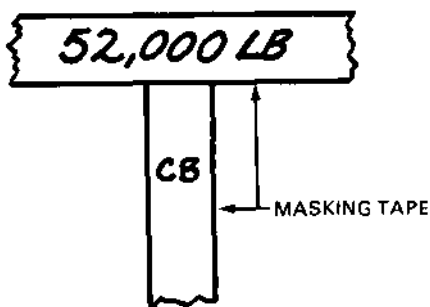
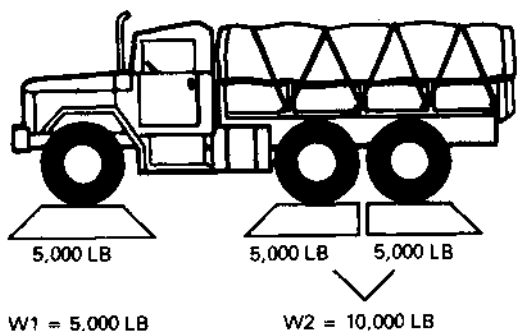

Figure 3-34. Center of balance marker

The following examples illustrate methods to determine weight and CB of typical cargo. The examples include single-axle, multi-axle, and tracked vehicles and skid-mounted cargo.

**EXAMPLE 1 — vehicles:**

STEP 1. Determine front and rear axle weights.



STEP 2. Determine distance from front and rear axles to the RDL.

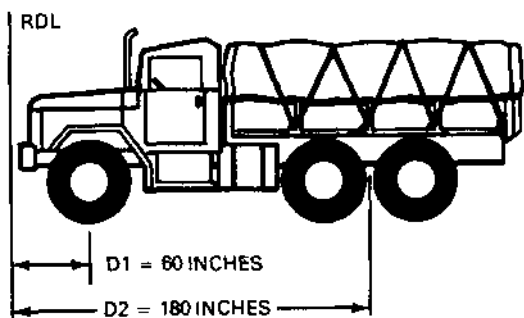

STEP 3. Enter the weights and distances into the CB formula:

$$\frac{(5,000 \times 60) + (10,000 \times 180)}{15,000} =$$

$$\frac{300,000 + 1,800,000}{15,000} =$$

STEP 4. Divide the total moment by the gross weight.

$$\frac{2,100,000}{15,000} = 140 \text{ inches}$$

The CB of the vehicle measured from the front end (RDL) is 140 inches.

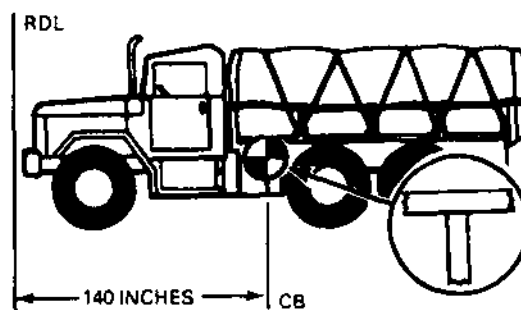

**EXAMPLE 2 — trailers:**

When using the formula to compute CB of a trailer, consider the tongue to be the front axle; consider the actual axle to be the rear axle.

STEP 1. Weigh tongue and axle.

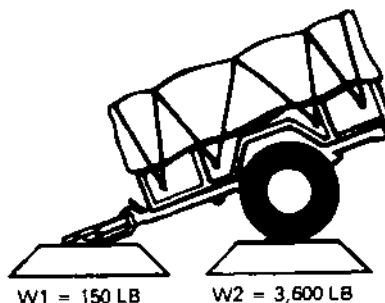

STEP 2. Measure the distance from the end of the tongue to the center of the axle.

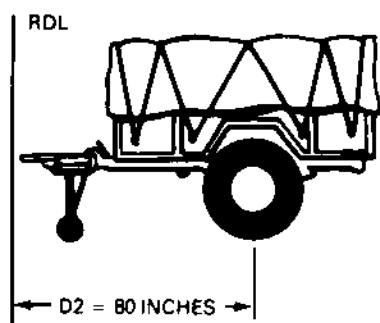

STEP 3. Enter the weights and distances into the formula.

$$\frac{(150 \times 1) + (3,600 \times 80)}{3,750} =$$

$$\frac{150 + 288,000}{3,750} = \frac{288,150}{3,750} = 76.84$$

The CB of the trailer measured from the tongue (RDL) is 77 inches.

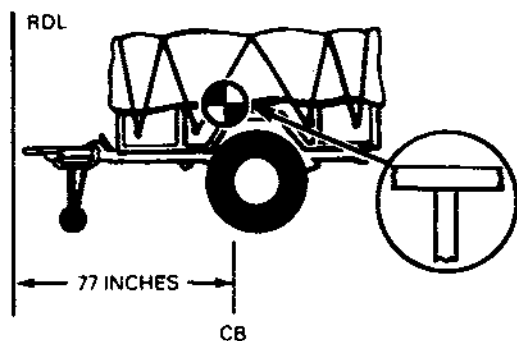

**EXAMPLE 3 — multi-axle vehicles:**

STEP 1. Determine all axle weights.

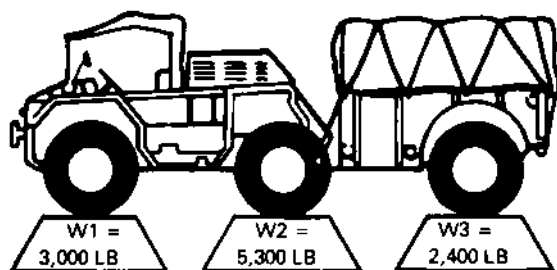

STEP 2. Determine distance from each axle to the RDL.

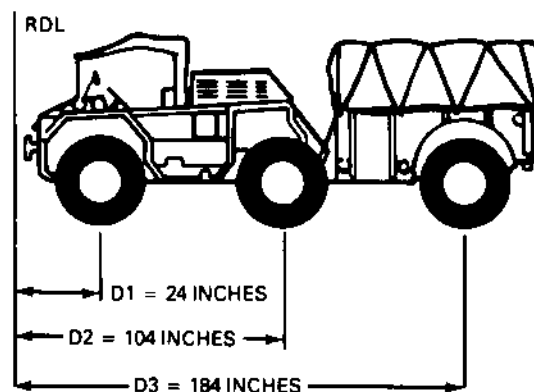

STEP 3. Enter the weights and distances into the formula.

$$\frac{(3,000 \times 24) + (5,300 \times 104) + (2,400 \times 184)}{10,700} =$$

$$\frac{72,000 + 551,200 + 441,600}{10,700} = \frac{1,064,800}{10,700}$$

STEP 4. Divide the total moment by the gross weight.

$$\frac{1,064,800}{10,700} = 99.5 \text{ inches}$$

The CB of the vehicle measured from the front end (RDL) is 100 inches.

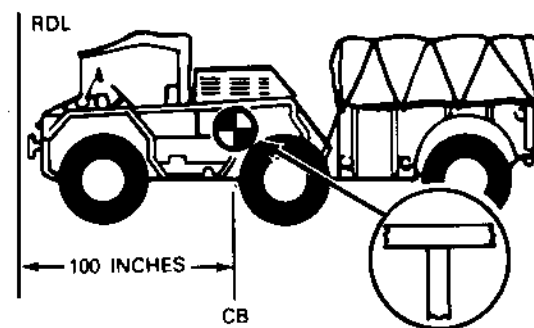

**EXAMPLE 4 — tracked vehicles:**

STEP 1. Weigh the vehicle on a platform scale (truck scale, coal yard scale) large enough to accommodate the entire vehicle. Record weight.

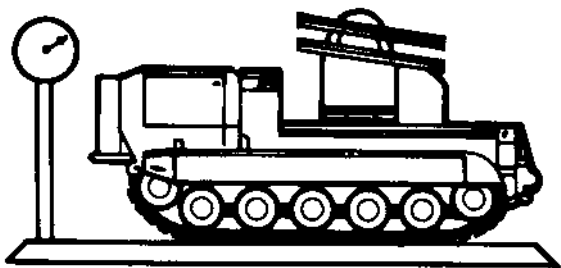

STEP 2. Drive the vehicle onto a wooden beam or pole until the vehicle tilts forward. Mark the CB and gross weight on the side of the vehicle at the point of tilt.

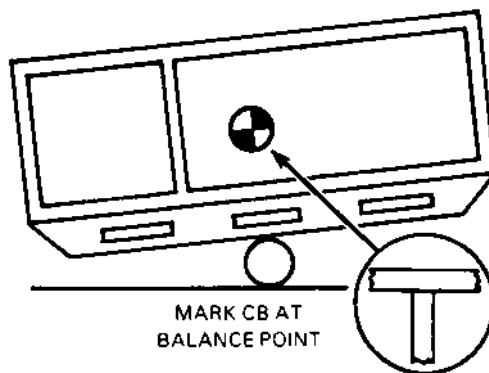

### EXAMPLE 6 — skid-mounted cargo:

If the skid-mounted cargo is too large to fit on a scale at one time, use the CB formula. Consider the support braces between the skids to be axles.

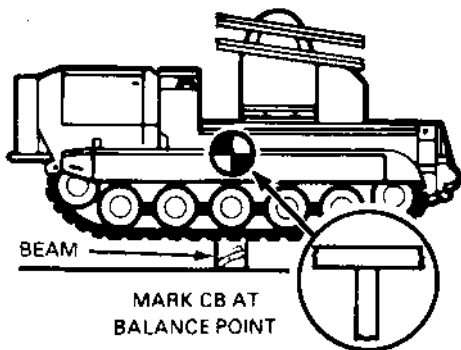

### EXAMPLE 5 — skid-mounted cargo:

STEP 1. If the skid-mounted cargo will fit on the scale, weigh the whole load.

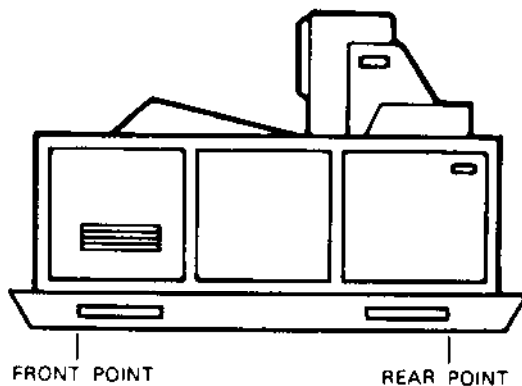

STEP 1. Support the overhang at the same height as the scale with a block of wood.

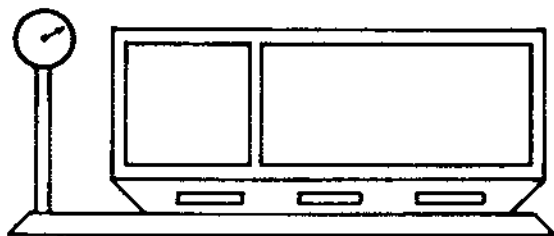

STEP 2. Place the load on a pipe and center it until it balances. Mark the CB at the balance point.

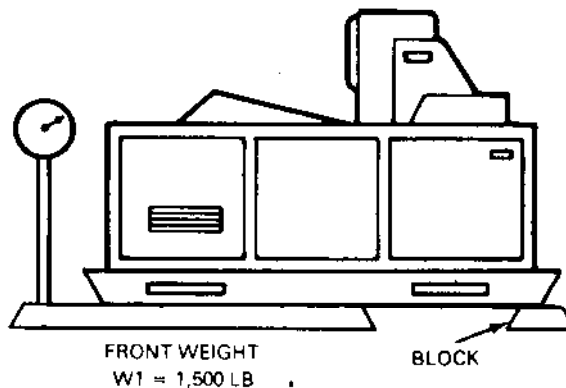



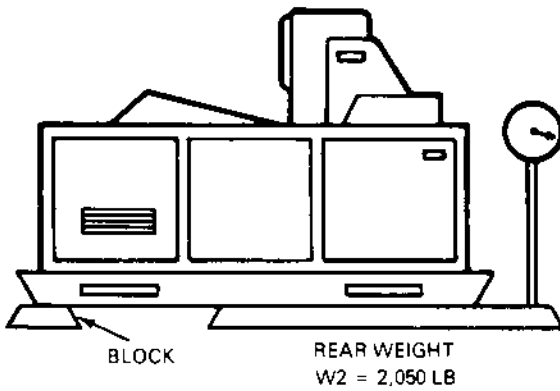

STEP 2. Measure the distance from the RDL to the front and rear points of support (same as axles).

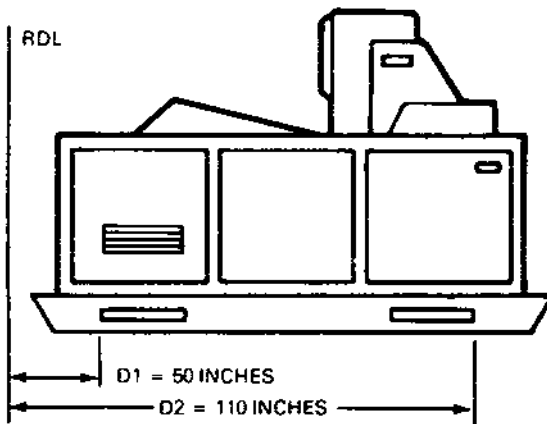

STEP 3. Enter the weights and distances into the formula.

$$\frac{(1,500 \times 50) + (2,050 \times 110)}{3,550} =$$

$$\frac{75,000 + 225,500}{3,550} =$$

$$\frac{300,500}{3,550} = 84.6 \text{ inches}$$

The CB of the cargo measured from the RDL is 85 inches.

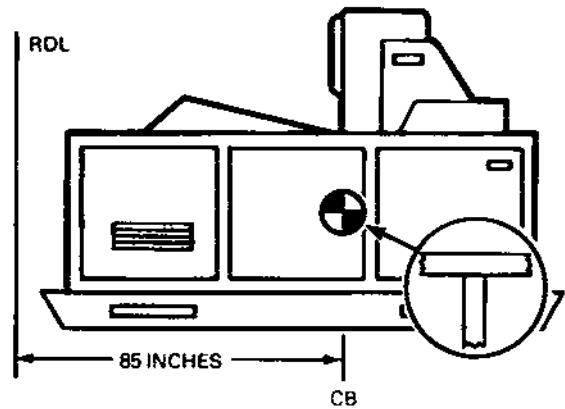

## Section II. MOTOR TRANSPORT DATA

The following data provides the motor transport planner with vehicle characteristics and capabilities. Other planning information includes statistics on safe vehicle distances, local and line-haul operations, and highway tonnage capabilities.

### VEHICLE CHARACTERISTICS

Tables 3-4 through 3-17 list mechanical data on authorized motor transport vehicles. This information includes truck performance data; CB of single-unit trucks; and axle weights, dimensions, and capacities for prime movers and towed vehicles.

**Table 3-4. Truck performance data**

Vehicle	Payload (lb)	Maximum Grade (%)		Maximum Safe Speed (MPH)	Cruising Range (mi)	Towed Load Allowance (lb)	Fording Depth (in)	
		w/Towed Load	w/o Towed Load				w/o Kit	w/Kit
Truck, utility, 1/4-T, 4X4, M151	800	60	—	66	300	1,500	21	60
Truck, utility, 1/4-T, 4X4, M151A1	800	75	—	65	300	1,500	21	60
Truck, cargo, 1 1/4-T, 4X4, M998	2,500	—	60	60	300	3,400	60	30
Truck, utility, 3/4-T, 4X4, M1009	1,200	—	30	55	250	<sup>1</sup> 3,000	20	—
Truck, cargo, 1 1/4-T, 6X6, M561	2,500	—	60	58	340	2,840	NA — swim cap	
Truck, cargo, 1 1/4-T, 4X4, M880	2,500	—	30	55	200	3,000	20	—
Truck, cargo, 1 1/4-T, 4X4, M881	2,500	—	30	55	200	3,000	20	—
Truck, cargo, 1 1/4-T, 4X4, M882	2,500	—	30	55	200	3,000	20	—
Truck, cargo, 1 1/4-T, 4X4, M883, w/comm shelter	<sup>2</sup> 2,500	—	30	55	200	3,000	20	—
Truck, cargo, 1 1/4-T, 4X4, M884, w/comm shelter	<sup>2</sup> 2,500	—	30	55	200	3,000	20	—
Truck, cargo, 1 1/4-T, 4X4, M885, w/comm shelter	<sup>2</sup> 2,500	—	30	55	200	3,000	20	—
Truck, cargo, 1 1/4-T, 4X2, M890	<sup>1</sup> 2,500	—	30	55	200	<sup>1</sup> 3,000	20	—
Truck, cargo, 1 1/4-T, 4X2, M891	<sup>1</sup> 2,500	—	30	55	200	<sup>1</sup> 3,000	20	—
Truck, cargo, 1 1/4-T, 4X2, M892	<sup>1</sup> 2,500	—	30	55	200	<sup>1</sup> 3,000	20	—
Truck, cargo, 1 1/4-T, 4X4, M1008	2,900	—	30	55	250	3,000	20	—
Truck, cargo, 1 1/4-T, 4X4, M1028	3,600	—	30	55	250	3,000	20	—
Truck, cargo, 2 1/2-T, 6X6, M35	5,000	46	63	58	300	6,000	30	72
Truck, cargo, 2 1/2-T, 6X6, M35A1	5,000	45	60	56	320	6,000	30	72
Truck, cargo, 2 1/2-T, 6X6, M35A2	5,000	45	60	56	275	6,000	30	72
Truck, cargo, 2 1/2-T, 6X6, M35A2C	5,000	45	60	56	275	6,000	30	72
Truck, cargo, 2 1/2-T, 6X6, M36A2	5,000	45	60	56	320	6,000	30	72
Truck, cargo, 2 1/2-T, 6X6, M36C	5,000	45	63	58	300	6,000	30	72
Truck, tk, fuel-svc, 1,200-gal, 2 1/2-T, M49A1C	<sup>3</sup> 600 gal	45	60	56	320	6,000	30	72
Truck, tk, fuel-svc, 1,200-gal, 2 1/2-T, M49A2C	<sup>3</sup> 600 gal	45	60	56	300	6,000	30	72
Truck, tk, water-svc, 1,200-gal, 2 1/2-T, 6X6, M50	<sup>4</sup> 400 gal	47	63	58	300	6,000	30	72

**Table 3-4. Truck performance data (cont)**

Vehicle	Payload (lb)	Maximum w/Towed Load	Grade (%) w/o Towed Load	Maximum Safe Speed (MPH)	Cruising Range (mi)	Towed Load Allowance (lb)	Fording Depth (in) w/o Kit	w/Kit
Truck, tk, water-svc, 1,200-gal, 2½-T, 6X6, M50A1	4400 gal	45	60	56	320	6,000	30	72
Truck, tk, water-svc, 1,200-gal, 2½-T, 6X6, M50A2	4400 gal	45	60	56	300	6,000	30	72
Truck, tk, water-svc, 1,200-gal, 2½-T, 6X6, M50A3	500 gal	45	60	56	300	6,000	30	72
Truck, dump, 2½-T, 6X6, M342A2	5,000	45	60	56	300	6,000	30	72
Truck, van, 2½-T, 6X6, M292A1	5,000	45	60	56	300	6,000	30	72
Truck, van, expansible, 2½-T, 6X6, M292A2	5,000	45	60	56	300	6,000	30	72
Truck, van, expansible, 2½-T, 6X6, M292A5	5,000	45	60	56	300	6,000	30	72
Truck, trac, 2½-T, 6X6, M275A1	57,000	36	60	56	275	617,000	30	72
Truck, trac, 2½-T, 6X6, M275A2	57,000	36	60	56	275	617,000	30	72
Truck, van, shop, 2½-T, 6X6, M109A2	5,000	45	60	56	300	6,000	30	72
Truck, van, shop, 2½-T, 6X6, M109A3	5,000	45	60	56	300	6,000	30	72
Truck, dump, 5-T, 6X6, M51A2	10,000	47	60	54	447	15,000	30	78
Truck, dump, 5-T, 6X6, M51A1	10,000	47	60	54	447	15,000	30	78
Truck, dump, 5-T, 6X6, M51	10,000	47	70	52	488	15,000	30	78
Truck, dump, 5-T, 6X6, M929	10,000	31	61	54	300	15,000	30	78
Truck, dump, 5-T, 6X6, M930	10,000	31	61	54	300	15,000	30	78
Truck, trac, 5-T, 6X6, M52	515,000	28	68	53	300	637,500	30	78
Truck, trac, 5-T, 6X6, M52A1	515,000	47	60	54	477	637,500	30	78
Truck, trac, 5-T, 6X6, M52A2	515,000	47	60	54	477	637,500	30	78
Truck, trac, 5-T, 6X6, M931	5715,000	31	60	54	400	6737,500	30	78
Truck, trac, 5-T, 8X8, M757	510,000	20	60	50	310	32,000	40	—
Truck, trac, 5-T, 6X6, M818	5715,000	42	60	52	300	6737,500	30	78
Truck, trac, 5-T, 6X6, M932	5715,000	31	60	54	400	6737,500	30	78
Truck, cargo, 5-T, 6X6, M54	10,000	51	74	53	214	15,000	30	78
Truck, cargo, 5-T, 6X6, M54A1	10,000	47	60	54	350	15,000	30	78
Truck, cargo, 5-T, 6X6, M54A1C	10,000	47	60	54	350	15,000	30	78

**Table 3-4. Truck performance data (cont)**

Vehicle	Payload (lb)	Maximum Grade (%)		Maximum Safe Speed (MPH)	Cruising Range (mi)	Towed Load Allowance (lb)	Fording Depth (in)	
		w/Towed Load	w/o Towed Load				w/o Kit	w/Kit
Truck, cargo, 5-T, 6X6, M54A2	10,000	47	60	54	350	15,000	30	78
Truck, cargo, 5-T, 6X6, M54A2C	10,000	47	60	54	350	15,000	30	78
Truck, cargo, 5-T, 6X6, M656	10,000	20	60	50	310	13,000	NA — swim cap	
Truck, cargo, 5-T, 6X6, M55A2	10,000	47	60	54	350	15,000	30	78
Truck, cargo, 5-T, 6X6, M55	10,000	47	60	54	220	15,000	30	78
Truck, cargo, 5-T, 6X6, M55A1	10,000	47	60	54	350	15,000	30	78
Truck, cargo, 5-T, 6X6, M813	10,000	42	67	52	350	15,000	30	78
Truck, cargo, 5-T, 6X6, M813A1	10,000	42	67	52	350	15,000	30	78
Truck, cargo, 5-T, 6X6, M814	10,000	38	61	52	350	15,000	30	78
Truck, cargo, 5-T, 6X6, M923	10,000	42	67	54	350	15,000	30	78
Truck, cargo, 5-T, 6X6, M925	10,000	42	67	54	350	15,000	30	78
Truck, cargo, 5-T, 6X6, M927	10,000	38	60	54	350	15,000	30	78
Truck, cargo, 5-T, 6X6, M928	10,000	38	60	54	350	15,000	30	78
Truck, wkr, 5-T, 6X6, M62	7,000	36	58	53	214	20,000	30	78
Truck, wkr, 5-T, 6X6, M936	7,000	31	46	54	500	20,000	30	78
Truck, van, expansible, 5-T, 6X6, M291A1	5,000	—	60	58	350	15,000	—	—
Truck, van, expansible, 5-T, 6X6, M291A1C	5,000	—	60	58	350	15,000	—	—
Truck, van, expansible, 5-T, 6X6, M291A1D	5,000	—	60	58	350	15,000	—	—
Truck, van, expansible, 5-T, 6X6, M291A2C	5,000	—	60	58	350	15,000	—	—
Truck, van, expansible, 5-T, 6X6, M934	5,000	41	65	54	300	15,000	30	78
Truck, van, expansible, 5-T, 6X6, M935	5,000	40	61	54	300	15,000	30	78
Truck, stake, 5-T, 6X6, M821	5,000	40	49	52	300	15,000	30	78
Truck, cargo, 8-T, 4X4, M520	16,000	27	60	30	300	20,000	NA — swim cap	
Truck, cargo, 8-T, 4X4, M877	16,000	27	60	30	300	20,000	NA — swim cap	
Truck, cargo, 10-T, 8X8, M977	22,000	30	60	55	300	<sup>8</sup> 30,000	48	—
Truck, cargo, 10-T, 8X8, M985	22,000	30	60	55	300	30,000	48	—
Truck, trac, 10-T, 6X6, M916	<sup>5</sup> 28,000	25	—	50	300	<sup>6</sup> 76,980	20	—

**Table 3-4. Truck performance data (cont)**

Vehicle	Payload (lb)	Maximum Grade (%)		Maximum Safe Speed (MPH)	Cruising Range (mi)	Towed Load Allowance (lb)	Fording Depth (in)	
		w/Towed Load	w/o Towed Load				w/o Kit	w/Kit
Truck, trac, 10-T, 8X6, M920	<sup>5</sup> 44,730	25	—	50	300	<sup>6</sup> 99,620	20	—
Truck, trac, 10-T, 6X6, M123A1C	<sup>5</sup> 30,000	47	60	40	350	<sup>6</sup> 80,000	78	30
Truck, trac, 10-T, 6X6, M123C	<sup>5</sup> 30,000	52	60	42	260	<sup>6</sup> 80,000	78	30
Truck, trac, 10-T, 6X6, M123D	<sup>5</sup> 30,000	52	60	42	260	<sup>6</sup> 80,000	78	30
Truck, trac, 14-T, 6X4, M915	<sup>5</sup> 40,000	—	17	55	—	—	20	—
Truck, trac, 22½-T, 8X8, M746	<sup>5</sup> 41,000	37	—	38	200	<sup>6</sup> 137,000	48	—
Truck, trac, 22½-T, 8X6, M911	<sup>5</sup> 48,000	20	—	43	173	<sup>6</sup> 137,000	28	—

<sup>1</sup>Highway requirement only.

<sup>2</sup>Increased loads authorized for several specific S250 shelter payloads.

<sup>3</sup>1,200-gal capacity for cross-country authorized by DA waiver, subject to local commander's discretion.

<sup>4</sup>1,000-gal capacity for cross-country authorized by DA waiver, subject to local commander's discretion.

<sup>5</sup>Vertical loads on the fifth wheel only.

<sup>6</sup>Towed load is the total weight of the semitrailer and payload.

<sup>7</sup>Vehicles approved for use with M871 semitrailer carrying loads up to 44,800 lb.

<sup>8</sup>Reduced payload required for this towed load.

Table 3-5. Vehicle axle weights

Vehicle	Curb Weight (lb)			Axle Load w/o Winch			Axle Load w/ Winch			Gross Weight, Payload & Personnel (lb)			
	Axle Load w/Winch		Total	Axle Load w/o Winch		Total	Axle Load w/Winch		Total	Axle Load w/o Winch		Total	
	Front	Rear		Front	Rear		Front	Rear		Front	Rear		
Truck cargo, 2½-T, 6X6, M34	5,900	6,280	12,180	5,400	6,370	11,770	6,320	11,210	17,530	5,830	11,290	17,120	
Truck cargo, 2½-T, 6X6, M35	5,810	7,070	12,880	5,310	7,150	12,460	6,250	11,970	18,220	5,761	12,060	17,811	
Truck cargo, 2½-T, 6X6, M35A1	6,580	7,320	13,900	5,980	7,420	13,400	7,470	16,830	24,300	6,970	16,820	23,790	
Truck cargo, 2½-T, 6X6, M35A2	6,340	7,290	13,630	5,700	7,530	13,230	6,600	16,930	23,530	5,990	17,040	23,030	
Truck cargo, 2½-T, 6X6, M35A2C	6,630	7,530	14,160	6,030	7,630	13,660	7,630	16,930	24,560	7,030	17,030	24,060	
Truck cargo, 2½-T, 6X6, M36A2	6,850	8,260	15,110	6,250	8,360	14,610	7,700	17,810	25,510	7,100	17,910	25,010	
Truck cargo, 2½-T, 6X6, M36C	6,140	9,100	15,240	5,640	9,190	14,830	6,750	13,840	20,590	6,150	14,030	20,180	
Truck cargo, 2½-T, 6X6, M211	5,740	7,840	13,580	5,300	7,870	13,170	6,070	12,870	18,940	5,630	12,890	18,520	
Truck tk, fuel-svc, 1,200-gal, 2½-T, 6X6, M49A1C	6,490	8,630	15,120	5,890	8,730	14,620	7,200	17,320	24,520	6,600	17,420	24,020	
Truck tk, fuel-svc, 1,200-gal, 2½-T, 6X6, M49A2C	6,260	8,180	14,440	5,070	8,540	13,610	7,480	16,200	23,680	6,680	16,270	22,950	
Truck tk, water, 1,000-gal, 2½-T, 6X6, M50	—	—	—	5,405	9,779	15,184	—	—	—	—	5,715	14,819	20,534
Truck tk, water, 1,000-gal, 2½-T, 6X6, M50A1	6,550	8,070	14,620	5,950	8,170	14,120	7,370	15,650	23,020	6,770	15,750	22,520	
Truck tk, water, 1,000-gal, 2½-T, 6X6, M50A2	6,410	8,170	14,580	5,790	8,290	14,080	7,220	15,710	22,930	6,700	15,730	22,430	
Truck tk, water, 1,000-gal, 2½-T, 6X6, M50A3	6,260	8,180	14,440	5,070	8,540	13,610	7,480	16,200	23,680	6,680	16,270	22,950	
Truck wkr, 2½-T, 6X6, M60	—	—	—	6,880	17,080	23,960	—	—	—	—	7,250	20,570	27,820
Truck van, shop, 2½-T, 6X6, M109	—	—	—	5,480	9,750	15,230	—	—	—	—	5,850	14,730	20,580
Truck van, shop, 2½-T, 6X6, M109A2	6,550	8,980	15,530	5,950	9,080	15,030	7,110	16,320	23,430	6,510	16,420	22,930	
Truck van, shop, 2½-T, 6X6, M109A3	6,500	8,940	15,440	5,880	9,050	14,930	7,220	15,710	22,930	6,700	15,730	22,430	
Truck van, shop, 2½-T, 6X6, M220	—	—	—	5,300	9,780	15,080	—	—	—	—	5,690	14,740	20,430
Truck repair, shop, van, 2½-T, 6X6, M185A3	—	—	—	5,980	10,820	16,800	—	—	—	—	6,290	15,910	22,200
Truck van, expansible, 2½-T, 6X6, M292	—	—	—	7,490	13,110	20,600	—	—	—	—	8,080	17,870	25,950
Truck van, expansible, 2½-T, 6X6, M292A1	—	—	—	8,050	13,160	21,210	—	—	—	—	8,640	17,970	26,610
Truck van, expansible, 2½-T, 6X6, M292A2	—	—	—	8,050	13,160	21,210	—	—	—	—	8,640	17,970	26,610
Truck van, expansible, 2½-T, 6X6, M292A5	—	—	—	7,520	15,410	22,930	—	—	—	—	8,110	20,220	28,330
Truck, trac, 2½-T, 6X6, M275A1	6,470	5,640	12,110	5,870	5,740	11,610	7,070	17,440	24,510	6,470	17,540	24,010	

**Table 3-5. Vehicle axle weights (cont)**

Vehicle	Curb Weight (lb)			Gross Weight, Payload & Personnel (lb)		
	Axle Load w/Winch		Total	Axle Load w/Winch		Total
	Front	Rear		Front	Rear	
Truck, trac, 2½-T, 6X6, M275A2	6,470	6,090	12,560	7,070	17,440	24,510
Truck, dump, 2½-T, 6X6, M342A2	6,920	8,580	15,500	6,950	18,490	25,440
Truck, cargo, 5-T, 6X6, M54	8,730	11,210	19,940	9,400	20,890	30,290
Truck, cargo, 5-T, 6X6, M54A1	8,730	11,210	19,940	9,400	20,890	30,290
Truck, cargo, 5-T, 6X6, M54A1C	8,730	11,210	19,940	9,400	20,890	30,290
Truck, cargo, 5-T, 6X6, M54A2	8,700	11,700	20,400	9,930	30,870	40,800
Truck, cargo, 5-T, 6X6, M54A2C	8,720	11,940	20,660	9,890	31,170	41,060
Truck, cargo, 5-T, 6X6, M55	9,000	15,060	24,060	9,180	24,880	34,060
Truck, cargo, 5-T, 6X6, M55A2	8,840	15,060	23,900	9,450	34,850	44,300
Truck, cargo, 5-T, 8X8, M656	12,200	5,100	17,300	13,480	14,220	27,700
Truck, cargo, 5-T, 6X6, M813	10,250	11,870	22,120	11,980	30,540	42,520
Truck, cargo, 5-T, 6X6, M813A1	10,250	11,890	22,140	11,980	30,560	42,540
Truck, cargo, 5-T, 6X6, M814	10,780	14,790	25,570	12,510	33,460	45,970
Truck, cargo, 5-T, 6X6, M923	—	—	—	—	—	—
Truck, cargo, 5-T, 6X6, M925	9,630	11,916	21,546	10,962	31,916	42,878
Truck, cargo, 5-T, 6X6, M927	—	—	—	—	—	—
Truck, cargo, 5-T, 6X6, M928	10,760	14,828	25,588	12,488	33,500	45,988
Truck, dump, 5-T, 6X6, M51	9,300	13,360	22,660	8,660	23,320	31,980
Truck, dump, 5-T, 6X6, M51A1	9,300	13,360	22,660	8,660	23,320	31,980
Truck, dump, 5-T, 6X6, M51A2	9,150	13,550	22,700	8,260	33,490	43,100
Truck, dump, 5-T, 6X6, M817	10,700	13,730	24,430	9,760	32,770	44,820
Truck, dump, 5-T, 6X6, M929	—	—	—	—	—	—
Truck, dump, 5-T, 6X6, M930	10,680	13,760	22,440	12,110	33,050	45,160
Truck, trac, 5-T, 6X6, M52	9,010	9,990	19,000	9,380	24,610	33,990
Truck, trac, 5-T, 6X6, M52A1	9,220	10,230	19,450	9,510	24,940	34,450
Truck, trac, 5-T, 6X6, M52A2	8,800	9,900	18,700	9,430	34,270	43,700
Truck, trac, 5-T, 6X6, M757	11,900	4,750	16,650	18,310	7,740	26,050
Truck, trac, 5-T, 6X6, M818	10,460	10,490	20,950	11,850	33,680	45,530
Truck, trac, 5-T, 6X6, M819	11,890	22,050	33,940	13,280	37,060	50,340
Truck, trac, 5-T, 6X6, M931	—	—	—	—	—	—
Truck, trac, 5-T, 6X6, M932	10,679	13,761	22,440	12,111	33,049	45,160
Truck, trac, wkr, 5-T, 6X6, M246	12,790	20,040	32,830	13,030	36,150	49,180
Truck, trac, wkr, 5-T, 6X6, M62	9,320	24,000	33,320	5,020	35,300	40,320

Table 3-5. Vehicle axle weights (cont)

Vehicle	Curb Weight (lb)			Gross Weight, Payload & Personnel (lb)								
	Axle Load w/Winch			Axle Load w/Winch			Axle Load w/o Winch			Total		
	Front	Rear	Total	Front	Rear	Total	Front	Rear	Total			
Truck, wkr, 5-T, 6X6, M543A1	9,300	25,100	34,400	—	—	—	—	—	—	—		
Truck, wkr, 5-T, 6X6, M543A2	9,300	25,100	34,400	—	—	—	—	—	—	—		
Truck, wkr, 5-T, 6X6, M816	12,010	24,120	36,130	—	—	—	13,060	35,470	48,530	—		
Truck, wkr, 5-T, 6X6, M936	11,990	24,150	36,140	—	—	—	13,060	35,470	48,530	—		
Truck, van, expansible, 2½-T, 6X6, M292	—	—	—	7,490	13,120	20,610	—	—	—	8,090	17,870	25,960
Truck, van, expansible, 5-T, 6X6, M291A2	—	—	—	9,000	17,100	26,100	—	—	—	9,960	31,540	41,500
Truck, van, expansible, 5-T, 6X6, M820	—	—	—	9,580	17,920	27,500	—	—	—	10,880	32,020	42,900
Truck, van, expansible, 5-T, 6X6, M820A2	—	—	—	9,730	19,520	29,250	—	—	—	11,030	33,620	44,650
Truck, van, expansible, 5-T, 6X6, M934	—	—	—	9,560	17,960	27,520	—	—	—	10,860	32,060	42,920
Truck, van, expansible, 5-T, 6X6, M935	—	—	—	9,710	19,560	29,270	—	—	—	11,010	33,660	44,670
Truck, van, expansible, 8-T, 4X4, M520	17,360	7,240	24,600	24,270	7,410	31,680	21,460	19,110	40,570	40,240	19,280	59,520
Truck, van, expansible, 8-T, 4X4, M877	17,480	7,950	25,430	25,100	8,120	33,220	21,700	19,700	41,400	41,070	19,870	60,940
Truck, trac, 5-T, 6X6, M931	—	—	—	10,077	13,751	23,828	—	—	—	11,509	33,039	44,548
Truck, trac, 5-T, 6X6, M932	10,679	13,761	24,440	—	—	—	12,111	33,049	45,160	—	—	—
Truck, trac, wkr, 5-T, 6X6, M246	12,790	20,040	32,830	—	—	—	13,030	36,150	49,180	—	—	—
Truck, trac, wkr, 5-T, 6X6, M62	9,320	24,000	33,320	—	—	—	5,020	35,300	40,320	—	—	—
Truck, wkr, 5-T, 6X6, M543A1	9,300	25,100	34,400	—	—	—	—	—	—	—	—	—
Truck, wkr, 5-T, 6X6, M543A2	9,300	25,100	34,400	—	—	—	—	—	—	—	—	—
Truck, wkr, 5-T, 6X6, M816	12,010	24,120	36,130	—	—	—	13,060	35,470	48,530	—	—	—
Truck, wkr, 5-T, 6X6, M936	11,990	24,150	36,140	—	—	—	13,060	35,470	48,530	—	—	—
Truck, van, expansible, 2½-T, 6X6, M292	—	—	—	7,490	13,120	20,610	—	—	—	8,090	17,870	25,960
Truck, van, expansible, 5-T, 6X6, M291A2	—	—	—	9,000	17,100	26,100	—	—	—	9,960	31,540	41,500
Truck, van, expansible, 5-T, 6X6, M820	—	—	—	9,580	17,920	27,500	—	—	—	10,880	32,020	42,900
Truck, van, expansible, 5-T, 6X6, M820A2	—	—	—	9,730	19,520	29,250	—	—	—	11,030	33,620	44,650



Table 3-5. Vehicle axle weights (cont)

Vehicle	Curb Weight (lb)			Gross Weight, Payload & Personnel (lb)								
	Axle Load w/Winch		Total	Axle Load w/Winch		Total	Axle Load w/Winch		Total			
	Front	Rear		Front	Rear		Front	Rear				
Truck, van, expansible, 5-T, 6X6, M934	—	—	—	9,560	17,960	27,520	—	—	—	10,860	32,060	42,920
Truck, van, expansible, 5-T, 6X6, M935	—	—	—	9,710	19,560	29,270	—	—	—	11,010	33,660	44,670
Truck, van, expansible, 8-T, 4X4, M520	17,360	7,240	24,600	24,270	7,410	31,680	21,460	19,110	40,570	40,240	19,280	59,520
Truck, van, expansible, 8-T, 4X4, M877	17,480	7,950	25,430	25,100	8,120	33,220	21,700	19,700	41,400	41,070	19,870	60,940
Truck, van, expansible, 10-T, 8X8, M977	20,930	17,240	38,170	20,430	16,840	37,270	27,740	32,430	60,170	27,240	32,030	59,270
Truck, van, expansible, 10-T, 8X8, M985	20,160	19,140	39,300	19,660	18,740	38,400	26,970	34,330	61,300	26,470	33,930	60,400
Truck, van, expansible, 10-T, 8X8, M983	24,220	14,750	38,970	23,730	14,340	38,070	24,220	26,750	50,970	23,730	26,340	50,070
Truck, trac, 10-T, 6X6, M123A1C	12,650	17,580	30,230	—	—	—	13,750	46,490	60,240	—	—	—
Truck, trac, 10-T, 6X6, M123C	12,650	17,580	30,230	—	—	—	13,750	46,490	60,240	—	—	—
Truck, trac, 10-T, 6X6, M123D	12,650	17,580	30,230	—	—	—	13,750	46,490	60,240	—	—	—
Truck, trac, 10-T, 6X6, M916	13,880	14,000	27,880	—	—	—	14,220	42,340	56,560	—	—	—
Truck, trac, 10-T, 8X6, M920	26,020	10,180	36,200	—	—	—	27,920	43,640	71,560	—	—	—
Truck, trac, 14-T, 8X4, M915	—	—	—	9,920	9,710	19,630	—	—	—	11,055	36,660	48,915
Truck, trac, 22 1/2-T, 8X8, M746	29,320	19,530	48,850	—	—	—	37,130	52,570	89,700	—	—	88,000
Truck, trac, 22 1/2-T, 8X8, M911	19,580	19,630	39,210	—	—	—	29,230	51,120	80,350	—	—	—
Sltr, stake, 6-T, 2-whl, M118A1	—	—	—	—	4,750	7,100	—	—	—	—	—	15,030
Sltr, van, 6-T, 2-whl, M119	—	—	—	—	4,920	7,180	—	—	—	—	—	14,160
Sltr, van, 6-T, 2-whl, M119A1	—	—	—	—	5,600	8,140	—	—	—	—	—	12,600
Sltr, van, shop, 6-T, 2-whl, M146	—	—	—	—	4,880	6,950	—	—	—	—	—	11,880
Sltr, van, shop, 6-T, 2-whl, M146F	—	—	—	—	4,880	6,950	—	—	—	—	—	11,880
Sltr, van, elct, 6-T, 2-whl, M373A2	—	—	—	—	6,040	9,430	—	—	—	—	—	12,540
Sltr, van, elct, 6-T, 2-whl, M348A2	—	—	—	—	5,090	9,810	—	—	—	—	—	12,930
Sltr, van, expansible, 6-T, 4-whl, M313	—	—	—	—	11,220	15,350	—	—	—	—	—	20,000
Sltr, van, stor, 6-T, 4-whl, M749	—	—	—	—	9,160	16,510	—	—	—	—	—	12,700
Sltr, van, stor, 6-T, 4-whl, M750	—	—	—	—	9,160	16,510	—	—	—	—	—	12,700
Sltr, stake, 6-T, 4-whl, M127	—	—	—	—	9,950	14,240	—	—	—	—	—	30,200
Sltr, stake, 12-T, 4-whl, M127A1	—	—	—	—	10,230	14,240	—	—	—	—	—	23,500

Table 3-5. Vehicle axle weights (cont)

Vehicle	Curb Weight (lb)			Gross Weight, Payload & Personnel (lb)			
	Axle Load w/Winch		Total	Axle Load w/Winch		Total	
	Front	Rear		Front	Rear		
Str, stake, 12-T, 4-whl, M127A1C	—	—	14,240	—	—	23,500	38,240
Str, stake, 12-T, 4-whl, M127A2C	—	—	13,840	—	—	23,930	37,840
Str, van, cargo, 12-T, 4-whl, M128A1C	—	—	15,600	—	—	24,000	39,600
Str, van, cargo, 12-T, 4-whl, M128A2C	—	—	15,220	—	—	24,570	39,220
Str, van, supply, 12-T, 4-whl, M129A1C	—	—	15,600	—	—	15,600	39,600
Str, van, supply, 12-T, 4-whl, M129A2C	—	—	15,400	—	—	24,670	39,400
Str, low-bed, wkr, 12-T, 4-whl, M269A1	—	—	14,200	—	—	28,040	38,200
Str, low-bed, wkr, 12-T, 4-whl, M269A1	—	—	14,200	—	—	28,040	38,200
Str, tk, fuel, 12-T, 4-whl, M967	—	—	14,040	—	—	29,220	39,840
Str, tk, fuel, 12-T, 4-whl, M969	—	—	16,060	—	—	30,780	41,860
Str, tk, fuel, 12-T, 4-whl, M970	—	—	16,810	—	—	30,900	42,610
Str, tk, fuel, 12-T, 4-whl, M131A2	—	—	12,400	—	—	26,200	42,900
Str, tk, fuel, 12-T, 4-whl, M131A4	—	—	12,900	—	—	29,520	48,150
Str, tk, fuel, 12-T, 4-whl, M131A4C	—	—	13,850	—	—	30,200	49,100
Str, tk, fuel, 12-T, 4-whl, M131A5	—	—	12,780	—	—	22,550	48,030
Str, low-bed, 22½-T, 4-whl, M871	—	—	15,900	—	—	35,320	60,700
Str, low-bed, 25-T, 4-whl, M172A1	—	—	15,500	—	—	40,850	65,500
Str, low-bed, 25-T, 4-whl, M172	—	—	15,500	—	—	40,850	65,500
Str, flat-bed, 34-T, 6-whl, M872	—	—	19,030	—	—	57,020	85,420
Str, low-bed, 40-T, 6-whl, M870	—	—	16,500	—	—	56,500	96,500
Str, low-bed, 55-T, 9-whl, M524E2	—	—	32,620	—	—	87,020	142,620
Str, tk, trans, 50-T, 8-whl, M15A2	—	—	41,790	—	—	81,890	141,790
Str, HET 60-T, 8-whl, M747	—	—	32,000	—	—	106,000	152,000
Trailer, cargo, ¼-T, 2-whl, M416	—	—	570	—	—	960	1,070
Trailer, cargo, ½-T, 2-whl, M416A1	—	—	670	—	—	1,020	1,170
Trailer, cargo, ¾-T, 2-whl, M101	—	—	1,340	—	—	2,670	2,840
Trailer, cargo, ¾-T, 2-whl, M101A1	—	—	1,340	—	—	2,640	2,840

**Table 3-5. Vehicle axle weights (cont)**

Vehicle	Axle Load w/Winch			Curb Weight (lb)			Axle Load w/o Winch			Gross Weight, Payload & Personnel (lb)		
	Front	Rear	Total	Front	Rear	Total	Front	Rear	Total	Front	Rear	Total
Trailer, ammo, 1½-T, 2-whl, M332	—	—	—	—	2,430	2,800	—	—	—	—	5,360	5,800
Trailer, cargo, 1½-T, 2-whl, M105A2	—	—	—	—	2,520	2,750	—	—	—	—	5,380	5,750
Trailer, tk, water, 1½-T, 2-whl, M107A1	—	—	—	—	2,010	2,280	—	—	—	—	5,340	5,610
Trailer, tk, water, 1½-T, 2-whl, M107A2	—	—	—	—	2,100	2,380	—	—	—	—	5,710	5,440
Trailer, tk, water, 1½-T, 2-whl, M149	—	—	—	—	2,260	2,500	—	—	—	—	5,570	5,830
Trailer, tk, water, 1½-T, 2-whl, M149A1	—	—	—	—	2,350	2,710	—	—	—	—	5,690	6,040
Trailer, tk, water, 1½-T, 2-whl, M149A2	—	—	—	—	2,400	2,730	—	—	—	—	5,730	6,060

**Table 3-6. Center of balance: location on single-unit vehicles**

Vehicle	CB Without Payload				CB With Evenly Distributed Payload			
	Location w/Winch		Location w/o Winch		Location w/Winch		Location w/o Winch	
	Above Ground (in)	Behind Front Axle CL (in)	Above Ground (in)	Behind Front Axle CL (in)	Above Ground (in)	Behind Front Axle CL (in)	Above Ground (in)	Behind Front Axle CL (in)
Truck, amb, 1¼-T, 4X4, M1010	—	—	36.4	66.0	—	—	—	—
Truck, cargo, 1¼-T, 4X4, M715	31.0	56.6	31.0	60.7	32.0	80.4	32.0	84.4
Truck, cargo, 1¼-T, 4X4, M725	—	—	39.0	71.0	—	—	42.0	84.0
Truck, cargo, 1¼-T, 4X4, M1008	—	—	30.5	57.6	—	—	—	80.5
Truck, cargo, 1¼-T, 4X4, M1028	—	—	30.5	54.9	—	—	—	83.9
Truck, cargo, 2½-T, 6X6, M35	37.7	77.0	37.5	81.0	48.0	97.0	48.0	100.0
Truck, cargo, 2½-T, 6X6, M35A1	38.0	81.0	38.0	85.5	46.0	110.0	46.5	113.0
Truck, cargo, 2½-T, 6X6, M35A2	38.0	82.0	38.7	86.5	47.7	100.2	47.0	104.0
Truck, cargo, 2½-T, 6X6, M35A2C	38.0	82.0	38.7	86.5	47.7	100.2	47.0	104.0
Truck, cargo, 2½-T, 6X6, M36A2	37.0	80.5	37.7	83.7	48.0	95.0	47.0	101.5
Truck, cargo, 2½-T, 6X6, M36C	34.7	95.0	34.3	98.5	43.0	110.0	42.6	113.5
Truck, cargo, 2½-T, 6X6, M211	37.0	89.0	37.0	89.0	49.0	106.0	49.0	106.0
Truck, cargo, 2½-T, 6X6, M135	38.0	85.0	38.0	88.0	48.0	102.0	48.0	105.0
Truck, tk, gas, 2½-T, 6X6, M49	41.1	90.2	41.0	94.0	49.8	105.8	50.0	109.0
Truck, tk, fuel-serv, 1,200-gal, 2½-T, 6X6, M49A1C	—	—	41.0	92.0	—	—	50.0	113.0
Truck, tk, fuel-serv, 1,200-gal, 2½-T, 6X6, M49A2C	40.5	87.0	41.0	91.5	44.0	93.0	44.5	97.0
Truck, tk, water, 1,000-gal, 2½-T, 6X6, M50	—	—	41.0	95.0	—	—	48.0	113.0
Truck, tk, water, 1,000-gal, 2½-T, 6X6, M50A1	41.0	85.0	41.0	89.0	50.0	105.0	50.0	109.0
Truck, tk, water, 1,000-gal, 2½-T, 6X6, M50A2	40.5	86.2	41.0	90.7	45.0	83.2	45.5	87.0
Truck, wkr, 2½-T, 6X6, M60	42.0	110.0	—	—	49.0	114.0	—	—
Truck, van, shop, 2½-T, 6X6, M109	—	—	41.2	102.0	—	—	54.0	113.5
Truck, van, shop, 2½-T, 6X6, M109A2	46.0	89.0	46.5	93.0	59	108.0	59.5	111.0
Truck, van, shop, 2½-T, 6X6, M109A3	46.0	89.2	46.5	93.5	54.5	101.5	55.5	104.5
Truck, van, repair shop, 2½-T, 6X6, M185A3	—	—	48.0	99.0	—	—	56.6	115.5
Truck, van, expandible, 2½-T, 6X6, M292A2	—	—	57.0	120.0	—	—	65.0	134.0
Truck, van, expandible, 2½-T, 6X6, M292A5	—	—	58.0	125.0	—	—	65.0	143.0
Truck, trac, 2½-T, 6X6, M275A1	38.0	66.0	38.0	70.0	—	102.0	—	105.0
Truck, trac, 2½-T, 6X6, M275A2	38.0	66.0	38.0	70.0	—	102.0	—	105.0
Truck, dump, 2½-T, 6X6, M215	36.0	89.0	36.0	92.0	45.0	108.0	45.0	110.0
Truck, dump, 2½-T, 6X6, M342A2	40.0	85.5	40.5	84.5	45.0	102.0	45.2	101.7
Truck, cargo, 5-T, 6X6, M54	39.9	99.8	40.1	105.9	54.1	124.4	54.7	128.8
Truck, cargo, 5-T, 6X6, M54A2	40.0	103.0	40.5	108.0	54.0	135.0	54.5	139.0
Truck, cargo, 5-T, 6X6, M54A2C	40.0	104.0	40.5	109.0	54.0	136.0	54.5	140.0
Truck, cargo, 5-T, 6X6, M55	40.3	134.8	—	—	49.1	157.1	—	—
Truck, cargo, 5-T, 6X6, M55A2	40.5	135.5	40.0	141.5	55.0	170.2	54.5	173.0
Truck, cargo, 5-T, 8X8, M656	—	42.2	—	50.6	—	76.2	—	83.0
Truck, cargo, 5-T, 6X6, M813	38.1	96.1	38.5	101.2	60.0	128.5	60.5	131.7

**Table 3-6. Center of balance: location on single-unit vehicles (cont)**

Vehicle	CB Without Payload				CB With Evenly Distributed Payload			
	Location w/Winch		Location w/o Winch		Location w/Winch		Location w/o Winch	
	Above Ground (in)	Behind Front Axle CL (in)	Above Ground (in)	Behind Front Axle CL (in)	Above Ground (in)	Behind Front Axle CL (in)	Above Ground (in)	Behind Front Axle CL (in)
Truck, cargo, 5-T, 6X6, M813A1	38.1	96.1	38.5	101.2	60.0	128.5	60.5	131.7
Truck, cargo, 5-T, 6X6, M814	38.1	131.5	38.7	141.1	61.2	158.2	61.5	161.5
Truck, cargo, 5-T, 6X6, M923	—	—	38.6	101.2	—	—	60.5	131.7
Truck, cargo, 5-T, 6X6, M925	38.1	96.1	—	—	59.9	128.5	—	—
Truck, cargo, 5-T, 6X6, M927	—	—	38.7	141.1	—	—	61.6	161.5
Truck, cargo, 5-T, 6X6, M928	38.1	131.5	—	—	61.2	158.2	—	—
Truck, dump, 5-T, 6X6, M51	38.7	98.3	38.9	102.7	47.4	118.4	47.7	121.7
Truck, dump, 5-T, 6X6, M51A2	38.7	99.7	38.7	104.0	58.0	130.0	58.0	133.0
Truck, dump, 5-T, 6X6, M817	37.0	93.8	37.0	98.4	49.0	122.1	49.2	125.5
Truck, dump, 5-T, 6X6, M929	—	—	37.0	98.4	—	—	49.2	125.5
Truck, dump, 5-T, 6X6, M930	36.9	93.8	—	—	48.9	122.1	—	—
Truck, trac, 5-T, 6X6, M52	34.5	87.8	34.0	92.6	46.2	120.7	45.7	124.0
Truck, trac, 5-T, 6X6, M52A2	34.0	88.5	34.5	94.0	—	131.0	—	134.0
Truck, trac, 5-T, 8X8, M757	36.3	43.6	36.0	51.8	—	67.3	—	73.3
Truck, trac, 5-T, 6X6, M818	33.0	83.5	33.2	87.4	—	126.8	—	129.1
Truck, trac, wkr, 5-T, 6X6, M819	56.5	127.0	—	—	—	127.0	—	—
Truck, wkr, 5-T, 6X6, M62	—	124.5	—	—	—	156.4	—	—
Truck, wkr, 5-T, 6X6, M543A2	47.0	131.0	—	—	—	—	—	—
Truck, wkr, 5-T, 6X6, M816	43.2	125.1	—	—	—	165.2	—	—
Truck, wkr, 5-T, 6X6, M936	43.2	125.1	—	—	—	165.1	—	—
Truck, van, expansible, 5-T, 6X6, M291A2	—	—	56.2	141.0	—	—	64	163
Truck, van, expansible, 5-T, 6X6, M820	—	—	54.3	138.0	—	—	—	161.2
Truck, van, expansible, 5-T, 6X6, M820A1	—	—	54.3	138.0	—	—	—	161.2
Truck, van, expansible, 5-T, 6X6, M934	—	—	54.3	138.0	—	—	—	161.2
Truck, van, expansible, 5-T, 6X6, M935	—	—	55.5	148.5	—	—	—	169.7
Truck, cargo, 10-T, 8X8, M977	44.7	95.0	—	—	62.4	113.2	—	—
Truck, cargo, 10-T, 8X8, M985	45.3	100.7	—	—	67.4	117.6	—	—
Truck, trac, 10-T, 8X8, M983	43.0	59.7	—	—	—	—	—	—
Truck, trac, 10-T, 6X6, M916	43.7	94.7	—	—	—	—	—	—
Truck, trac, 10-T, 6X6, M920	41.2	107.0	—	—	—	—	—	—
Truck, wkr, 10-T, 8X8, M984	45.5	101.0	—	—	—	—	—	—
Truck, fuel, svc, 10-T, 8X8, M983	49.0	65.6	—	—	—	—	—	—
Truck, trac, 22½-T, 8X8, M746	51.0	62.7	—	—	—	—	—	—
Truck, trac, 22½-T, 8X8, M911	59.5	119.0	—	—	—	—	—	—
Truck, utility, ¾-T, 4X4, M1009	—	—	30.5	57.6	—	—	—	80.5

**Table 3-7. Dimensions and loading capacity for cargo truck bodies**

Vehicle Type	Cargo Deck Dimensions			Cargo Body Loading Measurements								
	Length (in)	Width (in)	Height Above Ground (in)	Under (in)	Bows (cu ft)	Top of Side Racks (in)	Top of Side Racks (cu ft)	Top of Steering Wheel (in)	Top of Steering Wheel (cu ft)			
<b>¾-ton:</b>												
M37	78.0	64.0	35.2	54.0	1 2 3	134.8	35.4	1 2	84.3	29.3	1 2	66.7
M37B1	78.0	64.0	35.2	54.0	1 3	146.1	35.4	1	95.7	29.3	1	78.0
<b>1¼-ton:</b>												
M561	87.8	81.0	30.8	62.4	4 5	235.4	41.1	4	152.4	36.7	4 6	134.2
M715	92.8	64.0	36.5	55.5	7 8	182.0	38.5	7	129.0	22.8	7	78.4
M880	98.6	69.9	34.0	NA	NA	NA	NA	NA	NA	39.5	9 10	151.9
M881	98.6	69.9	34.0	NA	NA	NA	NA	NA	NA	39.5	9 10	151.9
M882	98.6	69.9	34.0	NA	NA	NA	NA	NA	NA	39.5	9 10 11	124.6
M883	98.6	69.9	34.0	NA	NA	NA	NA	NA	NA	39.5	9 10	151.9
M884	98.6	69.9	34.0	NA	NA	NA	NA	NA	NA	39.5	9 10	151.9
M885	98.6	69.9	34.0	NA	NA	NA	NA	NA	NA	39.5	9 10 12	151.9
M890	98.6	69.9	31.0	NA	NA	NA	NA	NA	NA	39.5	9 10	151.9
M891	98.6	69.9	31.0	NA	NA	NA	NA	NA	NA	39.5	9 10	151.9
M892	98.6	69.9	31.0	NA	NA	NA	NA	NA	NA	39.5	9 10 13	151.9
<b>2½-ton:</b>												
M34	147.0	80.0	44.0	60.0	14 15	389.0	36.5	(16)		38.0	14	245.9
M35	146.8	88.0	51.9	60.0	15	441.9	36.5	272.8	28.9			216.0
M35A1	146.8	88.0	51.9	60.0	15	441.9	36.5	272.8	28.9			216.0
M35A2	146.8	88.0	51.9	60.0	15	441.9	36.5	272.8	28.9			216.0
M35A2C	147.0	87.6	52.5	60.0	15	440.5	36.5	272.0	28.8			214.6
M36	210.0	88.0	51.8	71.8	17	759.3	36.4	389.2	28.7			306.9
M36A2	210.0	88.0	51.8	71.8	17	759.3	36.4	389.2	28.7			306.9
M135	147.0	80.0	44.5	60.0	15 18	391.0	36.4	18	237.7	35.3	18	229.5
M211	147.0	88.0	51.0	60.0	15	442.5	36.5	273.2	26.0			194.6
M602	147.0	88.0	53.0	60.5	15	446.3	36.5	273.2	27.9			208.8
<b>5-ton:</b>												
M41	165.0	88.0	49.2	60.0	19 20	2146.2	36.5	(16)		38.8	19 20	275.0
M54	168.0	88.0	56.5	60.0	22 23	480.2	36.5	22	286.1	29.0	22	222.0
M54A1	168.0	88.0	56.5	60.0	22 23	480.2	36.5	22	286.1	29.0	22	222.0
M54A1C	168.0	88.0	55.5	60.0	22 23	482.5	36.5	22	287.5	30.0	22	231.7
M54A2	168.0	88.0	56.5	60.0	22 23	480.2	36.5	22	286.1	29.0	22	222.0
M54A2C	168.0	88.4	55.5	60.0	22 23	482.5	36.5	22	287.5	30.0	22	231.7
M55	244.0	88.0	56.3	61.3	24	751.5	36.5	453.5	28.0			360.3
M55A1	244.0	88.0	56.3	61.3	24	751.5	36.5	453.5	28.0			360.3
M55A2	244.0	88.0	56.2	61.3	24	751.5	36.5	453.5	28.0			360.3
M328A1	219.3	97.8	64.8	50.5	25	626.7	25	(25)	(25)		(25)	
M656	181.0	88.0	56.8	60.0	23	546.0	27.0	248.8	(26)		(27)	
M812A2	210.0	120.0	60.0	28	79.0	29 1	152.0	(28)	(29)	(28)	(29)	
M813	168.0	88.3	56.8	57.2	24 30	468.0	36.5	30	298.8	29.3	30	237.0
M813A1	168.0	88.3	56.8	57.4	24 30	468.0	36.5	30	298.8	29.3	30	237.0
M814	243.8	87.8	57.3	60.0	24	733.0	36.3	449.6	31.3			387.5
M821	218.8	97.8	64.0	48.8	25	604.3	(25)	(25)	(25)		(25)	
M923	168.0	88.3	56.8	57.4	24 30	468.0	36.5	30	298.8	29.3	30	237.0
M924	168.0	88.3	56.8	57.4	24 30	468.0	36.5	30	298.8	29.3	30	237.0
M925	168.0	88.3	56.8	57.4	24 30	468.0	36.5	30	298.8	29.3	30	237.0

**Table 3-7. Dimensions and loading capacity for cargo truck bodies (cont)**

Vehicle Type	Cargo Deck Dimensions			Cargo Body Loading Measurements					
	Length (in)	Width (in)	Height Above Ground (in)	Under (in)	Bows (cu ft)	Top of Side Racks (in)	Top of Side Racks (cu ft)	Top of Steering Wheel (in)	Top of Steering Wheel (cu ft)
5-ton: (cont)									
Bridge transporter	213.0	97.8	64.8	50.5	25 <sup>6</sup> 608.7	(25)	(25)	(25)	(25)
8-ton:									
M520	197.5	97.8	43.3	88.5	23 <sup>31</sup> 888.4	(32)	(16)	65.0	6 <sup>31</sup> 520.9
M877	197.5	97.8	43.3	28 <sup>8</sup> 88.5	19 <sup>33</sup> 867.5	(32)	(16)	55.0	19 <sup>33</sup> 500.0
10-ton:									
M125	180.0	96.0	68.0	62.0	34 <sup>35</sup> 590.0	42.0	34 <sup>3</sup> 398.1	23.8	34 <sup>2</sup> 216.0
M125A1	180.0	96.0	68.0	62.0	34 <sup>35</sup> 590.0	42.0	34 <sup>3</sup> 398.1	23.8	34 <sup>2</sup> 216.1
M977	216.0	90.0	65.0	28 <sup>4</sup> 48.0	36 <sup>5</sup> 540.0	(31)	(32)	10 <sup>3</sup> 38.0	10 <sup>4</sup> 427.5
M985	216.0	90.0	65.0	28 <sup>4</sup> 48.0	36 <sup>5</sup> 540.0	(32)	(16)	10 <sup>3</sup> 38.0	10 <sup>4</sup> 427.5

- <sup>1</sup>Cubic capacity reduced 6.6 cubic feet for wheel wells.
- <sup>2</sup>Cubic capacity reduced 11.3 cubic feet for spare tire and carrier in cargo body.
- <sup>3</sup>Cubic capacity reduced 3.3 cubic feet for curve of bows.
- <sup>4</sup>Cubic capacity reduced 16.8 cubic feet for wheel wells.
- <sup>5</sup>Cubic capacity reduced 4.6 cubic feet for curve of bows.
- <sup>6</sup>Top of hood is higher than steering wheel.
- <sup>7</sup>Cubic capacity reduced 2.4 cubic feet for wheel wells.
- <sup>8</sup>Cubic capacity reduced 3.9 cubic feet for curve of bows.
- <sup>9</sup>Cubic capacity reduced 5.6 cubic feet for wheel wells.
- <sup>10</sup>Height and cube measured to top of cab.
- <sup>11</sup>Cubic capacity reduced 27.3 cubic feet for communication kit.
- <sup>12</sup>Cubic capacity reduced 0.8 cubic feet for communications tie-down brackets.
- <sup>13</sup>Cubic capacity reduced 40.1 cubic feet for communication kit.
- <sup>14</sup>Cubic capacity reduced 12.7 cubic feet for wheel wells.
- <sup>15</sup>Cubic capacity reduced 6.6 cubic feet for curve of bows.
- <sup>16</sup>See top of Steering Wheel column for cube.
- <sup>17</sup>Cubic capacity reduced 8.5 cubic feet for curve of bows.
- <sup>18</sup>Cubic capacity reduced 10.7 cubic feet for wheel wells.
- <sup>19</sup>Cubic capacity reduced 24.0 cubic feet for wheel wells.
- <sup>20</sup>Cubic capacity reduced 27.0 cubic feet for spare tire and carrier in cargo body.
- <sup>21</sup>Cubic capacity reduced 6.9 cubic feet for curve of bows.
- <sup>22</sup>Cubic capacity reduced 26.1 cubic feet for spare tire and carrier in cargo body.
- <sup>23</sup>Cubic capacity reduced 7.0 cubic feet for curve of bows.
- <sup>24</sup>Cubic capacity reduced 10.2 cubic feet for curve of bows.
- <sup>25</sup>Height and cube measured to top of bulkhead.
- <sup>26</sup>See Top of Side Racks column for height.
- <sup>27</sup>See Top of Side racks column for cube.
- <sup>28</sup>Height over spare tire.
- <sup>29</sup>Cubic capacity over materials-handling crane mounted in body.
- <sup>30</sup>Cubic capacity reduced 14.5 cubic feet for spare tire and carrier in cargo body.
- <sup>31</sup>Cubic capacity reduced 93.8 cubic feet for wheel wells.
- <sup>32</sup>See top of Steering Wheel column for height. Steering wheel is higher than side racks.
- <sup>33</sup>Cubic capacity reduced by 20.0 cubic feet for crane in cargo body.
- <sup>34</sup>Cubic capacity reduced 21.9 cubic feet for spare tire and carrier in cargo body.
- <sup>35</sup>Cubic capacity reduced 7.5 cubic feet for curve of bows.
- <sup>36</sup>Cube measured to top of spare tire.

**Table 3-8. Dimensions and loading capacity for dump truck bodies**

Vehicle Type	Cargo Deck Dimensions			Cargo Body Loading Measurements					
	Length (in)	Width (in)	Height Above Ground (in)	Top of Side Panels (in)	Top of Side Panels (cu ft)	Top of Steering Wheel (in)	Top of Steering Wheel (cu ft)	Top of Cab Shield (in)	Top of Cab Shield (cu ft)
<b>2½-ton:</b>									
M47	108.0	70.0	54.0	24.5	(1)	27.0	(1)	48.5	212.2
M59	108.0	70.0	54.8	24.5	(1)	26.5	(1)	49.0	214.3
M215	108.0	70.0	52.0	24.5	(1)	26.5	(1)	56.0	245.0
M342A2	132.0	70.0	55.2	24.5	(1)	26.5	(1)	47.1	251.8
<b>5-ton:</b>									
M51	123.0	82.0	59.0	25.0	(1)	27.0	(1)	51.0	297.6
M51A1	123.0	82.0	59.0	25.0	(1)	27.0	(1)	51.0	297.6
M51A2	123.0	82.0	59.0	25.0	(1)	27.0	(1)	51.0	297.6
M817	124.8	81.9	59.0	25.0	(1)	27.1	(1)	51.8	306.3
M929	124.8	81.9	59.0	28.0	(1)	27.1	(1)	51.8	306.3
M930	124.8	81.9	59.0	25.0	(1)	27.1	(1)	51.8	306.3
<b>20-ton:</b>									
F5070	191.5	85.1	66.5	34.3	(2)	NA	(2)	58.8	<sup>3</sup> 537.0
M917	216.0	84.0	68.0	31.0	(2)	NA	(2)	(2)	<sup>3</sup> 753.6

<sup>1</sup>Removed cab shield stowed in dump body. See Top of Cab Shield column for cube.

<sup>2</sup>Cab shield cannot be removed. See Top of Cab Shield column for Cube.

<sup>3</sup>Cube capacity reduced 12.9 cubic feet for hoist doghouse in dump body.

<sup>4</sup>Cube capacity reduced 1.8 cubic feet for ribs in dump body.

**Table 3-9. Dimensions and loading capacity for cargo trailer bodies**

Vehicle Type	Cargo Deck Dimensions			Cargo Body Loading Measurements					
	Length (in)	Width (in)	Height Above Ground (in)	Under Bows (in)	Under Bows (cu ft)	Top of Side Racks (in)	Top of Side Racks (cu ft)	Top of Side Panels (in)	Top of Side Panels (cu ft)
<b>¼-ton:</b>									
M100	71.5	37.8	24.5	NA	NA	NA	NA	18.0	<sup>1</sup> 29.7
M416	72.0	41.3	26.0	NA	NA	NA	NA	18.0	<sup>1</sup> 31.8
<b>¾-ton:</b>									
M101	94.8	65.3	31.7	49.0	<sup>2</sup> <sup>3</sup> 170.5	33.3	<sup>2</sup> 114.6	18.3	<sup>2</sup> 60.9
M101A1	94.8	65.3	31.7	49.0	<sup>2</sup> <sup>3</sup> 170.5	33.3	<sup>2</sup> 114.6	18.3	<sup>2</sup> 60.9
<b>1½-ton:</b>									
M104	110.0	74.0	38.3	59.3	<sup>4</sup> <sup>5</sup> 273.2	45.3	<sup>4</sup> 207.7	18.0	<sup>4</sup> 79.1
M104A1	110.0	74.0	38.3	59.3	<sup>4</sup> <sup>5</sup> 273.2	45.3	<sup>4</sup> 207.7	18.0	<sup>4</sup> 79.2
M105	109.8	74.0	37.0	60.0	<sup>4</sup> <sup>5</sup> 276.0	45.0	<sup>4</sup> 205.0	18.0	<sup>4</sup> 79.0
M105A1	109.8	74.0	37.0	60.0	<sup>4</sup> <sup>5</sup> 276.0	45.0	<sup>4</sup> 205.9	18.0	<sup>4</sup> 79.0
M105A2	109.8	74.0	37.0	60.0	<sup>4</sup> <sup>5</sup> 276.0	45.0	<sup>4</sup> 205.9	18.0	<sup>4</sup> 79.0

<sup>1</sup>Cubic capacity increased because top 4.5 inches of side panels are 46.0 inches wide.

<sup>2</sup>Cubic capacity reduced 4.6 cubic feet for wheel wells.

<sup>3</sup>Cubic capacity reduced 0.4 cubic feet for curve of bows.

<sup>4</sup>Cubic capacity reduced 5.6 cubic feet for wheel wells.

<sup>5</sup>Cubic capacity reduced 0.5 cubic feet for curve of bows.



**Table 3-10. Dimensions and loading capacity for stake and platform semitrailer cargo bodies**

Vehicle Type	Cargo Deck Dimensions			Cargo Body Loading Measurements	
	Length (in)	Width (in)	Height Above Ground (in)	Height (in)	Capacity (cu ft)
6-ton:					
M118	268.8	88.5	54.0	48.0	660.8
M118A1	268.8	88.5	54.0	48.0	660.8
12-ton:					
M127	335.8	88.8	60.6	47.8	824.8
M127A1	335.8	88.8	60.5	47.8	824.8
M127A1C	335.8	88.8	60.5	48.0	828.3
M127A2C	335.8	88.8	59.8	48.0	828.3
M270A1	459.8	84.0	51.8	48.8	1,090.7
22½-ton:					
M871	349.3	87.3	55.4	48.0	874.1
34-ton:					
M872	484.8	93.0	58.0	49.0	1,278.5
M872A1	484.8	93.0	58.0	49.0	1,278.5
M872A2	484.8	93.0	58.0	49.0	1,278.5
M872A3	484.8	93.0	58.0	49.0	1,278.5

**Table 3-11. Dimensions and loading capacity for van semitrailer cargo bodies**

Vehicle Type	Cargo Deck Dimensions			Cargo Body Loading Measurements	
	Length (in)	Width (in)	Height Above Ground (in)	Height (in)	Capacity (cu ft)
6-ton:					
M119	264.0	89.6	56.5	73.8	1,010.2
M119A1	264.0	89.6	56.5	73.8	1,010.2
M146	264.0	90.0	56.0	76.0	1,045.0
12-ton:					
M128	335.5	89.0	57.0	78.5	1,356.4
M128A1	333.5	89.0	57.0	78.5	1,356.4
M128A1C	336.0	89.0	60.0	78.5	1,358.4
M128A2C	337.5	89.5	60.0	78.5	1,372.2

**Table 3-12. Shipping dimensions and cube for cargo trucks**

Vehicle Type	Length (in)	Width (in)	Top of Side Racks		Top of Steering Wheel	
			Height (in)	Cube (cu ft)	Height (in)	Cube (cu ft)
<b>¾-ton:</b>						
M37	185.5	73.5	170.6	2557.1	164.5	2508.9
M37 WVN	190.3	73.5	170.6	2571.5	164.5	2522.1
M37B1	185.5	75.3	170.6	2570.7	164.5	2521.4
M37B1 WVN	190.3	75.3	170.6	2585.5	164.5	2534.9
<b>1¼-ton:</b>						
M561	226.3	85.3	171.9	2803.2	1367.3	2754.0
M561 WVN	231.1	85.3	171.9	2820.2	1367.5	2770.0
M715	210.3	85.3	175.0	2778.6	159.3	2615.6
M715 WVN	220.5	85.3	175.0	2816.3	159.3	2645.5
M880	218.5	79.8	NA	NA	473.5	4741.6
M881	218.5	79.8	NA	NA	473.5	4741.6
M882	218.5	81.3	NA	NA	473.5	4755.6
M883	218.5	79.8	NA	NA	473.5	4741.6
M884	218.5	79.8	NA	NA	473.5	4741.6
M885	218.5	79.8	NA	NA	473.5	4741.6
M890	218.5	79.8	NA	NA	470.5	4711.4
M891	218.5	81.3	NA	NA	470.5	4711.4
M892	218.5	81.3	NA	NA	470.5	4725.7
<b>2½-ton:</b>						
M34	261.3	88.0	180.5	(2 5)	182.0	2,091.2
M34 WVN	274.8	88.0	180.5	(2 5)	182.0	2,147.5
M35	264.8	95.4	188.4	2,129.3	180.8	2,181.2
M35 WVN	278.5	95.4	188.4	2,135.2	180.8	2,142.3
M35A1	264.8	95.4	188.4	2,129.3	180.8	2,181.2
M35A1 WVN	278.5	95.4	188.4	2,135.2	180.8	2,142.3
M35A2	264.8	95.4	188.4	2,129.3	180.8	2,181.2
M35A2 WVN	278.5	95.4	188.4	2,135.2	180.8	2,142.3
M35A2C	264.5	97.5	189.0	2,132.2	181.3	2,121.3
M35A2C WVN	278.5	97.5	189.0	2,139.5	181.3	2,127.5
M36	329.0	95.1	188.2	2,159.0	180.5	2,145.6
M36 WVN	343.1	95.1	188.2	2,166.4	180.5	2,152.0
M36A2	329.0	95.1	188.2	2,159.0	180.5	2,145.6
M36A2 WVN	343.1	95.1	188.2	2,166.4	180.5	2,152.0
M135	266.8	88.0	181.0	2,100.6	279.8	2,084.2
M135 WVN	266.8	88.0	181.0	2,100.6	179.8	2,084.2
M211	267.5	96.5	187.5	2,130.1	177.0	2,150.3
M211 WVN	267.5	96.5	187.5	2,130.1	177.0	2,150.3
M602	264.3	95.3	189.5	2,130.6	180.9	2,179.2
M602 WVN	277.8	95.3	189.5	2,137.2	180.9	2,139.5
<b>5-ton:</b>						
M41	297.3	96.0	185.7	(2 5)	188.0	2,145.5
M41 WVN	312.5	96.0	185.7	(2 5)	188.0	2,152.8
M54	297.0	98.0	193.0	2,156.5	185.5	2,144.1
M54 WVN	313.5	98.0	193.0	2,165.5	185.5	2,152.1
M54A1	297.0	98.0	193.0	2,156.5	185.5	2,144.1

**Table 3-12. Shipping dimensions and cube for cargo trucks (cont)**

Vehicle Type	Length (in)	Width (in)	Top of Side Racks		Top of Steering Wheel	
			Height (in)	Cube (cu ft)	Height (in)	Cube (cu ft)
5-ton (cont):						
M54A1 WVN	313.5	98.0	<sup>1</sup> 93.0	<sup>2</sup> 1,653.5	<sup>1</sup> 85.5	<sup>2</sup> 1,520.1
M54A1C	297.8	98.5	<sup>1</sup> 92.0	<sup>2</sup> 1,561.7	<sup>1</sup> 85.5	<sup>2</sup> 1,451.4
M54A1C WVN	314.5	98.5	<sup>1</sup> 92.0	<sup>2</sup> 1,649.3	<sup>1</sup> 85.5	<sup>2</sup> 1,532.8
M54A2	297.0	98.0	<sup>1</sup> 93.0	<sup>2</sup> 1,566.6	<sup>1</sup> 85.5	<sup>2</sup> 1,440.1
M54A2 WVN	313.5	98.0	<sup>1</sup> 93.0	<sup>2</sup> 1,653.5	<sup>1</sup> 85.5	<sup>2</sup> 1,520.1
M54A2C	297.8	98.5	<sup>1</sup> 92.0	<sup>2</sup> 1,561.7	<sup>1</sup> 85.5	<sup>2</sup> 1,451.4
M54A2C WVN	314	98.5	<sup>1</sup> 92.0	<sup>2</sup> 1,649.3	<sup>1</sup> 85.5	<sup>2</sup> 1,532.8
M55	376.1	98.0	<sup>1</sup> 92.8	<sup>2</sup> 1,979.4	<sup>1</sup> 85.3	<sup>2</sup> 1,819.4
M55 WVN	389.0	98.0	<sup>1</sup> 92.8	<sup>2</sup> 2,047.3	<sup>1</sup> 85.3	<sup>2</sup> 1,881.8
M55A1	376.1	98.0	<sup>1</sup> 92.8	<sup>2</sup> 1,979.4	<sup>1</sup> 85.3	<sup>2</sup> 1,819.4
M55A1 WVN	389.0	98.0	<sup>1</sup> 92.8	<sup>2</sup> 2,047.3	<sup>1</sup> 85.3	<sup>2</sup> 1,881.8
M55A2	376.1	98.0	<sup>1</sup> 92.8	<sup>2</sup> 1,979.4	<sup>1</sup> 85.3	<sup>2</sup> 1,819.4
M55A2 WVN	389.0	98.0	<sup>1</sup> 92.8	<sup>2</sup> 2,047.3	<sup>1</sup> 85.3	<sup>2</sup> 1,881.8
M328A1	372.3	115.1	<sup>1</sup> 115.3	<sup>2</sup> 2,859.3	(1 6)	(2 6)
M656	278.5	95.5	<sup>1</sup> 82.8	<sup>2</sup> 1,274.4	(1 7)	(2 8)
M656 WVN	229.0	95.5	<sup>1</sup> 82.8	<sup>2</sup> 1,368.2	(1 7)	(2 8)
M812	398.5	124.0	<sup>9</sup> 139.0	<sup>9</sup> 3,974.8	(10)	(9)
M813	304.0	98.0	<sup>1</sup> 93.3	<sup>2</sup> 1,608.1	<sup>1</sup> 86.1	<sup>2</sup> 1,484.4
M813 WVN	319.5	98.0	<sup>1</sup> 93.3	<sup>2</sup> 1,690.6	<sup>1</sup> 86.1	<sup>2</sup> 1,560.1
M813A1	306.8	98.1	<sup>1</sup> 93.3	<sup>2</sup> 1,625.0	<sup>1</sup> 86.1	<sup>2</sup> 1,499.6
M813A1 WVN	322.3	98.1	<sup>1</sup> 93.3	<sup>2</sup> 1,707.1	<sup>1</sup> 86.1	<sup>2</sup> 1,575.3
M814	377.8	98.0	<sup>1</sup> 93.5	<sup>2</sup> 2,003.4	<sup>1</sup> 88.5	<sup>2</sup> 1,896.2
M814 WVN	395.4	98.0	<sup>1</sup> 93.5	<sup>2</sup> 2,067.7	<sup>1</sup> 88.5	<sup>2</sup> 1,984.6
M821 WVN	378.3	114.3	<sup>16</sup> 112.8	<sup>26</sup> 2,822.6	(1 6)	(2 6)
M923	313.1	97.5	<sup>1</sup> 93.3	<sup>2</sup> 1,648.2	86.1	1,521.1
M924	313.1	97.5	<sup>1</sup> 93.3	<sup>2</sup> 1,648.2	86.1	1,521.1
M925 WVN	326.3	97.5	<sup>1</sup> 93.3	<sup>2</sup> 1,717.4	86.1	1,585.2
M926 WVN	326.3	97.5	<sup>1</sup> 93.3	<sup>2</sup> 1,717.4	86.1	1,585.2
M927	389.0	97.5	<sup>1</sup> 93.5	<sup>2</sup> 2,052.2	90.6	1,988.6
M928 WVN	402.0	97.5	<sup>1</sup> 93.5	<sup>2</sup> 2,120.8	90.6	2,455.0
Bridge Transporter	372.3	115.1	<sup>16</sup> 115.3	<sup>26</sup> 2,859.3	(1 6)	(2 6)
8-ton:						
M520	381.5	108.6	(1 11)	(2 5)	<sup>1</sup> 398.3	<sup>23</sup> 2,356.9
M520 WVN	381.5	108.6	(1 11)	(2 5)	<sup>1</sup> 398.3	<sup>2</sup> 3,356.9
M877 WOVN	381.5	108.6	(1 11)	(2 5)	<sup>1</sup> 398.3	<sup>2</sup> 3,356.9
M877 WVN	381.5	108.6	(1 11)	(2 5)	<sup>1</sup> 398.3	<sup>2</sup> 3,356.9
10-ton:						
M125 WVN	318.5	114.0	<sup>1</sup> 110.0	<sup>2</sup> 2,311.3	<sup>1</sup> 91.8	<sup>2</sup> 1,928.9
M125A1 WVN	318.5	114.0	<sup>1</sup> 110.0	<sup>2</sup> 2,311.3	<sup>1</sup> 91.8	<sup>2</sup> 1,928.9
M977	396.3	96.0	(11)	(5)	<sup>4</sup> 103.0	<sup>4</sup> 2,267.7
M977 WVN	396.3	96.0	(11)	(5)	<sup>4</sup> 103.0	<sup>4</sup> 2,267.7
M985 WOVN	396.3	96.0	(11)	(5)	<sup>4</sup> 103.0	<sup>4</sup> 2,267.7
M985 WVN	396.3	96.0	(11)	(5)	<sup>4</sup> 103.0	<sup>4</sup> 2,267.7

<sup>1</sup>For height over bows or top of cab shield, use operational height of vehicle listed in TB 55-46-1.

<sup>2</sup>For shipping cube over side racks/bows and/or top of cab shield, use operational cube of vehicle listed in TB 55-46-1.

**Table 3-12. Shipping dimensions and cube for cargo trucks (cont)**

- <sup>3</sup>Top of hood is higher than steering wheel.
- <sup>4</sup>Height and cube measured to top of cab.
- <sup>5</sup>See Top of Steering Wheel Column for cube.
- <sup>6</sup>Height and cube measured to top of bulkhead.
- <sup>7</sup>Side racks stowed in cargo body are higher than steering wheel. See Top of Side Racks column for height.
- <sup>8</sup>See Top of Side Racks column for cube.
- <sup>9</sup>Cube capacity over materials-handling crane mounted in body.
- <sup>10</sup>Height over spare tire.
- <sup>11</sup>Steering wheel is higher than side panels. See Top of Steering Wheel column for height.

**Table 3-13. Shipping dimensions and cube for dump trucks**

Vehicle Type	Length (in)	Width (in)	Top of Steering Wheel		Top of Side Panels	
			Height (in)	Cube (cu ft)	Height (in)	Cube (cu ft)
<b>2½-ton:</b>						
M47	235.0	84.3	(1 2)	(3 4)	2 581.5	4 6934.3
M47 WWN	248.5	84.3	(1 2)	(3 4)	2 581.5	4 6988.0
M59	237.1	95.8	(1 2)	(3 4)	2 579.3	4 61,042.4
M59 WWN	249.5	95.8	(1 2)	(3 4)	2 579.3	4 61,096.9
M215	240.3	96.0	(1 2)	(3 4)	2 578.5	4 61,048.0
M215 WWN	240.3	96.0	(1 2)	(3 4)	2 578.5	4 61,048.0
M342A2	260.3	95.6	(1 2)	(3 4)	2 582.3	4 61,185.2
M342A2 WWN	273.0	95.6	(1 2)	(3 4)	2 582.3	4 61,243.0
<b>5-ton:</b>						
M51	266.0	97.8	(1 2)	(3 4)	2 588.8	4 61,336.9
M51 WWN	281.5	97.8	(1 2)	(3 4)	2 588.8	4 61,414.8
M51A1	266.0	97.8	(1 2)	(3 4)	2 588.8	4 61,336.9
M51A1 WWN	281.5	97.8	(1 2)	(3 4)	2 588.8	4 61,414.8
M51A2	266.0	97.8	(1 2)	(3 4)	2 588.8	4 61,336.9
M51A2 WWN	281.5	97.8	(1 2)	(3 4)	2 588.8	4 61,414.8
M817	273.3	98.0	(1 2)	(3 4)	2 591.0	4 61,410.5
M817 WWN	288.3	98.0	(1 2)	(3 4)	2 591.0	4 61,487.9
M929	273.0	97.5	(1 2)	(3 4)	2 590.6	4 61,395.5
M930 WWN	288.5	97.5	(1 2)	(3 4)	2 590.6	4 61,474.8
<b>20-ton:</b>						
F5070	312.8	102.1	(2)	(3 4)	2 5125.0	4 62,310.2
M917	350.6	98.0	(2)	(3 4)	2141.0	42,803.6

- <sup>1</sup>Side panels stowed in cargo body are higher than steering wheel. See Top of Side Panels column for height.
- <sup>2</sup>For height over bows or top of cab shield, use operational height of vehicle listed in TB 55-46-1.
- <sup>3</sup>See Top of Side Panels column for cube.
- <sup>4</sup>For shipping cube over side racks/bows and/or top of cab shield, use operational cube of vehicle listed in TB 55-46-1.
- <sup>5</sup>Height of cab shield stowed in dump body.
- <sup>6</sup>Cube with cab shield stowed in dump body.

**Table 3-14. Shipping dimensions and cube for cargo trailers**

Vehicle Type	Length (in)	Width (in)	Top of Side Racks		Top of Side Panels	
			Height (in)	Cube (cu ft)	Height (in)	Cube (cu ft)
<b>¼-ton:</b>						
M100	107.5	56.3	NA	NA	<sup>1</sup> 42.5	<sup>2</sup> 148.9
M416	108.5	61.5	NA	NA	<sup>1</sup> 44.0	<sup>2</sup> 169.9
<b>¾-ton:</b>						
M101	147.0	73.5	<sup>1</sup> 65.0	<sup>2</sup> 406.4	<sup>1</sup> 50.0	<sup>2</sup> 312.6
M101A1	147.0	73.5	<sup>1</sup> 65.0	<sup>2</sup> 406.4	<sup>1</sup> 50.0	<sup>2</sup> 312.6
<b>1½-ton:</b>						
M104	165.3	83.5	<sup>1</sup> 83.6	<sup>2</sup> 667.8	<sup>1</sup> 56.3	<sup>2</sup> 449.7
M104A1	165.3	83.5	<sup>1</sup> 83.6	<sup>2</sup> 667.8	<sup>1</sup> 56.3	<sup>2</sup> 449.7
M105	166.0	83.0	<sup>1</sup> 82.0	<sup>2</sup> 653.8	<sup>1</sup> 55.0	<sup>2</sup> 438.5
M105A1	166.0	83.0	<sup>1</sup> 82.0	<sup>2</sup> 653.8	<sup>1</sup> 55.0	<sup>2</sup> 438.5
M105A2	166.0	83.0	<sup>1</sup> 82.0	<sup>2</sup> 653.8	<sup>1</sup> 55.0	<sup>2</sup> 438.5

<sup>1</sup>For height over bows or top of cab shield, use operational height of vehicle listed in TB 55-46-1.

<sup>2</sup>For shipping cube over side racks/bows and/or top of cab shield, use operational cube of vehicle listed in TB 55-46-1.

**Table 3-15. Shipping dimensions and cube for stake and platform semitrailers**

Vehicle Type	Length (in)	Width (in)	Top of Side Racks		Top of Cargo Floor	
			Height (in)	Cube (cu ft)	Height (in)	Cube (cu ft)
<b>6-ton:</b>						
M118	281.0	95.8	102.0	1,589.0	54.0	NA
M118A1	281.0	95.8	102.0	1,589.0	54.0	NA
<b>12-ton:</b>						
M127	345.5	97.3	108.3	2,106.9	60.5	NA
M127A1	345.5	97.3	108.3	2,106.9	60.5	NA
M127A1C	348.3	98.0	108.5	2,143.2	60.5	NA
M127A2C	351.5	97.8	107.8	2,144.6	59.8	NA
<b>22½-ton:</b>						
M871	358.0	96.0	103.0	2,048.6	55.0	NA
<b>34-ton:</b>						
M872	489.5	96.0	106.1	2,885.3	58.0	NA
M872A1	489.5	96.0	106.1	2,885.3	58.0	NA
M872A2	489.5	96.0	106.1	2,885.3	58.0	NA
M872A3	489.5	96.0	106.1	2,885.3	58.0	NA

**Table 3-16. Shipping dimensions and cube for van semitrailers**

Vehicle Type	Length (in)	Width (in)	Top of Van	
			Height (in)	Cube (cu ft)
6-ton:				
M119	275.5	98.0	133.8	2,090.5
M119A1	275.5	98.0	133.8	2,090.5
M146	276.0	96.0	129.0	1,978.0
12-ton:				
M128	344.3	96.8	139.1	2,682.8
M128A1	345.5	96.8	140.0	2,709.4
M128A1C	349.5	98.3	142.5	2,833.2
M128A2C	346.3	98.3	145.3	2,862.4

**Table 3-17. Shipping dimensions and cube for cargo carriers**

Vehicle Type	Length (in)	Width (in)	Height Top of Side Panels (in)	Shipping Cube (cu ft)
1½-ton:				
M116	188.0	84.5	63.3	772.2
6-ton:				
M548	232.0	100.0	<sup>1</sup> 76.8	<sup>2</sup> 1,031.1

<sup>1</sup>For height over bows or top of cab shield, use operational height of vehicle listed in TB 55-46-1.

<sup>2</sup>For shipping cube over side racks/bows and/or top of cab shield, use operational cube of vehicle listed in TB 55-46-1.

## PLANNING STATISTICS

Tables 3-18 and 3-19 include average vehicle stopping distances, unit capabilities, and payload capacities for prime movers and towed vehicles.

See Table 3-18 for average values to use to determine safe vehicle gaps at various speeds on average, hard-surfaced roads. Since well-trained drivers can reduce the distance traveled during the perception and reaction periods, the planner should consider the physical condition and training of drivers for a particular operation. Keep in mind that rain, snow, or ice

present special conditions. Braking distances are based on the assumption that vehicles are loaded and have good brakes, tires, and traction. The average values in Table 3-18 have been determined from the standpoint of safety only; the tactical situation may require larger or smaller gaps. In the absence of definite information, the rule of thumb method may be used for certain speeds to determine the gap between vehicles in a convoy: speedometer reading (MPH) X 2 = gap in yards (or speedometer reading (KPH) X 1.2 = gap in meters). Use this method only for speeds marked with an asterisk in Table 3-18.

**Table 3-18. Average vehicle stopping distances**

Speed			Average Distance							
(MPH)	(KPH)	(ft/sec)	Perception		Reaction		Braking		Total <sup>1</sup>	
			(ft)	(m)	(ft)	(m)	(ft)	(m)	(ft)	(m)
Passenger vehicles <sup>2</sup> :										
20*	32.2	29.3	22	6.7	22	6.7	25	7.6	69	21.0
25*	40.3	36.7	28	8.5	28	8.5	35	10.7	91	27.7
30*	48.3	44.0	33	10.0	33	10.0	48	14.6	114	34.6
35*	56.3	51.3	39	11.9	39	11.9	67	20.4	145	44.2
40*	64.4	58.7	44	13.4	44	13.4	90	27.4	178	54.2
45*	72.4	66.0	50	15.3	50	15.3	117	35.7	217	66.3
50*	80.5	73.4	55	16.8	55	16.8	148	45.2	258	78.8
55	88.5	80.7	61	18.6	61	18.6	185	56.4	307	93.6
60	96.6	88.0	66	20.1	66	20.1	228	69.6	360	109.8
65	104.6	95.4	72	21.9	72	21.9	275	83.9	419	127.7
70	112.6	102.7	77	23.5	77	23.5	332	102.5	486	149.5
Single-unit vehicles (gross weight less than 10,000 pounds):										
20*	32.2	29.3	22	6.7	22	6.7	30	9.2	74	22.6
25*	40.3	36.7	28	8.5	28	8.5	42	12.8	98	29.8
30*	43.3	44.0	33	10.0	33	10.0	58	17.7	124	37.7
35*	56.3	51.3	39	11.9	39	11.9	80	24.4	158	48.2
40*	64.4	58.7	44	13.4	44	13.4	106	31.4	194	58.2
45*	72.4	66.0	50	15.3	50	15.3	138	42.1	238	72.7
50	80.5	73.4	55	16.8	55	16.8	177	54.0	287	87.6
55	88.5	80.7	61	18.6	61	18.6	222	67.5	344	104.7
60	96.6	88.0	66	20.1	66	20.1	273	83.3	405	123.5
Single-unit, two-axle vehicles (gross weight 10,000 pounds or more):										
20*	32.2	29.3	22	6.7	22	6.7	40	12.2	84	25.6
25*	40.3	36.7	28	8.5	28	8.5	64	19.5	120	36.5
30	48.3	44.0	33	10.0	33	10.0	92	28.0	158	48.0
35	56.3	51.3	39	11.9	39	11.9	126	38.4	204	62.2
40	64.4	58.7	44	13.4	44	13.4	165	50.3	253	77.1
45	72.4	66.0	50	15.3	50	15.3	208	63.4	308	94.0
50	80.5	73.4	55	16.8	55	16.8	256	78.1	366	111.7
55	88.5	80.7	61	18.6	61	18.6	310	94.5	432	131.7
60	96.6	88.0	66	20.1	66	20.1	372	113.5	504	153.7
Single-unit, multiaxle vehicles and combination vehicle <sup>3</sup> (gross weight 10,000 pounds or more):										
20*	32.2	29.3	22	6.7	22	6.7	50	15.3	94	28.7
25	40.3	36.7	28	8.5	28	8.5	80	24.4	136	41.1
30	48.3	44.0	33	10.0	33	10.0	115	35.1	181	55.1
35	56.3	51.3	39	11.9	39	11.9	157	47.9	235	71.7
40	64.4	58.7	44	13.4	44	13.4	205	62.5	293	89.3
45	72.4	66.0	50	15.3	50	15.3	260	79.3	360	109.9
50	80.5	73.4	55	16.8	55	16.8	320	97.6	430	131.2
55	88.5	80.7	61	18.6	61	18.6	388	118.3	510	155.5
60	96.6	88.0	66	20.1	66	20.1	465	141.9	597	182.1

<sup>1</sup>Add 30 feet or 9 meters to each total stopping distance shown to determine actual gap to use between vehicles.

<sup>2</sup>Does not include buses. Refer to section with weights and axes corresponding to buses.

<sup>3</sup>Tractor trucks, semitrailers, and trailers.

\*Rule of thumb method may be used at this speed.

**Table 3-19. Motor transport units capabilities on surfaced roads**

Unit	TOE	Equipment	Pieces Auth	Pieces Avail (75%)	Planning Figure And Unit	Local Hauls		Line-Hauls	
						Trips Per Day	Capacity Per Day	Trips Per Day	Capacity Per Day
Light truck company	55-17H510 (2 shifts)	2½-T cargo truck	60	45	4 STONs or 20 pax'	4	720 STONs or 3,600 pax	2	360 STONs or 1,400 pax (16 pax/veh)
	55-17H520 (2 shifts)	5-T cargo truck	60	45	6 STONs or 20 pax'	4	1,080 STONs or 3,600 pax	2	540 STONs or 1,620 pax (18 pax/veh)
	55-17H530 (1 shift)	2½-T cargo truck	60	45	4 STONs or 20 pax'	2	360 STONs or 1,800 pax	1	180 STONs or 720 pax (16 pax/veh)
	55-17H540 (1 shift)	5-T cargo truck	60	45	6 STONs or 20 pax'	2	540 STONs or 1,800 pax	1	270 STONs or 810 pax (18 pax/veh)
Medium truck company (container/cargo)	55-18H610	5-T tractor (M915)	60	45	NA	NA	NA	NA	NA
		34-T semitrailer	120	90	22 STONs or 2 20-ft containers or 35 pax**	4	3,960 STONs or 360 20-ft containers or 6,300 pax	2	1,980 STONs or 180 20-ft containers or 3,150 pax
		or							
		12-T S&P semitrailer	120	90	12 STONs or 50 pax**	4	2,160 STONs 9,000 pax	2	1,080 STONs 4,500 pax
(POL)	55-18H620	5-T tractor (M915) w/5,000-gal fuel tank semitrailer	60	45	5,000 gal	4	900,000 gal	2	450,000 gal
(Refrigerator)	55-18H630	5-T tractor (M915) w/7½-ton refrigerator semitrailer	60	45	6 STONs	4	1,080 STONs	2	540 STONs
Medium truck company (container/cargo, 40-foot)	55-18J410	14-T tractor (M915)	60	45	NA	NA	NA	NA	NA
		34-T semitrailer	120	45	2 20-ft containers or 22 STONs gen cargo or 50 pax**	4	360 20-ft containers or 3,960 STONs gen cargo or 9,000 pax	2	180 20-ft containers or 1,980 STONs gen cargo or 4,500 pax
(POL)	55-18J411	Collapsible fabric water tank, 4,750-gal	60	45	4,750 gal	4	855,000 gal	2	427,500 gal
Command transport company	55-19H210	¾-T truck (M1009)	40	30	¾ STON or 2 pax	2	45 STONs or 120 pax	1	22½ STONs
		1¼-T truck (M1008)	20	15	1¼ STONs or 9 pax	2	37½ STONs or 270 pax	1	18¾ STONs or 135 pax
Command transport company, airborne corps	55-19H220	¾-T truck (M1009)	30	22	¾ STON or 2 pax	2	33 STONs or 88 pax	1	16½ STONs or 44 pax
		1¼-T truck (M1008)	30	22	1¼ STONs or 9 pax	2	55 STONs or 396 pax	1	27½ STONs or 198 pax
Command transport company	55-19J310	¾-T truck (M1009)	40	30	¾ STON or 2 pax	2	45 STONs or 120 pax	1	22½ STONs or 60 pax
		1¼-T truck (M1008)	20	15	1¼ STONs or 9 pax	2	37½ STONs or 270 pax	1	18¾ STONs or 135 pax
Command transport company, airborne corps	55-19J320	¾-T truck (M1009)	20	15	¾ STON or 2 pax	2	22½ STONs or 60 pax	1	11¼ STONs or 30 pax
		1¼-T truck (HMMWV)	20	15	1¼ STONs or 9 pax	2	37½ STONs or 270 pax	1	18¾ STONs or 135 pax
Medium truck company (container/cargo, 20-foot)	55-23J410	5-T tractor	60	45	NA	NA	NA	NA	NA
		22½-T semitrailer	150	112	15 STONs or 1 20-ft container	4	2,700 STONs or 180 20-ft containers	2	1,350 STONs



**Table 3-19. Motor transport units capabilities on surfaced roads (cont)**

Unit	TOE	Equipment	Pieces Auth	Pieces Avail (75%)	Planning Figure And Unit	Local Hauls		Line-Hauls	
						Trips Per Day	Capacity Per Day	Trips Per Day	Capacity Per Day
Cargo carrier (tracked) (POL)	55-23J411	Collapsible fabric water tank, 3,000-gal	60	45	3,000 gal	4	540,000 gal	2	270,000 gal
	55-27H510	6-T tracked cargo carrier	48	36	6 STONs	4	864 STONs	2	432 STONs
	55-27H511	6-T tracked cargo carrier, w/pump and tank unit	48	36	1,200 gal	4	172,800 gal	2	86,400 gal
Heavy truck company	55-28H510 (2 shifts)	Truck tractor (M911) HET, w/60-T low-bed semitrailer	24	18	1 tank or 40 STONs gen cargo	4	72 tanks or 2,880 STONs gen cargo	2	36 tanks or 1,440 STONs gen cargo
	55-28H520 (1 shift)	Truck tractor (M911), HET, w/60-T low-bed semitrailer	24	18	1 tank or 40 STONs gen cargo	2	36 tanks or 1,440 STONs gen cargo	1	18 tanks or 720 STONs gen cargo
Light-medium truck company	55-67H7	5-T cargo truck	60	45	6 STONs or 20 pax*	4	1,080 STONs or 3,600 pax	2	540 STONs or 1,620 pax (18 pax/veh)
		5-T truck tractor (M818)	10	7	NA	NA	NA	NA	NA
		22½-T semitrailer	20	14	1 container or 15 STONs or 35 pax**	4	28 containers or 420 STONs or 980 pax	2	14 containers or 210 STONs or 490 pax (18 pax/veh)
Light-medium truck company	55-67J4	5-T tractor (M818)	10	7	NA	NA	NA	NA	NA
		22½-T semitrailer	20	14	1 20-ft container or 15 STONs or 35 pax**	4	28 20-ft containers or 420 STONs or 980 pax	2	14 20-ft containers or 210 STONs or 490 pax (18 pax/veh)
Transportation motor transport company, air assault division	55-69J0	5-T cargo truck	50	37	6 STONs or 20 pax*	4	888 STONs or 2,960 pax	2	444 STONs or 1,480 pax
		5-T cargo truck	18	13	6 STONs or 20 pax*	2	156 STONs or 520 pax	1	78 STONs or 260 pax
		1½-T cargo trailer	18	13	1½ STONs	2	39 STONs	1	19½ STONs
		5-T tractor (M818) w/22½-T semitrailer	8	6	1 container or 15 STONs or 35 pax**	2	12 containers or 30 STONs or 70 pax	1	6 containers or 15 STONs or 35 pax
		5-T tractor (M818) w/12-T S&P semitrailer (M127)	8	6	12 STONs or 50 pax	2	144 STONs or 600 pax	1	72 STONs or 300 pax
		10-T tractor w/ 25-T low-bed semitrailer	2	1	25 STONs	2	50 STONs	1	25 STONs
		5-T tractor w/ 5,000-gal fuel tank semitrailer	10	7	5,000 gal	2	70,000 gal	1	35,000 gal
Transportation motor transport company, infantry division (mechanized)	55-84H0	5-T cargo truck w/tank and pump unit w/1½-T cargo trailer w/ tank unit	2	1	1,800 gal	2	3,600 gal	1	1,800 gal
		5-T tractor w/ 5,000-gal fuel tank semitrailer	34	25	5,000 gal	2	250,000 gal	1	125,000 gal
		5-T tractor	10	7	NA	NA	NA	NA	NA

**Table 3-19. Motor transport units capabilities on surfaced roads (cont)**

Unit	TOE	Equipment	Pieces Auth	Pieces Aval (75%)	Planning Figure And Unit	Local Hauls		Line-Hauls	
						Trips Per Day	Capacity Per Day	Trips Per Day	Capacity Per Day
	55-84H0 (cont)	12-T S&P semitrailer	20	15	12 STONs or 50 pax**	2	254 STONs or 1,500 pax	1	127 STONs or 750 pax
		or							
		22½-T semitrailer	20	15	1 20-ft container or 15 STONs or 35 pax**	2	14 20-ft containers or 210 STONs or 1,050 pax	1	7 20-ft containers or 105 STONs or 525 pax
		5-T cargo truck w/ tank and pump unit w/1½-T cargo trailer w/tank unit	6	4	1,800 gal	2	144,000 gal	1	7,200 gal
Transportation motor transport company	55-87H0	5-T cargo truck	60	45	5 STONs or 20 pax*	2	450 STONs or 1,800 pax	1	225 STONs or 900 pax
		5-T tractor	10	7					
		12-T S&P semitrailer	20	15	12 STONs or 50 pax**	2	168 STONs or 1,500 pax	1	84 STONs or 750 pax
		or							
		22½-T semitrailer	20	15	1 20-ft container or 15 STONs or 35 pax**	2	14 20-ft containers or 210 STONs or 1,050 pax	1	7 20-ft containers or 105 STONs or 525 pax
		5-T tractor w/ 5,000-gal fuel tank semitrailer	34	25	5,000 gal	2	250,000 gal	1	125,000 gal
Transportation motor transport company, heavy division	55-87J4	5-T cargo truck	36	27	6 STONs or 20 pax**	4	648 STONs or 2,160 pax	2	324 STONs or 864 pax (16 pax/veh)
		5-T tractor	33	24	NA	NA	NA	NA	NA
		22½-T semitrailer	66	49	1 20-ft container or 15 STONs or 35 pax**	4	96 20-ft containers or 1,440 STONs or 6,860 pax	2	48 20-ft containers or 720 STONs or 3,430 pax
		HET tractor w/ transporter	24	18	1 tank or 40 STONs gen cargo	4	72 tanks or 2,880 STONs gen cargo	2	36 tanks or 1,440 STONs gen cargo
Transportation motor transport company, infantry	55-88H0	5-T cargo truck	60	45	6 STONs 20 pax*	2	540 STONs or 1,800 pax	1	260 STONs or 720 pax (16 pax/veh)
		5-T tractor (M818) w/5,000-gal fuel tank semitrailer	16	12	5,000 gal	2	120,000 gal	1	60,000 gal
		5-T tractor	10	7	NA	NA	NA	NA	NA
		22½-T semitrailer	20	15	1 20-ft container or 15 STONs or 35 pax**	2	14 20-ft containers or 210 STONs or 490 pax	1	7 20-ft containers or 105 STONs or 245 pax
		or							
		12-T S&P semitrailer (M127)	20	15	12 STONs or 50 pax**	2	168 STONs or 700 pax	1	84 STONs or 350 pax

**Table 3-19. Motor transport units capabilities on surfaced roads (cont)**

Unit	TOE	Equipment	Pieces Auth	Pieces Aval (75%)	Planning Figure And Unit	Local Hauls		Line-Hauls	
						Trips Per Day	Capacity Per Day	Trips Per Day	Capacity Per Day
	55-88H0 (cont)	5-T cargo truck w/ pump and tank unit w/ 1 1/4-T cargo trailer w/tank unit	5	3	1,800 gal	2	10,800 gal	1	5,400 gal
Transportation motor transport company, infantry, division, light	55-88J8	5-T cargo truck	33	24	6 STONs or 20 pax*	2	288 STONs or 960 pax	1	144 STONs or 384 pax (16 pax/veh)
		5-T tractor w/ 22 1/2-T semitrailer	8	6	1 20-ft container or 15 STONs or 35 pax**	2	12 20-ft containers or 180 STONs or 420 pax	1	6 20-ft containers or 90 STONs or 210 pax

\*Recommended in emergencies only; no troop seats provided.

\*\*Number of trips based on tactical employment of unit (short turnaround times). For general troop movements, plan on four trips per day.

See Figure 3-35 for illustrations of Army motor transport vehicles.

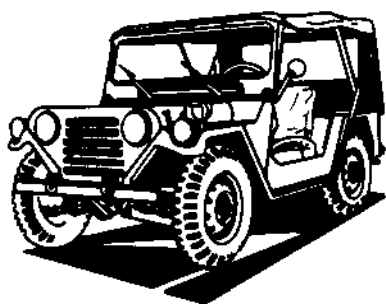

TRUCK, UTILITY, 1/4-TON, M161A2

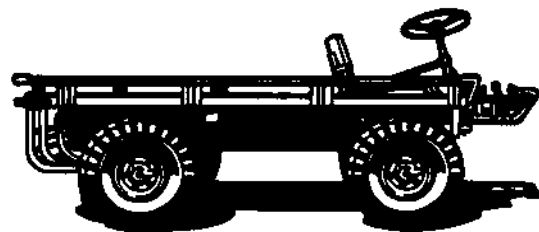

TRUCK, UTILITY, 1/2-TON, M274 (MULE)

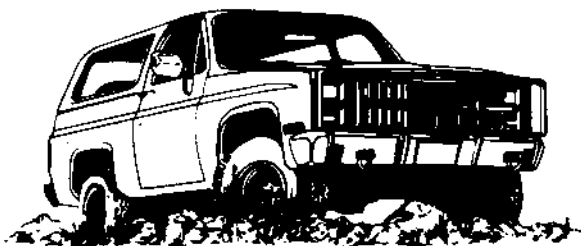

TRUCK, UTILITY, 4X4, 3/4-TON, M1009 (CUCV)



TRUCK, UTILITY-CARGO/TROOP CARRIER, 1 1/2-TON, M1038 (HMMWV)

**Figure 3-35. Army motor transport vehicles**

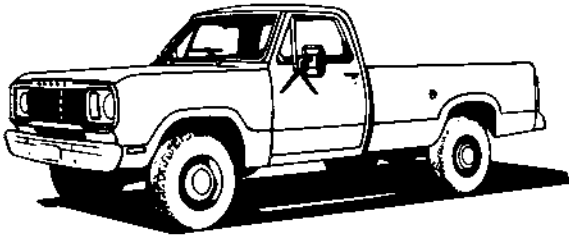

TRUCK, COMMERCIAL, 1 1/4-TON, M880

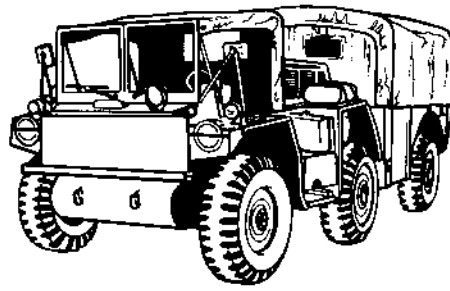

TRUCK, CARGO, 1 1/4-TON, M561 (GAMMA GOAT)

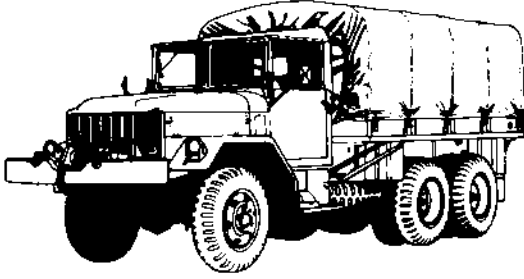

TRUCK, CARGO, 2 1/2-TON, M35A2

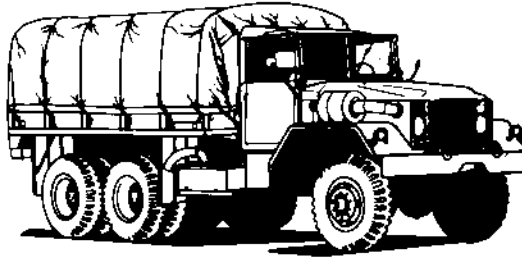

TRUCK, CARGO, 5-TON, M813

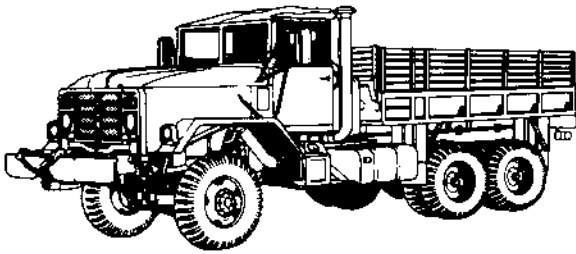

TRUCK, CARGO, 5-TON, M924



TRUCK, CARGO, 8-TON, M520 (GOER)

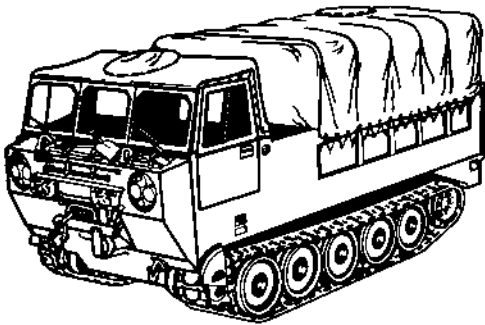

CARGO CARRIER, TRACKED, 6-TON, M548

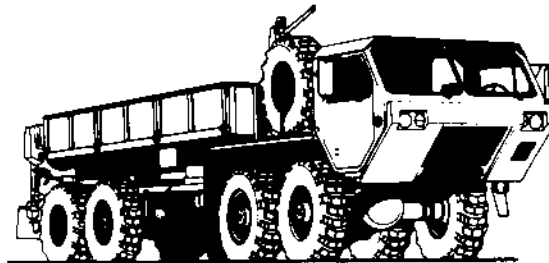

TRUCK, 8X8, 10-TON, M977 (HEMTT)

Figure 3-35. Army motor transport vehicles (cont) .

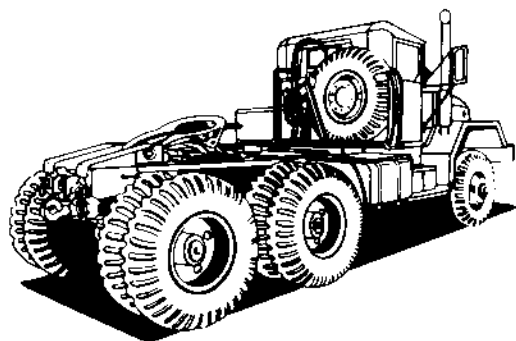

TRUCK-TRACTOR, 5-TON, M818

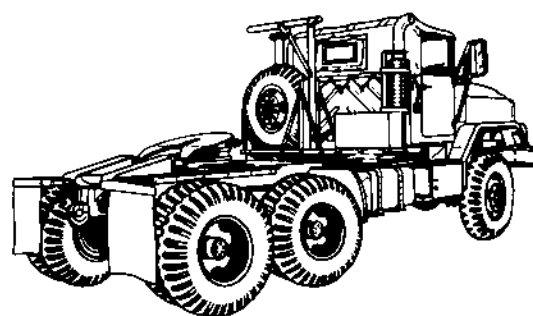

TRUCK-TRACTOR, 5-TON, M931

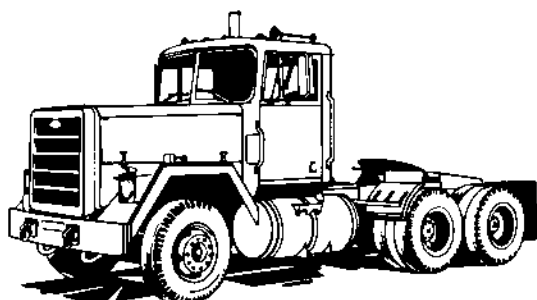

TRUCK-TRACTOR, LINE HAUL, 6X4, M915

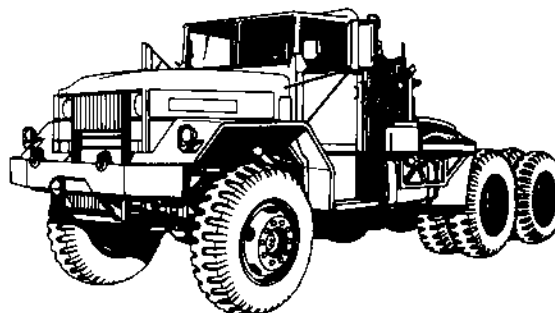

TRUCK-TRACTOR, 6X6, 10-TON, w/DUAL REAR WINCHES, M123E2

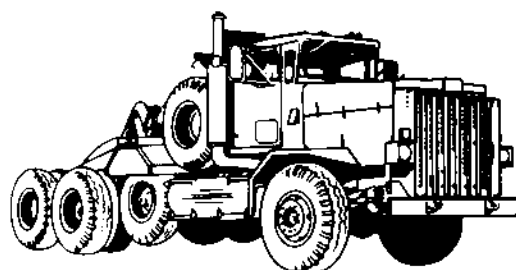

TRUCK-TRACTOR, 8X6, M911, COMMERCIAL HEAVY EQUIPMENT TRANSPORTER (CHET)



TRUCK-TRACTOR, 8X8, 22 1/2-TON, M746, HEAVY EQUIPMENT TRANSPORTER (HET)

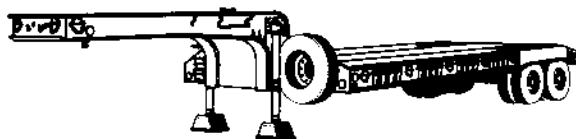

SEMITRAILER, LOW-BED, M172A1

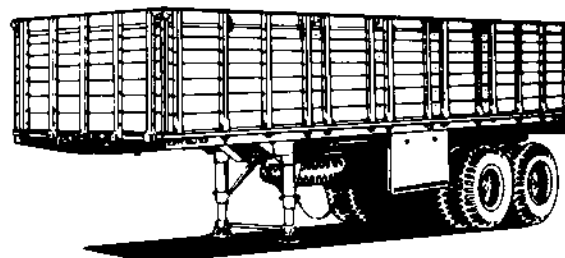

SEMITRAILER, STAKE, 12-TON, M172A2

Figure 3-35. Army motor transport vehicles (cont)

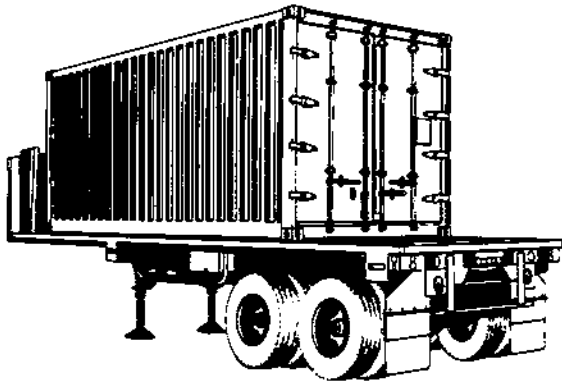

SEMITRAILER, FLATBED, BREAK-BULK/CONTAINER TRANSPORTER, 22 1/2-TON, M871

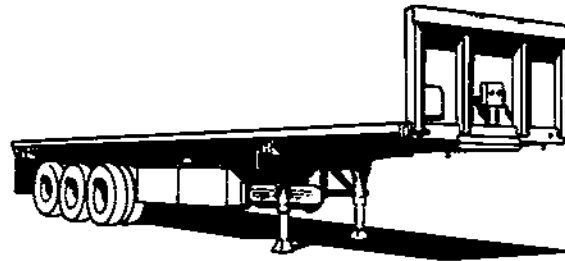

SEMITRAILER, 34-TON, DUAL-PURPOSE BREAK-BULK/CONTAINER TRANSPORTER, M872

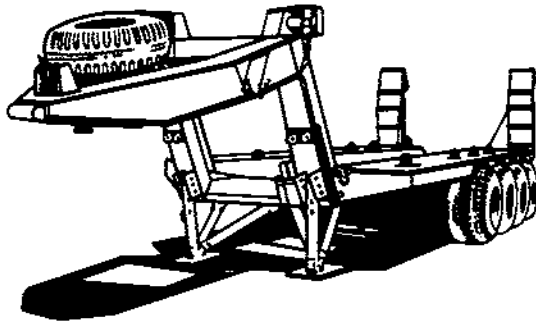

SEMITRAILER, LOW-BED, 60-TON, M747, HEAVY EQUIPMENT TRANSPORTER (HET)

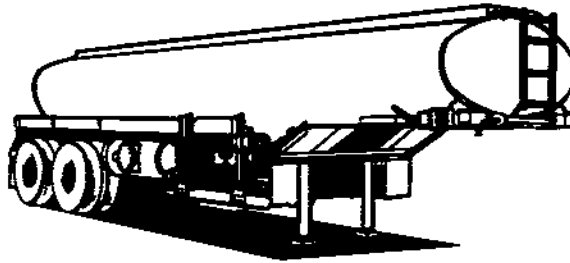

SEMITRAILER, FUEL TANK, 5,000-GALLON, M131A4C

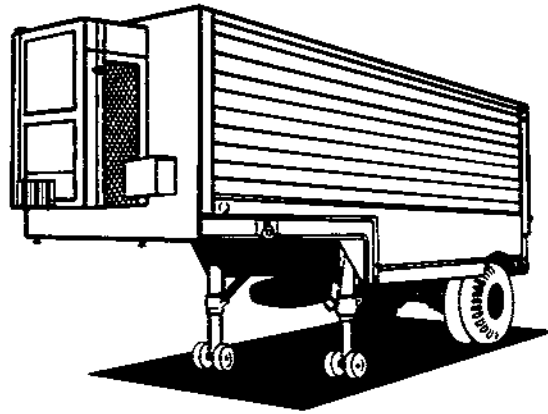

SEMITRAILER, REFRIGERATOR VAN, 7-TON, M349A4

Figure 3-35. Army motor transport vehicles (cont)

## CHAPTER 4

## RAIL TRANSPORT

## CONTENTS

	Page
<b>Section I. ORGANIZATION AND OPERATIONS</b>	
Railway Units .....	4-1
Administration .....	4-7
Planning .....	4-9
Equipment Requirements .....	4-13
Loading .....	4-14
Construction, Maintenance, and Supply .....	4-17
<b>II. RAIL TRANSPORT DATA</b>	
Locomotive Classification .....	4-21
Railway Equipment Characteristics .....	4-22
Clearances and Track Gages.....	4-34
Bridge Capacity .....	4-40
Maximum Bulk Loads .....	4-43

## Section I. ORGANIZATION AND OPERATIONS

## RAILWAY UNITS

The term "transportation railway service" (TRS) applies to railway units assigned or attached to the major transportation organization, normally a transportation command. Composed of supervisory, operating, and maintenance units, the TRS operates trains, maintains rail lines of communication, and performs direct support and general support maintenance on locomotives and rolling stock.

Depending on the extent of the operation, any TRS supervisory unit may perform staff and planning functions and serve as the highest echelon of the military railway service in a theater.

A breakdown of the railway units according to TOE, mission, assignment, and capability is outlined in Table 4-1. For a detailed discussion of these units, see FM 55-20.

*Table 4-1. Tables of organization and equipment—railway units*

UNIT	TOE	MISSION/ASSIGNMENT/CAPABILITY
Headquarters and headquarters company, transportation railway brigade	55-201H	<p><b>MISSION:</b> To command and provide operational planning, supervision, coordination, and control of transportation railway group or facility activities in the US and foreign nations.</p> <p><b>ASSIGNMENT:</b> To a theater army. Normally attached to a transportation command.</p> <p><b>CAPABILITY:</b> At level 1, this unit commands and supervises up to eight transportation railway groups as well as—</p> <ul style="list-style-type: none"> <li>• Provides planning for command and staff.</li> <li>• Supervises railway facility operations of US or foreign nations.</li> <li>• Supervises and assists in administrative and supply matters.</li> <li>• Plans for and supervises security of all buildings, structures, equipment, and in-transit (by rail) supplies.</li> <li>• Provides technical control over train movements, terminal operations, railway shops and enginehouses, car distribution, track and structure maintenance, and motive power allocation.</li> <li>• Allocates maintenance of way supplies and equipment.</li> </ul>
Headquarters and headquarters company, transportation railway group	55-202H	<p><b>MISSION:</b> To command, administer, and supervise the operation of railway battalions and attached supporting units.</p> <p><b>ASSIGNMENT:</b> To a theater army. Normally attached to a transportation railway brigade but may operate directly under a transportation command.</p> <p><b>CAPABILITY:</b> This unit commands and supervises three to eight transportation railway battalions and attached supporting units as required.</p>
Headquarters and headquarters company, transportation railway battalion	55-226H	<p><b>MISSION:</b> To command, administer, and supervise the operation of railway and attached supporting units of the transportation railway battalion.</p> <p><b>ASSIGNMENT:</b> Organic to a transportation railway battalion.</p> <p><b>CAPABILITY:</b> This unit—</p> <ul style="list-style-type: none"> <li>• Provides command, staff planning, administration, control, and supervision of a railway battalion and its assigned and attached units.</li> <li>• Dispatches all trains.</li> <li>• Supervises on-line operations.</li> <li>• Operates the railway station and signal towers within its responsibility.</li> <li>• Operates two dining facilities to support all elements of the battalion.</li> </ul>
Transportation railway engineering company	55-227H	<p><b>MISSION:</b> To maintain and repair railway track, bridges, and buildings within a railway division.</p>



*Table 4-1. Tables of organization and equipment—railway units (cont)*

UNIT	TOE	MISSION/ASSIGNMENT/CAPABILITY
Transportation railway equipment maintenance company	55-228H	<p><b>ASSIGNMENT:</b> Organic to a transportation railway battalion.</p> <p><b>CAPABILITY:</b> At level 1, this unit performs maintenance, repair, and limited construction of track, bridges, buildings, and structures of a railway division approximately 90-150 miles (145-240 kilometers) long.</p>
Transportation railway equipment maintenance company	55-228H	<p><b>MISSION:</b> To inspect, service, and make running repairs on diesel-electric locomotives and rolling stock.</p> <p><b>ASSIGNMENT:</b> Organic to a transportation railway battalion.</p> <p><b>CAPABILITY:</b> At level 1, this unit—</p> <ul style="list-style-type: none"> <li>• Performs daily and annual running repairs on 40 diesel-electric locomotives.</li> <li>• Performs daily running inspections on approximately 800 railway cars.</li> <li>• Performs limited repairs to railway-peculiar tools and equipment within the railway division.</li> <li>• Provides wreck train support to the railway division.</li> </ul>
Transportation train-operating company	55-229H	<p><b>MISSION:</b> To operate railway locomotives and trains.</p> <p><b>ASSIGNMENT:</b> To a transportation command. Normally attached to a transportation railway battalion. May operate separately under supervision of the appropriate transportation element.</p> <p><b>CAPABILITY:</b> At full strength, this unit provides 50 train crews daily for road or terminal operations, including switching, classifying, and making up trains for the road.</p>
Transportation electric power transmission company	55-217H	<p><b>MISSION:</b> To maintain and repair electric power transmission facilities for electrified railway operations.</p> <p><b>ASSIGNMENT:</b> To a transportation command. Normally attached to a transportation railway battalion.</p> <p><b>CAPABILITY:</b> At level 1 this unit—</p> <ul style="list-style-type: none"> <li>• Maintains and repairs electric power transmission facilities, including power substations and catenary, for a system of 200 miles (320 kilometers) of electrified railway comprising main lines, passing tracks, yard tracks, and sidings.</li> <li>• Operates power substations on a 24-hour basis.</li> </ul>
Diesel-electric locomotive repair company	55-247H	<p><b>MISSION:</b> To perform general support maintenance on diesel-electric locomotives and railway cranes.</p> <p><b>ASSIGNMENT:</b> To a transportation command, theater army. Normally attached to a transportation railway group.</p>

Table 4-1. Tables of organization and equipment—railway units (cont)

UNIT	TOE	MISSION/ASSIGNMENT/CAPABILITY
Transportation railway car repair company (general support)	55-248H	<p><b>CAPABILITY:</b> At level 1 this unit—</p> <ul style="list-style-type: none"> <li>• Provides the following annual man-hours of productive maintenance:                             <ul style="list-style-type: none"> <li>- Air brake repair—13,320</li> <li>- Diesel engine repair—145,520</li> <li>- Diesel-electric engine repair—109,890</li> <li>- Welding—3,330</li> </ul> </li> <li>• Provides internal Class IX supply; however, does not provide supply to supported units.</li> <li>• Provides technical assistance and maintenance support teams to user units on an exception basis for specific items of equipment. These are items which require GS maintenance but, because of operations, cannot be readily evacuated to a GS maintenance shop.</li> <li>• Provides GS maintenance for repair and return of diesel-electric locomotives and railway-crane-peculiar stocks to the Army system.</li> </ul>
Transportation railway service teams:	55-520H	<p><b>ASSIGNMENT:</b> To a transportation battalion or comparable unit.</p>
EA, railway station team		<p><b>MISSION:</b> To operate an on-line railway station.</p> <p><b>CAPABILITY:</b> This unit operates a railway station.</p>
EB, railway terminal detachment		<p><b>MISSION:</b> To operate a railway terminal on a 24-hour basis.</p> <p><b>CAPABILITY:</b> This unit operates a railway terminal with a capacity of ten trains per day.</p>
EC, railway section crew		<p><b>MISSION:</b> To perform railway maintenance of way.</p>

Table 4-1. Tables of organization and equipment—railway units (cont)

UNIT	TOE	MISSION/ASSIGNMENT/CAPABILITY
ED, diesel-electric locomotive maintenance crew (direct support)		<p><b>CAPABILITY:</b> This unit maintains approximately 15 to 24 track-miles (tracks, roadbeds, switches, and miscellaneous railway facilities).</p> <p><b>MISSION:</b> To perform DS maintenance on diesel-electric locomotives.</p> <p><b>CAPABILITY:</b> This unit performs DS maintenance on approximately seven diesel-electric locomotives per year. The unit provides the following annual man-hours of maintenance:</p> <ul style="list-style-type: none"> <li>• Air brake repair—3,330</li> <li>• Electric component repair—3,330</li> <li>• Nonelectric component repair—6,660</li> </ul>
EE, railway car repair crew (direct support)		<p><b>MISSION:</b> To inspect and maintain railway cars at distant points from fixed facilities.</p> <p><b>CAPABILITY:</b> This unit inspects and performs DS maintenance on approximately 400 railway cars per year. The unit provides the following annual man-hours of maintenance:</p> <ul style="list-style-type: none"> <li>• Air brake repair—9,990</li> <li>• Electrical repair—3,330</li> <li>• Metal working—6,660</li> <li>• Railway car repair—19,980</li> </ul>
EF, railway-yard-operating detachment		<p><b>MISSION:</b> To operate a rail yard.</p> <p><b>CAPABILITY:</b> This unit—</p> <ul style="list-style-type: none"> <li>• Operates a railroad yard on a 24-hour basis when yard train crews are provided and when not more than two receiving and classification yards, including humps, are to be operated.</li> <li>• Inspects and makes running repairs on rolling stock crossing the yard.</li> <li>• Inspects and, if necessary, adjusts or secures loads on cars passing through the yard.</li> </ul>
EG, bridge and building maintenance detachment (direct support)		<p><b>MISSION:</b> To maintain railway bridges and buildings.</p> <p><b>CAPABILITY:</b> This unit maintains bridges and buildings along 45 to 75 track-miles.</p>
EH, railway-train-operating section		<p><b>MISSION:</b> To operate trains.</p> <p><b>CAPABILITY:</b> This unit—</p> <ul style="list-style-type: none"> <li>• Operates two trains in either road or switching service, on a 24-hour basis.</li> <li>• When augmented by six additional brakemen (team EK), operates two trains in switching service on a 24-hour basis.</li> </ul>
EI, railway workshop mobile detachment (direct support)		<p><b>MISSION:</b> To perform DS maintenance of diesel-electric locomotives and rolling stock in areas with inadequate or no static facilities.</p> <p><b>CAPABILITY:</b> This unit performs inspection and DS maintenance on 20 diesel-electric</p>

*Table 4-1. Tables of organization and equipment—railway units (cont)*

UNIT	TOE	MISSION/ASSIGNMENT/CAPABILITY
EJ, railway maintenance of way crew		<p>locomotives and 100 railway cars. The unit provides the following annual man-hours of maintenance:</p> <ul style="list-style-type: none"> <li>• Air brake repair—6,660</li> <li>• Electrical repair—3,330</li> <li>• Electrical component repairs—19,980</li> <li>• Nonelectric component repairs—19,980</li> <li>• Machining—16,650</li> <li>• Metal working—3,330</li> <li>• Railway car repair—13,330</li> </ul>
EK, railway-train-operating section		<p><b>MISSION:</b> To perform maintenance of way functions.</p> <p><b>CAPABILITY:</b> This unit maintains approximately 40 track-miles (including track, bridges, buildings, railway signals, and communications lines) in a large terminal area.</p> <p><b>MISSION:</b> To augment railway-train-operating section (team EH) when it is required to operate two trains in switching service on a 24-hour basis.</p> <p><b>CAPABILITY:</b> Provides the brakemen necessary to operate two trains in switching service.</p>

## ADMINISTRATION

### Phases of Operation

There are three phases of military railway operation:

- Phase I, which is conducted exclusively by military railway personnel.
- Phase II, during which railway lines are operated and maintained by military railway personnel augmented with and assisted by local civilian railway personnel.

- Phase III, which is begun as soon as local conditions permit. Under this arrangement, local national civilian railway personnel operate and maintain railway lines under the direction and supervision of the highest military railway echelon in the theater. This arrangement releases railway unit personnel for other duties.

### Standing Operating Procedures

See Figures 4-1 and 4-2 for sample SOP formats for rail movements and the transportation railway service respectively.

(Classification)

**STANDING OPERATING PROCEDURE**

1. GENERAL. *Policies and factors involved in selecting and carrying out rail movements.*
2. SUPPLY MOVEMENTS
  - a. Releases. *Date required, procurement methods, formats, dissemination, action required.*
  - b. Routing. *Responsibilities and procedures.*
  - c. Diversions and reconsignments. *Authority and initiating procedures for method used.*
  - d. Records and reports. *Responsibilities and methods for maintaining specific records; appropriate references to reports.*
3. TROOP MOVEMENTS
  - a. Current situation (for example, war, peace, partial or full mobilization, civil unrest).
  - b. Distance to be traveled.
  - c. Origin and destination points.
  - d. Security requirements.
  - e. Tactical situation.
  - f. Types and amount of equipment available.
  - g. Priority.

(Classification)

*Figure 4-1. Sample format for rail movements SOP*

(Classification)

**STANDING OPERATING PROCEDURE**

**1. GENERAL**

- a. Rail transportation integration in the theater transportation net.
- b. Operational control.
- c. Coordination with adjacent commands for rail use and support of operating units.
- d. Coordination of the theater rail plan for selection, rehabilitation, and operation of rail lines to support theater strategic plans.

**2. MISSION.** *Rail net and facilities operated; terminals, installations, and commands supported.*

**3. ORGANIZATION.** *Available operating units, location, and operating limits.*

**4. FUNCTIONS.** *Responsibilities for operation and maintenance of military railways and equipment, as well as for freight, passenger, and special trains.*

**5. PLANNING**

a. Long-Range.

- (1) Responsibilities and procedures.
- (2) Primary and alternate rail routes selection.
- (3) Line capacity, troop equipment, and supply requirements.
- (4) Rehabilitation and projected requirements.
- (5) Communication and security requirements.
- (6) Demolition plans.

b. Short-Range.

- (1) Current operational plans.
- (2) Current rail-line capacity and requirements.
- (3) Phases of operation.
- (4) Selection and rehabilitation of new or additional railheads, yards, and installation facilities.

**6. OPERATIONS**

- a. Disseminating and implementing movement programs.
- b. Coordinating with the transportation movements officer.
- c. Setting priorities for rail equipment and its use.
- d. Preparing and compiling operational and situation reports.
- e. Ordering cars and documenting their use.
- f. Scheduling special trains.
- g. Constructing and using railcar spanners.
- h. Loading, blocking, and bracing cars and inspecting loaded cars.

**7. MAINTENANCE.** *Responsibilities, procedures, inspections, reports, and standards for maintaining military and utility railway facilities and equipment.*

**8. SUPPLY.** *Responsibilities and procedures for requisitioning, stocking, distributing, maintaining levels of, disposing of excess, and accounting for railway operating and maintenance supplies; requirements and priorities for major items, including locomotives and rolling stock.*

***Figure 4-2. Sample format for transportation railway service SOP***

9. INTELLIGENCE AND RECONNAISSANCE. *Responsibilities and procedures for collecting, processing, disseminating, and using intelligence.*

10. SECURITY. *Procedures, responsibilities, and coordination of security requirements for trains and rail line-of-communication facilities, defense and demolition plans, and supplies en route by rail.*

11. RECORDS AND REPORTS. *Responsibilities and procedures for records and reports of railway operations, situation, personnel status, equipment maintenance and inspection, equipment status, and project status.*

12. TRAINING. *Responsibility for conducting unit and technical training.*

(Classification)

**Figure 4-2. Sample format for transportation railway service SOP (cont)**

### PLANNING

When planning the most effective use of a railway system, you will need to consider—

- Line length.
- Roadbed and track condition.
- Track gage.
- Track type (single, double, or multiple).
- Rail weight.
- Ballast type and depth.
- Tie type (if wood, treated or untreated).
- Tie spacing.
- Axle load limitations (track and bridge).
- Line profile showing location and length of ruling grade.
  - Line alignment showing location and length of minimum-radius curves.
  - Location and description of bridges and tunnels.
    - Location and length of passing tracks.
    - Location, type, and quantity of fuel supply.
    - Location, quantity, and quality of water supply.
    - Location and capacity of yards.
    - Location and capacity of car repair shops and enginehouses.
- Type and availability of motive power (weight in working order, expected working tractive effort, drawbar pull, and age).
- Type and availability of rolling stock (capacity, dimensions, and age).
- Climatic and prevailing weather conditions.
  - Diagrams showing minimum structure, maximum unrestricted loading, and equipment gages.
  - Signal system (wire or radio requirements and coordinating responsibilities).
- Dispatching facilities.
- Route junctions.
- Availability of new equipment and repair parts.
- Local labor resources.

Since the direction of military supply movements is primarily forward, military rail-line capacity estimates are generally based on net tonnage moved in one direction. However, since total capacity is based on train density, the movements of trains in both directions must be considered. When the railway net under consideration includes several divisions and branch lines, a separate estimate should be made for each. The limiting factors to consider when estimating rail-line payload capacity are

power (locomotive) and resistance (rolling, grade, curve, and weather). Use the following planning formulas and factors in the order in which they are listed.

### Weight on Drivers

The weight on drivers of a locomotive is that weight which is supported by the driving (powered) wheels when they rest on a straight and level track. Weight on drivers does not include any of the remaining portion of the locomotive's weight.

Weight on drivers is expressed in short tons (STONs). Different types and classes of locomotives differ in weight. All locomotives are constructed to specifications issued by the purchaser, the using railroad, or the manufacturer. The weight on drivers of some common types of diesel-electric locomotives used by the Army is included here for ready reference. See FM 55-20 for a complete breakdown of Army locomotives' characteristics.

Locomotive Type	Weight on Drivers (STONs) HP	
Multigage, 0-6-6-0	120	1,600
Standard gage, 0-4-4-0	60	500

### Tractive Effort

Tractive effort (TE) is the horizontal force which a locomotive exerts if the wheels do not slip. Expressed in pounds, TE measures a locomotive's potential power. The TE is supplied by the locomotive's manufacturer. See FM 55-20 for TEs of Army locomotives. When TE data are not available, use the formulas below to compute TE. Be sure to allow for the locomotive's age and condition.

Starting TE is the power that a locomotive has available to move itself and its load from a stopped position. Continuous TE is the effort required to keep a train rolling after it has started. As train momentum increases, needed TE diminishes rapidly. In steam locomotives, there is no difference between starting and continuous TE. A steam locomotive can generally continue to pull what it can start. However, a diesel-electric locomotive cannot continue to exert the same force achieved in starting

without damaging its power unit. The continuous TE of a diesel-electric locomotive is about 50 percent of its starting TE.

Starting TE corresponds to the adhesion of the driving wheels to the rails. If the TE expended exceeds this adhesion element, the drivers will slip. Normally, the adhesion element is 30 percent of the weight on drivers for dry rails and 20 percent for wet rails—for an average of 25 percent.

The estimated starting TE for a locomotive is, therefore, 25 percent of its weight on drivers.

For an 80-ton (160,000-pound) locomotive on drivers:

$$\text{Starting TE} = 25\% \times 160,000 \text{ lb} = 40,000 \text{ lb}$$

For a steam locomotive with starting TE of 40,000 pounds:

$$\text{Continuous TE} = \text{Starting TE} = 40,000 \text{ lb}$$

For a diesel-electric locomotive with starting TE of 40,000 pounds:

$$\text{Continuous TE} = 50\% \times 40,000 \text{ lb} = 20,000 \text{ lb}$$

### Drawbar Pull

Drawbar pull is the pulling ability of a locomotive, less the effort needed to move the locomotive. Tests have shown that 16 to 20 pounds of pull per ton are needed to start the average locomotive or freight car on straight, level track under favorable weather and temperature conditions. A locomotive or car having roller bearings will start with somewhat less effort. For railway planning, use 20 pounds per ton. Resistance drops after equipment starts rolling. However, to establish pulling ability (drawbar pull) available for starting and pulling a train, subtract 20 pounds per ton of locomotive weight from the continuous TE of the locomotive. A diesel-electric locomotive having a weight on drivers of 80 tons and a continuous TE of 20,000 pounds has a drawbar pull of 18,400 pounds (20,000 pounds minus 1,600 pounds).

Maximum drawbar pull is exerted only at very low speeds—up to about 10 MPH—after



which it drops off sharply. To obtain drawbar pull at given speeds, apply a speed factor to the maximum drawbar pull. Remember that speeds differ for different types of locomotives. For one type of steam locomotive, drawbar pull was found to diminish in inverse ratio to speed: drawbar pull was 80 percent at 20 MPH, 50 percent at 50 MPH, and 20 percent at 80 MPH. Use this inverse ratio as a rule of thumb for estimating drawbar pull of steam locomotives at various speeds. Drawbar pull diminishes more rapidly at higher speeds for diesel-electric locomotives than for steam locomotives.

**Resistance Factors**

**Rolling resistance.** Rolling resistance includes the forces which act on a train in a direction parallel to the track and tend to hold or retard the train's movement. The components of rolling resistance are friction between the railheads and the wheel treads and flanges, resistance due to undulation of track under a moving train, internal friction of rolling stock, and resistance in still air. There is no absolute figure to use for rolling resistance. Experience has led to safe average values for rolling resistance in the theater of operations. These values are:

Average Value	Track Condition
5	Excellent
6	Good to fair
7	Fair to poor
8	Poor
9-10	Very poor

**Grade resistance.** Grade resistance is 20 pounds times the percent of grade (20 X % grade).

**Curve resistance.** No entirely satisfactory theoretical discussion of curve resistance has been published. However, engineers in the United States usually allow from 0.8 to 1 pound per degree of curve. Military railway planning allows 0.8 pound per degree of curve.

**Weather resistance.** Weather is another factor in train resistance. Experience and tests have proven that below-freezing temperatures diminish the hauling power of locomotives. Following are the effects of specific

temperatures shown in percent of hauling power loss:

Temperature (°F)	Loss in Hauling Power (%)
Above +32	0
+31 to +16	5
+15 to 0	10
-1 to -10	15
-11 to -20	20
-21 to -25	25
-26 to -30	30
-31 to -35	35
-36 to -40	40
-41 to -45	45
-46 to -50	50

Ordinarily, wet weather is regarded as local and temporary. Disregard it in normal planning. However, in countries with extended wet seasons, loss of tractive effort due to slippery rails may prove serious if sanding is inadequate. The applicable reduction in TE is a matter of judgment. However, in general, TE will not be less than 20 percent of weight on drivers.

**Gross Trailing Load**

Gross trailing load (GTL) is the maximum tonnage that a locomotive can move under given conditions, such as curvature, grade, and weather. Determine GTL by combining all of the factors discussed in the preceding paragraphs. Use this formula to calculate GTL:

$$GTL = \frac{DBP \times W}{RR + GR + CR}$$

- where GTL = gross trailing load
- DBP = drawbar pull
- W = weather resistance
- RR = rolling resistance
- GR = grade resistance
- CR = curve resistance

When using two steam locomotives (either double-heading them or having one pull and the other push), find GTL by taking 90 percent of the total GTL of both locomotives. The 90 percent figure is based on the difficulty in

perfectly coordinating the actions of two locomotive operators. However, when diesel-electric locomotives are used in multiple-unit operation, the GTL will be 100 percent of the total GTL for both locomotives since they are operated by one person from a single control.

**Net Trainload**

Net trainload (NTL) is the payload carried by the train. NTL is the difference between gross weight (total weight of cars under load) and tare weight (total weight of cars empty). In military railway planning:

$$NTL = 50\% \times GTL$$

**Train Density**

Train density (TD) refers to the number of trains that may be safely operated over a division in each direction during a 24-hour period. Work trains are not included when computing TD. However, their blocking the main track can reduce the density of a rail division. Train density may vary greatly over various divisions due to—

- Condition and length of the main line.
- Number and location of passing tracks.
- Yard and terminal facilities.
- Train movement control facilities and procedures.
- Availability of train crews, motive power, and rolling stock.

On a single-track line, passing tracks are normally 6 to 8 miles apart. Multiple tracks (three or more) are generally considered double track for planning purposes since it is often necessary to remove a portion of the third and fourth tracks to maintain the double-track line.

The capacity and turnover of cars and trains operating in and out of terminal yards must be considered, either from definite experience and intelligence factors or by inference from other related information.

Use the following formulas for reasonably accurate estimates of freight TD for lines with 20 percent passenger trains.

For a single-track operation, use this formula:

$$TD = \frac{(NT + 1)}{2} \times \frac{24 \times S}{LD}$$

- where TD = train density  
 NT = number of passing tracks  
 1 = constant (number of trains that could be run if there were no passing tracks)  
 2 = constant to convert to one direction  
 24 = constant (number of hours per day)  
 s = average speed (FM 55-20)  
 LD = length of division

When determining the number of passing tracks, do not include those less than 5 miles apart. The passing tracks selected should be uniformly spaced throughout the division.

Double-track operations must be fluid and flexible. Therefore, the number of trains operated should not exceed the number of trains which could be cleared off either main track at any given time in an emergency. Use the factors given for single tracks to find double-track TD (TD<sub>2</sub>):

$$TD = (NT + 1) \times \frac{24 \times S}{LD}$$

If there is not enough information available to evaluate the potential TD of a rail line, use a TD of 10 for single track and 15 for double track as a rule of thumb.

**Tonnage**

Net division tonnage (NDT) is the payload tonnage (in short tons) which can be moved over a railway division (90 to 150 miles) each day. NDT includes railway operating supplies, which must be programed for movement the same as the supplies of any other service. To determine NDT, multiply the NTL by the TD of the particular division. Compute NDT separately for each division.

When calculating NDT, certain other factors must be considered. For example, troop, passenger, or hospital trains will replace an equal number of tonnage (cars with loads) freight trains. When the operation of such

trains is expected, allowance in NDT estimates is made by adjusting the TDs of the divisions concerned.

End-delivery tonnage in military operations is that tonnage (in short tons) delivered at the end of the railway line (railhead) each day. In all rail movements, end-delivery tonnage is the same as the NDT of the most restrictive division.

### EQUIPMENT REQUIREMENTS

#### Rolling Stock

**Freight cars.** Compute requirements separately for operations between major supply installations and areas on each line of communication:

$$\text{number of cars} = \frac{\text{daily tonnage}}{\text{average tons per car}} \times \frac{\text{turnaround time}}{\text{time}} \times 1.10$$

Use these average planning factors for net load per car:

	Standard/Broad Gage (Tons)	Narrow Gage (Tons)
US equipment	20	15
Foreign equipment	10	7.5

Turnaround time is the estimated total number of days required for a car to complete a round-trip—the time from placement for loading at point of origin to destination and back. Allow 2 days at origin, 1 day at destination, and 2 days' transit time for each division, or major part of a division, which the cars must cross. Use this method rather than an actual hour basis to incorporate delays due to terminal and way station switching as well as to in-transit rehandling of trains. Dispatch times required are:

Location or Type of Operation	Dispatch Time (Days)
At base of operation	2
Forward traffic	1 per division
Return traffic	1 per division
At railhead	1

**Tank cars.** Compute tank car requirements separately, based on bulk POL requirement and turnaround time.

**Passenger cars.** Passenger car requirements vary, depending on policies for troop movement, evacuation, and rest and recuperation. Theater passenger car requirements are fulfilled with local equipment.

**Road locomotives.** Use this formula to determine the number of road locomotives required for operation over a given railway division:

$$\text{locomotives} = \text{TD} \frac{(\text{RT} + \text{TT})}{24} \times 2 \times 1.20$$

- where TD = train density
- RT = running time (length of division divided by average speed)
- TT = terminal time (time for servicing and turning locomotive)
- 24 = number of hours per day
- 2 = constant for two-way traffic
- 1.20 = constant allowing 20 percent reserve

“RT + TT” (called the locomotive factor) is the percent of time during a 24-hour period in which a road locomotive is in use. The locomotive factor provides for the pooled use of motive power which may make one or more trips per day over a short division. Estimates of downtime at terminals are 8 hours for steam locomotives and 3 hours for diesel-electric locomotives.

**Switch engines.** The number of switch engines required at a terminal is based on the number of cars dispatched, received, or passed through the terminal per day. As a reserve to allow for maintenance and operational peaks, add 20 percent to the total number of switch engines required for the railway line.

#### Average Speed

For planning purposes, use the following chart to estimate average speed values. Select the most restrictive factor of the eight factors shown. If the restrictive factor is not known, use an average speed value of 8 MPH (13 KPH) for single track and 10 MPH (16 KPH) for double track. If the most restrictive factor affects only a comparatively short distance (10 percent, or less) of the division, use the next

higher average speed. If the average speed falls below 6 MPH (10 KPH) because of the gradient, reduce tonnage to increase speed. (A 2 percent reduction in gross tonnage increases speed by 1 MPH.) If the ruling grade materially affects tonnage, consider using helper service.

Restrictive Factors	Average Speed			
	Single Track MPH	Single Track KPH	Double Track MPH	Double Track KPH
<b>Condition of Track</b>				
Exceptionally good	12	19.3	14	22.5
Good to fair	10	16.1	12	19.3
Fair to poor	8	12.9	10	16.1
Poor	6	9.6	8	12.9
<b>Grade (%)</b>				
1 or less	12	19.3	14	22.5
1 to 1.5	10	16.1	12	19.3
1.5 to 2.5	8	12.9	10	16.1
2.5 to 3	6	9.6	8	12.9

**LOADING**

**Open-Top Cars**

Military equipment loaded on DOD-owned cars traveling on common carrier lines in CONUS must meet the individual railroad's loading standards as well as those of the Association of American Railroads (AAR). This requirement also holds for military equipment loaded on common carrier cars. Loads on foreign railroads must meet the blocking and lashing standards of the country involved. Standardization Agreements (STANAGs) govern loading military equipment on NATO rail lines. The AAR's *Rules Governing the Loading of Department of Defense Material on Open-Top Cars* is on file at all ITOs in CONUS. See TM 55-2200-001-12 for a detailed discussion of loading standards.

**Explosives and Other Hazardous Materials**

**Regulations.** The US Code establishes DOT authority and responsibilities for handling and transporting hazardous materials (Section 831-835, Title 18, Chapter 39). The regulations are published in Parts 170-179, Title 49, Code of Federal Regulations (Transportation), and Bureau of Explosives Tariff 6000. The DOT is responsible for regulating interstate shipment and movement of all hazardous materials by

rail, air, highway, and water through its major operating agencies. These regulations outline requirements for classifying, packaging, marking, labeling, and storing hazardous materials. The regulations also ensure comparability of materials and govern placarding containers and vehicles carrying these materials. Title 49, CFR 174, establishes requirements for hazardous materials transported by rail. These regulations cover minimum transportation requirements only. DOD and DA may supplement DOT requirements when needed.

For more specific regulations and guidance, see:

- AR 55-355—for transporting military explosives and hazardous materials by military or commercial carriers within CONUS. AR 55-355 requires compliance with all regulations, including reporting accidents (according to AR 385-40), maintaining records, tracing shipments, completing SF 361 when required, and ensuring cargo security. AR 55-355 lists AAR loading rules for safe transportation. This regulation also contains information on placarding containers and vehicles.
- AR 385-40—for information on reporting accidents.
- MIL-STD- 129 series—for guidance on marking packages.
- Bureau of Explosives (AAR) pamphlets—for loading and bracing methods. Title 49, CFR 173-56, requires approval by the BOE (AAR) of all loading, blocking, and bracing methods used in rail shipment of unboxed explosive projectiles, torpedoes, mines, and bombs exceeding 90 pounds. Only the military is authorized to ship palletized explosive projectiles of not less than 4 1/2 inches in diameter without being boxed. See—
  - Pamphlet 6—for carload and less-than-carload shipments of explosives and other dangerous articles.
  - Pamphlet 6A—for carload and less-than-carload shipments of loaded projectiles and loaded bombs.
  - Pamphlet 6C—for trailer and less-than-trailer shipments of explosives and other dangerous articles via trailer-on-flatcar (TOFC) or container-on-flatcar (COFC).

Methods of bracing and blocking other than those given in these BOE pamphlets must be submitted through military transportation channels to the BOE for approval.

- TM 9-1300-206—for information on the care, preservation, and destruction of ammunition. See also data on quantity-distance standards for manufacturing, handling, storing, and transporting mass-detonating ammunition, explosives, and small arms ammunition. This technical manual also includes quantity-distance classes and tables for all classes of ammunition and explosives.

- TM 55-602—for general guidance on transporting special freight. This technical manual identifies applicable directives and regulations as well as agencies prescribing transportation policies.

- Army Materiel Command publications—for outloading drawings of ammunition, missile systems, special weapons, and other hazardous materials.

**Bracing and blocking.** Use only sound lumber free from cross grain, knots, knotholes, checks, or splits, which impair the strength of the material or interfere with proper nailing. Use nails plentifully and in the proper places; balanced nailing is important. All nails should be long enough for necessary holding power and ample penetration of car walls, floors, or other bracing and blocking. To obtain the greatest holding power, nails must be long enough to penetrate, but not protrude through, the timber holding the point of the nail. Nails must not be so large that they cause splitting. Place nails along the same grain in the wood. Whenever possible, drive nails straight—not toenailed. To prevent sparks, use brass or copper hammers to nail braces around packages of explosives.

Drive nails holding sidewall blocking into the heavy uprights supporting the car lining. Car lining is only three-quarters or seven-eighths of an inch thick and has little holding power for large nails.

**Basic precautions.** When loading packages in a car, avoid lost space by pressing each package firmly toward the end of the car as it is loaded.

Avoid high pressure on small areas. Use the largest possible area of a package to resist pressures. Nail beveled boards to the car floor to cover defects in the floor or projecting pieces of metal or nails. Cars with corrugated or pressed metal unlined ends, as well as cars with bowed ends, must be boarded up at the inside of the ends to the height of the load.

Avoid placing a large shipment in one end of a car. Do not load a shipment exceeding 12,000 pounds in one end of a car unless other freight is to be loaded to balance the other end. Failure to observe this precaution may cause the car to leave the track.

Never load or stow incompatible chemicals or explosives together (49 CFR 170-1 79).

Never use—

- Cars with end doors.
- Cars with automobile loading devices (unless the loading device is attached to the roof of the car so that it cannot fall—applicable to shipment of Class A explosives only).
- Refrigerator cars (unless use is authorized by the carrier or owner, ice bunkers are protected by solid bracing, and nonfixed floor racks are removed).

When loading in closed cars, secure the load so that it does not come in contact with side doors or roll and shift in transit.

When lift trucks move heavy loads in and out of cars, a temporary steel plate or other floor protection device of suitable size will prevent the truck from breaking through the floor. Place the load in the car so that there is no more weight on one side than on the other. Limit the load per truck to half the load limit stenciled on the car. Cars should be loaded as heavily as possible up to the load limit stenciled on the car.

Material loaded between truck centers and the ends of the car must not exceed 30 percent of the stenciled load limit (15 percent each end) when both ends are loaded and 10 percent when only one end is loaded.

When loading, blocking, and bracing ammunition for carload and less-than-carload shipments, make sure ammunition containers are tightly wedged in place at the time of

loading. Bulkhead braces for partial layers must be long enough to permit nailing to upright braces behind car lining. Length will vary, depending on weight of lading supported. The filler strips nailed to the sides of the car must be extended across the doorway. No other doorway protection is required.

**Dangerous-cargo placards.** On loaded cars, labels and placards are required for containers and railcars carrying explosives and other hazardous materials. See 49 CFR 172-174 for a description of labels and placards and FM 55-70 for a detailed discussion.

Empty tank cars and boxcars are often placarded with notices warning of lingering gases and fumes. These warning cards stress that care must be used in switching the cars as well as in unloading their contents.

### Cargo Security

**At origin.** The shipper is responsible for the security of carload freight until the car is coupled to a locomotive or train for movement. The shipper must be fully aware of this responsibility.

Before loading, the shipper should inspect the car thoroughly to ensure that it meets security and serviceability requirements. Cars with insecure doors or holes or damaged places in floors, roofs, or sides must be repaired before they are used.

The shipper is also responsible for properly loading and bracing the load and for closing and sealing the car. Improperly stowed or braced loads may be damaged in movement and so invite pilfering (see TM 55-601).

Loading should conform to the standards necessary for safe movement under existing conditions. Seal closed cars containing sensitive cargo—arms, ammunition, and explosives (AA&E)—with cable seal locks. If these locks are not available, use a Number 5 steel wire twist or a wire cable of larger or equivalent thickness, together with a ball-type, serialized seal to secure door hasps. Shipping papers furnished the carrier should specify that flame or heat-producing tools will not be used to remove sealing devices from AA&E shipments. For nonsensitive shipments (other than AA&E), a ball-type, serialized seal will

suffice. Cover shipments in open cars with securely fastened tarpaulins. Fasten small items shipped on flatcars securely to the car floor.

The shipper prepares an accurate list of contents, prepares the waybill, and affixes placards to the cars. The shipper also transmits/-mails an advance notice of AA&E shipments to the consignee. After a car is loaded, sealed, and documented, it should be moved as quickly as possible.

At military installations, the originating transportation officer and railway personnel must inspect all open-top cars before movement to ensure that they are loaded properly and meet clearance requirements.

**In transit.** The appropriate commercial railroad (in CONUS) and the TRS (in overseas theaters) are responsible for the security of all in-transit carload freight from the time the car is moved from its loading point until it reaches its designated unloading point. The originating rail carrier or the TRS prepares all car records, train documents, and other records required to speed movement and prevent loss of cars en route. When operating conditions permit, group the cars carrying pilferable freight for economical use of guards. Give special handling to mail or high-priority classified traffic.

In CONUS, the appropriate Army headquarters provides train guards. In overseas theaters, military police or other units assigned or attached to the TRS for security duties provide train guards. These units also guard cars and trains during movement in railroad yards. Sensitive supplies may be guarded by personnel assigned to the car by the loading agency. The yardmaster notifies the dispatcher on receipt of cars with special guards. The yardmaster also notes receipt on the train consist, which is transmitted to yards and terminals. This notification helps avoid delays in transit and expedites placement at the destination.

Guard crews check car seals and inspect trains for security. They prepare a record, by car number, of all guarded cars in trains and note any deficiencies or incidents en route.

When a relief guard takes over, the crews make a joint inspection and sign the record.

When a "bad-order" car containing supplies subject to pilferage is "set out," a member of the guard crew should remain with the car until properly relieved. Guard crews must be alert at all times, particularly when the train is stopped or passing through tunnels, cuts, and villages at slow speed.

**At destination.** When carload freight is placed at the designated depot, siding, or track, the consignee then becomes responsible for the shipment. Cars should be unloaded as quickly as possible to lessen chances of pilferage.

When removing wire seals from closed cars, be careful not to break latches on the car doors. Wire cutters are recommended for this purpose.

Do not use flame or heat-producing tools to remove sealing devices from shipments of arms, ammunition, or explosives.

## CONSTRUCTION, MAINTENANCE, AND SUPPLY

### Construction Requirements

For planning purposes, a railroad division includes 100 principal route miles of main line single or double track. The division includes terminal operation and maintenance facilities, fueling and watering facilities, and necessary signaling equipment or interlocking facilities.

Passing sidings on single-track lines, crossovers on double-track lines, and stations are located at intervals required by traffic. Normally, there is at least one spur or siding provided at each station.

The engineer service in the theater of operations is responsible for new rail construction and large-scale rehabilitation. TRS maintenance of way personnel, however, may be required to assist engineer personnel with rehabilitation.

See Table 4-2 for the materials and man-hours required for new construction of one mile of standard-gage (56 1/2-inch), single-track railroad. See Table 4-3 for expected rehabilitation requirements for a 100-mile standard-gage, single-track division extending inland from a port. The table shows average percentage of demolition over the entire division. For further information, see FM 5-35, FM 55-20, and TM 5-370.

### Maintenance Responsibilities

After railways are constructed and turned over to it for operation, the TRS is responsible for minor railway maintenance in the communications and combat zones to the forward limit of traffic. See TM 55-204 for further discussion of this subject.

The TRS is responsible for—

- Maintaining the railway communications circuits used exclusively for railway operation and administration. (Responsibility becomes effective when all circuits on the line have been turned over to the TRS.)

**Table 4-2. Material and man-hour requirements for railroad construction \***

ITEM	STONs	MTONs	MAN-HOURS
Grading (includes clearing average wooded terrain)	-	-	5,000
Ballast delivered, average haul—5 miles (8.05 km)	-	-	2,500
Tracklaying and surfacing	-	-	3,400
Bridging—70 linear feet (21.34 m)	128	111	3,200
Culverts, 7 per mile—280 feet (85.34 m)	8	7	1,400
Ties—2,900	218	300	-
Rail, 90-pound—ARA—A Section	79	45	-
115-pound—ARA—E Section	103	57	-
Fastening (based on 39-foot rail) (11.89 m)	33	10	-
<b>Total</b>	<b>569</b>	<b>530</b>	<b>15,500</b>

\*Per 1 mile of standard-gage single track.

*Table 4-3. Rehabilitation requirements per railroad division*

Item	Per 100 Miles (161 km)	Percent of Demolition	Rehabilitation (quantity)	Construction Material <sup>1</sup> STONS	Man-Hours <sup>1</sup> (Thousands)
Main line trackage	100 mi	10	7.0 mi	2,708	36.4
Port trackage <sup>2</sup>	-	100	3.0 mi	1,368	14.4
Passing sidings <sup>2</sup>	2.4 mi	80	2.4 mi	1,049	11.5
Station sidings <sup>2</sup>	1.6 mi	80	1.6 mi	730	7.7
Railway terminal <sup>2, 3</sup>	1.0 ea	75	0.75 ea	8,025	160.0
Water stations	3.0 ea	100	3.00 ea	135	9.0
Fuel stations	1.0 ea	100	1.00 ea	19	0.9
Bridging (70 ft per mile)	7,000	55	2,700 linear ft	2,700	70.0
Culverts	28,000 linear ft	15	4,200 (74 ea) linear ft	63	13.7
Grading and ballast	-	-	-	-	40.5

<sup>1</sup> Tunnels require special consideration. To repair (by timbering) a 50-foot demolition at each end of a single-track tunnel (100 ft total per tunnel), allow 70 STONS or 87 MTONs, and 3,000 man-hours.

<sup>2</sup> Estimate includes ties, rails, fastenings, turnouts, tracklaying, and surfacing. It is assumed ballast is available at work sites.

<sup>3</sup> Includes replacing buildings 100 percent, ties 30 percent, rail and turnouts 85 percent.



- Operating railway block signals of interlocking plants and centralized traffic control devices.
- Providing unit and intermediate maintenance of signals and control devices.
- Installing, maintaining, and operating internal communications.

The TRS is normally divided into a number of divisions for maintenance and operation. Each division is assigned a railway battalion; each battalion includes personnel from the railway engineering company to perform necessary maintenance of tracks and structures.

The battalion commander has overall responsibility for railway maintenance, including maintenance procedures, instructions, and work. The railway engineering company commander is maintenance of way superintendent. The superintendent is directly responsible for inspecting and maintaining tracks and structures and for supervising all maintenance work and procedures. Platoon and section leaders supervise assigned maintenance operations.

### Maintenance Categories

There are three categories of Army maintenance: unit, intermediate, and depot. They are discussed here as they apply to locomotives and rolling stock.

**Locomotives.** Suitable inspection pits and facilities must be provided for inspection, repair, and adjustment of locomotive parts. Locomotives must be inspected periodically and maintenance documented according to rail technical manuals. See DA Pam 738-750 and TM 55-203 for specific requirements.

Maintenance on locomotives is normally performed in an enginehouse. Enginehouses are of two general types: turnaround and maintenance. The turnaround enginehouse is small, equipped only for performing minor repairs and services usually requiring only 1 1/2 to 3 hours. The maintenance enginehouse has facilities for making major as well as minor repairs. Division locomotives are kept in good operating condition and at maximum availability. See FM 55-20 (for diesel-electric locomotives) for a general reference covering maintenance procedures at enginehouses.

**Unit maintenance.** Unit maintenance of locomotives consists of during-operation maintenance, inspection of visible moving parts, lubrication, and repair/replacement of parts which might otherwise interfere with efficient operation. The train-operating company performs during-operation maintenance. The engineman is responsible for the equipment he operates. The fireman maintains proper water level and steam pressure on steam locomotives. The balance of unit maintenance is the responsibility of the railway equipment maintenance company.

**Intermediate maintenance.** The railway equipment maintenance company and the diesel-electric locomotive repair company perform intermediate maintenance. If repairs are not too extensive, they are made and the locomotive put back into service. The mobile railway workshop supplements the railway equipment maintenance company's capability and functions under direction of the railway group headquarters. If repairs are beyond the railway workshop's capability, the unit makes only those repairs required to move the locomotive to a fixed installation for repair.

**Depot maintenance.** The diesel-electric locomotive repair company performs limited depot maintenance. The TRS has no units that perform full depot maintenance. This category of maintenance is beyond the capabilities of the railway car repair company and diesel-electric locomotive repair company and requires evacuation to CONUS or to an appropriate base or facility.

**Rolling stock.** Repair track installation (rip tracks) is normally set up at main terminals. Rip tracks are also located at other points of the division, such as junction points or heavy loading centers, to take care of repairs that cannot be made at the loading installation and to avoid moving the cars into the main terminal. The master mechanic (railway equipment maintenance company commander) is responsible for the operation of the rip tracks.

**Unit maintenance.** The railway battalion's train maintenance sections and crews perform unit maintenance (running repairs and inspection of rolling stock). Military or civilian car inspectors perform maintenance at the originating terminals and at inspection points

en route. Inspectors perform repairs required for safe train operation.

**Intermediate maintenance.** The railway battalion's train maintenance sections and crews and the railway car repair companies perform intermediate maintenance. Military or civilian maintenance personnel perform intermediate maintenance at the home terminals of the cars or at a prescribed location. Maintenance consists of running and emergency repairs that require taking the car out of service for a short time only (see TM 55-203).

**Depot maintenance.** The railway car repair companies perform limited depot maintenance.

### Maintenance of Way

**Roadway.** Roadway maintenance is the work required to keep the part of the right-of-way on which the track is constructed in serviceable condition. This part of the right-of-way includes excavations, embankments, slopes, shoulders, ditches, and road/stream diversions. See TM 55-204 for a detailed discussion of roadway maintenance.

**Track.** In a theater of operations, the track must be operable at all times. The four primary considerations in track maintenance are gage, surface, alignment, and dress. The continual passing of trains around a curve eventually moves the track, altering the alignment and distorting the curve (see subparagraph "Determining Track Curvature"). TRS maintenance of way personnel should restore the track to its correct curvature if any distortion exists. Inspect the roadbed and track frequently to avoid operating delays because of damage by sabotage, direct enemy action, or weather.

**Structures.** In a theater of operations, structures essential to railway operations must be maintained according to the prescribed maintenance standards. These structures include bridges, culverts, tunnels, and fuel and water facilities. When repairing structures, always observe minimum clearances.

### Determining Track Curvature

**Survey method Degree of curve (D)** is a measure of the sharpness of curvature and is defined as the angle subtended at the center of

curvature by a chord 100 feet long. **Radius of curvature (R)** is the distance (in feet) from the apex of the central angle out to the curve; mathematically, R is the reciprocal of the curvature (C) of a curve. A **chord** is a straight line joining two points on the curve. The **arc** is the continuous portion of that curved line (as a part of a circle) between the same two points. The smaller the central angle (and the greater the radius), the closer the arc measurement comes to the chord measurement (100 feet).

The area of the sector of a circle is expressed in either of two ways:

$$A = \frac{R \times \text{arc}}{2} \quad \text{or} \quad A = \frac{3.1416 \times R^2 \times D}{360}$$

where: A = area

R = radius of curvature in feet

D = degrees of curvature

arc = 100 ft (since arc and chord are almost the same for a 10 curve)

To solve for R:

$$R = \frac{\text{arc} \times 360}{2 \times 3.1416 \times D} = \frac{\text{arc} \times 57.3}{D}$$

R then equals 5,730 for a 10 curve and  $\frac{5,730}{D}$  for a D° curve.

The following chart shows the relationship between degree of curve and radius of curvature for simple curves.

D	R	D	R	D	R
1	5,730	7	819	13	441
2	2,865	8	716	14	409
3	1,910	9	637	15	382
4	1,433	10	573	16	358
5	1,146	11	521	17	337
6	955	12	478	18	318

**String method.** If a surveying instrument is not available, compute the degree of simple curvature (arc of a circle) of a track by the string method. Although this method is not exact, the degree of error is slight. A length of ordinary field "commo" wire makes an ideal string. Commo wire is readily available, will not stretch, and may be rolled up and carried in the pocket. The wire may be marked with three

dabs of white paint to indicate the beginning, middle, and end of the 62-foot length needed.

To determine the degree of track curvature by the string method—

- Select a portion of track well within the main body of the curve.
- Mark a 62-foot section on a length of wire or strong cord with dabs of white paint at the beginning (A), middle (M), and end (B) of the section.
- Secure A to inside of high rail (5/8 inch from top). Tightly stretch wire until B touches inside of rail (see Figure 4-3).
- Measure the distance R from M to inside of rail. Distance in inches equals approximate degree of curve.

If the distance R from M to rail measures 5 inches, then the degree of curve is 5. As a curve gets sharper, the distance R increases.

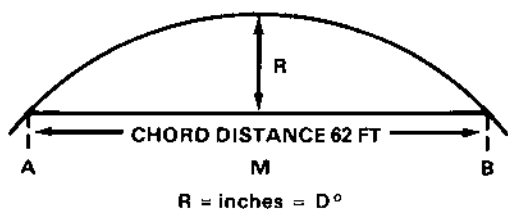

**Figure 4-3. Determining curvature (string method).**

### Supply Procedures

Railway supplies are expendable supplies required for the operation and maintenance of railway divisions. Railway supplies are distinguished from organizational supplies. All operating units must submit reports of supplies on hand at the beginning of operations.

Whenever possible, use local supply sources to reduce transportation requirements. In a

theater of operations, supplies may be procured from—

- Military stocks.
- Manufacturers in or near the theater.
- Foreign railways.
- Captured enemy material and equipment.
- Parts and assemblies manufactured or repaired by the railway battalion.
- Transfers from other railway operation units.

The battalion supply officer serves as fuel agent for the railway transportation battalion. He or she must make sure that the operating TRS agencies receive enough locomotive fuel regardless of source. Requisition fuel and lubricants through normal supply channels.

The supply officer of the highest transportation railway echelon prepares tables of allowances and supplies for all units within the command. The supply officer determines a workable stock level allowance for each unit to ensure its uninterrupted operation. Normally, stock levels for the railway division are determined from past requirements.

Estimate repair parts requirements by using the factor 1.5 STONs per month for each train moving in either direction per day. Beginning with the first railway division, select the train density established for the division and multiply by 2 (for two-way travel). Then multiply the result by 1.5 for the total amount in STONs of spare parts required per month for this division. Use this process for each successive division to determine the total STONs required per month for the entire railway. This total is an estimate only. Revise as necessary to fit operation conditions.

## Section II. RAIL TRANSPORT DATA

### LOCOMOTIVE CLASSIFICATION

#### Whyte System

Locomotives are classified according to wheel arrangement. The Army uses the Whyte

System. Although originally developed for steam locomotives, this system may be used for any type of motive power. Three or more digits separated by a hyphen designate the number of wheels on the locomotive. The first

digit represents the number of leading or “guide” wheels, the second the number of driving or powered wheels, and the third the number of trailing wheels. If there are no lead or trailing wheels, then the figure “0” is used in each case. If there are two separate sets of driving wheels, they are shown as two separate digits—always, of course, with a hyphen between them. For example:

- 2-8-2 Denotes a locomotive with one pair of leading wheels, four pairs of coupled driving wheels, and one pair of trailing wheels.

- 2-8-0 Denotes a locomotive with one pair of leading wheels, four pairs of coupled driving wheels, and no trailing wheels.

- 0-6-6-0 Denotes a locomotive with no leading or trailing wheels and two sets of three driving wheels each.

### Continental System

The classification system commonly used in Europe and other parts of the world classifies locomotives by axles rather than wheels. Powered axles are represented by letters—“A” being one powered axle; “B,” two powered axles; “C,” three; and so on. Nonpowered or idling axles are represented by numerals. Using this system, the Army 0-4-4-0 would be a “B-B” and the 0-6-6-0 would be a “C-C.” A 2-8-0 steam locomotive would be a 1-D-0. A locomotive with two six-wheeled trucks would not necessarily be equipped with all axles powered, usually the middle axle being an

idler. This locomotive would then be shown as an “A-1-A+ A-1-A,” the plus sign (+) representing the separation of the front and rear trucks.

### RAILWAY EQUIPMENT CHARACTERISTICS

Refer to Figure 4-4 and Tables 4-2 through 4-14 for railway equipment characteristics:

- Motive power.
  - Locomotives—Table 4-4.
  - Locomotive cranes—Table 4-5.
  - Railway maintenance motor cars—Table 4-6.
- US rolling stock.
  - Open-top cars (gondolas and hopper cars)—Table 4-7.
  - Flatcars—Table 4-8.
  - Boxcars—Table 4-9.
  - Tank cars—Table 4-10.
  - Refrigerator cars—Table 4-11.
  - Special-purpose cars—Table 4-12.
- DOD Military Rail Fleet—Figure 4-4, an extract from *The Official Railway Equipment Register* which provides an example of data available on DOD cars under MTMC control. This publication also contains data on all US rolling stock and is updated quarterly. The ITO at each CONUS installation should have the most current edition for reference.
  - West German rolling stock—Table 4-13.
  - Korean rolling stock—Table 4-14.

Table 4-4. Characteristics of locomotives

Type	Gage (in)	Weight (lb)	Length Over Couplers	Extreme Width	Extreme Height	Tractive Force (lb)		Horsepower	Curvature Minimum Radius (ft)	Fuel Capacity (gal)
						Starting at 30% Adhesion	Continuous			
Diesel-Electric: 131-T, 0-6-6-0, domestic and foreign svc	56 1/2	262,900	55'	10'0"	14'0"	75,700	37,850 at 10 MPH	1,000	231	1,600
127-T, 0-6-6-0, domestic and foreign svc	56 1/2	261,100	55'	10'0"	14'0"	75,700	37,850 at 10 MPH	1,000	231	1,600
120-T, 0-6-6-0, domestic and foreign svc	56 1/2, 60 63, 66	240,000	57'5"	9'8"	13'6"	73,000	37,000 at 10 MPH	1,600	193	1,600
120-T, 0-6-6-0, domestic and foreign svc	56 1/2	245,000 w/steam generator	56'9"	9'7"	13'5"	72,000	36,000 at 10 MPH	1,600	193	800 w/steam generator
120-T, 0-4-4-0, domestic svc	56 1/2	240,000	55'9"	10'3"	14'6"	75,000	40,000 at 11 MPH	1,500	150	800
120-T, 0-4-4-0, domestic svc	56 1/2	246,000	48'10"	10'2"	14'6"	73,000	36,000 at 10 MPH	1,200	100	750
115-T, 0-4-4-0, domestic svc	56 1/2	230,000	45'6"	10'0"	14'6"	69,000	34,000 at 15 MPH	1,000	50	635
100-T, 0-4-4-0, domestic svc	56 1/2	199,000	44'6"	10'0"	14'4"	59,700	28,750 at 10 MPH	660	50	635
100-T, 0-4-4-0, domestic svc	56 1/2	200,000	44'5"	10'0"	14'7"	69,700	35,000 at 10 MPH	800	100	600
80-T, 0-4-4-0, domestic svc	56 1/2	161,000	36'10"	9'6"	13'7"	48,000	24,000 at 10 MPH	500	75	400
80-T, 0-4-4-0, domestic svc	56 1/2	161,000	36'10"	9'6"	13'7"	48,000	24,000 at 10 MPH	470	75	400
80-T, 0-4-4-0, domestic svc	56 1/2	161,600	41'0"	9'6"	13'4"	48,000	21,000 at 5.2 MPH	550	75	400
65-T, 0-4-4-0, domestic svc	56 1/2	130,000	34'0"	10'1"	13'5"	39,000	19,500 at 10 MPH	400	75	250

**Table 4-4. Characteristics of locomotives (cont)**

Type	Gage (in)	Weight (lb)	Length Over Couplers	Extreme Width	Extreme Height	Tractive Force (lb)		Horsepower	Curvature Minimum Radius (ft)	Fuel Capacity (gal)
						Starting at 30% Adhesion	Continuous			
Diesel-Electric:										
60-T, 0-4-0, domestic and foreign svc	56 1/2, 60, 63, 66	122,000	38' 11" (Type E) 39' 3" (Williston)	9' 6"	13' 4"	26,000	15,680 at 7.78 MPH	500	75	500
45-T, 0-4-0, domestic and foreign svc	56 1/2	90,000	33' 6"	9' 7"	12' 0"	27,000	12,000 at 6 MPH	380	75	250
45-T, 0-4-0, domestic svc (side rod drive)	56 1/2	90,000	28' 4"	9' 6"	12' 0"	27,000	13,500 at 6.2 MPH	300	50	165
44-T, 0-4-0, domestic svc	56 1/2	91,270	33' 10"	9' 4"	13' 3"	26,400	11,000 at 9 MPH	380	75	250
44-T, 0-4-0, domestic svc	56 1/2	89,000	33' 5"	10' 1"	13' 3"	26,400	13,000 at 7.1 MPH	380	50	250
25-T, 0-4-0, domestic svc	56 1/2	50,000	16' 1"	8' 7"	10' 4"	15,000	6,200 at 6.2 MPH	150	50	75
Gasoline/Diesel-Mechanical:										
10-T, single-engine, 0-4-0, domestic svc	56 1/2	20,000	-	-	-	-	-	100	75	30 (diesel)

**Table 4-5. Characteristics of locomotive cranes**

Type	Gage (in)	Weight (lb)	Length Over Couplers	Extreme Height	Extreme Width	Boom Length (ft)	Reach Radius and Capacity	
							Main Hoist	Aux Hoist
Locomotive, steam, wrecking, 75-T, broad gage, domestic and foreign svc	56 1/2, 60 63, 66	191,000	30' 10"	17' 10"	10' 4"	25 (2-piece, curved)	16' (75-T) 25' (34-T)	25' (10-T) 30' (8-T)
Locomotive, crane, diesel, mech, 150-T, domestic svc	56 1/2	291,700	31' 0"	15' 6"	10' 4"	28 (2-piece, straight)	28' (67-T)	--
Locomotive, diesel, elec, 40-T, broad gage, domestic and foreign svc	56 1/2, 60 63, 66	221,500	36' 1"	13' 6"	10' 4"	50 (2-piece, straight)	12' (40-T) 50' (6 3/4-T)	-- --
Locomotive, diesel, elec, 40-T domestic svc	56 1/2	220,000	29' 4"	15' 1"	10' 6"	50 (2-piece, straight)	12' (40-T) 50' (6 3/4-T)	-- --
Locomotive, diesel, mech, 25-T, broad gage, domestic and foreign svc	56 1/2, 60 63, 66	148,000	27' 7"	13' 0"	8' 6"	50 (2-piece, straight)	12' (25-T) 50' (4-T)	-- --
Locomotive, diesel, mech, 25-T, narrow gage, foreign svc	36, 39 3/8, 42	152,000	32' 6"	12' 0"	8' 6"	40 (2-piece, straight)	12' (25-T) 40' (6-T)	-- --
Locomotive, diesel, mech, 25-T, domestic svc	56 1/2	155,000	30' 0"	15' 2"	10' 8"	50 (2-piece, straight)	12' (25-T) 50' (4-T)	-- --
Locomotive, diesel, mech, 35-T, domestic svc	56 1/2	167,000	30' 0"	15' 7"	10' 4"	50 (2-piece, straight)	12' (35-T) 50' (5-T)	-- --

**Table 4-6. Characteristics of railway maintenance motor cars**

Type	Gage (in)	Weight (lb)	Length (in)	Width (in)	Height (in)	Capacity	Horse-Power	Fuel Capacity (gal)
Gasoline, mech, 4 wheels, solid drawbar couplers, closed cab with hand brake	56 1/2	2,950	112	65	58 w/o cab	8 person	62.6	8
Gasoline, mech, 4 wheels, solid drawbar couplers, open body with hand brake	56 1/2	1,700	103	65	50	10 person	62.6	8

**Table 4-7. Characteristics of open-top cars**

Type	Gage (in)	Normal Capacity (lb)	Inside Dimensions			Light Weight (STONS)
			Length	Width	Height	
<b>Gondolas:</b>						
High side, 8W, narrow gage, foreign svc	36, 39 3/8, 42	60,000	34'5"	6' 10 1/2"	4'	13.0
Low side, 8W, narrow gage, foreign svc	36, 39 3/8, 42	60,000	34'6"	6' 10 1/2"	1'6"	12.1
High side, 8W, broad gage, foreign svc	55 1/2	80,000	40'	8' 3 3/4"	4'	18.0
Low side, 8W, broad gage, foreign svc	55 1/2, 60, 63, 66	80,000	40' 4 1/2"	8' 3 1/4"	1'6"	16.0
Low side, 8W, drop ends, domestic svc	55 1/2	100,000	41'6"	9' 6 1/8"	3'	23.0
High side, std gage, domestic svc	55 1/2	100,000	41'6"	9' 6"	4'6"	25.0
<b>Hopper Cars:</b>						
8W, domestic svc	55 1/2	100,000	33'	9' 5 1/2"	9'7"	-



**Table 4-8. Characteristics of flatcars**

Type	Gage (in)	Normal Capacity (lb)	Platform Length	Platform Width	Platform Height Above Rail	Light Weight (STONS)
8W, narrow gage, foreign svc	36, 39 3/8, 42	60,000	34' 8 1/2"	7'2"	3'7"	10.9
12W, domestic svc	56 1/2	200,000	54'	10' 6 1/2"	4' 1 1/4"	35.0
8W, domestic svc	56 1/2	140,000	49' 11 1/2"	10' 3 1/4"	3' 8 1/2"	27.0
12W, broad gage, foreign svc, 80-T	56 1/2, 60, 63, 66	160,000	46'4"	9'8"	4' 2 7/8"	35.3
12W, domestic svc (passenger train svc)	56 1/2	200,000	54'	10' 6 1/4"	4' 5 3/8"	-
8W, domestic svc	56 1/2	100,000	43'3"	10'6"	3'8"	25.5
8W, broad gage, foreign svc	56 1/2, 60, 63, 66	80,000	40'9"	8' 7 1/4"	3' 6 15/16"	14.5
8W, broad gage, depressed center, foreign svc	56 1/2, 60, 63, 66	140,000	50'7"	9'8"	NA	41.5

**Table 4-9. Characteristics of boxcars**

Type	Gage (in)	Capacity (lb)	Capacity (cu ft)	Inside Dimensions		Door Dimensions	Light Weight (STONS)
				Length	Height		
8W, domestic svc	56 1/2	100,000	3,975	50'6"	10'6"	10' wide, clear opening 8' high, clear opening	23.0
8W, broad gage, foreign svc	56 1/2, 60, 63, 66	80,000	2,520	40'6"	6' 5 5/8"	6' 8 3/4" wide 8' 3 1/4" high	18.5

**Table 4-10. Characteristics of tank cars**

Type	Gage (in)	Length Over Tank Heads	Normal Capacity (gal)*	Inside Diameter (in)		Light Weight (STONS)
				Tank	Dome	
Nickel-clad, ICC-103-AW, 8W, domestic svc	56 1/2	31' 11"	7,500	78 (approx)	45	-
ICC-103, ICC-103-W, 8W, domestic svc	56 1/2	34' (approx)	10,000	87 (approx)	59 3/8 (approx)	-
Caustic soda, ICC-103-W, 8W, domestic svc	56 1/2	34' (approx)	10,000	88 (approx)	64	-
Petroleum, 8W, narrow gage, foreign svc	36, 38 3/8, 42	38' 4 7/8"	6,000	62 1/2	54	16
Petroleum, 8W, broad gage, foreign svc	56 1/2, 60, 63, 66	38' 5 3/8"	10,000	80 3/4	66 1/2	19
Nitric acid, ICC-103-W, 8W, domestic svc	56 1/2	33' 7 1/2"	7,800	78 (approx)	33 3/8	-
Phosphorus, ICC-103-W, 8W, domestic svc	56 1/2	34' 8 1/4"	8,000	78 (approx)	64	-
Petroleum, std gage, domestic svc	56 1/2	-	10,000	-	-	23

\*Specific gravity of a liquid should be checked before it is loaded to avoid exceeding weight capacity of car.

**Table 4-11. Characteristics of refrigerator cars**

Type	Gage (in)	Normal Capacity (lb)	Length Inside End Lining	Width Inside Side Lining	Ice Capacity (lb)	Door Dimensions
8W, disassembled, broad gage, foreign svc	56 1/2, 60, 63, 66	80,000	32' 1/2"	7' 8" (approx)	11,000	4' wide 7' high
8W, mechanical, foreign svc	56 1/2, 60, 63, 66	80,000	40' 9" equipment compartment	7' 6" (approx)	None	6' wide 7' high

**Table 4-12. Characteristics of special-purpose cars**

Type	Gage (in)	Weight (lb)		Over End Sills		Height Above Rail	Remarks
		Light	Loaded	Length	Width		
Car, amb unit, 8W, domestic svc	56 1/2	157,000	167,300	78' 11"	10'	13' 6"	Capacity: 27 patients, 6 corpsmen, 1 nurse, 1 doctor
Car, guard, domestic svc	56 1/2	92,740	99,300	57'	9' 1"	14' 2 1/2"	Air-conditioned, shower, toilet, kitchen, 2 sleeping compartments
Car, kitchen, troop/amb train, 8W, domestic svc	56 1/2	100,160	NA	54' 2 1/2"	9' 5 3/4"	13' 6"	Width, side door opening: 6'
Car, kitchen, dining and storage, amb train, 8W, foreign svc	56 1/2, 60, 63, 66	111,400 (avg)	NA	63' 1/4"	9'	13'	Seat capacity: 24
Car, personnel, amb train	56 1/2, 60, 63, 66	111,400 (avg)	NA	63' 1/4"	9'	13'	Berth capacity: 15 EM, 4 doctors, 2 nurses

**Table 4-13. Characteristics of West German freight cars**

Type	Number of Axles	Light Weight (STONS)	Weight (STONS)	Capacity (cu ft)	Inside Dimensions			Door Dimensions		Height of Floor Above Top of Rail
					Length	Width	Height	Width	Height	
Boxcar, G	2	11.4	16.5	1,500	25' 11 3/4"	8'	7' 4 9/16"	4' 11 1/16"	6' 6 11/16"	4' 1/16"
Boxcar, GLMHS-50	2	13.4	23.1	2,500	36' 9 5/16"	8' 11 1/16"	9' 5/8"	6' 6 1/16"	6' 6 11/16"	4' 9/16"
Boxcar, GM-30	2	12.7	23.1	1,700	24' 10"	8' 10"	31' 4"	5' 6"	6'	not avail
Boxcar, GMS-54	2	12.6	23.1	2,100	30' 5 11/16"	8' 8 11/16"	8' 9 1/2"	5' 10 13/16"	6' 7 1/8"	4' 1/16"
Boxcar, KMMKS-51	2	12.5	30.8	1,420	28' 8 13/16"	9' 5/8"	5' 6 1/8"	5' 10 13/16"	4' 10 5/8"	4' 1 7/16"
Boxcar, KMMBKS-58	2	14.3	29.7	1,800	28' 8 9/16"	8' 11 1/16"	7' 1 5/16"	12' 8 3/4"	6' 6 11/16"	4' 1 1/16"
Gondola, X-05 (low side)	2	not avail	23.1	320	25' 7"	8' 7"	1' 4"	NA	NA	not avail
Gondola, XLM-57 (low side)	2	8.4	23.1	330	29' 7"	8' 6"	1' 4"	NA	NA	4'
Gondola, OMM-37 (high side)	2	9.7	24.6	1,210	27' 7"	9'	4' 10"	NA	NA	4'
Gondola, OMM-52 (high side)	2	11.0	28.6	1,200	28'	8'	4' 10"	NA	NA	4'
Gondola, OMM-55 (high side)	2	11.0	27.5	1,200	28' 8 9/16"	9' 3/8"	4' 11 1/16"	5' 10 1/2"	NA	4' 7/8"
Gondola, OMM-53 (high side)	2	12.1	27.5	1,200	28'	8' 9"	4' 10"	NA	NA	4'
Gondola, OMM-33 (high side)	2	11.5	27.0	1,260	28' 7 3/16"	9' 7/16"	5' 1"	4' 11 1/16"	NA	4' 5/8"

Table 4-13. Characteristics of West German freight cars (cont)

Type	Number of Axles	Light Weight (STONS)	Capacity Weight (STONS)	Capacity (Cu ft)	Inside Dimensions			Door Dimensions		Height of Floor Above Top of Rail
					Length	Width	Height	Width	Height	
Flatcar, R-10 <sup>1</sup>	2	10.6	16.5	NA	33' 25/16"	8' 9"	NA	NA	NA	4'
Flatcar, RM-31 <sup>1</sup>	2	14.3	22.1	NA	34' 11 9/16"	8' 5 5/16"	NA	NA	NA	4' 1 1/8"
Flatcar, RMM-33 <sup>1</sup>	2	11.4	27.0	NA	34' 8 3/8"	9' 2 1/4"	NA	NA	NA	4' 1 1/4"
Flatcar, RLMM5-56 <sup>1</sup>	2	14.0	25.3	NA	40'	8' 11"	NA	NA	NA	4'
Flatcar, SM-14 <sup>1</sup>	2	11.9	23.1	NA	41' 6"	8' 9"	NA	NA	NA	not avail
Flatcar, SS-15 <sup>1</sup>	4	21.5	40.2	NA	48' 2"	8' 9"	NA	NA	NA	not avail
Flatcar, SSLMA-44	4	22.7	44.1	NA	59' 2 7/16"	9' 1 1/4"	NA	NA	NA	4' 5 3/4"
Flatcar, SSLMAS-53	4	26.3	61.6	NA	60' 8 5/16"	8' 11 13/16"	NA	NA	NA	4' 6 1/8"
Flatcar, SSNM-49	4	17.1	55.1	NA	40' 8 3/4"	8' 5 15/16"	NA	NA	NA	4' 3 9/16"
Flatcar (USA-owned)	4	16.7	50.0	NA	40' 9"	8' 5 3/4"	NA	NA	NA	4' 3 9/16"
Tank car	2	14.0	NA	(2)	21' 2"	NA	not avail	NA	NA	5'
Tank car	4	26.4	NA	(3)	33' 1/2"	NA	not avail	NA	NA	5'
RS 683,684,685	4	(MTs)	(MTs)	(cu m)	(m)	(m)	(m)	NA	NA	(m)
RS689	4	24.0	56.0	51.3	18.5	2.77	NA	NA	NA	1.33
REMS665	4	23.6	56.0	51.0	18.5	2.77	NA	NA	NA	1.33
RES686	4	21.4	56.5	35.1	12.6	2.78	NA	NA	NA	1.33
SA705	4	25.0	55.0	49.0	18.5	2.75	NA	NA	NA	1.23
SA (h) S710	6	22.3	67.5	35.3	11.2	2.73	NA	NA	NA	1.43
SAhs 711	6	31.0	65.0	45.7	15.0	2.56	NA	NA	NA	1.37
	6	31.5	64.0	turning side jacks flooding molds	NA	2.90	NA	NA	NA	NA
SGjs 716 (w)718	4	24.0	18.8	55.0	2.7	NA	NA	NA	NA	1.24
shis	4	22.7	NA	NA	NA	NA	NA	NA	NA	NA
SAS709	6	30.6	65.0	46.0	15.0	3.09	1.37	NA	NA	NA
TS851	2	11.7	28.0	24.0	8.76	2.76	1.68	NA	NA	1.25
TCS850	2	11.6	28.0	24.0	8.66	2.76	1.68	NA	NA	1.25
TIS858	2	13.0	26.5	23.8	8.75	2.72	2.16	NA	NA	1.23
Tbis871	2	15.1	24.5	34.0	12.7	2.67	2.26	NA	NA	1.17
Tbis 869,870,875	2	14.4	25.5	34.0	12.7	2.67	2.26	NA	NA	1.17

1 Height of flatcar is determined by height of stanchion.  
2 4,356 US gallons.  
3 14,266 US gallons.

**Table 4-14. Characteristics of Korean freight cars**

Type	Number of Axles	Light Weight (STONS)	Capacity		Inside Dimensions (m)			Door Dimensions (m)		Height (m) of Floor Above Top of Rail
			Weight (lb)	Cube (cu m)	Length	Width	Height	Width	Height	
<b>Boxcar:</b>										
40-T	4	21	88,160	87	12.95	2.7	2.5	1.7	2.1	1.1
50-T	4	22	110,200	95	13.04	2.8	2.6	1.8	2.1	1.6
<b>Gondola:</b>										
40-T	4	19	88,160	40	11.00	2.6	1.4	NA	NA	1.1
50-T	4	20	110,200	49	13.04	2.7	1.4	NA	NA	1.6
<b>Flatcar:</b>										
40-T	4	16	88,160	NA	12.20	2.5	NA	NA	NA	1.1
50-T	6	20	110,200	NA	15.00	2.9	NA	NA	NA	1.2
Tank car (USA-owned)	4	22	88,160	(10,000 gal)	11.09	2.9	2.7	NA	NA	1.1

DEPARTMENT OF DEFENSE, MILITARY TRAFFIC MANAGEMENT COMMAND-WASHINGTON, D.C. 20315.																													
Reporting Marks and ACR Nos. — DODX - 1 158																													
GENERAL OFFICES: Headquarters, Military Traffic Management Command, Eastern Area, Attn: MTE-NR-M, Military Ocean Terminal, Bayonne, NJ 07002 (201)823-6411-6412-6413																													
FREIGHT EQUIPMENT																													
Cars are marked "DODX" and are numbered and classified as follows:																													
L 1 n 4 No	A.A.R. Mech. Desig.	DESCRIPTION	A.A.R. Car Type Code	NUMBERS Change from Previous Issue	DIMENSIONS										CAPACITY		No. of Cars												
					INSIDE			OUTSIDE					DOORS		Cubic Feet Level Full	Lbs. (000)													
					Length	Width	Height	Length	Width	Height from Rail	Side	Width of Opening	Height of Opening																
ft. in.	ft. in.	ft. in.	Rt. in.	ft. in.	Rt. in.	ft. in.	ft. in.	ft. in.	ft. in.	ft. in.	ft. in.	ft. in.																	
See Explanation Pages for Abbreviations & Symbols																													
1	XP	Box, End Doors: Width 8'2" & Height 10'2". Removable Shipping Containers. (Heat Exchangers)	A101	27480-27491	40	6	9	2	10	5	44	4	9	4	10	6	13	10	14	5	15	8	9	10	3903	100	12		
2	XP	Box, End Doors: Width 9'6" & Height 8'5". Removable Shipping Containers. (Heat Exchangers)	A506	29010-29024	59	9	9	5	9	9	55	5	9	11	10	8	12	1	14	14	9	27	8	6	5487	164	15		
3	XP	Box, End Doors: Width 9'6" & Height 8'5". Removable Shipping Containers. (Heat Exchangers). 15" Freightmaster End of Car Coupling	A506	29300-29314	59	9	9	5	9	9	57	10	9	11	10	8	12	1	14	14	9	27	8	6	5487	161	15		
4	FMS	Flat, Sd., Load Limit at Center of Car. (Navy Gun Mounts)	F211	32002	40	10	6				46	2			10	6	5	8	3	31	5	8				140	1		
5	FMS	Flat, Sd., Load Limit at Center of Car. (Navy Gun Mounts)	F211	32003-32007	40	9	1				43	2			10	2	3	8	3	8	5					140	5		
6	FM	Flat, Heavy Duty	F502	39016-39044	54	10	6				57	4			10	7	4	2	4	2	4	2				200	543		
7	FM	Flat, (Diesel Locomotives)	F502	39063-39429 39434-39488, 39517	54	10	6				56	5			10	7	4	2	4	2	4	2				200	5		
8	FM	Flat, (Navy Gun Mounts)	F502	38148-38176, 38190-38221, 38223, 38272, 38313	54	10	5																				17		
9	LF	Flat, Heavy Duty, Demountable Container	L007	38170-38187, 38200, 38290, 38311, 38566	54	10	6																				6		
NOTE																													
10	FW	Flat, Well, Four 4-Wheel Trucks, (Steam Generators), Axle Spec. 5'10", Truck Ctrs. 34'6"	F361	38891-38894	46	8	9																				2		
11	FW	Flat, Well, Four 4-Wheel Trucks, Axle Spec. 5', Truck Ctrs. 34'6"	F361	38852-38854	46	8	9																				2		
12	FW	Flat, Well, Four 4-Wheel Trucks, Axle Spec. 5', Truck Ctrs. 34'6"	F362	38864	53	6	10																				1		
13	FW	Flat, Well, Four 4-Wheel Trucks, (Steam Generators), Axle Spec. 5', Truck Ctrs. 40'4"	F461	38895-38897	46	4	9	1	8	69	5				10	8	8	3	4	2	8	3					400	3	
14	FM	Flat	F502	39085-39199	54	10	4				57	2			10	4	4	5	4	5							200	100	
15	FM	Flat	F301	39900-39949	50	10	3				53	3			10	3	3	8	3	8	3	8					160	73	
16	FMS	Flat, Chain Tie-Downs	F311	39503 39531-39533, 39544, 39552, 39560, 39563-39566, 39571-39573, 39575-39577, 39584, 39586, 39590-39592, 39595, 39597, 39602-39604, 39606, 39608, 39610-39611, 39617-39620, 39624-39625, 39627, 39629-39630, 39632, 39634-39635, 39645, 39647-39649	50	10	3					53	3			10	3	3	8	3	8	3	9					160	47
17	FM	Flat, (Navy Gun Mounts)	F301	39519-39558, 39569, 39582, 39623, 39626, 39639	50	10	3				53	3			10	3	3	8	3	8	3	9					160	7	
18	LF	Flat	L007	39524, 39599, 39637	50	10	3				53	3			10	3	3	8	3	8	3	8					160	3	
19	LF	Flat	L007	39535, 39546, 39551, 39559, 39579, 39587, 39588, 39596, 39609, 39612, 39616, 39640	50	10	3				53	3			10	3	3	8	3	8	3	9						160	12
20	FD	Flat, Well, Depressed Center	F433	39800-39809	72	8	10	2	2	8	79	8			10	2	4	11	4	11	6	4					300	10	
21	FD	Flat, Well, Depressed Center	F432	39810-39832	58	9	2	1			52	10			10	4	1	4	3	15	4						300	9	
22	FD	Flat, Well, Depressed Center	F432	39812, 39813, 39820-39821, 39824, 39825	58	9	2	1			52	10			10	4	1	4	3	13	10						300	6	
23	FD	Flat, Well, Depressed Center	F432	39819	58	9	2	1			52	10			10	4	1	4	3	15	4					300	1		
24	FD	Flat, Well, Depressed Center	F432	39826, 39827-39829, 39831, 39832	58	9	2	1			52	10			10	4	1	4	3	13	10					300	8		
25	FD	Flat, Well, Depressed Center	F432	39830	58	9	2	1			52	10			10	4	1	4	3	13	10					300	1		
26	FD	Flat, Well, Depressed Center	F433	39833-39847	71	8	9	2	2		77	1			9	2	4	11	4	11	15	4					318	4	
27	FD	Flat, Well, Depressed Center	F433	39833, 39836	71	8	9	2	2		77	1			9	2	4	11	4	11	15	4					318	2	
28	FD	Flat, Well, Depressed Center	F433	39839, 39843, 39847	71	8	9	2	2		77	1			9	2	4	11	8	4							318	3	
29	FD	Flat, Well, Depressed Center	F433	39840	71	8	9	2	2		77	1			9	2	4	11	10	4							318	1	
30	FD	Flat, Well, Depressed Center	F433	39841	71	8	9	2	2		77	1			9	2	4	11	15	4							318	1	
31	FD	Flat, Well, Depressed Center	F433	39842	71	8	9	2	2		77	1			9	2	4	11	15	1							318	1	
32	FD	Flat, Well, Depressed Center	F433	39844	71	8	9	2	2		77	1			9	2	4	11	7	2							318	1	
33	FD	Flat, Well, Depressed Center	F433	39845, 39846	71	8	9	2	2		77	1			9	2	4	11	15	1							318	2	
34	FMS	Flat, Insulated, Steam Coils	F411	39900	44	9	2	13	8		47	7			9	10	4	2	4	2	13	8					375	1	
35	FMS	Flat, Insulated, Steam Coils	F411	39901-39907	44	9	2				47	7			9	10	4	2	4	2	4	2					375	7	
36	FMS	Flat, Insulated, Steam Coils	F421	39911	40	10	8				70	8			10	8	4	3	4	3	7	5					621	1	
37	FMS	Flat, Insulated, Steam Coils	F421	39912-39913	50	10	8				70	8			10	8	4	3	4	3	7	5					616	2	
38	FMS	Flat, Axle Spec. 4'6", Truck Ctrs. 33'	F421	39914-39917	50	10	8				70	6			10	8	4	3	4	3	4	3					600	4	
39	FMS	Flat, Sd., Axle Spec. 5'6", Truck Ctrs. 46'3"	F423	40000-40100	58	10	3				72	10			10	6	3	9	4	4	1						299	101	
40	FMS	Flat, Sd., Axle Spec. 5'6", Truck Ctrs. 46'3"	F423	40101-40244	58	10	5				72	10			10	5	4	1	4	1	4	1					299	144	
T.O.M.															1177														
TANK EQUIPMENT																													
Cars are marked "DODX" and are numbered and classified as follows:																													
L 1 n 4 No	A.A.R. Mech. Desig.	CLASS	DESCRIPTION See Explanation Pages for Abbreviations & Symbols	A.A.R. Car Type Code	NUMBERS Change from Previous Issue	CAPACITY		L 1 n 4 No	A.A.R. Mech. Desig.	CLASS	DESCRIPTION See Explanation Pages for Abbreviations & Symbols	A.A.R. Car Type Code	NUMBERS Change from Previous Issue	CAPACITY		No. of Cars													
						Retard Gals. (00)	Lbs. (000)							Retard Gals. (00)	Lbs. (000)														
1	T		Tank	T103	6000-6109	110	127	1	T		Tank	T103	9600-9617		110	3													
2	T		Tank	T543	8849-8744	110	1	3	T		Tank, Steam Coils	T103	11636-11699		110	19													
3	T		Tank	T563	8813-8824	134	12	4	T		Tank	T103	11080-12873		110	523													
4	T		Tank	T103	9200-9401	110	177	5	T		Tank, Steam Coils	T103	12600-12899		110	63													
5	T		Tank, Insulated, Steam Coils	T103	9435-9499	154	50	5	T		Tank	T105	14000-14199		248	120													

Figure 4-4. Characteristics of DOD military rail fleet cars  
(Extract from The Official Railway Equipment Register)

DEPARTMENT OF DEFENSE, MILITARY TRAFFIC MANAGEMENT COMMAND-WASHINGTON, D.C. 20315.—Continued																		
L i n e #	A.A.R. Mech. Desig.	CLASS	DESCRIPTION See Explanation Pages for Abbreviations & Symbols	A.A.R. Car Type Code	NUMBERS Change from Previous Issue	CAPACITY			L i n e #	A.A.R. Mech. Desig.	CLASS	DESCRIPTION See Explanation Pages for Abbreviations & Symbols	A.A.R. Car Type Code	NUMBERS Change from Previous Issue	CAPACITY			
						Rated Gals. (00)	Lbs. (000)	No. of Cars							Rated Gals. (00)	Lbs. (000)	No. of Cars	
1	T		Tank (Sulfuric Acid)	T055	14000-14003			248	62	1	T	Tank	T563	16053			134	1
					14008-14010, 14012-14014, 14020											154	13	
					14025-14026, 14029, 14039											110	34	
					14046-14047, 14049, 14051, 14052											88	32	
					14056, 14069, 14070, 14072											88	1	
					14079-14080, 14083, 14086-14087											154	10	
					14089, 14093, 14098-14100, 14105,											151	1	
					14107, 14111, 14113, 14118, 14122													
					14125, 14129, 14131, 14132, 14135													
					14139-14140, 14148, 14150, 14151,													
					14153, 14155, 14159-14161, 14165,													
					14167-14168, 14172, 14175, 14181,													
					14184, 14191, 14198													
																	1422	
																	2599	
2	T		Tank	T105	14200-14201			200	162									
3	T		Tank	T103	18004-18187			110	6									
4	T		Tank	T563	18041-18084			136	4									
5	T		Tank	T563	16045			137	1									

**Notes 1—**Car is equipped with permanently applied container and framework as an enclosure for radioactive material. Container, empty 139,914 lbs., cooling unit 18,000 lbs., accessories 1,057 lbs., loaded 271,000 lbs. Railcar, ft. wt. 120,000 lbs.  
**Note 2—**Cars are equipped with permanently applied framework. Framework length 23 ft. 8 in., width 5 ft. 8 in., and maximum height above rail 5 ft. 3 in. Framework & car are weighted as a unit, 65,600 lbs.  
**Note 3—**Cars are equipped with permanently mounted container and framework. Container & framework length 22 ft. 4 in., width 10 ft., and maximum height above rail 12 ft. 6 in. Railcar, container & framework are weighted as a unit, 185,000 lbs. loaded & 122,000 lbs. empty.  
**Note 4—**Depressed center flatcars having four 4-wheel trucks with spac. between truck ctrs. 53 ft. & between axles 5 ft., length of depressed section 30 ft., height from rail to top of depressed section 2 ft. 6 in. These cars have 2 3/8" wood flooring each end & 3/8" flooring in depressed section. Load may equal 1d. lmt. cap. if supported on two cross bearers each side of center line of car. Lt. wt. 170,000 lbs.  
**Note 5—**Depressed center flatcars having two 6-wheel trucks with spac. between truck ctrs. 40 ft. & between axles 5 ft. Cars are equipped with permanently mounted container & framework as an enclosure for radioactive material. Container & framework, length 18 ft., width 9 ft., maximum height above rail 15 ft. 6 in., weight 231,000 lbs. loaded & 218,000 lbs. empty. Railcar, ft. wt. 130,000 lbs.  
**Note 6—**Depressed center flatcars having two 6-wheel trucks with spac. between truck ctrs. 40 ft. & between axles 5 ft. Cars are equipped with permanently mounted container & framework, length 31 ft., width 10 ft. 8 in., maximum height above rail 13 ft., 10 in., weight 250,000 lbs. loaded & 95,000 lbs. empty. Railcar, ft. wt. 130,000 lbs.  
**Note 7—**Depressed center flatcars having four 4-wheel trucks with spac. between truck ctrs. 47 ft. & between axles 5 ft. 4 in. Cars are equipped with permanently mounted container & framework as an enclosure for radioactive material. Container & framework, length 18 ft., width 9 ft., maximum height above rail 15 ft. 6 in., weight 231,000 lbs. loaded & 218,000 lbs. empty. Railcar, ft. wt. 122,200 lbs.  
**Note 8—**Depressed center flatcars having four 4-wheel trucks with spac. between truck ctrs. 47 ft. & between axles 5 ft. 4 in. Lt. wt. 122,200 lbs.  
**Note 9—**Heavy duty flatcar having four 4-wheel trucks with spac. between truck ctrs., 26 ft. & between axles 5 ft. Car is equipped with stl. loading deck & may be loaded to 1d. lmt. cap. if supported on two cross bearers each side of centerline of car or provided load is distributed not less than 7 ft. on each side of centerline of car & distributed over the full width of car. Car is equipped with permanently mounted container & framework as an enclosure for radioactive material. Container & framework, length 19 ft. 8 in., width 9 ft. 6 in., maximum height above rail 13 ft. 8 in., weight 333,000 lbs. loaded & 245,000 lbs. empty. Railcar, Lt. wt. 107,000 lbs.  
**Note 10—**Heavy duty flatcars having four 4-wheel trucks with spac. between truck ctrs. 26 ft. & between axles 5 ft. Car is equipped with stl. loading deck & may be loaded to 1d. lmt. cap. if supported on two cross bearers each side of centerline of car or provided load is distributed not less than 7 ft. on each side of centerline of car & distributed over the full width of car. Lt. wt. 107,000 lbs.  
**Note 11—**Heavy duty flatcar having four 6-wheel trucks with spac. between truck ctrs. 33 ft. & between axles 4 ft. 6 in. Lt. wt. 167,200 lbs.  
**Note 12—**Heavy duty flatcars having four 6-wheel trucks with spac. between truck ctrs. 33 ft. & between axles 4 ft. 6 in. Cars are equipped with permanently mounted container & framework, length 35 ft. 11 in., width 10 ft. 8 in., maximum height above rail 15 ft. 1 in., weight 425,800 lbs. loaded & 225,800 lbs. empty. Railcar, ft. wt. 172,300 lbs.  
 Report car movements, stray cars, mileage earnings and junction reports to HQ, MTMCEA Attn: MTE-WR-O, Bayonne, NJ 07002 (DOD/HQ, MTMCEA owner-shipper).  
 Pay mileage earnings by check drawn in favor of "Treasurer of the United States" and forward to HQ, MTMCEA, Attn: MTE-FMF, Bayonne, NJ 07002 (DOD/HQ, MTMCEA owner-shipper).  
 Report cars bad ordered, damaged, destroyed or requiring materials for repair to HQ, MTMCEA, Attn: MTE-WR-M, Bayonne, NJ 07002. Phone: (201)823-6411-6412-6413.  
 All cars initiated "DAFX", "USA" and "USAX" and not listed above are in intraplant service and are subject to movement in interchange as a result of transfer between government installations. Repair to these cars will be billed direct to: Commander, U.S. Army Troop Support & Aviation Materiel Readiness Command, Attn: DRSTS-NPB, 4300 Goodfellow Blvd., St. Louis, MO 63120 in accordance with Rule 112, A.A.R. Interchange Rules.  
 All cars initiated "USNX" or "USN" and not listed above are in intraplant service. Repairs should be billed to the installation requesting repairs to the cars. If installation information is not available, send bill to Commander, Naval Facilities Engineering Command, Attn: Code 064, 200 Stovall St., Alexandria, VA 22332.  
 For Billing HQ, MTMCEA, Attn: MTE-FMF-CA, Military Ocean Terminal, Bayonne, NJ 07002  
 Home Point(s)—

Figure 4-4. Characteristics of DOD military rail fleet cars  
(Extract from The Official Railway Equipment Register) (cont)

## CLEARANCES AND TRACK GAGES

### Standard Clearances

Overhead clearances and platform heights are measured from top of rail, side clearances from centerline of track. See Table 4-15 and

Figure 4-5 for standard minimum clearances. Local conditions may call for greater clearances. Clearances below those specified are dangerous and require appropriate warning signs or devices. For example, telltales must be used for overhead clearances ranging between 18 to 22 feet.

**Table 4-15. Standard minimum clearances—  
wires, buildings, and other structures**

Item	Clearance	
	(m)	(ft-in)
<b>Overhead clearances:</b>		
<b>Wires:</b>		
High voltage	8.53	28' 0"
Other	8.23	27' 0"
Structures	6.71	22' 0"
<b>Side clearances:</b>		
Buildings	2.59	8' 6"
<b>Canopies:</b>		
Up to 15' 6"	2.59	8' 6"
Higher than 15' 6"	1.68	5' 6"
<b>Platforms:</b>		
3' 9"	1.88	6' 2"
4'	1.52	5' 0"
<b>Refrigerator platforms:</b>		
3' 2"	1.88	6' 2"
4' 7"	2.59	8' 6"
<b>Enginehouse entrance:</b>		
Overhead	5.18	17' 0"
Side	1.98	6' 6"



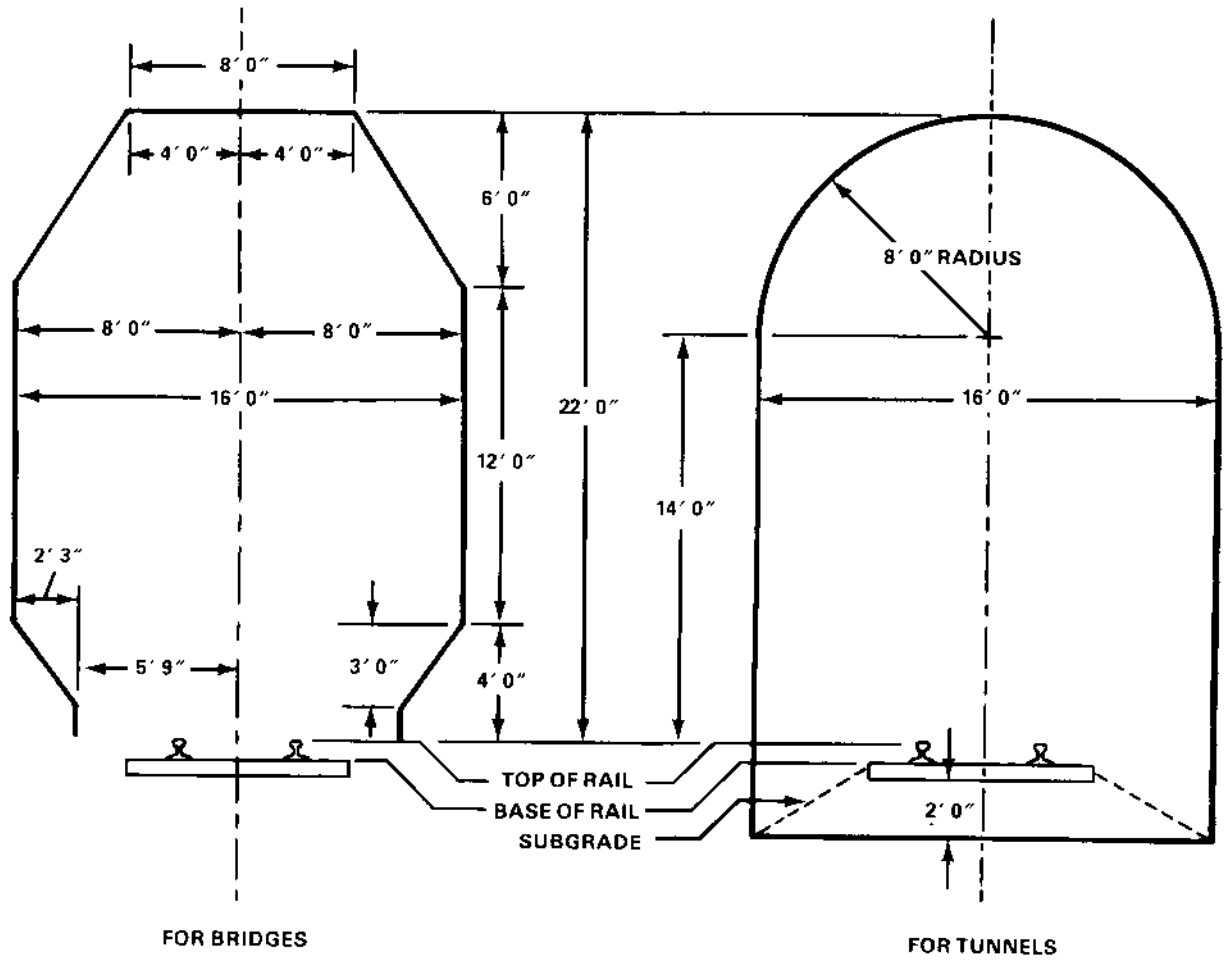

Figure 4-5. Standard minimum clearances—single-track bridges and tunnels

## Composite Clearance Diagrams

Sample clearance diagrams in Figures 4-6 and 4-7 show the distances that equipment or cargo may project to the sides at various heights above track level. The diagrams are composites of the minimum dimensions of all similar structures in the countries listed (with corresponding track gages) in Table 4-16. Therefore, not all the limiting clearances shown in the composites will exist at once on any particular rail line. A clearance diagram must be obtained or made for the rail line being

operated. Do not confuse horizontal distances shown in the diagrams with track gage.

For example: in Figure 4-6, a vertical clearance of 3 feet 8 inches corresponds to a width clearance of at least 9 feet 8 inches. A vertical clearance of 9 3/4 inches corresponds to a width clearance not less than 8 feet 1 1/2 inches. In Figure 4-7, a vertical clearance between 13 3/4 inches and 3 feet 4 inches results when the width clearance is not more than 8 feet.

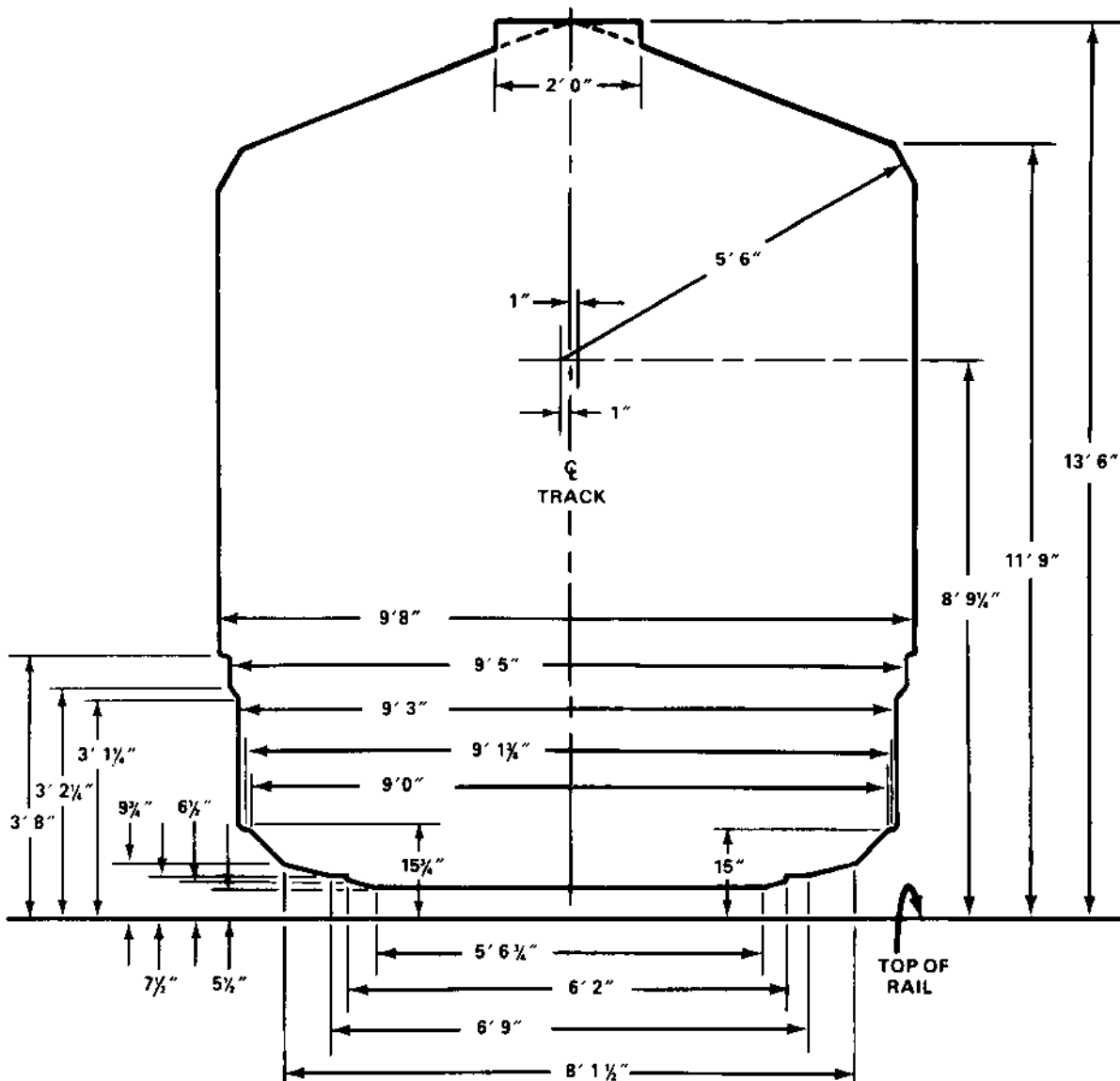

Figure 4-6. Composite clearance diagram for standard-gage (56 1/2") and broad-gage (60", 63", and 66") track



Table 4-16. Principal track gages of the world

Country	Gages (in)	Country	Gages (in)
<b>Africa:</b>		India	24, 30, 39 3/8, 66
Algeria	39 3/8, 41 9/16, 56 1/2	Indonesia	23 5/8, 29 1/2, 42
Angola	23 5/8, 42	Iran	56 1/2
Benin	39 3/8	Iraq	39 3/8, 41 1/4, 56 1/2
Cameroon	39 3/8	Israel	56 1/2
Central African Republic	42	Japan	42, 56 1/2
Chad	37 7/16, 42	Jordan	41 1/4
Congo (Brazzaville)	39 3/8, 42	Korea	30
Egypt	29 1/2, 39 3/8, 56 1/2	Laos	39 3/8
Ethiopia	39 3/8	Lebanon	41 1/4, 56 1/2
Gabon	39 3/8, 42	Malaysia	30, 39 3/8
Ghana	42	Nepal	30, 39 3/8, 66
Guinea	39 3/8, 56 1/2	Pakistan	30, 39 3/8, 66
Ivory Coast	39 3/8	Saudi Arabia	41 1/4, 56 1/2
Kenya	39 3/8	Sri Lanka	30, 66
Liberia	56 1/2	Syria	41 1/4, 56 1/2
Libya	37 7/16	Thailand	39 3/8
Madagascar	39 3/8	Tibet	39 3/8
Malawi	42	Turkey	29 1/2, 39 3/8, 41 1/2, 56 1/2, 60
Mali	39 3/8	USSR	39 3/8, 60
Mauritania	56 1/2	Vietnam	39 3/8
Morocco	56 1/2	<b>Europe:</b>	
Mozambique	29 1/2, 42	Albania	56 1/2
Niger	37 7/16, 56 1/2	Austria	30, 39 3/8, 56 1/2
Nigeria	30, 42	Belgium	39 3/8, 56 1/2
Reunion (France)	39 3/8	Bulgaria	23 5/8, 29 1/2, 30, 56 1/2
Senegal	39 3/8	Czechoslovakia	39 3/8, 56 1/2, 60
Sierra Leone	30	Denmark	56 1/2
Somalia	39 3/8	Estonia (USSR)	60
Sudan	42	Finland	29 1/2, 60
Swaziland	42	France	39 3/8, 56 1/2
Tanzania	39 3/8	Germany	23 5/8, 29 1/2, 39 3/8, 56 1/2
Togo	39 3/8	Greece	29 1/2, 39 3/8, 56 1/2
Tunisia	39 3/8, 56 1/2	Hungary	30, 56 1/2, 60
Uganda	39 3/8	Ireland (Republic)	63
Upper Volta	42, 56 1/2	Italy	37 5/8, 56 1/2
Zaire (Kinshasha)	23 5/8, 24, 39 3/8, 42	Latvia (USSR)	23 5/8, 29 1/2, 56 1/2, 60
Zambia	42	Lithuania (USSR)	23 5/8, 29 1/2, 56 1/2, 60
Zimbabwe	42	Luxembourg	56 1/2
<b>Asia:</b>		Netherlands	56 1/2
Afghanistan	39 3/8, 56 1/2, 60	Norway	39 3/8, 42, 56 1/2
Bangladesh	30, 39 3/8, 66	Poland	29 1/2, 56 1/2, 60
Borneo	39 3/8	Portugal	39 3/8, 66
Burma	39 3/8	Rumania	36, 56 1/2, 66
Cambodia	39 3/8	Spain	23 5/8, 36, 39 3/8, 66
China		Sweden	35, 42, 56 1/2
(People's Republic)	56 1/2	Switzerland	39 3/8, 56 1/2
China (Taiwan)	24, 30, 41 1/2	Turkey	56 1/2

Table 4-16. Principal track gages of the world (cont)

Country	Gages (in)	Country	Gages (in)
USSR	23 5/8, 39 3/8, 42, 56 1/2, 60	United States (CONUS)	56 1/2
United Kingdom	23 5/8, 24, 30, 42, 56 1/2	<u>South America:</u>	
Yugoslavia	23 5/8, 30, 39 3/8, 56 1/2	Argentina	29 1/2, 39 3/8, 56 1/2, 66
<u>Central America</u>		Bolivia	30, 39 3/8
<u>and West Indies:</u>		Brazil	30, 39 3/8, 56 1/2, 63
Costa Rica	42	Chile	23 5/8, 30, 39 3/8, 42, 56 1/2, 66
Cuba	36, 56 1/2	Colombia	36
Dominican Republic	30, 42, 56 7/8	Ecuador	30, 42
El Salvador	36	Guyana	56 1/2
Guatemala	36	Paraguay	24, 29 1/2, 30, 39 3/8, 56 1/2
Haiti	30, 42	Peru	23 5/8, 36, 56 1/2
Honduras	36, 42	Suriname	39 3/8
Jamaica	56 1/2	Uruguay	56 1/2
Nicaragua	42	Venezuela	24, 30, 39 3/8, 42, 56 1/2
Panama	36, 60	<u>Pacific Ocean:</u>	
Puerto Rico	39 3/8	Australia	30, 42, 56 1/2, 63
Trinidad	56 1/2	Hawaii (US)	36
<u>North America:</u>		New Caledonia	
Alaska (US)	56 1/2	(France)	39 3/8
Canada	36, 42, 56 1/2	New Zealand	42
Mexico	36, 56 1/2	Philippines	42
Newfoundland		Tasmania (Australia)	42
(Canada)	42		

## BRIDGE CAPACITY

### Cooper's E-Rating

The weight, in thousands of pounds, which a bridge can support for each driving axle of a locomotive is referred to as the Cooper's E-rating of the bridge. Military railroad bridges are normally designed for a Cooper's E-45 rating but may be built for lighter or heavier loads as required. Determine the required Cooper's E-rating of a bridge for a particular locomotive by dividing the locomotive's weight on drivers by its number of driving axles.

For example, for a 2-8-0 (steam) locomotive weighing 140,000 pounds on drivers to cross a bridge safely, the bridge must have a rating of E-35 or above:

$$\frac{140,000}{4} = 35,000$$

### Steel I-Beam Bridges

Use Table 4-17 to determine capacity of steel I-beam bridges constructed with two, four, six,

or more steel stringers or girders of equal dimensions. One stringer per rail is assumed. Measure the width and thickness of the lower flange of one stringer at the center of the span length (see Figure 4-8). Also measure the depth and length of the stringer. Then select the steel stringer that is nearest to these dimensions and find the corresponding E-rating of the bridge. The age and condition of a bridge can reduce its E-rating. The quantity of this reduction must be determined by qualified personnel, normally from the Corps of Engineers. For additional information concerning bridge capacities, refer to TM 5-312.

### Wooden Bridges

Use Table 4-18 to determine capacity of railway bridges with wooden stringers. Measure the width of each stringer under one track at the center of the longest span and add the measurements to obtain total stringer width. In Figure 4-9, the total stringer width is 2 X W. Also measure the depth and length of one stringer. Then refer to the table to find the corresponding E-rating.

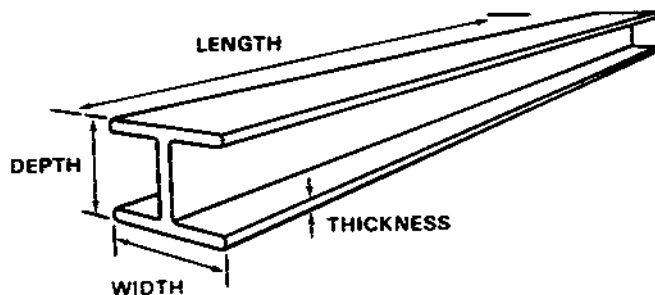

Figure 4-8. Dimensions of a steel stringer

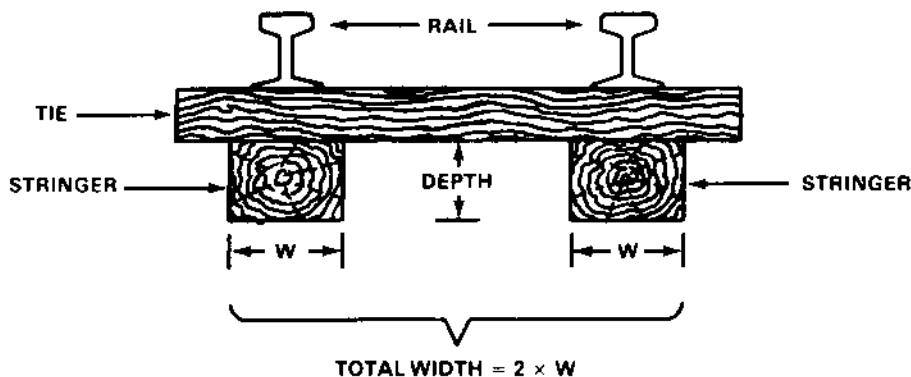

Figure 4-9. Dimensions of a wood stringer

Table 4-17. Capacity (E-Ratings)—steel I-beams bridges

Stringer Dimensions (in)			Bridge Capacity (E-Rating) Span Length (ft)																							
Thickness	Width	Depth	10	11	12	13	14	15	16	17	18	19	20	22	24	26	28	30	35	40	44	50	54	60	64	
3/8	8 3/8	18	E-42	E-41	E-41	E-41																				
3/8	10 3/8	24	E-59	E-48	E-40	E-40	E-35	E-31	E-27																	
1/2	10 3/8	30			E-61	E-59	E-51	E-46	E-41	E-37	E-33	E-30	E-27													
1/2	12 1/2	30					E-62	E-56	E-50	E-45	E-41	E-37	E-31	E-26												
1	14	36	E-60	E-58	E-55	E-54	E-51	E-48	E-43	E-39	E-34	E-26														
1/2	12 3/8	42			E-60	E-54	E-45	E-39	E-34	E-30	E-26															
1 1/8	14	42				E-63	E-60	E-57	E-54	E-51	E-45															
1 1/8	16	42																								
1 1/2	16	48																								
1	16	48																								
1 5/8	14	54																								
1 3/4	14	60																								
1 1/2	14	60																								
50			54	54	60	64	70	74	80	84	90															
E-57	E-54	E-46	E-41	E-34	E-31	E-26																				
E-56	E-48	E-40	E-35	E-30	E-26																					
E-62	E-54	E-44	E-39	E-32	E-29	E-25																				
2 1/2	15 1/2	72																								
2 1/8	14	78	E-64		E-52	E-46	E-39	E-35	E-30																	
2 1/2	16	84																								
2 1 1/16	20	96																								
					</																					

Table 4-18. Capacity (E-ratings)—wooden bridges

Stringer Dimensions (in)		Bridge Capacity (E-Rating)						
Width	Depth	Span Length (ft)						
		10	12	14	16	18	20	22
18	12	E-16	E-12					
18	14	E-22	E-18	E-10				
18	16	E-28	E-20	E-15	E-10			
18	18	E-38	E-26	E-18	E-14	E-12		
20	12	E-18	E-12					
20	14	E-25	E-17	E-12				
20	16	E-33	E-23	E-16	E-12	E-10		
20	18	E-43	E-29	E-21	E-16	E-13	E-10	
24	12	E-22	E-15	E-11				
24	14	E-30	E-21	E-14	E-11			
24	16	E-40	E-28	E-20	E-15	E-12		
24	18	E-52	E-36	E-25	E-19	E-15	E-12	E-10
36	12	E-34	E-23	E-17	E-12	E-10		
36	14	E-47	E-32	E-23	E-17	E-14	E-11	
36	16	E-62	E-43	E-30	E-23	E-19	E-15	
36	18	E-78	E-53	E-30	E-30	E-24	E-20	E-16
40	12	E-38	E-26	E-19	E-14	E-11		
40	14	E-52	E-36	E-26	E-20	E-16	E-12	
40	16	E-69	E-47	E-35	E-26	E-21	E-17	E-17
40	18	E-87	E-60	E-44	E-34	E-27	E-22	E-18
48	12	E-46	E-31	E-23	E-17	E-13		
48	14	E-63	E-43	E-31	E-24	E-19	E-15	
48	16	E-69	E-47	E-35	E-26	E-21	E-17	E-17
48	18	E-105	E-73	E-53	E-41	E-33	E-27	E-22
54	12	E-52	E-35	E-27	E-19	E-15		
54	14	E-72	E-49	E-35	E-22	E-18		
54	16	E-94	E-65	E-46	E-36	E-29	E-24	
54	18	E-119	E-42	E-60	E-46	E-38	E-30	E-25
60	12	E-58	E-40	E-30	E-22	E-17		
60	14	E-79	E-55	E-39	E-30	E-35	E-20	
60	16	E-104	E-72	E-52	E-40	E-33	E-27	
60	18	E-132	E-92	E-67	E-52	E-42	E-34	E-28



### MAXIMUM BULK LOADS

The rated weight capacity of a car does not mean that the car can carry the rated tonnage of all items. For many types of cargo, the cubic capacity of the car is reached ahead of the rated weight capacity. When this occurs, the tonnage of the maximum cubic capacity of the car represents its actual capacity.

Freight cars loaded with high-density items can nearly always be loaded to their rated capacity. Examples of high-density items are ammunition, barbed wire, cement, flour, gravel, corrugated iron, rails, rifles in chests, sand, stone, sugar, telephone wire, and engineer tools.

See Table 4-19 for rated and actual car capacities for some lighter bulk items.

**Table 4-19. Car capacity for some low-density items**

Item	Car Capacity (STONs)		
	Rated		
	30	40	50
	Actual		
Blankets, baled	27	32	40
Bread	19	24	30
Canned goods, boxed	30	36	45
Clothing, baled	27	32	40
Meat	15	24	35
Motor vehicle parts	24	28	40
Sandbags	21	24	30
Tentage	15	20	30
Ties, railroad	19	26	32

## CHAPTER 5

## WATER TRANSPORT AND TERMINAL OPERATION

## CONTENTS

	Page
<b>Section I. ORGANIZATION AND PLANNING</b>	
Water Transport and Terminal Units . . . . .	5-1
Terminal Planning . . . . .	5-12
Inland Waterway Planning . . . . .	5-21
Logistics-Over-The-Shore Planning . . . . .	5-24
<b>II. VESSEL DATA</b>	
US Navy Ship and Service Craft Designations . . . . .	5-32
US Army Vessel Designations . . . . .	5-34
US Army Vessel Characteristics . . . . .	5-34
MARAD Classification System . . . . .	5-41
<b>III. TERMINAL EQUIPMENT, CARGO CONTAINERS, PALLETS, AND MARKINGS</b>	
Terminal Equipment, . . . . .	5-42
Cargo Containers . . . . .	5-46
Pallets . . . . .	5-47
Cargo Address Markings . . . . .	5-48

## Section I. ORGANIZATION AND PLANNING

WATER TRANSPORT AND TERMINAL  
UNITS

Terminal commands may have any combination of assigned or attached units as required to carry out their mission:

**Transportation Units:**

- TOE 55-16 Headquarters and headquarters detachment,

- TOE 55-17

- TOE 55-18

- TOE 55-19

- TOE 55-28

transportation motor  
transport battalion

Transportation light truck  
company

Transportation medium  
truck company

Transportation car  
company

Transportation heavy  
truck company

- TOE 55-116 Headquarters and headquarters company, transportation terminal battalion
  - TOE 55-117 Transportation terminal service company, break-bulk
  - TOE 55-118H Transportation terminal transfer company
  - TOE 55-118J Transportation cargo transfer company
  - TOE 55-128 Transportation medium boat company
  - TOE 55-129 Transportation heavy boat company
  - TOE 55-139 Transportation medium amphibian company
  - TOE 55-157 Transportation floating craft general support maintenance company
  - TOE 55-158 Transportation lighterage maintenance company, general support
  - TOE 55-500 Transportation service organization headquarters units
- Other Units:**
- TOE 5-129 Engineer port construction company
  - TOE 5-500 Engineer administrative and headquarters teams
  - TOE 8-500 Medical service organization
  - TOE 10-500 Quartermaster service organization
  - TOE 11-500 Signal service organization
  - TOE 14-500 Finance service organization
  - TOE 19-76 Headquarters and headquarters detachment, military police battalion
  - TOE 19-77 Military police company
- A breakdown of Army water transport and terminal units according to TOE, mission, assignment, and capability is outlined in Table 5-1.

*Table 5-1a. Tables of organization and equipment—water transport and terminal units*

UNIT	TOE	MISSION/ASSIGNMENT/CAPABILITY
Headquarters and headquarters company, transportation terminal brigade	55-111H	<p><b>MISSION:</b> To command, plan, supervise, coordinate, and control the activities of brigade transportation terminal groups and other assigned or attached units and to perform staff planning for terminal operations.</p> <p><b>ASSIGNMENT:</b> To a theater army command. Normally assigned to the transportation command (TRANSCOM).</p> <p><b>CAPABILITY:</b> At level 1, provides command, control, and administration for up to eight transportation terminal groups and assigned/attached supporting units of other administrative or technical services. Performs unit maintenance on all organic equipment except communications equipment.</p>
Headquarters and headquarters company, transportation terminal group	55-112H	<p><b>MISSION:</b> To command units employed in the operation of water terminals and to perform staff planning for water terminal operations.</p> <p><b>ASSIGNMENT:</b> To a TRANSCOM. Normally attached to a transportation terminal brigade (TOE 55-111H).</p> <p><b>CAPABILITY:</b> At level 1, provides command and supervision of operations, training, and administration on a 24-hour basis for up to six transportation terminal battalions.</p>
Headquarters and headquarters company, transportation terminal battalion	55-116H	<p><b>MISSION:</b> To command units employed in the operation of water terminals.</p>

*Table 5-1a. Tables of organization and equipment—water transport and terminal units (cont)*

UNIT	TOE	MISSION/ASSIGNMENT/CAPABILITY
Transportation terminal service company (break-bulk)	55-117H	<p><b>ASSIGNMENT:</b> To a theater army area command. Normally attached to a transportation terminal group. May be attached to a transportation terminal brigade or may operate separately under the supervision of an appropriate commander.</p> <p><b>CAPABILITY:</b> At level 1, provides command, control, planning, and supervision for attached units required to discharge up to four ships simultaneously at an established water terminal or up to two ships at a LOTS site.</p> <p><b>MISSION:</b> To discharge, back-load, and transship break-bulk cargo at water terminals located at ports or beaches.</p> <p><b>ASSIGNMENT:</b> To a TRANSCOM. Normally attached to a transportation terminal battalion or may operate separately under supervision of an appropriate commander.</p> <p><b>CAPABILITY:</b> At level 1, with 75 percent equipment availability and 24-hour operation, this unit—</p> <ul style="list-style-type: none"> <li>• Discharges one break-bulk ship in a fixed port or over beaches at the daily rate of 1,000 STONs of cargo per day, or back-loads 500 STONs of cargo per day.</li> <li>• Sorts cargo by destination and loads cargo from marshaling yards on land transportation.</li> <li>• Accounts for all cargo handled as required by MILSTAMP; prepares necessary transportation documentation.</li> <li>• Provides limited in-transit storage as required.</li> <li>• Performs unit maintenance on all organic equipment except communications equipment.</li> </ul>
Transportation terminal transfer company	55-118H	<p><b>MISSION:</b> To transship cargo at Army air, rail, motor, and inland barge terminals.</p> <p><b>ASSIGNMENT:</b> Normally assigned to a theater army area command, TRANSCOM, or transportation brigade. May be attached to a motor transport group or terminal group.</p> <p><b>CAPABILITY:</b> This unit—</p> <ul style="list-style-type: none"> <li>• Operates up to three separate terminals on a round-the-clock basis (SRC 55-118H710). Each terminal transships 300 STONs of break-bulk cargo or 200 containers per day for a daily unit total of 900 STONs, 600 containers, or a mix thereof.</li> <li>• Operates up to three separate terminals on a single shift (SRC 55-118H720). Each terminal transships 150 STONs of break-bulk cargo or 100 containers per day for a daily unit total of 450 STONs, 300 containers, or a mix thereof.</li> <li>• Redocuments transshipped cargo or containers as required.</li> <li>• Stuffs and unstuffs containers on a limited basis.</li> </ul>
Transportation cargo transfer company	55-118J	<p><b>MISSION:</b> To transship cargo by air, rail, and motor terminals.</p> <p><b>ASSIGNMENT:</b> Normally assigned to a TRANSCOM or to a corps support command (COSCOM). Normally attached to a motor transport battalion, terminal, or aviation group or battalion.</p>

Table 5-1a. Tables of organization and equipment—water transport and terminal units (cont)

UNIT	TOE	MISSION/ASSIGNMENT/CAPABILITY
Transportation terminal service company (container)	55-119H	<p><b>CAPABILITY:</b> At level 1, this unit—</p> <ul style="list-style-type: none"> <li>• Operates up to three separate terminals on a round-the-clock basis (SRC 55-118J410). Each platoon transships 1,000 STONs of break-bulk cargo or 150 containers per day for a daily unit total of 3,000 STONs of break-bulk cargo, 450 containers, or a mix thereof.</li> <li>• Operates a single terminal on a round-the-clock basis (SRC 55-118J420). The unit transships 1,000 STONs of break-bulk or 150 containers.</li> <li>• Redocuments transshipped cargo or containers as required.</li> <li>• Stuffs and unstuffs containers on a limited basis.</li> </ul> <p><b>MISSION:</b> To discharge, back-load, and transship containerized cargo at terminals located at beaches or fixed ports.</p> <p><b>ASSIGNMENT:</b> To a TRANSCOM. Normally attached to a transportation terminal battalion or may operate separately under supervision of an appropriate commander.</p> <p><b>CAPABILITY:</b> At level 1, with 75 percent equipment availability and 24-hour operations, this unit—</p> <ul style="list-style-type: none"> <li>• Discharges or back-loads 300 containers, or simultaneously discharges 150 containers and back-loads 150 containers (LOTS operation).</li> <li>• Discharges or back-loads 600 containers, or simultaneously discharges 300 containers and back-loads 300 containers (fixed-port operations).</li> <li>• Sorts containers by destination, loads containers from marshaling yards on land transportation, and stuffs and unstuffs containers on a limited basis.</li> <li>• Receives and processes containers for retrograde.</li> <li>• Accounts for all cargo handled as required by MILSTAMP and prepares necessary transportation documentation.</li> <li>• Provides limited in-transit storage.</li> </ul>
Transportation terminal service company (container)	55-119J	<p><b>MISSION:</b> To discharge, back-load, and/or transship containerized cargo at water terminals located at beaches or fixed ports. On an exception basis when augmented with team JE, to discharge, back-load, and transship break-bulk cargo at water terminals located at beaches or fixed ports.</p> <p><b>ASSIGNMENT:</b> To an HHC TRANSCOM or a COSCOM when employed to support independent corps operations. Normally attached to an HHC transportation terminal battalion.</p> <p><b>CAPABILITY:</b> At level 1, in two shifts with four cranes operational and 75 percent availability of other mission equipment, this unit—</p> <ul style="list-style-type: none"> <li>• Discharges or back-loads 300 containers, or simultaneously discharges 300 containers and back-loads 300 containers (LOTS operation).</li> </ul>

**Table 5-1a. Tables of organization and equipment—water transport and terminal units (cont)**

UNIT	TOE	MISSION/ASSIGNMENT/CAPABILITY
Transportation terminal service company (break-bulk and container)	55-124J	<ul style="list-style-type: none"> <li>• Sorts containers by destination, loads containers from marshaling yards on land transportation, and performs limited stuffing/unstuffing of containers. Receives and processes containers for retrograde.</li> <li>• Accounts for all cargo handled as required by MILSTAMP and prepares necessary transportation documentation.</li> <li>• Provides limited in-transit storage.</li> <li>• Discharges one break-bulk ship in a fixed port or over the beach at a rate of 1,000 STONs of cargo per day (when augmented with team JH).</li> </ul> <p><b>MISSION:</b> To discharge, back-load, and transship break-bulk and containerized cargo at water terminals located at beaches or fixed ports.</p> <p><b>ASSIGNMENT:</b> To a TRANSCOM or to a COMSCOM when employed to support independent corps operations. Normally attached to a transportation terminal battalion.</p> <p><b>CAPABILITY:</b> At level 1—in two shifts with 75 percent operational availability of all mission equipment—</p> <ul style="list-style-type: none"> <li>• In a LOTS operation, this unit— <ul style="list-style-type: none"> <li>– Discharges 1,600 STONs of break-bulk cargo or back-loads at the same rate, or simultaneously discharges 800 STONs of break-bulk cargo and back-loads 800 STONs of break-bulk cargo.</li> <li>– Discharges 200 containers or back-loads 200 containers, or simultaneously discharges 100 containers and back-loads 100 containers (when supported by team JJ).</li> </ul> </li> <li>• In a fixed-port operation, this unit— <ul style="list-style-type: none"> <li>– Discharges 400 containers or back-loads at the same rate, or simultaneously discharges 200 containers and back-loads 200 containers (when supported by team JJ).</li> <li>– Discharges 2,500 STONs of break-bulk cargo or back-loads at the same rate, or simultaneously discharges 1,250 STONs of break-bulk cargo and back-loads 1,250 STONs.</li> <li>– Sorts break-bulk and containers by destination, loads break-bulk cargo and containers from the marshaling yards on land transportation, and performs limited stuffing and unstuffing of containers.</li> <li>– Receives and processes containers for retrograde.</li> <li>– Provides limited in-transit storage.</li> </ul> </li> </ul>
Transportation medium boat company	55-128H	<p><b>MISSION:</b> To provide and operate landing craft for the movement of personnel and cargo in Army water terminal operations and Army waterborne tactical operations and to augment naval craft in joint amphibious operations when required.</p> <p><b>ASSIGNMENT:</b> To a theater army command or other appropriate command in a theater of operation. Normally attached to a transportation terminal battalion (TOE 55-116) or a transportation</p>

**Table 5-1a. Tables of organization and equipment—water transport and terminal units (cont)**

UNIT	TOE	MISSION/ASSIGNMENT/CAPABILITY
Transportation heavy boat company	55-129H	<p>terminal group (TOE 55-112). May be attached in support of a joint amphibian operation or may operate separately under an appropriate commander.</p> <p><b>CAPABILITY:</b> At level 1, with 75 percent equipment availability and 24-hour operations, this unit—</p> <ul style="list-style-type: none"> <li>• Transports an average of 1,000 STONs of noncontainerized cargo, based on an average of 42 STONs each for 12 landing craft making two trips daily.</li> <li>• Transports in a one-time maximum lift 960 STONs of noncontainerized cargo, based on 16 landing craft.</li> <li>• Transports in a one-time maximum lift 3,200 combat-equipped troops, based on 16 landing craft.</li> <li>• Transports 240 20-foot containers per day, based on one container each for 12 landing craft making 20 trips daily.</li> </ul>
Transportation medium lighter company (LACV)	55-137H	<p><b>MISSION:</b> To provide lighterage for movement of general cargo and light wheeled vehicles between ships at anchorage and inland transfer and segregation areas in LOTS operations or amphibious operations.</p> <p><b>ASSIGNMENT:</b> To a TRANSCOM. Normally attached to a transportation terminal battalion or may operate separately under the supervision of an appropriate headquarters.</p>

*Table 5-1a. Tables of organization and equipment—water transport and terminal units (cont)*

UNIT	TOE	MISSION/ASSIGNMENT/CAPABILITY
Transportation medium lighter company (LACV)	55-137J	<p><b>CAPABILITY:</b> At level 1, this unit—</p> <ul style="list-style-type: none"> <li>• In a 24-hour operations, with 67 percent of the equipment operational, transports a daily average of 300 containers or 3,900 STONs of unitized cargo, based on eight LACVs. LACVs each average 1.87 containers per hour or 37.4 per day.</li> <li>• Using the operational swing crane installed on the vessel, off-loads transported containers where no cargo discharge facilities are available at a slight trade-off of cargo weight/mission endurance (fuel).</li> <li>• Operates inland over hastily prepared trails and barriers which are impassable to most cargo vehicles and materials-handling equipment.</li> </ul> <p><b>MISSION:</b> To provide lighterage for the movement of general cargo and light wheeled vehicles between ships at anchorage and inland transfer and segregation areas in LOTS operations or amphibious operations.</p> <p><b>ASSIGNMENT:</b> To a TRANSCOM. Normally attached to a transportation terminal battalion or may operate separately under the supervision of an appropriate headquarters.</p> <p><b>CAPABILITY:</b> At level 1, in two shifts, this unit—</p> <ul style="list-style-type: none"> <li>• With 67 percent of the craft operational, transports a daily average of 300 containers or 4,050 STONs of cargo, based on eight LACVs. LACVs each average 1.87 containers per hour or 37.4 containers per 20-hour operating day.</li> <li>• Operates from ship to shore, shore to shore, and inland over marginal terrain which is impassable to most cargo vehicles and materials-handling equipment.</li> </ul>
Transportation medium amphibian company	55-139H	<p><b>MISSION:</b> To provide lighterage for the movement of general cargo and light wheeled vehicles between ships at anchorage and inland transfer and segregation areas in LOTS or amphibious operations.</p> <p><b>ASSIGNMENT:</b> To a theater army command. Normally attached to a transportation terminal battalion. May be attached to a transportation terminal group or a transportation terminal brigade, or may operate separately under the supervision of an appropriate headquarters.</p> <p><b>CAPABILITY:</b> At level 1 (SRC 55-139H510), with 75 percent equipment availability (18 LARCs) and 24-hour operations, this unit—</p> <ul style="list-style-type: none"> <li>• Transports 1,080 STONs of noncontainerized cargo or light wheeled vehicles per day, each LARC carrying an average of 10 STONs of cargo per trip and averaging six trips per day (based on field experience).</li> <li>• Transports 360 20-foot containers (containers not exceeding 15 STONs and sea conditions not exceeding 5 feet), each LARC carrying one container and averaging 20 trips per day (based on field experience).</li> </ul> <p>With 75 percent equipment availability (18 LARCs), in a single shift (SRC 55-139H20), this unit—</p>



**Table 5-1a. Tables of organization and equipment—water transport and terminal units (cont)**

UNIT	TOE	MISSION/ASSIGNMENT/CAPABILITY
Transportation floating craft general support maintenance company	55-157	<ul style="list-style-type: none"> <li>• Transports 540 STONs of general cargo and light wheeled vehicles, each LARC carrying an average of 10 STONs of cargo per trip and averaging three trips per shift (based on field experience).</li> <li>• Transports 180-foot containers (containers not exceeding 15 STONs and sea conditions not exceeding 5 feet), each LARC carrying one container and averaging 10 trips per day (based on field experience).</li> </ul> <p><b>MISSION:</b> To provide intermediate maintenance for Army landing craft, amphibians, and harbor craft and to provide intermediate maintenance of radio and radar equipment organic to Army marine craft.</p> <p><b>ASSIGNMENT:</b> Normally to a TRANSCOM or transportation terminal group. May be attached to a transportation terminal battalion.</p> <p><b>CAPABILITY:</b> This unit—</p> <ul style="list-style-type: none"> <li>• Provides productive maintenance as listed in Table 5-1b.</li> <li>• Receives, stores, and issues approximately 9,000 line items of marine-peculiar repair parts and items required for its maintenance missions.</li> <li>• Performs marine salvage operations in conjunction with the floating craft intermediate maintenance mission.</li> </ul>
Transportation lighterage maintenance company, general support	55-158	<p><b>MISSION:</b> To provide intermediate maintenance for wheeled amphibians and landing craft and for radio and radar equipment installed on them and to provide unit-level repair parts, components, and maintenance supplies to support lighterage units' amphibians and landing craft, including radio and radar equipment.</p> <p><b>ASSIGNMENT:</b> To a terminal group or TRANSCOM. Normally attached to a terminal battalion but may operate separately under supervision of an appropriate commander designated by theater army.</p> <p><b>CAPABILITY:</b> This unit—</p> <ul style="list-style-type: none"> <li>• Provides productive maintenance listed in Table 5-1b.</li> <li>• Receives, stores, and issues approximately 5,000 line items of marine equipment repair parts and supply items required for the company's maintenance and supply mission.</li> <li>• Operates a direct exchange service for selected items.</li> </ul>
Transportation watercraft teams:	55-530H	<p><b>ASSIGNMENT:</b> To a watercraft unit or a transportation terminal headquarters.</p>
FA, Deck cargo barge, nonpropelled		<p><b>MISSION:</b> To transport cargo other than bulk liquid.</p>
FB, Picketboat, 46-foot		<p><b>MISSION:</b> To provide water transportation for patrol, command, inspection, and general utility services in support of terminal or inland waterway operations.</p>

**Table 5-1a. Tables of organization and equipment—water transport and terminal units (cont)**

UNIT	TOE	MISSION/ASSIGNMENT/CAPABILITY
FC, Deck or liquid cargo barge, 120-foot, nonpropelled		<p><b>CAPABILITY:</b> In 24-hour operations, carries up to 10 passengers at an average speed of 14 knots.</p> <p><b>MISSION:</b> To transport deck or bulk liquid cargo.</p>
FD, Harbor tug, 45-foot		<p><b>CAPABILITY:</b> In 24-hour operations, when under tow, transports up to 4,160 barrels of liquid cargo or 655 STONs of dry cargo.</p> <p><b>MISSION:</b> To perform tug and towing services in support of terminal and inland waterway operations.</p> <p><b>CAPABILITY:</b> In 24-hour operations, shifts small nonpropelled barges at variable speeds up to 6 knots. Assists in patrolling, firefighting, and general utility use.</p>
FE, Passenger and cargo or picketboat, 65-foot		<p><b>MISSION:</b> To provide transportation in a harbor area for personnel and cargo in support of terminal operations.</p> <p><b>CAPABILITY:</b> In 24-hour operations, transports up to 27 STONs of cargo or 24 passengers at an average speed of 11 knots. Serves as a command and control craft for boat operations. Vessel patrols offshore at a speed of 12 knots with a troop capacity of five.</p>
FF, Refrigerated cargo barge, 120-foot, nonpropelled		<p><b>MISSION:</b> To transport refrigerated cargo.</p> <p><b>CAPABILITY:</b> In 24-hour operations, when under tow, transports 355 STONs of refrigerated cargo.</p>
FG, Harbor tug, 70-foot		<p><b>MISSION:</b> To perform tug and towing service in support of terminal operations.</p> <p><b>CAPABILITY:</b> In 24-hour operations, shifts all size barges at variable speeds up to 11 knots. Assists in docking and undocking large vessels and in firefighting.</p>
FH, Barge crane, 68-ton		<p><b>MISSION:</b> To load and discharge heavy-lift cargo that is beyond the capability of ship's gear.</p>
FI, Barge crane, 100-ton		<p><b>CAPABILITY:</b> IN 24-hour operations, makes individual lifts up to 68 STONs.</p> <p><b>MISSION:</b> To load and discharge heavy-lift cargo that is beyond the capability of ship's gear.</p> <p><b>CAPABILITY:</b> Makes individual lifts up to 100 STONs. Operates on a 24-hour basis.</p>
FJ, Harbor tug, 100-foot		<p><b>MISSION:</b> To perform tug and general towing services in support of terminal operations.</p> <p><b>CAPABILITY:</b> In 24-hour operations, performs heavy tows within a harbor area or limited offshore towing between terminals. Berths and unberths oceangoing vessels. Transports itself with a qualified escort in transoceanic voyages</p>
FK, Oceangoing tug, 126-foot		<p><b>MISSION:</b> To make ocean tows of barges and vessels.</p> <p><b>CAPABILITY:</b> In 24-hour operations, makes ocean tows of barges and vessels.</p>
FL, Liquid or dry cargo barge, self-propelled		<p><b>MISSION:</b> To transport liquid or dry cargo in terminals or along coastwide routes not served by MSC.</p> <p><b>CAPABILITY:</b> In 24-hour operations, along coastwide routes not served by MSC.</p>
FM, Beach discharge lighter		<p><b>MISSION:</b> To transport large quantities of mobile or outsize equipment, unitized cargo, and containers from ships offshore to the beach.</p>

**Table 5-1a. Tables of organization and equipment—water transport and terminal units (cont)**

UNIT	TOE	MISSION/ASSIGNMENT/CAPABILITY
FN, Lighter, amphibian, LARC-LX		<p><b>CAPABILITY:</b> This team—</p> <ul style="list-style-type: none"> <li>• Marries with and discharges nine RO/RO vessels where port facilities for the vessel are not available.</li> <li>• Transports pier to pier one hundred 20-foot containers with an average weight of 15 STONs each; transports ship to pier 50 containers; or transports 200 empty containers.</li> <li>• Provides its own unit-level administration, supply, and food service and its own DS and GS maintenance.</li> </ul>
FO, Oceangoing tug, 143-foot		<p><b>MISSION:</b> To provide amphibious lighterage service primarily for heavy, outsize, or bulky equipment.</p> <p><b>CAPABILITY:</b> In 24-hour operations, with an amphibian availability rate of 75 percent, this unit—</p> <ul style="list-style-type: none"> <li>• Transports daily 450 STONs of heavy, outsize, or bulky noncontainerized cargo in five trips.</li> <li>• Transports daily twenty-one 20-foot containers or 2,625 combat-equipped troops in seven trips.</li> <li>• Provides its own unit-level administration, supply, maintenance, and surface transportation ashore.</li> <li>• Performs its own amphibian DS and GS maintenance.</li> </ul>
Transportation watercraft maintenance teams: IA, Diver team	55-550H	<p><b>MISSION:</b> To perform deep- and shallow-water diving functions.</p> <p><b>ASSIGNMENT:</b> To a transportation group or a transportation terminal battalion.</p> <p><b>CAPABILITY:</b> Performs approximately 24,800 annual man-hours of diving, underwater reconnaissance missions, and underwater welding and cutting, salvage, hull repair, and structure inspection and repair.</p>
IB, Floating craft maintenance team (GS)		<p><b>MISSION:</b> To perform GS maintenance on floating craft.</p> <p><b>ASSIGNMENT:</b> To a transportation group or a transportation floating craft GS maintenance company.</p> <p><b>CAPABILITY:</b> Provides personnel, skills, and equipment for the following annual man-hours of maintenance:</p> <ul style="list-style-type: none"> <li>• Hull repair/inspection—18,600</li> <li>• Machinist—9,300</li> <li>• Marine engine repair—12,400</li> <li>• Metal work—3,100</li> <li>• Plumber pipefitter—3,100</li> <li>• Radio repair—3,100</li> <li>• Rigger—3,100</li> </ul>

**Table 5-1a. Tables of organization and equipment—water transport and terminal units (cont)**

UNIT	TOE	MISSION/ASSIGNMENT/CAPABILITY
IC, Lighterage maintenance team (DS)		<p><b>MISSION:</b> To perform hull and engine maintenance on amphibians and landing craft.</p> <p><b>ASSIGNMENT:</b> To a transportation terminal battalion or a transportation lighterage DS maintenance company.</p> <p><b>CAPABILITY:</b> Provides personnel, skills, and equipment for the following annual man-hours of maintenance:</p> <ul style="list-style-type: none"> <li>• Hull repair/inspection—24,800</li> <li>• Machinist—6,200</li> <li>• Hydraulic repair—3,100</li> <li>• Radio repair—3,100</li> <li>• Marine engine repair—52,700</li> </ul>
Transportation terminal service teams:	55-560J	<p><b>MISSION:</b> To provide transportation terminal services.</p> <p><b>ASSIGNMENT:</b> To a transportation command for attachment as required.</p> <p><b>CAPABILITY:</b></p>
JA, Stevedore/container-handling equipment maintenance		Maintains stevedore gear and rigging equipment.
JB, Cargo documentation		Performs documentation required in the loading and discharge of 500 STONs of general cargo or 480 containers daily in a water terminal, railhead, truckhead, or airhead.
JC, Freight consolidation and distribution		Processes 100 LCL shipments daily at a consolidation and distribution point, fixed water terminal, barge site, railhead, airhead, or truckhead, or stuffs and unstuffs twenty-five 20-foot containers or equivalents daily.
JD, Transportation contract supervision		Arranges for the loading or discharge of cargo from ships or barges and the clearance of discharged cargo from the terminal by contract. Arranges for the movement of cargo from terminals, depots, or local procurement sources by inland waterways and highway transport contracts. Administers contracts made in connection with loading, discharge, terminal clearance, and transport of cargo.
JE, Cargo hatch gang		Provides personnel and equipment to handle 240 containers daily (two cranes on a one-shift basis) at a water terminal or provides personnel and equipment to handle 100 containers daily on a one-shift basis at a LOTS site (two cranes, one at ship-side and one at the beach).
JF, Container-handling (ship)		Provides personnel and equipment to handle 240 containers daily (two cranes on a one-shift basis) at a water terminal or provides personnel and equipment to handle 100 containers daily on a one-shift basis at a LOTS site (two cranes, one at ship-side and one at the beach). Also provides limited organizational maintenance to supporting unit.
JG, Container-handling (shore)		Provides personnel and equipment to transship 120 containers at a water terminal or 100 containers in a LOTS operation from the shore crane to the container-marshaling area and to operate the container-marshaling area in one shift.
JH, Break-bulk augmentation (container)		When attached and integrated into operations of a transportation terminal service company (container), discharges 1,000 STONs of break-bulk

**Table 5-1a. Tables of organization and equipment—water transport and terminal units (cont)**

UNIT	TOE	MISSION/ASSIGNMENT/CAPABILITY
Jl, Automated cargo documentation		cargo per day or back-loads 500 STONs of break-bulk cargo per day.  In two shifts, documents break-bulk cargo or containers being loaded or discharged from up to four ships in a fixed port operation or two ships in a LOTS operation.
JJ, Heavy crane platoon		<ul style="list-style-type: none"> <li>• In a fixed port operation, handles 400 containers in two shifts.</li> <li>• In a LOTS operation, handles 200 containers in two shifts.</li> <li>• Performs organizational maintenance on organic equipment, except C-E; performs DS maintenance on container-handling equipment.</li> </ul>

**Table 5-1b. Capabilities for TOEs 55-157 and 55-158 (approximate annual man-hours of productive maintenance)**

	TOE 55-157			TOE 55-158		
	Level 1	Level 2	Level 3	Level 1	Level 2	Level 3
Diving	21,700	21,700	18,600	-	-	-
Hull repair	86,600	74,400	65,100	68,200	52,700	49,600
Hydraulic repair	-	-	-	6,200	6,200	6,200
Instrument repair	3,100	3,100	3,100	-	-	-
Machining	24,800	21,700	18,600	9,300	9,300	6,200
Marine electrical repair	18,600	18,600	12,400	24,800	24,800	24,800
Marine engine repair	55,800	49,600	43,400	167,400	142,600	117,800
Power generator equipment repair	12,400	9,300	6,200	-	-	-
Plumbing and pipe fitting	9,300	9,300	9,300	6,200	6,200	6,200
Radar repair	9,300	6,200	6,200	6,200	3,100	3,100
Radio repair	12,400	12,400	9,300	6,200	6,200	6,200
Refrigeration	15,500	15,500	15,500	-	-	-
Rigging repair	12,400	9,300	9,300	-	-	-
Sheet metal working	12,400	9,300	9,300	-	-	-
Welding (blacksmithing)	12,400	9,300	9,300	-	-	-
<b>Total</b>	<b>306,700</b>	<b>269,700</b>	<b>235,600</b>	<b>294,500</b>	<b>251,100</b>	<b>220,100</b>

NOTE: Man-hours criterion for Category III (mobile) units is 3,100 available productive maintenance man-hours per repair person per year according to AR 570-2.

**TERMINAL PLANNING**

**Reference Publications**

There are several sources of information to use in the initial phases of port selection and water terminal planning—The *World Port Index (DMA Pub 150)* and *Sailing Directions*. These publications are published and updated by the Defense Mapping Agency Hydrographic/Topographic Center (DMAHTC), Washington, DC 20390. To ensure continuous updating of these references,

request to be put on the DMAHTC's mailing list for *Notice to Mariners*.

**World Port Index.** This publication includes location, characteristics, known facilities, and available services for over 7,200 ports, shipping facilities, and oil terminals throughout the world. The 7,200 ports are listed by their present and former names, applicable Sailing Direction number, and port index number. Chartlets showing the sequence of ports and examples of harbor types are also included.

Following is a list of items found in the index:

- *Index number.* Each port and place in the text is numbered consecutively. Index numbers for ports and places are found in the alphabetical index; page numbers are not listed. If there is an alternate or more familiar name, that name will have the same index number. However, only the approved name will appear in the text. In general, ports are listed under the names approved by the US Board on Geographic Names.

- *Ports.* Ports are grouped according to country and locality in the same geographic sequence as the chartlets in the forepart of the volume. The listing of ports in off-lying islands normally interrupts the coastal listing at some convenient place near the island. River ports are listed toward the beginning of navigation, alternating from bank to bank unless local considerations make another listing more practicable.

- *Latitude and longitude.* The position of each port is obtained from the best scale chart available, expressed in degrees and minutes.

- *Sailing Directions information.* The Sailing Directions publication number for the port or area in which the port is located is normally given.

- *Chart.* The number of the best scale chart issued by the DMAHTC is listed with no prefix. In some cases foreign charts are listed when the DMAHTC provides no coverage. These charts can be obtained from the hydrographic departments or services of the countries concerned or their authorized agents.

- *Size.* Classification of port size is based on area, facilities, and wharf space.

- *Harbor type.* The harbor is the principal water area of the port. Examples of harbor classifications are coastal natural, coastal breakwater, or open roadstead.

- *Shelter.* Shelter (from wind, sea, and swell) is the area where normal port operations are conducted, usually the wharf area. Shelter for the anchorage area is given for ports where cargo is handled by lighters.

- *Entrance restrictions.* These are natural factors such as ice or heavy swell that restrict the entrance of vessels.

- *Overhead limitations.* This entry only indicates that bridge and overhead power cables exist. Refer to the chart for particulars.

- *Depths.* Depth information is given for the main channel, main anchorage, and principal cargo pier and/or oil terminal. Depths refer to chart datum. Depths are given in increments of 5 feet (1.5 meters).

- *Channel (controlling).* The controlling depth of the principal or deepest channel at chart datum is given. The channel selected should lead to the anchorage (if within the harbor) or to the wharf or pier. If the channel depth decreases from the anchorage to the wharf/pier and cargo can be worked at the anchorage, then the depth leading to the anchorage is used.

- *Anchorage.* The depth in the anchorage is the least depth in the best or principal anchorage. The depth listed is a general depth rather than an isolated shoal spot. A shoal which does not necessarily obstruct the anchorage is not considered for the least depth if the rest of the anchorage is safe and usable.

- *Cargo pier and oil terminal.* Where applicable, the greatest depth alongside the wharf/pier and oil terminal is given according to chart datum. If there is more than one wharf/pier, then the one which has greatest usable depth is shown.

- *Tide.* The mean range in feet is normally given, but the mean rise is substituted if range data is not available. The distinction between range and rise can be disregarded without affecting the general usefulness of this publication.

- *Maximum size (vessel).* Sizes of vessels that can be accommodated are indicated by an L (ships over 500 feet) or an M (ships less than 500 feet).

- *Good holding ground.* Good holding ground is indicated only where actual anchorage conditions have been reported.

- *Turning area.* Entry indicates that a turning basin or other water area for turning vessels is available in the port.

- *First port of entry.* Entry indicates a port where a ship may enter and clear foreign goods through customs.

- *US representative.* Entry indicates whether the United States maintains civilian or military representation in that port.

- *ETA message.* Entry indicates whether an ETA message is required for that port.

- *Pilotage.* Entry indicates the necessity or advisability of taking a pilot. In some cases, pilotage may be compulsory although pilots are not actually stationed at the port in question and must be obtained elsewhere.

- *Tugs.* Entry indicates whether tugs are available for docking or anchorage assistance.

- *Quarantine.* Entries indicate if regular quarantine procedures are required or if further details must be found in other publications.

- *Communications.* Types of available communications are noted for the port or nearby area.

- *Load/off-load.* Entry refers to the area where normal port operations are conducted.

- *Medical facilities.* Entry indicates port has some form of medical facilities that will accommodate crew.

- *Garbage disposal.* Garbage can be disposed of at the pier or by lighters at the anchorage or mooring at indicated ports.

- *Degausser, dirty ballast, cranes, and lifts.* Facilities are available as indicated.

- *Services.* Availability of normal port services is indicated.

- *Supplies.* The availability of provisions, water, and fuel oil is listed. Fuel oil and diesel oil are listed separately. Where the original source information fails to distinguish between the two, both kinds of fuel are presumed available and are so listed.

- *Repairs.* Repair facilities for oceangoing vessels are classified as follows:

- A—major; extensive overhauling and rebuilding in well-equipped shipyards.

- B—moderate; extensive overhauling and rebuilding that does not require drydocking. Suitable drydocking facilities are usually lacking or inadequate.

- C—limited; small repair work in independent machine shops or foundries.

- D—emergency only.

- N—none.

- *Drydock and railway.* The general size and type of the largest underwater repair facility in a port is listed.

- *Sailing Directions.* There are 43 volumes of *Sailing Directions*—35 of *Sailing Directions En Route* and 8 of *Sailing Directions (Planning Guide)*. Each *Sailing Directions (Planning Guide)* covers one of the world's great land-sea areas, based on an arbitrary division of the world's seaways into eight ocean basins.

Chapter 1, Countries, contains information about all of the countries adjacent to a particular ocean basin covered by one of the eight publications. It also covers pratique, pilotage signals, and pertinent shipping regulations.

Chapter 2, Ocean Basin Environment, contains information on the physical environment of an ocean basin. Included are ocean summaries and local coastal phenomena not found in referenced atlases, as well as concise information about physical forces to consider during planning.

Chapter 3, Warning Area, includes the firing danger areas, submarine operating areas, and other cautions pertinent to an area.

Chapter 4, Ocean Routes, describes the recommended steamship routes as they originate from all major US ports and naval bases and terminate in foreign ports in the planning guide area. Applicable traffic separation schemes are also included.

Chapter 5, Navaid Systems, describes the radio-navigation systems pertaining to the ocean area described. National and international systems of lights, beacons, and buoys are described and illustrated.

### Elements of Terminal Planning

Twenty-four hours is generally considered a complete, round-the-clock working day for terminal and related water transport operations. The day consists of two 10-hour shifts with the remaining 4 hours taken up in mealtime, shift changes, and maintenance. For general planning purposes, a transportation terminal service company (TOE 55-117) or its equivalent is considered capable of discharging 1,000 STONs per 24-hour working day.

The elements normally considered in terminal planning are—

- Existing terminal capacity (total tonnage and personnel that can be received, processed, and cleared through the terminal in a day).
- Terminal work load required to support the particular operation (target cargo tonnage and number of personnel per day).
- Base development requirements needed to increase terminal capacity to meet the target tonnage (requirements for construction, equipment, and personnel).

**Terminal capacity.** Three major factors determine throughput capacity:

- *Terminal reception capacity*—the number and type of ships that can be moved into the harbor or coastal area of the terminal per day.
- *Terminal discharge capacity*—the amount of cargo and personnel that can be discharged in the terminal per day.
- *Terminal clearance capacity*—the amount of cargo and personnel that can be moved through and out of the terminal per day.

For planning purposes, express each factor as short tons per day, containers, or square feet/measurement tons per day. In every instance, one factor will be the limiting (determining) factor. Even though the limiting factor may be obvious, be sure to estimate all three factors accurately because the estimates will point out areas that need improvement.

Two more factors that impact on throughput capacity are—

**Transfer capacity**—the amount of cargo and personnel that can be moved from the discharge point to the in-transit storage areas.

**Storage capacity**—the amount of cargo that the in-transit storage areas can hold, based on the average dwell time of the cargo.

See Figure 5-1 for a checklist to use when determining throughput capacity. For further information, see FM 55-60, FM 101-10-1, MTMC Report TE 73-44, Parts I and II, and MTMC Report TE 73-44A.

**Terminal work load.** The theater commander assigns the mission (terminal work load) of a

particular terminal. The mission assignment is a target tonnage based on the terminal's throughput capacity. Both initial and anticipated tonnages are included in the target tonnage figure. Initial tonnage is the amount of cargo the terminal organization is expected to handle before its capability is increased by base development. Anticipated tonnage is the amount of cargo required at a future specified date to support a particular operation and to build up a reserve supply for the support of future operations. When the target tonnage assignment is made, the terminal commander estimates the construction, equipment, and personnel required to increase the terminal capacity to handle the anticipated tonnage. The actual capability of the terminal depends on its sustained ability to receive and clear the daily capacity over a period of time.

### Berthing Facilities and Anchorage Areas

Terminal discharge capacity is the 1-day capacity of a terminal to accommodate ships in the harbor and to discharge them. For general planning purposes, ships are discharged in two ways—by direct discharge onto the pier or wharf from vessels berthed alongside or by lighterage from vessels anchored offshore or in the stream. Deep-draft wharfage is required for pierside discharge; shallow-draft wharfage and anchorage areas are considered jointly for lighter discharge. See the glossary for definitions of anchorage, berth, mole, pier, quay, and wharf.

When planning, consider availability of harbor berths and anchorage, wharf capacity, lighterage discharge, and local conditions. Determine whether vessels can be brought into the anchorage areas and alongside the berth. Berths and anchorages are evaluated according to size of the vessels they can accommodate. Berthing capacity is then determined.

**Berth capacity.** Port capacity estimates are based on all available berthing facilities. Include all facilities suitable for handling cargo in the estimate. If the use of a particular berth is doubtful and its capacity has been included in the estimate, a clarification should be given. Berthing capacity is materially affected by the following factors.



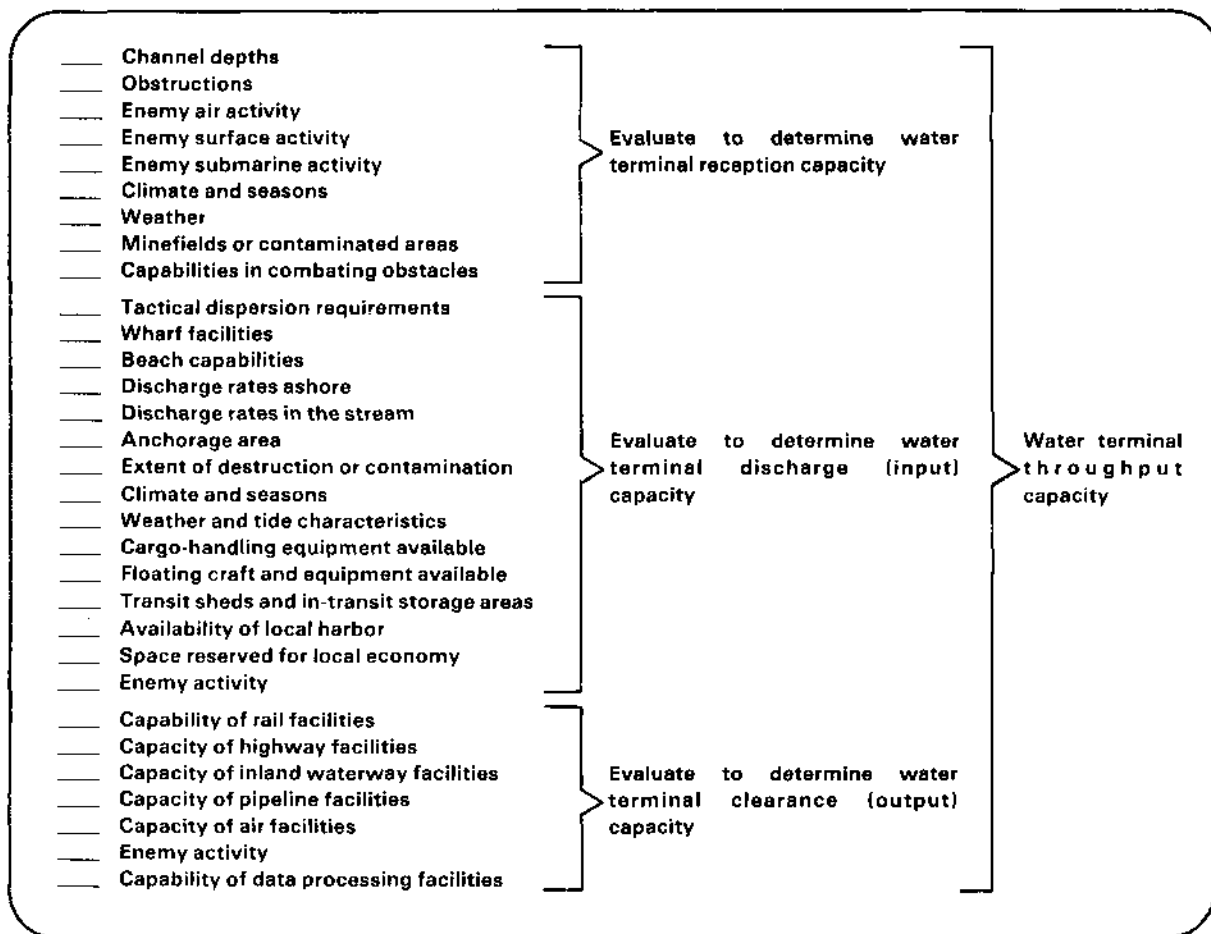

Figure 5-1. Terminal throughput capacity checklist

**Layout.** The analyst must consider the layout of the facility:

- Adequacy of approaches.
- Stacking space on the landward side.
- Raised or depressed tracks.
- Stuffing and stripping sheds.
- Truck backup for stuffing and stripping sheds.
  - Open storage space.
  - Transit shed space.
  - Number and size of transit shed doors.

Along with the berth layout, consider curbs, fences, and surfacing material, depth of water alongside at high and low water, and location of on- and off-loading ramps.

**Weather.** Weather has a direct bearing in

berth use and capacity—especially during extreme conditions.

**Alignment.** Wharf face alignment is important. Consider the angle points and curvatures along the wharf face. If they are excessive, reduce the usable linear footage appropriately.

**Wharf construction.** Deck strengths of piers, wharves, and transit shed floors are extremely important. A rule of thumb for determining if load capacity is adequate is the current use of the area in question. If it is known that a certain cargo is normally handled, a fair load-capacity evaluation can be made. The ideal load capacity is 800 or more pounds per square feet; 500 or less pounds per square feet is considered marginal to unacceptable. Consider the height of the wharf or pier deck relation to the rise and fall of the tide. This is extremely important when considering ramp use on RO/RO ships.

Several factors limit using the stern or side ramp on RO/RO vessels. The distance between the top of the pier and the water at mean low water (MLW) may prevent ramp use. If this distance is excessive and exceeds the angle limitations of the ramps, the side or stern opening may be below the top of the pier. On the USNS Comet, USNS Admiral William M. Callaghan, and USNS Meteor, it is possible for the ramp angles to be excessive because the ramp openings are too far above the pier. The vessel draft and the range of tidal change, of course, contribute to the magnitude of this problem. This limitation must be evaluated on a case-by-case basis to ascertain whether a specific ship can use its stern or side ramps for loading at a specific time period.

The working space is determined by the type wharf; the length and width of the apron, exits, and decking; type of cargo handled; and anticipated tonnages. The working space must be large enough to allow cargo to be unloaded and cleared without delay. See MTMC Reports TE 73-44 and TE 73-44A for detailed information on computing or projecting specific types of working spaces. Local customs, specialized construction, and the pier may cause variations in berth dimensions, but the loaded draft of the ship will always be the controlling factor. Vessels require 60 to 70 feet of wharf space in addition to their measured length overall (LOA) to allow their mooring lines to be properly stretched out. Use the following berth specifications for general planning.

General Berths		
Class	Length (ft)	Water Depth (ft) <sup>1</sup>
A	1,000	32-36
B	850	30-34
c	700	22-30
D	550	17-22
E	400	13-17
F	100	6-13

Tanker Berths		
Class	Length (ft)	Water Depth (ft) <sup>1</sup>
T-A	1,200	50-75
T-B	800	35-50
T-C	400	20-35
T-D	250	14-20

<sup>1</sup>Depths are computed for MLW.

Use the following formulas to calculate diameter of anchorage berths:

$$\text{Offshore anchorage (diameter)} = 2(7D + 2L)$$

$$\text{In-the-stream anchorage (diameter)} = 4D + 2L \times R$$

where:

D = depth of water at MLW

L = overall length of ship

R = reserve factor of 1.4

**Lighterage discharge.** Wharves used by lighters should be within a reasonable distance of enough anchorages and moorings. Lighterage berths are assigned in units of 100 feet for each lighter (to the nearest 100 feet). The unit measurement must be used realistically. Disregard length of wharf more than 100 feet but less than the next 100-foot unit. A 350-foot wharf accommodates three lighters at the same time. All alongside berths with depths less than 18 feet are considered lighter berths. For LASH and SEABEE barges, refer to "Basic Cargo Load/Unload Times."

**Temporary storage.** Break-bulk cargo can be temporarily stored in open or covered areas. To determine usable square foot space, allow for fire lanes and center, intersecting, and working aisles. To determine usable cubic foot space, you must allow for lost height in stocking odd-shaped items and for height restrictions caused by lighting and sprinklers. Use the following formulas for initial planning for open or closed storage:

$$\text{Usable square feet} = A \times .55$$

$$\text{Usable cubic feet} = A \times B \times .45$$

$$\text{Measurement ton capacity} = \frac{A \times B \times .45}{40}$$

where:

A = available square feet

B = height available in feet

Note: Cargo dwell time will greatly influence capacity of storage areas. Dwell time can also be very detrimental to the throughput capacity of the terminal.

**Open storage.** Approximately 10,000 square feet of space is required for each 1,000 MTON

of cargo (10 square feet per MTON) to allow 50 percent space for surge and security. Average stock height is 6 feet or two pallets high.

**Covered storage.** Approximately 7,500 square feet of space is required for each 1,000 MTONs of cargo (8 square feet per MTON), allowing 50 percent space for surge and security. Average stock height is 8 feet or two pallets high. Approximately 10 percent of each day's target tonnage will require covered storage.

**Long-term (open or covered) storage.** In a port area where temporary storage will be for more than five days, use the following formula to compute the storage area required:

$$\frac{\text{MTON/mo}}{2} \times \text{sq ft/MTON} \times \frac{\text{days storage}}{30} = \frac{\text{sq ft}}{\text{space}}$$

For open storage requiring 10 square feet per MTON:

$$\frac{\text{MTON/mo}}{2} \times 10 \times \frac{\text{days}}{30} = \frac{\text{sq ft open storage}}{\text{space}}$$

For covered storage requiring 8 square feet per MTON:

$$\frac{\text{MTON/mo}}{2} \times 8 \times \frac{\text{days}}{30} = \frac{\text{sq ft covered storage}}{\text{space}}$$

Conditions vary with localities and may sometimes be very unusual. When necessary, berth, wharf, and lighter discharge factors must be adjusted or reduced to meet emergencies caused by local conditions.

**Basic Cargo Load-Unload Times**

The ship load-unload times in Table 5-2 are based on a 20-hour workday. RO/RO and Seatrain load-unload times were computed from actual experience in past REFORGER (return of force to Germany) exercises. There has been enough REFORGER experience with MSC RO/RO ships to place a high reliability on the times shown.

**Helicopters on RO/RO ships.** Helicopter loading on RO/RO ships is a lift-on/lift-off operation. Additional effort is also required to place helicopters in their final stow position. Therefore, when transporting a significant quantity of helicopters on RO/RO vessels, allow additional load-unload time. REFORGER experience has shown that 1

**Table 5-2. Load-unload times for basic cargo**

Type of Ship	Time in Days <sup>1</sup>	
	Load	Unload
RO/RO <sup>2</sup>	1.0	0.75
RO/RO SL-7 <sup>2</sup>	1.5	1.0
Seatrain	3.0	2.0
<b>Break-bulk:</b>		
Ammunition	4.0	4.0
Unit equipment	4.0	2.0
General cargo	4.0	4.0
Container <sup>3</sup>	1 or 2 <sup>4</sup>	1 or 2 <sup>4</sup>
LASH <sup>5, 6</sup>	1 or 2 <sup>4</sup>	1 or 2 <sup>4</sup>
SEABEE <sup>5, 7</sup>	1 or 2	1 or 2

- <sup>1</sup> Assumes 20-hour workday; excludes weather and mechanical delays.
- <sup>2</sup> Refer to following paragraph on helicopter loading.
- <sup>3</sup> Assume availability of at least two gantry cranes per berth. Load-unload time is exclusive of container stuffing-unstuffing time.
- <sup>4</sup> One day required for less than 900 containers, 2 days for more than 900 containers.
- <sup>5</sup> These are general planning times; refer to following paragraphs for loading LASH and SEABEE ships.
- <sup>6</sup> One day to load or unload ships and two days (four for ammunition) to load or unload lighters; load-unload times for lighters should be increased to three days for a unit move involving helicopters. The ship and lighter operations may run concurrently. In any event, allow a minimum of two days for load-unload operations (including lighters) involving unit equipment or resupply.
- <sup>7</sup> One day to load or unload ship and two days to load or unload barges when barges are loaded or unloaded at SPOE. Allow a minimum of two days for concurrent operations, depending on barge berthing and terminal throughput capabilities.

hour must be added to the normal load time for each six helicopters.

**LASH and SEABEE.** Loading LASH and SEABEE ships involves two separate operations: loading cargo on the lighters/barges and loading lighters/barges on the mother vessel. These operations may be concurrent, or the mother ship may be loaded after all lighters/barges are stowed with cargo. The time required to load all of the lighters/barges with cargo is a dependent upon the berth space and the number of cranes devoted to the operation. See TM 55-1520-400-14 for detailed information and procedures on loading helicopters in LASH and SEABEE lighters.

LASH loading time depends on the load (commodity) materials-handling equipment cycle time, and stevedore gang productivity. Information from various ports and terminal

operators throughout the United States indicates that an average of 4 hours is required to load a LASH lighter with military equipment. This includes the time required to remove hatch covers, load cargo, block and brace, and secure hatch covers.

### Specialized Loading

When maximum unloading efficiency is the governing factor rather than economy of cargo space, the principles of combat loading should be employed. In this specialized type of loading, mixing cargo types within ships' holds is kept to a minimum and each hatch is self-sustaining.

Cargo stowage should be blocked vertically in each hatch; this saves time by reducing the number of times that cargo gear must be re-rigged or shifted. Within each cargo space, drafts of cargo should be palletized, netted, or containerized; drafts should not be tiered unless MHE is available to move cargo from the wings to the hatch square. When cargo is palletized, at least four pallets in each hatch square should have bridles intact so that no time is wasted in breaking the stowage.

Vehicles should not be floored over and tiered, even if space is available, because bulling vehicles to the square on the upper tier and clearing the flooring and shoring is time consuming. As far as possible, trailers should be stowed with their prime movers. Unit cargo may be loaded in vehicles to the lower reducible height if the ship's gear capacity is not exceeded. Powered vehicles must be in running condition with fuel tanks three-quarters full.

Use a profile loading diagram for the ship to compute unloading time for each hatch at time of prestowage. Obtain information for the profile loading diagram from the storage plan. Add the time factors for hatch opening, shift of gear, and all drafts to obtain total unloading time for each hatch. Enter this total in the tabulation for the hatch on the profile loading diagram.

Rig and boom capacities differ among hatches for each design of cargo vessel. In general, 5-ton booms are installed to serve each hatch. One or more hatches are also served by 30 to 60-ton capacity jumbo booms. The limiting load factor of the rig is the safe working load of

the wire rope multiplied by the number of parts. The normal safe load for a single-rigged yard-and-stay rig is 6,600 pounds for 5/8-inch wire and 8,000 pounds for 3/4-inch wire (improved plow steel) in good condition. Heavier weights must be lifted by doubled yard-and-stay rigs, swinging booms, four-boom rigs, or jumbo booms.

Average weights of drafts are—

- Palletized general cargo— 1 STON
- Palletized ammunition— 1 1/2 STONs
- CONEX—5 STONs

Vehicle weights depend upon type of preloading.

Use the following guidance to compute unloading time:

- Single-rigged yard-and-stay—5 minutes per draft (pallets, 1/4-ton trucks and trailers, 1/1 2-ton trailers, empty 3/4-ton trucks).
- Doubled yard-and-stay or double-purchase swinging-boom rig— 10 minutes per draft (CONEX, empty 2 1/2-ton trucks).
- Jumbo boom rig— 15 minutes per draft (vehicles heavier than 2 1/2-ton trucks, APCs, tanks).
- Opening hatch— 15 minutes average (25 minutes for weather-deck hatch, 10 minutes for 'tween-deck hatch).
- Shifting rig—30 minutes.

Unloading time strengths for specially equipped vessels (roll-on/roll-off and LKA equipped with special ramps, elevators, pallet conveyors, monorails, or other devices) must be developed from experience.

See FM 20-12 for detailed guidance on combat loading as well as commodity loading and selective loading. Loading diagrams for US Navy Amphibious Force vessels, as well as standard maritime-commission-design vessels, should be secured from the combat cargo officer assigned to an individual vessel. While these vessels may be of the same design, their loading capacity for each hold will differ.

### Container Operations

Unless local conditions dictate otherwise, container berths should be along a quay rather than a finger pier. Placing containers along a quay allows some flexibility in berth lengths.

**Terminal layout.** A typical container terminal consists of the ship berth, container cranes, entry facilities, marshaling area, container inspection garage, container packing shed, and equipment storage.

Containership berths require a minimum length of 1,000 feet to handle the size of vessels currently in use. A maximum length of 1,100 feet will take the largest containership presently afloat or contemplated.

Since most container vessels have no shipboard cranes to handle containers, container cranes will be required. Two or more cranes, working simultaneously, can unload and load a containership.

The truck entrance to a terminal should consist of two or three entry lanes with a corresponding number of departure lanes. Each lane should have a truck scale to weigh the containers in or out. A building will usually be located at this entry/exit point for handling necessary paperwork and assigning positions in the marshaling yard to incoming containers. Approach roads to the terminal should be generous. Container operations generate substantial truck traffic, peaking on days when ships are in port. This peak necessitates truck-holding lines at the terminal entrance.

Located near the entry building and next to the marshaling area is a small garage for the physical inspection of arriving or departing containers. Inspection is required because responsibility for the containers changes as they enter or leave the terminal. In addition, a maintenance garage is usually provided for stevedoring devices used to handle the containers in the marshaling yard.

A less-than-container load (LTCL) packing shed is usually provided. The term "container freight station" is often used for such a building. The building need not be next to the marshaling area and definitely should not assume the normal location of a transit shed. Any structures near the stringpiece tend to impair movement of containers to and from the cranes during loading and unloading operations. The size of packing sheds varies, but the general configuration resembles a typical truck terminal. Delivery trucks arrive at one side of

the building cargo is moved from these trucks directly into waiting containers on the opposite side with a minimum flooring of cargo. The packing shed, therefore, tends to be long and narrow with emphasis on the necessary number of truck and container doors.

**Container storage and retrieval systems.** A number of storage and retrieval systems and combinations of systems are in use at container terminals. Of these, the most common are chassis storage, straddle carrier, and travel crane. Where space is limited, a vertical storage and retrieval system is used.

**Chassis storage.** A container discharged by a ship is placed on a semitrailer chassis. The chassis is hauled by a yard tractor to an assigned terminal position and remains there until picked up by a highway tractor. Chassis-carrying export containers are similarly stored by highway tractors and later hauled to the ship by yard tractors. Since containers are stored one level high, this system requires more terminal storage space than any other container storage system. Handling efficiency is 100 percent because every container is immediately available to a tractor unit and all required handlings are productive. This system requires more chassis than any other system.

**Straddle carriers.** Containers are stacked two or three levels high by straddle carriers. These carriers straddle the containers and carry them between shipside and storage areas or onto trucks or railroad cars. Less storage space is required with this system since containers can be stored two or three high. Handling efficiency, however, is reduced to 50 percent or less because an upper container must be moved to reach a lower container. In some cases the tractor-chassis system is used between shipside and stacking area.

**Traveling bridge cranes.** Containers are stacked up to four high by traveling bridge cranes. These cranes can stack higher than straddle carriers and so increase the capacity for a given area. However, handling efficiency is reduced by the many nonproductive handlings required for retrieval of containers. Containers are delivered to and from the cranes by tractor-chassis units.

## INLAND WATERWAY PLANNING

Inland waterways include all rivers, lakes, inland channels, protected tidal waters, and canals deep enough to accommodate waterborne traffic. In a theater of operations, an inland waterway is normally operated as a complete system. The system includes locks, dams, bridges, and other structures that contribute to or affect movement of vessels carrying passengers and freight. Inland waterways are principally used by the civilian economy. Military use depends on waterway development, necessary rehabilitation, the tactical situation, and the impact of such use on the civilian economy.

***Inland Waterway Service.*** When required, an inland waterway service may be formed to control and operate a waterway system and to formulate and coordinate plans for using inland waterway transport resources. It may also be formed to integrate and supervise local civilian facilities supporting military operations. The inland waterway organization varies in size from a single barge crew to a complete inland waterway service, depending on requirements. The service may be composed entirely of military personnel, or it may be staffed by local civilians supervised by military units of the appropriate transportation staff section.

***Inland Waterway System.*** Three separate functional components—the ocean reception point (ORP), the inland waterway, and the inland waterway terminal—make up the inland waterway system. The transportation planner must estimate the capacity of each of these functional components; the lesser capacity becomes the capacity for the inland waterway system.

***Ocean reception point (ORP).*** An ORP consists of mooring points for ships, a marshaling area for barges or other lighterage, and a control point. There should be at least two stake barges at each ORP—one for import cargo and one for export. LASH, SEABEE, container, and general cargo vessels may discharge at an ORP. Because of the rapid discharge capability of LASH and SEABEE vessels, the ORP should have enough berthing to handle twice the barge capacity of that type ship. The ORP should have water space with enough stake barges to accommodate the same amount of

barges as the wharf space. Barges can be of the preloaded variety such as those discharged from LASH and SEABEE vessels; or they can be barges or other lighterage loaded from container or general cargo vessels. In either instance, there must be enough wharfage or stake barge space to handle barges from current working ships as well as those returning empty from previous working ships.

Reception, discharge, and clearance capacities of an ORP are computed in the same manner as for an ocean terminal—with minor differences. ORP clearance capacity is the number of personnel, containers, barges, or STONs of cargo that can be moved from the ORP via any mode. Just as terminal transfer and storage capacity influences terminal discharge capacity, so tugs and barges (terminal transfer) and wharves or stake barges (storage) influence ORP discharge capacity. Careful analysis determines the space required and available for stake barges as well as the space required to move barges to and from the stake barge. Also, transit time between the ship and the stake barge or wharf and other factors incidental to cargo (barge/lighterage) transfer and storage must be determined.

***Inland waterway terminal.*** An inland waterway terminal normally includes facilities for mooring, cargo loading and unloading, dispatch and control, and repair and service of all craft capable of navigating the waterway. Terminals are established at the origin and terminus of the inland water route. Intermediate terminals are located along the way wherever a change in transportation mode is required.

Terminals in an inland waterway system are classified as general cargo, container, liquid, or dry-bulk-commodity shipping points. Except for the general cargo type, terminals usually include special loading and discharge equipment that permits rapid handling of large volumes of cargo.

### **Inland Waterway Capacity**

The inland waterway's physical features affect its ability to carry cargo. Some of these features are—

- Width and depth of channel.
- Horizontal and vertical clearance of bridges.

- Number of locks.
- Method of lock operation.
- Time required to clear locks.

Freeze-ups, floods, and droughts also affect a waterway's capacity. The transportation planner must know when to look for seasonal restrictions and how long to expect them to last. Other factors to consider are speed, fluctuation, and direction of water current as well as availability of craft, labor, terminal facilities, and maintenance support. The number of craft or barges using the waterway determines the method for computing its capacity.

**Estimate.** Usually there are not enough craft or barges available to fill or exceed the capacity of an inland waterway. However, if there are enough, daily capacity can be estimated. Determine the number of craft per day that can be passed through the most limiting restriction (lock, lift bridge, or narrow channel); multiply this figure by the average net capacity of the barge or craft in use.

**Formula.** Normally the capacity of a waterway is so large or the availability of barges so limited that there are not enough barges to fill or exceed the waterway capacity. In this case, use the following formula to compute the number of tons a given number of barges can move a given distance each day:

$$F = \frac{H \times G \times E}{A}$$

where

- F = daily tonnage
- H = number of barges required or available
- G = tons per barge
- E = hours of operation per day
- A = turnaround time for barges in hours

**Turnaround time.** Turnaround time is the length of time it takes after leaving a point to return to it. If barges are being picked up at a wharf or stake barge, barge loading time is not part of the computation. If barges are picked up at shipside without marshaling at a wharf or stake barge, barge loading time is a factor in turnaround time. The following factors must be known before computing turnaround time:

- **Length of haul**— the round trip distance between the barge pickup point and barge delivery points.

- **Speed**— influenced by wind, current, power of craft, and size of load. If the craft's speed cannot be determined, assume it to be 4 miles per hour in still water (6.4 kilometers per hour). Speed and direction of current can frequently be discounted since resistance in one direction may be balanced by assistance in the other direction. However, this is not always the case.

- **Loading and unloading time**— the time it takes to load and unload a craft at origin and destination.

- **Time consumed in locks**— the time it takes a craft and its tow to pass through a lock. When exact data is lacking, assume lock time to be one hour per single lock.

- **Hours of operation per day**— usually planned as 20. Dropping barges from the tow, refueling, taking on stores, rigging up, and maintenance consume the remaining 4 hours.

- **Transit time**— the time to move the craft the length of the haul and return it to its origin. **Computing transit time is strictly a mathematical function:** the distance traveled divided by the speed of the craft. Transit time does not include stops or delays of any kind. Turnaround time, on the other hand, is the total time it takes for a barge or tug to go from start point to destination and return to start point, including transit time and all delays.

Use the following formulas to compute turnaround time (barge turnaround times always include unloading time; loading and unloading times do not apply to tugs):

Barges

$$K = \frac{B+C+D}{E} \quad A = B+C+D$$

Tugs

$$L = \frac{C+D}{E} \quad M = C+D$$

where

- A = barge turnaround time in hours
- B = unloading time per barge
- C = transit time

D = locking time  
 E = 24-hours per day  
 K = barge turnaround time in days  
 L = tug turnaround time in days  
 M = tug turnaround time in hours

**Barge and tug requirements.** Barge and tug requirements for containerships, LASH and SEABEE ship, and RO/RO ships cannot be figured on the basis of tons carried. For LASH and SEABEE vessels, loading time is completely omitted from the turnaround time formula at both the ORP and the inland waterway. Discharge tonnage for containers is expressed as containers per hour. Barge and tug requirements for these vessels depend on the sizes of tugs available, restrictions on the number of barges per ton, and the number of barges available.

**Barges.** To determine the number of barges needed to move a specified number of tons a specified distance each day, use the following formula:

$$H = \frac{F}{G} \times \frac{A}{E}$$

where

H = number of barges required  
 F = daily tonnage  
 A = turnaround time in hours  
 G = tons per barge  
 E = hours of operation per day

Note that since turnaround time in hours must be known to determine the number of barges required, turnaround time must be computed first.

**Tugs.** Once the number of barges required to perform a given task is known, the number of tugs or towboats needed to tow the barges can be computed. When tugs are used, the arrangement of the tows must be considered. It is sometimes possible to operate with fewer tugs than tows because tugs do not have to wait in port while cargo is being transferred. Moreover, one tug can often tow more than one barge. When planning a towing operation, consider the fit of the tow in the locks. Use the following formulas:

$$\text{Tows } J = \frac{H}{I}$$

where

J = number of tows  
 H = number of barges required or available  
 I = number of barges per tow

$$\text{Tugs } M = \frac{JL}{K}$$

where

M = number of tugs required  
 L = turnaround time for tugs in days  
 K = turnaround time for barges in days

Note that turnaround times for barges and tugs must be computed first.

**Inland Waterway Terminal Capacity**

Inland waterway terminals are staffed by appropriate transfer units or teams. The number of terminal transfer units required depends on the results of an inland waterway terminal throughput analysis. A throughput analysis should be conducted for each inland waterway terminal in the system. The restricting capacity (reception, discharge, or clearance) for each terminal determines its capacity. Then these individual capacities are combined into one cumulative capacity for the inland waterway terminal.

**Inland Waterway System Capacity**

After estimating the capacity of the three functional components of the inland waterway system, use the lesser of the three as the estimated capacity for the entire system. For example, if capacity per day is 3,000 tons (ORP), 2,000 tons (inland waterway), and 2,500 tons (inland waterway terminal), then 2,000 tons is the capacity for the inland waterway system.

Once the capacity of the inland waterway system has been determined, personnel requirements for each component of the system can be determined. If host-nation personnel will support part of the system, determine only US army personnel needs. When planning personnel and unit requirements for an inland waterway system, refer to FM 101-10-2.

When determining equipment needed to support the inland waterway system, first determine the number and capabilities barges and

tugs the host nation will supply to the US Army. Then determine the US Army's augmentation requirement. When deciding which equipment is best suited for the system, refer to FM 55-50. For more complete information on Army terminal operations, refer to FM 55-60.

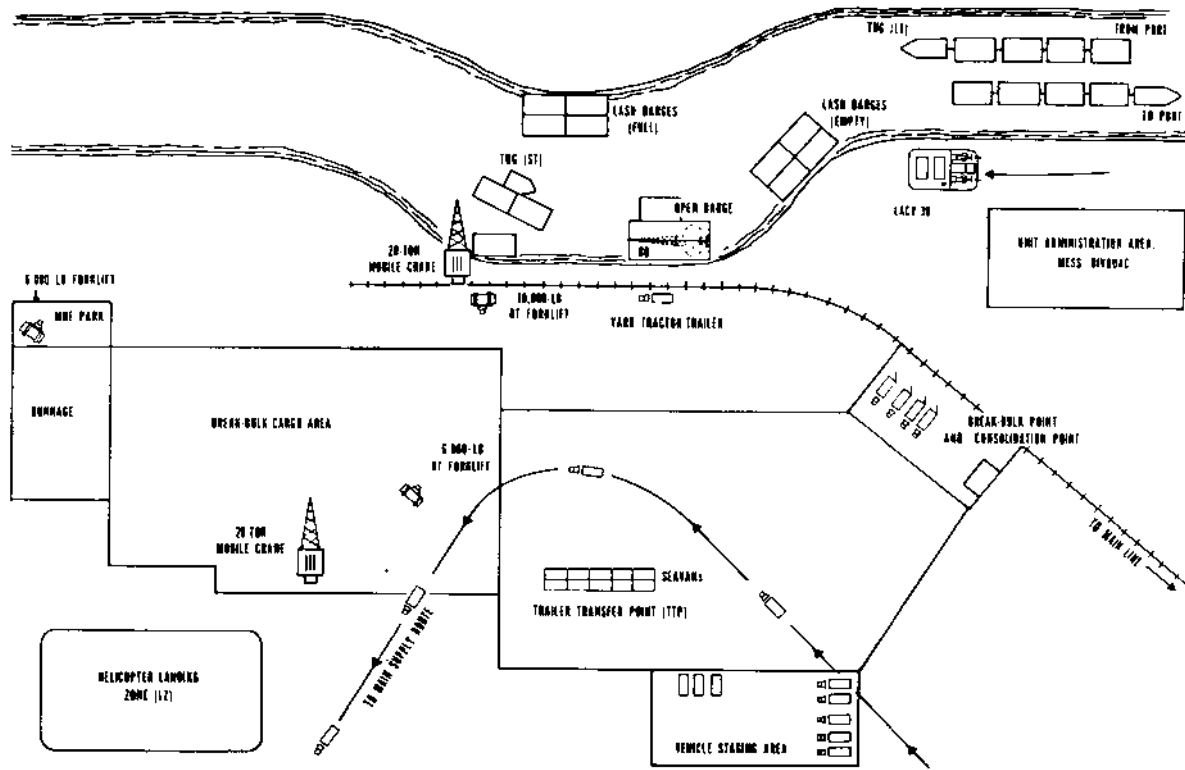

Figure 5-2. Typical inland barge terminal



## LOGISTICS OVER-THE-SHORE PLANNING

Historically, the phrase “logistics over the shore” (LOTS) has applied where a vessel anchored in open water was discharged into lighterage with the lighterage subsequently discharged over a bare beach. This definition was narrow and restrictive. The current definition of LOTS is “any vessel discharge operation other than one conducted at a fixed-pier facility.” A fixed-pier discharge operation is one where a vessel is discharged direct to land or land transportation. A LOTS operation is one where a vessel is discharged directly to other than land or land transportation. LOTS includes vessel discharge to lighterage and subsequent discharge over the shore. The type of beach or vessel anchorage plays no part in defining a LOTS operation. See FM 55-50 for a detailed discussion.

**Terms.** The planner should be familiar with these terms:

- **In-the-stream anchor**— anchorage in protected deep water such as a harbor.

- **Offshore anchor**— anchorage off the shoreline in unprotected deep water.

**NOTE:** From either of the above anchorages, the ship can discharge to lighterage for subsequent discharge to a fixed-port facility, unimproved facility, or bare beach.

- **Fixed port facility**— specifically designed to accommodate cargo discharge or backload operations; characterized by sophisticated equipment and procedures; frequently oriented toward a specific type of cargo such as container, RO/RO, hazardous, and general cargo, although there is a recent trend toward combination facilities; normally has extensive hardstand areas, transit sheds, shore cranes, and access to well-established, well-defined rail nets and roadnets.

- **Unimproved facility**— a fixed facility not specifically designed for cargo operations; for example, a pier facility frequented by fishing vessels; has hardstand or hard surface alongside a shallow body of water and perhaps some type of simple shore crane used for loading and discharging fishing boats; characterized by a marked lack of sophisticated facilities and equipment; water

depth and pier length inadequate for ocean-going vessels; sparse roadnets; rail nets probably nonexistent; existing facilities might be adapted for use in cargo operations, but MHE, transit sheds, marshaling area, and communications would have to be provided to support operations.

- **Bare beach operations**— beach essentially as nature made it; considerable engineer support needed to provide a facility suitable for cargo operations.

**NOTE:** These beach facilities are inefficient and only used when fixed or unimproved facilities are unavailable or inadequate. There are no preexisting facilities, but LOTS site location should be in proximity to highway and rail facilities. All other capabilities, MHE, hardstand, communications, and support facilities would have to be provided.

**Bare Beach Operations.** Existing port capacities in many areas will not be enough to support theater tonnage requirements. This, coupled with the possibility of enemy insurgent activities, means that emphasis in planning will be shifted from large port complexes to widely scattered beach operations. It is estimated that upwards of 40 percent of all cargo entering a theater by surface means will be delivered through dispersed beach terminals. Therefore, the senior terminal commander in the theater must continually plan to open new beaches. These beaches will—

- Absorb the tonnage capacity of a port or unimproved facility made untenable by enemy actions.

- Relieve congested routes of communications.

- Reduce land transportation required to support combat elements.

Plans should include—

- Proposed location and layout.
- Type of lighterage used.
- Task organization needed.
- Route and methods of movement to the area.
- Construction required.
- Communications requirements.
- Logistical support procedures.

**Supervision.** Close attention and supervision are required at each bare beach LOTS discharge point. The success of each beach operation depends to a great extent on the efficiency of cargo operation on the beach itself. Supplies and equipment being brought to the beach must be kept moving across it toward inland destinations as rapidly as possible. A cluttered beach offers a lucrative target to the enemy and hinders cargo movement. Using amphibians or LACV-30s for lightering general cargo aids significantly in reducing beach congestion.

Each two-ship terminal will be under the direct operational supervision of a terminal battalion. As a minimum, each will be manned by two terminal service companies, two light or medium amphibian companies, and one medium boat company. In addition, one or more truck companies may be attached for intraterminal transportation and clearance assistance. Terminal transfer elements may be required to aid in clearing cargo backlogs in discharge areas. Harbor craft teams may also be attached as required. The functions of a number of these terminals, dispersed along a maximum of 150 miles of shoreline, will be coordinated by a terminal group or brigade. Lighterage maintenance is provided at group level.

The minimum troop assignments given above are based on an average planning factor of 25 percent of all cargo entering a theater being vehicles and other heavy lifts and the remainder, general or container cargo. Of the 2,000 STONs of mixed general cargo which two terminal service companies can discharge per day (1,000 STONs each), 75 percent (1,500 STONs) will be lightered by the amphibian units. The remaining 25 percent will be delivered ashore by the medium boat company.

**Maintenance.** Employing terminal units over widely separated distances along a coastline requires careful evaluation of the maintenance system supporting a complex of scattered operations. Increased emphasis must be placed on organizational maintenance. Unit maintenance personnel should be well-trained and every effort made to remedy minor troubles and prevent costly equipment

breakdowns. The terminal group SOP should establish the procedure for providing maintenance support. Floating craft maintenance units supporting terminal operations over an extended coastline require mobile marine repair facilities and on-site repair service.

**Dispersion.** In dispersed beach terminal operations, terminal units, operating equipment, cargo, and facilities are separated as widely as operational efficiency permits. All activities are spread over a wide area to avoid offering the enemy a concentrated target. Discharge operations which offer the enemy a lucrative target are scheduled as seldom as possible and for as short a time as possible. Dispersion of terminal units greatly increases reliance on radio communications for effective command, control, and coordination. Therefore, communications security (COMSEC) and electronic counter-measures (ECCM) are critical to maintaining reliable communications.

**Site Selection.** The first step in site selection is to determine the beach areas available. Degree of dispersion that can be attained is directly related to daily tonnage requirement and size and nature of the assigned area. As soon as practicable after designating the limiting points of the area, reconnoiter the sites to determine those most suitable for operations. Selection of sites should be based primarily on their existing capability to accommodate desired tonnage. Consider these major factors:

- Tide.
- surf.
- Beach gradients.
- Bars.
- Bottom characteristics and beach surface.
- Anchorage areas.
- Weather.
- Topographic features.

Remember that LOTS depends almost wholly on favorable weather. Also, lighterage operations alongside a vessel are particularly hazardous if more than a moderate sea is running. Heavy surf reduces the amount of cargo brought in by lighters and can cause suspension of the entire operation.

Beaches ideally suited for LOTS without prior preparation or alteration are seldom found. Therefore, some engineering support is usually required for landing craft to beach and to provide exits from the beach to discharge areas and the clearance transportation net.

Normally, the terminal group or brigade commander, in consultation with naval authorities, initially selects possible beach sites for LOTS. This is done after an extensive study of maps and hydrographic charts and an analysis of aerial reconnaissance reports. A detailed ground and water reconnaissance of the selected area determines feasibility of the sites. The reconnaissance should be as thorough as time and the situation permit. Aerial reconnaissance is useful to verify information obtained from map reconnaissance. Road nets shown on the map may have been destroyed or made impassable; new roads may have been built. Bridges may have been destroyed, or structures may have been built on the beach. It is crucial that naval authorities be consulted early in the study. This is so that advice about possible anchorage areas as well as difficulties and hazards to navigation will be available as early as possible.

**Reconnaissance.** The party which conducts the ground and water reconnaissance must include personnel capable of advising the terminal group commander on the following:

- Engineering effort required to prepare and maintain the area.
- Signal construction and maintenance required for communication within the beach area, as well as between the beach area and the terminal group headquarters.
- Need for and location of beach dumps, transfer points, and maintenance areas.
- Type of lighterage that could be employed most effectively.
- Need for and location of safe-haven facilities for lighterage.
- Location and desirability of anchorage areas.
- Possibility of using spud (self-elevating, nonpropelled) piers and other special equipment.

- Vulnerability to enemy attack of the terminal area, its seaward approaches, and its connections with the interior.

The typical reconnaissance party should consist of but not be restricted to the following personnel:

- Representatives of the terminal group commander (to coordinate or supervise the reconnaissance team and to recommend task organization).
- The terminal battalion commander and appropriate staff members.
- An engineer officer (preferably from the supporting engineer unit).
- A signal officer (preferably from the supporting signal unit).
- Representatives of amphibian units (to locate desirable entrances to and exits from water, transfer points, and so forth).
- Representatives of landing craft units (to select beach areas, anchorages, maintenance areas, and navigation aids).
- Representatives of units with special equipment.
- US Navy representatives (to advise on anchorage areas and naval support required).
- A military police representative (to determine needs and plan military police support for traffic control and beach management).

In addition to gaging beach area characteristics, the reconnaissance party must determine whether the selected area has enough anchorage for the number and types of ships required to support planned beach operations. If the Navy representative indicates anchorage areas that are acceptable, they must be examined to see if lighterage can cross from the anchorage areas to the beach. For example, sandbars or reefs just offshore may preclude the use of LCMs, LCUs, or barges. These conditions may also require the use of amphibians until a channel is cleared. Important features to consider are depth, size, landmarks, and underwater obstacles.

**Depth.** For large cargo ships, a minimum depth of 30 feet and a maximum of 210 feet are required. Maximum draft of ships to be

discharged and the ground swell conditions decide minimum depth. The length and weight of anchor chain determine maximum depth.

**Size.** For planning purposes, the anchorage area should be a circle with an 800-foot radius to provide a safe free-swinging area for the standard five-hatch vessel. If larger vessels are anticipated in the operation, use the following formula:

$$2(7D + 2L) = R \text{ (diameter in feet)}$$

where.

D = depth of water in feet

L = length of vessel in feet

A much larger radius may be required for dispersion if operations are being conducted under threat of nuclear warfare. Bow and stern mooring is not considered desirable in tidal areas because athwartship currents cause excessive strain on mooring gear. Also, appreciable changes in depth require continuous watching of the anchored vessels. The type of offshore bottom also has a significant bearing on how close ships can be anchored to each other because a ship will drag anchor if the bottom is too rocky or slushy.

**Landmarks.** Landmarks (especially those assisting navigation and location of beaches), such as prominent hills, are helpful.

**Underwater obstacles.** Underwater obstacles should be noted. These include bars, shoals, reefs, rocks, wrecks, and enemy installations which might interfere with the passage of vessels to and from the area. Estimate the degree of interference offered and the amount of work involved to clear channels.

During the reconnaissance, the terminal battalion commander also selects and assigns company areas and frontages, indicates areas of defense responsibilities, and tentatively organizes the area of operations. On completion of the reconnaissance, findings are analyzed and the most desirable beach areas selected. Alternate beaches are chosen and listed in order of suitability. The battalion commander submits the sites selected to the terminal group commander along with a written plan for implementing operations at the selected beach.

**Beach Capacity.** For general planning, determine beach capacity by applying data contained in FM 101-10-1. However, this data is based on average conditions and must be adapted to specific beach operations. For a particular discharge site, several factors must be considered. These factors fall into two groups— those which limit the cargo-handling capacity of the beach and those which restrict the flow through the area because of the nature of the beach and the hinterland. Whichever group is more limiting to the quantity of supplies that can be handled determines the capacity of the beach. Beach terminal planning requires a beach capacity estimate and involves the same steps used in planning for a fixed ocean terminal.

**Personnel/equipment factors.** Cargo-handling capacity is affected by the following factors:

- Availability and expertise of personnel for discharging ships and handling cargo on the beach and in the discharge areas.
- Type and availability of mechanical aids and transportation equipment for beach clearance.
- Types and amounts of lighterage available for operation.
- Ability of the enemy to interrupt operations.

**Terrain factors.** Most terrain factors are self-explanatory, but beach exits and the hinterland play such important roles in beach capacity that they are discussed in detail. Possible terrain limitations are—

- Length and width of beach.
- Underwater obstacles.
- Tidal range.
- Strength and direction of tidal stream (rip currents and littoral currents).
- Surf.
- Gradient of beach.
- Bearing surface of the beach.
- Availability and type of beach exits.
- Hinterland.

**Beach gradient and materials.** Beach gradient, or the underwater slope of the beach, is usually expressed as a ratio of depth to horizontal distance. A gradient of 1 in 50 indicates an increase in depth of 1 foot to every 50 feet of horizontal distance. For landing and amphibious craft, usually only the gradient from the water's edge seaward to a depth of 3 fathoms (18 feet) needs to be determined. A gradient slightly steeper than 1 in 50 is considered suitable for a loaded landing ship tank (LST); a gradient of 1 in 20 is satisfactory for an LCM-8.

Following are classifications of beach gradients:

- Steep—More than 1 in 15 feet
- Moderate 1 in 15 to 1 in 30 feet
- Gentle— 1 in 30 to 1 in 60 feet

- Mild— 1 in 60 to 1 in 120 feet
- Flat — Less than 1 in 120 feet

Beach materials are classified according to particle diameter:

Material	Particle diameter	
	(in microns*)	(in inches)
Boulder	256,000 and over	10.24 and over
Cobble	256,000 - 64,000	10.24 - 2.56
Stone	64,000 - 4,000	2.56 - 0.16
Pebble	4,000 - 2,000	0.16 - 0.08
Very coarse sand	2,000 - 1,000	0.08 - 0.04
Coarse sand	1,000 - 500	0.04 - 0.002
Medium sand	500 - 250	0.002 - 0.001
Fine sand	250 - 125	0.001 - 0.0001
Very fine sand	125 - 62.5	0.0001 - 0.0000625
Silt	62.5 - 3.9	0.0000625 - 0.0000156

\*Micron is approximately 0.00003937 inch.

See Figures 5-3 and 5-4 for profile views of beach sites.

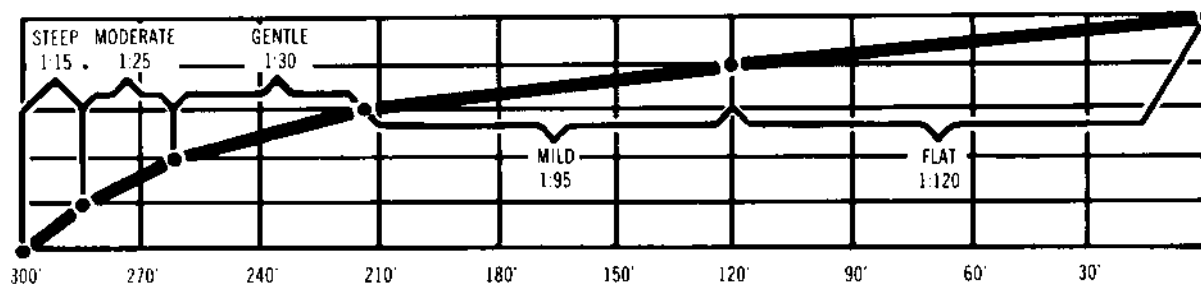

Figure 5-3. Profile view of typical underwater gradient

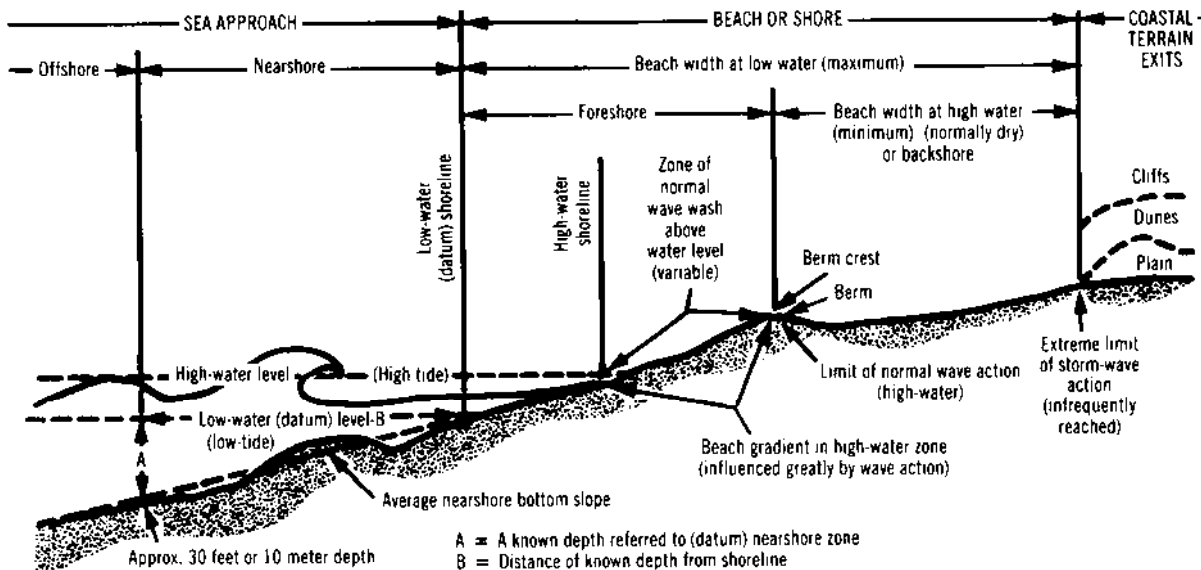

Figure 5-4. Marine beach profile diagram

**Beach exits.** The capacity of a beach to discharge and clear supplies and personnel is limited by the capacity of the roadnet from the waterline to inland destinations. These destinations include dumps, principal inland areas, and the interior communications net. Since the useful capacity of the beach can never exceed roadnet capacity, an early and detailed analysis must be made to determine the capacity of the existing roadnet. If the road net capacity is inadequate, new roads must be built, which will require additional engineer support both for construction and maintenance.

The number of exits required varies according to physical characteristics of the roads, the type and amount of cargo, and the type of conveyance used in beach clearance. Different types of equipment should have separate routes. The adjacent area is a factor which may limit the number of possible exits from the beach. An otherwise ideal beach may be backed by sand dunes, seawalls, swamps, or other obstacles which hamper clearance operations.

**Hinterland** Besides the beach and its exits, consider the following factors when selecting a beach for unloading cargo:

- Existing roadnet or rail net.
- Physical characteristics of existing roads.
- Strength and width of bridges in the existing roadnet.
- Possibility of building a roadnet (if none exists).
- Existing telephone and telegraph lines, radio stations, power lines.
- Need for new telephone lines, et cetera.
- Suitable area for heliport (if needed).

**Beach Transfer Points.** Beach transfer points are locations where cargo is transferred from amphibians to a clearance mode for delivery to destination. The requirement for beach transfer points is identified and their locations designated during reconnaissance. A desirable beach transfer point has the following characteristics:

- It should be located to the rear of the

beach so it will not interfere with operations at the shoreline.

- It should be on the route that amphibians travel when moving from and to the water.
- It should be near the clearance route where cargo trucks moving in the traffic pattern can receive their load without interfering with other traffic and still have access to an exit from the transfer point.
- It should allow amphibians to cross the beach, which makes it unnecessary to prepare a beach roadway for cargo trucks.
- There should be room for a roadway on either side of the MHE operating at the transfer point so that there is no interference between amphibians and cargo trucks.
- It should allow for location of cranes on firm, level ground with their longer axis parallel to the direction of vehicle movement so that loads can be transferred with the least amount of movement of the boom.

**Temporary Holding Areas.** In general, the problems of cargo clearance in beach operations are the same as in conventional port terminals. However, physical differences in the operating areas may require different procedures and equipment. In an ideal situation, clearance transportation capacity is balanced with discharge capability; cargo is moved through and out of the terminal area as fast as it is unloaded from the ships. In reality this balance seldom occurs. Some cargo backlog must be anticipated and provided for by establishing temporary in-transit storage areas. These areas should be located near transfer points used by amphibians to accommodate cargo that cannot be immediately transferred to clearance conveyances. Cargo unloaded from landing craft that cannot be immediately cleared should also be brought to in-transit storage areas to avoid congestion and cargo pile-up on the beach.

When clearance transportation later becomes available to move cargo from in-transit storage areas, this imposes an additional burden on terminal service companies which unload lighters delivering cargo from the ship. Any effort diverted by these units to handling cargo in the in-transit storage areas

only impairs their ability to keep the lighters moving. Eventually, the entire operation will stagnate. Assigning terminal transfer elements (squads, platoons, or companies) to load backlogged cargo in the in-transit storage area onto clearance transportation will solve the problem. Then cargo will flow out of the terminal without disrupting discharge operations at the ship because of slow lighter turnaround.

Temporary in-transit storage areas should be located away from main clearance roads to minimize road congestion and present less lucrative targets. Roads leading from main clearance roads to in-transit storage areas must be kept in good condition. Each area should have a separate entrance and exit. If tracked vehicles will be used as well as trucks and amphibians, separate traffic nets may be needed. The ground should be level, firm, and dry. The surrounding area should be large enough to allow in-transit storage facilities to expand to meet the maximum requirement anticipated.

**Traffic Control.** Traffic control is vital to prevent congestion in the terminal area and promptly clear cargo to its initial destination. To control vehicular traffic in the beach area—

- There should be enough drivers, MHE, and supervisors for around-the-clock operations.
- Motor transport equipment should be carefully planned for maximum use (see FM 55-30).
- Motor transport units should be attached at group level to operating terminal battalions according to requirement fluctuations and degree of dispersion between beach sites.
- Vehicles should be loaded to capacity if consistent with cargo segregation requirements.
- Where practical, vehicles should be loaded

so they can be unloaded completely at one discharge point to expedite turnaround time.

- Control procedures should be set up to provide readily available information on location and current use of all motor transport facilities. Equipment or units can then be quickly diverted with minimum disruption to the overall operation.

**Beach Management.** Requirements for clearing personnel, supplies, and equipment from beaches usually exceed available capacity. Careful planning and close supervision are needed for maximum use of equipment, personnel, and facilities. Some measures which can assist in clearing supplies and equipment from the beach area are—

- Using amphibians to the maximum.
- Continuously improving the beach in general.
- Planning handling of peak work loads so they will not disrupt operations.
- Closely coordinating with cargo transfer points and temporary holding areas to maintain near-capacity cargo flow but not exceed receiving capacity.
- Separating landing points for amphibians and landing craft.
- Keeping documentation, records, and reports to a minimum.
- Locating beach parking areas for MHE and clearance vehicles in areas readily accessible to discharge points.
- Adopting an enforced traffic circulation plan.
- Locating bivouac and messing areas to avoid time loss when moving personnel to and from working points.
- Adopting alert systems and defense plans to prevent surprise enemy attacks and maintain an adequate defense.





## Section II. VESSEL DATA

US NAVY SHIP AND SERVICE  
CRAFT DESIGNATORS

US Navy ships and service craft fall into two major categories: combat and auxiliary/support. A letter T before the identifying classification and hull number of a naval vessel indicates that the vessel is assigned to the Military Sealift Command (MSC). A letter N after the identifying classification indicates that the vessel is nuclear-propelled. An asterisk (\*) indicates that the vessel is a mobilization asset, not currently in the active fleet.

## Combatant Ships

**Aircraft carriers.** Aircraft carriers are designed primarily to conduct combat operations by aircraft which attack airborne, surface, subsurface, and shore targets. Conventional takeoff and landing aircraft carriers include:

- Multipurpose aircraft carrier—CV
- Multipurpose aircraft carrier—CVN
- ASW aircraft carrier\*—CVS

**Surface Combatants.** Large, heavily armed surface ships are designed primarily to engage enemy forces on the high seas:

- Battleship—BB
- Cruisers  
Gun cruiser\*—CA  
Guided missile cruiser—CG  
Guided missile cruiser—CGN
- Destroyers  
Destroyer—DD  
Guided missile destroyer—DDG
- Frigates  
Frigate—FF  
Guided missile frigate—FFG

**Submarines.** Submarines include all self-propelled submersible vessels, whether combatant, auxiliary, or research and development, which have at least residual combat capability:

- Attack submarines  
Submarine—SS  
Guided missile submarine—SSG  
Submarine—SSN

- Ballistic missile submarine—SSBN
- Auxiliary submarine—SSAG

**Patrol combatants.** Patrol combatants missions may extend beyond coastal duties. Their sea keeping capability should enable them to operate more than 48 hours on the high seas without support:

- Patrol combatant\*—PG
- Guided missile patrol combatant (hydrofoil)—PHM

**Amphibious warfare ships.** These ships have organic capability for amphibious assault and long duration on the high seas:

- Amphibious helicopter/landing craft carriers
- Amphibious assault ship (general-purpose)—LHA
- Amphibious assault ship (multipurpose)—LHD
- Amphibious assault ship (helicopter)—LPH
- Amphibious transport dock—LPD
- Landing craft carriers  
Amphibious cargo ship—LKA  
Amphibious transport—LPA  
Dock landing ship—LSD  
Tank landing ship—LST
- Miscellaneous  
Amphibious command ship—LCC  
Miscellaneous command ship (converted LPD)—AGF

**Mine warfare ships.** These are all ships whose primary function is mine warfare on the high seas.

- Minesweeper (ocean)—MSO
- Mine countermeasures ship—MCM

## Auxiliary Ships

**Mobile logistics ships.** These ships have the capability to provide underway replenishment to fleet units; they also can provide direct material support to other deployed units operating far from home base:

- Underway replenishment ships  
Ammunition ship—AE/TAE  
Store ship—AF

Combat store ship—AFSFS  
 Oiler—AO/TAO  
 Fast combat support ship—AOE  
 Replenishment oiler—AOR

- Material support ships  
 Destroyer tender—AD  
 Repair ship—AR  
 Submarine tender—AS

**Support ships.** Support ships are designed to operate in the open oceans in various sea conditions. They provide general support to either combatant forces or shore-based establishments. These ships include smaller auxiliaries which by the nature of their duties must leave inshore waters:

- Fleet support  
 Salvage ship—ARS  
 Submarine rescue ship—ASR  
 Auxiliary ocean tug—TATF  
 Salvage and rescue ship—ATS
- Other auxiliaries  
 Auxiliary crane ship—T-ACS  
 Miscellaneous—AG  
 Deep-submergence support ship—AGDS  
 Hydrofoil support ship—AGEH  
 Frigate research ship—AGFF  
 Missile range instrumentation ship—AGM  
 Oceanographic research ship—AGOR  
 Ocean surveillance ship—T-AGOS  
 Patrol craft tender—AGP  
 Surveying ship—AGS  
 Auxiliary research submarine—AGSS  
 Hospital ship\*—T-AH  
 Cargo ship—TAK  
 Vehicle cargo ship—T-AKR  
 Auxiliary lighter ship—ALS  
 Gasoline tanker—AOG  
 Transport oiler—T-AO  
 Transport—AP  
 Self-propelled barracks ship—APB  
 Cable-repairing ship—ARC  
 Repair ship (small)—ARL  
 Aviation logistics support ship—T-AVB  
 Guided missile ship—AVM  
 Auxiliary aircraft landing training ship—AVT  
 Repositioning ship—T-AKX

### Combatant Craft

**Patrol craft.** Surface patrol craft are intended

for use relatively near the coast or in sheltered waters or rivers:

- Coastal patrol combatants  
 Patrol boat—PB  
 Patrol craft (fast)—PCF  
 Patrol gunboat (hydrofoil)—PGH  
 Fast patrol craft—PTF
- River/roadstead craft  
 Mini-armored troop carrier—ATC  
 River patrol boat—PBR

**Amphibious warfare craft.** These amphibious craft have the capacity for amphibious assault; they operate mainly in coastal waters but may be carried aboard larger units:

- Landing craft  
 Amphibious assault landing craft—AALC  
 Landing craft, air-cushion—LCAC  
 Landing craft, mechanized—LCM  
 Landing craft, personnel, large—LCPL  
 Landing craft, utility—LCU  
 Landing craft, vehicle, personnel—LCVP  
 Amphibious warping tug—LWT  
 Side-loading warping tug—SLWT
- Naval special warfare craft  
 Light seal support craft—LSSC  
 Medium seal support craft—MSSC  
 Swimmer delivery vehicle—SDV  
 Special warfare craft, light—SWCL  
 Special warfare craft, medium—SWCM

**Mine warfare craft.** Mine countermeasures craft have the primary function of mine warfare; they operate mainly in coastal waters but may also be carried aboard larger units:

- Minesweeping boat—MSB
- Minesweeping drone—MSD
- Minehunter—MSH
- Minesweeper, river (converted LCM-6)—MSM
- Minesweeper, Patrol—MSR

**Support Craft (Service Craft).** These are Navy-subordinated craft (including non-self-propelled) designed to provide general support to either combatant forces or shore-based establishments:

- Dry docks  
 Large auxiliary floating dry dock, non-self-propelled (NSP)-AFDB  
 Small auxiliary floating dry dock (NSP)-AFDL

- Medium auxiliary floating dry dock (NSP)—AFDM
- Auxiliary repair dry dock (NSP)—ARD
- Medium auxiliary repair dry dock (NSP)—ARDM
- Bowdock—YBD
- Yard floating dry dock (NSP)—YFD
- **Tugs**
- Large harbor tug, self-propelled (SP)—YTB
- Small harbor tug (SP)—YTL
- Medium harbor tug (SP)—YTM
- **Tankers**
- Fuel oil barge (SP)—YO
- Gasoline barge (SP)—YOG
- Water barge (SP)—YW
- **Lighters**
- Open lighter (NSP)—YC
- Car float (NSP)—YCF
- Aircraft transportation lighter (NSP)—YCV
- Covered lighter (NSP)—YFN
- Large covered lighter (NSP)—YFNB
- Lighter (special-purpose) (NSP)—YFNX
- Refrigerated covered lighter (SP)—YFR
- Refrigerated covered lighter (NSP)—YFRN
- Harbor utility craft (SP)—YFU
- Garbage lighter (SP)—YG
- Garbage lighter (NSP)—YGN
- Gasoline barge (NSP)—YOGN
- Fuel oil barge (NSP)—YON
- Oil storage barge (NSP)—YOS
- Sludge removal barge (NSP)—YSR
- Water barge (NSP)—YWN
- **Miscellaneous**
- Barracks craft (NSP)—APL
- Deep-submergence rescue vehicle—DSRV
- Deep-submergence vehicle—DSV
- Unclassified miscellaneous—IX
- Submersible research vehicle—NR
- Miscellaneous auxiliary (SP)—YAG
- Floating crane (NSP)—YD
- Diving tender (NSP)—YDT
- Ferryboat (SP)—YFB
- Dry dock companion boat (NSP)—YFND
- Floating power barge (NSP)—YFP
- Covered lighter (range tender) (SP)—YFRT
- Salvage lift craft, heavy (NSP)—YHLC
- Dredge (SP)—YM
- Gate craft (NSP)—YNG
- Patrol craft (SP)—YP

- Floating pile driver (NSP)—YPD
- Floating workshop (NSP)—YR
- Repair and berthing barge (NSP)—YRB
- Repair, berthing, and messing barge (NSP)—YRBM
- Floating dry dock workshop (Machine) (NSP)—YRDM
- Radiological repair barge (NSP)—YRR
- Salvage craft tender (NSP)—YRST
- Seaplane wrecking derrick (SP)—YSD

**US ARMY VESSEL DESIGNATIONS**

**Designations.** Each vessel in the transportation marine fleet bears an individual serial number, preceded by an applicable prefix:

- Barge, dry-cargo, nonpropelled, medium (100 through 149 feet)—BC
- Conversion kit, barge deck enclosure—BCDK
- Barge, dry-cargo, nonpropelled, large (150 feet and over)—BCL
- Crane, floating—BD
- Lighter, beach discharge—BDL
- Barge, liquid-cargo, nonpropelled—BG
- Barge, dry-cargo, nonpropelled—BK
- Barge, pier, nonpropelled—BPL
- Barge, refrigerated, nonpropelled—BR
- Ferryboat—FB
- Dry dock, floating—FD
- Repair shop, floating, marine craft, nonpropelled—FMS
- Freight and supply vessel, large (140 feet and over)—FS
- Boat, utility—J
- Lighter, air-cushion vehicle—LARC
- Lighter, amphibious, resupply, cargo—LARC
- Landing craft, mechanized—LCM
- Landing craft, utility—LCU
- Tug, large, seagoing—LT
- Tug, small, harbor—ST
- Boat, passenger and cargo—T
- Temporary crane discharge facility—TCDF
- Vessel, liquid cargo—Y

**US ARMY VESSEL CHARACTERISTICS**

See Tables 5-3 through 5-9 for data and characteristics of US Army vessels and amphibians. See Figures 5-6 and 5-7 for illustrations of Army watercraft and barges.

Table 5-3. Transportation floating craft

Nomenclature	Designation	Classification	Length (Overall)	Beam (Molded)	Maximum Draft	Displacement (LTOns)		Capacity (gal) Water		Fuel	Speed (kn)	Range (NMs)	Cargo Capacity			Cargo Space		Lift Capacity (LTOns)		Remarks
						Light	Loaded	Potable	Nonpotable				Dry (cu ft)	Refrig (cu ft)	Liquid (42-gal bbl)	Hatches	Tanks	Std	Heavy	
Vessel, supply, diesel, steel, 176', Design 381	FS	STD-B	176' 6"	32' 0"	10' 0"	465.0	935	2,042	11,624	21,000	12.0	5,320	—	—	—	1	0	5	15	Designed as aircraft repair vessel, not as a cargo carrier, hatch size, 6' x 16'
Vessel, special-purpose, diesel, steel, 176', Design 427	FS	STD-B	179' 10"	32' 5"	11' 3"	684.8	899	1,502	14,449	33,992	12.0	4,500	21,462	—	—	2	0	4	15	
Vessel, dry-cargo, diesel, steel, 1,000-T, 210', Design 7013	FS	STD-B	222' 9 1/2"	38' 0"	14' 6"	892.0	2,150	10,000	15,940	54,100	13.37	6,750	56,400 - 3,400 special	—	—	3	0	5	—	Equipped with two level luffing cranes
Vessel, liquid-cargo, diesel, steel, 11,500 bbl, 210', Design 7014	Y	STD-A	222' 9 1/2"	38' 0"	17' 0"	797.0	2,500	10,000	15,940	58,670	12.7	7,700	3,382 special	—	11,079.8	1	9	2,000	—	Has one dry cargo hatch, 3,382 cu ft; nine liquid cargo tanks. Equipped with two 800-GPM cargo pumps

Table 5-4. Boats

Nomenclature	Designation	Classification	Length (Overall)	Beam (Molded)	Depth (Molded Amidships)	Displacement (LTOns)		Maximum Draft (aft)	Fuel Capacity (gal)	Fuel Consumption (gal/hr)	Fresh Water (gal)	Speed (kn)	Cruising Range (NMs)	Capacity		Remarks
						Light	Loaded							Cargo (LTOns)	Passenger	
Boat, picket, diesel, steel, 46' 4 1/2", Design 4003	J	STD-A	46' 4 1/2"	12' 3"	6' 3 3/4"	10	120	2' 9"	370	190	50	14	245	1.33	25	Transported on cradle, replaces 243-B.
Boat, picket, diesel, wood, 64' 11", Design 4002	Q	STD-A	64' 11"	15' 11"	8' 3"	31	34.5	5' 10"	900	242	400	14	468	4.0	5	Transported on cradle.
Boat, passenger and cargo, diesel, steel, 65' 6", Design 2001	T	STD-A	65' 6"	17' 8"	8' 9 1/4"	66	95.0	6' 6"	1,150	180	400	7	397	24.0	24	Normally deck-loaded. Limited ocean sailing under good conditions.

Table 5-5. Floating cranes

Nomenclature	Designation	Classification	Length (Overall)	Beam (Molded)	Depth (Molded)	Displacement (LTOns)		Draft		Capacity (gal)		Cargo-Handling Equipment Capacity	Remarks
						Light	Loaded	Light	Loaded	Fuel	Fresh Water		
Crane, barge, diesel-electric, revolving, steel, 60 LTOns, Design 413-D	BD	STD-A	142' 0"	58' 0"	12' 0"	1,132	1,192	5' 1"	5' 6"	1,350	600	Main hoist: 60 LTOns @ 73-ft radius Aux hoist: 15 LTOns @ 100-ft radius Main hoist reach below surface: 50 ft	Can be towed overseas. Boom length, 95' 6".
Crane, barge, diesel-electric, revolving, steel, 89 LTOns, Design 264-B	BD	STD-A	140' 0"	70' 0"	12' 6"	1,407	1,497	5' 7"	5' 11"	15,000	30,200	Main hoist: 75 LTOns @ 104-ft 6-in radius, 89 LTOns @ 80-ft radius Aux hoist: 15 LTOns @ 122-ft 6-in radius Aux hoist reach below waterline: 25 ft	Can be towed overseas. Boom length, 123' 6".

FM 55-15

Table 5-6. Landing craft

Nomenclature	Designation	Classification	Length (Overall)	Beam (Molded)	Depth (Amdships)	Light Displacement (LTONS)	Draft		Fuel Capacity (gal)	Fuel Consumption (gal/hr)	Speed Loaded (kn)	Operating Range (NMs)	Capacity Cargo		Cargo Dimensions		Ramp Opening	Remarks
							Fwd	Aft					(LTONS)	Troop	Length	Width		
Landing craft, utility, diesel steel, 115' Navy Design LCU, 1466 class	LCU	STD-A	115' 1"	34'	6' 0"	180.0	(Light) 2' 0" (Loaded) 3' 1"	(Light) 3' 10" (Loaded) 4' 0"	3,700	34	7.0	700	150.0	300	52'	29' 5"	14' 4"	Fresh water capacity, 9,563 gal.
Landing craft, utility, diesel steel, 135' Navy Design LCU, 1646 class	LCU	—	135' 1"	29'	(1)	65.1	(Loaded) 3' 6"	(Loaded) 6' 0"	3,290	25	92.0	1,200 <sup>2</sup>	170.0	(1)	105'	17' 0"	14' 0"	Fresh water capacity, not available
Landing craft, mechanized, diesel steel, 74', Mod I, Mark VIII, Navy Design LCM 8	LCM	STD-A	74' 0"	21'	9' 4"	57.8	(Light) 3' 6" (Loaded) 3' 0"	(Light) 3' 6" (Loaded) 5' 0"	864	43	9.0	900	53.5	200 <sup>3</sup>	42'	15' 0"	14' 6"	
Lighter, beach discharge, deck cargo, diesel steel, 338', Design 5002	BDL	STD-A	338' 0"	55'	21' 0"	1,548.8	(Beaching) 4' 0" (Ocean) 5' 6"	(Beaching) 10' 0" (Ocean) 13' 8"	69,753	155	8.5	5,500	(Beaching) 500 (Ocean) 2,200	200 w/o berms	(Total sq ft) 15,000		22' 0" (Overhead clearance) 13' 6"	Has ocean-sailing capability. Fresh water capacity, 23,941 gal.

<sup>1</sup>Information not available.  
<sup>2</sup>May vary according to propulsion design.  
<sup>3</sup>Combat-equipped.

Table 5-7. Amphibians

Nomenclature	Designation	Classification	Length (Overall)	Beam (Overall)	Height (Overall)	Light Displacement (LTONS)	Draft <sup>1</sup>		Fuel Capacity (gal)	Fuel Consumption (gal/hr)	Type Fuel	Speed		Range		Capacity		Cargo Dimensions	Ramp Opening	Speed Loaded	Payload/Endurance	Remarks
							Fwd	Aft				Land (MPH)	Water (kn)	Land (stat mi)	Water (NMs)	Cargo (LTONS)	Troops					
Lighter amphibious (LARC IV), nonpropelled diesel, aluminum, 15-T, Design 3004	LARC	STD-A	45' 0"	14' 7"	15' 6" <sup>2</sup>	20.81	(Light) 4' 0" (Loaded) 4' 11"	(Light) 4' 11" (Loaded) 5' 8"	360	(Land) 16.32 (Water) 28.16	—	29.5	8.6	300	54	15	50 <sup>3</sup>	24' 0" x 13' 6"	9' 0"			
Lighter amphibious (LARC LX), nonpropelled diesel, steel, 60-T, 61', Design 2353	LARC <sup>4</sup>	STD-A	62' 6"	26' 7"	19' 5" <sup>5</sup>	87	(Light) 6' 2" (Loaded) 7' 11"	(Light) 7' 5" (Loaded) 8' 8"	600	38	—	14.0	7.0	150	75	(Nom) 60 (Emerg) 100	(Nom) 125 (Emerg) 200	38' 3" x 13' 8"	14' 6"			
Lighter amphibious, LACV 30 air-cushion vehicle	LACV	STD-A	(On Cushion) 76' 3"	(On Cushion) 36' 4"	(On Cushion) 24' 4" (Off Cushion) 21' 5"	—	—	(Main tank) 2,365 (Emerg fuel capacity) 1,584	260	Jet A-1, JP4, JP5	—	—	—	—	—	—	—	51' 6" x 32' 6"	—	47 MPH max 57 MPH	30 LTONS/2 hr 27.3 LTONS/5 hr 23.7 LTONS/9 hr	Has self-unload capability with the addition of an optional bow-mounted swing crane.

<sup>1</sup>Draft is taken from the bottom.  
<sup>2</sup>Reducible to 13' 8".  
<sup>3</sup>Emergency.  
<sup>4</sup>Formerly EARC.  
<sup>5</sup>Reducible to 15' 4".

Table 5-8. Tugs

Nomenclature	Designation	Classification	Length (Overall)	Beam (Molded)	Depth (Molded Amidships)	Displacement (LTONS)		Maximum Draft (ft)		Fuel Capacity (gal)	Fuel Rate (gal/hr)	Fresh Water, Potable (gal)	Speed (kn)	Range <sup>1</sup> (NMs)	Bollard Pull (lb)	Remarks
						Light	Loaded	Light	Loaded							
Tug, harbor, diesel, 200 HP, steel, 45', Design 320	ST	STD-A	45' 2¼"	12' 9¼"	7' 9¼"	25	29	6' 0"	6' 0"	900	10.25	55	10	790	4,400	Deck loaded for overseas shipment.
Tug, harbor, diesel, 600 HP, steel, 65', Design 3004	ST	STD-A	70' 11½"	19' 6"	9' 7¼"	100	122	8' 2¾"	8' 2¾"	5,844	36.1	900	12	1,700 light (142 hr w/tow)	17,500	Normally transported overseas on a larger vessel. Has ocean sailing capability.
Tug, harbor, diesel, 1,200 HP, steel, 100', Design 3006	LT	STD-A	102' 0"	26' 6"	14' 10"	295	390	12' 2"	12' 2"	21,146	68.0	2,756	12	3,700 (294 hr w/tow)	27,500	

<sup>1</sup>Ranges estimated as free-running.

Table 5-9. Barges

Nomenclature	Designation	Classification	Length (Overall)	Beam (Molded)	Depth (Molded)	Displacement (LTONS)		Maximum Draft		Cargo		Remarks
						Light	Loaded	Light	Loaded	Liquid	Dry	
Barge, deck cargo, nonpropelled, steel, 570-T, 110', Design 7005	BC	STD-A	110' 0"	32'	9' 0"	120.0	690	1' 8"	7' 8"	—	570 LTONS	Conversion kit, barge deck enclosure. Design 7006, is adaptable to this item. Can be towed overseas.
Barge, deck cargo, nonpropelled, steel, 585-T, 120', Design 231A	BC	STD-A	120' 0"	33'	10' 6"	175.0	760	2' 4"	8' 0"	—	585 LTONS	Can be towed overseas; hull designed for relatively high-speed towing.
Barge, deck or liquid cargo, nonpropelled, steel, 578-T or 4,160 bbl, 120', Design 231B	BG	STD-A	120' 0"	33'	10' 6"	175.0	753	2' 4"	8' 6"	4,160 bbl	578 LTONS on deck	Can be towed overseas with full load provided maximum draft does not exceed 8'.
Barge, refrigerator, nonpropelled, steel, 14,200 cu ft, 120', Design 7010	BR	STD-B	120' 0"	33'	10' 6"	225.0	546	3' 0"	5' 10"	—	14,200 cu ft	Can be towed overseas.
Barge, refrigerator, nonpropelled, steel, 46,476 cu ft, 210', Design 7016	BR	STD-B	210' 0"	40'	15' 0"	1,100.0	2,250	5' 8"	8' 5"	—	46,476 cu ft	Can be towed overseas.
Repair shop, floating, marine equipment, nonpropelled, steel, 210', Design 7011	FMS	STD-A	210' 5"	40'	15' 0"	1,160.0	1,525	6' 1"	7' 9"	NA	NA	Can be towed overseas. Repair shops include electrical, carpentry, engine repair, battery, fuel injection, blacksmith, machine, refrigeration, sheet metal, welding, pipe fitting, paint, and ship fitting.
Barge, deck or liquid cargo, nonpropelled, steel, 21-T or 225 bbl, 45' knockdown, Design 218E	BK	STD-B	45' 0"	18'	3' 0"	13.0	33	0' 8"	1' 8"	225 bbl	20.98 LTONS on deck	Can be sectionalized for deck-loading and rail movement; barge is divided into two sections, each 9'2" x 45'5" x 3'0". Transports limited quantities of liquid or dry cargo on inland waters.
Barge, deck cargo, nonpropelled, steel, 130-T, 81', sectionalized, nesting, Design 7001	BK	STD-A	81' 0"	22'	7' 0"	57.5	203	1' 6"	4' 9"	—	(Deck) 130 LTONS (Hold) 150 LTONS	Can be sectionalized and nested for shipment. Lacks stability.
Pier, barge-type, self-elevating, nonpropelled, steel, 150' long, 60' wide, 10' deep, Design 7028	BPL	STD-A	150' 0"	60'	10' 0"	1,131.2	—	—	4' 8"	—	1,131.2 LTONS	Can be towed overseas. Used to construct piers and sea island terminals. Fitted with 2 compressors for 6 air jacks, 20 each 60" x 5' 11" caissons.
Pier, barge-type, self-elevating, nonpropelled, steel, 300' long, 80' wide, 13' deep, Design 7029	BPL	STD-A	300' 0"	80'	13' 0"	2,221.32	2,452.149	—	3' 9"	—	2,207.812 LTONS	Can be towed overseas. Same as Design 7028. Fitted with 2 compressors for 10 air jacks, 20 each 60" x 5' 11" caissons.

FM 55-15

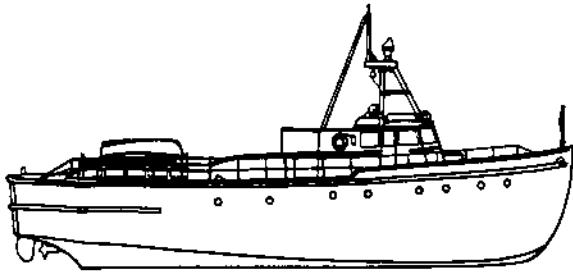

BOAT, PICKET, WOOD, DESIGN 4002

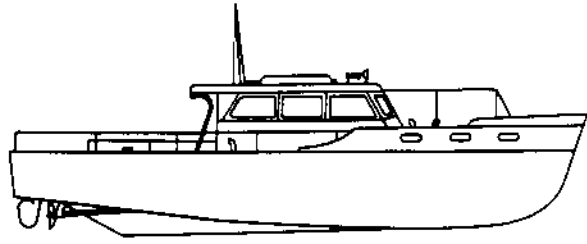

BOAT, PICKET, STEEL, DESIGN 4003

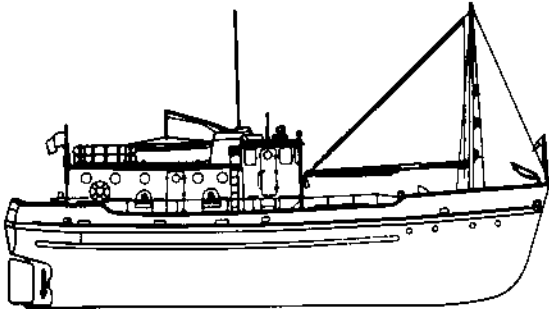

BOAT, PASSENGER AND CARGO, DESIGN 2001

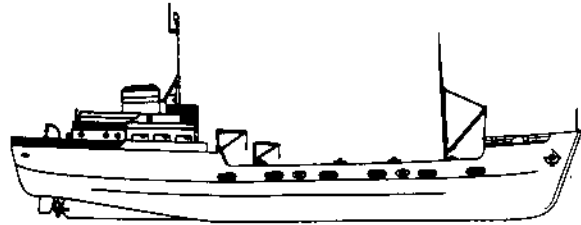

VESSEL, LIQUID CARGO, DESIGN 7014

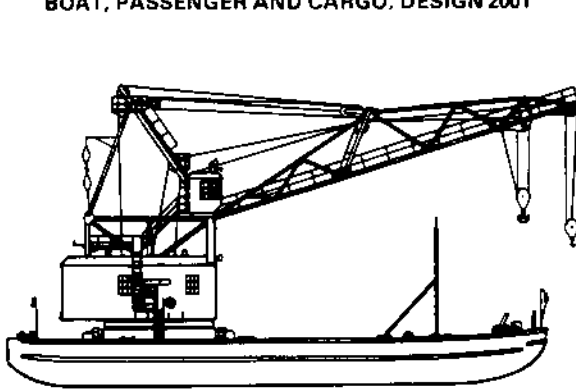

CRANE, BARGE, 60 LTONs, DESIGN 413D

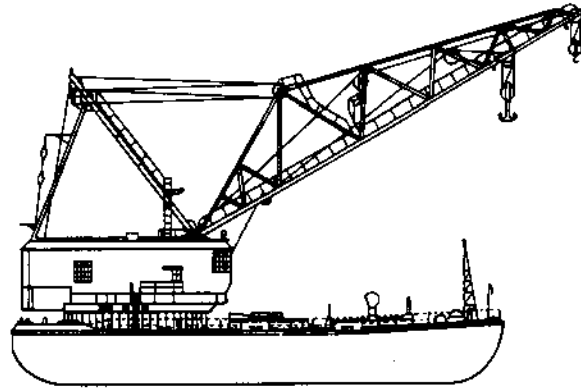

CRANE, BARGE, 89 LTONs, DESIGN 264-B

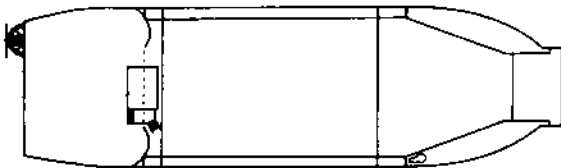

LANDING CRAFT, UTILITY, 1466 CLASS

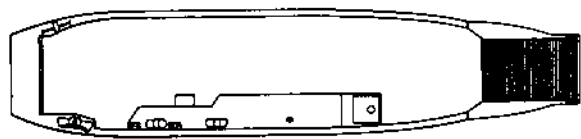

LANDING CRAFT, UTILITY, 1646 CLASS

*Figure 5-6. Army watercraft*

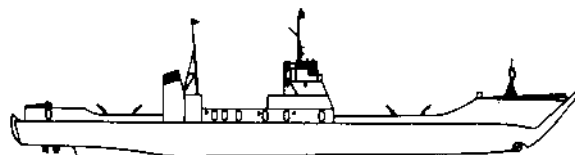
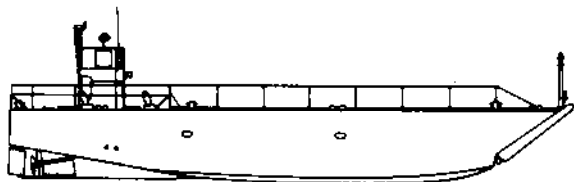
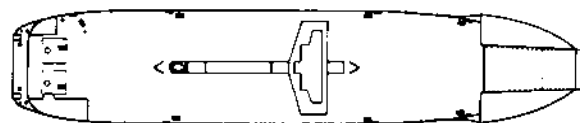
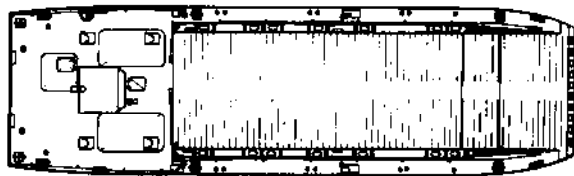

LANDING CRAFT, MECHANIZED, LCM-8

LIGHTER, BEACH DISCHARGE, DESIGN 5002

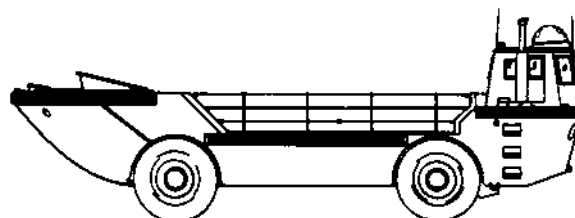
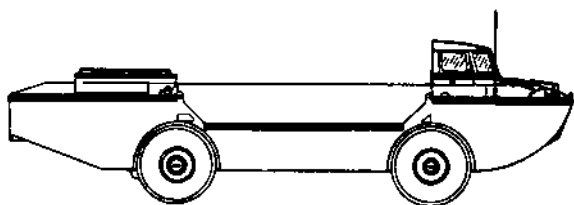
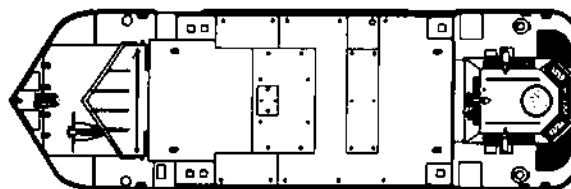
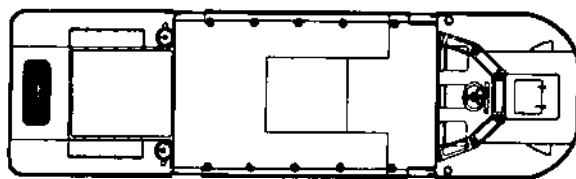

LIGHTER, AMPHIBIOUS, LARC-5

LIGHTER, AMPHIBIOUS, LARC-15

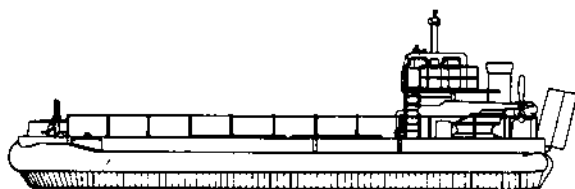
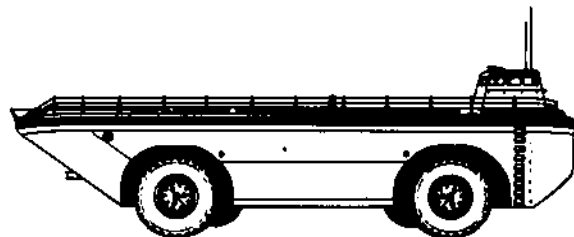
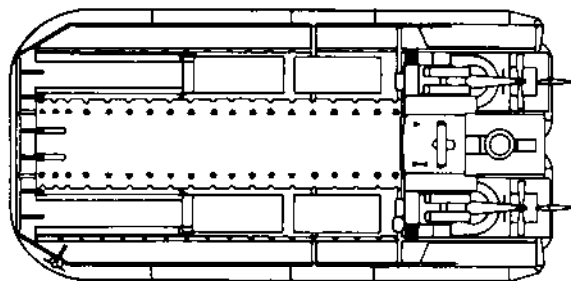
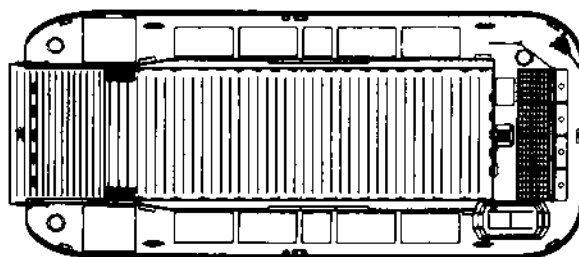

LIGHTER, AMPHIBIOUS, LARC-60

LIGHTER, AMPHIB, AIR-CUSHION VEHICLE, LACV-30

Figure 5-6. Army watercraft (cont)



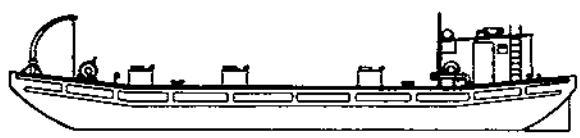
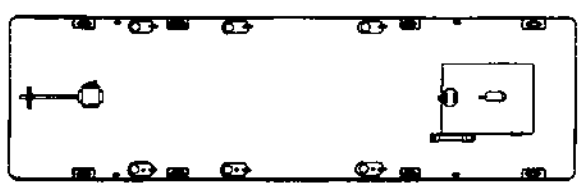
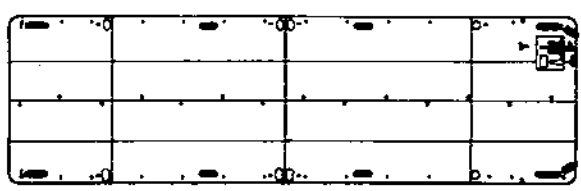

BARGE, DECK CARGO, DESIGN 231A

BARGE, DECK OR LIQUID CARGO, DESIGN 231-B

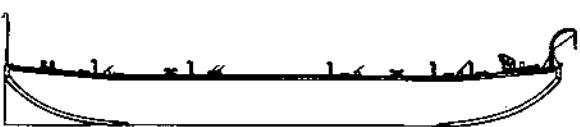
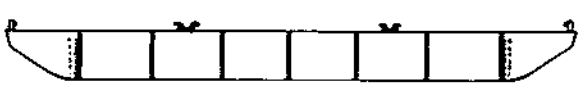
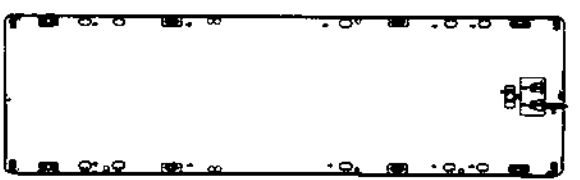
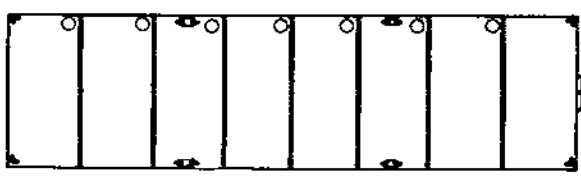

BARGE, DECK CARGO, DESIGN 7001

BARGE, DECK CARGO, DESIGN 7005

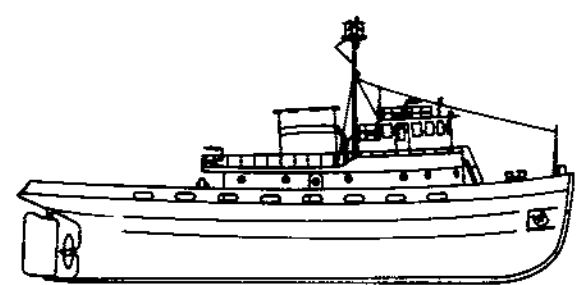
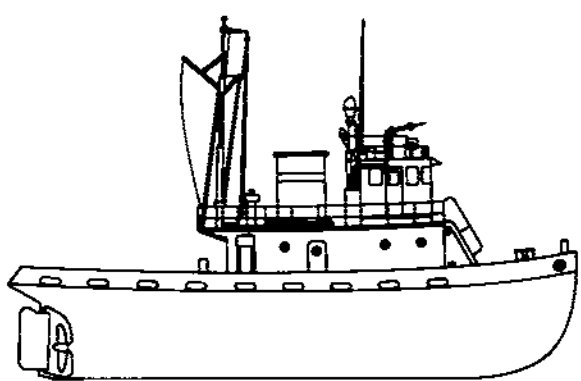

TUG, HARBOR, 65-FOOT, DESIGN 3004

TUG, HARBOR, 100-FOOT, DESIGN 3006

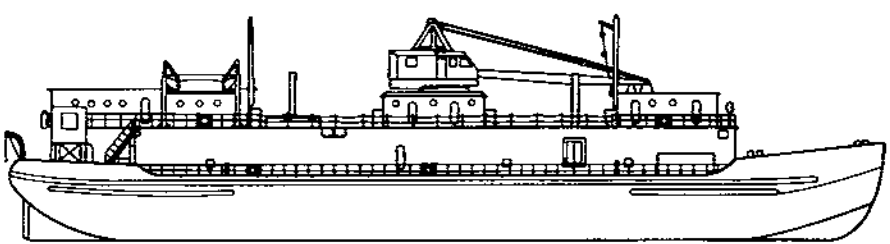

REPAIR SHOP, FLOATING, MARINE EQUIPMENT, DESIGN 7011

Figure 5-6. Army watercraft (cont)

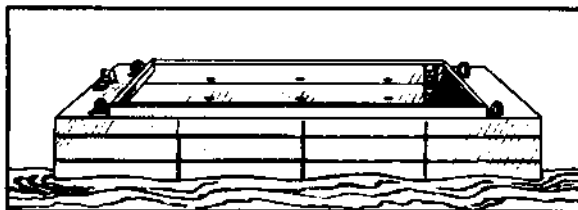

LASH

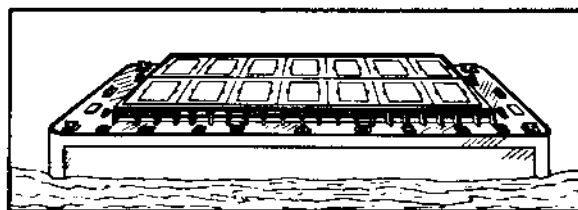

SEABEE

Figure 5-7. LASH and SEABEE barges

MARITIME ADMINISTRATION (MARAD)  
CLASSIFICATION SYSTEM

The MARAD system classifies ships by design type. Three groups of letters and numbers indicate the characteristics of the ship:

- Group 1 —type of ship and its length at the load waterline (LWL).
- Group 2—type of machinery, number of propellers, and passenger capacity.

- Group 3—chronological design number and alterations (assigned by MARAD).

For example, “C4-S-1a” denotes a cargo vessel of between 500 and 550 feet with steam propulsion and one propeller, carrying less than 12 passengers. The ship is version “a” of the first design. See Table 5-10 for the code classifications for Group 1. See Table 5-11 for code classifications for Group 2, the middle digits.

Table 5-10. MARAD classification system (group 1)

Ship	Length at Load Waterline (ft)							Remarks
	(1)	(2)	(3)	(4)	(5)	(6)	(7)	
B Barge	up to 100	100 to 150	150 to 200	200 to 250	250 to 300	300 to 350	350 to 400	(1)
C Cargo	up to 400	400 to 450	450 to 500	500 to 550	550 to 600	600 to 650	650 to 700	(1)
G Great Lakes cargo	up to 300	300 to 350	350 to 400	400 to 450	450 to 500	500 to 550	550 to 600	(1)
H Great Lakes passenger	up to 300	300 to 350	350 to 400	400 to 450	450 to 500	500 to 550	550 to 600	(2)
IB Integrated tug-barge	up to 200	200 to 300	300 to 400	400 to 500	500 to 600	600 to 700	700 to 800	(1)
J Inland cargo	up to 50	50 to 100	100 to 150	150 to 200	200 to 250	250 to 300	300 to 350	(2)
K Inland passenger	up to 50	50 to 100	100 to 150	150 to 200	200 to 250	250 to 300	300 to 350	(2)
L Great Lakes tanker (ore or grain)	up to 400	400 to 450	450 to 500	500 to 550	550 to 600	600 to 650	650 to 700	(1)
LG Liquid gas	up to 450	450 to 500	550 to 600	600 to 650	650 to 700	700 to 750	750 to 800	(1)
N Coastwise cargo	up to 200	200 to 250	250 to 300	300 to 350	350 to 400	400 to 450	450 to 500	(2)
OB Combination oil-bulk/ore	up to 450	450 to 500	500 to 550	550 to 600	600 to 650	650 to 700	700 to 800	(1)
P Passenger (100 or more)	up to 500	500 to 600	600 to 700	700 to 800	800 to 900	900 to 1000	1000 to 1100	(1)
Q Coastwise passenger	up to 200	200 to 250	250 to 300	300 to 350	350 to 400	400 to 450	450 to 500	(2)
R Refrigerated	up to 400	400 to 450	450 to 500	500 to 550	550 to 600	600 to 650	650 to 700	(2)
S Special X	up to 200	200 to 300	300 to 400	400 to 500	500 to 600	600 to 700	700 to 800	(1, 3)
T Tanker	up to 450	450 to 500	500 to 550	550 to 600	600 to 650	650 to 700	700 to 800	(1)
U Ferries	up to 100	100 to 150	150 to 200	200 to 250	250 to 300	300 to 350	350 to 400	(2)
V Towing vehicles	up to 50	50 to 100	100 to 150	150 to 200	200 over			

<sup>1</sup>Larger vessels are designated by successive numbers in 100-foot increments (C8 for 700 through 799 ft, and so forth).

<sup>2</sup>Longer vessels are designated by successive number in 50-foot increments (H8 for 600 through 650 ft, and so forth).

<sup>3</sup>The special designation X applies to certain Navy ships built by MARAD and other ships so specialized that they don't fit any other designation.

**Table 5-11. MARAD classification of ship machinery, propellers, and passenger capability (group 2)**

Machinery Type	Propellers	Passenger Capability		Machinery Type	Propellers	Passenger Capability	
		12 and Under <sup>1</sup>	Over 12 <sup>2</sup>			12 and Under <sup>1</sup>	Over 12 <sup>2</sup>
Steam	Single	S	S1	Steam	Twin	ST	S2
Motor	Single	M	M1	Motor	Twin	MT	M2
Steam and motor	Single	SM	SM1	Steam and motor	Twin	SMT	SM2
Turboelectric	Single	SE	SE1	Turboelectric	Twin	SET	SE2
Diesel-electric	Single	ME	ME1	Diesel-electric	Twin	MET	ME2
Gas turbine	Single	G	G1	Gas turbine	Twin	GT	G2
Gas turboelectric	Single	GE	GE1	Gas turboelectric	Twin	GET	GE2
Nuclear	Single	N	N1	Nuclear	Twin	NT	N2

<sup>1</sup>For triple- and quadruple-screw vessels, add TR or Q respectively to single-screw designation. For example, a triple-screw motor ship is MTR.

<sup>2</sup>For triple- and quadruple-screw vessels, make digit 3 or 4 respectively. For example, quadruple-screw steam is S4.

### Section III. TERMINAL EQUIPMENT, CARGO CONTAINERS, PALLETS, AND MARKINGS

#### TERMINAL EQUIPMENT

See Tables 5-12 through 5-16 for data on-

- Gasoline-powered forklifts.
- Rough-terrain forklifts.
- Wheeled warehouse tractors.

- Electric-powered forklifts.
- Truck-mounted cranes.

See Figures 5-8, -9, and -10 for descriptions of the rough-terrain container handler (RTCH), the yard tractor, and other terminal equipment.

**Table 5-12. Gasoline-powered forklifts**

Model Number	Length (in)	Width (in)	Height (in)	Weight (lb)	Lift Height (in)	Free Lift (in)	Capacity (lb)	Tire Type <sup>1</sup>
FB 20-24 (131)	63¾	32	83	4,304	130	12	2,000	S
KC 51T20H-RS53 (156)	70	32½	83	4,134	130	66	2,000	S
MY40RS (170)	97½	60½	90½	8,500	144	57	4,000	P
MY40 (170)	94½	60½	90½	8,500	144	57	4,000	P
G54P-4024RS (166)	92¾	63½	91	8,420	144	57	4,000	P
540 RS (160) V1	89¾	44	83	10,500	127	57	6,000	S
Yardlift 60 RS (115)	113	68	115	9,705	168	6¾	6,000	P
MY 60 RS (171)	110¼	70	110½	9,720	168	18½	6,000	P
GLF 100- (163)	110¼	53	68	13,200	100	43	10,000	S
Yardlift 150-53RS (151)	152	96	150	22,000	210	2½	15,000	P
H 150C (178)	145	81	152	19,050	210	2	15,000	P

<sup>1</sup>Tire types: S—solid rubber, P—pneumatic

**Table 5-13. Rough-terrain forklifts**

Model Number	Length (in)	Width (in)	Height <sup>1</sup> (in)	Weight (lb)	Lift Height (in)	Power	Capacity (lb)	Tire Type <sup>2</sup>
Baker RPF060M02 (164)	204	84	96	8,000	78	Gasoline	4,000 RT	P
Anthony MLT6	229½	86	94	16,800	144	Gasoline	6,000	P
MR 100 (173)	228	102	124 <sup>4</sup>	23,800	144	Diesel	6,000 RT	P
—	138 <sup>3</sup>	—	—	—	—	—	—	—
Millicin	244	103	100	30,000	144	Gasoline	10,000	P
—	252	—	133 <sup>4</sup>	—	—	—	—	—
RTL-10	203 <sup>3</sup>	106	—	34,500	142	Diesel	10,000 RT	P

<sup>1</sup>With mast collapsed.

<sup>2</sup>P—pneumatic.

<sup>3</sup>Less forks.

<sup>4</sup>With guard.

**Table 5-14. Wheeled warehouse tractors**

Model Number	Length (in)	Width (in)	Height (in)	Shipping Weight (lb)	Number of Wheels	Drawbar Pull (lb)	Tire Type <sup>1</sup>	Power
TSSA	89½	41½	62	2,740	3	2,000	S	Electric
MTT-W	79	42	48½	3,500	4	3,500	S	Electric
MW-4-SE	86	42	59	3,545	4	4,000	S	Electric
Clarktor-40-RS	110	65½	56	4,700	4	4,000	P	Gasoline
J-217-E	116	66	62	5,800	4	4,000	P	Gasoline
Clarktor-75	119	69	56½	9,940	4	7,500	P	Gasoline

<sup>1</sup>Tire types: S—solid rubber, P—pneumatic

**Table 5-15. Electric-powered forklifts**

Model Number	Length (in)	Width (in)	Height <sup>1</sup> (in)	Weight (lb)	Lift Height (in)	Free Lift	Capacity (lb)	Tire Type <sup>2</sup>
FSHEYG20/48	69½	34¼	83	3,808	130	5	2,000	S
Clipper ECE2024SE	64¼	34½	83	3,900	130	64	2,000	S
RAT 30 Type E	37¼	13	31¼	5,130	144	44	3,000	S
FTHEG 40/48	81	41½	91	6,950	144	7½	4,000	S
Carloader SE ELL 4024	77¼	41	91	6,613	144	70	4,000	S
FT 60/48	88	47½	83	8,000	127	61	6,000	S
EUT 6024 SE 50	92¼	43	133	8,550	168	6	6,000	S

<sup>1</sup>With mast collapsed.

<sup>2</sup>S—solid rubber.

**Table 5-16. Truck-mounted cranes**

Item	Capability (STGNs)	Length (in)	Width (in)	Weight (lb)	Basic Boom Length (ft)
20-ton crane	20 @ 10' radius	326	119.0	59,860	30
140-ton crane	140 @ 12' radius	873	132.5	195,000	50
250/300-ton crane	250 @ 18' radius	570	144.0	370,000	70
				w/120' boom	
				w/160' boom	

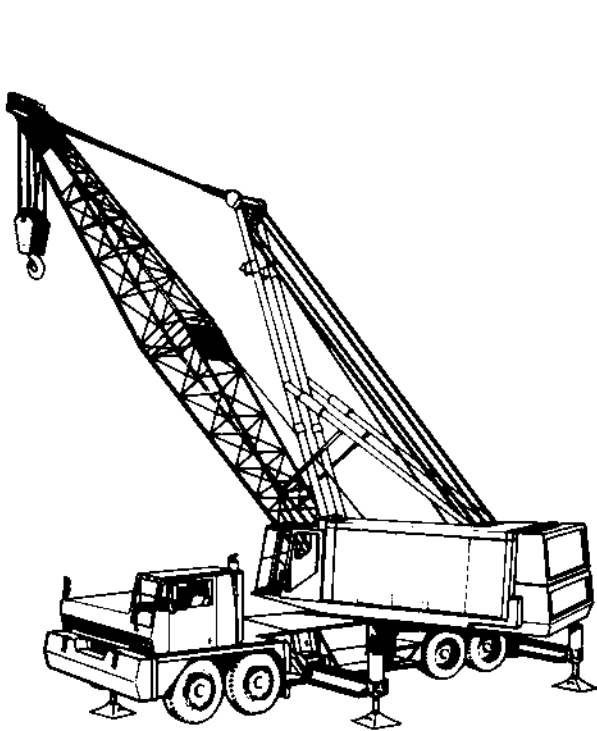

140-TON CRANE

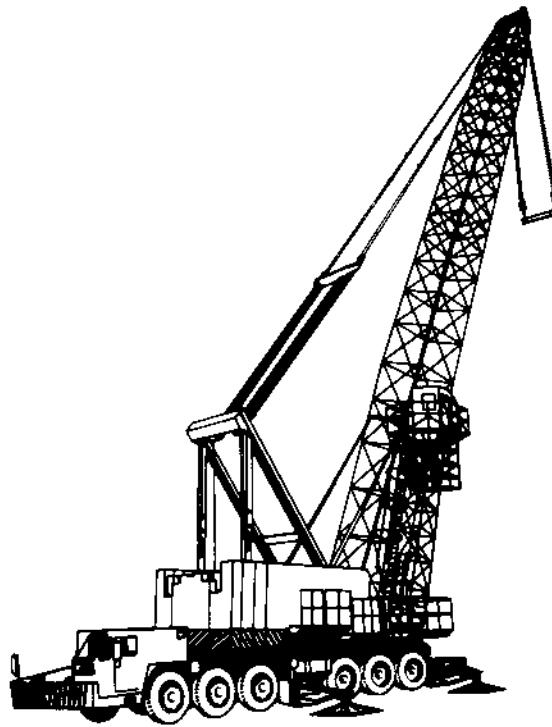

250-TON CRANE

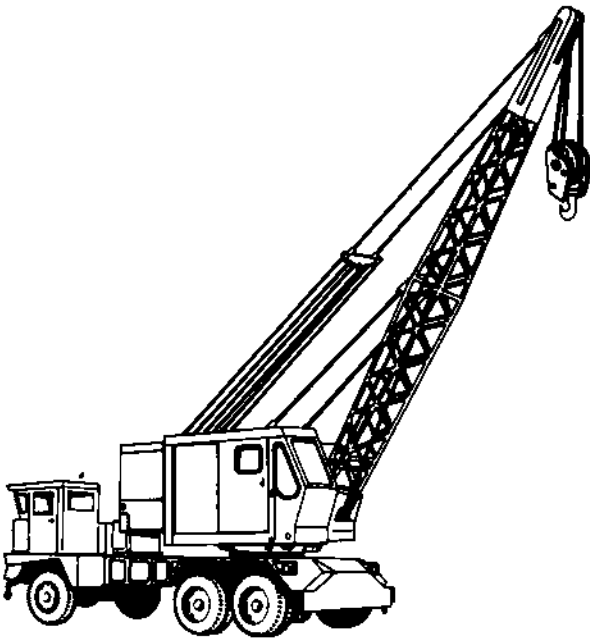

20-TON ROUGH TERRAIN CRANE

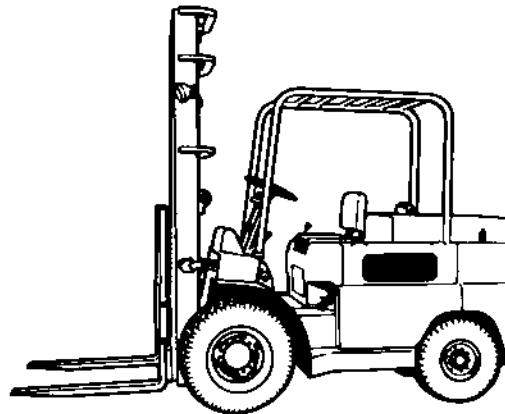

6,000-POUND FORKLIFT

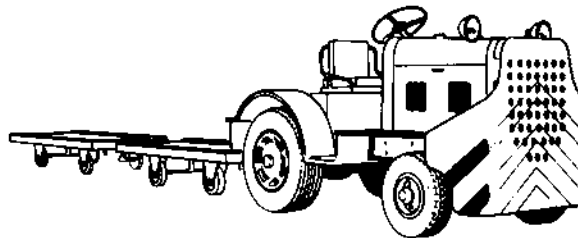

WAREHOUSE TRACTOR AND TRAILERS

*Figure 5-8. Terminal equipment*

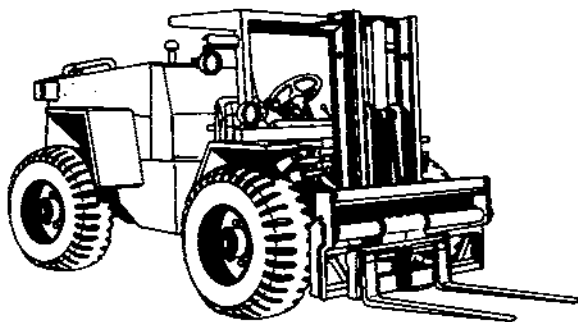

4,000-POUND ROUGH-TERRAIN FORKLIFT

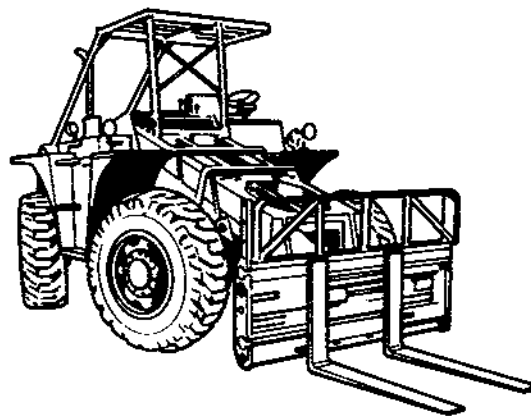

6,000-POUND ROUGH-TERRAIN FORKLIFT

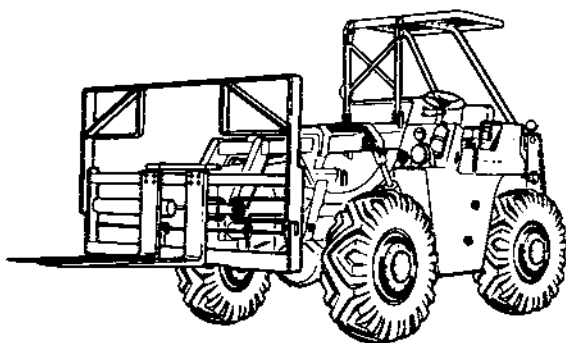

10,000-POUND ROUGH-TERRAIN FORKLIFT

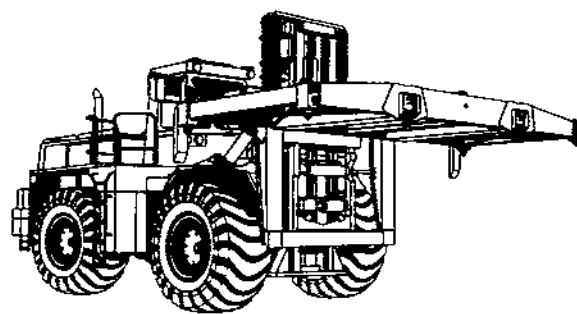

ROUGH-TERRAIN CONTAINER HANDLER (RTCH)

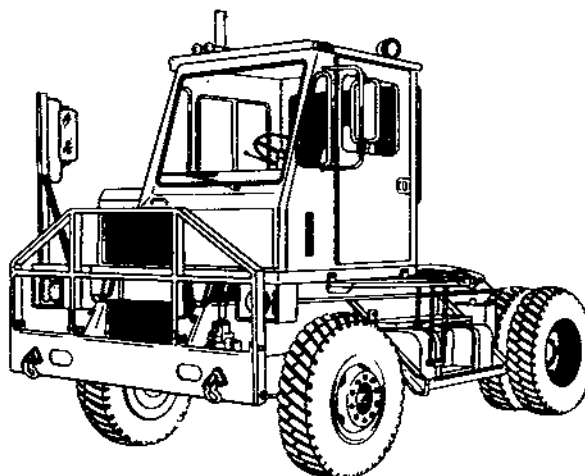

YARD TRACTOR

Figure 5-8. Terminal equipment (cont)

<b>Model:</b> Caterpillar <b>Length:</b> 423" <b>Width:</b> 140" <b>Height:</b> 167" <b>Max height at maximum lift:</b> 229" <b>Shipping weight (70% fuel):</b> 106,120 lb <b>Operational weight</b> Without top handler: 103,230 lb With 20' top handler: 107,030 lb With 35' top handler: 112,360 lb With 40' top handler: 113,160 lb	<b>Maximum speed (forward)</b> With rated load: 14.5 MPH Without rated load: 18.5 MPH <b>Maximum fording depth:</b> 60" <b>Lifting capacity:</b> 50,000 lb																
	<table border="1"> <thead> <tr> <th>Tophandler</th> <th>Length</th> <th>Width</th> <th>Weight</th> </tr> </thead> <tbody> <tr> <td>20'</td> <td>238"</td> <td>100"</td> <td>3,900 lb</td> </tr> <tr> <td>35'</td> <td>419 1/2"</td> <td>100"</td> <td>9,120 lb</td> </tr> <tr> <td>40'</td> <td>479 1/2"</td> <td>100"</td> <td>9,930 lb</td> </tr> </tbody> </table> Can lift container 118" above ground level (measured from bottom of container)	Tophandler	Length	Width	Weight	20'	238"	100"	3,900 lb	35'	419 1/2"	100"	9,120 lb	40'	479 1/2"	100"	9,930 lb
Tophandler	Length	Width	Weight														
20'	238"	100"	3,900 lb														
35'	419 1/2"	100"	9,120 lb														
40'	479 1/2"	100"	9,930 lb														

Figure 5-9. Characteristics of rough-terrain container handler

<b>Model:</b> Ottawa Model 50 <b>Vehicle weight:</b> 15,520 lb <b>Length:</b> 191 1/2" <b>Width:</b> 102 1/4"	<b>Height:</b> 129 5/8" <b>Fifth wheel lift capacity:</b> 70,000 lb <b>Fifth wheel lift:</b> 16 3/8"
--	--

Figure 5-10. Characteristics of yard tractor

**CARGO CONTAINERS**

There are three major kinds of cargo containers used in the DTS:

- CONEX (container express).
- MILVAN (military-owned remountable container).

- Commercial container.

**CONEX.** CONEXs are reusable metal shipping boxes mounted on skids and fitted with recessed lifting eyes or lugs at the top four corners. They are produced in two styles: full-size and half-size. See Figure 5-11.

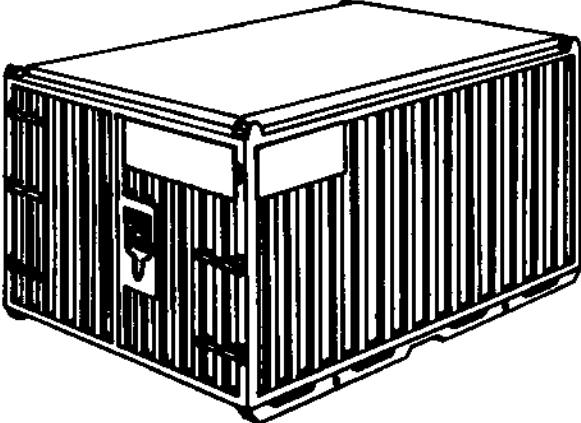

	Type 1 (Half Size)*	Type 2 (Standard)
<b>Inside</b>		
Length	3' 10 5/8"	8' 1 5/8"
Width	5' 11 3/4"	5' 11 3/4"
Height	6' 3/8"	6' 3/8"
<b>Outside</b>		
Length	4' 3"	8' 6"
Width	6' 3"	6' 3"
Height	6' 10 1/2"	6' 10 1/2"
Cargo Capacity	9,000 lb	9,000 lb
Empty Weight	900 lb	1,500 lb

\*For cargoes with overall density exceeding 45 pounds per cubic foot.

Figure 5-11. CONEX characteristics

**MILVAN.** MILVANs are standard 8-foot high and wide by 20-foot long remountable containers that may be moved by all modes of transportation. They conform to US and international standards. For highway movement,

the container is attached to a MILVAN chassis by coupling its lower four standard corner fittings to compatible mounting blocks on the chassis. See Figure 5-12.

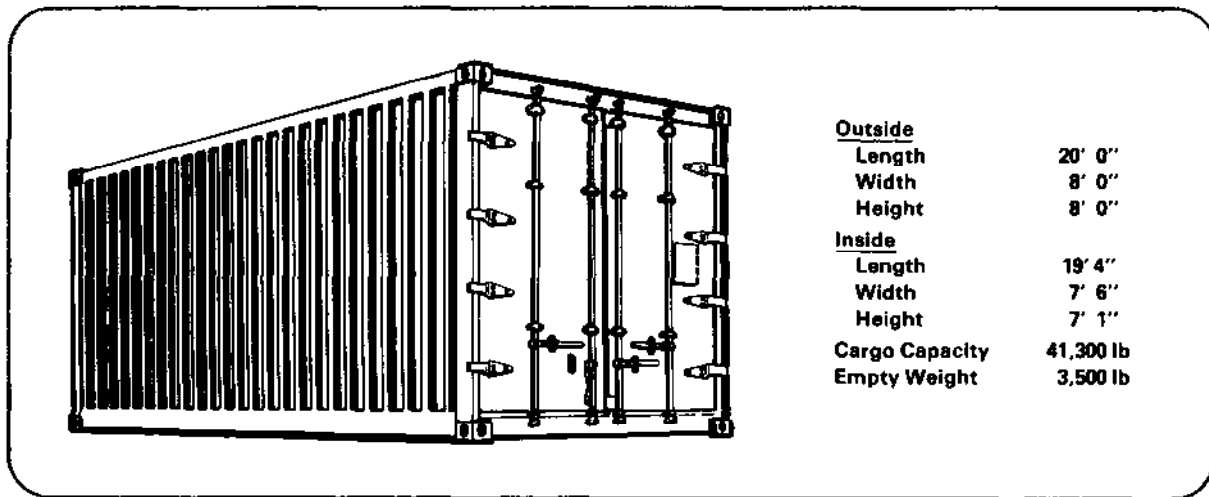

Figure 5-12. MILVAN characteristics

**Commercial container.** The commercial transportation industry uses many types of containers to transport different kinds of

cargo. The dry-van container is the most commonly used. See Figures 5-13 and 5-14.

TYPE	LENGTH (FEET)	TYPE	LENGTH (FEET)
Dry-van	20, 24, 27, 30, 35, 40, 45	Bulk-dry	24, 40
Reefer	20, 24, 27, 30, 35	Bulk-liquid	20, 35, 40
Refrigerated	20, 27, 40	Side door	20, 40
Ventilated	24, 27	Cartainer	35, 40
Insulated	20, 24, 35, 40	Cattletainer	35
Open-top	20, 35, 40	Garmenttainer	20, 40
Open-top (1/2 high)	40	Housing and office	40
Platform	20, 24, 27, 35, 40	Display	20, 40
Platform (1/2 high)	35, 40	Communications	40

Figure 5-13. Commercial container types

20' x 8' x 8'
20' x 8' x 8'6"
24' x 8' x 8'6"
27' x 8' x 9'6"
30' x 8' x 8'6"
40' x 8' x 8'
40' x 8' x 8'6"
40' x 8' x 9'
40' x 8' x 9'6"
45' x 8' x 9'6 1/2"

Figure 5-14. Dry-van container dimensions

## PALLETS

**General-Purpose.** The general-purpose pallet is a four-way-entry, wooden pallet 48 inches long, 40 inches wide, and about 5 1/4 inches high. It is used primarily for shipping palletized cargo. The pallet may be loaded and shipped from shipper to consignee without rehandling the cargo. The four-way-entry feature permits easy entry by forklift truck forks. See Figure 5-15.

**Sled Pallet.** The sled pallet consists of a heavy, timbered platform and runners on which 3,000 pounds of supplies and equipment may be secured with steel bands. The pallet



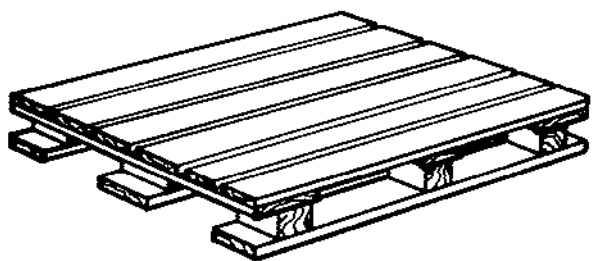

Figure 5-15. General-Purpose Pallet

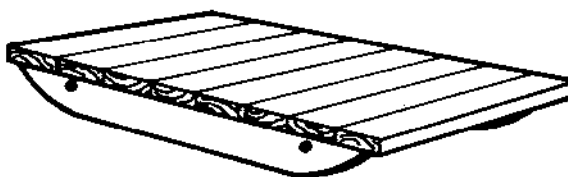

Figure 5-16. Sled pallet

alone weighs 200 pounds. Cables attached to the runners permit towing. Sled pallets maybe moved through any surf or over any beach which may be crossed by LVTPs, wheeled landing vehicles, or similar craft. Rations, water, fuel in 5-gallon containers, and ammunition are the most suitable supplies for pallet loading. See Figure 5-16.

**CARGO ADDRESS MARKINGS**

Cargo address markings show where a shipment is coming from and where it is going. Address markings are required on all items being shipped in the DTS. There are three methods of applying addresses, depending on type of container and priority of shipment: labels, tags, and stencils.

**Labels.** Labels are preprinted forms glued to the package being shipped. Shipping labels are used on boxes, crates, drums, and other containers when practical.

**Tags.** Tags are preprinted cards that have a hole at the center of one end and a string at-

tached through the hole for tying the tag to the cargo. Tags are used on SEAVANS/MILVANS, cloth bags, and other items when it is impractical to apply a label or stencil.

**Stencils.** Stencils are used when space or material surface permits and when the shipment has a low transportation priority not requiring an expedited handling label or tag. Stencils are locally produced address markings normally produced by punching out alphanumeric characters on stencil paper using a stencil cutting machine. The stencil is held against the crate and painted over. The stencil is then removed, leaving clear block letters on the crate.

**Format**

Regardless of whether a label, tag, or stencil is used, the format and information contained in the address marking are basically the same. See Figure 5-17. Numbers in parentheses in the following paragraphs refer to numbers in Figure 5-17.

DD FORM 1387-1 1 MAR 70 *GPO 388-730 EDITION OF 1 APR. 80 MAY BE USED. MILITARY SHIPPING TAG	TRANSPORTATION CONTROL NUMBER (1) AT401571502026 XXA (1)	ROD (2) 310 (2)	PROJECT (3) (3)	TRANS PRIORITY (4) 3 (4)
	FROM: A25788 T0BYHANNA ARMY DEPOT T0BYHANNA, PA 18466 (5)			PIECE NUMBER (10) 3
	TO: (POE when applicable) 3DK MILITARY OCEAN TERMINAL OAKLAND, CA. (6) (7)			
	POD (When applicable) UCL2 INCHON, KOREA (8)			TOTAL PIECES (11) 9
	ULTIMATE CONSIGNEE OR MARK FOR AT 4015 US AECOM DEPOT (9) BUPYONG, KOREA			WEIGHT THIS PIECE (12) 437 CUBE THIS PIECE (13) 73

Figure 5-17. Sample DD Form 1387-1 (Military Shipping Tag)

**Transportation control number (TCN) (1).** The TCN appears on the first line of the address on a cargo shipment label. The TCN is a 17-digit number/letter code group assigned to a shipment unit to identify and control the shipment throughout the transportation system. The TCN is the most important piece of information in the address because it is the reference point for all MILSTAMP documents, shipping actions, and tracer actions.

There are two types of transportation control numbers, MILSTRIP and non-MILSTRIP. The MILSTRIP TCN, which is the most commonly used, is discussed here. See Figure 5-18 for the data contained in a MILSTRIP TCN.

AT4015	7250	2026	X	X	X
1	2	3	4	5	6
1. Activity address code					
2. Year and Julian date of requisition					
3. Requisition serial number					
4. Suffix to requisition when filled by more than one supply agency					
5. Partial shipment indicator					
6. Split shipment indicator					
AT401572502026XAX			-- 1st increment		
AT401572502026XBX			-- 2nd increment		
AT401572502026XZX			-- Last increment		

**Figure 5-18. Example of MILSTRIP TCN**

**Required delivery date (RDD) (2).** The RDD is the Julian date the requisitioner expects the shipment. When necessary to expedite a shipment because of urgent demands, use the expedite-handling code "999" instead of the Julian date. Code "999" identifies the shipment as critically needed; it should receive the highest priority in processing and shipping. A red and white 999 label is put on the front and back of the container.

**Project code (3).** The project code is a three-position code used to identify a shipment made in support of a specific project, program, special exercise, or maneuver. When a project code is not assigned, the shipper leaves this block blank.

**Transportation Priority (4).** Each shipment moving in the DTS is assigned a transporta-

tion priority (TP) number. This priority determines the mode used to ensure delivery to the consignee by the RDD. The shipping transportation officer assigns the TP to the shipment based on information found on supply release documents.

**"From" section (5).** The shipper's coded, in-the-clear address is placed in this space. The coded address is taken from the Department of Defense Address Directory.

**"To" section (6).** When a shipment is going direct from a shipper to the requisitioner without going through an aerial or water port, the coded, in-the-clear address of the consignee (receiver) is placed in this block.

**Port of embarkation (POE) (7).** When a shipment is going to an aerial or water port for onward movement overseas, the coded, in-the-clear address of the POE is placed in the same block as the "to" address.

**Port of debarkation (POD) (8).** The POD is the coded, in-the-clear address of the aerial or water port that will discharge the cargo when it arrives in the overseas area.

**Ultimate consignee (9).** The "ultimate consignee or mark for" block is used only with overseas shipments. This block is not required for domestic shipments as the ultimate consignee will already have been indicated in the "to" block. Oversea shipments require the "ultimate consignee" block for the coded, in-the-clear address of the consignee because the "to" block has already been used for the POE address.

**Piece Number (10) and Total Pieces (11).** Pieces of cargo in a shipment are numbered 1, 2, 3, 4, 5, et cetera until each piece is assigned a number. The highest sequence number is the total pieces in the shipment. For example, if six crates of oranges are shipped to Maine, each crate (piece) will get a number. The second crate will be crate number two of six total pieces. A shipping piece number is applied to each container in a shipment except—

- Shipments of the same commodity in standard containers or packages.
- Full carload and truckload shipments of like items sent to a CONUS activity.

In addition to the individual piece number, the total number of pieces in the shipment is shown in the shipping address. When the address is stenciled on a container, the piece number is shown on the bottom line of the address followed by a slash and the total number of pieces in the shipment. When a label or tag is used, the piece number and total number of pieces are entered in the blocks provided on the bottom line of the address.

**Weight (12).** The gross weight (the combined weight of cargo, packing material, and container) in pounds is entered.

**Cube (13).** For shipping purposes, the cubic measurement (cube) of a piece of cargo is expressed in cubic feet. Shipments are occasionally received for transshipment that do not show the cube of the container. When this occurs, the checker should measure the container and mark the cube on it. Compute the cube by multiplying length, width, and height of the container. If the measurements are not all even feet, convert all dimensions to inches and divide the total by 1,728.

## APPENDIX A

## ORDERS, PLANS, AND SOP FORMATS

The formats in this appendix (Figures A-1 through A-12) have been condensed for the transportation planner. Normally, these formats apply only in the initial stages of planning. See AR 380-5 for classification procedures.

\_\_\_\_\_  
(Classification)

Copy \_\_\_\_\_ of \_\_\_\_\_ copies  
Issuing headquarters  
Place of issue (*may be in code*)  
Date-time group of signature  
Message reference number

OPERATION PLAN (ORDER): Type and serial number. (*Type is usually indicated for combined or joint operations but omitted for a single service. When required, a code title may also be included.*)

References: *Maps, charts, and other relevant documents.*

Time zone used throughout the order: \_\_\_\_\_

Task organization: *Task subdivisions or tactical components of the command. (When a task organization is not listed, this information is included in paragraph 3 or in an annex. If an annex is used, indicate "Annex A (Task Organization)."*

1. SITUATION. *General information on the overall situation required to understand current circumstances.*

- a. Enemy Forces. *Composition, disposition, location, movement, estimated strength, identification, and capability.*
- b. Friendly Forces. *Information on forces, other than those covered by this order, which may directly affect actions of subordinates.*
- c. Attachments and Detachments. *Units attached to or detached from the issuing unit (if not shown under task organization) and effective times. (If shown under task organization, appropriate reference is listed here.)*

**Figure A-1. Operation plan (order) format**

2. MISSION. *A clear, concise statement of the task and its purpose.*

3. EXECUTION.

a. First Subparagraph. *The operation's concept, including the commander's general plan for developing and phasing the operation, using fire support, instructing on preparatory fires, and designating unit making the main effort.*

b. Following Subparagraphs. *Specific tasks of each element charged with tactical missions, including the combat organization (if not given under task organization).*

c. Final Subparagraph (Coordinating Instructions). *Details of coordination and control measures applicable to the command as a whole. Also—to avoid repetition—coordinating and operating instructions which apply to two or more elements.*

4. SERVICE SUPPORT. *A statement of CSS instructions and arrangements supporting the operation. Also the commander's direction to CSS commanders. If lengthy, details may be included in an annex and referenced here. At higher levels of command, reference may be made to an administrative/logistics order.*

a. Materiel and Services.

b. Medical Evacuation and Hospitalization.

c. Personnel.

d. Civil-Military Cooperation.

e. Miscellaneous.

5. COMMAND AND SIGNAL. *Command and C-E operation instructions.*

a. Command. *Command post (CP) locations and axis of CP displacement, if not shown on an accompanying overlay. Liaison requirements, designation of alternate CP, and succession of command, if not adequately covered in the SOP.*

b. Signal. *Rules on use of communications and other electronic equipment (for example, radio silence). May refer to an annex, but, as a minimum, should list the current communications-electronics operation instructions (CEOI) index.*

Acknowledgment Instructions.

/s/ \_\_\_\_\_  
Commander (name and rank)

Authentication:

Annexes:

Distribution:

\_\_\_\_\_  
(Classification)

Figure A-1. Operation plan (order) format (cont)

\_\_\_\_\_  
(Classification)

(Change from oral orders, if any)

Copy \_\_\_\_\_ of \_\_\_\_\_ copies  
Issuing headquarters  
Place of issue (*may be in code*)  
Date-time group of signature  
Message reference number

ANNEX \_\_\_\_ (SERVICE SUPPORT) to OPERATION ORDER NO \_\_\_\_

References: *Maps, charts, and other relevant documents.*

Time zone used throughout the order: \_\_\_\_\_

1. GENERAL
2. MATERIEL AND SERVICES
  - a. Supply.
  - b. Transportation.
  - c. Services.
  - d. Maintenance.
  - e. Other (as necessary).
3. MEDICAL EVACUATION AND HOSPITALIZATION
4. PERSONNEL
5. CIVIL-MILITARY COOPERATION
6. MISCELLANEOUS

Acknowledgment instructions.

\_\_\_\_\_  
Last name of commander  
Rank

Authentication:  
Appendixes:  
Distribution:

\_\_\_\_\_  
(Classification)

**Figure A-2. Service support annex format**

(Appendix issued with the annex)

(Classification)

APPENDIX 1 (TRAFFIC CIRCULATION AND CONTROL) to ANNEX E (SERVICE SUPPORT) to OPERATION ORDER 14 - 23d Armd Div

Reference: Map, series V762, UNITED STATES, sheet 4071 (UPTON), edition 3-AMS, 1:50,000.

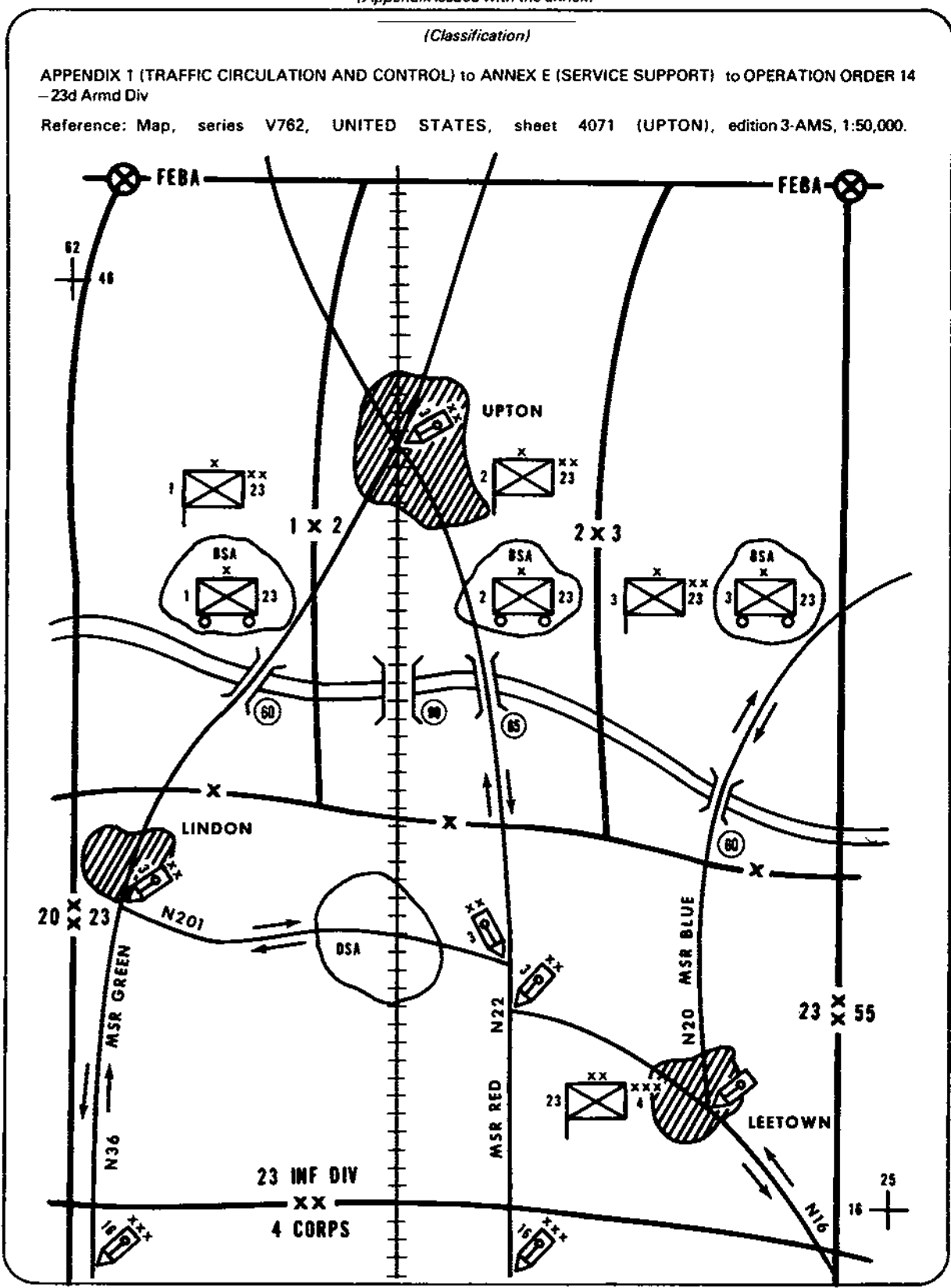

Figure A-3. Sample traffic circulation and control appendix to service support annex, division

(Classification)

(Change from oral orders, if any)<sup>1</sup>

Copy \_\_\_\_\_ of \_\_\_\_\_ copies  
 Issuing headquarters  
 Place of issue (may be in code)  
 Date-time group of signature (must include  
 time zone suffix)<sup>2</sup>  
 Message reference number

ADMINISTRATIVE/LOGISTICS PLAN (ORDER) NO \_\_\_\_\_<sup>3</sup>

RELATED OPERATION PLAN (ORDER) NO \_\_\_\_\_ (when applicable)

References: *Maps, charts, and other relevant documents.*<sup>4</sup>

Time zone used throughout the plan (order): \_\_\_\_\_

Composition and location of administrative and logistic service units. *This information may appear here, in the appropriate paragraph of the order, or in a trace or overlay. If units are not listed here, this heading may be omitted.*

*Notes appear at end of plan.*

**1. SITUATION.** *A general statement of administrative and logistic factors affecting support of the operation. Information from paragraph 1 of the related operation plan or order which is essential to combat service support.*

a. **Enemy Forces.** *Composition, disposition, location, movements, estimated strength, and identification. (Reference to an operation order or to the intelligence annex to an operation order, if available.) Enemy capabilities that may influence the CSS mission.*

b. **Friendly Forces.** *Pertinent information on own forces that may directly influence the CSS mission, if not covered by a referenced operation order or included in subsequent paragraphs.*

c. **Attachments and Detachments.**

d. **Assumptions.**<sup>5</sup>

**2. MISSION.** *A clear, concise statement of the CSS task and its purpose.*

**3. GENERAL.** *An outline of the general plan for CSS and any orders not covered by succeeding paragraphs (for example, location of the division support area and coordinating agencies, general instructions for movement of installation).*

**4. MATERIEL AND SERVICES**

a. **Supply.** *Subparagraphs for each class of supply, maps, water, special supplies, excess materiel, salvage materiel, and captured enemy materiel. When applicable, each subparagraph contains—*

- *Location of the installations concerned with handling supplies and materiel for supported units.*

**Figure A-4. Administrative/logistics plan (order) format**



- Opening and closing times.
- Operating units.
- Supported units.
- Levels of supply.
- Methods and schedules of distribution.
- Instructions for submission of routine reports concerning the supplies listed.
- Any other pertinent instructions or information needed by supported units.

*Instructions and information for two or more classes may be included under one subparagraph if entries are limited and clarity is not sacrificed. For Class V, include designation and location of approving agency, controlled supply rate (CSR), prescribed nuclear load (PNL), and chemical munition allocations, as appropriate.*

**b. Transportation.**

- (1) Location of terminals and installations (*rail stations, airfields, ports, and beaches*).<sup>6</sup>
- (2) Operating units.
- (3) Schedules (*march tables, timetables, and entraining tables*).
- (4) Area responsibilities of transportation movement officers and highway regulating teams.
- (5) Traffic control and regulation measures (*regulations, restrictions, allocation priorities, regulating and control points*).
- (6) Designation of main supply route (MSR).

**c. Services.** *Information and instructions for supported units—type of service available, designation and location of servicing unit or installation, support unit assignments, and service schedules, if applicable. Service missions for service units not covered in other orders (for example, priority of operating units and assignments to supported units). Special missions not covered in other orders.*

- (1) Construction.
- (2) Graves registration. *Collection points, evacuation procedures, and personal effects handling. Procedures for isolated burials and contaminated remains, if not contained in the unit SOP.*
- (3) Field services. *Laundry, bath, clothing renovation and exchange, bakery, and decontamination.*
- (4) Health services. *Medical, dental, veterinary services; laboratory and spectacle service, whole blood control, preventive medicine, and health and sanitation.*
- (5) Installation service. *Real estate, repair and utilities, fire protection, sewage and trash disposal, and water supply.*
- (6) Other. *Aviation, explosive ordnance disposal, photography, and procurement.*

**d. Labor.** *Policies and restrictions on using civilians, enemy prisoners of war (EPWs), and civilian internees and detainees; allocation and priorities of available labor; and designation and location of available labor units.*

**e. Maintenance.** *Include priority of maintenance, location of facilities, and collecting points.*

**5. MEDICAL EVACUATION AND HOSPITALIZATION.** *The plan for evacuation and hospitalization of sick, wounded, or injured military personnel.*

**a. Evacuation.** *The evacuation or holding policy. Responsibilities; evacuation routes, means, and schedules. Evacuation and en route treatment policies, when applicable. Specific policy for evacuation by air or ground and for evacuation of NBC-contaminated patients. Medical evacuation request procedures and channels, if different from SOP.*

**Figure A-4. Administrative/logistics plan (order) format (cont)**

b. Hospitalization. *List of all appropriate treatment facilities (dispensaries, aid stations, clearing stations, hospitals), their locations, and times of operation. Definitive treatment policies, including treatment of contaminated casualties, if established.*

c. Other Services. *Pertinent information on any other health services matters (dental, preventive medicine, medical supply, veterinary). Unit locations, support information, policies.*

6. PERSONNEL. *Information and instructions on personnel matters, including foreign civilian labor used in direct military support functions. Under each of the following subparagraphs are listed, when applicable—*

- Installation, location, and times of operation.
- Operating units.
- Units or area served.
- Rest, leave, and rotation criteria; quotas allocated to units.
- Unit responsibility for movement or administration of personnel.
- Reports, requisitions or plans.
- References to previous order, instructions, or SOP.

a. Unit Strength.

(1) Strength reports. *Instructions for submission of data required to keep the commander informed. Instructions include requirements for routine reports and special reports following a mass-destruction attack or a natural disaster.*

(2) Replacements. *A statement establishing validity of existing personnel requisitions. Instructions for submission of requisitions and for processing and moving replacements. Location of replacement units and the units each will support. Type and location of unit replacements under control of the issuing headquarters.*

b. Personnel Management.

(1) Military personnel. *Instructions on classification, assignment, promotion, transfer, reclassification, reduction, elimination, retirement, separation, training, rotation, and economic personnel use.*

(2) Civilian personnel. A list of—

- Sources of civilian labor.
- Locations of civilian personnel offices or other labor administration centers and labor pools.
- Procurement policies and procedures.
- Restrictions on use of civilian labor.
- Administrative and control procedures.
- Pay schedules, allowances, and CSS to be provided.
- Responsibilities of subordinate commanders for administration.

Reference appropriate SOP.<sup>7</sup>

(3) EPWs and civilian internees and detainees. *Instructions on collection, safeguarding, processing, evacuation, use, treatment, and discipline of EPWs and civilian internees and detainees and all other personnel arrested or captured but not immediately identifiable as POWs. Location of EPW and civilian internee facilities.*

c. Morale. *Instructions on leaves, rest and recreation facilities, decorations and awards, postal and finance services, chaplain activities, personal hygiene, morale support activities, post exchanges, and legal assistance.*

d. Discipline, Law, and Order. *Troop conduct and appearance. Control and disposition of stragglers, including location of straggler collecting points and special instruction for augmenting straggler control during mass-destruction attacks. Administration of military justice and relations between military and civilian personnel (fraternization, black marketing, selling government property, and respect for local laws).*

**Figure A-4. Administrative/logistics plan (order) format (cont)**

- e. Headquarters Management. *Instructions on movement, spaced arrangement, organization, and operation. Allocation of shelter for the headquarters and for troops in the HQ area.*
  - f. Miscellaneous. *Personnel administrative matters not specifically assigned to another coordinating staff section or included in the preceding subparagraphs.*
7. CIVIL-MILITARY COOPERATION. *Allocation of civil affairs units, control of refugees, and feeding and treatment of the civilian population.*
8. MISCELLANEOUS. *Special instructions not covered above.*
- a. Boundaries. *Location of rear boundary and any other boundary needed for CSS purposes.*
  - b. Protection. *Measures established for protection of CSS units and installations. Usually, an announcement of the tactical unit providing the protection, CSS units or installations receiving the protection, and any limitations to the protection.<sup>8</sup> Pertinent instructions from the rear area protection plan or reference to an annex.*
  - c. Special Reports. *Reports not included in previous paragraphs and those reports requiring special emphasis.*
  - d. Statement. *Include time or conditions under which the plan is to be placed in effect.<sup>2</sup>*
9. COMMAND AND SIGNAL. *Headquarters location and movements, liaison arrangement, recognition and identification instructions, and general rules on use of communications and other electronic equipment, if necessary. An annex may be used when considered appropriate.*

Acknowledgment instructions.

/s/ \_\_\_\_\_  
 Commander (name and rank)<sup>9</sup>

Authentication:<sup>10</sup>  
 Annexes:  
 Distribution:

<sup>1</sup>Applicable only to an order. The phrase "No change from oral orders" or "No change from oral orders except paragraph \_\_\_\_" will appear here if oral orders have been issued concerning this operation. In the absence of oral orders, this space is left blank.

<sup>2</sup>This is the time the commander actually signs the plan or order and is the effective time of the order unless stated otherwise in paragraph 8.

<sup>3</sup>The type of administrative/logistics plan (order) indicates whether it is Navy, Army, Air Force, combined, or joint. For a single service, the type of administrative/logistics order is normally omitted. When required, a code title may also be included.

<sup>4</sup>Reference to a map should include the map series number and, if required, the country or geographic area, sheet number, name, edition, and scale per STANAG 2029.

<sup>5</sup>Applicable only to a plan.

<sup>6</sup>Items listed in this subparagraph are not limited necessarily to transportation operations and may include ocean, inland waterway, coastal, highway, air, rail, pipeline, and miscellaneous activities.

<sup>7</sup>Or provide specific pay scales and other conditions of employment in an annex.

<sup>8</sup>This announcement is information for CSS units, not an order to the tactical unit involved.

**Figure A-4. Administrative/logistics plan (order) format (cont)**

<sup>9</sup>The commander's last name and rank appear on all copies. The original (copy number 1) must be signed by the commander or a specifically authorized representative. If the chief of staff signs the original, the phrase "FOR THE COMMANDER" is added. The signed copy is the historical copy that remains in the headquarters files.

<sup>10</sup>If the commander or his authorized representative signs a master copy which permits automatic reproduction of the signed document, no further authentication is required. If the signature is not reproduced, authentication by the preparing staff officer is required on all subsequent copies. The commander's last name and rank appear typed in the signature block.

\_\_\_\_\_  
(Classification)

**Figure A-4. Administrative/logistics plan (order) format (cont)**

\_\_\_\_\_  
(Classification)

(Change from oral orders, if any)

Copy \_\_\_\_\_ of \_\_\_\_\_ copies  
Issuing headquarters  
Place of issue (may be in code)  
Date-time group of signature  
Message reference number

ROAD MOVEMENT ORDER NO \_\_\_\_\_

(OR: ANNEX \_\_\_\_\_ (ROAD MOVEMENT) to OPERATION ORDER NO \_\_\_\_\_)

References: *Maps, tables, and other relevant documents.*

Time zone used throughout the order: \_\_\_\_\_ .

Task organization: \_\_\_\_\_ .

**1. SITUATION**

- a. Enemy Forces.
- b. Friendly Forces.
- c. Attachments and Detachments.

**2. MISSION**

**3. EXECUTION**

- a. Concept of Movement.
- b. Tasks of Subordinate Unit.
- c. Detailed Timings.
- d. Coordinating Instructions.
  - (1) Order of march.

**Figure A-5. Road movement order or annex format**

- (2) Routes.
- (3) Density.
- (4) Speed.
- (5) Method of movement.
- (6) Defense for move.
- (7) Start, release, or other critical points.
- (8) Convoy control.
- (9) Harbor areas.<sup>1</sup>
- (10) Halts.
- (11) Lighting.
- (12) Air support.
- e. Other (as necessary).

**4. SERVICE SUPPORT**

- a. Traffic Control.
- b. Recovery.
- c. Medical.
- d. Petroleum, Oil, and Lubricants.
- e. Water.

**5. COMMAND AND SIGNAL**

- a. Commanders.
- b. Communications.
- c. Position of Key Vehicles.

Acknowledgment instructions.

---

*Last name of commander*  
*Rank*

Authentication:  
Appendixes:  
Distribution:

---

<sup>1</sup>A harbor area is a space set aside for normal halts, traffic control, and emergency congestion relief. Harbor areas are used—

- To hold vehicles at both ends of a crossing or defile.
- To make changes in density, especially at first or last light.
- To contain spillovers in serious delays (likely to be caused by enemy air attack or its results).
- To allow columns to rest and carry out maintenance and decontamination.
- To allow elements to change position in column if there is a change in priorities.

---

*(Classification)*

**Figure A-5. Road movement order or annex format (cont)**

(Annex issued with the operation order)

(Classification)

APPENDIX 1 (ROAD MOVEMENT TABLE) to ANNEX K (ROAD MOVEMENT) to OPORD 9-20th Inf Div

Reference: Map, series M504, AFGAN, sheet 4842 (BHAD-WURST), edition 1-DMG, 1:100,000

Time zone used throughout the order: ZULU.

General Data:

1. Average Speed: 20 KPH.
2. Traffic Density: 20 VPK.
3. Halts: SOP.
4. Routes:
  - a. Route RED. Serials: 1, 2, 3, and 5.
  - b. Route BLUE. Serials: 2 and 6.

5. Critical Points:

- a. Route RED.
    - (1) Start point: RJ 413 at MB201699.
    - (2) Release point: RJ 211 at OA990628.
    - (3) Other critical points.
      - (a) RJ (VILLERS) at MB 330718.
      - (b) RJ 242 at NB455701.
      - (c) RJ (LAWST) at DA585692.
      - (d) BLUE River bridge at PA683686.
    - (4) Route classification: 6 x 50.
    - (5) Route restrictions: BLUE River bridge—6 x 50.
  - b. Route BLUE.
    - (1) Start point: RJ 526 at MS229509.
    - (2) Release point: RJ 105 at RS981511.
    - (3) Other critical points.
      - (a) RJ 592 at MS334481.
      - (b) RJ (CHANCE) at NS401490.
      - (c) RJ (VEGAS) at QT790501.
      - (d) BLUE River bridge at RS960495.
    - (4) Route classification: 10 x 50.
    - (5) Route restrictions: BLUE River bridge—6 x 50.
6. Main Routes to Start Points: \*\*\*  
7. Main Routes From Release Points: \*\*\*

NOTES

1. Only the minimum number of headings should be used. Include any information common to two or more movement numbers under the general data paragraphs.
2. Since the table may be issued to personnel concerned with traffic control, security must be remembered. It may not be desirable to include dates or locations.
3. If the table is issued by itself, not as an annex to a more detailed order, the table must be signed or authenticated in the normal way.
4. Critical point is defined as "a selected point along a route used for reference in giving instructions." Critical points include start points, release points, and other points along a route where interference with movement may occur or where timing is critical.
5. The movement number identifies a column (or element of column) during the whole of the movement.

Mov number	Date	Unit	No of vehicles	Load class of heaviest vehicle	From	To	Route	Route to start point	Critical points			Route from release point	Remarks	
									Ref	Due	Clear			
(a)	(b)	(c)	(d)	(e)	(f)	(g)	(h)	(i)	(j)	(k)	(l)	(m)	(n)	
1	***	1st Bde COL Lang, Comdr	***	***	BHAD area	WURST area	RED	***	SP RJ (VILLERS) RJ242 RJ (LAWST) BLUE River bridge RJ (HAINS) RP	0530 0610 0630 0715 0755 0815 0855	0635 0715 0735 0820 0900 0920 1000	***	***	PST 65 min
2	***	2d Bde COL Corley, Comdr	***	***	BHAD area	WURST area	BLUE	***	SP RJ592 RJ (CHANCE) RJ (VEGAS) BLUE River bridge RP	0530 0548 0630 0800 0840 0820	0635 0653 0735 0905 0945 1025	***	***	PST 65 min
3	***	3d Bde COL Smith, Comdr	***	***	BHAD area	WURST area	RED	***	SP RJ (VILLERS) RJ242 RJ (LAWST) BLUE River bridge RJ (HAINS) RP	0650 0730 0750 0835 0915 0935 1015	0755 0835 0755 0940 1020 1040 1120	***	***	PST 65 min
4	***	Div Arty COL Stephens, Comdr	***	***	BHAD area	WURST area	RED	***	SP RJ (VILLERS) RJ242 RJ (LAWST) BLUE River bridge RJ (HAINS) RP	0810 0850 0910 0965 1035 1055 1135	0920 1000 1020 1105 1145 1205 1245	***	***	PST 70 min
5	***	Div Trp LTC Camp, Comdr	***	***	BHAD area	WURST area	RED	***	SP RJ (VILLERS) RJ242 RJ (LAWST) BLUE River bridge RJ (HAINS) RP	0835 1015 1035 1120 1200 1220 1300	1131 1211 1231 1316 1356 1416 1456	***	***	PST 116 min
6	***	DISCOM COL Norling, Comdr	***	***	BHAD area	WURST area	BLUE	***	SP RJ592 RJ (CHANCE) RJ (VEGAS) BLUE River bridge RP	0944 1002 1044 1214 1254 1334	1200 1218 1300 1430 1510 1560	***	***	PST 136 min

Figure A-6. Sample road movement table appendix to road movement annex, division

## STANDING OPERATING PROCEDURES

(command)

1. **PURPOSE.** *Outline of purpose.*
2. **SCOPE.** *Application and coverage.*
3. **UNIT PROCEDURES.** *Action required by subordinate units in preparing unit SOP. A definite statement that SOP of subordinate units will be based on and conform to SOP of the issuing command.*
4. **RESCISIONS.** *Any publications superseded or rescinded by the SOP, including fragmentary SOPs, orders, memorandums, bulletins, and other directives.*
5. **REFERENCES.** *Publications to be used with the SOP.*
6. **DEFINITIONS.** *Terms defined, if required to understand and interpret the SOP.*
7. **TRANSPORTATION ORGANIZATION.** *Missions, organizations, and functions (unless published elsewhere) of:*
  - a. **Office of the Transportation Officer.**
    - (1) Transportation officer.
    - (2) Deputy transportation officer or executive officer.
    - (3) Staff sections.
    - (4) Liaison officers.
  - b. **Field Installations.**
    - (1) Water terminals.
    - (2) Transportation supply depots.
    - (3) Transfer points and other special transportation activities.
    - (4) Transportation movements branch and other transportation organizations.
8. **ADMINISTRATION.**
  - a. **General.** *Command policies and directives.*
  - b. **Correspondence.**
    - (1) **Types.** *Instructions for preparing, forwarding, and handling; paper economy measures.*
    - (2) **Classified documents.** *Types of classification and authority to classify; handling, delivery, and receipting methods and procedures; security measures and responsibilities.*
  - c. **Personnel.**
    - (1) **General.** *Command policies and directives.*
    - (2) **Local civilian labor.** *Command policies and administrative procedures for procurement, use, and pay; Geneva convention provisions.*
    - (3) **Prisoners of war.** *Command policies and administrative procedures for procurement as labor; use, treatment, and security; Geneva convention provisions.*
    - (4) **Replacements.** *Responsibilities and procedures for requisitioning transportation replacements, command policies and directives.*
  - d. **Reports.** *Types of administrative reports required; method and frequency of submission (samples to be appended); control procedures.*
9. **INTELLIGENCE**
  - a. **General.** *Transportation intelligence purpose, mission, types; command directives.*

**Figure A-7. Transportation SOP format for major commands**

- b. Information Collection. *Collection agencies, essential elements of information, sources, coordination, collection plan, methods, reporting and disposition of captured enemy material.*
- c. Information Processing. *Responsibilities and procedures for recording, evaluating, and interpreting information.*
- d. Dissemination. *Policies, methods, criteria, security classifications, transmissions, time considerations.*
- e. Use. *General application of intelligence to transportation operations and planning; precautions against enemy counterintelligence.*
- f. Counterintelligence. *Objectives, responsibilities, and application to the transportation service.*
- g. Reconnaissance. *Purpose and responsibilities.*

#### 10. PLANS

- a. Transportation Requirements. *Responsibilities for maintaining current lists of transportation requirements for movement of the unit or its elements by rail, truck, inland waterway, and air.*
- b. Transport Availability. *Responsibilities for maintaining current lists of available transportation—organic, assigned, or attached to the unit, including local civilian transportation.*
- c. Load Plans. *Responsibilities of subordinate units for maintaining current load plans; designation of vehicles to transport personnel, supplies, and organizational equipment.*
- d. Traffic Circulation Plans. *A statement that traffic circulation plans will be coordinated with traffic circulation plan of this headquarters.*
- e. Special Operations. *A statement that transportation aspects of subordinate troop plans for special operations (for example, river crossing, pursuit, retrograde movement) will be coordinated with this headquarters.*
- f. Plans by Units in Reserve. *Statements that plans by these units for forward or lateral movement will be coordinated with this headquarters.*
- g. Organizational Transportation Pool. *Procedures, including availability reports, unit responsibilities for furnishing personnel, maintenance of equipment, and administrative support.*
- h. Civil Aid. *A statement that services and subordinate units will submit plans in advance for movement of civilians and civil aid supplies and that plans will not be carried out without prior approval.*
- i. Main Supply Routes and Supply and Service Installations.

#### 11. TRAINING

- a. Responsibilities and procedures for preparing and supervising training programs of transportation units.
- b. Responsibilities and procedures for exercising technical supervision over transportation training throughout the command.

12. REAR BATTLE OPERATIONS. *Command policies and directives; responsibilities of units for BASE defense; defense against airborne operations, NBC attack, sabotage, infiltration, and guerrilla warfare; procedures for reporting enemy activity.*

#### 13. AMPHIBIOUS OPERATIONS

- a. General. *A statement that this SOP standardizes normal procedures for preparation and execution of amphibious operations and will apply unless otherwise prescribed.*
  - (1) Subordinate units will issue SOPs which conform to this SOP.
  - (2) References.
- b. Planning.
  - (1) Requirements of the tactical plan and the scheme of maneuver.

**Figure A-7. Transportation SOP format for major commands (cont)**



- (2) Availability of landing craft and ships by type, size, cargo, and personnel capacity.
- (3) Establishment of close liaison with the Navy and Air Force and with task force commanders.
- (4) Landing force embarkation and tonnage; equipment and supplies breakdown from tables submitted by task force commanders.
- (5) Unit loading and embarkation training arrangements and coordination.
- (6) Movement of the embarkation areas and delivery of equipment and supplies, including waterproofing, marking, and palletizing.
- (7) Supervision within the embarkation area.
- (8) Buildup period for supplies and ship turnaround time.
- (9) Alternate logistical procedures or an entire alternate plan to support alternate tactical plans being considered.
- c. Movement to Staging Area.
  - (1) Warning orders.
  - (2) Movement method—rail, highway, air, water.
  - (3) Movement control.
- d. Staging Area.
  - (1) Reception.
  - (2) Spot delivery of equipment.
  - (3) Control points which control flow of equipment and personnel to embarkation points or assembly areas.
  - (4) Assembly areas for temporary storage of equipment and supplies to be loaded on transports.
  - (5) Transportation for supplies and equipment from assembly areas to ships.
  - (6) Areas for final waterproofing.
  - (7) Facilities to prepare cargo not already processed for loading.
- e. Embarkation of Troops.
  - (1) Movement to embarkation point or assembly areas.
  - (2) Control of movement to vessels.
- f. Movement to Objective Area. In accordance with naval directives.
- g. Ship-to-Shore Movement.
  - (1) Debarkation of equipment, supplies, and service troops at the proper time to support tactical operation.
  - (2) Control and landing of emergency supplies.
  - (3) Evacuation of casualties by water.
- h. Beach Organization.
  - (1) Transportation unit reconnaissance party.
  - (2) Consolidation of supplies and transportation for subsequent logistical support of the landing force.
  - (3) Control.
    - (a) Vehicular traffic.
    - (b) Transfer operations (buildup area).
  - (4) Communication between beach organization and control vessel and ships.

#### 14. INSPECTIONS

- a. Reference. *Higher headquarters SOP on inspections.*
- b. Purpose.
- c. Policy.
- d. Types. *Vehicle use, transportation training, maintenance and maintenance support quality, operations efficiency, records system.*
- e. Frequency.

**Figure A-7. Transportation SOP format for major commands (cont)**

- f. Before-Inspection Procedures.
- g. After-Inspection Procedures.
- h. Reports. *A sample format, number of copies required, and distribution.*

15. AIRBORNE OPERATIONS. *Command policies and directives; responsibilities and procedures for transportation units participating in airborne operations.*

16. COMMUNICATIONS

- a. Communications for coordinating transportation.
- b. Air-ground communications for coordinating airdrops and land transportation.
- c. Reference to communications diagram.

/s/ \_\_\_\_\_  
Commander (name and rank)

Authentication:  
Annexes:  
Distribution:

*Figure A-7. Transportation SOP format for major commands (cont)*

**STANDING OPERATING PROCEDURES**

\_\_\_\_\_  
Unit

Section I. GENERAL

1. APPLICATION. *Operations which SOP covers.*
2. PURPOSE.
3. REFERENCES. *FMs, TMs, SOPs of higher headquarters, other.*
4. RESPONSIBILITY FOR PREPARATION, CHANGES, REVISIONS.
5. EFFECTIVE DATE.

Section II. COMMAND, STAFF, LIAISON

6. ORGANIZATION.
7. COMMAND POSTS.
  - a. Normal location in relation to next higher headquarters.
  - b. Change of location—reporting; coordinates and time.

*Figure A-8. Transportation SOP format for units*

- c. Forward command posts.
  - (1) Requirement.
  - (2) Organization.
  - (3) Personnel and equipment.
- 8. STAFF DUTIES
  - a. Staff officers.
  - b. Special staff officers.
- 9. LIAISON
  - a. Duties of liaison officers.
  - b. Unit's responsibilities for liaison -- higher, lower, and adjacent units.
- 10. PLANNING. *Responsibilities.*

### Section III. ADMINISTRATION

- 11. CHAIN OF COMMAND.
- 12. REPORTS.
  - a. Routine.
  - b. Special.
  - c. Submission.
    - (1) Title and reports-control symbol.
    - (2) Format.
    - (3) Date due.
    - (4) Number of copies.
    - (5) Negative report, if required.
- 13. PROMOTION POLICIES.
  - a. Officer.
  - b. Enlisted.
  - c. Battlefield.
- 14. COURTS-MARTIAL.
  - a. Location of jurisdiction.
  - b. Procedure for submitting cases.
- 15. MAIL.
  - a. Handling official mail.
  - b. Handling personal mail.
- 16. LEAVES AND PASSES.
  - a. Command policy. *Conduct, VD control.*
  - b. Authority.
- 17. JOURNALS AND HISTORY.
  - a. Unit journal and history.
  - b. Staff section journals.
- 18. MILITARY PUBLICATIONS. *Distribution.*
- 19. PRISONERS OF WAR
  - a. Reference.
  - b. Special instructions for capturing unit.

**Figure A-8. Transportation SOP format for units (cont)**

## 20. AWARDS AND DECORATIONS

- a. Channels.
- b. Form.
- c. Presentation.

## 21. ORDERS

## 22. BILLETS AND BIVOUACS

- a. Policies. *Occupation and clearance.*
- b. Billeting party.

## Section IV. MOVEMENT

23. HIGHER HEADQUARTERS SOP. *Reference.*

## 24. MOTOR MOVEMENT

- a. Vehicles. *Preparation for movement.*
- b. Motor marches.
  - (1) Strip maps.
  - (2) Route reconnaissance.
  - (3) Messing and refueling.
  - (4) Night marches.
  - (5) Makeup of march units and serials.
  - (6) Vehicle gap.
  - (7) Speed and rate of march.
    - (a) Column rate of march.
    - (b) Lead vehicle speed.
    - (c) Permissible catch-up speed.
    - (d) March unit or serial time length.
  - (8) Posting traffic guards during halt.
- c. Infiltration.
- d. Personnel. *Conduct during movement.*
  - (1) Passengers.
  - (2) Drivers.

## 25. VEHICLE AND EQUIPMENT OPERATIONS

- a. Motor pool.
  - (1) Dispatch.
  - (2) Service.
  - (3) Maintenance.
- b. Administrative vehicles. *Regulations.*

## 26. RAIL MOVEMENTS

- a. S1 Action. *Movement policy.*
- b. S2 Action.
  - (1) Reconnaissance report.
  - (2) Security.
- c. S3 Action.
  - (1) Troop list.
  - (2) Loading plan.
  - (3) Transportation movement teams.

*Figure A-8. Transportation SOP format for units (cont)*

- d. S4 Action.
  - (1) Transportation request.
  - (2) Troop and guard mess.
  - (3) Blocking and dunnage.
  - (4) Shipping documents.
  - (5) Rolling stock.
  - (6) Loading schedules and area.

27. AIR MOVEMENT

- a. S1 Action.
- b. S2 Action.
- c. S3 Action.
  - (1) Aircraft required.
  - (2) Loading plan.
  - (3) Loading schedule and areas.
  - (4) Air-transportability technique.
- d. S4 Action.
  - (1) Transportation request.
  - (2) Availability of tie-down devices or material.
  - (3) Weight-of-equipment data for loading computation.
  - (4) Shipping documents.
  - (5) Vehicles required to load and unload aircraft.

28. WATER MOVEMENT

- a. S2 Action. *Movement policy.*
- b. S2 Action.
  - (1) Reconnaissance report.
  - (2) Security.
- c. S3 Action.
  - (1) Troop list.
  - (2) Loading plan.
  - (3) Transportation movement teams.
- d. S4 Action.
  - (1) Transportation request.
  - (2) Troop mess.
  - (3) Shipping documents.
  - (4) Vessels required.
  - (5) Loading schedule and area.

Section V. SECURITY

29. POLICIES AND RESPONSIBILITIES

30. MOVEMENT SECURITY

- a. Air guards.
- b. Manning of vehicular weapons.
- c. Camouflage during halts.
- d. Advance, flank, and rear guards.
- e. Action to be taken in attack.

31. BIVOUAC SECURITY

- a. Camouflage.
- b. Mines and booby traps.

*Figure A-8. Transportation SOP format for units (cont)*

- c. Defensive positions.
  - d. Joint security.
  - e. Security plans.
  - f. Sentry posts and outposts.
32. ATTACK WARNING SIGNALS
- a. Air.
  - b. Airborne.
  - c. Mechanized.
  - d. Troops.
  - e. Nuclear, biological, chemical.
33. FIRE SAFETY AND FIRE FIGHTING
- a. Plans.
  - b. Fire personnel and duties.
  - c. Safety rules (*motor pool, kitchen, other*).
34. ALERT PLANS
- a. Unit plan.
  - b. Alert roster.
  - c. Armament and equipment.
  - d. Alert warning phase system.
35. EQUIPMENT DESTRUCTION

#### Section VI. COMMUNICATIONS

36. AVAILABLE COMMUNICATIONS MEANS
37. ESTABLISHMENT OF COMMUNICATIONS
- a. Organic communications.
  - b. Area communications support.
  - c. Responsibilities.
38. COMMUNICATIONS PROCEDURES
- a. Voice radio.
  - b. Radio and wire integration (RWI).
  - c. Message.
  - d. Visual and sonic.
  - e. Reference to higher headquarters CEOI.
39. SIGNAL MAINTENANCE RESPONSIBILITIES
- a. Commander.
  - b. Signal/communications officer.
  - c. Operators.
  - d. Users.

#### Section VII. RECONNAISSANCE, INTELLIGENCE, AND COUNTERINTELLIGENCE

40. RECONNAISSANCE. *Essential elements of information.*
41. COMBAT INTELLIGENCE
- a. Definition of "spot reports."
  - b. Requirement for spot reports.

**Figure A-8. Transportation SOP format for units (cont)**

- (1) Initial contact with enemy.
- (2) Marked change in enemy disposition or situation.
- (3) Armored, air, or airborne attack.
- (4) New units identified.
- (5) Enemy strength, composition, and movement.
- (6) Location of enemy installations.
- (7) Use of chemicals or new weapons.
- (8) New materials or equipment.

42. COUNTERINTELLIGENCE

- a. Mail censorship.
- b. Blackout discipline.
- c. Information.
  - (1) To enemy captors.
  - (2) To press representatives.
- d. Signs and countersigns.
- e. Classified documents destruction.
- f. Civilian control.
- g. Secrecy discipline.

Section VIII. SUPPLY AND MAINTENANCE

43. CLASS I SUPPLY

- a. Ration pickup.
- b. Daily ration return and cycle.
- c. Reserve rations.
  - (1) Unit.
  - (2) Individual.

44. WATER

- a. Authorized source.
- b. Expedient purification methods.
- c. Water economy.

45. CLASS II AND IV SUPPLY

- a. Requisition days for various services.
- b. Pickup procedure.
- c. Salvage turn-in procedures.
- d. Droppage by battle-loss certificate.

46. CLASS III SUPPLY

- a. Resupply.
- b. Fuel reserve.

47. CLASS IIIA SUPPLY

- a. Resupply.
- b. Fuel reserve.

48. CLASS V SUPPLY

- a. Requisition method.
- b. Required forms and certificates.
- c. Basic load.
- d. Salvage.

*Figure A-8. Transportation SOP format for units (cont)*

## 49. VEHICLE AND EQUIPMENT MAINTENANCE

- a. Maintenance category.
- b. Maintenance officer's responsibility.
- c. Required forms.
- d. Priorities.

## 50. REPAIR PARTS

- a. Requisition method.
- b. Stock level maintenance.
- c. Maintenance inspections.
- d. Parts and equipment record.

## 51. VEHICLE AND EQUIPMENT EVACUATION CHANNELS

/s/ \_\_\_\_\_  
Commander (name and rank)

Authentication:

Annexes (May include Wearing of the Uniform, Reports Formats, Destruction of Classified Documents, Duties of Staff Officers, Staff Section SOPs, Loading Plans, Alert Plan).

Distribution:

**Figure A-8. Transportation SOP format for units (cont)**

\_\_\_\_\_  
(Classification)

Issuing unit  
Place of issue (may be in code)  
Date-time group of signature

File No \_\_\_\_\_

Embarkation Plan No \_\_\_\_\_

Maps: *Those needed for understanding the plan.*

References: *SOPs, operation order, administrative order, and other relevant material.*

## 1. ORGANIZATION FOR EMBARKATION

- a. Troop list for each embarkation group. *May be issued as an annex.*
- b. Embarkation schedule. *Assignment of each embarkation group to shipping. Schedule shows berthing of ships and date and hour loading will begin. It also includes date and hour embarkation will be completed by each embarkation group. Other information pertinent to the embarkation schedule may be included. May be issued as an annex.*
- c. Advance parties.
  - (1) Composition.
  - (2) Functions.
  - (3) Movement to embarkation point. *References to SOP if applicable.*

**Figure A-9. Division embarkation order format**



2. SUPPLIES AND EQUIPMENT

- a. Amounts and types of supplies and equipment to be embarked.
- b. Preparation of supplies and equipment for embarkation. *Reference may be made to appropriate SOP.*
- c. Allocation of division supplies and equipment to cargo assembly areas. *May be issued as an annex with appendixes.*

3. EMBARKATION POINTS AND CARGO ASSEMBLY AREAS

- a. Assignment of embarkation points and cargo assembly areas for loading. *(May be a map, sketch, or overlay issued as an annex.)*
- b. Preparation of embarkation points and cargo assembly areas for loading; construction to improve embarkation exits and facilities.
- c. Assignment of mechanical loading devices, such as forklift trucks, cranes, roller conveyors, warehouse pallets.

4. CONTROL

- a. Establishment and functions of embarkation control officer. *Functions may be covered in SOP.*
- b. Traffic circulation and control system in embarkation area and between embarkation area and base camp.
- c. Establishment of security posts for prevention of fire, sabotage, and pilferage in cargo assembly and deck areas.
- d. Communications for embarkation. *References may be made to CEOI.*

5. PERSONNEL

- a. Schedule and method of movement from base camp.
- b. Schedule and instruction for embarkation.

6. MISCELLANEOUS

- a. Embarkation responsibilities and tasks. *Responsibility of embarkation group commanders and tasks of officers. Supply officer, motor transport officer, unit loading officer, other.*
- b. Special loading instructions. *Stowage of certain types of cargo, handling of fragile or dangerous items, other.*
- c. Miscellaneous instructions not covered elsewhere.

Acknowledgment instructions.

By Command of

/s/ \_\_\_\_\_  
Chief of Staff

Authentication:

Annexes:

- Organization of Embarkation Groups - Assignments of Shipping.
- Supplies and Equipment to be Embarked.
- Embarkation Points and Cargo Assembly Areas.
- Others as necessary.

Distribution:

OFFICIAL \_\_\_\_\_

G3

Figure A-9. Division embarkation order format (cont)

## TRANSPORTATION ESTIMATE

Transportation section (unit)

Location

Date-time group

References: *Maps, charts, and other relevant documents.*

1. **MISSION.** *Mission of the command; mission of transportation units in support of the command's tactical and logistical mission. May be obtained from higher headquarters orders or deduced from instructions or knowledge of the situation; may be expressed in terms of personnel or tons of cargo to be transported, discharged, or outloaded.*

### 2. SITUATION AND CONSIDERATIONS

a. **Intelligence.** *Reference to pertinent intelligence estimate.*

b. **Tactical situation.**

(1) Reference to current operation order.

(2) Present and planned disposition of major friendly tactical elements, with emphasis on those units defending lines of communication or transportation units and operations; effect of planned troop moves on transportation operations.

(3) All possible courses of action open to the command to accomplish the mission.

(4) Concept of projecting operations once the immediate mission is accomplished.

c. **Logistics.**

(1) Reference to current ADMIN/LOG order or overlay.

(2) Status of supplies and equipment in all transportation organizations of the command with any inadequacies highlighted.

(3) Any projected developments likely to affect the ability of transportation units to perform their mission from the logistical standpoint.

(4) Status of supplies and equipment in other logistical support units which might adversely affect accomplishment of the mission.

(5) All possible logistical courses of action and the effects of each on possible friendly tactical courses of action.

d. **Personnel.**

(1) Reference to current ADMIN/LOG order or overlay.

(2) Status of personnel in all transportation units, including morale and any other considerations likely to affect their performance.

(3) Status of personnel in other support units to be employed in logistical support of transportation operations which might adversely affect accomplishment of mission.

e. **Assumptions.** *Logical assumptions may be made when there are not enough facts available to prepare the estimate.*

f. **Transportation.** *All known information, as detailed as possible, on each mode of transportation activity.*

(1) Transportation activities. *The format shown in (a) below should be modified as required for (b) through (j).*

**Figure A-10. Transportation estimate format**

(a) Rail.

Unit	Location	Strength Actual & Auth	Facilities Actual & Required	Equipment Lacking	Capability Actual & Potential
------	----------	------------------------------	------------------------------------	----------------------	-------------------------------------

- (b) Motor.
- (c) Inland waterway.
- (d) Air.
- (e) Water.
- (f) Transportation movements.
- (g) Staging areas.
- (h) Transportation depots.
- (i) Pipelines *(even though not operated by transportation units.)*
- (j) Troop carrier space.

(2) Transportation units courses of action. *All courses of action open to transportation units for each possible logistical course of action set forth in paragraph c(5) above.*

g. Special Factors. *Any other factors which might influence the choice of a course of action or the ability to perform the mission, from both the transportation and overall mission standpoints.*

3. ANALYSIS. *A statement and analysis of the effects of each logistical course of action on each transportation activity.*

a. Course of Action. *Use the following format for each course of action mentioned in paragraph 2c(5).*

Activity*	Effect on personnel	Effect on equipment	Effect on facilities	Effect on capabilities
-----------	------------------------	------------------------	-------------------------	---------------------------

b. Alternate Course of Action. *Outline of alternate courses of action, if possible. Use same format as paragraph 3a.*

4. COMPARISON

a. *Dominant transportation factors and modes most likely to be used.*

b. *A comparison, based on the information in paragraph 3, of the various logistical courses of action, including their effects on each mode and its capabilities. The comparison will determine the most favorable course of action from a transportation standpoint.*

c. *Feasibility of the various lines of communications, ports, and beaches as affected by enemy capabilities, weather, terrain, et cetera.*

5. CONCLUSIONS

a. *Statement indicating whether the mission can be accomplished from the standpoint of transportation support.*

b. *Statement indicating which of the possible logistical courses of action can best be supported from the transportation standpoint.*

c. *Statement calling attention to any considerations required should alternate courses of action be chosen.*

(1) *Number and type of transportation units required over and above those available for each course of action if mission cannot be supported.*

(2) *Personnel and/or equipment shortages in existing units which would prevent mission accomplishment.*

\*Same as in paragraph 2f(1).

Figure A-10. Transportation estimate format (cont)

(3) Any repairs or construction work essential to successful mission accomplishment from the transportation standpoint.

(4) Any other transportation considerations which should be brought to the attention of the commander.

/s/ \_\_\_\_\_  
 Transportation officer  
 (name and rank)

Authentication:

Annexes:

Distribution:

*Figure A-10. Transportation estimate format (cont)*

### TRANSPORTATION PLAN NO<sup>1</sup> \_\_\_\_\_

Transportation section (unit)

Location

Date-time group of signature

Maps and references: *Sheet name, number, scale, unit of measure, and series for each map. Other references include city plans, navigation charts, and other plans bearing on the transportation plan.*

Task organization: Annex A, Task Organization.

#### 1. SITUATION

a. Enemy Forces. *All capabilities of the enemy to hinder, disrupt, or otherwise affect operations of transportation units and other elements of the command, including damage to lines of communications, and use of mass-destruction weapons (Annex B, Intelligence).*

b. Friendly Forces. *Units to be supported, their location and strength. Emphasis on units engaged in protection of lines of communication and transportation units or activities, including higher, adjacent, and supporting units of US and allied forces.*

c. Area of Operations.

(1) Weather. *Temperatures, wind conditions, rainfall, tide and river conditions, aeronautical weather information.*

(2) Terrain and hydrography. *Critical terrain features, soil trafficability, beach gradients, and any known obstacles; their possible effects on transportation modes.*

(3) Lines of communication. *All lines of communication and their physical condition.*

d. Attachments and Detachments.

*Figure A-11. Transportation plan format*

e. Assumptions and Policies. *Any pertinent policies and logical assumptions needed to prepare the plan—proposed locations of major unit boundaries, troop strengths supported in different phases of the operation, et cetera.*

2. MISSION. *Mission of transportation units in support of the command.*

3. EXECUTION

a. Concept of Operation. *The transportation officer's overall concept of the operation, including probable increases in supported units and additional territory to be supported. (Annex C, Concept of Operations).*

b. Rail. *Specific tasks assigned to rail units.<sup>2</sup>*

c. Motor.

d. Air.

e. Water.

f. Inland Waterway.

g. Transportation Movements.

h. Staging Areas.

i. Transportation Depots.

j. Pipelines *(even though not operated by transportation units).*

k. Troop Carrier Space. *Proposed use of air capacity allocated to the command.<sup>2 3</sup> (As indicated in b above, similar information for each mode of transportation is best submitted as an annex, the format of which should parallel that of the plan itself as much as practical.)*

l. Coordinating Instructions.

(1) Defense and security. *Reference to appropriate SOP or defense plan.*

(a) Individual.

(b) Facilities.

(c) Lines of communication.

(d) Shipments.

(e) Censorship.

(f) Communications.

(2) Counterintelligence. Annex B, Intelligence.

(3) Technical intelligence. Annex B, Intelligence.

(4) Effective time and date.

4. ADMINISTRATION AND LOGISTICS

a. Administration.

(1) Policies.

(2) Procedures. *SOPs and related guides of higher headquarters not covered elsewhere in the plan.*

(3) Required reports.

b. Logistics.

(1) Transportation supply. *The following items are covered by reference to current SOPs when applicable.*

(a) Levels of supply.

(b) Replacement factors and consumption rates.

(c) Requisition procedures and cycles.

(d) Emergency requisition procedures.

(e) Local procurement.

(f) Controlled items.

(g) Surplus material.

(h) Captured material.

(i) Salvage and scrap.

Figure A-11. Transportation plan format (cont)

- (j) Interservice supply.
  - (k) Class IV equipment.
  - (2) Equipment out of commission for parts procedures.
  - (3) Supply support of transportation mission by other services.
  - (4) Transportation maintenance. *Maintenance facilities by mode, shop locations, and responsibilities of each maintenance unit.*
  - c. Personnel.
    - (1) Policies.
      - (a) Local civilian personnel.
      - (b) Prisoners of war.
      - (c) US civilian personnel.
    - (2) Strengths.
    - (3) Replacements.
    - (4) Procedures.
5. COMMAND AND SIGNAL
- a. Command.
    - (1) Location of major command CPs.
    - (2) Location of transportation movements branches.
  - b. Annex D, Signal.

Acknowledgment instructions.

/s/ \_\_\_\_\_  
 Commander (name and rank)

Authentication:

Annexes:

Distribution:

<sup>1</sup>Any paragraph or subparagraph in the plan may consist wholly or in part of references to appropriate annexes. Annexes in turn may be simplified by referring to appendixes. Each transportation mode should have a separate annex.

<sup>2</sup>Projected loads, schedules, facilities, lines of communication, and similar information are best submitted as annexes to the plan.

<sup>3</sup>Transportation organizations do not assign tasks.

**Figure A-11. Transportation plan format (cont)**

### Feasibility Test for Transportation Plan

#### 1. GENERAL

- a. This test is prepared to enable transportation staff planners to check the feasibility of a transportation plan (annex to administrative orders, letter of instructions, other) after the plan has been prepared.

**Figure A-12. Transportation plan feasibility test format**

b. The test has been prepared in checklist form. Paragraph 2 lists general considerations which apply to all modes of transportation; the remaining paragraphs list items which apply to a specific mode.

c. When using the checklist, consider the items listed in paragraph 2 in addition to the paragraph that applies to the particular mode.

## 2. GENERAL CHECKLIST ITEMS

a. Calculated risks. *Calculated risks involved. Effect on the mission. Governing factors.*

b. Weather and terrain. *General considerations. Favorable or adverse effect on the mission.*

c. Enemy action. *Enemy guerrilla action, clandestine action, other.*

d. Political and economic situation. *Interference with local economy. Friendly or unfriendly attitude of the civilian population.*

e. Transportation net. *Integration of transportation net elements. Portions of the net reserved for civilian use. Emergency procedures for joint civil-military use. Engineer construction support of the present net and future operations.*

f. Allocation and use of modes. *Optimum use of transport capacity. Use of supporting services's capacities. Allocation to modes of tasks corresponding to their capabilities and equipment. Adequate provisions for retrograde cargo.*

g. Logistical support. *Support of modes in quantity and time to accomplish the mission (POL products, repair parts, and so forth).*

h. Task organization.

(1) Clear definition of command relationships, missions, and functions.

(2) Troop list assignments.

(a) Strength.

(b) Training.

(c) Morale.

(d) Available transport equipment.

i. Local civilian and EPW labor. *Availability in the skills required. Requirement for mobile civilian labor units for phase II and phase III operations. Adequate administrative and logistical support.*

## 3. MOTOR TRANSPORT CHECKLIST

a. Requirements versus capabilities.

b. Traffic circulation plan.

(1) Road net support of planned traffic.

(2) Requirement for additional highway regulation personnel.

(3) Adequate road repair and road maintenance support.

(4) Designation of routes (restricted, dispatch, other).

(5) Possible joint use of road net. *Can both combat forces (US and allied forces) and civilian traffic use it simultaneously?*

(6) Availability of hardstand, maintenance areas, truck parks, relay stations, transfer points.

(7) Marked routes; availability of marking signs.

## 4. RAIL

a. Requirements versus capabilities.

b. Unusual weather or terrain factors.

(1) Are heavy rains due that may cause washouts, floods, or landslides?

(2) Is extreme subfreezing weather due?

c. Engineer maintenance and construction support for rehabilitation or for major repair of rail line.

d. Yards, roundhouse, repair shops.

*Figure A-12. Transportation plan feasibility test format (cont)*

- e. Suitable water and fuel supplies (*if steam locomotives are used*).
  - f. Limiting factors.
    - (1) Bridge weight and clearance.
    - (2) Tunnel clearance.
    - (3) Roadbed and trackage.
    - (4) Rolling stock—condition, power, gage.
    - (5) Locomotives—condition, power, gage.
    - (6) Train operations communications.
5. INLAND WATERWAY
- a. Requirements versus capabilities.
  - b. Weather and terrain. *Freeze-up or flood period, tidal ranges, currents, fogs.*
  - c. Obstructions. *Low bridges, types of drawbridges. Natural obstructions, such as heavy weeds, that might foul propellers.*
  - d. Locks. *Locks controlled by assigned permanent personnel or the individual inland waterway craft. Size of locks; amount of time required to pass through.*
  - e. Channels. *Required maintenance. Size, depth, and width.*
  - f. Navigational aids. *Enough fixed or mobile navigational aids for full use, day and night.*
  - g. Requirement for intermediate transfers.
  - h. Condition of available watercraft.
  - i. Marine repair and maintenance support.
  - j. Inland waterway facilities, docks, cranes.
6. PORTS AND BEACHES
- a. Requirements versus capabilities.
  - b. Port facilities.
    - (1) Floating cranes for heavy lifts.
    - (2) Piers, docks, warehouses, open ground areas.
    - (3) Road and rail nets.
    - (4) Navigational aids.
    - (5) Protected anchorage areas.
    - (6) Utilities (electricity, other).
    - (7) Harbor craft.
    - (8) Berth space, lengths, and depths.
  - c. Beach facilities.
    - (1) Anchorage areas.
    - (2) Ingress and egress routes.
    - (3) Road and rail nets.
    - (4) Hardstand and open ground areas.
    - (5) Equipment (*forklifts, cranes, other*).
  - d. Weather and terrain.
    - (1) Ports.
      - (a) Tides and currents.
      - (b) Underwater obstructions.
    - (2) Beaches.
      - (a) Tides, currents, surf, gradient, tidal range.
      - (b) Underwater obstructions.
7. TRANSPORTATION MOVEMENTS
- a. Sufficient teams to accomplish mission.
  - b. Adequacy (flexibility or rigidity) of transportation movements plan.
  - c. Location of teams for maximum use.
  - d. Documentation procedures.

*Figure A-12. Transportation plan feasibility test format (cont)*



**8. STAGING AREAS**

- a. Capability of processing planned work loads.
- b. Adequate facilities.

**9. TRANSPORTATION DEPOTS**

- a. Ability to support the mission.
- b. Adequate facilities.

**10. AIR**

- a. Requirements versus capabilities.
- b. Marginal weather.
  - (1) Low ceilings.
  - (2) Low visibility.
  - (3) Snow and ice.
  - (4) Temperatures.
- c. Terrain. *Altitudes (temperature and altitude affect lift capabilities).*
- d. Navigational aids.
  - (1) Possibility of day and night operations.
  - (2) Ground stations.
    - (a) Ground-controlled approach (GCA).
    - (b) Radio range.
    - (c) Instrument-landing systems.
    - (d) Omnidirectional range (omni range).
    - (e) Radar-plotting station.
  - (3) Airborne navigational equipment.
- e. Communications. *Adequacy of unit communications; augmentation required.*
- f. Flight restrictions.
  - (1) Maintenance of established air routes, including fire lanes.
  - (2) Degree of air superiority.
  - (3) Arrangements for weather reports from Air Force.
- g. Adequacy and location of landing sites or airfields; facilities at these locations.
- h. Maintenance.
  - (1) Condition of aircraft (hours of previous operation).
  - (2) Maintenance units available.
  - (3) Repair parts available.
  - (4) Location and stock of depot support.
- i. Degree of training of supported units in use of logistical air support.

**11. FLEXIBILITY**

- a. Provision for rerouting or diversion.
- b. Interchange points.
- c. Transfer points.
- d. Substitution of one mode for another.
- e. Capability of handling emergency transportation tasks.

***Figure A-12. Transportation plan feasibility test format (cont)***

## APPENDIX B

## TRANSPORTATION-RELATED DATA

This appendix contains miscellaneous data that may be useful in the computations or decision-making processes of daily or long-range planning. It includes those odd pieces of information that are difficult to find or categorize.

## WEIGHT REQUIREMENTS

For methods used to determine weight requirements, see FM 101-10-1. The figures shown in Table B-1 are approximate and are to be used as guides only.

*Table B-1. Capabilities of transportation mediums*

Medium	Tons per day		Adequate to Maintain
	STONs	LTONs	
<b>Highway<sup>1</sup></b>			
Gravel . . . . .	3,400		2 divisions
Medium condition . . . . .	5,800		4 divisions
First-class . . . . .	8,400		7 divisions
<b>Railway, each way</b>			
Single track . . . . .	4,000	3,570	3 divisions
Double track . . . . .	12,000	10,700	9 divisions
<b>Gasoline pipeline<sup>2</sup></b>			
6-inch . . . . .	2,000	1,790	5 to 8 divisions
4-inch . . . . .	930	830	3 divisions
<b>Water terminal discharge rate<sup>3</sup></b>			
Average cargo ship . . . . .	720	643	1/2 division
<b>Across beach</b>			
Per 1,000 yards of beach . . . .	1,680	1,500	1 division plus

<sup>1</sup>Daily forward tonnage, assuming sustained operations, adequate road maintenance, and two-way traffic.

<sup>2</sup>The capacities of pipeline systems vary, depending on the size of pipe, gradient, location, size of pumps, and type of construction. Welded commercial pipelines can be operated at much greater pressures than standard military lines which have flexible couplings.

<sup>3</sup>Water terminal discharge rate of 1,440 STONs per day required to adequately maintain 1 division slice.

**Dogs**

Trained dogs may be used individually or in teams to transport cargo in arctic and subarctic areas. They also have limited use in temperate zones to carry messages and small packages of mail, usually in regions inaccessible to other means of transport. Dogs should be permitted to rest 10 minutes in each hour and should not be worked continuously for more than 16 hours per day. For planning purposes, towed loads should not exceed 100 pounds per dog, although the heavier breeds are capable of loads of 200 pounds per dog on a flat surface with good traction.

The Eskimo dog, or husky, is most commonly used in arctic and subarctic regions—the German shepherd in temperate zones. On packed snow with good traction, an individual dog in a sled team has the cargo-carrying capabilities shown in Table B-2 for carrying cargo packs, messages, and mail. These figures are for normal operating conditions and vary widely under extremes of weather and terrain.

**Table B-2. Cargo-carrying capabilities of sled dogs**

Terrain	Load per Dog <sup>1</sup>		Distance per Hour <sup>2</sup>	
	(lb)	(mi)	(km)	(mi)
Flat	50	9.6	6	
Hilly	50	4.8	3	
Mountainous	50	1.6	1	

<sup>1</sup>Includes weight of sled

<sup>2</sup>Reduce 50 percent when load is doubled.

On hard surfaces with good traction, an individual dog has the capabilities shown in Table B-3 for carrying cargo packs, messages, and mail.

**Table B-3. Carrying capacities of pack dogs**

Terrain	Load per Dog		Distance per Hour			
	Cargo Pack (lb)	Messages or Mail	Cargo Pack		Messages or Mail	
			(km)	(mi)	(km)	(mi)
Flat	35	5 percent	3.2	2	24	15
Hilly	30	of dog's	3.2	2	16	10
Mountainous	25	weight	1.6	1	8	5

**Pack Mules**

Pack mules are generally 59 to 62 inches tall and weigh 1,000 to 1,200 pounds. They can be used to transport one litter or two sitting casualties. They travel at a rate of 3.5 to 4 miles (5.6 to 6.4 kilometers) per hour and can carry from 200 to 250 pounds.

Pack mules require 10 pounds of oats and 14 pounds of hay per day. These amounts may be reduced for short periods up to 10 days without impairing capacity. Pack mules also require at least 10 gallons of water per day and can travel an average daily distance of 12 miles (19 kilometers) in mountainous terrain and 24 miles (39 kilometers) in rolling or flat terrain.

Pack mules can ascend at the rate of 1,650 vertical feet (503 meters) per hour. They are noneffective approximately 3.2 percent of the time. Carts pulled by horses or mules are capable of traveling 20 miles (32 kilometers) per day drawing a payload of 1,000 pounds.

**Table B-4. Transportability criteria for transporting pack mules**

Vehicle	Capacity (Horses or Mules)
Trailer, 2-horse van	2
Truck, 1 1/2-ton, cargo	2
Truck, 2 1/2-ton, cargo	4
Semitrailer, 6-ton, combination animal and cargo	8
Railroad stock car, 40-foot	Approx 25
Railroad stock car, 36-foot	Approx 20 to 25
Airplane, cargo transport	4 to 6 <sup>1</sup>

<sup>1</sup>May be transported at altitudes up to 18,000 feet with no ill effects.

**Human Bearers**

Males can carry an average cargo load of 80 pounds. Females can carry an average cargo load of 30 to 35 pounds. Each litter team consists of 8 to 12 humans.

For average conditions on level terrain, teams can march an average of 12 miles per day. To estimate the time needed to cover a given distance in hilly or mountainous areas, use the following equation. For these conditions, cargo loads given above for males and females should be reduced from 20 to 30 percent, depending upon the steepness of the terrain.

$$T = t + a + d$$

where:

T = total time required

t = time required to march  
a given map distance

a =  $\frac{\text{total ascent in feet during march}}{1,000}$

d =  $\frac{\text{total descent in feet during march}}{1,500}$

Overloading and speeding up operations increase the sick rate and cause desertion. Human bearers are noneffective approximately 30 percent of the time and must be closely supervised to prevent pilferage.

### STOWAGE FACTORS

#### Computation

The stowage factor is the number of cubic feet required to store 1 long ton (2,240 lb) of cargo. It may be computed by using the following formula:

$$\text{Stowage factor (cu ft)} = \frac{\text{cube of cargo (cu ft)}}{\text{weight in pounds}} \times 2,240$$

#### Weight-Volume Ratios

Weight-volume ratios are based on average cubage for each item. The measurement tonnage for any time can be found by multiplying its short ton weight by its conversion factor. Weight-volume ratios by classes of supply are shown in Table B-5. Table B-6 shows average stowage factors by service.

**Table B-5. Weight-volume ratios by classes of supply**

Item <sup>1</sup>	Conversion Factor (STONs to MTONs)	Stowage Factor
Class I:		
Rations	2.1	94
Class II:		
Chemical (incl Class IV)	2.3	103
Engineer	3.3	147
Medical (incl Classes I and IV)	2.5	112
Ordnance	1.8	80
Ordnance vehicle replacement	2.2	99
QM clothing and equipage	2.0	89

**Table B-5. Weight-volume ratios by classes of supply (cont)**

Item <sup>1</sup>	Conversion Factor (STONs to MTONs)	Stowage Factor
QM general supplies	2.8	125
Signal (incl Class IV)	3.8	170
Class III:		
Aviation fuel and lubricants (Class III A)	1.5	67
Fuel for temperate zone	2.0	89
Gas, oil, grease <sup>2</sup> (less aviation)	1.5	67
Class IV:		
Aviation, supply and replacement	4.0	179
Chemical (incl in Class II)		
Engineer construction material	1.5	67
Medical (incl in Class II)		
Ordnance motor maintenance	1.0	45
QM sales items	1.7	76
Signal (incl in Class II)		
Transportation	2.4	108
Class V:		
Ammunition (less aviation)	.9	40
Aviation ammunition	.9	40
Chemical ammunition	1.2	54

<sup>1</sup> Nongas conditions. Figures are based upon average conditions found in European and Pacific theaters; amounts will vary for polar regions.

<sup>2</sup> Consists of the following: 90 percent gasoline, 4 percent diesel fuel, 3 percent engine oil, 1 percent gear lube, 2 percent greases.

**Table B-6. Average of stowage factors by service**

Supply Service	Class of Supply	Stowage Factor
Chemical	All supplies less Class V	103
Engineer	All supplies	107
Medical	All supplies	112
Ordnance	All supplies less Class V	75
Quartermaster	All supplies	87
Signal	All supplies	170
Transportation	All supplies	108
Chemical	Class V	54
Ordnance	Class V	40

#### Average Densities of Common Materials and Specified Supply Items.

Figures shown in Table B-7 aid transportation planners and operators when making loading plans for any mode of transportation. The information given is for specific items. When planning loads for the general classes of supply, refer to Tables B-7, B-8, B-9, and B-10.

**Table B-7. Average densities of common material**

Material	Weight (lb per cu ft)	Material	Weight (lb per cu ft)	Material	Weight (lb per cu ft)
Acid		Coal and coke, piled		Hemp	90
Muriatic, 40%	75	Anthracite	47-58	Hickory timber	48
Nitric, 91%	94	Bituminous or lignite	40-54	Hornblende	187
Sulphuric, 87%	112	Charcoal	10-14	Ice	57
Alcohol, 100%		Coke	23-32	Indigo	63
Ethyl	49	Peat, turf	20-26	Iridium	1,383
Methyl	50	Cobalt	546	Iron	
Aluminum, cast-hammered	165	Concrete		Cast pig	450
Apple timber	44	Plain	140-150	Ferrosilicon	437
Asbestos	153	Reinforced	150	Gray cast	442
Ashes and cinders	40-45	Copper		Ore	
Asphaltum	81	Cast-rolled	556	Hematite	325
Ash timber		Ore, pyrites	262	Hematite in bank	160-180
Black	34	Cork	15	Hematite loose	130-160
White	42	Cotton, compressed	45	Limonite	237
Barley	39	Dolomite	181	Magnetite	315
Barytes	281	Earth		Slag	172
Basalt	184	Dry, loose	76	Spiegeleisen	468
Bauxite	159	Dry, packed	95	Wrought	485
Benzine	50	Moist, loose	78	Ivory	114
Birch timber	44	Moist, packed	96	Jute	30
Bluestone	159	Mud, flowing	108	Kerosene	50
Borax	109	Mud, packed	115	Lead	
Boxwood, dry	60	Ebony timber	78	Pure	710
Brass, cast-rolled	534	Elm timber	35	Ore, galena	465
Bronze		Ether	46	Leather	59
Aluminum	481	Excelsior, baled	19	Lime, gypsum, loose	53-64
Phosphor	554	Feldspar, orthoclase	162	Limestone	
Tin	509	Fir timber		Marble, quartz (solid)	155
Brick	100	Balsam	25	Marble, quartz (quarried, pile)	95
Calcium	98	Douglas	32	Locust timber	45
Cedar timber, white or red	134	Flax	26	Logwood, dry (average)	57
Cement		Flint	162	Lumber, structural (average)	24
Mortar	135	Garbage		Lye, soda (liquid)	106
Portland, loose, dry	94	Green	47	Magnesite	187
Portland, set	183	Tankage	27	Magnesium alloys	112
Chalk	143	Glass		Mahogany timber	44
Chestnut timber	30	Common	162	Manganese	
Cherry timber, wild red	27	Crystal	184	Pure	475
Chloroform	95	Flint	247	Ore, pyrolusite	259
Cinders		Plate or crown	151	Manila	26
Blast furnace	57	Gneiss	175	Maple timber	
Chemical plant	100	Gold		Hard or sugar	43
Clay		Cast-hammered	1,205	White	33
Damp, plastic	110	Coin (US)	1,073	Marble	170
Dry	63	Grain	48	Masonry	
Marl (mineral)	137	Granite	165	Ashlar	
Wet	80	Graphite	135	Bluestone	153
With gravel, dry	100	Gravel		Granite, syenite, gneiss	159
Coal		Damp, loose	87	Limestone	153
Anthracite	97	Dry, compacted	120	Marble	162
Bituminous	84	Greenstone, trap	187	Sandstone	143
Charcoal, oak	33	Gumwood	57	Brick	
Charcoal, pine	23	Gypsum, alabaster	159	Hard brick	128
Coke	75	Hay or straw (bales)	20	Medium brick	112
Lignite	78	Hemlock timber	29		
Peat, turf, dry	47				

**Table B-7. Average densities of common material (cont)**

Material	Weight (lb per cu ft)	Material	Weight (lb per cu ft)	Material	Weight (lb per cu ft)
Sand-lime brick	112	Yellow		Slag-sand	49-55
Soft brick	103	Long-leaf	44	Snow	
Concrete		Short-leaf	38	Compacted	20
Cement, cinder, etc	100	Pitch	69	Fresh	8
Cement, slag, etc	130	Plaster	53	Soapstone, talc	169
Cement, stone, sand	144	Plaster of paris	140	Soda ash	62
Dry rubble		Platinum, cast-hammered	1,330	Soda, bicarbonate	86
Granite, syenite, gneiss	130	Poplar timber	27	Sodium	61
Limestone, marble	125	Porphyry (mineral)	172	Soil, wet	70
Sandstone, bluestone	110	Potassium	54	Spruce timber, white or red	28
Mortar rubble		Pumice, natural	40	Starch	96
Bluestone	147	Quartz, flint	165	Steel	
Granite, syenite, gneiss	153	Rags, baled		Cold-drawn	489
Limestone	147	Cotton	18	Machine	487
Marble	156	Linen	23	Tool	481
Sandstone	137	Woolen	20	Stone riprap, wet	65
Mercury	847	Redwood timber (California)	26	Straw	
Mica	183	Riprap		Baled	24
Monel metal, rolled	555	Limestone	80-85	Loose	3
Mortar		Sandstone	90	Sulphur	125
Lime, set	103	Shale	105	Sulphuric acid	115
Portland cement	135	Rope	42	Sycamore timber	37
Mud (river mud)	90	Rosin	67	Syenite (mineral)	165
Nickel	537	Rubber		Talc	170
Oak timber		Caoutchouc	59	Tallow	59
Chestnut	46	Goods	94	Tar, bituminous	75
Live	54	Pure	60	Teak timber	
Red or black	42	Rye	45	African	62
White	48	Satt, granulated, piled	48	Indian	48
Oats	26	Salt peter	132	Terra-Cotta	122
Oils		Sand and gravel		Tin	
Mineral (lubricants)	57	Dry, loose	90-105	Cast-hammered	459
Vegetable	58	Dry, packed	105-120	Ore, cassiterite	418
Paper		Wet	126	Tobacco	28
Books	58	Sandstone	143	Tungsten	1,200
Manila	37	Sandstone, quarried, piled	82	Turpentine	54
News	38	Sawdust, dry	7	Walnut timber	
Wrapping	10	Serpentine (mineral)	171	Black	37
Writing	64	Shale		White	26
Paraffin	56	Quarried, piled	92	Water	
Petroleum, crude (average)	54	Slate	172	Fresh	62
Phosphate rock, apatite	200	Silver		Sea	64
Phosphoric acid	97	Cast-hammered	656	Wax, bees	61
Pine timber		German	536	Wheat	48
Norway	34	Sisal	24	Willow timber	28
Oregon	32	Slags		Wood pulp	29
Red	30	Bank	67-72	Wool, packed	82
Southern	40	Bank screenings	98-117	Zinc	
White	27	Machine	96	Cast-rolled	440
				Ore, blende	253

**Table B-8. Average densities of subsistence**

Material	Weight (lb per cu ft)	Material	Weight (lb per cu ft)	Material	Weight (lb per cu ft)
<b>Perishables and bulk staples</b>		<b>Poultry</b>		<b>Beets</b>	
<b>Dairy products</b>		Chicken, dressed		Bunched	18.1
Butter	59.0	Fryer	31.5	Topped	30.9
Cheese	30.0	Hen	40.2	Broccoli	17.8
Milk	65.0	Chicken, cut-up	29.6	Cabbage	24.5
<b>Eggs</b>	22.6	Turkey	29.3	Carrots	
<b>Fruits, fresh</b>		<b>Sausage</b>		Bunched	18.9
Apples	31.3	Bologna	32.5	Topped	30.0
Apricots	34.8	Frankfurter	35.2	Cauliflower	18.9
Bananas	13.2	Liver	36.5	Celery	23.4
Blackberries	21.5	Luncheon meat	37.3	Corn, sweet	16.8
Cantaloupe	26.8	Pork, bulk	46.6	Cucumbers	23.1
Casaba (honeydew melon)	24.0	Pork, link	35.2	Eggplant	16.4
Cherries	31.2	Salami	34.8	Lettuce	20.5
Cranberries	24.6	<b>Veal</b>		Onions	
Figs	34.8	Carcass and sides	13.7	Dry	30.9
Grapefruit	31.2	<b>Seafood</b>		Green	16.8
Grapes	28.9	Clams	28.2	<b>Peas</b>	
Lemons	33.2	Crab meat	27.1	Green	14.4
Limes	36.9	Fish		Shelled	26.0
Loganberries	21.1	Drawn	32.8	Peppers, sweet, green	17.6
Oranges	34.2	Fillet	22.1	Potatoes	
Peaches	23.3	Smoked	24.6	Irish	35.7
Pears	24.9	Smoked fillet	51.6	Sweet	31.3
Pineapples	22.1	Oysters	26.5	Radishes	21.6
Plums	25.6	Shrimp	23.9	Spinach	14.8
Raspberries	22.0	<b>Staples</b>		Tomatoes	33.3
Strawberries	22.0	Bread	18.0	Turnips	30.9
Tangerines	35.5	<b>Cereals, bulk</b>		<b>Vegetables, frozen (average for all)</b>	27.0
<b>Fruits, frozen (average for all)</b>	35.2	Barley	39.0	<b>Nonperishables in containers</b>	
<b>Meats</b>		Buckwheat	42.0	(No. 10 can)	40.0
<b>Beef</b>		Corn, rye	45.0	(No. 2½ can)	37.9
Boneless	36.7	Oatmeal	38.0	(No. 2 can)	38.0
Chuck	35.8	Oats	26.0	Apple butter	
Corned	37.1	Wheat	48.0	(No. 10 can)	47.5
Dried, canned	39.8	Coffee	37.0	(No. 2½ can)	45.0
Forequarter	27.0	Cornmeal	40.0	(No. 2 can)	44.5
Hindquarter	19.1	Fats (average)	58.0	Apples, dry (50-lb bag)	33.3
Liver	45.7	Flour		Apricots	
Loin	18.1	Loose	28.0	(No. 10 can)	43.8
Rounds	14.7	Packed	47.0	(No. 2½ can)	42.1
Ribs	23.3	Honey	90.0	(No. 2 can)	41.0
Tenderloin	46.6	Lard	60.0	Bacon (12-lb slab)	37.6
<b>Lamb and mutton Carcass</b>	9.4	Molasses	38.0	<b>Beans</b>	
<b>Pork</b>		Rice	50.0	(No. 10 can)	43.8
Bacon	36.9	Sugar		(No. 2½ can)	42.1
Boston butt	40.2	Brown	45.0	(No. 2 can)	41.0
Ham	40.2	White	42.0	(No. 1 can)	50.7
Ham, canned	37.4	Tea	16.0	Beans, dry (100-lb sack)	39.2
Loin	37.4	<b>Vegetables, fresh</b>		Beans, string	
Pork shoulder	30.9	Asparagus	21.0	(No. 10 can)	41.6
Salt pork	33.5	Beans		(No. 2½ can)	40.0
Spare ribs	30.9	Green or snap	14.7	(No. 2 can)	39.5
		Lima	18.3		

**Table B-8. Average densities of subsistence (cont)**

Material	Weight (lb per cu ft)	Material	Weight (lb per cu ft)	Material	Weight (lb per cu ft)
Beans, canned (5-lb can)	62.0	(No. 2 can)	39.5	Sauerkraut	
Beef, roast (No. 10 can)	42.5	Hash, corned beef (5½-lb pack)	33.1	(No. 10 can)	40.9
Beets		Hash, meat and vegetable		(No. 2½ can)	38.9
(No. 10 can)	42.5	(No. 10 can)	43.8	(No. 2 can)	39.5
(No. 2½ can)	40.0	Jam, assorted		Sausage (2-lb pack)	44.3
(No. 2 can)	41.0	(No. 10 can)	52.5	Sausage, Vienna (1½-lb pack)	36.7
Biscuits, type C (2-lb pack)	28.8	(No. 2½ can)	41.0	Soup, dehydrated (5-lb pack)	28.6
Bouillon cubes (100 per pack)	37.3	(No. 2 can)	47.0	Spaghetti	
Butter (5-lb pack)	45.6	Lard (37-lb container)	46.8	(No. 10 can)	43.2
Cabbage, dehydrated (5-lb pack)	13.8	Luncheon meat (5-lb pack)	49.5	(No. 2½ can)	41.1
Candy, hard (15-lb pack)	33.1	Mackerel (14-oz can)	26.7	(No. 2 can)	41.0
Carrots		Milk, powdered (5-lb container)	31.3	Spinach	
(No. 10 can)	42.5	Milk, evaporated (14½-oz pack)	42.3	(No. 10 can)	40.6
(No. 2½ can)	40.0	Oats, rolled (48-oz pack)	20.9	(No. 2½ can)	38.9
(No. 2 can)	41.0	Peanut butter		(No. 2 can)	38.0
Catsup		Peaches, and/or pears		Stew, meat and vegetable	
(No. 10 can)	45.0	(No. 10 can)	43.8	(28-oz pack)	40.7
(No. 2½ can)	42.1	(No. 2½ can)	41.1	(30-oz pack)	43.6
(No. 2 can)	41.0	(No. 2 can)	42.5	Sugar, granulated	
Cereal, uncooked (22 oz.)	32.7	Peanut butter		(10-lb pack)	56.4
Cereal, individual	8.7	(No. 10 can)	43.8	(100-lb pack)	40.0
Cheese, processed (6-lb pack)	54.4	(No. 2½ can)	41.1	Syrup	
Chile con carne		(No. 2 can)	41.0	(No. 10 can)	52.2
(No. 10 can)	42.5	Peas		(1-lb container)	62.1
(No. 2½ can)	40.0	(No. 10 can)	42.8	Tea (5-lb box)	13.0
(No. 2 can)	41.0	(No. 2 can)	41.0	Tomatoes	
Cocoa (5-lb bag)	25.0	Pickles (1-gal jar)	48.5	(No. 10 can)	41.9
Coffee (16-lb bag)	30.0	Pineapple, sliced		(No. 2½ can)	40.0
Corn		(No. 10 can)	43.8	(No. 2 can)	39.5
(No. 10 can)	43.2	(No. 2½ can)	42.1	Tomato juice	
(No. 2½ can)	41.1	(No. 2 can)	41.0	(No. 10 can)	41.6
(No. 2 can)	41.0	Pineapple juice		(No. 2½ can)	40.0
Crackers, Graham (2-lb pack)	30.0	(No. 10 can)	41.7	(No. 2 can)	39.5
Eggs, dehydrated (No. 10 can)	45.0	(No. 2 can)	41.0	Vegetables, mixed	
Figs		Potatoes, dehydrated		(No. 10 can)	42.5
(No. 10 can)	45.0	(No. 16-lb pack)	33.0	(No. 2 can)	39.5
(No. 2½ can)	42.5	(No. 10-lb pack)	24.7	Vinegar (1-gal jar)	67.0
(No. 2 can)	36.1	Prunes, dry			
Flour (98-lb sack)	36.1	(No. 25-lb bag)	60.0		
Grapefruit		(No. 5-lb bag)	44.4		
(No. 10 can)	41.6	Salmon (1-lb container)	47.7		
(No. 2½ can)	40.0	Salt (100-lb bag)	39.2		



**Table B-9. Average densities of clothing and individual equipment**

Material	Weight (lb per cu ft)	Material	Weight (lb per cu ft)	Material	Weight (lb per cu ft)
Axe, chopping	20	Gloves, cotton	18	Pocket, magazine	25
Bag, barracks	18	Gloves, leather	25	Pole, tent, shelter	28
Bag, duffel	22	Gloves, wool	11	Pouch, first aid	15
Bag, sleeping	17	Handkerchief	25	Raincoat	30
Bar, mosquito	20	Haversack	19	Roll, bedding	32
Belt, cartridge	20	Helmet, steel, boxed	15	Rope, manila	15
Belt, pistol	22	Holster, (various types)	15	Scabbard, rifle	13
Blanket, wool, OD	16	Jacket, field	21	Shirt, cotton, khaki	20
Boots, service, combat	18	Jumper, dungaree	21	Shirt, wool, OG	23
Bunting, wool	21	Laces, shoe	20	Shoes, low quarter	11
Can, meat, aluminum	13	Liner, helmet	6	Shovel, entrenching	28
Canteen, aluminum	9	Mittens, inserts	16	Socks, cotton	16
Cap, garrison, AG 44	18	Muffler, wool, OD	12	Socks, wool	14
Cap, service, wool	4	Necktie, mohair	15	Sweater, wool	15
Carrier, pack	16	Overcoat (w/wool insert)	20	Tent, shelter half	23
Case, canvas, dispatch	13	Pack, field, cargo	19	Towel, bath	15
Coat, wool	14	Pack, field, combat	18	Trousers, cotton, khaki	22
Comforter, wool	7	Pants, sweat	20	Trousers, wool serge	23
Cover, canteen	11	Parka, field, cotton	23	Undershirt, cotton	18
Cup, canteen, aluminum	11	Pin, tent	27		
Drawers, cotton	21	Pocket, cartridge	18		
Drawers, winter	18				

**Table B-10. Average density of organizational field equipment equipment**

Material	Weight (lb per cu ft)	Material	Weight (lb per cu ft)
Can, galvanized (10-gal)	17.6	Paulin, canvas, small <sup>1</sup>	21.0
(24-gal)	7.9	Paulin, canvas, large <sup>1</sup>	43.0
(32-gal)	8.4	Pillow, feather	8.0
Chair, folding, metal	12.8	Pillowcase	21.0
Chair, folding, wood	11.0	Pin, tent, 16-in	36.3
Chest, record, fiber	9.0	Pin, tent, 24-in	30.2
Container, insulated	16.0	Pole, tent, ridge	27.0
Container, water, 5-gal	11.6	Range, field	22.7
Cot, canvas, folding	27.0	Screen, latrine <sup>1</sup>	27.1
Cover, mattress	24.0	Table, camp, folding	9.2
Desk, field, empty, fiber	9.0	Table, mess	1.8
Duck, cotton <sup>1</sup>	32.0	Tent, command post <sup>1</sup>	11.7
Fly, tent, wall <sup>1</sup>	30.0	Tent, GP, med <sup>1</sup>	23.9
Kit, barber	23.0	Tent, storage <sup>1</sup>	36.3
Locker, trunk	9.0	Tent, wall, small <sup>1</sup>	13.0
Mattress, cotton	4.0	Tent, wall, large <sup>1</sup>	25.0

<sup>1</sup>Figures are average. Weight will vary with different types of material.

### Unit Weight for Shipment

For planning purposes, the weight in short tons of a unit is the sum of the combined weights of—

- TOE personnel and individual equipment, assuming an average weight of 240 pounds per man.
- Major items of organizational equipment,
- Class I supplies for three days, assuming 6.6 pounds per ration per man per day.
- Class III supplies necessary to move a unit 100 miles from the destination point after arrival, if authorized in shipment.
- Basic load of Class V.
- Added items that may be authorized by the theater commander or CONUS commander.

## SUPPLY

### Classes

The Army uses classes of supply to identify the different types of materials used for military operations. A general description of the type of material in each of the 10 classes of supply is as follows:

- Class I—subsistence.
- Class II—clothing, individual equipment, tents, tools, and other supplies.
- Class I II—petroleum, fuel, lubricants, and products.
- Class IV—construction material.
- Class V—ammunition.
- Class VI—personal demand (exchange) items.
- Class VII—major end items (tanks, vehicles, generators, and so forth).
- Class VIII—medical supplies,
- Class IX—repair parts,
- Class X—material for nonmilitary programs.

### Quantities

The quantities of material used by an Army force in combat operations will vary depending on such factors as climate and terrain in the area of operations, intensity of combat, size of the force, distances to be traveled, and the type and quantity of supplies available in the host country. When the details of a combat operation are not known or rough resupply estimates are required, general pounds-per-man-per-day planning factors can be used for most of the classes of supply. The planning factors below should be multiplied by the number of men deployed to estimate resupply requirements.

Class I—4.6 lb/man/day.

Class II—6.83 lb/man/day.

Class III (packaged) \*—1.28 lb/man/day.

Class IV—13.12 lb/man/day.

Class VI—0.61 lb/man/day.

Class VIII—0.35 lb/man/day.

Class IX—3.07 lb/man/day.

\*Consists of lubricants in containers and is computed separately from Class III bulk petroleum.

### Planning Factors

The planning factors specified will remain relatively stable regardless of size and type force, terrain, or combat intensity. However, supply Classes III, V, and VII consumption are directly dependent on these variables. At the theater level, 47.8 lb/man/day for Class III, 31.29 lb/man/day for Class V, and 18.84 lb/man/day for Class VII are frequently used for procurement and budgeting. These numbers should not, however, be used in planning for any size force less than a full theater of operations. The consumption factors in Table B-11 can be used for the type division shown and are considered valid for the European environment. Consumption factors for different size units (battalion, brigade, or corps) can be obtained from the US Army Logistics Center, Fort Lee, Virginia. Shipping data for commonly transported items are shown in Tables B-11 through B-14.

**Table B-11. Consumption factors**

Type Division	Class III	Class V	Class VII
Armored	229,381 gal/day	2,250,433 lb/day	1,827,354 lb/day
Infantry (Mech)	225,441 gal/day	2,245,160 lb/day	1,631,006 lb/day
Infantry	174,366 gal/day	2,006,359 lb/day	587,112 lb/day
Airborne	140,066 gal/day	1,362,222 lb/day	186,264 lb/day
Air assault	332,323 gal/day	1,975,446 lb/day	147,903 lb/day

**Table B-12. Shipping data for rations**

Type	Contents	Package or Case		Ration or Packet Including Packaging		Avg Calories Per Ration
		Weight (lb)	Volume (cu ft)	Avg Wt (lb)	Avg Vol (cu ft)	
Meat, Ready-to-eat, individual	12 meals	171	0.83	1.42		1,135
Food packet, long-range patrol	40 packets	36	1.84	0.90		1,100
Food packet, survival, general-purpose	24 packets	20	0.43	0.83		870
Field A <sup>1</sup>				6.0	0.183	4,200
Operational B <sup>2</sup>				6.0	0.127	4,400
Small detachment, five persons <sup>3</sup>	5 rations	28.5	1.1	5.8	0.2	3,600
Combat, indiv <sup>4</sup>	6 rations	38	1.2	6.5	0.2	3,600
Trail, frigid, indiv <sup>5</sup>	8 rations	34	1.6	4.0	0.2	4,400
Supplement, sundries pack (1 pack per 100 men per day) <sup>6</sup>		47	1.9			
Indiv, combat, meat type	4 rations	24		4.8	0.85	3,600
Supplement, aid station (100 8-oz drinks) <sup>7</sup>		20	1.1			
<b>Survival</b>						
Arctic, SA <sup>8</sup>	24 packets	34	0.7	1.5		2,000
Tropic, ST <sup>9</sup>	24 packets	36	0.7	1.5		1,700

<sup>1</sup> Basic field ration of approximately 200 items, including such perishables as fresh and frozen meats, vegetables, and fruit. For use primarily under stable conditions and during static phases of military operations when there are normal cooking and refrigeration facilities. Should be issued in preference to any other type of ration whenever circumstances permit. Components, weight, and volume vary.

<sup>2</sup> Canned or dry items or staple items; for use whenever mess facilities and personnel are available and no perishable foods are issued. Components, weight, and volume vary. SB 10-495 has information on its breakdown. Ration supplement spice pack consists of assorted spices, condiments, and leavening agents to supplement 1,000 operational B rations. The spice pack varies in weight and volume, being tailor-made for different situations and scaled to the B ration.

<sup>3</sup> Nonperishable precooked food which may be eaten hot when organized messing is impossible but feeding in small groups is possible.

<sup>4</sup> Nonperishable precooked food which may be eaten hot or cold and carried and prepared by the individual soldier. For use when the tactical situation is so unstable that messing in small groups is not possible and kitchen facilities are not available.

<sup>5</sup> For use in extremely cold climates by small patrols or trail teams when resupply is impossible.

<sup>6</sup> Comfort items such as toilet articles, tobacco, and candy as a supplement to B rations for issue before the establishment of adequate sales facilities.

<sup>7</sup> Special nourishment in the form of hot, stimulating beverages for combat zone casualties at aid and clearing stations.

<sup>8</sup> For survival kits aboard aircraft operating over arctic regions, in the emergency kit forming a part of the ejection seat in combat aircraft, and in emergency kits for passengers aboard transport aircraft.

<sup>9</sup> Palatable food of high caloric density carried in survival kits of aircraft operating over the tropics.

Table B-13. Shipping data for ammunition

Nomenclature	Number Per Unit	Weight (lb)		Volume (cu ft)		Stowage Factor	
		Crated	Uncrated	Crated	Uncrated	Crated	Uncrated
Block, deml, chain	16	61.1		1.28		44	
Block, deml, 2½ lb, plastic	24	75		1.60		47	
Canister, N2, 37-mm, G	20	102		2.04		45	
Cart, AP, cal .30, in cartons	1,500	112		1.5		30	
Cart, AP, cal .30, 8-rd clip	1,440	112		1.5		30	
Cart, AP, cal .50, in cartons	300	97		1.5		35	
Cart, AP, cal .50, in cartons	350	112		1.5		30	
Cart, AP, 3-in, M78	4	153		3.22		47	
Cart, AP, 7.62-mm, in cartons, grade MG	1,200	86		1.28		33	
Cart, AP, 37-mm, M51	20	104		2.01		43	
Cart, AP, 37-mm, M74	20	91		1.01		50	
Cart, AP, 75-mm, M72	3	80	66	1.51	.83	28	28
Cart, AP, 90-mm, M77	4	237		4.43		42	
Cart, APC, 37-mm, M59	25	99		2.03		46	
Cart, APC, 75-mm, M61	3	83	70	1.84	1.03	50	33
Cart, AP, I&T, cal .30, MLB	1,200	101		1.5		33	
Cart, AP, I&T, cal .50, MLB	265	103		1.5		33	
Cart, AP&T, cal .30, w/b	1,240	98		1.5		33	
Cart, AP&T, cal .30, w/b	1,250	100		1.5		34	
Cart, AP&T, cal .30, w/b	1,200	107		1.5		31	
Cart, AP&T, cal .30, w/b (100 rd)	1,200	92		1.5		37	
Cart, AP&T, cal .30, w/b, 250-rd mag, chest	1,000	77		.9		26	
Cart, B&T, cal .30, w/b	1,200	93		1.5		36	
Cart, B&T, cal .30, w/b 25-rd mag, chest	1,000	77		.9		26	
Cart, B&T, cal .30, w/b	1,250	96		1.5		35	
Cart, B&T, 7.62-mm, 100-rd belt	800			.91			
Cart, B&T, 7.62-mm, 210-rd belt	840			.91			
Cart, B&T, 7.62-mm, 220-rd belt	880			.92			
Cart, ball, cal .30 carbine	3,000	100		.85		19	
Cart, ball, cal .30 carbine	3,450	107		.9		19	
Cart, ball, cal .30, in cartons	1,500	111		1.5		30	
Cart, ball, cal .30, 5-rd clip	1,440	117		1.5		29	
Cart, ball, cal .30, 5-rd clip	1,500	114		1.5		29	
Cart, ball, cal .30, 8-rd clip	1,344	110		1.5		31	
Cart, ball, cal .45, in cartons	1,800	97		.8		19	
Cart, ball, cal .45, in cartons	2,000	111		1.0		20	
Cart, ball, 7.62-mm, linked, grade MG	880	78		.92		26	
Cart, grenade, cal .30, M3	2,000	90		1.5		37	
Cart, HE, 3-in	4	153		3.22		47	
Cart, HE, 37-mm, M54	25	99		2.03		46	
Cart, HE, 37-mm, M63	20	91		2.04		50	
Cart, HE, 37-mm, Mk11	60	114		1.60		31	
Cart, HE, 40-mm, Mk1	16	115		1.80		35	
Cart, HE, 60-mm, M49A2	18	103	82	3.23	2.51	70	69
Cart, HE, 75-mm, M48 w/f M48	3	80	69	1.35	.92	38	30
Cart, HE, 75-mm, M48 w/f M54	3	82	68	1.84	1.03	50	34
Cart, HE, 81-mm, M43A1	6	72	58	1.65	1.08	51	42
Cart, HE, 81-mm, M56	3	55	42	1.33	.91	54	42
Cart, HE, 90-mm, M71	4	237		4.43		42	
Cart, HE, 105-mm, M1 w/f M48	3	172	154	2.37	2.06	31	30
Cart, HE, 105-mm, M54 w/f	3	172	154	2.37	2.06	31	30
Cart, cal .50 in cartons	350	108		1.5		31	
Cart, LE, 37-mm, Mk1	60	105		1.38		29	

**Table B-13. Shipping data for ammunition (cont)**

Nomenclature	Number Per Unit	Weight (lb)		Volume (cu ft)		Stowage Factor	
		Crated	Uncrated	Crated	Uncrated	Crated	Uncrated
Cart, Mk1, 75-mm, wo/f	3	72	57	1.72	.96	54	38
Cart, practice, 37-mm, Mk11	40	90		1.38		34	
Cart, practice, 60-mm, M50A2	18	103	82	2.23	2.51	70	69
Cart, smoke, 75-mm, WP, Mk2	3	72	57	1.72	.96	54	38
Cart, smoke, 75-mm, WP, M64	3	82	70	1.66	.92	45	29
Cart, smoke, 81-mm, WP, M57	3	55	45	1.65	.91	67	45
Cart, smoke, 105-mm, WP, M60	3	172	159	2.37	2.06	31	29
Cart, tracer, cal .50, in cartons	350	111		1.5		30	
Cart, tracer, 7.62-mm, M62 in cartons, grade R	400	28		.54		43	
Cart, tracer, 7.62-mm, M62 in cartons, grade R	960	72		.91		28	
Cart, tracer, 7.62-mm, M62 in cartons, grade R	1,040	78		1.28		37	
Cart, 12-gage, No. 00 buckshot	500	62		.768		28	
Cart, 12-gage, No. 7½	500	58		.768		30	
Chg, prop, M1A1 (green bag) 155H	6	67	40	3.08	1.91	103	107
Chg, prop, M3 (green bag) 155H	6	82	53	3.33	2.68	91	114
Chg, prop, M2 (white bag) 155H	6	82	73	3.26	2.63	89	81
Explosive, cratering, 40 lb	1	51		1.21		53	
Explosive, TNT, 1 lb, B1	50	67.7		1.11		37	
Fuze, det, M6A2	200	64		2.50		88	
Fuze, M10A2	200	64		2.7		95	
Fuze, PD, M46	50	51		.89		39	
Fuze, PD, M47	50	53		.89		38	
Fuze, PD, M51, M51A1, M55, M55A1	25	83		1.46		39	
Fuze, PD, M67	25	78		1.46		42	
Grenade, AT, prct, M11A1	50	87		3.3		85	
Grenade, hand, frag, Mk 11	25	50		1.26		57	
Grenade, hand, off (unfused)	50	50		1.37		62	
Grenade, hand, tug, Mk1A1	24	47		.97		46	
Grenade, rifle, M9 and M9A1	10	32		1.2		83	
Grenade, rifle, prct, M11	50	108		2.8		58	
Mine, AP, blast, M25	96	30					
Mine, AP, frag, M16A1	4	44.8		.77		35	
Mine, AP, shrapnel, directional, M18A1	6	53		1.74		74	
Mine, AT, blast, metallic, hvy, M15	1	49		1.17		54	
Mine, AT, blast, nonmetallic, plastic, M19	2	71.8		1.57		49	
Mine, AT, shaped charge, metallic, M21	4	90.8		4.14		94	
Primer-detonator, M14, 1-sec delay	100	67		1.01		34	
Primer, perc, Mk11, Mk11A, Mk11A1	2,400	96		1.56		36	
Projectile, 8 in, how	1		200				
Projectile, 155-mm, AP, M112B1	1	117		1.34		26	
Projectile, 155-mm, all other	1		96		.83		19
Signal, illumination, ground M17 to M22	61			1.85			
Signal, pistol, rocket, Mk2, red & green star	103			2.57			
Signal, pistol, rocket, Mk2, red & white	31			.92			

**Table B-14. Shipping data for petroleum products**

Product/Container	Number Per Unit	Weight (lb)	Volume (cu ft)	Stowage Factor
<b>Aviation gasoline</b>				
55-gal drum, 18-gage steel	1	373	9.03	54
55-gal drum, 16-gage steel	1	389	8.8	51
55-gal drum, 18-gage light steel	1	364	9.2	56.5
5-gal can, 11-lb can	1	40.5	.81	44.8
<b>83 octane gasoline</b>				
55-gal drum, 18-gage steel	1	384	9.03	52.7
55-gal drum, 16-gage steel	1	400	8.8	49.2
55-gal drum, 18-gage light steel	1	376	9.2	55
5-gal can, 11-lb can	1	41.6	.81	43.6
<b>Kerosene</b>				
55-gal drum, 18-gage steel	1	421	9.03	48.1
55-gal drum, 16-gage steel	1	4379	8.8	45.1
55-gal drum, 18-gage light steel	1	351	9.2	58.8
5-gal can, 11-lb can	1	45	.81	40.4
<b>Diesel fuel</b>				
55-gal drum, 18-gage steel	1	432	9.03	47
55-gal drum, 16-gage steel	1	448	8.8	44.2
55-gal drum, 18-gage light steel	1	430	9.2	47.9
5-gal can, 11-lb can	1	46	.81	39.5
<b>Lubricating oils</b>				
55-gal drum, 18-gage steel	1	472	9.03	42.8
55-gal drum, 16-gage steel	1	488	8.8	40.5
55-gal drum, 18-gage light steel	1	462	9.2	44.6
5-gal can, 11-lb can	1	49	.81	37.1
1-qt cans, 12 per case (crated)	12	35	.88	56.6
1-qt cans, 24 per case (crated)	24	60	1.6	60
5-qt cans, 6 per case (crated)	6	77	1.9	55.7
<b>Grease</b>				
25-lb pails	1	29	.95	73.6
5-lb cans, 6 per case (crated)	6	44	1.1	56

**Planning Terms**

**Consumption Rate.** The average quantity of an item consumed or expended during a given time interval, expressed in quantities per applicable basis.

**Day of Supply.** That quantity of supplies estimated to be required for one day under the conditions of the operation and for the force stated.

**Replacement Factor.** A number expressed as a decimal which, when multiplied by the total projected quantity of an item in use, gives the quantity of that item required to be replaced during a given period of time.

**Slice.** An average logistical planning factor used to obtain estimates of requirements for personnel and material.

**Storage**

**Gross Storage Area.** Average ratio of open-to-covered by classes of supply.

	Ratios of Gross Storage Area	
	Open	Covered
All classes (except bulk POL)	5.5	1
Classes I, II, III (packaged and solid), and IV	4.7	1
Class V (including 10 percent of V-A)	12	1

**Average Stack Height.** Figures given are for use of all services in theaters of operation. For CONUS storage, the figures must be increased 25 percent.

- Covered storage—8 feet (2.4 meters).
- Open storage—6 feet (1.8 meters).

**Ammunition.** Ammunition storage per mile (1.6 km) of road is 1,000 short tons. Ammunition storage per square mile is 5,000 short tons. Table B-15 contains dimensions for packaged missiles and other special ammunition.

**Table B-15. Packaged missiles and other special ammunition**

Weapon	Container and Contents	Container Dimensions			Volume (cu ft)	Gross Weight (lb)	Remarks
		Length (in)	Width (in)	Height (in)			
Hawk	Complete round	216	28¾	41½	149.47	1,950	
	Guidance section	90	29	34		715	Data applicable only when guidance section is shipped separately
	Igniter, rocket motor	29¼	19¾	18½	5.96	155	Packed 24 in wooden box
	Safety and arming device, GM XM32E4 and XM326	28½	14½	10¾	2.46	72.3	Packed 8 in wooden box
	Igniter electrical power unit	17½	12¾	10¾	1.32	35	Packed 24 in wooden box
	Propellant grain, EPU	24¼	15¾	14¾	3.16	65.6	Packed 24 in wooden box
	Propellant grain, inert EPU	24¼	15¾	14¾	3.16	65.6	Packed 24 in wooden box
	Explosive release device	31¼	23¾	10¾	4.32	54.5	Packed 24 in wooden box
	Accumulator, hydraulic, pneumatic (squib activated)	20	20	29	6.50	88	Packed 1 to metal drum
	Guidance section	90	29	34	51.35	715	Metal shipping container Data applicable only when guidance section is shipped separately
Pershing	Warhead section w/ or w/o inert or empty warhead	168	51½	53	260	2,596	Packed in reusable metal container XM483
	Guidance control section, GM	90	65	72	235	2,532	Packed in reusable metal container, XM474
	First stage rocket motor, GM	145	65	70	381.8	9,193	Packed in reusable metal container, XM475
	Second stage rocket motor, GM	145	65	70	381.8	7,365	Packed in reusable metal container, XM476
	Case venting	50	7	12	2.4	32	Packed in reusable metal container, two each per container
SS11	Complete round	40	28	24½	6	157	Wooden crate
SS11/B1	Complete round	36	19¼	20¼	8.3	110	Fiberglass container
Redeye	3 complete rounds	55¼	21¼	20¼	10.4	144	Shipping and storage container, GM system XM547 (tripak)
Redeye	Unipack, 1 round	56½	10	15½	5.1	50	
Shillelagh	Complete round	51	14¾	14¾	6.4	709	Metal container
Entac	Complete round	31	15	15¾	4.1	112	Wooden container
XM454	Complete round	57	22	20	14.5	220	
Chaparral	Complete round	125	18	19	24.7	280	
Hellfire	Complete round	76¼	15½	16½	11.3	175	
Tow	Complete round	58¼	11¾	11¾	4.5	87	
Dragon	Complete round	47½	16	16	7.0	67	
Stinger	Complete round	67¼	13¼	10½	5.3	77	
Roland	Complete round	120	18½	21¾	27.5	625	

**Table B-15. Packaged missiles and other special ammunition (cont)**

Weapon	Container and Contents	Container Dimensions			Volume (cu ft)	Gross Weight (lb)	Remarks
		Length (in)	Width (in)	Height (in)			
Multiple Launch Rocket System (MLRS)	Six-round pod	166	41½	33	131.5	5,078	Six-round shipping and firing container
Pershing II	Guidance Control/Adapter Section	97	72	70½	285	3,500	Packed in reusable metal container
	Radome/Radar Section	78	37	45¾	76.4	1,708	Packed in reusable metal container
	Propulsion Section (1st stage)	190	72	70	554.1	14,410	Packed in reusable metal container
Lance	Guided Missile Main Assemblage, M5 Container	161	39	43	153	3,993	Packed in M599 container
	Guided Missile Main Assemblage, M5, without Propellant, with Gas Generator	161	39	43	153	2,457	Packed in M599 container
	Power Battery Assembly	5	5	4¾	.069	3.75	Packed in wooden box
	Thermal Dry Cartridge Impulse	4¼	3	3	.219	1.25	Packed in wooden box
	Igniter Assembly, S&A	14¼	7¼	7¼	.428	6	Packed in wooden box
	Generator Assembly, Gas Pressure	46	12½	18	4.24	88	Packed in wooden box
	Battery NICAD (CSTS)	19½	16¾	19	3.58	121	Packed in wooden box
	Missile Guidance Set, AN/DJW-48	16	16	24	6.7	78	Packed in metal box
	Pulse Battery	4½	3½	3½	.024	1.5	Packed in wooden box
	Gyroscope Assembly	7¾	7¾	6¾	.231	6.5	Packed in wooden box

**Vehicles.** Minimum hardstand for 2,500 vehicles is 110,000 square feet. Solid footing for a vehicle park for 2,500 vehicles is 4,000,000 square feet. Minimum hardstand for artillery and combat vehicles per item is 350 square feet.

**Containerized and Bulk Cargo.** Table B-16 gives the dimensions of drums, cans, and pails. Table B-17 shows bulk cargo capacities.

**Table B-16. Dimensions of containers**

Nomenclature	Units per Package	Type of Package	Size of Package		
			Length (in)	Width or Diameter (in)	Height (in)
<b>Drum</b>					
US 55-gal, 16-gage	1	drum	0	24½	34¾
US 55-gal, 18-gage	1	drum	0	24¾	34¾
<b>Can</b>					
US 5-gal (gasoline)	1	can	13¾	6½	18¾
US 5-gal (oil)	2	case	—	11¼ <sup>5</sup> / <sub>16</sub>	14¾ <sup>5</sup> / <sub>16</sub>
US 5-qt (oil)	6	case	—	14	10
US 1-qt (oil)	12	case	18	13	6
<b>Pail</b>					
US 25-lb (grease)	1	pail	.0	11½	11½



**Table B-17. Bulk capacities**

Carrier	Capacity (gallons)	Gasoline 91A (STONS)	Lube Oil (STONS)
Barge, coastwise <sup>1</sup>	200,000 to 400,000	45.9 to 91.8	761 to 1,522
Barge, harbor and canal <sup>2</sup>	15,000 to 30,000	257	57 to 114
Barge, Navy pontoon <sup>3</sup>	84,000	930	320
Pipeline <sup>4</sup>			
4-inch	304,000 per day	2,000	1,150
6-inch	655,000 per day <sup>5</sup>	3,500	2,500
8-inch	1,135,000 per day	614 to 1,228	4,350
Railroad tank car	8,000; 10,000; 12,000	24.1; 30.6; 36.8	30.4; 38.1; 45.7
Semitrailer, 12-ton, 4W	5,000	15.3	19
Ship, large tanker <sup>6</sup>	2.5 to 11 million	7,620 to 33,500	9,480 to 43,800
Ship, small tanker <sup>7</sup>	600,000 to 2 million	1,830 to 6,140	2,280 to 7,610
Tank, bolted-steel	10,500; 42,000; 420,000	32.2; 128; 1,280	39.9; 160; 1,600
Tank, portable, fabric <sup>8</sup>	10,000	30.6	38.1
Tank truck, F-3, fuel or oil	750	2.3	2.9
Tank truck, L-2, oil service	600	1.8	2.3
Trailer, fuel servicing	600	1.8	2.3
Transporter, liquid, rolling-wheel type (RLT), 1,000-gal T3 <sup>9</sup>	1,000	3.0	3.7
Truck, tractor and trailer, F-1	4,000	12.2	15.2
Truck, tractor and two trailers, F-1A	8,000	24.4	30.4
Truck, tractor and trailer, F-2	2,000	6.1	7.6
Truck, tractor and two trailers, F-2A	4,000	12.2	15.2

<sup>1</sup> Molded hulls.

<sup>2</sup> Rectangular hulls.

<sup>3</sup> A 6 x 18 pontoon barge carrying three 42,000-gallon tanks loaded to two-thirds capacity.

<sup>4</sup> In maintaining the same volumetric pipeline capacity for gasoline and oil, more pressure is required for the heavier liquid.

<sup>5</sup> Based on 32,500 gallons per hour for 20 hours of operation. In an emergency it can deliver 30,000 gallons per hour for 24 hours of operation or 720,000 gallons per day.

<sup>6</sup> The ship tanker most commonly used is the T2-SE-A1, a 5,922,000-gallon tanker. It is 425 feet long and draws 31 feet. It has three 8-flanged discharge outlets and four discharge pumps rated 1,000 gpm at 100 psi.

<sup>7</sup> Draft loaded, 12 to 20 feet.

<sup>8</sup> When filled, 40 feet long, 12 feet wide, 3 feet high. When empty, it can be rolled to 20 inches by 12 feet; 10 can be carried in a 6 x 6 truck.

<sup>9</sup> A pair of removable synthetic-rubber containers (fuel cells) mounted on an axle and towing unit. Each cell has a capacity of 500 gallons.



FM 55-15

**COLD WEATHER OPERATIONS**

**Consumption Rates**

**Fuel.**

*Coal stoves.* For heating, coal stoves require approximately 20 pounds of coal per day for summer operations (temperatures 10°F or above) and approximately 50 pounds of coal per day for winter operations (temperatures below 10°F). For cooking, coal stoves require approximately 50 pounds of coal per day.

*Generators.* A 5-kw generator burns approximately 20 gallons of gasoline per day in continuous operations. A 30-kw generator burns approximately 30 gallons of diesel fuel oil (VVF 800) per day. A 45-kw generator burns approximately 35 gallons of diesel fuel oil per day (VVF 800).

*Yukon Stoves.* A Yukon stove burns 5 gallons of gasoline in a 10 to 12 hour period while heating the 10-man arctic tent in temperatures of 0°F and lower. This stove will also burn wood or coal.

*Motors/Pumps.* Based on an average of 1 hour of operation per day, 0.2 gallon of gasoline is required to start motors and pumps.

**Lubrication.**

*Engine oil.* Large, general-purpose tractors consume approximately 2 gallons of engine oil per day. The rate is considered equal for OE 30-10-5. The consumption rate for a light vehicle is 0.006 gallon per mile.

*Gear oil.* The rate of gear oil consumption is 0.45 gallon per mile for a large, general-purpose tractor; 0.006 gallon per mile for a light vehicle.

*Grease, artillery and automotive.* GAA is used as an all-purpose grease (also used for water pumps and so forth). The consumption rate is 0.005 pound per mile. Consumption rates for generators and for starting motors and pumps are based on the data shown above for those items.

*Antifreeze.* Initial antifreeze will be added to all vehicles embarking on a cold-weather operation. Refer to Table B-19 to prepare antifreeze solutions.

**Table B-19. Guide for preparation of antifreeze solutions**

Lowest Expected Ambient Temperature (°F)	Arctic Grade Antifreeze (-90°F) (MIL-C-11755)	Ethylene-Glycol Antifreeze (-60°F) (spec O-E-771a, Type I)		Denatured Alcohol (Grade III) <sup>2</sup> Pints Per Gallon of Coolant Capacity <sup>1</sup>
		Pints Per Gallon of Coolant Capacity <sup>1</sup>	Specific Gravity (68°F)	
+20	Freezing point of -90°F	1½	1.002	1½
+10		2	1.036	2¼
0	Issued ready for use and must not be mixed with any other liquid.	2¾	1.047	2¾
-10		3¼	1.055	3¼
-20		3½	1.062	3½
-30		4	1.067	4½
-40		4¾	1.073	5
-50		4½		
-60		4¾		

<sup>1</sup>Includes heaters, and so forth.

<sup>2</sup>Used as temporary emergency expedient when neither arctic grade antifreeze nor ethylene-glycol antifreeze is available.

**CAUTION**

Do not use ethylene-glycol full strength. It will freeze at a higher temperature than ethylene-glycol mixed with water.

**Batteries**

The electrolyte in acid-type storage batteries normally is composed of sulfuric acid and pure water. The proportion of these two substances determines the specific gravity of the electrolyte and the specific gravity in turn determines the state of charge of the battery. When the battery discharges, water is formed, causing a reduction in specific gravity. When the

battery charges, sulfuric acid is formed, causing an increase in specific gravity. When the ratio of acid to water is such that the specific gravity is 1.275 to 1.300 at 80°F, the battery is fully charged. The proportions of acid to water shown in Table B-20 are used to make electrolytes of various specific gravities at 80°F. Freezing points of the resulting electrolytes are also shown.

**Table B-20. Proportions of acid to water/used to make electrolytes**

Parts concentrated sulfuric acid to one part of water		Specific Gravity	Approximate Freezing Point (°F)
By Volume	By Weight		
0.232	0.416	1.200	-16
0.250	0.545	1.210	-25
0.294	0.527	1.240	-51
0.364	0.667	1.280	-90

Extreme cold of arctic and subarctic areas has an adverse effect on storage batteries. At -30 °F, the available energy from a battery is only about 10 percent of what it would be at 80°F. For efficient operation, battery temperatures should be kept from dropping below +30°F. Normally, this is accomplished through the use of winterization kits. Also, the

specific gravity must be kept in the 1.275 to 1.300 range, when corrected to a temperature of +80°F. Specific gravity changes about .002 for each 5-degree temperature change below or above 80 degrees. Specific gravities and approximate state of charge for various temperatures are given in Table B-21.

**Table B-21. Specific gravities and approximate state of charge**

Temperature (°F)	Specific Gravity	Approximate State of Charge (percent)	Temperature (°F)	Specific Gravity	Approximate State of Charge (percent)
-80	1.000 (water)	Fully discharged	-20	1.235-1.260	65
-80	1.130	Discharged	-15	1.237-1.262	68
-75	1.213-1.238	46	-10	1.239-1.264	70
-70	1.215-1.240	48	-5	1.241-1.266	73
-65	1.217-1.242	50	0	1.243-1.268	75
-60	1.219-1.244	52	+5	1.245-1.268	77
-55	1.221-1.246	54	+10	1.247-1.270	79
-50	1.223-1.248	56	+15	1.249-1.272	80
-45	1.225-1.250	58	+20	1.251-1.274	82
-40	1.227-1.252	60	+25	1.253-1.278	84
-35	1.229-1.254	62	+30	1.255-1.280	85
-30	1.231-1.256	63	+80	1.275-1.300	100
-25	1.233-1.258	64			

**Power Vehicles and Sleds.**

Specifications for power vehicles and sleds used in cold weather operations are shown below.

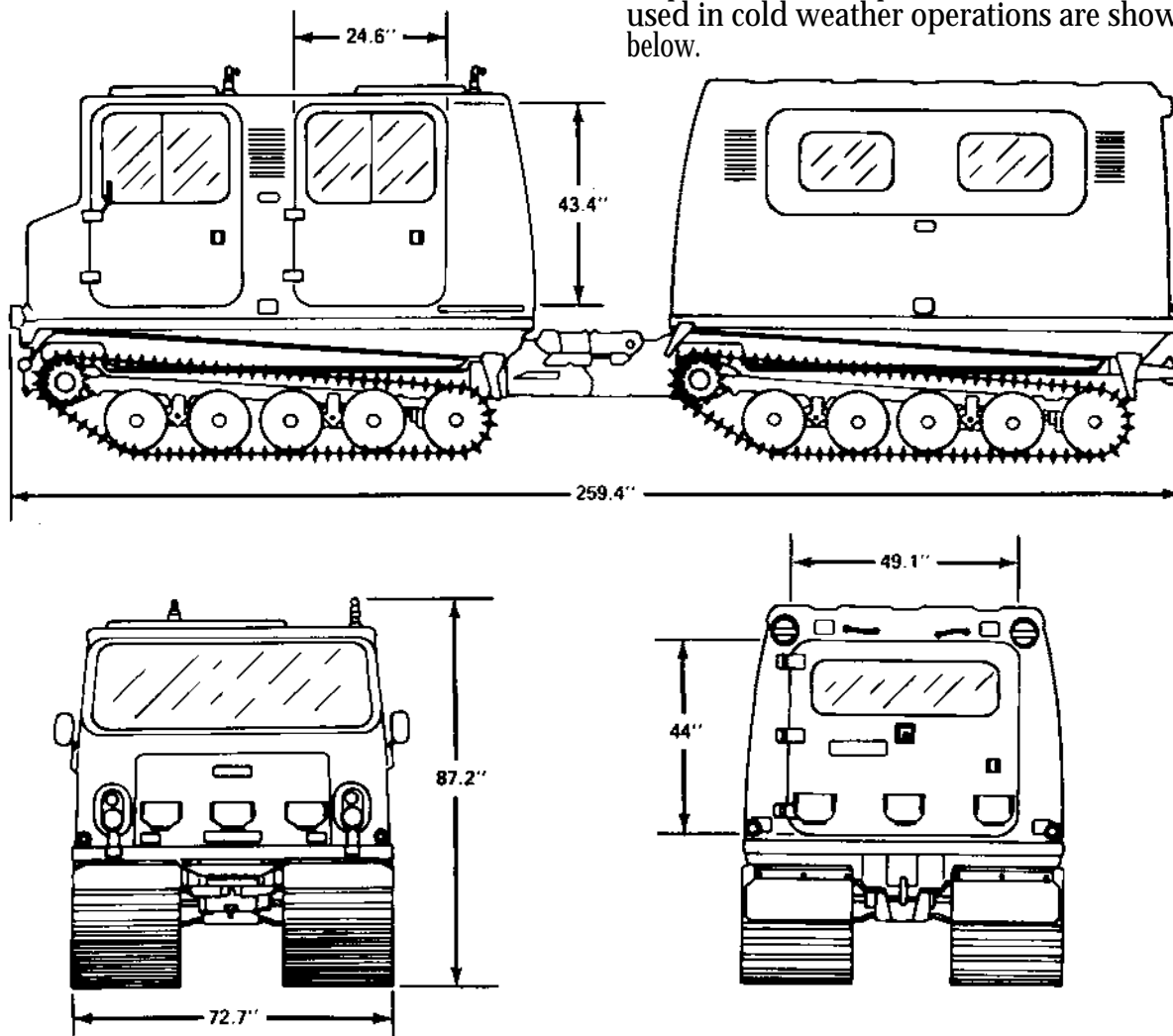

**Power Vehicle Type – BV-206**

<b>Gross weight</b>	<b>Max passenger</b>
Front car – 4800 lbs	Front car – 6
Rear car – 2900 lbs	Rear car – 11
<b>TOTAL 4400 lbs</b>	<b>Speed</b>
<b>Maximum payload</b>	Road – 34 mph
Front car – 1300 lbs	Water – 2.2 mph
Rear Car – 3100 lbs	<b>Forward gradeability</b>
<b>TOTAL 4400 lbs</b>	Hard surface – 31°
<b>Cargo space (LxWxH)</b>	Snow (32") – 17°
Front car – 32 × 57 × 37 inches	<b>Cruising range on roads – 186 mi</b>
Rear car – 98 × 57 × 43 inches	<b>Articulated turning radius – 23 feet</b>
<b>Engine</b>	
Ford V-6, gasoline	
<b>Sled type – AK10 (plastic boat type)</b>	
<b>Dimensions – 88 long × 25 wide × 8 inches deep</b>	
<b>Weight – 38 lbs</b>	
<b>Cargo capacity – 200 lbs</b>	

*Figure B-1. Power vehicle and sled specifications*

## Ice

The strength of ice varies with its structure, the purity of the water from which it is formed, the cycle of formation (freezing, thawing, and refreezing), temperature, snow cover, underlying water currents, and whether or not the ice

is water-supported. Although the sustaining capacity of ice cannot be determined accurately, experience and tests provide the working capacity figures for good quality freshwater ice (see Table B-22).

**Table B-22. Load-bearing capacity of waterborne freshwater ice<sup>1</sup>**

Load	Ice Thickness (in)	Distance Between Units (ft)
File of soldiers (2-pace interval)	3	
Vehicle class		
1	4	60
2	6	70
4	8	80
6	10	90
8	11.5	100
10	13	110
15	15.5	125
20	18	135
25	20	150
30	22	165
40	25	180
50	28	195
60	31	205

<sup>1</sup>Double figures for old sea ice and triple for young sea ice.

## Temperature, Snow Cover, and Precipitation

The temperature chart in Table B-23 may be used as a guide for preliminary planning of operations in the areas shown, keeping in mind that seasonal storms may cause some of the figures to vary for short periods of time. Planners should obtain further information concerning the particular areas and should allow appropriate safety factors when planning for individual clothing, winterization of equipment, and so forth. Temperatures in the chart are not averages, but are the high and low extremes

for each month for each place shown. The figures showing snow cover indicate expected snow depths since packing and partial melting reduce residual quantities. Mean annual precipitation includes snowfall and rain, with the total represented as inches of water (10 inches of snowfall equals 1 inch of water). Generally speaking, most of the precipitation above 70° latitude is snow. This rule should be used with discretion, however, since other factors (longitude, sea currents, air currents, and so forth) affect the type and quantity of precipitation.



## Windchill

For windchill factors, see Table B-24.

**Table B-24. Windchill chart**

Wind speed Knots) (mph)		Cooling power of wind expressed as "equivalent chill temperature"																				
		Air temperature (°F)																				
		40	35	30	25	20	15	10	5	0	5	10	15	20	25	30	35	40	45	50	55	60
Calm	Calm	40	35	30	25	20	15	10	5	0	5	10	15	20	25	30	35	40	45	50	55	60
	3-6	5	35	30	25	20	15	10	5	0	5	10	15	20	25	30	35	40	45	50	55	60
7-10	10	30	20	15	10	5	0	-10	-15	-20	-25	-35	-40	-45	-50	-60	-65	-70	-75	-80	-90	-95
	15	25	15	10	0	5	-10	-20	-25	-30	-40	-45	-50	-60	-65	-70	-80	-85	-90	-100	-105	-110
16-19	20	20	10	5	0	-10	-15	-25	-30	-35	-45	-50	-60	-65	-75	-80	-85	-95	-100	-110	-115	-120
	25	15	10	0	-5	-15	-20	-30	-35	-45	-50	-60	-65	-75	-80	-90	-95	-105	-110	-120	-125	-135
24-28	30	10	5	0	-10	-20	-25	-30	-40	-50	-55	-65	-70	-80	-85	-95	-100	-110	-115	-125	-130	-140
	35	10	5	-5	-10	-20	-30	-35	-40	-50	-60	-65	-75	-80	-90	-100	-105	-115	-120	-130	-135	-145
33-36	40	10	0	-5	-15	-20	-30	-35	-45	-55	-60	-70	-75	-85	-95	-100	-110	-115	-125	-130	-140	-150
	Winds above 0 mph have little additional effect)		LITTLE DANGER					INCREASING DANGER (Flesh may freeze within 1 minute)					GREAT DANGER (Flesh may freeze within 30 seconds)									



FM 55-15

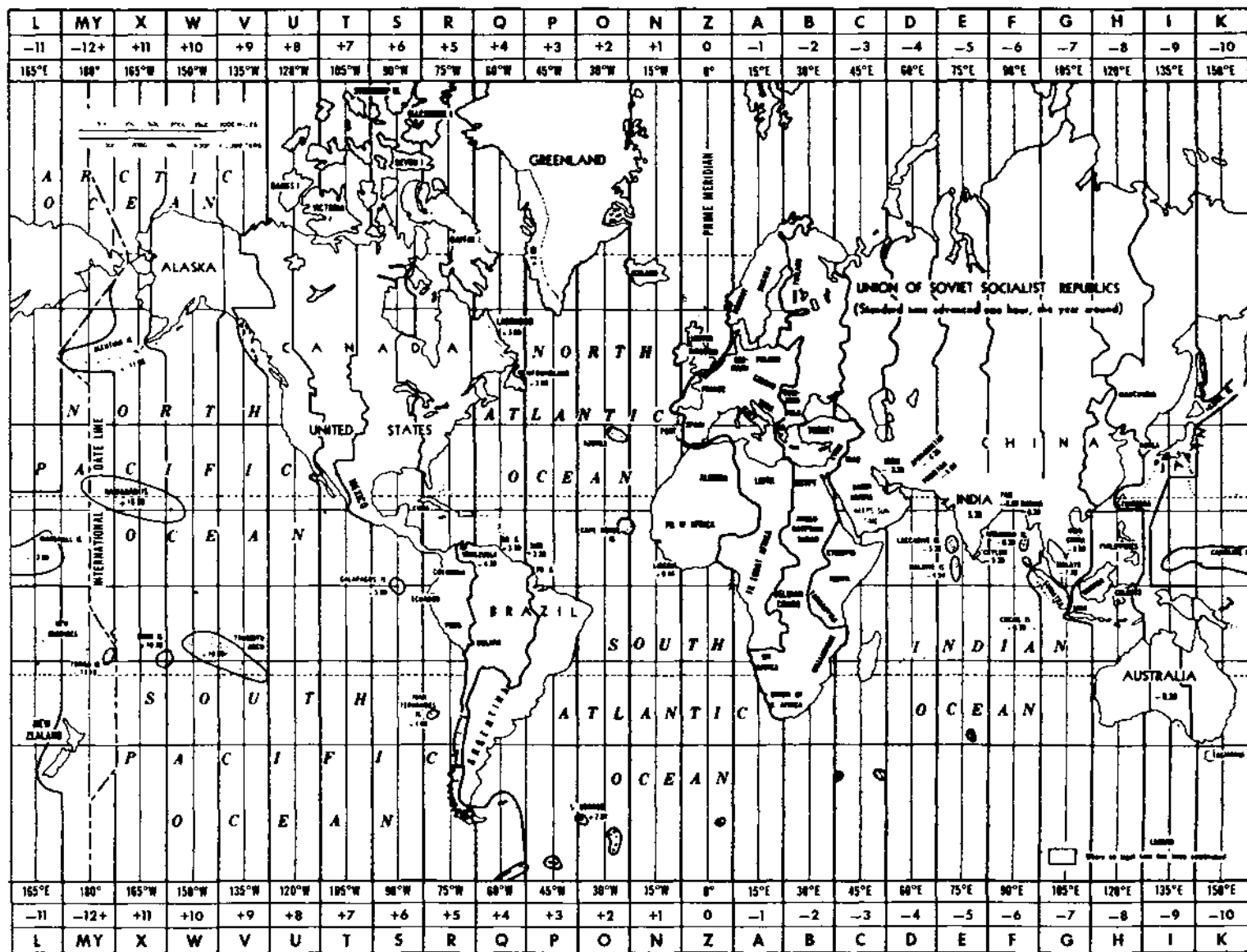

### ZULU TIME

The letter designations shown for each time zone in Figure B-2 are those used by the US Armed Forces in communications and operational planning for the identification of zone time (ZT) in the varying time zones. Greenwich mean time (GMT) or universal time, which is the zone time at Greenwich, is designated "Z" or "Zulu time." Zones to the east of Greenwich are designated alphabetically according to longitude, starting with A and ending with M; the letter J is not used. Zones to the west of Greenwich are similarly designated, starting with N and ending with M or Y ( $\pm 12$ ).

"Zulu" or "Z" time is used in communications when ships or activities in different time zones are involved. By looking at Figure B-2, the time anywhere in the world can easily be determined.

As an example, note that the eastern part of the United States lies in time zone R (Romeo), 5 hours later than Zulu time. Egypt lies in time zone B (Bravo), 2 hours earlier than Zulu time. Figure B-3 shows that at 1800 hours on any given day in New York, it is 0100 hours on the next day in Egypt.

It is sometimes necessary to indicate the date as well as the time in official communications. This is done by prefixing the time group and letter designator with two digits which indicate the date of the current month. Thus, "170925Z" would indicate a date/time of GMT 0925 on the 17th of the current month. This is "Zulu time." If a month other than the current one is to be used, the date/time group with the appropriate designator is used and the name of the desired month is added as a suffix. If a year other than the current year is used, it is indicated after the month. If the date/time of the message was for 1640 on 23 May 1985, the full group would read 231640 May 85.

TIME ZONE	HOURS OF DAY IN LOCAL MEAN TIME																																															
	PREVIOUS DAY							SAME DAY														NEXT DAY																										
	12	13	14	15	16	17	18	19	20	21	22	23	00	01	02	03	04	05	06	07	08	09	10	11	12	13	14	15	16	17	18	19	20	21	22	23	00	01	02	03	04	05	06	07	08	09	10	11
Z 0	12	13	14	15	16	17	18	19	20	21	22	23	00	01	02	03	04	05	06	07	08	09	10	11	12	13	14	15	16	17	18	19	20	21	22	23	00	01	02	03	04	05	06	07	08	09	10	11
A -1	13	14	15	16	17	18	19	20	21	22	23	00	01	02	03	04	05	06	07	08	09	10	11	12	13	14	15	16	17	18	19	20	21	22	23	00	01	02	03	04	05	06	07	08	09	10	11	12
B -2	14	15	16	17	18	19	20	21	22	23	00	01	02	03	04	05	06	07	08	09	10	11	12	13	14	15	16	17	18	19	20	21	22	23	00	01	02	03	04	05	06	07	08	09	10	11	12	13
C -3	15	16	17	18	19	20	21	22	23	00	01	02	03	04	05	06	07	08	09	10	11	12	13	14	15	16	17	18	19	20	21	22	23	00	01	02	03	04	05	06	07	08	09	10	11	12	13	14
D -4	16	17	18	19	20	21	22	23	00	01	02	03	04	05	06	07	08	09	10	11	12	13	14	15	16	17	18	19	20	21	22	23	00	01	02	03	04	05	06	07	08	09	10	11	12	13	14	15
E -5	17	18	19	20	21	22	23	00	01	02	03	04	05	06	07	08	09	10	11	12	13	14	15	16	17	18	19	20	21	22	23	00	01	02	03	04	05	06	07	08	09	10	11	12	13	14	15	16
F -6	18	19	20	21	22	23	00	01	02	03	04	05	06	07	08	09	10	11	12	13	14	15	16	17	18	19	20	21	22	23	00	01	02	03	04	05	06	07	08	09	10	11	12	13	14	15	16	17
G -7	19	20	21	22	23	00	01	02	03	04	05	06	07	08	09	10	11	12	13	14	15	16	17	18	19	20	21	22	23	00	01	02	03	04	05	06	07	08	09	10	11	12	13	14	15	16	17	18
H -8	20	21	22	23	00	01	02	03	04	05	06	07	08	09	10	11	12	13	14	15	16	17	18	19	20	21	22	23	00	01	02	03	04	05	06	07	08	09	10	11	12	13	14	15	16	17	18	19
I -9	21	22	23	00	01	02	03	04	05	06	07	08	09	10	11	12	13	14	15	16	17	18	19	20	21	22	23	00	01	02	03	04	05	06	07	08	09	10	11	12	13	14	15	16	17	18	19	20
K -10	22	23	00	01	02	03	04	05	06	07	08	09	10	11	12	13	14	15	16	17	18	19	20	21	22	23	00	01	02	03	04	05	06	07	08	09	10	11	12	13	14	15	16	17	18	19	20	21
L -11	23	00	01	02	03	04	05	06	07	08	09	10	11	12	13	14	15	16	17	18	19	20	21	22	23	00	01	02	03	04	05	06	07	08	09	10	11	12	13	14	15	16	17	18	19	20	21	22
M -12	00	01	02	03	04	05	06	07	08	09	10	11	12	13	14	15	16	17	18	19	20	21	22	23	00	01	02	03	04	05	06	07	08	09	10	11	12	13	14	15	16	17	18	19	20	21	22	23
N +1	11	12	13	14	15	16	17	18	19	20	21	22	23	00	01	02	03	04	05	06	07	08	09	10	11	12	13	14	15	16	17	18	19	20	21	22	23	00	01	02	03	04	05	06	07	08	09	10
O +2	10	11	12	13	14	15	16	17	18	19	20	21	22	23	00	01	02	03	04	05	06	07	08	09	10	11	12	13	14	15	16	17	18	19	20	21	22	23	00	01	02	03	04	05	06	07	08	09
P +3	09	10	11	12	13	14	15	16	17	18	19	20	21	22	23	00	01	02	03	04	05	06	07	08	09	10	11	12	13	14	15	16	17	18	19	20	21	22	23	00	01	02	03	04	05	06	07	08
Q +4	08	09	10	11	12	13	14	15	16	17	18	19	20	21	22	23	00	01	02	03	04	05	06	07	08	09	10	11	12	13	14	15	16	17	18	19	20	21	22	23	00	01	02	03	04	05	06	07
R +5	07	08	09	10	11	12	13	14	15	16	17	18	19	20	21	22	23	00	01	02	03	04	05	06	07	08	09	10	11	12	13	14	15	16	17	18	19	20	21	22	23	00	01	02	03	04	05	06
S +6	06	07	08	09	10	11	12	13	14	15	16	17	18	19	20	21	22	23	00	01	02	03	04	05	06	07	08	09	10	11	12	13	14	15	16	17	18	19	20	21	22	23	00	01	02	03	04	05
T +7	05	06	07	08	09	10	11	12	13	14	15	16	17	18	19	20	21	22	23	00	01	02	03	04	05	06	07	08	09	10	11	12	13	14	15	16	17	18	19	20	21	22	23	00	01	02	03	04
U +8	04	05	06	07	08	09	10	11	12	13	14	15	16	17	18	19	20	21	22	23	00	01	02	03	04	05	06	07	08	09	10	11	12	13	14	15	16	17	18	19	20	21	22	23	00	01	02	03
V +9	03	04	05	06	07	08	09	10	11	12	13	14	15	16	17	18	19	20	21	22	23	00	01	02	03	04	05	06	07	08	09	10	11	12	13	14	15	16	17	18	19	20	21	22	23	00	01	02
W +10	02	03	04	05	06	07	08	09	10	11	12	13	14	15	16	17	18	19	20	21	22	23	00	01	02	03	04	05	06	07	08	09	10	11	12	13	14	15	16	17	18	19	20	21	22	23	00	01
X +11	01	02	03	04	05	06	07	08	09	10	11	12	13	14	15	16	17	18	19	20	21	22	23	00	01	02	03	04	05	06	07	08	09	10	11	12	13	14	15	16	17	18	19	20	21	22	23	00
Y +12	00	01	02	03	04	05	06	07	08	09	10	11	12	13	14	15	16	17	18	19	20	21	22	23	00	01	02	03	04	05	06	07	08	09	10	11	12	13	14	15	16	17	18	19	20	21	22	23

Figure B-3. Worldwide time conversion chart

FM 55-15

**MEASUREMENTS, CONVERSIONS, AND EQUIVALENTS**

Units of measure, their conversions, and their equivalents are shown in Tables B-25

through B-33 and Figures B-4 through B-6. Figure B-7 shows warning labels for hazardous materials.

**Table B-25. Weights and measures**

Dry Measure	Fluid Measure
1 pint = 33.6 cubic inches	16 fluid ounces (USA) = 1 pint
2 pints = 1 quart	20 fluid ounces (Britain) = 1 pint
1 quart = 67.2 cubic inches	1 pint = 4 gills
8 quarts = 1 peck	2 pints = 1 quart
1 peck = 537.6 cubic inches	4 quarts = 1 gallon
4 pecks = 1 bushel	1 gallon = 8½ pounds (approximate)
1 bushel = 2,150.42 cubic inches	42 gallons, petroleum = 1 barrel
Linear Measure	Nautical Measure
12 inches = 1 foot	6 feet = 1 fathom
3 feet = 1 yard	100 fathoms = 1 cable length (ordinary)
16½ feet = 1 rod	120 fathoms = 1 cable length (US Navy)
5½ yards = 1 rod	6,080.2 feet = 1 nautical mile
320 rods = 1 mile	
1,760 yards = 1 mile	Square Measure
5,280 feet = 1 statute mile	144 square inches = 1 square foot
	9 square feet = 1 square yard
	4,840 square yards = 1 acre
Cubic Measure	43,560 square feet = 1 acre
1,728 cubic inches = 1 cubic foot	640 acres = 1 square mile
27 cubic feet = 1 cubic yard	272¼ square feet = 1 square rod

**Measurement of Surfaces and Solids**

Circumference of a circle	= Diameter x 3.1416 or 6.2832 x radius
Area of a square or rectangle	= Length x width
Area of a circle	= Square of the diameter x .7854
	or
	Square of the radius x 3.1416
Surface of a cube	= Area of one side x 6
Surface of a sphere	= Square of the diameter x 3.1416
Surface of a cylinder	= Area of two ends + (height x circumference of one circular base)
Cubic content of a cube	= Length x width x depth
Cubic content of a sphere	= Cube of the diameter x .5236
Cubic content of a cylinder	= Area of the circular base x the height of cylinder

**Table B-26. Equivalent units of weight**

<u>Metric Units</u>	<u>US Units</u>
Millier (tonneau, metric ton)	2,204.6 pounds
Quintal	220.46 pounds
Kilogram	2.2046 pounds
Hectogram	3.5274 ounces
Decagram	0.3527 ounces
Gram	15.432 grains
Decigram	1.5432 grains
Centigram	0.1543 grains
Milligram	0.0154 grains

<u>Ounces to Grams</u>		<u>Grams to Ounces</u>		<u>Pounds to Kilograms</u>		<u>Kilograms to Pounds</u>	
1	28.3	1	0.04	1	0.45	1	2.20
2	56.7	2	0.07	2	0.91	2	4.41
3	85.0	3	0.11	3	1.36	3	6.61
4	113.4	4	0.14	4	1.81	4	8.82
5	141.7	5	0.18	5	2.27	5	11.02
6	170.1	6	0.21	6	2.72	6	13.23
7	198.4	7	0.25	7	3.18	7	15.43
8	226.8	8	0.28	8	3.63	8	17.64
9	255.1	9	0.32	9	4.08	9	19.84
10	283.5	10	0.35	10	4.54	10	22.05

<u>Unit</u>	<u>Long Tons</u>	<u>Metric Tons</u>	<u>Short Tons</u>	<u>Kilograms</u>	<u>Pounds</u>	<u>Cubic Feet</u>
One long ton		1.0160	1.1200	1,016.0	2,240.0	
One metric ton	0.9842		1.1023	1,000.0	2,204.6	
One short ton	0.8929	0.9072		907.2	2,000.0	
One kilogram					2.2	
One measurement ton						40.0

**Table B-27. Equivalent Units of Length**

Inches to Centimeters		Centimeters to Inches	
1	2.54	1	0.39
2	5.08	2	0.79
3	7.62	3	1.18
4	10.16	4	1.57
5	12.70	5	1.97
6	15.24	6	2.36
7	17.78	7	2.76
8	20.32	8	3.15
9	22.86	9	3.54
10	25.40	10	3.94
11	27.94	11	4.33
12	30.48	12	4.72

Feet to Meters		Meters to Feet	
1	0.30	1	3.28
2	0.61	2	6.56
3	0.91	3	9.84
4	1.22	4	13.12
5	1.52	5	16.40
6	1.83	6	19.68
7	2.13	7	22.97
8	2.44	8	26.25
9	2.74	9	29.53
10	3.05	10	32.81

Yards to Meters		Meters to Yards	
1	0.91	1	1.09
2	1.83	2	2.19
3	2.74	3	3.28
4	3.66	4	4.37
5	4.57	5	5.47
6	5.49	6	6.56
7	6.40	7	7.66
8	7.32	8	8.75
9	8.23	9	9.84
10	9.14	10	10.94

Statute Miles	to	Kilometers	Kilometers	to	Statute Miles
1		1.61	1		0.62
2		3.22	2		1.24
3		4.83	3		1.88
4		6.44	4		2.49
5		8.05	5		3.11
6		9.66	6		3.73
7		11.27	7		4.35
8		12.87	8		4.97
9		14.48	9		5.59
10		16.09	10		6.21

Statute Miles	to	Nautical Miles	Nautical Miles	to	Statute Miles
1		0.87	1		1.15
2		1.74	2		2.30
3		2.61	3		3.45
4		3.48	4		4.60
5		4.35	5		5.75
6		5.22	6		6.90
7		6.09	7		8.05
8		6.96	8		9.20
9		7.83	9		10.35
10		8.70	10		11.50

KILOMETERS	10									0	10	20	30	40	50	60	70	80
NAUTICAL MILES	10									0	10	20	30	40				
STATUTE MILES	10									0	10	20	30	40	50			

KILOMETERS	100									0	1000	2000	3000	4000	5000	6000	7000	8000
NAUTICAL MILES	100									0	1000	2000	3000	4000				
STATUTE MILES	100									0	1000	2000	3000	4000	5000			

1 st mi = 0.87 NM      1 NM = 1.85 km  
 1 st mi = 1.61 km      1 NM = 1.15 st mi

Figure B-4. Conversion scale (km, NM, and st mi)

Table B-28. Equivalent Units of Volume

Ounces to Milliliters		Milliliters to Ounces	
1	29.57	10	0.34
2	59.15	20	0.68
3	88.72	30	1.01
4	118.29	40	1.35
5	147.87	50	1.69
6	177.44	60	2.03
7	207.01	70	2.37
8	236.59	80	2.71
9	266.16	90	3.04
10	295.74	100	3.38

Quarts to Liters		Liters to Quarts		Gallons to Liters		Liters to Gallons	
1	0.95	1	1.06	1	3.79	1	0.26
2	1.89	2	2.11	2	7.57	2	0.53
3	2.84	3	3.17	3	11.36	3	0.79
4	3.79	4	4.23	4	15.14	4	1.06
5	4.73	5	5.28	5	18.93	5	1.32
6	5.68	6	6.34	6	22.71	6	1.59
7	6.62	7	7.40	7	26.50	7	1.85
8	7.57	8	8.45	8	30.28	8	2.11
9	8.52	9	9.51	9	34.07	9	2.38
10	9.46	10	10.57	10	37.85	10	2.64

**Table B-29. Conversion Factors (Metric and US units)**

US or Imperial Units	×	Conversion Factor	=	Metric Units	Metric Units	×	Conversion Factor	=	US or Imperial Units
Acres		0.4947		Hectares	Centimeters		0.3937		Inches
Cubic feet		0.0283		Cubic meters	Cubic centimeters		0.0610		Cubic inches
Cubic inches		16.3872		Cubic centimeters	Cubic meters		35.3144		Cubic feet
Cubic inches		0.0164		Liters	Cubic meters		1.3079		Cubic yards
Cubic yards		0.7646		Cubic meters	Decameters		3.9317		Inches
Feet		0.3048		Meters	Grams		15.4324		Grains
Feet per second		18.288		Meters per minute	Grams		0.03527		Ounces (avdp)
Gallons (US)		3.7854		Liters	Hectares		2.4710		Acres
Gallons (imp)		4.543		Liters	Kilograms		2.2046		Pounds (avdp)
Grains		0.0648		Grams	Kilograms		35.2739		Ounces (avdp)
Inches		2.54		Centimeters	Kilometers		0.62137		Miles
Inches		0.0254		Meters	Liters		61.025		Cubic inches
Inches		25.4001		Millimeters	Liters		0.2642		Gallons (US)
Miles		1.6093		Kilometers	Liters		0.220		Gallons
Miles per hour		0.0447		Meters per second	Liters		2.1134		Pints (US)
Ounces (avdp)		28.349		Grams	Liters		1.76		Pints (imp)
Ounces (avdp)		0.92835		Kilograms	Meters		3.2808		Feet
Pints (US)		0.4732		Liters	Meters		39.37		Inches
Pints (imp)		0.568		Liters	Meters		1.0936		Yards
Pounds (avdp)		0.45359		Kilograms	Meters per minute		0.0547		Feet per second
Square feet		0.0929		Square meters	Meters per second		2.237		Miles per hour
Square inches		6.4516		Square centimeters	Metric ton		2,204.6		Pounds
Square miles		2.590		Square kilometers	Millimeters		0.03937		Inches
Square yards		0.8361		Square meters	Square centimeters		0.155		Square inches
Yards		0.914		Meters	Square kilometers		0.3861		Square miles
					Square meters		1.1960		Square yards
					Square meters		10.764		Square feet

TABLE 2-20. AVERAGE PETROLEUM PRODUCTS WEIGHTS, VOLUMES, AND CONVERSIONS

Product	Packaging	Volume (cubic capacity)			Conversion factors			Barrels per LTONs <sup>1</sup>	Packaging per			Vehicle capacity for carrying filled containers				
		Weight (lb)	Actual (cu ft)	Planning factor (cu ft)	Gal	Lb	Gallons per LTONs <sup>1</sup>		LTONs	LTONs	LTONs	1 1/2-ton trk	2 1/2-ton trk	5-ton trk		
					to lb	to gal									STONS	
AVGAS	Bulk	—	—	—	5.90	0.169	339.0	379.7	—	9.04	—	—	—	—	—	
	55-gal drums <sup>2</sup>	373.0	9.03	11	6.91	0.145	289.4	324.2	187.8	—	5.36	6.00	3.48	8	14	28
	55-gal drums <sup>3</sup>	389.0	8.80	11	7.20	0.139	277.8	311.1	192.8	—	5.14	5.76	3.57	8	13	26
	55-gal drums <sup>4</sup>	364.0	9.20	11	6.90	0.145	289.9	324.6	181.2	—	5.49	6.15	3.42	9	14	28
	5-gal cans <sup>5</sup>	40.5	0.81	1	8.00	0.125	258.0	280.0	200.0	—	49.40	55.30	40.00	74	124	248
Jet fuel (JPA)	Bulk	—	—	—	6.42	0.156	312.0	349.4	—	8.06	—	—	—	—	—	
	55-gal drums <sup>2</sup>	399.0	9.03	11	7.39	0.135	270.0	302.4	187.8	—	5.01	5.61	3.48	8	13	25
	55-gal drums <sup>3</sup>	415.0	8.80	11	7.68	0.130	260.0	291.2	192.7	—	4.82	5.40	3.57	8	12	24
	55-gal drums <sup>4</sup>	392.0	9.20	11	7.40	0.135	270.0	302.4	181.2	—	5.10	5.71	3.42	8	14	28
	5-gal cans <sup>5</sup>	—	—	—	6.11	0.164	327.3	366.6	—	8.73	—	—	—	—	—	—
MOGAS	Bulk	—	—	—	6.11	0.164	327.3	366.6	—	8.73	—	—	—	—	—	
	55-gal drums <sup>2</sup>	384.0	9.03	11	7.11	0.141	281.2	315.1	187.8	—	5.21	5.83	3.48	8	13	26
	55-gal drums <sup>3</sup>	400.0	8.80	11	7.41	0.135	269.9	302.3	192.8	—	5.00	5.60	3.57	8	13	26
	55-gal drums <sup>4</sup>	376.0	9.20	11	7.09	0.141	282.1	315.9	181.2	—	5.32	5.96	3.42	8	14	28
	5-gal cans <sup>5</sup>	41.6	0.81	1	8.32	0.120	240.4	269.2	200.0	—	48.10	53.80	40.00	73	121	242
Diesel fuel	Bulk	—	—	—	6.99	0.143	286.1	320.5	—	7.63	—	—	—	—	—	
	55-gal drums <sup>2</sup>	432.0	9.03	11	8.00	0.125	250.0	280.0	187.8	—	4.63	5.19	3.48	7	12	24
	55-gal drums <sup>3</sup>	448.0	8.80	11	8.30	0.120	241.0	269.9	192.7	—	4.46	5.00	3.57	7	12	24
	55-gal drums <sup>4</sup>	430.0	9.20	11	8.11	0.123	246.6	276.2	181.2	—	4.65	5.21	3.42	7	12	24
	5-gal cans <sup>5</sup>	46.0	0.81	1	9.20	0.109	317.4	343.5	200.0	—	43.50	48.70	40.00	66	109	218
Kerosene	Bulk	—	—	—	6.80	0.147	294.1	329.4	—	7.84	—	—	—	—	—	
	55-gal drums <sup>2</sup>	421.0	9.03	11	7.80	0.128	256.4	287.1	187.8	—	4.75	5.32	3.48	8	12	24
	55-gal drums <sup>3</sup>	437.0	8.80	11	8.09	0.124	247.2	276.9	192.8	—	4.58	5.13	3.57	7	12	24
	55-gal drums <sup>4</sup>	351.0	9.20	11	6.62	0.151	302.1	338.3	181.2	—	5.70	6.38	3.42	9	15	30
	5-gal cans <sup>5</sup>	45.0	0.81	1	9.00	0.111	222.2	248.9	200.0	—	44.40	49.80	40.00	67	112	224
Lub oils	Bulk	—	—	—	7.60	0.132	263.2	294.7	—	7.02	—	—	—	—	—	
	55-gal drums <sup>2</sup>	472.0	9.03	11	8.58	0.117	233.1	261.0	191.3	—	4.24	4.75	3.48	7	11	22
	55-gal drums <sup>3</sup>	488.0	8.80	11	8.87	0.113	225.5	252.5	196.4	—	4.10	4.59	3.57	7	11	22
	55-gal drums <sup>4</sup>	462.0	9.20	11	8.56	0.117	233.5	261.7	184.6	—	4.33	4.85	3.42	7	11	22
	5-gal cans <sup>5</sup>	49.0	0.81	1	9.80	0.102	204.1	228.6	181.2	—	40.80	45.70	40.00	62	103	206
	1-qt cans	35.0	0.88	1	—	—	—	—	—	—	58.00	64.90	40.00	86	143	286
	(12 per case)	—	—	—	—	—	—	—	—	—	—	—	—	—	—	—
	1-qt cans (24 per case)	60.0	1.60	2	—	—	—	—	—	—	33.40	37.30	20.00	50	84	168
	5-qt cans (6 per case)	77.0	1.90	2	—	—	—	—	—	—	26.00	29.10	20.00	39	65	130
	Greases	25-lb pails	29.0	0.95	1	—	—	—	—	—	69.00	77.20	40.00	104	173	346
5-lb cans (6 per case)	44.0	1.10	2	—	—	—	—	—	—	45.40	50.90	20.00	69	114	227	
Fog oils	SGF1	Bulk	—	—	—	7.11	0.140	281.0	314.0	—	7.49	—	—	—	—	—
	55-gal drums <sup>2</sup>	438.0	9.03	11	8.11	0.123	246.6	276.2	191.3	—	4.50	5.02	3.48	7	11	22
	55-gal drums <sup>3</sup>	588.0	8.80	11	8.40	0.110	238.0	266.6	196.4	—	4.32	4.84	3.57	7	11	22
	55-gal drums <sup>4</sup>	421.0	9.20	11	8.10	0.123	246.9	276.5	184.6	—	4.57	5.12	3.42	7	11	22
SGF2	Bulk	—	—	—	6.99	0.143	286.0	320.0	—	7.63	—	—	—	—	—	
	55-gal drums <sup>2</sup>	431.0	9.03	11	7.99	0.120	250.3	280.3	191.3	—	4.54	5.09	3.48	7	11	22
	55-gal drums <sup>3</sup>	616.0	8.80	11	8.28	0.120	241.5	270.5	196.4	—	4.39	4.90	3.57	7	11	22
	55-gal drums <sup>4</sup>	478.0	9.20	11	7.90	0.121	253.1	283.5	184.6	—	4.68	5.25	3.42	7	11	23

<sup>1</sup>For ocean shipping, storage, and pipeline computations, bulk petroleum products are usually measured in barrels of 42 gallons each or in LTONs.

<sup>2</sup>18-gage standard weighs 54 pounds empty; filled to 54 gallons with light products, 55 gallons with heavy products.

<sup>3</sup>16-gage standard weighs 70 pounds empty; filled to 54 gallons with light products, 55 gallons with heavy products.

<sup>4</sup>18-gage limited standard weighs 53 pounds empty; fill to 53 gallons with light products, 54 gallons with heavy products.

<sup>5</sup>For planning purposes, weight of MOGAS may be taken as 42 pounds and weight of kerosene for engines as 50 pounds per 5-gallon can, including weight of can. Five-gallon cans weigh approximately 11 pounds empty.

NOTE: Factors in this table are based on US gallons.  
 1 imperial gallon = 1.2010 US gallons.  
 1 liter = 0.2462 US gallons.

F 0 # 1 4



**Table B-31. Conversion factors — petroleum products**

<u>Multiply</u>	<u>By</u>	<u>To Obtain</u>
Cubic feet	7.48	Gallons
Cubic feet	0.1782	Barrels
Cubic feet	0.025	Tons, measurement
Cubic feet	0.01	Tons, register
Cubic feet	28.32	Liters
Cubic inches	0.0043	Gallons
Cubic meters	264.2	Gallons
Cubic meters	6.29	Barrels
Gallons	231.0	Cubic inches
Gallons	0.1337	Cubic feet
Gallons	3.7854	Liters
Gallons	0.0238	Barrels
Gallons (gasoline)	6.103	Pounds
Gallons (gasoline)	0.0031	Tons, short
Gallons (gasoline)	0.0033	Tons, measurement
Gallons (gasoline)	0.0027	Tons, long
Gallons (gasoline)	0.0026	Tons, metric
Gallons (oil)	7.434	Pounds
Kiloliters	0.159	Barrels
Liters	0.2642	Gallons
Liters	0.001	Cubic meters
Pounds	0.1639	Gallons (gasoline)
Pounds	0.1345	Gallons (oil)
Tons, long	367.21	Gallons (gasoline)
Tons, measurement	303.03	Gallons (gasoline)
Tons, measurement	1.0	Tons, short (grease)
Tons, measurement	1.1086	Tons, short (gasoline)
Tons, measurement	1.4285	Tons, short (gasoline in drums)
Tons, measurement	1.2048	Tons, short (oil in drums)
Tons, measurement	40.0	Cubic feet (gasoline)
Tons, metric	373.10	Gallons (gasoline)
Tons, short	327.8	Gallons (gasoline)
Tons, short (gasoline)	0.9195	Tons, measurement
Tons, short (gasoline in drums)	0.7	Tons, measurement
Tons, short (grease)	1.0	Tons, measurement
Tons, short (oil in drums)	0.83	Tons, measurement

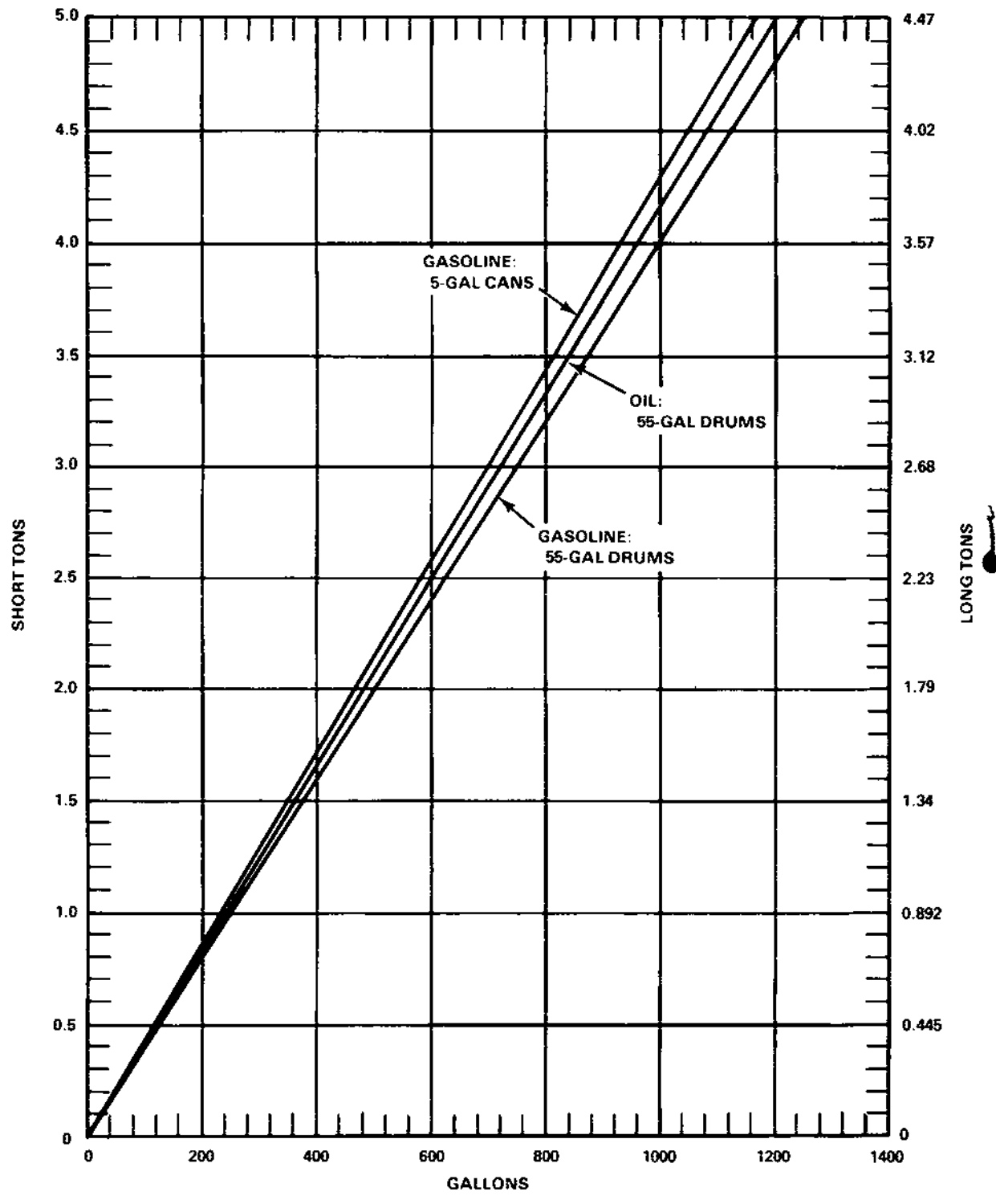

Figure B-5. Conversion scale (gallons, STONs and LTONs)— petroleum products

**Table B-32. Equivalent units of speed**

MPH	Kn	Ft/Sec	KPH	M/Sec
1	0.8684	1.4667	1.6093	0.447
2	1.74	2.94	3.23	0.897
3	2.59	4.41	4.83	1.34
4	3.46	5.90	6.45	1.78
5	4.34	7.33	8.05	2.23
6	5.20	8.80	9.65	2.68
7	6.07	10.30	11.30	3.13
8	6.95	11.80	12.90	3.58
9	7.81	13.22	14.50	4.03
10	8.68	14.67	16.09	4.47
11	9.55	16.20	17.70	4.92
12	10.40	17.62	19.30	5.37
13	11.23	19.10	20.90	5.82
14	12.10	20.60	22.60	6.27
15	13.00	22.10	24.20	6.71
16	13.90	23.50	25.80	7.16
17	14.75	25.00	27.40	7.63
18	15.60	26.40	28.90	8.05
19	16.45	28.00	30.60	8.50
20	17.40	29.30	32.20	8.95
21	18.20	30.90	33.80	9.39
22	19.10	32.20	35.40	9.85
23	20.00	33.80	37.10	10.30
24	20.80	35.30	38.60	10.75
25	21.70	36.70	40.30	11.15
26	22.50	38.20	41.90	11.60
27	23.40	39.70	43.50	12.10
28	24.30	41.20	45.10	12.50
29	25.20	42.60	46.70	13.00
30	26.00	44.20	48.30	13.40
31	26.90	45.60	50.00	13.90
32	27.80	47.00	51.50	14.30
33	28.60	48.50	53.00	14.73
34	29.50	50.00	54.55	15.20
35	30.40	51.50	56.50	15.65
36	31.20	53.00	58.00	16.10
37	32.00	54.50	59.70	16.50
38	32.90	56.00	61.40	17.00
39	33.80	57.50	62.80	17.40
40	34.60	58.80	64.50	17.83
41	35.60	60.50	66.00	18.38
42	36.40	61.90	67.70	18.80
43	37.30	63.40	69.20	19.20
44	38.20	64.80	71.00	19.70
45	38.90	66.50	72.50	20.20
46	40.00	67.50	74.00	20.60
47	40.70	69.10	75.90	21.00
48	41.50	70.50	77.50	21.40
49	42.40	72.00	79.00	21.80
50	43.50	73.80	80.50	22.30

**Table B-33. Temperature conversions—centigrade to Fahrenheit**

°C	to	°F	°F	to	°C
-20		-4	0		-17.8
-10		14	10		-12.2
0		32	20		-6.7
10		50	30		-1.1
20		68	40		4.4
30		86	50		10.0
40		104	60		15.6
50		122	70		21.1
60		140	80		26.7
70		158	90		32.2
80		176	100		37.8
90		194	120		48.9
100		212	140		60.0
			160		71.1
			180		82.2
			200		93.3

$$^{\circ}\text{C} = 5/9(^{\circ}\text{F} - 32)$$

$$^{\circ}\text{F} = 9/5(^{\circ}\text{C} + 32)$$

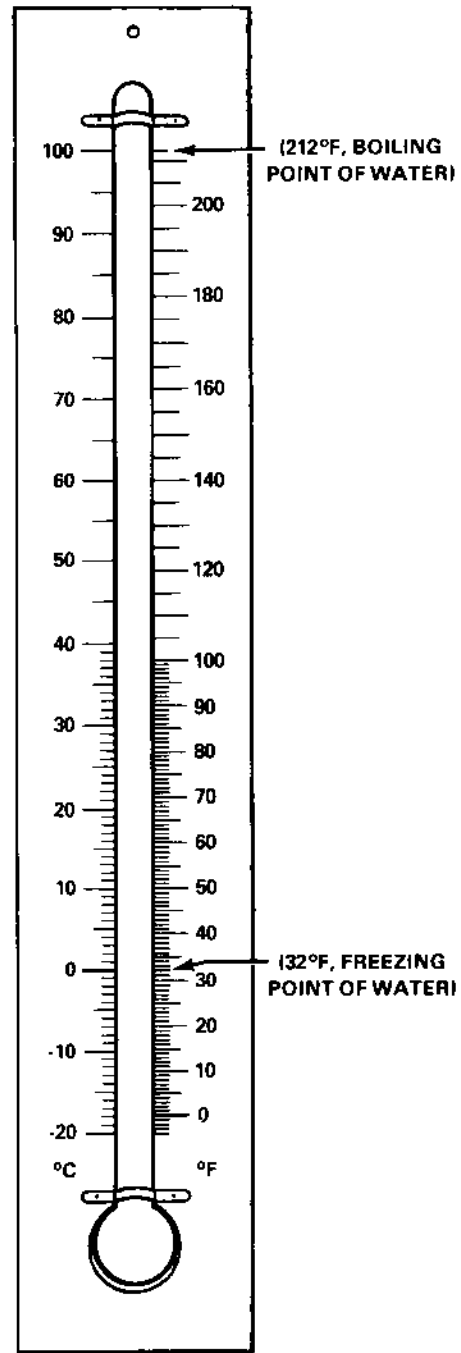
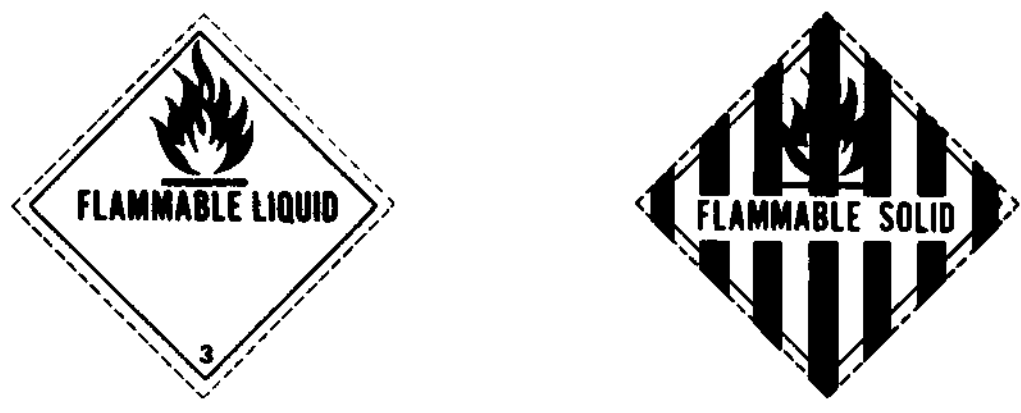

**Figure B-6. Temperature conversion scale**

EXPLOSIVES



FLAMMABLE LIQUIDS AND SOLIDS



POISONOUS MATERIALS

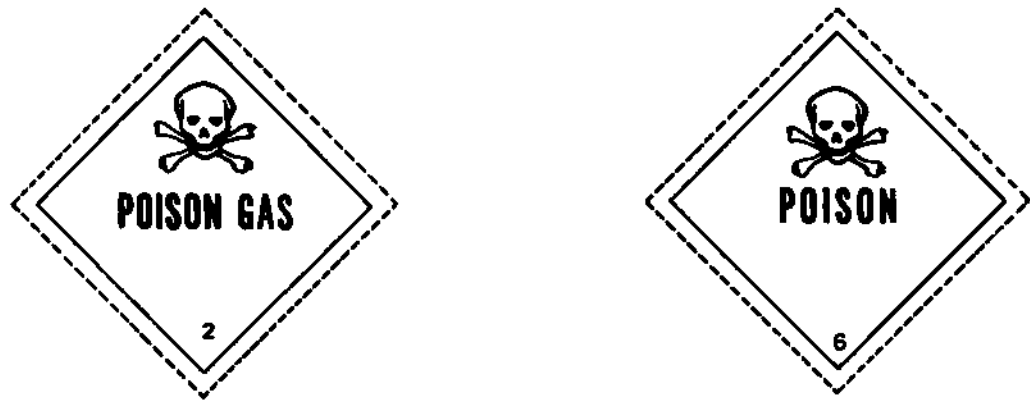
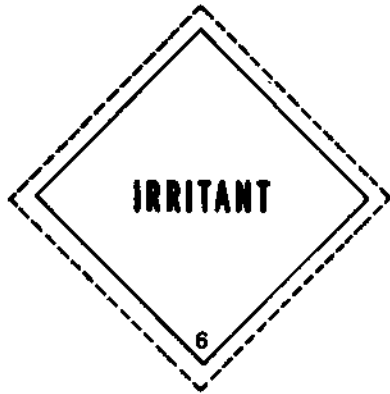

Figure B-7. Hazardous material warning labels

IRRITATING MATERIAL



COMPRESSED GASES

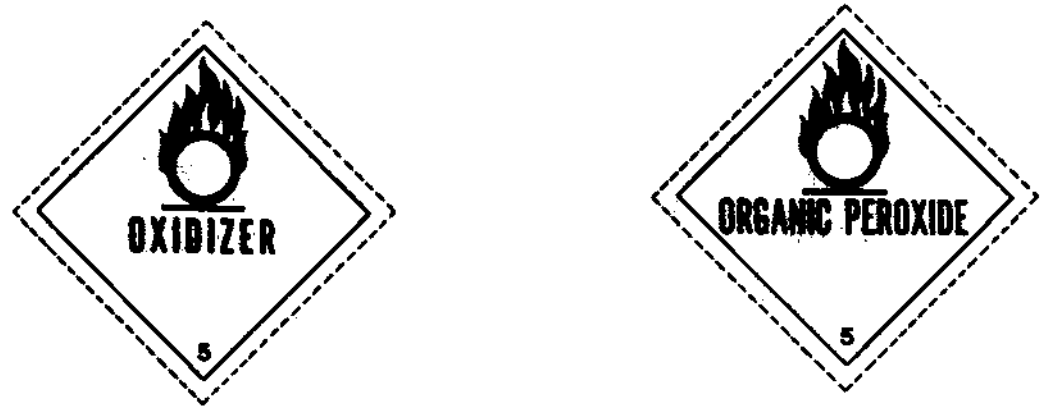

Figure B-7. Hazardous material warning labels (cont)

**RADIOACTIVE MATERIALS**



**OXIDIZING MATERIALS**



**SPONTANEOUSLY COMBUSTIBLE MATERIAL**



**WATER-REACTIVE MATERIAL**

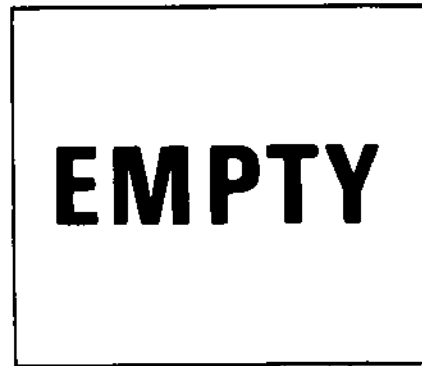

*Figure B-7. Hazardous material warning labels (cont).*

CORROSIVE MATERIAL



EMPTY



ETIOLOGIC AGENT<sup>1</sup>

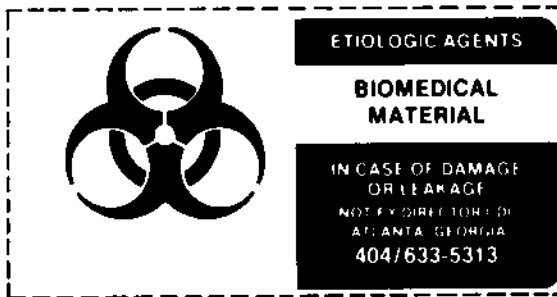

BUNG<sup>2</sup>



<sup>1</sup>Disease causing chemicals or organisms

<sup>2</sup>Used to relieve interior pressure in pressurized containers

*Figure B-7. Hazardous material warning labels (cont)*



## GLOSSARY

## Section I. ABBREVIATIONS AND ACRONYMS

AA&E	arms, ammunition, and explosives	arty	artillery
AACG	arrival airfield control group	ASE	aircraft survivability equipment
AAR	Association of American Railroads	ASG	area support group
abn	airborne	ASP	ammunition supply point
acft	aircraft	AT	antitank
ACL	allowable cargo (cabin) load	ATMCT	air terminal movement control teams
ACofS	Assistant Chief of Staff	attn	attention
ACR	armored cavalry regiment	auth	authorized
ADA	air defense artillery	AUTODIN	automatic digital network
ADC	area damage control	aux	auxiliary
admin	administration	AUTOVON	automatic voice network
ADP	automatic data processing	aval	available
ADPE	automatic data processing equipment	avg	average
ADPS	automatic data processing system	AVIM	aviation intermediate maintenance
AF	Air Force (USAF)	avn	aviation
AFB	Air Force base	AVSCOM	United States Army Aviation Systems Command
AFOE	assault follow-on echelon		
AG	Adjutant General	AVUM	aviation unit maintenance
AGL	above ground level	BARC	barge, amphibious, resupply, cargo
amb	ambulance		
ambl	airmobile	bbl	barrel
ambt	ambulatory	bde	brigade
ammo	ammunition	BC	barge, cargo
amph	amphibious	BDL	beach discharge lighter
AOC	airlift operations center	BMU	beachmaster unit
AP	armor piercing	bn	battalion
APC	armored personnel carrier	BP	boiling point
APOD	aerial port of debarkation	brg	bridge
APOE	aerial port of embarkation	C	Celsius
approx	approximately	cal	caliber
APU	auxiliary power unit	cap	capacity
AR	Army regulation	cart	cartridge
ARINC	Aeronautical Radio, Incorporated	cav	cavalry
armd	armored	CB	center of balance
		cbt	combat

CDI	cargo disposition instructions	DISCOM	division support command
cdr	commander	div	division
CDWT	cargo deadweight tonnage	DLA	Defense Logistics Agency
C-E	communications-electronics	DMAHTC	Defense Mapping Agency Hydrographic/Topographic Center
CEOI	communications-electronics operation instructions	DO	director of operations
CEWI	combat electronic warfare intelligence	DOC	Department of Commerce
CF	convertible freighter	DOD	Department of Defense
CG	center of gravity	DOI	Department of the Interior
cgo	cargo	DOT	Department of Transportation
chap	chapter	DPSC	Defense Personnel Support Center
CHAP/VUL	CHAPARRAL/VULCAN	DS	direct support
chg	charge	DSA	division support area
CL	centerline	DSU	direct support unit
co	company	DTO	division transportation officer
COFC	container-on-flatcar	DTS	Defense Transportation System
COMINT	communications intelligence	DTT	destination truck terminal
comm	communication	DWT	deadweight ton(nage)
COMMZ	communications zone	DZ	drop zone
COMPASS	Computerized Movement Planning and Status System	ea	each
COMSEC	communications security	EAT	external air transport
CONEX	container express	ECCM	electronic counter-countermeasures
cent	continued	elct	electronics
CONUS	Continental United States	elec	electric
COR	cargo outturn report	EM	enlisted member
COSCOM	corps support command	emerg	emergency
CP	command post	enr	engineer
CRAF	Civil Reserve Air Fleet	EPW	enemy prisoner of war
CSA	corps support area	equip	equipment
CSR	controlled supply rate	ETA	estimated time of arrival
CSS	combat service support	ETD	estimated time of departure
CS	combat service support system	ETR	export traffic release
cu	cubic	EXTAL	extra time allowance
CVA	carrier, vertical assault	EZ	extraction zone
CZ	combat zone	F	Fahrenheit
DA	Department of the Army	FA	field artillery
DACG	departure airfield control group	FASCO	forward area support coordinator
DCD	Directorate of Combat Developments	FAW	front axle weight
DCSLOG	Deputy Chief of Staff for Logistics	FCU	fuel consumption unit
DD	Department (of) Defense (form)	FLOT	forward line of own troops
DDC	division data center	FM	frequency modulated; field manual
deml	demolition	FOH	front overhang
det	detonating	FORSCOM	United States Army Forces Command
DIA	Defense Intelligence Agency	frag	fragmentation

FS	floor station	ICC	Interstate Commerce Commission
FSTC	United States Army Foreign Science and Technology Center	IFR	instrument flight rules
ft	foot, feet	in	inch(es)
ft/sec	feet per second	inf	infantry
FTRAC	full-tracked vehicle	INTACS	Integrated Tactical Communications System
fwd	forward	intel	intelligence
g	gravity; unit of force	ITO	installation transportation office(r)
G3	Assistant Chief of Staff, G3 (Operations and Plans)	JTB	Joint Transportation Board
ga	gauge	JTF	joint task force
GAA	grease, artillery, and automotive	km/hr	kilometers in the hour
gal	gallon	km	kilometer(s)
GBL	government bill of lading	kn	knot(s)
GCA	ground-controlled approach	KPH	kilometers per hour
gen	general	kw	kilowatt(s)
GM	guided missile	l	liter(s)
GMT	Greenwich mean time	LACV	lighter, air cushion vehicle
gp	group	LARC	lighter, amphibious resupply cargo
GP	general purpose	LAPES	low altitude parachute extraction system
GPM	gallons per minute	LASH	lighter aboard ship
GS	general support	lb	pound(s)
GSA	General Services Administration	LCC	landing craft, control
GSU	general support unit	LCM	landing craft, mechanized
GTL	gross trailing load	LCU	landing craft, utility
h	height	LE	low explosive
HE	high explosive	liq	liquid
HET	heavy-equipment transporter	LKA	amphibious cargo ship
hgt	height	LO	liaison officer
HICHS	Helicopter Internal Cargo Handling System	LOA	length overall
HHC	headquarters and headquarters company	log	logistics
HHG	household goods	LOTS	logistics over the shore
HMMWV	high mobility multipurpose wheeled vehicle	LST	landing ship tank
HMMS	HELLFIRE modern missile system	lt	light
hosp	hospital	LTON	long ton
how	howitzer	LTCL	less-than-container load
HP	horsepower	LVTP	landing vehicle, track, personnel
HQ	headquarters	LWL	load waterline
hr	hour	LZ	landing zone
HRP	highway regulating point	m	meter(s)
HRPT	highway regulating point teams	m/sec	meters per second
HTH	highway traffic headquarters	MAB	mobile floating assault bridge-ferry (US)
hvy	heavy	MAC	Military Airlift Command
		MACOM	major Army command
		mag	magazine
		maint	maintenance
		MAP	Military Assistance Program

MARAD	Maritime Administration	NCO	noncommissioned officer
MATCO	Military Air Traffic Coordination Office	NDT	net division tonnage
max	maximum	NICAD	nickel cadmium
MCA	movement control agency	NM	nautical mile
MCC	movement control center	no	number
MCO	movement control officer	NSP	non-self-propelled
MCT	movement control team	NTL	net trainload
mdm	medium	OB	obstruction
mech	mechanized	OD	olive drab
MEDDAC	medical department activity	off	offensive
mg	machinegun	OG	olive green
MHE	materials-handling equipment	op	operator, operations, operating
mi	mile	OPSEC	operations security
MIH	miles in the hour	ORP	ocean reception point
MILSTAMP	Military Standard Transportation and Move- ment Procedures	OTT	origin truck terminal
MIL-STD	military standard	oz	ounce(s)
MILSTRIP	Military Standard Requisitioning and Issue Procedures	pax	passengers
MILVAN	military-owned remountable container	pert	percussion
min	minute	pers	personnel
Mk	mark	PD	point detonating
ml	milliliter(s)	PLL	prescribed load list
MLB	metallic link belt	POC	point of contact
MLRS	Multiple Launch Rocket System	POD	port of debarkation
MLW	mean low water	POE	port of embarkation
mm	millimeter(s)	PNL	prescribed nuclear load
MMC	Materiel Management Center	POL	petroleum, oils, and lubricants
mo	month(s)	POV	privately owned vehicle
MOGAS	motor gasoline	POW	prisoner of war
MPH	miles per hour	prct	practice
MSC	Military Sealift Command	prop	propelling
MSR	main supply route	psi	pounds per square inch
MST	mechanics support team	pst	pass time
mtd	mounted	pt	point
MTMC	Military Traffic Management Command	PZ	pickup zone
MTMCTEA	Military Traffic Management Command Transportation Engineer- ing Agency	qt	quart
MTON	measurement ton	qty	quantity
NA	not applicable	RAW	rear axle weight
NATO	North Atlantic Treaty Organization	rd	round(s)
NBC	nuclear, biological, chemical	RDD	required delivery date
		RDL	reference datum line
		REFORGER	return of forces to Germany
		ref	reference
		refrig	refrigerated
		RLT	rolling liquid transporter
		RMCT	regional movement control teams
		ROH	rear overhang
		RO/RO	roll-on/roll-off
		RP	release point
		RTCH	rough terrain container handler

RWI	radio and wire integration	TNT	trinitrotoluene
S1	Adjutant (US Army)	TOE	table(s) of organization and equipment
S2	Intelligence officer (US Army)	TOFC	trailer-on-flatcar
S3	Operations and Training Officer (US Army)	TOW	tube-launched, optically tracked, wire-guided missile
S4	Supply Officer (US Army)	TP	transportation priority
/s/	signed	trac	tractor
S&P	stake and platform	trans	transporter
sec	second	TRANSCOM	transportation command
SF	standard form	trk	truck
SM	speedometer multiplier	TRS	transportation railway service
SOP	standing operating procedure	TTP	trailer transfer point
SP	self-propelled	US	United States
SPOE	seaport of embarkation	USMC	US Marine Corps
SRC	Standard Requirement Code	USN	US Navy
STANAG	Standardization Agreement	USNS	US Naval ship (civilian manned)
std	standard	util	utility
Stir	semitrailer	veh	vehicle
st mi	statute mile	VPH	vehicles per hour
STON	short ton	VPK	vehicles per kilometer
stor	storage	VPM	vehicles per mile
sup	supply	VSF	vessel stowage factor
svc	service, servicing	w	width
/t/	typed	w/	with
T	ton	w/b	webbed belt
TA	theater army	WB	wheelbase
TAACOM	theater army area command	wgt	weight
TCMD	transportation control and movement document	vhl	wheeled
TCN	transportation control number	wkr	wrecker
TD	train density	w/o	without
TDA	table(s) of distribution and allowances	wown	without winch
TE	tractive effort	WP	white phosphorous
tk	tank	WPOD	water port of debarkation
tlr	trailer	WR	wash room
TM	technical manual	wt	weight
TMO	transportation movement office(r)	WTCA	water terminal clearance authority
TMR	transportation movement release	wwn	with winch
TMT	transportation motor transport	yd	yard
		yr	year
		ZT	zone time

## Section II. TERMS

**Anchorage**— a harbor, river, or offshore area that can accommodate a ship at anchor either for quarantine, queuing, or discharge.

**Backhaul**— shipment of material to or through an area from which the material had previously been shipped.

**Back loading**— the act of loading outbound cargo on a semitrailer that delivered inbound cargo.

**Berth**— designated area alongside a wharf or anchorage.

**Break-bulk**— to unload and distribute a portion or all of a shipment.

**Cargo offering**— a requirement placed on a movement control authority by a shipping activity to obtain instructions for shipment of cargo.

**Cargo transporter**— reusable, metal, shipping container designated for worldwide surface and air movement of supplies and equipment.

**Common service**— that function performed by one military service in support of another military service for which reimbursement is not required from the service receiving support.

**Common-user transportation**— a point-to-point transportation service managed by a single service for common use by two or more services or other authorized agencies for which reimbursement is normally required from the service or agency receiving support.

**Container**— a reusable cargo container that is assigned a permanent control number; any container (for example, crate) packed with more than one shipment unit and assigned a one-time, container-control number according to Appendix B3, DOD Regulation 4500.32-R.

**Container control activity**— an activity exercising overall administrative control of container service and the movement of cargo transporters to, from, and within a theater. This activity is assigned to the freight movement division of the movement control agency.

**Container control officer**— a designated officer within an installation who receives and dispatches cargo transporters and who is responsible for control, efficient use, and report of cargo transporters at the installation to which he is assigned. He has custodial property responsibility for cargo transporters from the time received until the time he reports their dispatch.

**Controlled route**— a route, the use of which is subject to traffic or movement restrictions.

**Control point**— a position along a route of march at which men are stationed to give information and instructions for the regulation of supply or traffic.

**Date shipped**— the date a shipment is released by the consignor to the carrier.

**Density**— weight displacement of freight per cubic foot or other unit of volume.

**Dispatch route**— a roadway over which full control, both as to priorities of use and regulation of movement of traffic in time and space, is exercised. A movement credit is required for its use by an independent vehicle or group of vehicles, regardless of number or type.

**Diversion**— the rerouting of cargo or passengers to a new transshipment point or destination or to a different mode of transportation before arrival at ultimate destination.

**Frustrated cargo**— any shipment of supplies and/or equipment which, while en route to destination, is stopped before receipt and for which further disposition instructions must be obtained.

**Highway traffic headquarters**— headquarters exercising highway regulations to use highway transportation facilities and equipment most effectively according to assigned tasks. Regulations provide planning, routing, scheduling, and directing actual use of the highways by vehicles, personnel afoot (including troops, refugees, and other civilians), and animals.

**Installation transportation officer**— a qualified individual appointed on competent orders to serve a military installation or activity that requires commercial transportation service. He is a member of the technical staff of the commander of the activity to which assigned and serves essentially as the point of contact between the installation or activity and the representative of the movement management system.

**Intertheater shipments**— shipments that move into or out of the theater through water or aerial terminals.

**Intratheater shipments**— movements originating and terminating within the theater.

**Military Airlift Command (MAC)**— the single-manager operating agency for designated airlift service.

**Military Road Network**— includes all routes designated in peacetime by the host nations to meet anticipated military movements and transport movements, both allied and national.

**Military Road Maneuver Network**— the road system required by a commander for conducting a specific operation and for the required logistical support of that operation. It is defined and controlled (allotment of maneuver credits) by the military authorities, national or allied, according to the breakdown of responsibilities in the theater of operations.

**Military Sealift Command (MSC)**—the single manager of ocean transportation to provide, under one authority, the control, operation, and administration of sea transportation for personnel, mail, and cargo of the DOD; formerly designated Military Sea Transportation Service (MSTS).

**Military terminal**— any water or aerial port of embarkation operated by or for a military department as a terminal facility for receiving, loading, unloading, and forwarding military personnel or property. This term includes commercial terminals where activities are conducted under the guidance of the military.

**Military Traffic Management Command (MTMC)**— the jointly staffed, industrially funded major Army command, serving as the DOD single-manager operating agency for military traffic, land transportation, and common-user ocean terminal service.

**Mole**— a structure with a breakwater on one side and a loading/unloading facility on the other.

**Movement control**— the planning, routing, scheduling, and controlling of personnel and supply movements over lines of communication; also, an organization responsible for these functions.

**Pier**— a structure that projects from the shoreline to accommodate ships in discharge and loading. Often both sides are designed to receive ships.

**Quay**— a structure running parallel to the shoreline used to accommodate ships for discharge and loading.

**Receiving transportation officer**— the transportation officer serving the ultimate consignee.

**Report of shipment (REPSHIP)**— notification by the shipper to the consignee that a specific shipment is en route.

**Reserved route**— a route, the use of which is allocated exclusively to a particular authority or formation or which is intended to meet a particular requirement.

**Route**— the prescribed course to be traveled from a specific point of origin to a specific destination.

**Special cargo**— cargo which requires special handling or protection, such as pyrotechnics and precision instruments.

**Spotting**— the placing of trailers, container transporters, or railcars where required to be loaded or unloaded.

**Supervised route**— a roadway over which control is exercised by a traffic control authority by means of traffic control posts, traffic patrols, or both. A movement credit is required for its use by a column of 10 or more vehicles or by any vehicle of exceptional size or weight.

**Ton-miles**— a unit of measure expressed in number of short tons moved over a specific distance in miles.

**Tracing**— the act of requesting the location of a shipment to expedite its movement or to establish delivery time.

**Traffic control post**— point on the highway where the military police enforce highway traffic control and furnish information and directions.

**Transportation control and movement document**— the basic cargo movement document containing the basic information necessary to make movement management decisions through the worldwide, DOD transportation system.

**Transportation movement office**—an office designed to coordinate all movements to be carried out and to ensure maximum use of available resources. These movement offices are assigned to the communications zone, the field army, and the corps support brigade.

**Transportation movement release (TMR)**— shipping instructions issued by a movement control authority in response to a cargo offering.

**Transportation officer**— the person appointed or designated by the commander of a military activity to perform transportation services and movement management at a district, base, installation, or activity. This term also applies to movement management officers.

**Wharf**— a general term for mole, pier, or quay.



## REFERENCES

### *REQUIRED PUBLICATIONS*

Required publications are sources that users must read in order to understand or to comply with this publication.

#### Field Manual (FM)

101-10-1 Staff Officers' Field Manual: Organizational, Technical, and Logistic Data (Unclassified Data)

### *RELATED PUBLICATIONS*

Related publications are sources of additional information. They are not required in order to understand this publication.

#### Army Regulations (ARs)

55-4 CONUS Military Installation Materiel Outloading and Receiving Capability Report

55-9 Overseas Ocean Terminal Handling and Inland Line-Haul Cargo Cost Report

55-15 Land Transportation Within Areas Outside the Continental United States

55-19 Marine Casualties

55-23 Submission of Dry Cargo Requirements and the Assignment and Allocation of Sea Transportation Space

55-36 DOD Use of Domestic Civil Transportation Under Emergency Conditions

55-167 Policy Governing Transportation of Cargo by Military Sea Transportation Service

55-174 Disposition of Equipment and/or Material Used in Securing Cargo on Vessels

55-176 Logistics Over-the-Shore Operations in Overseas Areas

55-182 Single Manager for Ocean Transportation Accessorial and Other Miscellaneous Services Relative to Dry/Reefer Cargo

55-228 Transportation by Water of Explosives and Hazardous Cargo

55-292	Planning for, and Operation of, Staging Facilities in Continental United States
55-355	Military Traffic Management Regulation
56-9	Watercraft
220-10	Preparation for Oversea Movement of Units (POM)
310-25	Dictionary of United States Army Terms (SHORT TITLE: AD)
310-31	Management System for Tables of Organization and Equipment (The TOE System)
310-49	The Army Authorization Documents System (TAADS)
310-50	Catalog of Abbreviations and Brevity Codes
380-5	Department of the Army Information Security Program
385-40	Accident Reporting and Records
570-2	Organization and Equipment Authorization Tables
708-1	Cataloging and Supply Management Data
725-50	Requisitioning, Receipt, and Issue System

## **DEPARTMENT OF THE ARMY FORMS (DA FORMS)**

1248	Road Reconnaissance Report
1249	Bridge Reconnaissance Report
1250	Tunnel Reconnaissance Report
1251	Ford Reconnaissance Report
1252	Ferry Reconnaissance Report
2028	Recommended Changes to Publications and Blank Forms

## **DEPARTMENT OF THE ARMY PAMPHLETS (DA PAMS)**

310-35	Index of International Standardization Agreements
738-750	The Army Maintenance Management System (TAMMS)

## **DEPARTMENT OF DEFENSE FORMS (DD FORMS)**

1265	Request for Convoy Clearance
1266	Request for Special Hauling Permit
2133	Joint Airlift Inspection Record

**DEPARTMENT OF DEFENSE REGULATIONS (DOD REGS)**

4500.32-R Vol I	Military Standard Transportation and Movement Procedures
4500.34-R	Personal Property Traffic Management Regulation

**FIELD MANUALS (FMs)**

1-400	Aviator's Handbook
5-35	Engineer's Reference and Logistical Data
5-36	Route Reconnaissance and Classification
9-6	Ammunition Service in the Theater of Operations
10-13	Supply and Service Reference Data
10-500	Airdrop of Supplies and Equipment: Rigging Airdrop Platforms
10-501	Airdrop of Supplies and Equipment: Rigging Containers
19-25	Military Police Traffic Operations
20-12	Amphibious Embarkation
20-22	Vehicle Recovery Operations
21-26	Map Reading
21-30	Military Symbols
21-31	Topographic Symbols
21-60	Visual Signals
21-305	Manual for the Wheeled Vehicle Driver
29-51	Division Supply and Field Service Operations
31-11	Doctrine for Amphibious Operations
31-12	Army Forces in Amphibious Operations (The Army Landing Forces)
31-70	Basic Cold Weather Manual
31-71	Northern Operations
54-11	Container Movement and Handling in the Theater of Operations
55-1	Army Transportation Services in a Theater of Operations
55-2	Division Transportation Operations
55-9	Unit Air Movement Plan
55-10	Army Movement Management Units and Procedures
55-12	Movement of Army Units in Air Force Aircraft
55-17	Terminal Operations Coordinator's Handbook

55-20	Army Rail Transport Operations and Units
55-30	Army Motor Transport Units and Operations
55-40	Army Combat Service Support Air Transport Operations
55-50	Army Water Transport Operations
55-60	Army Terminal Operations
55-70	Army Transportation Container Operations
55-312	Military Convoy Operations in the Continental United States
55-450-1	Army Helicopter External Load Operations
55-450-2	Army Helicopter Internal Load Operations
55-501	Marine Crewman's Handbook
55-511	Operation of Floating Cranes
63-2	Combat Service Support Operations - Division (How to Support)
63-3	Combat Service Support Operations - Corps (How to Support)
90-6	Mountain Operations
100-5 (HTF)	Operations (How to Fight)
100-10	Combat Service Support (How to Support)
100-27	US Army/US Air Force Doctrine for Tactical Airlift Operations
101-5	Staff Organization and Operations
101-10-2	Staff Officers' Field Manual: Organizational, Technical, and Logistical Data Extracts of Non-divisional Tables of Organization and Equipment
101-20	United States Army Aviation Planning Manual

## **NORTH ATLANTIC TREATY ORGANIZATION (NATO) STANDARDIZATION AGREEMENT (STANAGS)**

1059	National Distinguishing Letters for Use by NATO Armed Forces
2002	Warning Signs for the Marking of Contaminated or Dangerous Land Areas, Complete Equipment, Supplies, and Stores
2010	Military Load Classification Markings
2019	Military Symbols
2027	Marking of Military Vehicles
2029	Method of Describing Ground Locations, Areas, and Boundaries

2096	Reporting Engineer Information in the Field
2115	Fuel Consumption Unit
2155	Road Movement Documents
2253	Roads and Road Structures

**STANDARD FORM (SF)**

361	Discrepancy in Shipment Report (DISREP)
-----	---

**SUPPLY BULLETIN (SB)**

10-495	Standard "B" Ration for the Armed Forces
--------	--

**TECHNICAL BULLETINS (TBs)**

43-0209	Color, Marking, and Camouflage Painting of Military Vehicles, Construction Equipment, and Materials-Handling Equipment
55-46-1	Standard Characteristics (Dimensions, Weight, and Cube) for Transportability of Military Vehicles and Other Outsize/Overweight Equipment

**TABLES OF ORGANIZATION AND EQUIPMENT (TOEs)**

1-167J1	Combat Aviation Company
1-257J	Combat Support Aviation Company
1-258JA	Combat Aviation Company
1-259J4	Combat Aviation Company
1-259H	Heavy Helicopter Company
5-129	Engineer Port Construction Company
5-500	Engineer Administrative and Headquarters Teams
8-500	Medical Service Organizations
10-500	Quartermaster Service Organizations
11-500	Signal Service Organizations
14-500	Finance Service Organizations
19-76	Headquarters and Headquarters Detachment, Military Police Battalion
19-77	Military Police Company
55-2H	Headquarters and Headquarters Company, Transportation Command
55-3H	Transportation Movement Control Agency
55-6H	Transportation Movement Control Center, COSCOM
55-11H	Headquarters and Headquarters Company, Transportation Motor Transport Brigade

55-12H	Headquarters and Headquarters Company, Transportation Motor Transport Group
55-16H	Headquarters and Headquarters Detachment, Transportation Motor Transport Battalion
55-17H	Transportation Light Truck Company
55-18H	Transportation Medium Truck Company
55-18J	Transportation Medium Truck Company
55-19H	Transportation Car Company
55-19J	Transportation Command Transport Company
55-23J	Transportation Medium Truck Company
55-27H	Transportation Cargo Carrier Company, Tracked
55-28H	Transportation Heavy Truck Company
55-28J	Transportation Heavy Truck Company
55-52H	Headquarters and Headquarters Company Transportation Composite Group
55-62H	Headquarters and Headquarters Company Transportation Brigade, COSCOM
55-67H	Transportation Light-Medium Truck Company
55-67J	Transportation Light-Medium Truck Company
55-69J	Transportation Motor Transport Company, Air Assault Division
55-84H	Transportation Motor Transport Company, Mechanized Division
55-87H	Transportation Motor Transport Company, Armored Division
55-87J	Transportation Motor Transport Company, Maintenance Support Battalion, Heavy Division
55-88H	Transportation Motor Transport Company, Infantry Division
55-88J	Transportation Motor Transport Company, S&T Battalion, Light Infantry Division
55-111H	Headquarters and Headquarters Company, Transportation Terminal Brigade
55-112H	Headquarters and Headquarters Company, Transportation Terminal Group
55-116H	Headquarters and Headquarters Company, Transportation Terminal Battalion
55-117H	Transportation Terminal Service Company, Break-Bulk
55-118H	Transportation Transfer Company

55-118J	Transportation Cargo Transfer Company
55-119H	Transportation Terminal Service Company, Container
55-119J	Transportation Terminal Service Company, Container
55-124J	Transportation Terminal Service Company, Break-Bulk
55-128H	Transportation Medium Boat Company
55-129H	Transportation Heavy Boat Company
55-137H	Medium Lighter Company (Air Cushion Vehicle)
55-137J	Medium Lighter Company (Air Cushion Vehicle)
55-138H	Transportation Light Amphibian Company
55-139H	Transportation Medium Amphibian Company
55-157H	Transportation Floating Craft General Support Maintenance Company
55-158H	Transportation Lighterage Maintenance Company
55-201H	Headquarters and Headquarters Company, Transportation Railway Brigade
55-202H	Headquarters and Headquarters Company, Transportation Railway Group
55-217H	Transportation Electric Power Transmission Company
55-226H	Headquarters and Headquarters Company, Transportation Railway Battalion
55-227H	Transportation Railway Engineer Company
55-228H	Transportation Railway Equipment Maintenance Company
55-229H	Transportation Train Operating Company
55-247H	Diesel-Electric Locomotive Repair Company
55-248H	Transportation Railway Car Repair Company, General Support
55-500H	Transportation Service Organizations
55-520H	Transportation Railway Service Teams
55-530H	Transportation Watercraft Teams
55-540H	Transportation Motor Transport Teams
55-550H	Transportation Watercraft Maintenance Teams
55-560H	Transportation Terminal Service Teams
55-560J	Transportation Terminal Service Teams
55-580H	Transportation Movement Control Teams

**TECHNICAL MANUALS (TMs)**

5-312	Military Fixed Bridges
5-370	Railroad Construction
9-1300-206	Ammunition and Explosives Standards
38-250	Packaging and Materials Handling Preparation of Hazardous Materials for Military Air Shipment
55-203	Maintenance of Railway Cars
55-204	Maintenance of Railroad Way and Structures
55-206	Railway Train Operations
55-500	Marine Equipment Characteristics and Data
55-601	Railcar Loading Procedures
55-602	Movement of Special Freight
55-1500-338-S	Preparation for Shipment of OH-58 Helicopter
55-1500-339-S	Preparation for Shipment of AH-1 Helicopter
55-1510-200-S	Preparation for Shipment of U-21 and RU-21 Aircraft
55-1520-214-S	Preparation for Shipment of OH-6A Helicopter
55-1520-237-23-2	Aviation Unit and Intermediate Maintenance Aircraft General Information Manual, UH-60A Helicopter
55-1520-237-23-4	Aviation Unit and Intermediate Maintenance Servicing, Ground Handling, Air Transportability, and General Maintenance Task Manual, UH-60A Helicopter
55-1520-241-S	Preparation for Shipment of CH-47 Helicopter
55-1520-242-S	Preparation for Shipment of UH-1/EH-1 Helicopters
55-1520-400-14	Transportability Guidance: Marine Transport of US Army Helicopter
55-2200-001-12	Transportability Guidance for Application of Blocking, Bracing and Tie-down Materials for Rail Transport

**OTHER PUBLICATIONS**

- Title 46, US Code of Federal Regulations, Parts 1 through 29, Shipping\*
- Title 49, US Code of Federal Regulations, Parts 170 through 179, Transportation\*
- Rules Governing the Loading of Department of Defense Material on Open-Top Cars (Association of American Railroads)\*
- Bureau of Explosives (AAR) Pamphlets 6, 6A, and 6C\*
- Bureau of Explosives Tariff 6000\*
- Military Standard 129 Sections 831 through 835, Title 18, United States code (Chapter 39, Explosives and Other Dangerous Articles)\*



MAC Regulation 3-3, Combat Control Team Operations and Procedures\*

MTMC Report TE 73-44, Manual Procedures for Estimating Marine Terminal Throughput, Parts I and II\*\*

MTMCTEA Report 73-44A, Marine Terminal Operations\*\*

MTMTS Report, An Analysis of Simulated Deployment of the US Army Airmobile Division\*\*

Sailing Directions\*\*\*

Publication Number 150, World Port Index\*\*\*

Notice to Mariners\*\*\*

---

\*Available from:

Superintendent of Documents,  
US Government Printing Office,  
North Capitol and H Streets, NW,  
Washington, DC 20402

\*\*Available from:

Military Traffic Management Command,  
Transportation Engineering Agency,  
PO Box 6276,  
Newport News, VA 23606

\*\*\*Available from:

Defense Mapping Agency,  
Office of Distribution Services,  
ATTN: DDCP,  
Washington, DC 20315

## INDEX

- A-22 Cargo bag, 2-15
- Address
  - Cargo, 5-48
  - MILSTAMP, 5-48
  - MILSTRIP, 5-48
- Administrative/Logistics plan (order), A-5
- AH-1G, 2-34
- AH-1S, 2-34
- AH-64, 2-34
- Aircraft restraint criteria, 2-41
- Air density, 2-5
- Airdrop
  - Delivery, 2-44
  - Ground-air emergency codes, 2-46
  - Low altitude parachute extraction system (LAPES), 2-45
  - Release methods, 2-45
  - Types of airdrop, 2-44
- Air movement (vehicle preparation), 3-64
- Ammunition, B-14
- Ammunition, Shipping Data, B-11
- Ammunition storage, B-13
- Amphibians
  - LACV-30, 5-39
  - LARC-5, 5-39
  - LARC-15, 5-39
  - LARC-60, 5-39
- Anchorage areas, 5-26
- Animals, B-1
- Antifreeze, B-18
- Army Aircraft
  - Aircraft Preparation, 2-39
  - Characteristics, 2-35
  - Profiles, 2-33
  - Speed and Range Factors, 2-39
- Aviation Units
  - Combat Aviation Company (1-257J410), 2-3
  - Combat Aviation Company (1-257J420), 2-3
  - Combat Aviation Company (1-257J430), 2-3
  - Combat Aviation Company (1-258JA), 2-2
  - Combat Aviation Company (1-259J4), 2-3
  - Combat Aviation Company (7-269J), 2-3
  - Combat Aviation Company (55-167J1), 2-2
  - Heavy Helicopter Company (55-259H), 2-3
- B707, 2-26
- B747, 2-26
- Barges, inland waterway, 5-22, 5-34, 5-38, 5-40
- Barges, 5-40
- Batteries, B-19
- Beach
  - Gradient, 5-28
  - Operations, 5-24
  - Reconnaissance, 5-26
  - Transfer points, 5-29
- Berth capacity, 5-15
- Boat companies (See transportation units)
- Boxcar characteristics, 4-27
- Bridge classifications, 3-43
- Bridge signs, 3-43
- Boats
  - Picket, wood, 5-38
  - Picket, steel, 5-38
  - Passenger and cargo, 5-38
- Bulk capacities, B-16
- C-5, 2-24
- C-12, 2-33
- C-130E/H, 2-22
- C-141, 2-23
- Capacity
  - Inland waterway, 5-21, 5-23
  - Water terminal, 5-15
- Cargo address, 5-48
- Cargo trailers, shipping dimensions, 3-89
- Cargo truck, shipping dimensions, 3-86
- Center of balance, 3-80
- Center of gravity
  - Aircraft, 2-41
  - Vehicle, 3-64
- Civil Reserve Air Fleet
  - Aircraft
    - B707, 2-26
    - B747, 2-26
    - DC-8, 2-26
    - DC-10, 2-26
    - L-1011, 2-26
  - Airlift services, 2-25
  - Capabilities, 2-25
  - Pallet profiles, 2-27
- CH-47, 2-34
- CH-54, 2-34
- Clearances, track, 4-34
- Clothing, average density, B-8
- Cold weather operations
  - Consumption rates

- Fuel, B-18
- Lubrication, B-18
- Batteries, B-19
- Ice, B-21
- Power vehicles, B-20
- Sleds, B-21
- Windchill chart, B-23
- Combat Aviation Companies, 2-2
- Combat conditions, planning, 3-23
- Common material, average density, B-5
- CONEX, 5-46
- Consumption by class of supply, B-9
- Consumption factors, B-10
- Consumption rate, B-13
- Container handler, rough terrain, 5-45 (see RTCH)
- Containers, 5-46
- Containers, aerial delivery, 2-45
- Container operations, 5-19
- Container terminals, 5-20
- Continental System, 4-22
- Conversion factors (metric and U.S.), B-30
- Convoy clearance, 3-17
  - Request for, 3-18
  - Special hauling permit, 3-20
- Convoy Commander's Report, 3-15
- Cooper's E-Rating, 4-40
- Covered storage, 5-18
- CRAF, 2-25
- Cranes
  - Truck-mounted
    - 20-ton, 5-44
    - 140-ton, 5-44
    - 250-ton, 5-44
  - Floating
    - 60-ton, 5-38
    - 89-ton, 5-38
  - Locomotive, 4-25
- Curve resistance, 4-11
  
- Daily lift, 3-22
- Days of supply, B-13
- DC-8, 2-26
- DC-10, 2-26
- Delay time, 3-22
- Densities, average
  - Clothing & individual equipment, B-8
  - Common material, B-4
  - Organizational field equipment, B-8
  - Subsistence, B-6
- Dimensions, container, B-15
- DOD freight car characteristics, 4-33
- Dogs, B-2
  
- Drawbar pull, 4-10
- Drum dimensions, B-15
- Dump truck, body dimensions, 3-84
- Dump truck, shipping dimensions, 3-88
  
- End delivery tonnage, 4-13
- Embarkation order, A-21
- Equivalent units of speed, B-34
- EXTAL (extra time allowance), 3-57
- External air transport
  - Advantages, 2-11
  - Cargo bags, 2-15
  - Cargo nets, 2-14
  - Equipment, 2-15
  - Personnel, 2-15
  - Responsibilities
    - Aviation Unit, 2-12
    - Receiving Unit, 2-12
    - Supported Unit, 2-12
  - Slings, 2-13
- Extraction zone, 2-45
  
- Flares, B-12
- Flatcar characteristics, 4-27
- FMS, 5-40
- Forklifts
  - 4,000 lb. rough terrain, 5-45
  - 6,000 lb. commercial, 5-44
  - 6,000 lb. rough terrain, 5-45
  - 10,000 lb. rough terrain, 5-45
- Forward load, 3-15
- Freedrop, airdrop, 2-44
- Fuel requirements, planning, 3-22
- Fuel Consumption Unit (FCU), 3-22
- Fuel requirements, 3-22
  
- Gages, track, 4-38
- General purpose pallet, 5-47
- Geneva Convention road signs, 3-47
- Grade resistance, 4-11
- Gradient of beach, 5-28
- Gross trailing load, 4-11
  
- HALO airdrop, 2-44
- Halts
  - On road, 3-59
  - Off road, 3-59
- Harbor/port information, 5-12
- Hazardous material labels, B-36
- Heavy helicopter company, 2-3
- HICHS, 2-21
- High-velocity airdrop, 2-44
- Highway tonnage factors, 3-40
- Hinterland, 5-29
- Human bearers, B-2

- Individual equipment, average density, B-8
- Inland waterway planning, 5-21
- Internal air transport
  - Advantages, 2-16
  - Disadvantages, 2-16
  - Helicopter Internal Cargo Handling System (HICHS), 2-21
  - Responsibilities
    - Aviation Unit, 2-17
    - Receiving Unit, 2-17
    - Support Unit, 2-17
  - Tie-down rings, 2-18
- KC-10A, 2-25
- Korean freight car characteristics, 4-31
- L-1011, 2-26
- Labels, hazardous material, B-36
- LACV-30, 5-39
- Landing craft, 5-28, 5-31, 5-33, 5-39
- Landing craft, mechanized-8, 5-39
- Landing craft, utility (LCU), 5-40
- Landing site
  - Selection, 2-6
  - Preparation, 2-9
- Landing zone, 2-6
- LAPES, 2-45
- LARC
  - 5, 5-39
  - 15, 5-39
  - 60, 5-39
- LCM-8, 5-39
- LCU, 5-40
- Lighter, Aboard Ship (LASH), 5-18
- Lighter, air cushion vehicle-30 (LACV-30), 5-39
- Lighter, amphibious, resupply cargo (LARC)
  - 5, 5-39
  - 15, 5-39
  - 60, 5-39
- Lighter, beach discharge, 5-39
- Lighterage discharge, 5-17, 5-21
- Lighters, 5-17, 5-21, 5-34, 5-38, 5-39, 5-40, 5-41
- Line haul leg, 3-23
- Loading time, 3-22
- Locomotive characteristics, 4-23
- Locomotive classification
  - Continental system, 4-22
  - Whyte system, 5-21
- Locomotive crane characteristics, 4-25
- LOTS (Logistics over the shore), 5-24
- Low-velocity airdrop, 2-44
- MAC, 2-22
- Maintenance, marine, 5-25
- Maintenance of way, 4-20
- Marine terminal capacity, 5-15
- Maritime Administration (MARAD) classification system, 5-41
- Measurements, conversions, and equivalents, B-26
- Metric conversion, B-26 thru B-30
- Military Airlift Command Aircraft
  - C-5, 2-24
  - C-130 E/H, 2-22
  - C-141, 2-23
  - KC-10A, 2-25
- Military load classification system, 3-40
- MILSTAMP address, 5-48
- MILSTRIP address, 5-48
- MILVAN, 5-46, 5-47
- Mines, B-12
- Missiles, packaged, B-14
- Motor pool facility, 3-29
- Motor transport data, 3-69
- Motor transport unit capabilities, 3-92
- Movement calculations
  - Gap, 3-54
  - Lead, 3-54
  - Length, 3-54
  - March rate, 3-54
  - Pass time, 3-54
  - Road distance, 3-54
  - Road space, 3-54
  - Time gap, 3-54
  - Time lead, 3-54
  - Time space, 3-54
- Movement control, 1-5
- Movement credit, 3-54
- Mules, pack, B-2
- Multiple movements, 3-59
- NATO military vehicle markings, 3-46
- NATO road signs, 3-51
- NATO warning signs, 3-53
- Navy vessels, designators, 5-32
- Net delivery tonnage, 4-12
- Net trainload, 4-12
- Ocean reception point (ORP), 5-4
- OH-6, 2-34
- OH-58, 2-34
- One time lifts, 3-23
- Open storage, 5-17
- Open-top car characteristics, 4-26
- Operation orders, A-1 thru A-30
- Operation plan, A-1 thru A-30
- Organizational field equipment, average density, B-8

- OV-1, 2-33
- Pack mules, B-2
- Pails, dimensions, B-15
- Passenger miles, 3-22
- Pallets
  - General purpose, 5-47
  - Sled, 5-47
- Parachutes, 2-45
- Petroleum products
  - Bulk capacities, B-16
  - Containers, B-13
  - Conversions, B-32
  - Measures, B-31
  - Shipping data, B-13
  - Weight, B-31
- Pickup zone, 2-6
- Planning, motor transport, 3-22
- Payload capacities, planning, 3-90
- Rail equipment requirements
  - Average speed, 4-13
  - Rolling stock, 4-13
- Rail loading
  - Basic precautions, 4-15
  - Blocking and bracing, 4-15
  - Cargo security, 4-16
  - Explosives and hazardous cargo, 4-14
  - Open top cars, 4-14
- Rail planning factors
  - Drawbar pull, 4-10
  - Gross trailing load, 4-11
  - Net trainload, 4-12
  - Resistance factors
    - Curve, 4-11
    - Grade, 4-11
    - Rolling, 4-11
    - Weather, 4-11
  - Tractive effort, 4-10
  - Train density, 4-12
- Tonnage
  - Net delivery, 4-12
  - End delivery, 4-13
- Weight on drivers, 4-10
- Rail SOP
  - Movement, 4-7
  - Railway service, 4-8
- Rail units (See transportation units)
- Rail bridge capacities, 4-40
- Railway construction, 4-17
- Railway maintenance motor car characteristics, 4-26
- Rations
  - Average calories, B-10
  - Size, B-10
  - Weight, B-10
- Reconnaissance, LOTS site, 5-26
- Refrigerator car characteristics, 4-28
- Release method (airdrop)
  - Door load, 2-45
  - Extraction, 2-45
  - Gravity, 2-45
- Repair shop, floating, marine equipment (FMS), 5-40
- Replacement factor, B-13
- Return load, 3-16
- Road movement graph, 3-57
- Road movement order, A-9
- Road movement table, 3-33, A-11
- Rolling resistance, 4-11
- Rough terrain container handler (RTCH), 5-45
- Round trip data, 3-16
- Route
  - Classification, 3-43
  - Formulas, 3-46
  - Obstructions, 3-45
  - Reconnaissance, 3-34
  - Reconnaissance symbols, 3-36
- RTCH, 5-45
- Sailing directions, 5-14
- Sea barge (SEABEE), 5-18
- Semitrailer cargo bed dimensions, 3-85
- Semitrailers, stake and platform, shipping dimensions, 3-89
- Semitrailers, van, shipping dimensions, 3-90
- Service support annex, A-3
- Shipping data
  - Ammunition, B-11
  - Petroleum products, B-13
  - Rations, B-10
- Shipping dimensions
  - Cargo trailers, 3-89
  - Cargo trucks, 3-86
  - Dump trucks, 3-88
  - Semitrailer, stake & platform, 3-89
  - Semitrailer, van, 3-90
- Shipping tag, 5-48
- Sled pallet, 5-47
- Slings, external air transport, 2-13
- Specific loads, 3-24
- Special purpose car characteristics, 4-29
- Standing operating procedures, A-12 thru A-21
- Standing operating procedures (motor transport), 3-12
- Static electric discharge probe, 2-15

- Stevedore companies (See transportation units)
- Stopping distances, vehicle, 3-90
- Storage
  - Covered, 5-18
  - LOTS, 5-29
  - Open, 5-17
  - Terminal, 5-17
- Stowage factors, B-3
- Substance, average density, B-7
- Supply
  - Ammunition, B-14
  - Classes, B-9
  - Planning factors, B-9
  - Quantities, B-9
  - Storage, B-13
  - Terms, B-10
- Support vessels, 5-33
- Sustained operations, 3-23
  
- Tank car characteristics, 4-28
- Temperature conversion, B-35
- Terminal equipment, 5-42
- Terminal estimates
  - Berth capacity, 5-15
  - Cargo load/unload time, 5-18
  - Covered storage, 5-18
  - Inland waterway capacity, 5-21
  - Temporary storage, 5-16
  - Terminal capacity, 5-15
  - Transportation, A-23
- Tentage data, B-17
- Tie-down rings, 2-18
- Time, B-24
- Time conversion chart, B-25
- TOE capabilities (see transportation units)
- Ton miles, 3-22
- Tractive effort, 4-10
- Traffic, control at marine terminal, 5-30
- Traffic circulation plan, 3-40
- Traffic density, 3-61
- Traffic density formula, 3-61
- Traffic density and flow graph, 3-62
- Traffic flow, 3-61
- Trailer, cargo, bed dimensions, 3-84
- Trailer transfer points, 3-25
- Train density, 4-12
- Transfer points, beach, 5-29
- Transportation Command, 1-4
- Transportation composite group, 1-4
- Transportation control number (TCN), 5-49
- Transportation estimate, A-23
- Transportation mediums, capabilities, B-1
- Transportation Movement Control Agency, 1-5
- Transportation Service Organization Headquarters Teams, 1-4
- Transportation plan, A-25
- Transportation planning, 1-1
- Transportation priority, 5-49
- Transportation Railway Service (TRS), 4-1
- Transportation Units
  - Cargo Carrier Company (tracked) (55-27H), 3-5
  - Cargo Transfer Company (55-118J), 5-3
  - Command Transport Company (55-19J3), 3-4
  - Diesel-electric Locomotive Repair Company (55-247H), 4-3
  - Floating Craft General Support Maintenance Company, (55-247H), 5-8
  - Heavy Boat Company (55-129H), 5-6
  - Heavy Truck Company (55-28H), 3-5
  - Light Truck Company (55-17H), 3-2
  - Lighterage Maintenance Company, General Support (55-158H), 5-8
  - Light-Medium Truck Company (55-67H), 3-6
  - Light-Medium Truck Company (55-67J4), 3-6
  - Medium Amphibian Company (55-139H), 5-7
  - Medium Lighter Company (LACV) (55-137H), 5-6
  - Medium Lighter Company (LACV) (55-137J), 5-7
  - Medium Truck Company (55-18H), 3-3
  - Medium Truck Company (container/cargo, 20 ft) (55-18J), 3-4
  - Medium Truck Company (container/cargo, 40 ft) (55-23J4), 3-4
  - Motor Transport Battalion (55-16H), 3-2
  - Motor Transport Brigade (55-11H), 3-1
  - Motor Transport Group (55-12H), 3-2
  - Motor Transport Teams (55-540H), 3-10
    - Car (55-540HGA), 3-10
    - Heavy Truck (55-540HGD), 3-11
    - Light Truck (55-540HGB), 3-10
    - Medium Truck (55-540HGC), 3-10
    - Trailer Transfer Point (55-540HGE), 3-11
  - Motor Transport Company
    - Air Assault Division (55-69J0), 3-7
    - Armored Division (55-87H), 3-7
    - Heavy Division (55-87J4), 3-8
    - Infantry Division (55-88H), 3-9
    - Infantry Division (Light) (55-88J8), 3-9
    - Infantry Division (Mechanized) (55-84H), 3-7
  - Movement Control Agency (55-004H), 1-5

Movement Control Center (COSCOM)  
(55-006H), 1-6

Movement Control Teams (55-580H)  
Highway Regulation Point (55-580HLH),  
1-8

Movement Control (55-580HLA), 1-6

Movement Control (55-580HLB), 1-6

Movement Control (55-580HLC), 1-6

Movement Control (Region) (55-580HLD),  
1-7

Movement Control (Region) (55-580HLE),  
1-7

Movement Control (Air Terminal)  
(55-580HLF), 1-7

Movement Control (Air Terminal)  
(55-580HLG), 1-7

## Railway

Battalion (55-226H), 4-2

Brigade (55-201H), 4-2

Car Repair Company (General Support)  
(55-248H), 4-2

Electric Power Transmission Company  
(55-217H), 4-3

Engineering Company (55-227H), 4-2

Equipment Maintenance Company  
(55-228H), 4-3

Group (55-202H), 4-2

Service Teams (55-520H)

Bridge and Building Maintenance  
(55-520 EG), 4-6

Detachment (Direct Support)  
(55-520HEG), 4-6

Car Repair Crew (Direct Support)  
(55-520HEE), 4-5

Diesel-Electric Locomotive  
Maintenance Crew (Direct Support)  
(55-520HED), 4-5

Maintenance-of-Way Crew (55-520HEJ),  
4-6

Section Crew (55-520HEC), 4-5

Station Team (55-520HEA), 4-5

Terminal Detachment (55-520HEB), 4-5

Train Operating Section (55-520HEH),  
4-5

Workshop Mobile Detachment (Direct  
Support) (55-520HEI), 4-6

Yard Operating Detachment  
(55-520HEF), 4-5

Train Operating Company (55-229H), 4-3

Service Organizations (55-500H)

Battalion Headquarters (55-500HAD), 1-5

Company Headquarters (55-500HAC), 1-6

Platoon Headquarters (Component)  
(55-500HAA), 1-4

Platoon Headquarters (Separate)  
(55-500HAB), 1-5

Terminal Battalion (55-116H), 5-2

Terminal Brigade (55-111H), 5-2

Terminal Group (55-112H), 5-2

Terminal Service Company (Break-Bulk)  
(55-117H), 5-3

Terminal Service Company (Break-Bulk  
and Container) (55-124J), 5-5

Terminal Service Company (Container)  
(55-119H), 5-4

Terminal Service Company (Container)  
(55-119J), 5-4

Terminal Service Teams (55-560J)

Automated Cargo Documentation  
(55-560JJI), 5-12

Break-Bulk Augmentation (Container)  
(55-560JJH), 5-11

Cargo Documentation (55-560JJB), 5-11

Cargo Hatch Gang (55-560JJE), 5-11

Container-Handling (Ship) (55-560JJF),  
5-11

Container-Handling (Shore) (55-560JJG),  
5-11

Freight Consolidation and Distribution  
(55-560JJC), 5-11

Heavy Crane Platoon (55-560JJJ), 5-12

Stevedore/Container-Handling Equip-  
ment Maintenance (55-560JJA), 5-11

Transportation Contract Supervision  
(55-560JJD), 5-11

Terminal Transfer Company, (55-118H), 5-3

Transportation Command (55-002H), 1-4

Transportation Composite Group (55-028H),  
1-4

Watercraft Maintenance Teams (55-550H)

Diver Team (55-550HIA), 5-10

Floating Craft Maintenance Team  
(General Support) (55-550HIB), 5-10

Lighterage Maintenance Team (Direct  
Support) (55-550HIC), 5-11

Watercraft Teams (55-530H)

Barge Crane, 68-ton (55-530HFH), 5-9

Barge Crane, 100-ton (55-530HFI), 5-9

Beach discharge Lighter (55-530HFM), 5-9

Deck Cargo Barge, Nonpropelled  
(55-530HFA), 5-8

Deck or Liquid Cargo Barge, 120-ft, Non-  
propelled (55-530HFC), 5-9

Harbor Tug, 70 ft. (55-530HFG), 5-9

Harbor Tug, 100 ft. (55-530HFJ), 5-9

- Lighter, Amphibian, LARC-LX (55-530HFN), 5-10
- Liquid or Dry Cargo Barge, Self-Propelled (55-530HFL), 5-9
- Oceangoing Tug, 126 ft. (55-530HFK), 5-9
- Oceangoing Tug, 143 ft. (55-530HFO), 5-10
- Picketboat, 46 ft. (55-530HFB), 5-8
- Passenger and Cargo or Picketboat, 65 ft. (55-530HFE), 5-9
- Refrigerated Cargo Barge, 120 ft. Non-propelled (55-530HFF), 5-9
- Truck axle weights, 3-74
- Truck body dimensions, 3-82
- Truck cargo bed dimensions, 3-82
- Truck center of balance, 3-80
- Truck companies (see transportation units)
- Truck performance data, 3-70
- Truck terminals, 3-25
- Tug, harbor
  - 65-foot, 5-40
  - 100-foot, 5-40
- Turnaround time, 3-23
- Type X route, 3-45
- Type Y route, 3-45
- Type Z route, 3-45
- U-8, 2-33
- U-21, 2-33
- UH-1, 2-34
- UH-60, 2-34
- Unimproved water terminal, 5-24
- Unit capability planning, 3-22
- Unit lift, 3-22
- Unloading time, 3-22
- U.S. Army vessels, 5-34, 5-38
- Vehicle axle weights, 3-74
- Vehicle capabilities, planning, 3-22
- Vehicle center of balance, 3-80
- Vehicle classification markings, 3-42
- Vehicle load placement, 3-31
- Vehicle performance data, 3-70
- Vehicle stopping distances, 3-91
- Vessel, liquid cargo, 5-38
- Vessels
  - Army
    - Characteristics, 5-35 thru 5-37
    - Designations, 5-34
  - Navy
    - Designations, 5-32
- Vessel berthing/anchorage, 5-15, 5-21
- Vessel loading, 5-18
- Watercraft, 5-32
- Water operations, 5-1
- Water port index and information, 5-12
- Water terminals, 5-12
- Water terminal capacity, 5-15, 5-21
- Weather resistance, 4-11
- West German freight car characteristics, 4-29
- Whyte system, 4-21
- World Port Index, 5-12
- Yard tractor, 5-45
- Zulu time, B-24