

MHI  
Copy 3

FM 8-35

DEPARTMENT OF THE ARMY FIELD MANUAL

---

TRANSPORTATION  
OF  
THE SICK AND WOUNDED

15  
04  
22070

DEPARTMENT OF THE ARMY

---



HEADQUARTERS, DEPARTMENT OF THE ARMY  
OCTOBER 1966

FIELD MANUAL }  
No. 8-35

DEPARTMENT OF THE ARMY  
HEADQUARTERS  
WASHINGTON, D.C., 19 October 1966

**TRANSPORTATION OF THE SICK AND WOUNDED**

	Paragraphs	Page
CHAPTER 1. GENERAL -----	1-3	2
2. MANUAL TRANSPORTATION		
Section I. Introduction -----	4-6	4
II. One-Man Carries (figs. 1-20) -----		5
III. Two-Man Carries (figs. 21-30) -----		14
IV. Special Manual Evacuation Techniques (figs. 31-35)		19
CHAPTER 3. LITTER TRANSPORTATION		
Section I. Litters -----	7-8	22
II. Litter Squad -----	9-12	25
III. Litter Drill -----	13-33	26
IV. Dressing the Litter -----	34	56
V. Litter Obstacles -----	35-43	59
VI. Improvised Litters -----	44, 45	69
VII. Aids in Litter Transportation -----	46	73
VIII. Litter Evacuation in Snow and Extreme Cold -----	47, 48	78
IX. Litter Evacuation in Mountain Operations -----	49, 50	81
CHAPTER 4. TRANSPORTATION BY GROUND VEHICLE		
Section I. Motor Ambulance -----	51-58	87
II. Conversion of Military Vehicles to Patient Carriers -	59-65	115
III. Rail Transportation -----	66-71	124
CHAPTER 5. EVACUATION BY AIR		
Section I. Introduction -----	72-78	128
II. Air Force Transport Aircraft -----	79-84	131
III. Army Fixed-Wing Aircraft -----	85-87	136
IV. Army Helicopter Aircraft -----	88-90	140
V. AMEDS Aeromedical Evacuation Operations -----	91-102	145
CHAPTER 6. TRANSPORTATION BY WATER		
Section I. Introduction -----	103, 104	157
II. Large Craft -----	105-108	157
III. Small Craft -----	109-114	161
APPENDIX REFERENCES -----		170

\*This manual supersedes Fm 8-35, 19 December 1955, including C 1, 29 September 1958, C 2, 5 August 1960, and C 3, 10 October 1963.

## CHAPTER 1

### GENERAL

---

#### 1. Purpose and Scope

The purpose and scope of this manual is to describe the principal methods and means of transporting the sick and wounded on land, in the air, and on water.

*a.* This material is applicable, without modification, to both nuclear and nonnuclear warfare.

*b.* This manual contains references to details of NATO agreements, STANAG No. 2087, Medical Employment of Helicopters in Ground Warfare; and STANAG No. 3204 and SOLOG No. 83, Aeromedical Evacuation. Specific references to these agreements are made wherever details are discussed.

*c.* Users of this manual are encouraged to submit recommended changes or comments to improve the manual. Comments should be keyed to the specific page, paragraph, and line of the text in which change is recommended. Reasons should be provided for each comment to insure understanding and complete evaluation. Comments should be forwarded direct to The Surgeon General, Department of the Army, Washington, D.C. 20315.

#### 2. Medical Evacuation and Transportation

*a.* Medical evacuation is the process of moving patients from sites as far forward as the battlefield to medical treatment facilities which can provide appropriate medical treatment. The evacuation and transportation of the sick and wounded and their medical treatment and care are continuing, parallel functions, beginning promptly at the place of injury or onset of illness continuing along a system of medical treatment facilities, and ending as far rearward as fixed medical installations. The military medical services accomplish these functions as rapidly, as orderly, and as effectively as pos-

sible, with the condition and safety of the patient as the primary concern. Patients are evacuated no farther to the rear than their condition requires or the military situation permits.

*b.* It is the policy of the Department of Defense that, in both peace and war, the transportation of patients of the Armed Forces be accomplished by aircraft when air transportation is feasible and available and conditions are suitable for air evacuation. Within a theater of operations, patients may be moved by manual means, litter, ground ambulance, aircraft, ambulance train, or by a combination of these means. From the theater of operations to the zone of interior, they are transported by aircraft, or by surface water means when air transportation is not feasible.

#### 3. Relation of Transportation to the Medical Task

The transportation of the sick and wounded to medical treatment facilities and the provision of appropriate medical treatment and care during transportation is one of the chief responsibilities of the military medical services.

*a.* Air transportation of the sick and wounded within the combat zone is a mission of the Army Medical Service. This includes battlefield pick-up of patients, their transportation to the initial point of treatment, and initial and subsequent transportation to hospital facilities within the combat zone. The Army Medical Service is also responsible for transportation of patients by litter and manual means and by ground ambulance. Ground ambulance is used for patient transportation to medical treatment facilities, to airstrips for air transportation from the combat zone by Air Force aircraft, and from the combat zone to and within the

communications zone. The Army also uses ambulance trains for patient evacuation. In general, ambulance trains are used for the transportation of patients who are unable to be moved by air because of their condition, or when aircraft transportation is not feasible or available for patient evacuation.

b. Patient evacuation by air over routes of sole interest to the Navy and within naval (including marine) combat areas is a function of the Navy. It is a responsibility of the Navy to provide water transportation for the sick and wounded from the theater of operations to the zone of interior. This means of transportation

is used as a supplement to aircraft transportation and as an alternative means when aircraft transportation is not available or advisable. It is accomplished by the Military Sea Transport Service.

c. The Air Force is responsible for providing air evacuation of patients from airheads in logistically supported airborne operations and between zones in a theater of operations (accomplished by the theater Troop Carrier Force); between theaters of operations and from the theater of operations to and within the zone of interior (accomplished by the Military Air Transport Service).

## CHAPTER 2

### MANUAL TRANSPORTATION

---

#### Section I. INTRODUCTION

#### 4. Handling the Patient

Careful and correct handling of the patient is of primary importance in the evacuation and transportation of the sick and wounded. If a patient is roughly or incorrectly moved, his injury may become more serious or even fatal.

#### 5. Treatment of the Patient

Many lifesaving and life preserving measures are carried out before transporting the wounded to medical treatment facilities. Before any movement of the patient is attempted, the type and extent of the injury is evaluated. Measures are taken to stop bleeding, establish airway and give artificial respiration when needed, protect wounds, and prevent or treat for shock. If a patient has a fracture or a suspected fracture, the part should be immobilized before he is moved. Every precaution must be taken to prevent the broken ends of bone from cutting through muscle, blood vessels, nerves, and skin. If a patient has a serious leg injury, the leg should be splinted to prevent further injury, even if the bone is not broken. For further discussion of emergency medical care and treatment, see TM 8-230.

#### 6. Manual Carries

Manual carries are tiring for the bearer and involve the risk of increasing the seriousness of the patient's injury. In some instances, litters are not available and patients *must* be transported by manual carries. In these instances, the patients should be transferred to litters as soon as litters are available. In certain types of terrain and in some combat situations, only manual transportation is feasible, and in

some situations, manual transportation is necessary to save a life.

*a.* Some of the carries discussed in this chapter may be used for unconscious patients. Others can be used only if the patient is conscious. Some of the carries must not be used if there is any evidence of a fractured arm, thigh, neck, back, or hip.

*b.* Manual carries are accomplished by one bearer or by two bearers. Two-man carries are used whenever possible. They provide more comfort to the patient, are less likely to aggravate injuries, and are also less tiring for the bearers, who are thus able to carry the patient farther.

*c.* The fireman's carry, which is one of the easiest ways for one man to carry another, is of special importance since the preliminary steps of the carry are used in several other one-man carries. An unconscious or disabled person can be raised from the ground in the first three steps of the carry.

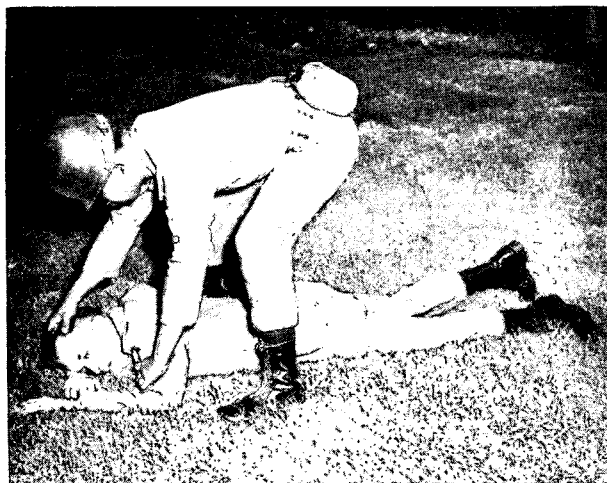
*d.* In this chapter, manual carries are described step by step and basic doctrine is explained. Certain flexibility is permitted in the application of the doctrine. In the discussion of the fireman's carry, the first three steps are described two different ways: starting at the back of the patient, and starting in front of the patient. The bearer, first determining the location of the patient's wound, can thus choose the method he believes to be the safer for the patient. In the discussion of some of the carries, the terms "left (right)" or "right (left)" are used to indicate that the various steps of the carry can be accomplished by starting from either the left or the right side.

## Section II. ONE-MAN CARRIES



(Can be used if patient is unconscious.) Turn patient face down.

*Figure 1. Fireman's carry (step one).*



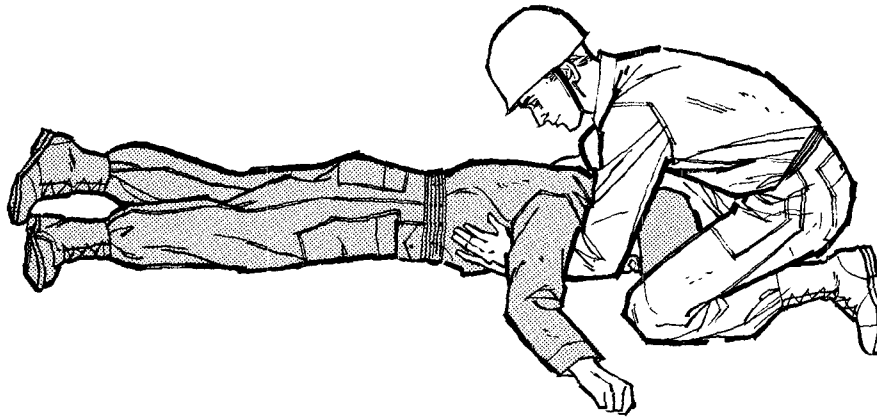
Support patient's head on his arm.

*Figure 2. Fireman's carry (step two).*



- a. Straddle patient.
- b. Grasp him by placing your hands under his armpits.
- c. Lift him first to his knees, get a better grip, and then raise him to a standing position until his knees lock.

*Figure 3. Fireman's carry (step three).*



- a. Turn patient face down on ground and, facing him, kneel on one knee at his head.      b. Place both hands under patient's armpits and gradually work them down his side and across his back.

*Figure 4. Fireman's carry (step one) (alternate method).*



Raise patient to his knees.

*Figure 5. Fireman's carry (step two) (alternate method).*



Take firmer hold across patient's back and raise him to his feet.

*Figure 6. Fireman's carry (step three) (alternate method).*



Support patient by placing an arm around his waist, and move to patient's front.

*Figure 7. Fireman's carry (step four).*



- a. Place right foot between patient's feet, and grasp patient's right wrist with your left hand.
- b. Bending at the waist, pull patient's right arm around the back of your neck.
- c. Pull patient's right arm down so that his body comes across your back.
- d. Encircle patient's right leg at the knee with your right hand.

*Figure 8. Fireman's carry (step five).*





Lift patient while straightening up, holding patient's right wrist in your left hand and the patient's right knee in your right hand.

*Figure 9. Fireman's carry (step six).*



Grasp patient's right wrist in your right hand, leaving your left hand free.

*Figure 10. Fireman's carry (step seven).*



(Useful when patient is only slightly injured.)

- a. Raise patient from ground as in fireman's carry.
- b. With your left (right) hand grasp patient's left (right) wrist and draw his left (right) arm around your neck. Place your right (left) arm around his waist.

(The patient is thus able to walk, using you as a crutch.)

*Figure 11. Supporting carry.*



(Use only when patient is conscious.)

- a. Raise patient to upright position.
- b. Support patient by placing an arm around his waist, and move to patient's front.
- c. Have patient encircle his arms around your neck.
- d. Stoop, raise him upon your back, and clasp hands beneath patient's thighs.

*Figure 12. Saddleback carry.*



(A good way of carrying an unconscious patient. Do *not* use if there is a fracture or suspected fracture of arm, leg, neck, back, or hip.)

- a. Raise patient from ground as in fireman's carry.
- b. Support patient by placing an arm around his waist, and move to patient's front.
- c. Grasp patient's wrists and hoist him so that his armpits are over your shoulders.

*Figure 13. Pack-strap carry.*



(May be used for long distances without undue fatigue of bearer.)

Link together two pistol belts to form a continuous belt under the patient's thighs and hips so that a loop extends from each side.

(Can be used with alternate equipment, such as one rifle sling, two triangular bandages, two litter straps, or any suitable material that will not cut or bind the patient's flesh and is long enough to pass around patient and be secured around carrier.)

*Figure 14. Pistol-belt carry (step one).*



- a. Lie between patient's extended legs and thrust your arms through the belt loops.
- b. Grasp patient's right (left) hand with your left (right) hand and the patient's right (left) trouser leg with your right (left) hand.

*Figure 15. Pistol-belt carry (step two).*



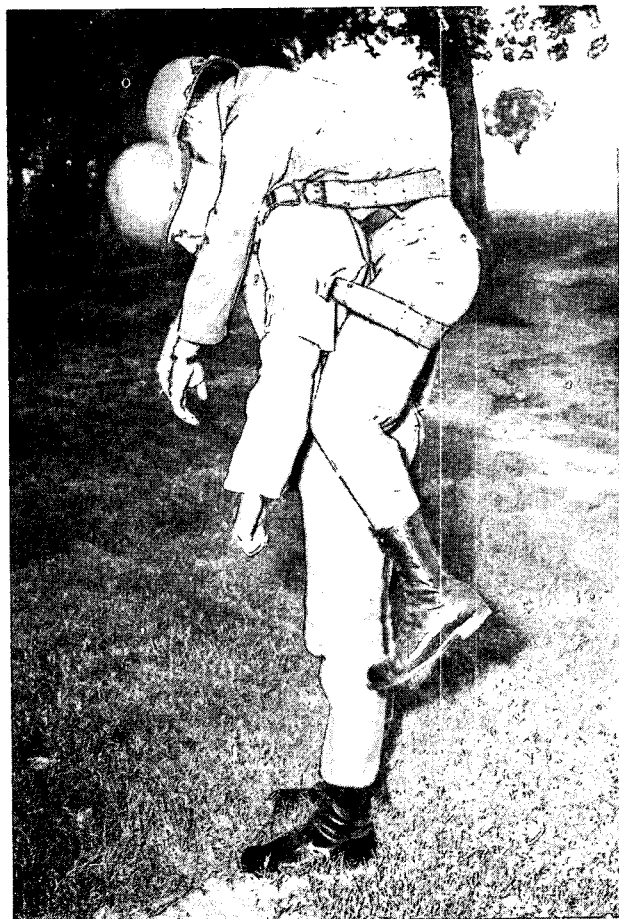
- a. Rolling toward the patient's uninjured side, roll over to the prone position, carrying the wounded man onto your back.
- b. Make necessary adjustments of slings before proceeding.

*Figure 16. Pistol-belt carry (step three).*



Rise to the kneeling position. (The continuous belt holds the patient firmly in position.)

*Figure 17. Pistol-belt carry (step four).*



Place one hand on your knee for support and rise to an upright position.

(The patient is now supported on your shoulders, held in position by the continuous belt. He will ride comfortably whether conscious or not.)

(You are ready to move, with your hands free for use in climbing steep banks or in surmounting obstacles.)

*Figure 18. Pistol-belt carry (step five).*



(Can be used for very short distances only. Affords protection in combat, since bearer and patient remain close to ground. Do not use if patient is suspected of having a fracture of the neck, back, hip, or thigh.)

a. Extend two pistol belts, or similar objects, their full

length, and join together to make one continuous loop.

b. Roll patient on back.

c. Pass loop over patient's head and work into position across his chest under his armpits.

d. Cross belts nearest you.

*Figure 19. Pistol-belt drag (step one).*



(Lie down on side with back away from patient, resting on right elbow.)

a. Slip loop over your arm and shoulder and turn over on abdomen.

b. Advance by crawling and drag the patient.

*Figure 20. Pistol-belt drag (step two).*

Section III. TWO-MAN CARRIES



(May be used for the unconscious patient. Do not use if there is evidence of a fractured arm, leg, neck, back, or hip.)

Method of accomplishment is similar to that for one-man supporting carry (fig. 11), except that two men are used instead of one.

*Figure 21. Two-man supporting carry.*



*Figure 22. Two-man arms carry (step one).*

(Particularly suited to lifting a patient onto a litter or other carrier.)

- a. The two bearers kneel at one side of the patient.
- b. One bearer places one arm beneath the patient's shoulders and the other arm beneath his back.
- c. The second bearer places one arm beneath the patient's hips and the other arm beneath his knees.

*Figure 22. Two-man arms carry (step one).*



Bearers lift the patient to their knees.

*Figure 23. Two-man arms carry (step two).*



Bearers rise together, lifting the patient and turning him in toward their chests.  
(Carrying patients high on the chests lessens fatigue.)

*Figure 24. Two-man arms carry (step three).*





(A good method for carrying an unconscious patient a short distance. Do *not* use if there is a fracture or suspected fracture of the arm, leg, neck, back, or hip.)

a. With patient lying on his back, front bearer spreads patient's legs, steps between them, faces away

from the patient, kneels, reaches back, and grasps patient behind the knees.

b. Rear bearer kneels at patient's head, and thrusts his arms under patient's armpits and across his chest, locking his hands together.

*Figure 25. Two-man saddleback carry (step one).*



Bearers rise together, lifting the patient.

*Figure 26. Two-man saddleback carry (step two).*



(A good carry for patients with injuries of the head or feet. Patient must be conscious so he can hold on.) Each bearer grasps his own left wrist with his right hand, and then grasps the other bearer's right wrist with his left hand.

*Figure 27. Four-hand carry (packsaddle carry) (step one).*



The patient sits on the interlocked hands of the bearers, supporting himself by placing an arm around each of their necks.

*Figure 28. Four-hand carry (packsaddle carry) (step two).*



(May be used if patient is unconscious. Do not use if it is suspected that patient has a fractured neck, back, or hip.)

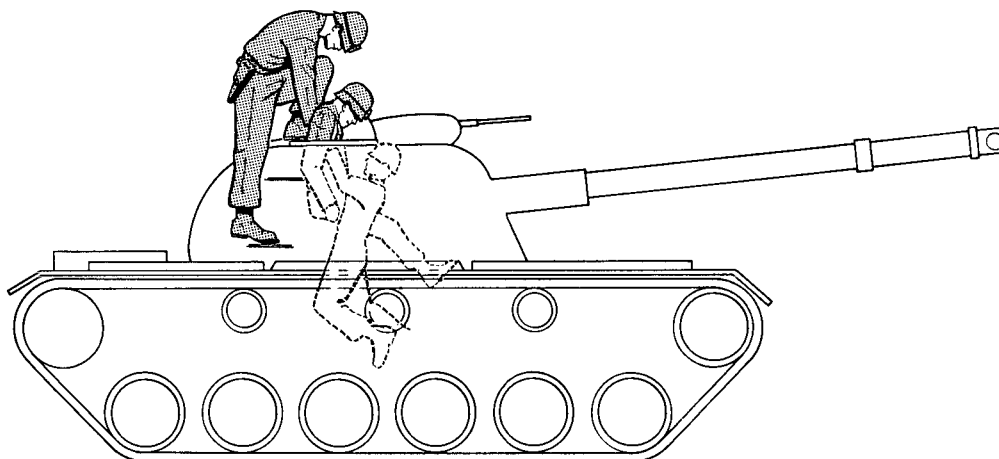
- a. With patient lying on his back, bearers kneel on opposite sides of the patient's hips.
- b. Each bearer passes his arms under the patient—one arm under the thighs and the other arm under the arms and behind the back—and then grasps the other bearer's wrist.
- c. The bearers rise together, lifting the patient.

*Figure 29. Two-hand carry (position of arms under patient's arms and back).*



*Figure 30. Two-hand carry (front view).*

Section IV. SPECIAL MANUAL EVACUATION TECHNIQUES

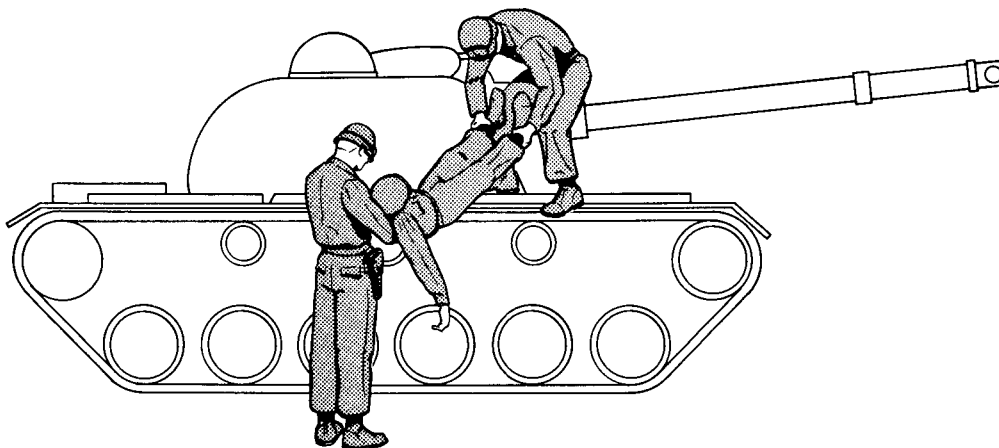


(Task of removing wounded man from interior of tank is difficult and requires speed, since stationary tanks are good targets, and all disabled armored vehicles are likely to explode. Two men, therefore, should be used. If only one is available, he uses a pistol belt,

or similar device to lift the injured man from the tank.)

- a. One man goes into the tank and supports the wounded man from below.
- b. The second man stands on top of the turret and lifts the injured man through the hatch.

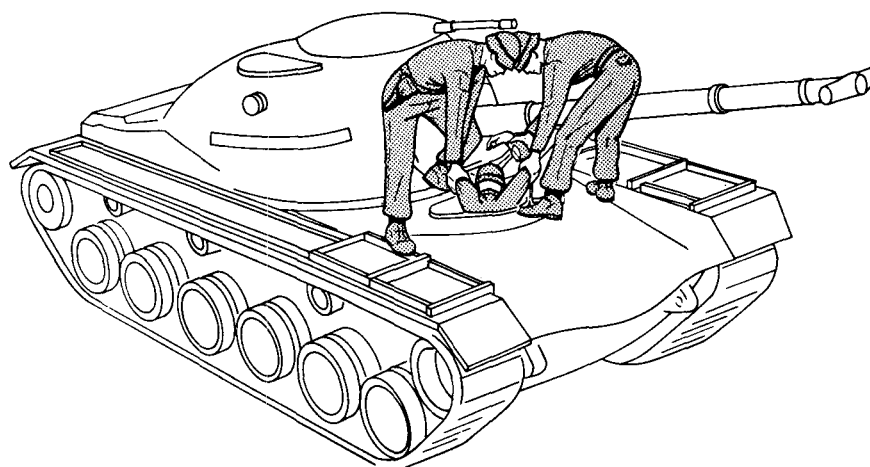
Figure 31. Removing a patient from a tank turret (step one).



- a. The second man holds the patient in place on the hatch rim, while stepping to the fender or stowage chest of the tank.

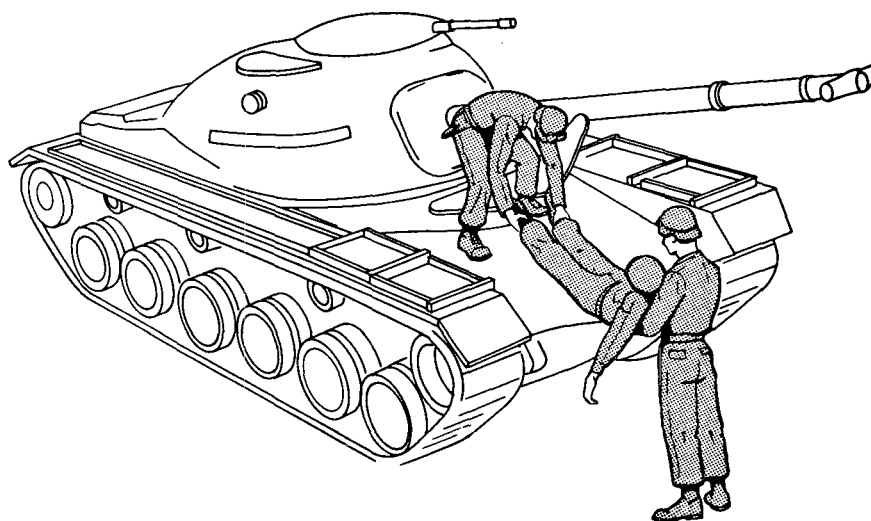
- b. He supports the patient until the first man can get out of the tank and jump to the ground.
- c. The second man then lowers the patient into the arms of the first man.

Figure 32. Removing a patient from a tank turret (step two).



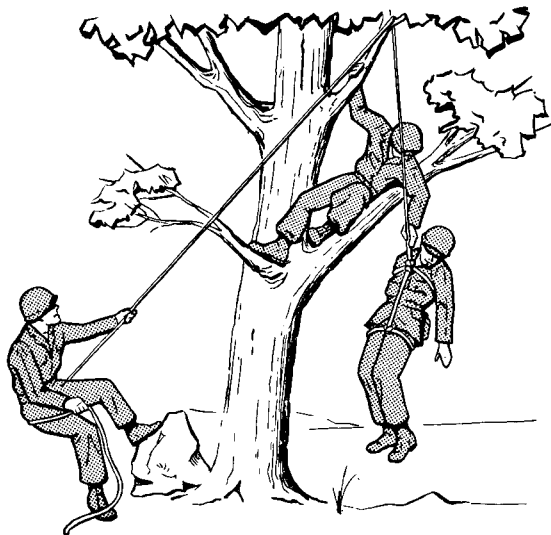
- a. The two men open the hatch, reach down, and fold the patient's arms across his chest.
- b. They turn the wounded man until he faces the rear.
- c. With one man standing on each side of the hatch, they lift the patient until he is sitting on the hatch rim.

*Figure 33. Removing patient from driving compartment (step one).*



One man jumps to the ground, while the other lowers the patient down the front slope plate.

*Figure 34. Removing patient from driving compartment (step two).*



(During airborne and mountain operations, it may be necessary to remove the wounded from trees. The method to use will vary, depending upon the size of the tree, the foliage, the strength of the branches, the manner in which the injured man is wedged, and the help available. It is best to use two men for this type of evacuation.

- a. One man stands on the ground and holds one end of a rope.
- b. The second man climbs the tree, taking the other end of the rope with him. He passes the rope over a branch of the tree above the position of the wounded man, and ties a bowline knot or some knot which will not slip. (If necessary, he administers emergency medical treatment.)
- c. He slips one loop over each thigh of the patient, and then with the same rope ties a bowline around the patient's chest.
- d. The man on the ground, holding the other end of the rope, lowers the injured man to the ground. The first man escorts the injured man in his descent and prevents his movement from being impeded by intervening limbs or branches.

(When only one man is available, he can climb the tree, attach the rope, climb down to the ground, and lower the injured man to safety.)

*Figure 35. Removing the wounded from trees.*

## CHAPTER 3

## LITTER TRANSPORTATION

## Section I. LITTERS

## 7. General

Patient transportation by litter is a task of Army Medical Service personnel which is begun at the critical point in the process of evacuation—the area between the patient on the field and the most forward ambulance or medical treatment installation. After being picked up in a forward area by litter bearers, patients may be moved on litters by vehicle to points as far rearward as fixed medical treatment installations. The patient who requires litter accommodation while in transit is referred to as a *litter (stretcher) patient*. The patient who is able to walk and requires only sitting accommodation in vehicles while in transit is a *walking (ambulatory) patient* (STANAG No. 3204 and SOLOG No. 83).

8. Types of Litters  
(figs. 36–41)

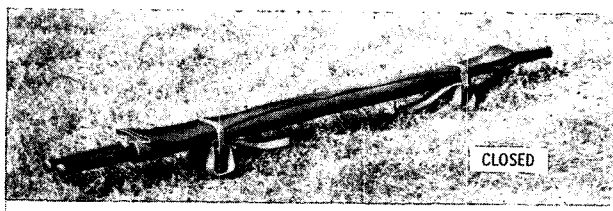
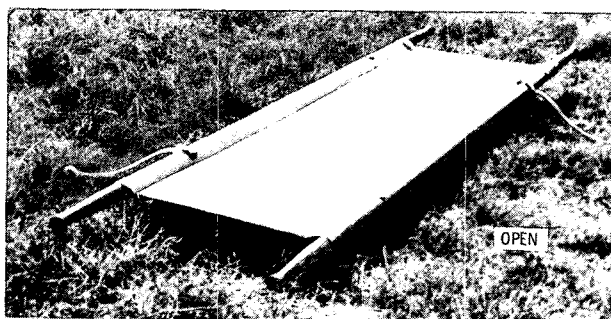
A litter may be a standard product, designed for the purpose of carrying a patient, or it may be a substitute improvised from certain available materials. A standard litter consists of a frame, a cover, and accessories, such as poles, stirrups, litter straps, and patient securing straps. The medical services of the Armed Forces use several types of standard litters, of which the most widely used is the durable straight aluminum litter.

*a.* Two types of litters have lightweight aluminum poles and are of the same general dimensions when open. One litter has rigid poles; the second type has folding poles, which permit the litter to be folded to one-half its length. This standardization allows a patient to travel in various vehicles on the same litter, minimizing the possibility of further harm to the patient and saving valuable time.

*b.* Four types of litters have been developed for special purposes—the Stokes metal litter, the semirigid poleless litter, the nonrigid pole-

less litter, and the mountain basket-type rigid litter.

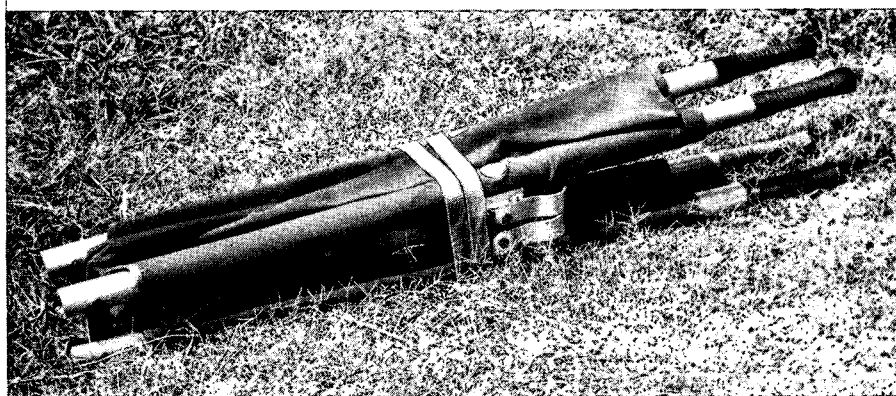
*c.* The ambulance litter, Bomgardner type, is designed for use in the metropolitan ambulance. It is not used in the field.



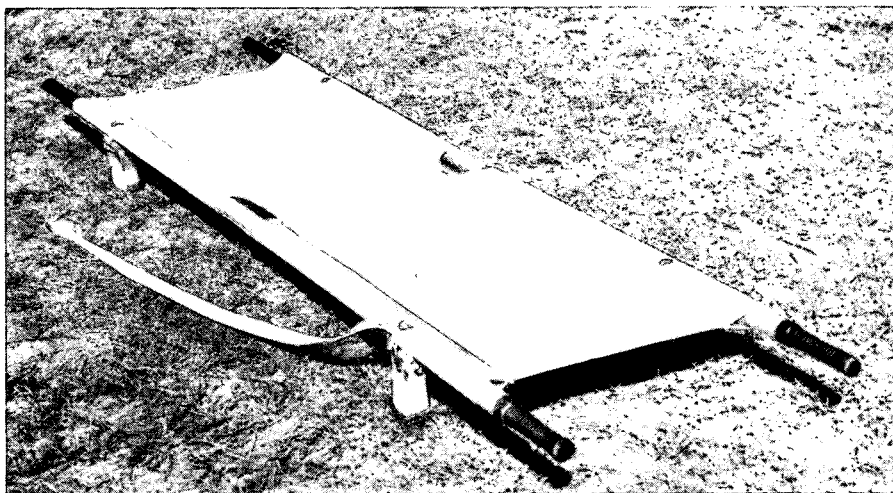
- a.* Folds in long axis only.
- b.* Basic components are two rigid, lightweight aluminum poles and a cover (bed) of cotton duck.
- c.* Four wooden handles are attached to poles.
- d.* Four stirrups, one bolted near the end of each pole, support litter when placed on ground.
- e.* Two spreader bars, one near each end of litter, extend crosswise at stirrups to hold cover taut when litter is open.
- f.* Two litter securing straps are attached, one to each pole at stirrup bolts, to strap litter when closed.
- g.* Two or four patients securing straps may be used as accessories.

(Overall length—90 inches  
Overall width —22 $\frac{1}{8}$  inches  
Bed length —72 inches  
Bed width —22 $\frac{1}{8}$  inches  
Weight —15 pounds.)

Figure 36. Straight aluminum litter.



Closed, folded, and strapped.



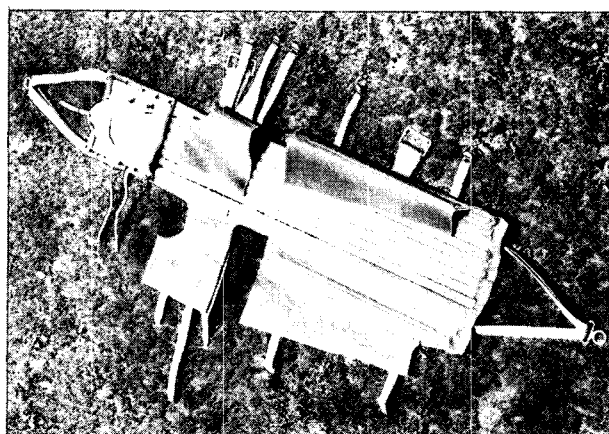
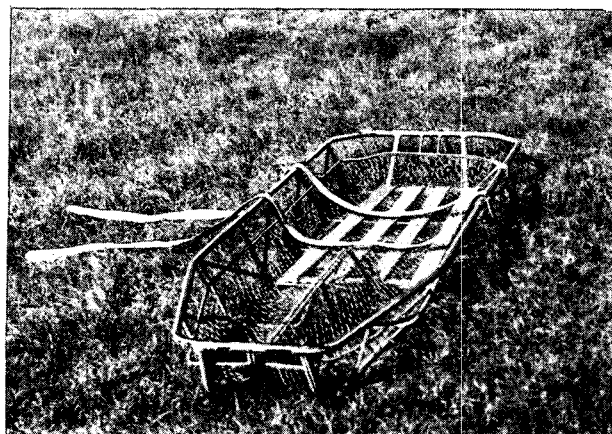
Open.

- a. Folds in both long and short axes. Is therefore easy to handle and store.
- b. Used in airdrops and airborne operations.
- c. Is similar to straight aluminum litter, except that poles are hinged in the middle and stirrups fold flat against poles when litter is collapsed.

(Overall length—90 inches  
Overall width —22 $\frac{7}{8}$  inches  
Bed length —72 inches  
Bed width —22 $\frac{7}{8}$  inches  
Weight —18 $\frac{3}{4}$  pounds.)

*Figure 37. Folding aluminum litter.*





Affords maximum security for patient when litter is tilted.

- a. Is a steel or aluminum tubular frame supporting a bed of wire mesh netting which has wooden support slats for support of patient's back.
- b. Lower half is divided into two compartments to accommodate legs of patient.
- c. Has four webbing patient securing straps, and one extra strap.
- d. Ropes and/or cable or steel rings are usually attached to each end for suspension operations.

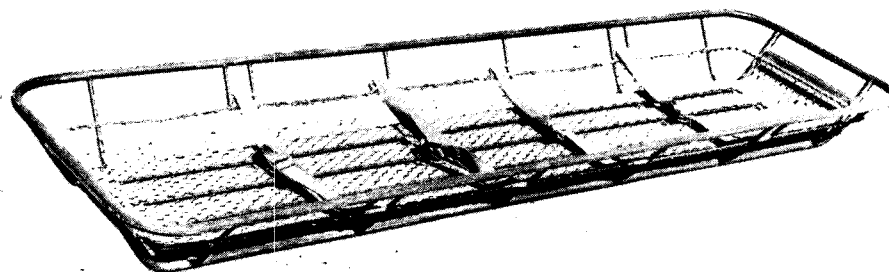
(Length—84 inches  
Width —23 inches  
Weight —31½ pounds.)

*Figure 38. Stokes metal litter.*

- a. Especially useful in evacuating patients from ships and in mountainous areas. Holds patient securely in position and facilitates movement of patients in vertical direction.
- b. Made of semirigid cotton duck cloth with wooden supports.
- c. Has four webbing handles, two at each end, for four-man carries.
- d. Has four loops for inserting poles for carrying purposes, headpiece to support patient's head, and seven patient securing straps to secure patient to litter.

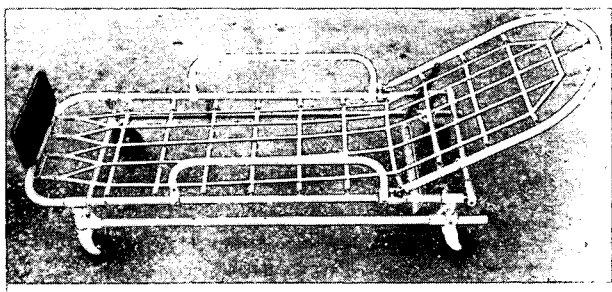
(Overall length—83¾ inches  
Width —22¾ inches.)

*Figure 39. Semirigid poleless litter.*



- a. Designed for use in mountain operations. Affords security for patient when litter is tilted. Can be pulled on ground without injury to patient.
  - b. Is a steel tubular frame supporting a bed of wire mesh netting with a base of four runner boards.
  - c. Has four webbing straps.
- (Overall length—84¾ inches  
Width —22¾ inches.)

*Figure 40. Mountain basket-type rigid litter.*



- a. Not used in forward areas. Designed for use in the metropolitan ambulance.
  - b. Consists of a two- or three-sectioned aluminum frame, an upholstered footrest, adjustable side rails, telescopic frame at head-end, and a mattress. Is mounted on four swivel casters with rubber tires.
- (Length—75 inches  
Width —22 inches.)

Figure 41. Stretcher, ambulance, Bomgardner.

## Section II. LITTER SQUAD

### 9. Composition

A litter squad ordinarily consists of four litter bearers (fig. 42), both for purposes of instruction and for actual field duty. The fatigue produced by long and frequent carries is difficult to withstand when the weight of the loaded litter is shared by fewer than four men.

### 10. Instruction and Drill

In the instruction and drill of the litter squad in handling the litter, each bearer is given a numerical designation, which carries with it the responsibility for certain duties. The squad is drilled first in handling the unloaded litter and then in handling the loaded litter. Paragraphs



Figure 42. Litter squad.

13 through 33 contain a drill guide, the use of which promotes uniformity and accuracy of methods and economy of valuable training time.

### 11. Designation and Duties of Bearers

A squad of litter bearers in line are numbered consecutively from right to left.

a. The bearer designated as No. 1 is the squad leader.

b. In the absence of No. 1, No. 4 assumes the duties of leader.

c. If both No. 1 and No. 4 are absent, No. 3 becomes the leader.

d. In the absence of No. 3 and No. 2, their duties are assumed by No. 1 and No. 4, respectively.

e. If No. 4 is absent, his duties do not require replacement.

### 12. Instruction in Reduced Squads

Under exceptional circumstances, when two-bearer squads are being instructed, the instruction will be as for No. 2 and No. 3 of the four-bearer squad.

## Section III. LITTER DRILL

### 13. Commands

Litter drill is not a precision drill; however, certain preparatory commands and commands of execution should be used to facilitate instruction. A *preparatory command* states the movement or formation to be carried out and mentally prepares the individual for its execution. A *command of execution* tells when the command is to be carried out. The use of these commands in actual operations is not contemplated. For purposes of identification in the discussion of the different types of litter drill, preparatory commands will be in lower case with initial capital letters and commands of execution will be in capital letters.

### 14. Litters

When a litter is not open, it may be referred to in one of the following ways:

a. *Litter, closed*, when the two poles are brought together and the canvas is evenly and smoothly doubled upon itself.

b. *Litter, folded*, when, after closing, it is doubled upon itself along the long axis at the hinges provided for that purpose. (Some litters have two pairs of hinges. Not all litters can be folded.)

c. *Litter, strapped*, when, after closing (and folding, if a folding-type litter), it is secured by cross-straps.

### 15. General Rules for Moving Patients

a. In moving a patient, either with or without a litter, every movement should be made deliberately and as gently as possible. The command STEADY should be used to prevent undue haste and other irregularities.

b. The rear bearers should watch the movements of the front bearers and time their own with them, so as to insure ease and steadiness of action.

c. The litter must be kept as nearly level as possible at all times. Care must be taken to do this in passing obstacles and ditches.

d. As a rule, the patient should be carried on the litter feet foremost, but in going uphill or upstairs his head should be forward.

e. In case of fractures of the lower extremities, the patient is carried uphill or upstairs feet foremost, and downhill head foremost. This prevents the weight of the body from pressing upon the injured part.

### 16. Basic Guides for Litter Drill

a. Several squads may be instructed simultaneously by one individual, or each squad may be instructed separately by an instructor or by the squad leader (No. 1).

b. For purposes of instruction, the unloaded *open* litter is handled as a loaded litter.

c. In the instruction with loaded litters, some men are designated "patients." These men should be frequently rotated with the men carrying the litters so that all may participate in each phase of the instruction.

d. To facilitate instruction in the handling of the different types of injuries, patients wear moulages, bandages, and splints to simulate actual disabilities.

e. In the early phases of instruction, patients may be positioned on the ground at suitable intervals near the line of litters, first with the head, and later with the feet, toward the litters. As the instruction progresses, their positions may be varied. Last, they may be dispersed or concealed to simulate positions the wounded might occupy on the battlefield.

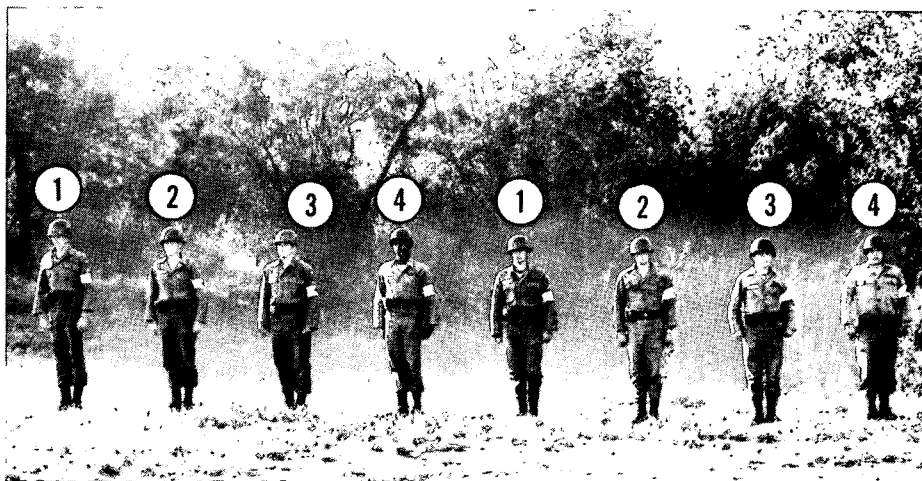
f. When patients are loaded on litters, their equipment is carried by No. 1 and No. 4, or it is placed on the litter.

## 17. Formations

a. *Formation for Instruction.* Appropriate drill commands are used to form and align the unit in a single rank for instruction in litter drill and to return the unit to its normal formation after completion of instruction.

b. *Formation of Litter Squads* (fig. 43). To form litter squads (with the unit in single rank and facing the front), the commands are By Four, Count, OFF.

c. *Designation of Squads.* To designate squads by number, the commands are By Litter Squad, Count, OFF. At the command Count, OFF, No. 1 man of each squad, except the right squad, executes Eyes, RIGHT; and beginning at the right, counts in consecutive order ONE, TWO, THREE, etc., until all squads have counted. Each No. 1 man turns his head and eyes to the front as he counts.



- a. At the command Count, OFF, all men, except the right file, execute Eyes, RIGHT.
- b. Beginning with the right file, they count, ONE TWO, THREE, FOUR, ONE, etc.
- c. Each man turns his head and eyes to the front as he counts.

*Figure 43. Formation of litter squads.*

## 18. To Procure Litter (figs. 44-46)

Litters are available in the immediate vicinity. Commands are Procure, LITTER.



At the command of execution, all No. 3 men take one step to the rear.

*Figure 44. Procure, LITTER (step one).*



a. No. 3 men execute Right (Left), FACE, as required by the location of the litters, and immediately proceed in column of files by the nearest route to the closed and strapped litters.

b. Each takes one litter and places it on his right shoulder, and all promptly return in reverse order to the rear of the line.

*Figure 45. Procure, LITTER (step two).*



No. 3 men turn and step into the line in unison.

*Figure 46. Procure, LITTER (step three).*



*Figure 47. Litter at the shoulder.*

### 19. To Return Litter

Instruction in the use of the litter having been completed, litters are returned to the place of procurement. Commands are Return, LITTER. The procedure is as for Procure, LITTER, in reverse.

### 20. Positions

The positions "litter at the shoulder" and "litter at the vertical" are assumed as illustrated and described in figures 47 and 48.

---

Litter is held at a 45° angle upon the right shoulder with canvas down, the right hand grasping lower right stirrup and the left hand at side.

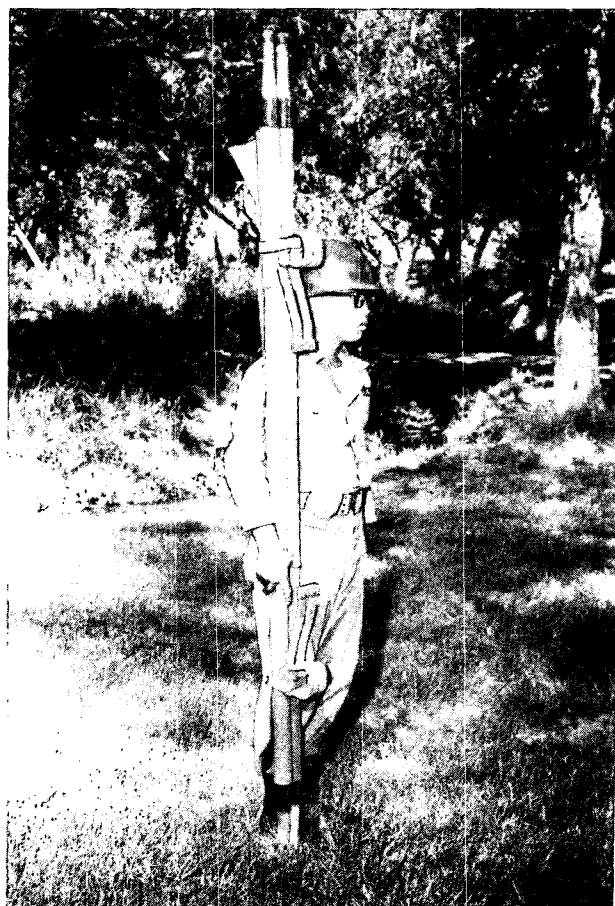
21. To Order Litter  
(fig. 49)

The litter is "at the shoulder." To order litter, the commands are Order, LITTER.



- a. In all motions from or to the shoulder, the litter should be brought to vertical position against right shoulder, canvas to the rear, right hand grasping right lower stirrup, and left hand steadying the litter against shoulder.
- b. The vertical position should be taken automatically by bearer when assuming place in line.
- c. When there is danger of the litter striking nearby persons, bearer brings litter to vertical position, resuming "at the shoulder" without command.

*Figure 48. Litter at the vertical.*



At the command of execution, litter is brought to vertical position and carefully lowered until lower handles are on ground outside right foot with canvas to the rear. Right arm is extended naturally with right hand grasping poles and left hand at the side.

*Figure 49. Order, LITTER.*

**22. To Shoulder Litter from the Order**

(figs. 50-52)

To shoulder litter from the order, commands are Shoulder, LITTER.



At the command of execution, litter is lifted with left hand.

*Figure 50. Shoulder, LITTER (step one).*



Litter is lifted to vertical position.

*Figure 51. Shoulder, LITTER (step two).*





Litter is laid canvas down upon shoulder.

*Figure 52. Shoulder, LITTER (step three).*

**23. To Carry Litter**

(figs. 53, 54)

*a. Designation of Litter Ends.* The part of the litter normally supported by No. 2 is the foot; that by No. 3, the head. With the exception of

a few special movements, such as carrying patients up or down an incline, the same designation applies.

*b. Being in Line.* Litters are "at the shoulder." Commands are Carry, LITTER.



At the command of execution, No. 3 brings the litter to the vertical position and takes two steps backward.

*Figure 53. Carry, LITTER, from shoulder (step one).*



a. No. 3 lowers the upper handles forward and downward until the litter is in horizontal position with the canvas up, and grasps the outside handle with his right hand.

b. Meanwhile, No. 2 steps to the front until he is opposite the front handles, then he grasps the outside handle with his left hand. No. 1 and No. 4 stand fast.

Figure 54. Carry, LITTER, from shoulder (step two).

c. *To Shoulder Litter from the Carry.* Being "at the carry," to shoulder litter, at the command LITTER, No. 3 advances to his former position in line, at the same time bringing the litter to the vertical and then to the shoulder position. In this movement he is aided by No. 2, who lifts his end of the litter to the vertical as he steps backward into his former position in line. No. 1 and No. 4 stand fast.

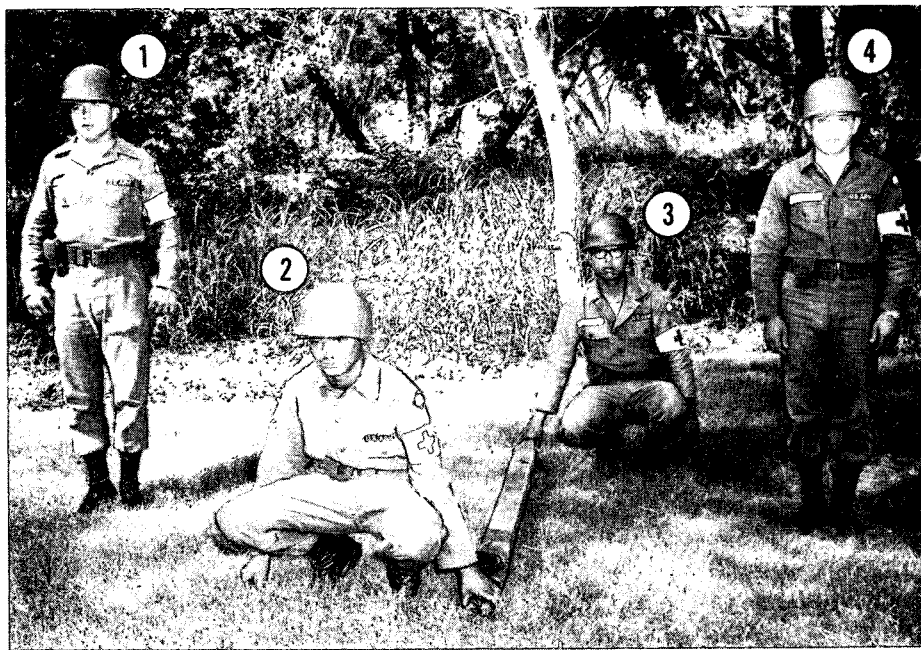
d. *Being at the Ground* (fig. 55). The litter "being at the ground," the commands are Carry, LITTER.

e. *Unloaded Litter in Marching.* In marching the unloaded litter is usually "at the carry," but, when space permits or squads are working independently, it may be "at the shoulder."

## 24. To Ground Litter

(fig. 56)

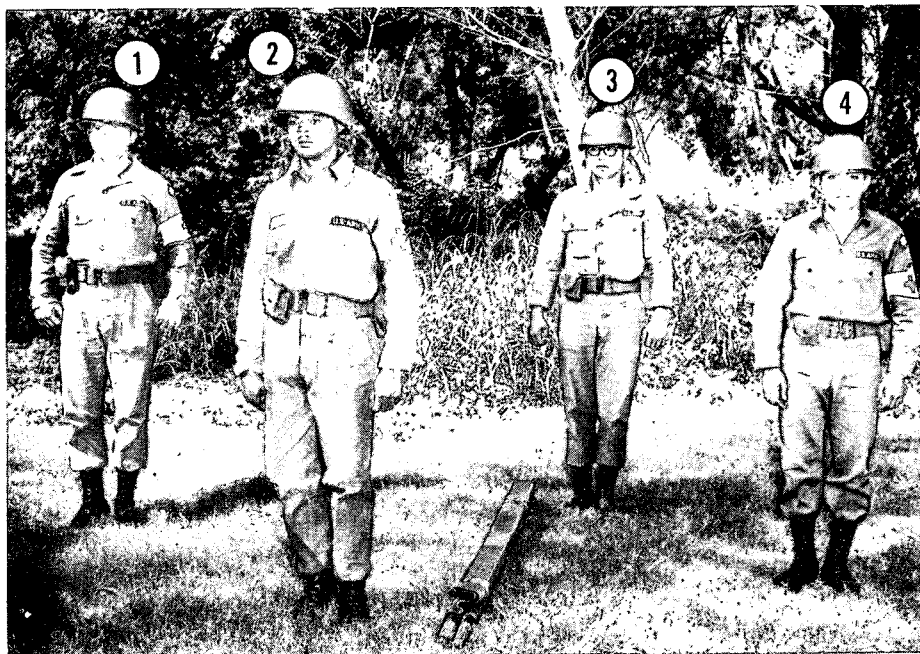
Being "at the carry," to ground litter, the commands are Ground, LITTER.



At the command of execution, No. 3, and No. 2, using their right and left hands, respectively, stoop, grasp

the outside handles, and raise the litter from the ground to the carry.

*Figure 55. Carry, LITTER, from ground.*



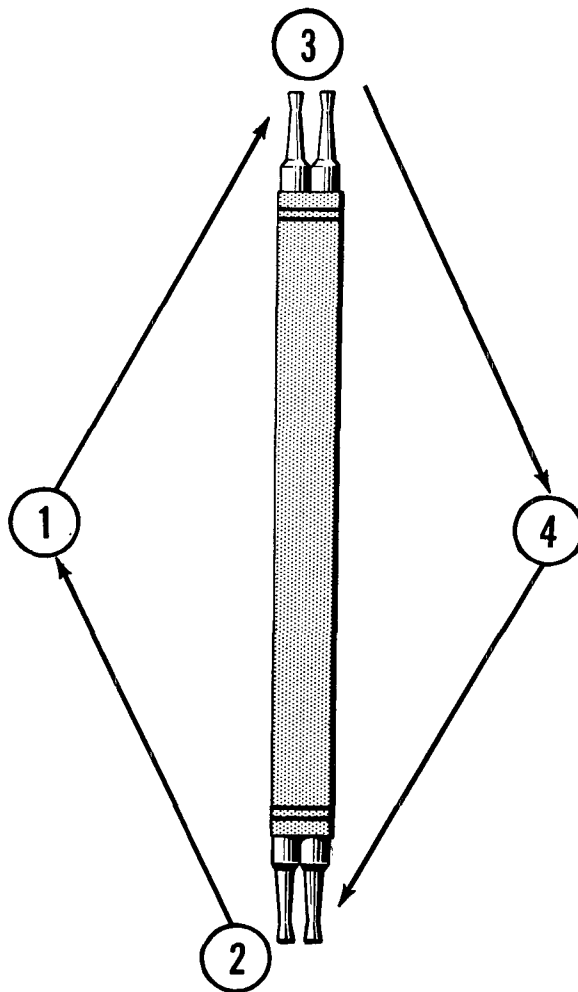
At the command of execution, No. 2 and No. 3 stoop and lower litter to the ground, canvas up, release the handles, and assume erect position.

*Figure 56. Ground, LITTER.*

**25. To Change Bearers**

(fig. 57)

Being "at the carry," to change bearers while marching, the commands are Change Bearers, MARCH. Bearers move in a clockwise direction. (Being "at the ground," closed, and "at the ground," open, bearers change positions as "at the carry.")



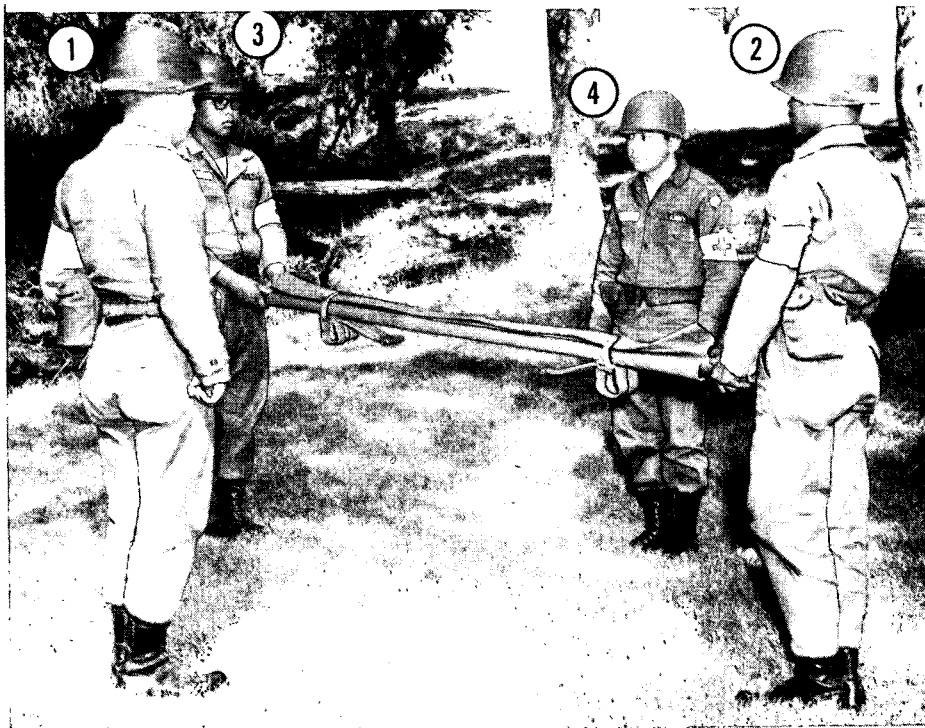
At the command of execution, No. 1, and No. 4 step to the right rear and left front of the litter, respectively, and grasp the handles relinquished by No. 2, and No. 3. No. 2 and No. 3 assume positions vacated by No. 1 and No. 4, respectively.

*Figure 57. Change bearers, MARCH.*

**26. To Open Litter**

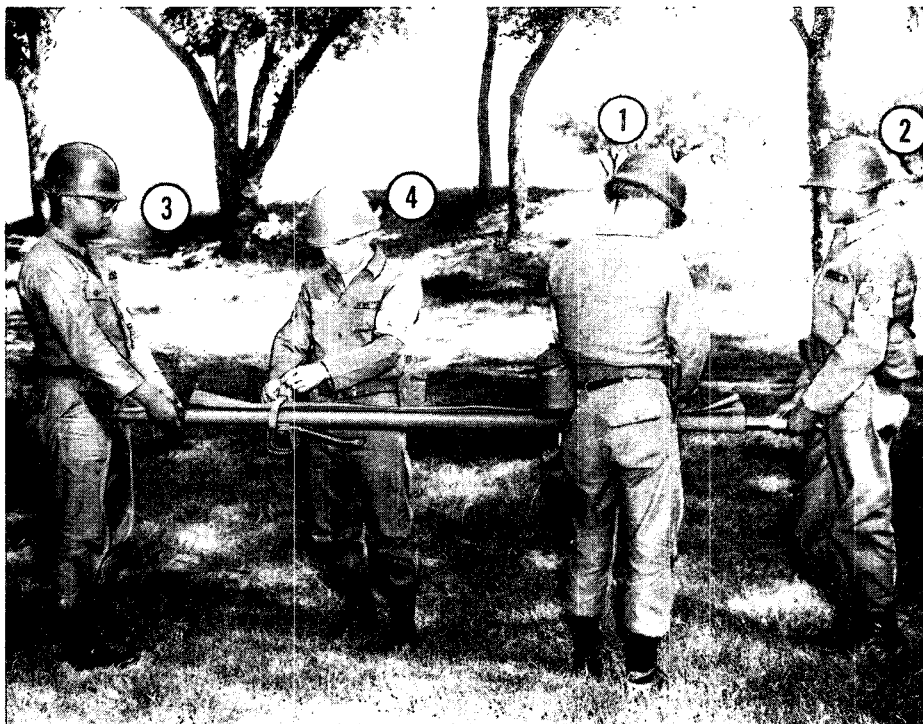
(figs. 58-61)

Being "at the carry," litter strapped, to open litter, the commands are Open, LITTER.



At the command of execution, all bearers face litter, with No. 2 and No. 3 holding the litter at each end.

*Figure 58. Open, LITTER (step one).*



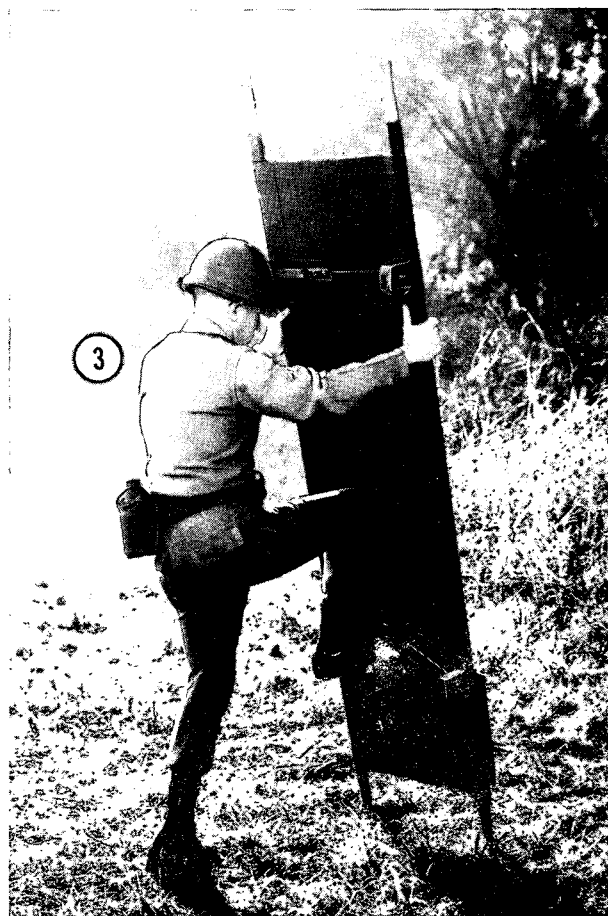
No. 2 and No. 3 support the litter on each end, and No. 1 and No. 4 unfasten the straps.

*Figure 59. Open, LITTER (step two).*



- a. No. 2 and No. 3 extend the litter by pulling the handles apart, canvas up.
- b. No. 2 lowers his end of the litter to the ground.

*Figure 60. Open, LITTER (step three).*



- a. No. 3 raises his end of the litter, until litter is standing vertical.
- b. He then extends the spreader bar by pushing with his foot, reverses the litter, and extends the second spreader bar.

(No. 3 lowers the litter to the ground, canvas up. All men return to their positions at litter posts.)

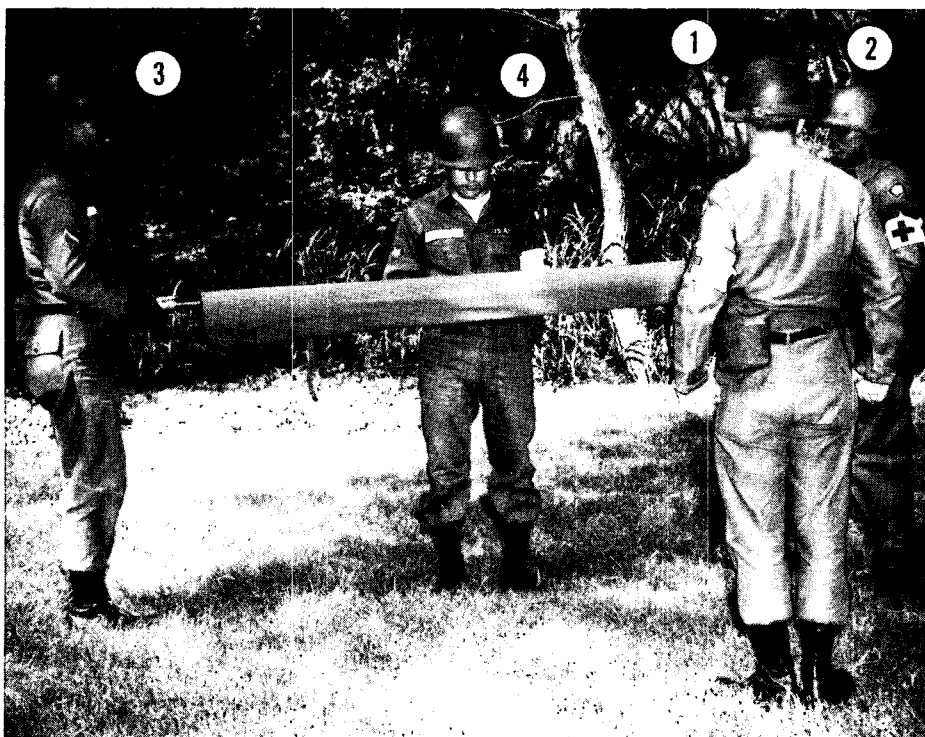
*Figure 61. Open, LITTER (step four).*



**27. To Strap Litter**

(figs. 62-64)

The litter being closed or open, to strap litter, the commands are Strap, LITTER.



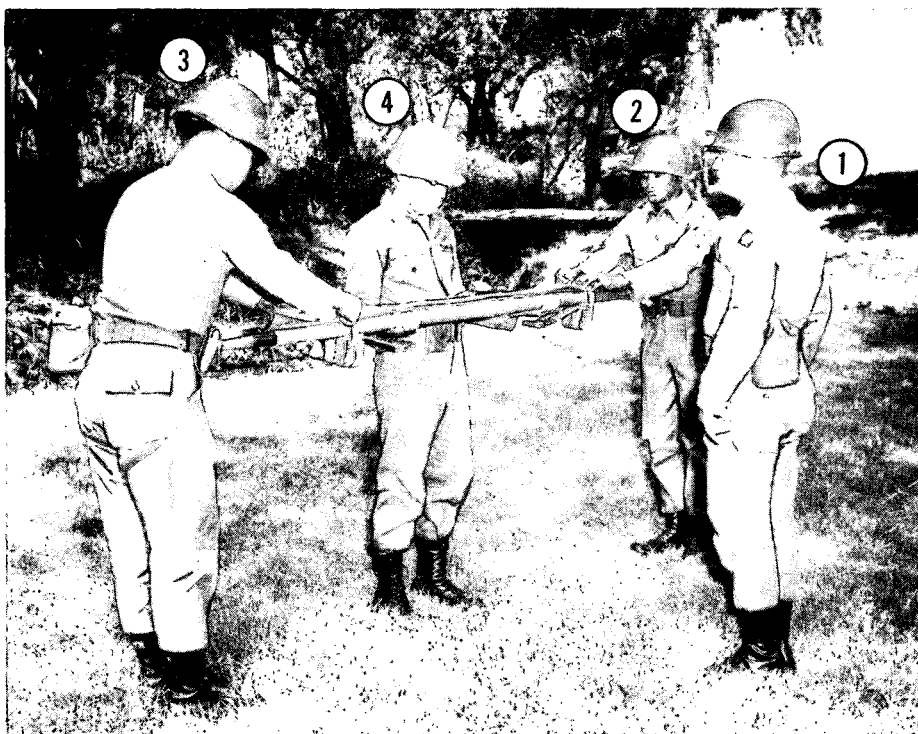
- a. At the command of execution, No. 1 and No. 4 face the litter.
- b. No. 4 supports the litter at the center.

*Figure 62. Strap, LITTER (step one).*



No. 2 and No. 3, assisted by No. 1, fold canvas by doubling it smoothly on top of the poles. (If litter is open, litter is closed and canvas folded.)

*Figure 63. Strap, LITTER (step two).*



No. 2 and No. 3 secure folded canvas and poles by fastening cross-straps at each end, and all bearers assume posts "at the carry."

(In the field, the litter should be carried closed and strapped, and opened only upon reaching the patient.)

*Figure 64. Strap, LITTER (step three).*

## 28. To Lift Open Litter, Loaded or Unloaded

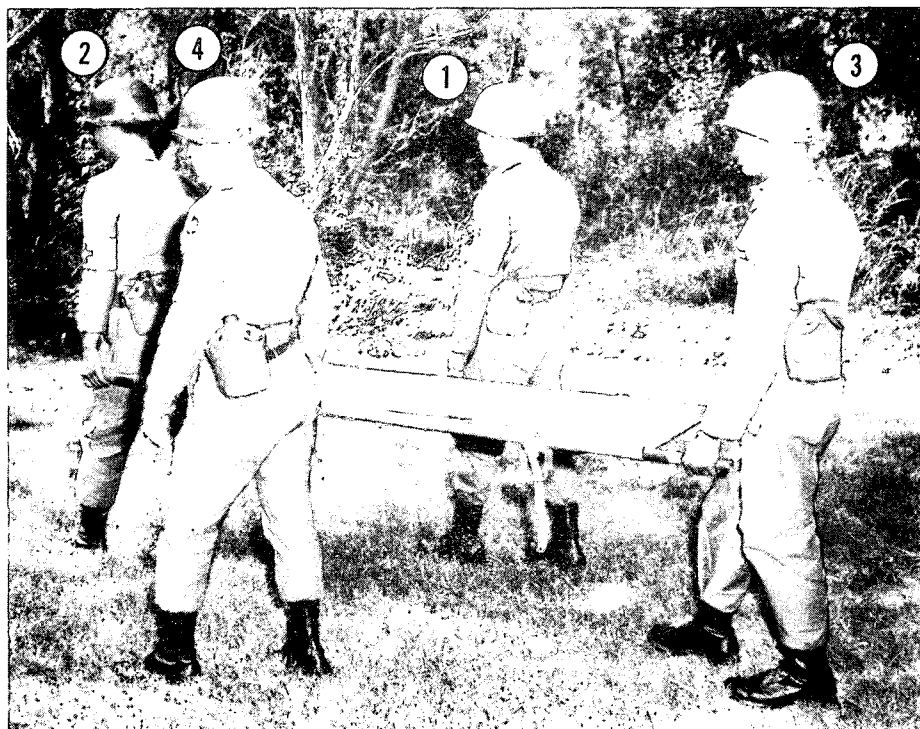
(figs. 65, 66)

The litter being "at the ground" with bearers at litter posts, to lift the litter, the commands are Prepare to Lift, LIFT.



- a. At the preparatory command, No. 2 and No. 3 stoop and grasp handles firmly.
- b. Meanwhile, No. 1 and No. 4 face the litter, stoop, and each grasps the adjacent pole.

*Figure 65. Prepare to lift, LIFT (step one) squad at prepare to lift.*



At the command of execution, No. 2 and No. 3 rise slowly, assisted in lifting by No. 1 and No. 4, all maintaining a level litter position at all times. (To march forward, commands are Forward, MARCH. No. 2 steps off with left foot, No. 3 with the right,

both taking short sliding steps of about 20 inches to avoid jolting and to secure uniform motion of litter. No. 1 and No. 4 step off with left foot, at normal pace at a cadence to conform with progress of No. 2 and No. 3.)

*Figure 66. Prepare to lift, LIFT (step two) litter lifted.*

**29. To Load and Unload Litter**

(figs. 67-70)

*a. Position for Lifting Patient.* The patient has been located, the general nature of his wounds determined, emergency treatment

given, and a litter is open and available. To place bearers in proper position to lift patient, the commands are Right (Left) Side, POSTS.



At the command of execution, bearers take the following positions:

*a.* No. 2 at the right (left) ankle.

*b.* No. 3 at the right (left) shoulder.

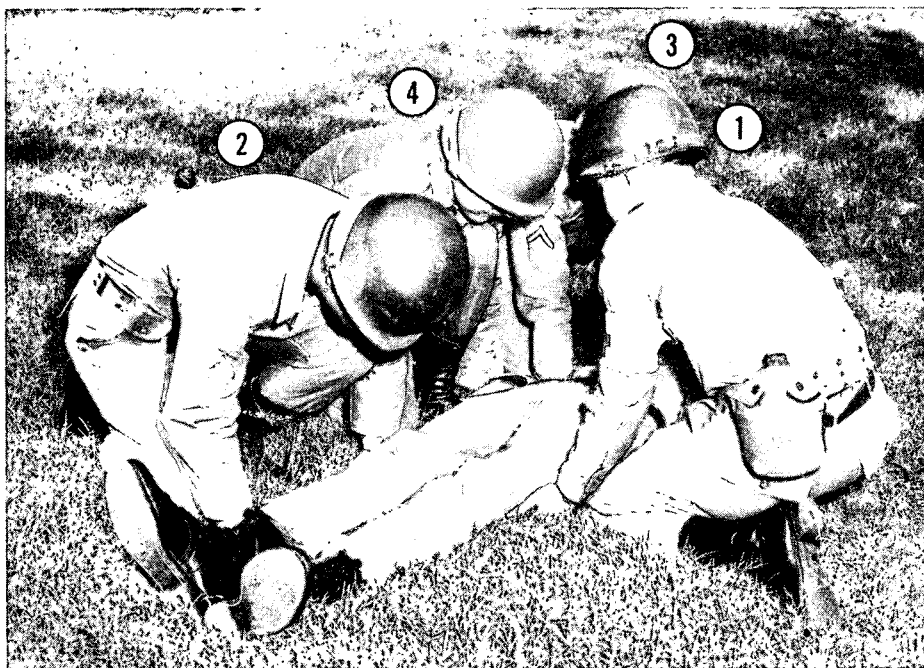
*c.* No. 4 and No. 1 at the right and left hips, respectively.

(All are facing the patient.)

*Figure 67. Loading litter (step one) squad at right side, POSTS.*

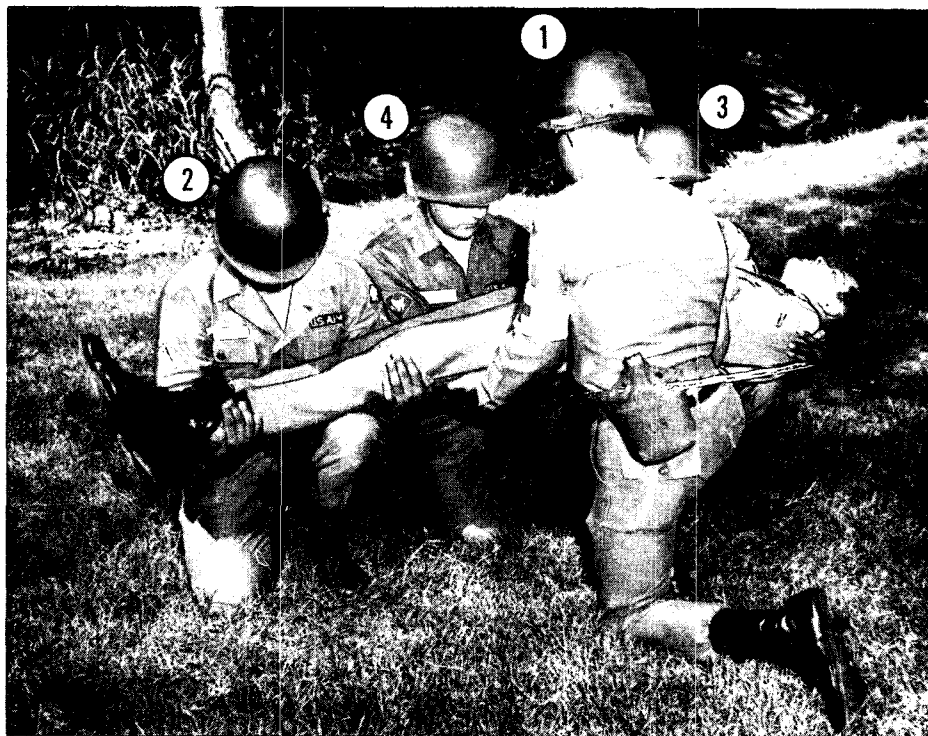
b. To Lift Patient and Place Litter in Position. The bearers are at posts. To lift patient

preparatory to placing him on the litter, the commands are Lift, PATIENT.



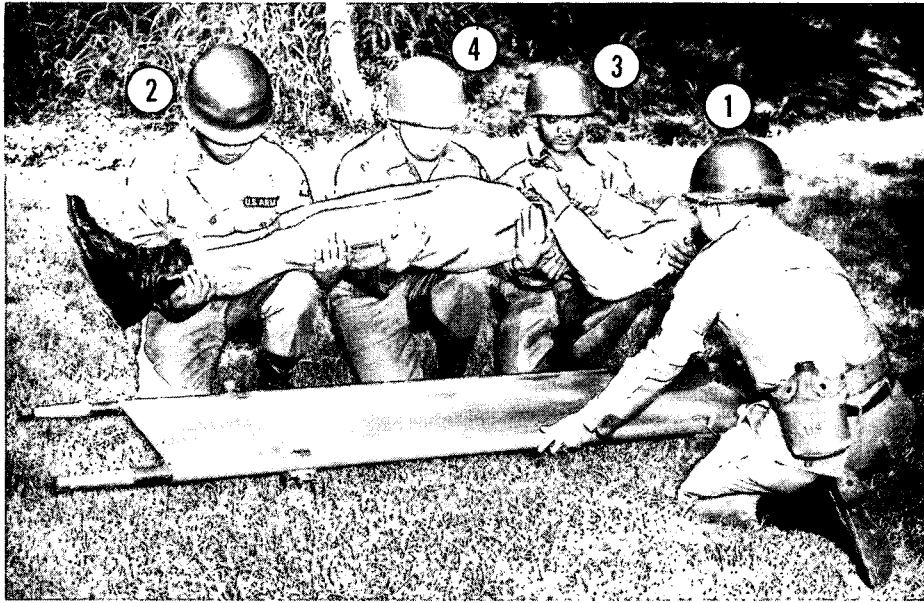
- a. At the preparatory command, bearers kneel on the knee nearest the patient's feet.
- b. No. 2 passes his forearms under the patient's legs, carefully supporting the fracture, if there is one.
- c. No. 1 and No. 4 place their arms under the small of the patient's back and thighs, without locking hands.
- d. No. 3 passes one hand under the patient's neck to the farther armpit, with the other supporting the nearest shoulder.

*Figure 68. Loading litter (step two) squad at lift.*



At the command of execution, all lift together, slowly and carefully, and place the patient upon the knees of the three bearers who are on the same side.

*Figure 69. Loading litter (step three) patient lifted.*



As soon as the patient is firmly supported there, the bearer on the opposite side (No. 1) relinquishes his hold, proceeds quickly by the nearest route to the

litter, which he takes and, returning rapidly, places under the patient and against the ankles of the three bearers.

*Figure 70. Loading litter (step four) litter placed beneath patient.*

*c. To Lower Patient on Litter.* The patient is on the knees of three bearers, and the litter is in proper position to receive the patient. To lower patient on litter, the commands are Lower, PATIENT. At the preparatory command, the free bearer (No. 1) resumes his former kneeling position opposite the other three bearers and prepares to assist in lowering the patient. At the command of execution, the patient is lowered gently upon the litter and made as comfortable as possible. Without further orders, all bearers rise and resume their positions at litter posts.

*d. To Unload Litter.* The patient is on the litter. To unload litter, the same commands

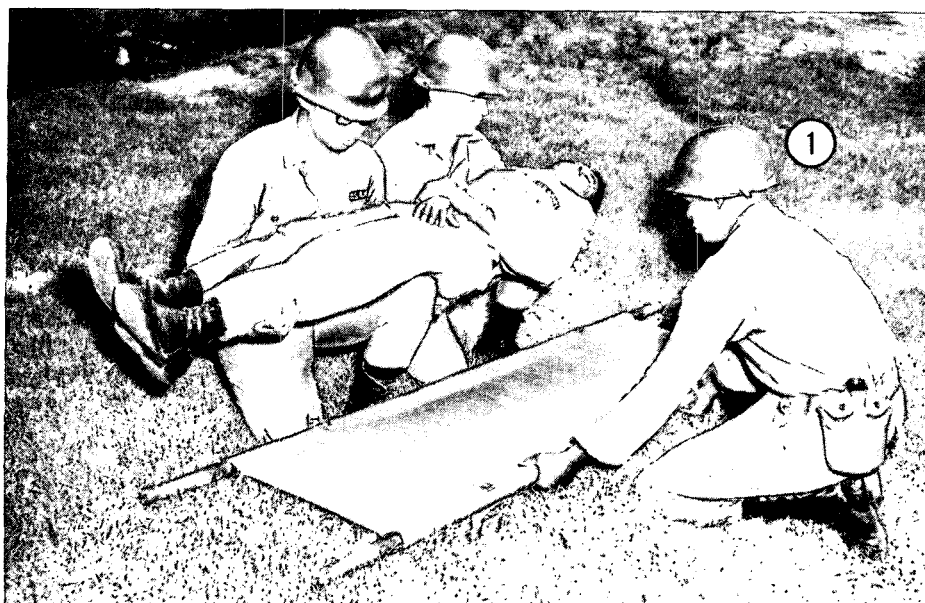
are given and the actions of the bearers are the same, except that, after the patient has been lifted to the knees of the three bearers, the free bearer *removes* the litter from beneath the patient.

### **30. To Load and Unload Litter (Three Bearers)**

(figs. 71, 72)

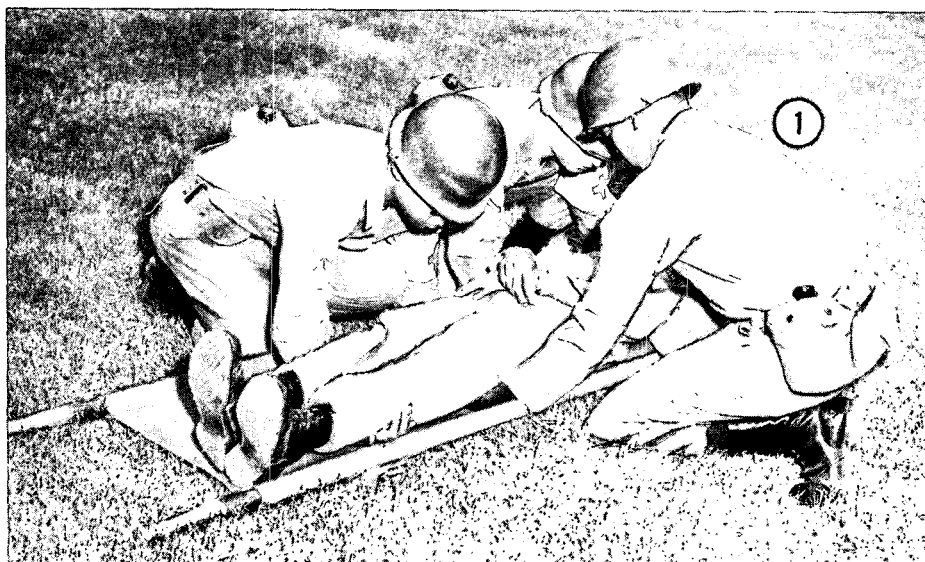
In the absence of one man from the litter squad, No. 2 or No. 3 is replaced by No. 4. With three bearers, the litter is placed as usual and, at the prescribed commands, the bearers take their proper positions.





Having been lifted by the three bearers, the patient is supported on the knees of the two on one side, while the third (No. 1) places the litter in position.

*Figure 71. Loading litter (three bearers) (step one).*



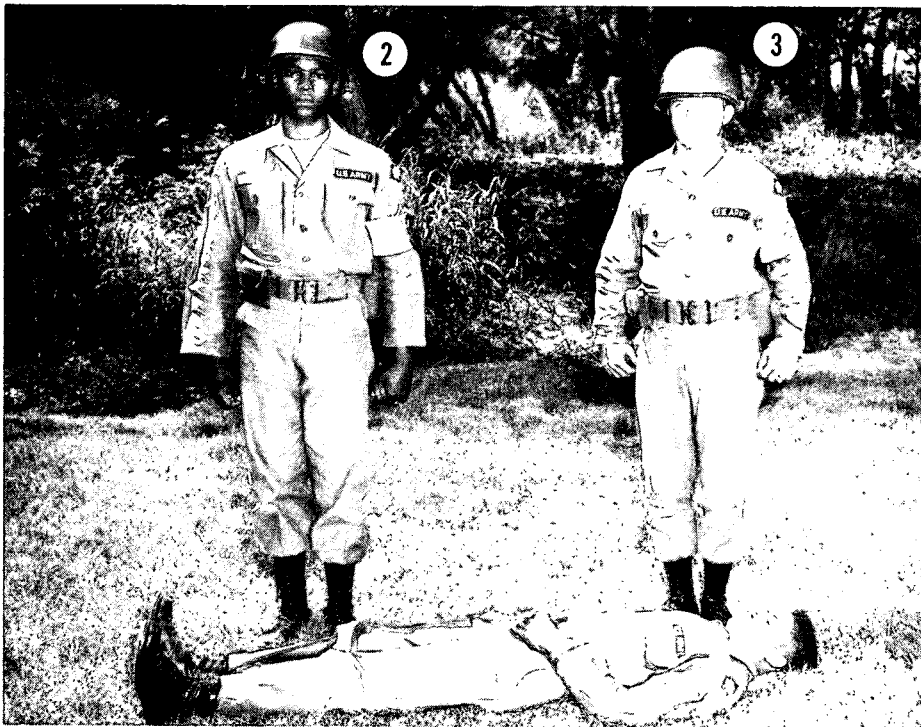
Patient is lowered on litter.  
(To unload litter, the procedure is reversed.)

*Figure 72. Loading litter (three bearers) (step two).*

**31. To Load and Unload Litter (Two Bearers)**

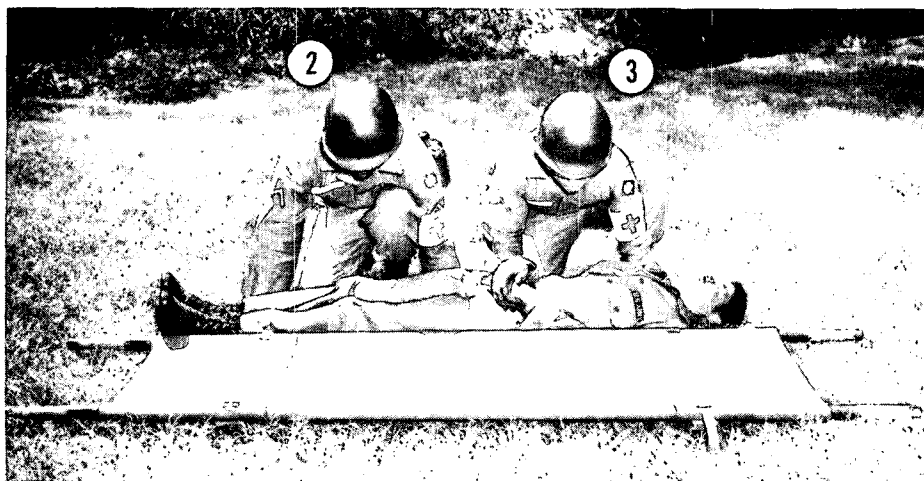
(figs. 73-76)

*a. With Bearers on Same Side.* To load and unload, posts are taken in the same way, at the proper commands.



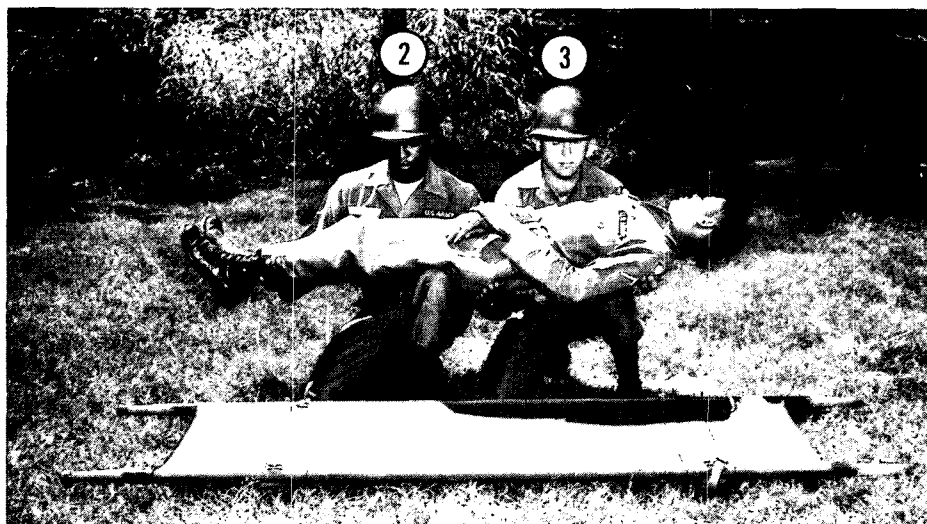
At the command POSTS, No. 2 and No. 3 take positions at patient's right (left) thigh and shoulder, respectively.

*Figure 73. Loading litter (two bearers, on same side) (step one).*



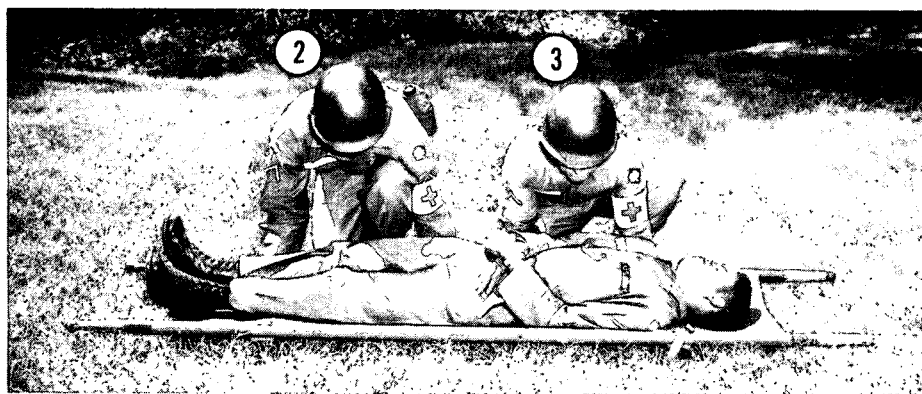
- a. At the command Lift, bearers kneel on the knee nearest patient's feet.
- b. No. 2 passes his arms beneath patient's hips and knees.
- c. No. 3 passes his arms beneath patient's shoulders and small of the back.

*Figure 74. Loading litter (two bearers, one same side) (step two).*



- a. At the command PATIENT, they lift together, raising patient upon their knees.
- b. Readjusting their holds, they rise to their feet and carry the patient to the side of the litter.
- c. At the command Lower, PATIENT, bearers kneel and place patient on their knees.

*Figure 75. Loading litter (two bearers, on same side) (step three).*



Bearers stoop forward and place patient on litter, then rise and assume position of Litter, POSTS, without command.

*Figure 76. Loading litter (two bearers, on same side) (step four).*



At the command POSTS, No. 2 and No. 3 take positions at patient's right and left hips, respectively, facing patient.

*Figure 77. Loading litter (two bearers, one on each side) (step one).*

b. *With Bearers on Opposite Sides* (figs. 77-80). If patient is conscious and able to cooperate in the movement, the bearers take positions on opposite sides of the patient. To carry out

this movement, the commands are Right (Left) Side, POSTS; Lift, PATIENT; and Lower, PATIENT.



At the command **Lift**, bearers kneel on the knee opposite patient's feet, raise him to a sitting position, and pass their arms around his back and under his thighs, locking hand.

The patient, if able, clasps his arms around bearers' necks.

*Figure 78. Loading litter (two bearers, one on each side) (step two).*



At the command **PATIENT**, they lift patient, both rising together, and carry him to center of litter.

*Figure 79. Loading litter (two bearers, one on each side) (step four).*



- a. At the command **Lower**, **PATIENT**, they stoop and lower patient upon the litter in a sitting position, and the patient releases his hold on the bearers' necks.
  - b. Both bearers assist the patient to lie down upon the litter after which they take the position of **Litter**, **POSTS**, without commands.
- (Unloading is performed in reverse order at the proper commands.)

*Figure 80. Loading litter (two bearers, one on each side) (step three).*

### 32. To Load and Unload Patients with Back Injuries

To avoid aggravating the condition of patients with actual or suspected back injuries, the procedures described in figure 81 will be followed.



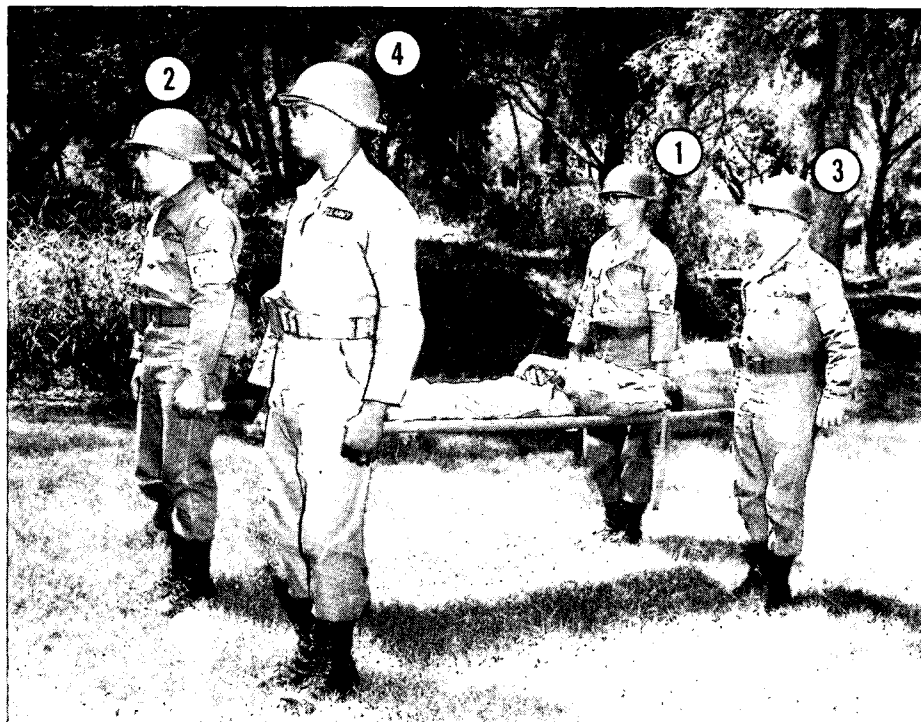
- a. No. 1 places blanket, coat, or jacket arranged in a firm roll or fold about 2 feet long and 6 inches in diameter on the litter in a position to support the arch of the patient's back.  
 No. 3 places one hand under the patient's head and the other under his shoulders.  
 No. 4 places his hands under the small of the back and buttocks.  
 No. 2 places his hands under the thighs and calves.  
 No. 1 assists No. 4 at the small of the patient's back.  
 All kneel on the knee nearest the patient's feet.
  - b. At the command **Lift, PATIENT**, all gently lift patient off ground about 8 inches, making sure that proper alinement of the patient is maintained. No. 1 places litter under the patient, and adjusts the roll under the patient's back.
  - c. At the command **Lower, PATIENT**, the three bearers lean forward and lower patient to litter, with the aid of No. 1.
- (If patient is unable to hold his hands on the litter, his arms should be tied in front of him before placing him on the litter in order to prevent injury to his arms.)

*Figure 81. Lifting patient with broken back.*

**33. To Carry Loaded Litter (Four Bearers)**

(fig. 82)

If it is desired that the four bearers carry the loaded litter while marching, the commands are **By Four, Carry, LITTER.**



- a. At the command **LITTER**, No. 1 steps backward to the right rear. No. 4 steps forward to the left front. Each grasps handle nearest him (relinquished by No. 2 and No. 3).
- b. No. 2 and No. 3, retaining their grasp on the other handles, move to one side.

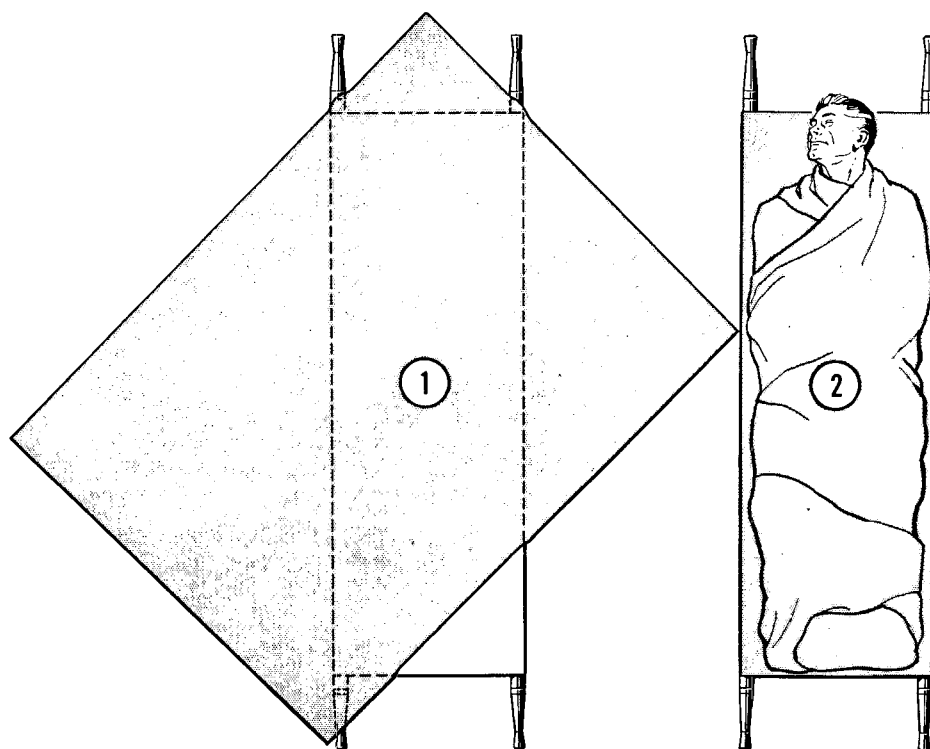
*Figure 82. Carrying loaded litter (four bearers).*



Section IV. DRESSING THE LITTER

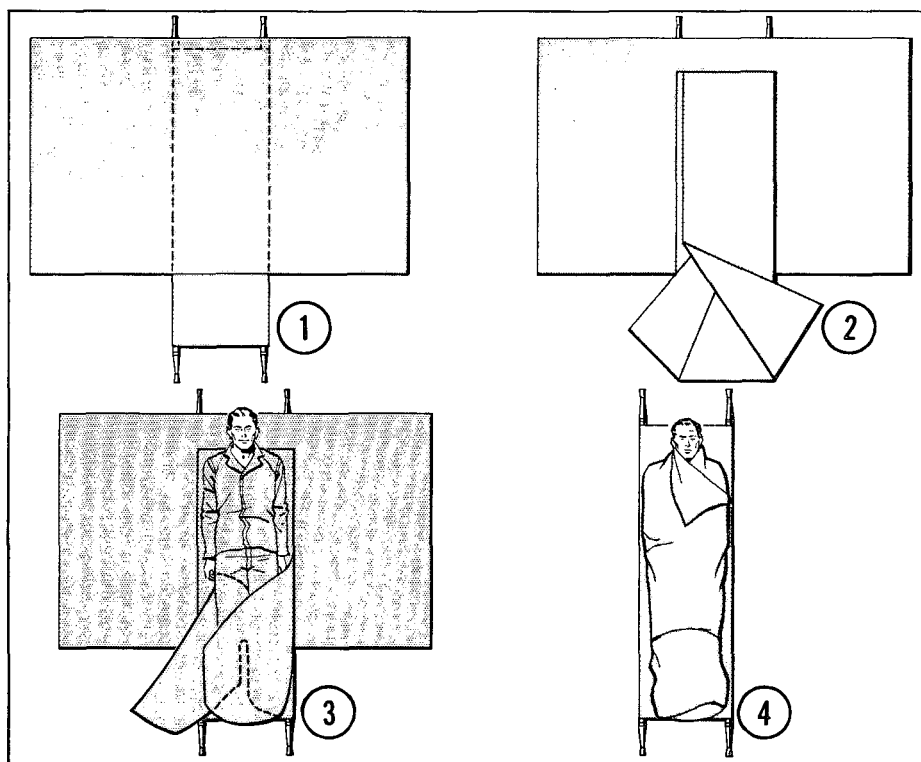
34. General

The litter is dressed with one, two, or three blankets to reduce the danger of shock and to afford warmth and comfort during transport (figs. 83-85).



- a. Place blanket diagonally over litter.
- b. Place patient on blanket, wrap the sides about his body, and tuck in at the head and feet.

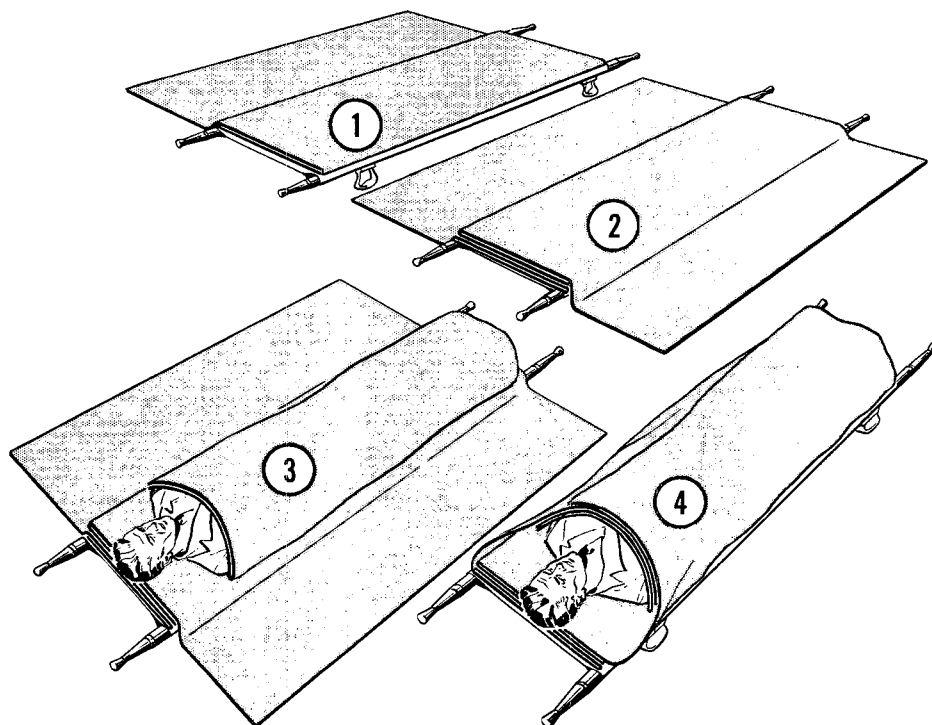
Figure 83. Dressing the litter (with one blanket).



- a. Place the first blanket lengthwise across litter with the blanket edge close to or just beyond the head end of litter.
- b. Fold second blanket in thirds, lengthwise, and place over the first, the upper edge of this folded blanket being about 10 inches below the upper edge of the first blanket. The exact position of the second blanket depends upon the height of the patient.
- c. To wrap patient, place him in position on the second blanket. Bring bottom of blanket up over the patient's feet, with a small fold between the feet. Tuck the two open folds closely over and around the feet and ankles.
- d. Finally, wrap first one, then the opposite, side of the first blanket over patient.

(Place lower on litter for taller men.) Open folds of second blanket for about 2 feet at the foot end.

Figure 84. Dressing the litter (with two blankets).



① First blanket.

② First two blankets.

a. Place first blanket on litter lengthwise so that one edge corresponds with outer pole of the litter and the upper edge is even with the head of the canvas. Fold blanket back upon itself once so that the folded edge is along the inside pole of the litter and the outer edge overhangs the outside pole.

b. Place second blanket lengthwise on the first so that one edge corresponds with the inner pole of the litter and the upper edge is again even with the head end of the canvas. Then fold the blanket back upon itself so that the folded edge overhangs the inside pole.

③ Third blanket.

④ Complete.

c. After placing patient on litter, fold third blanket once lengthwise and place it over the patient, one end under his chin. Then fold the free or overhanging edges of the first two blankets over the third and secure it in place with safety pins or litter securing straps.

(This method of dressing the litter gives four thicknesses of blankets over and under the patient, thus giving additional warmth and thereby assisting in the prevention of shock.)

Figure 85. Dressing the litter (with three blankets).

**35. General**

In litter transportation, bearers may be confronted with several types of natural or artificial impediments which must be surmounted. Orders for surmounting separate obstacles are neither necessary nor feasible. Hence, flexibility in the execution of orders concerning obstacles must be maintained, common sense dictating the details of action most suited to the situation.

**36. Litter Obstacle Course**

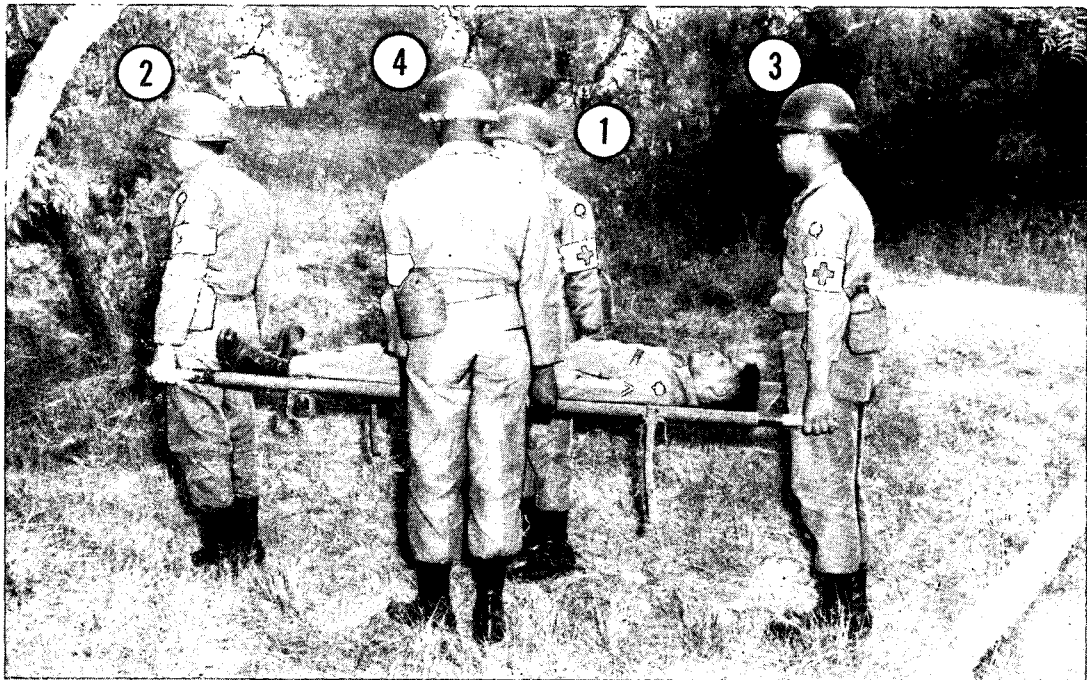
A litter obstacle course is useful, not only in presenting obstacles of all kinds and teaching

the proper methods for surmounting them, but in conditioning bearers physically for the arduous tasks they will encounter in combat. It can be constructed to simulate most of the natural and artificial obstructions that litter bearers are likely to meet. Where construction of a litter obstacle course is impracticable, many of the obstacles can be simulated from existing facilities.

**37. Minor Obstacles**

(fig. 86)

Minor obstacles include wide, shallow streams, rough or cultivated ground, or similar obstacles.

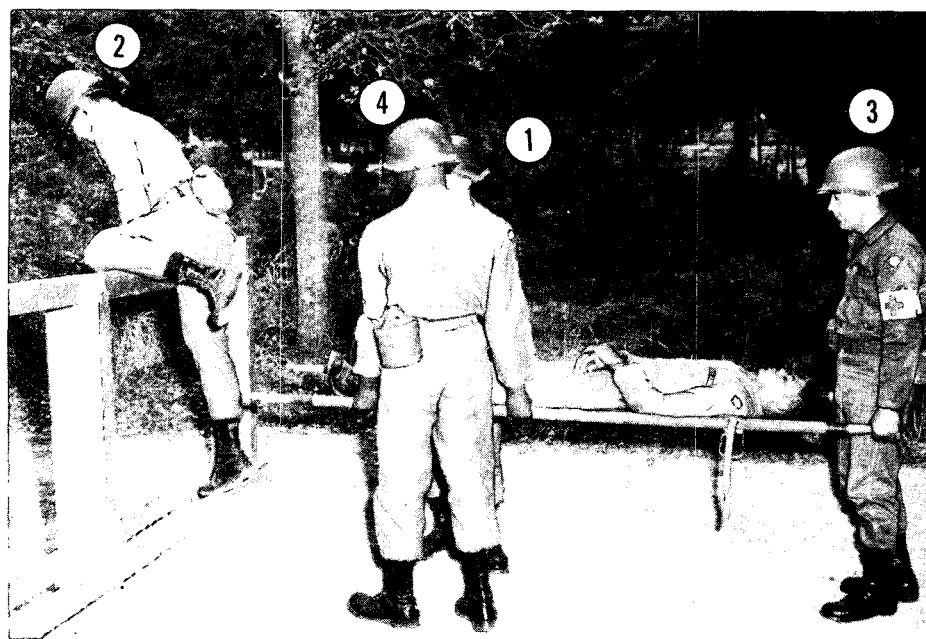


No. 1 and No. 4 close in, grasp the centers of the adjacent poles, and give support until the obstacle has been passed.

*Figure 86. Minor obstacles (rough terrain).*

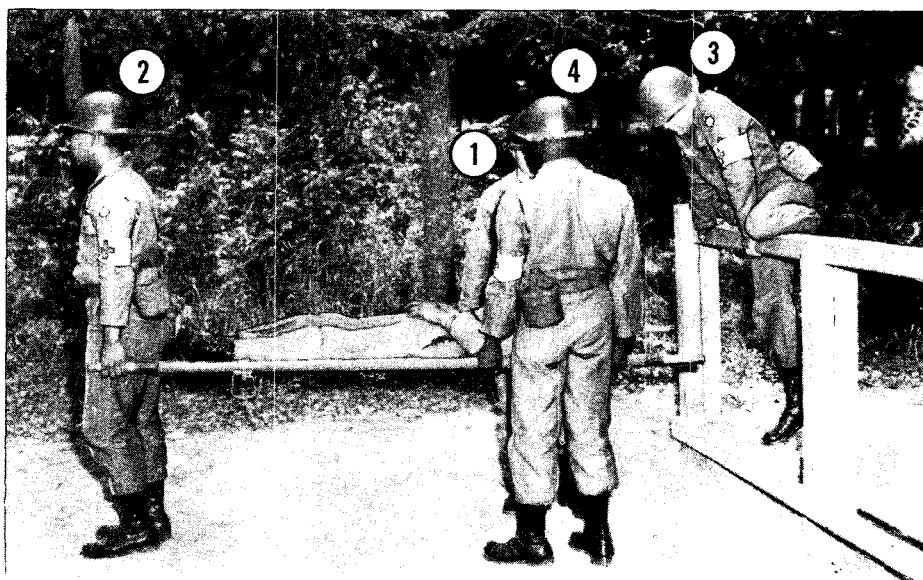
## 38. Major Obstacles (figs. 87-89)

Major obstacles include fences, ditches, and similar obstacles.



- a. No. 1 and No. 4 close in and grasp the adjacent poles to the rear of No. 2.
- b. No. 2 then relinquishes his grasp of the front handles and steps over the obstacle.  
(The other three bearers then advance the litter until No. 2 can resume his grasp of the front handles.)

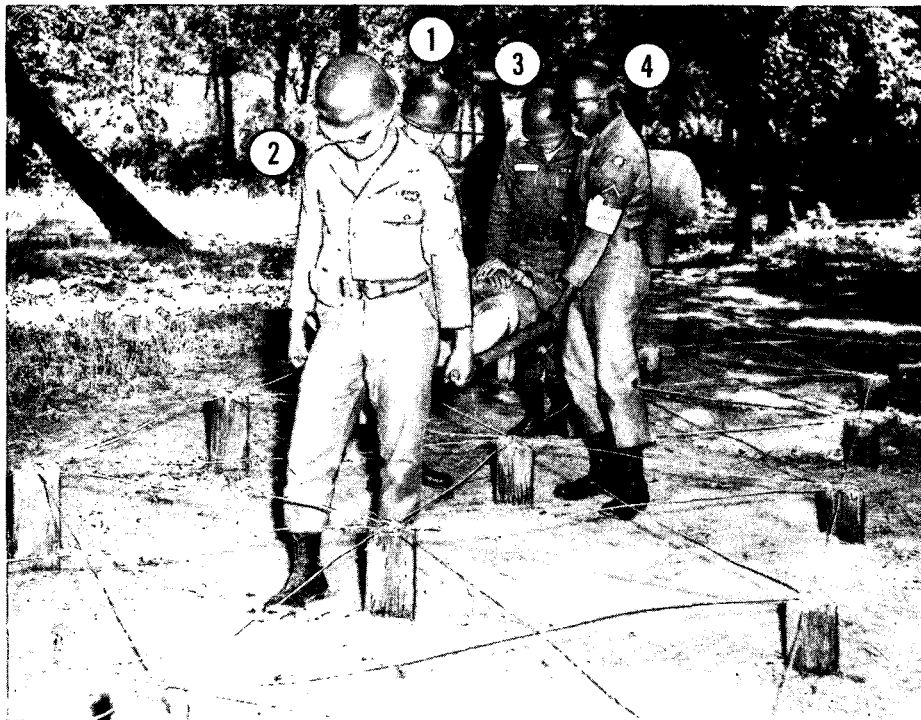
*Figure 87. Major obstacle (low hurdle) (step one).*



(No. 2 and No. 3 support the litter by the front and rear handles, respectively, while No. 1 and No. 4 step across the obstacle.)

- a. Having passed the obstacle, No. 1 and No. 4 grasp the adjacent poles forward of No. 3.

- b. No. 3 then releases his hold of the rear handles and steps across the obstacle.
- c. Having crossed, he again grasps the rear handles, and No. 1 and No. 4 return to their posts.



a. When a major obstacle is of such length that Steps One and Two are impossible, No. 1 and No. 4 close in and grasp the sides of the litter.

b. All four bearers then proceed, making their way over the obstacle and supporting the litter together.

(When a long litter carry involves a series of major obstacles, six men, if available, should be used. The two additional bearers grasp adjacent litter poles near the center, and all advance, supporting the litter

whenever an obstacle of sufficient difficulty is encountered.)

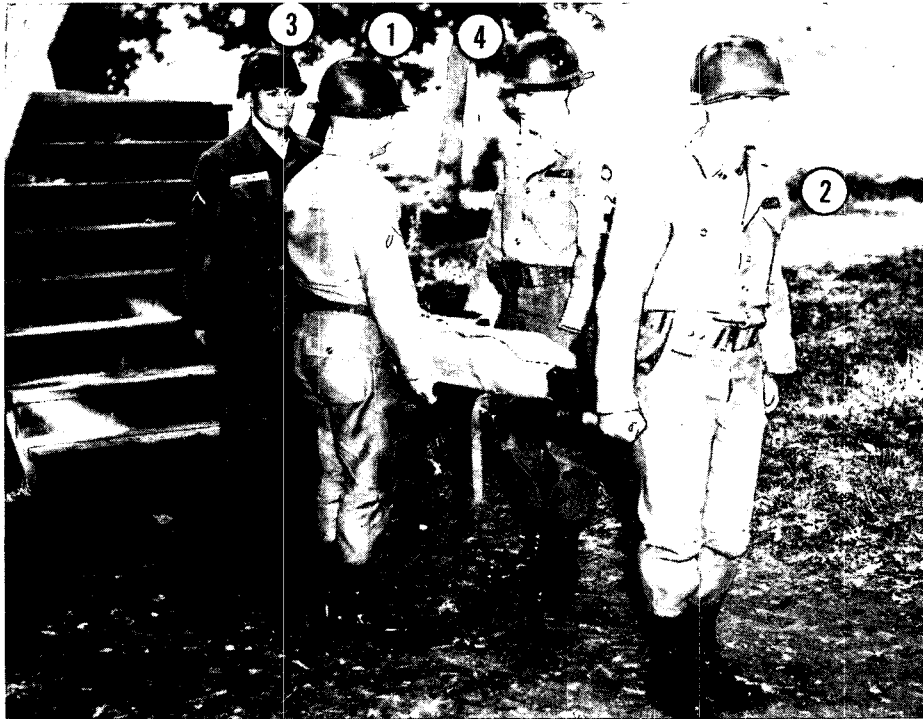
(When a major obstacle is over 5 feet high, litter is raised carefully to level of obstacle and advanced until front of litter has cleared or has become well anchored on the obstacle. No. 2 and No. 4 clear obstacle, assist in advancing the litter to the rear stirrups, and steady it, while No. 1 and No. 3 clear obstacle and again grasp rear handles. Litter is then lowered to former level.)

Figure 89. Major obstacle (low hurdle) (long obstacle).

**39. To Carry Loaded Litter Upstairs and Downstairs**

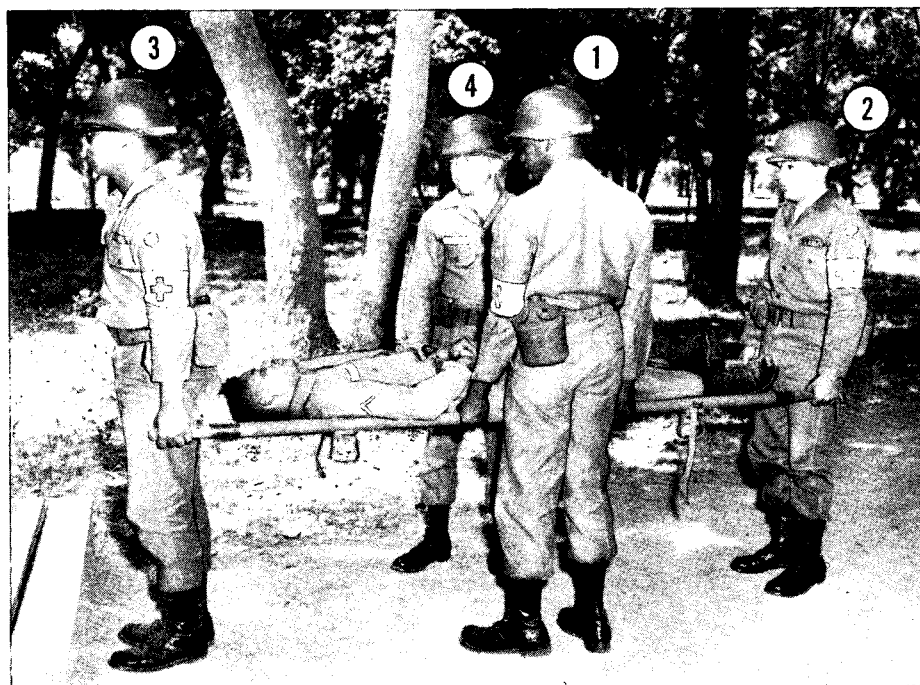
(figs. 90-93)

*a. Upstairs Carry.* Normally, a loaded litter is carried upstairs head first (para 15d).



With litter turned so that head of patient is toward stairs, litter is carried to the foot of stairs in the usual manner and halted.

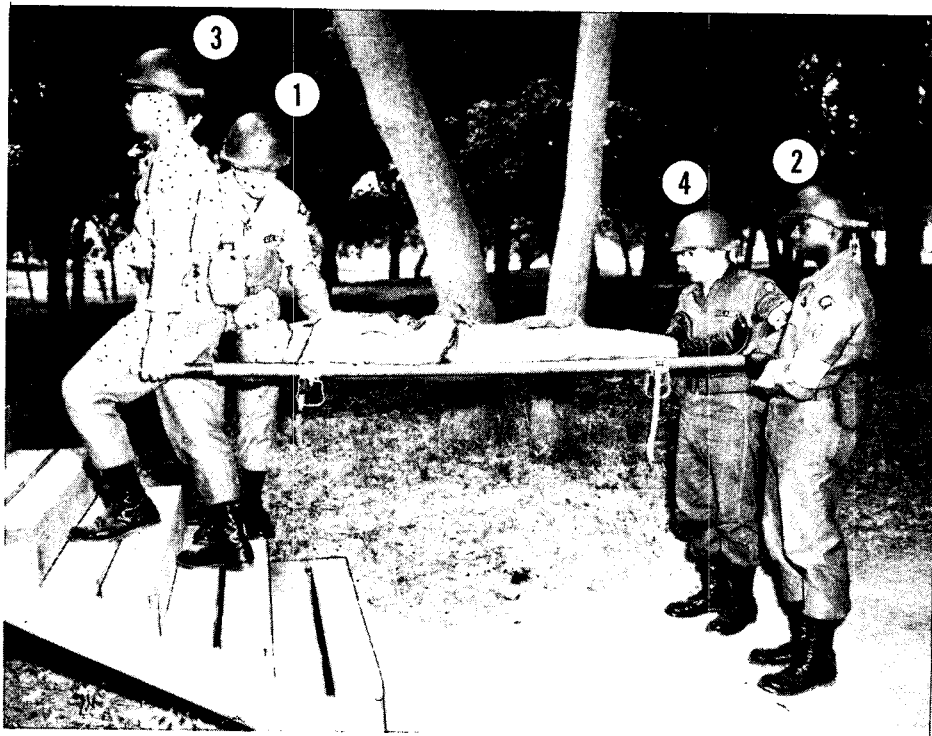
*Figure 90. Upstairs carry (step one)*



- a. No. 1 and No. 4 grasp litter at center of poles.
  - b. No. 2 and No. 3 then relinquish their grasps, face about, and resume hold of handles.
- (When only three bearers are used, litter must be placed on ground while bearers change positions at foot of stairs.)

*Figure 91. Upstairs carry (step two).*

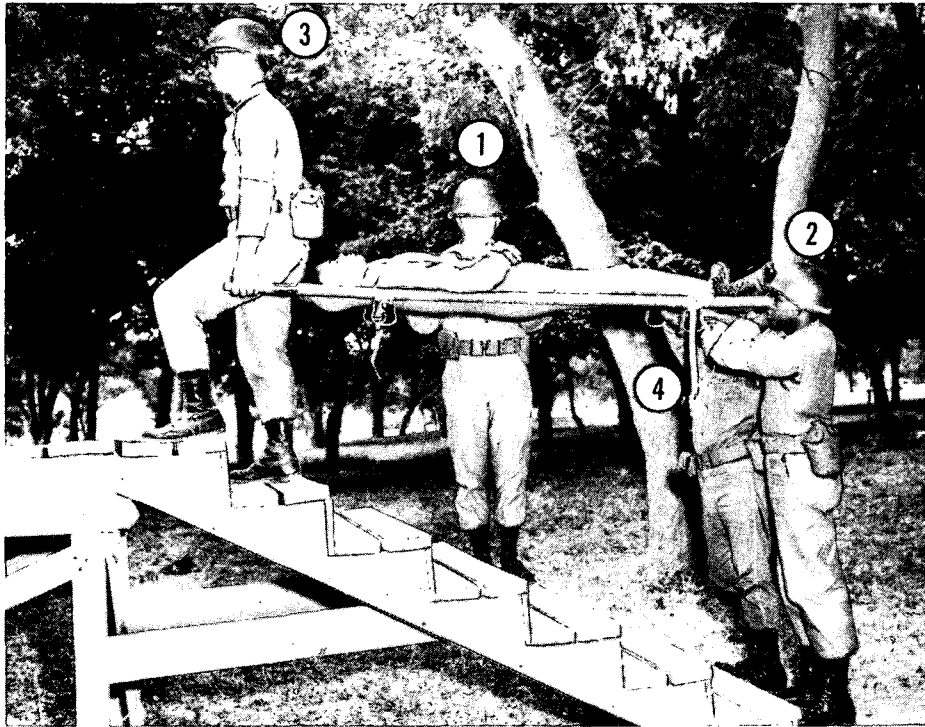




a. No. 4 steps to the handle nearest him at the foot of the litter and grasps it, while No. 2 maintains hold of opposite rear handle.

b. No. 1 meanwhile lets go of litter, advances up the stairs, and takes position at the side of the litter.

*Figure 92. Upstairs carry (step three).*

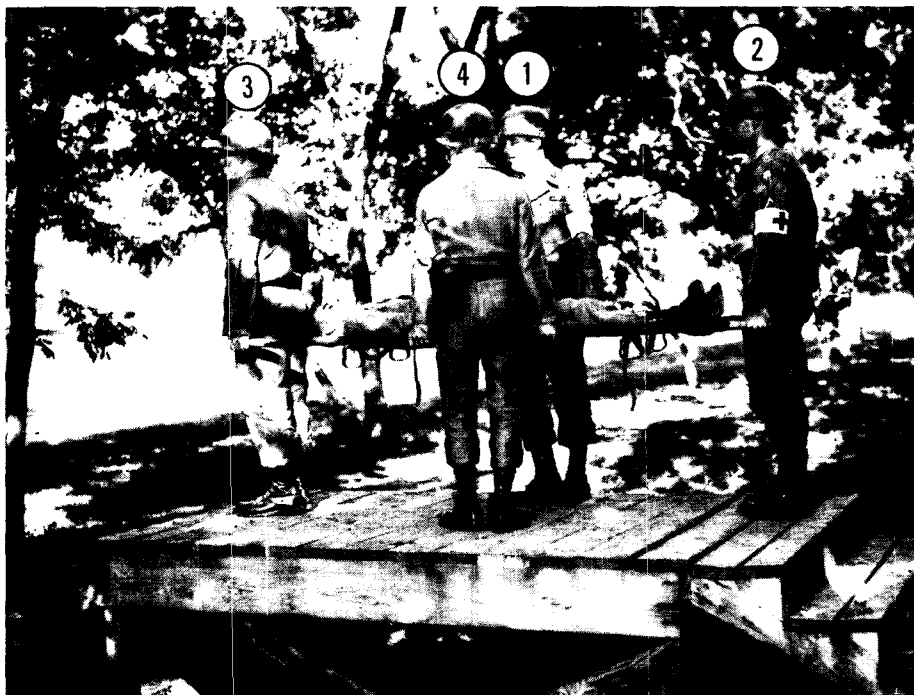


No. 2, No. 3, and No. 4 carry litter up the stairs, the rear bearers maintaining the litter level while No. 1 renders whatever assistance he can. (After mounting stairs, normal positions are resumed.)

*Figure 93. Upstairs carry (step four).*

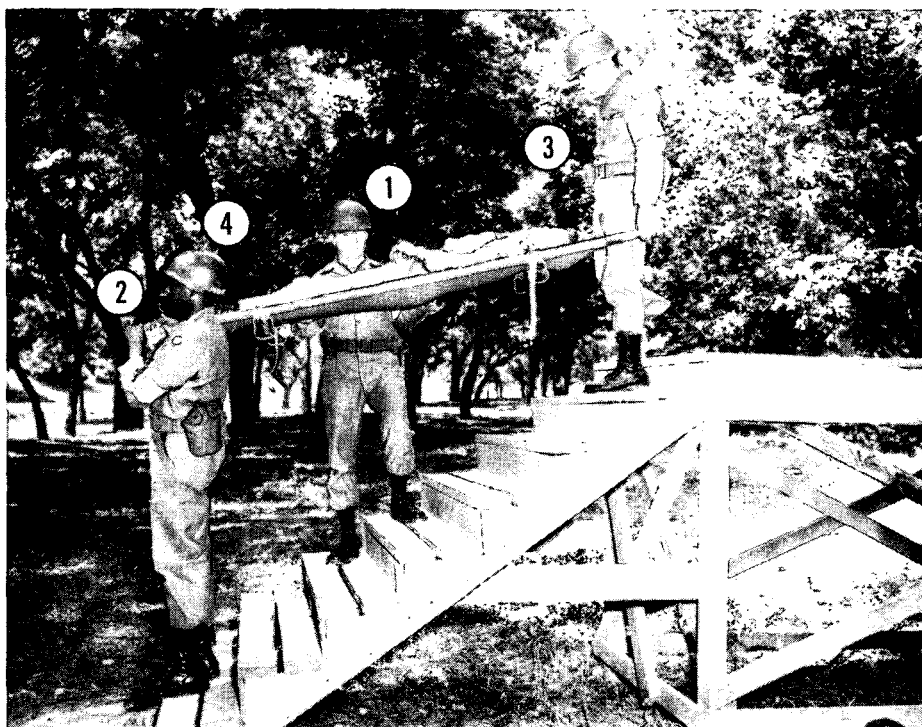
b. *Downstairs Carry* (figs. 94, 95). Normally, a loaded litter is carried downstairs feet first (para 15d); thus, when upstairs and down-

stairs obstacles are combined, the litter whenever possible should be wheeled about at the top of the obstacle before descending.



Litter is turned into feet-first position for descent.

*Figure 94. Downstairs carry (step one).*

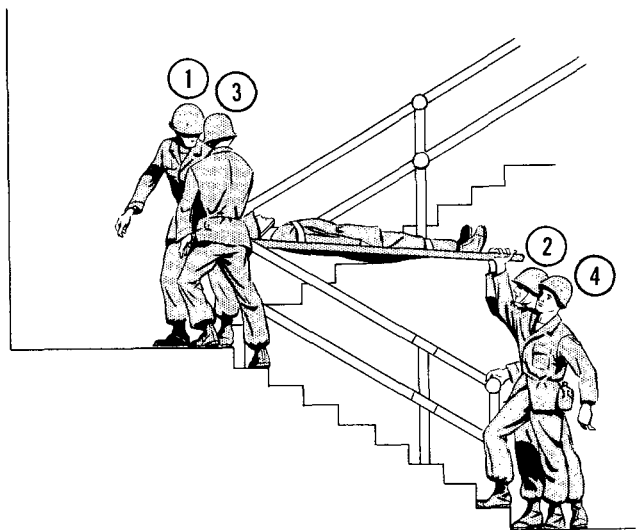


a. No. 4 grasps left front handle, and No. 2, the right front.

b. No. 3 maintains hold of rear handles and, assisted by No. 1, is responsible for maintaining the litter level during the descent.

Figure 95. Downstairs carry (step two).

c. *Carrying Patients with Leg Fractures.* When the patient being transported has a fracture of the leg or, if, for any reason, it is considered desirable to carry the patient upstairs feet first or downstairs head first, the bearers are reversed. In the former case No. 2, and in the latter case No. 3, become the front bearer.

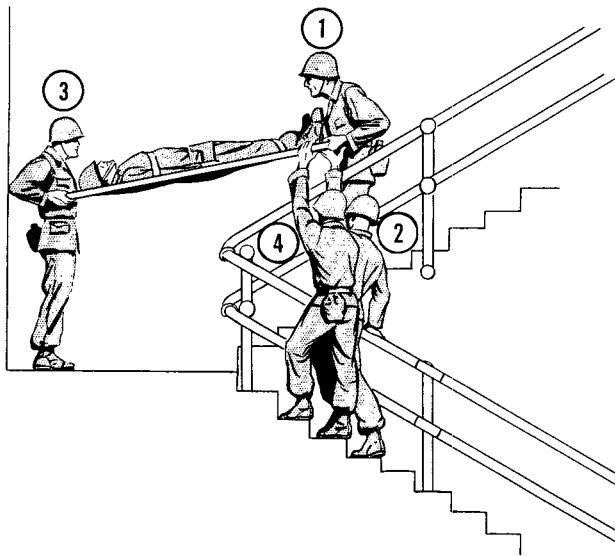


#### 40. Negotiating a Staircase Having Small Landings

a. *Upstairs Carry.* When carrying a loaded litter up a flight of stairs where there is not sufficient room on the landings to wheel the litter around, the procedure is as illustrated and described in figures 96 through 99. The patient must first be secured to the litter.

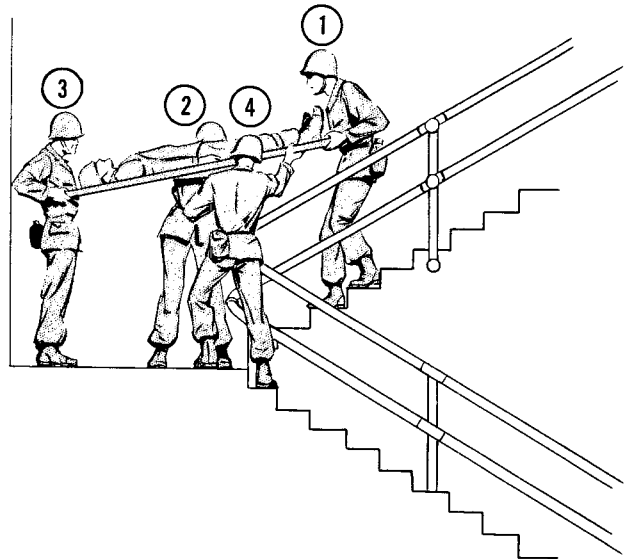
Squad proceeds up to first landing with No. 1 and No. 3 supporting head of litter, and No. 2 and No. 4 supporting the foot.

Figure 96. Carrying litter upstairs where landings are small (step one).



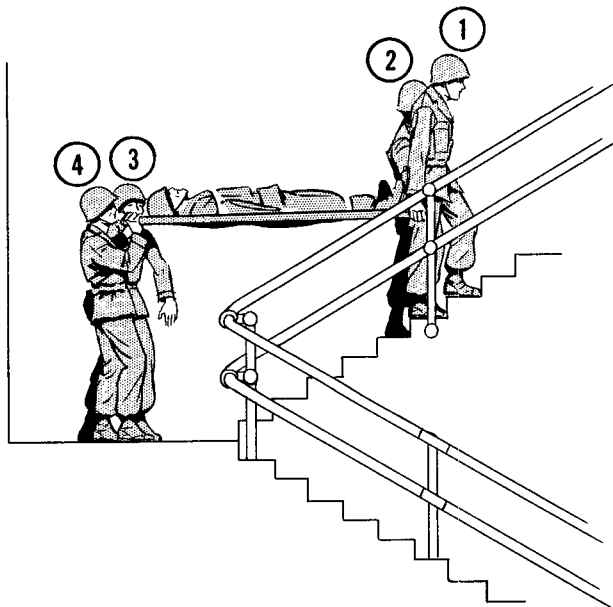
Upon arrival at first landing, No. 3 turns, facing head of litter and supporting it, while No. 1 proceeds several steps up the next flight of stairs. No. 2 and No. 4 raise foot of litter until No. 1 can grasp handles.

Figure 97. Carrying litter upstairs where landings are small (step two).



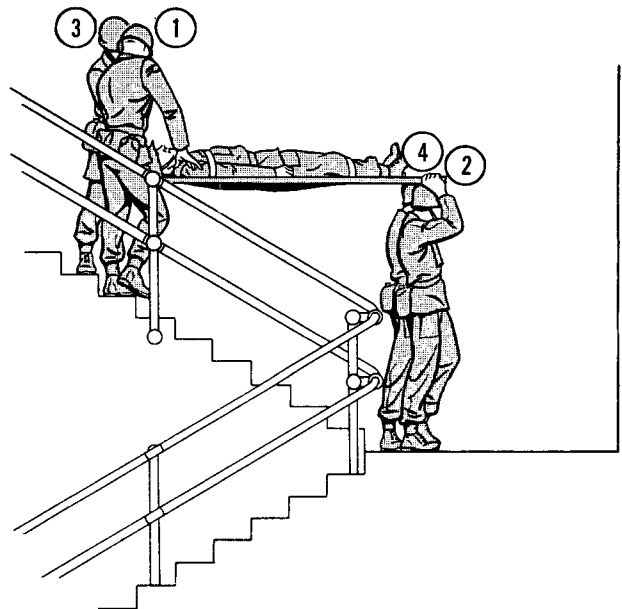
No. 1 and No. 3, with No. 2 and No. 4 assisting, then lift litter over banister to second flight of stairs.

Figure 98. Carrying litter upstairs where landings are small (step three).



No. 4 assists No. 3 in carrying head of litter up second flight, while No. 2 advances and assists No. 1 in carrying foot of litter.

Figure 99. Carrying litter upstairs where landings are small (step four).



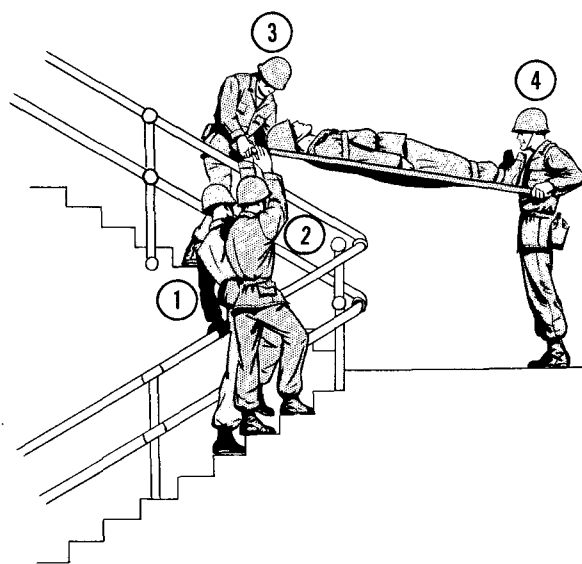
Squad proceeds down steps to first landing with No. 1 and No. 3 supporting head of litter, and No. 2 and No. 4 supporting the foot.

Figure 100. Carrying litter downstairs where landings are small (step one).

b. *Downstairs Carry.* When carrying a loaded litter down a flight of stairs where there is not sufficient room on the landings to wheel the litter about the procedure is as illustrated and described in figures 100, 101, and 102. The patient must first be secured to the litter.

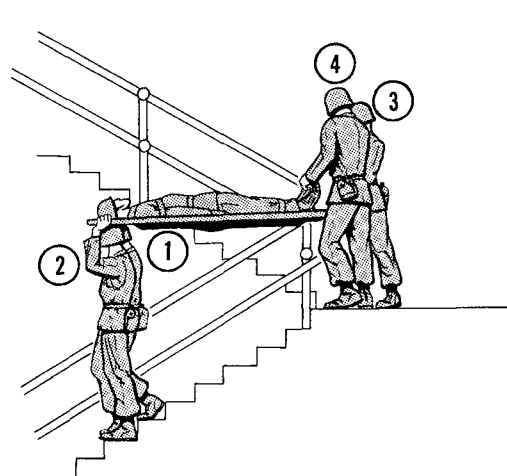
**41. Trenches, Dugouts, and Other Excavations**

To negotiate obstacles, such as narrow trenches and dugouts, No. 2 and No. 3 maintain their positions at the handles and, assisted by No. 1 and No. 4, lift the litter over their heads and above the narrow trench. Number 1 and No. 4 then step beneath the litter, grasp the



Upon arrival at first landing, No. 4 turns and faces litter and supports foot of it while No. 3 supports head. No. 1 and No. 2 descend a few steps of the second flight of stairs.

Figure 101. Carrying litter downstairs where landings are small (step two).



- a. No. 1 and No. 2 receive the head of the litter which is handed over the banister to them by No. 3.
- b. No. 3 then assists No. 4 to support foot of litter while No. 2 and No. 1 support the head, and all move down to the next landing.

Figure 102. Carrying litter downstairs where landings are small (step three).

litter poles, and assist in supporting the litter as all advance.

**42. Culverts, Tunnels, and Large Pipes**

To negotiate culverts, tunnels, large pipes, and similar obstacles, No. 2 faces the litter and backs through the obstacle, No. 3 maintaining hold of the rear handles. No. 1 precedes and No. 4 follows the litter.

**43. Narrow Bridges, Gangplanks, Catwalks, and Narrow Paths**

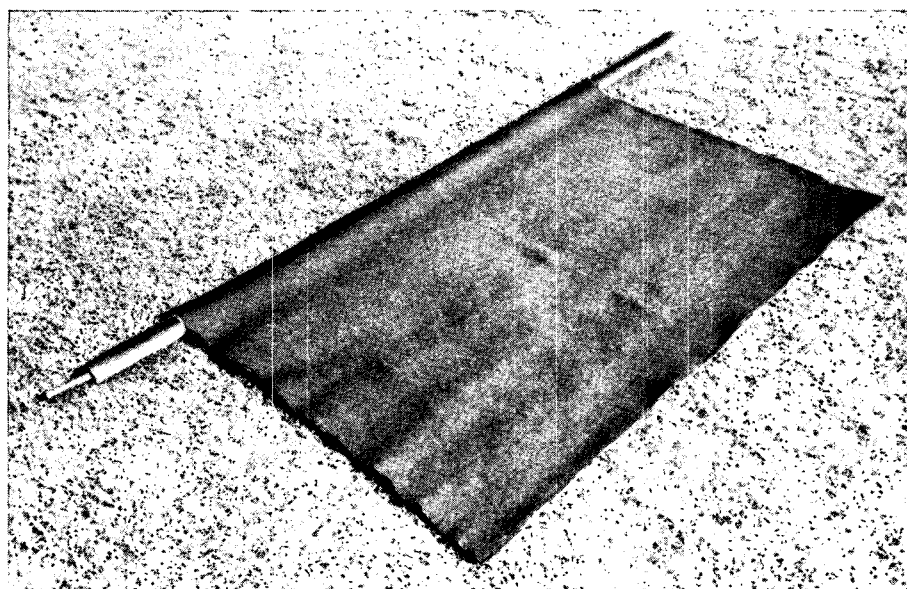
In carrying a litter across any obstacle too narrow to permit bearers to advance in normal positions, No. 1 precedes and No. 4 follows the litter as No. 2 and No. 3 maintain their usual positions of carry.

**Section VI. IMPROVISED LITTERS**

**44. General**

At times a patient may have to be moved when a litter is not available. The distance may be too long for manual carries, or the patient may have an injury, such as a fractured neck,

back, hip, or thigh, which would be aggravated by manual transportation. In these situations, litters may be improvised from certain materials at hand. Improvised litters must be well constructed to avoid the risk of dropping or fur-



A blanket, shelter half, tarpaulin, or similar material may be used for the litter bed. The poles may be improvised from branches, boards, tent poles, skis,

lengths of pipe, rifles, or any appropriate objects at hand.)

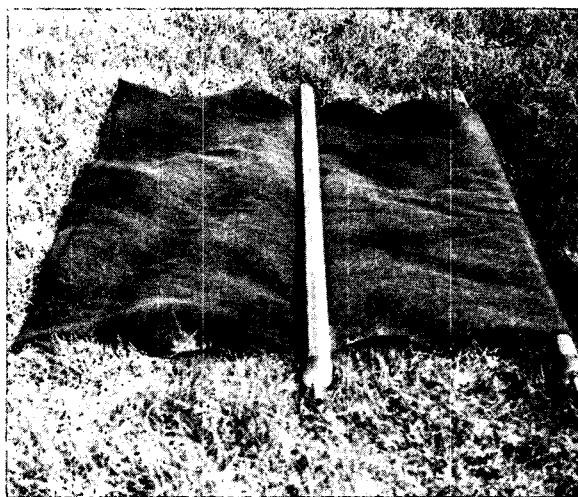
- a. Spread blanket open on ground.
- b. Lay one pole lengthwise across center, and fold the blanket over it.

*Figure 103. Pole and blanket litter (step one).*

ther injuring the patient. Improvised litters are emergency measures, however, and must be replaced by standard litters at the first opportunity, so as to provide maximum comfort and safety for the patient.

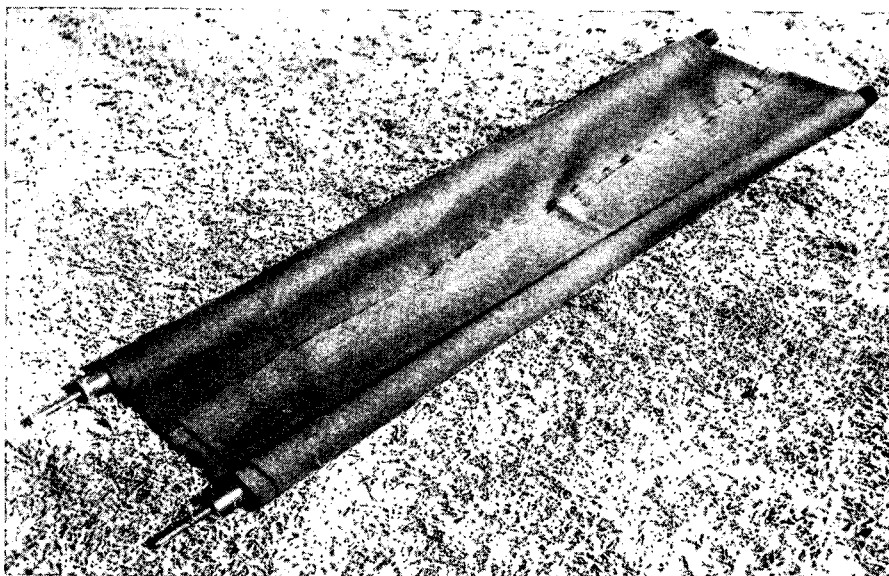
#### 45. Types

In most instances there will be material available with which a litter can be improvised. Many types of litters may be improvised, depending upon the materials available. Several of these are described and illustrated in figures 103 through 109.



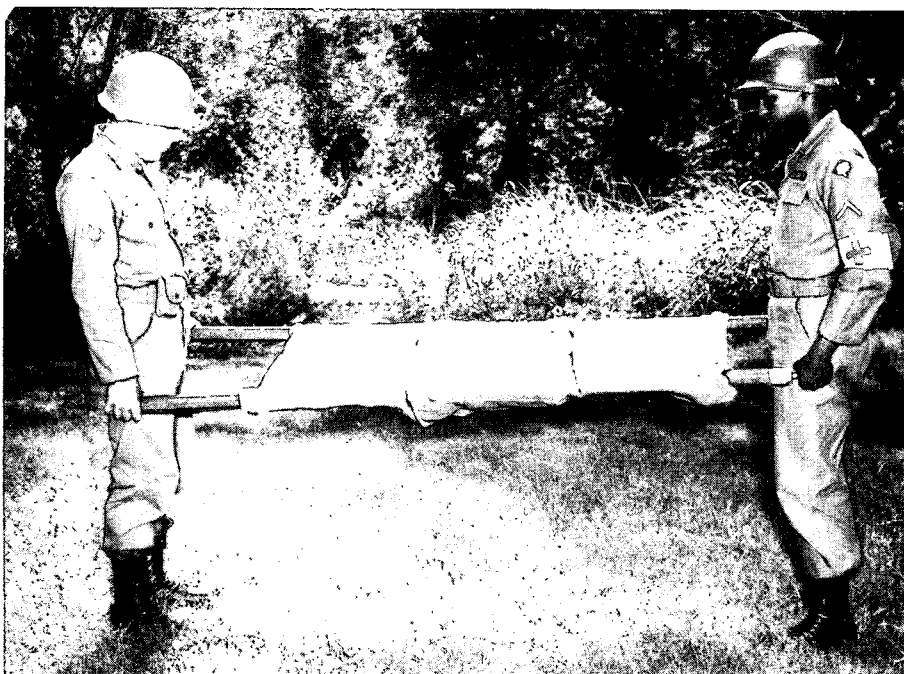
Place second pole across center of new fold.

*Figure 104. Pole and blanket litter (step two).*



Fold free edges of blanket over second pole.

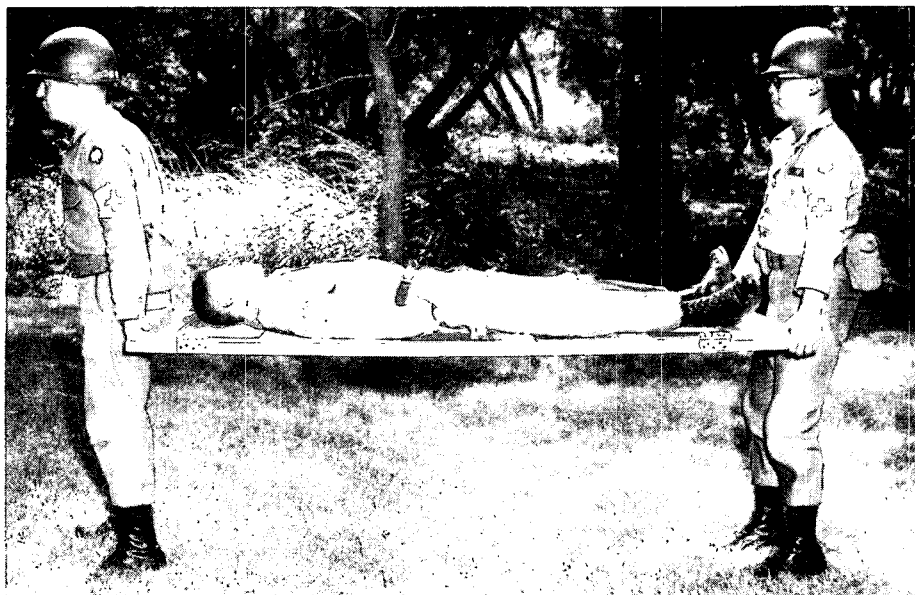
*Figure 105. Pole and blanket litter (step three).*



Fold two or three blouses, shirts, or jackets, button them, turn them inside out so that the sleeves are on the inside, and pass a pole through each sleeve.

*Figure 106. Litter improvised from poles and jackets.*





(Use plane-surfaced objects of suitable size, such as cots, window shutters, doors, benches, ladders, boards, or poles tied together.)  
Pad litter, if possible.

*Figure 107. Door or pole litter.*



- a. Rip open bottoms or corners of sacks, bags, or bed ticks, or cut mattress covers.
- b. Pass two poles through them.

*Figure 108. Litter improvised from poles and sacks.*



(If no poles are available, use a blanket, shelter half, tarpaulin, or similar object rolled from both sides toward the center.)

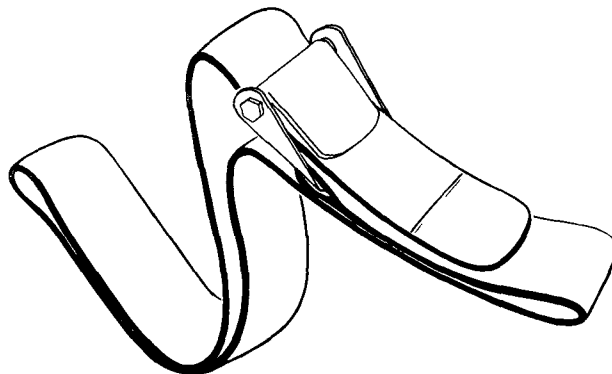
Use rolls as grips when carrying patient.

*Figure 109. Rolled blanket used as litter.*

## Section VII. AIDS IN LITTER TRANSPORTATION

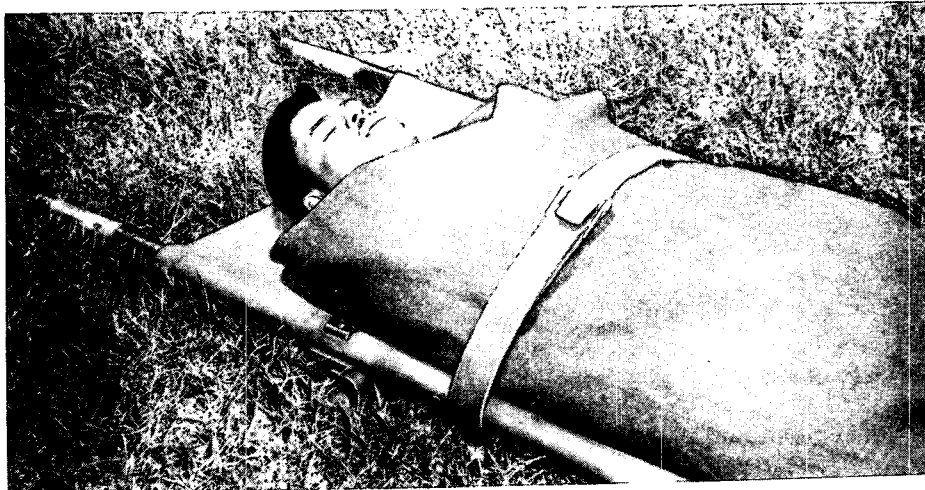
### 46. General

The manual transportation of a loaded litter is one of the most tiring tasks of the Army Medical Service personnel. Since it is performed at the critical point in the process of evacuation, every effort is made to minimize the task and thus speed evacuation. Any mechanical devices, issued or improvised, that will contribute to this effort are used (figs. 110 through 117).



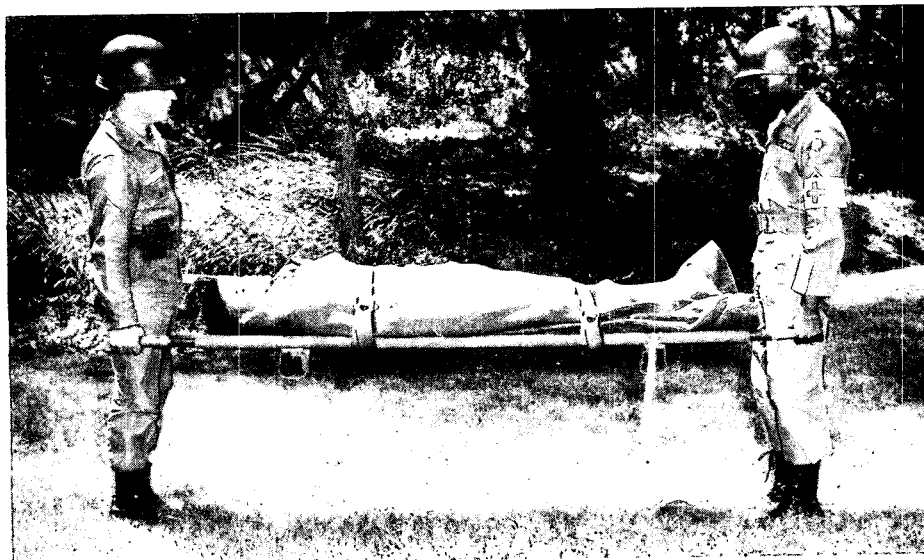
- a. The litter securing strap (available four per litter) consists of a length of 2-inch webbing with buckle which has a locking device and spring.
- b. The purpose of the litter securing strap is to hold the patient in position on the litter.
- c. The strap is designed to fit the straight aluminum litter and the folding aluminum litter.

*Figure 110. Litter securing strap.*



In securing the litter securing straps, carry the strap across the patient's body, extend it under the litter, and secure in place.

*Figure 111. Method of fixing litter securing strap in place.*



(When movement is over relatively level areas, two litter securing straps will normally be sufficient.)

Place one strap across the patient's chest and another across his legs below the knees.

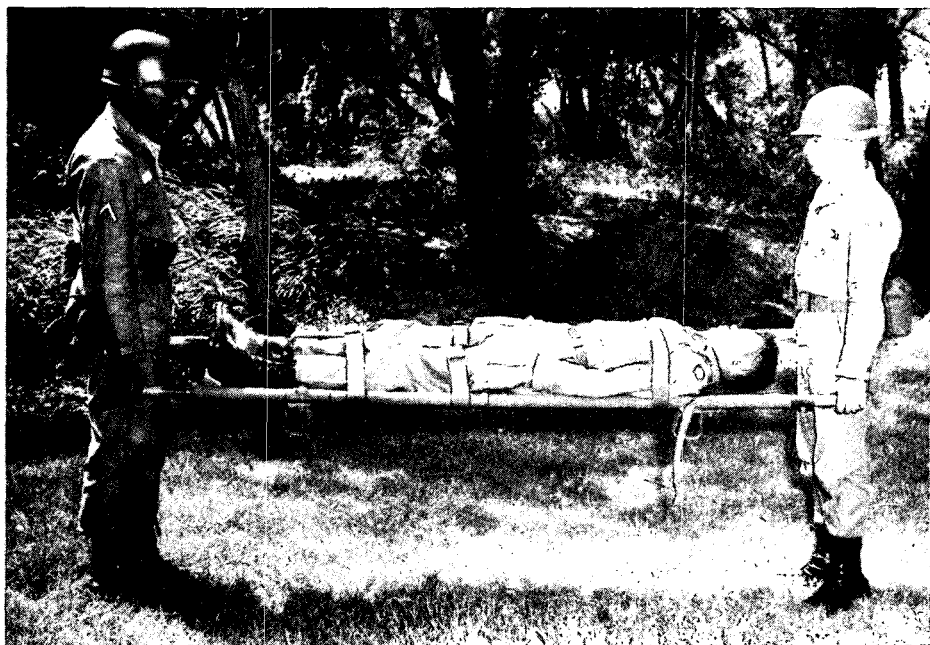
*Figure 112. Two litter securing straps (for normal terrain).*



(When the litter is to be moved over rough terrain, or the movement is of such nature that there is danger of the patient falling from the litter, use four litter securing straps.)

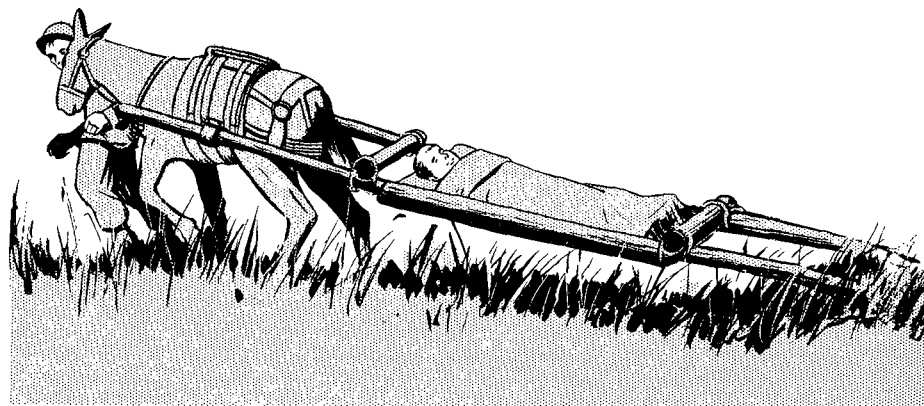
Place the four straps, one across the chest, one across the waist, one across the thighs, and one across the legs below the knees.

*Figure 113. Four litter securing straps (for rough terrain).*



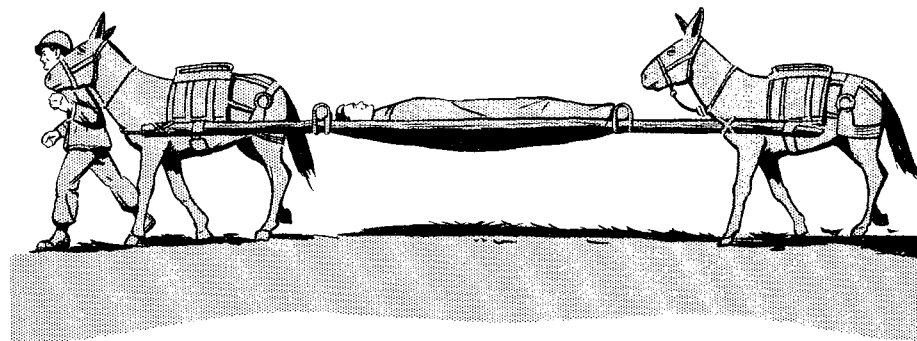
- a. Apply one strap across the chest.
- b. Apply the second strap across the legs.
- c. Carry strap over the thigh of one leg, and pass it between the legs and under the other leg to the far pole.
- d. Apply the fourth strap in the reverse manner; that is, carry it over the thigh of the far leg, under the near leg, and finally attach it to the near pole.

*Figure 114. Four litter securing straps fixed for movement up or down steep slopes.*



- a. Consists of two long poles lashed at one end to each side of a horse, or similar animal, the other end trailing the ground. Crossbars are lashed across these poles to receive the load.
- b. On the march, bearers should be ready to lift the rear end of the travois when passing obstacles, fording streams, or going uphill.
- c. To Construct:
  - (1) Cut poles about 16 feet long and 2 inches in diameter at the small end.
  - (2) Lay poles parallel to each other, large ends to the front and 2½ feet apart, the small ends 3 feet apart with one of the small ends projecting some 8 or 10 inches beyond the other to impart a rocking rather than a jolting motion to the load.
  - (3) Connect poles by a crossbar about 6 feet from the front end and another about 6 feet back of the first, each notched at the ends and securely lashed to corresponding notches in the long poles.
  - (4) Fill in litter bed (6 feet long) between crossbars with a blanket, canvas, or similar material, securely fastened to the poles and crossbars.
  - (5) In place of canvas or a blanket, a rope or straps may be stretched obliquely from pole to pole, in many turns, crossing each other to form a basis for a light mattress or improvised bed. A litter or cot may be fastened between poles for the same purpose.
  - (6) Fasten securely the front ends of the poles to the saddle of the animal.

Figure 115. Travois, one-horse.



If desired, the rear ends of the poles, instead of being allowed to drag, may be lashed to the saddle of a second horse which follows the first in tandem.

Figure 116. Travois, two-horse.



a. A packsaddle fitted with a litter is usually carried by a mule, but can be adapted to other animals.

b. It is particularly useful in mountain and jungle areas where long manual carries might otherwise be necessary.

*Figure 117. Packsaddle litter (improvised).*

## Section VIII. LITTER EVACUATION IN SNOW AND EXTREME COLD

### 47. General

Under conditions of extreme cold and deep snow, prompt collection of patients and rapid evacuation to locations where they can be kept warm is mandatory. Cold hastens the progress of shock and lessens the chances of recovery if a patient is exposed for any length of time.

a. The emergency medical treatment given is limited to the control of hemorrhage, clearing the airway, the prevention and treatment of infection, and the splinting of fractures. This treatment is modified according to the weather, the type of clothing worn by the patient, and the discretion of the person giving the treatment.

b. It is particularly important to guard against shock by conserving body heat. Patients

are, therefore, placed in specially constructed patient evacuation bags at the earliest possible moment. When they are not available, arctic sleeping bags or other articles are used for cover.

### 48. Aids to Litter Evacuation in Snow and Extreme Cold

Litter evacuation is difficult under conditions of extreme cold and deep snow and, as a result, litter bearers are subject to excessive fatigue. For this reason, litter aids, either hand-drawn by litter bearers, animal-drawn, or vehicle-towed, should be used whenever feasible.

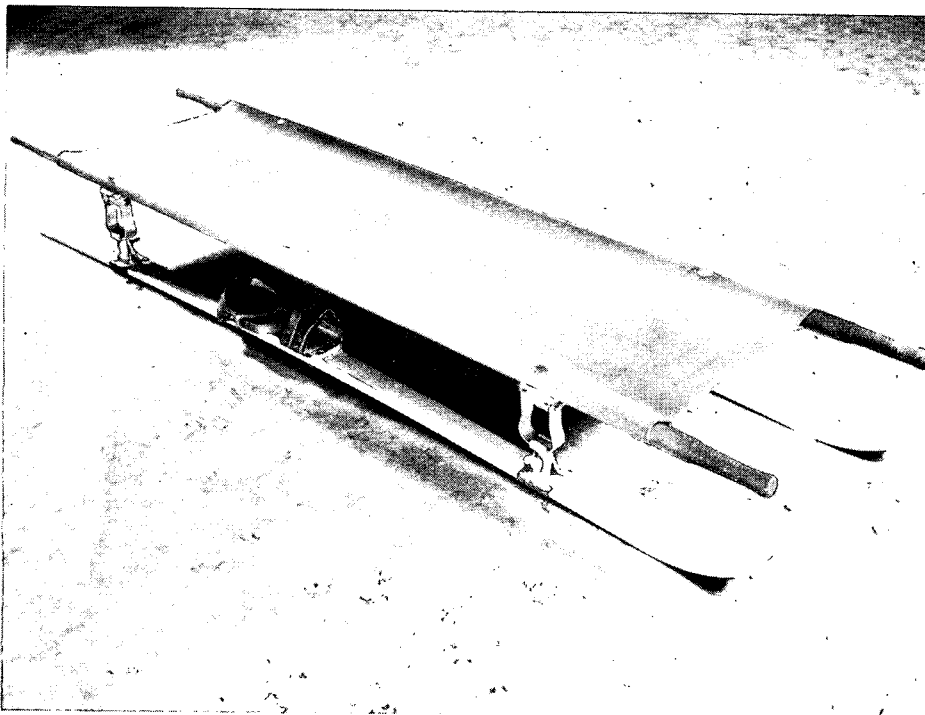
a. *Litter Kit, Ski-Sled.* The litter kit, ski-sled, is used for converting a pair of skis and ski poles to a sled for transporting patients. It con-

sists of one canvas platform, four brackets, two cross braces, two 7-foot and two 27-foot lengths of rope, and two patient securing straps.

*b. Ski Adapter* (fig. 118). The ski adapter consists of four adapters which hold a standard litter on skis. These adapters clamp on the litter stirrups and keep the litter above the surface of the snow. Patients can then be easily pulled by attaching ropes to the converted litter.

*c. Ahkio* (figs. 119–121). The ahkio is particularly useful where patients must be evacuated through deep snow.

*d. Evacuation Bag, Casualty* (fig. 121). The casualty evacuation bag is issued in cold climates to keep the patient warm. It zips up to protect all parts of the patient. Blankets may also be used inside the evacuation bag.



*Figure 118. Ski adapter.*





*Figure 119. Patient being transported on ahkio.*



*Figure 120. Patient on Ahkio being loaded into ambulance.*

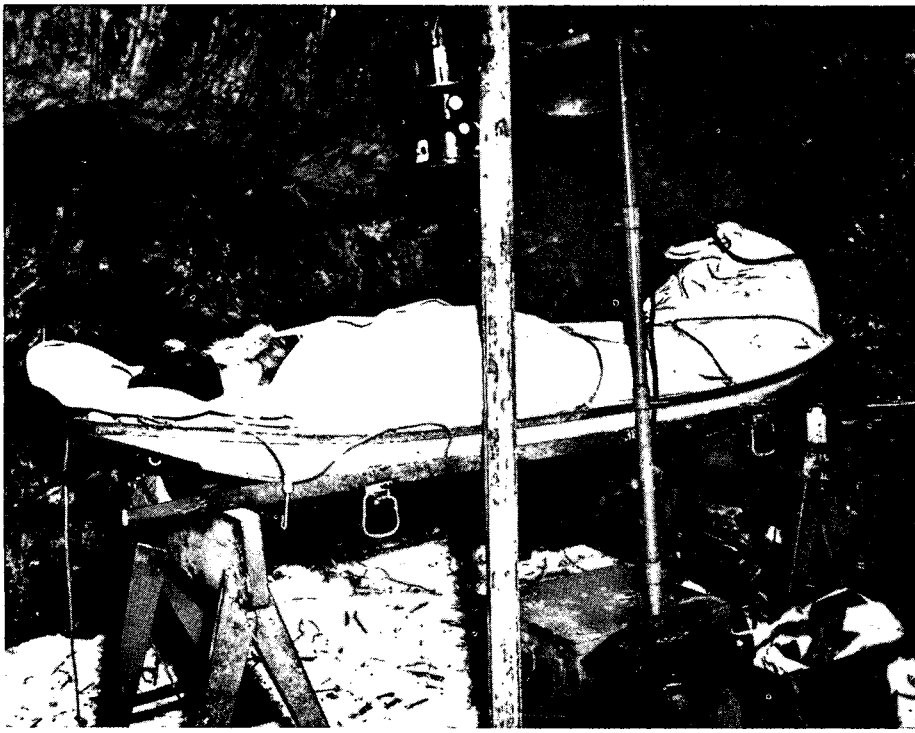


Figure 121. Patient on ahkio waiting for treatment at a medical treatment facility.

## Section IX. LITTER EVACUATION IN MOUNTAIN OPERATIONS

### 49. General

Transportation of the sick and wounded in mountain operations is hampered by the difficulty of movement in mountainous terrain and climatic conditions. There are great changes in elevation, extreme compartmentation, and poor roads. Temperatures are low, in some regions snow and ice cover the ground the year around, and there are abrupt local weather disturbances.

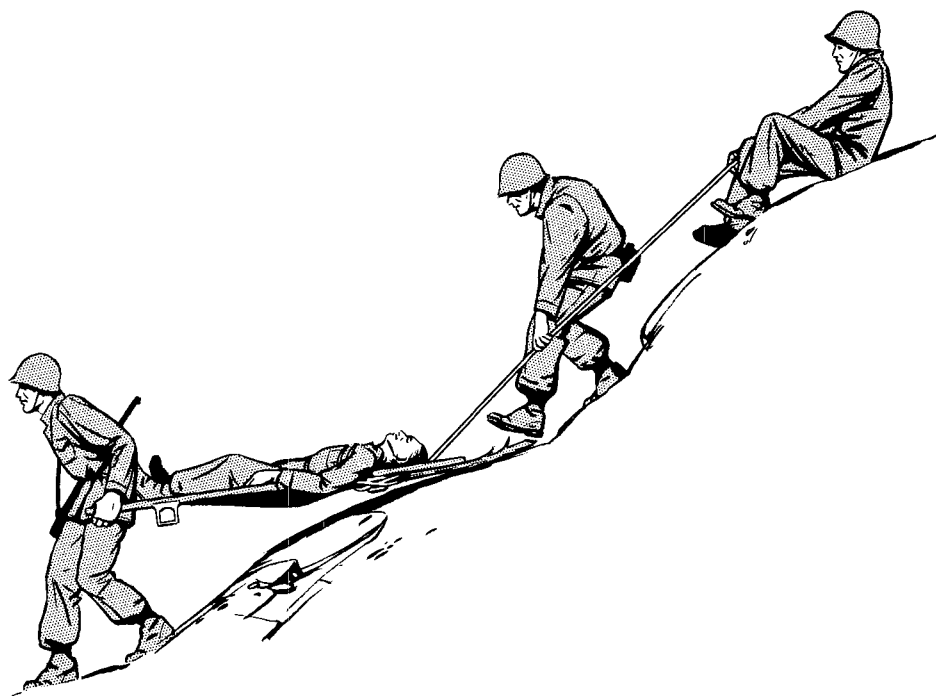
*a.* These conditions require modification in the normal handling of litter evacuation. It is customary for litter squads to be increased to six men each. On level terrain, a litter squad of four men can move a patient 1,000 yards and return in an hour. In mountainous country, a squad of six men may cover only 400 yards and return in the same time.

*b.* Whenever possible, litter relays should be employed. Using short hauls and frequent re-

lays enables bearers to operate at maximum efficiency. It also enables them to learn their section of the trail thoroughly and thus to move patients more safely during darkness and periods of poor visibility.

*c.* Men assigned to litter squads for mountain service must be trained in rock climbing, in the use of rope, and in individual and unit movements at high altitudes. For additional information on movement and operations in mountainous regions, see FM 31-72.

*d.* The smoothest available route should be selected. When the route is long and arduous, a series of warming stations should be established and staffed with medical personnel to permit proper emergency treatment of shock, hemorrhage, or other emergency conditions. When a patient develops new or increased signs of shock while being evacuated, he should be left at one of these stations until his condition warrants further evacuation.



Can be used when descending a relatively smooth slope. Considerable speed can be made on slopes, and cliff faces, 4 to 6 feet high, can be passed without difficulty.

a. Cut two poles about 18 feet long, the large end about 3 inches in diameter. Fasten poles to litter stirrups so that a length of from 5 to 10 feet of

the poles extends beyond the litter. This length of pole acts as a runner.

b. One bearer supports the foot of the litter by a rope sling and guides the litter downhill.

c. Another bearer uses a rope to lower the patient and litter.

d. A third bearer assists the man handling the rope and relieves him at frequent intervals.

*Figure 122. Modified travois.*

e. The patient should be kept as warm as possible during transportation and should not be handled more than is necessary. His helmet should be put over his head for protection from falling rock.

f. Since movement usually will be up or down slopes or along the side of a mountain, the patient must be securely lashed to the litter.

g. The mountain basket-type litters or the semirigid poleless litters are preferred for evacuation in mountain operations; however, any standard litter may be used.

## 50. Methods

(figs. 122-126)

Several methods of litter transportation which are adapted to mountain terrain and climatic conditions are described and illustrated below. They are subject to improvement and should be discarded as better methods are developed.



The litter is prepared as for descending.

- a. Two men take their places at the head of the litter. (A thin sapling passed through the stirrups, extending 18 inches on each side of the lines, affords a more secure grip for these two bearers.)
- b. A third, using an improvised rope sling, takes his place at the foot.
- c. The fourth and fifth men take their positions along the extended rope which is in the hands of the sixth.
- d. At the signal UP ROPE, the fourth, fifth, and sixth men pull, while the first, second, and third men lift the litter and slowly climb.

(The men carrying the litter should not try to do all the work but should allow themselves to be pulled up the slope while they hold the litter off the ground. The positions of the men should be rotated at each halt so that the work will be distributed equally.)

*Figure 123. Steep slope evacuation (ascending).*



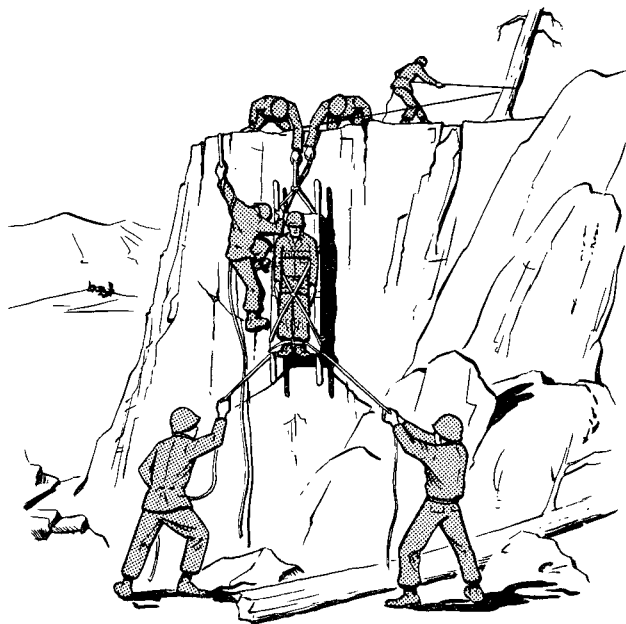
In making the descent, the most direct, practicable passage should be taken.

- a. To prepare the litter, litter securing straps are used, if available. If rope is used, it is passed through the head stirrups, lashed in place, and used as a support.
- b. Two men hold the rope to assist in lowering litter.

c. The three litter bearers take their positions as for ascent.

- d. The sixth man may assist with the litter or precede the team, picking a trail, making the passage more negotiable by clearing away shrubs and vines, and making a reconnaissance so that the team need not retrace its steps if a cliff should be encountered.

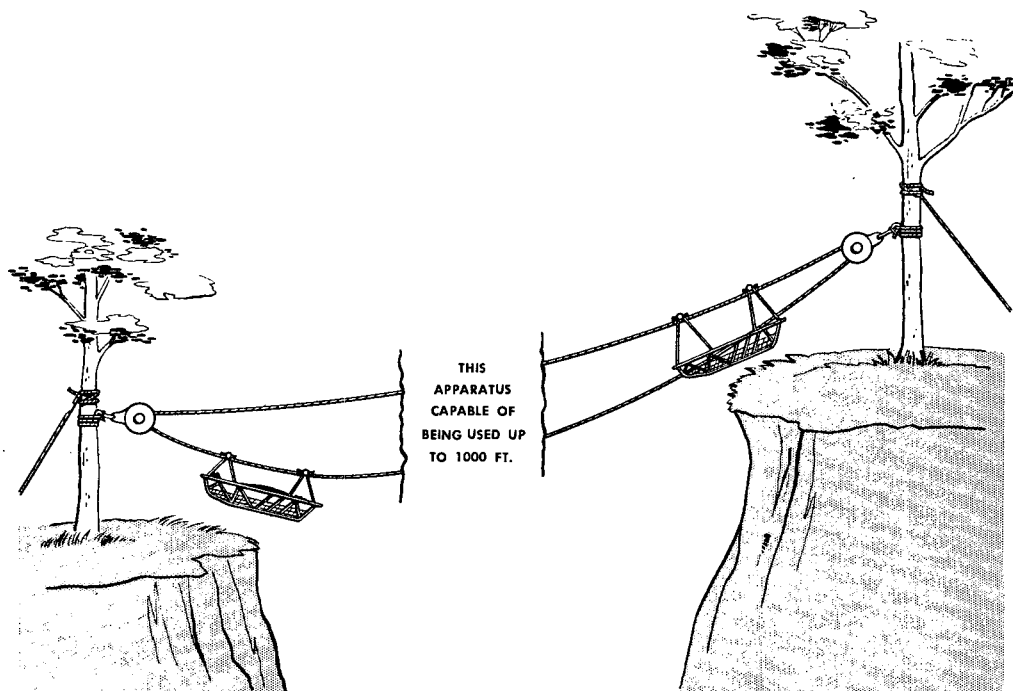
*Figure 124. Steep slope evacuation (descending).*



If a cliff is too extensive to bypass, select the smoothest face for descent.

- a. Secure patient as before.
- b. Attach two large poles, the length of the litter or longer, to the stirrups. Poles act as runners.
- c. Tie lashing ropes on poles in the notches cut in the poles, to prevent fraying from rubbing against stone cliff.
- d. Attach ropes to the stirrups at the foot of the litter to use as guy ropes to keep litter from revolving.
- e. Two men lower litter over cliff edge, while a third man secures the rope around a tree or large boulder.
- f. One man descends the cliff face on a rope, moving parallel to the litter, and assists the litter over any projections.
- g. The remaining bearers guide the litter from the foot of the cliff by holding the guy ropes.
- h. When the litter has almost reached the base of the cliff, they ease it to the ground.

*Figure 125. Lowering patient down cliff.*



Consists of a continuous wire rope cableway, secured by a system of snatch-blocks, spanning a maximum of 1,000 feet between terminals. (A slope of at least 10° is required for proper operation.) It is a standard item of issue. (For use and maintenance, see TM 5-270.)

- a. A Stokes litter with patient is suspended from the top of the cable at the upper terminal.
- b. An empty litter is suspended from the bottom of the cable at the lower terminal.

- c. The litter patient at the upper terminal is lowered by gravity to the lower terminal. (A belay line has been attached to the litter to prevent injury from a rapid and uncontrolled descent.) At the same time the empty litter at the lower terminal is raised to the upper terminal ready to receive another patient.
- d. One man stands at the upper terminal controlling the belay line, and another stands at the lower terminal ready to receive the patient.

*Figure 126. Monocable casualty evacuation apparatus.*

## CHAPTER 4

## TRANSPORTATION BY GROUND VEHICLE

## Section I. MOTOR AMBULANCE

**51. General**

Motor ambulances are vehicles specially designed for carrying patients. They are organic to the Army Medical Service units which are assigned the task of transporting the sick and wounded by ground ambulance. Motor ambulances are equipped with supplies, including litters, blankets, and splints, and are staffed with ambulance personnel qualified in basic emergency medical care and treatment procedures. An ambulance crew consists of a driver and an orderly.

**52. Types of Motor Ambulances**

These vehicles are of three major types—the field ambulance, the bus ambulance, and the metropolitan ambulance.

*a. Field Ambulances.* Field ambulances, designed for use with field units, can cross rough ground, climb steep grades, and, if required, can operate across country. There are several types of field ambulances.

- (1) *Truck, ambulance, 3/4-ton, 4 x 4, M43 or M43B1* (fig. 127). This vehicle, designed to transport the sick and wounded, is the standard field ambulance of the medical service units in divisions and in higher units. It is lightweight with a fully inclosed body mounted on a light truck chassis. The body of the vehicle is separated from the driver's compartment by a partition in which a small door is mounted. Two rear doors provide access to the body of the vehicle or the patients' compartment. This compartment is equipped with a heater and a surgical light. The M43 ambulance is capable

of fording bodies of water up to 42 inches in depth and can operate while completely submerged if equipped with a deep water fording kit. It can operate in temperatures as high as 125°F. and when equipped with an Arctic winterization kit, it can operate in temperatures as low as -65°F.

- (2) *Truck, ambulance, 1/4-ton, 4x4, M170, frontline* (fig. 128). This forward area ambulance is specially designed to combine the maneuverability of the ordinary 1/4-ton truck with some of the advantages of a closed ambulance. It is a lightweight vehicle with an open body and canvas cover. The spare wheel is carried inside at the right side of the front passenger seat. Additional facilities include crash pads and an interior emergency light. The tailgate can be lowered to facilitate the loading of the litters. This ambulance normally is used to evacuate patients from the frontline units to aid stations.

*b. Bus, 44-passenger, 4 x 2, Integral Type (Bus Ambulances)* (fig. 129). The bus is designed for rapid conversion into a bus ambulance. It is available to oversea general hospitals and other Army units. It can be used in support of the Army in the field as far forward as the road network and tactical situation will permit. It is most useful in situations where a large number of patients are to be transported for relatively short distances over improved roads, such as in transferring patients from holding companies and hospitals to airheads, railheads, and ports of embarkation.



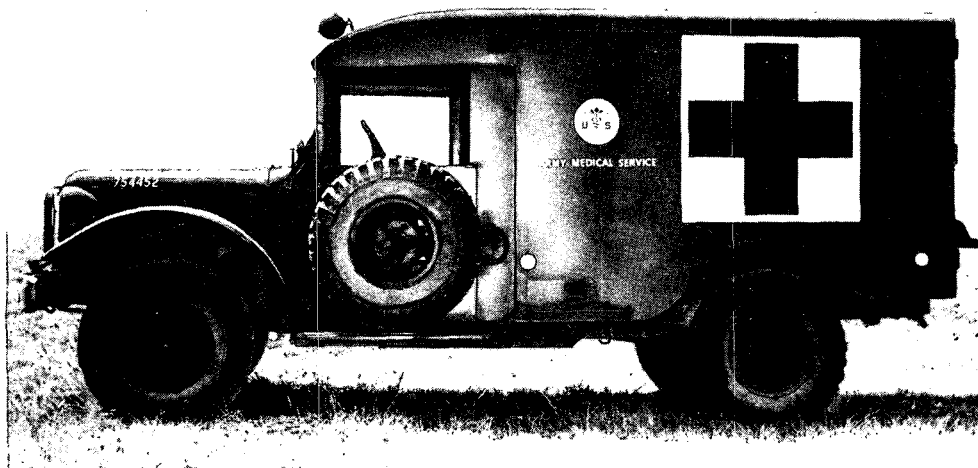


Figure 127. Truck, ambulance, 1/4-ton, 4 x 4, M43 or M43B1.



Figure 128. Truck, ambulance, 1/4-ton, 4 x 4, M170, frontline.

c. *Automobile, Ambulance, Metropolitan Type 4 x 2* (fig. 130). The large metropolitan ambulance is designed for use on good roads only. It is supplied to named Army hospitals and to certain other large hospitals. The ambulance cot litter, Bomgardner type, is ordinarily used with this ambulance. The capacity of this ambulance is one Bomgardner litter and three field litters, or four field litters. There is an attendant's seat in the patient's compartment.

d. *Truck, Ambulance, Light, 4 x 2* (fig. 131). This ambulance is designed for use on good roads only. It is supplied to Army hospitals and to dispensaries. The capacity of this ambulance is two Bomgardner litters and two field litters, one Bomgardner litter and three field litters, one Bomgardner litter and one field litter on one side and on the other side four ambulatory patients, or eight ambulatory patients.

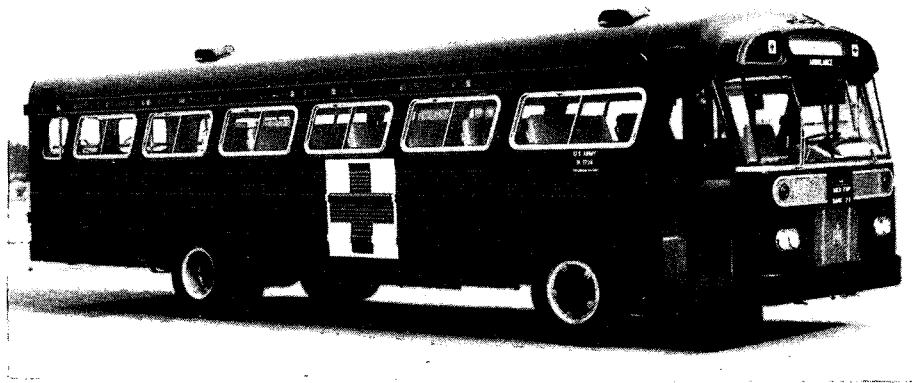


Figure 129. Bus, 44-passenger, 4 x 2, integral type (bus ambulance).

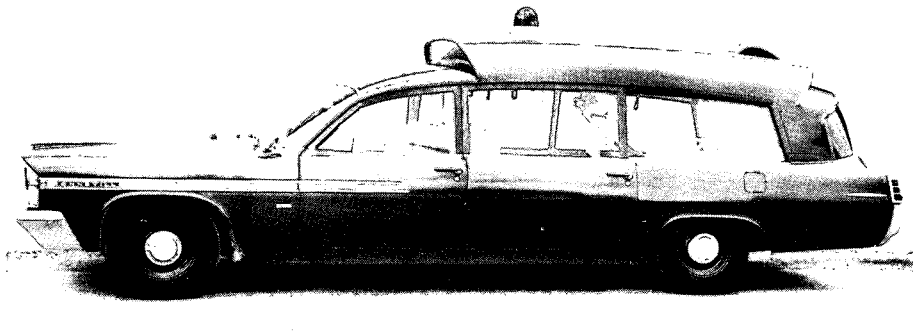


Figure 130. Automobile, ambulance, metropolitan type, 4 x 2.

### 53. Ambulance Driver

The ambulance driver is responsible for the ambulance at all times. He performs driver maintenance and is responsible for reporting major defects to his section chief or to the unit sergeant. When no ambulance orderly is assigned, he performs the duties of the orderly. The driver also has the following specific responsibilities:

- a. Providing maximum possible safety and welfare of patients entrusted to his care.
- b. Maintaining the proper number of litters, blankets, and splints within his ambulance.
- c. Preparing the ambulance for loading and unloading and thereafter for departure.
- d. Assisting the litter bearers in the loading and unloading of patients.

e. Carrying out property exchange when patients are loaded and unloaded.

f. Delivering messages and medical supplies upon request of authorized personnel.

### 54. Ambulance Orderly

The ambulance orderly acts as assistant driver when required, and performs the following duties:

- a. Becomes familiar with the condition of each patient being transported.
- b. Checks with the person in charge of evacuation for any special instructions in the care and treatment of patients while en route.
- c. Renders emergency medical treatment as required by the patients while in transit.
- d. Makes periodic checks of patients.

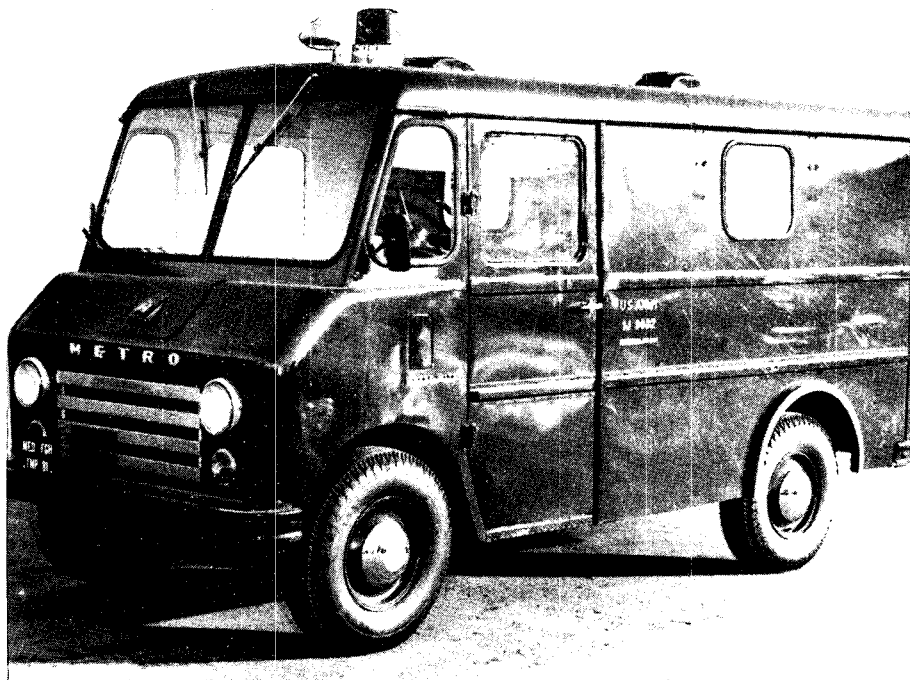


Figure 131. Truck, ambulance, light, 4 x 2.

e. Supervises and assists in the loading of patients, taking care that patients with wounds of the chest or abdomen and those wearing cumbersome splints are loaded in lower berths.

### 55. Ambulance Loading and Unloading

a. In loading and unloading all patient-carrying vehicles, litter patients are moved as carefully as possible to provide the maximum possible safety and comfort for them. Details of the loading and unloading procedures will vary slightly depending upon the number of bearers, the presence or absence of an orderly, and the type of vehicle used. Unless contraindicated by the nature of the patient's injuries, patients are loaded headfirst. Patients with wounds of the chest or abdomen and those wearing cumbersome splints are loaded in lower berths.

b. In the instruction for loading and unloading, men are numbered and formal commands are given so that each man can learn what his particular job is and all can learn to work as a team. Demonstration of the steps in ambulance loading and unloading, followed by application, is the recommended method of instruc-

tion. Before loading, patients are grounded three paces to the rear of and with the patient's head toward the ambulance.

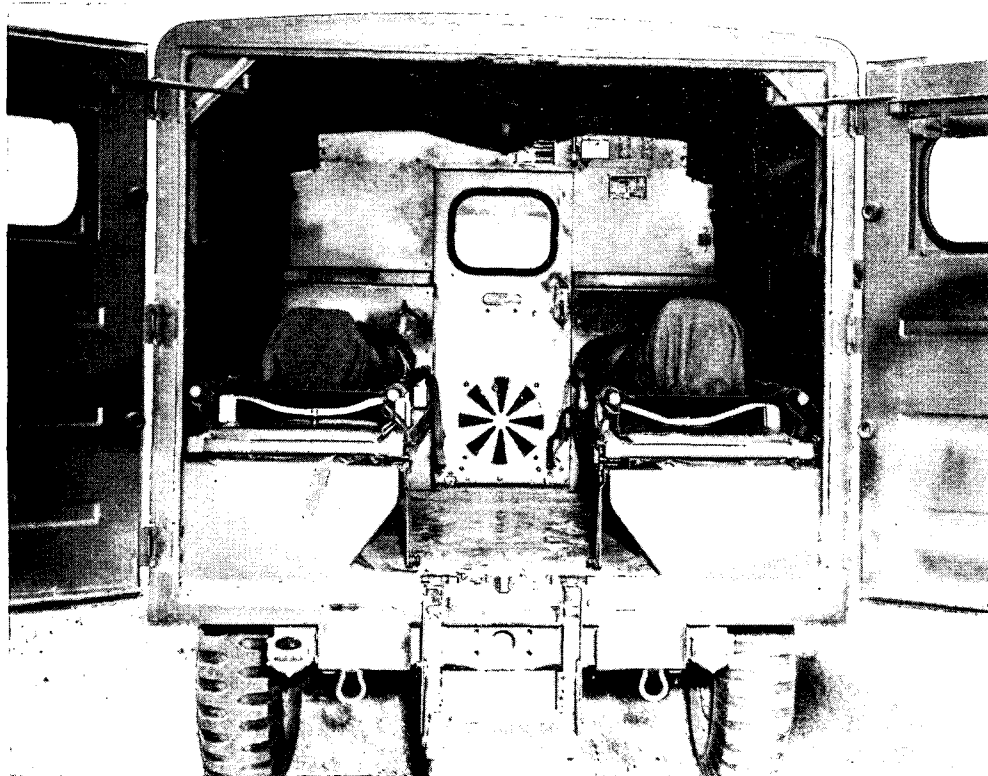
### 56. Truck Ambulance, $\frac{3}{4}$ -Ton, 4 x 4, M43 and M43B1

This ambulance can carry four litter patients or eight ambulatory patients. It is primarily designed for carrying no more than four litter patients, so that the attendant may have space to care for the patients. In an emergency, however, one additional litter patient can be carried on the floor (fig. 132). When only two litter patients are to be carried, the lower berths are used (fig. 133). When both litter and ambulatory patients are to be carried, they are loaded as in figure 134. The four longitudinal spaces formed within the body of the ambulance are known as berths, and are designated as right (left) and upper (lower). A three-man squad is needed to load and unload the ambulance.

a. *Loading the Ambulance.* The sequence for loading the berths is right upper, right lower, left upper, and left lower.



*Figure 132. Five litter patients in ambulance, in emergency.*



*Figure 133. Two litter patients in ambulance.*

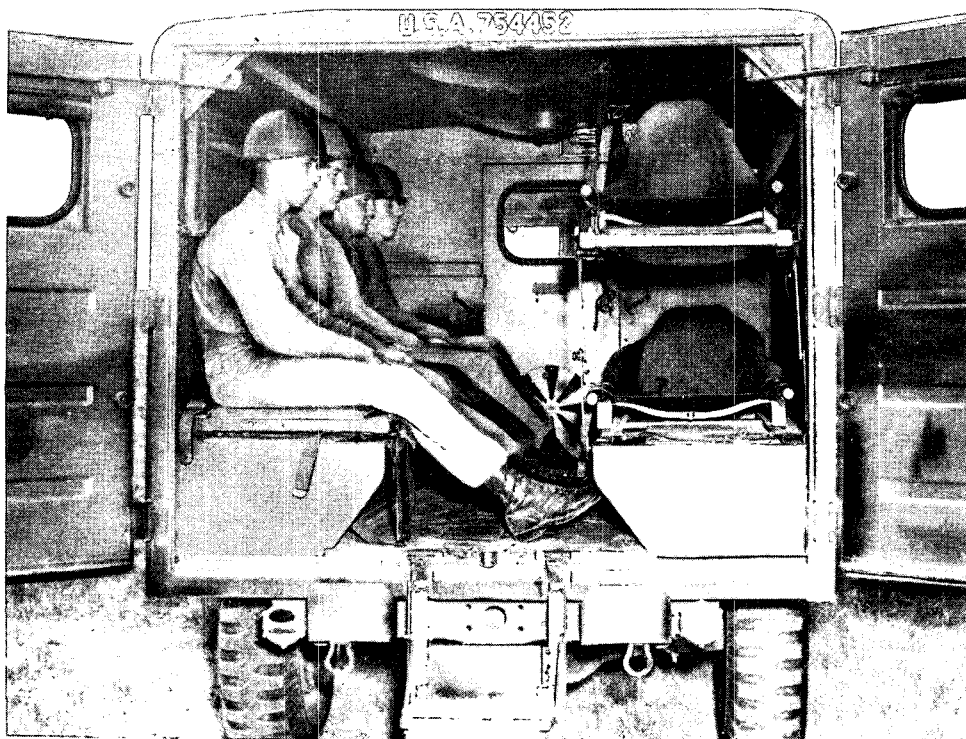


Figure 134. Two litter patients and four ambulatory patients in ambulance.

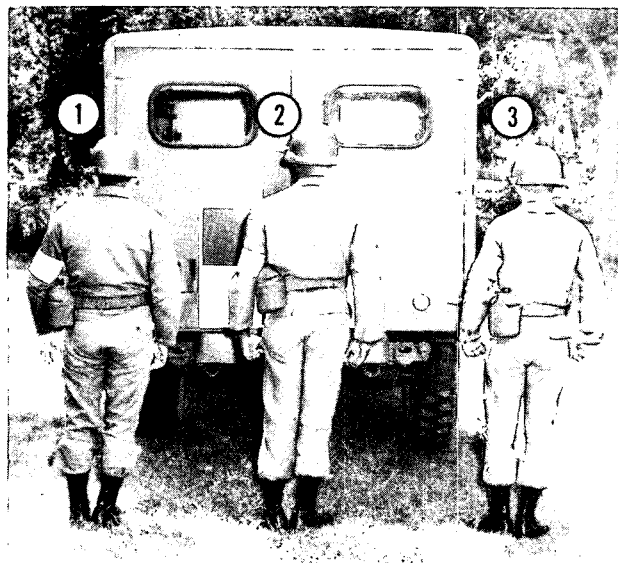
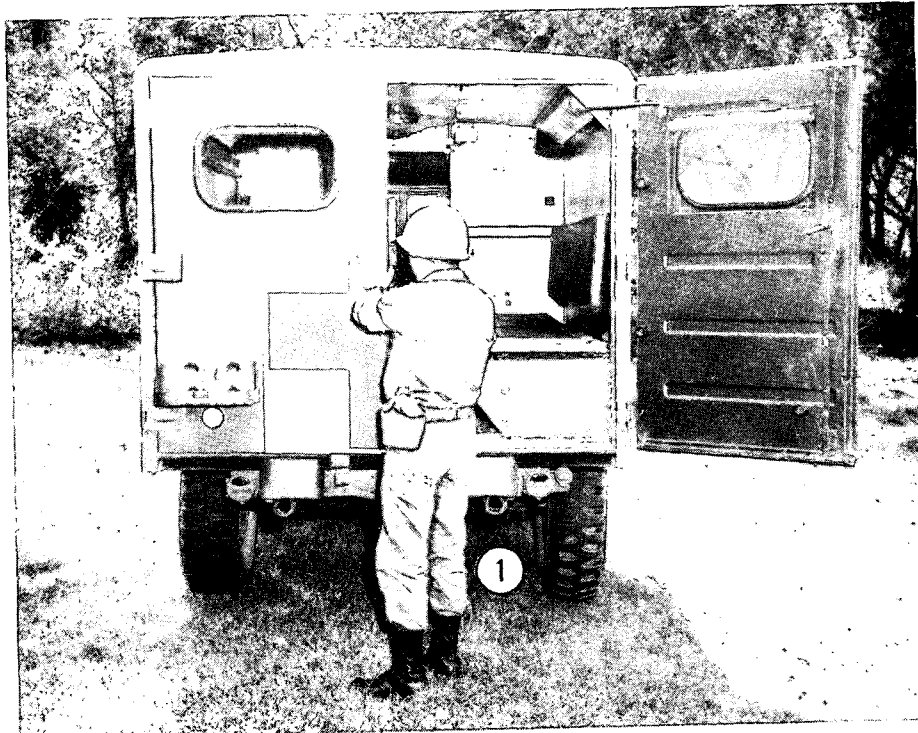


Figure 135. Squad at ambulance, POSTS.

- (1) The *first* command is Ambulance, POSTS (fig. 135).
- (2) The *second* command is Prepare Ambulance For, LOADING. At this command, No. 1 takes Steps One, Two, and Three, as illustrated in figures 136, 137, and 138.
- (3) The *third* command is Right Upper Berth, Prepare to Load, LOAD (figs. 139 through 143).
- (4) The *fourth* command is Right Lower Berth, Prepare to Load, LOAD. At this command the right lower berth is loaded (fig. 144).

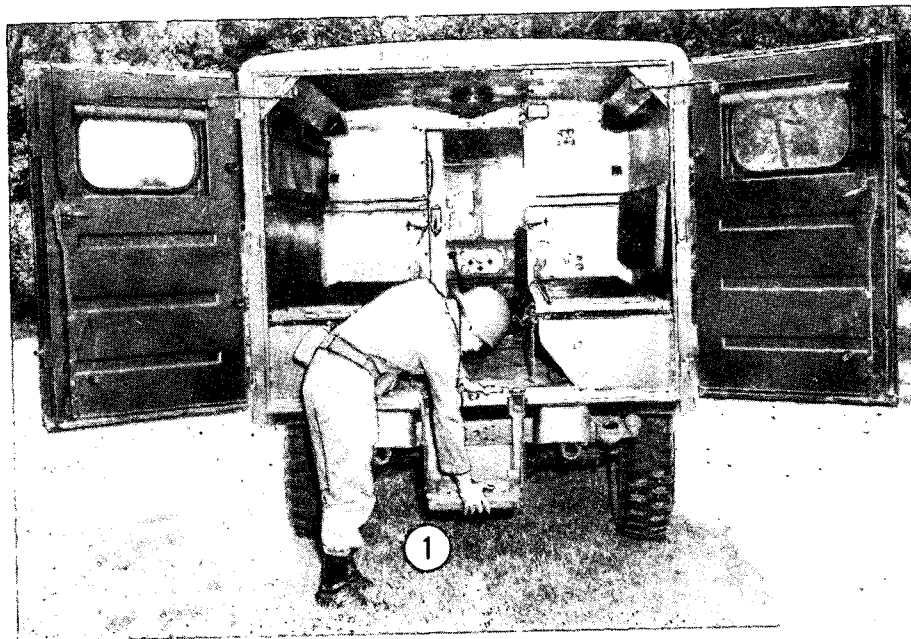
---

At the command of execution, members of the squad fall in, alining themselves in numerical sequence from left to right, one pace to the rear of and facing the ambulance.



Opens rear doors.

*Figure 136. Prepare ambulance for, LOADING (step one).*



Lowers rear step.

*Figure 137. Prepare ambulance for, LOADING (step two).*



- a. Enters ambulance, raises back rests, and latches them in place.
- b. Raises front of seats and attaches them to partition between the body and the cab to form the upper berths. (Resumes place with the rest of squad.)

*Figure 138. Prepare ambulance for, LOADING (step three).*



At the preparatory command, positions and procedures are as follows:

- a. No. 2, at foot of litter and facing the patient, stoops and grasps handles.
- b. No. 1 and No. 3, one on each side of the litter and facing the patient's shoulders, grasp the left and right poles, respectively.

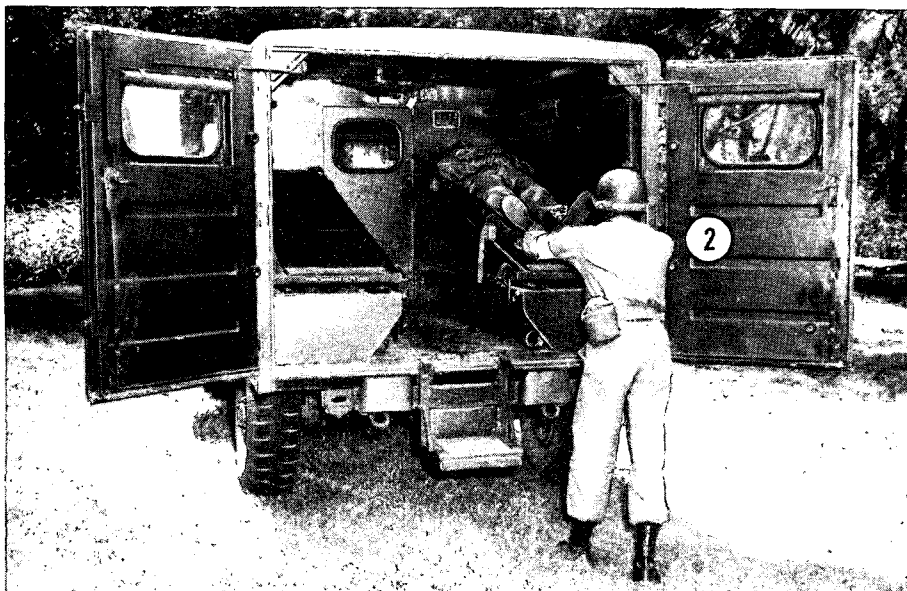
*Figure 139. Loading right upper berth (step one).*



a. At the command of execution, the litter is lifted and carried to the ambulance.

b. The front stirrups are placed in the grooves of the inclined upper berth.

*Figure 140. Loading right upper berth (step two).*



No. 2 slides litter into right upper berth.

*Figure 141. Loading right upper berth (step three).*

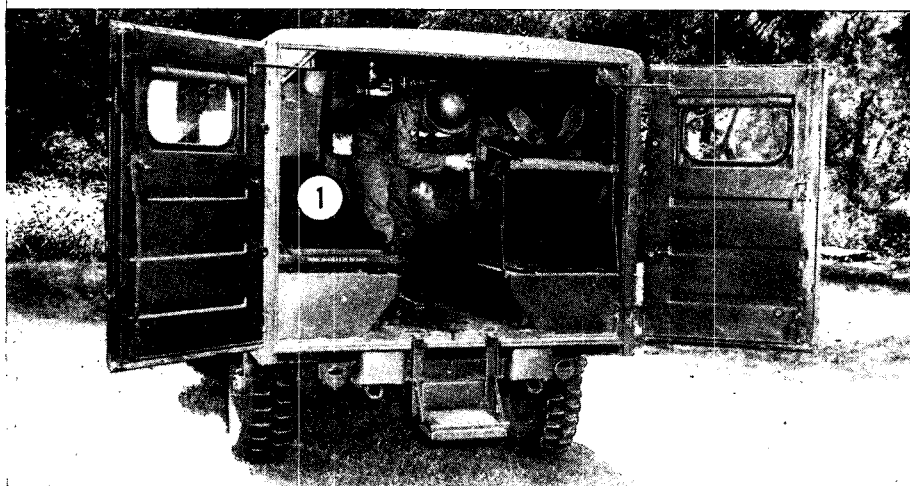




No. 2 pulls out the berth rods and raises them so that the upper berth with its litter is level, then pushes

the berth rods into their recesses to lock the berth in place.

*Figure 142. Loading right upper berth (step four).*



a. No. 1 enters ambulance and secures each litter handle with the strap that is attached to the berth for that purpose.

b. He also fastens the roof straps to the upper berth. (The squad then reassembles without command.)

*Figure 143. Loading right upper berth (step five).*

(5) When loading is completed, No. 1 raises the rear step (which forms a seat) and closes the rear doors. The squad then resumes position (Ambulance, POSTS) without command.

b. *Unloading the Ambulance.* The sequence for unloading is right lower, right upper, left lower, and left upper.

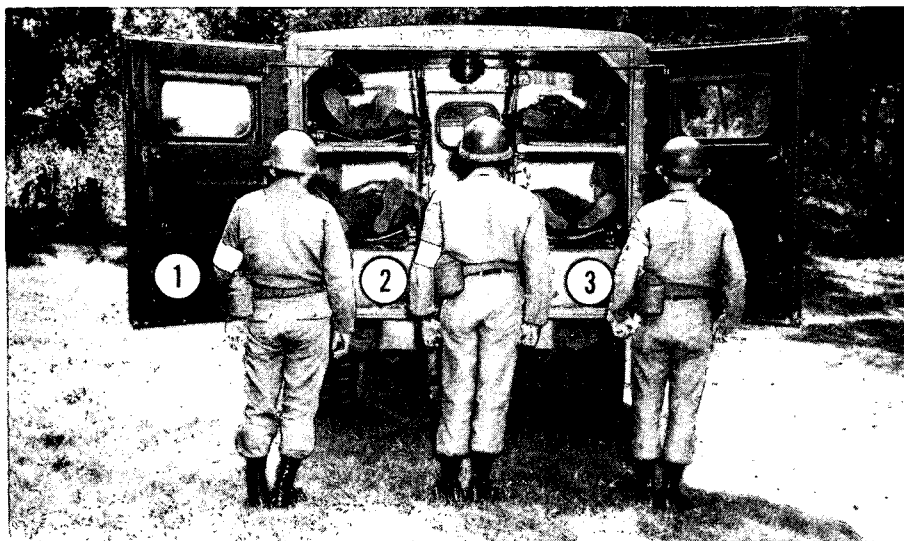
(1) The *first* command is Prepare Ambulance For, UNLOADING. The proce-



The litter is slid into place and the handles secured by straps as before.

(The left side of the ambulance is then loaded in a similar manner.)

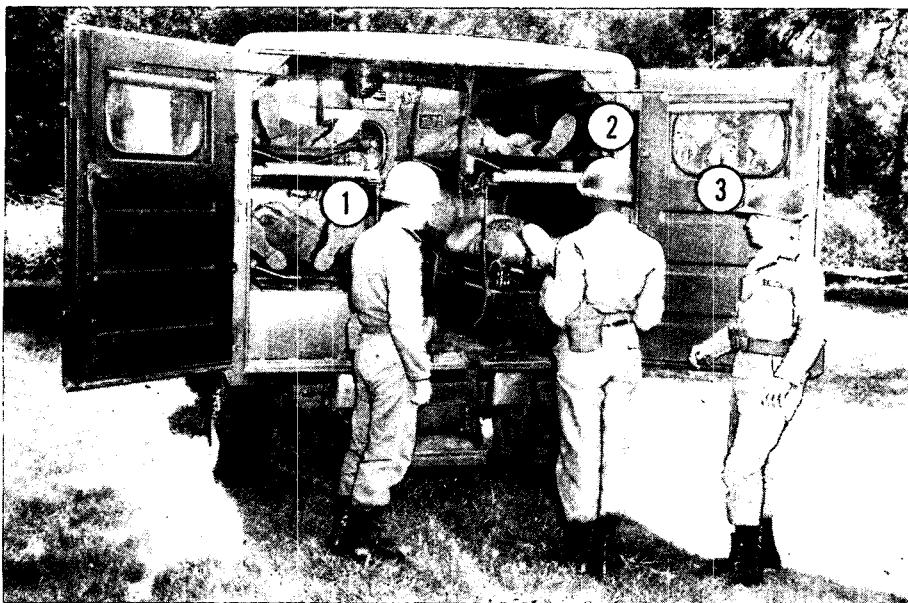
*Figure 144. Loading right lower berth.*



(No. 1 opens the rear doors, lowers the rear step, enters the ambulance, and releases the front straps securing the litters and the front roof straps.)

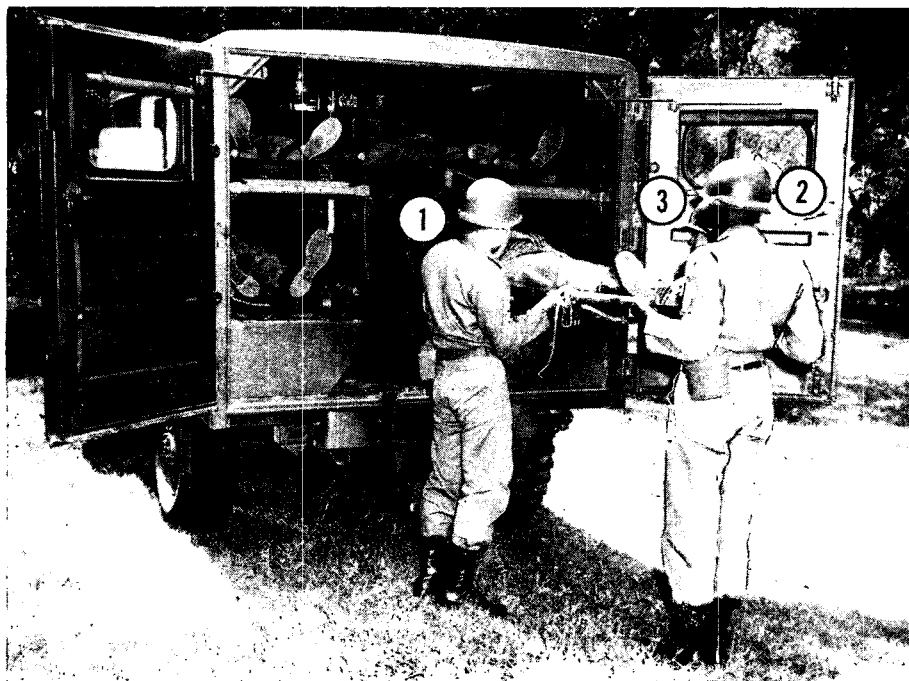
(Meanwhile, No. 2 and No. 3 release the rear straps securing the litter and the rear roof straps.)  
Squad resumes position (Ambulance, POSTS) without command.

*Figure 145. Squad at ambulance, POSTS, ready to unload ambulance.*



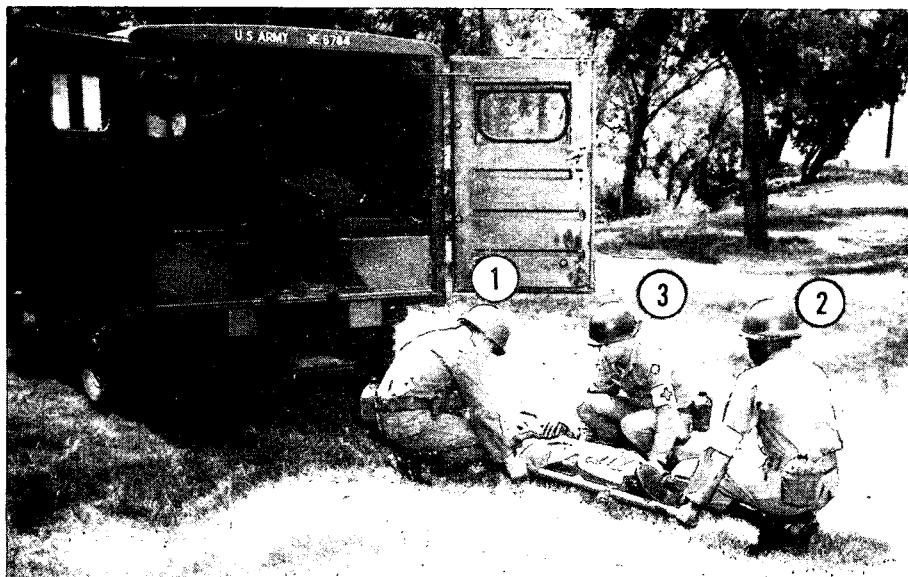
At the preparatory command, No. 2 grasps the rear handles of the litter in the right lower berth while No. 1 and No. 3 take their places on each side.

*Figure 146. Preparing ambulance for unloading right lower berth.*



At the command of execution, No. 2 pulls the litter from the berth while No. 1 and No. 3 grasp the litter poles toward the head as the litter slides out.

*Figure 147. Unloading right lower berth (step one).*



Squad removes litter at least three paces from ambulance and places it on the ground.

(Squad reassembles at rear of ambulance without command.)

*Figure 148. Unloading right lower berth (step two).*



a. At the preparatory command, No. 2 steps forward and pulls out the rods of the upper berth.

b. No. 1 collapses the upright supports.

c. No. 2 lowers the berth to unloading position.

(At the command of execution, No. 2 pulls out the litter while No. 1 and No. 3 grasp it as before.)

*Figure 149. Unloading right upper berth.*

dures following this command is similar to that for preparing the ambulance for loading (fig. 145).

- (2) The *second* command is Right Lower Berth, Prepare to Unload (figs. 146, 147, 148).
- (3) The *third* command is Right Upper Berth, Prepare to Unload, UNLOAD (fig. 149).
- (4) The *fourth* command is Left Lower Berth, Prepare to Unload, UNLOAD. The *fifth* command is Left Upper Berth, Prepare to Unload, UNLOAD. At these commands the left side is unloaded in the same manner as was the right side.

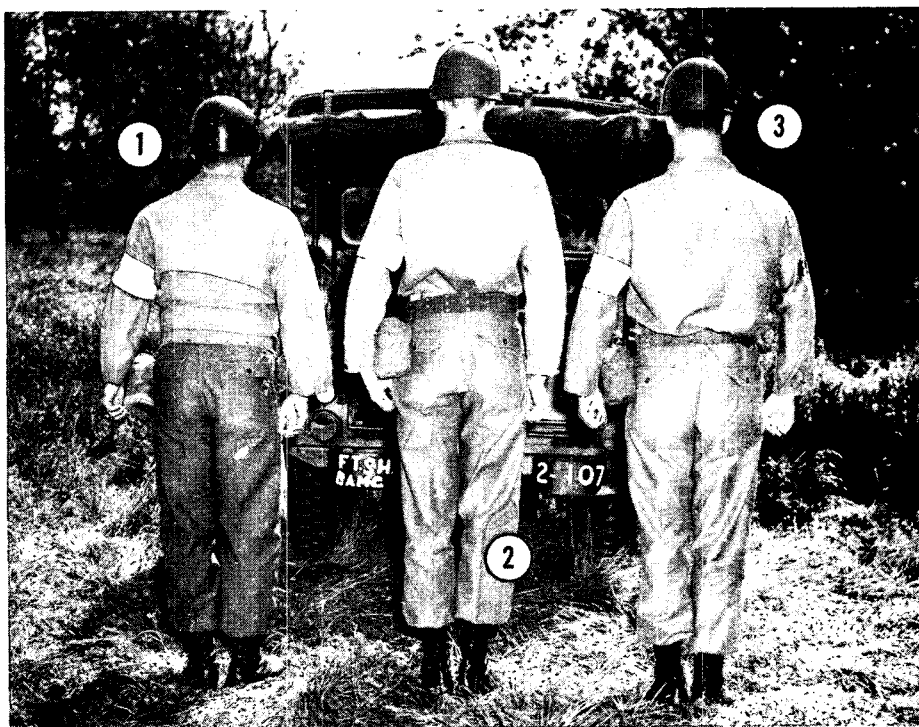
**57. Truck Ambulance, 1/4-Ton, 4 x 4, M170, Frontline**

The frontline 1/4-ton ambulance can accommodate three litter patients, or two litter patients and three ambulatory patients, or five

ambulatory patients. A three-man squad is required for loading and unloading.

*a. Loading the Ambulance.* The sequence for loading the berths is right upper, right lower, and left.

- (1) The *first* command is Ambulance, POSTS (fig. 150).
- (2) The *second* command is Prepare Ambulance For, LOADING (figs. 151-153). At this command, No. 1 takes position at the left side of ambulance, No. 3 at the right side, and No. 2 at the rear. All furl curtains at assigned positions.
- (3) The *third* command is Right Upper Berth, Prepare to Load, LOAD (figs. 154-156).
- (4) The *fourth* command is Right Lower Berth, Prepare to Load, LOAD. At this command the right lower berth is loaded. This berth consists of two



At the command of execution, members of the squad fall in, alining themselves in numerical sequence from left

to right, one pace to the rear of and facing the ambulance.

*Figure 150. Squad at ambulance, POSTS.*



No. 1 lowers the tailgate.

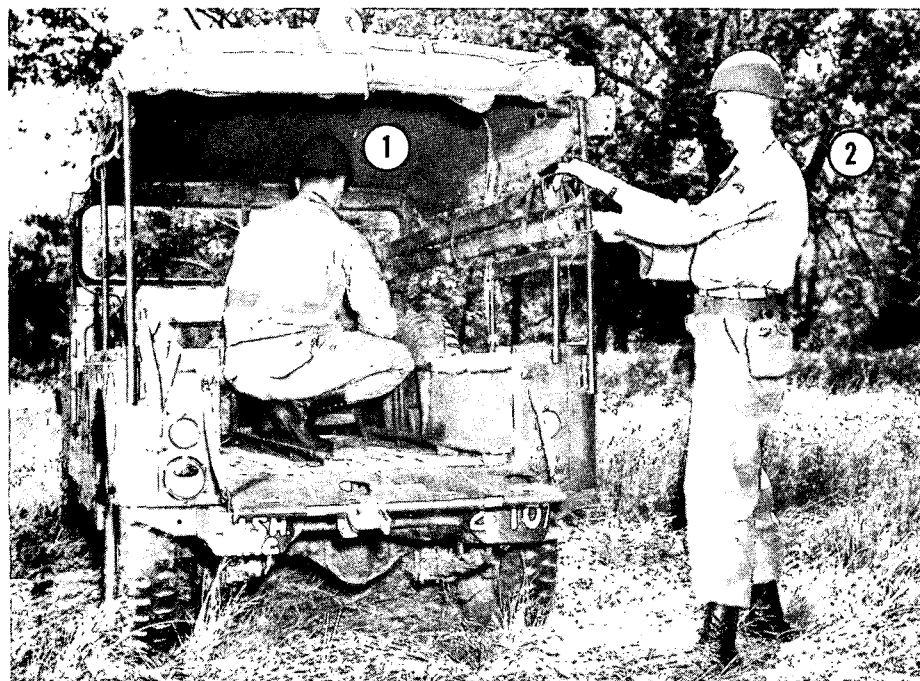
Figure 151. Prepare ambulance for **LOADING** (step one).

grooved tracks bolted to the floor of the ambulance (fig. 157).

- (5) The *fifth* command is Left Berth, Prepare to Load, **LOAD**. At the preparatory command, the procedure described in figure 154 is followed. At the command of execution, a third litter is loaded on the left side just above the seat for ambulatory patients (figs. 158, 159).

*b. Unloading the Ambulance.* In unloading the berths, the sequence is left, right lower, and right upper.

- (1) The *first* command is Ambulance, **POSTS**. At this command, the squad falls in (fig. 150).



- a.* No. 1 enters the ambulance and arranges the front passenger seat in crash pad position for upper and lower litter patients.

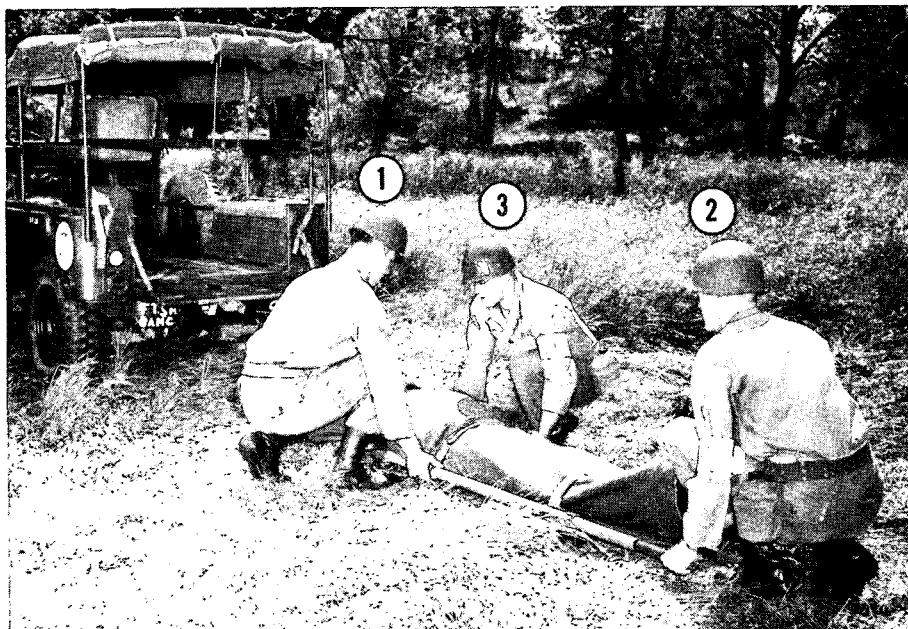
- b.* No. 2 unties litter rack storage strap, located on the right outside bow.

Figure 152. Prepare ambulance for, **LOADING** (step two).



No. 3, assisted by No. 1, sets up the upper litter rack.  
(All reassemble at the rear of the ambulance without command.)

*Figure 153. Prepare ambulance for, LOADING (step three).*

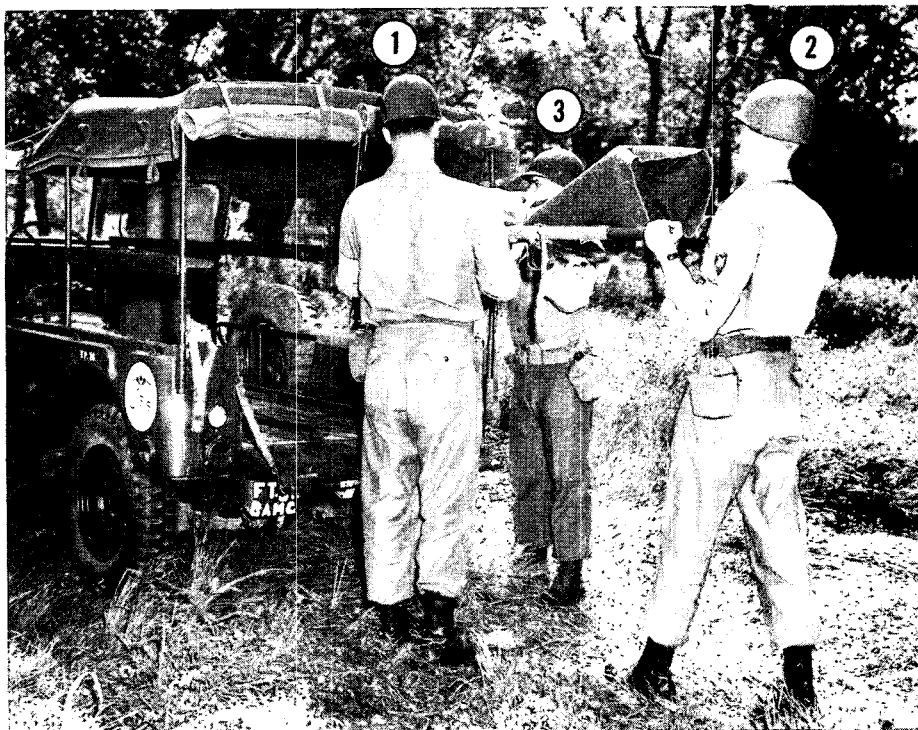


a. At the preparatory command, No. 2 takes position at the foot of the litter facing the patient, stoops, and grasps handles.

b. No. 1 and No. 3, one on each side of the litter and facing the patient's shoulders, grasp the left and right poles, respectively.

*Figure 154. Loading right upper berth (step one).*





(At the command of execution, the litter is lifted and carried to the ambulance. The front stirrups are placed in the grooves of the upper berth.)

(No. 2 slides litter into the berth. No. 1 enters ambulance. No. 3 goes to the right front entry of the ambulance and secures litter to the berth at the head.)

*Figure 155. Loading right upper berth (step two).*



Figure 156. Loading right upper berth (step three).

- (2) The *second* command is Prepare Ambulance For, UNLOADING (fig. 160). At this command bearers take positions and furl curtains.
- (3) The *third* command is Left Berth, Prepare to Unload, UNLOAD (figs. 161, 162).
- (4) The *fourth* command is Right Lower Berth, Prepare to Unload, UNLOAD (fig. 163).
- (5) The *fifth* command is Right Upper Berth, Prepare to Unload, UNLOAD, (fig. 164).

**58. Bus, 44-Passenger, 4 x 2, Integral Type (Bus Ambulance)**

*a. General* (figs. 165-167). Without modification, this bus has a capacity for 44 ambulatory patients. With modification, it can accom-

---

No. 2 secures litter to the berth at the foot, with the litter securing devices attached to the litter rack. (The squad reassembles without command.)

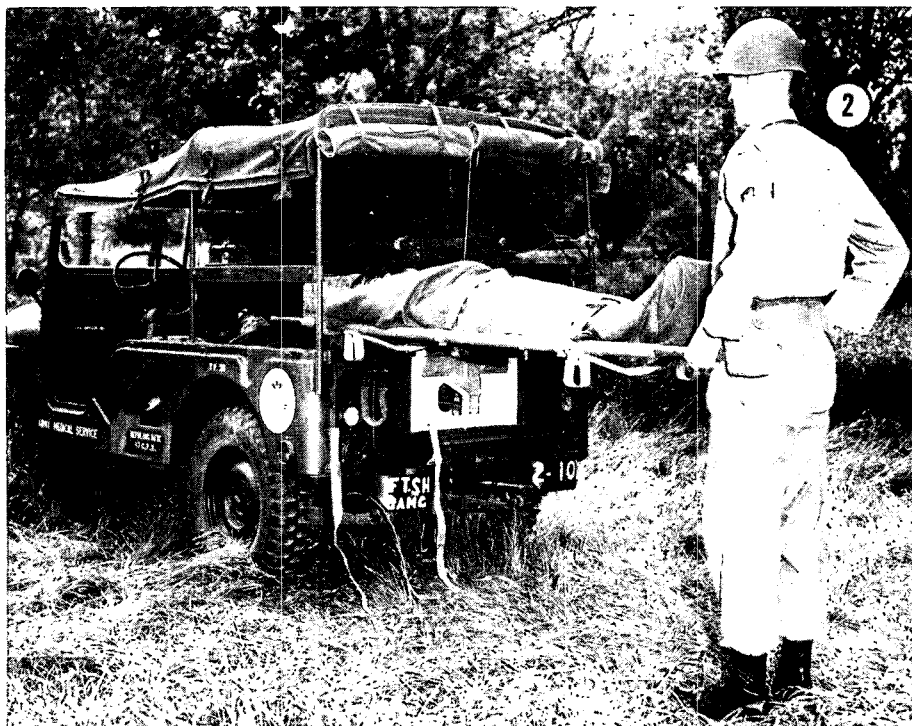


*a.* At the command of execution, the litter is carried to the ambulance and the front stirrups are placed in the grooves of the berth.

*b.* No. 2 slides the litter forward.

*c.* After the litter is in place, No. 1 and No. 3 raise and lock the tailgate, thus securing the litter.

Figure 157. Loading right lower berth.



(At the command of execution, the litter is carried to the ambulance, raised above the tailgate, and lifted into ambulance.)

(No. 1 and No. 3 rest the head of the litter on the rear litter supports of the left berth.)  
No. 2 supports the foot of the litter.

*Figure 158. Loading left berth (step one).*



(No. 1 enters ambulance from the front, comes to the rear of ambulance, and grasps both handles at the head of the litter.)

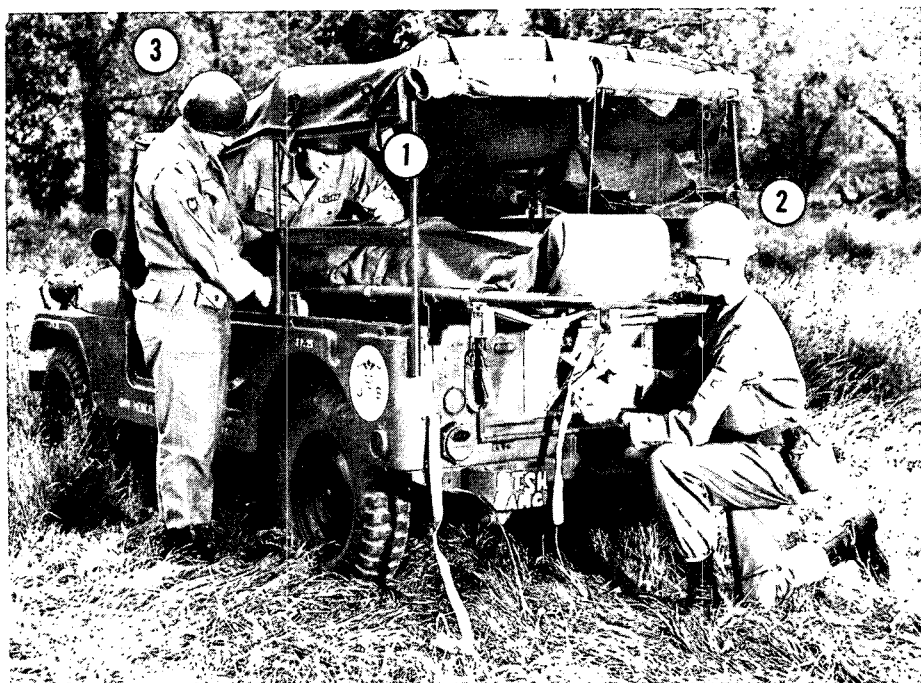
- a. With No. 2 at the foot and No. 1 at the head, they carry the litter to the front of the ambulance.
- b. No. 3 proceeds to the front of the ambulance on the left side and assists No. 1 in placing the litter

handles into the litter support rings, mounted on each side of the driver's seat.

- c. No. 2 places the rear handles of the litter in the rear litter support braces and secures the rear stirrups to the back of the ambulance with the straps that are attached for that purpose.

(Bearers unfurl and secure curtains.)

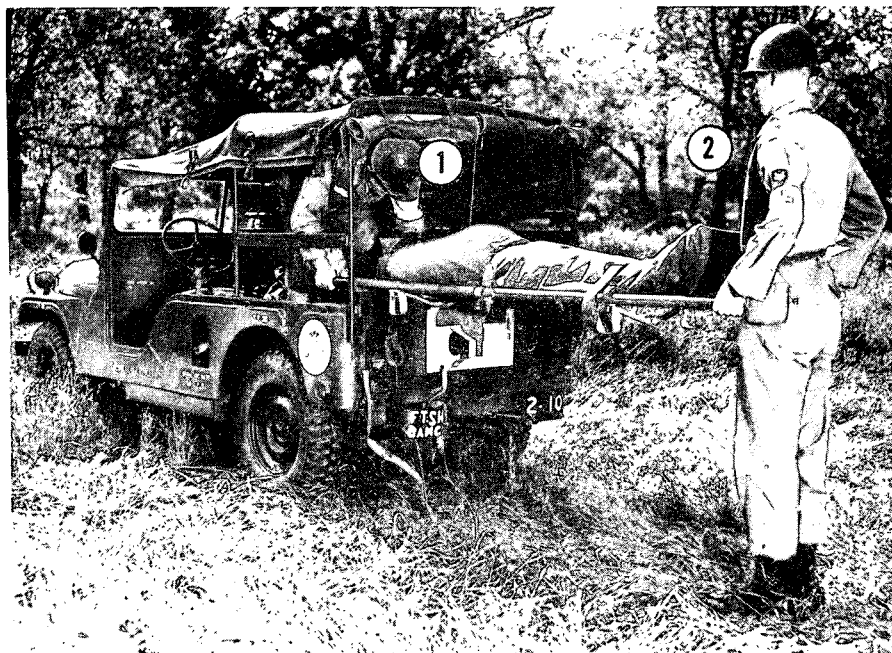
*Figure 159. Loading left berth (step two).*



a. No. 2 unfastens the straps securing the foot of the litter to the ambulance.

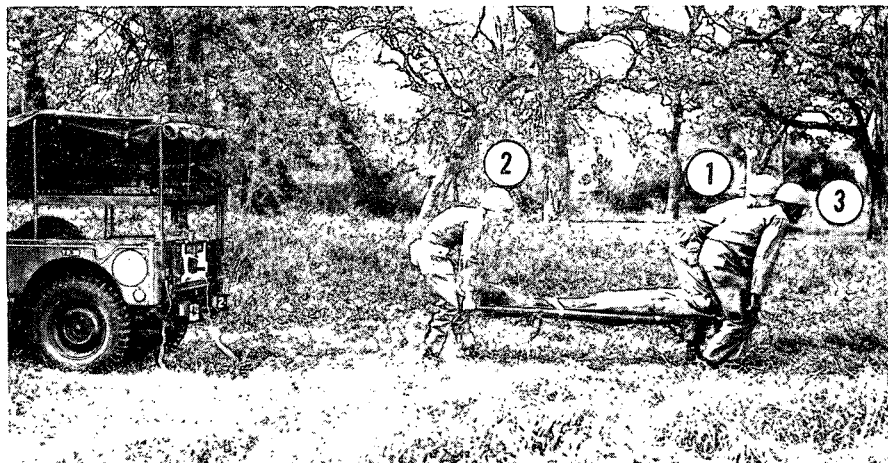
b. No. 1 and No. 3 go to the left side and No. 1 enters the ambulance.

*Figure 160. Prepare ambulance for, UNLOADING.*



- a. No. 1 (at head) and No. 2 (at foot) carry litter to rear of ambulance.
- b. No. 1 rests front litter handles on the rear supports, and No. 2 retains hold of handles at the foot of litter.  
(No. 1 comes out of ambulance.)

*Figure 161. Left berth, prepare to unload, UNLOAD (step one).*



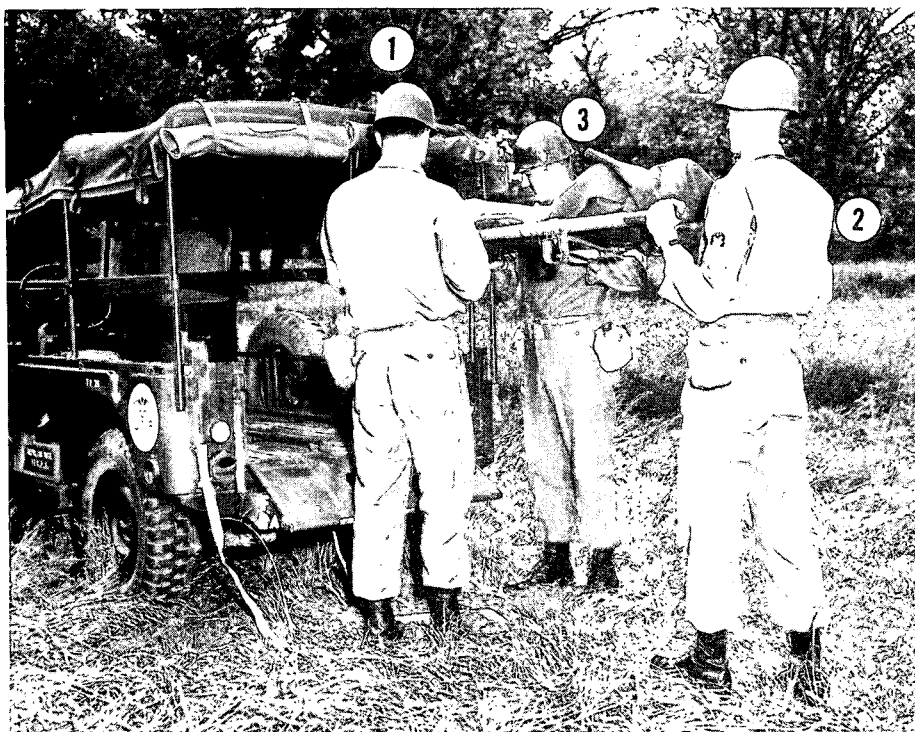
- a. At the preparatory command, No. 1 and No. 3 grasp litter handles at patient's head.
- b. At the command of execution, the three bearers lift litter from ambulance and carry it at least three paces to rear of ambulance and place it on the ground.  
(The squad then reassembles without command.)

*Figure 162. Left berth, prepare to unload, UNLOAD (step two).*



- a. At the preparatory command, No. 1 and No. 3 grasp gate and No. 1 and No. 3 take their positions, one on each side of the litter.
- b. No. 2 grasps the litter handles at the patient's feet.
- c. At the command of execution, No. 2 pulls the litter from the berth while No. 1 and No. 3 grasp the litter poles at the patient's shoulders as litter slides out of the berth.
- d. Before stirrups at head of litter reach the end of the grooved tracks, No. 1 halts the squad in place to prevent the patient's head from striking the floor of the ambulance.
- e. The three bearers lift litter from berth, carry it at least three paces to the rear of the ambulance, and place it on the ground.  
(Squad reassembles at the rear of the ambulance without command.)

*Figure 163. Right lower berth, prepare to unload, UNLOAD.*



(At the preparatory command, No. 1 enters the ambulance from the rear and releases the litter securing rings from the litter handles at the patient's head.)  
 (No. 2 unfastens the straps securing the litter to the berth at the feet.)

- a. No. 1 and No. 3 take their positions, one on each side of the litter, at the rear of the ambulance.
- b. No. 2 grasps the rear handles of the litter.
- c. At the command of execution, No. 2 pulls the litter from the berth.

d. No. 1 and No. 3 grasp the litter poles toward the head as the litter slides out, keeping it level at all times.

(The litter is lowered to the litter carry position, and all three bearers carry it at least three paces from the ambulance and place it on the ground.)

(When unloading is completed, No. 1 raises and locks the tailgate. Bearers unfurl and secure curtains. Squad then reassembles without command.)

Figure 164. Right upper berth, prepare to unload, UNLOAD.

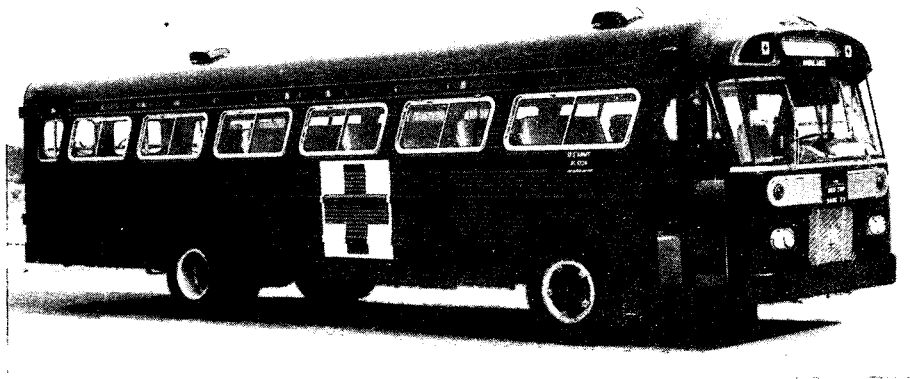
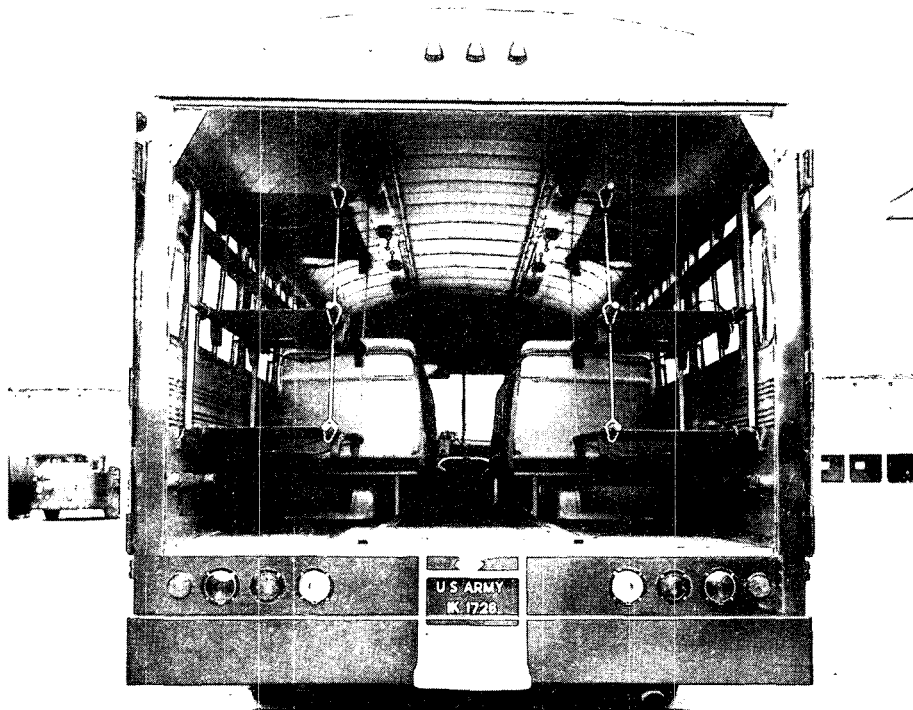


Figure 165. Bus, 44-passenger, 4 x 2, integral type (bus ambulance), exterior view.





*Figure 166. Bus, 44-passenger, 4 x 2, integral type (bus ambulance), interior view.*



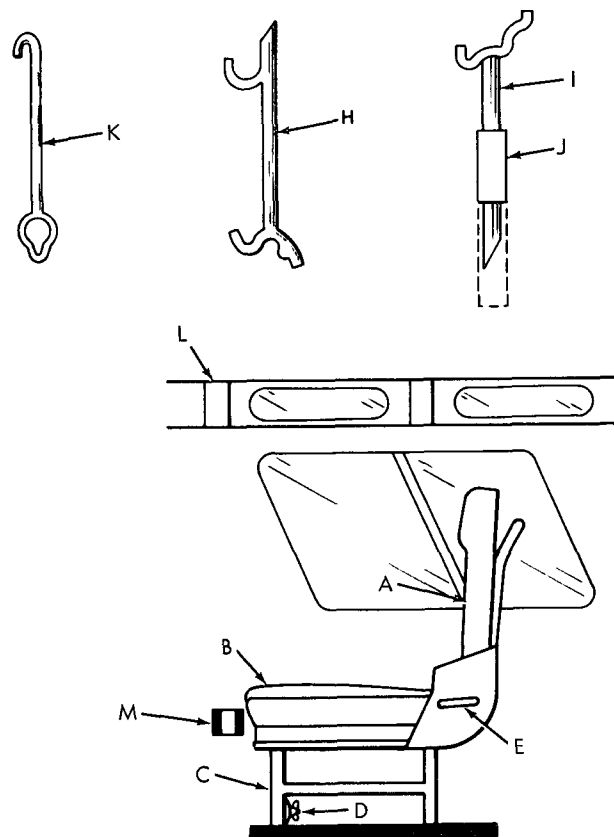
*Figure 167. Bus, 44-passenger, 4 x 2, integral type (bus ambulance), interior view, seats removed and litters installed.*

modate 18 litter patients and 4 attendants or ambulatory patients. A kit containing the necessary accessories for conversion is located in the compartment on the right side of the bus body (outside) approximately at the center of the bus.

b. *Conversion* (figs. 168, 169). For conversion, all seats are removed, except the seats immediately behind the driver. These seats are left in place to accommodate four medical at-

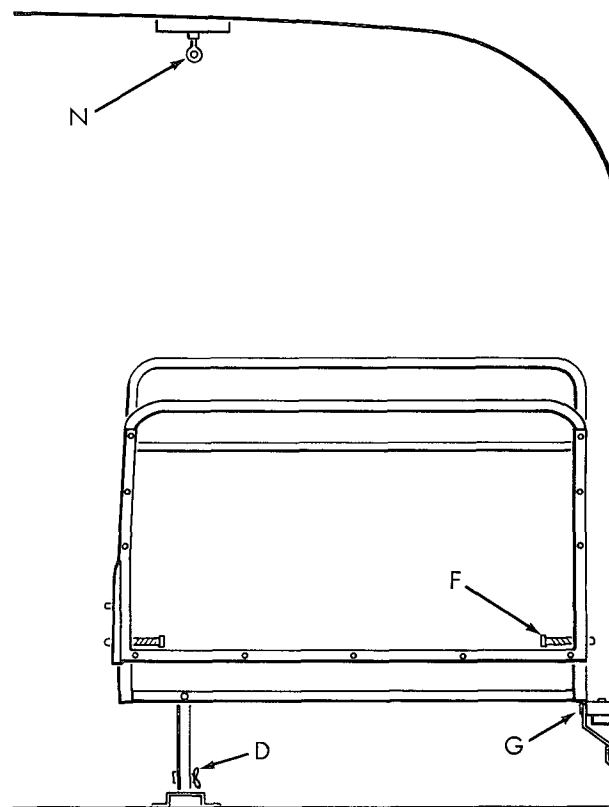
tendants or ambulatory patients. Litter support hooks are inserted in the brackets located at the top and bottom of the interior of the body side. The litter support hangers are then suspended from the hooks in the ceiling rails. To revert back to passenger operation, this procedure is reversed. Detailed instructions for conversion include the following steps:

- (1) Pull out seat pin (E) on the aisle side of the seat and turn about  $\frac{1}{2}$  inch clockwise, then release.
- (2) Pull out seat pin lock (E) on window side of seat and push seat backrest (A) forward.
- (3) Loosen wing-nut (D) located on front leg of seat on aisle side. Push wing-



- A. Seat Backrest
- B. Seat Cushion
- C. Seat Legs
- D. Leg Wing-Nut
- E. Seat Pin Lock, Center
- H. Litter Support Hook, Bottom or Lower
- I. Litter Support Hook, Top or Upper
- J. Sleeve
- K. Litter Support Hanger
- L. Hook Bracket, Top or Upper
- M. Hook Bracket, Bottom or Lower

Figure 168. Conversion accessories, bus, 44-passenger, 4 x 2, integral type (bus ambulance), side view.



- D. Leg Wing Nut
- F. Seat Pin Lock, Body Size
- G. Seat Latch
- N. Ceiling Hook, on Ceiling Rail

Figure 169. Conversion accessories, bus, 44-passenger, 4 x 2, integral type (bus ambulance), rear view.

nut (D) up and retighten, thus preventing latch from falling down.

- (4) Lift up aisle side of seat until legs are free of the legrest, then fold seats under by pushing toward window side and upwards.
- (5) Holding seat level, raise seat latch (G) on window side while at the same time pulling the seat slightly to the rear. Then lift seat out.
- (6) After removing seats, install lower litter support hook (H) in brackets (M), tapping if necessary to insure proper seating. Install upper litter support hook (I) by inserting the bent end of the hook into the slots (L) located above the windows.
- (7) Beveled edges of upper and lower litter support hooks (H and I) should

meet in such a manner that the sleeve (J) of the upper litter support hook (I) can slide freely over the two edges, locking them in place. When so locked the litter support assembly cannot be moved up or down.

- (8) Install the sectional litter support hangers (K) by suspending from the ceiling hooks (N). Add two more support hangers (K) by hooking through open end of the top hanger (K).
- (9) When bus is set up for litters, 9 seats may be stored under the lower litters, 4 on the left side and 5 on the right side, secured with litter straps; 6 immediately behind the driver's seat and secured with litter straps; and 7 on the right side immediately behind the passenger door.



- a. One litter team remains in the bus.
- b. A second litter team loads patients onto the floor of the rear of the bus where they are picked up

by the team in the bus and loaded onto appropriate berths.

*Figure 170. Loading patients on bus ambulance where loading ramps or platforms are not available.*

c. *Loading.* Two three-man litter squads are required to load and unload the bus ambulance. The bus is loaded from the *front to the rear* and from *top to bottom*. Unless contra-indicated by the nature of the patient's injuries, all patients are loaded into the bus with the patient's head to the front.

- (1) When loading from *loading ramps or platforms*, one litter team enters the rear of the bus with a litter patient, loads the patient on the appropriate berth, and exits through the front as the second team enters the rear with a litter patient. The second team loads its patient and exits through the front as the first team is entering the rear with its second patient. Only one of the teams is in the bus at a time,

thereby avoiding interference with each other.

- (2) When patients are to be loaded from ground level without the aid of loading ramps or platforms, the procedure is as described in figure 170.

d. *Unloading.* Patients are unloaded (contrary to the loading procedure) *from the rear to the front* and *from the bottom to the top*. When the bus is to be unloaded from loading ramps or platforms, the two litter teams alternate in unloading. If patients are to be unloaded without ramps, one litter team removes the litter patients from the berths in the bus and places them on the floor at the rear of the bus where they are picked up and unloaded by the second litter team.

## Section II. CONVERSION OF MILITARY VEHICLES TO PATIENT CARRIERS

### 59. General

Often in combat areas, ambulances will be unavailable or too few in number, or they may be incapable of evacuating patients in certain types of terrain. In these instances, many vehicles which are available to most units can be used with little or no change in structure. Some amphibious cargo and personnel carriers can be used for this purpose, their patient carrying capacity varying with the type of vehicle used. Methods of using several types of military vehicles as patient carriers will be described in this section.

a. Most of these vehicles are not inclosed. When using an open vehicle, litters must be lashed securely to the side of the vehicles, so that they will not bounce off while in transit. Lengths of rope, litter securing straps, or any convenient materials may be used to lash the litters to the vehicle.

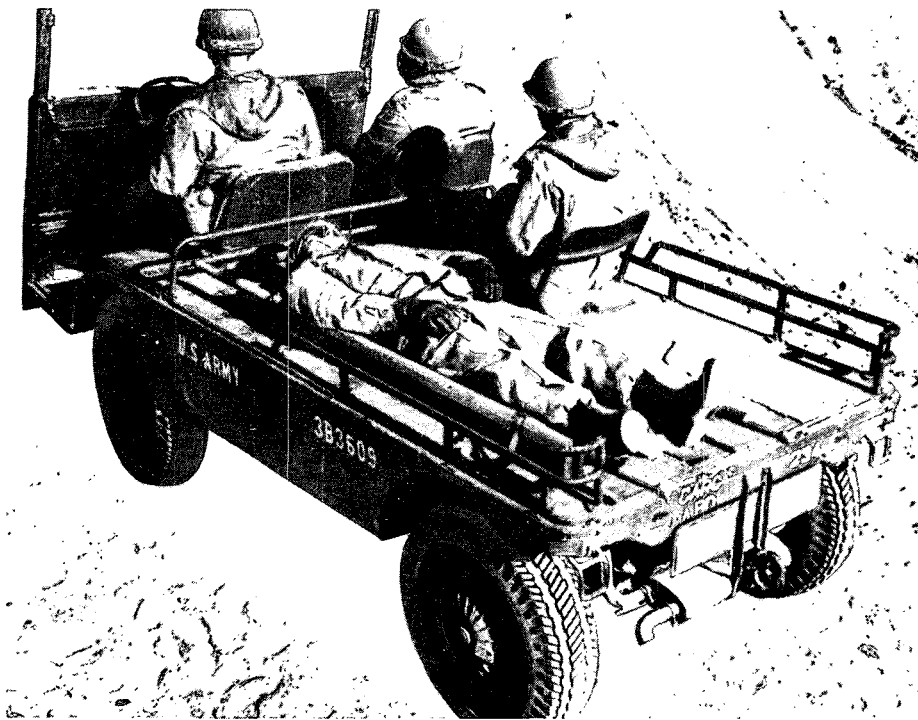
b. When litters are loaded lengthwise to the vehicle, the patient's heads normally are placed toward the front of the vehicle. When the litters are loaded crosswise, the patient's heads may be placed alternately to the right and to the left, in order to minimize the discomfort resulting from cases of nausea and vomiting.

### 60. Carrier, Light Weapons, Infantry, ½-Ton, 4 x 4, M274, W/E (figs. 171-173)

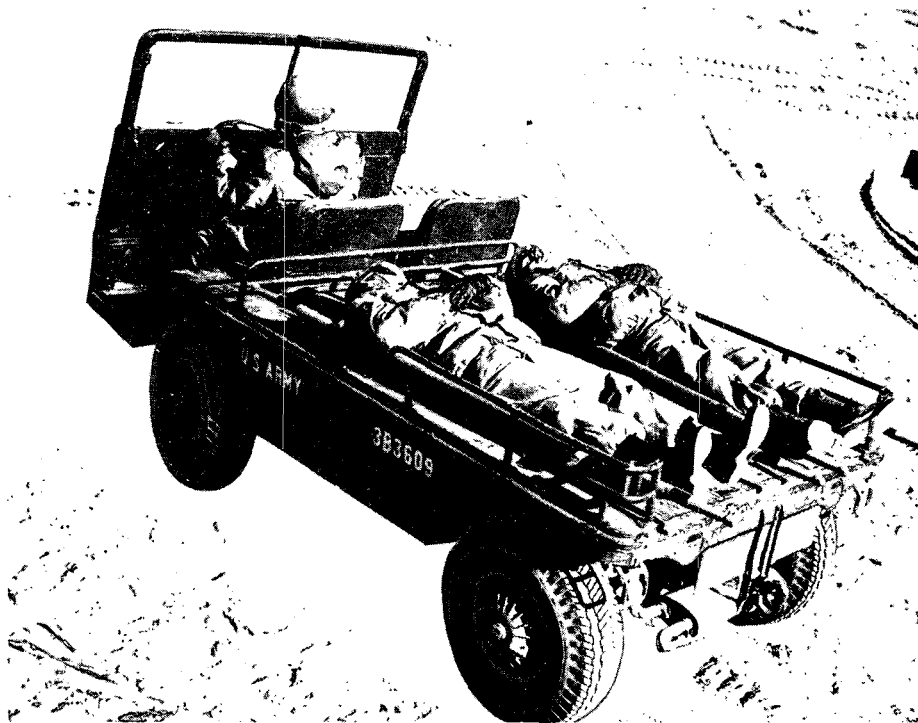
This vehicle is designed to carry light cargo over rough terrain at slow speed with the advantage in combat of a very low silhouette. It consists of a platform on which the driver's seat is mounted. The small size and cross-country mobility of this vehicle make it an expedient patient carrier for forward units. It is easily loaded with litter patients; however, the patients must be lashed securely to the litters in all types of terrain. It can transport as many as three litter patients. The most satisfactory method of using this vehicle as a patient carrier is to place two litter patients lengthwise on the vehicle. A two-man team is used for loading.

### 61. Truck, Utility, ¼-Ton, 4 x 4, M38 or M151

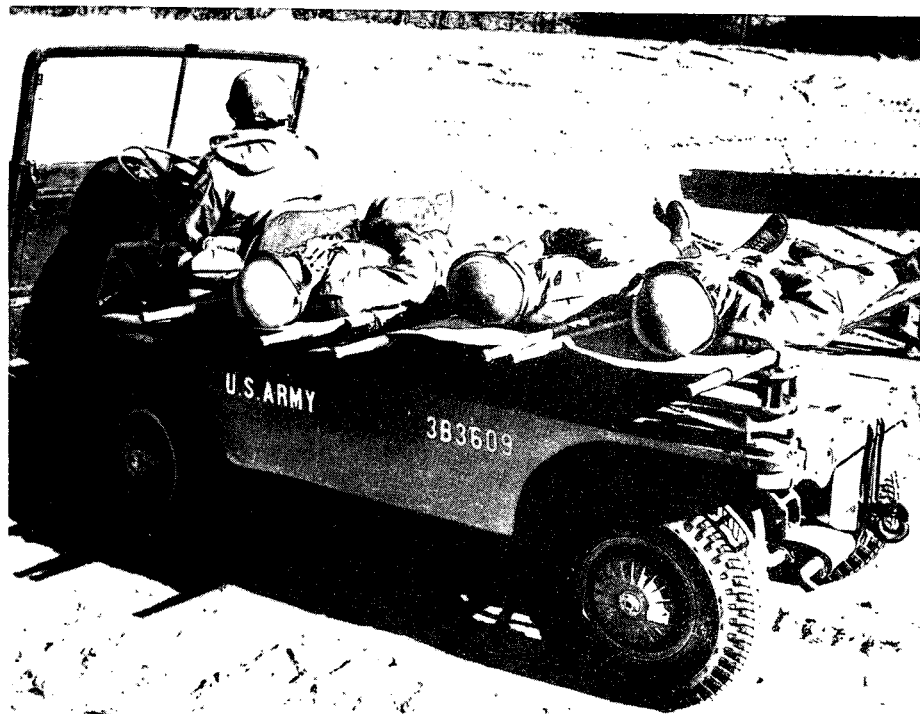
The ¼-ton truck is a forward area vehicle designed for maneuverability and close-in support. It is a vehicle with a four-passenger capacity, open-type body, normally used as a general purpose personnel or cargo carrier. The ¼-ton truck and the ¼-ton trailer, M110, are standard equipment of the medical company as well as many other units of the Army. They generally are available and can be easily converted to patient carriers.



*Figure 171. Carrier, light weapons, infantry, ½-ton, 4 x 4, M274, W/E, transporting one patient.*

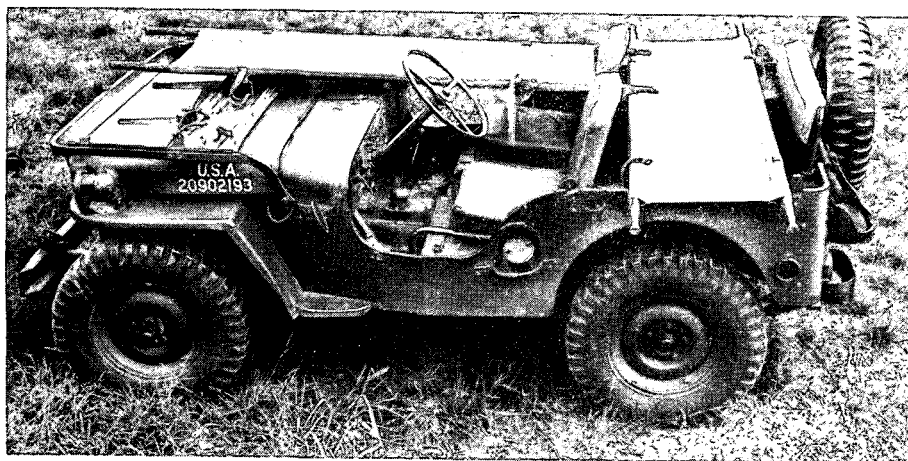


*Figure 172. Carrier, light weapons, infantry, ½-ton, 4 x 4, M274, W/E, transporting two patients.*



When transporting three patients, they must be placed across the body of the vehicle.

*Figure 173. Carrier, light weapons, infantry, 1/2-ton, 4 x 4, M274, W/E, transporting three patients.*



- a. Place one litter across the back of the truck with the litter handles resting on the truck sides. (When route of evacuation is along narrow roads or trails, take care that handles of litter do not catch on trees or bushes.)
- b. Place second litter lengthwise on right side of truck with the rear handles resting on the side of the

first litter and the front stirrups fitting into the groove below the windshield.

(The second litter can also be placed with the front handles resting on the windshield frame and the rear handles straddling the spare tire, with the litter riding above the first litter.)

*Figure 174. Truck, utility, 1/4-ton, 4 x 4, M38 or M151, with two litters.*



- a. Bind together four poles, saplings, or boards to resemble a two-rung ladder.
- b. Lash this frame to the truck with ropes or straps.

- c. Load litters with patients' heads placed toward the front.

*Figure 175. Truck, utility, 1/4-ton, 4 x 4, M38 or M151, with two litters loaded on improvised sapling frame.*

a. Two litter patients can be carried on the 1/4-ton truck without altering the vehicle or using additional equipment (fig. 174).

b. A pole or sapling frame can be improvised to permit carrying two litter patients lengthwise on the rear of the truck (fig. 175).

c. The trailer, 1/4-ton, 2-wheel, M115, designed as a trailer to the 1/4-ton truck, may be readily converted into a patient carrier (fig. 176). When attached to the 1/4-ton truck, two patients may be transported on each. The trailer cannot be attached if an improvised sapling frame is used on the truck.

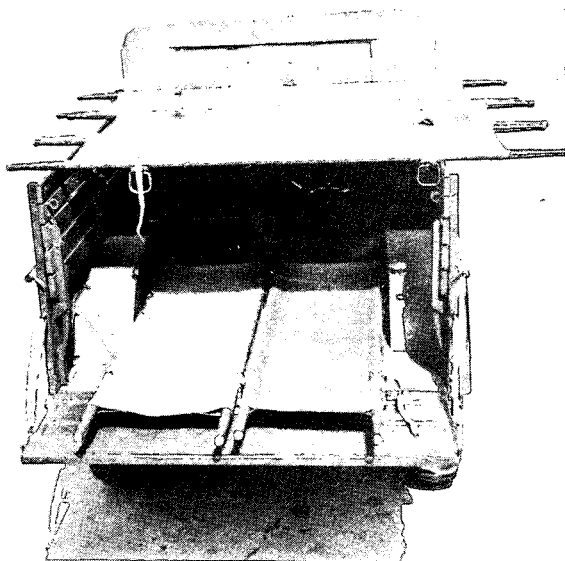


- a. Load 1/4-ton truck with two litters as described in figure 174.
- b. Place two litters lengthwise on trailer side by side.

- c. Bind handles of litter to the small hooks on sides of the trailer body.  
(To unload, remove litters from their respective sides.)

*Figure 176. Truck, utility, 1/4-ton, 4 x 4, M38 or M151, with trailer, 1/4-ton, 2-wheel, M115 (two litters each).*

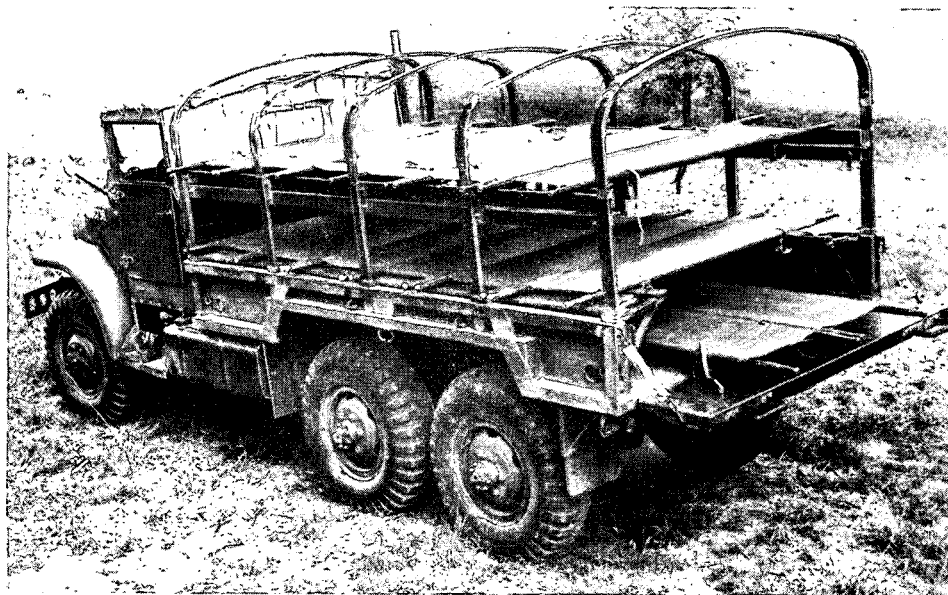
**62. Truck, Cargo, 3/4-Ton, 4 x 4, M37 and M37B1 (fig. 177)**



The 3/4-ton cargo truck is a lightweight, open-top, cab-type vehicle used to transport personnel or light general cargo. It is a common vehicle for almost all units and can be easily

- a. Remove canvas top by rolling toward front of truck. Remove center bows and secure to canvas roll. Raise seats. Raise tailgate slightly to horizontal position to prevent litters from sliding off.
  - b. Place a layer of *three* litters side by side, crosswise on vehicle resting on bow braces, and secure handles to bow braces.
  - c. Place *two* litters lengthwise, headfirst, in the bottom of truck with litter ends protruding and supported by tailgate. Bind protruding ends with rope.
- (To unload, remove litters in the reverse order of loading.)

*Figure 177. Loading the 3/4-ton cargo truck, 4 x 4, M37 and M57B1, with five litters.*



- a. Remove canvas roll by rolling toward front of truck. Remove center bows and secure to canvas roll. Raise seats.
- b. Place six litters crosswise on bow braces for top layer of litters.
- c. Place six litters crosswise on seats for middle layer of litters.
- d. Load four litters lengthwise in two rows of two litters each on floor of truck.
- e. Lash top layer litters to bow braces, and lash middle layer litters to seats. Lower tailgate almost to horizontal position to prevent bottom layer litters from sliding off.

*Figure 178. Loading the 2 1/2-ton cargo truck, 6 x 6, M135 or M135A1, with 16 litters.*

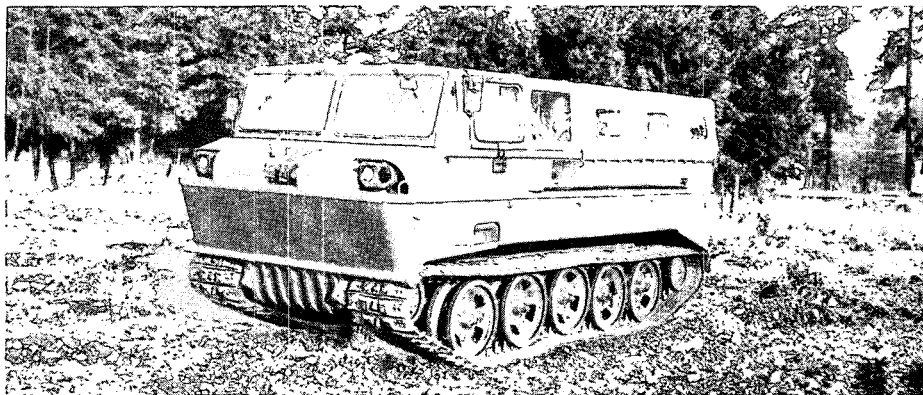


adapted for use as a carrier with a capacity for five litter patients.

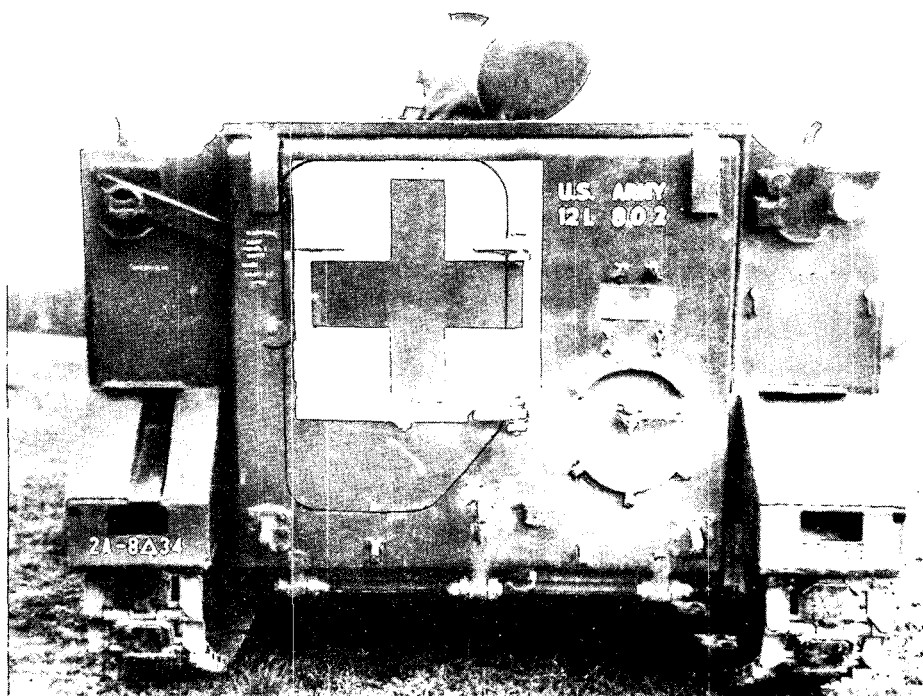
**63. Truck, Cargo, 2½-Ton, 6 x 6, M135 or M135A1**  
(fig. 178)

The 2½-ton truck, 6 x 6, normally is used to transport general cargo and personnel. It

has a canvas-covered cab, is the open-top type, and has removable tarpaulin braces and body side boards. This vehicle has a maximum capacity of 16 litter patients. It can be loaded in three layers from front to rear, in any convenient order. Loading must be done carefully so as not to obstruct the placing of one litter by the premature loading of another.



*Figure 179. Carrier, cargo, amphibious, tracked, M116.*



*Figure 180. Carrier, personnel, full-tracked: armored, M113, T113E2, W/E.*



At this command, No. 2 takes the following steps:

- a. Assists the driver in lowering the rear ramp.
- b. Enters the vehicle and assists the driver to install the chain conversion kit.

(Litter support chains are adjusted to D-rings which are welded to the overhead doors on the right side of the rear compartment so that two litter patients can be supported lengthwise on

the vehicle to form a double tier. Litter support chains are adjusted to the left side of the rear compartment in the same manner to form another double tier.

All litter chains are secured to bed of vehicle to keep tiers from swinging when vehicle is in motion.)

- c. Resumes place with rest of squad.

*Figure 181. Carrier, personnel, full-tracked: armored, M113, T113E2, W/E, converted and ready for loading.*



**64. Carrier, Cargo, Amphibious, Tracked, M116**  
(fig. 179)

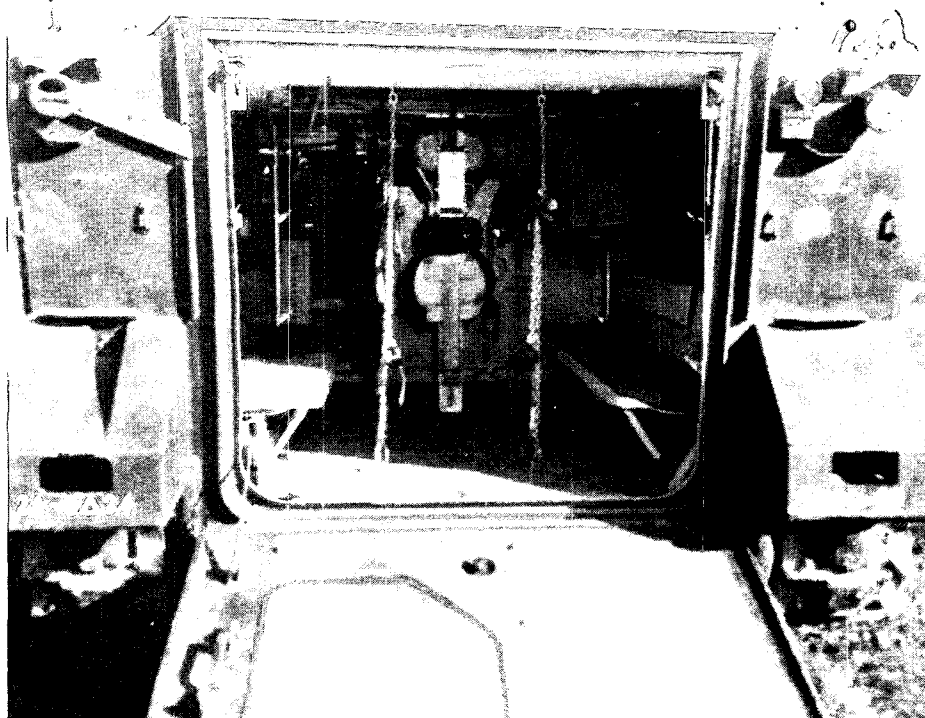
This type of tracked vehicle can be converted to a patient carrier for operations over marshes, snow, and ice. It is small but valuable in Arctic operations. In low temperatures, a special top is necessary. With the top installed, the carrier has a litter capacity of four; two litter patients can be loaded on the floor of the

At the preparatory command, positions and procedures are as follows:

- a. No. 1 and No. 3, at the foot of the litter and facing the patient, stoop and grasp handles.
- b. No. 2 and No. 4, at each side of the litter and facing the patient's shoulders, grasp the left and right poles, respectively.
- c. At the command of execution, the litter is lifted and carried to the vehicle.
- d. The driver grasps the handles at the head of the litter and assists in placing litter in right upper berth.

(The pole on the right side of the litter is placed in the brackets installed on the right side of the vehicle. No. 3 and No. 4 secure the left pole to the chain by straps.)

*Figure 182. Carrier, personnel, full-tracked: armored, M113, T113E2, W/E, driver receiving patient.*



*Figure 183. Carrier, personnel, full-tracked: armored, M113, T113E2, W/E, right upper berth, loaded and secured with litter straps attached to the chains.*

vehicle and two more in the additional inclosure provided by the top. A conversion kit is provided for the installation of the special top. Without the top installed, four litters can be placed lengthwise on the vehicle.

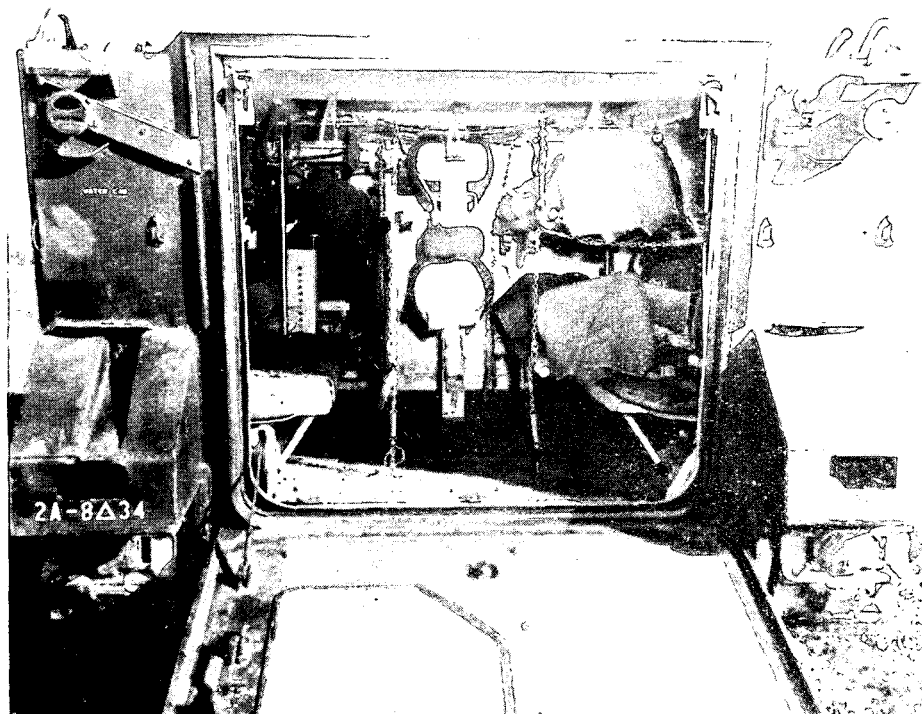
**65. Carrier, Personnel, Full-Trackd:  
Armored, M113, T113E2, W/E**

The M113 armored personnel carrier (fig. 180) is a standard item available to several units. It is a lightweight vehicle capable of amphibious operation on inland lakes and streams, of extended cross-country travel over rough terrain, and of high-speed operations on improved roads and highways. Movement of the tracks propels and steers the vehicle on both land and water. This vehicle has a conversion kit which can be easily and quickly installed and gives the vehicle a normal capacity of four litter patients. The four longitudinal spaces formed by the chain conversion kit are known as berths and are designated upper and lower (right and left). A squad of four men is needed to load and unload the vehicle.

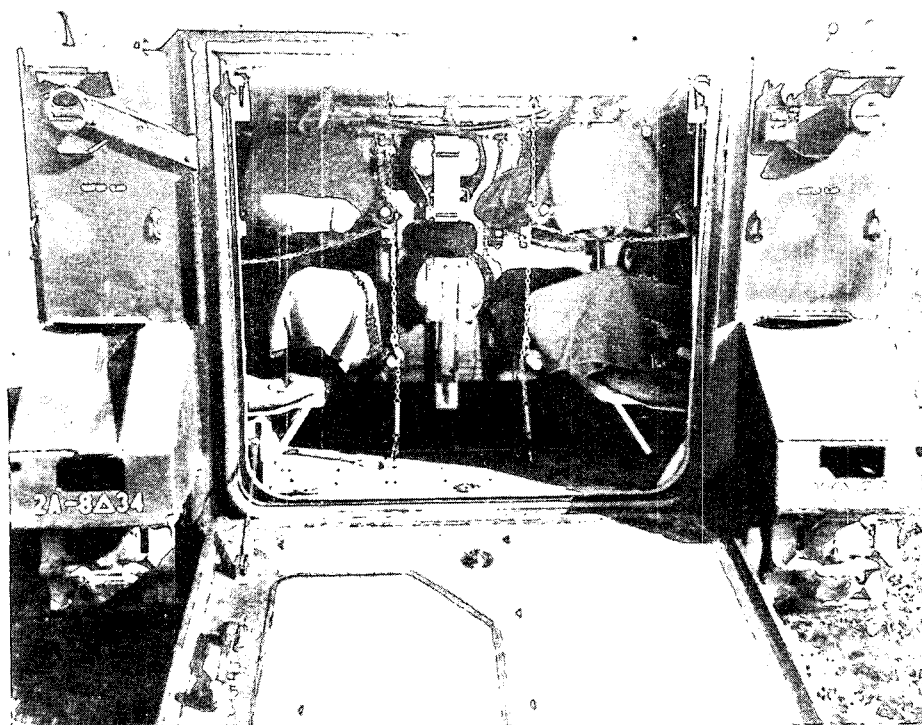
*a. Loading the M113.* The sequence for loading is right upper, right lower, left upper, and left lower.

- (1) The *first* command is Ambulance, POSTS. At the command or execution, the members of the squad fall in, aligning themselves in numerical sequence from left to right, one pace to the rear of and facing the vehicle.
- (2) The *second* command is Prepare Vehicles For, LOADING (fig. 181).
- (3) The *third* command is Right Upper Berth, Prepare To Load, LOAD (figs. 182, 183).
- (4) The *fourth* command is Right Lower Berth, Prepare to Load, LOAD. At this command, the litter is loaded as described in figures 184 and 185.

*b. Unloading the M113.* The sequence for unloading is left lower, left upper, right lower, and right upper. The procedures are the same as for loading, except in reverse.



*Figure 184. Carrier, personnel, full-trackd: armored, M113, T113E2, W/E, upper and lower (right) berths loaded.*



Left side of vehicle is loaded as is the right side.  
(No. 2 then assists driver in raising and securing rear ramp, and squad reassembles without command.)

*Figure 185. Carrier, personnel, full-tracked: armored, M113, T113E2, W/E, vehicle fully loaded.*

### Section III. RAIL TRANSPORTATION

#### 66. Use of Ambulance Trains

Ambulance trains, operated over commercial or Army-controlled railroads, are another means of overland transportation of the sick and wounded. In general, they are used when movement of patients by aircraft is not feasible or available. In a theater of operations, ambulance trains evacuate patients to transfer points and to embarkation points within the combat and communications zones. In the zone of interior they are used to move patients from various debarkation points to Armed Forces hospitals and to transfer patients between medical treatment facilities.

#### 67. Responsibilities for Rail Transportation

The Army Medical Service is responsible for the determination of rail evacuation require-

ments and for staffing and equipping ambulance trains with medical personnel and equipment. It is also responsible for the administration, training, and discipline of medical personnel assigned to ambulance train duties, the welfare and safety of patients being transported, and the maintenance of equipment used in patient care. The United States Army Materiel Command is charged with the procurement of necessary rail rolling stock to meet rail evacuation requirements, the maintenance of this equipment, and all rail operations relative to the movements of ambulance trains. For further information, see AR 40-4.

#### 68. Types of Ambulance Trains

a. Most ambulance trains are standard trains operating under the prescribed TOE or TD.

The three principal types of standard ambulance trains are the wide-gage and the narrow-gage rail ambulance cars, both of which operate in the theater of operations, and the ambulance unit car, which operates in the zone of interior. The number of cars in a standard ambulance train varies, depending upon available locomotive power, the number and types of patients being transported, and the number of medical personnel required to care for patients en route.

*b.* In an emergency, practically any type of standard sleeper, chair car, or baggage car may be used to transport the sick and wounded. Passenger-type cars are preferred, and in all instances every effort is made to provide the maximum possible comfort of the patients. Standard baggage cars may be used on an improvised ambulance train for transporting baggage and equipment of patients, duty personnel, medical equipment, and other supplies. A baggage car may also be converted into a kitchen car.

### 69. Theater of Operations Ambulance Train (Wide-Gage Rail)

This train (56½-, 60-, 63-, and 66-inch gage rail) consists of six air-conditioned ambulance cars, two ambulance personnel cars, and one ambulance kitchen, dining, and storage car.

*a. Ambulance Car.* Each ambulance car has six double-tiered berths and six three-tiered berths which can accommodate 30 nonambulatory patients. The six three-tiered spaces can be converted to seat 24 ambulatory patients. The car has a combination receiving room and nurse's station, toilet rooms, bedpan washer and sterilizer, and sink.

*b. Ambulance Personnel Car.* This car is divided into two compartments with double-tiered berths with accommodations for four male officers; one compartment with a double-tiered berth for two female ANC officers; and five compartments with three-tiered berths to accommodate 15 enlisted men. It has separate toilet facilities for male and female personnel and common shower facilities for all personnel.



Figure 186. Ambulance unit car, made up for litter patients.

*c. Ambulance Kitchen, Dining, and Storage Car.* This car provides kitchen and food storage facilities for the preparation of meals for approximately 175 patients and ambulance train personnel. The car has tables which can seat 24 and storage space for medical and unit supplies and equipment.

**70. Theater of Operations Ambulance Train (Narrow-Gage Rail)**

This train (36-, 39<sup>3</sup>/<sub>8</sub>-, and 42-inch gage rail) has the same number and type of cars as does the wide-gage rail ambulance train.

*a. Ambulance Car.* Each ambulance car has 10 double-tiered berths, which accommodate 20 nonambulatory patients. Four of the double-tiered berths can be converted to seat 16 ambulatory patients. The car has a combination receiving room and nurse's station, toilet rooms, bedpan washer and sterilizer, and sink.

*b. Ambulance Personnel Car.* This car is divided into two compartments, one with a

double-tiered berth for two male officers, and one with a double-tiered berth for two female ANC officers. An open section, the enlisted men's section, has seven double-tiered berths to accommodate 14 enlisted men. Four of the double-tiered berths can be converted to provide seats for 16 individuals. The car has common showers for all personnel and separate toilet facilities for male and female personnel.

*c. Ambulance Kitchen, Dining, and Storage Car.* This car is the same as that of the wide-gage rail train, except that tables are available to seat only 14 individuals.

**71. Zone of Interior Ambulance Unit Car (Standard 56<sup>1</sup>/<sub>2</sub>-inch Gage Rail)**  
(figs. 186, 187)

In the zone of the interior ambulance unit cars (standard 56<sup>1</sup>/<sub>2</sub>-inch gage rail) are used and operated on commercial railroads. Depending upon the number of patients to be transported and the economical use of rolling stock, unit cars may be grouped to form an ambulance



*Figure 187. Ambulance unit car, made up for ambulatory patients.*

train or integrated independently into trains within the commercial rail system operating on regular schedules.

*a.* An ambulance unit car has nine three-tiered berths accommodating 27 nonambulatory patients; two three-tiered berths for six medical enlisted personnel assigned to train duty; and a separate compartment for a male officer and another for the ANC officer. All patient-berth spaces may be converted to seat 36 ambulatory patients, and berth space for medical personnel may be converted to seat eight individuals. One three-tiered section in the patient area is

screened in such a manner as to permit the transportation of mental patients.

*b.* This car is air-conditioned and has a combination receiving room and nurse's station, partitioned toilets and lavatory, bedpan washer and sterilizer, and cabinet space for storage of linens and baggage. It has a kitchen equipped to prepare food and serve approximately 75 persons. It also has a common dressing room and shower and separate toilet facilities for patients and for male and female officer personnel.



## CHAPTER 5

### EVACUATION BY AIR

---

#### Section I. INTRODUCTION

#### 72. General

The Department of Defense policy requires the use of aircraft as a means of transportation of the sick and wounded, unless medically contraindicated, and whenever appropriate aircraft can be made available. A major objective of patient evacuation by air is to transport the sick and wounded in the shortest time to and between medical treatment facilities so that they can receive specialized medical care. The expediency and flexibility of air transportation are two major factors which lead to the attainment of this objective.

#### 73. Advantages and Disadvantages of Air Evacuation

*a. General.* Aircraft is the preferred means of transportation of the sick and wounded because of its many advantages. These advantages, as compared with other means of transportation, may be measured in terms of the lives, time, and resources saved. The speed with which aircraft cover long distances may create a tendency to overevacuate. This disadvantage may be overcome, however, by exercising care in the selection of patients. In general, the time saved by the use of aircraft transportation results in the saving of lives, economy and maximum use of resources, and greater continuity of the medical effort.

*b. Advantages.*

- (1) The speed with which the sick and wounded can be transported by air from locations with limited medical treatment capability to appropriate medical treatment facilities insures timeliness of treatment, thus contributing to the saving of lives, to the reduction of permanent disability, and to an increase in the number of patients returned to duty.
- (2) The range of aircraft makes it possible to transport patients by air over relatively long distances in short periods of time. This requires less frequent displacement of medical treatment facilities, a factor which will be of even greater significance as battlefields become more dispersed.
- (3) Helicopter aircraft can transport patients quickly over terrain where evacuation by other means would be difficult and perhaps impossible to accomplish in a way that would save lives. The minimum landing requirements of helicopters and VTOL and STOL (vertical/short takeoff and landing) aircraft permit patients to be picked up well forward and delivered to the immediate vicinity of supporting medical treatment facilities.
- (4) Because of the speed, range, flexibility, and versatility of aeromedical evacuation, patients can be moved directly to that medical installation best equipped for the care of the particular injury. Specialized treatment is placed in direct support of every forward surgeon. Patient flow from overloaded hospitals can be diverted to others with fewer patients, thus minimizing the time from hospital admission to surgical treatment and adding to the chances for recovery.
- (5) The selectivity possible in aeromedical evacuation procedures permits economy in the use of medical treatment facilities. Fewer specialty treatment

teams are required because of the capability to move patients to hospitals with the required specialties rather than attempt to place surgical specialties in every hospital. Hospitals are required to move less often, thereby reducing periods of noneffectiveness during movement and re-establishment.

- (6) The ease and comfort of aircraft movement reduces the patient's discomfort and the shock that might otherwise be suffered from more handling and longer, rougher, movement. Thus they arrive at medical treatment facilities in far better condition with greater chances for recovery. These advantages combine to improve patient morale, as well as the morale of the fighting man when he realizes that, if wounded, he can quickly receive specialized medical treatment. This is a factor which will be of increased importance in the dispersed battlefields of the future.

*c. Disadvantages.*

- (1) *Overevacuation.* It is desirable to keep the wounded man as far forward as his recovery will permit so as to preclude unnecessary personnel replacements for experienced personnel. The capability of modern aircraft to transport patients a great distance in a short time may create a tendency to evacuate patients too far to the rear and overfly intermediate medical facilities. This is particularly true if the request for aeromedical evacuation is not processed through medical channels. When evacuation requests are retained in medical channels, the surgeon, based upon medical considerations, decides whether to evacuate by air and thus avoids unnecessary movements.
- (2) *Weather and darkness.* Extreme weather conditions limit the use of aircraft for aeromedical evacuation. Army aircraft are equipped with navigational equipment to make instrument flights during IFR (instrument

flight rules) conditions or marginal weather conditions. Night evacuations are accomplished routinely, but require more coordination and information, such as that involving the use of the guide slope, signal devices, or radar. The pilot is the final authority for any aeromedical evacuation mission.

- (3) *Enemy action.* Enemy air superiorities may be a disadvantage in the employment of aircraft for aeromedical evacuation. The AMEDS air ambulance, although unarmed, has an advantage in that it is highly maneuverable and capable of flying nap of the earth.

#### **74. Army Evacuation by Air**

The assigned function of the Army is to provide air transportation for the sick and wounded within the combat zone. This includes battlefield pickup of patients (except those from an airhead or airborne objective area which is supported by Air Force airlifted logistical support), their air support to initial points of treatment, and any subsequent moves to hospital facilities within the Army combat zone. It is a mission of the Army Medical Service to carry out this function.

*a.* Army aeromedical evacuation is that part of the combat zone medical evacuation function which uses Army Medical Service (AMEDS) air ambulances for patient evacuation to and between medical treatment facilities and provides in-flight medical treatment and/or surveillances. Combat zone aeromedical evacuation operations under all conditions are conducted exclusively under the operational control of the responsible surgeon.

*b.* Army air movement of patients is that part of the combat zone medical evacuation function which employs AMEDS air ambulances or non-AMEDS air vehicles under the operational control of the surgeon and in which prior medical treatment precludes the need for in-flight medical treatment and/or surveillances. When Army aviation elements are committed to patient-moving missions, they respond exclusively to the direction of the responsible surgeon in regard to point of origin, desti-

nation, and the time frame in which patients are to be moved.

### 75. Air Force Aeromedical Evacuation Systems

The assigned function of the Air Force is to provide air evacuation of patients from airheads in logistically supported airborne operations, between zones in a theater of operations, between theaters of operations, and from theaters of operations to and within the zone of interior. To carry out this function, the Air Force operates three major aeromedical systems.

*a. Tactical Aeromedical Evacuation System.* Tactical systems operate within theaters of operations or oversea areas to provide aeromedical support for the Armed Forces. This includes air transportation for patients from points of treatment within the combat zone to points outside the combat zone and between points within the communications zone. The operation of these systems is the mission of the Air Force troop carrier units and Air Force aeromedical evacuation groups. While Air Force tactical systems are organized, equipped, and oriented to the primary mission of combat support, they also render close support to the Army Medical Service. In wartime, their primary task is combat support; in peacetime, their services are comparable to those of the domestic system (*c* below).

*b. Strategic Aeromedical Evacuation System.* This system of aeromedical evacuation provides for air transportation for patients from overseas areas of from active theaters of operations to the zone of interior or to a temporary safe haven. This is accomplished by the Military Air Transport Service (MATTS), under the control of the Air Force. The Military Air Transport Service operates on air routes to all major points throughout the world where American troops are stationed.

*c. Domestic Aeromedical Evacuation System.* This is a daily system of flights which operate in the continental United States to transfer patients from aerial ports of debarkation to destination hospitals, and to transfer patients between medical facilities within the continental United States. It is accomplished by the Military Air Transport Service.

### 76. Medical Evacuation Units

*a. Army.* Air ambulance units of the Army Medical Service (AMEDS) perform aeromedical evacuation within the combat zone.

- (1) The Army's major air ambulance unit is the medical air ambulance company, which is designed to support the increasingly fluid field army. The medical air ambulance company may be assigned to a field army, independent corps, or task force. The major responsibilities of these units are aeromedical evacuation of emergency-type and routine patients, air movement of patients, and movement of medical personnel and of medical supply and equipment. A medical air ambulance company may be reinforced by attaching, as required, helicopter ambulance medical detachments.
- (2) The helicopter ambulance medical detachment is a small, highly mobile, cellular organization which normally is attached to another medical organization for training and administrative support. It may serve as an augmentation unit for the medical air ambulance company, or it may furnish aeromedical support for small independent task force organizations. The mission, purpose, and employment of these units are similar to those of the medical air ambulance company.

*b. Air Force.* The Air Force aeromedical evacuation group is used in conjunction with troop carrier units. Its organization consists of a headquarters and four flights.

- (1) The headquarters consists of an administrative section and an operations section, which provide the personnel to operate the Aeromedical Evacuation Control Center.
- (2) The flights provide the personnel who operate staging facilities, serve as Aeromedical Evacuation Control Officers (AECO's) from the Aeromedical Evacuation Control Center to the using service, and supervise the loading and unloading of patients aboard an aircraft. Specially trained medical personnel of the flights are organized

into medical flight teams, which provide medical care and treatment of patients during flight.

## 77. Patients Evacuated by Air

*a. Criteria for Priority Movement.* The need for evacuation of some patients is more urgent than it is for others. It is therefore necessary to classify patients according to the urgency of need for air movement so, that if aircraft space is limited, the most urgent cases have priority. Normally three movement classifications are used—urgent, priority, and routine (AR 40–535). Classification is a responsibility of the attending medical officer as the representative of the medical facility commander that made the request for evacuation.

*b. Criteria for Acceptance.* Patients selected for transportation by air must be passed as physically and mentally fit for the proposed flight by the medical officer in charge of the aeromedical treatment facility. Fitness considerations must be balanced with the availability of suitable in-flight medical attention, the urgency of treatment in a reception area, and the proposed altitude and flight time of the aircraft (NATO STANAG No. 3204, ANNEX B). Almost every patient can be evacuated by air, if aircraft is suitably staffed and equipped with medical personnel and facilities. Careful screening of all patients by a flight surgeon, aviation medical officer, or, in their absence, a medical officer, is accomplished in order to determine the advisability of transportation by

air. Certain categories of patients, however, should not be transported by air if there are alternatives (AR 40–535). Each case must be judged on its own merits, weighing the advantages to the patient of transfer against the possible harmful effects of the flight (NATO STANAG No. 3204, ANNEX B).

*c. Preparation of Patients for Air Transportation.* The air transportation of patients is a cooperative ground-air procedure. The originating hospital must assume certain responsibilities in preparing the patients for transportation at the time request is made for air transportation. This includes the providing of special instructions, clinical records, special supplies and equipment, and the classifying of patients into categories according to physical and mental condition (AR 40–535). All agencies use this classification, which is primarily for identification and loading purposes from the point of view of in-flight safety and the capability of rendering a maximum amount of sustaining care to the patients.

## 78. Aircraft

The Armed Forces are authorized aircraft which are specifically designed for aeromedical evacuation and are organic to aeromedical evacuation type units. The majority of other utility and transport aircraft can be equipped and used for air transport of patients. These aircraft range in size from the utility helicopter of the Army to the heavy transport fixed-wing aircraft of the Air Force. These aircraft are discussed in detail in paragraphs 79 through 90.

## Section II. AIR FORCE TRANSPORT AIRCRAFT

### 79. General

The Air Force uses two major types of aircraft for the transportation of the sick and wounded—medium-range and long-range. These aircraft are operated by Air Force troop carrier units in the tactical systems and by the Military Air Transport Service in the strategic and domestic systems. Most of these aircraft are used both for forward transportation of troops and for rearward transportation of patients. Aircraft used in the domestic system are specially designed for the aeromedical mission.

### 80. Types of Aircraft

*a.* The C-130 (fig. 188) is a long-range transport with a pressurized cabin. It can accommodate 92 ambulatory patients with two attendants, 68 litter patients with six attendants, or a combination of the two. The litters are carried aboard through the cargo loading ramp door, and are placed in four lengthwise rows in the cargo compartment. The aircraft can land and take off on short runways and can be used on landing strips such as those found in advance base operations. Its normal use is within a theater of operations.

b. The C-118 (fig. 189) has a capacity of 54 litter patients or 68 ambulatory patients. It is equipped with standard litter support straps and wall brackets. Patients are loaded through the main cargo doors, located in the forward and rear sections of the aircraft. Special lifting devices and ramps are used. The position of the litter patient in this aircraft is feet forward. The C-118 is excellent for air evacuation because of its automatically pressurized and air-conditioned cabin. It is used in the MATS strategic systems.

c. The C-121 (fig. 190) is equipped with 24 airline seats on one side and fixtures for secur-

ing 24 litter patients on the opposite side. The seats can be moved to provide space for 48 litter patients—six tiers of four litters each on both right and left sides, or 76 ambulatory patients. Standard web strapping and wall brackets are used to secure the litters. Ramps or mechanical loading devices are required when loading litter patients. Patients are loaded feet forward. These aircraft are used in the MATS strategic systems.

d. The C-124 (fig. 191) is a large transport which has two passenger decks. The upper deck can be removed. If both are used, it is capable of carrying 78 litter patients or 169 ambulatory

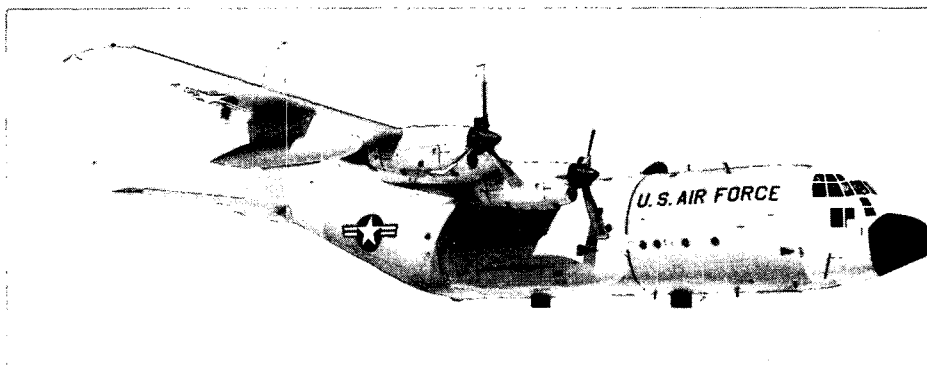


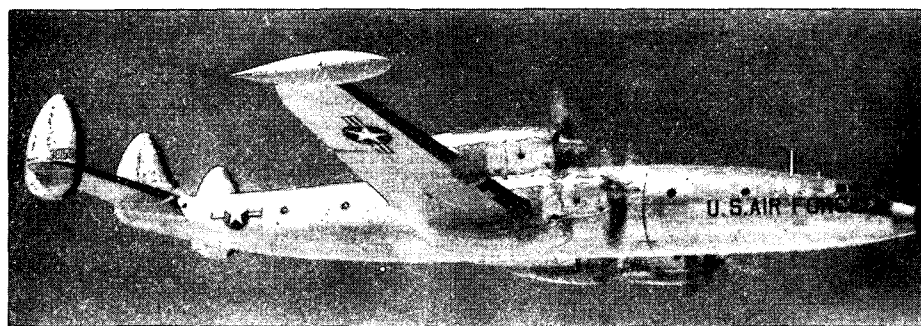
Figure 188. C-130 Hercules.



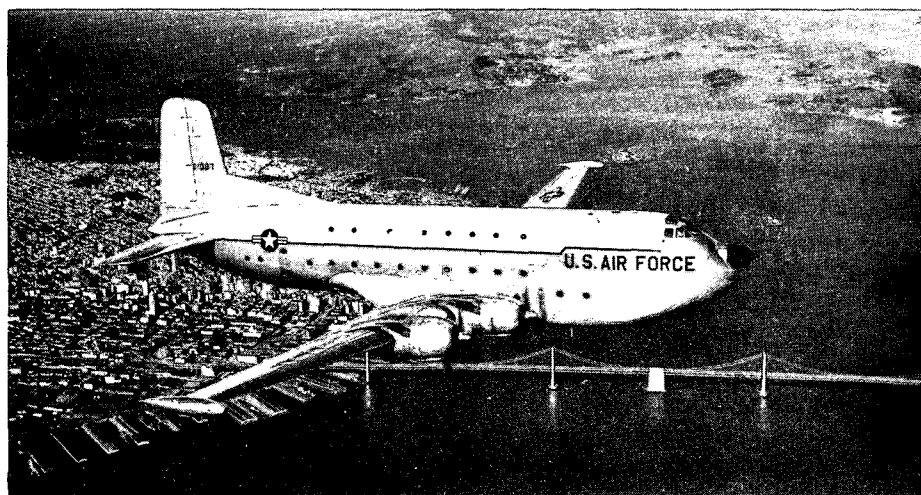
Figure 189. C-118 Liftmaster.

patients. Usually only ambulatory and litter patients who are capable of becoming ambulatory are loaded on the upper deck. Standard wall brackets and webbing straps are used to secure the litters in tiers of four each on both sides, with double tiers of four in the center. The brackets of the center tiers are fastened to metal poles which fold up against the ceiling when not in use. Patients can be loaded by using the built-in ramps in the nose of the aircraft, or by using the built-in power elevator in the rear section of the aircraft. Litter patients are placed feet forward in the tiers. The C-124 is a MATS aircraft, which may be used for intratheater (troop carrier) or inter-theater (MATS) operations.

e. The C-131A Samaritan (fig. 192) is the primary peacetime aeromedical aircraft. These aircraft are used in the domestic system. They are specially designed as "Flying Hospital Wards" for the aeromedical evacuation mission. The C-131A is a pressurized aircraft which can accommodate a maximum of 27 litter patients or 36 ambulatory patients. A combined load uses 15 litters along the left side and 20 rearward-facing airline seats on the right side. It is equipped with standard litter securing devices to support three tiers of four each on both sides. An additional tier of three can be loaded on the rear left side; however, this space normally is used for baggage and equipment stowage. Litter patients are loaded through



*Figure 190. C-121 Constellation.*



*Figure 191. C-124 Loadmaster or Globemaster.*

the cargo door in the left rear section with the aid of a special ramp or mechanical loading device. These patients can be loaded by way of the built-in steps in the right forward section of the aircraft.

f. The C-135 Stratolifter can accommodate 44 litter patients or 119 ambulatory patients. This aircraft is used by MATS in the strategic systems.

## 81. Preparing the Aircraft to Receive Patients

The aircraft crew is responsible for preparing the aircraft to receive litter patients. Before the aircraft is loaded with patients, the senior Air Force Medical Service attendant conducts an inspection of the aircraft to include the following:

a. Inspection of such accessories as litter straps, clamps, stanchions, hot cups, and spare flashlights.

b. Inspection to insure that rigging is secure and that all equipment is in satisfactory operational order.

c. Check of equipment, such as medical chests, water and coffee jugs, walk-around oxygen bottles, trash receivers, and other movable items to see that they are properly lashed to withstand flying conditions and constitute no hazard to occupants of the aircraft.

d. A communications check with the pilot to insure that the cabin-to-cockpit communications system is operative.

e. Inspection of the loading of patients' survival equipment and other equipment to insure conformity with the existing instructions for that particular aircraft.

## 82. Developing the Loading Plan

Loading patients aboard the larger transport aircraft requires planning, depending upon the capacity of the aircraft, the length of the flight, and the number of litter and ambulatory patients to be transported. Normally, the aeromedical evacuation group is responsible for developing loading plans. Transport aircraft carry litters in tiers normally four litters high. In developing a loading plan, the objective is to place each litter patient in a position that will provide the most comfort for him and still not detract from the comfort of the other patients. It is necessary to consider the diagnosis, any preflight preparation or medication to be given the patient, the point where he is to be unloaded, and the amount of care required in flight. In developing the loading plan, the following general rules for loading are considered:

a. On aircraft equipped with tricycle landing gear, all patients should be loaded with feet toward the front of the vehicle. This position



Figure 192. C-131A Samaritan.

offers the greatest protection in the event of sudden deceleration. Deviation from this procedure may be made only when medically indicated, as determined by the senior Air Force Medical Service attendant.

*b.* In aircraft that land in the tail-low position, patients are loaded with their heads toward the front of the aircraft.

*c.* So far as possible, ambulatory patients are assigned to the top litters of all tiers first, and the remaining distribution in the aircraft is determined by the senior Air Force Medical Service attendant.

*d.* The correct placing of litter patients on the aircraft is determined by the patient's injury or illness. Those patients in plaster casts or splints must be placed on the side of the aircraft which would make the injured limb accessible for treatment. Certain types of patients, because of their condition, may be required to travel in the sitting or semiprone position on a litter. In these cases, the space for two litters must be used.

*e.* Female patients should be segregated as much as possible from male patients.

*f.* Patients requiring bedpans, transfusions, special treatment or dressings during flight should be placed in the middle tier where they are more accessible for care.

*g.* Patients who are unable to help themselves should, if possible, be located near the main cargo door to facilitate their egress in event of an emergency.

*h.* Loading plans generally insure that patients suffering mental disturbances are located in positions that afford maximum observation. Those with a diagnosis of tuberculosis or other communicable disease should be loaded in forward litter tiers. Patients who are restless (such as those with head injuries) or are unconscious are placed on the bottom tier. Patients with coughs or those subject to air sickness should be placed on the bottom tier positioned at the down-wind end of the normal ventilation flow.

*i.* When all patients have been loaded, their valuables and personal effects can be stowed in

the baggage compartment or the after part of the cabin in the aircraft.

*j.* A preflight briefing should be given to all patients. The senior Air Force Medical Service attendant is responsible for insuring that it is conducted as flight routine before each flight. Briefing should be complete and conducted in such a way as not to alarm patients who in many cases are flying for the first time.

### **83. Responsibilities for Loading**

The commander originating the patients is responsible for delivering them to the landing field and for loading them aboard the aircraft. The actual loading normally is performed under the supervision of aeromedical evacuation group personnel. In airhead operations, patients normally are transported by jeep or litter bearers to designated points within the perimeter of the airhead where assault aircraft normally are present. These points are identified by checkered flags. Here elements of the forward aeromedical evacuation flights take over the supervision of the loading operations.

### **84. Loading**

Four men, plus the crew chief, normally load fixed-wing aircraft. The crew chief, or other member of the aircraft crew, supervises the loading of all patients.

*a.* In large transport aircraft where the loading of many patients is involved, two of the litter bearers normally remain within the cabin for the placing of patients on litter racks. At least one of them, in addition to a member of the aircraft's crew, must be familiar with the methods by which litters are secured. The No. 2 man of the litter bearer team normally would be one of the two men to enter the aircraft.

*b.* The other two litter bearers remove litters from the ambulances and carry them to the aircraft. With the crew chief supervising and assisting where necessary, the two men within the aircraft receive the litter and carry it to its predetermined place inside the aircraft. Litters are generally loaded in order from top downward and from the front to the back.



## Section III. ARMY FIXED-WING AIRCRAFT

**85. General**

The capability of Army fixed-wing aircraft to land on and take off from selected, small, unprepared areas permits the evacuation of patients from areas of operations which would be inaccessible to larger aircraft. These aircraft can fly slowly and maintain a high degree of maneuverability, which further enhances their value in forward areas under combat conditions. Army fixed-wing aircraft are limited in speed and range as compared with larger transport-type aircraft, but they are capable of more speed and longer operating range than are rotary-wing aircraft. The Army, therefore, uses fixed-wing aircraft when adequate airfields are available and the rapid flight and longer operating range of these aircraft are desirable. These aircraft may be used in forward areas for air transport of patients from division medical installations. This is a secondary mission for these aircraft, which will be utilized only to augment AMEDS air ambulance capabilities.

**86. Types of Army Fixed-Wing Aircraft**

The four Army fixed-wing aircraft used for air transport of troops are as follows:

*a. U-6 Beaver* (fig. 193). This aircraft is the Army's standard fixed-wing utility class

aircraft employed at division and higher headquarters to expedite operations in the combat zone. It can carry two litter patients or five ambulatory patients.

*b. U-1A Otter* (figs. 194-196). This is a rugged aircraft with large wing surfaces, which is assigned to fixed-wing tactical transportation companies. It is designed for maximum efficient operation from short unimproved fields. It can carry six litter patients or 10 ambulatory patients.

*c. CV-2A Caribou*. (figs. 197-199). The CV-2A Caribou is a sturdy transport aircraft with vertical take-off and landing characteristics. It is assigned to company-sized units normally operating at corps and Army level. It may be operated from unprepared fields or hastily prepared strips. The Caribou is authorized four litter kits—a right aft kit, a left aft kit, a right forward kit, and a left forward kit. This aircraft has a litter patient capacity of 20 or an ambulatory patient capacity of 32.

*d. CV-7A Buffalo*. This aircraft has a litter patient capacity of 24 or an ambulatory patient capacity of 42.

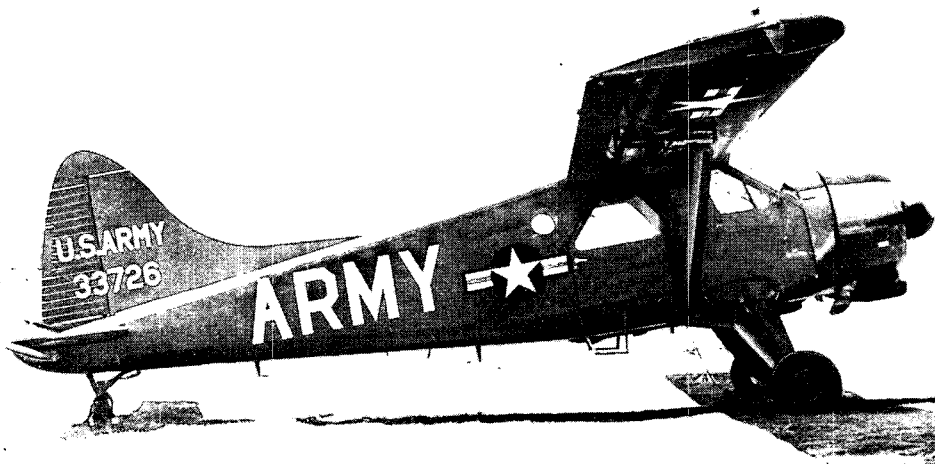


Figure 193. U-6 Beaver.

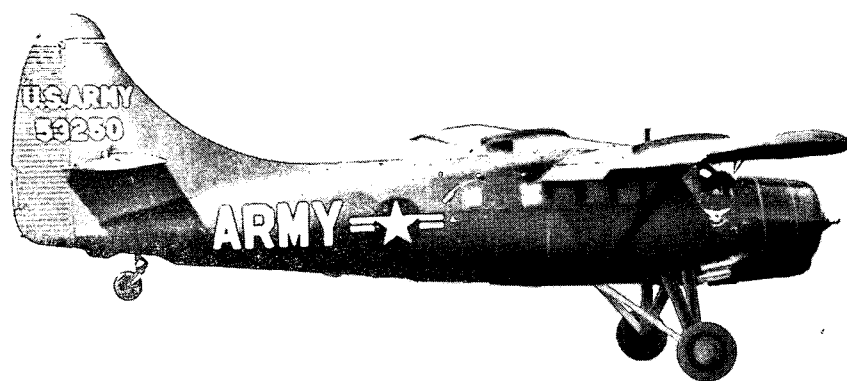


Figure 194. U-1A Otter, exterior view.

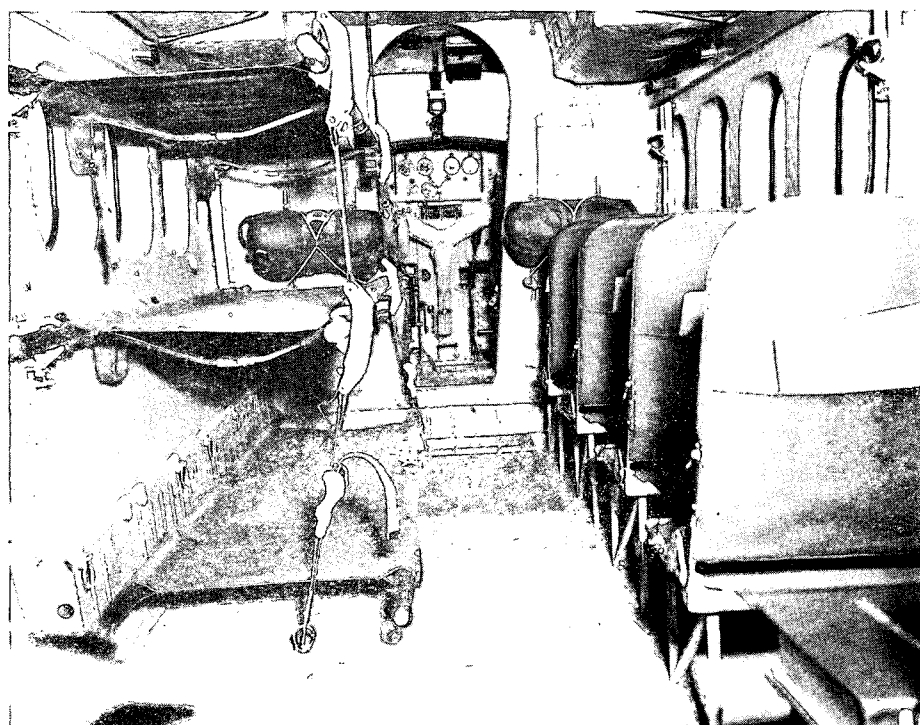


Figure 195. U-1A Otter, interior view, showing the cabin set up to receive three litter patients and four ambulatory patients.

### 87. Loading Patients Aboard Light Fixed-Wing Aircraft

Loading patients aboard light fixed-wing aircraft is accomplished by the motor vehicle personnel that transport the patients to the landing strip. Litters are generally loaded in order

from the top downward and from the front to the back.

a. Four men, plus the crew chief, normally load fixed-wing aircraft.

b. The crew chief, or other member of the aircraft's crew, supervises the loading of all patients.



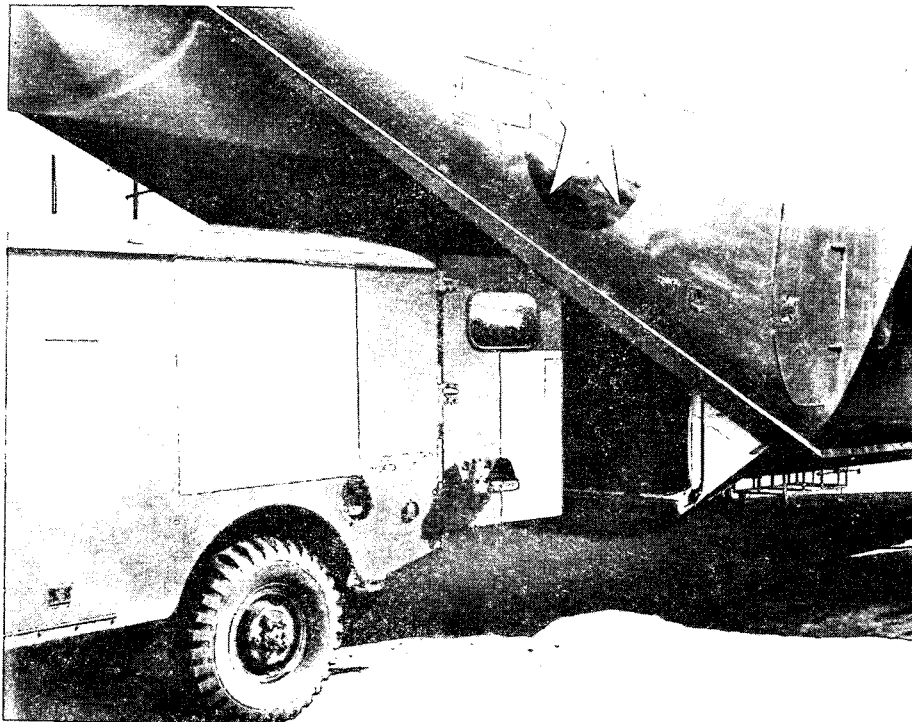
*Figure 196. U-1A Otter, crew chief receiving patient from litter bearer team.*



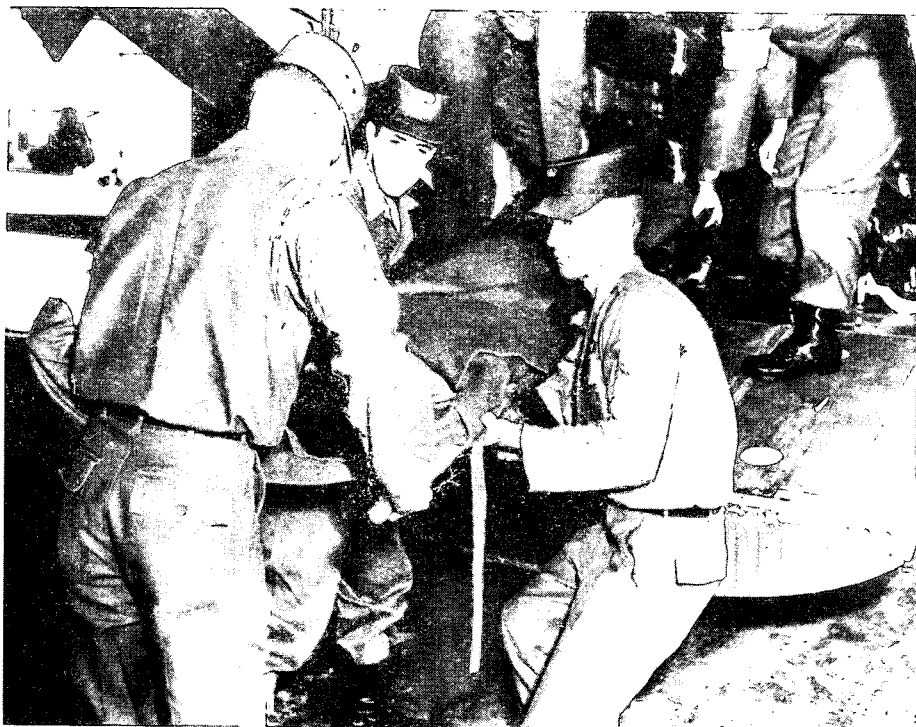
*Figure 197. CV-2A Caribou, in flight.*

c. No. 2 of the litter bearer team would normally enter the aircraft to assist the crew chief or other crew member in the supervisory position, in the loading of the litter.

d. Loading plans (para 82) may be required for CV series aircraft.



*Figure 198. CV-2A Caribou, motor ambulance in position to load CV-2A.*



*Figure 199. CV-2A Caribou, litter patient being loaded into the CV-2A.*

## Section IV. ARMY HELICOPTER AIRCRAFT

**88. General**

Helicopters are rotary-wing aircraft capable of horizontal, vertical, lateral, and hovering flight. Their ability to circumvent terrain and obstacles and minimum requirements for take-off and landing enables them to operate from areas otherwise inaccessible to fixed-wing aircraft or surface vehicles. The capability of helicopters for flight at relatively slow speeds permits operations during periods of reduced ceiling and visibility. Helicopters are organic to the Army Medical Service air ambulance units and aviation units of the division corps, and field army.

**89. Types of Helicopters**

Helicopters are classified in three categories according to basic missions—observation helicopter (OH), utility tactical transport helicopter (UH), and transport helicopter (CH). The last two categories of aircraft will be utilized for air transport of litter patients. A description of each type follows:

*a.* The UH-1D Iroquois (figs. 200, 201) is the preferred aircraft for use as an Army Med-

ical Service air ambulance; however, the Army Medical Service uses a mixed force of UH-1D and UH-1B aircraft for this purpose. The UH-1D has a litter patient capacity of 6 or an ambulatory patient capacity of 10.

*b.* The UH-1B Iroquois (figs. 202, 203) has a litter patient capacity of three or an ambulatory capacity of six.

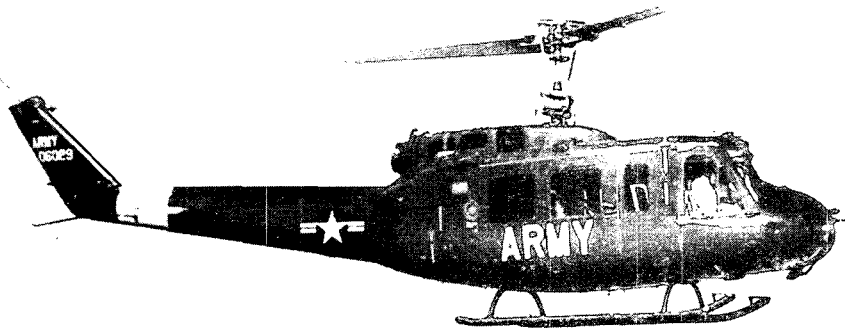
*c.* The CH-47 Chinook (fig. 204) has a litter patient capacity of 24 or an ambulatory patient capacity of 33.

*d.* The CH-21 Shawnee (fig. 205) has a litter patient capacity of 12 or an ambulatory patient capacity of 20.

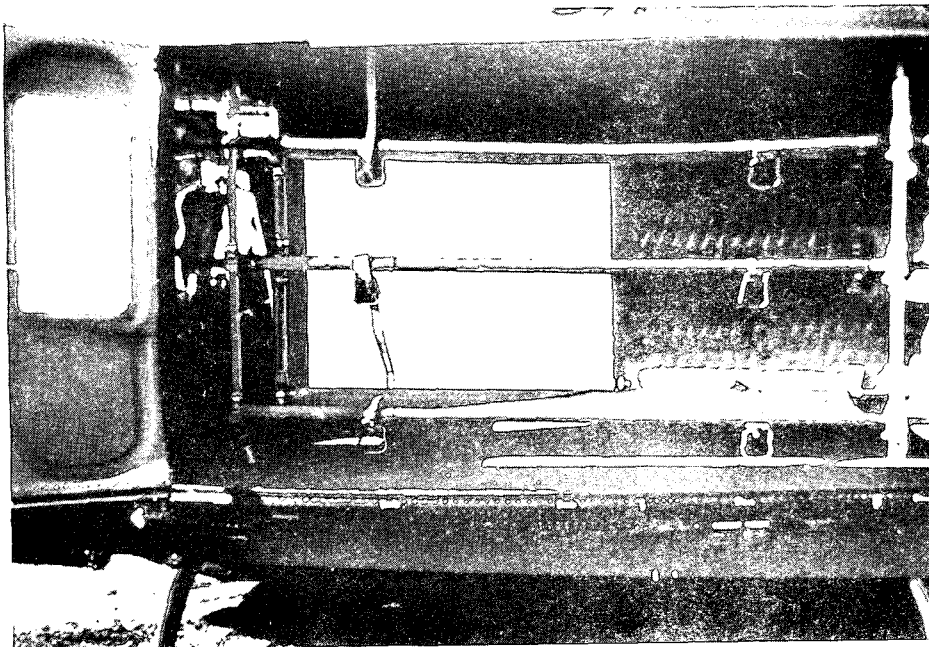
*e.* The CH-37 Mojave (fig. 206) has a litter patient capacity of 24 or an ambulatory patient capacity of 23.

*f.* The CH-34 Choctaw (fig. 207) has a litter patient capacity of eight or an ambulatory patient capacity of 12 to 18.

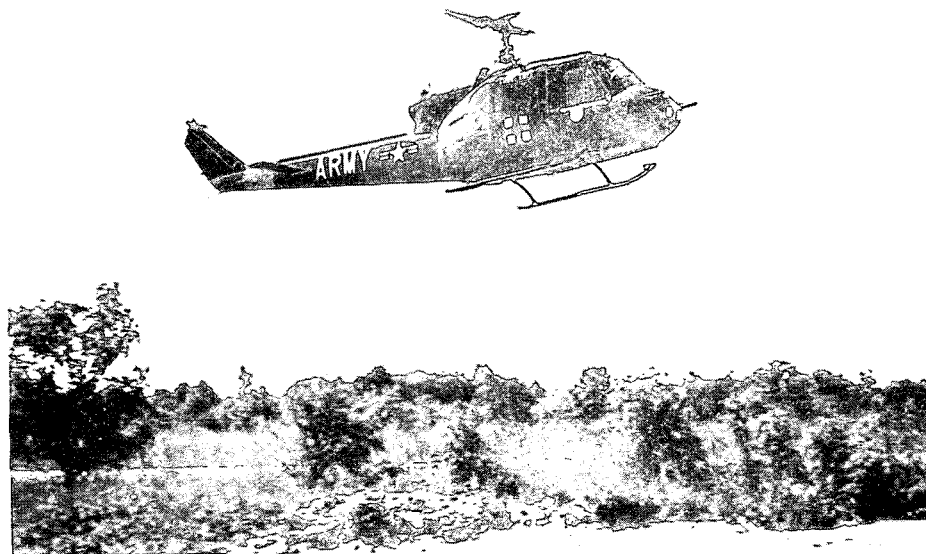
*g.* The UH-19 Chickasaw (figs. 208, 209) has a litter patient capacity of six or an ambulatory patient capacity of 8 to 10.



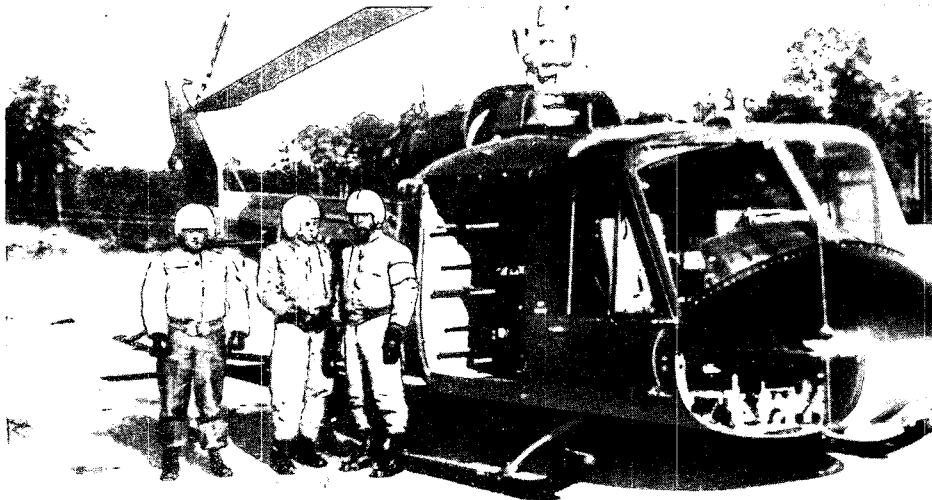
*Figure 200. UH-1D Iroquois, in flight.*



*Figure 201. UH-1D Iroquois, interior view.*



*Figure 202. UH-1B Iroquois, in flight.*



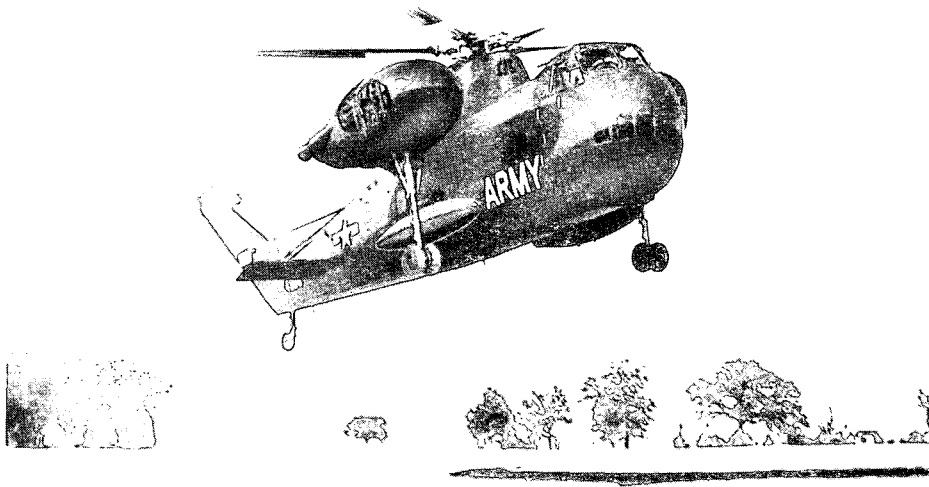
*Figure 203. UH-1B Iroquois, interior view.*



*Figure 204. CH-47 Chinook.*

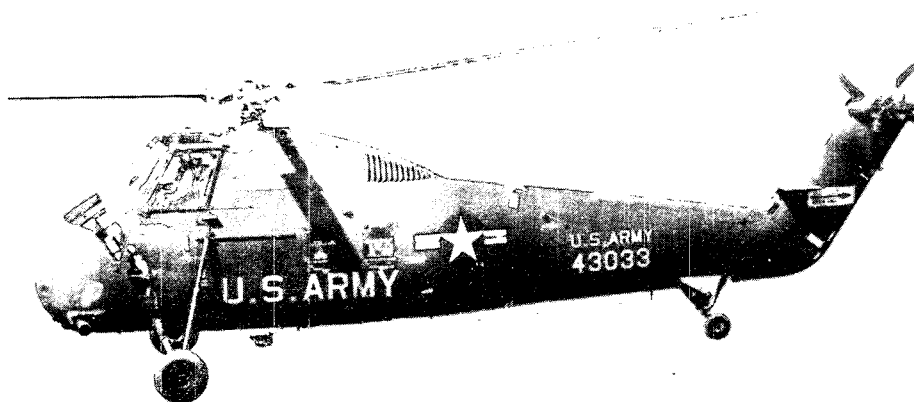


*Figure 205. CH-21 Shawnee.*

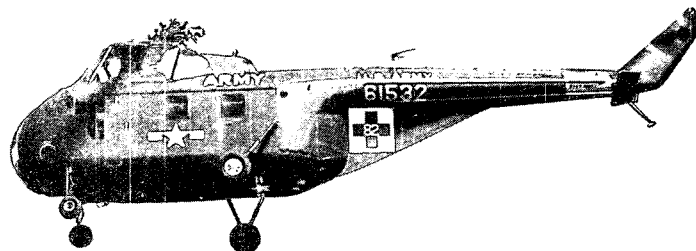


*Figure 206. CH-37 Mojave.*





*Figure 207. CH-34 Choctaw.*



*Figure 208. UH-19 Chickasaw, in flight.*

### **90. Loading Patients Aboard Helicopters**

Generally, the procedures outlined in paragraph 87 are applicable for loading patients aboard helicopters. Loading plans may be required for the transport helicopters. Specific loading instructions for air ambulances are provided in paragraphs 101 and 102. When loading and unloading rotary-wing aircraft, certain precautionary measures will be ob-

served. Litter bearers should present as low a silhouette as possible, and must keep clear of the rotors at all times. Smoking is not permitted in close proximity to the aircraft. Helicopters should not be approached until signaled to do so, and then should be approached at a 45 degree angle from the front of the aircraft. Directions given by the crew will be followed and litters will be carried parallel to the ground.

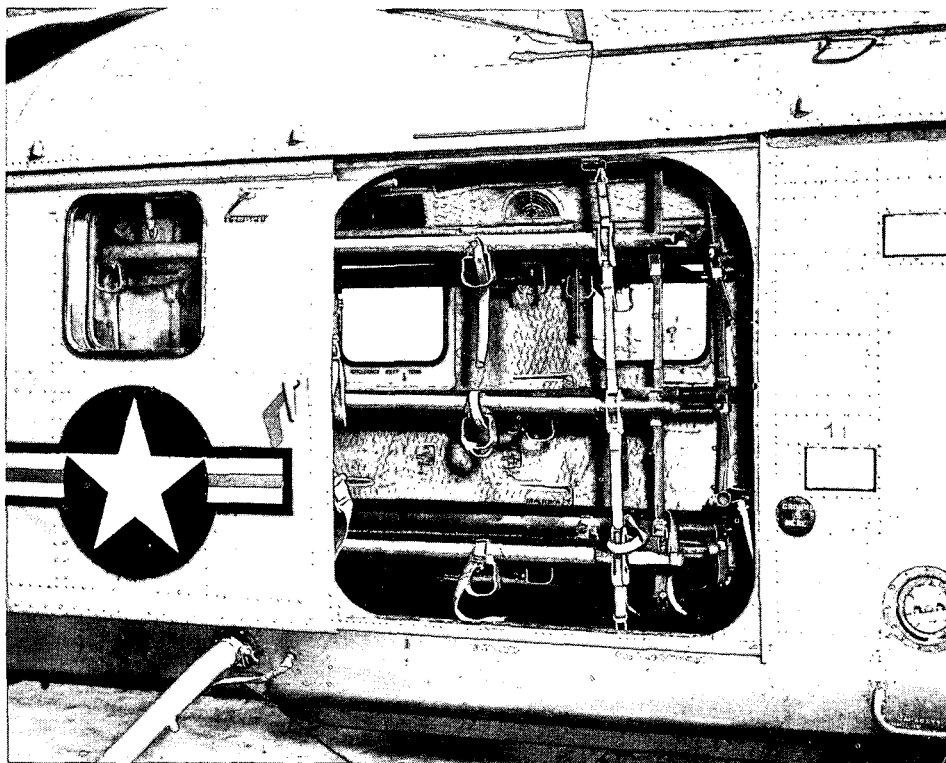


Figure 209. UH-19 Chickasaw, interior view.

## Section V. AMEDS AEROMEDICAL EVACUATION OPERATIONS

### 91. General

This section includes the provisions of NATO STANAG No. 2087, Medical Employment of Helicopters in Ground Warfare.

### 92. Missions

The primary mission of air ambulance units is aeromedical evacuation of patients. Additional missions include air movement of patients, critical medical supplies, personnel, and equipment.

### 93. Medical Employment

Medical employment of helicopters in ground warfare will include planning and organizing for fulfillment of missions which fall within the purview of the Army, regardless of which force operates the helicopters. Control of operations will be in accordance with local directives and the organization of the forces concerned.

### 94. Selection of Patients for Helicopter Evacuation

Based upon the decision of the medical officer in charge, suitable types of patients for helicopter evacuation will be:

- a. Those for whom helicopter evacuation is necessary as a lifesaving measure.
- b. Those who, by prognosis, would definitely benefit by helicopter evacuation.
- c. Those who urgently require specialized treatment.
- d. Those who are likely to suffer unnecessary pain or discomfort unless evacuated by helicopter.
- e. Those who are likely to go into shock as a result of prolonged or rough surface evacuation.

### 95. Selection of Helicopter Landing Sites

The unit requesting air ambulance service is responsible for selecting and properly marking the helicopter landing sites.

a. The helicopter landing site and approach zones to the areas should be free of obstructions. Inclosed areas of restricted space, such as small clearings, will be avoided. Sufficient space must be provided for the hovering and maneuvering of the helicopter during landing and takeoff. The approach zones should permit the helicopter to land and take off into the prevailing wind. It is desirable that landing sites afford helicopter pilots the opportunity of making shallow approaches.

b. Definite measurements for landing sites cannot be prescribed, since they must vary with temperature, altitude, wind, terrain, loading conditions, and individual helicopter characteristics. The minimum requirement for light helicopters is a cleared area 100 feet in diameter with an approach and departure zone clear of obstruction.

## 96. Marking the Obstructions

Any object likely to be blown about by the wind from the rotor (for example, paper, cartons, clothes, or parachutes) should be removed from the landing area. Obstacles, such as cables or wires, at or near landing sites, which cannot be removed and may not be readily seen by a pilot, must be clearly marked.

## 97. Identifying the Landing Site

(figs. 210–212)

a. The landing site should be outlined with material, such as engineer tape or rocks, of a color contrasting with the background.

b. Where the tactical situation permits, a landing site should be marked with a letter "H," using identification panels or other appropriate marking material.

c. If the tactical situation permits, the wind direction may be indicated by a small wind sock or rag tied to the end of a stick in the vicinity of the site, by a man standing at the upwind edge of the landing site with his back to the wind and his arms extended forward, or by a large smoke pot set off to emit colored smoke as soon as the helicopter is sighted.

## 98. Considerations for Night Operations

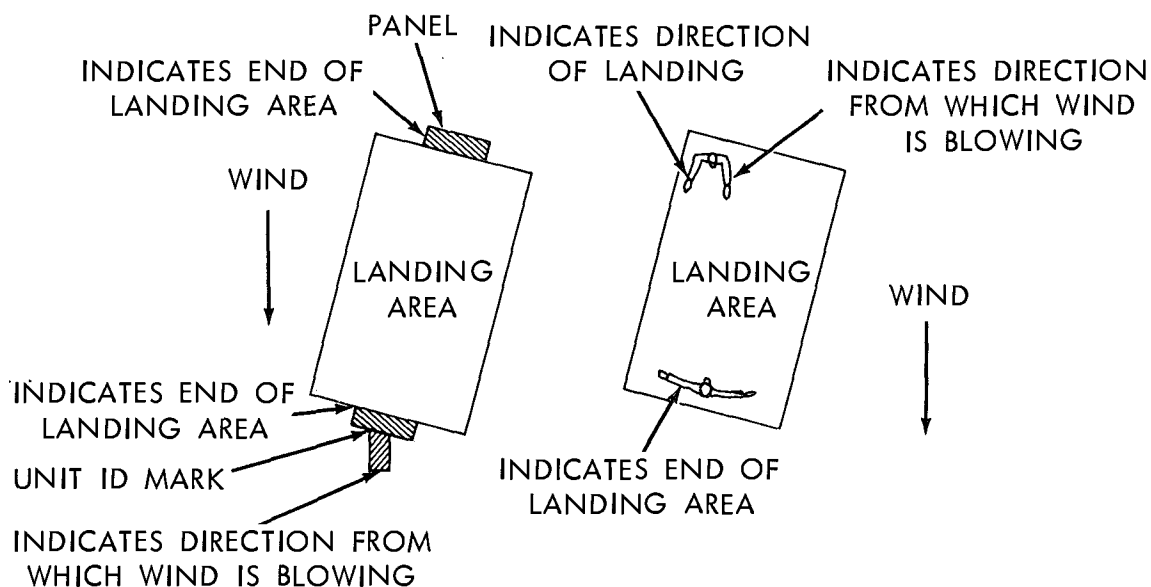
Providing time is available and the tactical situation permits, the pilot should be permitted time to make an aerial and ground reconnaissance of the sites and routes during daylight hours. The requirements for night operations are the same as for daylight operations with the following additional requirements:

a. For a landing site to be used at night there must be no obstructions in the vicinity which are higher than the surrounding trees, nor any which would be invisible to the pilot (for example, wires or poles). These obstructions must be removed even though the pilots may have become familiar with their locations during daylight operations.

b. If changing the landing site is preferred to removing the obstructions, ample time for a daylight ground and aerial reconnaissance of the new location should be allowed.

c. One of the many ways that a landing site is marked is with four lights placed, one at each corner of the usable landing area. These lights should be colored in order to distinguish them from other lights which may appear in the vicinity. The color in this case also constitutes one element in identifying the site. Flare pots, or other types of open lights, should not be used since they usually are blown out by the rotor down-wash and often create a glare and reflection on the aircraft windshields, which tends to blind the pilots. The site is further identified and distinguished from others operating in the general vicinity by a coded signal flash to the pilot from a ground operator using the directed beam of a signal lamp, flashlight, vehicle lights, or other means which have been agreed upon at the time the request for the mission was made. The coded signal is continuously flashed to the pilot until recognition is assured. The signal operator who has taken his position on the upwind side of the landing site then directs the beam of light downwind along the ground so as to bisect the landing area. The pilot makes his approach for landing in line with the beam of light toward its source and lands at the center of the marked area. All lights are displayed for only a minimum time before arrival of the helicopter and are turned off immediately after the landing. Usually, the

DAYLIGHT OPERATIONS



NIGHT OPERATIONS

SMOKE POTS OR LANTERNS    FLASHLIGHT POINTED TO GROUND    VEHICLE LIGHTS

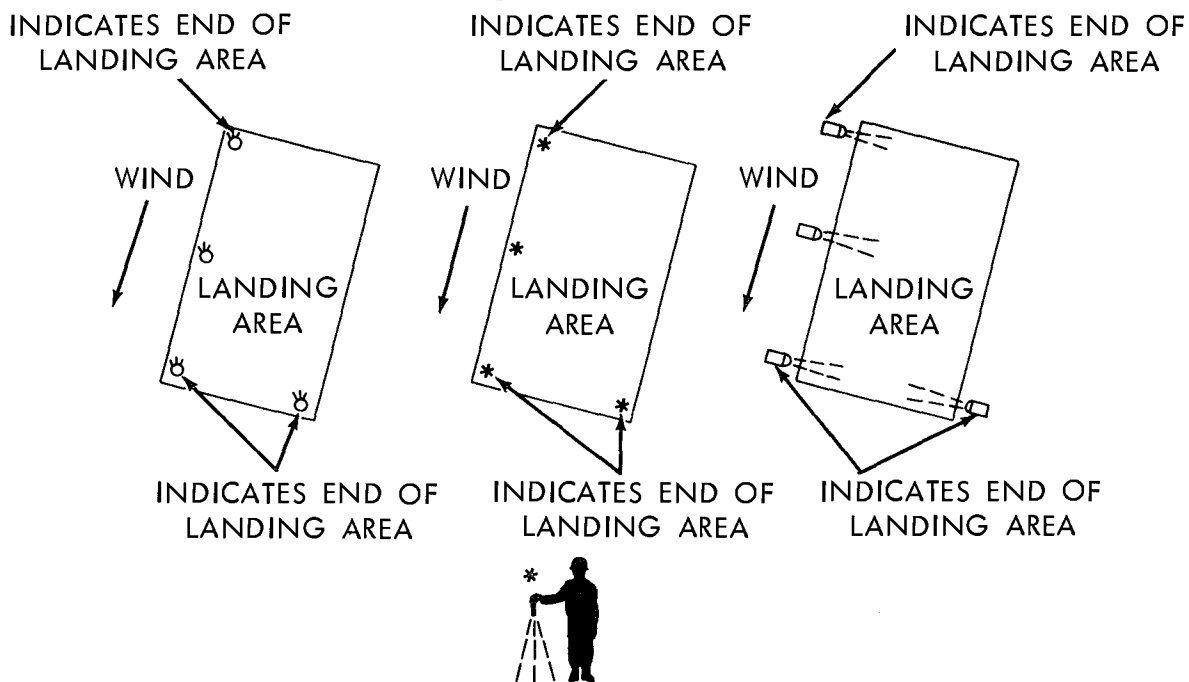
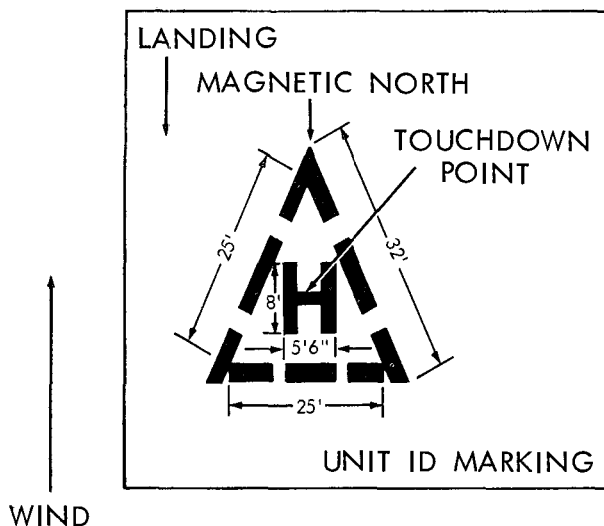


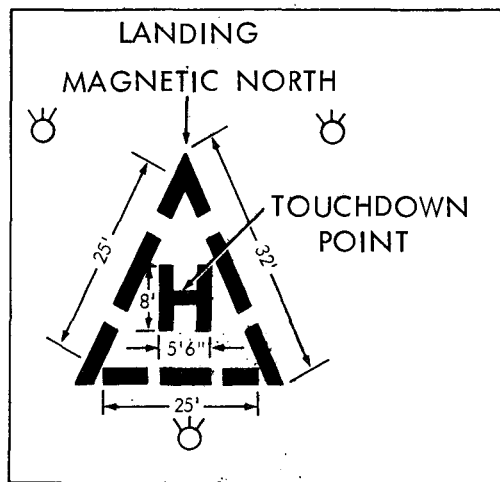
Figure 210. Marking and lighting of airfields.

DAYLIGHT OPERATIONS



NIGHT OPERATIONS

SMOKE POTS OR LANTERNS



VEHICLE LIGHTS

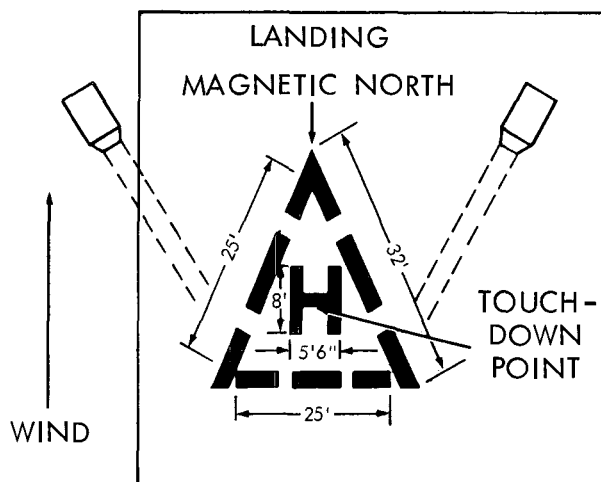


Figure 211. Marking and lighting of heliports.

pilot will be able to take off without the assistance of lighting. During takeoff only those lights requested by the pilot are displayed; they are turned off immediately after his departure. Usually, no navigational or landing

lights will be displayed on the helicopter. The ground contact team must, therefore, listen for the helicopter and locate its exact position by the exhaust flame or its silhouette against the sky during its approach.

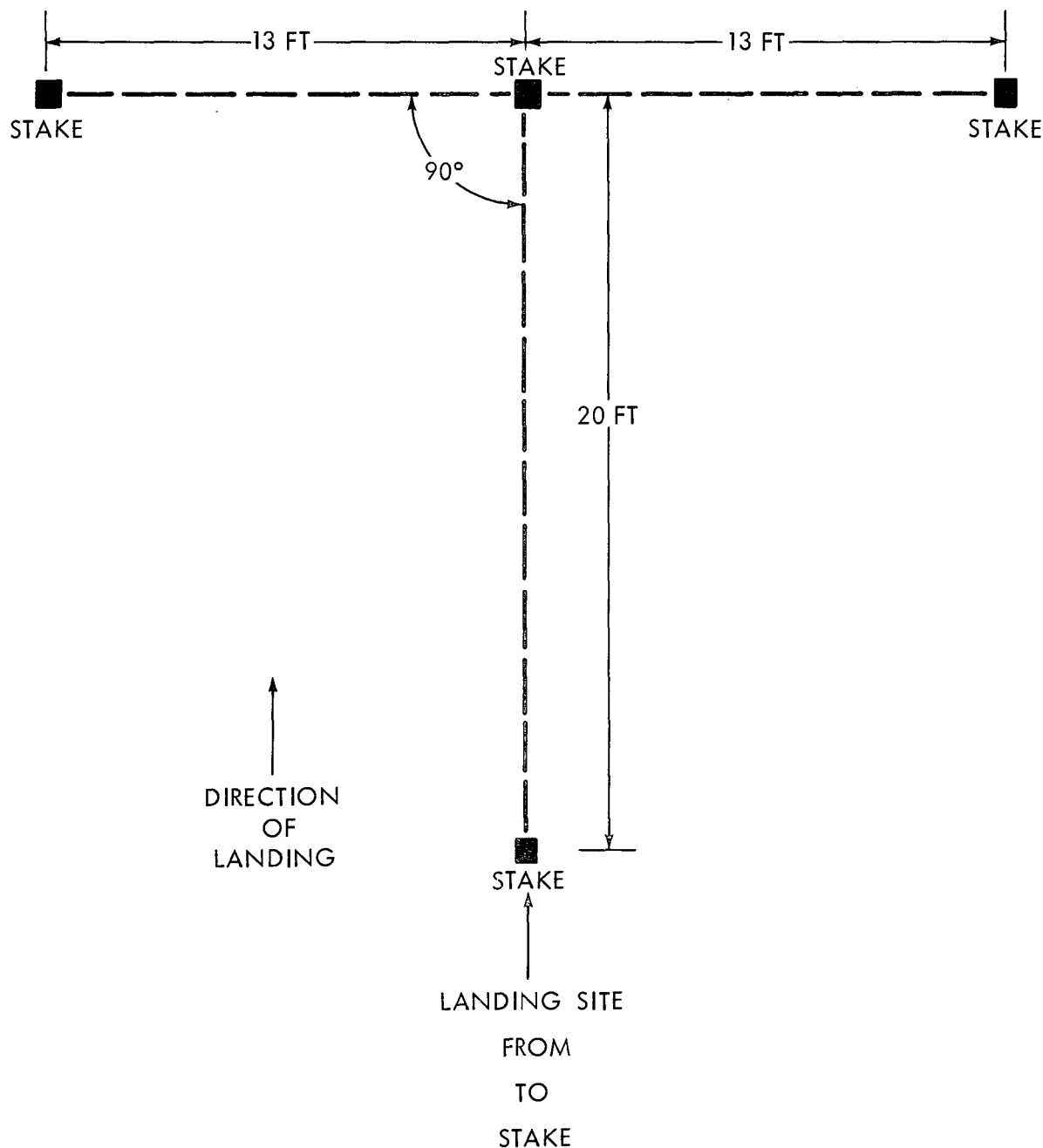


Figure 212. Layout of heliport night-landing system (field expedient).

## 99. Operation

Medical agencies are responsible for the movement of patients to and from helicopter landing sites, rapid loading and unloading of patients, and in-flight medical care. In the absence of military medical personnel, the senior military authority present will be responsible.

*a. Responsibility for Loading and Securing.* The pilot of the aircraft is responsible for insuring that prescribed methods of loading and securing litters and related equipment are followed by the personnel loading patients in the helicopter. The final decision as to how many patients may be safely loaded lies with the pilot in command of the aircraft.

*b. Requests for Helicopter Evacuation.* The unit surgeon initiates helicopter evacuation missions through available communications channels with the surgeon of the command echelons concerned. Requests for these missions may be processed through medical technical channels or command channels according to local directives and the organizations of the force concerned. In addition to clinical data (normally prescribed in SOP) which may be required by higher authority, requests for helicopter evacuation should include the following:

- (1) Location of the landing site, usually by map coordinates.
- (2) Weather conditions.
- (3) Color of panels, smoke, or lights.
- (4) Freedom from enemy activity in the area.
- (5) Number of patients, diagnosis, condition, and nationality.
- (6) The time patients will be available for evacuation.
- (7) Requirements for special items of medical supplies or whole blood and for medical personnel to act as escort.
- (8) Tactical considerations.

*c. Contact Man.* Upon anticipating the evacuation of patients by helicopter, the unit commander should assure himself that a contact man familiar with the principles of helicopter operations is designated to conduct the operation at the landing site, load or unload the aircraft, and secure the site after the opera-

tion is completed. The contact man has the following duties:

- (1) Select and prepare the landing site.
- (2) Brief his crew on safety measures.
- (3) Contact the pilot personally and receive any supplies which may be delivered.
- (4) Direct the loading and unloading of the aircraft according to the pilot's instructions.
- (5) Brief the pilot on the position of enemy troops, direct him to other units in the area if he should inquire, and make every effort to speed the helicopter on its way.
- (6) Be prepared to report the type of supplies received, quantity, where delivered, and patients evacuated.

*d. Communications.* Communications facilities between the body in control of evacuation missions, the helicopters, and the requesting body must be provided whenever possible. Communications will be minimized by accurate information in the original request for air ambulance service. Changes in the tactical situation may require relocating of the landing site or rerouting the flight to another facility.

## 100. Checklist

The following list contains the more important items which must be considered in selecting, preparing, marking, and operating a helicopter landing site. It is recommended as a checklist to insure that the landing site is adequately prepared for operation.

- a.* Is all pertinent information properly assembled for the request of a helicopter mission?
- b.* Are the terrain features such that the operation of the helicopter will be practical and safe?
- c.* Are the approaches of satisfactory width and length? Are they free of obstruction?
- d.* Is the site itself large enough for the safe landing, loading, and takeoff of the largest type aircraft expected?
- e.* Are the correct identification symbols and wind indicators available for display in advance of the arrival of the helicopter, and are they of the proper color in accordance with information included in the request?

f. Is the contact man properly briefed for aiding the pilot in landing, unloading, and loading the helicopter, and briefing the pilot on enemy capabilities and location of friendly troops?

g. Have all personnel been properly briefed on safety precautions?

h. Have personnel been designated to clear the site of panels and other characteristics which, upon conclusion of the operation, might identify it as a helicopter landing site to the enemy?

## 101. Army Medical Service Air Ambulance (UH-1B Iroquois), Loading and Unloading

This aircraft is equipped with a folding rack designed to accommodate two standard litters,

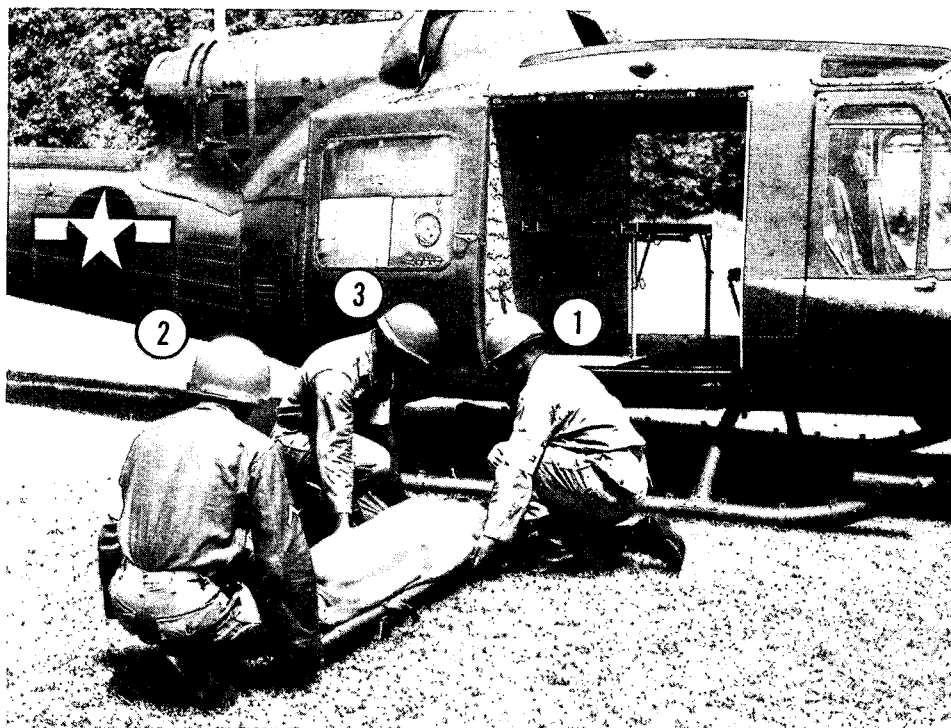
as well as to permit the loading of a third standard litter on the cabin floor. Two passenger safety belts are used to secure each litter patient. The rack may be folded to make room for four ambulatory patients. A medical attendant's seat faces the litter rack. Three men are required to load and unload the aircraft.

a. *Loading* (figs. 213-215).

- (1) To load this helicopter, the *first* command is Helicopter, POSTS.
- (2) The *second* command is Prepare to Load, LOAD.

b. *Unloading*. To unload the aircraft, the reverse of the loading procedure is followed.

- (1) The *first* command is Helicopter, POSTS. At the command of execution, the squad members position

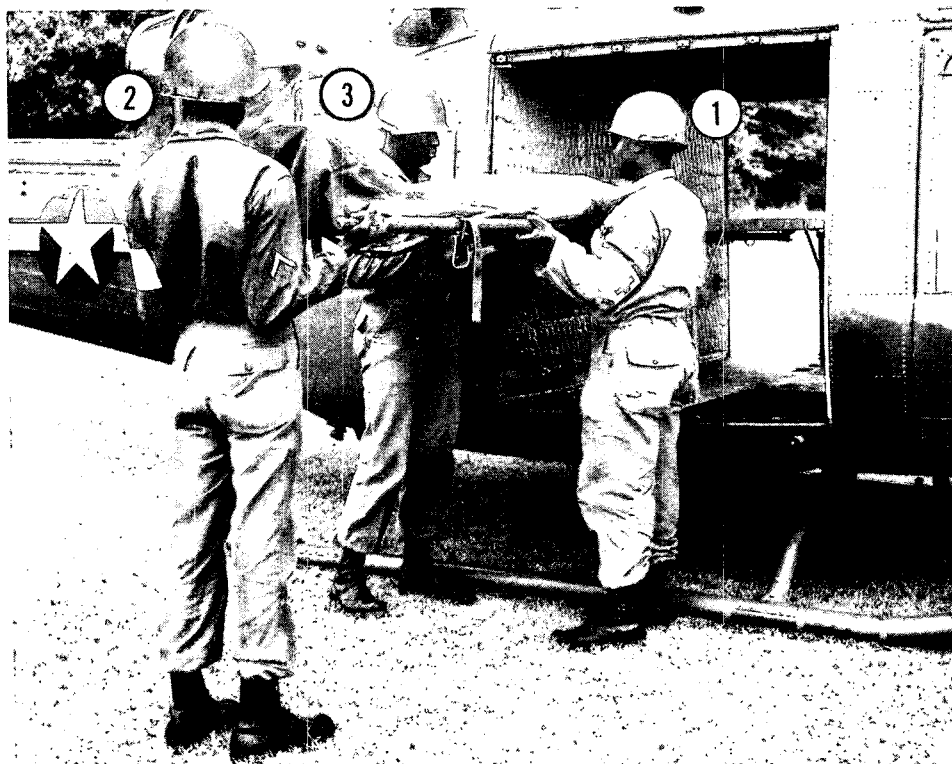


a. At the command of execution, squad members ground litter three paces from the open door of the aircraft, with the head of the litter near the open door.

- b. No. 1 and No. 3 position themselves at the right and left of the head of the litter, respectively.
- c. No. 2 is at the foot of the litter.

*Figure 213. Army medical service air ambulance (UH-1B), loading, squad in position to load upper berth.*





a. At the command of execution, the litter is raised and transported to the open door of the aircraft.

b. No. 1 and No. 3 place the stirrups of the front of the litter into the grooves of the upper berth of the helicopter litter rack.

*Figure 214. Army medical service air ambulance (UH-1B), loading, front stirrups of litter are placed into grooves of upper berth.*

themselves so that No. 2 and No. 3 are at the right and left of the open door of the aircraft, while No. 1 enters the cabin.

(2) The *second* command is Prepare to Unload, UNLOAD.

(a) At the command of execution, No. 1 unbuckles the patient securing straps and loosens the litter retaining straps of the litter in the lower berth of the cabin.

(b) No. 2 grasps the litter handles of the foot end of the litter, and, with the assistance of No. 3, pulls the litter from its berth.

(c) Before the time the stirrups of the head of the litter reach the end of the grooved tracks, No. 1 halts the other two bearers in place, gets out

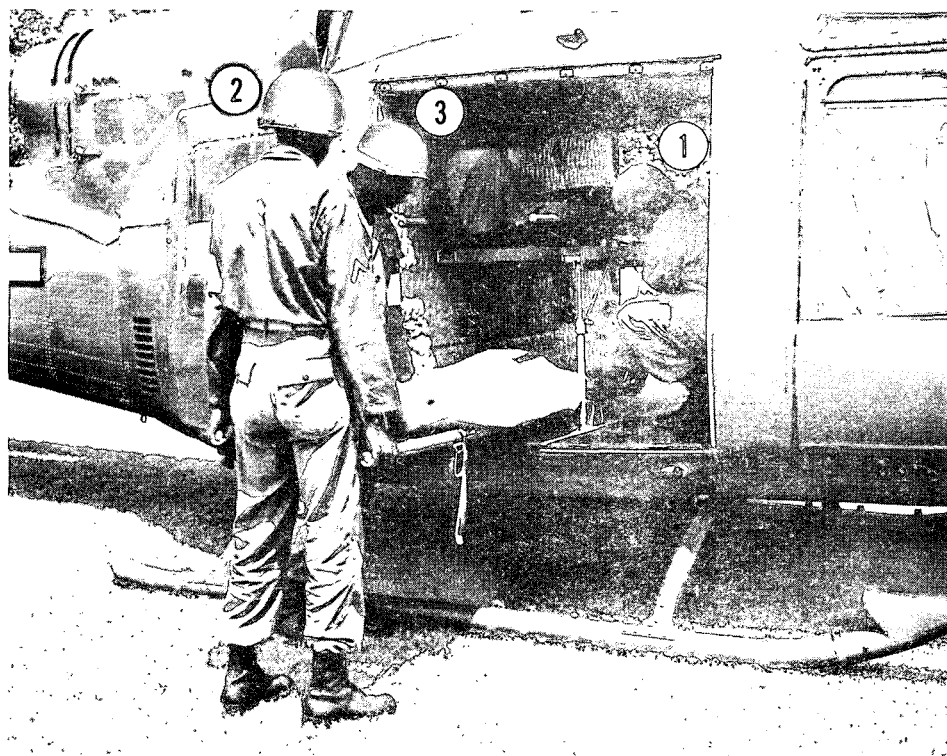
of the aircraft, and assists No. 3 at the head of the litter.

(d) The three litter bearers then raise the litter from its berth and transport it to the appropriate surface ambulance or medical receiving facility.

(e) The second and third patients are unloaded in the same manner.

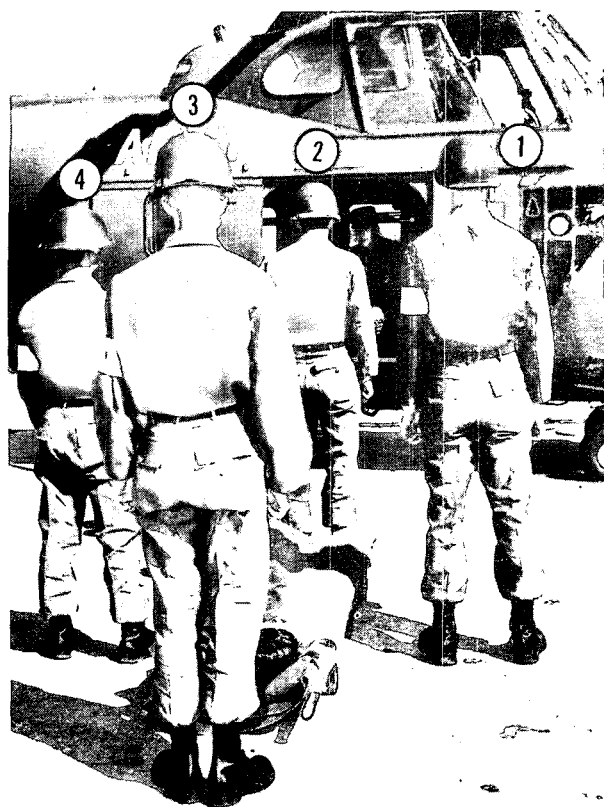
## 102. Army Medical Service Air Ambulance (UH-19), Loading and Unloading (figs. 216-218)

On each side of the interior of the aircraft cabin, there are facilities for carrying a tier of three litters (fig. 218). Six litters can be supported by their handles in litter support brackets fixed to the sides of the cabin, and by retainer straps suspended from the cabin's ceiling. The litter support brackets can be ad-



- a. With the litter thus supported, No. 1 enters the cabin of the aircraft.
- b. No. 2 and No. 3 slide the litter into the berth, assisted by No. 1, who helps guide and secure the litter into the slots.
- c. No. 1 also secures the patient on the litter by means of the passenger safety straps.  
(In the same manner, the second litter is placed under the first litter and the third litter is placed on the cabin floor.)

*Figure 215. Army medical service air ambulance (UH-1B), loading, litter being placed into the berth.*



- a. At the command of execution, the members of the litter bearer squad ground the litter at least three paces from the open cabin door of the aircraft, and position themselves as follows:
  - b. No. 2 at the foot of the litter.
  - c. No. 3 at the head of the litter.
  - d. No. 4 and No. 1 at the left and right of the litter, respectively.
 (Grounding the litter three paces from the open cabin door gives the crew chief, or other responsible personnel, an opportunity to check litter support brackets and retainer straps in order to assure that they are in proper position to receive litters.)

Figure 216. Army medical service air ambulance (UH-19), loading, litter is grounded at least three paces from open door of helicopter ambulance.

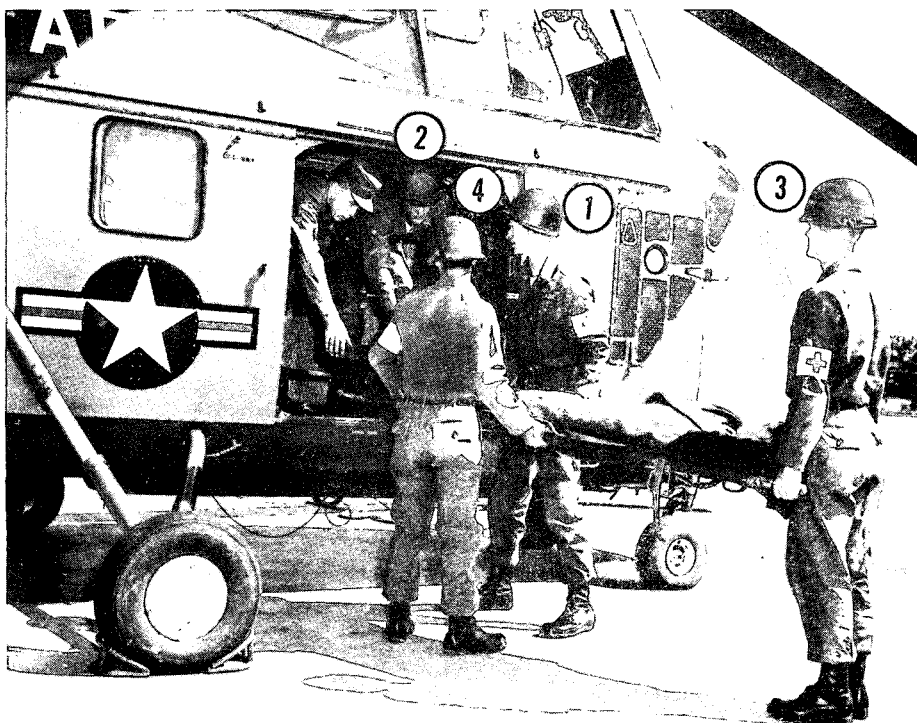
justed, so that litters can be leveled. A four-man litter squad is used for loading and unloading.

a. *Loading.*

- (1) The *first* command is Helicopter or Aircraft, POSTS.
- (2) The *second* command is Prepare to Load, LOAD.

b. *Unloading.* To unload the aircraft, the reverse of the loading procedure is followed.

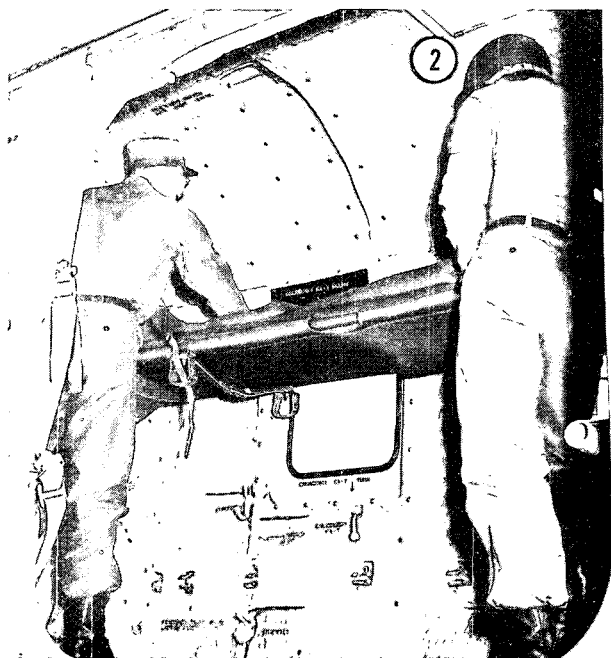
- (1) The *first* command is Helicopter or Aircraft, POSTS. At the command of execution, the squad falls in, facing the aircraft and three paces from the open door.
- (2) The *second* command is Prepare to Unload, UNLOAD.
  - (a) At the command of execution, No. 2 joins the crew chief, or crew member, within the cabin and assists in unbuckling patient securing straps and loosening litter retaining straps.
  - (b) No. 1 and No. 3 take their positions beside the open cabin door.
  - (c) No. 4 takes position two paces in front of the open cabin door.
  - (d) No. 2 and the crew chief, or crew member, raise the litter from its support brackets and transport it to the open door of the aircraft.
  - (e) No. 1, No. 3, and No. 4 receive the litter and transport it to the appropriate surface ambulance or medical receiving facility.
  - (f) Additional patients are unloaded in the same manner, right tier of litters, from the bottom up, and then left tier of litters, from the bottom up.



a. At the command of execution, the litter is raised and carried to the aircraft.

b. At the door, No. 2 releases handles of foot end of litter to No. 4 and No. 1, and joins the crew chief, or crew member, within the aircraft.

*Figure 217. Army medical service air ambulance (UH-19), loading, litter ready to be placed in helicopter.*



- a. No. 1, No. 3, and No. 4 then deliver the litter to the crew chief, or crew member, and No. 2.
- b. Crew chief, or crew member, and No. 2 place the litter on the appropriate support brackets within the helicopter, with the patient's head toward the front of helicopter.
- c. Where the loading of more than one patient is involved, No. 2 normally remains within the helicopter to assist the crew chief, or crew member, in loading patients; and No. 1, No. 3, and No. 4 remove patients from motor ambulances and carry them to the aircraft.

(Additional patients are loaded in the same manner, loading from top to bottom, left wall first and then the right wall.)

*Figure 218. Army medical service air ambulance (UH-19), loading patient within helicopter.*

## CHAPTER 6

TRANSPORTATION BY WATER

---

## Section I. INTRODUCTION

**103. Responsibilities**

*a.* Evacuation of the sick and wounded of the Armed Forces by ocean-going vessels is a responsibility of the Department of the Navy. The areas of Navy responsibility include trans-oceanic, intra-theater, and coastwise evacuation.

*b.* Patient evacuation over water barriers, such as rivers and lakes, normally is a responsibility of the medical service of the Armed Force concerned.

*c.* The Navy is also responsible for the medical care and treatment of patients when they are embarked on Navy ships or small craft. All but the very smallest craft used for evacuation of patients are staffed with Navy medical personnel. Army or Air Force personnel may be assigned to these vessels to augment the Navy medical staff.

**104. Types of Craft Used**

*a.* The large, ocean-going vessels used for the evacuation of the sick and wounded are of four major types—hospital ships (AH), attack transport hospital ships (APH), attack transports (APA), if properly fitted for evacuation of the sick and wounded, and large landing craft (LST), when augmented with medical personnel and supplies.

*b.* Small craft, which are used in the evacuation of patients from shore to ship, include small landing craft, such as the Landing Craft, Vehicle, Personnel (LCVP), the Landing Craft, Mechanized (LCM), and the Landing Vehicle, Tracked, Personnel (LVTP). Amphibious Vehicles, such as the Amphibious Truck, 2½ Ton (DUKW) and the Amphibious Lighter, Resupply, Cargo, 5 Ton (LARC-5), are also used in shore-to-ship evacuation. Engineer assault boats, when available, may be used in evacuating patients across small bodies of water. Small surface craft are used for evacuation in aircraft crashes occurring over bodies of water.

## Section II. LARGE CRAFT

**105. General**

*a.* During an amphibious operation, vessels of the Navy provide care, treatment, and evacuation of patients. Several types of large craft are used. Attack transports which move troops to the area of operations receive patients from medical installations ashore and the hospital ship. The force hospital ship is an evacuation means with definitive care and treatment capability. It may remain in the area for this purpose. The large Landing Ship, Tank (LST), can be used in amphibious landings as an emergency treatment and patient sorting ship.

*b.* Water transportation for the evacuation of patients from the theater of operations to the zone of interior is accomplished by the Military Sea Transport Service (MSTS), under the control of the Navy. The Military Sea Transport Service operates all hospital ships and troop transports other than those assigned to the Navy fleet. Water transportation for evacuation from the theater of operations to the zone of interior is used as a supplement to aircraft transportation and as an alternative means when aircraft transportation is not available or advisable.

c. All of the Navy ships discussed in this section, which normally are equipped for patient handling, can increase their emergency patient handling capacities by augmentation of medical personnel and materiel.

### 106. Hospital Ships (fig. 219)

The hospital ship is the floating hospital of the Navy. Hospital ships, designed to operate either with the fleet or the Military Sea Transport Service, are designated by the Navy as AH (followed by a number).

a. These vessels are constructed and used so as to conform to the provisions of the Geneva Convention, under which they are immune from enemy attack. The exterior of the ship is painted white with a horizontal green stripe encircling the hull. The Red Cross flag is flown and lights, sufficient to show the character of the ship, are displayed at night. The hospital ship's company must be composed of noncombatants. The hospital ship cannot be used for any military or unneutral purpose, and before it is used its identity must be announced to the enemy.

b. The number of medical personnel assigned to a hospital ship is roughly equivalent to that assigned an 800-bed hospital, and includes medical and surgical specialists of most categories. The hospital ship has all the facilities of a well-equipped hospital, including wards, operating rooms, X-ray, clinical and pharmaceutical laboratories, and a dental section.

c. The hospital ship provides medical support to the fleet and to the amphibious force to which it is attached. It remains in the area of operations providing patient care for embarked patients and transfers convalescent patients to other units leaving the area. In addition to its own requirements, it carries sufficient medical stores to provide resupply for the medical service of advance units and ships of the fleet. Hospital ships attached to the Military Sea Transport Service (MSTS) provide

medical care and treatment while in transit from the theater of operations to the zone of interior.

### 107. Transport Ships (fig. 220)

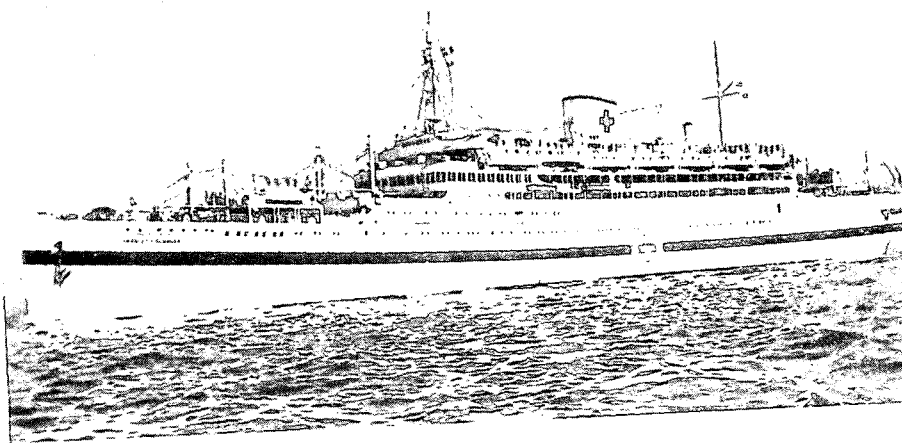
a. Certain attack-type transport ships are used as hospital ships. Transports selected for this purpose usually are arranged so deck space easily lends itself to the handling of litter patients and the installation of operating rooms, wards, and other facilities. The attack transport hospital ship, designated by the Navy as APH (followed by a number), is a fast troop transport, heavily armed, and equipped and staffed with special medical facilities and personnel for the care of embarked patients. Other transports, designated by the Navy as APA (followed by a number), although possessing no special hospital facilities other than those of any transport, are used for the reception and evacuation of patients from a theater of operations.

b. The staffing of transport ships with medical personnel is a Navy responsibility. Army and Air Force medical personnel may be assigned to supplement the ship's normal medical complement.

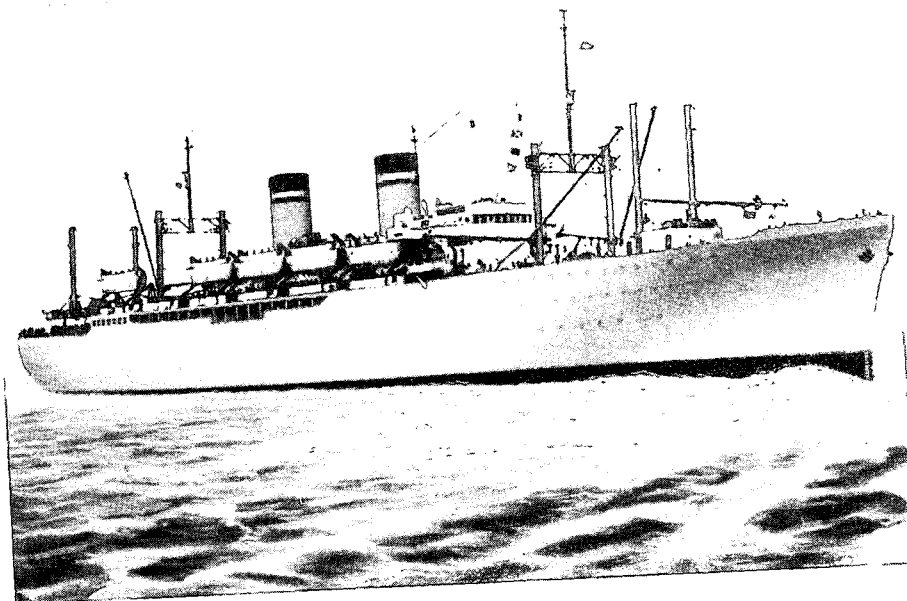
c. Because the primary use of transport ships is military in nature, they are not protected by the Geneva Convention.

### 108. Large Landing Craft (figs. 221, 222)

The large landing craft used in the transportation of the sick and wounded are exemplified by the Landing Ship, Tank (LST). The primary medical mission of this craft is the regulation of patient flow from the beach to transports and hospital ships. The craft is designed for the landing of personnel and equipment through a bow door and ramp. It has sufficient special medical personnel and facilities to render it capable of providing patient medical and surgical care aboard. It can carry 120 litter patients or 180 ambulatory patients.

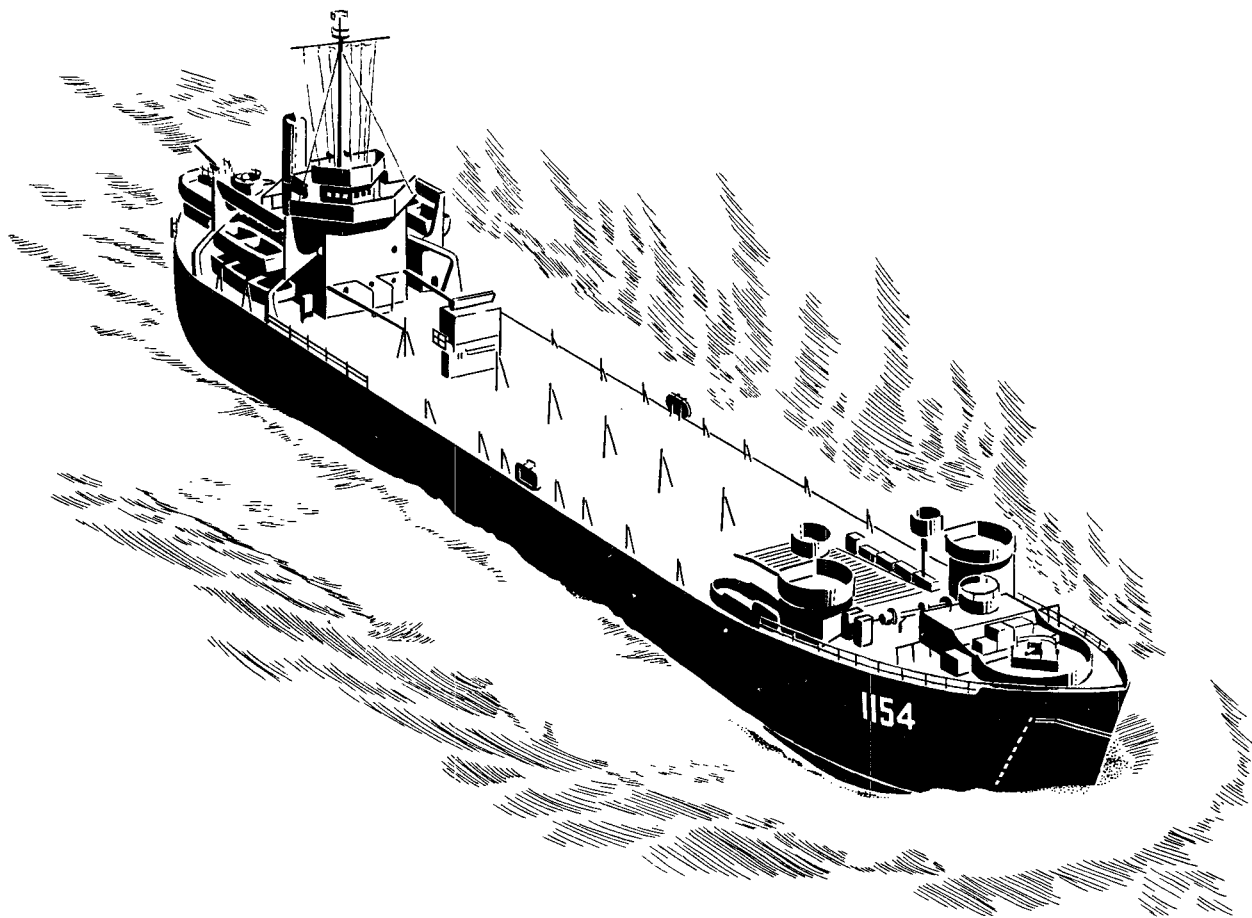


*Figure 219. Hospital ship.*

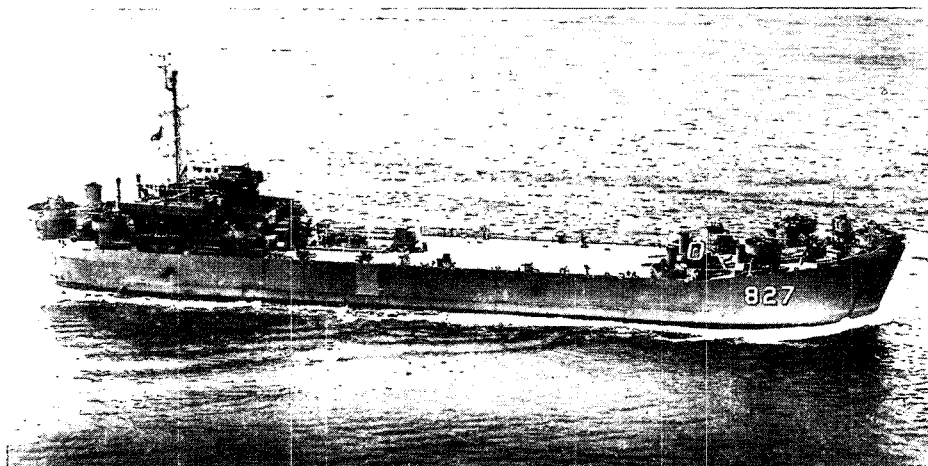


*Figure 220. Transport ship.*





*Figure 221. Landing ship, tank (LST), view from above.*



*Figure 222. Landing ship, tank (LST), view from side.*

## Section III. SMALL CRAFT

**109. General**

In the early phase of amphibious operations, docks or piers may be inaccessible or nonexistent and embarkation must be accomplished when the recipient ship is anchored at some distance from the shore. In these situations, the patients are transported from the beach to the ship by small craft, such as small landing craft, amphibious vehicles, and helicopters.

**110. Small Landing Craft**

The various types of small landing craft used in the evacuation of patients from shore to ship include the Landing Craft, Vehicle, Personnel (LCVP), the Landing Craft, Mechanized (LCM), and the Landing Vehicle, Tracked, Personnel (LVTP).

*a.* The LCVP (figs. 223, 224) has a patient capacity of 17 litter patients or 36 ambulatory patients. Only seven litter patients can be carried if the vehicle is to be hoisted aboard for loading.

*b.* The LCM-6 (figs. 225, 226) has a patient capacity of 30 litter patients or 120 ambulatory patients. The LCM-8 can carry 50 litter patients or 200 ambulatory patients.

*c.* The LVTP-5 (figs. 227, 228) can carry 34 ambulatory patients, and the LVTP-6 can carry 20 ambulatory patients.

**111. Amphibious Vehicles**

Amphibious vehicles are also used for patient evacuation from shore to ship.

*a.* *Truck, Amphibious, 2½ Ton (DUKW)* (fig. 229). This vehicle usually is available only to troops in or contemplating amphibious operations. It is most useful in transferring patients from shore to ships nearby. The same truck that moves supplies to the shore may carry patients back to the ship. The maximum capacity of the truck is 12 litter patients, six on the bottom and six on the top.

*b.* *Lighter, Amphibious, Resupply, Cargo, 5-Ton (LARC-5)* (fig. 230). The LARC-5 and other amphibious vehicles can also be used for patient evacuation from shore to ship.

**112. Methods of Embarkation**

Upon arrival at their ship, transport, hospital ship, or LST, patients are embarked from small craft in the following ways:

*a.* Litter hoist—manual or mechanical, singly or in multiples on prepared frames or platforms.

*b.* Ladder—Jacobs, or cargo net. This method is suitable only for fully ambulatory patients.

*c.* Hoisting of boat by davits to deck level.

*d.* Marriage of boat by davits to bow ramp of LST.

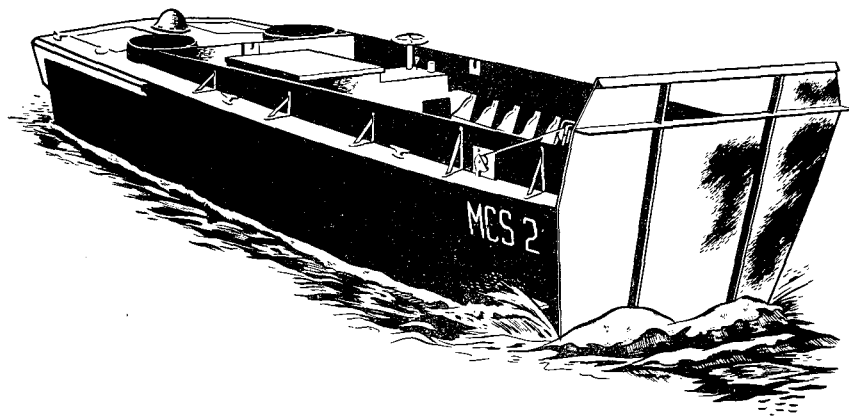


Figure 223. Landing craft, vehicle, personnel (LCVP).

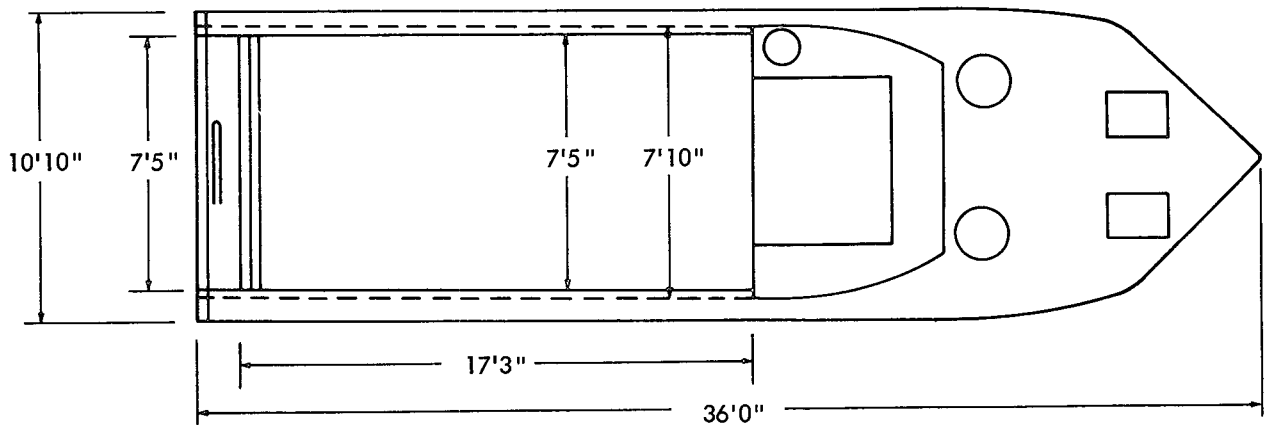
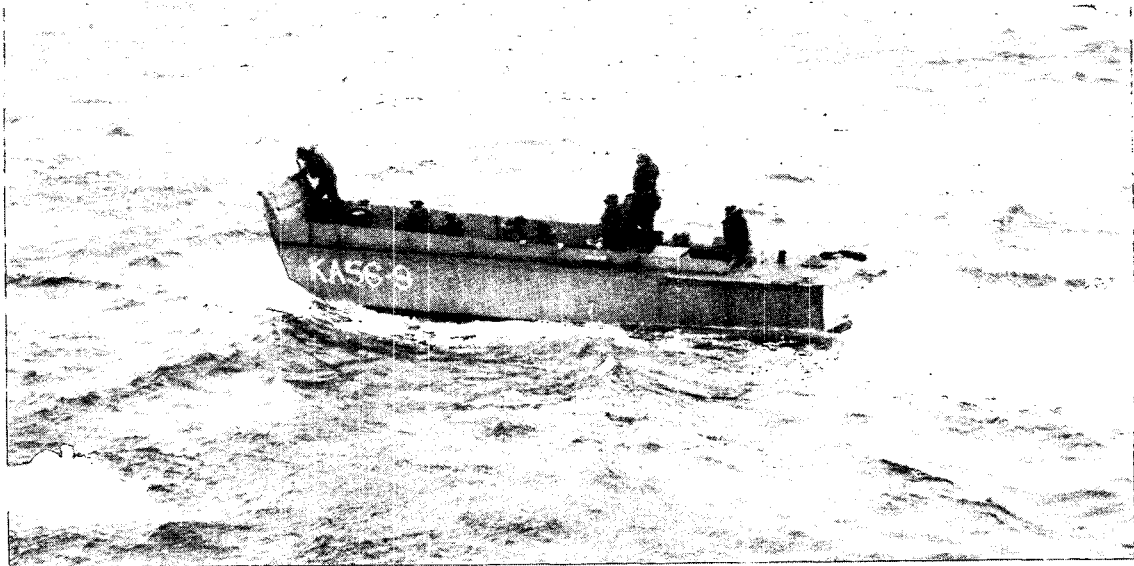
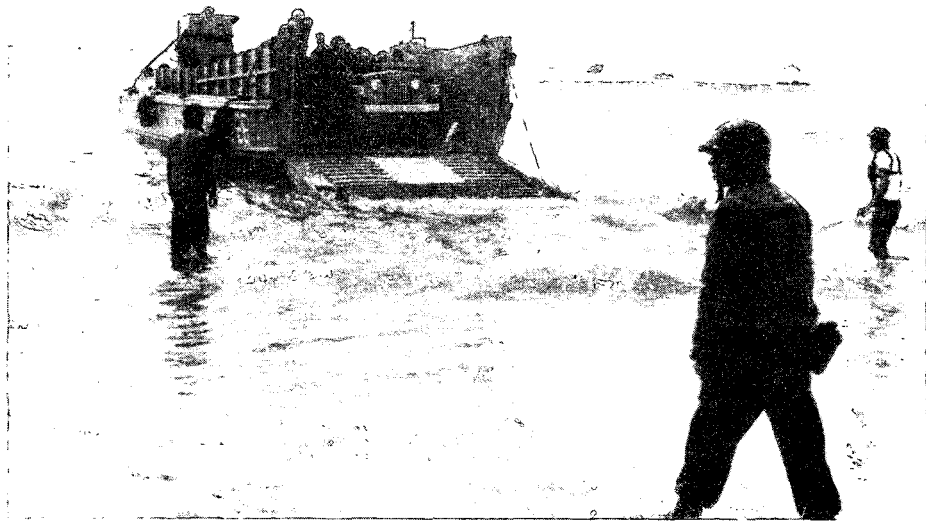
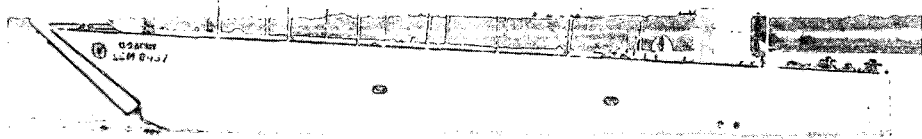


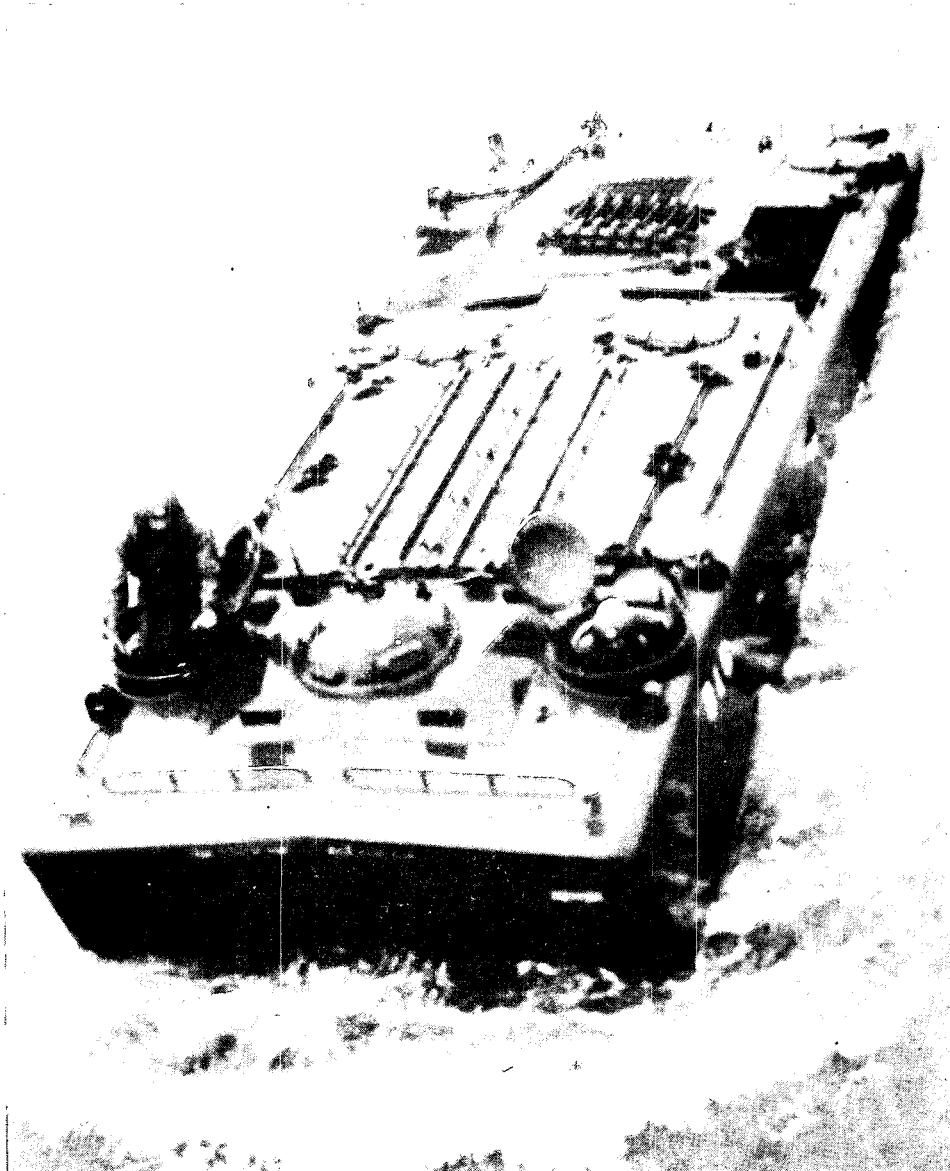
Figure 224. Landing craft, vehicle, personnel (LCVP), with diagram showing dimensions.



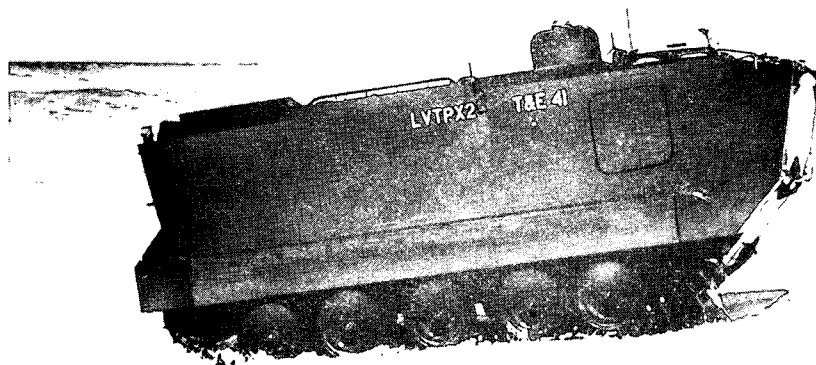
*Figure 225. Landing craft, mechanized (LCM-6).*



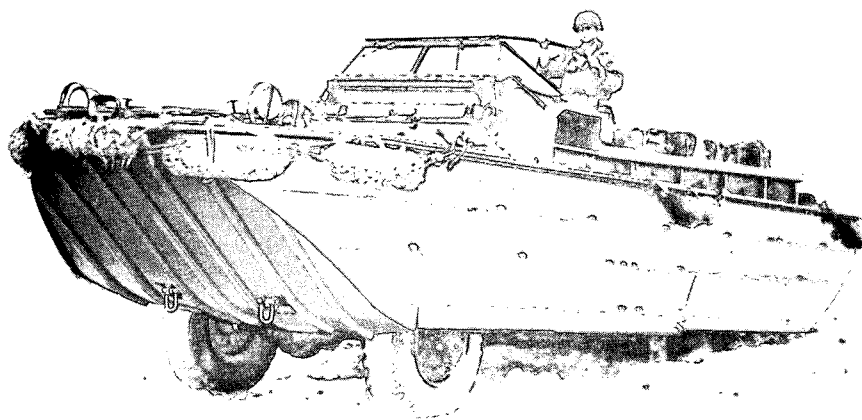
*Figure 226. Landing craft, mechanized (LCM-8).*



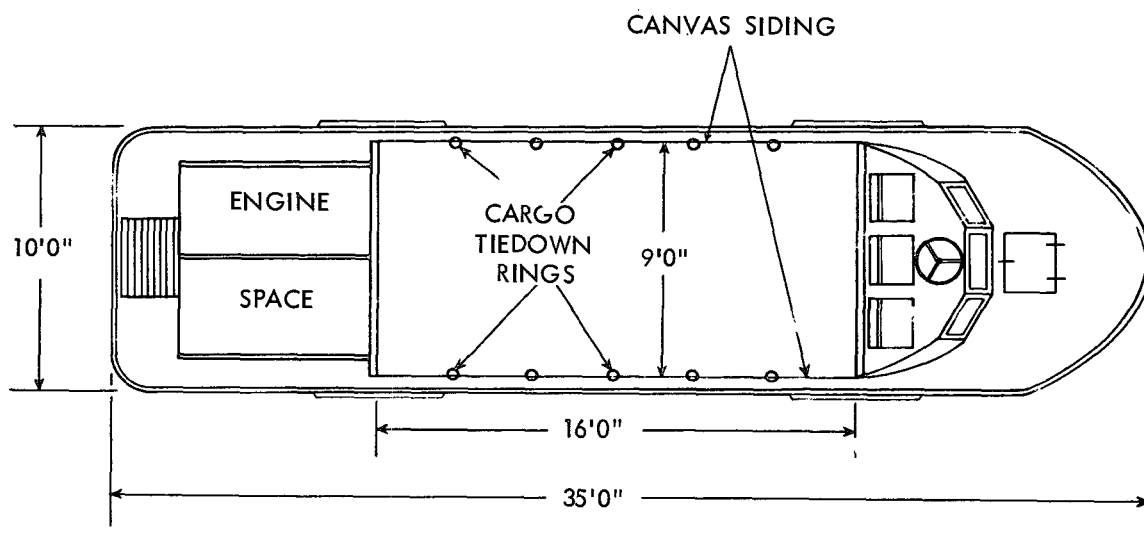
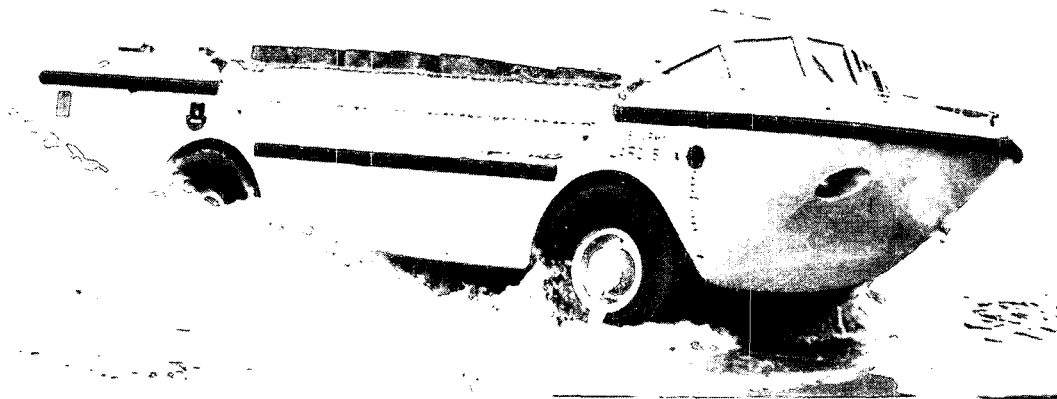
*Figure 227. Landing vehicle, tracked, personnel (LVTP-5).*



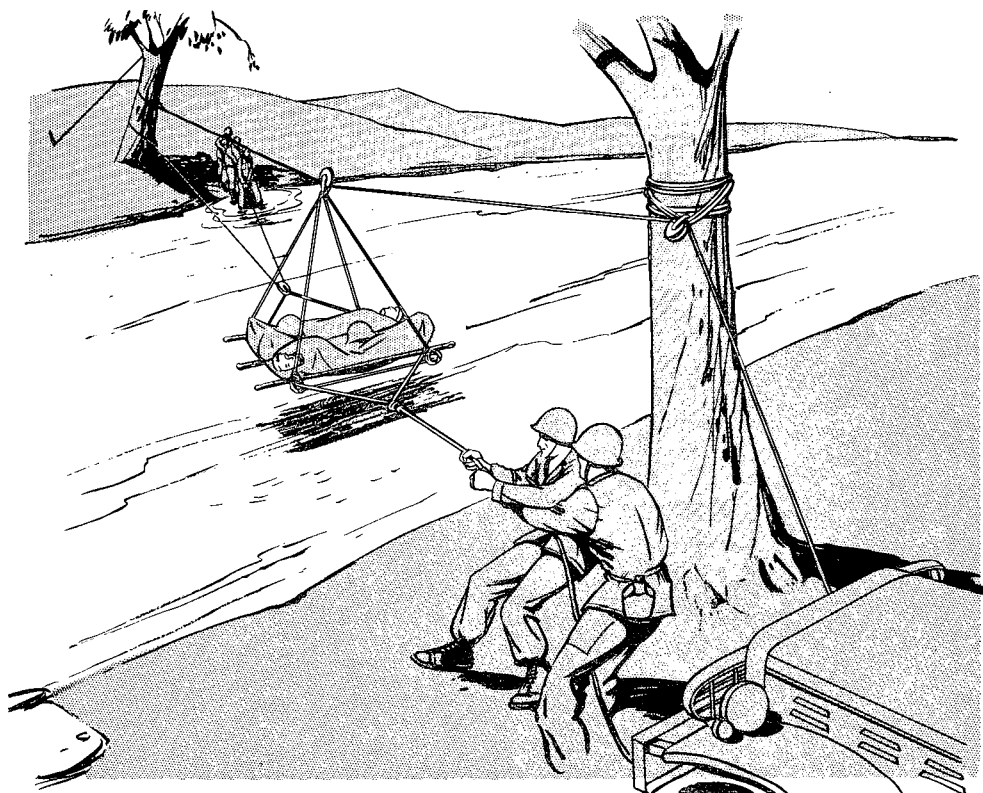
*Figure 228. Landing vehicle, tracked, personnel (LVTP-6).*



*Figure 229. Truck, amphibious, 2½ ton (DUKW).*



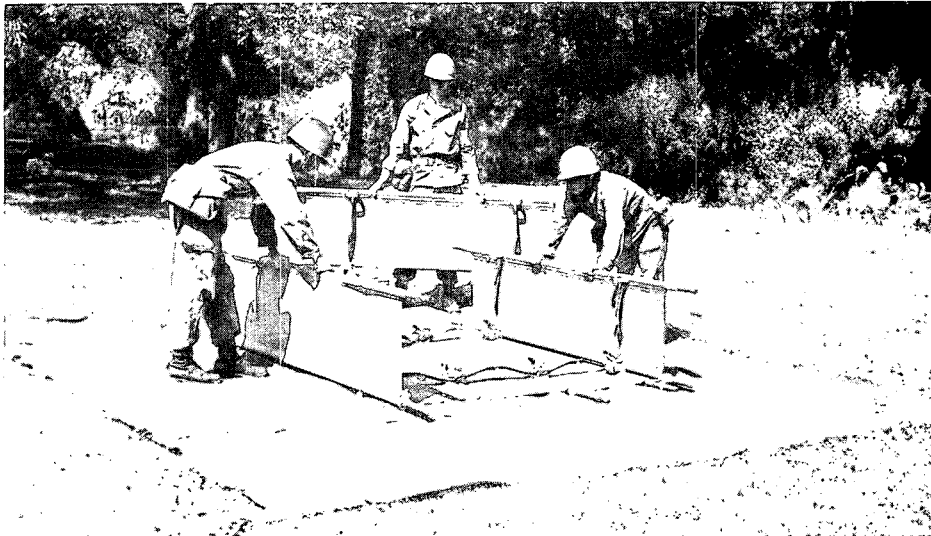
*Figure 230. Lighter, amphibious, resupply, cargo, 5-ton (LARC-5), with diagram showing dimensions.*



- a. String the cable of a 2½-ton winch truck through a pulley and fasten it to a tree.
- b. Carry it across the stream and fasten it to another tree or other holding device on the opposite shore.
- c. Allow a second pulley to run free along the cable.
- d. Take two saplings, poles, or other appropriate objects of the width of two litters, and suspend them from the second pulley by ropes. The litters rest upon these poles, with the litter stirrups just inside the poles and holding them in position.
- e. A man on the near shore pulls the litters across, and a second man, on the far shore, maintains control by holding them back, when necessary.
- f. When the litters have crossed, the patients are removed, the device is pulled back to the other side, and two more patients are sent across.

*Figure 231. Cable and sling method using winch cable from 2½-ton truck.*





- a. Spread the paulin open on the ground, and place three litters, stirrups up, in its center.
- b. Place the other four litters on their sides to form the basis of the four walls of the raft, their handles interlocking and lashed together with lengths of rope.
- c. Lift the sides of the paulin, fold sides over the four litters and tie in place, thus completing the raft walls.

*Figure 232. Litter and paulin raft, construction.*



*Figure 233. Litter and paulin raft, patient being transported.*

e. Embarkation of DUKW or LVTP on LST via bow ramp.

## 113. Assault Boats

Engineer assault boats, when available, are readily adaptable for use in patient evacuation across rivers or other small bodies of water. Two litter patients can be placed lengthwise in the bottom of the boat and four above them crosswise, with the litter handles resting on the gunwales and the litter stirrups just inside the boat holding the litters in place. Room is thus allowed in the bow and stern for personnel to paddle the boat.

## 114. Cables and Rafts

a. *Cables* (fig. 231). Two litter patients can be transported across the stream by the cable

and sling method. The entire apparatus can be erected in less than half an hour with the use of equipment readily available to medical troops. Once constructed, it permits an uninterrupted flow of litter patients across the stream. Because of the limited length of the cable available, the use of this method is restricted to bodies of water less than 200 feet in width.

b. *Litter and Paulin Raft* (figs. 232, 233). Two litter patients plus escort can be transported across a river, lake, or small body of water by a litter and paulin raft. A raft may be constructed of seven litters and the paulin from a 2½-ton truck. With proper direction, it can be constructed in 15 minutes even by untrained men. It is very stable and can be operated by paddling or being pulled.

APPENDIX

REFERENCES

AR 40-2	Army Medical Treatment Facilities—General Administration.
AR 40-4	Army Medical Service Facilities.
AR 40-20	Evacuation of Patients.
AR 40-535	Worldwide Aeromedical Evacuation.
AR 95-100	Clarification of Roles and Missions of the Departments of the Army and the Air Force Regarding Use of Aircraft.
AR 320-5	Dictionary of United States Army Terms.
AR 320-50	Authorized Abbreviations and Brevity Codes.
AR 700-26	Designating, Redesignating, and Naming Military Aircraft.
DA PAM 108-1	Filmstrips, Slides, Tapes, and Phono-Recordings.
DA PAM 108-2	Film Reference Guide for Medicine and Allied Sciences.
DA PAM 310-2	Index of Blank Forms.
DA PAM 310-3	Index of Doctrinal, Training and Organizational Publications.
DA PAM 310-4	Index of Technical Manuals, Technical Bulletins, Supply Manuals (types 7, 8 and 9) Supply Bulletins, Lubrication Orders, and Modification Work Orders.
FM 1-5	Army Aviation Company Organization and Employment.
FM 1-100	Army Aviation.
FM 8-5	Medical Service Units, Theater of Operations.
FM 8-10	Medical Service, Theater of Operations.
FM 21-11	First Aid for Soldiers.
FM 22-5	Drill and Ceremonies.
FM 31-12	Army Forces in Amphibious Operations (The Army Landing Force).
FM 31-72	Mountain Operations.
FM 60-30	Embarkation and Loading Amphibious.
FM 101-10-1	Organization, Technical, and Logistical Data, Part I—Unclassified Data.
TM 5-270	Cableways, Tramways and Suspension Bridges.
TM 8-230	Medical Corpsman and Medical Specialist.
TM 9-500	Data Sheets for Ordnance Type Materiel.

By Order of the Secretary of the Army:

HAROLD K. JOHNSON,  
*General, United States Army,*  
*Chief of Staff.*

Official:

KENNETH G. WICKHAM,  
*Major General, United States Army,*  
*The Adjutant General.*

Distribution:

To be distributed in accordance with DA Form 12-11 requirements for transportation of Sick and Wounded.