

# Professional Knowledge Gained from Operational Experience in Vietnam, 1967



**U.S. Marine Corps**



DEPARTMENT OF THE NAVY  
Headquarters United States Marine Corps  
Washington, DC 20380-0001

8 August 1989

## FOREWORD

### 1. PURPOSE

Fleet Marine Force Reference Publication (FMFRP) 12-41, *Professional Knowledge Gained from Operational Experience in Vietnam, 1967*, is published to ensure the retention and dissemination of useful information which is not intended to become doctrine or to be published in Fleet Marine Force manuals. FMFRPs in the 12 Series are a special category of publications: reprints of historical works which were published commercially or by the U.S. Government Printing Office and are no longer in print.

### 2. SCOPE

This reference publication complements existing training manuals on small-unit tactics, patrolling, weapons, mines and boobytraps, and leadership. Written by a multitude of Marines during the Vietnam War, this volume is an excellent compendium of lessons to be learned from the Marine Corps' experience in 1967. It is enthusiastically recommended to all junior officers, SNCOs, and NCOs who will profit from the principles presented.

### 3. CERTIFICATION

Reviewed and approved this date.

BY DIRECTION OF THE COMMANDANT OF THE MARINE CORPS



M. P. SULLIVAN

Major General, U.S. Marine Corps  
Deputy Commander for Warfighting  
Marine Corps Combat Development Command  
Quantico, Virginia

DISTRIBUTION: "TL7"



## TABLE OF CONTENTS

<u>Chapter</u>	<u>Page</u>
I MARINES IN VIETNAM - 1967	
III MAF Balanced Campaign.....	1
Operations in the DMZ Region.....	4
Operations in the Nui Loc Son Basin.....	8
Amphibious Operations of 7th Fleet's Special Landing Forces.	11
Small Unit Counter guerrilla Operations.....	14
Revolutionary Development and Pacification.....	16
II TACTICS	
Rules of Engagement.....	21
Offense.....	30
Defense.....	55
Ambush Tactics.....	80
Monsoon Operations.....	91
Land Navigation and Movement....	93
Snipers.....	104
Artillery.....	109
Tracked Vehicles.....	124
Intelligence.....	132
Dogs in III MAF.....	141
The Combined Action Company....	146
Kit Carson Scouts.....	152
Riverine Operation.....	157
Weapons and Munitions.....	169
U.S. Army Battalion Commander..	184

<u>Chapter</u>	<u>Page</u>
III NATURE OF THE ENEMY	
The Enemy.....	189
NVA/VC Registration Technique ..	207
Enemy Fortifications .....	208
Enemy Employment of RPG-2	
Antitank Rocket Launchers .....	209
Enemy Snipers.....	210
VC Warning Device.....	212
VC Tricks.....	213
VC Deception.....	214
VC Attacks.....	216
VC Counterambush Technique.....	217
Viet Cong River-Crossing Tech- niques.....	218
Viet Cong Medicine.....	219
Overt Viet Cong Meetings .....	225
Viet Cong Rice Ration .....	226
VC Topographical and Military Symbols .....	229
IV AVIATION	
The Helicopterborne Assault .....	247
Helicopter Retraction.....	257
Reconnaissance Party Insertion and Extraction.....	262
Combat Resupply by Helicopter....	267
Medical Evacuation by Helicopter.	275
Monsoon Weather Flying.....	285
Night Helicopter Operations .....	288
Pilots Briefing on Emergency Missions .....	290

<u>Chapter</u>	<u>Page</u>
IV AVIATION (Continued)	
Reaction Force Deployment by	
Helicopter .....	292
Helicopter Limitations.....	293
Helo-Ground Communications ...	295
Interference and Bogus Trans-	
missions .....	296
Helicopter Crew Protection .....	297
Helicopter Gunners .....	298
Ordnance Loading for Armed	
UH-1E Helicopters .....	299
Aircraft Bilge Drainholes.....	300
Visual Reconnaissance From	
Helicopters .....	301
Tip for Aircrews .....	302
Prevention of Midair Collisions	
in Low Visibility .....	302
Increasing Helicopter Visibility..	303
TACAN Maps .....	303
Monsoons and Map Changes .....	304
You Are Mr. Clean .....	304
Use of SATS Loader and Univer-	
sal Weapons Cradle When	
Loading Napalm and 2.75-	
Inch Rockets on the F-4B.....	305
RCPT-105 Dual Starting System .	307
SERE Kits .....	307
F-4 Drag Chute Door Latch .....	308

<u>Chapter</u>	<u>Page</u>
IV AVIATION (Continued)	
Altitude Separation.....	309
Night Air Attacks.....	310
Keep a Clean Cockpit .....	310
Employment of A-6A Aircraft.....	311
Airstrike Tactics .....	312
NATOPS Program .....	313
Pilot Frequency Cards .....	314
C-117D Maintenance .....	314
V MINE WARFARE	
Definitions .....	315
Facts We Have Learned About Viet Cong Manufacture and Use of Mines, Sabotage Devices and Boobytraps.....	317
Punji Pits .....	340
Boobytrapped Enemy Propaganda Displays.....	341
VC/NVA Mine Tactics.....	342
Tricks Frequently Employed by VC/NVA.....	345
Antitank Boobytraps.....	349
Defense Against Mines .....	350
Detection of Antitank Mines.....	353
Probe Culverts .....	353
Rough Rider Mine Sweep.....	354
Converging Mine Sweep Teams....	355
Mine and Explosive Device Pro- tection .....	357



<u>Chapter</u>	<u>Page</u>
V MINE WARFARE (Continued)	
VC Construction Block Mine.....	357
VC/NVA Utilization of Mines.....	358
VI COMMUNICATIONS	
Radio Operators.....	359
AN/PRC-25 .....	360
AN/PRC-25 Battery Installation ..	362
AN/PRC-47 Radio .....	363
Antennas.....	364
Backup Communications .....	367
Record Friendly Frequencies .....	368
Vehicular Radios.....	369
Squad Level Radio .....	370
External Power Source Telephone TA-312 .....	372
Ground Return Communications ...	373
Field Wire Line Tests.....	373
Switchboard Operations .....	375
SB-86 Switchboard Demagnetiza- tion .....	376
Protect Power and Communication Cables .....	377
Protect Communication Compo- nents .....	377
Security for Wire Teams .....	378
Communication Security .....	379
Checklist for Communications.....	381

<u>Chapter</u>	<u>Page</u>
VII LOGISTICS	
MILSTAMP and MILSTRIP.....	383
Embarkation.....	385
Supply Economy .....	389
Field Expediency.....	392
Maintenance .....	398
Spare That Bridge .....	410
Generators.....	411
Sanitizing Food Service	
Equipment .....	413
Flak Jacket Repair .....	414
Long Range Patrol Rations.....	414
VIII CIVIC ACTION - PSYCHOLOGICAL OPERATIONS	
Revolutionary Development .....	417
Civic Action .....	420
Understanding the Vietnamese .....	427
Chieu Hoi Program.....	439
County Fair.....	443
Psychological Warfare in Vietnam .	447
Population and Resources Control.	460
IX MEDICAL	
Prevention, Not Treatment.....	465
Acclimating Marines to Hot-Wet	
Climate.....	466
Heat Casualties.....	473
Medical Problems in the Monsoon	
Season .....	475
Tips From the Corpsmen .....	478

<u>Chapter</u>	<u>Page</u>
IX MEDICAL (Continued)	
Night Medical Evacuation.....	479
Malaria Preventive Treatment..	480
Leech Bites.....	480
Plasma Expander .....	481
Field Ambulance Support .....	481
Mobile MEDCAP .....	482
Intravenous-Injection Supply	
Chest.....	483
Portable Stand for Intravenous	
Solutions.....	483
Poisonous Snakes of Vietnam....	484



Chapter I: MARINES IN  
VIETNAM - 1967



1. III MAF BALANCED CAMPAIGN

The focal point of the Vietnam war in 1967 was in I Corps Tactical Zone. As the year progressed, the DMZ region of northern Quang Tri Province and, to the south, the Nui Loc Son Basin, emerged as primary scenes of contention. It was in these areas that the enemy, seeking to stem exploitation of the III MAF balanced campaign, marshaled major formations and resources.

The enemy's motive for combat in the jungle highlands of the DMZ was clear. Protection of his guerrilla infrastructure, the key to his influence among the population of the coastal lowlands, demanded a diversion of the U.S./GVN

forces involved in the lowland pacification effort. The enemy knew that invasion of South Vietnam, or the threat of invasion, would probably draw friendly power into northern Quang Tri Province, thus drawing attention from the joint U.S./GVN Pacification Program. The Nui Loc Son Basin, located between Danang and Chu Lai, was a major source of the enemy's rice, manpower, and intelligence. He could not afford to relinquish it to Free World forces without a fight. These two areas, the DMZ and the Nui Loc Son Basin, were therefore of critical importance to the enemy if he was to impede the Pacification Program by drawing allied forces into the hinterland and at the same time retain a degree of control over the rice rich Nui Loc Son Basin.

The III MAF balanced campaign consisted of: (1) large unit operations, (2) small unit counter-guerrilla operations and (3) Revolutionary Development and Pacification.

Centered primarily in the DMZ region and, to the south, in the Nui Loc Son Basin, III MAF units and the 7th Fleet's Special Landing Forces conducted 116 battalion or larger size operations. In this effort, the Marines defeated the enemy's four major invasion attempts across the DMZ, inflicting heavy personnel losses on him.

The small unit counter-guerrilla element of III MAF's 1967 balanced campaign established a record pace of operations, showing an increase of 180 percent over the 1966 total.

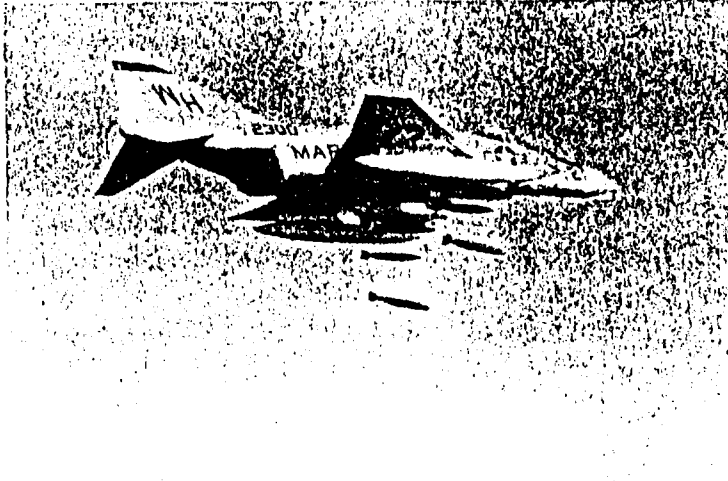

---

In support of large unit and small unit counter-guerrilla operations, Marine fixed-wing and helicopter operations also accelerated, keeping pace with the intensified operations of III MAF, ARVN, and other Free World forces in I CTZ.

By mid-year, and after a period of regression, the Revolutionary Development Program began to show signs of power and cohesion. Due in part to the increasing competence exhibited by ARVN forces assigned in support, the U.S./GVN program displayed modest progress during the latter half of 1967. III MAF's combat successes, coupled with the accomplishments of the ARVN in support of RD and the success of the Vietnamese national elections, created conditions in 1967 which allowed 250,000 people to flee the

Viet Cong and find a refuge with the Government. These same conditions were a major factor in the record number of enemy defections, which was up 54 percent over the 1966 total.

#####

## 2. OPERATIONS IN THE DMZ REGION

Operations in the DMZ region during 1967 were marked by four periods of intense combat: in late February and early March, in late April and early May, in early July, and throughout most of September. Each period reflected a major enemy combined arms effort to achieve a victory in northern I CTZ by means of a trans-DMZ invasion. Each effort was defeated by a combination of Marine ground/helborne maneuver and the supporting fires of air, artillery, and naval gunfire.

The initial 1967 enemy invasion effort was signaled in February by aerial reconnaissance detection of substantial troop and supply train movement north of the Ben Hai River. The enemy offensive followed closely III MAF's initiation of artillery attacks into the DMZ and North Vietnam. Authorized on 25 February by COMUSMACV, the artillery attacks were aimed at the destruction of known and suspected enemy troop and supply installations previously immune from friendly fires.





The enemy's marshaling areas, weapons positions, and logistic installations were damaged by these fires, and his reaction was rapid. Beginning on 26 February, he launched a series of mortar and rocket attacks against the Marines' northern positions, followed by a large-scale thrust across the DMZ--an attempt to silence the firing positions. This enemy effort was repulsed northwest

of Cam Lo by Operation PRAIRIE, conducted in coordination with the Special Landing Force of the 7th Fleet in Operation BEACON HILL, a heliborne/amphibious assault against the enemy's east flank. NVA losses were 1,107 killed.

The second major enemy offensive occurred in late April and early May, when he advanced a strong force--three NVA regiments--against Khe Sanh in the western DMZ area, and also attempted concurrently to overrun the outpost at Con Thien in the eastern sector of northern Quang Tri Province. In the Khe Sanh area, aggressive patrolling detected the presence of the 325C NVA Division before the enemy could launch his attack. This encounter triggered a powerful Marine air/ground team counterattack, which defeated the enemy's forces, during the first week of May, in the Hill 861-881 complex northwest of Khe Sanh. At Con Thien, meanwhile, an NVA two-battalion, mortar supported attack was thrown back with heavy losses on 8 May.

Exploiting the defeat inflicted on the enemy, III MAF invaded the southern half of the DMZ in mid-May. This combined operation, which involved Marines of III MAF and the Special Landing Forces, along with ARVN units, opened Route 561 north from Cam Lo and forced the enemy's retreat across the Ben Hai River into NVN. NVA casualties in May were 1,880 dead--the largest monthly total in the DMZ area through the end of 1967.

In July, the enemy's invasion effort was marked by increased heavy weapons fire support from his NVN sanctuary. Long range Russian artillery weapons, introduced in April, delivered a heavy volume of fire against Marine installations near the DMZ, as a five-battalion NVA invasion force once again crossed the provisional military demarcation line. On 2 July, a Marine company engaged this enemy force two miles north of Con Thien. III MAF's Operation BUFFALO, complemented by amphibious Operations BEAR CLAW and BEAVER TRACK, maneuvered to flank the NVA battalions, and by mid-July, the enemy had withdrawn to the north, suffering the loss of over 1,300 killed.

The enemy's fourth invasion attempt, launched in September and again directed at the Marine strong point at Con Thien, was characterized by the largest volume of heavy weapons fire yet fired on the Marines (over 9,000 rounds of artillery, mortar, and rocket fire, of which 6,058 rounds, or 87 percent fell on Con Thien). The operation was begun with the movement of the 812th NVA Regiment into an attack position south of Con Thien. Detected in its early stages by Marine patrols, the enemy effort was defeated by a combined arms counterattack.

At year's end, the enemy was engaged in a major buildup in the western DMZ area near Khe Sanh.

#####

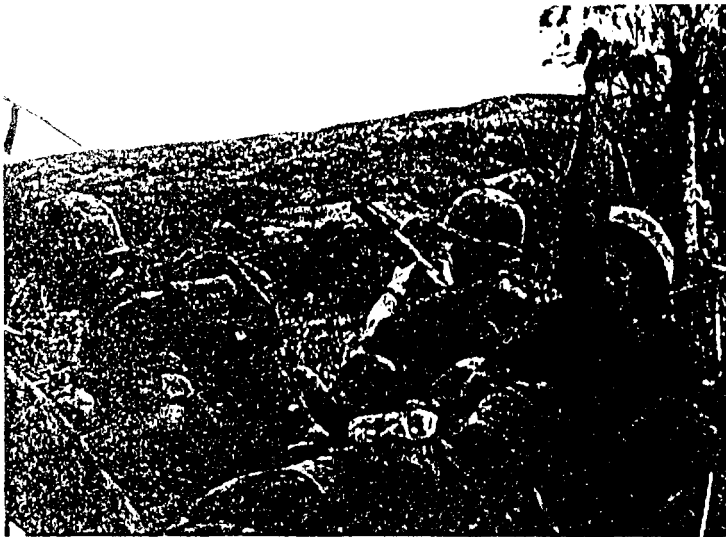

### 3. OPERATIONS IN THE NUI LOC SON BASIN

The April to May arrival of Task Force Oregon in the southern sector of I CTZ freed two Marine battalions for deployment into the Nui Loc Son Basin region, midway between Danang and Chu Lai. Prior to April 1967, although desirable, there had been little opportunity to conduct a major offensive in this area.

In April, a Marine patrol operating near Nui Loc Son ridge made contact with a large enemy force and triggered the UNION series of operations. For a period of 6 weeks, heavy fighting ensued, with Marines of III MAF and the 7th Fleet's Special Landing Forces combining heli-borne and ground maneuver to inflict a succession of defeats on the 3d and 21st NVA Regiments.

By early June, hard results were evident. At least 1,747 enemy had been killed, with hundreds more estimated to have died in bunkers and tunnels collapsed by artillery and air attacks. More important, however, was the reaction of the local Vietnamese population, which, encouraged by the continuing presence of friendly forces, began to respond favorably to the U.S./GVN pacification effort.



The enemy's reaction was violent. By mid-August, he had deployed the entire 2d NVA Division (the 3d and 21st NVA Regiments, and the 1st VC Regiment), into the Nui Loc Son region, making it clear that he intended to contest the U.S./GVN presence. Subsequently, Marine Operations ADAIR, PIKE, COCHISE, and SWIFT, coordinated with Special Landing Force amphibious Operations BEACON TORCH and BEACON GATE

and U.S. Army Operations BENTON, WHEELER and WALLOWA, trapped the 2d NVA Division between the Marines on the north and the Army on the south. ARVN units, which had made a commendable showing during UNION I and II, also make a significant contribution to the continuing effort, accounting for a total of 418 enemy killed in LIEN KET, 112 and 116 in August and September.

The enemy's attempts to escape were unsuccessful. In August, his forces were driven south out of the basin by Marines in Operation COCHISE, only to be chased back to the north by the U.S. Army Operation BENTON. In September, two of the regiments, the 1st VC and 3d NVA, were attacked in Operation SWIFT and lost 571 killed to the Marine air-ground team, as Marine air flew 535 attack sorties in support of the ground maneuver. Operation WHEELER concluded the entrapment, as three U.S. Army battalions moved into the area west of Tam Ky, cutting off the enemy's escape route.

During the period 22 April - 30 September, friendly forces killed 4,222 enemy troops in the Nui Loc Son Basin, the 2d NVA Division had been reduced to only marginal combat effectiveness, and the enemy, at end-September, no longer enjoyed free access to the population and resources of the Quang Nam-Quang Tin border region. In October, the arrival in I CTZ of the 3d Brigade, 1st Air Cavalry Division (Airmobile) freed two Marine battalions for deployment

out of the Nui Loc Son area of operations, northward to the DMZ region.

#####

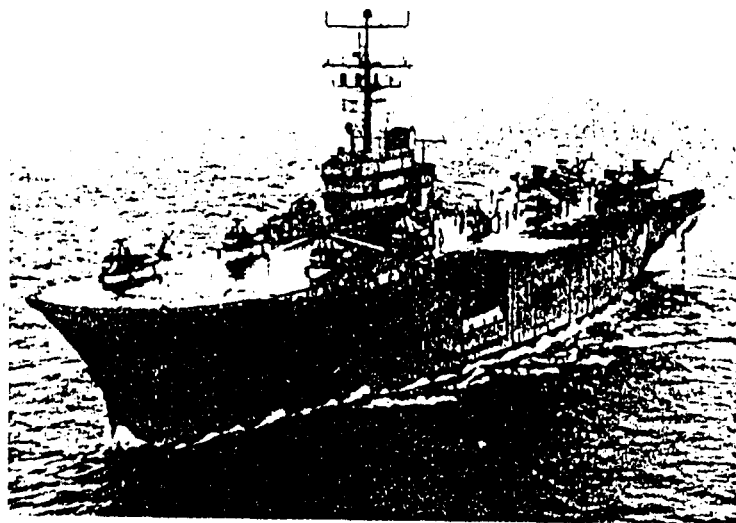

#### 4. AMPHIBIOUS OPERATIONS OF 7TH FLEET'S SPECIAL LANDING FORCES

Integrated with, and complementing the success of III MAF's large unit operations in 1967 were the Special Landing Forces of the 7th Fleet.

Taking advantage of the flexibility inherent in existing amphibious doctrine, the SLF's operations in 1967 were conducted under a special arrangement established to meet the specific needs of the Vietnam conflict.

Each of the two Special Landing Forces (the second SLF was activated on 1 April 1967) consists of a Marine battalion landing team and a Marine helicopter squadron. Embarked in ships of the 7th Fleet's two Amphibious Ready Groups, the SLF's are capable of projecting their power ashore either in an independent operation or in support of combat maneuver already underway by shore based ground units.

It is in this latter role that the most noteworthy results are achieved, employing the "hammer and anvil" technique to trap enemy forces already pinioned ashore, or to drive the enemy into a prepositioned blocking force. Employed almost exclusively in this manner to support and influence a scheme of maneuver ashore, the Special Landing Forces accounted for a total of 2,134 enemy killed in 25 amphibious operations in 1967.

However, the number of enemy killed by the landing force does not reflect a true measure of the success of amphibious operations, since the landing force should also be credited with being the instrument which drives the enemy, in many cases, into the killing area of forces ashore, thus contributing materially to the success of the companion operation already established ashore.

In addition to the amphibious operations by the Special Landing Forces to support operations ashore in the DMZ, the six operations discussed





below portray the contribution made to the war by the amphibious arm during 1967.

In February, Special Landing Force Alfa landed against the exposed flank of enemy units engaged with Marines in southern I Corps.

In late April, Special Landing Force Alfa cut off the retreat of elements of the 2d NVA Division attempting to escape from Marine operations in the Nui Loc Son Basin. Marines of III MAF and the Special Landing Force combined to kill 1,046 enemy troops in this effort.

In May, both Special Landing Forces executed heliborne assaults into the DMZ, joining the scheme of maneuver of Marine Operation HICKORY and ARVN Operation LAM SON 54. In

this, the first penetration of the DMZ, enemy casualties were counted at 837 dead.

In June and July, Special Landing Forces Alfa and Bravo assaulted the beaches northwest of Hue and, in each case, drove an enemy battalion into waiting ARVN forces. These two efforts accounted for a total of 535 enemy killed.

In August, Special Landing Force Alfa set a blocking position between Thang Binh and Tam Ky, trapping elements of the 21st NVA Regiment in the Nui Loc Son Basin. III MAF and ARVN units combined with the Special Landing Force to kill 384 enemy.

#####

## 5. SMALL UNIT COUNTERGUERRILLA OPERATIONS

The major result of III MAF's counter guerrilla campaign has been the continued erosion of the guerrilla structure, to such an extent that basically qualified replacements for the Viet Cong forces, once drawn from the VC's manpower pool of irregulars, now include increasing numbers of NVA soldiers. In the spring of 1965, nearly all enemy forces in I CTZ were Viet Cong while, by the end of 1967, nearly 60 percent of the main force enemy was composed of North Vietnamese Army regulars. The replacement NVA regular, operating in unfamiliar terrain and among peasants who both fear and distrust the soldiers of the north, is at a disadvantage.



He does not blend into the population with the ease displayed by his home-grown VC predecessor, nor is he as readily accepted. Sometimes poorly fed, possibly suffering from malaria, the NVA regular finds it difficult to rival the effectiveness of the local guerrilla.

His one advantage lies in the weapons carried by his parent unit from North Vietnam. This was the source of the rockets, manpack flamethrowers, and tear gas first used against Free World forces in I CTZ in 1967. And, because of his possession of the more modern NVA weaponry, the guerrilla enemy increased his rate of mortar, rocket and artillery attacks during the year.

#####



## 6. REVOLUTIONARY DEVELOPMENT AND PACIFICATION

During 1967, the enemy accelerated his campaign to disrupt the Revolutionary Development Program, but to little avail. Vietnamese civilians, seeking security and protection, continued their alignment with the GVN in growing numbers.

The GVN/III MAF Pacification Program began a resurgence in April, gained momentum in mid-summer, and reflected significant accomplishment by year's end. The 1967 increase of nearly 200,000 people considered by III MAF to be living in secure areas is one indicator. A record number of enemy defections (2,539), an increase from 280,000 in January to 530,000 at end-December in the number of civilians seeking refuge from Viet Cong domination, and an increase in the impact of the Combined Action Program on the advancing security of the Vietnamese countryside, all lent credence to the expanding influence of the GVN in the I CTZ.

a. Elections

The most significant manifestation of progress during 1967 in the RD and Pacification Programs was the series of hamlet through national-level elections. Having begun in September 1966 with the election of the national constitutional convention, the process of democratic selection culminated in October 1967, with the election of a national constituent assembly. This voting process entailed the selection of village officials in April, the hamlet elections in May, and the choosing of the national executive branch on 4 September.

The enemy, recognizing the threat these elections posed to his objectives, launched an I CTZ-wide campaign of terror and intimidation against the voting populace. Aimed at discrediting



the entire process by limiting the voter turnout to an insignificant sampling of the people, this campaign was a failure, as 82.3 percent and 78.8 percent of the eligible voters in I CTZ went to the polls during the village and hamlet elections, respectively.

Following the failure of his earlier anti-election efforts, the enemy vowed that the September elections would not be held. A well-coordinated sequence of murders, kidnappings and attacks against government facilities and military installations was initiated in early August, reaching a crescendo as election day, 4 September, approached. Despite the total of 673 innocent civilians killed or kidnapped, and the 272 acts of violence aimed at the electorate, 86 percent of the eligible Vietnamese people in I CTZ, in

defiance of the enemy terrorists, voted for the candidates of their choice.

The October elections were a reinforcement of the victories won earlier in 1967. The Viet Cong, realizing the free Vietnamese were not to be kept from the polls, did not wage their expected campaign of terror. In consequence, there was very little anti-election activity throughout the five provinces. Again the people voted, with 77.9 percent of the eligible voters casting their ballots.

# # # # #





Chapter II: TACTICS



1. RULES OF ENGAGEMENT

The rules of engagement set forth below are used by one Marine unit in the densely populated areas of Vietnam to minimize noncombatant

personnel and property losses which may occur in the execution of military operations.

a. General

The use of unnecessary force leading to noncombatant battle casualties in areas temporarily controlled by the enemy will embitter the population, drive them into the arms of the enemy and make the long range goal of RD more difficult and costly. Accordingly, these circumstances call for the exercise of restraints not normally required on the battlefield. All unit commanders must apply only that force necessary to accomplish their mission, giving due regard to the safety of their command and the importance of preventing injury to the noncombatant populace.

Incidents of noncombatant casualties and destruction of property by RVNAF and Free World combat forces are exploited by the enemy to the fullest extent to enhance their objectives, to foster resentment against the GVN and to effect the permanent alienation of the people from the Government.

A unit must establish the reputation of being able to move at will throughout assigned area of responsibility and to defeat any enemy force encountered. Concurrently, units must constantly demonstrate their concern for the safety of noncombatants, compassion for the injured and willingness to aid and assist the sick, hungry, and dispossessed.

b. Application

All commanders are directed to plan and conduct operations in accordance with the following guidelines:

➔ Both the military and psychological objectives of each operation will be considered. Strikes in populated areas, reconnaissance by fire into hamlets, and poorly selected harassing and interdiction fires are examples of military measures which will be counterproductive in the long run.



➔ Troop indoctrination briefings will be held before each operation to emphasize both the short and long range importance of minimizing noncombatant battle casualties. These briefings will include the location of noncombatants

and friendly forces, measures to prevent mutual interference, safety precautions for fire control support, rules of engagement, identification and recognition signals, emergency procedures and other appropriate matters.

→ Concurrent air/ground planning to ensure that proper selection of helicopter landing zones and the proper employment and integration of artillery, naval gunfire, and airstrikes will avoid unnecessary damage to lives and property of noncombatants.

→ All persons involved in the control and coordination of supporting arms will be briefed on areas to be avoided due to the presence of friendly or potentially friendly populace. Such information must be sought from local officials at province and district levels.

→ Specified strike zones should be configured to eliminate populated areas except those in accepted enemy bases.

→ Operations should be planned in coordination with province and district chiefs with due regard to security of plans. A liaison officer from Marine forces conducting operations in a particular province should be positioned at the district headquarters for coordination. The district advisors will perform this function in the absence of a liaison officer.

→ With due regard to security and success of the mission, the people will be warned by

leaflets and broadcasts, whenever possible, of impending airstrikes or operations. This warning should emphasize that the enemy by his presence makes the action necessary, further that the enemy is directly responsible for damages incurred resulting from combat in populated areas.

→ Assignment to Marine forces of qualified RVNAF liaison officers from appropriate RVNAF commanders is essential and will be arranged between Marine commanders and advisors for each significant operation. These liaison officers, through their knowledge of the area of operations and the population, can assist in identification of friend from foe and can help ensure close coordination with all RVN forces.

→ Each operation plan or order will include a psychological warfare annex and a civil affairs annex, and all persons concerned will be familiar with them. Fragmentary orders will include reference to these annexes and appropriate unit orders and SOP's on psychological warfare operations and civil affairs.

→ The participation of RVN forces in operations will be encouraged so that the war does not appear to be a U.S. action against the Vietnamese people. Regional and Popular Force participation will be sought at Marine battalion or company level so that they may assist in the search of private dwellings, obtain information and contribute to the desired effect of the cooperative war effort.

→ In carrying out search and destroy operations, take all practicable measures to minimize the destruction of indigenous private property and to ensure proper control, disposition, and safeguarding thereof. Plans will include procedures for the protection of private property and reporting, security and disposition of excess supplies.

→ A civic action plan will support each operation even if the area has been controlled by the enemy. As the situation dictates, operation plans will provide for utilization of all available assets to include a program for dispensing of medical supplies; transportation and distribution of emergency rations; medical evacuation of injured or sick regardless of suspected or known political affiliation; and light engineering work within the capabilities of tactical units.

→ Established rules of good military conduct and discipline will be enforced.

→ Nothing in the above shall be construed to inhibit the inherent right of a Marine unit or other U.S. unit to defend itself against hostile action from any source.



c. Conduct of Operations

(1) General

➔ During hours of darkness the sequence of engagement will be:

- Challenge.
- If the person challenged makes an overt attempt to avoid apprehension, opens fire or commits any other hostile act and thereby endangers the life of the challenger, the challenger may fire.
- Unit commanders may prescribe illumination prior to firing if local circumstances allow.
- The requirement for challenge may be waived by the local commander if required

by the tactical situation and no friendly forces are known to be operating in the area.

→ Magazines will not be inserted in weapons in a camp area during daylight hours unless under attack.

→ Warning shots will not be employed on contact with the enemy with the exception of daytime control of waterborne traffic. Craft failing to respond to challenge may be warned by fire.

→ Rounds will not be chambered in individual weapons unless contact with the enemy is imminent. The senior Marine present will determine if, in his judgment, the measure must be taken to preserve the lives of personnel. Initiation of any offensive or defensive formation implies imminent contact with the enemy.

→ Within the TAOR, and during operations in areas external thereto, the establishment of a curfew is the responsibility of GVN officials. Assistance in enforcing the curfew will normally devolve upon division units. In such instances, indigenous personnel will be informed of the time limits involved and the requirement for strict adherence. It will be further explained that the curfew is to ensure that innocent civilians are not mistaken for the enemy and shot.





d. Destruction of VN Property

➔ Civilian dwellings will not be burned, nor will private property, including livestock, be destroyed except as an unavoidable consequence of combat actions.

➔ Destruction of Vietnamese dwellings and livestock as a measure of denying their use to the enemy is left to RVNAF units. Requests from Vietnamese authorities for employment of Marine forces to perform such destruction will be referred to the III MAF headquarters.

e. Miscellaneous

USMC units do not have the authority to exercise police powers over the Vietnamese people; hence the majority of controls will have

to be established by the National Police, Army of Vietnam Military Police, or other RVNAF military units and Regional and Popular Force units as appropriate. In the event of civil disturbance, the nearest Vietnamese National Police establishment will be notified. 3d MarDiv units will take no action other than to defend themselves and the property of the U.S.

## ## ## ##

## 2. OFFENSE

### a. Small Unit Tactics

Enemy long range small arms fire is often used to slow troop movement and inflict casualties. Utilization of the practices summarized below will assist in minimizing the effects of such fire:

- ➔ Avoid patterns of movement, diversify patrol formations, times and routes.
- ➔ Use all available forms of concealment.
- ➔ Wear your armored vest.
- ➔ Establish a base of fire before crossing open areas.
- ➔ Use Marine snipers to counter enemy fire.
- ➔ Request aerial observers.
- ➔ Move on one or more approach routes, when possible.

- Be especially cautious at first light.
- Plan for and keep within supporting arms coverage.
- Practice march discipline at all times, including assigned sectors of observation and fire and established intervals between troops.
- When fire is received, return it and maneuver quickly.

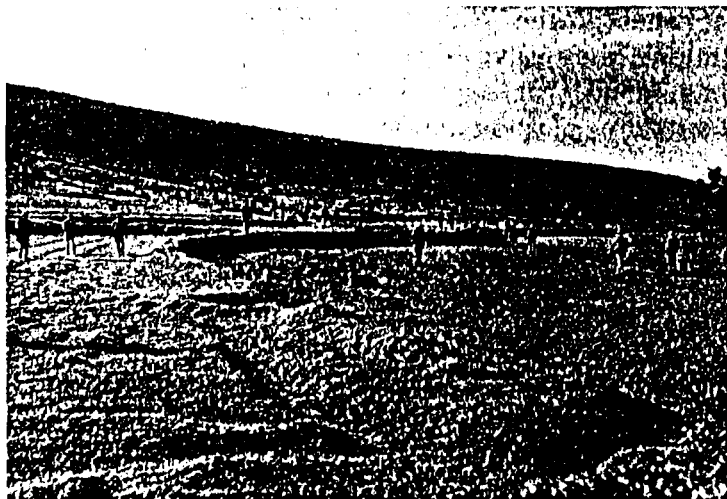

b. Rapid Reporting at Time of Contact

Once contact is established with the enemy and the firefight begins, the platoon leader and company commander have a multitude of tasks to perform. One of these tasks, and a very important one, is the rapid and accurate reporting of the contact so that higher echelons can take the necessary action in support of the encounter. However, the importance of accurate and timely

reporting of contact is sometimes overlooked by small unit leaders because of other duties.

To make certain that reports of contact are relayed immediately it is a good idea to train Marines, other than the unit leader, in the procedures of accurate and timely reporting of contact. This will take some of the load off the unit leader and ensure that battalion is kept abreast of the situation. They can't support you unless they have valid information. The III MAF has found that such a system works well on the company, platoon and squad levels.

c. Control in Dense Jungle Areas

A combat reconnaissance patrol operating in Viet Cong territory was moving with great effort through dense brush in column formation. After a few hours of negotiating the rugged terrain, personnel became fatigued and the column inadvertently became a "V." One member of the point, hearing noise and seeing obscure movement to his left rear, became alarmed and opened fire. Although the cease fire was given immediately, the damage was already done. Results: One Marine killed, two wounded.

This tragedy points out what can happen in dense jungle areas where control and identification become life and death matters. A definite SOP for opening fire must be established and, although positive identification may not always

be possible, repeated emphasis must be placed on target identification prior to opening fire.

#### d. Organization of Command Group When on the Move

The majority of command group personnel are armed with the .45 caliber pistol because of the type of duty they perform and the fact they are not expected to engage in the firefight. However, during operations in dense jungle terrain, flank security sometimes is inadequate and units always face the possibility of becoming separated for short periods of time. If the command group is attacked by the enemy under such circumstances, it has extremely limited firepower to repel the assault unless it has been properly organized.

In view of this, always carefully consider the organization of tactical command groups when disposing firepower means within the unit. Ensure that an adequate number of personnel armed with rifles and automatic weapons are in close proximity to the command group at all times.

#### e. Sweep and Block Forces

Operations, whether of the search and destroy, or search and clear types, normally involve a sweep force and a blocking force. The technique of sweep and block constitutes an effective means of sweeping an area if executed correctly. Speaking in terms of company-size



operations of this nature, the following are several techniques that have spelled the difference between a successful operation and a long hot uneventful walk:

→ Rarely, if ever, will any attempt to establish a block or cordon from a permanent patrol base located within 2000 meters of the objective area be successful. As is generally the case, the block or cordon is set prior to first light which usually necessitates establishing an operating base near the objective area the previous evening. Nothing can spoil an operation faster than a force moving into close proximity of the objective area and allowing the ever observant VC a 6- to 8-hour headstart in fleeing the area.

→ Attempt wherever feasible to seal the area off by approaching the blocking position from

as many different directions as possible. Not only is a certain degree of deception gained by utilizing smaller sized units infiltrating from several directions, but it also denies the enemy several routes of egress. Essentially, the small units "block and sweep" against each other while moving into the blocking positions.

➔ If armor is to be used either as a part of the block force or the sweep force, do not allow the tank commander to start his vehicles' engines any sooner than 5 minutes prior to moving out. The second of armor starting up early in the morning is just like ringing a loud warning bell for all the VC within 3 miles of the objective area. Armor movement should be fast and direct in order to gain maximum shock effect. It has been found much better to give the infantry a headstart on the approach march and have the tanks catch and pass the infantry approximately three-quarters of the way to the LOD.

➔ Prep fires should be used judiciously and sparingly. If not absolutely necessary, they should be avoided. They tend to broadcast the "operation" to everyone in the area.

➔ Consider the use of feints and deceptions as much as possible. It must be assumed that every move the operational force is making is being followed closely by the VC or their informants. The use of feints or similar deployment may invoke a false sense of security among

the VC in the area and deprive them of precious escape time once the sweep is commenced.

➔ Use every means available to maintain the momentum of the sweep force. Anticipate those situations which might cause the sweep to lose its forward momentum (i.e., resupply, casualties, darkness, demolitions work). Once the pressure is applied, keep it on steadily. Hesitation allows the VC the opportunity to escape or place mines and boobytraps in the sweeping force's path. There is no substitute for well-developed and all-encompassing plans at all levels.

➔ Don't allow operations to become stereotyped. Seize upon innovation. If the VC are able to anticipate our every move, our initiative is lost and the results unsatisfactory.

## f. Blocking Position Security

Blocking forces are frequently harassed by sniper fire from the rear while in the blocking position. To counter this type harassment, ambushes should be placed covering likely avenues of approach and/or sniper positions, 200 or 300 meters to the rear of the blocking force. This precaution provides the blocking force with security from the rear and an early warning system against VC attack.

## g. Resupply for Recon

Resupply of small reconnaissance patrols should be avoided whenever possible. Generally



these units can be expected to operate up to 5 days without resupply, provided water can be obtained in the area of operations. This type patrol should normally be withdrawn when supplies carried into the field are expended.

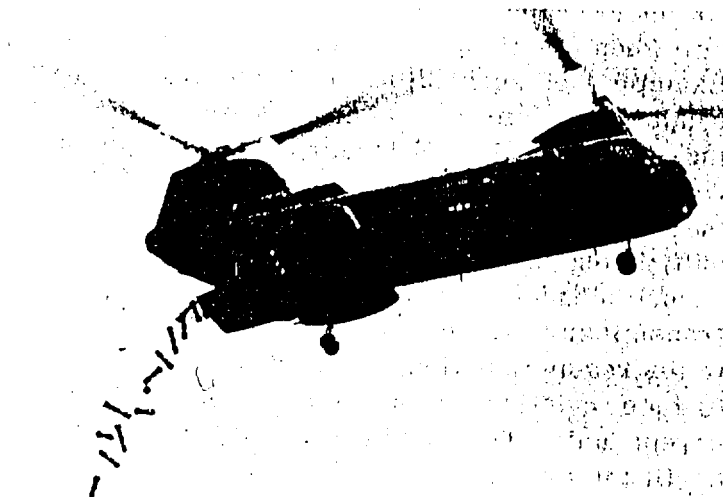

Resupply can be made by helicopter, should operational commitments dictate. In such situations, if special consideration is given to: selection of the resupply site and preflight briefing; preparation of supplies to be delivered; and deceptive measures taken during delivery, the likelihood of preserving the patrol's clandestine nature can be increased materially. The following considerations of these three areas are pertinent:

→ Selection of the resupply site and preflight briefing. In addition to the normal

considerations for LZ selection; e.g., capable of being locally secured and offering good approaches for helicopters, the site selected for resupply should be positively secure from observation at ground level. That is, there must be no observation by the enemy of activity in the site when a helicopter is approaching the ground. Examples of such sites are hedge enclosed rice paddies and depressions near the top of a dominating hill mass. Patrol leaders must be capable of recognizing these areas. When a site is selected, the coordinates should be radioed to the parent unit, using shackles or other secure means. To reduce chance of compromise by further radio transmission, the patrol locations should be given to the resupply helicopter flight leader in a face-to-face briefing by a member of the patrol's parent unit. The briefing should include other pertinent information such as radio frequencies and alternates, ground signals to be used, patrol size and uniform (for aircrew recognition of patrol as friendly), thrust points in use if any, etc. During this briefing a deception plan can be worked out with the flight leader. If possible, the Marine briefing the flight leader should accompany the resupply run.

➔ Preparation of supplies to be delivered. Resupply will include mainly rations and radio batteries. Handling these items can be facilitated by preparing a "package" for each patrol member. All miscellaneous packaging material, which if included would have to be hidden or buried by

the patrol, should be removed and the supplies placed in sandbags. These bags can be placed near the helicopter exit door and at the proper time can be pushed out in a matter of seconds. When delivery to the site is completed, the patrol leader can have each of his men grab a sandbag and the patrol can evacuate the area expeditiously without stopping to open boxes, distribute loads, place rations in packs, or bury trash. Refinements of the packages could include labels to indicate special items such as radio batteries, rifle cleaning supplies or messages for the patrol leader. If time permits, an improvised carrying sling may be placed on each sandbag.

→ Deceptive measures taken during delivery. With a map plot of the patrol's reported location, the helicopter flight can approach the general area at an altitude out of small arms range. Remaining at altitude, the aircrew(s) should attempt to spot the patrol while flying a random pattern over the general area. The patrol should mark the landing site with air panels and may signal the aircraft with mirrors or lights. If the site is properly selected, none of these markers or signals will be visible to the enemy on the ground. If necessary, the aircraft can enter the reconnaissance unit net to receive directions from the patrol leader. Smoke should not be used by the patrol to mark the site. When the patrol is spotted, the flight leader should begin a series of deceptive maneuvers which will eventually bring the supply carrying aircraft to

a landing or hover in the site occupied by the patrol. If the flight includes two or more aircraft, only the supply-carrying helicopter need fly to ground level; the remaining aircraft can maintain altitude and provide support, if required. The pilot of the aircraft carrying the supplies can execute a series of landings or near landings, one of which will be in the actual resupply site. Deception can be increased during these maneuvers by firing machineguns in some of the "landing sites," dropping smoke grenades in some sites, and taking such other actions as may be considered appropriate to confuse any enemy observer.

h. Basic Tactics Again

Almost without exception, combat reports from Vietnam continue to underscore the need for fundamental patrol training. Patrolling occupies a major part of Marine operations and the following points are repeatedly emphasized:

- ➔ Automatic weapons and radios should be concealed as much as possible within formations.
- ➔ Flankers and point men must be well away (100 meters) from the main body when terrain permits.
- ➔ All patrol members should be thoroughly briefed on patrol mission, objectives and other details.

→ Suspected enemy positions should be designated as concentrations for supporting artillery and mortar fires and personnel should know how to call for and adjust these fires.



i. Tunnel Denial

The use of a tunnel can be denied to the enemy effectively by the following method:

- Pump smoke with a Mity Mite blower into the tunnel to determine the location of tunnel exits.
- Place sacks of CS several feet inside the tunnel.
- Dig one to three holes, 4 feet deep and 5 feet back from and around each exit located. Place 5 pounds of tamped explosive in each hole.

➔ Connect all charges (at all exits) and all sacks of CS with detonating cord.

➔ Detonate all charges simultaneously. This will seal the tunnel, trapping the CS inside.

Thus the use of the tunnel is denied the enemy at a considerably less cost in explosives than would be required to completely destroy it.

#### j. Tunnel Clearing and Injuries

It is essential that all Marines handling explosives be familiar with their characteristics including damage radius. Equally important is the necessity for the small unit leader to properly supervise the demolition of caves and tunnels. In a period of one month, recently, three Marines from one unit received injuries from their own explosives while engaged in this type work. All of the injuries were caused by a lack of knowledge and awareness of the radius of injury associated with various types of explosives.

Also, remember to include a safety radius for possible secondary explosions.

#### k. Tactical Decisions

The close jungle and rugged terrain in many areas of Vietnam have demonstrated the necessity for quick tactical decisions on the part of small unit leaders. Frequently, contact with the enemy develops at ranges of less than 100 meters with



fleeting targets. A high volume of fire and rapid, well-controlled maneuvering are the decisive factors in these meeting engagements. If contact continues, supporting arms should be delivered on the target. This requires a positive communication channel to an airborne controller and/or a supporting artillery unit.

Shoot, move, and communicate is still the best policy for the small unit leader.

#### 1. Preconvoy Liaison

There is no substitute for personal liaison and extensive discussion between the man responsible for convoy vehicles and the unit leader providing convoy security. Many coordination problems can be solved such as the time and

place where the security elements join the convoy, radio frequencies and call signs, and location of the security elements with the convoy. Conduct this face-to-face meeting as far in advance of convoy departure time as possible.

## m. Convoy Security

Experience with Rough Rider convoys using engineer mine sweep support has demonstrated that aerial observation of the routes of advance and return is a prerequisite to effective security for the convoy proper and the engineer support element. While the convoy is staging for the return, this observation often lapses along the intended return route. This enables enemy mining agents to plant mines unobserved. Continuous aerial observation of the convoy route should be conducted if possible. This will hinder or prevent enemy mine activity along the convoy route thus providing more effective security.

## n. Encirclement

The Viet Cong are quick to locate and exploit any weak points in our dispositions. During operations to encircle a VC element, unit commanders must quickly prepare to realign their forces to provide a continuous band of offensive strength around the guerrillas. When entrapped the VC will make repeated attempts to probe encircling units, especially at night, to locate an escape route. Aggressive patrolling, illumination, machinegun interdiction, artillery and



mortar concentrations, all will help to contain the encircled force. In such circumstances, the Viet Cong sometimes attempt to cache their weapons and exfiltrate as members of the local populace. In cases where this is suspected, Popular Forces and interpreters are useful, particularly if they are familiar with regional accents and local characteristics.

o. Moving Targets

Frequently a moving or fleeting target is observed and the forward observer directs a fire mission on it. In most instances there is a delay of several minutes between the initial request and the first adjusting round. This delay, caused by the necessity for clearance and computation, can be negated if the forward observer will estimate the projected location of the moving target at the arrival time of the first round and use this point as his target location for the initial request.

p. Deception

The departure of patrols from a base area is often difficult to conceal if it is under observation by local villagers, who can count the number of Marines, follow them, and determine their direction of travel. Suggested techniques



for patrols to employ, where movement under observation is unavoidable, include:

- ➔ Dispatching elements of a patrol at periodic intervals, about every half hour in different directions. Later the patrol can rally in a secure area and continue its mission.

➔ Two patrols can pass as one by combining and then separating when remote from visual observation. One element can detach itself and remain in ambush for a brief period to see if it is being followed.

➔ Strict security procedures are essential when employing these deception techniques since small patrols are particularly susceptible to guerrilla ambush.

## q. Two-Man Point

One battalion conducting search and destroy operations in an area known to be heavily mined and boobytrapped successfully employed the following method to reduce casualties sustained by mines and boobytraps.

The procedure employs two Marines as point to reduce the possibility of detonating camouflaged mines and boobytraps. The first Marine surveys the immediate area being traversed for tripwires, lines, and punji pits, while the second Marine observes forward and to the sides as usual. This method proved most successful in detecting camouflaged devices, and, as a consequence, appreciably reduced friendly casualties.

## r. Spare the Point

When operating in a known mined area, there is a possibility that enemy explosive devices

can detonate the fragmentation or WP grenades carried by the man closest to the blast. The point is likely to be that man; his grenades should be temporarily carried by another patrol member.

s. Searching and Clearing Populated Areas in RVN

Even though some USMC units become adept at searching villages, ethnic and environmental reasons make ARVN units exceptionally good at searching and clearing populated areas.

Whenever possible, ARVN units should be used along with Marines when searching villages. Attaching a platoon of ARVN to a Marine rifle company can be a successful arrangement. The three ARVN squads can then work directly with three Marine rifle platoons. Thus, the individual Marine can learn useful techniques. After several of these operations, the rifle companies should possess the capability to train new men in the search techniques and procedures most successful in RVN.

t. Popular Force Scouts

Recently, one unit in Vietnam operated in a completely new area for about 3 weeks with little success. After a month they established contact with the village chief and Popular Force personnel and began to build a rapport with them.

They suggested going on joint patrols and establishing joint ambushes. After a few weeks the PF's suggested an ambush site and three PF's and the village chief led a Marine squad to the location. The result was 4 VC KIA and one weapon captured. Since then over 50 percent of the unit's kills have been on joint patrols. One PF per fire team was found to be ideal for patrol organization.



## u. Use of Popular Forces

It is common practice for the Viet Cong to send Vietnamese civilians from VC hamlets and villages to government controlled areas to obtain supplies. These people will usually possess valid identification cards, and will generally have no difficulty in being cleared through a checkpoint by Marines. One unit has achieved a greater

degree of success in preventing VC supply procurement by using Popular Force personnel with Marines at checkpoints. The Marines provide the necessary security while the Popular Forces conduct the searches and check identification. The Popular Forces can readily detect the presence of strangers which has resulted on many occasions in intercepting foodstuffs and medicine destined for enemy forces.

v. Patrols Entering Villages

In relatively close terrain, Marines have a tendency to select the easiest approach into a village. They often use a trail or road and seldom delay unless taken under fire. The VC are well aware of this fact and frequently orient their defenses down the main roads and trails leading into the villages. A flank approach into villages not only lends the element of surprise to the patrol, but also circumvents the main enemy defenses.

w. VC Houses

Marine patrols in Vietnam have occasionally encountered deserted huts and houses surrounded by thorn and bramble fences. These locations are considered off-limits by the villagers because they have been formerly occupied by the Viet Cong. The area surrounding the houses is usually entrenched and contains punji pits as well as signs with VC slogans. Exercise caution when approaching these areas.

## x. Keep Going

If a patrol sustains a casualty from sniper fire, continue to seek out the sniper aggressively. Don't let the entire patrol become involved in treating the wounded and securing a landing zone only to sustain another casualty from the same sniper when the patrol once again moves forward.

## y. Look Up

During two actions between North Vietnamese and Marine forces, the enemy attempted an ambush using a conventional U-shaped ambush with one modification; enemy troops were positioned in trees overlooking the zone of fire and were armed with automatic weapons and grenades. Advance guards and point men must look upward into trees and brush as well as forward and to the flanks.

## z. Combat Tips

➔ Ensure separation of communication capabilities so the probability of incoming rounds destroying all communications is reduced to a minimum.

➔ The second in command at all echelons should be prepared to assume command under most adverse conditions; he should be positioned so the odds of his becoming a casualty day or night at the same time as the commander are minimized.



- ➔ Be continuously alert to enemy tactics of trying to separate a unit, a point or a rear element from the main force or body.
- ➔ Rehearse every, repeat every, recon, combat patrol or contemplated offensive action whenever possible.
- ➔ Provide every patrol with the capability of calling in supporting fire.
- ➔ If taken under mortar or artillery fire, prepare to return fire within 30 seconds. This capability requires at a minimum:
  - Mortar positions that can be occupied while under fire.
  - All personnel being capable of determining direction from which mortars are



being fired (crater analysis) and a reporting procedure for passing on such information immediately.

➔ Platoon commanders and company commanders should always be in a position to control and maneuver all of their units and supporting arms. For example, a platoon commander who acts as squad leader or a point, is not a platoon commander.

➔ When halted for any period of time, dig in, improve holes, and cut into the sides of holes so VT can be called in on the position if such action becomes necessary.

➔ When a Marine hits the deck, he should immediately roll to either the left or right to confuse the enemy as to his exact position.

➔ When a unit halts at night, a change of position should be made during first hours of darkness.

➔ When patrol bases are employed, prepare alternate positions. Avoid staying in one position more than one night.

➔ Never occupy old positions (friendly or enemy).

➔ Emphasize to Marines that stopping to render first aid while in the attack will only result in more casualties through loss of firepower and momentum.

➔ No area, regardless of past activities, can be considered safe from possible enemy attack.

➔ Communications have always been a lucrative source of intelligence. No matter what method of communication is used, except runners, we must assume that the enemy is listening. Don't shackle known enemy locations. Don't disclose frequencies and call signs. Don't discuss/disclose friendly locations and scheme of maneuver. Conduct comprehensive communications security training especially at the company level.

➔ Learn all you can about the customs of the people.

➔ Never sacrifice security for speed.

➔ Practice fire discipline--shoot accurately and follow fire commands quickly. Fire at suspected enemy positions but don't squander your ammunition.

➔ Listen to suggestions from others and adopt them if they are sound.

➔ Use frag orders when the situation permits.

➔ Don't overwhelm men with the "Big Picture."

➔ Keep abreast of the tactical situation and keep your men informed.

➔ Set the example.

➔ Protect ammunition from deterioration. Use radio battery plastic covers and fuze cans for this purpose.

- Move through jungle in multiple columns with all-around security using connecting files.
- Move on concealed routes whenever possible.
- Practice use of the compass, pacing and terrain orientation on all movements.
- Use arm and hand or any other silent signals whenever possible.
- Practice fire discipline.
- Keep weapons immediately available for use. Maintain contact with the enemy once it is gained.
- Test fire weapons before each operation.
- Consider combat efficiency over personal comfort.

#####

### 3. DEFENSE

#### a. Tactical Security

Military history indicates that all successful commanders have been governed in their actions and decisions by several fundamental principles. These are now known as the principles of war and apply to the leader of a fire team as well as the battalion commander. The extent and manner of application of these principles have always determined the success or failure of military operations. While adherence to these



principles cannot guarantee success, failure to apply them almost always leads to disaster.

Failure of a leader to apply the principle of war called SECURITY in all his operations, both while engaged in offensive as well as defensive operations, will almost certainly lead to

complete and utter defeat. The majority of unit leaders in Vietnam today are well versed in the importance of security. Reports are replete with instances of American units foiling Viet Cong attempts to infiltrate or surprise their positions. However, not all unit leaders have learned their lesson in this respect. An examination of situation reports and afteraction reports reveal that some American fighting men in Vietnam have become battle statistics because they or their leaders didn't understand the importance of security.

All leaders in combat will normally incur casualties at one time or another. The number of casualties sustained is in direct relation to the tempo of operations and the vagaries of combat. Casualties incurred under these circumstances reflect neither credit nor discredit on a leader. They are the cold hard facts of war.

However, casualties suffered by a leader who has been surprised by the enemy while in a defensive position are normally unforgivable and a useless waste of lives. The enemy, on occasion, may outmaneuver you, may concentrate more troops on the field of battle and may be more mobile. A leader, especially a small unit leader, might not have absolute control over such occurrences. He does, however, have control over the security of his unit and when it is surprised by the enemy, particularly in a defensive position, he is guilty of committing an unpardonable crime

against his profession and the men who pay the supreme price.

It is well to remember that security embraces all the measures taken by a unit to protect itself from observation, surprise, and annoyance by the enemy. It includes those measures necessary to obtain early warning through the employment of security detachments and to prevent acts which might give information to the enemy. To guard against surprise requires an accurate estimate of enemy capabilities, adequate security measures, effective reconnaissance, and readiness for action on the part of all units.



## b. Review of Defensive Principles

While continuous emphasis must be placed on offensive operations if the war in Vietnam is

to be successfully concluded, the fact remains that we must, of necessity, spend part of the time in defensive positions. Whether we are defending a large fixed installation such as the airfield at Chu Lai, or establishing a night perimeter during a search and destroy operation, certain basic principles and techniques must be adhered to if Marine lives are to be saved. The following principles and techniques are not new but should be reviewed periodically:

→ The best defense is offensive action; a series of outposts and ambush sites should be established in depth at dusk or shortly after dark. During daylight, saturation patrolling as well as outposts should be employed.

→ Defensive positions must provide all-around protection with the capability for rapidly massing fires on any location around or within the perimeter. Always "fire in" defensive concentrations, if possible. This is important especially in temporary perimeters.

→ For fixed and semifixed installations, barbed wire barriers (concertina, single- and double-apron fence, tanglefoot) should be constructed around the perimeter of the installation and around sensitive locations inside the perimeter. Although a good barrier plan is essential, the internal security cannot depend solely on the physical barriers placed around the installation.

→ Trenches should be dug in a zigzag pattern between bunkers. Grenade sumps are required in trenches.

→ Bunkers, by the nature of their fixed positions, are most vulnerable to infiltration attack, or attack by direct fire weapons. Bunkers must be located at least 50 meters behind the inner barrier wire to reduce the damage from VC-emplaced Claymore mines and to prevent handgrenades from reaching them from positions outside the wire. All bunkers should have reinforced overhead cover capable of withstanding the effects of mortar fire. They should be camouflaged, if possible, to increase the problem of identifying them at night. Bunkers should be mutually supporting whenever possible.

→ Claymore mines, emplaced inside the barrier wire for command detonation, are most effective against personnel. Improvised flame devices, such as the electrically detonated "fougasse," also are effective.

→ The M79 grenade launcher is effective in covering dead space in final protective fires close to the edge of the defensive perimeter. A clear field of fire must be obtained to avoid premature detonation caused by rounds striking branches or limbs.

→ A well-coordinated illumination plan tightly controlled by the commander must be developed in order to prevent indiscriminate use





of illumination. Improper illumination may reveal friendly forces and defensive positions to the enemy.

→ Locate guard or reserve forces throughout the internal area to combat small unit infiltrations. A plan to utilize reserve forces to prevent or repel penetrations of the perimeter must be developed.

→ Establish multiple means of communications within bunkers and internal security posts.

→ There must be a minimum of movement inside the perimeter after dark. If firing of weapons or explosions of grenades occur inside the perimeter (not from protective bunkers or

firing pits), all personnel not in protective positions should "freeze" in a firing position. Anyone running or moving about should be considered enemy. Signals must be used to identify friendly counterattack forces. After firing ceases, conduct a sweep inside the perimeter.

→ Disperse key personnel, weapons and equipment in order to avoid excessive losses.

→ The chain of command within all units must be well defined to preclude confusion resulting from key personnel becoming casualties.

→ Emergency plans to restore communications, to provide medical aid and to ensure uninterrupted defense of the area must be developed and rehearsed.

→ Search civilian workers upon their departure from the installation to prevent removal of arms, ammunition or other property. Areas where personnel were working must be swept to remove marker signs emplaced to locate bunkers, automatic weapons sites, or other sensitive fixtures for unfriendly forces outside the installation.

→ Establishment of hasty defensive perimeters during the conduct of other operations requires consideration of the following:

Provide for ambush patrols and early warning devices to cover avenues of

approach into the perimeter. Emplace the ambushes while moving into the area.

- Stop before dark to set up camp for the night.

- Halt on the most defensive terrain available. During rest stops, ensure that designated guards are alert and outposts are placed.

- Consider the technique of stopping an hour before last light, approximately 300-500 meters from the intended night base camp. Establish good local security, and then use this halt for chow, minor first aid, weapons maintenance or to accept a helicopter resupply. Send a patrol to reconnoiter your intended base. When this patrol locates suitable, defensible terrain for a base and reconnoiters for defensive ambush and OP/LP sites, the patrol sends back guides to the main body, and also maintains surveillance of the base area. After dark, the main body is guided to the actual base, occupies assigned sectors of the perimeter by units, and digs in quietly. Ambushes and OP/LP's are established in accordance with previous daylight reconnaissance, to include an ambush on the route used by the unit to reach the actual base. For normal indirect fire support planning for the actual base area, plan concentrations for the first (temporary) base, and likely approaches into that area.

➔ The enemy will make every effort to remove all casualties, weapons and documents from the battlefield in order to prevent accurate

assessment of their losses. Use long range automatic weapons fire combined with continuous illumination of the area to keep the enemy from "policing" the battlefield as they withdraw. Casualties left behind by the enemy are often booby-trapped. Exercise extreme caution when searching or moving enemy casualties.

→ Remove all tripflares and boobytraps at first light.

→ Do not disclose automatic weapon positions by firing when the enemy harasses with sniper fire.



### c. Defense of Isolated Positions

Recently a 105mm howitzer battery, situated in a relatively isolated location, was attacked by a well-trained and armed force of

Viet Cong. The number of enemy has never been determined other than that it was in excess of 50 men.

The attack started at 0155, during the darkness of the moon with a mortar barrage on the nearest unit. This unit was a 155mm howitzer battery and was located about 1000 meters away. There was no attack on this position and as it was later determined, the objective of the Viet Cong was to pin this unit down. Simultaneously, the Viet Cong attacked the 105mm battery from three directions. Two attacks came from the south utilizing bangalore torpedoes to breach the perimeter wire. Rocket launchers were used on the bunkers near the breaches. The attack from the north was accomplished in a silent manner, breaching the wire with cutters. The attention of the defenders was focused on the southern forces and the northern forces was inside the wire before it was discovered.

The northern force threw satchel charges in the living quarters and sprayed the defenders with automatic weapons fire. Both forces made for the gun pits and succeeded in damaging two howitzers plus destroying a ready ammunition pit. It is estimated that as many as 40 Viet Cong were inside the perimeter.

The defenders were aided by continuous artillery illumination plus a flare ship. The 155mm battery fired several rounds of direct fire. The nearest infantry company had only a skeleton

force in the company command post. The remainder of the company was deployed remotely from the scene of the attack. A small force of Viet Cong pinned down the company command post with automatic weapons fire.

Contact was maintained with the Viet Cong until daybreak (0555). Sixteen dead Viet Cong were left in the position. Numerous grenades and weapons were left behind. At approximately 0700, an engineer road grader struck a mine which was planted in the road between the battery position and the nearest infantry battalion command post. All wire lines of communication had been cut during the first few minutes of the attack. It was later discovered that these lines were cut in as many as three different locations.

The following are some of the lessons learned from the above experience:

### Significant Points

- The entire area of the attack had been well reconnoitered. Specific locations of units, roads, bunkers and other defenses had been pinpointed by the Viet Cong.
- Wire lines of communication were cut at terminal strips located near the perimeter wire.
- An attack was made from the south with no attempt to be quiet. The main attack from the north was extremely quiet.

→ Once the Viet Cong were inside the wire, there was nothing to impede freedom of movement throughout the entire battery area. They could run directly to the gun pits, ammunition pits and other installations.

→ The best road available for use by a counterattacking force was mined.

### Conclusions

→ Periodically and without setting a pattern, shift men on perimeter defenses from bunkers to fighting holes. This should be done after dark.

→ Perimeter fences should be high enough to prevent their being crossed by means of matting. Use a minimum of two fences around the position so that the enemy must use at least two demolition teams to effect a breach. Be sure to stake down concertina to prevent its being lifted.

→ When an attack is made in one direction and is detected, look to the rear for another attack. Do not focus the defenses in one direction.

→ Compartmentalize the interior of positions by a maze of three-strand cattle fences. Use offset entrances to gun pits and other vital areas to slow down personnel trying to enter. An attack similar to the one described was made on a combination artillery and tank position at Cam Lo in September 1966. The Viet Cong were able

to breach the perimeter wire, but were completely baffled by the compartmentation. As they bunched up, the tanks and defenders were able to inflict severe casualties.



- Use dummy communications trunklines in the position to confuse the Viet Cong. Place all terminal strips well within the positions.
- After an attack, beware of mines on access roads to the position. Request a mine sweep of all roads and trails.
- Ensure that sufficient backup radios are in position to ensure reliable communications when the wire is cut.
- Form a reaction force from personnel located in the same area. Rehearse this force frequently.



➔ Remember that any change in the defense will act as a deterrent to the Viet Cong as far as their mounting an attack. It must be presumed that the defenses have been scouted. Use of a tank or Ontos in the position at random periods is an excellent means of varying the defenses.

➔ Cover all perimeter wire by fire.

➔ Make extensive use of Claymore mines, taking care to remove them at daybreak and to vary their positions. Do not set a pattern. Never place the Claymores beyond the perimeter wire and where possible keep them under observation.



#### d. Night Positions

Aggressive offensive action requires speed of maneuver, maximum utilization of available

time, and economy of force. The speed and ease with which units can deploy into a nighttime defensive perimeter are often hindered by the dense foliage found in many regions of Vietnam. In certain instances it is more advisable to consider deploying for night positions in ambush fashion rather than in perimeter form. An example of an ambush which also fulfills the function of a night defensive position is the "Yankee Formation" or "Y" ambush. Such a position employs three legs running out from a central point with a strong point at the end of each leg. Each of the legs is capable of firing in either direction and supporting the other two. Such a deployment is one accomplished by having alternate individuals within each leg cover sectors to the left or right along the long axis of the leg. The center of the "Y" where the three legs join is the control point and the position of the unit leader. From such a position he can control and maneuver his unit most advantageously.

This formation is highly effective as an ambush and as a defense against attack from any direction. Such a formation can be easily altered to conform to the terrain requirements and can be utilized by a small-sized unit.

Furthermore, its triangular concept is easily adaptable to the Marine organization. There is a further advantage in such a formation. In heavy foliage, units may deploy far more easily than in a perimeter defense. Each leg is given a general direction of deployment and need only

be tied in at the center. This curtails the problems of shifting lines or clearing additional lines of communication to the center of a perimeter. There is also less movement involved in deploying in such a manner.

## e. Flash Observation Procedures

The increase in VC mortar, artillery and rocket attacks has made it essential that all units have effective countermortar, counterartillery, and counterrocket plans. The success of counterfire plans is dependent largely on two factors: the speed with which the enemy firing positions can be located, and the speed with which this information can be passed to the FSCC.

Speedy resolution of these factors has been accomplished in one area in RVN by the establishment of a system of flash observation posts. The observation posts are located on the highest ground near the command bunker of each perimeter section. Additional observation posts are maintained at combat outposts and in the airstrip control tower. Each OP is manned by a sentry whose primary mission is to locate enemy mortar, artillery and rocket positions. The location of all the OP's are plotted on a command map in the battalion combat operations center. When enemy muzzle flashes are sighted, polar plots are reported to the COC by the reporting observation posts. Once the enemy position is pinpointed by graphic intersection from two or

more OP sightings, concentrated fire can be placed on the target.

The following recommendations can assist in establishing an effective counterfire plan and are particularly valuable for units that defend large, semipermanent bases and installations that are prime targets for VC attack:

→ Establish flash OP's in each sector of the perimeter on high ground that commands the best observation of the area. Observation towers are excellent for this purpose and may also be used for maintaining surveillance over the area, and adjusting artillery fire.

→ Plot the location of all OP's on a map in the COC and/or FSCC.

→ Brief all personnel manning flash OP's in proper communications procedures, use of the lensatic compass, flash-bang method of range estimation, and artillery fire request procedures.

→ Relieve OP sentries at least every 2 hours and more often when the situation permits.

## f. Natural Camouflage Will Save Lives

Are you, as a unit commander, making full use of individual and natural camouflage? Are your men "making like a bush" in the field, blending with the natural foliage, and breaking their outlines against the sky? Give the matter



a little serious thought. Do you camouflage your helmet and body?

Have you ever advised a Marine in winter service uniform that if he had to walk on a highway at night to hold a white handkerchief in his outboard hand so that car lights could spot and avoid killing him? The same Marine in the jungle or on patrol is going to present a white face, arms and hands unless he properly camouflages these parts with his green stain. His face, arms, and hands can gleam enough against a green background to help the VC spot and kill him.

Marines are supposed to be pros but some of the pictures coming out of Vietnam must make our old adversaries the Japanese shudder in horror. The Japanese used camouflage to full advantage--leaves, vines or grass interwoven

on helmet and pack made the Japanese soldier extremely difficult to see, particularly in defensive positions. We must believe, however, that the Viet Cong welcome all the obvious lapses in camouflage discipline.

Natural camouflage; i.e., grass, leaves or vines that will blend with the area in which the unit is operating, will take only minutes to apply and costs absolutely nothing. It is a battle-tested fact, however, that its judicious use will save lives, for it is difficult to shoot and kill what you cannot see!

Pictures and TV reports from Vietnam strongly indicate the need for strict enforcement of camouflage discipline at all echelons of command. Vehicles, tanks, helicopters, boats can all be camouflaged; the variety and extent are only limited by the intelligence and ingenuity of the commander. Above all, the individual Marine must be trained in the use of natural camouflage which will save his life. It must become as instinctive as wearing his dog tags.

Unit leader, ask yourself this question-- Do my men know how to camouflage a helmet, or does the individual Marine keep his white cigarette package up there for the Viet Cong to draw a bead on.

Perhaps, if time permits, a simple demonstration might bring home the shocking truth. Put a few salvaged helmets out 200 yards and let the troops draw a bead on them. Count the hits.

Then use natural camouflage around the same helmets, a la Japanese style, blending with the area. Now have the same troops fire and count the hits. The results might be surprising!

There are those who advocate natural camouflage only in night or defensive positions on the assumption that "making like a bush" will lessen the aggressive spirit necessary to close and destroy the enemy. A little reasoning and proper leadership should convince any Marine that there is nothing ridiculous about using natural camouflage. In fact, once discovered and experienced, natural camouflage provides added confidence that the individual is not sticking out like a sore thumb for all to take a shot at!

Older Marines know that the battlefield is a terribly lonely place for the younger Marine. Natural camouflage properly utilized will help him blend with his surroundings and make it more difficult for the Viet Cong to shoot and kill him. Natural camouflage can save his life! You must do everything in your power as a Marine leader to see that he uses natural camouflage instinctively.

The following basic tips can assist in making individual camouflage effective:

- Break up the shape of the helmet with leaves or twigs.
- Tone down all visible skin areas with face paint, burnt cork, or charcoal.

- Attaching vegetation to clothing will help if it blends with the background.
- Remove the shine from metal objects with mud or face paint.

Below are a few basic tips that can assist in camouflaging equipment and emplacements:

- Avoid regular, geometric layouts of vehicles, weapons and supplies.
- Avoid activity, such as continued movement of personnel and equipment over the same routes, that can change the original appearance of an area.
- Conceal all vehicle tracks so that the ground appears unmarked.
- Eliminate the shine on all vehicles and equipment.
- Use shadows and ensure that the silhouettes of emplacements and equipment are broken.

## g. Claymores for Night Defense

When employing the Claymore mine for defense of night positions, care must be taken to ensure that the enemy does not have the opportunity to locate the Claymores and turn them around or remove them. Reconnoiter locations for the Claymores in daylight, but do not actually put them in place until it is too dark for the enemy to observe your actions clearly. The wires of the Claymore should be run back to the friendly positions in a zigzag fashion and not along easily





discovered trails or open areas. By placing a strip of white adhesive tape on the back of the mine, the mine can be more easily kept under observation.

#### h. The Key to Success

The best defense is a good offense. Without vigorous patrolling in a unit's area of responsibility, even the best defense is vulnerable to infiltration. Villagers who see Marines daily feel a greater sense of security. Viet Cong have difficulty in massing any larger units than a squad, and night mass assaults are more vulnerable to detection when Marines patrol incessantly.

i. You and Your Shadow

The enemy in Vietnam habitually shadows U.S. Forces. They assign observers to watch and report on every movement and activity. This is why so much emphasis is placed upon varying patrol times, patterns, and routes. When the enemy perceives a pattern, he is afforded the opportunity to strike under conditions of his own choice. When your unit has been in a temporary position for more than a few days, be especially alert. Effective close-in patrolling will limit the enemy's observation of your position and activities. This will disrupt his habit of staying close by for observation. Be aware of the fact that whatever your unit does is being observed and reported.

j. Fixed Illumination

Units in static defensive positions where electrical power is available can develop an excellent illumination system using salvaged vehicle headlights. The silence and immediacy in reaction time of an electrical lighting system give no prior warning to the enemy. Lighting should be directed towards possible avenues of approach and may be rigged for adjustment by guidewires from a bunker containing the on-and-off switch. Ordnance-type illumination should be kept available for emergency lighting situations and as a positive backup for the electrical system.

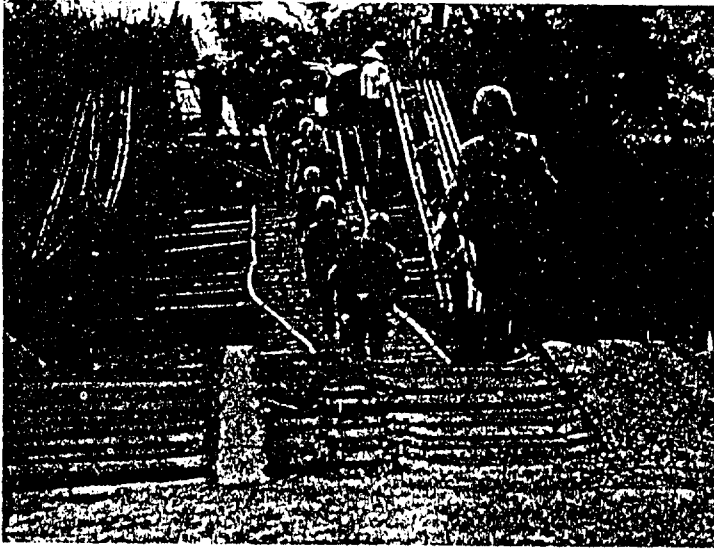

k. Bridge Security

Many of the bridges that have been destroyed by the VC have been blown by satchel charges attached to the bridge pilings below the waterline. To guard against this, divers are frequently used to check the pilings for possible demolitions. A unique method of underwater illumination using flares has proven effective. A hand illumination flare (Signal Illuminating, Ground, White Star Parachute M127A1) fired straight down into the water next to the piling will ignite at a depth of approximately 75 feet. As it burns it will start to rise slowly to the surface enabling the observer to check the piling for demolitions from 18 to 20 feet below the waterline to the surface.

#####

#### 4. AMBUSH TACTICS

##### a. Ambush Preparation

Ambushes that are conducted with imagination and skill are an effective means of inflicting casualties on the enemy. Successful ambushes require patience, endurance, perseverance, aggressiveness, and a high degree of self-discipline on the part of ambush team members. Experienced ambush team leaders have noted a relationship between the size of the ambush and the personal attitude of the personnel comprising the ambush unit. Members of a squad-size patrol usually are alert and vigilant en route to and within the ambush site. However, the average Marine appears to feel less responsibility and is more relaxed when he is part of an ambush force larger than a squad. This false sense of security can result in carelessness and lax discipline which may cause the ambush to fail. In addition to the personal requirements, certain other factors are influential in the success or failure of ambushes.

Most ambushes are set at night and during early morning hours since these are the hours during which the enemy is most active. Careful consideration of intelligence information will indicate best times for intercepting enemy movement. The time factor also has counterintelligence implications. Departure from and reentry into friendly lines should be planned for a period when

the patrol will be least exposed to enemy surveillance. The proper moment to spring an ambush once the enemy is sighted must be thoroughly understood by all members of the patrol. Prematurely triggered ambushes yield fewer enemy kills and can result in Marine casualties. The first shot should be held until the patrol leader is positive that the enemy is in the killing zone.

The assumption that the enemy will use the obvious trails, roads and stream crossings should be avoided. All available intelligence information should be collected on enemy routes of movement to aid in the choice of ambush sites. In many instances, the enemy avoids using obvious routes in order to keep from walking through likely ambush positions.

Noise, light and camouflage discipline have an extremely important effect on the chances for success of an ambush. A breach of any one of these will jeopardize the success of the mission. A noisy, careless Marine in an ambush site is the only warning device the VC needs. The key to a successful ambush is surprise.

The absence of stealth is a common error and often leads to compromise of ambushes. Every precaution must be taken to avoid being observed by civilians, leaving signs, or giving any other indication of the patrol's presence when moving to an ambush location. The site should be reconnoitered in such a manner that the intention to use the site for an ambush is not

disclosed. If the enemy is aware of the movement to the ambush position, chances of success are negligible.

Thorough consideration of the factors above will increase the odds in favor of a successful ambush. Supervision and discipline are the keys.



b. Ambush Techniques

All too frequently ambushes are well laid, properly planned, and correctly positioned, only to fail because of an oversight on the part of the ambush leader or one of his men. Some of the common deficiencies are as follows:

- Noise discipline--coughing, talking, shifting about, clattering of equipment, etc.
- Springing the ambush too early or with a poor signal.
- Lack of sufficient firepower being placed in the killing zone.
- Failure to pursue by fire when the enemy moves into the jungle.
- Failure to quickly exploit and search the immediate area for casualties.
- Failure to establish a preplanned search of the area.
- Failure to boobytrap or block the opposite side of the trail.
- Failure to block escape routes.
- Failure of ambush leaders to use supporting arms.

c. The SID Ambush

The seismic intrusion device (SID) is adaptable in a remote ambush position for use with either the Claymore directional mine or the 3.5-inch rocket. (See fig. 2-1.) When used in this manner, the ambush site is chosen to take

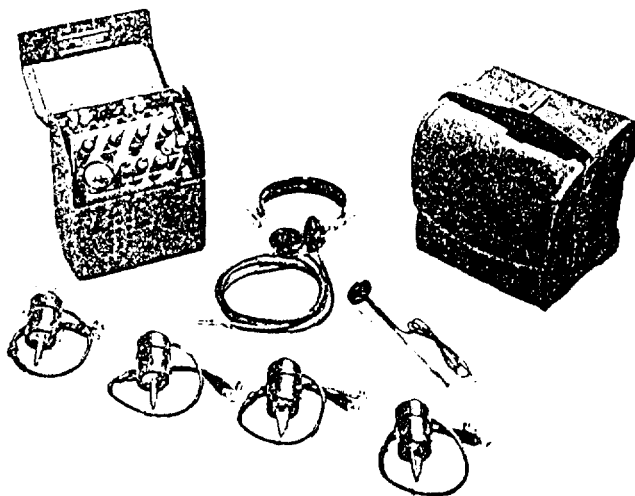

maximum effect of the shock of these weapons. A seismometer is positioned on the approaches to the ambush site and another is placed in the killing zone. Through careful positioning, this second device will not be destroyed when the mine or rocket explodes. The killing zone itself can be covered by a Claymore mine or an electrically detonated 3.5-inch rocket; the cardboard shipping tube makes an expedient rocket launcher. Electrical ignition of the rocket is possible by separating the two wires covered with white or clear colored plastic in the rocket nozzle, then stripping off about 2 inches of insulation and splicing them to the firing wire. A ten-cap blasting machine or a battery of appropriate voltage can provide the necessary charge.



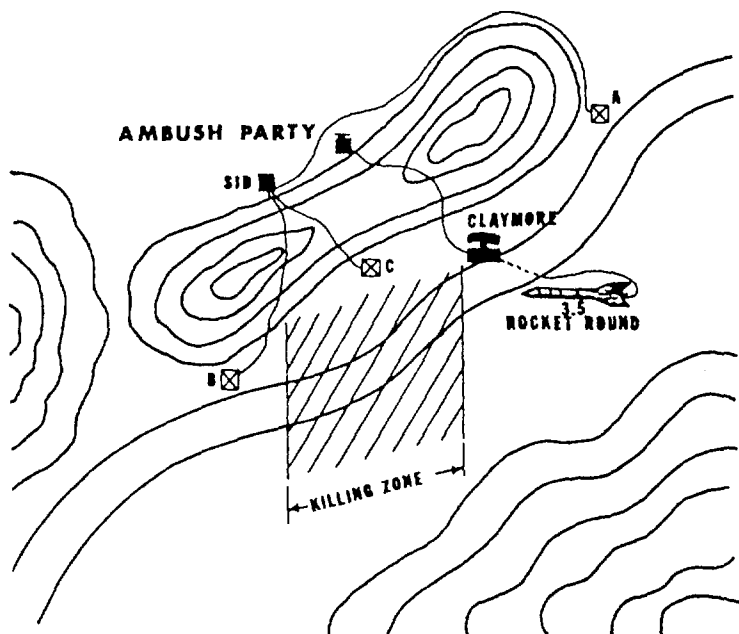

Figure 2-1

The ambush party is alerted when the enemy passes either point A or B and enters the killing zone. The ambush is triggered manually when the enemy passes point C. Once the ambush has been triggered, the ambush party can disconnect the seismometers and withdraw, recovering the seismometers at a later time.

#### d. Ambush in or Around a Village

When an ambush is planned in the vicinity of a village, units should consider making a sweep prior to establishing the ambush. This will

enable the unit leader to reconnoiter the area and at the same time leave the village with the impression that the searchers are satisfied that all of the enemy have withdrawn.

Recently, one rifle company was moving through a ricefield area to a preselected ambush site when it was sighted by local villagers. The company immediately countermarched and swept the village. Villagers were questioned and houses searched before the unit moved on, giving the impression that it was apparently satisfied that there were no VC in the area. After moving approximately 500 meters beyond the village the unit stopped, deployed and waited. During the sweep the commander had selected an ambush site adjacent to the village. At 1830 he moved an ambush patrol into the site and had them dig positions. At 2000, two VC walked down the trail from the village. The result was one confirmed VC KIA and one probable.

This is a good example of the use of ingenuity and imagination on the part of the company commander. Stealth was employed in moving back to the ambush site and care was taken so no weapons were laid on azimuths that could endanger the friendly villagers.

#### e. Watch the Rear

Frequently the Viet Cong follow a patrol, waiting for the unit to make a mistake or for a

chance to ambush from the rear. There are three recommended ways to counter this VC threat;

- ➔ Drop a fire team or squad ambush on a prearranged signal.
- ➔ Circle back on the patrol route forcing the VC to worry about his rear.
- ➔ Alter direction of movement every few hundred meters to confuse the enemy as to location and direction of movement of the patrol.



## f. The Point and Ambushes

The North Vietnamese Army's tactic of ambushing the point unit of a rifle company is extremely effective, and unless immediate action is taken by the friendly unit, heavy casualties may result. If the enemy chooses to stand and fight after springing an ambush, supporting arms

will usually be used by the Marines. If the enemy retreats, this is normally the end of the encounter because of the extreme difficulty in conducting a pursuit in dense jungle. In any event, the point squad leader must be able to relay to the company commander, via the platoon leader, an accurate estimate of the situation. Fire superiority must be gained as soon as possible by the point element. Though this may appear difficult, small arms fire, LAW's, M-79's, and handgrenades fired in the direction of the enemy will usually do the job. By the time fire superiority is gained, the platoon leader should be up front communicating with the company commander concerning his estimate of the situation. As most ambushes of this nature take place at extremely close ranges, the leading elements will have to withdraw a considerable distance if supporting arms are used.

Before moving into an area where ambush is likely, it is a good idea to consider the following:

- Brief the point in detail of what actions are to be taken upon ambush. Include details on when you expect to commence the attack or withdrawal in countering the ambush.
- Inform supporting arms of your route and plan concentrations on likely trouble spots.
- Always know the location of the point so no time is lost in adjusting supporting arms.
- Have a workable casualty evacuation system.

→ Consider having the point reconnoiter danger areas by fire. This usually causes NVA units to flee or spring the ambush prematurely.

## g. Vehicle Ambushes by the Viet Cong

In some areas the manner in which the Viet Cong have conducted ambushes against small vehicles has been fairly well standardized. The first thing that the Viet Cong do is shoot at the passenger side of the vehicle to hit the "shotgun." The driver is too busy with the vehicle to offer much resistance, thus giving the Viet Cong time to fire at him next. It has been found that the windshield on the passenger side of the vehicle has generally been in a raised position.

It is felt that the windshield on these vehicles had been down, and the driver wearing goggles, it would have minimized the chance of ambush. Even if one is prepared to fire and is alert in the vehicle, it is extremely difficult to fire to the front with the windshield up. It is awkward, and there is a natural tendency to be a little hesitant about firing to the front directly through the windshield. With the windshield down, the ability to return fire to the front is not hampered.

## h. Be Flexible

Patrol reports from Vietnam have drawn attention to a technique used by the Viet Cong to determine the size and composition of patrols.

Local villagers are used to count the number of men in a patrol both on departing and entering friendly positions; the direction of the patrol's movement is also reported. When the patrol size is reduced during the course of a patrol, the VC deduce that an ambush party has been positioned somewhere along their route.

A technique has been devised to make it more difficult for the enemy to notice if patrol elements have been dropped off at some intermediate position. First, the ambush party is dispersed throughout the larger patrol; the ambush element keeps its radio antenna detached and is equipped and armed similar to other patrol members. The party detaches itself covertly from the patrol when in the desired ambush site. Since many ambushes are positioned after sundown, the darkness and surrounding foliage hide their maneuver from enemy observation. The next day another patrol can drop off a different element and pick up the other ambush party. Except for the first time, the patrol size remains constant. The old ambush party may move to an OP, and the pickup patrol can force the enemy into open ground or toward the OP site where they can be brought under fire.

#####



## 5. MONSOON OPERATIONS

The effects of monsoon weather on combat operations are so significant that they dominate all aspects of both planning and operations. The successful accomplishment of a mission will depend upon the preparation of detailed primary and alternate plans which are designed to accomplish missions under the most unfavorable weather conditions and exploit short periods of advantageous weather.

Normally, the primary plan will be based on courses of action which can accomplish the mission in any weather. This should preclude reliance on air support in any form. With the limitation imposed by loss of aerial lift, resupply, MEDEVAC, reconnaissance, and observation, the

range and scope of the primary plan are reduced. The staying power of a deployed unit becomes an important consideration. The duration of an operation is calculated on the unit's ability to sustain itself without resupply, to care for and move casualties without evacuation, and to accomplish its mission without reinforcement. Thus, plans for monsoon operations must allow for increased combat loads and provide for the combat power necessary to compensate for loss of flexibility.

Time-space factors vary widely. For example, a movement to the objective area may be made in 15 minutes by helicopter in good weather, 5 hours by foot in marginal weather, and 24 hours by foot in bad weather, which requires a circuitous route to avoid impossible terrain and extends the movement into darkness.

A more ambitious alternate plan must be prepared which will capitalize on the use of air support when weather conditions permit. Deploying units must be prepared to exploit the advantage of brief periods of good weather during any phase of the operation. In dense canopy or other unfavorable terrain, the location and availability of helicopter landing zones become a vital concern. Deployed units may use possible landing zones for tactical objectives, maintaining their readiness to increase the range and scope of their operations by keeping "one foot in an LZ" at all times.



In short, remember that planners of operations down to the small patrol level must be constantly aware of the sudden and drastic changes in streams, rivers, watersheds, lakes, ditches, ricefields, and lowlands caused by the heavy rainfall of the Southeast Asia monsoons. The primary plan for combat operations during the monsoon season should provide for the accomplishment of the mission under the limitations of the most adverse weather. An alternate plan should be available to provide for the extension of operations during any phase whenever favorable weather permits.

#####

## 6. LAND NAVIGATION AND MOVEMENT

### a. Maps in Vietnam

Units in Vietnam generally have excellent 1:50,000 maps of operational areas; however, it must be remembered that at this scale little detail can be given and only major terrain features are shown. Additionally, it is not uncommon to find smaller villages and areas using local names not agreeing with your map. Check with your interpreter or ARVN troops to avoid confusion. Map tips to remember include:

→ The G-M angle for Vietnam is not large enough to be considered when planning a route.

→ In populated areas, pagodas, churches, schools and bridges make good reference points for checking location.

→ The key to your map is contained in the marginal information. Study it thoroughly.

→ Accuracy is essential when working with the 1:50,000-scale map. Remember a 1.27-inch square covers 1 square mile. Be correct. Map errors cost lives.



b. Be a Map Expert

The majority of operations in Vietnam are conducted by small units. Many of these operations involve long hours of patrolling to collect pieces of information which build a picture of local guerrilla activities. It is essential that the patrol leader have the ability to locate accurately his position at any time, day or night.

Inaccurate location means inaccurate reporting, possible disorientation of the unit, probability of inadequate fire support, and compromise of the unit's mission.

Map reading and proficiency with the compass are the bases for accurate location. Continual use of the compass on patrols should be standard practice. Frequent cuts (azimuths) on known terrain features check the patrol's dead reckoning. Elapsed time and rate of movement, combined with map inspection, can provide the patrol leader with a known position at all times. Small units should make a practice of locating themselves at least each half hour and always when the unit halts. The assignment of two or more two-man teams for this task will allow a cross-check. Careful preplanned illumination missions can assist in patrol location. Daylight reconnaissance of the patrol route, map inspection, and close liaison with other patrol leaders and the unit S-2 are sound practices for patrol preparation.

### c. Land Navigation

In the generally flat terrain of the Con Thien area south of the DMZ, the hedgerows and lack of reference points make it extremely difficult to navigate and determine location. Two

suggestions that may be employed in such areas to lessen these difficulties are:

→ When possible conduct a helicopter reconnaissance prior to entry into an area. This should include as many small unit leaders as feasible.

→ Artillery and mortar illuminating rounds fired during daylight hours can be used to locate one's position on the ground. This is done by plotting a back azimuth from the point of detonation. The point at which back azimuths, from two widely separated rounds, intersect should be one's approximate location (illuminating rounds should be fired at given coordinates).

#### d. Cross-Country Movement in Rough Terrain

"The terrain was the greatest single limiting factor in this operation. Ninety percent of the area consisted of dense secondary undergrowth with a 60 to 100-foot canopy, the rest was elephant grass up to 15-feet high. Trails had to be hacked out, and machetes were a must." That is a brief description of one Marine battalion's operating area, which also included precipitous slopes and areas with drastic changes in elevation. Formations for extended periods were restricted to columns abreast. In this way, if one point element was taken under fire, there was another platoon abreast of it to assist.

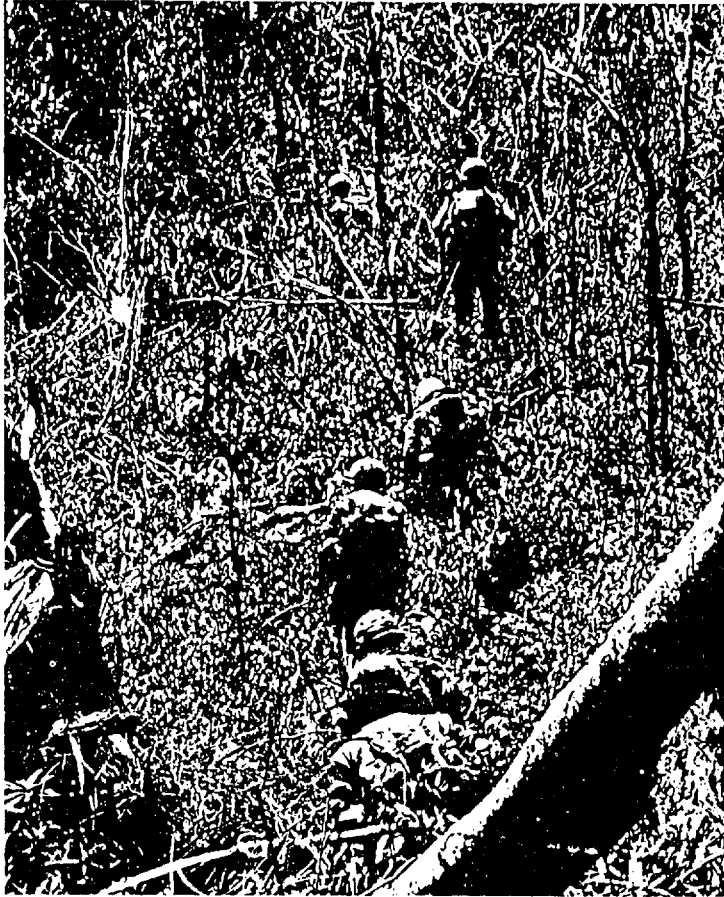

In terrain and vegetation such as was encountered above, it is of paramount importance to know the exact location of other units to avoid firing on friendly troops. Constant radio contact and a direction of march along a fixed azimuth reduces the probability of contact developing between friendly units. The point element should always be well forward of the main body by about

50 meters. The point will normally be the first unit to be engaged and usually by ambush. If the point is well forward, the enemy may be forced to engage prematurely.

e. Jungle Navigation

Many area maps are prepared primarily from photos. Thick jungle canopy may hide many deep and narrow ravines thus preventing their appearance on maps. These hidden features can easily cause lengthy delays and detours. When planning for cross-country movement through the jungle, anticipate such delays and adjust your time frame accordingly.

f. Night Movement

Movement at night and during periods of reduced visibility in areas covered by jungle canopy is extremely difficult. Direction is easily lost, physical exertion is increased, and maximum small unit leadership is required to enforce noise and light discipline. The following items will aid in successful night movement:

→ Personnel physically unable to complete a night march should be evacuated or left behind.

→ Night marches should be short and over previously scouted trails. Use clearly defined objectives and thoroughly brief all hands

on routes to be taken, azimuths, alternate routes, and rendezvous areas.

→ Use guides at trail junctions to help following units stay on course.

→ Reflective tape, if available, or plain white adhesive tape worn on the rear of the helmet should be used to help maintain contact. Luminous vegetable decay found on the jungle floor makes a satisfactory substitute if tape is not available.

→ Use the noise created by rain, wind, or artillery to mask sounds of movement.

→ The period between moonrise and moonset on bright clear nights will often allow conventional control methods.

## g. March Discipline

Personnel recently arrived in a combat environment have a tendency to relax their march discipline when crossing streams and during daylight periods when the column halts. Strict control is necessary when a column crosses a stream to limit the number of personnel refilling their canteens at any time. When column control is lost, units become separated and vulnerable to ambush. Captured enemy personnel have commented on the relatively slow reaction by U.S. troops when fired on during march stops. Security elements had not moved far enough from

the main body and searched adequately to ensure security.

Do not let down your guard at any time.

## h. Deceptive Terrain

What often appears to be flat hard ground in Vietnam often turns out to be just a hard crust covering soft sand beneath. Vehicles of all types will break through the crust and on occasion will become mired. This situation exists usually in areas where the water table is high. Some indications of the existence of this condition are pools of water with no apparent source, areas where patches of ground have sunk a foot or two, and areas where streams appear to begin.

Other points to remember are that soft marshy ground often exists at the entrance to draws that lead toward high ground, and that streams that have hard gravel beds might have soft, spongy sand below.

## i. Cutting Trails Through Bamboo

In jungle terrain, bamboo tree lines can impose a difficult barrier to the movement of foot troops. Experience has shown that the only way to overcome such obstacles is to cut the bamboo about 1 inch below or above the joint



of the stem. A cut in any other location simply shatters the stem and delays clearing.



j. Silent Movement

It is possible for patrols and small units to move through jungle and thickly vegetated

areas with comparative silence. Combat reports emphasize the following points:

- Move carefully and steadily--part the undergrowth whenever possible rather than crush it.
- Avoid stepping on rotten wood, dry leaves and sticks.
- Use silent hand-and-arm signals.
- Cut vegetation as a final resort. If you decide to cut:
  - Use a sharp machete or knife.
  - Use a sawing motion rather than a slash. It is just as fast and less tiring and noisy.

## k. Tactical Movement Tips

Some measures that have proven of value in minimizing the effect of enemy small arms fire during tactical movement are listed below:

- Diversify patrol routes and formations; avoid setting a pattern of movement.
- Use covered routes of approach when possible.
- When feasible, reconnoiter probable sniper positions by fire.
- Establish a covering base of fire before crossing an open area, then "leapfrog" elements across.
- Immediately return enemy fire. Do not allow the element to be pinned down.

- ➔ Use a sniper team for counterharassing fire and to hit long range targets of opportunity.
- ➔ Have supporting arms observers travel in close proximity to the unit commander.
- ➔ Maintain established intervals at all times.
- ➔ Be particularly cautious at first light.
- ➔ Maintain assigned sectors of observation and fire.
- ➔ When in full combat gear, ensure that the armored vest is zipped or buttoned to the neck.

#####



## 7. SNIPERS

### a. Use Your Snipers

Infantry regiments and reconnaissance battalions now have a specially trained and equipped sniper unit capable of killing enemy personnel with single shots from concealed positions. In the regiments there are three squads of five two-man teams. The reconnaissance battalions have a similar organization with four squads of three two-man teams. Each platoon, in addition to the platoon leader and platoon sergeant, has a rifle team equipment armorer capable of second echelon maintenance. The basic unit is a team consisting of two men trained as both snipers and observers. Each team is equipped with one high-powered sniper rifle (Remington 40x7.62mm) with telescopic sight (Redfield 3x9) and a pair of wide-angled binoculars.

Team members are skilled in fieldcraft and are all expert riflemen with superior marksmanship qualities. Training qualifies them for single-shot kills at 800 meters. Such feats have adverse psychological effects on the enemy out of proportion to the means used to attain them.

Contact the operations officer of the organization having control of the sniper platoon for the method of employment best suited to your situation.

b. Employment of Snipers

Daily employment of snipers varies with the unit to which attached. Sniper teams are normally attached to the battalions for a period of approximately 2 weeks and then rotated back to regiment to check weapon's zero, to rezero and to make any repairs or conduct maintenance on the weapons and scopes which cannot be accomplished at battalion level. During the period of attachment, snipers are under operational control of the unit to which they are attached. Employment will vary depending upon the mission of the unit. Appropriate methods of employment for scout sniper teams are:

- As part of a blocking force.
- Outpost security (daylight hours).
- As part of daylight patrols.
- As part of daylight ambushes.
- Long range covering fire for advancing units.

Employment of sniper teams for patrols, outpost security and as members of blocking forces constitute the most prevalent types of employment in RVN.

The main capabilities of the sniper teams are:

- The ability to provide accurate long range precision fire upon enemy snipers, troops

in the open, automatic weapon emplacements and mortar positions.

→ In suitable terrain, the denial to the enemy of freedom of movement.

The principal limitations of sniper teams are:

→ The effectiveness of the sniper is greatly reduced in heavy jungle growth, high grass or during heavy rain.

→ Snipers cannot react swiftly with a high volume of fire. This dictates that the sniper not be utilized in positions that require automatic weapons such as on a point or flank position in a unit.

→ Snipers must work in teams in order to observe the results of their shots and to be able to quickly adjust subsequent rounds. One man observes and calls adjustments of subsequent rounds.

#### c. Extend Night Sniper Ranges

The sniper may find his night ranges limited to 300 meters when using the infrared weapon sight with the self-contained light source. The same weapon and telescope assembly, when used in coordination with the Xenon tank-mounted searchlight, can extend the range to 800 meters. A technique which has been used effectively is to position the sniper in the loader's seat in the

tank. The turret is traversed with the infrared light turned on, allowing the sniper to keep his weapon aligned with the light.

It takes just a short time to develop the necessary coordination between tank commander and sniper to illuminate possible targets. With a properly zeroed rifle first-round hits are possible at maximum ranges.

#### d. Immediate Action to Counter Enemy Snipers

When taken under fire by a sniper, personnel often fall to the ground and seek cover. It cannot be overemphasized that the requirement to bring fire to bear on the suspected sniper location is as important as individual protection. Immediate action drills and directing immediate, rapid and accurate fire into the general location of a sniper should be emphasized in training. This includes grenade, 3.5-inch rocket, M79 and 60mm mortar fire.

#### e. Countering VC Sniper Tactics

One of the more common types of contact with the VC is a sniping incident. The sniping varies from a single sniper who fires a quick round or two and then disappears, to a squad of VC firing heavily for several minutes. Incidents usually take place at ranges of 200 to 300 meters or more. Snipers are well concealed and Marines usually cannot see a target to engage. Large

search and destroy operations have little success in killing or capturing this type of VC guerrilla, but well-planned and executed small unit patrols carried out as indicated below have proven effective in coping with snipers:

→ An operational area is saturated with squad-sized daylight combat patrols to become familiar with the terrain and to make contact with the enemy. Patrol leaders are thoroughly debriefed and current information is kept on when and where patrols received fire. As soon as several contacts have been made in a specific area, one or more squad-sized patrols are sent out during the hours of darkness. They are positioned in fire team-sized OP's or blocking positions where they will be able to cover those positions from where sniper fire was previously received.

→ After daylight, a combat patrol is sent out to patrol through the same area to engage the enemy. The fire team OP's then engage any VC observed moving into their normal sniping positions to snipe at the combat patrol. If the snipers are not first seen from the OP's, the OP's maintain their blocking positions while the patrol physically pursues the snipers attempting to maneuver them toward one of the OP's or blocking positions until they can be engaged.

→ Over a 2-week period, the above tactics produced several significant contacts resulting in confirmed VC kills and capture of VC weapons,



including one with a high-power scope. To achieve maximum effectiveness, patrol members must be thoroughly familiar with the terrain and all details of the patrol plan must be known and understood by the OP/blocking positions and the combat patrol. Patience, alertness, and fire discipline on the part of each Marine are requisites.

#####



## 8. ARTILLERY

### a. Artillery Support

The following information has been extracted from a U.S. Army report on the employment of field artillery:

The mission assigned to artillery units, the ammunition used, and the basic techniques of

employment are no different in Vietnam than elsewhere in the world. Here, as in Korea, artillery accounts for a large percentage of the enemy casualties. Instances are known in which the enemy actually has called off attacks on friendly installations because of his fear of artillery. There are, however, refinements in artillery techniques required by the special circumstances of the fight against this enemy. For example, special attention must be given always to the reduction of casualties among noncombatants who are often intermingled with the enemy troops. Salient lessons learned encompass many local variations in normal artillery employment procedures which increase the effectiveness of fire support missions.

#### (1) Positioning of Artillery Units

→ Since the effectiveness of artillery fire decreases as the number of firing elements is reduced, artillery normally should not be employed in less than battery-sized units. Three suitable battery position layouts which may be used are the "triangular," "hexagonal," and "star" formations. The advantage of such dispositions is that a good dispersion pattern is maintained regardless of the direction of fire. The large number of areas requiring artillery support may reduce the number of units which can be massed on a single target; however, each fire unit should have another fire unit within supporting range for mutual defense against ground

attack. Artillery must be disposed to provide support for all deploying units at all times. A direct support artillery battalion's capability to support multiple company/platoon-sized operations can be enhanced considerably through the formation of a fourth, four-gun battery. Employing three four-gun batteries and a six-gun battery, the battalion can provide adequate firepower to support several small operations while still retaining the capability to mass the fires of two or more batteries.

➔ Be prepared for the unexpected; never assume artillery will not be needed. The threat of an enemy attack from any direction is constant. Artillery units should always be prepared to fire in any direction from the firing position.

➔ The requirement for all-round fire support necessitates a change in the normal plotting chart procedures used in the FDC. Battery positions frequently are plotted at the center of the chart, and the size of the chart is increased on one or all four sides to permit maximum range measurements for the weapon being employed. The 1:50,000-scale firing chart normally is used for medium and heavy artillery units. A larger scale would be too large for a 6400 mil firing capability.

➔ Azimuth stakes should be positioned around the gunpit revetment every 800 mils to facilitate rapid change of direction and reduce the

possibility of firing in the wrong direction (3200 mils out). For the same reason, fire commands include the desired azimuth of fire as their second element.

→ Artillery units should also be prepared for rapid movement to new areas by boats, helicopters, transport airplanes, M113's or conventional vehicles. Helicopter air movement has the advantage of increasing the number of accessible firing positions while not requiring secure ground routes.

→ The enemy considers artillery positions prime targets for mortar and ground attack. Consistent with providing prompt fire support, defensive positions with overhead protection should be prepared and improved as time permits. The FDC and ammunition should be revetted first and the position continuously improved while occupied. Defensive positions should be destroyed upon departure, since the enemy occupy abandoned positions and attempt to prevent our return. In most cases, artillery security requires reinforcement of artillery position area defense with infantry.

## (2) Observation and Adjustment of Fire

→ Ground observation of artillery fire is hampered by dense vegetation. To overcome this limitation, units should take advantage of air observers for adjustment of artillery fire. The employment of WP, smoke, or a high airburst

on the first round often will assist the observer in bringing subsequent rounds rapidly on target.

→ Ground and aerial observers often can be employed effectively as a team. The ground observer marks his position and gives directions to the aerial observer, who subsequently adjusts the fire.

→ A system has been developed for rapid location of target areas using an alphabetical designation for each 1000-meter map grid square within a unit's sector of responsibility. The system has been used to good advantage by some units.

### (3) Coordination and Communication

→ There is a great volume of air traffic throughout Vietnam. Consequently, the ability for close, rapid coordination must be maintained with operational flight elements at all times. In addition, each unit should have an individual at the firing position watching for friendly aircraft along the gun-target line. Artillery can be fired safely over air columns if the fires are coordinated closely with the flight leaders. One effective method of coordination is to place an artillery forward observer with each FAC to coordinate artillery firing during air-strikes. This technique ensures that all elements are informed of firing in progress and provides immediate response for lifting or shifting of fires.

→ Radio has been the primary means of communication for the artillery. Experience has indicated that most artillery units are employed beyond the normal rated range of their FM radios. As a result, it is necessary frequently to rely on continuous employment of FM airborne radio relays and on use of AM radio communications in order to control artillery fires.

→ During field operations, aircraft control and coordination may be obtained by using an artillery advisory broadcast on a predetermined channel. The advisory consists of essential information such as the artillery position, direction of fire and impact area.

#### (4) Special Considerations

→ In addition to delivering destructive fires on the enemy, artillery can be utilized to illuminate critical areas at night, to orient friendly combat forces in dense undergrowth areas, to flush the enemy from hidden locations, to deny him escape routes, to deceive him as to avenues of attack, to interdict suspected enemy positions and for numerous other missions. Harassing and interdiction (H&I) fires based on an understanding of the current intelligence situation can be very effective in demoralizing the enemy both day and night.

→ The selection of fuze action cannot be dictated by terrain alone, as might be expected; rather, the fuze action that actually gives

the best results against each specific target must be determined and selected. For example, it has long been thought that the employment of the VT fuze in the dense jungle area would be ineffective. The enemy positions numerous snipers high in the trees of the jungle canopy. VT fuze action has been used to attack successfully this type of target.

→ Several methods have been developed for using artillery as navigational aids to infantry units in dense jungle when the sky is overcast or cannot be seen through the jungle canopy. Two such methods are:

- To help a lost patrol generally locate itself on a map, an artillery round is fired at a location such as a gridline intersection near the patrol. Several rounds may have to be fired and the patrol may have to shift rounds based on sound. When a round is close enough to the patrol for a definite sensing, the patrol can then determine its general location on a map relative to the coordinates fired by the artillery.

- To help a unit maintain its direction of attack in heavy jungle, artillery may be fired several hundred meters in front of the unit, shifting to new targets in the direction of march. The unit then "follows" the artillery to the objective. This system is preplanned and based on the infantry scheme of maneuver. The

concentrations are preplanned so that the artillery forward observer with the infantry unit can call for particular concentrations.



b. Revised Artillery Fire Request

The elements of the initial fire request for supporting artillery/mortar fires have been revised, as have some of the terms used by the forward observer. FM 6-40 has been revised to incorporate these changes. The revisions are as follows:

Terms

Direction	Azimuth
Final protective fire (FPF)	Barrage
Check firing	Cease firing



Terms

Grid	Coordinates
Target	Concentration
Converge	Converge sheaf
Cancel check firing	Fire (cease fire)
Cancel at my command	Fire when ready
Shot	On the way
Repeat	Repeat fire for effect
Platoon (battery)	Salvo right (left)
right (left)	
Adjust fire	Will adjust

Initial Fire Request

Observer identification	Observer identification
Warning order	Warning order
Location of target	Location of target
Description of target	Nature of target
Method of engagement	Classification of fire
Method of fire and control	Type of adjustment
	Type of projectile
	Fuze action
	Control

Radiotelephone procedures have been changed to reduce the use of the word "over" and to discontinue the use of the word "wait" as a terminating word. Call signs will continue to be eliminated after identities have been established and when no confusion will result. A sample fire

mission illustrates the use of some of these new terms:

Observer: Big Deal 15, this is Big Deal 25, Fire Mission, over.

FDC : (Acknowledges initial call.)

Observer: Grid 123456, direction 2500, machine-guns firing, time, adjust fire, over.

FDC : (All repeatbacks are terminated with OUT.) After order is issued, FDC transmits; Battalion, Bravo, 3 rounds, target BK 1035, over.

Observer: (Repeats FDC Transmission, terminates with OUT.)

FDC : Shot, over.

Observer: Shot, out.

### c. Artillery Support

Artillery employment in Vietnam demands rapid response, adaptability, and preparation for the unexpected. One Marine field artillery battery in RVN was required to demonstrate all of these qualities in a recent multinational operation.

The support which this battery provided was comparable to the support normally expected from an artillery battalion. The battery had to deploy in three widely separated platoon positions, each with its own fire direction center and communications system. Each howitzer was required to maintain a firing capability of 360

degrees. The battery fire direction center coordinated all the reinforcing fires of both its own platoons and a nearby Vietnamese Special Forces artillery platoon. The initial movement and subsequent resupply was accomplished on short notice, and required the breakdown of the howitzers and equipment into helicopter transportable packages.

This form of versatility is essential if artillery units are to do their full share.



#### d. Warning Order to Firing Batteries and FSCC

Forward observers should be aware that the artillery team must be kept constantly informed of the tactical situation.

To lessen reaction time, the artillery forward observer should notify the fire direction

center that contact is imminent or occurring. This starts the wheels rolling for more timely delivery of fires. The liaison officer, with this warning order, can initiate a SAV-A-PLANE which is a safety measure designed to prevent friendly aircraft from flying into the airspace of the artillery projectiles. Without verification from higher headquarters of receipt of the SAV-A-PLANE by friendly air, a fire mission cannot be cleared unless the ground unit is heavily engaged. Many critical minutes have been saved in Vietnam by immediate FSCC clearance of a fire mission due to the early submission of SAV-A-PLANE. If the forward observer notifies the fire direction center of a possible fire mission, a rough azimuth of fire can be established and relayed to the firing battery which can then shift guns to support the infantry with a minimum of delay.

#### e. H&I Fires Are Effective

The daily thunder of artillery engaged in harassing and interdiction missions is not without its merits. Recent reports of extended patrol operations commented that although no VC had been engaged in their operating areas during the patrolling, it was evident that they had recently displaced. Also noted was the effect that H&I fires had on the enemy; campsites had received hits and near misses, supply caches were destroyed, trail systems and river crossing sites were struck, forcing the VC to dislocate. Although

enemy casualties from H&I fires are seldom discovered by friendly patrols, dried blood and discarded dressings have been located, and villagers occasionally have reported VC carrying parties moving their wounded to more secure locations.

Select target areas for H&I fires based on the best intelligence of known and suspected enemy activities.



f. Artillery Parapets

Artillery units have found that artillery parapets should have at least a 60-degree slope. This slope enables the parapet to withstand the shock of heavy, continuous firing and does not erode as rapidly during heavy rains. One method that has worked satisfactorily is to build a step-like arrangement of earthfilled ammo boxes which are in turn covered with a layer of sandbags. This

provides a semipermanent structure which is much easier to maintain.

g. Artillery Tips

→ Bring supporting arms to bear as quickly as possible.

→ Positive contact with the enemy must be followed by fast and aggressive action.

→ Plans to shift radio frequencies if circuits become inoperable must be made in advance.

→ Supply needs of an engaged unit must be anticipated by supporting supply activities to preclude unacceptable delays.

→ A subordinate who enjoys the confidence of his seniors will perform better when he knows about it.

→ The enemy knows and uses English phrases; be wary, make positive identifications.

→ A unit should not operate in enemy territory without plotting oncall fires along its route or in defense of stationary positions. This procedure enables the artillery to make a more rapid response to requests for fire support.

→ Whenever a unit makes contact with the enemy, one of its first reactions should be to call for supporting artillery fire. The enemy under artillery fire tends to be less aggressive and is preoccupied with seeking cover rather than fighting.

→ In areas where map resection is difficult, artillery can and should be used to get a good location; particularly for night positions.

→ Defensive fires, to be effective, must be plotted accurately and the unit the fires are to protect must be sure of its location. If possible, fire in at least one concentration.

→ All leaders must be capable of requesting and adjusting artillery and mortar fires.



h. SAV-A-PLANE

On all artillery fire missions, it is the responsibility of the battalion or regimental FSCC to initiate the SAV-A-PLANE system. This is accomplished by sending the following five elements to the Division FSCC:

- Location of target
- Location of unit firing

- Time firing commenced
- Time firing ceased
- Maximum ordinate of the trajectory

# # # # #

## 9. TRACKED VEHICLES

### a. Indirect Tank Fire

The use of tanks in both a direct and indirect fire support role in Vietnam is not uncommon. Tanks which are used in an indirect role may be able to position themselves to take advantage of the fire direction capabilities of an artillery battery. Here is a technique used with success. First, tank commanders and unit leaders should be familiar with FM 17-12 (Tank Gunnery). Inclined ramps are constructed for each tank; the artillery aiming circle is used to lay each tank. Close check must be maintained between the tank azimuth indicator and a compass to ensure that the tank guns and the artillery tubes are laid on the same azimuth. Compensation for the difference in target and tank altitude is made by computing the angle of site. Cant of the tank may be a problem since the vehicle is usually ramped in one direction. Large errors can be introduced when the gun is traversed perpendicular to the established direction of fire. A safety margin should be added when firing from this position in support of troop units.



Tank gunners should be schooled on the importance of accurate settings for their indirect fire control systems.

b. Long Range Tank Fires

The Viet Cong do not normally move in large groups during daylight hours. Thus, when discovered, they are often able to disperse before artillery fire can be adjusted. On occasion, the M-48A1 tank's long range direct fire capability has been used against the VC with excellent results. Tanks have been able to achieve first- or second-round hits at ranges of 4000 meters. Commanders should be alert to this capability.

Position tanks so they can be employed as long range direct fire weapons when they are available.

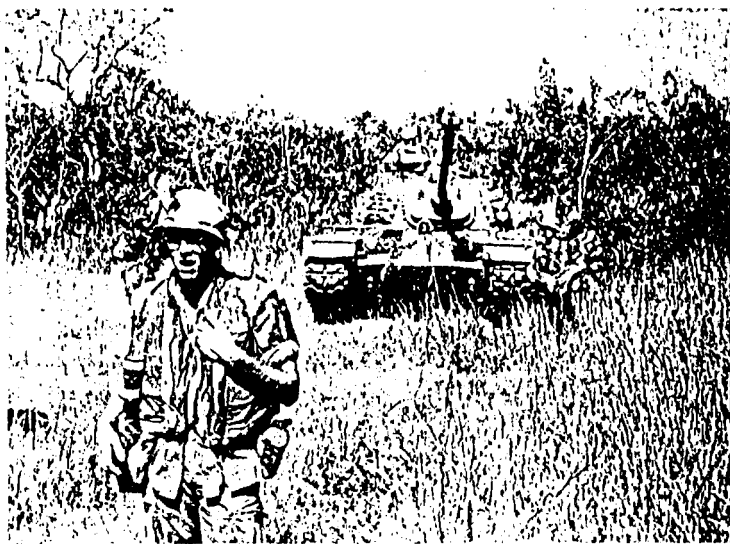

c. Tank Operations

When tanks are operating in areas where small streams and ricefields are found, each tank should carry a dozen or more filled sandbags for use as emergency dunnage material.

When a tank bogs down while attempting to climb out of a soft streambed or ricefield, the filled sandbags can be used in constructing a ramp.

d. Verification of Range Card Firing Data

During the monsoon season when tanks are positioned in static firing positions, indirect firing is conducted by using range card firing data. However, a point to remember is that even though the tank is not moved from its position, the range card firing data can change from day to day. The weight of the vehicle coupled with the repeated recoil action of the main gun when fired will cause the tank to shift position in the soft ground. When this occurs, the elevation and azimuth values obtained from the reference point for various targets become erroneous. Remember that the range card firing data must be verified at least once each day during daylight hours by laying the gun on the reference point to check the established elevation and azimuth values. If an error in either value is noted, a new range card must be prepared.

e. Tank Xenon Searchlights and Infantry Sniperscopes

Utilization of the tank xenon searchlight has been recommended, but, so far, not utilized to its fullest extent. Many positions maintained by tank-infantry forces are necessarily static. During night defensive operations, a sniper team tied in with the tank's TI phone can obtain up to 700 to 800 yards of visibility by using the sniper-scope (without the IR backpack) in conjunction with the tank's xenon searchlight.

f. Tank Lights and A4 Skyhawk Aircraft

Searchlight beams from two Marine tanks marked the spot for two A4's to successfully drop their ordnance during a night mission in support of a surrounded reconnaissance patrol in RVN.

The recon patrol was positioned in a small defensive perimeter on a mountain near Dong Ha. The enemy was so close to the Marine position that the airborne air controller had recommended against making flare drops.

At the base of the mountain, more than a mile away, two Marine tanks with xenon searchlights cast steady beams on the NVA force position.

The two Skyhawk pilots, using the crossed beams as an aiming point, dropped their rockets and bombs on the illuminated enemy with excellent results. After several bombing runs the NVA withdrew with their dead and wounded.

The recon personnel were lifted safely from the position and returned to their base camp by CH-46 helicopters.

Another example of the use of ingenuity, resourcefulness and getting the maximum from all supporting agencies.

## g. Tank Cables

It is useful to keep one tow cable attached to a front tow hook and one attached to the rear tow hook when operating on soft ground. This technique eliminates the need to dig down to a tow hook in order to attach a cable when the vehicle becomes mired. The length of the tow cables normally allows the towing vehicle to remain on solid ground. It was also found that with a cable attached to a hook on each end of the vehicle, two more could be easily carried in the normal cable storage location.

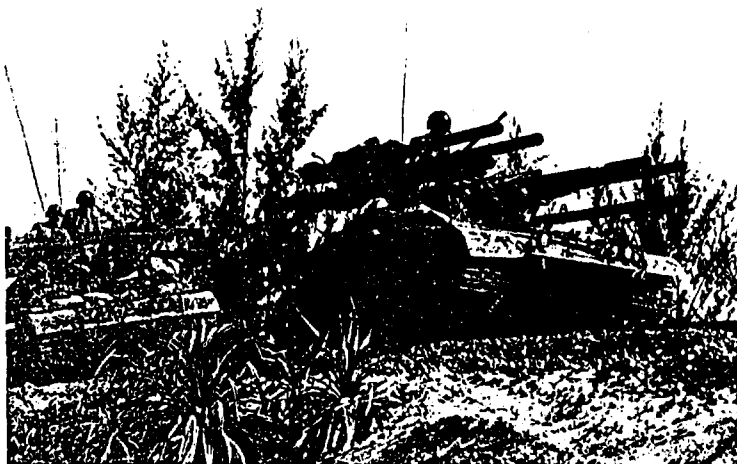

## h. Tank and Ontos Firing Positions

Alternate firing positions for tanks and Ontos become increasingly important when the monsoon season restricts trafficability and defensive tactics are employed more frequently. Enemy recoilless rifle teams will often aim in on a target during daylight and then fire the mission at night. Movement of armor after dark to alternate positions effectively counters such enemy tactics.

## i. Sandbags Aboard Tanks

Tanks often operate in areas known or suspected to contain mines and/or boobytraps. At times, tank crewmen must dismount from the tank in such areas to repair or service the vehicle and to prepare firing positions. Visual reconnaissance of the ground area surrounding the tank for evidence of mines or boobytraps is extremely difficult from a position on the tank. Filled sandbags carried on the tank can be thrown to the ground by crewmen from the protection of the turret. A "stepping stone" patch around the tank can be formed. The impact of the sandbags might also detonate any mines or boobytraps surrounding the vehicle.

## j. Flame Tanks

Flame tanks have been valuable in exposing and destroying VC caves, boobytraps and fortifications. Cave entrances hidden in undergrowth

or hedgerows and camouflaged entrances to spider traps have, on numerous occasions, been exposed by burning. Additionally, some boobytrapped areas have been neutralized by burning. In one instance, 11 explosions resulted from firing one flame tank load into a suspected boobytrapped area.

k. LVTP

When using the LVTP-5 for river operations, little or no protection from sniper fire is afforded personnel riding on top of the vehicle. By piling sandbags three high on each side of the vehicle top, some protection is gained without impairing the tactical response of the infantry aboard. Overcrowding should be avoided to prevent excessive casualties and allow adequate maneuverability.

1. Protection for Ontos Drivers

Although the Ontos has the capability of withstanding the effects of most antipersonnel mines, it is extremely vulnerable to antitank mines. The left front of the vehicle has little capability to absorb the fragmentation and blast of an antitank mine. Since the driver sits in the left front, his only protection is the engine compartment immediately to his right. However, sandbags placed on the deck in the driver's compartment have proven to be an excellent expedient for absorbing the effects of antitank mines.

Recently, an Ontos was destroyed by an antitank mine consisting of one 105mm HE round

and one or more 82mm mortar rounds. The driver received serious injuries but was not in danger of death. He credited the sandbags on the deck of the compartment with saving his life.

#####



## 10. INTELLIGENCE

### a. Combat Intelligence

In an environment such as Vietnam, which is characterized by small unit actions against dispersed enemy units, successful combat operations are usually the result of responding quickly to combat intelligence. Inherent in this quick response is a knowledge of the terrain, including the local villages, and the command and control flexibility to exploit the knowledge gained. The following illustrates a highly successful operation based on quick reaction to intelligence on the enemy's movement.

An aerial observer spotted about 40 VC in an area of known VC activity. Within 1 hour of the initial report, elements of a nearby infantry company moved to the area and an alert force was landed by helicopter to assist them. A VC returnee (Hoi Chanh) was instrumental in pointing out enemy hiding places. During the next 4 hours, 19 VC were killed by Marine patrols. A letter was recovered from one of the bodies which announced a meeting of VC village cadre 3 days hence in a village about 5 miles from the initial engagement. A raiding force of an infantry company was landed at the village at the scheduled meeting time of noon. They were met by mortar, small arms, and machinegun fires in the LZ; the battle raged throughout the village for several hours. Result: 61 VC dead.



b. Intelligence Notebooks

In a counter guerrilla situation, the intelligence workbook, as described in FM 30-5, can be modified to accommodate the short notice demands for a wide variety of information on a large geographic area. One infantry battalion which had been operating in the same area for several months, found that by using a two-notebook system, intelligence was quickly available to patrol leaders and unit commanders. One notebook contained information by subject (attacks, fortifications, mining, etc.) and the second notebook cataloged information by subdivided areas within the battalion's assigned zone. The battalion area and the area immediately adjacent to it were divided on the basis of natural terrain subdivisions influenced by reported or experienced enemy activity.

Such a system means double bookkeeping for the S-2 section but its worth far outweighs the extra effort. The notebook organized by subject is useful in analyzing enemy patterns or trends, while the area notebook presents a complete picture of enemy activities within any particular region. Together these two sources provide the essentials of combat intelligence in an accessible and usable form.

c. Retention of POW's With a Sweeping Unit

While questioning a young, disillusioned VC during an operation, an ITT unit realized that the

individual would be helpful in revealing the location of boobytraps, mines, and possible VC ambush sites. During the balance of the operation, the VC revealed 30 boobytraps and the location of two, company-to-battalion-size VC ambushes. Appropriate action was taken in all cases saving many casualties.

If immediate and on-the-spot interrogation shows a VC in willing to reveal information, he should be retained with a sweep unit, preferably at the battalion S-2 level, to assist in locating enemy installations.



#### d. Enemy Captives

There is a belief among the VC and NVA that common soldiers will be mistreated and killed upon capture, while officers will be given preferred treatment. For this reason, captives

often claim to be officers during initial interrogation in order to avoid mistreatment.

While this type of deception becomes obvious during the interrogation, it is often too late to prevent false information from being disseminated to higher headquarters in the form of spot reports.

To avoid this, a quick evaluation of the captive's general military knowledge combined with the interrogator's estimate of his relative intelligence will usually confirm his identity and avoid unnecessary confusion.

#### e. Documents Found on Prisoners

When a prisoner of any importance is captured, documents are usually found on his person or with his equipment. These documents are necessary in checking a prisoner's story and ascertaining the truth of what he says. Many times these documents are inadvertently separated from the prisoner prior to his interrogation.

The interrogating officer should check with the capturing unit prior to commencing his interrogation. If documents were not with the captive, determine if documents were captured. A copy of the translation of the documents should accompany the prisoner through the evacuation/interrogation chain.



f. Interrogation of Vietnamese Civilians

It has been noted that, although Vietnamese civilians often possess information which could be of use to Marines, such information is sometimes not freely offered. This does not necessarily mean that they will refuse to divulge the information when properly approached. Vietnamese civilians will often provide useful information when engaged in casual conversation, but often will not respond to formal type interrogation. The "soft sell" approach, therefore, is often best when seeking information from Vietnamese civilians.

g. Followup Interrogation of Wounded Captives

Several interrogators have noticed that wounded captives, when questioned on their admittance to a hospital, present false information

or confusing stories. After about a 48-hour period, the subject becomes more cooperative. This situation is probably due to the indoctrination the VC receive in regard to U.S. treatment of captives. The captive expects harsh treatment or execution. He has been told to lie. After proper medical treatment, food, and humane care, the subject's attitude often changes. When a wounded captive presents a confusing story, it is often beneficial to reinterrogate the subject after a 48-hour delay.

## h. Use of ITT and CI Teams

The use of ITT and CI teams with forward units, especially during search and destroy operations, often provides intelligence that can be used immediately by the supported unit.

During a recent operation one of the participating battalions attached its ITT and CI teams to the forward companies where interrogation could be accomplished immediately. Needless to say, a great deal of valuable tactical intelligence was received.

## i. VC Tax Collectors and Couriers

The VC have been known to take advantage of the average Marine's tendency to be compassionate and sympathetic toward those he regards as less fortunate than himself. They have used crippled children and other deformed individuals as tax collectors and couriers.

When conducting searches, attention must be paid to cripples and deformed individuals as well as to healthy persons.



j. Identification of Enemy Weapons

The correct identification and prompt, accurate reporting of enemy weapons which have been captured is valuable combat intelligence. This knowledge can assist a unit commander in determining enemy strength and mission; with it he can take prompt action to maneuver against the enemy. Learn the design features and the names of the various items of enemy weapons and equipment so that you can identify and report them accurately.

k. Counterintelligence

After 2 years of counterintelligence operations in South Vietnam, the following general conclusions are considered valid for guidance in future operations:

→ Counterintelligence teams must be integrated into all tactical operations. Counterintelligence is an essential ingredient in County Fair, search and destroy, and sweep operations, and should not be considered a function separate and distinct from tactical operations.

→ A more aggressive and imaginative collection effort can provide sound intelligence on which to base tactical operations. Several recent operations conducted on the basis of intelligence collected through counterintelligence sources have resulted in the capture of key infrastructure personnel. The counterintelligence team has proven to be the best source of intelligence on the VC infrastructure--the priority intelligence target.

→ The counterinsurgency environment requires an intensification of the normal counterintelligence effort. Two additional teams have been provided III MAF to augment the normal counterintelligence support capability.

→ The counterintelligence team has proven to be a flexible and adaptable organization. Although normally organized into three-man subteams, the CI team has effectively employed two-man subteams in Vietnam. Additionally, each of

the operating areas (TAOR's) poses unique counterintelligence/security problems. The inherent flexibility of the CI team organization has permitted rapid adaptation to the environment and threat.

To exploit the counterintelligence potential in the Vietnam environment, a reorientation of counterintelligence training is being accomplished. The following comments are provided for guidance in training CI personnel for Vietnam assignments:

- Cross-training, or at least close familiarity with order of battle, combat intelligence procedures, and positive collection operations is essential.
- Increased interrogation training is recommended, both with and without an interpreter.
- Coordination with other agencies, particularly the IT teams, is essential. Counterintelligence personnel must be familiar with the activities and responsibilities of the IT teams, civil affairs units and RD teams.
- Teams must be familiar with the nature, purpose, and modus operandi of the Viet Cong infrastructure. This is the priority counterintelligence target.
- Language training is highly desirable.



1. Ralliers and the MEDCAP

MEDCAPS in secure areas provided excellent points at which ralliers can make contact with allied forces either in person or through an intermediary. They are also a good place to have ralliers stationed to point out the VC. MEDCAP activities should be exploited by intelligence personnel and used to disseminate Chieu Hoi information.

#####



11. DOGS IN III MAF

a. Scout/Sentry Dogs

Scout dog teams and sentry dog teams have been employed in Vietnam by Marines since April 1966. There is a basic difference in their

employment. The scout dog alerts on scent and sound and usually does not attack; whereas the sentry dog, which also alerts by scent and sound, can be released to attack an intruder.

Scout dog teams are employed in operations such as combat patrols and ambushes, search and clear operations, and to a limited degree, as listening posts. During patrolling actions, the scout dog is usually employed with the point element to detect enemy personnel, equipment, and tunnels. En route to an ambush site, the scout dog assists in providing security, and, on arrival at the site, provides warning of approaching personnel. During village searches, the dog's keen sense of smell has proven invaluable.

Scout dogs should not be used during the initial search of a village because they will be distracted by normal village activity. After the initial search, villagers should be removed to an area downwind from the village, and the dog team allowed to conduct a systematic search. When the dog alerts, the handler interprets the alert as to direction and distance and passes this information to the patrol leader. Dogs will tire after several hours of activity. For this reason, two dog teams should be used, with one team working while the other rests. The team should be rotated about every 2 hours.

Sentry dog teams are ideally suited for manning sentry posts, since detection of intruders

is greatly increased by the dog's sense of smell and hearing. Sentry dog team posts should be isolated, and traffic in and around the post strictly controlled. This will keep the dog from continually alerting and becoming unduly fatigued. When the sentry dog alerts, the handler can either release the dog or request assistance.

## b. Employment of Scout Dogs

Scout dogs have proven to be a valuable asset when properly employed; however, it must be remembered that they lose their effectiveness when tired. Hot weather and rugged terrain require the dogs to have frequent breaks and sufficient water. Additional guides for the employment of scout dogs are:

- The dogs' keen sense of smell and hearing will often provide early warning of the enemy when employed with night ambush patrols.
- Keep the dog and your interpreters separated as the dog does not distinguish between friendly and enemy Vietnamese.
- If either dog or handler becomes a casualty, evacuate both on the same helicopter.
- Use scout dogs to augment security: early warning; detect infiltrators, tunnels, and devices.
- Ensure dog smell every member of patrol.

- Use dog on point whenever possible.
- Move dog to rear if speed is essential, if wind is blowing from the rear, or if dog is disinterested.
- Provide security for dog teams.
- Keep dog behind assault elements in the attack.
- Brief patrols on proper utilization of scout dog teams prior to operations.

### c. Scout Dogs

During a recent operation in Vietnam, one Marine unit used scout dogs with particular success. A combat patrol with a scout dog team attached fired at four Viet Cong who fled into a nearby hamlet. The patrol pursued into the hamlet and conducted a detailed search. During the search the scout dogs found two VC hiding in a tunnel and flushed another from a nearby tree line. Results were two Viet Cong dead and one captured.

If employed properly with qualified handlers, scout dogs can be a real asset to many types of combat operations. Dogs have a keen sense of smell and excellent hearing. However, when employing them it is well to remember that they become tired much faster than a Marine.

### d. Scout Dogs Bite

Scout dog handlers continually advise Marines to stay away from the valuable but highly

sensitive dogs. Do not pet, feed, or attempt to make friends with the dog. A "friendly" scout dog recently inflicted serious facial injury to an overfriendly, unsuspecting Marine. The Marine, besides requiring 13 stitches in his face, nearly lost his left eye. Leave the care of the dogs to the dog handler.

#####



## 12. THE COMBINED ACTION COMPANY

The information presented below has been extracted from an FMFPac order which presents not only a clear insight into the organization and functions of the combined action company, but also the importance of this Marine innovation to ultimate victory in Vietnam.

### a. Background

By mutual agreement between the Commanding General, III Marine Amphibious Force and the Commanding General of I Corps Tactical Zone, Marine units have been integrated with Popular Force units within certain villages and hamlets to assist in providing security and pacification measures.

The combined action company has been organized to provide a sufficient force to occupy and control areas uncovered by the forward movement of the U.S. Marine and ARVN units and to assist in revolutionary development efforts within these areas. It has been found that Popular Force units native to the area, assisted by U.S. Marines, form a unit ideally suited to the task of providing security to hamlets and villages in cleared or semicleared areas. The CAC is afforded the aid of U.S. Marine Corps and ARVN supporting arms in the accomplishment of its mission. The coordination of activities is the responsibility of the commander of the area of responsibility in which the CAC is located.

b. Organization

A combined action unit consists of two elements, PF and USMC, integrated into a single operational entity. Organization follows the PF structure in which the platoon normally is the largest tactical unit. The combined action company is organized to supervise a grouping of platoons, and is capable of supporting up to 12 platoons. The Marine element of a combined action platoon consists of one Marine rifle squad and one U.S. Navy corpsman, which augments and reinforces the PF platoon composed of three rifle squads and a platoon headquarters.

c. Concept of Operation

The combined action units are used in cleared and semicleared areas to provide security in villages and hamlets and to provide training for Popular Forces. Combined action platoons are provided the capability to call for and adjust supporting arms. Secondary missions are to conduct civic action and gather intelligence for CAC and other friendly forces operating in the area, and to provide other appropriate assistance to Vietnamese and U.S. officials in furtherance of Revolutionary development activities. With the advent of the 1967 Revolutionary Development Plan, actions by U.S. civilian and military units, other than CAC, will extend into more and more hamlets. As the only U.S. representative physically present on a continuing basis, and conversant with many facets of life in the hamlet, the

USMC squad leader is in effect the U.S. representative for revolutionary development activities in his hamlet and is expected to so function. This relationship has been agreed to by regional officials of the Office of Civil Operations.

#### d. Location

Combined action platoons (CAP) are positioned at critical locations determined by mutual agreement between the local Marine commander, as approved by the Commanding General concerned, and appropriate district chiefs.

#### e. Tasks

Appropriate tasks for the combined action companies are as follows:

- Motivate, instill pride, patriotism and aggressiveness in Popular Forces.
- Conduct day and night patrols and ambushes in assigned areas.
- Conduct training in general military subjects, leadership and language for all personnel of the combined action platoon to increase the proficiency of PF elements so that Marine elements may ultimately be withdrawn and PF elements may continue to perform in a proficient manner.
- Conduct combined operations with ARVN and U.S. Marine Corps units in coordination with the district chief and the Marine TAOR commander within the CAC platoon area of responsibility.



→ Marine squad leaders in individual CAC platoons function as U.S. revolutionary development representatives for the hamlet which they serve.

→ Establish an intelligence apparatus in and about the hamlet in which located, in conjunction with local indigenous, ARVN and civilian representatives. Ensure that information gathered is made available promptly and on a regular basis to the intelligence center at district level as well as to the headquarters to which responsible.

f. Command

Command of combined action companies is the responsibility of the commanding general of the command in whose area of operation the unit is located.

Operational control of each CAC unit is specified by the commanding general/commanding officer concerned if delegated below division/task force/FLC level.

Command, less OPCON, is exercised at division/task force command level, using the administrative subunit assets which have been provided for this purpose. Certain administrative functions (e.g., provision of rations, transportation, and local supply of consumables) may be delegated to subordinate operational commanders, provided these responsibilities are specifically set forth.

Commanding generals ensure that a continuing system of command monitoring and inspection of CAC units is in force. Monthly reports are submitted.

The III MAF Combined Action Company Programs Officer, a member of the staff of the Commanding General, III MAF, conducts frequent and informal staff visits to various CAC units throughout the I CTZ, and keeps the commanding general continually informed on all pertinent matters pertaining to the status of the CAC program.

Command relationships within the CAC platoons are on a coordination and cooperation basis. The USMC squad leader does not command the PF element of the platoon, nor does the PF platoon leader command the Marines. Neither has authority to discipline members of the other component. Offenses by Marines will be handled through normal command channels, and incidents involving PF soldiers will be reported to the district chief.

#### g. Administration and Supply

The Marine element of the CAC is administered and supported through Marine channels although it lives in conjunction with its PF counterparts. Shelter and living accommodations, which are not available from village sources, are provided from Marine assets. Commanders provide centralized administration and supply

support in order to relieve tactical battalions and regiments of this responsibility.

Personnel assigned to CAC units must meet the following criteria:

→ Preferably with 2 months in country and a minimum of 6 months remaining on current tour.

→ Be a mature, motivated Marine and be highly recommended by his commanding officer for duty with CAC. Selection of the squad leader receives special attention because of the importance of his function.

#### h. Nature of the Popular Force Soldier

The PF soldier is the lowest paid soldier in the ARVN. He must augment his pay by working part of the time in or near the hamlet/village where he is located in order to provide the basic living essentials for his family. This fact must be taken into account in assigning duties and conducting combined activities. Commanders can assist the PF soldier by ensuring the delivery of the PF food supplement (provided by USAID) through the district chiefs. This food supplement may be further increased from Marine sources where possible. In addition, when organic assets permit, supplies such as cots, shelter and other appropriate equipment can be shared with the PF platoon.

#####



### 13. KIT CARSON SCOUTS

#### a. General

In July 1966 former VC were first used to work with Marine units on small unit tactical operations, County Fairs and psychological operations. It was soon recognized that their knowledge of the VC "Modus Operandi" was invaluable in assisting tactical units in identifying VC with whom they formerly served. For example, one ex-VC identified over 30 enemy in 2 months while employed in the role of a scout with a Marine unit. In October a pilot group was hired (three teams of two men each) on a permanent basis to live and work with units of the First Marine Division. These returnees were named "Kit Carson Scouts" by the Commanding General, 1st Marine

Division, after the famous guide of the 19th century. The program proved so successful that the CG, 1st MarDiv immediately requested that it be expanded to provide two scouts for each rifle company.

The scouts have been most successful when employed in their former areas of operation. They are invaluable in identifying the enemy, a problem that has always plagued commanders in a counter-insurgency environment. There is no substitute for their knowledge of the terrain and the tactics and techniques employed by their former comrades.

The program has yielded substantial results. The scouts have assisted Marine units in all types of operations ranging from major unit actions to the interrogation of Viet Cong suspects.

Thus far, there has not been a single instance in which a scout has turned against a friendly unit or attempted to lead it into an ambush. However, as the program is expanded, the possibility of the VC being able to insert an agent is increased. Caution, therefore, must always be used when employing the Kit Carson Scouts, and a highly selective screening process and a detailed training schedule must be established.

## b. Method of Employing Kit Carson Scouts

The various methods of Kit Carson Scout employment available to the industrious unit commander is limited only by his imagination.

Experience has indicated that effective techniques of employment become more numerous as the scout becomes accustomed to the hosting unit. For this reason, the scout should be permitted to become as familiar as possible with a particular unit when he is initially placed in the field. As he begins to feel at home and grows more accustomed to Marine living conditions, customs and equipment, his talents can be employed with various units in a command.

A scout is normally assigned to a unit operating in an area in which he is familiar with the terrain, population and VC. Remember this: It is the key to getting an effective return from the scout. The information and knowledge that the new scout brings to his first unit will be relatively fresh and may be the most important contribution that he will be able to make. It doesn't take long for enemy intelligence to determine this man is helping the Marines and the scout's information must be exploited before the VC have time to relocate hiding places and personnel to new locations.

A scout should have a few days to get acquainted with his new unit, weapon, and personal equipment. The Marine(s) assigned to look after the scouts play a very important part in the success of future operations. They must be selected accordingly. It may be necessary for the Marine(s) to literally live with the scouts and therefore it should be a voluntary assignment.

The more the scouts fell a part of the unit, the better they will produce.

The scout should have a thorough briefing on the importance of his selection and new assignment.

As the scouts become familiar with the Marines assigned to work with them, along with the interpreter (a most important individual), they should be put to work without delay in order to take advantage of their knowledge of the enemy while it is still current. Operations and patrols should be planned around this information. A common mistake observed regarding scout employment in the past has been the tendency to place the scouts on the routine patrols without considering the type of knowledge of the enemy they possess. Personnel should be constantly aware of the language barrier and the scouts oriental custom of being hesitant to criticize. A patrol leader may be making mistakes and passing up excellent opportunities in the eyes of the scouts. In extreme cases, a new scout may simply walk along with the patrol and remain silent rather than make recommendations and have the patrol leader lose face. This is fairly easy to guard against and can usually be overcome by frequently questioning him about the area, trails and people encountered on patrols. He must be made to realize the importance of reporting information promptly and pointing out mistakes of Marines when observed.

The recommendations contained herein are not meant to encourage Marines to become over-reliant on the scout although he must be listened to and relied upon to be effectively utilized. The possibility always exists that a VC agent could enter the program and eventually be selected as a Kit Carson Scout. Complacency could be costly and discretion must be used at all times.

The following are recommendations for the utilization of Kit Carson Scouts which have proven effective in the past:

- ➔ Assist in search operations for the detection of VC by facial recognition. There is no substitution for this method of positive identification.
- ➔ Assist in search operations for VC equipment and supplies. The scouts know many techniques used by the enemy to conceal their supplies and equipment.
- ➔ Assist in the control and identification of the population. Returnees can be used to speak to the population to gain support of the GVN. Their personal story of defecting will add considerable credibility to what they are saying.
- ➔ Assist in the location of caves and tunnels.
- ➔ Assist in the exploitation of other returnees. When a person rallies under the Chieu Hoi program, it is important that a returnee speak to him as soon as possible to strengthen



his decision of defecting. New returnees with "hot" information may be persuaded to accompany a scout into the field on short operations to seize an important objective.

➔ Assist in guiding Marine units through VC controlled areas or over rough terrain.

#####



#### 14. RIVERINE OPERATION

The following is information taken from a combat afteraction report written by a Marine officer serving as a battalion advisor with the Vietnamese Marine Corps. The operation took place in the Rung Sat Special Zone (RSSZ), a large mangrove swamp area, which is located astride the main shipping channel between Saigon

and the South China Sea. NHA BE, which is mentioned several times in this report, is the location of the headquarters of the special zone.

The Vietnamese Marine battalion was assigned a TAOR of 200 square miles in the eastern portion of the Rung Sat and included terrain west and south of the main shipping channel.

The RSSZ is an area of dense mangrove swamps interspersed with nipa palm groves. Innumerable rivers, streams and small canals crisscross the area. These are the principal lines of communication for civilians, enemy and friendly units. Some canals are manmade and are utilized to cross the Rung Sat. Normal elevation in the area is 1 meter or less above high water. The highest point in the TAOR is a 10-meter high hill or rock outcropping.

Until mid-June, vegetation in the TAOR was dense and provided excellent concealment for individuals, boats and positions. Defoliation in late May and early June provided excellent results and removed foliage in areas of many bunker complexes and camp areas. In nipa palm groves, defoliation had little effect except to whiten the palm. In the mangrove areas, the leaves fell away thus revealing campsites underneath. Especially effective was the defoliation of the area west of the main channel. Some 30 bunker and camp complexes were discovered in an area of 20 square kilometers and was undoubtedly a large guerrilla base camp complex.

The tidal range in the TAOR is approximately 12 feet, with two highs and two lows each day. At low tide many small streams are dry and larger rivers and streams present high, steep banks. The rapid currents during filling and receding tides make small streams dangerous for troop crossings and difficult for small boats. At high tide it is virtually impossible to move rapidly by foot. Individuals in ambushes placed along the streams often found themselves waist deep in water for at least half of the ambush period. This constant exposure of weapons to damp and wet conditions caused considerable corrosion and rust problems.

The weather during the period varied from late dry season weather to early monsoon weather. During the dry season, many areas dried quickly with a dry crust of several inches of firm terrain. A significant fact involved drying after the tides receded. The edges of trench lines, bunker tops and lips of foxholes stood out distinctly from the air and contributed greatly to the discovery of many Viet Cong positions. With the advent of the rainy season, the combination of tides and daily rains inundated the area of all times. At the time the battalion departed, the terrain remained saturated with the combination of rain and tidal activity. Intelligence on VC units and positions was available to the battalion from various sources; but aerial observation provided the primary information which was acted upon. In most cases accuracy was excellent and a large number of targets was identified.



a. Intelligence

The Viet Cong units operating in the Rung Sat Special Zone are under the command of a military and political headquarters, the T-10. The Rung Sat is referred to as Military Region 10 and was designated such in August 1966. Under direct control of the Central Office of South Vietnam (COSVN), the highest Viet Cong headquarters in South Vietnam, the T-10 directs the activities of some eight main force companies. Each has a heavy weapons platoon of .50 caliber machineguns and 57mm recoilless rifles. In addition, the companies possess water mine, demolition, communication, and assorted small arms capabilities. Mortar capability is unknown and no mortar activity took place during the operation. In support of the main force units, seven local force guerrilla platoons and district and

village infrastructure exist. Due to extensive operations in the Rung Sat by U.S. Army, Vietnamese Marine, Regional and Popular Force units, the Viet Cong operated in small, decentralized units of three to ten guerrillas, In addition to these sapper squads, whose mission is to interdict traffic on the main shipping channel (LONG TAU), tax collectors, food collectors, and logistic elements were continuously operating within the TAOR. The VC maintained the ability to mass by using a system of tower stations which will be discussed in detail below.

(1) Tactics. In the Rung Sat, the Viet Cong attempt to achieve two missions: First, to interdict shipping and traffic on the main channel and second, to ensure that at least three Free World force battalions operate in the Rung Sat, thus denying their availability to other Corps zones. By utilizing small elements to harass and raid at opportune moments, a relatively small force is maintaining enough activity to require the battalions to operate in this area. However, interdiction of the main shipping channel has not been successful for sometime, though on several occasions river patrol boats (PBR's) and minesweepers were attacked while carrying out their security missions. The Viet Cong ambush is usually a well-timed and coordinated attack of short duration (15 to 30 seconds) with escape by sampan and dispersion before sufficient reaction forces can be introduced. The ambush site generally consists of four foxholes. The first foxhole contains a recoilless rifle, the second an

activator for a command-detonated mine, the third an automatic weapon, and the fourth a group of riflemen. Many of these four-foxhole positions were observed throughout the Rung Sat during the operation. The Viet Cong utilized a simple early warning system. Near each active camp located in the TAOR was a tree platform or tower. On 10 occasions VC were observed either in the towers or dropping from them and running into the nearest dense area. These towers are located across the Rung Sat and undoubtedly serve to signal elements crossing the Rung Sat between adjacent provinces as well as providing early warning and unit massing capability.

b. Mission of the Vietnamese Marine Battalion

- ➔ To prevent interdiction of the main shipping channel by continuous patrol and ambush activity in areas adjacent to the river.
- ➔ To conduct operations and search out guerrilla elements, and campsites located in the TAOR.
- ➔ To provide security for the village of Tam Tho Hiep and the battalion CP.

c. Execution

The Vietnamese Marines located their CP at the village of Tam Tho Hiep. This village is on high ground and supported the artillery positions and boating requirements, as well as the battalion



command post. The central location of this village greatly facilitated artillery support for Vietnamese and U.S. units as well as providing an LZ for the medical evacuation of personnel.

During the 70-day operation, continuous company level operations involving saturation patrolling and selective ambushes were conducted.

These operations were highly successful in locating guerrilla camps and bunker complexes. In conjunction with the ground operations, extensive aerial observation missions were also conducted. Supporting arms included air, naval gunfire and artillery.

Two companies were inserted by River Assault Group-22 (RAG) for 2 to 3 days into assigned sectors, while the remaining two companies established a reserve and provided CP and village security positions. Platoons operated from patrol bases with squad patrols and ambushes predominating. Reaction platoons in each company had swimmer support boats (SSB's) available for rapid reaction. The operating companies assumed an area of responsibility of approximately 10 to 12 square kilometers. One helicopter was attached to the battalion each day and was used extensively in air reconnaissance missions and for medical evacuations.

This operation in the Rung Sat was essentially counter guerrilla in nature, and conducted on a decentralized basis with emphasis upon riverine capabilities. The lack of Viet Cong mobility due to difficult terrain forced their elements to disperse into small units until such times as swift attacks could be planned and conducted. This factor made it possible for the battalion to decentralize and operate on platoon and squad level. Former operations in which battalions or companies moved in one or two columns through dense vegetation and deep water or mud,



wasted considerable time and effort. Encirclement and block and sweep operations are still valid techniques and are used by nearly every unit of company- or battalion-size. The following page describes a technique utilized by this battalion. Briefly the technique is based upon area saturation and quick reaction. Companies are inserted by RAG units into two sectors, each of 5 to 6 square kilometers. Platoons are decentralized into 6 or 8 subsectors with one platoon designated a reaction force at the company CP. The platoons in patrol bases have two to three SSB's for use of their reaction forces. The additional member of the battalion team, and probably most important, is the air observer in the command and control helicopter. Also available was a VNMC spotter and F/O (XO of the battalion) who directed the troop units to targets located by the helicopter. By making a series of low-level searches of the sectors, actual camp and bunker complexes were located as well as suspect areas. Once located, the air observer and VNMC spotter mark the target continuously with smoke while mobile squads in SSB's move to the location. Reaction elements were used to block or assist in attacking the camps. In some cases helicopter gunships were used to cover the C/C ship during low-level reconnaissance in particularly difficult areas. The VNMC officer continually directed the movement of the ground troops by giving them compass azimuths from their locations to the enemy, or by pointing out streams to follow to the target area. With this

technique, 16 active Viet Cong camps were discovered and destroyed. Each camp contained equipment and VC were usually observed running from the area. It is virtually impossible to block and contain VC in this terrain even on company level because of the early warning capability they possess--the towers and warning shots. Covering and marking the camp with the helicopter forced VC to abandon the camp when it was discovered, but ambushes established near the captured camps resulted in five VC KIA. In each case these were sapper teams moving back into the area to set mines and boobytraps as the contents of the sampans proved. The great amount of time saved by ground units using the technique of reacting to aerial spotting was the prime reason for its use. For troop units to patrol the very swampy areas with no actual objective except to patrol is unproductive. The air observer has excellent surveillance at low level and virtually every camp or bunker complex located was discovered after passes over the site. In some cases highly suspect thickets or dense areas were pointed out to ground units for their patrols. To support this technique, RAG boats with direct fire capability, helicopter gunships, and artillery spotted by the A/O were available and utilized. Movement to and from company sectors offered little difficulty and companies were inserted and extracted every 2 or 3 days in order to maintain troop physical strength and endurance. In conjunction with the technique described, company sectors were varied in different areas of the

TAOR and emphasis was placed upon patrolling and ambushing primary Viet Cong crossing areas and routes.

d. Summary

During the operation a total of 49 Viet Cong harboring sites were located. Generally, the sites were a camp with buildings (tin roof and frame sides) and thatch shelters, a bunker or several bunkers with foxholes and trench lines, or a small peripheral campsite with a warning tower and one or two small shelters and a bunker. Only three camps were discovered by ground patrols without the assistance of an air observer. The remainder were located as a result of aerial reconnaissance in and around the TAOR. Eight suspected areas were searched out by the A/O based upon intelligence information provided by a variety of intelligence sources. These were fired upon by artillery and naval gunfire. During the period seven VC were killed (2 probable) and 25 suspects were detained and subsequently released. A total of 21 active sites were destroyed with a total of 118 shelters, 18 bunkers and one medical aid station being either burned or destroyed by ground units and supporting arms. Arms and equipment captured or destroyed included four rifles, 18 sampans, one outboard motor, 73 boobytraps, 23 grenades, 19 mines and in excess of 5000 rounds of assorted small-arms ammunition. Rice, sugar, salt, rubber

boots, water jars and cooking utensils were also confiscated during the operation.

e. Analysis

This riverine operation was characterized by close cooperation and coordination between ground, air, naval, and supporting arms units. This, coupled with excellent intelligence and rapid reaction to the information provided, enabled the units to accomplish all three missions with the minimum of forces. The results prove the validity of such techniques in the delta and provide a basis for future operations in similar terrain.

#####

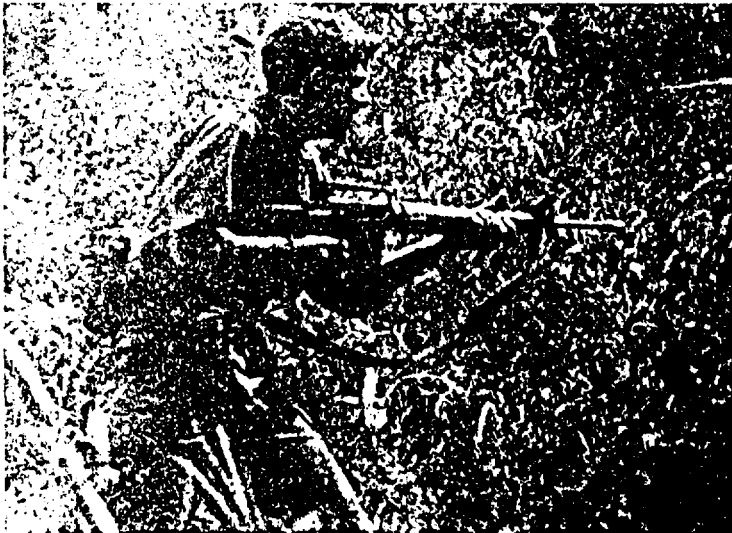

## 15. WEAPONS AND MUNITIONS

### a. M-16 Rifle

The M-16 rifle has the following unique features:

→ The simplicity of design and fewer functional parts than other shoulder weapons ensure better reliability.

→ The straight-line construction coupled with the 5.56mm cartridge (cal. 223) reduces recoil and increases controllability in automatic fire.

→ The weight of the weapon is noticeably less than other service rifles (the M-16 weighs 7 pounds loaded). Part of this reduction in weight is realized by the stamped aluminum of the lower receiver, the molded plastic stock which includes the straight-line recoil system, and the molded plastic handguards and pistol grip.

→ Another feature is the break-open shotgun design which permits quick, easy access to the receiver group.

→ The feature which has the most dramatic appeal is the muzzle velocity (3200 fps) which, translated into layman's language, means killing power. As a comparison, the muzzle velocity of the M-16 is 390 percent greater than the .45 caliber pistol (830 fps), and 12 percent greater than the M-14 rifle (2750 fps).



b. Care and Cleaning of the M-16 Rifle

➔ Clean the chamber, locking lugs and locking recess with chamber brush and bore cleaner at the earliest opportune moment after firing. If the correct chamber brush is not available, an M-14, M-60, or .45 caliber pistol brush can be used as a field expedient. The chamber should be wiped dry with patches and given a light coat of oil for storage or left dry for immediate firing.

→ Clean the bolt carrier key with a bore brush preferably a used one) and bore cleaner as soon as possible after firing. The carrier key should be cleaned daily and lubricated inside with one drop of oil (PL Special).

• Disassemble all bolt and carrier parts from the bolt carrier and clean and inspect as soon as possible after firing. Clean with bore cleaner, wipe dry, and oil with two drops of semi-fluid lubricating oil (LSA) on the bolt rings. Add a light coat of oil (3 drops on a patch) to all surfaces of the bolt and the bolt carrier.

NOTE: FOR FIELD USE, DO NOT APPLY OIL TO SURFACES OF THE BOLT AND CARRIER. MERELY APPLY LUBRIPLATE TO SLIDING CONTACT SURFACES, HAMMER CAM SURFACE (ON BOTTOM OF CARRIER) AND BOLT CAM PIN.

→ Clean the end of the gas tube inside the upper receiver at the earliest opportunity after firing. Use bore cleaner and a worn bore brush attached to a section of cleaning rod.

→ Clean the lower receiver as well as possible without disassembling it; use bore cleaner, brush and patches. Wipe dry and apply light coat of oil.

NOTE: FOR FIELD USE, DO NOT APPLY OIL INSIDE LOWER RECEIVER; MERELY PUT ONE DROP OF OIL AT EACH END OF THE HAMMER, TRIGGER, TAKEDOWN AND PIVOT PINS. LUBRICATE THE SELECTOR AS REQUIRED.

- Keep the outside of the weapon dry.
- Clean and lightly lubricate the action spring and guide when required.
- Never pour oil into any part of the rifle.
- Clean the magazines and loaded ammunition each time the rifle is cleaned but DO NOT OIL THE MAGAZINES OR AMMUNITION.

The most critical areas in cleaning the M-16 are:

- Chamber and locking recess.
- Bolt and bolt carrier: Carrier key, bolt face, locking lugs, extractor claw, bolt rings and shoulders.
- Magazines and loaded ammunition.

Load a maximum of 18 rounds in the magazine.

Never leave a round chambered for longer than necessary: Rounds left in the chamber for excessive periods can fail to extract, particularly if the weapon has been fired just prior to chambering the round.

Wipe magazines and ammunition as soon as possible after rains, river crossing, or exposure to dust and dirt.

Never tape magazines together.

Each man armed with the M-16A1 rifle should carry his issue cleaning gear.



## COMMON MALFUNCTIONS: PREVENTION AND CORRECTION

<u>MALFUNCTION</u>	<u>REPORTED CAUSES</u>	<u>PREVENTION/ CORRECTION</u>
Failure to extract*	Dirty chamber; dirty or corroded ammunition; faulty extractor or extractor spring	Clean the chamber and ammunition; replace defective parts
Failure to feed	Overloaded, dirty or un-serviceable magazines	Inspect magazines for cleanliness and serviceability; load not more than 18 rounds
Failure to fire	Buildup of dirt or carbon on the firing pin shoulders; improper assembly of the bolt and bolt carrier; faulty ammunition	Check for proper assembly of the bolt and carrier; clean the firing pin; replace ammunition
Inoperative	Lack of lubrication	Lubricate as required

\*NOTE: Failure to extract is most often the result of a dirty chamber or ammunition. Inspection of the cartridge case, however, many indicate a faulty extractor or a weak extractor spring. A faulty extractor will often fail to grasp the cartridge rim concentrically and a weak spring will permit the extractor claw to ride over the rim. In either instance, the cartridge rim is usually marked by the extractor claw in such a manner as to permit identification of the problem.

## c. Added Firepower

Two powerful mobile and versatile U.S. Army weapons are being employed in Marine areas in Vietnam. These are the twin 40mm carriage-mounted cannon, and the four, caliber .50 machineguns mounted in a turret on a wheeled vehicle. These dual-purpose guns are employed in a ground support role and are available for air defense should the requirement arise. In a ground support role both weapons can be used effectively for convoy escort and perimeter defense. For convoy escort the weapons are usually dispersed throughout the convoy with one near the front and another at the rear of the column. The convoy alert force will usually have weapons positioned nearby in case of ambush.

These guns have proven effective for the protection of command posts, engineer working parties, and in defense of fixed installations. Their high rates of fire (40mm - 200 rds/min., cal. .50 - 2000 rds/min.) provide an unparalleled shock effect. For air defense the guns can use fire control information employing the parent battalion's radar system. Direct and indirect fire can be employed.



d. Machinegun Laying

The proper employment of one or a combination of several field expedient methods will ensure more effective employment of the M-60 machinegun in engaging preselected targets.

The notched stake or tree crotch technique is used with the bipod-mounted MG to engage preselected targets within a sector or to define the sector limits. This method is effective in all conditions of visibility and requires a minimum of additional material. The horizontal log method is used with either the bipod- or tripod-mounted machinegun to mark sector limits and provide a sector of grazing fire.



e. 3.5-Inch Rocket Launcher

In recent operations, close combat has been frequent and fierce. Utilization of supporting arms was not always feasible against enemy automatic weapon positions and strong points due to the closeness of friendly troops. An immediately available and highly effective source of firepower was the 3.5-inch rocket launcher.

f. Rocket Safety

Frequently in RVN, 3.5-inch rocket rounds are carried lashed to a packboard in such a manner that the bore-riding safety clip is apt to be torn off by a vine or branch. This clip should be secured to the round with a strip of adhesive-type tape to prevent its loss and the possible inadvertent arming.

g. Protection for 3.5-Inch Rockets

When operating in the rain or damp weather, the 3.5-inch rocket rounds should be kept in their canisters until required for use. During the monsoon season this is particularly important, as was evidenced on a recent operation when it was necessary to destroy 17 rounds because dampness had rendered them unreliable. It is better to spend a few extra seconds preparing a round that can be counted on than having a number of unreliable rounds immediately available.

h. Secure Those Grenades

The explosive power of a fragmentation grenade can generate great respect in the individual Marine, particularly if he is on the receiving end. This should be all the more reason to carry grenades firmly affixed to the person. The grenade pouch is provided for just this reason. Recently, while patrolling through a small hamlet, a Vietnamese boy grabbed a grenade which was hanging by the safety lever from a Marine's cartridge belt and attempted to escape with it. The child was quickly apprehended along with another boy. They stated that they had been instructed by the local VC cadre to steal the grenade. The two boys then led a patrol to a nearby cave where a VC food cache was discovered.

Every possible source of enemy munitions must be strictly controlled.



i. All-Around Mortar Fire

Mortar crews in Vietnam are frequently required to fire missions beyond the usual 3200 mils coverage. An additional set of aiming stakes 3200 mils to the rear of the front set of stakes easily accommodates this situation. All that is needed to shift fires is to swing the tube and bipod legs to the rear, align the sight and begin firing. Practice this technique during training and be proficient at it before you use it in combat.

j. All Purpose Demolition Kit

The continuing demand for a capability to destroy enemy explosive devices, caves, and fortified positions has led to the development of a demolition kit for squad use.

Demolition training for members of the squad can be accomplished through the technical services of an engineer unit. Four men in addition to the squad leader should be trained to use these demolitions.

The kit can be carried in a haversack or in the cloth carrying bag in which plastic explosive is packaged. There is sufficient room in the latter by removing one of the blocks of plastic explosive. These are the suggested components for the unit demolition kit:

- Seven 2½-pound blocks of composition 4.
- One pair of blasting cap crimpers.
- Ten to fifteen feet of time fuze.
- Five to seven M1 fuze lighters.
- Ten M1 nonelectric blasting caps with protective container (carried separately).
- Twenty to thirty feet of detonating cord.

#### k. Carrying 60mm Mortar Ammo

When a shortage of 60mm mortar pouches exists, an empty M-37 demolition bag can be used as a field expedient. Seven 60mm rounds and demolition bag weigh approximately 35 pounds. One bag can be worn crossbody with the strap across the right shoulder and the bag riding on the left hip. When carrying two, they can be tied together by the carrying straps and worn with straps running across each shoulder with one bag on the chest and the other on the back.



1. Tracer Rounds

During periods of darkness or reduced visibility, tracers are useful to mark targets and adjust fires. Team leaders can carry one full magazine of tracer rounds for marking purposes. Individual accuracy is improved when



a few tracer rounds are included in rifle magazines to see the strike of the round in darkness. Remember, the long red finger of that tracer points right back to the place where it started, so use it wisely.

## m. Starlight Scope Handling

The starlight scope increases the ability of the individual Marine to accomplish night combat surveillance and enables him to direct aimed fire during night operations. The scope can be hand held or mounted on the M-14, M-16, or M-60. Usable range and target detection is dependent upon terrain, vegetation, atmospheric conditions, and light levels existent at the time of employment.

This scope can withstand rugged environmental conditions but, like other optical equipment, must be handled with care to avoid damage to the lenses, adjustment knobs, power switch, etc. Caution must be taken to prevent high intensity light from being shown directly into the objective lens. High intensity light can seriously damage the scope. Always keep the lens cap on the objective lens when operating in daylight conditions.

The starlight scope is an important piece of your equipment. Take good care of it. For organizational and direct support maintenance instructions refer to TM 11-1090-268-13 dated July 1967.

n. O-Chlorobenenealmalonitrile

More commonly known as tear gas or CS by Marines who have stumbled out of a gas chamber; the gas produces immediate, effective and very incapacitating results. CS causes burning of the eyes, a heavy flow of tears, coughing, difficult breathing, closing of the eyes, tightness in the chest, dizziness, and other uncomfortable side effects. Heavy concentrations may cause nausea and vomiting. The immediate onset of the above can prevent affected personnel from taking appropriate action to counteract these effects.

CS can be dispensed by grenades, blowers, or launched cartridges. Descriptions of the various means available for disseminating CS are shown below:

→ Grenade, Hand, Riot, CN 1, M25A2. Normally used to control riots. The radius of burst (visible cloud agent) is approximately 5 meters, but fragments of the plastic grenade occasionally fly as far as 25 meters. Effective quantities of the agent may be carried as far as 70 to 95 meters downwind. The average Marine can throw this grenade approximately 50 meters.

→ Grenade, Hand, CS, M7A2/M7A3. This grenade is an irritant agent, special purpose munition used to control riots, mobs, and other disturbances. It may also be used to simulate casualty agents during training of personnel. The irritant is emitted from this grenade for 15 to 35 seconds and provides a greater volume of agent

than the M25A2. If persistent results are desired, this grenade is preferred over the M25A2.

→ Launcher, 35mm Ctg, 16-Tube E8. The E8 launcher is capable of firing 64 E23 cartridges utilizing 16 tubes. The launcher tubes are arranged in a rectangular pattern with the tubes positioned to give a wide impact pattern on the target. The typical agent cloud generated when fired from a firmly emplaced launcher at a 40-degree elevation will be rectangular in shape and will cover 30 meters in the target area. The duration of agent dissemination is 10 to 15 seconds after the cartridge lands in the target area.

→ Mity Mite Blower. The Mity Mite is a lightweight, gasoline-operated blower which can be used in a variety of ways. When used with chemical agents it will:

- Force the evacuation of unmasked personnel from a tunnel system by blowing riot control agent into the tunnel. (Use the Grenade, Hand, CS, M7A2/M7A3.)
- Discourage reentry into a tunnel by contaminating it with a powdered riot control agent.

#####

16. U.S. ARMY BATTALION COMMANDER

The following observations concern the experiences of a U.S. Army battalion commander operating in the III Corps Tactical Zone of Vietnam. They are published to acquaint Marines with the problems encountered by one battalion commander and to demonstrate his method of operating in the jungle terrain of War Zones C and D.



a. Intelligence

"Good intelligence is the real key to success in Vietnam. This is particularly true at the battalion level. There is no place in Vietnam that a U.S. infantry battalion cannot go, with almost complete freedom, as long as it is within range of its supporting weapons. The trick then is determining where to go in order to deal the VC a

blow. This is the job of combat intelligence. In WW II or Korea (even though the destruction of enemy forces was the primary mission) it was very closely tied to seizure of terrain. In Vietnam, the VC very seldom place any importance on terrain unless it contains a supply or base complex. The primary purpose of combat intelligence therefore is to locate the enemy. This we are doing with only a fair amount of success. There are many ways to improve upon this. Most of these (agents, electronic means, etc.) are not within the capability or scope of an infantry unit. The one thing which can be done at this level is to ensure rapid, free, and complete exchange of information. This is not being done (sometimes even within the battalions of a brigade) fast enough.

"If a battalion is on a pacification mission, the need for intelligence is paramount. Not only must they know where the VC units are, but they must be able to identify, by name, the local guerrillas who are the members of the cadre or infrastructure. In guerrilla warfare, it is almost impossible to separate tactical military intelligence from political intelligence, but the problem is the same. Everyone (ARVN, National Police and U.S.) must have access to all available information. There is a risk of a security leak under these conditions, but this risk is less serious than no exchange of information at all.

"Our intelligence personnel are surprisingly well trained considering the lack of emphasis placed on combat intelligence in peace time. This does not present a real problem. The problem is that we don't exchange information up, down, and crosswise quickly enough to become useful to the recipient."

## b. Supervision

"The big problem in the operation field is the individual soldier. Our training centers do an excellent job of training individual soldiers, however, this same soldier will become lax, indifferent, and slovenly unless he is forcefully and skillfully led. This leadership must be exercised constantly. Soldiers in combat tend to become lazy. They spend many hours waiting, or merely doing nothing. This leads them to form bad habits which are fatal when under fire. A soldier will fail to dig, disperse, or to clean his weapon unless he is required to do so; even though he knows such a failure could well lead to his death.

"It is not that soldiers don't know what to do, or what is right or wrong. It is that they fail to do these things unless made to do so. Our junior leaders, both officer and NCO, don't practice the military adage of checking on everything. Some of this is caused by the mistaken idea that looking after the men means to be easy on them. Allowing men to ride, when for safety's sake they should walk, and letting them dig prone

shelters rather than fighting holes are but a few examples of this. In the main, a soldier will do only what is required of him. If junior leaders don't check, the men will not perform properly. It has been said, with a great deal of insight into the problem, that if we could get every man to do three things every day we would have no problems. The first of these is to dig. The second is to keep clean--not only himself, but his weapon, and his area. The third is to stay alert. This includes keeping spread out, keeping scouts or security out at all times, and staying off of well-used trails. Constant application of these three rules would solve the vast majority of the troubles in infantry units in Vietnam."



c. Health

"A major health problem that a unit commander, within a battalion, must concern himself with is skin disease. Ringworm, skin rashes, immersion foot, and infections caused by thorn or bamboo scratches cause loss of time and disability if not treated at once. This is particularly true during the rainy season.

"Time lost due to skin disease can be kept to a minimum if the commanders are alert. Squad leaders and fire team leaders must check every day to ensure that men wash and shave, that they change their socks, dry their feet and that minor cuts and scratches are treated. If this is not done, infection is almost certain to set in, and a man is lost for several days or weeks."

# # # # #



Chapter III: NATURE OF THE ENEMY



1. THE ENEMY

a. The Individual

You will encounter a variety of enemy troops, ranging from the poorly trained and

equipped hamlet guerrilla to the well-trained, indoctrinated, and equipped North Vietnamese soldier. In any case, he is an elusive and determined foe. He must endure many hardships, and he is often very dedicated. He is an expert in the arts of camouflage, deception, and ambush. He is a hardy and ruthless fighter, but he is not invincible.

The enemy is considered in three general categories:

→ The local hamlet, village, or district guerrilla is poorly educated and trained. He may be armed with a few grenades, an old French or German rifle, or a captured U.S. weapon. Although he may only be a part-time soldier, he is an important part of the VC effort. The local guerrilla knows the people and the terrain. He controls the local populace and supports VC units operating in his area. He may serve the VC as a porter, guide, or trail watcher; he may maintain a local cache and prepare village fortifications, or provide an early warning screen for regular units; he may conduct acts of terrorism, harassment, or sabotage; and he may serve as an intelligence agent.

→ The Main Force Viet Cong is a full-time soldier. He may have gained combat experience against French, ARVN, or U.S. forces, or he may be a recent recruit from the local forces. He is usually well-trained and equipped. He is outfitted with his weapon, a few grenades, a pack, a tubular shaped sack of rice which he

slings across his shoulder, a hammock, a set or two of black pajamas, and a pair of rubber sandals. He carries a modern and effective ChiCom copy of a Russian family of weapons (SKS carbine, AK-47 assault rifle, RDP LMG, and RPG-2 rocket launcher). The carbine, assault rifle and light machinegun all use a standard 7.62mm cartridge.

→ The North Vietnamese soldier has, in most cases, been carefully indoctrinated and trained before his long march into South Vietnam. He has been provided a simple, but lightweight and well-adapted set of equipment, including khaki uniforms, a sun helmet, standard load bearing equipment, a plastic canteen, canvas rubber-soled shoes, and rubber sandals. He also carries a modern and effective ChiCom copy of a Russian family of weapons (SKS carbine, AK-47 assault rifle, RPD LMG, and RPG-2 rocket launcher). He has normally trained and infiltrated with his unit into South Vietnam.

## b. Military Organization

The highest enemy military headquarters in the Republic of Vietnam is the Central Office, South Vietnam (COSVN), which receives instructions from Hanoi. COSVN has overall responsibility for VC military operations in RVN and exercises direct control over certain units. Six VC military regions are subordinate to COSVN. The military region is a political headquarters with a closely integrated military component

which directs military operations of subordinate units. At provincial and district levels, the VC political and military structure closely parallels that of the Government of South Vietnam. Each VC political headquarters at province, district, village, and hamlet levels includes a military component which exercises control over Viet Cong military units assigned to its area of jurisdiction. This organization technique subordinates the military to the political and promotes unity of effort. The VC organization is patterned after that used in Vietnam.

North Vietnamese Army and Main Force VC units are organized into squads, platoons, companies, battalions, regiments and divisions. All these units follow the "triangular" concept; i.e., three squads per platoon, three platoons per company, etc.

→ The squad includes 10 men organized into three cells. The first cell consists of the squad leader and three other men. The remaining six personnel are organized into two cells of three men each. The assistant squad leader is the leader of one of these, and the senior member leads the third cell. The squad is armed with carbines, assault rifles, and handgrenades.

→ The rifle platoon has three rifle squads and a weapons squad. The weapons squad is equipped with light machineguns.

→ The rifle company has a strength of 60 to 130 men and includes three rifle platoons

and a weapons platoon. The weapons platoon is armed with the 60mm mortar, 57mm RR, and light machineguns.

→ Each battalion (300 to 600 men) has three or four rifle companies, a heavy weapons company, and special purpose platoons (signal, engineer, reconnaissance). The heavy weapons company employs the 81mm or 82mm mortar, the 57mm RR, and heavy machineguns.

→ A typical regiment (1400 to 2000 men) consists of two to four rifle battalions, a heavy weapons battalion, and special purpose companies (antiaircraft, signal, engineer, reconnaissance, and medical). The heavy weapons battalion employs 81mm or 82mm mortars, 75mm recoilless rifles, and heavy machineguns.

→ The enemy is beginning to use division level headquarters, conducting multiregimental operations.

→ The enemy is employing artillery rockets (Soviet 122mm and 190mm) in attacks by fire in support of some ground operations. Limited use of artillery (up to 152mm) is being made in certain areas, normally along the DMZ or from sanctuaries in Laos.

→ Local force units are usually encountered in squad and platoon strength. However, local force companies and battalions are known to exist and operate in many areas.

→ Military units vary considerably in strength and equipment, depending upon subordination, location, health rate, availability of food and recruits, degree of VC control and results of recent engagements with FWMAF forces.



c. Tactics and Techniques

(1) General

→ The basic tactical code of the VC is "When the enemy advances, withdraw; when he defends, harass; when he is tired, attack; when he withdraws, pursue." Emphasis is placed upon speed, security, surprise, and deception. The VC exhibit great skill in making the most of their enemy's weaknesses.

→ Enemy operations are planned in detail and are based upon careful reconnaissance and collection of intelligence. Troops are prepared

for a mission with detailed rehearsals, including the use of mockups, sand tables, and similar terrain. Once a plan has been prepared and rehearsed, the VC seem reluctant to depart from it. A certain inflexibility is apparent in many VC operations, but on some occasions, VC forces have shown themselves to be capable of improvisation.

→ The VC are very cautious and attempt to determine in detail the size, disposition, and direction of movement of their opponents before engaging them. They would rather let an opportunity slip by than act hastily without proper intelligence and preparation. For this reason, a meeting engagement, which usually does not provide a marked advantage to the VC, is avoided at all costs. However, should such an action take place, they are taught to "Be the first to deploy troops to critical terrain, be the first to open fire, be the first to assault." The purpose of this aggressive action is to seize the initiative and to delay and disorganize the enemy by causing him to deploy rapidly under fire. During the resultant confusion, the VC break contact and withdraw.

→ Local Viet Cong forces tend to operate near roads and villages where they may control the local populace, and assist the regular units which cannot so easily avoid detection. Main force and NVA units normally move and establish bases in more remote areas, usually along natural lines of drift, such as trails, streambeds, and valleys. They take maximum advantage of

heavily vegetated terrain which provides them concealment from aerial observation. They move deep into difficult terrain, such as high mountain ranges, only when pressed by our forces.

➔ The VC will normally make use of every opportunity to harass, to delay, and disorganize our forces through the use of snipers, mines, boobytraps, probing attacks, etc. They will usually attempt to disengage and withdraw when faced with superior firepower, or when they no longer enjoy an advantage. In contrast, NVA units may defend tenaciously, or vigorously press an attack, even in the face of overwhelming U.S. firepower. They frequently attempt to employ "close embrace" tactics, or engagements at very close range, to prevent our use of supporting fires. They often disengage and withdraw only after suffering severe losses.

## (2) Offensive Tactics

➔ An important VC offensive tactic is the raid. It may be conducted by units from squad to regimental size, and is most often executed during the hours of darkness. Two basic types of VC raids have been noted. The surprise raid is the most common. Security and speed are key considerations in this type of action because the VC raiding party may have less numerical strength than the defending force. The power raid is one in which the VC employ overwhelming strength and firepower in order to annihilate a defending unit. The time the raid begins may be



a clue to its nature. Raids begun after 0200 hours are rarely power raids.

→ The ambush is one of the most effective VC offensive tactics. Ambushes are normally established along roads, trails, streams, and other natural routes of movement. Enemy force patterns are studied in detail, and then ambushes are established along regularly traveled routes. VC ambushes are usually short, violent actions followed by a rapid withdrawal. Frequently the VC have established ambushes behind friendly patrols after they left their patrol bases. When the patrol retraced their routes, they were caught in ambushes when patrol members were tired and security was lax.

→ The "lure and ambush" is a commonly used VC tactic. The basic principle is to draw the attention of friendly forces and lure them into prepared ambushes. Many variations of this tactic have been noted. Some of the variations are as follows:

- The VC have attacked an outpost or vulnerable unit and then attempted to ambush relief forces at nearby landing zones or along principal avenues of approach.

- Withdrawing VC units have attempted to lead friendly forces into the ambushes of other VC units.

- Snipers have drawn the attention of friendly units and enticed them into ambushes.

- The VC have mortared friendly base camps and then ambushed friendly forces in search of mortar positions.

- The VC have used some of the above methods to entice friendly units into heavily boobytrapped or mined areas.

→ Harassment is a basic tactic of VC guerrillas. Sniper activity and probes are used to demoralize, confuse, and mislead friendly forces. Diversionary harassing attacks have been used to draw friendly forces away from vulnerable VC installations.

→ The VC are experts at infiltration. They have infiltrated friendly positions during periods of reduced visibility and adverse weather, often combining the infiltration with a feint or ruse. Frequently they have infiltrated friendly positions disguised as local civilians. Objects of VC infiltration are sabotage, assassination, demoralization of friendly troops, collection of intelligence, and disorganization of friendly units. Rapid deterioration of organized defenses and many accidental casualties have been caused by these infiltration tactics.

→ The VC have been known to follow a friendly unit to a helicopter or truck pickup point. They then launch an attack as the last units are leaving, and when departing troops are most vulnerable and least prepared mentally to react quickly.

(3) Defensive Techniques

The Viet Cong avoid defense because they cannot withstand friendly firepower. However, they may defend vulnerable units, bases, and installations for short periods of time.

The Viet Cong prepare extensive defensive positions throughout their operational areas. If surprised by friendly forces, they will, if possible, withdraw to a previously prepared position and defend until they can break out, most probably during the hours of darkness. VC positions are characterized by defense in depth, mutual support, overhead cover and maximum use of natural cover and concealment. Defenses are oriented along trails and other obvious avenues of approach. Boobytraps are often incorporated in the defenses, particularly in VC base areas.

As a reaction to friendly heliborne operations, the VC have prepared defensive positions at the edges of prominent landing zones in their operational areas. In some instances they have remained covered in a second line of fortifications several hundred yards from the landing zone while friendly artillery and Tac Air prepared the landing zone. When the preparation ended, the VC moved forward to defend at the edge of the landing zone, and then withdrew to the second line of trenches when necessary.

(4) Withdrawal Techniques

The Viet Cong include a withdrawal plan with every offensive and defensive plan. As soon as the situation becomes unfavorable to their forces, they withdraw rapidly along preplanned, concealed escape routes. They often break down into small groups and withdraw along the same route they used in their approach.

During the withdrawal, the VC make extensive use of rearguard personnel whose mission is to delay the pursuing friendly force until withdrawal of the VC main force is accomplished. Ambushes designed to slow friendly forces are also frequently employed.

A typical withdrawal technique used by small VC forces in danger of an unfavorable, close-range contact is to drop their packs and run. Friendly forces have been inclined to slow their pursuit in order to inspect the packs.

The VC may also evade capture by hiding or by blending in with the local populace. Hiding places used by the VC are almost limitless, although underground locations appear to be the favorite. Underground means of hiding troops and equipment range from simple "spider holes" to elaborate, reinforced rooms. From the surface, these underground installations are most difficult to detect. Critical points are entrances and exits, which are usually concealed in gardens, animal pens, under piles of straw or dung, in or under structures, and in riverbanks.

Extensive and ingeniously constructed underground tunnel systems are one of the unique features of underground hiding places. Most are constructed in such a manner that they permit short term underground habitation. They are usually built in a zigzag, multilevel form with ventilation holes at various intervals. This type of construction may provide protection from grenades or discovery. When cornered underground by friendly forces, the VC will often eject a grenade from one of these holes and attempt to escape through another exit during the resulting shock and smoke.



#### d. Boobytraps and Mines

Boobytraps are favorite devices of the VC. Grenades, spike traps, poison arrows, unexploded ordnance (duds), and a variety of other means are

employed to harass, slowdown, confuse, and kill friendly forces. The forms of these weapons are limited only by the imagination of the designer.

Boobytraps have most often been used along trails, in moats and entrances to villages, in gaps in fences or thick brush, at fording sites, at bypasses to obstacles, in doorways, and on abandoned bodies, weapons, and equipment.

Grenades are commonly used as boobytraps because they are lightweight, easy to carry and conceal, and readily adaptable. They are frequently put in trees or bushes along trails friendly forces are expected to use, with tripwires strung across the pathway.

Spiked foot and mantraps are common types of boobytraps found throughout Vietnam. The spikes may be sharpened bamboo sticks, or they may be barbed wood or metal spikes emplaced in wooden, concrete or metal blocks. The spiked devices are placed in holes along routes of movement, and carefully camouflaged to prevent detection, or they may be placed in rows on top of the ground.

The VC also employ crude but effective tripwire type devices along trails and paths which release arrows, bamboo whips, and other swinging, barbed, club-type objects. Barbs are often dipped in poison to compound casualty effects.

Antipersonnel and antitank mines are used extensively in VC operations. They may be of the

crude homemade variety or they may be similar to those in the U.S. inventory. When AT mines are employed, they are used exclusively on roads and trails capable of carrying vehicular traffic. The VC have not been known to mix AT and AP mines in their minefields. However, AP mines are employed on defensive terrain nearby so that personnel taking to the high ground to protect a disabled vehicle are then subjected to the AP mines and boobytraps. AP mines are used to defend entrances to VC underground hiding places and along trails.

AT mines are placed in hollowed-out places on bridges or in holes which have been dug in roads. In order to make the hole difficult to discover, the VC may scatter dirt across the road for several hundred meters or dig several dummy holes for deception or for mine employment at a later date. Water buffalo dung has also been used for camouflage. Shoulders along roads are often mined, and occasionally the VC tunnel in from the shoulders to plant electrically controlled mines directly in the center of the road. This latter practice permits "selective targeting" of vehicular traffic. On some occasions the VC have buried wire leading to a road, but have not emplaced a mine. When friendly troops failed to discover the wire, the VC then emplaced the mine and destroyed the next target of their choosing.



e. Miscellaneous Observations

The VC are very nonchalant in areas they believe are safe. They travel almost exclusively on trails, and security is very lax. When they



know enemy units have moved into an area, they shift from the major trails to low terrain, stream-beds, etc.

Although the VC are accustomed to moving along trails at night and conducting well-rehearsed night attacks or probes in familiar terrain, they are not experienced in night combat and are often surprised and confused when engaged unexpectedly by friendly forces at night.

Typical signs of enemy presence are dead foliage which may be camouflage for a trap, tied down brush which may be a firing lane for a defensive or ambush position and villages which have been recently abandoned by women and children.

Enemy caches are usually at convenient locations, beside secondary trails, etc. Typical hiding places for VC equipment are rafters, thatched roofs, rice or rice bags, haystacks, dung piles, and wells.

Local guerrillas prefer to live in villages with their families at night. Movement of guerrillas out of villages at dawn and into villages at dark is a pattern in many areas.

The VC attempt to locate distinguishing features of friendly forces when engaged. They will fire most often upon personnel distinguished by radio antennas or back packs, insignia or rank, or automatic weapons with bipods. They will con-

concentrate fires upon anyone who appears to be giving commands.

In preparation for an engagement, the VC will prestock the battle area and rally points with resupplies of ammunition, medical supplies and equipment.

The VC often prepare covert mortar firing positions for use without a base plate. An angled (preaimed) cylindrical hole is dug at the mortar position. During the attack, the VC move forward to the hole, emplace the mortar tube, fire the desired number of rounds, and then hide the tube at another location, or withdraw with the tube.

The VC often use a creeping pattern in support of ground attacks. In other words, the mortar rounds fall very closely in front of the advancing troops.

The VC are experienced in breaching unobserved wire which has not been supplemented with detection devices.

As an adjunct to their operations orders, the VC prepare elaborate plans to insure the recovery of dead, wounded, weapons, ammunition, and equipment from the battlefield.

## ## ##



## 2. NVA/VC REGISTRATION TECHNIQUE

It has been recently noted that NVA/VC have been registering their mortars prior to an infantry attack. The registration normally consists of one round near a specific position. For example, on a recent date one round hit 50 meters from an 81mm mortar position at 1700. This was followed at approximately 2400 by a combined infantry/mortar attack in which the 81mm mortar position received 20 rounds of mortar fire.

If at all possible, friendly positions subjected to this tactic should be moved prior to any possible infantry/mortar attack. Where relocation is not possible, the defensive posture should be strengthened through the appropriate means.

#####



### 3. ENEMY FORTIFICATIONS

Recently discovered North Vietnamese Army bunker systems and field fortifications were characterized by their excellent concealment and narrow fields of fire. Most of the bunkers could not be detected until Marines were within 10 to 30 feet of the fortification. The lack of a wide field of fire from the bunkers was partially compensated for by numerous spider traps which were positioned to protect the bunker systems. The principal direction of fire from the bunker was invariably along trails and avenues of approach that would afford each movement to attacking Marine forces.

The avoidance of obvious avenues of approach can negate planned enemy fires, achieve surprise, and render the fields less destructive.

#####

#### 4. ENEMY EMPLOYMENT OF RPG-2 ANTI-TANK ROCKET LAUNCHERS

Recent encounters between our tanks and the enemy armed with RPG-2 rocket launchers have indicated an established pattern of employment. As the tank approaches a hidden antitank position, the crew's attention is diverted by automatic weapons fire. The natural instinct of the tank commander and gunner is to traverse the turret toward the automatic weapons and engage them with the coaxial machinegun or main gun. With the turret turned, for example, to 2 or 3 o'clock, the RPG-2 antitank man inevitably will get off a shot from 10 to 11 o'clock on the turret's flat side.

Tank commanders and gunners should be alert to this feint and not bring all weapons to bear on one area. It is recommended that the tank commander counter the small arms and automatic fire with his .50 caliber machinegun. The gunner should remain alert to fire the coaxial machinegun or main gun with canister in the other direction from ranges of 30 to 300 meters. Infantry working in close support should be briefed on this problem and should be prepared to maintain frontal fire for short range or long range protection.

# # # # #



## 5. ENEMY SNIPERS

An analysis of the techniques and tactics of enemy snipers reveals several points of interest. Enemy snipers are organized into teams or cells.

The team (5 men) and the cell (3 men) are trained as snipers by an organized unit with which they operate. Snipers have used the K-44 rifle (7.62mm Mosin Nayant) with scope attached. This is a bolt-action rifle with a 5-round magazine: Maximum effective range with the scope is 1400 meters, and the maximum horizontal range is 3500 meters. Trained snipers employ mines and other explosive devices to cause casualties; to channel friendly troop movements and to facilitate their own withdrawal. Snipers may engage at distances between 50 to 600 meters depending on the terrain. The snipers are usually deployed so as to permit the friendly force to be engaged initially from head on, and then from the flanks and rear. The initial fire is usually aimed at the point element in an effort to fix the friendly unit's attention toward its front.

Remaining snipers are concealed in predetermined positions along the route of friendly advance. The flank and rear snipers' principal targets are the unit commander and men carrying automatic weapons and radios. Enemy snipers usually do not fire more than about 5 rounds, with most casualties resulting from the first 2 or 3 rounds. Trained snipers will normally maintain contact with a target by withdrawing along preplanned routes paralleling the route of advance of the friendly column. Firing is continued from predetermined positions.

Much of the fire reported as sniper fire can be attributed to local guerrillas. Such fire can be

distinguished by its larger expenditure of ammunition and the shorter ranges involved. It is also usually less accurate. The local guerrilla operates independently, with a sector of responsibility rather than as part of a team.

The basic tactic of enemy snipers should be studied to determine the most effective means of countering them. Unit commanders should bear in mind that harassing or sniper fire can be extremely effective, and can slow or even halt the friendly advance.

# # # # #

## 6. VC WARNING DEVICE

The Viet Cong have devised many ways to provide warning and protection from approaching patrols. One method is to place large piles of cut tree branches on trails approaching villages. These brush piles extend completely across the trail, and are from 3 to 6 feet in width, with heights up to 4 feet. Removal of these obstacles is difficult without creating noise which will alert the enemy; movement around them is just as difficult. The patrol leader must be prepared to expend as much time as is necessary to move around the branches or to quietly remove them to avoid detection.

The Viet Cong also have used a number of warning signals to alert their forces of the approach of friendly patrols. Warning devices have



included blinking lights, drumbeating and small arms fire. In one area VC sympathizers were instructed to remove and wave their hats when Marine patrols approached. All unit leaders should take note of any unusual occurrences which could alert the enemy of the presence of Marine patrols.

Marine security patrols in one hamlet area noticed a marked lack of contact at night with the Viet Cong. In discussing this with a hamlet official, the Vietnamese attributed it to a warning system that certain villagers use to advertise patrol movements. A single light in a house window meant that patrols were in the area; two lights meant all clear. The houses displaying these lights are situated on the edge of the hamlet near an open field where the signal could be seen from any of several paths leading toward the hamlet.

# # # # #

## 7. VC TRICKS

Rock throwing can be harassing, and even dangerous, when it is used as a deception measure. The VC have frequently thrown rocks at Marine positions at night to harass and distract the sentries. The enemy has been known to include a grenade in a barrage of stones. The best protection against such a tactic is to be alert and have a well-prepared position including protective wire beyond grenade range. Treat any such incident as just what it is--potentially dangerous.

The Viet Cong do not limit themselves to the use of explosive devices when attempting to harass U.S. troops. During a recent operation by a Marine unit, a discarded VC pack was cautiously examined. It contained no explosives, but something just as deadly--a bamboo viper. The snake was killed and that unit learned a new enemy invocation.

#####



#### 8. VC DECEPTION

Deception in all forms is practiced by the Viet Cong. The following example illustrates an attempt by the VC to halt naval gunfire bombardments. A naval gunfire airborne spotter had directed fire missions on a known VC base area; the missions had been properly cleared, and the gunfire was on target. The following morning a

sampan approached the gunfire ship. Several elderly Vietnamese were on board displaying national flags and holding up papers. Two of them were taken aboard the ship, and the local district chief and advisory personnel were flown aboard to aid in interpreting. The papers were requests to the ship not to fire on the hamlets near the coast. This was an obvious deception as the two hamlets were known to be VC controlled and used as enemy bases. Both hamlets had long been a source of trouble for patrols. The VC forced the local village elders to present false complaints about civilian casualties due to gunfire. In this case, both hamlets had long been vacated by those people who were not VC or VC sympathizers. The villagers were advised subsequently by the district chief that firing would not be necessary near these villages if the people made the VC leave.

Deceptions are a commonplace tactic of the guerrilla. Each seemingly valid request must be investigated to determine whether some form of deception is being attempted and how best to counter it.

#####



## 9. VC ATTACKS

An analysis of combat reports of Viet Cong attacks against U.S. and other friendly fixed positions shows the intensity and duration of the attacks have varied widely. As has been emphasized before, the VC thoroughly prepare for such attacks. This preparation is not without indicators if you know where they are to be found. For instance, adult men rather than children have herded cattle near friendly positions one or more days prior to the attack. The familiar patterns of neighboring village routine are noticeably altered; fewer people attend market days; more or fewer persons are observed riding the local bus; the general attitude of the villagers is less warm and conversations more circumspect; the village chief is not available for daily liaison visits.

Members of the local populace can be VC sympathizers and, although they appear to be engaged in routine activities, they can actually be supporting the Viet Cong with an action such as one noted by an alert Marine patrol. During movement near a small hamlet, one patrol observed a group of villagers who all appeared to have one stiff arm, while the other arm was normal. When the group was questioned and searched, they were all found to have a weapon concealed in their sleeve. All indicators such as these can be arrows pointing to potential trouble spots. Counterinsurgency, like good police work, means lots of routine legwork and continuous evaluation of evidence and circumstances.

The intensity and short duration of attacks mean that every minute is critical in reducing casualties. Reconnaissance and tight local security are good preventive measures; well dug in positions save lives.

#####

## 10. VC COUNTERAMBUSH TECHNIQUE

One ambush technique utilized by the VC is to preposition an automatic weapon approximately 100 to 150 meters from a known or probable USMC ambush site. Prearranged left and right lateral limits are then selected. These limits are usually natural terrain features that are easily identified (trees, boulders or houses). Two enveloping elements consisting of two or three VC,

usually armed with grenades, are then dispatched.

The enveloping element moves out and takes positions at the prearranged left and right lateral limits, at which time the VC automatic weapon delivers well dispersed fire over the entire probable ambush site or several sites. Marines who immediately return fire give away their positions. The VC automatic weapon ceases fire at this time enabling envelopment units to move in undetected and saturate the ambush site with grenades.

It is, therefore, well to remember not to immediately return fire when a friendly ambush site receives a large volume of fire from a relatively great distance. Keep under cover and stay alert to respond to the situation as it develops.

#####

## 11. VIET CONG RIVER-CROSSING TECHNIQUES

Conversations with Popular Forces personnel reveal that the Viet Cong, in heavily patrolled areas, do not always use boats as a means of crossing rivers. In areas where rivers are rather wide, the Viet Cong will tie or strap their weapons across their backs, inflate an easily obtainable plastic bag and float slowly across with only their heads showing. To mark the point where the individual is to land, the Viet Cong have used the

technique of placing a simple bicycle taillight reflector mounted on a bamboo stick at the desired landing point. On moonlit nights, the reflector provides adequate light for navigation purposes. Tinfoil has also been used as a means of providing an unattended navigation light.

#####

## 12. VIET CONG MEDICINE

The following account of Viet Cong medical practices was written by Captain Arthur Mason Ahearn, MC, USA, and first printed in the March 1966 edition of Military Medicine. Captain Ahearn was a member of the 5th Special Forces Group (ABN) in Vietnam and served as the surgeon to a "C" detachment in I Corps.

### a. Introduction

Any discussion of Viet Cong facilities and activities is subject to strict security control. Much of the documented information on Viet Cong medicine is at present classified and cannot be printed. What follows is a combination of the author's personal experience, informal reports from colleagues, and information from unclassified reports. It is hoped that it will serve as an enlightening, if brief, introduction to some of the medical practices of our enemy in Vietnam.

b. Personnel and Training

Physicians are, of course, quite scarce. Prior to the Geneva Partition of 1954, the French trained many of the doctors now practicing with the Communists in both North and South Vietnam. Now they must train their own, relying upon their own resources and upon technical assistance from nations sympathetic to them. The Viet Cong have augmented their shortage by establishing a 12-month school for "medical officers" in a safe area hidden in the jungles. Candidates have completed basic aid cycles and have served with troops in the field. In the school they are taught the structure and function of the organ systems, basic diagnosis and treatment, and traumatic surgery. The program is quite similar to that studied by the U.S. Army Special Forces Medic. It would appear that the instruction is largely didactic with little emphasis upon practical work or student contribution.

Nurses, midwives, aids, cooks, and bearers also fit into the medical organization. In addition to their professional training, these workers are so impressed with the patriotic aspects of tending and comforting their fallen comrades that they bring an amazing zeal to the bedside.

c. Battlefield Practices

The guerrilla is quite concerned about his wounded. Outnumbered as he is, he can less afford



his losses than can his conventional opponent. Moreover, wounded and dead constitute important sources of intelligence which he little cares to give his enemy. Accordingly, the Viet Cong make every effort to retrieve their casualties. In many areas they attack with one leg wrapped in a length of vine. This permits the soldier to be dragged hastily from the field should he fall. A hook similar to that used by stevedores has also been used on dead and seriously wounded soldiers. This is inserted under the chin and serves as another dragging device. Viet Cong medics brave defending fire during attack lulls to extricate wounded and dead from wire entanglements. In some areas U.S. soldiers have been surprised to note that when one Viet Cong is hit, his two adjacent comrades quit the fight and assist him to the rear. It must be remembered that the Viet Cong usually attack in vastly superior force.

It is evident that some triage is performed on the battlefield. Although no eyewitness accounts of dispatch have reached the author, there are numerous reports of Viet Cong dead bearing serious body cavity wounds, who also have neat gunshot wounds of the head.

Individual aid kits usually contain a dressing, chloroquine tablets, an antibiotic powder, and a handful of herbs for a stimulating tea. Unit level aid kits contain surgical instruments, frequently Chinese, and assorted antibiotics, vitamins, and stimulants, usually nikethamide preparations. Medicines are almost always

in parenteral form due to the Vietnamese preference for the intravenous route. This preference reflects the French influence.

Following a sustained attack, defenders always find an area used by the Viet Cong as a forward aid station. Discarded items indicate that the treatment here is limited to dressings, life-saving procedures, and administration of antibiotics. No use of plasma expanders has been reported.

d. Forward Hospitals

Specific information on numbers, locations, and organization of forward hospitals is, of course, classified. However, it is safe to state that many forward hospitals do exist in Viet Cong safe areas. Here definitive treatment must be administered.

The patient is prepared for surgery with a stimulant--again usually nikethamide. Anesthesia is by a combination of intravenous induction agents and local infiltration. The dripping of procaine on exposed tissue has been described. There is no evidence of inhalation equipment, and only rarely is the use of open-drop ether reported.

Descriptions of debridement indicate that the Viet Cong have a full knowledge of ballistic injuries. Surgeons have described several techniques of intestinal anastomosis. Although the danger of infection is great, some orthopedic

cases are handled with internal fixation devices. However, amputation is frequently the treatment of choice.

Captured equipment indicates that routine laboratory procedures on blood, urine, stool, and smears are available at these hospitals.

It should be noted that some definitive treatment is received by Viet Cong in hospitals of the South Vietnamese civil government. The guerrilla's technique of blending in with the civilian population makes it possible for him to feign refugee status and to secure treatment in the hospitals of his enemy.

e. Evacuation

Evacuation to the rear proceeds backwards up the "Ho Chi Minh Trail." In the delta, the sampan affords easy transportation and ready concealment. In flatlands, a favorite conveyance is a litter mounted between two bicycles. In jungle and mountainous areas, transportation is via human and animal bearers. The trail is constructed in a similar manner to the mission highways of old with way stations spaced a day's journey apart. Members of the local population are frequently impressed into service between two of these way stations carrying supplies forward and wounded backward. Doubtless, many a Viet Cong has enjoyed the dubious luxury of an elephant ambulance.

f. Drugs

The Viet Cong secure their pharmaceuticals through several channels. Their own supply system is one of these. Another is the black market in South Vietnam. In Danang, a 250 milligram tetracycline tablet sells for 28 piasters or about 23 cents. Another channel is that of the legitimate South Vietnamese drug market. Most items sold by prescription only in the United States can be purchased openly in Vietnamese drug stores. Tifomycine (Chloramphenicol) is featured in display windows, and highway billboards sport advertisements of antihelminthics complete with attractive illustrations of the parasites. This ready access alarms officials who are concerned with resources control.

In addition to western pharmaceuticals, the Viet Cong employ a battery of herbs and native medicines. A medical missionary working in a Montagnard area has reported that he suspects the Viet Cong of using a crude digitalis preparation to poison their enemies, due to the slow pulse, vomiting, and cardiac irregularities of the victims.

g. Other Practices

The Viet Cong employ the same oriental techniques as do their noncommunist countrymen. Needles and bits of glass are used to prick the skin in a pattern determined by the nature of the malady. Glass bottles are heated and applied to the skin so that the suction generated as the

contained air cools may draw the evil agents from the body.

h. Conclusion

In summary, the tendency to downgrade the extent and effectiveness of the Viet Cong medical operation should be avoided. Although it is true that in many aspects Viet Cong medicine is at a level parallel with American medicine during our Civil War, it is believed that if the full truth were known, all would be amazed at the quality of medical care they are able to give their sick and wounded.

# # # # #

13. OVERT VIET CONG MEETINGS

Patrols operating in or around villages should be particularly aware of any gatherings of Vietnamese males during day or night. These gatherings should be thoroughly investigated and if feasible, the group leader brought in for formal interrogation.

Recent Viet Cong meetings have been held during broad daylight in villages by the use of simple card games or local village games. Americans, unfamiliar with the language, may walk right by a group of Vietnamese supposedly engaged in a friendly game, but who are actually planning an attack on friendly positions.

# # # # #



#### 14. VIET CONG RICE RATION

Just how much rice do the VC need each day to have enough strength to pull a trigger or to pull some of his old harassing tricks? Did you ever wonder how much rice he consumes per day? Some interesting figures have been provided recently by II FFORCEV which provide a good

idea of how much we hurt the VC when we capture and extract his vital rice caches.

Recent military operations have had an impact on limiting VC capabilities. A newspaper article indicated that the rice captured in Operation Cedar Falls, which at that time amounted to 3,170 tons, was "enough to feed a Viet Cong battalion for a year." This quantity of rice was in fact enough to feed more than 20 battalions (500 hungry men each) for a year.

The VC rice ration varies according to the area he is in and the type of work that he does. In certain areas where rice is abundant, his daily ration may amount to a full kilogram (2.2 lbs), but this is unusual. From a review of numerous captured VC documents we find that a normal rice ration per man usually runs between 700 grams in garrison to 750 grams in combat. This rice ration is augmented by fruit, vegetables, some fish or meat and a small amount of money for local food purchases. In remote mountain regions, the rice ration often is reduced. Manioc and other rice substitutes are used to make up perhaps 50 percent of the authorized ration.

The VC evidently do not appreciate how hard their administrative personnel work because the ration of these personnel is only 600 grams of rice per day. On the other hand, artillery troops are authorized up to 875 grams in combat.









Here are a few figures on rice that will help you estimate how badly you hurt the Viet Cong when you carted off his rice. The VC figure that one ton of rice will feed 40.4 men for a month. We recommend that the figure of 1 1/2 pounds of rice per man per day be used in computing the impact of rice captured from the Viet Cong. In estimating total weight of rice captured, units should use the figures 50 pounds per cubic foot for milled rice and 35 pounds per cubic foot for paddy (unmilled) rice.

# # # # #















## 15. VC TOPOGRAPHICAL AND MILITARY SYMBOLS

The following is a listing of commonly used Viet Cong symbols as compiled from agent reports, interrogation reports and captured documents which have been received from American and Vietnamese agencies:

<u>UNITS</u>		
<u>BASIC SIGN</u>	<u>VARIATION</u>	<u>MEANING</u>
		AIRBORNE
		INFANTRY UNIT
		ENGINEER UNIT
		SIGNAL UNIT
		MILITARY MEDICAL SERVICE UNIT
		JUNK FORCE
		MORTAR UNIT
		ILLEGIBLE - PROBABLY ARTILLERY UNIT
		ARMORED UNIT

## PERSONNEL

<u>BASIC SIGN</u>	<u>VARIATION</u>	<u>MEANING</u>
		SQUAD MEMBER
		SQUAD LEADER
		ASSISTANT SQUAD LEADER
		PLATOON LEADER
		ASSISTANT PLATOON LEADER
		COMPANY COMMANDER
		COMPANY EXECUTIVE OFFICER
		COMPANY PETTY OFFICER
		DEPUTY COMPANY PETTY OFFICER
		BATTALION COMMANDER
		REGIMENTAL COMMANDER
		DIVISION COMMANDER

## EQUIPMENT

### BASIC SIGN

### VARIATION

### MEANING



CARGO TRUCK



ARMORED CAR



TANK



SHIP



HELICOPTER

## TACTICAL SYMBOLS



PLATOON IN ATTACK POSITION



COMPANY IN ATTACK POSITION













BATTALION IN ATTACK POSITION





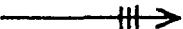

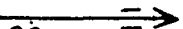

PLATOON IN THE ADVANCE

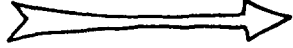

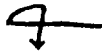
COMPANY IN THE ADVANCE

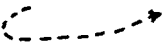
<u>BASIC SIGN</u>	<u>VARIATION</u>	<u>MEANING</u>
		BATTALION IN THE ADVANCE
		PLATOON IN THE ADVANCE (mechanized)
		COMPANY IN THE ADVANCE (mechanized)
		BATTALION IN THE ADVANCE (mechanized)
		SQUAD COMBAT FORMATION
		PLATOON COMBAT FORMATION
		COMPANY COMBAT FORMATION
		TRUCK COMBAT FORMATION
		CONVOY MOVEMENT
		CONVOY WITH ARTILLERY
		CONVOY WITH TANKS

<u>BASIC SIGN</u>	<u>VARIATION</u>	<u>MEANING</u>
		BATTLE POSITION
		PRONG OF ATTACK
		HALT
		WITHDRAWAL.
		ATTACK CHECKED
		ATTACK CHECKED AND FORCED TO WITHDRAW
		DIRECTION OF WITHDRAWAL
		MAIN ATTACK FORCE
		SECONDARY ATTACK FORCE

BASIC SIGN

VARIATION

MEANING



RAID TEAM



RAID UNIT



OBJECTIVE



IMMEDIATE MISSION



PRIORITY MISSION













MISSION OF THE DAY

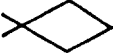
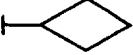

REASSEMBLY AREA

## TRACKED VEHICLE SYMBOLS

<u>BASIC SIGN</u>	<u>VARIATION</u>	<u>MEANING</u>
		LIGHT TANK
		MEDIUM TANK
		HEAVY TANK
		SELF-PROPELLED TANK
		FLAMETHROWER TANK
		FLAIL TANK
		AMPHIBIOUS TANK
		COMPANY COMMANDER'S TANK
		BATTALION COMMANDER'S TANK
		REGIMENTAL COMMANDER'S TANK
		DIVISION COMMANDER'S TANK

BASIC SIGN

VARIATION

MEANING

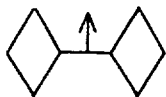

COMBAT FORMATION

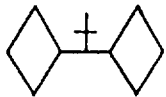

PLATOON IN CLOSE FORMATION

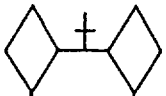

PLATOON IN INITIAL FORMATION



PLATOON IN COMBAT FORMATION



COMPANY IN COMBAT FORMATION



BATTALION IN COMBAT FORMATION

LANDING ZONES











PARATROOP DROP ZONE



HELICOPTER LANDING ZONE



FORTIFICATIONS AND EMPLACEMENTS

<u>BASIC SIGN</u>	<u>VARIATION</u>	<u>MEANING</u>
		SQUARE INDIVIDUAL EMPLACEMENT
		ROUND INDIVIDUAL EMPLACEMENT
		RAMPART WITH EMBRASURES
		WARNING CELL
		BUNKER
		GUARD POST
		COMMUNICATION TRENCH UNDERGROUND COMMUNICATION TRENCH COMBAT TRENCHES
		INTERRUPTED COMBAT TRENCHES

OBSTACLES

BASIC SIGN

VARIATION

MEANING



BARRIER FENCE



BAMBOO FENCE



CONCERTINA



SINGLE STRAND BARBED WIRE

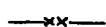

DOUBLE STRAND BARBED WIRE



THREE OR MORE STRANDS OF BARBED WIRE

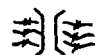

GATE OR OPENING IN FENCE



WOOD POLE FENCE

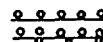

INTERLACED TREE FENCE



LATTICE WOODEN FENCE



WOODEN FENCE



FORTIFIED HAMLET



ANTIASSAULT TRENCH WITH SPIKES

BASIC SIGN

VARIATION

MEANING



SPIKE PIT



SPIKE FIELD



PUNJI TRAP

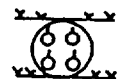

MINEFIELD



ANTITANK MINEFIELD



COMBINED MINEFIELD

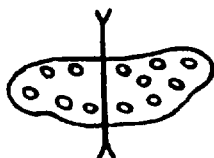

LANE THROUGH MINEFIELD

TRAIL SYMBOLS







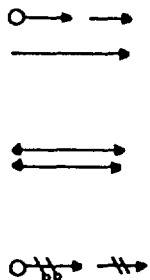
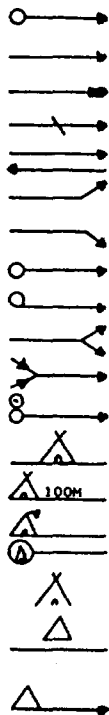

BASIC SIGN

VARIATION

MEANING

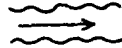













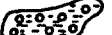

- TO START
- FOLLOW THIS WAY
- QUICKLY
- SLOWLY
- RETURN
- TURN LEFT
- TURN RIGHT
- CROSS OBSTACLE
- W.P.L. WATER
- DIVIDE INTO TWO GROUPS
- UNITE INTO ONE GROUP
- RETURN BACK TO CAMP
- THIS WAY TO CAMP
- 100 METERS TO CAMP
- CAMPING AREA
- CAMP RIGHT HERE
- PLACE TO ENTER CAMP
- DANGER (PROBABLY REFERS TO ENEMY CAMP.)
- UNHEALTHY

<u>BASIC SIGN</u>	<u>VARIATION</u>	<u>MEANING</u>
		SAFETY
		ENEMY IN ADVANCE
		ENCOUNTERED OPPOSITION HERE
		PROHIBITED ROAD
		WAIT HERE FOR FEW MINUTES
		THIS WAY TO THE RIVER
		LETTER IN TREE
		5 METERS TO LETTER
		WATER FALLS 100 METERS

GROUP SYMBOLS

<u>BASIC SIGN</u>	<u>VARIATION</u>	<u>MEANING</u>
○		PRO-VC PEOPLE
◐		AGENTS AND CADRE
◎		FARMERS ASSOCIATION
●		COMMUNIST PARTY MEMBERS
⊙		ELEMENTS IMPRISONED BY THE VC
○		ELEMENTS UNDER SURVEILLANCE
⊗		FAMILIES WHICH NEED BRAINWASHING
◑		SUSPECTS

## TERRAIN SYMBOLS

<u>BASIC SIGN</u>	<u>VARIATION</u>	<u>MEANING</u>
		HIGH HILL
		MOUNTAIN
		FOREST
		DENSE FOREST
		SPARSE FOREST
		JUNGLE
		ROCKY MOUNTAIN
		SWAMP
		THIN FOREST WITH HEAVY HEMP
		DRY RICEFIELD
		FLOODED RICEFIELD
		BUSH

BASIC SIGN

VARIATION

MEANING



ISOLATED TREE



LARGE RIVER



STREAM



DRY STREAM

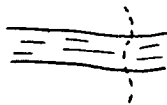

FORDING PLACE

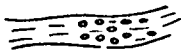

RIVER WITH ROCKS ON BOTTOM



FERRY

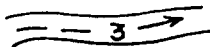

SPEED AND DIRECTION OF FLOW



BASIC SIGN

VARIATION

MEANING



RIVER WITH SANDY SHOALS



RIVER 50M WIDE AND 4M DEEP

# # # # #



## Chapter IV: AVIATION

The following operating procedures, tactics and pilot techniques are currently being employed by Marine helicopter units in the Republic of Vietnam:

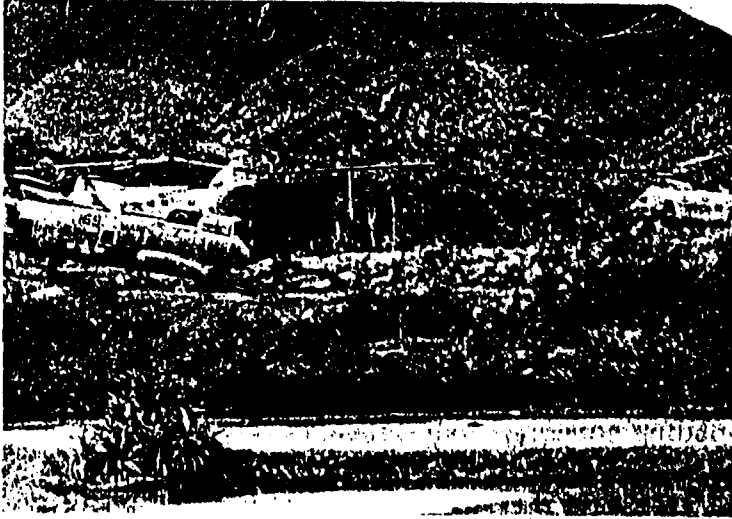

### 1. THE HELICOPTERBORNE ASSAULT

#### a. Planning and Coordination

The planning for a major helicopterborne assault should be detailed, timely and effected concurrently by all participating units. Failure to achieve positive coordination or to provide for the smallest detail or to commence early planning will inevitably reduce the probability of success. While certain overall aspects of planning and coordination must, of necessity, be

accomplished at the Division/Wing level, the responsibility for detailed planning should be passed as soon as possible to the unit commanders who will execute the assault.

b. The Loading Phase

The size of the loading zone, in terms of the number of helicopters that can be landed safely therein, is critical to the success of the entire operation. A single zone, free of obstacles and with a large capacity for helicopters and troops, is preferred and will greatly simplify and facilitate the loading plan.

The key personnel in the loading zone are the loadmasters from the helicopter unit and the troop unit, all of whom must be thoroughly knowledgeable concerning the loading plan. The loading plan should be designed to provide the loading sequence that supports the ground scheme of maneuver, provide troop unit integrity, and maintain or provide for the flight integrity of the helicopter formations.

The loading zone will normally be organized with loading spots for the number of helicopters which constitute one wave, with designated points for formation of troops into heli-teams located abeam the helicopter spots, and with specified areas for staged cargo. Some flexibility in setting up the zone must be allowed in the event of a major shift in wind direction.

A conference between the helicopter unit loadmaster (an officer or senior SNCO) and the troop loadmaster, one or more hours prior to the start of the loading, is always advisable. Invariably, one of the biggest problems in maintaining the sequence in the loading plan is that the final troop count and amount of cargo may differ considerably from the planning figures.

Many last minute problems in loading can be resolved by providing the loadmaster with an FM radio capability for communication with helicopter flight leaders. This FM frequency should not be the same frequency used in the landing zone (LZ). Use of this frequency by the helicopter pilots to report discrepancies in loading, to report "loaded and ready" for takeoff, etc., will expedite the loading operation.

### c. The En Route Phase

If the loading zone will accommodate the entire flight of helicopters, the flight leader will usually remain in the loading zone until the pre-calculated takeoff time in order to arrive at the LZ precisely at "L" hour without making any delaying turns or orbits. Frequently the loading zone will be in an area within range of sniper fire. In this case, the helicopters will climb over known safe areas or execute a spiralling climb over the loading zone and effect the rendezvous at 1500 feet above ground level (AGL) or higher.

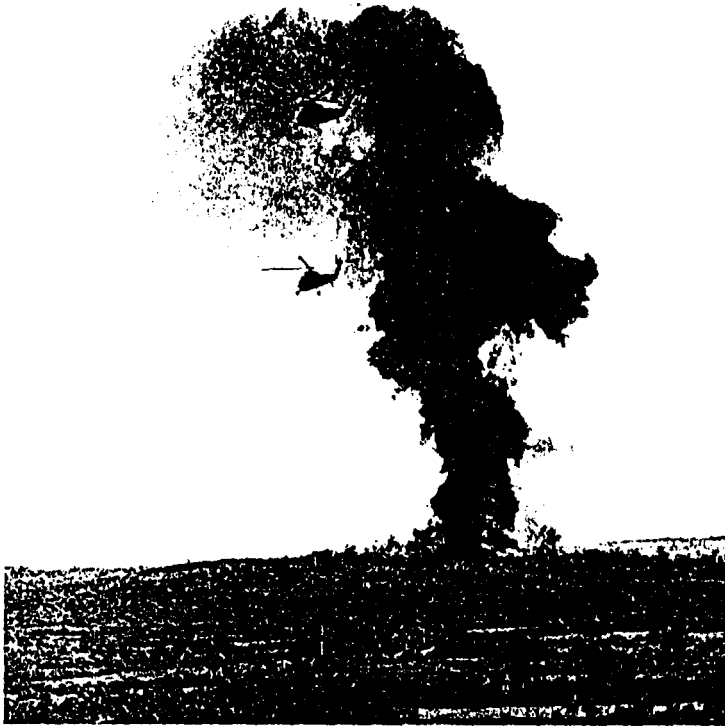

The en route flight formation is always free cruise, tactical, with at least two rotor diameters separation between aircraft in the same division. The cardinal rule is never to fly directly behind another aircraft except momentarily while sliding in a turn. Many of the enemy gunners are poor marksmen; i.e., they have a tendency to aim directly at the helicopter;

therefore, if the wingman flies a position behind the leader at a distance of one rotor diameter, he may receive ground fire aimed at the leader. Whether to use three plane formation or four plane formation has been a matter of squadron preference. The number of troops to be lifted, the size of the zones and other factors frequently dictate the formation to be employed.

Weather permitting, the usual en route altitude for transport helicopter flights in the Vietnam environment where there is largely .30 caliber fire, is 2500 feet AGL. In locations which are reported to offer .50 caliber opposing fire, the normal en route altitude is 5000 feet AGL. In locations which are reported to offer larger caliber anti-aircraft weapons in opposition, the preferred flight altitude is approximately 100 feet AGL, in defilade whenever possible.

d. The Approach Phase

As soon as possible after the first wave has effected a rendezvous, the flight leader establishes communications with the TAC(A) (Tactical Air Controller Airborne) or HC(A) (Helicopter Controller Airborne) who will provide such pertinent information to the flight leader as wind direction, weather, enemy situation, etc., at the LZ. Based on the provided information, the flight leader will decide on the direction and type of approach and will so inform the TAC(A).

At the predesignated initial point (IP), the flight leader will report his arrival to the (TAC(A)).

If the gunships have not effected rendezvous prior to the arrival of the flight at the IP, they should join up at this point in abeam positions on both sides of the transports. At approximately 2000 to 3000 meters from the LZ, the flight leaders should request that the TAC(A) mark the LZ with a smoke rocket or grenade. Timely marking of the LZ is critical. A late mark, caused by the TAC(A) being out of position, can cause unnecessary delay and orbits of large formations of helicopters at a most inopportune time. If the TAC(A) leads the flight into the LZ, the flight leader should stay well behind in order to plan and fly his own approach.

In a helicopterborne assault, the preferred approach to the LZ is a high speed letdown (for maximum rate of descent) and a right-hand turn into the LZ, which will allow the flight leader to keep the LZ in full view during the entire approach. A 90° right turn into the LZ makes it easier for all helicopters in the flight to make the approach without steep turns or radical maneuvers; however, a 180° right turn gives the flight leader a good look at the zone as he arrives abeam the zone and commences the approach. A straight-in approach is frequently used to effect the initial landing in minimum space and time, although the descent is somewhat more difficult to judge and wingmen have a tendency to hold their stepped-up position which may cause them to land beyond the leader. A spiralling approach in formation is considered the least desirable for an



assault landing involving large helicopter formations and should be used only if the flight arrives over the zone and the leader is forced to set up an orbit because he cannot locate the exact area of the landing zone. A spiralling approach information cannot be effectively supported by gunships; consequently, in this case the gunships establish independent patterns around the LZ. An approach using a left-hand turn is employed when the enemy situation dictates or may be employed on subsequent approaches to the same LZ in order to introduce a variable into the flight pattern.

e. Suppressing Fire in the LZ

Scheduled helilift of troops into unsecure LZ's carries with it the requirement for thorough prep by fixed-wing aircraft or artillery bombardment. Experience has shown that in spite of adequate prep, the transport helicopters inbound to the LZ's are frequently fired on from locations nearby. On scheduled strikes, helicopter gunners take under fire any enemy positions adjacent to the LZ; i.e., tree lines, trenches, bunkers, etc. The helicopters land in an inverted "V" formation to permit the outboard gunners to fire at targets of opportunity. This tactic is permissible only on the first wave. Gunners must be thoroughly briefed on the proximity of friendly troops and the location of adjacent LZ's into which simultaneous landings may be taking place. (See fig. 4-1.)

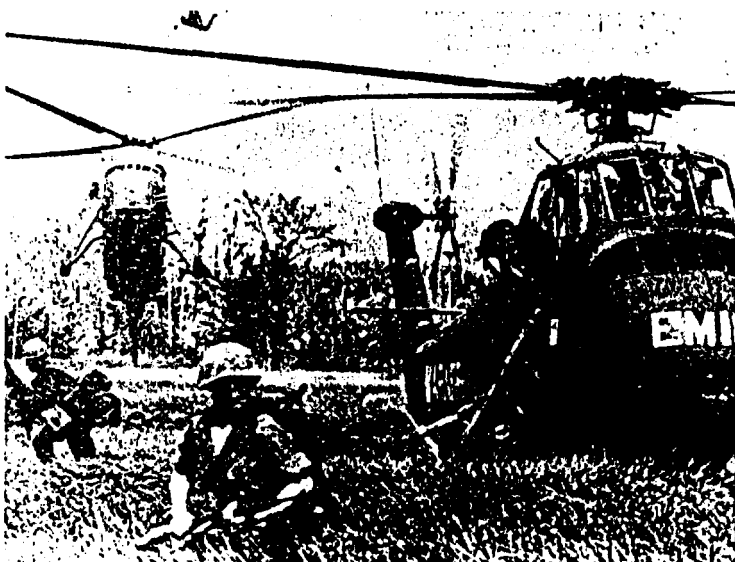

f. In the LZ

Frequently the LZ terrain will dictate the exact landing spots. If there are no terrain restrictions, the helicopters normally land in regular flight formation with comfortable lateral separation.

Troop debarkation occurs quickly and all helicopters are taking off within a few seconds in proper order. Only under the most unusual circumstances would a helicopter take off prior to the aircraft ahead. Those circumstances are that the aircraft ahead has been obviously delayed and the LZ is receiving enemy fire.

It is highly advisable to arrange for designated troops landed in the first wave to place high visibility panels in the LZ as markings for

subsequent helicopter waves or, if one pre-designated aircraft from each division pops a smoke grenade in the landing zone as it departs, the zone will be continually marked for the succeeding waves of helicopters.

## HELICOPTER LANDING DIAGRAM

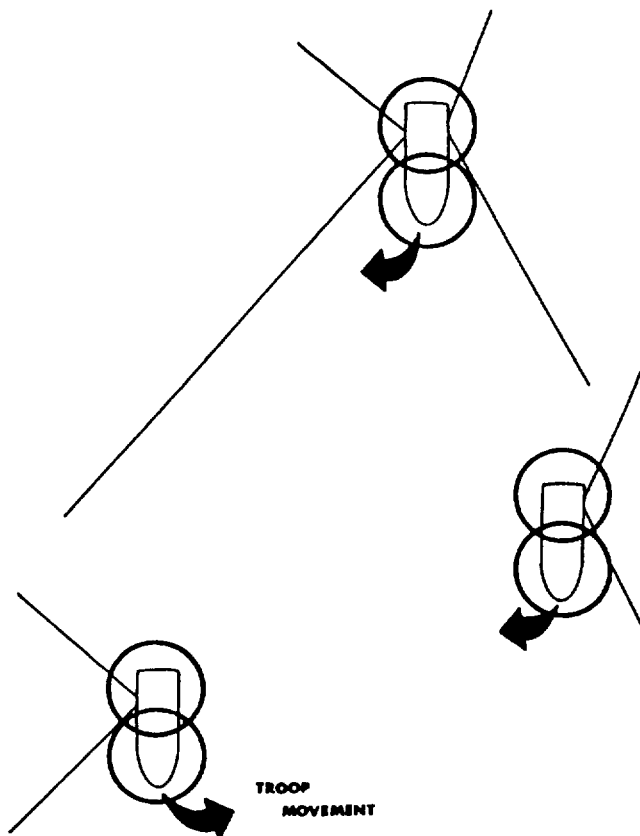

Figure 4-1



g. Departure From the LZ

Although the departure route is always pre-planned and prebriefed, frequently last second changes are dictated by the enemy situation in the vicinity of the zone. The flight leader should announce via radio any changes to the briefed departure for the benefit of his flight, escorting gunships and the TAC(A). In order to reduce the likelihood of a conflict between approach and climbout patterns, the turn after takeoff normally should be opposite in direction to that of the approach turn.

On the takeoff and high-power climbout, the flight will avoid, if possible, flying over villages, riverbanks, tree lines and high terrain any of which could conceal enemy positions. While below 1000 feet AGL, the flight leader should

execute abrupt changes of heading (10° to 20°) at irregular intervals while climbing. Normally the flight will not be able to join up on climbout until a reasonably safe altitude (above 1000 feet AGL) is reached and the flight leader reduces power and executes a rendezvous turn, although members of the flight will attempt to close in every turn.

#####

## 2. HELICOPTER RETRACTION

### a. Planning

The tentative plan for retraction of troop units should be accomplished as a part of the planning for the helicopterborne assault. The final planning for a troop retraction should be as detailed and as well coordinated as the planning for the assault; too frequently this is not realized because of the exigencies of the battle situation, and inevitably the difficulties encountered in the troop retraction will reflect the planning deficiencies.

The selection of a suitable large area for the LZ is of paramount importance. It must not have any avenues of approach such as villages which offer concealment; it must not be on or near a river unless the other side of the river is occupied by a friendly force; it must not be near dominating terrain unless that terrain is occupied by a friendly force.

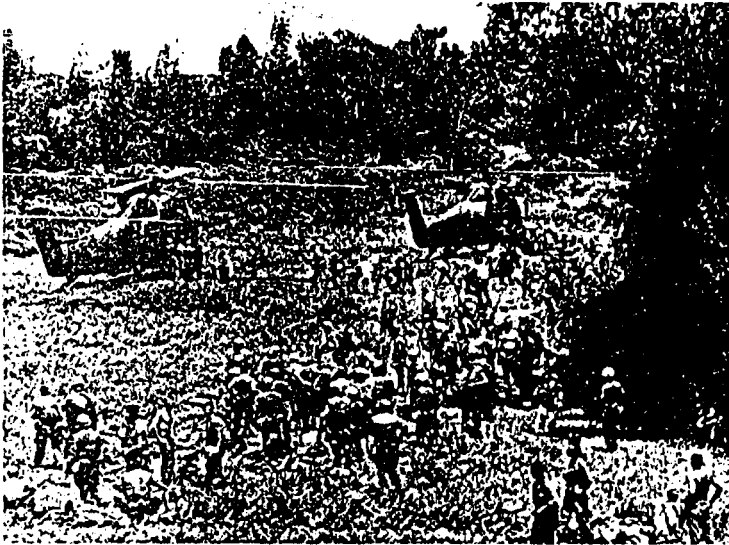

b. The Loading Phase

All aspects of the loading phase for a helicopterborne assault also apply in the helicopterborne retraction, the important difference being that the loading zone may be only temporarily secure or perhaps never secure from direct enemy fire.

The major problem in a troop retraction is that of providing security for the LZ as the troop units are withdrawn. Although this is the ground commander's responsibility, the helicopter commander has a direct personal interest in the plan for an orderly withdrawal of the troops from the LZ. For this reason a personal conference between the ground commander and the helicopter commander prior to commencing the retraction is advisable. In addition to LZ security,

two critical items which must be discussed during this brief conference are the provision for FM radio communications between the loadmasters and flight leaders and an accurate troop count.

c. The Final Wave

The crucial phase of the troop retraction is the formation and expeditious departure of the last wave of helicopters. Keeping in mind that the enemy will recognize this moment as the golden opportunity to strike a decisive blow against our reduced force, the number of helicopters in the last wave must be tailored to lift out the sizable force required to secure the LZ until the last minute. Conversely, the size of the security force must be tailored to the helicopter availability. In either case, the security force is lifted out as a unit in the last wave. During this crucial phase it is imperative that adequately armed helicopter and fixed wing support be on station.

d. The Emergency Evacuation

In all helicopter evacuations under emergency conditions, the possibility of PANIC exists. This possibility is greater when such an operation is to be conducted under enemy fire and must be anticipated whenever possible. After the decision has been made to conduct an emergency evacuation, the planning must include an analysis to determine the likelihood of an uncontrolled situation in the pickup zone and to determine control measures in such an eventuality to prevent



swamping of the helicopters. If the emergency evacuation involves Vietnamese personnel, civilian or military, the problem is compounded severely by the language barrier between passengers and helicopter crews and by the lack of passenger indoctrination in helicopter operations. The loadmaster personnel usually furnished by a helicopter unit to direct the loading of passengers and cargo in a retraction will be quickly overwhelmed when a panic situation occurs.

Whenever an emergency retraction/evacuation mission is assigned wherein the possibility exists that a panic situation may develop during the loading phase, the helicopter commander will take the following action:

- Analyze the known factors and anticipate the likelihood of an uncontrollable situation.



- Provide increased numbers of load-masters organized and equipped as deemed appropriate.
- Attempt to establish direct liaison and/or communications with the leaders of personnel to be evacuated.
- Provide interpreters, if required.
- Provide aircraft equipped with a loud-speaker system and Vietnamese speaking personnel, if appropriate.

Instruct helicopter crews and load-masters in the application of the following measures to be taken progressively in a step-by-step manner commensurate with the degree of severity of the mob action encountered:

- Control the number of passengers by blocking entrance to the helicopter.
- Employment of physical force.
- Hover the helicopter or takeoff and remain airborne until order has been restored.
- Use of tear gas or other riot control agents.
- Use of rifle butts or riot clubs.
- Fire over the heads of the mob or into the ground in front of the mob.

→ When all of the foregoing either have failed or are impossible to execute, fire at the leaders of the mob aiming low in an effort to stop rather than kill them.

#####

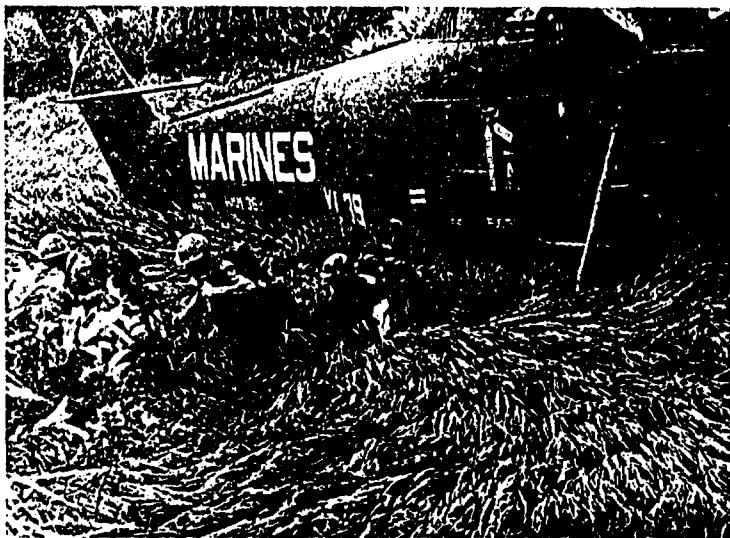

### 3. RECONNAISSANCE PARTY INSERTION AND EXTRACTION

#### a. Recon Insertion Procedures

A reconnaissance patrol or party insertion consists of a one-wave troop landing in an isolated area from which the reconnaissance will be initiated. The object is to introduce the patrol into the area as surreptitiously as possible and to complete the insertion in the shortest time

possible before any enemy forces can react. Normally the flight leader bases his preflight planning on the information given in the frag order and the intelligence provided at the squadron level. A brief conference covering the following points between the patrol leader and the flight leader at the pickup site is always beneficial in finalizing the flight leader's plan of action:

Confirm FM frequency and call signs for air-ground communications.

Confirm LZ location.

Confirm number of troops.

Emergency procedure in the event the patrol receives fire immediately after landing-- usually immediate extraction. The patrol leader should ride in the flight leader's helicopter in case further conferring becomes necessary.

If armed helicopter support has been provided, it is advisable to have the gunships precede the transport flight to the proposed LZ by a few minutes, the purpose being to check the LZ for signs of enemy activity, and to estimate and relay the capacity of the LZ. After takeoff from the LZ, empty helicopters will climb over the zone in such a manner as to provide some fire support, if required, to landing aircraft. When the latter becomes airborne, the empty helicopters proceed to a designated "empty circle" and hold a safe altitude until the last helicopter is clear of the LZ.

If the patrol insertion is made in a mountainous area where wind direction and velocity are more critical and more difficult to estimate from natural indicators, the flight leader will normally drop a smoke grenade prior to the first landing in the interest of flight safety even though it may increase the probability that the patrol insertion will be detected by the enemy.

The most critical period for a helicopter-borne patrol is during and immediately after its insertion into the operating area. Because of voids in knowledge of the enemy situation, it is during this time that the patrol is most likely to encounter unexpected enemy resistance. Fixed-wing aircraft assistance or emergency helicopter extraction may be necessary during this period. After departure from the LZ, the helicopters should remain on the patrol net frequency until they return to base.

## b. Improving LZ's

Effective operations require a positive LZ improvement program. Continuous efforts are required to develop new LZ's that can be utilized for reconnaissance insertions and extractions, communication sites, and observation posts. One method of LZ improvement that has proven successful is the use of daisy cutter bombs dropped from fixed-wing aircraft.

The daisy cutter utilizes an extender on the normal fuze, which causes the bomb to detonate up to 36 inches from the ground. This above-the-

ground detonation produces a shearing effect which aids in the clearing of LZ's. Multiple bombing runs over an area of medium vegetation will normally clear an LZ large enough to accommodate one CH-46. In heavy canopy, the use of daisy cutters will not completely clear an LZ, but the fragments will cut away sufficient vegetation to enable a support team to rappel in. Once the support team has landed, they can then prepare a zone that is adequate for helicopter landings.



### c. Extraction Procedures

A recon patrol or party extraction consists of a onewave helicopter recovery at the completion of the reconnaissance mission or in some instances when the patrol's position has become or is expected to become untenable.

Prior to commencing the extraction, it is important to verify the number of troops involved.

With rare exceptions, the patrol to be extracted has FM radio communications and is expecting the helicopters at the scheduled time; therefore, location of the patrol is seldom a problem. The patrol normally pops a smoke grenade as soon as the helicopters arrive in the general area. If the landing zone will accommodate the entire flight, all aircraft land, load, and depart together. Otherwise, the land, load, and take-off cycle is repeated expeditiously while providing mutual fire support by flying low cover for each other insofar as possible. Mutual fire support will be unnecessary if the extraction is being supported by gunships.

#####

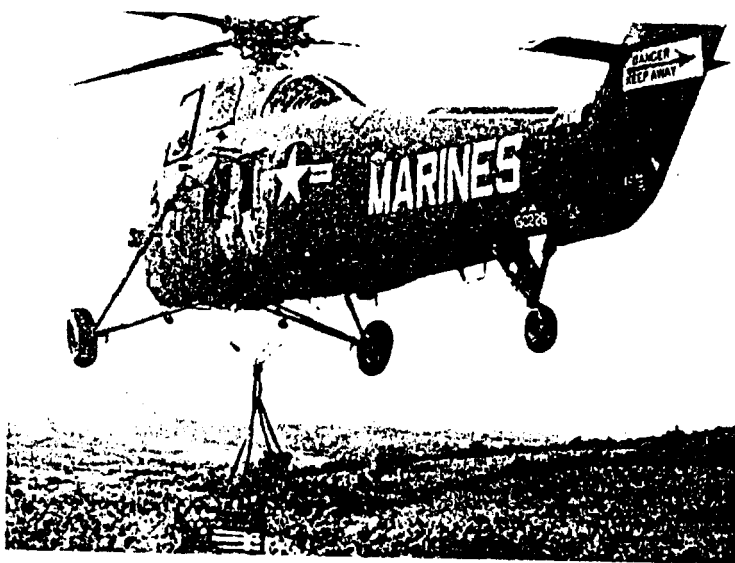

#### 4. COMBAT RESUPPLY BY HELICOPTER

##### a. Forward Support Area Operations

The helicopter support team (HST) concept of employment set forth in FMFM 4-3, section 8 is valid in the counterinsurgent environment subject to some modifications. Primarily, the difference is in the location of the LZ at which the HST performs the shore party function for the helicopterborne assault force. The HST is not a part of the assault force but establishes its support organization at a logistic support area (LSA) or at a beach support area near the battle zone but in a relatively secure area. From this forward support area the helicopterborne assault force receives its logistical support by helicopter under positive control of the aviation element of the HST, which includes the landing zone control team with appropriate communications and an aviation refueling section (TAFDS unit). Normally, helicopter maintenance support is not provided at the forward support area.

One of the major problems encountered in the operation of helicopters at forward support areas has been the ingestion of sand and dirt into fuel and lubricating systems. In spite of additional precautions, such as more frequent filter changes, this ingestion of fine particles of sand and dust has caused many engine failures and other malfunctions. Occasionally, a grassy area can be

located to be used as a helicopter field; but the area must be guarded zealously to prevent destruction of the grass by tracked vehicles, etc.

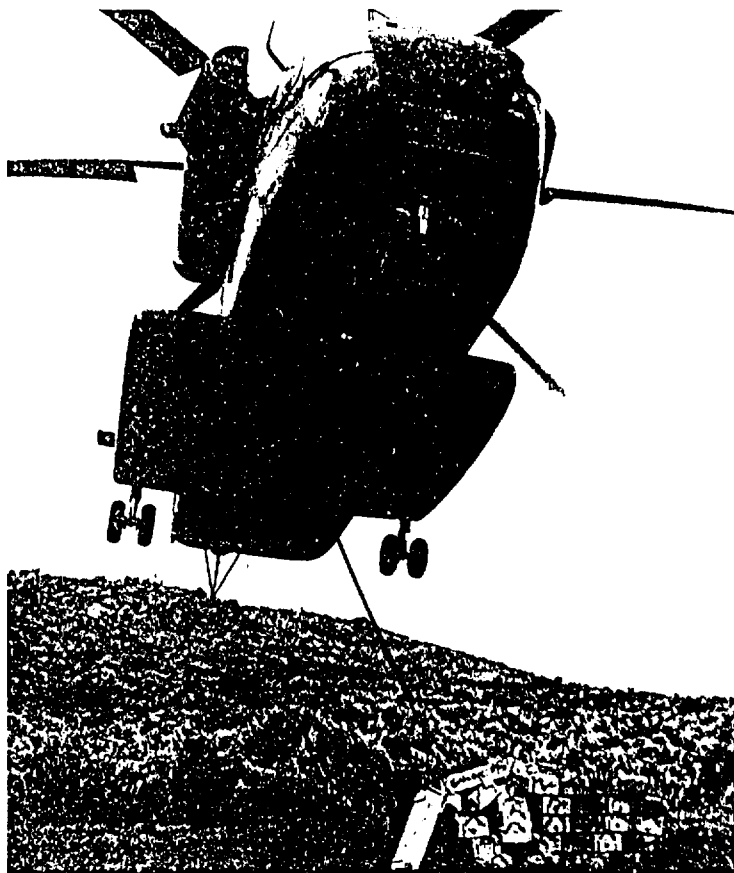

b. Cargo Movement by CH-53A Helicopters

Since the CH-53A helicopter began operations in RVN, internal movement of cargo to forward combat areas has been extensive. When



the external method of cargo movement was used in support of ground operations, results indicated that over relatively short distances (less than 50 miles) external cargo movement is much more desirable and efficient. Additionally:

Twice as much cargo per hour was moved externally as was move internally, or the same amount of cargo was moved twice the distance when handled externally.

The average ground time lost in the pickup/drop zones was a minimum of 15 minutes for each zone when loaded/off-loaded by hand compared to less than 2 minutes in either zone when externally loaded.

The efficiency of the aircrew and the loading/off-loading working party decreases greatly in proportion to the amount of cargo to be handled. This results in increased ground time which can be relieved by using external vice internal lift and by prestaging cargo in cargo nets.

It is apparent that when two or more aircraft are used, external cargo movement will greatly reduce pickup/drop zone congestion and virtually eliminate the need for one aircraft to orbit, which is often the case, while the other loads/unloads.

Due to the lack of adequate mechanized loading equipment, it has been found that internally moved cargo must often be hand-loaded/unloaded. This usually requires a 20 to 25 man working

party per aircraft in both the pickup/drop zones. External cargo handling eliminates the need for large working parties for cargo handling, thus making more men available for other tasks.

## c. Selecting Helo LZ's

Field units often choose a small helicopter zone for resupply near their positions rather than a larger zone a slight distance away. The larger zones have the advantage of affording the resupply helicopters a short roll-on landing, thereby increasing the payload. Consult a Forward Air Controller when selecting these landing zones; he can assist in a choice which will satisfy the needs of the supported unit and the helicopters.

## d. Assignment Procedures

The technique of assigning specifically designated helicopters for logistic support of infantry units has proven itself to be highly successful. Two variations are employed:

With a battalion in a fast-moving situation, covering difficult terrain, two helicopters can be assigned in direct support of the battalion for medical evacuation, resupply, evacuation of prisoners and equipment, and displacement of Marine personnel, supplies and equipment.

For battalions in relatively static situations, logistic support can be provided by assigning direct support helicopters to the shore party group commander, therein providing the means for delivery and pickup.

e. Internal and External Loads

Some cargo items have the weights clearly marked or are familiar items which have known weights. The weight in many instances must be estimated, as accurately as possible. The crew chief should keep pencil and pad handy so that mistakes caused by mental arithmetic can be eliminated.

The procedures for external loads in the combat environment are unchanged except that it is more important to join up the flight at least in twos or threes for mutual safety on the en route flight.

f. Outpost Resupply (ARVN)

This type of ARVN resupply mission is from a support base, which frequently is not as secure as one would prefer, to an ARVN outpost which is secure for a radius of 1000 meters or less. It usually involves transporting supplies of rice, ammunition, fish oils, wheat, lumber, wire and/or soliders with wives, children, dogs, household goods, etc. For this mission the helicopter unit always provides a loadmaster; nevertheless, if there is no American or Australian advisor or English speaking ARVN officer to help with control and coordination, some difficulties must be anticipated.

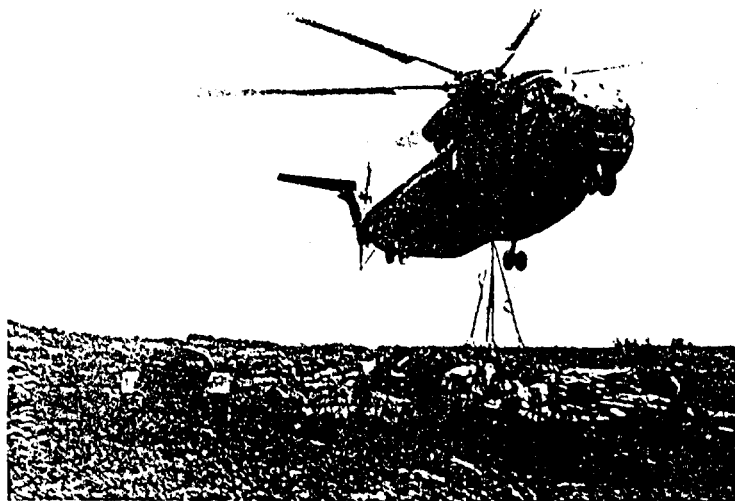

g. Pilot Procedures and Techniques

On combat resupply mission, either in support of a ground operation or in support of mountain outposts, a great variety of situations and conditions can be encountered. Therefore, the helicopter pilots must be flexible, versatile, and alert for the unexpected.

If a fixed-wing attack escort has been provided, the establishment of communications and the rendezvous with the escort should be effected at the time and place designated in the frag order. En route to the LZ, the helicopter commander will brief the flight leader of the attack escort on the pertinent aspects of the mission which will include the locations of known enemy positions from which fire may be expected. During critical periods of the flight, the helicopter

commander should inform the attack escort leader when the "assault wave pattern" is considered appropriate.

Although the normal en route altitude for resupply missions is 2500 or 3000 feet, when flying over mountainous terrain the altitude should be increased to provide an appropriate margin of safety from small arms fire. The flight leaders will always endeavor to avoid known "hot" areas where enemy fire has been frequently received. In the counterinsurgent environment helicopter pilots should refrain from the stateside practices of departing on course while climbing at low altitude and of commencing a letdown at some distance from the destination, thereby placing the aircraft in a low and slow condition well outside of the field boundary. The safer procedures are:

→ To effect a spiralling climb after take-off over the most secure area to an altitude above 1000 feet AGL prior to proceeding on course.

→ To execute a spiralling approach singly or in formation from en route altitude. Some pilots prefer to letdown en route to 1500 feet AGL over the point of intended landing, thereby always flying the spiralling approach through the same vertical airspace on every approach to reduce the probability of errors in judgment. The airspeed maintained in the spiralling approach

may be varied as required to achieve the result desired; i.e., a slower airspeed of 60 knots produces a tighter spiral keeping the helicopter as close as possible to the secure landing area; whereas, a higher airspeed of 100 knots produces a substantial increase in rate of descent but also a much wider spiral.

Landings at mountaintop outposts usually require a percision approach to a small cleared area which rarely accommodate more than two aircraft. Although personnel at the outpost are supposed to mark the landing spot with a smoke grenade, frequently they do not. Since wind information in a mountainous area is critically important to the landing of a helicopter, the flight leader will drop his own smoke grenade on a low pass over the site prior to approaching for a landing if there is no other positive indication of wind condition at the site. Pilots should be aware that the wind direction at the base of a mountain may be significantly different from the wind direction at the top of the mountain.

# # # # #

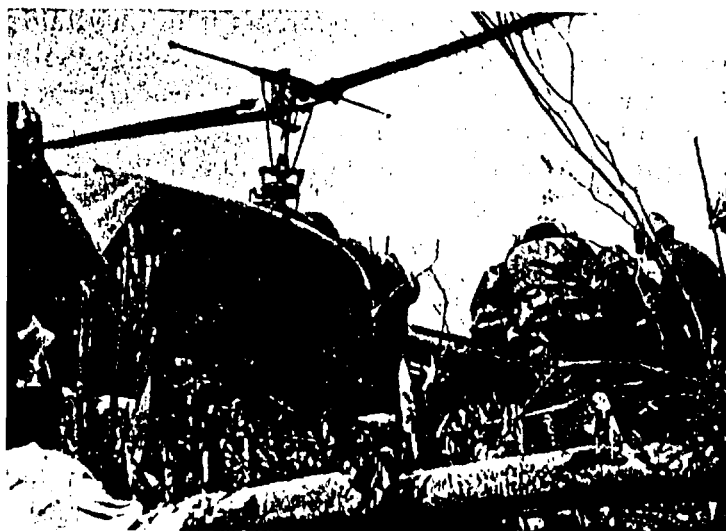

## 5. MEDICAL EVACUATION BY HELICOPTER

### a. General

Of the diverse missions performed by helicopter, the evacuation of battlefield casualties ranks in several aspects as the most significant. Such categorization is reflected in the fact that regardless of demands upon helicopter availability to perform other missions, there will always be helicopters set aside for the sole purpose of responding to requests from casualty evacuation. Further, the aviation elements concerned with the execution of MEDEVAC missions regard such activities as the ultimate of the various categories of air support rendered. As a result, cognizant command and control agencies authorize MEDEVAC missions under conditions which would normally cancel missions of another nature.

Under these circumstances it is inevitable that attrition of helicopters and crews engaged in MEDEVAC missions will be higher than associated with other missions. Current 1st MAW statistics indicate that while MEDEVAC missions account for but 7.5 percent of total helicopter missions, such missions account for 32 percent of the total crew casualties resulting from enemy fire.

There is probably no action which may be taken to reduce the hazard level of MEDEVAC missions to the general level of overall helicopter operations. It is necessary, however, that every effort be made to minimize the associated attrition rate. This necessity touches directly upon the ground commander for it is he who declares the requirement for MEDEVAC and it is he who does or does not undertake facilitating preparatory and supporting actions.

To this end, continuing command attention is directed to the following matters:

The determination as to whether the MEDEVAC is to be classified and passed through air request channels as routine, priority or emergency rests with the ground commander on the scene. The following general classification criteria are used:

Emergency. Critical wound, injury or illness, judged to require immediate evacuation as a matter of life or death.



Priority. Serious wound, injury or illness judged to require early hospitalization but not requiring immediate evacuation as a matter of life or death.

Routine. Wound, injury or illness of a minor nature which requires the attention of other than locally available medical resources. This classification will additionally be normally applied for evacuation of deceased personnel and for transfer of patients between medical facilities.

Since the call for emergency MEDEVAC may entail and/or inspire extraordinary risk acceptance on the part of the participating helicopter crew, full and continuing attention is directed to the following:

It is not practical to provide a complete listing of wounds/injuries/ailments which do or do not constitute cause for emergency evacuation. In general, ambulatory patients will positively not be so classified; personnel with penetrating wounds of the head and body cavities or who have suffered loss of an extremity will be.

An emergency MEDEVAC takes precedence over all others. The commander calling an emergency must do so with full realization that his action may cause a significant delay in the evacuation of other wounded Marines.

This consideration plus attendant risk factors dictates that the determination to call

for emergency evacuation be invariably derived from a totally honest appraisal of that professional or lay medical evaluation and advice which is available on the scene or through rapid communication channels.

Overall considerations and facilitating actions to be taken by the ground commander:

It serves no purpose to call a helicopter into an environment in which it cannot survive. The security of the LZ from which the evacuation is to be made must be evaluated and if not secure:

The evacuation must be moved to a reasonably secure area or, if this is not feasible:

→ The LZ must be made secure while the evacuation is in progress by application of that suppressive fire available to the ground commander in the immediate area or by artillery fire or by fixed-wing cover and/or by a combination of the three.

The medical evacuation helicopter will normally be accompanied by armed helicopter escort. Such escort is effective for suppressing localized small arms fire but cannot outduel multisource automatic weapons fire and/or concentrations of small arms fire. With present armament, and armed UH-1E may be shot out of the sky by a .50 caliber machinegun before it can bring its own weapons to bear. Within

a hostile environment with which it can contend, the armed helo escort is most effective if the pilot is aware of the LZ situation and enemy positions prior to arrival. It is accordingly essential that the supported unit make every effort to establish radio contact and exchange pertinent information with the aircraft before it approaches the LZ. The frequency for this purpose must be specified in the MEDEVAC request.

An adequate and mutually acceptable landing site should exist. In this matter, the supported unit is expected to advise the pilot with respect to prospective pickup point, but the ultimate choice must be made by the pilot who must base his decision not only on ground dispositions and situation, but also on the capabilities of his aircraft under the prevailing flight conditions.

If terrain or vegetation conditions are such that an adequate landing site neither exists nor can be cleared by reasonable effort and it is impossible to move the casualty overland to a more suitable area, then and only then will the evacuation be accomplished by hoist. This mode is particularly hazardous because:

The helicopter is totally vulnerable to any degree of enemy fire while maintaining the necessary stationary hover.

Any degree of pendulum motion may result in fouling the hoist if the operation is being attempted through a jungle canopy. In this regard, extreme care must be taken by personnel



on the ground to ensure that the hoist cable extends vertically (without deflection by tree branches, etc.) from the helicopter to the ground and that the evacuee is secured to the cable at that point. Under no circumstance may the cable be pulled from the vertical. A potentially disastrous pendulum motion can be the only result. A true vertical lift must be set up by the personnel

on the ground, by moving the evacuee to the vertical (free-hanging) cable preferably, or if this is physically impossible, by instructing the pilot to adjust his hover position to a point directly over the evacuee as evidence by the ground contact point of the free-hanging cable.

The unit requesting a MEDEVAC must be prepared to assist the pilot in locating the casualty pickup point. Any available means including voice radio and pyrotechnics may be used. If the evacuation is to be made at night, the supported unit must light the intended pickup zone utilizing flashlight or other light sources at the approximate four corners of the obstruction-free area. If this is not feasible, inability to light the zone must be indicated on the MEDEVAC request and the requesting unit must be prepared to accept flare illumination.

Every effort must be taken to minimize the time that the evacuation helicopter must remain on the ground. The stationary helicopter constitutes an extremely lucrative target and the longer it remains on the ground, the more intense the enemy fire usually becomes. To this end, the evacuee should be prepared and positioned immediately adjacent to the pickup point before the helicopter lands.

b. Pilot Procedures

If communications can be established with the ground unit which requested the MEDEVAC, it is usually not difficult to locate the site except

during a condition of reduced visibility caused by darkness or bad weather. There are several methods or navigational aids that can be utilized to locate the pickup:

Obtain the TACAN bearing and distance for the coordinates given from the DASC or TADC.

When the ground unit FAC has the aircraft in sight, he can direct the pilot over the site and/or mark the site with signal mirror, smoke grenade or flare, as appropriate.

Plot a course which follows rivers, coastline, highways or other prominent terrain features to the pickup area even if the route is a few miles farther.

If the ground unit FAC can transmit on UHF, home on his signal using the ARA-25 direction finder.

Although a MEDEVAC pickup site itself may be secure from enemy fire because of defilade, frequently the areas over which the helicopter must approach and depart may not be secure. Therefore, it is imperative that the pilot obtain from the ground unit FAC the best quadrant/direction for approach and retirement as well as the location of nearby enemy positions. The gunship can be very effective on a mission of this type. Even the presence of the gunship will, at times, suppress enemy fire. Occasionally a pickup zone which has been declared "secure" and has, in fact, received no enemy fire for sometime,

suddenly becomes "hot" when the helicopter presents a lucrative, highly visible target that draws direct and indirect fire. While waiting in the landing zone the helicopter pilot can gain some important knowledge of the local ground picture by simple observation; e.g., if all or almost all of the troops are in the prone position behind the dikes, etc., the zone must be "hot"; also if most of the troops appear to be facing and pointing rifles in the same direction, that must be the direction of the enemy, so do not take off in that direction.

Night lighting for a MEDEVAC pickup is a serious problem which will not be solved until ground units are issued sets of portable, directional lights (strobe lights preferred) with which to mark the landing zone with a 100-foot square pattern. Meanwhile, flashlights, gasoline fires in pits, and anything available will be used to mark a safe landing area. Although it may be necessary at times because of enemy fire to make an approach with lights "out," pilots should be advised to use aircraft lights as required to accomplish a safe landing. The vertical-hover light, painted red, has been found to be quite effective for night landing under these conditions.

There are a number of questions relating to pilot judgment which are difficult to answer:

→ At what point does enemy fire become too heavy to continue mission? An answer which may be oversimplified is "When the enemy fire

sounds heavy but is not hitting the helicopter, the mission should be continued"; on the other hand, "When the enemy fire sounds heavy and is hitting the helicopter, the mission should be aborted until the situation can be rectified."

→ At what point does the weather become too bad to continue the mission? Another over-simplified answer is "When the situation appears to be making demands that exceed the capabilities of the aircraft or the pilot, it is time to abort." The common tendency is to go too far or to hesitate too long.

#####



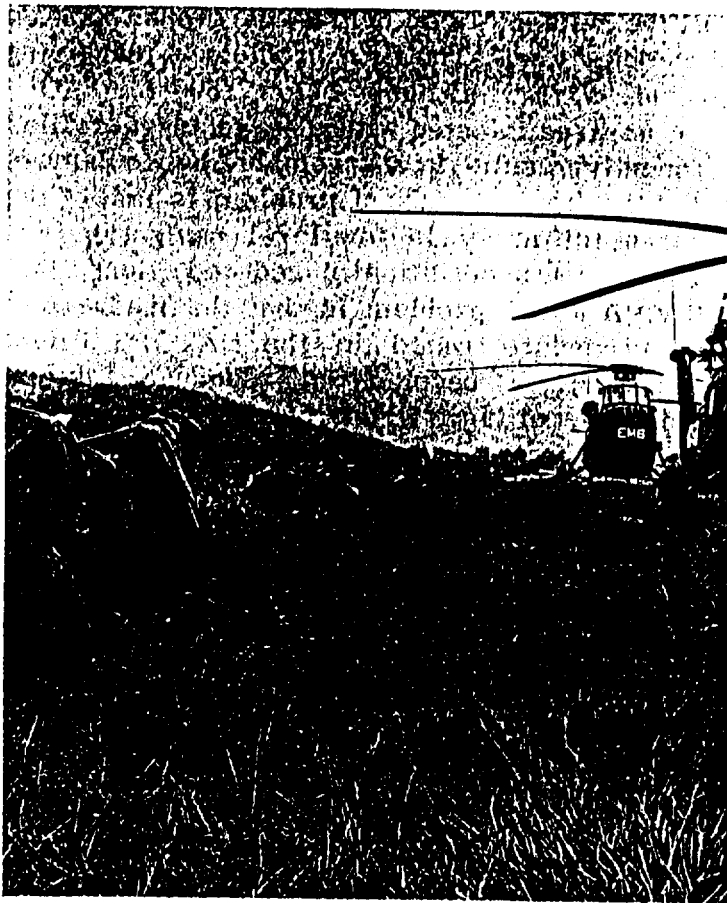

## 6. MONSOON WEATHER FLYING

### a. Flight Problems Induced by the Monsoon

From October through March annually, the Danang/Chu Lai region is affected by the north-east monsoon which causes low cloud ceilings and flight visibility on 15 to 20 days per month. However, on the days of marginal weather, rarely

will the helicopters be held on the ground because of weather itself. The first problem is that flying aircraft at low altitude, below 1500 feet AGL, over an area infested with insurgents/guerrillas frequently results in unacceptable battle damage and casualties. A second problem is that of the inherent difficulty in low-level navigation aggravated by a condition of reduced flight visibility. A third problem is that the inadvertent IFR procedure listed in the NATOPS Flight Manual (UH-34) becomes an inadequate solution in the case of large flights of helicopters; and if the air traffic control system is already saturated at the time, the NATOPS inadvertent IFR procedure would be ill-advised.

## b. Procedure

### First Problem (low flight and enemy fire)

If the mission calls for flight over an area which has been quiet (no hit reports) for a considerable period of time, the flight leader may elect to attempt the mission in spite of a low cloud ceiling. The availability of UH-1E gunships for helo escort would be a factor influencing the flight leader's decision.

If the mission has been assigned a priority of "mandatory," there is no question that every effort will be made to accomplish the mission in spite of weather and risk.

The mission may be delayed until the weather has improved to acceptable minimums.

The mission may be canceled when there appears to be no chance of weather improvement within the required time frame.

Even a mandatory mission may be aborted when the weather encountered creates a situation which, in the judgment of the flight leader, is beyond the capabilities of the pilots or the aircraft.

### Second Problem (low-altitude navigation)

On a low-altitude flight in a condition of low flight visibility, line-of-sight radio aids to navigation are frequently unusable. Therefore, the flight leader must rely on dead reckoning (heading-time-distance) navigation or navigation by following prominent terrain features such as highways, or rivers, etc., a combination of both which is usually the case.

The preflight planning for a low altitude/low visibility flight must be done carefully. The route selected must provide the best terrain aids to navigation even if the distance is greater than a direct route; e.g., from A to B follow Highway 1 (estimated time en route: 10 minutes); hold a magnetic heading of  $260^{\circ}$  for approximately 3 minutes to intercept river at C; follow river in southerly direction to D.

### Third Problem (inadvertent IFR procedures)

It is extremely difficult to fly formation with helicopters in the dark, heavy clouds

associated with monsoon weather. To enter heavy weather with a large formation of helicopters is to invite disaster. When confronted with the immediate prospect of taking a formation of helicopters into IFR conditions and a 180° turn is elected as the course of action, the flight leader should descend immediately to keep the surface in sight and turn in the direction which appears to offer the best horizon; e.g., if flying over the water parallel to the beach line, turn toward the land. When confronted with the immediate prospect of taking a formation of helicopters into IFR conditions and the decision is to continue straight ahead, the flight leader should descend immediately from 100 to 200 feet AGL in order to keep the surface in sight. If the visibility is extremely poor, the airspeed should be reduced to approximately 60 knots. The wingmen are still in visual contact with the surface; therefore, comfortable formation flight is still feasible. The foregoing low altitude/low visibility procedures for helicopter formations are not recommended for night flights.

#####

## 7. NIGHT HELICOPTER OPERATIONS

### a. General Considerations

Night helicopterborne assault missions are feasible and have been conducted regularly in Vietnam. There are many special considerations in the planning and execution of such missions:

→ The planning must be more detailed with the closest possible coordination between ground and aviation units participating; therefore, decentralized planning and execution under centralized supervision and control become increasingly important.

The loading zone will be organized in the same manner as for daytime. There is an additional requirement for portable lights with which to mark aircraft spots and positions for heliteams. The portable lights are part of the helicopter squadron's T/E allowances.

The flight formations should be modified so that the basic formation is the two-plane section. The number of helicopters per flight should be reduced to a comfortable number, perhaps six. The overall number of aircraft, fixed and rotary wing, which occupy the same general airspace at the same time must be held to a controllable minimum.

Except for areas which are absolutely devoid of obstacles, it is considered essential to provide constant flare light for helicopter formation landings at night. Multiple flare drops of millions of candlepower will provide a half-light or twilight condition entirely acceptable for visual control of helicopters. However, it should be expected that slender defoliated trees, wires, and other similar objects will not be readily visible in the subdued light.

b. Night Lighting of Rough Area LZ's

Satisfactory illumination of LZ's is a major factor in the accomplishment of night missions. Illumination has been provided at the one time or another by strobe lights, flashlights, cigarette lighters, jeep lights, tank lights and burning smudge pots, to name a few. Each has advantages and disadvantages depending upon the weather and the tactical situation. Vehicle lights illuminate the zone too brightly and disclose the zone to the enemy. Lights from a flame source are not beamed, therefore are not readily visible under conditions of poor visibility.

Flashlight wands similar to those used by aircraft taxi directors are much superior to other methods of lighting in that they produce a high visible, but not harsh light.

#####

8. PILOTS BRIEFING ON EMERGENCY MISSIONS

Prompt and safe execution of emergency helicopter missions is greatly expedited if the information required by the pilot upon arriving at the landing zone is readily available.

As the urgency of the mission increases, the time factor for the exchange of information is lessened, hence the readiness of the ground unit to pass desired information will greatly expedite execution of the mission.

A good mental checkoff list should be made prior to a helicopter entering your LZ. Have this info ready before the helo arrives.

Approximate size of the LZ.

When was enemy fire last received and from what direction?

Where are the nearest friendly troops? (If possible mark their position if pilot requests it.)

Are there any obstacles in the approach path of the helo?

Are there any obstacles on the ground in the LZ?

From what direction would the helo most likely receive enemy fire?

From what direction should the helo approach LZ?

Is pilot cleared to fire if he receives enemy fire?

Have MEDEVACS ready at the LZ when helo arrives.

Pop smoke when pilot asks for it.

Stay on your radio until the helo departs.

# # # # #

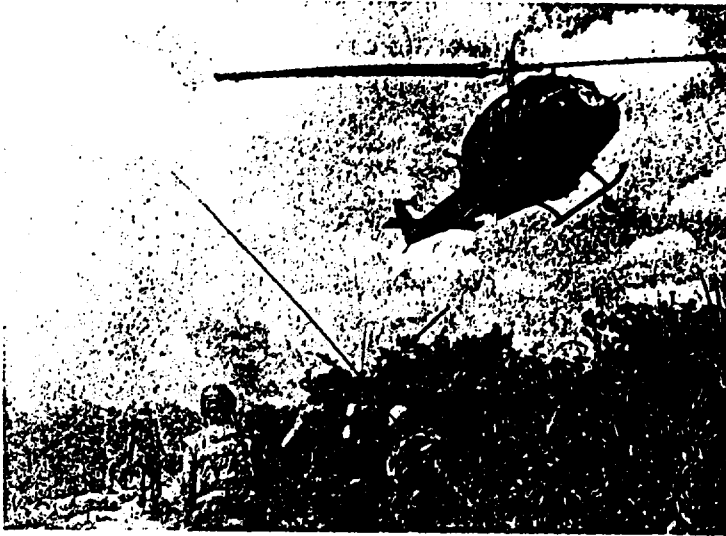

#### 9. REACTION FORCE DEPLOYMENT BY HELICOPTER

The troops to be deployed as a reaction force and the requisite number of transport helicopters and armed helicopter escort are placed on an alert standby condition with a specified reaction time. If the troops of the reaction force are billeted near the helicopter parking area, the reaction time can be reduced by 10 to 15 minutes. Some units attempt to react so quickly that they eliminate any time for briefing, a practice which can be justified only in a truly emergency situation. The reaction time of the helicopters can be reduced by the following:

→ Aircraft engines should be warmed up periodically.



- All pilots, crewmen, and troop leaders should receive a common intelligence briefing once or preferably twice daily during the period of standby.
- All troops should be organized into heli-teams and assigned to specific aircraft.
- The flight leader should conduct a thorough flight briefing upon assumption of standby, presenting a generalized plan of action designed to fit most situations and locations.

#####

## 10. HELICOPTER LIMITATIONS

Except for the individual Marine, the most useful all-purpose item in use in RVN is the helicopter. Whether utilized as a means of evacuation, transport, observation, or as a gunship, the helicopter is always busy. Though extremely versatile, there are times when the helicopter is unable to perform an assigned task, even though it may appear that the task is within aircraft capabilities. Most of these failures can be attributed to insufficient lift being available to enable the helicopter to perform as required. Lift is the force that gives the helicopter its "go power." A certain amount of lift is required to keep the helicopter in the air; the remaining lift can be utilized to carry an equivalent amount of weight.

Many personnel who are not familiar with the helicopter's flight characteristics do not fully understand this relation of lift to load-carrying ability; nor are they fully aware that the helicopter's performance is directly related to the operating conditions in which it is performing. Many factors affect the amount of lift available to the helicopter pilot. As a result, a load that can be carried easily under one set of conditions may not even be lifted a foot off the ground under different temperature and altitude conditions.

An increase in operating altitude, such as is encountered when flying over mountaintops, decreases the efficiency of the helicopter and decreases lift. An increase in temperature causes a loss of lift. Another factor that is extremely important to maximize helicopter operating capabilities is LZ selection. Since the flight characteristics of the helicopter are such that available lift is at a minimum up to approximately 20 knots of airspeed, an LZ that has enough clear area for the takeoff run should point into the wind. The utilization of a landing zone surrounded by obstacles causes the capability of the helicopter to decrease drastically. This type zone creates the necessity for a vertical takeoff pattern with no forward airspeed. This decreased lift, due to a lack of a clear area, reduces forward airspeed and limits maximum lift capability.

Selection of the best possible LZ by the user can assist in maintaining the normal helicopter lift capability. Planners and pilots must give full

weight to all lift limitation factors when making mission assignments. Knowing and properly weighing the factors affecting lift capability can assist in the successful completion of an assigned mission.

#####



## 11. HELO-GROUND COMMUNICATIONS

Helicopter commanders repeatedly have difficulty reaching ground units on designated radio frequencies, even though the helicopters have been requested by the ground units. Helicopter commanders need to know information pertaining to wind direction, zone obstructions and zone security prior to landing. Except in an emergency, pilots will not make an initial landing in a zone where ground-to-air radio contact has not been established. Ground units that have requested

helicopters for their support should make every possible effort to contact the helicopters by voice communications when the aircraft appear over their position. Common FM radio frequencies are usually available to the ground and helicopter commanders. Requesting units should specify the FM frequency to be used for helo-ground communications when submitting their requests. A secondary frequency should also be specified. This will provide both the ground and helo command with the information needed to establish contact.

#####

## 12. INTERFERENCE AND BOGUS TRANSMISSIONS

Noise interference has frequently been noted on radio channels used by helicopters and fixed-wing aircraft. In addition, bogus transmissions have been received which gave false turn and drop directions to fixed-wing aircraft, and have attempted to lure helicopters into false landing zones. To reduce the effect of bogus transmissions and interference the following measures should be taken:

- Proper use of the authentication frequency
- Use of alternate frequency
- Change color codes frequently
- Occasional substitution of squadron call signs instead of collective calls

#####

### 13. HELICOPTER CREW PROTECTION

The pilot's and copilot's compartment in the CH-46A, because of a wide expanse of glass, is vulnerable to enemy gunfire and shrapnel. Extra back plates (ARMOR AIRCREW SMALL ARMS PROTECTIVE BACK FSN 8470-926-1571) placed in the bottom glass area beneath the rudder pedals, on both the pilot's and copilot's side, provide good protection from enemy fire. These plates have been tested in one squadron and have prevented injury to three pilots by stopping shell fragments. The plates do not unduly hinder vision beneath the aircraft, are reasonably lightweight and have proven very successful in providing protection for the aircraft and aircrew members.

#####

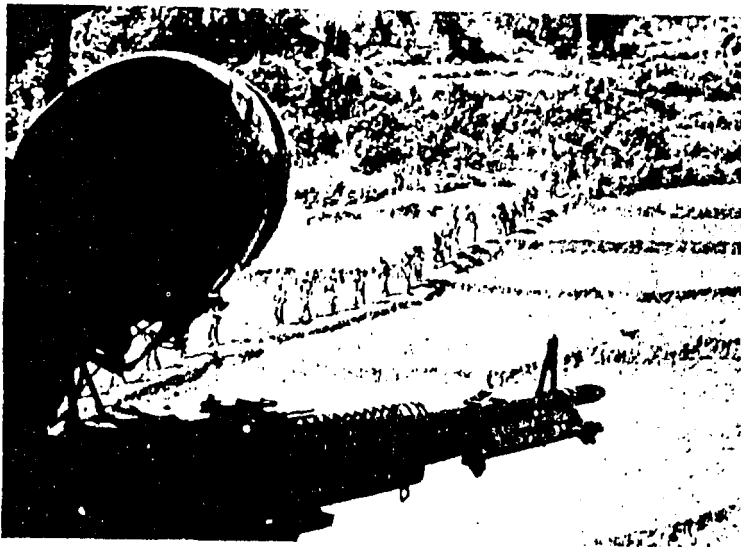

#### 14. HELICOPTER GUNNERS

The side gunners provide the primary defense for the transport helicopters; they usually are the first to spot a source of enemy fire; and they provide the marking of the location of the enemy fire for the helo escort. In gunner training and in preflight briefings, the gunners must be impressed with the importance of dropping red smoke grenades at the first instant that enemy fire is detected.

The normal sequence of actions for a gunner of a helicopter receiving enemy fire is considered to be: drop red smoke grenades, shoot if target identification of the enemy is reasonably certain, and report the details (clock code, range and description of location) to the pilot. In the event that the motion of the helicopter is about to mask the target from his view or from his cone of fire, the gunner should ask the pilot for a turn in the appropriate direction to bring the target back into view or into the firing cone. Under certain circumstances the pilot may be unable to comply with the request for a turn but may be able to yaw the helicopter to unmask the target for the gunner. The en route flight formation should be flown sufficiently wide so that the gunners are afforded complete coverage of the terrain below the helicopter flight.

Quick return fire by helicopter gunners is demoralizing to the enemy and has a definite suppressive effect if accurately delivered. The concentrated tracer fire of several helicopter gunners

can be great assistance to the helo escort in locating the source of enemy fire.

Aggressive, competent, alert helicopter gunners are those who have good eyesight, who have been conscientiously trained, and who have been properly briefed prior to the flight.

#####

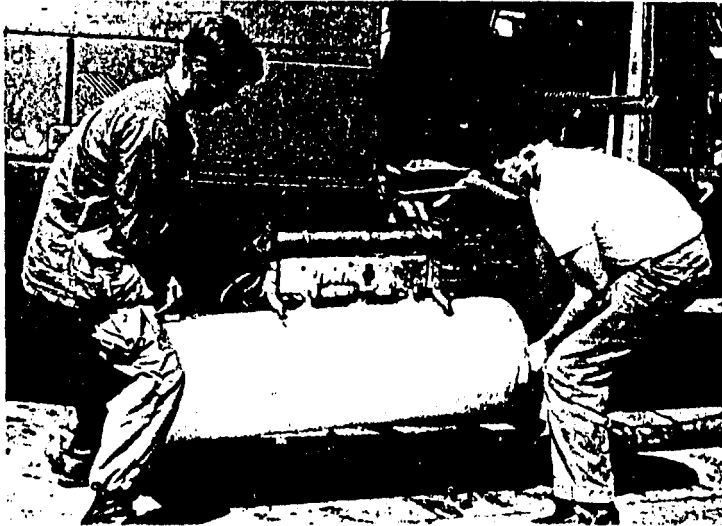

#### 15. ORDNANCE LOADING FOR ARMED UH-1E HELICOPTERS

At present, there are two types of 2.75-inch rockets available for use of the UH-1E helicopters; the white phosphorus (WP) warhead and the high-explosive warhead. When the UH-1E is employed in the helicopter escort role, the requirement is for the destructive HE warhead.

When employed in the TAC(A) role, the requirement is for WP warhead to mark the target for the attack aircraft. Experience has shown that UH-1E aircraft are often required to deliver both types of ordnance during the same flight. As a result, a standard ordnance load has evolved. The right rocket pod is loaded with WP rockets and the left rocket pod is loaded with HE rockets. Although this somewhat reduces the destructive power of the escort helicopter, it provides the pilot with the added capability of marking the target for attack aircraft. In addition, it gives him the capability to generate a small WP screening smoke cloud. This smokescreen has proven to be an effective means of fire suppression.

#####

## 16. AIRCRAFT BILGE DRAINHOLES

Recently a CH-46 aircraft experienced trouble when called upon to lift a load that was computed to be well within the aircraft's performance capability. When the CH-46 returned to its base airfield, it was discovered that several hundred pounds of water was trapped in the bilge. Close inspection of the bilge drainholes is necessary to ensure that they do not become clogged with sand and debris. Ensure that the aircraft's basic capabilities are not impaired.

#####





## 17. VISUAL RECONNAISSANCE FROM HELICOPTERS

Experience has proven that helicopters receive more enemy fire and hits when they fly below the normal 1500-foot minimum operating altitude to conduct visual reconnaissance. Binoculars should be used by air observers on all visual aerial reconnaissance missions to better observe an area rather than make low passes. Low passes are considered appropriate only in those instances where no other means is available to adequately observe or identify the target or friendly forces in question.

#####

## 18. TIP FOR AIRCREWS

On several occasions after carrying ARVN troops, members of the crew have found ammunition, grenades and various objects in the radio compartment of the aircraft. On another occasion, a confirmed VC document was discovered when the aircraft was swept out. The document had been folded to approximately the size of a quarter and sewn into a cloth jacket. It must be realized that some ARVN troops may be VC sympathizers.

All aircraft crew personnel must be alert to closely observe actions of ARVN troops while embarked, and upon departure of troops, the aircraft should be thoroughly inspected for loose ammo, documents, or other items of possible intelligence value.

# # # # #

## 19. PREVENTION OF MIDAIR COLLISIONS IN LOW VISIBILITY

Since many helicopters fly regularly traveled routes during marginal weather conditions without traffic control procedures, midair collisions are a distinct possibility. Pilots should illuminate the aircraft landing light and have it pointed ahead of the aircraft to permit the aircraft to be seen from a greater distance. This procedure has proven to be beneficial in helping to prevent midair collisions during daylight and darkness. Due consideration must be given to the enemy threat in

the area being overflowed so as not to provide a better aircraft target for enemy fire.

#####

## 20. INCREASING HELICOPTER VISIBILITY

High-performance jet aircraft escorting helicopters experience difficulty in maintaining visual contact with camouflaged helicopters, particularly during haze conditions.

As a field expedient the tops of one or two main rotor blades may be painted a contrasting light color, thus making these aircraft much easier to see.

#####

## 21. TACAN MAPS

Aircrews in Vietnam have found that they can arrive at their target with the least amount of navigational delay by using the following technique. When using a map for operations in the vicinity of a TACAN station, 10<sup>0</sup> radials and 10-mile distances are marked on the map. It is then covered with a piece of lightweight clear plastic on which grease pencil annotations may be made and erased quickly. This provides for faster target acquisition and reduces the number of marked maps which have to be discarded.

#####

## 22. MONSOONS AND MAP CHANGES

Frequently, the heavy rains associated with a monsoon season cause changes in the appearance of depressions, streams, small bodies of water, and the surrounding terrain. This is more apparent to an aerial observer than to a man on the ground. These changes can delay needed close air support, and cause aircraft to be exposed to enemy observation and fire for an unnecessary period of time due to delays in identifying target areas. Changes can even result in selection of the wrong target. Apparent changes to terrain features should be reported during pilot debriefings. Maps and aerial photographs must reflect these changes. There will be a consequent savings of aircraft airborne time and an increase in the accuracy of air-delivered weapons.

# # # # #

## 23. YOU ARE MR. CLEAN

Equipment maintained in a high state of cleanliness has consistently proven to be the most dependable. A problem in the preventive maintenance of multiple ejection racks (MER) and triple ejection racks (TER), used on tactical aircraft, has been the removal of carbon deposits from the breech mechanisms. A simple and effective cleaning solution for the breech mechanisms is hot soapy water; use immersion burners to heat the water, and alkaline soap. Trichlorethylene or acetone can be used to clean the breech

caps and reduce the incidence of broken firing pins. The reliability of MERs and TERs can be increased by regular cleaning and periodic testing and repair.

#####



24. USE OF SATS LOADER AND UNIVERSAL WEAPONS CRADLE WHEN LOADING NAPALM AND 2.75-INCH ROCKETS ON THE F-4B

The use of the SATS loader during combat operations has proven most satisfactory as an expedient method of loading ordnance on the F-4B. It also provides a safety factor against physical fatigue, particularly during hot weather operations. Only 1-inch horizontal clearance is

available between the SATS loader boom and the external wing tanks when "soft" ordnance is to be attached to the outboard shoulder stations of the TER. The boom, approaching from forward of the aircraft, has to be turned 90 degrees for ordnance alignment. This is a critical phase since the clearance is such that any carelessness may allow the external wing tanks to be damaged by the boom.

When the "Weapons Cradle Universal, Small, MAV-63E" is utilized, the distance between the boom assembly of the SATS loader and the external wing fuel tanks increases from 1 to 4 inches. The bomb or pod is placed on the cradle which is lifted by the SATS loader. The additional height provided by the cradle lowers the boom elevation requirements which results in the additional clearance. This cradle also provides protection against loading damages to the "soft" ordnance itself.

Here are some do's and donot's for SATS weapon loader operators:

- Do check oil levels daily and always before operation. Add oil if necessary.
- Do ensure that all wheel lug nuts are tight before operating. Replace missing nuts.
- Do check hydraulic lines for leakage and frayed sections. Replace frayed sections and add hydraulic fluid as required.

- ➔ Don't ride the clutch.
- ➔ Don't use the loader like a hotrod.

#####

## 25. RCPT-105 DUAL STARTING SYSTEM

In order to reduce the starting times for multiple aircraft launches, especially the ground-to-air alert, the RCPT-105 starting system may be modified to allow dual aircraft starts. By attaching an additional 10 feet of air hose to the RCPT-105, two F-4's placed side by side with wings folded can be started without having to move the starting unit. (The AC power cable is of sufficient length to reach each the external power receptacles of both aircraft and requires no cable extension.) This simple modification saves time and manpower and efficiently utilizes equipment.

#####

## 26. SERE KITS

Inspect pilots' SERE (survival, escape, rescue, evasion) kits frequently for serviceability. Recent spot checks have revealed that through normal wear and tear the morphine syrettes had become cracked or punctured and were completely unserviceable.

#####

27. F-4 DRAG CHUTE DOOR LATCH

Reports have been received concerning instances where the drag chute door of the F-4B has "popped" open during taxi and takeoff operations. The drag chute has fallen out during these incidents and caused serious material and safety problems. The primary cause of these occurrences has been the failure to properly secure the drag chute door when the parachute was installed.

The manufacturer's "Product Support Digest" has recently recommended the following simple procedure that will enable personnel to ensure that the drag chute door is properly secured: First, ensure that the drag chute door is properly latched in the closed position. File a small notch in the "over center latching handle" close to the fuselage skin. This notch can be inspected visually in the daytime and can be touched in the dark. If the notch can be seen or felt, the door will be in the properly latched position. If the notch is not visible or cannot be felt, the chute door is not properly secured and the latching procedures must be repeated.

# # # # #





## 28. ALTITUDE SEPARATION

During the conduct of close air support and direct air support missions, more than one flight of aircraft may be required to orbit over a specific area. When these occasions occur, the aircraft controller will usually be occupied primarily with the execution of the assigned mission. Also, the pilots of the orbiting aircraft are occupied with attempting to identify the target visually. In this situation, when all personnel are devoting maximum attention to the accomplishment of the tactical mission, a potentially dangerous situation exists due to the possibility of midair collisions. To avoid such an accident, it is of the utmost importance that the proper altitude separation between flights be maintained.

When entering an area where flights may be "stacked," or where other flights can be expected, flight leaders should identify themselves by call sign, state the flights assigned/intended orbit altitude, and receive acknowledgment from other flight leaders in the area.

#####

## 29. NIGHT AIR ATTACKS

Controlled close air support attacks and armed helicopter operations have been successfully conducted under flares. These operations require a high order of pilot proficiency and judgment. Pilots should be alert to avoid burn-out flares descending in parachutes. Prior to night operations, each flight should be briefed on the altitude and heading of the flare drop aircraft and the burning time and rate of descent of the type flares employed. Training programs should include practice in this technique of night close support.

#####

## 30. KEEP A CLEAN COCKPIT

Dust and sand can cause major aircraft maintenance problems. Dust and sand have caused many spring-loaded pushbutton-type controls to stick. A dangerous situation would exist, for example, if the boost pump test button were to stick in the "in" position, unnoticed, after the

pump check. This would render the boost pump inoperative.

Canopies must be kept closed whenever possible

All dust covers must be installed.

Vacuum the cockpit periodically.

A thin clear plastic, placed over push-buttons, keeps foreign matter out while permitting free movement of controls.

#####

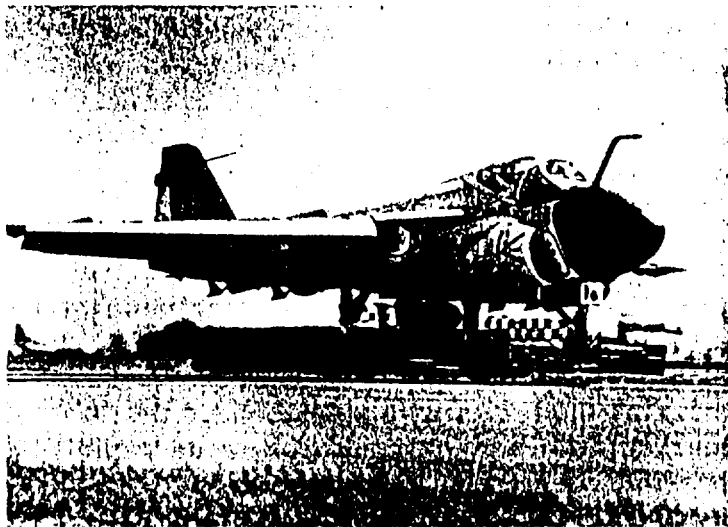

### 31. EMPLOYMENT OF A-6A AIRCRAFT

Extensive experience in employing systems delivery of ordnance has resulted in increased effectiveness in this new area of warfare.

Offsets for preplanned targets should be computed trigonometrically to gain the best accuracy.

Whenever possible, the offset bearing should be used as a run-in heading to eliminate azimuth error. This procedure keeps the target between the aircraft and the aiming point so that the aiming point remains on the scope throughout the run. If the computer fails during the run, the attack may often be completed by using preplanned manual range.

Bombardier/navigators should practice acquiring moving targets on secondary and dirt roads, in all types of terrain.

#####

## 32. AIRSTRIKE TACTICS

The enemy often withdraws rapidly from areas marked with smoke in order to avoid the following airstrike. To obtain maximum strike effectiveness, attack aircraft should be prebriefed prior to arrival over the target and prior to marking the target with smoke. Once the target is marked, the strike should follow as rapidly as possible to obtain maximum surprise and effectiveness. When visual contact has been made with the enemy, intensive surveillance must be maintained to discover enemy withdrawal routes.

Followup attacks should be directed, first against observable targets, and then on likely avenues of escape.

#####

### 33. NATOPS PROGRAM

To ensure the safest possible operation of aircraft, the Naval Air Training and Operations Procedures System philosophy must be stressed at all levels, as the tempo of combat increases.

Too often, particularly during periods of heavy operations, aircraft accidents/incidents are directly attributable to laxity in adherence to established procedures. In the interest of expediting mission accomplishment, pilots tend to disregard the solid philosophy of the NATOPS program. In some cases, even supervisory personnel regard the increased tempo of combat operations as a license to shelve vital NATOPS functions.

Times of crisis can point out deficiencies in a system that are not readily apparent during normal operational periods. If it can be established that NATOPS procedure is unduly hampering operations, it is the obligation of the individual or unit to recommend changes. Until changes are recommended and approved, basic NATOPS procedures should be closely followed.

#####

#### 34. PILOT FREQUENCY CARDS

Communication security in combat requires the use of many color-coded frequencies to prevent compromise. The normal practice is to indiscriminately list the colors and frequencies in no particular order. This requires a momentary search of the pilot's kneeboard card to match the color given with the correct frequency. By alphabetizing the color codes of the frequency cards, the given color can be rapidly located by scanning directly to its alphabetical precedence. This is a simple procedure to adopt and has been found to be extremely useful.

# # # # #

#### 35. C-117D MAINTENANCE

Aviation mechanics in Vietnam have learned that timely and adequate preventive maintenance will increase the usability of the R-1820-80A engine for the C-117D. The practice of changing the oil on each 60-hour check, changing the plugs ever 200 hours and frequent changing of the carburetor air filter will substantially lengthen engine life.

# # # # #

Chapter V: MINE WARFARE



1. DEFINITIONS

A mine is an explosive device designed to destroy or damage vehicles, ships or aircraft or to wound or kill personnel. It may be

detonated by the action of its victim, by the passage of time, or by controlled means. There are land and water mines. Land mines are usually classified as antipersonnel or antivehicular.

A boobytrap is a device that will injure a person who disturbs an apparently harmless object or performs a presumably safe act.

#####





2. FACTS WE HAVE LEARNED ABOUT VIET CONG MANUFACTURE AND USE OF MINES, SABOTAGE DEVICES, AND BOOBYTRAPS

a. General

The Viet Cong, being very resourceful, make maximum use of all explosive ordnance at their disposal. The Viet Cong search the battle area for unexploded munitions (duds) and modify them for use as mines, sabotage devices or boobytraps. They also use the explosive filler for locally manufactured munitions.

The Viet Cong use all the standard initiating methods for fuzing various types of devices; i.e., pressure, pressure-release, pull-release, pull-friction, chemical delay, mechanical delay, initiation by tidal water rise, and command controlled detonation. The complexity of these fuzing systems, their construction, and their intended use are limited only by the materials available, the knowledge, and training of the individual who constructs them. One or more fuzing system may be found in each type of explosive device. Almost any type of container may be used to fabricate mines and sabotage devices; e.g., USAID soybean oil cans of 1- to 5-gallon capacity, pieces of bamboo, etc. The VC recently smuggled plastic explosives into a Bachelor Enlisted Quarters. The explosives, with a time delay device, were placed in a pair of combat boots that were seldom used by the owner. The occupant of the room was

seriously injured upon detonation of the explosives. This was a new approach to VC terrorist activities. The VC addressed boobytrapped packages to U.S. officers working in sensitive positions. Some of these packages contained such items as exploding fountain pens and cigarette lighters. These devices were meant to maim rather than kill. Homemade grenades and small bangalore torpedoes concealed in loaves of bread, briefcases, baskets of fruit, radios, and coconuts have also been used as boobytraps. Directional mines and shaped charges have been hidden in motorcycle saddle bags or on bicycles. On numerous occasions bicycle frames have been completely filled with explosives. Automobiles and panel trucks have been made into large bombs by filling the enclosed sections of the hood, fenders, and body paneling with explosives. These types of bombs need not be in close proximity to the target to cause death or destruction.

b. Fuzes

(1) Pressure-Type Fuzes

Pressure-type fuzes are probably the simplest fuzes to produce locally. The basic components are a firing pin, a cartridge primer, and a detonator. A pressure-type fuze can be made from a nail, a small arms cartridge, and a block of wood (fig. 5-1). They may be of more sophisticated design having a firing pin retained in a cocked position by a key slot which, when

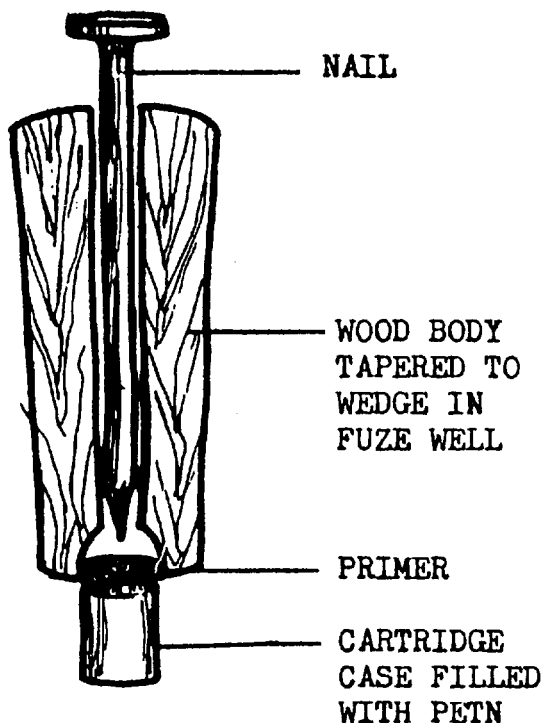

BASIC COMPONENTS OF A PRESSURE TYPE FUZE

Figure 5-1

depressed, releases the firing pin under spring pressure, detonating the device (fig. 5-2). The VC also use modified mortar and artillery fuzes as pressure firing devices (fig. 5-3).

(2) Pressure-Release Type Fuzes

Pressure-release type firing devices, normally called "mouse traps," can be easily made by using the design of commercial-type

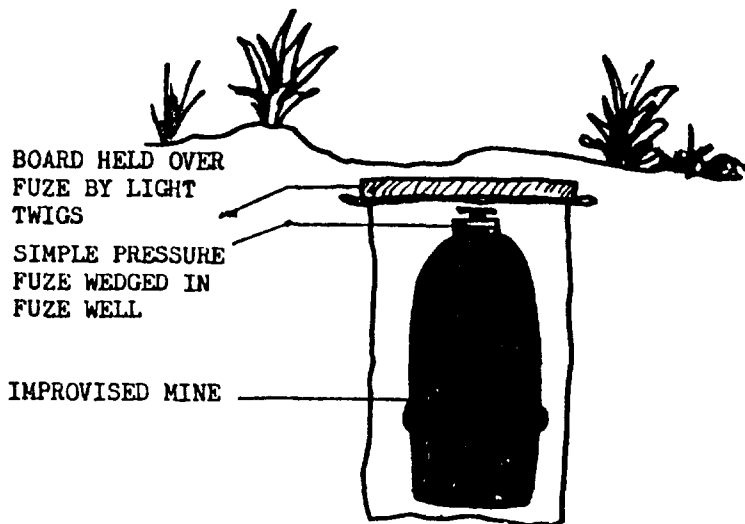

SIMPLE PRESSURE TYPE

Figure 5-2

mouse traps. With innovations applied to utilize the munitions that are on hand, the VC employ this device primarily in modified boobytraps such as bomblets, dud artillery rounds, and U.S. aerial bomb duds. The device shown in figure 5-4 is activated by the removal of the weight which releases the mouse trap device, thus detonating the mine or boobytrap. The VC sometimes use a standard grenade fuze with the safety pin removed and with sufficient weight on the handle to hold the firing pin in the cocked position. When the weight is removed from the handle the spring loaded firing pin strikes the primer exploding the boobytrap.

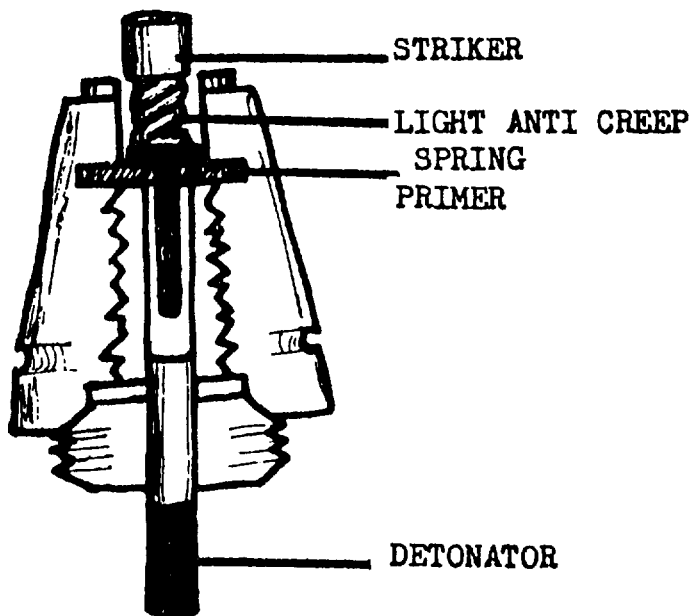

MODIFIED PRESSURE TYPE FIRING DEVICE

Figure 5-3

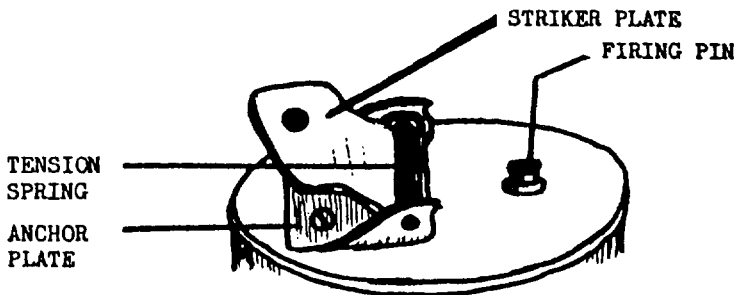

MODIFIED PRESSURE-RELEASE FIRING DEVICE

Figure 5-4

### (3) Pull-Type Firing Devices

The most common pull-type firing device used by the VC is the pull-friction fuze similar to those encountered in the VC and Chinese Communist stick grenades (fig. 5-5). When used as a mine or boobytrap fuze, the delay firing train is usually removed and replaced with an explosive detonator which instantaneously detonates upon ignition of the fuze. As with all pull-type firing devices, the mechanical pull-type firing device is characterized by a slack tripwire. The mechanical pull-type firing device has not been used as commonly as the pull-type friction device; however, an increasing number of this type of locally manufactured VC initiating device has recently been recovered (fig. 5-6). Many

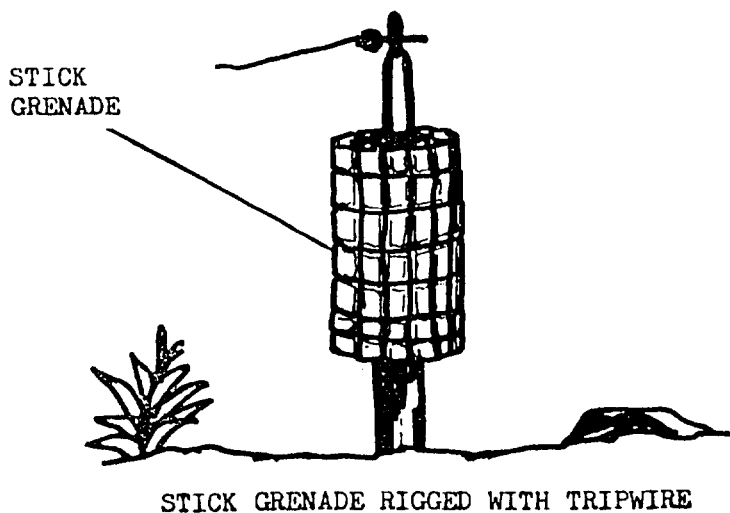

Figure 5-5

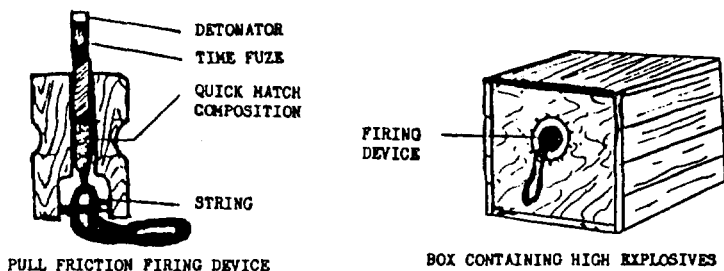

Figure 5-6

devices of the type shown in figure 5-5 were used against the French. A Chinese Communist or VC copy of the Russian MUV firing device is more likely to be used in the Republic of Vietnam. The MUV fuze was widely used in Korea during the Chinese Communist intervention.

#### (4) Pull-Release Type Firing Devices

Pull-release firing devices are designed for activation by either an increase (pull) or decrease (release) in tension on a taut wire or vine (fig. 5-7). Pull-release firing devices are also called tension release devices. Extreme caution must be observed when encountering a taut wire or vine, as a cocked striker is always used in this method of initiation; thus any movement of the wire, vine, or explosive item may activate the striker detonating the device. To render safe a pull-release device, the striker must be blocked with a positive safety between the striker and primer. Many pull-type firing

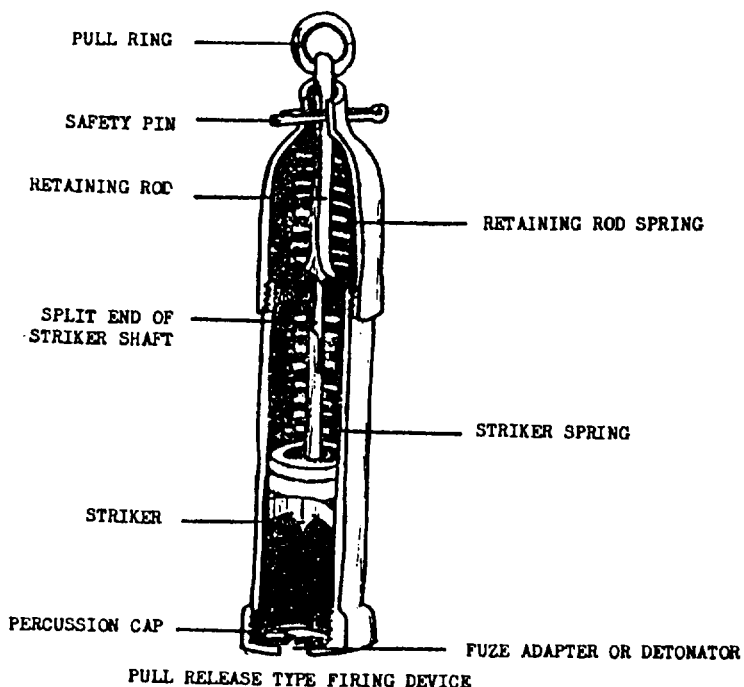

Figure 5-7

devices can be used as a pull-release device by attaching the tripwire or vine to the striker. Pull-type devices rigged for pull-release action normally activate when the tripwire is broken.

#### (5) Tilt-Rod Mine Firing Devices

The VC have constructed this type of device from a small arms cartridge, a threader base, and a spring-loaded striker. The cartridge case is modified by removal of the primer cap, and the base is slotted to accept the spring-loaded striker. A primer detonator is placed on the



threaded base and a length of bamboo or tree branch is inserted in the other end of the cartridge case. There is usually a hole in the threaded base for inserting a safety or nail thus preventing the spring-loaded striker from impacting on the primer during fuzing installation. The assembly is then screwed into the mine and the safety removed. This device is activated by moving the rod approximately 20° from the vertical, which will release the spring-loaded striker and detonate the mine. The VC utilize this device most commonly by installing it in landing zones as an antihelicopter mine, in paths of foot troops, and in areas being cleared by tanks and bulldozers. They have been used in various types of VC mines including the Nuoc Mom pot-shaped mine, and homemade VC cylindrical mines (figs. 5-8 and 5-9).

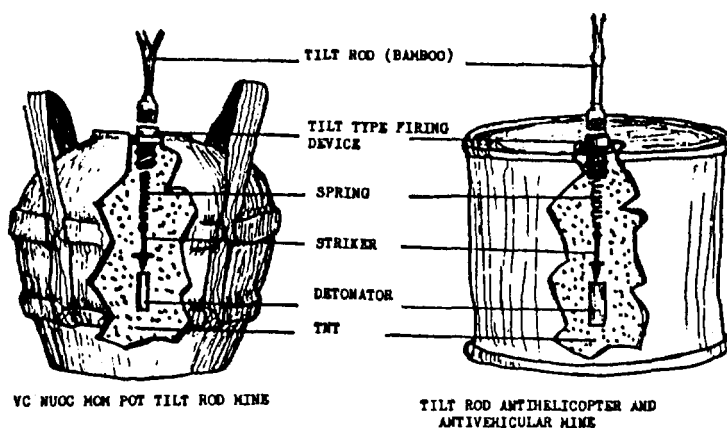

Figure 5-8

Figure 5-9

(6) Control of Command Fired Fuzing Systems

All the firing devices mentioned can be command detonated by a person lying in wait for a prime target. The fuzing system can be activated by a VC observer from a distance when a suitable target presents itself. The most common method of controlled firing practiced by the VC is by electrical means. This is accomplished by placing an electrical blasting cap in the mine or boobytrap fuze well, leading a firing cable to a concealed position, and connecting a battery or electrical blasting machine when the target comes into range. The VC use this type of initiation for all types of munitions, including water mines (figs. 5-10 and 5-11).

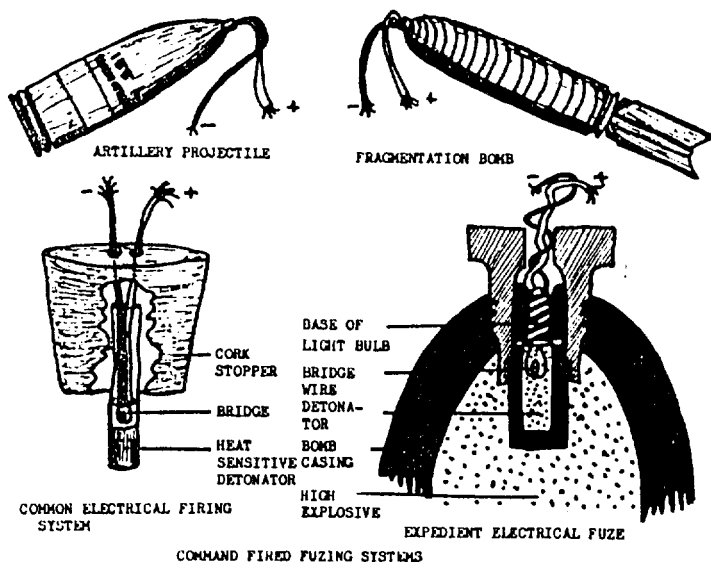
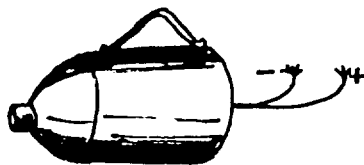
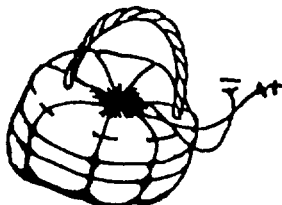

Figure 5-10



CYLINDRICAL A.T. MINE



CONCRETE BASKET AP MINE

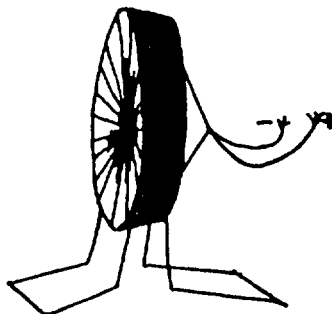

ANTIPERSONNEL DIRECTIONAL  
FRAGMENTATION MINE

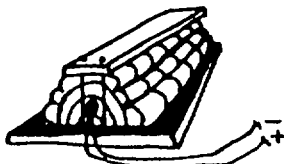

CONCRETE TURTLE AP MINE



CONICAL SHAPED CHARGE A.T. MINE



PLASTIC DUAL PRIMED A.T. MINE

COMMAND FIRED FUZING SYSTEMS

Figure 5-11

(7) Time-Delay Firing Devices

Mechanical delay and chemical delay-type firing devices have been encountered throughout South Vietnam. The mechanical delay is the most common. One type of VC mechanical delay firing device is made from commercial watches with two electrical contacts being added. One is soldered to the case of the watch and the other is wired through the crystal of the watch. At the desired time of detonation, the moving hand makes contact with the wire projecting through the watch crystal completing the electrical circuit, and initiating an electrical blasting cap which detonates the explosives (fig. 5-12). Small alarm clocks have been used utilizing the clocks alarm system to complete the circuit. Chemical delay firing devices used by the French have also been

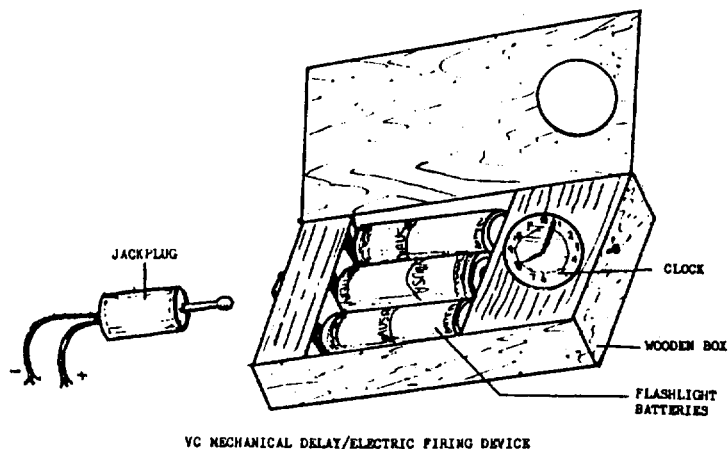

Figure 5-12

encountered in scattered incidents. These are similar to the U.S. chemical delay firing device type M-1.

c. Main Charges

(1) Grenades

Many small explosive items, resembling grenades and normally used as such, are also employed extensively by the VC as antipersonnel mines and boobytraps. Both percussion-type and pull-friction type fuzes with the delay element are used in these items.

(a) As a Boobytrap

A grenade was placed under a bag of rice in a VC base area. The weight of the bag of rice held the grenade handle in the cocked position. Upon removal of the rice by friendly forces, the grenade exploded (fig. 5-13).

(b) As an Antipersonnel Mine

A grenade with a safety pin removed was placed in a hollow length of bamboo. A tripwire was attached to the grenade. Pressure on the tripwire would have pulled the grenade from the bamboo releasing the handle and allowing the striker to initiate the action detonating the grenade. This device was discovered before it could inflict any damage (fig. 5-14).

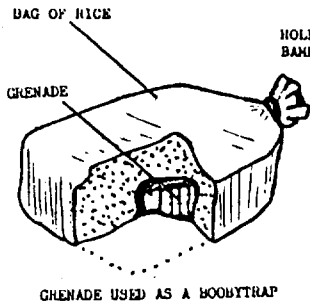

Figure 5-13

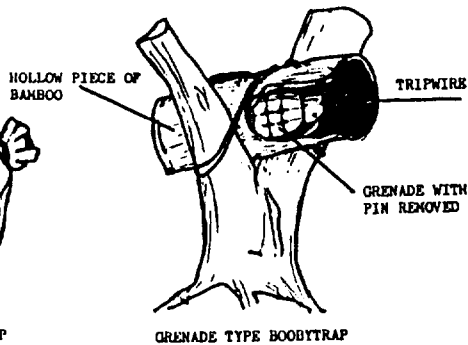

Figure 5-14

(2) Artillery Projectiles, Aerial Bombs, Mortar Ammunition and Explosives

All sizes of dud artillery projectiles, aerial bombs, rockets, and mortar projectiles are used by the VC as mines or boobytrap devices. They use the smaller ammunition as antipersonnel mines or boobytrap devices and the larger type as antitank and antivehicular mines. Both categories may be equipped with any of the previously mentioned firing devices. Various examples are:

(a) As an Antipersonnel Mine

A VC modified U.S. BLU-3/B bomb-let was wired to the side of a tree with a tripwire across the trail. The tripwire was a monofilament cord resembling fish line leader and difficult to

see (fig. 5-15). A patrol, not seeing the tripwire, suffered heavy casualties.

(b) As an Antipersonnel Mine

A tilt-rod firing device was placed in a Nuoc Mom pot filled with explosives (fig. 5-16). The mine was emplaced in a heavily folliaged path leading to a VC bunker complex. The rod assembly resembled the surrounding vegetation, but the lack of camouflage around the fuze assembly revealed the mine. This mine was recovered intact and no casualties were experienced.

(c) As a Boobytrap

The VC placed the tail fins of a 250-pound bomb on the ground, giving the appearance of a dud bomb. Explosive ordnance personnel were called to investigate, and discovered that a VC

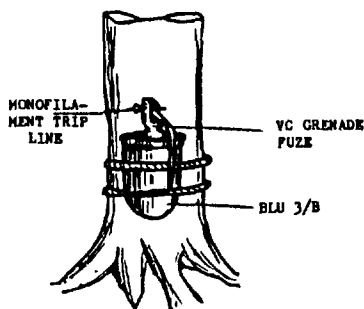

BLU-3/B USED AS A BOOBYTRAP

Figure 5-15

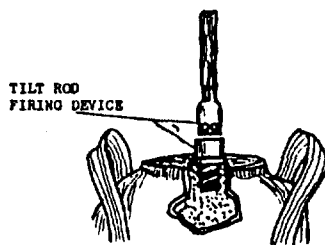

TILT ROD FUZED IN NUOC MOM POT

Figure 5-16

modified U.S. BLU-3/B antipersonnel bomblet, using a mouse trap device, had been placed and camouflaged beneath the bomb fins (fig. 5-17). Disturbance of the bomb tail fins by inexperienced personnel would have resulted in casualties.

(d) As an Antitank/Antivehicle Mine

A 105mm artillery projectile was buried in a dirt road and rigged to be fired electrically (fig. 5-18). The charge was detonated under a 3/4-ton vehicle. Many incidents have occurred involving artillery projectiles emplaced in roads and command detonated when a prime target presented itself.

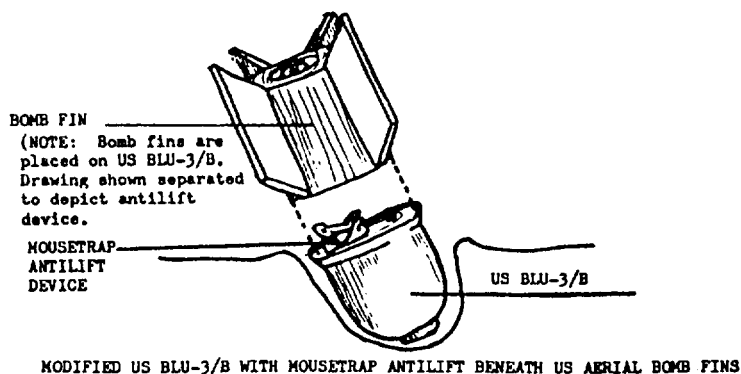
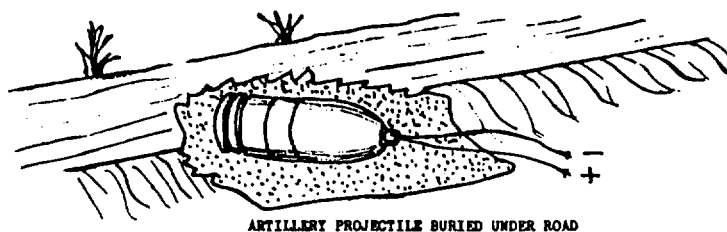

Figure 5-17





ARTILLERY PROJECTILE BURIED UNDER ROAD

Figure 5-18

(e) As an Antipersonnel Mine

A large number of artillery rounds, 75mm, 155mm, and 20-pound aerial fragmentation bombs were suspended from trees (fig. 5-19). Some were command detonated, while others were rigged with tripwires. The controlled mines were detonated when friendly forces came within range. Those rigged with tripwires were set off by friendly forces looking up in trees for mines and unsuspectingly tripping the wires on the ground. The VC also consider the 20-pound fragmentation aerial bomb to be an excellent antipersonnel mine. The larger bombs (100 to 1000 lbs) will destroy any type vehicle. The VC are now using bombs as mines more frequently than in the past and are known to use excessive amounts of explosives to complete their mission. Bombs are also used near VC safe havens, preplanted on likely avenues of approach, and are either command detonated or set off by any of the other mentioned methods of activation.

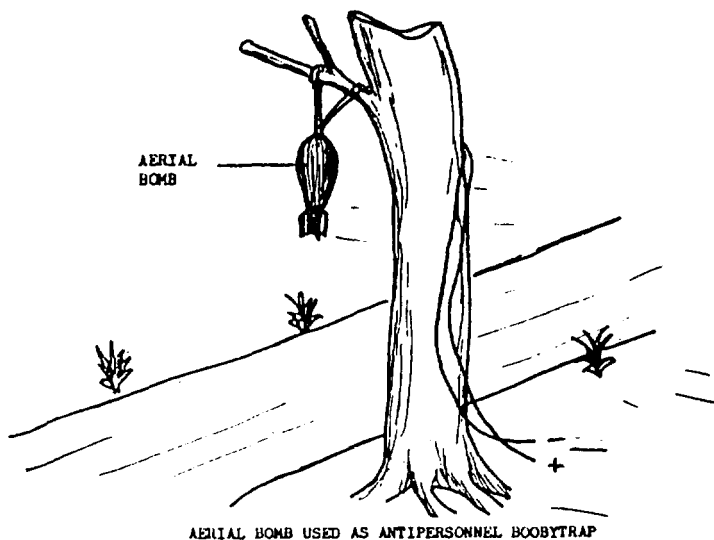

Figure 5-19

(f) As an Antitank/Antivehicle Mine

The VC have used 15 to 20 pounds of plastic explosives wrapped in plastic ground cloth or placed in a wooden box. The VC attach a conventional type nonelectrical blasting cap to a pressure-fuze. The blasting cap is attached to a length of detonating cord and used as a primer for the explosives. The VC then emplace this crude, but effective, mine in the road as an anti-vehicular mine. A ceramic cup used on rubber plantations for collection of latex is placed in the inverted position over the fuze for protection (fig. 5-20). When mine clearing parties clear the road, metallic type detectors do not detect the fuze. Consequently, mine clearing crews have missed

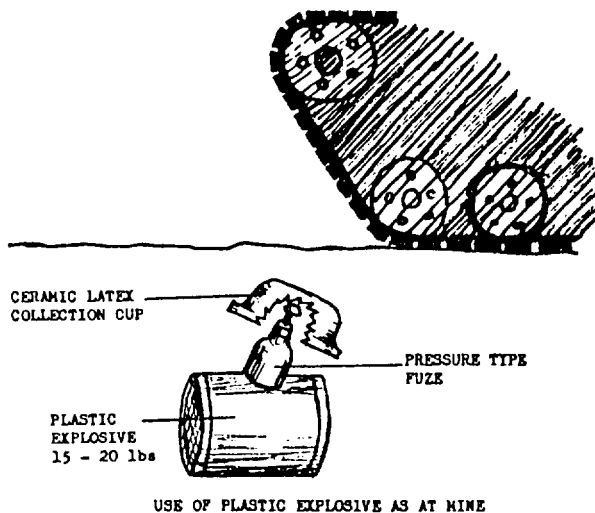

Figure 5-20

this recent adaptation by the VC resulting in damage to equipment and loss of personnel.

d. Viet Cong Locally Manufactured Mines

The homemade or locally manufactured mines come in many sizes, shapes, and forms (fig. 5-21). They may be constructed of light metal, cast iron, or explosives packed into bamboo tubes, boxes, wrapping paper or plastic ground cloth. The intended use for a mine normally governs its size, shape, and construction.

The most infamous and widely used locally produced mine is the direction-type mine commonly referred to as the "Claymore." These items have been found in sizes ranging from 5 to

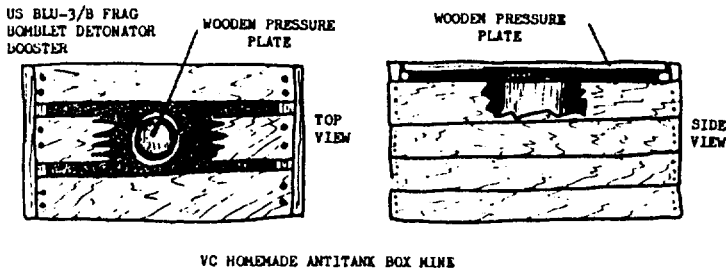

Figure 5-21

8 inches in diameter. There is also a type produced which resembles the U.S. M18A1 "Claymore" directional mine, being similar in configuration. The principle of directional mines is that a large number of fragments are propelled in a given direction by an explosive force. The maximum effective range is approximately 200 meters with a dispersion pattern of approximately 16 to 20 meters wide at the maximum range. VC directional mines have been used against light vehicles, armored personnel carriers, troops, billets, bus stops, helicopters in landing zones, in breaching barbed wire barriers, and as a dispersant for CS gas, accomplished by mounting a satchel of CS wrapped in plastic to the front of the mine and detonating the mine. The VC have also used 10 to 12 grenades or modified U.S. BLU-3/B bomblets mounted on a wooden plank as an antihelicopter and anti-personnel mine. This mine is a modified "Fougasse," consisting of approximately 5 to 10 pounds of explosives, which is laid in the bottom

of a hole with the opening toward the enemy. The hole is at a 45° to 90° vertical angle depending on the type of employment. The charge is covered with a layer of earth and the board containing the grenades or modified U.S. BLU-3/B is placed in the hole and camouflaged. The grenades or U.S. BLU-3/B bomblets are modified with standard VC grenade fuzes which may or may not incorporate a delay train of 3 to 5 seconds depending upon employment. Nails are driven into the board forming a holder for each device. One nail is on each handle to hold the handle in place and the safety pin is removed. When a suitable target presents itself, the explosive charge is command detonated hurling the board containing the grenades into the air. Three to five seconds after the initial blast, the grenades, having become dislodged from the board, explode in the air hurling fragments for approximately 200 meters in all directions (fig. 5-22).

e. Detonation by Tidal Action

This type of firing device was recently recovered by Republic of Vietnam troops after the VC had destroyed a bridge. The device was of the electrical type and placed in the main stream under the bridge. The device consisted of a stake, hollow bamboo, a sealed "C" ration can, and two electrical wires attached to the "C" ration can. As the rising tidal water enters the water inlet of the firing device the "C" ration can, is floated upward until contact is made completing the circuit and detonating the explosives (fig. 5-23).

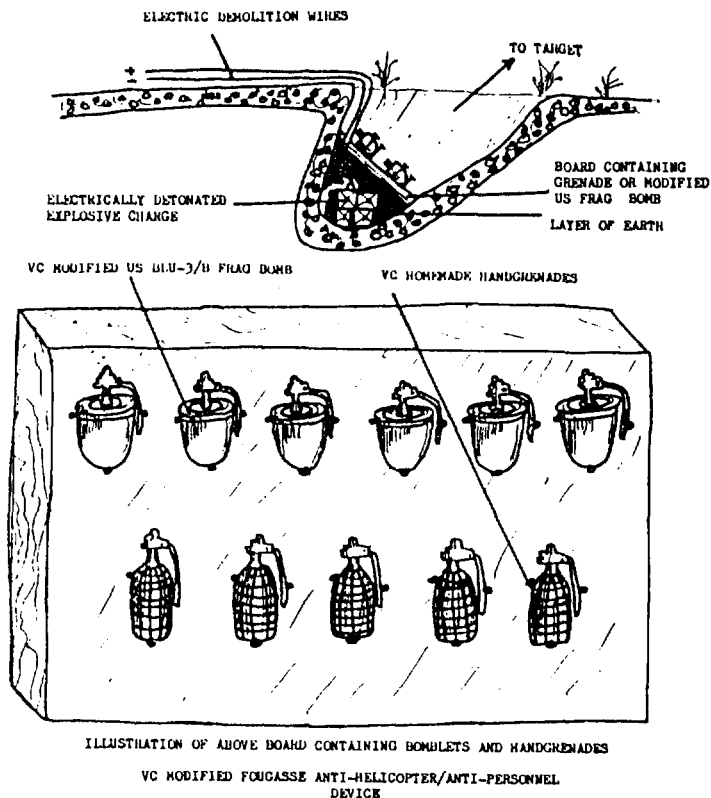

Figure 5-22

f. Chinese Communist Antipersonnel Mine Captured in South Vietnam

A Chinese Communist copy of a Soviet POMZ-2 antipersonnel mine equipped with an electric blasting cap for command detonation was recently captured for the first time in South Vietnam (fig. 5-24). This mine is normally

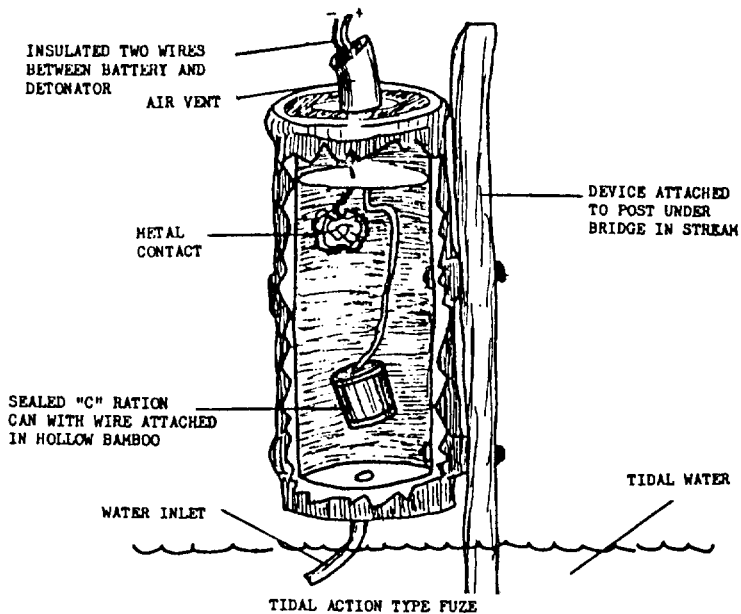

Figure 5-23

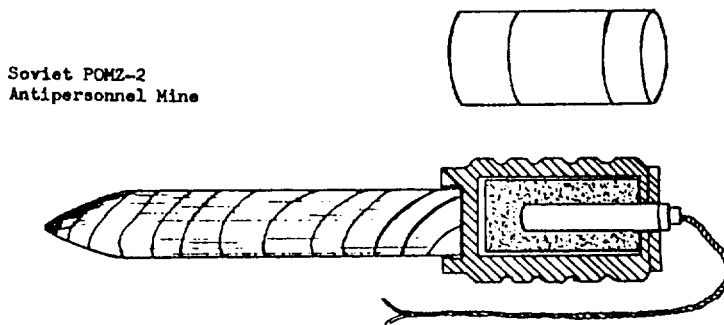
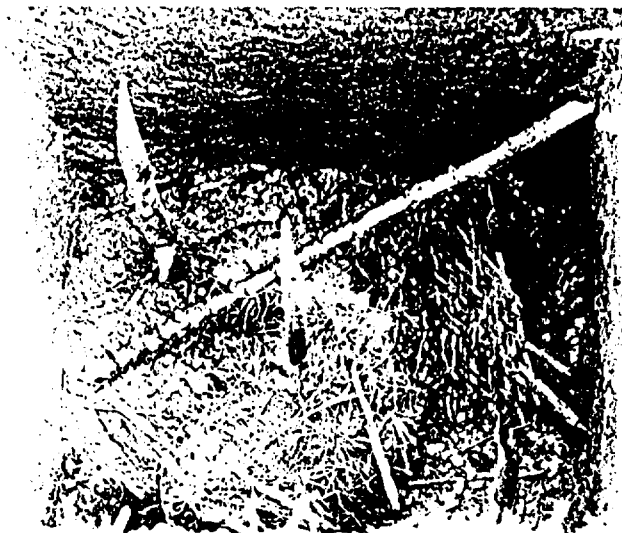

Figure 5-24

detonated by a tripwire attached to the firing pin retainer. It weighs only 4.4 pounds and is easily emplaced. These features plus the command-detonation capability make it appropriate for use in ambushes.

#####



### 3. PUNJI PITS

The VC frequently construct punji pits in sandy areas by placing a wicker basket in a hole 4 to 5 feet deep, emplacing the punji sticks, and then concealing the pit with a thin wicker mat covered by sand. The sand-covered tops are sometimes darker than the surrounding



sand, and are particularly obvious in wet sand. Marines should be alert for such signs and check suspected areas by probing. Remember punji pits may be boobytrapped, so always remove the cover with the help of a long rope or cord.

#####

#### 4. BOOBYTRAPPED ENEMY PROPAGANDA DISPLAYS

Beware of enemy flags and displays of enemy propaganda materials. VC flags and eye-catching displays of enemy propaganda materials are often boobytrapped to inflict casualties on unsuspecting trophy seekers. When enemy displays are discovered, extreme caution must be exhibited by all personnel. The surrounding area should be searched for Claymore-type mines directed at the display. A search should be made for wires that could lead to a command-detonated mine. The display itself must be approached with extreme caution due to the possibility of pressure-type mines in the area, or the presence of an explosive device rigged to explode when the display is disturbed. Don't let souvenir hunting cause casualties in your unit.

#####



## 5. VC/NVA MINE TACTICS

VC/NVA mine warfare doctrine closely parallels that of the Chinese Communist Army, although it is heavily influenced by past guerrilla warfare in the Republic of Vietnam as well as that acquired during the French Vietnamese War.

Present practice of the VC/NVA is to make use of numerous isolated mines and groups of mines for their nuisance value and to create casualties, fear, and overcautiousness.

Generally mines are used wherever troops are expected to bunch up, slow down, or present a good target. Such areas are bridges, curves in roads, single track roads or trails, junctions, hillsides, huts, and likely rest areas. Any place that is a good ambush site is usually a good mine site, and mines are often employed with ambushes.

The VC/NVA often use command detonated mines. One method requires a man to be concealed some distance from the explosive with a battery pack or hand held generator which is connected by wires to the mine. When troops or vehicles are in a position where the mine will do the most damage, the VC detonates it. It is important to check trees, bushes and the edges of roads for wires.

The pull wire is another command detonation device that is commonly used. A pull wire is connected to a pull-release device or to a friction igniter, and a VC conceals himself at the other end. When the target is in position, the VC pulls the wire and detonates the mine.

The soft earth shoulders of surfaced roads are often mined. This tactic is easily accomplished and provides an effective trap for

unwary troops. This method is not limited to hard surfaced roads but also may be used on dirt roads and trails. Roadside mining is used most often in ambush sites where the vehicles and men are to be driven off the road by fire. Heavy casualties have resulted in this type of operation.

The VC employ mines above the ground along land and water routes used by the enemy. This is a particularly favored and effective method of using mines improvised from artillery or mortar ammunition. The mines may be placed in rotten tree trunks, on sticks, next to or in termite mounds, at the base of or in the branches of trees, in bushes, or in any concealment that affords a "sweeping" action for the fragments. In high grass areas the VC may just lay the mines on the ground with no other camouflage.

Mines may be laid on the bottom of streambeds for tripwire initiation, pressure initiation or command detonation. These mines may be placed at fords or wherever troops could be expected to wade through the water.

#####



## 6. TRICKS FREQUENTLY EMPLOYED BY VC/ NVA

Dirt roads and trails are easily mined, since the traces normally can be completely eliminated. In instances where traces cannot be eliminated, the VC use a number of tricks in addition

to the normal mine laying techniques used by both sides.

One unusual technique takes advantage of the mine detection personnel's carelessness. The VC dig up the road and leave--a normal method of cutting lines of communications. Friendly troops fill in the dug up sections and the VC return to lay mines in the refilled areas. These areas must be checked day after day even though nothing is found. The VC expect you to assume an area is clean after it has been checked and to become careless and not recheck it. The VC may dig holes in the road, lay mines in a few of them, and refill them with dirt. After the mine detecting teams check dozens of holes and find nothing, the next hole may be expected to be empty and may not be checked.

Another method is emplacing mines in a road and then surrounding the area with pieces of metal to negate the use of a mine detector. Some mines may be emplaced and then covered with straw, grass, dung or any natural looking substance. Employment of mines on hard surfaced roads presents more of a problem than do dirt roads. The VC tunnels under the road from the shoulder and emplaces a mine. The VC prepare the mine for command detonation, usually electrical, and carefully fills the tunnel. Traces of this burrowing activity can be eliminated because of the dirt shoulder. The leads to the mine are concealed and generally terminate in

a place where a VC can hide while waiting for his victim. This setup is a very difficult one to detect and requires careful inspection of the shoulders of the road for wires or traces of digging.

Tricks are employed which are similar to those used on dirt roads. One of these includes digging up sections of the road. After these areas are filled in, the VC return and lay mines in a few of them. This is the same tactic used on dirt roads and is countered by constant checking.

The VC smear the road with mud. This condition forces a mine detecting team to check the area carefully. The smearing may go on for several days until one day the VC emplace mines in the muddied sections. The mine detecting teams having checked the areas before with no results, may become a little careless and miss these mines. Again this carelessness is what the VC expect. The smeared areas must be carefully checked each time troops must cross them.

Another trick is to dig up the road, emplace the mine, and refill the hole with asphalt. A spot usually remains that contrasts with the surrounding asphalt. To avoid detection, the VC use a tire to mark across the patch and blend it in with the road surface. To counter this tactic, the detection team must be alert for any signs of road repair. Each spot must be carefully checked with a detector and a probe.

A 13-year-old Vietnamese boy recently claimed that the VC had forced him to reconnoiter helicopter landing zones and routes used by U.S. and ARVN forces. The boy was instructed by the VC to place handgrenades in helicopter landing zones which would detonate when the troops disembarked. This was to be accomplished by pulling the pin and wrapping a piece of string around the spoon to hold it in place temporarily. The free end of the string is then tied to a piece of heavy paper or cardboard, which in turn is laid over the grenade in the landing zone. Rotor wash from a landing helicopter blows the paper, thereby unwrapping the string, and releasing the safety lever.

### Beware of debris in LZ's!

The VC continue to demonstrate their adeptness at modifying all types of discarded or dud munitions for use as simple mine devices. A Marine patrol discovered a pressure-type anti-personnel device which had been made from an M-79 round. The head of the M-79 cartridge was removed and the centrifugal arming device rotated until the round was armed. A triggering device was the detonating contact. The device was then buried along a trail with the camouflaged trigger device above ground, where the pressure from the weight of a man would be sufficient to cause detonation.

This illustrates the importance of caring and accounting for all ordnance or explosive devices.



Recent instances have revealed the VC use of bandoliers as tripwires for mines/boobytraps. The bandoliers are torn into thin strips which, because of the color, allow the tripwire to blend in with the natural foliage making it extremely difficult to detect. All units should be advised of the VC use of discarded bandoliers, and steps should be taken to ensure used bandoliers are properly destroyed.

# # # # #

## 7. ANTITANK BOOBYTRAPS

A recent search and destroy operation conducted in I Corps revealed the enemy's use of RPG-2 rocket rounds as antitank boobytraps. Lengths of bamboo had been emplaced at 45° angles along the shoulders and banks of the road on the route of advance. The empty bamboo poles were seen during the approach march but were not removed. That night when the Marine force returned through the same area, the enemy had inserted RPG-2 rockets on the stakes, wired them for command detonation and effected a hit on one tank.

Advancing troops must be alert to unusual signs and apparently harmless objects. They may have a lethal mission.

# # # # #



## 8. DEFENSE AGAINST MINES

→ Reinforce with sandbags or armor plate the bottom of the driver and passenger-carrying compartments of all vehicles that frequent roads outside protected areas.

- Completely destroy/mutilate all discarded batteries of any size or type, since batteries are used as initiators in improvised mines.
- Enforce strict accountability for all grenades, trip flares, demolition materials, smoke grenades, ordnance items, etc. These items comprise the largest number of mines and/or initiating devices discovered.
- Maintain constant surveillance/control of all known minefields, since unattended mines are a source of supply for the VC.
- If possible, recover and destroy all expended trip flares, LAW's, smoke and illumination grenades, and 40mm clips. These items can all be used as components of a mine.
- Whenever possible, recover, cut and/or mutilate all abandoned communication wires. This wire may be used in command-detonated mines.
- Avoid establishing any pattern of movement in time and route.
- Report all duds immediately. If possible, surveillance should be maintained until destruction is accomplished. Duds are a prime source of VC mines.

➤ Destroy, crush or turn in all containers including "C" ration cans, beer and soda cans and ammunition boxes since these are used extensively as improvised mines.

➤ Avoid driving over potholes, road shoulders, boxes, cans, grass matting, loose boards or other foreign items in the road. These items may conceal a hastily emplaced mine.

➤ Adhere strictly to combat convoy intervals. Doing so can prevent damage to two vehicles.

➤ Observe civilian activities. A lack of local people along a route that is normally well traveled often indicates the presence of mines.

➤ During hot weather, avoid stopping vehicles in shaded areas or near a stream, since these are prime mining targets.

➤ Reemphasize limiting vehicular traffic to essentials. Numerous casualties have occurred on "sightseeing" trips.

#####



## 9. DETECTION OF ANTITANK MINES

Pressure detonated AT mines are sometimes placed under large flat stones and usually in the most heavily traveled tracks in the road.

Vehicle crews should be alert for stones or other suspicious objects in the road, and mine sweep teams should be especially attentive to well-traveled tracks in the road.

#####

## 10. PROBE CULVERTS

Pressure-type road mines have been detonated where the road has recently been swept by engineers. Investigation showed that the mines

were laid in close proximity to a metal drain culvert; consequently the mine detectors could not distinguish the mine from the culvert.

Those parts of roads in the vicinity of metal culverts should be probed by hand after the shoulders and culvert have been inspected for wires leading to a command-detonated mine.

# # # # #

## 11. ROUGH RIDER MINE SWEEP

Excellent results have been obtained on convoy mine sweeps by using the following system:

An engineer sweep team was placed on a hardened 6 x 6 truck accompanied by a squad (rein) of infantry for security. On an additional hardened 6 x 6 truck, one U.S. Army M-55 (Quad -50) was mounted for additional security. The concept of operation provided for the sweep team and security vehicle to cross the IP 30 minutes prior to the lead elements of the convoy, and maintain radio contact with the convoy commander on the convoy control net. When the sweep team reached the first checkpoint, they waited until the lead elements of the convoy crossed the IP before proceeding to the next checkpoint. Before the leading element of the convoy crossed the IP, air support in the form of gunships, air observer, and fixed wing was on station and could provide support to the sweep team as well as the convoy

itself. This procedure enabled the sweep team to clear the highway without causing delay to the convoy.

# # # # #

## 12. CONVERGING MINE SWEEP TEAMS

When sweep teams consistently start at separate points on a given route and sweep toward each other, there is a tendency for the VC to install a mine or boobytrap device at the point where the teams usually meet. The apparent reason for this is the opportunity to inflict heavier casualties. If teams sweep to a predetermined point, but do not physically meet, there is a danger that one team will complete its sweep and be secured, thus opening the route to traffic from one direction before the road is completely swept.

One solution is for the sweep teams to converge at a point which is close to a friendly position. This denies the VC the opportunity of mining or boobytrapping the area. An alternate solution is for the sweep teams to establish a system of converging at different points on successive days. Extreme caution must be exercised to ensure that no traffic is allowed over the road until all teams have completed their sweep.

# # # # #





### 13. MINE AND EXPLOSIVE DEVICE PROTECTION

The danger from mines and explosive devices is ever present in Vietnam. The enemy does not plant explosives at ground level only. Frequently, explosive devices are hidden in trees or overhead in existing structures. These antipersonnel devices are usually command detonated to cause maximum casualties to personnel. Crewmen in tanks, LVT's, Ontos, and other vehicles are particularly susceptible to this danger. Crewmen should wear protective clothing and take positions that afford minimum exposure to overhead explosions. Be alert for mines and explosive devices at all times.

# # # # #

### 14. VC CONSTRUCTION BLOCK MINE

The Viet Cong have devised a new mine for use against construction projects. This new device is prepared by filling a hollow cement building block with explosive. This mine can be employed by itself or in series and is detonated electronically prior to, during, or after construction is completed. The advantages of utilizing such a mine are obvious, since it is relatively easy to smuggle these explosives into pacified areas when they are disguised as building material. To guard against this new sabotage technique, security forces should check all building

material entering populated areas and inspect all buildings and construction projects for exposed wires associated with demolitions.

# # # # #

## 15. VC/NVA UTILIZATION OF MINES

Marines in northern I Corps discovered a minefield 1500 meters long, adjacent and parallel to Route #9. Thirty ChiCom DH-10 mines were emplaced approximately 50 meters apart. The majority of these were about 10 meters from the road. It appeared that the enemy had emplaced the mines as part of a planned ambush. The mines were emplaced in an upright position on stumps, about 1 foot above the ground, with tripwires 5 feet long attached. At several locations, two mines were placed about 8 feet apart with one tripwire between them and were positioned where troops were likely to debark from vehicles. Several mine locations were marked by stones placed in an arrow pattern on the road pointing toward the mines; others were marked by a series of 10 stones in a row.

Unusually placed rocks, logs, bamboo and other irregularities in terrain along lines of communications often identify VC minefields, punji traps and other obstacles. Personnel must be alert at all times for indicators of enemy minefields.

# # # # #

Chapter VI: COMMUNICATIONS



1. RADIO OPERATORS

Units in Vietnam rely almost exclusively on radio communications during field operations. Highly trained radio operators are essential to avoid confusion and delay, and to ensure that orders and reports are transmitted quickly and clearly. Transmissions should be brief, yet complete. Operators must be highly motivated and imbued with a sense of responsibility for the importance of their contribution to the successful accomplishment of the mission.

#####

## 2. AN/PRC-25

Since the battery compartment of the PRC-25 radio is not waterproof, operators must ensure that the battery case is drained and dried after each immersion or exposure to rain. When prolonged exposure is anticipated, a waterproof-type tape should be used to seal the battery box and the radio telephone unit.

Ensure that connector covers are used on the AN/PRC-25. If excessive moisture or water gets into the connector, the radio will short circuit when the handset is keyed. If the covers become lost, tape can be used as a field expedient.

The electrical equipment harness used to carry the PRC-25 radio can cause discomfort to operators of short-stature by digging into the small of the back. To cure this, the lower frame is bent backward about 3 inches. Once bent, no attempt should be made to straighten the frame. Operators of slim stature may find it more comfortable to cross the lower harness straps over the chest.

In dense underbrush PRC-25 antennas and bases may become detached and lost. Chances of this happening can be reduced by tying a short piece of nylon cord securely to the PRC-25 carrying handle on one end and to the coiled portion of the antenna base on the other end. In the event the antenna and base are lost, placing a rifle (barrel end), bayonet, or one's index finger at the point the antenna base screws into

the radio will permit transmissions for short distances. The use of a radio frequency amplifier, AM-306/PRC-25, with the PRC-25 radio greatly increases its range.

In hot weather the radio set should be protected from as much heat as possible. Extreme heat affects the components of the frequency synthesizing system to the extent that a change of frequency rating may occur. Radio operators and unit leaders should attempt to keep the radio in the shade when tactically feasible.

Some AN/PRC-25 models do not contain a diode in the module A3 to protect it from high frequency signals. Even though the PRC-25 has been turned off, the receive circuit of the RT-505/PRC-25 can be damaged if the radio is in the immediate vicinity of a higher powered transmitter, as may be found in an AN/VRC-12 or VRC-43-49. Antennas mounted on PRC-25's which do not contain the protective diode should be kept a minimum of 10 feet from high-power radio sets.

To provide more protection for the H-138/PRC-25 handset, a simple lanyard may be attached. This will not only protect the handset by securing it to the operator when not in use but will permit the operator free use of both hands. Without the handset, the radio is useless--protect it!

The life of the BA-386 battery for the AN/PRC-25 radio can be prolonged by rotating it

with another battery every 6 to 8 hours. When radio operators in a base location assume the radio watch, they should rotate batteries. During field operation, carrying at least one spare battery will permit accomplishing the desired rotation.

Used BA-386 batteries will provide flashlight batteries when broken apart. Each BA-386 will provide four BA-30's and six BA-58's which can be used in flashlights to provide an average of 2 days' power. This practice also ensures total destruction of the batteries and prevents their use by the VC as a power source for detonating mines and boobytraps.

#####

### 3. AN/PRC-25 BATTERY INSTALLATION

The battery BA-386 for the AN/PRC-25 radio has been redesigned with a "floating" battery terminal to preclude damage to either the battery or the radio set while changing or installing the battery. Terminal damage can occur as a direct result of improper battery installation procedures. TM-11-5820-398-12 should be checked for the correct procedure. It should be noted that throughout the installation, the radio remains on its side and not in an upright position.

Battery installation in the AN/PRC-25 is a continuing problem because of the fragile nature of the connector plate on the battery. Certain

precautions are necessary when both removing and replacing the battery. A recommended procedure is described below:

- ➔ Stand the radio on level surface with front panel facing upward.
- ➔ Release the battery case clamps by pushing the upper part of each clamp down and away from the radio.
- ➔ Lift the radio upward and away from the battery and place it on its side.
- ➔ Slide the new battery into the radio case so that the connector mates with the battery plug.
- ➔ Slide the battery cover over the battery until it meets the radio case.
- ➔ Refasten both clamps at the same time.

Install the battery only when the radio is lying on its side. Don't cause a radio to become unserviceable by improperly connecting a battery.

#####

#### 4. AN/PRC-47 RADIO

The AN/PRC-47 radio has a tendency to overheat if the cycle (2 minutes transmit; 9 minutes receive) is exceeded. A built-in thermal cutoff switch will automatically cut the radio off when the heat exceeds a certain level,

thus preventing internal damage to the equipment. However, if the thermal cutoff switch is overridden by depressing the battery test button while continuing to talk, permanent damage can, and probably will, result. This procedure should be followed only under extreme emergency conditions.

#####



## 5. ANTENNAS

The AS-1320/PRC-47 antenna is extremely unwieldy when fully assembled. If the fully assembled antenna is screwed into the radio chassis, permanent damage can result to the threads of both the antenna base and the radio



connection. To avoid this damage, attach the base section of the antenna to the radio chassis first, then assemble the remaining sections and attach them to the base section.

The proper antenna selection can improve the efficiency of the AN/PRC-47 radio. When operating between 2 and 9 megacycles, the long wire antenna is more efficient than the whip antenna. In the frequency range from 9 to 12 megacycles, the whip antenna is comparable to the long wire and the ease with which it can be employed makes it preferable. When erecting a long wire antenna, it should be elevated as high as possible. The table below offers a guide to the antenna length.

<u>Frequency (mc)</u>	<u>Length (ft)</u>
2 - 5	45
2 - 9	25
2 - 12	15

Radio transmissions can be improved by counterpoising (grounding) the whip antenna when the radio is used from a fixed position. Lay wires along the ground radially from the radio; WD-1/TT can be used effectively. These wires provide a better reflection of the transmitted signal. Without this counterpoise, the signal energy would be absorbed in the ground. Note that the wires are not attached to the antenna base but should be grounded to the radio case.

The length of the wires should be between one-half to one wavelength.

## Counterpoise Length (AN/PRC-25)

<u>Frequency (mc)</u>	<u>Length (ft)</u>
30	16-32
40	12-24
50	10-20
60	8-16
70	7-14

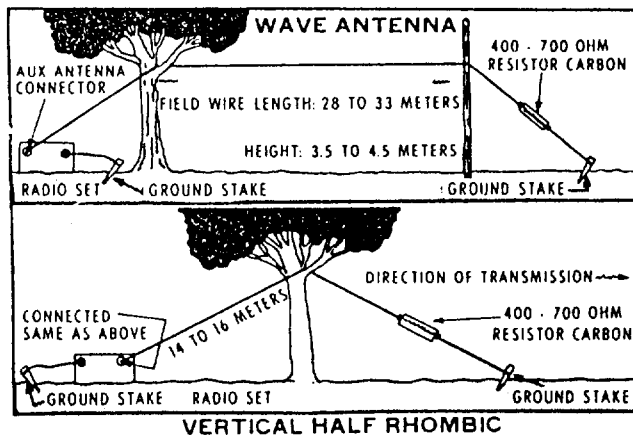

The Wave and Vertical Half Rhombic antennas are two field-expedient methods that can be used with FM radio sets. These antennas can be constructed using field wire with lance poles or trees for support. The antennas will transmit and receive in the direction of the resistor terminated ends. They will normally double or triple the rated operating range of

the FM radio sets. The antennas are terminated with one 400 or 700 ohm carbon resistor. When no resistor is available, the antenna will still increase the range of FM sets. However, it will not be as great an increase because the antenna will be radiating in two directions rather than one. The antenna is connected to the auxiliary antenna connector.

The range of most FM radio equipment is substantially reduced when operating in dense vegetation. Much of the radio energy is absorbed by the surrounding foliage thereby reducing radio range. To compensate for this loss, the RC-292 antenna should be elevated to the limit of the antenna cable.

Units employing the RC-292 antenna in semi-fixed positions can counter the effects of rust and corrosion by using brake fluid on the ends of the sections and then taping the joint with plastic electrical tape. The antenna elements can be protected from moisture by spraying with Humiseal Protective Coating, type 1A27.

#####

## 6. BACKUP COMMUNICATIONS

The enemy has frequently attempted to isolate a unit by cutting its wire lines prior to an attack. This tactic can prove particularly effective at night and adds to the confusion during a night attack. To avoid being isolated, it is imperative

that a backup communication capability be maintained at all times. As wire is extremely vulnerable to cutting, or destruction by mortar and artillery fire, radio equipment should be readily available to provide a backup means. Ensure that frequencies on backup equipment are preset, antennas are assembled and the equipment is ready for instant use.

#####



## 7. RECORD FRIENDLY FREQUENCIES

Unit operations officers should maintain a listing of the radio frequencies of U.S. and allied agencies in the zone of operations. Frequent liaison visits by command and staff personnel are a means of keeping the frequencies current.

The following incident illustrates the value of such a listing.

During the course of a combined operation, a friendly allied battalion in motor convoy was attacked in daylight along a road. A Marine operations officer, observing this attack, attempted unsuccessfully to contact a friendly unit by radio. Seeing a U.S. observation plane circling the area, he gained radio contact with the observer because he remembered the observation frequencies used a month earlier. In a matter of minutes artillery fire was directed on the enemy. The operations officer also contacted a local U.S. advisor on another net who directed additional fires on the now-withdrawing VC. Within a half hour of the first radio contact, air and ground supporting fires had been delivered on the enemy ambush force.

#####

## 8. VEHICULAR RADIOS

The basic units of the FM vehicular radio, AN/MRC-109-110, are watertight when issued. However, accessories, connectors, and receptacles require additional waterproofing prior to fording operations.

The operator/driver must be cautioned that the AN/MRC-109-110 radio vehicle is less stable than the AN/MRC-38. This is particularly true since the installed radio equipment has a higher

center of gravity, and is more susceptible to overturning while executing sharp turns at relatively high speeds. The suspension system of the new AN/MRC-109-110 provides a comparatively easy ride, thus reducing driver awareness of the necessity to maintain a safe speed for the existing driving conditions. Observe safe driving precautions at all times with this vehicular radio. Keep it upright and operating.

The M-151 Jeep (AN/MRC-109-110) vehicle does not have an aluminum alloy body and therefore is extremely vulnerable to one of the enemies encountered constantly in RVN--RUST. One problem area to watch closely on these vehicles is the battery compartment. The eight drainholes beneath the battery tray can easily become plugged with dirt and foreign matter. Supervisors should continually spot check these vehicles to ensure that operators are keeping the battery tray area clean.

# # # # #

## 9. SQUAD LEVEL RADIO

The squad level radio, AN/PRT-4 transmitter and AN/PRR-9 receiver, to be employed by rifle platoon leaders, platoon sergeants, squad leaders and fire team leaders, is currently being procured by the Marine Corps. This radio will provide an interim communication capability at

the platoon level, pending development of a single-unit transceiver. First deliveries to field units are expected by the first part of 1968.

The radio transmitter, AN/PRT-4, is a dual channel transmitter capable of transmitting voice or internally generated tone signals. The microphone is contained in the front of the case. A collapsible antenna, which is approximately 24 inches long when extended, slides down along the side of the transmitter housing when collapsed. This unit can be carried in the shirt or flak vest pocket; can be clipped to clothing; or can be carried in the hand.

The radio receiver, AN/PRR-9, is a self-contained, single-channel receiver designed to be attached to a standard combat helmet, clipped to a harness, or placed in a shirt or flak vest pocket. A lanyard is provided as a retainer to prevent loss. An 18-inch stainless steel whip antenna is provided and may be utilized in either of two positions; perpendicular to the receiver housing or parallel to the housing.

Both transmitter and receiver are dry battery powered, with a normal battery life of 30 to 40 hours. Normal communication range under optimum conditions, is approximately 500 meters.

#####

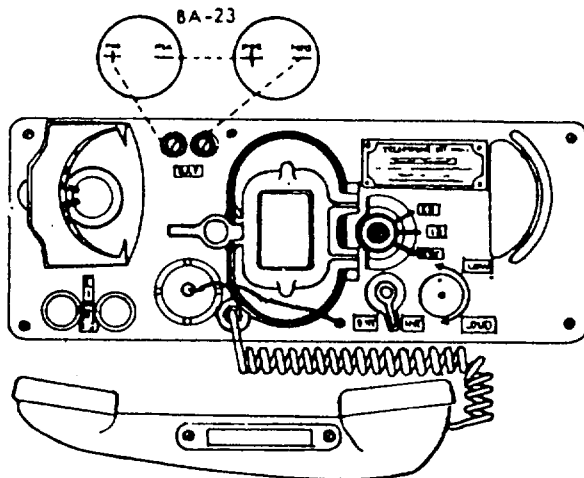

#### 10. EXTERNAL POWER SOURCE TELEPHONE TA-312

On the face of the TA-312 telephone there are two chrome screws marked "Bat." These screws are to be used as a field expedient method of connecting an external 3-volt power source, such as two BA-23 batteries shown in the opposite sketch. When BA-30 batteries normally used with this field telephone are not available, there are some other batteries with  $\frac{1}{2}$ -volt sections which may be used. These are:

- ➔ BA-386 (PRC-25 batteries)
- ➔ BA-279 (PRC-10 batteries)
- ➔ BA-270 (PRC-6 batteries)

#####



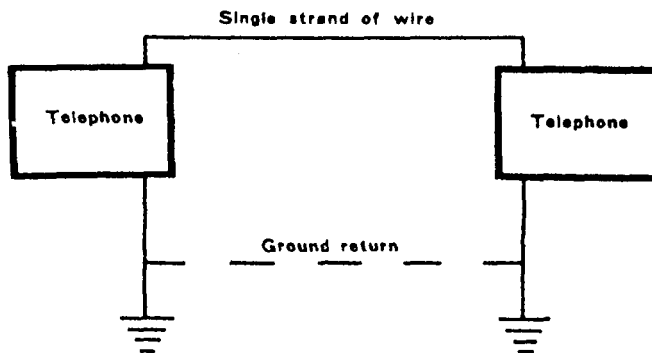

## 11. GROUND RETURN COMMUNICATIONS

If the wire on your field telephone suddenly fails, take both pieces of wire and place them in the same terminal post. From the other post run a piece of wire to a ground stake. The same thing must be done at the other end of the line. If both positions follow this procedure, communications may be restored.

If wire is temporarily in short supply, lay one strand of wire, connect it to one terminal, ground the other terminal, and continue with dependable communications.

#####

## 12. FIELD WIRE LINE TESTS

Field wire line defects can cause various degrees of trouble by intermittent or total failure of the field wire system or its components.

Testing the field wire system can isolate problem areas and enable repair personnel to eliminate trouble quickly. The below listing indicates common wire system problems, probable causes, methods of testing with the field telephone, and the symptom.

<u>TROUBLE</u>	<u>CAUSE</u>	<u>METHOD OF TESTING</u>	<u>SYMPTOM</u>
Short	TWO conductors of ONE pair in electrical contact.	Connect BOTH conductors of the pair to be tested to the line terminals of the test telephone. Turn the generator crank rapidly.	If the generator crank turns HARD the circuit is SHORTED.
Ground	ONE or BOTH conductors are in electrical contact with the ground or a grounded object.	Connect ONE conductor of the pair to be tested to ONE line terminal of the test telephone. Connect the 2ND line terminal of the test telephone to a ground stake. Turn the generator crank rapidly.	If the generator crank turns HARD that conductor is GROUNDED.
Cross	A conductor of a pair is in electrical contact with a conductor of a DIFFERENT pair.	Connect BOTH conductors of one pair to ONE line terminal of the test telephone and BOTH conductors of the 2ND pair to the 2ND line terminal of the test telephone. Turn the generator crank rapidly.	If the generator crank <u>does not</u> turn FREELY there is a CROSS.
Open	ONE or BOTH conductors of a pair broken.	Connect BOTH conductors of the pair to be tested to the line terminals of the test telephone. Turn the generator crank rapidly.	If the generator crank turns FREELY the circuit is OPEN.

## ## ## ##

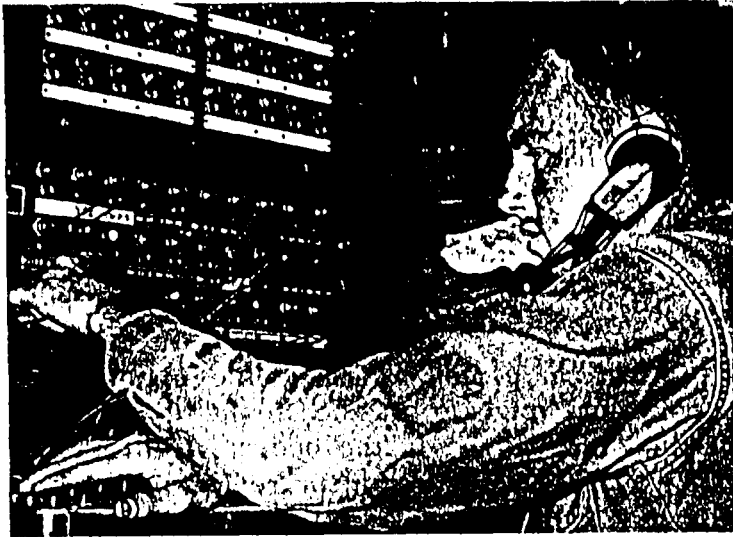

### 13. SWITCHBOARD OPERATIONS

Several adverse effects associated with switchboard operations have been noted in Vietnam during the monsoon season. One of the most common and more troublesome of these problems is "crosstalk." This results when the wire conductors connected to the terminals in the rear of the switchboard become moist or wet, thus allowing transmission current to cross channels through the moisture around the terminals. When a switchboard is established in a forward area, the tactical situation requires the location of the equipment to be underground or at least completely sandbagged. This situation adds to the moisture problem which in turn increases "crosstalk."

To counter this, the back cover of the switchboard should be removed and all terminals exposed to a strong light; e.g., a 500-watt searchlight (type ADRI4), in order to dry moisture and eliminate "crosstalk."

#####

## 14. SB-86 SWITCHBOARD DEMAGNETIZATION

After a period of use, line signals and supervisory signals in the SB-96 switchboard become magnetized in the operate (white) position. The normal solution is replacement of the signal at a cost of approximately \$9.50.

It was discovered that the use of a tape recorder head demagnetizer will restore the signal to normal (black) position with no damage. A head demagnetizer, with a switch, is plugged into a 110v 60-HZ outlet and located within easy reach of all the signals on the switchboard. When one of the signals fails to restore to the normal position after the plug is inserted, the demagnetizer is touched to the lens of the signal and switched on. A second or two is all that is required to restore the signal to normal. The cost of the head demagnetizer is approximately \$3.50.

#####

15. PROTECT POWER AND COMMUNICATION  
CABLES

Unprotected cables linking permanent fixed command or communication facilities with remote equipment are extremely vulnerable during enemy attacks. Flying debris and shell fragments can easily slice unprotected cables, causing a loss of communications with the command and control agencies. The resulting problems are far out of proportion to the physical damage received. Scrupulous attention to proper safeguarding of cables by burying or shielding will enable command and control agencies to continue vital operations during attacks.

#####

16. PROTECT COMMUNICATION COMPONENTS

The high heat and humidity of Vietnam accelerate the deterioration of the rubber components on communication-electronics equipment. To prevent this drying-out process, apply a thin coat of DC4 lubricant to these parts daily. Components such as push-to-talk switch covers will last longer.

#####



## 17. SECURITY FOR WIRE TEAMS

Certain dangers are inherent in troubleshooting wire lines because the lines are stationary and the enemy can predict routes the wire teams will be using. An adequate number of personnel should accompany the wire team to provide protection and should be equipped with

a radio. When checking the wire lines, the wire team must not establish a pattern, but vary their routine each time. Walk varying distances from the wire and approach wire at right angles. Check the wire carefully for boobytraps before testing. Only one man should approach the wire to trouble shoot. All except the inspecting wireman keep spread out and alert. The same caution should be exercised on the return trip as the area should never be considered safe.

# # # # #

## 18. COMMUNICATION SECURITY

The communication equipment available to field units includes the most advanced and extensive array ever provided. Yet, without proper security measures, the use of this equipment can be more harmful than useful.

The enemy in Vietnam possesses the ability to intercept friendly radio transmissions. Any information passed in the clear must be assumed to have been subject to intercept. Operators and supervisory personnel must ensure that adequate security measures are employed with all transmissions. The correct use of shackling and the use of call signs is a must.

Attempts by the enemy to intercept communications are not limited to radio equipment. U.S. forces have detected numerous attempts to disrupt telephone communications and even enter

these conversations in attempts to deceive and disrupt them. On one occasion, just prior to an attack on a U.S. installation, the Viet Cong entered the telephone communications system inside the installation perimeter and conversed in fluent English, free of any trace of accent. Detailed conversations were carried on until the U.S. personnel became suspicious of the type of questions that were asked by the unidentified party. Later, investigation revealed the location of the line tapping. Security measures must be developed to counter such a possibility and constant attention must be paid to limiting telephone and radio conversations to essential information properly protected by security measures.

#####





19. CHECKLIST FOR COMMUNICATIONS

- Plan for primary, alternate, and emergency means of communication.
- Keep communication equipment clean, dry and as cool as possible.
- Adhere to proper radio procedures.
- Reduce radio traffic by establishing signals (key handset).
- Tie both the mounted and the extra antennas to the radio or backpack.
- Move radio a few meters if reception is poor.
- Use RC-292 or field-expedient antennas to increase communications range.
- Disperse radios.
- Camouflage communication equipment.
- Ensure all leaders know operational frequencies.

#####



## Chapter VII: LOGISTICS



### 1. MILSTAMP AND MILSTRIP

#### a. Transportation and Movement Doctrine

MILSTAMP represents the title, "Military Standard Transportation and Movement Procedures." The final work concerning MILSTAMP is the Department of Defense Regulation 4500.32-R. This manual provides guidance, regulations, and code designators and establishes the procedures to be followed by shipping and receiving activities. When processing, handling, or moving material from one location to another, these regulations should be adhered to closely. The work of handling and moving material may

sometimes seem dull and routine to the transporters and movers. However, to the Marine in combat who is anxiously awaiting the arrival of the right box of gear, very few, if any, shipments are routine. All personnel involved in the handling and movement of material must be thoroughly familiar with the provisions of MILSTAMP--the right gear, at the right place, at the right time depends on it.

## b. Attention Supply Personnel

Some difficulty is being experienced with the MILSTRIP coding now being used in the supply system. To make the system work efficiently, the codes must be understood and used properly. Remember:

→ The document identifier code (DIC) provides ready identification of each type of MILSTRIP transaction, such as requisition, passing action, status request, receipt or adjustment. The DIC is found in the first three positions (card columns 1-3) in the MILSTRIP format. By this code, ready identification is available on the data and action that is required to be performed on the requisition. The document identifier code (DIC) is a mandatory entry on all MILSTRIP documents. Commonly used DIC's are published in the current edition of MCO P4400.15, Organic Property Control Procedures Manual. Correct utilization of these codes will speed supply response.

→ Pending modification at the inventory control points, document identifiers in the RM (requisition modifier) series will not process in the current program. Requisitioning activities are reminded that a priority can only be upgraded by canceling the original requisition and submitting a new requisition stating the appropriate priority designator, quantity, and the required delivery date (RDD).

#####

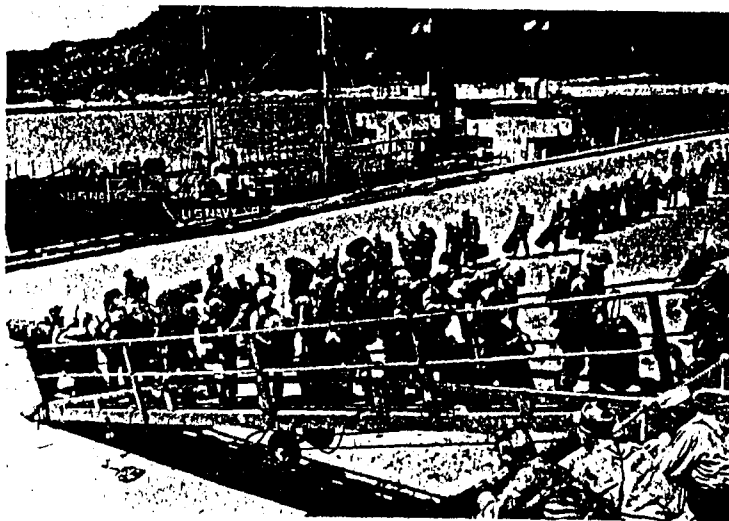

## 2. EMBARKATION

### a. Embarkation Readiness

Success or failure of embarkation operations is dependent upon proper embarkation planning. To ensure rapid and orderly

deployment, it is mandatory that units maintain a high state of embarkation readiness at all times. Experience has shown that units which have encountered difficulty during embarkation for deployment have not planned nor trained properly. Some of the major errors of omission are:

→ Embarkation personnel responsible for loading ships are not thoroughly familiar with embarkation procedures.

→ Accurate embarkation data are not readily available. As a result, shipping requirements cannot be rapidly and accurately estimated for unit lifts.

→ Cargo and equipment are not properly boxed, crated and/or palletized.

In order for any unit to be prepared for a rapid and orderly deployment, the following measures are required:

→ Up-to-date embarkation SOP.

→ Complete, accurate and up-to-date cargo manifests.

→ Trained embarkation personnel onhand.

→ Complete and accurate tactical markings displayed where required.

→ Sufficient packing and crating material onhand.

→ Periodic embarkation inspections of subordinate units.

→ Initiation of timely followup embarkation actions and assistance, when indicated, to ensure maximum readiness.



Embarkation procedures can be improved by following the points below:

→ Take advantage of embarkation school quotas. The unit embarkation officer and his assistant should be school-trained whenever possible.

→ Embarkation should be an all-hands effort. Complete, accurate data from all sections are necessary in order to prepare effective plans.

→ Use standard-sized pallets with stringers running the shorter length of the pallet.

Ensure that loads do not protrude beyond the pallet edge. Use the widest banding available and reinforce it with lumber if there is any doubt that the package can withstand rough handling.

➔ When packaging lumber, do not rely on banding alone. Reinforce the package with lengths of wood under the banding and perpendicular to the lumber.

➔ Plan for embarking items of equipment or supplies which are on requisition but not yet onhand.

#####





### 3. SUPPLY ECONOMY

One of the biggest problems unit leaders at all levels are faced with in a combat situation is supply economy. Personnel serving in a combat area for the first time have a tendency to feel that any item lost or damaged can automatically be written off as a combat loss. Stress to all new personnel that resupply in a combat situation is at times extremely limited and that each individual is directly responsible for each item of individual equipment in his possession. Should this item be lost or damaged through negligence, the individual may be punished. More importantly, the item may be needed later when a replacement cannot be obtained.

During the monsoons in the I Corps area, proper handling and distribution of all supplies become even more necessary. Unit shortages on some critical items such as boots, utilities and 782 gear can sometimes be traced directly from poor supervision by unit leaders to the trash dump. Inundated roads and low cloud cover restrict distribution, so each item must be conserved and utilized to the fullest extent possible. However, too much conservation can be as bad as too little. Stockpiling supplies not immediately required by a using unit may deprive another Marine unit of urgently needed gear.

## a. Economy of Fuel Filters

Replacement of fuel filters for the TD-18 tractor can be reduced by transferring the auxiliary filter to the primary position and placing the new filter in the auxiliary position. This method may also be applied to the dual-oil filters used on multifuel engine trucks. The estimated reduction of filter usage is approximately one-third.

## b. Prolong Battery Life

The life of a BA-386 battery for the AN/PRC-25 radio can be prolonged by rotating it with another battery every 6 to 8 hours. When radio operators in a base location assume the radio watch, they should rotate batteries. During field operation, carrying at least one spare battery can accomplish the same thing.

## c. Class V Management

The indiscriminate expenditure of ammunition and practices contributing to its deterioration in storage have no place in combat operations. Commanders at all levels must be alert to eliminate undesirable ammunition handling practices such as are outlined below:



→ Carrying linked machinegun ammunition wrapped around the shoulders and upper body. This removes the ammunition from its protective packaging and permits the accumulation of moisture, sand, and dirt on the exposed rounds. Any of these conditions could cause a weapon malfunction. Inside each bandolier of 7.62mm machinegun ammunition (100 rounds) is a cardboard container protecting it. If the ammunition is removed from its packaging, leave it inside the bandolier until just prior to firing.

→ Frequently, ammunition beyond the immediate requirement is removed from its container. Mortar propellants in particular are susceptible to moisture, and prolonged exposure can result in short rounds or misfires.

→ Improper and inadequate field storage practices contribute to ammunition deterioration. Check the appropriate publication for the accepted methods.

#####

#### 4. FIELD EXPEDIENCY

Do you need an idea for an expedient means of bridging a small stream? How much sand, mortar and water make a good batch of concrete? What size culverts will support tanks and how much fill should cover the culvert? How many pounds in 1100 kilos of rice? What are the dimensions of an M51 dump truck? Need a winch for some heavy hauling?--use truck wheels.

All this information and more is contained in the recently revised Engineer Field Data Manual (FM 5-34). Keep a copy handy. It will quickly provide you with the correct solution to many of your minor engineering problems.

##### a. Field-Expedient Cleaning Tank

A field-expedient cleaning tank for telephone components can be constructed by using a 55-gallon steel drum, or a similar container, cut down to a 36-inch height; a 10-foot length of 5/16-inch-copper tubing; and a vacuum cleaner. This cleaning tank is particularly useful

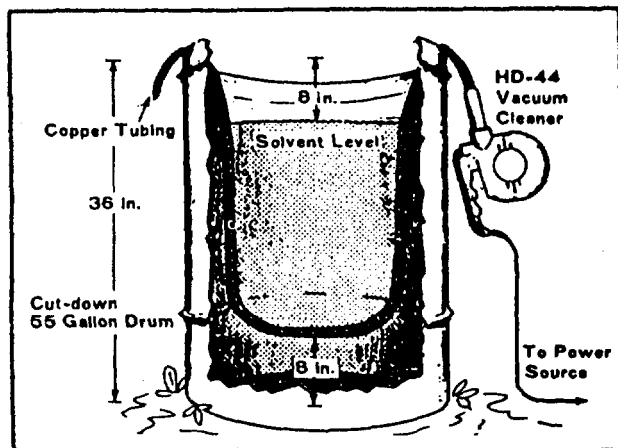

Figure 7-1

for cleaning components that have a heavy accumulation of dust and grease. (See fig. 7-1.)

The construction is simple. This aerated bath of cleaning solvent is very effective and can be used to clean any mechanical part that is normally cleaned with solvent. The article to be cleaned should be suspended to allow sediment to settle to the bottom of the tank. (CAUTION: Do not house apparatus indoors.)

#### b. Battery Salvage

If your penlight battery is worn out, the BA-386 battery can be the source for a replacement. The BA-386 of a certain manufacture contains six small AA (penlight) batteries. When

the BA-386 has been expended for normal radio use, it can be cut open and the smaller components removed. This prevents its reuse by the enemy and provides a possible additional battery supply for a small penlight.

c. Emergency Vehicle Repairs

→ To repair a small hole in a punctured fuel tank, remove a self-tapping screw and washer from the body or cab of the vehicle. Then cut a small piece of leather from a tarpaulin strap. Punch a hole through the leather and work the screw with the washer attached through the leather. Insert the self-tapping screw in the hole in the fuel tank and tighten it to the point where the leather expands slightly.

→ When a fan belt breaks and a replacement is not immediately available, a fiber rope from the vehicle tarpaulin or a length of field telephone wire may serve as a substitute. The generator mounting blocks should be loosened and the generator pushed toward the engine block. The rope or wire should then be looped around the pulleys two or three times and securely tied; trim the loose ends to prevent them from damaging the radiator. Push the generator gently back into position until the rope is reasonably taut and tighten the generator mounting blocks.

→ Broken fuel or oil line--Breaks on these lines are under low pressure or a vacuum and may be temporarily spliced by forcing a piece of

hose over the broken ends of the line. A piece of hose cut from the windshield wiper may be used.

→ Broken brake line--Crimp the cut brake line, thus allowing the remaining vehicle wheels to continue functioning without loss of the brake fluid.

→ Cracked distributor cap--Cracked distributor caps have a tendency to fill with moisture. Sparks running along this moisture can cause the cap to burn, creating carbon deposits. Scrape a notch in the cap or rotor deep enough to remove all the carbon from the crack, then fill the crack with tar from the top of the battery.

→ Vapor lock--This is common in hot climates or when the operating temperature of the engine becomes too high. The fuel vaporizes in the pump, which will not pump vapor alone. Wrap the fuel pump with a piece of cloth that has been soaked in water. This will lower the fuel temperature enough to keep the fuel in a liquid state.

#### d. Substitute V-Belt

The generator belt used on the M-422 Mity Mite may be used as an interim substitute for the drivebelts found on the AN/MRC-109 radio jeep. Both belts must be replaced on the MRC-109 since the M-422 V-belt is approximately 3/8 inch smaller in diameter. The FSN of the substitute belt is 3030-528-4446.

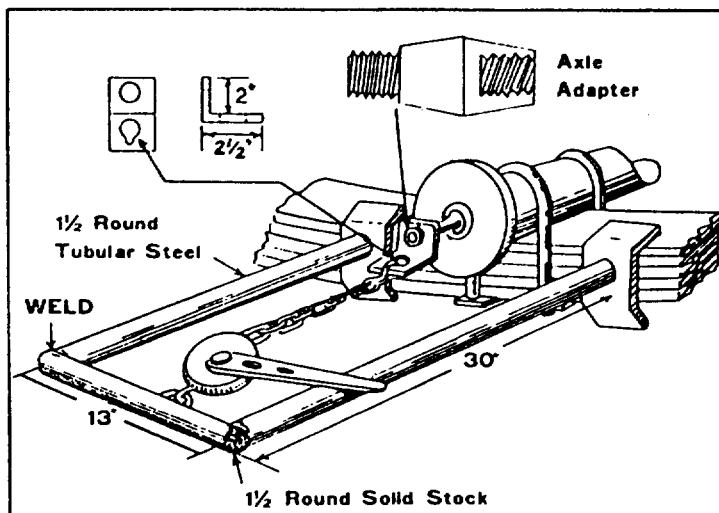

Figure 7-2

#### e. M38 Axle Puller

A Vietnam-based maintenance unit has devised an axle puller for M38 1/4-ton vehicles that has consistently removed rear axles when the old slapstick method has failed. Utilizing the devised axle puller (see fig. 7-2), two Marines were able to remove rear axles which required repair even when other methods such as heating the axle housing failed. The damage to the cone and rollers usually associated with other methods is eliminated. All the parts used to fabricate these devices are found around vehicle maintenance shops; scrap material can be used for all metal parts.



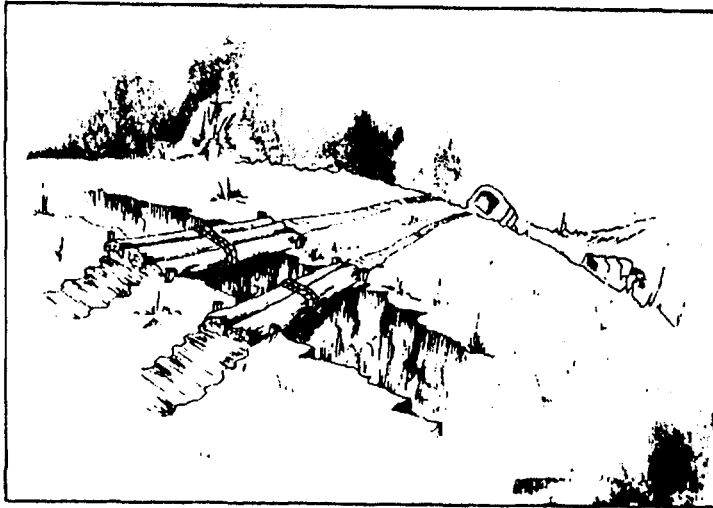

Figure 7-3

f. Ditch Crossing

The use of five logs will permit a convoy of mixed vehicles to cross ditches that are too deep to drive through. The logs should be about 10 inches in diameter and 3 to 4 feet longer than the width of the ditch. To prevent the logs from spreading apart, drive stakes into the ground on both sides and lash them together with rope, chain or communications wire. Only two logs are needed to pass a dual-wheeled vehicle across a ditch by allowing the dual wheels to straddle the log as the vehicle crosses. Single front wheels can be converted to duals by using the spare wheel and by removing the outer wheel of one of the sets of rear duals. Four logs are necessary to

pass a vehicle equipped with single wheels. By lashing the logs together in pairs, the wheels ride between the logs. Guides must be provided to ensure that the vehicles and the logs are aligned properly. (See fig. 7-3.)

#####



## 5. MAINTENANCE

### a. Preventive Maintenance Indicators

The human body and items of equipment can both show certain indications of poor health or ill use. However, equipment is unlike the body in that it does not have built-in mechanisms to ward off disease once infection sets in. It does not take a highly skilled mechanic to practice sound preventive maintenance procedures. It

takes goods eyes, common sense, an oilcan, perhaps a wrench, a willingness to inspect equipment, and a realization that without inspections the equipment will get "sick."

Rust, loose connections, split rubber gaskets, bent couplings and condensation are just a few indicators that mean further inspection is needed. Each item in the table of equipment has certain preventive maintenance procedures. Learn them, follow them and tell the men with whom you work what they are.

b. Effect of Monsoon Conditions on the Mity Mite

During periods of heavy rain, mud, and deteriorating road surfaces, the M-422 Mity Mite experiences excessive wear to the idler pulley, brakeshoes, and brakedrums on rough roads. Frequent inspections, thorough driver maintenance, and an intensified training program to ensure that drivers exercise necessary caution while driving on rough roads are essential. Undercarriages of all vehicles must be cleaned as often as possible to preclude bearing, brake and universal joint wear, engine clogging, and to aid in visual inspection to detect disorders before they render the vehicle useless.

c. Brake and Clutch Free Travel

Drivers and mechanics should be aware of the proper clutch and brake free travel

distance on the vehicles which they operate and repair. Free travel distance takes on added importance when the vehicle is operating in sand and laterite, and over rough terrain. When the clutch is not properly adjusted, pressure on the disk, pressure plate and throwout bearing causes excessive wear on the whole assembly. Improper free travel of the brake pedal can cause partial engagement of the brakes while the vehicle is moving. This condition wears out the brakeshoes and builds up pressure in the brake system which could result in system failure. The correct free travel adjustments are integral to a sound preventive maintenance program. Consult the appropriate technical publication for specific information.

#### d. Fuel Tanker Condensation

Wide differences between day and night temperatures and humidity can lead to increased condensation in fuel tanks. Continued use of contaminated fuel can cause engine damage. This problem can be reduced if fuel tankers are kept full at night, leaving little or no space for moisture-laden air in the tanker. In addition, a weekly check with water-finding paste can reduce contamination problems.

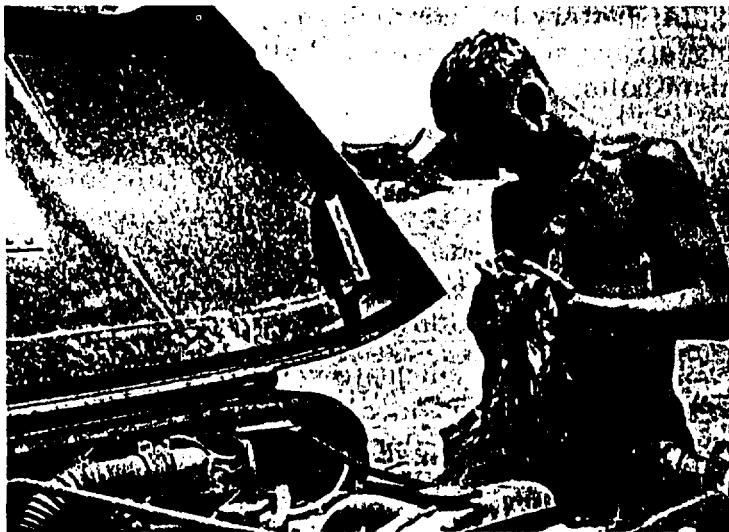

e. Tightening Vehicle Hardware

A continuing problem exists for vehicle operators and mechanics in attempting to keep vehicle hardware tight. Once boltholes or mating surfaces become elongated or warped, it is almost impossible to tighten hardware securely. The secret in preventing the development of loose hardware is to take corrective action before the nuts and bolts become loose. Indications that hardware is loose are: mud and dirt not collecting on a nut or lockwasher; shiny metal surfaces around the bolt; or red streaks staining the painted surface adjacent to mating surfaces. Some of the pertinent areas to watch closely are: wheel lug nuts; door, cab, and bed mounting bolts; subassembly and unit mounting bolts; spring "U" bolts; drive shafts and axle flange

bolts; battery holddown clamps; fuel tank mounting straps and supports; and all steering mechanism bolts.

Particular attention to the above problem areas by drivers will prolong the life of all equipment and will result in fewer vehicles becoming deadlined.

## f. Vehicle Washing

The lack of adequate vehicle washing facilities in RVN makes local self-help programs a must. However, when utilizing a nearby river or stream to wash a vehicle, do not "dunk" the vehicle all the way up to the vehicle bed. When water flows over the top of the wheels, system components such as seals, bearing and brakes are subject to excessive deterioration caused by the water. A good rule of thumb to follow is that when the depth of the water reaches the bottom of the wheel rim, stop. Accidental submersion beyond this point should be reported to unit maintenance personnel.

## g. Multifuel Drivers

Keep vehicles out of 2d or 3d echelon maintenance by performing a simple weekly check on engine mounting bolts and the steering gear-box mounting bolts. If either of these work loose, they will cut into the injection pump hose and fuel will wind up in places other than in the engine.

## h. Maintenance Procedures on the M52A2, Multifuel Tractor

The exhaust from this vehicle is directed toward the ground and stirs up dust and dirt which are picked up by the air intake on the supercharger. To remedy this, install the exhaust extension of the short deepwater fording kit. The amount of dust and dirt entering the air intake is considerably reduced.

### i. Overheating Problems

The multifuel engines in the 2½-ton and 5-ton trucks are designed to operate between 170° and 200° F.; however, when the temperature goes above 90°, the coolant temperature can go as high as 220° without damage to the engine, providing the radiator pressure cap is functioning properly. If these engine temperatures are exceeded, the following action should be taken:

- Check water level; do not rely on visual inspection as water can be in the filler neck and give a false indication of level. Check water level by filling radiator until it overflows.
- Check fan belt tension.
- Check radiator core for dirt plugging.
- Check for headgasket leaks by observing radiator water for bubbling or appearance of oil.

→ Check radiator pressure cap for looseness in the normal position. Can pressure be heard escaping when cap is loosened on a hot engine? CAUTION SHOULD BE USED TO PREVENT SCALDING WHEN LOOSENING THE CAP!

If the above checks do not solve the overheating, replace the thermostat. If a new thermostat is not available, the engine may be operated without one providing the bypass to the water pump is blocked. This is the 2-inch diameter pipe that extends from the bottom of the thermostat housing and is connected to the water pump by a short hose section. A tapered wooden plug is recommended in the rubber hose section between the thermostat housing and the water pump. Care should be taken to ensure that the plug does not protrude beyond the diameter of the pipe and does not have sharp edges. When operating without the thermostat, the engine will tend to remain cooler than usual under normal conditions. However, in weather above  $90^{\circ}$ , the engine will reach a maximum of  $220^{\circ}$ . Under emergency conditions when operating the engine without the thermostat and without blocking the bypass, extreme caution must be taken to avoid overheating the engine. It is recommended that a coolant temperature limit of  $200^{\circ}$  be established to ensure a safety margin. Loads and speeds should be reduced to prevent exceeding the coolant temperature limit.



j. Jeep Battery Compartment

The M-151 Jeep (AN/MRC-109-110) vehicle does not have an aluminum alloy body and therefore is extremely vulnerable to one of the enemies encountered constantly in RVN--RUST. One problem area to watch closely on these vehicles is the battery compartment. The eight drainholes beneath the battery tray can easily become plugged with dirt and foreign matter. Supervisors should continually spot check these vehicles to ensure that operators are keeping the battery tray area clean.

k. 2½- and 5-Ton Truck Air Reservoir Tanks

Recent inspections of 2½-ton and 5-ton trucks have disclosed that the inboard air reservoir tanks are not being properly drained. Moisture that accumulates in air reservoir tanks can cause brake failures and damage to all components of the vehicle's brake system. TM 11240-15/1A specifies that the driver has the responsibility to drain the air reservoir tanks daily. Draining the tanks should be a normal portion of the vehicle operator's after-operation services. Deadlined vehicles should be checked daily to prevent the accumulation of moisture in the air reservoir tanks.

l. Vehicle Rivets

Operating vehicles over rough terrain with heavy loads can cause the rivets securing the

crossmembers of the vehicle frame to break or crack. This has happened to several 2½-ton and 5-ton vehicles in Vietnam. This situation is predominant on the extended beds of the M-36 and M-49 Fuel Tanker, and the M-50 Water Tanker. Rivets most often break on the second and third crossmembers. The twisting action of the frame caused by the engagement of the sprag units may be the cause of this. Vehicles should be inspected weekly for signs of broken or cracked rivets and, when discovered, must be reported for appropriate corrective measures.



m. Xenon Searchlight Preventive Maintenance

It has been discovered that a green mold will develop on the inside of the protective glass shield and on the reflector of the tank-mounted Xenon searchlight. This mold develops rapidly

during the monsoon season. The illumination capability of the light is reduced considerably, especially as the mold accumulates on the reflector.

During the monsoon season, on a weekly basis, tank crewmen should clean the protective glass shield and the reflector with medical alcohol and a clean, soft cloth.

## n. Rough Terrain Forklifts

The rough terrain forklift needs much the same preventive maintenance and driver training as a heavy truck. Daily operator checks before and after operation are necessary for such items as lubrication, oil, water and component adjustments. The forklift technical manuals and lubrication charts are based on normal operation conditions. More frequent servicing may be necessary. Driver training should emphasize the proper use of the clutch cutoff control and the necessity to bring the vehicle to a complete halt before reversing directions.

## o. Maintenance of Gasoline-Engine-Driven Chain Saws

The gasoline-engine-driven chain saw is a rugged tool, and it will tolerate a limited amount of abuse without being rendered unserviceable; however, for optimum performance it is absolutely necessary that routine and unscheduled

maintenance be performed when prescribed or when necessary.

Operator abuse is a major factor in chain saw failures. Improper lubrication is one of the most frequent causes of inability to start. Lubricating oil of the prescribed weight and type must be mixed with gasoline in the correct proportions, no more, no less, if the saw is expected to operate properly. Too little oil will cause excessive engine wear. All preventive maintenance services must be performed before attempting to start the engine.

A clogged muffler or exhaust port may be the cause of failure to start, hard starting, or loss of power. The muffler and exhaust port should be cleaned of carbon periodically. Remove and scrape carbon from the muffler. Scrape carbon from the exhaust port. **CAUTION:** Before attempting to clean the exhaust port, the piston must be moved to the bottom of the cylinder to avoid damage to the piston and piston rings. If the exhaust port is divided, care must be exercised not to break out the divider. After the exhaust port has been cleaned, the engine should be cranked over rapidly by hand several times with the muffler removed in order to blow out any carbon remaining in the cylinder.

While operating the saw, it should be stopped immediately if unusual noises are heard or erratic operation is observed. The trouble should be located and corrected before again

starting the saw. The cutter bar and chain must be lubricated at intervals while the saw is in operation. The chain must be sharp and properly adjusted.

After use, the engine should be stopped by shutting off the fuel supply at the tank. This procedure will minimize the possibility of flooding when the engine is restarted. If it is found that failure to start is caused by flooding, the engine should be cranked with the fuel shut off and spark plug removed until the excess fuel mixture has been purged from the cylinder and crankcase. The spark plug should be thoroughly dried or replaced with a new one, and the starting procedure repeated. CAUTION: The spark plug cable should be firmly grounded to the engine when the engine is cranked with the spark plug removed.

When the saw is not being used, and while it is stored, it should be treated with the same care as any other precision tool or piece of machinery. It should not be carelessly thrown on the ground or tossed into the body of a truck. Above all, it should not be laid on rock, concrete, or gravel surfaces. In summary, if supervisors and operators ensure that chainsaws are properly maintained and handled with care they will be ready for the big job where required.

#####



## 6. SPARE THAT BRIDGE

Many bridges in Vietnam are not capable of supporting the heavy engineer and tracked equipment which U.S. forces employ. Engineer units are replacing or reinforcing many of these bridges. During this rework, the new or improved bridges are marked on the approaches and on the bridge itself to show a classification number representing the safe load carrying capability. Bridge classification numbers range from 4 to 100. All vehicles and items of heavy equipment with a gross weight of over 3 tons, and all trailers with a payload over a ton and a half are similarly assigned classification numbers ranging from 4 to 150. The planned movement of heavy equipment and loaded vehicles must include a route reconnaissance to include

the classification number of each bridge. Unless the bridge capacity (classification) and the classification number of the load is known, crossing a bridge could be hazardous. Two recent bridge failures illustrate this hazard. A tank retriever towing M-48 Tank attempted to cross a triple-single Bailey bridge. The combined load (class 100) caused the bridge (class 55 normal, class 65 risk) to collapse at the center. A wrecker towing a 2½-ton truck attempted to cross an Eiffel bridge. Again the combined load (class 32) exceeded the bridge capacity (class 9). FM 5-34, Engineer Field Data Manual, provides detailed information on the marking of bridges and the classification of both bridges and vehicles. Use it and spare the bridge.

# # # # #

## 7. GENERATORS

➔ Cold generators should be run for at least 10 minutes before applying a load. The circulation of air around the stator windings will tend to remove the accumulated moisture inside the equipment, which is the cause of most generator breakdowns.

➔ Proper protective measures must be taken to keep generators free of excessive water and sand. Sandbags placed 4 feet from the generator at a minimum height of 2 feet, with a protective covering (such as a tarp or tent) placed over

the generator, will cut down unnecessary exposure of the generator to weather elements.

→ Centralization of 45-kilowatt generator maintenance results in significantly lower deadline rates and improves responsiveness when generator troubles occur.

→ The elevation of generators a few feet off the ground will reduce the amount of sand drawn into the stators while the generators are in operation.

→ When a unit is deployed under field conditions for sustained operations, suitable downtime should be scheduled in order to accomplish required maintenance on each electrical power generator. When scheduling downtime, consideration should be given to the electrical power requirement for operating the electrical equipment usually powered by each generator. For continuous operations, at least one generator should be maintained on a standby basis at all times.

→ Generators damaged by rats or other small rodents can be repaired and/or protected from further damage by ordinary plastic insulating tape and fungus proofing spray. The damaged wires or insulation should be sprayed with fungus spray, then wrapped with plastic tape, and given a final coating of the fungus spray.

#####



## 8. SANITIZING FOOD SERVICE EQUIPMENT

Galley floors and walls, as well as all equipment used in food preparation such as can openers, ice cream scoops, glass cleaning brushes, etc., must all be kept scrupulously cleaned and sanitized. Heat and chemicals are the two means used to sanitize.

Dishes and utensils may be washed by hand or by machine depending upon the equipment available and the tactical situation. Whatever the method, satisfactory results depend upon conscientious use by the personnel concerned of the equipment and materials provided.

Dishwashing and sanitizing equipment, dishwashing methods (including improved methods for use in the field), dishwashing compounds, sanitizing agents, drying, storing and handling of utensils are all thoroughly described in NAVMED P5010-1, Manual of Naval Preventive Medicine, Chapter 1, Food Sanitation. The principles set forth therein must be strictly followed to prevent galley casualties.

#####



#### 9. FLAK JACKET REPAIR

Flak jackets in Vietnam receive rough treatment and are easily torn. To prolong their life, repairs should be made immediately. Six-inch wide communication tape is an excellent expedient when sewing is not possible. This tape is strong and waterproof and, if available, will serve the purpose until permanent repairs can be made.

#####

#### 10. LONG RANGE PATROL RATIONS

The lightweight patrol rations used in Vietnam have been praised for their taste, compactness and variety of menu. Although these rations were not intended to be used for extended periods

of time, long patrols, up to company-size, have used them for periods of 6 days. Each menu consists of a precooked, dehydrated combination item which requires reconstitution by the addition of water. A confection, a cereal or fruitcake bar, and coffee, cream and sugar complete the menu. A total of eight menus are included in the ration carton, three of each menu. The packaging weight and configuration of the packets is such that a 3-day supply can readily be carried in a light marching pack; four packets could also be carried in utility jacket pockets. An available supply of water is required for reconstitution in the foil lined packet itself. A combination of canned rations, patrol packets and rice can make meals wholesome and appetizing with a minimum of effort. Keep in mind food requirements for operations and tailor them to meet the mission.

# # # # #



Chapter VIII: CIVIC ACTION -  
PSYCHOLOGICAL OPERATIONS



1. REVOLUTIONARY DEVELOPMENT

a. RD Coordination

The rapidly expanding Revolutionary Development Program involves the participation of an increasing number of organizations and agencies which assist the GVN at all levels of government (hamlet, village, district, province). The effort of all these organizations must be coordinated to ensure that the success of the program is realized. The distribution of supplies by Marines must be coordinated with and accomplished through the local officials, to ensure that the refugee camps, orphanages and other selected recipients are not already programmed for assistance from the GVN, USAID or another

organization. The same is true for construction projects, MEDCAP and any other civic action project.

There are important additional benefits from this coordination. The personal prestige of the local Vietnamese officials is considerably enhanced by deferring to them. Consequently, their respect for us is increased, and they are encouraged to improve their performance.

b. The Resettlement of Villagers

One of the byproducts of Revolutionary Development programs is the resettlement of local villagers from VC dominated and terrorized areas to areas where government and U.S. troops can provide protection for them. Initial contact with these people should point out that resettlement of other villages has been successful. The village and district chiefs, as well as selected village elders, should accompany the party making this first contact. The villager will be assured that he will be provided with land to farm, an initial allowance of money and materials for food and shelter, medical treatment and, in general, a far better prospect for a secure life.

The conduct of resettlement operations can make a good impression on the Vietnamese. If the troops are helpful and friendly, and exhibit respect for elders, the people will be impressed.

If the local tactical situation permits, villagers who are evacuated for medical reasons

should be tagged in a manner similar to medically evacuated military personnel. Tags should be made in duplicate. The original should be attached to the patient and the duplicate delivered to the civil affairs officer. All reasonable steps should be taken to ensure that children are accompanied by an adult, preferably a parent or a member of the immediate family.

This method can eliminate problems which could arise later during followup visits by civil affairs officers.

c. Psyops Support for RD Operations

The mission of psychological operations in the I Corps Tactical Zone is to support the GVN integrated military and civilian program to restore, consolidate, and expand governmental control as a part of nation building. During the clearing phase of Revolutionary Development, psyops support is provided by means of ground combat loud-speaker teams, leaflet operations and aerial broadcasts, with emphasis on Chieu Hoi appeals for defector inducement. In the securing phase of RD, propaganda is directed at the entire population of the area, utilizing newspapers, radio, audiovisual teams, and cultural team performances. This phase of propaganda is mainly informative in nature, and explains government programs and goals. The psyops effort is directed at influencing VC families to develop ralliers.

#####



## 2. CIVIC ACTION

### a. The Importance of Civic Action

The presence of a legally operating, friendly government in South Vietnam makes military civic action conducted by U.S./FWMAF forces unique, as compared with similar action in previous wars. Our efforts are directed at



strengthening and expanding the authority of the Government of Vietnam (GVN) which, in turn, is responsive to the needs and desires of the people. In this effort, we must work through the Vietnamese governmental system and help it work. Working through local GVN officials improves their image in the eyes of the people and encourages them to do a better job. These officials should be encouraged to submit requests through the proper channels of their government for hamlet improvement projects and materials for improvements that the GVN can provide. Efforts should then be made, with the help of sector and subsector advisors, to ensure that such requests are filled. This will foster the people's confidence in and support for their government. The fulfillment of such requests by the GVN also will encourage local officials to submit other requests to improve the way of life of their constituents and further their support for their government.

All civic action projects conducted by Marines must meet the needs of the people. The people must have a sense of participation in the project and must feel that the project is their own and not the Marines'. If the people do not help build a project, they will probably not protect or maintain it. The VC will hesitate to destroy projects that the people have worked on because they know that such an act will turn the people against them. This makes self-help-type projects a key element in civic action.

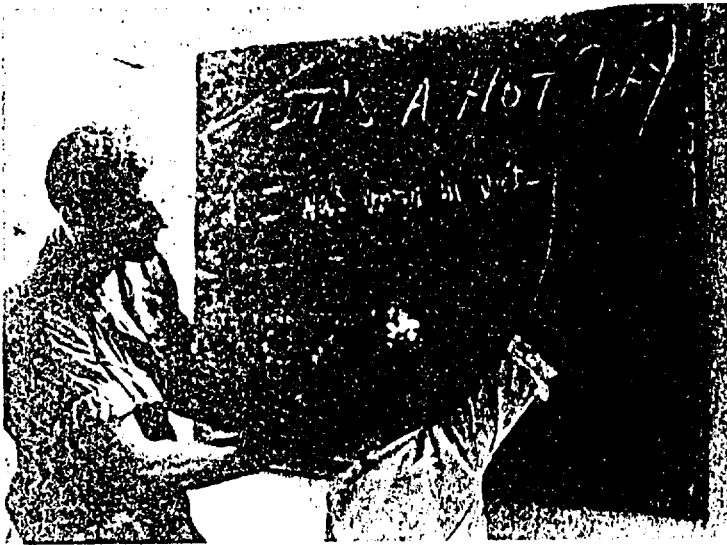

Of primary importance in civic action is thorough coordination of all civic action projects; not only with local GVN officials, but with all personnel (MACV subsector advisors, CORDS officials, Marine Corps civic action personnel, etc.) who might be concerned with the project. This will ensure maximum support for the project and will prevent the duplication of projects that are already planned and budgeted for by the GVN.

Remember that the projects should be high impact, low cost, and as short term as possible from conception to completion.

Remember too, that the people must be capable of supporting and running the project when the Marines leave. Schools without teachers

or dispensaries without trained medical workers are of little value.

b. Civic Action Coordination

Two potential problems in a civil affairs program are coordination and cooperation among military units and the Vietnamese. There will frequently be more than one military unit conducting civic action in a particular area. This can cause duplication of effort, confusion, and misunderstandings. The other potential problem relates to finding out what civic action programs are wanted and needed by the Vietnamese. Often Vietnamese and Americans differ on the value of civic action projects.

Both problems can be minimized by organizing a village civic action coordination committee. This committee should include both Vietnamese officials (village chief, hamlet chiefs, police chief, etc.), and military officials (all units having either civic action responsibility or tactical responsibility in the area). A good interpreter should be used. The village chief should be the chairman of the committee. The Vietnamese should be encouraged to bring up their problems, and discussions should be held regularly and a report should be made of all activity since the last meeting. This committee strengthens the local government by giving the officials more recognition and assuring coordination. The committee can also be used as an instrument to strengthen district-village relations by having a district representative present at each meeting.

c. Project Submittal Sheet

Civil affairs officers are frequently besieged with requests for material aid. Problems exist as to whether the project is justified, how much material is needed, whether the project has been coordinated with the local officials, and who will coordinate the Vietnamese action on the project.

A bilingual project submittal sheet can be reproduced at the unit level. This sheet can be filled out in duplicate by the Vietnamese project coordinator. It provides a space for a description of the project, the material, and quantity requested, the location of the project, the name of the project coordinator, and provides a space for the signature, and an endorsement of both hamlet and village chiefs. The use of this sheet requires the project to be planned and coordinated.

d. Security and Civic Action

A basic requirement for a successful civic action program is security. When adequate security cannot be provided, any civic action endeavor presents an open invitation to enemy attack. Civic action programs pursued in areas where security is inadequate often result in additional hardships rather than benefits for the people. The Vietnamese who participate actively in our civic action programs are frequently singled out by the Viet Cong for severe pressure and intimidation. If this occurs, future civic action efforts can be hampered due to fear by the

people that participation will result in reprisals by the Viet Cong. Security and Successful civic action programs go hand-in-hand.



## e. Civic Action Checklist

The following questions, arranged as a checklist, can be used to assist in analyzing prospective civic action projects and to check the rate of progress of current projects. These questions contribute to individual awareness of the many facets of civic action projects.

### (1) Agriculture

What crops, animals, vegetables form the basis of the local food supply?

What weather, climate and topographic factors assist or restrict plant and animal growth?

Which plants and animals could best adjust to local conditions and benefit the local food supply?

What animal/vegetable raising projects can be initiated to improve local economic conditions?

What source of seed, fertilizers, and animals is available?

What production methods which exist in adjacent areas could be introduced?

Is there a potential and an outlet for a local cash crop?

What local customs or other possible restrictions could handicap local economic improvement?

Are there plans for agricultural improvement? If so, what are they?

## (2) Home Industries

What industries already exist? (Brick making, basket weaving, etc.)

What GVN plans exist for local home industries?

Can local villagers now produce the basic items needed?

What machinery would assist villagers in providing more of their basic needs? (Examples: brick presses and kilns, hand forges, weaving looms.)



Do the villagers have certain basic skills?

What financing arrangements are available?

Is there a potential for cash income from the sale of home manufactured items?

#####

### 3. UNDERSTANDING THE VIETNAMESE

#### a. The Vietnamese Peasant: His Value System

The following is an excerpt from an October 1965 research report by the United States

Information Agency Research and Reference Service (it is not a statement of agency policy):

"The Vietnamese peasant lives in a small world limited by the bamboo hedge around his village. He is aware of his traditional history, but his first loyalty is to his family. The peasant's spiritual world is large and alive with the spirits of nature and of all creatures who lived before, particularly his ancestors. These must be propitiated at his family and village altars with the aid of spirit specialists who guide him through life's crises. Most peasants are also at least nominally Catholic, Cao Dai, Hoa Hao or, more usually, Buddhist. While many, resorting occasionally to the Buddhist pagoda, have not always considered themselves Buddhists, Buddhist awareness has grown.

"Face is all important, but face concerns appearances, not truth or morality. The peasant is not a moralist and considers flexibility more important than fixed principles. Peasant aspirations have risen because of many promises made by both the Viet Cong and the Government. The peasant now expects change and wants a better life.

"Vietnamese life is oriented to the family, which is the religious, social, economic and political unit and provides security for its members. The Vietnamese woman is very influential both in the family and in the marketplace.



"The Viet Cong have devoted enormous efforts to winning the peasants, who provide the bulk of their economic support and manpower. Communist propaganda is tailored to meet individual and local wants. The Viet Cong first used terrorism to create a 'Robin Hood' image by eliminating corrupt officials. More recently terrorism has become less discriminating, and harsh Viet Cong methods are increasingly alienating the peasants.

"Peasants rarely see newspapers or magazines and few have radios, consequently word-of-mouth communications are important. The leading village opinion-moulders are teachers and local officials. Because his life is dull, the peasant can most easily be reached by meeting his desire for entertainment, but he prefers traditional types. He is most responsive to communications he can understand in local and personal terms. . ."

b. Elder/Adult Friendships

Successful operations in Vietnam are heavily dependent on achieving the friendship and understanding of the Vietnamese adult population. Due to the important status of the village elders in their villages and the older people in the families, their influence on the remainder of the population is great. As a result, effort should be directed toward the elders and older people in furthering Vietnamese/Marine friendship and understanding. A Vietnamese Province Chief has

recently stressed the importance of parties for the elders in furthering this effort. Parties and other exhibitions of friendship should be emphasized for adults in general. These face-to-face displays of respect will help reduce suspicions as to our purpose, and influential friendships will be generated.



To date, much of our effort in achieving Vietnamese friendship has been concentrated on the children. The primary benefit of these efforts will be realized in the future when the children become better educated adults. Currently, however, adverse effects may result if our generosity toward children undermines the authority and status of parents and elders, and encourages beggarism. Gifts to children should always be offered through responsible adults. This will foster confidence by both child and adult.

c. Social Attitudes/Religious Beliefs

The social attitudes of oriental peoples have been developed from concepts which westerners sometimes do not understand. For example, the concept of time to a man raised in America can be represented as a straight line. That is, the period from 1000 B.C. to A.D. 1967 runs in a line in which no year repeats itself. The oriental concept can be represented as being circular or repeating. For example, the Buddhist cycle of 12 years in a circular concept. The Year of the Goat (1967) will come again (1979) and again (1991). This concept stems from a religious belief that a person will live many lives. Time is considered plentiful by an oriental so there is no need to rush headlong into a project. Sudden actions or split-second decisions are looked upon by the Vietnamese with disapproval. They consider it good taste to proceed cautiously, and they carefully consider their problems before making a decision.

Death and sickness are common experiences in Vietnam. The various religious observances affecting death and illness should be studied so that they may be better understood. For instance, many Vietnamese homes will have a mirror and red ribbon placed near the doorway to ward off any spirits which may carry sickness. The family is constantly reminded of their ancestors through the ancestor shelf, which has a prominent place in most Vietnamese homes. The respect of a family for a deceased member

is evident by the number of mourners and the amount of food, music and drink at the funeral, consistent with the family's income. The reflection of these beliefs by the Vietnamese is evidenced in a kind of fatalism about death.



d. Ancestor Worship

Probably no other act creates such indignation and resentment among the Vietnamese as an apparent lack of regard for Vietnamese ancestor worship and disrespect for their graves. The VC are exploiting this aspect as an effective propaganda wedge against the Free World forces. Marines must remember that deliberate or thoughtless acts of disrespect provide ready propaganda for the VC in the war for the hearts of the people.

e. The Symbol of the Republic of Vietnam

The symbol of the Republic of Vietnam has as its central theme the flexible bamboo; symbolizing consistency, faithfulness, and vitality. The bamboo is flanked by a writing brush, the symbol of culture; and a sword, representing strength and determination.

Bamboo is typical of the Vietnamese countryside. Thick hedges of the woody plant form a protective wall around almost every village in the central coastal plains. For many Vietnamese, bamboo is associated closely with their rural life, which to them is a happy image of home and traditions rooted in a time-honored past.

The inner strength of the bamboo, coupled with its flexibility and modest appearance, is considered as representing the virtues of a gentleman. An ancient proverb says, "the taller the bamboo grows, the lower it bends"; meaning that a great man is humble, modest, and tolerant. A fierce storm may uproot proud, stately, and seemingly indestructible trees; but after the storm subsides, the flexible bamboo emerges straight and as verdant as before. This reflects the Vietnamese approach to life.

f. Be Courteous to the Vietnamese

(1) DO

→ Respect the people of Vietnam. Improper conduct toward Vietnamese women can hurt our cause as much as any other mistake

that might be committed. It is well to remember that commanders at all levels are responsible for their men's behavior.

→ Encourage local officials to participate fully in all Revolutionary Development programs, underscoring and praising their contributions to such programs.

→ Practice speaking and writing simple Vietnamese words and phrases regularly. Ask assistance from a villager. He will be flattered by your interest.

→ Learn the local festival days and how they are celebrated. Plan to participate in these events, if invited.

→ Greet passing villagers in their own language or try the silent greeting with the right hand in a fashion similar to the thumbs up gesture.

→ Recognize the wooden structures on stakes that resemble houses. These structures are spirit houses erected as a religious gesture for wandering spirits. They usually contain a small pot or cup filled with earth in which a few incense sticks are placed, and sometimes a candle or a small dish of food. Remember to respect them.

→ Pay respect to GVN officials (province, district, hamlet chiefs, RVNAF officers) by saluting and addressing them as "Sir."

→ Observe these simple actions when speaking with Vietnamese elders:

- Stand on slightly lower ground.
- Stand close to the person being addressed.
- Speak softly.
- Smile.
- Fold your arms or keep them at your side. Hands on hips mean the individual is about to strike the person being addressed.

(2) DON'T

- Display wealth and privilege.
- Consume alcohol with or around the Vietnamese. It is an invitation to trouble.
- Be impatient. Vietnamese habitually exercise caution, and this process often takes more time than Americans might wish.
- Exhibit intolerance or anger. These are attitudes that exhibit no real understanding.
- Pay more than the agreed price for services.
- Permit another Marine to act undignified or disrespectful in his relations with the Vietnamese. If the Marine acts through ignorance, square him away.
- Violate the symbols of the local religious creed any more than you would your own. The

five virtues and five commandments of Buddhism are worth practicing by everyone.

- March indiscriminately through local gardens or ricefields. They represent the people's food supply.
- Discuss politics with local officials.





g. Winning and Maintaining Civilian Support

Winning and maintaining the friendship and cooperation of the Vietnamese civilians living within the operational area is an essential step in reducing the effectiveness of the local Viet Cong guerrillas --they cannot operate effectively without civilian support. The two main aspects of our military presence which contribute toward good civil-military relations are the individual Marine's positive attitude in his dealings with local civilians, and the planned civic actions of military units.

The Viet Cong attempt to separate our soldiers from the local civilians by showing that we are cruel, unthinking, and not concerned with the welfare of the local peoples. The VC can be defeated in these efforts by the strength and generosity we show in our daily life. The "Nine Rules" for the military man in Vietnam provide the guide for doing this. Study them and govern your conduct accordingly. The "Nine Rules" are as follows:

REMEMBER WE ARE GUESTS HERE:  
WE MAKE NO DEMANDS AND SEEK NO SPECIAL  
TREATMENT.

JOIN WITH THE PEOPLE: UNDER-  
STAND THEIR LIFE, USE PHRASES FROM  
THEIR LANGUAGE AND HONOR THEIR CUS-  
TOMS AND LAWS.

TREAT WOMEN WITH POLITENESS  
AND RESPECT.

MAKE FRIENDS AMONG THE SOL-  
DIERS AND COMMON PEOPLE.

ALWAYS GIVE THE VIETNAMESE THE  
RIGHT-OF-WAY.

BE ALERT TO SECURITY AND READY  
TO REACT WITH YOUR MILITARY SKILL.

DO NOT ATTRACT ATTENTION BY  
LOUD, RUDE OR UNUSUAL BEHAVIOR.

A VOID SEPARATING OURSELVES  
FROM THE PEOPLE BY A DISPLAY OF WEALTH  
OR PRIVILEGE.

ABOVE ALL ELSE, WE ARE MEMBERS  
OF THE U.S. MILITARY FORCES ON A DIF-  
FICULT MISSION, RESPONSIBLE FOR ALL OUR  
OFFICIAL AND PERSONAL ACTIONS. REFLECT  
HONOR UPON OURSELVES AND THE UNITED  
STATES OF AMERICA.

#####



#### 4. CHIEU HOI PROGRAM

##### a. Chieu Hoi Success

III MAF contribution to the Republic of Vietnam Chieu Hoi Program is illustrated by the success Marines have enjoyed in applying revolutionary development techniques to one particular hamlet.

The hamlet, known as "Chieu Hoi," is populated by five hundred Vietnamese who have rallied to the Republic of Vietnam from unpacified I Corps areas in response to the Chieu Hoi (Open Arms) amnesty program. In May '66, III MAF assumed sponsorship of the hamlet and directed initial efforts at providing badly needed medical treatment for the inhabitants. Only 15 townspeople responded to the first sick call. Others displayed anxiety and even fear and hostility at the Marine presence. Slowly, however, the work of the Navy Medical Team, together with Marine donations of tools, lumber and other aid, produced confidence in the people.

Today, a little more than 6 months later, the villagers are working and planning together in open cooperation. Wells have been dug, roads built, programs of animal husbandry started and an eighty acre project for vegetable farming initiated. A temporary school has been built and is operating, while planning continues for both a permanent school and a church. Further, the time-honored Marine practice of weekly "field days" has been adopted by the villagers as a routine sanitation measure.

A final indicator of the progress of the villagers is found in their willingness to help the Republic of Vietnam amnesty program expand. With GVN and III MAF support, they now provide homes for the families of new defectors during their first days in the hamlet.

b. New Chieu Hoi Leaflet

The tempo of the allied program in Vietnam to encourage the VC and NVA to defect is on the increase. One of the means to reach the guerrilla forces is by the distribution of Chieu Hoi leaflets. All allied forces in Vietnam must be informed of the procedures for rallying by the enemy to the government's cause. A new leaflet explaining the rallying procedure has been published. The instructions printed on both sides in Vietnamese tell the rallier that he will be treated kindly and that his family will be treated kindly and will be well protected. He is instructed to hide his weapon, present himself to the friendly forces in the daytime, with raised hands and bearing this leaflet or a surrender pass. Even if he has no leaflet, he is advised to seek the friendly forces and present himself with raised hands; the allied soldiers will understand this gesture. As an inducement, a reward will be paid to him for leading allied troops to any weapon caches.

c. Refugees

Unit operations in areas controlled by the Viet Cong usually generate a large number of refugees. Prior to the commencement of an operation, and if feasible, close liaison should be established with local U.S. and GVN agencies to ensure that maximum assistance is given to these refugees. Planning must include details on the means of evacuation, medical assistance, temporary settlement locations, shelter, food and



clothing. Planning will serve to reduce the hardship and suffering on the part of the refugees, and will minimize their interference with combat operations. Well-planned and humanely executed evacuation operations will also illustrate the value placed by the GVN and U.S. on the welfare of the Vietnamese people.

Refugees offer an important means of communication with the enemy. Many refugees come from enemy controlled areas and some have relatives and friends in the enemy camp. Some refugees may eventually return to insecure areas where their villagers are located. If they are knowledgeable of and impressed by the Chieu Hoi Program, they can become effective salesmen. Some can persuade relatives to rally under the Chieu agreement; others might be willing to deliver safe conduct passes and other leaflets to

enemy guerrillas. Armed propaganda teams and former guerrillas who have rallied to the Government (Hoi Chanhs) should be encouraged to work in the refugee camps making speeches, contacting guerrilla relatives, and recording broadcasts. Leaflets and other printed material should be disseminated in these resettlement camps.

Every possible means of using the refugees in local psychological operations should be reviewed, and the people convinced of the value of the Chieu Hoi Program.

# # # # #

## 5. COUNTY FAIR

Part of the coordinated military and government program for ferreting out the Viet Cong and gaining the trust, confidence and active cooperation of the people of Vietnam is called COUNTY FAIR. These operations comprise a combination of military, local government, and psychological warfare action designed to re-establish government control. County Fair is designed to separate the VC from the loyal villagers while refraining from actions which alienate the populace. At the same time, operations capitalize on the opportunity to convince the villagers, through vigorous civic action and psyops, of the merits of the Government. The role of local civil and police authorities is stressed, and military participation is restricted to

temporarily isolating the objective and combatting enemy military actions if they should develop. The size of the military force involved is limited to that necessary to conduct searches and cordon the village. A careful use of this force will prevent the people from openly resenting its presence. The presence of local officials and police deny the Viet Cong the opportunity later to propagandize that National Forces did not support the operation. The evident participation by local officials, civilian and military, assist in developing government leadership down to the hamlet level. These officials become more dedicated to preventing infiltration and more skilled in those civil and military activities necessary for national unity.

In general, the operation follows a pattern once the hamlet has been selected. Isolation and search is the initial military action. A Marine force is employed for the cordoning operation, while clearing and searching is best accomplished by local police or civil authorities supported by government security forces. In both planning and execution, it is necessary to stress to both U.S. and GVN participants the mutual advantages of using only the degree of force required. Interrogation, segregation and the psyops actions involved are best left to direct participation by the Government and civil authorities. Local customs, traditions and the language all present potential stumbling blocks for direct participation by U.S. forces. Support by U.S. can be in the form of loudspeaker equipment, leaflet printing, taping messages from



local officials, propaganda films and equipment, medical assistance, tents, and kitchens including foods. While each County Fair possesses individual characteristics, operations are relatively frequent and minimum advance warning is common.



The basic logistic support for each County Fair can be reduced to a standard package which can be maintained for required operations. Such a package could include:

- 5 Fly tents
- 2 Lister bags
- 4 Battery powered hand speakers
- 2 Mallets
- 12 Metal stakes
- 1 Pair wire cutters
- 5 Wooden collapsible tables

- 10 Folding stools
- 1 Plywood bulletin board
- 1 Immersion burner
- 1 Trash can (24 gal)
- 1 Water trailer
- 16 Water cans
- Sufficient rope or engineer tape for delineating restricted areas

As a result of the search operations, a portion of the villagers will be dislocated temporarily and will not have access to their homes. Those unable to provide or prepare their own meals will have to be fed. Remember that village economy is marginal, and if a villager is denied access to his cropland for even a day it means his family goes without food. The U.S. force assigned to support a County Fair can greatly assist in providing and preparing meals for these villagers. Frequently, it will be necessary to provide and prepare up to 1200 meals per day. Based on that figure, foods can be obtained through USAID and civil affairs channels. The following amounts will support an average of one County Fair operation per week (1200 meals per day).

- 600 lbs - Milled rice
- 100 cans - Assorted foods (vegetables, meat, etc.)
- 8 cans - Soup base (100 rations)

There is much detailed planning and preparation involved in successful County Fair operations.

It is important to emphasize this detailed planning and close coordination at all levels to both U.S. and GVN participants. The measure of success of each operation lies in this coordination and cooperation.

# # # # #

## 6. PSYCHOLOGICAL WARFARE IN VIETNAM

### a. Handling of Noncombatants in the Objective Area

A major problem facing U.S. forces when engaged with the Viet Cong is the handling of noncombatants in the objective area. The VC use populated areas as hiding places and as areas to regroup their forces after contact has been made with the enemy. Firing on aircraft and ground forces from the villages is a favorite tactic of the Viet Cong. When the fire is returned by friendly air the probability of noncombatants being killed or wounded runs high, especially when no attempt is made to control the movement of the people. Should noncombatants be injured in such a situation, the VC exploit it by saying the Americans are indiscriminately killing and maiming innocent people.

Recently, an American infantry division was conducting sweep operations in Vietnam with the objective of clearing Xom La Ran, a VC hamlet, and the wooded area adjacent to the hamlet.

Planning for the operation included the requirement to separate combatants from noncombatants in the hamlet.

After receiving a thorough briefing on the tactical operation, personnel of a Psyops Company, supporting the division, designed and produced two warning leaflets and a number of loudspeaker tapes in support of the operation. The tapes were recorded by the ARVN District Chief of Tan Uyen District. These messages warned the people of the impending attack and advised them to remain calm and await instructions on what to do and where to go to avoid the engagement.

As the operation progressed, friendly elements swept the wooded area adjacent to Xom La Ran. Prior to the ground force advancing on the hamlet, loudspeaker and leaflet missions were flown over the hamlet advising the people to remain calm and instructing them to assemble at the schoolhouse and await further instructions from the district chief. Some 20,000 leaflets were dropped in the hamlet and in the immediate vicinity.

As the sweeping elements were securing the area, the district chief entered the hamlet and went directly to the schoolhouse to meet with the people. He separated the men and women into two groups. All the men between the ages of 16 and 30 were checked for identification and draft cards. Seven suspected draft dodgers were found among the group and taken into custody.

The district chief then spoke to both groups explaining that the Americans were in their hamlet to secure it from the VC and that the ultimate goal of the Americans in Vietnam was to bring a lasting peace to the country. Throughout his talk the people remained apathetic. Although many persons clutched one of the leaflets which had been dropped earlier, the impression gained was that the villagers believed as long as they held on to the leaflet they would not be harmed by the Americans.

While the district chief was talking to the people, two 2½-ton trucks, loaded with approximately 10 tons of rice taken from a nearby VC cache, passed by the schoolhouse. The district chief immediately took advantage of the situation explaining to the people that the rice loaded on the trucks was their rice; that the Government was going to redistribute it; and, the VC were exploiting them by taking the rice away from them. He pointed out that the Government was working hard to put a stop to VC rice requisitions. He also pointed out that without the support of the people, the VC would no longer be able to wage war, causing innocent people to be killed.

A question and answer period was held in which the villagers complained about the slow bureaucratic process of the Government. The district chief fielded the questions admirably and seemed pleased with the results of the session. The villagers expressed interest in what

could be done to rid the area of the VC and were witnessing the first steps at doing that very thing.

The most significant aspect of this operation was the success achieved by the close coordination between the psyop element and the combat element of the unit conducting the sweep through the hamlet. In this case both elements were coordinated by the battalion S-3 which resulted in excellent timing of psyops missions with the tactical maneuvers. The end result was that not a shot was fired during the sweep of the hamlet and the villagers were under control at all times. Experience has shown that in similar situations where psyop was not employed the villagers will panic in the face of advancing troops resulting in unnecessary casualties among noncombatants.

Through the effective use of face-to-face techniques, the district chief was able to convince the people that the Government with the help of its allies was in a position to free the people from the demands of the VC and to take positive steps toward improving the conditions under which the people live.

This operation is a good example of using psyops to minimize noncombatant casualties. The target was the peasant who had lived under VC control; had been filled with suspicion, fear and doubt toward the GVN and the Americans; and who could, if uncontrolled, end up as an inadvertent combat victim. The objectives were

to solicit their cooperation, to control their movements during the operation and to minimize the chance of innocent people being injured or killed. The results; no one was injured and the first steps were taken to remove the suspicions, doubts and fears of the peasants. This is the kind of integrated psychological and combat operation that will ultimately win the battle for men's minds in Vietnam. Without psyops, a successful sweep could have left the people with such hate and misery that any military success would have been negated.

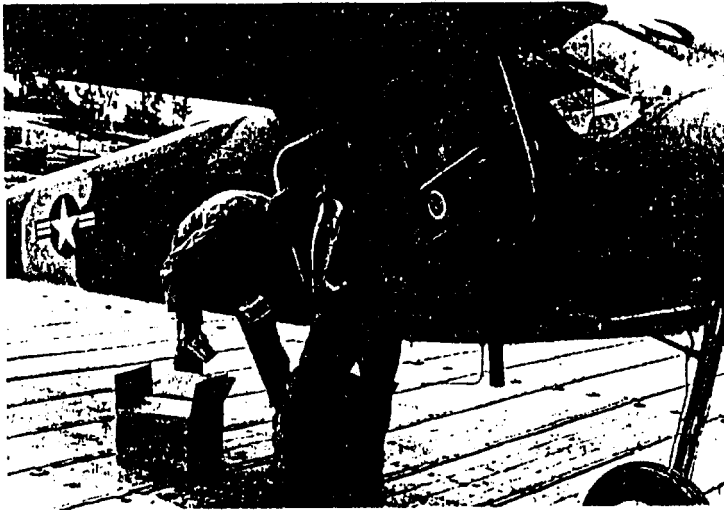

b. Psychological Support of Tactical Operations

The 244th Psychological Operations Company (USA) has been providing support to III MAF in the psyops field. This support consists of

combat speaker teams, audiovisual teams, liaison teams, leaflets, tape recordings, and Joint U.S. Public Affairs Office (JUSPAO) newspapers. Psyops support of tactical operations has increased with the recent Marine augmentation of the psyop company and, as additional enemy vulnerabilities have been discovered, intensive psyop support of tactical operations has resulted in a sharp increase in returnees. The following example demonstrates the effective use of psyops on the battlefield.

Early on the morning of 11 November 1966, an Army psychological warfare team was airlifted from its CP to an LZ close to the point where a battalion was engaged in a fire fight. The psywar team moved to the forward positions and placed speakers in a nearby tree. The latest enemy intelligence was obtained and molded into an appeal to fit the existing situation by deliberately capitalizing on the enemy's weak position and low morale. After approximately 20 minutes, the first NVA soldier walked directly to the speakers, following instructions explicitly, and surrendered with his weapon. After the prisoner was fed, the psychological warfare team convinced him that the Government of Vietnam and its American allies did not want to harm him, and that his comrades' senseless struggle could only end in death. An appeal was devised with the concurrence of the prisoner to urge his fellow soldiers to surrender. Current intelligence was acquired from the prisoner and used to make the



basic appeal more personalized and meaningful. Shortly thereafter, five more NVA soldiers walked in. At this time, it was learned that the executive officer of the opposing enemy battalion was killed. This information was immediately incorporated into the appeals and more soldiers chose "to rally to the GVN with honor than to continue to fight and be killed and buried in an unknown grave." Approximately 1 hour later, the American battalion commander directed the team to move to his vantage point, a tall tree located on the crest of the hill, and continue the mission. From this location appeals were broadcasted and several more NVA soldiers surrendered.

It was during these broadcasts that an intense fire fight broke out in one company area. The psychological warfare team was immediately displaced forward to this position, the speakers were set up during the first lull in the fire fight and broadcasting was begun "face-to-face" with the enemy. The team emphasized that the "soldiers of the Screaming Eagle were everywhere, that the NVA cause was lost and that death was soon to be their only honor." Greater impact was gained by using a wounded NVA soldier lying nearby. Five more "hard core" soldiers chose life rather than death.

By 1800, the enemy's position had been overrun, and the psywar team returned to battalion CP. During the day's action eighteen prisoners were used in live broadcasts, four special personalized appeals were made and a total of 9

hours of speaker time was recorded. These appeals were modified as fresh intelligence and changing battle conditions dictated.

It should be pointed out that it is most likely that the results achieved would not have been possible had it not been for the constant pressure placed on the surrounded enemy by the American infantry. In this case, psychological warfare had the unique advantage of being in the right place, at the right time, with the right appeals. The enemy was under great pressure from the infantry, and psychological warfare offered an "honorable" way out. The choice was theirs -- life or death.

Many critical lessons were learned which stress the fact that psychological warfare is most effectively utilized on the ground in direct support of the ground troops. Briefly they are:

In jungle terrain, the enemy often finds it easy to detach himself from air appeals since the aircraft is often hidden from view by the thick foliage and the message is sometimes garbled by aircraft and atmospheric conditions. However, when made on the ground, the appeal is direct and personal and is not distorted by the jungle canopy. The sound appears to reverberate off the ground and the jungle canopy achieving a surprising range.

On the ground the appeal can be instantly molded to fit everchanging battle conditions, and it can employ spontaneous prisoner appeals.

A loudspeaker appeal on the ground during lulls in intense fire fights helps to stress the magnitude of American technology and has a definite demoralizing effect on the enemy.

It was also noted that although leaflets were on the ground, many were inaccessible due to thick vegetation. Trails seem to be the most profitable target for leaflet dissemination.

During lulls in ground contact, psychological warfare is most effectively employed by using aircraft for broadcasts and leaflet dissemination. However, once significant contact with the enemy is made, the psychological warfare effort should be on the ground with the units in contact.

A well-planned psychological operation may include the use of printed leaflets dropped from an aircraft. In friendly areas, aircraft leaflet drops can cause local hamlets to become unnecessarily littered. This may not be in the best civic interest and could cause an adverse reaction to the leaflets.

When possible, leaflets should be passed out by hand during the course of small unit operations. This serves to reduce the littering problem and to permit those passing out the leaflets to observe the reaction and overhear the comments of the villagers.

c. Psyops Leaflet and Poster Writing

If the message is to be effective, the wording in psychological operation leaflets and posters must be in language that the target audience can understand. A verbatim translation of English to Vietnamese does not normally result in the phraseology that would commonly be used by the Vietnamese. When the message is written first in English and then translated, almost invariably the fact that the material originated in English is evident. As a result, the message does not communicate well. This can cause the people to attribute portions of the information to American sources with a resulting failure to believe in the truth of the information. When preparing psyops material, the thoughts, ideas, and facts to be presented should be explained to a Vietnamese writer who can express the information in proper Vietnamese. If the material must originate in English, a Vietnamese writer/translator should study the material until he understands the intended meaning before writing it in original Vietnamese. When the material is intended for use in a newspaper, it should be written in the Vietnamese journalistic style. A psyops message designed to influence people must be presented in the people's language.

d. Example of Special Appeals

(1) Soldiers of the 5th Bn, 95th NVA Regiment

The GVN and its allies are your friends and do not want to harm you. We give you a

choice--life or death. If you come in now, you will have life--is it not better to rally now to the GVN with honor than to continue to fight and be killed and buried in an unknown grave (and have your soul wander the earth forever)? This choice is yours--life or death. Your family and your loved ones want no harm to come to you. They need you. The choice is yours. Life or death.

(2) Soldiers of the 5th Bn, 95th NVA Regiment

Do you want to be buried in an unmarked grave? That is the only honor you will have if you continue your senseless fight. Do you think that's right? The soldiers of the Strike Force Airborne Division are everywhere. Approach the Americans with your hands above your head. Wave something white. Have your weapon muzzle down and you will not be harmed. Wave something white. This is your last chance and only hope. Life or death--the choice is yours.

(3) Soldiers of the 5th Bn, 95th NVA Regiment

Your life is about to end! Are you ready to die? The soldiers with the eagle on their shoulders are everywhere. They are now closing in. This is your last chance, this is your last chance. If you do not come in now, you will be killed without mercy. Wave something white, have your hands up. Bring your weapon with you, muzzle down. This is your last chance.  
This is your last chance.

e. Aerial Broadcasts

Experience in Vietnam has shown that aerial broadcasts are one of the more effective psychological operations medias. Broadcasts can be rapidly employed to exploit a particular situation and can be heard over a large area. Messages should be short and repeated continuously to ensure that the intended target audience gets the entire message. Broadcasts conducted in the early evening hours have provided the best results. At that time, wind conditions are usually suitable for aerial broadcasting and the Vietnamese family is together.

Family influence has proven to be one of the most important factors in influencing enemy defections. When possible, broadcasts should be directed at particular groups, units, or individuals and should mention such target audiences by name in order to counteract the tendency of many Vietnamese to disassociate themselves from the broadcasts. Also, broadcasts of tape recordings made by enemy defectors and the use of enemy defectors to make live broadcasts have proven highly effective. The use of these personnel discredits the enemy's claim that defectors are killed and helps to instill confidence in the GVN Chieu Hoi Program.

f. Use of the Vietnamese National Flag in Propaganda

The Vietnamese feel that excessive reproduction of the National flag or any indiscriminate

VIETNAMESE GOVERNMENT SAFE-CONDUCT PASS

# GIẤY THÔNG-HÀNH



SAFE-CONDUCT PASS TO BE HONORED BY ALL VIETNAMESE GOVERNMENT AGENCIES AND ALLIED FORCES

이 안전보장책소는 평남정부와 모든 연합군에 의해 인정된 것입니다.  
 รัฐบาลเวียงจันทน์และหน่วยพันธมิตร ยินดีให้เกียรติยอมรับท่านปลอดภัยนี้.

(Front)

SAFE-CONDUCT PASS TO BE HONORED BY ALL VIETNAMESE GOVERNMENT AGENCIES AND ALLIED FORCES

MANG TÂM GIẤY THÔNG HÀNH  
 này về cộng tác với Chính Phủ  
 Quốc Gia các bạn sẽ được :

- Đón tiếp tử tế
- Bảo đảm an ninh
- Đãi ngộ tương xứng



Xương Văn Tý



TẤM GIẤY THÔNG HÀNH NÀY CÓ GIÁ TRỊ VỚI TẤT CẢ CƠ-QUAN  
 QUÂN CHÍNH VIỆT-NAM CỘNG-HÒA VÀ LỰC-LƯỢNG ĐỒNG-MINH.

(Back)

use of the flag in propaganda is distasteful and disrespectful. Use of the national flag should be limited to propaganda of significant national importance. Safe conduct passes are an example of items that are of national significance. The Vietnamese flag or reproductions of the flag should be

used with extreme care and discrimination and only after consultation with Vietnamese officials.

#####

## 7. POPULATION AND RESOURCES CONTROL

The objective of a population and resources control program is to deprive the VC of the support of the population and the material resources needed to engage in continuous warfare. The extensive effort of the GVN to win over the population has resulted in the following procedures being established for population and resources control:

### a. Population Control

The Vietnamese have been using individual identification cards since 1939. Today, all persons over the age of 18 must be in possession of an ID card. The present card is laminated and contains a photograph and prints of the left and right index finger of the bearer.

Curfews are imposed only as necessary and primarily in areas where the VC or VC supporters are active. Any person having a legitimate need to be outside his area during curfew hours must be issued a special curfew pass. Curfew violators are assumed to be insurgents or supporters until proven otherwise.

Travel permits in most areas are required for any travel outside an individual's village or area. These permits may be issued to individuals



or groups, either on a one-time basis or a multiple-day basis, usually not to exceed 90 days.

b. Enforcement

To enforce the controls imposed on the population, a system of checkpoints is established on roads and highways, railroads and bus terminals and airlines. Along the 2,500 miles of waterways in the delta region, rivercraft and assault boats provide control. Mobile checkpoints, both land and water, are established on an irregular basis to apprehend personnel attempting to avoid or bypass fixed checkpoints.

Civil police are suited, by training and experience, to conduct this type of operation. Their normal police operation, in their own specific area, provides them with a familiarity of the area, and its people. Police may require support from the military when insurgents or sympathizers are actively belligerent, but generally, the military is called in for support only in cases where superiority in manpower and armament is required for effective enforcement.

U.S. forces do not have authority or jurisdiction over Vietnamese nationals. On joint operations, U.S. military police check only U.S. vehicles and personnel while civil police check Vietnamese vehicles and personnel.

c. Resources Control

It is imperative that the populace be controlled if basic resources are to be denied the VC.



Resources required by the VC to continue operations are the same as those required by insurgents everywhere. Critical items are:

Food. This includes anything fit for human consumption. Most of the food obtained by the VC is procured locally, either by "taxation"

of the local population or from sympathizers and supporters, or in some cases, is grown by the VC in remote areas.

Medicines and medical supplies.

Arms, ammunition and explosives.

Clothing and textile materials.

Money.

Transportation of all types.

Various control procedures have been established to deny the VC access to the resources he needs. Among these are inventories of material manufactured and shipped from processors and importers, and maintenance of formal records of the amounts of material being shipped and the destination. Upon arrival at the final destination, the goods are inventoried again to ensure that there has been no loss or pilferage.

Foodstuffs and clothing are rationed to prevent delivery of these items to the VC by local supporters. Police also guard supply depots and storage areas where such items are stored.

The most effective method of resource control employed by the civil police is the search of land and water vehicles. Critical items required by the VC are hidden by sympathizers and supporters in every imaginable place in an attempt to pass inspection at checkpoints. Thorough inspections by land and river police are a tedious and painstaking process but are necessary if the resources control operation is to succeed.

# # # # #

Chapter IX: MEDICAL

1. PREVENTION, NOT TREATMENT

The following comment is taken from a combat operation after action report:

"It was apparent that many of the medical problems encountered could have been prevented by more aggressive instruction of the individual Marine by corpsmen and Marine staff NCO's. Foot inspections, supervision of water purification, and stressing of individual hygiene responsibilities could have prevented a high percentage of casualties on this operation."

Prevention, not treatment, is the objective. Casualties due to carelessness in personal hygiene have just as great an impact on a unit's effectiveness as those caused by enemy action. Ensure that all possible health-saving measures are employed at all times. Instruct, implement, inspect and supervise.

#####



## 2. ACCLIMATING MARINES TO HOT-WET CLIMATE

During and shortly after World War II, American and British Armed Forces were confronted with the problem of acclimatizing troops for service in hot-dry climates such as North Africa, Kuwait, and Aden. As a result, a large body of information was accumulated dealing with the problems encountered under such environmental conditions. More recently, however, the scene of the action has shifted to hot-wet climates, such as Vietnam. Experience has shown that adaptation to hot-dry conditions is similar but not identical to that for hot-wet conditions, and that data collected under the first situation

are not necessarily applicable to the second. In a hot-dry climate the evaporation of sweat provides a cooling mechanism which assists the body in keeping its temperature stable; in a hot-wet climate the air may be so humid that the sweat does not evaporate and the body temperature continues to rise.

In spite of this difference, acclimatization to a hot-dry environment increases the ability of men to work well under hot-wet conditions, and vice versa, suggesting that certain underlying mechanisms are common to both conditions. Among them are the following:

- Merely resting in the heat develops only a limited degree of acclimatization; full acclimatization can be achieved only by working in the heat.
- Men in good physical condition generally acclimatize to heat faster than do men in poor condition, but excellent physical condition does not confer automatic acclimatization.
- The acclimatized individual is characterized by a markedly increased sweat rate, a decreased heart rate, and lower body temperature on exposure to heat stress as compared with the unacclimatized man.
- The increased sweating capacity is a result of sweat gland conditioning and is not dependent on elevated body temperature.

Many of these same adjustments appear to be typical of the trained athlete. Regardless of the outside temperature, his strenuous workouts in sweat suits or other heavy clothing surround him with a hot-humid microclimate. His body becomes accustomed to repeated elevations of body temperature and stimulations of his sweating mechanism. As he becomes well conditioned, there is a lower production of heat relative to his body surface area; more effective cardiovascular functioning, resulting in improved heat dissipation; and a greater sensitivity of his sweating response, resulting in more effective cooling. As a result of these bodily adjustments, the trained athlete demonstrates a greater ability to withstand heat stress than do nonathletes.

British scientists have conducted a long series of ingenious experiments in attempting to artificially acclimatize men by having them exercise in heat chambers before sending them to hot climates. The results were reasonably good and they concluded that his general technique "is probably the most practical for large-scale use in the Army." Such techniques do not appear to be of great potential value to the U.S. Marine Corps. In event of an emergency, the Marines are required to respond immediately. It is highly unlikely that they would ever have time for conditioning in heat chambers, even if chambers sufficiently large for the purpose were available.

A more promising approach may be found in the fact that a Marine infantryman is regularly



exposed to vigorous physical training. By use of a field jacket, poncho, or other garment during this training, he could surround himself with a personal hot-humid climate, just as does the athlete, and thereby achieve a degree of heat acclimatization. This could be done ashore or afloat, as it requires neither special equipment nor special training areas.

Commanders in Vietnam have commented that it takes about a month for newcomers to become acclimatized to that area, and that some units have had difficulty in combat because of numerous cases of heat prostration. Obviously, a practical system of acclimatizing Marines to heat before their arrival would be of great potential value. To determine whether the method suggested above was of any measurable value, the Naval Medical Field Research Laboratory undertook a practical experiment with a military police battalion in the spring of 1966.

Two companies, Alfa and Bravo, were assigned to participate in this investigation. The MP's had been formed at Camp Pendleton, California, in the early spring and had been training in the moderately cool weather characteristic of the area at that time of the year. In the opinion of the two commanding officers, both companies were in above-average condition, with Bravo company perhaps a bit more accustomed to hard work. In order to eliminate any possibility that this might bias the results, Alfa company was

designated the experimental unit and Bravo company the control group.

The battalion embarked in the USNS UPSHUR at San Diego, California, on 7 May 1966. Bravo company was asked to establish its exercise program as if no study were being undertaken, with the provision that it should last for 45 minutes, should take place on deck, and the men should be lightly clothed, weather permitting. Short rest pauses were scheduled at frequent intervals so that the men would be engaged in vigorous activity but, so far as possible, without stimulating the sweat glands into activity. Alfa company was permitted to use a vacant hold in the afterpart of the ship. The ventilating equipment was shut off and hatches and doors were kept closed during the exercise period in order to raise the internal temperature as much as possible. Under these conditions the men could not tolerate an exercise program as vigorous as that used by the men on deck. It was found necessary to start them at a somewhat lower level of exertion and to continue exercising for only 30 minutes if a number of subjects were not to become incapacitated by nausea and dizziness. This effect was probably augmented by the normal movement of a vessel at sea. Accordingly, it was necessary for Bravo company to reduce its work stress and time to agree with that of Alfa. As the latter became able to tolerate longer and more vigorous activity, the stress on both companies was increased simultaneously. Within a few days both were exercising vigorously for 45 minutes.

Alfa company wore sweat shirts and sweat pants. Half of them exercised 8 to 10 minutes. They then sat down and removed their sweat shirts to permit their bodies to cool while the other half of the company exercised. This afforded an opportunity for repeated stimulation of the sweat glands, rather than bringing them to the point of sweating and keeping them there. There is some evidence that after a long period of perspiring, sweat gland fatigue results. On the basis of this analogy, it was reasoned that the most effective way to improve the functional performance of the sweat glands might be use of methods similar to those which weight trainers employ to improve the functional performance of muscles; that is, periods of vigorous activity separated by rest pauses.

On 30 May 1966 the ship arrived at Danang and on the following day the men made a joint forced march. The two companies walked in file, one on each side of the road in order to provide comparable conditions of terrain, breeze, sunshine, etc. The surface was graded dirt and reasonably smooth, but with occasional grades and heavy dust. There were no trees or other shade anywhere along the route. Atmospheric temperatures were recorded at intervals by means of a sling psychrometer. Extra water was carried and made available at the rest stops; there were no restrictions on the amount consumed. Salt tablets were available and were issued prior to the start of the march. During the march, the troops

carried arms, cartridge belts with two canteens, and light marching packs, and wore helmets and utilities.

Heat casualties in Alfa company amounted to 7.5 percent, while those in Bravo company reached 25.3 percent. Statistically, there is less than one chance in a hundred that a difference of this magnitude could be due to chance.

The results strongly support the theory that men designated for duty in a hot-humid climate can be preacclimatized by the use of clothing and exercise programs which enable each man to create his own hot-wet climate for about an hour a day. It must be appreciated that men engaged in such a training program can suffer heat trauma. Troops engaged in such conditioning programs should be under the close observation of a medical officer or an experienced physical fitness instructor.

## ## ## ##



### 3. HEAT CASUALTIES

Most Marines are familiar with the effects of strenuous physical activity under conditions of high temperature and humidity. Three kinds of heat injuries can result; cramps, exhaustion (prostration), and heat (sun) stroke. Several factors influence the susceptibility of individuals to heat injury. The person who is overweight is particularly susceptible. The length of exposure and the degree of physical activity play important parts. Acclimatization time varies with each individual, but 1 month is the accepted period to become adequately acclimatized.

Summarized below are the principal symptoms, preventive measures, and treatment for heat injuries:

	<u>CRAMPS</u>	<u>EXHAUSTION</u>	<u>STROKE</u>
Patient notices	Mild to Severe pain.	Exhaustion, faintness.	Feeling of extreme heat, weakness, no sweating, confusion, possible unconsciousness.
Others notice	1. Spasms, rigidity of muscles. 2. Normal temp.	1. Profuse sweating. 2. Normal temp or slightly elevated. 3. Unconsciousness on rare occasions.	1. Hot, dry skin. 2. Elevated temp (102°-112°). 3. Flushed skin; strong, rapid pulse. If skin becomes pale and grey with weak pulse, critical condition exists. 4. Possible unconsciousness and convulsions.
Prevented by	1. Salt or salt tablets added to water.	1. Less exertion on hot days. 2. Use of shade, salt and water.	1. Avoiding over-exertion on hot days. 2. Use of shade, salt and water.
Treatment	1. Give salted water and/or salt tablets. 2. Massage muscles.	1. Rest on back in shade. 2. Loosen clothing. 3. Cool water compresses to face. 4. Salt tablets.	1. Ideally, submerge patient in cool water to lower body temp to 100°; when temp is normal (check every 10 mins) start saline solution by vein, or 2. Flap alcohol moistened sheets over naked body.

#####



#### 4. MEDICAL PROBLEMS IN THE MONSOON SEASON

Past experiences have shown that certain medical problems are presented by the monsoon season. Items deserving special consideration are:

→ Immersion Foot, Considerable research has been directed toward the use of a silicone foot protective ointment as a preventive for immersion foot. To date, the results have been promising. The cooperation of all hands in using the foot protective ointment, as directed by competent authority, and complying with other instructions related to foot care will result in healthier feet and fewer casualties due to immersion foot.

➔ Care of Medical Gear in Small Units. One of the major problems encountered during the monsoon season is keeping medical gear dry. The extent to which we may control this situation varies directly in proportion to the dry housing area available. The proper care of medical gear during the wet season entails medical personnel using their own ingenuity in planning and scheduling routine work, in devising protective covers for the various medical items, and paying special attention to see that all protective covers are used properly. In addition, it should be remembered that one must always take advantage of a dry period, however short, in which to air and dry out medical gear to the extent possible.

➔ Evacuation of Patients. During bad weather, additional precautions will be required to ensure patient safety and comfort. In a combat environment, limitations are necessarily imposed by the tactical situation. However, proper planning for evacuation of patients can ensure that the patient is moved in reasonable comfort, regardless of the weather. Such things as adequate clothing, properly prepared litters, and a transportation schedule to preclude undue waiting in an uncovered area will help eliminate many problems.

#####







## 5. TIPS FROM THE CORPSMEN

Patients should be loaded on helicopters head first and not feet first. Occasionally, in haste or under fire, stretchers are dropped. This can result in further injuries to the already wounded Marine. Loading the patient head first will tend to minimize any injury to the patient caused by dropping the stretcher. Stretcher bearers should, if possible, stand by until an evacuation helicopter arrives so they can be of assistance in loading the patient aboard. There have been instances in which one corpsman was left alone to load litter

patients into a helicopter. This requires a crew-member to leave his position aboard the helicopter and assist in loading the patient.

# # # # #

## 6. NIGHT MEDICAL EVACUATION

Medical evacuation during the hours of darkness can be very difficult and hazardous. Adequate landing zones are extremely scarce. Landing zones are frequently masked by either hilly terrain or jungle canopy, making identification and approaches extremely difficult and time consuming.

Each patrol or unit operating independently should carry a minimum of five flashlights and three hand illumination grenades. The flashlights should be placed at the perimeter of the LZ to form a square. The hand illumination should be used to orient the helo pilot and silhouette the surrounding terrain and canopy. Hand illumination grenades should not be used when the aircraft is within 300 meters of the LZ unless specifically requested by the pilot. The other flashlight should be used to identify the location of personnel adjacent to or on the LZ. To be most effective, the perimeter marking lights should be vertical. This can easily be accomplished by tying the marking lights to the handle of a K-bar/bayonet and driving the blade into the ground.

# # # # #

## 7. MALARIA PREVENTIVE TREATMENT

Modern science has developed various medications to help prevent malaria. The one which most Marines are familiar with is the Chloroquine-Primaquine tablet. On occasion, some persons may experience a case of upset stomach due to the side effects from this tablet. If this should happen, the unit medical officer can determine the cause and a substitute preventive medicine may be prescribed.

By all means, if you are supposed to take these pills periodically, don't neglect it. An upset stomach and a trip to the local dispensary for a substitute medicine is far better than the serious effects of malaria.

# # # # #

## 8. LEECH BITES

There are times and circumstances when Marines in the field cannot stop to have leeches removed by corpsmen. Several hasty removal methods can be used:

- ➔ A lighted cigarette applied to the leech will cause it to release.
- ➔ Salt from a C-ration packet sprinkled on the leech near its attachment to the skin will cause its release.
- ➔ Spraying insect repellent on the leech is the most successful method.

# # # # #

## 9. PLASMA EXPANDER

Reports from infantry battalion medical officers cite the value of Dextran as a plasma expander in the treatment of battle injuries. Dextran expands the blood volume three times and the solution has an osmotic effect. Plastic catheters have advantages not realized by the use of straight needles. They are self-contained and easy to use with a minimum of instruction. Dextran and threadable plastic catheter intracaths should be part of the unit's medical supplies. Two bottles of Dextran, plus the regular amount of serum albumin and an assortment of large and medium intracaths, should be carried by the battalion aid station for use in treating battle injuries.

# # # # #

## 10. FIELD AMBULANCE SUPPORT

The casualty evacuation system in Vietnam is being supplemented in some Marine units by the use of M-43 Field Ambulances. Assigning this vehicle to a regimental aid station on a temporary basis greatly assists in evacuating men who have minor wounds or who are ill and require treatment. The unit's organic jeep ambulance is then used for local emergencies, and the medical evacuation helicopters can concentrate on emergency missions. Field ambulances have also been used effectively in resupply convoy

operations to carry persons who are incapacitated but may not require emergency evacuation.

# # # # #

## 11. MOBILE MEDCAP

A new concept, termed Mobile MEDCAP, is being used to provide medical treatment to Vietnamese villages. Traveling medical teams visit the villages within their area to provide treatment. The most notable feature of the Mobile MEDCAP is the specially configured and equipped vehicle trailer. The concept makes limited medical facilities and treatment available to those who are unable to travel to a fixed location; enables a medical team to be seen throughout a wider area while engaged in humanitarian as well as military missions; and increases the awareness of villagers to the presence of medical assistance.

Some villagers who live within 500 meters of the regular MEDCAP and did not know of its existence, are now being treated by the mobile unit. Other villagers who had been bedridden are now receiving attention. In one area, the hostile attitude of the people toward the Marines notably improved when the Mobile MEDCAP efforts showed the villagers that the Marines and medical personnel were genuinely interested in their welfare.

# # # # #

## 12. INTRAVENOUS-INJECTION SUPPLY CHEST

81mm mortar boxes are ideal for use as portable containers for the resupply of intravenous solutions. With minor modifications these boxes can be used to carry four intravenous-solution bottles, four intravenous-injection sets, two cans of human-serum albumin and needles or accessories. These boxes, which are readily available, are particularly useful when sturdy containers are needed.

# # # # #

## 13. PORTABLE STAND FOR INTRAVENOUS SOLUTIONS

Portable stands to hold bottles while administering intravenous solutions can be easily constructed from the end sections and metal rod of a 105mm howitzer box. The end section with the rod still inserted is utilized by nailing a short piece of lumber crosswise to keep the rod from falling out. This also acts to steady the stand and prevent it from collapsing. A piece of heavy wire is bent over the top of the rod and taped. The free end of the wire is then bent to form a durable hook from which the solution bottles can be suspended.

All materials used are readily available in the field, and the stands may be utilized in the sickbay, operating room, or while patients are awaiting transportation for further treatment.

# # # # #

## 14. POISONOUS SNAKES OF VIETNAM

"Yes, those green bamboo snakes are the worst," says the oldtimer to the newly arrived Marine. "The natives call them the 'five-step snake,' you know. That's because you only live long enough to take five steps after it bites you!"

This kind of information (or misinformation) is common in Vietnam these days, and unfortunately much of it is believed.

The "oldtimer" relating the tale probably has been in the country for less than 2 months himself; and, most likely, he has yet to see his first snake of any kind. Snakes are not highly visible in any tropical country. Yet, lurid tales are the usual cover for ignorance and, so far, there is still no "Field Guide to the Snakes of Vietnam" available at the local bookstore or Post Exchange.

It is still a considerable struggle to try to determine what snakes are found in Vietnam, and their geographic distribution within the country is almost unknown. A list of the land snakes that has been compiled from various sources totals 115 species--about the same number as are found in the United States. Seventeen are venomous and some of these are extremely dangerous. Besides the land snakes there are 15 or more kinds of sea snakes that are found in the South China Sea and the Gulf of Tonkin just offshore, and all of these have highly toxic venom. A list of more than 30 venomous snakes for an area as small as



Vietnam is rather impressive and it is difficult in the face of this to convince a newly arrived Marine that he is not in imminent danger of becoming a snakebite casualty. Yet death from snakebit is a rare occurrence in Vietnam. How can this be?

a. Seasonal Occurrence

For one thing, snakes are not equally abundant in all seasons. If the situation in neighboring Thailand (which is better known) can be taken as a guide, you can expect the snakes in the Saigon region to disappear underground during the "summer" months of March to May and to be rare during the dry season, "winter" months of December to February. The young snakes are born or hatched in February and may make a brief appearance before the beginning of the hot summer.

Snakes would be expected to appear in some numbers with the onset of the rainy season in June and would build up in numbers during the season to give a maximum snakebite danger in September or October. They become less active, and thus less a menace, at the end of the rainy season in November.

The seasons are not all in identical months in the various regions of Vietnam, but the correlations of snake abundance with season would be expected to hold throughout. Thus for about half the year the danger of snakebite is minimal.

b. The Geographic Base

Vietnam is often thought of as a small country. This is true when compared with the rest of Asia, and it is relatively small in area. However, it is as far from the southern tip of Vietnam to the Chinese border as it is from Key West to New York. It is a long and mountainous country and, except for the huge Mekong and Red River deltas near Saigon and Hanoi, it has a very narrow coastal plain. Most of the countryside is made up of high mountains (many over 8,000 feet), upland plateaus and narrow river valleys.

Due to its elongated shape and the nature of the terrain, few kinds of snakes are found throughout the country. Just as in the United States, a species is likely to be restricted to the north or to the south, to the uplands or to the lowlands. The change in reptile fauna, due to the number of species involved, is much more impressive than the differences that occur along the eastern seaboard of the United States.

c. The Problem of Identification

The countries of Southeast Asia have a greater variety of snakes than any region in the world, and many of them appear strange, even bizarre, to the eyes of an American. There are tree snakes with projecting snouts, water snakes with flaplike "tentacles" on their noses, sea snakes with a flat, oarlike tail, and of course cobras with a hood. The whole idea of

snakes (some of them venomous) living in trees is foreign; the cold winters discourage such habits in temperate regions. And how about that 15-foot snake in the path? Is it a python (nonvenomous) or king cobra?

None of the venomous snakes of Vietnam wears the "rattle" that characterizes 14 of the 19 venomous snakes in the United States. About half of the venomous land snakes are pit vipers, with the broad, distinct head, "cat-eyes" and deep pit in the side of the face that characterize these snakes. However, many of the nonvenomous snakes have some of the same features. Pythons, for example, have eyes with elliptical pupils and there appear to be whole groups of harmless snakes that "mimic" the venomous species--some looking like cobras (even like king cobras) and others like vipers. The identification of such snakes may be puzzling even to the expert.

Furthermore, the cobras, kraits, and Asian coral snakes which make up the other half of the venomous snake fauna have no such distinctive features. They possess relatively indistinct, narrow heads, round-pupilled eyes, and have nothing like a loreal pit. As distinctive looking a snake as a cobra looks pretty much like any other snake when it is minding its own business; the hood is spread only if the cobra is threatened or thinks it is.

Fortunately, it is not necessary to distinguish all the venomous snakes from all the

nonvenomous kinds. There are relatively few venomous kinds in any one region and they are easy to distinguish as individual species.

d. The Southern Vipers

There are only three kinds of vipers known in South Vietnam and none of these are particularly dangerous.

(1) White-Lipped Bamboo Viper

In the Mekong River Delta region around Saigon and along the narrow coastal plain to the north, the most commonly encountered venomous snake is the white-lipped bamboo viper, the "green bamboo snake" of the "oldtimer's" tale. This small pit viper (adults average about 2 feet) is active mainly at night, when it crawls about on the ground and in the trees in search of the lizards and mice that make up its diet. During the day it remains coiled about some low-hanging branch or bush, from which it is reluctant to be dislodged. Rather than retreating in the face of disturbance, it is likely to stay put and to strike out at an aggressor--even if the "aggressor" is just some Vietnamese or Marine who is trying to make his way through the thick brush.

This sedentary but militantly defensive habit has made the green bamboo vipers the main source of snakebite accidents in such well-studied areas as Hong Kong and Taiwan (Formosa). Fortunately, their venom is but weakly toxic to man and bites by these snakes seldom result in

more than a sore and swollen area at the site of the bite. Death from the bite of green bamboo viper is, in contrast to the "old-timer's" story, almost unknown.

### (2) Malayan Pit Viper

A somewhat more dangerous snake that inhabits the same southern lowlands is the Malayan pit viper. It apparently does not range as far north as Hanoi. It is a ground-dwelling snake somewhat like the American copperhead in habits.

With its irregularly patterned, brown coloration, it is difficult to see on the forest floor, and the Malayan pit viper is the main source of snakebite accidents in Malaya. Like the bites of the bamboo vipers, that of the Malayan pit viper is seldom fatal. However, it may result in the destruction of considerable tissue in the affected area and sometimes causes serious damage to other parts of the body.

### (3) Mountain Viper

The white-lipped bamboo viper and the Malayan pit viper are absent from the Annam Mountain Range that makes up the western border of central Vietnam. Their place is taken by the dark, brown-blotched mountain viper. This is another of the militantly defensive vipers. It is likely to stand its ground and strike out rather than retreat. Fortunately, it is a relatively small snake, which averages less than 2 feet in length,

and its bite is painful rather than lethal. It apparently does not bite enough people to provide a statistical record of the effect of the bite.

All three of the pit vipers that occur in the south are small and relatively innocuous. The vipers of North Vietnam are another story. Besides those of the south, there are several larger and more dangerous vipers in the region north of Hanoi.

e. Northern Vipers

There is a rare horned tree viper that is known from the Fan Si Pan Mountains near the Chinese border and from nowhere else. Another very rare viper, Fea's viper, is known only from a few mountain localities in north-eastern Vietnam and adjacent China.

(1) Sharp-Nosed Pit Viper

There, however, are some dangerous vipers that range over the northern and eastern borders into Vietnam. Undoubtedly the most dangerous is the sharp-nosed pit viper, another relative of the copperhead and cottonmouth of the United States. It is known as the "five-pace snake" or the "hundred-pace snake" in Taiwan, and it much more nearly deserves the name than does the relatively innocuous bamboo viper. The sharp-nosed pit viper attains a length of about 5 feet and it has long fangs with which to inject its ample supply of toxic venom. It is considered a dangerous snake wherever it occurs.

(2) Ilabus

The two other large northern vipers belong to the same group as the habus of Okinawa and Taiwan. They are large snakes, attaining lengths of nearly 6 feet, and have long fangs. However, their venom does not appear to be highly toxic to man. One, the Chinese habu, is found through the hills and lowlands of north-eastern North Vietnam. The other, Jerdon's viper, is found in the high mountain regions of the northwest. The Chinese habu is responsible for a number of snakebite cases and some deaths in Taiwan and Jerdon's viper holds a similar record in Burma and northern India.

Fortunately, none of these large vipers appear to be common enough to be a major concern. The Chinese bamboo viper, which is so similar to the white-lipped viper that it takes an expert to distinguish them, has also been reported in the northern highlands. It, like its southern relative, is responsible for many bites but no adult deaths.

Thus, the common vipers appear to offer little danger and the dangerous vipers are restricted to the far north and are relatively uncommon. This is not true of the other group of dangerous snakes, the elapids. They are widely distributed in both North and South Vietnam, and some of the most dangerous kinds have the broadest distribution.

f. Elapid Snakes

The elapid snakes of Vietnam are represented by cobras, kraits, coral snakes and sea snakes.

(1) Asian Cobra

The Asian cobra probably provides the greatest danger of any snake in Vietnam. It is a snake of only moderate size, with an adult length that averages less than 5 feet. Yet the venom glands of such an average individual may contain sufficient venom to kill three or four men. In Vietnam the cobras appear to be restricted to the heavily populated deltas and coastal plain.

Through the centuries cobras have adapted to life with dense populations of men so that they may be found commonly at the very edges of villages, or perhaps even under a house in the village. Though they are normally active during the day, in such heavily populated regions they tend to emerge at dusk to search for mice and rats. The combination of abundance, proximity to large human populations, and their habit of hunting at dusk make them a prime cause of snakebite throughout Asia and the major reported cause of serious snakebite cases in Vietnam during the French administration of that country. The three deaths that were reported (all from Asian cobras) for the period 1948 to 1952 makes one wonder how good the reporting system was, however.



Cobras almost always raise their head and spread the hood when disturbed, making them easy to identify. Also, their short (quarter to half-inch) fangs make them less dangerous to people in western clothing than they are to the barelegged native population. It is also comforting to know that the cobra's strike is not the short speedy thrust of a viper but a long, sweeping arc from the raised position of the head, forward and down. It is, therefore, a much easier strike to avoid than that of the rattlesnake or copperhead. Asian snake charmers have learned to gauge the distance and path of a cobra's strike to within fractions of an inch and manage to remain just outside of effective range. This is not recommended for the amateur.

## (2) King Cobra

The most impressive venomous snake in Vietnam, and probably the most impressive of all dangerous snakes, is the king cobra. Attaining a reported length of more than 18 feet, and with an average adult length of 12 to 14 feet, it has a very large supply of toxic venom--enough, reportedly, to kill an adult elephant. Without question the king cobra is potentially one of the most dangerous snakes in the world.

It is a snake-eating snake that is not drawn to the mouse-and-rat-infested towns and it is generally found far from civilization. Nowhere is it common and nowhere does it constitute an important source of snakebite accidents. The "king cobras" pointed out by native guides often

are harmless Asian rat snakes that also attain lengths in excess of 12 feet. Both of these snakes have daylight habits, are brown and big. Like other cobras the king cobra raises its head and spreads a hood when disturbed; perhaps its conspicuous appearance keeps it from being a serious threat. There appear to be no records of a snakebite by this species in Vietnam. However, it should be pointed out that elsewhere few of the king cobra's victims have survived for more than half an hour.

### (3) Kraits

The banded krait is found throughout Vietnam. It grows to a length of more than 6 feet and has an exceedingly toxic venom. But it is so sluggish during the day that many native people believe it to be a harmless snake. It is far from aggressive during its nighttime activities, too, and would appear to be a danger only to persons who step on it or pick it up.

Such cannot be said for the Malayan krait of the southern coastal plain or its close relative the many-banded krait of the north. Although they are active mainly at night and relatively sluggish during the day, occasional individuals will strike out unexpectedly with little provocation. They have short fangs (about one-quarter inch) so that western clothing offers considerable protection. However, an effective bite by either of these kraits is almost invariably fatal without prompt treatment.

(4) Asian Coral Snakes

One kind of coral snake or another occurs in every part of Vietnam. There is one species in the mountains, another in the southern lowlands and still another in the northern lowlands. These are all brightly colored, slender, semiburrowing snakes that give little indication of their venomous nature except in their red "warning color." They, like their American relatives, are seldom seen except when they are exposed by removal of the rock or log under which they are hiding. They would appear to offer no danger except to persons that pick them up in the belief that they are harmless. Like the American coral snakes and their cobra relatives the Asian coral snakes have a highly toxic venom.

(5) Sea Snakes

A special word should be said about sea snakes, which are unknown to most Americans. They, too, are cobra relatives, or better, krait relatives that have become adapted for aquatic life. With their flattened, oarlike tail and valvular nostrils, they are a characteristic part of the Western Pacific fauna. About 15 species are found in the waters off Vietnam. In any one area, however, there is usually one common species with several others making up the remainder.

In the Saigon region and southward, Hardwick's sea snake, one of the more dangerous species, makes up 75 percent of the sea snake fauna. This would suggest care in swimming off the beaches of this area. North of Nha Trang, the banded smallheaded sea snake makes up the main population. This sea snake is specialized for feeding on small or elongated fishes and, as its name suggests, has a very small head. It is not considered a danger in other parts of its range. No sea snake of any kind appears to have been explicitly reported in North Vietnam, but some kinds are found in nearby Hainan and probably also off the Vietnam coast.

During the rainy season between July and November sea snakes invade the river mouths and estuaries along the coast, perhaps to feed on the fishes that are concentrated there at that time. They are practically helpless on land and never leave the water voluntarily, but during the wet season may be found far from their usual coastal habitat.

There are conflicting reports on the danger of sea snakes to people in the water. On the one hand native fishermen pull them out of their nets with little thought of danger, while on the other there are reports of swimmers being bitten and killed. A part of the reasons for the different stories is the different species of sea snakes, which vary in temperament and in the effectiveness with which they can deliver a bite. Thus, both the Beaked and Hardwick's sea snakes

are large and largeheaded species that may lash out unexpectedly. These are the two kinds that cause the majority of bites throughout Southeast Asia. The other smallheaded kinds seem to have more gentle dispositions and with their small mouths might have difficulty in biting an arm or leg if they tried.

In any case, only two incidents of swimmers being attacked by sea snakes (in Malaya) have been reported recently. Most sea snake bites are inflicted on the fishermen that handle them often. Nowhere in the area that sea snakes are commonly found--from the Persian Gulf to Japan and Australia--are they considered a major hazard.

g. Summary. Bites by bamboo vipers, the mountain viper and the Malayan pit viper are likely to be more painful than serious, though large individuals of the latter two are capable of causing dangerous bites. Only the Asian cobra and the Malayan and many-banded kraits appear to be sufficiently common, sufficiently venomous and sufficiently aggressive to provide a snakebite hazard. Even so, the few statistics available suggest that death from snakebite was a rarity in prewar Vietnam and that a man who has the opportunity to watch where he puts his hands and feet is most unlikely to be bitten.

Vietnam has a large snake fauna, about 115 species of land snakes, of which 17 are

venomous. The United States also has about 115 species of snakes--of which 19 are venomous. The danger of snakebite in most areas of Vietnam does not appear to be appreciably greater than it is in our own southern states, but a reasonable amount of care is desirable in both places.

# # # # #