

# FM 31-70

DEPARTMENT OF THE ARMY FIELD MANUAL

---

# BASIC COLD WEATHER MANUAL

---

This copy is a reprint which includes  
current pages from Change 1.

HEADQUARTERS, DEPARTMENT OF THE ARMY  
APRIL 1968

FIELD MANUAL

No. 31-70

HEADQUARTERS  
DEPARTMENT OF THE ARMY  
WASHINGTON, D.C., 12 April 1968

## BASIC COLD WEATHER MANUAL

---

	Paragraphs	Page
CHAPTER 1. INTRODUCTION	1-1, 1-2	3
2. INDIVIDUAL CLOTHING AND EQUIPMENT		
Section I. General .....	2-1-2-3	5
II. Clothing .....	2-4-2-11	6
III. Equipment .....	2-12-2-17	16
CHAPTER 3. SMALL UNIT LIVING		
Section I. General .....	3-1, 3-2	22
II. Tentage and other equipment .....	3-3-3-12	22
III. Improvised shelters .....	3-13-3-21	29
IV. Food and water .....	3-22-3-32	35
V. Hygiene and first aid .....	3-33-3-44	43
VI. Bivouac routine .....	3-45-3-58	50
CHAPTER 4. SKIING AND SNOWSHOEING		
Section I. Introduction .....	4-1, 4-2	60
II. Snow and terrain .....	4-3-4-5	61
III. Military skiing .....	4-6-4-35	62
IV. Military snowshoeing .....	4-36-4-39	91
V. Application of ski and snowshoe technique .....	4-40-4-44	95
CHAPTER 5. MOVEMENT		
Section I. Problems affecting movement .....	5-1, 5-2	104
II. Foot movement .....	5-3, 5-4	105
III. Trailbreaking .....	5-5, 5-6	106
IV. Land navigation .....	5-7-5-9	113
V. Action when lost .....	5-10-5-12	114
VI. Mechanized aid to movement .....	5-13-5-15	115
VII. Sleds .....	5-16, 5-17	119
VIII. Aircraft .....	5-18, 5-19	121
CHAPTER 6. COMBAT TECHNIQUES		
Section I. The individual and northern warfare .....	6-1, 6-2	122
II. Individual weapons and instruments .....	6-3-6-6	122
III. Fire and movement .....	6-7-6-12	124
IV. Fighting techniques .....	6-13-6-15	132
V. Camouflage and concealment .....	6-16-6-26	137
VI. Mines and obstacles .....	6-27-6-32	142
CHAPTER 7. SMALL UNIT LEADERS		
Section I. General .....	7-1, 7-2	148
II. Peculiar problems of leaders .....	7-3, 7-4	149

\*This manual supersedes FM 31-70, 24 February 1959, including all changes.

AGO 8641A

1

DISTRIBUTION RESTRICTION: Approved for public release; distribution is unlimited.

	Paragraphs	Page
<b>APPENDIX A. REFERENCES</b> -----		151
<b>B. GROUND/AIR EMERGENCY CODE FOR USE IN AIR/LAND RESCUE SEARCH</b> -----		154
<b>C. SKI DRILL</b> -----		157
<b>D. EFFECTS OF COLD WEATHER ON WEAPONS</b> -----		165
<b>E. WEIGHTS OF COLD WEATHER CLOTHING AND EQUIPMENT AND TYPE LOAD</b> -----		170
<b>F. ENVIRONMENTAL EFFECTS</b> -----		172
<b>G. COLD WEATHER HINTS</b> -----		181
<b>H. MEASUREMENT CONVERSION FACTORS</b> -----		191
<b>GLOSSARY</b> -----		192
<b>INDEX</b> -----		194

CHANGE }  
No. 1 }

HEADQUARTERS  
DEPARTMENT OF THE ARMY  
WASHINGTON, D.C., /7 December /968

**BASIC COLD WEATHER MANUAL**

FM 31-70, 12 April 1968, is changed as follows:

Page 53, paragraph 3-51 b, In line 16 "(LOW)" is changed to read "(LAW or Lubricant, Semi-Fluid, MIL-L-46000A(LSA))."

Page 165, paragraph D-2 a. In line 10 "(LOW)" is changed to read "(LAW or Lubricant, Semi-Fluid, MIL-L-46000A(LSA))."

Page 166, paragraph D-3a (2). In line 21 "LOW" is changed to read "LAW or Lubricant, Semi-Fluid, MIL-L-46000A(LSA)."

Page 166, paragraph D-3 a (3), In lines 3 & 4 "LOW" is changed to read "LAW or Lubricant, Semi-Fluid, MIL-L-46000A(LSA)."

Page 166, paragraph D-3 b (4). In line 7 "LOW" is changed to read "LAW or Lubricant, Semi-Fluid, MIL-L-46000A(LSA)."

Page 170, paragraph E-2 a. In line 14 "Cap, Cold Weather" is changed to read "Cap, Insulating, Helmet Liner-Helmet."

Page 171, paragraph E 2c. Entire page 171 is deleted and the following is added:

Weapon, Antipersonnel (Claymore).....	3. 00
Pistol, Automatic, Cal. 45.....	2. 50
250 rounds, 7.62mm, Machinegun.....	22. 00
Bandoleer, w/7.62mm Ammunition (60 rds).....	3. 61
Compass, Lensatic.....	. 30
Grenade Launcher, M79.....	6. 00
81mm Mortar, M29:	
Barrel.....	28. 00
Mount, M23A1.....	31. 00
Baseplate, M3.....	28. 50
3.5" Rocket Launcher:	
Launcher.....	13. 00
Rockets.....	9. 00
Rifle, 90mm, M67:	
Rifle.....	35. 00
Ammo.....	9. 25
Stove, One Burner, Squad.....	1. 30
Reel, DR8, w/WD1 Wire.....	13. 00
Radio, AN/PRC 6.....	7. 50
Radio, AN/PRC 25.....	24. 72

**E-3. Type Load**

The loads shown below are *type* loads which could be worn during moderately cold weather (approx-

mately 15° F to -15° F). The term moderately cold is used only as a descriptive term. What is termed as moderately cold to one person, may be extremely cold to another. The windchill factor must also be considered, a moderate cold could change momentarily to extreme cold by the addition of high winds. Therefore, the commander should use the type loads for planning only and should adjust them accordingly to fit a given situation and temperature condition.

**a. Fighting Load.**

<i>Clothing</i>	<i>Weight</i>
Helmet, w/liner.....	3. 00
Undershirt, 50/50.....	0. 82
Drawers, 50/50.....	0. 89
Socks, Cushion Sole.....	0. 19
Suspenders.....	0. 25
Trousers, Cotton Nylon WR.....	2. 10
Shirt, Wool Nylon OG.....	1. 50
Coat, Cotton Nylon WR.....	3. 20
Liner, Coat, Nylon Quilted.....	0. 73
Cap, Insulating Helmet Liner-Helmet..	0. 26
Hood, Winter.....	0. 96
Muffler, Wool.....	0. 38
Mitten Shells, Trigger Finger.....	0. 43
Mitten Inserts, Wool Nylon.....	0. 22
Overwhite Set.....	4. 00
Boots, Insulated, White.....	5. 50
<b>Total clothing.....</b>	<b>24. 43</b>

**Equipment:**

Rifle, M14.....	9. 08
Grenade, M26 (2 ea).....	1. 90
Magazine, w/7.62mm ammo (5 ea).....	7. 85
Pouch, Ammo, 7.62mm, M14 (2 ea)...	1. 46
Canteen, Cold Climatic.....	3. 85
Belt, M14, w/first aid packet & pouch..	1. 01
Intrenching Tool, w/carrier.....	3. 96
Bayonet, w/scabbard.....	1. 07
Snowshoes, Magnesium.....	4. 60
Body Armor.....	8. 87
Protective Mask.....	2. 88

**Total equipment..... 46. 53**

<i>Carried in pockets:</i>	<i>Weight</i>
Chasstick.....	0. 10
Sun Glasses, w/case.....	0. 30
Box, Match, Waterproof.....	0. 15
Knife, Pocket.....	0. 40
Thong, Emergency.....	0. 12
	<hr/>
Total.....	1. 07
	<hr/>
<b>Total Fighting Load.....</b>	<b>72. 03</b>
	<hr/> <hr/>

**b. Existence Load.**

Rucksack, Nylon Duck, OG.....	3. 60
Following items are carried in or attached to the rucksack:	
Bag, Sleeping (Outer).....	7. 06
Bag, Sleeping (Innor).....	5. 41
Mattress, Pnoumatic.....	3. 00
Case, Water Repellent.....	2. 25
Liner, Trousers, Nylon Quilted.....	0. 64
Socks, Cushion Sole (2 pr).....	0. 38
Poncho, Nylon Twill.....	2. 00
1/3 Ration.....	2. 13
Toilet Articles.....	2. 00
Towel, Turkish.....	0. 64
Starter, Fire.....	0. 15
Mitton Inserts, Wool Nylon.....	0. 22
	<hr/>
<b>Total Existence Load.....</b>	<b>29. 48</b>
	<hr/>
<b>Total of Fighting and Existence Load.....</b>	<b>101. 51</b>

*c. Supplemental Existance Load.* The following are items of clothing not immediately needed by the individual during moderately cold weather. These items are normally carried in the duffle bag on unit transportation and should be available to the individual when needed:

Undershirt, 50/50  
 Drawers, 50/50  
 Socks, Cushion Sole (3 pr)  
 Trousers, Cotton Nylon, WR  
 Shirt, Wool Nylon, OG  
 Parka, Cotton Nylon  
 Liner, Parka, Nylon Quilted  
 Mitten Set, Arctic

Page 184, paragraph G-6a. In line 1 "(LOW)" is changed to read "(LAW or Lubricant, Semi-Fluid, MIL-L-46000A(LSA))."

By Order of the Secretary of the Army:

Official:

KENNETH G. WICKHAM,  
*Major General, United States Army,  
 The Adjutant General.*

W. C. WESTMORELAND,  
*General, United States Army,  
 Chief Of Staff.*

Distribution:

To be distributed in accordance with DA Form 12-11 requirements for Basic Cold Weather Manual.

## CHAPTER 1

### INTRODUCTION

---

#### 1-1. Purpose and Scope

a. This manual is designed to prepare the individual soldier and small unit commander to conduct military operations for extended periods of time under the most severe and varying cold weather climatic conditions. The doctrine and techniques in the manual are applicable in any area that has cold weather and snow with their accompanying operational problems. Troops *properly trained* in this doctrine and these techniques will be able to fight; live; and move in any cold weather area of the world.

b. The provisions of SOLOG Agreement 23R, Arctic Doctrine are implemented in this manual.

c. The material contained herein emphasizes that cold, with its attendant problems affects military operations but does not prevent them. The proper use of authorized equipment and field expedients will, to a major degree, overcome any problems encountered as a result of the cold. It is the commander's responsibility to train his men so they can make the environment save military operations, *not hinder them*. The material presented herein is applicable, without modification to nuclear and nonnuclear warfare, employment of, and protection from, chemical, biological, and radiological agents, and internal defense and development operations.

d. Throughout this manual reference is made to the additional time required to conduct various tasks in cold weather operations. This requirement cannot be overemphasized and must be included in all planning. In addition to the increased amount of time consumed in actual movement, allowance must be made for other time consuming tasks that are not present in temperate zone operations.

These include, among others, erecting and striking tents, performing maintenance, constructing roads, starting and warming engines, movement of supplies, and hundreds of other small tasks that must be performed while wearing bulky cold weather clothing.

e. Insofar as possible illustrations used in this manual reflect Standard A items of clothing and equipment. However, because of non-availability of some items at time of publication, some illustrations show Standard B or C items of clothing (para 2-7).

f. Measurements in this manual to the extent practicable, reflect both the Metric and U.S. systems; however, in some cases figures will show only the U.S. system. For ease in transposition, meters have been converted to yards on a one for one basis. For more exact measurements use the conversions shown in appendix H.

g. Users of this manual are encouraged to submit recommendations to improve its clarity or accuracy, Comments should be keyed to the specific page, paragraph, and line of the text in which the change is recommended. Reasons should be provided for each comment to insure understanding and complete evaluation. Comments should be forwarded direct to Commanding General, United States Army, Alaska, APO Seattle 98749. Originators of proposed changes which would constitute a significant modification of approved Army doctrine may send an information copy, through command channels, to the Commanding General, United States Army Combat Developments Command, Fort Belvoir, Virginia 22060, to facilitate review and followup.

#### 1-2. Relation to Other Manuals

This manual is prepared with the assumption that normal individual and basic unit

training have been completed. The manual should be used in conjunction with the basic field manuals of the arms and services as well as FM 31-71 and FM 31-72. Appropriate technical manuals contain detailed information

beyond the treatment given in this manual on the operation and maintenance of equipment during cold weather operations. Appendix A contains a list of supplementary manuals and references.

## CHAPTER 2

### INDIVIDUAL CLOTHING AND EQUIPMENT

---

#### Section 1. GENERAL

##### 2-1. Basis of Issue

a. As used in this manual, individual clothing and equipment are those items issued or sold to a soldier for his personal use, and include certain organizational equipment utilized by the individual. The basis of issue of cold weather clothing and equipment may be found in TA 50-901. Mandatory items of personal clothing are listed in AR 700-8400-1.

b. The U.S. Army, through continuous research and development, endeavors to maintain the best clothing and equipment in the world. When properly fitted and properly utilized this clothing will provide adequate protection from the elements and will enable trained, well disciplined troops to carry out year-round field operations under cold weather conditions, wherever they may be encountered.

c. To utilize fully the protection afforded by the present standard cold weather clothing and equipment, it is necessary to understand the principle involved and the correct function of each item. This chapter covers basic principles and provides general guidance on the purpose and use of cold weather clothing and equipment.

##### 2-2. Commander's Responsibilities

a. Many factors will influence the commander's decision as to what items of clothing and equipment his troops should wear or carry. These include the weather, mission at hand, actual duties to be performed, overall physical condition of individuals and their degree of proficiency. If a movement is involved he must consider the distance to be traveled, the method of travel, and how the troops will be fed en route, if applicable. If the movement is on foot, he must bear in mind that under nor-

mal winter conditions, 65 to 70 pounds is the maximum weight a man can normally wear and carry and still be effective on reaching his destination.

b. The weight of individual clothing and equipment is covered in appendix E. Commanders should give particular attention to additional organizational equipment required for a given operation. Some of the more common items are also listed in appendix E. Since the individual soldier's combat load in cold weather operations exceeds that of a temperate climate load by more than 20 pounds, these organizational items (such as binoculars, compasses, radios and batteries, pioneer tools, crew served weapons, etc. ) become major considerations and must be included at all levels of planning.

c. In addition to the individual combat load, another 45 to 55 pounds of clothing and equipment is required for the protection and comfort of each individual under conditions of *extreme cold*. Transportation must be provided for this additional load whenever possible.

d. The commander must take positive action to insure that a balance exists between what the individual is wearing and what he is required to carry in the way of equipment. He must also insure that troops dress as lightly as possible consistent with the weather in order to reduce the danger of excessive perspiring and subsequent chilling. The complete cold-wet or cold-dry uniform for the applicable environmental conditions must be readily available. A large proportion of cold weather casualties results from too few clothes being available to individuals when a severe change in the weather occurs. Because of the differences in individual metabolism, commanders



must not be arbitrary in delineating strict uniform requirements, but must allow some personal choice of undergarments.

### 2-3. Cold Weather Conditions

The use of cold weather clothing is affected by two types of weather conditions: wet and dry. These conditions are amplified by humidity coupled with temperature and wind velocity; high humidity (wet conditions), low humidity (dry conditions).

*a. Wet Conditions.* Cold-wet conditions occur when temperatures are near freezing and variations in day and night temperatures cause alternate freezing and thawing. This freezing and thawing is often accompanied by rain and wet snow, causing the ground to become

muddy and slushy. During these periods troops should wear clothing which consists of a water-repellent, wind-resistant outer layer and inner layers with sufficient insulation to provide ample protection in moderately cold weather (above 14°F.).

*b. Dry Conditions.* Cold-dry conditions occur when average temperatures are lower than 14°F. The ground is usually frozen and snow is usually dry, in the form of fine crystals. Strong winds cause low temperatures to seem colder and increase the need for protection of the entire body (windchill) (fig. F-1). During these periods, troops should have available additional insulating layers of clothing. This is particularly true when entering static situations form a period of strenuous exercise.

## Section II. CLOTHING

### 2-4. Purpose of Clothing

*a. Protection of Body Against Climatic Factors.*

- (1) If the body is to operate efficiently, it must maintain a normal temperature. The body attempts to adjust itself to the variable external conditions it encounters. These attempts are evidenced by the need for more food to produce additional heat during colder weather, by perspiration to increase removal of heat during hot weather, and by the gradual darkening of the skin as protection against extended exposure to the rays of the sun.
- (2) Proper clothing, correctly worn, will assist the body in its adjustment to extreme climatic conditions. The clothing does this by holding in the body heat, thereby insulating the body against the cold outside air. The problem of protection becomes acute when freezing temperatures are involved. To understand this problem requires a knowledge of the methods by which the body resists the effects of climatic changes.

*b. Balancing Heat Production and Heat Loss.* The body loses heat at variable rates. This heat may flow from the body at a rate equal to or greater than the rate at which it is produced.

When heat loss exceeds heat production, the body uses up the heat stored in its tissues, causing a rapid drop in body temperature. Excessive heat loss can result in shivering. Shivering uses body energy to produce heat which at least partially offsets the heat loss and slows the rate at which the body temperature will drop. Shivering is an important warning to start action to rewarm, either by adding more clothing, by exercising, by eating some food, or by entering a warm shelter, or by any combination of these actions. In freezing temperatures it is as important to remove and adjust clothing to prevent excessive overheating as it is to add clothing to prevent heat loss.

### 2-5. Principles of Clothing Design

Certain principles are involved in the design of adequate cold weather clothing to control the loss of heat from the body, to facilitate proper ventilation, and to protect the body.

*a. Insulation.* Any material that resists the transmittance of heat is known as an insulating material. Dry air is an excellent insulator. Woolen cloth contains thousands of tiny pockets within its fibers. These air pockets trap the air warmed by the body and hold it close to the skin. The principle of trapping air within the fibers or layers of clothing provides the most efficient method of insulating the body against

heat loss. Fur provides warmth in the same way; warm, still air is trapped in the hair and is kept close to the body.

*b. Layer Principle.*

- (1) Several layers of medium-weight clothing provide more warmth than one heavy garment, even if the single heavy garment is as thick as the combined layers. The effect results from the several thick layers of air which are trapped between the layers of clothing, rather than one or two layers of large volume. These layers, as well as the minute air pockets within the fibers, are warmed by the body heat.
- (2) The layers of clothing are of different design. The winter underwear is most porous and has many air pockets. These air pockets trap and hold the air warmed by the body. To keep the cold outside air from reaching the still inside air that has been warmed by the body, the outer garments are made of windproof, water-repellent fabric.
- (3) The layer principle allows maximum freedom of action and permits rapid adjustment of clothing through a wide range of temperatures and activities. The addition or removal of layers of clothing allows the body to maintain proper body heat balance.

*c. Ventilation.* Perspiration fills the air-spaces of the clothing with moisture laden air and reduces their insulating qualities. As perspiration evaporates, it cools the body just as water evaporating from a wet canteen cover cools the water in the canteen. To combat these effects, cold weather clothing is designed so that the neck, waist, hip, sleeve, and ankle fastenings can be opened or closed to provide ventilation. To control the amount of circulation, the body should be regarded as a house and the openings in the clothing as windows of the house. Cool air enters next to the body through the openings in the clothing just as cool air comes into a house when the windows are open. If the windows are opened at opposite ends of a room, cross-draft ventilation results. In the same way, if clothing is opened at the waist and neck, there is a circulation of fresh

air. If this gives too much ventilation, only the neck of the garment should be opened to allow warm air to escape without permitting complete circulation.

**2-6. Winter Use of Clothing**

*a. Basic Principles of Keeping Warm.*

- (1) Keep clothing Clean.
- (2) Avoid Overheating.
- (3) Wear Clothing Loose and in layers.
- (4) Keep clothing Dry
- (5) Remember C-O-L-D to keep warm in winter.

*b. Application of Basic Principles.*

- (1) Keep clothing clean. This is always true from a standpoint of sanitation and comfort: in winter, in addition to these considerations, it is necessary for maximum warmth. If clothes are matted with dirt and grease, much of their insulation property is destroyed; the air pockets in the clothes are crushed or filled up and the heat can escape from the body more readily. Underwear requires the closest attention because it will become soiled sooner. If available, light cotton underwear may be worn beneath winter underwear to absorb body oils and lengthen the time interval between necessary washings of these more difficult to clean and dry garments. Winter underwear (Army issue is a 50/50 cotton/wool blend) and cushion sole socks (Army issue socks are 50 percent wool, 30 percent nylon, 20 percent cotton) should be washed in lukewarm water, if available. Hot water should not be used because it is injurious to the wool fibers and causes shrinkage. Synthetic detergents are more soluble than soap in cool water and also prevent hard-water scum, and are therefore recommended, if available. When outer clothing gets dirty it should be washed with soap and water. All the soap or detergent must be rinsed out of the clothes, since any left in the clothing will lessen the water-shedding quality of the clothing. In addition to destroying much of the nor-

mal insulation, grease will make the clothing more flammable. All outer garments of the Cold Weather Clothing System are washable and have laundry instruction labels attached. If washing is not possible for clothing that would normally be washed with soap and water, dry rubbing and airing will rid them of some dirt and accumulated body oils.

- (2) *Avoid overheating.* In cold climates, overheating should be avoided whenever possible. Overheating causes perspiration which in turn, causes clothing to become damp. This dampness will lessen the insulating quality of the clothing. In addition, as the perspiration evaporates it will cool the body even more. When indoors, a minimum of clothing should be worn and the shelter should not be overheated. Outdoors, if the temperature rises suddenly or if hard work is being performed, clothing should be adjusted accordingly. This can be done by ventilating (by partially opening parka or jacket) or by removing an inner layer of clothing, or by removing heavy mittens or by throwing back parka hood or changing to lighter head cover. The head and hands, being richly supplied with blood, act as efficient heat dissipators when overheated. In cold temperature it is better to be slightly chilly than to be excessively warm. This promotes maximum effectiveness of the body heat production processes.
- (3) *Wear clothing loose and in layers.* Clothing and footgear that are too tight restrict blood circulation and invite cold injury. Wearing of more socks than is correct for the type of footgear being worn might cause the boot to fit too tightly. Similarly, a field jacket which fits snugly over a wool shirt would be too tight when a liner is also worn under the jacket. If the outer garment fits tightly, putting additional layers under it will restrict circulation. Additionally, tight garments lessen the volume of

trapped air layers and thereby reduce the insulation and ventilation available.

- (4) *Keep clothing dry.*
- (a) Under winter conditions, moisture will soak into clothing from two directions-inside and outside. Dry snow and frost that collect on the uniform will be melted by the heat radiated by the body.
- (b) Outer clothing is water-repellent and will shed most of the water collected from melting snow and frost. The surest way to keep dry, however, is to prevent snow from collecting. Before entering heated shelters, snow should be brushed or shaken from uniforms; it should not be rubbed off, because this will work it into the fabric.
- (c) In spite of all precautions, there will be times when getting wet cannot be prevented and the drying of clothing may become a major problem. On the march, damp mittens and socks may be hung on the pack. Occasionally in freezing temperatures, wind and sun will help dry this clothing. Damp socks or mittens may be placed, unfolded near the body, where the body heat will dry them. In bivouac, damp clothing may be hung inside the tent near the top, using drying lines or improvised drying racks. It may even be necessary to dry each item, piece by piece, by holding before an open fire. Clothing and footwear should not be dried to near a heat source. Leather articles, especially boots, must be dried slowly. If boots cannot be dried by any other method, it is recommended that they be placed between the sleeping bag and liner. Heat from the body will aid in drying the leather.

## 2-7. Components of Cold Weather Uniforms

The items of clothing below are Standard A as listed in SB 700-20. It should be borne in mind however that procurement may or may not have been started on some of the items

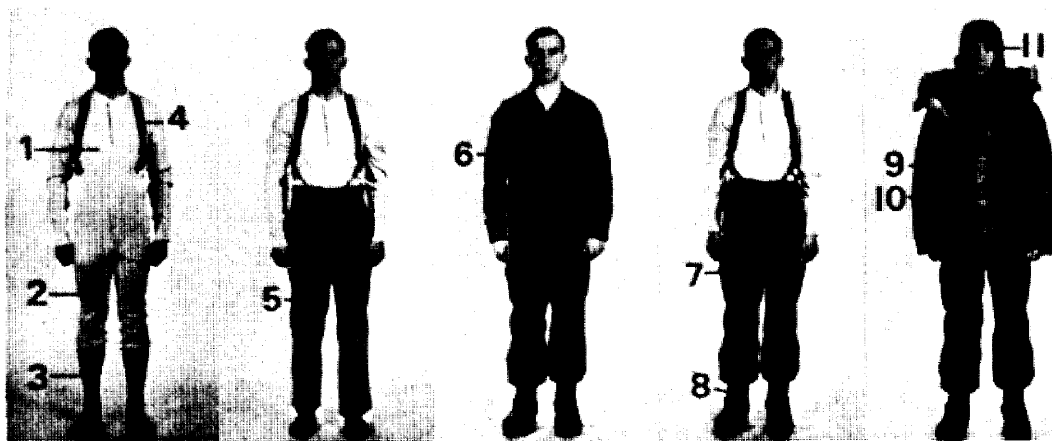

Figure 2-1. Basic components of cold-wet uniform.

and upon requisitioning some Standard B clothing may be issued. Although not shown as basic items of the cold weather uniforms, light cotton underwear may be worn under the winter underwear (para 2-6 b (1)).

a. *Cold-Wet Uniform.* The basic components of the cold-wet uniform are illustrated in figure 2-1 unless otherwise indicated.

- (1) *Undershirt Mens.* 50 Cotton 50 Wool, Full Sleeve.
- (2) *Drawers Mens.* 50 Cotton 50 Wool, Ankle Length.
- (3) *Socks Mens.* Wool Cushion Sole, OG 408, Stretch Type.
- (4) *Suspenders Trousers.* Scissors Back Type.
- (5) *Trousers Mens.* Wool Serge, OG 108.
- (6) *Shirt Mens.* Wool Nylon Flannel, OG 108.
- (7) *Trousers Mens.* Cotton Nylon, Wind Resistant Sateen, 8.5 oz, OG 107.
- (8) *Boot Insulated Cold Weather.* Mens Rubber Black (or Boot Combat: Mens Leather Black 8½" high with Overshoe: Rubber Man's High Cleated 5 Buckle).
- (9) *Coat Man.* Cotton and Nylon Wind Resistant Sateen, 8.5 oz, OG 107, with integral hood.
- (10) *Liner Coat Mens.* Nylon Quilted 6.2 oz, OG 106.
- (11) *Cap Insulating, Helmet Liner-Helmet.* Cotton Nylon Oxford, OG 107.

- (12) *Glove Shells.* Leather Black with Glove Inserts; Wool and Nylon Knit, OG 208, or Mitten Shells; Trigger Finger Leather Palm and Thumb with Mitten Inserts; Wool and Nylon Knit, OG, Trigger Finger, or Mitten Set Arctic; Gauntlet Style Shell with Leather Palm (fig. 2-5).

- (13) *Hood Winter.* Cotton and Nylon Oxford, OG 107, with drawcord and fur.

- (14) *Poncho.* Coated Nylon Twill, OG 207 (not illustrated).

b. *Cold-Dry Uniform.* The basic components of the cold-dry uniform are illustrated in figure 2-2 unless otherwise indicated.

- (1) *Undershirt Mens.* 50 Cotton 50 Wool, Full Sleeve.

- (2) *Drawers Mens.* 50 Cotton 50 Wool, Ankle Length.

- (3) *Socks Mens.* Wool Cushion Sole, OG 408, Stretch Type.

- (4) *Suspenders Trousers.* Scissors Back Type.

- (5) *Shirt Mens.* Wool Nylon Flannel, OG 108.

- (6) *Trousers Mens.* Cotton Nylon, Wind Resistant Sateen, 8.5 oz, OG 107.

- (7) *Liner Trousers.* Nylon Quilted, 6.2 oz, OG 106.

- (8) *Boot Insulated Cold Weather.* Mens Rubber White, w/release valve.

- (9) *Coat Man.* Cotton and Nylon Wind Resistant Sateen, 8.5 oz, OG 107.

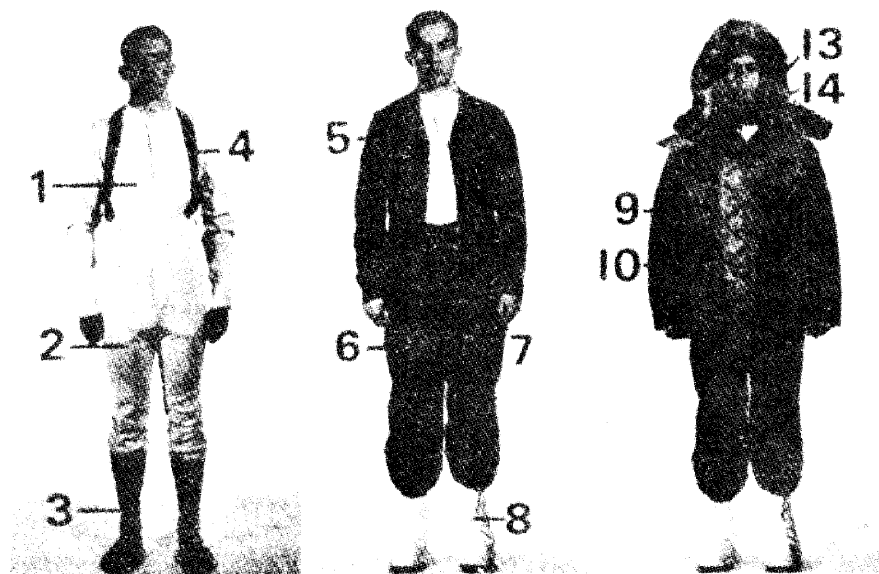

Figure 2-2. Basic components of cold-dry uniform.

- (10) *Liner Coat Mans.* Nylon Quilted, 6.2 oz, OG 106.
- (11) *Parka Mans.* Cotton and Nylon Oxford OG 107, w/o hood (not illustrated),
- (12) *Liner Parka Mans.* Nylon Quilted, 6.2 oz, OG 106 (not illustrated).
- (13) *Cap, Insulating, Helmet Liner.* Cotton Nylon Oxford, OG 107.
- (14) *Hood Winter.* Cotton and Nylon Oxford, OG 107, w/drawcord and fur.
- (15) *Glove Shells.* Leather Black with Glove Inserts; Wool and Nylon Knit, OG 108, or, Mitten Shells; Trigger Finger Leather Palm and Thumb with Mitten Inserts; Wool and Nylon Knit, OG, Trigger Finger, or, Mitten Set Arctic; Gauntlet Style Shell with Leather Palm (fig. 2-5).
- (16) *Poncho.* Coated Nylon Twill, OG 207 (not illustrated).
- (17) *Gloves Cloth.* Work Type (not illustrated).

## 2-8. Description and Wearing of the Uniform Components

### a. Cold-Wet.

#### (1) *Inner layer.*

- (a) *Underwear.* The underwear is loose fitting and is made of 50 percent cotton and 50 percent wool. It is

constructed so that circulation and ventilation are not restricted.

- (b) *Suspenders.* The scissors-type suspenders are worn over the under-shirt. The drawers and all succeeding layers of trousers are supported by the suspenders. The use of suspenders allows the drawers and trousers to be worn loose at the waist so that neither circulation nor ventilation is restricted.
- (2) *Intermediate layer.* The intermediate layer consists of the wool OG shirt and trousers which provide excellent insulation against the cold. The shirt is worn outside the trousers for better control of ventilation. The wool trousers and shirt are not designed to be worn as outer garments under field conditions since they lose their insulating qualities if they become wet or matted with dirt. When engaged in strenuous activity, care must be taken so that the wool material will not come in contact with the skin, thus causing possible irritation and discomfort.
- (3) *Outer layer.*
  - (a) *Coat.* The coat ensemble is made up of a shell and a detachable liner.



Figure 2-3. Cap insulating helmet and helmet liner.

The coat has a combination slide, snap and touch-and-close fastener front closure. The sleeves have adjustable cuffs with a hand shield extension. A lightweight hood is an integral part of the coat. When not being used the hood is secured under the collar and is concealed by a slide fastened enclosure. The detachable liner is made of quilted nylon and is extremely light and warm. The liner has a collar, open underarms, and buttonhole tabs for attachment to the coat.

- (b) *Trousers.* The trousers are made of smooth, light, wind resistant sa-teen. They have extra closures and adjustments, to provide for ventilation and better fit.
- (4) *Headgear.*
- (a) *Cap.* The insulating helmet liner cap (fig. 2-3) is close fitting, visorless, and of helmet style. It has a combined one-piece earlap and neck protector, and utilizes an overlap touch-and-close fastener. The cap is designed to be worn under the steel helmet or under the winter hood. When worn as an outer headpiece, the lower flap portion of the cap may be folded up

around the top with the touch-and-close fasteners crisscrossed in the front (fig. 2-3).

- (b) *Hoods.* The winter hood (fig. 2-4) is a one-piece covering for the head, face, and neck. It utilizes touch-and-close fasteners and can be worn over the steel helmet. A malleable wire inside the fur ruff may be shaped as desired for visibility or greater protection of the head and face. Unit commanders must enforce "hood discipline," especially while men are on sentry duty or on patrols. The winter hood and the cold weather cap with flaps down will greatly reduce a man's hearing capabilities. When the temperature or wind does not require the use of heavier headgear, the cold weather cap and the lightweight hood should be worn. Hoods should be removed before the head starts to perspire. Breathing into the winter hood causes moisture and frost to accumulate and should be avoided as much as possible. Accumulated frost should be removed frequently.
- (5) *Handwear.* See *c* below.
- (6) *Footwear.* See *d* below.

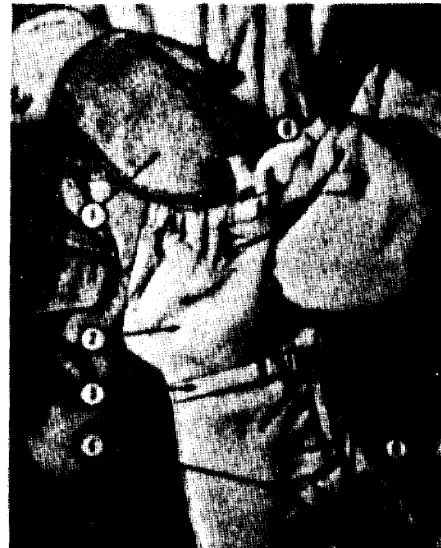

Figure 2-4. Winter hood.

b. Cold-Dry.

(1) *Inner Layer.* Same as cold-wet.

(2) *Intermediate Layer.* The wool OG shirt is worn as the basic upper body garment. The wind resistant sateen trousers with the quilted nylon liner are worn as the basic lower body garment. In extreme cold weather, the



Mitten insert 4 Trigger finger loop  
Mitten shell 5 Trigger finger  
Adjustable wrist strap 6 Cord loop

Figure 2-5—Continued.



Mitten insert 4 Snap fastener  
Mitten shell 5 Cord loop  
Adjustable gauntlet strap



1 Wool insert 2 Leather shell

Figure 2-5. Types of gloves and mittens.

coat with detachable liner, used as an outer layer in the cold-wet uniform, may be worn as an intermediate layer in cold-dry conditions.

(8) *Outer Layer.* Depending on temperature the outer garment may consist of the coat with detachable liner, the parka, with detachable liner, or both,

The parka is a three-quarter length, unlined coat with adjustable cuffs. It has a combination slide and snap fastener front fly closure, waist and hem drawcords and a split lower back. The parka has a detachable quilted nylon liner.

(4) *Headgear*. Same as cold-wet.

(5) *Handwear*. See *c* below.

(6) *Footwear*. See *d* below.

*c. Handwear.*

(1) *Gloves*.

(a) Standard black leather gloves are worn in mild weather or when work must be done that requires more freedom of finger movement than can be acquired with heavier handwear. In colder weather the same gloves are worn with wool inserts (fig. 2-5). Gloves may be worn with either the cold-wet or cold-dry uniforms when the weather is not cold enough to require the use of mittens.

(b) Personnel engaged in delicate finger operations, such as instrument adjustment may be issued lightweight cotton work gloves. These gloves allow for finger dexterity, have leather palms, and prevent the skin from sticking to cold metal. They will provide protection against cold for only a very short period.

(2) *Mittens*.

(a) The trigger finger mitten shells (fig. 2-5), are worn with wool trigger finger inserts during periods of moderate cold. The mittens may be worn with either the cold-wet or cold-dry uniform. Figure 2-5 shows the Standard B mitten. The Standard A item, although identical in outward appearance has had the trigger finger loop deleted and is lined on the inside upper surface with lightweight quilted nylon.

(b) During periods of extreme cold the arctic mitten set is worn (fig. 2-5). The mitten has a liner, a leather palm, a cheek warmer and a fast-

ener on the back. A neck strap is attached to both mittens to prevent loss. The neck strap permits the mittens, when not required for warmth, to be conveniently carried snapped together behind the back. The arctic mitten set is carried whenever there is the possibility of the onset of severe cold weather, regardless of the mildness of the weather when setting out.

(3) *Utilization*.

(a) The general rules concerning the use of clothing apply also to handwear—keep it clean, avoid overheating, wear loose in layers, and keep it dry.

(b) The outer shells should always be worn with the minimum insulation necessary to provide protection, thus avoiding perspiration. Inserts should never be worn by themselves because they wear out quickly and provide little warmth alone. Trigger finger inserts are designed to fit either hand. Changing them to opposite hands frequently will insure even wear.

(c) Tight fitting sleeves should be avoided. They may cut down circulation and cause hands to become cold.

(d) When handling cold metals, the hands should be covered to prevent cold burns (immediate freezing of the flesh in contact with cold soaked metals).

(e) To keep hands warm when wearing mittens, the fingers should be curled (inside the mittens) against the palm of the hand, thumb underneath the fingers, or flexed inside the mitten whenever possible to increase the blood circulation. Hands may be exercised by swinging the arms in a vertical circle. Frost-bitten hands can be warmed by placing them next to the skin under the armpits.

(f) An extra pair of mitten inserts should be carried.



d. *Footwear.*

(1) *General.* The feet are more vulnerable to cold than are other parts of the body. Cold attacks feet most often because they get wet easily (both externally and from perspiration) and because circulation is easily restricted. Footgear is therefore one of the most important parts of cold weather clothing.

(2) *Principles.*

- (a) The rule of wearing clothing loose and in layers also applies to footgear. The layers are made up by the boot itself and by the socks. Socks are worn in graduated sizes. The instructions pertaining to fitting of footgear, as outlined in TM 10-228, must be carefully adhered to. If blood circulation is restricted, the feet will be cold. Socks, worn too tightly, might easily mean freezing of the feet. For the same reason: **AVOID LACING FOOTGEAR TIGHTLY.**
- (b) Since the feet perspire more readily than any other part of the body, the rules about avoiding overheating and keeping dry are difficult to follow. Footgear is subjected to becoming wet more often than are other items of equipment. The insulated boots with release valve (white, cold-dry and black, cold-wet) are designed to contain perspiration within the interior of the boots. A change of dry socks should be carried at all times. Whenever the feet get wet, dry as soon as possible and put on a pair of dry socks. Also, the inside of the boots should be wiped as dry as possible.
- (c) Footgear should be kept clean. Socks should be changed when they become dirty. Socks and feet should be washed frequently. This washing will help keep feet and socks in good condition.
- (d) The feet should be exercised. Stamping the feet, double-timings few steps back and forth, and flexing and wiggling toes inside the

boots all require muscular action, produces heat, and will help keep the feet warm. The feet should be massaged when changing the socks.

(e) Boots are designed to permit attachment to individual oversnow equipment (skis and snowshoes). **BINDINGS MUST BE ADJUSTED CAREFULLY.** If they are too tight, the circulation of blood is restricted and feet will get cold. Improperly adjusted bindings may soon chafe feet or badly wear and tear the boot.

(3) *Types.*

(a) *Boot, insulated, cold weather: mens, rubber, black.* These boots (1, fig. 2-6) are particularly useful in snow, slush, mud, and water (cold-wet conditions), but are not adequate for prolonged wear in temperatures below  $-20^{\circ}$  F. They are specifically designed for combat personnel who may not have the opportunity to frequently change to dry socks. Insulating material is hermetically sealed into the sides and bottoms of the boots. The insulation takes the place of removable innersoles and the secondary layer of socks worn in other types of cold weather boots. Perspiration from the feet and water spilling over the tops of the boots cannot reach the insulating material because it is sealed-in and always remains dry. Moisture from outside sources or from perspiration may make the socks damp; this dampness is not harmful to the feet, provided they receive proper care such as frequent drying and massaging. If socks are not changed and feet dried regularly (at least twice daily) the skin becomes softened and is more readily chaffed or blistered. These effects are occasionally mistaken for superficial frostbite. *Only one pair of cushion-sole socks* are worn with

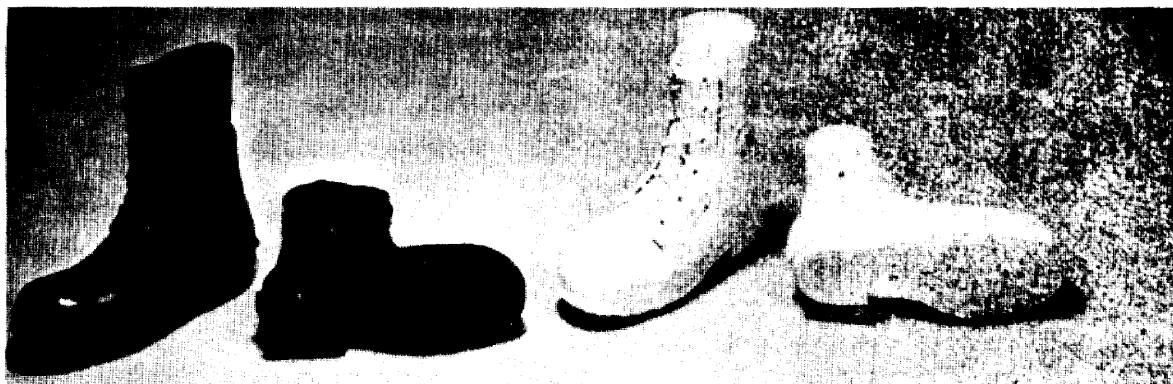

1. Boot, insulated, black

2. Boot, insulated, white, w/release valve

Figure 2-6. Types of boots.

the boots. Additional socks should not be worn as the feet may become cramped, resulting in restricted blood circulation and cold feet.

- (b) *Boot, insulated, cold weather: mens, rubber, white, w/release valve.* The insulated white boot (2, fig. 2-6) is designed for wear in cold-dry conditions and will protect the feet in temperatures as low as  $-60^{\circ}$  F. The boots have a seamless inner and outer carcass, sealed insulation, and an outside air release valve used to compensate for air differentials. The white boots are worn over *one pair of cushion sole socks*. The air release valve provides airborne troops a means of equalizing external and internal air pressures when undergoing extreme changes in altitude. This valve must remain closed at all other times to prevent the possibility of introducing any amount of moisture into the insulation of the boot and rendering it permanently unserviceable.

## 2-9. Nose and Cheek Protectors and Masks

- a. The Mask, Cold Weather may be issued

for use during severe windchill conditions. The mask *must* be removed at intervals to check for frostbite.

- b. A certain amount of protection can be gained by covering as much of the face as possible with a wool scarf. It may be adjusted from time to time, and should be rotated when the section opposite the mouth and nose becomes covered with frost. The frozen end should be left outside the coat or parka. The scarf, like the mask, *must* be removed at intervals to check for frostbite.

## 2-10. Camouflage Clothing

- a. Winter camouflage clothing (overwhites) consists of white trousers and lightweight parka with hood. White covers are also issued for the rucksacks.

- b. Camouflage clothing provides a means of concealment and camouflage from the enemy—both from the ground and from the air—in winter conditions. Use of the white camouflage clothing is, however, dependent on the background; generally speaking, on vegetation and the amount of snow on the ground. The complete white suit (fig. 6-26) is worn when terrain is covered with snow. Mixed clothing (fig. 6-27)—white parka and dark trousers, or vice versa—is used against mottled back

grounds. The correct use of camouflage clothing is extremely important (para 6-22).

c. Overwhites may become frosty and icy after use. As with all clothing, the frost and ice must be removed to expedite drying. Soiled camouflage clothing will lose its effectiveness; therefore, care must be exercised when handling stoves, digging in ground, and performing similar tasks. Avoid scorching or burning the garments when drying or when lying down by an open fire. The clothing should be washed or changed frequently. When changing, clothing should be checked to insure that it fits over the basic garments without restricting movement.

## 2-11. Maintenance of Clothing and Equipment

### a. Footgear.

(1) *Boots.* The leather in boots should be treated with approved agents. Normally, the insulated boot can be repaired with ordinary tire patching or air mattress patching material. If these items are not readily available, friction tape or even chewing gum may be used temporarily to plug up the hole and prevent moisture from damaging the insulation. If the damage cannot be repaired, the boots should be removed, airdried, and

turned in for replacement as soon as possible. The inside of the boots should be washed at least once a month with a mild soap, and rinsed with warm water.

**Caution: Do not clean with abrasive materials. Also do not apply polish or paint to any part of the boot as it will result in deterioration of the rubber.**

(2) *Socks.* Socks should be washed daily, using lukewarm water to avoid excessive shrinkage. After washing, they should be wrung out and stretched to natural shape before drying. Holes in socks should be repaired as soon as possible, taking special precautions to avoid bunching or roughness of the mended area. It should be noted that proper repairs under field conditions are almost impossible and that blisters should be expected if field mended socks are worn.

b. *Handgear.* Holes should be mended promptly. Gloves or mittens should not be dried too near an open fire.

c. *Headgear.* Headgear should be washed as required to remove perspiration, dirt, and hair oils. When drying, normal care must be exercised to avoid scorching or burning.

## SECTION III. EQUIPMENT

### 2-12. Sleeping Equipment

a. The complete sleeping bag for use in cold climates consists of three parts: a case, of water-repellent material; an inner bag (mountain type), of quilted tubular construction, filled with a mixture of down and feathers; and an outer bag (arctic bag), of the same material as the inner bag. In addition, an insulating air mattress and a waterproof bag into which the sleeping bags are packed are issued.

b. When temperatures are normally above 14° F., only one bag is used. It is placed in and laced to the cover. When temperatures are below 14° F., both bags are used. The inner bag is placed inside the outer bag and secured at

the foot with the loops and tie straps provided and the cover laced over the outer bag.

c. When the bag is used, it is first fluffed up so that the down and feather insulation is evenly distributed in channels, thus preventing matting. Since cold penetrates from below, and the insulation inherent in the bag is compressed by the weight of the body, additional insulation is placed under the bag whenever possible. Added insulation can be obtained by placing ponchos, extra clothing, backboards, fiber ammunition or food containers, or boughs between the sleeping bag and the ground. The insertion of a waterproof cover, such as a poncho, between the sleeping bag and air mattress will prevent the mattress and bag from freezing together at very cold

temperatures. This is caused by condensation on the mattress due to the difference in temperatures between the lower side touching the ground and the upper side touching the relatively warm sleeping bag. Care must be taken to prevent puncturing the mattress or damaging sleeping bags. In general, the more insulation between the sleeping bag and the ground, the warmer the body.

*d.* If the tactical situation permits, individuals should avoid wearing too many clothes in the sleeping bag. When too many clothes are worn they tend to bunch up, especially at the shoulders, thereby restricting circulation and inducing cold. Too many clothes also increase the bulk and place tension upon the bag, thus decreasing the size of the insulating airspaces between layers and reducing the efficiency of the insulation. In addition, too many clothes may cause the soldier to perspire and result in excessive moisture accumulating in the bag, a condition which will likewise reduce the bag's insulating qualities.

*e.* The sleeping bag is equipped with a full length slide fastener which has a free running, nonlocking slider. In an emergency, the bag can be opened quickly by grasping both sides of the opening near the top of the slide fastener and pulling the fastener apart. As a safety precaution, bags should be tested at frequent intervals to insure that the slide fastener operates freely and will function properly.

*f.* The sleeping bag should be kept clean and dry. It should be opened wide and ventilated after use to dry out the moisture that accumulates from the body. Whenever possible, it should be sunned or aired in the open. The bag always should be laced in its water-repellent case and carried in the waterproof bag to prevent snow from getting on it. The warmth of the body could melt the snow during the night and cause extreme discomfort. Individuals should avoid breathing into the bag. If the face becomes too cold it should be covered with an item of clothing. Sleeping bags should be drycleaned at least twice a year. As a safety precaution, bags should be thoroughly aired prior to use to prevent possible asphyxiation from entrapped drycleaning solvent fumes.

## 2-13. Manpack Equipment

*a. Rucksack-Nylon, OG 106* (fig. 2-7).

(1) The nylon rucksack consists of the following:

- (a) A lightweight aluminum alloy frame to which all other components are attached.
- (b) A lightweight aluminum alloy cargo support shelf provided as optional equipment for attachment to the frame when the frame is used as a packboard.
- (c) A pouch fabricated from 4-ounce nylon fabric.
- (d) Nylon left and right shoulder straps. The left shoulder strap has a quick-release device designed to facilitate rapid doffing of the rucksack. The right shoulder strap has a rapid adjustment buckle for lengthening the strap which allows the wearer to fire his rifle while in the prone position. The two straps are interchangeable to accommodate left-handed soldiers.
- (e) A nylon webbing waist belt designed to prevent the rucksack from swinging to either side or bouncing during body movements.
- (f) A rifle carrier consisting of a rifle butt pocket, constructed of nylon webbing, with a double hook and a rifle strap.

(2) The nylon rucksack is the normal pack equipment used for operations in northern areas and replaces the rucksack, with frame (Standard C). It should be noted that this item may be issued in lieu of the nylon rucksack. It should also be noted that the plywood packboard may be issued in lieu of the nylon rucksack. The soldier using the rucksack can carry extra clothing and rations in the nylon pouch and can also carry one sleeping bag (in waterproof bag). When the nylon pouch is removed and cargo support shelf attached, the rucksack may be used as a packboard for carrying loads weighing approximately 50 pounds (TC 10-8).

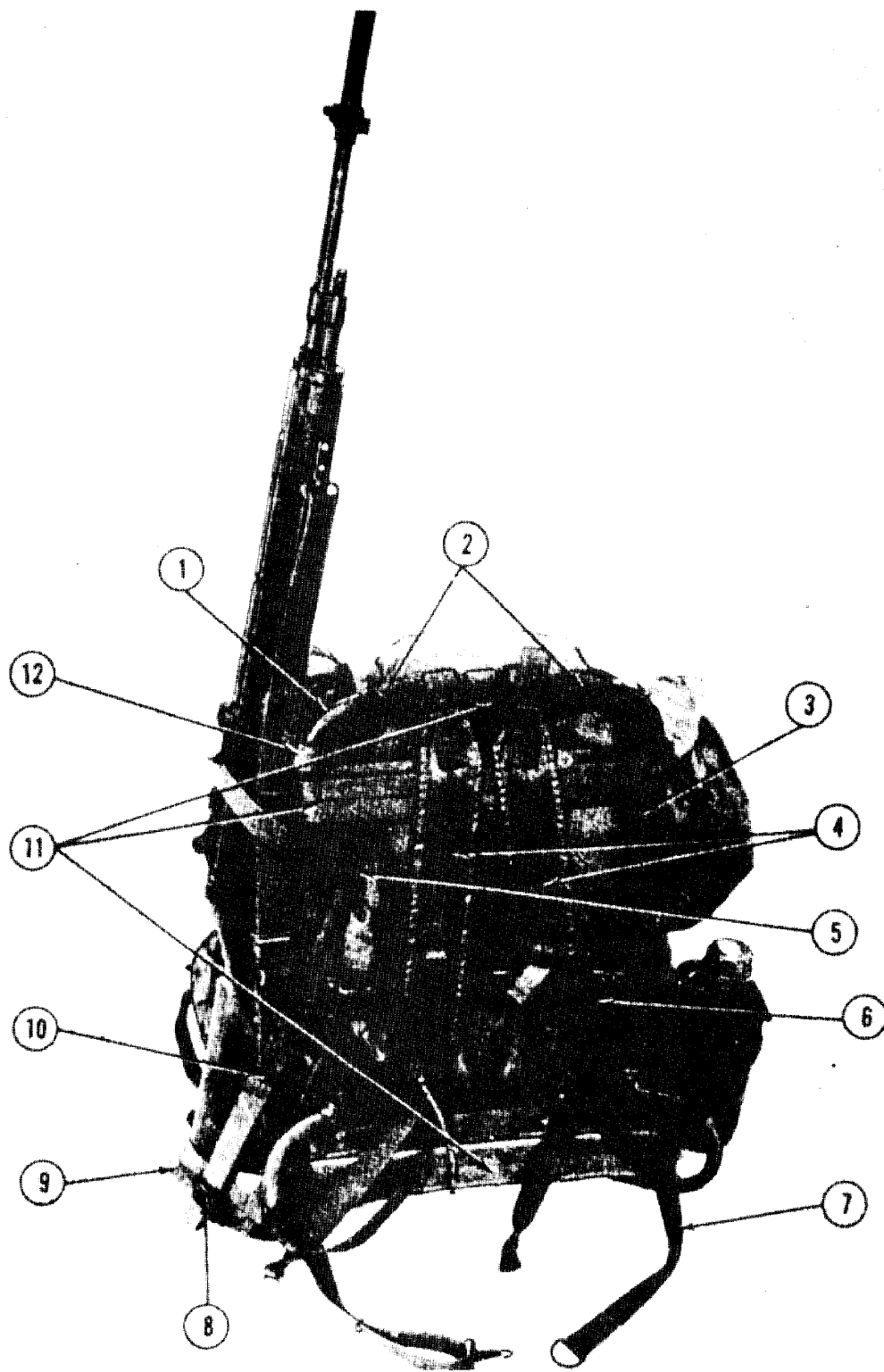

- 1 Top horizontal bar
- 2 Cargo straps
- 3 Frame
- 4 Shoulder straps

- 5 Rifle strap bracket
- 6 Combat pack
- 7 Waist strap
- 8 Rifle strap buckle

- 9 Rifle butt pocket
- 10 Rifle strap
- 11 Back straps
- 12 Rifle strap loop end

Figure 2-7. Rucksack nylon OG 106.

*b. Suspenders and Belt, Individual Equipment.* The suspenders and belt of the M-56 standard load-carrying equipment is worn beneath the nylon rucksack to carry ammunition pouches, first aid or compass case, and the entrenching tool. The suspenders and belt should be adjusted to fit loosely over the cold weather clothing, to allow for proper ventilation. The suspender belt combination is designed so that the belt can be worn unbuckled while on the march, if additional ventilation is required.

## 2-14. Miscellaneous Equipment

*a. Sunglasses.* Sunglasses always should be worn on bright days when the ground is covered with snow. They are designed to protect the eyes against sun glare and blowing snow. If not used, snow blindness may result. They should be used when the sun is shining through fog or clouds. A bright, cloudy day is deceptive and can be as dangerous to the eyes as a day of brilliant sunshine. The sunglasses should be worn to shade the eyes from the rays of the sun that are reflected by the snow. Snow blindness is similar to sunburn, in that a deep burn may be received before discomfort is felt. To prevent snow blindness, sunglasses must be used from the start of exposure. Waiting for the appearance of discomfort is too late. The risk of snow blindness is increased at high mountain altitudes because the clear air allows more of the burning rays of sunlight to penetrate the atmosphere. When not being used, they should be carried in the

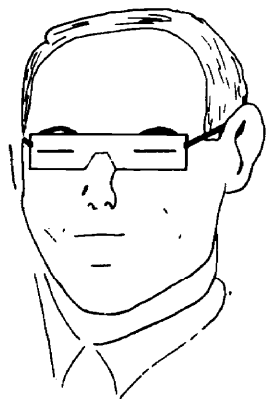
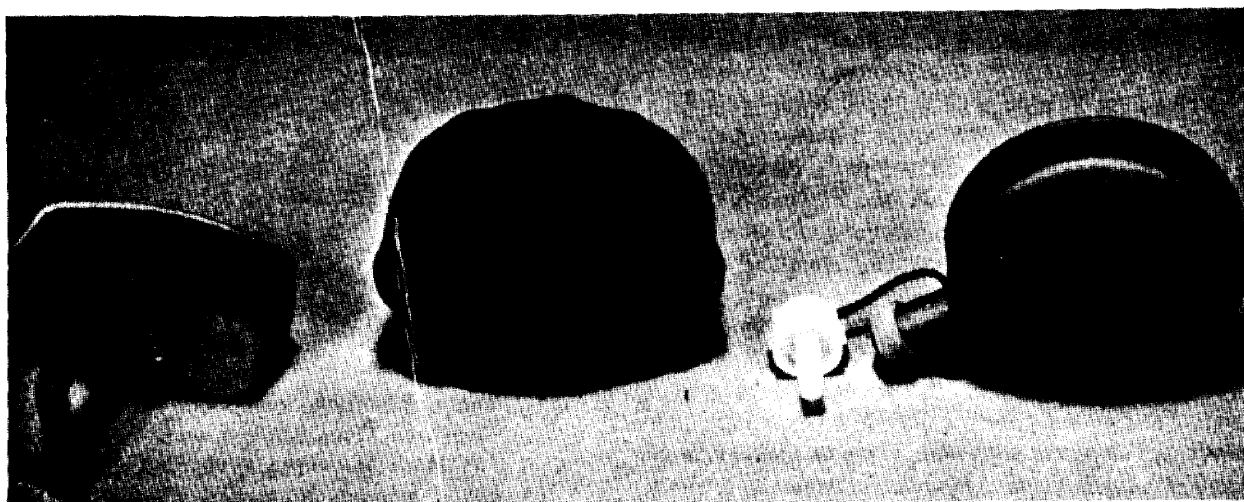

**Figure 2-8. Improvised sunglasses.**

protective case to avoid scratching or breaking the lens. If sunglasses are lost or broken, a substitute can be improvised by cutting thin, 3 cm (1") long slits through a scrap of wood or cardboard approximately 15 cm (6") long and 3 cm (1") wide. The improvised sunglasses (fig. 2-8) can be held on the face with strips of cloth if a cord is not available.

### *b. Canteens.*

- (1) *Canteen, water; cold climatic* (fig. 2-9), This canteen is a vacuum-insulated canteen of one quart capacity with an unpainted dull finish steel exterior. The inner and outer stainless steel vessels are welded together at the top of the neck. A nonmetallic mouthpiece at the neck prevents lips from freezing to the metal neck. A plastic cap seals and protects the mouthpiece. A nesting type metal cup with a capacity of one pint is provided for eating and drinking beverages. The canteen with cup is carried in a canvas cover which fastens to field equipment in a manner similar to the conventional canteens. Care must be taken to insure that the mouthpiece or cap are not lost. A sharp blow to the canteen may result in denting or rupture with consequent loss of insulating capabilities.
- (2) *Conventional metal and plastic canteens.* Conventional canteens are carried in a fabric carrier; however, this will not keep the liquid in the canteen from freezing in extreme cold. When possible, the canteen should be carried in one of the pockets or wrapped in any woolen garment and packed in the rucksack. If available, warm or hot water should be placed in the canteen before starting an operation. During extreme cold the canteen should never be filled over two-thirds full. This will allow room for expansion if ice should form, and will prevent the canteen from rupturing. Insure that the gaskets are in the cap at all times. This is an important precaution and will prevent the liquid from leaking out and dampening the clothing in the ruck-



*Figure 2-9. Canteen, water; cold climatic.*

sack. Conventional thermos bottles will keep liquids hot, or at least unfrozen for approximately 24 hours, depending on temperatures. If canteens or thermos bottles freeze, they should be thawed out carefully to prevent bursting. The top should be opened and the contents allowed to melt slowly.

*c. Pocket Equipment.* There are several small items that should be carried in the pockets so they will be readily available for use. Having these items when they are needed will contribute to the well-being of individuals and help prevent injuries. A good sharp pocketknife is an essential item. It is useful for cutting branches, in shelter construction, in repairing ski bindings, and numerous other tasks. Waterproof matches should be carried and kept in the watertight matchbox and used only in an emergency. They should never be used when ordinary matches and lighters will function. Sunburn preventive cream will protect the skin from bright, direct sunshine, from sunrays reflected by the snow, and from strong winds. The chapstick will prevent lips from chapping or breaking due to cold weather or strong winds. The chapstick should be protected from freezing. The emergency thong has numerous uses, such as lashing packs, replacing broken bootlaces, and repairing ski and snowshoe bindings.

*d. Emergency Kit.* It is recommended that all personnel carry an emergency kit for use in individual survival. With this kit, an individual can survive off the land by trapping and fishing and can procure the minimum amount of food necessary to maintain his strength for a short period of time.

- (1) 1 each emergency thong.
- (2) 1 each sharp pocketknife.
- (3) Single-edge razor blades.
- (4) Waterproof matches.
- (5) Safety pins.
- (6) Fishing line.
- (7) Fire starters.
- (8) Salt tablets.
- (9) High protein candy bars.
- (10) Bouillon cubes.

## **2-15. Steel Helmet**

The steel helmet may be worn during warm periods in cold areas in the same manner as in moderate climates. During cold periods it is normally worn over the Cap, Insulating Helmet Liner-Helmet. The helmet may also be worn under the winter hood.

## **2-16. Protective Mask**

*a.* The Mask, Protective, Field, M17 is the Army standard protective mask. Information on this mask can be found in TM 3-4240-202-15. TM 3-4240-202-15, describes the winterization measures for the M17 Mask. In addition to the wearing of tinted antiglare

outserts for the plastic lenses, this kit provides for winterization inlet and nosecup valves together with an ice prefilter. This allows the standard mask to be worn at temperatures down to  $-50^{\circ}$  F. with the M6A2 hood.

*b.* The protective mask may be worn in moderately cold weather in the same manner as in moderate climates. When the mask is used in extreme cold, the rubber facepiece should be warm enough to make it pliable when it is adjusted to the wearer's face. One method of keeping the mask warm is to carry it inside the outer garments and next to the body. It is also recommended that the mask be kept inside the sleeping bag during the night. On removing the mask, any moisture on the face should be wiped off immediately to prevent frostbite. After drying the face, the facepiece of the mask should be thoroughly dried to prevent freezing of moisture inside the mask. The rubber cover of the outlet valve should also be raised and the valve, surrounding area, and the inside of the cover wiped dry to prevent the outlet valve from icing.

*c.* If it becomes necessary to wear the mask for protection against chemical agents during extreme cold weather, troops must be advised

that the facepiece of the protective mask will not protect the face from the cold and that, in fact, the opposite is true. The danger of frostbite increases when the mask is worn.

*d.* The three automatic atropine injections of 2 mg each, carried as accessories during moderate temperature conditions, are carried in a pocket of the protective mask carrier. In cold weather ( $40^{\circ}$  F. and below), the injectors will be removed from the carrier and placed in the inside of the right-hand pocket of the OG shirt, where body temperature will prevent freezing.

## **2-17. Body Armor**

Standard issue body armor may be worn with either of the cold weather uniforms. When worn with the cold-wet uniform it is worn over the OG shirt and under the coat and liner. When worn with the cold-dry uniform it is worn over the OG shirt and under the coat and liner or the parka and liner. Although the body armor is worn primarily for protection against shell and mortar fragments, it may provide additional environmental protection for the user; however, because of the weight, armor should be worn only for its primary purpose and not for additional warmth.



## CHAPTER 3

### SMALL UNIT LIVING

---

#### Section 1. GENERAL

##### 3-1. Characteristics of Operations in Cold Weather

Unlimited space and a sparse, widely scattered population are dominant features of most of the colder regions of the world. Such conditions permit unrestricted maneuver for troops properly trained and equipped for cold weather operations. Warfare under such circumstances is characterized by, widely dispersed forces operating at great distances from other units or their parent organization. Units must be highly mobile and have the ability to sustain themselves while carrying out independent operations over extended periods of time.

##### 3-2. Composition of Units

*a.* Small units (squad, gun crew, tank crew, wire team, etc.) form the basic working group

for cold weather operations. Under normal operating conditions they will work together, cook and eat together, and share the same tent or other shelter. These small units should be formed at the beginning of training and, if possible, kept intact. The standard to be achieved is a unit which can make or break camp quickly, efficiently, and silently under all conditions; one in which each man knows the tasks to be completed and does them without having to be told.

*b.* Small units operating in cold weather must be thoroughly familiar with the special equipment required and the techniques involved in living away from their parent organization for extended periods of time. Equipment, and the techniques of using it, are discussed in this chapter.

#### Section II. TENTAGE AND OTHER EQUIPMENT

##### 3-3. General

A considerable quantity of various types of special equipment is required to maintain small units in cold weather. Permanent shelters are usually scarce in northern areas of operations and heated shelters are required. Special tools are necessary for establishing bivouacs, breaking trails, and constructing temporary winter roads and battle positions.

##### 3-4. Need for Shelter

*a.* In order to conduct successful military operations in cold weather and maintain a high level of combat efficiency and morale, heated shelter must be provided for all troops. An individual's ability to continue to work, live, move, and fight under extreme climatic condi-

tions depends upon adequate shelter. Tents and stoves, therefore, become a vital part of cold weather equipment.

*b.* In cold weather, tents should be placed as close as practicable to the scene of activity, whether the activity be combat or administrative. By so placing the tents, rotation of men for warmup is possible and maximum continuity of effort can be maintained.

*c.* Tents vary in size and shape, depending on their purpose. Small units such as a rifle squad, artillery section, or similar type unit are normally equipped with one 10-man arctic tent. During combat, fewer tents will be needed, as part of the personnel are always on guard detail, occupying positions, or performing similar missions. It may become necessary

for the unit, temporarily, to use only one-half or one-fourth of its tentage; i.e., one 10-man tent per platoon, with the men sleeping on a rotation basis. Reduced numbers of tents and stoves will decrease the requirement for logistical support, such as fuel and transportation.

*d.* Elements smaller than the rifle squad (tank and SP artillery crews), which require less shelter space, are normally equipped with the 5-man tent (FM 31-71).

*e.* Normally, small reconnaissance patrols are not equipped with tents, as tents tend to hamper the mobility and speed of the patrol. Strong combat patrols and long-range reconnaissance patrols may be equipped with tents and stoves if sufficient transportation is available to move the extra weight. When speed is of the essence, patrols will improvise shelters built from local materials at hand. For semi-permanent base camps, portable type frame shelters may be erected for increased comfort of the troops.

### 3-5 Description of Tentage

*a. General.* Tentage issued for use in cold weather is designed on the same layer principle as cold weather clothing. It is, however, made of only two layers. The outside layer is made of strong, tightly woven fabric. It is water repellent and impervious to rain and snow. The inner layer is much lighter in weight than the outer layer. The liner is fastened by toggles to the tent and provides an

airspace the same as in clothing. It is designed to provide insulation against the cold. It also prevents frost from forming on the inside of the tent. Heat is provided by stoves (normally the M-1950 Yukon stove).

*b. Tent, Artic, 10-Man* (fig. 3-1). The six-sided, pyramidal tent, supported by a telescopic pole, normally accommodates ten men and their individual clothing and equipment. It will accommodate additional men by leaving individual packs and equipment outside the tent overnight and by lowering the telescopic pole to spread the sidewalls to cover more ground surface. It may also function as a command post, aid station, or as a small storage tent. The tent has two doors; this permits tents to be joined together, with access from one to the other, when additional space is required. A snow cloth is attached to the bottom of the sidewalls for sealing the tent to the ground. This is accomplished by piling and packing snow on the snow cloth. If the tent is used in terrain where there is no snow, sod or other materials may be used to seal the bottom of the tent. Flexible plastic screen doors are provided and may be attached front and rear of the tent for protection against insects. The tent is ventilated by four built-in ventilators on opposite sides and near the peak of the tent. Four lines are provided for drying clothing and equipment. Total weight, to include the pins and tent pole, is 76 pounds. The tent is heated by an M1950 Yukon stove.

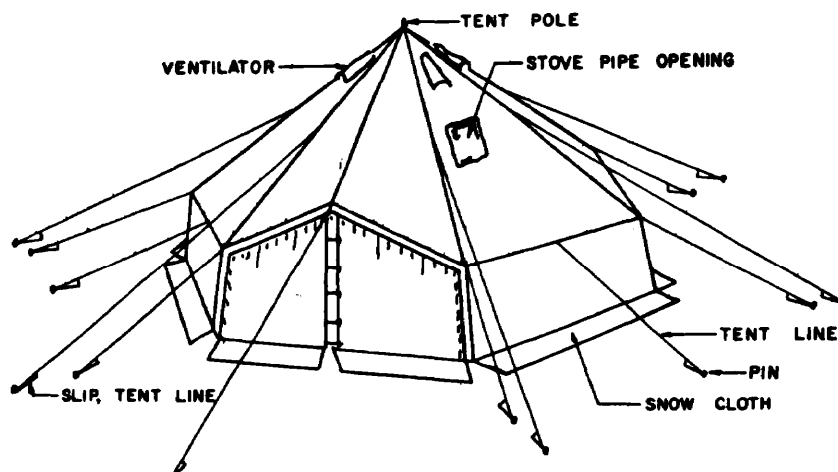
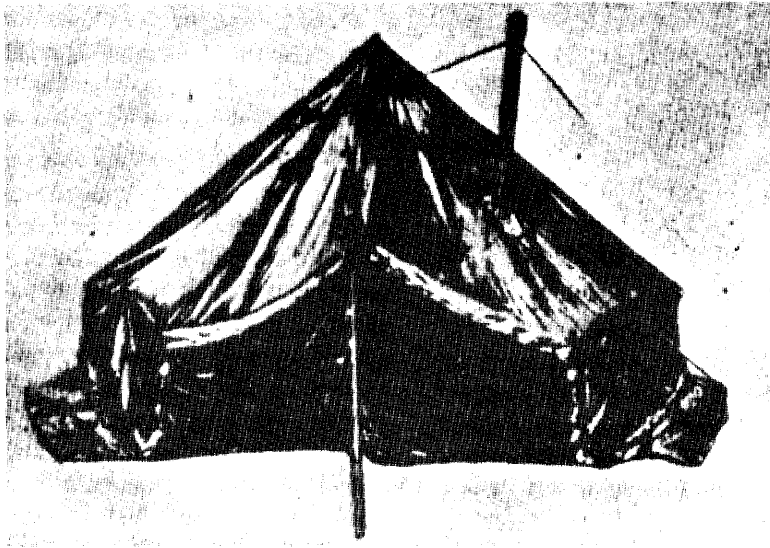

Figure 3-1. Tent, arctic, 10-man.

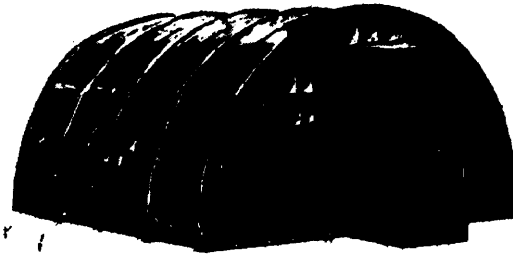

*Figure 3-2. Tent, hexagonal, lightweight.*

*c. Tent, Hexagonal, Lightweight* (fig. 3-2). This tent is also six-sided, pyramidal, and supported by a telescopic tent pole. It is designed to accommodate four to five men and their individual clothing and equipment. Under emergency conditions one tent may provide shelter for a rifle squad or other similar unit when rucksacks are placed outside the tent. The tent has one door; ventilation is provided by two built-in ventilators located on opposite sides and near the peak of the tent. Three lines are provided for drying clothing and equipment. Total weight of the tent, including the pins and center poles, is 48 pounds. The tent is heated by an M1950 Yukon stove.

*d. Tent, Frame-Type, Sectional* (Jamesway). This 16 by 16 frame-type tent (fig. 3-3) is a lightweight unit that offers protection for one squad. It has wooden floor units, a frame, a rounded roof, and comfortable head clearances along the centerline of the shelter. The roof and ends of the tent are fabricated from insulated, coated, fabric blankets. The structure is fastened to the ground with tent pins or snow with improvised devices. An optional vestibule may be erected at one or both ends. Additional floor sections may be added to each other lengthwise for creating larger buildings. Extra end sections may be installed along any rib as interior partitions. It weighs approximately 2,250 pounds and is

heated by one tent stove M1941. The heavier weight of this tent restricts its normal use to permanent or semipermanent base camps. It could be used for forward elements under stabilized conditions.



*Figure 3-3. Tent, frame type, sectional.*

*e. Tent, General purpose, Small* (fig. 3-4). This tent is a six-sided pyramidal tent fabricated of cotton duck cloth. A liner is available to insulate the tent during cold weather. The tent is equipped with slide fastener doors, screened doors, screened ventilators, and stove-pipe opening. It has a front and rear entrance, each with a lacing flap arrangement to permit attachment of the vestibule or erection of tents in tandem. The tent is supported by eight ad-



*Figure 3-4. Tent, general purpose, small.*

justable aluminum poles around the eave line and a standard telescopic magnesium pole at the peak. The tent is used for command posts, fire direction centers, battalion aid stations, or for any general purpose use. Although similar in appearance to the Tent, Arctic, 10-man, the tent has an eave height of 152.40 cm (60") compared to 91.44 cm (36") for the 10-man tent. The complete tent, with liner, pins and poles weighs 186 pounds.

### **3-6. Pitching and Striking Cold Weather Tents**

*a.* With proper training, small troop units will be able to pitch tents in 15 to 30 minutes. Additional time will be required to complete the camouflage of the tent. Pitching and striking of the tents are performed in a routine drill manner in accordance with instructions contained in FM 20-15.

*b.* The following must be considered when pitching or striking the tents in snow or on frozen ground:

- (1) Whenever possible snow should be cleared to the ground surface to ob-

tain a lower silhouette and gain advantage of ground temperatures which are generally warmer than air temperatures. Coniferous boughs or similar material should then be placed on the ground for insulation and comfort. When it is impractical to remove snow to ground level, an adequate tent site may be made by packing the snow with skis or snowshoes until a firm base is provided for pitching. In this case, the tent pole is placed on a log or other suitable support to keep the pole from sinking into the snow. Support is also needed for the stove under similar conditions.

- (2) In open terrain, with a strong wind, it may become necessary to build a snow wall on the windward side of the tent to protect it from the wind. The snow wall also makes it easier to heat the tent and less likely that the tent will blow down. The tent is pitched with the entrance 45° down-

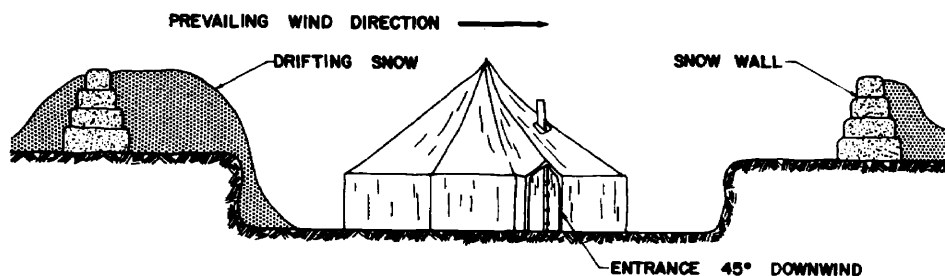
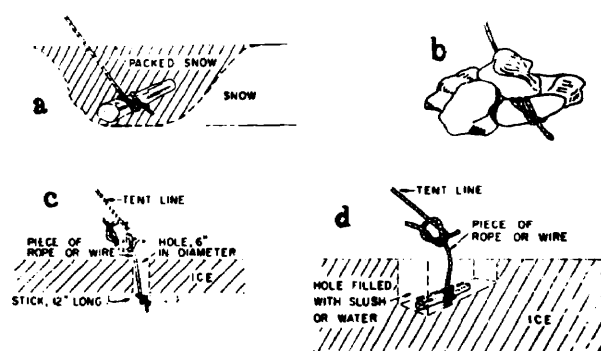

Figure 3-5. A tent dug in with snow wall windbreak.

wind (fig. 3-5). Variable winds may require construction of a windbreak at the entrance. High winds in certain cold areas necessitate anchoring the tent securely. When the tent is set up, the snow cloth should be flat on the ground outside the tent. Stones, logs, or other heavy objects should be placed on the snow cloth in addition to the snow to assist in anchoring the tent. If this is not done, the tent will be drafty and very difficult to keep warm.

- (3) Tents may be pitched rapidly and anchored securely by attaching the tent lines to trees, branches, logs or stumps whenever possible. If these natural anchors are not available, suitable holes are dug into the snow for the purpose of using "deadmen." This is accomplished by digging a hole into the snow large enough to insert a pole or log approximately one meter (3') long with the tent line attached. The hole is then filled with snow, well packed, and in a short period of time the packed snow freezes and the tent will be securely anchored (a, fig. 3-6). Driving metal pins into frozen or rocky ground should be avoided when excessive force is required. On rocky ground, tent lines may be tied around heavy rocks and then weighted down with other stones (b, fig. 3-6).
- (4) Tents are also occasionally pitched on ice. When the thickness of the ice is not excessive, a small hole is chopped

through the ice. A short stick or pole with a piece of rope or wire tied in the middle of it is pushed through and then turned across the hole underneath the ice (c, fig. 3-6). If the ice is very thick a hole 30 to 60 cm (1' to 2') deep is cut in it, the "deadman" inserted and the hole filled with slush or water (d, fig. 3-6). When the slush or water is frozen, an excellent anchor point is provided. When the "deadman" is placed underneath or into the ice, a piece of rope or wire should be fastened to the rope or wire after the "deadman" is secure. This may prevent the tent line from being accidentally cut or damaged when being removed from the ice.



- a. "Deadman" buried in packed snow
- b. Tent line buried under stones
- c. Lowering anchor through ice
- d. "Deadman" placed in thick ice

Figure 3-6. Improvised methods of anchoring tents.

- (5) When striking the tent in winter it normally will be covered with snow and ice which must be removed or the tent may double in weight. Snow and ice can be removed easily by shaking the tent or by beating it with a mitten or a stick. If the snow cloth is frozen to the ground, the snow and ice around it must be carefully removed by chopping or shoveling in order to avoid damage to the material. One method of accomplishing this is to ease the shovel between the cloth and the ground and gently pry the cloth away from the ice.

c. The vestibule attached to the basic frame-type tent (Jamesway) helps reduce heat loss when the door is frequently used. The main door of the tent opens inward, and thus cannot be blocked by drifting snow if the occupants are equipped with a shovel or improvised digging equipment. However, the vestibule door opens outward and can be blocked by drifting snow during a violent storm. A safe practice is to install the vestibule only at one end facing the prevailing wind and to use no vestibule on the more leeward end where drift will probably accumulate. Rapid exit in case of fire or other emergency is then assured. Where severe winds are expected the tent should be sited crosswise to the anticipated wind direction since the curved roof tolerates the wind load better than the flat ends, and buffeting is reduced. A vestibule should not be used on a tent intended for aid station use, since a standard litter cannot negotiate the right angle turn required in the short vestibule.

### 3-7. Ventilation

a. Tents are pitched to protect occupants from the elements and to provide necessary warmth and comfort. When the bottom of the arctic tent is properly sealed and the doors are zipped shut, moisture will form on the inside of the tent and accumulate on clothing and equipment, thereby causing dampness and hoarfrost. In addition, carbon monoxide, carbon dioxide, and fumes from the stoves may soon accumulate to a dangerous degree. To offset these factors, the built-in ventilators near the peak of the tent must be kept open.

b. To improve ventilation, a draft channel

may be constructed by forming a pipe with green logs (fig. 3-7). The channel is buried in the floor and has an opening under the stove. The draft of the stove draws fresh air from outside the tent into the channel.

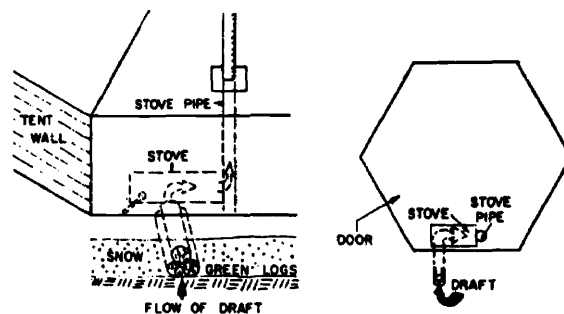
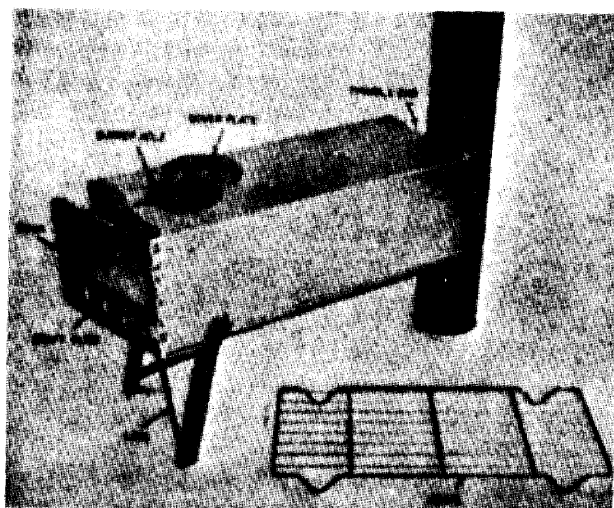

Figure 3-7. Draft channel for stove.

### 3-8. Heating Tents with Stove, Yukon, M1950, 60,000 BTU

a. *General.* The Yukon stove (1, fig. 3-8) is used to heat the 10-man, 5-man, and GP Small tents. In addition to providing heat, the top surface of the stove and, to a small degree, the area beneath the stove, may be used to cook rations or heat water. The Yukon stove utilizes standard leaded motor fuel as its normal fuel, but may also be operated with white gasoline, kerosene, light fuel oil, naphtha, or JP-4 fuel, without modification (2, fig. 3-8). During low temperatures the stove will burn five gallons of gasoline every 8 to 12 hours. When solid fuels (wood, coal, etc.) are used, the stove must be modified by removing the oil burner from the top of the stove, closing the opening where the burner was installed, and turning over the wire grate so that there is space below the grate for draft and ashes. A piece of plywood slightly larger than the base of the stove should be carried as part of the tent group equipment. The plywood is covered with aluminum foil and is used to provide a firm base for the stove and to prevent it from melting down into the snow.

b. *Operating Procedures.* The compact, lightly constructed, 33-pound Yukon stove permits all accessory parts to be packed within the stove body for convenient portability in a sled or on a packboard. A draft diverter is issued as a component part of the stove. It shields the top of the stovepipe from the wind and pre-



1 Body assembly

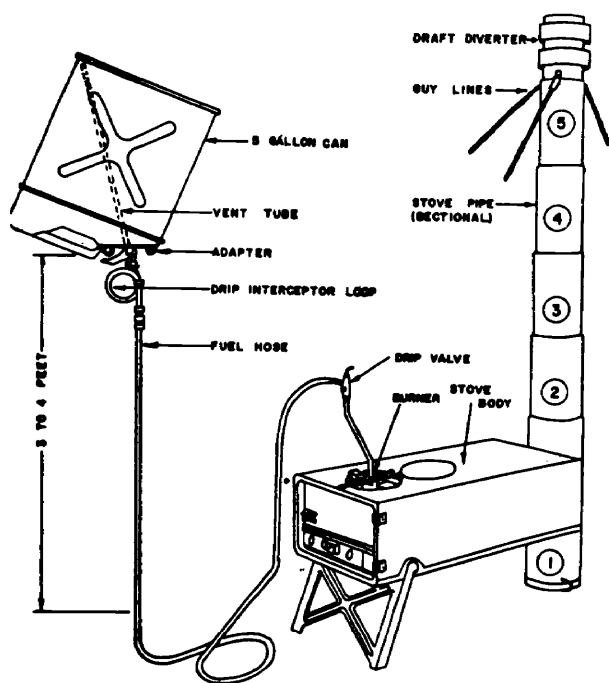

2 Installation setup

Figure 3-8. Stove, Yukon, M1950.

vents a backdraft from forcing smoke or gases into the stove and tent. Three, 4.5 meter (15') guylines tied to the draft diverter serve to anchor the stovepipe in strong winds. These guylines must be anchored to the tent or tent ropes, not to the ground or nearby trees. A simple method of erecting a tripod for the fuel can is to obtain three poles about 2 meters

(6') in length; the poles are tied about two-thirds of the way up using wire from ration cases, string, rope, or emergency thong, and then spread out to form a tripod. The fuel can should be at least one meter (3') higher than the stove. The lowest part of the inverted gasoline can should be a minimum of 30 cm (1') above the level of the needle valve of the Yukon stove. It should not be higher than 1.50 meters (5') if the valve is to operate smoothly. If the fuel can is wobbly or if there is some wind the can must be tied to the tripod for additional protection. Make certain that the can is tilted so that air is trapped in the uppermost corner. The stove is assembled, operated, and maintained in accordance with TM 10-735.

c. *Precautions.* The following precautions must be observed when the Yukon stove is used:

- (1) *Burning liquid fuels.*
  - (a) All stovepipe connections must be tight and necessary tent shields adjusted properly.
  - (b) Stove must be level to insure that the burner assembly will spread an even flame within the stove.
  - (c) The fuel hose must be protected so it cannot be pulled loose accidentally. If necessary, a small trench may be dug and the hose imbedded where it crosses the tent floor.
  - (d) The fuel line must not be allowed to touch the hot stove.
  - (e) When adjusting the fuel flow, the drip valve lever must be turned carefully to prevent damage to the threads.
  - (f) Rate of fuel flow must be checked at regular intervals. The rate of flow will change as fuel supply level drops and will require some adjustment. The stove should never be left unattended. Maintaining a hotter fire than necessary may cause the stove body to become overheated and warp.
  - (9) If the flame is accidentally extinguished, or if the fuel can is being changed, the drip valve must be closed. When the stove has cooled, any excess fuel inside the stove

must be wiped up and 2 or 3 minutes allowed for gas fumes to escape before relighting the burner. *The burner must be cool before relighting stove. If stove lit before burner is cool, the fuel will vaporize prior to ignition, causing an explosion.*

- (h) All fuel supplies must be kept outside the tent. Spare cans of gasoline or other fuel should never be stored inside the tent. Fuels used in combat areas in the north are normally low temperature fuels which will flow freely.
- (2) *Burning solid fuels.*
  - (a) Fuel should be fed a small amount at a time until the bed of coals is burning brightly.
  - (b) Stove should not be allowed to overheat.
  - (c) Oil or gasoline should not be poured on the fire.
  - (d) Ashes should not be allowed to accumulate below the grate.
  - (e) Clinkers should be removed to prevent grate from becoming blocked.

### 3-9. Heating of Semipermanent Tents With Tent Stove, M1941

Stoves of this type normally are used to provide heat for the semipermanent, frame-type, sectional tent. The stove may be operated with wood or coal or with various types of oil and gasoline. This stove has the same general characteristics and safety features outlined for the Yukon stove in paragraph 3-8.

### 3-10. Fuel Economy

The minimum daily fuel consumption per Yukon stove approximates five gallons of gasoline per 8 to 12 hours of operation. The M1941

Tent Stove will burn five gallons in 3 to 4 hours. Prior planning must be accomplished to reduce the number of stoves required, especially for operations that are some distance from a road net. Wood should be used as fuel whenever possible. Cooking and heating are combined and, when extra heat is required to dry clothes, all individuals should dry clothes at the same time, when possible.

### 3-11. Lighting Tents

Candles will provide light in forward areas. In rear areas, gasoline lanterns or lighting equipment sets may be used.

### 3-12. Tools

a. Handtools are needed by small units for several purposes such as erection and striking the tent, building ski and weapon racks, building field latrines, chopping firewood, etc. Tools are also needed for trailbreaking, preparation of positions, and similar tasks. Because entrenching tools are lightly constructed, they are of little value for work in heavy timber or frozen ground. The following tools are needed by squad sized units to accomplish routine tasks in cold regions, regardless of the season of the year:

- (1) One axe, chopping.
- (2) One saw (Buck or Swede).
- (3) Two machetes with sheaths.
- (4) One shovel, general purpose.

b. Tools must be kept sharp, clean, oiled and in good condition. Care must be taken to preclude small tools and items of equipment from being left in the snow or thrown aside where they may become buried and lost in the snow. Particular care must be exercised while wearing gloves because ice or frost may form on the gloves and cause the tools to slip from the users hands, resulting in injury to nearby personnel and/or loss of equipment.

## Section III. IMPROVISED SHELTERS

### 3-13. Requirement for Improvised Shelters

a. There are many occasions when tents or other regular shelters are not available. In summer, if the weather is mild, individuals may need protection only from insects. In winter, however, individuals cannot stay in the

open for long periods unless they are moving. The requirement for improvised shelters may arise for several reasons, e.g., vehicles carrying tents may be unable to reach the troops due to difficult terrain or enemy action. In case of emergency, each individual must know how to protect himself from the effects of the weather.



b. If suitable natural shelters such as caves or rock shelves are available, they should be used. If natural shelters are not available, a temporary improvised shelter must be established.

c. The type of improvised shelter to be built depends on the equipment and materials available. By the proper use of materials available, some sort of shelter can be built during any season of the year. In open terrain a shelter can be built using ponchos, canvas, snowblocks, or other materials. Snow caves, snow trenches, or snow holes may be constructed in the winter if the snow is both deep and well-compacted. In the woods, a lean-to is normally preferable to other types of shelter. In northern areas, nature provides the individual with the means to prepare a shelter. His comfort, however, greatly depends on his initiative and skill at improvising.

d. A shelter should always provide adequate protection from the elements, retain heat, have suitable ventilation, and provide drying facilities.

### 3-14. Poncho Shelters

A poncho is a part of an individual's uniform. It is a multipurpose piece of equipment that may be used as a rain garment, a waterproof bedcover, a ground sheet, or a shelter. The simplest type of shelter can be made by merely pulling the poncho over the sleeping bag. For additional comfort, various types of

shelters and lean-tos may be made by attaching ponchos to trees, tree branches or poles.

a. *One-Man Shelter.* A one-man shelter (fig. 3-9) may be made from one poncho. The poncho is spread, hood side up, on the ground, and the hood opening is tightly closed by adjusting and tying the hood drawstrings. The poncho is raised at the middle of its short dimension to form a ridge, and then staked out at the corners and sides. Side stakes should not be driven through the grommets at the corners or sides, because this may tear the poncho. A short piece of rope is tied to the grommets and, in turn, to the stakes. Snow, sod, or boughs are used to seal two sides and one end of the shelter to provide additional protection from the wind and to retain heat inside the shelter.

b. *Two-Man Shelter.* To construct a two-man shelter (fig. 3-9), ponchos are spread on the ground, hood side up, with the long sides together so that the snap fastener studs of one poncho may be fastened to the snap fastener sockets of the other poncho. Hood openings must be tightly closed by adjusting and tying the hood drawstrings. Ponchos are raised where they are joined to form a ridge; ropes are then attached to grommets at the ends of the ridge and run over forked sticks. The shelter tent is then staked out at the corners and sides, as described in *a* above. A third poncho may be snapped into the other ponchos to form a ground cloth.

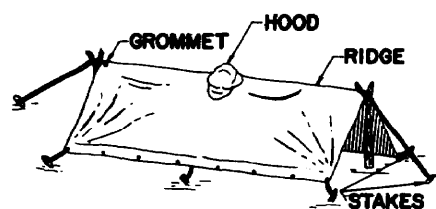

1. ONE-MAN SHELTER

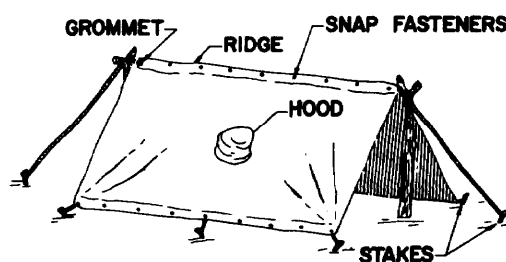

2. TWO-MAN SHELTER

Figure 3-9. Poncho shelters.

### 3-15. Lean-To

a. *Materials.* The lean-to shelter, used in forested areas, is constructed of trees and tree limbs. String or wire helps in the building, but is not necessary. A poncho, a piece of canvas, tarpaulin, or a parachute, in addition to the boughs, may be used for covering.

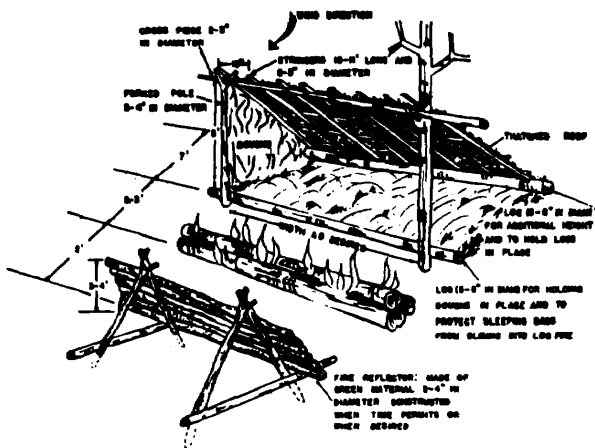

Figure 3-10. Single lean-to.

b. *Size.* The lean-to is made to accommodate a variable number of individuals. It may be built for one man only, teams, gun crews, patrols, or similar small groups. From a practical point of view, a rifle squad is the largest element to be sheltered in one double lean-to.

c. *Types.* Depending on the number of individuals to be sheltered, two types of lean-tos, single and double, are used.

d. *Construction.*

- (1) *Single lean-to* (fig. 3-10). To save time and energy, two trees of appropriate distance apart, and sturdy enough to support the crosspiece approximately 1.50 meters (5') off the ground, are selected when operating in forested areas. It may be necessary to cut two forked poles of desired height, or construct two A-frames to hold the crosspieces, or use a combination of these supports when bivouacking in sparse wooded or semi-open areas. A large log is then placed to the rear of the lean-to for added height. Other methods that may be used are packing the snow down or

using snowblocks instead of a heavy log. Stringers approximately 3 meters (10') long and 5 to 8 centimeters (2" to 3") in diameter are then placed, approximately 46 cm (18") apart, from the crosspiece over the top of the log in the rear of the shelter. Material such as cardboard, canvas or ponchos may be placed over the framework to preclude falling or melting snow, warmed by the fire, from dropping through. One or both sides of the lean-to and the roof are then thatched.

- (2) *Double lean-to* (fig. 3-11). Two single lean-tos are built facing each other and approximately 1.50 to 2 meters (5' to 6') apart. The space between single lean-tos must be sufficient to permit the occupants to move freely around the log fire placed along the centerline of this space and to allow the smoke to get out through the opening instead of gathering under the roofing. If desired, one end of the middle space may be covered by a wall made of boughs or other materials for additional protection from the draft and wind.

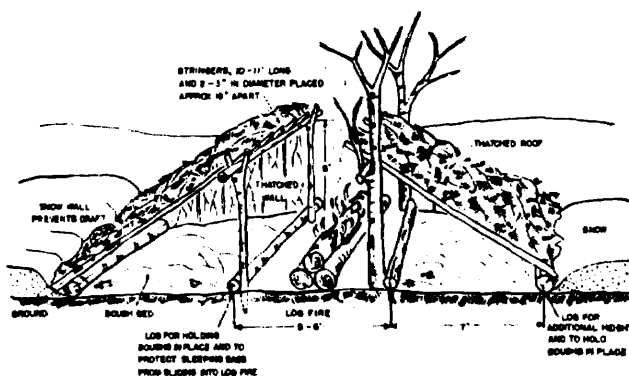

Figure 3-11. Double lean-to.

- e. *Heating.* In heating a lean-to, any kind of oven fire may be used. The best type for large size lean-tos, however, is the log fire, so the heat will be evenly distributed over the entire length of the lean-to, see paragraph 3-21 d. In employing open fires for heating, precautions must be taken to prevent the fire from burning

too hot and burning down the shelter or setting the roof on the with sparks.

### 3-16. Tree Shelter

a. *Tree-Pit Shelter.* In wooded areas, the deep snow and tree-pit shelter (fig. 3-12) furnishes temporary protection. To construct a tree-pit shelter a large tree is selected with thick lower branches and surrounded with deep snow. The snow is shaken from the lower branches and the natural pit is enlarged around the trunk of the tree. The walls and floor are then lined with branches and the roof thickened. Canvas or other material on hand may be used for the roof.

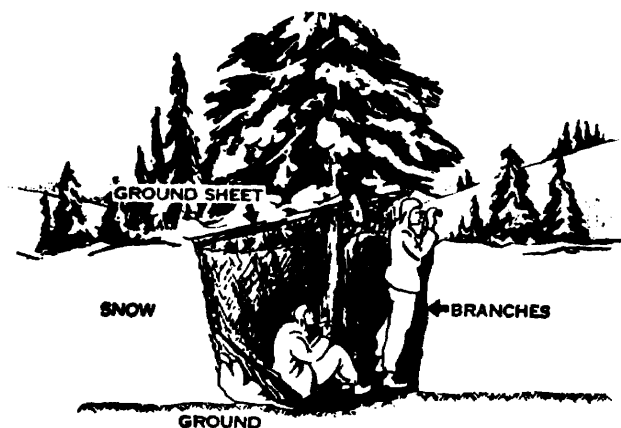

Figure 3-12. Tree-pit shelter.

b. *Fallen Tree Shelter.* An emergency shelter for one man can be constructed by cutting down a coniferous tree at a point about one meter (3') from the ground. The underside is trimmed and the cut material placed on the ground to provide insulation. This shelter will provide some protection from the elements for a man in his sleeping bag. Another way to build this shelter is to tie a pole to a tree and drape a poncho or similar material over the pole.

### 3-17. Wigwam

A conventional wigwam or tepee can be built in wooded areas by typing a number of poles near the top and spreading them at the bottom to form a large circle. This framework is then covered with available tree boughs, canvas, cardboard, or other suitable material.

### 3-18. Snow Wall

In open terrain with snow and ice, a snow wall (fig. 3-13) may be constructed for protection from strong winds. Blocks of compact snow or ice are used to form a windbreak.

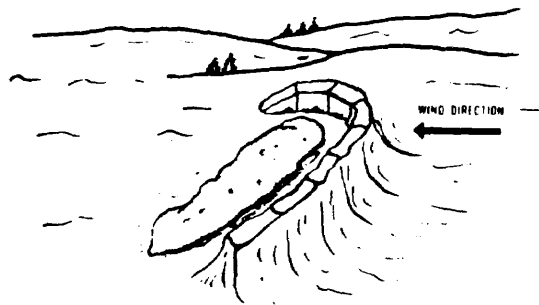
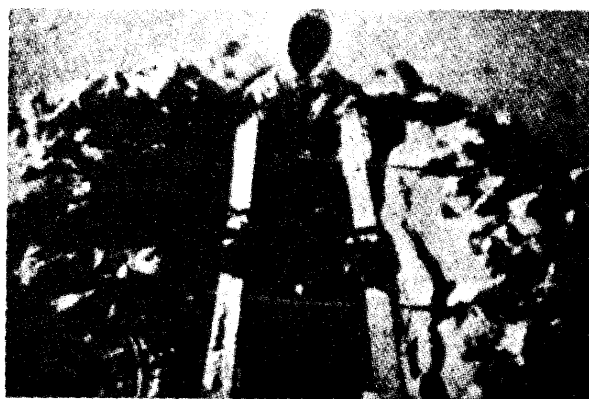

Figure 3-13. Sleeping behind snow wall.

### 3-19. Snow Hole

A snow hole (fig. 3-14) provides shelter quickly. It is constructed by burrowing into a



1 Snow hole partially constructed.



2 Snow hole completed.

Figure 3-14. Snow hole.

snowdrift or by digging a trench in the snow and making a roof of ponchos and ice or snow-blocks supported by skis, ski poles or snowshoes. A sled provides excellent insulation for the sleeping bag. Boughs, if available, can be used for covering the roof and for the bed.

### 3-20. Snow Cave

*a. Location.* A snow cave (figs. 3-15 and 3-16) can be used as an improvised shelter in the open areas where deep and compacted snow

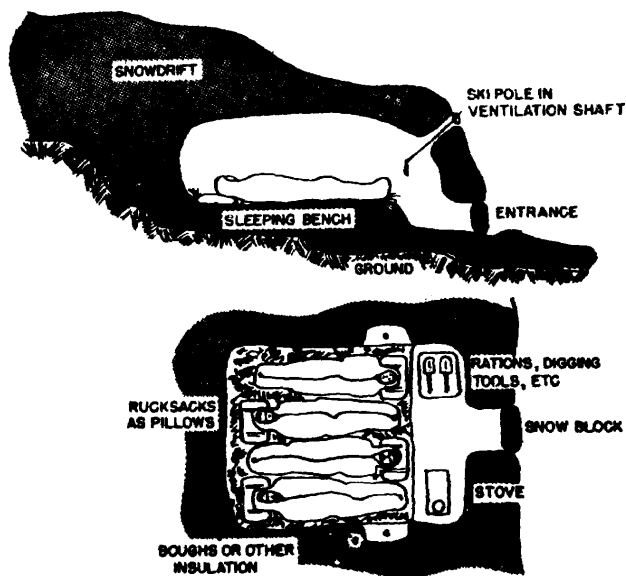
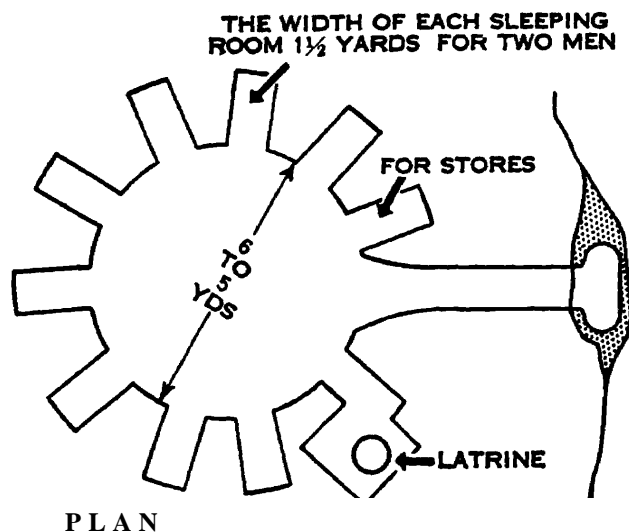

Figure 3-15. Snow cave for four men.



PLAN

Figure 3-16. Snow cave for sixteen men.

is available. Normally, a suitable site is located on the lee side of a steep ridge or riverbank where drifted snow accumulates in unusual depths.

*b. Basic Construction Principles.* Basic principles for construction of all snow caves are as follows:

- (1) The tunnel entrance must give access to the lowest level of the chamber, which is the bottom of the pit where cooking is done and equipment is stored.
- (2) The snow cave must be high enough to provide comfortable sitting space.
- (3) The sleeping areas must be on a higher level than the highest point of the tunnel entrance so that the rising warm air will permit the men to sleep more comfortably.
- (4) The roof must be arched both for strength and so that drops of water forming on the inside will not fall on the floor, but will follow along the curved sides, glazing over the walls when frozen.
- (5) The roof must be at least 30 cm (1') thick.

*c. Size.* The size of the snow cave depends upon the number of men expected to occupy it. A large cave is usually warmer and more practical to construct and maintain than several small caves. In good snow conditions a 16- to 20-man cave is the most practical.

*d. Shape.* The shape of the snow cave can be varied to suit conditions. When the main cave is built, short side tunnels are dug to make one- or two-man sleeping rooms, storage space, latrine and kitchen space.

*e. Construction.* The following steps should be observed in construction:

- (1) A deep snowdrift at least 243 cm (8') deep is located. Newly fallen, powdery or loose snow should be avoided.
- (2) The depth of a snowdrift may be tested with a sharpened sapling approximately 365 cm (12') in length, or in the absence of trees the shorter ski pole or avalanche probe (The availability of an avalanche probe is discussed in FM 31-72.)

- (3) The entrance is chosen carefully so the wind will not blow into the cave or the entrance become blocked by drifting snow.
- (4) A small tunnel is burrowed directly into the side of the drift for one meter (3'). A chamber is excavated from this tunnel.
- (5) Excavation is done to the right and left so that the length of the chamber is at right angles to the tunnel entrance.
- (6) Due to the fact that the individuals digging will become wet, they should wear the minimum amount of clothing possible to insure that they have a change of dry clothing upon completion of the task.

*f. Heating and Safety Measures.* The cave can be heated with the one-burner gasoline stove or with candles. The fires should be extinguished when individuals are sleeping, thus reducing the danger of fire and asphyxiation. If the weather is severe and it becomes necessary to keep a fire going while the individuals are asleep, an alert fire guard must be posted in each cave. The ventilation holes must be inspected every 2 or 3 hours to insure that they have not become clogged by snow or by icing.

*g. Insulation.* To insure that the cave is warm, the entrance should be blocked with a rucksack, piece of canvas, or snowblock when not in use. All available material, such as ponchos, cardboard, brush, boughs, etc., should be used for ground insulation.

*h. Other Precautions.* Walking on the roof may cause it to collapse. At least two ventilators, one in the door and one in the roof, are used. A ski pole can be stuck through the roof ventilator to clear it from the inside. Extra care must be exercised to keep air in the cave fresh when heating or cooking. The entrance should be marked by placing a pair of skis or other equipment upright on each side of the entry way.

### 3-21. Campfires

*a. Matches and Fire Starters.* A supply of matches in a waterproof container, heat tablets, or fire starters must be carried by all individuals operating in cold weather. They

are a necessity, especially where snow and ice add to the problems of securing tinder for starting a fire. In emergencies, matches should be used sparingly and lighted candles used to start fires whenever possible, or if available, a little engine oil will help ignite wet or frozen wood without the flash hazard of the more volatile petroleum fuels. As a safety precaution, it should be remembered that fire starters are extremely inflammable and must be kept away from open flames and heat.

*b. Selecting Site.* Individuals building a fire in the field should carefully select a site where the fire is protected from the wind. Standing timber or brush makes a good windbreak in wooded areas, but in open country some form of protection must be provided. A row of snowblocks, the shelter of a ridge, or a scooped-out side of a snowdrift will serve as a windbreak on barren terrain.

*c. Starting and Maintaining Fire.* Before using matches, a supply of tinder must be on hand. The use of heat tablets is recommended for the safe starting of fires. In inclosed areas, gasoline or other high inflammable fire starters will not be used. In the open, and under very strict control, small quantities of gasoline may be used to start fires when other means are not available. Many types of fuel are available for fires. The driest wood is found in dead, standing trees. Fallen timber may often be wet and less suitable. In living trees, branches above snow level are the driest. Green and frozen trees are generally not suitable because they will not burn freely. Splitting green willows or birches into small pieces provides a fairly good method of starting and maintaining a fire, if no deadwood is available. Also, dry grass, birchbark, and splits of spruce bark with pitch tar are excellent fire starters. It is good practice to secure a sufficient amount of firewood to last throughout the night, before retiring.

*d. Types of Fire.* Any kind of open fire may be used with most of the improvised shelters. In deep snow, a fire base (fig. 3-17) of green wood should be built first to protect the campfire from sinking into the snow. For a single lean-to or snow wall, a fire reflector (fig. 3-10) may be built of green logs or poles to reflect the heat into the shelter and to serve as a

steadily. The most suitable types for single and double lean-tos are the log fires (fig. 3-18).

- (1) Two, preferably three, logs are used for this type of campfire. Dry, hard-wood logs, if possible, 20 to 40 cm (approx 1') in diameter and approximately the same length as the lean-to

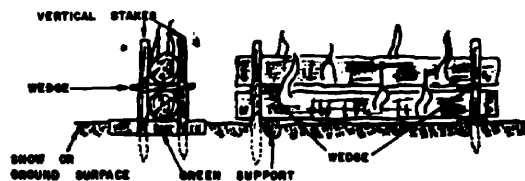

1 Two-log fire

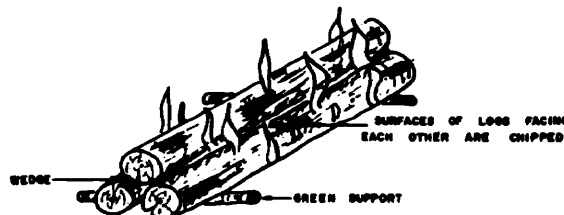

2 Three-log fire

Figure 3-18. Log fires.

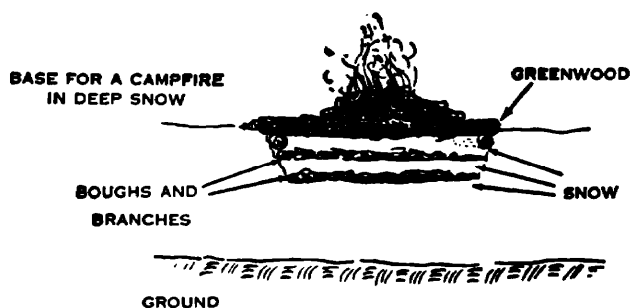

Figure 3-17. Camp fire and fire base on snow.

are selected and brought to the fire site. First, two logs are placed side by side on small green blocks to support them above the snow or ground for a better draft. Then the third log is placed in the middle and on the top of the other two logs. For better burning, the surfaces of logs which face each other are chipped. Before lighting the fire, small wedges are placed between the chipped surfaces of the logs for better draft. Fire is then started at several places to help it spread the entire length of the logs. A log fire of this type will burn all night with only minimum care.

- (2) When only two logs are used, four vertical stakes must be driven into the snow to keep one log on top of the other. A disadvantage of this type of log fire is the fact that the vertical stakes tend to give way when the snow starts melting around the fire.

## Section IV. FOOD AND WATER

### 3-22. Principles

*a. Importance of Balanced Meals.* Army rations are well balanced. The ration for 1 day provides all the essential foods the body requires. However, all the ration must be eaten if

all the caloric value is to be obtained. Some items may, at times, not appeal to the individual sense of taste, but they must be eaten. The tendency to be lazy about preparing and eating satisfactory morning and evening meals

before and after a hard day on the trail must be avoided, since it is exceedingly detrimental to continued good health. After having been without normal supplies for a period of time, it is essential that men be provided with a balanced meal containing the three basic food requirements (fats, protein, and carbohydrates). When possible and especially when troops are involved in rigorous activity, it may be desirable to feed four times daily. A desirable feeding plan would be the normal heavy breakfast meal, a light midmorning meal, a light afternoon meal, with the supper meal being the main meal of the day. The mid-morning and midafternoon meal should consist of foods high in carbohydrates and include a hot liquid. Concentrated foods found in some special and survival rations are suitable for this purpose. Hot soup or tea are most desirable for the liquid. The evening meal should be heavily fortified with protein and eaten just before going to sleep. This heavy protein meal will increase body combustion above basal level, resulting in what is known as specific dynamic heat. This increase in the output of heat within the body also aids in keeping the individual warm while sleeping. If awakened by cold a small snack eaten inside the sleeping bag may increase heat production enough to permit further comfortable sleep.

*b. Importance of Liquids.* In cold regions, as elsewhere, the body will not operate efficiently without adequate water. Dehydration, with its accompanying loss of efficiency, can be prevented by taking fluids with all meals, and between meals if possible (para 3-34). Hot drinks are preferable to cold drinks in low temperatures since they warm the body in addition to providing needed liquids. Alcoholic beverages should not be consumed during cold weather operations since they can actually produce a more rapid heat loss by the body.

*c. Use of Mess Gear.* Individual mess gear will be difficult to clean and sterilize, therefore arrangements must be made for return of dirty mess gear to the battalion trains area where it is cleaned under the supervision of the mess stewards. Clean mess gear is sent forward with subsequent meals. During periods of extreme cold, it may be advisable to utilize paper plates and cups instead of mess gear. If utilized,

they should be issued with the rations and sent forward to companies with the meal. When using paper plates and cups, commanders must insure that they are not haphazardly left in the unit area. Controlled disposal must be practiced by burning at squad level or by consolidating at company level and returning them to the battalion trains area. This problem is minimized, and cooling of food is minimized, by the use of individual operational rations which may be consumed directly from their containers.

### 3-23. Rations

Many types of rations are used for operations in cold weather. The type of ration to be used will be determined by the location, supply situation, mission, and duration of the operation. Rations are normally prepared in the unit kitchens. Insofar as possible two hot meals per day should be served. These generally will be the breakfast and supper meals. In situations where this is not practicable, group rations are utilized and prepared by one member of the small unit. Under certain conditions an individual ration may be issued to each man. When serving meals without shelter, food may become cold or frozen before it can be eaten. Therefore, and whenever possible, shelters should be provided for the preparation and serving of food. Certain packaged rations and food packets are ideal under these circumstances because they are precooked and some components or all of the ration can be eaten without heating. However, one of the components should be heated when possible.

*a. Bulk Supplied Rations.* Rations of this type are desirable whenever possible. They are characterized by a need for maximum time and effort for preparation, high palatability, a large variety in menus and a high caloric content. These rations are also heavy and bulky.

- (1) "A" Ration. The standard "A" Ration consisting of fresh foods is issued whenever possible. The caloric content of the ration is increased to compensate for the added caloric re-

quirements of cold weather operations.

- (2) *"B" Ration.* The standard "B" Ration is the field ration used for mass feeding in areas where kitchen facilities, with the exception of refrigeration, are available. The ration consists of approximately one hundred nonperishable foods. These are canned and dehydrated. Hot meals furnish approximately 3,900 calories per day with a 15-day cycle of menus. Caloric content may be varied to meet requirements of varying climatic conditions or degree of physical activity.

*b. Packaged Operational Rations.* Rations found in this category are characterized by a need for minimum time and effort for preparation. They have a high caloric content, limited menus and are lightweight. Maximum advantage is taken of dehydration and concentration. They are for the most part served hot, but certain components may be consumed cold.

- (1) *Ration, individual, trail, frigid.* This ration is designed for trail use under cold weather conditions. While hot meals can and are intended to be prepared from this ration, all components, except the dehydrated soups and beverages may be eaten without preparation. Components of the ration such as, processed cheese, fruitcake bars and candy are especially adaptable to consumption in mobile situations. The inclusion of several condiments enables maximum flexibility in component preparation. The ration supplies a minimum of 4,400 calories. It is intended for use by members of small patrols or trail parties for short periods of time during which resupply is not feasible.
- (2) *Meal, combat, individual.* This ration is designed for and is issued as the tactical situation dictates. It can be used in individual units as a meal or in multiples of three meals as a complete ration. Twelve menus are available. Each meal furnishes approximately one-third of the minimum

nutrient intake prescribed by Army regulations.

- (3) *Food packet, long-range patrol.* The packet was designed for use by forces in remote areas where resupply may be uncertain for as long as 10 days, under tactical situations that require men to eat as individuals, but where normal supply of water is available. There are eight menus, all flexibly packaged. Each furnishes over 1,000 calories, and consists of a precooked, dehydrated, combination item as the main component, with a confection, a cereal, or fruitcake bar, coffee, cream, sugar, toilet paper and matches. Five menus also include cocoa beverage powder. The average volume is 40 cubic inches and the average gross weight is 11 ounces. The principal menu components are packaged in a flexible combination package attached to a chipboard base which gives the package a rigid bottom while the food is being reconstituted in the bag. The main component may be eaten dry with drinking water or reconstituted. If hot water is used the main component will reconstitute in 2 minutes, if cold water is used, in 5 minutes.
- (4) *Survival rations.* Survival rations are designed for use in emergency situations. The food is highly concentrated, lightweight and requires little or no preparation. Per volume it is high in caloric content but contains much less than the minimum required nutrient prescribed by Army regulations. These rations, when available, are especially good to supplement the special rations discussed above.

### 3-24. Individual or Small Unit Messing

Frequently, while on patrol or during combat conditions, individuals will find it necessary to prepare their own meals or to combine rations with other individuals within the unit.

*a. Equipment.*

- (1) The one-burner M1950 gasoline cook-



ing stove is a cooking and heating unit for a group of from 2 to 5 men operating in an isolated or forward area where the use of heavier equipment is not practical. The mountain cookset is combined with the stove to make the one-burner cooking outfit.

- (2) Rations may also be heated on the M1950 Yukon stove. The top and to a small degree the area underneath the stove is used for this purpose.
- (3) Any fuel-burning device will give off carbon monoxide, which is poisonous. Adequate ventilation must be provided when using fuel-burning equipment under shelter.

*b. Preparation.*

- (1) First priority is the procurement of water (para 3-30). If snow or ice must be melted to obtain water, all available stoves are utilized for this purpose. After water is obtained, the stoves are used for food preparation. For convenience in preparation of meals and for conservation of fuel and labor, cooking should be done for as large a group as the situation permits.
- (2) Meals must be prepared efficiently and as quickly as possible. Areas sheltered from the wind should be chosen for stoves or fires. A few blocks of snow or ice or a hole dug in the snow will serve as a windbreak and provide for more efficient use of fires. Heating tablets are not efficient in extremely cold weather accompanied by high winds. Individuals may have to prepare and eat one item at a time, but a hot meal will be worth the effort.
- (3) Instructions for preparing the components of the rations will be found on, or inside, the package. The possibility of combining the various ration components, i.e., mixing meat and vegetables to make stew, should also be considered.
- (4) Canned foods are cooked and require

little heat to make them edible. Overcooking will waste fuel. The juices in canned vegetables are tasty, and contain vitamins and minerals. Drinking them will conserve the water supply. Cans must be punctured or opened before heating by open fires or stoves. Failure to do this may result in an explosion. No puncturing is needed if the can is submerged in water during the heating process.

- (5) Food, including frozen meat, should be thawed before cooking. Partly frozen meats may cook on the outside while the center remains raw. Fresh meats must be cooked thoroughly to kill any germs or parasites that may be present.
- (6) Whenever possible, dried fruit should be soaked overnight in cold water, then simmered slowly in the same water until tender, and sweetened to taste.
- (7) Canned rations, either frozen or thawed, can best be heated by immersion in boiling water. This water can then be used for making tea, coffee, or soups and for washing soiled utensils or personal hygiene.

*c. Storage.*

- (1) In winter the simplest way to preserve certain perishable foods such as meat products is to allow them to freeze. Rations should be stacked outside the shelter and their location carefully marked. Only as much food as can be thawed and consumed before spoiling should be brought into the shelter.
- (2) Frozen food should not be placed near heat where it may be thawed and later refrozen. Once thawed, certain foods may spoil. Meat thawed and refrozen two or three times is tasteless and watery, and resultant bacterial growth may be sufficient to cause food poisoning.

*d. Eating.* Meals should be prepared at regular times and as much time as possible allowed

for cooking and eating. Men should be allowed to relax after each meal. There will be times when it may not be possible to prepare a meal. Under such circumstances the meal or components of meals must be distributed to individuals before breaking camp. Any frozen food is thawed before issue to individuals. These items are wrapped in spare clothing and placed in the rucksack or in the pack to prevent them from refreezing. If time permits, halts should be made for the purpose of heating food and drink. To the extent possible, preparation of the following day's food should be done during the night bivouac in order to shorten the time required to break camp in the morning.

*e. Suggestions.*

- (1) Organize and control cooking.
- (2) Insure that all food is eaten; save any usable leftovers for snacks between meals.
- (3) The squad leader supervises the meals and makes sure that each man is receiving his portion.
- (4) Check continuously to see that each man's mess equipment is kept clean.
- (5) Food is prepared for as large a group as possible.
- (6) Fuel is conserved by prethawing food. This may be done by utilizing heat in the engine compartment of a vehicle or by placing cans of food under and around the tent heating stove.
- (7) Canned rations, either frozen or thawed, can best be heated by immersion in a pot of hot water on the stove. This water can then be used for washing soiled utensils.
- (8) Adequate training of all men in the preparation and cooking of cold weather rations is imperative.
- (9) One-pot meals, such as stews, save preparation time and fuel and can be kept warm more easily than several different food items.

### 3-25. Small Unit Messing

*a. One Man Responsible.* One man should be

responsible for the preparation of each meal and this job should be rotated throughout the squad. The squad leader is responsible for supplying any additional assistance needed by the cook.

*b. Ingenuity in Cooking.* Ingenuity on the part of the man assigned to cook for the small unit will aid immeasurably in the success of field messing in cold weather. Potatoes, onions, or bacon, when available, will increase the palatability of the food and can satisfactorily be added to many foods. The habit of making the morning coffee the night before, or using two stoves to melt snow or ice for the evening's water supply, and of thawing out those rations that are going to be used the next morning, will save time and greatly simplify food preparation at mealtime.

*c. Eating Arrangement.* When the weather is moderate, the mess line feeding system may be used. During cold weather in a bivouac area the food can be prepared hot and then carried in insulated containers to each tent for consumption in a heated shelter. Food may also be transported in this manner to frontline troops by using track vehicles or other methods of transport.

### 3-26. Natural Food Resources

*a.* In some cold regions, animals are abundant at certain seasons of the year. In other areas, very little game can be found during any season of the year. A person without food in these areas must know how to "live off the land" and subsist on what is available. Fish are present in fresh-water lakes and rivers during all seasons of the year, and some salt water near shore will normally yield fish. Fish will form the most readily available and largest portion of available nourishing foods.

*b.* Small animals and birds are also present in most areas at all times of the year. Large animals, because of migratory habits or other characteristics, are not a reliable source of food in many areas. Game should not be shot unless necessary for survival. Animals to be used for food should be thoroughly bled, internal organs removed, and the carcass chilled as soon as possible. This will prolong the keeping time of the meat. To expedite the

chilling clean snow can be packed in the body cavity. All meat should be cooked thoroughly as a safeguard against harmful micro-organisms and parasites that might be present in the carcass. Only healthy animals should be used; in the absence of a person qualified to determine if the animal is healthy, meat from the animals that appear sick should not be handled or eaten. For additional information, see FM 21-76.

### 3-27. Animals of Cold Regions

#### a. *Caribou and Reindeer.*

- (1) These are mainly herd animals found in the high plateaus and mountain slopes as well as in the grassy tundra areas. Their favorite year-round food is the lichens or "reindeer moss." Their summer diet consists of grasses, shrubs, and brush tips. They are very curious animals and will often approach a hunter merely from curiosity, thus presenting a good target. Sight of a human may have no effect on them but the slightest hint of human scent will send them galloping. It is possible to attract them near enough for a shot by waving a cloth and moving slowly toward them on all fours. In shooting, the aim should be for the shoulder or neck rather than the head.
- (2) Reindeer have long been domesticated in Scandinavia and northern Asia for their meat, milk, hide, and as draft animals.
- (3) Both caribou and reindeer should be skinned promptly. Animal heat is the largest factor in meat spoilage. Fast and complete field dressing will eliminate most of this hazard and airing will finish the work. The bones and muscles can hold heat for as long as 48 hours, if the surrounding temperature is not below freezing. Fat should be kept with the carcass, not with the skin. If time does not allow skinning, at least the entrails and genitals should be cleaned out of the animal.

- (4) A poncho may be used for wrapping the meat, whether for packing it out or if it is to be left hanging for the second trip. Meat should be raised off the ground as soon as possible because this will cool it sooner and keep it away from predators. Dirt and contamination should be washed from the meat and the meat then dried, if possible. A carcass should never be washed until it has cooled and is ready to be butchered and stored.

#### b. *Mountain Sheep and Goats.*

- (1) These animals are available in many northern areas. Although they normally live in the higher elevations, during periods of heavy snow, they may be more readily available than other animals.
- (2) The procedures for skinning and care of caribou and reindeer are also applicable to sheep and goats.

#### c. *Moose.*

- (1) The moose is the largest known species of the deer family. They are found in most areas of the northern hemisphere. Full grown bulls weigh from 1,000 to 1,200 pounds and may stand two meters (6') high at the shoulder. They require a large amount of forage and usually may be found in areas where food of this type is plentiful, such as burn-offs, swamps, and lake areas.
- (2) The procedures for the skinning and care of caribou and reindeer meat are applicable to moose.

#### d. *Seals.*

- (1) Seals are widely distributed and generally common. Their flesh is an excellent food. The liver should be avoided since it may contain toxic levels of Vitamin A.
- (2) The seals should be shot as they come to the surface of the water to breathe or as they are basking on rocks. The aim should be for the head. Most of the seals shot through the head will

float, while about half of those shot through the body will not. Seals will also be found in the open leads in the icepack or may be found at their breathing holes in the ice. However, hunting seals through breathing holes requires extreme patience and the holes are difficult to locate without the use of dogs.

- (3) In the spring, mother seals and their pups may sometimes be located under snow hummocks adjacent to and over breathing holes, where they have given birth to their young. In the spring, also, seals lie on the ice and bask in the sun. They must be carefully stalked and the hunter must be close enough at the time he shoots to retrieve the dead seal before it slips into a hole in the ice.
- (4) It takes great skill to stalk a seal. The Eskimo usually tries to imitate noises made by the seal, and he may use a white screen behind which he crawls while the seal sleeps, remaining absolutely still when the seal raises its head to look around. Seals normally sleep only for a few seconds at a time and then look around for their enemies for a few seconds before sleeping again. Seal meat from which the blubber (fat) has not been entirely removed will turn rancid in a short time.

*e. Walrus.* The meat and blubber (fat) of walrus are edible, as are the clams which may be found in their stomachs.

*f. Bears.* All bears are edible, although the flesh must be thoroughly cooked to guard against trichinosis. The liver of the polar bear should not be eaten because of toxic Vitamin A concentration. All bears are dangerous and hard to kill. There should be two or more hunters in the party when hunting; soft-nosed bullets should be used. The shoulder shot is best. If the bear stands up, the aim should be at the base and center of the throat for a shot which will sever the vertebrae.

*g. Wolves and Foxes.* Wolves and foxes are edible. Wolves follow caribou herds. Arctic

foxes follow polar bear and eat their leavings. Foxes will hang around a camp or follow a trail party and try to steal food.

*h. Rabbits or Hares.* Rabbits or hares can be snared or shot. They should be shot in the head or very little meat will be left. A whistle will probably cause a running one to stop long enough for an aimed shot. When cooking hare or rabbit, fat of some sort, should be added as the meat is very lean. They should not be dressed or cut up with bare hands because of the danger of contracting tularemia (rabbit fever) from contact with the raw flesh. Completely cooked flesh is safe to handle and eat.

*i. Marmots.* Marmots are woodchuck-like animals that live above the treeline in the mountains. They are excellent food, especially in late summer when they are very fat. The hunter should wait until the marmot moves away from his den before shooting or he may fall into his burrow.

*j. Porcupines, Beavers, and Muskrats.* These animals are found throughout the colder regions. Porcupines are excellent food, as are both beaver and muskrat. All are easily obtained. The porcupine, beaver, and muskrat when found on land, can be easily killed with sticks.

*k. Ground Squirrels.* Ground squirrels abound in most cold areas and are easy to catch. They can be easily dug out of their burrows. They are especially common along streams with sandy banks.

### 3-28. Birds

All birds and their eggs found in cold regions are edible. Certain nonmigratory birds are found in cold regions in wintertime. Several species of grouse, like the ruffed, sharp tail, spruce, and ptarmigan (which turn white in winter) are common. To obtain the greatest food value from birds, they should be plucked rather than skinned.

### 3-29. Fish

Fish form a large part of the native diet in cold regions and are almost the entire diet of work dogs in these areas. Along the coast, salmon, tomcod, flounder, sculpin, sand sharks,

herring and other fish are found. Inland waters yield salmon, several varieties of whitefish, blackfish, and suckers. All fish and shellfish are edible, with the exception of the black mussel. Mussels from Pacific waters should be avoided entirely. Mussels are easily distinguished from clams and oysters by their orange-pink flesh. Shellfish can be cooked by boiling them in water.

### 3-30. Water

Water points, operated by Corps of Engineer personnel, offer the best source of water supply for all troop units in any area and in any season. Under normal operating conditions, an Engineer unit with a water point capability will be attached to task forces of brigade size or larger. Engineer water point operations under cold weather conditions are discussed in FM 31-71. This paragraph, together with paragraphs 3-31 and 3-56 offers possible solutions to the problem of water supply that confronts individuals and small detachments operating in isolated areas away from normal support activities.

*a.* Water is plentiful in most cold regions in one form or another. Potential sources are streams, lakes and ponds, glaciers, fresh-water ice, and last year's sea ice. Freshly frozen sea ice is salty, but year-old sea ice has had the salt leached out. It is well to test freshly frozen ice when looking for water. In some areas, where tidal action and currents are small, there is a layer of fresh water lying on top of the ice; the lower layers still contain salt. In some cases, this layer of fresh water may be 50 to 100 cm (20" to 40") in depth.

*b.* If possible, water should be obtained from running streams or lakes rather than by melting ice or snow. Melting ice or snow to obtain water is a slow process and consumes large quantities of fuel, 17 cubic inches of uncompacted snow, when melted, yields only 1 cubic inch of water. In winter a hole may be cut through the ice of a stream or lake to get water; the hole is then covered with snow-blocks or a poncho, board, or a ration box placed over it. Loose snow is piled on top to provide insulation and prevent refreezing. In extremely cold weather, the waterhole should

be broken open at frequent intervals. Water-holes should be marked with a stick or other marker which will not be covered by drifting snow. Water is abundant during the summer in lakes, ponds, or rivers. The milky water of a glacial stream is not harmful. It should stand in a container until the coarser sediment settles.

*c.* In winter or summer, water obtained from ponds, lakes and streams must be purified by chemical treatment, use of iodine tablets or in emergencies by boiling.

*d.* During chemical, biological, and/or nuclear warfare, precautions should be taken against using contaminated water sources. In general, cold weather conditions tend to prolong or conceal contamination hazards, and unexpected contamination may thus be encountered. When snow or ice is thawed to provide water supplies, detection tests should be conducted during or after the melting operation, since frozen contamination may not be detectable. Radiological contamination which has been covered with snow or ice may or may not show up on radiac instruments, depending upon the thickness of the cover. Boiling or treating with water purification tablets has no effect on radioactive contaminants in water. In emergencies, water suspected of radiological contamination may be filtered through a 15 cm (6") column of loose dirt and then chlorinated or iodinated. Purification of water showing, or suspected of containing, chemical contamination should not be attempted.

*e.* After the water is obtained, the problem of transporting and storing it arises. Units operating in the field under cold weather conditions may store water in 5-gallon water cans with insulated covers, or other similar type containers for use by small detachments or individuals. Immersion-type heaters may be used to prevent freezing of water supply tanks. Some points to be remembered are-

- (1) Transportation of water by wheeled vehicles in barren, sparsely settled areas under snow and ice conditions is practicable only when there is a road net established. The best way to transport water in cold regions is by the use of track-laying vehicles which are not dependent on roads for ma-

neuverability. If 5-gallon cans are used to carry water, they are filled only three-quarters full to allow agitation of the water and help prevent freezing while in transit. Cans are stored off the floor in heated shelters as soon as they are delivered. Sled-mounted, 250- to 300-gallon water tanks in which immersion-type heaters have been installed have proved satisfactory.

- (2) For small units of two to four men, the 5-gallon insulated food container is satisfactory for water storage. These can be filled at night and will hold enough water for the next day's needs for about four men. The insulation of these containers is sufficient to keep water from freezing for as long as 40 hours at an ambient temperature of  $-20^{\circ}$  F., if the temperature of the water was at boiling point when the container was filled.

### 3-31. Types of Ice and Snow

*a.* When water is not available from other sources, it must be obtained by melting snow or ice. To conserve fuel, ice is preferable when available; if snow must be used, the most compact snow in the area should be obtained. Snow should be gathered only from areas that have not been contaminated by animals, humans, or toxic agents.

*b.* Ice sources are frozen lakes, rivers, ponds, glaciers, icebergs, or old sea ice. Old sea ice is rounded where broken and is likely to be pitted and to have pools on it. Its underwater part has

a bluish appearance. Fresh sea ice has a milky appearance and is angular in shape when broken. Water obtained by melting snow or ice may be purified by use of water purification tablets, providing it has not been contaminated by toxic agents.

*c.* If chemical, biological, or radiological contamination is detected, procedures as outlined in paragraph 3-30 *d* will be followed.

### 3-32. Procedures for Melting Snow and Ice

*a.* Burning the bottom of a pot used for melting snow can be avoided by "priming." Place a small quantity of water in the pot and add snow gradually. If water is not available, the pot should be held near the source of heat and a small quantity of snow melted in the bottom before filling it with snow.

*b.* The snow should be compacted in the melting pot and stirred occasionally to prevent burning the bottom of the pot.

*c.* Pots of snow or ice should be left on the stove when not being used for cooking so as to have water available when needed.

*d.* Snow or ice to be melted should be placed just outside the shelter and brought in as needed.

*e.* In an emergency, an inflated air mattress can be used to obtain water. The mattress is placed in the sun at a slight inclined angle. The mattress, because of its dark color, will be warmed by the sun. Light, fluffy snow thrown on this warm surface will melt and run down the creases of the mattress where it may be caught in a canteen cup or other suitable container.

## Section V. HYGIENE AND FIRST AID

### 3-33. General

In cold weather, the care of the body requires special emphasis. If men are allowed to go without washing, fail to eat properly, do not get sufficient liquids or salt, efficiency will suffer. Lowered efficiency increases the possibility of casualties, either by cold injury or enemy action.

AGO 8641A

### 3-34. Dehydration

*a. Definition and Principle.* Dehydration means to lose or be deprived of water or the elements of water. A growing plant loses (uses) water in the growing process. If this water is not replaced by either natural means (rain) or by watering, the plant will wither and eventually dry up. The same principle applies to the human body which loses water and,

an additional element, salt. A certain amount of this loss is taking place constantly through the normal body processes of elimination; through the normal daily intake of food and liquids, these losses are replaced.

*b. Dangers.* When individuals are engaged in any strenuous exercises or activities, an excessive amount of water and salt is lost through perspiration. This excessive loss creates what is known as "imbalance of liquids" in the body and it is then that the danger of dehydration arises, unless this loss of liquids and salt is replaced immediately and individuals are allowed sufficient rest before continuing their activities.

*c. Training and Discipline.* The danger of dehydration for troops operating under cold weather conditions and over ice and deep snow is a problem that does exist and cannot be overemphasized. It is equally important, however, to recognize that the problem can be overcome and will present no great obstacle to well trained, disciplined troops who have been thoroughly oriented in the causes, the symptoms, and the effects of dehydration and who have been properly instructed in preventive measures.

*d. Differences.* It is important, therefore, to be aware that the danger of dehydration is as prevalent in cold regions as it is in hot, dry areas. The difference is that in *hot weather* the individual is conscious of the fact that the body is losing liquids and salt because he can see and feel the perspiration with its saline taste and "feel" it running down the face, getting in the eyes, and on the lips and tongue, and dripping from the body. In *cold weather*, it is extremely difficult for an individual who is bundled up in many layers of clothing to realize that this condition does exist. Under these conditions, perspiration is rapidly absorbed by the heavy clothing or evaporated by the air and is rarely visible on the skin.

*e. Cause, Symptoms, Effects, Preventive Measures, and Treatment.*

- (1) Dehydration results from failure to correct the body's "imbalance of liquids" through replacing liquid and salt which has been lost.
- (2) The symptoms of cold weather dehy-

dration are similar to those encountered in heat exhaustion. The mouth, tongue, and throat become parched and dry and swallowing becomes difficult. General nausea is felt and may be accompanied by spells of faintness, extreme dizziness and vomiting. A feeling of general tiredness and weakness sets in and muscle cramps may occur, especially in the legs. It becomes difficult to keep the eyes in focus and fainting or "blacking out" may occur.

- (3) The effect of dehydration on the individual is to incapacitate him for a period of from a few hours to several days. The effectiveness of the individual's unit is likewise reduced by the loss of his contribution to the accomplishment of the unit mission. Small patrols and detachments operating beyond range of immediate help from the parent unit must be extra-cautious to avoid dehydration since they run the risk of a secondary but more dangerous effect of dehydration, that of becoming cold weather casualties while incapacitated.
- (4) Dehydration can be prevented during cold weather operations by following the same general preventive measures applicable to hot, dry areas. Salt and sufficient additional liquids are consumed to offset excessive body losses of these elements. The amount will vary according to the individual and the type of work he is doing, i.e., light, heavy, very strenuous, etc. Rest is equally important as a preventive measure. Each individual must realize that any work that must be done while bundled in several layers of clothing is extremely exhausting. This is especially true of any movement by foot, regardless of how short the distance.
- (5) In treating a person who has become dehydrated, the individual should be kept warm but his clothes loosened sufficiently to allow proper circulation; liquids and salt should be fed to him gradually and, most important

of all, he must have plenty of rest. When salt tablets are not available, common table salt may be used. Approximately one-half of a level mess spoon of salt mixed in one gallon of water makes a palatable solution. The individual should receive prompt attention of trained medical personnel.

### 3-35. Personal Hygiene

Because of the extremes in temperatures and lack of bathing and sanitary facilities, keeping the body clean in cold weather will not be easy.

*a.* The entire body should be washed at least weekly. If bathing facilities are not available, the entire body can be washed with the equivalent of two canteen cups of water, using half for soap and washing, and half for rinsing. If circumstances prevent use of water, a rubdown with a dry cloth will help. Care should be taken not to abrade the skin. The feet, crotch, and armpits should be cleaned daily.

*b.* A temporary steam bath can be built in a large-size tent. Stones are piled up to form a furnace. The furnace is either heated inside the tent (ventilation flaps wide open) or in the open with the tent pitched over the furnace after the stones are heated. Wood is used for fuel. Seats and water buckets are taken into the tent after the stones are nearly red-hot and the fire has died down, so that they do not get sooty. The pouring and washing water is usually heated outside the tent. The water is thrown on the hot stones in small quantities. Thus it does not drop into the ashes and the temperature does not rise too fast. A naked person spends from 15 minutes to 1 hour in this steam bath. After thoroughly perspiring, the body is washed with tepid water.

*c.* Beards should be shaved or clipped close. Hair should be combed daily and not allowed to grow too long. A beard or long hair adds very little in insulation value and soils clothing with the natural hair oils. In winter, a beard or a mustache is a nuisance since it serves as a base for the buildup of ice from moisture in the breath and will mask the pres-

ence of frostbite. All individuals should shave daily, when possible. Because shaving with a blade and soap removes the protective face oils, the individuals should shave, if possible several hours before exposing his face to the elements. This action will reduce the danger of frostbite. Shaving with an electric razor will not remove the protective oils. Under chemical or biological warfare conditions a beardless face and daily shaving are especially important, since an airtight seal of the protective mask is difficult to obtain with even stubble on the face.

*d.* Socks should be changed and the feet washed daily. If this is not possible, the boots and socks should be removed, and the feet massaged and dried. By sprinkling the feet liberally with foot powder and then rubbing the powder off, the feet can be efficiently dry-cleaned.

*e.* Sleeping bags should be kept clean. Subject to operational requirements, the best method is to wear the minimum clothing in the sleeping bag. Never wear damp socks or underwear in the sleeping bag. Dry underwear and socks should be put on before going to sleep and the other set hung up to dry. Perspiration will soil a sleeping bag, and cause it to become damp, therefore, the bag should be aired as frequently as possible. In the morning, the bag should be opened -wide and air pumped in and out to remove the moist air within the bag.

*f.* Teeth should be cleaned daily. If a toothbrush is not available, a clean piece of gauze or other cloth wrapped around the finger, or end of a twig chewed into a pulp may be used in lieu of a toothbrush.

*g.* Underwear and shirts should be changed at least twice weekly; however, if it is not possible to wash the clothing this often the clothing should be crumpled, shaken out, and aired for about 2 hours.

### 3-36. Cold Injury

*a. Frostbite.* Frostbite is the freezing of some part of the body by exposure to temperatures below freezing. It is a constant hazard in operations performed at freezing temperatures, especially when the wind is strong. Usu-



ally there is an uncomfortable sensation of coldness followed by numbness. There may be a tingling, stinging, or aching sensation, even a cramping pain. The skin initially turns red. Later it becomes pale gray or waxy white. For all practical purposes frostbite may be classified as superficial or deep. Treatment and management are based solely upon this classification.

- (1) It is easier to prevent frostbite, or stop it in its very early stages, than to thaw and take care of badly frozen flesh. Clothing and equipment must be fitted and worn so as to avoid interference with circulation. To prevent severe frostbite—
  - (a) Sufficient clothing must be worn for protection against cold and wind. The face must be protected in high wind, and when exposed to aircraft prop blast.
  - (b) Every effort must be made to keep clothing and body as dry as possible. This includes avoidance of perspiring. For heavy work in the cold, remove outer layers as needed, and replace as soon as work is stopped. Socks should be changed as needed whenever the feet become moist, either from perspiration or other sources.
  - (c) Any interference with the circulation of the blood reduces the amount of heat delivered to the extremities. All clothing and equipment must be properly fitted and worn to avoid interference with the circulation. Tight fitting socks, shoes and hand wear are especially dangerous in very cold climates.
  - (d) Cold metal should not be touched with the bare skin in extreme-low temperatures. To do so could mean loss of skin.
  - (e) Adequate clothing and shelter must be provided during periods of inactivity.
  - (f) The face, fingers, and toes should be exercised from time to time to keep them warm and to detect, any numb or hard areas. The ears

should be massaged from time to time with the hands for the same purpose.

- (g) The buddy system should always be used. Men should pair off and watch each other closely for signs of frostbite and for mutual aid if frostbite occurs. Any small frozen spots should be thawed immediately, using bare hands or other sources of body heat.
- (2) Some cases of frostbite may be superficial, involving the skin. But if freezing extends to a depth below the skin it constitutes a much more serious situation, demanding radically different treatment to avoid or minimize the loss of the part (fingers, toes, hands, feet). If a part of the body becomes frostbitten it appears yellowish or whitish gray. Frequently there is no pain, so keep watching one another's face and hands for signs. The face, hands, and feet are the parts most frequently frostbitten. The problem is to distinguish between superficial and deep frostbite. This can usually be told with respect to the face. The hands and feet are a different matter. A person may be able to judge by remembering how long the part has been without sensation. If the time was very short the frostbite is probably superficial. Otherwise assume the injury to be deep and therefore serious.
  - (3) For treatment of superficial frostbite in the field—
    - (a) Cover the cheeks with warm hands until pain returns;
    - (b) Place uncovered superficially frostbitten fingers under the opposing armpits, next to the skin.
    - (c) Place bared, superficially frostbitten feet under the clothing against the belly of a companion.
    - (d) Do not rewarm by such measures as massage, exposure to open fires, cold water soaks, rubbing with snow.

- (e) Be prepared for pain when thawing occurs.
- (4) In treatment of deep frostbite (freezing injury) the following measures must be taken: If freezing is believed to be deep, do not attempt to treat it in the field. Get to a hospital or aid station by the fastest means possible. *If transportation is available, avoid walking.* Protect the frozen part from additional injury but do not attempt to thaw it out by rubbing, bending, massage. Do not rub with snow; do not place in either cold or warm water; do not expose to hot air or open fires; do not use ointments or poultices. Thawing in the field increases pain and invites infection, greater damage, and gangrene. There is less danger of walking on feet while frozen than after thawing. Thawing may occur spontaneously, however, during transportation to a medical facility. This cannot readily be avoided since the body in general must be kept warm.

*b. Trenchfoot.* Trenchfoot is the thermal injury sustained as a result of exposure to cold, short of freezing, in a damp or wet environment. Arbitrarily, it is said to occur in the temperature range between 32° F. and 50° F. Partial causes include immobility of the limbs (legs and feet down as in sitting or standing), insufficient clothing, and constriction of parts of the body by boots, socks, and other garments. This type of cold injury is almost identical with gradual frostbite, which might be expected, since the primary causes are the same except for differences in the degree of cold. In the early stages of trenchfoot, feet and toes are pale and feel cold, numb, and stiff. Walking becomes difficult. If preventive action is not taken at this stage, the feet will swell and become painful. In extreme cases of trenchfoot the flesh dies and amputation of the foot or of the leg may be necessary. Because the early stages are not painful, individuals must be constantly alert to prevent the development of trenchfoot. To prevent this condition—

- (1) Feet should be kept dry by wearing waterproof footgear and by keeping the floor of shelters dry.

- (2) Socks and boots should be cleaned and dried at every opportunity, preferably daily.
- (3) The feet should be dried as soon as possible after getting them wet. They may be warmed with the hands. Foot powder should be applied and dry socks put on.
- (4) If it becomes necessary to wear wet boots and socks, the feet should be exercised continually by wriggling the toes and bending the ankles. Tight boots should never be worn.
- (5) In treating trenchfoot, the feet should be handled very gently. They should not be rubbed or massaged. If necessary, they may be cleansed carefully with plain white soap and water, dried, elevated, and allowed to remain exposed. While it is desirable to warm the patient, the feet should always be kept at room temperature. The casualty should be carried and not permitted to walk on damaged feet.

*c. Immersion Foot.* Immersion foot is a form of injury which follows prolonged immersion of the feet in water not sufficiently cold to cause freezing or frostbite. It has been observed after exposure in subtropical waters also. Clinically and pathologically, it is indistinguishable from trenchfoot which would be expected, since its cause is essentially the same, lowering of the temperature of the part of the body involved. It is usually associated with dependency (legs and feet down as in sitting or standing) and immobility of the lower extremities and with constriction of the limbs by clothing and shoes. Other factors which play more or less important roles are-body cooling, as the result of wind; total immersion; and inadequate clothing (protection), sickness, and starvation. The incidence and severity of immersion foot however, is more directly influenced by the other factors listed. The treatment is the same as that given for trenchfoot.

*d. Total immersion.* Immersion in near freezing water for but a few minutes, or exposure to severe dry cold while inadequately dressed will cause total body cooling, including

a marked drop in the inner body (core) temperatures. For description and therapy see appendix F.

*e. Miscellaneous.* The length of time that a casualty may be exposed to the weather without danger of cold injury varies directly with the temperature and wind velocity. The lower the temperature and the stronger the wind, the sooner injury will occur. There is a great variation in individual reactions to cold. To give competent care to the injured in extreme cold, the medical personnel must have heated shelter in which to operate. Battle wounds in the cold are no different from those sustained in more temperate climates, and should be treated in the same manner. Morale is helped by the assurance that the sick and wounded can be rapidly evacuated from the battlefield to hospitals, and that for the nontransportable cases requiring prompt lifesaving surgery, hospitals with highly skilled surgical personnel are available adjacent to division clearing station level.

### 3-37. Shock

Shock is brought about by a reduction of the circulating blood volume within the body. This can be caused by severe injuries, loss of blood, pain, emotional disturbances, or any of many factors. The normal reaction of the body to severe cold, reduction of the volume of blood circulating to extremities, is very similar to the reaction of the circulatory system to the condition of shock. Shock will usually develop more rapidly and progress more deeply in extreme cold than in normal temperature.

*a. Signs of Shock.* The signs of shock are apprehension; sweating; pallor; rapid, faint pulse; cold clammy skin; and thirst. If the patient is not given good first aid treatment immediately the condition of shock may progress until the patient passes into unconsciousness and further into death.

#### *b. First Aid for Shock.*

- (1) The injured person should be made as comfortable as possible.
- (2) Pain may be relieved by proper positioning, good bandaging and splinting. Aspirin will also help, if it is

available and if there is no known or suspected abdominal injury.

- (3) The litter should be positioned so that the patient is comfortable and not apt to inhale vomitus.
- (4) The patient should be kept warm with blankets and sleeping bags.
- (5) When the patient is conscious he should be given warm soup, chocolate, coffee, or tea if there is no known or suspected abdominal injury.
- (6) The patient should receive medical attention as soon as possible.

### 3-38. Sunburn

An individual may get sunburned when the temperature of the air is below freezing. On snow, ice, and water, the sun's rays reflect from all angles; in a valley the rays come from every direction. Sunlight reflected upward from the bright surfaces attacks man where the skin is very sensitive—around the lips, nostrils, and eyelids. The exposure time which will result in a burn is reduced in the clear air of high altitudes. Sunburn cream and a chapstick should be carried in the pocket, and applied to those parts of the face that are exposed to direct or reflected light. In mild weather protection of the neck and ears can be improvised by draping a handkerchief over the back of the head which is held in place by the cap in the manner of a desert neckcloth. Soap or shaving lotions with a high alcoholic content should not be used because they remove natural oils that protect the skin from the sun. If blistered, report to an aid station as soon as possible, as the blistered area, especially lips, may become badly infected.

### 3-39. Snow Blindness

Snow blindness occurs when the sun is shining brightly on an expanse of snow, and is due to the reflection of ultraviolet rays. It is particularly likely to occur after a fall of new snow, even when the rays of the sun are partially obscured by a light mist or fog. The risk is also increased at high altitudes. In most cases, snow blindness is due to negligence or failure on the part of the soldier to use his sunglasses. Waiting for discomfort to develop

before putting on glasses is folly. A deep burn of the eyes may already have occurred by the time any pain is felt. Putting on the glasses then is essential to prevent further injury but the damage has already been done. Symptoms of snow blindness area sensation of grit in the eyes with pain in and over the eyes made worse by eyeball movement, watering, redness, headache, and increased pain on exposure to light. First aid measures consist of blindfolding, which stops the painful eye movement, or covering the eyes with a damp cloth, which accomplishes the same thing. Rest is desirable. If further exposure to light is unavoidable the eyes should be protected with dark bandages or the darkest available glasses. The condition heals in a few days without permanent damage once unprotected exposure to sunlight is stopped.

### 3-40. Constipation

*a.* When operating under cold weather conditions there is a general tendency for individuals to allow themselves to become constipated. This condition is brought about by the desire to avoid the inconvenience and discomfort of relieving themselves under adverse conditions. This condition is also caused by changes in eating habits and failure to drink a sufficient amount of liquids.

*b.* Constipation can usually be prevented by adjusting the normal eating and drinking habits to fit the activities in which engaged, and by not "putting off" the normal, natural, processes of relieving the body of waste matter. Medical personnel should be consulted if constipation persists. Each individual must be educated concerning the consequences of neglecting personal hygiene habits.

### 3-41. Carbon Monoxide Poisoning

*a.* Whenever a stove, fire, gasoline heater, or internal combustion engine is used indoors there is danger of carbon monoxide poisoning. A steady supply of fresh air in living and working quarters is vital. Carbon monoxide is a deadly gas, even in low concentration, and is particularly dangerous because it is odorless.

*b.* Units should appoint a qualified carbon monoxide safety officer. AR 386-55 and TB

Med 269 should be used as references by these safety officers.

*c.* Generally there are no symptoms. With mild poisoning, however, these signs may be present-headache, dizziness, yawning, weariness, nausea, and ringing in the ears. Later on, the heart begins to flutter or throb. But the gas may hit without any warning whatsoever. A soldier may not know anything is wrong until his knees buckle. When this happens, he may not be able to walk or crawl. Unconsciousness follows; then death. Men may be fatally poisoned as they sleep.

*d.* In a case of carbon monoxide poisoning, the victim must be moved into the fresh air at once, but must be kept warm. In the winter, fresh air means merely circulating air that is free from gases. Exposure to outdoor cold might cause collapse. If the only fresh air is outdoors, the patient should be put into a sleeping bag for warmth. A carbon monoxide victim should never be exercised, because this will further increase his requirements for oxygen. If a gassed person stops breathing or breathes only in gasps, mouth-to-mouth resuscitation should be started immediately. In the latter case, the operator's movements must be carefully synchronized with the victim's gasps. Breathing pure oxygen removes carbon monoxide from the blood faster than does breathing air and greatly hastens recovery. Carbon monoxide is serious and a victim who survives it must be kept absolutely quiet and warm for at least a day. Hot water bottles and hot pads are helpful in maintaining body temperatures.

### 3-42. Care of Casualties

If any member of a group is injured, the most important course of action is to get him to competent medical aid as soon as possible. The casualty should be given first aid treatment, protected from the cold and shock effects, and evacuated to an aid station with a minimum of delay. He should be placed in a casualty bag, sleeping bag, or the best available substitute. He should have warm drinking water or other hot drinks, *except in the case of abdominal injury.*

**Warning:** Once a tourniquet has been applied, the wounded man should be examined by a medical officer as soon as possible.

If possible, the tourniquet should not be loosened by anyone except a medical officer who is prepared to stop the hemorrhage or bleeding by other means and to administer other treatment as necessary. Repeated loosening of the tourniquet by inexperienced personnel is extremely dangerous, can result in considerable loss of blood, and endanger the life of the patient. Halting of circulation to the extremities is an invitation to frostbite. If morphine is to be administered, caution must be exercised to avoid overdosage.



Figure 3-19. Evacuation of wounded on sled.

the fastest means of transport available. Sleds can be used if oversnow vehicles or air evacuation facilities cannot be obtained. It may be necessary to use manhauled sleds to move the wounded a safe distance behind the frontlines before they can be transferred to faster means of transport (fig. 3-19). Speed in evacuation is essential because of the combined effects of severe cold and shock on the wounded.

### 3-44. Body Parasites

*a. General.* Body parasites are very common in the more populated cold regions because of the crowded living conditions and shortage of bathing and cleaning facilities. When in the midst of a native population, or when occupying shelters which have been used before, individuals must inspect clothing and body each night for parasites.

*b. Means of Control.* If clothing has become infested with lice, the following methods of removing them are recommended:

- (1) While extreme cold does not kill lice, it paralyzes them. The garments should be hung in the cold; then beaten and brushed. This will help rid the garments of lice, but not of louse eggs.
- (2) An appropriate insecticide powder can be used to free the body and clothing of body parasites.

### 3-43. Emergency Evacuation

Personnel who have been wounded should be evacuated to the nearest medical facility by

## Section VI. BIVOUAC ROUTINE

### 3-45. Location of Bivouac Sites

The selection of bivouac sites in northern areas is all-important and requires careful consideration. The problem of selection varies with the tactical situation, weather conditions and terrain. Terrain hazards such as steep rock faces concealed by snow, glaciers, crevasses and avalanches are typical, especially in mountainous areas. Guides familiar with terrain peculiarities must be used to the greatest extent during the troop movement.

*a.* If possible, the bivouac area should be tactically located in accordance with the principles of security and defense. It should be

located so that it would be advantageous for future operations. If contact with the enemy is imminent, the bivouac should be located on high ground; this, at times, is disregarded in favor of cover and concealment, more suitable ground conditions, etc.

*b.* Cover and concealment against air and ground observation is essential for the bivouac area. Forested areas pose few problems in comparison to that area north of the treeline. Particular attention must be given in selecting areas in cold regions to insure that local camouflage materials are available.

*c.* In the winter, protection from the wind is

a prime consideration. This is particularly true in areas of northern operations, where violent local gales frequently occur. In wooded areas the wind has little effect on tentage or individuals.

d. The condition of the ground is important and, if possible, the bivouac should be located on hard, dry ground.

e. Construction materials play an important part in the selection of a bivouac. When making a reconnaissance for the area, such things as the availability of firewood, water, snow for snow shelters, boughs, etc., must be reconsidered.

### 3-46. Bivouac in Forests

a. Most forests in cold regions provide excellent bivouac sites and should be reutilized whenever possible. Forests provide many natural materials such as boughs for insulation, firewood, and camouflage construction materials. They also provide excellent concealment against enemy air and ground observation. Coniferous (cone-bearing trees) provide better protection from wind and better insulation material and firewood than deciduous forests. Pine and spruce forests, normally found on well drained soil, offer the best hardstand for shelter.

b. Tracks are visible in both summer and winter. On dry ground, however, they normally are not as noticeable as on wet soil. Consideration should be given to building dummy positions for the purpose of misleading the enemy (fig. 3-20). Track discipline must be rigidly enforced in the bivouac area. Once tracks are made, all movement within the areas should be restricted to those tracks.

### 3-47. Bivouac on Marshy Ground

a. In winter, when the ground is frozen, good bivouac sites may be found in areas which otherwise would not be usable. Some swampy areas may not freeze during the winter, because of warm water springs or gases. They provide poor facilities for the bivouac site. If it becomes necessary to establish the bivouac on swampy ground, flooring for shelters must be constructed. If tree trunks are available, a

“float” may be built under the shelter (fig. 3-21). In the absence of tree trunks, brush matting will serve the same purpose.

b. Areas to be used for extended periods of time require draining, clearing of existing creeks, digging of ditches around the shelter, or preparing a water trench inside the shelter.

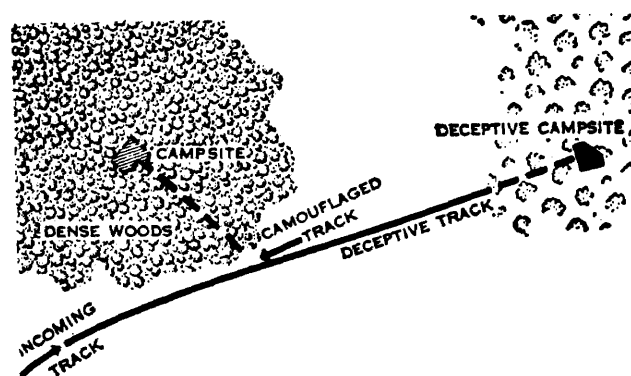

Figure 3-20. Selection of route when entering bivouac in forest.

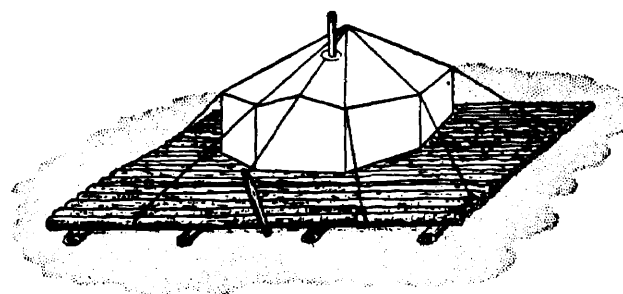

Figure 3-21. “Float” under shelter.

### 3-48. Bivouac in Open Terrain and on Ice

a. Due to strong winds, drifting snow, and poor concealment, bivouac areas in the barren tundra must be carefully chosen.

b. Tents should be pitched where they can be sheltered by natural windbreaks whenever possible. The windbreak may consist of depressions in the ground or pressure ridges on the ice. A visual inspection will indicate the degree of drifting, direction of the prevailing wind, and more suitable protected areas for locating the shelters. In areas where natural windfalls do not exist, snow walls may be constructed to provide protection from winds and

enemy small arms fire, as well as concealment from ground observation. In open areas with high winds, snow gathers rapidly on the lee side, making it necessary to clear the sides and tops of the tents periodically to prevent the weight of the drifting snow from collapsing the tent. The entrance to the shelter should face downwind from the prevailing wind. This will prevent the snow from blocking the exit and cutting off the ventilation.

c. When the tent is pitched on ice, holes are chopped where the tent pins are normally set. "Deadmen" are inserted in the holes at right angles to the tent. The holes are then packed with snow or filled with water and left to freeze.

### 3-49. Bivouacs in Mountains

a. Mountainous terrain is characterized by strong turbulent winds, cold and general lack of concealment above the timberline. The wind overhead creates an extensive lee near the mountain. The overhead lee resembles the dry space behind waterfalls caused by water having such speed that it shoots over the edge of the cliff and descends in a curve. An inland wind blowing 50 miles an hour (43 kts) may not strike the ground for several kilometers after passing the edge of a cliff or a very steep slope. While such a lee is an attractive bivouac site from the standpoint of wind protection it should be noted that such a lee area is often an area of maximum snow deposit. The requirement to constantly dig out vehicles, walkways, and weapons positions may offset the windfree advantages of a lee site during snowfall or snowblowing weather.

b. Cold air is heavier and frequently settles in valleys. The point where the temperature starts changing is low in summer and higher and more noticeable in winter. Therefore, in some instances it is better to establish a bivouac up the hillside above the valley floor and below the timberline, where applicable. Avalanche hazard areas must be carefully avoided.

### 3-50. Establishing Bivouac

a. *General.* Setting up a bivouac is a routine based on SOP which enables the commander to control the bivouac area, have it always

protected, camouflaged, and the personnel ready to fight. Only the minimum amount of time should be devoted to pitching and striking the shelters and to general housekeeping. Bivouacking in a routine manner allows more time for daily movement, establishing an effective security system, and defense of the bivouac site. Finally, it allows more time for rest and to make preparations for the continuation of the operation.

b. *Responsibilities of Unit Leader.* On entering the bivouac site, the unit leader is responsible for—

- (1) Posting a security guard.
- (2) Checking the bivouac site.
- (3) Determining exact tent locations providing the best natural shelter and camouflage.
- (4) Designating an area from which construction material and firewood will be obtained.
- (5) Selection of a water point, or marking off the snow area to be utilized for water.
- (6) Designating latrine and garbage disposal sites.
- (7) Designating a site for weapon and ski racks. Temporary placement for weapons and equipment must be arranged until the bivouac has been established.
- (8) Breaking a minimum number of trails between the tent site and area assigned for firewood and construction material, water point, and latrine.
- (9) Maintaining camouflage and track discipline at all times.
- (10) Organization and assignments for the work details as follows:
  - (a) Clearing and leveling the shelter sites. In winter the snow is dug to the ground level or in an emergency, packed down by trampling with skis, snowshoes, or tracked vehicles.
  - (b) Pitching tents (when used).
  - (c) Cutting, trimming, and hauling

- trees and boughs for construction of improvised shelters and bough beds (when tents are not available).
- (d) Construction of improvised shelters best suited to the area concerned.
  - (e) Construction of windbreaks, if necessary.
  - (f) Building necessary weapon and ski racks. Special care must be given to the protection of the weapons from the elements.
  - (g) Construction of field latrines and garbage disposal sites.
  - (h) Preparing a water point.
  - (i) Gathering and cutting a supply of firewood.
  - (j) During cold weather, situation permitting, starting fires and preparing hot drinks for all individuals.
  - (k) Upon completion of shelter construction, starting a warm meal.
- (11) Maintaining and emphasizing cleanliness, tidiness, and teamwork.
  - (12) Upon completion of the bivouac, arranging equipment within the outside of shelters.
  - (13) Preparing defensive positions and breaking and marking a trail from the shelters to the positions.
  - (14) Maintaining a duty roster for exterior guards, fire guards, and similar assignments.
  - (15) Rotating individuals on all jobs on a daily basis.
  - (16) Assigning specific sleeping areas for all individuals in accordance with the duty roster.
  - (17) Upon establishing the bivouac, removing the exterior guard in case the parent unit has taken over the security of the area.
  - (18) Inspecting the area, examining the security, camouflage, cover, weapons, skis, sleds, vehicles (if applicable), and the conditions of the men and their equipment.

- (19) Outlining and rehearsing the action to be taken in the event of attack.
- (20) Assuring that necessary safety precautions are taken to eliminate or control any hazards that could result in unnecessary accidental loss of men and their equipment.

### 3-51. Shelter Discipline

*a.* When a shelter is finished, the first man entering it will arrange all equipment in the proper place. The stove, water can, firewood, tools, and rations are placed in the most convenient place by the door of the tent. In a snow shelter, a special storeroom may be dug for these items.

*b.* In low temperatures, weapons should be left outside on improvised weapon racks in order to avoid condensation. However, as a word of caution commanders must insure that weapons left outside are properly secured, e.g., providing security guards or securing the weapons in an unheated shelter. When cold weapons are taken into heated shelters, condensation will form as the warm air comes in contact with cold metal. This "sweating" will continue for about one hour. If weapons are brought into a warm shelter they should be placed at floor level away from direct heat to minimize condensation. To avoid freezing of moving parts, moisture must be removed and Lubrication Oil, Weapon (LOW) applied to the weapon before it is taken outside. If the situation requires that weapons be taken inside and later outside before they can be dried, the working parts must be hand operated until the moisture is frozen and there is no danger of parts freezing together.

*c.* Before entering the shelter, hoarfrost and snow must be brushed off clothing and equipment. This keeps the clothing dry and the shelter clean.

*d.* To live comfortably in a shelter is not an easy art. Individuals usually are crowded and must keep their equipment orderly and out of the way of other occupants of the shelter. Unnecessary running in and out of the shelter should be avoided whenever possible.

*e.* The use of fire and lights in the shelter



must be carefully supervised. Security, fuel economy, and the prevention of fire and asphyxiation are essential. When wood is available, it is burned in the stoves in place of gasoline. Lamps must be extinguished before retiring for the night. All lamps and cooking stoves must be filled and lighted outdoors. A stand or bracket should be made for the lamps or candles and they should be placed where they are least likely to be knocked over. Sparks on the tent or lean-to must be extinguished at once. Smoking while in the sleeping bag is not permitted.

*f.* As many tasks as possible should be accomplished before retiring in order to conserve time in the morning. All eating utensils should be cleaned, snow melted, canteens or thermos bottles filled, and all weapons should be checked.

*g.* Upon breaking the bivouac in the morning all personal equipment should be rolled, warm drinks and breakfast should be consumed, and last-minute details accomplished prior to resuming the march.

### 3-52. Heat Discipline and Fire Prevention

Heat discipline presents a paramount problem during periods of extreme cold.

*a.* Overheating the shelter is very common and can and should be avoided. It causes sweating of individuals and increases the fire hazard.

*b.* There are many ways to save fuel. Cooking and heating may be combined. The melting of snow and ice uses large amounts of fuel and should be avoided when water from other sources is available. In cooking, liquid fuel is used sparingly. Wood should be burned when available. In extreme cold it may be necessary to keep the fire burning throughout the night in order to keep the men warm, especially when living in temporary shelters which provide little heat. The drying of wet clothing and the providing of hot drinks for combat reliefs are also necessary throughout the night.

*c.* Fire prevention during both summer and winter seasons is extremely important. The combination of low humidity and the drying

effect of continuously heated shelters is conducive to fire. Shifts in wind and the accumulation of frost or soot in the stovepipe lead to backfiring of flaming fuel into the shelter. The excessive spilling of fuel containers, lamps, and candles create additional hazards. The stamping of feet to shake off snow or frost may cause stoves and small heating units to spill and spread fire. The strict enforcement of all regulations is necessary in order to avoid fire hazards. No set rules can be given for each occasion. Common sense in the handling of all kinds of fires, fuels, and flammable materials is essential; alert, wide-awake fire guards must be on duty in each shelter at all times when men are sleeping and a fire is burning. Applicable technical manuals should be consulted prior to operating tent stoves, cooking stoves or gasoline lanterns.

*d.* A base made from green logs must be placed under the stove if the snow has not been shoveled away from the tent site. Fire reflectors may be used not only to get more warmth, but also to keep the fire burning evenly and to help avoid sparks.

*e.* Care must be exercised when lighting the gasoline-type stove; it may flare up and either damage the tent or set it on fire. All stovepipes must be cleaned frequently. When using wood as fuel, cleaning must be done every day in order to maintain a good draft and avoid fires in the stovepipes. Stoves burning petroleum fuels tend to accumulate more soot when operated at low settings because of cooler pipe temperatures. It is better to turn the stove off in mild weather than to run it at low settings. Detailed instructions for operating stoves are covered in TM 10-735 (Yukon stove) and TM 10-725 (Stove M1941). Precautions against forest and ground fires in summertime are extremely important. Coniferous forests are highly inflammable during the summer season. Ground fires can burn for months in muskeg and are extremely hard to put out. A fire ditch is always dug before lighting fire. A base of green wood, gravel, or rocks must be used under the fire; the fire must be made on high ground when the forest is dry. Before leaving the campsite, individuals must always be sure that the fire is completely out.

### 3-53. Drying Clothes

a. Keeping dry is important in low temperature. At times it is impossible to avoid sweating. The drying of clothes and footgear is therefore a necessity. Every opportunity must be used by each individual to dry his clothing.

b. When drying outside using an open fire, clothes should not be placed downwind from the fire, due to the sparks and smoke. Clothes hung for drying should be frequently checked and not left unattended. Clothing should never be placed too close to the fire or stove in the shelter. Leather items are extremely vulnerable to extreme heat. Clothing being dried in the shelter is placed on drying lines.

c. The use of a "Christmas Tree" (fig. 3-22) for drying in the shelter is handy when operating in a wooded area. Branches are cut off a dry or green tree which is then made to stand up in the shelter next to the center pole so that it is in the air current. This offers an excellent place for drying heavy items such as boots and parkas. The Tent, 10-Man, Arctic, is also equipped with strong hooks at the inside peak for suspending lighter weight clothing for drying.

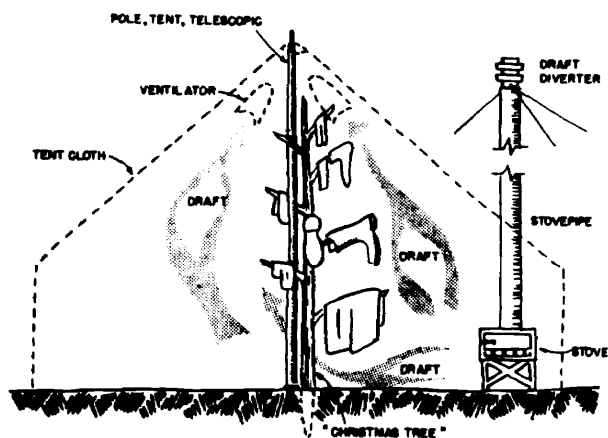

Figure 3-22. "Christmas Tree" for drying clothing.

### 3-54. Sleeping Arrangements in Bivouac

a. When arranging the sleeping procedures in a tent or improvised shelter, the position of every man, especially the position of reliefs for sentries, is planned. Each man must know

where his relief is sleeping. Therefore, the floorspace is occupied by the individuals in accordance with the duty roster. The number one man sleeps next to the door, number two man towards the rear. In this manner, starting from the door, the relief is easily located without waking up all occupants. The systematic sleeping arrangement will also permit exit from the tent in an organized manner in case of alert.

b. Ground insulation is most important. Often the occupants may have to improvise insulation using all available material. Backboards, snowshoes, man-hauled sleds, and empty cartons may be used. In timbered areas evergreen boughs are especially suitable. On the tundra, dry lichen, grass, or shrubs provide effective insulating material. To make a bough bed, one single bed is constructed for all; the size varies with the number of persons. For improvised shelters, logs approximately 8 cm (3") in diameter are pegged or fitted around the bough or grass bed. This helps to keep the boughs in place. If material and time permit, a 15 to 30 cm (6" to 12") thick shingled bed made from spruce, fir, or balsam boughs (fig. 3-23) gives excellent insulation and provides a soft mattress.

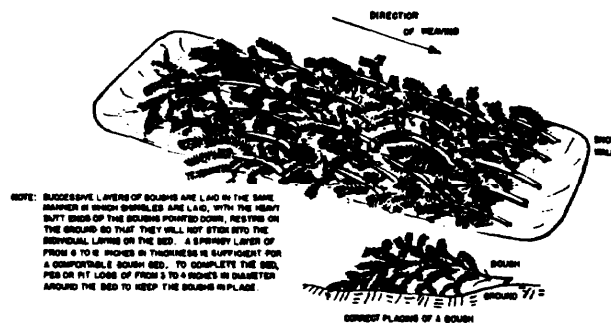

Figure 3-23. Building bough bed.

c. The tactical situation dictates whether or not sleeping bags are used. The amount of clothing to be worn when sleeping on a bough bed or in the sleeping bag can be best judged by experience and will depend on temperature and the tactical situation. As a minimum, outer clothing is usually removed when the sleeping bag is used. The removed clothing is placed beneath the individual for additional

insulation and instant availability. In an emergency it may be necessary to dress in the dark. In the morning all ice and frost is removed and the bag ventilated before rolling it up. Time permitting, it is hung up by the strings and thoroughly dried.

*d.* When sleeping in a heated tent without a sleeping bag, boots are usually removed, situation permitting. The parka is used like a blanket. The rucksack makes a good pillow. The clothing is always loosened.

### 3-55. Water Points and Snow Area Locations

During the winter it may be necessary to obtain water by melting snow or ice. When such a source is utilized for drinking purposes, an area should be set aside and restricted to this purpose only. A preferable site is one upwind from the bivouac and isolated from the latrine and garbage disposal areas. If such an area is not available, then snow should be gathered from the branches of trees or lightly skimmed from a carefully isolated area adjacent to the individual shelters. Water obtained in this manner must be boiled for one minute or chemically treated. Chemical sterilization of water under freezing conditions requires a longer period because the disinfecting compounds act with retarded efficiency under such conditions. The time allotted for contact with purification tablets should be two to four times the normal period of one-half hour. Eating ice or snow is unsatisfactory and may result in injury to lips or tongue. Contamination may also be a hazard. If no other water source is available, as in a survival situation, snow can be eaten but it must first be brought to the melting point by holding it in the bare hand. It may then be eaten slowly and in small amounts. This is best done during periods of temporary heat excess, as during marching, or while in the sleeping bag. The risk of frostbite to the hand must be considered and balanced against the need for fluids. Should some water be available in an uninsulated canteen during a survival situation, this should be warmed under the clothing or in the sleeping bag. Then snow may be added to the canteen after each drink to replace the water consumed. Body heat stored in the slightly warmed water will

thus melt the snow with less risk of cold injury to hands or lips. A glass bottle or plastic bag can be used in place of an uninsulated canteen.

### 3-56. Bough and Firewood Areas

The areas for cutting boughs and firewood should be immediately designated when a bivouac site is selected.

*a. Bough Area.* The area for cutting boughs for bedding as well as for construction of improvised shelters should be common to all individuals of the group. It is selected in a dense area of woods in which springy, unfrozen boughs are available, and should not be too close to the bivouac site. It is advisable to use sleds in hauling material to the shelter site. Due to the camouflage and track discipline, only one well-concealed trail is used. When cutting boughs, the unnecessary felling of trees should be avoided because trees lying on the ground can be easily observed from the air. Instead of felling trees, only the lower branches should be used.

*b. Firewood Area.* It is advisable to have the firewood area nearby the area designated for bough cutting so that the same track can be used. Dry, dead pine trees make the best firewood. If no dead trees are available, green birch trees may be chopped; they possess excellent burning qualities even when frozen. The top parts of dead trees should be burned during the daytime, as they give off lighter colored smoke. The lower part of the trunk has more resin and tar, and burns better, but makes more and much darker smoke.

### 3-57. Storage

Storage problems in winter are increased by snow, low temperatures, thaws, limited storage space, and the increased problems of transportation. Space in any shelter is limited. Only items which are affected by cold, or which must be immediately available, should be stored inside. All other stores must be concentrated, well marked, covered, and left outside. On the other hand, some perishables which are difficult to preserve in summer may be kept during the winter months in a natural "deepfreeze" over an extended period of time. In areas where permafrost exists, a hole can

be dug or blasted out and then covered with insulating material, such as boughs. A constant low temperature can thus be maintained.

*a. Rifle Stand and Hanging of Weapon.* In wooded terrain a weapon rack may be built from poles placed in a horizontal position and covered with boughs (fig. 3-24). When boughs are not available, various other materials such

as empty cardboard boxes, tent or sled covers, waterproof bags or ponchos can be utilized to protect the weapons from rain, dust, and falling or drifting snow. When weapons are hung outside on stacked skis, or suspended above the snow in some other manner, they are hung with the muzzle down to keep falling or blowing snow out of the barrel and working parts.

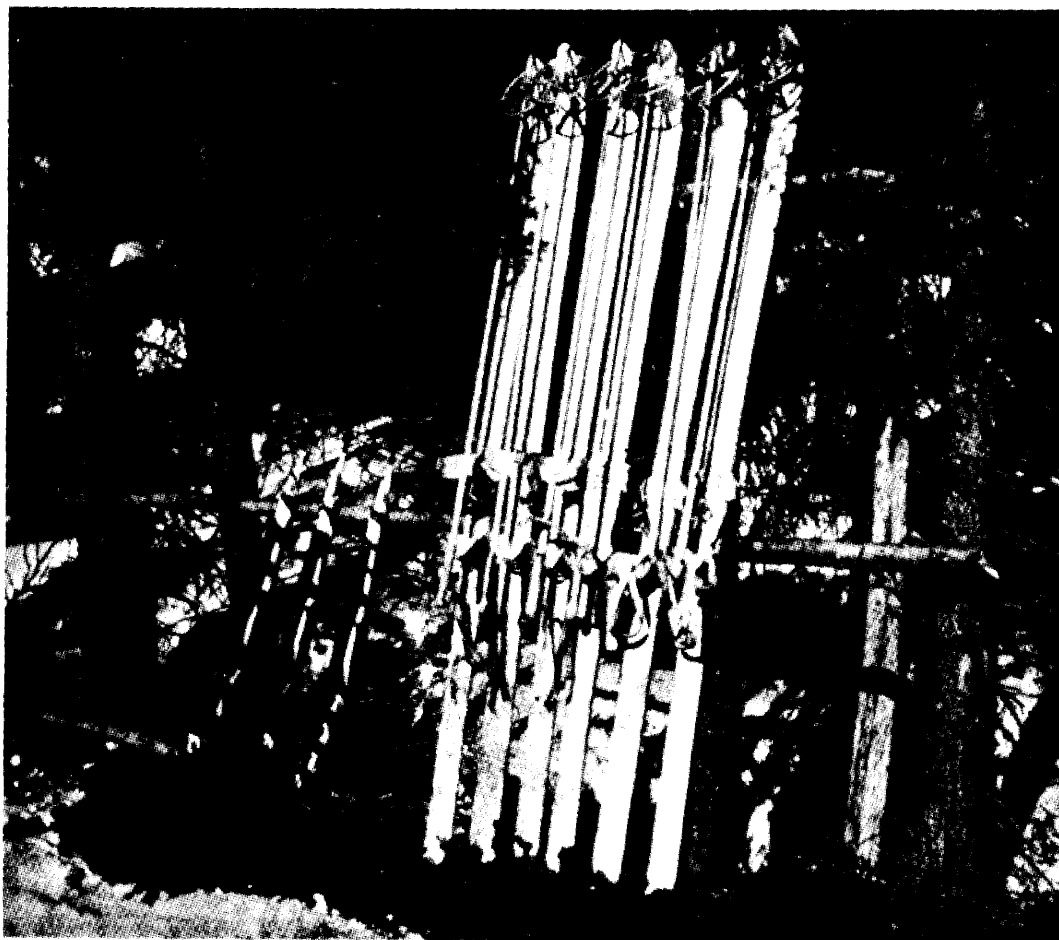

*Figure 3-24. Rifle and ski stand.*

*b. Ski Racks and Stacking of Skis.* Care of skis in the field is highly important because unit and individual mobility depends upon them. If left lying on the snow in the bivouac area the bindings and running surfaces will freeze and render the skis unusable for a long period of time, or they may be entirely lost under drifting snow. Therefore, the skis and ski poles are placed on an improvised ski rack made of one or two long poles which have

been secured between two growing trees horizontal position (fig. 3-24). In open areas, skis are simply stuck upright or stacked in the snow as described in appendix C.

*c. Sleds.* Sleds are placed on their sides or on end outside. If loaded sleds are left on the snow, sticks, poles, or branches are laid under the runners to prevent them from freezing to the snow. Heavy cargo sleds, 1-ton or larger, must be placed on top of heavy poles or logs

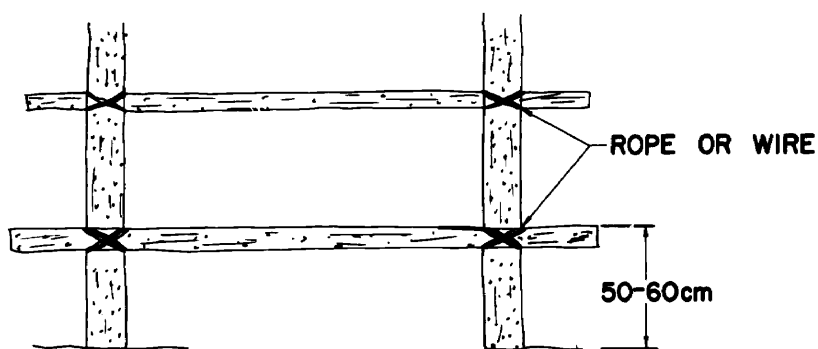

Figure 3-25. Field latrine in the forest.

due to the fact that sled runners remain hot after extensive usage and tend to settle into the snow and become frozen, making movement of the sled difficult the following day.

*d. Vehicles.* Vehicles are driven under a big tree or in lee of a shelter or snowdrift. Vehicles should be parked so the least amount of snow can get into the engines and parked on brush, logs, dry ground, or other surfaces not liable to thaw from heat of tires and tracks and refreeze.

*e. Ammunition and Fuel.* Ammunition and fuel are stored separately outside. Ammunition boxes should be stacked off the ground in a dry place and covered with canvas or boughs. In order to locate stacks if snow-covered, a pole should be erected near them. Boughs or poles are placed under fuel containers to prevent them from freezing to the snow.

### 3-58. Field Sanitation

*a. Waste Disposal.* Field sanitation in the

colder regions is based on the same principles as in temperate climates. The extremes in climate and weather, however, make the problem more acute. The wastes that present constant and real problems are human excreta, garbage, and trash.

- (1) In bivouac areas, pit or "cross-tree" type latrines are used for the disposal of human waste (fig. 3-25). One latrine will usually serve the needs of individuals occupying 3 to 4 shelters, or a unit of platoon size. The latrine is placed downwind from the bivouac, but not so far from the shelters as to encourage individuals to break sanitary discipline. Ration boxes or similar material should be used to collect waste. A urinal, designated for each shelter, should be located within 4 to 5 meters (4 to 5 yards) of the shelter. A windbreak of boughs, tarpaulins, ponchos, or snow wall should

be constructed to protect the latrine from the wind.

- (2) When breaking bivouac, the human waste that has accumulated in the latrine will be burned or buried. All closed latrine sites, tactical situation permitting, will be clearly marked.

*b. Trash and Garbage Disposal.*

- (1) In winter the edible portion of food waste may be collected in receptacles and disposed of by burial in the snow at a safe distance from the bivouac. Every effort should be made to burn the bulk of the trash and garbage. During seasons and in locations where bears are found, all edible garbage should be burned to avoid attracting bears to campsites.

- (2) All trash and garbage dumps should be marked with appropriate signs to warn troops who might occupy these disposal sites at a later time.

- (3) Strict camouflage of all trash and garbage is essential. Dark trash on the white snow is easily seen from the air. Glittering tin cans or bottles may be seen by the enemy. Trash and garbage should be placed under any available cover and camouflaged with snow, branches, or other materials.

*c. Rats and Mice.* Rats and mice will be found in most of the habitable cold regions of the earth. They are a definite menace to health and property and should be kept under strict control. Rat poisons or traps should be used when available.

## CHAPTER 4

## SKIING AND SNOWSHOEING

## Section I. INTRODUCTION

**4-1. Purpose and Scope**

a. The purpose of this chapter is to provide information concerning—

- (1) Techniques used in military skiing and snowshoeing.
- (2) Application of these techniques to facilitate the oversnow mobility of troops engaged in military operations.

b. This chapter also describes—

- (1) Equipment available for military skiing and snowshoeing.
- (2) Maintenance and care of that equipment.

**4--2. General Considerations**

a. *The Need for Individual Mobility.*

- (1) Warfare in snow-covered areas requires oversnow mobility off the roads. Well-trained ski and snowshoe troops are a definite asset on the snow-covered battlefield. In deep snow (61 cm (2') or greater in depth) the individual has almost no mobility without the aid of skis or snowshoes. Troops on skis attain mobility, are not roadbound, and are able to move cross-country over all types of snow-covered terrain. They are ideally suited for reconnaissance, security missions, and deep penetration patrols conducting unconventional type operations. Aggressive action can be carried out with advantage against the enemy flanks, rear, or communication lines by lightly equipped, fast-moving troops on skis.
- (2) Deep snow hinders movement on foot.

By using snowshoes, individual mobility will be restored to a point approximately equal to that of foot movement on hard ground. Skis, on the other hand, provide individual mobility usually exceeding that possible on foot.

b. *Need for Certain Techniques.*

- (1) During cross-country marches and in combat the soldier on skis or snowshoes will be required to negotiate various types of terrain conditions. He will be moving and operating in different weather and snow conditions. Carrying a rucksack-and a weapon, he will be required to move in forests, over open terrain, uphill and downhill, and often while pulling a sled.
- (2) In order to execute his mission with the least wasted effort, the soldier must apply the proper techniques of skiing and snowshoeing required for the various conditions under which he will operate.

c. *Use of Oversnow Equipment to Achieve Mobility.*

- (1) The means available to the individual soldier for obtaining oversnow mobility are skis and snowshoes. When operating in snow-covered terrain the soldier must be equipped with either skis or snowshoes at all times. Using skis, he is normally able to execute long marches with less effort and in less time than when using snowshoes. Cross-country movement by soldiers on skis can be facilitated by towing

the skiers with tracked vehicles or animals (skijoring). Snowshoes are more suitable than skis in confined areas, when working close to heavy weapons, or when training time is limited.

- (2) Rates of movement over snow-covered terrain cannot be given in exact time requirements. They vary in each situation. However, as a guide, the following rates are listed. Rates are given for movement over flat or

gently rolling terrain while individuals are carrying a rifle and loaded rucksack.

	<i>Unbroken trail</i>	<i>Broken trail</i>
On foot (less than 30cm (1') of snow).	1-2 mph	1¼-2 mph
On foot (over 30cm (1') of snow).	¼-¾ mph	1¼-2 mph
Snowshoeing -----	1-2 mph	2-2½ mph
Skiing -----	1-3½ mph	3-3½ mph
Skijoring -----	N/A	5-15 mph (depending on terrain)

## Section II. SNOW AND TERRAIN

### 4-3. Snow Composition

Snowflakes are formed from water vapor, at or below 32° F., without passing through the liquid water state. Newly fallen snow undergoes many alterations on the ground. As the snowmass on the ground packs and becomes denser, the snowflakes consolidate and the entrapped air is expelled. These changes are caused by effects of temperature, humidity, sunlight and wind.

*a. Temperature.* In general, the lower the temperature, the drier the snow and the less consolidation. As the temperature rises, the snow tends to compact more readily. Temperatures above freezing cause wet snow conditions. Lowered night temperatures may refreeze wet snow and form an icy crust on the surface.

*b. Sunlight.* In the springtime, sunlight may melt the surface of the snow even though the air temperature is below freezing. When this occurs, dry powder snow is generally found in shaded areas and wet snow in sunlight areas. Movement from sunlit areas into shaded areas is difficult because the wet snow will freeze to skis and snowshoes. After sunset, however, wet snow usually refreezes and the ease of movement improves.

*c. Wind.* Wind packs snow solidly. Wind-packed snow may become so hard that skiing or even walking on it makes no appreciable impression on its surface. Warm wind followed by freezing temperatures may create an icy, unbreakable crust on the snow. Under such conditions, skiing and snowshoeing are very

difficult. Another effect of wind is that of drifting the snow. The higher the wind velocity and the lighter the snow, the greater the tendency to drift. All troop movement is greatly affected by drifting snow and wind, the effect depending on the relative direction and velocity. In addition, as the wind, increases, the effect of extreme cold (windchill effect) on the body may slow down or temporarily stop movement, possibly requiring troops to take shelter. The snowdrifts created by wind usually make the snow surface wavy, slowing down movement, especially in darkness.

### 4-4 Snow Characteristics

The characteristics of snow which are of greatest interest to the soldier are—

*a. Carrying Capacity.* Generally, when the snow is packed hard, carrying capacity is greater and movement is easier. Although the carrying capacity of ice crust may be excellent, movement generally is difficult because of its slippery surface.

*b. Sliding Characteristics.* All-important to the skier are the sliding characteristics of snow. They vary greatly in different types of snow and temperature variations and materially increase or decrease the movement of the skier, according to the conditions that exist.

*c. Holding Capacity.* The holding capacity of snow is its ability to act upon ski wax in such a way that backslapping of the skis is prevented without impairing the forward sliding capability. Holding capacity changes greatly with different types of snow, making it



necessary to have a variety of ski waxes available.

**4-5. Effects of Snow and Terrain on Individual Movement**

a. Skis or snowshoes are usually employed in military operations when the depth of snow is 30 cm (1') or more. This equipment is needed in deep snow conditions to provide the necessary oversnow mobility of the individual and the maneuverability of troops.

b. Snow cover, together with the freezing of waterways and swampy areas, changes the terrain noticeably. Generally, the snow covers minor irregularities of the ground. Many obstacles such as rocks, ditches, and fences are eliminated or reduced. Lakes, streams, and muskeg, impassable during the summer, often afford the best routes of travel in the winter when they are frozen and snowcovered. During breakup periods this advantage is reduced, since the snow becomes slushy and the carrying capacity is poor. Even so, skiing or snowshoeing, although slow, is often the only practical way to move during this period. The drop in temperature at night will still freeze the snow surface, creating a good route for a skier or snowshoer during the night and early morning.

c. The effects of snow and terrain on individual movement vary in different areas.

- (1) The arctic tundra and vast subarctic plateaus are similar. They are characterized by large plains and gently rolling terrain with scant vegetation where rocky ridges, scattered rock outcroppings, riverbanks, and scrubby brush still create obstacles to individual movement, when encountered. The shallow snow cover nor-

really found in these areas, as a rule, is firmly packed by wind action and will usually support a man on foot. When the snow has not been wind packed and is still soft, mobility will be increased by the use of skis or snowshoes.

- (2) Forested areas include vast coniferous forests, dense brush, swamps, and numerous lakes and rivers. Skiing and snowshoeing are relatively easy on frozen, snow-covered rivers, lakes, and swamps. In wooded areas concealment is best, but movement is hampered by vegetation and soft snow, therefore, greater skill is required in skiing to avoid trees and other obstacles. These disadvantages are reduced by careful selection of the best routes and following proper trailbreaking procedures. Woods retard the melting of snow in spring often allowing skiing after the open fields are clear of snow. In autumn, the situation is reversed; the deeper snow is generally found in the open fields allowing skiing earlier than in wooded areas.
- (3) Mountains present special problems. Their varied and steep terrain place additional demands upon the skill of a skier and make movement on snowshoes or skis very difficult. Slopes which are easy to negotiate in summer often become difficult and dangerous to cross in winter because of deep snow cover which is prone to avalanche. Large drifts and snow cornices present other obstacles and dangers. Snow cover on glaciers obscures crevasses and makes their crossing hazardous (FM 31-72 ).

**Section III. MILITARY SKIING**

**4-6. Advantages and Disadvantages**

a. *Advantages.*

- (1) In snow-covered terrain the weakest and the most vulnerable points of the enemy are usually the open flanks, rear areas, and the lines of communication. Attacking, defending, or de-

laying troops require a high degree of oversnow, cross-country mobility to reach these objectives. Units on skis are the most suitable troops to be used for surprise attack on distant objectives.

- (2) A trained individual or a unit on skis

can execute cross-country marches on roadless, variable, and snow-covered terrain more efficiently and quickly than on snowshoes or on foot.

- (3) Skiing over snow-covered terrain by properly trained troops is comparatively less tiring than marching on snowshoes or on foot. Sliding characteristics obtained by the skier increase speed, mobility, and rate of march.
- (4) Due to increased weight bearing surface, a skier or a unit on skis is able to cross frozen lakes and rivers when the ice will not support a man on foot.
- (5) The use of oversnow vehicles and other suitable means of towing troops further increases their mobility.

*b. Disadvantages.*

- (1) Individuals require a considerable amount of training before becoming proficient in the use of skis for military purposes.
- (2) Certain terrain features, such as very dense brush and windfall areas, materially decrease the rate of march of a ski unit.
- (3) Skis often require rewaxing for changing snow conditions, which consumes time. Skis also do not provide good traction regardless of wax used, for pulling loads.

#### 4-7. Training Objectives

*a. General Considerations.* A soldier on skis must be capable of moving under control across diversified, snow-covered terrain while carrying the arms and equipment necessary for tactical operations. Since skis are often the most efficient means of transportation in winter warfare, the soldier should be so skilled in their use that skiing becomes a natural method of movement. Since the skiing soldier will utilize his skis for the greater portion of movement over snow-covered terrain, it is important that he acquire good skiing technique in order to be able to move anywhere required both quickly and with the least expenditure of energy. The soldier must develop these tech-

niques so that his movement either uphill or downhill will not delay the movement of his unit. When operating in mountainous areas, the soldier must possess efficiency in both basic and advanced military ski techniques in order to move easily and safely over steep and rough terrain; the soldier must possess endurance and must be in top physical condition.

*b. Training Time Required.* To walk on snowshoes, one day of instruction is generally sufficient. However, several days use of snowshoes during normal training will rapidly increase proficiency. In a period of 2 weeks a soldier can be taught enough ski techniques to enable him as an individual to negotiate flat or rolling terrain with greater speed than if he were on foot or snowshoes, but he will not yet be able to operate effectively as a combat skier within a unit. At least 8 weeks of intensive training are needed in order to become a military skier capable of operating proficiently in any type of terrain. It should be noted that the level of skiing skill developed by the soldier during any period of ski instruction is improved by participating in unit training which is done on skis.

#### 4-8. Ski Equipment

*a. Skis.* Military skis were formerly issued in 198 cm (61/2'), 213 cm (7') and 229 cm (7½') lengths. The standard issue ski is now 213 cm long (7') ; however, until stocks are depleted the other length skis may be issued in lieu of the standard ski. The standard skis are of laminated wood construction with hickory tops and running surfaces. They are all terrain cross-country skis with steel edges (fig. 4-1). The metal edges give better gripping action in turns and on icy and hard packed snow which results in better control. All skis are painted white and have a hole in the tip through which a cord can be threaded when it is necessary to pull them as ski bundles or as an improvised sled.

*b. Ski Binding, All Terrain.* The binding consists of a toeplate, toe straps, soleplate, heel cup, quick-release fasteners and mounting hardware (fig. 4-2). The toe plate is aluminum; the toe strap and heel cup are made of white rubber and three plies of dacron, the soleplate is made of fiberglass. This binding will accom-

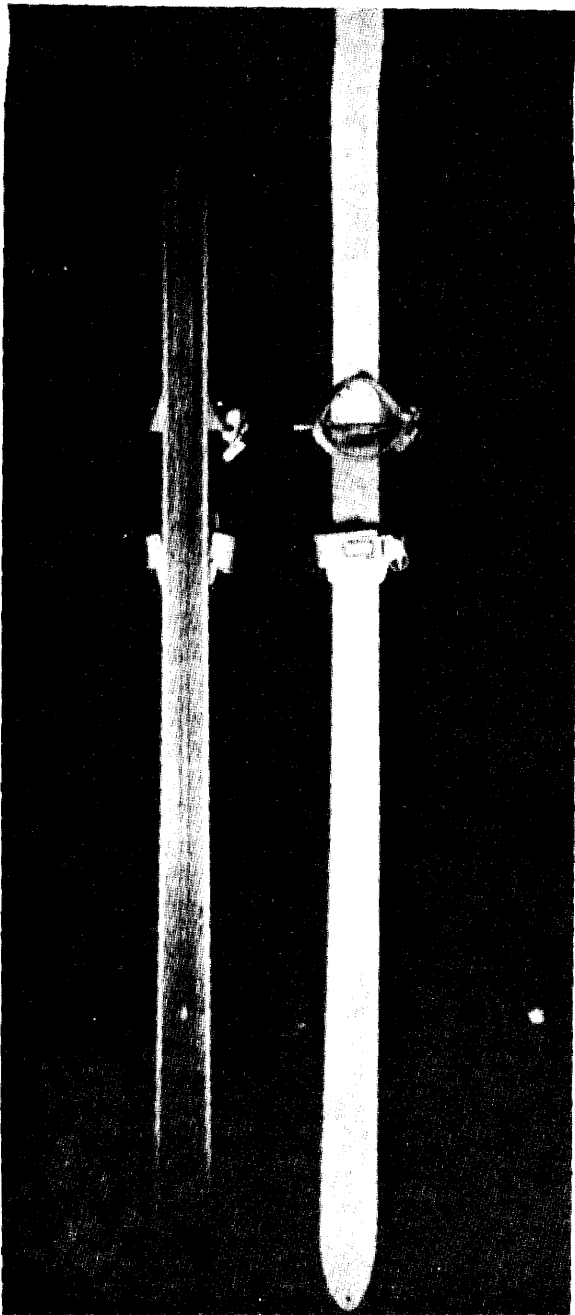

Figure 4-1. Ski, military, all terrain.

modate all types of cold weather footgear and is easily put on and removed. The soleplate is flexible and allows free vertical movement of the heel which assists normal foot movement.

*c. Ski Poles.* Nonadjustable tubular steel poles, 130 (51"), 137 (54") and 147 cm (58") in length, are the standard item of issue, however, the adjustable ski pole is being used until

stocks are depleted. Figure 4-3 illustrates the different parts of the ski pole. In an emergency, the poles can also be used for tent poles, markers, or in the construction of emergency litters.

*d. Ski Repair Kit and Emergency Ski Tip.* This kit contains pliers, screwdriver, screws, wire, drill, strips of steel edging, and leather thongs for use in emergency repair of skis, poles or bindings while in the field. An emergency ski tip is also available. This can be used to repair or replace broken ski tips and allow the individual to continue the march until replacement skis can be obtained. Ski repair kits and emergency ski tips are usually issued to units and are not intended for individual issue. One ski repair kit per rifle platoon and one emergency ski tip per squad is usually sufficient.

*e. Ski Waxes.* Ski wax is used to obtain the sliding and climbing characteristics necessary for efficient military skiing. The waxing of skis is covered in paragraph 4-10.

*f. Ski Climbers.* Climbers are strips of canvas with mohair secured to the running surface, which are attached to the bottom of the skis by means of straps (fig. 4-4). When attached, the mohair material lies with the ends pointing towards the heel of the skis. Forward movement of the ski does not disturb the material, thereby allowing the ski to slide. Backward pressure, however, causes the material to become roughened, preventing the skis from backslapping. Climbers are used by troops to make the climbing of steep slopes faster and less tiring, providing the ascent is sufficiently long to justify the time required to put them on and take them off. They may also be used to give more traction while pulling sleds, and for descents where sliding is not desired.

#### 4-9. Preparation of Skis

*a. General.* Pine tar or ski lacquer is applied to the running surface of the skis to fill the pores of the wood and to furnish a base so that the skis may be properly waxed. They are also applied to the running surface of the skis to prevent moisture from being absorbed by the wood. For military skiing, pine tar is preferred as a base. If this is not available, ski lacquer is a suitable substitute. They must

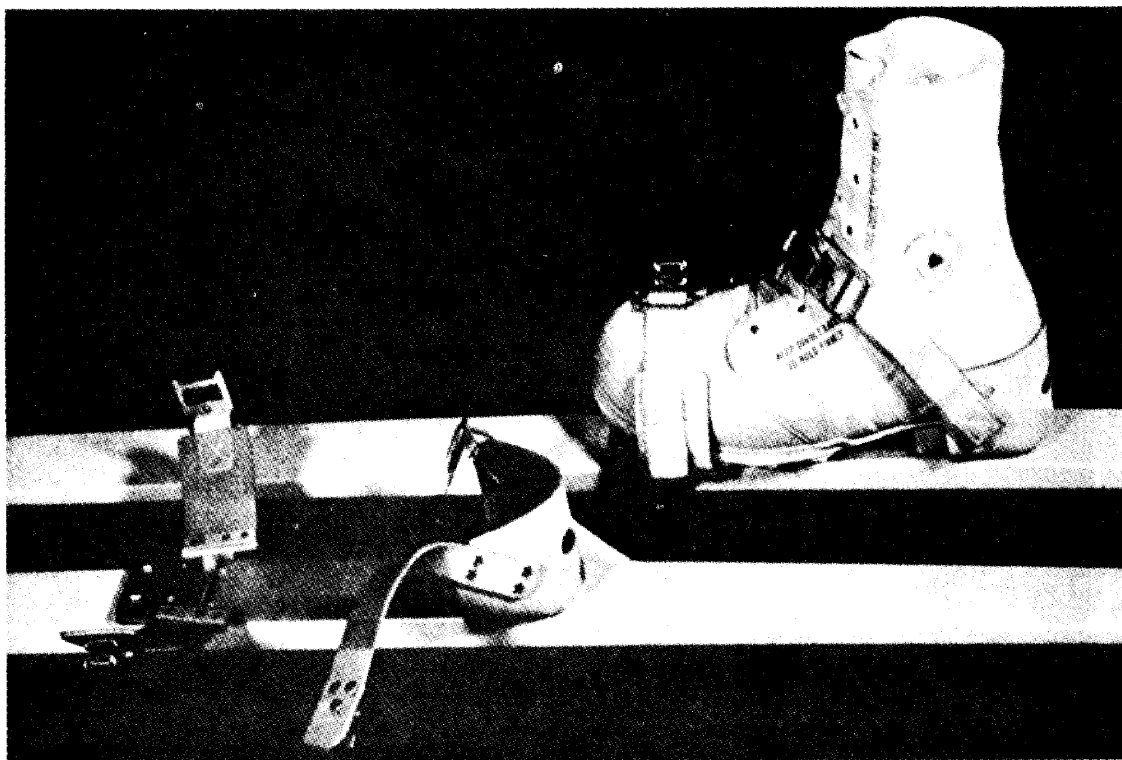

Figure 4-2. Ski binding, all terrain.

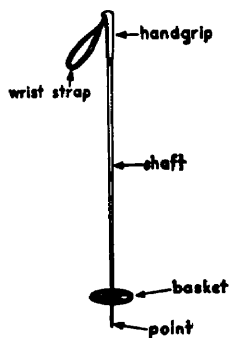

Figure 4-3. Ski pole.

be used separately since they do not mix together.

*b. Application of Pine Tar or Ski Lacquer.*

- (1) *Preparation of skis.* The running surface must be clean to prepare the skis for pine-tarring or lacquering. If the ski has been used, the old base and wax must be removed. The easiest way to accomplish this is to use a

scraper and sandpaper. Caution should be exercised to insure that the running surface of the ski is not damaged. Old wax can also be removed by the use of steel wool or a rag moistened with a high flashpoint solvent. Solvent should only be used in an adequately ventilated working area with no smoking or open flames. If conditions are such that these materials are not available, heat can be used to remove the wax.

- (2) *Tarring procedure.* After the ski has been cleaned, a light coat of pine tar is then applied with a soft brush or a rag. If the pine tar is stiff, it should be heated slightly so it can be evenly distributed. Heat is then applied to the running surface to cause penetration of the pine tar into the pores of the wood. The source of heat may be a blowtorch (fig. 4-5), one burner stove, or an open fire (fig. 4-6). To obtain the best penetration, work



*Figure 4-4. Attaching ski climbers.*

progressively on one section at a time rather than heating the whole surface of the ski. Care must be taken to avoid burning or scorching the wood by application of too much heat. It may be necessary to repeat this procedure several times to obtain a sufficient coating. Excess pine tar is removed during the heating process by means of a rag. When finished, the running surface of the ski should be dry and not sticky to the touch.

- (3) *Lacquering procedure.* After the ski has been cleaned, the surface is allowed to dry thoroughly before applying the lacquer. The lacquer is applied with a clean brush, rag, or sponge, starting at the tip and working towards the heel using smooth, even strokes in a continuous motion. None of the lacquered areas should be touched until the lacquer is completely dry. This requires several hours. The application should be made at

room temperature for best results. At least two separate coats should be applied, making certain that each one is completely dry before the next one is applied. It is recommended that the surface be lightly sanded with fine sandpaper or steel wool, between coats. Care must be exercised not to inhale toxic lacquer fumes. For prolonged or repeated exposure to such fumes, unapproved respirator should be worn. No smoking or open flames should be permitted in or around the work area and adequate ventilation should be provided.

#### **4-10. Waxing of Skis**

*a. General.* There are no standard ski waxes available in the supply system therefore commercial waxes must be procured and used. The purpose of ski wax is to provide the ski with necessary climbing and sliding qualities to prevent backslip in various snow conditions. When snow conditions and temperature change, the



Figure 4-5. Heating pine tar with a blowtorch.

type and method of application of ski wax will also differ. Before wax can be properly selected and applied, the individual must learn to recognize the different types of snow conditions. It is also valuable to have some knowledge of how ski wax performs in relation to snow. After snow has fallen on the ground, its crystalline structure is continuously altered by the effects of temperature, wind, and humidity. In very cold weather these changes occur much more slowly than when temperature is near 32° F. Therefore, the most important factor of waxing is the effect that temperature has on the character of the snow and its sliding qualities.

*b. Snow and its Effects on Wax.*

(1) *The effects of snow crystals.* It is important to understand the relation of

wax to the holding and sliding capabilities of the snow. For this reason there are specific waxes to use in cross-country skiing under different snow surface conditions.

- (a) *Proper wax.* When the soldier is skiing on the level, or uphill, his body weight gives maximum pressure to the skis. The soft quality of the wax allows the crystal structure of the snow to penetrate the wax under this pressure and thus keep the ski from backslapping. When the pressure is lifted and the ski allowed to slide forward, the penetrating snow crystals will slide free from the surface of the wax reducing friction. Continuous forward motion, as in sliding, keeps the crystals from penetrating the wax.
- (b) *Wax too soft.* When the skis slide poorly, the following condition generally exists: the snow crystals have penetrated into the wax but will not slide free. This causes clogging of the snow on the running surface and may eventually cause ice to form. Under these conditions the soldier will find that even vigorous sliding of the ski will not break the snow loose from the wax surface. Little or no forward slide can be gained.
- (c) *Wax too hard.* When the skis slide well, but backslip on the level and when moving uphill, the following condition exists: the snow crystals are not penetrating the wax. The soldier will find he has excellent sliding when going downhill, but climbing uphill or skiing on level ground is very exhausting because of backslip. This is the primary deterrent to the use of "downhill" waxes for cross-country skiing.
- (2) *Classification of snow.* Snow is classified here into four general types. This classification is intended to assist the soldier in snow identification, choice of wax, and its proper application under these different conditions.
- (a) *Wet snow.* This type of snow is



*Figure 4-6. Heating skis over an open flame.*

mostly found during the spring, but it may also occur in the fall or late winter, particularly in regions of moderate climate. This type of snow can be readily made into a heavy, solid snowball. In extreme conditions, wet snow will become slushy and contain a maximum amount of water.

- (b) *Moist snow.* This type of snow is generally associated with early winter, but may also occur in mid-winter during a sudden warmup period. This type of snow can be made into a snowball, but will not compress as readily or be as heavy as a wet snowball. It will have a tendency to fall apart.
- (c) *Dry snow.* This type of snow is generally associated with winter at its height, but it can occur in late fall

as well as in spring, when abnormally low temperatures occur. This snow is light and fluffy. It cannot be compressed into a snowball unless the snow is made moist by holding it in the hand. At extremely low temperatures, such as those found in the far northern regions, this snow is like sand, and has very poor sliding qualities.

- (d) *New snow.* This is snow which is still falling or has recently fallen on the ground, but has not been subject to changes due to the sun or temperature variation. It can be wet, moist, or dry in nature.

*c. Proper Selection and Application of Waxes.* Cross-country ski waxes are formulated to provide optimum sliding and climbing characteristics for various types of snow conditions. Each type is labeled with appropriate instruc-

tions on its intended use, i.e., wet, moist or dry snow conditions. Since the types of wax vary between manufacturers, no particular type of wax can be prescribed for each classification of snow; however, the instructions on each container specifies the weather conditions and type of snow where performance of the wax is best. Proper application of all waxes is important to achieve desired results whether they be traction or sliding action. As a general rule, the wax that gives the best sliding surface for all types of snow provides an excellent base for application of other waxes. To provide traction, varying amounts, combinations, and methods of application of other waxes are used. When pulling a sled or carrying a heavy load, thicker coats of wax may be required to insure traction.

*d. Waxing Procedure.*

- (1) Whenever possible, the waxing of skis should be done before the march when shelter and heat are available, as the running surface of the ski should be warm and dry to obtain best results. When on the march, ski wax should be carried in the pockets, if possible, so that body heat will keep the wax soft and easy to use. If the skis need waxing during the march, the running surfaces are dried as much as possible by the use of paper or dry mittens. Whenever possible, old wax should be removed before rewaxing skis particularly when a different type of wax is being used. Refer to paragraph 4-9 *b* (1) for proper method for removing old wax.
- (2) To apply, cover the running surface with wax. Next, smooth the wax by rubbing it with the hand, using the heel of the palm or the fingers (fig. 4-7), a waxing cork, or a heated iron. When heat is available, this process can be made easier by warming the wax that has been applied. It is normally best to work progressively on a section at a time, from the ski tip towards the heel. If the waxing is done in a shelter, or heat is used, the skis should be allowed to cool to outside air temperature before being

used. Do not place the running surfaces of skis on snow immediately after waxing if heat is used or if waxing is done in a heated room or shelter as the snow may stick and freeze to the running surface. For the same reason protect the running surfaces against wind driven snow. To insure that wax is properly chosen and applied, the skis should be tested before being used on an extended march.



*Figure 4-7. Smoothing wax with bottom of hand.*

## 4-11. Care of Ski Equipment

*a. General.*

- (1) A broken ski or binding may put a



soldier at the mercy of the enemy and the elements and prevent him from accomplishing his mission. If the soldier keeps his skis and equipment in good condition, he will find that ski marches are easier and less tiring and that he will not be the cause of any unnecessary delays and halts by his unit. Care of ski equipment is the responsibility of the individual soldier—he must check it before starting out on a mission, during breaks, and when in bivouac. At least once a week the ski equipment should be thoroughly checked by unit leaders. During combat the inspection must be done whenever the situation permits.

- (2) Skis must be checked for proper base of pine tar, evidence of possible warping and splitting, loss of camber, defective edges, and broken steel edge sections or screws. At the same time bindings must be checked for worn straps, missing rivets and screws, and proper adjustment. Ski poles should be checked to insure that wrist straps, handgrips, baskets, and points are firmly fastened and that no breakage has occurred.

*b. Daily Care.*

- (1) After each day's use, the skis and the skiing equipment should be checked and necessary repairs made by the individual as follows:
  - (a) *Skis.* Remove any snow or ice that has frozen to the ski. This may be done with heat. If heat is not available, this can be done with a mitten, wooden stick, or piece of metal. Check the heels and tips of the skis for cracks. Badly cracked skis must be replaced, as they are weakened and break easily. At the same time, check for and replace defective or missing edges and screws. The condition of ski bottoms is then checked and, if needed, additional pine tar or base wax is applied. The surface waxing for the next day's march is deferred until snow con-

ditions are determined in the morning or shortly prior to departure. After maintenance of skis is completed, they should be placed indoors, preferably in a ski rack (fig. 4-8). Under field conditions, skis are placed in an improvised ski rack, planted upright in the snow or stacked.

- (b) *Bindings.* Insure that all straps, buckles, screws and rivets are present and in good condition. Replace parts which are unserviceable. If necessary, readjust the fit of the bindings.
  - (c) *Poles.* Check wrist straps, handgrips, shafts, baskets, and points to insure that they are in good condition. Broken parts should be replaced at the first opportunity. Temporary repairs can be made with wire, cord, or tape.
- (2) When snow cover is comparatively thin, be careful not to damage the skis while skiing in rocky or stumpy terrain. Sometimes there is water under the snow cover on frozen rivers or lakes. Try to cross them at a dry place; make an improvised hasty bridge from trees or boughs, if time permits. If the skis become wet during a crossing of water, the ice which forms on the skis must be removed after reaching the bank. A long march or sudden change in temperature may require rewaxing of skis during the march. When skis are removed, do not leave them on the snow. It may stick and freeze on the running surface. Remove the snow from the skis and stack them beside the ski tracks or lean the skis against a tree. A ski stack can be built by each squad.

*c. Repair.*

- (1) *General.* Repair of unserviceable ski equipment requires qualified personnel with necessary tools and facilities. Therefore, the soldier will only be permitted to make emergency repairs such as replacing bindings, screws, and steel edges.

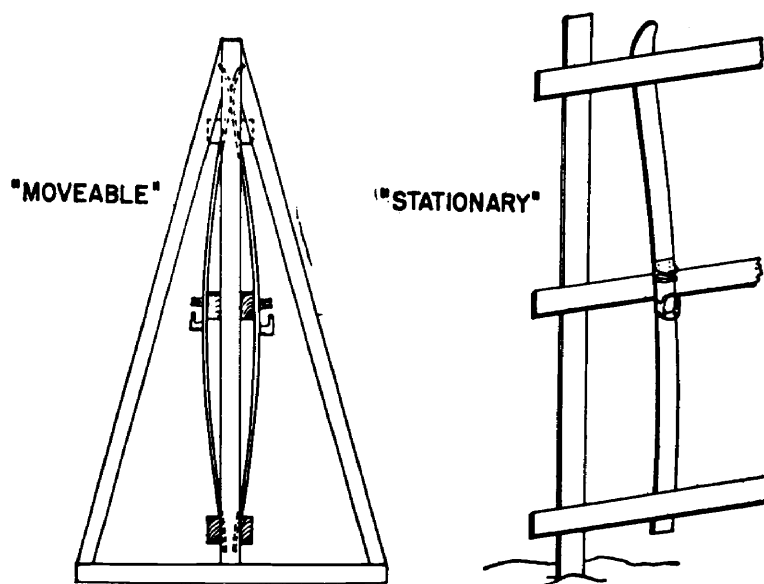

Figure 4-8. Two types of ski racks.

(2) *Emergency repair.* The repair of ski equipment under field conditions is emergency repair. In many cases broken skis or worn out parts of ski equipment must be replaced. To facilitate this, the following arrangements are necessary:

- (a) Every unit should have replacement skis, bindings, and poles. There should also be available, ski repair kits, pine tar or lacquer, and waxes.
- (b) Every squad should have one emergency ski tip (fig. 4-9) and each platoon, one ski repair kit.
- (c) Every man should have the following in his possession at all times:
  1. Emergency thong.
  2. Pocketknife.
  3. Piece of light wire (malleable) or nylon cord.

(3) *Combat repair.* During combat, the most suitable time for maintenance and repair of skis and ski equipment is when the unit is in reserve.

d. *Storage.*

(1) Proper storing of skis and skiing equipment is most important, during off seasons. Improper care in storage



Figure 4-9. Attaching an emergency ski tip.

procedures will damage this equipment, making it unserviceable.

(2) When the skiing season is over, skis and poles are turned in by the using unit for storage. Before doing so, the

skis must be cleaned and old waxes removed.

- (3) Skis and poles are then checked thoroughly. Those in good condition are separated from those in need of repair or salvage. Necessary repairs are made. Ski bindings are not removed. All skis should be pine-tarred or lacquered. If needed, skis are repainted. Skilled personnel are needed for repairing skis and poles and for preparing them for storage.
- (4) In further preparation, the skis are tied together by matching pairs according to their factory markings not unit markings. A piece of string or cord is used to tie the skis at their tips and heels with running surfaces facing each other. A wooden block (waxing cork may be used) is then placed between the skis at the metal toe plates. The correct spread is about 6 to 8 cm (2" to 3"). After being blocked, the skis are stored in a vertical position, with the tips down. If the skis must be stored horizontally, they should be supported at both ends and at the middle, with the end supports on the top side of the ski and the middle support beneath and arranged so that tension is maintained on the camber. Each ski should be supported individually when stored horizontally. The storage room should be dry with an even temperature and good ventilation (fig. 4-10).
- (5) After ski poles are checked, repaired, and reconditioned, they should be placed in the same storage area as the skis.

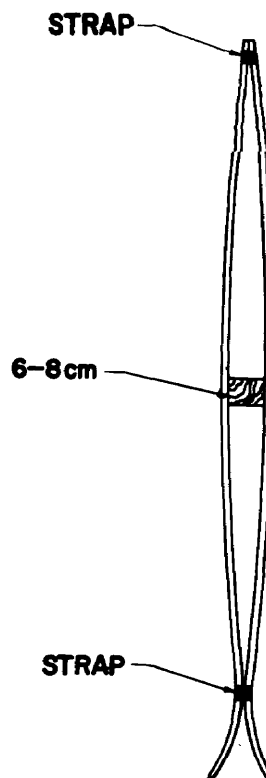

Figure 4-10. Blocked skis for storage.



- 1 From the starting position the right ski will be placed approximately 45° to the right.

Figure 4-11. Step turn.

## 4-12. Basic Movement

*a. General.* In moving on skis for the first time, most beginners find that skis are awkward to handle due to the difficulty of obtaining the necessary balance and coordination. To overcome these difficulties, the first instructional phase is devoted to step turns and walking on level ground in order to obtain the balance, correct body position, coordination, and rhythm necessary in skiing. In addition, this



2 After placing the right ski, the left ski will be brought alongside and placed parallel.

Figure 4-11—Continued.



4 As many repetitions of this cycle as necessary are made until the new desired direction of travel is reached.

Figure 4-11—Continued.

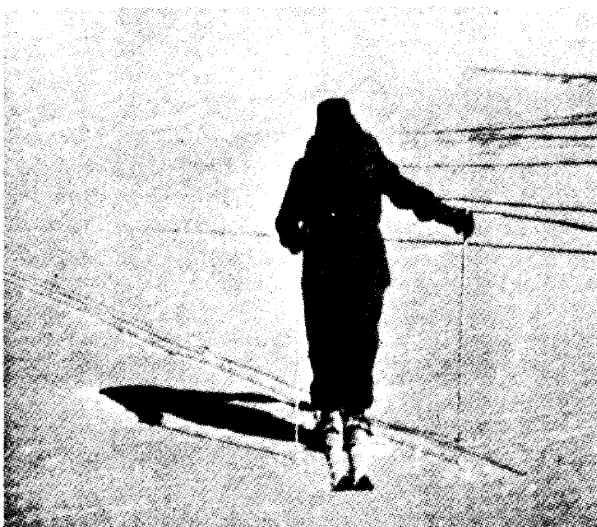

3 As the left ski pole is finally brought in alongside the left ski, the cycle is completed.

Figure 4-11—Continued.

basic movement is a means of forming the foundation for further instruction. Ski drill techniques are covered in appendix C.

*b. Skiing Without Poles.* The soldier will find that in performing duties, especially in combat, he will be required to ski either with poles carried in one hand or without poles. For

this reason, it is important that he practice all techniques with and without the use of ski poles. This is especially important in the beginning stages of skiing, as practice without ski poles will aid in learning proper transfer of body weight, balance, timing, and control of the skis.

#### 4-13. Step Turn

*a. Use.* The step is the simplest means of changing direction from a standing position. It is particularly valuable in brushy and wooded terrain (fig. 4-11).

*b. Technique.*

- (1) From the standing position the right (left) ski tip is raised, the ski is rotated to the right (left) side, using the heel of the ski as a pivot.
- (2) The ski is placed on the snow and the body weight shifted onto it.
- (3) The left (right) ski is moved alongside the right (left) in the same manner.
- (4) Each pole is raised, moved, and placed with the corresponding ski (i.e., right ski, right pole).
- (5) The same movement is repeated until the desired direction is obtained.

- (6) In confined areas it may be necessary to use the tip of the ski instead of the heel as a pivot point. In turning to the right (left) the heel of the left (right) ski is raised off the snow and moved to the left of its original position. Then the right (left) ski is moved alongside the left (right) ski and this sequence repeated until the desired direction is achieved.

#### 4-14. Kick Turn

*a. Use.* The kick turn is a method for reversing the direction of a skier when in a standing position. It is used on both flat and steep terrain. In combat, it is also useful to conceal a change of direction in a ski track (fig. 4-12).

*b. Technique.*

- (1) Beginning in the standing position with skis level, the left (right) pole is placed alongside the left (right) ski approximately 45 to 60 cm (18" to 24") in front of the toe of the foot. At the same time the right (left) pole is placed alongside the right (left) ski about 45 to 60 cm (18" to 24") behind the heel of the foot.



Prepared for a kick turn to the right by swinging the right foot and ski to the rear a slight amount.

*Figure 4-12. Kick turn.*

- (2) The right (left) leg is swung forward and upward until the ski is momen-



- 2 The right ski is then swung forward and the heel placed in the snow, approximately even with the left ski tip.

*Figure 4-12—Continued.*



- 3 From the vertical position the right ski is allowed to swing away from the body, keeping the heel in place, and rotated until it is parallel with the left ski.

*Figure 4-12—Continued.*

tarily perpendicular, its heel alongside the tip of the left (right) ski. To obtain sufficient momentum for this movement, a preliminary backward movement of the right (left) ski should first be made.

- (3) The right (left) ski is then pivoted on its heel and lowered, pointing in



- 4 The left ski is lifted and rotated around to the new position, parallel with the right ski.

Figure 4-12—Continued.

the opposite direction and parallel to the left (right) ski.

- (4) The body weight is shifted to the right (left) ski, bringing the left (right) ski and pole around and alongside the right (left) ski in the new direction, placing the ski pole in the snow.
- (5) On a gentle slope the procedure is the same, except the uphill ski should be turned first.
- (6) On a steep slope, the skis are placed horizontally across the slope and edged into the slope for necessary stability. The movements in executing the turn are the same as described above except that both ski poles are initially placed in the snow above the skis and the downhill ski is turned first. Then the uphill ski and pole are brought around simultaneously to complete the turn.

#### 4-15. The Walking Step

*a. Use.* This is the simplest movement in skiing and is used as the basic step in forward motion. In military skiing, its application is for situations where walking or climbing is necessary. On level ground, sliding action of variable degrees can be obtained.

#### *b. Technique.*

- (1) From the position of attention on skis (para C-17) left unweighted ski is slid flat over the surface of the snow and straight forward as in normal walking.
- (2) At the same time, both knees are bent and the body weight is gradually shifted onto the advanced foot. The heel of the rear foot is raised.
- (3) The right ski pole is moved forward and the basket is placed close to the right ski, towards the tip, with its shaft leaning to the front.
- (4) A push to the rear with the pole is made, assisting in the forward body motion.
- (5) The above motion is repeated with the right ski.
- (6) On level ground the skis are kept flat and parallel.
- (7) The skis are not lifted off the snow, and the weight of the skis is carried by the snow.

#### 4-16. One Step

*a. General.* The basic movement of the one step is the walking step. Forward motion and glide are increased when the skier applies more effort to his step. This added effort is obtained by a lunge coordinated with an increased push from the poles.

*b. Use.* The one step is the most widely used of all skiing steps. It is applied under all types of snow conditions on level ground (fig. 4-13).

#### *c. Technique.*

- (1) The one step is started by a forward lean of the body, with well bent knees and ankles. The feet are kept flat and the body weight is on the right ski, from which the initial movement (lunge) is made.
- (2) The left, unweighted ski is slid flat and straight forward by a springing motion from right ankle, knee, and hip, straightening the body and transferring the weight to the left sliding ski.
- (3) The springing motion (lunge) above,

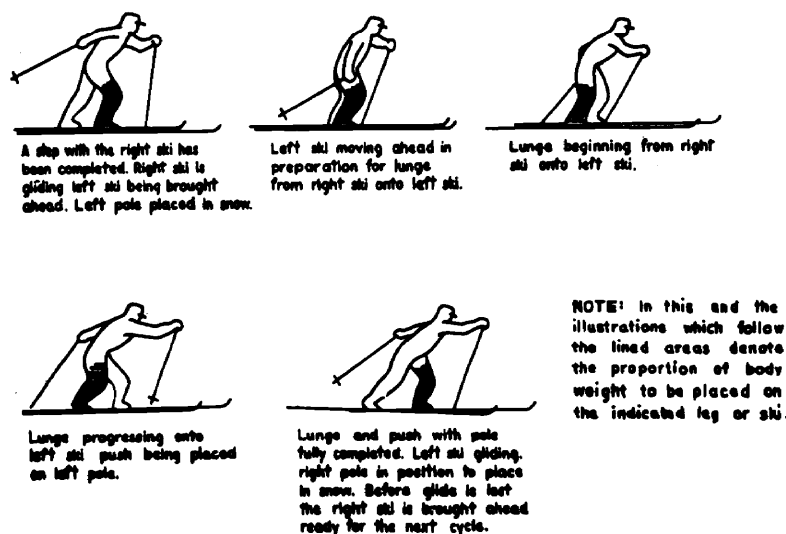

Figure 4-13. One step.

is completed by straightening the right knee and pushing off from the right foot, thus completing the weight transfer.

- (4) The body weight is kept on the sliding (left) ski and, as the glide nears completion, the left knee and ankle are bent in preparation for the next lunge. Meanwhile, the right leg is relaxed and moves the ski forward in preparation for the next step. As this leg reaches a position approximately alongside the left leg, the next step is made with the right ski by lunging from the left leg.
- (5) When using the poles, the lunge is executed as above except that as the left foot is slid forward the right ski pole is swung straight to the front and placed towards the tip of the right ski or, when the right ski is slid forward, the left ski pole is brought forward.
- (6) The slide is increased by a push with the ski pole. The ski pole is leaned slightly to the front and the arms kept close to the body.
- (7) The pushing action of the ski pole is increased progressively by the muscles of arms and shoulders. The push is finished off by a sharp straighten-

ing of the arm for added power. When the push has been completed the arm is relaxed and brought forward close to the body in preparation for the next poling action.

- (8) During the coordinated movement of poles and lunge, correct timing and a long glide are emphasized. The main power glide is obtained from the lunge executed by each leg, the poling action provides only a secondary source of momentum. All motions are rhythmic and fluent. Poles are used in a relaxed manner and the pressure of pushing is allowed to come on the wrist strap.

#### 4-17. Two Step and Three Step

*a. Use.* This step is used to attain a longer and faster glide on the level. It is also used as an aid through dips and over bumps.

*b. Technique.* The technique of the two step is a combination of an accelerated walking step and a one step. In the two step the push is obtained by the use of double poling (fig. 4-14).

- (1) From a standing position with the knees slightly bent, a walking step is made with the left ski to start the body in motion initially.
- (2) A lunge is then made from the left

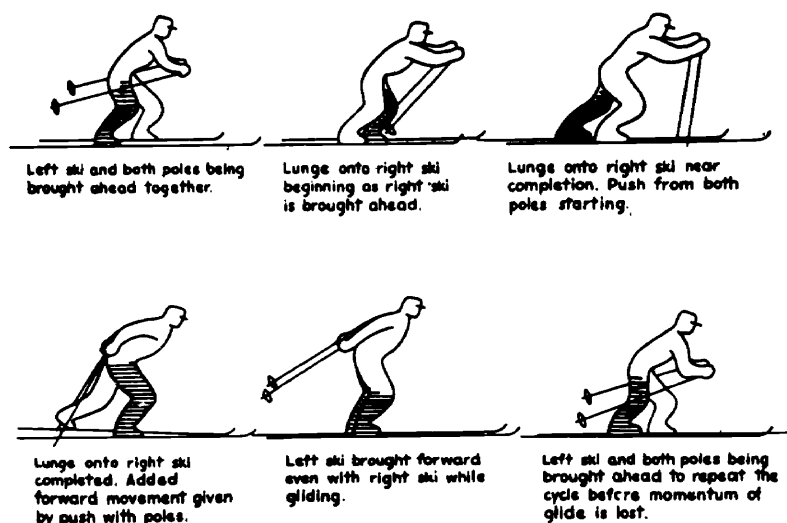

Figure 4-14. Two step.

leg, in a continuous rhythmic motion, to produce a long glide on the right ski.

- (3) While gliding on the right ski, the left ski is brought slowly forward and even with the other ski to complete the first two step and in preparation of the next two step. This action should be started before the momentum of the glide has been lost.
- (4) As the first step is made, both ski poles are brought straight to the front in a comfortable reach and set into the snow alongside the skis in coordination with the lunge of the second step.
- (5) The pushing action with the poles is applied in the same manner as described above in using one pole. As the poles leave the snow, they are brought forward in a straight line in preparation for the execution of the next step. It is most important to time this motion properly to coordinate with the next lunge.

*c. Three Step.* In addition to the two step, the three step may be used anytime when changing ski steps and when sliding is poor. The initial steps are intended to produce more initial power. It has an advantage over the two step since it allows double poling and lung-

ing from alternate feet. The step is made in the same manner as the two step except that two walking steps are taken before each lunge.

#### 4-18. Variations and Applications of Ski Steps

*a.* In long, cross-country movement, particularly when skiing with pack and rifle, it is most important to apply techniques properly according to the terrain to insure that energy is spent wisely and conserved as much as possible. To this end, the individual must attempt to obtain as much glide as possible from his skis during each step. Although lasting only for a short moment, the glide will allow the skier to rest temporarily. In addition, all movements must be made in a relaxed manner, which necessitates continuous individual training. The constant use of the same step is monotonous and increases fatigue. To avoid this, various steps are used temporarily. The same effect is also necessary in poling. In order to relax arm and shoulder muscles, a series of steps may be made without poling. In the one step, for instance, the first two steps can be made without using the poles. Any additional combination of steps and poling may be made at one's discretion for the same reason, placing more emphasis on leg rather than arm work, or vice versa.

*b.* In bumpy terrain, ski steps and poling



may be used individually or in various combinations to provide a strong pushoff to provide the skier with sufficient glide for a continuous motion through a dip and over a bump. When a series of bumps and dips is encountered, the poling action is generally applied on the crest of the first bump in order to obtain sufficient momentum to reach the top of the next bump in a continuous glide. A step supported by double poling may be applied when skiing through the dip. There are other situations where double poling may be applied to gain or increase forward motion of the ski without taking a step.

#### 4-19. Falling

*a. General.* In military skiing there are two types of falls, controlled and unintentional.

- (1) *Controlled falls.* The controlled fall has definite value. It can be used to avoid excessive speed or to avoid hitting obstacles if other means are not possible. The controlled fall can be done safely only at slow to moderate speeds. It is used to take cover quickly, assume a firing position or for a

quick stop to avoid hitting an object. When properly used, it can be accomplished without injury to the individual.

- (2) *Unintentional falls.* Unintentional falls are undesirable and may cause serious injury. Other undesirable results of an unintentional fall are increased fatigue, possible frostbite, and holes in the snow which may cause other skiers to fall. Factors which may contribute to unintentional falls are poor skiing ability, lack of control, snow conditions, fatigue, and excessive speeds.

#### *b. Technique of Falling.*

- (1) If a fall is imminent, an attempt is made to relax, lower the body, and to land sideways and to the rear.
- (2) While falling, an attempt should be made to stretch the body, to extend the arms and to keep the ski poles to the rear (fig. 4-15). Care should be taken to keep the knees from digging into the snow, as such action is a major cause of injury.



1 Falling on the slope

Figure 4-15. Falling and recovery.



**2 Recovery from a fall on the slope.**

*Figure 4-15—Continued.*

- (3) The impact of the fall should be absorbed by the hips or buttocks.
  - (4) The unintentional fall is avoided as much as possible. It is often prevented by the correction of a faulty ski or body position.
  - (5) Landing directly on a knee or hand must be avoided since the resulting blow may cause serious injury. This is especially serious in heavy wet snow or breakable crust because the extended arm or knee may penetrate and be locked firmly in place before the body has lost momentum.
  - (6) Although falling or "sitting down" with the skis facing downhill is the preferred method, occasionally a fall "over the tips" cannot be avoided. The important thing to remember is RELAX.
- c. Recovery.*
- (1) To recover from a fall, the skier must first figure out what to do before attempting to rise. A little planning will save time and energy.
    - (2) If necessary, the pack and other restrictive loads are removed.
    - (3) Skis are untangled and brought parallel, feet together. Knees are pulled up to bring the skis close to the body. The body is then moved forward and raised, pushing with the pole if assistance is needed.
    - (4) To use the ski poles, both hands are first removed from the straps. The poles are then placed together with baskets in the snow slightly to the rear, grasped with one hand above the basket, palm facing downward, and with the other hand close to the top, palm facing upward.
    - (5) The procedure for recovery from a fall on a slope is the same except that the skis are placed below the body and perpendicular (at right angles) to the fall line. To obtain this position it may be necessary to roll onto the back, lifting the skis in the air and then in the proper position. Poles are then used as described on the uphill side (fig. 4-15).

#### 4-20. Straight Uphill Climbing

*a. Use.* Straight uphill climbing is a method of ascending gentle and moderate slopes.

*b. Technique.*

- (1) Take the first step as in walking the body leaning forward with knees well bent.
- (2) On gentle slopes, slide the skis forward without lifting them from the snow. On steeper slopes, more knee bend is required which causes a transfer of body weight. It may become necessary to lift the ski as the step is made, and to place it with a stamping action upon the snow. This will give the ski wax better holding qualities because it will not break down the snow crystals by first sliding over them.
- (3) Use the ski poles to assist the body in its uphill movement and to minimize backslip.
- (4) The degree of slope which may be ascended using this method is limited by the holding characteristics of the wax used. With repeated backslapping of the skis, the slope should be traversed thereby decreasing the angle of climb, or a different method of climbing should be used.

#### 4-21. Sidestep

*a. Use.* The sidestep is an effective method of climbing a short, steep slope, where space is confined; it may be the only practical means of ascending slopes. It is also useful for stepping sideways over logs, stumps, and other obstacles.

*b. Technique.*

- (1) The skis are placed together and perpendicular (at right angles) to the slope (fall line). To prevent slipping sideways, the uphill edges of both skis are forced into the snow by pushing both knees forward and toward the slope. Avoid leaning into the slope. Initially, the weight of the body is placed on the lower ski.
- (2) The uphill is lifted in a sideways step up the slope (fig. 4-16) and the body

weight placed upon it. The upper ski pole is moved at the same time and placed above and alongside this ski.



Figure 4-16. Sidestep.

The lower ski is then moved up as close as possible to the uphill ski, while the skier is supported by a push on the lower pole. This pole is then brought up and placed alongside the lower ski. This completes one cycle of the sidestep. Merely repeat until the desired elevation is reached.

#### 4-22. Uphill Traverse

*a. Use.* This method of climbing is used when the slope becomes too steep for going straight uphill. Although a traverse generally involves a zigzag route, it will often be the least tiring method of ascending, thereby conserving time and energy.

*b. Technique.*

- (1) An angle of ascent is selected which will allow climbing without backslip.
- (2) The skis are edged into the slope on

each step with the ski poles used as in straight uphill climbing.

- (8) In changing the direction of ascent a kick turn or a herringbone turn, (para 4-24d) can be utilized. Long traverses should be used whenever possible, since elevation is gained more effectively and with less expenditure of energy in this manner.

#### 4-23. Sidestep Traverse

*a. Use.* This step is a combination of a sidestep and the uphill traverse. It allows greater vertical climb in each traverse.

*b. Technique.*

- (1) The movement is the same as in the uphill traverse, except the ski is raised slightly and placed uphill as it is brought forward with each step.
- (2) The skis are kept parallel and edged, as in the sidestep.
- (3) The ski poles are moved in the same sequence as in the sidestep.

#### 4-24. Herringbone

*a. Use.* The herringbone is used to climb short, moderate, or steep slopes. It provides a quicker ascent than the sidestep. It is more tiring and should be used only for relatively short ascents.

*b. Technique.*

- (1) The body is faced uphill with skis spread to form a wide V. This is obtained by spreading both ski tips outward. The skis are edged sharply inward, to prevent backslip, by bending the knees forward and inward (fig. 4-17).
- (2) The first step is made by placing the weight on one ski, raising the other slightly above the snow and moving it forward and upward. This ski is then placed in the snow, edged inward, and the body weight transferred to it. The other ski is then moved in the same manner and placed slightly ahead.
- (3) The ski poles are used in the same manner as the sidestep, except they are alternately placed to the rear of



1 Herringbone



2 Half herringbone

Figure 4-17. Herringbone and half-herringbone methods of ascending.

the body and to the outside of each ski to act as a brace and to aid in the climb.

*c. Half-Herringbone.*

- (1) *Use.* The half-herringbone is a variation of the herringbone technique and is used to aid in preventing backslip on gentle to moderate slopes in both straight uphill climbing and traversing (fig. 4-17).
- (2) *Technique.* The half-herringbone is executed with one ski in the herringbone position, the other pointing in the direction of movement. The poles are used for support to prevent the ski pointed uphill from backslapping while the other ski is advanced. The downward angle and edging of this ski is increased with the steepness of the slope ascended.

*d. Herringbone Turn.*

- (1) *Use.* The herringbone turn is a method of changing direction while traversing a slope, while climbing, or when in confined areas where a kick turn may be difficult to use. It is also used to change direction from a herringbone position.
- (2) *Technique.* From a traversing position the upper ski is moved first in the desired direction, using its heel as a pivot point. This ski is then placed into the snow, as in a herringbone step, with the full body weight on it. The other ski is moved up in the same way and placed into the snow. This brings the skier into a herringbone position. Both poles are held to the rear to brace the body during this movement. This cycle is repeated until the lower ski has reached the desired direction. The upper ski is brought parallel with the lower ski into a traversing position again, completing the herringbone turn.

**4-25. Straight Downhill Running**

*a. Use.* Straight downhill running is the first technique learned in skiing downhill. It pro-

vides the individual with the balance which he must have before he can effectively descend a slope or learn more advanced techniques. Although it is the fastest means of descending, speed must be kept within the capabilities of the skier (fig. 4-18).

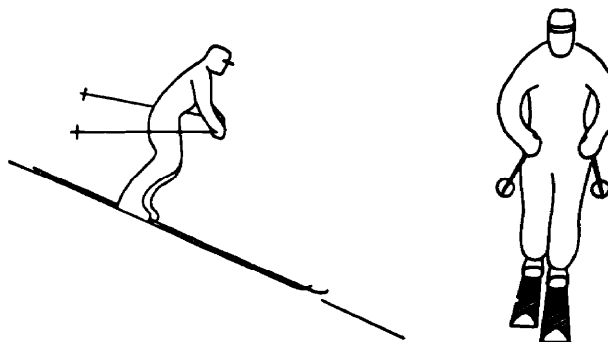

*Figure 4-18. Straight downhill running.*

*b. Technique.*

- (1) In a normal standing position with skis flat and parallel, one ski is advanced 10 to 15 cm (4" to 6").
- (2) Body weight is evenly distributed on both skis. The knees are bent and pushed forward from the ankles, keeping the heels flat on the skis.
- (3) The body is leaned slightly forward in a relaxed and natural upright position, head up, knees and ankles flexed without bending the body at the waist to the front.
- (4) Ski poles are held pointing to the rear with baskets above the snow. The arms are bent slightly at the elbows and held close to the body with hands to the front.
- (5) Body and arms are kept relaxed. Knees are kept supple to act as shock absorbers. The skier must be alert at all times.

**4-26. Downhill Traverse**

*a. Use.* This is the method most commonly used in descent; either used by itself or in combination with other techniques. An individual who has learned the techniques and has chosen a gradual route of descent can, in com-

ination with a kick turn, travel over a great variety of terrain (fig. 4-19).

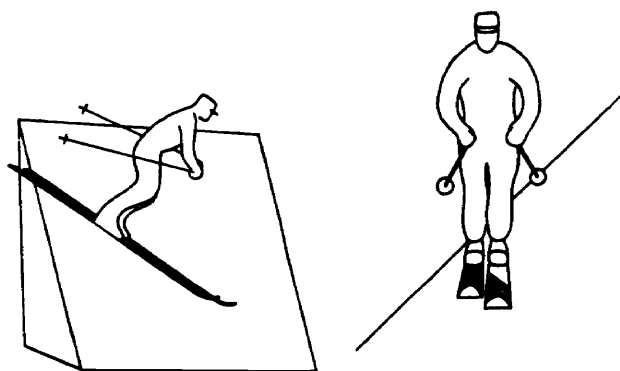

Figure 4-19. Downhill traverse.

*b. Technique.*

- (1) The basic position is that of straight downhill running, except that the uphill shoulder and ski is always slightly advanced and most of the weight is on the lower ski.
- (2) Stand directly over the skis and avoid leaning into the slope. Both skis being edged into the slope.
- (3) If more edging is needed, it is controlled by knee and ankle action, and is kept even and constant.
- (4) The ski poles are held as in the straight downhill positions.

**4-27. Snowplow**

*a. Use.* The snowplow is a means for controlling and slowing down forward motion in all types of terrain. In gentle or moderate terrain it can be used for stopping. The snowplow uses fundamental positions which are employed for furthering other skiing techniques (fig. 4-20).

*b. Techniques.*

- (1) *From straight downhill running.*
  - (a) To move into a snowplow, both heels are pushed outward evenly, keeping the ski tips even and close together, forcing the skis to form a wide V.
  - (b) The body weight is kept even on both skis. The knees are bent well

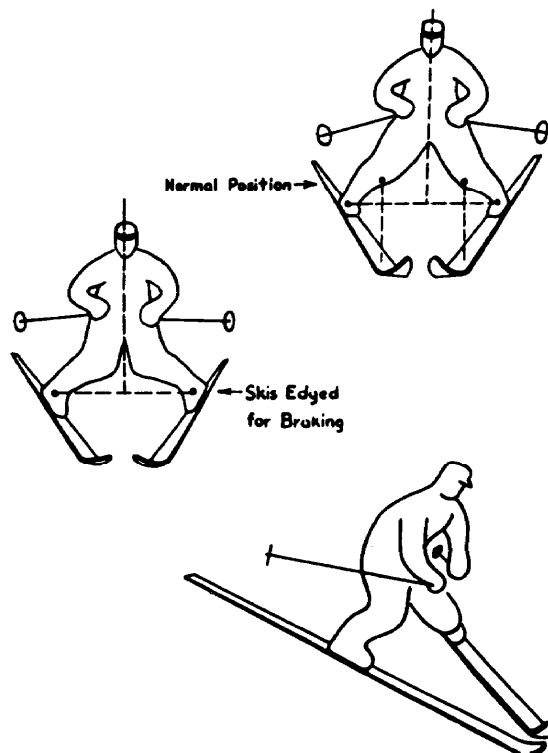

Figure 4-20. Snowplow.

forward in the direction of the ski tips, causing the skis to be edged slightly inward. The heels are kept constantly on the skis while continuous outward heel pressure upon the skis is applied.

- (c) The upper part of the body and the ski poles are held as in the straight downhill running position.
  - (d) To increase the braking action, the skis are moved into a wider V and edged more.
- (2) *Half snowplow.*
    - (a) When only one ski is brought into snowplow position, this is referred to as a half snowplow. The half snowplow is used in confined areas and in traversing where a full snowplow is impractical for braking action. It is also used in conjunction with basic and advanced turns.
    - (b) This motion is executed by pushing only one ski outward in the snow-

plow position described above. Braking action is controlled by the degree of weight placed on this ski and the amount of edging applied. It is important that the ski be edged to a pronounced degree on the inside to eliminate the possibility of "catching" an outside edge.

(3) *The snowplow while traversing downhill.*

(a) To move into a snowplow from a downhill traverse, the body weight is shifted momentarily to the uphill ski. The lower ski is then moved downhill into a half snowplow position by dropping the tail and keeping the ski tips in the same relative positions and edging slightly. The body weight is then transferred back onto this lower ski. Additional braking action can be obtained by increasing the edging of this ski and placing more weight on it. To complete the snowplow, the upper ski is flattened and pushed uphill in full V (fig. 4-21).

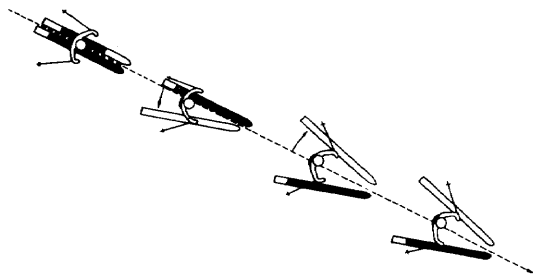

**Figure 4-21.** Method of getting into a snowplow while in a downhill traverse.

(b) If it is desired to continue traversing in a snowplow, most of the weight is kept on the lower ski. Braking action is increased by a wider spread of the skis and increased edging of both skis.

finer areas where ability to control descent is limited by snow conditions, terrain features, or obstacles. Two different methods are used (fig. 4-22).



**1** Straight downhill



**2** On a downhill traverse

**Figure 4-22.** Ski pole riding.

**4-28. Ski Pole Riding**

a. *Use.* Ski pole riding is a braking method which is sometimes necessary to use in con-

*b. Technique.*

(1) Poles are kept together and to the rear and held between the legs for vertical descents.

(a) From a straight downhill running position the lateral spread of the skis is increased and both hands are removed from wrist straps. Both poles are held together and placed to the rear between the legs and the heels of the skis.

(b) The body is placed in a squatting position with the weight over the skis and one hand grasping the pole handles in front of the body with the palm facing upward, while the other hand is placed to the rear, grasping the shafts above the baskets, palm facing down.

(c) Control of descent is obtained by applying the required pressure on the ski poles to force the baskets into the snow.

(d) The braking action may be increased by using the half snowplow or snowplow position.

(2) Poles together and on either side of the body for traversing.

(a) From a downhill traversing position both hands are removed from wrist straps and the poles are held together on the uphill side.

(b) The hand on the uphill side grasps both pole shafts near the baskets with palm facing down and the other hand is held near the pole handles, palm facing upward.

(c) The uphill arm is braced tightly against the hips to increase the braking action.

**4-29. Sideslipping**

*a. Use.* Sideslipping is a braking method used in descending slopes at all speeds. It is especially useful in confined areas and in steep terrain where the snowplow or pole riding is impractical. It is the least tiring method of braking. In addition, it employs a sliding action which is characteristic in advanced skiing techniques.

*b. Technique.*

(1) A downhill traverse position is assumed. The edging of both skis is decreased by bending both knees well forward and slightly outward. This minimizes the holding power of both ski edges so that gravity will cause the skier to slide sideways down a hill (fig. 4-23).

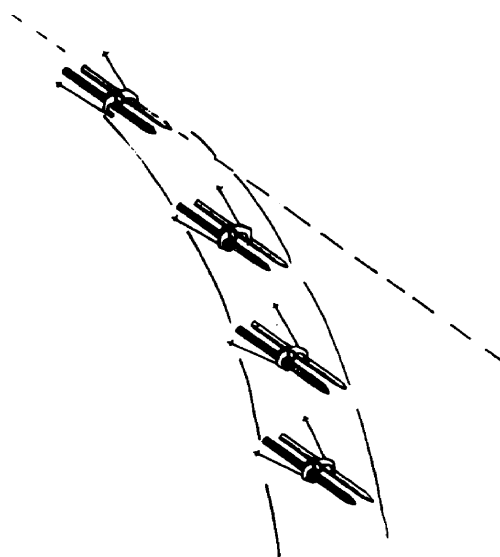

*Figure 4-23. Sideslipping from traverse.*

(2) Care must be taken that the weight is kept well centered on the skis and that the lower ski pole is not placed in the snow during the sliding action. The uphill pole may be used to initiate the sideslipping action and for balance. Avoid the tendency to lean on the uphill ski pole which will hinder the skier's ability to maintain a good sideslipping body position.

(3) By shifting the body weight in front of the center of the skis while sideslipping, the tips will drop toward the fall line; by bringing the weight to the rear, the heels of the skis will move toward the fall line. This is a means of correcting or controlling the angle of descent during the sideslip (fig. 4-24).

(4) The speed of descent is controlled by the degree of edging applied to the



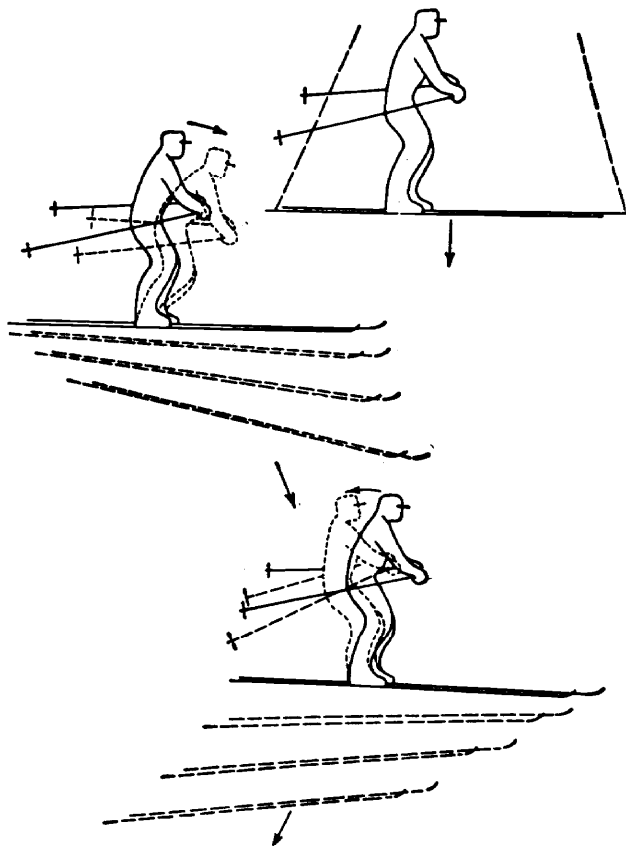

Figure 4-24. How the body position affects the skis in sideslipping.

skis. To stop sideslipping, the edging is gradually increased by pressing the knees forward and toward the slope.

- (5) In adverse terrain and snow conditions the aid of both ski poles may be used on the uphill side while sideslipping. The poles are used in the same manner as in pole riding on a traverse. This method adds a third point of suspension and braking action.
- (6) At all times during sideslipping, delicate control of knee and ankle action is important to prevent the downhill edges from "catching."

### 4-30. Step Turn in Motion

*a. Use.* This method of changing direction while in motion is useful at slow speeds in all snow and terrain conditions. It is particularly useful in adverse snow conditions and in confined areas.

#### *b. Techniques.*

- (1) Before turning, lead with the ski which corresponds with the direction of the turn, i.e., right ski ahead when turning to the right.
- (2) In turning to the right the weight is placed upon the left ski, which is then edged to the right. The unweighted right ski is then raised and placed on the snow in the new direction. The weight is transferred to this ski by moving the body in the new direction while pushing off from the left ski. The unweighted left ski is then lifted off the snow, and placed close to the right ski to complete the turn. Complete transfer of body weight is essential, and the movements must follow smoothly and almost simultaneously. The ski poles are held to the rear (fig. 4-25). The higher the speed, the more the center of gravity is lowered by bending the knees and ankles. This adds stability and aids in keeping up with the turn.

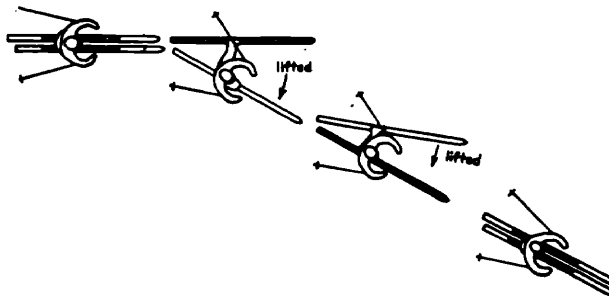

Figure 4-25. Step turn in motion.

- (3) If desired, the steps can be continued as long as the skier is in forward motion and until the desired direction is obtained.

#### *c. Variation.*

- (1) *Use.* A variation of the step turn in motion is the skating step. It is used to accelerate forward motion on level ground or gentle slopes and is a useful aid in developing balance, weight shifting, and coordination. Basically, the movements of shifting body weight from one ski to the other are

the same as in the step turn in motion except that direction is not changed and the skis are edged inward on each pushoff.

(2) *Technique.*

- (a) From a straight downhill position body weight is placed upon either ski and knee and ankle bend is stressed:
- (b) The other ski is lifted above the snow with the tip pointed slightly outward.
- (c) The weighted ski is edged inward as the body is pushed off at a slight angle to the front, i.e., in the direction the lifted ski is pointed.
- (d) The lifted ski is moved to the front, placed flat on the snow and weight is shifted to it.
- (e) The unweighted ski is lifted from the snow and brought to the front near the weighted ski in preparation for the next step. These pushing steps are alternated left and right.
- (f) A strong pushoff should be made with each step to lengthen the glide and gain acceleration. Knee and ankle bend should be stressed with each step.
- (g) The step can be aided by double poling, especially to gain initial momentum.

#### 4-31. Snowplow Turn

*a. Use.* The snowplow turn is efficient for use at slow speeds, especially when carrying a pack and rifle. Because the snowplow position is retained, this turn enables the individual to maintain good control. In this turn, fundamental body positions and movements are used which are an important part of advanced turns.

*b. Technique (fig. 4-26).*

(1) *Straight down the slope.*

- (a) In executing a snowplow turn to the LEFT while snowplowing directly down a slope, the body weight is transferred smoothly

onto and over the right ski (note that this ski is already pointed to the left) by a rotation of the body to the right and by a pronounced bend of the right knee to drop all body weight onto the right ski. This transfer of body weight initiates the turning action.

- (b) As the turn progresses, the body is not allowed to rotate beyond the new direction of travel, i.e., face straight ahead, not uphill. The left knee is kept well bent with this ski flat and unweighted throughout the turn.
- (c) Ski tips remain even and the V-angle of the skis constant. Avoid leaning into the slope. Ski poles are carried as in the snowplow position. Care must be exercised to keep them pointed to the rear as the body is rotated.
- (d) As the turn is completed the body weight is either placed evenly on both skis to continue in a snowplow or gradually transferred to the left ski to start a turn to the right.

(2) *From downhill traverse.*

- (a) In making a turn while traversing, the snowplow position is assumed as described in paragraph 4-27 *b* (3) *(a)*. The edging of the lower ski is decreased and the body leaned forward and both ski tips allowed to drop into the fall line in order to bring the skier into the fall line in preparation for the turn, as described above. As the tips come downhill the snowplow position must be maintained by a holding push on the tails. The turn should be continued until the skier has obtained the desired angle of descent (fig. 4-27). As the tips pass the fall line, body weight must be transferred to the downhill ski to complete the turn.
- (b) After the snowplow turn has been completed and it is desired to continue with both skis together, as

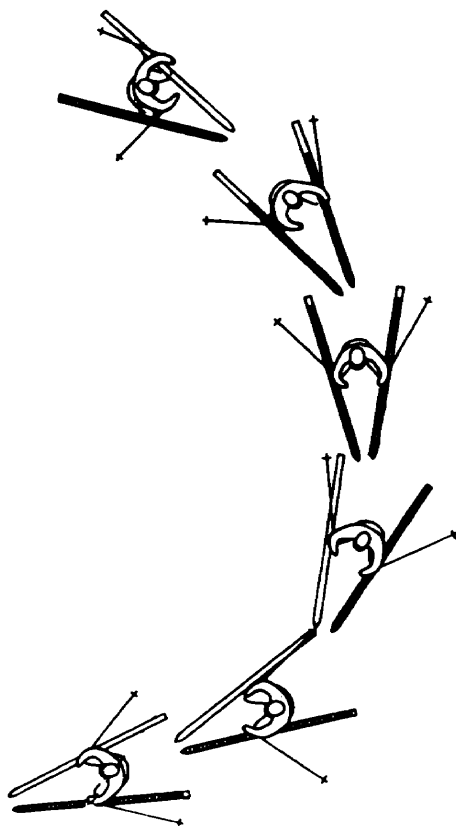

Figure 4-26. Snowplow turn.

in the downhill traverse, the body weight is kept on the lower ski while the upper unweighted ski is brought parallel with it into a traversing position (fig. 4-27). This turn is also known as stem turn.

- (3) *Variation.* To make a snowplow turn from a traversing downhill position in variable snow conditions, and when skiing with a pack, it is advantageous to make the half snowplow with the uphill ski. In this method the body weight remains on the lower ski. The upper, unweighted ski is moved into a half snowplow, kept flat, and the tips of both skis even. The edging of the lower ski is decreased, knees bent more, and the body leaned further forward to bring the skier into the fall line. In reaching the fall line, both skis are brought into a full snowplow and the body weight is gradu-

ally shifted over and onto the other ski in executing a snowplow turn as described above.

#### 4-32. Advanced Turns

The advanced turns used in military skiing are the christiania turns. These are applied at all speeds to change directions, to reduce speed, or to stop. These are the most advanced turns taught in military skiing and are executed with the basic motions already learned, such as forward lean, edge control, and body rotation. The application of these turns may be limited by terrain and snow conditions, as well as the degree of proficiency attained and the load carried by the individual soldier. The christiania turns are started from a variety of positions, but all are completed in the same manner (fig. 4-28).

#### 4-33. Uphill Christiania

The uphill christiania is used to turn uphill, to reduce speed and to stop. It also forms the basic movement which is used in completing other christiania turns.

a. In preparing for the uphill christiania during a downhill traverse, the upper shoulder is brought well forward in order to increase the body rotation that will, be applied during the turn.

b. The turning action of the skis is started by decreasing the amount of edging and, at the same time rotating the lower shoulder and hip forward in the direction of the turn. Forward lean of the body and knee bend are increased and the upper ski leads throughout the turn (1, fig. 4-28).

c. During the turn, both skis are controlled by gradually edging them into the slope. The weight is directly over the skis. Avoid leaning into the slope.

d. Forward lean and body rotation are increased and continued as the turn progresses. Forward speed will gradually decrease, permitting the skier the choice of continuing in a new direction or coming to a stop.

e. Care must be exercised so that the ski poles are not allowed to swing to the front during the rotation of the body.

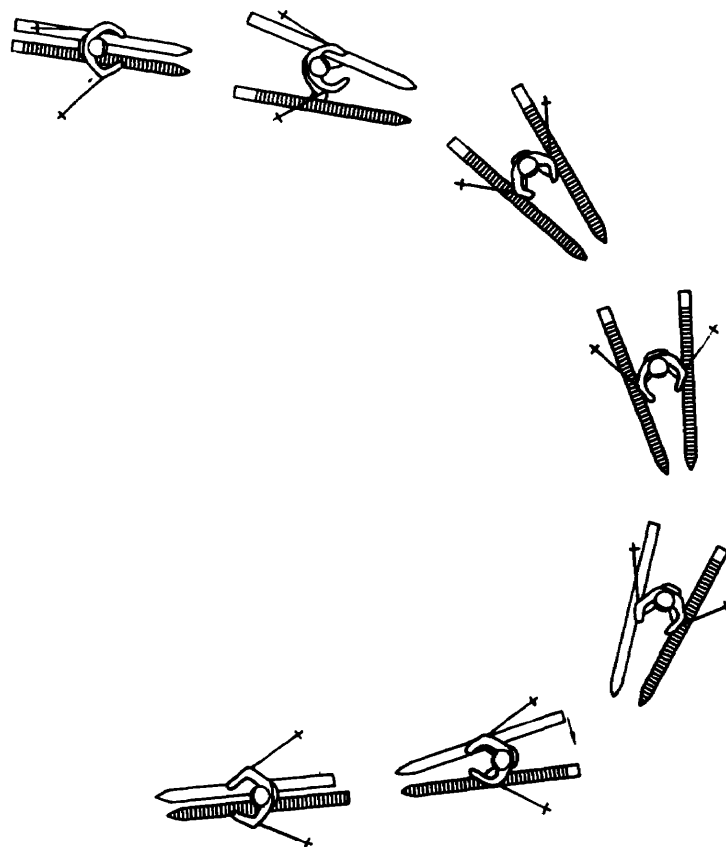

*Figure 4-27. Snowplow turn made from downhill traverse back into traversing position.*

*f.* This turn can be made from any angle across the slope to and including the fall line.

*g.* From a fall line the turn can be made in either direction. In preparation, the ski corresponding with the direction of turn is advanced (i.e., left ski leads for a left turn) and more of the body weight placed on the other ski. Emphasis is given to body rotation and knee bend to initiate the turning action of the skis.

*h.* To assist the turning action, a down-up motion can be used in this turn. As the turning action is stated as in *b* above, the body is lowered and returned to normal as the turn is completed.

#### 4-34. Snowplow Christiania

*a. Technique.* The snowplow christiania, also referred to as the stem christiania, is

used on turns made downhill while traversing at greater speeds than employed in the basic turns. For this reason the turn looks complicated to the student. Basically, it is a combination of the snowplow turn and the uphill christiania. The basic techniques of the snowplow turn made from a traverse position are also used here to reach the fall line. The uphill christiania is then applied to either change direction or to stop. In combining these methods the speed must be greater, the body weight shifted more rapidly, and the spread of the skis in the snowplow position at a narrower angle. Using the snowplow christiania it is possible to link a number of turns together to control speed in a continuous descent. A breakdown of the technique is as follows:

- (1) In making a downhill turn to the left from a downhill traverse, the body weight is shifted momentarily to the uphill ski. The lower ski is then

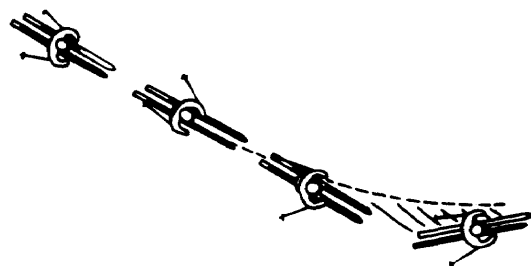

1 Uphill christiania.

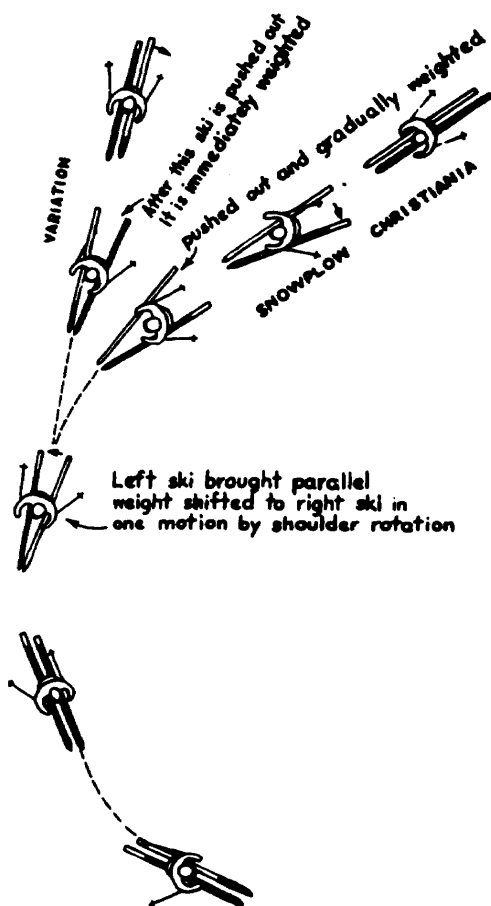

2 Snowplow christiania and variations.

Figure 4-28. The christiania turns.

moved downhill into a half snowplow position, keeping the ski tips even. At the same time, the lower shoulder is brought forward. The uphill ski is then pushed uphill to form a snowplow.

- (2) Body weight is then transferred back to the upper ski by body rotation, initiating the turning action.

- (3) As the fall line is reached, the unweighted left ski is brought slightly forward and parallel with the right ski. The turn is then completed as in the uphill christiania (2, fig. 4-28).
- (4) The upper body is kept from leaning into the slope throughout the turn, especially during the initial turning phase. Forward lean and knee bend are increased. All motions are fluent and smooth and must be well timed during the turn.
- (5) When a decrease in speed is desired before starting the turn, there are two methods which can be used. In the first method the lower ski is first placed into a half snowplow position. Temporarily transferring the body weight to the ski and edging it will cause a braking action. When speed has been decreased as desired, the upper ski is pushed upward, the edging of the lower ski decreased, and the turn continued as in (2), (3), and (4) above. In the second method both skis are kept parallel and a sideslip from the moving traverse position is started. Edging of the skis in this movement will provide braking action. When speed has been decreased as desired, the turn is started as from the downhill traverse position.

b. Variations.

- (1) In difficult snow and terrain conditions another method may be used to execute a snowplow christiania. In making a downhill turn to the left from a downhill traverse with this method, the upper (right) ski is brought into a half snowplow position. Leaning well forward, increasing the knee bend and decreasing the edging of the lower ski will bring the skier smoothly towards the fall line; the body weight is transferred over and onto the right ski in a smooth forward and downward motion, assisted by bringing the right shoulder forward. As the transfer of body weight is completed, the unweighted left ski is brought forward and parallel with

the right ski and the turn completed from the fall line as in the uphill christiana.

- (2) As more skills and balance are acquired, the snowplow christiana may be done at higher speeds with the angle of turn kept closer to the fall line. In this method only a half snowplow with the upper or lower ski is used in the preparatory position, or skis are kept parallel and the fall line is reached with a pronounced knee bend and forward lean of the body while the turn is completed with an uphill christiana.

#### 4-35. The Lifted Christiania

*a. Use.* The lifted christiana turn is very useful in adverse snow conditions and in confined terrain where a short radius turn is necessary. It is also useful for skiing at night and with heavy loads, since it is a slow turn made with one ski pole being used to increase lateral stability.

#### *b. Technique.*

- (1) The turn is started by applying either of the methods described for christiana turns, except that the speed is adjusted to suit the circumstances.
- (2) For a turn to the left as the skier approaches the fall line, the left ski pole is placed in the snow forward and down the slope, but not directly in front of the left ski tip. The reach should not be overextended. The right pole is held in the normal manner. Weight is then applied to the left ski pole, using it for means of support and as a pivot point.
- (3) Body weight is then shifted to the right ski. Since it is difficult to turn the left ski in such a short radius, this ski is lifted and placed parallel to, and slightly ahead of, the right ski, and the turn completed as in the uphill christiana.

### Section IV. MILITARY SNOWSHOEING

#### 4-36. Purpose and Scope

*a.* Snowshoes are individual aids for over-snow movement. Like skis, they provide flotation in snow and are useful for cross-country marches and other activities which require movement in snow-covered terrain.

*b.* The snowshoe is an oval or elongated frame braced with two of three crosspieces and the inclosed space filled with a web lacing. A binding or harness attached to the webbing secures the wearer's foot to the snowshoe. Flotation is provided by the webbing, which is closely laced and prevents the snowshoe from sinking too deeply into the snow when weight is placed upon it. Depth and consistency of snow will determine the amount of support obtained on the snow cover and the rate of movement.

*c.* Snowshoes are particularly useful for individuals working in confined areas such as bivouac sites and supply dumps, for drivers of various types of vehicles, gun crews, cooks,

mechanics, and for similar occupations where aids to movement in snow are necessary. Transporting, carrying, and storing snowshoes is relatively easy due to their size and weight. Maintenance requirements are generally negligible and little skill is required to become proficient on snowshoes. However, the requirement for physical conditioning is as great, or greater, as that needed for skiing. The use of snowshoes when pulling and carrying heavy loads is particularly practical, as the hands and arms remain free. On steep slopes, however, the use of snowshoes is considerably limited because traction becomes negligible and the snowshoe will slide, causing loss of footing. Generally, the rate of movement in any type of terrain is slow because snowshoes will not glide over the snow. The gliding properties of the ski are not obtained with the snowshoes; this adversely affects the amount of time and energy spent in movement. In deep snow the trailbreaker must be changed frequently. Especially when wet, snow tends to stick to the

webbing, thereby adding weight to the snowshoe.

d. There are three types of standard issue snowshoes: the trail, the bearpaw, and the magnesium. They can be used with all types of winter footgear. The trail snowshoe weighs approximately 6.5 pounds, the bearpaw, 5.5 pounds and the magnesium, 4.6 pounds.

- (1) *Trail.* The trail-type snowshoe is long, with a rather narrow body and up-turned toes (fig. 4-29). The two ends of the frame connect and extend tail-like to the rear. The turned-up toe has a tendency to ride over the snow and other minor obstacles. The excellent flotation provided by its large surfaces makes the trail snowshoe best for cross-country marches, deep snow conditions, and trailbreaking.



Figure 4-29. Trail snowshoe.

- (2) *Bearpaw.* This type of snowshoe is short, wide, and oval in shape, with no frame extension (fig. 4-30). The bearpaw snowshoe is preferable to the trail type for close work with weapons and vehicles, in heavy brush, and in other confined areas. Carrying or storing is also easier.
- (3) *Magnesium.* The magnesium snowshoe is the lightest and most durable of the three types (fig. 4-31). The snowshoe has a magnesium frame with the center section made of steel, nylon-coated wire. The magnesium snowshoe is 17.70 cm (approx 7") shorter than the standard wooden trail snowshoe but is 9.50 cm (approx 4") wider giving it approximately the same flotation characteristics.

e. The trail and bearpaw snowshoes have their own individual bindings, however, the,

“Binding, Snowshoe, Bearpaw and Trail Type” has been developed for use on all three types. This binding consists generally of a toe strap and a heel and instep strap. The straps are made of nylon and are secured by keepers and cam lever quick-release buckles. The method of securing the binding to the magnesium snowshoe is shown in figure 4-32.

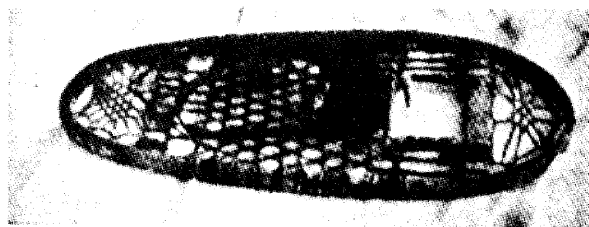

Figure 4-30. Bearpaw snowshoe.

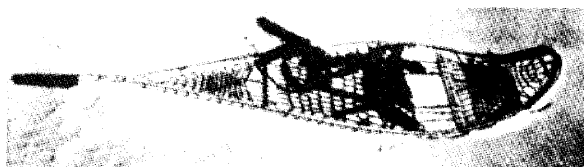

Figure 4-31. Magnesium snowshoe.

#### 4-37. Care and Storage of Snowshoes

a. *Care.* Snowshoes must always be kept in good condition. Frequent checks are necessary, particularly of webbing and binding, because individual strands may be ripped or worn out. Repairs must be made immediately, otherwise the webbing will loosen and start to unravel. If unvarnished, the rawhide webbing on wooden snowshoes will absorb moisture, stretch and turn white, particularly in wet snow. It should be dried out slowly, avoiding direct flames, and be revarnished at the first opportunity. Wooden frames may fray from hard wear and should be sanded and varnished. When needed, other minor repairs should be made as soon as practicable. When snow cover is shallow, care must be taken not to step on small tree stumps, branches, or other obstacles, since the webbing may be broken or damaged. Stepping into water is to be avoided; the water will freeze and snow will stick to it. When not in use in the



Front view



Rear view

*Note.* After tightening, strap should be doubled back under keeper.  
*Figure 4-32. Binding, snowshoe, bearpaw, and trail type.*



field, snowshoes are placed in temporary racks, hung in trees, or placed upright in the snow. They should be kept away from open fires and out of reach of rodents.

*b. Storage.* In off-seasons, wooden snowshoes are stored in a dry, well-ventilated place so that the rawhide will not mildew or rot and the frames warp. Each snowshoe is closely checked for possible damage, repaired if needed, and revarnished. As in the field, snowshoes are protected against damage and from rodents. Magnesium snowshoes are cleaned and repainted if necessary. Webbing is examined and repaired or replaced if needed.

#### 4-38. Snowshoe Technique

*a.* A striding technique is used for movement with snowshoes. In taking a stride, the toe of the snowshoe is lifted upward, to clear the snow, and thrust forward. Energy is conserved by lifting it no higher than is necessary to clear the snow and slide the tail over it. If the front of the snowshoe catches, the foot is pulled back to free it and then lifted before proceeding with the stride. The best and least fatiguing method in travel is a loose-kneed rocking gait in a normal rhythmic stride. Care is taken not to step on or catch the other snowshoe.

*b.* On gentle slopes, ascent is made by climbing straight upward. Traction is generally very poor on hard-packed or crusty snow. Steeper terrain is ascended by traversing and packing a trail similar to a shelf across it. When climbing, the snowshoe is placed as horizontally as possible in the snow. On hard snow, the snowshoe is placed flat on the surface with the toe of the upper one diagonally uphill to get more traction. In the event the snow is sufficiently hard-frozen to support the weight of a person, it is generally better to remove the snowshoes and proceed temporarily on foot. In turning around, the best method is to swing the leg up and turn in the new direction, as in making a kick turn on skis (fig. 4-33).

*c.* Obstacles such as logs, tree stumps, ditches and small streams should be stepped over. Care must be taken not to place too much strain on the snowshoe ends by bridging a gap, since the frame may break. In shallow



*Figure 4-33. Making a kick turn on snowshoes.*

snow there is danger of catching and tearing the webbing on tree stumps or snags which are only slightly covered. Wet snow will frequently ball up under the feet, interfering with comfortable walking. This snow should be knocked off with a stick or pole as soon as possible. Although ski poles are generally not used in snowshoeing, one or two poles are desirable when carrying heavy loads, especially in mountainous terrain. The bindings must not be fastened too tightly or circulation will be cut off, and frostbite may occur. During halts, bindings should be checked for fit and possible readjustment.

#### 4-39. Training

Snowshoe training requires little technical skill. However, emphasis must be placed on the physical conditioning of the individual and the

development of muscles which are seldom used in ordinary marching. The technique, as such, can be learned in a few periods of instruction. Stiffness and soreness of muscles are to be expected at first. The initial training should be gradual with regard to loads carried and distances covered. It should be progressive, with ample time allowed for the individual to acquire physical proficiency, gradually increas-

ing the distance covered and weight carried or pulled. Overcoming obstacles such as dense brush, fallen timber, and ditches should be emphasized during training. Trailbreaking, with frequent change of lead man, should also be stressed. Snowshoe training can be accomplished concurrently with other training requiring individual cross-country movement.

## Section V. APPLICATION OF SKI AND SNOWSHOE TECHNIQUE

### 4-40. Skiing in Variable Terrain and Snow

*a. General.* As a military skier the individual must be prepared to move in a great variety of terrain and snow conditions during daylight and darkness. He must be constantly alert in order to judge conditions on the route ahead and to off set the sudden changes often encountered. The techniques of skiing which he has learned will allow him to operate effectively on slopes only if he is capable of applying these methods properly and of keeping his skis under control at all times.

*b. Variable Terrain.* The forward lean of the body must be increased as a slope suddenly steepens, since skis will slide faster. The opposite is true as the slope is lessened. Generally, the body should be nearly perpendicular to the slope regardless of pitch, to insure proper balance. When skiing over bumpy terrain, the stability of the skier is greatly disturbed. To minimize this the knees are kept supple to act as shock absorbers, permitting the center of the body to maintain as straight a line as possible. To further increase stability on large bumps the skier increases knee bend, lowering the body when approaching the top of the bump, riding over it in this position, and then assuming a normal running position as soon as the top is passed (fig. 4-34), i.e., allowing the skis to drop away. This action will lessen the chance of the skier being thrown into the air. When moving through a hollow the normal ski and body position is maintained, with the knees absorbing the sudden change of pressure. In deep snow the leading ski should be further advanced to improve balance. The center of gravity must be kept lower by more bending of the knees. As forward lean of the body is not practical under these conditions, weight

shift will need to be controlled to a greater extent by the knees and the advancement of one ski in front of the other.

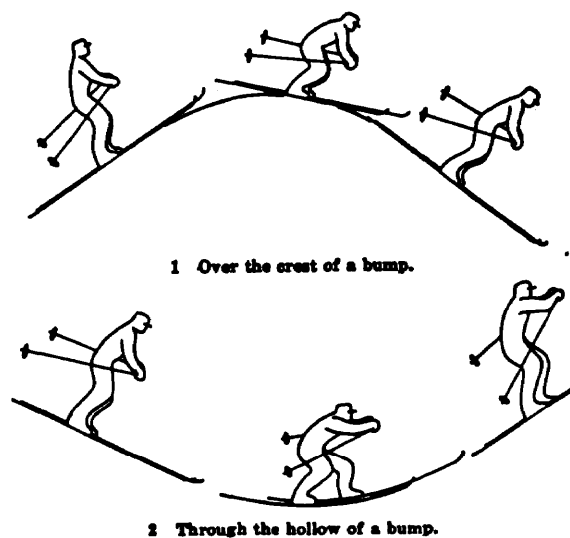

Figure 4-34. Position of the body in downhill bump riding.

*c. Variable Snow.* When skiing from soft snow onto hard snow the forward lean of the body must be increased, since the skis will gain speed and have a tendency to run from under the skier. The opposite is true when running from hard snow onto soft snow. In this case the body leans slightly to the rear and the leading ski is advanced farther ahead just before the soft snow is entered. Lateral stability can be increased by extending the arms sideways as is done when attempting to keep balance when walking a log or a railroad track, but the ski poles must still be kept pointing to the rear. When skiing on icy crust, stability is improved by keeping the skis farther apart or by running in a slight snowplow

position. However, if the slope is rutted snowplowing may become hazardous because the tips tend to get caught. To control speed under these conditions, sideslipping and pole riding may be used. Pole riding is less effective and in extreme cases the use of sideslipping may become necessary. On icy snow the skis may chatter in a turn. To correct this, body weight is kept well forward and the edging of the skis carefully controlled as the turn is made. Crusty snow which will not support the skier's weight (breakable crust) is the most difficult to cope with. Speed is kept slower while making all turns. It may become necessary to use the step turn in motion or a kick turn to change direction.

*d. Forest.* Due to the limited skiing room in wooded terrain, movements for changing direction must be rapid and of shorter radius than in open terrain, especially during downhill movement. In addition, the skier must be more alert so that obstacles may be quickly overcome with a minimum of delay. The step turn in motion is a very useful technique for changing direction in this type of terrain, but speed must be reduced to use this technique. In descending narrow trails in wooded terrain or during night movements, the half snowplow or pole riding are useful for control of speed. During unit movement in wooded terrain, one man falling can block the progress of all personnel behind him. If an individual falls he should remove himself from the track in the fastest way possible, even if this results in losing his original position in the column. The baskets of ski poles have a tendency to snag branches during movement in wooded terrain, resulting in loss of balance. To avoid this as much as possible, the shafts of the ski poles should be pointed directly to the rear.

#### 4-41. Obstacles

*a. General.* Snow-covered terrain will contain many small obstacles such as fences, tree windfalls, and small streams or ditches. The individual must be skilled enough to cross them easily to save time and energy. Crossing obstacles can be very time consuming for a unit. Wherever possible, the men should be dispersed so as to enable them to cross on a broad front. In some cases the overall time needed can

be reduced if skis are removed while overcoming the obstacles.

*b. Fences and Windfalls.* Low fences and windfalls 30 to 60 cm high (1' to 2') are crossed by skiing or snowshoeing beside the obstacle so that the skis or snowshoes are parallel and alongside it, then stepping over first with one foot then the other, or a kick turn may be made over the obstacle. In the case of rail fences or large diameter windfalls it may sometimes be easier to sit on the obstacle and swing both feet simultaneously to the other side. High barbed wire fences can be crossed by removing pack and rifle and crawling underneath (fig. 4-35).

*c. Ditches or Small Streams.* These are crossed by stepping over them sideways, using the ski poles for support (fig. 4-35). If the ditches are deep and wide it is better to descend to the bottom either by sidestepping or sideslipping and then climb the other side by sidestepping. However, care must be taken to avoid rocks or other obstacles which might damage the skis or snowshoes.

*d. Steep Slopes.* When it is necessary for troops to descend or ascend slopes which are too steep for their ability, or where traversing is not practical, the sidestep should be used or the skis should be removed and the slope negotiated on foot whenever snow depth will permit.

#### 4-42. Skiing With Pack and Weapon

*a. General.* When skiing with pack and weapon the same techniques apply. However, the added weight carried, changes the center of gravity and will affect the manner in which movements are made.

*b. Effects on Movements.*

- (1) Lunges are shorter and pushes with poles less powerful.
- (2) To aid in maintaining balance when skiing downhill over rough terrain, the leading ski is advanced farther and the knees kept more flexible than when skiing without a load.
- (3) Speed of descent is reduced and techniques are applied more cautiously.
- (4) Rotation of arms and shoulders is

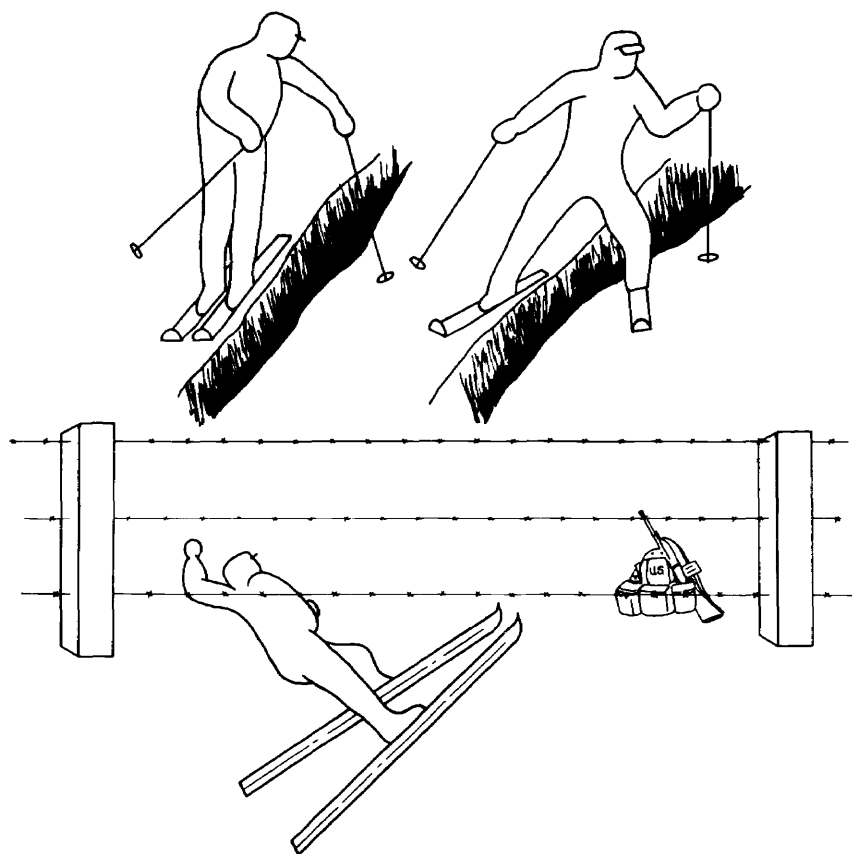

Figure 4-35. Crossing obstacles.

- made with less vigor and emphasis.
- (5) Slopes are climbed with a more gradual traverse.
  - (6) When skiing through woods or in brushy terrain, care must be exercised in order to prevent any protruding parts of the weapon from catching on branches, causing loss of balance.
  - (7) In the event of a fall it is sometimes more efficient to remove the pack and weapon before attempting to regain footing.

#### 4-43. Sled Pulling

*a. General.* Pulling a sled is hard work, but it will be easier if proper techniques are used. The movements and techniques used should be within the ability of all members of the team, and, where possible, teams should be formed with this in mind. Generally speaking, the

methods of hauling sleds apply to both skiers and snowshoes.

##### *b. Preparation for Sled Pulling.*

- (1) The tow ropes must be of the proper length and also properly laid out and fastened by snap buckles in tandem system (fig. 4-36). The sled harnesses are adjusted to fit loosely on the individuals.
- (2) If skis are to be used for pulling, they must be properly waxed. More emphasis must be placed on insuring good holding capacity of the wax on the snow. However, sliding capacity should not be entirely forfeited.
- (3) Proper loading and lashing of sled must be checked before moving out.

*c. Pulling on Varied Terrain.* When pulling a sled over comparatively flat terrain, skiers normally use the one step ski technique. When





1 Sidestep



2 Herringbone

*Figure 4-37. Sled team using the sidestep and herringbone technique for ascending a slope.*

tened to the sled. The pullers then climb uphill as far as the rope allows. Standing in place, the sled is then pulled up to their position. This procedure is repeated as many times as is necessary to reach the top. When using this technique care must be taken to insure that the sled is well anchored each time the pullers move up since a runaway sled may not only damage itself but is a serious hazard to anyone below. Where steep slopes must be ascended for considerable distances, less energy will be expended if the sleds are left behind and the sled load backpacked to the objective.

*e. Downhill Movement.* In descending a slope the following methods can be used:

- (1) On very gentle slopes and in poor snow conditions where the sled will not descend on its own accord, the skier can use a double poling technique or one step. However, it will be necessary to control the speed to prevent the sled from overrunning the pullers. The rear man can assist in this by braking the sled, although in most cases very little braking will be needed. If the team is on snowshoes, the pullers can descend normally while the man in the rear insures that the sled does not overrun those in front.
- (2) A short, steep slope can be descended by sidestepping either on skis or snowshoes. If necessary, the rear man is assisted in the braking action



*Figure 4-38. Sled team descending a slope using the snowplow for braking.*

by one or more members of the team. Skiers can also use sideslipping for this type of terrain. For short descents in wooded areas, the braker should position himself behind a tree for added stability in lowering the sled. If necessary, a succession of position moves are made.

- (3) On long, moderate slopes skiers can use the snowplow as a braking method (fig. 4-38). If more braking is necessary than can be supplied by the rear man, the puller closest to the sled may move to one side or he may remove his rope and refasten it to the rear of the sled and assist the rear man for more effective braking. Snowshoes on this type of slope may also change pullers to brakers to aid in descent.
- (4) On a long, steep slope requiring the team to go straight down, all men will

be needed to brake the sled. This can be done by fastening all tow ropes to the rear of the sled with all men braking from the rear and/or one skier controlling the sled by straddling the front of the sled (fig. 4-38), and controlling the sled by himself or assisted by one or more brakers. The snowplow or sideslipping techniques are used as the braking method.

- (5) Traversing by both skiers and snowshoes may be used on long, steep downhill slopes. In this case the puller nearest the sled and the rear man should remain above the sled and as far from it as the ropes will allow. From this position they can brake, preventing the sled from sideslipping.
- (6) In very steep terrain a long rope, when available, may be used to lower the sled straight down the slope. This procedure is the reverse of the uphill



Figure 4-39. Skijoring.

relay method described in *d* (4) above, and is a very practical method for evacuating wounded.

#### 4-44. Skijoring

*a. General.* Skijoring, as used in this manual, is the term applied to moving men on skis over snow by towing them with vehicles. This provides a faster and less tiring method for individual movement than is possible under their own locomotion. Oversnow vehicles, track and wheeled vehicles can be used for pulling skiers (fig. 4-39). The best routes for skijoring are snow covered roads and trails, frozen lakes, rivers, or paths made by tracked vehicles. Speeds up to 24 KmPH (15 MPH) may be maintained on level ground by trained troops, depending on weather and trail conditions. Normally, one rifle squad can be towed behind a light carrier and two squads behind a squad carrier. Towing more than two squads by one vehicle is impractical, due to the increased length of the column, difficulty in making turns, and the limitations of the vehicle and the skiers using the technique over steep or wooded terrain, and during poor or spotty snow conditions.

*b. Use of Tow Rope.* (For a description of knots see FM 31-72.)

- (1) Two ropes 36.50 meters (120') long are used for towing a rifle squad behind a vehicle and for the purpose of securing sufficient space between the individuals. The skiers, in columns of

of twos, are spaced at equal intervals behind the vehicle and outside the ropes. A gap of approximately 4 meters (12') is left between individuals.

- (2) Several methods of towing can be used according to the situation, the terrain, and the distance of movement:
  - (a) The skier grasps a bight of rope and makes a 25 cm (10") loop by tying an overhand knot. The loop is held with one hand and poles are held in the other, or a long loop can be formed by tying an overhand knot in a 1.50 to 2 meter (5' to 7') bight of rope. The skier leans against the loop after placing it around the buttocks. He does not place the body through the loop (1, fig. 4-40).
  - (b) Using the ski pole method (2, fig. 4-40), the skier rests both arms and body and can arrive at the destination in better physical condition. Another advantage in this method is that a skier can easily exercise his hands to prevent frostbite during movement in extreme cold.
  - (c) When being towed through dense wooded areas, or when contact with the enemy is imminent, skiers may simply grasp the rope without tying a knot or using the ski poles as



a rest. Thus, they can maneuver through narrow trails and are more ready for immediate combat.

(3) No matter what method of towing is



1 Long overhand knot



2 Using ski poles as a rest

Figure 4-40. Methods of towing or skijoring.

being used, individuals must never be allowed to fasten themselves to the tow rope. In case of a fall they must be able to release their hold immediately to avoid serious injury to themselves or other skiers. The ski poles are usually held in one hand and available for instant use. During training and in combat situations when contact with the enemy is not probable, the ski poles may be loaded on the vehicles to avoid accidents.

c. *Skijoring Technique.*

- (1) The track is made as simple as the terrain permits. Steep slopes, obstacles, and sharp turns are avoided. When these cannot be bypassed the speed must be reduced in order that the skiers can maneuver. A high degree of cooperation between the driver of the towing vehicle and the skiers is necessary. One man, usually the assistant driver, is responsible for stopping or slowing the vehicle in order to prevent casualties due to speed or obstacles. He constantly observes the skiers and other vehicles, gives the driver orders, and signals the skiers when the vehicle will slow down, speed up, or stop.
- (2) When the vehicle begins its forward movement each man on the rope should move forward under his own power for a few steps, gradually placing tension on the towing rope to prevent being suddenly jerked into motion, causing a fall. When under way, the skier's body is leaned slightly backward, the knees are bent slightly, and the upper body is nearly straight. Skis may be farther apart than in normal skiing. One ski is kept slightly ahead. The position should be one in which the skier can relax but still be alert to sidestep quickly in order to avoid obstacles and maintain misbalance. If a skier falls, he should release the towing rope immediately.
- (3) When approaching a sharp curve where the area for movement is confined, the vehicle should be slowed

down or, in some instances, stopped. When negotiating a sharp turn, the vehicle should be slowed to a walking speed and skiers walk around the curve being careful not to drop or step on the tow rope. Normal speed is resumed after the last man has made the turn. Failure to do this may result in being pulled off balance by the rope as the vehicle completes the turn and proceeds in the new direction. Vehicle stops and starts must be in a gradual manner which allows for a smooth rather than a jerky ride for the skier.

- (4) When descending hills the men can brake by using the snowplow or half

snowplow, if space allows, to prevent overruling the vehicle or, if conditions warrant it, they may move to the side of the track where the softer snow will decrease their speed. If the terrain will not allow for controlled braking and collision with the vehicle seems imminent, the individuals should release the rope and disperse to the sides of the track. On short downhill slopes the vehicles should increase speed temporarily so that the skiers need not brake. On long, steep slopes the men can descend independently of the vehicle and reattach themselves after the slope has been negotiated.

## CHAPTER 5

### MOVEMENT

#### Section I. PROBLEMS AFFECTING MOVEMENT

##### 5-1. General

The lack of roads, the soft, wet terrain prevalent in the summer, the snow and blizzards in winter, thick forests in mountains and birk, and the innumerable waterways are some of the barriers to movement in most cold areas of the world. The ability to overcome the many obstacles to movement may well be the deciding factor in winning or losing a war in these cold areas. Mobility begins with the individual.

##### 5-2. Influence of Seasonal Changes in Weather and Terrain on Mobility

###### a. Spring Breakup and Fall Freezeup

- (1) The spring breakup and fall freezeup periods are by far the most difficult seasons in which to maintain mobility. The period of breakup may last from 3 to 6 weeks and will present restrictions to movement (fig. 5-1). The snow becomes slush and will support little weight. Winter roads break down, the ice in waterways melts, rivers are swollen and become torrents. Movement at this time of year poses many problems, however, movement is possible in cold areas at all times. Normally, at this time of year, temperatures drop at night, freezing the surface, and mobility during this period can be maintained. During the day caution should be exercised in shady areas as they may contain ice and snow even though daytime temperatures are above freezing.
- (2) The period of freezeup with rain and open or half-frozen waterways will

also present barriers to movement. Complete freezeup may take up to 3 months, often restricting the movement of heavy equipment across lakes until late January.

- (3) The early winter period, when there is little snow and the ground and waterways are firmly frozen, will provide excellent trafficability for foot soldiers and vehicles.



Figure 5-1. Breakup season.

*b. Winter.* The low temperatures, snow, blustery winds, and bulky clothing and equipment required during winter hinder movement as it is known in more temperate climates. By the proper use of specialized equipment for cold weather operations, mobility can be maintained. Using skis, snowshoes, oversnow vehicles, and aircraft, mobility is possible. In the barren tundra or on icecaps the hard snow found in these areas will readily support an individual on foot as well as oversnow vehicles. In the forested areas the snow will normally

be deeper and the temperatures lower. The depth of the snow and the trees in these areas will prove to be the greatest obstacles to mobility. With oversnow equipment such as skis and snowshoes, properly trained, equipped, motivated and conditioned troops can maintain mobility.

*c. Forested Areas.* A great portion of the North is covered with evergreen forests and

with numerous swamps and water courses. Few trails exist through the forests and those that do exist are of poor construction, making progress difficult and slow. The numerous waterways, once they become frozen, will normally provide excellent routes for foot and some vehicle movement. Whenever possible they should be used to the maximum for the ease of movement they offer.

## Section II. FOOT MOVEMENT

### 5-3. General

Winter cross-country travel in the North is difficult and complex. Of necessity, travel will be slower. However, with the proper training in the use and maintenance of equipment, the proper enthusiastic leadership, and the will to accomplish the mission, nothing is impossible.

### 5-4. Basic Rules for Foot Movement

The following guides are based on experience factors and should be considered in preparing for cross-country movements in the northern areas.

*a.* Insure that all personnel participating in the move are fully aware of the mission, route, etc. Equipment must be checked and loads evenly distributed. Dispatch trailbreaking teams far enough in advance to insure continuous, uninterrupted movement of the main body. Men should be dressed as lightly as possible consistent with the weather to reduce excessive perspiring and subsequent chilling. Complete cold weather uniforms must be available while operating in cold environments. A large proportion of cold weather casualties result from too few clothes being available to individuals at such time as a severe change in the weather occurs. Therefore, unit clothing discipline must be enforced consistent with prevailing weather.

*b.* The first halt after initiating a march should be made in approximately 15 minutes. This will allow adjustment of clothing and equipment. Subsequent halts should be frequent and of short duration to insure rest and to prevent chilling. Halts should, so far as possible, be made in sheltered places which will

provide protection from the elements. Warm drinks should be provided during the march if possible.

*c.* The buddy system is mandatory in the North and men must be instructed to watch their buddy carefully for early signs of frostbite. Individuals must not be allowed to fall out of the line of march, except in an extreme emergency. If this should occur, proper care must be taken to insure that he does not become a cold weather casualty. Normally, the second-in-command will bring up the rear of the column and, in each halt, will check the men and report their condition to the leader.

*d.* Prior detailed reconnaissance is most important to insure successful mobility in the northern areas. Maps may or may not exist and those that do exist may not always be accurate. In planning a move, maximum advantage must be taken of map studies, aerial photographs, ground and aerial reconnaissance. Without detailed reconnaissance and prior planning, unit movement may be slowed or stopped by long detours or obstacles.

*e.* Marching in single file is often the best formation. It maintains track discipline, camouflage, and reduces the number of trailbreakers and reconnaissance parties required. Natural obstacles may limit the use of other formations. Large units in single file however, become excessively long and will be slow to react to enemy action to the front or rear. Tactical considerations will often require the use of other formations. The double track of vehicles may be used as pathways for foot troops, but will rarely afford ease of movement for ski or snowshoe mounted troops.

## Section III. TRAILBREAKING

## 5-5. General

## a. Purpose.

- (1) The purpose of trailbreaking is to make the march of the main body as easy and fast as possible in order that the troops will arrive at their destination in good fighting condition. Trailbreaking accomplished at any time of the day or night through deep snow and difficult terrain is hard and time-consuming work. The progress of trailbreaking is dependent on the terrain, weather and snow conditions, vegetation, physical condition of the trailbreaking detachment and, finally, on the tactical situation. Therefore, plans must be carefully made and trailbreaking parties well organized.
- (2) In addition to trailbreaking, the mission of providing frontal security for the main body is a normal function of the trailbreaking party. Approximately one-fourth of a unit is given the mission of trailbreaking and frontal security for the march. For example, the battalion normally assigns one rifle company this mission. The quartering party may accompany the trailbreaking party or may follow later. The company in turn assigns one rifle platoon to lead, functioning simultaneously as a trailbreaking party for the lead company. Since the trailbreaking unit is the first to arrive in the new bivouac area, its commander is also responsible for establishing temporary security of the area. When the quartering party arrives in the bivouac area they will perform the normal functions of a quartering party as outlined in FM 7-20.

b. *Planning.* Based upon an estimate of the tactical situation, terrain, weather and snow conditions, the most suitable route is selected for the movement. As a general rule terrain features which offer least resistance will be followed. In selecting a route, consideration must be given to all of the following:

- (1) *Open terrain.* In order to keep the main body sufficiently dispersed, ski trails are more widely separated in open terrain. For concealment, normally only one ski trail is broken across open terrain. When possible the trail is broken close to the edge of the forest so shadows will help conceal the trail and troops moving over it. In open terrain light tracked vehicles should be used for breaking trail and for towing the trailbreaking party by skijoring to the maximum extent to save time and energy of the individuals. At times it may be desirable to break additional trails to expedite troop movement across open areas.
- (2) *Covered terrain.* Whenever possible, time and situation permitting, the trail should follow along forest terrain with little or no underbrush. It provides good concealment and protection against wind. The trail should be broken close to bushy trees in order to provide better concealment. Thickets and windfall forest areas should be avoided, as it requires a great amount of effort to break a trail in areas of this type. If a triple trail is broken for sleds, wide curves must be made when changing direction and the bushes and branches must be cut from the inside of the curve. The thoroughness with which the small trees, bushes, and branches on both sides of the broken trail are cleared will depend on the time allowed the trailbreaking party.
- (3) *Hilly and mountainous terrain.* When the situation permits, valleys will most often provide the easiest route. Frozen rivers frequently afford the easiest route in this type of terrain. If the valleys cannot be used, the trail may be broken on the lee side of the ridge line or hill mass that dominates the valley. Care must be exercised to detect avalanche snow conditions and bypass these areas as

necessary. Use gentle inclines when climbing uphill or descending. When trails are broken downhill the speed of the trailbreaking party is often slow, because of soft and deep snow. However, when packed, the same trails may make the speed of the skiers in the main body too fast. This will result in many falls, especially during darkness.

- (4) *Water routes.* Frozen lakes, rivers, and creeks offer the most suitable routes for the trails. They also help in land navigation. For best protection and concealment, the trailbreaking party skis very close to the shore or on the bank, as this facilitates better concealment of the individuals and units, their trail, and any quick movements into the wooded areas of the shore. Sometimes in winter, and especially in the spring, there may be water under the snow surface on surfaces on the lakes and rivers, thus causing the running surfaces of the skis to freeze. Check for concealed water under the snow before starting to break trail across the ice. Areas in which water is found under snow should be bypassed. If this is not possible, the crossing site must be reinforced with snow or with a combination of brush and snow. Also, the thickness of the ice must be carefully checked before using any ice route. The minimum thickness of ice for one rifleman on skis is 5 cm (2") ; for an infantry column in single file on foot, 10 cm (4") ; and for the single light artillery piece or 1/4-ton truck, 4 x 4, 20 cm (8"). See load bearing capacity tables in FM 31-71. Warm water springs are prevalent in northern areas of operations and create a hazard to both foot and vehicle movement. Many of these springs do not freeze, even in extremely low temperatures, and may cause streams to have little or no ice and some lakes to have only thin ice. Their presence in muskeg or tundra areas can cause weak spots in otherwise trafficable terrain. These areas should be either bridged, reinforced, or bypassed.
- (5) *Obstacles.* Since even minor obstacles retard the march, they are bypassed whenever possible. If a wide obstacle is met, such as a ridge or a steep riverbank, several trails are broken over the obstacle so that the main body can cross it on a broad front. Trees and brush are cut well below the bottom of ski tracks in order to avoid twigs and branches entangling in ski bindings and tow ropes. Obstructions such as fences may be cut in order to allow the skier to pass through.
- (6) *Weather and snow condition.* In early winter there is more snow in open terrain than in dense forest; therefore, the trail should be broken close to the forest edge. In late winter the reverse is true. In early spring more snow can be found in ditches, ravines, and on the shadowy side of hills. Maximum advantage should be taken for movement during periods of reduced visibility, such as snowstorms. These storms will conceal movement and at times completely camouflage the trail after the unit has moved over it. Care should be exercised to preclude moving directly into a strong wind. Movement in the same direction of the wind usually requires much less effort. Under the most adverse conditions, navigation will also become extremely difficult. Trails may become covered very quickly after being broken, requiring the distance between the trailbreaking unit and the main body to be shortened. Adverse conditions such as driving snowstorms will slow the movement but will facilitate security.
- (7) *Darkness.* Skiing and snowshoeing at night is slow and exhausting. Therefore, the trail for a night march must be broken along the easiest terrain available. Avoid all rough terrain if possible. Navigation of the trailbreaking party demands special skill in

darkness and during periods of reduced visibility. Rivers, creeks, ridge lines, and forest boundaries should be used as aids to navigation in spite of the fact that the broken trail might become longer. Because of the darkness it may be necessary to leave guides posted at locations where the main body may take the wrong course.

(8) *Enemy activity.*

(a) When breaking trail within the frontline area, the requirements for concealment are most important. Therefore, the trailbreaking party is forced to ski along covered terrain whenever possible. However, if the mission requires fast movement, a trail is broken along the shortest course, paying less attention to concealment. The security mission normally given the trailbreaking unit will take on added importance and may require more support for this unit.

(b) These responsibilities affect the course of trail. In frontline areas the trail should be broken along terrain features which facilitate observation and deployment of the main body. Also, the route should follow terrain which offers a sound approach and suitable places for temporary defense. Sometimes it is necessary to check critical terrain features located near the trail before the trailbreaking party moves forward. Elements of the trailbreaking party may occupy certain security positions and remain stationary until the main body has passed these critical points, at which time they may rejoin the rear of the column. For the purpose of deceiving the enemy, it may be desirable to create numerous false trails crisscrossing and angling off in all directions. In burned-over areas or thin deciduous forests, concealment from aerial observation is practically impossible. A single trail clearly indicates the

whereabouts and approximate size of the unit making it. Miscellaneous trails, therefore, create confusion. Of course, the breaking of false trails is time consuming and will also acquaint the enemy to the fact that a sizable unit was required for the amount of work accomplished.

(9) *Number of trails used.* The number of trails to be broken depends upon the size of the column using them, the tactical situation, and time available for trailbreaking. An organization of battalion size normally requires two or more march trails and one or more communication trails for messenger service and control of the march column. In cases where time is very limited for preparations, only one trail may be established for a battalion. When contact with the enemy becomes imminent, greater emphasis is placed on security and less emphasis placed on trailbreaking. The possibility for a rapid deployment of the troops requires that the number of trails or tracks be increased from that of a routine cross-country march.

*c. Organization.* The trailbreaking party preceding units mounted on skis should also be mounted on skis. The trailbreakers of elements on snowshoes should also be mounted on snowshoes. Mixing of skiers and snowshoes on the same track is not recommended. Snowshoes tend to compact the snow on ski trails making it difficult for the main body to follow on skis.

(1) The lead company normally will be assigned the mission of breaking trail for one complete day. It is replaced by another company on the following morning. One rifle platoon at a time is assigned as lead platoon and is called a Trailbreaking Party. It may also include engineers whose duties would include reconnoitering ice routes, seeking suitable terrain for permanent type winter roads, preparing ice reinforcements, and performing other engineer tasks. Forward

observers may also accompany the trailbreaking party.

- (2) Depending on terrain conditions, 1 to 2 oversnow vehicles, when available, should be assigned to the party to be used for breaking trail in open terrain, skijoring, and carrying individual loads and platoon equipment. In unfavorable terrain conditions the vehicles remain under company control or with the higher echelon. The trailbreaking party consists of its organic rifle squads, called Trailbreaking Squads. A trailbreaking party is expected to break trail approximately a half a day at a time, but may be rotated sooner depending on local conditions. Trailbreaking squads, in turn, are normally rotated as often as necessary in order to maintain the speed necessary to complete the mission in time.

*d. Trailbreaking Squad.* The organization, duties, and special equipment of the trailbreaking squad are indicated in figure 5-2. Squad leaders must insure that their men have a sufficient number of tools of proper size before moving out. The tools are part of the tent group equipment and are used in preference to entrenching tools. To conserve energy and to assure an uninterrupted march, the leading man (breaker) of the squad is regularly relieved. In very deep and heavy snow a relief may become necessary every 150 meters (150 yds). When the change is ordered by the team leader, the man to be relieved steps sideways out of the path and falls in at the rear of the team. The man following him then becomes the breaker. Special equipment is exchanged by passing it to the next man in line during the rotation. The breaking team will be relieved by the reserve team as directed by the squad leader whenever the point team tends to slow down due to fatigue.

*e. Trailbreaking Party.* The trailbreaking party consists of two or more trailbreaking squads. Normally a rifle platoon will be assigned this mission, especially if the snow is heavy and the weather severe.

- (1) One of the squads is always desig-

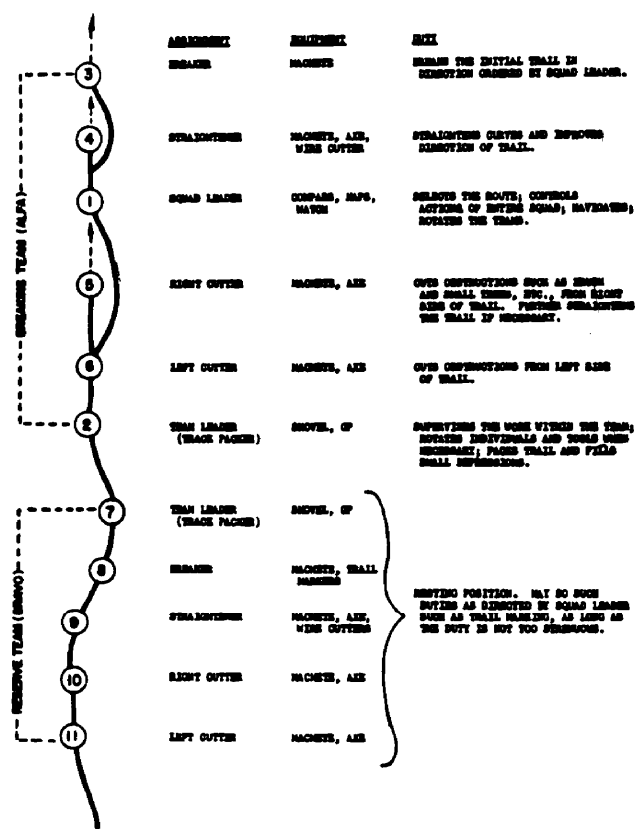

Figure 5-2. Organization of trailbreaking squad.

nated as the base squad and is responsible for navigation and the general direction to be followed. The platoon leader and the navigation detail directly under his control will follow the base squad. When dead reckoning is required, the base squad breaks the center trail and works slightly ahead of the other squads for the purpose of maintaining the proper direction of the squads which are moving on both sides of the track made by the base squad (fig. 5-3). In cases where the party follows easily recognizable terrain features, such as small creeks or the edge of open terrain, the base squad follows next to this terrain feature, making navigation easier. The other squads are echeloned to the right or left, and their breaker (the first man) to the right or left of the last man of the squad ahead (fig. 5-4).



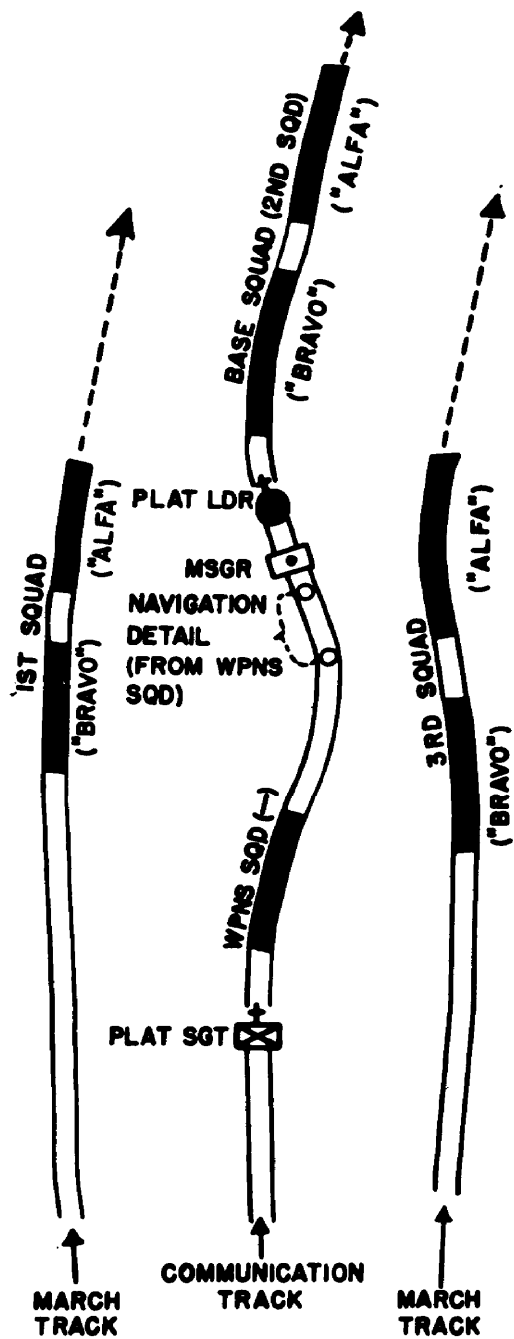

Figure 5-3. Trailbreaking party (dead reckoning).

- (2) Interval between the trails varies from about 15 meters (15 yds) in covered terrain to approximately 100 meters (100 yds) in open areas, depending on the local situation. The depth of the party varies from 100 to 200 meters (100 to 200 yds). Mem-

bers of the weapons squad may be assigned to the navigation detail, to flank security missions, to assist the vehicles in breaking their trail off the ski trails, and similar duties. The weapons squad may follow and improve the trails being established, as directed by the leader of the trail-breaking party. From the area where vehicles are temporarily halted due to the close proximity of the enemy, one track may be widened into a triple track to facilitate the movement of heavy weapons, ammunition, and

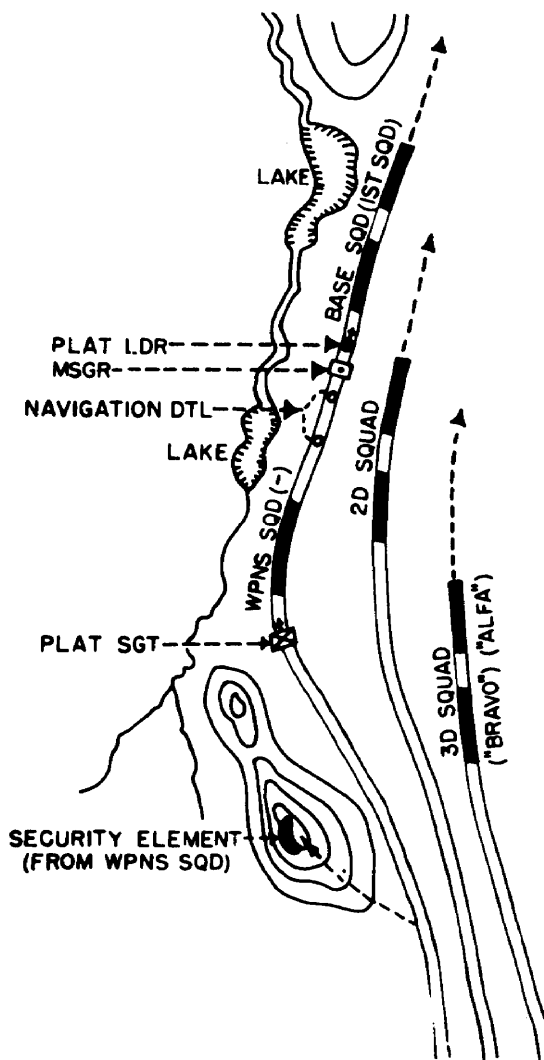

Figure 5-4. Trailbreaking party following recognizable terrain features.

warming tents. This equipment is usually moved forward by man-drawn sleds.

- (3) The trailbreaking party moves far enough ahead of the column to permit a steady rate of march by the main body. This distance varies according to the tactical situation, snow, weather conditions, and terrain encountered. For covered movements through territory controlled by friendly troops, the trailbreaking party normally precedes the main body by 1 hour for each 5 km (3 miles) of marching distance. For example, if a 25 km (15 miles) march is planned, the trailbreakers leave 5 hours in advance of the parent unit. For uncovered moves, the trailbreakers precede the main body by a distance dictated by the tactical situation.

*f. Techniques.* The trailbreaking squad may break a normal or triple track as required. On *normal track* the first man makes his tracks so that the grooves are a little wider apart than usual, approximately 30 cm (1'). The trailbreaker usually uses the one step technique. In deep and soft snow, however, his steps will be shorter than normal and he will be forced to lift his skis at each step to prevent the tips from running under the surface of the snow. Progress will be slow and may be exhausting. Therefore, the man in the breaker position must be rotated often.

- (1) When track-laying vehicles and cargo sleds cannot be used any further due to the tactical situation, the crew-served weapons, ammunition and warming tents must be moved to the units in man-drawn sleds. Therefore a triple track is broken because the normal trail is too narrow. When starting a triple trail (1, fig. 5-5), the leading three men of the breaking team will break a normal trail of two grooves. The third groove is started by the fourth man who keeps one ski in the already broken groove and makes a new groove with his left (right) ski, depending on which side

of the original groove the new track will be broken. Alternate men behind the fourth man, both in breaking and reserve teams, ski along the original tracks made by the first three leading men, the others following the tracks

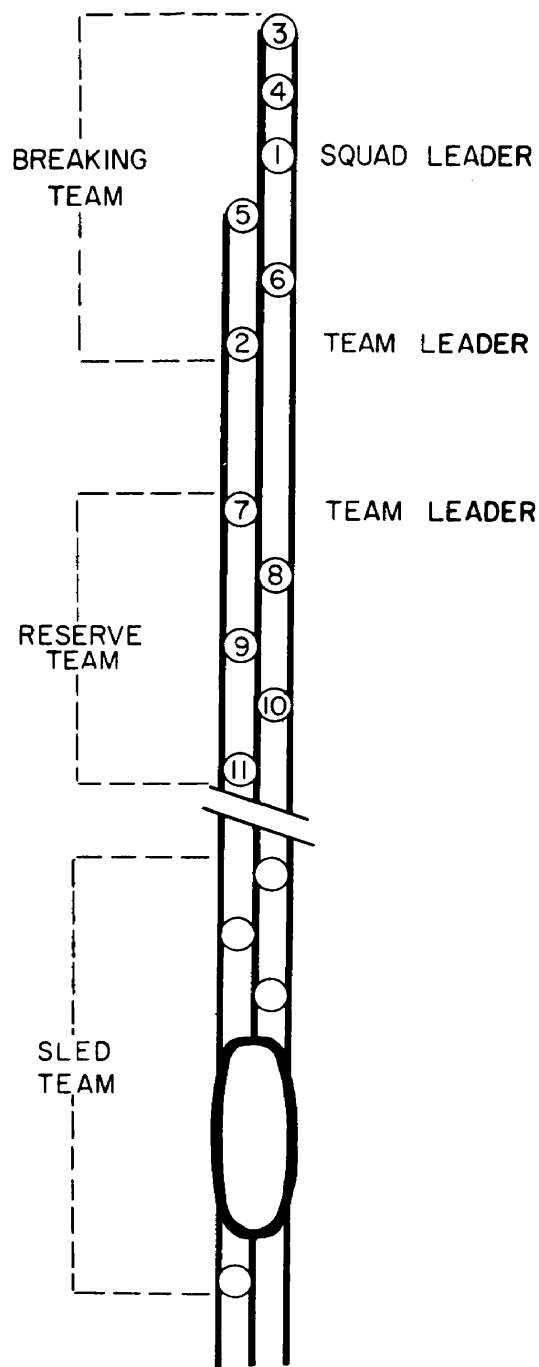

1 Organization of the trailbreaking squad.  
Figure 5-5. Breaking of triple track.

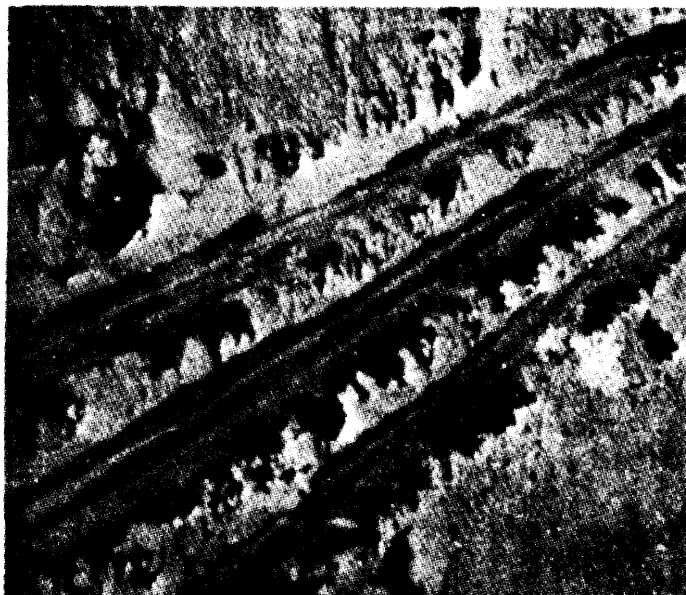

2 Triple track completed.

Figure 5-5—Continued.

made by the fourth man. This creates a trail with three tracks, a triple trail (2, fig.5-5). This provides the proper type of trail for pulling man-drawn sleds. Due to the fact that sleds tend to destroy the ski trails, only one of the ski trails will be prepared as a triple trail and this trail will be used for man-drawn sleds only.

- (2) Ski trails must be kept separate from the trails and roads established for vehicles and cargo sleds, due to the fact that the vehicles tend to destroy the ski trails and, conversely, the skiers on the winter road tend to harass the vehicular traffic. Signal wire layed alongside the ski trail must be located far enough to the side so as not to become entangled with skis and ski poles. When crossing the ski trail the wire must be buried well below the trail or secured overhead, whichever is most desirable.

## 5-6. Marking the Trails

*a.* The trailbreaking squad marks its trails as uniformly as possible. The types of markings used must be known to the unit that fol-

lows. When several squads are operating, marking by the base squad is usually sufficient. The marking is simple, and recognizable by night as well as by day. Temporary trails through new snow need simple markings only where the trails or roads are crossed by other trails. Trails that are frequently used for long periods are more permanently marked. The following can be used as trailmarkers:

- (1) Twigs on trees and shrubs broken in a predetermined manner, or blazes (nicks) in tree trunks made by using a hatchet or machete.
- (2) Poles or guiding arrows planted in the snow.
- (3) Markers made of rags or colored paper.
- (4) Trailmarkers (willow wands).

*b.* Snowfalls, fog, poor observation, and uniformity of the terrain necessitate thorough and frequent markers spaced at uniform intervals and numbered successively in the direction of march. To avoid the destruction of trailmarkers by traffic, the markers are placed about 1 meter (3') off the trail. When strange tracks cross the trail of the unit they are obliterated at the point of crossing. Guides are posted at crossings, if necessary, to direct units that follow.

## Section IV. LAND NAVIGATION

**5-7. Effects of Environment**

*a. General.* Basically, mapreading, as well as navigation under cold weather conditions, follows the same principles as in the temperate zones. In addition to the normal procedures, every individual must be most familiar with certain conditions peculiar to the cold weather regions and the techniques applicable to navigation. Due to the fact that a technical failure or human error may easily, and especially in the winter, be fatal to the individual or to a unit, great care must be exercised when navigating in low temperatures.

*b. Navigation Problems.* The following conditions, characteristic of the cold weather regions, will make accurate navigation very difficult:

- (1) Lack of adequate large scale maps in the sparsely populated areas which will increase the requirements for and the use of aerial photographs.
- (2) Photos of many areas will be difficult to read and interpret because of the absence of relief and contrast, and absence of manmade works for use as reference points.
- (3) Dense forests and wildernesses offer few landmarks and limit visibility. Also, barren, monotonous tundra areas north of the tree line are characterized by lack of landmarks as aids for navigation.
- (4) In winter, short daylight, fogs, snowfall, blizzards, drifting snow, especially in the barren areas, drastically limit visibility. At times an overcast sky and snow-covered terrain create a phenomenon called whiteout which makes recognition of irregularities in terrain extremely difficult.
- (5) Heavy snow may completely obliterate existing tracks, trails, outlines of small lakes, and similar landmarks. Because the appearance of the terrain is quite different in winter from that in summer, particular attention must be paid to identifying land-

marks, both on the ground and in aerial photos.

- (6) Magnetic disturbances are encountered, making magnetic compass readings difficult and sometimes unreliable.
- (7) Magnetic declination in different localities varies considerably, and must be taken into consideration when transposing from a map to a compass.
- (8) Handling maps, compass, and other navigation instruments in low temperatures with bare hands is difficult. Removing handgear may often be possible for a very short period of time only.

**5-8. Methods of Land Navigation**

*a.* The normal methods of land navigation under cold weather conditions remain the same as anywhere else. Maps and aerial photos may be used alone during daylight in terrain which offers enough distinctive terrain features to serve as useful landmarks. They may also be used in conjunction with a compass, especially in terrain which contains insufficient landmarks or under circumstances when visibility is limited. However, in most instances, utilizing the map and compass together will provide for the surest land navigation in northern areas of operation.

*b.* Depending on various conditions, certain supplementary methods, such as position of the sun in daytime, North Star and Big Dipper at night, as described in FM 21-26, may be used to aid in land navigation. Where possible, these methods should be employed in conjunction with the normal methods described above.

*c.* It is obvious that on vast barren grounds as well as in wide forest, navigation by dead reckoning often becomes the only practical method. Dead reckoning is the process by which position at any instant is found by applying to the last determined position the direction and distance of the course traveled. This method should also be used in areas where landmarks are very limited or totally nonex-

istent. It is also desirable when the landmarks are obliterated by the limited visibility.

### 5-9. Navigation by Dead Reckoning

Navigation by dead reckoning is performed in accordance with FM 21-26. Due to the peculiarities of the cold weather regions, the following hints should be observed when applicable:

*a.* Responsibility for navigation is assigned to a detail of one officer or noncommissioned officer and 1 to 2 men, all thoroughly experienced in navigation techniques. The detail is placed directly under the control of the unit commander and must be released from the carrying of individual heavy loads and from details such as trailbreaking in order to perform their duties properly. Using a small detail rather than a single navigator is based upon the fact that the method of pacing distances in deep snow has to be modified as described in *c* below.

*b.* In general, the navigation detail is responsible for—

- (1) Accumulating necessary instruments and equipment.
- (2) Keeping instruments and equipment serviceable.
- (3) Performing the detailed duties of taking and recording necessary data for precise location at all times.
- (4) Maintaining liaison with the commander of the unit.
- (5) Supplying data to keep the column on course.

*c.* Due to the sliding capacity of the skis, normal pacing system is very inaccurate or, in certain cases, such as on steep slopes, entirely useless. Pacing on snowshoes can be done in emergency. It must be borne in mind, however, that an individual mounted on snowshoes takes much shorter paces than on foot. The only recommended method for accurate ground measurements is a piece of line or field wire

preferably 50 meters long (50 yds) used by two navigators.

*d.* Keeping a log is mandatory. The preparation of the log, as well as plotting the route from the log data on the face of the map or on a separate piece of paper at the same scale as the map, must be completed prior to the departure to minimize the use of instruments and equipment in low temperatures with bare hands.

*e.* Certain mechanized aids are highly valuable for navigation by dead reckoning.

- (1) A magnetic compass has been developed for mounting in all vehicles.
- (2) Odograph M1 is an instrument which automatically plots the course of a moving vehicle. It consists of three principal units—the compass; the plotting unit; and the powerpack. All components are interconnected by electric cable and flexible shafts. It was originally designed for use in the 1/4-ton truck, but can be used in other vehicles to include track-laying vehicles and sleds for operation under winter conditions.
- (3) Odograph M2 is much more accurate and convenient to use than the M1. It utilizes the miniature gyro-compass for the input of direction. In normal operations, if the map coordinates of the starting point are set on the instrument, it will provide the true coordinates of any point along the course of travel.
- (4) The use of rotary wing aircraft for “pathfinding” in bush country greatly assists in land navigation. From the tactical point of view, however, it is less feasible because it tends to disclose the movement. Troops can reveal their position to the aircraft by the use of colored smoke. The pilot can then give them their position location by radio or dropped message.

## Section V. ACTION WHEN LOST

### 5-10. General

Prior march reconnaissance includes memo-

rizng details of the country to be traversed. Routes should be plotted and as many land-

marks located as possible to insure that personnel will not be without recognizable features for any appreciable length of time. If on barren terrain, all navigation instruments must be thoroughly checked and one of the most experienced men should be given the job of navigating and maintaining the "dead reckoning log." It is possible to become temporarily lost while operating in friendly areas of enemy terrain, as on a long range patrol. Each situation should be considered separately, and the main point to remember in any case is to remain calm.

### 5-11. When Lost Within Known Locality

If the sector is quiet and there is an absence of war noises or aircraft to guide the patrol toward friendly lines, stop in place. In a wooded area steps should be retraced to the last known point. If this is not practical, estimate the present location and send a small detail in search of the next known point. Opinions should be taken from the group as a whole if it is felt they will contribute. Search parties must mark their trail carefully in order that they may return and guide the main group forward or rejoin the group should their search be fruitless. In the meantime, the remainder of the group should seek shelter. If

it is still not possible to locate the route, carry out the group action discussed in paragraph 5-12.

### 5-12. Conduct When Lost

At the first suspicion that a patrol or unit is not on the right course, it should not keep moving in the hope that it will come across a known landmark. The leader should halt the patrol, not cause unnecessary panic by appearing concerned, and immediately make a detailed check of the route starting at the last known point passed. If extensive checking of the position does not clarify the situation, inform all concerned personnel of the circumstances. When it has been determined the group is definitely lost, the patrol leader must accomplish the following:

- a. Seek a shelter, evaluate the situation, and formulate a plan.
- b. Gather all food and drink and institute a rationing system.
- c. Send a few selected personnel to search for a route, while the balance of the party remains in a sheltered position.
- d. Arrange necessary ground-to-air signals appendix B.

## Section VI. MECHANIZED AID TO MOVEMENT

### 5-13. Track-Laying Vehicles

a. *General.* So far as small units and individuals are concerned, vehicles of the track-laying type are the best aid to movement in northern regions. Deep snow and extreme cold impose special problems of operations and maintenance (app. F). Mandatory characteristics of any vehicle to be used in support of small units and individuals in the Far North during all *seasons* are mobility over muskeg and tundra, through brush and light timber, and the ability to break trail in deep snow. A complete discussion of these problems is beyond the scope of this manual. This manual is limited to a brief discussion of the general capabilities and employment of vehicles which are capable of tactical cross-country movement during all seasons. In order to conserve

the energy of troops, mechanized transportation of heavy weapons, ammunition, tentage, sleeping equipment, rations, and individual packs must be utilized to the maximum. Troops burdened with carrying or pulling these items soon become exhausted and lose their mobility and fighting capacity. Wheeled vehicles are generally restricted to road movements and have little use in cross-country operations of small units. The series of pictures contained in figures 5-6 through 5-12 illustrate construction problems entailed in negotiating winter trails with track-laying vehicles.

b. *Tractor Trains.* The purpose of tractor trains is to furnish oversnow movement of supplies and equipment. Tractor trains will be utilized normally from a railhead, truckhead, or airhead to the division or brigade support

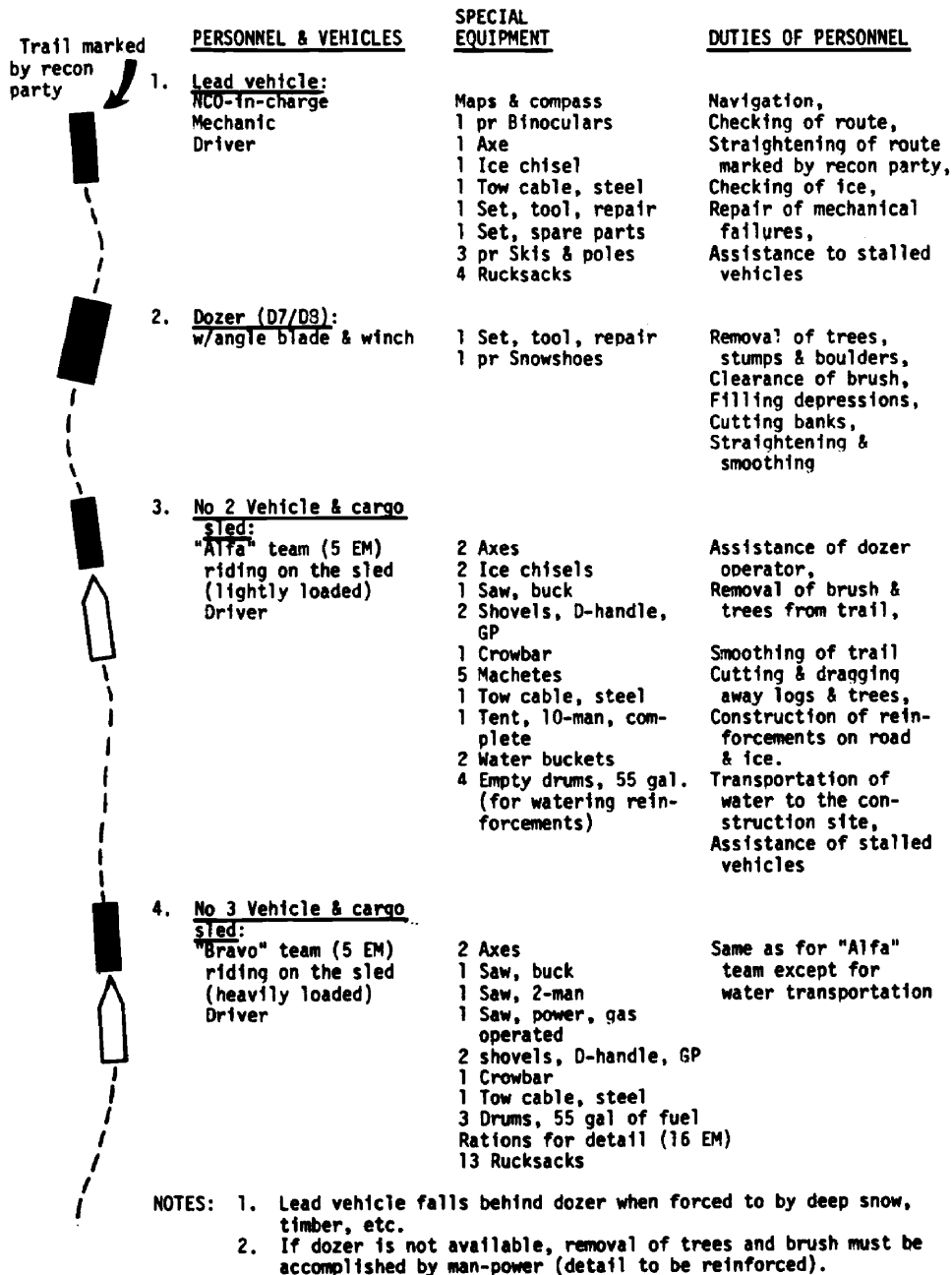

Figure 5-8. Construction detail for winter roads.

area. The tractor train is a means of moving large quantities of supplies cross-country. The trains are composed of cargo sleds drawn by construction type tractors and normally, due to their size and slow rate of march, are not used forward of the brigade support area. The tractor train in no way takes the place of wheeled cargo carriers that may be able to operate on roads or trails.

### 5-14. The Full Track Personnel Carried

The full track cross-country carriers are considered to be the best vehicles for use by combat troops in the North. The armored and unarmored carriers are capable of transporting a complete rifle squad together with its equipment and impedimenta. In an emergency these vehicles can furnish limited heat, shelter, and sleeping accommodations. The design of these



Figure 5-7. Road reinforced with snow.

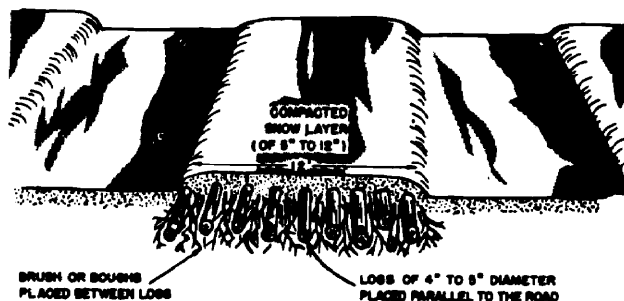

Figure 5-9. Road reinforced with brush, logs, and snow.



Figure 5-8. Road reinforced with brush and snow.

carriers permits their functioning as cargo and weapons carriers, as command posts, or for evacuation of litter patients. While the armored carrier is capable of reconnaissance, mounts armament, and has armor protection from small arms fire, the unarmored carrier provides better mobility and greater range on less fuel. The inclosed watertight hulls provide an amphibious capability and some protection against radioactive fallout.

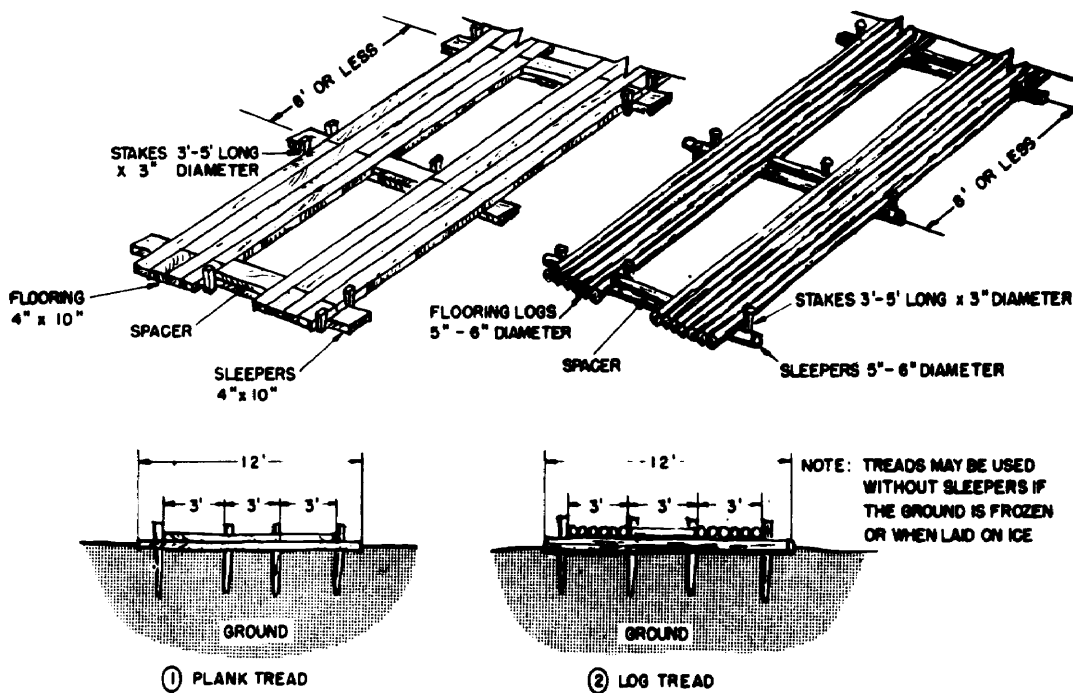

Figure 5-10. Road reinforced with tread.

### 5-15. Tanks

Tanks are designed for cross-country mobility to include traveling in deep snow. In addition to their normal tactical missions they may be

employed to transport personnel in an approach march and, in an emergency, to tow skiers. Windchill factors must be taken into consideration prior to moving troops on tanks



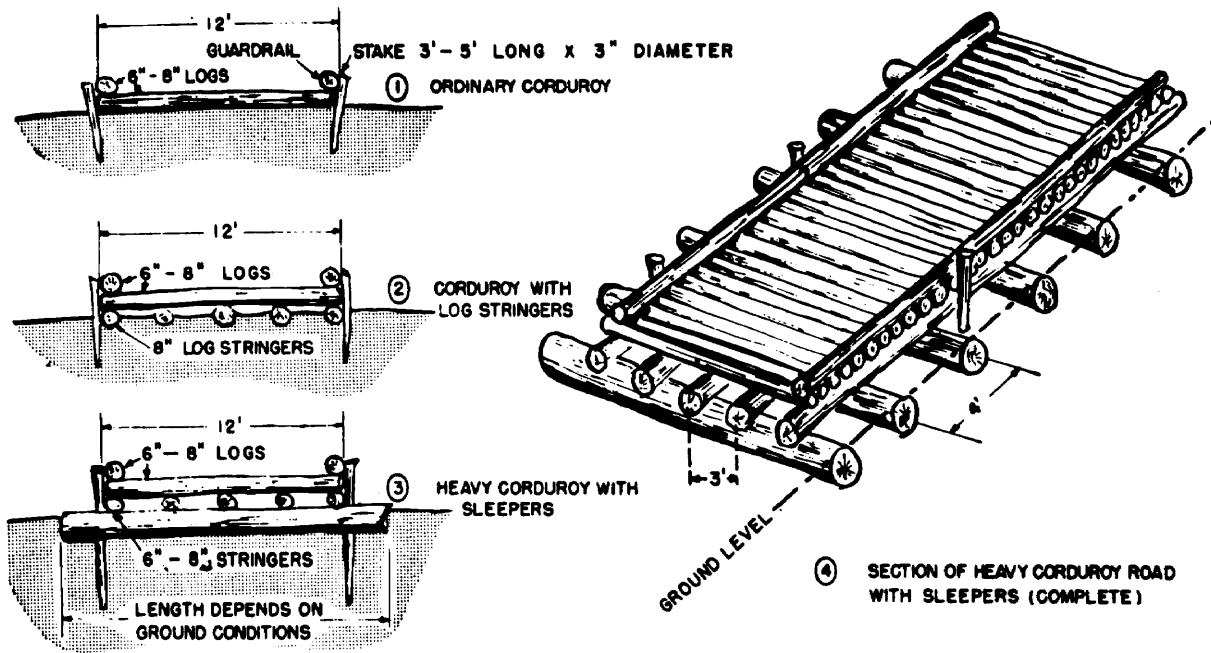

CROSS SECTION DETAIL OF VARIOUS CORDUROY ROADS

Figure 5-11. Types of corduroy roads.

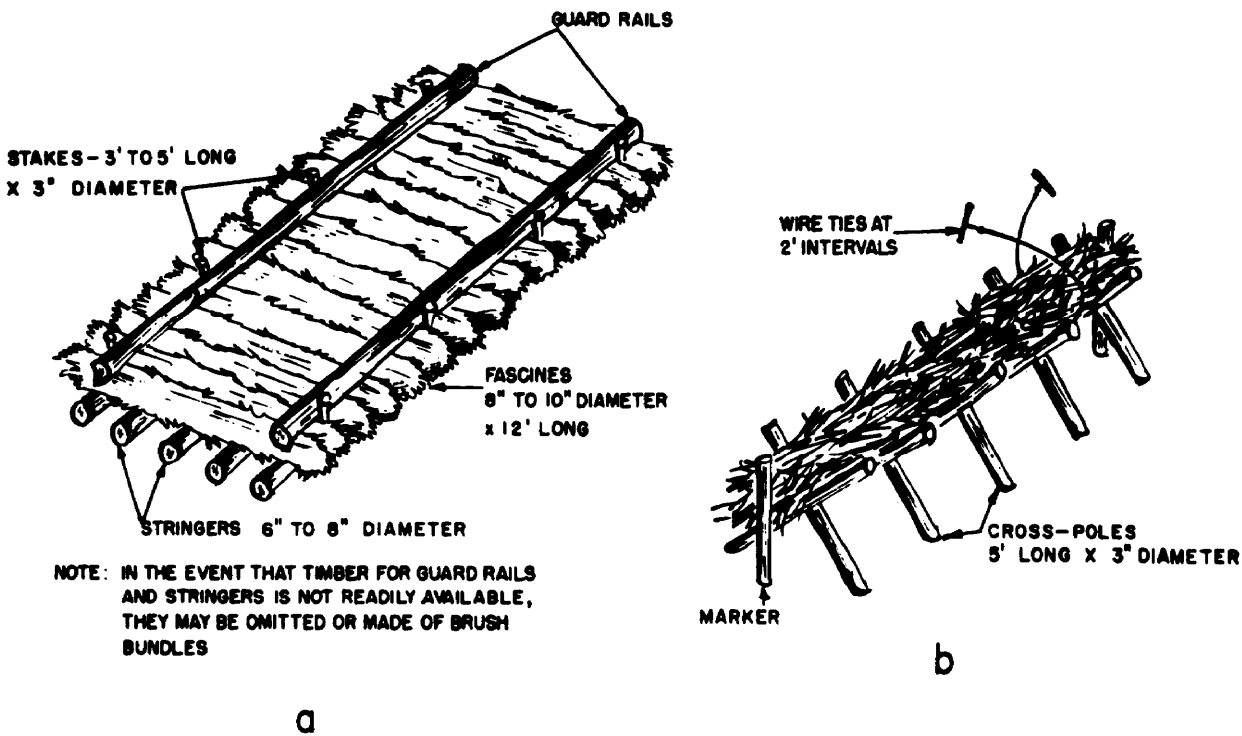

- a. Section of road completed.
- b. Use of "Sawhorse" for making brush bundles.

Figure 5-12. Corduroy fascine road.

for any appreciable distance to insure against frostbite. Tanks may also be used to pull cargo sleds; however, damage can be caused to sled tongues by the fast, jerky starting which is

characteristic of tanks. Tank tracks may provide routes of advance for troops, especially in the assault phase of the attack.

## Section VII. SLEDS

### 5-16. Man Hauled Sleds

*a. Sled, Scow-Type 200-Pound Capacity. (Ahkio).* Man-hauled sleds are necessarily light. They can carry a load of 200 pounds over difficult terrain and are used for carrying tents, stoves, fuel, rations, and other necessary items of each tent group. They are also used for carrying weapons and ammunition. They may be used as a firing platform for machine-

guns in deep snow and are particularly useful in the evacuation of casualties. Sleds are seldom used by small reconnaissance patrols because of the decreased speed of the individuals. Strong combat patrols, however, frequently use them for carrying their equipment or for evacuation in cases when faster means are not available. Sleds are provided with white canvas covers for camouflage, to hold the contents in

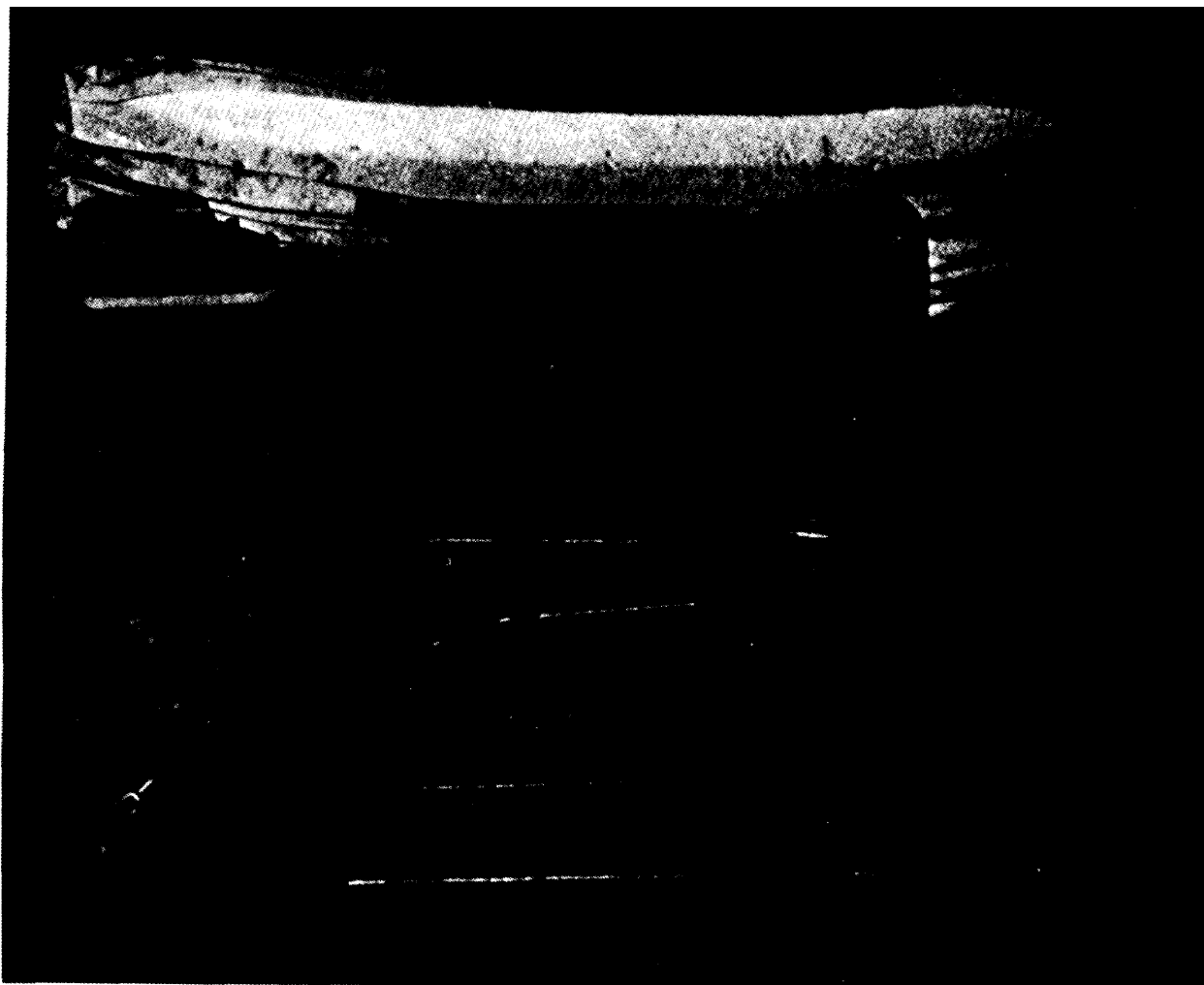

*Figure 5-13. Sled, scow-type, 200-pound capacity, with tent group equipment.*

place and protect them from the elements (figs. 4-36, 4-37, 5-13).

- (1) The sled has an approximate weight of 38 pounds, is 223.5 cm (88") long, 61.0 cm (24") wide, and has a depth of 20.3 cm (8"). It is towed by a team of four men. For the purpose of towing, a harness, sled, single trace, is provided. It consists of a loose-fitting web belt which is fastened at the side by a quick release buckle, an adjustable shoulder strap which supports the belt at the desired position on the hips, and a 2.75 meter (9') towing rope with snap buckles at each end. Metal D-rings are positioned at the front and rear of the belt.
- (2) Normally, sleds are towed by manpower only for short distances over prepared trails during an approach march or a similar type movement. Usually, the sled and equipment is transported on cargo sleds or by tracked vehicles. A number of loaded sleds, can be placed in cargo sleds (1 ton or heavier) or, in an emergency, can be hooked on improvised tow bars and towed behind the tracked vehicles. A triangle made of green poles and attached to the rear of the vehicle or cargo sled provides an excellent "tow-bar." Four small sleds can be towed by each vehicle when sleds are tied in tandem to allow two sleds to follow each vehicle track.
- (3) The sled, because of its boatlike shape, is easily maneuverable under a variety of snow and terrain conditions. It is superior to flat surfaced toboggans in maneuvering over difficult terrain, especially in deep snow and in heavily wooded areas.
- (4) It is important to distribute the load of the sled properly (fig. 5-13). In loading, place heavy equipment on the bottom and slightly to the rear and lighter equipment toward the top, in order to prevent the loaded sled from being top heavy. After the sled

has been loaded, the canvas covers of the sled should be folded over the load. To keep snow from getting under the canvas and to keep the load from shifting, lash the load tightly by crisscrossing the lashing rope from the lashing ring on one side of the sled to the other. Place tools such as shovels, axes, and saws on top of the load outside the canvas so that they are readily available for trailbreaking and similar purposes during the movement.

*b. Improvised Sleds.* Different types of sleds can be improvised from skis, plywood, lumber, or metal sheeting.

### 5-17. Cargo Sleds

*a.* For military purposes sleds are classified light or heavy. Lightsleds are under 5-ton payload capacity, and sleds with payload capacity of 5 tons or over are considered heavy.

*b.* Light sleds presently in use are designed to carry 1- or 2-ton payloads. The 1-ton cargo sled (fig. 5-14) is normally used with a light tracked vehicle as a prime mover; and 2-ton sleds (available in limited quantities but not a standard item) with the squad carrier or tractor as a prime mover. Care must be exercised, when towing these sleds with tracked vehicles, to avoid snapping the sled tongues in quick starting. Light sleds are suitable for use when rapid travel is involved and in areas where the freezing season has mean temperatures which do not form more than moderate thicknesses of ice on rivers and lakes.

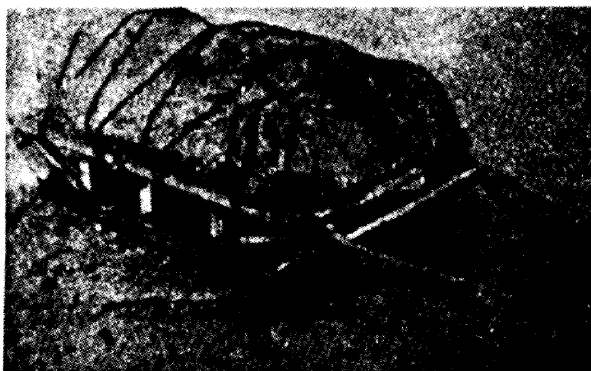

Figure 5-14. Sled, cargo, 1-ton.

c. Heavy sleds (of a commercial type) which may be used are of 10- to 20-ton payload capacity. It is anticipated that the bulk of supply will be transported on heavy sleds as opposed to light sleds. The operating radius of sleds is restricted only by the terrain and capability of the prime mover. The heavy sled is

best suited for use over flat or gently rolling terrain and in areas where rivers and lakes are frozen to sufficient depths to permit use as "highway." In some cases specially constructed "iced roads" are required to operate motorized sled trains with heavy sleds.

## Section VIII. AIRCRAFT

### 5-18. Aircraft

The lack of ground communication routes in the northern latitudes causes an extensive use of air transportation. Both fixed-wing and rotary-wing type aircraft are used. Troops and supplies may be transported from one existing or improvised airfield to another. In some situations both supply and evacuation by air may be the only feasible method. Bad weather may limit air operations for short periods of time.

a. *Fixed-Wing.* The vast stretches of the northern regions can be reconnoitered with a minimum time and effort by liaison fixed-wing aircraft. The ability of the ski-equipped aircraft to land on frozen lakes, streams, and in open fields in winter affords advantages and opportunities to supplement the ground reconnaissance. In addition to reconnaissance, fixed-wing aircraft are used to supplement the overland movement of troops and supplies, evacuation, and many other purposes.

b. *Rotary-Wing.* The dominant characteristics of this type craft, such as vertical ascent and descent and requirement for short landing

areas, make it valuable for reconnaissance, evacuation, troop movements, command control, resupply, and many other types of missions. Aviators must exercise caution when hovering over loose snow as it may swirl up and cause loss of visual reference.

### 5-19. Airfields

There are many potential landing sites in the area of northern operations. Runways can be constructed by grading and compacting snow. In general, airplanes equipped with skis require about 15 percent more landing and takeoff space than those equipped with wheels. Aircraft can use airfields constructed on frozen lakes and rivers, after a suitable ice reconnaissance has been made (FM 31-71). Design criteria for Pioneer, Hasty, and Deliberate Army airfields and heliports are listed in TM 6330. As a rule of thumb for planning purposes, the airfield for liaison type aircraft (O-1 and U-6) should be a minimum of 30 meters (30 yards) wide and 400 meters (400 yards) long. Refer to the Flight Handbook for exact landing and takeoff distances of various aircraft.

## CHAPTER 6

## COMBAT TECHNIQUES

## Section I. THE INDIVIDUAL AND NORTHERN WARFARE

**6-1. Problems of Northern Warfare**

Two opponents face the soldier in northern warfare—the enemy, who must be defeated, and nature, which must be made an ally. We fight the enemy, but we must accept nature as it is, making nature fight with and for us. Proper clothing and equipment will help overcome the hazards of nature. Training teaches the individual how to use natural conditions for movement concealment, and protection, as well as how to operate efficiently when the weather is good or bad, and in all types of terrain. The trained soldier moves, fights, lives, and works easily and confidently because he knows his job.

**6-2. Nature of Northern Warfare**

*a.* During winter the vast, empty spaces of the northern regions permit unrestricted maneuver and movement for troops sufficiently equipped and trained to operate in these circumstances. Dispersion is simplified; hostile artillery and mortar fire can be evaded or avoided. A mobile force can gain surprise and strike deep in the flanks and rear areas of the enemy, disrupting his lines of communications

and finally destroying him. However, the mountainous areas of the northern regions will have the same limitations to movement as those in more temperate climates.

*b.* The principles of war remain unchanged. Tactics used in the northern latitudes are the same as anywhere else in the world. The waging of successful warfare in the extreme cold depends on the use of a great number of techniques. For the purpose of carrying out their mission, all individuals and units concerned must be indoctrinated and thoroughly trained in these techniques.

*c.* There is always opportunity for each soldier as an individual to display his initiative. Initiative is shown not only in combat, but also in the small things which can be done to make life more comfortable and more interesting in the North.

*d.* In the isolated areas of the North it is most essential that a system of teams be developed. Pair men together as “buddies” and insure a higher standard of efficiency, safety, and morale. If it can be avoided, never send one man alone on a mission—at all times try to keep “buddies” together.

## Section II. INDIVIDUAL WEAPONS AND INSTRUMENTS

**6-3. Effects of Northern Conditions on Weapons and Instruments**

The year-round necessity for supervised care, cleaning, and maintenance cannot be overstressed. Effects of cold weather on various types of weapons are covered in detail in appendix D.

**6-4. Care, Cleaning, and Maintenance**

*a.* Weapons will function under extreme conditions, provided they are properly maintained. Normal lubricants thicken in cold weather and stoppages or sluggish actions of firearms will result. **DURING THE WINTER, WEAPONS MUST BE STRIPPED COM-**

PLETELY AND CLEANED WITH A DRY-CLEANING SOLVENT TO REMOVE ALL LUBRICANTS AND RUST PREVENTION COMPOUND. The prescribed application of special northern oils should then be made. These lubricants will provide proper lubrication during the winter and help minimize the freezing of snow and ice on and in weapons.

*b.* Soldiers must insure that snow and ice do not get into the working parts, sights, or barrels of weapons. Even a small amount of ice or snow may cause malfunction of the weapons. Muzzle and breech covers should be used. Before firing, the weapon must be examined carefully, especially the barrel, which may be blocked with ice or snow and will burst when fired. Snow on the outside, if not removed, may drop into the breech and later form ice, causing malfunctioning of the weapon.

*c.* Condensation forms on weapons when they are taken from the extreme cold into any type of heated shelter. This condensation is often referred to as "sweating." For this reason weapons should be placed near or at the floor level where the temperature will be lower and there will be less condensation. Every effort must be made to remove condensation as soon as possible or the film will freeze when the weapons are subsequently taken into the cold. The ice so formed may seriously affect the operation of the weapon unless it is manually operated until the moisture freezes. This prevents the parts from freezing together and allows continued operation. If security conditions permit weapons should be left outdoors, in racks or unheated shelter.

*d.* When weapons are taken into a heated shelter, "sweating" may continue for as long as 1 hour. When time is available, men should wait 1 hour and then remove all condensation and clean the weapon.

*e.* During the freezeup and breakup seasons, the danger of rust and corrosion is at its greatest. In the winter the lack of moisture in the air decreases this danger, but the problem of ice and snow will necessitate frequent checking and cleaning of weapons,

*f.* Should parts of a weapon become frozen, warm them slightly and move them gradually until unfrozen. If the weapon cannot be

warmed, all visible ice and snow should be removed and parts moved gradually until action is restored. Ice in the barrel can be removed with warm (standard issue) gun oil if slow warming is not possible.

*g.* When firing, do not let the hot parts of the weapon come in contact with the snow. The snow will melt and, on cooling, form ice. When changing barrels, do not lay them on the snow; *rapid cooling may warp them.*

*h.* Snow, even of the lightest variety, has a tremendous smothering effect on fragmenting munitions. Even a few inches of light snow can drastically affect the lethality of this type munition. Understanding this, commanders must insure that antipersonnel mine directional paths are cleared in snow to prevent loss of velocity to fragments and deflection of fragments by snow. Grenadiers should always attempt to obtain airbursts by placing fire on the brush in the target area rather than in the snow. Indirect fire weapons should make maximum use of airbursts provided by time and proximity fuzes.

## 6-5. Ammunition

Extreme cold does not materially affect the accuracy of weapons nor the performance of small arms ammunition. Ammunition should be kept at the same temperature as the weapon. It should be carried in the bandoleers and the additional ammunition placed in the pockets of the outer garment and in the rucksack. Ammunition clips, and magazines must be cleaned of all oil and preservative and must be checked frequently; all ice, snow, and condensation should be removed. Cartridge containers, magazines, and ammunition drums must be kept closed in order to prevent the formation of rust or ice.

*a.* Ammunition should be stored in its original container, raised off the ground, and covered with a tarpaulin. Ammunition so stored should be suitably marked in order to locate and identify it in the event it becomes covered with snow.

*b.* Resupply of ammunition may be restricted. All personnel must be made aware of the necessity for ammunition economy and fire discipline. Loaded clips, magazines, or single

rounds dropped into the snow are quickly lost; therefore, careful handling of ammunition is essential.

### 6-6. Care and Maintenance of Special Items

*a.* The liquid in the lensatic compass, aiming circles and in weapons sights congeals in extreme cold. This situation will cause sluggish movement of the arrows and bubbles and increase the probability of error. The compass should be carried near the body in inner clothing in order to keep the liquid warm and thin. Other instruments and sights should be kept as warm as possible and should be exposed to the cold only during periods of actual use.

*b.* Binoculars and other liquid-free optical instruments are not affected by cold weather.

However, condensation does form when these instruments are taken from cold air into warm air. Therefore, these instruments should be left outside.

*c.* Extreme cold will lower the efficiency of all batteries and eventually they may freeze. Batteries must be kept from freezing and, if possible, men should carry radio and flashlight batteries close to the body in order that full efficiency will be available when needed.

*d.* Low temperature dry cell batteries may be issued for cold weather use. These batteries are distinguished by 2000 series-type numbers, such as BA-2030 for a flashlight battery. These batteries must be stored at temperatures near 0° F. to conserve their shelf life.

## Section III. FIRE AND MOVEMENT

### 6-7. Blowing Snow and Fog

*a.* These restrictions will affect both friendly and enemy forces. Full advantage must be taken of them in order to effect concealment, surprise, and eventual success.

- (1) Defense positions should be located on high ground, thus forcing the enemy to attack uphill in deep snow. Each weapon must be assigned a field of fire and emplaced on an improvised platform which will insure fire being brought to bear at man-height level on the likely enemy approaches. Thus during fog, storm, or darkness, effective unobserved fire can be brought to bear.
- (2) In areas of fog, if possible, outpost and observation post positions should be located where warmer air or wind eliminates fog or at least makes it less dense.

*b.* By proper reconnaissance and the use of trailmarkers it may be possible for an attacking force under cover of fog or blowing snow to approach very close to the enemy before the final assault. During blizzards or blowing snow the attacker should, if possible, attack downwind or at a slight angle to it in order that he will force the enemy to face into the full force of the storm.

*c.* Ice or vapor fogs are very common in extreme low temperatures. Such fogs are primarily the result of natural phenomena, but also result from many other causes such as vehicle exhausts, cooking, breathing, and weapons firing. Fogs of this nature hang overhead and could be clear markers of a position. They will also limit visibility. The observed fire of automatic and direct fire weapons is handicapped considerably by the fog, smoke, and whirling snow caused by muzzle blast. Placing observers away from the weapons positions may be necessary to control the fire. Placing tarpaulins under the guns, or packing or icing the snow, will assist in reducing the effect of muzzle blast. Pauses in firing or change of position may be necessary in order to obtain better fire effect.

### 6-8. Fire Positions

*a.* Digging firing positions in soft or hard snow is relatively easy and quick. In a static position every effort must be made to improve the position and, if time permits, to dig it into the frozen ground. The use of explosives to dig emplacements and fires to thaw the ground will help. A position in the snow is only temporary and cannot withstand artillery and continuous small arms fire. Icing of the position or use of tree trunks and branches will

afford added protection (fig. 6-1). Sandbags filled with snow may be used quite effectively for this purpose.

b. The digging oppositions in snow and the types constructed are, in general, similar to those discussed in FM 5-15. Foxholes, trenches, and other types are used.

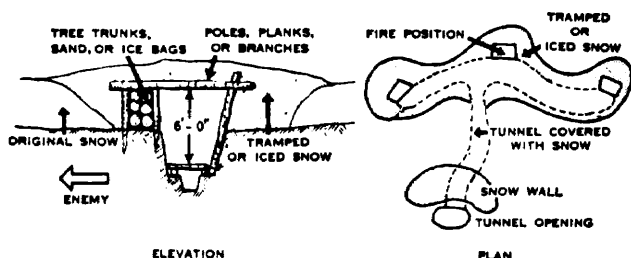

Figure 6-1. Example of position constructed in snow and extended into frozen ground.

c. Every effort must be made toward improvement of positions; snowblocks, iceblocks, sandbags, logs, and branches can be used to strengthen them. In addition, water may be poured onto the snow to form ice. In static positions, when time allows water mixed with dirt, sand, or gravel can be poured into wooden forms. This is called "icecrete." The icecrete must be well tamped as it is poured to make it compact. Usually there is no necessity for removing the forms unless the wood is required for other purposes. Icecrete is darker than ice and will absorb more heat from the rays of the sun, causing melting. Icecrete construction must therefore be covered with snow, both to overcome its melting and to camouflage its contrasting color. Icecrete is much stronger than ice, provides considerable protection from small arms fire and shell fragments, and is a useful material for preparation of defensive positions. Icecrete, however, is brittle, and sustained fire reduces its protectiveness, thus requiring frequent repairs.

d. The action of winds and tides during winter rips the sea ice surface and then forces the ice into high piles extending in lines for miles. These ice barriers afford excellent firing positions and protection because of their thickness and the fact they command the usually flat expanses between ridges. Iceblocks can be cut from numerous sources and used to

strengthen a position. The ice should be covered with packed snow which will help camouflage and assist in eliminating the possibility of ricochets, shell fragments, and lethal ice splinters.

e. In a woods the thickest and strongest trees provide the best protection for the individual. In order to use the added protection afforded by the trees, perimeter positions should not be on the edge, but should be slightly deeper in the woods, depending on its density and consistent with the required fields of fire (fig. 6-2). A tree 50 cm (20") in diameter will provide protection from small arms fire. If the tree selected is smaller, packed snow, dirt, branches, or deadfalls may be used to increase protection.

f. The improvement of fields of fire in woods is most important. The lower branches of trees, up to 2 meters (6') high, which restrict fields of fire must be removed. Underbrush and perhaps even a few trees will have to be cut; however, do not strip the area. In the first phase of improvement, crisscrossing snow tunnels under the trees is carried out. Then, if time allows, those fields are extended wider and deeper. In the final phase, obstacles and traps are constructed and mines laid in these areas (fig. 6-2).

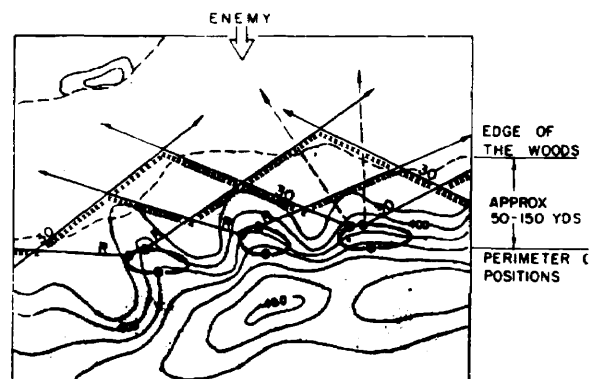

Figure 6-2. Perimeter positions at the edges of woods and clearing of fields of fire.

## 6-9. Use of Ski Poles and Sleds in Firing

a. When firing in snow, it is necessary that a firm support be used, as snow will compact. On hard packed snow the weapon may slide. Therefore, any item available in the area or





*Figure 6-3. Standing position.*

n the men's possession should be used to insure a solid base; e.g., branches, skis, snowshoes, or sleds.

*b.* Skis and ski poles can be used in a variety of ways to form weapons rests while firing on the move. Figure 6-3 illustrates the standing position. Use this position only in hasty situations, as when surprised by enemy fire.

*c.* Ski poles may be used as an elbow rest or as weapon support when firing from a kneeling position in shallow crusted snow (fig. 6-4). For firing in deep, soft snow the position of the poles can be reversed for added stability.

*d.* When firing from the prone position, the skis or ski poles may be used as an elbow rest or as supports for the weapon (figs. 6-5, 6-6, and 6-7).

*e.* Automatic weapons may be fired from the prone position using a snowshoe or ski pole basket as a rest for the biped (fig. 6-8). A fairly wide strip of canvas maybe permanently attached to each leg of the biped. On opening the biped, the canvas will stretch out between the legs over the snow and stop the legs from sinking.

*f.* To prevent weapons from sinking in deep snow, machineguns may be fired from sleds in case of emergency (fig. 6-9). The weapons can be mounted either with regular or improvised mountings. However, it is essential that weapons be placed in a dug-in position as soon as possible.

## **6-10. Strength of Snow, Ice, and Frozen Ground for Cover**

*a. General.* The soft, spongy ground of the

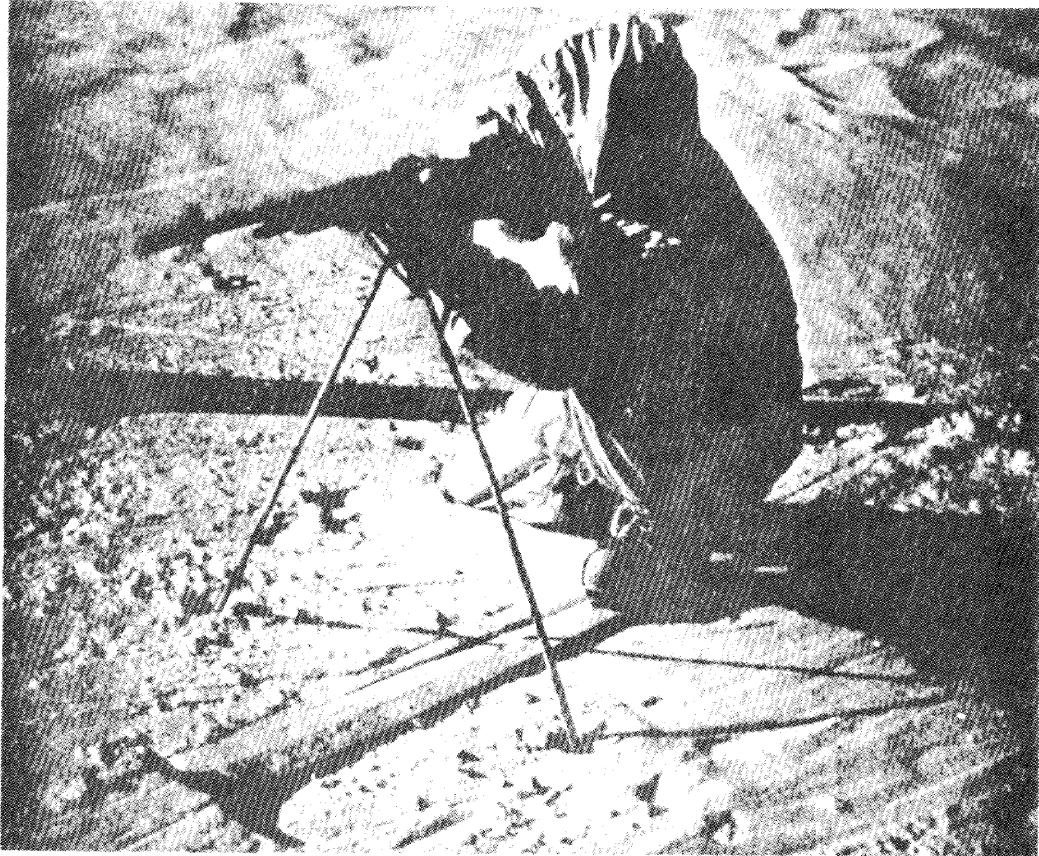

*Figure 6-4. Kneeling position.*



*Figure 6-5. Prone position. Skis used as weapon support.*

North in the summer, and the snow surface in the winter, have a smothering effect on fire from all types of weapons. Hard frozen, bare

ground or ice, when not covered with snow, greatly increases the number of ricochets and fragmentation effects. The resistance or pro-

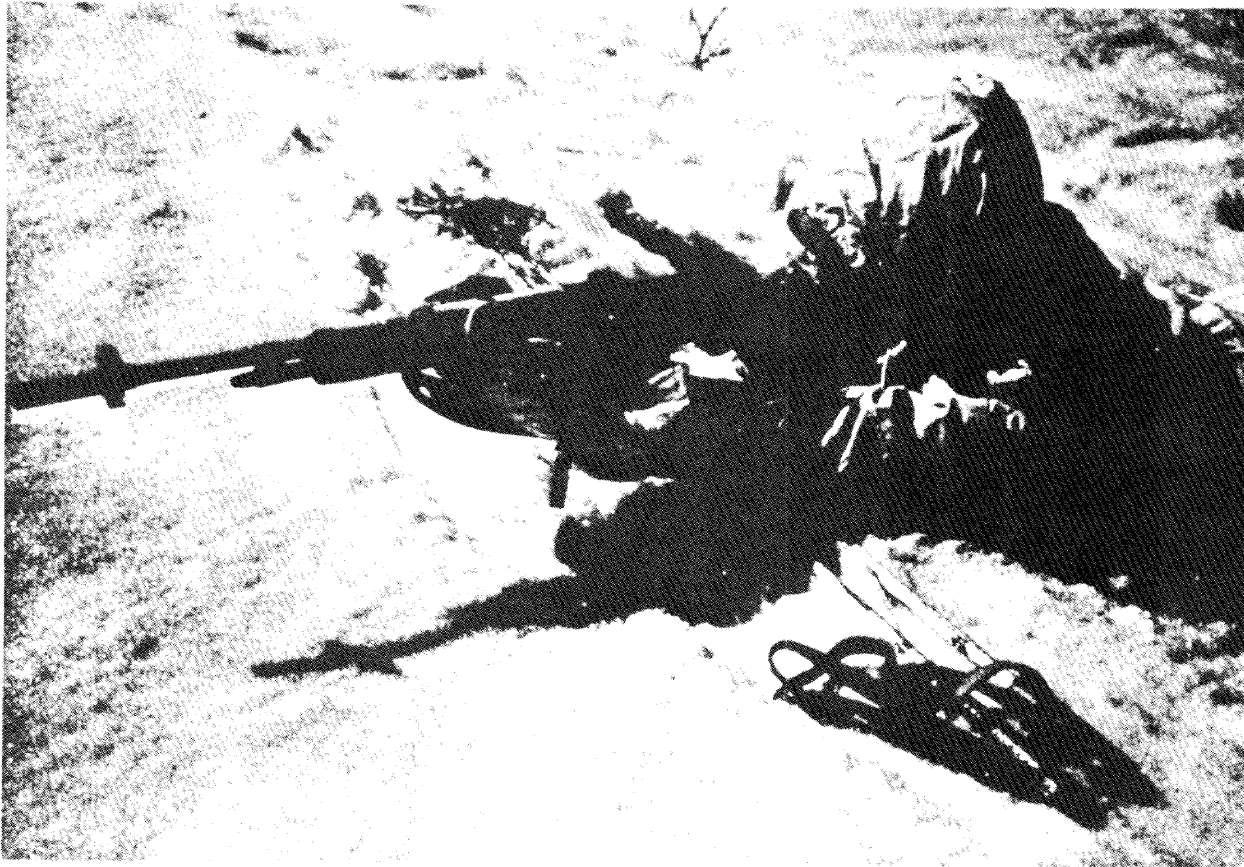

*Figure 6-6. Prone position. Ski poles used as elbow rest.*



*Figure 6-7. Prone position. Ski poles used as weapons support.*



*Figure 6-8. Use of snowshoe or ski pole basket as weapon support.*

tection offered by snow, ice, or frozen ground against enemy fire is variable.

*b.* Penetration. A rifle bullet rapidly loses its penetrating power depending on the density of the snow. Snow packed in layers tends to

deflect the bullet at each new layer. Loose snow spread over a defense position will help smother ricochets. The minimum thickness for protection from rifle bullets and shell fragments is shown in the following table:

*Penetration Table*

Snow wall material*	Minimum thickness	
	Feet	Centimeters
Newly fallen snow -----	13	400
Firmly frozen -----	8 to 10	245 to 300
Packed snow -----	6½	200
Frozen snow-water mixture --	4 to 5	120 to 150
Ice -----	3¼	100
Icecrete -----	1	30

\* These materials will disintegrate under sustained fire.

### 6-11. Effect of Snow, Ice, Frozen Ground, and Muskeg on Shells and Grenades

a. Loose snow greatly reduces the explosive and fragmentation effects of shells. The depth, type of snow, and ammunition are naturally the main consideration. The use of a delayed action fuze will generally cause the shell to penetrate the snow blanket and explode underneath, smothering and reducing the effect of



*Figure 6-9. Machinegun firing from a sled.*

the fragmentation. One meter (3') of snow will provide some protection against most light artillery fire. A superquick fuze setting will increase the effect of artillery fire, while airbursts will inflict still more casualties on surface targets.

b. In the summer the many areas of muskeg and water will also limit the effects of artillery fire. On ice or frozen ground, and during periods of freezeup, the effect will be greatly increased as the result of flying ice splinters and frozen clods of ground. In these seasons and areas, covered positions must be increased in strength. Overhead protection must be sought whenever possible.

### 6-12. Crew-Served Weapon Positions

a. Detailed information and guidance for construction of emplacements and shelters is contained in FM 5-15. The dimensions are applicable for both winter and summer. The gun emplacements for MG's, rocket launchers,

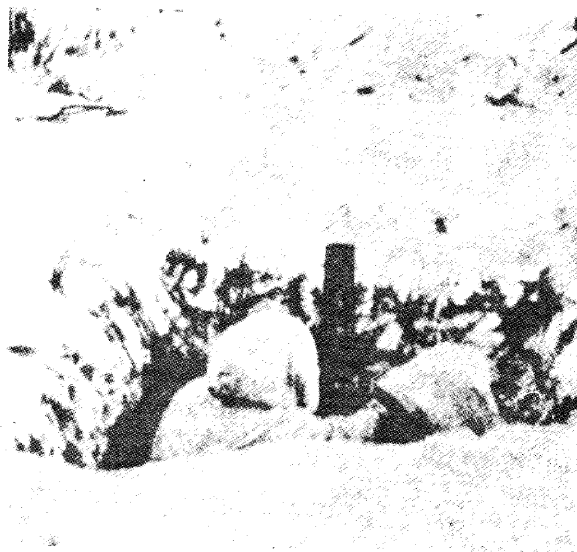

*Figure 6-10. Mortar position in snow.*

and recoilless rifles are square-type positions. The gun platform can be made from packed snow and is about waist high. Open space must be left behind the gun to allow for the back blast of the rocket launcher and recoilless rifle.

b. Mortar positions in snow are normally round shaped (fig. 6-10). Because of the frozen ground a mat made from tree branches or sandbags filled with snow must be placed under the baseplate when firing. See FM 5-15 and FM 23-90.

c. Bunker-type positions will give better protection for the gun crew against enemy fire and weather than will open positions (figs. 6-11, 6-12, and 6-13). A hasty bunker-type position is normally built as follows:

- (1) A square shaped hole is dug in the snow, the dimension depending on the purpose of the bunker position.
- (2) A heavy log or a tree trunk is placed lengthwise on each side of the snow hole. They are supported by four heavy, forked poles.
- (3) A layer of logs is placed crosswise in the top of the two support logs.
- (4) A layer of boughs is placed on the first layer of logs in order to prevent melting snow from dripping into the bunker.
- (5) Two or three more layers of logs are placed on the top of the boughs.

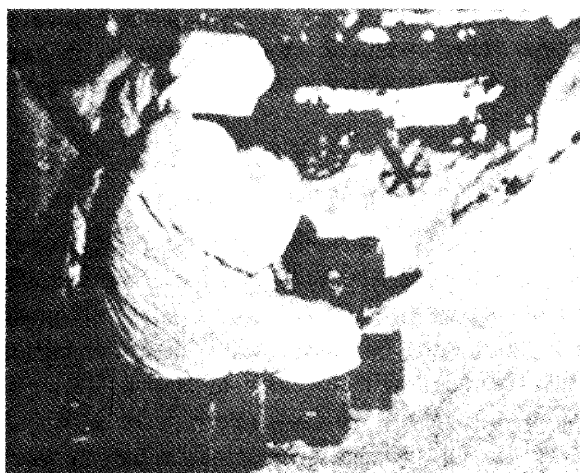

Figure 6-11. Bunker-type position (from inside).

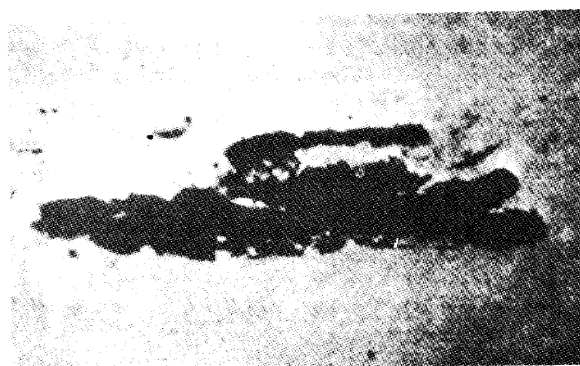

Figure 6-12. Bunker-type position (from the front; partially camouflaged).

- (6) Finally, the roof is covered by smoothing and packing the snow in order to eliminate any sharp features that may produce shadows.
- (7) A small embrasure reinforced with sandbags and snow is left open, in the direction of the field of fire.
- (8) The rear entrance is covered with a white tarpaulin or a white camouflage suit.



Figure 6-13. Bunker-type position. (from the front; camouflaged).

d. Tents are often used in temporary defense positions to shelter the men. They must be close to the combat positions and should be in defilade. The tents must be dug into the deep

snow, or even into the ground in order to protect the men against enemy fire. The tent ropes must be well anchored by using deadman anchors or upright poles placed deep in packed snow. Immediately outside the tent, defense positions must be dug for use in case of sudden alert (fig. 6-14).



*Figure 6-14. Tent dug into snow with individual firing positions.*

*e.* When near the surface the covering snow is easy to dig with individual entrenching tools; the difficulties will start when ground is reached. Several small holes should be dug in the ground and attempts made to break the frozen ground between them. The men should temporarily exchange the different types of entrenching tools in order to make the digging faster. During darkness, or in areas not under the enemy's direct observation, heavy tools such as picks, crowbars, and shovels are used so that positions can be completed rapidly.

*f.* Using explosives provides the easiest and

fastest way to break the frozen ground. However, the use of demolitions will be restricted when under enemy observation. Composition C-4, tetrytol, and TNT are the best explosives for use in northern operations because they retain their effectiveness in cold weather. Dig a hole in the ground in which to place the explosive and tamp the charge with any material available to increase its effectiveness. Either electric or nonelectric circuits may be used to detonate the charge. For a foxhole, 10 pounds of explosive will usually be sufficient. Another formula is to use 2 pounds of explosive for every 30 cm (1') of penetration in frozen ground. Shaped charges can be used very efficiently to make holes in frozen ground as described in TM 5-349.

*g.* Some improvised means as listed below may be used to break the frozen ground when no others are available:

- (1) In rear areas frozen ground can be thawed by starting a campfire in the place where it is desired to dig.
- (2) Two or three handgrenades tied together can be used to blast a hole in the frozen ground.
- (3) Existing craters caused by enemy or friendly artillery fire can be utilized.

*h.* Often the tops of ridges or hilltops will be rocky and with very little snow on the ground because of wind action. If the time and situation allow, the snow situation can be improved by erecting snow fences in the place planned for defense positions. Within a few days the snow fences will collect drifting snow in bank-like forms in which it is easy to dig positions.

## Section IV. FIGHTING TECHNIQUES

### 6-13. Formations

Squad and platoon formations for tactical movements remain basically the same as for temperate regions; however, terrain and deep snow cover will necessitate some modifications. In deep snow, when speed is of the essence, a column formation may be preferable to a line formation because it will require fewer trails. Old, well-settled snow will normally provide

good flotation and will facilitate skiing for the individuals. Since the trailbreaking requirement is reduced and may under favorable circumstances be nonexistent, line formations may be used without loss of speed. Downhill movement, even in deep snow, may also indicate the use of line formations when it would not be considered feasible on level terrain under the same snow conditions.

#### 6-14. Handling of Ski and Snowshoe Equipment and Individual Weapons

a. The purpose of using skis or snowshoes in combat is to expedite the movement of individuals over deep snow in the most rapid manner, thus exposing them to hostile fire for the shortest possible period of time. In order to obtain the maximum advantage of skis they should be used as far forward as possible, leaving them behind only when the objective can be reached more quickly and easily on foot. It is finally up to the small unit leader to decide at which phase in the attack this may be done. As a rule of thumb the skis are left at the final coordination line, because close combat on foot is more effective and easier to execute than if mounted on skis. Conversely, deep snow may force units to close into the objective on skis.

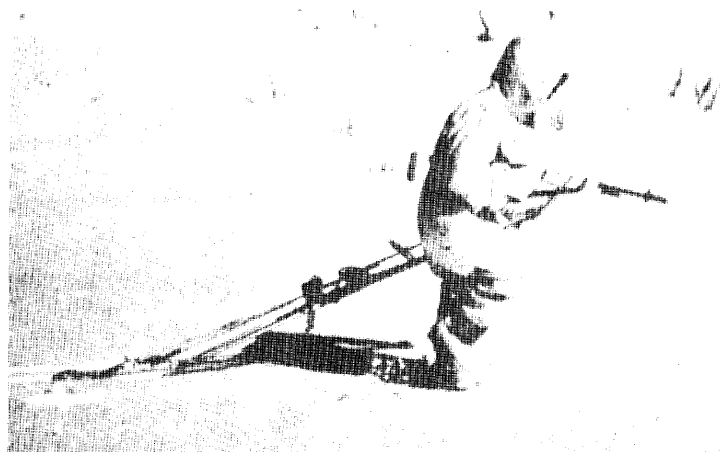

*Figure 6-15. Dragging of skis in rush.*

c. The quick-release feature of the All-Terrain ski binding provides the means to quickly dismount from skis when hostile fire becomes effective. Under favorable snow conditions, as well as in emergencies, the ski bindings are kept on when lying down and firing between rushes (fig. 6-16).

d. When contact with the enemy is not expected, the individual weapon is carried across the back with the sling over either shoulder, the butt at the side or attached to the rucksack (if carried by the individuals) (fig. 6-17). When contact with the enemy is imminent, the weapon is slung around the neck and in front of the body thus releasing both arms for rapid

AGO 8641A

Individuals using snowshoes may keep them on through all phases of the attack. Under favorable snow conditions they may be left piled together at the final coordination line or fastened to the individual's equipment where they will least hinder him.

b. As friendly forces approach the effective range of enemy weapons, they move by fire and maneuver. The individuals proceed by short rushes on foot, on skis, or on snowshoes whichever is most feasible. Rushing on foot, the skis are dragged by holding them together by the tips (poles through the two straps) in one hand, with the weapon readily available for action in the other (fig. 6-15). Skis may also be tied to the belt with the emergency thong slipped through the holes at the ski tips.

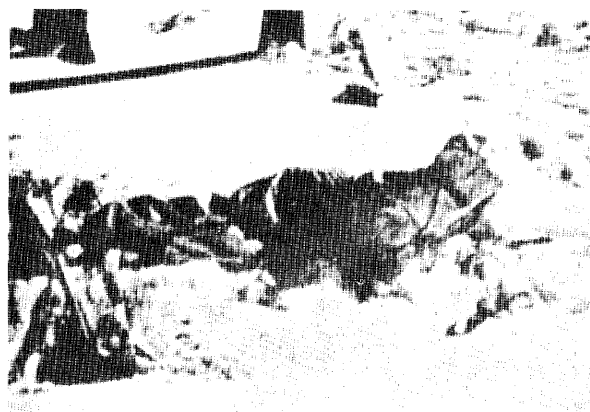

*Figure 6-16. Lying down between rushes.*





*Figure 6-17. Weapon carried across back.*



*Figure 6-18. Weapon slung around neck.*

skiing (fig. 6-18). When contact with the enemy has been established, the weapon is carried in one hand and the ski poles in the

other so the weapon is readily available for action (fig. 6-19).

e. Under conditions where the depth of the snow is less than 50 cm (20"), skis may be left in the attack position if it becomes evident that launching an attack on foot can be executed in a more rapid and efficient manner than using skis.



*Figure 6-19. Weapon carried in right hand and ski poles in left hand.*

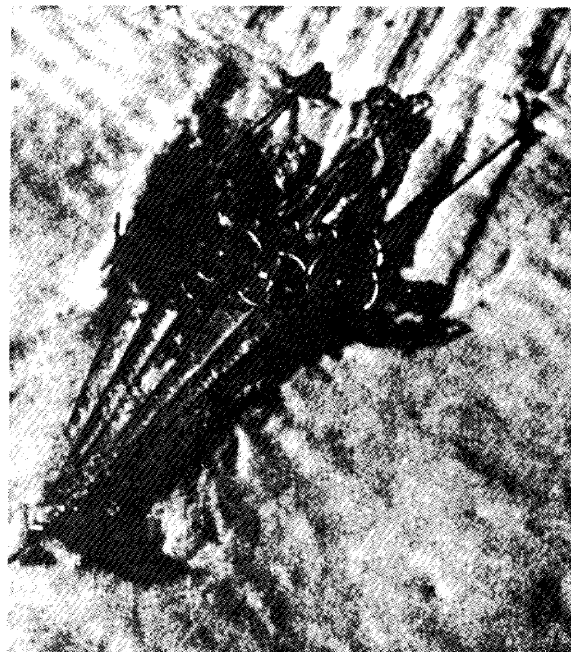

*Figure 6-20. Ski bundle.*



*Figure 6-21. Advancing in a high crawl.*

f. As soon as the objective has been seized, the skis, ski poles or snowshoes may be recovered and brought forward. A two-man team can quickly make a ski bundle (fig. 6-20) and drag the skis of an entire squad at one time.

### 6-15. Additional Techniques

a. In deep, loose snow under hostile fire it may be more advantageous to advance in a high crawl position by holding the skis with hands through the toe straps and taking full



Figure 6-22. Sliding forward in a low crawl.

advantage of snowdrifts and bushes. A position such as illustrated in figure 6-21 should be adopted. Snowshoes may be used in the same manner.

b. Sliding forward in a low crawl on skis is another method of advancing, especially over firm snow (fig. 6-22). The rifle can be slung over the shoulder or laid on the skis directly in front of the individual. The latter is possible only when the snow is hard so that it cannot get into the rifle.

c. In deep snow, trenches may be dug in the snow leading in the direction of the objective when it is too difficult to be reached by over-snow movement. Snow trenches are dug on a zigzag course (fig. 6-23 ) by throwing the snow out under cover of darkness or, in an emergency, the digging may be masked by smoke-screens. The snow shoveled from the trench should be placed on the enemy side of the trench to allow the individuals to crawl along the trench without being observed by the enemy.



Figure 6-23. Snow trenches.

d. Snowdrifts and vehicle tracks may be utilized when found in the battlefield. Snow fills in ditches and rolling ground and tends to flatten the terrain in general. The wind builds up snowdrifts and cornices and can change the contour of the ground a great deal. Snow-covered terrain must be continually studied and every feature utilized. On the downwind side of every obstacle, tree, house, and bush there is always a hollow which may provide an excellent observation point or firing position (fig. 6-24).

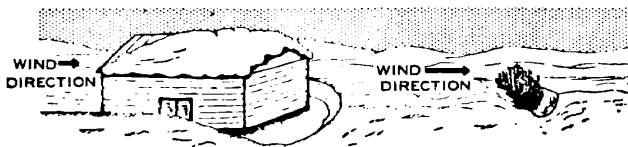

Figure 6-24. Action of wind.

e. The wind, particularly in open areas, may form long, wavy snowdrifts which are almost natural snow trenches. They may at times be used as an approach to the objective.

f. Frozen streams or sunken riverbeds may be used as another means of advance (fig. 6-

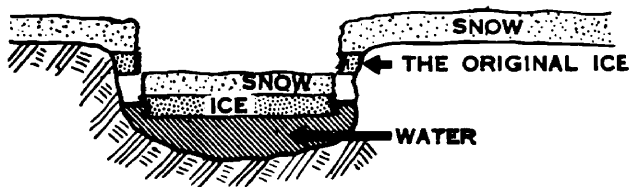

Figure 6-25. Sunken river bed.

all 35) ; often they may represent a longer but safer route.

g. An early fall frost will form a layer of ice on creeks or streams when the water level is high. Later, when the flowing water becomes lower and reaches its winter level, the top surface will again freeze so that there are two layers of ice. This is called shell ice or overflow ice and is not always safe.

h. Certain swampy areas do not freeze solidly during the coldest periods of winter. They are often covered with snow, hiding the water underneath and making the swamps an obstacle. Only experience and the knowledge that they exist in the local area, will prevent accidents. Suspected areas should be avoided and bypassed with no attempt made to cross.

i. Snowbanks beside plowed roads and tracks often provide excellent cover in wintertime. These banks or drifts will remain far into the spring thaw period, especially in areas of heavy snowfall.

j. The tracks left by tanks and oversnow vehicles in snow may provide routes of advance. Continuous traffic packs the snow and may allow movement on foot without skis or snowshoes. In the advance, infantry may utilize tracks left by their advancing armor.

k. In static situations the ski equipment becomes vulnerable to small arms fire and shell fragments. When troops are expected to remain in the same position for an extended period of time, skis, poles, and snowshoes should be placed in a covered position.

## Section V. CAMOUFLAGE AND CONCEALMENT

### 6-16. General Considerations

a. In winter the whiteness of the countryside emphasizes any item which may not blend in naturally with the surroundings. Furthermore, every movement by vehicles or dismounted troops leaves tracks in the snow. Before every movement, consideration must be given to how these tracks can be kept to a minimum. Nature may assist by covering tracks with newly fallen snow or by providing a storm in which

movement will be concealed. Camouflage and concealment from air observation is of the greatest concern.

b. In the northern landscape, backgrounds are not necessarily all white. Rocks, scrub bushes, and shadows make sharp contrast with the snow.

c. Snow-covered terrain in the wooded regions, when viewed from the air, reveals a surprising proportion of dark areas.

### 6-17. Vapor Clouds

Firing of weapons, vehicle exhausts, and breathing will, in extreme cold, cause local fog or vapor clouds which can be seen by the enemy even though the weapon, vehicle, or soldier is well concealed. Smoke from fires hangs immediately above and will disclose the position if there is no wind to blow it away. Under certain conditions, if the position is on a high point, smoke may flow downward into depressions and may be used as a deceptive measure. It may be necessary to move weapons frequently, shut off vehicle motors, or leave vehicles in rear areas. Conversely, deception or concealment might be gained by deliberately creating vapor fogs or clouds.

### 6-18. Sounds

The still, cold air of the North carries sound much farther than in temperate climates. All sounds must be kept to a minimum. Noise caused by motors, men coughing, and skiers breaking through snow crust may warn the enemy of activity at extreme distances.

### 6-19. Visibility

The long hours of daylight in the North during the summer allow for longer periods of aerial reconnaissance and increase the possibility of detection. The short hours of daylight during the winter months materially decrease the time available for reconnaissance. As an example, during the period 15 December to 15 January at 68° N. Lat. the sun will never appear over the horizon. Daylight will consist of only twilight and will last for only 4 or 5 hours.

### 6-20. Tracks

*a.* Tracks made in a soft surface may become quite firm if the temperature drops during the night, and will remain indefinitely as indications of movement. Special consideration must be given to the tracks in bivouacs and base camps. Number and size of trails must be kept to a minimum. All unnecessary "streets," turnaround loops, and parking areas must be avoided. Individuals may be forced to use only a certain trail. From the air, tracks, even through wooded areas, appear like a white scar.

Coniferous branches can be laid in a staggered pattern on each side of the track as well as on it. Strict track discipline both during movement as well as in bivouacs and base camps must be maintained at all times.

*b.* Aerial photographs are closely examined and from them can be gathered a great deal of information. The depth of a track will show the amount and the direction of movement. Vehicle or sled tracks may indicate the type of vehicle and conclusions can be made as to the type of weapons. Every effort must be made to mislead the enemy. It may be advantageous to make more tracks or trails and show greater signs of strength. All marks made in the open are generally visible to the camera.

### 6-21. Camouflage Materials

*a.* White is the predominant color in winter and snow is the most important camouflage material. By intelligent use of camouflage clothing and equipment together with what nature makes available, effective individual and group camouflage can be achieved.

*b.* Improvised camouflage clothes can be made from sheeting, tape, whitewashed sack- ing, or painted canvas. White paper, when wet, can be applied and allowed to freeze on all kinds of surfaces. Snow thrown over the object helps to increase the camouflage effect.

*c.* White paint has many uses in winter camouflage. Weapons, vehicles, skis, and sleds can be effectively painted with white non-glossy paint.

*d.* On occasion, white smoke may be used to help the camouflage plan. The major problem is to make the installation blend in with the countryside.

*e.* Camouflage face paint, white and loam color combination, may be applied to exposed areas of the face and hands to blend effectively in with the snow cover.

### 6-22. Individual Camouflage and Concealment

*a.* During the summer the normal principles of using camouflage clothing will apply. However, as winter approaches, men must use partial white winter camouflage to match the

changing conditions; men should be trained to avoid areas of local growth and dark outlines (fig. 6-26).

b. In fairly open forest areas during the winter, men wearing "whites" should avoid the dark background of trees. In the same manner, if wearing dark clothing, men should stay under trees and avoid the open.

c. In mixed surroundings frequent changes of camouflage clothing become necessary. The use of mixed clothing is often the most preferable (fig. 6-27).

d. All equipment worn on the outside should



Figure 6-26. Camouflage in open snow conditions.



Right



Wrong

Figure 6-27. Use of mixed clothing.

be camouflaged. Contrasting equipment worn on the camouflage suit will increase the possibility of enemy detection. Loose items such as grenades or fieldglasses should be kept concealed inside the suit.

### 6-23. Camouflaging Equipment

Skis, rifles, and sleds may be painted white prior to issue. If they are unpainted, white camouflage paint or improvised local materials can be used. Sleds will be issued with white covers for concealing the load. Finally, individual weapons can be camouflaged with strips of white garnish or white adhesive tape. The tape also provides protection for the hands when handling the weapon in extreme cold.

### 6-24. Camouflage and Concealment of Small Groups

*a.* In selecting a position, enemy ground and air observation must always be considered. A location which requires the least amount of modification is the most suitable, since there is less requirement for disturbing its "natural" appearance. The camouflaging of a position commences before occupation of the position. The most suitable covered approaches must be used and tracks, if not hidden, must be kept to a minimum. Where possible, approaches should be made under the concealment offered by trees or bushes, behind snowdrifts or slopes, and in shaded areas. Poor camouflage at this point may make position camouflaging ineffective. If tracks cannot be concealed, then tracks should lead through the position to one or more dummy positions. On occupation of a position, disturb its appearance as little as possible. Snow or earth removed from the position should be thrown to the enemy side. If the position is of snow or ice construction, it must be rounded off in order to avoid reflection and marked shadows. Overhead tarpaulins or camouflage nets should be used to cover any extensive digging in snow or earth.

*b.* In placing the individual and the weapon it is most important that he is not silhouetted or contrasted with his background. Low positions that blend into the background is the secret.

*c.* If time allows, positions can be greatly

improved by constructing an overhead cover of suitably camouflaged materials such as branches, nets, blankets, etc. (fig. 6-28).



*Figure 6-28. Covered foxhole in snow.*

*d.* The tent is one of the largest items to be camouflaged (fig. 6-29). Although large, by careful site selection using both artificial and natural camouflage material, it can be readily hidden. A decreased number of tents and stoves, due to tactical reasons, will automatically assist in keeping the bivouac area camouflaged. Occasionally, the camouflage of the tents in sparse vegetation, barren tundra, and especially under winter conditions becomes very difficult. Use white materials such as individual overwhites or snowblocks to protect the dark material from observation. In emergencies the white inside liner may be removed and placed on the top of the tent. Frequently all fires in the stoves as well as the open fires must be extinguished and the warming factor sacrificed for camouflage and safety reasons.



*Figure 6-29. Camouflage tent in snow.*

### 6-25. Camouflage of Vehicles

*a.* In winter all vehicles should be painted

white to fit the predominantly white terrain. In forested areas it is relatively easy to darken a white vehicle with issued or improvised camouflage material. In areas with definite contrasts, for example in the wooded areas, or during breakup and freezeup periods, a mottled effect should be used. See FM 31-71.

*b.* In addition to the vehicle painting, each vehicle should be equipped with an all seasonal camouflage net to be used when required. Concealment will be more effective if vehicles are parked close to dark features or in shaded areas. Always try to break the silhouette and avoid vehicle shadows. Try to make it appear flat when observed from the ground or air.

*c.* In wooded areas lean-tos can be built to conceal vehicles. In a static situation a snow shelter can be constructed to provide cover and concealment.

*d.* In extreme cold consideration must be given to the exhaust from vehicles since it will form ice fog and provide the enemy with additional means of detection.

## 6-26. Deception

*a.* More opportunities for unit or individual deception exist in the North during winter than possibly in any other areas. However, deception measures are not sufficiently effective to lessen the requirement for good concealment. Unless unit and individual camouflage is effective, the value of any deception plan will be greatly reduced. Deception must be based on well-coordinated plans which must be logical and not too obvious. Dummy positions must be positioned to follow the tactical plan, but far enough removed from actual position so that fire directed at the dummy position will not endanger the real position (fig. 6-30).

*b.* A few skiers or oversnow vehicles can create a network of trails or tracks to mislead the enemy as to direction, strength, location, and intentions.

*c.* Regular pneumatic deception devices are inoperable and should not be used in temperatures below zero degrees. Improvised devices,



*Figure 6-30. Deception area, showing trails and tracks in forest and dummies in open areas.*

however, can be made from snow, branches, canvas; and any other available material. Dummy weapons, positions, tents, and vehicles of all kinds can be constructed (fig. 6-31). They must not appear obvious but should appear camouflaged and only “discovered” as a result of a camouflage violation. A dummy bivouac area must appear to be occupied. Small gasoline or oil flames may be used to simulate stoves or idling engines. In a bivouac area the place must appear to look occupied; a fire or smoke could easily be used to produce this effect.



*Figure 6-31. Snow dummy of a tracked vehicle.*



Section VI. MINES AND OBSTACLES

6-27. Use of Antitank Mines

a. Antitank mines must be placed on a solid base, otherwise when pressure is applied they will sink into the soft ground or snow and lose much of their effectiveness. In shallow snow a hole may be dug and the mine placed on the frozen ground. In deep snow they must be supported. Additional charges will help overcome the smothering effect of deep snow. The snow may be tamped down or frozen, or the mine may be placed on a plank or something similar to provide the required firm support (fig. 6-32). In all cases they must be covered

with snow or dirt, but not buried too deeply; otherwise the top layer may accept the weight and not detonate the mine. A piece of cardboard over the mine will protect it from moisture which may freeze and hinder the working parts.

b. In snow-covered terrain, the mines should be painted white to aid in concealment. All minefield must be marked and recorded.

6-28. Antipersonnel Mines

a. Antipersonnel mines are adaptable to northern operations. If using pressure-type

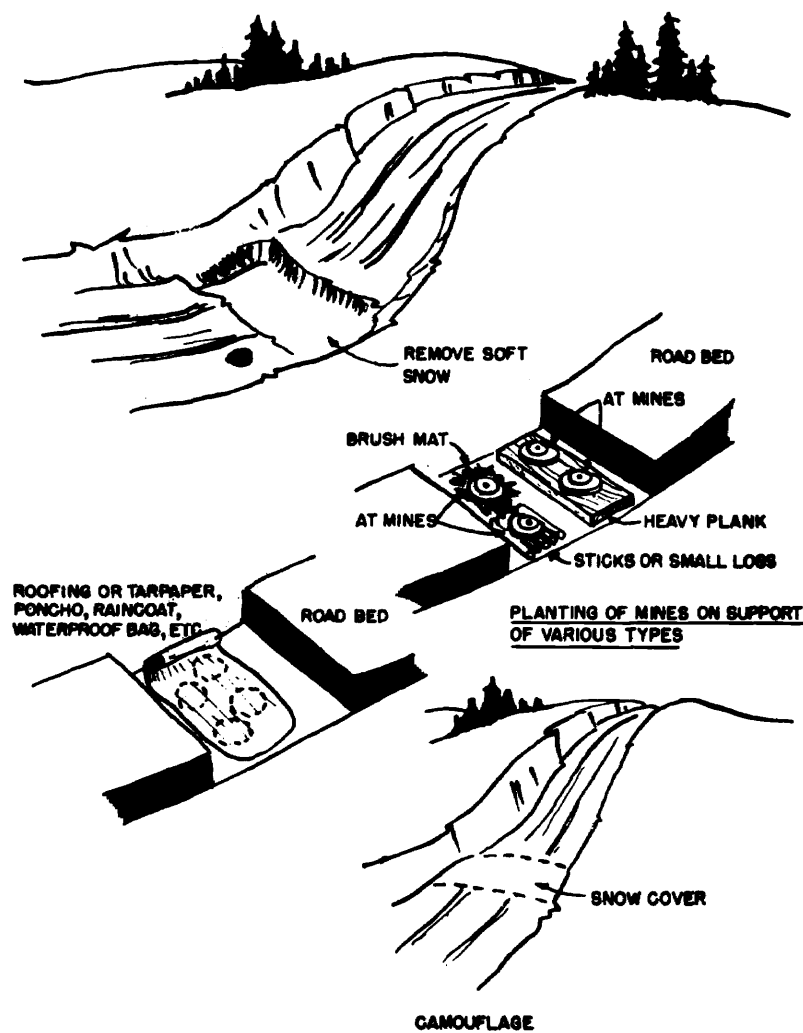

Figure 6-32. Laying mines in deep snow.

igniters, solid support for the mine is necessary. If mines are buried too deeply in snow it is possible that the snow will provide a "bridge" and prevent the mine from detonating. Therefore, when using the pressure-type igniters, place the mine about 3 cm (1") beneath the snow.

b. Tripwires should be placed at various levels above the snow when using pull-action igniters. Tripwires placed beneath the surface of the snow often freeze in and fail to function. Time permitting, tripwires should be painted white.

c. Mines can be placed on ski or snowshoe trails (fig. 6-33 ). Tripwire firing systems are



Figure 6-33. Placing mine on ski track.

the best when using antipersonnel mines in this manner. If pressure-type igniters are used, insure that the mine is placed in such a manner that the maximum weight of the individual will be brought to bear on the mine. Care should be taken to insure that the mine will not be "bridged" by a ski or snowshoe, and fail to detonate.

### 6-29. Use of Demolitions in Ice

a. In summer, the thousands of lakes, rivers and swamps of the northern regions provide formidable obstacles to armor and personnel. In winter, however, when frozen to sufficient depth, they provide excellent avenues of approach. They also lengthen the frontline of a given sector, requiring more troops and weapons to defend it than in summer. Necessary action must be taken to deny these natural routes to the enemy under winter conditions.

#### b. Preparing Ice Demolitions.

- (1) In order to create water obstacles during winter conditions, explosives are used to blow gaps in lake and river ice to make it impassable to enemy personnel and armor. To install the demolition in ice (fig. 6-34), holes are sunk 3 meters (10') apart in staggered rows by use of axes, chisels, ice augers (fig. 6-35 ), steam point drilling equipment, or shaped charges. The shaped charges

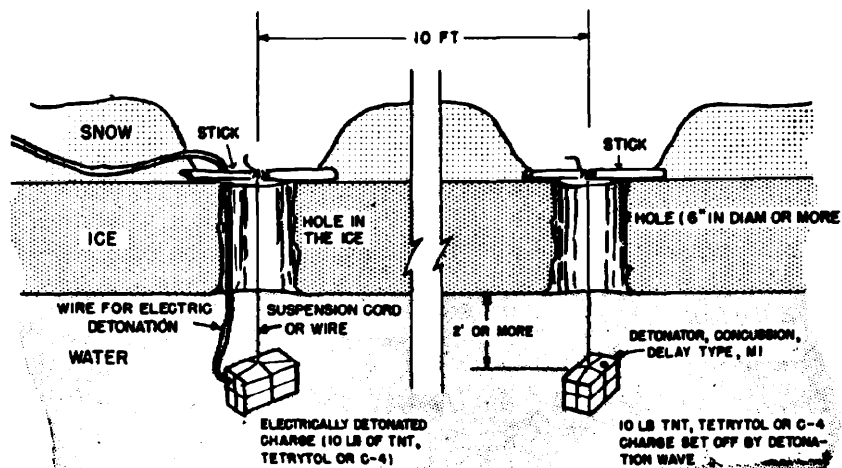

Figure 6-34. Method of placing charges in ice.

will not make a hole large enough to pass the charge through but must have the hole widened by other means. Charges are suspended in the water below the ice by means of cords tied to sticks bridging the tops of the holes. The charges should be

of an explosive not affected by water. Plastic explosives should be protected from erosion by water currents. Demolitions laid early in the winter must be placed deep enough so that they will not be encased in the ice as it grows thicker.

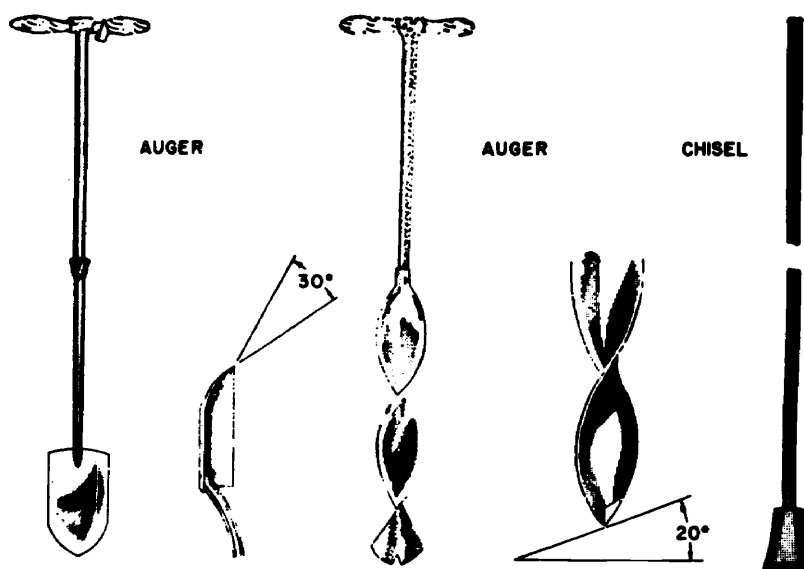

Figure 6-35. Types of ice augers and ice chisel.

- (2) The normal thickness of fresh water ice is approximately 120 cm (4') or less. In extremely cold areas 150 cm (5') of ice is not uncommon. At the time the minefield is established, it is difficult to determine how thick the ice will be at the time the ice demolition is detonated. As a rule of thumb, if the ice is expected to be 120 cm (4') thick the charges should be approximately 10 pounds. In the event the depth of the ice is expected to exceed 120 cm (4'), an addition of 2.5 pounds per additional 30 cm (1') of thickness should be emplaced. Electrical firing devices are attached to three charges in each underwater demolition, one in each end charge and one in the middle charge. The rest of the charges may be primed with concussion detonators or electrically primed. The large number of

charges does limit the use of electrical means of firing. An ice demolition may consist of several blocks of charges echeloned in width and depth and has at least two rows of mines, each row alternating with the one before it. Blowing a demolition such as this creates an obstacle for enemy armor and vehicles for approximately 24 hours at  $-24^{\circ}$  F (FM 5-25).

- (3) Great care must be exercised when handling electrical firing devices under winter conditions. Because of improper grounding of an individual caused by the snow and ice covering on the ground, the static electricity that builds up might possibly detonate the device. Individuals must insure that they are properly grounded prior to handling any type of electrical firing devices. Care should be

taken to insure that no radio transmitters are operating in the immediate area. The type of radio signals emitted by this type of equipment can detonate electrical firing devices.

*c. Advantages.*

- (1) Long sectors of the frontline may be cut off at a critical moment from enemy infantry and armor.
- (2) Number of personnel and AT weapons needed to defend a given sector is reduced.
- (3) Friendly troops may advance or withdraw at any place over the charges without being restricted to the cleared lanes.
- (4) Charges laid under thick ice are difficult, and often impossible, to detect by use of mine detectors.
- (5) When the holes over the charges have refrozen, the field is very difficult for the enemy to breach.
- (6) The charges are not affected by weather or snow conditions.

- (7) After a snowfall, detection of the demolitions by the enemy is extremely difficult.

*d. Disadvantages.*

- (1) Emplacing the explosives requires considerable time even when ice cutting equipment is available.
- (2) The charges can be set off when hit by artillery fire.
- (3) The gaps blown in the ice tend to freeze over rapidly in low temperatures.
- (4) Continued exposure of the demolition firing system to weather reduces the reliability of the system.

*e. Tactical Use.* Ice demolitions are used for protection from frontal or flanking attacks. Normally, one or more sets of charges are laid close to the friendly shore and others farther out in the direction of the enemy (fig. 6-36). If desired, the enemy may be allowed to advance past the first set of charges and then both detonated at the same time. The enemy thus will be marooned on an ice floe, unable

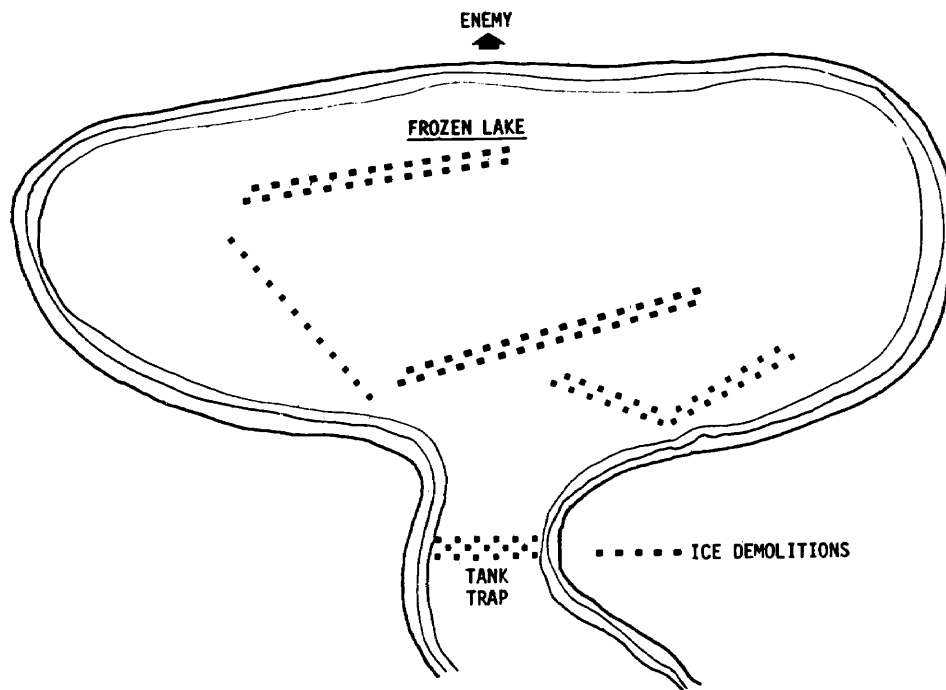

Figure 6-36. Ice demolitions.

to continue to advance or retreat, and can be destroyed. The same trapping method may be used against enemy armor, or the charges may be detonated directly under the advancing tanks. Ice demolitions must be kept under observation and secured by friendly fire.

### 6-30. Natural Obstacles

*a. Snow-Covered and Icy Slopes.* A steep slope is an obstacle to troops and vehicles even under normal conditions. When covered by deep snow or ice, it becomes much harder to surmount. The bogging-down action and the loss of traction caused by deep snow frequently create obstacles out of slopes which might be easily overcome otherwise. Pads of track-laying vehicles should be removed when encountering this type terrain.

*b. Windfalls.* Occasionally, strong winds knock down many trees in a wooded area. These fallen trees are known as windfalls. They are very effective obstacles when covered with snow, especially to personnel wearing skis or snowshoes.

*c. Lakes and Streams.* Not all natural obstacles are equally effective in the winter as in the summer. Normally, bodies of water are considered natural obstacles, but under winter conditions the ice which forms may turn these former obstacles into excellent avenues of approach. This illustrates an important reason for reevaluating defensive positions before cold weather arrives.

*d. Avalanches.* An avalanche makes an excellent obstacle for blocking passes and roads. Since it occurs in mountainous country where there are few natural avenues of approach, an avalanche can have a far-reaching influence over combat operations. The problem with those avalanches which occur naturally is that, unless their timing and location are just right, they may be of help to the enemy. It is possible to predict in advance where an avalanche can and probably will occur. Then by the use of recoilless rifle or artillery fire, bombs, or explosives it is possible to induce the avalanche to slide at the desired time. This type avalanche is an artificial obstacle in the technical sense. Generally it will be of more value than the natural type. Precautions

against avalanche hazard are covered in FM 31-72.

### 6-31. Artificial Obstacles

*a. Barbed Wire.* There are many types of artificial obstacles used under summer conditions which are appropriate for winter use. Barbed wire normally employed makes an effective obstacle in soft, shallow snow. Triple concertina is especially effective since it is easy to install in addition to being difficult to cross. As the snow becomes deeper and more compacted, a point is reached where it is possible to cross the barbed wire on top of the snow. One type of barbed wire obstacle built to overcome this problem is known as the Lapland fence (fig. 6-37). Types of wire entanglements and winter obstacles are covered in FM 5-15.

*b. Lapland Fence.* The Lapland fence uses a floating type of anchor point or one which is not sunk into the ground. Poles are used to form a tripod. The tripod is mounted on a triangular base of wood. Six strands of wire are strung along the enemy side of the fence, four strands along the friendly side, and four strands along the base. As the snow becomes deeper, the tripods are raised out of the snow with poles or by other means to rest the obstacle on top of newly fallen snow. The base of the tripod and the base wires give enough bearing surface to prevent the fence from sinking into the snow.

*c. Abatis.* An abatis is similar to a windfall. Trees are felled at an angle of about  $45^\circ$  to the enemy's direction of approach. The trees should be left attached to the stump to retard removal. Along trails, roads, and slopes, abatis can cause much trouble for skiers and vehicles.

*d. Iced Road Grades.* A useful obstacle can be made by pouring water on road grades. The ice that forms will seriously hamper vehicular traffic.

### 6-32. Means of Improving Obstacles After Heavy Snowfalls

*a. Knife Rests.* Knife rests are portable barbed wire fences, usually constructed prior to the snowfall. The fences are constructed by tying two wood poles at their center, forming an X. A similar X is made out of two other poles and then the two Xs are lashed at either

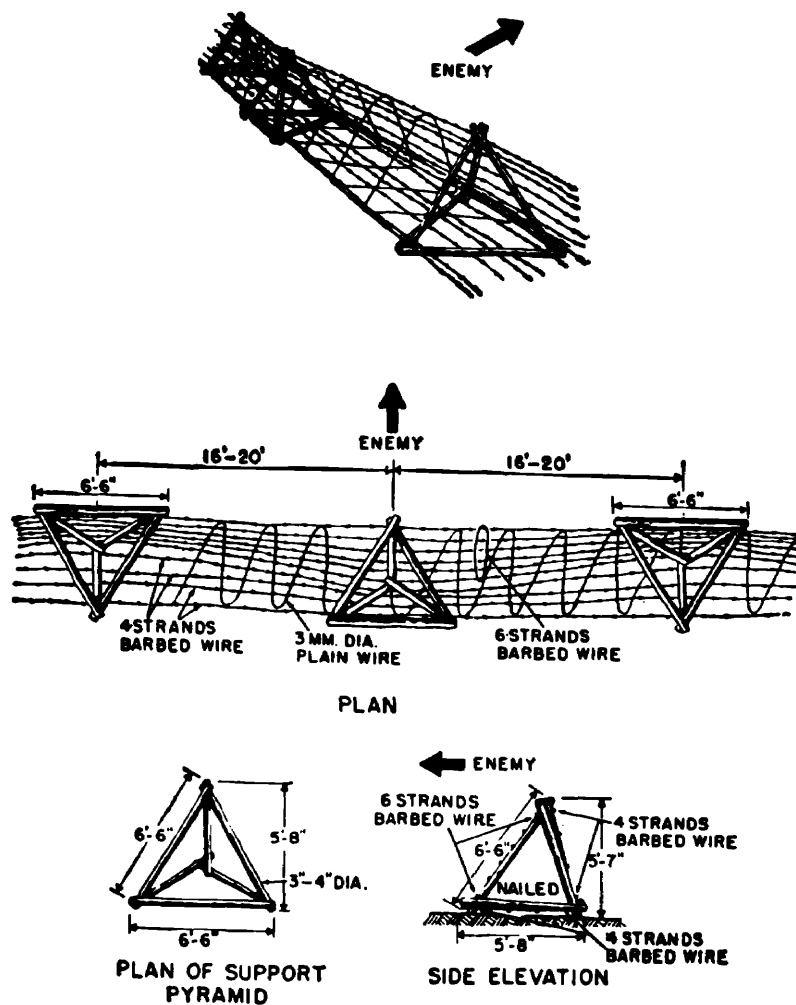

Figure 6-37. Lapland barbed wire.

end of a 3 meter (10') to 3.50 meter (12') pole. This forms a framework to which barbed wire is fastened on all four sides. The obstacle can be stored until needed and then easily transported to the desired location (fig. 6-38).

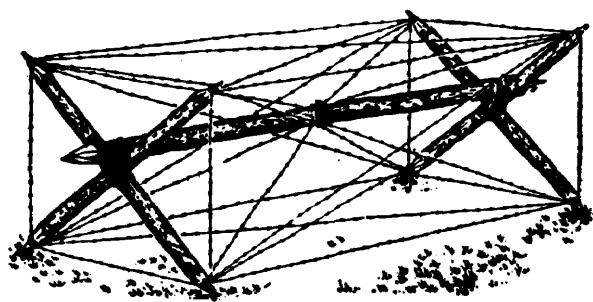

Figure 6-38. Knife rest.

b. *Concertina Wire.* Concertina wire is another quick way to improve on snow-covered obstacles. The concertina comes in 15 meter (50') sections which can be quickly anchored to the top of existing obstacles.

c. *Additional Barbed Wire.* The possibility of using additional barbed wire strands should not be overlooked. Frequently, obstacles will have protruding poles to which extra barbed wire strands can be tied. Also, additional strands placed underneath such floating obstacles as Lapland fences and knife rests will help prevent the enemy from tunneling under these obstacles.

## CHAPTER 7

### SMALL UNIT LEADERS

---

#### Section I. General

#### 7-1. Leadership Traits

*a.* The traits, qualities, and abilities requisite to good leadership in any theater of operations assume their greatest importance during operations in cold weather areas. Leaders must be impressed with and made clearly aware of this fact. With proper training, leadership, and discipline, few men will be unable to meet the rigid standards and the difficult service required of northern operations.

*b.* Military leadership is the art of influencing and directing men to an assigned goal in such a way as to obtain their obedience, confidence, respect, and loyal cooperation. The individual who demonstrates the traits of a leader and applies the fundamental principles of leadership will be a successful leader of men in cold weather areas.

*c.* All leadership traits as outlined in FM 22-100 are of importance to the leader assigned to units operating in cold weather areas. Peculiar conditions of cold increase the necessity for certain traits to a marked degree. Traits of utmost importance to the leaders are-

- (1) *Initiative.* The energy or aptitude displayed in the initiation of action, self-reliance, enterprise and self-initiated activity must be an outstanding characteristic of leaders who are involved in such operations, especially when units may become isolated. This requirement is more pronounced in the North than in other theaters of operation. In all training of leaders, initiative and improvisation must be carefully encouraged.
- (2) *Endurance and mental and physical*

*stamina.* Extremes of climate and the vastness of the area increase the necessity for strong mental and physical endurance. These conditions may cause early physical and mental fatigue, but can be overcome by determination, forcefulness, and aggressiveness.

- (3) *Unselfishness.* This is exemplified by the leader who does not take advantage of a situation for personal gain or safety at the expense of the unit. The physically competent, vigorous leader who can resist the natural desire of first providing for his own comfort will be a successful and respected leader of his unit.

#### 7-2. Leadership Principles

As in leadership traits, all leadership principles as outlined in FM 22-100 apply to leaders directing operations in cold weather latitudes, with particular emphasis placed on the following:

*a. Know the Job.* Every leader must know thoroughly the job at hand. The leader's actions must demonstrate to his subordinates his capabilities as a leader and his genuine desire to accomplish the mission with a minimum of effort expended by the men. The leader should frequently visit isolated units in adverse weather and show the men that he is a member of the team. He must earn the respect of the men and the right to command by a thorough understanding of the technical and tactical aspect of the task.

*b. Know the Men and Look Out for Their Welfare.*

- (1) The small unit leader must know the mental and physical capabilities of each of his men. Knowing this, he will be able to utilize them effectively. As an example, a strong stable soldier should be matched in the "buddy system" to guide and assist a weaker soldier.
- (2) In isolated areas recreation facilities normally are not available. It will be the leader's responsibility to insure that, during periods of rest or off-duty hours, men are not allowed to become psychological casualties. A good leader will gainfully employ his men, but not run the risk of "hounding" them. The good leader will, with ingenuity, devise projects which will occupy their minds and at the same time improve their professional qualifications as soldiers during periods of inactivity in isolated places.
- (3) In cold weather areas the problem of obtaining supplies assumes major proportions. Supply economy must be enforced at all times. Clothing and equipment must be checked frequently and maintained in first class condition. Continuous individual supervision on the part of the leader is mandatory.
- (4) Under adverse conditions the standards of personal hygiene and group sanitation will gradually become lower if not carefully supervised. These lowered sanitation standards are a sure indication that supervision is lacking and that morale is slipping. Men must not be allowed to become lazy about their personal habits. Rules of personal hygiene and sanitation must be enforced by the leader at all times.

*c. Insure That the Task is Understood, Supervised, and Accomplished.* Orders issued must be well thought out. When required the leader must be prepared to take the leading part in carrying them out. Issuing an order is only the first and relatively small part of the leader's responsibility. The principal responsibility lies in supervision to insure that the order is properly executed. Cold regions can be friendly, but at the same time do not allow for errors or carelessness. An effective commander leads, not drives, therefore he must be able to differentiate between the two.

## Section II. PECULIAR PROBLEMS OF LEADERS

### 7-3. Mental Processes

*a. Cocoon-Like Existence.* Many men, when bundled up in successive layers of clothing and with the head covered by a hood, tend to withdraw within themselves and to assume what has been termed a "cocoon-like existence." When so clothed, an individual's hearing and field of vision are greatly restricted and he tends to become oblivious to his surroundings. His mental processes become sluggish and although he looks, he does not see. These symptoms must be recognized by leaders and overcome. The leader must realize that it can happen to him and must be alert to prevent the growth of lethargy within himself. He must always appear alert to his men and prevent them from sinking into a state of cocoon existence. The remedy is simple and basic: **ACTIVITY**. Throw the hood back and engage in

physical activity. Although the remedy is simple, the recognition of the condition requires leadership.

*b. Individual and Group Hibernation.* This process is again a manifestation of withdrawal from the surrounding environment. It is generally recognized by a tendency of individuals to seek the comfort of sleeping bags, and by the group remaining in tents or other shelter at the neglect of their duties. In extreme cases, guard and security measures may be abandoned and the safety of the unit jeopardized. The remedy is simple: **ACTIVITY**. The leader must insure that all personnel remain alert and active. Rigid insistence upon proper execution of all military duties and the prompt and proper performance of the many group "chores" is essential.

*c. Personal Contact and Communication.* It



is essential that each individual and group be kept informed of what is happening. Due to the normal deadening of the senses a man left alone may quickly become oblivious to his surroundings, lose his sense of direction and his concern for his unit, and in extreme cases, for himself. He may become like a sheep and merely follow along, not knowing nor caring whether his unit is advancing or withdrawing. Each commander must take strong measures to insure that each small unit leader keeps his subordinates informed. This is particularly true of the company commanders keeping their platoon leaders informed, of platoon leaders informing their squad leaders, and the squad leaders informing their men. General information is of value but greatest importance must be placed on matters of immediate concern and interest to the individual. The chain of command must be rigidly followed and leaders must see that no man is left uninformed as to his immediate surroundings and situation.

*d. Time and Space.* Northern operations require that tactical commanders be given every opportunity to exploit local situations and take the initiative when opportunity is presented. Because of the increased amount of time involved in actual movement and the additional time required to accomplish even simple tasks, deviation from tactical plans is difficult. Tactical plans are developed after a thorough reconnaissance and detailed estimate of the situation. Sufficient flexibility is allowed each subordinate leader to use his initiative and ingenuity in accomplishing his mission. Time lags are compensated for by timely issuance of warning orders, and by anticipating changes in the tactical situation and the early issuance of fragmentary orders. Recognition of time and space factors is the key to successful tactical operations in northern areas.

*e. Conservation of Energy.* Two environments must be overcome in cold regions; one created by the enemy, and the second created by the climate and terrain. The climatic environment must not be permitted to sap the energy of the unit to a point where it can no longer cope with the enemy. The leader must be in superior physical condition or he cannot expend the additional energy required by his concern for his unit and still have the neces-

sary energy to lead and direct his unit in combat. He must remember that there are seldom any tired units, just *TIRED COMMANDERS*.

#### 7-4. Summary

*a.* The leader who is selected to lead troops in areas of the world where the extreme cold and rugged, trackless terrain make living and fighting more difficult, will face one of the greatest challenges of his lifetime.

*b.* He must possess the highest qualities of leadership and have the initiative, the confidence, and the endurance to utilize these qualities to the utmost. He must have the woods man's knowledge of bushcraft and be able to navigate over rugged, trackless terrain. He must be physically strong, mentally alert, and able to stand on his own two feet and make decisions when on independent missions.

*c.* He must be more proficient than others, not only in command but in actual doing. He must be able to improvise and to teach his men to do likewise. He must be able to endure greater hardships than his men and be quick to recognize indications of mental lethargy. He must know the weaknesses and strengths in his men so that he may pair them more effectively in the buddy system. He must be firm when issuing orders but must also realize that as the men become colder and more miserable the time required to accomplish a task will be greatly increased. He must have patience and understanding and be able to lead without driving. In short, he must be the prototype of all leaders.

*d.* Military operations can be carried out successfully under the extreme conditions arid over the difficult terrain conditions peculiar to the cold areas of the world. The task of the troop leader under conditions such as these becomes more difficult, but not impossible.

*e.* The leader must face up to his responsibilities and expend unselfishly and tirelessly of his time and his talents toward the betterment of the safety, the welfare, and the morale of his men.

*f.* The troop leader who knows his job and who makes proper application of the principles of leadership will earn the confidence and respect of his men and will be successful in the accomplishment of his mission.

## APPENDIX A

## REFERENCES

---

AR 40-501	Standards of Medical Fitness.
AR 320-5	Dictionary of U.S. Army Terms.
AR 320-50	Authorized Abbreviations and Brevity Codes.
AR 380-5	Safeguarding Defense Information.
AR 380-40	Safeguarding Crypto Information.
AR 380-41	Control of Cryptomaterial.
AR 385-10	Army Safety Program.
AR 600-20	Army Command Policy and Procedures.
AR 700-8400-1	Issue and Sale of Personal Clothing.
FM 1-100	Army Aviation Utilization.
FM 1-105	Army Aviation Techniques and Procedures.
FM 1-110	Armed Helicopter Employment.
FM 3-8	Chemical Reference Handbook.
FM 3-10	Employment of Chemical and Biological Agents.
FM 3-12	Operational Aspects of Radiological Defense.
FM 5-15	Field Fortifications.
FM 5-20	Camouflage, Basic Principles and Field Camouflage.
FM 5-21	Camouflage of Fixed Installations.
FM 5-25	Explosives and Demolitions.
FM 5-26	Employment of Atomic Demolition Munitions (ADM).
FM 5-29	Passage of Mass Obstacles.
FM 5-31	Boobytraps.
FM 5-36	Route Reconnaissance and Classification.
FM 7-11	Rifle Company, Infantry, Airborne and Mechanized.
FM 7-15	Rifle Platoon and Squads, Infantry, Airborne, and Mechanized.
FM 7-20	Infantry, Airborne Infantry, and Mechanized Infantry Battalions.
FM 7-30	Infantry, Airborne and Mechanized Division Brigades.
FM 8-35	Transportation of the Sick and Wounded.
FM 9-6	Ammunition Service in the Theater of Operations.
FM 10-8	Air Delivery of Supplies and Equipment in the Field Army.
FM 10-60	Supply of Subsistence in a Theater of Operations.
FM 11-50	Signal Battalion, Armored Infantry, and Infantry (Mechanized) Divisions.
FM 17-1	Armor Operations.
FM 17-15	Tank Units, Platoon, Company and Battalion.

FM 17-30	The Armored Division Brigade.
FM 17-36	Divisional Armored and Air Cavalry Units.
FM 19-45-1 (Test)	Rear Area Protection.
FM 20-15	Pole and Frame Supported Tents.
FM 20-32	Landmine Warfare.
FM 21-5	Military Training Management.
FM 21-6	Techniques of Military Instruction,
FM 21-10	Military Sanitation.
FM 21-11	First Aid for Soldiers.
FM 21-26	Map Reading.
FM 21-30	Military Symbols.
FM 21-40	Chemical, Biological and Nuclear Defense.
FM 21-41	Soldier's Handbook for Chemical and Biological Operations and Nuclear Warfare.
FM 21-50	Ranger Training and Ranger Operations.
FM 21-75	Combat Training of the Individual Soldier and Patrolling.
FM 21-76	Survival, Evasion and Escape.
FM 22-5	Drills and Ceremonies.
FM 22-100	Military Leadership.
FM 23-90	81mm Mortar M29.
FM 24-1	Tactical Communications Doctrine
FM 24-17	Tactical Communications Center Operations.
FM 24-18	Field Radio Techniques.
FM 24-20	Field Wire and Field Cable Techniques.
FM 29-3	Direct Support Supply and Service in the Field Army.
FM 30-5	Combat Intelligence.
FM 31-71	Northern Operations.
FM 31-72	Mountain Operations.
(C) FM 32-5	Signal Security (U).
FM-41-10	Civil Affairs Operations.
FM 44-1	U.S. Army Air Defense Artillery Employment.
FM 54-2	The Division Support Command.
FM 55-35	Motor Transport Operations and Motor Transport Units.
FM 57-10	Army Forces in Joint Airborne Operations.
FM 57-35	Airmobile Operations.
FM 61-100	The Division.
(S) FM 100-1	Doctrinal Guidance (U).
FM 100-5	Field Service Regulations; Operations.
FM 100-10	Field Service Regulations; Administration.
FM 101-5	Staff Officers' Field Manual; Staff Organization, and Procedure.
FM 101-10-1	Staff Officers' Field Manual; Organization, Technical, and Logistical Data—Unclassified Data.
FM 101-31-1	Staff Officers' Field Manual, Nuclear Weapons Employment, Doctrine and Procedures.

(S) FM 101-31-2	Staff Officers' Field Manual; Nuclear Weapons Employment Effects Data (U).
FM 101-31-3	Staff Officers' Field Manual; Nuclear Weapons Employment Effects Data (Unclassified).
Pam 108-1	Index of Army Films, Transparencies, GTA Charts, and Recordings.
Pam 310-1	Military Publications-Index of Administrative Publications.
Pam 310-2	Military Publications-Index of Blank Forms.
Pam 310-3	Military Publications—Index of Doctrinal, Training, and Organizational Publications.
Pam 310-4	Military Publications—Index of Technical Manuals, Technical Bulletins, Supply Bulletins, Lubrication Orders and Modification Work Orders.
Pam 385-1	Unit Safety Management.
SB 11-6	Dry Battery Supply Data,
SB 700-20	Army Adopted Items of Materiel.
TA 50-901	Clothing and Equipment (Peace).
TB Med 81	Cold Injury.
TB Med 269	Carbon Monoxide Poisoning, Etiology, Systems, Treatment and Prevention.
TB Sig 189	Cold Weather Photography.
TB Sig 346	Maintenance of Radiac Equipment.
TC 10-8	The Lightweight Rucksack: Nylon OG 106.
TM 1-300	Meteorology for Army Aviation.
TM 3-210	Fallout Prediction.
TM 3-215	Military Chemistry and Chemical Agents.
TM 3-220	Chemical, Biological and Radiological (CBR) Decontamination.
TM 8-366	Flame Fuels.
TM 3-4240-202-15	Mask, Protective, Field, M17.
TM 5-315	Firefighting and Rescue Operations in Theaters of Operation.
TM 5-330	Planning, Site Selection and Design of Roads, Airfields, and Heliports in the Theater of Operations.
TM 6-349	Arctic Construction.
TM 8-601	Nutrition.
TM 9-207	Operation and Maintenance of Ordnance Materiel in Extreme Cold Weather (0° to – 65° F.).
TM 9-278	Lubrication of Ordnance Materiel.
TM 9-1300-203	Ammunition for Antiaircraft, Tank, Anti-tank, and Field Artillery Weapons.
TM 9-1900	Ammunition, General.
TM 9-1960	Rockets.
TM 9-8662	Fuel-Burning Heaters for Winterization Equipment.
TM 10-228	Fitting of Footwear.
TM 10-275	Cold Weather Clothing and Sleeping Equipment.
TM 10-725	Stove, Tent, M1941, Complete, and Burner, Oil Stove, Tent, M114.
TM 10-735	Stove, Yukon, M1950.
TM 21-305	Manual for Wheeled Vehicle Driver.
TM 21-306	Manual for the Full Track Vehicle Driver.
TM 38-760	Army Equipment Record Procedures.
TM 55-404	Fundamentals of Army Airplane Maintenance.
TM 743-200-1	Storage and Materials Handling.

APPENDIX B

GROUND/AIR EMERGENCY CODE FOR  
USE IN AIR/LAND RESCUE SEARCH

**B-1. General**

Experience has shown the requirement for simple visual signals for use in an emergency by personnel who have become lost, crashed, or parachuted (or who are members of search

parties), and who have need for medical assistance, food, information regarding the route to be followed, etc. Three types of such visual signals are contained in figures B-1, B-2, and B-3.

NO.	MESSAGE	CODE SYMBOL	NO.	MESSAGE	CODE SYMBOL
1	REQUIRE DOCTOR - SERIOUS INJURIES	I	10	WILL ATTEMPT TAKE-OFF	▷
2	REQUIRE MEDICAL SUPPLIES	II	11	AIRCRAFT SERIOUSLY DAMAGED	◻
3	UNABLE TO PROCEED	X	12	PROBABLY SAFE TO LAND HERE	△
4	REQUIRE FOOD AND WATER	F	13	REQUIRE FUEL AND OIL	L
5	REQUIRE FIREARMS AND AMMUNITION	∨	14	ALL WELL	LL
6	REQUIRE MAP AND COMPASS	◻	15	NO	N
7	REQUIRE SIGNAL LAMP WITH BATTERY AND RADIO	I	16	YES	Y
8	INDICATE DIRECTION TO PROCEED	K	17	NOT UNDERSTOOD	JL
9	AM PROCEEDING IN THIS DIRECTION	↑	18	REQUIRE RESCUER	W

*Figure B-1. Ground/air visual signals for use in emergency by survivors.*

**B-2. Visual signals**

The use of one or more of these signals or types of signals will depend on individual circumstances and availability of signal material. However, as far as possible, the following in-

structions will be adhered to with respect to the signals contained in figures B-1, and B-2:

- a. Form signals by any available means. (Some of the means usually available in an emergency situation are strips of fabric, para-



NO	MESSAGE	CODE SYMBOL	NO	MESSAGE	CODE SYMBOL
1	OPERATION COMPLETED	LLL	5	HAVE DIVIDED INTO TWO GROUPS. EACH PROCEEDING IN DIRECTION INDICATED	
2	WE HAVE FOUND ALL PERSONNEL	LL	6	INFORMATION RECEIVED THAT AIRCRAFT IS IN THIS DIRECTION	
3	WE HAVE FOUND ONLY SOME PERSONNEL	++	7	NOTHING FOUND. WILL CONTINUE TO SEARCH	NN
4	WE ARE NOT ABLE TO CONTINUE. RETURNING TO BASE	XX			

Figure B-8. Ground/air visual signals for use in emergency by search parties.

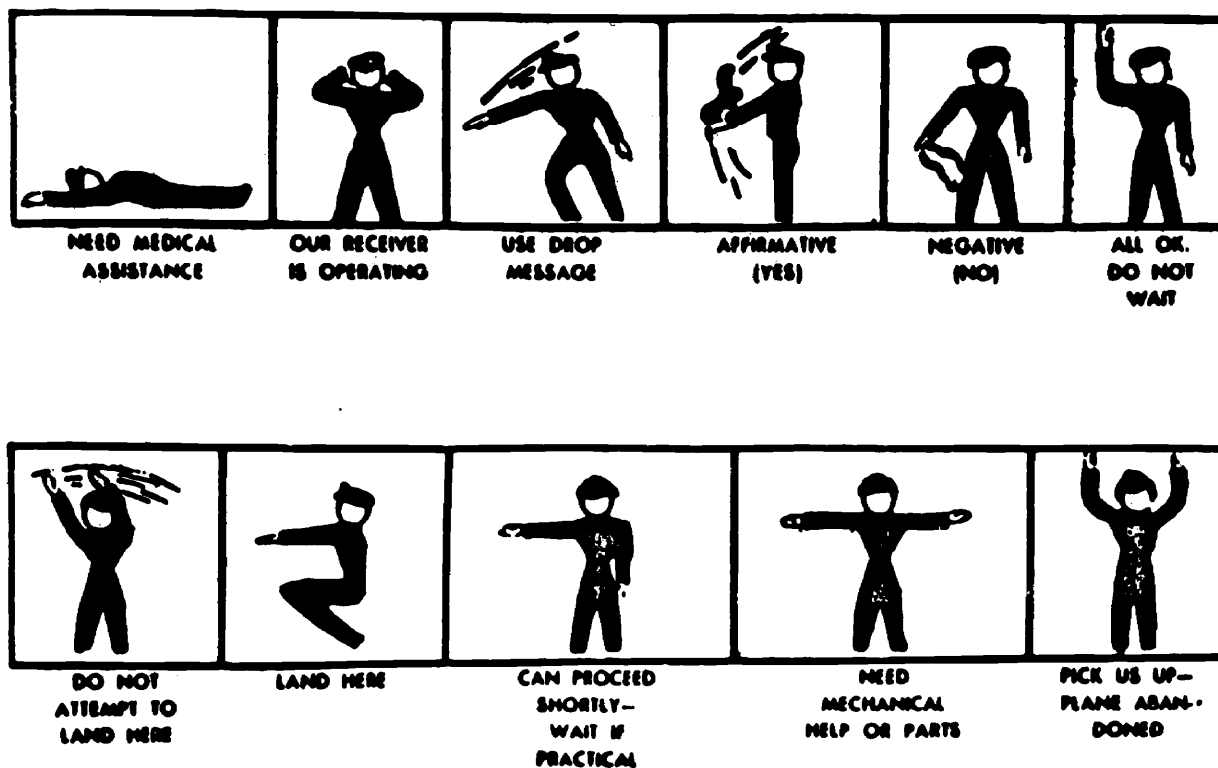

Figure B-3. Ground/air visual body signals for use in emergency by survivors.

chute material, pieces of wood, stones, boughs, or by marking the surface by tamping snow or staining with oil, etc.).

b. Make signals not less than 3.5 meters (10.5') in length.

c. Take care to lay out signals exactly as depicted to avoid confusion with other symbols.

d. Provide as much color contrast as possible between material used and the background.

e. Make every effort to attract attention by other means such as radio, flares, smoke, or reflected light. Smoke is one of the best attraction methods, because it can be seen for a great distance and will be investigated by all pilots, both military and civilian, as a routine matter. Be sure to give your signal while the aircraft is approaching you. Do not wait until the aircraft is straight above or has passed by.

f. The emergency signals included in this manual should be reproduced for use by in-

dividuals and/or small units which are required to accomplish independent or semi-independent missions.

### B-3. Conveying and Acknowledging Information

a. When it is necessary for an aircraft to convey information to individuals who have become lost or isolated, or to search parties, and two-way radio is not available, the crew will, if practicable, convey the information by dropping a message or by dropping communication equipment that will enable direct contact to be established.

b. When a signal has been displayed and is understood, the pilot will acknowledge by dipping the aircraft's wings from side to side or by other prearranged signals.

c. When a signal has been displayed and is NOT understood, the pilot of the aircraft will so indicate by making a complete right turn or by other prearranged signals.

## APPENDIX C

## SKI DRILL

## Section I. INDIVIDUAL DRILL

**C-1. General**

Ski drill and ski training should be given concurrently. Ski drill is kept to the minimum necessary for assembly, organization, instruction, and speedy reaction to commands. Only those infantry drill movements in FM 22-5 which are easily performed on skis are used. If weapon is included, it is either carried across the back with the sling over the left shoulder, butt at the right side, or attached to the rucksack, if used. Before falling in for drill, skis are strapped with running surfaces together, tip to tip, using one strap to secure them tightly together between the toe and heel section of the bindings. Poles are interlaced by drawing the shaft of one through the basket of the other.

**C-2. Fall In**

The command is FALL IN. A normal interval, 100 cm (40"), is taken and skis are held in the position of Order Skis.

**C-3. Order Skis**  
(fig. C-1)

This is the position of attention with skis, except during Inspection of Skis. The skis are grasped with the right hand between the toe and heel section of the binding and held in a vertical position with the edges to the front. The tips of the skis rest on the ground, on line with and touching the toe of the right boot. The poles are held by placing the left hand through both wrist straps and grasping both handgrips. They are placed in a vertical position with the baskets on line with and touching the left boot. Both elbows are held close to the body.

**C-4. At Ease and Rest**

The same procedure is followed as in FM

AGO 8641A



*Figure C-1. Position of Order Skis.*



22-5, except that the skis take the place of the rifle.

### C-5. Facings

Facings are executed as prescribed in FM 22-5 except that the skis take the place of the rifle. The ski poles are held in the left hand.

### C-6 Hand Salute, Dismounted

At the position of Order or Right Shoulder Skis, the salute is rendered in the same manner as the rifle salute. To accomplish this, release the grip on the ski poles with the left hand allowing the poles to hang from the wrist while the salute is executed. Regrasp the pole handles after execution of the salute.

### C-7. Right Shoulder Skis (fig. C-2)

This is a four count movement. Being at the position of Order Skis, the command is RIGHT SHOULDER SKIS. At the command SKIS, the skis are lifted vertically until, the upper right arm is horizontal. At the same time, the left hand grasps the skis over the front edges and approximately 30 cm (1') below the front of the toe section of the binding. The ski poles remain on the left wrist as the movement is executed. (TWO) The right hand moves down and grasps the skis over the front edges, midway between the ski tips and the front of the toe section of the binding. (THREE ) Skis are lowered so that the balance point rests on the shoulder and the skis are at an angle of approximately 45° to the horizontal, with the right elbow close to the side. (FOUR) The left arm is cut smartly back to the side and the grip on the ski poles resumed.

### C-8. Order Skis from Right Shoulder Skis

This is a four count movement. The command is ORDER SKIS. At the command SKIS, the left hand grasps the skis midway between the toe section of the binding and the right hand. The poles hang from the wrist by the straps. (TWO) The skis are brought down until they are in a vertical position approximately 45 cm (18") from the ground. (THREE) The right hand grasps the skis over the rear edges between the toe and heel section of the bindings. (FOUR) The skis are lowered gently to the ground. At the same



Figure C-2. Position of right shoulder skis.

time, the left hand grasps the handgrips of the poles and is brought back to the left side.

### C-9. Open and Close Ranks

Same as FM 22-5 except that each rank takes double the distance.

For example:

- a. Front rank takes 4 steps forward.
- b. Second rank takes 2 steps forward.

- c. Third rank stands fast.
- d. Fourth rank takes 4 steps backwards.

### C-10. Inspection Skis

Being at Order Skis, the command is INSPECTION SKIS (fig. C-3). At the command SKIS, the skis are unstrapped with the left hand and the loose strap placed in the pocket. The skis are separated and the position of attention assumed, holding one ski in each hand between the toe and heel section of the bindings, running surfaces to the front and the tip of each ski in line with and approximately 8 cm (3") outside the toe of the corresponding boot. The ski poles are placed in the snow beside the left foot. After the inspecting officer has examined the running surfaces, the skis are rotated 180° to display the top surface. When the inspecting officer has passed, the skis are refastened and the position of Order Skis resumed.

### C-11. Ground Skis

This movement is done in 3 counts. Being at Order Skis, the command is GROUND SKIS. At the command SKIS, take two steps to the rear, leaving the ski tips in place. Lower the skis partially to the ground by sliding the right hand toward the heels of the skis. (TWO) The skis are then placed on the ground, on edge. (THREE ) A position is taken directly to the left of the ski bindings, facing the tips of the skis. The poles are placed on the left, parallel to the skis, baskets to the rear, midpoint of the shafts even with and close to the left boot, The position of attention is then assumed.

### C-12. Take Skis From Ground Skis

The command is TAKE SKIS. At the command SKIS secure ski poles, reverse the three movements of Ground Skis, and assume the position of Order Skis.

### C-13. Stack Skis (fig. C-4)

This movement is done in four counts. The command is STACK SKIS. At the command SKIS, the first two movements of Ground Skis are executed. (THREE) The ski poles are sep-



Figure C-3. Position of inspection skis.

arated and the points placed in the ground on each side of the ski heels, approximately 1 meter (3') apart. A V is made of the handgrips by interlacing each wrist strap over the opposite handgrip and crossing the right pole in front of the left. The poles are then grasped with the right hand at the point where they intersect. (FOUR) The heels of the skis are picked up with the left hand and placed, edges

up, running surfaces together, into the V-formed by the handgrips. At the same time, the poles are tilted forward so that they are approximately 45 cm (18") from the ski heels. This increases support. A position of attention is then assumed beside the ski bindings, with the stack to the right.

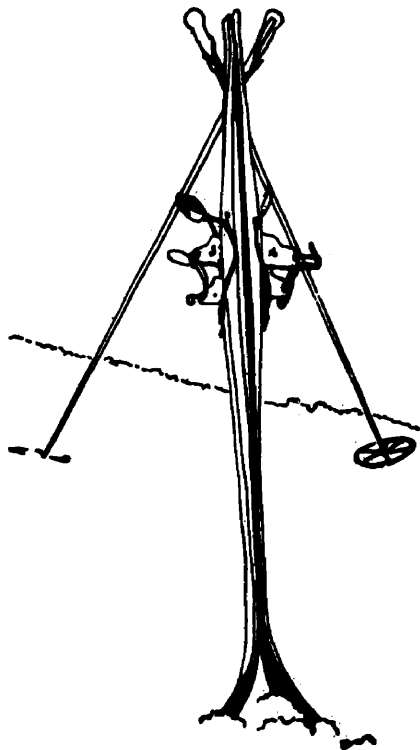

Figure C-4. Position of skis in stack skis.

#### C-14. Take Skis from Stack Skis

The command is TAKE SKIS. At the command SKIS, the movements of Stack Skis are reversed and the position of Order Skis assumed.

#### C-15. Stack Equipment

With skis stacked, the command is STACK EQUIPMENT. At the command EQUIPMENT, the pack is hung over the heels of the skis by both shoulder straps with the body of the pack to the right of the individual as he faces to the rear. The rifle remains attached to the pack when applicable or, when unattached, it is also hung to the right, vertically and with the receiver down. Any additional equipment is hung in a similar manner.

#### C-16. Take Equipment

The command is TAKE EQUIPMENT. At the command EQUIPMENT, the rifle, pack, and equipment are removed and a position of attention resumed beside the skis.

#### C-17. Mount Skis

This movement is done in 5 counts. Being in line at open ranks, the command is MOUNT SKIS. At the command SKIS, the first three movements of Ground Skis are executed. (FOUR) The skis are straddled. (FIVE) The ski's are separated (from each other) placed on the ground axial the boots are secured to the bindings. Poles are then separated and grasped with the left hand. The right hand is inserted up through the wrist strap from underneath so that the wrist strap is around the back of the wrist. Then the handgrip is grasped. This procedure is repeated with the left hand and the position of attention is assumed. On skis this is as follows (fig. C-5):

- a. Skis are parallel and approximately 8 cm (3") apart, with the weight of the body evenly on both skis.
- b. Poles are placed vertically with each basket in line with, and touching the toe of, the corresponding boot.
- c. Elbows are close to the body, with the position of the hands dependent on the length of the pole.

#### C-18. Dismount Skis

The command is DISMOUNT SKIS. At the command SKIS, the movements of Mount Skis are reversed and the position on Order Skis assumed.

#### C-19. At Ease and Rest, Skis Mounted

When mounted on skis, the right ski must be left in place when At Ease is given. At Rest, both skis may be moved.

#### C-20. Hand Salute, Skis Mounted (fig. C-6)

When mounted on skis, the hand salute is rendered the same as prescribed in FM 22-5. The right hand is removed from the wrist strap if time permits. If time does not permit,

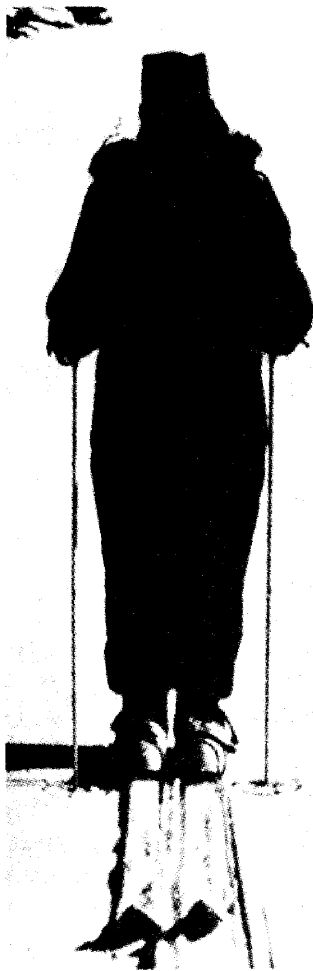

Figure C-5. Position of attention, skis mounted.



Figure C-6. The hand salute, skis mounted.

the pole hangs from the wrist by the strap until after the salute is executed.

**C-21. Ski Interval**  
(fig. C-7)

Maneuvers on skis are done at ski interval. If skis are already mounted, ski interval will be taken by each individual when falling in, unless otherwise specified. The ski interval is approximately 3 meters (9') and is measured by extending both the right arm and right-ski pole and the left arm with the left pole hanging from theorist. When skis are mounted in ranks while at normal interval, the command is TAKE SKI INTERVAL TO THE RIGHT (LEFT). On this command, interval is taken as described in FM 22-5, except that the step turn to the left is executed rather

than a face to the left in marching. The interval is measured as described above. If it is desired to straighten the ranks after ski interval has been taken, the command AT SKI INTERVAL, DRESS RIGHT DRESS is given.

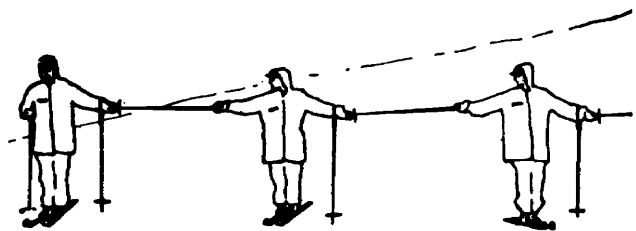

Figure C-7. Taking ski interval.

**C-22. Right or Left Face**

When mounted on skis, this movement is executed in four counts. The command is **RIGHT FACE**. At the command **FACE**, the right ski is raised slightly and rotated 45° to the right, using its heel as a pivot. (TWO) The left ski is moved alongside the right ski. (THREE) The first movement is repeated. (FOUR) The second movement is repeated. Each ski pole is raised, moved, and placed with the corresponding ski. Left Face is executed in the same manner except the 45° movement is made to the left with the left ski.

**C-23. About Face**

This movement is executed in four counts.

The command is **ABOUT FACE**. At the command **FACE**, the left pole is placed alongside the left ski approximately 45 to 60 cm (18" to 24") in front of the toe. At the same time, the right pole is placed alongside the right ski approximately 45 to 60 cm (18" to 24") in the rear of the toe. (TWO) The right ski is raised until it is perpendicular, with its heel alongside the tip of the left ski. (THREE) Using the heel as a pivot, the right ski is rotated and placed alongside the right pole and pointing in the opposite direction. (FOUR) The left ski and ski pole are then brought around simultaneously and the left ski placed in the new direction alongside the right ski, with the left ski pole placed by the toe of the left foot.

**Section II. UNIT DRILL****C-24. Moving at Right Shoulder Skis**

*a. Drill.* To move men out at right shoulder skis, the preparatory command **FORWARD** is given with sufficient pause before the command of execution **MARCH** to allow the men to bring their poles up onto the left shoulder and placed with baskets to the rear under the skis (1, fig. C-8). To move from Right Shoulder Skis to Order Skis after halting, the preparatory command **ORDER** is given with sufficient pause before the command of execution **SKIS** to allow the men to bring their poles down to the left side.

*b. Marches.* There are three methods of carrying skis which may be used in marching, their use depending on the length of march and the type of terrain. If the march is relatively short, at the command **ROUTE STEP** the poles may be removed from under the skis and brought down to the side at the discretion of the individual. This enables him to rest or warm his arm and hand or to use the poles for support when climbing a slope. Skis may also be alternately shifted from shoulder to shoulder to reduce fatigue. At the command **SQUAD**, **PLATOON**, or **COMPANY ATTENTION**, the position of Right Shoulder Skis is resumed with poles under the skis. Allow sufficient time between the preparatory command and the command of execution for individuals to place the skis and poles in proper position. For longer marches where the ter-

rain is flat or rolling, the poles may be strapped to the skis with the baskets over the tips and the skis alternated between the right and left shoulder to avoid fatigue (2, fig. C-8). This method is valuable in cold weather, as it enables the individual to alternate warming of each hand by swinging it or placing it under his outer clothing. For longer marches, especially over steep terrain, the skis may be tied to the rucksack. One is tied on each side with the tips up and strapped together at the top to form an A-shape (3, fig. C-8). This method allows the individual to use the poles for additional support either together, in one hand, or separately, one in each hand.

**C-25. Flanking Movement From Normal Interval**

This movement is used when it is desired to move men to the flanks when mounted on skis at normal interval. The movement is done in 4 counts. The commands are to the **RIGHT (LEFT) FLANK AT INTERVAL**, **MARCH**. At the command **MARCH**, the right flank man pivots on the heel of his right ski 45° to the right and slides slightly forward on it. (TWO) The left ski is brought up parallel to the right ski, allowing this ski also to slide slightly forward. (THREE) The first movement is repeated. (FOUR) The second movement is repeated and a normal pace taken in the new direction. As the right flank man takes his



1 Using the ski poles for support

2 Skis and poles strapped together to leave hands free

*Figure C-8. Various methods of carrying skis.*

third step, the next man starts his first step. This procedure is followed by each man in line. When the last man has finished this movement, the unit will be marching in the new direction at ski intervals. Flanking to the left is executed in the same manner, except that the left flank man starts the movement with his left foot.

#### **C-26. Flanking Movement From Ski Interval**

This movement is made by first commanding RIGHT or LEFT FACE. When this facing

has been completed the command FORWARD MARCH is given.

#### **C-27. Column Movement**

When mounted on skis, the commands are COLUMN RIGHT (LEFT), MARCH. At the command MARCH, the leading man takes a full step forward, then turns as in facing on skis, except that at each step a short slide forward is made. The fourth step is of full length in the new direction. Succeeding men follow in his trace. For COLUMN HALF

RIGHT (HALF LEFT) the same procedure is followed except that the second step is of full length in the new direction.

### C-28. To March to the Rear

For this movement, when mounted on skis, three separate commands are given, allowing each movement to be completed before the next command is given. These commands in order are HALT, ABOUT FACE, FORWARD MARCH. The about face is executed as described in paragraph C-23.



3 A-frame method  
*Figure C-8—Continued.*

## APPENDIX D

EFFECTS OF COLD WEATHER ON WEAPONS

---

**D-1. General**

*a.* In cold areas many climatic conditions will greatly affect the operation and employment of infantry weapons. All individuals must be well aware of these conditions in order that they may properly handle and care for their weapons under adverse circumstances.

*b.* As a safety measure, extreme care must be exercised in touching cold weapons with bare flesh because the flesh may freeze to the metal. Gloves or the trigger finger mitten should always be worn when handling weapons during periods of extreme cold.

**D-2. Factors Affecting Weapons**

*a. Sluggishness.* A common problem is the sluggishness of the operation of the weapons in extreme cold. Normal lubricants thicken in low temperature and stoppage or sluggish action of firearms results. During the winter, weapons must be stripped completely and cleaned with a drycleaning solvent to remove all lubricants and rust prevention compounds. The prescribed application of lubrication oil, weapons (LOW) should then be made. These lubricants will provide proper lubrication during the winter and help minimize snow and ice from freezing on the weapons.

*b. Breakages and Malfunctions.* Another problem that faces the soldier in the areas of severe cold is a higher rate of breakage and malfunctions. These can also be attributed primarily to the cold, although snow in a weapon may cause stoppage and malfunctions. The tempered metal of automatic weapons, for example, will cool to a point where it cannot be touched by human flesh. This extreme cold makes the metal brittle. When the weapon is

fired at subzero temperatures, the temperature of the barrel and gun will rapidly rise to between 200° and 750°, depending upon the number of rounds fired. This again reduces the temper and, because the parts are working, breakages will occur early in the firing while the weapon is warming up. Many malfunctions also occur during this period due to the presence of ice or snow in the weapon or freezing of working parts. The weapons should first be fired at a slow rate of fire. Once the parts have warmed up, the rate of fire may be increased to the cyclic rate. One of the main problems is to insure that snow and ice do not get into the working parts, sights, or barrel. The weapon must be carefully handled during movement through the snow-covered woods, and especially under combat conditions in deep snow.

*c. Condensation.* Condensation forms on weapons when they are taken from the extreme cold into any type of heated shelter. This condensation is often referred to as "sweating." When the weapon is taken out into the cold air, the film of condensation freezes, especially in the internal parts, and stoppages and malfunctions result. When weapons are taken into heated shelter for cleaning purposes, "sweating" may continue for as long as 1 hour. Therefore, when time is available, wait 1 hour, remove all condensation, and then clean the weapon.

*d. Visibility.* A problem of visibility close to the ground occurs when a weapon with excessive muzzle blast is fired in temperatures below -37° F. As the round leaves the weapon, the water vapor in the air is crystallized, creating minute ice particles which produce ice fog. This fog will hang over the weapon and follow the path of the projectile, obscur-



ing the gunner's vision along his line of fire. If the air is still, the ice fog will remain for many minutes and hover in one place. Therefore, the weapon will have to be displaced to the right or left to again secure use of its sights if firing is to be continued.

*e. Emplacement.* Most crew-served infantry weapons need a natural "base" or gun platform so it may be fired accurately. In summer the ground provides a solid base and yet has enough resilience to act as a shock absorber. In winter the soft snow gives under the recoil of the gun. If the weapon is emplaced on the solid frozen ground, there is no "give" and all the shock of firing is absorbed by the weapon itself, resulting in breakage (para 6-7). Also the slippery surface of the frozen ground may allow the weapon to slide. If the snow is not too deep, and if time is available, tripods and baseplates should be dug into the ground or solidly positioned by expedient means to keep them from moving.

### D-3. Cold Effects on Various Types of Weapons

#### *a. Small Arms.*

- (1) *Pistols.* Pistols cannot be fired while wearing the arctic mitten set. The firer must remove his mittens or use the lighter weight trigger finger mitten. The only other difficulty that may be encountered is the breakage of moving parts in extreme cold.
- (2) *Rifles.* Firing rifles will also necessitate the use of trigger finger mittens. This means that the firer cannot operate the weapon over a sustained period of time in extreme cold. All rifles will create ice fog. However, since the firer can readily move his position, this poses no serious problem. The main problem is that more malfunctions and breakages are caused in firing because of the cold or because of fouling of the weapon with ice or snow. Parts most subject to breakage are sears, firing pins, and operating rods-parts that are moving or affected by recoil. Malfunctions in automatic rifles may be

caused by snow or ice plugged magazines. Wingnuts on bipeds tend to freeze in position. To avoid this problem, apply LOW on parts concerned.

- (3) *Machineguns.* These weapons normally should be well lubricated with LOW because of their many moving parts. If LOW is not available, these weapons, when fired cold and dry, will have fewer malfunctions if fired at a slow rate of fire. Once the parts have warmed up, temperate zone lubricants can be applied and the rate of fire gradually increased. However, if temperate zone lubricants are used the gun must be kept warm. If it is allowed to become cold it will fail to operate upon resumption of firing. The gun should therefore be cleaned and fired dry and cold until it again warms up. MG's have a high rate of breakages and malfunctions because of the cold weather. Parts especially affected are the sear and bolt. Extra parts of this type must be carried by gun crews. One common malfunction, occurring early in firing is called short recoil (bolt does not recoil fully to the rear). Prescribed immediate action for the particular weapon should be applied. As the metal warms, the problem will diminish. A second malfunction is caused by freezing and hardening of buffers. This in turn causes great shock and rapid recoil, thereby increasing the cyclic rate. When this happens and the gun continues to fire, something has to give, and generally parts will break. Condensation will cause the freezing of parts as on most other weapons. Ice fog greatly impairs accurate firing, therefore, 2 to 3 alternate gun positions must be prepared.

#### *b. Recoilless Rifle.*

- (1) Propellants will tend to burn slower in the cold. Therefore, the firing data for temperate climates cannot be used and the weapon must be zeroed for the temperature in which it is

being fired. Once zeroed the weapons are again highly accurate. The rate of fire will be slower because of slow burning propellants. This is because after the round leaves the muzzle, burning gases remain in the barrel and the weapon cannot be reloaded until they burn out. The phenomenon is known as "afterburn." Gunners must exercise care to avoid premature explosion of the round in the weapon. A period of at least 60 seconds must elapse between firing and reloading.

- (2) One of the major problems in the firing of recoilless rifles is the formulation of ice fog. This will require frequent displacement of the weapon so that the gunner can regain visibility and also to avoid detection by the enemy.
- (3) Applicable training manuals for the recoilless rifle prescribe back blast danger areas for temperate zone firing. The danger areas must be tripled for safe operations in cold areas.
- (4) The Spotter-Tracer Rifle on the 106-mm Rifle creates problems because its trajectory and that of the recoilless round do not coincide. Metal parts of the spotter rifle are also subject to breakage. As in other weapons it is lubricated with LOW or fired dry.
- (5) Another phenomenon that occurs in extreme cold is deformity of the barrel because of solar radiation. This will happen if the weapon is foresighted, for example, prior to sunrise. If the sight reticle and the bore have been placed on the same target in the early morning hours, after the sun rises the bore may be pointing at one target and the sight reticle at the original one. The barrel has been actually bent because of the increase in temperature and thus the zero has been lost. After the weapon has been fired for several rounds, it is again boresighted and retains its accuracy. This condition concerns itself with gaining first round hits; the crew

must be aware of this and must know how to correct it. The gunner should not *rely entirely* on the firing tables in low temperatures, but should correct the data based upon experience and the best available data currently at hand.

*c. Rocket Launchers.* The main problem with rocket launchers is in the ammunition. The rocket has a burning propellant which moves it toward the target. This propellant because of the effect of the blast and its slow burning qualities in cold weather can be extremely dangerous in low temperatures. The gunner and loader can be burned and lacerated by particles of the burning propellant as the rocket leaves the muzzle of the launcher. The firing of these weapons (peacetime training) is normally restricted to temperatures above 20° F, but extreme caution should be exercised when firing at any temperature below freezing. Operating personnel must be equipped with face masks and gloves. Like the recoilless rifle, the back blast danger area must be tripled. The launchers have no emplacement problem, but will create ice fog and will have to be moved when the fog persists. The range is reduced because of slow burning propellants. The gunner will have to make his own firing tables and will probably have to sight high, especially at longer ranges.

*d. Grenades.*

- (1) *Handgrenades.* No particular problems exist in the use of handgrenades in extreme low temperatures with the exception that they lose much of their effectiveness when detonated under snow. The following are precautions necessary for throwing handgrenades by personnel wearing arctic handgear during extreme cold conditions.
  - (a) Handgear must be completely dry. Handling of snow and ice may result in grenades freezing to the wet handgear.
  - (b) Grenades must be held near the neck of the fuze to avoid slipping or turning of the grenades when safety pins are removed.

- (c) Right hand throwers must place the grenade so that the safety lever rests on the first knuckle of the thumb to insure a sensitive feeling of the safety lever.
- (d) Left handed throwers must place the grenade so that the safety lever rests between the first and second knuckles of the fingers, to insure a sensitive feeling of the safety lever and good access to the safety pin ring.
- (2) *Grenade launcher.* No particular problems exist in the operation of the 40mm grenade launcher at extreme low temperatures; however, like the handgrenade, the grenade itself will lose much of its effectiveness when detonated under snow and a higher proportion of duds will result. The launcher should be fired dry or lubricated lightly with LAW.

*e. Tank Main Armament.* These weapons have many of the problems of recoilless rifles. Breakage and malfunctions are few. The two primary problems are the formation of ice fog when the weapon is fired and distortion of the tube caused by solar radiation. The problems of lubrication and breakage are greatly diminished because of the fact that most of the working parts of the weapon are inclosed in a warmed turret. The major problem is the effect of temperature changes on the ammunition. Ammunition stored inside the turret will be warm and have the same general ballistic characteristics of ammunition fired in temperate climates. The weapon is generally zeroed with this warm ammunition. Other ammunition is stored outside the tank where the temperature is extremely cold. When this ammunition is fired, the powder will burn slowly and it will have completely different ballistic characteristics, thus rendering the initial zero useless. If possible, the ammunition brought in from the outside should be heated in the turret before firing. In a combat situation this is not practical because the ammunition may have to be used immediately. The gunner must have his own data for cold ammunition or be ready to hastily rezero the weapon. In either case he will have to make sight adjustments. There is

also the problem of snow particles being blown up in front of the sights by the muzzle blast and obscuring the visibility of the gunner.

*f. Mortars.* The matter of breakage in mortars is a minor one since there are few parts. However, firing pins often get brittle and break. The baseplate must be solidly positioned to prevent sliding. It may be necessary to dig into the ground to accomplish this. When the weapon is emplaced on frozen ground, the combination of the cold making the metal brittle and the tremendous shock that the baseplate receives when a round is fired, occasionally may cause the baseplate to crack. Frozen ground has no resiliency, and the baseplate and other bracing parts of the weapons absorb the entire shock of firing.

- (1) One field expedient that will reduce the possibility of a cracked baseplate is to place a brush matting under the baseplate. The matting should be thick enough to act as a shock absorber, but not so thick as to cause the baseplate to bounce out of its dug in position. Another method of positioning the weapon is to place bags of dry sand or snow beneath the baseplate. The sandbags will provide the weapon with a solid, yet resilient, shock absorbing base. An additional problem with the mortars is that they cannot be handled without touching bare metal as can other infantry weapons with wooden or plastic handles and stock. The crew must keep their gloves or mittens on and avoid touching the metal surface with bare flesh. There are practically no lubrication or ice fog problems with the mortars. Malfunctions are also quite infrequent.
- (2) The ammunition is affected by the cold in the same manner as the other types of ammunition. Firing tables may be utilized provided the proper range K's are established through experience. Applicable field manuals should be consulted for charge restrictions at low temperatures. The

VT-fuze type ammunition is considered the most effective mortar ammunition in the northern latitudes in the winter. Contact-detonated ammunition will penetrate the snow before exploding and much of its effective-

ness is lost and dissipated in the snow. A greater frequency of short rounds, as much as 1,000 to 1,400 meters short, (1,000 to 1,400 yds) may be experienced at low temperatures from the 4.2-inch mortar.

APPENDIX E

WEIGHTS OF COLD WEATHER CLOTHING AND EQUIPMENT AND TYPE LOAD

E-1. General

The weights shown in this appendix are for Standard A items of clothing and equipment. As new items are developed and standardized, their weights will be reflected by changes to the manual.

E-2. Clothing and Equipment

The list below includes all items of clothing and selected items of equipment. Insofar as possible abbreviated nomenclature has been used. A type load is shown in paragraph E-3.

a. Clothing.

	<i>Average weight in pounds (size medium regular)</i>
Undershirt, 50/50 .....	0.82
Drawers, 50/50 .....	0.89
Socks, Cushion Sole .....	0.19
Suspenders .....	0.25
Trousers, Wool Serge .....	1.68
Trousers, Cotton Nylon, Wind Resistant .....	2.10
Liner, Trousers, Nylon Quilted .....	0.64
Shirt, Wool Nylon, OG .....	1.50
Coat, Cotton Nylon, Wind Resistant ..	3.20
Liner, Coat, Nylon Quilted .....	0.73
Parka, Cotton Nylon .....	1.98
Liner, Parka, Nylon Quilted .....	0.95
Cap, Cold Weather .....	0.26
Hood, Winter .....	0.96
Muffler, Wool .....	0.38
Glove, Shells, Leather .....	0.22
Glove Inserts, Wool Nylon .....	0.13
Mitten, Shells, Trigger Finger .....	0.43
Mitten Inserts, Wool Nylon .....	0.22
Mitten Set, Arctic .....	1.08
Poncho, Nylon Twill .....	2.00
Boot, Insulated, White or Black .....	5.50
Overwhite, Set:	
Parka .....	1.94
Trousers .....	1.00
Mitten .....	0.31
Rucksack .....	0.75

b. Individual Equipment.

	<i>Weight in pounds</i>
Bag, Sleeping (inner) .....	5.41
Bag, Sleeping (outer) .....	7.06
Mattress, Pneumatic .....	3.00
Case, Water Repellent .....	2.25
Helmet, Steel, w/liner .....	3.00
Rucksack, Nylon Duck, OG .....	3.60
Canteen, Cold Climatic, w/cup & cover... 2/3 full.	3.85
Belt, M14, w/first aid packet & pouch ..	1.01
Rifle, M14, w/sling .....	9.08
Bayonet, w/scabbard .....	1.07
5 Magazines, w/ammunition .....	7.85
Ammunition pouch (2 ea) .....	1.46
2 Grenades (M26) .....	1.90
Intrenching Tool, w/carrier .....	3.96
Body Armor .....	8.87
Mask, Protective .....	2.88
1/3 Ration .....	2.13
Skis, All Terrain, w/bindings and poles..	9.50
Snowshoes, Magnesium, w/bindings ..	4.60
Ski Wax (per box) .....	0.25
Chapstick .....	0.04
Thong, Emergency .....	0.12
Glasses, Sun, w/case .....	0.30
Sunburn Preventive Cream .....	0.19
Camouflage face paint, white/loam ..	0.08
Box, Match, Waterproof, w/matches ..	0.15
Starter, Fire .....	0.15
Knife, Pocket .....	0.40
Towel, Turkish .....	0.64
Comfort Items (approx) .....	1.00
Toilet Articles (approx) .....	2.00

c. Organizational Equipment. The commander must also consider the additional weight imposed on individuals within the unit by the necessary inclusion of many items of organizational equipment and crew-served weapons needed for a given mission. The following list is not intended to be complete, but to be used as a guide for planning purposes.

Machinegun, M60 .....	23.00
Grenades (M34)(WP) .....	1.81

Weapon, Antipersonnel (Claymore) -----	3.00
Pistol, Automatic, Cal. 45 -----	2.50
250 rounds, 7.62mm, Machinegun -----	22.00
Bandoleer, w/7.62mm ammunition (60 rds). -----	3.61
Compass, Lensatic -----	.30
Grenade Launcher, M79 -----	6.00
81mm Mortar, w/mount:	
Barrel -----	28.00
Bipod -----	40.00
Baseplate -----	25.50
3.5" Rocket Launcher:	
Launcher -----	13.00
Rockets -----	9.00
Rifle, 90mm, M67:	
Rifle -----	35.00
Ammo -----	9.25
Stove, One Burner, Squad -----	1.30
Reel, DR8, w/WD1 wire -----	13.00
Radio, AN/PRC 6 -----	7.50
Radio, AN/PRC 25 -----	24.72

Equipment	Weight
Rifle, M14 -----	9.08
Grenade, M26 (2 ea) -----	1.90
Magazine, w/7.62mm ammo (5 ea) --	7.85
Pouch, Ammo, 7.62mm, M14 (2 ea) --	1.46
Canteen, Cold Climatic -----	3.85
Belt, M14, w/first aid packet & pouch	1.01
Trenching Tool, w/carrier -----	3.96
Bayonet, w/scabbard -----	1.07
Snowshoes, Magnesium -----	4.60
Body Armor -----	8.87
Protective Mask -----	2.88
<b>Total equipment -----</b>	<b>46.53</b>

*Carried in pockets:*

Chapstick -----	0.10
Sun Glasses, w/case -----	0.30
Box, Match, Waterproof -----	0.15
Knife, Pocket -----	0.40
Thong, Emergency -----	0.12
<b>Total -----</b>	<b>1.07</b>
<b>Total Fighting Load -----</b>	<b>72.03</b>

**E-3. Type Load**

The loads shown below are *type* loads which could be worn during moderately cold weather (approximately 15° F to -15° F). The term moderately cold is used only as a descriptive term. What is termed as moderately cold to one person, may be extremely cold to another. The windchill factor must also be considered, a moderate cold could change momentarily to extreme cold by the addition of high winds. Therefore, the commander should use the type loads for planning only and should adjust them accordingly to fit a given situation and temperature condition,

*a. Fighting Load.*

*Clothing:*

	Weight
Helmet, w/liner -----	3.00
Undershirt, 50/50 -----	0.82
Drawers, 50/50 -----	0.89
Socks, Cushion Sole -----	0.19
Suspenders -----	0.25
Trousers, Cotton Nylon WR -----	2.10
Shirt, Wool Nylon OG -----	1.50
Coat, Cotton Nylon WR -----	3.20
Liner, Coat, Nylon Quilted -----	0.73
Cap, Cold Weather -----	0.26
Hood, Winter -----	0.96
Muffler, Wool -----	0.38
Mitten, Shells, Trigger Finger -----	0.43
Mitten Inserts, Wool Nylon -----	0.22
Overwhite Set -----	4.00
Boots, Insulated, White -----	5.50
<b>Total clothing -----</b>	<b>24.43</b>

*b. Existence Load.*

	Weight
Rucksack, Nylon Duck, OG -----	3.60
Following items are carried in or attached to the rucksack:	
Bag, Sleeping (Outer) -----	7.06
Bag, Sleeping (Inner) -----	5.41
Mattress, Pneumatic -----	3.00
Case, Water Repellent -----	2.25
Liner, Trousers, Nylon Quilted -----	0.64
Socks, Cushion Sole (2 pr) -----	0.38
Poncho, Nylon Twill -----	2.00
½ Ration -----	2.13
Toilet Articles -----	2.00
Towel, Turkish -----	0.64
Starter, Fire -----	0.15
Mitten, Inserts, Wool Nylon -----	0.22
<b>Total Existence Load -----</b>	<b>29.48</b>
<b>Total of Fighting and Existence Load. -----</b>	<b>101.51</b>

*c. Supplemental Existence Load.* The following are items of clothing not immediately needed by the individual during moderately cold weather. These items are normally carried in the duffle bag on unit transportation and should be available to the individual when needed:

- Undershirt, 50/50
- Drawers, 50/50
- Socks, Cushion Sole (3 pr)
- Trousers, Cotton Nylon, Wind Resistant
- Shirt, Wool Nylon, OG
- Parka, Cotton Nylon
- Liner, Parka, Nylon Quilted
- Mitten Set, Arctic

## APPENDIX F

## ENVIRONMENTAL EFFECTS

## Section I. THE ENVIRONMENT

**F-1. Terrain**

The terrain of northern latitudes consists of exposed bedrock, plains and plateaus covering this rock, and rugged mountains. Much of the area is within earthquake belts with active volcanoes and glaciers present. Sedimentary deposits on slopes greater than 3° are constantly moving.

*a.* The plains have numerous shallow glacial depressions, sloughs, swamps, ponds, and lakes. These features range from 30 to 1,500 cm (1' to 50') deep with banks from a few centimeters (inches) to hundreds of meters (yards) high.

*b.* The plateaus have relatively smooth uplands, many rolling hills, and broad sweeping valleys. Scattered rock outcroppings are present. The elevations vary from hundreds to thousands of meters over distances of several hundred kilometers (miles).

*c.* Mountain elevations range from 1,500 meters (5,000') to more than 5,500 meters (18,000') within a few kilometers (miles). Weathering processes as well as mountain forming processes are found.

*d.* Streams often have swift currents and extremely rocky bottoms. The many glacial rivers are silt-laden with numerous sandbars, shifting channels, and undercut banks.

*e.* Perennially frozen ground, or permafrost, is found in most of the subarctic and arctic. It varies in thickness from a few centimeters (inches) to several hundred meters (yards) in loosely defined continuous, discontinuous, and sporadic zones. The presence of permafrost affects drainage due to its impervious

nature. When the permafrost thaws, the material changes to muck because of the large water content. Therefore, the presence or absence of permafrost can affect military activities.

*f.* Heavy forests with dense coniferous tree stands are found where little or no permafrost is present. Certain broad leaf trees will mix with narrow leaf types in zones of sporadic permafrost. As the area of permafrost becomes more continuous, vegetation growth becomes more stunted and is replaced by sedges, grasses, and mosses.

**F-2. Atmosphere**

*a.* Cloud cover is extensive and wide, low clouds cause bleak and monotonous conditions. In very high latitudes, overcast often persists for weeks and clear days are rare.

*b.* Precipitation varies from about 10 to 600 cm (4" to 200") per year, depending upon the area. Snow may fall during any month, but does not always account for the major quantity of precipitation as the ratio in volume of snow to water can vary from 2 to 1 to 10 to 1. Although this area has very little atmospheric moisture, it has relatively high humidity due to the low temperatures.

*c.* Ground level air temperatures may vary from extremes of -95° F. to +100° F. During the period of solar light, the extreme variation for one day might be as high as 100° F.

*d.* In most areas, visibility is either very good or very poor with average visibility considered uncommon. Fog, blowing snow, and variation in air density can cause impaired visibility. In most areas, fog causes less prob-

lems in late winter. Periods, when blowing snow has reduced visibility below 1,000 meters (1,000 yds) range from 79 hours for an entire winter in one area to 265 consecutive hours in another. Light, reflected at various angles in air of changing density, produces mirages which confuse detail of the landscape. Often, flat terrain features are upended; objects far below the true horizon appear near at hand in sharp relief; and objects above the true horizon completely disappear. In unusual cases, terrain features are reflected in the sky.

*e.* During winter, long periods of darkness with heavy overcast are a problem. However, at many times, the quality of available light must also be considered. Most activities can be carried on in bright moonlight while light from the stars and the aurora is sufficient for many purposes. Sunlight, when reflected from snow and ice, becomes brighter. This light may be so intense that shadows are eliminated. This absence of contrast can make it impossible to distinguish outlines of terrain features or large objects, even at close range.

*f.* Wind velocity varies with the particular area and season. Maximum wind speed occurs during periods of changing temperatures and prolonged velocities above 90 knots have been recorded. Snow and silt begin drifting with winds above 8 knots. With moderate winds, it is often difficult to determine whether snow is falling or being swirled up from the surface.

*g.* Sound transmission depends upon wind, temperature, and surface conditions. Normally, with an increase in elevation, wind speeds increase and temperatures decrease, resulting in above normal sound intensity downwind. However, as temperature inversion is common in northern areas, this effect is not always as pronounced. In addition, soft snow will absorb sound energy while hard-crusting snow or ice will aid sound reflection. Normal conversation has been carried on at a distance

of 2.4 km ( 1 1/2 miles) and shouted words have been heard at 4 km (2 1/2 miles). However, under other climatic conditions, the sound of an aircraft engine at full throttle has been inaudible at 0.8 km (1/2 mile).

### F-3. Climate

*a.* The northern year is divided into winter and summer. These periods are defined by thermometer readings rather than calendar dates. Winter occurs when the average daily temperature falls and remains below freezing, while summer occurs when this average temperature remains above freezing. Periods of transition with wide temperature variation precede each season.

*b.* Winter progresses from north to south preceded by autumn freezeup and deep penetration of frost as the hours of sunlight decrease. The days begin to shorten with the summer solstice; however, since the daily change is about 6 minutes, the effect is not often noticed until passage of the autumnal equinox. As a result, the gradual descent of the long winter night appears to be sudden. During early autumn, the weather is relatively dry. As winter approaches, there is an increase in precipitation and muddy conditions. Snow and thin ice appear as early as late September and deep cold as early as October. In November, water courses freeze solidly and temperatures fall as low as  $-50^{\circ}$  F in many areas. Snowfall varies but snow depths of 60 to 150 cm ( 15" to 60") are common, and deep drifts in valleys and hollows change the appearance of the landscape.

*c.* With passage of the winter solstice, the hours of daily sunlight increase. After the spring equinox, fluctuations in temperature cause daytime thaw and nighttime freeze. Continued melting conditions cause the spring breakup which, in addition to the spring rains, flood lakes and streams and turn the surrounding plains into quagmires.

## Section II. EFFECTS ON THE ENVIRONMENT OF MAN

### F-4. General

Accommodation to the environment is required of all men. This requires psychological

and physiological adjustments, and not all men are equally suited to the requirement. Men with medical histories of upper respiratory



tract disease, emotional disturbances, rheumatoid disease, digestive and coronary disorders, high susceptibility to infectious disease, and defective vision are more likely to become casualties to rigorous exposure. However, it is not essential that man be warm to be effective, as the absence of complete comfort can induce increased effort. Neither is it essential that man have a certain number of hot meals each day. The normal human body will remain effective as long as the caloric and fluid intake and dissipation are reasonably matched, nitrogen balance is maintained, and the body is not subjected to destructive influence.

### F-5. Cold

*a. General.* In intense cold a man may become intellectually numb neglecting essential tasks. In addition, the essential tasks require more time and effort to achieve. Under some conditions (particularly cold water immersion) a man in excellent physical condition may die in a matter of minutes. The destructive influence of cold on the human body is defined as hypothermia.

*b. Hypothermia.* Hypothermia is a term used to describe general lowering of body temperature due to loss of heat at a rate faster than it can be produced. Frostbite may occur without hypothermia when extremities do not receive sufficient heat from central body stores due to inadequate circulation and/or inadequate insulation. However both conditions, hypothermia and frostbite, may occur in the same case if exposure is to below freezing temperatures as in the case of an avalanche accident. Hypothermia may also occur from exposure to temperatures above freezing, especially from immersion in cold water or from the effect of wind. Physical exhaustion and insufficient food may raise the risk of hypothermia, as has occurred when inexperienced and ill-equipped hikers have been caught in mountain storms. Exposure to wet-cold conditions has also led to hypothermia in cave explorers. Aviators downed in cold water, and boating accidents in northern waters are other examples of situations in which hypothermia is a risk. Intemperate use of alcohol leading to unconsciousness in a cold environment is still another condition which can result in hypothermia.

- (1) *Dangers of hypothermia.* As central body temperature falls from the normal level of 98.6° F, various body processes are slowed. Circulation of blood is retarded, movements become sluggish, coordination is reduced, judgment becomes impaired. With further cooling unconsciousness results. At a deep body temperature below 85° F. there is increased risk of disorganized heart action or heart standstill which results in sudden death.
- (2) *Prevention.* Prevention of hypothermia consists of all actions which will avoid rapid and uncontrolled loss of body heat. Divers, boaters and aviators operating in cold regions must be equipped with protective gear such as immersion suits and liferafts with spray covers. Ice thickness must be tested before river or lake crossings. Anyone departing a fixed base by aircraft, ground vehicle, or on foot must carry sufficient protective clothing and food reserves to allow survival during unexpected weather changes or other unforeseen emergencies. Traveling alone is never safe. Expected itinerary and arrival time should be left with responsible parties before any departure of base in severe weather. All persons living in cold regions should become skilled in the construction of expedient shelters from available materials. The excellent heat insulating qualities of snow should be emphasized.
- (3) *Treatment.*
  - (a) The objective of treatment is to re-warm the body evenly and without delay, but not so rapidly as to further disorganize body functions such as circulation. A person suspected of hypothermia should be immediately protected by all available dry clothing or a sleeping bag, and then be moved to a warm enclosure. A useful procedure in case of accidental breakthrough into ice water, or other hypothermia accident, is to im-

mediately strip the victim of wet clothing and bundle him into a sleeping bag with a warm companion whose body heat will aid in rewarming. Mouth-to-mouth resuscitation should be started at once if the victim's breathing has stopped or is not regular and of normal depth. Warm liquids may be given gradually to a conscious patient, but must not be forced on an unconscious or stuporous person for fear of strangulation.

- (b) If movement is necessary the hypothermia patient should be handled on a litter since the exertion of walking may aggravate circulation problems.
- (c) A medical officer is needed without delay to attend any serious hypothermia patient, since this condition is life-threatening until normal body temperature has been restored. Immersion of a hypothermia patient in a warm water bath is a rapid means of restoring body temperature, but since this rapid rewarming may aggravate heart and circulation problems temporarily, this procedure should only be done with a medical officer in attendance.

*c. Windchill.* Frostbite can occur even in relatively warm temperatures if the wind penetrates the layer of insulating warm air to expose body tissue. As an example, with the wind calm and a temperature of  $-20^{\circ}$  F. there is little danger from windchill. However, if the temperature is  $-20^{\circ}$  F. and there is a wind of 20 kts, the equivalent chill temperature is  $-75^{\circ}$  F. Under these conditions there is great danger and exposed flesh may freeze within 30 seconds (fig. F-1).

#### **F-6. Physical**

*a.* It can generally be expected that exposure to climatic extremes will increase the effects of any physical disorder. Men with heart diseases often become quick casualties due to necessary increased physical exertion. Men susceptible to upper respiratory tract infections become casualties due to the humidity,

abrasive silts, and the wide temperature variations. The individual with arthritis suffers from damp and cold plus abnormal physical exertion.

*b.* In winter, the threat of exposure is matched by the dangers of dehydration and exhaustion as the body must accelerate the production of heat. This results in greater fluid loss. Rigid self-discipline is required to maintain proper habits of elimination. In summer, there are the usual dangers of bacterial contamination of food and water and insect-carried communicable diseases.

#### **F-7. Mental**

The isolation of the area, the long periods of darkness and light, and the immobilizing effect of the weather can all effect the mental stamina of man. The cabin fever stories of the trapper and the prospector and the tales of moon sickness of the Indian and Eskimo are not all just myths. The effect will vary with the individual and varies from nervous tension in some to loss of mental equilibrium in others.

#### **F-8. Adjustments**

It appears that some racial groups, particularly the Nordics, have been more successful in the physiological and psychological adjustment to the environment than have other groups. This is due, in part, to accepting the natural conditions and adjusting and adapting actions to fit these conditions.

*a.* The human body must be protected. To remain functional, it must be kept clean, dry, and reasonably warm with normal body processes maintained. Rest and nourishment are vital. A little food and water consumed at regular intervals and at body temperatures are preferable to large quantities of hot food and liquids consumed infrequently.

*b.* All heat and energy, regardless of the source, must be conserved and profitably used.

*c.* An operating base to supply basic needs is necessary for efficient operations.

WIND SPEED		COOLING POWER OF WIND EXPRESSED AS " EQUIVALENT CHILL TEMPERATURE "																					
KNOTS	MPH	TEMPERATURE (°F)																					
CALM		40	35	30	25	20	15	10	5	0	-5	-10	-15	-20	-25	-30	-35	-40	-45	-50	-55	-60	
		EQUIVALENT CHILL TEMPERATURE																					
3-6	5	35	30	25	20	15	10	5	0	-5	-10	-15	-20	-25	-30	-35	-40	-45	-50	-55	-60	-70	
7-10	10	30	20	15	10	5	0	-10	-15	-20	-25	-35	-40	-45	-50	-60	-65	-70	-75	-80	-90	-95	
11-15	15	25	15	10	0	-5	-10	-20	-25	-30	-40	-45	-50	-60	-65	-70	-80	-85	-90	-100	-105	-110	
16-19	20	20	10	5	0	-10	-15	-25	-30	-35	-45	-50	-60	-65	-75	-80	-85	-95	-100	-110	-115	-120	
20-23	25	15	10	0	-5	-15	-20	-30	-35	-45	-50	-60	-65	-75	-80	-90	-95	-105	-110	-120	-125	-135	
24-28	30	10	5	0	-10	-20	-25	-30	-40	-50	-55	-65	-70	-80	-85	-95	-100	-110	-115	-125	-130	-140	
29-32	35	10	5	-5	-10	-20	-30	-35	-40	-50	-60	-65	-75	-80	-90	-100	-105	-115	-120	-130	-135	-145	
33-36	40	10	0	-5	-15	-20	-30	-35	-45	-55	-60	-70	-75	-85	-95	-100	-110	-115	-125	-130	-140	-150	
WINDS ABOVE 40 HAVE LITTLE ADDITIONAL EFFECT		LITTLE DANGER										INCREASING DANGER (Flesh may freeze within 1 minute)						GREAT DANGER (Flesh may freeze within 30 secs)					

Figure F-1. Windchill chart.

## Section III. EFFECTS OF THE ENVIRONMENT ON FACILITIES

**F-9. Industry**

To provide industrial needs, man must solve certain engineering problems in an acceptable time frame and in an economical manner. A major problem which must be solved is the effect of permafrost. During construction, any disturbance of the established temperature balance of the ground, without provision of compensating factors, will change the foundation characteristics. Subsurface strengths and drainage patterns change and affect entire structures. The solution to the permafrost problem is costly and time consuming and can involve the use of insulation, drainage, flotation, excavation, refrigeration, or complicated combinations of these.

**F-10. Agriculture**

Permafrost, combined with low evaporation rates, low temperatures, sporadic precipitation, and irregular seasons, prevents extensive agricultural development. However, as permafrost prevents precipitation loss by normal drainage processes, many areas having a semiarid climate support luxuriant natural vegetation. This vegetation, by insulating the underlying permafrost, prevents deep thawing, depresses soil temperatures, and prevents deep root systems. This prevents agriculture in continuous permafrost zones. In discontinuous and sporadic zones, only hardy plants which mature in one short growing season can be planted.

**F-11. Materials**

Low temperatures change the strength, elasticity, and hardness of metals and generally reduce their impact resistance. Leather fabrics and rubber lose their pliability and tensile strength. Plastics, ceramics, and other synthetics are less ductile. Items composed of moving parts and of differing types of materials operate with reduced efficiency.

*a.* Rubber, in warm weather, is flexible; during extreme cold it becomes stiff, and bending will cause it to break e.g., when a vehicle is parked for several hours during subzero weather, flattened-out areas develop in tires; these flattened-out areas have little resiliency until after the tires have warmed up,

incident to operation. Rubber heater hoses, some hydraulic lines and the fuel hose on the Yukon stove may break if they are suddenly bent during periods of extreme cold. Rubber, rubber compound seals and O-rings tend to warp and break.

*b.* Water freezes and expands; while it is expanding in a restricted space (as in an engine) it has tremendous power, enough to crack the toughest of iron.

*c.* Canvas becomes stiff much the same as does rubber and it becomes difficult to fold or unfold without damaging it.

*d.* Glass, being a poor conductor of heat, will crack if it is exposed to any sudden increase in temperature. As an example, the windshield on a vehicle may break if intense defroster heat is suddenly applied.

*e.* Gasoline will not freeze but becomes more difficult to vaporize. Since only vapor will burn, combustion of gasoline inside an engine is more difficult and unburned gasoline dilutes the oil in the crankcase contributing to the formation of sludge.

*f.* Oils have a tendency to become thick, and consequently retard the flow through the oil pump to places where it is needed for lubrication. Thickened oils also increase the drag on the entire engine, thus making it more difficult to turn over.

*g.* Grease, which is a semisolid to begin with, becomes hard and loses a great amount of its lubrication properties.

*h.* Leather cracks unless properly treated with neat's foot oil.

*i.* Paint tends to crack very easily when exposed to extreme cold for any great length of time.

*j.* Dry cold weather produces great amounts of static electricity in the layers of clothing worn by personnel and in liquids being transported. Extreme caution must be exercised when refueling vehicles, stoves, lanterns, etc., because the spontaneous discharge of static electricity may ignite these inflammable fuels.

Static electricity should be “drained off” by grounding vehicles or fuel containers prior to starting refueling operations. Personnel

should ground themselves by touching a vehicle or container (away from vapor openings) with the hand.

#### Section IV. EFFECTS OF THE ENVIRONMENT ON VEHICLES

##### F-12. General

A great amount of effort and research has gone into giving the individual soldier the best clothes to keep him combat effective in cold weather. A vehicle is affected by cold in much the same manner as a man. Consider the effects on a platoon if the platoon leader did not take the necessary steps to compensate for the cold to which his men are exposed. The driver of a vehicle must realize the same effects of cold are suffered by motor vehicles and certain precautions are necessary. The purpose of the following paragraphs is to explain briefly what must be done to reduce the adverse effects of cold weather on vehicles and the extra precautions that must be taken during winter driving. Detailed instructions for the operation and maintenance of ordnance materiel in extreme cold are covered in TM 9-207.

##### F-13. Maintenance

*a.* Unless vehicles are kept in the best possible mechanical condition during cold weather they will not operate properly. Successful cold weather operation depends on a high standard of maintenance discipline, proper starting procedures and command supervision. A large portion of deadlines can be attributed to too many cold starts and improper driving habits.

*b.* All maintenance outlined in appropriate TM's for a particular vehicle must be accomplished and extreme care taken to insure all adjustments are exact as possible. Only adequately powered vehicles can overcome the adverse effects of cold weather. Proper lubricant must be used, these can be readily determined by consulting the appropriate lubrication order. One loose battery terminal, points slightly out of adjustment, a sparkplug wire loose, a ground cable loose or a frozen gasline are only some of the deficiencies that can make starting a vehicle difficult, or prevent starting altogether.

*c.* Drivers, during cold weather operations, must be disciplined to conduct prestarting, starting, warmup, operation and shutdown and/or, cooldown and stopping procedure exactly as directed in TM 9-207.

*d.* Additional time must be allowed for “thaw time” before equipment entering a shop can be worked on under “inside conditions.” These “thaw times” must be added to otherwise normal average repair times. The length of this additional time is affected by the length and depth of exposure to subzero “cold soak” prior to entering shops.

*e.* As a safety precaution, all garages, shops and enclosures used for vehicle maintenance or other areas which are subject to carbon monoxide concentrations should be inspected at least once every 3 months. If inspection reveals a potentially dangerous level of carbon monoxide (50 parts per million or more) immediate corrective actions, such as improving ventilation or removal of personnel from the hazardous area, must be taken by responsible personnel. Test results should be recorded and monitored by the unit for 3 months. Rough terrain operations can result in engine exhaust system component failures. Therefore, all motor driven vehicles should be tested for carbon monoxide concentrations in the cabs and passenger carrying compartments at least once every 3 months. Any vehicle failing this test must be immediately deadlined until cause is isolated and corrective action completed. Tests should be recorded on DA Form 2408-1 (Equipment Daily or Monthly Log). Tests indicated above should be made using the Detector Kit, Carbon Monoxide, Colorimetric.

*f.* Mechanic efficiency is reduced by the bulk and clumsiness of the clothing that must be worn in extreme-cold areas. As it is impossible to handle extremely cold metal with a bare hand, some form of mitten or glove must be worn at all times. The resulting loss of the sense of touch further reduces the efficiency of personnel. Even the most routine operations,

such as handling latches or opening engine enclosures, become exasperating and time consuming when they must be performed with mittened hands. Experiments have proven, for example, that the time required by men to screw a nut on the largest bolt available, was twice as long when mittens were worn over a similar operation conducted with bare hands.

The space required to insure access to controls, adjustable devices, and to assemblies which are commonly replaced or which require periodic adjustment, inspection, and cleaning is also increased when the bulky cold weather clothing is worn. The comparison measurements of personnel with warm weather clothing and cold weather clothing are shown below.

### Comparison Clothing Measurements

	Warm weather	Cold weather
Hand (width) -----	10 cm (4")	15 cm (6")
Wrist (circumference) -----	19 cm (7½")	53 cm (21")
Head (circumference) -----	58 cm (23")	96 cm (38")
Breadth across shoulders -----	46 cm (18")	81 cm (32")
Foot (width & length) -----	9 × 28 cm (3½' × 11")	13 × 35 cm (5" × 14")

## F-14. Driving

*a. General* The basic rules for driving during cold weather include all of the rules that apply under normal conditions. However, the necessity to adhere to these rules with the increased hazards of ice and snow is magnified. *All drivers must be trained in proper winter driving techniques before they engage in cold weather operations.*

*b. Visibility.* Good all-around visibility is the first requirement for safe driving.

- (1) Remove all ice, snow, fog, etc., from all windows and keep the windows clear at all times to give all-around vision.
- (2) Use defrosters to keep windshield free from ice.
- (3) Clean and adjust rear view mirror.
- (4) Use lights during snowstorms, while driving in light dry snow or just prior to dusk and dawn, and at all other times when visibility is reduced, providing the tactical situation permits.
- (5) Allow for additional distance between vehicles when exhaust is causing ice fog.
- (6) Use a guide when backing up or where a guide can assist in picking a trail in deep snow.

*c. Traction for Driving and Stopping.*

- (1) Use chains in deep snow and on ice.

They will increase traction for both movement and stops.

- (2) Place brush or burlap under wheels to aid in movement through deep snow and on ice.
- (3) The correct method for applying brakes is especially important. Never jam on brakes as this will lock the wheels and cause the vehicle to skid and require more distance for stopping. The correct method for braking a vehicle on snow and ice is to release accelerator slowly and apply brakes with a feathering action.
- (4) Keep pioneer tools on all vehicles ready for use in removing excess snow and for cutting brush.
- (5) Full tracked vehicle drivers must be prohibited from using neutral steer when the tactical situation permits. Use of the neutral steer capability places avoidable stress and abuse on the suspension system and related power and drive components.

*d. Additional Hints for Safe Cold Weather Driving.*

- (1) Never sleep in the cab or passenger carrying compartment of a vehicle with engine or heater running. Exhaust gases may cause death by asphyxiation.
- (2) Always adjust speed to road conditions.

- (3) Keep proper interval and compensate for road conditions (three to eleven times greater stopping distance may be needed on snow and ice).
- (4) Slow down before going around a curve.
- (5) Make slow, steady turns and stops.
- (6) Keep windows open slightly when heaters are being used.
- (7) Never stop in the center of a road.
- (8) Never pull off to the side of a road unless the shoulder has been checked. Large ditches covered with snow give the appearance of a firm shoulder.
- (9) When hauling troops in the rear of a truck, be certain to instruct them to wait for the driver to assist in their off loading.
- (10) Never overcrowd the cab of a vehicle with extra personnel or extra equipment. This cramps the driver, cuts down on his vision, and prevents him from maneuvering freely.
- (11) During halts, always check the vehicle for any troubles which may have occurred during operation.
- (12) Remove frost from headlights and stoplights.
- (13) Above all, use good judgment, be alert for other drivers errors, and obey all traffic rules and regulations.

## APPENDIX G

COLD WEATHER HINTS

---

**G-1. General**

Success in Northern Operations depends upon forceful leadership and application of proven techniques and maintenance procedures. Ample documents exist to provide these techniques and procedures; however, experience has shown that the same mistakes are continually repeated. To assist personnel in overcoming these recurring errors this list of hints is provided.

**G-2. Engineer Operations***a. Winter Road and Trail Construction.*

- (1) Make a map, aerial, and ground reconnaissance.
- (2) Roads in forward areas should be provided with vehicle turnouts.
- (3) Remain on high ground following routes of solid foundations and minimum grades where feasible.
- (4) Determine approximate period of use and maximum classification of route.
- (6) Check ice thickness of ice crossings. Make test holes 8 meters (25') apart and at a distance of 8 meters (25') from, and parallel to, the centerline of crossing. The holes should be staggered so that they are at 45° angles to each other.
- (6) Mark route clearly.
- (7) Use trailblazing tractors in pairs, one with winch and angle blade.
- (8) Plan route requiring only equipment organic to constructing unit.

*b. Mines and Minefields.*

- (1) Provide sufficient support to detonate mines.

- (2) Cover mines with material to keep out snow.
- (3) Weatherproof fuses with a light coat of automotive water pump grease.
- (4) Allow extra time for placing mines.
- (5) Use both electric and nonelectric firing systems on demolitions in ice to insure detonation.
- (6) Cover AP mines with loose snow.
- (7) Avoid lifting mines by hand after arming in snow.
- (8) Install tripwires above snow surface.

*c. Water Supply.*

- (1) Install immersion heaters in water trailers. Extra precautions must be taken when temperature is below -30° F.
- (2) Carry ice auger or axe head welded to steel bar to locate water and check ice depth.
- (3) Locate water point near swift moving water if possible.
- (4) Drain water supply equipment immediately after use when heated Shelter is not utilized.

*d. Field Fortifications.*

- (1) Mix sand and gravel with packed snow and frequently sprinkle with water to reinforce positions when time will not permit making of ice-crete.
- (2) Camouflage with fresh loose snow.
- (3) Provide sumps for melting snow.
- (4) Insulate interior of fortification.
- (5) Keep wire above snow.



- (6) Locate fortifications on high ground during periods of possible breakup.

## *e. Engineer Equipment Maintenance.*

- (1) Provide adequate stock of spare parts, with special emphasis on high mortality parts such as front power control units (PCU) parts for caterpillars.
- (2) Provide maintenance shelters, where practicable. Improvise shields for driver operator comfort and protection.
- (3) Warm front PCU with external heat before using when snow or moisture is present. Improvise canvas covers to prevent snow from entering. PCU should be left in lockout position when not in use to prevent brake band from freezing on drum.
- (4) Use cutaway snow pads to prevent track breakage. Snow pads are available in stocks or may be cut by maintenance organizations.
- (5) Make every effort to warm gearboxes and engines before starting.
- (6) Maintain extra safety vigilance at all times during subzero operations because of the tendency of steel to become brittle and break at extreme low temperatures. Tools should be used cautiously. Stand clear of taut cables.
- (7) Use air duct heaters, oil burning flares, and electrical heating elements for preheating equipment when required.
- (8) Attend fires constantly if open flame heat is used, especially in windy weather. Fire extinguishers, CO<sub>2</sub> type, should be on hand. Winterize CO<sub>2</sub> bottles by the use of 15 percent nitrogen.
- (9) Keep engines and radiators covered; test thermostats.
- (10) Raise low idle speed to a point where full oil pressure is maintained.
- (11) Use truck mounted cranes only when

footing is solid. They cannot be operated in snow or soft terrain.

- (12) Place one-half pound of sodium bicarbonate near each space heater,

## *f. Tractor Extraction.*

- (1) Remember tractors must often be lifted as well as pulled in order to clear an ice shelf or to climb from a soft mud bottom to a frozen earth bank. This lift must be provided with materials at hand. If the stuck tractor is operative a ramp can be built, logs can be fed under the revolving tracks, or logs can be chained to the tracks and revolved under. If gravel or sandbags are available they can also be fed under the revolving tracks. Usually above measures plus at least one winch tractor will be required. If above measures fail, demolitions in the hands of a qualified demolitions specialist may be used to provide a final boost. Demolition should be considered only after exhausting all other resources.
- (2) After extraction, thaw all gearboxes, drain and relubricate the crankcase, drain and refill fuel tanks, and check all adjustments before attempting to operate.

## G-3. Health and First Aid

### *a. Preventative Measures.*

- (1) Accomplish regular body waste elimination.
- (2) Wash out insulated boots weekly, if possible.
- (3) Use "buddy system" to maintain constant check for indications of frostbite or exhaustion.
- (4) Check more often for frostbite as the windchill becomes higher.
- (5) Drink sufficient water and take necessary salt even in extreme cold. Dehydration is more frequent than cold injury during fieldwork.
- (6) Refrain from drinking alcoholic beverages and excessive smoking when in extreme cold.

- (7) Do not become overheated from overdressing.
- (8) Practice personal hygiene.
- (9) Prior to sun and wind exposure, apply sunburn preventive cream to exposed skin areas; apply chapstick to lips; and put on sunglasses to protect eyes from the sun.

*b. First Aid Treatment.*

- (1) Thaw minor frostbite by placing frozen part against unfrozen area of body.
- (2) Keep medical installations well forward and displace them frequently.
- (3) Evacuate cases of frostbite, other injuries, and illnesses to medical facility immediately. Remember that frostbite of the feet requires a litter evacuation.
- (4) Frostbitten areas should not be rubbed with snow or ice.
- (5) Place frostbite casualty in a warm area but not too near heat sources.
- (6) Place casualties in protected areas prior to administering first aid, injury permitting.
- (7) Casualties must not be left unattended.

*c. Miscellaneous.*

- (1) If unable to walk or exercise vigorously, keep hands and feet warm by moving fingers and toes. Fingers may be warmed quickly by swinging arms in a wide arch from an extended side position to a front position and hitting hands together until warmth is restored.
- (2) Move lips from side to side and up and down to increase blood circulation throughout the face to help prevent cold injury to facial tissue.

**G-4. Vehicles**

*a. Preparatory Measures and Procedures.*

- (1) Make certain that operators and maintenance personnel are well trained and thoroughly familiar with

the methods of vehicle operation and maintenance in extreme cold (TM 9-207).

- (2) Wear gloves when handling metal because exposed skin will freeze upon contact.
- (3) Exercise care in moving vehicles after they have been cold soaked.
- (4) Reduce loads appropriately under adverse conditions.
- (5) Exercise constant vigilance in operation of vehicles on cross-country trails. Consider radiators when crossing wooded terrain and undercarriages when traveling through downed timber or snags. Movement over frozen water courses and ice must be in accordance with FM 31-71.
- (6) To prevent freezing in, recover vehicles as quickly as possible after they have bogged down in muskeg or broken through ice.
- (7) Have recovery equipment well forward to assist in proper recovery of bogged vehicles.
- (8) Use heavy tracked vehicles to break trails in heavily wooded areas.

*b. Lubricants and Related Items.*

- (1) Lubricate and change oil more often than normal to compensate for abnormal operation, severe conditions or contaminated lubricants.
- (2) Keep oil and gasoline containers sealed tightly to prevent snow and ice moisture from entering.
- (3) Always make a complete change of engine or gear oil instead of mixing various grades.
- (4) Standard and arctic type antifreeze should not be mixed.
- (5) Allow for expansion when filling radiators.

*c. Winterization Equipment.*

- (1) Use powerplant and personnel heaters when required by ambient temperatures.
- (2) Service fuel filter more frequently

than for normal operations in temperate climates. The frequency may need to be increased to as often as every 4 hours. When the liquid freezes in the filter, it will be necessary to disassemble the unit and remove the ice and other residue,

- (3) Cold Aid Starting Kit on wheeled vehicles should not be used as a substitute for powerplant heaters.
- (4) Maximum use should be made of the Cold Aid Starting Kit when vehicles not equipped with powerplant heaters are to be started after being shut down for periods long enough to lose their residual heat.

*d. Tires.*

- (1) Check prior to operation during extreme cold.
- (2) Increase tire pressure approximately 10 percent in extremely cold weather.
- (3) Tighten valve cores securely in extreme cold.
- (4) Tires should not be bled during or immediately after operation.

*e. Engine Starting and Warmup.*

- (1) Pre-warm vehicle engine with auxiliary type heaters when temperatures are below  $-25^{\circ}\text{F}$ .
- (2) Utilize winter fronts and shutters to obtain and maintain normal engine operating temperatures.
- (3) Insure that an alert licensed operator is present in vehicle when engine is operating. Operator must observe oil pressure gauges, warning lights, and temperature indicator to prevent damage to engine.
- (4) Warm engines to operating temperatures before accelerating.

*f. Power Train and Suspension Units.*

- (1) Operate vehicles at reduced speeds long enough to thoroughly warm up chassis components after prolonged shutdown.
- (2) Clean snow, slush, and other material out of tracks and suspension *immedi-*

*ately* after stopping vehicle to prevent freezing in place.

- (3) Park on brush, logs, dry ground, or other surfaces not liable to thaw from heat of tires and tracks and re-freeze.
- (4) Avoid using sharp instruments to free frozen tires. Use pioneer equipment to break tracks free before attempting to move tracked vehicles.
- (5) Gasoline or other inflammables should not be used to build fires for freeing tracks.
- (6) Do not attempt to free vehicles frozen to a parking area by jerking or rocking under its own power. Use another vehicle to tow the frozen vehicle if one is available.
- (7) Overloading vehicles causes excessive parts breakage.

### **G-5. Ammunition**

*a.* Protect variable time fuses from temperatures below  $-20^{\circ}\text{F}$ . Fuses are designed for use between limits of  $0^{\circ}$  and  $120^{\circ}\text{F}$ , and for storage between limits of  $-20^{\circ}$  and  $130^{\circ}\text{F}$ . If fuses are fired outside temperature ranges, performance may be severely reduced; firing safety will not be affected.

*b.* Place ammunition on dunnage during storage.

*c.* Clean snow and ice from ammunition prior to repacking.

*d.* Leave containers or components closed during temperature conditioning to prevent condensation.

*e.* Fire rockets only above safe firing temperatures indicated on containers.

*f.* Unpack only that ammunition required for the mission.

### **G-6. Weapons**

*a.* Use lubricating oil weapons (LOW) for all small arms at temperatures below  $0^{\circ}\text{F}$ .

*b.* Keep all sighting equipment at outside temperatures to prevent fogging.

c. Wrap optics in heavy blankets prior to entering warm shelters to allow gradual warm-up. Keep wrapped *at least* 4 hours to prevent moisture damage.

## G-7. Individual and Small Unit Equipment

### a. *Pneumatic Mattress.*

- (1) Avoid placing mattress on sharp objects.
- (2) Inflate mattress, allow it to cool, and inflate again.
- (3) Wipe dry and deflate completely prior to packing.

### b. *Sleeping Bag.*

- (1) Wear only enough clothing to keep warm in sleeping bag.
- (2) Do not use the sleeping bag in direct contact with the ground or snow; insulate by using on top of air mattress, shelter half, poncho, or coniferous boughs.

### e. *Rucksack.*

- (1) Load heavy objects near frame in bottom of rucksack.
- (2) Place sharp and hard objects inside where they will not rub against side or wearer's back.
- (3) Use outside pockets for articles which are frequently used.

### d. *Skis.*

- (1) Defer waxing skis until snow conditions and type of wax are determined.
- (2) Clean and inspect skis and bindings daily after use.
- (3) Make sure bindings are properly adjusted to boots.
- (4) Skis should not be left on ground or snow.
- (5) Store skis and ski poles away from excessive heat.
- (6) Carry extra skis, ski poles, bindings, ski wax, pine tar, and facilities for repairing skis and snowshoes in each unit supply section.

### e. *Snowshoes*

- (1) Place upright in snow or hang on trees or racks.
- (2) Repair all breaks as soon as possible.
- (3) Snowshoes should be dried by indirect heat in a moderately warm room or tent.
- (4) Avoid small trees, stumps, branches, or other rough or sharp objects.

### f. *Tents.*

- (1) Brush snow and ice from tent before packing.
- (2) Keep can or cup of water on tent stove when fire is burning in order to increase humidity and reduce fire hazard.
- (3) Keep one-half pound box of sodium bicarbonate with each tent group to combat fuel fires.

### g. *Protective Mink.*

- (1) Warm mask to room temperatures every 24 hours.
- (2) Carry mask under outer clothing.
- (3) Place mask inside sleeping bag at end of day.
- (4) Inspect outlet and intake valves for icing and cracks after use.
- (5) Adjust head harness to obtain gas tight seal with minimum tension on harness straps to avoid restriction of blood circulation in the face.

### h. *Chemical Agent Detector Kit.*

- (1) Carry kit under outer clothing.
- (2) Mix reagents only as use is anticipated or required.

i. *Five-Gallon Water Cans.* Fill cans only three-fourths full and use insulated covers.

### j. *Small Equipment Item.*

- (1) Use chapstick to prevent wind and cold from chapping lips and as protection against serious windburn and sunburn caused by reflection of sun on snow and ice. Use sunburn preventive cream on exposed skin areas.
- (2) Carry sunglasses on the person at all times. If broken or lost, substitute

may be improvised by cutting thin 2.50 cm (1") long slits in pieces of wood or cardboard.

- (3) Carry waterproof matches in a waterproof box at all times.
- (4) Use mountain cookset to melt snow for drinking and cooking water, as well as for the preparation of food. Stir snow constantly until at least 2.50 cm (1") of water is formed on the bottom of the pan to avoid burning the pan. Select only uncontaminated snow. Iodine water purification tablets should be used to disinfect drinking water prepared by melting snow.
- (5) Allow space in canteens for expansion of ice.

*k. Rations.*

- (1) Issue a hot ration to troops prior to start of day's operations if possible.
- (2) Improve methods for providing hot liquids and soups to troops engaged in winter operations.
- (3) Eat cold rations only as a matter of necessity.
- (4) Eat all of the ration components as the complete balanced ration is designed to meet body requirements.

*l. Cold Weather Clothing.*

- (1) Keep it clean.
- (2) Avoid overheating. Loosen closures before starting to perspire. Remove layer of clothing if closure loosening is not sufficient.
- (3) Wear it in loose layers. Weight does not mean warmth, but layers do.
- (4) Keep it dry, outside and inside. Brush, rather than rub snow from clothing.
- (5) Dry socks by hanging them on the lines inside the tents.
- (6) Dry socks by placing inside clothing during daytime and in sleeping bag at night when other methods are not available.

*m. Petroleum.*

- (1) Clean around opening before removing plug or cap from petroleum container.
- (2) Use spark proof tools when working in storage areas.
- (3) Carry proper POL dispensing equipment to avoid spilling. Avoid spilling gasoline on clothing; frostbite may result.

G-8. Communications

*a. Maintenance and Care of Equipment.*

- (1) Keep equipment in best possible operating condition by organizing a thorough and comprehensive preventive maintenance program.
- (2) Take precautions to prevent damage to equipment due to moisture condensation. Cold equipment should be wrapped in a blanket or parka before being brought into a heated shelter and allowed to warm gradually.

*b. Dry Cell Battery.*

- (1) Use low-temperature winter type batteries. These batteries are distinguished by 2000-series type numbers, such as Battery BA-2279 for Radio Set AN/PRC-10 or BA-2386 for Radio Set, AN/PRC-25 (para 11-6). Store 2000-series batteries at 0° F.
- (2) In low ambient temperatures, batteries should be carried inside clothing to keep them warm.
- (3) Reactivate cold soaked batteries (other than 2000-series) by warming thoroughly at temperatures not to exceed 100° F. Batteries (other than 2000-series) give the best performance when operated at 70° F.
- (4) Carry spare set of batteries for field phones on person and change with batteries in phone at frequent intervals.

*c. Rubber and Rubber Type Compounds.*

- (1) Flex cordage slowly and carefully in order to minimize breakage after

cordage has been exposed to cold weather.

- (2) Warm cables before they are laid in the open.

*d. Radio Receivers and Transmitters.*

- (1) Stress the vital importance of communications during northern operations.
- (2) Place sets in sheltered locations whenever possible. Erect lean-tos, snowcaves, windbreaks, or any other appropriate type of shelter which will protect the equipment from direct exposure to extreme climatic conditions.
- (3) Require installation of complete antenna system, such as long wire antenna, elevated ground plane antenna, single wire inverted L-antenna, doublet antenna, which are more efficient than fractional wavelength whip antennas.
- (4) Cut doublet antennas to operating frequency. The length of this antenna is determined by the following formula:  $L = 468 / F$ ; where  $L$  is length in feet and  $F$  is operating frequency in megacycles (468 is a constant factor derived from the basic formula). This formula does not apply to antennas longer than half-wave.
- (5) Keep in mind that the radiation pattern of a doublet antenna is maximum at right angles to the plane of the antenna.
- (6) Elevate radio frequency cables above the surface to insure that they will not freeze to the ground.
- (7) Construct a counterpoise system in locations where frozen ground prevents installation of a ground rod or where a good earth ground is not available.
- (8) Use radio retransmission stations to extend communications beyond distance normally covered by one radio set.
- (9) Use arctic lubricants on Radar and Beam antennas.

- (10) Warm up radio sets for at least one-half hour before applying plate voltage to transmitter tubes. *The sets may be turned on but do not transmit for at least one-half hour.*

- (11) Frequently check antenna system on mobile units and remove snow, ice, or slush formations.

*e. Microphones.*

- (1) Place frost shield covers over microphone and earphone elements of handsets. If not available, such covers may be fabricated out of the plastic bag material in which dry batteries are packed.
- (2) Carry a spare microphone, if available, under outer garments.

*f. Gasoline Driven Generators and Reel Units.*

- (1) Keep battery fully charged.
- (2) Set carburetor for richer mixture than required for higher ambient temperatures.
- (3) Maintain engine temperature within the range 140° F. to 190° F. Cover units when required to obtain quick warmup.

*g. Wire Communication Equipment.*

- (1) Install teletypewriters and switchboards in heated shelters.
- (2) Remove all snow, ice, water, and dirt from cable stubs before connecting.
- (3) Avoid tight loops.
- (4) Prevent excessive lubrication.
- (5) Insulate teletype and crypto equipment during tactical movement to reduce warmup period required when reestablishing communications. (Salvaged sleeping bags or blankets are excellent for this purpose.)
- (6) Keep snow or moisture from the inside of telephones and switchboards.
- (7) Place wire lines well off frequently traveled cross-country trails.

*k. Miscellaneous Equipment.*

- (1) Carry flashlight in inner pocket, exposing to cold only during use.
- (2) Remove batteries from lanterns not in use. Store in warm place.

## G-9. Transportation

### a. Sled Operation.

- (1) Operate sleds consistent with supply requirements, the capability of drivers, and tactical situation.
- (2) Establish supply and maintenance points along route.
- (3) Insure sled cargo is thoroughly lashed.
- (4) Load trailbreaking sleds lightly.
- (5) Load sleds so that center of gravity is slightly to the rear of the sled center.
- (6) Inspect cargo sleds thoroughly at each halt.
- (7) Mark dangerous portions of trails.
- (8) Execute turns in wide circles.
- (9) Load sleds with packages which can be easily handled by two or three men.
- (10) Avoid hills and boulder strewn terrain when selecting routes.
- (11) Sleds should not be backed.
- (12) Leave 10 to 15 cm (4" to 6") of snow on sled trails.

### b. Truck and Convoy Operation.

- (1) Carry no more than sixteen personnel and equipment in personnel carrier, 2 1/2-ton.
- (2) Provide propositioned bivouac area for mess, latrine, maintenance, and sleeping facilities.
- (3) Provide each vehicle with the following equipment:
  - (a) Driver's personal gear and field equipment.
  - (b) Vehicle maintenance tools.
  - (c) One case of operational rations for emergency use.
  - (d) Extra engine oil.

- (e) Extra antifreeze.
- (f) Extra gasoline.
- (g) Tow and tire chains.
- (h) Pioneer tools.
- (i) Strip map showing locations of telephones, bivouac areas, fueling points, etc.
- (j) Highway warning device.
- (k) Fire starter.

## G-10. Intelligence

### a. Enemy.

- (1) The enemy's ability to inflict maximum casualties on U.S. Forces will depend on the enemy's ability to move. Immediate relay of information pertaining to the enemy's capabilities and modes of cross-country travel, and airmobility is essential.
- (2) The ability of enemy soldiers to live and fight during extended periods of extreme cold will affect the commander's decisions, and ultimately the outcome of the battle. Intelligence collection agencies should in compiling information regarding the enemy and his environment include the following:
  - (a) Level of cold weather training or experience of units in contact.
  - (b) Types of weapons and ammunition.
  - (c) Types of vehicles and aircraft.
  - (d) Types of cold weather clothing and equipment.
  - (e) Communications equipment. Types and methods of employment.
  - (f) Types of navigational aids suitable for northern operation.
  - (g) Types of rations and method of distribution.
  - (h) Types of wildlife, fuel, and vegetation in the area that could be used in emergency.
  - (i) Types of arctic shelters for personnel and equipment.

### b. Weather.

- (1) Because weather is a paramount consideration in northern latitudes, im-

mediate dissemination of weather forecasts to lowest echelon is essential.

- (2) Arctic weather is characterized by drastic temperature changes in short periods of time.

*c. Winter Terrain Studies.*

- (1) Prepare detailed studies. Revise as necessary to insure accuracy and reflect changing trafficability conditions.
- (2) Locate and indicate condition of existing road net.
- (3) Locate and plot other local roads that are used as winter roads but not shown on maps.
- (4) Show forest density, tree size, water routes, ice condition and thickness, snow condition, including average depth, and general terrain features applicable to cross-country movement, routes of march, and avenues of approach. Frozen rivers and lakes increase possibilities of movement and operations. Conduct exacting ice reconnaissance before considering them as axis of advance for vehicles.

*d. Reconnaissance.*

- (1) Include time required to complete patrol under conditions encountered in the northern latitudes. This may be from 1 1/2 to 2 times longer.
- (2) Route reconnaissance parties must include personnel technically qualified to report trafficability conditions of ice and snow.
- (3) Make extensive use of Army aircraft for reconnaissance, radio relay (retransmission), aerial observation posts, terrain study, and spot photography.

*e. Counterintelligence.*

- (1) Insure that personnel receive camouflage and deception instruction peculiar to northern operations.
- (2) Because of long periods of winter darkness and the ability of sound un-

der certain arctic conditions to travel long distances, light, sound and fire discipline must be strictly enforced.

**G-11. Operations**

*a. Land Navigation.*

- (1) Know compass deviation and magnetic declination.
- (2) Become familiar with landmarks, ridge lines, direction of riverflow, and direction of prevailing wind before going unto unknown areas.
- (3) Estimate distance traveled by using methods stated in paragraph 6-9.
- (4) Keep parka fur hood with wire loop away from compass when taking reading.

*b. Bivouac.*

- (1) Select bivouac areas on high ground when tactically possible. Cold lies in low areas. Erect tent in snow for additional protection.
- (2) Insulate tent floor with evergreen boughs for extra protection and warmth.
- (3) Use "dead man" to anchor tent ropes in area where strong winds prevail.
- (4) Burn wood whenever possible.
- (5) Build a lean-to for storage and protection of gear if time permits. This will provide more space in tent.
- (6) Have fire guard on duty when stove is burning.
- (7) Bivouac in wooded area if available.
- (8) Fill stoves and lanterns and store gasoline outside of tents.

*c. Cross-Country Movement and Field Operations.*

- (1) Load transportation units with the quantity and type of equipment and supplies that will enable crew and passengers to live independent of outside help for 2 or 3 days.
- (2) Reduce man-towing of equipment in 200 pound sleds to an absolute minimum.



- (3) Do not travel alone in the northern latitudes.

*d. Tactics, Methods, and Techniques Peculiar to Winter Operations.*

- (1) Place increased importance on value of reconnaissance, particularly route reconnaissance, because of widely separated units, heavily wooded areas, sparsely populated areas, and few maps.
- (2) Use ground reconnaissance to make final selection of routes.
- (3) Take advantage of ski and snowshoe mobility when snow conditions are favorable.
- (4) Use good skiers for long-range patrols.
- (5) Consider endurance and physical condition of troops at all times during winter operations.
- (6) Attack front, flanks, and rear of enemy defensive position simultaneously, when possible, in order to isolate and inclose him. Minimize execution of assault in deep snow against commanding terrain.
- (7) Use skijoring when feasible.
- (8) Insure tactical requirements are fulfilled in conditions of extreme cold.
- (9) Leave skis and snowshoes at assembly area or attack position only if enemy may be reached more quickly and easily without them.
- (10) Consider frozen lakes, rivers, and streams as avenues of approach for enemy and as route of advance for friendly forces.
- (11) Assault on foot instead of skis when it can be done effectively and rapidly. Skis are recovered and brought forward by detail from each squad.
- (12) Do not use same tracks or route for vehicles when moving over terrain with low load bearing capability.
- (13) Do not use wheeled trailers behind tracked vehicles in cross-country movements if other means are available.

*e. Airborne Operations (FM 31-71).*

- (1) Inspect personnel to insure correct fit of parachutes over arctic clothing and proper attachment of equipment.
- (2) Parachutists should jump with skis or snowshoes if snow is present on the DZ (TM 57-220).
- (3) Keep cargo compartment of aircraft from becoming overheated during flight to prevent cold weather injuries to personnel due to chilling after the jump.
- (4) Employ standard methods of aerial delivery as methods and techniques do not vary with cold weather conditions.
- (5) Start recovery immediately after air-drop completion.
- (6) Provide goggles for jumpmaster to preclude watering eyes when observing from open door, for IP's and DZ's.

## **G-12. Logistics**

*a. General.*

- (1) Provide troops with hot meals and drinks at least twice daily, or provide them with the time and means to do so themselves.
- (2) Use rotary and fixed wing aircraft capable of making airdrops or landing in higher elevations, whenever possible.

*b. Supply Areas.*

- (1) Locate supply areas near terrain suitable for airstrip or drop zone.
- (2) Provide continuous all around security of supply areas.
- (3) Employ fixed and rotary wing aircraft to deliver critical supplies from supply areas to combat troops.
- (4) Provide heated storage for certain perishable foods and freezable medical supplies.
- (5) Provide heated shelter for medical evacuees, POW's and IPW team.
- (6) Establish rigid control of POL to avoid waste.

APPENDIX H  
MEASUREMENT CONVERSION FACTORS

---

<i>Multiply</i>	<i>By</i>	<i>To obtain</i>
Centimeters -----	.03281	<b>Feet</b>
Centimeters -----	.3937	<b>Inches</b>
Meters -----	3.281	<b>Feet</b>
Meters -----	39.37	<b>Inches</b>
Meters -----	1.0936	<b>Yards</b>
Kilometers -----	.62137	<b>Miles</b>
Inches -----	2.54	<b>Centimeters</b>
Inches -----	.0254	<b>Meters</b>
Feet -----	30.48	<b>Centimeters</b>
Feet -----	.3048	<b>Meters</b>
Yards -----	.9144	<b>Meters</b>
MPH -----	1.6093	<b>KmPH</b>
MPH -----	.8684	<b>Knots</b>
Knots -----	1.1516	<b>MPH</b>

## GLOSSARY

- Ablation**—Net loss of snow or ice by melting, sublimation, evaporation, or wind action during a specific period of time. The opposite of accumulation.
- Accumulation**—Net gain of snow or ice during a specific period of time. The opposite of ablation.
- Active layer**—(annually thawed layer) Layer of ground that thaws in the summer and freezes again in the winter (equivalent to seasonally frozen ground).
- Akkio**—Boat-like sled used for pulling squad equipment over snow.
- Breakup**—Period of spring thaw during which the ground surface is excessively wet and soft, and ice is disappearing from streams and lakes. Duration of the breakup period varies usually from 1 to 6 weeks depending on regional and local climatic conditions. The breakup season causes difficult movement problems.
- Chilblains**—A cold injury which causes lesions—usually on the hands—caused by prolonged or repeated exposure to mild humid cold.
- Chinook**—Warm dry wind which raises the temperature and melts snow from the ground.
- Cold injury**—An inclusive term applied to injuries resulting from cold. The most common are frostbite, trenchfoot, immersion foot, and chilblains.
- Cornice**—An overhanging formation of snow, usually formed on a mountain ridge, at the crest of a gully and/or a steep slope.
- Crack**—A fissure or crevice in a rock or ice formation.
- Crevasse**—A deep crack or fissure in the ice of a glacier.
- Cyclonic storms**—A storm system of winds, often violent, with abundant precipitation and a usual diameter of 80 to 14,000 km (50 to 900 miles). It is characterized by winds rotating about a calm center of low atmospheric pressures, often at speeds as high as 80 to 120 kts. These storms are called hurricanes in the West Indies. The winds rotate clockwise in the Southern Hemisphere and counter-clockwise in the Northern Hemisphere.
- Disposal bags**—Heavy waterproof bags into which personnel defecate—used because it is sometimes impractical to prepare pit latrines in swampy or frozen ground.
- Dry snow zone**—Zone on icecap where maximum temperatures are not high enough to cause melting.
- Edging**—To place or hold a ski at a different angle than that of the supporting snow.
- Fall line**—The imaginary line running directly down a slope in relation to the skier. The line of gravity pull or of straight descent down which a ball of snow would roll.
- Fast ice**—All types of ice, broken or unbroken, attached to the shore, beached, stranded, or attached to the bottom in shoal water.
- Freezeup**—Periods during which the ground surface freezes and ice cover forms on streams and lakes. This period varies from 1 to 3 months depending on regional and local climatic conditions. Maintaining mobility during this period becomes easier as the period progresses.
- Frostbite**—A cold injury caused by freezing of the body tissues.
- Frost boil**—Accumulation of excess water and mud in subsurface materials during spring thawing. It usually weakens the surface and may break through, causing a quagmire.
- Frostline**—(See frost table).
- Frost mound**—A localized uplift of land surface caused by frost heaving or by ground water pressure. Also called earth mound, earth hummock, pals, pingo, or pingok.

- Frost table*—More or less irregular surface that represents the depth of penetration of the winter frost in the seasonal frozen ground. It may or may not coincide with the permafrost table.
- Fuel tablets*—Concentrated chemical fuel dispensed in tablet form for heating rations, or starting wood fires.
- Hypothermia*—General lowering of body temperature due to loss of heat at a rate faster than the body can produce it.
- Icecrete*—A mixture of sand, gravel, and water poured into forms and frozen. The process is much the same as making concrete except that ice (instead of cement) forms the bonding material.
- Ice fog*—A fog of suspended ice crystals usually formed with the introduction of water vapor into clear, calm air of low temperature ( $-37^{\circ}$  F. or lower). Ice fog is rare at temperatures above  $-37^{\circ}$  F. and almost always present at temperatures below  $-50^{\circ}$  F. Ice fog may form over a body of troops, herd of animals, bivouac areas, motor parks, convoys, and gun positions during firing.
- Immersion foot*—An injury resembling trenchfoot caused by prolonged immersion of the extremities in water (generally from  $74^{\circ}$  to  $88^{\circ}$  F.).
- Layer principle*—Attaining additional insulation by trapping dead air in the space(s) between successive layers of clothing. Two or more thicknesses of clothing, with intervening airspace, provide greater insulation than the same thickness of clothing of the same material in a single layer.
- Muskeg*—Poorly-drained organic terrain which is characteristic of the subarctic, covered with a thick, resilient carpet of water-sodden mosses and tussocks, and underlain by a high water table, peat of variable thickness, and often permafrost.
- Pack ice*—Any large accumulation of floating ice driven closely together.
- Poling*—A pushing movement of arms and body with the ski poles against the snow to increase momentum in the glide. Single poling is referred to when each pole is used alternately to obtain this propulsion. Double poling is the use of both poles at the same time.
- Sastruga*—Zastruga (Russian)—One of a series of long parallel snow ridges occurring on the open plains and formed by the action of winds.
- Snow anvil*—See Sastruga.
- Snow bridge*—The snowmass that sometimes covers the surface opening of a crevasse.
- Tractor sled train (for oversnow movement)*—A train usually composed of cargo sleds and towed by track laying vehicles.
- Treeline*—The upper limit of tree growth in mountainous regions of the northern limit of tree growth in the Arctic.
- Trenchfoot*—A thermal injury resulting from exposure to cold, short of freezing, in a damp or wet environment.
- Tundra*—A flat or gently rolling area with a muck to rock surface over permafrost and consisting of a low mat of grasses, shrubs, and other plants. This area is found above or north of the treeline.
- Whiteout*—A condition of visibility which exists when an overcast sky prevents shadows and snow-covered terrain reflects light at about the same intensity as the sky causing the horizon to be indistinguishable and the recognition of irregularities in terrain very difficult. Only very dark objects can be seen. Fog will sometimes create a similar condition.
- Williwaw*—A sudden violent and cold downslope wind, which is common along mountainous coastal areas in the northern latitudes. A williwaw may last several days.

INDEX

	Paragraph	Page		Paragraph	Page
<b>Action when lost:</b>			<b>Clothing (individual):</b>		
Conduct of individual .....	5-12	115	Adjustment .....	2-4, 2-5	6
Ground-to-air signals (code) ..	App B	154	Basis of issue .....	2-1	5
Planning of movement .....	5-10	114	Camouflage .....	2-10	15
Within known locality .....	5-11	115	Components .....	2-7, 2-8	8, 10
<b>Aerial:</b>			Layer principle .....	2-5, 2-6	6, 7
Photographs .....	6-20	138	Load .....	App E	170
Reconnaissance .....	6-19	138	Maintenance .....	2-11	16
<b>Aircraft:</b>			Principles of design .....	2-5	6
Fixed-wing .....	5-18	121	Proper use .....	2-5, 2-6,	6, 7,
Rotary-wing .....	5-18	121	5-4		105
<b>Airfields and airstrips .....</b>	5-19	121	Purpose .....	2-4	6
<b>Ammunition:</b>			Weights .....	App E	170
General .....	6-5	123	<b>Cold injury .....</b>	2-4, 3-36	6, 45
<b>Storage:</b>			<b>Cold weather:</b>		
Bivouacs .....	3-57	56	Conditions .....	2-3	6
Positions .....	6-5	123	Effects .....	App F	172
<b>Atmosphere .....</b>	App. F	172	Hints .....	App G	181
<b>Avalanche .....</b>	3-50, 6-30	52, 146	Operations .....	6-2	122
<b>Bath. (See Hygiene and first aid.)</b>			<b>Combat:</b>		
<b>Bivouac:</b>			Characteristics .....	6-1, 6-2	122
Breaking .....	3-52, 3-58	54, 58	Defensive techniques .....	6-8, app D	124, 165
Establishment .....	3-51	53	Load. (See Individual load.)		
Routine .....	3-50	52	Offensive techniques .....	6-8—6-15	124
Security .....	3-50	52	<b>Concealment:</b>		
Sites .....	3-45	50	Bivouacs .....	3-45—3-49	50
<b>"Blacking out." (See Dehydration.)</b>			General considerations .....	6-16	137
<b>Body:</b>			Individuals and groups .....	6-22—6-24	138
Armor .....	2-17	21	Ski trails and tracks .....	3-46, 3-50,	51, 52,
Cleanliness .....	3-35	45	5-5, 6-20		106, 138
Heat .....	2-4, 2-5	6	Vapor clouds (ice fog) .....	6-17	138
Parasites .....	3-44	50	<b>Condensation .....</b>	3-51	53
Protection .....	2-4	6	<b>Constipation .....</b>	3-40	49
<b>Breakup season. (See Mobility.)</b>			<b>Construction:</b>		
<b>"Buddy system" .....</b>	3-36, 5-4,	45, 104,	Bough bed .....	3-54	55
6-2		122	Field latrine .....	3-58	58
<b>Camouflage:</b>			Improvised shelters .....	3-13—3-20	29
Bivouacs .....	3-45, 6-24	50, 140	Positions .....	6-8	124
Clothing .....	2-10, 6-22	15, 138	Storage .....	3-57	56
Equipment .....	6-23	140	Trash and garbage disposal ..	3-58	58
General considerations .....	6-16	137	Water point .....	3-55	56
Smoke .....	3-56	56	Weapon and ski stand (rack) ..	3-50, 3-57	52, 56
Tracks .....	3-46, 3-50,	51, 52,	<b>Cover .....</b>	6-7, 6-10,	124, 126,
5-5, 6-20		106, 138	6-15		136
Vehicles .....	6-25	140	<b>Deception .....</b>	6-26	141
<b>Carbon monoxide poisoning .....</b>	3-41, app. F	49, 172	<b>Dehydration .....</b>	3-34	43
<b>Chilling (See Hygiene and first aid.)</b>			Use of liquids .....	3-22	35
<b>Christmas Tree. (See Drying.)</b>			<b>Digging:</b>		
			Ditches for drainage .....	3-47	51
			Frozen ground .....	6-12	130

	Paragraph	Page
Positions .....	6-8, 6-12	124, 130
Tents into the snow .....	3-48, 6-22	51, 138
Weapons emplacements .....	6-8	124
<b>Discipline:</b>		
Dehydration .....	3-34	43
Garbage disposal .....	3-58	58
Heat .....	3-20, 3-52	38, 54
Hood .....	2-8	10
Personal hygiene .....	3-35	45
Shelter .....	3-51	53
Track .....	3-46, 3-50, 5-4, 6-20	51, 52, 105, 138
Water purification .....	3-30	42
<b>Drying:</b>		
Clothing .....	2-6, 3-53	7, 55
Use of "Christmas Tree" .....	3-53	55
<b>Environmental effects:</b>		
Clothing .....	2-2, 2-4	5, 6
Instruments .....	6-3	122
Mobility .....	5-2	104
Operations .....	6-2	122
Shells and grenades .....	6-11	130
Weapons .....	6-3, App D	122, 165
<b>Equipment:</b>		
Availability .....	5-4	105
Effects on movement .....	4-42	96
Group .....	3-3, 3-9, 3-14, 4-2, 6-12	22, 30, 60, 130
Individual .....	2-7-2-16, 3-54-3-58, App E	8, 55, 170
Load .....	App E	170
Oversnow .....	4-2, 4-8- 4-11, 4- 36-4-43, 5-16	60, 68, 91, 119
<b>Evacuation:</b>		
Battle casualties .....	3-43	50
Frostbite casualties .....	3-36	45
Existence load .....	App E	170
Explosives .....	6-12	130
Field sanitation .....	3-58	58
Fighting load .....	App E	170
<b>Fire:</b>		
Base .....	3-21, 3-52	34, 54
Environmental effects .....	6-11	130
Guard .....	3-20, 3-21	33, 34
Hazard .....	3-51, 3-52	53, 54
Observation and control .....	6-7	124
Prevention .....	3-52	54
Small arms .....	6-8	124
Starting and maintaining .....	3-21, 3-53	34, 55
Types .....	3-21	34
Wood .....	3-52, 3-56	54, 56
<b>Food:</b>		
Balanced meals .....	3-22	35
Natural resources .....	3-26-3-29	39
Ration types .....	3-23	36

	Paragraph	Page
<b>Footgear:</b>		
Principles of wear .....	2-8	10
Types for cold weather .....	2-8	10
Forest .....	5-2	104
Freezing .....	3-36	45
Freezeup season. (See Mobility.)		
Waterways and swamps .....	6-15	136
Frostbite .....	2-4, 3-36	6, 45
<b>Fuel:</b>		
Economy .....	3-10, 3-52	29, 54
Firewoods .....	3-52, 3-56	54, 56
Storage in bivouac .....	3-57	56
Ground-to-air emergency code .....	App B	154
Handgear and Headgear .....	2-7, 2-8	8, 10
<b>Heat:</b>		
Balance .....	2-4	6
Loss .....	2-4	6
<b>Heating:</b>		
Lean-to .....	3-15	31
Shelter .....	3-51	53
Snow cave .....	3-20	33
Tents .....	3-8, 3-9	27, 29
Hoarfrost .....	3-51	53
<b>Hygiene and first aid:</b>		
Application of tourniquet .....	3-42	49
Bathing facilities .....	3-35, 3-44	45, 50
Body parasites .....	3-44	50
Carbon monoxide poisoning .....	3-41	49
General considerations .....	3-35-3-44	45
Waste disposal. (See Field sanitation.)		
<b>Ice:</b>		
Conditions .....	5-5	106
<b>Effects:</b>		
Mines .....	6-27	142
Shells and grenades .....	6-11	130
Weapons .....	6-4, App D	122, 165
"Icecrete" .....	6-8	124
Ice fog .....	6-7, 6-17, App D	124, 138, 165
Load bearing capacity .....	5-5	106
Melting .....	3-31, 3-32, 5-2	43, 104
Reinforcements .....	5-13	115
Strength for cover .....	6-10	126
<b>Individual load:</b>		
Types .....	App E	170
Weights .....	App E	170
Initiative .....	6-2	122
<b>Instruments:</b>		
Care and maintenance .....	6-6	124
Environmental effects .....	6-3, 6-6	122, 124
<b>Insulation:</b>		
Clothing .....	2-5	6
Ground .....	3-54	55
Snow cave .....	3-20	33
Land navigation .....	5-7-5-9	113

	Paragraph	Page		Paragraph	Page
<b>Layer:</b>			<b>Overheating</b> .....	2-6—2-8	7
<b>Components:</b>			<b>Paper plates</b> .....	3-22	35
Cold-dry weather uniform	2-7	8	<b>Penetration:</b>		
Cold-wet weather uniform	2-7	8	Ice .....	6-10	126
Intermediate .....	2-8	10	Icecrete .....	6-10	126
Outer .....	2-8	10	Snow (various types) .....	6-10	126
Principle .....	2-4, 2-5	6	Timber .....	6-8	124
<b>Leadership</b> .....	7-1—7-4	148	<b>Principles:</b>		
<b>Lean-to. (See Shelters.)</b>			Application of basic .....	2-6	7
<b>Living off country</b> .....	3-27—3-29	40	Clothing design .....	2-5	6
<b>Loads:</b>			Feeding .....	3-22	35
Distribution .....	5-4	105	Keeping warm .....	2-6	7
Individual .....	App E	170	Layer .....	2-5	6
Weights .....	App E	170	Leadership .....	7-2	148
<b>Maintenance:</b>			Wearing footwear .....	2-8	10
Clothing and equipment .....	2-11	16	<b>Protection:</b>		
Skis and snowshoes .....	4-11, 4-37	69, 92	Avalanches .....	6-30	146
<b>Measurement Conversion Factors</b> .....	App H	191	Body .....	2-4	6
<b>Mess gear</b> .....	3-22	35	Small arms fire .....	6-8	124
<b>Messing</b> .....	3-24, 3-25	37, 39	<b>Rations. (See Food.)</b>		
<b>Mines</b> .....	6-27—6-29	142	<b>Rats and mice. (See Field sanitation.)</b>		
<b>Mobility:</b>			<b>Rescue</b> .....	App B	154
Individual .....	4-2, 5-1	60, 104	<b>Responsibilities of unit leader</b> .....	2-2, 3-50, 7-2	5, 52, 148
<b>Influence:</b>			<b>Roads:</b>		
Breakup and freezeup .....	5-2, 6-3	104, 122	Lack .....	5-1	104
Terrain .....	5-2, 5-13, 5-14, 6-14	104, 115, 116, 133	Winter .....	5-2, 5-13	104, 115
Weather .....	5-2, 5-18	104, 121	<b>Route:</b>		
Oversnow equipment .....	4-2	60	<b>Influence:</b>		
Rates of movement .....	4-2	60	Seasonal changes .....	5-2	104
Techniques .....	4-2, 4-44	60, 101	Terrain .....	5-2	104
<b>Moisture</b> .....	2-3	6	Weather .....	5-2	104
<b>Movement:</b>			Obstacles .....	5-5	106
Air .....	5-18	121	Reconnaissance .....	5-4, 5-7	105, 113
Barriers .....	5-1, 5-2	104, 133	Selection .....	5-5	106
Cross-country .....	4-2, 4-6, 4-36, 5-3, 5-4	60, 62, 91, 105	Water .....	5-1, 5-2, 5-5	104, 106
Effects of individual equipment .....	4-42	96	<b>Safety Measures:</b>		
Environmental effects .....	5-4, 5-1	62, 104	<b>Against:</b>		
Foot .....	5-4	105	Asphyxiation .....	3-20	33
Mechanized aids .....	5-13—5-18	115	Avalanches .....	6-30	146
Rates of movement .....	4-2	60	Chilling .....	5-4	105
Requirement for trailbreaking. (See Trailbreaking.)			Dehydration .....	3-34	43
Skijoring .....	4-44	101	Fire .....	3-21, 3-45, 3-52	34, 50, 54
<b>Observation:</b>			"Buddy" system .....	6-2	122
Fire .....	6-7	124	Health hazards .....	3-36, 3-41	45, 49
<b>Obstacles:</b>			<b>Search</b> .....	App B	154
Artificial .....	6-27—6-31	142	<b>Security:</b>		
Crossing technique .....	4-41	96	Bivouacs .....	5-5	106
Improving after snowfall .....	6-32	146	Marches .....	5-5	106
Natural .....	6-30	146	<b>Shelters:</b>		
Swamps .....	6-15	136	Construction of improvised .....	3-13—3-18	29
<b>Operations:</b>			Living .....	3-51	53
Characteristics .....	3-1	22	Need .....	3-4	22
Composition of units .....	3-2	22	<b>Shock. (See Hygiene and first aid.)</b>		
Rescue .....	App B	154	<b>Ski:</b>		
			Binding .....	4-8	63

	Paragraph	Page		Paragraph	Page
Care and storage	4-11	69	Sunburn. ( <i>See Hygiene and first aid.</i> )		
Drill	App C	157	Sunlight:		
Equipment	4-8, 6-9	63, 64	Effects on snow composition	4-3	61
Pole	4-8	63	Tanks	5-15	117
Preparation	4-9, 4-10	64, 66	Team System	6-2	122
Racks (stands)	3-57	56	Temperature:		
Skijoring	4-44, 5-5	101, 106	Effects on snow composition	4-3	61
Stacking	3-57, App C	56, 157	Tentage:		
Waxing	4-10	66	Description	3-4, 3-5	22, 23
Skiing:			Heating	3-8, 3-9, 3-52	27, 29, 54
Advantages and disadvantages	4-6	62	Lighting	3-11	29
Consideration of mobility	4-2	60	Pitching and striking	3-6, 3-48, 6-12	25, 51, 130
Preparation of equipment	4-9, 4-10	64, 66	Tools	3-12	29
Techniques	4-12, 4-40	72	Use in combat	6-12	130
Skijoring:			Ventilation	3-7	27
Effect on mobility	4-44	101	Terrain:		
Techniques	4-44	101	Barren tundra	3-48	51
Sled:			Effects on mobility	4-5, 5-2	62, 104
Handling and placement in			Forests	3-46	51
bivouac	3-57	56	Hazards	3-45	50
Harness, sled, single trace	5-16	119	Marshy ground	3-47, 6-10, 6-11	51, 126, 130
Pulling techniques	4-43	97	Mountains	3-50	52
Types	5-16, 5-17	119, 120	Suitability for trailbreaking	5-5	106
Use of triple-track	5-5	106	Thawing	2-3	6
Sleeping:			Tools:		
Arrangements in shelter	3-54	55	Placing inside of shelter	3-51	53
Bough bed	3-54	55	Requirement for:		
Snow:			Digging in frozen ground	6-12	130
Blindness. ( <i>See Hygiene and first aid.</i> )			Small unit	3-12	29
Characteristics	4-4	61	Trailbreaking	5-5, 5-6	106, 112
Classification	4-10	66	Effects:		
Composition	4-3	61	Terrain	4-5, 5-2, 5-5	62, 104, 106
Conditions	5-5	106	Weather	5-5	106
Drifts	3-48, 6-15	51, 136	Trails:		
Effects:			Camouflage and concealment	3-46, 3-50, 5-5, 6-20	51, 52, 106, 138
Mines	6-27	142	Types	5-5	106
Shells and grenades	6-11	130	Training:		
Weapons	6-4, App D	122, 165	Objectives for military skiing	4-7	63
Fences	6-12	130	Snowshoeing	4-39	94
Melting	3-31, 3-32, 5-2	43, 104	Requirement for cold weather operation	6-1	122
Reinforcements	5-13	115	Trench foot. ( <i>See Hygiene and first aid.</i> )		
Shelters	3-16—3-20	32	Types of Loads. ( <i>See Individual load.</i> )		
Shoes	4-2	60	Uniform:		
Strength for cover	6-10	126	Cold dry weather	2-8	10
Snowshoeing:			Cold wet weather	2-8	10
Need for mobility	4-2, 4-36	60, 91	Vehicles:		
Techniques	4-38	94	Development of vapor clouds	6-17	138
Soil Condition:			Maintenance	App F	172
Effects on shells and grenades	6-11	130	Operational procedures	App F	172
Sounds	6-18	138	Placing in bivouacs	3-57	56
Storage	3-57	56			
Stove:					
Operating procedures	3-8, 3-52	27, 54			
Types:					
Tent, M-1941	3-9	29			
Yukon, M-1950	3-8	27			



	Paragraph	Page		Paragraph	Page
<b>Vehicles—Continued</b>			<b>Stand (rack)</b> .....	3-50, 3-51, 3-57	52, 53, 56
Types .....	5-13—5-15	115	<b>Support used in snow</b> .....	6-9	125
<b>Ventilation:</b>			<b>Weather:</b>		
Clothing .....	2-5	6	Blizzards .....	5-1	104
Tentage .....	3-7	27	Blowing snow .....	6-7	124
<b>Visibility:</b>			<b>Effects:</b>		
Effects:			Infantry weapons .....	App D	165
Land Navigation .....	5-8	113	Trailbreaking .....	5-5	106
Operations .....	6-19	138	Fog .....	6-7	124
Trailbreaking .....	5-5	106	Ice fog phenomenon .....	6-17	138
Ice Fog .....	6-7, App D	124, 165	Limitations on air operations	5-18	121
<b>Water:</b>			Seasonal changes .....	5-2	104
Availability in cold regions ..	3-30	42	Sudden changes .....	5-4	105
Consumption .....	3-22	35	<b>Weights:</b>		
Dehydration .....	3-22, 3-34	35, 43	Individual clothing and		
Points .....	3-30, 3-55	42, 56	equipment .....	App E	170
Purification .....	3-30	42	Individual loads .....	App E	170
Sources .....	3-30, 3-31	42, 43	<b>Wind:</b>		
Transportation .....	3-30	42	Chill .....	App F	172
Ways .....	5-1, 5-2, 5-5	104, 106	<b>Effects:</b>		
<b>Weapons:</b>			Bivouacs .....	3-48, 3-49	51, 52
Care, cleaning and mainte-			Combat .....	6-7, 6-15	124, 136
nance .....	6-4	122	Ice .....	6-8	124
Environmental effects .....	6-3, 6-7, 6-17, App D	122, 124, 138, 165	Snow composition .....	4-3	61
Handling in combat .....	6-14	133	"Falls" .....	4-41, 6-30	96, 146
Hanging .....	3-57	56	<b>Windchill</b> .....	App F	172
Positions in winter .....	6-8,	124	<b>Winter:</b>		
			Effects on mobility .....	5-2	104

By Order of the Secretary of the Army:

Official:

**KENNETH G. WICKHAM,**  
*Major General, United States Army,*  
*The Adjutant General.*

**HAROLD K. JOHNSON,**  
*General, United States Army,*  
*Chief of Staff.*

Distribution:

To be distributed in accordance with DA Form 12-11 requirements for Basic Cold Weather Manual.

U.S. GOVERNMENT PRINTING OFFICE : 1994 O - 154-616

