

FM 29-20

DEPARTMENT OF THE ARMY FIELD MANUAL

MAINTENANCE MANAGEMENT IN THEATERS OF OPERATION



HEADQUARTERS, DEPARTMENT OF THE ARMY
JULY 1968

FIELD MANUAL }
 No. 29-20 }

HEADQUARTERS
 DEPARTMENT OF THE ARMY
 WASHINGTON, D.C., 26 July 1968

MAINTENANCE MANAGEMENT IN THEATERS OF OPERATIONS

	Paragraphs	Page
PART ONE. MAINTENANCE SUPPORT PRINCIPLES, FUNCTIONS, CONTROLS, AND ORGANIZATION		
CHAPTER 1. INTRODUCTION	1-1-1-4	1-1, 1-2
2. LOGISTICS AND THE ROLE OF MAINTENANCE	2-1-2-6	2-1-2-4
3. MAINTENANCE IN RELATION TO TYPES OF OPERATIONS	3-1- 3-11	3-1- 3-14
4. TYPE THEATER MAINTENANCE SUPPORT ORGANIZATIONS	4-1-4-9	4-1-4-7
5. MAINTENANCE CATEGORIES, STANDARDS, POLICIES, PRINCIPLES, AND PROBLEMS	5-1-5-6	5-1-5-9
PART TWO. MAINTENANCE MANAGEMENT: RESPONSIBILITIES AND FUNCTIONS		
CHAPTER 6. INTRODUCTION	6-1-6-3	6-1, 6-2
7. MAINTENANCE MANAGEMENT IN THE COMMZ		
Section I. Theater Headquarters (Unified/Specified Command)	7-1-7-3	7-1, 7-2
II. Combined Command	7-4-7-6	7-2
III. Theater Army Headquarters	7-7, 7-8	7-3
IV. Theater Army Support Command (TASCOM) Headquarters	7-9-7-11	7-3
V. Supply and Maintenance Command	7-12- 7-15	7-6- 7-11
VI. Field Depot	7-16- 7-18	7-13 7-16
VII. Area Support Command	7-19- 7-21	7-19- 7-21
VIII. Area Support Group	7-22- 7-24	7-24- 7-26
CHAPTER 8. MAINTENANCE MANAGEMENT IN THE COMBAT ZONE		
Section I. Army Group	8-1, 8-2	8-1
II. Field Army	8-3-8-5	8-1, 8-2
III. Field Army Support Command	8-6- 8-12	8-2- 8-12
IV. Support Brigade	8-13- 8-16	8-12 8-14
V. Corps	8-17, 8-18	8-16- 8-17
VI. Support Group (Corps or Army)	8-19-8-21	8-17
VII. Division	8-22, 8-23	8-18, 8-19

*This manual supersedes applicable portions of FM 55-45, 1 June 1965, and together with FM 29-22, 26 July 1968, supersedes FM 29-21 (TEST), 7 April 1967.

	Paragraph	Page
VIII. Division Support Command	8-24—	8-19—
	8-27	8-22
IX. Separate Brigade	8-28—	8-22,
	8-31	8-23
CHAPTER 9. MAINTENANCE MANAGEMENT OPERA-		
TIONAL PROCEDURES		
Section I. Maintenance Management Centers	9-1—	9-1—
	9-6	9-14
II. Maintenance Management in the Divisions	9-7,	9-15,
	9-8	9-16
III. Combat Service Support Data System	9-9,	9-16,
	9-10	9-17
IV. Interim Procedures for Maintenance Management ..	9-11, 9-12	9-18
APPENDIX A. REFERENCES		A-1
INDEX		INDEX 1

PART ONE
MAINTENANCE SUPPORT PRINCIPLES, FUNCTIONS,
CONTROLS, AND ORGANIZATION

CHAPTER 1
INTRODUCTION

1-1. Purpose and Scope

a. Purpose.

(1) To provide commanders and staffs of echelons above battalion level with a single source of reference describing the composition of the maintenance support structure for support of the Army in the field and command and control of this structure.

(2) To indicate the principles, policies, and practices involved in providing maintenance support and to describe their application in the management of maintenance service.

(3) To describe the interaction of maintenance management with the planning and conduct of combat operations.

b. Scope.

(1) This manual is divided into two parts. Part one deals with the planning, establishment, and characteristics of the maintenance support structure in a theater of operations. Maintenance principles, policies, and problems are also addressed. A discussion of the interrelationship of logistics and tactics is presented to establish a basis for understanding the role played by logistics in limiting or qualifying military operations, and to indicate the contribution of maintenance to the overall logistical and tactical effort.

(2) Part two is devoted to management of maintenance support operations and resources. The functions and methods of operation of maintenance staffs and maintenance management centers at various echelons are discussed in detail.

(3) For specifics on types of units provided for maintenance support of Army materiel and the procedures and controls used at

battalion and lower levels, see FM 8-10, FM 8-15, FM 10-8, FM 29-22, FM 29-27, FM, 29-30, FM 55-21-1(TEST), and FM 55-50-1(TEST). For information on the overall combat service support structure and its operations in a theater of operations, see FM 100-10. For reference data useful in maintenance support planning, see FM 3-8, FM 5-35, FM 8-55, FM 9-2A, FM 10-13, FM 24-19, FM 55-15, FM 101-10-1, and FM 101-10-3. For information on the maintenance functions and responsibilities of agencies and activities above theater level and for a description of the maintenance system in posts, camps, and stations in the continental United States, see FM 38-5.

(4) For details on planning, staff coordination, and staff relationships within and between the various headquarters in a theater of operations, see JCS Pub 2 and JCS Pub 3, and FM 100-5, FM 101-5, FM 100-10, and FM 100-15.

(5) In addition to maintenance, this manual discusses "maintenance resources." These include repair parts (class IX supplies), maintenance materials, and tools (class II supplies) required for the performance of maintenance; time; personnel, to include local civilian labor; and facilities.

1-2. Application

a. The procedures discussed herein are particularly applicable at echelons from support group through theater army headquarters. This manual can also be used as a reference document on maintenance support characteristics, principles, and controls at any echelon concerned with maintenance support planning and management. For example, personnel as-

signed to military assistance advisory groups may find this manual of use in providing advice on development and management of a maintenance support structure to support the military establishment of the host country.

b. Effective maintenance management requires a continuous and accurate flow of data relative to materiel readiness, maintenance performance, maintenance requirements, and the like. Currently, such data is provided under the provisions of AR 11-14, AR 220-1, TM 38-750, and TM 38-750-1. Such data, however, comprises only a portion of the total data available and required for maintenance management as described in part two of this manual. The combat service support data system described in chapter 9, will provide for the collection and processing of data for combat service support applications on a refined and expedited basis through large-scale use of automatic data processing facilities. Until the system is fully implemented, the maintenance management system must depend on data provided in accordance with the aforementioned Army regulations and technical manuals, supplemented by such manually-prepared reports as may be required.

c. This manual is applicable to nuclear and nonnuclear warfare; to operations in a cold, limited, or general war; and to operations wherein chemical, biological, or radiological weapons are employed. The influences of special type operations are introduced, as necessary, within the text.

d. This manual is to serve as a guide to permit understanding and solution of prob-

lems inherent to the planning, management, and control of maintenance service. Users of this manual, acting within the scope of their designated authority, may vary these procedures when it is evident that such variations will result in improved maintenance service.

1-3. Changes

Users of this manual are encouraged to submit changes or recommendations to improve its clarity or accuracy. Comments should be keyed to the specific page, paragraph, and line of the text in which the change is recommended. Reasons should be provided for each comment to insure understanding and permit complete evaluation. Comments should be forwarded direct to the Commanding Officer, U.S. Army Combat Developments Command Maintenance Agency, ATTN: CDCMA-D, Aberdeen Proving Ground, Maryland 21005. Originators of proposed changes which would constitute a significant modification of approved Army doctrine may send an information copy, through command channels, to the Commanding General, U.S. Army Combat Developments Command, Fort Belvoir, Virginia 22060 to facilitate review and followup.

1-4. Definitions and Abbreviations

Most of the terms used in this manual are defined in AR 320-5; most of the abbreviations are explained in AR 320-50. Those terms and abbreviations not yet incorporated in these regulations are defined or explained when first introduced in the text.

CHAPTER 2

FUNCTIONS AND RELATIONSHIP OF MAINTENANCE SERVICE

2-1. Introduction

a. Tactical as well as strategic plans must be based on those resources that can be made available to conduct and support contemplated military operations. Organizationally, these resources are divided into three categories; combat, combat support, and combat service support. Such a division facilitates discussion of individual elements of the overall structure and description of their functions. However, all are part of one integrated, singular military force with but one objective—the accomplishment of the overall mission of the force.

b. This manual is concerned with combat service support operations, and more specifically, with maintenance and maintenance-related functions.

(1) Combat service support is defined as that assistance provided to operating forces in the field of administrative services, chaplain service, civil affairs, finance, legal service, military police, replacements, supply, transportation, medical service, maintenance, and other logistical services. For further information on combat service support to the theater of operations, see FM 100-10.

(2) Maintenance is defined as all actions necessary for retaining or restoring an item to a specified condition. It includes inspection, testing, servicing, classification as to serviceability, repair, rebuilding, and reclamation (AR 320-5).

2-2. Maintenance, A Command Responsibility

a. Maintenance is a prime concern of all commanders. Maintenance, whether accomplished by elements organic to combat and combat support units or provided by combat service support maintenance units, contributes to the materiel and operational readiness

of a command, and thus contributes to the command's combat potential.

b. At lower levels of command, maintenance resources of limited scope are provided as organic elements of the command, as in infantry and tank battalions. These organic resources contribute significantly to the materiel and operational readiness of the command and its ability to perform its operational mission; however, these resources must be supplemented and backed up by maintenance support elements charged with the primary mission of providing direct support maintenance.

c. At higher echelons, such as division, independent corps, field army, and theater army, a separate and identifiable combat service support organization containing a maintenance support structure is provided as a separate command, which is assigned to major command headquarters of the force. The commander of the combat service support organization commands and supervises the maintenance support units and other support units comprising the organization. He must plan, deploy, and employ his maintenance resources in a manner that will best support operations of the supported force. The combat service support commander and his staff must continually remain cognizant of current and future maintenance support requirements of the supported force, the current tactical situations, and future tactical plans, and must be prepared to participate in the development of overall operational plans.

d. The tactical commander and his staff are responsible for overall operational planning and for properly integrating all aspects of operations, including maintenance, essential to execution of the overall plan of operations. The tactical commander and his staff must be kept informed on the pertinent aspects of mainte-

nance and maintenance related operations, as well as on other aspects of logistics, that will influence their planning, and must consider the capabilities and limitations of the maintenance support structure in developing their operational plans.

e. Therefore, a continuous interchange of information between tactical and combat service support unit commanders and their staffs is necessary to successful military operations. This interchange of information is accomplished primarily by liaison and coordination between staff elements, and is supplemented by briefings and the dissemination of reports, data, plans, and estimates that are meaningful and in terms understandable to the coordinating headquarters.

2-3. Functions of Maintenance Service

Maintenance service includes more than the repair of equipment—

a. At the using unit level it involves timely, adequate and efficient performance of all maintenance tasks required at this level, and management of the organizational maintenance effort.

b. At the direct support unit level, maintenance service includes inspection, testing, servicing, maintenance calibrating, classification as to serviceability, and repair of equipment. It also involves the return of repaired items to using units and arranging for the evacuation of repairables that cannot be repaired at the direct support level. Repair parts supply to using units is also a function of maintenance at the direct support level. Limited parts fabrication may also be performed. Also included is assistance to supported units through the conduct of maintenance inspections, through the provision of technical assistance, and through the provision of assistance in equipment recovery, when necessary. Maintenance service at this level requires close coordination and liaison with supported units to determine support requirements and problem areas, and to keep supported units informed of maintenance policies and plans.

c. At the general support unit level, maintenance service involves the performance of repair functions that generally take more time

than available at the direct support level. Also involved is the performance of direct support workload evacuated as overflow work. Inspection, testing, and classification as to serviceability are also involved at this level. Repaired items normally are returned to the supply system. Repair parts supply is not a function of general support maintenance.

d. At higher echelons, combat service support commanders and staffs are responsible for maintenance objectives and the means for accomplishing these objectives; maintenance support planning and supervision; mission assignments and the deployment and redeployment of maintenance support units; development and/or implementation of policies and directives; determination of requirements for maintenance support and the allocation of resources; overall materiel and operational readiness of equipment and units; collection, processing, and analysis of maintenance and related data; and the coordination of maintenance and maintenance related activities.

2-4. Relationship of Maintenance to Supply

a. To function effectively, the Army must have sufficient equipment, at the right place, at the right time, and this equipment must be kept in a serviceable condition. This is especially true in combat, where failure to keep equipment operable has the same effect as combat losses. Equipment breaks down, wears out, or suffers damage due to enemy action, improper operation, lack of care, misuse, or deterioration due to conditions of climate, terrain, or weather. The user must operate without unserviceable equipment until it can be replaced by supply action or made serviceable by maintenance action.

b. There are many variables that influence the decision to either replace an item by supply action or restore it to serviceability by maintenance action. A list of these influencing factors includes: the ability of the supply system to provide replacement items, criticality of the items; the speed with which replacements must be provided; the time and work required to return the unserviceable items to serviceability; the availability of repair parts and technical skills required for repair; and the

expected service life of the item after repair; costs of repair as opposed to costs of new items; maintenance workloads; and policies of higher headquarters. Evacuation policy which may limit the amount of work done on an unserviceable item at the direct support level also influences this decision. Policies regarding repair of equipment as opposed to replacement of unserviceable items are determined and published by major headquarters.

c. Depending on the degree of unserviceability and the level where the maintenance is to be performed, it is often more practical and economical to repair unserviceable items for return to the supply system or to the user, rather than replace the items. Repair reduces the demands on the supply system for replacement items; conserves transportation, including shipping space from CONUS to an overseas theater; conserves productive capacity and raw materials in the CONUS base; eases the strain on the national economy; is normally less costly than provision of a replacement item; and most often results in more prompt reaction to user requirements. Maintenance, however, depends on the supply system to provide the repair parts and materials required for equipment repair.

d. In some cases it is more economical to reclaim or discard an unserviceable item and secure a new item from supply. In fact, some items are purposely designed to permit their "throwaway" when they become unserviceable. Normally, when an unserviceable item requires repairs with cost exceeding "economical repair limits" established in appropriate publications, the item is salvaged and supply provides a replacement. Items scheduled for disposal are normally routed through collection and classification units where usable and needed repair parts and components are reclaimed for return to the supply system.

e. The decision to repair an item or reclaim it and provide a replacement from supply are based on the criticality of the item, the considerations noted above, and resources available to the commander making the decision.

f. Maintenance and maintenance-related activities such as maintenance collecting points also reduce demands on the supply system

through their reclamation actions. This is done by removing serviceable or economically repairable components, assemblies, and repair parts from end items or large components that have been classified as uneconomically repairable. To a lesser extent, maintenance units can also supplement the supply system by the fabrication of certain items not available in supply channels.

g. The results of a reduced maintenance capability or efficiency are felt in the supply system as increased demands for end items and components, and in the transportation system as increased requirements on transportation resources to make distribution. When demands for end items exceed supply resources, the maintenance system can respond by more extensive maintenance operations, provided the necessary resources are available. When the supply system cannot provide all the repair parts required for maintenance performance, increased emphasis must be placed on reclamation or parts fabrication within maintenance channels or local procurement within supply channels. The inadequacy of either maintenance or supply must be counterbalanced by increased effort and response of the other, otherwise it will adversely affect the materiel readiness of the command and, consequently, its combat potential. Therefore, close coordination and cooperation between supply and maintenance are necessary.

2-5. Relationship of Maintenance to Transportation

a. Transportation and aviation units are among the largest customers of the maintenance system in a theater of operations. Thus, the location of transportation terminals and airfields must always be considered when planning the location of maintenance support units. This is especially true in the case of aircraft, railway, and marine equipment maintenance units.

b. While the transportation system must satisfy extensive demands for its services, transport requirements of the maintenance support structure must be considered in allocating priorities for available transportation. The transportation systems must deliver re-

pair parts and operational readiness float items (para 5-5s) to maintenance units, evacuate unserviceable materiel, and assist in the deployment of maintenance units. Although each maintenance support unit has organic transportation, most such units will require additional transportation support from time to time for displacement or for performance of certain mission functions. Such requirements must be considered in the determination of priorities and the allocation of transportation available to a command.

2-6. Communications

Reliable and effective communications are also necessary to maintenance support operations. High speed, automated systems, are required for the transmission of information between elements of the maintenance support structure. Responsive communications are required for command and control of maintenance support units, for the submission of requirements, and for coordination with supported units, adjacent units, and higher headquarters.

CHAPTER 3

MAINTENANCE IN RELATION TO TYPES OF OPERATIONS

3-1. Peacetime and Cold War Operations

a. The United States is a party to many mutual defense agreements, and contributes advisors, forces, and/or logistical support to friendly allied countries and multinational defense forces. As a result, U.S. Army elements are deployed in many foreign countries. Maintenance support of these forces must be provided; and in some cases the maintenance system must provide support to allied forces using U.S. equipment.

b. In most areas of the world, U.S. forces are operating in essentially a peacetime atmosphere, despite threats, shows of force, demonstrations, harassments, and the requirement for constant vigilance that have become associated with what has been termed cold war. The provision of maintenance support in such situations presents many problems which differ from those encountered in wartime. These problems challenge the ingenuity and test the planning and management capabilities of commanders and staffs at all echelons. Some of the problems and limitations to be contended with are:

(1) Planning for expansion of services and the assimilation of augmenting forces during those periods of the cold war and in those places where escalation to actual conflict is threatened.

(2) Providing maintenance services and maintenance supply support using an organizational structure that is inhibited by personnel limitations and one that depends, to a great extent, on augmentation by local civilian labor. Additionally, operational limitations are imposed by budgetary considerations, status of forces agreements, multinational agreements to which the U.S. subscribes and the laws and customs of the area in which operations are being conducted.

(3) Performing maintenance in accordance with standards that are generally higher than those required in wartime.

(4) Participating in reorganizations and the testing of new concepts in an effort to improve organization and operations.

c. At any time, the U.S. may be required to increase its troop commitment in the country of an ally to counter or forestall threat of aggression; it may be required to engage in combat against insurgent forces operating in the country of an ally; or forces may be required in entirely new operational areas to counter actual or potential aggression. When this happens, commitments may be reappraised at Department of Defense level and priorities of effort may be modified. As a consequence, maintenance support in other operational areas may be affected as follows:

(1) Leadtime for obtaining repair parts and replacement equipment in one theater or an area in a theater may increase because of priorities for resupply and shipping to a more critical area. This may affect maintenance support operations by requiring increased maintenance effort to repair unserviceable items rather than replace them, and may require more emphasis on reclamation of parts and components from uneconomically repairable end items.

(2) Budgetary restrictions may affect maintenance support operations by limiting the quantity of replacement items and repair parts available, by limiting local procurement of maintenance supplies required for maintenance performance, and by limiting use of civilian labor to augment the maintenance effort.

(3) Personnel shortages may limit maintenance support operations because of a lack of sufficient personnel or lack of personnel

FM 29-20

with the proper skills for maintenance performance, requiring more emphasis on local training and cross-training of personnel.

(4) More rapid personnel turnover will also affect maintenance operations and require local training and cross-training of maintenance personnel.

d. In the planning, conduct, and management of maintenance support in a peacetime and cold war environment, commanders and staffs develop operational plans and procedures within the framework of: personnel and budgetary limitations; regulations and directives of Department of the Army and responsible higher headquarters; national and Department of the Army policies; and responsibilities assigned by major headquarters which may be multinational in nature. Other influencing factors include agreements, treaties, or memorandums of understanding established by the U.S. Government, U.S. force headquarters, or the headquarters of multinational forces such as NATO or the UN and the government of the friendly country where operations are taking place.

3-2. Transition from Peacetime to Wartime Operations

a. General.

(1) This paragraph covers operations in areas where U.S. troops have been committed prior to the outbreak of active hostilities in accordance with treaties, agreements, and mutual defense pacts. In these areas there exists an established maintenance support complex, established communications and supply lines, supply stocks, and other facilities necessary to provide support. The problem for commanders and staffs is to develop the support complex, as necessary, to compensate for the increased tempo of operations, to maximize use of available resources until required buildup can be achieved, to adopt previously prepared contingency plans based on developments of the tactical situation, and to prepare plans for reaction to a situation which may be initially favorable to the enemy since the area of hostilities and the scope of the conflict could initially be of the enemy's choosing.

(2) When U.S. forces are to be committed

in areas where they have not been committed previously, as in amphibious assaults on enemy territory or rapid deployment to a threatened friendly country in response to requests for assistance, a requirement for troop planning, phasing, and base development exists. For more information on these subjects, see FM 101-10-1.

b. Considerations Affecting Maintenance Support.

(1) In some respects, the planning and provisioning of maintenance support during hostilities are simpler than in peacetime; e.g., personnel policies may be such as to preclude loss of experienced personnel due to separation or rotation, with personnel being required to serve for the duration of the conflict, or personnel requirements of the area of operations may be given top priority over requirements of other areas of operation. Also, many regulatory or financial limitations on operations are modified or lifted and support from the CONUS or other logistical base may be provided on a priority basis. Conversely, other problems are compounded and new ones appear; for example, increased equipment usage and battle damage to equipment will increase maintenance workloads; enemy action may interdict supply routes, damage maintenance facilities, eliminate or reduce the effectiveness of maintenance support units, and force frequent deployment of maintenance units. All these factors increase the problems of providing maintenance support. Requirements for rear area protection operations, FM 19-45-1 (TEST), may further reduce the capability of maintenance support units to perform mission functions.

(2) In the transition period between peacetime and wartime operations, the management and direction of resources available in the theater must be geared to satisfying the most critical requirements first and to make fullest use of available resources. Although buildup of the area force structure, to include maintenance elements, may be required, it will take time to mobilize, train, equip, and transport the men and provide the supplies that may be required on a large scale to bring U.S. forces

in the theater up to required strength. Modern techniques of air-delivery of forces, and the availability of stand-by forces, ready and equipped to fly to any part of the world on short notice, can do much to bolster theater strength.

(3) Rapid buildup of the combat strength in a theater must be accompanied by a corresponding buildup of the support structure, to include maintenance support units. This requires coordination between the theater and CONUS on the numbers and types of units to be deployed to the theater and when they can be expected to arrive. The theater then must make plans to receive and process such units when they arrive, must be prepared to provide any administrative support required, and must have developed plans for employment of such forces upon arrival, to include mission assignments.

(4) Another factor to be considered in theater buildup is the massive arrival of supplies and equipment, to include repair parts, that is normally associated with such a buildup. The arrival of supplies and equipment in large quantities may result in problems of identification and distribution of such supplies and problems in terminal clearance. Plans for the receipt and distribution of such supplies must be well coordinated. Combat service support commanders and their staffs must assure that support units are on hand prior to the arrival of such supplies. These support units will include maintenance units as required to deprocess materiel and to reassemble items that may have been broken down for shipment. Further, priorities for off-loading vessels and aircraft must be developed beforehand to assure that priority supplies and equipment are not delayed in handling at terminals. Such planning requires close cooperation and coordination between maintenance and supply staff elements.

(5) Additionally, commanders and their staff will be faced with such requirements as—

(a) Implementing plans to use resources of the local economy to the fullest (consistent with requirements of the local government) to lessen the strain on the transportation system and the industrial base in CONUS,

thereby releasing ships, aircraft cargo space, and industrial production to critical needs that cannot be supplied from within the theater.

(b) Providing training required by the increase of equipment types and models entering the theater and modifying maintenance and supply plans accordingly; e.g., revision of repair parts stockage lists and revision of troop lists.

(c) Implementing contingency plans, to include establishment of duplicate or alternate facilities (e.g., maintenance management centers and stock control centers) to compensate for losses of primary facilities.

(d) Bringing reduced strength or type B maintenance units to authorized strength in U.S. personnel as required by increased workloads and the loss of local civilian laborers who may be conscripted into the armed forces of the friendly nation where operations are taking place.

(e) Implementing more rigid security measures.

(f) Reconstituting maintenance units or installations made ineffective through enemy action.

(g) Modification of support plans as required by the dynamics of the situation (e.g., reduction, at the direct support level, of the maximum number of man-hours to be spent on specific maintenance tasks to permit the mobility required; reliance on controlled cannibalization as a source of certain repair parts).

3-3. Limited War

a. General. A limited war presumes restraint on the part of U.S. and enemy forces with respect to use of nuclear, chemical, biological, and radiological weapons. When such weapons are used, the situation becomes one of general war, and the guidance contained in paragraph 3-4 must be applied to material in this paragraph.

b. Offensive Operations (Ground).

(1) Prior to initiation of offensive operations, equipment of participating units is inspected, required maintenance is performed, equipment shortages are made up, repair parts stockage is brought up to desired levels, and

reserve stocks of critical items are established. Operations and administrative orders are prepared and disseminated (FM 101-5). Priorities are established for support of units, to include priorities for issue of float stocks and critical repair parts. Procedures, priorities, and conditions for aerial resupply are established. At higher levels, such as theater army and field army, plans, orders, and mission assignments are broad in scope; at successively lower echelons, plans are more complete and detailed.

(2) Maintenance planning, prior to the offensive, considers task assignments of maintenance units, stock levels for repair parts, maintenance expenditure limits to govern the time spent in repair of specific items by particular categories of support, the forward displacement of maintenance units, and channels and procedures for recovery, collection, evacuation, and disposition of captured or abandoned materiel. Repair parts stockage, in terms of days of supply, is held to a minimum consistent with the mobility requirements of the unit or facility possessing the stocks, the ability of backup supply sources to effect resupply, the availability and capability of transportation means, and the order and ship time involved. Based on the type of operation, the geographical area, and terrain and weather conditions, certain items in the supply stockage are increased; for example, extensive operations over rough terrain would dictate buildup of stockages of vehicle springs, shock absorbers, and tires.

(3) As the operation develops, it must be remembered that the wide frontages and dispersion of troops that often characterize a rapidly-moving offensive operation have an adverse affect on maintenance support operations. As the tempo of the situation and the distances involved increase, maintenance support units may have difficulty keeping pace with requirements. Displacement of maintenance support units as far forward as practical is the standard operating procedure, but must be accomplished in light of the vulnerability of these units, the capability of the enemy to launch a successful counterattack, and the requirements for maneuver room and

road space by combat elements. In operations where the overall situation requires bypassing of pockets of the enemy or guerrilla elements, the effect of such bypassing on maintenance support units and other logistical activities must be considered. In some situations, assistance from combat elements may be required to provide security to threatened logistical facilities.

(4) A point of concern to combat service support commanders and staff officers is the redirection of logistical support to satisfy changing tactical requirements. Combat forces can be easily tailored by withdrawing elements from one force and attaching them to another, and the direction of attack can be changed almost at will if the enemy situation in any particular sector permits such action. Redirection of effort and redirection of supplies as well as redeployment of maintenance units, realignment of the maintenance support structure, and changes in support procedures and emphasis are matters that require detailed planning and close coordination with tactical commanders.

(5) If the offensive is successful and gains momentum, a point may be reached where logistical support limitations make the entire force vulnerable. Lacking the ability to maneuver and displace as rapidly as combat forces, combat services support forces may be outdistanced by the combat forces and normal maintenance and supply support may be impossible. Resupply of repair parts by unit distribution may break down or become ineffective due to lack of transportation, difficulty in locating units, and increased order and ship time. At the same time, the maneuvering combat forces are suffering losses to equipment, are consuming repair parts, and the efficiency of equipment is deteriorating — factors which affect combat power. The force commander must be kept informed of the effect of the tactical situation on the capabilities of the maintenance support structure to provide required support. A few expedients that may have to be resorted to in a fast-moving situation to provide maintenance support to the force are as follows:

(a) Equipment operated at reduced efficiency. This is an interim measure only, and will subsequently increase maintenance and supply requirements.

(b) Increased emphasis on controlled cannibalization by direct and general support units to satisfy requirements for critically needed repair parts.

(c) Increased emphasis on evacuation of unserviceable equipment, with repair operations in forward areas limited to component replacement, adjustments, and servicing.

(d) Round-the-clock operations of supporting units to the limits of physical endurance, with increased emphasis on on-site support.

(e) Limited supply of repair parts by aerial delivery, the availability of aircraft and command of the air permitting.

(f) Attachment of small contact teams carrying small quantities of repair parts and mechanic's tool sets to perform on-site maintenance.

c. Offensive Operations (Airborne or Airmobile).

(1) Airborne or airmobile operations are generally of short duration and based on withdrawal of the force after mission accomplishment or linkup with advancing ground forces. Assault forces participating in such operations are expected to be self-sustaining, both tactically and logistically, for short periods (several days).

(2) Direct support maintenance and repair parts supply to such forces before they are committed, are provided by direct support elements organic to the force. These elements rarely accompany assault elements into the airhead or air landing zone if the operation is of short duration. If the operation is to last longer than several days, detachment-size maintenance support elements are brought into the objective area with the follow-up echelon. If the operation increases further in scope and additional buildup is planned, additional forces, to include maintenance support, are brought in.

(3) Before the operation, maintenance supply stocks are brought up to desired level;

equipment is replaced, as required; and necessary maintenance is performed. These actions take place during the mounting and before the marshalling phase, and are accomplished with strict observance of security requirements. Additional support is provided by non-divisional direct support maintenance units. Such additional support takes the form of assisting in the inspection of using unit equipment and performance of maintenance.

(4) The airborne or airmobile forces carry with them 2-3 days of accompanying supplies, including repair parts. An additional quantity of supplies, to include a small stock of critical repair parts, is maintained by supporting elements near the departure airfields to be delivered automatically or on call. These procedures are followed commencing at D+1 and until combat service support units can be air landed in the objective area and routine supply procedures instituted. In airborne operations, backup supply support is the responsibility of a designated TASCOM field depot, which arranges for its delivery to departure airfields; in airmobile operations, backup supply support is the responsibility of supporting elements remaining in the base area.

(5) During the assault phase, maintenance operations in the airhead are limited to those which can be performed readily by organizational maintenance personnel. If possible, unserviceable items are moved to centralized collecting point(s) in the objective area(s). Direct support maintenance detachments, when committed, assist in the performance of organizational maintenance, as necessary, and perform limited direct support maintenance, consisting of minor component replacement and direct exchange of small end items. Unserviceable items requiring evacuation for higher category repair are evacuated by air to the extent permitted by the availability of air transport not required for more critical evacuation missions (e.g., evacuation of wounded). Replenishment repair parts and replacement end items are delivered by air drop or air landing. Requirements for critical repair parts are satisfied, to the extent practical, by

controlled cannibalization of unserviceable items earmarked for evacuation. Unserviceable items that cannot be evacuated and where linkup with friendly forces is not anticipated, are stripped of critically needed items and destroyed to the extent necessary to make them militarily useless.

(6) The ground tactical plan for air-mobile or airborne operations includes the assault plan to secure objectives, and plans for defense, linkup, withdrawal, subsequent offensive operations, and displacement, as appropriate. Withdrawal of the force, if appropriate, may be accomplished by air, or by ground transportation if linkup has been achieved. If withdrawn by air, all equipment that cannot be evacuated is destroyed, if withdrawn by ground transportation after linkup, supporting elements of the linkup force may assist in the maintenance and evacuation of unserviceable equipment.

(7) In operations of long duration planned to support or augment friendly guerrilla elements operating at some distance from the base area of the airborne or air-mobile force, or in shows of force or demonstrations designed to bolster a friendly nation that is being threatened by insurgency or invasion, support plans must make provision for regular replenishment of repair parts. These are provided by air or surface transportation, or both. Communications must be reliable so that requirements may be made known. Operations of this type require full utilization of resources available in the area of operations and the adoption of field expedients.

d. Defensive Operations.

(1) The fundamental forms of defense are the area defense and the mobile defense (FM 61-100).

(2) In an area defense, the defending force remains in position for longer periods and movement and maneuver of the defending force are considerably reduced in comparison to a mobile defense or an offensive operation. In an area defense, maintenance support units supporting the force do not have to deploy as frequently as in other types of operations. More time is available for main-

tenance support operations and maintenance facilities can operate more efficiently since they do not have to react so often to changing situations and requirements. The maximum amount of maintenance is performed by the various categories of maintenance. Repair parts stockages are generally increased and reserves of critical items are built up. Equipment inspections and technical assistance are emphasized by direct support maintenance units to assure a force posture that will enable it to undertake offensive operations when required to do so and the situation permits. With regard to repair parts stockage in support and supported units, such supplies must not be allowed to build up to the extent to render units immobile.

(3) A mobile defense requires maneuver and movement on the part of elements of the defending force. Even in a mobile defense, deployment of maintenance support units may be infrequent, for while individual combat battalions may move frequently, the trains elements and headquarters of supported units may stay in place, and most of the business of maintenance and repair parts supply is transacted with these elements. In the mobile defense, vehicular maintenance requirements are greater than in an area defense, particularly with respect to tracked vehicles. This will result in increased evacuation from maintenance units in direct support of units in contact and will result in greater workloads for nondivisional maintenance support units.

(4) In any type of defense, if the situation becomes critical the maintenance support effort in divisions may be suspended and organic maintenance support units may be diverted to defensive combat roles. Such a situation may require large-scale backup maintenance support from nondivisional sources.

e. Retrograde Operations. In such operations, maintenance facilities are located well to the rear of the battle area. Maintenance support to retrograding forces consists of emergency support by contact teams. Equipment that cannot be repaired readily or evacuated is destroyed. Successive dis-

placement of maintenance facilities to the rear is planned and effected so as not to conflict with the movement of combat elements. To the extent possible, maintenance support elements will displace at night. Direct support units provide support on a priority basis to units that have completed the retrograde to new locations and are preparing or organizing a new position. Direct support maintenance units emphasize support to units that have suffered severe damage during the operation. Equipment most critical to combat operations will be given priority, with emphasis on unserviceable equipment that can be repaired most readily. Most of the unserviceable equipment may have to be evacuated to nondivisional maintenance support elements. All maintenance plans must be coordinated with tactical plans to provide maximum support without interfering with the operations of combat elements. During movement, small contact teams carrying small quantities of repair parts and mechanic's tool sets may be attached to tactical elements to provide on-site maintenance service. Nondivisional maintenance support elements may also be required to assist in the refitting of divisional troops and the evacuation of unserviceable materiel.

3-4. General War

a. General war may involve the use of any or all of the following: chemical, biological, radiological, or nuclear weapons. In the planning and conduct of operations, commanders and staff officers must anticipate that an enemy may utilize such weapons at any time, with little or no warning. Use of such weapons by an enemy complicates the problems of maintenance management and makes movement difficult because of the necessity to use alternate routes to avoid contaminated or rubble-strewn areas. It may also increase order and ship time for repair parts of force adoption of expedients such as large-scale cannibalization because of contamination or destruction of repair parts stocks or disruption of supply routes. In addition, maintenance unit workloads are increased because of the requirement for decontamination of

equipment, and widespread damage to and requirement for evacuation of vehicles, weapons, and communications equipment in the event of nuclear attacks. Use of such weapons by friendly forces affects operations because of the precautions that must be taken and because certain areas or facilities which may otherwise be ideally suited for the conduct of future maintenance support operations are rendered untenable due to contamination.

b. Detection of contamination and decontamination measures are necessary to reduce personnel casualties resulting from the handling, processing, and maintenance of contaminated equipment. Casualties which may result from handling contaminated equipment reduce unit capability, place additional requirements on the replacement system, and may necessitate the training of replacements. Severe exposure to any type contamination will produce immediate casualties and seriously curtail operational capabilities of maintenance support units. Even moderate exposure can reduce efficiency and capability. Therefore, under conditions of nuclear warfare or chemical, biological, or radiological operations, prompt detection of chemical contamination, monitoring for radiological contamination of equipment and operational areas, and thorough decontamination must be emphasized. It must be realized, though, that when support units are engaged in detection, monitoring, decontamination, or rear area protection operations, the performance of their support missions will be hampered or delayed, while at the same time maintenance support requirements are increased substantially.

c. During a general war, commanders and planners view dispersion requirements in the light of operational requirements and the degree of control necessary for these operations. Dispersion, as a defensive measure, requires dispersion between units and, to a lesser extent, dispersion within units. In considering dispersion, the inefficiency of operations inherent in dispersion and the result of such dispersion on the total support system must be weighed against the degree of security required. In addition to aggra-

vating problems of maintenance management and control, excessive dispersion increases the probability of pilferage, increases the susceptibility of units to guerrilla attack, and precludes adoption of the most efficient layouts for unit operations. Thus, commanders must be willing to accept certain risks for the sake of operational efficiency.

d. For further details on the effects of nuclear, biological, and chemical warfare on combat service support operations, see FM 100-10, FM 19-45-1 (TEST), FM 54-6-1 (TEST), and FM 10-15 provide information on rear area protection planning. FM 3-12 provides information on the operational aspects of radiological defense. TM 3-210 provides information on fallout protection. FM 21-40 and FM 21-41 contain information on CBR defense. Details on chemical, biological, and radiological decontamination are contained in TM 3-220. FM 101-40 contains armed forces doctrine for chemical and biological weapons employment and defense.

3-5. Counter guerrilla Operations

a. General.

(1) U.S. forces may be employed in a counter guerrilla role in any type of terrain or climate. In addition to the special problems presented by the peculiarities of the area (para 3-6 through 3-10), the operational methods of the guerrilla force, and terrain and climate, there are many other problems that confront the counter guerrilla force and its supporting maintenance system. Prior planning and continuous modification of plans and profiting from the experience of others in similar situations will go far to eliminating or minimizing such problems. In counter guerrilla operations, for example, no area is immune to guerrilla attack, and maintenance units must devote more time, effort, resources, and planning for local security. Road nets may be non-existent; and if they do exist, they may be insecure. Combat troops may have to be diverted to provide security for maintenance and other logistical activities, and to escort troop and supply convoys.

(2) In many situations, particularly in

jungle and mountain areas, air delivery may be the prime means of moving maintenance contact teams and supplying repair parts. The supported counter guerrilla force may be widely dispersed and may change locations quite frequently, making maintenance and repair parts support difficult. Maintenance units, especially the supply areas thereof, may become prime targets for guerrillas seeking arms and other supplies. In addition to mission operations, maintenance units may be required to participate in civic action projects.

(3) All of these factors, as well as the type, scope, and tempo of counter guerrilla operations, will influence the size, composition, and operations of the supporting maintenance structure. Specific information on the conduct of counter guerrilla operations is beyond the scope of this manual; for such information, see FM 31-16 and FM 31-22.

b. Maintenance Support.

(1) Paragraph 4-8 describes the types of maintenance support units that may be employed to support counter guerrilla forces of different size. This paragraph places emphasis on problems in maintenance at the direct support level, since this is where most problems exist and support is most critical. General support maintenance units will operate to provide backup support to direct support maintenance units as described in FM 29-22. One of the most significant problems will be the evacuation of unserviceable materiel from direct support to general support because of the insecurity of roads over which equipment must be moved. As far as materiel evacuation is concerned, it may be necessary to rely more heavily on air evacuation.

(2) At the direct support (DS) level, more emphasis on controlled cannibalization as a source of repair parts may be necessary, and requirements for providing assistance to supported units in the performance of organizational maintenance may be increased. In addition, general support (GS) units may be required to provide personnel to augment the productive capacity of DS maintenance

units, especially when evacuation of unserviceables becomes a problem because of insecure roads. At the GS level, it must be anticipated that overflow DS maintenance workload will be increased over that encountered in other types of operations. Damage to vehicle undercarriages will occur with greater frequency due to rough roads and use of mines and obstacles by guerrillas, increasing GS maintenance requirements in this area. Workload for repair of heavy construction equipment and aircraft may be significantly greater.

(3) Maintenance support of a counter-guerrilla force operating in an environment that vacillates from secure to insecure in a short period requires the most effective preventive and organizational maintenance on the part of individuals and organizational maintenance elements. On-site maintenance is practiced to the fullest by supporting DS maintenance units, consistent with the urgency of its need, the degree of repair required, and characteristics of equipment. Exchange of small radios, small arms, and non-integrated fire control instruments from float stocks is routine in forward areas. In such areas, DS maintenance is normally limited to those operations that can be performed speedily and without recourse to heavy repair equipment and heavy repair parts. Whenever possible, unserviceable components and end items requiring complex repairs are evacuated to backup maintenance facilities in the logistical base supporting the operation.

(4) Direct support maintenance units supporting the counter-guerrilla force operate from brigade combat bases, and from the division support command area when a division is employed. Maintenance teams for the performance of vehicular, armament, communications, and, if required, aircraft maintenance may be detached from the brigade combat bases for operations at battalion forward area combat bases.

(5) At the brigade combat base area, the DS maintenance unit supporting the brigade performs DS maintenance on equipment evacuated from battalion combat bases and equip-

ment of other units operating in the brigade combat base area, and provides contact teams as needed, to support all brigade units. The contact team may consist of a work party to perform on-site maintenance, technical assistance, or liaison. In an operational environment where dependence must be placed on air delivery of men and materiel, DS elements operating in the brigade combat base must be allocated a portion of the airlift available to the brigade to transport contact teams, evacuate materiel, and deliver repair parts and operational readiness float items. Dependable radio communications between maintenance and supported units, and between separated maintenance elements and their parent headquarters is necessary.

(6) In the division support area, the main support company of the division maintenance battalion provides DS maintenance and repair parts support to other units operating in the area, provides backup support to the DS elements deployed in the brigade combat base areas, serves as a source of repair parts supply and control for DS elements operating in brigade areas, and establishes a maintenance collecting point for unserviceable and captured enemy equipment destined for evacuation to the logistical base. The aircraft maintenance company also operates from the division support area if this is where the airstrip is located.

(7) When the counter-guerrilla force is an airborne or airmobile type unit, evacuation will be primarily by air. In such cases, aircraft returning from supply missions will be utilized for evacuation of materiel to the extent permitted by other requirements. When secure land or water routes are available, surface transportation may be used for evacuation.

c. Repair Parts Support.

(1) In counter-guerrilla operations, prescribed loads and authorized stockage lists may vary considerably from those used in a limited or general war. Quantities of repair parts stocked at various levels depend on what is needed at that level, mobility requirements, and the ease of resupply. These factors must be considered in developing prescribed load lists (PLL) and authorized stockage lists (ASL) (AR 711-16 and AR 735-35). Repair parts

stockage at company and battalion bases is held to a minimum, and limited to those types and quantities of items essential for contemplated operations. Minimum stockage forward is necessary to permit mobility in a dynamic environment; to reduce the number of personnel required for storage, maintenance, and security of such stocks; to avoid deterioration of stocks due to weather and climatic conditions, since adequate storage facilities in forward areas will be limited or nonexistent; and to prevent large stockages from falling into guerrilla hands in the event forward bases become indefensible and evacuation of supplies is impossible. Greater stockages are maintained at supporting bases at brigade, division, and points of entry (logistical bases), with dependence on air transportation for rapid resupply of forward locations.

(2) Supported units operating near the brigade combat base are provided repair parts support by supply point distribution. Unit distribution is used, when possible, for units operating away from the brigade combat base, with air resupply being a normal procedure when other lines of communication cannot be relied on.

3-6. Desert Operations

a. Desert operations present many problems for maintenance because of the sand and heat, rapid movement, long lines of communication, poor roads, and difficulty in locating supported and supporting units. Because of these factors, air transportation can be used to great advantage for the movement of contact teams for on-site maintenance and delivery of repair parts.

b. In desert operations, requirements for certain maintenance functions will increase significantly over those encountered in other types of operations. Preventive maintenance is vital. More frequent inspections and scheduled organizational maintenance are required. For example, it becomes necessary to clean air cleaners more frequently, to flush and clean cooling systems often, to replace filters more often, to decrease intervals between lubrications and oil changes, to clean weapons repeatedly, and to take all possible measures to avoid sand contamination of equipment. For example, fire

control instruments should not be disassembled in the open.

c. At the direct support maintenance level, operations will be influenced as follows:

(1) Distances to supported units will be increased, and supported units may be more difficult to locate when on-site maintenance or recovery assistance are required.

(2) Passive air defense measures, such as use of camouflage nets to hide vehicles and facilities, will require extensive effort. Dispersion, as a protective measure, will also be required.

(3) Stockage levels of certain repair parts may have to be increased; e.g., filters, bearings, cooling system components.

(4) Maintenance personnel will lose productivity during the heat of the day, and as much maintenance as possible should be done at night. Operations at night will require maintenance performance under blackout conditions.

(5) Requirements for assistance to supported units in the performance of organizational maintenance may increase, thereby requiring an increase in the amount of work evacuated to GS maintenance as DS maintenance overload.

(6) To the extent possible, all maintenance should be performed under or behind shelter of some kind to prevent entry of sand into the internal working parts of materiel that have been exposed during maintenance operations. Even when performing maintenance on site, a shelter or barrier of canvas can be constructed to provide some protection from blowing sand.

(7) Because of increased mobility requirements of supported units, more emphasis on contact team support may be required.

(8) Increased workloads at the DS level may require an increase in the number of DS units to reduce DS workload being evacuated to GS maintenance units as DS overflow.

(9) Communications with supported units may become a problem because of distance factors. More reliance must be placed on radio, and additional radios may be required.

d. At the GS level, maintenance workloads may increase because of increased evacuation from DS maintenance units.

e. Defense of units against air and long-range missile attack will require greater dispersion between elements of the unit and result in less efficiency in production.

f. For details on operations in the desert, see FM 31-25.

3-7. Jungle Operations

a. In jungle operations, the heat and moisture directly affect equipment, requiring strict adherence to preventive maintenance practices, more frequent inspections, and more frequent scheduled maintenance. The rough terrain and poor roads will also adversely affect vehicular equipment, and may require more maintenance at all levels. Increased maintenance requirements, coupled with transportation difficulties, may require units to carry increased loads of repair parts.

b. The availability or nonavailability of trails, roads, and waterways; the density of natural growth; the season; the security of routes; and general terrain conditions will have a significant influence on the type of transportation that can be used and, consequently, on the functioning of the maintenance support system. At the DS maintenance level, on-site maintenance will be practiced to the degree practicable, with air delivery of contact teams being used where practicable and possible. Aircraft may be required for the delivery of repair parts, the transport of on-site maintenance (contact) teams, and the evacuation of materiel.

c. When support is being provided to units that are widely dispersed, DS maintenance units may be required to augment the organizational maintenance capability of supported units by providing repairmen to assist organization maintenance personnel. At the DS maintenance level, maintenance units may be required to perform more extensive maintenance than in normal operations because of difficulties in evacuating materiel for backup maintenance.

d. Because terrain conditions restrict the number of good sites available for maintenance operations, considerable engineer effort may be required to prepare suitable locations. There-

fore, maintenance units may not be able to deploy as often as they would in more favorable terrain. In areas where monsoon rains are experienced, careful consideration must be given to site selection. These limitations may force maintenance units to locate with other types of units, forming a concentration of support type units in one area. This simplifies the problems of security of such areas from ground attack, and may well be necessary in areas of largescale guerrilla activity. Such concentrations, however, provide good targets for air attack and require provisions for air defense.

e. For details on jungle operations, see FM 31-30.

3-8. Mountain Operations

a. Maintenance support in mountain operations is very difficult. The elevation itself hampers operating efficiency of personnel and equipment. The rugged terrain limits the availability of roads and suitable areas for support operations. Weather conditions also influence the performance of troops and equipment.

b. For operations in such areas, training and acclimatization of personnel are necessary. Adjustments to equipment to permit efficient operation at higher elevations may be required. Changes in equipment and organization of combat and support troops are often necessary, with specific decisions in these areas depending on the specific area involved and the season. From the standpoint of maintenance support, operations will be influenced as follows:

(1) Supported units will have less heavy equipment such as tanks. Thus, repair parts loads at the direct support level for such items will likewise decrease. However, support requirements will increase for other items of equipment; particularly communications and aircraft.

(2) Wear and tear on equipment is more rapid and severe than under normal environmental conditions. Weapons, radio sets, and other items of equipment are vulnerable to excessive damage while being transported or carried in difficult terrain. Emphasis must be placed on preventive and organizational maintenance by using units, and effective maintenance supervision is required.

(3) It may be necessary to use rotary wing aircraft for delivery of repair parts, movement of contact teams for the performance of on-site repair, and evacuation of unserviceable items.

(4) Technical assistance and on-site maintenance will be emphasized to reduce evacuation requirements. Direct support maintenance units may attach contact teams to the organizational maintenance elements of supported units to perform DS maintenance and to assist in organizational maintenance.

(5) Because of the limited road net, it may be necessary to utilize mobile repair teams to patrol the roads and repair vehicles. When such vehicles cannot be repaired promptly, they must be evacuated speedily to avoid blocking roads.

(6) Although the number of vehicles requiring support may be reduced, maintenance requirements for those remaining will be increased. For example, operation of vehicles in mountainous areas will result in increased requirements for maintenance of brake, suspension, and transmission systems. Thus, repair parts stockage for such repairs may have to be increased.

(7) While direct support maintenance units will locate as close as practical to the units they support, the limited availability of terrain suitable for logistical support operations and the requirements of various types of support units for such areas may well dictate where maintenance and other support units establish their operations. Because of the criticality of maintenance support to mountain operations, the commander making area assignments must give maintenance units a high priority for areas required for maintenance operations, and the maintenance unit commander must make known his requirements in terms of firm and fairly level terrain and acreage.

c. For additional details on mountain operations, see FM 31-72.

3-9. Operations in Northern Regions

a. The terrain and climate of the northern regions (and other areas where similar terrain and climate are experienced) complicate mili-

tary operations. Operations in snow and extreme cold require special training and acclimation of personnel, and the use of special equipment and operational techniques.

b. Trafficability is one of the biggest problems in northern operations, especially during the spring breakup and during the summer when the ground thaws and ice in streams and lakes melts. Since there are few roads in such regions, track-laying vehicles of the low ground pressure type provide the only means of cross-country mobility in certain situations. Ground movement is hampered by mud, muskeg, swamp, marsh, and open water in the spring and summer seasons, and thorough ground reconnaissance is required for overland movement. In the winter, the effects of extreme cold on the snow improve trafficability, although tracked vehicles and sleds may be required for movement. Weather conditions may limit the use of aircraft.

c. Northern operations are characterized by the requirement for a considerable amount of specialized equipment such as tracked vehicles, sleds, and heated shelters. Every item of equipment used in northern operations is affected by extreme cold and snow in winter, and mud and water in the summer. Thus, the extensive amount of equipment needed and the seasonal effects tending to cause abnormal wear and tear on equipment increase maintenance requirements and problems. Other factors affecting maintenance support operations are as follows:

(1) Heated shop facilities are essential to maintenance support operations.

(2) Evacuation of unserviceable items from using units to support maintenance is made more difficult because of the terrain.

(3) On-site maintenance is difficult because of cold weather and blowing snow which hamper operations and curtail personnel effectiveness.

(4) Repair parts requirements will be larger than normal, in terms of quantity and variety.

(5) The maintenance performed on site under extreme climatic conditions will take more time and effort than under temperate

conditions, as will the recovery and evacuation of disabled equipment.

d. For more information on operations in northern regions, see FM 31-70 and FM 31-71.

3-10. Riverine Operations

a. General

(1) This paragraph describes maintenance support of brigade and division-size forces used in such operations, with emphasis at brigade level.

(2) Maintenance personnel and organizations in riverine operations function essentially the same as in more conventional operations. Maintenance support for a brigade size force is provided by a forward support company of a division maintenance battalion operating from the brigade afloat and/or land base. Support for a division land base and backup support for brigade bases is provided by the main support company and the aircraft maintenance company of the division maintenance battalion operating in the division base area, which may or may not be located in the riverine area. General support maintenance and supply facilities will normally be located outside the riverine area.

b. *Factors Influencing Maintenance Requirements.*

(1) Rapid deterioration of equipment caused by weather, mud, and frequent immersion in water.

(2) The necessity to leave many items of heavy equipment in standby storage at the division base area, particularly in the case of units stationed on the afloat base. This requires tailoring of support units and repair parts stockages based on types and quantities of equipment supported.

(3) The augmentation of Army units with assault boats and outboard motors to move troops and supplies, requiring an increased maintenance capability for support of such items as well as increases in repair parts levels for such items.

(4) Insecure land and water routes of communication, making movement of maintenance contact teams difficult.

(5) The wide dispersion of units during

combat and the difficulty of contact teams in reaching them to perform on-site maintenance.

(6) Difficulties in recovery and evacuation of materiel due to mud and water.

(7) Limited shop space and repair facilities available for Army use aboard ships of the afloat base.

(8) The need for more contact teams to perform maintenance on site.

c. *Organizational Maintenance.* Preventive and organizational maintenance are of paramount importance because of the environment. Command supervision is necessary to assure that individual personnel and equipment crews know and perform preventive maintenance on their equipment. Organizational maintenance personnel aboard barracks ships of the afloat base perform organizational maintenance functions on equipment deployed with the afloat force. To facilitate such maintenance, limited shop facilities for repair of small arms and communications/electronics equipment are provided aboard barracks ships. Maintenance contact teams from the forward support company may be placed aboard these ships to provide limited direct support and technical assistance, as required.

d. *Direct Support Maintenance.*

(1) Direct support maintenance in riverine operations is limited to critical repairs and repairs that can be completed speedily, without heavy repair equipment or heavy, bulky repair parts. This support is provided by contact teams from the forward support company operating in the brigade land or afloat base. Contact teams may accompany maneuver battalions, or they may be held on call at the land or afloat base and move into the area of operations by helicopter when their services are required. Items that cannot be repaired by the contact teams are evacuated to the brigade land or afloat base by watercraft, helicopter, or vehicle.

(2) The forward support company, with augmentation from the main support company and the aircraft maintenance company of the division maintenance battalion, operates as part of the logistic element at a brigade-size land base. From this location, the forward support company provides DS maintenance and repair

parts supply for the brigade and its attached units. The company concentrates on on-site repairs and repairs that can be accomplished quickly. Items requiring complex repairs and workload exceeding local capability is evacuated to the main support company operating in the division base area.

(3) Army units stationed on an afloat base are provided DS maintenance by a forward support company that is tailored in accordance with support requirements. This company is provided billet and working space aboard Navy repair ships of the force. Maintenance operations aboard these ships are closely coordinated so that Navy personnel can work with Army maintenance personnel and vice versa.

(4) The remainder of the division maintenance battalion operates in the division base area to provide DS maintenance and repair parts support to units located there and back-up for DS elements operating in brigade land or afloat bases.

e. Repair Parts and Operational Readiness Float.

(1) In riverine operations, repair parts stocks are held to a minimum because of limited storage space availability at land or afloat bases and deterioration that is caused by climatic conditions. Prescribed load lists of using units and authorized stockage lists of support units are modified to include repair parts for special equipment needed for riverine operations, and to delete repair parts for equipment left in standby storage. Procedures for repair parts supply to combat units are as simple as possible. Direct exchange procedures are utilized to the fullest for resupplying recoverable repair parts.

(2) Maximum use is made of an operational readiness float to provide supported units with immediate replacements for unserviceable equipment. The float will consist primarily of small arms, fire control instruments, man-portable radio sets, and outboard motors.

3-11. Stability Operations

a. General.

(1) The term "stability operations" refers to that type of internal defense and internal development operations and assistance provided

by the armed forces to maintain, restore, or establish a climate of order within which responsible government can function effectively and without which progress cannot be achieved (FM 31-23). All Army units may have roles in stability operations.

(2) Maintenance support units contribute to stability operations by providing support to other Army forces engaged in such operations, as described in FM 31-23, by participating in civic action projects, and by engaging in internal development operations.

(3) This paragraph describes those internal development operations that can be taken by maintenance units to strengthen the local government economically. However, it must be pointed out that while the actions listed contribute to internal development, the same types of actions may be taken in all types of operational environments and are not limited to areas wherein assistance in internal development is required.

(4) It also must be pointed out that the actions listed in the following subparagraphs have civil affairs implications. Civil affairs staffs at various levels will provide advice and guidance on availability and use of civilian labor, availability of local facilities and resources, and the like. For details on civil affairs operations, see FM 41-10.

(5) For details on the entire spectrum of internal defense and internal development operations, see FM 31-22, FM 31-23, and FM 100-20.

b. The Role of Maintenance Units.

(1) *Employment of local civilian labor.*

(a) Civilian labor of the host country may be profitably employed to perform many functions incident to maintenance operations. The employment of local civilian labor has the advantage of increasing the productive capacity of a military unit without increasing troop requirements, and it can give an economic boost to the civilian economy of the area. Civil affairs elements at all levels advise on the availability of civilian labor for military purposes and on the essential manpower needs of the local economy, and recommend policies appropriate to meet the various aspects of the commander's overall mission. The payment of

civilian labor is an important consideration, and wage scales should be compatible with those of the local economy to avoid strained relations, distrust, and unfavorable competition with the local economy.

(b) In active theaters of war, the use of civilian labor will generally be restricted to the communications zone and the rear of the field army area where conditions are more stable and movement requirements are not as great. In active theaters not divided into a COMMZ and combat zone, as such, civilian labor may be employed at logistical bases and terminals. In inactive theaters or areas wherein operations are of the peace-keeping type, such labor may be employed in any area, depending on the ability to utilize such labor, the capabilities of the workforce, and security requirements.

(c) The use of civilian labor is subject to many restrictions and limitations. Civil affairs and legal elements must be consulted to determine what type of labor can be used, where it can be used, and the limitations on its employment.

(d) Foreign civilian labor is not employed in sensitive tasks or in areas where sensitive materiel is stored or handled. Additionally, sabotage and pilferage must be guarded against. Therefore, units employing civilian labor normally coordinate with Army intelligence units for the screening of key personnel. The employing unit must provide close supervision of non-U.S. workers to deny the opportunity for sabotage or pilferage.

(e) Subject to the restrictions and limitations indicated above, maintenance units may employ local civilian labor for the following type tasks:

1. Activities concerned with the storage and handling of materiel, to include: driving trucks; operating materials handling equipment; loading, off-loading, and movement of materiel; clerical functions (provided the laborer has a knowledge of the English language or such knowledge is not required for the function); construction of boxes, pallets, or storage bins; and stencilling and packaging operations.

2. Activities involving administra-

tion, support, and upkeep of the activity or installation to include: clerical assistance; mess functions; janitorial functions; maintenance of buildings; maintenance of utilities, particularly if local utilities systems are being utilized; and construction or improvement of facilities, as required (e.g., construction of storage sheds, improvement of roads, etc.).

3. Simple, easily-learned, repetitive-type functions associated with maintenance operations to include: disassembly and minor re-assembly operations; cleaning, painting, preservation, and movement of materiel; and boxing and crating operations. Such operations as production-line maintenance of components can profitably utilize civilian laborers at various stations in the line. Collecting points can employ such personnel for disassembly and segregation operations.

4. Generally, in active theaters military units will not be able to employ civilian personnel in jobs for which extensive training is required. In non-active theaters or areas where the existing threat is insurgency, such training may be practicable, in the long run, and may even be directed as a major contribution to the internal defense and internal development effort by providing training that may later be put to good use in the civilian economy. Policies will be established and published to govern actions in this area.

5. For details on the use and administration of foreign labor during hostilities, see FM 27-10 and DA Pam 690-80.

(2) *Local procurement.*

(a) Local procurement of supplies and services will be accomplished in accordance with policies established for the theater or area, and under the supervision, control, and direction of the procurement officer of the command. Within established policies, maintenance units will indicate their local procurement needs through command channels to the officer charged with procurement responsibility. Local procurement may be utilized to obtain such items as metal stock for parts fabrication, sheet steel for automotive body work, coal for heating, chemicals for cleaning, gases for welding, construction materials, common hardware, wire, etc.

(b) With respect to local procurement, a general purchasing agency system may be established in oversea commands in time of war in furtherance of the overall policy of making maximum use of available resources in supplying the needs of U.S. forces in the command. This is accomplished to conserve vital air/sea lift capability required for support of the command. This system will fulfill the functions of a coordinating staff or board activity, rather than those of an operating procurement agency as described in FM 54-5-1 (TEST).

(3) *Contract maintenance.* This activity is also subject to the restrictions indicated previously, and involves contracting for the performance of maintenance functions when Army forces lack sufficient capability or capacity. If facilities and required resources are or can be readily made available, and the required skills are available or can be developed, con-

tract maintenance may be utilized for the rebuild of end items, overhaul of components, rebuild of tires, fabrication of parts, and related maintenance functions. Such maintenance, though, must be performed in accordance with established Army maintenance policies and Department of the Army restrictions (e.g., with respect to rebuild of end items), and will be subject to Army supervision and inspection.

(4) *Lease and rental of facilities and real estate.* Maintenance units can profitably utilize shop buildings and other large structures for the performance of maintenance. Policies and agreements on facility and real estate use by U.S. forces will be established at levels higher than the maintenance unit. Individual units, though, will be required to survey their requirements and make these requirements known through command channels.

CHAPTER 4

TYPE THEATER MAINTENANCE SUPPORT ORGANIZATIONS

4-1. General

a. Theaters of operation vary in size and geographical configuration. A theater of operations may embrace a large land mass, a portion thereof, or a small peninsula. It may consist of an island or a group of islands. It may develop in friendly countries, in countries liberated from an enemy, or in the enemy homeland itself. The territory may be agricultural, industrial, or a combination of both. The enemy force may consist of conventional military forces using traditional tactics and armed with modern weaponry; it may consist of conventional forces which are not well equipped and using tactics designed to offset limitations in equipment and logistical support; it may be a guerrilla force; or any combination of all three may be encountered. All of these factors, as well as many others, have a bearing on the configuration and operations of the maintenance support structure deployed within a theater of operations.

b. This chapter describes various types of maintenance support structures that might be employed in a theater of operations. The supported forces discussed in this chapter range in size from an independent division supported by a division support brigade, to a field army force of 12 divisions supported by a field army support command (FASCOM) and a theater army support command (TASCOM). The type support structures discussed may serve as starting points for force or logistical planners charged with developing force structures and troop lists; however, the composition of the actual maintenance structure will depend on support requirements, types and numbers of support units available, troop ceilings, the availability of local labor and other resources, the proximity of a supporting logistical base, and other factors such as the location and distances

separating major elements of the combat force. This chapter does not address itself to procedures for development of a theater of operations; for such information see FM 100-10 and FM 101-10-1.

4-2. Maintenance Support of a Large Theater

a. General.

(1) An established theater of operations embracing a large geographical area may be divided into a communications zone and a combat zone. Within the combat zone, one or more field armies may be employed. If the theater is on a large land mass, the COMMZ comprises that portion of the theater to the rear of the field army or army group boundary; everything forward of this boundary is considered the combat zone.

(2) Figure 4-1 depicts a type theater army structure which could be employed on a large land mass. Within such a theater of operations, TASCOM (fig. 4-1) exercises primary responsibility for maintenance support. Maintenance and supply support within the combat zone is provided by FASCOM and division support commands.

Figure 4-1. Type theater army structure depicting breakout of the theater army support command (TASCOM).

(Located in back of manual)

b. Maintenance Support in the COMMZ.

(1) The bulk of the maintenance support mission in the COMMZ is performed by maintenance support battalions attached to area support groups of the area support command; GS maintenance battalions attached to field depots of the supply and maintenance command; ammunition battalions of the ammunition group, supply and maintenance command; and certain other specialized maintenance units at-

tached to field depots such as marine and railway maintenance units and cryptographic maintenance teams.

(2) The maintenance support battalions of the area support command provide DS maintenance and maintenance supply in support of COMMZ troop units and units moving through the COMMZ. The GS maintenance battalions perform GS maintenance in support of the theater supply system by repairing items evacuated from the combat zone and items evacuated by COMMZ DS maintenance units, and by performing support maintenance, as required, on field depot stocks.

(3) Ammunition depot complexes, containing conventional and special ammunition companies, provide ammunition supply support for the theater as a whole, perform in storage maintenance on ammunition items, and maintenance and supply support of special ammunition and associated test and handling equipment. At least two of the depots will also contain missile maintenance companies for the performance of GS maintenance on all components, less warheads, of missile systems and missile-peculiar ground guidance, launching, test, and handling equipment. These companies also provide inspection and maintenance of missiles in the class V supply channels, to include missiles evacuated from using units, to insure missiles in storage are in a ready-for-issue condition.

(4) Conventional ammunition depots are operated by ammunition companies, DS/GS. Special ammunition depots are operated by special ammunition companies, GS. These units provide complete-round general support supply for missiles, large rockets, nuclear warheads, nuclear projectiles, and atomic demolition munitions, certain chemical and biological munitions and selected ammunition, and replacement components and repair parts peculiar to warheads and warhead sections. The special ammunition companies, GS, also perform DS and GS maintenance on nuclear items they support (except for missiles). This includes backup GS maintenance for the field army.

(5) General support maintenance for missile systems (less warheads) and missile-peculiar

ground guidance, launching, and handling equipment is provided by the guided missile maintenance company, GS. This company provides support to ammunition depots, DS elements organic to missile firing battalions, and backup GS maintenance for the field army. When necessary, missile maintenance detachments (ordnance detachment, rocket & missile maintenance support), of the TOE 9-550 series are used to provide DS/GS maintenance and repair parts supply for small missile systems deployed in COMMZ, (e.g., Redeye, Shillelagh). This detachment will also furnish support for the FAAR, Lance, TOW, Dragon, and Chaparral/Vulcan. Missile system repair parts support for DS and GS missile maintenance detachments and companies and DS missile maintenance elements organic to missile firing battalions is provided by designated repair parts supply companies. For details on ammunition service and maintenance support of ammunition and guided missile materiel, see FM 9-6 and FM 9-6-1 (TEST).

(6) Other units are provided within the supply and maintenance command or as elements of major organizations that are part of theater army for the maintenance support of items not supported by maintenance battalions and the ammunition battalions which operate the ammunition depot complexes. For example, units of the supply and service battalions of the supply and maintenance command provide support for airdrop equipment, clothing, and light textiles; maintenance support for medical materiel is provided by elements of the medical command. Maintenance support for cryptographic materiel is provided by GS cryptographic maintenance teams attached to field depots. For further details see FM 8-17, FM 29-11 (TEST), and FM 54-5-1 (TEST). Figure 4-2 depicts a type maintenance organization that may be employed in a COMMZ supporting a field army force of 12 divisions.

Figure 4-2. A type organization and deployment of a COMMZ maintenance organization in support of a 12-division field army (maintenance support for class V ammunition items has been excluded).

(Located in back of manual)

c. Maintenance Support in the Combat Zone.

(1) Within the combat zone, most of the maintenance support required by the divisions is provided by division maintenance battalions which operate in division areas.

(2) In the corps and field army service areas, the bulk of the maintenance support is provided by DS maintenance battalions and GS maintenance battalions of the corps and army support brigades, the aircraft maintenance GS battalions of the army support brigade, and ammunition battalions of the ammunition group.

(3) Division maintenance battalions and nondivisional DS maintenance battalions provide DS maintenance and repair parts support for most types of maintainable Army materiel (exceptions are medical, ammunition, missile systems, rail and watercraft, cryptographic items, certain items of typographic and printing equipment maintained by the user, clothing, textiles, and airdrop supplies). Direct support maintenance and repair parts supply for guided missile system materiel (less warheads) and associated ground guidance, launching, and handling equipment is provided by direct support elements organic to missile firing battalions (for large missiles) and by missile support detachments of the TOE 9-550 series for small missiles such as Redeye and Shillelagh. This detachment also provides support for future systems as indicated in *b(5)* above. These missile support detachments can be attached to either DS maintenance battalions or ammunition battalions. Future doctrine envisages their assignment in the divisional maintenance battalion. For details on how support is provided at the DS level, see FM 8-16-1 (TEST), FM 9-6, FM 9-6-1 (TEST), FM 29-22, FM 29-30, and FM 54-2.

(4) General support maintenance battalions perform overflow DS maintenance and GS maintenance in support of divisional and non-divisional DS maintenance battalions and the supply system—they have no repair parts supply missions. Repair parts supply is provided by supply units of the supply and service battalions (except for those items provided by special ammunition companies, GS) as des-

cribed in FM 29-45. The GS maintenance battalions provide maintenance support for the same types of items supported by the DS maintenance battalions. Ammunition battalions provide GS maintenance and supply support for ammunition, missiles, and related items, to include special and conventional ammunition but excluding repair parts support for non-explosive components of missile systems (FM 9-6-1 (TEST)). The aircraft maintenance GS battalion provides GS maintenance and overflow DS maintenance for Army aircraft and aerial armament.

(5) Figure 4-3 depicts a type maintenance support organization for a field army of 8 divisions, expandable to a 12 division force.

Figure 4-3. Type maintenance support structure for a field army force of 8 divisions.

(Located in back of manual)

4-3. Maintenance Support of an Independent Army

a. The field army may have to operate independently, being responsible for providing all of the combat service support required by the field army force, to include that support normally provided by COMMZ units. Such operations may become necessary in the initial development of a theater of operations, or in a small theater.

b. For the support of such operations, FASCOM may assume the functions normally performed by a TASCOM operating in the COMMZ. The support structure is augmented with COMMZ-type units normally assigned to TASCOM, to include supply, maintenance, medical, transportation, personnel, construction, military police, and civil affairs units. The maintenance support structure for this force consists of DS and GS maintenance battalions of the support groups of the corps support brigades; and the DS, GS, and aircraft maintenance battalions of the support groups of the army support brigade. For the maintenance of ammunition and guided missile system materiel, ammunition battalions are provided in each of the corps support brigades. These are the same type field army support units described in paragraph 4-2 and shown on figure 4-3.

c. In addition to these units, the army support brigade will be augmented by maintenance units of the type normally found in the COMMZ, such as maintenance support battalions normally assigned to area support commands; GS maintenance battalions attached to field depots of the COMMZ supply and maintenance command; marine and railway maintenance units, if required; ammunition battalions; and teams or detachments as required (e.g., for cryptologistics support). These COMMZ-type units are the same types as described in paragraph 4-2 and shown on figure 4-2; moreover, in most cases these units are of the same type and perform the same type mission as units assigned to FASCOM.

4-4. Maintenance Support of an Independent Corps

a. In small theaters of operation, the independent corps may be the Army component of the theater and have the status and functions of theater army. In such a situation, the independent corps is responsible for providing all of the combat service support required by the force. This support includes the type of support units and activities normally deployed in the corps area, certain elements that are normally deployed in the field army service area, and theater base (COMMZ) type activities required to support the force. The organization established to provide such support is the corps support command (COSCOM). A corps support brigade (fig. 4-3) serves as the nucleus of the COSCOM. Augmentation is provided, as required, in the form of type units and activities normally employed in the field army service area and/or the COMMZ.

b. Figure 4-4 depicts a type COSCOM for the support of an independent corps of three divisions. A detailed breakout of the maintenance support organization is provided. The type and quantity of combat service support units on the figure serve only to indicate the type of units that may be provided; thus, the figure provides a frame of reference only. The specific composition of the COSCOM depends on the size, composition, and mission of the force; resource limitations; environmental conditions; characteristics of the area of opera-

tions; the type warfare being conducted; and the proximity of other supporting logistical bases.

c. The organization depicted on figure 4-4 may prove adequate to support an independent corps employed in a relatively small theater where the terrain is gently rolling, where there is no significant guerrilla activity, and where divisions are employed abreast utilizing frontages and depths normally associated with division and corps type operations in this type of terrain.

Figure 4-4. A type combat service support structure for a 3-division independent corps (maintenance organization depicted in detail).

(Located in back of manual)

4-5. Maintenance Support of an Independent Division

a. The Army component of a theater of operations may consist only of an independent division plus supporting combat support and combat service support to the independent division. Units of the type normally employed in the COMMZ are added, as necessary (e.g., for maintenance of marine and/or rail equipment).

b. Figure 4-5 depicts a type support brigade for the support of an independent division in a small theater of operations.

Figure 4-5. A type combat service support structure for an independent division (with maintenance organization broken out).

(Located in back of manual)

4-6. Separate Corps/Division

a. A separate corps or division is a force that operates separately from another force of similar or larger size, and is responsible to the higher headquarters in the theater that is controlling the operations of both forces. Because of the size or composition of the theater, because of enemy threats within the theater, or because of tactical plans, the bulk of the combat forces in the theater may be employed in one portion of the theater while a separate corps or division may be employed in a separate location of the theater.

b. In such situations, a COMMZ or logistical base will exist to support overall theater of operations requirements. The type of support normally provided by FASCOM support ele-

ments, however, will not be reasonably available to the separate force because of extreme distances, water, or terrain barriers separating it from the larger force supported by a FASCOM-type support structure. Maintenance support for the separate force is provided by organizing a support command (corps) COSCOM or support brigade (division), in accordance with requirements, and patterned after the structures depicted in figures 4-4 and 4-5. In this case, the support structure need not be as large as that required for an independent corps or division, nor do support capabilities have to be as extensive or varied, for backup support will be available from a COMMZ or logistical base in the theater.

4-7. Support of Combined or Joint Forces

a. The land combat force in a theater may be a combined force wherein forces of two or more allied nations are involved or may be a joint force of Army and Marine Corps units functioning as part of a unified or specified command. For a discussion of unified and specified commands, see JCS Pub 2. Guidance on logistics planning and support of such commands is contained in JCS Pub 3.

b. In a combined operation, allied forces are normally responsible for providing their own combat service support, including maintenance and repair parts support. U.S. forces may have to assist in this effort, particularly if the allied forces are equipped with U.S. equipment. The degree of U.S. participation in such support depends on requirements which should be determined beforehand, as they will have an effect on force planning and mission assignments. From a maintenance standpoint, this assistance may be as limited as the provision of advisory assistance to support elements of allied forces, or may involve provision of maintenance and repair parts support by U.S. maintenance and supply units which also support U.S. forces. In determining support requirements and procedures, command planning, requirements determination, and development of operational procedures between commanders and staffs of allied forces being supported and appropriate commanders and staffs of U.S. elements that will provide the support are essential. Such

planning and procedural development must fully consider differences in techniques, operational methods, and capabilities characteristic to the allied forces that must be supported.

c. The land combat component of a unified or specified command may consist solely of U.S. Army elements, or it may be a joint force of Army and Marine Corps units. In an operation involving forces of more than one Service, each of the Services is responsible for combat service support of its own forces, except when support is provided for by agreements or assignments for cross-servicing, joint servicing, or common servicing. Normally, each Service provides for its own organizational, direct, and general support maintenance and repair parts requirements. However, operational considerations, peculiar support requirements, and composition and location of forces of various Services in the area may require the establishment of maintenance facilities for joint use, the provision of repair parts to elements of another Service, or provision of support to elements of another Service by a support unit whose primary mission is to support elements of its own Service. Thus, in a theater of operations wherein a Marine division is employed along with Army divisions, the Marine division would have its organic direct support within the division, provided by the division service battalion. Backup maintenance support for the Marine division would normally be provided by a Marine Corps force service regiment; however, in the absence of such an organization, Army nondivisional support elements may be required to provide such support in accordance with cross-servicing agreements or by direction of a unified or specified command commander.

4-8. Maintenance Support Organization for Counter guerrilla Operations

a. General. This paragraph concerns itself with the maintenance support of a U.S. Army force that has been organized and deployed into a host country for the purpose of conducting counter guerrilla operations. The size, composition, and equipage of the counter guerrilla force depend on many factors. The force may consist solely of U.S. Army personnel provided as advisors to host country military

forces (FM 31-22 and FM 31-73), or it may consist of a separate brigade or one or more divisions. This paragraph concerns itself with support of a brigade or larger force committed in a counter guerrilla warfare role. For details on counter guerrilla operations, see FM 31-16. Paragraph 3-5 discusses some of the problems associated with maintenance support of counter guerrilla operations.

b. The Supporting Maintenance Organization.

(1) *Direct support maintenance.*

(a) *General.* When a separate brigade organization is employed, DS maintenance and repair parts support are provided by a maintenance company, support battalion, separate brigade. This is an organization designed to support a separate brigade by providing DS maintenance and related services for all types of maintainable equipment except medical, cryptographic, ADPE/EAM, and air delivery items. The medical company provides support for medical materiel. If cryptographic, ADPE/EAM, and airdrop items require support, specialized support elements may be attached to the support battalion.

(b) *Brigade detached from parent division.* When a brigade is withdrawn from a division to perform counter guerrilla operations separately, a corresponding portion of the division's organic support capability must be provided to the force. A provisionally-organized support battalion, organized from division support command units, is normally provided for combat service support. This support battalion will include a rotary wing aircraft repair section and a forward support company (or platoon in the case of the airborne division) of the maintenance battalion. The forward support company/platoon is augmented with personnel and equipment from other elements of the maintenance battalion (e.g., small arms, automotive, and instrument repair augmentation may be provided). The division support command cannot furnish this additional capability to the support battalion without reducing its own capability below an acceptable level. Therefore, the support command must be augmented by non-divisional maintenance elements.

(c) *Division.*

1. A division, when employed in counter guerrilla operations, will be provided DS maintenance by its own organic DS maintenance units. Such support is provided by the division maintenance battalion in the armored, mechanized, infantry, and airborne divisions, and by the maintenance battalion and the aircraft maintenance and supply battalion in the airmobile division. These battalions contain elements that are deployed in the brigade areas of operation as well as elements that operate in the division base area. Support for other items is provided by other elements organic to the division as described in FM 29-30 (e.g. signal battalion for cryptographic maintenance, medical battalion for support of medical materiel).

2. In counter guerrilla operations, brigades may operate at great distances from the division base. In such cases, the direct support maintenance capability normally provided to the brigade may be augmented by elements of the division maintenance battalion. FM 29-30 describes the organization and operations of the maintenance support structure in the division.

(2) *General support maintenance.*

(a) Units committed to counter guerrilla operations must be provided GS maintenance and supply support from a secure logistical base. This base may be established within a nearby friendly country, or preferably, at the point of entry or other secure location in the host country. Depending on the workload, the size of the supported force, and any requirements to provide support to host country elements, GS maintenance will be provided by any required combination of GS maintenance units (fig. 4-3) organized into GS maintenance battalions. General support maintenance units may be augmented by local civilian labor.

(b) In addition to maintenance units, the GS maintenance battalion may include a collection and classification (C&C) company for the operation of a maintenance collecting point to receive, process, and properly dispose of unserviceable or recovered materiel evacu-

ated by divisions or separate brigades. If the size of the evacuation workload does not justify the use of a C&C company, the maintenance collecting point may be operated by a GS maintenance unit, by a platoon from the C&C company, or by a separate detachment.

(c) For details on GS maintenance and collecting point operations, see FM 29-22; for details on GS supply operations, see FM 29-45.

(3) *Logistical base controlling headquarters*. The necessity to establish a logistical base within the host country will require the establishment of a support command to provide

combat service support to U.S. forces and, as necessary, to forces of the host country. Units of the type indicated in (2) above, plus DS maintenance, supply and services, administrative, signal operations, air delivery, transportation, medical, military police, civil affairs units, and headquarters elements will constitute the support command.

4-9. Maintenance Support for Riverine Operations

See paragraph 3-9.

CHAPTER 5

MAINTENANCE CATEGORIES, STANDARDS, PRINCIPLES, POLICIES, AND PROBLEMS

5-1. Maintenance Categories

a. General. The Army maintenance system is divided into four categories: organizational, direct support, general support, and depot support (AR 750-1). Organizational maintenance is performed by personnel of the organization possessing and using the equipment. It consists of preventive maintenance functions; inspections and serviceability checks; periodic servicing such as changing oil, adding coolant to vehicles, lubrication, and the like; and replacement of minor parts and components. Organizational maintenance is the responsibility of all Army units, and is a basic requirement for combat readiness. The other categories of maintenance (direct, general, and depot support) involve the performance of more extensive tasks, generally take more time, and require more elaborate tools and more extensive repair parts than are available at the organizational level. These latter categories are termed "support maintenance" and are the responsibility of specific units whose primary mission is maintenance support (except as noted in *c* below).

b. Organizational Maintenance.

(1) Organizational maintenance is the keystone of the entire maintenance system and must be given proper emphasis and support at all levels of command. Provision should be made for sufficient training in organizational maintenance, adequate supervision of such maintenance, and the allocation of sufficient time for its performance. When a unit is incapable of performing all its required organizational maintenance functions because of a lack of time, lack of capability, or excess workload, direct support maintenance units will assist through the provision of technical assistance and/or assisting in actual work performance.

(2) Organizational maintenance consists of operator/crew maintenance and unit maintenance. Maintenance functions authorized to be performed at organizational level are listed in the maintenance allocation charts (MAC) published in organizational maintenance technical manuals dealing with specific items of equipment.

(a) Operator/crew maintenance embraces those preventive maintenance services that are the responsibility of the operator/crew using the piece of equipment, such as proper operation, inspection, cleaning, lubrication, and adjusting as prescribed in technical manuals and lubrication orders. It also involves minor repairs to equipment. Operator repairs are confined to minor adjustments and replacements limited by the tools and repair parts contained in the Basic Issue List Items (AR 700-18) and degree of elementary maintenance instruction incorporated in operator training courses.

(b) Unit maintenance is that maintenance performed by specialists assigned at company level and the maintenance functions performed by battalion-level maintenance activities (e.g., battalion maintenance platoon of the tank battalion). Maintenance allocation charts in technical publications differentiate between and list the maintenance functions to be performed at company and battalion levels. Units use parts from their prescribed loads to perform authorized repairs on equipment. Prescribed loads consist of repair parts and special tools prescribed for stockage in applicable Department of the Army publications. Personnel, tools, test equipment and other items of equipment required for unit maintenance (e.g., maintenance shelters), are provided in the unit TOE.

c. Direct Support Maintenance.

(1) Direct support maintenance is performed by designated maintenance activities in direct support of using organizations (AR 750-5). Depending on requirements, these activities may be of team, detachment, company, or battalion size.

(2) The prime objective of DS maintenance is to keep a maximum amount of equipment in the hands of troops, thus contributing to the combat potential. All DS functions and efforts are influenced by this objective.

(3) In most cases, DS maintenance activities are separate entities from the unit or units being supported. Support is normally provided on a combination area and unit support basis wherein the DS unit provides support to all units travelling through a designated area. In other cases, DS units may be assigned the mission of supporting only a limited number of designated units. In some cases where the density of specific types of equipment is low, where use of this equipment is limited to a few units of a specific type, or where reaction time to an equipment malfunction is critical, DS maintenance elements are made an organic part of the using organization (e.g., missile firing battalions and engineer construction battalions).

(4) The functions authorized to be performed at the direct support category of maintenance are also listed in MAC's published in organizational maintenance equipment technical manuals. The performance of these functions generally requires more extensive skills, more time, better facilities, more repair parts, and more extensive tools and test equipment than provided at the organizational level. Direct support maintenance functions include—

(a) Providing on-site maintenance and technical assistance to supported units.

(b) Providing direct exchange service by supplying selected serviceable items in exchange for unserviceable components or assemblies.

(c) Maintaining an operational readiness float (AR 750-1 and AR 750-5) of selected end items for exchange with using units when the need for a serviceable item is such

that the supported unit cannot wait for repair and return of the unserviceable item.

(d) Supporting all units in a specific area (area support mission) and/or specific forces or specific elements of a supported force (unit support mission).

(e) Assisting supported units in the performance of organizational maintenance and in the recovery of unserviceable or abandoned materiel, as necessary.

(f) Arranging for the evacuation of unserviceable materiel that cannot be repaired at the direct support level. The actual movement of such items is a responsibility of the transportation system.

(g) Assisting commanders in the performance of maintenance inspections.

d. General Support Maintenance.

(1) General support maintenance is performed by designated TOE and TD organizations in support of the supply system and DS maintenance units. In some cases, particularly in the COMMZ, GS maintenance units may also provide DS maintenance to using units. At the GS level, more time and better facilities are normally available than at the DS level. This permits more efficient work, more production, and better standards of serviceability.

(2) Specific repair functions authorized at this level are also listed in the MAC published in technical manuals. Normally, GS maintenance units repair equipment for return to the supply system. General support maintenance units:

(a) Repair end items of equipment and overhaul assemblies and components. To the extent practicable, repair is accomplished by use of production-line techniques.

(b) Return repaired items to supply stocks (except for those items returned to using units when the GS maintenance unit also has a DS maintenance mission, and those items evacuated to the GS unit for repair and return to the using unit through its supporting DS maintenance unit).

(c) Receive workload from DS maintenance units, collection and classification companies, supply units, and, in some cases, from using units.

(d) Provide backup and overflow support to DS maintenance units by accepting work that is beyond the capability or workload capacity of direct support.

(e) Provide technical assistance to DS maintenance units and using units, as required.

e. Depot Maintenance.

(1) Depot maintenance activities augment the procurement program in satisfying overall Army requirements and, when required, provide for repair of materiel beyond the capability of general support maintenance units (AR 750-5). Depot maintenance includes repair, overhaul, and rebuild functions. Repair and overhaul in depot maintenance facilities is performed in accordance with the IROAN principle to the extent practicable (para 5-3b).

(2) Rebuild is a repair action wherein unserviceable items are returned to a standard as near as possible to new condition in accordance with original manufacturing standards. This is accomplished through complete disassembly of the item, inspection of all parts or components, repair or replacement of worn or unserviceable elements using original manufacturing tolerances and/or specifications and subsequent reassembly of the item.

(3) Overhaul consists of that maintenance necessary to restore an item to completely serviceable condition, as prescribed by maintenance standards in technical publications for each item of equipment, but normally does not return an item to like-new, zero-mileage, or zero-hour condition.

(4) Depot maintenance may be performed overseas during wartime, as necessary and feasible, to support military operations in general or for specific commodities.

(5) While the maintenance function "overhaul" may be performed by either the general support or depot categories of maintenance, "rebuild" is performed only at the depot maintenance level. Rebuild is performed only when specifically approved by the Deputy Chief of Staff for Logistics, Department of the Army (AR 750-5). Also see AR 750-1.

(6) In a theater of operations, the requirement for and the practicality of rebuild of unserviceable equipment are based on a variety of factors which include:

(a) Availability of adequate supplies of power, water, and skilled manpower in the theater.

(b) Reduced availability of production capability or other resources in CONUS.

(c) Scarcity of inter-theater shipping or interdicted shipping lanes.

(d) Continuing critical shortage of the item within the theater supply system.

(7) A prime requirement for rebuild operations is a sufficient quantity of unserviceables to maintain a continuous production-line operation. This may be overridden if the conditions of (b) and (c) above exist; however, in such cases the cost of rebuild will be high in terms of dollars per item. Rebuild will also require a complete set of original specifications and/or drawings, quantity of repair parts over and above normal theater requirements, and fixtures, machine tools, dies, jigs, and dynamometers not normally available within a combat theater.

5-2. Maintenance Allocation Charts

Maintenance allocation charts for each major end item of equipment assign functions and repair operations to be performed by the lowest appropriate category of maintenance. Such charts are prepared during the development cycle of the materiel. They are published as Part II of the technical manual pertaining to the piece of equipment, and indicate the repairs to be performed by each category of maintenance. Functions to be performed by specific categories of maintenance are based on missions of the units involved, the peculiarities of the item involved, the complexity and bulkiness of equipment, the operational locations of units, existing maintenance support doctrine, the nature of the support structure, and readiness requirements. See AR 750-6.

5-3. Repair Standards, Techniques, and Limits

a. Repair and Overhaul Standards and Maintenance Support Plans.

(1) Repair and overhaul standards for equipment are prepared by the Department of the Army agency responsible for preparation of the maintenance support plan (MSP) for the item of equipment. The MSP is a continual-

ly updated plan initiated at the beginning of the development phase for an item of equipment of military design and at the beginning of the procurement phase for a commercial item. Its purpose is to indicate how maintenance support of a specific item will be provided within the maintenance support structure in the field, to assure proper testing and evaluation of materiel during development, and to identify requirements for operation and support of materiel in terms of: maintenance to be performed at each category of maintenance; special tools, test equipment, handling and calibration equipment, and operational readiness float requirements; MOS and special training requirements for operator and maintenance personnel; technical publications requirements; technical assistance requirements; and repair parts provisioning procedures. For additional details on maintenance support planning and plans, see AR 750-6.

(2) Repair and overhaul standards and serviceability criteria are published in equipment publications developed for support of specific items of materiel (technical manuals, technical bulletins, and supply bulletins indexed in DA Pam 310-4). These publications provide serviceability standards for equipment and indicate the degree of technical compliance required at the several repair levels. They serve as the basic standards and specifications for inspection and repair of equipment. Standards may also be provided by the following media: operating manuals, handbooks, data prepared by the equipment manufacturer, drawings, and technical instructions issued by the Department of the Army.

b. *IROAN (Inspect and Repair Only as Needed)*.

(1) When practical, all maintenance efforts at all levels are guided by this principle. The objective of IROAN is to accomplish adequate repair while eliminating unnecessary disassembly and parts replacement. It provides for maximum use of diagnostic devices in the inspection and testing of equipment in order to reduce or eliminate the complete disassembly of the item and unnecessary installation of new parts. It emphasizes continued use of parts, components, and assemblies to the

limit of their designed service life, and requires that they not be replaced merely because of a little wear. While this technique limits disassembly and parts replacement to conserve time and repair parts, it nevertheless requires proper inspection and complete repair to insure serviceability and safety. See AR 750-1.

(2) The proper application of IROAN requires sound judgment. For example, while it limits disassembly to that which is necessary, it must be recognized that the repair of components by production-line methods, as is common at the general support level, may require extensive disassembly of the item being processed on the line. Thus, extensive disassembly becomes *necessary* and does not violate the IROAN principle. Moreover, in some maintenance operations the bulk of repair time is spent in actual disassembly to gain access to the unserviceable assembly, subassembly, or piece part. In such cases it is often desirable to replace other parts evidencing wear, as well as the malfunctioning part, when these parts are made accessible by disassembly and experience indicates that they may not last much longer or may not function efficiently in conjunction with the new part being used in repair.

c. *Repair Limits*. Repair limits are of two types: "expenditure repair limits," and "time repair limits."

(1) *Expenditure repair limits*.

(a) Before undertaking the repair of an unserviceable end item, the economic repairability of the item must be determined. Factors to be considered are the cost of replacing the item as opposed to the cost of repairs. Also considered is the value (in terms of service life) that will be restored to the item if it is repaired. Value restored through repair may be measured by comparison of subsequent probable maintenance costs of new equipment. For this reason, expenditure repair limits are established to assist in determining economic repairability. When repair costs exceed maximum limits, cannibalization or disposal of the unserviceable item is undertaken, unless military necessity dictates otherwise (e.g., in some cases the criticality of the item and the diffi-

culty to replace it require that it be repaired regardless of cost). Repair limits are published in AR 750-27 and technical bulletins for appropriate commodity groupings.

(b) During wartime, expenditure repair limitations as indicated above may not be applied in an oversea theater. Instead, repair limitations will be based on availability of the item in the theater, time and repair parts necessary for repair, ease of resupply and availability of replacement items, and maintenance workloads.

(2) *Time repair limits.*

(a) In addition to economic repair limitations, the extent of maintenance performed on specific items at specific levels is often restricted by time limitations for the repair of specific items. These limitations are all geared to satisfying the most pressing requirements of the combat situation and are designed to return the greatest number of items to using units by concentrating repair efforts on the less time-consuming jobs. Based on such factors as availability of replacement items in the supply system, shop workloads, time available for maintenance, and the combat situation, various headquarters establish time repair limitations for maintenance units under their control. For example, such limits may indicate that vehicles requiring a certain stated number of man-hours of maintenance effort will be evacuated to a higher echelon for repair, even though the evacuating unit has the capability and is authorized to perform the required maintenance. Time limitations so established are subject to fluctuation, based on changes in condition upon which they were established.

(b) These repair time limits have their greatest impact at the direct support level and during periods when the intensity of combat is increased. For example, in a fast-moving situation that requires frequent displacement of DS maintenance units to permit them to stay within support distance of supported units, the DS unit cannot afford to build up large backlogs of work and take on jobs requiring extensive maintenance. Repair time limits will be established to permit a DS unit to concentrate on high priority jobs and those

requiring the least maintenance effort, with the remainder being evacuated to a higher category maintenance unit. In static or slow-moving situations, the DS maintenance unit may be allowed to establish greater backlogs and perform more time-consuming repairs.

5-4. Maintenance Principles (AR 750-1)

a. Each commander is responsible for the maintenance of equipment issued to his unit.

b. The maintenance system is most efficient when founded on sound preventive maintenance practices in using organizations. This includes correct operation and use of equipment and early detection and correction of incipient failures, as well as the performance of those inspection and maintenance functions required of the equipment operator or crew. When preventive and organizational maintenance are performed adequately, equipment will perform better and will last longer, and the workload of supporting maintenance units will be lessened. In addition, supply requirements and transportation requirements will be reduced and combat and materiel readiness will be improved.

c. Maintenance will be performed in accordance with published maintenance doctrine at the lowest category consistent with the tactical situation and the skills, time, repair parts, tools, and test equipment available and allocated to each category. In addition to the foregoing, mobility requirements, criticality of an item to the performance of a unit's mission, and frequency of failure are considered when allocating repair functions, especially at the organizational level. For example, an infantry company that may be required to move rapidly and often is not burdened with a large quantity of repair parts and tools and test equipment that would inhibit its mobility; nor is it required to perform very time-consuming repair operations. Other units that do not have to move as often or which have items critical to their mission and requiring prompt repair (e.g., artillery and signal units) may be provided with more extensive skills, repair parts, tools, and test equipment to accomplish more extensive and time-consuming maintenance functions.

d. Repairs will be accomplished on site, whenever feasible. It is often more practical to move maintenance personnel to equipment than to move equipment to maintenance personnel. To satisfy this requirement, mobile contact teams (transported by ground vehicle, air, or by water, if appropriate) are used to perform on-site maintenance at the site of equipment failure or the operational location of the supported unit. This technique must be applied with reason to avoid excessive loss of productive time through travel.

e. Maintenance will be accomplished in accordance with the applicable maintenance allocation chart (para 5-2).

f. Unserviceable materiel which is beyond the maintenance authority or capability of a using organization will be reported or evacuated promptly to the organization responsible for the next higher category of maintenance.

g. Unless precluded by the operational situation, all authorized maintenance within the capability of a using organization will be accomplished before equipment is evacuated to the next higher category of maintenance.

h. TOE units will not ordinarily be designated to perform, as a primary mission, a combination of categories of maintenance; e.g., direct support and general support maintenance. However, specific exceptions to this principle may be authorized by HQ, DA, in special cases involving unit assignment, low density equipment, complex weapons systems, and similar instances, when justified.

i. Each unit will possess an organizational maintenance capability to the extent practical, considering the size of the unit, mission, economy of resources, and the normal operational assignment and environment.

j. Maintenance will be accomplished with due consideration to the economy of resources. Where practical, the IROAN (para 5-3b) policy will be applied at all categories of maintenance.

k. Continuous command emphasis on the prompt evacuation of repairable unserviceable components and end items to direct support, general support, and depot maintenance facilities is mandatory to enable timely maintenance contribution to materiel readiness.

l. Components and end items returned for overhaul or rebuild will be complete with unserviceable or serviceable components, accessories, and basic issue items, to the maximum extent possible.

m. Organizations evacuating unserviceable repairable equipment for repair, overhaul, or rebuild will insure that adequate packing, packaging, preservation, and storage methods are applied to preclude equipment damage or loss while in transit or storage (AR 710-50, TM 38-230).

5-5. Maintenance Policies (AR 750-5)

a. The maintenance function "repair" (AR 320-5) may be assigned to organizational, direct, general, or depot support maintenance.

b. The maintenance function "overhaul" will be assigned to general support or depot maintenance categories.

c. The function "rebuild" will be assigned only to the depot maintenance category and will be performed only when specifically approved by the Deputy Chief of Staff for Logistics, Department of the Army.

d. The maintenance system is organized and deployed to assure the provision of adequate maintenance support as close to using units as practicable. For this reason, direct support maintenance units are deployed throughout the theater and establish their bases of operation near the units requiring most of the support effort. This speeds the responsiveness and reaction of DS maintenance units to the requirements of the units supported. For example, aircraft maintenance DS companies operate from areas at or near the airfields of aviation units; DS maintenance units operating in rear areas may establish themselves near transportation terminals; or DS maintenance units supporting a variety of using units will establish themselves in centrally-located areas within the complex of supported units and as near as practicable to the units requiring most of the support effort. By the same token, GS maintenance units and collection and classification companies are located throughout the theater in order to provide convenient and responsive support to DS maintenance units. Tire repair companies, if used in the theater, are normally found in the

army service area or the COMMZ. Depot maintenance organizations, if utilized in the theater, are normally found only in the COMMZ.

e. The mobility of maintenance support units must be compatible with that of the forces they support. For example, DS maintenance units that support highly mobile and maneuverable tactical forces must possess sufficient mobility to enable them to execute rapid movement to another location when distances become too great to permit efficient and timely support from the original area of operations. This does not mean that a DS maintenance unit must move every time the supported force moves; for too frequent movement consumes time and effort that could be otherwise expended in mission support operations, and severely curtails the amount and type of support that can be provided during the move. However, when distances to supported forces become too great to permit efficient and responsive support from the original area of operations, the DS maintenance unit must displace. When a DS maintenance unit has to move, time is required to prepare for movement, load equipment and supplies, evacuate or complete uncompleted workload, and reestablish in the new location—while this is being done, little can be accomplished in the way of support maintenance except on site maintenance by contact teams. General support maintenance units, which require more extensive facilities and which accomplish the more time-consuming or more complicated maintenance tasks, cannot move as often as direct support units.

f. At the direct support level, repair of end items is normally accomplished by the replacement of unserviceable components to facilitate prompt return of the end item to using units. Unserviceable components can then be repaired on a production-line or planned basis, normally by GS maintenance units.

g. General and direct support categories of maintenance will perform the maintenance functions of lower categories when required because of a lack of capability or capacity of lower categories. Before excess DS maintenance workload is evacuated to GS, maintenance

management activities attempt to balance workloads at the DS level.

h. Evidence of continued equipment abuse or failure to perform preventive maintenance will be reported to the proper commander for correction action. The maintenance support unit, through liaison and technical assistance, attempts to resolve such problems when they become apparent; however, if such remedial action proves ineffective command action will be required.

i. Before initiating repair of a piece of equipment, a diagnostic inspection is made to determine the extent of repair necessary to facilitate correct assignment of work and to determine parts requirements. For some types of items, though, the extent of repair required, type of repair needed, and repair parts requirements can be determined only after disassembly of the unserviceable item, or testing of the item using bench or van-mounted test equipment.

j. Maintenance at all levels of command will be performed under the supervision of an assigned maintenance staff officer in consonance with staff concepts in FM 101-5.

k. Equipment (except COMSEC) not eligible for repair will be evacuated to the property disposal activity after cannibalization in accordance with the provisions of AR 750-50. Disposition of COMSEC equipment will be in accordance with AR 750-18.

l. Controlled cannibalization is accomplished by direct and general support maintenance units and collection and classification companies in accordance with the procedures of AR 750-50.

m. Technical assistance is a responsibility of each echelon in the maintenance support structure. It includes advice, assistance, and training pertaining to installation, operation, and maintenance of equipment. At the DS maintenance level, technical assistance to supported units may be required to train organizational maintenance personnel in the use of diagnostic test equipment to avoid unnecessary part and/or component replacement and unnecessary evacuation of materiel.

n. Required unserviceable items that are economically repairable are evacuated through

maintenance channels to a point where repairs are made and the items returned to using organizations, supply stockage, or operational readiness floats (AR 750-1 and AR 750-5).

o. Unserviceable parts removed from equipment during maintenance will be repaired, evacuated, or otherwise disposed of without delay in accordance with the source, maintenance, and recoverability code assigned to the item and indicated in the equipment technical manual (AR 700-18).

p. An uneconomically repairable item is evacuated through maintenance channels to a salvage collection or property disposal facility after required usable or economically repairable components, assemblies, or parts have been removed by direct and general support maintenance organizations or collection and classification companies.

q. Excess serviceable or unserviceable, economically repairable equipment is disposed of through designated supply or property disposal installations in accordance with established disposition instructions.

r. When equipment failure occurs as a result of other than normal wear, operational malpractice, or accidental damage, the submission of an equipment improvement recommendation is mandatory. The activity determining the cause of an equipment failure is responsible for the preparation and submission of the equipment improvement recommendation in accordance with TM 38-750. Equipment damaged or destroyed as a result of accident or malpractice will be subject to the provisions of AR 735-10 and AR 735-11.

s. At the direct support level, unserviceable end items of using unit equipment may be immediately replaced with serviceable end items from an operational readiness float (AR 750-6) when prompt repair by the supporting maintenance unit is not feasible. While such replacement items are issued by DS maintenance units, these float items are really supply system assets and are provided through maintenance units to satisfy critical and pressing requirements. Thus, whenever possible, replacement end items will be obtained through regular end item supply channels. Commanders must establish policies and priorities govern-

ing the establishment, maintenance, and use of operational readiness floats. Operational readiness floats will be provided:

(1) For issue as replacements for unserviceable, economically repairable equipment to meet operational commitments, provided the equipment cannot be repaired in time to meet operational requirements.

(2) To overseas organization commanders and CONUS strategic and air defense organization commanders on a loan basis for items lost, destroyed, or determined to be uneconomically repairable. This procedure applies only when the supply delivery date is determined to be after the operational need date. When a float item is issued under these conditions, the user is responsible for requisitioning a replacement item and returning the float item to his supporting unit.

(3) An operational readiness float will be established to support high priority units before equipment is issued to lower priority units.

t. Each unit and organization is authorized and required to have on hand a prescribed load of repair parts to accomplish authorized repairs. The supply of repair parts for organizational maintenance is a normal function of direct support maintenance units.

u. The calibration and certification of operational devices and maintenance test, measuring, and diagnostic equipment are functions of maintenance as prescribed by AR 750-25.

v. Maximum practical utilization of interservice support will be achieved when overall economies can be realized without impairment of military effectiveness. Interservice support will be performed through the media of interservice support agreements on a cross-service basis under the provisions of AR 750-11.

w. Army field commanders are responsible for maintaining a self-sufficient military capability and capacity for organizational, direct, and general support maintenance. Contracting for the performance of this maintenance is authorized by AR 750-5 to provide an additional maintenance capability and/or resource to insure continued operational readiness and a cushion of flexibility to maintenance pro-

grams. Contract maintenance is considered an alternate capability—

(1) To augment existing maintenance resources.

(2) To accomplish fluctuating workloads in excess of existing capacities for an interim period.

(3) To accomplish modification or modernization work that initially requires the technical skills of the equipment manufacturer.

x. Maintenance support of nonstandard items procured with appropriated funds (research and development and production prototypes, special training devices, and limited density of special procurement items) and issued to the field for training and other purposes will be provided by the most economical means as determined by the procuring agency. To the extent that tactical and operational requirements permit, support will be provided by: contractor maintenance support, including supply of repair parts, tools, test and handling equipment which is not available through the military supply system; utilization of commercial literature and repair parts lists; controlled cannibalization as a source of low mortality repair parts; local procurement of required support items in accordance with AR 715-30; or, where practicable, maximum use of cross-service support with the other military Services. When conditions do not permit support of nonstandard equipment in the aforesaid fashion, support may be provided through: one-time procurement of peculiar repair parts, tools, test and handling equipment for the estimated life of the end item or system; authentication of commercial operator and maintenance literature as official DA publications; and procurement of field engineering services for the purpose of providing necessary technical assistance in the operation and maintenance of equipment.

5-6. Problems Affecting Maintenance Support Operations

The following problems are presented to indicate the type problems experienced by maintenance support units and to indicate how they can be avoided, solved, or alleviated.

a. Personnel Shortages. Lack of sufficient and trained maintenance personnel may be experienced from time to time by maintenance support units. These problems can be alleviated by proper planning of the troop basis, by the detachment and attachment of personnel and organizational elements, by use of local civilian labor to augment the capacity of maintenance support units, by proper assignment of personnel in accordance with their MOS qualifications, by on-the-job and cross training, by the establishment of local schools, by taking advantage of service school quotas, or by a combination of the foregoing.

b. Repair Parts Shortages. The problem of repair parts shortages can be alleviated to some extent by parts fabrication and controlled cannibalization, by taking steps to improve malfunction diagnosis to eliminate unnecessary parts replacement, by repairing components instead of replacing them, by making arrangements for throughout delivery from the unit having the required repair parts to the unit requiring them, by local procurement, or by the cross-leveling of repair stocks among units. Repair parts problems can also be caused by the deployment of new systems or equipment in a theater prior to the receipt of sufficient repair parts in the theater. The required parts should be provided before the equipment is deployed, or concurrently.

c. Increased Skill Requirements. The wholesale introduction of complex and costly equipment has resulted in a requirement for maintenance personnel with higher technical skills. The time, personnel, and other resources required to perform this maintenance must be provided beginning at organizational level and extending throughout the system.

d. Data Requirements. Procedures and facilities exist for the collection, rapid transmission, processing, and analysis of data required for maintenance management and control; however, the data available from the system are only as good as the information fed into the system by personnel who provide the raw data. Emphasis on full and accurate maintenance data reporting is necessary at all levels. Without full and accurate reports, errors in equipment design inefficiency in equipment

operation, poor materiel readiness, misdirection of maintenance efforts, insufficient repair parts stockages, and insufficiency of support personnel and equipment are but a few of the maintenance problems that may go uncorrected.

e. Dispersal Requirements. The advent of nuclear warfare and chemical and biological operations requires the dispersal of maintenance facilities. Dispersal reduces the efficiency of these facilities. The degree of dispersion depends on the risk the commander is willing to take to get the maintenance job done, and the magnitude of the maintenance job.

f. Logistical Buildup. Unless combat force buildup is accompanied by corresponding buildup of the maintenance support structure and development of a sound logistical base, materiel readiness will deteriorate rapidly, maintenance support unit workloads will increase, repair parts requirements will outstrip capabilities of the supply system, and overall operational readiness will be degraded. Planning of buildups requires proper integration of tactical and combat service support units, planned development of port facilities, air terminals, and other logistical installations required to support the force, and sufficient transportation to satisfy requirements of both tactical and combat service support elements.

g. Support of Host Country Equipment. U.S. forces may be required to provide support for host country equipment provided over a period of years through assistance programs. Such equipment may be no longer included in the current U.S. Army inventory but obtained specifically for host country use under the MAP program. Repair parts support for such equipment may be a problem, and parts may have to be purchased on the commercial market. In addition, the lack of maintenance skills to support such equipment may cause problems and require establishment of a training program.

h. Deployment of Type "B" Maintenance Support Units.

(1) A type "B" unit is one organized under a table of organization and equipment calling for a minimum of specialized and/or

supervisory personnel. Such units must be augmented by additional personnel, other than U.S. military, to perform the mission assigned by the TOE. These units are used in areas where the local civilian force can provide the necessary skills required for mission operations of the unit.

(2) Type "B" units minimize the requirement for U.S. military personnel. Use of such units has drawbacks which should be recognized by the troop planner. When these units are deployed to an operational location, a considerable amount of time will elapse before they can effectively perform mission operations. As much as six months may be required to obtain and train the necessary local civilian personnel.

(3) Instead of organizing type "B" units in the CONUS base and deploying them overseas, troop planners should consider organizing these units as full-strength TOE units and deploy them overseas in full-strength TOE configuration. These units could then be immediately productive in carrying out mission operations. At the same time, local civilian personnel could be hired and trained to fill TOE positions indicated in the type "B" column of the TOE. When sufficient personnel are obtained and trained, the unit could then be converted to a type "B" unit and the additional U.S. personnel utilized to fill other critical positions. Another factor to be considered in the use of "B" type units is host-country language training for supervisory personnel.

i. Deployment of Maintenance Units Without Their ASL's. At times, DS maintenance units are deployed to an overseas theater without their authorized stockage list (ASL) of repair parts. Upon arriving at their destinations, such units are ineffective until their ASL's are received, inventoried, stored, and posted to stock records. Thus, ASL's should accompany such units when they are deployed.

j. Equipment, Non-Standard, Urgent Requirement (ENSURE).

(1) U.S. Army forces engaged in active military operations may develop urgent requirements for end items of a type not included in Army stock. These may include

non-standard items or developmental equipment. Such requirements are transmitted to Department of the Army by the most expeditious means.

(2) ENSURE is a Department of the Army procedure to provide such items through expedited development of the required items or through procurement of commercial-type items that will satisfy the requirements.

(3) While every effort is made to provide for complete support of such end items when they are made available, problems can arise. Such problems may include lack of repair parts to support the end item, lack of trained personnel to perform maintenance, and insufficiency of equipment publications on operation and maintenance of such equipment.

(4) Thus it is essential that repair parts required to support ENSURE items be delivered concurrently with the end items; that training teams be provided, prior to or concurrent with delivery of the items; that required technical and supply publications be provided concurrently with the items; and the development of appropriate doctrine, operational, and organizational concepts be expedited.

k. Establishment of Priorities. Frequently a combination of problems discussed in this paragraph (lack of resources, e.g., repair parts, personnel, facilities) causes maintenance activities to become "bogged down," in that all required maintenance actions cannot be accomplished within the desired time frame. Therefore, it becomes imperative that maintenance managers effect coordination with higher headquarters and with supported units/activities to permit them to establish realistic priorities for maintenance.

l. Maintenance Units Deployed Without Equipment.

(1) On occasion, units are deployed to an area of operations without mission equipment or with equipment shortages. Upon arrival, they are provided equipment from prepositioned stocks earmarked for this purpose. Shortages may also be filled from in-country or by separate shipment from CONUS.

(2) Use of prepositioned stock expedites deployment of the unit by air. However, the

prepositioned equipment must be kept in a good state of readiness, and it should be of the same type with which the unit was trained. Unless there is definite assurance that necessary equipment, of the right type and quantity will be available in the area of operations, maintenance units should be deployed with all their mission equipment.

m. Redeployment of Supported Units. Major shifts of supported units from one area to another, can cause problems in providing maintenance support. Combat service support commanders should be given advance notification of such changes to permit maintenance support planning, realignment of the maintenance support structure, introduction of additional support units, if necessary, and redeployment of units. Some types of problems that might occur are indicated below:

(1) The introduction of an airmobile division into the force structure will require a greater maintenance capability for aircraft at the general support level.

(2) The movement of low-density type units (e.g., 175-mm gun battalions) using equipment that is not common throughout the area may cause problems in repair parts supply. Redeployment must be accompanied by the transfer of repair parts peculiar to such weapons from the DS unit losing support responsibility to the DS unit assuming the responsibility.

(3) Within the divisions, the composition of brigades can change very rapidly from infantry heavy to tank heavy, and vice versa. Transfer of repair parts for support of tanks from one forward support company to another may be necessary and even transfer of personnel may be required.

n. Security Requirements. Insofar as possible, maintenance support units and personnel should be relieved of extra duties that detract from mission performance. Traditionally, maintenance support units have been responsible for their own security, but when such requirements require a major portion of a unit's personnel strength, consideration should be given to providing security forces from other sources, to include security guards or paramilitary forces from friendly host governments.

PART TWO
MAINTENANCE MANAGEMENT: RESPONSIBILITIES AND FUNCTIONS
CHAPTER 6
INTRODUCTION

6-1. General

a. The operational readiness of Army units is a matter of concern at all levels of command, and all commanders have major responsibilities for such readiness. Operational readiness refers to the state of preparedness of a unit to execute its normal mission as reflected in the table of organization and equipment under which it is organized. Materiel readiness of equipment is one of the principal criteria in determining the operational readiness of units (AR 11-14 and AR 220-1). The attainment and maintenance of adequate materiel readiness depend on many factors, including—

(1) Availability and proper training of personnel to operate and maintain equipment.

(2) Availability of supporting logistical units and facilities.

(3) Capability of supporting logistical units to respond to support requirements on a timely and adequate basis.

(4) Availability and proper deployment of end items of equipment and the repair parts required for its support.

(5) Complete and accurate reporting of equipment location, maintenance requirements, equipment use, equipment serviceability, maintenance actions, and failures.

b. Proper maintenance is the foundation for materiel readiness which, in turn, is a key factor in determining operational readiness. It requires effective maintenance management. Such management must be exercised at all levels, from the user of equipment throughout the Department of Defense.

c. Maintenance management involves the application and control of all available resources in a manner best suited to accomplish the main-

tenance mission. It involves use of rapid and reliable communications for the transmission of information, instructions, and decisions. It makes use of automatic data processing techniques when the necessary equipment is available. It requires the development and modification of operational procedures, as necessary. It requires timely and complete information to enable continuous assessment of status, requirements, and problem areas. And, it requires realignment of missions, as necessary, and supervision of operations.

d. Effective maintenance management requires planning; supervision; direction; organization; assignment of functions, responsibilities, and resources; delegation of authority; leadership; and flexibility to permit adaptation to changing requirements and operational conditions. All commanders have certain responsibilities for maintenance management. The maintenance manager, whether he be a tactical unit commander or the commander of a maintenance support organization, is concerned with the management of materiel (tools, repair parts, end items), facilities, time, and personnel. All of the aforementioned resources must be present in sufficient quantity and where and when needed if the maintenance job is to be done—this, perhaps, is one of the most difficult jobs of the maintenance manager, for often it is difficult to establish priorities in the face of conflicting requirements.

6-2. Purpose and Scope

a. Part Two of this manual concerns itself primarily with those activities within the theater of operations, above battalion level, which have major functions and responsibilities.

ties relating to or affecting maintenance direction and management. Coverage includes the maintenance functions and responsibilities of theater headquarters of a unified or specified command, combined command, joint command, joint task force, theater army, theater army support command (TASCOM), supply and maintenance command, area support command, field depot, support group, field army headquarters, corps, field army support command, support brigade, division headquarters, the division support command, and separate brigades. Emphasis is placed on those headquarters having specific and detailed operational responsibilities in the area of maintenance management. Organization and operations of maintenance management centers (MMC), the principal activities within the maintenance support structure engaged in day-to-day management and control of maintenance support operations, are treated in detail in chapter 9. Maintenance management and operations at battalion and lower levels are covered in detail in FM 29-22 and FM 29-30.

b. The maintenance functions and maintenance staff organization of many of the headquarters discussed herein are quite similar. In many cases, overall functions are the same but the degree of their application at various levels and the interrelationships within the command and with other commands differ. It is necessary to view functions and operational methods at various echelons in accordance with their position in the overall structure. Thus, instead of discussing the maintenance functions and operational methods of maintenance

staffs in general, the staff at each echelon is discussed in relation to its position in the overall command structure.

6-3. Use of ADPE in Maintenance Management

a. Maintenance management in a theater of operations uses automatic data processing equipment to increase responsiveness to user requirements and management needs. The ADP system employs high capacity, digital computers and high speed terminal input/output devices linked together by a high capacity and reliable communications system. Chapter 9 provides details on ADP support of the maintenance management effort. FM 54-8 (TEST) provides coverage on the application of ADP to all aspects of combat service support operations.

b. At major headquarters levels, management by exception is the policy and is made possible through extensive use of summary reports and printouts of the ADP system located at the various headquarters and commands. These summary reports and printouts indicate trends or situations which require direct intervention by staff or command elements to insure timely and effective maintenance support operations.

c. Routine maintenance management is accomplished by maintenance management centers attached to major headquarters. Maintenance management centers depend on a continuous and timely flow of information and data relating to maintenance status, operations, and requirements, which are provided by supporting ADP centers.

CHAPTER 7

MAINTENANCE MANAGEMENT IN THE COMMZ

Section I. THEATER HEADQUARTERS (UNIFIED/SPECIFIED COMMAND)

7-1. General

a. In a theater of operations employing significant components of two or more Services, the theater headquarters is normally established as a unified command. When the forces in the theater are composed primarily of forces from but one Service, a specified command may be established. See JCS Pub 2.

b. Each of the Services represented in a unified or specified command is normally responsible for logistical support for its own forces. Normally, existing policies and procedures of the Services represented in the command are used for the provision of maintenance and other combat service support, and the Service component commander (e.g., theater army commander) exercises control to insure that such support is provided. The commander of the unified or specified command, however, has the authority to coordinate logistics policies and procedures through the separate military commanders of component forces, and to influence the logistics effort to the extent required to carry out his assigned missions, tasks, and responsibilities.

7-2. Functions of the Commander That Influence Maintenance

a. Exercises directive authority to insure effective operations and to prevent or eliminate duplication of facilities and overlapping of functions among the Service components of the command. The directive authority of the commander of a unified or specified command extends to the coordination, as necessary, of:

(1) Acquisition, storage, movement, distribution, maintenance, evacuation, and disposition of materiel, to include repair parts.

(2) Acquisition or furnishing of services.

(3) Acquisition or construction, maintenance, operation, and disposition of facilities. For further details on the exercise of directive authority in the field of logistics within unified and specified commands see JCS Pub's 2 and 3 and FM 100-15.

b. Reviews the recommendations bearing on the budget from the component commanders to their parent military departments to verify that the recommendations are in agreement with his plans and programs.

c. Disseminates information on the overall plans and programs of the command to the component commanders to enable them to exercise planning and management within their areas of responsibility and in order to provide a basis for requirements determination.

d. Reviews requirements of the Service components and coordinates priorities and programs to effectively utilize supplies, facilities, and personnel (AR 1-35).

e. May direct the establishment of maintenance facilities for joint use; e.g., a primary calibration facility.

f. Indicates, by directive, the type of information and communications on supply and maintenance matters that will be submitted to or through the command headquarters, and those matters on which Service components may communicate directly with their respective military departments.

g. Recommends the priority of the phased buildup of supplies, installations, and organizations essential to furtherance of the command's mission.

h. Establishes the necessary reports and methods of obtaining requirements of allied forces that are logistically supported by U.S.

forces so that this data may be included in the command's requirements report.

i. Establishes bases to accomplish the command's mission, and plans and coordinates base development in accordance with joint and Service plans.

j. May assign existing facilities to elements of the command. In occupied areas, maximum use is made of local facilities. Because of military departmental responsibilities for facility funding and support, except in emergencies no reassignment of existing facilities between Services or assignment action affecting the owning Service's utilization will be effected without concurrence of the Services concerned.

7-3. Role of the Staff J-4

The staff of the commander of a unified or

specified command is termed a "joint staff." It includes members of the several Services comprising the force. The head of the logistics division of the joint staff is designated as the J-4. He is charged with the formulation of plans and the coordination and supervision of supply, maintenance, repair, evacuation, transportation, construction, and related logistic activities. Since many of the problems facing this division are of a uni-Service nature, the division must give full consideration to established policies of the military departments. This division is responsible for advising the commander on the extent of logistic support which can be given to proposed lines of action and the policies necessary to insure effective logistic support for all forces in the command.

Section II. COMBINED COMMAND

7-4. Description

a. Combined operations involve the military forces of two or more nations operating under a single commander. The commander of such a command may, or may not, be a U.S. commander. U.S. forces participate in such combined operations as directed by the President.

b. The U.S. component of a combined command may be a unified command, a specified command, a joint task force, or the forces of a single Service. When a unified or specified command is employed, the commander of such a command exercises control and direction over maintenance and related activities of his command to the extent indicated in paragraph 7-2. The commanders of the Service elements represented in such commands/forces plan, direct, and control maintenance requirements for their respective elements.

7-5. Support of Other Forces

Support, by U.S. forces, of forces of other nations participating in a combined operation, will be in accordance with previously established agreements and orders establishing the force. Planning, at force level, will consider requirements for such support and assign re-

sponsibilities for its provision. When such support is provided, U.S. forces will normally be required to provide liaison officers and/or advisors to determine requirements and provide guidance on the use of equipment, procedures for obtaining support, and the like. Support for allies falls within the scope of international logistics, and guidance is furnished in JCS Pub 3. FM 38-8 provides details on how such support is provided, to include planning and management of such support and functions of the various agencies involved.

7-6. Combined Staff

To assist the commander of a combined command in the planning and supervision of operations, a combined staff is established. Such a staff consists of personnel from all nations represented in the command. The logistics officer keeps the commander informed on the overall logistical situation, supervises implementation of the commander's policies, assists in overall planning and requirements determination, and coordinates with other staff sections and the staffs of major elements comprising the command.

Section III. THEATER ARMY HEADQUARTERS

7-7. Responsibilities

Figure 4-1 depicts a type theater army organization in a large theater of operations. Among the responsibilities of theater army headquarters is the requirement to organize, operate, and control the necessary supply, maintenance, and services for combat service support of U.S. Army forces in the theater, and for such other forces as may be directed. If a theater army support command (TASCOM) headquarters is not used in the theater, the theater army headquarters will have to perform those TASCOM functions described in paragraphs 7-9 through 7-11.

7-8. Role of the Staff

The theater army headquarters delegates to TASCOM responsibility for preparation of detailed maintenance and other combat service support plans, directives, and guidance affecting theater army as a whole. The theater army G4 and other staff elements do not become involved in detailed operational functions; they are primarily concerned with broad, long-range planning at theater army level and with the formulation of policies and directives. If theater army headquarters assumes the functions of headquarters TASCOM, a minimum number of combat service support staff specialists are added to the staff (FM 54-7).

Section IV. THEATER ARMY SUPPORT COMMAND (TASCOM)

7-9. Mission and Functions

a. The TASCOM (fig. 4-1) provides combat service support to Army forces in a theater of operations and to other forces as designated. Services provided include general support to the field army, direct and general support to the COMMZ, and rear area protection within the COMMZ. Direct and general support services include supply and maintenance.

b. The TASCOM headquarters commands and controls units assigned or attached to the command; develops and provides broad policies and planning guidance; develops and recommends priorities and allocations in coordination with the related tactical headquarters of the theater; coordinates and exercises broad management control over combat service support activities of its subordinate commands; and provides staff advice and planning assistance to the theater army commander on combat service support matters. The TASCOM headquarters uses a coordinating staff as depicted in figure 7-1. For more detailed information on TASCOM headquarters operations, see FM 54-7.

7-10. Concept of Operations

a. The TASCOM commander plans and executes missions assigned by the theater army commander. The TASCOM staff develops and provides overall plans, policies, priorities, and

allocations to the subordinate operating commands and coordinates their activities. TASCOM headquarters doesn't become involved in day-to-day or detailed operations, planning, implementation, or management except as may be required to implement the TASCOM commander's missions. The headquarters functions, primarily, on a management-by-exception basis, with summary management reports and information provided by the subordinate commands. This permits TASCOM headquarters to perform its primary missions of planning and coordinating mid- and long-range combat service support operations in support of theater army missions.

b. The TASCOM headquarters staff provides guidance to subordinate commands through command channels. On technical matters, there is direct liaison with staff counterparts of higher, parallel, and subordinate commands. The staff sections also communicate directly with commands and activities in CONUS on technical matters within their particular areas of interest. For more information on TASCOM headquarters staff composition and operations, see FM 54-7 and FM 101-5.

7-11. Maintenance Staff Organization and Functions

A type internal organization of the TASCOM

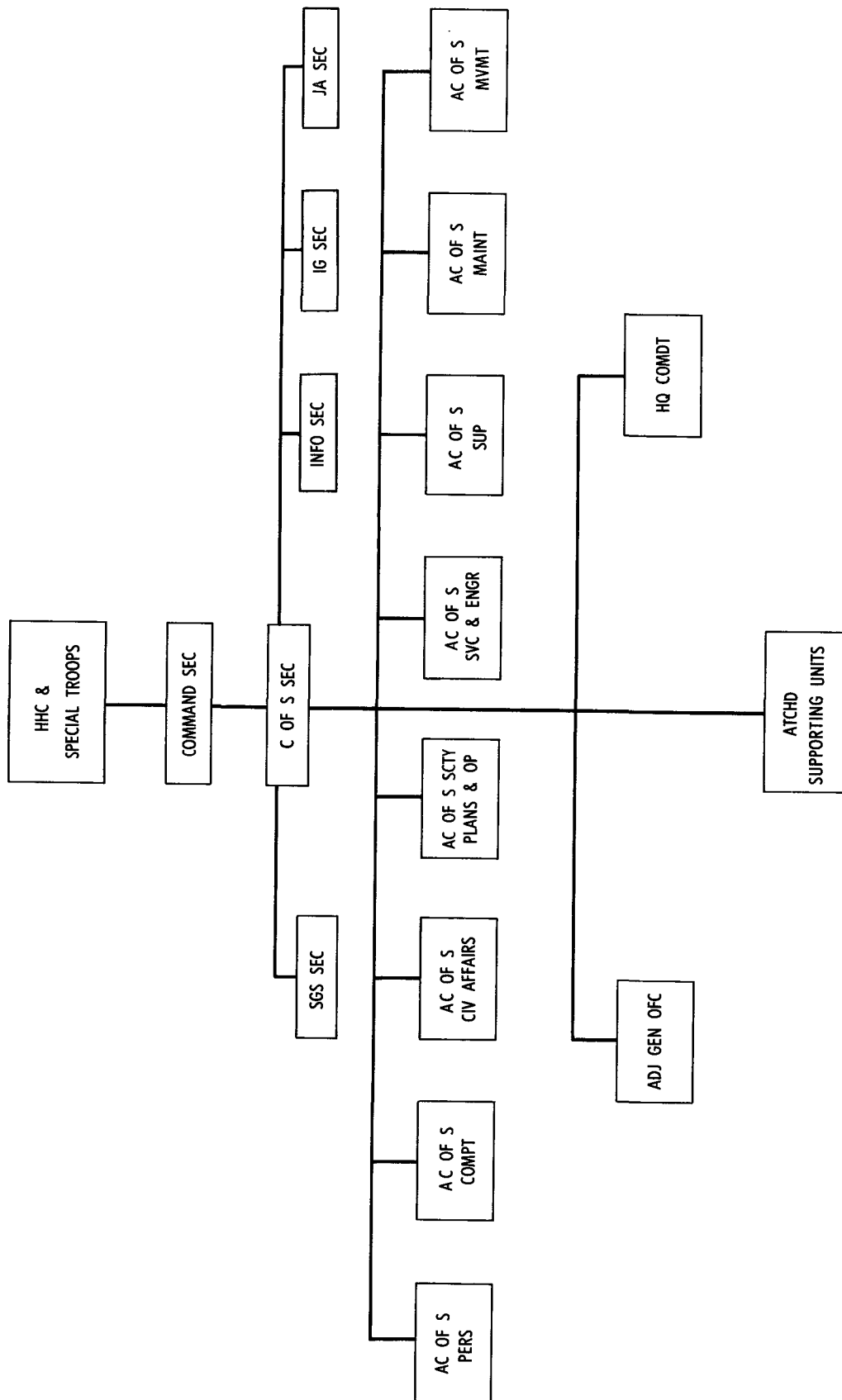

Figure 7-1. HHC and Special Troops, TASCOM.

headquarters maintenance staff would include the office of the ACofS, maintenance; a plans and operations branch, an electronics branch, a weapons branch, and a mobility and special equipment branch (fig. 7-2). The office of the ACofS, maintenance, supervises, controls, and directs operations of all elements of the staff. It also serves as the office of the staff materiel readiness officer who coordinates all matters that relate to materiel readiness (AR 11-14). The operational branches perform the functions of staff planning, supervision, and coordination necessary to accomplish the overall functions of the ACofS, maintenance section. Specific functions of the ACofS, maintenance and the operational branches of the maintenance staff are as indicated below:

a. ACofS, Maintenance. The coordinating staff officer for maintenance in the TASCOM headquarters is the ACofS, maintenance. Assisted by the operational branches of the maintenance staff section he performs the following functions:

(1) Prepares broad planning guidance and policies relative to maintenance operations.

(2) Reviews, analyzes, and evaluates materiel status reports.

(3) Establishes uniform procedures for the collection and presentation of maintenance management information.

(4) Reviews priority schedules for reconditioning and overhaul of materiel to cover theater requirements for the present and the predictable future.

(5) Performs long-range maintenance support planning and provides staff advice and recommendations on maintenance matters to the commander and, as required, to higher headquarters. Planning functions include planning for the improvement or development of maintenance facilities. Also included is planning for deployment of existing units, the phase-in of new TOE units, or development of TD-type organizations.

(6) Maintains close liaison with the ACofS, supply to insure that the maintenance effort is directed toward the timely repair and return to the supply system of critical items or items in short supply, and to assure that the supply system responds to requirements of

the maintenance system for repair parts, tools, and test equipment required for maintenance performance.

(7) Establishes maintenance standards for inspections and disseminates this information to subordinate commands.

(8) Recommends depot maintenance policies, as appropriate.

(9) In coordination with the ACofS, supply, establishes and disseminates policies for the collection, reclamation, salvage, and evacuation of materiel, to include evacuation instructions and condition standards.

(10) Provides recommendations relative to policies and procedures for implementing the Closed Loop Support (CLS) program and develops procedures and controls for the maintenance aspects of this program within the theater. This is a totally integrated and controlled program in which DA designated end items or components and assemblies are intensively managed through supply, retrograde, and overhaul to and from respective commands to maintain prescribed levels of readiness, and provide positive control. For additional details, see AR 700-69.

(11) Serves as the theater army contact point with CONUS commodity commands and technical schools on matters relating to specialized maintenance unit support, special training requirements, and introduction of new materiel into the theater.

(12) Determines requirements for and makes recommendations relative to providing maintenance support to other services as required. Policies and principles for interservice and interdepartmental logistic support are contained in AR 1-35.

b. Plans and Operations Branch. This branch performs long range maintenance planning, to include theater programing of modification work orders. It also establishes broad training objectives for maintenance personnel, evaluates new equipment implications, provides overall staff supervision for technical training of personnel associated with maintenance, and coordinates overall theater maintenance personnel requirements. In addition, it maintains liaison with the maintenance staffs of higher, subordinate, and supported commands, and recom-

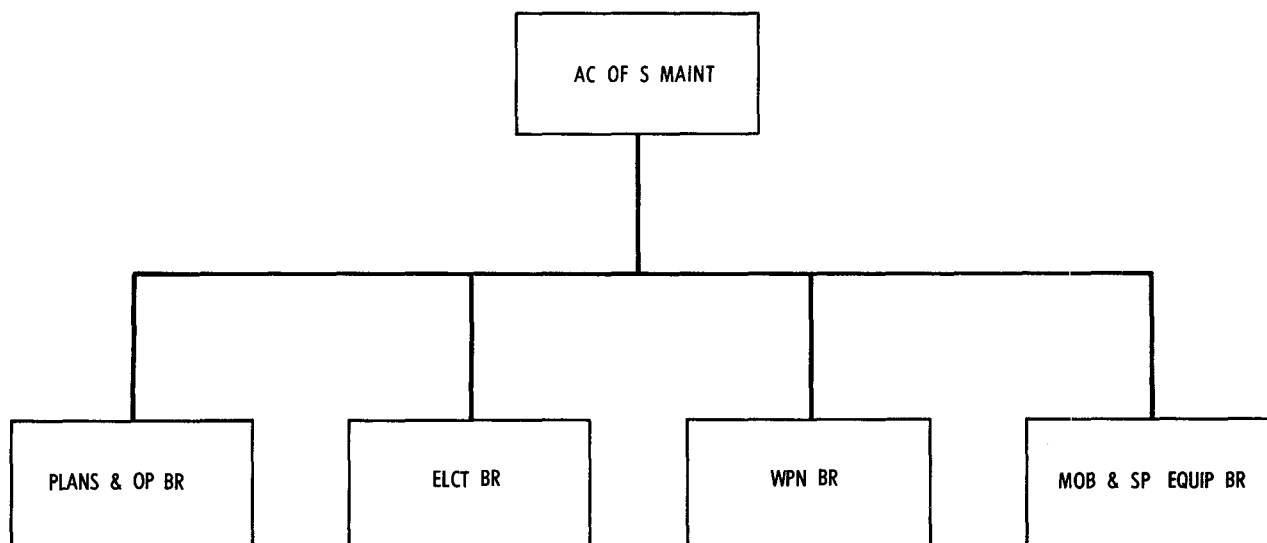

Figure 7-2. Typical internal organization of the TASCOM ACoS, maintenance section.

mends the maintenance unit troop basis for support of current and future operations.

c. *Equipment Branches (Electronics, Mobility and Special Equipment, and Weapons)*. These branches exercise staff supervision and provide technical information concerning equipment maintenance within their respective commodity areas. They—

(1) Review equipment records data and reports, such as status of MWO, overall deadline rates, etc.

(2) Make recommendations for long range repair priorities or rebuild activities.

(3) Develop and/or recommend policies and directives relative to maintenance support.

(4) Provide data and recommendations to the plans and operations branch relative to unit, personnel, equipment, and training requirements.

(5) Make recommendations for items to be nominated for inclusion in the CLS program in accordance with AR 700-69.

(6) Make recommendations to eliminate or alleviate problems relative to poor materiel readiness, excessive backlogs, premature equipment failures, etc.

Section V. SUPPLY AND MAINTENANCE COMMAND

7-12. Mission and Functions

a. The supply and maintenance command (fig. 4-1) directs, coordinates, and provides general support supply and maintenance services to U.S. Army forces and, as directed, to other elements of the theater.

b. Major functions of the S&M command headquarters include:

(1) Providing command, staff planning, control, administration, and supervision for all assigned or attached units.

(2) Advising the TASCOM commander and his staff on matters falling within the S&M command's area of combat service support responsibilities.

(3) Performing theater maintenance management functions for TASCOM, to include collection, processing, and analysis of maintenance and related data for the theater as a whole.

(4) Developing and providing broad policies and planning guidance relative to supply, field service, and maintenance matters.

(5) Coordinating with other mission command headquarters and with supporting activities in CONUS.

c. For details on the organization and operations of the S&M command, see FM 54-5-1 (TEST).

7-13. Staff Composition

The composition of the staff is similar to the TASCOM staff as shown in figure 7-1 except that the S&M command staff has no civil affairs and movement staff sections. In addition, since the S&M command is charged with detailed planning and supervision of supply and maintenance operations on behalf of TASCOM, an inventory control center (ICC) and a maintenance management center (MMC) are provided by attachment. These latter elements are called functional control centers and work under the direct supervision of the ACofS, supply and ACofS, maintenance, respectively, to perform day-to-day, theater level management of supply and maintenance operations.

7-14. Maintenance Staff Organization and Functions

The maintenance staff section of S&M command headquarters (fig. 7-3) is identical in organization to the TASCOM maintenance section except that a maintenance management detachment is attached to serve as the MMC for the command. Specific functions of the ACofS, maintenance and the operational branches of the maintenance staff are as indicated below:

a. ACofS, Maintenance. The ACofS, maintenance is the coordinating staff officer and principal advisor on maintenance to the S&M command commander. His maintenance responsibilities and functions are primarily geared to management of the maintenance effort in support of the theater army supply system and performing those functions relating to overall theater maintenance management that do not require decisions at TASCOM level. Specific functions of the ACofS, maintenance, as related below, require the contribution of all the various elements of the maintenance staff, as well as the MMC and supporting ADP center.

(1) Develops, plans, and establishes policies and procedures for maintenance support within the field depot system and for maintenance of class VII and IX components of guided missile systems.

(2) Provides advice, recommendations, planning and operational data, and recommended policies and directives to assist the S&M

command commander in carrying out his maintenance responsibilities.

(3) Provides staff supervision and exercises management over command maintenance activities, and exercises control over maintenance mission assignments of field depots and guided missile maintenance companies (GS) attached to ammunition depots. Recommends changes in such mission assignments, as required, due to workloads or specific projects or support requirements. Provides guidance and direction to maintenance units of the field depots and the ammunition group relative to changes in support requirements, priorities for the repair of specific type items, maintenance standards to be applied, techniques to be employed, schedules that must be met and controls that must be carried out.

(4) As directed by TASCOM, performs the following functions related to overall theater maintenance management:

(a) Develops and recommends plans, policies, and procedures for theater-wide collection and processing of maintenance data. Supervises maintenance data collection and processing efforts of the MMC and ADP center of the command to assure that the requirements of the command, and TASCOM, are met.

(b) In coordination with the ACofS, supply, develops criteria for establishment of repair priorities.

(c) Establishes and monitors the equipment modification program.

(d) Provides TASCOM reports or data indicating the requirement for management decisions at TASCOM level.

(e) Serves as the point of contact between the theater and CONUS on matters relating to calibration, maintenance requirements, maintenance data and reports required by CONUS activities, technical information, and evacuation of materiel for CONUS depot maintenance.

(f) In coordination with the ACofS, supply, develops theater stockage objectives for repair parts, requirements for overhaul of materiel, work program guidance, evacuation policies with respect to unserviceable materiel that cannot be repaired by FASCOM or ASCOM

maintenance units, and instructions for the disposition of repaired materiel.

(g) Maintains maintenance management data to facilitate planning maintenance requirements for future operations. Provides such data to other staff sections, the commander, and TASCOM, as required. Data includes current and projected workloads; modification work order status and accomplishment; experience data relative to manhour, skill, and repair parts requirements for specific type maintenance operations; repair parts that can be fabricated by maintenance units; maintenance skills that can be provided by local labor, if required; maintenance resources that can be provided from the local economy; and facility requirements for special operations (end item depot maintenance programs, if authorized; calibration facilities).

(5) Determines the need for and makes recommendations on—

(a) The allocation of maintenance support units and collection and classification companies.

(b) The employment of local civilian labor.

(c) Local procurement of facilities, maintenance supplies, and maintenance services.

(d) The distribution of maintenance personnel and maintenance supplies.

(e) Changes in maintenance missions to balance workloads.

(6) Supervises, directs, and controls theater army calibration service activities. Coordinates with FASCOM and ASCOM on calibration support requirements.

(7) Provides statistical data, operational data, requirements, and recommendations as required by TASCOM.

(8) Contributes to or prepares the maintenance and evacuation portions of S&M command and TASCOM orders or directives, as required.

(9) Provides input to base development plans in support of current or planned maintenance requirements.

(10) Establishes and publishes maintenance evaluation standards for repair and inspections.

(11) Keeps the commander informed on progress, status, requirements, anticipated or

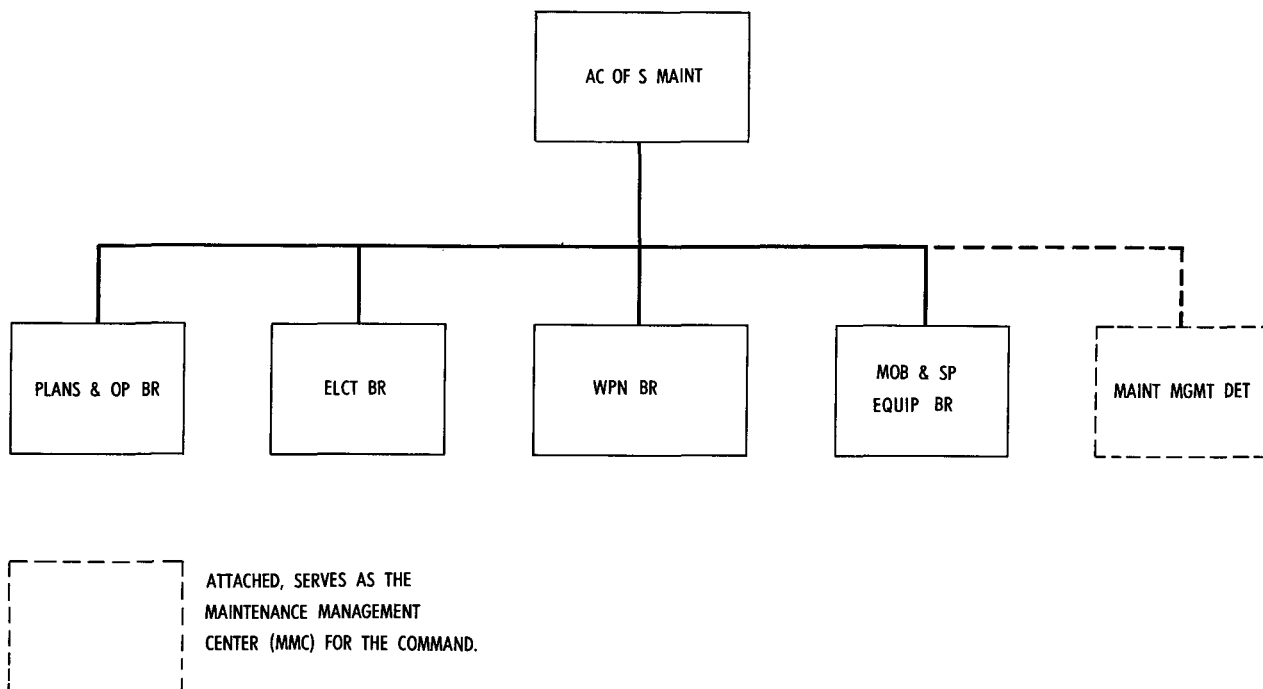

Figure 7-3. Type internal organization of the ACofS, maintenance section, S&M command headquarters.

actual problem areas, and remedial actions recommended or already started.

(12) Recommends policies and procedures for providing backup support to field armies and the ASCOM.

(13) Develops, implements, and supervises plans and procedures for materiel readiness of the command.

(14) Maintains liaison with the maintenance staff sections of TASCOM, FASCOM, and ASCOM.

(15) Maintains policy, historical, and data files.

(16) Recommends the reorganization, combination, or augmentation of S&M command maintenance units to satisfy requirements.

(17) Provides information to and coordinates with the ACofS, security, plans, and operations on the preparation of plans, utilization of sites and facilities, training requirements, redeployment of units, and mission assignments.

(18) Provides information to and coordinates with the ACofS, services and engineering on matters relating to real estate and facility requirements and transportation requirements.

(19) Coordinates with the ACofS, personnel on requirements for personnel and unit replacements, unit augmentation, and requirements for local civilian labor.

(20) Coordinates with the ACofS, security, plans, and operations on matters pertaining to rear area protection activities, unit augmentation, and attachment of additional units.

(21) Coordinates with the engineer command on matters relating to general support maintenance of construction equipment.

(22) Maintains and analyzes reports and data with respect to materiel readiness, maintenance performance, workloads, problem areas, and trends that must be evaluated and watched. Provides this information to other staff elements, higher headquarters, and subordinate commands, as required. Recommends or takes action based on requirements indicated in analyzed data.

b. Plans and Operations Branch.

(1) This branch provides the facility for the ACofS, maintenance to accomplish his re-

sponsibilities with respect to maintenance planning and operations for the command. Planning is accomplished in light of overall operations, both current and planned. Maintenance planning affects, and is affected by—

(a) The availability of facilities.

(b) The availability and deployment of maintenance support units.

(c) The availability of supplies (both repair parts and end items), civilian labor, transportation, and communications means.

(d) Personnel limitations and training.

(e) Budget limitations.

(f) Maintenance policies of higher headquarters and field armies.

(g) The area of operations and characteristics of the operations being conducted therein.

(h) National policy, host country agreements, and tactical and strategic plans and operations. See chapters 3 and 4.

(2) The above factors weigh heavily in the development of maintenance plans and programs at TASCOM and theater army levels; however, they also affect the planning and conduct of operations at the S&M command level, and will directly influence the type of workload of the S&M command, the volume of work, the scope of repairs that must be accomplished, and the procedures used.

(3) The plans and operations branch determines area, facility, personnel, and equipment requirements for future operations. In coordination with its counterpart in the ACofS, supply section, it determines and recommends the organization and deployment of field depots and subordinate units thereof. It provides similar recommendations relative to the employment and deployment of guided missile maintenance companies (GS) of the ammunition group.

(4) This branch develops the maintenance, calibration, and evacuation portions of S&M command planning documents and directives, and contributes similar material to TASCOM plans and operations as required. It develops plans and programs, to include production timetables, when necessary, and also including the programming of depot-level modification work orders and plans for the overhaul or re-

build of materiel. Maintenance plans and programs and the allocation of priorities for the repair of specific types of items are based on TASCOM direction, workloads, theater policy on depot maintenance, the status and requirements of the supply system, the ability of the CONUS or other logistic base to adequately support the theater (e.g., sufficient shipping and security of shipping routes, ability of the production base to satisfy supply requirements) and the criticality of specific items requiring repair. Contingency plans should also be prepared by this branch. For example, when shipping routes are subject to interdiction and the availability of ships and aircraft is insufficient to satisfy theater end item resupply requirements or to permit evacuation of items from the theater for depot repair in CONUS, the plans and operations branch may have to plan for more extensive repair within the theater. Such repair may involve rebuild.

(5) This branch also develops plans for maintenance technical training, including requirements for training on new materiel expected to enter the theater and for materiel readiness. It determines requirements for overhaul or rebuild and calibration support, and requirements for additional units, skills, personnel, and civilian labor, and provides recommendations on these matters to the ACofS, maintenance. It maintains close liaison with the maintenance staffs of TASCOM, FASCOM, and ASCOM for the interchange of technical and operational information. It recommends the optimum use of available resources based on work requirements, to include mission assignments, unit transfers, and organization for maintenance performance.

(6) It also maintains and evaluates data required for long-range maintenance planning, to include historical data on man-hour and repair parts expenditures for type maintenance operations, and area and facility requirements for maintenance operations, and experience data related to specific types of repair operations. Such data, if not physically stored within the branch, must be readily available from the supporting ADP center or the MMC.

(7) The branch also reviews and analyzes data and reports provided by the MMC to de-

termine whether plans and procedures require revision, to determine whether new plans or procedures need to be developed, and to discover trends or undesirable conditions that will affect planning and operations. It also informs the MMC of its report and data requirements, to include type, format, and frequency of required data.

(8) In order to accomplish its functions, this branch coordinates with and provides information to other staff elements, the MMC, and the ICC, as required.

c. Equipment Branches. These commodity-oriented branches (electronics, mobility and special equipment, and weapons) provide the ACofS, maintenance with a capability for staff supervision and technical information related to equipment maintenance for the command. Each of the branches, within its specific area of interest—

(1) Advises the ACofS, maintenance and other command and staff elements on technical aspects of equipment and calibration requirements.

(2) Reviews materiel readiness reports, determines causes for poor materiel readiness, and recommends action to improve readiness. Also participates in inspections within the command, as necessary, to verify or determine materiel readiness of command materiel.

(3) Develops and/or recommends policies and directives relative to maintenance procedures, inspection and serviceability standards, production techniques, maintenance controls, and the like. Provides recommendations and data to other staff branches and the ACofS, maintenance.

(4) Provides data and recommendations to the plans and operations branch relative to maintenance and materiel readiness planning, organization for maintenance operations, training requirements, resource requirements, augmentation requirements, and long-range repair priorities or requirements, to include depot maintenance (if authorized).

(5) Makes recommendations to eliminate or alleviate problems in areas of excessive backlogs of work, repair parts shortages, unsatisfactory maintenance performance, shortages of

skilled personnel, and inadequacy of tools and facilities.

(6) Performs liaison visits to TASCOM, FASCOM, ASCOM, the ammunition group, and subordinate field depots for the interchange of information, determination of problem areas, and the establishment of good working relationships.

(7) Assists in the development of or recommends policies and procedures for maintenance support, collection and classification, and calibration operations.

(8) Recommends the programing of specific type items for overhaul or rebuild.

(9) Coordinates with and provides information to other staff elements, the MMC, and the ICC, as required. Provides staff advice and assistance to the maintenance staffs of major subordinate units.

(10) Reviews reports and data provided by the MMC. This information stems from data processed by the supporting ADP center and submitted by subordinate units of the command in accordance with maintenance management data collection requirements, as well as reports submitted by S&M command units directly to the MMC which cannot be automated. Also analyzes reports and data provided by higher echelon (CONUS Logistics Data Center and commodity commands) data processing activities, such as equipment improvement report (EIR) digests. Based on such reviews and analyses, recommends command or staff action with respect to training, modification of mission assignments, repair procedures and priorities, inspections, and evacuation policies and procedures.

(11) Determines requirements for maintenance data and reports and recommends the type, format, and frequency of reports and other type maintenance data to be provided to satisfy branch requirements.

7-15. Method of Operation, S&M Command Maintenance Staff

a. General. The S&M command provides overall direction for the theater supply system (except for medical items) and provides back-up support required by the FASCOM and ASCOM for general support maintenance, evacuation of materiel to sources outside the theater

for higher category maintenance, and for the disposition of scrap. If rebuild of end items (depot maintenance) is performed within the theater, the S&M command, on behalf of TASCOM, will plan for and direct such maintenance. End item rebuild, if performed, will be accomplished as indicated in *b* below and in paragraph 5-1e.

b. Performance of Depot Maintenance.

(1) The assignment or authorization of a depot maintenance mission carries with it a number of responsibilities for the ACofS, maintenance. He must analyze requirements for the mission, determine the adequacy of facilities, review the long range program to determine the value to be gained from such a program, and determine that he will have the unserviceable assets available to overhaul/rebuild (information obtained from the ACofS, supply). He makes an appropriate request for the task assignment which includes an estimated cost of the program, the number of items to be overhauled/rebuilt, and the time frame involved. This request is submitted to TASCOM headquarters which, after evaluation and approval, passes on the request to the theater commander for his review, evaluation and for submission of the request to Department of the Army.

(2) Authorization to start the overhaul/rebuild program is sent to the theater in the form of a Depot Maintenance Work Requirement (provided by the Army Materiel Command in CONUS). This document includes the specifications to which the item will be overhauled/rebuilt, authorization for the required repair parts, authorization for the expenditure of funds, and the directive to proceed. This action places a further requirement on the ACofS, maintenance to report on the progress of the program. Further, such programs require close coordination with the ACofS, supply and the comptroller. As stated earlier, rebuild will be the exception rather than the rule; normally general support will be the highest level of maintenance in the theater. For more specific information on the interrelationship and interface between the theater and Department of the Army and the Army Materiel Command on matters relating to depot maintenance, see AR 750-4.

c. General Support Maintenance.

(1) The maintenance structure within the fields depots of the S&M command exists, primarily, to support the supply system by the repair of components or end items for return to stockage within the depot system. Exceptions to this rule exist in the case of the collection and classification companies whose major functions are geared to the receipt of material evacuated by FASCOM or ASCOM units and the processing of such items, in accordance with condition and supply system requirements, for shipment to maintenance units for repair, further evacuation to CONUS, shipment to a property disposal unit, or other disposition as directed. Another exception exists in the case of the army calibration company which has no mission repair function, but which operates from one of the depot complexes to provide secondary reference and secondary transfer calibration for all Army equipment requiring such support within the theater.

(2) The guided missile maintenance companies (GS) of the ammunition group perform general support maintenance on missile system items in support of the ammunition supply system.

d. Maintenance and Supply Coordination.

(1) The entire mission of the S&M command requires constant coordination and cooperation between its supply and maintenance elements. This is true for all levels within the command structure, and must be made a matter of command policy and supervision.

(2) At headquarters level, a close working relationship must exist between the ACofS, maintenance and the ACofS, supply and the elements under their control. Such coordination and cooperation are required for both long range planning as well as day-to-day operations of the command. Elements of the maintenance staff section and the MMC deal directly with elements of the supply staff section and the ICC in accordance with procedures developed jointly by the ACofS, maintenance and the ACofS, supply, and only matters requiring the intercession of the ACofS of either staff section are referred to the ACofS himself.

(3) Within the maintenance staff section, for example, planning and programing of general support maintenance operations, priority determination, resource allocation, and direction of the maintenance effort are based on supply system requirements for the repair of end items and components, and the priority for the repair of specific items within these groups as indicated by the ICC. Thus, the maintenance complex within the command satisfies a large part of the command's supply requirements by the repair of unserviceables for return to the supply system. The maintenance organization within the command, though, requires support of the supply organization for repair parts and maintenance materials, POL, and other supply requirements. Additionally, when the maintenance organization is unable to cope with supply system requirements for the repair of items for return to supply stocks, the ICC must satisfy such requirements by local procurement or requisitioning on the CONUS (or other supporting base) supply system.

(4) Special instructions, guidance, and other information developed by the ACofS, maintenance section or higher headquarters are provided to S&M command maintenance units by the MMC, which exercises management of day-to-day maintenance operations of maintenance units within the command. The ACofS, maintenance and his staff operate on a "management-by-exception" basis as indicated in *g* below.

e. Evacuation Instructions.

(1) The maintenance staff section, in coordination with the supply section, provides instructions to FASCOM and ASCOM relative to evacuation of unserviceable materiel to S&M command facilities for repair, reclamation, or disposition as scrap. Normally, such instructions are prepared as part of the TASCOM evacuation and maintenance support plans. When it is necessary to provide FASCOM or ASCOM with specific shipping instructions for specific items or shipments, such instructions will be provided by the ADP center, and will be based on destination information developed through coordination between the ICC or MMC.

(2) Unserviceables (except for missile system items, aircraft, cryptographic items, and medical material) are normally directed to a collection and classification company, where they are inspected, disassembled as necessary, and routed to maintenance facilities or disposed of as scrap. Some items that are obviously serviceable (e.g., tires reclaimed from uneconomically repairable end items) may be shipped directly to a supply facility; however, most items received at a collecting point will be shipped to a maintenance facility for proper classification and repair. Missile system components (less class V components) are evacuated to a designated guided missile maintenance company (GS). For certain items, direction may indicate shipment to a specific maintenance facility (e.g., in the case of components like tires, aircraft items, and items for which an overhaul and rebuild program has been established and certain units or facilities designated to accomplish the work). In addition, ASCOM units may be directed to evacuate unserviceable but repairable items to designated field depot maintenance units.

f. Maintenance Data Collection. Another responsibility of the S&M command is to serve as the control point for the collection of maintenance data throughout the theater. To this end, the ACofS, maintenance assures that data required by TASCOM and higher headquarters is submitted to and processed by the ADP center, that processed data is provided in required form and frequency, and that it contains the information desired. This is accomplished by the supporting MMC, as indicated below. Such data, after collection, processing, and analysis, is forwarded to TASCOM or CONUS agencies, with copies of reports and

summaries provided to the principal commands that submitted the data (FASCOM, ASCOM).

g. Maintenance Management. The S&M command MMC, operating under the direction and control of the ACofS, maintenance, performs maintenance management of routine day-to-day maintenance operations of the command. It also performs routine maintenance management functions related to overall theater maintenance functions in support of TASCOM requirements, and is responsible for monitoring the collection and processing of maintenance data and the preparation of reports and summaries pertinent to the theater army as a whole. Matters of a non-routine nature, matters not covered by existing policies and directives, information relating to existing or potential problems, and other data requiring command or staff action are reported to the ACofS, maintenance section for "management-by-exception" action as described in paragraph 9-4. For details on MMC operations, see chapter 9.

h. Information and Data Sources. The S&M command maintenance section requires a lot of information and data to satisfy its requirements and those of higher headquarters. Such information and data comes from subordinate field depots, ASCOM, FASCOM, higher headquarters, and CONUS sources. In most respects, this data is similar to that required at FASCOM level, but includes requirements of theater army as a whole. Data sources, requirements, and use at the FASCOM level are discussed in detail in paragraph 3-11. Most of this information is equally applicable at the S&M command level, and thus will not be repeated here.

Section VI. FIELD DEPOT

7-16. Mission, Organization, and Functions

a. The field depot is a command-type, group-size organization that performs general support supply and maintenance in a theater of operations. It consists of a headquarters and headquarters company to which a variable number of units can be assigned or attached. These units include functional supply units,

functional maintenance units, specialized units, and specialized teams and detachments of the TOE 500-series. Functions of a field depot include: receiving, storing, and issuing class I, II, III, IV, VI, VII, IX, and X supplies; performing general support maintenance on class II, VII, IX, and possibly class X items; providing designated field services to include preparation of supplies for airdrop; and maintain-

ing in storage a prescribed portion of theater army stocks.

b. Two types of depots, forward and rear, are located throughout the COMMZ (or other type of logistical base if a COMMZ is not employed). Forward depots are expected to move as the field army advances. The rear depots are located near beaches, ports, or air terminals where supplies are expected to enter the theater. Actual locations depend upon

topography, rail and road networks, and existing facilities.

c. Figure 7-4 depicts the type of units that may be assigned or attached to a field depot. Not all depots will contain all of the types of units indicated on the figure. Further, while most field depots will have both general support supply and maintenance missions, this will not hold true in all cases—some depots may have a supply mission only.

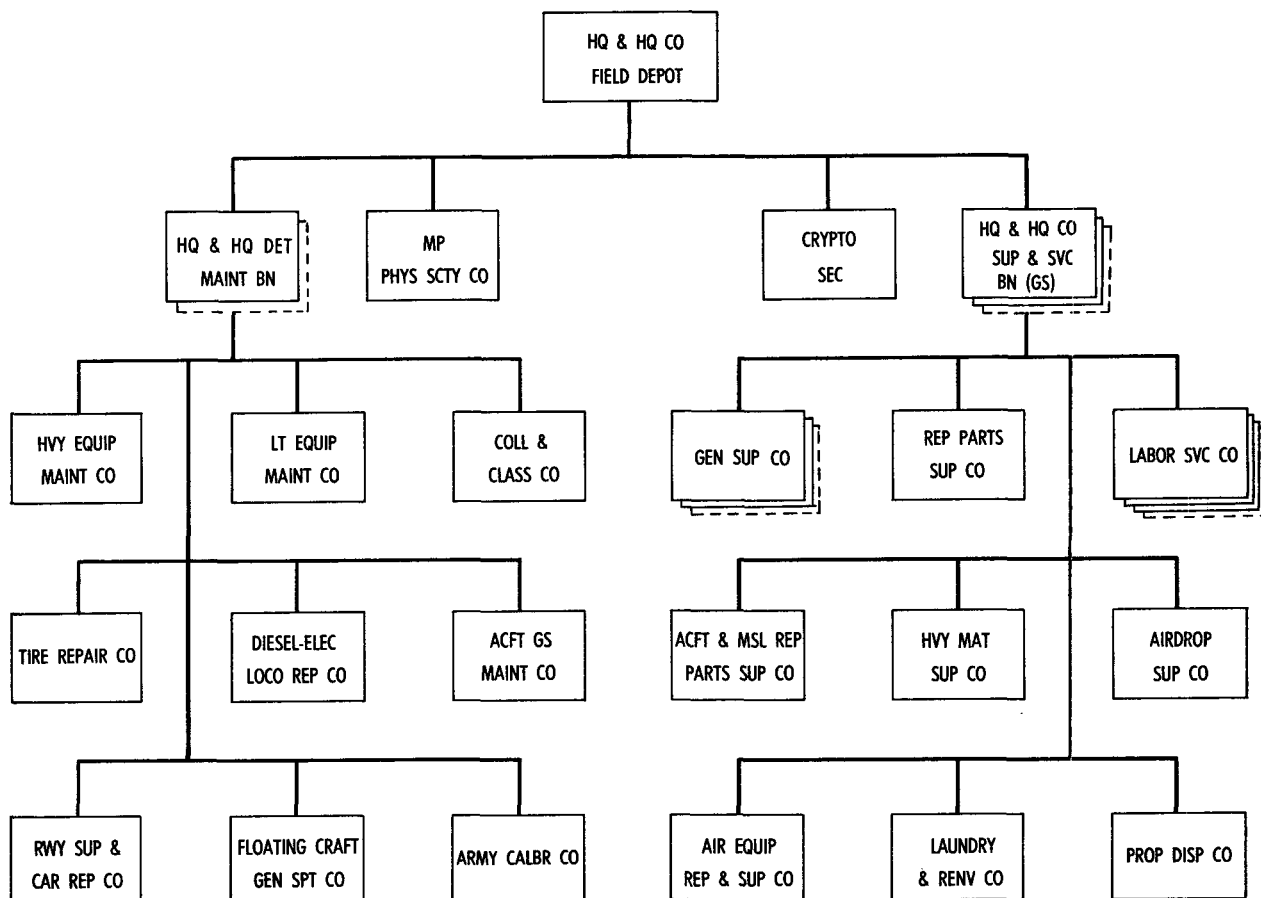

Figure 7-4. A type field depot organization.

d. This section is concerned, primarily, with the maintenance aspects of field depot operations. For broad coverage of overall depot operations and specifics on depot supply operations, see FM 54-5-1 (TEST) and FM 54-7.

7-17. Depot Headquarters Maintenance Staff Organization and Functions

a. General. The field depot commander is

provided a directorate-type staff (fig. 7-5) to assist in planning, supervising, and directing depot operations. The director of maintenance operations serves as principal advisor to the depot commander on all aspects of maintenance and maintenance related matters, and may serve as the depot materiel readiness officer. The director of maintenance operations also exercises staff and technical supervision over

subordinate maintenance and collection activities in the accomplishment of the depot maintenance mission. When no maintenance mission or maintenance units are assigned to the depot, the director of maintenance operations serves as staff advisor to the depot commander on maintenance functions pertaining to—

- (1) Materiel readiness of depot units.
- (2) DS and GS modifications of equipment in stock.
- (3) Obtaining maintenance support services for depot units, to include support for the application of DS and GS MWO's to materiel stored in the depot.

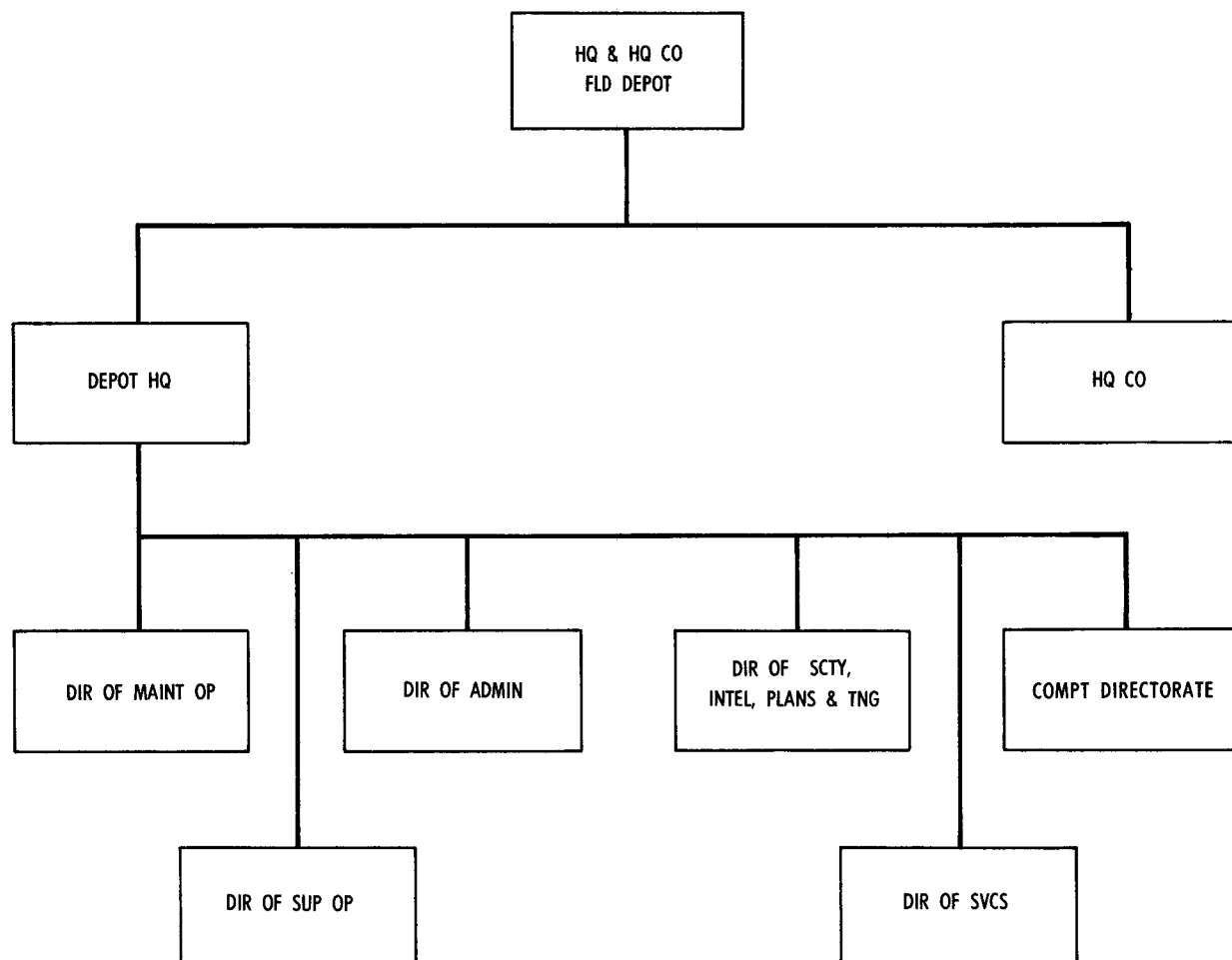

Figure 7-5. HHC, field depot.

b. Organization of the Depot Directorate for Maintenance Operations. The depot directorate for maintenance operations is organized into an office of the director, a planning branch, and a control branch. Personnel of the maintenance staff are specialists in the maintenance aspects of specific commodity groupings of materiel, and are capable of conducting staff and technical assistance visits to subordinate units to determine mission accomplish-

ment; adherence to priorities, schedules, and policies; and to provide technical advice and recommendations. In depots that have no assigned maintenance mission or maintenance units, the staff of the director of maintenance operations will be reduced and will consist primarily of personnel to perform inspections of depot units to determine materiel readiness condition, to provide staff advice relating to maintenance and materiel readiness aspects of

depot operations, and to provide recommendations on DS and GS level modification of depot stocks, as necessary.

c. Functions. The maintenance directorate functions in accordance with policies of the depot commander and policies, instructions, and directives of the S&M command. The S&M command provides field depots with instructions, policies, directives, revised mission statements, priorities, maintenance standards, anticipated workloads, and the like. Most such direction and guidance is provided by the MMC as described in chapter 9. Specific functions of the directorate of maintenance operations include, but are not limited to, the following:

(1) Directing, coordinating, and supervising the mission operations of maintenance and collection and classification units assigned or attached to the field depot. Assisting subordinate units in determining standards to be employed, in the establishment of appropriate production and quality control techniques, and in the resolution of problem areas that develop, to include those related to facility, repair parts, special equipment, and personnel requirements.

(2) Maintaining long-range maintenance forecasts for the depot, based on advice and information from TASCOM, S&M command, the ICC, the MMC, and the directorate of supply operations.

(3) Maintaining lists of materiel to be repaired.

(4) Coordinating with the ICC on repair parts requirements for repair operations and on the programming of kits and related materiel for the accomplishment of modification work orders.

(5) Coordinating with other staff elements of the depot headquarters on all matters pertaining to or contributing to the accomplishment of the maintenance mission. Availability and assignment of local shop facilities and transportation requirements are examples of actions that must be coordinated with other directorate staffs.

(6) Planning, scheduling, and conducting inspections of the operations of assigned maintenance or collection units.

(7) Providing advice, recommendations, and technical information to the commander

and other staff elements on all matters relating to depot maintenance operations.

(8) Providing technical assistance and advice to subordinate units on all aspects of maintenance procedures, techniques, tasks, and standards.

(9) Making recommendations to the director, security, intelligence, plans and training, relative to training requirements of subordinate maintenance units.

(10) Assuring implementation of policies and directives of higher headquarters, interpreting policies and directives as necessary, disseminating information and guidance to subordinate maintenance and collection units, and preparing depot policies, plans, and SOP's relative to maintenance and collection and disposition of materiel which are based on policies and plans of higher headquarters.

(11) Determining reporting requirements. Providing staff advice on the format, content, and frequency of required reports. Also evaluating reports and other maintenance management or materiel readiness information provided by higher headquarters. Taking or recommending action to remedy problem areas or to improve efficiency.

(12) Evaluating, utilizing, and disseminating management data and other maintenance management information developed and provided by the S&M command MMC.

(13) Providing staff recommendations relative to materiel readiness within the field depot complex.

(14) Determining requirements for civilian labor or military personnel, as required for augmentation of subordinate maintenance units, and making recommendations relative thereto.

7-18. Field Depot Maintenance Organization and Operations

a. General. The total maintenance support capability of the S&M command is found in the field depots of the command, and in the ammunition depots operated by units of the ammunition group. Field depots provide general support maintenance for most items of maintainable materiel except medical, ammunition, and missile system items. Support for

medical items is provided by units of the medical command. General support maintenance for ammunition and missile system peculiar items is provided by units of the ammunition group, as described in FM 9-6 and FM 29-22. This paragraph concerns itself with the maintenance and maintenance related aspects of field depot operations.

b. Command and Technical Supervision of Maintenance Units. All depots will not have identical maintenance missions; therefore, the assignment of maintenance units to each depot will vary. Some depots may have no maintenance units attached; others may have only one or two. In such situations, a command headquarters for the maintenance organization of the depot is not used; instead, command and technical supervision of depot maintenance units is exercised directly by the field depot headquarters director of maintenance operations. When the depot composition includes three or more maintenance companies, a headquarters and headquarters detachment, GS maintenance battalion is employed for command, control, administration, coordination of efforts, and technical supervision of general support maintenance units.

c. Depot Maintenance Structure. Types of maintenance units that may be assigned to a field depot include any combination of the units listed below, depending on the maintenance mission assigned by the S&M command. (Also see fig. 4-2.) Details on the mission, organization, and operations of these units are contained in FM 29-22. With the exception of those units indicated in (7) through (10) below, these maintenance units are attached to the headquarters and headquarters detachment, GS maintenance battalion, when a battalion headquarters is used.

- (1) *Army Calibration Company.*
- (2) *Light Equipment Maintenance Company (GS).*
- (3) *Collection and Classification Company.*
- (4) *Tire Repair Company.*
- (5) *Heavy Equipment Maintenance Company (GS).*
- (6) *Aircraft General Support Maintenance Company.*

(7) *Floating Craft General Support Company.* This unit is normally attached to the terminal group or brigade which it supports.

(8) *Diesel-Electric Locomotive Repair Company.* Depending on its operational location, this unit may or may not be attached to the maintenance battalion headquarters. If operating away from the depot complex, it is normally attached to the transportation railway service.

(9) *Railway Supply and Car Repair Company.* Depending on its operational location, this unit may or may not be attached to the maintenance battalion headquarters. If operating away from the field depot complex, it is normally attached to the transportation railway service.

(10) *Cryptologistics teams.* If the depot mission includes cryptologistics, such units are provided for maintenance.

d. Receipt and Disposition of Work.

(1) The primary function of the GS maintenance units of the field depot is support of the theater army supply system. This function includes repair of unserviceable components, assemblies, and end items returned through evacuation channels; repair of depot stocks that have become deteriorated or damaged while in storage; and the application of directed GS modifications for maximum modernization of equipment. They may also be required to apply DS level MWO. Items repaired by GS maintenance units are returned to depot supply stocks for reissue. Routine inspection and in-storage maintenance of depot supply stocks are the responsibilities of supply units of the depot.

(2) General support maintenance units of the field depots will not ordinarily be assigned an area support mission. They may be directed to provide overflow DS maintenance support to specific maintenance support companies of area support groups located in their vicinity (fig. 4-1 and 4-2), and in some instances may provide DS maintenance to units passing through the depot area. However, DS maintenance to using units, if furnished, will be on an emergency basis or when directed by higher headquarters for limited and specific periods of time.

(3) In addition to maintenance and supply support, the S&M command is responsible for providing calibration service for the theater army. Such support is provided by an army calibration company which is attached to a field depot for operational purposes, with policy direction and priorities being provided by the ACofS, maintenance, S&M command. For details on the provision of calibration service, see FM 29-27.

(4) The workload of field depot maintenance units is of two types—

(a) Items in depot stocks that require modification or that require GS repair because of deterioration, damage by enemy action, or damage due to accident or natural disaster.

(b) Items that have been rendered unserviceable through use or by enemy action while in the hands of using units, and that cannot be repaired at the DS level.

(5) Unserviceables requiring repair reach a field depot through one of the channels listed below:

(a) Transfer from depot stocks.

(b) From the collection and classification company of a field depot.

(c) Directly from a maintenance support company (COMMZ) of an ASCOM area support group.

(d) Directly from the C&C company of the corps or army support brigade.

e. Staff Influence and Technical Supervision Over Depot Maintenance Operations.

(1) The maintenance workload of depot maintenance units depends on the mission assigned by the S&M command and workload directed into the depot by the S&M command. The S&M command assigns maintenance missions to the field depot and provides the necessary maintenance units to accomplish this mission. The S&M command, based on depot organization and mission assignments and current workloads, provides instructions to FASCOM and ASCOM as to particular depots or specific depot units (e.g., the collection and classification company or the aircraft GS maintenance company) to which unserviceable items are to be shipped.

(2) The S&M command provides direc-

tives, policies, and instructions to be implemented by field depot maintenance units. Through its MMC, the S&M command provides information on workload to be directed into the depot, production-line maintenance requirements, requirements and scheduling for MWO applications, maintenance priorities and standards, problem areas uncovered through analysis of maintenance data, and the like. Thus, the MMC exercises a great deal of influence over the operations of depot maintenance units. Guidance relating to routine maintenance operations is provided directly; instructions and guidance requiring command knowledge and/or attention are provided through command channels (e.g., S&M command, to field depot headquarters, to maintenance battalion headquarters, to individual maintenance company). Instructions for the disposition of repaired items, scrap, and salvage are provided by the ADP center and are based on instructions provided to the ADP center by the ICC.

(3) Requirements for DS and GS maintenance of depot supply stocks and procedures for providing such maintenance are determined through coordination between the field depot directors of maintenance and supply. Direct support and general support maintenance of, and modifications to depot stocks are accomplished by GS maintenance units of the field depot; if the field depot has no GS maintenance units, such support must be provided by maintenance units of other depots.

(4) Technical supervision of actual maintenance performed within the field depot is a day-to-day function of depot headquarters, with responsibility being vested in the director of maintenance operations and his staff. The director of maintenance operations and his staff concern themselves with staff supervision and monitorship of maintenance performance.

(5) The director of maintenance operations and his staff will perform inspections as required by the depot commander or higher headquarters. Most of these inspections will be of the materiel readiness and CMMI type (AR 220-1 and AR 750-8) for all depot units; however, many will be informal-type inspections of depot maintenance operations. The

conduct of inspections, though, is but a minor aspect of the directorate's overall responsibilities. Primarily, the director of maintenance operations serves as the staff advisor on depot maintenance operations, being responsible to the depot commander to assure continuity of operations and effectiveness and efficiency of maintenance performance.

f. Data Requirements, Submission, and Use.

(1) Efficient operation of the maintenance directorate depends on timely receipt of information and data relating to: materiel readiness of depot units; workload status, performance figures, backlogs, and related information pertaining to the maintenance operations of depot maintenance units; and areas wherein difficulty is being experienced and which require command attention. Under conditions of full automation, most such information and data will be obtained from the S&M command ADP center in response to specific queries or to satisfy requirements for "feedback" information as directed by the MMC. Such "feedback" data will be based on information and data submitted by depot units to the ADP center for processing or for the updating of information maintained in the files of the ADP center. Information and guidance developed by the MMC as a result of review and analysis of data and reports developed by the ADP center or submitted directly to the MMC will also be provided.

(2) Under conditions of limited availability of ADP equipment, the maintenance directorate may be provided the above types of information through "information" copies of manually-prepared reports developed by depot units and provided directly to the MMC. These may include such reports as "Materiel Readiness" reports; reports that indicate workload received, in process, and completed, called "Status or Activity" reports; and reports called "Production Difficulty" reports.

(3) Subordinate maintenance units provide maintenance data and reports directly to the S&M command MMC and ADP center. To the extent possible (and depending on availability of ADP facilities and command operating requirements) data and reports are prepared in machine language format for transmission directly to the ADP center supporting the S&M command MMC. Depending on facilities and equipment available, such data and reports may be transmitted through facilities that may be located at battalion headquarters or a signal center.

(4) Required reports which do not lend themselves to machine processing (as well as other reports and data that must be submitted in manual format when ADP facilities are not available), are submitted directly to the MMC. For such reports, particularly those relating to problems and workloads, an information copy is provided to field depot headquarters. Thus, while depot headquarters does not become interposed between its subordinate units and the S&M command MMC and the ADP center on matters relating to the submission of routine maintenance data and reports, provisions are made for the receipt of information which requires the attention or action of the director of maintenance operations of the field depot.

(5) The director of maintenance operations cannot depend solely, or even primarily, on reports and feedback data to determine efficiency, production, and problem areas. Personnel of his section will spend a great deal of time visiting subordinate maintenance units and the S&M command maintenance staff to interchange information, discuss existing or potential problem areas and ways of solving them, to observe maintenance operations, to obtain data relative to workloads and production, to determine training requirements, and to provide advice and assistance.

Section VII. AREA SUPPORT COMMAND

7-19. Mission and Functions

a. The area support command (ASCOM) (fig. 4-1) is a major subordinate command of TASCOM. It provides direct support services

(less medical and ammunition) to the theater army support command to units passing through or located in the COMMZ, and to such other forces as directed by the TASCOM com-

mander. The ASCOM is also responsible for planning, coordinating, and instituting rear area protection operations within the COMMZ.

b. The ASCOM headquarters exercises command over assigned or attached combat service support units and such other tactical units as may be provided for rear area protection operations. It plans for the support of forces operating in or passing through the COMMZ, implements policies and directives of higher headquarters, develops and publishes policies and procedures based on those of higher headquarters and requirements of the command, and exercises operational control over units assigned or attached to the command.

c. The ASCOM headquarters staff is similar to the TASCOM staff as depicted in figure 7-1, except that ASCOM has no movements staff section.

d. For complete details on the organization and operations of the ASCOM, see FM 54-6-1 (TEST). This section is concerned primarily with the maintenance support aspects of the ASCOM mission.

7-20. Maintenance Staff Organization and Functions

a. Introduction.

(1) The internal organization of the ASCOM ACofS, maintenance section is identical to that depicted for the S&M command maintenance section in figure 7-3. The ASCOM maintenance staff is assisted in the accomplishment of its functions by the ASCOM MMC, which is attached to the section and operates under the direction and control of the ACofS, maintenance. As was the case with S&M command, the maintenance staff and the MMC receive ADP support from the ADP center supporting the command. Functions of the MMC are described in chapter 9.

(2) The scope of interest of the maintenance section embraces all activities related to the ASCOM maintenance mission, to include: direct support maintenance, repair parts supply at the direct support level, repair parts requirements for direct support maintenance, management of operational readiness floats, and evacuation of unserviceable mate-

riel. The maintenance section concerns itself with the maintenance support aspects of all types of maintainable materiel except class V, medical and air delivery items, light textiles, and footwear. While the maintenance support structure of ASCOM normally does not include units for direct support of rail, marine, and class VII and IX components of missile systems, such units are provided on an organic or attached basis to major organizations requiring their support, and maintenance management functions relating to such items must be accomplished by the ASCOM maintenance section as with other items.

b. *ACofS, Maintenance.* The ACofS, maintenance, is responsible for:

(1) Providing advice and assistance to the ASCOM commander on all matters relating to maintenance operations and materiel readiness; planning, management, and supervision of the command maintenance support effort to include assignment of support missions to subordinate units; and direction and supervision of the ASCOM maintenance data collection efforts of the MMC and the supporting ADP center.

(2) The specific functions of the ASCOM ACofS, maintenance are similar to the functions indicated in paragraph 7-14b for the ACofS, maintenance of the S&M command, except that they must be related to the direct support mission of ASCOM rather than the general support maintenance functions performed by the S&M command. The functions listed in paragraph 7-14b will not be repeated here; therefore, paragraph 7-14 must be used in conjunction with this paragraph to determine the full scope of functions of the ASCOM ACofS, maintenance.

(3) Other functions include:

(a) Maintains liaison with TASCOM headquarters on matters relating to long range resource requirements (e.g., personnel, materiel, and maintenance troop units) and with the S&M command headquarters on matters relating to evacuation of workload overflow, scrap, and items requiring higher category maintenance.

(b) Maintains close coordination with major troop commanders of units assigned, attached, or passing through the COMMZ to

obtain information relative to planned operations and deployment and requirements for maintenance support, and to indicate how such support will be provided.

(c) Coordinates maintenance support operational matters with the supporting headquarters in the COMMZ (S&M command) to include evacuation of workloads exceeding the repair capacity or capability of ASCOM.

(d) Provides information to the S&M command relative to secondary reference and secondary transfer calibration requirements. Effects necessary coordination with the activity/unit responsible for providing this support.

(e) Institutes action, as required, to balance workloads among area support groups. Keeps track of workloads and overloads within support groups so that maintenance units may be transferred among groups or workload evacuated to offset overload conditions.

(f) Provides information to and coordinates with the ACofS, supply, on repair parts problem areas and information required from the ICC which will affect maintenance management (e.g., repair parts status, status of end items, disposition of scrap, and requirements for fabrication of repair parts). Also coordinates on requirements for special tools and equipment for maintenance performance, other supply requirements of subordinate maintenance units, local procurement, and on matters relating to use and control of items in the "command-controlled" category.

(g) Establishes overall policies for maintenance technical assistance.

(h) As directed by the ASCOM commander, conducts inspections of subordinate units. As directed, provides policy and procedural guidance for command maintenance management inspection teams.

c. Plans and Operations Branch. The functions of this branch are the same as those indicated for the plans and operations branch of the S&M command maintenance staff in paragraph 7-14c except that functions are in support of the ASCOM direct support maintenance mission.

d. Equipment Branches (Electronics, Mobility, and Special Equipment, Weapons). These

branches function similarly to, and have the same responsibilities as their counterparts on the S&M command maintenance staff, except that direct support maintenance for COMMZ units is their primary concern. For a full description of the range of functions of these branches, see paragraph 7-14d.

7-21. Method of Operations, ASCOM Maintenance Staff

a. General.

(1) The ACofS, maintenance and his staff determine maintenance support resource requirements, in terms of personnel, unit, facility, and materiel requirements to support the mission of the command, and provide appropriate recommendations and plans to the commander in order to enable him to obtain the required resources from TASCOM headquarters. Staff coordination with other staff sections is a continual requirement to keep abreast of changing plans, troop densities, and support requirements. The operational mission of providing maintenance support to user troops in the COMMZ (including direct support repair parts supply) is the responsibility of area support groups and their attached maintenance battalions.

(2) Staff planning, coordination, and supervision are effected in accordance with the procedures described in FM 101-5. The staff concurrently plans and modifies plans for current operations while making plans for future operations. The staff requires a continuous flow of data and information relative to—

(a) The status and operations of subordinate maintenance units; the materiel readiness condition of both supported and support units; current and projected requirements for support, to include anticipated increases or decreases in the troop density supported; and the density of major items of equipment requiring support and any special problems inherent in the support of such equipment (e.g., calibration requirements).

(b) Movement of major elements of the supported forces from one portion of the area to another; the current status of repair parts and the ability of supporting field depots to

satisfy repair parts requirements; requirements for special controls on the usage and distribution of certain items (e.g., critical items, command-controlled items, operational readiness float stock); and those supported units which require priorities for issue or operational readiness float or direct exchange stocks.

(c) Destinations to which unserviceable items are to be evacuated when repair exceeds the capability or capacity of maintenance units of the command (e.g., some items may have to be shipped back to CONUS for repair; others may require shipment to specific field depots); information on requirements for parts fabrication; and policies and directives of higher headquarters.

b. Control and Disposition of Maintenance Workloads.

(1) The maintenance and repair parts supply missions of the command are carried out by DS maintenance battalions attached to area support groups. The specific composition of each maintenance battalion and the number of battalions in each area support group are based on support requirements and span of control factors. Each support group is assigned a mission to provide support on an area basis. Within the support group assigned area, battalions are assigned missions of supporting troops in or passing through designated areas. Maintenance units of the battalions are assigned on an area and unit support basis, with responsibilities for providing support to all units within a specified area and to other units passing through or temporarily bivouacked in the area. For details on the organization and operations of ASCOM maintenance support units, see FM 29-22.

(2) Maintenance companies provide direct support maintenance and repair parts supply and technical assistance to units they support. Inasmuch as there are no collection and classification companies in the ASCOM support structure, maintenance support companies and aircraft maintenance companies will also perform limited collection and classification functions with respect to materiel of the type they support.

(3) The ASCOM MMC keeps track of workloads, status, problem areas, and produc-

tion of maintenance units. This is accomplished primarily through analysis of data and summary reports provided by the supporting ADP center, and based on data submitted by maintenance support units of the command. When ADP support is lacking, information and reports are provided directly to the MMC by subordinate units. Such information is continually provided to the ACofS, maintenance section. This information is necessary to balance workloads, to identify problem areas so that remedial action may be taken, and to assign or reassign support missions and units. Routine day-to-day management of the maintenance support effort is accomplished by the MMC (chapter 9); the ACofS, maintenance section takes action on a management-by-exception basis when intercession by the ASCOM staff or command elements is necessary.

(4) Neither the ASCOM maintenance staff nor the MMC exercises direct control over items evacuated by subordinate maintenance units except when necessary to direct evacuation to other maintenance support units to cross-level workloads, or to the S&M command to relieve overload conditions. Items requiring evacuation or disposal (scrap, uneconomically repairable items, or items that exceed the repair capabilities or capacities of the command) are reported to the ADP center, which provides shipping instructions based on supply system requirements and workloads of field depot maintenance units. These instructions are based on guidance provided by the ASCOM MMC, which are in turn based on instructions and guidance provided by the S&M command MMC and ICC. Such instructions will direct shipment to a collection and classification company, a specific maintenance company of a field depot, or a property disposal company—based on item condition, supply status, and maintenance unit workloads. If ADP support is not available, the MMC receives the reports and issues instructions.

c. Overloads and Deadlines.

(1) Date or reports submitted to the ADP center or the MMC which reflect overloads, deadlines, or problems may result in action by the ACofS, maintenance section to augment

overloaded units. This may be accomplished by use of cellular teams, civilian production personnel, or by the temporary attachment of appropriate elements from other maintenance units. Such reports may also result in the introduction of additional maintenance support units or the reduction of repair time limits for specific items with a corresponding increase in the number of items evacuated for maintenance by a field depot.

(2) Unless the ASCOM ACofS, maintenance section maintains continuous and timely information on current and anticipated support requirements and the status and production of maintenance units of the command, overloads may become a serious problem. Overloads can occur because of weather or geographical conditions that adversely affect operations and cause premature equipment failure. Requirements for application of modification work orders, unless properly programmed, can also result in sudden overloads. Sometimes, the necessity to apply urgent MWO's will not permit adequate time for their programmed application and assistance from resources outside the command may have to be obtained. Overloads may also occur due to personnel shortages or the sudden, unanticipated buildup of the size of the force requiring support.

(3) Temporary overloads caused by sudden, but temporary, increases in workload can sometimes be accommodated by requiring maintenance units to work longer hours to reduce backlogs. Such an expedient must be of very short duration, for after some time fatigue will result in reduced efficiency and performance. Repair time limits, which govern the amount of time that can be spent in the repair of specific items at specific support levels may also be reduced. This expedient will result in a greater evacuation of materiel to field depots. Temporary augmentation of the support capacity of overloaded units by the attachment of elements of units from other areas that are not working at capacity is normally the best solution. If conditions warrant, entire companies or battalions may be transferred from one support group to another.

(4) If overloads are caused by the build-

up of the supported force, and such buildup is of a permanent or semi-permanent nature, steps must be taken to obtain the assignment of additional support units and the reassignment of support missions to balance workloads.

(5) Subordinate unit overloads resulting from inability to cope with the volume of the direct support maintenance workload and deadlines resulting from lack of parts for maintenance performance require investigation as to cause, and command or staff action to remedy the situation. In the management of deadlines and overloads, the ACofS, maintenance section compares the workload, production, and deadline figures of similar-type units, and when figures differ significantly from one unit to the next, investigation of causes and remedial action may be called for. Some of the actions that may be indicated include: augmentation of overloaded units; changes in mission assignments; investigation of inspection, production control, maintenance, and repair parts procedures; training of personnel and assuring that they are being properly utilized in accordance with their MOS; and proper application of maintenance standards and production control and maintenance management techniques, to include application of work simplification and work measurement techniques.

d. Materiel Readiness, Maintenance, and Maintenance Related Data.

(1) Maintenance support units of the command, as well as supported units, submit data on materiel readiness, maintenance performance, and other data related to the maintenance of equipment to the ADP center supporting ASCOM. Such data is submitted in machine-language format to the extent possible. The ADP center processes such data to satisfy the data and report requirements of ASCOM and higher headquarters. Data and reports required for materiel readiness and maintenance management at ASCOM level are provided through the MMC. In the absence of ADP, data is submitted to the MMC and the MMC furnishes information to higher headquarters.

(2) The MMC, based on requirements of the S&M command and requirements of ASCOM headquarters command and staff elements, particularly those of the ACofS,

maintenance section, provides instructions to the ADP center relative to the format and content of required reports and summaries. The MMC receives and analyzes reports and summaries provided by the ADP center and assure their distribution to other staff sections and other headquarters (both higher and lower). The MMC also prepares graphic portrayals of data, and assists other maintenance staff elements in determining format for and obtaining data or summaries as may be re-

quired, provided the required information is available from data stored at the ADP center.

(3) Special reports and summaries may be provided by higher headquarters as a result of data received and/or consolidated and analyzed at higher headquarters levels.

(4) Types of data that may be provided through machine processing of data submitted to the ADP center and their use in maintenance management are discussed in chapter 9.

Section VIII. AREA SUPPORT GROUP

7-22. Mission and Functions

a. Area support groups are composite, multi-functional organizations that provide direct combat service support (less ammunition and medical) to TASCOM mission commands and other designated units in the COMMZ. They are major subordinate elements of the area support command (fig. 4-1), and contain the operating units that perform those ASCOM functions listed in paragraph 7-19. Area support groups are assigned areas of responsibility dependent on densities of personnel and materiel to be supported, as well as political boundaries and identifiable terrain features. Each area support group is specifically tailored for the mission it is to perform. Figure 7-6 illustrates a type area support group organization. For further details on overall group organization and operations, see FM 54-6-1 (TEST).

b. Overall direction and control of group combat service support operations is exercised by ASCOM through directives, instructions, changes in mission assignments, assignment of priorities, and other command guidelines. These directions and instructions should be sufficiently broad to permit the group commander and his staff to exercise management and control at the group level in accordance with ASCOM policies and direction.

c. The direct support maintenance and repair parts supply portion of the group mission is normally performed by a maintenance battalion. This battalion is composed of a headquarters and headquarters detachment, one or more maintenance support companies,

COMMZ, and, if required, an aircraft maintenance DS company. These units provide direct support maintenance and repair parts supply support to units in or passing through the COMMZ. In the event that less than three maintenance companies are assigned to an area support group, a battalion-type organization utilizing a battalion headquarters and headquarters detachment is not employed; instead, the maintenance company(ies) operate directly under the supervision of the support group director of maintenance. For specific information on the operations of these maintenance support units, see FM 29-22.

7-23. Maintenance Staff Organization and Functions

The staff of area support group headquarters is a directorate-type staff (fig. 7-7). The maintenance directorate is the element charged with staff supervision, planning, and direction of maintenance support operations of the group. For operational purposes, the maintenance directorate is normally organized into an office of the director of maintenance, a plans operations branch, and a materiel branch. Specific functions of the director of maintenance and the elements of his staff are as indicated below:

a. *Director of Maintenance.* The director of maintenance directs, coordinates, and supervises maintenance support operations of the group in accordance with policies of the group commander and plans, programs, policies, and instructions of ASCOM. Specific functions of the director of maintenance are the same as

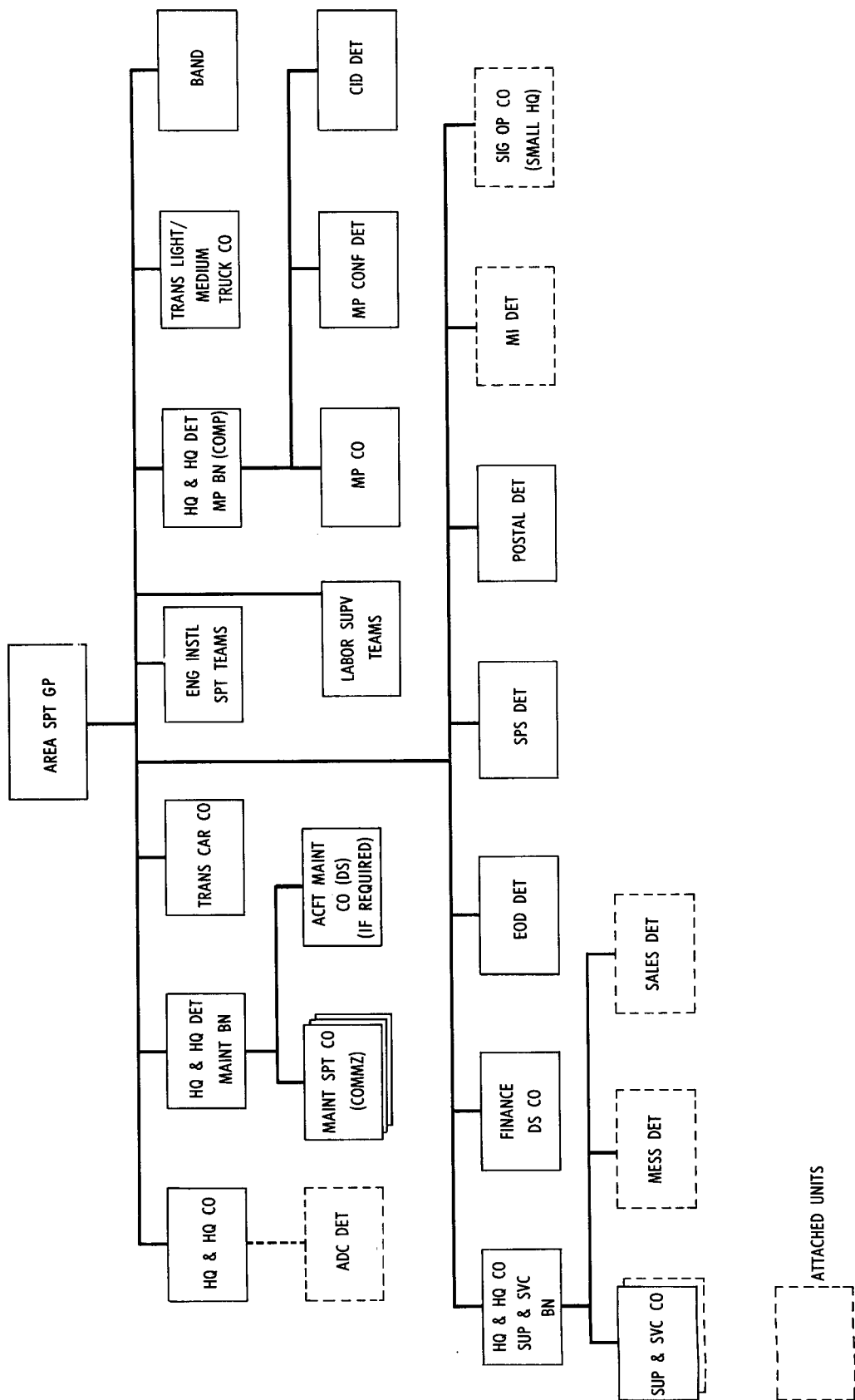

Figure 7-6. Type Area Support Group, ASCOM.

those listed for the director of maintenance in the field depot (para 7-17c); however, they must be viewed in relation to the direct support maintenance mission of the area support group. In addition to the functions listed in paragraph 7-17c, the director of maintenance:

(1) Recommends realignment of support missions of units of the maintenance battalion as necessary to compensate for overload conditions in workloads. Recommends increases in group maintenance capability or changes in the support mission of the group as necessary because of overall group overloads.

(2) Recommends deployment of maintenance units of the group in accordance with plans of higher headquarters.

(3) In coordination with the director of supply, periodically reviews proposed additions or deletions from authorized stockage lists of subordinate maintenance units to assure realistic stockage in accordance with mission requirements, exercises staff supervision over repair parts supply functions, and supervises implementation of policies and procedures for issue and control of operational readiness float stocks.

b. Plans and Operations Branch. This branch concerns itself with maintenance support planning. It determines area, facility, personnel, equipment, and deployment requirements in accordance with contemplated operations and deployment of supported forces and in accordance with anticipated support requirements. It recommends the utilization of available resources based on work requirements, to include mission assignments, unit transfers, and optimum location of maintenance support elements to best support the supported troop disposition within the command's area of responsibility.

c. Materiel Branch. This branch contains personnel skilled in the maintenance aspects of a specific commodity grouping of materiel. Each commodity-oriented element of the branch, within its specific area of interest—

(1) Advises on technical aspects of equipment.

(2) Develops and recommends policies and procedures relative to maintenance performance, technical assistance, inspection and

serviceability standards, controlled cannibalization, production techniques, maintenance controls, and managerial techniques.

(3) Makes recommendations to eliminate or alleviate problems in the areas of materiel readiness, excessive backlogs of work, premature equipment failure, repair parts shortages, unsatisfactory maintenance performance, shortage of skilled personnel, and inadequacy of facilities.

(4) Analyzes reports and data provided by higher echelon data processing activities. Based on such reviews and analyses, recommends command or staff action with respect to training, modification of mission assignments, inspections, support priorities, evacuation policies and procedures.

7-24. Method of Operation, Group Maintenance Staff

a. The maintenance workload of group maintenance units depends on mission assignments directed by ASCOM headquarters. The ASCOM headquarters will assign, to each support group, responsibility for providing maintenance support to all units within or passing through a specified area. The maintenance battalion in each area support group deploys its subordinate units in a manner best designed to satisfy support requirements in its area, and assigns support missions to each maintenance company of the battalion.

b. The ASCOM headquarters provides directives, policies, and instructions for implementation by group. It provides instructions on evacuation of unserviceables or scrap, policies for instructions on repair time limits for the repair of specific types of items. It also directs fabrication of repair parts, when necessary; provides information on the deployment of new troops into the area that require support; indicates priority of effort for specific supported units, and directs investigation of problem areas as evidenced in reports or data arriving at higher headquarters. In addition, it indicates supply levels for repair parts stockage and directs redeployment of units or reassignment of support missions when necessary to satisfy differing support requirements. Most of these instructions and guidance relative to

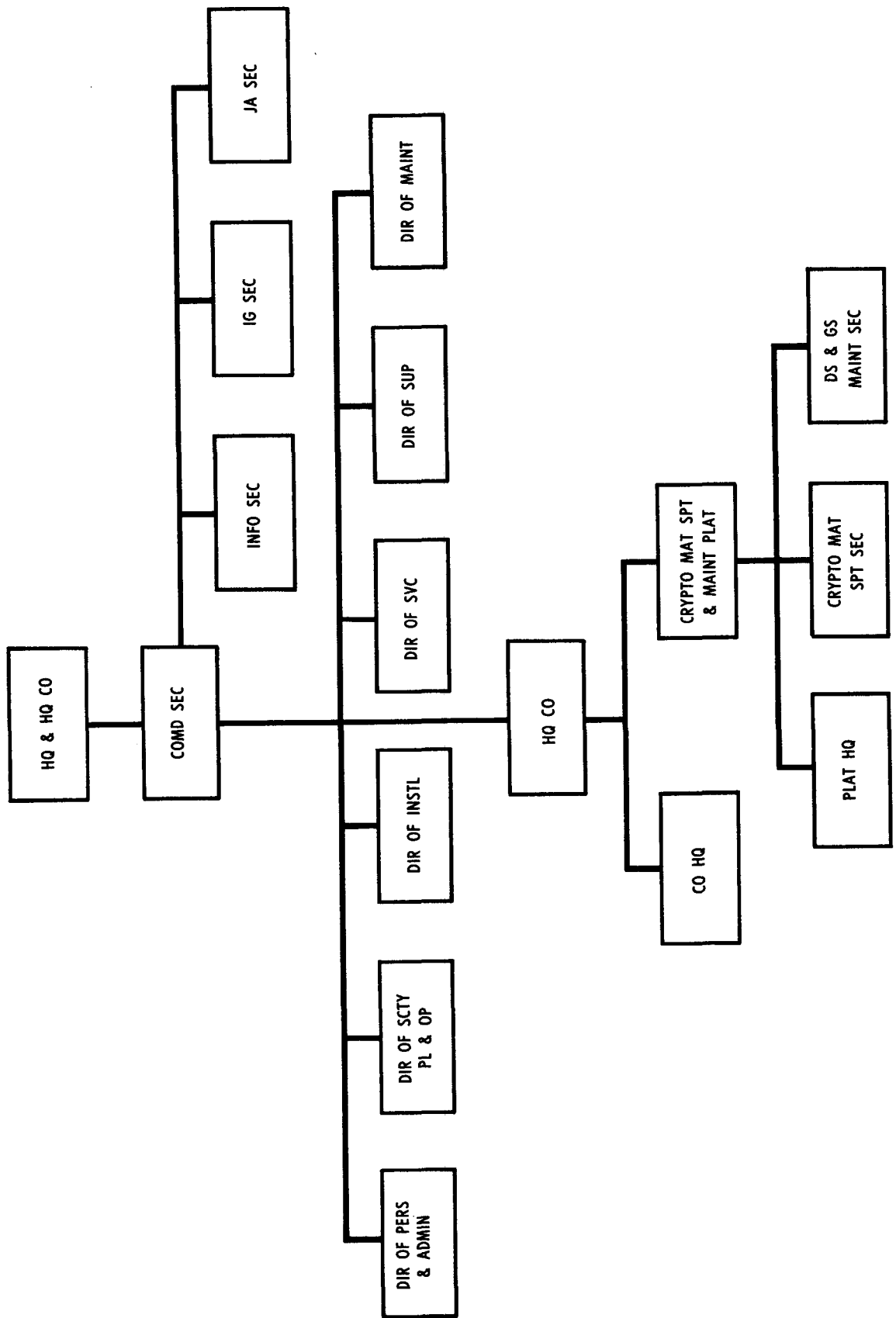

Figure 7-7. HHC, Area Support Group.

maintenance operations of the group and its maintenance units are provided by the ASCOM, MMC. Thus, the MMC exercises a great deal of influence over operations of group maintenance units.

c. Staff supervision and direction of group maintenance support operations and recommendations relating to the employment and deployment of subordinate maintenance units to satisfy mission requirements is a day-to-day function of group headquarters, with responsibility being vested in the director of maintenance and his staff. In addition, the director of maintenance and his staff concern themselves with improvement of maintenance or maintenance management and repair parts operational control of maintenance unit operations is exercised by maintenance battalion headquarters (unless a maintenance battalion headquarters is not used, in which case the group maintenance directorate performs these functions).

d. The maintenance directorate will perform inspections as required by the group commander or higher headquarters, or to determine whether the repair parts and maintenance support missions of subordinate units are being accomplished in accordance with proper procedures and in accordance with established policies, SOP's, directives, and priorities.

e. When the maintenance management system uses data provided in machine format and processed by ADP facilities, the maintenance directorate will be provided data on subordinate unit workloads, production, and like information from the ASCOM ADP center.

f. When the data collection system is not automated, the directorate obtains information copies of "status or activity" reports, production difficulty reports, and other reports prepared by subordinate units and submitted to the MMC of higher headquarters. These reports contain such information as workload status, performance figures, backlogs relating to specific items wherein the command has a special interest (normally major items) and problems that cannot be handled

at reporting unit level and require the attention, assistance, or support of higher headquarters. When the director of maintenance and his section can take action at group level to remedy difficulties or potential problem areas evidenced in the information copies of these reports, they will do so and inform higher headquarters of the action taken.

g. Radio and/or wire means of communication are used by maintenance units of the support group to submit data and reports directly to the ASCOM MMC or ADP center. To the extent possible, data and reports will be submitted in machine-language format directly to the ADP center. Actual transmission of such data will require use of facilities at battalion headquarters or at a signal center. Similarly, the ASCOM MMC provides routine maintenance management information and direction directly to group maintenance units, bypassing intermediate headquarters.

h. While the area support group does not become interposed between its subordinate units and its higher headquarters on matters relating to routine maintenance management, it nevertheless must assure its receipt of current instructions, data, and other information pertaining to or affecting operations of units of the group and required for command and staff supervision functions at the group level. The ASCOM MMC provides the area support group with pertinent information obtained through data processing and analysis at higher headquarters level, instructions relating to priorities, time expenditure limits, standards, warning orders for redeployment of units, requirements for processing or control of critical or controlled items, and policies with respect to operational readiness floats. Instructions, policies, guidance, and directives affecting the operations of maintenance units of the group which are non-routine are provided through group headquarters so that the group commander and his director of maintenance may place emphasis on the supervision and direction of critical or problem areas. For details on MMC operations, see chapter 9.

CHAPTER 8

MAINTENANCE MANAGEMENT IN THE COMBAT ZONE

Section I. ARMY GROUP

8-1. Introduction

The army group is organized for strategic and tactical operations. It is employed, when required, as a major subordinate element of theater army. It is primarily a tactical unit with limited combat service support responsibilities. It consists of a headquarters and special troops required for command and communication, two or more field armies, and in some situations, independent corps and separate divisions. For specific information on the overall operations of an army group, see FM 100-15.

8-2. Army Group Headquarters Functions Impacting on Maintenance Operations

The army group headquarters is primarily concerned with implementing the broad strategic plans and instructions of theater army headquarters. As an operational headquarters, it keeps abreast of overall capabilities and limitations of combat service support elements organic to subordinate field armies so that army group planning and mission assignments to subordinate armies may recognize and al-

low for logistical requirements, capabilities, and limitations. Therefore, the army group commander, based on recommendations and advice of his staff, performs the following functions which have an impact on maintenance and maintenance related functions:

a. Establishes overall priorities for support of major subordinate units and informs TASCOCOM of such priorities.

b. Establishes priorities for the allocation of replacements to major subordinate commands.

c. May control the allocation of supply items and services in accordance with assigned tactical missions.

d. Ascertains that subordinate commands are adequately supported by TASCOCOM.

e. Estimates overall requirements to support army group operations and makes recommendations to the theater army commander for the allocation of appropriate means.

f. Insures compliance, within subordinate field armies, with established maintenance and supply policies and procedures.

Section II. FIELD ARMY

8-3. Introduction

a. The field army is the largest, self-contained U.S. Army organization that has both tactical and administrative functions. It consists of a headquarters, certain assigned and attached army troops, field army support command (FASCOM), and a variable number of corps and divisions (fig. 4-1).

b. The field army commander is responsible to the army group commander or to the theater army commander for tactical and combat

service support operations within the field army.

8-4. Army Headquarters Functions Impacting on Maintenance Operations

a. Theater army allocates maintenance support means to army groups or field armies to support the campaign plan. Field army further allocates these means or employs them based, in part, on recommendations of the corps and FASCOM, to support subordinate corps and

divisions in furtherance of the field army plan of operation.

b. The field army allocates available resources to subordinate units based on requirements and missions of these units. When requirements exceed available means, assistance is sought from theater army. When such assistance cannot be provided, requirements are reappraised, priorities modified, and operational plans reevaluated and changed as necessary.

c. At field army it is absolutely essential that maintenance support planning be interwoven into the operational plan. Such planning is necessary to permit necessary buildup of maintenance supplies, deployment of maintenance and supply units and facilities, construction or improvement of support facilities and supply routes, and the development of support procedures and priorities for operations contemplated weeks or even months in advance. In planning field army operations, the capability to provide maintenance and maintenance supply support for a particular course of action is often a controlling factor in the commander's decision.

d. The field army commander is responsible for the maintenance of items issued to field army units. This includes organizational maintenance performed by using units and repairs and other maintenance functions performed by assigned or attached maintenance support units. Included in this responsibility is the provision of repair parts and maintenance materials. The commander determines, through inspections, reports, and briefings, whether the status of materiel readiness and maintenance support within the field army is satisfactory. He exercises his influence over maintenance operations through the dissemination of priorities and allocations, and supervision of subordinate units.

e. The field army commander may also be responsible for providing combat service sup-

port to forces of other Services and allied nations located in the combat zone. Such support is provided in accordance with Department of Defense (DOD) directives, theater policy, and inter-service and international agreements. Support to forces of other U.S. Services may include supply of Army-procured items as well as DS and GS maintenance support of Army-procured equipment.

8-5. Staff Composition and Functions

a. The field army commander exercises overall supervision of operations, but relies on the AC of S G4 for staff supervision of combat service support operations and the development of logistical plans and orders. For operation of the maintenance support system, he relies on the FASCOM commander. To assure integration of effort, he requires constant coordination and liaison between the members of his staff and the staff of the FASCOM commander.

b. The AC of S G4 is the principal staff assistant on matters pertaining to the provision of supply, maintenance, transportation, and miscellaneous logistics services for the command. He does not become involved in the operational functions related to maintenance operations. Instead, he concerns himself with long-range planning and the formulation of policies and directives; the preparation of logistic estimates, reports, and plans; and the preparation, authentication, and distribution of the administrative order and/or the administrative annex to an operation plan or order. Detailed functions associated with planning, directing, controlling, and supervising the maintenance support effort and the provision of detailed information and recommendations required by the army AC of S G4 in developing his estimates, plans, and reports are accomplished by the FASCOM commander and his staff.

Section III. FIELD ARMY SUPPORT COMMAND

8-6. Introduction

a. The principal organization for providing combat service support to the field army is the

FASCOM. A major subordinate unit of field army, it operates under the guidance and direction of the field army commander. FAS-

COM elements are deployed, primarily, in the corps and army service areas, and from these areas provide support to divisions and units and activities in the corps and army service areas. The size and composition of the FASCOM are determined by—

- (1) Strengths to be supported.
- (2) Types and densities of equipment to be maintained.
- (3) Characteristics of the area of operations.
- (4) Tons of supplies and materiel to be handled or moved.
- (5) Type of warfare being conducted.
- (6) Number and variety of items to be stocked.
- (7) Traffic to be controlled.
- (8) Civilian population and resources to be considered.

b. The FASCOM is organized using “building blocks” that normally consist of company-sized units designed to perform a specific workload in their particular area of combat service support. A sufficient number of these “building blocks” are provided to give the FASCOM the capability of meeting the overall quantitative requirements of the supported force. Control headquarters (e.g., support brigade headquarters) are provided to the FASCOM on the basis of the number of “building blocks” required and/or the organization and deployment of the force to be supported.

c. The FASCOM consists of a headquarters, associated functional control centers (ICC, MMC, MCC), a corps support brigade in support of each corps, an army support brigade, and the following types of functional brigades: civil affairs, medical, military police, and transportation. In addition, engineer construction units may be attached to the FASCOM by field army, when required. For specifics on FASCOM organization and operations, see figure 4-3 and FM 54-8 (TEST).

d. Support brigades are the major subordinate commands of the FASCOM. These support brigades are composite, multi-functional task organizations that provide combat service support to units in a designated area of the combat zone. As noted on figure 4-3, the composition of the support brigades in the army

and corps service areas differs; consequently, capabilities also differ. The support brigades provide the following types of combat service support:

- (1) Supply of all classes (except medical and in the army support brigade, ammunition).
- (2) Direct and general support maintenance.
- (3) Technical and administrative services such as legal services, graves registration, laundry, bath, postal services, chaplain services, transportation, decontamination, personnel and administration, and finance disbursing. In addition, the corps support brigades provide ammunition service.

8-7. FASCOM Headquarters Functions and Staff Composition

a. Functions. The FASCOM headquarters is charged with development of detailed implementing plans, policies, and directives for combat service support (less replacements) to the field army in conformance with army plans and policies. It also commands, controls, directs, and supervises combat service support units which are assigned or attached. Specific functions of FASCOM headquarters that influence maintenance support operations include—

- (1) Developing plans and policies and supervising activities related to—
 - (a) Manpower management and personnel replacements for the command.
 - (b) Administration of labor management policies with respect to non-U.S. civilian and prisoners of war labor.
- (2) Preparing current and long-range plans, procedures, policies, and programs pertaining to FASCOM operations and functions.
- (3) Obtaining and allocating troops by types and numbers required to support the mission of FASCOM.
- (4) Assigning support missions, attaching support units in accordance with mission requirements, and/or directing the transfer of workloads or units to make maximum utilization of support capabilities and to maintain a balanced workload.
- (5) Providing centralized contracting

services for FASCOM headquarters and field army elements as required.

(6) Keeping subordinate units informed of future plans and contemplated operations that will influence their planning.

(7) Determining the type and frequency of reports required from subordinate units and providing instructions on their preparation and submission.

(8) Developing requirements for and acquiring, allocating, administering, and disposing of field installations, facilities, and real estate in the FASCOM area of responsibility.

(9) Developing and disseminating plans, policies, and guidance for the evacuation of excess, surplus, captured, or salvage materiel.

(10) Developing plans, policies, and procedures and supervising activities pertaining to—

(a) The determination of supply requirements for supported forces and for the FASCOM.

(b) The acquisition, receipt, storage, distribution, and documentation of supplies and equipment.

(c) Stock management.

(11) Planning, supervising, and coordinating activities pertaining to the maintenance and evacuation of materiel to include:

(a) Providing policy and procedural guidance.

(b) Indicating support priorities.

(c) Maintenance management and control.

(d) Materiel readiness.

(12) Establishing and disseminating policies for controlled cannibalization of materiel as a source of low mortality repair parts supply (AR 750-50).

(13) Providing policies and procedures for the control of operational readiness float stocks and critical and controlled items of supply.

b. Staff Composition. Staff organization is similar to that depicted for the TASCOT staff in figure 7-1, except that an ADP center is added to provide support for the various service support control centers (e.g., maintenance management center, inventory control center) attached to the headquarters.

8-8. Organization and Functions of the Maintenance Staff

a. For operational purposes, the FASCOM headquarters maintenance section is organized into the office of the ACofS, maintenance and plans and operations, electronics, mobility and special equipment, and weapons branches. The organization is identical to that depicted for the S&M command maintenance staff (fig. 7-3), and operations are very similar. A maintenance management detachment is attached to the FASCOM maintenance section and serves as the MMC for FASCOM. The MMC operates under the control and supervision of the ACofS, maintenance, and is supported by the FASCOM ADP center for the collection and processing of maintenance data. Specific functions of the ACofS, maintenance and branches of the maintenance staff are as indicated below.

b. ACofS, Maintenance. The ACofS, maintenance is charged with the responsibilities and accomplishes the functions indicated below. These responsibilities and functions are grouped to indicate specific relationships to the FASCOM commander, other staff elements, and other headquarters. He is assisted by a deputy, personnel of the various staff branches indicated in figure 7-3, the FASCOM MMC, and the supporting ADP center.

(1) *Relationships to the commander.* The ACofS, maintenance—

(a) Serves as principal staff advisor and coordinator to the FASCOM commander on all matters pertaining to the maintenance support mission.

(b) May serve as the FASCOM "Materiel Readiness Officer," (AR 11-14).

(c) Is responsible to the FASCOM commander for overall maintenance staff supervision and maintenance support planning within the field army, and for the development of materiel readiness plans and programs.

(d) Keeps the FASCOM commander informed on progress, status, requirements, and anticipated or existing problems, including remedial actions recommended, planned, or instituted.

(2) *Relationships with other principal FASCOM staff officers.*

(a) Coordinates with other principal staff officers of FASCOM headquarters on maintenance matters having a bearing on functions within their scope of responsibility.

(b) Provides information to and coordinates with the ACofS, security, plans and operations, on the preparation of support plans, to include unit augmentation and requirements for additional units, relocation of units, use of sites and facilities, intelligence matters, training requirements and mission assignments.

(c) Provides information to and coordinates with the ACofS, services, on matters relating to real estate and facility requirements.

(d) Coordinates with the ACofS, personnel, and the ACofS, civil affairs, on matters pertaining to the use of civilian labor to augment subordinate units, to include availability and skills of labor, restrictions on employment, labor relations, and payment.

(e) Coordinates with the ACofS, personnel, on requirements for personnel and unit replacements and use of prisoner of war labor.

(f) Coordinates with the ACofS, supply, on repair parts requirements to support the maintenance effort, priorities for the issue of repair parts stocks, priority requirements for the repair of end items or components that are in short supply, requirements for special tool sets for maintenance performance, requirements for fabrication or local procurement of repair parts, requirements for reclamation of required supply items from uneconomically repairable end items, and the disposition of scrap.

(3) *Relationships with other headquarters.*

(a) As directed by the FASCOM commander, represents the commander at field army level briefings and meetings having a bearing on maintenance support operations or materiel readiness.

(b) Maintains coordination with the field army staff, particularly the AC of S G4, to obtain information relative to planned operations and deployment and requirements for maintenance support, and to provide current information on the status, capabilities, and

limitations of that portion of the FASCOM structure engaged in maintenance support operations.

(c) Maintains liaison with the maintenance staff of TASCOM headquarters on matters relating to long-range resource requirements and theater level maintenance plans and programs.

(d) Maintains liaison with the maintenance staff of the S&M command on matters relating to evacuation of materiel to COMMZ field depots for repair, and calibration requirements of the field army.

(e) Coordinates with the commanders of major commands subordinate to FASCOM on matters of mutual concern.

(4) *Internal management functions.*

(a) Exercises staff supervision and control over the FASCOM headquarters maintenance section, establishes policies for its operation, and directs its efforts.

(b) Exercises staff supervision and control over the FASCOM MMC. The MMC is responsible for routine maintenance management for FASCOM and overall direction and control of the maintenance data collection and processing efforts within the field army.

(c) Maintains policy and historical data related to staff operations (e.g., policy files, staff journal).

(d) Maintains data on maintenance support requirements, status of maintenance support operations and materiel readiness, problem areas, production figures, and similar information related to or affecting maintenance support operations and materiel readiness. Such data is required for planning, to provide reports required by higher headquarters, and to permit briefings of the FASCOM or field army commanders.

(e) Determines requirements for recurring or special reports to satisfy the informational and management needs of FASCOM and higher headquarters.

(5) *Operational functions.*

(a) Establishes and publishes for the command, policies, and procedures for maintenance support operations. Included is such information as: maintenance and inspection standards; type, format, and frequency of re-

ports required; priorities for repair of materiel; instructions on modification work order implementation; limitations on the time to be expended in the maintenance of specific types of materiel by the various categories of maintenance; and guidance on controlled cannibalization of materiel.

(b) Establishes and provides policies and guidance relative to the collection and evacuation of unserviceable materiel.

(c) Develops and publishes managerial techniques to improve efficiency and production of maintenance support operations.

(d) Determines support requirements and develops procedures and the support structure to satisfy such requirements. Plans long-range maintenance support operations and requirements, and provides information to support brigades upon which to base their planning.

(e) Provides recommendations on the composition, employment, and realignment of the maintenance support structure. Recommends deployment or transfers of maintenance units within the structure, as necessary.

(f) Informs support brigades of problems or potential problems discovered through reports analysis at FASCOM or higher levels, or problems occurring outside the maintenance support structure which will influence maintenance support operations. Directs action to solve problems or provides recommendations to the FASCOM commander when his intercession is required.

(g) Institutes action to balance workloads among support brigades. Keeps track of workloads and overloads within support brigades so that maintenance units may be transferred among brigades or workload evacuated to offset overload conditions.

(h) Collects and evaluates maintenance data and reports and takes any necessary action based on the information contained therein. Provides reports and data to higher headquarters and higher echelon maintenance data collection and processing activities. Most of these reports and data will be provided by or through the ADP center.

(i) Organizes and provides policy and procedural guidance for command mainte-

nance management inspection teams (AR 750-8).

(j) Establishes overall policies for maintenance technical assistance. Recommends the provision of maintenance specialists and contract technical services personnel for the provision of technical assistance in accordance with the provisions of AR 700-4.

(k) Analyzes data generated through maintenance data collection procedures. Briefs the FASCOM commander and the field army commander and staff on materiel readiness condition and problem areas. Recommends policies or procedures designed to improve materiel readiness within the field army.

(l) Provides representation to the combat service support element of the field army tactical operations center (FATOC). Insures that the FATOC is provided current information on maintenance unit deployment, employment, capabilities, and limitations that may have an influence on FATOC operations.

(m) Prepares the maintenance support and equipment evacuation portions of operations orders issued by FASCOM and provides input for field army administrative and operations orders.

c. Plans and Operations Branch.

(1) This branch concerns itself with long-range maintenance support planning. It determines area, facility, personnel, equipment, and deployment requirements for future operations. This branch also establishes maintenance programs for the repair of critical items of equipment. Priority for the repair of such items is based on the shortage of these items in the supply system and the relative importance of the items.

(2) This branch develops plans for technical training, including requirements for training on new materiel expected to enter the area. It develops plans for support of other forces (other Services or allies) as required. It determines and indicates requirements for production-line maintenance and requirements for additional units, skills, personnel, and auxiliary labor. It maintains close liaison with the maintenance staffs of the support brigades of field army and the S&M command for the interchange of technical and operational in-

formation, and with the field army and corps staffs on matters relating to support requirements for contemplated operations and support priorities required. It recommends the optimum use of available resources based on work requirements, to include mission assignments, unit transfers, and organization for maintenance performance.

(3) Recommends the maintenance support structure for separate task force organizations and obtains, maintains, and evaluates data required for long-range maintenance planning, to include historical data on man-hour and repair parts expenditures for type production-line maintenance operations. It maintains experience data related to specific support requirements and problems peculiar to specific types of tactical operations or weather and environmental conditions. Such data, if not physically stored within the branch, must be readily available from the supporting ADP center. Additionally, the branch maintains operational overlays on the location and possible deployment of maintenance units within the field army.

d. Electronics, Mobility and Special Equipment, and Weapons Branches. Each of these branches contains officer and enlisted personnel skilled in the maintenance support aspects of a specific commodity grouping of materiel. Each branch, within its specific area of interest:

(1) Advises the ACofS, maintenance, or other command and staff elements, on technical aspects of equipment.

(2) Develops and recommends policies and directives relative to maintenance support procedures, inspection and serviceability standards, production techniques, maintenance controls, managerial techniques, and the like. Provides recommendations and data to other staff branches and the ACofS, maintenance.

(3) Provides data and recommendations to the plans and operations branch relative to maintenance support planning, organization for maintenance support operations, training requirements, resource requirements, and augmentation requirements.

(4) Makes recommendations to eliminate or alleviate problems in the areas of poor ma-

teriel readiness, excessive backlogs, equipment failure, production rates, repair parts supply, maintenance performance, personnel, or facilities.

(5) Maintains liaison with the field army staff, the FASCOM ICC, and the maintenance staffs of support brigades and the S&M command.

(6) Assists in the development of or recommends policies and procedures for maintenance support, collection operations, controlled cannibalization, and technical assistance.

(7) Recommends maintenance priorities and the programing of specific type items for production-line maintenance.

(8) Coordinates with and provides information to other staff elements, as required. Provides staff advice and assistance to support brigade maintenance staffs.

(9) Reviews reports and data provided by the MMC. Such information stems from data processed by the supporting ADP center and submitted by support brigades. Also analyzes reports and data provided by higher echelon data processing activities. Based on such reviews and analyses, recommends command or staff action with respect to training, modification of mission assignments, inspections, maintenance and repair parts priorities, and evacuation policies and procedures.

(10) Determines requirements for maintenance data and reports. Recommends the type, format, and frequency of reports and other maintenance data to be provided by subordinate brigades and the MMC. Requirements on the latter source will consist of summaries, reports, and other type data generated by the machine processing of data submitted in accordance with the data collection system requirements.

8-9. Maintenance Management Center

The attached maintenance management center serves as the FASCOM MMC. Operating under the direction and control of the ACofS, maintenance, and supported by the FASCOM ADP center, this center performs maintenance management of routine day-to-day maintenance operations. For details on MMC operations, see chapter 9.

8-10. Method of Operation, FASCOM Maintenance Staff

a. General.

(1) The FASCOM maintenance staff concerns itself with planning affecting the entire FASCOM maintenance support structure; overall maintenance support status, materiel readiness, and requirements for maintenance support within the entire field army structure; resource and priority allocation in accordance with overall plans of field army; and the solution of problems that cannot be resolved at support brigade level or which are common to all support brigades. Much of the data required for maintenance staff operations is provided by the FASCOM MMC and ICC.

(2) For the proper integration of the FASCOM maintenance and supply effort, effective and simple working relationships must be established to permit the exchange of information and requirements between each of these staff sections, and between the ICC and the MMC. The ACofS, maintenance, and the ACofS, supply, through coordination and collaboration, establish policies and procedures to permit rapid exchange of necessary data and information between their staff sections and between the ICC and the MMC. Procedures must be sufficiently flexible and definitive to permit day-to-day liaison and interchange of information and requirements between the supply and maintenance staffs and between the ICC and MMC.

b. *Maintenance Support Planning.* At FASCOM level, planning is the most significant element of management. Planning must be accomplished in light of overall operations of the field army, both current and planned, current and forecasted requirements, current capabilities of the maintenance support structure, and the availability of augmentation to increase these capabilities. Long-range maintenance support planning is accomplished by the plans and operations branch. Plans for the resolution of existing or potential problems relating to materiel readiness or support of specific types of equipment are developed by the appropriate equipment branch of the staff.

c. *Planning for Production-Line Maintenance Operations.* General support units of the maintenance support structure routinely utilize

production-line procedures for the repair of items for which they are responsible. However, critical shortages of specific items within the supply system, as identified by the ICC, and inability of the COMMZ field depot system to keep pace with such requirements, may necessitate the initiation of large-scale production-line maintenance operations for the repair of such items. Detailed planning of such operations is left to the support brigade designated to do the work. The FASCOM maintenance staff will—

(1) Determine the support brigade that will do the work.

(2) Prepare necessary instructions and guidance.

(3) Indicate the number of serviceable items that must be generated by the responsible unit or group of units within a specified time period.

(4) Direct the modification of support brigade evacuation instructions to insure that unserviceables are properly routed.

(5) Indicate reporting requirements.

(6) Coordinate with the ICC to assure availability of repair parts and maintenance materials for such production runs.

(7) Indicate the maintenance standards to be used.

d. *Planning for Application of Modification Work Orders.* In accordance with instructions provided by higher echelon maintenance management activities or CONUS national maintenance points, the staff determines requirements for the plans the application of MWO's, with priority to those classed as "Urgent." Support brigades are immediately informed of such requirements so that their planning can commence. The ICC is also notified so that action may be taken to obtain and distribute the required MWO kits. The MMC is directed to place requirements on the ADP center to provide information on quantities of items requiring modification and where these items are located. Such information is available in the data stored at the ADP center. The maintenance staff will also provide support brigades with the necessary technical directions on MWO application; may direct completion of MWO application by a specific date; and will

require reports on the progress of MWO application.

e. Maintenance Management. One of the prime functions of the FASCOM maintenance staff is maintenance management. This management does not duplicate that exercised by the MMC or subordinate support brigades. The maintenance staff section of each support brigade is responsible for maintenance management and control of the support brigade's maintenance resources; the FASCOM MMC exercises routine, day-to-day maintenance management of overall FASCOM maintenance support operations based on information provided by support brigades. Thus, maintenance management by the FASCOM maintenance staff is "management-by-exception" and is accomplished to resolve problems affecting the field army as a whole, problems that could not be resolved at support brigade level, and to provide that direction and control that must emanate at the FASCOM level. With respect to maintenance management, some of the principal functions of the maintenance staff include, but are not limited to, the following:

(1) Determining and publishing priorities for support of specific units or specific items.

(2) Determining and publishing maintenance data reporting requirements.

(3) In coordination with the ICC, developing and publishing instructions to indicate types of unserviceable materiel to be evacuated to COMMZ, and the destinations to which such items are to be evacuated.

(4) Initiating investigative action or directing support brigades to take such action as necessary because of problems evidenced in reports or reported through other sources.

(5) Determining requirements for application of MWO's, directing such application, and keeping track of the status of application.

(6) Establishing criteria to guide the maintenance efforts of subordinate units. Such criteria will include, but not be limited to, the following:

(a) *Repair time limits and evacuation criteria.*

1. The FASCOM maintenance staff establishes time limits for the performance of

maintenance on specific items of equipment at various categories of maintenance. These time limits are based on policies of the field army and FASCOM commanders, the scope and intensity of field army tactical operation, maintenance requirements, and the ability of the supply system to provide replacement items on a timely basis. Such time limits will be changed when the conditions upon which they were based change.

2. Time repair limits established for DS maintenance operations will be based on the tactical situation and mobility requirements of DS maintenance units. For example, in a fast-moving situation which requires frequent movement of DS maintenance units, time limits will be lower than in a static-type situation. This is necessary to avoid accumulation of a backlog of work which will hamper mobility.

3. Time limits for GS maintenance will consider the dynamics of the operational situation which will dictate how long GS units can operate from one location. The availability of better facilities for performance of GS maintenance will also be considered when establishing time limits for maintenance performance at this category of support. The criticality of end items within the field army will be an overriding factor, and in many cases will require the performance of extensive maintenance despite economic repairability aspects.

4. Time limits will be tied in with evacuation plans and policies to indicate when specific items of a specific type are to be evacuated and the destinations to which items are to be shipped.

(b) *Standards.* In the absence of maintenance or inspection standards, particularly for production-line maintenance, the FASCOM maintenance section will be responsible for determining and publishing such standards to guide subordinate units, and for indicating any deviation from standards necessary because of changes in the tactical situation or inability to apply published standards because of time, personnel, or equipment limitations. The standards established for each situation must be based on such factors as the requirement for materiel; the availability of person-

nel, time, and repair parts; and the ability of the enemy to interfere with maintenance operations.

8-11. Information and Data Sources, Requirements, and Use

a. General.

(1) Timely and accurate data relating to materiel readiness, maintenance performance, requirements, capabilities, limitations, and problem areas is a prime requirement for maintenance management. This data stems from many sources. Some of this data, for example, personnel status and status of repair parts stockage, is developed primarily for other applications; yet, it is necessary for and must be provided to the maintenance manager. The maintenance manager also needs information on planned tactical operations so as to be able to properly plan for support of such operations.

(2) ADP techniques are being applied increasingly to the collection, processing, and dissemination of information and data required for all aspects of management and control for all types of application. This paragraph provides an indication of the sources and types of data available to the maintenance manager at FASCOM level; however, it must be emphasized that the data types and sources indicated here are by no means the only types and sources of information and data that will be available.

(3) Most of the information contained in this paragraph is applicable, with appropriate modification, to other echelons in the maintenance management system; e.g., S&M command, ASCOM.

b. Combat Service Support System Data. This system will provide for the rapid reporting, processing, storage, and provision of most of the data required for maintenance management, as well as for other combat service support applications. It will provide for the automation of data to support combat service support functions of the army in the field. For more details on this system, see chapter 9.

c. Maintenance Management Center (MMC).

(1) This activity obtains most of the management information required by the maintenance staff. The MMC maintains daily

contact with the support brigades and the FASCOM ADP center. Based on the requirements of the FASCOM maintenance staff and higher headquarters, the MMC provides guidance to the ADP center with respect to special data requirements, requirements for listings or summaries, requirements for consolidation or isolation of data, and formats for reports.

(2) Some of the types of consolidated data listings that may be provided by the ADP center include: equipment density within the field army by specific types of major items; nonavailable equipment as of a specific date; equipment profile; summarized status of modification work orders; and man-hours expended in the performance of maintenance on specific items by different units. This data may be supplemented by reports and data developed by the S&M command ADP center and containing such data as repair frequency for specific types of items, repair parts required for a specific period to support a given density of equipment of a certain type, and mean time between failure for specific types of equipment.

(3) While the FASCOM maintenance staff uses the data indicated above, it also checks with the ADP center to assure that required data is provided to the S&M command MMC (through its supporting ADP center), which will submit such data to DA level agencies, as required. Additionally, the FASCOM maintenance staff will assure that listings and analyses are provided to major supported units and to the FASCOM support brigades. Dissemination of this information on a timely basis is necessary to permit effective and efficient maintenance management and programming at subordinate levels, and to permit rapid reaction to existing or potential problems. At the FASCOM level, data from the listings indicated above are used for the following purposes:

(a) As an indication of equipment density within the field army by specific major item.

(b) To indicate the status of application of modification work orders, the workload involved, and requirements for kits and related hardware to accomplish MWO application.

(c) To indicate failure rates of specific types of items so that the causes of these failures may be pinpointed and remedial action taken.

(d) To indicate time required for support maintenance of particular types of equipment which, when compared with other data, can be used to determine personnel or unit augmentation requirements. It may also be used as a basis for organizing, programing and scheduling production-line maintenance operations.

(e) To forecast S and GS repair parts requirements and to plan repair parts requirements for production-line maintenance. This information is particularly valuable at support brigade level where the detailed planning and programing of production-line maintenance is accomplished.

(f) To identify problems in the area of support maintenance which require command attention or support (e.g., addition of more units, cross-leveling of workloads, unit augmentation, reduction in time limits for the performance of maintenance on specific items with corresponding increase in evacuation of items to COMMZ).

(g) To identify problem areas in obtaining repair parts. These may influence direction for fabrication of required items or cannibalization, and serve as a basis for removal of specific type components, parts, or assemblies from unserviceable assets which are to be reclaimed at collecting points.

d. CONUS National Maintenance Points and the Army Logistics Data Center. These activities receive, process, and analyze maintenance data generated on a world-wide basis, and provide a variety of reports based on analysis of this data. Information generated by these activities in the form of reports or summaries is useful by all echelons concerned with maintenance management, and FASCOM must assure that such reports, when received, are provided down to the lowest level that can make use of them.

e. FASCOM and Higher Headquarters. From this source, the FASCOM maintenance staff obtains such information as: the commander's policies with respect to use of operational readiness floats; direction on the relax-

ation of maintenance standards, when necessary, as in an offensive operation where it may be necessary to use equipment to the limit of its usefulness despite less than optimum equipment performance; support priorities; policies for command control of critical items; type and extent of future operations to facilitate requirements and support planning; policies and procedures for the interchange of information between tactical and logistical staff elements; and requirements of higher echelon commanders and staffs for data, reports, and input to operations and administrative orders.

f. Inventory Control Center (ICC). The ICC provides much data required for proper management of the maintenance operation. The FASCOM maintenance staff will coordinate with the FASCOM supply staff on its data requirements and the procedures by which the ICC will provide data to the FASCOM maintenance staff. From the ICC, the maintenance staff obtains data on repair parts availability, availability of special items and tool kits required for the performance of maintenance, data on unserviceable assets requiring repair, requirements for the fabrication or local procurement of maintenance supplies or for overhaul of end items or assemblies because of the current and projected status of such items within the field army supply system, and repair parts consumption. Such information is used to establish policies and procedures with respect to parts fabrication, local procurement, evacuation, controlled cannibalization, the degree of maintenance to be performed within the field army, and the scope of repairs to be undertaken on specific items within the field army area.

g. Inspection Reports. Results of inspections such as the command maintenance management inspection (CMMI) will indicate problem areas in maintenance and maintenance supply, and pinpoint deficiencies that require command action by FASCOM headquarters and/or other field army elements. Such reports may indicate the need for: additional technical assistance, the establishment of courses of instruction, the modification of support procedures, and even the re-

FM 29-20

quirement for additional maintenance support personnel or units.

h. Liaison With COMMZ. Liaison is maintained with the maintenance staff of the S&M command to maintain current information on the destination to which evacuated materiel is to be shipped and to indicate requirements for calibration support. Liaison and information flow between the FASCOM and TASCOM headquarters maintenance staffs are also necessary, as TASCOM is responsible to the theater army commander for command, control, and direction of maintenance operations within the COMMZ; for theater-level, long-range maintenance support planning, to include requirements determination; and for development of maintenance policies.

i. Other FASCOM Staff Sections. From other sections of the FASCOM staff the maintenance section obtains such information as: the availability of replacements; the availability of local civilian labor to augment maintenance support units; the availability of real estate, facilities, repair parts, and local procurement of common maintenance supplies and raw materials for the performance of various aspects of the maintenance support mission; planned deployment and employment of FASCOM and field army elements; and legalistic aspects of operations with respect to

use, handling, and compensation for property, facilities, supplies, and labor required for Army use.

8-12. Orders

a. The FASCOM publishes an operation order to its subordinate units, as required, containing instructions on how the combat service support operation will be conducted. Maintenance and maintenance related aspects of operations will be included. This order is of primary concern to FASCOM combat service support units.

b. In many situations, fragmentary orders are the normal means of issuing combat service support instructions. Such orders may direct deployment of maintenance support units, establishment of maintenance collecting points, or other aspects of maintenance operations.

c. Many aspects of maintenance support and related operations are routine in nature and are properly included in standing operating procedures. This simplifies issuance of orders, expedites operations, and facilitates coordination between supporting and supported elements.

d. For details on the types, preparation, content, and format of orders, see FM 101-5.

Section IV. SUPPORT BRIGADE

8-13. Introduction

a. The support brigade is a principal major subordinate unit of the FASCOM. A corps support brigade is provided in support of each corps; an army support brigade is provided in support of the army service area. The support brigade headquarters commands, controls, and operates its combat service support resources in accordance with the policies and direction of FASCOM headquarters and the requirements of supported units. Types of support brigades are depicted in figure 4-3.

b. The composition of brigade headquarters and the functions and responsibilities of command and staff personnel are similar to those of FASCOM (para 8-7); however, the headquarters is smaller in size and its efforts are focused on operations and requirements with-

in its area rather than the entire field army. At support brigade level, ADP equipment and computer facilities are provided for supply management, movements management, and the receipt, storage, and processing of maintenance and materiel readiness data.

c. Functions of the support brigade headquarters having a major impact on maintenance support operations include, but are not limited to—

(1) Developing plans, policies, and procedures and supervising and coordinating activities pertaining to the supply, maintenance, and evacuation of materiel.

(2) Assigning missions to subordinate units.

(3) Developing and disseminating procedures for implementing the Closed Loop Sup-

port (CLS) program for management of specified critical items (AR 700-69).

(4) Obtaining and allocating maintenance units, by types and numbers, required to support the mission of the brigade.

(5) Keeping subordinate units informed of future plans and contemplated operations that will influence their planning.

(6) Providing information on support priorities and changes thereto.

(7) Deploying support-type units of the brigade in accordance with support requirements.

(8) Maintaining liaison and coordination with higher headquarters, corps headquarters, and major subordinate units.

(9) Planning support requirements for counter guerrilla operations and area damage control activities, as required. Supervising the implementation of such plans when necessary.

(10) Conducting inspections of subordinate units.

8-14. Organization and Functions of the Maintenance Staff

The support brigade maintenance staff section is identical in organizational makeup to the maintenance staff sections of FASCOM and S&M command (fig. 7-3). It is composed of the office, ACofS, maintenance and plans and operations, electronics, mobility and special equipment, and weapons branches. A maintenance management detachment is attached to the section. This detachment serves as the MMC for the support brigade, and operates under the supervision and control of the ACofS, maintenance. For the collection and automated processing of maintenance and maintenance related data, the maintenance staff and the MMC are supported by the brigade ADP center. Specific functions of the ACofS, maintenance and branches of the maintenance staff are as indicated below.

a. ACofS, Maintenance. The functions of the ACofS, maintenance are the same as the functions of the ACofS, maintenance FASCOM as listed in paragraph 8-8b. The major differences are in the scope of interest, the degree of control exercised over operations of subordinate units, and the manner in which such control is exercised. For example, plan-

ning at support brigade level is more detailed and the support brigade maintenance staff exercises more direct control over operations of subordinate units. In addition to the type functions listed in paragraph 8-8b, the support brigade ACofS, maintenance—

(1) Plans, coordinates, and supervises activities pertaining to the repair of unserviceable materiel (except medical and, in the army support brigade, ammunition items). In coordination with the ACofS, supply and in conformance with FASCOM policies and directives, develops implementing policies, procedures, and operational instructions for issuance to subordinate DS and GS maintenance and ammunition battalions relative to maintenance; collection, classification, evacuation and disposition of materiel; controlled cannibalization; and repair priorities and requirements.

(2) Institutes action, as required, to balance workloads among subordinate DS and GS maintenance units.

(3) Develops detailed maintenance support plans to support the operations of the supported corps.

(4) Plans and programs large-scale production-line maintenance operations to satisfy requirements indicated by FASCOM, establishes policies and procedures therefor, and determines the organization(s) to be employed in such operations.

(5) Controls the input of workload into the various GS maintenance units of the brigade. Under automated procedures, this is accomplished by providing instructions to the ADP center relative to specific units to which unserviceables are to be directed. Under non-automated procedures, such directions will be published in command evacuation instructions.

b. Plans and Operations Branch. This branch performs the same functions as its counterpart at FASCOM level (para 8-8c) except that they are performed to satisfy support brigade requirements. In addition to the functions in paragraph 8-8c, which must be related to mission operations and functions at the support brigade level, this branch:

(1) Plans and programs production-line maintenance operations and application of modification work orders.

(2) Maintains close coordination with the corps staff (corps support brigade only) for the development of maintenance support plans for future operations.

c. Electronics, Mobility and Special Equipment, and Weapons Branches. These branches perform the same functions as their counterparts at FASCOM (para 8-8d) except that these functions must be related to support brigade functions and operations.

8-15. Maintenance Management Center

a. The attached maintenance management detachment functions as the brigade MMC. Under the direction, supervision, and control of the ACofS, maintenance, it performs maintenance management of brigade maintenance support operations on a day-to-day basis as described in chapter 9.

b. Unlike the FASCOM MMC, the support brigade MMC exercises control over routine maintenance support and collection and classification activities of subordinate units, particularly with respect to distribution and management of general support maintenance workloads. Matters of a non-routine nature, matters not covered by existing policies and directives, information relating to existing or potential problems, and other data requiring command or staff action or attention are reported to the appropriate branch of the ACofS, maintenance section, which operates on the principle of "management by exception."

8-16. Method of Operation, Support Brigade Maintenance Staff

a. General. The support brigade maintenance staff operates in much the same fashion as the FASCOM maintenance staff (para 8-10). However, while the FASCOM staff is concerned with the field army as a whole, the support brigade maintenance staff is primarily concerned with planning, control, and supervision of operations of maintenance support units and collection and classification units of the support brigade, maintenance requirements of units supported by the brigade, materiel readiness of brigade units and units supported by the brigade, and the operational readiness, capabilities, workloads, and problems of brigade maintenance units.

b. Control and Disposition of Maintenance Unit Workloads. Control of day-to-day maintenance operations of units of the brigade is left to the MMC. The brigade maintenance staff, while it must be kept informed of workload, production, and requirements, does not participate in day-to-day maintenance management except to indicate priorities and to develop plans and policies for the guidance of the MMC. The brigade maintenance staff takes management action only when problems occur or are anticipated, or when changes in plans, policies, priorities, or directives are necessary. For details on how workload is controlled by the MMC, see chapter 9.

c. Production Methods.

(1) To the extent possible, maintenance at the general support level emphasizes the repair of components by production-line methods. Facilities and workload permitting, this method of maintenance is the most efficient and productive where large quantities of items are involved. However, this production technique requires the planned development of backlogs to achieve economy and efficiency of operations. This does not mean that GS maintenance units will be required to store vast quantities of unserviceables (although some provision may be required for such storage). Rather, quantities of items required for a profitable and productive production run within a specified GS unit (or group of units) will be determined, and such quantities will be directed into the unit(s) charged with performing the work.

(2) The MMC will take all possible action, with emphasis on improved management techniques and recommendations to the ACofS, maintenance section relative to balancing of workloads, to keep end items within the direct support category of maintenance so that general support maintenance operations may concentrate on the repair of components. At the DS level, repair operations, for the most part, consist of inspection, testing, adjustments, and replacement of defective components, with the defectives being evacuated for general support maintenance and repaired items being returned to the user. At the DS level, maintenance of end items is performed by using bench-shop or bay-shop production

methods and on-site maintenance procedures.

(3) Despite the foregoing, GS maintenance units will not be limited to the repair of components. For example, certain critically needed end items may be sent to general support by a DS maintenance unit, and require repair and return of the items to the using unit. This is accomplished by passing on the job order to general support rather than turning in the item to the supply system as is normal for most unserviceables being evacuated from the DS level to GS facilities. This situation may occur when end item supply channels cannot respond in time to satisfy the using unit's need for the item, and the DS unit is unable to accomplish its repair. Additionally, at times other end items may be evacuated for GS maintenance because of overloads at the DS level, and may require employment of bench-shop or bay-shop production methods at the GS level. Items in this category, though, are reported to the supply system as unserviceable assets to be repaired by the maintenance system for return to supply stocks. However, as stated earlier, the MMC and the brigade maintenance staff must take all action possible to keep end items at the DS level where they may be repaired and returned to users.

(4) To assure that repair of end items at the DS level is expedited and to signal areas of difficulty so that management or command action may be taken, the MMC will require data on end items deadlined at the DS level, and reasons therefor. In addition, information is required on maintenance unit workloads, production accomplished, and overloads occurring during the reporting period. When the maintenance management system is fully automated, such information will be readily available from the brigade computer at the ADP center; when automated facilities are lacking, such data will be obtained from such manually-prepared reports as the "Deadline" and "Status or Activity" reports described previously. The MMC provides information on deadlines, overloads, and other reported or identified problems to the ACofS, maintenance section as "exception" data that may require staff or command action.

(5) For further information on production methods, see FM 29-22.

d. Staff Action with Respect to Deadlines or Overloads. In the management of deadlines and overloads, the ACofS, maintenance staff compares the workload and production figures of similar-type units. This information is provided by the MMC. When figures indicate general overload conditions throughout the brigade, action to obtain augmentation of resources, to cross-level workloads between brigades, or to increase evacuation to supporting activities in COMMZ may be indicated. When deadline and overload figures differ significantly from one unit to the next, investigation of causes and remedial action may be called for. Remedial action may consist of investigation of inspection, production control, and maintenance procedures; investigation of repair parts procedures; inspection and modification of maintenance procedures; training of personnel and assuring that they are properly utilized in accordance with their MOS; transfers of workloads to other maintenance units; changes in support missions to better balance workloads; and proper application of inspection and maintenance standards and production control and maintenance management techniques, to include application of work simplification and work measurement techniques.

e. Planning for Production-Line Maintenance.

(1) Based on types of workload being received, forecasted workload, supply system shortages, and priorities for repair of items, the plans and operations branch plans and schedules the performance of production-line maintenance and determines the organization(s) within the GS maintenance structure that will be so employed.

(2) Organization for production-line operations may require the combination of subordinate units into one maintenance activity or the augmentation of specific platoons/sections of subordinate maintenance units with like sections/platoons from another maintenance unit for the performance of specific types of production-line maintenance functions. Civilian labor, if available, can also be employed for such augmentation. Large-scale production-line operations of this nature are more likely to be found within the army sup-

port brigade's area (and COMMZ field depots) rather than in the corps support brigade.

(3) Based on the recommendations of the plans and operations branch, the ACofS, maintenance takes action to reorganize units, change mission assignments, redeploy units or elements thereof, or obtain augmenting civilian labor, as required. Such actions require coordination with other staff sections of brigade. The MMC is informed of such plans and schedules so that action may be taken, in coordination with the stock control center, to properly direct incoming workload and to preplan repair parts requirements for production-line maintenance operations.

(4) Repair parts preplanning is based on experience in similar-type repair operations which may be recorded by subordinate maintenance units that have accomplished such operations in the past, or repair parts consumed in similar operations by other units in another area of the theater. In the latter case, computers and data banks of the ADP centers supporting data collection, storage, and processing efforts of the field army or S&M command may provide information of assistance. Data so provided includes repair parts consumption, by type, as well as time expenditures and repair actions involved to assist in planning, scheduling, and controlling the operation. During the performance of maintenance on a production-line basis, the MMC

assures conformance to schedules through review of production reports and through action taken to resolve problems as they occur.

(5) Even though large-scale production-line maintenance operations are planned by the ACofS, maintenance section, this does not prohibit individual GS maintenance units from using such production procedures for small-scale production runs when they can be profitably used.

f. Data and Information Requirements.

(1) The ACofS, maintenance section requires a steady flow of current and accurate information and data relating to maintenance and materiel readiness. This data and information is of the same type as that required by the ACofS, maintenance, FASCOM (para 8-11), with emphasis on that data and information pertinent to units of the support brigade and units supported by the brigade. At the brigade level, this information and data is more specific and detailed to satisfy the maintenance and materiel readiness requirements of the support brigade.

(2) Major sources of information and data include higher headquarters, major supported headquarters, the MMC and supporting ADP center, and the brigade stock control center (SCC). Paragraph 8-11 indicates the types of data available from such sources and its application to maintenance management. Also see paragraph 9-5.

Section V. CORPS

8-17. General

a. The corps is a tactical unit. It fights the tactical battle for the field army. Its composition is not fixed. The field army assigns or attaches combat and combat support units to the corps in accordance with the corps mission, characteristics of the area of operations, availability of units, the enemy situation, and the type of operations contemplated.

b. A corps functioning as part of a field army has no organic combat service support elements. A corps support brigade of the FASCOM, tailored in accordance with mission requirements, is provided to provide combat serv-

ice support to the corps. A type corps support brigade is depicted in figure 4-3.

c. Normally, the corps depends on the field army commander to provide the combat service support required by the corps (provided by the FASCOM commander through a corps support brigade); however, there are occasions when the corps has major functions in the area of combat service support. These will include functions related to maintenance planning and management.

(1) As indicated in paragraph 4-4, an independent corps may be the Army component in a theater of operations and its composition

may include a corps support command. In such a case, the corps would have the status and perform the functions of theater army as regards combat service support (para 7-7).

(2) The corps may also function separately, as described in paragraph 4-6. Again a requirement would exist to provide a combat service support organization in the form of a corps support command, and the functions and responsibilities of the corps with respect to maintenance support for the force would be similar to those of the field army (para 8-3 and 8-4).

8-18. Influence on Maintenance Support Operations

a. The corps commander and staff normally influence maintenance support operations only to the extent necessary to assist operations of the corps. This is accomplished by—

(1) Providing recommendations to the corps support brigade commander on measures

concerning support of units attached to the corps.

(2) Providing recommendations to the support brigade commander relative to the locations of maintenance support units supporting the corps.

(3) Indicating allocations for regulated items and priorities for support of certain units, as necessary.

(4) Keeping track of materiel readiness of units of their command and providing command support to all activities designed to improve this readiness.

b. While the corps support brigade is part of FASCOM, and receives instructions and guidance from that source, timely and efficient support of the corps requires liaison and the interchange of plans and information between the staffs of the corps and the corps support brigade.

Section VI. SUPPORT GROUP (CORPS OR ARMY)

8-19. Introduction

a. The support group is a major subordinate element of the support brigade. The support group organization normally includes one or more DS maintenance battalions, and one or more GS maintenance battalions. In addition, each support group in the army support brigade normally contains a GS aircraft maintenance battalion. Figure 4-3 indicates type composition of support groups.

b. The support group headquarters performs command functions, provides administrative support to group units, and is responsible for materiel readiness of group units. It does not exercise control over technical mission operations. With respect to the maintenance support operations of group maintenance units, control, direction, and staff supervision are accomplished at support brigade level by the ACofS, maintenance section. Such control, direction, and staff supervision are accomplished by the use of high speed, reliable communications and automatic data processing equipment.

c. In addition to its functions of command, control (except for technical mission operations), and supervision, support group headquarters provides GS cryptological services

(supply and maintenance) to units having an organic DS capability in this area, and DS cryptological services to units not having an organic DS capability.

d. For specific information on the operations of support group headquarters, see FM 54-8 (TEST).

8-20. Staff Composition and Functions

a. Headquarters, support group, is provided a S-type staff which functions essentially as do comparable staffs (FM 101-5). Figure 8-1 depicts the organization of group headquarters, to include staff organization.

b. Since the group headquarters does not have control over group maintenance support operations, the maintenance staff of the headquarters is small. It consists of maintenance officers and enlisted advisors who comprise a portion of the group headquarters S4 section. This element works under the direct supervision and control of the group S4.

8-21. Functions of the Group Maintenance Staff

a. Materiel readiness is one of the principal

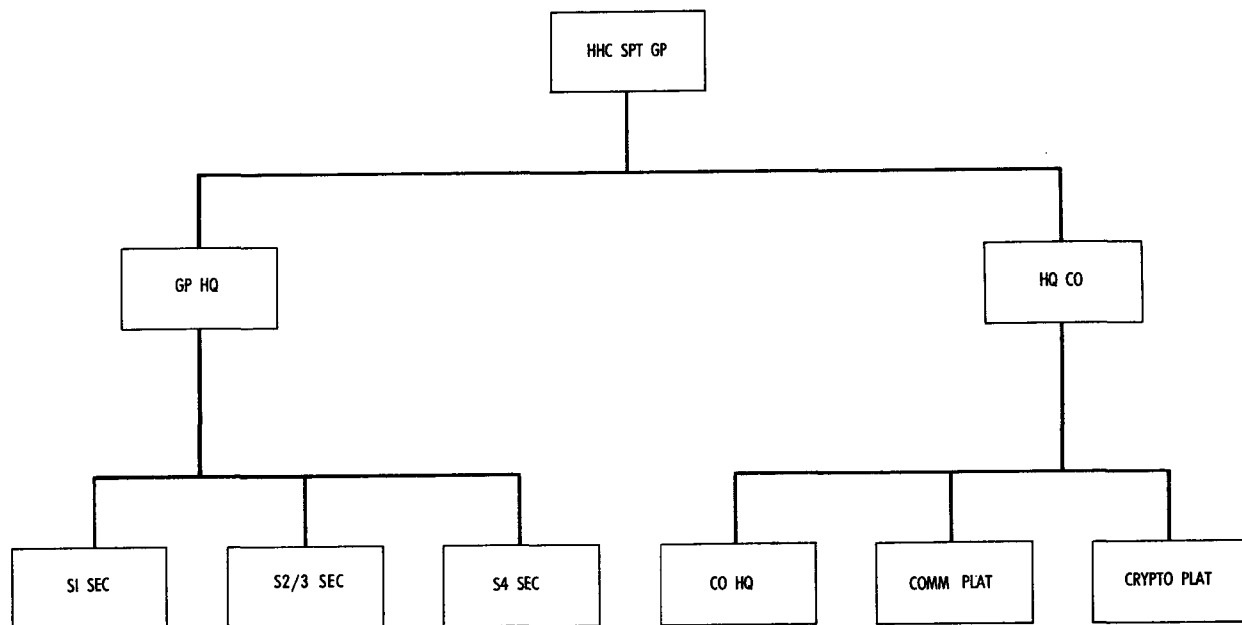

Figure 8-1. HHC, support group, corps or army.

functions of the group maintenance staff. The group maintenance officer is normally designated the group materiel readiness officer. He is responsible for collecting, analyzing, and recommending appropriate action on the basis of materiel readiness reports submitted by group units; briefing the commander on the materiel readiness condition of subordinate units; and assuring that materiel readiness reports are submitted to higher headquarters. The maintenance officer and staff also provide advice and assistance to subordinate units relative to materiel readiness of unit equipment. They also conduct periodic inspections to assure the validity of reported equipment serviceability condition and to assure that organizational main-

tenance is being performed on unit organic equipment, to include operational readiness float items of DS units. In addition, they periodically check subordinate unit repair parts PLL's to assure that required repair parts and maintenance materials are available for the performance of organizational maintenance.

b. This staff will also maintain liaison with subordinate units to determine problem areas and requirements wherein the group headquarters may be of assistance, to determine efficiency of operations, and to provide staff advice and assistance. The staff, for example, may provide advice on the implementation of production control procedures or work simplification techniques to improve efficiency of operations.

Section VII. DIVISION

8-22. General

a. The division is both a tactical and administrative unit. It consists of a relatively fixed command, staff, and support structure to which are assigned combat battalions (airborne infantry, infantry, mechanized infantry, airborne infantry, tank) in types and numbers appropriate to the division's mission and its anticipated operational environment. The division

has its own organic combat service support structure (division support command); thus, the division can operate self-sufficiently for limited periods.

b. The division commander's responsibilities and functions with respect to combat service support are similar to those of the field army commander (para 8-4), except that requirements and planning are more immediate and

more detailed. The division commander is vitally concerned with materiel readiness of his division; division preventive and support maintenance plans, programs, and SOP's; the adequacy of support being provided by the corps support brigade; the adequacy and efficiency of the organizational and support maintenance organic to the division; and the proper distribution of resources within the division.

c. The division commander influences the maintenance support effort within the division by provision of command guidance, establishment of policies, determination of priorities, and the development of operational plans and orders which will require reaction by the maintenance support structure within the division (maintenance battalion(s) of the division support command).

d. For recommendations and development of policies relating to maintenance support requirements and operations in support of the tactical plans of the division, the division commander relies on his ACofS, G4. For detailed operations relating to planning and providing maintenance support within the division, for specific technical recommendations relating to

such support operations, and for information on the capabilities and limitations of the maintenance battalion(s), the division commander relies on the support command commander (para 8-24). Therefore, there must be a close and harmonious relationship between the AC ofS, G4 and the support command commander.

e. For specific information on the organization and operations of the division, see FM 61-100.

8-23. Staff Composition and Functions

a. The division uses the general staff structure. The staff structure is similar to that used at corps and field army headquarters (fig. 8-1), with the exception of variations in the composition of the special staff group.

b. The functions of the division ACofS, G4 parallel those indicated for the Army ACofS, G4 in paragraph 8-5. It is the division ACofS, G4 that prepares logistics estimates and administrative annexes to division operation orders; however, the preparation of these documents requires close coordination with and detailed information from the division support command commander and his staff.

Section VIII. DIVISION SUPPORT COMMAND

8-24. Division Support Command

a. The division support command is a major subordinate unit of the division at the same echelon of command as the brigades and division artillery. It is organized to provide most of the combat service support required by the division. Figure 8-2 illustrates the composition of the division support command in the armored, infantry, and infantry (mechanized) divisions. The same basic type support organization is used in the other types of divisions (airborne and airmobile), with variations existing in the structure because of the type and densities of equipment supported and the manner in which the division is employed. For example, the airmobile division, because of the high density of aircraft it possesses, is provided an aircraft maintenance battalion; in the airborne division, an air equipment support company is provided for support of air delivery operations.

b. The commander of the support command is the principal combat service support operator

for the division. He assists in the development of and carries out the division combat service support plan. He commands all units of the support command and is responsible for their operations (except for the administration company); establishes policies and procedures governing operations of the support command; publishes support command orders and SOP's, and furnishes combat service support information to the division staff for inclusion in administrative annexes or overlays to division plans and orders.

c. Specific functions of the support command commander with respect to maintenance and maintenance-related activities include:

(1) Advises the division commander and staff on repair parts supply, maintenance, equipment recovery, and maintenance collecting point operations.

(2) Supervises and controls operations of support command maintenance units.

(3) Conducts inspections to determine the

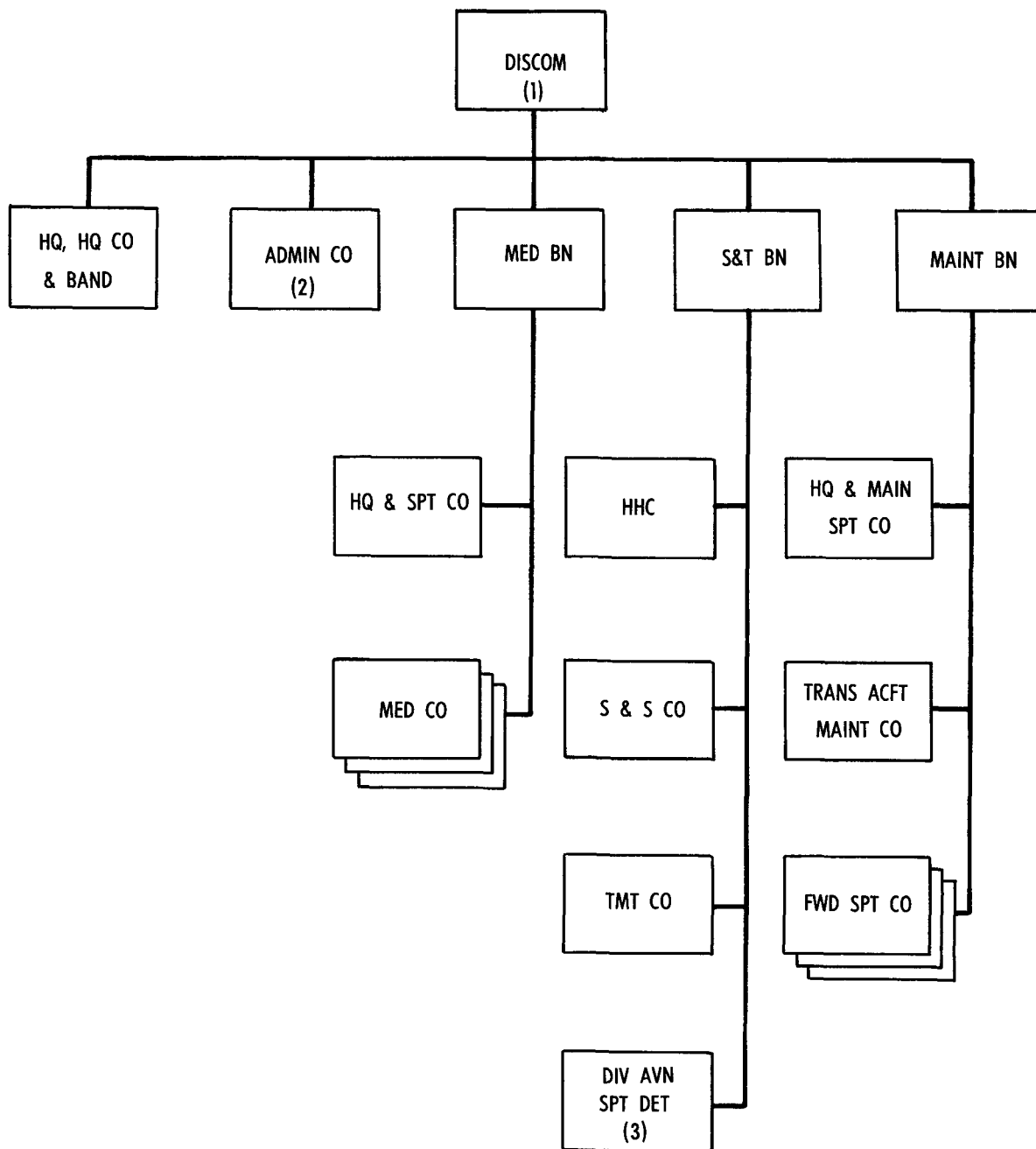

- (1) THIS CHART DEPICTS A BASIC ORGANIZATION FOR A DIVISION SUPPORT COMMAND. FOR SPECIFIC VARIATIONS EXISTING IN THE AIRBORNE AND AIRMOBILE DIVISIONS, SEE FM'S 29-30 AND 54-2.
- (2) THE SUPPORT COMMAND COMMANDER'S RESPONSIBILITIES ARE LIMITED TO TACTICAL, SECURITY, AND MOVEMENT ASPECTS. THE COMPANY IS NORMALLY LOCATED AT DIVISION REAR.
- (3) ORGANIC TO THE ARMORED AND INFANTRY (MECHANIZED) DIVISIONS ONLY.

Figure 8-2. Armored, infantry, and infantry (mechanized) division support commands.

proficiency of the support command and attached units to function in the field.

(4) Provides technical assistance to the division staff for the supervision of maintenance and related operations (except for medical and cryptographic), throughout the division.

(5) As required, provides personnel for the conduct of command maintenance management inspections, the provision of maintenance technical assistance, and the operation of division-level schools on maintenance, materiel readiness, and related matters.

(6) Develops, implements, and supervises the maintenance management program for the division.

d. For more detailed information on the organization and operations of the division support command, see FM 54-2.

8-25. Staff Composition and Functions

a. The commander of the support command has a coordinating unit staff, or "S" staff, and a small special staff. The unit staff consists of the executive officer and the S1, S2, S3, and S4, except that in the airborne and airmobile divisions there is a combination S2/S3. The special staff consists of the chemical officer and the chaplain. The division ammunition officer and the division transportation officer assigned to the support command headquarters have operational functions as well as staff functions in their areas of interest.

b. The staff performs those planning and staff supervisory functions required to assist the commander in fulfilling his functions as listed in paragraph 8-24*c*. The operations officer, S3, is the principal staff assistant and exercises staff responsibility for activities pertaining to: development of plans, policies, programs, and procedures pertaining to the operations and functions of the support command; organization of the support command for logistic support operations; selection and allocation of units needed to support the mission of the support command based on requirements determined by the S4; and coordination of the plans of organic and attached units for logistic support to be provided by the support command. The logistics staff officer, S4, is the

principal staff assistant and exercises staff responsibility for activities pertaining to: providing information to the S3 for plans, programs, policies, and procedures pertaining to the logistic operations and functions of the command; determining logistic requirements for supported forces and the support command; planning and supervising supply, services, and maintenance support rendered by the support command; and coordinating maintenance services provided by the support command. Most recommendations and plans in the logistics area are based on information and recommendations provided by commanders and staffs of major combat service support units of the command (e.g., maintenance battalion commander for maintenance and repair parts functions). Staff responsibilities and relationships of the unit and special staffs are as described in FM 54-2 and 101-5.

c. The commander of the support command depends on the commanders of major subordinate units to provide advice and recommendations as well as technical information in their particular areas of interest. In effect, these personnel (e.g., maintenance battalion commander) perform as special staff officers to provide detailed and technical data required by the support command commander and his staff. Further, the support command commander may designate such personnel to represent him in advising the division commander and staff in technical areas.

8-26. Maintenance Battalion Commander

a. The staff functions of the maintenance battalion commander are as follows:

(1) Advises and assists the support command commander and staff on all maintenance support and repair parts supply matters for which the maintenance battalion is responsible.

(2) Provides recommendations and information to the commander and staff to meet the informational needs of the command and higher headquarters.

(3) Assists the commander of the support command in exercising technical supervision over maintenance operations and training within the battalion's area of mission responsibility.

(4) Advises the commander on all aspects of materiel readiness.

(5) When directed or authorized, represents the support command commander in providing advice and assistance to the division commander and staff on maintenance support operations for which the battalion is responsible.

(6) Manages the maintenance support effort within the division (except for medical and cryptographic equipment, and in the airmobile division, aircraft). May provide personnel for the establishment and operation of a division-level maintenance management center. This maintenance management activity will function similarly to the MMC's described in chapter 9, except that operations will be focused on direct support maintenance operations within the division. When maintenance management is not automated, functions in this area will usually be performed at maintenance battalion headquarters.

b. For more specific information on maintenance battalion operations and the role of the battalion commander, see FM 29-30.

8-27. Commander, Transportation Aircraft Maintenance and Supply Battalion

a. The airmobile division, because of its great

density of aircraft, requires a battalion-size organization for direct support maintenance of aircraft. The commander of this battalion has responsibilities to the support command commander and staff that are similar to those discussed above for the maintenance battalion commander, except that functions and activities relate to direct support maintenance and repair parts support for aircraft. Under automated procedures for maintenance management requiring establishment of one maintenance management element at support command level, the commander of the transportation aircraft maintenance and supply battalion will have prime responsibility for maintenance management within the division, and will cooperate with the maintenance battalion commander to establish the activity and procedures that will satisfy the requirements of both battalions.

b. For further details on operations of the transportation aircraft maintenance and supply battalion, see FM 29-30.

Section IX. SEPARATE BRIGADE

8-28. General

a. The separate brigade, like the division (sec. VII), is a tactical and administrative unit capable of independent operations for limited periods. At present, there are five types of separate brigades (armored, airborne, infantry, light infantry, and mechanized), each structured for employment in a specific type of operational environment. Separate brigades are particularly suited for employment in areas where a large combat force is not required, or for independent operations as part of an overall force in stability or counter guerrilla operations.

b. The brigade commander's responsibilities and functions with respect to combat service support are similar to those of the division commander (para 8-22); however, requirements are more demanding because the brigade often operates in semi-isolation; often has to depend on an air line of communications for

combat service support; and cannot shift resources with the facility of division.

8-29. Staff Maintenance Functions

The brigade staff is a unit staff as described in FM 101-5. The S3 influences maintenance support operations by designating priorities for support in accordance with the mission of the brigade and its operations. Such priorities are established in terms of support priorities for specific units, priorities for support of a specific type of equipment, or a combination of both. For example, the armored cavalry troop may be given first priority for maintenance support of radios; the next priority will probably be given to the field artillery battalion; and the next priority to the infantry company (ies) involved in the specific operation.

8-30. Support Battalion

a. Combat service support for the separate

brigade is provided by an organic support battalion whose composition varies among the various brigades. This support battalion has functions and responsibilities similar to that of the division support command (para 8-24—8-27), but on a smaller scale.

b. The support battalion commander is the logistical operator for the brigade and advises the brigade staff on matters pertaining to combat service support. His responsibilities and functions parallel those of the division support command commander as described in paragraph 8-24.

c. Among the responsibilities of the support battalion commander is the provision of maintenance support and repair parts for brigade units. Such support is provided by the organic maintenance company (or maintenance and supply company, depending on support battalion organization) as described in FM 29-30.

d. The support battalion commander is also responsible for materiel readiness of equipment of support battalion units; overall materiel readiness within the brigade is the responsibility of the deputy commander of the brigade.

8-31. Brigade Maintenance Officer

a. Each separate brigade has a brigade maintenance office which operates under the direc-

tion and supervision of the brigade maintenance officer. In some separate brigades, the brigade maintenance office is part of the maintenance company; in others, the office comprises part of the headquarters and headquarters detachment, support battalion. Regardless of location, the brigade maintenance officer is a staff officer responsible directly to the support battalion commander; he does not directly intervene in the day-to-day operations of the maintenance company (or maintenance and supply company) except to influence its operations through the exercise of his normal staff officer's responsibilities.

b. The brigade maintenance officer is responsible for overall staff supervision of maintenance efforts of individual units of the brigade, for staff supervision of maintenance support operations of the maintenance company, for ensuring that maintenance policies and priorities are enforced, and for providing staff planning and recommendations to the support battalion commander, and, as necessary, to the brigade commander, relative to maintenance and maintenance related operations. The responsibilities of the brigade maintenance officer parallel the staff responsibilities of the division maintenance battalion commander as described in paragraph 8-26.

CHAPTER 9

MAINTENANCE MANAGEMENT OPERATIONAL PROCEDURES

Section I. MAINTENANCE MANAGEMENT CENTERS

9-1. Introduction

a. The maintenance management center (MMC) is but one type of functional control center used in a theater of operations. This section provides doctrinal guidance for the operation of MMC's. It describes, in general terms, the types of data available for maintenance management, how such data is provided, and how it may be used. Specific technical instructions on the processing and manipulation of data are contained in procedures manuals and are not included herein.

b. Other types of functional control centers include the personnel and administration center (PAC), inventory control center (ICC), stock control center (SCC), and movements control center (MCC). These control centers are attached to the various major headquarters and subordinate commands in the combat service support structure. In some cases, only one functional control center is attached to a headquarters; in other cases, two or more such control centers may be attached to a headquarters, as at FASCOM. These functional control centers are provided ADP support by the automatic data processing center (ADP center) attached to the headquarters.

c. The control centers serve as "commodity managers" for their respective functional areas. They accomplish day-to-day planning for operations, implement policies and plans of the coordinating staff, develop and apply operating procedures, make continuing analyses of operations and apply corrective action, develop pertinent portions of plans and programs to support requirements of the coordinating staff, apply priorities and controls as provided by the staff, and make management decisions pertaining to daily operations.

d. It should be noted that the provision of maintenance and supply support, as well as transportation services, requires continuing and close cooperation, coordination, and interchange of information and requirements among functional control centers. Further, data collected primarily for management of one functional area is often needed for management in another area. In addition, where several different functional control centers are attached to a headquarters, they all depend on ADP support from the ADP center supporting that headquarters. Thus, it would be quite normal and even preferable to locate the MMC, ICC/SCC, MCC, and ADP center in one location or in very close proximity to each other. Figure 9-1 depicts the groupment of functional control centers at FASCOM headquarters level, the interrelationship and functions of these centers with each other and the ADP center, and the controls exercised by elements of the headquarters coordinating staff.

Figure 9-1. FASCOM functional control center complex depicting relationships, controls, and functions.

(Located in back of manual)

e. MMC's are attached to support brigade, FASCOM, ASCOM, and S&M command headquarters. The MMC of the S&M command also performs overall maintenance management functions for the TASCOM. No specific TOE organization is provided for the operation of a division-level MMC. Maintenance management functions for the division are performed by personnel of the maintenance battalion headquarters (and the transportation aircraft maintenance and supply battalion headquarters in the airmobile division).

f. All MMC's in a theater of operations operate similarly. All have responsibilities for ob-

taining, analyzing, and distributing the maintenance and materiel readiness data needed by the maintenance staff and for routine maintenance management. However, some exercise direct control over maintenance operations of subordinate maintenance support units; others do not. The support brigade MMC performs the most extensive functions with respect to maintenance management and control of activities of subordinate maintenance support units; therefore, coverage in this section emphasizes the functions and methods of operation of the MMC at the support brigade level. However, since all MMC's are structured similarly, and the operations of all are similar, this section provides guidance for MMC operation at any level. Specific guidance is provided for MMC operation at specific levels, when appropriate.

g. Maintenance management procedures, as discussed in this section, are based on availability of ADP equipment and ancillary communications equipment to support data collection and processing efforts at support brigade, FASCOM, ASCOM, and S&M command levels. When such equipment is not available, or its availability is limited, more dependence must be placed on manual methods for data processing, and the volume and type of data collected and processed will be reduced as described in section IV. Figure 9-2 illustrates a type distribution of data processing facilities; however, the number and actual location of such installations will depend on force deployments, operational requirements, and available resources. FM 54-8 (Test) provides doctrine on application of ADP systems to combat service support. Paragraph 9-6 describes alternate procedures for maintenance management in the event of destruction of communications facilities, ADP equipment, or personnel directly concerned with maintenance management. Paragraphs 9-11 and 9-12 describe procedures for maintenance management during the interim period pending full-scale availability of ADP equipment.

h. It should be noted that although the maintenance management system, as discussed in this manual, excludes medical equipment,

the maintenance staff sections, MMC's, and ADP centers at various echelons will have to support requirements for collection, processing, and provision of data relative to medical equipment. While medical materiel is managed outside the maintenance management structure discussed in this manual, the ADP center will maintain such data as materiel readiness status of medical units so that the commander may have a ready source of current data when he needs it, and so that automated reports described in TM 38-750-1 may be provided to CONUS activities.

9-2. Maintenance Management Center— Mission, Assignment, and Functions

a. The maintenance management detachment functions as the maintenance management center for the headquarters to which it is assigned. It is assigned to the S&M command and ASCOM in the COMMZ, and to the FASCOM and each support brigade in the field army area. It is attached to the ACofS, maintenance section of the command where assigned and operates under the direction and control of the ACofS, maintenance.

b. As the MMC, this detachment performs routine maintenance management functions for the headquarters to which assigned and supervises the maintenance data collection efforts of the command. It obtains and analyzes maintenance data, reports, and listings, most of which are provided by the supporting ADP center. This data includes that submitted by subordinate maintenance units as well as data emanating from supported units and commands.

c. Specific functions of the MMC are as follows:

(1) Advises the ACofS, maintenance, and the commanders and staffs of major supported organizations on the application, use, capabilities, and processing of maintenance data for maintenance management purposes.

(2) Analyzes and evaluates processed data provided by the supporting ADP center and analyzes reports submitted by subordinate units in hard copy format (for those reports that cannot be automated, or one-time reports where the establishment of a

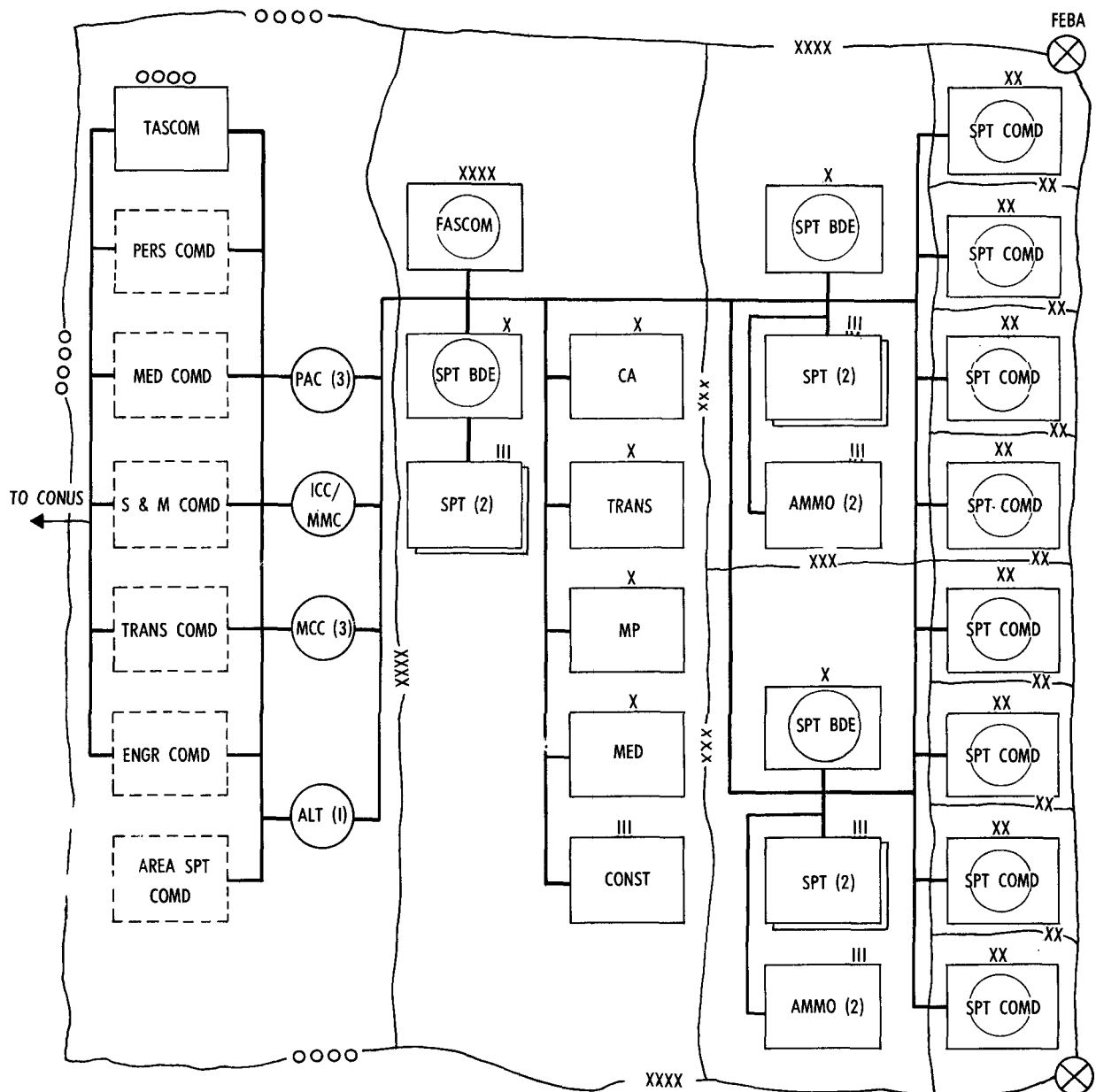

○ Denotes ADP center/computer facility. Unless specifically designated as to type of function supported, these facilities support all ADP requirements of the headquarters to which attached; e.g., maintenance management, stock control, movements control, and other combat service support requirements.

- (1) This facility supports the requirements of ASCOM (e.g., for maintenance management); supports requirements of the Engineer Command, and serves as the alternate facility for other TASCOM ADP centers.
- (2) Although not depicted on the illustration, most data will actually flow between subordinate elements of these groups (e.g., maintenance battalions) and the ADP center.
- (3) All ADP centers/computer facilities indicated will receive, process, and distribute maintenance management data except those facilities provided especially to satisfy the requirements of the PAC and MCC.

Figure 9-2. Installation location and data flow for combat service support of an 8-division field army.

computer program is not justified). Analysis is to permit routine day-to-day maintenance management by the MMC and to identify trends, problem areas, and other information that must be brought to the attention of other elements of the maintenance staff or higher headquarters for more detailed analysis, decisions, and other staff or command action.

(3) Provides the ACofS, maintenance, higher headquarters, and other commands with charted data, recommendations, graphical data, and reports. As directed, the MMC also performs routine maintenance management functions for a higher headquarters; this is particularly true of the MMC of the S&M command which also supports the requirements of the ACofS, maintenance, TASCOC, and thus serves as the theater MMC.

(4) Provides instructions to subordinate units on the types and frequency of reports required for routine maintenance management, and provides direction to the supporting ADP center on the processing of data submitted by subordinate units of the command.

(5) Influences the performance of maintenance and maintenance-related operations of subordinate units of the command by providing instructions and guidance, or by recommending policies and procedures to the ACofS, maintenance. Directives and instructions to subordinate units are normally disseminated directly unless the information is such that command attention, action, or knowledge, is necessary, in which case they are distributed through command channels.

(6) Through receipt and analysis of reports, keeps track of maintenance and collection and classification unit workloads, problems, and production, and takes or recommends action, depending on whether control is being exercised.

(7) Coordinates, on behalf of the ACofS, maintenance, with the ICC or SCC to keep abreast of the status of end items and repair parts stocks, requirements for establishment of repair priorities, and requirements for establishment of repair priorities, and requirements for parts fabrication of cannibalization, and provides information to the

maintenance staff and subordinate units based on this information. Coordination with the ICC or SCC is also required to provide information relative to repair parts requirements and problems, capabilities, and workloads of subordinate maintenance units.

(8) Maintains status information on MWO's and provides guidance on their application. Provides other types of guidance and instructions to subordinate units relative to maintenance operations (e.g., standards, priorities).

(9) Provides information to the ADP center relative to the evacuation of unserviceable materiel requiring repair. Based on such instructions, the ADP center provides specific shipping instructions to units reporting materiel requiring evacuation for higher category repair.

(10) Coordinates the publication of maintenance and materiel readiness summaries and, as required, prepares special lists and reports on the status of equipment (this type of information is normally prepared by the ADP center in accordance with requirements instructions furnished by the MMC).

(11) Coordinates with the cryptologic management element of the ICC/SCC on matters relating to materiel readiness and maintenance of cryptologic equipment. See FM 29-11 (TEST).

(12) The MMC is also responsible for monitoring the quality and accuracy of data used in maintenance management. It reviews and distributes processed data received from the ADP center. This data stems from data submitted by subordinate units of the command, as well as data and reports submitted to the ADP center by supported organizations (e.g., materiel readiness reports from artillery units). It provides the ADP center with instructions on processing and the type and content of data that must result from automated processing. Processed data is reviewed to determine requirements for additional data, additional processing requirements, and adherence to prescribed formats. In addition, the MMC:

(a) Assists in developing data accuracy checks.

(b) Prepares information as required by the ACofS, maintenance, higher headquarters, and other staff elements.

(c) Prepares graphical presentations of data for briefings and for use as management control devices.

(d) Disseminates reports, listings, and summaries to higher headquarters, subordinate units, and other commands. Most such reports and data are actually provided through computer-to-computer links between the major headquarters' ADP centers and in accordance with instructions provided by the MMC.

(13) In addition to the above functions, MMC's serving the support brigades perform the following functions with respect to general support maintenance activities of the command:

(a) Direct maintenance workload input to GS maintenance units. In this connection, see subparagraph 9-3e (2) below.

(b) Balance workloads of subordinate units by redirecting work or recommending changes in mission assignment.

(c) Determine repair priorities and direct application of specific production techniques and standards, as appropriate.

(d) Provide instructions on the evacuation of unserviceables to COMMZ activities for repair.

9-3. Operational Differences Among Various MMC's

a. *General.* Depending on the command to which assigned, the functions and operations of the various MMC's differ. Although the functions of data collection, analysis, and distribution and the development of operational guidance are essentially the same, the degree of control over the operations of maintenance and collection and classification (C&C) companies of the command differs, as well as the procedure by which this control is exercised. In addition, the higher level MMC's (e.g., FASCOM and S&M command), in conjunction with their supporting ADP centers, may develop reports, listings, or summaries that are not required by specific subordinate MMC's or which require more

processing time than can be made available at subordinate levels.

b. TASCOM/S&M Command MMC.

(1) The MMC of the S&M command, which also supports TASCOM requirements, influences operations of subordinate units by recommending changes in mission assignments and recommending changes in policies and procedures. Based on policy and directive guidance from the ACofS, maintenance, S&M command and TASCOM, it will disseminate instructions and guidance to subordinate units. It does not exercise control over activities of subordinate units, for such control is exercised by the field depot and ammunition group commanders. However, since this MMC also serves as the TASCOM MMC, it will control the type and frequency of maintenance data and reports submitted to the MMC and ADP center for processing and analysis, to include that data submitted in processed format by lower level MMC's (ASCOM and FASCOM) as well as the reports and data submitted by subordinate units of the S&M command. These reports and other data are designed to satisfy the requirements of TASCOM, the S&M command, and Department of the Army level agencies (e.g., the Army Logistics Data Center).

(2) While systems design largely determines the format of reports available through automated procedures, the MMC can influence modifications to produce other types of data.

(3) This MMC will monitor the collection and processing of data and the preparation of reports and summaries pertinent to the theater army as a whole. For example, data available from subordinate units of the S&M command and data provided by the FASCOM and ASCOM MMC's can be processed by the ADP center supporting the TASCOM MMC to provide such reports and listings, applicable theater-army wide, as: the status of modification work orders, the repair frequency rate for specific types of equipment, mean time between failures for specific types of equipment, and repair parts required in a specific period of time to support the repair of a given density of equipment by type. Such reports, together with others such as listings

of equipment shortages, are used for maintenance planning and management at the S&M command and TASCOM levels; are provided to CONUS activities, as required; and are also disseminated to subordinate commands as feedback information useful in maintenance planning and management at subordinate levels.

c. ASCOM MMC. The ASCOM MMC receives and analyzes reports and data received from maintenance support units of the command relative to their materiel and operational readiness, production and problems, man-hour and repair parts expenditures, and related data associated with the maintenance management data collection system (e.g., the CS₃ system described in para 9-9 and 9-10. It will also receive and analyze materiel readiness and maintenance data submitted by supported units. As with the other MMC's, most of these reports and data are provided through the supporting ADP center, which collects, processes, and disseminates data and reports in accordance with guidance provided by the MMC. Based on analysis of such data and reports, the ASCOM MMC will make recommendations to the maintenance staff relative to materiel readiness, changes in mission assignments, problem areas uncovered, or additional unit requirements. It will also make sure that listings, summaries, and analyses are provided to subordinate units and to major supported headquarters to keep these echelons informed on maintenance and materiel readiness status and to permit command and management action at these levels.

d. FASCOM MMC.

(1) The FASCOM MMC does not exercise direct control over operating maintenance support units. This MMC is the highest level MMC operating in the combat zone. It receives data and reports that have already been processed by the MMC's and ADP facilities of the support brigades. Such information includes data and reports developed by data processing activities supporting the divisions. It assures the processing and consolidation of this data for use by the FASCOM maintenance staff and commander, analyzes

data and reports and provides recommendations or results of analyses to the FASCOM maintenance staff, and assures that processed data (and detailed data as required) are provided to the S&M command to satisfy TASCOM and higher level data requirements. It maintains data required for overall planning and management by FASCOM and provides feedback to subordinate commands and the divisions.

(2) Operations of the FASCOM MMC are based largely on summary and exception data provided by the support brigade MMC's. While detailed data is also available, such detailed data normally passes through the FASCOM ADP center to the S&M command ADP center, where it is used to develop such reports as mean time between failure (MTBF) and mean time to repair (MTTR) of major items of equipment, by type. Such reports developed at S&M command level will usually be fed back to the FASCOM MMC.

(3) The FASCOM MMC serves as the day-to-day maintenance control activity of FASCOM. Working from information and guidance provided by other maintenance staff elements and the FASCOM ICC, and information submitted by support brigades and the FASCOM ADP center, it determines and indicates priorities for the repair of unserviceable materiel. In coordination with the ICC, it provides evacuation instructions with respect to unserviceable materiel to be evacuated from the army area, and provides instructions to support brigades relative to requirements for parts fabrication and the reclamation of needed items from unserviceables that are earmarked for disposition. Based on data provided by the S&M command MMC (and based on detailed data submitted to the S&M command ADP center for processing), it will assist in the development of bills of materials for repair parts for production-line maintenance operations, and provide such information to support brigades that will be engaged in such production. The FASCOM MMC influences the maintenance and collection operations of subordinate units by recommending changes in policies, procedures, or priorities to the FASCOM maintenance staff.

Additionally, it will provide guidance on maintenance and maintenance-related matters to subordinate commands through command channels.

(4) The MMC maintains close coordination with the FASCOM ICC to keep apprised of repair parts and end item supply status within the field army, and to provide information on projected repair parts requirements. Close coordination is also necessary with the maintenance management centers of the support brigades and the TASCOM S&N command for the interchange of information and data, evacuation or balancing of workloads, and for overall control of the maintenance effort. The MMC receives required reports and other information from support brigades that is not provided through machine processing facilities, receives reports and listings generated as a result of data processed by the FASCOM ADP center, and provides information and recommendations to other staff elements.

(5) Most data and reports from support brigade level are provided to FASCOM on a computer-to-computer basis between ADP centers serving support brigade and FASCOM. Reports and other data from divisions are also provided through the support brigade MMC's and supporting ADP centers. The FASCOM MMC provides instructions to lower level MMC's on its data and report requirements (type of input, content, frequency) and provides instructions to the FASCOM ADP center on the processing of such data received from lower levels. Instructions to the ADP center include requirements for consolidation of data, format for reports and content of listings. After receipt of processed information from the FASCOM ADP center, the MMC analyzes reports and listings; takes any action indicated from the content of such reports when such action is within the scope of its authority; provides recommendations to the ACofS, maintenance or staff sections; and makes sure that reports and listings are disseminated to the various staff sections and to other staff and command elements within the field army, as may be required.

(6) The types of reports and listings

developed at FASCOM level for use in maintenance management are similar to and based on those developed and provided by the MMC's and ADP centers of the support brigades (para 9-5) and those provided by data processing facilities supporting the divisions. However, at FASCOM level, data and reports from supported elements are provided as summaries or exception reports used to determine status, problems, and management information appropriate to the field army as a whole. Such reports may be further processed to develop specific reports and listings required at the FASCOM level, but not required at or requiring too much time for development at subordinate levels.

e. Support Brigade MMC. Unlike the other MMC's, the support brigade MMC actually exercises direct control over the routine maintenance activities and the collection efforts of support brigade maintenance and collection and classification companies. It operates in accordance with the policies and directives of the brigade ACofS, maintenance, and instructions and guidance provided by the FASCOM MMC. It performs routine maintenance management on a day-to-day basis, collects maintenance data generated within the support brigade and provided by division support commands, assures that data is furnished in the proper format and on schedule, provides instructions to the supporting ADP center relative to the processing of such data, analyzes data received and takes or recommends action based on this data. Based on instructions and guidance from the maintenance staff, information received from the stock control center (SCC), and maintenance data and reports provided by division maintenance battalions; the headquarters and headquarters company, support group (for reports relating to cryptographic maintenance); and the DS and GS maintenance battalions and ammunition battalions of the brigade, the brigade MMC—

(1) Coordinates the input of maintenance workloads of subordinate GS maintenance units.

(2) In coordination with the SCC, develops instructions for DS maintenance

units relative to evacuation of unserviceable items requiring higher category maintenance and provides disposition instructions for scrap. Similarly, develops instructions for division maintenance battalions relative to the evacuation of unserviceable materiel (corps support brigade only). Under automated procedures, such instructions are provided to the ADP center, which provides shipping instructions to maintenance units after the latter have reported the unserviceable items to the supply system (through the ADP center). Under non-automated procedures, such instructions will be published in command evacuation instructions.

(3) Provides guidance to the collection and classification company relative to processing of materiel.

(4) Provides information to brigade maintenance units relative to repair priorities.

(5) Provides data for brigade staff and higher headquarters use relative to production, deadlines, and problem areas.

(6) Informs subordinate units of data and report requirements for brigade maintenance management.

(7) Coordinates with the SCC on repair parts requirements for production-line maintenance, priorities for repair of specific items that may be in short supply, and requirements for controlled cannibalization or parts fabrication.

(8) Balances workloads among subordinate maintenance units.

(9) Makes recommendations on the combination of units and the combination of like sections from several units for the performance of production-line maintenance, and on the basis of such organization for specific types of maintenance, directs unserviceable input of appropriate types to these units.

(10) Reviews reports and data required by brigade or higher headquarters and submitted by subordinate units and division support commands. Provides copies of these reports or extracts therefrom for use by the maintenance staff. Evaluates reports and listings processed by the ADP center and provides such reports and listings, as well as ap-

propriate recommendations, to the ACofS, maintenance section.

(11) Assures the proper processing of maintenance data by the supporting ADP center, provides instructions relative to this processing, and assures the dissemination of reports, summaries, and listings (as appropriate) to FASCOM headquarters, subordinate, and supported commands.

(12) Provides instructions, information, and direction to subordinate maintenance units.

9-4. Method of Operation

a. General. The following is written in terms of the MMC of the corps support brigade, since this MMC performs more extensive functions related to routine maintenance management and exercises control of the day-to-day maintenance functions performed by the general support maintenance units of the command. All MMC's, however, function similarly, with the principal difference being the extent and manner in which they control maintenance operations. When applying this material to other MMC's, the operational differences pointed out in paragraph 9-3 should be remembered.

b. Control of Workload Input.

(1) The MMC directly controls the workload input of subordinate GS maintenance units and the collection and classification company. This is accomplished in accordance with overall plans, policies, and directives of the ACofS, maintenance and higher headquarters, and supply system capabilities and requirements as indicated by the SCC. Plans and policies of higher headquarters include programs for production-line repair operations and planned application of modification work orders. Supply system requirements obtained from the SCC include such things as requirements for priority repair of certain types of components because of supply system shortages, requirements for fabrication of certain types of items, and the like. The brigade maintenance staff, while it must be kept apprised of day-to-day maintenance operations, does not participate in day-to-day maintenance manage-

ment; rather, it takes action only when problems occur or are anticipated, or when changes in plans, policies, procedures, and priorities are necessary.

(2) In controlling workload of GS maintenance units and the collection and classification company, the MMC considers overall brigade workload, the workloads of individual units, the type of materiel being repaired by each unit, planned production-line maintenance operations, the condition of materiel, and the needs of the supply system. Control of workload input is accomplished by the development of instructions (in accordance with the SCC) that provide guidance to DS maintenance units for repair or reclamation, establish criteria to determine eligibility of items for repair, and identify destinations to which unserviceable items are to be evacuated for repair or other disposition.

(3) Shipping instructions for unserviceable items are provided by the ADP center to the DS unit. These are provided after DS units turn-in the items to the SCC (accomplished through submission of turn-in documents through the ADP center). Specific shipping instructions furnished by the ADP center are within parameters established by the SCC in coordination with the MMC. These instructions will direct the DS unit to ship the item to a specific GS maintenance unit, a collection and classification company, a property disposal facility, or other appropriate destination.

(4) Workload of DS maintenance units is only indirectly controlled by the MMC, since these units are directly responsive to the units they support. Control is accomplished through recommendations to the brigade maintenance staff relative to changes in mission assignments, changes in evacuation policy, lowering of time limits authorized for repair of specific items, or recommendations for unit augmentation. Such recommendations are based on status reports indicating DS maintenance unit overloads. The ACofS, maintenance section may act on such recommendations, or may develop other solutions to problem areas.

c. Evacuation of Materiel from the DS Level.

(1) At the DS level, unserviceable

materiel is repaired for return to supported units, the operational readiness float, or direct exchange stocks. However, some items received by DS units for repair are beyond their repair capability or capacity and are evacuated. Decisions as to the ultimate disposition of these items are not a responsibility of DS units.

(2) Direct support maintenance units having unserviceable materiel requiring salvage, reclamation, or GS maintenance report such items to the brigade SCC, through the ADP center. This action, in effect, establishes a turn-in of the items to the supply system. Items are evacuated in accordance with shipping instructions provided by the ADP center, as described in *b* above. Shipping instructions are based on the types and quantities of items requiring repair or reclamation, the needs of the supply system, workloads of brigade GS maintenance units, units specifically designated to perform production-line maintenance, and plans and policies of the command.

(3) Normally, materiel which can be repaired at the GS level is evacuated to GS maintenance units specializing in the repair of the particular items involved. Items to be repaired in accordance with planned production-line maintenance operations are evacuated to the unit designated to do the work, or to a specifically-designated holding facility when necessary to stockpile unserviceables in anticipation of a production run. Items requiring higher category maintenance and uneconomically repairable items whose only value rests in the reclamation of serviceable or repairable needed components, are routinely evacuated to a collection and classification company. In some cases, evacuation instructions for certain items may require air shipment to COMMZ, logistical base, or CONUS for repair; in such cases, specific air facilities will be designated to receive such items and specific packaging instructions may be required.

(4) There is a constant interplay between the MMC and the SCC, for the operations of each require the support of the other. For example, the SCC will provide the MMC with lists of items requiring repair on a priority basis by GS maintenance units, and items re-

quiring reclamation at the maintenance collecting point (operated by the C&C company). The MMC keeps the SCC informed of repair parts requirements, repair capabilities, specific maintenance units which will be engaged in the production-line repair of certain types of items, and other matter that will have an effect on operations of the SCC.

(5) The MMC also provides information on deadlines, overloads, and other identified or reported problems to the ACofS, maintenance as "exception" data that may require command or staff action.

d. Disposition of GS Maintenance Unit and Collection and Classification Company Workload.

(1) GS maintenance units and C&C companies routinely report the type and condition of workload received (through the ADP center) to the brigade SCC. This is necessary for stock control purposes, and is accomplished by submission of supply documentation (indicating types and quantities of items and the fact that they are unserviceable) to the ADP center, which also supports the SCC. They also report workload completed to the ADP center. At any time, the MMC can query the ADP center and, based on information provided by subordinate GS units, get a report on GS maintenance unit workload, by type and unit, items completed, and related data necessary to manage workloads.

(2) Under non-automated procedures, subordinate units will provide a manual report to the MMC relative to workload received, processed, and completed during a specified reporting period. This "status of activity" report is a management tool used by the MMC to keep track of workloads, progress, and problem areas and is normally limited in content to specific types of items or specific category groupings of interest to the brigade. Such a report is a necessary management tool under conditions of no or limited automation of maintenance management functions; when necessary ADP facilities and machine time are available, such reports will be automated, negating the requirement for manually-prepared reports.

(3) When items are repaired by GS

maintenance units or serviceable items are reclaimed from uneconomically repairable end items, such changes in status are again reported to the SCC (through the ADP center) so that stock record adjustments may be made.

(4) Based on such reports of serviceable assets, the SCC, in coordination with the MMC, determines and provides disposition instructions to direct return of assets to supply system stockage, either at the DS or GS level. Normally, disposition instructions will be provided to subordinate units through the ADP center. Instructions for the disposition of scrap are provided in the same fashion.

(5) Data obtained from the ADP center relative to GS maintenance unit overloads, or similar information obtained from the non-automated "status of activity" report mentioned earlier, may result in brigade taking action to augment overloaded units or to direct further evacuation if the capacity of brigade is overtaxed. Overload conditions may also result in brigade action to lower repair time limits authorized for specific type items, to modify procedures, to change priorities, or to expedite supply of repair parts required for specific types of maintenance—depending on the problem as evidenced in reports and confirmed by investigation.

e. The Role of the ACofS, Maintenance Section.

(1) The MMC exercises direction and control, on a day-to-day basis, over those maintenance operations and functions of subordinate units that are routine or repetitive in nature, or which are accomplished in accordance with established policies and directives. Matters of a non-routine nature, matters not covered by existing policies and directives, information relating to existing or potential problems, information required for planning, trends that may change support requirements, and other data requiring staff or command action or attention are reported to the appropriate branch of the ACofS, maintenance section as "exception data." The ACofS, maintenance section, which performs maintenance management on a "by exception" basis, analyzes these data and takes or recommends action to resolve current problems and prevent

potential problems from developing. Exception data provided to the ACofS, maintenance section stems from data processed by the ADP center and provided by the MMC, and/or reports and information submitted to the MMC by subordinate units in manual format. This data includes, but is not limited to:

(a) Overloads in maintenance units resulting from the inability to cope with the volume of work because of lack of sufficient personnel or facilities, or lack of adequately trained personnel.

(b) Specific repair parts problem areas that require action and coordination with the ACofS, supply.

(c) The status of modification work order application, particularly URGENT MWO's.

(d) Reports reflecting materiel readiness of subordinate and supported units.

(e) Trends which may necessitate modification of support plans or procedures (e.g., abnormal failure rates of the same part or assembly requiring the submission of equipment improvement recommendations (EIR), emphasis on technical assistance, establishment of courses of instruction, and/or increased stockage of the failing part or assembly).

(f) Status information relating to workloads and production relative to specific items or groups of items on which the ACofS, maintenance staff desires to be kept informed (e.g., critical items, expensive items, items in short supply, items wherein problems have been experienced and continued attention is necessary to determine effectiveness of adopted remedial measures).

(g) Information indicating the need for training or emphasis on technical assistance.

(h) Any other types of data or reports which indicate the need for investigative action, changes in policies or procedures, or modification of mission assignments.

(2) In the management of deadlines and overloads, the ACofS, maintenance section compares the workload and production figures of similar-type units. Data for such comparisons is provided by the ADP center. When

figures differ significantly from one unit to the next, investigation of causes and prompt remedial action is required. For details on functions and operations of the ACofS, maintenance section, see chapter 8.

9-5. Data Collection and Use by the Support Brigade MMC

a. The MMC has access to various sources of information and data upon which to base its maintenance management activities. Much of this information and data is used by the MMC in its management and control of maintenance activities of brigade maintenance units. Some of this data and information is also required by the brigade SCC for use in its supply management functions. Much of this data is provided as feedback to subordinate units and supported commands for use in their maintenance management operations. In addition, specific reports, listings, and summaries are provided to satisfy the requirements of the ACofS, maintenance section and higher headquarters, and certain exception-type information and reports are provided to the appropriate branches of the ACofS, maintenance section, to permit "management by exception" as described in paragraph 9-4. Types of data available and data flow within a theater of operations using fully automated procedures are illustrated in figure 9-3.

Figure 9-3. Sample type of data flow for maintenance management in a theater of operations under fully automated procedures.

(Located in back of manual)

b. The combat service support data system, (para 9-9 and 9-10), when fully implemented, will provide most of the information and data required for maintenance management. This system is a consolidation, refinement, and extension of various other systems already in being for the collection and use of various types of data for management purposes. Based on current knowledge and estimated capabilities of automatic data processing systems and equipment proposed for use in the field army, it is expected that the sources and types of data will include, but not be limited to, the following:

(1) *ACofS, maintenance section and higher headquarters.* From this source the MMC will receive information and guidance on maintenance policies, programs, priorities, plans, and the like developed by the brigade maintenance staff or provided by higher headquarters. Such information is utilized as a basis for the operations of the MMC and to provide guidance to subordinate maintenance units. Specific types of guidance provided by this source will include, but not be limited to, the following: expected influx of new equipment, maximum time to be expended in the repair of specific items by various categories of maintenance, changes in support priorities, priorities for the repair of specific types of items, standards to be used in maintenance performance in the absence of published standards or when established standards require modification, changes in mission assignments which will require redirection of workload by the MMC, destinations to which overflow work is to be evacuated, and report and data requirements.

(2) *Subordinate units.* From maintenance units of the brigade the MMC receives a steady flow of information relative to workloads, status of production, resource requirements, and problem areas. Under automated procedures, most of this information is provided through the ADP center; under non-automated procedures, the submission of manually-prepared reports to the MMC will be required. To subordinate units, the MMC provides direction and guidance resulting from its own maintenance management functions or based on information, directives, or guidance provided by the brigade maintenance staff or higher headquarters. Such instructions and guidance include planned workload input, planned production-line maintenance requirements, priorities for the repair of certain items, instructions on controlled cannibalization, requirements for parts fabrication, standards to be employed, production or management techniques to be followed, reports required, and problem areas discovered through reports and data analysis.

(3) *Stock control center.* Day-to-day activities of the MMC require liaison and coordination

with the brigade SCC and the interchange of information between both activities. For example, information relating to parts requirements, problems, parts failure, and the like, which will affect supply system operations is provided to the SCC. Based on its stock control records, information from the MMC relating to repair parts requirements and parts failure experience, command direction, and information and requirements indicated by the FASCOM ICC, the SCC provides the MMC with information on the type of components, assemblies, and end items that should be given maintenance priority because of supply system shortages. It also indicates requirements for reclamation of serviceable or economically repairable components from items to be scrapped, repair parts and other maintenance materials that must be obtained through local procurement or fabrication, and disposition instructions for repaired items and scrap generated at the GS maintenance level.

(4) *Supporting ADP center.*

(a) The most significant source of data upon which to base or modify brigade maintenance support operations stems from reports, listings, and graphic portrayals of data relating to maintenance condition and performance which is reported, collected, processed, and analyzed under established systems for the collection and analysis of maintenance and materiel readiness data (e.g., TM 38-750, TM 38-750-1). At various levels of command, facilities are provided for the receipt of such data, its processing and analysis, and its distribution laterally, upward and downward through the command chain to all commands and staff elements having a need for such data.

(b) Supported units submit maintenance and materiel readiness data and reports to the ADP center supporting the brigade, in accordance with procedures established for submission of such data by the appropriate command. Direct and general support maintenance units of the brigade submit data relative to their own maintenance operations, in machine language format, to the ADP center. Data and reports developed at DS and GS maintenance unit level are provided to the parent maintenance battalion headquarters or

an area signal center for transmission to the ADP center. The MMC, based on FASCOM headquarters requirements, requirements of the support brigade commander or maintenance staff, and requirements of major tactical unit commanders (e.g., corps), provides instructions to the ADP center relative to processing of data and provides instructions on the type and content of required reports, summaries, and listings.

(c) The MMC receives and analyzes processed data provided by the ADP center and assures its distribution to other brigade elements, FASCOM headquarters, and other command and staff elements within or supported by the support brigade, as appropriate. The MMC also prepares graphic portrayals of data and provides assistance to brigade maintenance staff elements in determining format for and obtaining special summaries or listings as may be required, provided the information required is available from data stored at the ADP center.

(d) Reports and listings required by the brigade commander and staff are provided in the format and frequency required and containing the information desired. Some types of reports and listings that may be developed through processing data available at the brigade ADP center are discussed below. The following is by no means a complete listing, but is representative of the types of listings that may be developed. The maintenance manager may require other types of reports or listings. Moreover, depending on policies and procedures developed by higher echelon maintenance management activities, machine time available at the ADP center, and the time required for processing data to develop some of the reports and listings indicated, some of the following listings may be developed at higher echelons in the maintenance management organization, with feedback provided to subordinate elements.

1. *Equipment density.* This is a list of mission essential, maintenance significant items specified for inventory reporting in such regulatory media as TM 38-750. Under the CS₃ system described in section III, this data base will be expanded to include all maintain-

able items. Listings may be prepared as extracts or as summaries by owning unit or by type of equipment, or a combination of both. The brigade maintenance staff should maintain listings of types of equipment in the hands of brigade units and supported units in the brigade area of operations. Summaries, by division, for each division comprising the corps should also be maintained as this equipment represents potential GS maintenance workload. For corps equipment, summaries may be provided by the brigade ADP center. Division summaries may be obtained from the maintenance data activity serving the division. Such data is used to determine what is supported, who has it, deployment and employment of maintenance units, and support requirements.

2. *Modification work order status.* This listing contains, by organization and type/model/series equipment, the status of modification work order accomplishment as well as the unaccomplished MWO workload. Information concerning MWO status is necessary to insure that equipment requiring modification is supported by required kits or material and that required modifications are accomplished.

3. *Repair parts usage.* This listing develops type and quantity of repair parts required in a specified period of time to support the repair actions of a given density of type/model/series equipment. Such listings can be prepared to reflect either organizational or support maintenance performance and can be utilized to determine and indicate parts requirements for repair operations.

4. *Nonavailable equipment.* This is a listing of nonavailable equipment as of a specific date, to include repair parts required and controlled secondary items, if applicable.

5. *Equipment availability.* This is a listing indicating the percentage of time equipment was available during a specified period of time, and breaking out the nonavailable days resulting from organizational and support maintenance.

6. *Maintenance man-hour expenditures.* This listing provides a comparison of man-hours expended in the performance of

maintenance on like items of equipment by different units.

7. *Maintenance and materiel status.*

See paragraph 9-10 and figure 9-3.

(5) *Higher echelon data collection and processing activities.*

(a) In addition to reports, listings, and summaries provided by the ADP center supporting the brigade, the support brigade MMC will receive reports and listings or special printouts developed by the ADP centers supporting FASCOM and the S&M command. These listings and reports, are based on the consolidation of information received from all subordinate commands. For example, the FASCOM ADP center consolidates data received from all support brigades and processes this data to satisfy requirements for data reflecting maintenance status, performance, and problem areas in the entire field army. The S&M command MMC and ADP center concern themselves with data pertaining to S&M command operations as well as overall data on the entire theater army.

(b) The FASCOM ADP center will not consolidate all data it receives. Much of the detailed data received is passed on to the ADP center at S&M command level where it is processed into reports having theater-wide application and forwarded to higher echelon activities, and provided as feedback to lower level maintenance management activities. Typical of such reports are the mean time between failure (MTBF) and the mean time to repair (MTTR) reports.

1. *MTBF report.* This is a listing of the mean time between failure for specific types of equipment. Repetitive failures may indicate substandard maintenance, equipment abuse, or an item for which an Equipment Improvement Report (EIR) should be submitted.

2. *MTTR report.* This is a listing of the average man-hours required per maintenance action for specific types of end items and components. This report can be identified with equipment by type/model/series/component.

(6) *CONUS information sources.*

(a) The Army Logistics Data Center, national maintenance points, and commodity

commands are also key elements in the maintenance management system. These elements receive, process, and analyze maintenance and related data received from Army units worldwide (provided through ADP facilities as well as from the major command headquarters like the S&M command in a theater of operations). Such data is used for a multitude of purposes by these CONUS activities, to include satisfying DA requirements for information, identification and solution of problems, identification of trends, determination of service life of equipment, and the like.

(b) These CONUS activities also provide feedback information for use by field commands and maintenance management activities in the field. This information includes reports and listings on the world-wide status of items of equipment, failure rates, modification work order requirements and status, and other types of information to assist in the management and control of maintenance activities. When feasible, such reports are provided in machine format so that they may be automated.

(c) To facilitate coordination between CONUS activities and theater combat service support elements on maintenance and related matters, the TASCOM S&M command is connected directly (by ADP network) to CONUS national maintenance points (FM 54-5-1 (TEST) and FM 54-7).

9-6. Alternate Procedures in the Event of Destruction of Equipment or Personnel

a. Maintenance management, as described in the foregoing portions of this chapter, depends on the availability and operability of ADP and associated equipment, the availability of personnel to operate and maintain this equipment, the availability of communications for the rapid transmission of data and information to those elements which require it, and the availability of staff and management personnel at various echelons for the performance of maintenance management functions. Data processing installations and communications facilities are vulnerable to enemy destruction, as are the headquarters and maintenance man-

agement activities (MMC's) where the maintenance management personnel are located. In fact, the destruction of either an MMC or its supporting ADP center could well result in the destruction of both, since the MMC ideally locates near the ADP center. Thus, contingency plans must be developed at FASCOM and support brigade levels in the field army area and at S&M command and ASCOM levels in the COMMZ to provide for alternate means of communication, alternate facilities for collection and processing of data, and the reconstitution of maintenance staffs or MMC's which may have been destroyed by enemy action.

b. In the event of loss of an ADP center, another ADP center (designated in contingency plans) will assume the data collection and processing responsibilities of the destroyed installation until such time as the required capability can be reestablished. This will require designation, by appropriate command elements, of each facility that will serve as alternate for another, and will require notification of units and facilities submitting maintenance data and reports of the requirement to submit data to an alternate facility (unless procedures and facilities are available for automatically switching incoming data to the alternate facility). The creation of an alternate capability also requires that each ADP center duplicate data required by an alternate facility for assumption of data processing responsibilities, and that this data be provided

to the facility designated as alternate. Such duplicate data will normally be prepared on magnetic tape, which can be delivered to the facility or other site selected for data storage. This will constitute the maintenance management data base which will be periodically updated by erasing the old magnetic tape and dumping up-to-date data to the tape.

c. Within the field army area, the data processing facility of one division may serve as the alternate facility for another division; the ADP center of one corps support brigade serves as the alternate for another corps support brigade; and the FASCOM ADP center and army support brigade ADP center will serve as alternates for each other. In the COMMZ, the S&M command and ASCOM ADP centers may serve as alternates for each other.

d. In the event of destruction of communications lines and equipment, data required for maintenance management can be delivered by messenger until communications are restored.

e. In the event of neutralization of the ACofS, maintenance staff or the MMC at any echelon, the surviving element would assume the responsibilities of the other element until it can be reconstituted.

f. If existing ADP facilities are destroyed and alternate facilities are not available to support maintenance management requirements, necessary reports and data will have to be submitted in manual format as described in paragraph 9-12*d*.

Section II. MAINTENANCE MANAGEMENT IN THE DIVISIONS

9-7. Introduction

a. In all divisions except the airmobile division, management of the maintenance support effort is the responsibility of the division maintenance battalion for all items supported by the battalion. Such management is accomplished by the materiel section of the maintenance battalion headquarters. These management functions embrace all types of materiel used by the division except ammunition, cryptographic, medical, EAM, and airdrop items. Support for ammunition items is provided by appropriate elements of the corps ammunition

group as described in FM 9-6. Support for other excluded items and management of the support effort is performed by those elements charged with providing such support; e.g., signal battalion for cryptographic materiel, medical battalion for medical items, administration company for EAM equipment, and air equipment support company for airdrop items (FM 54-2).

b. In the airmobile division, with its preponderance of aircraft, prime responsibility for management of the maintenance support effort rests with the commander of the transporta-

tion aircraft maintenance and supply battalion and his staff for aircraft and related items. The maintenance battalion manages the maintenance support effort for other items (with the same exceptions listed above).

9-8. Operational Procedures

a. Management of maintenance support operations within the division will be accomplished by the maintenance battalions as described in FM 29-30. Such management is similar to that for all maintenance battalion operations as discussed in detail in FM 29-22, and is geared to management of the battalion's own support operations. Overall supervision is exercised by the support command commander and his staff.

b. Maintenance and materiel readiness summaries and exception data generated within the division are provided to the corps support brigade MMC (through its supporting ADP center). If ADP support is available to the division, data from the maintenance battalion(s) and other required maintenance-related data from other divisional units, such as materiel readiness, is provided in machine language format to the division data center. The division data center will provide summarized,

exception, and detailed data as necessary, to the support brigade ADP center and higher echelons. The division data center, when established, will also provide machine support for the management of all maintainable equipment provided support within the division.

c. When sufficient resources are available, divisions will be provided organic computer facilities for automation of combat service support operations. Such facilities will be located at support command headquarters. When this occurs, the maintenance battalion will provide a maintenance management element to perform maintenance management functions at the computer site. In the airmobile division, prime responsibility for organization and direction of such an element will rest with the commander of the transportation aircraft maintenance and supply battalion; however, personnel resources and operational guidance must also be provided by the maintenance battalion commander. As necessary, other elements of the division having maintenance support responsibilities in special areas may provide personnel to complement the management element. This management element will operate as a small MMC, with emphasis on maintenance support and materiel readiness within the division.

Section III. COMBAT SERVICE SUPPORT DATA SYSTEM

9-9. Introduction

a. When fully implemented, this system will contain most of the data required for maintenance management, as well as for other combat service support applications. It provides for the automation of data to support logistical, personnel, and administrative functions of the Army in the field. A key feature of the system is the combining of data collection, processing and storage related to a groupment of support functions (e.g., supply, maintenance, transportation, personnel, and others) in an ADP center. This permits more efficient use of the interrelated files and the specially-trained personnel, equipment, and other resources available for collection, processing, storage, and distribution of data on an automated basis. When the system is fully implemented, these ADP centers, equipped with computers, inquiry de-

vices, communications equipment, and ancillary ADP equipment, will operate at division support command, support brigade, and FAS-COM headquarters within the field army and at major supporting headquarters in the COMMZ (fig. 9-2). On-line, computer-to-computer communications will be established between and among the various ADP centers, including those designated as alternates for other ADP centers.

b. Army Equipment Record Procedures and Maintenance Management Field Command Procedures, as documented in TM 38-750 and TM 38-750-1, together with pertinent Army Regulations and related documentation on materiel and unit readiness reporting (AR 11-14 and AR 220-1) establish the current basis for most maintenance and materiel readiness data. Such data comprises only a portion of the total data

available and required under combat service support data system maintenance management procedures. The data system will provide for the collection and processing of data on a refined and expedited basis through use of ADP facilities; will negate the requirements for submission of data and reports through command channels, allowing units to provide input directly to the ADP facility; and will provide for the preparation and dissemination of those reports and data required by command echelons, management activities, and Department of the Army.

9-10. Maintenance, Materiel Status, Personnel, and Supply Data in the Combat Service Support Data System

a. General. The following paragraphs list a few of the categories of data included in the overall data system; however, they provide most of the data required for maintenance management.

b. Types of Data Available. Types of data included in the above categories include, but are not limited to the following:

(1) *Maintenance data.* Data included in this category includes such things as: density and location of items supported, workload of maintenance units, manpower expenditures, repair parts usage, and related data pertaining to operations of maintenance support units. Such data is used for determination of workloads and repair parts requirements, for distribution or redistribution of work, for assignment and reassignment of missions and deployment and redeployment of maintenance units, and for determination of augmentation requirements or requirements for additional units. It is also used for modification of repair time limits and evacuation policies, for monitoring accomplishment of MWO, for determination of failure patterns, for assessment of adequacy and efficiency of maintenance, and for a myriad of other applications related to maintenance support planning and management.

(2) *Materiel status.*

(a) Data in this category includes the serviceability status of specific end items and components in the supply system and in the hands of troops. It provides data on item his-

tory, operational status, and supply status of specific items and components of interest to management. Data will be available in varying degrees of detail, depending on the significance of the item involved; e.g., at one extreme a data file may be established relating to one truck having a specific FSN, and containing a complete history of everything that has happened to the truck; at the other extreme, one data file may be established relating to all mess kits within a corps area, and containing only general information relating to such items.

(b) Currently, materiel status data is obtained in accordance with requirements and procedures indicated in AR 11-14, AR 220-1, and TM 38-750. Under the combat service support data (CS₃) system, most data for maintenance management will be available from the materiel status files forming an integral part of the system, to include the specific types of data indicated in (1) above. See figure 9-3.

(c) Master files containing data on end items and components will be maintained at the ADP center, and reporting units will report to the ADP center only when significant things happen with respect to their equipment, requiring changes of information in master files. Thus, the data collection system for maintenance management will be based on a "near real time system" in which basic files are established and changes are reported as they occur. These files can be queried to provide a variety of specific types of data as indicated in figure 9-3. From a maintenance standpoint, such data is required for determining support priorities in relation to types of items or specific units, for management of operational readiness float, for planning technical assistance, and for programing effort. It is also useful in assessing the adequacy and efficiency of maintenance.

(d) To a large extent, maintenance management will be by exception when reported data reflects deviations from established parameters. Significant facts will be reported only once, and will be available to anyone who has a need for them.

(3) *Personnel data.* Data in this category relates to the status of individuals and units. While of primary concern for personnel and

administration functions, the maintenance manager is concerned with such data as it relates to personnel availability and shortages and lack of personnel with required MOS for the accomplishment of specific functions. Such information is used by the maintenance manager to determine man-hours available for maintenance within specific units, requirements for personnel augmentation, capability to perform specific types of work, and requirements for shifting personnel.

(4) *Supply status.* This category includes such data as status of stocks, requirements, and availability of replenishment stocks. The maintenance manager requires such information to determine availability of repair parts for repair functions, requirements for cannibalization and parts fabrication, priority determination, and programming of effort, especially at the general support maintenance level.

Section IV. MAINTENANCE MANAGEMENT—INTERIM PROCEDURES

9-11. Introduction

Maintenance management, as described in the basic portion of this text, is predicated and dependent on full availability of ADP equipment to support the maintenance staffs and MMC's concerned with maintenance management at various levels in the theater of operations (e.g., support brigade, FASCOM, ASCOM, and S&M command). However, the standardization and fielding of the necessary ADP equipment, the training and deployment of operating and maintenance personnel, and the establishment and refinement of detailed operational procedures for use of ADP equipment will be phased over a period of time. This is to assure orderly transition, maximum economy of resources, minimum disruption to operations, and most efficient use of equipment as it becomes available. Thus, automation of data transmission, storage, and processing as a tool of maintenance management cannot be used to the degree visualized in the basic portion of this text until sufficient equipment becomes available and procedures for its use become finalized. Nevertheless, effective maintenance management, with or without the benefit of machine support, must be exercised during

c. Provision of Data to Staff Elements. Since the ADP center at a particular echelon in the field army supports the requirements of all functional control centers and staff sections at that echelon, the ADP center is, in reality, a large data bank and collection and processing facility for all combat service support data required at that echelon. While it is possible for each staff element to go directly to the ADP center for data, even though the data desired is within the primary area of interest of another staff section, in practice, required data is obtained through the functional control center or appropriate staff section having primary interest in the data. This is necessary to assure that data is current, has been properly analyzed, and to preclude the initiation of action to remedy problem areas that have already been recognized and attended to, or require joint staff effort.

the period of transition. This section provides guidance for maintenance management during this *interim* period.

9-12. Interim Procedures for Maintenance Management

a. Even though ADP equipment may not be available in sufficient quantities at proper locations to permit complete automation of maintenance data processing and storage, sufficient equipment will be available, in the interim period, to permit the collection and processing of certain maintenance and materiel readiness data by automated procedures. Thus, while data requirements for maintenance management are the same under automated or non-automated procedures, the maintenance manager must have plans for implementation when maintenance management cannot be automated, and must tailor his data and report requirements to the facilities available.

b. At present, ADP equipment is being used on a fairly large scale for various applications, to include inventory control, personnel, and finance. Automatic data processing units (TOE 12-510) are assigned to headquarters of major commands to collect, audit, and maintain per-

sonnel, organizational, and equipment data utilizing automated techniques and equipment. The FASCOM inventory control center has an organic data processing capability to support its operations. In addition, data processing teams provided by TOE 29-500 are utilized where automatic data processing techniques and equipment are being used for other applications.

c. At a minimum, computer facilities to support combat service support operations will be located at the S&M command and FASCOM inventory control centers. These facilities, within their capabilities, will also support overall TASCOM and FASCOM requirements for processing selected data required for maintenance management. Such support, though, will be limited because of ADP requirements for stock management. The degree of support provided for the maintenance management effort will be determined through coordination between the ACofS, maintenance, and the ACofS, supply, for the ICC operates under the control and supervision of the latter.

d. Under conditions of no or limited ADP support, MMC's will remain the key elements in routine management of maintenance operations. These MMC's at support brigade, FASCOM, ASCOM, and S&M command level will depend, to a great extent, on review and analysis of data and reports submitted in manual format. Such reports as "deadline reports," "production difficulty reports" and "status and activity reports," as described in FM 29-22, will provide most of the data and information used for maintenance management and control. The ACofS, maintenance staff at each echelon will continue to manage maintenance on a "by exception" basis. Under such a system, however, maintenance management will be severely degraded, and greater reliance must be placed on decentralized maintenance management.

e. Maintenance battalion headquarters will play a greater role in maintenance management, and will function in accordance with procedures established in FM 29-22.

APPENDIX A

REFERENCES

The following references should be checked frequently for latest changes or revisions relating to material covered in this manual.

1. Army Regulations (AR)

- | | |
|--------|--|
| 1-35 | Basic Policies and Principles for Interservice and Interdepartmental Logistic Support. |
| 11-14 | Materiel Readiness. |
| 37-27 | U.S. Army Financial Inventory Accounting and Reporting System. |
| 220-1 | Unit Readiness. |
| 320-5 | Dictionary of United States Army Terms. |
| 320-50 | Authorized Abbreviations and Brevity Codes. |
| 700-4 | Supply and Maintenance Technical Assistance Program. |
| 700-18 | Repair Parts Allocation and Allowances. |
| 700-69 | Management of Critical Items—Closed Loop Support (CLS). |
| 710-50 | Intensive Management of Secondary Items. |
| 711-16 | DSU/Installation Stock Control and Supply Procedures (Army Field Stock Control System). |
| 715-30 | Local Purchase of Civilian Type Items. |
| 725-50 | Requisitioning, Receipt, and Issue System. |
| 735-10 | Principles and Policies: Accounting for Lost, Damaged, and Destroyed Property. |
| 735-11 | Accounting for Lost, Damaged, and Destroyed Property. |
| 750-1 | Maintenance Concepts. |
| 750-4 | Depot Materiel Maintenance and Support Programming for Oversea Commands. |
| 750-5 | Organization, Policies, and Responsibilities for Maintenance Operation. |
| 750-6 | Maintenance Support Planning. |
| 750-8 | Command Maintenance Management Inspections (CMMI). |
| 750-11 | Maintenance Responsibilities of the Department of the Air Force and the Army on Common Supplies and Equipment. |
| 750-12 | Cooperative Logistics Maintenance Support and Services Arrangements. |
| 750-18 | Communications Security Equipment Maintenance. |
| 750-25 | Army Metrology and Calibration System. |
| 750-27 | Repair Cost Estimates and Maintenance Expenditure Limits. |
| 750-50 | Use of Controlled Cannibalization as a Source of Repair Parts for Supply Augmentation. |

FM 29-20

2. Field Manuals (FM)

- 3-8 Chemical Reference Handbook.
- 3-12 Operational Aspects of Radiological Defense.
- 5-35 Engineers' Reference and Logistical Data.
- 8-10 Medical Service, Theater of Operations.
- 8-15 Division Medical Service, Infantry, Airborne, Mechanized, and Armored Divisions.
- 8-16-1 Medical Service, Field Army.
- (TEST)
- 8-17-1 Medical Command, COMMZ.
- (TEST)
- 8-55 Army Medical Service Planning Guide.
- (S)9-2A Special Ammunition Logistical Data (Classified Data) (U).
- 9-6 Ammunition Service in the Theater of Operations.
- 9-6-1 Ammunition Service, FASCOM.
- (TEST)
- 10-8 Air Delivery of Supplies and Equipment in the Field Army.
- 10-13 Quartermaster Reference Data.
- 19-45-1 Rear Area Protection.
- (TEST)
- 21-40 Chemical, Biological, and Nuclear Defense.
- 21-41 Soldier's Handbook for Defense Against Chemical and Biological Operations and Nuclear Warfare.
- 24-19 Communications-Electronics Reference Data.
- 27-10 The Law of Land Warfare.
- 29-3 Direct Support Supply and Service in the Field Army.
- (TEST)
- 61-100 The Division.
- 100-10 Combat Service Support.
- 100-15 Larger Units, Theater Army—Corps.
- (C)100-20 Field Service Regulations; Internal Defense and Internal Development (IDAID) (U).
- 101-5 Staff Officers' Field Manual: Staff Organization and Procedures.
- 101-10-1 Staff Officers' Field Manual: Organization, Technical, and Logistical Data (Unclassified Data).
- 101-10-2 Staff Officers' Field Manual: Organization, Technical, and Logistical Data, Extracts of Tables of Organization and Equipment.
- (S)101-10-3 Staff Officers' Field Manual: Organizational, Technical, and Logistical Data (Classified Data) (U).
- 101-40 Armed Forces Doctrine for Toxic Chemical and Biological Weapon Employment and Defense.

3. Joint Chiefs of Staff Publications (JCS Pubs)

- 2 Unified Action Armed Forces (UNAAF).
- (C)3 Joint Logistics and Personnel Policy and Guidance (U).

4. Technical Manuals (TM)

3-210	Fallout Prediction.
3-220	Chemical, Biological, and Radiological (CBR) Decontamination.
38-750	Army Equipment Record Procedures.
38-750-1	Maintenance Management: Field Command Procedures.
38-230-1	Preservation, Packaging, and Packing of Military Supplies and Equipment: Preservation and Packaging (Vol 1).
750-5-15	Chemical Weapons and Defense Equipment.

5. Technical Bulletins (TB)

AVN 23-8	Reporting Criteria and Instructions for Processing Damaged or Deteriorated Aircraft.
----------	--

6. Department of the Army Pamphlets (DA Pam)

29-10	Supply Management in the Field Army.
29-11 (TEST)	Cryptologistics Support to the Army in the Field, 1965-1970.
29-22	Maintenance Battalion and Company Operations (Nondivisional).
29-27	Army Calibration Company.
29-30	Direct Support Maintenance in Divisions and Separate Brigades.
29-45	General Support Supply and Service in the Field Army.
31-16	Counter guerrilla Operations.
31-22	U.S. Army Counterinsurgency Forces.
31-23	Stability Operations—U.S. Army Doctrine.
31-30	Jungle Training and Operations.
31-70	Basic Cold Weather Manual.
31-71	Northern Operations.
31-72	Mountain Operations.
31-75	Riverine Operations.
31-73	Advisor Handbook for Counterinsurgency.
38-5	Logistics, Maintenance Management.
38-8	International Logistics Management.
41-5	Joint Manual for Civil Affairs.
41-10	Civil Affairs Operations.
54-2	The Division Support Command.
54-5-1 (TEST)	The Supply and Maintenance Command.
54-6-1 (TEST)	The Area Support Command.
54-7	The Theater Army Support Command.
54-8 (TEST)	The Administrative Support, Theater Army (TASTA-70).
55-15	Transportation Reference Data.

FM 29-20

55-21-1 (TEST)	Transportation Railway Units and Operations.
55-50-1	Transportation Amphibian Operations.
310-1	Index of Administrative Publications.
310-2	Index of Blank Forms.
310-3	Index of Doctrinal, Training, and Organizational Publications.
310-4	Index of Technical Manuals, Technical Bulletins, Supply Manuals (Types 7, 8, and 9), Supply Bulletins, Lubrication Orders, and Modification Work Orders.
310-7	U.S. Army Equipment Index to Modification Work Orders.
690-80	Administration of Foreign Labor During Hostilities.

INDEX

	Paragraph	Page		Paragraph	Page
ADP center	9-5b(4), 9-9, 9-9a	9-12, 9-16, 9-16	Combat zone maintenance support (fig. 4-3)	4-2c	4-3
ADPE in maintenance management	6-3, 9-6, 9-9, 9-10	6-2, 9-14 9-15, 9-17	Combined command	7-4	7-2
Airborne operations	3-3c	3-5	Combined forces	4-7	4-5
Airmobile operations	3-3c	3-5	Combined staff	7-6	7-2
Alternate data collection facilities	9-6	9-14	Commander's maintenance responsibilities	2-2	2-1
Alternate procedures for maintenance management	9-6	9-14	Communications	2-6	2-4
Ammunition depots	4-2b	4-1	COMMZ maintenance support (fig. 4-2)	4-2b	4-1
Area defense	3-3d(2)	3-6	Considerations affecting maintenance	3-2b	3-2
Area support command:			Contract maintenance	3-11b(3), 5-5w	3-16, 5-8
Functions	7-19b	7-20	Controlled cannibalization	5-5l	5-7
Maintenance management center	9-3c	9-6	Control of workload	7-20b, 8-16b, 9-4b	7-20, 8-14, 9-8
Maintenance staff	7-20, 7-21	7-20 7-21	Coordination requirements	7-15d	7-12
Mission	7-19a	7-19	Corps	8-17	8-16
Organization (fig. 4-1)		4-1	Corps, separate	4-6	4-4
Army group	8-1, 8-2	8-1	Corps support command (fig. 4-4)	4-5, 4-6,	4-4
Army Logistics Data Center	8-11d, 9-5b(6)	8-11 9-14	Counterguerrilla operations	3-5, 4-8	3-8, 4-5
Assistant chief of staff, maintenance:			Data:		
Area support command	7-20b	7-20	Collection	9-5	9-11
Field army support command	8-8b	8-4	Flow (figs. 9-2, 9-3)		9-3, 9-11
Supply and maintenance command	7-14a	7-7	Listings	8-11c(2)	8-10
Support brigade	8-14a	8-13	Processing	9-5, 9-6, 9-9	9-11, 9-14, 9-16
Theater army support command	7-11a	7-5	Requirements	7-18f, 7-20a(2), 8-11, 8-16	7-19, 7-20, 8-10, 8-14
Buildup	3-2b	3-2	Sources	8-11	8-10
Brigade maintenance officer	8-31	8-23	Submission	7-18f, 7-21d, 7-24f	7-19, 7-23, 7-28
Calibration service	7-18d(3)	7-18	Use	8-11, 9-5	8-10, 9-11
Categories of maintenance	5-1	5-1	Deadlines	7-21c, 8-16d	7-22, 8-15
Civil affairs	3-11a(4), 3-11b	3-14	Defensive operations, support of	3-3d	3-6
Civilian labor, employment of	3-11b(1)	3-14	Depot maintenance	5-1e, 7-15b	5-3, 7-11
Closed loop support (CLS)	7-11a(10)	7-5	Desert operations	3-6	3-10
Cold war operations	3-1	3-1	Differences among MMC's	9-3	9-5
Combat service support, definition of	2-1b(1)	2-1	Directive authority	7-2a	7-1
Combat Service Support System (CS _s)	8-11b, 9-9, 9-10	8-10, 9-16, 9-17			

	Paragraph	Page		Paragraph	Page
Director of maintenance:			Operations	7-18	7-16
Area support group	7-23a	7-24	Organization (figs. 4-2, 7-4)		
Field depot	7-17	7-14		7-16c,	7-14,
Direct support maintenance	5-1c	5-2	Float, operational readiness	7-18	7-16
Dispersion, effects of	3-4c	3-7	Fragmentary orders	5-5s	5-8
Disposition instructions	9-4d	9-11	Functional control center	8-12b	8-12
Disposition of workload	8-16b	8-14	complex (fig. 9-1)		
Division:			Functional control centers	7-13,	7-7,
Data center	9-8b	9-16		8-6c,	8-3,
G4	8-22d,	8-19,		8-1b	9-1
	8-23b	8-19	Functions:		
Independent	4-5	4-4	Area support group	7-22c	7-24
Maintenance management	8-26,	8-21,	Area support group main-		
	8-27,	8-22,	tenance staff	7-23	7-24
	9-7,	9-15,	Army group headquarters	8-2	8-1
	9-8	9-16	Army G4	8-5b	8-2
Support command (fig. 8-2)	8-24	8-19	ASCOM headquarters	7-19b	7-20
Support command staff	8-25	8-21	ASCOM maintenance staff	7-20	7-20
Employment of civilian labor	3-11b	3-14	Corps	8-17c,	8-16,
ENSURE	5-6j	5-10		8-18	8-17
Equipment branches, functions of:			Depot maintenance directo-		
ASCOM maintenance staff	7-20d	7-21	rate	7-17c	7-16
FASCOM maintenance staff	8-8d	8-7	Direct support maintenance	5-1c(4)	5-2
S&M command maintenance			Division support command		
staff	7-14c	7-10	staff	8-25b	8-21
Support brigade mainte-			FASCOM headquarters	8-7a	8-3
nance staff	8-14c	8-12	FASCOM maintenance staff	8-8	8-4
TASCOM maintenance staff	7-11c	7-6	General support maintenance	5-1d(2)	5-2
Equipment availability listing	9-5b(4)	9-13	Maintenance battalion com-		
	(d)5		mander	8-26	8-21
Equipment density listing	9-5b(4)	9-13	Maintenance management		
	(d)1		center	9-2c	9-2
Equipment, Non-Standard, Ur-			Maintenance officer, separate		
gent Requirement			brigade	8-31	8-23
(See ENSURE.)			Maintenance service	2-3	2-2
Evacuation criteria	8-10e(6)(a)	8-9	Maintenance staff sections	9-4e	9-10
Evacuation instructions	7-15e	7-12	S&M command	7-12b	7-6
Evacuation of materiel	9-4c	9-9	S&M command maintenance		
Exception data	8-16c(4),	8-15,	staff	7-14	7-7
	9-4c(5),	9-10,	Separate brigade mainte-		
	9-4e(1)	9-10	nance staff	8-29	8-22
Expedients, maintenance support	3-3b(5)	3-4	Support brigade	8-6d	8-3
Expenditure repair limits	5-3c(1)	5-4	Support brigade headquar-		
Facilities, lease of	3-11b(4)	3-16	ters	8-13c	8-12
FASCOM (See Field army support			Support brigade mainte-		
command.)			nance staff	8-14	8-13
FASCOM MMC	9-3d	9-6	Support command com-		
Field army (fig. 4-1)	8-3	8-1	mander	8-24c	8-19
Field army staff	8-5	8-2	Support group headquar-		
Field army support command			ters	8-19b	8-17
(FASCOM):			Support group maintenance		
Functions	8-8	8-4	staff	8-21	8-17
Headquarters functions	8-7a	8-3	TASCOM	7-9	7-3
Maintenance staff	8-8,	8-4,	TASCOM maintenance staff	7-11	7-3
	8-10	8-8	Theater army staff	7-8	7-3
Organization (fig. 4-3)	8-6	8-2	Theater commander	7-2	7-1
Field depot:			General purchasing agency		
Maintenance staff (fig. 7-5)	7-17	7-14	system	3-11b(2)(b)	3-16
Mission	7-16	7-13			

	Paragraph	Page		Paragraph	Page
General support maintenance	7-15c	7-12	Management detachment	9-2	9-2
General support maintenance functions	5-1d(2)	5-2	Planning	3-3b(2)	3-4
General war	3-4	3-7	Policies	5-5	5-6
Host country equipment, support of	5-6g	5-10	Principles	5-4	5-5
ICC (See Inventory control center)			Resources	1-1b(5), 2-2b	1-1 2-1
Independent army, maintenance support of	4-3	4-3	Staff organization (See Staff organization.)		
Independent corps, maintenance support of (fig. 4-4)	4-4, 4-5	4-4	Support battalions	4-2b, 4-2c	4-1, 4-3
Independent division, maintenance support of (fig. 4-5)	4-5	4-4	Support expedients	3-3b(5)	3-4
Information and data sources	7-15h, 8-11	7-13, 8-10	Support of various types of operations:		
Inspection reports	8-11g	8-11	Airborne or airmobile	3-3c	3-5
Interim procedures for maintenance management	9-12	9-18	Counter guerrilla	3-5	3-8
Internal development	3-11a(3)	3-14	Defensive	3-1, 3-3d	3-1, 3-6
Interservice support	5-5v	5-8	Desert	3-6	3-10
Inventory control center	7-13, 8-11f	7-7, 8-11	General war	3-4	3-7
IROAN	5-3b, 5-4j	5-4, 5-6	Jungle	3-7	3-11
J-4 functions	7-3	7-2	Limited war	3-3	3-3
Joint forces	4-7	4-5	Mountain	3-8	3-11
Joint staff	7-3	7-2	Northern	3-9	3-12
Jungle operations	3-7	3-11	Retrograde	3-3e	3-6
Lease of facilities	3-11b(4)	3-16	Riverine	3-10	3-13
Limited war	3-3	3-3	Stability	3-11	3-14
Limits, repair	5-3c	5-4	Support organizations:		
Local procurement	3-11b(2)	3-15	Combined force	4-7	4-5
Logistical buildup	5-6f	5-10	Counter guerrilla operations	4-8	4-5
Maintenance:			Independent army	4-3	4-3
Allocation charts	5-2	5-2	Independent division (fig. 4-5)	4-5	4-4
Battalion commander	8-26	8-21	Independent corps (fig. 4-4)	4-4	4-4
Battalion, division	9-7	9-15	Joint force	4-7	4-5
Categories	5-1	5-1	Large theater (figs. 4-1, 4-2, 4-3)	4-2	4-1
Considerations	3-2b	3-2	Separate corps	4-6	4-4
Data	8-11, 9-10b(1)	8-10, 9-17	Separate division	4-6	4-4
Data collection	7-15f	7-13	Support plan	5-3a(1)	5-3
Definition of	2-1b(2)	2-1	Support planning	8-4c, 8-10b	8-2, 8-8
Functions (See Functions.)			Maintenance and supply:		
Management	6-1c, 7-15g, 8-10e, 8-26, 9-1, 9-12	6-1, 7-13, 8-9 8-21, 9-1, 9-18	Coordination	7-15d	7-12
Management center	7-13, 8-9, 8-11c, 8-15, 9-1— 9-6	7-7, 8-13, 8-10, 8-14, 9-1— 9-14	Integration	8-10a(2)	8-8
			Maintenance services:		
			Functions	2-3	2-2
			Relationships	2-4, 2-5	2-2, 2-3
			Management-by-exception	7-15g, 8-10e, 9-4	7-13, 8-9, 9-8
			Management of deadlines	8-16d	8-15
			Management of overloads	8-16d	8-15
			Man-hour expenditure listing	9-5b(4) (d) 6	9-13
			Manual data processing	9-12d	9-19
			Materiel branch, area support group	7-23c	7-26
			Materiel status	9-10b(2)	9-17

FM 29-20

	Paragraph	Page		Paragraph	Page
Materiel readiness reports	7-18f(2)	7-19	Operations, staff sections (<i>See</i> Method of operations.)		
Mean time between failure report	9-5b(5)(b)	9-14	Operator maintenance	5-1b(2)	5-1
Method of operation:			Orders	8-12	8-12
Area support group maintenance staff	7-24	7-26	Organizational maintenance	5-1b	5-1
ASCOM maintenance staff	7-21	7-21	Organization:		
FASCOM maintenance staff	8-10	8-8	Area support group (fig. 7-6)		7-25
Field depot	7-18	7-16	Area support group maintenance staff (fig. 7-7)	7-23	7-24
Maintenance management center	9-1— 9-6	9-1— 9-14	ASCOM (fig. 7-1)		7-4
S&M command maintenance staff	7-15	7-11	ASCOM maintenance staff	7-20	7-20
Support brigade maintenance staff	8-16	8-14	Corps support command (fig. 4-4)		4-4
TASCOM	7-10	7-3	Division support command (DISCOM) (fig. 8-2)	8-24	8-19
Theater army staff	7-8	7-3	FASCOM (fig. 4-3)	8-6	8-2
Missile systems, support of	4-2b(5)	4-2	FASCOM maintenance staff	8-8	8-4
Mission:			Field depot (fig. 7-4)		7-14
Area support group	7-22a	7-24	Field depot maintenance staff	7-17	7-14
ASCOM	7-19a	7-19	Production line repair operations	8-16e(2)	8-15
Corps support command (COSCOM)	4-4	4-4	S&M command (fig. 4-1)		4-1
Division support brigade	4-6	4-4	S&M command maintenance staff	7-14	7-7
FASCOM	8-6	8-2	Support brigade (fig. 4-3)		4-3
Field depot	7-16a	7-13	Support brigade maintenance staff (fig. 7-3)	8-14	8-13
Maintenance management detachment	9-2	9-2	Support group (fig. 8-1)	8-19	8-17
S&M command	7-12a	7-6	TASCOM (fig. 4-1)		4-1
Support brigade	8-13	8-12	TASCOM maintenance staff (fig. 7-2)	7-11	7-3
TASCOM	7-9a	7-3	Other forces, support of	7-5	7-2
MMC (<i>See</i> Maintenance management center.)			Overhaul	5-1e(3), 5-5b	5-3, 5-6
Mobile defense	3-3d(3)	3-6	Overloads	8-16d	8-15
Mobility, maintenance support units	5-5e	5-7	Peacetime operations	3-1	3-1
Modification work order (MWO) planning	8-10d	8-8	Personnel data	9-10b(3)	9-17
Modification work order status	9-5b(4) (d)2	9-13	Planning:		
Mountain operations	3-8	3-11	Application of modification work orders	8-10d	8-8
National maintenance points	8-11d	8-11	Maintenance support	8-10b	8-8
Near real time data collection system	9-10b(2) (c)	9-17	Production line maintenance operations	8-10c, 8-16e	8-8, 8-15
Nonavailable equipment listing	9-5b(4) (d)4	9-13	Plans and operations branch:		
Nonstandard items	5-5	5-6	Area support group maintenance staff	7-23b	7-26
Northern operations	3-9	3-12	ASCOM maintenance staff	7-20c	7-21
Offensive operations, support of	3-3b	3-3	FASCOM maintenance staff	8-8c	8-6
On-site maintenance	5-4d	5-6	S&M command maintenance staff	7-14b	7-9
Operational readiness	6-1a	6-1	Support brigade maintenance staff	8-14b	8-13
Operational readiness float	3-10e, 5-5s	3-14, 5-8	TASCOM maintenance staff	7-11b	7-5
Operation order	8-12a	8-12	Policies, maintenance	5-5	5-6
Operations, maintenance management center (<i>See</i> Method of operations.)			Principles, maintenance	5-4	5-5

	Paragraph	Page		Paragraph	Page
Problems, maintenance	3-1b, 3-1c, 3-5b, 5-6	3-1 3-8, 5-9	Supply and maintenance command (S&M command):		
Production difficulty reports	7-18f(2), 7-24f	7-19, 7-28	Functions	7-12b	7-6
Production line maintenance op- erations	8-10c, 8-16c, 8-16e	8-8, 8-14, 8-15	Maintenance management center	9-3b	9-5
Production methods	8-16c	8-14	Maintenance staff (fig. 7-3)	7-13— 7-15	7-7— 7-11
Provision of data	9-10c	9-18	Mission	7-12a	7-6
Rebuild	5-1e, 5-5c, 7-15a, 7-15b	5-3, 5-6 7-11	Organization (fig. 4-1)		4-1
Redeployment of supported units ..	5-6m	5-11	Supply status	9-10b(4)	9-18
Redirection of logistical support ..	3-3b(4)	3-4	Support battalion	4-8b(1)(b), 8-30	4-6, 8-22
Relationships:			Support brigade:		
Maintenance to supply	2-4	2-2	Functions	8-13c	8-12
Maintenance to transporta- tion	2-5	2-3	Maintenance management center	9-3e, 9-4	9-7, 9-8
Repair parts:			Maintenance staff	8-14— 8-16	8-13, 8-14
Preplanning	8-16e(4)	8-15	Mission	8-13a	8-12
Support, airborne operations ..	3-3c(4)	3-5	Organization (fig. 4-3)		4-3
Support, counterguerrilla operations	3-5c	3-9	Support command commander	8-24b, 8-24c	8-19
Usage listing	9-5b(4)(d)g	9-13	Support group:		
Repair standards	5-3	5-2	Functions	8-19	8-17
Repair time limits	5-3c, 8-10e(6)(a)	5-4, 8-9	Maintenance staff	8-20, 8-21	8-17
Reports (See Data.)			Mission	8-19	8-17
Resources, maintenance	1-1b(5), 2-2b	1-1, 2-1	Organization (figs. 4-3 & 8-1)		4-3, 8-18
Responsibilities for maintenance ..	2-2	2-1	Support maintenance	5-1a	5-1
Retrograde operations, support of ..	3-3e	3-6	Support of:		
Riverine operations, support of	3-10	3-13	Combined forces	4-7	4-5
Security requirements	5-6n	5-11	Joint forces	4-7	4-5
Separate brigade	8-28— 8-31	8-22, 8-23	Other forces	7-5, 8-4e	7-2, 8-2
Separate corps, support of	4-6	4-4	Technical assistance	5-5m	5-7
Separate division, support of	4-6	4-4	Theater army:		
Shipping instructions	9-4b(3)	9-9	Organization (fig. 4-1)		4-1
Specified command	7-1-7-3	7-1, 7-2	Staff functions	7-8	7-3
Stability operations	3-11	3-14	Theater army support command (TASCOM):		
Staff operations (See Method of operations.)			Concept of operations	7-10	7-3
Staff organization (See Organi- zation.)			Functions	7-9	7-3
Staff relationships	8-8b	8-4	Maintenance staff (fig. 7-2) ..	7-11	7-3
Standards, repair	5-3, 8-10e(6)(b)	5-2, 8-9	Mission	7-9	7-3
Status or activity reports	7-18f(2), 7-24f, 8-16c(4), 9-4d(2)	7-19, 7-28 8-15— 9-10	Organization (fig. 4-1)		4-1
Stock control center (SCC)	9-5b(3)	9-12	Theater commander	7-2	7-1
			Time repair limits	5-3c(2)	5-5
			Transition, peacetime to wartime operations	3-2	3-2
			Type "B" units	5-6h	5-10
			Types of maintenance support organizations (figs. 4-1-4-5) ..	4-1-4-9	4-1-4-7
			Types of reports	9-3b(3)	9-9
			Unified command	7-1a	7-1
			Unit maintenance	5-1b(2)(b)	5-1

By Order of the Secretary of the Army:

Official:

KENNETH G. WICKHAM,
*Major General, United States Army,
The Adjutant General.*

W. C. WESTMORELAND,
*General, United States Army,
Chief of Staff.*

Distribution:

To be distributed in accordance with DA Form 12-11 requirements for Maintenance Management in Theaters of Operations.

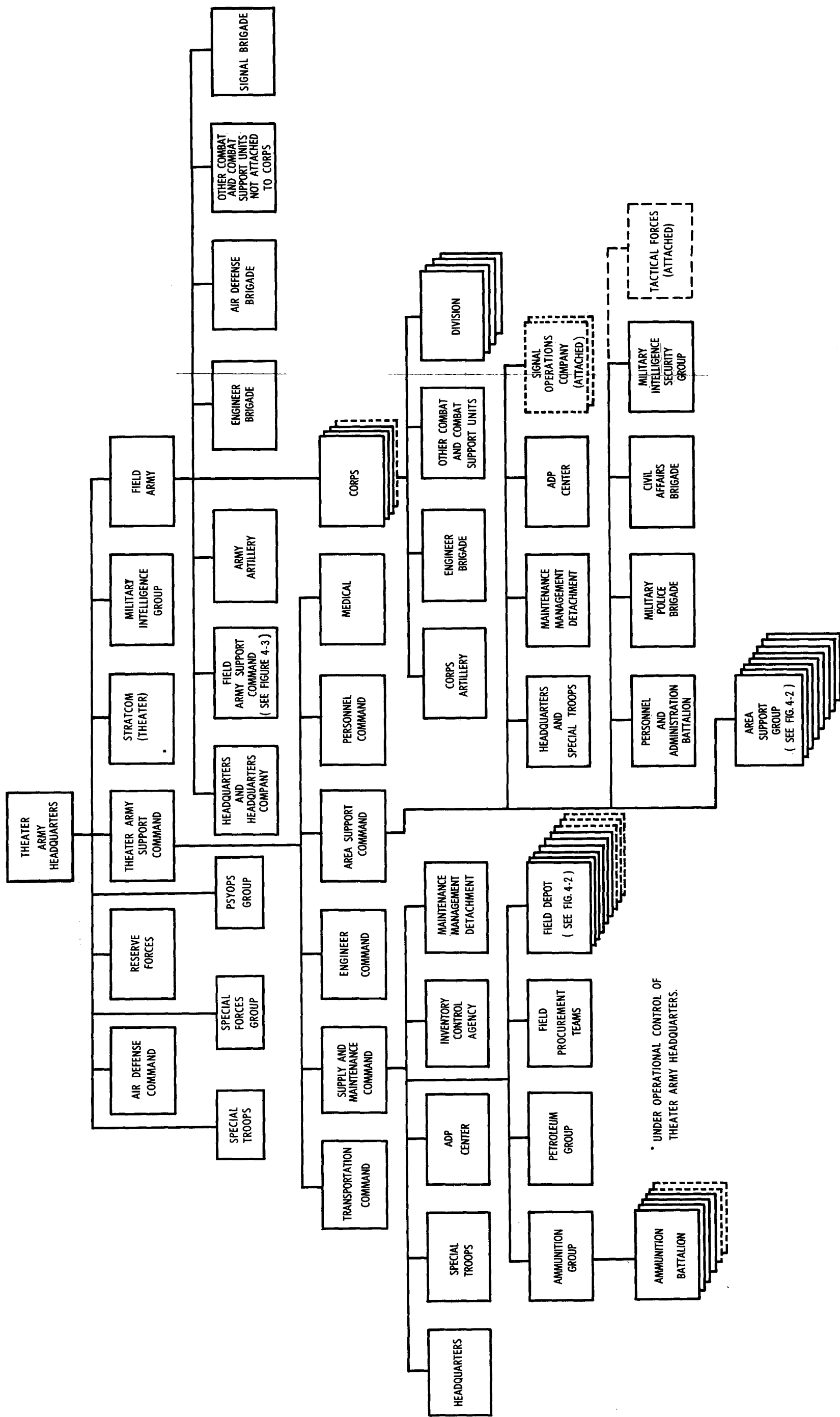
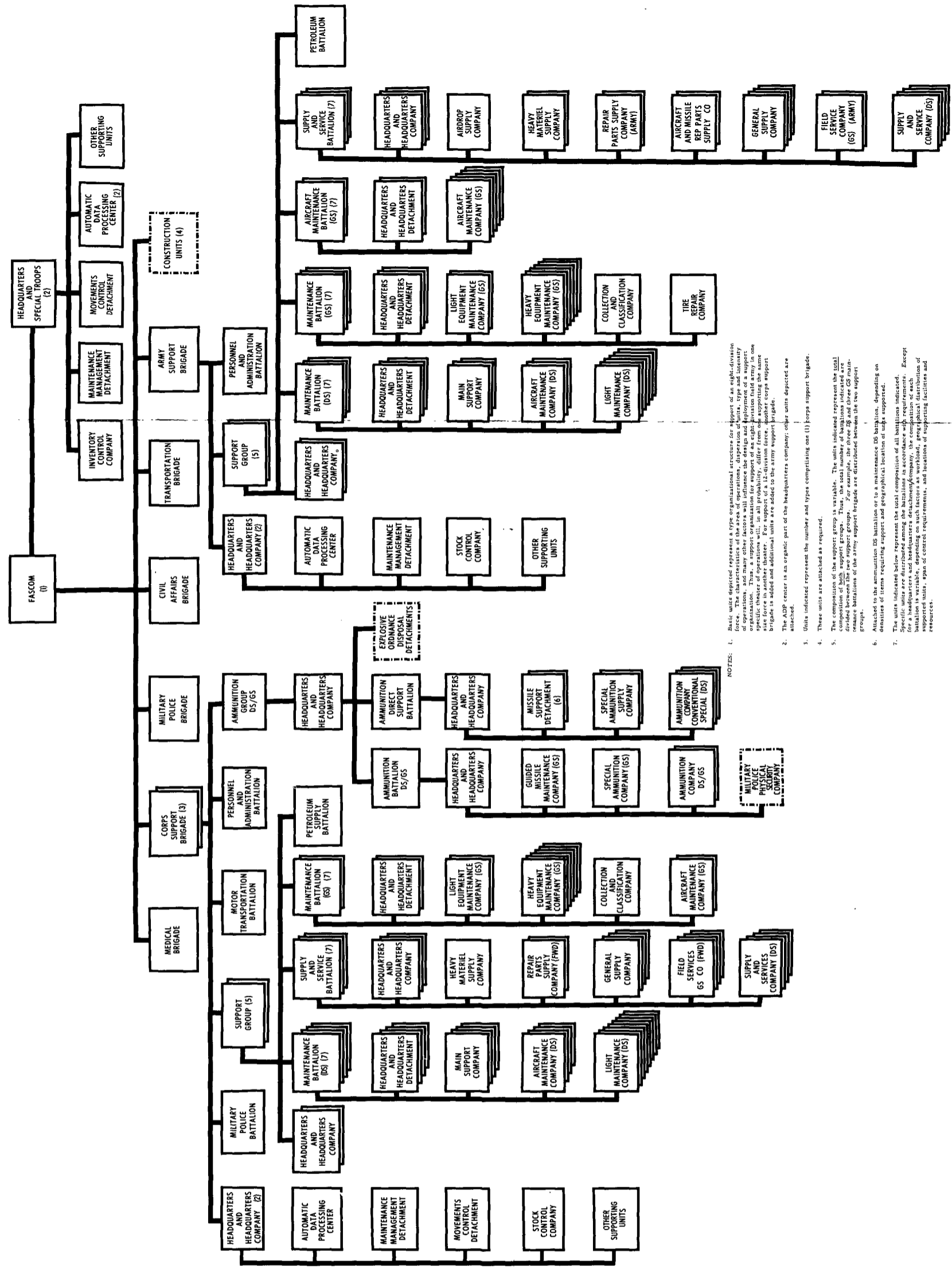

Figure 4-1. Type theater army structure depicting breakout of the theater army support command (TASCOM).



- NOTES:
1. Basic units depicted represent a type organizational structure for support of an eight-division force. The characteristics of the area of operations, dispersion of units, type and intensity of operations, and many other factors will influence the design and employment of a support organization. This diagram is a generalization for support of an eight-division force in one specific theater of operations. It is not intended to represent the actual organization of a specific force in another theater. For support of a 12-division force, another corps support brigade is added and additional units are added to the army support brigade.
 2. The ADP center is an organic part of the headquarters company; other units depicted are attached.
 3. Units indicated represent the number and types comprising one (1) corps support brigade.
 4. These units are attached as required.
 5. The composition of the support group is variable. The units indicated represent the total composition of both support groups. For example, the three DS and three GS maintenance battalions of the army support brigade are distributed between the two support groups.
 6. Attached to the ammunition DS battalion or to a maintenance DS battalion, depending on densities of items requiring support and geographical location of units supported.
 7. The units indicated below represent the total composition of all battalions indicated. Specific units are distributed among the battalions in accordance with requirements. Except for a headquarters and headquarters detachment/company, the composition of each battalion is variable, depending on such factors as workload, geographical distribution of units, type, type of control requirements, and locations of supporting facilities and resources.

Figure 4-8. Type maintenance support structure for a field army force of 8 divisions.

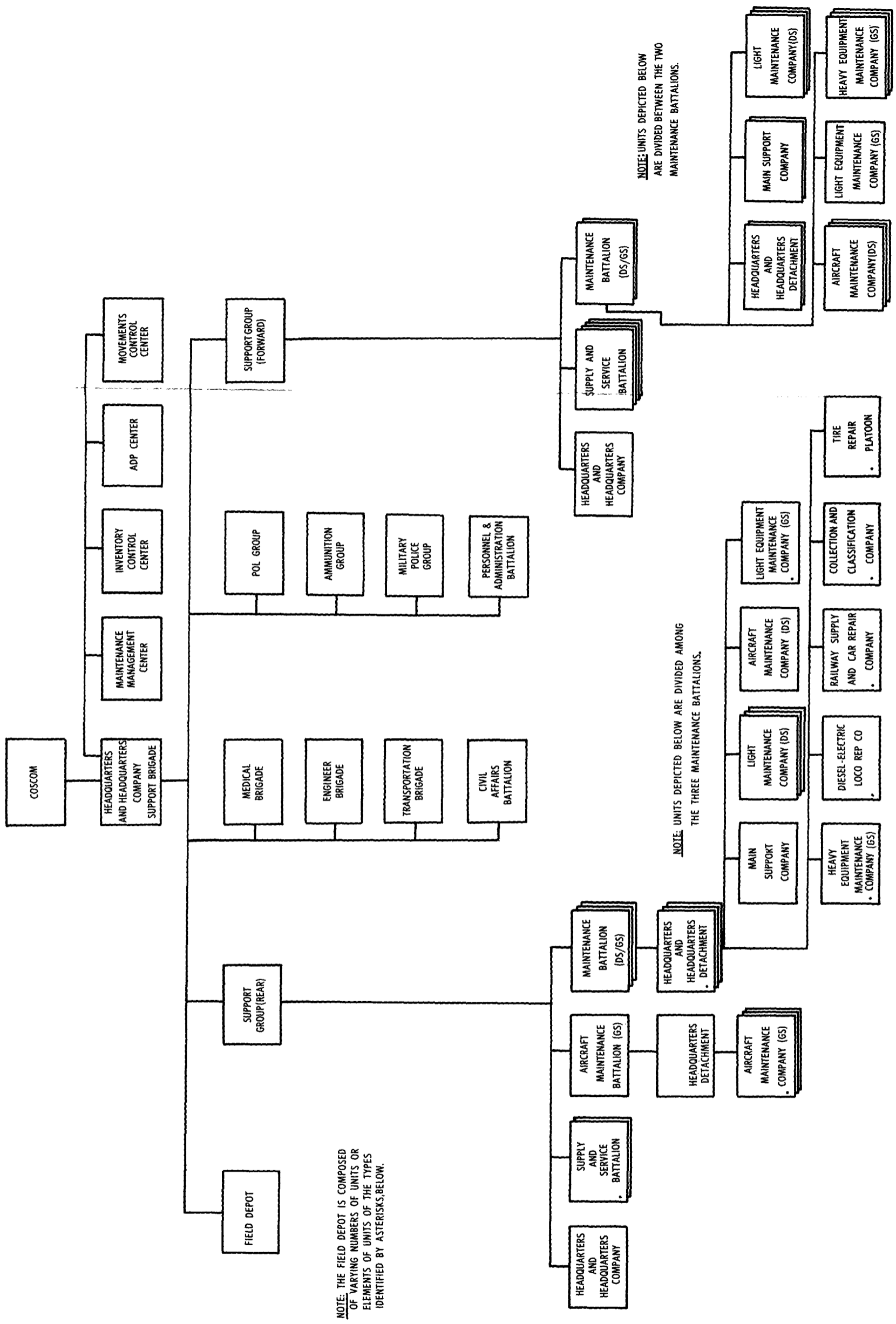

Figure 4-4. A type combat service support structure for a 3-division independent corps (maintenance organization depicted in detail).

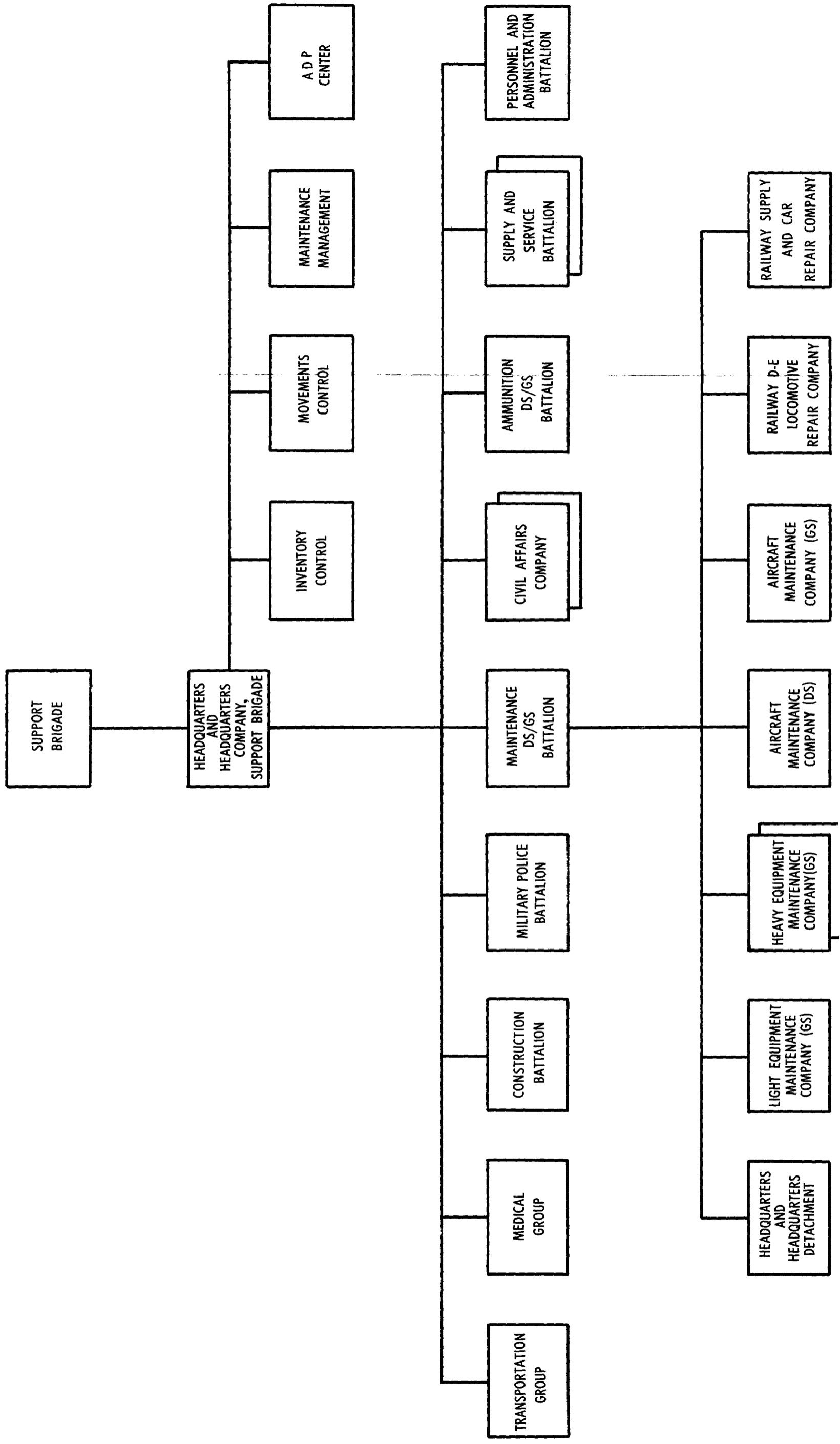

Figure 4-5. A type combat service support structure for an independent division (with maintenance organization broken out).

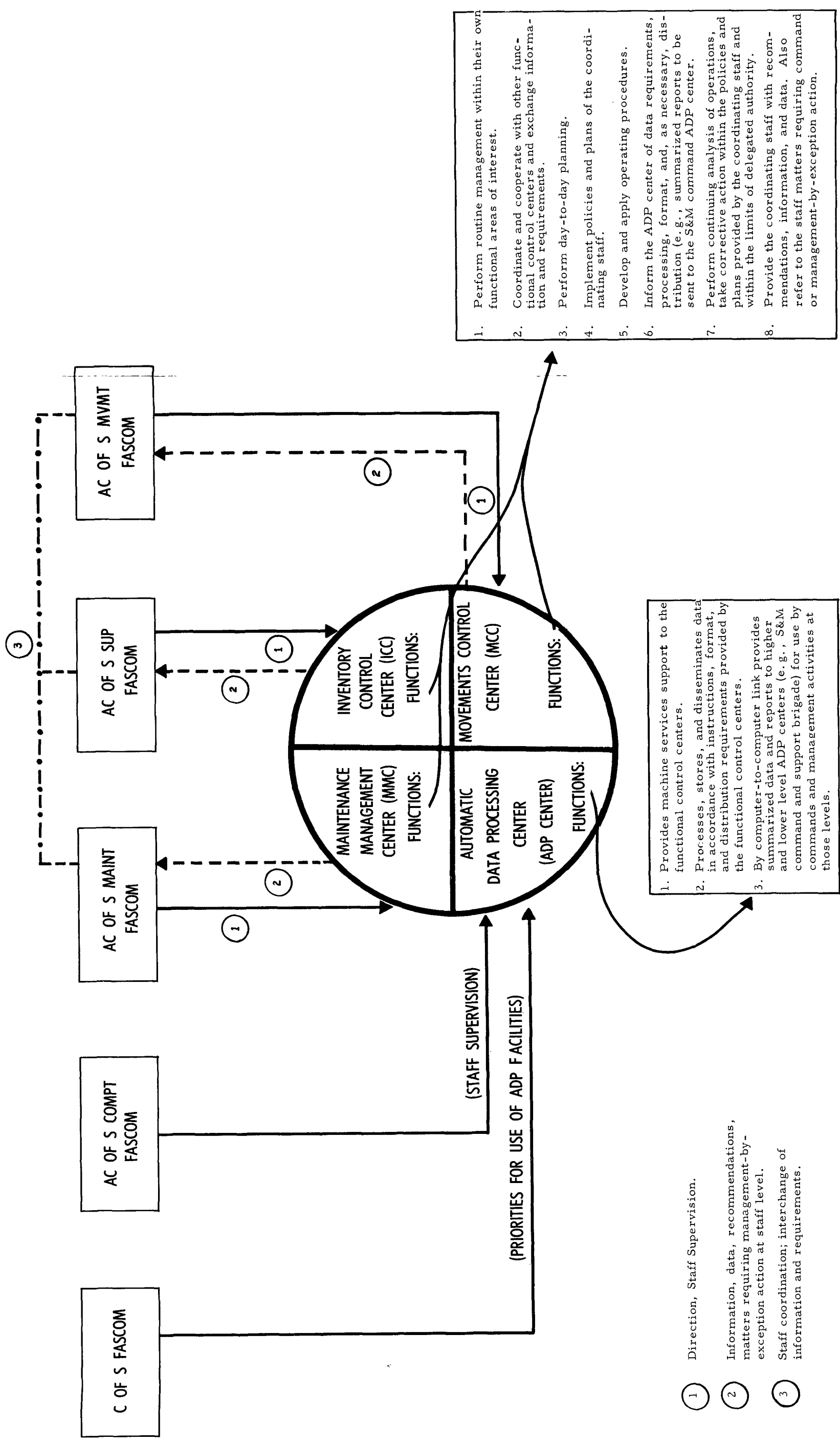
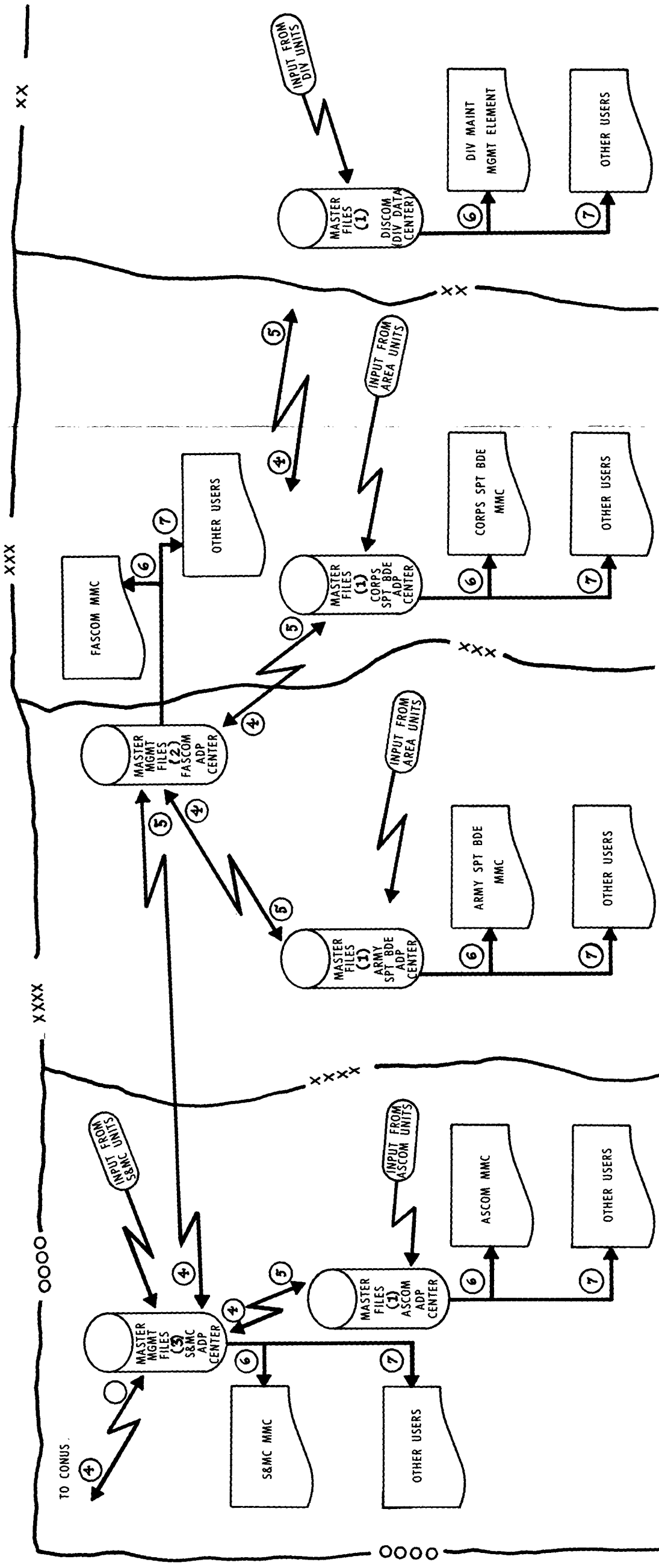

Figure 9-1. FASCOM functional control center complex depicting relationships, controls, and functions.



NOTE: This figure depicts sample type of data flow and sample types of data utilized in the system. No attempt is made to depict all types of files, all types of data, nor complete distribution of data within the system. For example, information and data flow between the various MMC's and subordinate maintenance units of the command has not been depicted because of space limitations. Data flow between the MMC's and subordinate units is explained in the text.

- (1) These include such files as the EIMF (End Item Master Identification File), CMIF (Component Master Identification File), and the MWOCF (Modification Work Order Control File). After establishment of these basic files, input from reporting units is required only to report changes. These files will be able to provide such information as: equipment status; materiel readiness (by unit, equipment type); deadlines, workloads at various levels; status of MWO's, and data related to repair frequencies and time for repair of materiel.
- (2) Master management files contain summarized data relating to the overall command, exception data, and detailed data required for specific functions (e.g., determining mean time between failure (MTBF) for certain types of items or determining mean time to repair (MTTR) certain types of items.
- (3) Master files containing data relating to the theater, as a whole, and specific data relating to maintenance status and operations of units of the S&MC.

- (4) Primarily EXCEPTION and SUMMARIZED data required to keep higher echelons informed of status, progress, and difficulties. Also includes such specific and detailed data as may be required to satisfy specific informational requirements; e.g., for determining overall MTBF or MTTR.
- (5) Feedback provided by higher echelons in the maintenance management system--summaries, identification of specific problems, data provided in response to specific queries.
- (6) Data required for maintenance management functions. Includes specific data of the type indicated in (1) above.
- (7) Data required by other command and staff activities; e.g., materiel readiness, MWO status, problem areas requiring command attention.

Figure 9-3. Sample type of data flow for maintenance management in a theater of operations under fully automated procedures.