

MAST

MHI
Copy 3

*Superseded by 8-10
2 Oct 78*

FM 8-10

DEPARTMENT OF THE ARMY FIELD MANUAL

MEDICAL SUPPORT THEATER OF OPERATIONS

PROPERTY OF
QUARTERMASTER SCHOOL LIBRARY
U. S. ARMY QUARTERMASTER SCHOOL
FORT LEE, VA. 23801



HEADQUARTERS, DEPARTMENT OF THE ARMY

APRIL 1970

FIELD MANUAL

No. 8-10

HEADQUARTERS
DEPARTMENT OF THE ARMY
WASHINGTON, D.C., 10 April 1970**MEDICAL SUPPORT
THEATER OF OPERATIONS**

	Paragraphs	Page
CHAPTER 1. INTRODUCTION	1-1-1-4	1-1
2. MEDICAL SUPPORT—GENERAL		
Section I. General	2-1, 2-2	2-1
II. Field Medical Support	2-3-2-6	2-1
III. The Geneva Conventions Affecting Medical Support	2-7-2-10	2-3
CHAPTER 3. THEATER ARMY		
Section I. General	3-1, 3-2	3-1
II. Theater Army Support Command	3-3, 3-4	3-1
III. Theater Army Medical Staffs	3-5, 3-6	3-4
IV. Theater Army Medical Command	3-7-3-9	3-5
CHAPTER 4. FIELD ARMY		
Section I. General	4-1-4-5	4-1
II. Field Army Medical Staffs and Organizations	4-6-4-8	4-1
CHAPTER 5. CORPS		
Section I. General	5-1, 5-2	5-1
II. The Corps Surgeon	5-3-5-5	5-1
CHAPTER 6. PATIENT EVACUATION		
Section I. General	6-1-6-4	6-1
II. Medical Regulating	6-5-6-7	6-3
✓III. Evacuation Within the Combat Zone	6-8, 6-9	6-6
✓IV. Evacuation From the Combat Zone	6-10-6-16	6-7
CHAPTER 7. HOSPITALIZATION		
Section I. General	7-1-7-3	7-1
✓II. Hospitalization in the Field Army	7-4-7-6	7-2
✓III. Hospitalization in the Communications Zone	7-7-7-10	7-3
CHAPTER 8. BLOOD BANK SERVICE, THEATER ARMY		
✓9. MEDICAL SUPPLY AND MAINTENANCE		
Section I. General	8-1-8-5	8-1
✓II. Medical Supply in the Combat Zone	9-1-9-9	9-1
✓III. Medical Supply in the Communications Zone	9-10, 9-11	9-3
✓IV. Medical Equipment Maintenance	9-12, 9-13	9-3
CHAPTER 10. DENTAL SERVICE		
Section I. General	9-14-9-19	9-4
II. Dental Staff Officers	10-1-10-3	10-1
III. Dental Service in the Combat Zone	10-4, 10-5	10-2
IV. Dental Service in the Communications Zone	10-6, 10-7	10-2
CHAPTER 11. VETERINARY SERVICE		
Section I. General	10-8, 10-9	10-2
II. Veterinary Staff Officers	11-1-11-3	11-1
III. Veterinary Service in the Communications Zone	11-4-11-5 11-6-11-10	11-1 11-2

* This manual, together with FM 8-15, 20 May 1968, supersedes FM 8-10, 3 November 1959, including all changes. This manual rescinds FM 8-5, 28 October 1959, including all changes; FM 8-16, 23 June 1965, including all changes; FM 8-16-1 (TEST), 20 March 1967; and FM 8-17-1 (TEST), 8 March 1967.

	Paragraphs	Page
Section IV. Veterinary Service in the Combat Zone	11-11—11-15	11-3
CHAPTER 12. PREVENTIVE MEDICINE		
Section I. General	12-1, 12-2	12-1
II. Preventive Medicine Staff		
Functions	12-3, 12-4	12-1
III. Organization and Operations	12-5, 12-6	12-2
CHAPTER 13. MEDICAL SUPPORT OF OPERATIONS IN A CBR AND NUCLEAR ENVIRONMENT	13-1—13-7	13-1
14. STABILITY OPERATIONS	14-1—14-3	14-1
APPENDIX A. REFERENCES		A-1
B. AUTOMATIC DATA PROCESSING (ADP) IN THE THEATER OF OPERATIONS		B-1
C. AIR DEFENSE		C-1
D. STANDARDIZATION AGREEMENTS		D-1
E. MEDICAL UNITS		E-1
INDEX		I-1

CHAPTER 1

INTRODUCTION

1-1. Purpose and Scope

a. This manual prescribes doctrine for use by Army Medical Department unit commanders and staffs in providing medical support to the army in the field, and to familiarize others with the medical support system.

b. The organization, mission, capabilities, and concepts of operation are described in broad terms. Unit and division level medical support, as well as medical support in stability operations, and the impact of nuclear, biological, and chemical operations, thoroughly covered in other manuals, are discussed briefly in order to supplement doctrine common to all areas of operation.

c. This manual is in accordance with the following International Standardization Agreements (STANAG) which are identified by type of agreement and number at the beginning of each appropriate chapter and are contained in appendix D:

Title	NATO STANAG	CENTO STANAG	SEATO SEASTAG	ABCA SOLOG
Patient Evacuation Tag	2051	...	2051	81
Procedures for Disposition by Medical Installations of Allied Patients ----	2061	2061	2061	66
Patient Reporting by Medical Treatment Facilities	2075	2075	2075	74
Radiological Hazards --	2083	----	----	128
Medical Employment of Helicopters in Ground Warfare	2087	2087	2087	---
Medical and Dental Supply Procedures	2128	----	----	---

1-2. Application

This manual is applicable to—

a. General war, to include consideration for the employment of, and protection from, nuclear, biological, and chemical munitions and operations in chemical, biological, and radiological (CBR) environments.

b. Limited war.

c. Cold war, to include stability operations.

1-3. Explanation of Terms

Terms and abbreviations used in this manual are

in consonance with those contained in AR 310-25, AR 310-50, and JCS Pub 1. Key terms, not incorporated in above references but applicable specifically to medical activities, are explained below.

a. *Area Medical Support.* This concept of medical support involves the delineation of support responsibility by geographical area. It includes the provision of unit level medical support to organizations that do not possess an organic medical capability. Medical units required for this support are allocated based upon troop strength, and are established where and when requirements indicate.

b. *Aeromedical Evacuation.* Aeromedical evacuation is the movement of patients to and between medical treatment facilities by aerial vehicles that are specially crewed and equipped to accommodate patients and to provide required in-flight medical care.

c. *Dental Service.* Dental service includes those health services which promote, improve, conserve, or restore the physical well-being of dental patients.

d. *Health Services.* The term "health services," as used in this manual, includes all services performed, provided, or arranged for, by the Army Medical Department, which promote, improve, conserve, or restore the mental or physical well-being of personnel in the Army and, as directed, in other services, agencies, and organizations. They include, but are not limited to, the management of health services resources, e.g., manpower, monies, and facilities; preventive and curative health measures; the health services doctrine; transportation of the sick and injured and wounded; selection of the medically fit and disposition of the medically unfit; medical supply and equipment and maintenance thereof; and medical, dental, veterinary, laboratory, and optometric services.

e. *Medical Service.* The Army Medical Service (AMEDS) has been redesignated as the Army Medical Department (AMEDD). Therefore, in this manual, the term "medical service" is used to differentiate between specific branches within the AMEDD (i.e., medical service, dental service, veterinary service), and as a title of the subdivision

of a hospital that provides for the care and treatment of medical patients (e.g., medical service, surgical service, orthopedic service).

f. Medical Support. Medical support, in its broadest conotation, includes all health services (para *d*, above) utilized in support of the Army in the field.

g. Morbidity. The term "morbidity" describes the incidence and prevalence of specified morbid conditions (disease, injury, or other excused-from-duty condition) in a given area or unit.

h. Optometric Service. Optometric service is, specifically, that health service which includes examination of eyes and prescription of treatment to conserve or improve vision without the use of medicine or surgery.

i. Theater Patient Evacuation Policy. The theater patient evacuation policy is established by the Secretary of Defense with the advice of the Joint Chiefs of Staff, and upon the recommendation of the theater commander. The policy establishes the maximum duration (expressed in days) of fixed hospitalization authorized in the theater. The projected hospitalization period for individual patients is computed from the date of admission to a fixed hospital. The policy does not imply that a patient is held in the theater for the limit of time set. Patients who are not expected to be returned to duty within the specified period will be evacuated out of the theater as soon as the appropriate medical authority determines that further evacuation will not aggravate their disabilities.

j. Veterinary Service. Veterinary service includes, but is not limited to, the following:

(1) Those health services performed or provided which promote, improve, conserve, or restore the physical well-being of Army-owned or otherwise authorized animals.

(2) The inspection of prescribed foods and food-processing facilities and advice to proper authority on their acceptability.

(3) The prevention and control of zoonotic diseases.

1-4. Comments on Publication

Technological advances, as well as improved organization or operational procedures, will require changes in this manual. Users of this manual are encouraged to submit recommended changes and comments to improve the publication. Comments should be keyed to the specific page, paragraph, and line of the text in which the change is recommended. Reasons will be provided for each comment to insure understanding and complete evaluation. Comments should be prepared using DA Form 2028 (Recommended Changes to Publications) and forwarded direct to the Commanding Officer, United States Army Combat Developments Command Medical Service Agency, Fort Sam Houston, Texas 78234. Originators of proposed changes which would constitute a significant modification of approved Army doctrine may send an information copy, through command channels, to the Commanding General, United States Army Combat Developments Command, Fort Belvoir, Virginia 22060, to facilitate review and followup.

CHAPTER 2

MEDICAL SUPPORT – GENERAL (NATO STANAG 2087; CENTO STANAG 2087; SEATO SEASTAG 2087)

Section I. GENERAL

2-1. Introduction

The Army Medical Department supports all elements of the Army and is primarily concerned with maintaining the health and fighting efficiency of the individual soldier. The mission of the Army Medical Department in a theater of operations is to conserve the fighting strength of the Army by recommending, supervising, and implementing measures for safeguarding the health of the troops through effective medical care and treatment, rapid and orderly evacuation of the sick and wounded, and early return of patients to

duty. The medical support system is a single, integrated system that reaches from the area of operations to the Zone of Interior (ZI).

2-2. Characteristics

Medical support is continuing and interzonal. Efficiency of operations depends on the effective distribution of patients to those medical facilities that are capable of providing the required treatment in the shortest possible time. Patients must be regulated and evacuated without regard to lateral or rear boundaries.

Section II. FIELD MEDICAL SUPPORT

2-3. Mission

Medical support for the army in the field is provided by Army Medical Department units or elements. The mission of the Medical Department is to conserve manpower by planning, recommending, and supervising measures necessary for safeguarding the health of troops and for providing treatment and rapid evacuation of the sick and injured.

2-4. Functions

The general functions of the Army Medical Department are treatment; evacuation; hospitalization; preventive medicine; medical supply and maintenance; dental, veterinary, laboratory, and optometric services; and command and control of medical units. In addition, medical assistance to civilians is provided within the limits of available resources.

2-5. Principles of Patient Care and Treatment

Medical care and treatment is based upon fundamental principles as follows:

a. Continuity. Health services must be continuous. Interruption of treatment results in increased morbidity and mortality. Once begun, treatment does not terminate until the patient

has been returned to duty or discharged from the service. Army medical support is organized into levels—unit, division, field army, communications zone (COMMZ), and Zone of Interior. Procedures should be standardized to assure accomplishment of essential treatment and other functions appropriate in all levels.

(1) The hospitalization-evacuation system is based on the doctrine that subordinate elements are supported by the next higher echelon. Medical units are not normally required to evacuate patients beyond their rearmost medical facility.

(2) No patient is evacuated further to the rear than his physical condition warrants or the military situation requires. The evacuation policy of the command designates a maximum period of time during which patients may be retained for treatment within the command prior to being returned to duty. Patients who will require treatment for longer periods of time are evacuated to the next level of medical support as soon as practicable.

(3) The medical support plan must be simple, particularly in the combat area. Facilities must not be immobilized by instituting long and complicated procedures. Except for minor injuries or illnesses that can be treated with minor

surgery or available medicines, treatment in forward areas is limited to those emergency measures which preserve life and limb and prepare the patient for further evacuation or return to duty.

b. Control. Control of medical support resources must rest with the medical staff officer or commander having responsibility for providing health services within the command.

(1) If medical support units are to respond to the commander's plans in a timely manner, the surgeon responsible for direction of the support must influence the operations of medical units. For this reason, medical units are not attached if their mission can be accomplished by placing them in support.

(2) Since the objective of military medicine is to conserve trained manpower, medical resources must be employed to do the most good for the greatest number. When a wide disparity exists between requirements and available means, it may be necessary to favor those patients who can be returned to immediate duty, rather than those more seriously injured.

(3) The treatment to be performed at each level of support must be commensurate with the available resources at each level. Since medical resources are limited, it is essential that control of these resources be retained at the highest medical level consistent with the tactical situation.

c. Proximity. The medical means must be as close to casualties as time/distance factors and the tactical situation permits. Early collection, sorting, and treatment of patients must be provided.

(1) The speed with which medical treatment can be initiated is extremely important in reducing morbidity and mortality. When planning support of a tactical operation, the medical planner is confronted with two alternatives. He must either move the patient to a medical treatment facility, or move the medical facility to the patient. Two factors will govern the choice—the military situation, and the condition of the patient. The medical facility must be located as far forward as possible so as not to unnecessarily jeopardize the patient's chances for normal recovery and survival; yet, it must be located far enough to the rear not to interfere with combat operations or be subjected to enemy interferences. Thus, a location which provides close medical support where helicopters are used is quite different from that required when evacuation is provided by litterbearers operating over difficult terrain.

(2) Normally, the best solution will be a combination of the two alternatives. In forward

areas, medical support is provided by locating medical treatment facilities as far forward as possible, moving as necessary to maintain contact, and by rapid evacuation of patients. When evacuation time exceeds that period considered necessary to hold morbidity and mortality to a minimum, the medical treatment facility must be moved closer to the patient, or faster, more efficient evacuation provided. In either case, patients and treatment facility must be brought together as promptly as possible.

d. Flexibility. Medical support must be flexible. Changes in tactical plans or operations may require redistribution of medical resources. The medical commander must be able to shift medical resources to meet the changing requirements. Alternate plans and plans for a medical reserve are essential. No more medical troops should be committed nor medical facilities established than are required.

e. Mobility. Contact with supported units must be maintained; therefore, medical units must have mobility comparable to that of the units they support.

(1) The mobility of a unit is measured by the extent to which it can move its personnel and equipment with organic transportation.

(2) Once entirely committed, the mobility of a medical unit can be regained only by the prompt evacuation of patients. When the mobility of a medical unit is jeopardized by the accumulation of patients, it may be necessary to leave a holding detachment with patients while the main part of the medical facility is moved.

f. Conformity. Conformity with the tactical plan is one of the most fundamental elements in the provision of field medical support. It is only by analyzing the commander's plan of operation that the medical planner can determine the medical support requirements. Plans should provide adequate medical support at the right place at the right time.

2-6. Organizational Levels of Medical Support in a Theater of Operations

Health services in a theater of operations for support of combat, combat support, and combat service support units are organized into four organizational levels extending rearward in an integrated and continuous system to the Zone of Interior.

a. Unit level. Unit level medical support includes preventive medicine activities, acquisition of the sick and wounded, emergency medical treatment (EMT), and evacuation from the point

of onset of illness or injury to the point of initial professional treatment at the aid station. Unit level medical support is provided by medical elements assigned or attached to battalions or comparable units of the arms and services. Units without organic medical elements are furnished unit level medical support on an area basis by the nearest appropriate medical facility.

b. Division Level. Division level medical support has the primary functions of evacuating patients from unit level aid stations, providing further medical treatment at clearing stations, and providing area medical support. Medical support is provided by the division medical battalion. In separate brigades and the armored cavalry regiment, division level medical support is provided by assigned or attached medical companies (FM 8-15).

c. Field Army Level. Field army level medical support has the primary functions of evacuating patients from division and nondivisional units, providing resuscitative and definitive medical treatment, and area medical support. Field army medical support is provided by the field army medical brigade.

d. Communications Zone Level. Communications zone medical support has the functions of surface evacuation of patients from the field army; providing area medical support in the COMMZ; and providing definitive medical treatment at fixed hospitals. Air evacuation from the field army is a responsibility of the Air Force. Communications zone level medical support is provided by the medical command.

Section III. THE GENEVA CONVENTIONS AFFECTING MEDICAL SUPPORT

2-7. General

The conduct of armed hostilities on land is regulated by the law of land warfare which is both written and unwritten. The law of war is derived from two principal sources—lawmaking treaties (or conventions), such as the Hague and Geneva Conventions, and custom. A detailed discussion of the various treaties and laws governing land warfare is contained in DA Pam 27-1, and FM 27-10. The Geneva Conventions applicable to this manual are—

a. Geneva Convention for the Amelioration of the Condition of the Wounded and Sick in Armed Forces in the Field of 12 August 1949 (Treaties and Other International Acts Series 3362) (GWS).

b. Geneva Convention Relative to the Treatment of Prisoners of War of 12 August 1949 (Treaties and Other International Acts Series 3364) (GPW).

c. Geneva Convention Relative to the Protection of Civilian Persons in Time of War of 12 August 1949 (Treaties and Other International Acts Series 3365) (GC).

2-8. Geneva Convention (GWS)

Provision must be made for the collection of the sick and wounded, and their treatment, whether friend or foe, military or civilian, regardless of legal status. Only urgent medical reasons will determine priority in the order of treatment to be administered. Regarding those wounded as a result of military operations, dual responsibilities

must be carried out—custodial and medical—for those who are not United States or Allied personnel. Those persons whose legal status is in doubt will be accorded protection and treatment as prisoners of war (PW) until such time as adjudication is made. The custodial and accounting functions are a responsibility of the military police.

a. Identification and Protection of Medical Personnel.

(1) Personnel performing medical duties in connection with the sick or wounded in medical units or establishments shall wear, affixed to the left arm, a water-resistant armband bearing the distinctive emblem prescribed by the Geneva Convention.

(2) Each person shall also carry a special identity card bearing the distinctive emblem. This card shall be water-resistant and of such size that it can be carried in the pocket. It shall be worded in the national language of the issuing force, contain at least the surname and first names, the date of birth, and the rank and the service number of the bearer; and shall state in what capacity he is entitled to the protection of the Convention. The card shall bear the photograph of the owner and his signature, or fingerprints, or both. The card shall be embossed with the stamp of the appropriate military authority.

b. Self-Defense. Medical personnel may carry arms for personal defense and for the protection of the wounded and sick in their care. Overall security defense plans must not require medical units to take offensive action against enemy

troops. Medical personnel are permitted to fire on enemy troops only when they or their patients are under attack; but if they use arms in violation of the laws of war, they are subject to penalties related thereto and, provided they have been given due warning to cease such acts, may also forfeit the protection of their unit or the unit they are supporting.

c. Marking.

(1) *Medical units and establishments.* The distinctive flag of the Convention shall be hoisted only over such medical units and establishments as are entitled to be respected under the Convention, and only with the consent of the military authorities. Marking of facilities and the use of camouflage are incompatible and should not be attempted concurrently. Use of the red cross is authorized; however, the tactical commander may not want such distinctive markings displayed in his area.

(2) *Ambulances.*

(a) Medical vehicles (ambulances) exclusively employed for the removal of wounded and sick or for the transport of medical personnel and equipment shall not be attacked. Ambulances will not be used to transport nonmedical troops or materiel not required for the medical mission.

(b) Air and ground ambulances will be marked with the distinctive emblem as prescribed in the Convention.

2-9. Geneva Convention (GPW)

The Army is responsible for prisoners of war

from the moment of capture. Below brigade level, PW are handled by combat troops who bring them to brigade collecting points. Sick, injured, or wounded prisoners are treated and evacuated through normal medical channels but are physically segregated from United States and Allied patients. Guards are provided from other than Medical Department personnel resources.

a. Prisoner-of-war patients will be evacuated from the combat zone as soon as possible. Only those sick or wounded prisoners who would run a greater health risk by being immediately evacuated may be kept temporarily in the combat zone.

b. When intelligence sources indicate that large numbers of PW may result from an operation, medical units may require reinforcement to support the PW patient workload. Procedures for estimating the medical workload involved in the treatment and care of enemy PW patients is described in FM 8-55.

2-10. Geneva Convention (GC)

Civilians wounded or sick as a result of military operations will be provided medical treatment and, when followup treatment is required, transferred to a civil medical facility. All those wounded and sick as a result of an armed conflict will be collected and cared for. Each military police and medical element exercises its responsibilities in the custody and treatment of captured or detained personnel.

CHAPTER 3

THEATER ARMY

Section I. GENERAL

3-1. General

a. United States Forces assigned to a theater or area of operations may range from relatively small task forces to a full array of large land, sea, and air forces. The U.S. Army element in the force structure may vary from a division or less to one or more Army groups with the necessary combat, combat support, and combat service support units. Normally, the theater army is organized into a theater army headquarters, a theater army support command (TASCOM), one or more field armies and other commands as indicated in figure 3-1. In each case the command and organizational structure will depend upon the size of the force and the extent of participation by other services and Allied Forces.

b. The overall control of combat service support operations is retained at theater army level to assure uniformity of the support effort within the combat and communications zones. Control is maintained through promulgation of appropriate policies, broad planning and program guidance, allocations, and priorities for achieving the theater army mission. The theater army commander is responsible for all Army elements in the theater and for health services within the command. A detailed description of the theater army is provided in FM 100-15.

3-2. Organization of a Theater of Operations

a. The President, through the Secretary of Defense, establishes the geographic limits of a theater of operations (FM 100-10). That portion of a theater of operations required for ground force operations is normally divided into a combat zone and a communications zone (fig 3-2).

(1) *Combat zone.* The combat zone is that

part of the theater of operations that combat forces require for operations. The combat zone includes the ground, air, and sea areas within which the commander can influence the progress or outcome of operations directly by maneuvering his ground-gaining elements or delivering firepower with the fire support systems under his control or command. Its size depends on the mission, organization, and equipment of the force involved and the nature of the country. For tactical control, the combat zone may be divided into army group, field army, corps, and division areas. The theater commander designates the rear boundary of the combat zone; the boundary changes as the field armies move forward.

(2) *Communications zone.* The COMMZ is the rear part of a theater of operations (behind and normally contiguous to the combat zone) that contains the lines of communications, establishments for supply and evacuation, and other agencies required for the immediate combat service support of the field forces. The COMMZ includes sufficient area for the operation of supply, evacuation, transportation, and combat service support installations and for their defense. The COMMZ also includes any area necessary for the operation or support of Navy or Air Force elements based outside the combat zone. The rear boundary of the COMMZ is normally the rear boundary of the theater as designated by proper authority. Area responsibility for the COMMZ normally is delegated to headquarters, theater army support command.

b. Territorial organization of a theater of operations varies with the type of theater, the type of forces in a theater, and the nature of the operations planned. FM 100-10 provides a more complete discussion of the territorial COMMZ.

Section II. THEATER ARMY SUPPORT COMMAND

3-3. General

a. The theater army support command provides combat service support in the COMMZ to Army forces and to other designated forces. Sup-

port provided includes general support to the field army, direct and general support in the COMMZ, and rear area protection (RAP) responsibility and participation in stability operations within

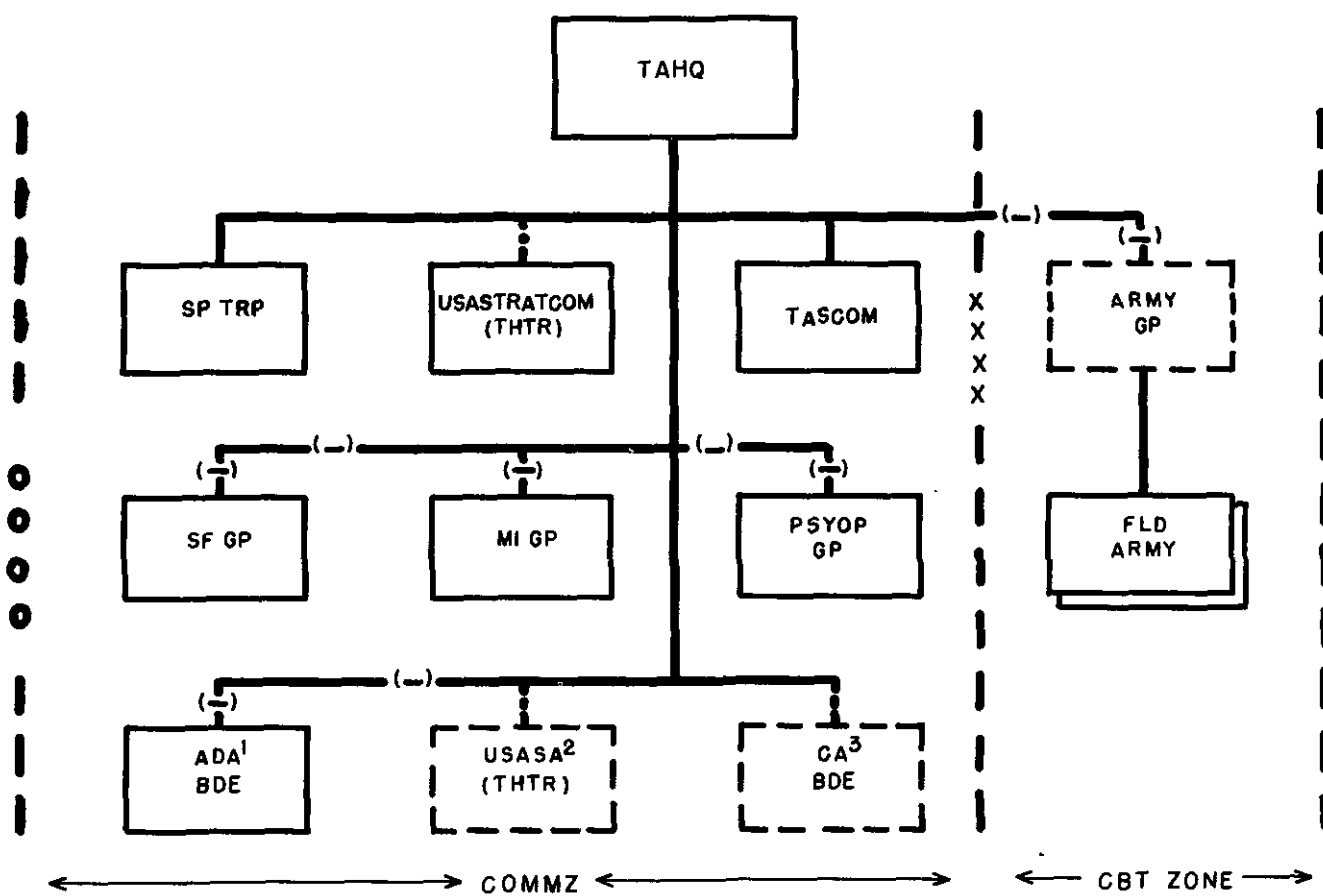

LEGEND:

- As required.
- Command.
- Operational control.
- (•)— Command during peacetime. Command less operational control normal during wartime.

¹ May be designated as ADA command. Command less operational control is normal to ADA during peacetime and wartime.

² Provides support in accordance with AR 10-122.

³ May be designated a CA command.

Figure 3-1. Type of theater army structure.

the COMMZ. The headquarters provides broad overall plans and policies, establishes priorities and allocations to operating commands, and coordinates support activities. Mission-type orders are issued to subordinate commands thereby allowing TASCOM headquarters to perform its primary function of planning and coordinating mid-

and long-range combat service support operations.

b. The TASCOM is normally organized with the following major subordinate commands:

- (1) Personnel command.
- (2) Supply and maintenance command.
- (3) Engineer command.

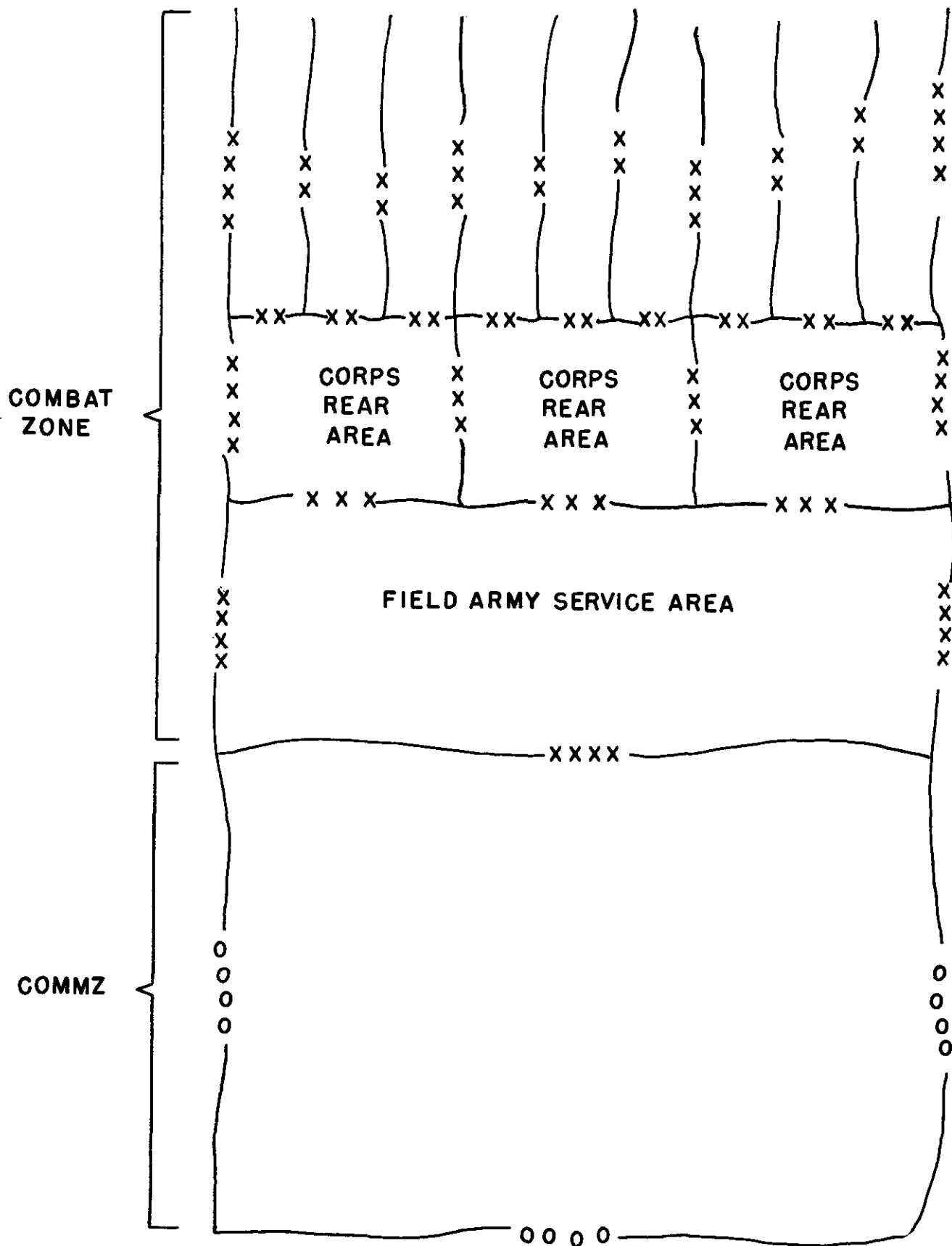

Figure 3-2. Territorial organization of a theater of operations.

- (4) Transportation command.
- (5) Medical command.
- (6) Area support command.

The first five of these major subordinate commands provide combat service support to the theater army and other forces and activities as the TASCOM directs. The sixth subordinate command, the area support command, provides direct support services (less medical and ammunition) to the TASCOM, to units passing through or located in the COMMZ, and to such other forces as the TASCOM commander directs.

c. The TASCOM commander's area of responsibility includes the entire COMMZ. The TASCOM commander assigns the authority and area responsibility for the COMMZ to the area support command commander. He further assigns area responsibility to his subordinate area support group commanders. The TASCOM organization is adaptable to any size theater. For example, in a small theater, combat support groups may constitute the TASCOM subordinate commands. As the theater expands, the subordinate commands enlarge; however, the basic organization of the subordinate commands remains unchanged. If the COMMZ is extremely large, the TASCOM commander may provide for two area support commands (forward and rear).

3-4. Theater Army Headquarters Assumption of TASCOM Headquarters Function

The theater army headquarters, in wartime, may assume the TASCOM function of planning and

coordinating combat service support within the COMMZ. The theater army headquarters issues mission orders to its major subordinate assigned units and provides procedures and guidance for establishment of appropriate channels of communications between Department of the Army, unified command headquarters, army group/field army, and the major subordinate commands within the COMMZ. The theater army headquarters' assumption of direction of the combat service support mission in the COMMZ does not influence the established working relations for routine combat service support operations. Direct and continuous contact is maintained between appropriate major subordinate commands in COMMZ (normally assigned to TASCOM headquarters) and with the field army support command. TASCOM major subordinate commands are designed to operate with minimum direction from a higher headquarters. Staff functions for day-to-day combat service support operations will be accomplished by the headquarters of the functionally-oriented subordinate commands. In the absence of the TASCOM headquarters, theater army general staff elements manage by exception, using automatic data processing (ADP) summary printout reports. Provisions must be made for increased activity in detailed planning and policy guidance, specific quantity allocations, and increased coordination with the supported forces. The theater army general staff sections may require personnel increases in those staff elements concerned with combat service support operations, theater-army wide, and with RAP operations within the COMMZ.

Section III. THEATER ARMY MEDICAL STAFFS

3-5. Theater Army Surgeon

a. *Command and Staff Relationships.* The theater army surgeon is a member of the special staff of the theater army commander. He functions under the general staff supervision of the assistant chief of staff, G1, personnel, with access to the commander and all members of the staff concerning medical matters.

b. *Functions, Duties, and Responsibilities.* The surgeon provides information and medical professional advice to the theater army commander and to the general and special staff; and maintains current data with regard to the condition, capabilities, and requirements for the theater army medical support. As the principal medical staff officer of the theater army, he is responsible to the commander for staff planning and coordinat-

ing the medical support of the theater army forces as a whole. The theater army surgeon develops policy and coordinates rather than conducts operations. The surgeon—

(1) Advises on the health services of the command and the occupied or friendly territory within the commander's area of responsibility.

(2) Advises on the medical effects of the environment and of nuclear, biological, and chemical weapons on personnel, rations, and water.

(3) Determines requirements for the requisitioning, procurement, storage, maintenance, distribution, and documentation of medical, dental, and veterinary equipment and supplies.

(4) Determines requirements for medical personnel and makes recommendations pertaining to their assignment.

(5) Plans and coordinates medical training in the command.

(6) Submits to The Surgeon General appropriate recommendations on professional problems requiring research and development.

(7) Plans and coordinates the following medical support operations:

(a) The system of treatment and patient evacuation, to include aeromedical evacuation by Army medical air ambulance units and air movement of patients by nonmedical Army evacuation units.

(b) Preventive medicine in the command and, as required, in public health activities.

(c) Professional medical support in subordinate units.

(d) Veterinary food inspection service and animal veterinary service of the command and, as required, in civilian veterinary activities.

(e) Preparation of reports on, and custody of, the medical and other hospital administrative records of injured, sick, and wounded personnel.

(f) Medical supply, maintenance, and repair facilities.

(g) Examination and processing of captured medical equipment and supplies of nonintelligence interest and necessary inspection service for captured animals and food supplies.

(h) Technical inspection of medical materiel.

(i) The equipment status reporting system within his area of responsibility.

(j) Medical laboratory service.

(k) Blood transfusion service.

(l) Blood bank service.

(m) Optical service.

(n) Medical civic action program.

c. *Organization.* The size and composition of the theater army surgeon's office vary in accord-

ance with the strength of the Army forces in the theater, the nature of military operations to be conducted, and the specific responsibilities assigned. The office may be divided into the following divisions: administrative, historical, plans, medical records and statistics, nursing, operations, personnel, professional services, preventive medicine, supply, veterinary, dental, fiscal, and management.

3-6. TASCOM Medical Staff

a. *Command and Staff Relationships.* The TASCOM staff does not include a surgeon; however, a medical branch is present as part of the ACofS, personnel, section. (The medical command commander is also the TASCOM surgeon.) The medical staff consists of a medical officer, medical service plans officer, medical service staff officer, and enlisted assistants. The medical officer is authorized direct access to the TASCOM commander and staff on medical matters of command interest.

b. *Functions, Duties, and Responsibilities.* The functions of the medical staff officer are to—

(1) Advise the commander and staff on health service matters.

(2) Develop, prepare, and coordinate with the medical command the health service portions of TASCOM plans and policies.

(3) Plan and recommend assignment of medical support units to the medical command.

(4) Plan and coordinate the medical aspects of rear area protection.

c. The TASCOM commander may designate the medical staff officer or the medical command commander to serve as the command surgeon. When so designated, the designee assumes the functions, duties, and responsibilities of a surgeon (FM 101-5).

Section IV. THEATER ARMY MEDICAL COMMAND

3-7. Mission and Organization

a. *Mission.* The mission of the medical command is to provide COMMZ level medical support within the theater of operations.

b. *Organization.* The number and size of the units assigned are subject to wide variation, depending on such factors as the size and locations of forces to be supported, the type of operation, and the evacuation policy. In general, the medical command consists of a headquarters and headquarters company and health service units and

detachments concerned with command and control, evacuation, hospitalization, preventive medicine, laboratory service, dental service, veterinary service, medical supply and maintenance, and such other specialized units required to perform the mission (fig 3-3). The medical command headquarters and headquarters company is described in appendix E.

3-8. Concept of Operations

a. *Command and Control.* The medical com-

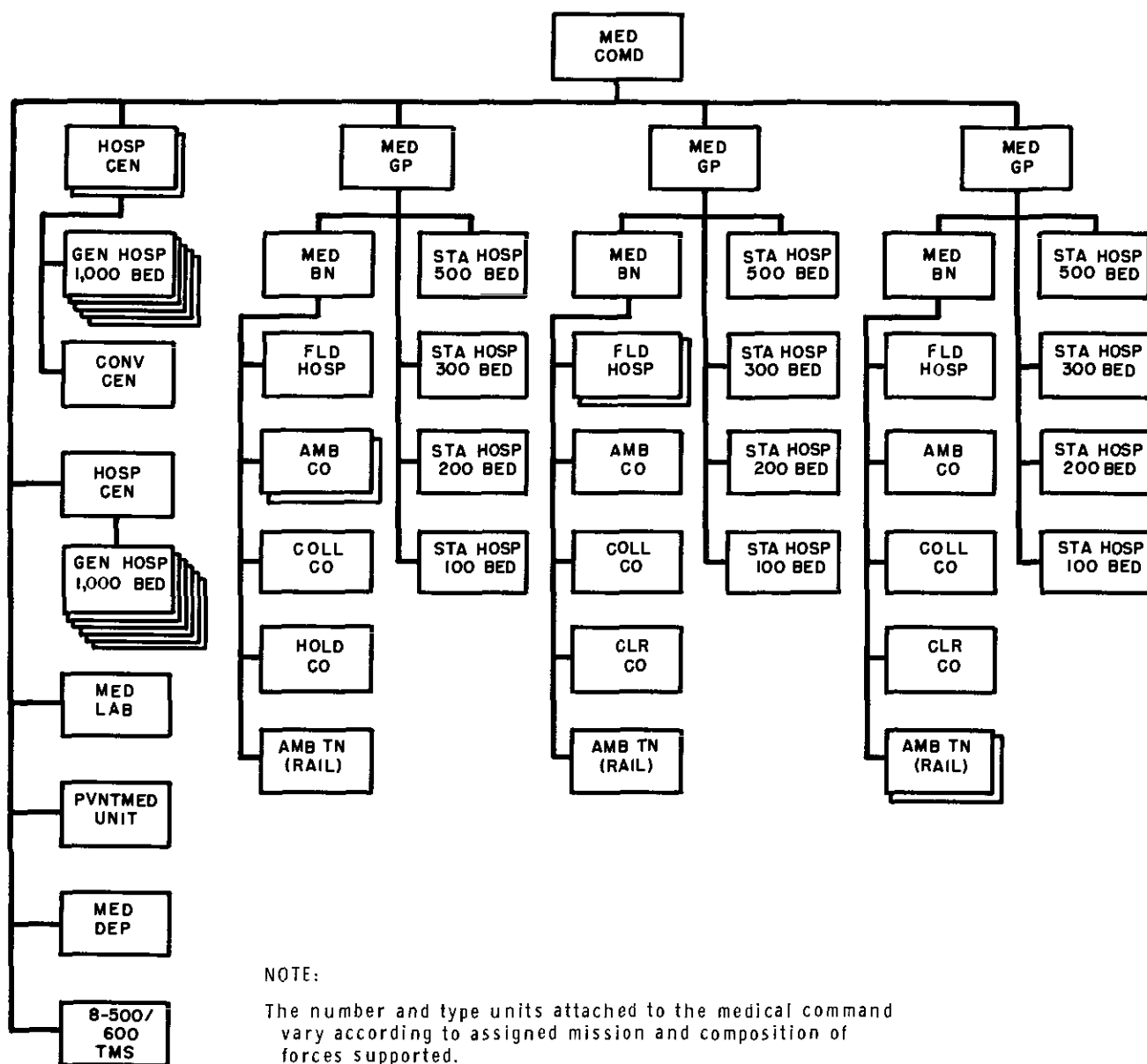

Figure 3-3. Type medical command (8-division force.)

mand headquarters commands and controls all assigned and attached units. Its major subordinate command and control units are the hospital center and the medical group headquarters.

(1) *Hospital center headquarters.* The hospital center functions as a controlling agency for attached units, commands two or more general hospitals, a convalescent center, and, when appropriate, other medical units.

(2) *Medical group headquarters.* The medical group headquarters units normally provide command, control, staff planning, and supervision of operations, training, and administration of attached health service units. Medical groups

may have dual missions of providing support to health service units operating in the combat zone and medical support to COMMZ troops. Support to the combat zone consists of relieving medical units of patients and, in general, reinforcing the combat zone health services. Medical battalion headquarters units are assigned to the medical command and attached to the medical groups to exercise command and control, and to provide personnel, supply, and vehicle maintenance services to attached units.

b. Hospitalization. Hospitals and other treatment facilities of the command provide the required treatment necessary to return patients to

duty or to prepare patients for evacuation to the Zone of Interior. Hospitalization is provided for patients from medical treatment facilities located in both the combat zone and the COMMZ, and for direct admission from troop units located in the COMMZ. See chapter 7 for a discussion of hospitalization.

c. Evacuation and Treatment. Medical evacuation is related to patient treatment and assures en route patient care to points where definitive treatment is provided. The COMMZ medical evacuation units are responsible for the surface evacuation of patients from the combat zone, coordinating air evacuation from the combat zone, and coordinating evacuation out of the COMMZ. See chapter 6 for a discussion of patient evacuation.

d. Area Medical Support.

(1) The area support command does not have medical units assigned or attached. Personnel of, and those serviced by, the area support command must receive medical support from health service facilities of the medical command on an area basis. Medical support can be provided most economically and efficiently on an area basis by extension of dispensary services from hospital facilities. Health service units required for this service are normally allotted based on troop strength.

(2) To insure adequate medical support to the area support command and area support groups, coordination between the area support command and the medical command is necessary. An exchange of information through effective liaison will provide the medical command commander with the extent and location of troop concentrations to be supported, and will provide the area support command commander with the type and amount of service to be furnished. The senior medical commander located within the geographical boundaries of an area support group will normally provide medical staff advice for the area support group commander. Standing operating procedures will be developed by the medical command and the area support command governing the relationship between each area support group commander and the senior medical commander in his area.

(3) The senior medical commanders located within the boundaries of area support groups normally will be responsible for the development of health service plans in support of the area support group commander's RAP plan. Once developed, these plans will be coordinated with the medical command to insure availability of ade-

quate medical support to perform all assigned missions.

e. Preventive Medicine. Prevention of disease and injury reduces military manpower losses, patient loads, and evacuation requirements. Specialized preventive medicine personnel and units assist organic medical personnel and medical commanders that provide area medical support in conducting the field army and COMMZ preventive medicine programs. Preventive medicine units provide services in surveillance and control of health hazards which are beyond the capabilities of organic medical personnel and area medical support units.

f. Medical Laboratory Support. The medical laboratory (TOE 8-650G) provides complete laboratory support facilities to include laboratory procedures listed in AR 40-4, medical research and technical inspection, and the establishment of a histopathology center. Medical laboratories are organized to operate a base laboratory and three mobile laboratories that can support medical and nonmedical units throughout the theater.

g. Dental Service. Dental service in the communications zone is furnished through hospital and area dental facilities. General, station, field hospitals, and convalescent centers have organic dental services for the support of personnel admitted to these facilities. Dental service units provide area dental service based on troop population.

h. Veterinary Service. Veterinary service in the communications zone includes treatment, hospitalization, and dispensary service for military animals; the control of zoonotic diseases; subsistence inspections; the control of foodborne diseases; and other assigned preventive medicine activities. These services are provided on an area basis by veterinary hospital, dispensary, and food inspection teams that normally are under the command and control of a veterinary headquarters unit.

i. Medical Supply and Maintenance. See chapter 9.

3-9. Command Relationships

a. Command Relationships With Higher Commands. The MEDCOM commander reports directly to the TASCOM commander. The coordination of medical command staff matters with the theater army and its staff normally is through command channels, except that health service professional matters are coordinated directly.

b. Command Relationship With Lower Commands. The staff elements of the medical com-

mand headquarters have normal staff relationships with respect to subordinate health service elements. The dental surgeon and veterinary staff officer of the command headquarters normally are delegated operational control of subordinate dental and veterinary units.

c. Command Relationship With Field Army.

(1) *With headquarters, field army.* Coordi-

nation with headquarters, field army, is through normal command channels except that health service professional matters may be coordinated directly with the field army surgeon.

(2) *With field army medical brigade.* Direct coordination on technical matters between the medical command and the medical brigade is authorized.

CHAPTER 4

FIELD ARMY

Section I. GENERAL

4-1. General

The field army is the largest self-contained tactical organization in the United States Army. It has territorial, tactical, and administrative responsibilities but has no fixed organization. The number and types of corps, divisions, and other combat and supporting elements are determined by the mission, availability of forces, availability and use of nuclear weapons, terrain and climate, and probable hostile forces.

4-2. Mission

The mission of the field army is to close with the enemy and destroy his will to resist by ground combat within an assigned area.

4-3. Organization

a. The field army may consist of a headquarters and headquarters staff, two or more corps, combat support troops, and combat service support troops. Combat service support troops are organized into a field army support command (FASCOM) but may, if required, function directly under the control of field army headquarters (fig 4-1).

b. The field army headquarters is composed of a command element and staff assistants organized into general, personnel, and special staff sections, including a medical section. The staffs of the field army headquarters and the FASCOM headquarters supplement each other.

4-4. Operations

a. The field army headquarters commands and controls combat operations of the subordinate corps. The army commander normally establishes

forward tactical command post to supervise combat and combat support operations. Operational planning and associated tasks usually are done at the main command post under the supervision of the chief of staff.

b. The FASCOM headquarters conducts the combat service support operations of the field army. This headquarters is centrally located toward the rear of the army service area.

4-5. Field Army Support Command

The field army support command is designed to provide combat service support to a field army. The FASCOM provides combat service support primarily through two kinds of major subordinate elements—army-wide service organizations and support brigades. The army-wide services are provided by the medical brigade, military police brigade, transportation brigade, and civil affairs brigade. The support brigades provide combat service support to divisional and nondivisional units. In supporting an 8-12-division field army, one support brigade (corps support brigade) is employed in each corps area and another (army support brigade) is employed in the field army service area. The commander of the FASCOM and his staff are responsible for the success of combat service support operations related to the tactical operations in progress and for detailed planning for support of operations in the near future. This responsibility includes the development of detailed implementing plans, the establishment of policies, and the exercise of technical supervision over subordinate commands, and directives for combat service support. FM 54-3 provides a detailed description of the functions and operations of the FASCOM.

Section II. FIELD ARMY MEDICAL STAFFS AND ORGANIZATIONS

4-6. The Field Army Surgeon

a. Command and Staff Relationships. The field army surgeon is a special staff officer of the field army commander. The surgeon functions under a

the general staff supervision of the field army headquarters ACoFS, G1, personnel, and coordinates medical matters with members of the general and special staff. On medical professional

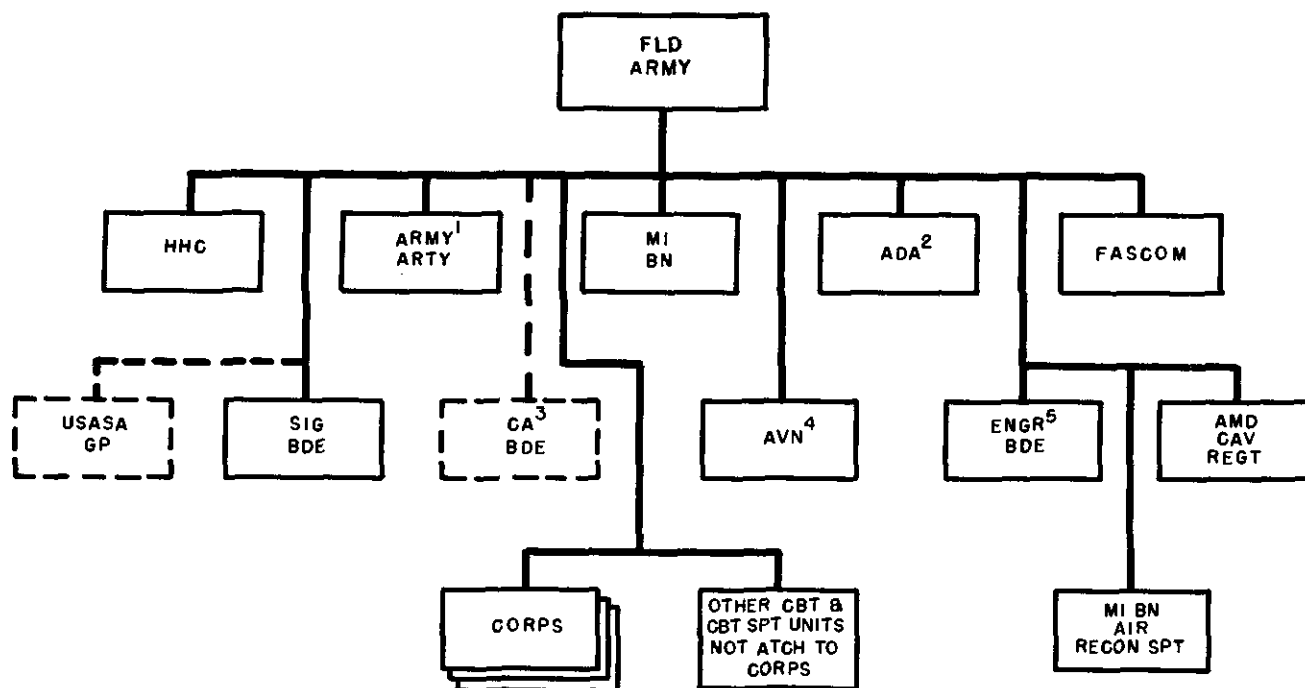

LEGEND:

----- Attached as required.

- ¹ Army artillery section plus field army group headquarters and battalions not attached to corps.
- ² HHC, ADA brigade, plus ADA group headquarters and battalions not attached to corps.
- ³ Assigned one per field army and may be attached to FASCOM.
- ⁴ Aviation company assigned. Other elements attached as required.
- ⁵ HHC, engineer brigade, plus engineer combat groups, and engineer topographic battalion, Army.

Figure 4-1. Organization of a "type" field army.

and technical matters affecting the health of the command and combat operations, he has direct access to the field army commander.

b. Functions, Responsibilities, and Duties. The surgeon is responsible for keeping the commander and the staff informed on the state of health of the command, and on the medical aspects of combat effectiveness and combat operations. As the principal medical staff officer, he advises the commander and the staff on all medical support matters. His duties normally include the following:

(1) Developing, preparing, and coordinating the broad medical support plans and policies of the command.

(2) Developing, preparing, and coordinating the health service portions of Army plans.

(3) Providing current information on the Army health service situation to the surgeons of the next higher and subordinate headquarters.

(4) Maintaining close liaison with ACofS, G5, civil affairs, on civil affairs medical support requirements.

(5) Exercising staff and technical supervision over health service operations in the field army.

(6) Recommending the assignment and reassignment of Army Medical Department personnel.

(7) Maintaining a chronological record of

health service operations, activities, events, and other information of historical significance.

(8) Furnishing health consultation services to the field army.

(9) Preparing or consolidating health service statistical and other reports as required.

(10) Recommending policies and determining requirements and priorities for medical supply and medical equipment maintenance services.

(11) Recommending policies concerning the medical aspect of the military civic action program.

(12) Assuming responsibility for compliance with the theater army blood program as described in chapter 8.

c. Field Army Headquarters Staff Medical Section (Office of the Surgeon). The field army staff medical section includes the surgeon and commissioned and enlisted assistants. In addition, a number of professional consultants are included to satisfy medical requirements resulting from unusual climatic, geographical, battle, or other conditions. Office organization is not standard and must be flexible to permit shifts of emphasis as the situation requires. The following organizational outline is furnished as a guide for normal operations:

(1) The administrative branch is responsible for—

(a) Operating the message center.

(b) Performing administrative functions.

(c) Coordinating public information matters.

(d) Furnishing administrative consultation assistance.

(e) Collecting, evaluating, interpreting, and presenting medical statistical data.

(2) The plans branch is responsible for—

(a) Developing the health service portion of field army plans.

(b) Coordinating the medical support operations of the field army including the recommendations for field army evacuation policies.

(c) Developing health service training policies and programs for the field army.

(d) Developing, preparing, and coordinating the medical supply and medical equipment maintenance plans and policies for the field army.

(e) Coordinating requirements for critical medical materiel, maintenance schedules, and blood distribution.

(3) The personnel branch is responsible for—

(a) Monitoring availability of critical

Army Medical Department personnel in the field army.

(b) Recommending assignment, reassignment, and utilization of critical Army Medical Department personnel.

(4) The preventive medicine branch is responsible for developing, preparing, and coordinating the field army preventive medicine program.

(5) The dental branch is responsible for—

(a) Developing, preparing, and coordinating the dental portion of health service plans and policies to include a preventive dentistry program.

(b) Collecting, consolidating, evaluating, and preparing dental reports, statistics, and other information.

(c) Furnishing dental consultation.

(d) Providing policy for the management of dental materiel.

(6) The professional service branch is responsible for—

(a) Furnishing medical consultation services.

(b) Disseminating medical professional and technical information.

(c) Formulating recommendations regarding the treatment of sick, wounded, or injured personnel.

(d) Reviewing and evaluating medical technical reports.

(7) The veterinary branch is responsible for—

(a) Developing, preparing, and coordinating veterinary plans and policies for the command.

(b) Collecting, consolidating, evaluating, and preparing veterinary reports, statistics, and other information.

4-7. The FASCOM Surgeon Section

This section provides staff support to the FASCOM commander in a manner similar to that medical staff support provided to the TASCOC command by the TASCOC medical staff (para 3-6b).

4-8. Field Army Medical Brigade

a. Mission. The mission of the medical brigade is to provide Army level medical support within a field army.

b. Organization. The medical brigade is a functionally-oriented organization consisting of a headquarters and headquarters detachment, a

number of medical groups, medical battalions, and other medical units of the field army (fig 4-2). The medical brigade is tailored to the field army mission. Flexibility of organization is inherent and permits rapid organizational adjustment to changing medical support requirements. The Medical Brigade, Headquarters and Headquarters Detachment, TOE 8-112G, is described in appendix E.

c. Concept of Operations.

(1) *Command and control.* The field army medical brigade headquarters commands, controls, plans for, and operates the field army medical support system. The medical support mission is accomplished through centralized control of decentralized operations. Policies are provided for the effective integration of health service activities in the field army and are coordinated with supported units. The major subordinate command and control elements of the medical brigade in a type field army are the headquarters of the forward and rear medical groups.

(a) *Medical group headquarters.* The number of units attached to the medical group headquarters may vary according to the requirements of the tactical situation and specific mission assigned. The span of control of medical groups is reduced by attaching company and smaller sized units to the attached medical battalion headquarters.

(b) *Forward and rear medical groups.* The forward medical groups are concerned pri-

marily with evacuation and treatment of patients from divisions. These groups will operate as close as possible to the combat units without interfering with combat operations. The rear medical groups primarily are designed to provide continuous hospital service for the field army. Forward and rear medical groups are shown in figure 4-2.

(2) *Hospitalization.* The field army medical brigade provides hospitalization for all classes of patients in the combat zone. Hospitals and other treatment facilities provide patients with the treatment necessary to return them to duty or to prepare them for further evacuation (chap 7).

(3) *Evacuation.*

(a) The field army medical units are responsible for evacuating patients from division clearing stations, separate clearing stations, non-divisional dispensaries, and aid stations to hospitals of the field army. Evacuation is by ground and air ambulance (chap 6).

(b) The ground ambulance companies are responsible for the routine evacuation of patients from division and field army to, and between, appropriate medical treatment facilities. Normally, patients evacuated from divisions by ground ambulances will flow into supporting hospital facilities over relatively fixed routes.

(c) The air ambulance companies and detachments are responsible for evacuating all categories of patients to designated medical facilities. Normally, medical air ambulances will be used on an "on-call" basis. Aeromedical evacuation prior-

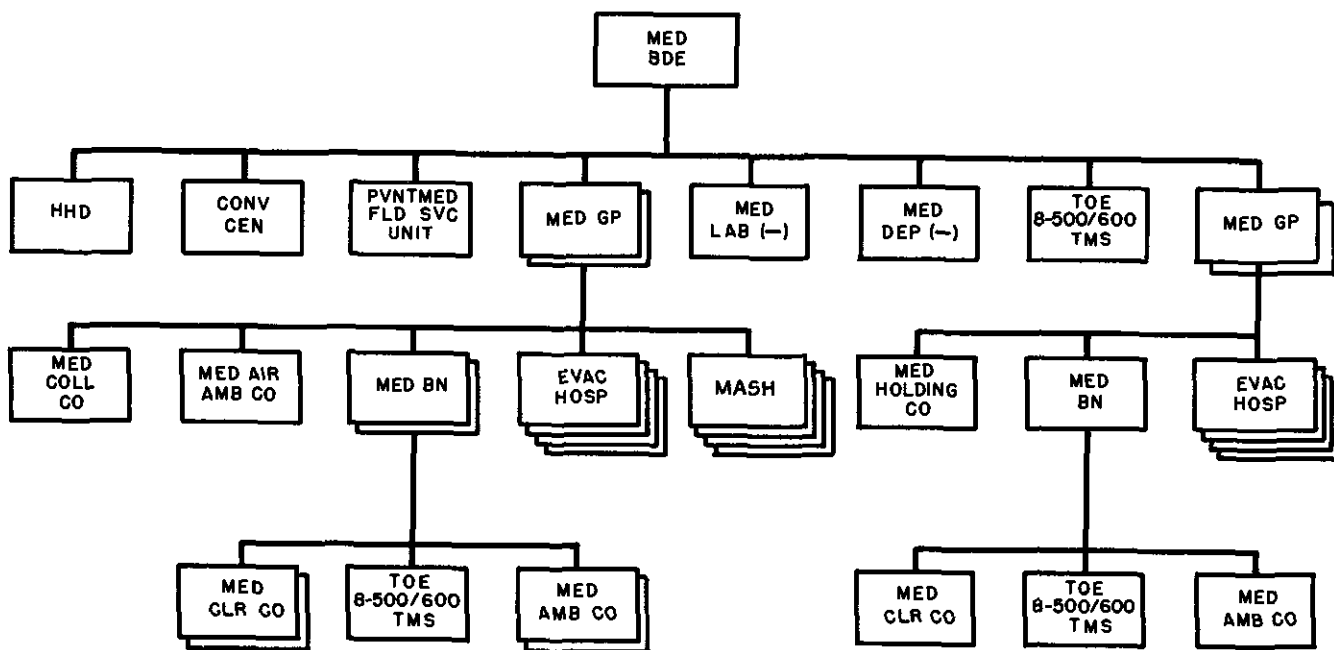

Figure 4-2. "Type" medical brigade (8-division force).

ity will be given to the seriously wounded. When available, and circumstances permit, aeromedical evacuation means will be the preferred method of patient evacuation. Greater flexibility and responsiveness is introduced into the medical evacuation system with increased use of air ambulances.

(d) When available, ambulance trains may be used for routine evacuation of patients from combat zone hospitals to hospitals within the COMMZ (chap 6).

(4) *Medical supply and maintenance.*

(a) The Army medical depot operates directly under the command and control of the medical brigade headquarters. The medical depot provides medical supply, medical equipment maintenance, and optical fabrication services for all units in the field army area. Advance depots establish supply points well forward in the corps to provide direct support to division medical battalions, hospitals, and other units in the area.

(b) The medical depot establishes its base depot in the field army service area. Supply levels of advance depots will be kept at a minimum to permit their relocation whenever necessary to provide close and timely service to supported units. Division medical battalions submit their supply requirements to the supporting advance depot. Requirements are forwarded through the ambulance evacuation shuttle system, other vehicles, or by other means of communication available. Normally, medical supply distribution is through backhaul of medical brigade ambulance elements supporting the division. Field army medical units and all other nondivisional units obtain medical supply and maintenance services on a direct support basis from the supporting base or advance depots. Unfilled and replenishment requirements of advance depots are transmitted to the field army medical inventory control point through combat service support data system (CS_s) communications channels. Distribution is accomplished by shipment to advance depots or, if necessary, by throughput to using units. Unfilled and replenishment medical supply requirements of the field army are transmitted from the field army medical inventory control point (ICP) to the COMMZ medical ICP through the CS_s communications system. Distribution from COMMZ medical depots is accomplished by bulk shipments to the base depot or by throughput to advance depots.

(5) *Convalescent center.* A convalescent capability is provided for the field army to permit rapid restoration of patients to full duty. Patients

from field army hospitals requiring only convalescent care and reconditioning are evacuated to the convalescent center prior to being returned to duty.

(6) *Preventive medicine.* A preventive medicine field service unit provides comprehensive preventive medicine support services to the field army which are beyond the capabilities of commanders and their organic medical personnel.

(7) *Medical laboratory support.* The medical laboratory (TOE 8-650G) provides complete laboratory support facilities consisting of a base laboratory and three mobile laboratories. It performs laboratory functions authorized in AR 40-4, provides medical research and technical inspection services, and establishes a histopathology center. The laboratories support medical and nonmedical units throughout the theater.

(8) *Dental service.* Routine dental treatment for the field army is provided by mobile dental units operating under the command and control of the medical brigade (chap 10). Dental officers assigned to hospitals provide inpatient treatment.

(9) *Veterinary service.* Veterinary services are provided on an area basis by veterinary units. The detailed operations of these units are discussed in the description of Medical Department units (app E).

d. Command Relationships.

(1) *Command relationship to higher commands.* The medical brigade commander reports directly to the FASCOM commander. The coordination of medical command staff matters with the field army commander and staff is normally through command channels, except that health service professional matters are coordinated directly.

(2) *Command relationship to lower commands.* The staff elements of the medical brigade headquarters have normal staff relationships with respect to subordinate elements. The dental and veterinary staff officers of the brigade headquarters normally are delegated operational control of subordinate dental and veterinary units.

(3) *Command relationship to corps and division.* Coordination with corps and division headquarters is through normal command channels except that health service professional matters may be coordinated directly with the corps and division surgeons.

(4) *Command relationships to the medical command.* Direct coordination between the medical brigade and the medical command is authorized.

CHAPTER 5

CORPS

Section I. GENERAL

5-1. General

The corps, a task force of combined arms and services, is a tactical unit of execution. Its composition is not fixed; however, the TOE 52-series establishes the organization of the corps headquarters and headquarters company. Units normally are assigned to provide the means needed to facilitate command and control. The field army assigns or attaches units to the corps. The type and number of troop units assigned or attached to the corps depend on the mission, the characteristics of the area of operations, the availability of units, the enemy situation, and the type of operations contemplated. The corps organization permits great flexibility since the field army organizes it for a specific tactical mission.

5-2. Employment

A corps may be employed as a major subordinate

command of army groups or of theater army groups or of theater army. When the corps is employed in such a role, or when the mission assigned to the corps requires it to operate far removed from the field army, the corps is said to be on an independent operation. It is similar to a theater army in that it normally has area responsibilities encompassing theater base functions and is, therefore, responsible for its own combat service support.

It is provided a corps support command (COSCOM), which provides services similar to those a FASCOM provides to a field army. FM 100-15 provides a detailed discussion of the corps operation.

Section II. THE CORPS SURGEON

5-3. General

The corps surgeon is a special staff officer of the corps commander. He is responsible for keeping the commander and staff informed on the current medical support situation. In addition to the normal duties of a surgeon (FM 101-5), the corps surgeon—

- a. Advises the commander of the medical situation in all attached divisions.
- b. Develops plans and recommendations for the reinforcement of division medical support within the corps.
- c. Assumes the duties similar to the army surgeon when the corps is operating as an independent corps.

5-4. Staff Relationships

The corps surgeon operates under the general staff supervision of the corps ACofS, personnel, and coordinates medical matters with the corps staff. He has direct access to the corps commander on professional and technical matters affecting the health of the command, and on medi-

cal matters affecting corps operations. Coordination with surgeons and medical commanders of higher, subordinate, and lateral headquarters is through command channels, except for medical professional matters which may be coordinated directly.

5-5. Corps Medical Support

Normally, medical units are not attached to an army corps. Medical support is tailored to the mission, the composition of the supporting force, and the geographical area of operations. The field army medical brigade provides a medical group with appropriate attached medical units to meet support requirements. Designated units provide unit and field army level health services to assigned and attached nondivisional units of the corps on an area support basis. The medical group commander works in close coordination with the corps surgeon in planning and implementing medical support. When a corps is assigned an independent mission, the medical group is tailored to the mission and attached to the COSCOM

FM 8-10

as the operating medical command of the independent corps. The group commander and his increased staff (Type B, TOE 8-122G) must as-

sume duties and responsibilities similar in scope to those normally performed by the medical brigade commander and staff.

CHAPTER 6
PATIENT EVACUATION
(STANAG 2051)
(STANAG 2061)
(STANAG 2128)

Section I. GENERAL

6-1. General

a. Patient evacuation is the process of moving patients from the battlefield or other locations to and through successive medical treatment facilities. The term "evacuation system" is applied to the linear system of successive agencies and installations engaged in collection, treatment, transportation, and hospitalization. The most forward facility of an evacuation system in a theater of operations is an aid station and the rearmost installation, a general hospital. From the combat area to the rear, each successive medical facility provides a more extensive type of medical care. Figure 6-1 depicts the patient evacuation flow within the theater of operations.

b. Evacuation of patients is a difficult task even under the most favorable conditions. Evacuation must be made against a constant forward flow of troops and supplies, with a minimum of interference with these activities. The majority of patients are gathered as individuals from forward areas of the combat zone and provided with individual care and treatment through all successive stages of the hospitalization and evacuation system.

6-2. Sorting (Triage) of Patients

Sorting is the process of examining sick and injured patients in order that they may be properly routed to, and within, the appropriate medical facility. Sorting includes establishing a priority for treatment to assure the most beneficial medical care for the largest number of patients and assisting in determining the ultimate destination of each patient as early as possible. The most experienced medical officer is usually in charge of triage. Sorting is the key to the effective management of patients. Patients must not be evacuated farther to the rear than their physical condition warrants or the military situation requires. Every case evacuated without sufficient reason

imposes an unnecessary burden upon three agencies—the patient's unit, which must go short-handed until the individual is discharged for return to duty with the unit or is replaced; the replacement system, which must procure, equip, train, and transport a replacement; and the Medical Department units which must provide evacuation and medical care and treatment for the patient. The problem created by one such case is not impressive, but the total effect of indifferent sorting may jeopardize the success of combat operations. Unnecessary evacuation of patients is of the nature of subsidized straggling. When decision for hospitalization is made, the illness or injury must be incapacitating or of such nature that serious consequences would result if the patient were discharged immediately for return to duty. This decision is often difficult when there is little time for observing patients. When the tactical situation permits, however, reasonable doubt must be in favor of the patient.

6-3. Evacuation Lag

Delays are inevitable. They may be inherent in the system, or may arise from circumstances within a particular military situation. The sum of such delays is referred to as "evacuation lag." If not properly considered in medical planning, it may immobilize medical facilities and further retard the process of evacuation. The most significant causes of evacuation lag are—

- a. Enemy action and combat requirements.
- b. Nonavailability of transportation.
- c. Treatment time required en route.
- d. Delayed receipt of the evacuation requests.
- e. Road, terrain, and weather conditions.

6-4. Theater Patient Evacuation Policy

a. The theater patient evacuation policy is established by the Secretary of Defense with the advice of the Joint Chiefs of Staff, and upon the

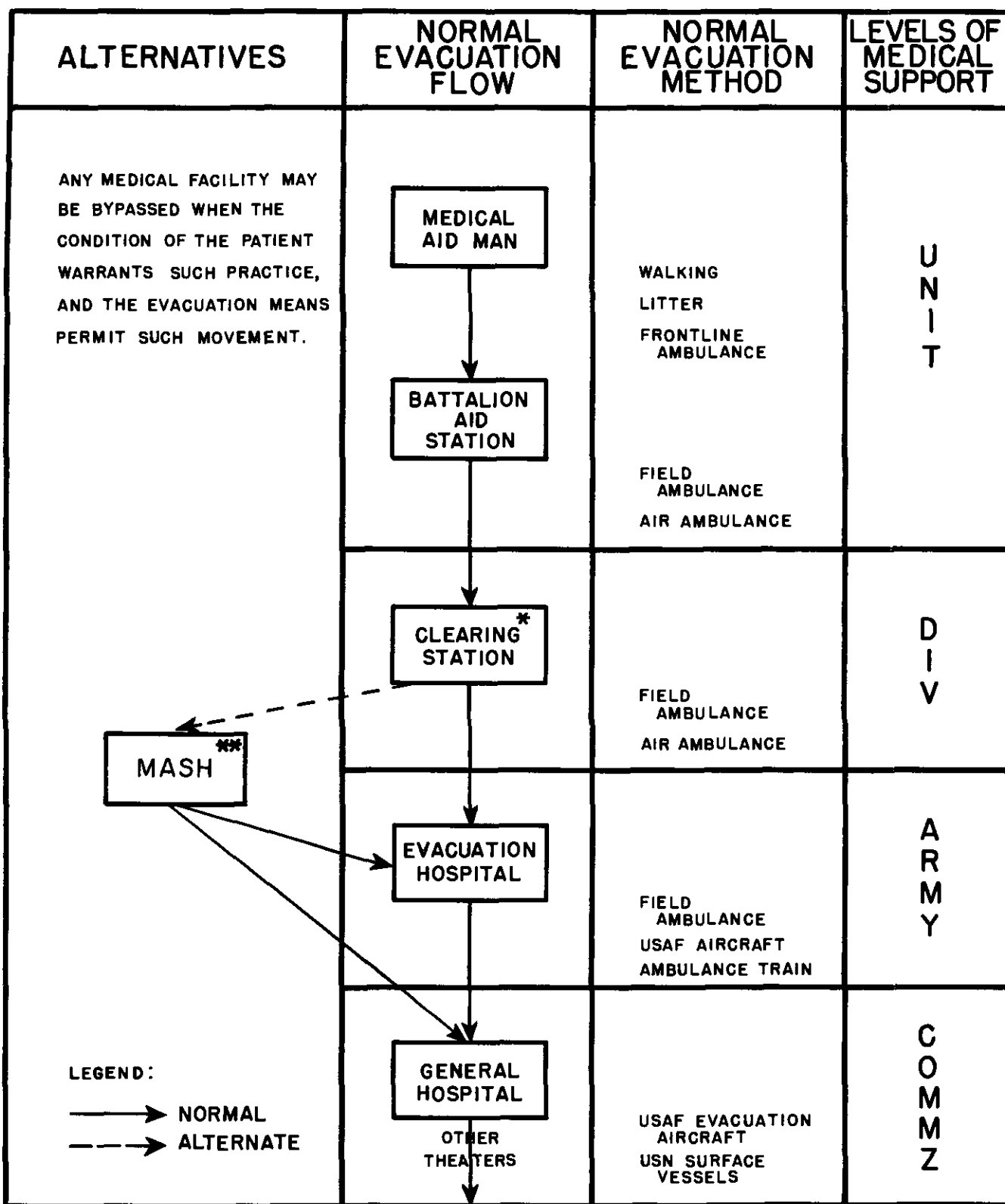

* THE FLOW OF EVACUATION FROM THE CLEARING STATION IS GENERALLY TO THE EVACUATION HOSPITAL; HOWEVER, SELECTED CASES GO INTO THE MASH

** MAY BE LOCATED IN EITHER DIVISION OR FIELD ARMY AREA.

Figure 6-1. Normal patient evacuation flow.

recommendation of the theater commander. The policy establishes the maximum duration (expressed in days) of fixed hospitalization authorized in the theater. The projected hospitalization period for individual patients is computed from the date of admission to a fixed hospital. The policy does not imply that a patient is held in the theater for the limit of time set. Patients who are not expected to be returned to duty within the specified period will be evacuated out of the theater as soon as the appropriate medical authority determines that further evacuation will not aggravate their disabilities.

b. The theater evacuation policy specified has direct impact on—

- (1) The number and type of medical units required in COMMZ to support the combat zone.
- (2) The amount of medical materiel requirements.
- (3) The amount and timing of engineering support.
- (4) The volume and type of transportation.
- (5) The rate of patient returns-to-duty.
- (6) The theater personnel replacement requirements.
- (7) The number of hospital beds required in the continental United States (CONUS) to support the theater. The shorter the theater evacuation policy, the fewer the number of fixed hospitals and other supporting resources that will be required in the theater, and the greater the number of hospital facilities that will be required in the CONUS. In general, for a longer evacuation policy, the reverse is true.

c. In conformity with the theater evacuation policy, intratheater patient evacuation policies may be established by subordinate commands, subject to approval by the theater commander. For example, a short evacuation policy usually is established for the combat zone hospitals so as not to impair their mobility or their capability to accommodate surges of patients. These intratheater

evacuation policies must be flexible and changed as dictated by the tactical situation. This does not imply that a patient is held at each level (combat zone or COMMZ) of medical treatment for the limit of time set. The time a patient spends in the combat zone evacuation chain does not apply to the theater patient evacuation policy time limit. In low-level conflicts, to include stability operations, and, when combat zone hospitals (evacuation and field hospitals) have been designated as fixed-bed units, patients may be retained for longer periods. However, this in no way changes the mission of the COMMZ hospitals or the application of the theater evacuation policy. The application of any evacuation policy is a management tool in the selection of patients, for evacuation requires close and continued coordination between all command surgeons concerned. The efficiency of medical support operations depends on the effective distribution of patients to those facilities that are capable of providing the required treatment in the shortest possible time.

(1) *In static situations.* During a slow-moving or stabilized situation, when patients are received at a fairly constant rate, combat zone hospitals may be permitted to approach the rated bed capacity by retaining patients who do not require treatment in a COMMZ general hospital.

(2) *During heavy combat.* When heavy combat causes a large number of patients, the intratheater evacuation policy must be adjusted to make beds available for current and anticipated needs, and as a result, a lesser proportion of patients admitted are retained for treatment. Evacuation policies may differ among the hospitals in the field army area, depending on their location, facilities, staffs, and the type of patients received. The forward displacement of hospitals temporarily reduces the number of beds available for patients and results in a greater number being evacuated to the communications zone.

Section II. MEDICAL REGULATING

6-5. General

a. The medical regulating system controls the movement of patients for hospitalization and treatment. The system of successive agencies and installations which are engaged in this collection, transportation, treatment, and hospitalization of the sick and injured is called the hospitalization and evacuation system.

b. Many factors are considered in controlling the movement of patients through the hospital-

ization and evacuation system. Some of these factors are the—

- (1) Patients' condition.
- (2) Current bed status of treatment facilities (e.g., beds available, beds occupied).
- (3) Surgical backlog in hours.
- (4) Location of treatment facilities with special capabilities or resources.
- (5) Number and location of patients by diagnostic category.

- (6) Tactical situation in the combat zone.
- (7) Location of airfields and railheads.
- (8) Availability of transportation.

c. The medical regulating system is under the technical control and supervision of the medical regulating officers (MRO) located at various medical headquarters throughout the theater army. These officers coordinate with, and require information from, staff officers and organization throughout the entire command.

6-6. Description of a "Type" Medical Regulating System

a. General. There are several medical regulating systems in operation throughout the Army. All of these systems have the same basic principles of operations as described in AR 40-350; AR 40-535; FM 8-35; and FM 8-55, but the procedures and agencies involved may differ somewhat from system to system (fig 6-2).

(1) Medical regulating is generally informal

within the field army. Control of patient evacuation from the treatment facilities of the division to hospitals of the field army is exercised by the medical brigade MRO assisted by MROs of subordinate medical groups. Since the medical evacuation system is both vertical and lateral, a direct and uninterrupted communications capability is required between operational headquarters and between division and field army levels of medical support. Through a system of periodic and "spot" reports, the movement of patients is controlled so that treatment requirements can be balanced against available field army treatment capabilities to prevent the overloading of hospital facilities and the development of surgical backlog. The operations officer of the division medical battalion is responsible for medical regulating when movement of patients between divisional treatment units is necessary.

(2) The "formal" medical regulating system

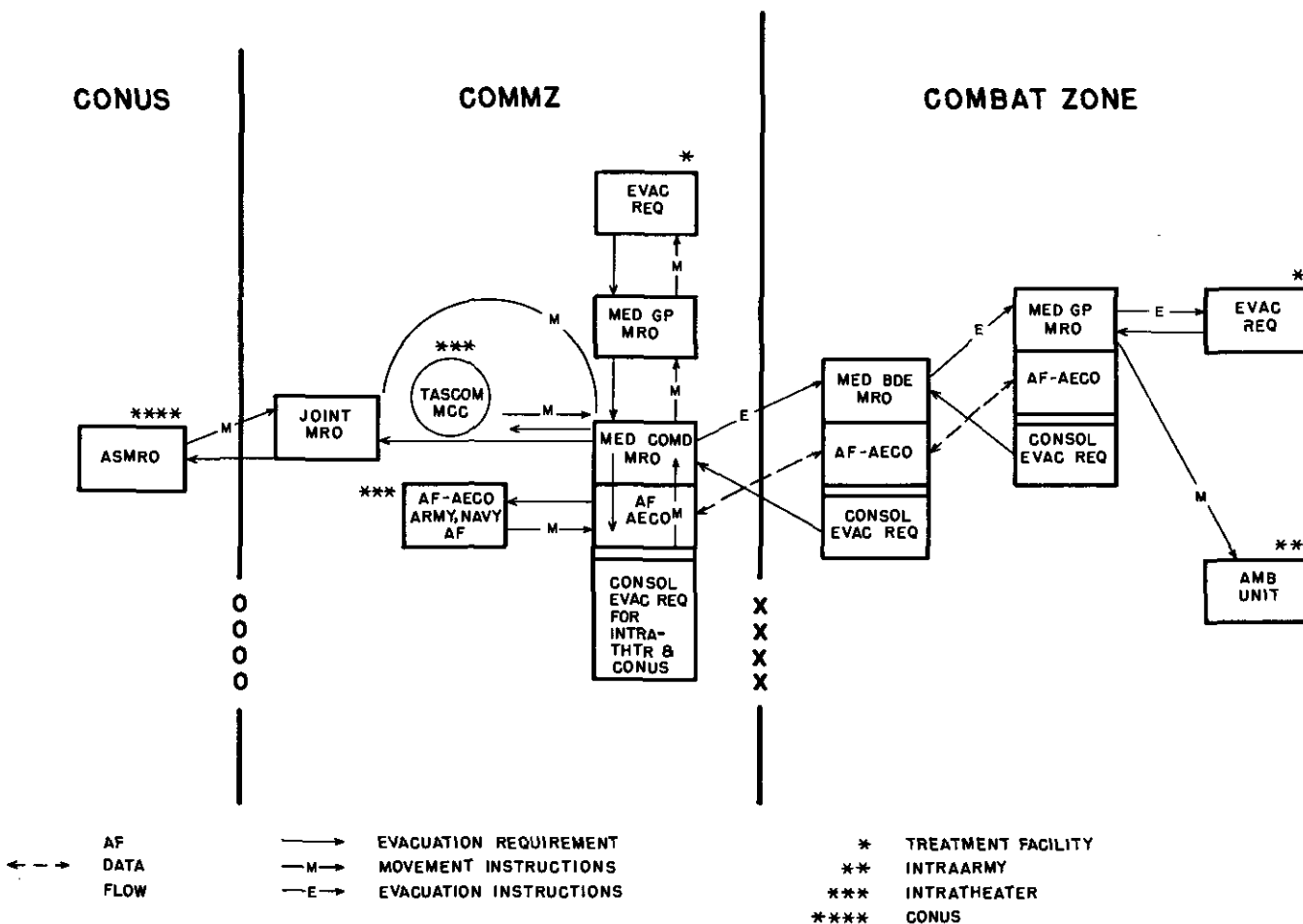

Figure 6-2. "Type" medical regulating system.

starts in the hospitals assigned to the field armies.

(a) Hospital physicians submit daily reports to the hospital registrar listing the patients requiring evacuation the following day. The registrar assembles all pertinent information and transmits a report to the medical group headquarters to which the hospital is attached. This report is a request for transportation as well as a notification of the number of patients requiring evacuation. The report classifies patients according to diagnostic category, transportability (litter or ambulatory), official status, nationality, desired onload points, and time patients will be available for evacuation.

(b) The medical regulating officer at the medical group headquarters consolidates these reports from each hospital assigned to the group and forwards his report to the field army MRO located at the medical brigade headquarters. The brigade MRO consolidates the reports for the field army and transmits the data to the theater army MRO located at the medical command headquarters. The medical command MRO, through daily reports, is informed of the location and status of general hospital beds and make a determination for the distribution of patients. To assist the medical command MRO in developing an evacuation plan, all accumulated information is processed through the personnel administration center (PAC) computer. Printout data received from the PAC facilitates the preparation and implementation of the evacuation plan. The medical command MRO submits the request for movement of patients to the Army movement control center (MCC) for surface transportation and to the Air Force aeromedical evacuation control officer (AECO) for air movement.

b. Air Evacuation.

(1) The aeromedical evacuation control officer is an Air Force officer assigned to an Air Force unit (i.e., aeromedical evacuation squadron) whose mission is to control the movement of, and to arrange for intransit medical care of, patients when they are under the control of the Air Force. There is an AECO located at the medical command, medical brigade, and at each of the field army medical group headquarters. At each level of command the AECO works closely with the MRO, providing detailed flight schedules, technical information on aircraft, and patient preparation requirements for air movement.

(2) Upon receipt of a request for air evacuation of patients from the medical command MRO, the medical command AECO forwards the

movement requirements to the theater Air Force aeromedical evacuation control center (AECC). This center is responsible for coordination with the Army, Air Force, and Navy with respect to forward air movement of cargo and personnel and the movement of patients aboard Air Force aircraft. After the schedules have been arranged, the AECC provides the AECO with a detailed flight schedule. In turn, the AECO gives the medical command MRO a detailed flight schedule and disseminates the patient evacuation status information to his subordinate AECOs. The medical command MRO then issues to subordinate MROs the instructions and authority to move patients.

c. Ground Evacuation.

(1) It is not possible to move all patients by Air Force aircraft from the combat zone. Several reasons which prevent this are—

(a) Operational aspects which preclude the use of aircraft.

(b) Patients who cannot be moved by AIR.

(2) The alternate means of patient movement is by ground transportation—either by rail, field, or bus ambulance.

(a) *Rail.* Ambulance trains (rail) may be used for transporting patients from the combat zone to the communications zone when ground or surface transportation is employed. Since the hospital cars are assigned to the medical command, the medical command MRO coordinates the evacuation movement requirement with the TASCOM movement control center. When hospital cars are assembled into trains, the transportation railway service is responsible for their movement and the maintenance of the equipment while en route. Upon receipt of a request for railway evacuation of patients from the medical command MRO, the movement control center coordinates the movement requirement with the transportation railway service. After the railway movement schedules have been confirmed with the medical command MRO, the transportation railway service provides the motive power and train crew to move the train to the receiving medical facility. Hospital trains have priority of movement while en route with patients.

(b) *Field ambulance.* Field ambulances supplement normal air and rail movement. The medical brigade, medical command, and medical group MROs provide the necessary coordination and planning for patient evacuation missions.

(c) *Bus ambulance.* Bus ambulances are employed in the COMMZ in lieu of field ambulances when feasible.

(d) *Ambulance convoy control.* Operation of ambulance convoys over controlled routes will be coordinated with the highway traffic headquarters in the TASCOM MCC or regional transportation movement office. Good route planning for medical evacuation will expedite coordination procedures and ensure the establishment of appropriate traffic priorities.

6-7. Medical Regulating to the Zone of the Interior

a. The general hospitals within the COMMZ report to the medical command MRO the numbers and types of patients requiring evacuation to the ZI. The medical command MRO then submits a consolidated report to a joint agency at theater headquarters, the joint medical regulating office (JMRO). This agency coordinates with a similar agency in the Zone of the Interior, a joint agency, the armed services medical regulating office

(ASMRO). The ASMRO authorizes, through the JMRO at theater headquarters, the transfer of patients by providing ZI hospital destinations for designated patients. The destination hospital determination is based upon the patient's needs, the hospital having the capability of meeting the patient's needs, and, where possible, the hospital closest to the patient's home.

b. When authorized to move patients, the theater JMRO coordinates through the joint military transportation board (JMTB) or J4, transportation services, for air transportation with the military airlift command (MAC) and the military sea transportation service (MSTS) for surface means. When transportation requirements cannot be accomplished by direct coordination with MAC and MSTS for programmed transportation, the JMRO will coordinate with the MCC for nonprogrammed movement.

Section III. EVACUATION WITHIN THE COMBAT ZONE

6-8. General

The field army medical support system is responsible for evacuating patients from division clearing stations to the hospitals of the field army. Careful control of the evacuation of patients to field army hospitals is necessary to effect an even distribution of cases, to assure adequate beds for current anticipated needs and to route patients requiring specialized treatment to the proper installations. In the combat zone, evacuation involves the movement of patients in a fairly continuous flow directly to hospitals. This is in contrast to evacuation in the COMMZ wherein patients are moved intermittently in large numbers. The field army medical brigade is responsible for evacuation within the combat zone.

a. Divisions and Corps.

(1) The responsibility for evacuating patients normally passes to the field army at division clearing stations and aeromedical evacuation of all categories of patients may take place from any point within the division. In the airmobile division, aeromedical evacuation is performed by both division and field army medical aircraft (FM 8-15).

(2) Transportable patients are evacuated as soon as practicable. Prompt evacuation is essential to avoid immobilizing clearing stations with large numbers of patients. Patients normally are evacuated to an evacuation hospital by field ambulance or air ambulance. Whenever a patient requires immediate resuscitative surgery, he may

be transferred to a mobile army surgical hospital (MASH). After the patient is stabilized, he is moved back into the normal system of evacuation.

b. *Field Army.* Field army medical units, using organic ambulances, collect patients from dispensaries and aid stations of units to the rear of division boundaries and transport them to evacuation hospitals, or, on occasion, to field army clearing stations. Patients from field army clearing stations normally are taken to an evacuation hospital, an army convalescent center, or to units established for the treatment of special type cases, e.g., mobile army surgical hospital.

6-9. Evacuation Operations

The medical brigade commander is responsible for the operation of the field army system of evacuation and for obtaining the use of the areas, buildings, and routes necessary for the coordinated operation. Evacuation of patients from divisions in land warfare is carried out as follows:

a. *Arrangements.* Evacuation of patients from divisions is instituted through medical channels. The arrangements include an estimate of the number of patients to be evacuated, the locations of the clearing stations, the schedule to be followed, and the routes to be taken.

b. *Control.* Control of patient evacuation to field army hospitals is necessary to insure an even distribution of patients, adequate beds for current and anticipated needs, and the proper routing of patients requiring specialized treat-

ment to appropriate installations. This control is exercised by the MRO of the medical brigade assisted by MRO of subordinate medical groups. An efficient evacuation system will decrease the number of times a patient is handled between the division clearing station and the combat zone hospital, and between one combat zone hospital and another; it will also prevent the routing of ambulances to several installations in the attempt to find beds for patients. Rigid control is maintained for the evacuation of patients in need of surgery. Without this control, backlogs of patients awaiting surgery occur in the hospitals closest to the combat action. Sound, professional judgment must be exercised in division clearing stations in deciding whether a patient is transportable, and whether he must be evacuated to a nearby hospital, or evacuated farther to the rear.

* *c. Care and Treatment En Route.* Prior to evacuating a patient, the clearing station should note his condition and special care requirements should be indicated on a field medical card. In addition, the medical officer at the clearing station should remind air ambulance aid men, ambulance drivers, or orderlies of any special attention that may be required by the patient en route. The ambulance orderly is responsible for the safety and comfort of all patients.

d. Feeding En Route. When schedules are made for the day's evacuation, an effort must be made to avoid having patients on the road during meal-times. Receiving hospitals must be kept informed of the expected time of arrival of ambulances to enable the hospital commander to make necessary arrangements for the reception and feeding of patients. If an ambulance trip is over 3 hours, additional facilities should be established en route for feeding, examination, and emergency treatment of patients.

e. Property Exchange. Field army ambulances carry sufficient equipment to provide exchange of property. The clearing station is responsible for the actual exchange of property. See paragraph 9-4 for additional information on property exchange. STANAG 2128 (app D) contains international agreements on medical property exchange procedures.

f. Communications. An efficient system of communications must be established for the control of evacuation since it is not unusual for the entire evacuation pattern to be changed day to day during combat, or even several times during one 24-hour period. It is essential that a shift from one plan to another be made smoothly and rapidly.

Section IV. EVACUATION FROM THE COMBAT ZONE

6-10. General

The evacuation of patients from the combat zone to the COMMZ requires detailed planning and coordination between the field army medical brigade and the COMMZ medical command. Unlike evacuation in the combat zone which involves a fairly continuous movement of patients to hospitals, evacuation to the COMMZ involves large numbers of patients moved intermittently to airfields and railheads located in the vicinity of hospitals. Normally, evacuation hospitals are the rearmost medical treatment facilities in the field army evacuation system. At these hospitals the responsibility for evacuation passes to the COMMZ medical command.

a. The availability of transportation determines the extent to which evacuation can be performed. Aeromedical evacuation will be used whenever possible. The Medical Department controls field, bus, and rail ambulances for evacuation from the combat zone to the communications zone. For additional means of evacuation, the Medical Department is dependent upon the Air

Force or Navy or the Army command controlling other forms of transportation. The medical command commander must, therefore, continuously forecast the requirements for land, rail, air, and water evacuation.

* *b.* The medical brigade commander is responsible for the selection of patients to be air evacuated from medical installations under his control. Within its area of operations, the field army is responsible for—

(1) Providing a holding facility at designated air terminals when the Air Force cannot provide one.

(2) Loading and unloading of patients on aircraft when the Air Force has not established a casualty facility.

(3) Providing additional equipment made necessary by the impracticability of property exchange with air evacuation units.

6-11. Evacuation by the Air Force

Based on information received from the medical brigade, the medical command commander places

requirements upon the aeromedical evacuation control officer to evacuate specific numbers of patients from the combat zone. The AECO is furnished information on the number of patients to be evacuated, their location in the combat zone, and destination in the COMMZ. The AECO furnishes the medical command commander an air evacuation schedule which may or may not provide sufficient transportation for all patients awaiting evacuation. The medical command headquarters furnishes evacuation information to the COMMZ medical facilities concerned and to the medical brigade. Patients are transported by Army field or bus ambulance units to Air Force casualty staging facilities or Army holding units established at airfields in the combat zone, where they are enplaned in accordance with the air evacuation schedule. At the destination airfields in the COMMZ, Air Force casualty staging facilities or Army holding units receive and hold the patients until they are transported by Army ambulance units to the receiving hospitals.

6-12. Evacuation by Army Medical Ambulance Units

The medical brigade and the medical command headquarters plan and coordinate evacuation missions by ambulance companies of COMMZ medical groups supporting the combat zone. Field and bus ambulances supplement normal air and rail transportation when these means are not available, when they are insufficient, or when the distances involved are such that use of field and bus ambulances is more efficient.

6-13. Evacuation by Ambulance Trains

The medical brigade and the medical command coordinate the planning for use of ambulance trains. The medical command MRO requests motive power for the ambulance trains from the TASCOM movement control center and informs the MCC of pickup and destination locations. The transportation railway service furnishes the appropriate railway movement schedule, motive power, train, and maintenance personnel. The medical command commander issues implementing instructions to the COMMZ medical facilities concerned and to the medical brigade. The medical brigade and the medical command are responsible for the transporting of patients to and from railheads and for establishing holding facilities at these locations.

6-14. Holding Facilities

Holding facilities, either Army or Air Force, are

essential to the evacuation system and are necessary for the proper care and stabilization of patient's condition. A requirement for the care and treatment of patients exists at each location where there is a major change in mode of evacuation. Patients must be collected at railheads and held ready for the arrival of ambulance trains which continue evacuation. Movement of the number of patients required to fill an ambulance train, from scattered medical units to the entraining point, requires an unusually large number of ambulances, disrupts normal operations, and often results in hardships for patients. The same considerations apply to airhead and ports of embarkation and debarkation. At air, rail, and water terminals, provisions are required for the reception and distribution of patients to appropriate hospital facilities. When the route of evacuation extends over long distances, intermediate facilities may be necessary to provide rest and treatment for patients en route. These facilities provide temporary shelter and emergency medical treatment to patients awaiting transfer. Units used to perform such missions may include hospitals, medical clearing companies, and Air Force casualty staging units.

6-15. Evacuation Within the Communications Zone

a. Medical evacuation units are placed throughout the COMMZ based on population concentrations and evacuation channels. These units evacuate sick or injured patients to an initial treatment facility or to a subsequent treatment facility for more definitive treatment. Arrangements for this service are made between the treatment facilities concerned and the medical units responsible for furnishing evacuation support.

b. Patient evacuation to general hospitals from any other COMMZ medical treatment facility requires coordination through the medical command. Planning and coordinating is accomplished in much the same manner as described for the combat zone.

6-16. Evacuation From the Communications Zone

Patients designated for evacuation from the COMMZ are transported to air terminals and sea-ports by Army bus ambulances, field ambulances, or ambulance trains. The medical regulating and evacuation procedures have been previously described.

CHAPTER 7

HOSPITALIZATION

Section I. GENERAL

7-1. General

The term "hospitalization" is used to indicate medical care and treatment provided at hospitals for serious cases or cases requiring extended care, as contrasted with emergency medical treatment or outpatient treatment provided at a hospital.

a. Objective. The objective of hospitalization is to return sick or injured personnel to duty as rapidly as possible. Because of their training and experience, they are the most valuable of all replacements.

b. Concept of Patient Care. Under combat conditions, medical means must be distributed in order to provide the greatest service to the greatest number. To devote a disproportionate amount of time and effort to one patient at the expense of the treatment of the majority is to subordinate the common welfare of many to one. It is important that emphasis be placed on the treatment of those conditions commonly encountered in military practice, rather than on rare and unusual types. The orderly processes and policies of evacuation are not to be hindered because of scientific interest in certain patients.

c. Interdependence of Evacuation and Hospitalization. Each of these functions is dependent on the other for efficient operation; therefore, evacuation and hospitalization must always be considered jointly.

7-2. Hospitalization Planning

a. Principal Considerations. Basic planning requires four major considerations: First, plans pertaining exclusively to the Medical Department; second, plans requiring coordination with other services and agencies of the Army; third, plans involving joint action with the Navy and the Air Force; and fourth, plans pertaining to combined operations with other Allied Powers. The Army Medical Department must operate as a part of the joint service team in order to accomplish its primary mission. Plans prepared by the Medical Department, and which depend upon the joint action of the Army, Navy, or Air Force

for implementation must be based on policies and directives of the theater or joint commander concerned.

b. Planning Factors.

(1) *General.* In hospitalization planning, there are certain basic factors necessary to establish hospitalization requirements for a theater of operations. To compute bed requirements for a specific operation, it is necessary to establish a theater patient evacuation policy; forecast daily admission rates to hospitals; know the troop strength of the theater; and estimate accumulation and dispersion factors. The method of calculating the total number of fixed beds required in a theater of operations is provided in FM 8-55 and FM 101-10-1. In addition to the number of fixed beds required for Army personnel in a theater of operations, allowances must be made for other personnel who may be dependent upon the Army for medical care. These personnel include Navy and Air Force personnel, merchant seamen, civilian employees, and liberated U.S. and Allied nationals. In addition, hospitals are required for prisoner-of-war and labor units of indigenous personnel recruited in the theater.

(2) *Theater patient evacuation policy.* See paragraph 6-4.

(3) *Daily admission rates.* The daily admission rate is a statistical expression that reflects the number of persons admitted to hospitals or excused from duty for medical reasons on a 1,000-troop-strength basis. While it is a major planning factor employed by the Medical Department it is also used by other agencies preparing analyses of Army experience data. Admission rates are usually based on statistics accumulated over a period of time. These rates, under various circumstances, are contained in FM 101-10-1 and FM 8-55.

(4) *Accumulation factor.* Patients will accumulate in hospitals at a certain determinable rate depending upon the admission rate, the type of disability, and the average period of hospitalization under a given evacuation policy. Rates have

been compiled into accumulation tables, which are contained in FM 8-55 and FM 101-10-1.

(5) *Dispersion factor.* A portion of the fixed hospital beds in a theater will not be immediately available for reasons enumerated below. This fact must be considered when computing hospital bed requirements and adjustments made by application of a dispersion factor. Experience has shown that an allowance of 20 percent applied against the computed hospital requirement will generally suffice to offset these temporary losses. Factors contributing to dispersion are—

(a) Wards for patients of different sexes; cases of contagious disease; and cases needing different types of treatment require a safety margin of beds in each ward, since the proportion of these different classes varies.

(b) Daily admission and disposition rates vary from day to day and must be considered when allowing for an extra margin of available beds.

(c) A certain proportion of authorized beds may be packed for shipment within the theater at any given time.

(d) Troop units may be widely dispersed; therefore, additional hospitalization facilities will be required in order to provide a sufficient number of hospital beds. As a result, these hospital facilities may not be fully utilized. The greater the dispersion of troops—the greater the dispersion factor.

(e) Hospitals may not be given the most favorable location in relationship to the most effective evacuation patterns, and, therefore, the dispersion factor increases.

(f) Any fixed hospital delayed by any cause from being placed in operation increases the dispersion factor.

7-3. Classifications

Hospitals are classified as fixed and nonfixed. Fixed hospitals include general and station hospitals, and field hospitals when so designated. Nonfixed hospitals include mobile army surgical hospitals, evacuation hospitals, and field hospitals when employed on other than fixed hospital mission. A detailed description of these fixed and nonfixed hospitals is provided in appendix E.

Section II. HOSPITALIZATION IN THE FIELD ARMY

7-4. General

a. The employment of field army hospitals is governed by two basic principles: First, hospitalization is provided as close as practical to the troops requiring it; and, second, the maximum number of personnel are returned to duty within the combat zone. Although hospitalization is provided in forward areas, the retention of all serious cases in the most forward units should be avoided. Patients should be distributed to hospitals according to type and professional capabilities of hospital staffs. Evacuation is regulated to effect a distribution of cases so that each patient can receive appropriate treatment.

b. Hospitals of the field army area are characterized by their tactical mobility which is maintained by transferring patients to hospitals in the communications zone. Both mobile and semimobile hospitals can be established in a matter of hours when personnel, equipment, and transportation are readily available. These hospitals can be established, without functional impairment, under shelter other than that provided by the tables of organization and equipment (TOE); prepared for movement several hours after patients have been evacuated; and rapidly transported to a new location. Field army hospitals must main-

tain the flexibility inherent in mobile and semimobile units. They are not concerned with construction standards, except as they may be affected by special environmental needs such as insectproofing, protection for extremes of heat and cold, or protection from enemy weapons.

7-5. Types of Field Army Hospitals

Field army hospitals include mobile army surgical hospitals and evacuation hospitals. Facilities for the treatment of certain conditions, such as psychiatric disorders, may be established by the addition of professional teams and extra equipment. A detailed description of these hospitals is provided in appendix E.

7-6. Location of Field Army Hospitals

Field army hospitals should be located near the troops to be supported and should be accessible, both from forward and rear areas, by normal means of transportation. Sites are undesirable if they cannot be easily evacuated and cannot effectively display the Geneva Cross. They should not be located near supply or ammunition dumps, important crossroads, or other areas of potential enemy attack.

Section III. HOSPITALIZATION IN THE COMMUNICATIONS ZONE

7-7. General

The medical command provides hospitalization for all Army patients and those of the other military services, as directed, originating in the communications zone and those evacuated from the combat zone. The number and types of hospitals depend upon the location of the communications zone in relation to the Zone of Interior; the extent of the zone; troop strength of the theater; nature of military operations, character of hostile resistance; and the theater patient evacuation policy. Communications zone hospitals are characterized by the immobility of their facilities. Unless major tactical, strategic, or logistical conditions require a change in location, communications zone hospitals should remain stationary. Hospitals in the communications zone are the rear terminals of the theater evacuation system. They must absorb a large volume of patients and can reduce the patient load only by returning patients to duty or evacuating them out of the theater.

7-8. Types of Communications Zone Hospitals

Communications zone hospitals include general hospitals; station hospitals; and field hospitals. Detailed descriptions of these hospitals are provided in appendix E.

7-9. Location of Communications Zone Hospitals

In order to reduce evacuation requirements, general hospitals should be located as far forward as possible, but only to the extent that enemy action will not prejudice their full and continued operation. The effect of nuclear warfare on centers of population may prevent the location of hospitals in these areas and, thus, increase the requirement for additional hospital construction materials. Fixed hospitals must be located in accordance with the evacuation pattern from the combat zone and the evacuation pattern within, and

from, the COMMZ. Hospitals must be served by roads, rail, and air, when possible. Suitable railway sidings must be provided near general hospitals for obtaining the best possible advantage of rail evacuation. The availability of nearby landing fields for the use of evacuation aircraft is most desirable. Utilities, such as heat, electrical power, air conditioning, and sewerage are essential for the efficient functioning of hospitals. Establishment and expansion of hospitals are dependent on the availability of these utilities.

7-10. Communications Zone Hospital Planning

a. In order to provide the required number of fixed beds by the time desired, timely planning and coordination with the engineer command are essential in preparing detailed plans and specifications for the various types of hospitals to be constructed. The development of fixed hospitals must be undertaken without delay. Temporary improvisation only delays the establishment of fixed hospitals, and increases the movement and dispersion of patients. Regardless of its capacity, a fixed hospital is designed to operate as an entity; fragmentation of the unit for operation in more than one location is not desirable. Planning must include requests for hospital plants, which should be submitted well in advance. Since facilities designated for other purposes are difficult to obtain, it is necessary to mark potential sites while they are still in enemy-held territory.

b. The time necessary for the development of the hospital program depends on plant availability, engineer technical assistance, labor, and supplies. The arrival of unit personnel and equipment and availability of transportation contribute greatly to the prompt completion of the hospital program. Construction of hospitals is time consuming, even under favorable conditions. The timelag existing between planned fixed beds and actual fixed beds available will vary according to the availability of the manpower and materiel required for the construction of the hospitals.

CHAPTER 8

BLOOD BANK SERVICE, THEATER ARMY

8-1. General

The theater army blood bank service functions as a theater-wide service and interfaces with the continental United States system. The service's operations include the receipt, storage, and distribution of whole blood and blood components (frozen blood, fresh frozen plasma, and living tissue components of blood) received from CONUS and the collection, processing, storage, and distribution of whole blood and blood components obtained within the theater.

8-2. Mission

The mission of the theater blood bank service is to support U.S. military and, as directed, Allied military and indigenous civilian medical establishments.

8-3. Functions

Specific functions of the blood bank service units are—

- a. Command of subordinate units.
- b. Receipt of whole blood and blood components from CONUS and movement from terminals to storage areas, transshipment points, or to using units, as required.
- c. Collection and processing of whole blood in the combat zone and communications zone, and delivery to storage areas, transshipment points, or to using units, as required.
- d. Storage and distribution of theater army whole blood stocks.
- e. To determine requirements and insure adequacy of procurement, storage, distribution, and proper use of whole blood and blood components.

8-4. Command and Control

a. *Theater Army.* When designated by the theater commander, the theater army commander, through his surgeon, exercises overall control of the theater blood program. The medical command commander normally will be given operational responsibility for the service. A Medical Corps officer, assigned to the medical command, normally will be designated as the theater blood program officer and will provide the staff planning

and supervision of the theater blood bank program. The theater blood program officer—

- (1) Prepares basic policy and procedure for handling and use of whole blood.
- (2) Determines theater army whole blood requirements for the theater.
- (3) Insures proper training for theater army personnel procuring and processing of whole blood.
- (4) Insures quality control of blood.
- (5) Controls the total COMMZ blood inventory.
- (6) Designates blood distribution elements (e.g., blood distribution teams, medical depot).

The resources for technical assistance of the medical laboratory and the storage and distribution capabilities of the medical depot will normally be made available to the blood program officer.

b. Field Army.

(1) The field army commander, through his surgeon, insures compliance with the policies of the theater army blood program. The field army surgeon exercises staff supervision over the blood receipt, collection, processing, storage, and distribution function performed by field army units.

(2) In the field army area the medical brigade commander, in coordination with the field army surgeon, designates a blood program officer who exercises control of whole blood and blood components stored in the field army. Whole blood requirements of medical units are forwarded to the appropriate blood distribution element designated by the field army blood program officer. Once blood has been authorized, resupply is through normal blood bank service channels using the most expeditious means of transportation available.

8-5. Concept of Operations

a. The blood bank service's operations are conducted without regard to sectional or zonal boundaries within the theater. Full advantage will be taken of the procurement, storage, and distribution capabilities of Teams NA, NB, and NC and the storage and distribution capabilities of medical depots assigned to the theater. In-

creased communications for elements of the theater blood program may be obtained by collocating these units with other medical units possessing a greater communications capability. In addition, each hospital is provided blood collection and processing equipment to utilize local donor populations when the normal whole blood supply is interrupted or an emergency requirement arises.

b. The blood bank service delivers blood and blood components to the using medical facilities with the least possible delay. In order to effect rapid blood delivery, intermediate storage and distribution facilities may be required. Establishment of intermediate blood storage facilities is dependent upon the responsiveness of the supply of blood from CONUS. Lateral shipment of blood between storage facilities may be necessary in order to satisfy urgent requirements or to reduce losses due to outdating.

c. *Blood Bank Service Units.*

(1) *Blood bank service headquarters (Team AJ).* The blood bank service headquarters in the COMMZ functions as the intersectional theater blood bank service headquarters. One team is capable of managing blood bank services in support of a 12-division-size theater army force.

(2) *Blood processing detachment (Team NA).* Two blood processing detachments normally are attached to the blood bank service headquarters of the medical command. These teams receive, process, and store blood collected in the COMMZ as well as assist in processing and storing blood received from CONUS and possibly field army. The teams may also be employed in the field army to support blood collecting detachments (Team NB) when the latter are being employed in that area and to process blood received from out-of-theater sources which bypass or overfly the COMMZ.

(a) One Team NA receives, processes, and stores blood collected in the COMMZ, and assists in processing and storing blood received from other sources (CONUS and field army).

(b) The second Team NA is employed in the field army to support blood collecting detachments (Team NB) when used in that area, and to process blood received from out of theater sources which bypass the COMMZ.

(3) *Blood collecting detachment (Team NB).* Up to six blood collecting detachments are attached to the blood bank service headquarters. NB teams normally are employed in the COMMZ, but may be profitably employed in the field army area when sufficient donors are available. In this latter instance, when processing of the blood collected has been completed, the storage capability of these teams can be used, when needed, pending distribution of the blood by the blood distribution detachments (Team NC) in the area.

(4) *Blood distribution detachment (Team NC).* Six blood distribution detachments are considered adequate to support a 12-division size theater army force. NC Teams will be attached to the blood bank service headquarters and used for the movement of blood on relatively short trips to and from airfields and to and between using medical facilities and between blood collecting and storage facilities. Prolonged travel over rough-surface roads will shorten appreciably the "shelf life" of this essential, fragile commodity. When movement over long distances is required, or rough roads are encountered, blood must be moved by air except when the tactical situation, weather conditions, or other conditions prevent this service. Plans to cover air movement must be considered when allocating available aircraft resources for mission assignments. Medical air ambulance units currently provide emergency transportation for whole blood, blood substitutes, and other essential medical supplies. When requests for blood distribution occur daily or at other regular intervals, they are no longer considered emergencies, and specific distribution provisions as well as schedules should be implemented. Conceptually, these teams would be employed in both the COMMZ and the field army, with three teams supporting each.

CHAPTER 9

MEDICAL SUPPLY AND MAINTENANCE

(STANAG 2128)

Section I. GENERAL

9-1. General

a. The theater army commander is responsible for the development of supply systems that will insure adequate provision of supplies for theater army forces and, when applicable, for Navy, Air Force, Allied forces, and civil affairs activities. The commander determines the system to be employed and the days of supply to be maintained.

b. The theater army surgeon develops the theater army medical supply and maintenance system for the commander. He assists in planning, recommending policies, and establishing priorities for the system; and exercises staff supervision over, and determines the number of, medical supply and maintenance units required to conduct operations. Requirements for civilian communities and related administration will be developed in cooperation with the ACofS, G5, civil affairs. Commanders of the theater army medical command and field army medical brigade exercise command and control over the medical supply and maintenance units assigned or attached to their respective commands. The theater army medical command and medical brigade commanders also exercise technical supervision over medical supply and maintenance activities of the theater army and field army, respectively.

c. Determination of the number, type, and location of medical supply and medical maintenance units to be established generally is dependent upon the number of troops to be served, their locations, and the availability of means for storage and distribution.

9-2. Local Purchase of Supplies and Equipment

a. A general purchasing agency system may be established in oversea commands in time of war in furtherance of the overall policy of making maximum use of available local resources in supplying the needs of U.S. forces in the command in order to conserve vital airlift and sealift

capability required for support of the command. If established, this general purchasing agency system will fulfill the functions of a coordinating staff or board activity rather than those of an operating procurement agency.

b. Many classes of supplies may be procured on the local oversea market; however, procurement of medical supplies may be limited because of the following considerations:

(1) Foreign-produced medical materiel that may not be acceptable.

(2) The requirement for special training to operate nonstandard equipment.

(3) Difficulties in the procurement of repair parts and replacement items.

(4) Drugs and biologicals that may not meet standards and specifications required by the U.S. Government.

(5) The problems of operating a medical supply system involving a large number of foreign-produced nonstandard items.

(6) The time necessary for production and delivery.

9-3. Medicinal Gases

Since a large amount of medicinal gases such as oxygen is required by medical facilities in a theater of operations, arrangements must be made for the refilling of cylinders without the necessity of returning them to the Zone of Interior. Army engineer gas generating units normally provide medicinal gas. In addition, the capabilities of the theater Air Force and local commercial outlets should be exploited as a backup resupply source when Army gas generating units become inoperable.

9-4. Property Exchange

In the process of patient evacuation, litters, blankets, pillows, splints, and like items of supply accompany patients. In order that these items may not be drained from the units through which pa-

tients pass, an exchange system must be established. Wherever practicable, there is a direct item-for-item exchange. The increased use of aeromedical evacuation imposes severe restrictions upon the property exchange system. Nonmedical aircraft used for emergency evacuation will not carry items for exchange. Medical evacuation aircraft normally will carry only litters and blankets for exchange purposes. Procedures for accounting for, and the replacement of, special items of equipment transported with the patient should be included in field army medical brigade and theater army medical command regulations. To avoid depletion of property exchange supplies, plans should provide for the stockpiling of such items in areas of probable usage. In addition to normal supplies, items to be authorized for hospitals and other medical installations involved in property exchange will be determined by the medical brigade and medical command commanders. In anticipation of combat operations, stocks or exchange items should be considered in all supply planning. Provision for laundering or cleaning of certain exchange items must be planned in advance. STANAG 2128, appendix D, contains the details on this agreement.

9-5. Supplies for Prisoners of War, Civilians, Displaced Persons, Refugees, and Civilian Internees

The Army is responsible for providing medical care and treatment for prisoners of war, and may become responsible for providing medical care or assistance to civilians, displaced persons, and refugees. In computing requirements for supplies and equipment needed to perform this function, full use should be made of all available intelligence data pertaining to estimates of the numbers of individuals for whom medical care must be provided, and the incidence of disease among them. It is possible that the number of prisoners of war will be such as to require the establishment of special PW hospitals (FM 41-5, FM 41-10, and FM 100-10).

9-6. Local and Prisoner-of-War Labor

a. Local Labor. Local labor should be used whenever and wherever possible. Language difficulties and adaptability of available individuals will largely determine how they will be used.

b. Prisoners of War. Prisoners of war used as laborers have been of great value in past opera-

tions, and the tasks performed have been as varied as the skills of the individuals. Equipment maintenance and repair functions may be carried on by skilled prisoners when adequately supervised. Using agencies are responsible for providing fully qualified personnel for the technical supervision of PW work details. Since guards must be provided for prisoner-of-war labor, it is most economical to work prisoners in large groups. Security and the probability of sabotage and pilferage must always be considered in the employment of prisoners of war.

9-7. Captured Supplies and Equipment

Medical supplies and equipment captured from the enemy are turned over to designated medical supply facilities. Medical materiel is segregated and that of value picked up in theater stock. Captured medical supplies of no value to the military forces will be disposed of in accordance with theater policies. Since captured medical personnel are familiar with such equipment, captured supplies and equipment are of particular value in the treatment of prisoners of war. This practice tends to conserve the medical equipment and supplies provided for friendly troops. It is essential that adequate samples of all captured medical items be preserved and forwarded to intelligence agencies for evaluation. In the event that large amounts of enemy medical supplies and equipment are captured, it is frequently advisable to concentrate this materiel in one or more medical supply installations where it may be examined for intelligence value, classified, and issued promptly for the treatment of PW and the indigenous population.

9-8. Disposition of Medical Supplies Subject to Capture

When the capture of medical supplies by enemy forces is imminent, medical supplies must not be destroyed purposely. Every attempt must be made to evacuate all medical supplies and equipment. Those that cannot be evacuated should be abandoned, but the abandonment of medical supplies is a command decision.

9-9. Medical Supply and Maintenance Units

A detailed description of field army medical supply and maintenance units is found in appendix E.

Section II. MEDICAL SUPPLY IN THE COMBAT ZONE

9-10. General

Medical supplies are managed by the TASCOM medical inventory control point, which is located in the army medical depot but operates under the control and supervision of the medical brigade headquarters. The army medical depot provides medical supply, spectacle fabrication, and medical equipment maintenance services for all units in the combat zone.

9-11. Operations

The medical depot establishes a base depot in the field army service area, and advance depots well forward in the corps areas to provide direct support to division medical battalions, hospitals, and other supported units. Supply levels of advance depots are kept at a minimum to permit relocation when necessary in providing close and timely service to supported units. Division medical battalions submit supply requirements to the supporting advance depot. Requirements are forwarded by ambulance, other vehicles, or any available means of communication. Field army and all other nondivisional units obtain medical supply, maintenance, and optical services on a di-

CAMP

rect support basis from the supporting base or advance depots. Direct depot support is provided on a supply point and unit distribution basis. Unfilled and replenishment requirements of advance depots are transmitted to the FASCOM medical inventory control center (ICC). Distribution is accomplished by shipment to advance depots or throughput to using units. Unfilled and replenishment medical supply requirements of the field army are transmitted from the FASCOM medical ICC to the TASCOM medical ICC. Distribution from TASCOM medical depots is accomplished by shipments to the field army medical base depot or by throughput to advance depots or using units. When feasible, the army medical depot is located centrally within the field army service area, easily accessible to motor vehicles operating from division, corps, and army medical unit supported. Bulk issues are made from the base depot to advance depots, but issues may also be made to nearby maintenance and using units as required. Hospitals in the field army area draw their medical supplies directly from the base depot or the nearest advance depot. Small nondivisional medical units may be satellited on the base depot, advance depot, or hospitals.

Section III. MEDICAL SUPPLY IN THE COMMUNICATIONS ZONE

9-12. General

Communications zone medical depots provide support to the field army based on requisitions submitted from the field army base medical depot. Depots, receive, store, and distribute medical supplies in a theater of operations. The medical depots stock supplies to meet the demands of the field armies and Army units within the COMMZ as well as those of other services, allies, and civilians.

9-13. Operations

a. Management of medical supplies is accomplished by the medical ICC commodity managers of the medical command. The medical ICC may be located with an operating depot, but, regardless of location, control of the medical ICC remains with the medical command.

(1) Segregation of medical supplies from mixed shipments will take place at points of discharge (beaches, ports, or air terminals) or at a

transportation terminal established at a designated inland location.

(2) Throughput of medical supplies designated for the field army will be accomplished by the transportation movement control center in coordination with the TASCOM medical ICC.

(3) Medical supplies designated for COMMZ medical depots will generally be moved from ports or air terminals by appropriate movement elements of the transportation command. Medical supplies for COMMZ medical depots which are not segregated and shipped from discharge points, will be shipped to medical depots from the inland transportation terminals having a segregation mission.

(4) COMMZ medical depots provide both general and direct medical supply and medical equipment maintenance support. Additional direct support medical supply points may be established with cellular supply detachments.

(5) COMMZ medical units normally obtain needed medical supplies and equipment on a sup-

ply point distribution basis although maximum use is made of backhaul medical evacuation means in the distribution of medical supplies to using units. When required, movement elements of the transportation command will be used for unit distribution. Movement of medical supplies into the field army normally is accomplished by the transportation command.

(6) Medical installations and units submit replenishment requisitions for medical equipment and supplies direct to designated medical supply installations. Requisitions for regulated, command controlled, and items of equipment in ex-

cess of authorized allowances are submitted through command channels for approval.

(7) Inventory control of medical command medical supply assets is centralized at the medical ICC. The medical ICC may possess sufficient ADP equipment to operate an independent, automated supply management system. All medical supply support for the COMMZ and to the combat zone will be as directed by the medical ICC.

b. Medical supply facilities in the communications zone are operated by units augmented, whenever possible, by local and prisoner-of-war labor.

Section IV. MEDICAL EQUIPMENT MAINTENANCE

9-14. General

a. The objectives and concepts of maintenance, policies governing the conduct of maintenance operations, and the responsibilities for the maintenance of equipment adopted for Army use are covered in detail in AR 750-series. Army medical equipment maintenance procedures are described in FM 8-55.

b. Medical Department organization for the army in the field provides resources for required direct and general medical equipment maintenance support. Organizational level medical equipment maintenance resources, above that which is inherent to capabilities of equipment users or operators, are provided organically in units having equipment densities that justify full utilization of one or more medical equipment maintenance specialists. Normally, units having organic medical equipment, but no medical equipment maintenance specialists assigned, are satellited for organizational maintenance on units having the required maintenance capability. Where satellization is not feasible, direct medical equipment support facilities provide the required services using contact teams. Division medical battalion equipment maintenance resources are organizationally incorporated in medical supply sections or branches of medical facilities. Separately-identified medical equipment maintenance elements are provided in medical depot organizations and cellular TOES. Command and staff personnel engaged in management of medical materiel at all levels also participate in the management of medical equipment maintenance. Repair priorities are influenced by availability of replacement items, the highest priority being assigned to items in short supply and critical items.

*c. Preventive maintenance takes precedence over all but emergency repair requirements at or-

ganizational level. Workload, available skills, and availability of repair parts permitting, organizational level medical equipment maintenance resources may be utilized in accomplishing direct and general support level maintenance. Higher level maintenance will not be accomplished at organizational level when such action will be detrimental to satisfying preventive maintenance requirements or when such action will create a backlog in equipment needing repairs that fall within the purview of organizational maintenance. Normally, excessive backlog at all organizations, regardless of the extent of repair required, will be resolved by evacuation to the next higher maintenance echelon. When required, low density life-saving diagnostic and therapeutic equipment at operating treatment facilities will be repaired or replaced immediately. Direct medical equipment maintenance support facilities must make provisions for immediate repair or replacement. Operational readiness floats will be established to assure availability of replacement items; however, higher headquarters must approve of such action.

9-15. Objectives of Medical Equipment Maintenance

The objectives of medical equipment maintenance are—

a. The prevention of equipment failure by timely and adequate preventive maintenance service in using organizations.

b. The early detection and correction, at the lowest practical level of maintenance, of potential or actual equipment failures.

9-16. Principles of Maintenance

Direct support maintenance must be provided as near to users as feasible. Performing repairs

close to users reduces time-consuming evacuation procedures and results in the rapid return of serviceable equipment to the using unit. Equipment that is beyond the maintenance service capability of any organization, or equipment that requires an excessive amount of time to repair, is evacuated promptly to the next higher level maintenance organization.

9-17. Categories of Maintenance

a. Maintenance responsibilities are assigned to specific levels of command in accordance with the primary mission characteristics, mobility of the level involved, and the economical distribution of resources.

b. The maintenance system is divided into four mutually supporting categories in order to—

(1) Relate maintenance to other military operations.

(2) Provide organization for maintenance operations in the field.

(3) Facilitate the assignment of maintenance missions and responsibilities to specific levels of command.

(4) Permit the orderly and efficient distribution of available maintenance resources.

c. The four categories of maintenance are—

√(1) *Organizational*. Organizational maintenance is that maintenance normally authorized for, performed by, and which is the responsibility of, a using organization on equipment in its possession. It includes preventive maintenance and minor repairs performed by individual users, or by specially trained personnel of the organization.

√(2) *Direct support*. Direct support maintenance is that maintenance performed by specialized maintenance units operating in direct support of using organizations. This maintenance is limited to the repair of end items or unserviceable assemblies on a return-to-user basis.

√(3) *General support*. General support maintenance is that maintenance authorized and performed by designated TOE and table of distribution-augmentation (TDA) organizations. The principal function performed by these units is the repair of equipment for return to stock.

√(4) *Depot maintenance*. Depot maintenance consists of the complete reconditioning of equipment for return to depot stock.

9-18. Organization of Medical Equipment Maintenance

a. *Theater Army*. The theater army surgeon determines the medical maintenance support re-

quirements of a theater army, recommends the allocation of maintenance units to major subordinate commanders, and formulates broad plans for the provision of support and supervision of the execution of these plans. The medical staff officers of the theater army prepare broad plans, policies, and procedures for the maintenance and repair of equipment issued by the Army Medical Department. After approval by the theater army commander, these plans—usually are published as maintenance directives. Medical staff officers normally exercise staff supervision over the execution of the theater army medical maintenance directives.

b. *Communications Zone*. The commander of the medical command is responsible for developing the implementing policy and guidance for the management of medical materiel and medical equipment maintenance as prescribed by the theater army headquarters. The medical command ACofS, supply, maintenance, and services, exercises staff supervision of medical equipment maintenance within the COMMZ. The Medical Depot, TOE 8-187G, provides direct and general support maintenance to medical units located within the COMMZ. The degree and amount of direct support requirements placed upon the depot depends upon the maintenance support satellization programs. The medical depot also provides backup general support maintenance to the army medical depot. Most items of equipment evacuated to COMMZ medical depot can be repaired by that unit. Items that exceed the capability of the depot may be returned to the CONUS.

√c. *Combat Zone*. The commander of the medical brigade is responsible for providing medical materiel and medical equipment support maintenance within the field army. The medical brigade S4 exercises staff supervision over the assigned Army Medical Depot, TOE 8-667G.

(1) The base depot normally provides general support to the advance depots. Under some circumstances individual medical units located within the army service area may receive direct and general support medical maintenance from the base depot. Where a satellization system of maintenance is in effect, larger medical treatment facilities may provide direct support maintenance for their smaller medical unit satellites, thus elevating the base depot to a general support role. Backup general support maintenance is provided to the army medical depot by the Medical Depot, TOE 8-187G, in the COMMZ.

(2) *Corps rear area*. Medical units operating

in nondivisional areas of the corps rely on the advance depot of the army medical depot for direct support maintenance. The repairs accomplished by the advance depot are done either on site by a contact team, or in the maintenance shop of the depot. Items requiring repairs beyond the capabilities of the advance depot are evacuated to the base depot of the army medical depot. The evacuation hospital and the mobile army surgical hospital have an organizational medical equipment maintenance capability. The mobile army surgical hospital can perform repairs to electronic equipment.

(3) *Division/separate brigade.* The commander of the division medical battalion is responsible for medical supply and medical equipment maintenance for units organic or attached to the division. Organizational maintenance of medical equipment, above operator level, is performed by the medical equipment repairman assigned to the medical battalion. The medical battalion division medical supply officer exercises staff supervision over these maintenance activities. The extent of repairs accomplished at this level is limited by the personnel qualifications, capabilities, tools available, and the time available within which to accomplish the repairs. The medical company of the separate brigade has a medical equipment organizational maintenance capability. Direct and general support maintenance is provided to the division/separate brigade by the Army Medical Depot, TOE 8-667G. A contact team from an advance depot of the army medical depot may move to the division area for

short periods and provide on-site direct support maintenance to the division medical battalion. General support maintenance for the division/separate brigade is provided by the base depot of the army medical depot. Mobile army surgical hospitals, which may be operating in the area, possess the capability of performing repairs to electronic equipment and offer another potential source of direct maintenance support to the division/separate brigade.

9-19. Medical Equipment Maintenance Teams

a. Team GD, Medical Equipment Maintenance Detachment, TOE 8-500G, provides direct medical equipment maintenance support for medical facilities that support a force of 100,000. This detachment is assigned to the field army on the basis of 1 per independent corps task force not supported by an army medical depot and to the theater army support command on the basis of 1 per additional 100,000 troops not supported by the medical depot in the COMMZ.

b. Team GC, Medical Equipment Maintenance Detachment, TOE 8-500G, provides direct support medical equipment maintenance for medical facilities that support a force of 50,000. This detachment is assigned to the field army on the basis of 1 per additional corps not supported by the army medical depot or Team GD and to the theater army support command on the basis of 1 per additional 50,000 troops in the COMMZ not supported by the medical depot or Team GD.

CHAPTER 10

DENTAL SERVICE

Section I. GENERAL

10-1. General

Dental service in the theater of operations is one of the Army health services and, as such, shares the responsibility for the conservation of the health, strength, and effectiveness of the command. The dental support system is established throughout the theater in a manner designed to provide effective dental care and treatment in order to prevent unnecessary evacuation of individuals requiring expedient dental treatment. The theater of operations dental service encompasses dental command and control, treatment, and laboratory service. It provides dental support sufficient to maintain the oral health of the troops in the theater, with priority given to the combat and combat support troops. A vigorous preventive dentistry program with command support is conducted to maintain the oral health of the command. When the situation dictates, dental personnel may be required to support other medical missions.

10-2. Mission

The mission of dental service in a theater of operations is to conserve the oral health of the command by preventing oral diseases, promoting dental health, and providing treatment to eliminate or reduce the effects of dental disease and injury. This service must be performed with minimum interference with the operational mission of supported troops and without undue loss of duty time by personnel. The accomplishment of the dental mission in a theater of operations is dependent upon the following principles:

a. To be effective, dental support must be brought to the areas of troop populations.

b. Dental Corps officers assigned as commanders of dental command and control teams or dental staff officers of the medical command, the

medical brigade, or other commands will control and/or technically supervise assigned dental units.

c. Routine dental treatment, with emphasis on preventive dentistry procedures, must be made available by area dental units to all personnel, as the tactical situation permits.

d. Expedient dental treatment is provided by dental personnel organic to other than dental units.

10-3. Methods of Providing Dental Service

a. Unit. Unit dental support is that treatment provided by Dental Corps officers organic to divisions, hospitals, and convalescent centers. Unit dental support is characterized by expedient dental treatment which provides treatment necessary to return dental patients to duty as quickly as possible or to prepare them for further evacuation. Unit dental support provides for the institution of as many preventive measures as possible to reduce the dental patient load. Unit dental support also plans for the support of the medical mission.

b. Area. Routine dental treatment in a theater of operations is provided by area dental units and dispensaries in support of assigned geographical areas. Dental units required for this service are allocated on the basis of troop strengths. Area dental support is characterized by a vigorous preventive dentistry program in order to improve the level of oral health in the supported units. These dental units normally operate under the control of dental service headquarters unit or dental staff officers assigned to headquarters units of the medical brigade, medical command, or other commands. Dental units are discussed in appendix E.

Section II. DENTAL STAFF OFFICERS

10-4. General

Dental staff officers are assigned to field army headquarters, the medical brigade headquarters, the medical command headquarters, and normally are included on the staff of the theater army surgeon. In general, dental staff officers at theater army and field army headquarters are concerned with broad long-range planning and policymaking. Dental staff officers of the medical command and the medical brigade are concerned with the development and implementation of detailed plans.

10-5. Functions of the Dental Staff Officer

The dental surgeon—

a. Coordinates dental activities with the surgeon.

b. Exercises staff supervision over the dental service of the command.

c. Determines requirements for, and recommends employment of, dental units and personnel.

d. Plans and supervises the preventive dentistry program.

e. Recommends modification of dental equipment.

f. Determines the needs and priorities for dental equipment and supplies.

g. Prepares reports on the dental activities of the command.

h. Advises commanders and staffs on dental matters.

i. Exercises operational control over subordinate units when such authority has been delegated by the appropriate commander.

Section III. DENTAL SERVICE IN THE COMBAT ZONE

10-6. Area Dental Support

The largest volume of routine dental treatment for the troops in the combat zone is performed by area dental support units. Centralized control of dental resources is essential for the immediate response of the dental service to the needs of combat units. The combat units are available for routine dental support and treatment only at limited times; hence, area dental units must be available for immediate deployment to combat troop areas. Some area dental units must be kept in the vicinity of divisions anticipating times when division troops are available for routine dental treatment. Close liaison must be maintained with these divisions. When practical, the same dental unit or units should remain in support of a specific division. In the absence of a unit dental surgeon, the unit surgeon is responsible for maintaining liaison with the field army dental support. Priority of treatment in forward areas of the combat zone will be to combat and combat support troops of divisions or separate brigades; priority for routine dental treatment in the rear

areas will be to divisions or brigades retraining, regrouping, or in reserve. When providing routine dental treatment over an extended period of time, sections or teams of the area dental support units may be attached (less operational control) to divisions. Operational control of the area dental support units remains with the dental or medical headquarters to which they are assigned or attached.

10-7. Unit Dental Support

Unit dental support provides dental officers and enlisted personnel to hospitals, convalescent centers, and divisions to perform expedient dental treatment which will return patients to duty as soon as possible or to prepare them for further evacuation. The unit dental personnel are not allocated in sufficient numbers to accomplish full dental treatment. Full routine dental treatment for troops is provided by, and is the responsibility of, the area dental support units. Unit dental support provided the divisions is discussed in more detail in FM 8-15.

Section IV. DENTAL SERVICES IN THE COMMUNICATIONS ZONE

10-8. Area Dental Support

Dental service for a communications zone, as in the combat zone, utilizes both unit and area dental support concepts. Routine dental support is provided by area dental units and is available throughout the communications zone in proportion to troop concentrations. When applicable,

priority of treatment will be for individual and unit replacements being processed or prepared for duty in the combat zone. This necessitates close liaison to determine movement and planned disposition of such individuals and units located in, or staged through, the communications zone. Centralized control of dental units

having area responsibility will insure this effort. Area dental support units will be dispersed to the extent necessary to assure the minimum in lost duty time required for patients to travel to treatment facilities.

10-9. Unit Dental Support

Unit dental support in the communications zone consists of dental services organic to the various

hospitals, dispensaries, convalescent centers, and to combat divisions that may be located in the communications zone. Unit dental personnel in the communications zone provide expedient dental treatment on an area basis. In addition, dental personnel in the hospitals and convalescent centers have the primary mission of providing dental support to hospital patients. The mission of dental personnel assigned to the divisions is discussed in FM 8-15.

CHAPTER 11

VETERINARY SERVICE

Section I. GENERAL

11-1. General

Veterinary service is an integral part of the Army health services in a theater of operations. Veterinary organization, doctrine, training, and equipment must be adequate to support the Army in the field under all conditions and in any environment.

11-2. Mission

The mission of the veterinary service is to provide veterinary support that contributes to conserving the health of the command. This integral part of medical support is provided by the inspection of subsistence; control of zoonotic and food-borne diseases; assistance in the preventive medicine program; maintaining the health of military animals; inspecting, monitoring, and testing subsistence contaminated or suspected of being contaminated with chemical, biological, and radiological agents; and by participating, when directed, in other activities. The mission of the veterinary service in a theater of operations will be facilitated by adhering to the following doctrine:

a. Veterinary service, either routine or emergency, must be available as far forward as operational considerations and the tactical situation permit.

b. Veterinary personnel will emphasize the preventive aspects of their duties. Preventive measures apply in reducing the deterioration and spoilage of subsistence; reducing the incidence of zoonotic diseases; and reducing the incidence of disease and injury in military animals.

11-3. Veterinary Service System

Veterinary service in a theater of operations is normally provided on a unit and area basis.

a. Unit Veterinary Service. Veterinary service at unit level is provided by veterinary personnel organic to nonmedical TOE units such as the infantry scout dog platoon. Nonmedical units to which veterinary personnel are not assigned are provided veterinary service on an area basis or by the attachment of veterinary personnel or units.

b. Area Veterinary Service. Area veterinary service is provided by the allocation of veterinary units to support geographical areas and is the primary method of providing veterinary service in both the combat zone and communications zone. Veterinary units required for this service are allocated primarily on the basis of troop strength and military animal strength.

Section II. VETERINARY STAFF OFFICERS

11-4. General

Veterinary Corps officers are assigned to the field army headquarters, the field army medical brigade, the theater army medical command, and normally are included on the staff of the theater army surgeon. In general, veterinary staff officers at theater army and field army headquarters are concerned with long-range planning and policy-making. Veterinary staff officers of the medical command and medical brigade are operators and are concerned with the development and implementation of plans to carry out the policies of higher headquarters.

11-5. Functions of the Staff Veterinarian

The functions of the staff veterinarian with respect to specific activities are—

a. Recommending assignment and deployment of veterinary units and personnel.

b. Preparing and coordinating veterinary policies and plans.

c. Developing and coordinating procedures and plans for the inspection of food and food sources.

d. Developing procedures and planning for the care and treatment of military animals and control of military significant animal diseases.

e. Performing liaison with veterinary staffs of higher and subordinate headquarters.

f. Preparing veterinary statistical, historical, and other reports.

g. Providing advice to the commander and staff through the surgeon on all veterinary professional and technical matters.

h. Developing and coordinating plans for technical assistance and supervision of veterinary activities, in cooperation with the assistant chief of staff for civil-military operations or a responsible civil affairs unit, in support of military civic action projects.

Section III. VETERINARY SERVICE IN THE COMMUNICATIONS ZONE

11-6. General

All veterinary service in the communications zone of the theater of operations is performed by veterinary units of the medical command. This does not include activities in agriculture or other activities normally assigned to civil affairs units.

11-7. Subsistence Inspection

a. Effective subsistence inspection support must provide for the inspection of subsistence from the time it is received or procured until it is issued to the using unit. The COMMZ is the principal location of subsistence inspection activities within a theater of operations. Most subsistence provided from the CONUS base passes through the COMMZ. In addition to the inspection of subsistence supplied from CONUS, there will also normally be requirements to inspect locally procured subsistence, as well as subsistence for military animals. Other inspection activities in both the COMMZ and combat zone may include inspection of captured enemy rations, inspection of indigenous subsistence when units are forced to "live off the land," and, as directed, inspection of subsistence for civilian use. The major quantity of subsistence consumed in the theater will be received through the ports and over the beaches operated by the transportation command. These installations, then, are the initial inspection points for subsistence received in the theater. Veterinary subsistence inspection at ports of entry is designed to determine fitness for human consumption and suitability for storage and shipment. Condemnation of unfit subsistence at this point will result in an economy of transport means available for port clearance. Inspection of subsistence in the COMMZ forward of the ports or beaches will be at rear and forward field depots operated by the supply and maintenance command; ration storage and distribution points operated by the area support command; and subsistence processing establishments. As appropriate, inspections will be conducted at the time of procurement; while in storage; at the time of

shipment, receipt, and issue; and, as appropriate, will determine wholesomeness, quality, and suitability for storage and shipment.

b. The Army normally is responsible for the wholesale distribution of subsistence within a theater of operations. Consequently, the veterinary service must be capable of inspecting all subsistence at the wholesale level which is supplied to all forces supported by the Army in a theater of operations, to include Air Force, Navy, Marine, and Allied personnel. The inspection of subsistence at wholesale level, for other than Army use, normally is performed only in the COMMZ. Subsistence inspection service is provided on an area basis. Normally, the large veterinary service detachment (TOE 8-500G, Team JB), or multiples thereof, will be used to provide subsistence inspection service in the communications zone. Individuals, or varying sized mobile service teams may be used to provide an area subsistence inspection service to units, storage and distribution points, or subsistence processing establishments. The use of large veterinary service detachments in lieu of many small detachments will result in reduced administrative requirements and a more efficient use of personnel.

11-8. Care of Military Animals

a. Veterinary support for military animals in the communications zone is provided on an area basis by veterinary units of the medical command. The only exception is the unit level animal care provided by veterinary personnel organic to TOE units such as military police guard companies. The units having a capability for providing animal care are large and small veterinary service detachments and veterinary small animal hospitals and dispensaries. Although the large and small veterinary service detachments possess the capability, the majority of animal care will be provided by small animal hospitals and dispensaries.

b. The normal flow of animal patients is from using units to veterinary small animal dispen-

saries. Dispensaries are located so as to be readily accessible to the military animal population supported. They normally provide outpatient support; however, they also have a limited animal-holding capability. Military animals which require hospitalization are evacuated from dispensaries to veterinary small animal hospitals. Hospitals are provided for the hospitalization of military animals which have been evacuated from the combat zone or disabled in the COMMZ. Veterinary units do not possess the means to provide an evacuation service; consequently, the unit with property responsibility for the military animal will evacuate it to the site of treatment or hospitalization using organic or supporting transportation means. When available, veterinary personnel will determine if evacuation is required. Military animals are not evacuated to CONUS; therefore, the veterinary hospitalization facilities in the COMMZ are the rear terminals of the military animal hospitalization system. At this point, the condition of the animal must be such that it can be returned to duty within a period of time specified by theater army or it will be destroyed. In the treatment and evacuation of animal patients, their disposition at all levels in the treatment system is based on the number of animal patients and treatment facilities; value of the animal patients; availability of replacement animals; and estimated length of hospitalization. The disposition of animal patients may be any of the following:

- (1) Treatment and return to duty without hospitalization.
- (2) Hospitalization within the COMMZ.
- (3) Destruction of animal patients having

no possibility of being restored to an active, useful status within acceptable time limits.

11-9. Zoonotic Disease Control

It is essential to establish a program for the prevention or control of animal diseases transmissible to man (zoonoses). To facilitate the prevention or control of the zoonoses, the medical command veterinarian may divide the communications zone into areas of responsibility for the various veterinary units of the command. In assigning areas of responsibility, consideration is given to the capabilities of the units; zoonotic diseases prevalent in the areas; indigenous domestic and wild animal populations; obstacles to the movement of animals such as rivers and mountains; roads and rail nets used for the movement of animals; direction of the flow of streams; prevailing winds; and routes followed by migratory wildlife. All veterinary units included in the theater army forces are capable of participating in a zoonotic disease control program.

11-10. Other Activities

Participation by veterinary personnel and units in preventive medicine activities and military civic action projects will be used as directed by higher authority. It is important that plans to quarantine animals and control animal traffic be fully coordinated with civil affairs and military police personnel. If subsistence supplies are contaminated with chemical, biological, and radiological agents, veterinary personnel will provide appropriate recommendations as to their disposition following inspection, monitoring, and testing.

Section IV. VETERINARY SERVICE IN THE COMBAT ZONE

11-11. General

Veterinary services provided in the combat zone are similar to those provided in the communications zone but are less comprehensive. In this zone of the theater of operations the services are performed by veterinary units of the medical brigade. The material presented in this section is based on veterinary service in a field army and is equally applicable to operations by independent forces of corps or division size.

11-12. Subsistence Inspection

a. Throughput of subsistence supplies is a characteristic of the supply system in a theater of operations. Subsistence supplies may be

shipped from a rear field depot to the division support command (DISCOM), thus bypassing the storage and distribution points operated by the army support brigade and corps support brigades. Consequently, veterinary personnel must be located throughout the theater in order to provide an effective inspection service. Inspection of subsistence in the combat zone will be at storage and distribution points operated by the army support brigade, corps support brigades, and division support commands. The larger quantities of subsistence located at the storage and distribution points operated by the army support brigade and corps support brigades normally will necessitate the allocation of veterinary

service detachments to the areas supported by these brigades, rather than to divisions.

b. The large veterinary service detachment provides an area inspection service in the area supported by the army support brigade. The small veterinary service detachments provide an area inspection service in the areas supported by the corps support brigades. The small veterinary service detachments also provide an area inspection service for the divisions. If subsistence is procured within the combat zone, the majority of such subsistence normally will originate in the army service area. The large veterinary service detachment normally conducts procurement inspections for all subsistence procured within the combat zone. Normally, one large veterinary service detachment and multiples of the small veterinary service detachment are allocated to provide subsistence inspection support in the combat zone. In areas of low and mid-intensity conflict, the small veterinary service detachment may be allocated, one per division, to provide direct support to divisions. Individuals, or varying sized mobile service teams, from both the large and small veterinary service detachments may be used to provide an area subsistence inspection service to units, storage and distribution points, or food-processing establishments. To the maximum extent practicable, the large veterinary service detachment should be employed in lieu of many small veterinary service detachments. This will result in reduced administrative requirements and a more efficient use of personnel.

11-13. Care of Military Animals

Veterinary support for military animals in the combat zone is provided on an area basis by veterinary units of the medical brigade. The only exception is the unit-level animal care provided by veterinary personnel organic to TOE units such as infantry scout dog platoons. The forward terminals for animal care in the combat zone are at those units having assigned or attached veterinary personnel, and the rear terminals are at veterinary small animal hospitals of the medical brigade. The normal flow of animal patients is from using units to veterinary small animal dispensaries and, as required, from dispensaries to veterinary small animal hospitals. The disposi-

tion of small animal patients may be of any of the following:

- a. Treatment and return to duty without hospitalization.
- b. Hospitalization within the combat zone.
- c. Evacuation of animal patients for hospitalization in the COMMZ.
- d. Destruction of animal patients having no possibility of being restored to an active, useful status.

11-14. Zoonotic Disease Control

The control of animal diseases transmissible to man presents many problems in the combat zone which are either absent or materially reduced in the communications zone. This is due to such factors as abandonment of animals by civilians, capture or liberation of animals, inability to conduct definitive surveys, tactical requirements, and others. The control program must, of necessity, be limited. Areas of responsibility for zoonoses control in the combat zone normally will be assigned to various veterinary units supported as appropriate by preventive medicine units. Control measures must include quarantine and examination of captured or liberated animals; examination of domestic and wild animals suspected of having zoonotic diseases; collection and submission of specimens to the medical laboratory; control of animal traffic; and, as required, the destruction of animals and supervision of disposition of carcasses.

11-15. Other Activities

Participation by veterinary personnel and units in preventive medicine activities and military civic action projects will be as directed by higher authority. Participation in military civic action projects in the combat zone usually will be much less comprehensive than in the communications zone. It is important that plans to quarantine animals and control animal traffic be fully coordinated with civil affairs and military police personnel. If subsistence supplies are contaminated with chemical, biological, or radiological agents, veterinary personnel will provide appropriate recommendations for their disposition following inspection, monitoring, and testing.

CHAPTER 12

PREVENTIVE MEDICINE

Section I. GENERAL

12-1. General

Preventive medicine (PVNTMED) enhances individual unit effectiveness by reducing environmental and other health hazards. Preventive medicine programs normally are established at all levels of command. They are dependent upon command interest and support for their success.

12-2. Preventive Medicine Program

a. Preventive medicine programs provide—

(1) Professional and technical advice to commanders at all levels on measures to reduce noneffectiveness from disease and injury.

(2) Surveillance of the health of the command, to keep the commander informed, and to provide a sound basis for recommendations when indicated.

(3) Education of troops in appropriate hygienic practices and the training of field sanitation teams.

(4) Professional supervision of a program of immunization and drug prophylaxes for the prevention or suppression of disease.

(5) Surveillance of military environments to detect and identify actual or potential health hazards and to formulate suitable means of minimizing their effects.

(6) Advice and consultation on the planning, design, construction, operation, and maintenance of water supply systems, waste disposal systems, food-handling facilities, troop housing, and medical facilities.

(7) An environmental hygiene program for the detection and elimination of health hazards due to excessive noise, climate extremes, air contamination, and electromagnetic radiation.

(8) Consultation and advice on the means and methods of controlling arthropods and rodents.

(9) Consultation concerning the selection and development of campsites.

b. The services listed above are called unit level preventive medicine services when they are provided either by organic medical personnel of nonmedical units or by area medical service units. Services which are beyond the capability of unit level medical personnel because of their complexity, extent, or specialized nature are provided by preventive medicine units and medical laboratories, and are termed "preventive medicine support services."

c. General requirements of the PVNTMED programs are stated in AR 40-5 and medical technical bulletins. Implementing directives and special requirements for a specific operational area must be prepared early in the planning phases.

d. Special environmental conditions may be overriding consideration in planning and may have an immediate impact on the number, composition, and scheduling of the early arrival of PVNTMED units and those supplies that are needed to implement control measures.

Section II. PREVENTIVE MEDICINE STAFF FUNCTIONS

12-3. General

A preventive medicine officer normally is included as a staff member of the surgeon's section of major headquarters units and medical command and control units. In addition to serving as a technical adviser, the PVNTMED officer assists the surgeon in staff supervision of the activities of assigned and attached PVNTMED units.

12-4. Functions of the Preventive Medicine Officer

a. The PVNTMED officer and his assistants aid in the staff supervision of the command PVNTMED program. Through continual planning, disease and injury problems are anticipated and reduced in order to maintain optimum command effectiveness.

b. To facilitate planning, preventive medicine officers maintain liaison with appropriate staff officers in their own headquarters, subordinate organizations, higher headquarters, and with civilian health authorities. The information sought through such liaison includes tactical, logistical,

and personnel situations; number, location, and physical condition of prisoners of war; civilian disease potential and incidence that would affect friendly troops; and command directives and guidance requiring clarification or additional emphasis.

Section III. ORGANIZATION AND OPERATIONS

12-5. Organization

a. The following preventive medicine units are located in the theater of operations:

(1) Preventive Medicine Service Unit, Field (TOE 8-204G).

(2) Preventive Medicine and Control Detachment (Team LA, TOE 8-500G).

(3) Preventive Medicine Survey Detachment (Team LB, TOE 8-500G).

b. A detailed discussion of these units is provided in appendix E.

12-6. Operations

Field army and COMMZ preventive medicine

functions are accomplished with medical resources available within the theater. These resources include preventive medicine officers and specialists at various headquarters assigned preventive medicine units and unit level medical facilities. Basic preventive medicine functions ordinarily are accomplished by personnel furnishing unit level medical service. In the field army, preventive medicine units or portions of preventive medicine units may be placed in support of corps or divisions to provide preventive medicine support services. In the communications zone, preventive medicine units or portions of preventive medicine units may be placed in direct support of area support commands.

CHAPTER 13

**(NATO STANAG 2083; ABCA SOLOG 128)
MEDICAL SUPPORT OF OPERATIONS
IN A CBR AND NUCLEAR ENVIRONMENT****13-1. Purpose and Scope**

This chapter provides guidance for health service support during operations in chemical, biological, radiological, and nuclear environments. The material presented provides emphasis and cohesiveness of thought for contingency planning of medical support, particularly those immediate problems confronting the Army health services following an enemy chemical, biological, or nuclear attack. The influx of large numbers of patients or the loss of medical facilities and personnel from nuclear attacks or chemical/biological agent attack will impair health services. Concepts on use of the remaining medical resources effectively are discussed.

13-2. Basic Principles

a. In nuclear attacks, many more burns, low-velocity missile wounds, and ionizing radiation injuries can be expected as compared to a predominance of high-velocity missile wounds associated with conventional warfare. Casualties will be produced faster, and locally available means for early resuscitative care may quickly prove inadequate.

b. Enemy employment of chemical and biological agents and some nuclear bursts may produce militarily significant CBR contamination and materially increase operational problems. Commanders must consider this contamination in planning under the threat or actual use of nuclear weapons or chemical/biological agents by the enemy.

c. Civilian casualties may be a significant problem in populated areas and the Army health services may be required to assist in treating civilian casualties when civil medicine cannot handle the problem.

d. In planning for support following enemy nuclear or chemical/biological attack, every effort must be made to conserve and achieve the best possible use of available medical personnel (TM 8-285).

(1) Each soldier must be trained to apply first aid to himself (self-aid) and to others (buddy-aid) (FM 21-11, FM 21-40), FM 21-41). First-aid training of nonmedical personnel for nuclear casualties should stress simple treatment techniques based on improvisations with available materials.

(2) Each physically capable individual is responsible for carrying out required decontamination of himself and his equipment as soon as possible. The medical personnel are responsible only for the decontamination of patients who have reached medical facilities and are unable to perform self-aid.

(3) Trained medical personnel should be used primarily to provide emergency medical care or, if time and resources permit, more extensive treatment. Nonmedical personnel should provide for search and rescue of the injured or wounded, immediate first-aid, and initial chemical agent decontamination. Nonmedical vehicles should be used to supplement the movement of patients to the initial medical treatment facility.

(4) Dental officers and assistants will be used in providing emergency medical treatment.

e. Decontamination stations must be established at treatment facilities and should be conveniently located for the flow of patient traffic, with consideration given to the principles indicated in TM 3-220. Patients received at these stations should not be admitted or removed from decontamination stations, medical facilities, or other inclosed spaces in clothing or blankets known to be contaminated. Proper steps must also be taken to obtain timely replacement of items made unusable by contamination and to insure the salvage and decontamination of such equipment. Patients should be decontaminated, whenever possible, prior to their movement through the evacuation chain. When this is not possible, hazards to other persons may be reduced by following simple procedures as stated in TM 8-285. Nuclear and chemical casualties must be

considered separately as follows:

(1) *Chemical.*

(a) A frequent problem at the treatment facility will be to determine whether the surgical condition or the chemical agent hazard requires priority of attention.

(b) At the earliest practicable moment, and with due consideration given to the condition of the patient, clothing and equipment contaminated with chemical agents should be removed from the patient and decontamination started.

(c) The rapidity and irreversible reaction to some of the chemical agents, especially the nerve agents, dictate that medical treatment be started as soon as possible after symptoms appear.

(2) *Nuclear.* Since the physical injuries resulting from nuclear weapons detonations will be of greater significance to the individual than radiological contamination, consideration should always be given to providing first aid or emergency medical care before decontamination begins.

f. Detailed information on chemical, biological, radiological, and nuclear defense is contained in FM 21-40. Detailed guidance on the widely varying possible doses of radiation is contained in FM 3-12.

13-3. Medical Planning

a. Definitive planning and coordination are mandatory at all command levels in an effort to provide adequate medical support. Higher headquarters should distribute timely plans and directives to subordinate units. Provisions for emergency medical care of civilians must be included.

b. The surgeon, although not responsible for casualty estimates, should make an appraisal to determine medical requirements. Medical support will not be delayed pending such estimates. A nuclear medical consultant is assigned to the medical command to assist the surgeon in the development of the medical plan.

c. In developing medical plans, the commander should consider various simplified and standardized procedures for patient care in the postattack emergency phase, thus allowing less qualified medical personnel to perform treatment. Command emphasis must be placed on the first-aid training of nonmedical personnel.

13-4. Medical Sorting

a. The mass casualties produced as a result of a nuclear, chemical, or biological attack will saturate the medical treatment facilities with patients. In order to achieve the maximum use of

the medical treatment capabilities, it is necessary to quickly classify the incoming patients. The classification procedure is known as medical sorting (triage) and is a classification according to the type and seriousness of the injury. Establishment of a priority for treatment and evacuation is based on the sorting category assigned to the patient. The following categories may be designated:

(1) *Minimal.* Individuals who can be returned to duty immediately.

(2) *Immediate.* Patients requiring immediate treatment to save life or limb.

(3) *Delayed.* Patients who, after emergency care, incur little additional risk by delay in further treatment.

(4) *Expectant.* Patients so critically injured that only complicated and prolonged treatment offers any appreciable improvement in life expectancy.

b. For additional information, see TB MED 246.

13-5. Nuclear, Biological, and Chemical Casualties

Treatment and evacuation of patients will be based upon signs and symptoms of injury. Suspected nuclear radiation injury alone without specific symptoms and physical findings, however, will not justify evacuation. Ordinarily, in nuclear and conventional warfare, burns or traumatic injury will be the basis for early medical care and evacuation. Standing operating procedures (SOP) will govern the use of prophylactic measures following known or suspected chemical or biological agent attack.

13-6. Reinforcement of Medical Support

Commanders must provide for the equitable allocation of medical means for the support of the tactical mission as well as rear area protection. Subsequent to a nuclear, chemical, or biological attack, additional support, personnel, and vehicles may be required from nonmedical units. Subject to the provisions of the Geneva Conventions, military police may make available PWs and civil affairs units may procure indigenous personnel who may be employed to assist in both military and civilian patient collection and evacuation.

13-7. Prepositioned Medical Materiel

a. *Prepositioned Medical Materiel Program for Nuclear Casualties (MMPNC).*

(1) The MMPNC is designed for the prepositioning of materiel to support treatment of mil-

itary casualties resulting from nuclear warfare as defined in the Emergency Medical Care Program, AR 40-3.

(2) The MMPNC materiel will consist of two units identified as follows:

(a) *Emergency medical treatment unit, phase I.* This unit provides a 72-hour supply for use in self or nonprofessional initial emergency treatment of patients occurring in 100 personnel. The components of this kit will not be used except for the purpose intended without authority of The Surgeon General.

(b) *Emergency medical treatment unit, phase II.* This unit provides a 20-day supply for use in professionally directed survival case of 1,000 patients.

b. *Prepositioned Materiel Program for Defense Against Biological and Chemical Agents (MMPDABC).* Positioning of these medical supplies increases the capability of the Army to cope with the effects of biological and chemical agents. The program provides for augmentation and prepositioning of medical supplies for military and U.S. national noncombatant personnel and oversea commands and for military personnel assigned to United States Strategic Army Forces (STRAF) units in CONUS.

c. For additional information concerning responsibilities, accounting, listing of components, and inspection of units see AR 40-61, MMPNC and MMPDABC.

CHAPTER 14

STABILITY OPERATIONS

14-1. General

This chapter provides a brief discussion of the role of the Army and Army health services in stability operations. FM 31-23 provides detailed information and guidance concerning operational aspects of internal defense and internal development by host country and U.S. Forces.

14-2. Stability Operations Roles

Military forces accomplish stability operations missions through the conduct of advisory assistance and civil affairs functions, psychological and intelligence operations, populace and resources control, and tactical operations. These operations may be conducted by the military alone or in coordination with other governmental agencies in support of internal defense and internal development programs. Through these operational roles, the full capabilities of military forces can be coordinated and directed toward the attainment of internal security objectives. Stability operations is that type of internal defense and internal development operations and assistance provided by the Armed Forces to maintain, restore, or establish a climate of order within which responsible government can function, and without which progress cannot be achieved.

a. Internal Defense. Internal defense is the full range of measures taken by a government and its allies to free and protect its society from subversion, lawlessness, and insurgency. Internal defense is intended to create an atmosphere of internal security and relative peace within which internal development can assure national growth through controlled social, economic, and political change. Both internal defense and internal development must be coordinated and mutually supporting at all levels.

b. Internal Development. Internal development is the strengthening of the roots, functions, and capabilities of government and the viability of its national life toward the end of internal independence and freedom from conditions fostering insurgency.

14-3. Medical Support of Stability Operations

a. Tactical Operations. The nature of the terrain in which most stability operations will occur and the unpredictable nature of guerrilla tactics necessitate that certain measures be adopted in the establishment of medical support for military forces engaged in stability operations, including the following:

(1) Provision of medical treatment and patient holding capabilities at lower levels of medical support than is normal, particularly at area control bases and with security detachments. Patients to be evacuated by ground transport are held until movement by means of a secure convoy is arranged, because of the vulnerability of ground evacuation means to guerrilla ambush and attack.

(2) Provision of sufficient air or ground means to move medical units or elements.

(3) Maximum use of air evacuation means.

(4) Provision of small medical elements to furnish unit-level medical support to small mobile units engaged in independent or semi-independent combat operations in hostile areas through which secure ground evacuation may be impossible, and from which evacuation of patients by air may be difficult.

(5) Assignment to mobile units of specially trained medical technicians, capable of operating medical treatment facilities for short periods of time with a minimum of immediate professional medical supervision.

(6) Formation of non-U.S. litterbearer teams to accompany combat units where terrain or other obstacles preclude transportation or evacuation of patients by other means.

(7) Strict supervision of sanitation, maintenance of individual medical equipment, and advanced or special first-aid training throughout the command.

(8) Greater emphasis on basic combat training of medical department personnel; arming of

Medical Department personnel, as required; and use of armored carriers for ground evacuation.

(9) Use of Allied medical resources and capabilities whenever they are available.

b. Medical Civic Action. Medical civic action is the medical support provided to civilians which contributes to their general welfare and serves to improve the standing of the host country government and its allies with the population. Poor health and sanitation conditions may be anticipated in many areas in which the U.S. participates in stability operations. Such conditions may include inadequate water supply and sewage disposal facilities, insufficient housing, and lack of good sanitary discipline and medical care facilities. Although some medical civic action will be performed at all levels of conflict, its greatest application and importance are in stability operations. Basic principles of medical civic action are as follows:

(1) Medical civic action will not be undertaken at the expense of health service support for U.S. personnel.

(2) Although one purpose of medical civic action is to gain, restore, or maintain public confidence in the host government and its military forces and allies, such programs should not be openly identified with the psychological operations program.

(3) Medical civic action cannot be expected to solve the health problems of a nation; rather, it is a supplement to the public health program with which it must be coordinated.

(4) Medical civic action programs should extend host government public or private health facilities into remote or unsafe areas, but not du-

plicate or otherwise compete with established health services.

(5) Emphasis should be directed toward solving simple health problems benefiting the maximum number of people, rather than trying to treat the major problems of a few people. Serious illness requiring long-term treatment is referred to the civilian public health service and transportation to a civilian hospital may be provided.

(6) Long-term benefits can be achieved by teaching personal hygiene and sanitation.

(7) Civilians injured as a result of military operations will be provided appropriate treatment in accordance with the severity of their injuries. Indigenous personnel treated for wounds and injuries should be interrogated in order to determine the cause of injury. Reports of treatment of wounded personnel are provided to proper authorities.

(8) Medical civic action is coordinated with the ACofS, operations, and ACofS, civil affairs, to focus the effort where needed and to assure compatibility with tactical operations.

(9) Indiscriminate dispensing of medical supplies may result in diversion of these supplies into enemy hands or into the illicit market. Personnel engaged in medical civic action must be informed of this consideration. Locally developed policy and procedures for dispensing medical supplies are required to prevent or minimize the diversion of these civic action supplies.

(10) Supply planning for medical civic actions will be required, since increased demand will occur for supplies needed for other than tactical operations, i.e., pediatric, gynecological, and geriatric.

APPENDIX A

REFERENCES

A-1. ARMY REGULATIONS (AR)

- 40-3 Medical, Dental, and Veterinary Care.
- 40-4 Army Medical Department Facilities.
- 40-5 Preventive Medicine.
- 40-61 Medical Materiel Policies and Procedures.
- 40-350 Medical Regulating to and Within the Continental United States (BUMEDINST 6320.1B/AFR 160-107/PHS GEN CIR NO. 14).
- 40-535 Worldwide Aeromedical Evacuation (AFR 164-1/OPNAVINST 4630.9B/MCO P4630.9).
- 310-25 Dictionary of U.S. Army Terms.
- 310-50 Authorized Abbreviations and Brevity Codes.
- 711-16 DSU/Installation Stock Control and Supply Procedures (Army Field Stock Control System).
- 725-50 Requisitioning, Receipt, and Issue System.
- 750-Series Maintenance of Supplies and Equipment.

A-2. Department of the Army Pamphlets (DA Pam)

- 310-Series Indexes of Publications.
- 700-4 Digest of Supply and Maintenance Policies.

A-3. Field Manuals (FM)

- 3-12 Operational Aspects of Radiological Defense.
- 8-15 Medical Service in Divisions, Separate Brigades, and the Armored Cavalry Regiment.
- 8-35 Transportation of the Sick and Wounded.
- 8-55 Army Medical Service Planning Guide.
- 14-3 Comptroller Support in Theaters of Operation.
- 16-5 The Chaplain.
- 19-40 Enemy Prisoners of War and Civilian Internees.
- 21-11 First Aid for Soldiers.
- 21-40 Chemical, Biological, Radiological, and Nuclear Defense.
- 21-41 Soldier's Handbook for Defense Against Chemical and Biological Operations and Nuclear Warfare.
- 27-10 The Law of Land Warfare.
- 31-23 Stability Operations, U.S. Army Doctrine.
- 41-5 Joint Manual for Civil Affairs (OPNAV O 9B2P1/AFM 110-7/NAVMC 2500).
- 41-10 Civil Affairs Operation.
- 54-3 The Field Army Support Command.
- 100-10 Combat Service Support.
- 100-15 Larger Units Theater Army—Corps.
- 101-5 Staff Officers' Field Manual: Staff Organization and Procedure.

101-10-1 Staff Officers' Field Manual: Organizational, Technical, and Logistical Data, Unclassified Data.

A-4. Joint Chiefs of Staff Publication

1 -Dictionary of United States Military Terms for Joint Usage (JD).

A-5. Technical Bulletin (TB)

MED 246 Medical Management of Casualties in Nuclear Warfare.

A-6. Technical Manuals (TM)

3-220 Chemical, Biological, and Radiological (CBR) Decontamination.

8-285 Treatment of Chemical Agent Casualties.

A-7. Tables of Organization and Equipment (TOE)

8-Series Medical Groups and Activities.

29-Series Composite Units and Activities.

52-series Corps Organization.

APPENDIX B

AUTOMATIC DATA PROCESSING (ADP) IN THE
THEATER OF OPERATIONS**B-1. General**

a. The introduction of Automatic Data Systems within the Army in the Field (ADSAF) program, when fully implemented, will provide systems to perform data acquisition, transmission, processing, and dissemination. The aim of the program is twofold—

(1) To increase the commander's capability to employ his available resources effectively by providing him accurate and timely information for consideration in arriving at command decisions.

(2) To provide for the automated solution of problems subject to mathematical analysis and for the near real-time dissemination of resulting data.

b. The ADSAF program consists of three related but semi-independent functions. Each will address one of the three areas inherent in the conduct of military operations in the field, i.e., employment of maneuver elements, control of supporting artillery fires, and provision of effective combat service support. Respectively, the functions are designated—

(1) *The Tactical Operations System (TOS)*. The TOS will provide commanders and staffs at field army and below with current, accurate, and timely information and intelligence for consideration in making operational decisions.

(2) *Tactical Fire Direction System (TAC FIRE)*. The TAC FIRE will increase the effectiveness of fire support through improved accuracy, faster use of target information and greater efficiency in the determination of fire capabilities, and the allocation of fire units to targets.

(3) *Combat Service Support System (CS₃)*. The CS₃ will provide combat service support unit commanders with data leading to operational decisions based on best utilization of available resources; tactical commanders and their staff with current, accurate information on the combat service support situation; and Headquarters, Department of the Army, agencies with information required for their mission.

(a) The logistical portion of CS₃ is designed to provide a more effective control of logistics, increase its responsiveness, reduce inventories and personnel requirements, and provide timely and accurate status information to aid in the decision-making process.

(b) The personnel and administration portion of CS₃ is designed to increase the timeliness and accuracy of personnel and administrative information, reduce administrative workloads of tactical commands, and maximize the utilization of personnel resources for administrative functions. It is within this subsystem that Army field medical support functions have been analyzed, evaluated, and designed for ADP application.

(c) In the initial development of CS₃, four medical functions were identified as possible candidates for automation:

1. Patient accounting/reporting.
2. Medical regulating.
3. Medical supply.
4. Medical intelligence.

(d) Of the above listed functions, patient accounting/reporting and medical regulating were selected for initial testing in a prototype installation; therefore, only these functions will be addressed in subsequent paragraphs.

B-2. Purpose

The purpose of this appendix is to describe—

a. The use of automatic data processing equipment (ADPE) by Army Medical Department units in the field.

b. The procedures to be used in patient accounting/reporting and medical regulating.

B-3. Scope

The following requirements for ADP support of patient accounting/reporting and medical regulating functions in a theater of operations are identified:

- (1) To record, transmit, process, and sum-

marize data in support of patient accounting/reporting and medical regulating.

(2) To provide the timely acquisition, processing, and reporting of medical data.

(3) To provide the timely information that will help reduce the timelag in the treatment and movement of patients. The general objectives of automating selected medical support functions are to—

(a) Improve the efficiency and responsiveness in the care and treatment of patients.

(b) Improve accuracy, availability, and completeness of medical data.

(c) Reduce the administrative workload.

B-4. System Considerations

The CS₃ system places computers at each major echelon of support from the division to the COMMZ, and will include items of ADP equipment necessary for medical support functions. Input/output (I/O) devices will be required to provide the means of entry into, and exit from, the automated system. Ultimately, each major medical treatment facility in the corps and field army will be provided with its own on-line I/O device which will transmit information to the appropriate computer with information copy forwarded to group or center headquarters. In addition, Medical Department units will require on-line I/O devices at medical command and control headquarters and medical depots.

B-5. Patient Accounting and Reporting

a. Basic Considerations. Patient accounting begins at the time patients are located by medical personnel and are brought to, or enter, a treatment facility where data pertaining to admission, diagnosis, and/or disposition is recorded. This recording procedure is repeated each time a patient is subsequently received by another treatment facility. Patient information is either entered directly (corps, field army) to the supporting computer by the medical facilities or forwarded to the data processing detachment (division) for edit and correction prior to entry into the automated system. At each level, data is consolidated, summarized, disseminated locally, and forwarded to the next higher echelon. The personnel administration center (PAC) computer, located in the TASCOM, maintains a master personnel records file containing medical data received from all the medical treatment facilities in the theater of operations. The master file provides information for statistical reports required by the Office of The

Surgeon General, and a data base for reconstructing facility files at lower echelons.

b. Source Information Required. Standard format input documents will be utilized by all reporting elements to record and report accounting data. The following essential elements of information must be included in patient accounting/reporting:

(1) *Unit data.* Unit identification, bed capacity, bed status, and report period.

(2) *Patient data.* Admission, diagnosis, disposition, name, serial number, organization, and environmental data.

(3) *Special data.* Special selected information which is collected and reported as it occurs.

c. Transmission. Transmission of patient information to the supporting computer center will be on a daily basis; however, situations will occur where it may become necessary to forward the information more frequently. Medical reporting elements will forward patient information to the data processing detachment (division level) in the format required for entry into the ADP system. The detachment then will cause this patient accounting information to be inserted into the computer by the servicing on-line I/O device. Medical elements of higher echelons will enter patient information directly to appropriate computers via I/O devices with information copy going to the group or center headquarters.

d. Output. The output of the patient accounting/reporting function may be divided into three categories—

(1) Reports prepared for the medical facilities concerning admission and disposition data and summary information.

(2) Summary information to be transmitted to the FASCOM and PAC computer for consolidation and dissemination to command surgeons, major medical commanders, and the Office of The Surgeon General.

(3) Individual patient information.

B-6. Medical Regulating

a. Method. With the introduction of CS₃, the current medical regulating function, as described in paragraphs 6-5 through 6-7, will be automated.

b. Data Input.

(1) *Sources.* The originators of input information for medical regulating in the field army are the evacuation and surgical hospitals, and in COMMZ, the medical treatment facilities. The most common documents used are medical facility

status reports, evacuation requests, and inquiries. Input information received by the medical command medical regulating officer (MRO) from the PAC computer and other computers at the theater army level includes evacuation schedules and inquiry transactions. Input to the medical regulating function at the PAC computer includes—

(a) Reports prepared and received from the FASCOM computer.

(b) Aircraft schedules received from the aeromedical evacuation control center.

(c) Requests for ambulance train evacuation schedules which are entered by the medical command MRO and transmitted by the computer to the CS₃ movements control center computer.

(d) Management parameters and inquiry transactions.

(e) Source documents from the medical groups and hospital centers organic to the medical command; e.g., evacuation requests, medical facility status reports, and inquiries.

(2) *Transmission.* Input will be transmitted in the same language/format required for entry into the ADP system by on-line I/O devices, thus permitting the entry of data to an appropriate central computer for processing and dissemination. Medical facility status information will be transmitted as an integral portion of the medical regulating function.

(3) *Preparation.* Source information in field army will be entered into the computer system by means of the medical facility's remote input/output device which will be on line to the corps support brigade computer. The information then is switched by this computer to the FASCOM computer where the processing will be accomplished. In the communications zone the source information from hospitals will be transmitted to the PAC computer. The management parameter transaction is used to enter manage-

ment controls into the automated system. These controls provide a means for automatically producing exception reports and transmitting them to the MRO's for appropriate action, e.g., a parameter setting of 75 percent hospital bed occupancy would cause a message to be transmitted to the appropriate MRO for his attention when that occupancy level was reached or exceeded. An inquiry will be used to initiate the production of requested report such as a medical facility status report.

c. Output. The outputs of the medical regulating function at the field army level and communications zone level may be divided into three categories—

(1) Reports, e.g., summary evacuation data, evacuation schedules, and inquiries.

(2) Requests to be transmitted to higher echelons, e.g., request for evacuation schedules and inquiries.

(3) Responses to requests originating at lower echelons.

B-7. Medical Functions Under Consideration for Future Automation

There are several other ADP applications which may be beneficial from a functional point of view. These include, but are not limited to, clinical record cover sheet, inventory control, distribution of whole blood, optometric statistics for resource management, medical consultant statistics or analysis of disease/injuries, statistical routines for development of accumulation-decumulation factors and other measures in medical planning, and medical services account (MSA) program. Further investigation will be required before a determination can be made as to which of these areas are the most likely candidates for inclusion in the ADSAF program.

APPENDIX C

AIR DEFENSE

C-1. Defensive measures by medical units consist principally of developing a passive and active air defense.

C-2. Passive air defense is directed toward the protection of patients, personnel, and equipment by training personnel in aircraft recognition; digging shelters for patients and personnel near working areas or hospital wards; dispersing vehicles and equipment; concealing bivouacs and working areas when authorized; and providing an effective warning system.

C-3. Active air defense is limited to engaging low flying hostile aircraft with small arms fire, and then only when the medical unit or facility is under direct attack. The low altitude air threat which may face medical units may be partially countered by aggressive use of large volume of fire which unit (nonair defense) weapons can place against this threat. Use of unit weapons in this role must be balanced against the requirement to prevent disclosure of position, and premature expenditure of ammunition.

a. Rule of Engagement. In the absence of orders to the contrary, individual weapon operators will engage attacking aircraft. Engagement of all other hostile aircraft will be supervised by unit leaders. Nothing in this rule is to be taken as requiring actions prejudicial to accomplishment of the primary mission of the unit.

b. Techniques. The following techniques should maximize the destructive or deterrent effect against aircraft. Aircraft may be divided into two categories—low speed and high speed. Low-speed aircraft include helicopters and liaison, reconnaissance, and observation fixed-wing propeller aircraft. High-speed aircraft include all other propeller aircraft and all jet fixed-wing aircraft. This distinction will result in simplified engagement procedures.

(1) *Engagement of low-speed aircraft.* In accordance with the rule of engagement, engage low-speed enemy aircraft with aimed fire, employing the maximum weapon rate of fire. Aerial gunnery techniques generally applicable to all

small arms and automatic weapons are presented in FM 23-65.

(2) *Engagement of high-speed aircraft.* In accordance with the rule of engagement, engage high-speed enemy aircraft with maximum fire aimed well in front of the aircraft, and above its flight path, in order to force it to fly through a pattern of fire. This technique is not unaimed "barrage" fire, but requires a degree of aimed fire. It does not, however, call for careful estimation of aircraft speed and required lead.

(3) *Use of tracer ammunition.* This type of ammunition is intended for use with other types to show the gunner, by its trace, the path of the bullets, thus assisting in correcting aim. Automatic weapons should use the highest practical proportion of tracer ammunition to enhance the deterrent or disruptive effect.

(4) *Massed fire.* Units should employ a massed fire technique when using small arms and automatic weapons in an air defense role.

c. Standing Operating Procedures. Medical units standing operating procedures should cover, but not be limited, to, the following items relevant to engagement of aircraft with nonair defense weapons:

(1) *Applicability.* (Operators of designated weapons.)

(2) *Relation to primary mission.* (Primary mission is never prejudiced.)

(3) *Relation to passive air defense.* (The necessity for aggressively engaging hostile aircraft is balanced with the requirement to place in proper perspective the tactic of withholding fire to preclude disclosure of position.)

(4) *Authority to engage.* (Authority to engage attacking aircraft delegated to individual weapons operators and to engage all other hostile aircraft on orders through unit chain of command, subject to the rule of engagement and rules for withholding fire.)

(5) *Rule of engagement.* (Normally, self-defense only against all attacking aircraft and those positively identified enemy aircraft which pose a threat to the unit.)

(6) *Rules for withholding fire.* (When ordered. When not positive that aircraft are actually attacking or otherwise hostile. When friendly aircraft or troops are endangered.)

(7) *Firing techniques.* (Lead and superele-

vation.) Massed fire. Maximum rate of fire. Maximum use of tracer ammunition.)

(8) *Unit training requirements.* (Motivation and discipline. Gunnery. Aircraft recognition.)

APPENDIX D
STANDARDIZATION AGREEMENTS

NATO-UNCLASSIFIED

STANAG No. 2051

DETAILS OF AGREEMENT
PATIENT EVACUATION TAG

GENERAL

1. This agreement takes into account that a patient cannot discharge the responsibilities of an ordinary passenger. The responsibilities therefore for a patient in transit will devolve on the National Agencies concerned. The agreement provides for a common printed form to meet the requirements of armed forces for transit identification of patients, notation concerning medical care en route and as an aid for continuous control for each patient throughout the evacuation.

AGREEMENT

2. The patient evacuation tag normally shall be used by rear or base medical installations. Identification of patients on evacuation from front to rear areas is catered for by the Field Medical Card referred to in STANAG 2039.

3. The hospital/medical unit preparing patients for evacuation by land-air-sea is responsible for initiating a "patient's evacuation tag," the minimum information on which is indicated below. When patients moved out for evacuation are returned to the initiating hospital/medical unit because of postponement of their departure, dates and effective entries on the tag will be corrected by the appropriate personnel concerned.

4. This tag will be printed in English, French, and the national language of the using country if the national language is other than English or French.

DETAILS OF PATIENTS' EVACUATION TAG AND INSTRUCTIONS FOR USE

5. The tag will be affixed to the clothing of each patient to be evacuated under the provisions of the agreement. The tag will consist of at least three parts: the basic tag, the embarkation tag and the debarkation tag.

6. At the beginning of the patient's journey, the hospital/medical unit which will deliver the patient to the Carrier for the first stage of the journey will prepare the tag. If the journey is made in several stages so that the patient enters medical treatment facilities for brief periods between stages, the basic tag will be preserved by these medical treatment facilities and forwarded with the patient, affixed to the clothing of the patient, when embarking on the next stage of the journey (such medical treatment facilities are referred to as "remaining overnight facilities," "holding facilities," or "debarkation facilities").

NATO-UNCLASSIFIED

NATO-UNCLASSIFIED

INFORMATION TO BE CONTAINED ON THE TAG

7.
 - a. Name and initials.
 - b. Service number.
 - c. Rank/Rating/Grade.
 - d. Armed force of origin.
 - e. Evacuating unit.
 - f. Diagnosis.
 - g. Type of casualty.
 - h. Transport category.
 - i. Number of cabin, bunk or seat (to be completed by transportation authorities).
 - j. Ship/aircraft number and type (to be completed by transportation authorities).
 - k. Date.
 - l. Signature.
8. These details are defined as follows:
 - a. Name and initials—self-explanatory.
 - b. Service number—self-explanatory.
 - c. Rank/Rating/Grade—self-explanatory.
 - d. Armed force of origin—enter the authorized provisions as detailed in STANAG No. 1059.
 - e. Evacuating unit—enter the designation and geographical location of the hospital/medical unit from which the journey originated. Geographical locations will be indicated by authorized provisions as set forth in STANAG No. 1059.
 - f. Diagnosis—enter a brief diagnosis providing only such detail as will be useful in caring for the patient during the journey.
 - g. Type of casualty—the types or classes shall be noted as follows:
 - battle casualty
 - accident,
 - sick,
 - psychiatric.
 - h. Transport category—the transport categorization is as follows:
 - lying, sitting, to be isolated, to be kept under observation.
 - i. Number of cabin, bunk or seat—to be completed by transportation authorities.
 - j. Ship/aircraft number and type—to be completed by transportation authorities.
 - k. Date—date of signature of tag.
 - l. Signature—that of authorized evacuation officer, either medical or administrative.
9. The reverse side of the basic tag will contain detail to be filled in where necessary at any state of the evacuation as follows:
 - a. Diet recommended—indicate whether regular or special diet; if special, describe.
 - b. Treatment recommended en route—enter information necessary for the guidance of medical personnel accompanying the patient.
 - c. Treatment and progress record—this space is provided for notes of examination and treatment en route where such information requires recording but is not of sufficient importance to justify opening the patient's records.

NATO-UNCLASSIFIED

NATO-UNCLASSIFIED

10. At Annex "A" is the Draft Format for the French Patient Evacuation Tag, provided for information and as an example only of a tag that meets the requirements of this agreement. An Annex "B" the disposition of three parts of the tag (as used by the medical authorities of the United Kingdom and United States) is provided for information and as an example only.

Note. Annex "A" and Annex "B" omitted.

NATO-UNCLASSIFIED

NATO-UNCLASSIFIED

STANAG No. 2061

DETAILS OF AGREEMENT
PROCEDURES FOR DISPOSITION BY MEDICAL
INSTALLATIONS OF ALLIED PATIENTS

1. GENERAL

It is agreed that the NATO Armed Forces will use the standard procedures for disposition by Medical Installations of Allied Patients indicated in the paragraphs shown below.

The procedures outlined herein are based on the principles which should govern the return of patients received in Allied Medical Installations to their own National Organizations.

2. TRANSFER OF PATIENTS

a. The medical welfare of the patient must be the paramount consideration. When deciding upon the transfer of a patient, due consideration should be given to any increased medical hazard which the transfer might involve.

b. Arrangements for disposition of the patients should be capable of being implemented by existing organizations. Consequently, no new establishment should be required specially for dealing with the transferring of allied casualties.

c. Patients will be transferred to their own national organization at the earliest practicable opportunity consistent with the observance of principles established in paragraphs a and b above and under any of the following conditions:

(1) When a medical facility of their own nation is within reasonable proximity of the facility of the holding nation.

(2) When the patient is determined to require hospitalization in excess of 30 days.

(3) When there is any question as to the ability of the patient to perform duty upon release from the hospital.

d. The decision as to whether a patient, other than those requiring transfer under 2c. above, is fit for release from the medical treatment facility is the responsibility of the commander of the medical facility treating the patient.

e. All clinical documents, to include X-rays, relating to the patient will accompany him on transfer to his own national organization.

f. The decision for suitability for transfer and the arrangements for transfer will be the responsibility of the holding nation.

g. Final transfer channels should be arranged by local liaison before actual movement.

h. Patients not suitable for transfer to their own national organization must be dealt with for treatment and disposition purposes as patients of the holding nation until they are transferred, i.e., they will be dealt with either in military hospitals, military medical installations, or in civilian hospitals that are part of the military medical evacuation system of the holding nation.

NATO-UNCLASSIFIED

NATO-UNCLASSIFIED

3. CLASSIFICATION OF PATIENTS

Different channels for disposition will be required for the following two types of cases:

a. *Patients Not Requiring Admission*

Patients not requiring admission to a medical unit will be returned to their nearest national unit under arrangements to be made locally.

b. *Patients Who Have Been Admitted to a Medical Installation*

All such patients will be dealt with in accordance with paragraph 2 above.

NATO-UNCLASSIFIED

NATO-UNCLASSIFIED

STANAG No. 2075

DETAILS OF AGREEMENT
PATIENT REPORTING BY MEDICAL TREATMENT
FACILITIES

GENERAL

1. This agreement takes into account the fact that any one National medical formation/unit in a force may admit, transfer and discharge nationals of the other NATO countries. Further, that each medical formation/unit has the responsibility for notifying the national authority concerned of information concerning casualties of that nation, either direct or through the reporting nation's staff channels.
2. It is agreed that the NATO Armed Forces will follow the procedures set forth herein so that patient reporting between nations will be standardized.

PROCEDURES

3. Medical treatment facilities which administratively admit patients (some are described below) will prepare daily separate lists of admissions, transfers and discharges of personnel of each NATO nation serving in the Force.
4. These lists (para 3) will contain the information detailed in paragraph 9 below, and will cover the period 0001 hours to 2400 hours, being serially numbered.
5. The lists will be dispatched to medical authorities to be detailed by the Force Commander.
6. Special lists will be maintained of patients considered by the appropriate medical authority to be Very Seriously Ill and/or Seriously Ill. The placing on or removal from these lists of a patient will be made known by fastest means to the authorities detailed in accordance with paragraph 5.
7. a. Notification of deaths in medical installations will be made by fastest means to the authorities detailed in accordance with paragraph 5, showing cause of death.
b. Notification of loss of a hand(s), foot(feet), limb(s), or eye(s) will be made to the authorities detailed in accordance with paragraph 5.

MEDICAL LEVEL OF NOTIFICATION

8. The following equation of some NATO medical installations is given for illustrative purposes only. Notification in accordance with preceding paragraphs would normally be made by the installations underlined:

NATO-UNCLASSIFIED

NATO-UNCLASSIFIED

<i>UK</i>	<i>US</i>	<i>FR</i>
Regimental Aid Post Casualty Clearing Post	Battle Group (Bn) Aid None Station	Corps Medical Unit <u>Medical Company</u>
<u>Advanced Dressing Station</u>	<u>Clearing Station</u>	<u>Medical Battalion</u>
<u>Casualty Clearing Station</u>	<u>MASH & Evac. Hospitals</u>	<u>Field Hospital</u>
<u>Hospital (forward)</u>	<u>Hospital (station/ field)</u>	<u>Hospital (forward)</u>
<u>Hospital (rear)</u>	<u>Hospital (general)</u>	<u>Specialized Fwd Hospital</u> <u>Hospital (rear)</u>

PATIENT REPORTING

9. The following details will be the minimum shown on all lists issued under the preceding paragraphs:
- a. Designation and nationality of medical unit issuing list.
 - b. Serial number and date of issue of list.
 - c. Personal number of each casualty.
 - d. Rank/grade of each casualty.
 - e. Surname and initials of forenames of each casualty.
 - f. Unit/regiment of each casualty.
 - g. Nationality of the casualty's Unit/Regiment.
 - h. Diagnosis (also showing whether Very Seriously Ill (V.S.I.) or Seriously (S.I.) and indicating if loss of a hand(s), foot (feet), limb(s) or eye(s) has occurred.)
 - i. Categorization:
 - (1) Battle Casualty (BC)
 - (2) Non-Battle Accident/Injury (NBA/NBI)
 - (3) Sick/Disease (S/D)
 - j. Date of:
 - (1) Admission.
 - (2) Transfer out, or
 - (3) Discharge.
 - k. Unit to which transferred or discharged (show nationality or unit).
 - l. If died, to be shown as DIED giving date.

NATO-UNCLASSIFIED

Agreed English/French Texts

STANAG 2083

DETAILS OF AGREEMENT (DofA)

RADIOLOGICAL HAZARDS

- Enclosures: Annex 'A' (DofA)--Commander's Guide on the Acute Effects of Whole-Body Penetrating Ionizing Radiation of Personnel (United Kingdom) (For Information Purposes Only)
- Annex 'B' (DofA)--Effects Associated with Various Exposures to Penetrating Radiation (United States).
- Annex 'C' (DofA)--Symptoms and Probable Effects for Various Exposures to Penetrating Radiation (United States).
- Annex 'D' (DofA)--Schematic Showing Relationship Between Remaining Radiation Service Categories and Risk Levels (United States).
- Annex 'E' (DofA)--Nuclear Radiation Armed Forces Personnel Safety Criteria (United States).

AGREEMENT

1. It is agreed that the NATO Armed Forces will use the information contained herein to enable commanders to:
 - a. Determine what constitutes a radiological hazard to armed forces personnel in war.
 - b. Weigh the effect of a radiological hazard on armed forces personnel.

GENERAL

2. The hazards shown herein cover only those which might be expected to have an effect on the military effectiveness of armed forces personnel in war.
3. In nuclear warfare military operations may require that peacetime regulations on limits of radiation exposure and requirements for radiation protection be exceeded.
4. The risk involved from radiological exposure must be evaluated in accordance with the military situation and the state of emergency.
5. The final decision on the dose to which armed forces personnel may be exposed will be made by the responsible commanders concerned. Nothing in this STANAG should be interpreted as limiting the commander's authority in this respect.

RADIOLOGICAL HAZARD

6. All nuclear radiation, even in very small doses, has some harmful effect on the body and should be avoided whenever possible to do so without interfering with military operations.
7. All nuclear radiation doses referred to herein are due to external whole body exposures to penetrating radiation.

NATO-UNCLASSIFIED

NATO-UNCLASSIFIED

8. Some of the factors influencing the injury caused by penetrating nuclear radiation are:

- a. The total dose accumulated from previous radiation exposure.
- b. The periods over which the doses are received.
- c. The periods of recuperation between periods of radiological exposure.
- d. The physical condition, sex and age of the individual at the time of radiological exposure.
- e. The presence or absence of any additional injuries.

ASSESSMENT OF THE HAZARD

9. Provided that no appreciable dose has previously been received (i.e. 75 rad or less) the following may be used as a guide:

- a. 5 rad or less in 24 hours is a low dose (negligible risk) and is acceptable during routine operations. However, more than 5 rad per day or 75 rad in a 30-day period is not acceptable.
- b. 5-20 rad in 24 hours is a moderate dose (moderate risk) and is acceptable in close support operations.
- c. 20-50 rad in 24 hours is a serious dose (emergency risk).
- d. 500 rad total in any increments will probably result in the non-effectiveness of personnel and the unit.

GUIDES TO EFFECTS OF EXPOSURE TO PENETRATING RADIATION

10. Exposure tables submitted by some NATO Nations for the information of all NATO Nations are attached as annexes to this Agreement. These tables are intended to serve as a guide. Agreement with their contents is not implied by the Nations ratifying this STANAG. The tables are subject to revision in the light of future research and experience which may be gained in this field. The circulation of new information throughout NATO is encouraged. Nations are invited to continue to submit new information for incorporation as annexes to this STANAG.

IMPLEMENTATION OF THIS AGREEMENT

11. This STANAG will be considered to have been implemented when the necessary orders/instructions to use the information contained in this Agreement have been issued to the forces concerned.

NATO-UNCLASSIFIED

ANNEX A(DofA) TO STANAG 2083

COMMANDER'S GUIDE ON THE ACUTE EFFECTS
OF WHOLE-BODY PENETRATING IONIZING RADIATION OF
PERSONNEL

(Information submitted by the United Kingdom)

(This table applies equally to initial and residual gamma radiation)

Serial (a)	Dose Received in less than 24 hours (b)	Effect (Post-Exposure) (c)
1	0-200 rads	No acute effects but increasingly serious long term hazard.
2	200-350 rads	Incapacitation in 9-24 hours. Some deaths.
3	350-500 rads	Incapacitation in 5-24 hours. Many deaths.
4	500-1,000 rads	Incapacitation in about 3-24 hours. Most die.
	Dose received in more than 24 hours to 2 weeks	
5	0-200 rads	No acute effects.
6	200-500 rads	Incapacitation from about 1 week. Many deaths.
7	500-1,000 rads	Incapacitation from about 4 days. Most die.

NOTES:

- (1) It is currently estimated that an instantaneous whole-body dose of 5,000 to 10,000 rads would lead to immediate incapacity; i.e. loss within about 1 minute, of the capability to perform an organized task.
- (2) These figures should only be used as a broad guide since:
 - a. Whole-body dose will only occur rarely and partial dose due to partial body shielding will be more common.
 - b. Individuals will vary in their resistance to radiation injury.
 - c. Individual reaction to radiation will occur.
 - d. Mechanical injury will affect the biological response to radiation injury.
 - e. Estimates of whole-body absorbed dose are likely to be only $\pm 50\%$ accurate.
- (3) For operational planning in combat situations, biological recovery is not significant during a one or two weeks' protracted exposure.

AMENDMENT NO. 1.

NATO-UNCLASSIFIED

NATO-UNCLASSIFIED

Annex 'B' (DofA) to STANAG 2083

EFFECTS ASSOCIATED WITH VARIOUS EXPOSURES TO
PENETRATING RADIATION

(Information submitted by the United States)

Exposure (rad)	Effect
150	Slight but not incapacitating illness in a few individuals.
150-250	Nausea and vomiting within 24 hours in 1/3 to 2/3 of the exposed individuals; routine tasks possible but sustained combat, etc., hampered for 6-12 hours; hospitalization required for approximately 50% of exposed individuals within 3 weeks postexposure.
250-500	Nausea, vomiting, and fatigue in most individuals; may perform routine tasks, with increasing hampering of sustained effort; hospitalization required for all exposed personnel within 14 days postexposure; death may approach 50%.
500-1000	Incapacitation within 6 hours in most exposed individuals; hospitalization for all within 7 days; ultimate deaths approaching 100%.
1000	Incapacitation within a few hours; hospitalization required for all; ultimate death for all exposed individuals within 2 weeks.

Notes:

1. This table is applicable to exposures to either initial or residual hard, penetrating radiations and total body exposures.
2. It is assumed that the indicated exposures, if received within 1 day to 1 week, will have similar effects and will apply to individuals exposed for the first time or following an interval that would permit "full" recovery from previous exposures.

NATO-UNCLASSIFIED

NATO-UNCLASSIFIED

Annex 'C' (DofA) to STANAG 2083

SYMPTOMS AND PROBABLE EFFECTS FOR VARIOUS EXPOSURES TO PENETRATING RADIATION

(Information submitted by the United States)
(Based on total body, single, acute exposure to gamma and/or neutron radiation)

Initial symptoms	Onset of symptoms	Incapacitation	Hospital course	Duration of hospitalization	Final disposition	Estimated exposure range (rad)
None to transient, mild headache.	Approximately 6 hours after exposure if they occur.	None to slight decrease in ability to conduct normal duties.	Hospitalization required for less than 5% in upper part of exposure range.	45-60 days in upper part of range.	Duty. No deaths anticipated.	50-200
Headache, nausea, and vomiting; malaise. Symptoms not relieved by antiemetics in upper part of exposure range.	Approximately 4-6 hours after exposure.	Can perform routine tasks. Sustained combat or comparable activities hampered of 6 to 20 hours.	Hospitalization required for 90% of exposed personnel in this range. Hospitalization follows latent period of 17-21 days duration.	60-90 days.	Some deaths anticipated; probably less than 5% at lower part of range, increasing toward upper end.	200-250
Nausea and vomiting prolonged, intractable, and severe. Diarrhea and fever early in upper part of exposure range.	Approximately 1-4 hours after exposure.	Can perform only simple routine tasks. Significant incapacitation in upper part of exposure range. Lasts more than 24 hours.	Hospitalization required for 10% of exposed personnel. Latent period short, 7-10 days in lower range to none in upper range.	90-120 days for the surviving.	Approximately 50% deaths at lower part of range, increasing toward upper end; all deaths occurring within 45 days.	500-1000
Severe vomiting, diarrhea, and prostration. Disorientation, lack of muscular coordination, and coma in upper part of range.	Less than 1 hour after exposure.	Progressive incapacitation following an early capability for intermittent heroic response.	Hospitalization required for 100% of exposed personnel. No latent period.	3-30 days.	100% deaths occurring within 30 days.	Greater than 1000

NATO-UNCLASSIFIED

NATO-UNCLASSIFIED

Annex 'D' (DofA) to STANAG 2083

**SCHEMATIC SHOWING RELATIONSHIP BETWEEN
REMAINING RADIATION SERVICE CATEGORIES AND RISK LEVELS**

(Information submitted by the United States)

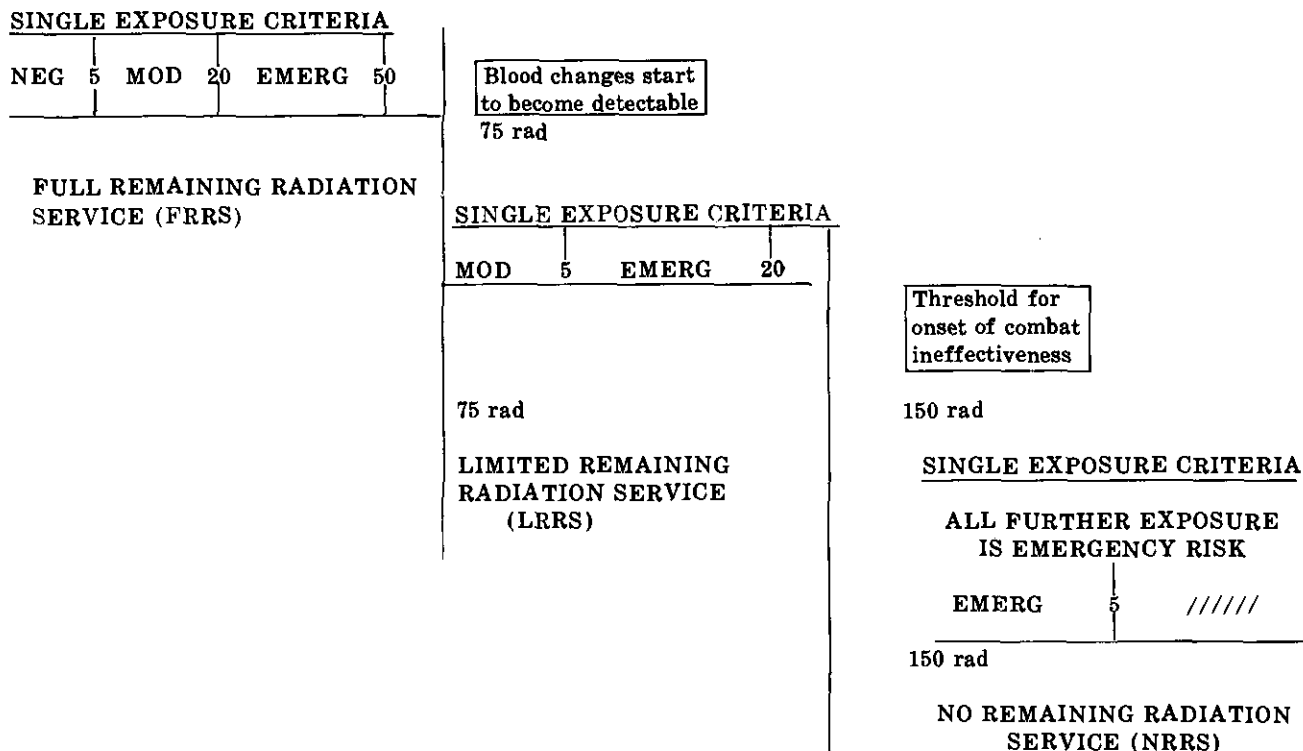

Notes:

1. Remaining radiation service categories account for previous exposure history.
2. Risk levels are graduated with Remaining Radiation Service (RRS) categories in order to provide more stringent criteria as the accumulation of dose becomes more serious.
3. No allowance is made for recovery from radiation injury. All exposures are considered to be simply additive.
4. Reclassification of units from a more serious Remaining Radiation Service (RRS) category to a less serious one is done by the commander upon advice of the surgeon after ample observation of actual state of health of the exposed armed forces personnel has been made.

NATO-UNCLASSIFIED

Annex 'E' (DofA) to STANAG 2088

**NUCLEAR RADIATION ARMED FORCES PERSONNEL SAFETY
CRITERIA**

(Information submitted by the United States)

Status	Criteria
FRRS Units (Total past cumulative dose <75 rad)	NEGLECTIBLE RISK <5 rad MODERATE RISK >5, ≤20 rad EMERGENCY RISK >20, ≤50 rad (Use appropriate column in FM 101-31-2, 3 for armed forces personnel safety exposure to friendly weapons)
LRRS Units (Total past cumulative dose >75, <150 rad)	Risk levels for this category will be either MODERATE or EMERGENCY MODERATE RISK ≤5 rad (Use Negligible Risk columns in FM 101-31-2, 3 for armed forces personnel safety exposure to friendly weapons) EMERGENCY RISK >5, ≤20 rad (Use Moderate Risk columns in FM 101-31-2, 3 for armed forces personnel safety exposure to friendly weapons)
NRRS Units (Total past cumulative dose >150 rad)	All future exposure is considered to be EMERGENCY RISK (Use Negligible Risk column in FM 101-31-2, 3 for armed forces personnel safety exposure to friendly weapons)

Note. For operations in radiologically contaminated areas, use any number in the risk range appropriate to the Remaining Radiation Service (RRS) status and the mission for the operation exposure guidance.

NATO-UNCLASSIFIED

STANAG No. 2087

DETAILS OF AGREEMENT
MEDICAL EMPLOYMENT OF HELICOPTERS IN
GROUND WARFARE

GENERAL

1. It is agreed that the NATO Armed Forces will follow the principles outlined herein in planning for and organizing the medical employment of helicopters in ground warfare, missions which fall within the purview of the Army regardless of which force operates the helicopters.
2. Control of operations will be done according to local directives and the organization of the forces concerned.
3. Emergency helicopter evacuation is concerned with the prompt movement of medical or surgical patients where rapid, atraumatic evacuation or treatment will reduce morbidity and mortality. Such patients must be picked up as soon after the request for air evacuation as possible and evacuated directly to designated treatment facilities.
4. Routine helicopter evacuation is used when surface means are either non-existent or inadequate or where aerial evacuation is more effective. In these cases, time is not of the same essence as in the emergency category. If properly prepared prior to evacuation routine air evacuees will require only nominal in-flight medical care.
5. Helicopter ambulances are used as far forward as the tactical situation will permit. If necessary, this may apply to evacuation from enemy territory.

REQUEST FOR EVACUATION

6. The unit surgeon initiates helicopter evacuation missions by direct contact with the surgeon of the command echelon concerned, i.e. the battle group/regiment, the division, the corps, the army. Requests for these missions may be processed through medical technical channels or command channels according to local directives and the organizations of the force concerned.
7. In order that the surgeon and the controlling agency may be able properly to evaluate and establish priorities for evacuation, requests should contain the number of cases to be evacuated, the diagnosis of each case and the qualification 'in-board' or 'out-board' patient. Requests must include the exact location by grid coordinates, identification of the landing site, the time patients will be ready for evacuation and any requirements for special items of medical supplies or whole blood and for medical personnel to act as escort.

PRIMARY MEDICAL MISSION

8. The primary mission of medical air ambulance units and helicopters made available for medical purposes is to provide aeromedical evacuation for selected patients.

NATO-UNCLASSIFIED

NATO-UNCLASSIFIED

SELECTION OF PATIENTS

9. Based upon the decision of the medical officer in charge, suitable types of casualties for helicopter evacuation will be:
 - a. Those for whom helicopter evacuation is necessary as life saving measure.
 - b. Those who, by prognosis, would definitely benefit by helicopter evacuation.
 - c. Those who urgently require specialized treatment.
 - d. Those who are liable to suffer unnecessary pain or discomfort unless evacuated by helicopter.
 - e. Those likely to go into shock as a result of prolonged or rough surface evacuation.

SECONDARY MISSIONS

10. Secondary missions of helicopters made available for medical purposes should include:
 - a. Airlift of critical medical supplies.
 - b. Aerial movement of medical specialist personnel.
 - c. Movement of casualties to hospitals capable of providing specialized surgical treatment.
 - d. Other medical evacuation missions as required.

LOADING AND SECURING

11. The pilot of the aircraft is responsible for seeing that the prescribed methods of loading litters and related equipment, and securing same as outlined in the applicable flight handbook, are followed by the personnel loading casualties in the helicopter. The final decision as to how many litter patients may be safely loaded, and where those patients may be loaded, lies with the pilot in command of the aircraft.
12. Ground medical personnel on the landing area will be responsible for the landing, loading and securing of patient evacuees. Training of these personnel will include:
 - a. Familiarization with all types of helicopter capable of performing medical evacuation missions;
 - b. Familiarization with the medical care likely to be required during flight and with the special medical equipment necessary for this purpose.
 - c. Demonstrations of the various types of safety devices used for the transportation of casualties by helicopter.
13. In the absence of medical military personnel in the landing area, the senior military authority present will be responsible for landing, loading, and securing the patient evacuees.

MISCELLANEOUS

14. Medical agencies are also responsible for:
 - a. The movement of patients to and from helicopter landing sites.
 - b. Rapid loading and unloading of patients.
 - c. In-flight medical care.

NATO-UNCLASSIFIED

NATO-UNCLASSIFIED

15. Communications facilities between the body in control of evacuation missions, the helicopters, and the requesting body must be provided whenever possible. Communications will be minimized by accurate information in the original request for ambulance service. Changes in the tactical situation may require a change in the landing point or rerouting of the flight.

PREPARATION AND MARKING OF LANDING SITES

16. The following factors must be considered when selecting and identifying landing sites:

a. *General:* Landing areas and approaches thereto should be free from obstruction. Enclosed areas of restricted space, such as small clearings, etc will be avoided. Sufficient room must be provided for hovering and manoeuvring of the helicopter during landing and takeoff. Approaches should permit the helicopter to land and take-off into the prevailing wind wherever possible. It is desirable that, where possible, landing sites should afford helicopter pilots the opportunity of making shallow approaches.

b. *Size:* While definite measurements for landing sites cannot be prescribed since they must vary with temperature, altitude, wind, terrain, loading conditions and individual helicopter characteristics, minimum requirements are a cleared area 100 feet in diameter with approaches clear of obstruction, for light helicopters. This circle could be outlined with some such material as engineer tape, rocks, etc, of a color contrasting with the background, to facilitate identification.

c. *Marking Obstructions:* Obstacles, at or near landing sites, such as cables, wire, etc which cannot be removed and may not be readily seen by a pilot, must be clearly marked. In this connection any object likely to be blown about by the wind from the rotor, such as paper, cartons, cloth, parachutes, etc should be removed from the landing ground.

d. *Identification:*

(1) Where the tactical situation permits, a landing site should be marked with a letter H.

(2) If the tactical situation permits, the wind direction may be indicated by a small wind sock displayed in the vicinity of the site; or, alternatively, by a man placed at the upwind edge of the landing site with his back to the wind and his arms extended forward; or by a large smoke pot set off as soon as the helicopter is sighted.

(3) The marshalling signals to be employed on a landing site are set out in STANAG No. 3117.

NATO-UNCLASSIFIED

NATO-UNCLASSIFIED

STANAG 2128

NAVY/ARMY/AIR

DETAILS OF AGREEMENT (DofA)
MEDICAL AND DENTAL SUPPLY PROCEDURES

AGREEMENT

1. The NATO Armed Forces have agreed to adopt for the use by their Medical Services:
 - a. Standardized procedures for the exchange, at all levels within a Theatre of operations, of non-expendable items of medical and dental property required to accompany patients during the process of evacuation from the battlefield to the appropriate medical and dental unit.
 - b. The metric system of weight and measures for dosage information on the labels of medical supplies.
 - c. Standardized colours and procedures to identify the contents of atropine and morphine self-injection devices.

MEDICAL AND DENTAL EXCHANGE PROCEDURES

2. Each nation is to, if possible, return at once to the nation of origin any non-expendable item of medical or dental property accompanying patients of another nation received by them.
3. If it is not possible, items such as stretchers (litters), non-expendable splints, blankets, etc, are to be immediately replaced by the receiving nation who will hand over functional equivalent items in exchange for those received.
4. The handling of non-expendable items of medical or dental property are to, in general, conform to national procedures irrespective of the country of origin of the equipment.
5. Nevertheless, each nation is to undertake to segregate as soon as possible non-expendable items of medical or dental property belonging to another nation and return them to that nation through property exchange points.
6. Property exchange points at which items of equipment are sorted and exchanged with owner nations are to be arranged as circumstances may require at the appropriate levels related to the national administrative control and in accordance with the national supply procedures.
7. Each exchange point is to be staffed with personnel familiar with the items of medical and dental property peculiar to each nation.

LABELS FOR MEDICAL SUPPLIES

8. Medical supplies to be used by the NATO Armed Forces are to be labelled supplies with the metric system of weights and measures.

NATO-UNCLASSIFIED

NATO-UNCLASSIFIED

9. It is further agreed that where countries are in a transitional period (i.e., changing from avoirdupois to metric system) these countries are to label supplies with both metric and avoirdupois systems.

COLOURS FOR ATROPINE AND MORPHINE SELF-INJECTION DEVICES

10. One or more circular bands coloured **BRIGHT RED** are to encircle the syrettes and/or containers for morphine self-injection devices.

11. One or more circular bands, coloured **BRIGHT YELLOW**, are to encircle the syrettes and/or containers for atropine or equivalent self-injection devices.

12. Other markings may be placed, according to national legislation dealing with toxic matter, on the labels on morphine and atropine self-injection devices. However, the colours **BRIGHT RED** for morphine and **BRIGHT YELLOW** for atropine should be used.

NATO-UNCLASSIFIED

APPENDIX E

MEDICAL UNITS

Section I. GENERAL

E-1. General

This appendix describes the missions, capabilities, limitations, organizational characteristics, and employment modes of nondivisional medical units in a theater of operations, and includes staff functions, duties of personnel, and concepts of operations. It is based on TOE current at the time of publication of the manual.

E-2. Kinds of Medical Units

Each medical unit is designed to perform a specific function, or group of functions. Since some jobs are large, units to perform the jobs are correspondingly large. Such units are normally self-sufficient; they have built-in mess, personnel administration, motor maintenance, and other non-mission capabilities. Units of this kind are usually of company size or larger and each has an individual TOE number. Other units are small and

do not have any nonmission, self-support capabilities. They range from command units through a wide range of units that provide specialized or augmentation support. Such units are called cellular units or teams, and most are authorized in TOE 8-500G. Teams are normally either satellited on larger units for administrative support or are formed into provisional organizations that include command units and administrative support units. Succeeding sections of this appendix contain descriptions of medical units under the following groups:

- a. Section II: Command and Control Units.
- b. Section III: Patient Evacuation Units.
- c. Section IV: Hospital Units.
- √d. Section V: Medical Supply Units.
- e. Section VI: Professional Service Units.
- f. Section VII: Veterinary Units.
- g. Section VIII: Preventive Medicine Units.
- h. Section IX: Other Medical Units.

Section II. COMMAND AND CONTROL UNITS

E-3. Headquarters and Headquarters Company, Medical Command (TOE 8-111 T)

a. *Mission.* The mission of the headquarters and headquarters company, medical command, is to command and control all attached and assigned health service units and to provide communications zone level medical support within a theater (area) of operations.

b. *Assignment and Basis of Allocation.* The headquarters and headquarters company, medical command, is assigned to the theater army support command or to theater army on the basis of one per theater army support command or theater army.

c. *Capabilities.* The headquarters and headquarters company, medical command, provides the following:

(1) Command, control, staff planning and supervision of operations, training, and adminis-

tration of three to seven hospital centers or an equivalent mix of hospital centers and medical groups engaged in providing communications zone level health services.

(2) Medical regulating functions.

(3) Professional specialty consultation service.

(4) Policy and guidance for management of medical materiel and medical equipment maintenance.

(5) Medical staff services to include—

(a) Keeping the TASCOM commander and his staff informed on the health of the command and on medical aspects of matters affecting combat service support.

(b) Providing current information concerning the medical aspects of the combat service support situation to the surgeons of higher headquarters.

(c) Coordinating medical support operations of the communications zone.

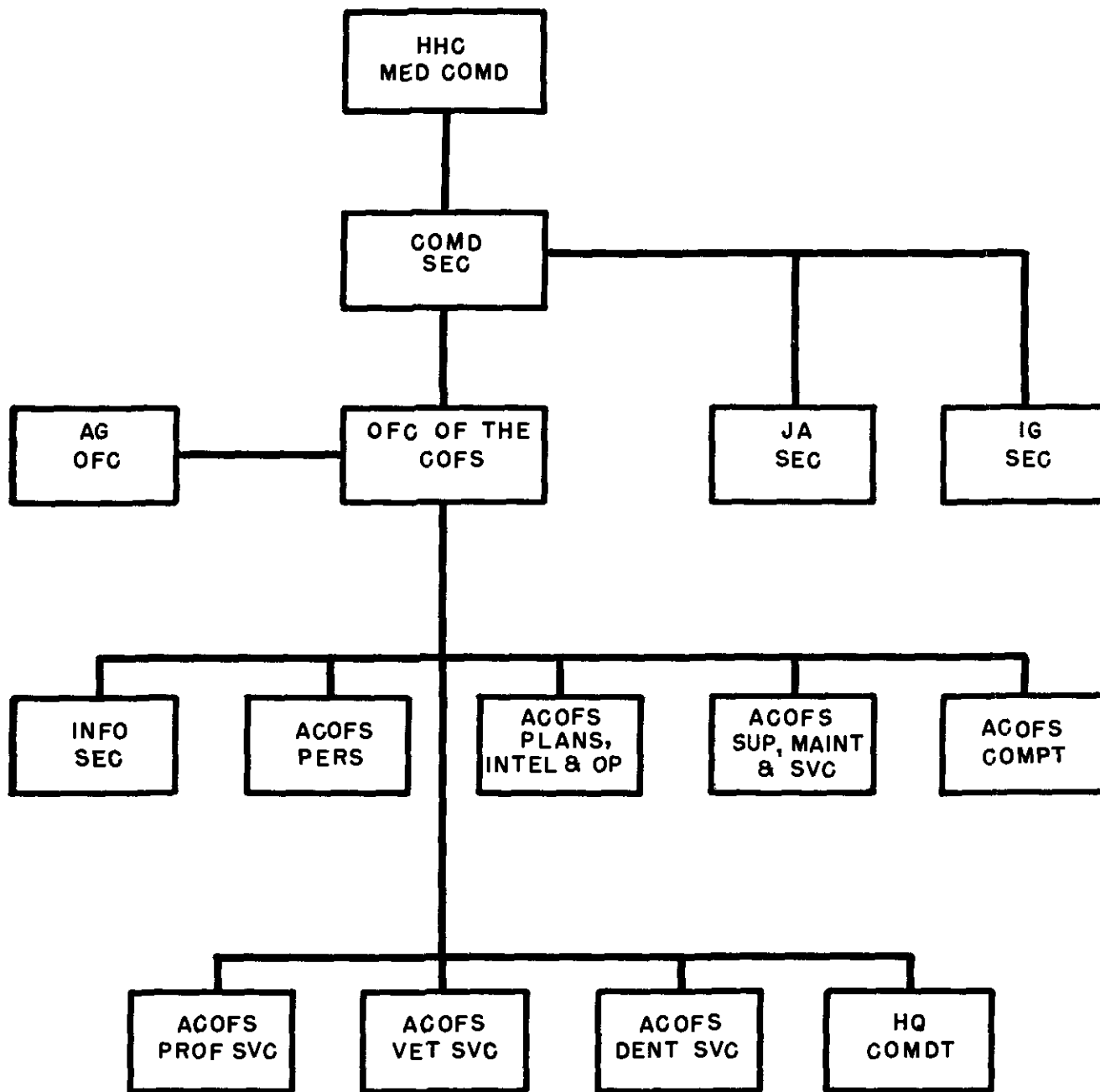

Figure E-1. Medical command headquarters.

(d) Advising the commanders of the TASCOM personnel, supply and maintenance, transportation, engineer, and area support commands on medical matters.

d. *Medical Command Headquarters Staff Organization and Functions.* The medical command staff consists of the following:

(1) *Command section.*

(a) *General.* The commanding general of the medical command is the operator, director,

and commander of the health service units of the COMMZ. He has complete responsibility for the command, control, and supervision of all health service units assigned or attached to the medical command. He is provided the authority, staff capability, and operating units for the accomplishment of the medical support mission.

(b) *Functions, responsibilities, and duties.* The medical command commanding general, assisted by a deputy commanding general for professional services, and a deputy commanding general

for support services, is charged with responsibility for the following:

1. Commanding and controlling all units assigned or attached to the medical command.

2. Developing, refining, and coordinating medical support plans, in consonance with theater army and theater army support command health plans and as influenced by the assigned mission.

3. Developing health service policy for the COMMZ in conformance with policies of higher headquarters, and implementing procedures to assure adherence to established policy within his area of jurisdiction.

4. Controlling and directing all assigned medical support operations of the communications zone in accomplishment of the assigned mission.

5. Furnishing current information to the TASCOM commander and staff concerning the health of the command, and all aspects of medical support related to combat effectiveness, and combat service support operations.

6. Coordinating with the commander of all TASCOM functional commands, the area support commands, and the commanders of other service units, when indicated, regarding area medical support.

7. Maintaining liaison with the surgeons of higher headquarters and major combat zone units supported for the coordination of health services.

(2) *Chief of staff section.* The chief of staff is the coordinator and supervisor of the general and special staffs. His role calls for directing staff activities to coordinate action and free the commander from routine details. The responsibilities of a chief of staff are described in FM 101-5.

(3) *Adjutant general section.* The adjutant general is assigned operational and technical supervision responsibilities as described in FM 101-5.

(4) *Information section.* The information officer advises the commander and staff on all aspects of command information, public information, and community relations. A discussion of the duties of the information officer is contained in FM 101-5.

(5) *Judge advocate section.* The staff judge advocate provides legal advice to the commander, staff, and subordinate commanders on all matters involving military law, domestic law, foreign law, status-of-forces agreements, and international law. A detailed description of the duties

and responsibilities of the staff judge advocate is contained in FM 101-5.

(6) *Inspector general section.* The inspector general inquires into, and reports on, matters pertaining to the performance of the mission, state of discipline, efficiency, and economy by conducting inspections, investigations, surveys, and studies as directed by the commander and as prescribed by law and regulations. A description of the duties of the inspector general is contained in FM 101-5.

(7) *Assistant chief of staff, personnel.* The assistant chief of staff, personnel, is the principal staff assistant to the commander in the administration and management of individuals under U.S. military control. A discussion of the functional areas of administration and management is contained in FM 101-5.

(8) *Assistant chief of staff plans, intelligence, and operations.* The ACofS for plans, intelligence, and operations, plans, coordinates, and supervises activities pertaining to:

(a) Intelligence activities of the medical command to include the collecting, processing, and disseminating of intelligence information; intelligence training; censorship activities; and the conduct of security investigations.

(b) Provision of installation-type security for units of the medical command and medical command participation in support of rear area protection.

(c) Preparation of current and midrange plans, policies, procedures, and programs pertaining to health service operations and functions.

(d) Organization of the medical command to include the compilation and submission of the phased troop basis for the medical command to higher headquarters.

(e) Selection and allocation of medical troops by types and numbers required to support the medical command mission.

(f) Relocation and attachment of units assigned to the medical command.

(g) Priorities to allocate equipment in short supply within the medical command.

(h) Conduct of inspection of units, installations, and activities within the medical command.

(i) Training of subordinate units.

(j) Medical regulating in the communications zone.

(k) Construction of medical treatment and hospitalization facilities or modifications of existing facilities.

(l) Medical automatic data processing system (ADPS) design.

(m) Medical support for communications zone civil affairs operations and medical civic action programs and projects when directed.

(n) Assignment of health service task responsibilities.

(9) *Assist chief of staff, supply, maintenance, and services.* The ACofS for supply, maintenance, and services, plans, coordinates, and supervises medical command activities pertaining to:

(a) General supply and maintenance.

(b) Management of medical materiel.

(c) Management of medical equipment maintenance.

(d) Local procurement of emergency medical supplies required by medical command units.

(e) Spectacle fabrication.

(f) Supply and maintenance inspections within the medical command.

(g) Evacuation or disposition of excess, surplus, and salvage materiel.

(h) Development of requirements for acquisition, allocation, administration, and disposition of medical command installations, facilities, and real estate.

(i) Development of requirements for communications and ADPS services required for support of the medical command as pertains to medical supply activities.

(j) Allocation of supplies and equipment in critical supply within the medical command in accordance with priorities established by the ACofS, plans, intelligence, and operations.

(k) Performance of materiel readiness and other duties as prescribed in FM 101-5.

(10) *Assistant chief of staff, comptroller.* The ACofS, comptroller, serves as principal staff officer to the commander for those activities pertaining to management engineering; reviewing internal controls; controlling reports; programing and budgeting; and reviewing established ADPS and automatic data processing equipment (ADPE) utilization. The management engineering functions are responsive to conducting management surveys, special fiscal studies, and administering the reports control program of the command. The program/budget functions are responsive to analyzing funding programs and budgeting guidance and recommending courses of action; coordination and development of a command position on budgeting matters and preparation of reports; and performing periodical analy-

sis of fund utilization. The data services functions are responsive to reviewing established ADPS and ADPE utilization; coordinating changes in ADPS requirements with TASCOC headquarters; and maintaining inventory and operating status reports of ADPE assigned to command and subordinate elements. The internal review function is responsive to conducting internal reviews involving security controls and procedures for achieving goals; auditing nonappropriated funds; interpreting regulations and directives governing nonappropriated funds and indoctrinating responsible personnel; and processing reports of surveys.

(11) *Assistant chief of staff, professional services.* The ACofS, professional services section, provides the necessary professional consultant personnel to supervise activities pertaining to:

(a) The practice of medicine and surgery within communications zone medical treatment facilities.

(b) Preventive medicine.

(c) Neuropsychiatric service.

(d) Blood transfusion service within the theater of operations.

(e) Nursing service.

(f) Dietetic service.

(g) Training of professional personnel.

(12) *Assistant chief of staff, veterinary service.* The command veterinarian is responsible for:

(a) Advising commanders and their staffs on veterinary matters.

(b) Preparing the veterinary portion of plans and policies.

(c) Planning and supervising veterinary activities.

(d) Establishing priorities for the assignment of veterinary service personnel.

(e) Establishing priorities for issue of veterinary equipment in short supply.

(f) Advising veterinary staff officers of higher headquarters on veterinary matters.

(g) Exercising operational control over veterinary units attached to subordinate commands not authorized a veterinary staff officer.

(h) Preparing reports on veterinary activities of the MEDCOM.

(13) *Assistant chief of staff, dental service.* The dental surgeon is responsible for:

(a) Advising the TASCOC and the MEDCOM commanders and their staffs on dental matters.

(b) Preparing the dental portion of TASCOC and MEDCOM plans and policies.

(c) Planning and supervising the dental activities.

(d) Establishing priorities for assignment of dental service personnel.

(e) Establishing priorities for issue of dental equipment in short supply.

(f) Advising dental surgeons of higher commands on dental matters.

(g) Exercising operational control over dental units attached to subordinate commands not authorized a dental staff officer.

(h) Providing policy for the management of dental materiel.

(i) Preparing reports on dental activities of the MEDCOM.

(14) *Headquarters commandant.* The headquarters commandant exercises operational control over headquarters troops not assigned or attached to subordinate commands. His specific duties are described in FM 101-5.

(15) *Headquarters company.* The headquarters company is responsible for the general housekeeping support of the command headquarters to include mess, vehicle maintenance, and limited administration.

e. Concept of Operations. The medical command headquarters is responsible for command, control and supervision of assigned and attached units. The primary function is planning for and executing communications zone medical support. The following are descriptions of the medical relationships with other headquarters units:

(1) *Command and control.* The TASCOM commander, or theater army commander when a TASCOM is not employed, exercises command and control over all assigned or attached troops (including those assigned to the MEDCOM). The MEDCOM commander exercises command and control over all assigned and attached medical units. He also commands and controls any nonmedical unit assigned or attached to the MEDCOM for support of communications zone health service operations.

(2) *Planning.* The MEDCOM commander provides assistance in preparing broad plans, policies, and directives for implementing so much of the theater army plans as pertain to COMMZ health services.

(3) *Coordination and liaison.* The MEDCOM commander conducts liaison and coordinates with the other major mission commands of the TASCOM and appropriate Air Force and Navy headquarters to insure the overall adequacy of the support received or provided.

f. Mobility. The medical command headquar-

ters and headquarters company is 20 percent mobile.

E-4. Headquarters, Hospital Center, Team A11, TOE 8-500G

a. Mission. The mission of the headquarters hospital center is to command and control two to eight general hospitals or their equivalent in a combination of general hospitals and other health service units.

b. Assignment and Basis of Allocation. Team AH is assigned to the medical command on the basis of 1 per 8,000 fixed beds required.

c. Capabilities. The headquarters, hospital center commands and controls two or more general hospitals. It is capable of assisting assigned hospitals by coordinating and consolidating a major portion of the administrative detail connected with the operation of these hospitals.

d. Organization. A brigadier general commands the headquarters, hospital center. Twelve additional commissioned officers are assigned to this headquarters. Enlisted personnel with the appropriate training in required specialties are also provided. The duties of personnel assigned to this headquarters are as follows:

(1) *Commanding general.* The commanding general is responsible for the organization, operation, administration, and discipline of the entire center. The center commander maintains liaison with the appropriate higher headquarters regarding the operation of the center, its incoming patients, and the center's requirements with respect to evacuation means, such as ambulance trains, air ambulance means, and field ambulance units.

(2) *Administrative officer.* An administrative officer provides administrative support for the headquarters.

(3) *Plans and operations officer.* The operations officer supervises and coordinates the overall training program adopted for the hospital center's assigned units. He keeps the center commander informed on all matters relating to the current status, changes, and directives from higher authority pertaining to operations and training procedures within the center. He also prepares the necessary operational plans and the operational orders, rules, and local regulations for publication by center headquarters. Other duties include serving as the center medical regulating officer, and exercising general supervision over the defensive measures employed to safeguard center installations and the communications system thereof.

(4) *Dental staff officer.* The staff dental officer coordinates, and acts as consultant for, the dental service of the hospitals assigned to the center. He also acts as a special staff officer to the center commander.

(5) *Veterinary staff officer.* The veterinary staff officer coordinates and acts as consultant for the veterinary service detachments assigned or attached to the center and also performs such other special staff duties pertaining to veterinary service matters as may be directed by the center commander.

(6) *Chief nurse.* The chief nurse acts as an adviser and consultant to the center commander on all matters pertaining to the Army nursing service and the Army Nurse Corps. The chief nurse consults with the staff medical officer relative to medical plans and policies having implications for nursing service and its function and inspects nursing activities to insure adherence to established nursing service standards, policies, and training.

(7) *Sanitary engineer officer.* The sanitary engineer acts as staff adviser to the center commander on all phases of environmental health engineering. He plans and directs a comprehensive environmental health program to reduce adverse effects of actual or potential health hazards; reviews plans and specifications for medical facility construction; and makes periodic inspections of the center's physical facilities and utilities. He also conducts environmental engineering investigations and prepares reports and recommendations.

(8) *Staff supply officer.* The center headquarters supply officer advises the center commander on matters pertaining to the supply situation of the center and of the headquarters. The staff supply officer assists attached units in obtaining supplies, edits supply requisitions for discrepancies, directs the disposition of excess supplies by transfer to units requiring the items, reviews and recommends revision of stock levels where necessary, and inspects the supply services of the hospitals to insure that operations are being conducted in accordance with prescribed directives. The staff supply officer also supervises the center's laundry facilities and services.

(9) *Executive officer.* The executive officer is the principal administrative assistant to the center commander. In this capacity, he supervises the administrative function of the headquarters.

e. Concept of Operations.

(1) *Location.* Hospital center installations are located in the communications zone. Since the

hospital center headquarters, including its assigned hospitals, requires not only extensive ground areas but certain adjuncts (water, power, and sewerage disposal facilities) for its operations, ideal sites are seldom encountered. However, so far as possible, the center's location should conform to established principles regarding the locating of medical installations of this type. These basic principles include the adaptability of existing physical plant structures to the center's requirements.

(2) *Centralized functions.* The headquarters, hospital center commander and staff, using their centralized facilities, correlate and coordinate the overhead activities of attached hospitals. They assist the attached hospital staffs by coordinating and consolidating a major portion of the administrative details associated with such services as supply and maintenance, transportation, utilities, and similar essential services. These actions result in the immediate advantage of an economical utilization of personnel and equipment. The hospital center commander exercises control over the movement of patients to and from hospitals assigned to the center. Certain hospitals operating under the center headquarters may be staffed and equipped to provide specialized treatment. Thus, the hospital center affords the opportunity for increased specialization in certain fields of medicine. This procedure insures the additional advantage of fully utilizing the skills possessed by highly qualified medical professional personnel.

f. Mobility. This unit operates as a fixed installation. Organic transportation provided the headquarters, hospital center, is sufficient only for administrative and housekeeping purposes of the unit. In the event this headquarters must move, additional transportation will be required. Responsibility for providing this additional transportation will be that of the higher commander under which the headquarters, hospital center, is functioning. The hospital center headquarters is 25 percent mobile.

g. Attached Units. In order to properly accomplish the mission, the hospital center organization requires various specialized services including supply, maintenance, engineer, finance, military police, and postal unit attachments.

h. Contingency Employment in the Event of Mass Casualties. In the event of an enemy nuclear, biological, or chemical attack resulting in large numbers of patients, this headquarters can function as a command and control headquarters

in directing medical operations in support of the affected area.

E-5. Headquarters and Headquarters Detachment, Medical Brigade (TOE 8-112G)

a. Mission. The mission of the headquarters and headquarters detachment, medical brigade, is to command and control all attached or assigned units and to provide army level medical support within a field army.

b. Assignment and Basis of Allocation. Medical brigade headquarters and headquarters detachment is assigned to the field army on the basis of one per field army support command.

c. Capabilities. The headquarters and headquarters detachment, medical brigade, provides the following:

(1) Command, control, staff planning, and supervision of operations, training, and administration of three to seven medical groups or their equivalent of attached units engaged in providing field army level medical support.

(2) Special staff services to include:

(a) Keeping the FASCOM commander and his staff informed on the health of the command and on the medical aspect of matters affecting combat service support to the Army.

(b) Advising the FASCOM commander and his staff on all medical professional and technical matters.

(c) Developing, preparing, and coordinating the medical portion of the FASCOM plans and policies.

(d) Providing current information concerning the medical aspects of the combat service support situation to the surgeons of higher headquarters.

(e) Coordinating medical support operations of the field army.

(f) Field army medical regulating.

(g) Field army medical supply.

d. Medical Brigade Headquarters Staff Organization and Functions.

(1) *Brigade headquarters.*

(a) *General.* The medical brigade commanding general is the operator, director, and commander of all units attached or assigned to the brigade headquarters. He is provided the authority, staff capability, and operating units for the accomplishment of the field army medical support mission.

(b) *Functions, responsibilities, and duties.* The medical brigade commanding general, assisted by a deputy commander, dental surgeon,

veterinary staff officer, chaplain, executive officer, adjutant, operations and training officer, supply officer, personal aid, and sergeant major, is responsible for the following:

1. Commanding and controlling all medical units assigned to the field army.

2. Developing, refining, adjusting, coordinating, and implementing medical plans in consonance with the assigned mission.

3. Developing medical policy in consonance with policies of higher headquarters and implementing procedures to assure adherence to established policy.

4. Controlling and directing the area health services and medical support operations.

5. Furnishing current information concerning the health of the FASCOM, the command aspects of medical matters affecting combat effectiveness and combat operations, and combat service support operations.

6. Maintaining medical liaison and coordinating medical professional and technical matters with the surgeons of higher, lateral, and subordinate headquarters.

(2) *Detachment headquarters.* The detachment headquarters, commanded by the adjutant, provides mess, motor maintenance, and clerical personnel to support the brigade headquarters.

(3) *Personnel administration section.* This section provides for:

(a) Management of military and civilian personnel as individuals; manpower management; reports; and personnel replacements for the brigade.

(b) Medical records and medical reporting.

(c) Administration of labor management policies and their execution with respect to non-U.S. civilian employees and prisoner-of-war labor.

(d) Development and maintenance of morale.

(e) Discipline, law, and order.

(f) Graves registration.

(g) Patient status reporting.

(h) Decorations and awards.

(i) Headquarters management.

(j) Miscellaneous administrative services to include reception of visitors; personnel aspects of estimates, plans, orders, reports, and administrative matters not assigned specifically to another section.

(4) *Plans, intelligence, and operations section.* The plans and operations officer coordinates and supervises activities pertaining to—

(a) Intelligence activities of the medical brigade to include the collecting, processing, and disseminating of intelligence information; intelligence training; censorship activities; and the conduct of security investigations.

(b) Installation-type security for units of the medical brigade and participation in support of rear area protection operations.

(c) Current and midrange plans, policies, procedures, and programs to health services operations and functions.

(d) Selection and allocation of medical units by types and numbers required to support the medical brigade mission.

(e) Relocation and attachment of medical units attached to the medical brigade.

(f) Priorities to allocate equipment in short supply within the medical brigade.

(g) Inspection units, installations, and activities within the medical brigade.

(h) Training of subordinate units.

(i) Medical regulating in the combat zone.

(j) Medical support for combat zone civic action operations.

(k) Assignment of medical task responsibilities.

(l) Unit readiness activities.

(5) *Supply section.* The supply officer coordinates and supervises medical brigade activities pertaining to:

(a) General supply and maintenance.

(b) Management of medical materiel.

(c) Management of medical equipment maintenance.

(d) Local procurement of emergency medical supplies required by medical brigade units.

(e) Supply and maintenance inspections within the medical brigade.

(f) Evacuation and disposition of excess, surplus, and salvage materiel.

(g) Development of requirements for acquisition, allocation, administration, and disposition of medical brigade installations, facilities, and real estate.

(h) Development of requirements for communications and automatic data processing services required for support of the medical brigade as pertains to medical supply activities.

(i) Allocation of supplies and equipment in critical supply within the medical brigade in accordance with priorities established by the ACofS, intelligence and operations.

(j) Performance of materiel readiness duties as outlined in FM 101-5.

(k) Supervision of food service activities of the brigade.

(l) Unit readiness activities.

(6) *FASCOM surgeon section.* The FASCOM surgeon section is composed of plans, medical supply and maintenance officer, and necessary administration personnel to assist the brigade commander in his role as FASCOM surgeon.

e. Duties of Dental Surgeon, Veterinary Staff Officer, Chaplain, and Comptroller.

(1) *Dental surgeon.* The dental surgeon (normally designated as the FASCOM dental surgeon) plans and coordinates the dental activities of the medical brigade and exercises technical supervision over dental units and personnel assigned or attached to the medical brigade. He normally is delegated operational control over subordinate dental units.

(2) *Veterinary staff officer.* The veterinary staff officer (normally designated as the FASCOM veterinary staff officer) plans and coordinates veterinary activities of the field army and exercises technical supervision over veterinary units and personnel attached or assigned to the medical brigade. He normally is delegated operational control over subordinate veterinary units.

(3) *Chaplain.* The chaplain provides staff and technical supervision of religious activities throughout the brigade. In addition to the staff duties of chaplains as discussed in FM 16-5, and as outlined in FM 101-5, the brigade staff chaplain performs the following specific functions:

(a) Furnishes recommendations for the assignment and professional use of chaplain personnel and their enlisted assistants.

(b) Develops plans and coordinating procedures for a sustained program of denominational religious services throughout the brigade.

(c) Develops and coordinates plans for area religious activities.

(d) Furnishes the chaplain portion of brigade contingency plans and provides implementing procedures for shifting brigade chaplain personnel in support of brigade medical units handling mass casualties or an unusual flow of patients.

(4) *Comptroller.* The position of comptroller is not contained in TOE 8-112G; however, a comptroller may be assigned when the degree of budgeting and management restrictions imposed during peacetime and during stability operations so warrants. Establishment of this position requires the approval of the theater army commander. Specific comptroller functions that may

be performed and a recommended organizational structure of that office are identified in FM 14-3.

f. Concept of Operations. The concept of operations and command relationship are discussed in chapter 4.

g. Mobility. The medical brigade headquarters and headquarters detachment is 80 percent mobile.

E-6. Headquarters and Headquarters Detachment Medical Group (TOE 8-122G)

a. General. The medical group headquarters is one of the major subordinate command and control elements of the theater army medical command and is the major subordinate command of the field army medical brigade. The medical group headquarters receives mission type orders and attachment of medical units from the medical command and medical brigade.

b. Mission.

(1) *Type A.* The mission of the type A medical group headquarters is to provide command, control, and administrative supervision of attached medical units.

(2) *Type B.* The mission of the type B medical group headquarters is identical as that of the type A headquarters with the added mission of providing medical special staff services to the headquarters of a corps support command.

c. Assignment and Basis of Allocation.

(1) *Type A.* The type A medical group headquarters units are assigned to the theater army medical command on the basis of four per COMMZ in support of each field army, to the field army medical brigade on the basis of two per corps supported, and three per independent corps.

(2) *Type B.* The type B medical group headquarters unit is assigned to an independent corps on the basis of one per independent corps.

d. Capabilities.

(1) *Type A.* The type A unit provides command, control, staff planning, and supervision of operations, training, and administration of three to seven nondivisional medical battalions, or their equivalent; limited administrative support of attached units; and staff advice to a headquarters providing combat service support to an army corps or comparable force.

(2) *Type B.* The type B unit capabilities are generally the same as the type A organization; however, the type B capabilities are modified to permit the headquarters to function as the principal medical command and control headquarters in an independent corps.

(3) Both types of group headquarters are dependent upon subordinate or adjacent units for messing and organizational maintenance.

e. Organization. The medical group headquarters and headquarters detachment consists of a group headquarters, organized into "S" type staff sections; a detachment headquarters; an administrative section; a plans, intelligence, and operations section; and a supply section. When dental or veterinary units are attached, the group may be provided with dental and veterinary headquarters units for command and control.

(1) *Group headquarters.* The personnel of the headquarters perform command, staff planning, coordination, and supervision of the units attached to the group. There are five officers assigned. They include the commander, the executive officer, the adjutant, the operations and training officer, and a supply officer.

(2) *Detachment headquarters.* The adjutant acts as the detachment commander in addition to other duties. The sergeant major also acts as the first sergeant, with administrative assistance provided by the detachment clerk.

(3) *Administrative section.* The adjutant, with the assistance of a personnel staff noncommissioned officer and clerk-typists, performs the usual headquarters administration. This includes correspondence, filing, and the compilation of medical statistics and reports.

(4) *Plans, intelligence, and operations section.* This section is supervised by the operations and training officer with an assistant operations officer who is designated the intelligence officer. It maintains information concerning units attached to the group and develops operational plans and directives. The liaison officer provides liaison to the supported corps, the medical brigade, and to other medical units. This section operates the group communications center.

(5) *Supply section.* The supply officer supervises the supply, maintenance, transportation, and food services within the group. Duties include:

(a) Development of detailed supply planning in support of group planning. This includes procedures for allocating and monitoring critical items.

(b) Frequent inspections of attached units to determine the status of equipment, stockage, and supply facilities.

(c) Arrangement of food service and maintenance support of the group headquarters.

(d) Supervision of food service activities of units within the group.

(e) Supervision of maintenance and transportation activities.

(6) *Medical special staff section (type B unit)*. The medical special staff element provides personnel for the accomplishment of medical special staff functions at a corps support command headquarters. The medical group commander is also the corps support command surgeon.

f. *Concept of Operations*. Medical units are assigned or attached to the group headquarters by the theater army medical command or the field army medical brigade. This assignment is based on the mission and the medical resources available. A type B medical group, with appropriate attached health service units, will normally be assigned to an independent corps. This group headquarters organization provides for additional personnel to act as medical staff advisers to the independent corps headquarters. A type medical group may consist of a group headquarters unit, medical battalion headquarters units, ambulance company, air ambulance units, clearing companies, collecting companies, surgical hospitals, evacuation hospitals, and cellular medical units of the TOE 8-500G series (fig 4-2.). Medical groups are employed in the combat zone and the COMMZ.

(1) *Combat zone*. In the combat zone the support consists of relieving divisional and nondivisional units of their patients and reinforcing combat zone medical units. Units of the medical group operate as closely as possible to combat units without interfering with combat operations.

(2) *Communications zone*. The nature of the COMMZ requires that medical groups be employed to perform dual-mission responsibilities consisting of medical support to forces in the combat zone and medical support to the COMMZ forces. Medical groups located farther to the rear provide medical support on an area basis. In addition to units shown in figure 4-2, dispensaries, preventive medicine, dental, and veterinary units may be attached to the medical group headquarters.

g. *Mobility*.

(1) *Type A*. The type A medical group headquarters is 65 percent mobile.

(2) *Type B*. The type B medical group headquarters is 50 percent mobile.

h. *Contingency Employment in the Event of Mass Casualties*. In the event of an enemy nuclear, biological, or chemical attack resulting in large numbers of patients, this headquarters can function as a command and control headquarters

in directing health service operations in support of the affected area.

E-7. Headquarters and Headquarters Detachment, Medical Battalion (TOE 8-126G)

a. *Mission*. The mission of the Headquarters and Headquarters Detachment, Medical Battalion, is to provide command, control, and planning for a medical battalion (nondivisional) to include supply and organizational maintenance support.

b. *Assignment and Basis of Allocation*. The Headquarters and Headquarters Detachment, Medical Battalion, is assigned to the medical brigade or independent task force and to the medical command on the basis of one per three to seven medical companies or equivalent units.

c. *Capabilities*. At full strength (level 1) the headquarters and headquarters detachment provides command, administration, and control of three to seven nondivisional medical companies.

d. *Organization*. The unit consists of a battalion headquarters; a detachment headquarters; a plans, intelligence, and operations section; a supply section; and a maintenance section.

(1) *Battalion headquarters*. The personnel in this headquarters perform command, staff planning, and coordination functions, and control the units attached to this headquarters. The headquarters is organized with a modified "S" type staff.

(2) *Detachment headquarters*. The adjutant is also the headquarters and headquarters detachment commander.

(3) *Plans, intelligence, and operations section*. Personnel of this section plan, prepare, order, and supervise execution of all battalion missions. They also perform intelligence, liaison, and troop information functions and supervise area damage control activities. The section functions under the supervision of the operations officer. The assistant plans and operations officer is the intelligence officer.

(4) *Supply section*. The supply officer supervises both this section and the maintenance section. This section provides medical and general supply support for all units attached to the battalion. Small medical units, not part of the battalion, may also be provided medical supply support by this section.

(5) *Maintenance section*. Personnel of this section assist in organizational vehicle maintenance. They may perform all organizational

maintenance for the parent group headquarters and for any battalion unit which does not have an organic maintenance capability. Appropriate teams of TOE 29-600G, Organizational Maintenance Teams, are used to provide organizational maintenance when organic resources are inadequate to support units attached to the battalion headquarters.

e. Concept of Operations. Medical battalion headquarters units are located throughout the combat and communications zone providing command and control to separate company or detachment size medical units. Medical battalions may be given an area support mission or a direct support mission and are provided with appropriate medical units as determined by the mission. The medical battalion headquarters unit is normally attached to a medical group, but may operate directly under the command and control of the medical brigade or medical command.

f. Mobility. The medical battalion headquarters unit is 65 percent mobile.

E-8. Company Headquarters, Team AC, TOE 8-500G

a. Mission. The mission of the Team AC is to provide command and control for separate medical detachments or equivalent strength units.

b. Assignment and Basis of Allocation. Team AC is assigned to the medical brigade and medical command or task force on the basis of one per two or more medical detachments or equivalent.

c. Capabilities. The Team AC is capable of commanding and controlling two or more medical detachments whose aggregate strength is not less than 75 or more than 150 individuals.

d. Concept of Operations. The Team AC consists only of a headquarters. It normally functions under, and receives administrative and logistical support from, a headquarters and headquarters detachment of a separate medical battalion; or may be attached to other medical or support elements. The team is used primarily in situations which require less than a battalion-size medical support unit or to command a medical unit composed of several teams. Attachments may be tailored to perform a specific medical mission or to provide composite medical support on an area basis. Team AC must be augmented by appropriate detachments of TOE 29-600G in order to provide company level mess and wheeled vehicle maintenance support to attached units.

e. Mobility. The Team AC is 100 percent mobile.

E-9. Headquarters Unit Receiving Center, Team AE, TOE 8-500G

a. Mission. The mission of the Team AE is to provide administrative support to nondivisional medical units that have been withdrawn for reorganization and to medical units arriving from the Zone of Interior.

b. Assignment and Basis of Allocation. The Team AE is assigned to the medical command on the basis of 1 per port designated to receive medical troops, but allocated only to theaters of 500,000 population or larger.

c. Capabilities. The Team AE, when augmented with the appropriate supply, maintenance, postal, finance, engineer, and military police elements, is capable of providing the required overhead services for the administration and control of attached nondivisional medical units.

d. Concept of Operations. Nondivisional medical units arriving at a port of entry in a theater of operations are attached to a headquarters, unit receiving center, unless they are assigned immediately to operate a medical facility. Each medical unit attached to this type center remains there until its future assignment is determined or the facility it is to operate is made available. Usually, the installation operated by this center is under the jurisdiction of the medical command commander who controls the assignment of units or replacements to the center and their subsequent reassignments. The medical command commander may control the details of supply, administration, and the operation of the center's facilities. In order to accomplish its mission, the headquarters, unit receiving center, requires a number of service detachments. Among those required are personal services, supply, maintenance, postal, finance, engineer, and military police elements. These detachments, together with the organic staff personnel, complete the organizational framework of a unit receiving center.

e. Mobility. The Team AE is 100 percent mobile.

E-10. Headquarters, Veterinary Professional Service, Team AF, TOE 8-500G

a. Mission. The mission of the Team AF is to provide command and control for veterinary hospitals, dispensaries, and service detachments.

b. Assignment and Basis of Allocation. Team AF is assigned to the medical brigade and the medical command on the basis of one per three to

seven veterinary hospitals, dispensaries, and service detachments.

c. Capabilities. Team AF provides command and control of three to seven veterinary hospitals, dispensaries or service detachments, or combinations thereof.

d. Concept of Operations. The headquarters team, normally attached to a medical group headquarters, maintains liaison between the subordinate veterinary detachments and the appropriate higher command headquarters. The location of Team AF is primarily dependent upon the location of its subordinate veterinary detachments. Veterinary service detachments usually are located where there are concentrations of subsistence items, while veterinary hospital and dispensary detachments are normally located in areas where military animals are present.

e. Mobility. The Team AF is 100 percent mobile.

E-11. Headquarters, Medical Professional Service, Team AG, TOE 8-500G

a. Mission. The mission of the Team AG is to provide command, control, and administrative support for up to 24 professional service detachments.

b. Assignment and Basis of Allocation. Team AG is assigned to the medical command on the basis of 1 per 30,000 fixed beds and to the medical brigade on the basis of 1 per 8 evacuation hospitals allocated.

c. Capabilities. Team AG provides the necessary supervision, control, and administrative support for attached professional service teams. The Team AG evaluates requirements for specialized professional assistance and provides appropriate professional service teams in support of operating medical treatment units. A continuing evaluation must be made to afford the most effective and economical use of highly specialized professional personnel.

d. Concept of Operations.

(1) Health services teams (not attached to a medical operating unit for administrative control upon arriving at a theater of operations) are attached to a headquarters, medical professional service, Team AG. These teams are further attached to appropriate medical treatment units; however, Team AG maintains close liaison and retains operational control.

(2) The headquarters, medical professional service, is normally established in a location which affords liaison with the surgeon or commander of the command to which attached. Team

AG is, preferably, located in the general vicinity of hospitals for which professional service augmentation is being provided. It provides liaison between the next higher command and the medical units operating under its administrative control. The team does not provide transportation for the assigned professional service detachments. Circumstances may require the attachment of an appropriate number of teams (TOE 29-600G) perform organizational vehicle maintenance functions for the professional service detachments.

(3) Personnel of the headquarters, professional service, perform frequent technical inspections to insure compliance with current policies with regard to professional standards prescribed for military medical practice. In this connection, the headquarters conducts a continuing indoctrination program for personnel of the detachments under its control.

e. Mobility. The Team AG is 45 percent mobile.

E-12. Headquarters, Dental Professional Service, Team AI, TOE 8-500G

a. Mission. The mission of the Team AI is to provide command, control, and administration for separate dental service detachments.

b. Assignment and Basis of Allocation. The Team AI is assigned to the medical brigade and to the medical command on the basis of 1 per 6 to 12 dental treatment units.

c. Capabilities. The Team AI is capable of providing command and control for 6 to 12 dental treatment units.

d. Concept of Operations.

(1) The headquarters, dental professional service, is normally attached to a medical group headquarters for administration and logistical support. Operational control would be retained by the medical brigade or medical command headquarters as appropriate. The dental unit commander normally is designated as group dental surgeon to provide technical control of medical unit dental services. Consideration is given to the size of the units supervised and thereby, indirectly, to the population of the area served. The 6 to 12 treatment unit allocation is based upon a mix of dental operating detachments (KI) serving 1,000 personnel; dental service detachments (KJ) serving 15,000 personnel; and various prosthetic detachments. Six KI detachments would normally serve too small an area to warrant a headquarters and; conversely, 12 KJ detachments would serve an area so large that com-

munication and proper supervision would be difficult for one headquarters. Consideration is also given to locating in proximity to the headquarters of the units being furnished dental service.

(2) When a type B medical group headquarters is employed in support of an independent corps, a dental headquarters unit will be provided if dental units are attached or if medical units subordinate to the group have dental services requiring technical control.

(3) Unit personnel conduct frequent inspections to insure the compliance with established dental professional policies, adherence to professional standards, and to evaluate accomplishments and requirements. Developing, preparing, and coordinating the preventive dentistry program of the area being supported is also a responsibility.

e. Mobility. The Team AI is 70 percent mobile.

E-13. Blood Bank Service Headquarters, Team AJ, TOE 8-500G

a. Mission. The mission of the Team AJ is to provide command, control, and administrative support for a group of blood bank service detachments.

b. Assignment and Basis of Allocation. The Team AJ is assigned to the medical command on the basis of 1 per 10 blood detachments (Teams NA, NB, NC) or major fraction thereof.

c. Capabilities. The Team AJ is capable of commanding its component units; supervising the receipt of whole blood supplied from CONUS; supervising the collecting and laboratory processing of whole blood and delivery to storage or transshipment points, or to using units as required; and supervising the storage and distribution of theater army whole blood stocks.

d. Concept of Operations. The theater army blood bank service furnishes whole blood to all theater army medical units; to other U.S. military, Allied military, and indigenous civilian medical establishments as directed. The theater army commander, through his surgeon, exercises overall control of the service, but normally delegates to the medical command commander the executive responsibility to operate the service. The medical command is authorized a blood transfusion officer who provides staff planning and supervision of the service's operations. The ser-

vice's operations are conducted without regard to sectional or zonal boundaries within the theater. The service attempts to deliver blood to the using medical facility with the least possible delay. Because inventory and movement control of blood stocks cannot be sufficiently precise and flexible to permit delivery directly from the processing center to each using unit, certain intermediate theater army storage and distribution facilities must be maintained. Storage is provided at the lowest level permitted by the responsiveness and reliability of the principal supply line from CONUS. Transshipment of blood between theater storage facilities is avoided wherever possible. Control of the total COMMZ stored blood inventory is exercised by the blood bank service.

e. Mobility. The Team AJ operates as a fixed facility.

E-14. Medical Control, Team SA, TOE 8-500G

a. Mission. The mission of the Team SA is to control and provide medical professional supervision of a maximum of nine Teams SB, Medical Support, within a theater of operations.

b. Assignment and Basis of Allocation. The Team SA is normally authorized and allocated on the basis of one per nine medical support teams SB or fraction thereof.

c. Capabilities. The Team SA provides supervision and control of up to nine Teams SB, Medical Support, within a theater of operations.

d. Concept of Operations. The Team SA consists of one Medical Corps officer who coordinates and directs the activities of attached SB Teams. The team is normally the medium through which the plan for medical support of special action or counterinsurgency forces is implemented. The control officer directs deployment of SB Teams; allocates available resources to ensure the most efficient use; ensures that maximum use is made of indigeneous personnel; and maintains surveillance of the technical aspects of team operations. The team is dependent upon the unit to which it is attached for administrative and logistical support.

e. Mobility. The Team SA is not provided organic transportation and normally moves with SB Teams.

Section III. PATIENT EVACUATION UNITS

**E-15. Medical Holding Company
(TOE 8-57G)**

a. Mission. The mission of the medical holding company is to provide patient holding facilities and limited medical treatment at patient transfer points such as airheads, railheads, and ports of embarkation.

b. Assignment and Basis of Allocation. The medical holding company is assigned to the field army medical brigade and to the theater army medical command on the basis of one per corps supported.

c. Capabilities. At full strength (level 1) this company can accommodate 300 patients in a single holding facility, or when augmented by mess teams, operate as 3 separate platoons, each capable of caring for 100 patients, providing necessary emergency treatment, supportive therapy, continuation of established treatment regimes, and nursing care. The company is designed to provide a facility where patients awaiting further evacuation by sea, air, or land can be assembled.

d. Organization. The medical holding company consists of a company headquarters and three holding platoons.

(1) *Company headquarters.* The company headquarters may be organized as follows:

- (a) Command and unit administration.
- (b) Food service.
- (c) Supply and motor maintenance.

(2) *Holding platoon.* Each of the three holding platoons includes a Medical Corps officer who is the platoon leader. He is assisted by a Medical Service Corps officer who functions as the assistant platoon leader. Enlisted personnel with appropriate specialties are included in the TOE.

e. Concept of Operations. The medical holding companies are attached to medical groups or battalions as required. The company is usually established and maintained at location(s) which support the patient evacuation channels. When employed, the company may be used on unusually long routes of evacuation where patients can rest and receive additional supportive medical care and treatment. It is desirable to establish medical holding facilities near existing rail or airheads. Establishment at airheads, however, must be coordinated with the theater air force.

f. Mobility. The medical holding company is 50 percent mobile.

**E-16. Medical Ambulance Company
(TOE 8-127G)**

a. Mission. The mission of the medical ambulance company is to provide field or bus ambulance evacuation of patients.

b. Assignment and Basis of Allocation. The medical ambulance company is assigned to—

(1) The field army medical brigade on the basis of one per division supported or its equivalent in separate combat brigades/armored cavalry regiment and one per corps supported.

(2) The theater army medical command on the basis of two per corps supported.

c. Capabilities. The medical ambulance company is capable of providing field or bus ambulance evacuation service with the combat and communications zones. It is operationally self-sufficient. At full strength (level) the company has a single-lift capability for evacuating 144 litter patients or 288 ambulatory patients. When bus ambulances are authorized in lieu of field ambulances to perform mass evacuation mission, the single-lift capability is increased by 125 percent at each level.

d. Organization. The medical ambulance company consists of a company headquarters and three identical ambulance platoons.

(1) *Company headquarters.* This headquarters includes the personnel required to perform command and administration, food service, and supply and motor maintenance.

(2) *Ambulance platoons.* Each ambulance platoon leader is assisted by a platoon sergeant and a light truck driver. Ambulance drivers and ambulance orderlies are included in each platoon.

e. Concept of Operations. The medical ambulance companies are attached to medical groups or medical battalions. In the combat zone, field or bus ambulances evacuate patients from division and nondivision clearing stations and dispensaries to hospitals. They also provide evacuation from hospitals to air and railheads. In the COMMZ, ambulance companies transport patients to or from hospitals or treatment facilities to air or railheads and are used for the movement of patients between hospitals. In some instances, field or bus ambulances will evacuate patients from the combat zone to the COMMZ hospitals when air or rail evacuation is unavailable and when distances are not too great. The company may employ individual ambulances, section, or

platoons in order to perform its mission.

f. Mobility. The medical ambulance company is 100 percent mobile.

E-17. Medical Clearing Company (TOE 8-128G)

a. Mission. The mission of the medical clearing company is to receive, sort, and provide emergency or resuscitative treatment for patients until they are evacuated and to provide definitive treatment for patients with minor illnesses or injuries.

b. Assignment and Basis of Allocation. The medical clearing company is assigned to the field army medical brigade on the basis of 4 per corps and 3 per field army and to the theater army medical command on the basis of 4 per communications zone in support of a 12-division field army.

c. Capabilities. Under normal operating conditions, the medical clearing company can provide medical care and treatment for a total of 240 patients which may be expanded in emergencies to 360 patients. The company, or one or more of its three platoons, may operate as a provisional convalescent or holding facility, expand the capabilities of other medical units, and provide unit level medical support on an area basis. It may replace or supplement the services of division medical clearing stations. When the unit operates more than one clearing facility mess augmentation must be provided.

d. Organization. The unit consists of a company headquarters and three identical clearing platoons.

e. Concept of Operations. The medical clearing company is attached to medical battalions or groups and used where required. The company, or one or more of its three platoons, may operate as a provisional holding unit at such points as airstrips, railheads, ports of debarkation and embarkation, and on feeder road nets. The company may be used to establish and operate small specialized treatment centers such as psychiatric treatment stations formed by augmentation with psychiatric detachments (Psychiatric Detachment, Team KO, TOE 8-500G). The clearing company has no significant postoperative capability; therefore, when the company is established as a specialized treatment center involving the care of postsurgical patients, it must be augmented with appropriate nursing service personnel and equipment.

f. Mobility. The medical clearing company is 100 percent mobile.

E-18. Medical Collecting Company (TOE 8-129G)

a. Mission. The mission of the medical collecting company is to provide litterbearer support in the theater of operations as required.

b. Assignment and Basis of Allocation. This unit is assigned to—

(1) The field army medical brigade on the basis of one per corps.

(2) The theater army medical command on the basis of one per corps supported.

(3) Two per independent corps.

c. Capabilities. At full strength (level 1) the medical collecting company is capable of augmenting other medical service units by providing the services of 4 litterbearer platoons of 40 litterbearers each. The patient handling capability per platoon will vary with the local situation and circumstances.

d. Organization. The medical collecting company consists of a company headquarters and four identical collecting platoons.

(1) *Company headquarters.* The company headquarters may be organized into the following sections:

(a) Command and administration.

(b) Food service.

(c) Supply and motor maintenance.

(2) *Collecting platoons.* Each of the 4 collecting platoons is commanded by a Medical Service Corps (MSC) platoon leader and assisted by a platoon sergeant. There is a total of 40 litterbearers in each platoon. Litterbearer teams may also administer company aid-type emergency medical care and treatment.

e. Concept of Operations. The medical collecting company is attached to medical groups, medical battalions, hospitals, or other medical treatment facilities. Platoons or sections of the company may be employed to assist in loading and unloading patients at airheads, railheads, hospitals, or other treatment facilities, and may also be employed in hospitals to move litter patients from one hospital section to another. In division areas, the company may be used in support of special type operations; e.g., river crossings, amphibious operations, or mountain operations.

f. Mobility. The medical collecting company is 50 percent mobile.

E-19. Medical Air Ambulance Company (TOE 8-137G)

a. Mission. The mission of the medical air ambulance company is to provide—

(1) Aeromedical evacuation of selected patients.

(2) Emergency movement of medical personnel and equipment and supplies.

(3) Uninterrupted delivery of whole blood, biologicals, and medical supplies.

b. Assignment and Basis of Allocation. The medical air ambulance company is assigned to a field army, independent corps, or task force, as required, on the basis of one per corps and one per independent corps or task force.

c. Capabilities. The medical air ambulance company is operationally self-sufficient and is capable of performing the following functions:

(1) Aeromedical evacuation of critically wounded patients who are not transportable by other means to the nearest medical unit capable of providing required surgery and medical treatment.

(2) Pickup of patients from units in direct support of combat troops, except from an airhead or airborne force objective area that is logistically supported by the U.S. Air Force.

(3) Augmentation of ground patient evacuation units when vehicular evacuation is not feasible or is insufficient.

(4) Expeditious delivery of medical personnel and medical materiel to meet emergency treatment requirements within the combat zone.

d. Concept of Operations. The company is normally employed under the overall direction of the medical brigade commander who exercises operational control through a subordinate medical group. The company usually operates under mission-type orders which assign the role in supporting a corps. The company commander provides detailed direction of his unit's operations. He simultaneously acts as staff adviser to the parent medical group headquarters in all aeromedical operations. Individual evacuation mission requests are processed through appropriate communications channels for approval. Assignment of priority by the surgeon at each level is in accordance with the command aeromedical evacuation standing operating procedures (SOP). Subsequent to approval, requests are forwarded to the company headquarters or directly to helicopter ambulance platoons, as the situation dictates. Platoons may operate semi-independently of the parent company for a limited period and may be placed in direct or general support of combat units. Air ambulance company capabilities may be reinforced by attaching helicopter ambulance detachments, Team RA, TOE 8-500 (not exceeding four per company).

e. Organization. The medical air ambulance company consists of a company headquarters, a flight operations platoon, a maintenance platoon, and four identical helicopter platoons.

(1) *Company headquarters.* The company headquarters may be functionally organized into the following sections:

(a) Command and administration.

(b) Food service.

(c) Supply and motor maintenance.

(2) *Flight operations platoon.* The primary function of this platoon is to plan and direct company operations in accordance with the commander's policies. The flight operations platoon also coordinates the company's individual and unit training. It consists of a platoon headquarters, an operations section, and a communications section.

(a) *Platoon headquarters.* The operations officer also acts as the platoon leader, supervising the operations section and the communications section. He plans and directs operations of the company and maintains liaison with the parent medical group headquarters; the surgeons of the major commands supported; other medical support units; and the Army flight control agencies in coordinating helicopter ambulance flights. The operations officer keeps the company commander advised on company operations and capabilities.

(b) *Flight operations section.* This section operates one heliport in the vicinity of the company headquarters. It also provides the operations officer with a radio communications capabilities to net with the headquarters of supported units and with the headquarters of the deployed helicopter platoons. In addition, this section maintains individual aviator flight records and operates the flight control facility.

(c) *Communications section.* This section is responsible for the installation, maintenance, and repair of the communications equipment of the company. It operates the telephone switchboard and teletypewriter set and has a capability of communicating with field army, corps, and medical group headquarters.

(3) *Helicopter platoons.* Each helicopter platoon can, when augmented by a section of the maintenance platoon and an element of the airfield service section, operate in a separate location for a limited period of time. Under such circumstances, the dispersed platoon may receive logistical support from a nearby unit; however, the platoon remains dependent upon the company headquarters for administrative support. The platoon flight leader may, when operating separately, as-

sume total responsibility for direction of platoon operations. Six helicopters are authorized each platoon. Each helicopter crew includes a medical aid man. The ambulance crew must be capable of providing emergency medical treatment. The pilot supervises the crew in treating and preparing the patient for flight and instructs the crew in procedures for inflight medical emergencies.

(4) *Maintenance platoon.* This platoon consists of a platoon headquarters, four identical maintenance sections, and an airfield service section.

(a) *Platoon headquarters.* The platoon leader and his technical inspectors perform technical inspections of all aircraft after maintenance, and at such other times as necessary to ensure that the aircraft operate safely and efficiently. Ground controlled approach and aviation electronic equipment organizational maintenance support is provided by this element. The platoon headquarters obtains aircraft spare parts from supporting transportation corps aircraft maintenance units and distributes them to the maintenance sections as required. The headquarters maintains consolidated aircraft maintenance records for the company and coordinates aircraft maintenance support provided by a transportation aircraft direct support company.

(b) *Maintenance sections.* Each of these four sections is identical and provides necessary organizational maintenance for the aircraft assigned or attached to the company. One section may be used in support of one helicopter platoon.

(c) *Airfield service section.* This section provides service for the company's heliport and the four platoon heliports when dispersed, including heliport lighting, helicopter fueling, firefighting, and aircraft crash and rescue.

f. *Mobility.* The medical air ambulance company is 100 percent mobile using organic air and ground vehicles.

E-20. Helicopter Ambulance Detachment, Team RA, TOE 8-500G

a. *Mission.* The mission of Team RA is to provide—

(1) Aeromedical evacuation of selected patients.

(2) Emergency movement of medical personnel and equipment and supplies.

(3) Uninterrupted delivery of whole blood, biologicals, and medical supplies.

b. *Assignment and Basis of Allocation.* Team RA is assigned to the medical brigade on the

basis of one per division and to the medical command on the basis of two per corps.

c. *Capabilities.* The Team RA provides an immediate response for battlefield aeromedical evacuation of patients from as far forward as the tactical situation permits. It performs inflight medical treatment and surveillance for patients en route to treatment facilities. The unit is also capable of aerial delivery of medical personnel and emergency delivery of medical supplies.

d. *Concept of Operations.*

(1) *Combat zone.* The helicopter ambulance medical detachment is located within the combat zone, but specific operational locations will depend upon the mission. The helicopter ambulance will be employed as far forward as the tactical situation permits. Evacuation of patients is to the division medical facilities or to a nondivisional medical facility as professionally indicated. Normally, in this type of operation, the commander of the division medical battalion will exercise operational control of the helicopter unit. Location of the unit with the division medical battalion is considered desirable. When the division is in reserve or otherwise withdrawn from combat, the Team RA may be attached to an air ambulance company. The Team RA is ideally suited for operations with a separate task force and under these circumstances may function under the direction of the task force surgeon.

(2) *Communications zone.* The helicopter ambulance detachment provides emergency evacuation of patients requiring urgent and special types of medical care and treatment. Evacuation within the COMMZ may be from patient sites to hospital, from one hospital to another, or between air or rail terminals and hospitals. The unit may be attached to medical groups or battalions.

e. The Team RA is 100 percent mobile.

E-21. Ambulance Detachment, Team RB, TOE 8-500G Ambulance Detachment (Bus), Team RE, TOE 8-500G

a. *Mission.* The mission of Teams RB and Team RE is to provide ambulance service in the communications zone.

b. *Assignment and Basis of Allocation.* Teams RB and RE are assigned to the theater army medical command on the basis of two per corps supported.

c. *Capabilities.*

(1) The Team RB, when equipped with field

ambulances, is capable of providing for the movement of 24 litter patients or 48 ambulatory patients or combinations thereof.

(2) The Team RE provides for the movement of 54 litter or 132 ambulatory patients or combinations thereof by bus ambulances.

d. Concept of Operations. The location of the ambulance detachment in a theater of operations conforms to the tactical disposition of the unit to which attached. The function of the detachment is to augment ambulance facilities currently in operation in the communications zone, and to provide motor ambulance service to units or other elements having only temporary need for such services. The detachment may be employed to transport patients to airfields, hospital ships ambulance trains, nearby hospitals, convalescent centers, and other medical facilities. In combination with two or more detachments and a headquarters element, a provisional ambulance platoon or company may be formed.

e. Mobility. The Team RB is 100 percent mobile; Team RE is 100 percent mobile.

E-22. Helicopter Ambulance Air Crash Rescue Detachment, Team RC, TOE 8-500G

a. Mission. The mission of Team RC is to provide rescue service to occupants of crashed aircraft.

b. Assignment and Basis of Allocation. Team RC is assigned to the field army medical brigade or independent corps on the basis of 1 per division and 2 per corps, and to the theater army medical command on the basis of 1 per 100 Army aircraft operated in the communications zone.

c. Capabilities. Team RC provides immediate response for extrication of personnel, suppression of post-crash fires, forced entry, as necessary, and aeromedical evacuation of patients from crashed aircraft. In addition, medical aid men provide emergency medical treatment at air crash site and inflight treatment while en route to a medical treatment facility. Team RC provides command and control for a maximum of four augmentation detachments, Teams RD.

d. Concept of Operations.

(1) The helicopter ambulance air crash rescue detachment is located in the combat zone and communications zone as required. At least one air crash rescue helicopter and crew remains on alert and immediately available continuously while flight operations are in progress. The establishment of a system and the furnishing of necessary equipment for immediate notification to, and dis-

patch of, the air crash rescue unit is the responsibility of the airfield commander. Appropriate facilities and airfield service must be provided and the unit must be given the highest priority for aircraft maintenance.

(2) The majority of aircraft accidents or crashes occur in the vicinity of airfields, therefore, the air crash rescue unit is organized and employed primarily for air crash rescue operations in the vicinity of airfields; but the air crash rescue unit will respond to on-base crashes if required. When dispatched, the alert flight unit of the air crash rescue detachment will immediately proceed to the scene of the crash; control or extinguish the aircraft fire; extricate the occupants from the wreckage of the aircraft; provide emergency medical treatment; and provide aeromedical evacuation to the nearest designated medical treatment facility. During the rescue mission, continuous communications will be maintained with the controlling flight operations center in order to facilitate requests for assistance, to obtain additional aeromedical flight units in the event of large numbers of injured, and to notify medical treatment facilities of patient arrivals.

(3) A requirement for air crash rescue support may result from the cumulative operations of a number of smaller air activities within a specific area, although no major airfields or aircraft concentrations exist. This requirement may be met by the location of an air crash rescue unit at the most central activity where appropriate support is available. The unit will then respond to call for assistance on an area basis. Flight control will be accomplished through an air operations control element organic to one of the supported facilities. The medical unit commander responsible for area health services will establish procedures and provide guidance through the air installation commander to the appropriate air operations control element for the dispatch of air crash ambulances. The responsible medical commander will also technically supervise the air crash rescue unit and designate medical facilities to which patients will be evacuated.

(4) In addition to the employment described above, the helicopter ambulance air crash rescue detachment normally provides area support within its capabilities and the range of its organic aircraft. As determined by the commander of the unit to which assigned or attached, air crash rescue flight units may be dispatched to the scene of any crash if required. The air crash rescue plan, developed in coordination with the commander of the medical unit providing area medi-

cal support, should designate areas of responsibility and identify navigation and control facilities. The plan is then disseminated to the commander of all aviation units operating within the areas. The air crash rescue unit is not responsible nor does it have the capability for primary search for downed aircraft. Air crash rescue flight units may accompany search aircraft to distant areas in order to be promptly responsive once the downed aircraft is located.

e. Relationships. When the team is based at major Army airfields or with concentrations of Army aircraft, the unit remains attached to, and under, the operational control of the medical commander having the responsibility for medical support of the area. The airfield commander has the responsibility for dispatch of crash rescue units.

f. Mobility. Team RC is 100 percent mobile.

E-23. Helicopter Ambulance Air Crash Rescue Augmentation Detachment, Team RD, TOE 8-500G

a. Mission. The mission of Team RD is to reinforce helicopter ambulance air crash rescue detachments (Team RC) and to provide that unit with an increased capability to accomplish its assigned mission of providing rescue service to occupants of crash aircraft at locations other than Army airfields.

b. Assignment and Basis of Allocation. The Team RD is assigned to the field army medical brigade and to the theater army medical command on the basis of from 1 to 4 teams per helicopter ambulance air crash rescue detachment (Team RC) when aircraft supported by that detachment exceed 100.

c. Capabilities. This team supplements the capabilities of Team RC.

d. Concept of Operations. Team RD is employed as a reinforcement to Team RC.

e. Mobility. Team RD is 100 percent mobile.

E-24. Ambulance Train, Rail (TOE 8-520G)

a. Mission. The mission of the ambulance train, rail, is to evacuate patients from hospitals or holding units of the combat zone to the communications zone; between hospitals of the communications zone; and from hospitals to aerial or water ports of embarkation.

b. Assignment and Basis of Allocation. The ambulance train, rail, is assigned to the theater army medical command on the basis of six per field army supported.

c. Capabilities. At full strength (level 1) the

ambulance train, rail, provides rail transportation and en route medical care for 180 litter patients; or 108 ambulatory and 72 litter patients; or 72 litter patients and 144 ambulatory patients not requiring litter berth accommodations. The unit is not administratively or logistically self-sufficient and must be attached to a command capable of supporting it.

d. Organization. The ambulance train, rail, consists of an administrative section and a professional service section.

(1) *Administrative section.* This section provides control over the activities of the administrative and professional services of the unit. The unit commander, a Medical Corps officer, is responsible for the command, administration, training, coordination, and operational control of the ambulance train unit. He maintains liaison with the appropriate headquarters regarding source and destination of patients; local evacuation policies; and other related matters. The unit commander is assisted by an administrative officer who also functions as the unit medical supply officer.

(2) *Professional service section.* This section includes a Medical Corps officer who supervises all aspects of medical care and treatment required by patients en route. A head nurse directs the activities of nursing service personnel providing prescribed nursing service for patients. Nursing service personnel may include general duty nurses, medical specialists, and medical corpsmen. Nonsupervisory enlisted personnel, consisting of ward specialists and ward attendants perform assigned duties under the supervision of wardmasters.

e. Concept of Operations. The ambulance train, rail, may be attached to medical groups as required. All cars, including ward, personnel, and kitchen are organic to the Army ambulance train units. The motive power and personnel for operation and maintenance of the train are provided by the transportation command. Routing of ambulance trains is controlled by the transportation command; however, technical details such as source and destination of patients are coordinated through the medical regulating officer of the medical command. Patients may be evacuated by ambulance train from evacuation hospitals or other forward medical facilities in the combat zone to the communications zone general hospitals, and from general hospitals to ports of embarkation.

f. Mobility. When the unit is not operating an ambulance train, it is immobile and transportation must be provided for movement of the unit.

Section IV. HOSPITAL UNITS

E-25. General

Army hospitals are organized to provide the administrative, logistical, and patient care services that are required to process inpatient and outpatient workloads. Organizational structures normally provide for the deliberation of major functions and consolidation of closely associated minor functions. The organization of individual hospitals may vary according to the hospital size, mission, and the tactical situation; however, the basic functions are similar. The TOEs for hospitals normally indicate the unit capabilities at various strength levels. These levels are—level 1, organization at authorized full strength U.S. personnel. This allows for completion of services stated in the mission of the unit. Levels 2 and 3 adopt the authorized strength for reduced operational capabilities. Normally, the operational capabilities are reduced by 10 percent decrements. The capabilities of a type B organization are the same as those of a level 1 organization. The type B organization adopts the TOE to lesser requirements for U.S. military personnel. Vacancies existing in the type B column of the TOE indicate the positions which can be filled by non-U.S. personnel. The number of non-U.S. personnel must be determined by the major commands to which the unit is assigned and will depend upon the capacity of available personnel to produce, number of shifts, and local conditions. Interpreters and translators required when organized under the type B column will be provided from appropriate teams available to the theater commander. Hospitals normally are dependent on other units for finance service and on military police teams when PWs are hospitalized. Hospitals may be augmented with professional teams when performing missions that require additional means. The following description of the organization and functions of a “type” hospital does not represent a particular existing unit, but is designed to show a typical hospital organizational structure and to describe the functions and responsibilities of the various branches, services, and sections of hospital units:

(1) *Organization.* The “type” hospital is organized into a hospital headquarters, administrative services, and professional services. The administrative and professional services are subdivided into branches and professional service sections (fig E-2).

(2) *Functions.*

(a) *Hospital headquarters.* The hospital headquarters provides command and control and technical supervision over the operation of the hospital. This includes all professional matters pertaining to patient care and the administrative details concerning the operation of the hospital.

(b) *Administrative services.* The various functions performed by the administrative services sections include all the basic administrative services necessary for the hospital to perform its mission.

1. *Unit headquarters.* This branch performs the usual unit command and administrative functions to include intrahospital assignments and the training and discipline of enlisted personnel.

2. *Administrative branch.* This branch provides administrative support to the hospital headquarters and functions under the appropriate headquarters staff officer or adjutant.

3. *Registrar branch.* The medical registrar branch performs all administrative functions involved in admission and disposition of patients. These include initiating medical records, completing medical records prior to the disposition of patients, arranging for the patient's return to duty, or arrangements for further evacuation. This branch maintains a depository for patients' funds and valuables and operates patients' baggage (clothing) facility. The registrar may also perform the duties of the detachment of patients' commander.

4. *Food service branch.* The food service branch is responsible for the procurement, storage, and preparation of food. Its staff includes the necessary personnel to provide food for the patients and hospital personnel 24 hours daily.

5. *Supply and services branch.* The supply and services branch is an amalgamation of hospital supply and logistical service functions under the direction of the hospital supply officer. The supply section is responsible for medical and general supplies for the hospital and for medical equipment maintenance. The staff includes the hospital supply officer, who also performs the duties of motor officer, and the necessary enlisted supply, clerical, and medical equipment maintenance personnel. The service section also provides laundry or linen exchange service, custodial service, utilities service, and motor pool service.

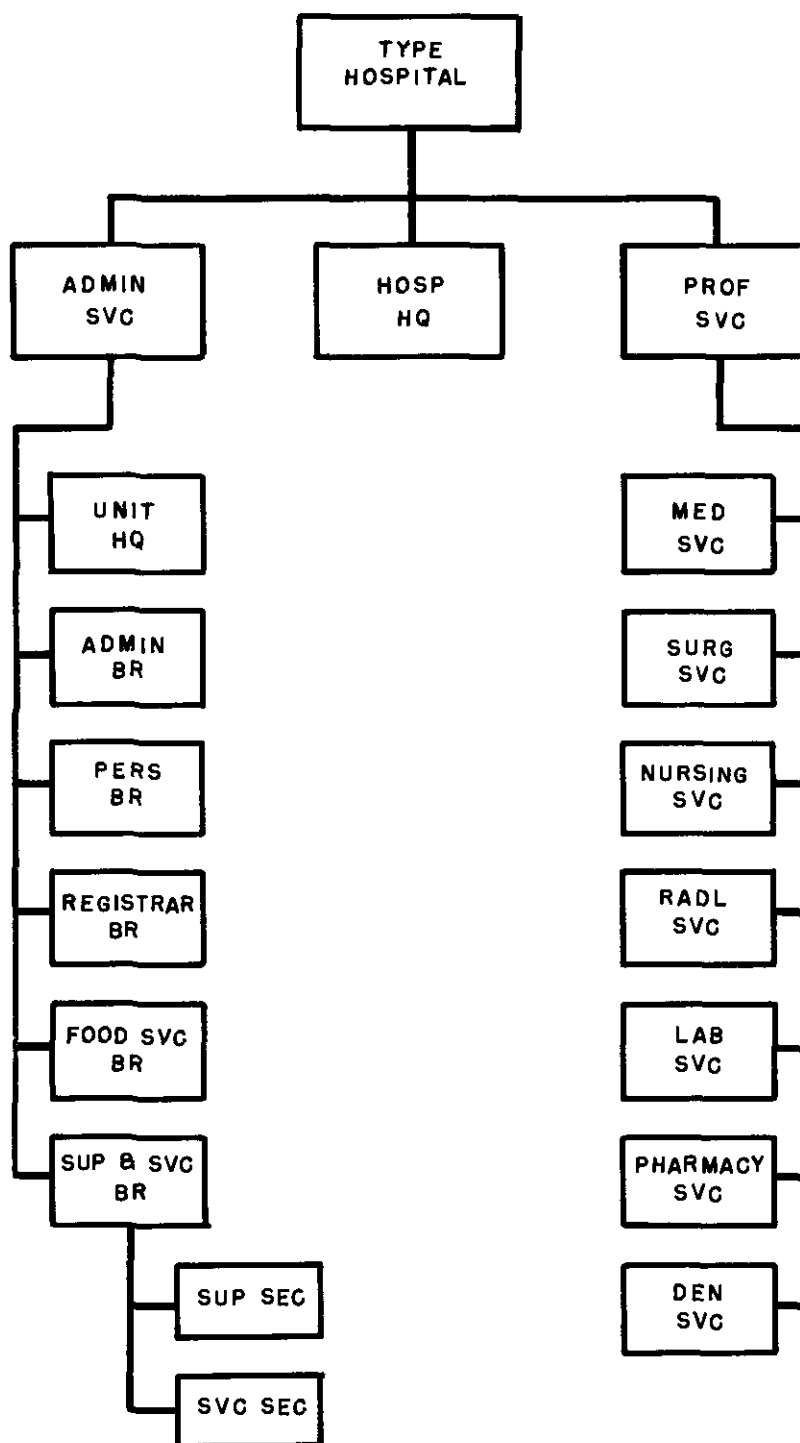

NOTE: SECTIONS WITHIN HOSPITALS ARE ESTABLISHED OR MAY BE COMBINED, DEPENDING ON THE SIZE AND/OR MISSION OF THE HOSPITAL.

Figure E-2. A "type" hospital organization.

6. *Admission and disposition section (A&D).* An A&D section is not separately identified in the TOE of hospital units, however, it is normally established from resources available within a hospital unit. This section will usually operate under the direction of a Medical Corps officer designated by the hospital commander and normally will be staffed with personnel from the medical service and from the registrar section. Upon the arrival of patients, this section examines, classifies, and assigns them to appropriate wards; initiates the proper field hospital medical records, records the admissions on a station log, and notifies the registrar of the new admission; delivers the patients to the proper wards; and exchanges property with incoming ambulances. This section also assumes charge of all patients awaiting further evacuation or return to duty; collects and makes appropriate entries on the medical records of outgoing patients; prepares tally sheets of patients being returned to duty or being evacuated; and exchanges property with outgoing ambulances. This section provides clothing and equipment for the hospital personnel and for patients returning to duty and operates a patients' baggage (clothing) facility.

(3) *Professional services.* Depending upon its assigned mission and patient load, the hospital may be organized to include a varied number of professional services. The professional services of the hospital are directed by an officer who is designated by the hospital commander as the chief of professional services. The chief of professional services is responsible for the administration and operation of the services including the care and treatment of patients. Normally, the following professional services are established with the hospital:

(a) *Medical service.* The chief of the medical service section is normally a specialist in internal medicine. The medical service provides diagnostic service and treatment to medical patients and may also provide psychiatric care and treatment. The medical service section may be organized into a number of subsections such as cardiovascular, gastroenterology, general medicine, communicable disease, or others as required.

(b) *Surgical service.* The surgical service section is composed of officers, nurses, and enlisted personnel as prescribed by the unit commander. The service may be organized to provide a number of subelements such as orthopedic; urological; otolaryngology; ophthalmology; optometry; septic surgery; general surgery; or others as required. The surgical section operates the

centralized material service which prepares, stores, and issues supplies used in the operating room and sterile supplies used throughout the hospitals.

(c) *Neuropsychiatric service.* This section may be organized as required to provide care for those patients who require psychiatric care and those psychotic or seriously ill neuropsychiatric patients who require additional treatment before returning to duty. This function is established within the medical service section in smaller hospitals.

(d) *Nursing service.* Hospital nursing service is composed of a number of sections to provide nursing care to patients; it may include, among others, medical, surgical, neuropsychiatric, outpatient nursing, and centralized materiel sections.

(e) *Radiological service.* This service performs radiographic and fluoroscopic procedures and provides consultant services in support of the hospital.

(f) *Laboratory service.* The laboratory service performs the bacteriological and biochemical procedures in support of the hospital.

(g) *Pharmacy service.* This section is organized to receive, store, prepare, issue, and advise on the use of pharmaceutical preparations required for patient care.

(h) *Dental service.* The dental service provides diagnosis, treatment, and preventive dentistry services to inpatients. This service is composed of those subsections necessary to provide treatment which will return the patient to duty, or prepare him for further evacuation.

E-26. Field Hospital (TOE 8-510G)

a. *Mission.* The normal mission of a field hospital is to provide hospitalization in the communications zone when *limited* treatment facilities are required for temporary hospitalization. A mission of providing care and treatment to the indigenous population; displaced persons, and prisoners of war may be assigned.

b. *Assignment and Basis of Allocation.*

(1) Field hospitals are assigned to the theater army medical command on the basis of 3 per 10,000 fixed beds required in the theater.

(2) Type B organization field hospitals are assigned to the COMMZ on the basis of 1 per 40,000 medically destitute civilians; 1 per 10,000 displaced persons; and 1 per 10,000 prisoners of war requiring support.

c. *Capabilities.* The field hospital is capable of—

(1) Operating a single hospital with a bed capacity for 400 patients or operating three 100-bed hospitalization units, each capable of separate, independent operations at full strength (level 1). When operating independently for extended periods, hospitalization units must be augmented with administrative and logistical personnel.

(2) Providing 2 hospitalization units of 100-bed capacity each, and 1 hospitalization unit of 60-bed capacity at strength level 2.

(3) Providing 2 hospitalization units of 100-bed capacity each at strength level 3.

d. Organization.

(1) *General.* The field hospital TOE provides a headquarters and 3 hospitalization units. When operating as a 400-bed facility, the field hospital adopts the standard organization described previously for a "type" hospital.

(2) *Hospitalization units.* There are three identical hospitalization units included in the field hospital. Each unit is capable of establishing a hospital on a small scale apart from the remainder of the organization. A Medical Corps officer, qualified as a general surgeon, commands the hospitalization unit. When the unit is operating independently, he assumes full command responsibility. When the field hospital operates as a whole, he may be designated chief of one of the professional services in accordance with his professional training. Each hospitalization unit may be organized to function similarly to a "type" hospital less a dental section. When the field hospital operates as a whole, the units are merged to operate as a single unit.

e. Concept of Operations. Field hospitals are assigned to the theater army medical command and are normally attached to medical groups for command and control. Field hospitals are not normally counted as fixed-bed facilities, but may be designated as such. Operating units of the field hospital are normally located in the forward area of the COMMZ. These units provide area health services and, in emergencies, hospitalization of patients from the combat zone. The field hospital type B organization adapts the TOE to lesser requirements for U.S. military personnel. Some positions may be filled by non-U.S. personnel as determined by the major commands to which the unit is assigned. Interpreters and translators are provided from teams when the unit is in support of the indigenous population and prisoners of war.

f. Mobility. The field hospital is 40 percent mobile. The organic motor transportation provided

field hospitals is sufficient only for routine overhead functions and normal housekeeping services. When movement of the hospital is directed, additional transportation must be provided.

g. Contingency Employment in the Event of Nuclear Warfare. In the event of an enemy nuclear attack resulting in large numbers of casualties, a unit of this type can be utilized to operate treatment stations in the immediate vicinity of the stricken area. Three hospitalization units in three separate locations may be established or a complete field hospital may be established at a single location. In either case, this unit performs the functions of receiving and sorting patients; providing emergency medical/surgical care and treatment; and preparing the patients for further evacuation. The flexibility of the field hospital enhances its value for use in situations involving the care and handling of mass casualties. Therefore, it is vitally important that detailed and comprehensive plans be formulated for the utilization of this type unit under these circumstances. These plans should include provision for a speedy change from routine operations to those required for the early management of mass casualties. A field hospital operating as a complete unit, or a hospitalization unit operating separately, must monitor, for radiological contamination, those patients received directly from a stricken area.

**E-27. General Hospital, 1,000-Bed
(TOE 8-551G)**

a. Mission. The mission of the general hospital is to provide hospitalization (1,000-bed) to include—

(1) Medical treatment of a definitive and specialized nature.

(2) Observations and studies of patients with serious or complicated illnesses, diseases, injuries, or combat-incurred wounds.

b. Assignment and Basis of Allocation. The general hospital is assigned to a theater army medical command on the basis of 15 per 20,000 theater army fixed bed requirements.

c. Capabilities.

(1) At full strength (level 1) the general hospital provides services as stated in the unit mission and for reception and treatment of patients evacuated from—

(a) Forward medical units, including those in support of combat troops.

(b) Station and field hospitals.

(c) Dispensaries in the immediate vicinity of the hospital.

(2) At strength levels 2 and 3 this unit can provide and operate a 900-bed or 800-bed fixed hospitalization facility.

(3) When operating as a type B TOE, the U.S. personnel vacancies can be filled by non-U.S. personnel as required by the local area conditions of employment.

d. Organization. The general hospital is organized and operates as described in the discussion of a "type" hospital (para E-25).

e. Concept of Operations. General hospitals are assigned to the theater army medical command and are normally attached to hospital centers in order to insure efficiency in the command, control, and use of personnel. The majority of patients admitted to general hospitals will come from the combat zone; however, patients are also received from other medical facilities of the COMMZ.

f. Mobility. The general hospital is a fixed facility.

g. Contingency Employment in the Event of Nuclear Warfare. In the event of an enemy nuclear attack resulting in large numbers of casualties within the communications zone, units of this type can be employed effectively in the reception, sorting, and providing of emergency medical and surgical care and treatment. Medical teams can also be organized and utilized to operate treatment sections, or to augment other medical units providing emergency medical care and treatment to the patients near the damaged area. Detailed and comprehensive plans should be formulated as early as possible by each general hospital in order to meet contingencies of this type. These plans should include provisions for a speedy change from routine operations to those required for the early medical management of mass casualties.

E-28. Station Hospital, 100-200-300-500-Bed, TOE 8-563G, TOE 8-564G, TOE 8-555G, and TOE 8-566G

a. General. Station hospitals are organized and equipped under four different TOE. The mission for each of the hospitals is the same, but the basic difference is the number of beds that can be supported with the personnel and equipment authorized.

b. Mission. The mission of the station hospital is to provide station-type hospitalization, outpatient service, and medical logistic support to an installation or military population of a specified geographical area.

c. Assignment and Basis of Allocation. The

station hospital is assigned to the theater army medical command as required to satisfy fixed bed requirements.

d. Capabilities.

(1) At strength level 1 station hospitals provide and operate a 100, 200, 300, or 500-bed fixed hospitalization facilities and normally provide the following services:

(a) Medical, surgical, and dental care and treatment for inpatients.

(b) Preparation of patients for further evacuation.

(c) Limited outpatient service, not to include dental care.

(d) Limited optometrical, medical supply, and medical equipment maintenance support to a military population or geographical area.

(2) At strength levels 2 and 3, the operational capabilities are reduced by 10 percent decrements.

(3) These units are not adaptable to a type B organization.

e. Organization. Station hospitals are organized and operate as described for a "type" hospital (para E-25).

f. Concept of Operations. Station hospitals are assigned to the theater army medical command and are normally attached to hospital centers or medical groups. Subject to fluctuations in admission rates, disposition, and accumulation factors, the following table may be used as a guide in estimating the capabilities of station hospitals:

<i>Station hospital</i>	<i>Troop population</i>
100-bed	Up to 4,000
200-bed	4,001 to 8,000
300-bed	8,001 to 12,000
500-bed	12,001 to 20,000

Station hospitals are established at locations in the communications zone where there is a concentration of military personnel.

g. Mobility. All station hospitals are considered to be fixed installations.

h. Contingency Employment in the Event of Mass Casualties. In the event of an enemy nuclear attack resulting in large numbers of casualties within the communications zone, station hospitals can be effectively employed in the same manner as outlined for general hospitals.

E-29. Mobile Army Surgical Hospital (TOE 8-571G)

a. Mission. The mission of the surgical hospital is to provide resuscitative surgery and medical treatment necessary to prepare critically in-

jured or ill patients received from division medical elements for further evacuation.

b. Assignment and Basis of Allocation. Surgical hospitals are assigned to the field army medical brigade, independent corps, or task force on the basis of one per division.

c. Capabilities.

(1) At strength level 1 the surgical hospital is capable of providing the following:

(a) Resuscitative surgery and medical treatment necessary to prepare critically injured or ill patients for further evacuation to other medical facilities capable of providing definitive treatment.

(b) Postoperative treatment and holding facilities for a maximum of 60 patients that are not transportable for medical reasons or that are awaiting evacuation.

(2) At strength levels 2 and 3 the capabilities are reduced by 10 percent decrements.

d. Organization. The hospital consists of hospital headquarters; supply and service; preoperative and shock; operating; postoperative; pharmacy, laboratory, and X-ray; and holding sections. The organization and functions of the hospital headquarters, supply and service section, pharmacy, laboratory, and X-ray sections are similar to that of a "type" hospital as previously described (para E-25).

(1) *Preoperative and shock section.* Personnel of this section prepare incoming patients for surgery and perform necessary resuscitation of patients suffering from shock. In addition to shock therapy, diagnostic procedures are performed.

(2) *Operating section.* Personnel of this section perform resuscitative surgery. Sufficient personnel and equipment are provided to operate three surgical teams simultaneously. The section consists of general, orthopedic, and thoracic surgeons; a general medical officer; anesthesiologist; nurse anesthetists; operating room nurses; and enlisted operating room centralized materiel specialists. Normally, a basic surgical team will consist of a surgeon, an operating room nurse, an anesthetist, a senior operating room specialist, and an operating room specialist. Personnel of the centralized materiel service in this section prepare, store, and issue supplies used in the operating unit and sterile supplies used throughout the hospital.

(3) *Postoperative section.* Personnel of this section provide postoperative treatment. A general surgeon, a general medical officer, a medical-surgical nurse, general duty nurses, and ap-

propriate enlisted personnel are included in this section.

(4) *Holding section.* When it becomes necessary to move the hospital forward, the unit detaches its holding section to preserve the hospital's mobility and to continue the necessary medical and nursing care for patients, pending their evacuation. Normally, a Medical Corps officer, a nurse, necessary enlisted specialists, and house-keeping personnel are designated by the commanding officer to remain with this section while the main body moves forward. As soon as all patients are evacuated, the holding section rejoins the main body. This section receives patients from the postoperative section and provides treatment until they are evacuated.

e. Concept of Operations. The surgical hospital normally is attached to a medical group, but may be attached to a medical battalion and provides direct support to combat divisions. This hospital is an alternative to the normal chain of evacuation and usually receives critically ill or injured personnel only. The hospital may be located in the division rear area when conditions permit; otherwise, it will be centrally located behind the division rear boundary. The hospital will normally move forward when the supported division moves, leaving patients in the holding section until they can be evacuated.

f. Mobility. The surgical hospital is 100 percent mobile.

g. Contingency Employment in the Event of Mass Casualties. In the event of an enemy nuclear, biological, or chemical attack resulting in large numbers of patients, this hospital can be used effectively in a manner comparable to that outlined for the evacuation hospital.

E-30. Evacuation Hospital, Semimobile (TOE 8-581G)

a. Mission. The mission of the evacuation hospital is to provide hospitalization for all classes of patients within the combat zone.

b. Assignment and Basis of Allocation. The evacuation hospital is assigned to the field army medical brigade, independent corps, or task force on the basis of two per division.

c. Capabilities.

(1) At full strength (level 1), the evacuation hospital provides—

(a) Hospitalization for 400 patients of all classes.

(b) Definitive treatment within limitations imposed by the evacuation policy.

(c) For the preparation of patients for evacuation to other medical facilities.

(d) Limited outpatient service to the military population in the immediate vicinity of the hospital.

(2) At strength levels 2 and 3 operational capabilities are reduced by 10 percent decrements.

(3) The evacuation hospital is not adaptable to type B organization.

d. Organization. The evacuation hospital is composed of a hospital headquarters section, administrative services, and professional services and operates similar to a "type" hospital as described (para E-25).

e. Concept of Operations. Evacuation hospitals are attached to medical groups and provide the primary means of hospitalization in the combat zone. The hospital is in the normal chain of evacuation and receives patients from divisional and nondivisional units, surgical hospitals and by direct admission. Two hospitals normally support one division and may be echeloned in depth or laterally.

f. Mobility. The evacuation hospital is 50 percent mobile.

g. Contingency Employment in the Event of Mass Casualties. In the event of enemy nuclear, biological, or chemical attack resulting in large numbers of patients, this unit can be used effectively in receiving, sorting, and providing emergency medical/surgical care and treatment of these patients. Detailed and comprehensive plans should be formulated as early as possible to meet a contingency of this type. These plans should include provisions for a prompt change from routine operations to those required for the early medical management of mass casualties.

E-31. Convalescent Center (TOE 8-590G)

a. Mission. The mission of the convalescent center is to provide facilities for the convalescent care and physical reconditioning of patients.

b. Assignment and Basis of Allocation. The convalescent center is assigned to the field army medical brigade on the basis of 1 per field army and to the theater army medical command on the basis of 1 per 10,000 fixed beds in the COMMZ.

c. Capabilities.

(1) At level 1 this unit provides the following for 1,500 patients:

(a) Convalescent care and physical reconditioning of patients expected to be returned to duty under the prevailing evacuation policy.

(b) Dispensary-type medical and dental treatment.

(c) Dispensary-type optometric care.

(d) Expedient dental care for inpatients.

(2) At level 2 the unit provides care for 1,350 patients and at level 3, care for 1,200 patients.

(3) The center is adaptable for type B organization and the capabilities are the same as that for level 1.

d. Organization. The convalescent center is organized into a center headquarters, administrative service, clinical service, and a reconditioning battalion.

(1) *Center headquarters and administrative service.* The center headquarters and administrative service are organized and operate similar to a "type" hospital as described (para E-25).

(2) *Clinical service.* The operation of the clinical service is supervised by a senior Medical Corps officer designated by the center commander. The clinical service provides dispensary-type care; physical examination and exercise-tolerance test evaluation; physical classification; makes recommendations for each patient's assignment to an appropriate reconditioning company; and provides physical reclassification at periodic intervals so that the most effective reconditioning of the patient may take place in a minimum period of time. During the patient's stay at the center, the clinical service is provided with information concerning the patient's exercise tolerance, rate of progress, and reconditioning activities. Whenever practicable, all patients originating from the same unit are assigned to the same reconditioning company for the maintenance of proper morale and esprit de corps. The clinical service consists of medical, surgical, dental, optometry (including single-vision spectacle fabrication and repair), pharmacy, laboratory, and X-ray sections. These sections operate as described for a "type" hospital (para E-25).

(3) *Reconditioning battalion.* The reconditioning battalion consists of a headquarters and 6 reconditioning companies. Each company has a capacity for 200 patients and is designed to provide the type of exercise required by patients (i.e., light, moderate, and heavy exercise). The initial assignment of patients and their rate of progress through the various reconditioning companies is based upon a medical appraisal of the patients' physical status and the evaluation of their exercise tolerance. Officer and noncommissioned officer patients are used whenever practicable as platoon leaders and instructors in the various

phases of the reconditioning program, including athletic, recreational, and educational activities. Screening of qualifications, special abilities, and combat experience of all patients upon admission affords the opportunity for selecting individuals with the proper background and training for the performance of these duties. When these individuals are physically and mentally fit for return to duty, they will not be retained for the sole purpose of being used as instructors but will be promptly returned to duty.

e. Concept of Operations.

(1) The convalescent center(s) are established in the combat zone and COMMZ, where required, in order to prevent unnecessary evacuation of patients requiring only convalescent care and physical reconditioning prior to returning to duty.

(2) The convalescent center is not considered a hospital when estimating fixed-bed requirements.

f. Mobility. The convalescent center is considered a fixed installation.

g. Contingency Employment in the Event of Mass Casualties.

(1) In the event of an enemy nuclear, biological, or chemical attack resulting in large numbers of patients, the convalescent center could—

(a) Provide personnel and materiel to reinforce other medical units servicing the affected area.

(b) Provide emergency medical treatment teams to operate independently in or to reinforce other medical units supporting the affected area.

(c) Upon being augmented by appropriate medical professional and technical teams, provide austere hospital-type treatment support to the affected area.

(2) Plans should be formulated for the full utilization of the center's personnel in the event of a contingency of this type.

Section V. MEDICAL SUPPLY UNITS

E-32. Medical Depot (TOE 8-187G)

a. Mission. The mission of the medical depot is to furnish medical depot support within a theater of operations.

b. Assignment and Basis of Allocation. The medical depot is assigned to the theater army medical command on the basis of two per field army supported.

c. Capabilities.

(1) At level 1, with augmentation of labor personnel, this unit is capable of providing general and direct medical supply support to a maximum of 350,000 troops in a theater of operations to include—

(a) Receipt, classification, storage, and issue of 50 short tons of medical supplies daily.

(b) Direct and general support maintenance of medical equipment of using organizations in the communications zone, and backup general support maintenance to the Army Medical Depot, TOE 8-667G).

(c) Optical laboratory service.

(d) Assistance in the distribution of whole blood to hospitals in the COMMZ.

(2) At reduced strength levels 2 and 3, the operational capabilities are reduced to approximately 90 percent and 80 percent, respectively.

(3) The capabilities of a type B organization are the same as those of a level 1 organization.

d. Organization. The depot consists of a depot

headquarters, company headquarters, stock control section, storage and issue section, medical maintenance section, optical laboratory section, and a blood distribution section.

(1) *Depot headquarters.* The depot headquarters consists of the depot commander, executive officer, sergeant major, and a clerk typist. The depot commander is responsible for the command, administration, and operation of the depot. He maintains liaison with higher headquarters regarding the status of supplies and other operational details concerning the depot activities.

(2) *Company headquarters.* The depot company headquarters consists of the company commander and the necessary personnel for the routine administration and maintenance of the depot.

(3) *Stock control section.* This section includes personnel who maintain an effective stock record account with an adequate supporting system of debit and credit vouchers; initiate action to maintain depot stocks of supplies; declare and take action to dispose of excess property and maintain requisition and shipping order files which indicate the quantities of each item on hand, issued or shipped, dues-in and dues-out. The section prepares periodic and special reports on depot supply operations and status of supplies for the depot commander.

(4) *Storage and issue section.* This section includes personnel required to supervise and coordinate the receipt, storage, and issue of supplies.

The section is staffed with a complement of personnel comprised of—

(a) The storage and issue officer who supervises the operation of the section. He establishes procedures for warehousing, receiving, issuing, packaging, shipping, and physically inventorying the supplies within the depot. Normally, he will establish and maintain locator files, and inspect the condition of materiel in storage. All aspects of this latter function, as they pertain to drugs, narcotics, precious metals, and potable alcoholic items, are normally performed by a pharmacy officer who is assigned to this section. The storage and issue officer is also responsible for the labor and equipment pool.

(b) Receiving personnel who segregate, by type of item, materiel received, check incoming shipment against appropriate shipping documents, and route materiel to the appropriate storage area. In addition, these individuals maintain receiving documents necessary for stock record account.

(c) Storage and issue personnel who store, issue, and perform in-storage maintenance of stored supplies. Assignment of storage space is made by medical supply classes. A loose issue area is also maintained by this section in order to serve local installations and to provide less than original package quantities.

(d) Shipping personnel are assigned the task of directing the collection of outgoing materiel from storage areas, and of preparing, documenting, and shipping this materiel from the depot.

(e) The labor pool, which includes the labor personnel, provides the depot with storage and handling operations.

(5) *Maintenance section.* This section is responsible for repairing, rebuilding, and renovating all medical materiel, and for the operation and organizational maintenance of depot utilities and motor transport vehicles.

(6) *Optical section.* The optical section fabricates and repairs spectacles for all military personnel in the area supported by the medical depot. An optometrist supervises the operation of the optical section.

(7) *Blood distribution section.* The blood distribution section receives and stores whole blood. It also delivers whole blood to using medical facilities. In the performance of these functions, the section is directly supervised by a medical supply officer, who establishes operational plans and procedures for the section based on pol-

icies established for the theater blood bank service.

e. Concept of Operations.

(1) The medical depot is employed to serve as a receiving depot at a port or as a distribution depot. When employed as one of several medical depots, it may be assigned a key or reserve depot mission. Specific missions for medical depots are designated by the medical command. The depot's location will be directly influenced by its mission. When the primary mission is that of receiving incoming supplies from a port, it will be located as close as possible to the port. When the primary mission is that of a distribution depot, it will be located within its area of responsibility with consideration given to the tactical and strategic effort, location of ports, and the major usable transportation facilities. Other considerations are adequate dispersion, defensibility, local roads and railyards, hardstandings, communications, existing buildings and structures, utilities, and availability of local labor.

(2) Shipments from ports or other medical depots constitute the bulk of the depot's receipts. Other receipts are generated by excess and unserviceable returns, local procurement, and captured enemy materiel. Incoming materiel is normally transported to the depot by motor vehicle and rail; a small percentage is transported by air.

(3) Approximately 90 percent of medical materiel requires covered storage. Provision must be made for the protection of items (drugs) that are susceptible to damage from freezing; items subject to pilferage (narcotics and precious metals); and items requiring refrigeration (whole blood and biologicals). Facilities are established for classification and preservation processing of returns and captured materiel. Provisions are also made for processing and disposal of salvage.

(4) Locally procured whole blood as well as that received from out of the theater is processed as required, stored, and transported by the pooled blood program and depot resources (when collocated). Surface transportation organic to these units is normally used when possible. Shipments may be made by air when warranted by distance, emergencies, or enemy activities.

(5) The depot provides spectacle frame repair and fabrication of multifocal and single-vision prescriptions requiring lens grinding in support of medical facilities located within its distribution area. Delivery of finished products is normally made through use of postal services to an optometry officer for dispensing to the patient.

(6) Direct and general support medical equipment maintenance is provided to units supported by the depot. Direct support is provided by means of repair and return to user, or by direct exchange using materiel designated as operational readiness float. The depot's medical equipment maintenance element also accomplishes classification and repairs to unserviceable returns in conjunction with the in-storage surveillance program.

f. Mobility. The medical depot is a fixed unit.

E-33. Army Medical Depot (TOE 8-667G)

a. Mission. The mission of the army medical depot is to furnish medical depot support to a field army.

b. Assignment and Basis of Allocation. The depot is normally assigned to the field army medical brigade on the basis of one per medical brigade. It may be attached in whole, or in part, to a corps support command with further attachment to a medical brigade or to a type B medical group during an independent corps operation.

c. Capabilities.

(1) At level 1, this unit is capable of providing general and direct medical supply support to a maximum of 400,000 troops in a combat zone to include—

(a) Establishment of the base depot and three advance depots to provide medical depot support on an area basis.

(b) Receipt, storage, and issue of medical supplies and equipment.

(c) Direct and general support maintenance of medical equipment.

(d) Optical laboratory service.

(e) Distribution of whole blood throughout the army area.

(f) Operation of the army medical inventory control point.

(2) Under strength levels 2 and 3 the operational capabilities are reduced by 10 percent decrements.

(3) The capabilities of a type B organization are the same as those of a level 1 organization.

d. Organization. The major elements of this unit consist of the depot headquarters, company headquarters, base depot, and three advance depots. The base depot has a base depot headquarters, stock control section, blood distribution section, medical maintenance section, optical laboratory section, and the base depot storage and issue section. Collectively, these base depot elements

operate the base medical depot facility. The advance depots have an advance depot headquarters, medical equipment repair team, optical repair team, and a storage and issue section. These advance depots operate the forward medical supply and maintenance depots.

(1) *Depot headquarters.* The depot commander, assisted by an executive officer, sergeant major, and a clerk typist is responsible for the overall operation of the depot; command; administrative; and liaison functions.

(2) *Company headquarters.* This element is supervised by a company commander who is directly responsible to the depot commander for the routine company administration, unit supply, food service, motor maintenance, and communications.

(3) *Base depot.* The base depot consists of headquarters, stock control section, blood distribution section, medical maintenance section, optical laboratory section, and the base depot storage and issue section. These elements function as follows:

(a) *Base depot headquarters.* The operations of the base depot are supervised by a medical supply officer who is responsible for the control, management, and related administrative tasks of the stock control, blood distribution, medical maintenance, optical laboratory, and base depot storage and issue sections.

(b) *Stock control section.* This element maintains accountability for all medical and dental materiel received, stored, and issued to the field army. It functions as the medical inventory control point for the field army.

(c) *Blood distribution section.* This section receives, stores, and distributes whole blood to the field army medical facilities. Blood distribution is made to the advance depots, to medical facilities in the corps rear, and field army service area through the use of refrigerator equipped trucks. Blood may be moved by airlift when feasible.

(d) *Medical maintenance section.* This section performs direct and general medical equipment maintenance. Two medical equipment warrant officers are assigned to this section. The services of the medical equipment maintenance personnel are made available, on an oncall basis, to the medical facilities located in the base depot area of responsibility.

(e) *Optical laboratory section.* This section provides base level optical support to the optical teams of the advance depots and overall fabrication and repair support for the field army service area.

(f) *Base storage and issue section.* This section accomplishes receipt, storage, and issue functions in support of the forward advance depots medical facilities located in the field army service area.

(4) *Advance depot headquarters.* This headquarters accomplishes the control, management, and related administrative tasks of the medical equipment repair team, optical repair team, and storage and issue section.

(a) *Medical equipment repair teams.* This team is capable of performing organizational and direct support medical maintenance to units supported either on site or at advance depots.

(b) *Optical repair team.* This team is capable of providing single-vision spectacle repair and fabrication services to units supported by the advance depot within the limitations imposed by their supplies and equipment.

(c) *Storage and issue section.* The advance depot storage and issue section functions in the same manner as the base depot storage and issue section. The only difference is the number of items handled and tonnage.

e. Concept of Operations.

(1) The unit is normally under control of the medical brigade commander when employed in the field army, or to a medical brigade or the type B medical group commander when employed in an independent operation.

(2) When supporting the field army, the unit establishes a base depot and three advance depots. The base depot is centrally located within the army service area. The advance depot is normally employed on the basis of one per corps and is located in the corps rear area. When supporting an independent corps operation, a base depot and one advance depot are required.

(3) The army medical depot is capable of maintaining 10 days of medical supply for the field army. In ordinary depot operations, bulk issues are made to the advance depots and issues are also made to medical units and elements located in the army service area on an area basis. Direct and general support medical maintenance, spectacle repair and fabrication, medical inventory control, and assistance in whole blood distribution may also be provided by the base depot in support of both the advance depots and medical facilities located in the army service area.

(4) The advance depots maintain from three to five days of medical supply for the supported units. They provide medical supply; whole blood, when directed; and direct support medical equipment maintenance to divisions and other medical

facilities located within their respective area of responsibility.

(5) The base and advance depots receive demands for medical supply directly from users. Demands for controlled and regulated medical items are processed through the medical brigade headquarters in the field army or the type B medical group in the independent corps operation. The base and advance depots edit requisitions and complete necessary supply actions. A medical inventory control point is established at the base depot. Receipt, issue, turn-in, and due-out data are provided to the inventory control point by the base and advance depots using the ADPE typewriter input-output service. The inventory control point maintains a record of stock balances, computes requirements, and initiates resupply action. This is accomplished in the inventory control point manually until such time as data processing system equipment can be standardized. Resupply of the advance depot is accomplished by shipment from the base depot or throughput from a COMMZ medical depot. When required, lateral redistribution of supplies between the advance depots is accomplished to satisfy specific issue demands.

(6) When assigned the responsibility, the base depot receives whole blood from the COMMZ medical depot or the field army collection and processing system. Distribution of whole blood to the advance depots and hospitals in the army service area is accomplished by the blood distribution section base depot by direction of the medical brigade commander. The advance depots store and issue whole blood to the divisions and medical treatment facilities located in their area of responsibility.

(7) The advance depots are staffed and equipped to provide direct support medical maintenance. The base depot, medical maintenance section, provides direct support medical maintenance to the medical facilities in their area of responsibility in the field army service area, and general support medical maintenance for the field army.

(8) The optical laboratory of the base depot provides the spectacle repair and fabrication for the medical facilities in the army service area.

(9) Captured enemy medical materiel will normally be evacuated to the base depot. When required, the base depot establishes a captured materiel section for the purpose of identifying and classifying the materiel. After release by a medical technical intelligence representative, the materiel is identified and classified, and appro-

priate information is provided to the medical inventory control point. The inventory control point maintains balance records for captured materiel and provides the medical brigade commander with available data. Issue of captured materiel is normally controlled by the medical brigade commander. Issues will usually be limited to facilities providing health services to captured enemy personnel.

f. Mobility. The army medical depot is 75 percent mobile.

E-34. Medical Supply Detachment, Teams FB and FC, TOE 8-500G

a. Mission. The mission of the Team FB and Team FC is to augment existing medical supply installations in a theater of operations and to provide medical supply support to separate task forces of varying types and sizes.

b. Assignment.

(1) The Team FB is assigned to the field army medical brigade on the basis of 1 per division not supported by a depot and to the theater army medical command on the basis of 1 per additional 20,000 troops in the COMMZ not supported by a depot.

(2) The Team FC is assigned to the field army medical brigade on the basis of 1 per additional corps not supported by a depot or a Team FB and to the theater army medical command on the basis of 1 per additional 50,000 troops in the COMMZ not supported by a depot or Team FB.

c. Capabilities. The supply detachments Teams FB and FC are capable of receiving, storing, and issuing medical supplies, either as separate medical supply detachments operating with a task force or as augmentation teams functioning with existing medical installations. When augmented with appropriate maintenance and optical teams, these units provide depot level support.

d. Concept of Operations. When operating in a theater of operations, teams may be used to augment existing medical supply installations or other types of medical facilities. When attached to separate task forces, locations must conform to the tactical disposition of the combat elements being provided medical supply services.

e. Mobility. The Teams FB and FC are 100 percent mobile.

E-35. Optical Detachment, Team GA, TOE 8-500G; Optical Detachment Augmentation, Team GB, TOE 8-500G

a. Mission. The mission of Team GA and Team GB is to furnish personnel and equipment for the manufacture and repair of spectacles in a theater of operations.

b. Assignment and Basis of Allocation.

(1) The Team GA is assigned to the field army medical brigade on the basis of 1 per additional corps not supported by a depot or Team GB and to the theater army medical command on the basis of 1 per additional 75,000 troops in the COMMZ not supported by a medical depot.

(2) The Team GB is assigned on the basis of 1 per independent task force of division size or smaller and to the field army medical brigade on the basis of 1 per additional division not supported by a medical depot or Team GA.

c. Capabilities.

(1) The Team GA is capable of providing presurfaced single-vision and special type spectacle prescription (excluding multifocals) repair and fabrication services for a force of 75,000 troops.

(2) The Team GB is capable of providing presurfaced single-vision spectacle prescription fabrication and repair services for a force of 10,000 troops.

(3) These teams are not adaptable to organization and equipment levels 2 and 3.

d. Concept of Operations. These teams can be located in troop areas containing troop populations requiring optical services. The teams are normally attached to a medical depot and used to augment optical capabilities of the depot.

e. Mobility. The optical detachments GA and GB teams are 100 percent mobile.

E-36. Medical Equipment Maintenance Detachment, Teams GC and GD, TOE 8-500G

a. Mission. The mission of Teams GC and GD is to perform medical equipment maintenance.

b. Assignment and Basis of Allocation.

(1) Team GC is assigned to the field army medical brigade on the basis of 1 per additional corps not supported by a medical depot or Team GD and to the theater army medical command on the basis of 1 per additional 50,000 troops not supported by a medical depot or Team GD.

FM 8-10

(2) Team GD is assigned to the field army medical brigade on the basis of 1 per independent corps not supported by a medical depot and to the theater army medical command on the basis of 1 per additional 100,000 troops not supported by a medical depot.

c. Capabilities.

(1) Team GC is capable of performing direct medical equipment maintenance support for medical facilities that support a force of 50,000 troops.

(2) Team GD is capable of supporting a force of 100,000 troops.

d. Concept of Operations. These teams are normally attached to medical supply installations in a theater of operations. They are used to augment or provide a direct support or general support medical equipment maintenance capability.

e. Mobility. The medical equipment maintenance detachment Teams GC and GD are 100 percent mobile.

Section VI. PROFESSIONAL SERVICES UNITS (TOE 8-500G)

E-37. General

Professional service teams provide medical, surgical, psychiatric, and dental specialty services. Medical, surgical, and psychiatric teams are organized and equipped for the mission of augmenting units and facilities requiring specialty reinforcement or support. Dental professional teams are organized and equipped for the mission of establishing dental treatment facilities independent of existing units; for augmenting established facilities; and for augmenting each other as required.

a. Assignment. Unless specifically limited by capabilities, the professional services teams may be assigned to a field army medical brigade, theater army medical command, independent corps, task force, or special action force.

b. Capabilities.

(1) The level 1 capabilities of these units vary with the size, groupings, and specialties of the individual teams. Team capabilities are as indicated in the following paragraphs.

(2) Under strength levels 2 and 3 the operational capabilities of all teams are reduced by 10 percent decrements.

(3) These teams are not adaptable to a type B organization.

c. Relationships. Professional teams are normally attached to a professional service headquarters team for command and control. When a team is operationally attached to a unit or facility requiring a particular specialty, the team is normally commanded by that unit and control is normally exercised by the unit's specialty service section during the period of attachment.

E-38. Surgical Detachment, Team KA, TOE 8-500G

a. Assignment and Basis of Allocation. Team KA is assigned to the field army medical brigade on the basis of 1 per 4 evacuation hospitals, and

to the theater army medical command on the basis of 1 per 5,000 fixed beds required.

b. Capabilities. This team is primarily designed to function as a single operative team, performing general surgery and related patient care procedures. Two general surgeons are provided Team KA; therefore, in an emergency and when additional personnel and equipment are provided by the unit to which it is attached, it can perform, for a limited period, as two operative teams or as a split-shift, single team to provide 24-hour coverage. The organic medical equipment of this team is oriented toward supplementing the equipment of the unit which it augments and to provide those items that are peculiar to its specialized service. The team depends on the unit that it augments for a portion of the basic items that are required for the accomplishment of major surgery; sheltered working space; resupply; centralized materiel services; clinical, and other services.

c. Concept of Operations. This team is normally under the control of a professional services headquarters. Based on predetermined or present requirements, the team is operationally attached to a medical unit or facility which requires augmentation. The team may be redeployed frequently to accommodate mission adjustments or shifting workloads. When attached to a unit for operations, the team normally functions as an operative team in support of the unit's surgical service.

d. Mobility. Team KA is 100 percent mobile and is 100 percent air-transportable.

E-39. Orthopedic Detachment, Team KB, TOE 8-500G

a. Assignment and Basis of Allocation. The Team KB is assigned to the field army medical brigade on the basis of 1 per 4 evacuation hospitals allocated and to the theater army medical command on the basis of 1 per 10,000 fixed beds required.

b. Capabilities. This team is capable of providing specialized treatment for all orthopedic cases including skeletal traction, reduction of fractures, and other orthopedic procedures. The Medical Corps officer personnel act as consultants when required.

c. Concept of Operations. This team is organized and operates in the same manner as Team KA; the only difference is the type of specialty involved.

d. Mobility. Team KB is 100 percent mobile.

E-40. Shock Detachment, Team KC, TOE 8-500G

a. Assignment and Basis of Allocation. Team KC is assigned to the field army medical brigade on the basis of 1 per 8 evacuation hospitals allocated, and to the theater army medical command on the basis of 1 per 10,000 fixed beds required.

b. Capabilities. This team provides personnel and augmentation materiel for shock therapy. Staffing and equipment of all patient care facilities normally provide sufficient resources for the average shock therapy workload. When a unit is subjected to an unusual number of seriously ill patients, there is a corresponding increase in the need for professional and ancillary services to perform shock prevention and shock treatment tasks. The shock team is capable of augmenting or replacing a like number of personnel engaged in shock therapy at the unit which it augments. When used to replace unit personnel, the efforts of the augmented unit's personnel can be diverted to other patient care procedures.

c. Concept of Operations. The shock detachment operates in the same manner as the Team KA; the only difference is the type of specialty involved.

d. Mobility. Team KC is 100 percent mobile.

E-41. Maxillofacial Detachment, Team KD, TOE 8-500G

a. Assignment and Basis of Allocation. Team KD is assigned to the field army medical brigade on the basis of 1 per 8 evacuation hospitals, and to the theater army medical command on the basis of 1 per 20,000 fixed beds required.

b. Capabilities. This team is capable of furnishing specialized medical and dental treatment for patients suffering from face and jaw wounds and fractures. The team operates in a similar manner as Team KA; the differences concern the specialty of the personnel and the type of equipment required. Because of the diversity in the

specialties of its surgeons, the detachment cannot be split into two operative teams.

c. Concept of Operations. The team operates in the same manner as the Team KA; the only difference is the type of specialty involved and the inability to operate as two separate teams.

d. Mobility. Team KD is 100 percent mobile.

E-42. Neurosurgical Detachment, Team KE, TOE 8-500G

a. Assignment and Basis of Allocation. Team KE is assigned to the field army medical brigade on the basis of 1 per 4 evacuation hospitals allocated, and to the theater army medical command on the basis of 1 per 10,000 fixed beds required.

b. Capabilities. This team is capable of providing specialized neurosurgical treatment, including the treatment of brain, spinal cord, and peripheral nerve injuries.

c. Concept of Operations. Team KE operates in a similar manner as Team KA; however, it normally functions as a single operative team.

d. Mobility. Team KE is 100 percent mobile.

E-43. Thoracic Detachment, Team KF, TOE 8-500G

a. Assignment and Basis of Allocation. Team KF is assigned to the field army medical brigade on the basis of 1 per 8 evacuation hospitals allocated and to the theater army medical command on the basis of 1 per 20,000 fixed beds required.

b. Capabilities. This team performs thoracic surgery and related patient care procedures and normally functions as a single operative team.

c. Concept of Operations. The surgeon's qualifications and the medical equipment of this team are oriented toward thoracic surgery. The team is equipped, staffed, and operated in the same manner as Team KA.

d. Mobility. The Team KF is 100 percent mobile.

E-44. Medical Treatment Detachment (Chemical Agents), Team KG, TOE 8-500G

a. Assignment and Basis of Allocation. Team KG is assigned to the field army medical brigade on the basis of 1 per 8 evacuation hospitals allocated and to the theater army medical command on the basis of 1 per 20,000 fixed beds required.

b. Capabilities. This detachment provides the unit to which it is attached facilities for the care and treatment of patients exposed to chemical agents. The detachment uses its own facilities for

treating and sheltering up to 24 patients at a time.

c. Concept of Operations. When Team KG is given the mission to augment a medical unit, the team establishes a treatment facility near the supported unit. When in operation, the team receives, decontaminates, and provides treatment for those chemically injured patients that require intensive care. When not actively engaged in providing treatment for chemically injured patients, the detachment is normally employed to augment a medical facility, and, within the qualifications of its assigned personnel, provide for routine care of patients.

d. Mobility. Team KG is 40 percent mobile.

E-45. X-ray Detachment, Team KH, TOE 8-500G

a. Assignment and Basis of Allocation. Team KH is assigned to the field army medical brigade on the basis of 1 per 24 evacuation hospitals allocated, and to the theater army medical command on the basis of 1 per 30,000 fixed beds required.

b. Capabilities. This team performs radiography and fluoroscopy procedures. Approximately 12 fluoroscopic procedures can be accomplished per day without exposing operating personnel to excessive radiation. When limited to the accomplishment and interpretation of radiography, 100 procedures can be completed per day. Approximately 50 radiographic and 12 fluoroscopic procedures can be performed each day. The team can provide a unit with an X-ray capability or it can be used to increase the capability of a unit's X-ray service.

c. Concept of Operations.

(1) Upon being assigned a specific mission, the team moves and establishes a complete X-ray facility or augments the existing facilities of the unit to which it is operationally attached.

(2) When not performing a specific mission, the team normally augments a large medical treatment unit or facility and provides assistance in patient care procedures.

d. Mobility. Team KH is 70 percent mobile.

E-46. Dental Operating Detachment, Team KI, TOE 8-500G

a. Assignment and Basis of Allocation. Team KI is assigned to the field army medical brigade and to the theater army medical command on the basis of 1 per 1,000 troop population not served by Team KJ.

b. Capabilities. Team KI is capable of furnish-

ing emergency dental treatment and limited routine dental treatment to a force of 1,000 troops. Equipment is not authorized for the performance of prosthodontic and major oral surgery procedures.

c. Concept of Operations. This team will normally operate under the control of a dental service headquarters. It may be employed in direct support of a single unit, in general support of several units, or in reinforcing an existing dental facility. Normally, the team establishes a dental clinic in a central location within the area occupied by troops for which dental service is being provided. This location is generally in the vicinity of the medical dispensary serving the same troops. If these troops comprise several dispersed units with considerable distance intervening, the team moves from unit to unit to provide dental service.

d. Mobility. Team KI is 100 percent mobile.

E-47. Dental Service Detachment, Team KJ, TOE 8-500G

a. Assignment and Basis of Allocation. Team KJ is assigned to the field army medical brigade and to the theater army medical command on the basis of 1 per 15,000 troop population.

b. Capabilities. This team is capable of providing routine dental treatment, except for those cases requiring hospitalization, for 15,000 troops.

c. Concept of Operations. Team KJ can operate as a consolidated facility or as a headquarters with dispersed teams. When operating as a consolidated facility, the detachment functions as a dental clinic consisting of a headquarters, a 12-chair general dentistry element, a 1-chair oral surgery element, a 1-chair prosthetic element, a prosthetic laboratory, and, when equipment is available, a 5-chair oral hygiene element. When providing dispersed facilities, the team functions as a headquarters section with 5 mobile operating teams, 3 semimobile operating teams, and a prosthetic team as follows:

(1) *Headquarters section.* This section provides command, control, administration, and support to its dispersed elements. It is normally collocated with Team 8 and the prosthetic team.

(2) *Mobile operating teams.* The 5 mobile operating teams, numbered 1 through 5, furnish dental care and treatment to troop units. These teams may be used on an itinerant basis when numerous small units are scattered within an area. They can also be used to augment semimobile

teams when the troop concentration requires. Each mobile operating team is composed of a dental officer and a dental hygienist. When the mobile teams are deployed, the capability of the Team KJ oral hygiene element is reduced.

(3) *Semimobile operating teams.* The 3 semimobile operating teams are numbered 6 through 8. Teams 6 and 7 can each furnish dental care to approximately 2,000 troops; Team 8 can provide such service to 4,000 troops.

(4) *Prosthetic team.* This team normally functions with one of the semimobile teams. The team prosthodontist provides prosthetic support to the entire Team KJ and supervises the fabrication of dental prosthetic appliances.

d. Mobility. Team KJ is 100 percent mobile when consolidated. When dispersed into separate teams, mobility is restricted.

E-48. Dental Prosthetic Detachment, Mobile, Team KK, TOE 8-500G

a. Assignment and Basis of Allocation. Team KK is assigned to the field army medical brigade and to the theater army medical command on the basis of 1 per 30,000 troop population.

b. Capabilities. This team can provide dental prosthetic service and limited laboratory service in support of dental care and treatment facilities.

c. Concept of Operations. Team KK receives prosthetic patient overloads from other dental facilities located in its area of responsibility, and provides prosthodontic and prosthetic fabrication services to troops not otherwise provided these services. The team may operate independently or may reinforce the dental services of hospitals or other dental service detachments.

d. Mobility. Team KK is 100 percent mobile.

E-49. Dental Prosthetic Detachment, Fixed, Team KL, TOE 8-500G

a. Assignment and Basis of Allocation. Team KL is assigned to the theater army medical command on the basis of 1 per 60,000 troop population in the COMMZ.

b. Capabilities. Team KL is capable of providing dental laboratory support to dental facilities engaged in providing dental care and treatment for a force of 60,000. Support provided by the detachment consists of processing that portion of the prosthetic fabrication workload or procedures that is beyond the capability of the units providing dental care and treatment.

c. Concept of Operations. This team estab-

lishes a dental laboratory in the communications zone. Its location is primarily governed by existing lines of communication which will provide a means for the rapid transfer of dental prosthetic cases to and from the laboratory. Existing buildings or prefabricated shelters are normally used to house the facility. The location of the team will also be influenced by the availability of electric power and other essential utilities.

d. Mobility. Team KL operates as a fixed installation.

E-50. Central Dental Laboratory, Team KN, TOE 8-500G

a. Assignment and Basis of Allocation. Team KN is assigned to the theater army medical command on the basis of 1 per 200,000 troop population in the COMMZ.

b. Capabilities. The central dental laboratory is capable of providing dental prosthetic laboratory service including procedures requiring special fabrication methods.

c. Concept of Operations. This laboratory may support laboratories of other dental facilities when a prosthetic overload develops, or may provide assistance for those prosthetic appliances which are beyond the technical capability of the personnel and equipment of smaller laboratories. The location of this laboratory will generally be governed by existing lines of communication which will provide a means for rapid transfer of dental prosthetic cases to and from the laboratory. Existing buildings or prefabricated shelters must be used to house the facility. The location of the unit will also be influenced by the availability of electric power and other essential utilities.

d. Mobility. Team KN operates as a fixed installation.

E-51. Psychiatry Detachment, Team KO, TOE 8-500G

a. Assignment and Basis of Allocation. Team KO is assigned to the field army medical brigade on the basis of one per corps and to the theater army medical command on the basis of one per three corps supported.

b. Capabilities. This team provides psychiatric treatment for 200 to 300 patients; operates within the facilities of the medical unit to which it is attached; and is also capable of providing psychiatric consultation and specialized treatment teams on a mobile basis for use as required in providing field army level psychiatric medical support to combat operations.

c. Concept of Operations.

(1) In the combat zone Team KO is normally employed by augmenting a separate medical clearing company or other medical facility to form a specialized treatment station. In the communications zone the team augments the psychiatric capabilities of hospitals and may be employed at ports and replacement camps for the treatment of mental patients capable of being returned to duty. In the interim between assignments the team is normally located in the area where the headquarters professional service team (AG) is in operation.

(2) Therapy performed by the team in cases of combat exhaustion emphasizes simple treatment measures and expectancy of return to duty. Narcosynthesis or hypnosis may be employed when indicated to recover repressed traumatic battlefield experiences. The team functions primarily in open wards, but must be professionally capable of treating closed ward cases and employing accepted procedures such as milieu therapy, chemotherapy, and electroshock as well as neurological procedures. The team may be used to provide specialized treatment in the psychiatric sections of wards functioning as convalescent or reconditioning units. When employed to provide

field consultation and treatment services, the team may be divided into a field section and a ward and clinic section. The field section provides consultation to troops at their place of duty. The ward and clinic section provides assistance to forward medical treatment facilities.

d. Mobility. Team KO is 100 percent mobile.

E-52. Renal and Electrolyte Metabolism Detachment, Team KP, TOE 8-500G

a. Assignment and Basis of Allocation. Team KP is assigned to the theater army medical command on the basis of 1 per 150,000 troops in a theater of operations.

b. Capabilities. This team is capable of providing an augmentation facility capable of caring for a maximum of 20 seriously ill patients with acute renal failure and providing consultation services to supported medical units.

c. Concept of Operations. Team KP will normally be attached to a fixed-type hospital and will be dependent upon the facility for normal administrative and logistic support.

d. Mobility. The Team KP operates as a fixed installation.

Section VII. VETERINARY UNITS

E-53. Veterinary Large Animal Hospital Detachment, Team IA, TOE 8-500G

a. Mission. The mission of Team IA is to provide hospitalization and medical and surgical treatment for equines or other large animal species.

b. Assignment and Basis of Allocation. Team IA is assigned to the field army medical brigade on the basis of 1 per 600 large animals supported; and to the theater army medical command on the basis of 1 per port designated for receiving and shipping animals and 1 per remount unit processing 1,500 animals per month.

c. Capabilities. The team is capable of providing hospitalization for approximately 30 large animals which require medical or surgical treatment and minor surgery on an area basis.

d. Concept of Operations. This detachment is dependent upon the unit to which it is attached for mess, administrative, personnel, and motor maintenance services. Normally, the team will establish a hospital near the major animal population and provide medical and surgical treatment

as required. The team receives animal patients evacuated from Team IB located in the field army or communications zone. Control is normally provided by Team AF.

e. Mobility. Team IA is 80 percent mobile.

E-54. Veterinary Large Animal Dispensary Detachment, Team IB, TOE 8-500G

a. Mission. The mission of Team IB is to provide dispensary service for equines or other large animal species.

b. Assignment and Basis of Allocation. Team IB is assigned to the field army medical brigade and the theater army medical command on the basis of 1 per 300 large animals or major fraction thereof to be supported.

c. Capabilities. Team IB provides dispensary service for large animals on an area basis to include emergency treatment and minor surgery.

d. Concept of Operations. Normally, Team IB will establish a dispensary close to organization or installations employing large animals. Maximum effort is exercised by personnel of the team

in large animal preventive medicine measures and in emergency treatment and procedures to prevent loss of animals to supported units by unnecessary evacuation. Control of Team IB is normally provided by Team AF.

e. Mobility. Team IB is 100 percent mobile.

E-55. Veterinary Small Animal Hospital Detachment, Team ID, TOE 8-500G

a. Mission. The mission of Team ID is to provide hospitalization, medical and surgical treatment, or observation for small animals (military dogs or laboratory animals) on an area basis.

b. Assignment and Basis of Allocation. Team ID is assigned to the field army medical brigade and the theater army medical command on the basis of 1 per 500 small animals, or major fraction thereof, to be supported.

c. Capability. Team ID is capable of providing hospitalization, medical or surgical treatment, or observation for approximately 50 small animals and also provides emergency treatment and minor surgery on an area basis.

d. Concept of Operations. Team ID is dependent upon the unit to which it is attached for mess, administrative, personnel, and motor maintenance services. Normally, the team will establish a hospital centrally located in reference to the supported animal population and provide veterinary services to organizations or installations which have military dogs or laboratory animals. Control is normally provided by Team AF.

e. Mobility. Team ID is 35 percent mobile.

E-56. Veterinary Small Animal Dispensary Detachment, Team IE, TOE 8-500G

a. Mission. The mission of Team IE is to provide dispensary service for small animals (military dogs or laboratory animals).

b. Assignment and Basis of Allocation. Team IE is assigned to the field army medical brigade and the theater army medical command on the basis of 1 per 100 small animals, or major fraction thereof, to be supported.

c. Capabilities. This team is capable of providing dispensary service to include emergency treatment and minor surgery on an area basis.

d. Concept of Operations. Normally, this team will establish a dispensary to provide limited veterinary service to organizations or installations which have dogs or other small animals. Maximum effort is exercised by the personnel of the detachment to prevent loss of small animals to the

supported troop units by unnecessary evacuation. Control is normally provided by Team AF.

e. Mobility. Team IE is 35 percent mobile.

E-57. Veterinary Service Detachment, Small, Team JA, TOE 8-500G

a. Mission. The mission of Team JA is to provide subsistence inspection, animal care, and veterinary preventive medicine support.

b. Assignment and Basis of Allocation. Team JA is assigned to the field army medical brigade on the basis of 1 per corps supported and to independent corps or task forces and to the medical command on the basis of 1 per 25,000 or fewer troops supported not provided veterinary services by Team JB.

c. Capabilities. This team is capable of providing food inspection service, zoonotic and food-borne disease control, and emergency treatment for animals in a theater of operations. It inspects subsistence and food-producing animals exposed to chemical, biological, and radiological agents; conducts ante-mortem and post-mortem examinations of food animals not to exceed 90 cattle, 130 hogs, or 150 sheep per day; performs procurement and surveillance food inspection of not more than 110 short tons of subsistence per day.

d. Concept of Operations.

(1) Team JA is dependent upon the unit to which it is attached for mess, administrative, personnel, and motor maintenance services. It may be attached to medical units; port commands; isolated units dependent upon local food supplies in countries where approved inspection service is not available; ration breakdown points; subsistence depots; and procurement points. The tactical situation will dictate the specific theater location of such elements.

(2) Control is provided by Team AF or Team JB, depending on the location of the team.

e. Mobility. Team JA is 100 percent mobile.

E-58. Large Service Detachment, Veterinary, Team JB, TOE 8-500G

a. Mission. The mission of Team JB is to provide subsistence inspection, animal care, and veterinary preventive medicine support.

b. Assignment and Basis of Allocation. Team JB is assigned to the field army medical brigade on the basis of 1 per field army and to the theater army medical command on the basis of 1 per 200,000 troops supported in the theater.

c. Capabilities. Team JB possesses all the capabilities of Team JA. It provides food inspection,

zoonotic and foodborne disease control, and emergency treatment for animals in a theater of operations. It also has a capability of performing procurement and surveillance food inspections for not more than 1,000 short tons of subsistence per day; inspecting subsistence and food-producing animals exposed to CBR agents; and conducting ante-mortem and post-mortem examinations of food animals.

d. Concept of Operations.

(1) Command and control of Team JB is normally provided by Team AF. Team JB or its mobile service teams may be attached to medical

units, port commands, subsistence depots, procurement points, ration breakdown points, or other designated locations.

(2) Team JB can provide a maximum of eight mobile service teams. Such teams can be tailored to fulfill the requirements of any specific area or mission. A "type" team may parallel the composition of a Team JA or it may be given an added animal treatment capability or food inspection capability.

(3) Team JA may be attached to Team JB to assist in the performance of the mission.

e. Mobility. Team JB is 100 percent mobile.

Section VIII. PREVENTIVE MEDICINE UNITS

E-59. Preventive Medicine Service Unit, Field (TOE 8-204G)

a. Mission. The mission of the preventive medicine service unit, field, is to provide professional consultation services, support and training in the fields of medical epidemiology and medical zoology, sanitary engineering, and veterinary aspects of zoonotic and foodborne disease control which are beyond the routine responsibilities and capabilities of the commander and his organic medical personnel.

b. Assignment and Basis of Allocation. This unit is assigned to the field army medical brigade and the theater army medical command on the basis of one per field army supported, and one per COMMZ in support of a field army.

c. Capabilities. At full strength (level 1) this unit provides the following:

(1) Epidemiological investigation and evaluation of conditions affecting the health of humans and animals.

(2) Field surveys, investigations, and evaluation of significant environment health factors.

(3) Collection, computation, and evaluation of medical, veterinary, and sanitary data in the area of operations.

(4) Planning and application of measures for prevention and control of diseases and injuries.

(5) Investigation and evaluation of militarily significant disease reservoirs in the civilian population and indigenous animals.

(6) Planning and supervising health education programs to include basic sanitation, personal health, and field sanitation team training.

(7) Screening health protection surveys of industrial operations, including medical X-ray facilities.

(8) Control of militarily significant disease reservoirs in the civilian population and indigenous animals.

d. Organization.

(1) Organizational elements of this unit are command headquarters, company headquarters, medical zoology service (composed of one survey section and three field control sections), sanitary engineer service (composed of an environmental sanitation base section and three environmental sanitation forward sections), epidemiology service and veterinary service.

(2) The unit command headquarters directs the technical operations of all elements of the unit.

(3) The company headquarters provides supervision of the unit's administrative support to the entire organization, including unit supply, communications, and organizational maintenance of equipment. The company's mess capability is limited to less than the unit's full strength on the assumption that a percentage of its personnel will always be operating away from the base facility.

(4) The medical zoology service directs activities of its survey section and three field control sections. The survey section determines the incidence and geographical and seasonal distribution of arthropods and rodents which are vector reservoirs of disease. Survey reports provide direction for formulating control programs. Each control section supervises indigenous labor or military personnel engaged in programs for control of animal reservoirs and disease vectors.

(5) The sanitary engineering service consists of an environmental sanitation base section and three identical environmental sanitation sections. Each section normally operates multiple 2-

man teams from a sanitation section base facility and assists organic medical personnel or area medical support personnel in maintaining surveillance of water supplies, waste disposal practices, food handling, housing, and occupational hazards. The service provides advice on means of controlling environmental health hazards and on the construction and operation of facilities or utilities which have impact on health.

(6) Epidemiology service is composed of two, 3-man field teams. Under the direction of the epidemiologist, these teams plan and coordinate execution of programs to study, define, prevent, and control militarily significant diseases. The teams evaluate the significance of disease reservoirs in the indigenous populace and determine the incidence and circumstances of disease and nonbattle injuries among troops. These activities provide bases for recommending corrective measures. The service also coordinates its operations with those of supporting medical laboratory facilities in conducting etiologic, pathologic, and epidemiologic studies.

(7) Veterinary services are performed by a 3-man field team under the supervision of the veterinary staff officer. The team investigates and evaluates foodborne diseases and animal diseases transmissible to man or which may be a hazard to military animals. The resulting data are utilized in plans for necessary control measures. The team also determines the suitability of indigenous food establishments which may be used to supply troops, including their production facilities, methods of preparation and handling, and sources of raw materials. The veterinary team is also capable of providing a limited food quality control function.

e. Concept of Operations. The preventive medicine service unit is normally employed under the overall direction of the medical brigade or medical command commander. The unit depends upon higher command headquarters for certain administrative and logistical support and, when certain arthropod control operations are to be conducted, must be provided labor service teams, equipment, and vehicles to transport them to and from operational sites.

(1) The unit investigates, collects, and evaluates data (including biological specimens) concerning unusual conditions which adversely affect the health of the command. It reports these conditions to the commander of the supported unit and provides scientific consultation on methods to prevent or curtail potential loss of manpower.

(2) Each service is designed to fragment into small teams which may be temporarily attached to other units for administrative and logistical support only.

(3) When augmented from medical resources, the operating teams of each service are capable of forming task elements, thus combining skills for investigation, evaluation, and limited control, to deal with unusual epidemiologic problems, comprehensive training missions, or to support separate forces of various sizes.

f. Mobility. The preventive medicine service unit is 100 percent mobile. The unit has sufficient transportation to accomplish an administrative movement. When functionally deployed, mobility is lessened and assistance is required. Additional vehicles are also required to provide optimum mobility and effectiveness when small teams are formed.

E-60. Preventive Medicine Control Detachment, Team LA, TOE 8-500G

a. Mission. The mission of Team LA is to provide technical supervisory personnel for the control of disease vectors or reservoirs and related environmental hygiene functions and to assist in training troops in environmental hygiene.

b. Assignment and Basis of Allocation. Team LA is assigned to the field army medical brigade or independent task force on the basis of one per division not provided preventive medicine support, and to the theater army medical command on the basis of one per independent corps or task force supported.

c. Capabilities. The Team LA is capable of providing technical supervisory personnel for the elimination of disease reservoirs including control measures for arthropods, rodents, and related environmental hygiene. It is capable of assisting in the training of troops in environmental hygiene.

d. Concept of Operations. The preventive medicine control detachment operates in any location within its area of responsibility. The assigned area of responsibility of a specific detachment is determined by the medical command to which it is attached. The total number of control detachments assigned to a specific area depends upon the extent and magnitude of environmental sanitation problems. When functioning, the detachment requires labor details from civilian, prisoner-of-war, or friendly troop sources. The unit may conduct basic surveys, when necessary, prior to initiating control measures. It may also conduct

on-the-job training in the control of animal reservoirs and vectors of disease for troop field sanitation teams. When acting in support of combat units, specific functions of the detachment may be carried out as far forward as required by the general tactical situation. The detachment cooperates with Navy, Air Force, and Allied forces personnel engaged in similar tasks. The detachment normally performs its functions in locations exterior to the bivouac areas of other units, but may be called upon to act in an advisory capacity on sanitation problems to unit commanders in its established area of responsibility.

e. Mobility. Team LA is 100 per cent mobile.

E-61. Preventive Medicine Survey Detachment, Team LB, TOE 8-500G

a. Mission. The mission of Team LB is to provide professional and technical personnel for the field study, survey, evaluation of disease vectors and reservoirs, and related environmental health problems.

b. Assignment and Basis of Allocation. This team is assigned to the field army medical brigade and to theater army medical command on the basis of one per one to three Team LA authorized.

c. Capabilities. Team LB is capable of providing technical personnel for the field study, survey, and evaluation of arthropod and rodent-borne disease problems. It can provide mobile en-

tomological laboratory service in support of preventive medicine survey activities, and assists in training troops in environmental hygiene.

d. Concept of Operations. The preventive medicine survey detachment operates in any location within its assigned area of responsibility. The assigned area of responsibility is determined by the medical unit to which the detachment is attached. Normally, preventive medicine survey detachments are assigned to an area on the basis of one survey detachment per three preventive medicine control detachments (Team LA). The detachment cooperates with Navy, Air Force, and Allied forces personnel engaged in similar tasks. The total number of survey detachments assigned to a specific area is dependent upon the extent and magnitude of environmental sanitation problems. In instances where the detachment is directed to perform specialized operations for which organic equipment is inadequate, the necessary additional materials are provided from appropriate supply installations. The preventive medicine survey detachment also provides instruction in the control of various animal reservoirs and vectors of disease to personnel of other units during noncombat phases of training. The detachment, in general, provides assistance on matters pertaining to the potential importance and actual incidence of arthropod-borne and related diseases and effectiveness of current control measures to the medical command commander.

e. Mobility. Team LB is 100 percent mobile.

Section IX. OTHER MEDICAL UNITS

E-62. Medical Laboratory (TOE 8-650G)

a. Mission. The mission of the medical laboratory is to furnish complete medical laboratory service within a theater of operations.

b. Assignment and Basis of Allocation. The medical laboratory is assigned to the field army medical brigade on the basis of 1 per field army and to the theater army medical command on the basis of 1 per 30,000 fixed beds.

c. Capabilities.

(1) At strength level 1 this unit provides medical laboratory service in direct support of a field army or general support within a theater of operations, and is capable of—

(a) Performing those laboratory examinations indicated in AR 40-4 within the capabilities of a unit of this type.

(b) Conducting medical research, investigations, and technical inspections.

(c) Establishing a histopathology center.

(d) Operating one base and three mobile laboratories.

(2) At strength level 2 the capabilities are the same as those of level 1, but the operational capabilities are reduced to approximately 90 percent.

(3) At level 3 the capabilities are the same as those of level 1, but the operational capabilities are reduced to one base and two mobile laboratories.

(4) The unit is adaptable to a type B organization and the capabilities are the same as those of a level 1 organization.

d. Organization. This unit is comprised of a headquarters section and a laboratory section organized to provide a base laboratory and three mobile laboratories.

(1) *Headquarters section.* This section prov-

ides command, supply, maintenance, and utilities functions for laboratory operations. It coordinates and supervises the activities of the base and mobile laboratories. The laboratory commander may act as a theater army or field army laboratory consultant, in which capacity he supervises and inspects the operation of laboratory sections of medical treatment facilities.

(2) *Base laboratory.* The base laboratory functions include performing standardized clinical pathology and anatomic pathology tests and examinations, water analysis, veterinary food testing, and epizootiological investigations; manufacturing special medical laboratory reagents, culture media, biologicals, and bacterial antigens not available through routine medical supply channels; augmenting laboratory services of other health service units; and acting as a histopathology center when required. The base laboratory operates in close coordination with preventive medicine units in studies and surveys of common interest. The facilities of the laboratory also may be used in public health work. The base laboratory may be functionally organized as follows:

(a) *Pathology.* With histopathology and autopsy subsections.

(b) *Biochemistry.* With diagnostic, toxicology, and food and water subsections.

(c) *Bacteriology.* With diagnostic, serology, intervenous fluids, and virology subsections.

(d) *Zoology.* With entomology and parasitology subsections.

(e) *Clinical laboratory.* With subsections concerned with hematology, urinalysis, and other general laboratory procedures.

(f) *Medical radiological laboratory.* With field survey and spectroscopy subsections.

(g) *Veterinary.* With food testing and epizootiological investigation subsections.

(h) *Preventive medicine.* The base laboratory operates in close coordination with preventive medicine units in studies and surveys of common interest.

(3) *Mobile laboratories.* Each of the three mobile laboratories duplicates, in part, but to a lesser degree, the operation of facilities provided by the base laboratory. Laboratory work beyond the capabilities of a mobile laboratory is submitted to the supporting base laboratory. This is particularly true of veterinary, parasitology, entomology, and immunology work submitted to a mobile laboratory. However, if requirements for capabilities beyond that normally furnished by a

mobile laboratory are anticipated, a mobile laboratory may be augmented (by augmentation assemblages and personnel of the base laboratory) to provide the service required. The composition of the mobile laboratory should not be considered fixed; and when special studies must be done in areas inaccessible to the base laboratory, and desired combination of specialized personnel may be formed to augment a mobile laboratory unit. The mobile laboratory commander acts as laboratory consultant to the area surgeon when the mobile unit operates in an area distant from the base laboratory.

e. *Concept of Operations.* The medical laboratory is employed centrally in the field army and communications zones. Mobile laboratories are employed wherever required and may be attached to a medical group or medical battalion for administrative support. The laboratory maintains liaison with the laboratories of other services when their operations pertain in any way to the health of the command. Technical control of the mobile laboratories, when attached to another command, remains with the laboratory commander.

f. *Mobility.* The headquarters and base laboratory are fixed. The mobile laboratories are 100 percent mobile.

E-63. General Dispensary, Teams MA, MB, MC, TOE 8-500G

a. *Mission.* The mission of these dispensaries is to provide outpatient service for units or military personnel stationed in areas not provided with unit dispensary service.

b. *Assignment and Basis of Allocation.* The Teams MA, MB, and MC are assigned to the theater army medical command on the following basis:

Team MA—One per troop population of 1,500 to 3,000.

Team MB—One per troop population of 2,000 to 5,000.

Team MC—One per troop population of 5,000 to 10,000.

c. *Capabilities.*

(1) The dispensary teams are capable of providing outpatient service to an area or installation with troop populations as indicated in paragraph b above.

(2) Team MA can provide general medicine, dental, pharmacy, and simple laboratory and X-ray procedures.

(3) Teams MB and MC can provide surgical,

internal medicine, dental, optical, pharmacy, X-ray, and laboratory services.

d. Concept of Operations. In general, the employment of these dispensaries is dependent upon the size of the military population to be served and the availability of hospitals in given areas of military installations. Variations in specific location assignments of the dispensary units will be dictated, to some extent, by the population limits each type of dispensary is capable of serving. Team MC, having bed facilities for overnight care, may be frequently located in remote or isolated areas not provided with this service. Normally, Teams MA and MB are located in areas where there are large troop concentrations, headquarters, rest camps, or a transient military population. Under normal conditions, the teams do not provide medical treatment beyond the scope of outpatient service. Patients may be referred to hospitals providing area support for consultation and specialty services. Due to the limited number of dental personnel assigned to a dispensary, organic dental officers cannot provide routine dental treatment to the large number of troops for which these units provide outpatient service. Augmentation from dental units providing area dental support will be necessary to provide routine type dental treatment.

e. Mobility.

(1) Team MA—40 percent mobile.

(2) Team MA—25 percent mobile.

(3) Team MC—15 percent mobile.

(4) Movement of these three types of dispensary units is held to a minimum. The dispensaries are authorized transportation sufficient only for administrative purposes. When movement is directed, the units must be provided with additional transportation by the command to which they are assigned.

**E-64. Blood Processing Detachment,
Team NA, TOE 8-500G**

a. Mission. The mission of this team is to perform the necessary procedures involving laboratory testing, classification, processing, and storing of whole blood.

b. Assignment and Basis of Allocation. Team NA is assigned to the theater army medical command on the basis of one per six Teams NB.

c. Capabilities. The Team NA supervises and operates in conjunction with 6 Teams NB; processes 1,200 units of whole blood daily; and can store a maximum of 3,600 units of whole blood.

d. Concept of Operations. Team NA is nor-

mally assigned to a Blood Bank Service Headquarters, Team AJ, TOE 8-500G, and will be positioned in the communications zone to best facilitate the exploitation of blood donor populations. The team relocates with sufficient frequency to minimize the necessity to transship blood en route from collecting units. This team works in close coordination with collecting teams and other medical units. It may be associated with the Medical Laboratory, TOE 8-650 G, in a particular arrangement which provides augmentation of personnel, equipment, training, and consultation support. Team personnel receive blood, determine blood groups, RH type, and perform serological tests. Outside assistance is required for housekeeping, administrative, and logistical services.

e. Mobility. Team NA is 70 percent mobile.

**E-65. Blood Collecting Detachment,
Team NB, TOE 8-500G**

a. Mission. The mission of Team NB is to procure whole blood from donors and to store blood pending delivery to a blood processing detachment, Team NA.

b. Assignment and Basis of Allocation. Team NB is assigned to the theater army medical command on the basis of two per corps supported.

c. Capabilities. This team is capable of procuring from donors 200 units of whole blood daily and is capable of storing 600 units. The team must be supported by a medical laboratory or unit having a blood processing capability.

d. Concept of Operations. The team under control of the blood bank service headquarters is located near donor density areas and moves as more donors are required. Detachment personnel obtain pertinent medical history data from donors, and perform required prewithdrawal physical examinations to determine suitability. After withdrawal, personnel observe the donors to insure that no unfavorable reaction develops. When withdrawal operations are completed daily, collected blood is transported to the supporting blood processing unit. The detachment requires approximately lighted and heated shelter and is dependent upon other units for housekeeping services and administrative support.

e. Mobility. Team NB is 100 percent mobile.

**E-66. Blood Distribution Detachment,
Team NC, TOE 8-500G**

a. Mission. The mission of Team NC is to transport packaged blood to or from air terminals, from collecting to processing detachments,

from processing detachments to storage or transshipment points, or to using units as required.

b. Assignment and Basis of Allocation. Team NC is assigned to the field army medical brigade and to the theater army medical command on the basis of six per field army supported.

c. Capabilities. The detachment is capable of operating 3 blood distribution teams with a total single-lift capability of 2,808 units of blood. It has the capability of storing 1,200 units of blood. Personnel assigned are capable of operating in two 12-hour shifts.

d. Concept of Operations. Team NC is attached to a Team AJ, blood bank service headquarters, or may be attached to a Team NA or NB with control provided by the senior officer of the team to which attached. It is normally located in the vicinity of collecting or processing units, or terminals, and may be divided into three teams operating separately if the situation indicates. Distribution functions of the team must be in close coordination with Teams NA and NB.

e. Mobility. Team NC is 100 percent mobile.

E-67. Medical Detachment, Team OA, TOE 8-500G

a. Mission. The mission of Team OA is to provide dispensary service for troops not otherwise provided unit medical support.

b. Assignment and Basis of Allocation. Team OA is assigned to the field army medical brigade on the basis of 10 per corps supported and to the theater army medical command on the basis of 1 per 1,000 troop population not otherwise provided unit medical support.

c. Capabilities. The Team OA medical detachment is capable of providing dispensary service for approximately 1,000 troops.

d. Concept of Operations. The location of this medical detachment conforms to the disposition of the unit(s) for which medical support is furnished. When suitable buildings are available, the medical detachment uses the physical facilities of such shelter. When this is not feasible, the dispensary normally is established under organic tentage. This medical detachment normally provides dispensary service to troop units which, by reason of their relatively small size, mission, and location in rearward areas, are not assigned medical personnel. In furnishing dispensary service, the team must be supported by designated evacuation units. Patients may be referred to hospitals providing area support for consultation and specialty services.

e. Mobility. Team OA is 100 percent mobile.

E-68. Medical Illustration Detachment, Team PA, TOE 8-500G

a. Mission. The mission of Team PA is to provide art and photographic services in the production of medical illustrative material.

b. Assignment and Basis of Allocation. Team PA is assigned to the theater army medical command on the basis of one per theater.

c. Capabilities. This team is capable of providing facilities for recording or illustrating medical procedures, cases, and specimens by the various art and photographic processes; and producing lantern slides, prints, transparencies, and motion pictures in black and white and color.

d. Concept of Operations. Normally, the medical illustration detachment will be located in the vicinity of the headquarters, medical command. Appropriate sections of the medical art and photographic segments, or tailored combinations, are attached to selected medical installations to accomplish specific recordings of a medical nature. Upon completion of assignments, personnel return to the parent unit for final processing of collected material.

e. Mobility. Team PA is 40 percent mobile.

E-69. Medical Support, Team SB, TOE 8-500G

a. Mission. The mission of Team SB is to provide unit level medical support for U.S. personnel as required.

b. Assignment and Basis of Allocation. Team SB is assigned as required.

c. Capabilities. This team is capable of providing unit level medical support to U.S. military forces; advise and train in medical treatment and preventive medicine procedures as required; and provide, as authorized, limited medical treatment for Non-U.S. civilian and military personnel.

d. Concept of Operations. Team SB operates under the command of the unit to which assigned and normally operates under the control of Team SA, Medical Control. The team consists of enlisted men who have had sufficient training and skill to enable them to operate without the direct supervision of a medical officer. The team can operate with special action forces, civic action teams, or may act independently in remote areas for relatively long periods.

e. Mobility. Team SB is 100 percent mobile.

INDEX

	Paragraph	Page		Paragraph	Page
Accumulation factor	7-2b(4)	7-1	Functions	8-3	8-1
Admission rates:			General	8-1	8-1
Daily admission rates	7-2b(3)	7-1	Mission	8-2	8-1
Aeromedical evacuation:			Units	8-5c(1)— (4), App E	8-2, E-42
Air ambulance company	App E	E-15	Chemical, Biological, Radio- logical (CBR) and nuclear environment. (See medical support.)		
Defined	1-3b	1-1	Civic action (medical)	14-3b	14-2
Helicopter ambulance detachment	App E	E-17	Combat service support system (CS _s):		
Units	App E	E-15	System considerations		
Air crash rescue:			Command and control	App B 4-8, App E	B-2 4-3, E-1
Units	App E	E-18, E-19	Communications zone (COMMZ):		
Air defense	App C	C-1	Area medical support	1-3a, 3-8d	1-1, 3-7
Air Force:			Blood bank service	8-4a	8-1
Aeromedical evacuation			Dental support	10-8— 10-9 3-2a(2)	10-2— 10-3 3-1
control officer	6-6b	6-5	Establishment	3-2a(2)	3-1
Evacuation	6-11	6-7	Evacuation from	6-16	6-8
Ambulance:			Evacuation within	6-15	6-8
Bus	6-6c(2)(c)	6-5	General (hospitalization)	7-7	7-3
Convoy control	6-6c(2)(d)	6-6	Location of hospitals	7-9	7-3
Field	6-6c(2)(b)	6-5	Medical equipment maintenance		9-5
Marking	2-8c(2)	2-4	Medical supply:		
Rail	6-6c(2)(a)	6-5	General	9-12	9-3
Restricted use	2-8c(2)	2-4	Operations	9-13	9-3
Area dental service:			Medical support	2-5a(3)	2-1
Combat zone	10-6	10-2	Planning (hospitalization)	7-10	7-3
Communications zone	10-8	10-2	Types of hospitals	7-8	7-3
Defined	10-3b	10-1	Veterinary service:		
Area medical support:			Care of military animals	11-8	11-2
Defined	1-3a	1-1	General	11-6	11-2
Theater army medical command	3-8d	3-7	Other activities	11-10	11-3
Area veterinary service:			Subsistence inspection		11-2 11-2
Combat zone	1-11— 11-15	11-3; 11-4	Zoonotic disease control	11-7 11-9	11-2 11-3
Communications zone	11-6— 11-10	11-2, 11-3	Convalescent center	4-8c(5), App E	4-5, E-26
Automatic data processing (ADP):			Corps:		
Combat service support system (CS _s)	App B	B-1	Employment	5-2	5-1
Function requirements	App B	B-1	General	5-1	5-1
General	App B	B-1	Maintenance support	9-18c(2)	9-5
Medical regulating	App B	B-2	Medical support	5-5	5-5
Patient accounting and reporting	App B	B-2	Surgeon:		
System considerations	App B	B-2	General	5-3	5-1
Tactical fire direction system (TAC FIRE)	App B	B-1	Staff relationships	5-4	5-1
Tactical operations systems (TOS)	App B	B-1	Dental service:		
Blood bank service:			Area	10-3b	10-1
Command and control:					
Communications zone	8-4a	8-1			
Field army	8-4b	8-1			
Theater army	8-4a	8-1			
Concept of operations	8-5	8-1			

	Paragraph	Page		Paragraph	Page
Combat zone	10-6, 10-7		Location	7-6	7-2
Communications zone	10-8, 10-9	10-2, 10-3	Types	7-5	7-2
Defined	1-3c	1-1	Hospitalization (<i>See</i> field army hospitals.)		
General	10-1	10-1	Medical brigade:	4-8 ✓	4-3
Medical brigade	4-8c(8)	4-5	Concept of operations	4-8c	4-4
Medical command	3-8g	3-7	Mission	4-8a	4-3
Methods of providing	10-3	10-1	Organization	4-8b	4-3
Mission	10-2	10-1	Medical support	2-6c	2-3
Staff officer:			Mission	4-2	4-1
Functions	10-5	10-2	Operations	4-4	4-1
General	10-4	10-2	Organization	4-3	4-1
Unit	10-7, 10-9	10-2, 10-3	Surgeon	4-6	4-1
Units	App E	E-34, E-35	Field army support command (FASCOM)	4-5	4-1
Dispersion factor	7-2b(5)	7-2	Surgeon	4-7	4-3
Evacuation:			Field medical support:		
Aeromedical (<i>See</i> aeromedical evacuation.)			Functions	2-4	2-1
Air	6-6b	6-5	Mission	2-3	2-1
By ambulance trains	6-13	6-8	Principles of patient care and treatment	2-5	2-1
By Army medical ambulance units	6-12	6-8	Geneva convention and prisoners of war (PW):		
By the Air Force	6-11	6-7	General	2-7	2-3
Control	6-9b	6-6	Marking of ambulances	2-8c(2)	2-4
From the combat zone	6-10	6-7	Marking of medical units and establishments	2-8c(1)	2-4
From the communications zone	6-16	6-8	Prisoners of war and retained personnel	2-8— 2-10	2-3, 2-4
General	6-1	6-1	Protection and identification of medical personnel	2-8a	2-3
Ground:			Self-defense	2-8b	2-3
Bus ambulance	6-6c(2)(c)	6-5	Health services:		
Defined	6-6c	6-5	Defined	1-3d	1-1
Field ambulance	6-6c(2)(b)	6-5	Holding facilities:		
Rail (ambulance trains)	6-6c(2)(a)	6-5	Combat zone	6-14	6-8
Holding facilities	6-14	6-8	Hospital center headquarters	3-8a(1)	3-6
Lag	6-3	6-1	Hospitalization:		
Medical brigade	4-8c(3)	4-4	Accumulation	7-2b(4)	7-1
Medical command	3-8c	3-7	Classification of hospitals	7-3	7-2
Medical regulating:			Communication zone:		
Automatic data processing (ADP)	App B	B-2	General	7-7	7-3
General	6-5	6-3	Location of hospitals	7-9	7-3
"Type" medical regulating system	6-6	6-4	Types of hospitals	7-8	7-3
Operations	6-9	6-6	Concept of patient care	7-1b	7-1
Patient	6-1	6-1	Daily admission rates	7-2b(3)	7-1
Sorting of patients	6-2	6-1	Field army:		
Theater evacuation policy	6-4	6-1	General	7-4	7-2
To the Zone of Interior	6-7	6-6	Location of hospitals	7-6	7-2
Units	App E	E-14	Types of hospitals	7-5	7-2
Within the combat zone:			General	7-1	7-1
General	6-8	6-6	Medical brigade	4-8c(2)	4-4
Division and corps	6-8a	6-6	Medical command	3-7	3-5
Field army	6-8b	6-6	Objective	7-1a	7-1
Within the communications zone	6-15	6-8	Planning:		
Field army:			Communications zone (COMMZ)	7-10	7-3
Blood bank service	8-4b	8-1	Factors	7-2b	7-1
Evacuation from	6-8b	6-6	Principal considerations	7-2a	7-1
Hospitals:			Units (<i>See</i> hospital units.)		
General	7-4	7-2	Hospitals:		
			Classification	7-3	7-2

	Paragraph	Page		Paragraph	Page
Communications zone (COMMZ):					
General	7-7	7-3			
Location	7-9	7-3			
Planning	7-10	7-3			
Types	7-8	7-3			
Field army:					
General	7-4	7-2			
Location	7-6	7-2			
Types	7-5	7-2			
Units	App E	E-20, E-26			
Labor, local	9-6	9-2			
Medical brigade:	4-8	4-3			
Command relationships	4-8 <i>d</i>	4-5			
Concept of operations	4-8 <i>c</i>	4-5			
Convalescent center	4-8 <i>c</i> (5)	4-5			
Dental service	4-8 <i>c</i> (8)	4-5			
Evacuation	4-8 <i>c</i> (3)	4-4			
Hospitalization	4-8 <i>c</i> (2)	4-4			
Medical laboratory	4-8 <i>c</i> (7)	4-5			
Medical supply and maintenance	4-8 <i>c</i> (4)	4-5			
Mission	4-8 <i>a</i>	4-3			
Organization	4-8 <i>b</i>	4-3			
Preventive medicine	4-8 <i>c</i> (6)	4-5			
Veterinary service	4-8 <i>c</i> (9)	4-5			
Medical command:					
Area medical support	3-8 <i>d</i>	3-7			
Command relationships	3-9	3-7			
Concept of operations	3-8	3-5			
Dental service	3-8 <i>g</i>	3-7			
Evacuation and treatment	3-8 <i>c</i>	3-7			
Hospitalization	3-8 <i>b</i>	3-6			
Medical laboratory support	3-8 <i>f</i>	3-7			
Medical supply	3-8 <i>i</i>	3-7			
Mission	3-7 <i>a</i>	3-5			
Organization	3-7 <i>b</i>	3-5			
Preventive medicine	3-8 <i>e</i>	3-7			
Veterinary service	3-8 <i>h</i>	3-7			
Medical depot	4-8 <i>c</i> (4) (a), App E	4-5, E-27			
Medical equipment maintenance:					
Categories	9-17	9-5			
General	9-14	9-4			
Objectives	9-15	9-4			
Organization:	9-18	9-5			
Combat zone	9-18 <i>c</i>	9-5			
Communications zone (COMMZ)	9-18 <i>b</i>	9-5			
Theater army	9-18 <i>a</i>	9-5			
Principles	9-16	9-4			
Units	9-19	9-6			
Medical group headquarters:					
Forward and rear	4-8 <i>c</i> (1) (b)	4-4			
Medical brigade	4-8 <i>c</i> (1) (a)	4-4			
Medical command	3-7 <i>c</i> ,	3-5,			
Medical laboratory:	App E	E-40			
Medical brigade	4-8 <i>c</i> (7)	4-5			
Medical command	3-8 <i>f</i>	3-7			
Medical personnel:					
Arming	2-8 <i>b</i>	2-3			
Protection and identification	2-8 <i>a</i>	2-3			
Medical planning:					
Chemical, biological, radiological (CBR), and nuclear	13-3	13-2			
Communications zone (COMMZ)	7-10	7-3			
Factors	7-2 <i>b</i>	7-1			
Hospitalization	7-2	7-1			
Principal considerations	7-2 <i>a</i>	7-1			
Medical regulating:					
Air evacuation	6-6 <i>b</i>	6-5			
Automatic data processing (ADP)	App B	B-2			
General	6-5	6-3			
Ground evacuation:					
Bus ambulance	6-6 <i>c</i> (2) (c)	6-5			
Field ambulance	6-6 <i>c</i> (2) (b)	6-5			
Rail (ambulance train)	6-6 <i>c</i> (2) (a)	6-5			
To the Zone of Interior	6-7	6-6			
"Type" medical regulating system	6-6	6-4			
Medical service:					
Defined	1-3 <i>e</i>	1-1			
Medical sorting (triage)	6-2	6-1			
Medical staff:					
Corps surgeon	5-3	5-1			
Dental staff officer (<i>See</i> dental service.)					
Field army surgeon	4-6	4-1			
Staff relationships	5-4	5-1			
TASCOM medical staff	3-6	3-5			
Theater army surgeon	3-5	3-4			
Veterinary staff officer (<i>See</i> veterinary service.)					
Medical supply:					
Automatic data processing (ADP)	9-11, 9-13 App B	9-3 B-1			
Captured supplies and equipment	9-7	9-2			
Combat zone:					
General	9-10	9-3			
Operations	9-11	9-3			
Communications zone (COMMZ):					
General	9-12	9-3			
Operations	9-13	9-3			
Disposition of medical supplies subject to capture	9-8	9-2			
General	9-1	9-1			
Local and prisoner-of-war (PW) labor	9-6	9-2			
Local purchase of supply and equipment	9-2	9-1			
Medical brigade	4-8 <i>c</i> (4)	4-5			
Medical command	3-8 <i>i</i>	3-7			
Medicinal gases	9-3	9-1			
Prepositioned medical materiel	13-7	13-2			
Property exchange	6-9 <i>e</i> , 9-4	6-7, 9-1			
Supplies for prisoners of					

	Paragraph	Page		Paragraph	Page
war (PW), civilians, displaced persons, refugees, and civilian internees	9-5	9-2	Headquarters and headquarters detach- ment, medical group, TOE 8-122G	5-5, App E	5-1, E-9
Units	App E	E-27, E-31	Headquarters hospital center, Team AH, TOE 8-500G	App E	E-5
Medical support:			Headquarters, medical professional service, Team AG, TOE 8-500G	App E	E-12
Area	1-3a	1-1	Headquarters, unit receiving center, Team AE, TOE 8-500G	App E	E-11
Chemical, biological, radiological (CBR), and nuclear environment:			Headquarters, veterinary professional service, Team AF, TOE 8-500G	App E	E-11
Basic principles	13-2	13-1	Medical control, Team SA, TOE 8-500G	App E	E-13
Civic action	14-3b	14-2	Hospital units:		
General (Purpose and scope)	13-1	13-1	Convalescent center, TOE 8-590G	App E	E-26
Medical planning	13-3	13-2	Evacuation hospital (semi-mobile), TOE 8-581G	App E	E-25
Nuclear, biological, and chemical casualties	13-5	13-2	Field hospital, TOE 8-510G	App E	E-22
Prepositioning medical materiel	13-7	13-2	General	App E	E-20
Reinforcement of medical support	13-6	13-6	General hospital, 1,000-bed, TOE 8-551G	App E	E-23
Sorting of patients	13-4	13-2	Station hospital, 100-200-300-500-bed, TOE 8-563G, TOE 8-564G, TOE 8-565G, TOE 8-566G	App E	E-24
Stability operations, in	14-3	14-1	Mobile Army Surgical Hospital, TOE 8-571G	App E	E-24
Characteristics of	2-2	2-1	Medical supply units:		
Corps	5-5	5-1	Army medical depot, TOE 8-667G	9-18c, 9-18c(3), App E	9-5, 9-6, E-27
Defined	1-3f	1-2	Medical depot, TOE 8-187G	9-18b, App E	9-5 E-27
Field	2-3—	2-1, 2-2	Medical equipment maintenance detach- ment, Team GC, TOE 8-500G	9-19b, App E	9-6 E-31
Organizational levels:			Medical equipment maintenance detach- ment, Team GD, TOE 8-500G	9-19a, App E	9-6 E-31
Communications zone	2-6d	2-3	Medical supply detachment, Team FB, TOE 8-500G	App E	E-31
Division	2-6b	2-3	Medical supply detachment, Team		
Field army	2-6c	2-3	Medical supply detachment, Team		
Unit	2-6a	2-2	Medical supply detachment, Team		
Medical units:			Medical supply detachment, Team		
General	App E	E-1	Medical supply detachment, Team		
Cellular teams	App E	E-1	Medical supply detachment, Team		
Command and control units:	App E	E-1, E-13	Medical supply detachment, Team		
Blood bank service headquarters, Team AJ, TOE 8-500G	8-5c(1) App E	8-2, E-13, E-42	Medical supply detachment, Team		
Company headquarters, Team AC, TOE 8-500G	App E	E-11	Medical supply detachment, Team		
Headquarters, dental professional service, Team AI, TOE 8-500G	App E	E-12	Medical supply detachment, Team		
Headquarters and headquarters company, medical command, TOE 8-111T	App E	E-1	Medical supply detachment, Team		
Headquarters and headquarters detach- ment, medical battalion, TOE 8-126G	App E	E-10	Medical supply detachment, Team		
Headquarters and headquarters detach- ment, medical brigade, TOE 8-112G	4-8, App E	4-3, E-7	Medical supply detachment, Team		

	Paragraph	Page		Paragraph	Page
FC, TOE 8-500G	App E	E-31		TOE 8-500G	App E E-15
Optical detachment, Team GA, TOE 8-500G	App E	E-31		Medical air ambulance company, TOE 8-137G	App E E-15
Optical detachment augmentation, Team GB, TOE 8-500G	App E	E-31		Medical ambulance company, TOE 8-127G	App E E-14
Organizational maintenance Teams, TOE 29-600G	App E	E-10, E-11, E-12		Medical clearing company, TOE 8-128G	App E E-15
Other medical units:				Medical collecting company, TOE 8-129G	App E E-15
Blood collecting detachment, Team NB, TOE 8-500G	8-5c(3), App E	8-2, E-42		Medical holding company, TOE 8-57G	App E E-14
Blood distribution detachment, Team NC, TOE 8-500G	8-5c(4), App E	8-2, E-42		Preventive medicine units:	
Blood processing detachment, Team NA, TOE 8-500G	8-5c(2), App E	8-2, E-42		Preventive medicine control detachment, Team LA, TOE 8-500G	12-5a(2), App E 12-2, E-39
General dispensary, Team MA, TOE 8-500G	App E	E-41		Preventive medicine survey detachment, Team LB, TOE 8-500G	12-5a(3), App E 12-2, E-40
General dispensary, Team MB, TOE 8-500G	App E	E-41		Preventive medicine service unit, field, TOE 8-204G	12-5a(1), App E 12-2, E-38
General dispensary, Team MC, TOE 8-500G	App E	E-41		Professional services units:	
Medical detachment, Team OA, TOE 8-500G	App E	E-43		Central dental laboratory, Team KN, TOE 8-500G	App E E-35
Medical illustration detachment, Team PA, TOE 8-500G	App E	E-43		Dental operating detachment, Team KI, TOE 8-500G	App E E-34
Medical laboratory, TOE 8-650G	3-8f, App E	3-7, 4-5, E-40, E-42		Dental prosthetic detachment, fixed, Team KL, TOE 8-500G	App E E-35
Medical support, Team SB, TOE 8-500G	App E	E-43		Dental prosthetic detachment, mobile, Team KK, TOE 8-500G	App E E-35
Patient evacuation units:				Dental service detachment, Team KJ, TOE 8-500G	App E E-34
Ambulance detachment, Team RB, TOE 8-500G	App E	E-17		General	App E E-32
Ambulance detachment (bus), Team RE, TOE 8-500G	App E	E-17		Maxillofacial detachment, Team KD, TOE 8-500G	App E E-33
Ambulance train, rail, TOE 8-520G	App E	E-19		Medical treatment detachment (chemical agents), Team KG, TOE 8-500G	App E E-33
Helicopter ambulance air crash rescue augmentation detachment, Team RD, TOE 8-500G	App E	E-19		Neurosurgical detachment, Team KE, TOE 8-500G	App E E-33
Helicopter ambulance, air crash rescue detachment, Team RC, TOE 8-500G	App E	E-18		Orthopedic detachment, Team KB, TOE 8-500G	App E E-32
Helicopter ambulance detachment, Team RA,					

	Paragraph	Page		Paragraph	Page
Psychiatry detachment, Team KO, TOE 8-500G	App E	E-35	Theater army surgeon	3-5c	3-5
Renal and electrolyte metabolism detachment, Team KP, TOE 8-500G	App E	E-36	Optical service: Army medical depot	App E	E-29
Shock detachment, Team KC, TOE 8-500G	App E	E-33	Medical depot	App E	E-27
Surgical detachment, Team KA, TOE 8-500G	App E	E-32	Units	App E	E-31
Thoracic detachment, Team KF, TOE 8-500G	App E	E-33	Optometric service: Defined	1-3h	1-2
X-ray detachment, Team KH, TOE 8-500G	App E	E-34	Patient: Accounting and reporting	App B, D	B-2, D-7
Veterinary units: Veterinary large animal dispensary detachment, Team IB, TOE 8-500G	App E	E-36	Care	7-1	7-1
Veterinary large animal hospital detachment, Team IA, TOE 8-500G	App E	E-36	Care and treatment en route	6-9c,d	6-7
Veterinary small animal dispensary detachment, Team ID, TOE 8-500G	App E	E-37	Evacuation and treatment	3-8c	3-5
Veterinary small animal hospital detachment, Team IE, TOE 8-500G	App E	E-37	Holding facilities	6-14	6-8
Veterinary service detachment, small, Team JA, TOE 8-500G	App E	E-37	Principles of patient care and treatment	2-5	2-1
Veterinary service detachment, large, Team JB, TOE 8-500G	11-7b, App E	11-2, E-37	Theater evacuation policy	1-3i	1-2
Marking of ambulances	2-8c(2)	2-4	Preventive medicine: General	12-1	12-1
Marking of units and establishments	2-8c(1)	2-4	Medical brigade	4-8c(6)	4-5
Morbidity: Defined	1-3g	1-2	Medical command	3-8e	3-7
Neuropsychiatric	App E	E-35	Officer (functions)	12-4	12-1
Nuclear warfare: Contingency employment in the event of nuclear warfare. (See individual medical units.)	13-1— 13-7	13-1, 13-2	Operations	12-6	12-2
Nursing service	App E	E-20	Organization	12-5	12-2
Office organization: Field army medical section	4-6c	4-3	Program	12-2	12-1
			Staff functions: General	12-3	12-1
			Preventive medicine officer	12-4	12-1
			Units	App E	E-38, E-40
			Principles of patient care and treatment	2-5	2-1
			Prisoners of war (PW):	2-8—	2-3,
			Medical supply for	2-10	2-4
			Labor	9-5	9-2
			Professional services. (See professional services units.)	9-6b	9-2
			Property exchange	6-9e	6-7
			Retained personnel	2-8— 2-10	2-3, 2-4
			Sorting of patients	6-2, 13-4	6-1, 13-2
			Special action forces (medical support units)	App E	E-13, E-43
			Stability operations: Civic action in	14-3b	14-2
			General	14-1	14-1
			Internal defense	14-2a	14-1
			Internal development	14-2b	14-1
			Medical support	14-3	14-1
			Roles	14-2	14-1
			Standardization agreements (STANAG): Medical and dental supply procedures	1-1c, App D	1-1, D-18
			STANAG No. 2128	App D	D-18
			Medical employment of helicopters in ground warfare	1-1c, App D	1-1, D-15
			STANAG No. 2087	App D	D-15
			Patient evacuation tag	1-1c,	1-1,
			STANAG No. 2051	App D	D-1

	Paragraph	Page		Paragraph	Page
Patient reporting by medical treatment facilities -----	1-1c, App D	1-1, D-6	service headquarters ..	8-5c(1), App E	8-2, E-42
STANAG No. 2075			Team FB, Medical supply detachment ----	App E	E-31
Procedures for disposition by medical installations of allied patients -----	1-1c, App D	1-1, D-4	Team FC, Medical supply detachment	App E	E-31
STANAG No. 2061			Team GA, Optical detachment -----	App E	E-31
Radiological-hazards -----	1-1c, App D	1-1, D-8	Team GB, Optical detachment		
STANAG No. 2083			augmentation	App E	E-31
Tables of organization and equipment:			Team GC, Medical equipment maintenance detachment ..	9-19b, App E	9-6, E-31
TOE 8-57D, Medical holding company -----	App E	E-14	Team GD, Medical equipment maintenance detachment	9-19a, App E	9-6, E-31
TOE 8-111T, Headquarters and headquarters company, medical command -----	App E	E-1	Team IA, Veterinary large animal hospital detachment	App E	E-36
TOE 8-112G, Headquarters and headquarters detachment, medical brigade -----	4-7, App E	4-3, E-7	Team IB, Veterinary large animal dispensary detachment ..	App E	E-36
TOE 8-122G, Headquarters and headquarters detachment, medical group -----	5-5, App E	5-1, E-9	Team ID, Veterinary small animal hospital detachment	App E	E-37
TOE 8-126G, Headquarters and headquarters detachment, medical battalion -----	App E	E-10	Team IE, Veterinary small animal dispensary detachment	App E	E-37
TOE 8-127G, Medical ambulance company -----	App E	E-14	Team JA, Veterinary service detachment, small	App E	E-37
TOE 8-128G, Medical clearing company -----	App E	E-15	Team JB, Veterinary service detachment, large ..	11-7b App E	11-2 E-37
TOE 8-129G, Medical collecting company -----	App E	E-15	Team KA, Surgical detachment	App E	E-32
TOE 8-137G, Medical air ambulance company -----	9-18b	9-5,	Team KB, Orthopedic detachment	App E	E-32
TOE 8-187G, Medical depot	App E	E-27	Team KC, Shock detachment	App E	E-33
TOE 8-204G, Preventive medicine service unit, field -----	12-5a(1), App E	12-2, E-38	Team KD, Maxillofacial detachment	App E	E-33
TOE 8-500G, Medical service organization:			Team KE, Neurosurgical detachment	App E	E-33
General -----	App E	E-1	Team KF, Thoracic detachment	App E	E-33
Kinds of medical units ..	App E	E-1	Team KG, Medical treatment detachment (chemical agents) ...	App E	E-33
Team AC, Company headquarters -----	App E	E-11	Team KH, X-ray detachment	App E	E-34
Team AE, Headquarters unit receiving center ..	App E	E-11	Team KI, Dental operating detachment ..	App E	E-34
Team AF, Headquarters veterinary professional service -----	App E	E-11	Team KJ, Dental service detachment ...	App E	E-34
Team AG, Headquarters, medical professional service	App E	E-12	Team KK, Dental prosthetic detachment, mobile	App E	E-35
Team AH, Headquarters hospital center	App E	E-5			
Team AI, Headquarters dental professional service	App E	E-12			
Team AJ, Blood bank	App E	E-24			

	Paragraph	Page		Paragraph	Page
Team KL, Dental prosthetic detachment, fixed	App E	E-35	TOE 8-565G, Station hospital, 300-bed	App E	E-24
Team KN, Central dental laboratory	App E	E-35	TOE 8-566G, Station hospital, 500-bed	App E	E-24
Team KO, Psychiatric detachment	App E	E-15	TOE 8-571G, Mobile army surgical hospital	App E	E-24
Team KP, Renal and electrolyte metabolism detachment	App E	E-36	TOE 8-581G, Evacuation hospital	App E	E-25
Team LA, Preventive medicine control detachment	12-5a(2), App E	12-2, E-39	TOE 8-590G, Convalescent center	App E	E-26
Team LB, Preventive medicine survey detachment	12-5a(3), App E	12-2, E-40	TOE 8-650G, Medical laboratory	3-8f, 4-8c(7), App E	3-7, 4-5, E-40, E-42
Team MA, General dispensary	App E	E-41	TOE 8-667G, Army medical depot	9-18c, 9-18c(3), App E	9-5, 9-6, E-27, E-29
Team MB, General dispensary	App E	E-41	TOE 29-600G, Organizational maintenance teams	App E	E-10, E-12
Team MC, General dispensary	App E	E-41	Theater army:		
Team NA, Blood processing detachment	8-5c(2), App E	8-2, E-42	Assumption of TASCOM headquarters functions	3-4	3-4
Team NB, Blood collecting detachment	8-5c(3), App E	8-2, E-42	Blood bank service	8-1— 8-5	8-1
Team NC, Blood distribution detachment	8-5c(4), App E	8-2, E-42	General	3-1	3-1
Team OA, Medical detachment	App E	E-43	Medical command	3-7—3-9	3-5
Team PA, Medical illustration detachment	App E	E-43	Organization	3-2	3-1
Team RA, Helicopter ambulance detachment	App E	E-15	Surgeon	3-5	3-4
Team RB, Ambulance detachment	App E	E-17	Theater of operations:		
Team RC, Helicopter ambulance air crash rescue detachment	App E	E-18	Combat zone	3-2a(1)	3-1
Team RD, Helicopter ambulance air crash rescue augmentation	App E	E-19	Communications zone (COMMZ)	3-2a(2)	3-1
Team SA, Medical control	App E	E-13	Organization	3-2	3-1
Team SB, Medical support	App E	E-43	Theater army medical command	3-7—3-9	3-5
TOE 8-510G, Field hospital	App E	E-22	Theater army support command (TASCOM):		
TOE 8-520G, Ambulance, train, rail	App E	E-19	General	3-3	3-1
TOE 8-551G, General hospital, 1,000-bed	App E	E-23	Medical staff	3-6	3-5
TOE 8-563G, Station hospital, 100-bed	App E	E-24	Organization	3-3b	3-2
TOE 8-564G, Station hospital, 200-bed	App E	E-24	Theater patient evacuation policy:		
			Defined	1-3i	1-2
			Implementation	6-4	6-1
			Triage (sorting of patients)	6-2	6-1
			Veterinary service:		
			Area	11-3b	11-1
			Care of military animals	11-8, 11-13	11-2, 11-4
			Combat zone:		
			Care of military animals	11-13	11-4
			General	11-11	11-3
			Other activities	11-15	11-4
			Subsistence inspection	11-12	11-3
			Zoonotic disease control	11-14	11-4
			Communications zone (COMMZ):		
			Care of military animals	11-8	11-2
			General	11-6	11-2

	Paragraph	Page		Paragraph	Page
Other activities	11-10	11-3	Other activities	11-10,	11-3
Subsistence inspection ..	11-7	11-2		11-15	11-4
Zoonotic disease			Unit	11-3a	11-1
control	11-9	11-3	Units	App E	E-36, E-37
Defined	1-3j	1-2	Veterinary service system ..	11-3	11-1
General	11-1	11-1	Veterinary staff officers:		
Medical brigade	4-8c(9)	4-5	Functions	11-5	11-1
Medical command	3-8h	3-7	General	11-4	11-1
Mission	11-2	11-1	Zoonotic disease control	11-9,	11-3,
				11-14	11-4

By Order of the Secretary of the Army:

Official:

KENNETH G. WICKHAM,
*Major General, United States Army,
The Adjutant General.*

W. C. WESTMORELAND,
*General, United States Army,
Chief of Staff.*

Distribution:

To be distributed in accordance with DA Form 12-11 requirements for Medical Service, Theater of Operations.