

MHI
COPY 3

*Supers by
FM 19-25
Dec 1977*

FIELD MANUAL

MILITARY POLICE TRAFFIC CONTROL

LOGISTICS LIBRARY BR, 12220

CHANGE

No. 1

HEADQUARTERS
DEPARTMENT OF THE ARMY
WASHINGTON, DC, 30 October 1974**MILITARY POLICE TRAFFIC CONTROL**

FM 19-25, 1 December 1971, is changed as follows:

1. New or changed material is indicated by a star.
2. Remove old pages and insert new pages as indicated below:

<i>Remove Pages</i>	<i>Insert pages</i>
i and ii	i and ii
1-1 thru 1-6	1-1 thru 1-6
2-1 and 2-2	2-1 and 2-2
4-5 and 4-6	4-5 and 4-6
4-17 thru 4-20	4-17 thru 4-20
5-1 and 5-2	5-1 and 5-2
6-5 thru 6-12	6-5 thru 6-17
7-1 thru 7-4	7-1 thru 7-4
7-9 and 7-10	7-9 and 7-10
8-1 and 8-2	8-1 and 8-2
12-1 thru 12-10	12-1 thru 12-11
13-1 thru 13-4	13-1 thru 13-4
13-13 and 13-14	13-13 thru 13-15
F-3 and F-4	F-3 and F-4

3. File this change sheet in front of the manual for reference purposes.

By Order of the Secretary of the Army:

Official:

VERNE L. BOWERS
Major General, United States Army
The Adjutant General

FRED C. WEYAND
General, United States Army
Chief of Staff

DISTRIBUTION:

Active Army, ARNG, USAR: To be distributed in accordance with DA Form 12-11A requirements for Military Police Traffic Control (Qty rqr block no. 140).

FIELD MANUAL }
No. 19-25 }

HEADQUARTERS
DEPARTMENT OF THE ARMY
WASHINGTON, D.C., 1 December 1971

MILITARY POLICE TRAFFIC CONTROL

	Paragraph	Page
PART ONE. GENERAL		
CHAPTER 1. INTRODUCTION		
Section I. General, STANAG 2151, 2154	1-1--1-8	1-1
II. Role of commanders and staff officers	1-9--1-11	1-4
III. The military police role in traffic control	1-12--1-14	1-5
PART TWO. TRAFFIC CONTROL IN POST, CAMP AND STATION OPERATIONS		
CHAPTER 2. THE SUPERVISION AND PLANNING OF TRAFFIC CONTROL		
Section I. Principles of supervision	2-1--2-8	2-1
II. Principles of traffic planning	2-9--2-19	2-4
CHAPTER 3. POINT CONTROL OF TRAFFIC		
Section I. General	3-1--3-3	3-1
II. Point control operations	3-4--3-8	3-4
CHAPTER 4. TRAFFIC CONTROL OPERATIONS		
Section I. Parking in relation to traffic control	4-1--4-4	4-1
II. Operation of checkpoints, roadblocks and dismount points	4-5--4-9	4-5
III. Traffic control at construction sites and detours	4-10--4-12	4-10
IV. Traffic signs and signals	4-13--4-20	4-17
CHAPTER 5. MOTOR PATROLS		
Section I. Preparation	5-1--5-3	5-1
II. Methods of patrolling	5-4--5-8	5-2
III. Escorts	5-9, 5-10	5-4
CHAPTER 6. TRAFFIC LAW ENFORCEMENT		
Section I. Principles and policies	6-1--6-4	6-1
II. Speed measurement devices	6-5, 6-6	6-2
III. Other traffic law enforcement	6-7--6-17	6-11
CHAPTER 7. PROCEDURES FOR STOPPING VIOLATORS OF TRAFFIC LAWS		
Section I. Identification, pursuit, and approach of violators	7-1--7-5	7-1
II. Dealing with violators	7-6--7-15	7-6
PART THREE. TRAFFIC CONTROL IN THE THEATER OF OPERATIONS		
CHAPTER 8. GENERAL PRINCIPLES, PLANNING, AND SUPERVISION		
9. TRAFFIC CONTROL POSTS		
Section I. Organization and equipment	9-1--9-3	9-1
II. Functions of a TCP	9-4--9-9	9-2
CHAPTER 10. TRAFFIC PATROLS		
Section I. Organization and equipment	10-1--10-3	10-1
II. Functions and methods for patrolling	10-4--10-7	10-1
CHAPTER 11. OPERATION OF CHECKPOINTS, ROADBLOCKS, DEFILES, AND DISMOUNT POINTS		
12. RECONNAISSANCE		
Section I. Traffic reconnaissance (STANAG 2015, 2151, SOLOG 53)	12-1--12-6	12-1
II. Traffic maps	12-7--12-12	12-6
III. Escorts	12-13--12-18	12-7
CHAPTER 13. SPECIAL OPERATIONS		
Section I. River-crossing operations	13-1--13-15	13-1
II. Other special operations	13-16--13-25	13-11
★III. Passage of lines	13-26--13-28	13-14
APPENDIX A. REFERENCES		A-1
B. HAND SIGNALS		B-1

*This manual supersedes FM 19-25, 7 October 1964, including all changes.

	Page
APPENDIX C. TABLE OF COMMON TRAFFIC VIOLATIONS	C-1
D. EQUIPMENT CHECKLIST	D-1
E. NATO STANDARD OFFENSE REPORT	E-1
★F. NATO ROAD NETWORK—DEFINITIONS AND CHARACTERISTICS	F-1
G. MOTOR VEHICLE EXAMINATION	G-1
H. UNITS OF MEASURE AND CONVERSION	H-1
I. SURVEILLANCE, TARGET ACQUISITION AND NIGHT OBSERVATION (STANO) EQUIPMENT	I-1
INDEX	Index-1

This manual contains material reproduced with the permission of the following agencies:

1. "Radar Procedures and Policies," published by the Department of Public Safety, St Paul, Minnesota (para 6-6b).
2. Training Key 13, "Stopping the Traffic Violator" (1966) and Training Key 14, "Stopping the Felony Suspect" (1966), published by the International Association of Chiefs of Police, Washington, DC (para 7-3, 7-4).
- ★3. Traffic Law Enforcement series, *Stopping and Approaching the Traffic Violator*, reference 62.620 through 62.670, Traffic Institute, Northwestern University (para 7-1 through 7-5).

PART ONE
GENERAL
CHAPTER 1
INTRODUCTION

Section I. GENERAL, STANAG 2151, 2154

1-1. Purpose and Scope

a. This manual is a guide to military police and others involved in planning and controlling motor vehicle traffic.

b. This manual presents systems, methods, means, and techniques for controlling traffic on posts, camps, and stations and during field operations.

★*c.* Users of this publication are encouraged to submit recommended changes and comments to improve the publication. Comments should be keyed to the specific page, paragraph, and line of the text in which the change is recommended. Reasons will be provided for each comment to insure understanding and complete evaluation. **Comments should be prepared, using DA Form 2028 (Recommended Changes to Publications and Blank Forms) and forwarded direct to Commandant, United States Army Military Police School, ATTN: ATSJ-CTD-DT, Fort Gordon, Georgia 30905.**

★*d.* The methods and procedures depicted in this manual are designed for use in countries where traffic drives on the right side of the road. Modifications must be made for use in those countries where traffic is required to use the left side of the road.

★*e.* The material presented herein is applicable without modification to both nuclear and nonnuclear warfare, and internal defense and development.

1-2. Definition of Terms

a. In this manual traffic is defined as the movement of vehicles, pedestrians, and animals over roads and highways.

b. Highway regulation is the coordination of the actual use of a road net by vehicles, personnel, and animals to meet military operational requirements. (The basic tool of the commander

for accomplishing highway regulation is the highway traffic headquarters and its subordinate highway regulating point teams in the field.)

c. Military traffic is the movement of military personnel, supplies, and equipment over roads and highways. It is further classified by the degree of control exercised over the movement.

(1) Organized military movements are internally controlled groups moving on schedule and complying with the highway traffic regulation plan. Convoys, serials, and march units are organized military movements.

(2) Casual military movements are the movements of individuals or small groups who comply with the highway traffic regulation plan as they perform routine administrative or supply duties.

(3) Indigenous traffic consists of refugee and local civilian traffic and casual non-US military movement. The presence of such unorganized traffic may require control measures to restore efficient use of the road net.

d. Highway traffic control is the enforcement of the rules of the road, traffic regulations and road discipline, including point control of traffic. It is a function of the provost marshal and the military police.

e. Movement credit is the allocation granted to one or more vehicles in order to move over a controlled route in a fixed time according to movement instructions (STANAG 2154).

f. A controlled route is a route, the use of which is subject to traffic or movement restrictions (STANAG 2151).

★(1) A supervised route is a roadway over which regulation is exercised by traffic control authority by means of traffic control posts, traffic patrols or both. A movement credit is required for a column of 20 or more vehicles or by

any vehicle of exceptional size or weight to use the route (STANAG 2151).

(2) A dispatch route is a roadway over which full control is exercised. (Control through priorities of use and the regulation of traffic movement in time and space.) A movement credit is required for the use of a dispatch route by any independent vehicle or group of vehicles regardless of number or type (STANAG 2151).

(3) A reserved route is a route which is controlled and its use is—

(a) Allocated exclusively to a particular authority or formation, e.g., route reserved for the 10th Division, or

(b) Intended to meet a particular requirement, e.g., route reserved for evacuation (STANAG 2151).

(4) An open route may be used without a movement credit (STANAG 2151).

(5) A prohibited route is a route or section of route over which traffic is prohibited (STANAG 2151).

g. Area traffic control is external control of all the traffic within or through a given area, under policies set down by the area commander concerned.

h. Organizational traffic control is that control used by the commander of the organization or unit using a roadway to insure that observance of rules of the road, traffic laws and regulations, speeds, spacing, routes, schedules, discipline en route and at halts, and local security measures are maintained. This control includes the posting of guides or signs along a route.

i. The traffic circulation plan in highway operations details the use of the transportation network in order to implement the traffic regulation plan.

j. A traffic control plan is for enforcing the provisions of a traffic circulation plan, traffic rules, and regulations of a command by military police.

k. The traffic flow system is the implementation of the traffic control plan and traffic circulation plan.

l. A critical point is a selected point along the route of a motor movement which is used for reference in giving instructions. It includes a start point (SP), release point (RP) and other points along the route of march where interference with other movements may occur or where timings are critical (STANAG 2041).

★*m.* Highway traffic management is the maintenance of order on streets and highways within existing regulations to make their use safe and expeditious. Highway traffic manage-

ment includes the investigation of traffic accidents, traffic control, and traffic law enforcement.

n. Highway safety is the activity which improves traffic conditions and the administration and enforcement of traffic regulations.

1-3. Military Traffic Control

a. The basic principle of military traffic control is maximum flow with minimum control and direction.

★*b.* Military police, as a part of their function in support of the commander's plans, enforce compliance with highway traffic regulations. However, they have no authority over civilian traffic on public roads in the United States except on those public roads located within the exclusive or concurrent jurisdiction of military reservations. Coordination with local and state police should be effected to assist in military traffic movements which might impede or otherwise affect civilian traffic outside the geographical boundaries of military reservations.

c. Military traffic control involves the direction of traffic movements to meet the military requirements. Examples of these functional areas are traffic information and highway security, which consists of movement and route security.

★*d.* Military traffic control is accomplished through the use of traffic patrols, traffic control posts (TCP), traffic information posts, collecting points, checkpoints, roadblocks, dismount points, directional signs, control devices, and escorts. It embodies the enforcement of traffic laws and regulations, the prevention of traffic accidents, the investigation of traffic accidents, the conduct of route and area reconnaissance, the conduct of traffic control reconnaissance, traffic surveys and studies, and the planning for and rerouting of traffic under emergency conditions to meet the military requirements.

e. Traffic control in a theater of operations is influenced by and is responsive to the tactical requirements of the combat situation.

(1) The goal of traffic control in the theater of operations is the uninterrupted movement and the certainty of the arrival of vehicles, personnel and cargoes at their intended destinations according to schedule.

★(2) The goal of traffic control in the zone of interior is the safe, efficient, and economical movement of vehicles, personnel, and cargo.

f. The idea of applying traffic control to all types of geographical areas cannot be over-

looked. Military police may be required to provide military traffic control on waterways as well as on roadways.

1-4. Traffic Engineering

a. Traffic engineering planning is required to construct means which will insure a smooth flow of traffic. It is accomplished primarily through the proper design of the highway system, to include roadways, parking areas, and other physical objects and areas.

b. Traffic engineering in road design, building and maintenance provides for an increase in efficient, continuous, and safe flow of traffic by eliminating or minimizing basic traffic frictions. Most terrain may be used as roadway, but failure to select and prepare the terrain for a road impedes the movement of traffic. Traffic engineering permits a reduction in military police control. To achieve minimum necessary control, an effective education program should also be employed with traffic engineering.

1-5. Traffic Education

Traffic education provides for informing road users of traffic rules, regulations, and laws that are intended to promote an orderly relationship. The ideal situation is the voluntary compliance with these rules by each individual. As individuals adopt voluntary compliance, the need for military police in traffic control should decrease proportionately.

1-6. Traffic Enforcement

a. Traffic enforcement is any action taken to create a deterrent to the commission of offenses against traffic rules, regulations, and laws. Two major activities in traffic enforcement are the detection of defects in behavior or equipment of the road users and the institution of appropriate action to correct such defects.

b. Effective enforcement encourages voluntary compliance. This enforcement complements traffic engineering and traffic education. The effectiveness of the enforcement can be indicated by the volume of personnel, equipment, and supplies which move safely without interruption or delay. Effectiveness can be further measured by the increase or decrease in the number of traffic accidents. It cannot be measured in terms of the number of violators apprehended or reported.

c. Preventive enforcement is the presence or the suggested presence of military police at points where violations, congestion, or accidents frequently occur. The purpose of preventive en-

forcement is to deter traffic violations. Preventive enforcement is especially useful where free movement of traffic is essential and detailed control is unnecessary. Military police may be assigned for the specific mission of preventive enforcement. These military police concentrate their efforts on making themselves obvious to users of the roads, supervising traffic and assisting and advising the road users. Properly performed, preventive enforcement tends to create good public relations.

d. Selective traffic enforcement is the planned distribution of military police and traffic control devices so that the enforcement effort is applied where and when it is needed for the specific purpose of reducing traffic hazards.

1-7. Traffic Planning

Sound and practicable traffic planning is based on the development of balanced programs in traffic engineering, education, and enforcement. A balance between these programs is essential to the effective use of the road net and the efficient flow and control of highway traffic.

1-8. Traffic Law

Traffic laws vary from state to state as well as among countries; therefore, it is necessary that military policemen know the traffic laws, ordinances and regulations of the particular jurisdiction or jurisdictions in which he is operating prior to performing his traffic duties. The military policeman performs three general functions in traffic control: first, he directs the movement of traffic; second, he encourages voluntary compliance with traffic laws; and third, he enforces traffic regulations, apprehending violators when necessary. Consequently, the military policeman must know the scope of his authority, the rules of the road, good driving practices, and traffic laws, ordinances, and regulations.

a. The authority of the military policeman to perform his police functions is received from the commander and from the Uniform Code of Military Justice.

b. The rules of the road are outlined in TM 21-305. The military policeman should be qualified as a driver and be able to apply all the driver skills identified in that manual.

★*c.* The Uniform Vehicle Code and the Model Traffic Ordinance published by the National Committee on Uniform Traffic Laws and Ordinances is the common guide used by many communities and states in developing their traffic laws. The Manual on Uniform Traffic Control Devices published by the Bureau of Public

Roads establishes the US standards for road signs and control devices. Oversea theaters publish material applicable to host countries

even when these countries are not signatories to standards or formal documents agreed upon by the United States and the host country.

Section II. ROLE OF COMMANDERS AND STAFF OFFICERS

1-9. The Commander

The responsibility for all aspects of traffic rests with the commander. The commanders of battalion size and larger units usually delegate their planning and supervisory functions to members of their staff. In the division and larger units, military police are provided as an element of command control to assist in planning and other traffic responsibilities.

1-10. The Staff

In the interest of simplicity the staff functions presented herein are those of the Army Division. They are applicable, with necessary modification, to staffs of other levels and types.

a. The ACofS, G1, has staff responsibility in the area of safety, discipline, law and order. Under field conditions he has an interest in movements so far as replacements, rotations of individuals, civilian internees, prisoners of war, health services and displacement of the headquarters are concerned.

★b. The ACofS, G2, has staff responsibility for the collecting, processing and dissemination of information and intelligence. The G2 determines unit map requirements. The G2 exercises staff supervision over counterintelligence activities including those involving movements of personnel and supplies. Due to the characteristic employment and nature of activities of military police, they may have access to information of intelligence interest. Examples of activities observed by military police that could be of value as intelligence are: movements and actions of indigenous personnel; observations made by patrols and at checkpoints; information gained through liaison with civil and military law enforcement agencies; and observations made during security and escort functions. In all of their missions, the military police are valuable collectors of information.

c. The ACofS, G3, has staff responsibility for all aspects of troop movements under tactical or training conditions. He plans the use of roads when tactical considerations are involved. These activities are coordinated with the G4 at the highway traffic headquarters.

★d. The ACofS, G4.

(1) The G4 is the staff officer responsible for

transportation and logistical support. Included in his responsibilities are the selection of routes, the scheduling of movements, and the preparation for the commander's approval of the highway regulation plan. The G4 is assisted in these areas by the transportation section. Within this section are the highway movements specialists.

(2) A highway traffic headquarters is established under the control of the division transportation officer and general staff supervision of the G4. This headquarters has the mission of promoting efficient highway regulation; planning routes, scheduling and directing use of the road net; and serving as a coordinating agency for staff sections and units that also have an interest in the use of the road net. The highway traffic headquarters is composed of representatives of the G4, PM, Engineer and Support Command. It is normal to have representatives from the other general and special staff sections on call as required.

★e. The ACofS, G5, Civil-Military Operations, is responsible for planning and coordinating functions pertaining to the relationship between the military forces, civilian authorities, and the development of favorable emotions and attitudes in neutral, friendly, or hostile civilian groups. Specifically in the area of traffic control, the G5 is concerned with the movement of refugees and the local population and he assists in the coordination of these activities at highway traffic headquarters.

★f. The provost marshal is the principal staff officer concerned with traffic control. His responsibilities include:

(1) Advising the commander and staff on plans, policies and procedures pertaining to traffic control.

(2) Providing a permanent military police traffic control representative at highway traffic headquarters.

(3) Preparing the traffic control plan based on the traffic circulation plan, and coordinating this plan at highway traffic headquarters for incorporation into the highway regulation plan.

(4) Coordinating traffic control activities and policies with other headquarters and appropriate civil authorities.

(5) Providing timely information to com-

manders about the military police assistance they may expect during a road movement.

(6) Timely reporting to G2 of intelligence/counterintelligence information collected as a result of military police operations.

(7) Contributing information and assistance in the implementation of a traffic accident prevention program.

(8) Recommending and implementing traffic accident investigation policies.

(9) Coordinating with and providing notification to the local USACIDC field office for investigative support in connection with fatal traffic accidents when there is:

(a) Indication of a criminal act.

(b) Indication of criminal negligence.

(c) A possibility of a claim against the US Government.

(10) Coordinating with the safety director concerning traffic enforcement and investigation matters, and providing factual investigative data on accidents.

(11) Exercising operational control over the division military police company and attached or supporting military police units.

(12) Coordinating with G3 concerning the training of military police.

(13) Conducting traffic control surveys and studies.

g. The signal officer is responsible for planning signal support beyond the organic capability of the military police and providing guidance concerning efficient use of existing resources.

h. The engineer officer is responsible for road construction and maintenance; bridge construction, repair, and classification; permanent

road signs; detailed route reconnaissance; and providing an engineer representative at highway traffic headquarters. The division engineer advises the division commander and staff on matters relating to the condition, capabilities and limitation of the road net. The engineer plans and supervises engineer operations pertaining to procurement, storage, reproduction and distribution of maps, map substitutes, and related mapping material in accordance with ACofS, G2, guidance.

i. The Staff Judge Advocate is responsible for furnishing information and guidance concerning the legal aspects of traffic control and traffic enforcement.

j. The transportation officer makes plans and recommendations for the availability and employment of transportation and transportation troops. Additionally, he plans and coordinates the establishment, operation, and supervision of the highway traffic headquarters and is responsible for the development of traffic circulation plans in conjunction with the engineer officer and provost marshal.

★1-11. Other Commands

a. Support Command. This command furnishes ordnance, motor transportation, map, general supply, evacuation, and medical support services to assist in accomplishing the division traffic control mission.

b. US Army Criminal Investigation Command (USACIDC). The field elements of USACIDC (field offices and resident agencies) provide investigative support as defined in AR 195-2.

Section III. THE MILITARY POLICE ROLE IN TRAFFIC CONTROL

1-12. General

Traffic control requires planning, coordination, and team operation to be successful. The organization, equipment, and training of different military police units provide different capabilities for traffic control. Maintaining unit integrity during traffic control operations will enhance the effectiveness of the operation.

1-13. Military Police Traffic Duties

Military police performing traffic duties will, within the scope of their authority—

a. Enforce traffic rules, regulations and orders.

b. Operate traffic control posts and patrols. This includes the operation of traffic control at

points of conflict or congestion and operating information posts. During combat operations, the operation of dismount points, roadblocks and checkpoints, escorts and other control measures are required to assure adequate traffic control.

c. Report observations and information on traffic and roads and other information of intelligence interest. Information about traffic control and hasty route reconnaissance, progress of movements, and the results of traffic surveys will also be documented.

d. Be prepared to implement use of alternate and temporary routes.

e. Investigate and prepare reports of traffic accidents.

f. Provide the commander information on his accident prevention and vehicle safety programs.

g. Recommend the type and location of permanent or temporary traffic control devices as required.

h. Actively participate in counterguerrilla, rear area protection, and disaster control operations.

★i. Perform other duties involving security, law enforcement, and crime prevention.

1-14. Preparation for Traffic Control Duties

It is important that the military policeman is prepared to perform his duties. It is the responsibility of the provost marshal and unit commander to insure that the military policeman on duty has a thorough knowledge of traffic laws, rules, and regulations; and awareness of community problems; and the necessary equipment at his disposal. (See chapters 2 through 13 for specific information pertaining to post, camp, and station and theater of operation preparations.)

a. It is important that the military policeman is adequately prepared to perform his duties. This includes a positive approach toward assisting in the safe, orderly flow of traffic and assuring that road users comply with laws, rules, and

regulations. The elimination of the negative approach or single objective that he is the "strong arm of the law, bent on catching the violator," is paramount. The latter leads to poor performance of duty which, in turn, adversely affects the attitude of the road user toward police or traffic enforcement. The appearance and manner of the military policeman encourages respect for the law, thus making his job easier. These qualities are achieved by thorough preparation and maintenance of his uniform and equipment prior to going on duty and thorough knowledge of his orders and duties.

b. In addition to such common equipment as a pencil, notebook, military police forms (AR 190-45), flashlight and whistle, the military policeman performing traffic control duty may require other special equipment which may include safety equipment, motor vehicle, communications equipment, cameras, accident investigation kit, and other like items. To insure that these items are ready to serve their functions when needed, they must be maintained at the highest standards and *inspected* by supervisory personnel at frequent intervals. These high standards of performance, appearance, and maintenance enhance the capability of the military policeman to perform his duties and to achieve the objectives of the traffic control program.

PART TWO
TRAFFIC CONTROL IN POST, CAMP, AND STATION OPERATIONS
CHAPTER 2
THE SUPERVISION AND PLANNING OF TRAFFIC CONTROL

Section I. PRINCIPLES OF SUPERVISION

★2-1. General

a. Traffic control planning is the staff responsibility of the provost marshal. The provost marshal constantly evaluates the traffic situation, makes recommendations to the commander concerning traffic control, and prepares appropriate regulations and the traffic control plan. In CONUS, post, camp, and station operations, the provost marshal is generally the staff officer who prepares the traffic circulation plan, serves as the coordinator for the installation with civilian traffic authorities, and is responsible for the registration of private and commercial vehicles on the installation.

b. Some military police units that provide area military police functions have organic operations sections down to company level. These unit and local provost marshal sections are capable of planning and supervising traffic control operations.

c. The table of distribution (TD) for post, camp, and station units usually provides appropriate teams (TOE 19-510H) to perform necessary functions of traffic control planning and supervision for the provost marshal.

★2-2. Supervisor Responsibilities

The direct supervision of traffic control personnel and operations is accomplished by the military police officers and noncommissioned officers assigned or on duty with the provost marshal's office. (These supervisors may include, but are not limited to, the provost marshal, military police company commander or platoon leader, MP duty officer, MP platoon sergeant, patrol supervisor, or desk sergeant.) Maximum effectiveness and team work is achieved when the same officer and noncommissioned officer are responsible for and supervise the duty performance of military policemen from their own

unit. These supervisors must know, understand, and teach the principles and techniques of traffic control. The military policeman normally performs his duties individually and only occasionally receives the benefit of direct supervision; therefore, all errors observed or learned during these periods of direct supervision must be immediately corrected. Irregularities that are noted by the supervisor may be an indication of major problems or habits which will adversely affect the performance of duty. For example, improper hand signals may be an indication of inadequate training in point control of traffic or, the disregard of minor traffic regulations such as "no parking" signs or "making improper U-turns" may reflect a poor attitude toward other rules. Not only must the supervisor make on-the-spot corrections, but also insures that proper remedial training is taken, if required.

2-3. Report Review Function

The military police supervisors review the preparation of the patrolman's reports. Traffic reports should be clear, accurate, concise, and complete. The questions who, what, when, where, how, and why are answered to the best of the military policeman's ability and all sources of information must be identified. Opinions must be separated from facts and all charges must be supported. During the review of reports, the supervisor is constructively critical; by doing so, he improves the questioning and recording techniques of the patrolman.

2-4. The Military Police Supervisor as a Coordinator

a. The supervisors coordinate the activities of all military police to insure team work. The traffic activities of a patrol affect, and are directly

connected with, other military police who implement the traffic plan.

b. When the traffic plan and local SOP do not provide guidance in a given situation, it is the responsibility of the supervisor to provide the necessary instruction and guidance, and to submit appropriate recommendations for changes to the operations section. Supervisors should insure that the following coordinating instructions or guidance is followed:

(1) *At fixed traffic posts.*

(a) Main roads must be defined and a flow pattern should be established to meet local needs. This pattern must be understood by all military police if the traffic plan is to be properly implemented.

(b) Guidelines for changing the traffic flow at a post must be provided to the MP. The most common criterion for a flow change is a combination of time and location, e.g., a certain time elapses or traffic backs up to a given place.

(c) Conflicts between military police and control devices must be eliminated, to include turning off signals or covering signs when necessary.

★(2) *Disaster patrol coverage must be supervised.* The sudden withdrawal of military police from their normally assigned areas and the requirement to continue routine patrol missions should be expected during a disaster because heavy traffic, evacuation, and disruption of traffic control is common. Under these conditions immediate action is required to implement prepared military police disaster contingency plans which reassign available military police personnel based on the following general guidelines:

(a) Adjustment is accomplished based on the overall police requirement and available number of personnel.

(b) The traffic plan may contain key locations that require military police control at prescribed times regardless of the disaster. These locations are manned to insure continuity of the traffic control plan. This insures that areas of known traffic problems or high accident occurrences are provided military police coverage.

(c) A reduction in the effectiveness of military police traffic control may result when available personnel are over-committed while trying to meet the normal commitments *in addition* to the disaster control. Consequently, it

may be better to leave an area unpatrolled for a short period of time, providing military police attention only when an incident occurs, rather than attempting to patrol all areas as under normal conditions.

(3) *Major construction sites or detours must be supervised.* The traffic supervisor should not be restricted in movement and should perform the functions of a mobile patrol through the area. Special emphasis should be placed on patrolling and observing the approaches to construction or detour areas. This will prevent congestion and other traffic problems. While patrolling, the supervisor constantly checks signs and traffic control devices. If there is a shortage of military police and a heavy flow of traffic, the supervisor must be prepared to act as a temporary relief for personnel performing point control duty.

(4) *Motor escort duty.*

(a) When clearing the way for escorts through congested traffic or areas, the supervisor is located where he or she can best control the movement. Normally, the supervisor stays immediately in front of the escorted vehicles. Thus, the supervisor is able to observe and exercise control over the leading military police vehicle as well as the escorted vehicles. Escorted vehicles usually lack radio communication; therefore, it becomes necessary to rely on signals. If feasible, a portable radio which nets with the military police should be issued to the escorted vehicle. The supervisor briefs the driver of the escorted vehicle on a simple signal system (FM 21-60). Traffic escorts are covered in more detail in paragraphs 5-9 and 5-10 and paragraphs 12-13 through 12-18.

(b) During the escort of classified materiel, the supervisor must be located where he or she can best control the defense and security of the movement. Normally, the supervisor is located immediately behind the escorted vehicle where he or she can observe the vehicle containing the classified shipment and direct the conduct of its defense. In developing the escort plan, the supervisor insures that all-around security is achieved as well as assuring there is as little traffic interruption as possible. For security requirements during movements, see FM 19-30.

(c) The supervisor maintains a reserve force, or the capability of obtaining reserve support when required.

(5) *Actions at an accident scene.* The senior military policeman is responsible for coordinating all military police action at the scene of the accident. Immediately upon arrival at the accident scene, the senior military policeman must evaluate the accident situation to decide whether any existing or potential hazards could make the accident worse. Then, the occupants of the accident vehicles must be cared for as quickly as possible. (Often one military policeman will set up traffic control to prevent the accident from getting worse while the other patrol partner aids the injured.) Fatal accidents require the coordination of the military police duty officer and the local criminal investigation representative. The military policeman completes the interviews and reports, but the review and authentication of reports are accomplished by the military police supervisor. For more detailed information concerning the supervision of traffic accident investigators, see FM 19-26.

2-5. Patrol Supervisor

a. The patrol supervisor is the senior noncommissioned officer assigned to patrol duty and coordinates all patrol actions with the desk sergeant. He circulates on an irregular schedule to all patrol areas. To provide effective traffic control, he frequently checks known areas of traffic congestion. When a new or unexpected traffic problem is reported, he visits the scene, evaluates the problem, and reports his findings and recommendations to the military police desk or operations center.

b. The patrol supervisor should be aware of each accident and be prepared to advise the military policemen who are investigating the accident. Each accident report and traffic report must be critically reviewed by him to insure that it is complete, objective, and accurate.

c. The patrol supervisor's experience, training, and knowledge of the area of responsibility makes him a vital source of information for conducting an effective traffic plan. When on a patrol, or when reviewing military police reports, the patrol supervisor periodically evaluates the traffic plan and recommends necessary changes.

d. In special situations the duties of the patrol supervisor may be divided between a police patrol supervisor and a traffic patrol supervisor. Under this concept, the traffic patrol supervisor exercises primary interest in, and supervisory control over, traffic patrols and point control opera-

tions. However, since police patrols also perform functions in the traffic control area, both patrol supervisors have an interest in traffic matters.

e. For other duties of the patrol supervisor, see FM 19-5 and FM 19-10.

2-6. The Desk Sergeant

a. The desk sergeant is the noncommissioned officer in charge of all military police station and patrol activities. When the entire platoon is committed at one time, the platoon sergeant may fill this position. The desk sergeant is assisted by the desk clerk and radio operator. The fixed location and communications available to the desk sergeant provide the means to control all military police activities. Specific traffic supervisory duties include—

(1) Assignment of military police to perform specific tasks outlined in the traffic control plan.

(2) Dispatch of military police to traffic accidents and locations of actual or likely traffic congestion.

(3) Supervision of the preparation, completion, and review of all traffic reports.

(4) Review of all activities as to their effect on the traffic plan and prepare recommendations to insure that the traffic plan is current and complete.

b. The duties of all personnel assigned to the military police desk are described in FM 19-10.

2-7. The Military Police Duty Officer (MPDO).

a. The military police duty officer is responsible for all military police activity during his tour of duty. He is normally located at the military police station where he is readily available. Common type traffic incidents that may require immediate personal action by the duty officer are—

(1) Supervision at serious accident scenes, to include coordination to insure that an investigation has been initiated by the CID when appropriate, or that emergency equipment is obtained.

(2) Determination of the causes of unexpected traffic problems and congestion.

(3) Determination of action to be taken with major traffic violations and offenders.

(4) Directing military police activities in incidents involving traffic that are of command interest or that have interest to news media.

FM 19-25

b. For other duties of the military police duty officer, see FM 19-10.

2-8. The Stabilization of Military Policemen Among Various Patrol Assignments

Military policemen, recognized by their supervisor as successful in serving a particular traffic

control duty, should be stabilized by their supervisors. This tends to increase the patrolman's effectiveness on that patrol to include execution of police operations, development of police intelligence of the area and its population, and encourages close relationships between military police and the segment of the community served.

Section II. PRINCIPLES OF TRAFFIC PLANNING

2-9. General

a. A military installation is made up of numerous functional components. While some small installations may have only a few of these components, usually larger installations have more of the components listed below. The most common functional components are—

- (1) Headquarters areas, to include office building complexes.
- (2) Barracks areas.
- (3) Residential areas.
- (4) Service areas to include PX, stores, theaters, service clubs, etc.
- (5) Hospitals and medical facilities areas.
- (6) Industrial areas.
- (7) Warehouse areas.
- (8) Range areas.
- (9) Testing areas.
- (10) Classified and restricted areas.
- (11) Training areas.
- (12) Heliports and airfields.

b. To insure the integrity of the functional components, the following principles should be used as a guide in the establishment of a traffic plan:

- (1) Traffic movement should be concentrated on a minimum number of clearly defined routes. These primary routes should be ample and efficiently controlled so that drivers will be encouraged to use them.
- (2) When establishing the primary circulation system, traffic should be routed around functional areas rather than through them.
- (3) Traffic movement within an installation should be segregated according to its destination. For example, one route should lead to the service area while another route leads to the headquarters area; therefore, the traffic loads for the two areas are not superimposed on one route.
- (4) Where there is a major movement from points outside the installation to points within

the installation, a direct route is desirable to avoid needless traffic circulation and conflict with internal traffic of the installation.

c. All long-range changes to the physical features of the installation should meet the requirements of an approved master plan. The arrangement of new buildings, recreation areas, parking lots, gates, access routes, or modifications of any of these facilities, should compliment the various functions of an installation. This grouping will improve the overall circulation plan. Any changes to traffic circulation plans are coordinated with the installation engineer. In most cases there should be coordination with civilian highway engineers to determine the effect an installation traffic circulation plan will have on adjacent communities. Coordination with civilian agencies will also assist in determining the effect their circulation plan will have upon the installation.

2-10. Minimizing Traffic Loads

A fundamental step toward minimizing traffic loads on an installation, or between that installation and nearby communities, is to attain the maximum use of available public transportation. As reliance on private automobiles for transportation increases, less efficient use is made of available roadways and parking areas. The following are techniques which can minimize traffic loads:

- a. Stagger work hours.
- b. Encourage the use of car pools and ride-sharing.
- c. Encourage the use of public transportation by improving its efficiency and service.
- d. Restrict the number of vehicles authorized to enter the installation.
- e. Use post transportation to shuttle traffic among parking lots within the installation boundaries.

2-11. Considerations in Traffic Planning

a. The first step in the development of a new traffic plan, or the review of an existing plan, is to select the routes which could form the primary circulation system. This system should conform to the physical plan of the installation and have due regard for the integrity of functional components. Interconnecting routes should be selected which pass around the borders, rather than through these components. As a general rule, only that number of primary routes necessary to handle the traffic volume and to provide access to the various areas should be selected. All possible steps should be taken to make these few routes highly efficient. Through the use of a minimum number of primary routes, problems of route construction and maintenance, traffic control, and police supervision, are reduced. But, it must be remembered that an adjustment at one intersection or location can adversely affect other intersections or locations.

b. Streets and roads which are not included in the primary routes fall into a secondary category, and can be controlled in accordance with the needs of the area in which they are located. For example, in residential areas streets can be circuitous or contain offsets or dead ends to discourage through movement. If through movement persists, barriers of some type may be warranted.

2-12. One-Way Routes

The following principles will serve as a guide for planning one-way routes which will be used as a part of the circulation system:

a. A narrow roadway can carry a higher volume of traffic with one-way operation than with two-way movement because traffic can move in more lanes. For example, a 32-foot pavement can carry only two lanes under the two-way pattern; with one-way operation it can accommodate three lanes. Also, in one-way operation the number of left turn conflicts is reduced. See figures 2-1 and 2-2.

b. When traffic volume causes congestion, curb parking should be eliminated so that two-way traffic is allowed to continue. If this is unsuccessful, it may be necessary to resort to a one-way system to relieve the congestion.

c. It is easier for pedestrians and vehicle operators to cross a one-way route than a two-way route.

d. One-way systems are applicable in areas of high traffic volume where the streets follow a regular grid pattern.

e. Special one-way routes may be used under certain conditions. For example, at a complex intersection where a number of streets intersect, one or more of the streets of minor importance may be made one-way, outbound from the intersection.

f. Caution should be exercised when designating one-way streets. When two one-way streets are used to move traffic that a one two-way street previously handled, traffic is dispersed over a greater number of streets, inviting throughway movement in residential areas. In such a case, care should be used in designating one-way traffic in these areas. Also, the creation of one-way streets often results in the addition of more mileage to the primary circulation system, thereby increasing the task of police supervision and the requirements for street maintenance.

g. As a general rule, one-way systems have application to installations under several conditions:

(1) They may be required on certain primary entrance roads to accommodate the inbound rush in the morning and the outbound rush in the evening.

(2) They may be required in areas that have large concentrations of vehicles and pedestrians, but narrow streets.

(3) They may be required in special situations, such as at complicated intersections where circulation may be improved and conflicts reduced (*a* above) by the use of one or more one-way streets. These one-way streets are not necessarily part of the primary circulation system.

(4) They may reduce congestion caused by conflicting traffic movement; for example, when traffic flow is slowed by left turns.

(5) They may reduce accident frequency at intersections where traffic studies have indicated that two-way traffic causes excessive accident exposure.

h. Methods used to determine volume, capacity and conflict on a road are found in TM 19-251.

2-13. Establishing Speed Zones

a. Speed zones should be selected in accordance with the type of district through which the road passes. Speed limits which are excessively

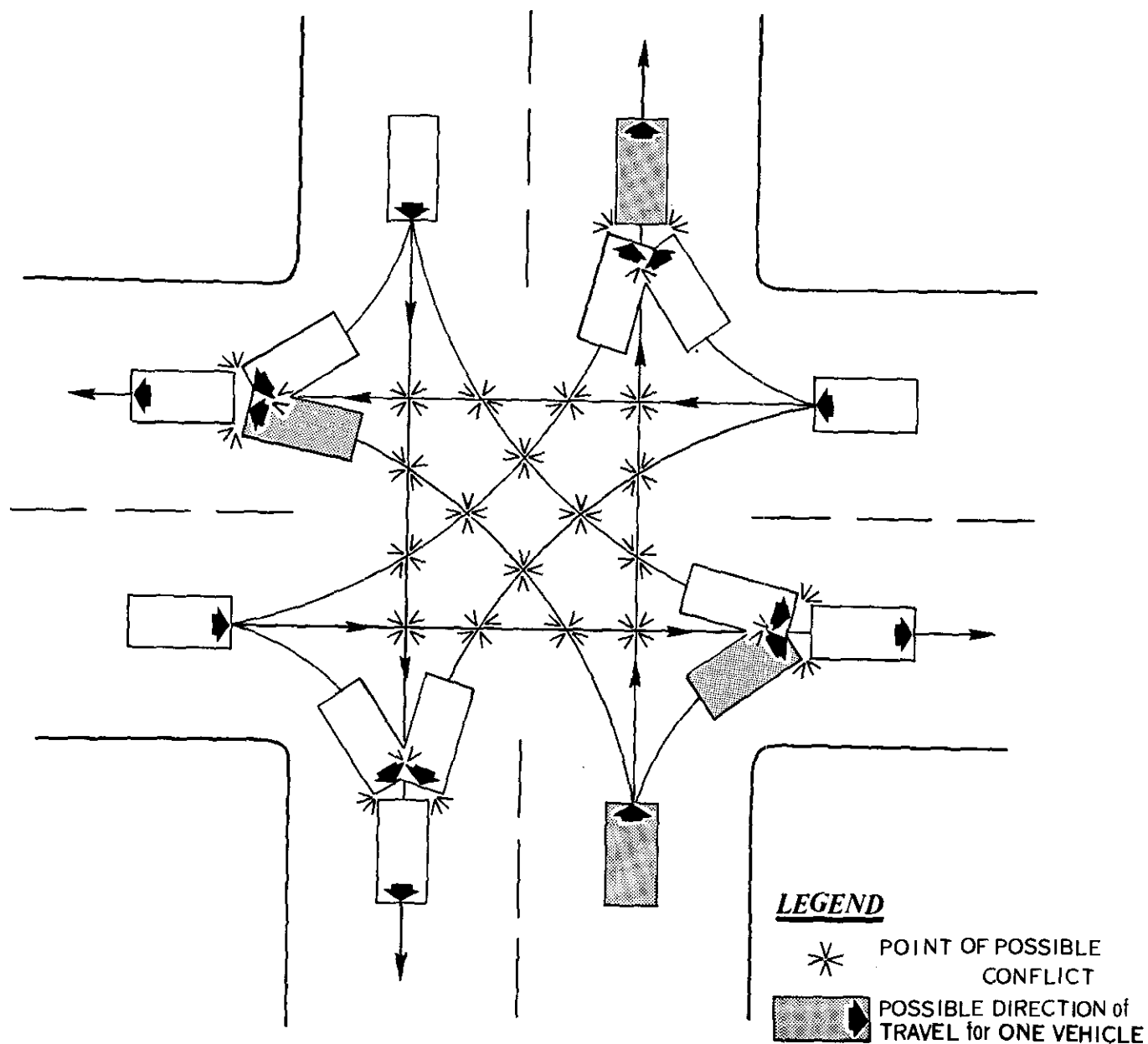

Figure 2-1. Conflict on a two-way street.

restrictive may be ignored by drivers, requiring unrealistic enforcement efforts. More reasonable limits earn a greater driver cooperation and permit the direction of police efforts against the small percentage of drivers who travel at excessive speeds. Periodically, the provost marshal will review spot speed checks to assure that speed limits have been properly established.

b. The following criteria are considered when establishing speed limits:

(1) The traffic speed the road is designed to handle safely (obtained from the installation engineer).

(2) The 85 percentile rule (TM 19-251).

(3) The maximum speed which still will allow sufficient stopping distance between the point of first perception of a hazard and the hazard itself. The condition diagram (TM 19-251) and the speed nomograph (FM 19-26) will help during this analysis.

c. If a minimum speed is necessary for travel on a high-speed roadway, (4-lane or expressway) the 15th percentile rule should be used.

2-14. Street Lighting

a. The provost marshal recommends procedures which will enhance traffic safety. By know-

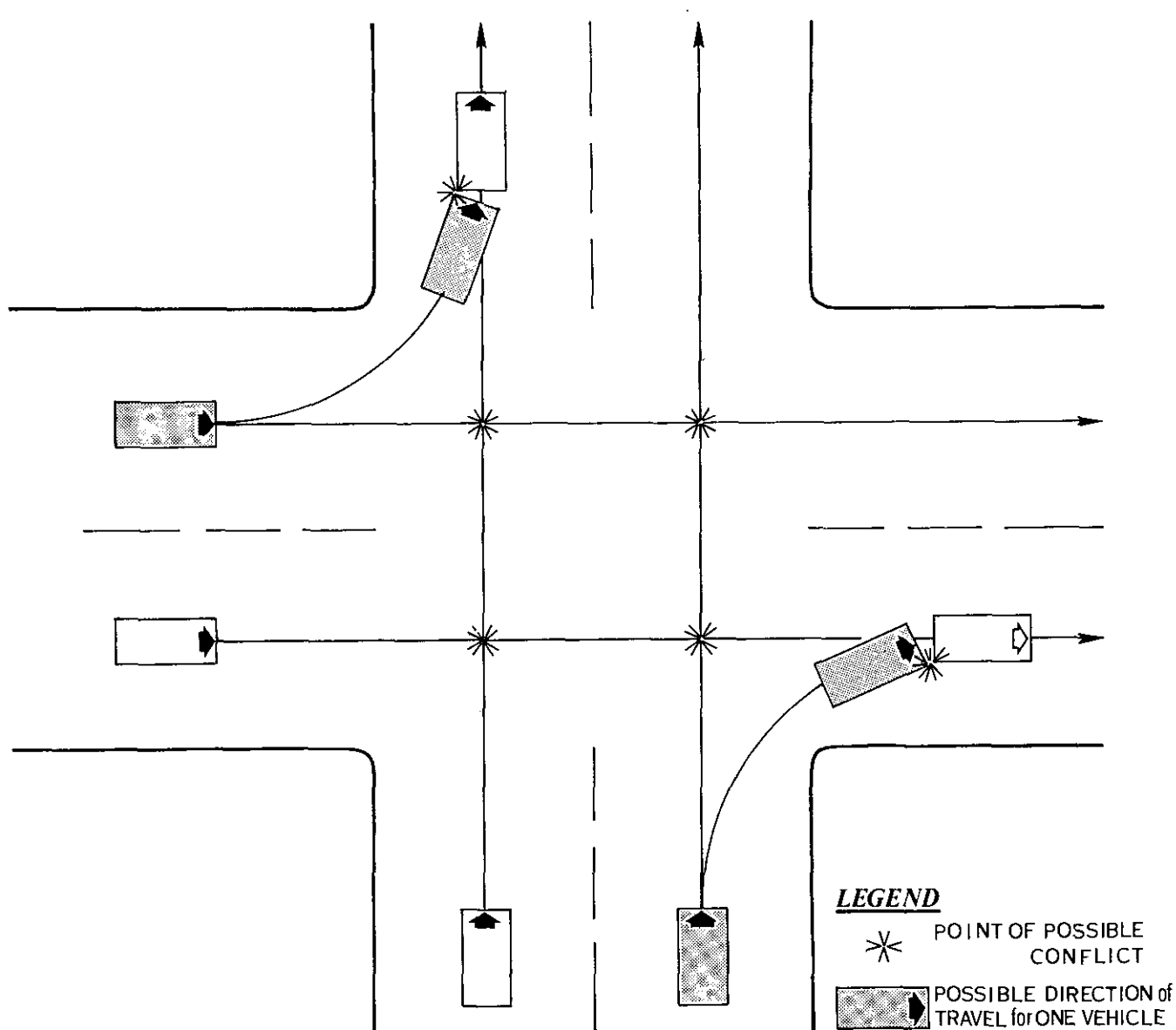

Figure 2-2. Conflict on a one-way street.

ing the existing traffic problems, his recommendations to the commander and to the installation engineer officer will be timely and appropriate. For example, the lighting or other traffic control devices at intersections, on curves, bridges, or other street locations are particularly important in traffic safety. A review of traffic accident statistics might reveal information to support a recommendation to install street lighting.

b. Proper street lighting helps reduce nighttime traffic accidents and, on occasion, may permit an increase in the speed limit, which, in turn, can increase highway efficiency. Additionally, the capacity of a road or intersection can

be increased at night by eliminating the tendency of drivers to stay only in the better lighted lanes.

2-15. Pedestrian Control

a. An installation traffic control plan must also provide for safe and efficient pedestrian movement.

b. Those locations designated as pedestrian street crossings must be conspicuously marked.

c. Crossing locations are identified for the pedestrian and the motorist by—

(1) Marking the crossing area with lines which cross the street surface.

(2) Establishing warning signs, especially at hazardous locations.

(3) Providing a control system such as "Walk" and "Don't Walk" signs.

2-16. Parking

Plans for parking should be based upon results of surveys. Off-street parking is more effective than on-street parking since it increases the safety and efficiency of traffic movement, increases the capacity of streets, and assists the safety of pedestrians. The methods used to conduct parking and parking lot surveys are found in TM 19-251.

2-17. Traffic Control Devices

a. Traffic control devices enhance the traffic flow efficiency and reduce manpower requirements.

b. When employing these devices, they should be—

- (1) Conspicuous.
- (2) Legible.
- (3) Brief.
- (4) Clearly understood.
- (5) Used in accordance with the Manual on Uniform Traffic Control Devices.

c. The methods used to determine the type of sign or device needed in the control of traffic are found in TM 19-251.

2-18. Traffic Control for Special Events

a. Special events, such as parades, displays, and sporting events, normally generate heavy traffic and require special consideration.

(1) Direct routes to the area of the special event are planned. These routes might lead from the residential area of the installation or from the surrounding communities. These routes must not merge or cross each other.

(2) Parking areas should terminate the main routes. Ideally, a parking area is established for each route, thus providing a means of segregating traffic.

(3) Special parking areas are normally established for official vehicles and special guests.

A system of color cards for identifying vehicles of special guests may be used.

(4) Special routes are planned and used to handle emergency vehicles such as ambulances and fire trucks.

(5) Detours are planned for the normal area traffic to insure that it does not conflict with the special event traffic.

(6) The traffic plan, and in particular, instructions for the road user, must be publicized as an aid to traffic control and as a means in reducing congestion. The appropriate information officer should be contacted for necessary publicity.

(7) Maximum use is made of guide and direction signs.

(8) Helicopters may be used by supervisory personnel to provide maximum observation of traffic, thus allowing the placement of control personnel or devices where and when needed.

b. The traffic plan for a special event is normally delineated as a map, sketch or strip map (fig. 2-3).

2-19. Disaster Control

Disaster control planning in CONUS should assure maximum military police traffic support to local and state police. Since the general public can be expected to respond to pleas for assistance by converging from all directions to the disaster location, planning for traffic control must include provisions for establishing information posts at key points of ingress. These posts should be marked and manned by personnel who can direct the delivery of blankets, food, water, medical supplies, etc., to the proper collection/distribution center and guide persons offering other services to the responsible civilian agency. Curiosity seekers should be directed away from the disaster area to permit the efficient flow and operation of emergency vehicles and equipment and the disaster assistance personnel. Combined military and civilian police patrols are especially useful in providing on-site coordination and assistance of general public support. Traffic control and/or information posts should be located outside the disaster area to redirect traffic and to prevent congestion in the disaster area by restricting the entrance of unessential traffic (curiosity seekers). (See part three, FM 19-15.)

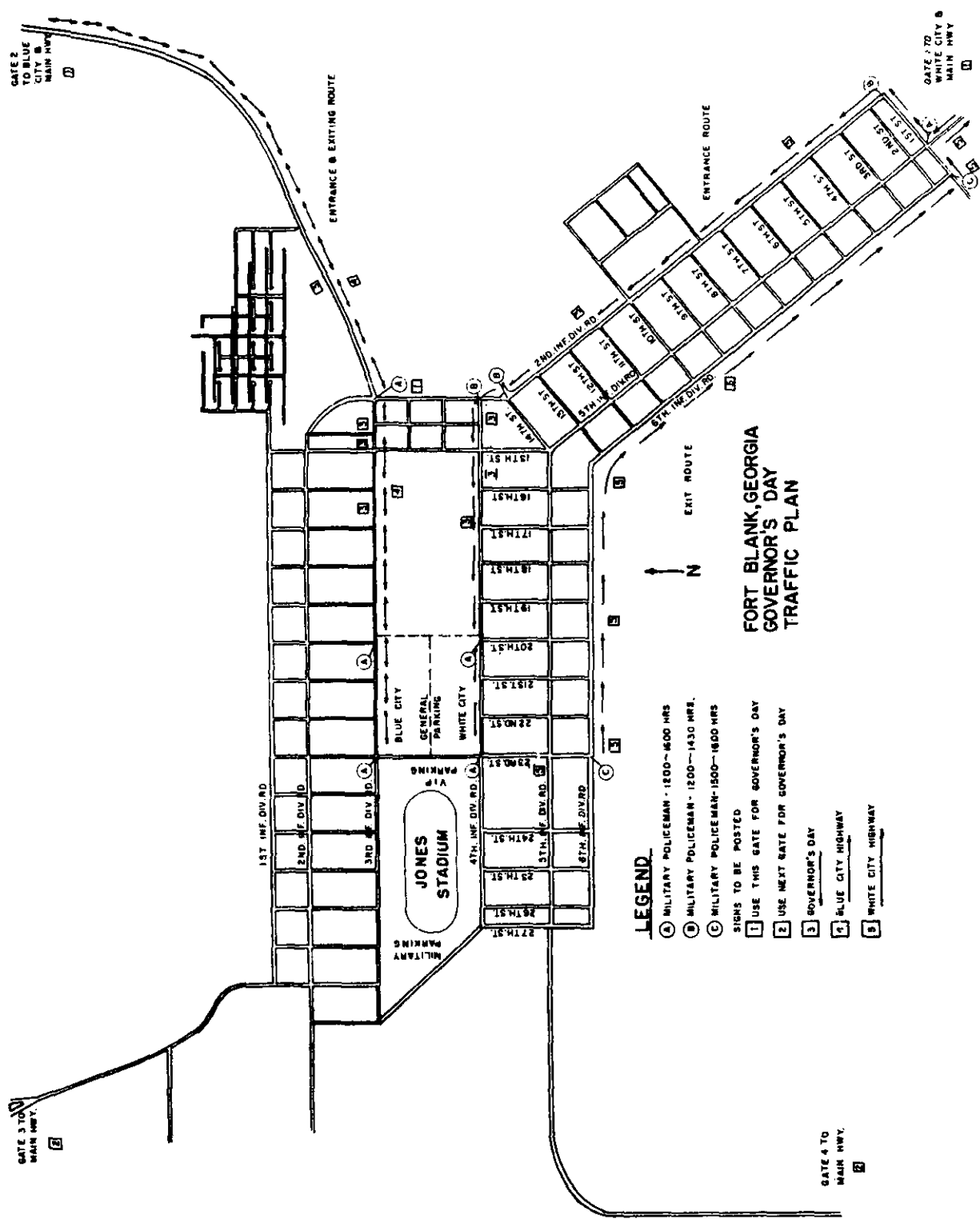

Figure 2-3. Sample Traffic Plan Map for a special event.

CHAPTER 3

POINT CONTROL OF TRAFFIC

Section I. GENERAL

3-1. General

The effective point control of traffic requires that basic rules be followed so that traffic will proceed in an orderly manner. These basic rules are based on command requirements and upon common sense. An explanation of some of the traffic rules and goals for point control, together with related terms are set forth below:

a. Terms.

(1) *Point control.* Point control is the use of mechanical devices or personnel for the control of traffic at intersections or at other points of possible conflict and/or congestion.

(2) *Traffic control device.* A traffic control device is any sign, mechanical signal, physical marking, display, or other device placed or erected for the purpose of regulating, warning, or guiding traffic.

(3) *Traffic studies.* Traffic studies are special efforts to determine practical capacities of roadways; provide basic information required to update traffic regulations; establish priorities for street improvements; and serve the needs for traffic planning.

(4) *Traffic flow system.* A traffic flow system is the safe, orderly, direction of traffic on a road or street network, or section thereof. It may be depicted by a traffic circulation plan.

(5) *Delay.* A delay in traffic is represented by the time consumed while traffic or a specified component of traffic is impeded in its movement by some element over which it has no control (usually expressed in seconds per vehicle).

(6) *Other terms.* Other applicatory terms are found in the glossary of TM 19-251.

b. Goals. There are three primary goals sought in point control of traffic:

(1) Insure the orderly movement of traffic in accordance with the traffic control plan and in keeping with command safety requirements.

(2) Prevent unnecessary traffic delay through the effective planning and the application of minimum essential control methods. Attaining this goal requires the voluntary compliance with traffic laws and rules of the road by the drivers.

(3) Use of traffic control devices, where possible, to relieve military police from point control duties. Military police are best used for enforcement; i.e., suppressing violations of traffic laws and regulations, and responding to violations of these laws and regulations.

c. Rules.

(1) Point control is established when one or more of the following conditions exist:

(a) When the road network is inadequate to accommodate traffic.

(b) When serious congestion or conflict occurs or can be anticipated.

(c) When traffic studies and/or surveys indicate that point control is required (see TM 19-251).

(d) When the security of designated persons requires special point control (see FM 19-30).

(e) When interruptions in the flow of traffic are reported to the military police traffic supervisors, and every effort is made to restore the normal flow of traffic (para 3-6 and 3-7).

(2) Major rerouting of traffic is coordinated through the traffic headquarters. Emergency rerouting is reported as it occurs.

(3) Personnel assigned duties at a traffic control post are not removed until they are relieved by proper authority.

3-2. Preparation for Point Control of Traffic

a. Prior to being assigned to a traffic control point, the military policeman is given all possible information concerning the control requirements

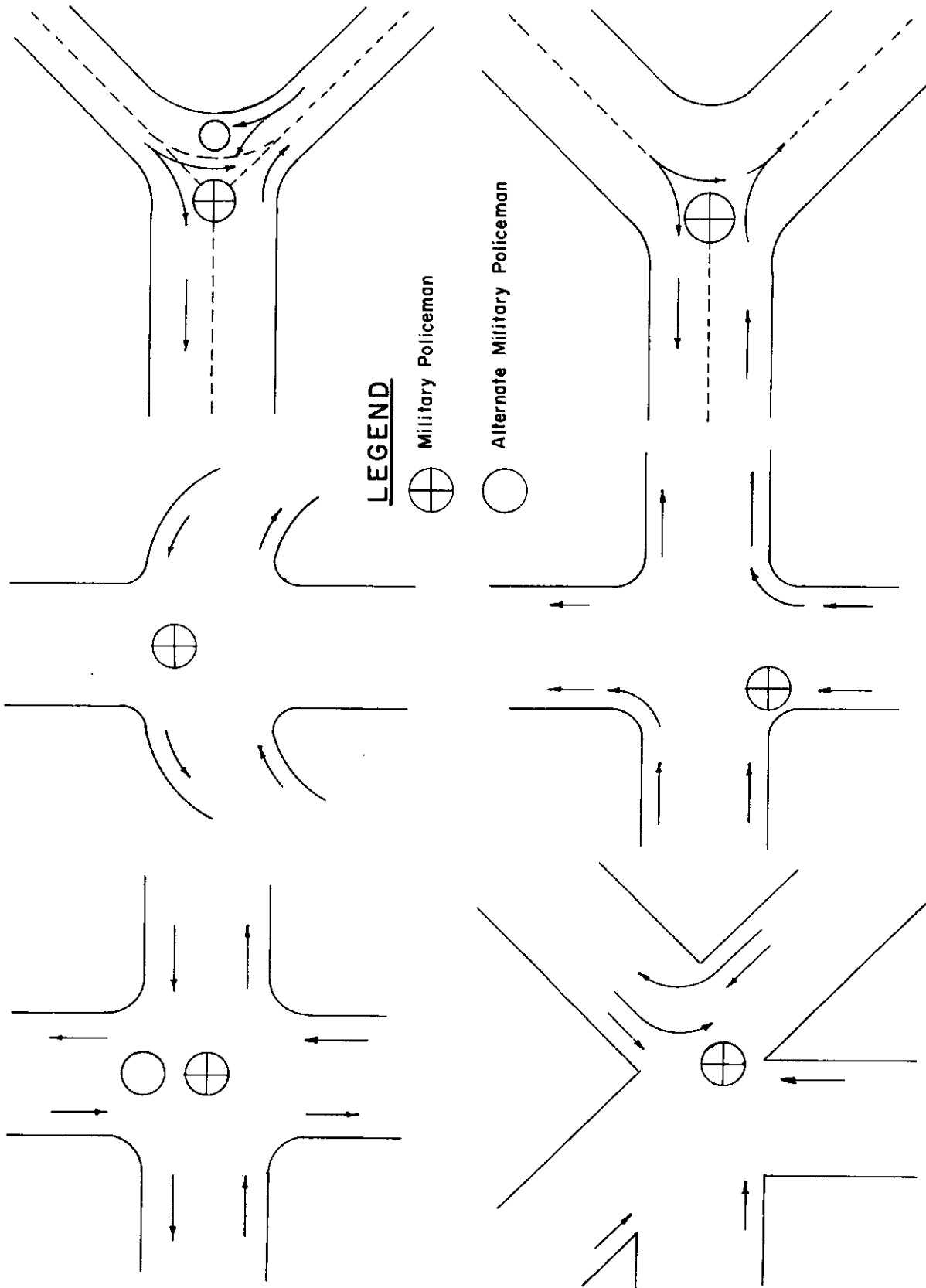

Figure 3-1. Military police positions at various intersections. The position is not fixed and the military policeman may move to meet traffic flow needs.

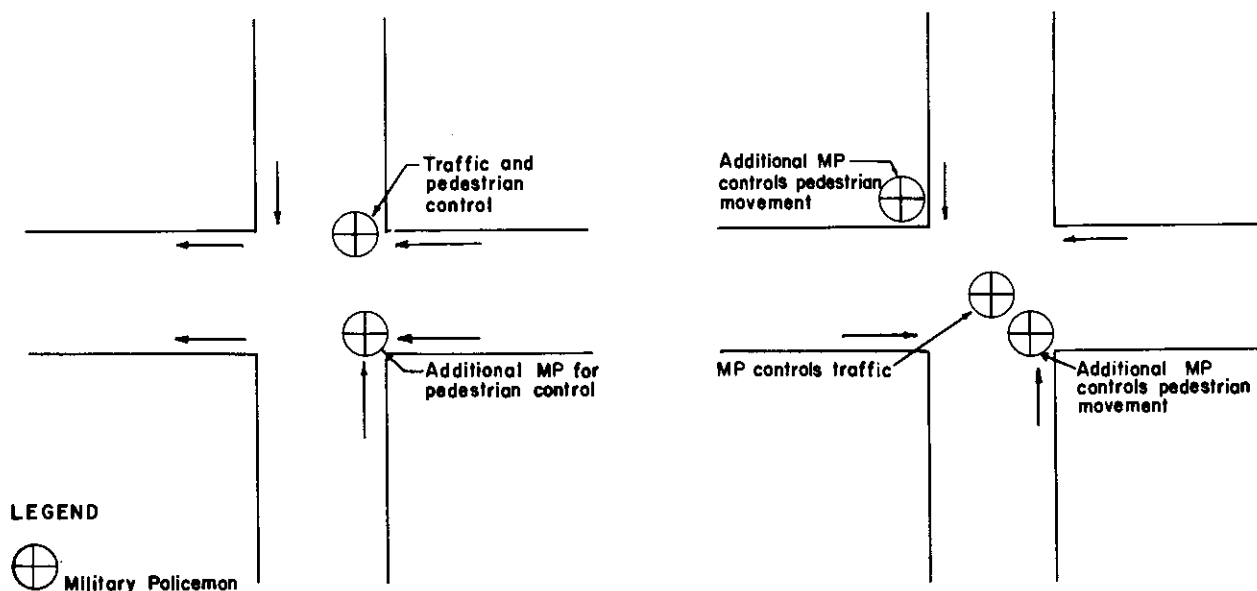

Figure 3-2. Military police ground orientation at intersections requiring more than one military policeman.

at that point. He receives this information from the following sources:

- (1) Briefings from his supervisors.
- (2) Other military policemen previously assigned to that point.
- (3) Traffic surveys or studies.
- (4) Observing the control point in operation. Prior to assuming point control duties at busy intersections, new personnel should have the opportunity to observe traffic control at that point conducted by military policemen whom they are to relieve.

b. Necessary safety equipment is issued to the military policeman prior to his assuming point control duties. Some of the most commonly used individual items of safety equipment for point control duty are:

- (1) *Reflectorized crossbelts, vests, sleevelets, and flashlights.* These make the military policeman more conspicuous to drivers.
- (2) *Raised platform.* This affords the military policeman a clearer view of traffic and makes him easily seen by drivers.
- (3) *Temporary signs.* These alert drivers that a traffic control point or control device is ahead.
- (4) *Traffic cones.* These temporary devices are used to guide traffic flow over short portions of roadway to avert danger, to prevent congest-

tion, or to keep vehicles away from newly painted markings or from road construction. (See app D for additional information on equipment required.)

3-3. On-Site Location

a. The military policeman should be located at the position which offers the greatest degree of effectiveness. Some factors which affect this position follow:

- (1) Design of the intersection.
- (2) Traffic volume characteristics.
- (3) Light/darkness conditions.
- (4) Degree of control required.

b. It is of the utmost importance that the military policeman be able to observe and be visible to approaching motorists. This helps to insure his personal safety. At many intersections, this point will be the center of the intersection. Sometimes the military policeman should keep to one side of the main traffic flow, especially when there is one-way traffic or when the road is unusually narrow (fig. 3-1).

c. When two or more men work together at a control point, the senior is placed in charge. Additional men may be used to control major secondary traffic movements at the control point (fig. 3-2).

For example:

- (1) Movement from and into a parking lot.
- (2) Pedestrian traffic.

- (3) At a wide, divided roadway.
- (4) At any intersection where complex traffic movements occur.

Section II. POINT CONTROL OPERATION

3-4. Hand Signals

a. Hand signals are the most frequently used methods used to direct traffic during the point control of traffic. These signals have been standardized to accommodate foreign drivers in NATO countries (app B). Sometimes civilian police of foreign countries use a variety of hand and arm signals. But, provost marshals may choose to adopt the standard signals used by the host nations when, under local arrangements, military police personnel are permitted to control traffic in the civilian communities. The use of these signals may prove to be beneficial during emergencies on civilian roadways when traffic control is necessary until local police arrive. These signals especially apply in those countries where Status of Forces Agreements (SOFA) preclude traffic control by the US military off US military installations and outside training areas. Arrangements must be made with host nation police to learn the signals used in host countries. Nonstandard or poorly executed signals tend to confuse drivers and destroy the effectiveness of the control point. To insure maximum personal safety, it is imperative that all signals, day or night, are executed distinctly and deliberately. Any changes to the basic signals used by the military police must be widely publicized to the drivers. A dangerous situation can result from the failure of drivers to understand these signals.

b. The traffic baton or flashlight is used to supplement the hand signals during hours of darkness or reduced visibility. The baton signals used during those times differ from the daytime signals, and must be learned thoroughly both by the military police and drivers (app B). *During periods of extreme reduced visibility, e.g., heavy fog or snow, the railroad safety red flare is excellent to alert drivers of impending danger. During extreme reduced visibility, supervisors should be aware of the hazardous conditions under which traffic control personnel are working. Sometimes it will be necessary for supervisors to recall personnel from point control when the safety of the military policeman is in jeopardy. The supervisor must weigh the hazard of the*

traffic moving without point control against the hazard facing the man remaining at the point.

c. When using hand signals, the military policeman must apply the following basic rules:

(1) He must assume a correct stance for controlling traffic, thus reducing fatigue and presenting a good appearance (fig. 3-3).

(a) The body should be erect, with feet approximately 8 to 10 inches apart. (This distance is dependent upon the height of the individual military policeman.)

(b) The arms should hang naturally by the sides.

(c) He should distribute his weight evenly on both feet.

(d) He should stand so that the plane of his shoulders is parallel to the stream of traffic.

(2) Prior to executing a traffic control signal, he should look at the traffic to insure that the driver can respond to the signal without confusion or danger.

(3) Prior to instructing a road user to move or turn, he should insure that conflicting traffic is stopped. Since the military policeman is controlling the traffic, he is responsible for insuring that the movement he directs is safe because the driver is relying on his decisions.

(4) He must execute distinct and complete signals. Each signal made by the military policeman must be understood by the road user. If it appears that the road user does not understand, he should repeat the signal. The military policeman must not change his visual instruction once the signalling movement has been started.

(5) The key rule to remember is that the military policeman must *LOOK* carefully at the developing traffic situation, *EXECUTE* the appropriate signal precisely, and then *COMPLETE* each signal distinctly.

d. The principles and rules outlined as a guide for manual point control of traffic are applicable to the positioning of mechanical devices.

3-5. The Whistle in Controlling Traffic

a. In addition to the visual means of traffic control, the military policeman is supplied with

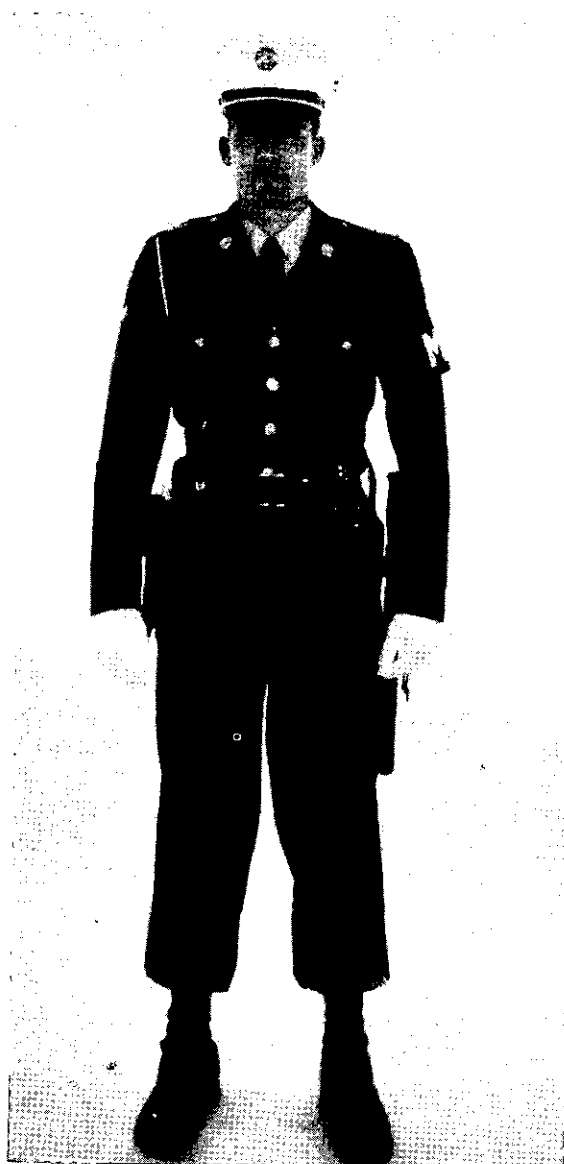

Figure 3-3. Correct stance for military policemen controlling traffic.

a whistle, which is used to call the driver's attention to the military policeman's signal or warn of the impending danger. When used too frequently for routine signals, the effectiveness of the whistle is lost.

b. The standard whistle signals are:

- (1) STOP, one long whistle.
- (2) GO, two short whistles.
- (3) ATTENTION, several short (approximately 4) whistles, repeated as necessary to attract the attention of the operator.

3-6. Expediting Traffic

a. To operate an effective traffic control point,

the military policeman must recognize the early signs of a traffic jam. These indicators include, but are not limited to the following:

(1) Backed-up lanes of traffic.

(2) Excessive change in the flow speed, from slow to fast, which can result in rear-end collisions.

(3) Vehicles blocking a portion of an intersection.

b. When the military policeman recognizes these traffic jam signs, he must hold certain lanes of traffic until the situation clears. When an exit lane fills up, no vehicles must be permitted to enter the intersection unless they use those exit lanes which are free. When it is necessary to merge two incoming lanes of traffic to form a single outgoing lane, it is better to alternate the flow rather than to try to mix the two lanes together. Alternations should be long enough to permit a substantial number of cars to go through, thus minimizing the stop-and-go effect. The elimination of turning movements speeds up through-traffic, but this restriction must be used with care. Vehicles will have to turn eventually. The arbitrarily shunting of turning movements onto the next intersection may greatly increase the control problem at that location.

c. Traffic on the major route must get priority. When alternating traffic flow, the military policeman allows maximum "go" time to vehicles on the major road. When traffic backs up on the major road, the flow from the secondary road should be stopped and traffic on the major road allowed to proceed, even if all traffic on the secondary road has not cleared. The following additional rules should be applied when changing the flow of traffic:

(1) Traffic from the secondary road is allowed to proceed during breaks in the traffic on and the main road.

(2) If breaks do not occur on the main road, traffic from the secondary road is allowed to accumulate before being directed to enter or cross the main road. This may result in comparatively longer waiting time for traffic on the secondary road than the major road.

(3) A change in flow is made without having traffic stop in or block the intersection.

(4) A change in traffic flow is not to be made when heavy equipment will be the first vehicles to enter the intersection. Ideally, the first few vehicles waiting for a flow change should be

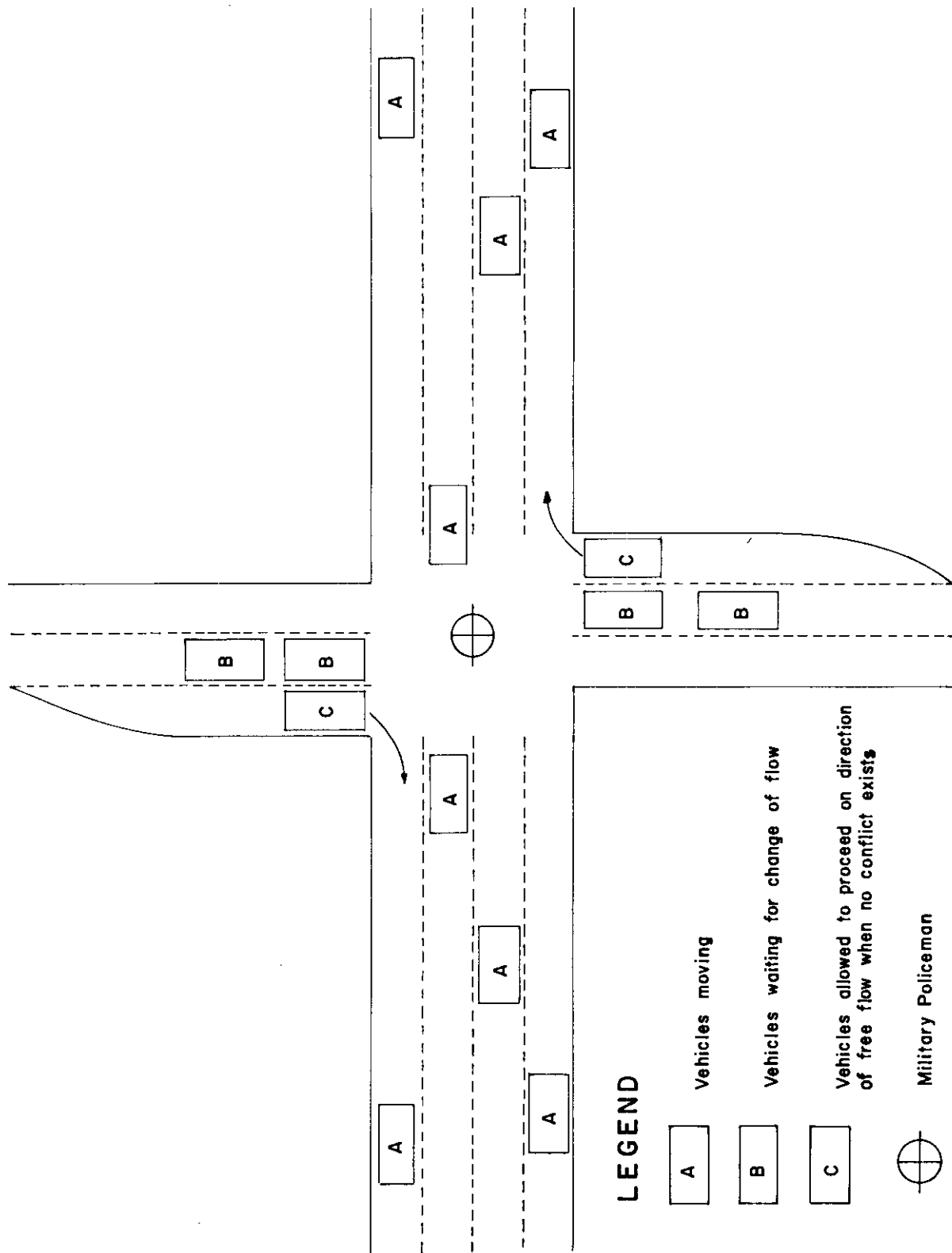

Figure 3-4. Traffic flow—right turn.

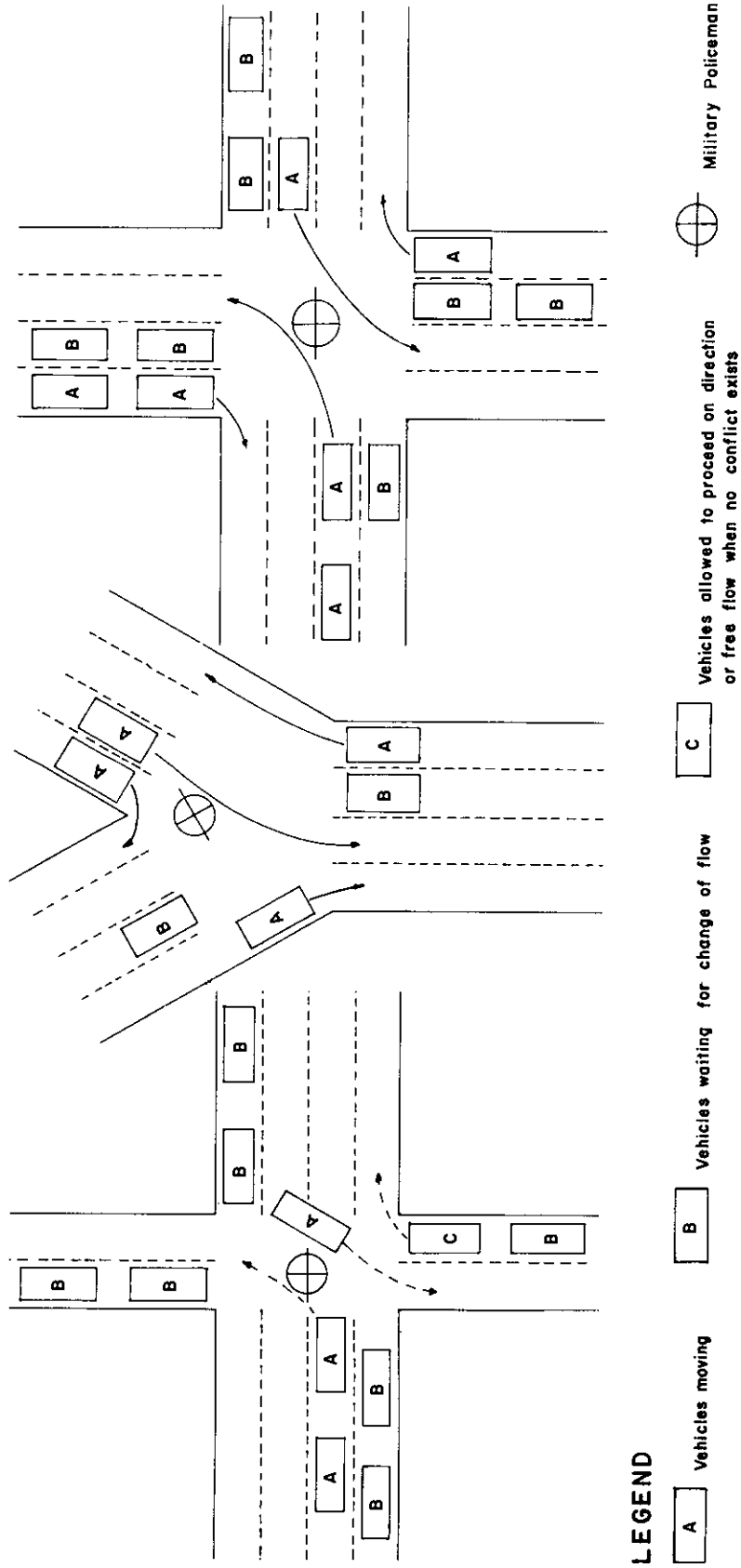

Figure 3-5. Traffic flow turns.

Various turns can be permitted provided they do not conflict with other movements.

sedans or light vehicles that do not require excessive distances to build up speed. This allows maximum "go" time because the heavy equipment builds some speed while lighter vehicles at the front of the column start moving.

(5) Right turns from the stopped flow are permitted whenever they do not interfere with the "go" traffic, or do not conflict with pedestrians (fig. 3-4).

(6) Left turn traffic is allowed to turn into the "go" flow by:

(a) Integrating the left turns of a two-lane road through the opposite flow or stopping the opposite flow to allow the left turn traffic to proceed.

(b) Stopping the left turn traffic until the through traffic has cleared the intersection or a suitable break in the flow occurs. Then the left turn traffic should clear the intersection before the traffic flow direction is changed again. (This is for a three or four-lane road with designated left turn lanes.)

(c) Limiting or halting left turns when the exit road begins to fill.

(7) Blending turning movements should be permitted only when there is no conflict of lane usage. This usually occurs when the intersection expands into a four-lane road. (For examples of turning movements, see figure 3-5.)

3-7. Coordination Within The Traffic Flow System

Smooth and efficient traffic flow depends in part on coordination with other control points. Forcing or restricting turns to keep one intersection open may disrupt the area plan and may create problems at other points. To maintain an even flow, each control point must be synchronized with adjacent and nearby control points. Where

a major control point is regulated by traffic signals, adjacent points should regulate flow to take maximum advantage of the signal alternations. Where there is no signal in use and a group of control points must work cooperatively, one control point should be identified as the key point, with the adjacent points coordinating their flow with it (fig 3-6).

3-8. Special Point Traffic Control

a. One of the most important special control points is at school crossings. General traffic control principles are applicable; however, due to immaturity and lack of safety knowledge, school children require special control measures. The military policeman must understand that children's actions are impulsive and must be constantly observed. At school crossings the military policeman should apply the following principles:

(1) Whenever possible, he should face the children.

(2) He should require motor traffic to move through the crossing with caution. He should not permit the children to cross the roadway until they are standing in an orderly manner on the sidewalk and the crossing is clear.

(3) He should insure that school patrols supporting him properly perform their duties.

b. Emergency entrances to hospitals, fire stations and other facilities may require the adjustment of traffic point control to meet special situations. The most common adjustment is the sudden change in traffic flow. When this occurs, the military policeman must respond quickly. With the guidance presented in this chapter, the problems which may arise at emergency entrances will be overcome.

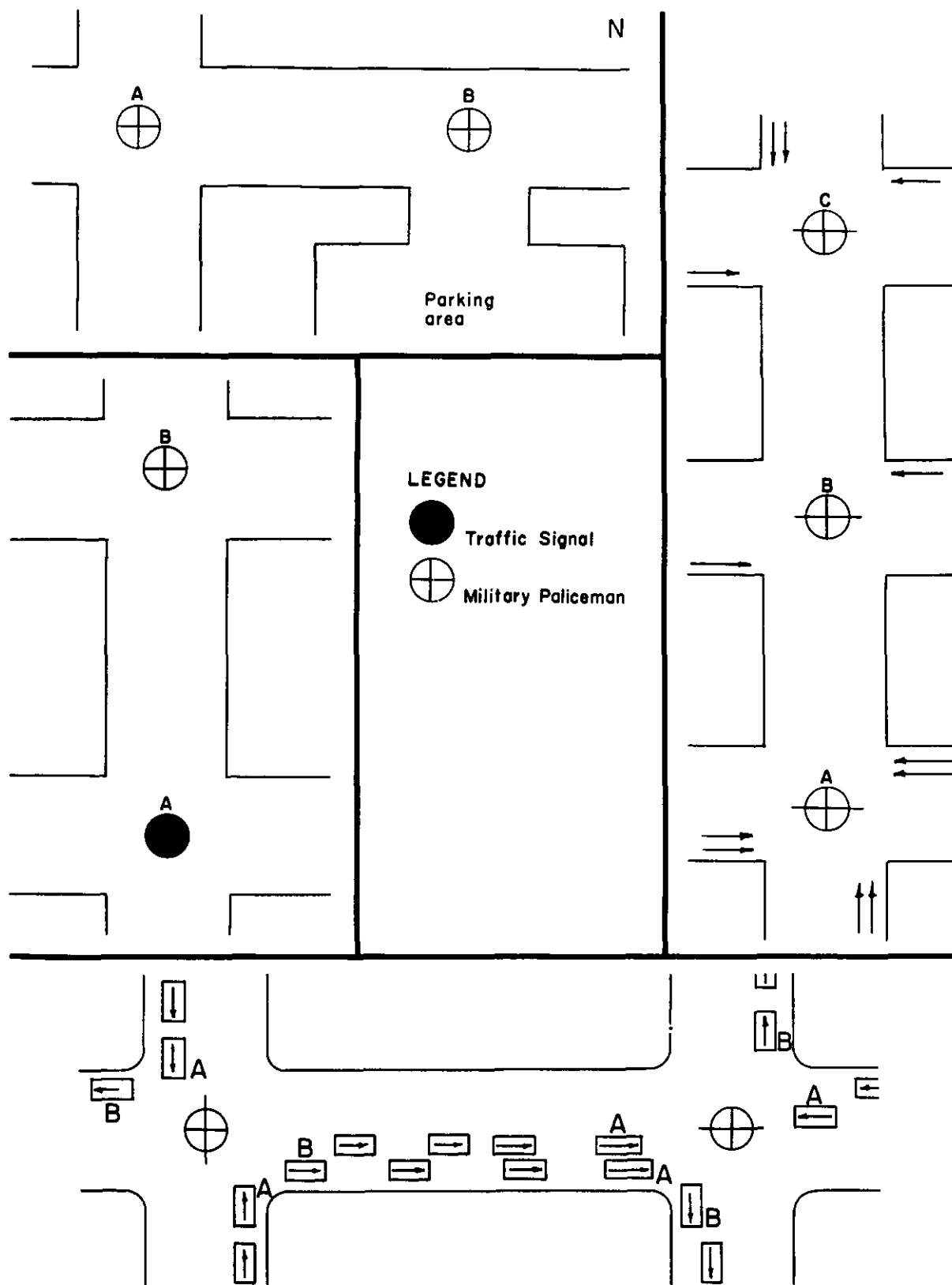

Figure 3-6. Example of coordinated traffic flow.

In the figure above, position A is the major intersection. Military policeman at positions B and C regulate the traffic flow so that it is synchronized with position A.

CHAPTER 4

TRAFFIC CONTROL OPERATIONS

Section I. PARKING IN RELATION TO TRAFFIC CONTROL

4-1. Introduction

Military police traffic control operations include the application of enforcement techniques and control tasks. Generally, these tasks and techniques are applied the same in peacetime as in time of war. However, techniques may vary according to support requirements peculiar to the different missions of the command. For further information on parking, see TM 19-251, Traffic Control Studies.

4-2. Installation Parking

Parking violations can contribute to congestion both in post, camp and station operations as well as in the theater of operations. Parking on the traveled portion of the roadway, parking in prohibited areas, and unauthorized stops for loading or unloading, are some of the obvious offenses which impede traffic flow. Other parking violations which cause inefficient use of parking space serve to aggravate congestion by requiring additional "cruising" by drivers still in search of a parking space. Enforcement of time limits on parking will make more spaces available.

4-3. Permanent Parking

Permanent parking facilities are developed as an integral part of the whole traffic and building plan of the installation. Military police gather and supply information which is used to form the plan and insure its accuracy. The military policeman must continually report problems that arise with regard to parking. Some characteristics of a parking problem are:

- a. Excessive, illegal, and overtime parking.
- b. Excessive cruising to find parking spaces.
- c. Extensive congestion in the traffic flow caused by cars attempting to park.
- d. Parking in excess of 400 feet from the destination of the occupants of the vehicle.

4-4. Temporary Parking

Military police frequently will be required to establish temporary parking facilities for special events.

a. Prior to establishing a temporary parking area, military police will survey the area to be used, marking all areas that can not be used because of ruts, rocks, trees, or other obstructions. If time permits, a diagram of the area should be made. All parking lots should have a number of clearly defined entrances and exits, preferably on secondary roads. If it becomes necessary to position an entrance or exit at a primary road, additional control is necessary to reduce congestion and prevent accidents. When routing traffic into and through a parking lot, every attempt should be made to segregate pedestrian from vehicle traffic.

b. When it is anticipated that vehicles using the temporary facility will enter and exit within a relatively short period of time, the parking plan should use 90° parking stalls. The outside row of vehicles should be a single row of vehicles backed into position. (This parking will consume the most time and should be filled by directing a limited amount of traffic into this area.) Other vehicles should be parked in double rows. The recommended minimum stall is 8.5 feet in width and 20 feet in length. To provide for emergencies and departures, an aisle of 23 feet is provided between each double row of vehicles (fig. 4-1). If it is anticipated that a large number of small cars will use the parking facility, designate an area for them to achieve maximum utilization of space. Make every effort to insure that the area is filled without congestion. When emptying the parking area, make every effort to provide for equal flow from each parking aisle. The flow should be changed during breaks in the stream of traffic or when all traffic has stopped, thus reducing the time lost during the safety period necessary for a change of direction.

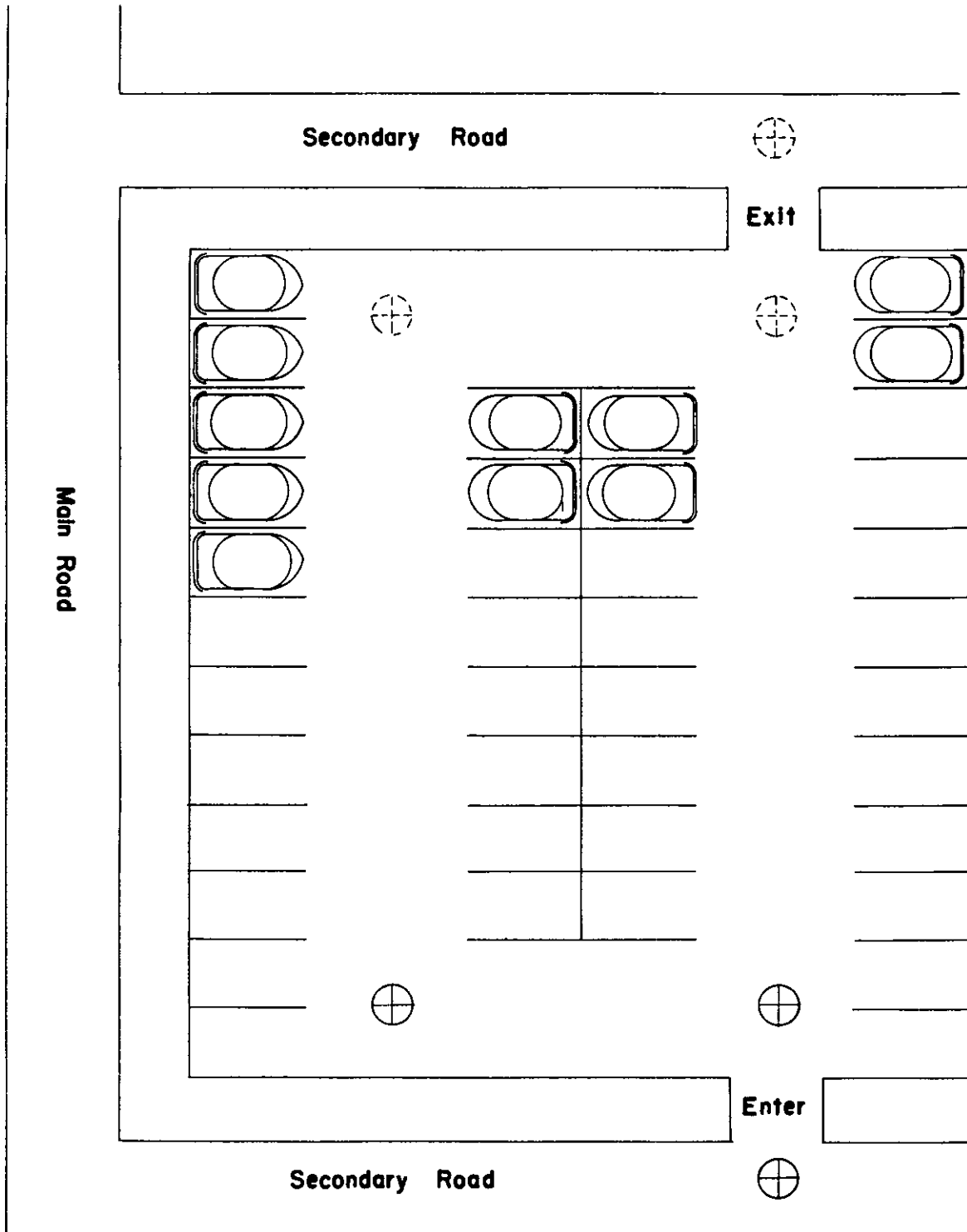

LEGEND

- ⊕ Military Policeman Entering Movement
- ⊕+ Military Policeman Exiting Movement

Figure 4-1. Example of a temporary parking facility with no turnover.

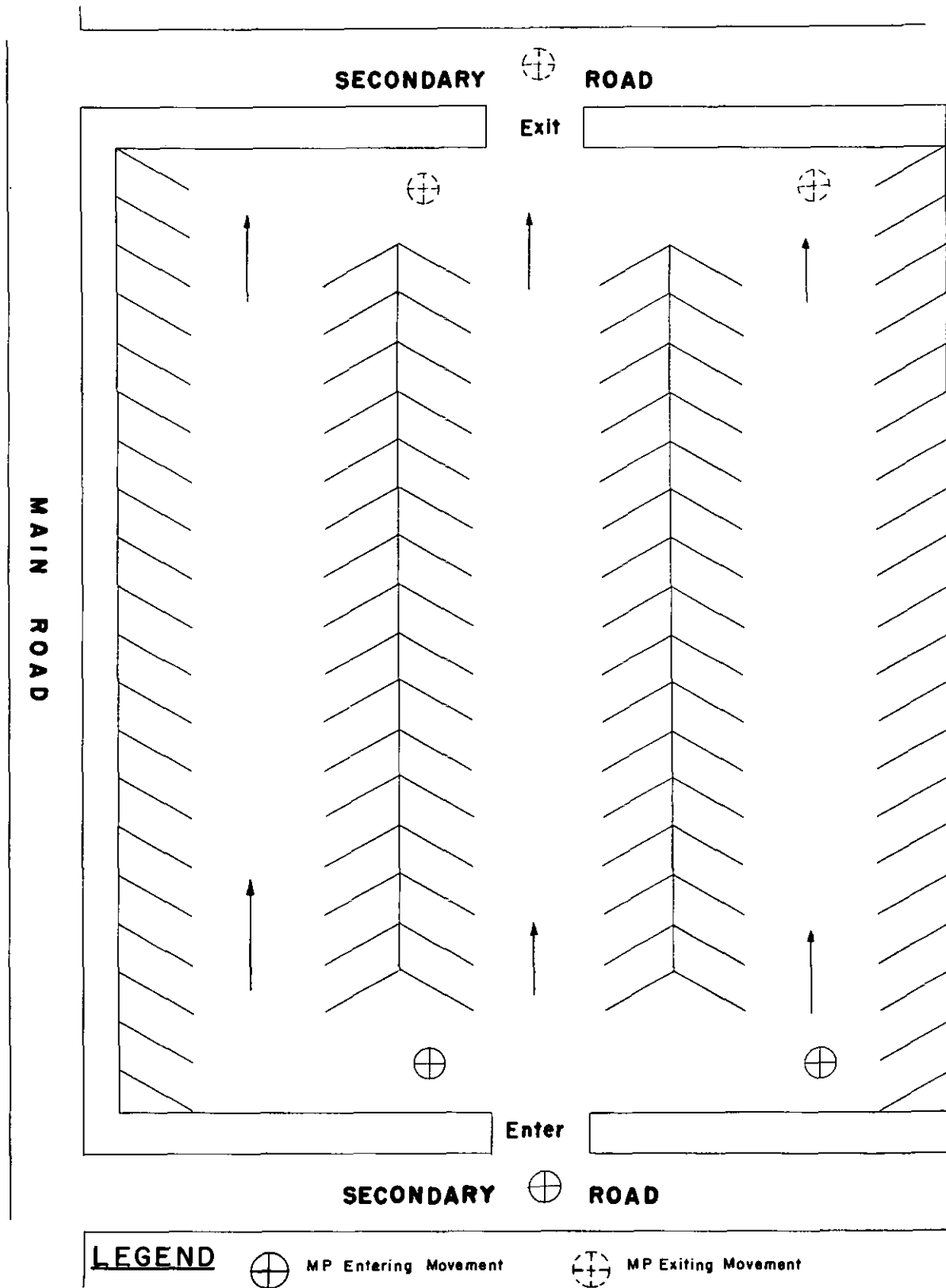



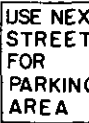



Figure 4-2. Example of a temporary parking facility with turnover.

LOCATION OF SIGNS

- ① 
- ② 
- ③ 
- ④ 
- ⑤ 
- ⑥ 

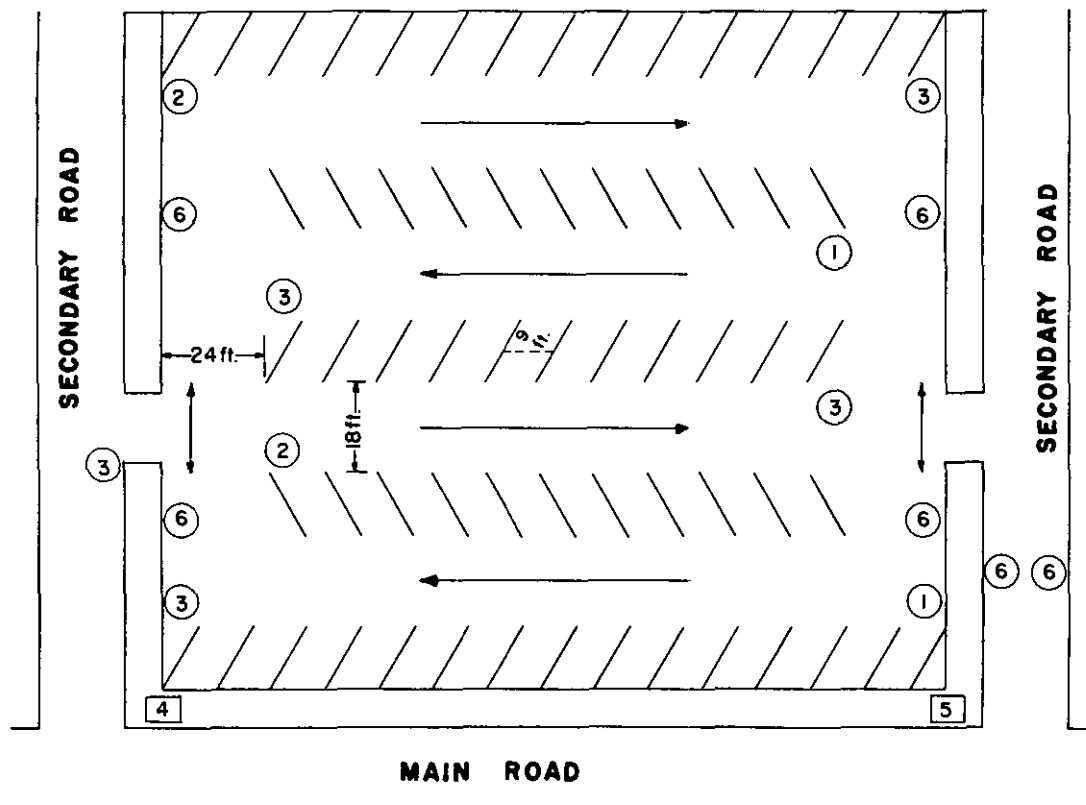
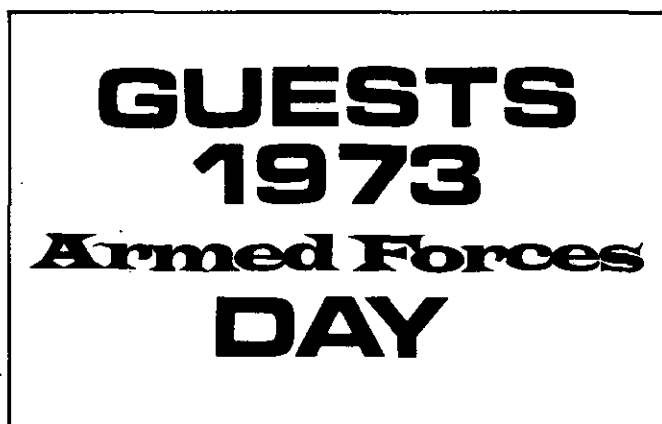
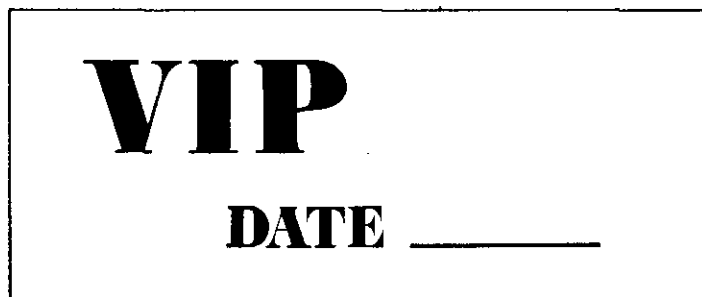

Figure 4-3. Example of a temporary parking facility with a turnover, using alternating one-way aisles.

c. When parking is required where there is constant vehicle rotation, such as a post exchange parking area, the parking plan should provide 60° parking stalls, 9 feet wide. This angle provides ease in entering and leaving. The aisles will provide one-way traffic and should be a minimum of 18 feet wide (fig. 4-2). Controls must be maintained to insure that drivers do not cruise to find parking space. If there is a shortage of military policemen for this duty, the one-way flow on aisles and the direction of angle should be alternated among rows (fig. 4-3). The roadway on both ends of the parking area must have a

minimum width of 24 feet to accommodate two-way traffic. Signs should be erected to reduce confusion and congestion. Tapes, lines, or paint may be used to mark stalls to provide better parking.

d. Special parking areas are normally provided for official vehicles and special guests. To eliminate confusion and delays in large parking areas, a system of color cards which identify the vehicles of designated personnel helps the military police direct such personnel to their reserved or special parking areas (fig. 4-4).



★Figure 4-4. Sample special parking card.

These cards are locally fabricated and should be different for each special event.

Section II. OPERATION OF CHECKPOINTS, ROADBLOCKS, AND DISMOUNT POINTS

4-5. Checkpoints

Military police checkpoints are established to insure proper use of routes and to check the cargo passengers, or condition of vehicles. (See paragraph 11-2 for theater of operation checkpoints.)

a. Military police are used at checkpoints on posts, camps and stations to—

★(1) Check vehicles for obvious safety deficiencies.

(2) Prevent illegal removal of government property from the installation.

(3) Enforce post registration and insure that drivers' licenses are valid, adequate, and up-to-date.

(4) Prevent unlawful entry onto the installation.

(5) Check the validity of the orders, passes and identification cards of personnel.

★b. During checkpoint operations privately-owned vehicles should not be stopped unless some safety violation, dangerous condition, or other deficiency is observed. On posts with a controlled access policy during certain hours, all privately owned vehicles without post registration decals should be stopped and checked to assure the individual(s) in the vehicle has proper authority to be on the post.

4-6. Operation of a Checkpoint

a. A checkpoint should be established at a position where oncoming traffic will approach the checkpoint after negotiating a sharp curve.

C 1, FM 19-25

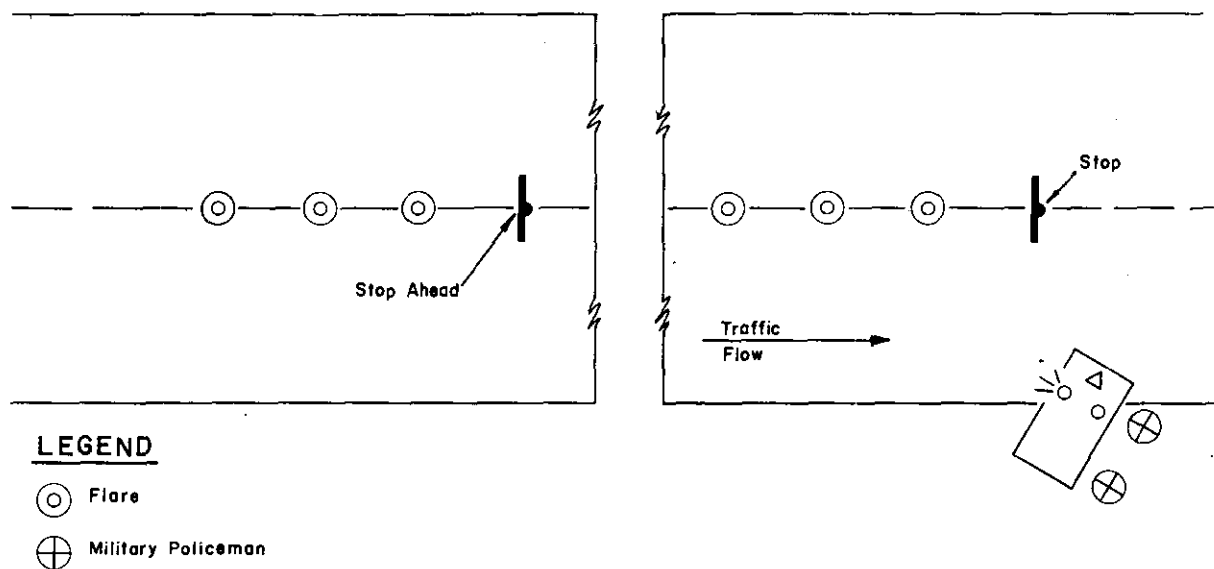

TO STOP TRAFFIC FROM ONE DIRECTION ONLY

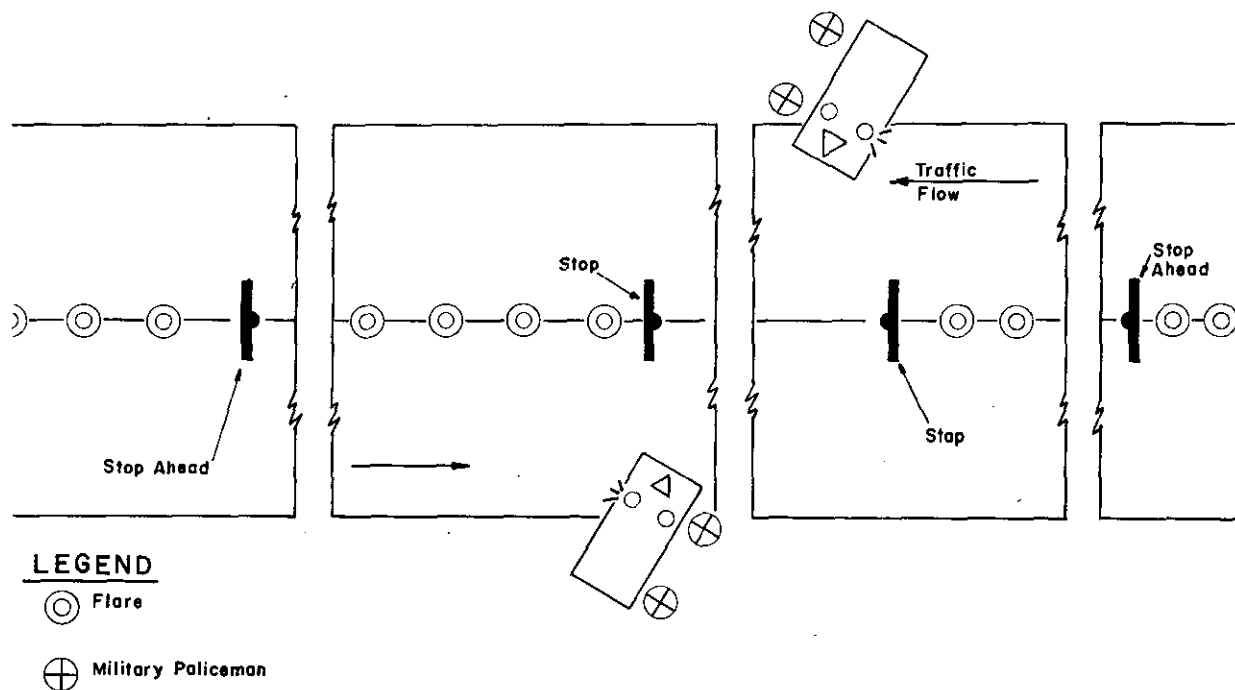

TO STOP TRAFFIC FROM TWO DIRECTIONS

Figure 4-5. Example of a two-lane roadblock.

or hill. This hides the military police, thus denying the approaching drivers a chance to make a U-turn, or take other evasive action to avoid the checkpoint. The safety of the personnel operating the checkpoint is also a consideration in site selection.

b. Every effort should be made to inform the road user that checkpoints are in operation. This will encourage voluntary compliance with the highway regulations. However, the exact location of the checkpoint is never given.

c. The checkpoint should provide an area where vehicles can be moved off the road when necessary.

d. The approach lanes should be outlined with traffic cones, wooden stakes, or other clearly visible markings.

e. Signs should be posted identifying other requirements, e.g., "turn off headlights."

f. A barrier such as a wooden pole or gate should be used to prevent vehicles from progressing beyond the checkpoint until allowed to proceed by checkpoint control personnel.

g. A military police patrol vehicle should be available to pursue vehicles or individuals who

fail to stop at the checkpoint or who turn around when they see the checkpoint to avoid the search.

h. Military police should be on the alert for and report new methods used to bypass the checkpoint or to conceal unauthorized items.

4-7. Police Roadblocks

a. Roadblocks are normally established to apprehend criminals or to seal off areas in which a crime has been committed. Usually two or more motor patrols are used to form a roadblock, however, sometimes one patrol is satisfactory.

b. Military police headquarters normally provide direct roadblock operations by radio. The headquarters will assess the need for additional military police, insure that all available information is disseminated to personnel participating in the operation, and maintain a roadblock operation center according to local SOP.

c. Ideally, the roadblock should be established at a location that will provide cover for the military policeman and minimize the risk of innocent personnel becoming involved or injured in the event of violence.

d. Roadblock operations are hazardous. Some-

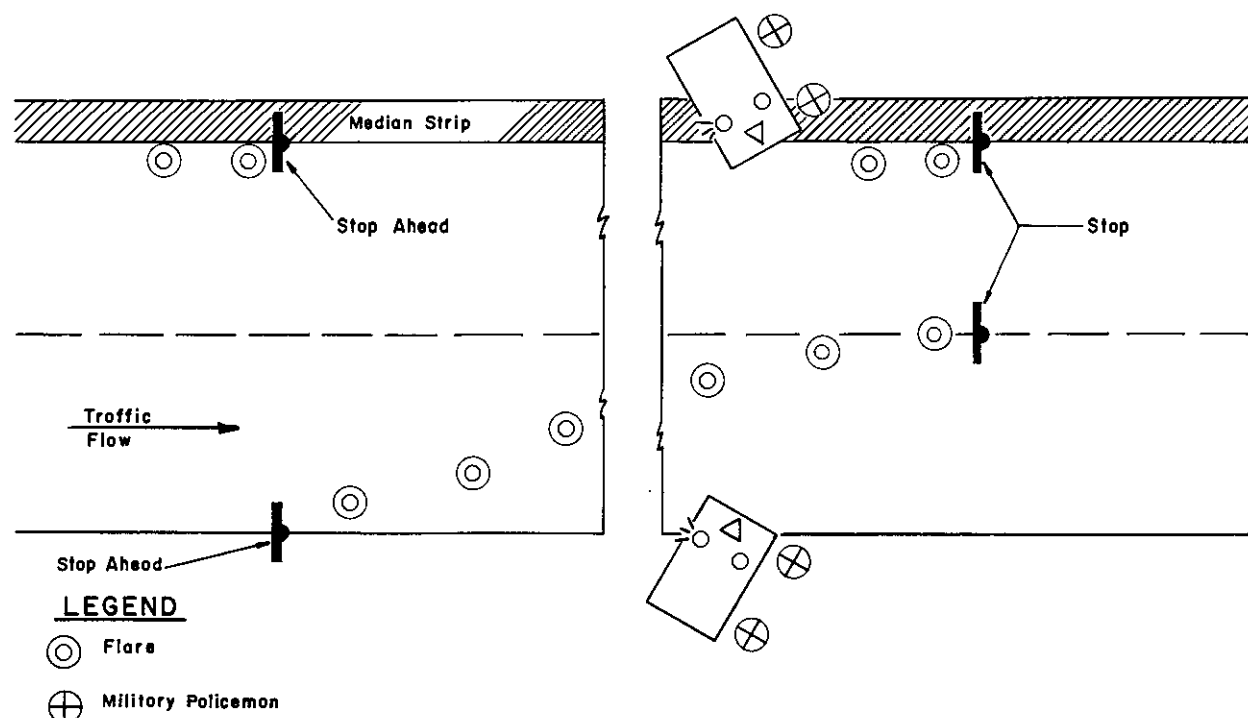

Figure 4-6. Example of a multilane roadblock.

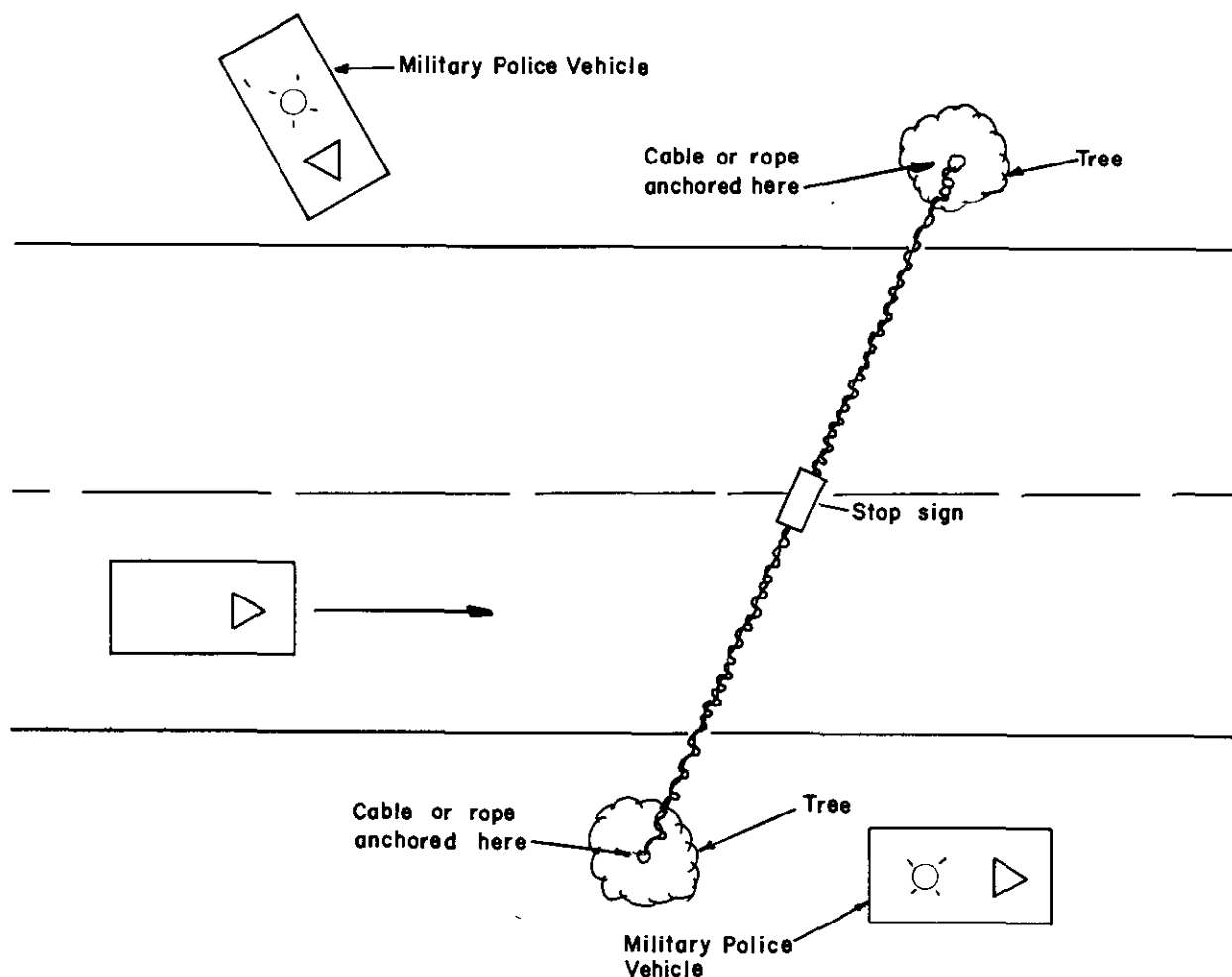

Figure 4-7. Example of a roadblock using rope.

one must be exposed to danger, but the number exposed should be kept to a minimum. Selection of the roadblock location will be made using the criteria discussed in paragraph 11-2.

e. Roadblocks are organized according to the situation and the road network.

(1) *Two-lane road.* When it is necessary to block a two-lane road, military police vehicles should be parked at 45° angles to the roadway, partially blocking the traffic lanes. Warning signs should be placed in the center of the roadway. The military police vehicles should be stationed or placed 15 to 25 yards apart (fig. 4-5).

(2) *Multilane road.* It is usual when blocking a multilane road to funnel traffic into one lane in each direction. An additional vehicle may be placed near the roadblock to pursue vehicles which fail to stop (fig. 4-6).

f. Flares, traffic cones, temporary warning

signs, etc., should be used to guide motorists through the roadblock.

g. Ropes, cables (fig. 4-7), or barricades (fig. 4-8) are effective roadblocks, but the safety of the road user must be considered when using them. A large truck or tractor trailer may be used to block lightly traveled roads or when a road must be completely blocked (fig. 4-9).

4-8. Operations of a Roadblock

a. Roadblocks are normally established where there is sufficient space to park vehicles and conduct searches and interrogations of detained personnel. Searches must be thorough. Involved military personnel must be briefed on the object of the search and those techniques being used to conceal contraband from detection.

b. The roadblock area must be organized to prevent persons from avoiding the search.

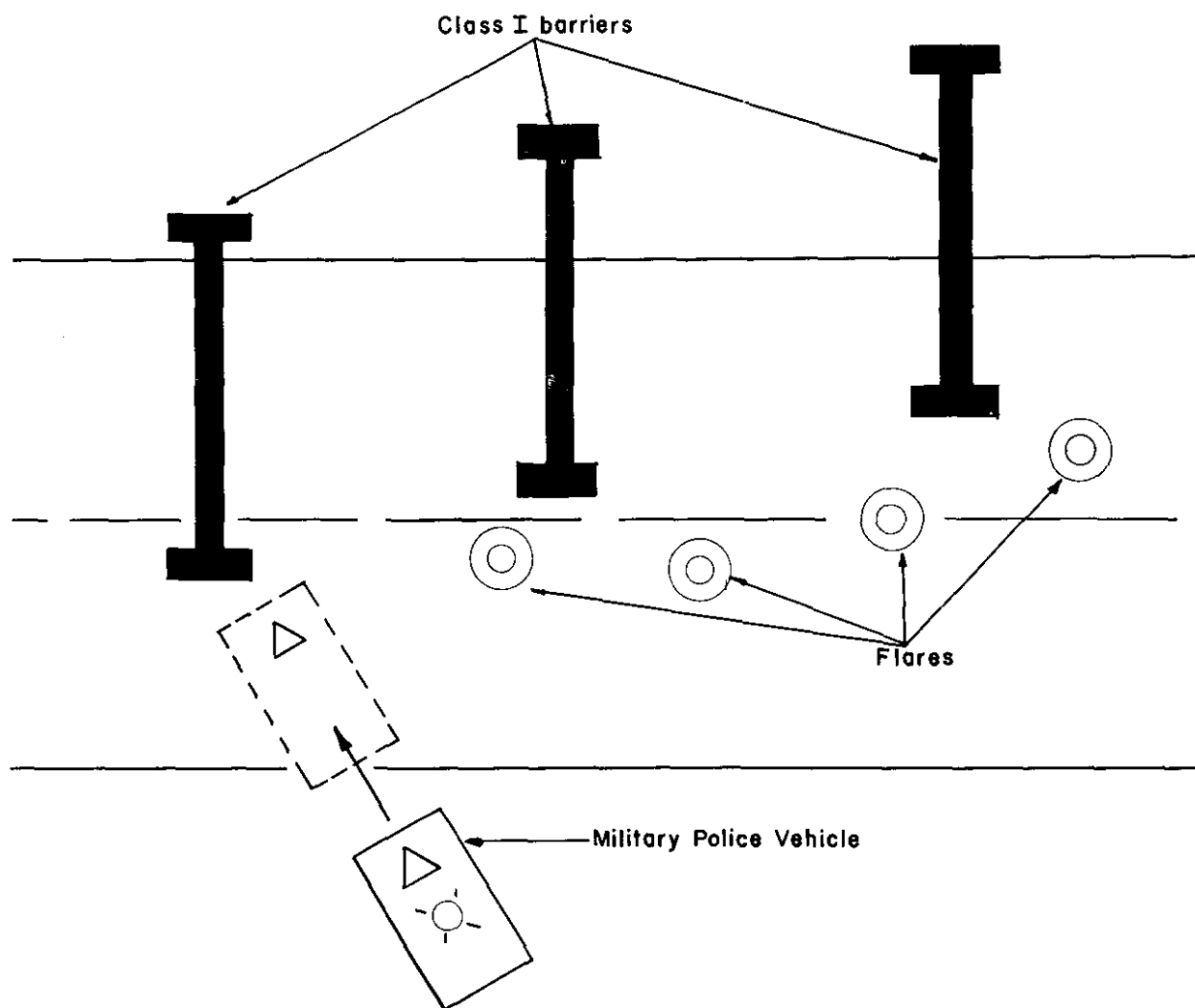

Figure 4-8. Example of a roadblock using a barricade.

(1) The following obstacles, portable but sturdy enough to stop a vehicle, are placed on the roadway to canalize traffic:

- (a) Iron bars.
- (b) Logs—fallen trees.
- (c) Sandbags.
- (d) 55-gallon drums filled with sand.
- (e) Ditches.
- (f) Vehicles (if other objects are not available).

(2) The shoulders and ditches of the road must be impassable so that vehicles cannot bypass the roadblock, or the barrier system must be extended to provide this denial.

4-9. Dismount Points

a. A dismount point is a location where enforcement personnel require all visitors or design-

nated personnel to dismount and proceed from that point on foot. The activity at this point is controlled or regulated by personnel assigned police or sentry duties. More detailed information on the operation of a dismount point is contained in chapter 11.

b. Military police may establish dismount points at special events, such as parades, retirement ceremonies, special briefings, etc. Duties of personnel assigned to these points normally consist of—

- (1) Directing traffic in and out of designated personnel areas.
- (2) Insuring that designated military and civilian vehicles park in the specified areas.
- (3) Preventing unauthorized persons from entering the area established for designated personnel.

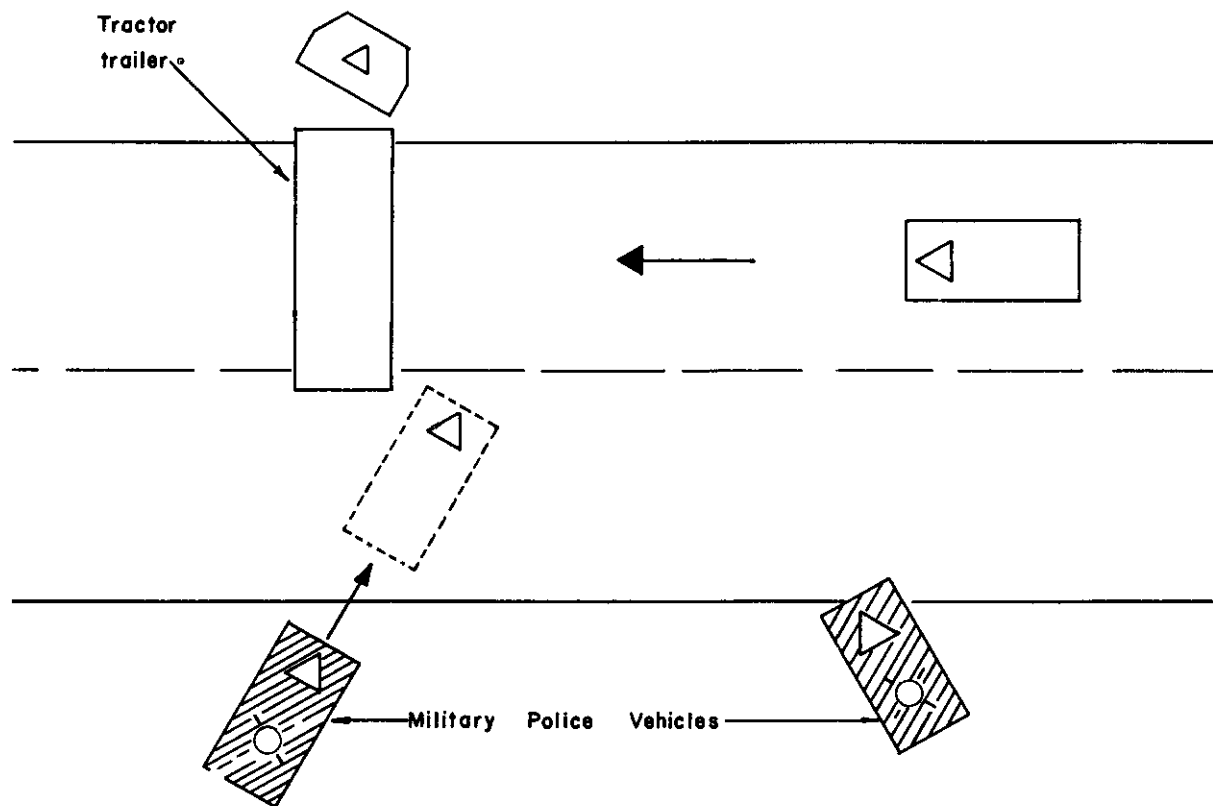

Figure 4-9. Example of a tractor trailer used as a roadblock.

Section III. TRAFFIC CONTROL AT CONSTRUCTION SITES AND DETOURS

4-10. Traffic Control for Construction and Detour Areas

a. Serious problems of traffic control occur under the special conditions when traffic must be moved through or around road construction, detours, and maintenance operations. Such conditions are essentially temporary, and therefore and more dangerous and difficult to deal with because they appear unexpectedly to the driver and are not in accord with the normal pattern of highway traffic. (For information on traffic control at defiles, see chap 11.)

b. There is no one standard of control or control signs which is an inflexible solution for all situations. Even for one project, the necessary control may vary from hour to hour, from day to day, or particularly between day and night. Simple painted signs or barricades may be sufficient by day, but must be reflectorized and/or supplemented by torches, lanterns, flashers, or other illumination at night. On the other

hand, some maintenance work is discontinued at night, leaving the highway unobstructed.

c. Maintenance activities such as shoulder mowing, tree trimming, and ditch clearing, may require that traffic use extra care and reduce its speed due to the occasional encroachments by standing or slowly-moving equipment. Pavement or culvert repair may close portions of the roadway for extended periods. Major projects may reduce the traveled way to a single lane, over which traffic must move alternately in one direction at a time. In the extreme case, there is complete closing of a road, with the diversion of traffic onto a temporary route.

d. Normally, the responsible agency, such as the engineers or construction companies, will provide traffic control for road work projects. The military police will provide advice and assistance. The provost marshal insures that construction personnel integrate their system with the area traffic plan. Patrols operating in the

vicinity of these hazards report traffic conflicts. During periods of heavy traffic or congestion the military police will assume control at these locations.

4-11. Traffic Signs at Construction or Detours

Temporary signs are usually placed around these hazards. The guidelines established in figures 4-10 to 4-14 are generally applicable for sign placement, but the type of signs used will conform to local standards (NATO vs CONUS). Detour reassurance signs should be erected along the detour with a maximum of one half mile between signs and at all intersections.

4-12. Detour Traffic Direction

a. Whenever possible, detour traffic will be routed to the right on roads capable of carrying the traffic.

b. When the road net is limited or bridge capacity is restrictive, trucks and passenger cars should use separate roads if at all possible.

c. To eliminate congestion, signs or point control is used at junctures and turns.

d. Speed limits must be based on the actual road conditions, and not set at an arbitrary figure.

e. Rear-end collisions are more frequent at detours because drivers fail to maintain safe intervals. Traffic flow onto a detour may be controlled or drivers can be warned verbally or with signs.

f. Alternating one-way operation is used when no bypass is possible. In this operation, a military policeman will be stationed at each end of the detour. One of the following systems can be used to change the traffic flow:

(1) *Flags*. The military policeman at the entrance to the detour either gives a flag to the last driver of the entering group of vehicles or attaches a flag to the last vehicle of the entering series. This flag is retrieved by the military policeman at the exit of the detour. The retrieving military policeman then starts a group of vehicles through the detour in the opposite direction and again gives the flag to the last driver, or attaches it to the last vehicle of the group he starts. The process is repeated as required.

(2) *Trail vehicle*. A military police vehicle enters as the last vehicle in a group that is

started into the detour. When the military police vehicle emerges from the detour, the military policeman at that end starts a group of vehicles through the opposite direction. The military police vehicle again becomes the last of the entering group of vehicles. This method gives assurance that the area is clear for a return group of vehicles and provides for assistance in emergencies.

(3) *Lead vehicle*. When the detour is long and the road is confusing, the military police may use the lead vehicle technique to guide traffic through the detour. While the military police vehicle leads traffic through the detour, other military policeman must be stationed at each entrance of the detour to keep traffic from venturing into the area without guides. The military police guide should lead all traffic that enters the area.

(4) *Military police rider*. A military policeman mounts the last vehicle in the entering group and rides in it to the end of the detour. Then he rides back in the other direction in the trail vehicle. This technique may be used when it is essential to insure that all vehicles have cleared the area and that only military vehicles are using the road.

(5) *Radio or telephone*. By using reliable communications between traffic control personnel at the ends of a detour, vehicles can be started alternately from each end of the detour. However, the road must be capable of handling two-way traffic.

(6) *Turnout*. A turnout is a side area where one group of vehicles can turn off the traveled road while other traffic passes. A turnout in the middle of a long detour enables traffic to start from both ends of the detour simultaneously. The first group to reach the turnout pulls completely off the road, thus permitting the group moving in the opposite direction to continue. As soon as the end of the moving group has passed the turnout, the parked group emerges from the turnout and completes its movement. Control personnel are required at the turnout. This technique makes maximum use of road space in a long detour; however, it can create traffic jams if it is not carefully executed. If there are stalled or disabled vehicles in the detour, the turnout technique may be inadvisable, because the turnout area may be required for repair or recovery operations (fig. 4-15).

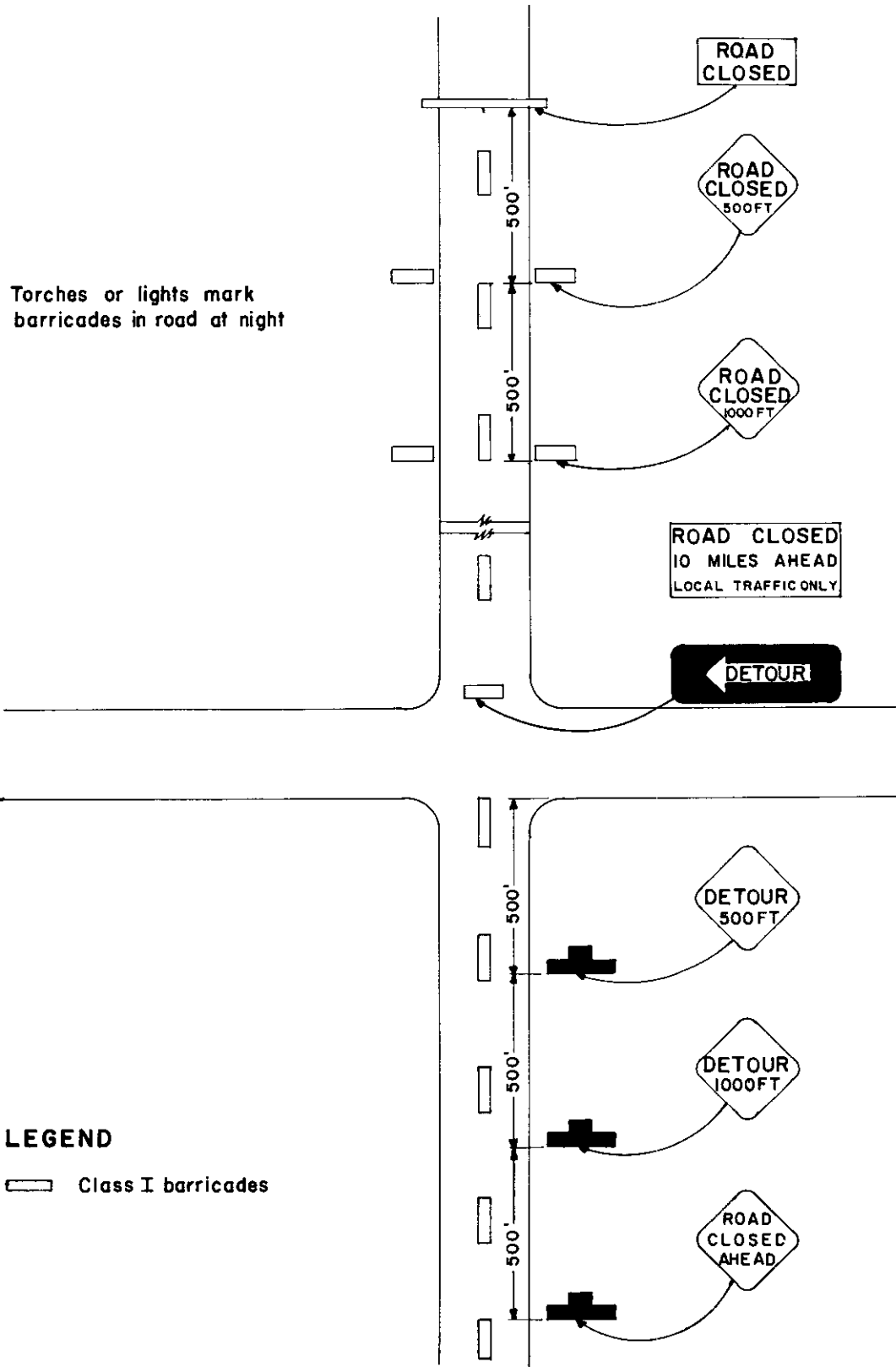

Figure 4-10. Example of signs for a closed road.

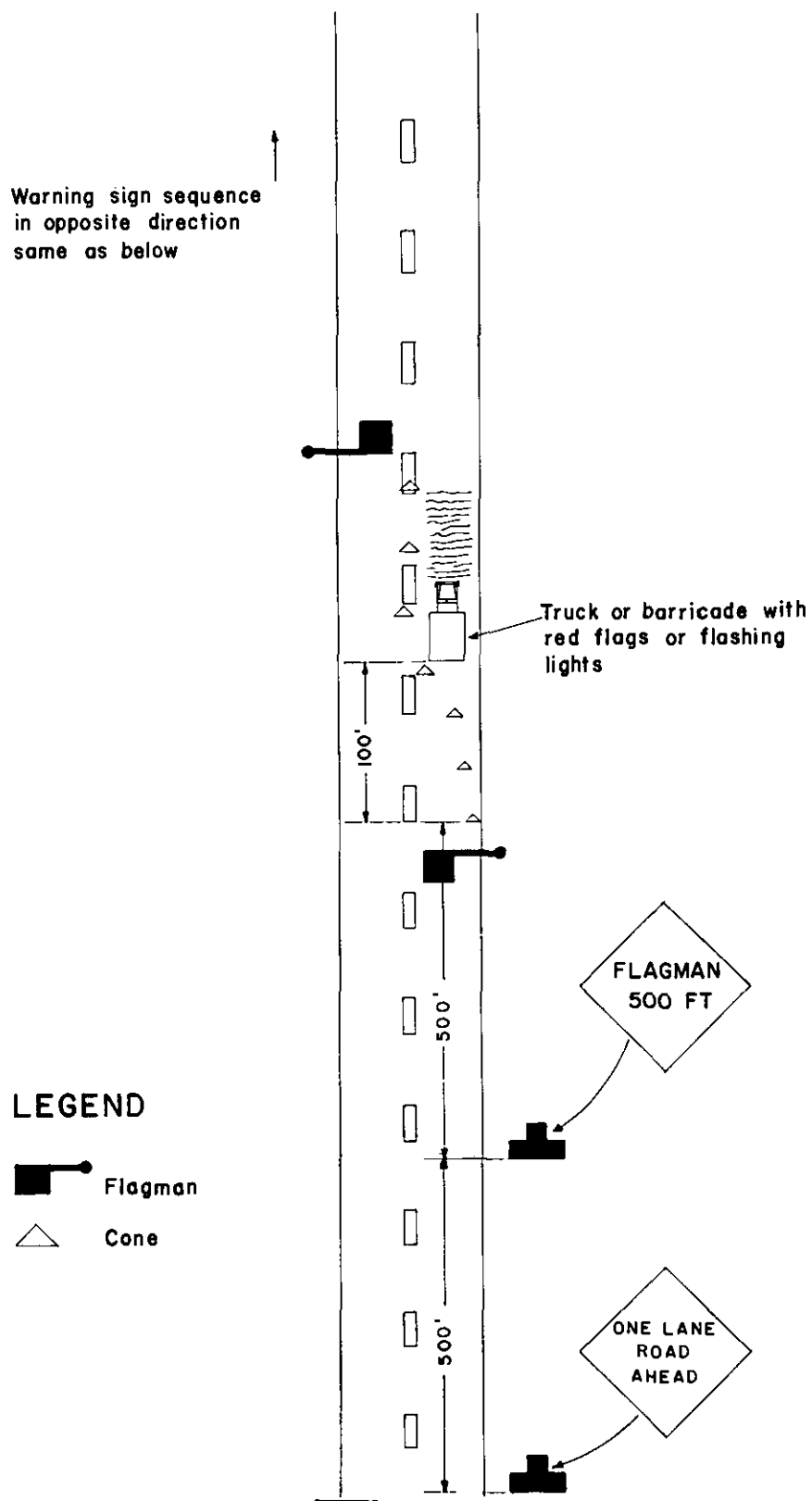

Figure 4-11. Example of a road with one lane closed.

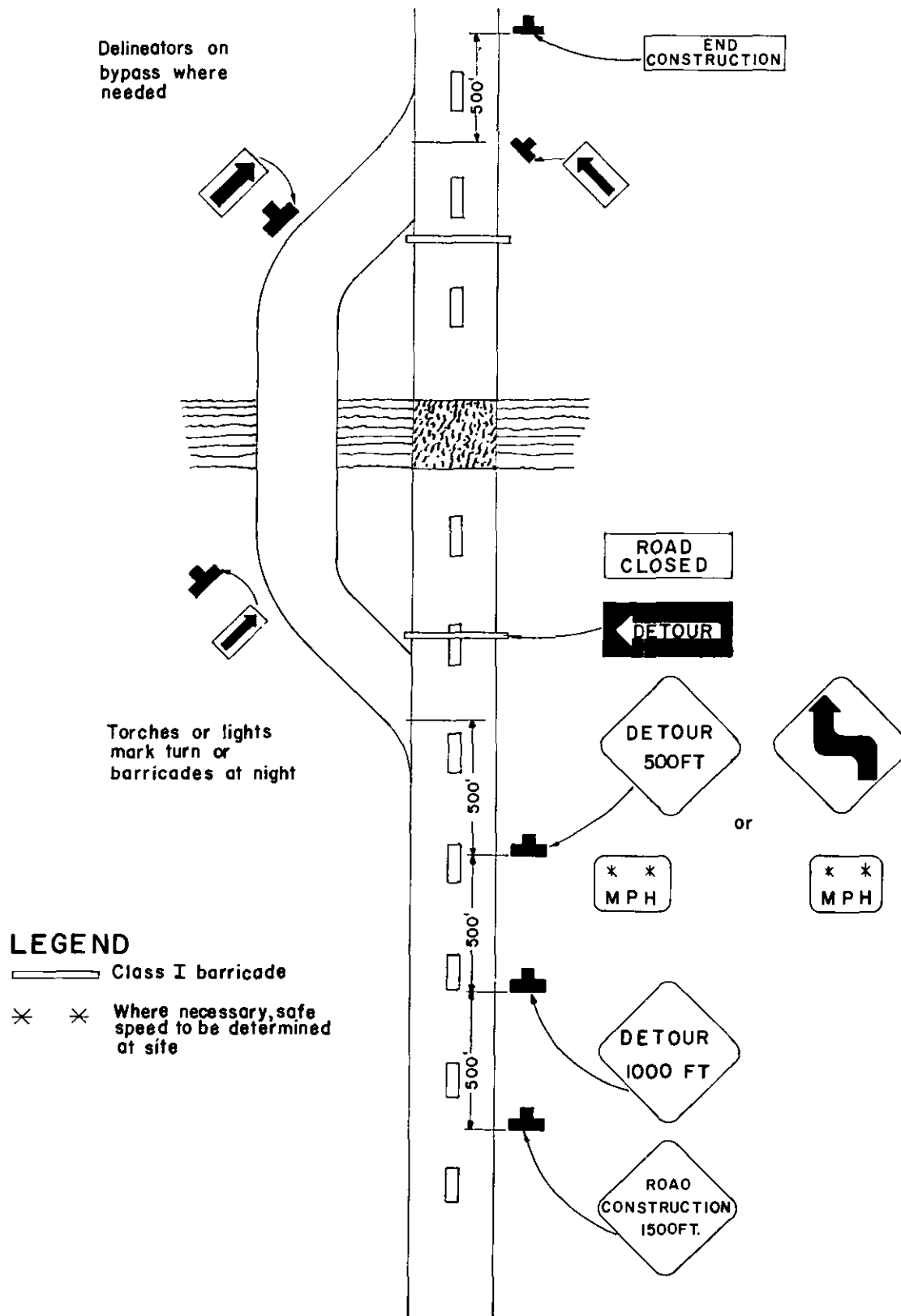

Figure 4-12. Example of signs used for a bypass road.

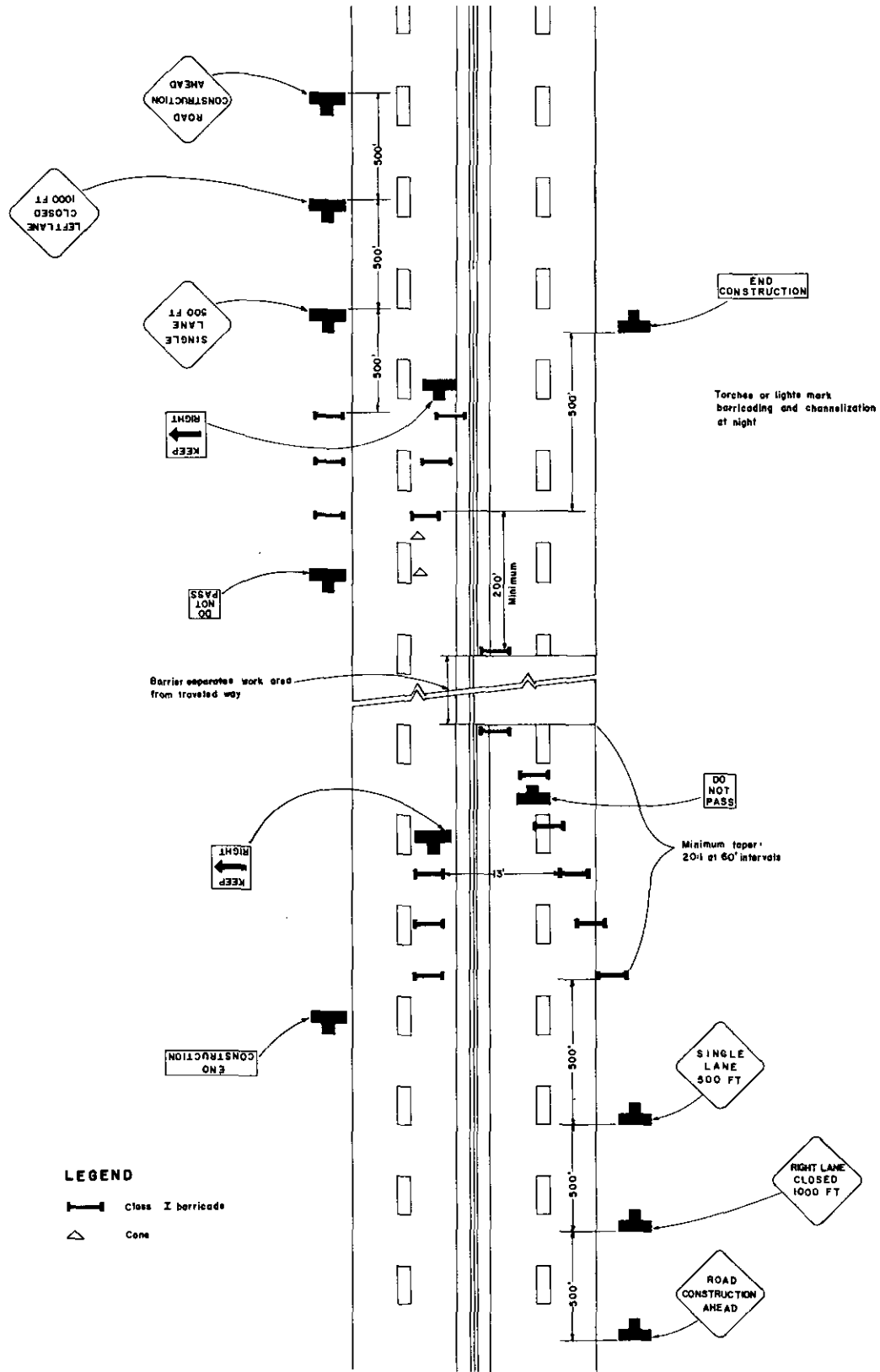

Figure 4-13. Example of a crossover on a four-lane high-speed road.

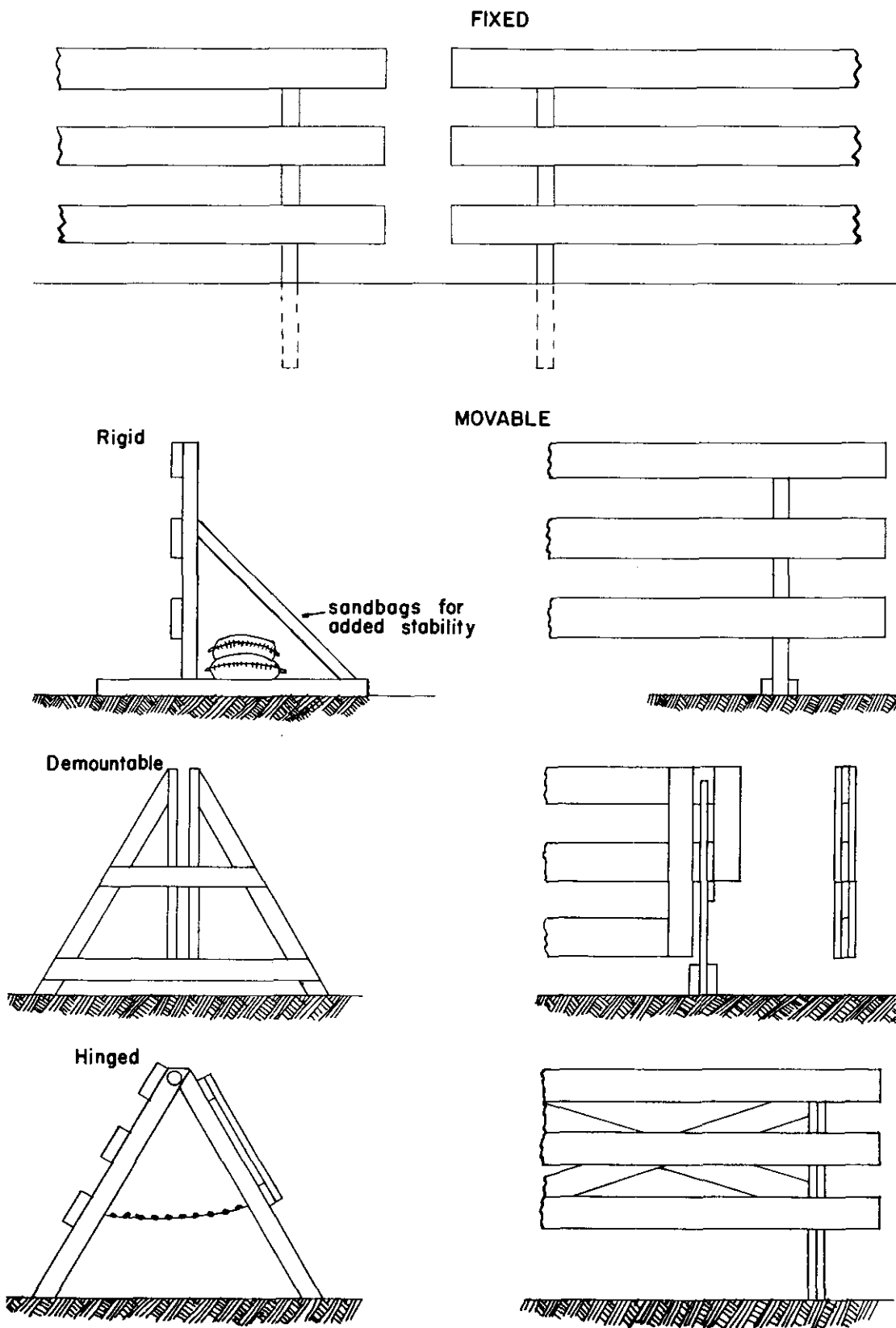
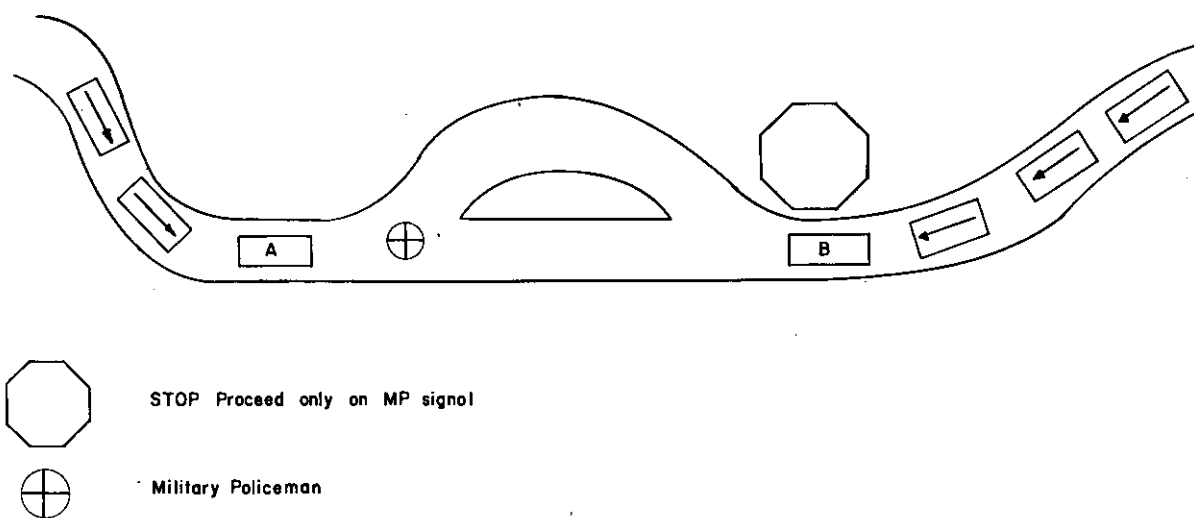

Figure 4-14. Class I barricade.



Convoy A directed into turnout to allow convoy B to pass

Figure 4-15. Detour using a turnout.

Section IV. TRAFFIC SIGNS AND SIGNALS

4-13. Traffic Signs and Signals—Post, Camp and Station

The erection and maintenance of signs is the responsibility of the engineer. However, the military police assist them by reporting needs for signs and requirements for maintenance, and have the responsibility for the erection and maintenance of temporary signs.

4-14. Function of Signs

The traffic sign is the basic device for controlling, safeguarding, or expediting traffic. As with any other type of traffic control, signs are used only where necessary and where justified by field studies. Signs are not ordinarily needed to confirm well-known or universally recognized rules of the road, such as that requiring drivers to keep to the right. But, they are essential where special regulations apply at specific places, times, or where hazards are not evident. They are also needed to inform traffic of the highway routes, directions, destination, and points of interest.

4-15. Classification of Signs

Functionally, signs are classified as follows:

- a. Regulatory signs inform the road user of traffic laws or regulations that apply at a given place or on a given roadway.
- b. Warning signs call attention to conditions in or adjacent to a roadway that are potentially hazardous to traffic.

c. Guide signs show route designations, destinations, directions, distances, points of interest, and other geographical information.

4-16. Effective Use of Signs

Regulatory and warning type signs should be used only where required; the excessive use of such signs will destroy their effectiveness. On the other hand, a frequent display of guide signs (route markers and directional signs) keeps the driver informed of his location.

4-17. Standardization of Signs

The US Army signs are standardized by the uniform issuance through engineer supply channels and through the use of sign reproduction kits. When these sources are not available, every effort must be made to produce signs conforming to the standards of the country in which the military police are located. In the United States, the guide for signs is the *Manual on Uniform Traffic Control Devices*.

4-18. Rules of Erection of Temporary Signs

★a. Signs erected along rural roads shall be mounted so that the height measured to the bottom of the signs is at least 5 feet above the level of the roadway edge. On highspeed roads (roads with speed limits in excess of 50 MPH) the height of all route markers, warning and regulatory signs will be at least 6 feet and all directional signs will be at least 7 feet.

★b. Roadside signs will be placed at the edge of the road shoulder with the nearest edge of the sign not less than 6 feet and not more than 12 feet from the edge of the pavement or roadway, except when these conditions cannot be met. On highspeed roads, the nearest edge of the sign will not be closer than 6 feet to the roadside (fig 4-16).

★c. All signs will normally be mounted at right angles to the direction of, and facing, the traffic that they are intended to serve.

d. A regulatory sign, as a rule, is placed where its mandate or prohibition applies. A stop sign, for example is erected as near as practicable to the point where the stop is to be made.

e. A warning sign should be placed a suitable distance in advance of the condition to which it calls attention. The following rules apply as a guide to this distance:

(1) In cities or areas where speeds are relatively low—250 feet in advance.

(2) In rural areas—750 feet in advance.

(3) On highspeed roads and expressways—1,500 feet in advance.

(4) Where the distance is in excess of 750 feet the warning sign should be repeated before the hazard.

f. Guide signs are placed at and in advance of intersections and interchanges, and between such points of decision, to keep the driver well informed about the route to his destination. The following are rules for the erection of guide signs:

(1) Within residence and business districts advance guide signs and reassurance route markers should be erected not more than 500 feet on each side of an intersection. All intersections on a route within a congested area should be marked.

(2) In rural areas advance guide signs and reassurance markers will not be closer to an intersection than 300 feet. Route markers will be used at the intersection of major secondary roads (fig 4-17).

(3) On highspeed roads three advance guide signs will be located at evenly spaced intervals from the intersection. The first advance guide sign will be a minimum of 750 yards from the intersection. The remaining signs will be at 500 yards and 250 yards before the intersection. Guide signs will be located at all intersections. The reassurance sign should be located not closer than 200 yards or more than 500 yards past the intersection. Signs should be located on the median strip as well as the shoulders of expressways.

(4) Except for limited access roads, reassurance signs will be erected at ¼ mile intervals when there is no route sign present in an area in excess of 1½ miles.

★g. When temporary signs are intended to supersede permanent signs, whether warning, regulatory, or guide, the superseded sign must not be visible to the driver. This is required to prevent confusion. Permanent signs may be covered for a short period with paper and tape. When the temporary sign will be in effect for extended periods, the permanent sign should be covered with wood or cloth. For example, when highway construction forces a detour, old highway route markers must be covered and replaced by temporary signs when the direction to the area under construction differs from the detour route.

★h. Temporary signs must be removed upon completion of mission.

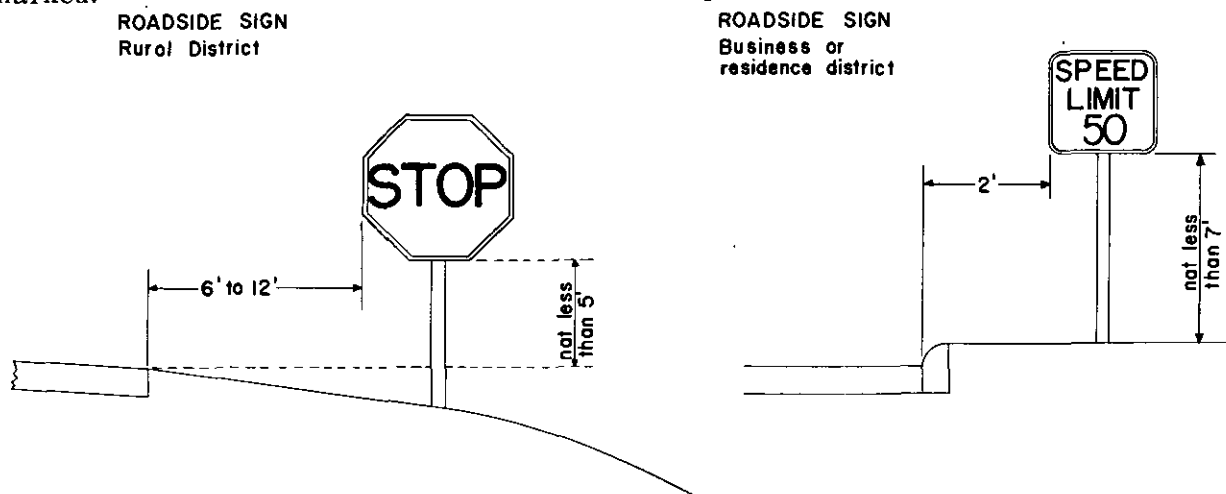

Figure 4-16. Examples of erection of temporary signs.

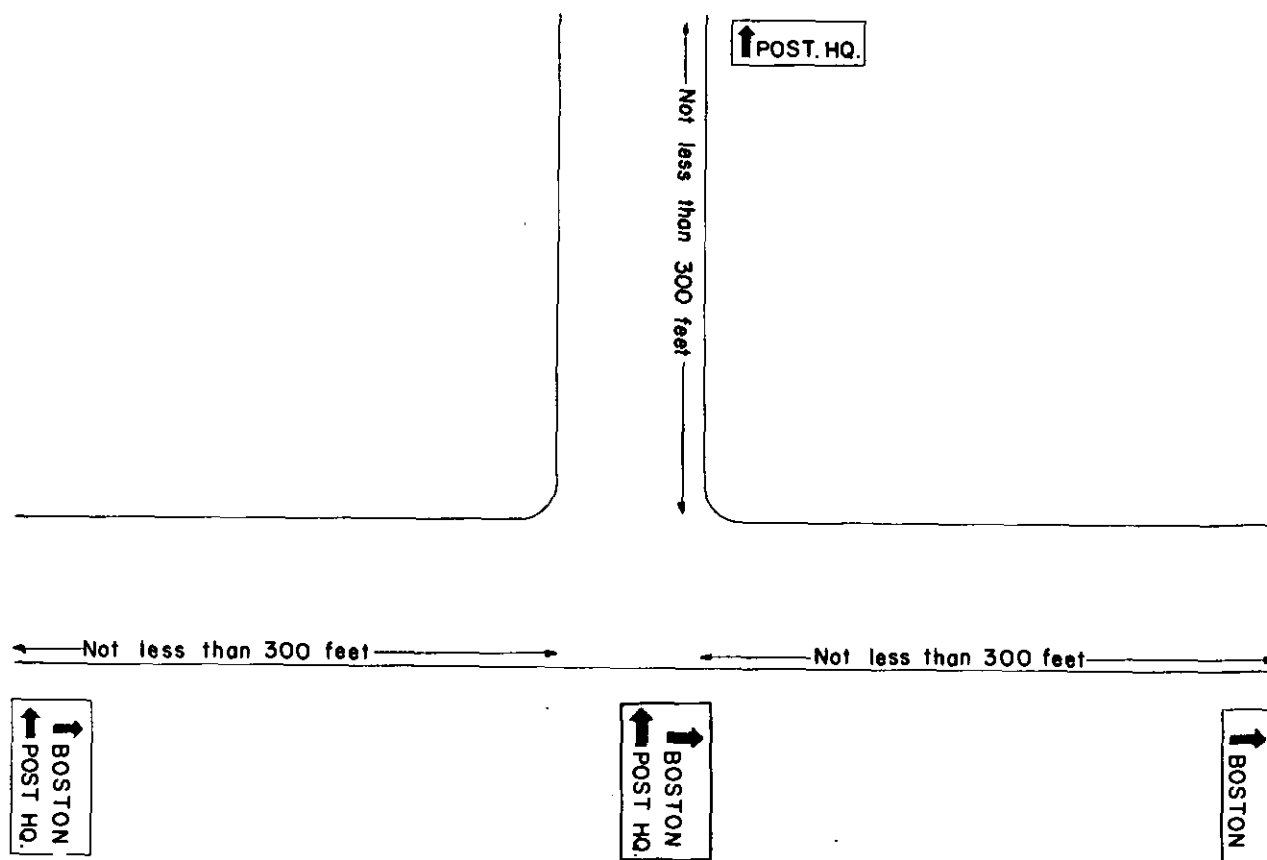

Figure 4-17. Example of rural area guide signs.

4-19. Variable Signs

A variable sign is one that can be changed. The most common is the maximum speed sign which provides different speeds for different conditions. Variable signs may be fluorescent and automatic or may require the military police to change the sign manually. Specific operating rules for the variable signs will be published in local SOP. The following general rules are applicable under normal conditions:

a. Any changes to regulating signs should be conducted according to a schedule. Promptness is critical when the regulation involves signs controlling lane usage or traffic direction.

b. Warning signs such as "FOG AHEAD" or "ICE" will be used only during the period of danger. Excessive use of warning signs causes driver disregard for the warning.

c. All signs and covers will be secured to prevent the wind from exposing an improper signal.

d. When changing a series of regulatory signs, the military police will start at the end of the series and proceed to the starting point. This prevents driver confusion.

e. Continuous monitoring of variable signs is necessary to insure that they are providing the proper information at the proper time.

4-20. Traffic Signals

a. Traffic signals are erected after there has been a detailed study of the signals and traffic flow plans. When new control measures are required, appropriate signs are added as required. The manual operation of traffic signals must also be integrated with traffic flow plans. Those signals that can be manually operated will have detailed instructions at the control box explaining the mechanical steps necessary for manual operation. Those principles of flow adjustment presented in paragraphs 3-6 and 3-7 above must be applied to manual operation of signal devices. Caution must be exercised in changing the signals. Once the sequence, green-amber-red, has begun, it usually cannot and should not be reversed. When manually operated, the amber or yellow time indicated on the control drive should not be bypassed; if it is, drivers will become confused. Most traffic signals control two or more lanes of traffic at the same time. This requires that the signal operator observe both

C 1, FM 19-25

directions of traffic at the same time. Military policemen who operate signals must have a full understanding of the traffic flow system, the phase and cycle time requirements, and be experienced in point control of traffic.

b. When conditions require the military policeman to perform manual point control of traffic where there is an automatic traffic signal, the signal must be turned off. During conditions of poor visibility on a high-speed road, a flashing signal may be used instead of turning the signal off. The color indication given to the traffic should be based on the following considerations:

(1) The traffic traveling on a through street should be given a flashing yellow (caution) indication and the other traffic should be given a flashing red (stop) indication.

(2) When the safe approach speed of traffic on one street differs from the safe approach speed of traffic on the other street or streets, the traffic having the higher safe approach speed should be given the flashing yellow (caution) indication and other traffic should be given a flashing red (stop) indication.

(3) If the safe approach speed and traffic volumes on both streets are not significantly different, the traffic signal may be operated as a flashing red for all traffic.

c. When a traffic signal becomes inoperative and it will not flash, the discovering military police patrol must report this condition and establish point control until the signal is repaired or it is covered. This action is mandatory to pre-

vent confusion and congestion because the road user will assume that an uncovered signal is operating with one or more of the lights burned out. Covering of a traffic signal is ideally accomplished by cloth. However, any material that will convince the road user that the signal is inoperative may be used.

d. In disaster relief operations, the civil defense organization assumes a major role. Military police and civil defense organizations work closely together. Consequently, military policemen should receive unit training in the identification of civil defense signs. Unit SOP should prescribe military police actions in event of disaster (fig 4-18).



24" X 30"

Figure 4-18. Example of civil defense road signs.

CHAPTER 5

MOTOR PATROLS

Section I. PREPARATION

5-1. General

a. On military posts with good road networks, military police motor patrols greatly assist in the control of traffic. Effective patrolling tends to reduce the need for point control of traffic. The motor patrol has several distinct advantages over foot patrols; these are:

- (1) Greater area of coverage is possible with fewer military police resources.
- (2) More people can observe the patrol, making them aware that the military police are present. This encourages voluntary compliance with the traffic laws and regulations.
- (3) Increased communication capability.
- (4) Fast response to emergency situations.

b. Just as there are advantages, there are also disadvantages to motor patrols; they are:

- (1) Less personal contact with the general public.
- (2) During heavy traffic congestion, the motor patrol cannot respond to some emergencies as fast as the foot patrol.
- (3) The foot patrol can make a more detailed inspection of an area.

5-2. Motor Patrol Preliminary Checks

a. Motor patrols normally use ¼-ton trucks or sedans; however, in the absence of those vehicles, other vehicles may be used, e.g., ¾-ton trucks or ½-ton pickup trucks. Military police have to be capable (licensed) of operating many kinds of vehicles. The patrol relies on the vehicle and its equipment. It is the responsibility of the operator to thoroughly check the patrol vehicle prior to leaving the military police station. Any defective equipment such as tires, lights, or horn could prove fatal to the patrol and to other road users. Patrol vehicles must receive proper daily maintenance. Appropriate technical manuals provide guidance on the maintenance of vehicles and patrol equipment.

b. Radio communication is an integral part of standard equipment for a military police motor patrol. To be effective, a motor patrol must be

capable of two-way radio communication with the military police station, the patrol supervisor, and all others in the military police net. Military police using communication equipment must perform their portion of the maintenance as outlined in the technical manual published on the equipment.

5-3. Special Items of Equipment

The following special items of equipment used by motor patrols are in addition to the equipment mentioned in paragraphs 3-2 through 3-5. Other items may be added depending on the task to be accomplished and availability of funds.

★a. Warning equipment is mandatory to provide safety to the road user and the military police. Warning lights and sirens are normally mounted on military police vehicles. Flares, portable lights, safety cones, signs and other such items are issued to patrols through supply sources. (When operating on public highways in CONUS, flashing warning lights must be used in accordance with state or Federal policies. In foreign countries, the off-post utilization of flashing warning lights and sirens must be in accordance with the policies of the host country and/or the Status of Forces Agreement.)

b. First aid equipment and blankets are considered the minimum emergency equipment to provide first aid under normal conditions. When the need for first aid appears, the average road user turns to the military police. To meet this requirement the military police must have at least the minimum equipment, and know how to use it.

c. All patrols should have certain equipment for use at accident scenes. This would include ropes, crow bars, axes, shovels, pickaxes, and brooms modified so that they can be carried in the vehicle. Handtools and jacks, normally organic to the vehicle, may also be used at an accident scene. When military-type vehicles are in use, the pioneer tools of the vehicles may be

used to replace some of the equipment indicated above. As a minimum, the military police patrol should have a carbon dioxide fire extinguisher in the patrol vehicle. See FM 19-26 for further information about MP duties at the accident scene.

d. Equipment to assist the military policeman in preparing his written reports ranges from clip boards to specially designed desks for vehicles. Means to insure that patrols have the necessary forms to perform their duties are normally developed by the local unit.

e. The general public normally looks to the military police for assistance and for proper direction to any given area or facility. To perform this function properly, the patrol must be equipped with maps, directories, and other general information. This public service function is

an important source of favorable public relations for the military police.

f. STANO equipment to aid the patrol performing water patrol duty (para 10-7) can greatly assist the military police in locating and detecting water crafts. This equipment is—

(1) Electromagnetic Intrusion Detector (EMID).

Use: This hand-emplaced item is used to detect the movement of personnel, powered and unpowered small boats, and vehicles with very low false alarm rates.

(2) Patrol Electromagnetic Intrusion Device (PEMID).

Use: The PEMID is designed for use by patrols to detect intrusion of personnel, and watercraft. This device provides line sensor intelligence data on intruder movement without alerting the intruder.

Section II. METHODS OF PATROLLING

5-4. Patrolling

a. An important mission of the motor patrol is to encourage voluntary compliance with all the laws, not just traffic laws, rules, and regulations. In addition, the patrol supplies information, assistance, and services; it reports traffic violations; performs traffic reconnaissance; provides emergency traffic escorts for emergency vehicles and convoys; assists traffic control personnel at fixed posts; and aids at accident scenes. By their presence the patrols enhance the command accident prevention program.

b. The motor patrol is normally made up of two military policemen; the driver and the senior military policeman. The title "driver" adequately describes the principal duties of the first military policeman. The requirement for safety restricts this military policeman to the operation of the vehicle when it is in motion. Otherwise, he performs normal military police duties. (The responsibility of all military police is to set the example while patrolling.)

c. The senior military policeman's duties include the direction of the driver, observation of traffic, and performance of other military police type duties such as physical security, and prevention of crime.

d. Nothing in the foregoing is intended to prohibit the senior military policeman from

driving the patrol vehicle when necessity or advisability requires it. The "driver" may require a relief to prevent excessive fatigue.

5-5. Methods of Patrolling

a. Parked Patrol.

(1) When using the parked vehicle technique for enforcement, the military police should choose a location which will allow them to be easily observed. This location may be—

(a) At major intersections.

(b) Where numerous violations have occurred at particular times.

(2) The parked patrol can enhance voluntary compliance with traffic laws and regulations.

(3) During the hours of darkness or periods of reduced visibility, the patrol parks with its parking lights on for safety reasons.

(4) The military police patrol does not park where the patrol vehicle would be hidden. The hidden vehicle creates a poor impression of police action on the driving public, and violates the goal of preventive enforcement.

(5) The parked patrol has the following limitations:

(a) It reduces area coverage of military police crime prevention efforts by reducing the amount of military police exposure to an area.

(b) It restricts military police reconnaissance coverage of an area, to include routine patrol reporting.

(c) It gives the public the impression of an inactive patrol.

b. Moving Patrol.

(1) Moving with the flow of traffic is the most common method of patrolling. In this method, the patrol enters the main traffic lane and maintains the speed of the traffic as long as it is not in excess of the speed limit or endangers the patrol or other road users. The main disadvantage of this method is the low exposure to the driving public and the lack of opportunity for observing traffic generally. It is used mainly to move from one area to another while on reconnaissance, or when performing a crime prevention activity.

(2) Patrolling slower than the posted speed limit allows the patrol to observe general road conditions and the surrounding area. Slow-moving patrols are useful in built-up areas; however, when this method is used on the open road, it has a tendency to slow up the normal traffic flow, often causing traffic congestion and creating traffic hazards. Military police vehicles should keep to the right and whenever possible, permit faster moving traffic to pass them. Patrolling faster than the posted speed limit is a violation of the basic traffic control goal, i.e., to encourage voluntary compliance with laws. This also violates sound safety procedures and is not an acceptable method of performing motor patrol duty.

c. Other Methods of Motor Patrolling. The military police patrol may combine its movement through its patrol area by parking at certain locations during a tour of duty, and later, moving with traffic in the patrol area. Traffic control plans usually schedule places and times at which the patrol will perform point control duties.

5-6. Patrol Route Short Cuts

Many times the military policeman knows several short cuts through his patrol area which can save time. When the patrols know these short cuts, in emergencies they can avoid heavy traffic.

5-7. Road and Safety Reconnaissance

a. The military policeman on traffic patrol is constantly alert for road and safety hazards.

Observations are recorded and reports are made to the military police station reflecting problem areas and recommendations. This information provides basic data which traffic supervisors rely on to base recommendations designed to enhance the traffic safety program. When a radical change in traffic, road, or safety conditions takes place, the military police immediately report the change. Observations to be reported include, but are not limited to, the following:

- (1) Changes in the volume of traffic.
- (2) Changes in the time of day for "rush hour" traffic.
- (3) Changes in the direction of normal traffic flow.
- (4) Changes in the use of roads for heavy traffic.
- (5) The opening or closing of a facility that generates traffic, i.e., PX, playground, theater.

b. The military police report on the effects of any change in the traffic plan and provide planners at the military police station with the data upon which to base future plans. If the military police fail to report this information, it detracts from the effectiveness of the traffic control program.

c. Road maintenance is a function of the Corps of Engineers; however, since the military police are constantly on the road, they may be the first to note road deterioration. The military police should report such conditions as—

- (1) Damage from storms.
- (2) "Pot holes."
- (3) Obstructions to traffic (tree limbs, rubbish, etc.).
- (4) Road construction, degree of construction, and the times when the construction is completed. If an area is under construction, it may be necessary to reroute traffic and establish traffic control and signs. The date when the construction is to be completed should be obtained by the patrol so that provisions can be made to alert the public to changes in traffic flow.

d. Traffic signs are a tool for the control of traffic. Included in the term "traffic signs" are road markings such as crosswalks and center strips. The patrol reports the signs which need repair or are not visible to the motorist or pedestrian. An inventory of all traffic control signs in a given area should be conducted on a scheduled basis to assure they are properly maintained.

5-8. Installation Registration of Privately-Owned Vehicles

Privately-owned vehicles driven on military installations must have proper authorization (AR 190-5). This authorization shows that the driver of the vehicle has reason to be on the post, and that the vehicle that he is driving is properly maintained, insured, etc. Frequently, the installation registration process is long, drawn-out, and tedious. To reduce the registration process-

ing time, the post commander and provost marshal should insure that the administration of the registration is efficient, but still thorough. Any methods that will reduce the time needed to register vehicles should be implemented as long as desired standards are met. Newly arrived personnel should be provided the blank forms that must be completed before entering the registration office. This will alleviate unnecessary congestion and delays at the installation registration office.

Section III. ESCORTS

5-9. Traffic Escorts, Posts, Camps, and Stations

Military police traffic escorts are provided to prevent congestion and to expedite the safe movement of convoys or other special traffic elements. The convoy commander is responsible for convoy discipline, while the military police provide necessary assistance. The military police do not determine the general procedures for the movement of the convoy; however, they enforce traffic control regulations and highway movement regulations established by the installation or higher headquarters commander. The goal of the military police during escorts is to provide a safe and law-abiding movement for the convoy. Safety is not sacrificed for speed during the normal escort, and consideration is given by military police escorts and convoy commanders to the other road users. Military police also perform security escorts; basic methods and techniques presented herein apply to the requirements for and the composition of security escorts. Further discussion on security escorts is contained in FM 19-30, Physical Security.

5-10. Methods of Escorting

The military police use several methods of escorting; these are—

a. Leading and Following. This method uses the military police patrols to lead and follow the vehicle(s) escorted. The *leading* patrol secures the right of way. Lights and sirens are used as prescribed by law and the local SOP. When the escort is approaching an intersection, the leading patrol dismounts and performs point control until the head of the column reaches the intersection; at that time the military policemen remount and resume their lead role. The *following* patrol keeps the end of the column

closed up, renders assistance, and provides necessary security.

b. Leading. Only one vehicle is used in this method as a lead vehicle for those escorted. This is not the most desirable escort method. However, it is commonly used because the military police patrol, called upon for an emergency escort, is limited to one vehicle. The escorting vehicle then provides clearance through intersections and traffic congestion.

c. Empty Truck. This technique is used for posting traffic control personnel ahead of the movement they are escorting. The traffic control personnel who are to perform point control at key intersections and other points of difficulty are mounted in a truck, which departs prior to the movement, and are posted along the route of the escort. An empty vehicle follows the movement and picks up these traffic control personnel. Control personnel should be numbered so that none will be missed by the pickup vehicle. This technique is normally used in addition to the one described in *a*, above, with the empty truck taking the place of the following vehicle. If temporary signs are used to guide the movement, it is normally the duty of personnel in the empty truck to retrieve them after the movement has passed.

d. Leapfrog. Leapfrog is a technique employed by escort patrols, who move ahead of the movement and assume traffic control posts at intersections and other points where delay or congestion may occur. As soon as the movement passes their posts, the escort personnel remount, overtake and pass the movement, and assume successive posts along the route of escort. Personnel may be assigned to specific posts according to a prearranged plan. This technique has definite limitations on narrow or heavily

traveled roads because escort patrols may have difficulty passing the movement due to heavy opposing traffic, hills, curves, and other such conditions.

e. Modified Leapfrog. The modified leapfrog escort normally involves two patrol vehicles. The patrols move ahead of the movement and are positioned at successive locations where control is needed. As soon as the escorted vehicles, moving at close interval, enter the intersection, traffic from other directions is stopped. Then the patrol remounts its vehicle, passes the movement, and proceeds to the next point where control is needed. This procedure is repeated by each patrol until the movement reaches its destination.

f. Perimeter. This technique employs escorts on all four sides of the escorted vehicles. While the perimeter escort may consist of a vehicle in front, a vehicle following and one vehicle

on each side as a minimum, it can be expanded with the addition of more perimeter rings.

g. Routes Used. A route selected for the escort may necessitate traveling through a large town or built-up area, through flat and open country, or through a combination of both. As the areas change, the traffic escort method is also changed. The escort used in flat, open country, may not necessarily be adequate for going through a large town or built-up areas where heavy traffic congestion is anticipated. Prior to the movement, coordination is made with local law enforcement agencies who can assist the military police escort through congested or built-up areas, or onto high-speed roadways from secondary roads. This eliminates the need for the military police traffic control at major intersections within built-up areas, but unit guides and adequate posting of signs along the route is required to prevent the loss of stragglers from the convoy.

CHAPTER 6

TRAFFIC LAW ENFORCEMENT

Section I. PRINCIPLES AND POLICIES

6-1. Traffic Violations

a. Definition. A traffic violation or offense is broadly defined as the commission or omission of any act prohibited or required by rules, regulations, or laws governing the conduct of traffic. Unlike many other offenses, traffic offenses do not ordinarily involve the question of intent. A table of common traffic violations will be found in appendix C.

b. Application. Traffic violations are studied for enforcement and traffic safety purposes. Reports of violations are passed on to the commander who decides what corrective action is to be taken, if appropriate. Generally, his corrective action has the greatest single effect on the development of the willing obedience to traffic regulations.

6-2. Principles of Traffic Law Enforcement

a. The manner in which military police enforce the law can greatly influence the reaction of drivers to traffic regulations and to police enforcement. To some drivers, a traffic violation is only that behavior for which they must account to the nearest military policeman. The military police, by observation and with the use of special equipment, determine the action of the road user and make a comparison of this action with requirements stated in the law. If this comparison reveals a conflict, then a traffic violation has taken place.

b. Military police should take uniform action for the same violation under like conditions. However, several factors exist for which precise measurements have not been developed. Only by the training and experience of the military police can these factors be prevented from adversely affecting traffic enforcement. These factors include the military policeman's ability to—

(1) Detect and identify unusual or illegal behavior, or those conditions which produce or

accompany such behavior, e.g., drunken driving or driving too fast for conditions.

(2) Evaluate the legality or illegality of such behavior or conditions, interpreting on-the-spot *all* applicable law, in light of the circumstances.

(3) Apprehend a violator under adverse conditions.

(4) Apply tolerances and determine the nature of evidence which can be developed to support the formal citation of an offense.

c. In enforcing traffic laws, it is necessary for the military policeman, once he has observed an offense, to take immediate action. This action is taken consistent with the safety of both the public and the military policeman. Failure to take such immediate action leads to other violations, accidents, and beliefs by drivers that enforcement is lax or ineffective.

6-3. Selective Enforcement

a. The presence or the implied presence of the military police, coupled with the drivers' belief that apprehension will follow any traffic violation, will tend to deter violations. Distribution of military police personnel and equipment is planned so that the enforcement effort is applied where and when it is needed. This application of enforcement is called selective enforcement. It may take the form of assignment of military police to a certain location at a given time to prevent specific traffic offenses. The selection and announcement of certain driver violations which have contributed to recent accidents or increased congestion tend to enhance the general preventative enforcement.

b. The normal basis for the selective enforcement program is the reports that originate with the military police. The whole program is dependent on how well the military policeman performs his duties and how accurately he reports what he observes.

6-4. Enforcement Policies

a. Well-defined policies must be established by the commander with respect to the enforcement program. These policies can best be described as tolerances which take into account human and mechanical fallibility and other considerations. These policies may provide adequate guidance in most cases, but in other instances the military policeman must decide on the spot what action he will take based on the specific situation. He must *not*, however, apply his own tolerances simply because he considers the traffic regulations overly lax or restrictive. Tolerances are not publicized; to do so defeats their purpose and tends to make the tolerated deviation a standard. It is difficult, in some cases, to determine when a violation has occurred, and often, where such determination is possible, it is neither practicable nor reasonable to enforce the "letter of the law."

b. It is theoretically possible to measure speed to a fraction of a mile per hour. Technically, a speeding offense has occurred when any vehicle exceeds the posted speed limit at any time. But, human and mechanical errors make it difficult to be sure of the exact speed of a vehicle. In

most cases, a suspect has to be paced for a sufficient distance, and the military policeman must follow him closely enough to be sure of a violation. It is a common practice of military police units to instruct patrolmen to refrain from issuing citations for speeds which exceed posted limits by only a few (up to 5) miles per hour. This "leeway" does not weaken enforcement, it strengthens enforcement. When military police appear in court over a contested speeding violation, for example, driving 45 mph in a 35 mph zone, the speedometer reading on the patrol vehicle read 50 mph. The 5 mph tolerance takes into consideration the factor of possible human or mechanical error on the part of the MP patrol and tends to lend support to the allegations made against the violator in court. However, if the military policeman adds other leeways, the enforcement program is weakened. It is not considered speeding for enforcement purposes if only a short burst of speed is used to get around a slow-moving vehicle. This decreases the time required to pass and reduces the likelihood of an accident. In accordance with this policy, however, such speed should not be excessive or used in a reckless manner, and must be reduced once safely past the overtaken vehicle.

Section II. SPEED MEASUREMENT DEVICES

6-5. Speed Measurement Devices

While speeding is not the cause of all accidents, it has a marked effect on the severity of accidents. In nearly all cases, the higher the speed of the involved vehicles, the more severe the accident. When speed measuring devices are used in traffic study and traffic control operations, adequate advance notice must be given to the applicable personnel. Speed measuring devices are not intended for use in increasing the number of traffic violations or for use arbitrarily; rather, they are intended for use in enhancing self-imposed control over speed and in conduct of studies to better determine reasonable speeds for particular areas. When employed in this manner, they should be placed in areas of known high accident experience or areas where other restrictive enforcement practices are required, e.g., hospital and school zones. Further, such devices will be operated only by fully-trained personnel, who will insure that the devices are properly calibrated.

a. *General Considerations.* The selection of speed measuring devices is based on the mission

of the military police unit in a field army or CONUS environment. The installation size, road net, volume of traffic, permanency, jurisdiction and mission all contribute to identify the opportunity for employment as well as determining the benefits derived from the utilization of the above speed measuring systems and devices. Considerations of cost, source of purchase, and maintenance of speed measuring devices further influence the selection of the system best suited for a command.

b. *Assistance.* The US Army Military Police School is prepared to provide assistance to commanders and military police personnel regarding speed measuring devices. The MP School, upon request, will disseminate information concerning the characteristics and manufacturer's data on various speed measuring devices. Address requests to: Commandant, US Army Military Police School, Fort Gordon, Georgia 30905.

6-6. Speeding

The following methods are most frequently used to measure vehicle speeds:

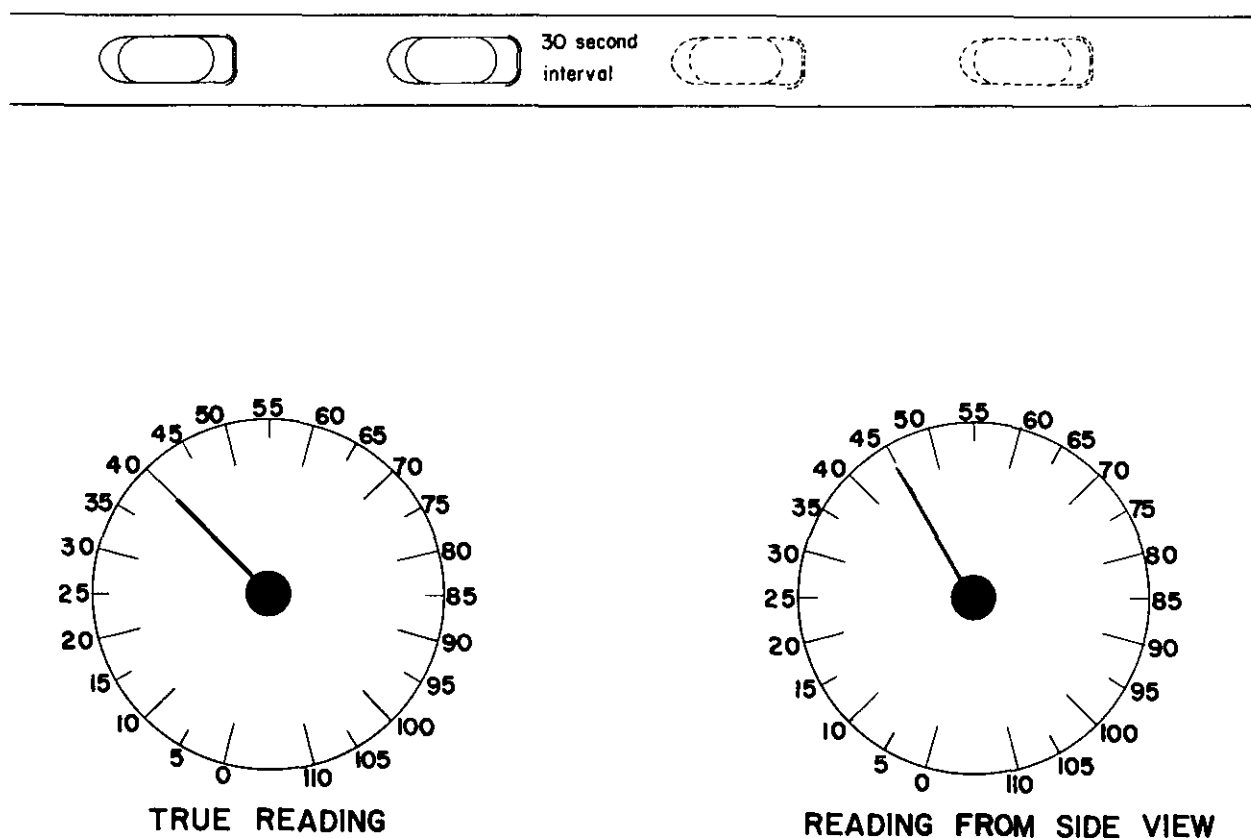

Figure 6-1. Example of a speedometer with and without distortion.

a. The Speedometer or "Pace" Method.

(1) A vehicle suspected of speeding may be paced by following the speeding suspect in a patrol vehicle at a constant interval, for a reasonable distance (approximately three to five tenths of a mile). The military policeman matches the speed of his vehicle to that of the suspect vehicle, and notes the speed indicated on his speedometer when the distance between the vehicles appears to remain the same. After maintaining this consistent distance, for the three tenths of a mile, he again notes his speed recorded on his speedometer to confirm the first reading.

(2) This method is subject to mechanical and human error.

(a) Speedometers are normally accurate. Mechanical error is reduced when speedometers are periodically calibrated. It is important that military policemen keep a valid record of speedometer calibrations with the vehicle. A record of speedometer calibrations should be kept with the vehicle log book to confirm the MP vehicle's speedometer calibration accuracy.

(b) Human errors are corrected by training. The military policeman must accurately read

the speedometer and no attempt should be made to read the speedometer without adequate light or from an angle which distorts the correct reading. A "true reading" is easily read when the viewer's line of sight is perpendicular to the speedometer face. Figure 6-1 shows the difference in readings made at the same speeds by the driver (True Reading) and the passenger (Reading From Side View).

b. Radar. Radar offers an accurate, efficient means for determining the speeds of vehicles at given positions. In addition to the visual reading obtained by the operator, radar devices may be equipped to make graphic recordings of the speeds of passing vehicles. Instructions for operating specific types of radar equipment are provided by the manufacturers, and when properly operated and calibrated, any tolerance may be reduced toward zero miles per hour. The principle of operation is simple. The radar timer is actually a low power radio transmitter and receiver. The transmitter sends out continuous, unmodulated radio waves at a frequency of 10,525 megacycles, (the waves travel at the speed of light) and on meeting the metal surface of the

car being timed, are reflected. A moving car changes the length of the wave and, therefore, changes the frequency. The change in frequency is proportional to the speed of the car and this change is about 31.4 times the speed of the car. Thus, 10 miles an hour gives a frequency change of 314 cycles per second. These changes in frequency are converted by the radar timer into miles per hour and shown on a direct reading meter scale.

(1) Since the radar is a fairly complicated and technical device, the operator must be well-trained and properly versed in its functions and limitations. The operator must be trained in the following areas:

(a) Good site selection.

(b) Proper positioning and handling of the antenna.

(c) Judging effective operating ranges at different locations and recognizing the various forms of radar interference.

(d) Identifying speeding vehicles.

(e) Satisfying legal requirements.

(2) The radar is a fragile piece of equipment and must be properly maintained.

(a) The device must be calibrated every 6 months by a licensed technician and a record of the calibration must be maintained. Periodic inspections of equipment must be made to keep the radar in operating order.

(b) Patrol vehicles assigned to speed surveillance duties using radar must be modified to provide an individual, filtered and fused power connection. Also, in some cases this connection must be shielded to prevent interference from the ignition. Depending on the amount of radar operation expected in the patrol vehicle, a permanent or temporary detachable electrical connector can be joined into the vehicle's electrical system. Finally, the system should be mounted in an eye-level position whereby the operator can observe meter readings with minimum difficulty.

(c) The radar cabinet, containing the calibration and adjusting controls, must be mounted securely in a stable, well-ventilated position.

(d) The radar antenna is mounted on an adjustable fixture within the patrol vehicle. Since the antenna housing contains a very expensive high frequency transmitter tube, it must be handled with care.

(3) *Radar operating procedures.*

(a) The radar is to be used in areas of known speed violations. Generally, the radar op-

erating unit should attempt to work on single-lane roads, or multi-lane streets which have light traffic. When this condition is met, more accurate readings are insured. The radar unit should not be positioned near changes in speed limits or areas of high acceleration or deceleration.

(b) The radar unit can be used during all degrees of darkness and is not affected by weather. However, the unit should not be used primarily in one location, but should be moved frequently.

(c) When the radar unit is positioned and readied for operation, the operator must log the time and location of transmitter operation (to meet FCC regulations). Then, test runs by patrol units with calibrated speedometers are made in all directions which traffic will be monitored. These test runs must be recorded, with the results, vehicles, location, and time noted.

(d) To insure accurate readings during radar operation, the user must—

1. Choose an operating location which is not bothered by outside interference. (Interference consists of other radio signals, large metal objects, or fluorescent and neon lighting.)

2. Position the antenna as near as possible to the line of travel of the monitored traffic to reduce errors in the readings from traffic not paralleled to the radar units. (This error usually gives a slower reading than the actual speed.) The radar antenna is aimed at a point in the center of the lane of traffic being checked. (Usually this distance is 400 ft from the antenna.)

3. Disregard the readings if more than one vehicle is in the radar zone, since it is difficult to determine which vehicle is being monitored.

(4) *Speed checking.* Generally, single vehicles within the range of the radar present few problems. However, if several vehicles are in range, good judgment is required. The following are some factors to be considered:

(a) The radar speed meter indicates the instantaneous speed of the fastest vehicles in range, provided it presents a reasonably large relative area to act as a reflector to the radar beam.

(b) It is possible for a faster, overtaking vehicle to be screened by a larger, slow-moving vehicle through the radar-beam area. In this case the speed of the slower vehicle is represented on the speed meter.

(c) The range of the radar depends largely on the reflective area of the vehicle being checked. A motorcycle at 150 feet may be out of

range, while a large semitrailer or bus at 1,600 feet would thus give a steady reading. In this situation it is concluded that the reading obtained is from the semitrailer or bus, due to the fact that after the motorcycle passed through the area being checked, a steady reading continues on the speed meter, indicating that the target is still in the radar beam.

(d) Low-slung vehicles with large glass area and small vehicles make aiming of the radar beam more critical to obtain satisfactory readings.

★(e) Do not operate the radio transmitter while observing speed readings since this action may cause an erroneous high radar reading. Any mobile transmitter operating within approximately 50 feet may cause an erroneous reading on the high side. The radio transmitter may be used *after* observing a high reading in order to notify the apprehending patrol.

(f) When the radar is in operation, antennas should never be left pointed at stationary metallic objects within a distance of 4 feet from the end of the antennas. To do so may damage the mixer crystal in the radar head, causing the radar to suffer a loss of range or permanent damage.

(g) Before leaving an operating location, calibration of the radar should be checked and the results logged. If at a single location for a long period of time, additional calibration checks may be made. All calibration checks should be logged for future reference.

★(5) During the operation of radar, usually two patrols are used. One patrol vehicle is responsible for the radar operation. The second is the apprehending patrol. Each of these units has specified duties, for which successful prosecution depends.

(a) The military police in the car operating the radar device are responsible for the correct procedures for setting up the radar unit. These procedures include—

1. Voltage tests, accuracy (proper calibration), and test runs by the apprehending car through the radar net, both before and after the apprehension.

2. Operating the equipment according to schooling and that it appeared to be functioning properly.

3. Reading of the radar dial.

4. Description of car (as complete as possible, including license, color, make, year, and model).

5. Place and time of the violation and the location of traffic/speed signs.

6. Relaying information to the military police in the apprehending car. (In a contested case, both the radar operators and the apprehending military police will usually be required to testify. The radar operators should testify as to what they observed and that they gave this information to the military police in the pursuit car.)

(b) Military police in the apprehending patrol obtain information and testify to—

1. The receipt of information concerning violator from the radar car. (In a contested case, they should testify that they received information from the radar operators, and that upon the receipt of this information, they stopped the violator.)

2. The speedometer reading of pursuit car if the violator was paced.

3. The accuracy of pursuit patrol's speedometer (factory certified or calibrated) and result of test runs through radar net before and after the violator's apprehension.

4. The description of the violator, car license, color, make, year, model, and as they observed them.

5. Identification of accused as the driver of the vehicle.

6. Conversation with the violator (the MP may testify they told the accused that the other MPs in the radar car radioed them that the vehicle—described as to license, color, make, model, etc., was operating at a certain speed in violation of the law and to any further conversation).

★(6) A compact radar system called "speedgun" is now being used by some military police units.

(a) This hand-held battery powered, portable unit is operable by one man. It can be carried on the seat of a military police sedan or employed by a motorcycle/motorscooter MP.

(b) The MP need only point the speedgun at a possible violator's vehicle. The flip of the camera-shaped device's trigger emits a microwave which bounces off the vehicle and returns to an absorbing shield in the device. The microwave feedback is instantly translated into a digital readout that indicates the violator's speed.

★c. VASCAR. In addition to radar, VASCAR is now being used by many military police units. This device is a small electronic computer which makes speed computation by dividing distance by time. This device can measure speeding vehicles up to 1 mile from the unit; has an

operating error of less than 1.75 miles per hour, and can be operated effectively by one patrol.

(1) The three basic components of VASCAR are a computer, a control module and an odometer module. The odometer module feeds the distance information into the computer while time input is controlled by manipulation of the "time switch" on the control module.

(2) Both distance and time input are controlled by toggle switches on control module. Through a simple series of manipulations turning time and distance inputs to the computer "on" and "off," the previously unknown quantities of time and distance are relayed to the computer which gives a readout of the average speed. This average speed reading is displayed in bold illuminated numerals on the control module.

(3) VASCAR can "clock" a vehicle by any of the following methods:

- (a) Patrol vehicle following the violator.
- (b) Patrol vehicle meeting the violator.
- (c) Violator crossing in front of patrol vehicle.
- (d) Violator following patrol vehicle.

d. *Mirror Box.* The mirror box is an L-shaped box with open ends, containing a mirror that reflects the image of a vehicle as it enters or leaves a measured course (fig 6-2). Using one or two mirror boxes and a stopwatch, military police clock the vehicle passing through the measured zone. Two factors, time elapsed and distance traveled, are used to compute the speed at which the vehicle is traveling. The method is simple and accurate. The operator is provided with a tally sheet on which to record the speeds of passing vehicles. This sheet contains a table that translates time and distance factors into the speed of the vehicle in miles per hour (fig 6-3). When conducted by a man trained with this device, the tolerance may be reduced toward zero miles per hour. The steps listed in (1) through (7) below should be followed when using a mirror box:

(1) *Select the place.* Select a straight stretch of level roadway. Measure carefully an 88- or 176-foot line of sight course at a place where the military policeman has unobstructed vision of the road, but where he and the mirror box equipment are not unduly obvious to passing drivers. The site on which the equipment is to be placed should be approximately level with the surface of the road.

(2) *Determine the number of boxes.* One box is suitable for measuring speeds of vehicles on the approaches to intersections and, to a large

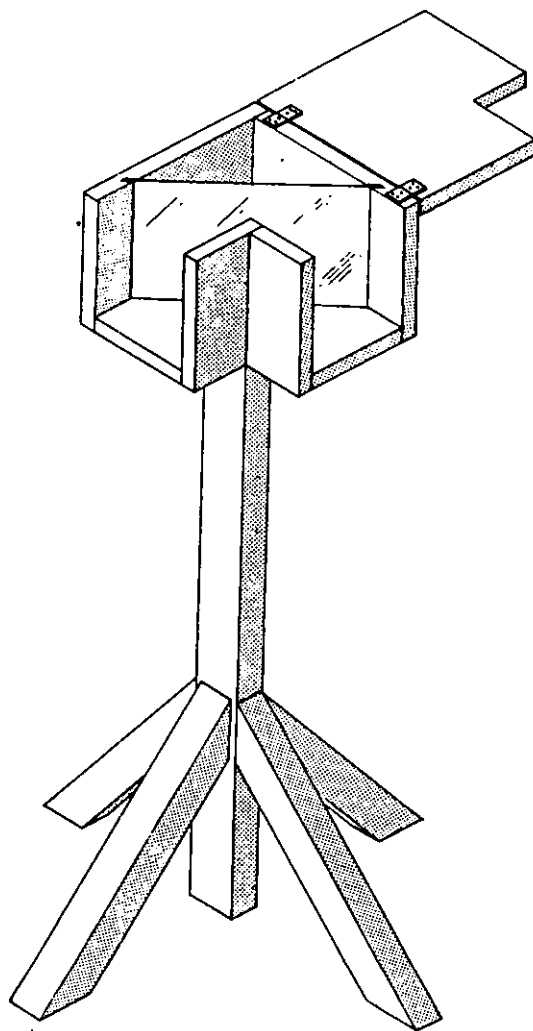

Figure 6-2. Mirror box.

extent, in any urban location (fig 6-4). Two boxes are recommended for use with the 176-foot course because it is easier for the military policeman to see flash images in the two boxes (fig 6-5). Two boxes used with the 176-foot course produce more accurate results, particularly when relatively high speeds are to be measured. Two boxes are also recommended when the speed of vehicles moving in both directions is to be measured.

(3) *Install the equipment.* Each mirror box should be placed so that one open end points along an imaginary line across the roadway and the other open end points along an imaginary line along to the roadway. For daytime use, stakes should be placed on the other side of the road directly opposite each mirror box. At night, lanterns or other suitable sources of light should be placed in the same position prescribed for the stakes.

SPEED CHECK FIELD DATA

Date _____ Time begun _____ Road _____ Direction _____
 Surface _____ Time ended _____ Location on road _____
 Dist. in ft. _____ Timed _____ Clear width _____ Clear before _____ After _____ Observer _____

Time sec.	M.P.H. for		Passenger		1/4 & 3/4 Ton		Other trucks & buses		Total
	88ft.	176ft.	Tally	No.	Tally	No.	Tally	No.	No.
1.	60.0	120.0							
1.1	54.5	109.0							
1.2	50.0	100.0							
1.3	46.1	92.2							
1.4	42.8	85.7							
1.5	40.0	80.0							
1.6	37.5	75.5							
1.7	35.3	70.6							
1.8	33.3	66.6							
1.9	31.6	63.2							
2.	30.0	60.0							
2.2	27.2	54.5							
2.4	25.0	50.0							
2.6	23.0	46.1							
2.8	21.4	42.8							
3.	20.0	40.0							
3.2	18.7	37.5							
3.4	17.6	35.2							
3.6	16.6	33.3							
3.8	15.7	31.5							
4.	15.0	30.0							
4.2	14.2	28.9							
4.4	13.6	27.2							
4.6	13.0	26.1							
4.8	12.5	25.0							
5.	12.0	24.0							
5.5	11.5	21.8							
6.	10.0	20.0							
6.5	9.2	18.5							
7.	8.5	17.1							
7.5	8.0	16.0							
8.	7.5	15.0							
8.5	7.0	14.1							
9.	6.6	13.3							
10.	6.0	12.0							
11.	5.4	10.9							
12.	5.0	10.0							
14.	4.2	8.5							
16.	3.7	7.5							
18.	3.3	6.5							
20.	3.0	6.0							
Total Timed									
Not Timed									
Grand Total									

Figure 6-3. Sample speed study field sheet.

(4) *Station the observer.* If one box is used, the observer should be at the end of the measured course away from the mirror box. He should be stationed so that he can see the flash images from the mirror box and also look directly along an imaginary line across the roadway. If two boxes are used, the observer should be stationed between the boxes so that he can observe the flash images from both mirror boxes.

(5) *Begin operation.*

(a) *One box.* As a vehicle enters the measured course, a flash image in the mirror box will be visible to the observer. He should start the stopwatch at the exact moment he sees

the flash image and allow the watch to run until the front bumper of the vehicle crosses the end of the measured course. After he stops the watch, the observer should note the time it took the vehicle to run the course. He should then make a mark on the field sheet opposite the column indicating the time elapsed under the heading of the type of vehicle that was clocked.

(b) *Two boxes.* The observer should look in the direction from which the vehicle is approaching and observe the flash image in the mirror box. He should start the watch at the moment he observes the flash image. He should then turn and observe the mirror box at the other end of the measured course. When the

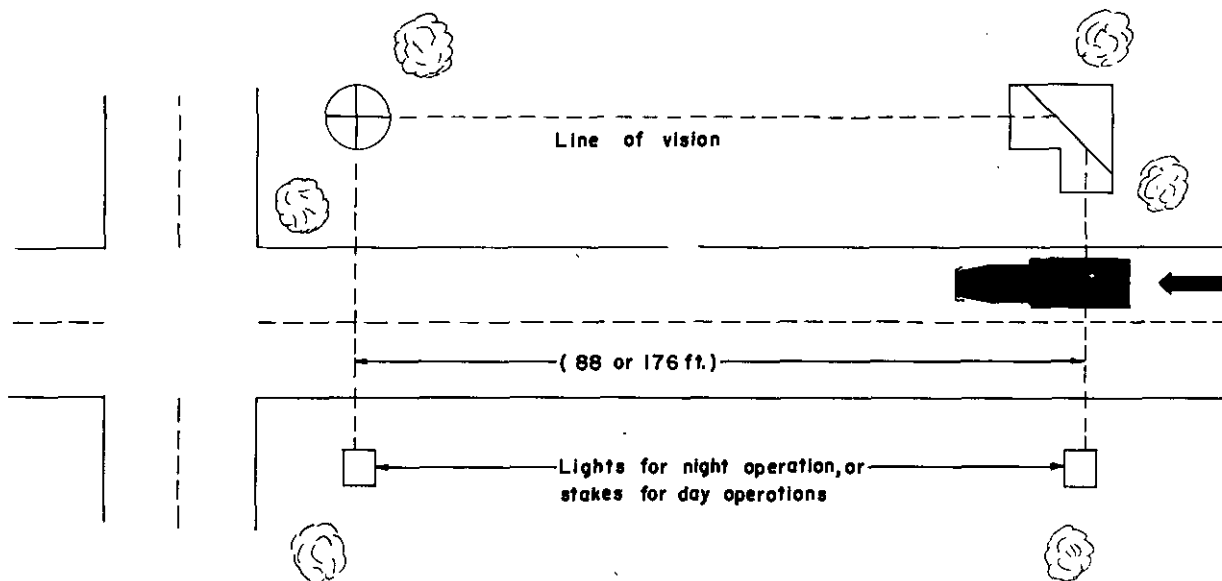

LEGEND

 Military Policeman

Figure 6-4. Location of one mirror box and military policeman.

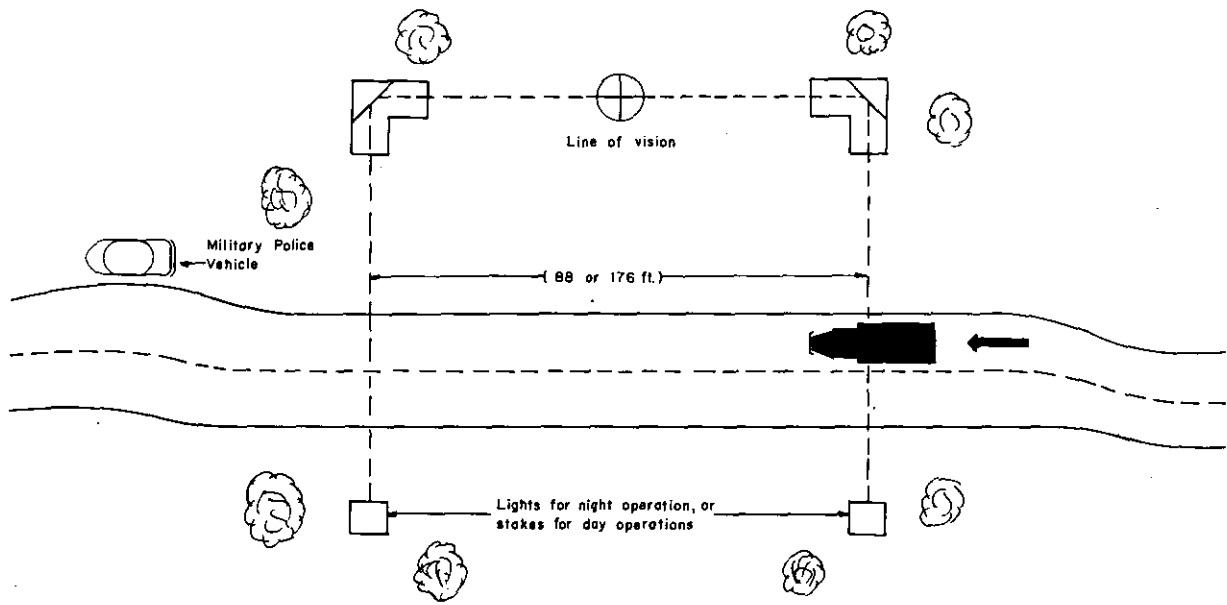

LEGEND

 Military Policeman

Figure 6-5. Location of two mirror boxes and military policeman.

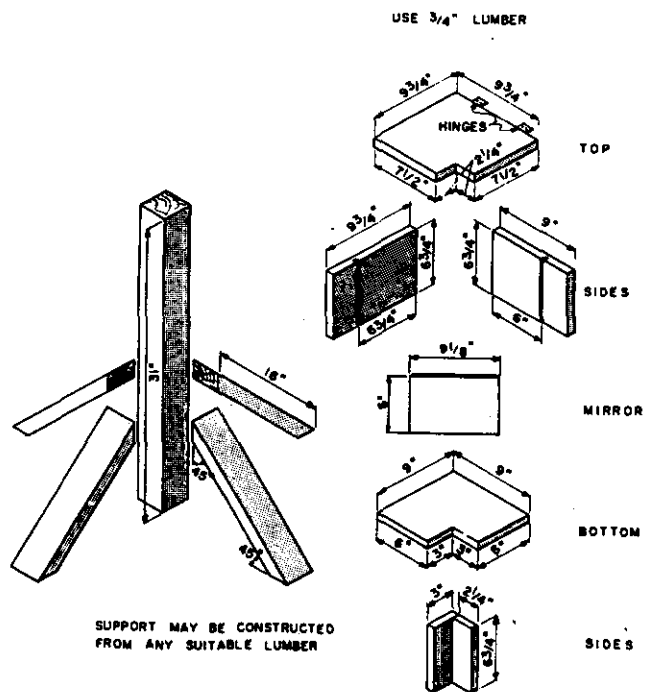

Figure 6-6. Dimensions of a Mirror box.

flash image (made by the vehicle crossing the end of the course) appears in the mirror box, the observer should stop the watch, note the elapsed time, and record it on the field sheet.

(6) *Special problem.* If two vehicles enter the course at about the same time, the observer should clock the first vehicle only.

(7) *Use of mirror box.* The mirror box may be used in the course of a survey to determine prevailing speeds or for the purpose of apprehending violators. When the mirror box operator has completed and recorded his calculations, he will, if apprehension is contemplated, notify other military police who have been previously positioned to make the apprehension (fig 6-5).

e. Aircraft Traffic Monitoring. Aircraft, either rotary or fixed-wing can be used effectively to monitor traffic. Advice, assistance, or information can be communicated from aircraft to surface traffic by use of loudspeakers, radio equipment, or by landing and conveying messages directly to the person concerned. Helicopters have been particularly effective for monitoring traffic in remote areas, where large expanses of highways must be monitored with minimum manpower. (See paragraph 10-6 for the use of aircraft in the theater of operations. The techniques discussed below can be modified for use in the theater of operations.)

(1) The light observation helicopter (LOH) is the most effective rotary-wing aircraft for

traffic monitoring. The military police observation/timer should be seated next to the pilot. A second MP may be carried to function as a witness or to issue the traffic citation in cases where the aircraft lands to halt the violator. Signs made of a flexible material spelling "Military Police" in 3-inch letters inserted in the cockpit bubble below the feet of the pilot observer are easily readable from the ground and assist greatly when hovering the aircraft over the road to stop an offender. Appropriately marked, the helicopter can hover over the road in front of the offending vehicle which is waved to the side of the road.

(2) The highway should be marked at 176 feet measured intervals with white paint similar to that used to mark airfield runways. The marks should be painted at the center of the road (so traffic can be monitored in either direction) in 3 feet by 3 feet squares. Care must be taken to insure that the inner edges of the marks are exactly 176 feet apart. Then, when traffic is timed between these measured zones, the velocity can be computed using the methods discussed in *c* above. In order to be able to testify that the vehicle speed was checked more than once, it is advisable to have measured zones in sets of three. Each measured distance should be separated by an area significantly larger or smaller than 176 feet in order to avoid confusion. Also, the use of wide publicity in the form of news releases and warning signs to inform the public of the use of aircraft to detect traffic violators encourages drivers to stay within posted speed limits.

(3) Flying at an elevation of from 300 feet to 500 feet provides the best view of the roadway. Lower elevations limit the expanse of the highway which can be seen, and reaction time for the aircraft to find the probable violator and time it before the aircraft flies past it, and calls attention to the aircraft. When flying above 500 feet it is difficult to discern the identity of the vehicle.

(4) When aircraft are paired with ground patrols for traffic law enforcement only a short 3 to 4 mile stretch of highway should be patrolled. The ground units should be stationed at each end of the roadway under observation by the aircraft; violators are apprehended as they depart the patrolled area. Generally, this technique is productive only where there is relatively steady volume of traffic.

★f. Considerations for Selection of Speed Measuring Devices. Each type of device discussed in this section has specific advantages and disadvantages which, situationally, make one

device superior to another. The major advantages/disadvantages are:

(1) *Pace car.*

(a) *Advantages:*

1. Can be accomplished by any MP vehicle.

2. Simple, easy operation requiring minimal training of personnel (as compared to other devices).

3. Little expense, if any, is involved.

(b) *Disadvantages:*

1. The speedometer of any vehicle employed as a pace car must be calibrated periodically, preferably monthly.

2. Requires pursuit through traffic.

(2) *Radar.*

(a) *Advantages:*

1. Usually portable.

2. Darkness has no effect on operation.

3. Simple training of operators.

(b) *Disadvantages:*

1. Easily damaged requiring sophisticated maintenance/repairs.

2. Expensive.

(3) *VASCAR.*

(a) *Advantages:*

1. Can be operated from moving police vehicle by qualified operators.

2. No VASCAR equipment is visible to the violator.

3. Federal Stock Number makes procurement less difficult (FSN 7440-401-2674 YU).

(b) *Disadvantages:*

1. Expensive.

2. Nonportable. When a VASCAR-equipped vehicle is not operating due to maintenance or damage, VASCAR cannot be easily put in another vehicle.

3. Sophisticated systems require highly qualified repairmen, normally not available on a military post.

4. Qualifying operators requires approximately thirty days (less in some jurisdictions).

(4) *Mirror boxes (Enoscope).*

(a) *Advantages:*

1. Inexpensive.

2. Totally portable.

3. Personnel are easily trained.

(b) *Disadvantages:*

1. Considerable time required to "time" each vehicle.

2. Human error can easily occur.

(5) *Aircraft traffic monitoring.*

(a) *Advantages:*

1. Large remote areas effectively covered.

2. Increased visibility.

(b) *Disadvantages:*

1. Dependent on aircraft availability from aviation organization.

2. Ineffective during periods of limited visibility and darkness.

3. Expensive.

Section III. OTHER TRAFFIC LAW ENFORCEMENT

6-7. Stop Sign Enforcement

Stop sign regulations require a full stop to be made at either a painted cross walk or stop line, or prior to entering the intersection. For enforcement purposes, however, the exact point of stopping often cannot be determined. It is not always clear where the stop should be made, as for example, where the stop sign is placed some distance from the intersection and/or there is no painted stop line. Sometimes when two or more cars stop in a column, the second (and often the third) car may stop at or near the place required by law. When these cars move out after the stop, it is difficult for drivers to know if (or where) they should stop again. A full stop is difficult to distinguish from an "almost" or "rolling" stop, especially with automatic transmissions where a slight "creep" is not uncommon. There is no specific guide as to what constitutes a reasonable opening in traffic so that a movement from a

full stop can be made into opposing traffic safety. The decision rests solely upon the military policeman.

6-8. Distances

It is necessary to allow a reasonable margin before taking enforcement action regarding estimates of distances in order to compensate for normal observational and judgment errors. Many decisions regarding distance criteria are difficult to make. Some examples of distance difficult to measure are—

a. When a driver is following too close.

b. Distance travelled from the point where a turn signal is given prior to turning. Other distances which are specified in regulation, e.g., distance a vehicle may be parked away from a curb, or the distance a vehicle may be parked from an intersection or from a fire hydrant, should always be estimated in favor of the individual, i.e., estimated so as to insure that two or

three feet more have been allowed above the specified allowance before issuing a traffic citation.

6-9. Time Limit: Parking

The enforcement of time limits for parking presents a technical problem of time measurement and a practical problem of making frequent checks. It is possible, with precision watches, to check the exact time of arrival and departure of every vehicle, but this is not practical. Several good enforcement methods can be used; these are—

a. Marking of the tires and pavement with chalk and rechecking the parking area after the allowable time has elapsed.

b. Noting the odometer mileage of the parked vehicle and rechecking it after the allowable time has elapsed.

c. As stated in *a*, and *b*, both are good enforcement measures, but may involve too much time. Making an enforcement check every 75 or 90 minutes will normally assure good compliance in a 60 minute zone.

6-10. Reserved Parking

Reserved parking spaces are normally established by the installation commander or his designated representative. Requirement to issue parking violations to persons unauthorized to park in reserved spaces should be outlined in the post regulations. Usually, areas set aside by company commanders or section chiefs for the convenience of their personnel will not normally be enforced by the military police unless the post regulation states that subordinate commanders have authority to designate reserved areas.

6-11. Driving Too Slow

Driving too slow is not normally a direct cause of accidents; however, it may produce congestion and be a mediate cause of accidents. Local traffic laws, regulations, and rules will define this violation. The method described in paragraph 6-6 may be used to determine if a driving-too-slow violation has occurred.

6-12. Improper Use of Lanes

a. The "lane straddler" blocks two lanes of traffic, and often compounds the offense with slow driving. Other drivers are unable to pass and thus traffic accumulates behind him.

b. The "lane hopper" is a driver who cuts in and out of traffic, weaving from one lane to another. This driver, under certain conditions,

can be a serious traffic hazard, and his erratic and unconventional behavior makes other drivers apprehensive. Other drivers are slowed or stopped unnecessarily or are placed in danger.

c. Military police detect these violations by observation of traffic. They can issue citations to those who commit them when regulations are published which prohibit them.

6-13. Turning Movements

Turning from improper lanes or without signaling, turns made in prohibited places or in an improper manner (as U-turns), or the blocking of a lane reserved for turning movements, are some of the movements which impede traffic. Turns which cannot be completed, when cutting across opposing traffic, and turns into or out of alleys or narrow driveways also tend to block the flow of through traffic.

6-14. Parking Violations

Parking violations can contribute to congestion. Double-parking, parking on the traveled portion of the roadway, parking in prohibited areas, and unauthorized stopping for loading or unloading are some of the obvious offenses that directly impede traffic flow. Other parking offenses serve to aggravate congestion by causing additional "cruising" by other drivers in search of parking space. Enforcement of time limit parking tends to make more space available.

6-15. Pedestrian

Violations by pedestrians often lead to, or aggravate, traffic accidents and contribute to congestion. Crossing at unauthorized places, crossing against signals, or non-observance of military police directions or of "walk" or "don't walk" signals all tend to impede traffic. Pedestrians may crowd onto the roadway, waiting for the traffic to change; at other times the continuous flow of pedestrians impedes the movement of vehicles. Compliance with traffic laws and regulations by pedestrians depends, to a large extent, on safety education. When enforcement has been used judiciously, the educational process has been markedly accelerated.

6-16. Drunken Driving

★a. The Uniform Code of Military Justice, Article 111, makes punishable the operation of any vehicle while drunk. Drunkenness is defined in paragraph 191, MCM, US, 1969. Military police normally detect this violation by observation of unusual or abnormal driver behavior. Some examples are—

(1) Extreme caution, especially slow speed on through streets and highways, unnecessary stops where no stop is required, long stops at stop signs, or apparent confusion at intersections.

(2) Failure to dim headlights or the switching from dim to bright headlights when approaching other vehicles.

(3) Lane straddling, speeding, or failure to signal a turn.

(4) Moving over the center line, particularly when negotiating curves or approaching other vehicles.

(5) Erratic movement such as weaving, driving in the wrong lane, or driving onto the shoulder of the road.

(6) Repeated difficulty in engaging the gears of a vehicle or engaging gears with a loud clashing.

(7) Swerving farther than necessary when passing another car or taking an unusually long time to return to the proper lane.

★*b.* When a traffic accident or violation occurs and law enforcement personnel observe unusual, abnormal, or illegal driver behavior indicating driving ability might be impaired by use of alcohol or drugs, observations and behavioral tests should be made and recorded (AR 190-5). The results of observations and behavioral tests conducted on persons suspected of driving under the influence of alcohol/drugs will be made on DD Form 1920 (Alcoholic Influence Report). The order in which the form is completed, including when to offer chemical testing of blood alcohol level, may be established by local policy. When chemical tests indicate that the suspect is intoxicated (0.10 percent or more alcohol by weight in blood), it will normally not be necessary to complete sections II, III, and V of the DD Form 1920.

(1) The heading of the form is self-explanatory and contains only identifying information. Make no entry in the blocks when the information is unknown.

(2) *Section I—Observations.* Enter short, appropriate descriptions where necessary. In the “clothing” portions, strike out the inappropriate word or words. Mark (X) blocks that apply to the subject. In each category (Breath, Attitude, Unusual Actions, Speech), one, or more than one, or no blocks may be marked to help describe the specific subject. In the “Spontaneous Acts” block, note the observations of any unusual movements or statements, i.e., “trouble finding wallet,” “yelled obscenities,” or other

acts of frustration which tend to indicate that the individual is impaired.

(3) *Section II* of the form is used to record results of simple performance tests. The subject, military or civilian, must be fully advised of his/her rights prior to being administered these tests. Procedures for warning of rights are contained in AR 190-30, appendix C. The subject may refuse to take the tests. If this is the case, enter “refused test” in the remarks block of this section. If at any time the subject requests a lawyer or indicates that he/she does not desire to cooperate, move immediately to section IV of the form. With an uncooperative subject or one who requests a lawyer, complete only the heading of the form and sections I, IV, V, and VI, in accordance with the instructions below.

(a) *Balance.* Ask the subject to stand upright, arms outstretched, on one foot, then the other foot. Next, have the subject stand upright, feet together, eyes closed, and head tilted backward Mark (X) the block that best describes how the subject performed these tests.

(b) *Walking and turning.* This is the “walk a straight line” test. Have the subject walk about 15 feet, placing heel to toe. Next, sharply request the subject to, “Turn around, please, and walk back in the other direction.” Mark (X) in the block that best describes the subject’s ability to perform this test.

(c) *Finger to nose.* Have the subject stand erect, arms extended horizontally, and eyes closed. Have the subject then touch his/her nose with right, then left index fingers. Mark (X) the appropriate blocks on the DD Form 1920.

(d) *Coins.* Simply place a few coins on the floor and ask the subject to pick them up. Mark (X) the appropriate block and record comments as to the subject’s ability to maintain balance.

(e) Mark (X) the remaining blocks in the Performance Test section of the form to indicate appropriate descriptions. Add remarks for other unusual or unexplained behavior.

(4) *Section III* of the form is used to record the subject’s responses to questions. The subject must *again* be fully advised of his/her rights before questioning. Enter “NA” if the question does not apply to the subject being interviewed. In all other spaces, enter the subject’s response to the question. Before requesting the subject’s signature (or other handwriting sample), the subject must again be advised of rights for the signature/handwriting sample.

(5) *Section IV—Chemical test data* is used to record results of quantitative chemical tests to determine the percentage of alcohol in the

ALCOHOLIC INFLUENCE REPORT					
INSTALLATION <i>FT. BLANK, GA</i>		VIOLATION REPORT NO. <i>A509022</i>		ACCIDENT REPORT NO. <i>N/A</i>	
DATE, TIME AND LOCATION OF ACCIDENT OR INCIDENT <i>13 FEB 75, 2330 HRS., JACKSON RD. AT 38TH ST.</i>			DATE AND TIME IN CUSTODY <i>13 FEB 75, 2330 HRS.</i>	APPREHENDING OFFICER <i>JONES</i>	
NAME OF SUBJECT <i>SMITH, HARRY Q.</i>			GRADE/CATEGORY <i>SP4</i>		SSN <i>276-78-2461</i>
UNIT OF ASSIGNMENT/ADDRESS <i>CO. B, 3/60TH INF, FT. BLANK, GA 30905</i>				<input checked="" type="checkbox"/> DRIVER <input type="checkbox"/> PASSENGER <input type="checkbox"/> PEDESTRIAN	
AGE <i>21</i>	SEX <input checked="" type="checkbox"/> Male <input type="checkbox"/> Female	APPROX WEIGHT <i>175</i>	OPERATOR'S LICENSE NO. <i>5525-767-53-030-306</i>		STATE <i>FL</i>
Check all applicable boxes describing conditions observed, i.e., more than one box may be checked to describe conditions observed.					
SECTION I - OBSERVATIONS					
MADE BY (Name, grade, SSN & organization) <i>ALICE G. JONES, SPA, 769-27-6231</i> <i>559TH MP CO., FT. BLANK, GA 30905</i>			WITNESSED BY (Name, grade, SSN & organization) <i>JAMES R. BROUSER, PFC, 236-72-8647</i> <i>559TH MP CO., FT. BLANK, GA 30905</i>		
CLOTHES <small>(Describe type & color)</small>	HAT OR CAP <i>NONE</i>				
	JACKET OR COAT <i>GREEN, FUR COLLAR</i>				
	SHIRT OR DRESS <i>BLUE PLAID</i>				
	PANTS OR SKIRT <i>BROWN</i>				
	CONDITION <input type="checkbox"/> Disorderly <input type="checkbox"/> Disarranged <input type="checkbox"/> Soiled <input type="checkbox"/> Mussed <input checked="" type="checkbox"/> Orderly		DESCRIBE <i>NEATLY DRESSED</i>		
BREATH	ODOR OF ALCOHOLIC BEVERAGE <input type="checkbox"/> Strong <input type="checkbox"/> Moderate <input checked="" type="checkbox"/> Faint <input type="checkbox"/> None				
ATTITUDE	<input type="checkbox"/> Excited <input type="checkbox"/> Hilarious <input type="checkbox"/> Talkative <input type="checkbox"/> Carefree <input type="checkbox"/> Sleepy <input type="checkbox"/> Profanity <input type="checkbox"/> Combative <input type="checkbox"/> Indifferent <input type="checkbox"/> Insulting <input type="checkbox"/> Cocky <input checked="" type="checkbox"/> Cooperative <input type="checkbox"/> Polite				
UNUSUAL ACTIONS	<input type="checkbox"/> Hiccoughing <input type="checkbox"/> Belching <input type="checkbox"/> Vomiting <input type="checkbox"/> Fighting <input type="checkbox"/> Crying <input type="checkbox"/> Laughing				
SPEECH	<input type="checkbox"/> Not understandable <input type="checkbox"/> Mumbled <input type="checkbox"/> Sturred <input type="checkbox"/> Mush mouthed <input type="checkbox"/> Confused <input type="checkbox"/> Thick tongued <input type="checkbox"/> Stuttered <input type="checkbox"/> Accent <input checked="" type="checkbox"/> Fair <input type="checkbox"/> Good				
SPONTANEOUS ACTS (Statements, walking, turning, etc) <i>HAD TROUBLE FINDING LICENSE</i>					
INDICATE BRIEFLY WHAT FIRST LED YOU TO SUSPECT ALCOHOLIC INFLUENCE <i>DRIVING TOO SLOWLY (10 MPH IN A 45 MPH ZONE)</i>			SIGNS OR COMPLAINT OF ILLNESS OR INJURY <i>NONE</i>		
SECTION II - PERFORMANCE TESTS <small>(Warning of rights in accordance with separate departmental policy is required for military personnel)</small>					
ADMINISTERED BY (Name, grade, SSN & organization) <i>JONES</i>				DATE & TIME TESTS PERFORMED <i>14 FEB 75, 0010 HRS.</i>	
BALANCE	<input type="checkbox"/> Falling <input type="checkbox"/> Needed support <input type="checkbox"/> Wobbling <input checked="" type="checkbox"/> Swaying <input type="checkbox"/> Unsure <input type="checkbox"/> Sure				
WALKING	<input type="checkbox"/> Falling <input type="checkbox"/> Staggering <input checked="" type="checkbox"/> Stumbling <input type="checkbox"/> Swaying <input type="checkbox"/> Unsure <input type="checkbox"/> Sure				
TURNING	<input type="checkbox"/> Falling <input type="checkbox"/> Staggering <input checked="" type="checkbox"/> Hesitant <input type="checkbox"/> Swaying <input type="checkbox"/> Unsure <input type="checkbox"/> Sure				
FINGER TO NOSE	RIGHT <input checked="" type="checkbox"/> Hesitant <input type="checkbox"/> Completely missed <input type="checkbox"/> Sure		LEFT <input checked="" type="checkbox"/> Completely missed <input type="checkbox"/> Hesitant <input type="checkbox"/> Sure		
COINS	<input type="checkbox"/> Unable <input checked="" type="checkbox"/> Fumbling <input type="checkbox"/> Slow <input type="checkbox"/> Sure <input type="checkbox"/> Other		BALANCE DURING COIN TEST <i>HAD TO REST KNEE ON FLOOR</i>		
ABILITY TO UNDERSTAND INSTRUCTIONS <input type="checkbox"/> Poor <input checked="" type="checkbox"/> Fair <input type="checkbox"/> Good			EFFECTS OF ALCOHOL <input type="checkbox"/> Extreme <input checked="" type="checkbox"/> Obvious <input type="checkbox"/> Slight <input type="checkbox"/> None ABILITY TO DRIVE <input checked="" type="checkbox"/> Unfit <input type="checkbox"/> Fit		
REMARKS					

SECTION III - INTERVIEW <small>(Warning of rights in accordance with separate departmental policy is required for all personnel)</small>				
Were you operating a vehicle? <u>YES</u> Where were you going? <u>HOME</u>				
What street or highway were you on? <u>DON'T KNOW N/A</u> Direction of travel? <u>"TOWARD HOME"</u>				
Where did you start from? <u>EM/EW CLUB</u> What time did you start? <u>DON'T KNOW</u> What time is it now? <u>MIDNIGHT</u>				
What city (county) are you in now? <u>FT. BLANK</u> What is the date? <u>13 FEB</u> What day of the week is it? <u>THURSDAY</u>				
INTERVIEWER TO FILL IN ACTUAL	TIME <u>0025</u>	DAY <u>FRIDAY</u>	DATE <u>14 FEB 75</u>	INTERVIEWER'S NAME <u>JONES</u>
When did you last eat? <u>4 HRS. AGO</u> What did you eat? <u>HAMBURGER, FRENCH FRIES</u>				
What were you doing during the last three hours? <u>TALKING WITH FRIENDS</u>				
Have you been drinking? <u>SOME</u> What? <u>BEER</u> How much? <u>A FEW</u> Where? <u>EM/EW CLUB</u>				
Time started? <u>1830 HRS</u> Time stopped? <u>DON'T KNOW</u> Are you under the influence of an alcoholic beverage now? <u>NO</u>				
What is your occupation? <u>SOLDIER</u> When did you last work? <u>TODAY</u>				
Do you have any physical defects? <u>NO</u> If so, what's wrong? <u>N/A</u>				
Do you limp? <u>NO</u> Have you been injured lately? <u>NO</u> If so, what's wrong? <u>N/A</u>				
Are you ill? <u>NO, JUST TIRED</u> If so, what's wrong? <u></u>				
Did you get a bump on the head? <u>NO</u> Were you involved in an accident today? <u>NO</u> Have you had any alcoholic beverage since the accident? <u>N/A</u>				
If so, what? <u>N/A</u> Where? <u>N/A</u> How much? <u>N/A</u> When? <u>N/A</u>				
Have you seen a doctor or dentist lately? <u>NO</u> If so, who? <u>N/A</u> When? <u>N/A</u>				
What for? <u>N/A</u> Are you taking tranquilizers, pills or medicines of any kind? <u>NO</u>				
If so, what kind? (Get sample) <u>N/A</u> Last dose? <u>N/A</u> Do you have epilepsy? <u>NO</u> Diabetes? <u>NO</u>				
Do you take insulin? <u>NO</u> If so, last dose? <u>N/A</u> Have you had any injections of any other drugs recently? <u>NO</u>				
If so, what for? <u>N/A</u> What kind of drug? <u>N/A</u> Last dose? <u>N/A</u>				
When did you last sleep? <u>LAST NIGHT</u> How much sleep did you have? <u>7 HOURS</u> Are you wearing false teeth? <u>NO</u> Glass eye? <u>NO</u>				
HANDWRITING SPECIMEN <small>(Signature and/or anything he chooses)</small>		<u>Harvey D. Smith, SPA</u>		
SECTION IV - CHEMICAL TEST DATA				
TYPE OF SPECIMEN <input checked="" type="checkbox"/> Blood <input type="checkbox"/> Breath <input type="checkbox"/> Saliva <input type="checkbox"/> Urine <input type="checkbox"/> Other		TIME, DATE AND LOCATION OF TEST <u>0045 HRS, 14 FEB 75, BLANK ARMY HOSP.</u>		
ADMINISTERED BY (Name, grade, SSN & organization) <u>WILLIAM X. BROWN, MAJ, MC, BLANK ARMY HOSPITAL</u>			TEST RESULT <u>SEE ATTACHED REPORT</u>	
IF TEST REFUSED, OR UNABLE TO BE ADMINISTERED, STATE REASON				
SECTION V - VIDEO TAPE, MOTION PICTURE, VOICE RECORDINGS				
TYPE COVERAGE <input type="checkbox"/> Video tape <input type="checkbox"/> Motion picture <input checked="" type="checkbox"/> Voice		SCOPE OF COVERAGE <input type="checkbox"/> Observation <input type="checkbox"/> Performance test <input checked="" type="checkbox"/> Interview		
TAKEN BY (Name, grade, SSN & organization) <u>BROUSER</u>			REFERENCE CODE	
SECTION VI - SUPPLEMENTARY DATA				
WITNESSES	NAME	ADDRESS	TELEPHONE NO.	CONDITION
PASSENGERS IN SUSPECT'S VEHICLE	NAME	ADDRESS	TELEPHONE NO.	CONDITION

Figure 6-7—Continued.

subject's blood. Under the implied consent policy outlined in AR 190-5, any person who operates a motor vehicle on a military installation is deemed to have given consent to a chemical test or tests of his/her blood, breath, or urine for the purpose of determining the alcoholic content of the person's blood. This applies when the person is apprehended, cited, or stopped for any offense arising out of acts alleged to have been committed while the person was driving or in actual physical control of a motor vehicle, while under the influence of intoxicating liquor. (Actual physical control includes driving, operating, and even simply sitting in a position from which the vehicle could be operated, such as asleep or passed out in the driver's seat with the motor running.) The installation commander will determine the type or types of chemical tests to be administered.

(a) *Warning.* Military police will warn apprehended subjects that under the implied consent policy (AR 190-5), failure to submit to or complete a chemical test will result in a six month revocation of the subjects' installation driving privileges. If apprehended subjects ask for a lawyer prior to stating whether or not they will submit to a chemical test, they shall be told that they do *not* have the right to have an attorney present before stating whether or not they will submit to a test or during the actual test. If a subject refuses to be tested or fails to complete a test, the apprehending MP will complete a sworn statement stating why the MP had reasonable cause to believe the subject was driving (or in actual physical control of) a vehicle while under the influence of alcohol (AR 190-5). The MP shall also state that the subject refused to submit to or failed to complete a chemical test. This statement, preferably DA Form 2823 (fig 4-1, AR 190-5), when forwarded to the installation commander or the commander's designee, will enable the commander to revoke the subject's installation driving privileges. If a subject refuses to submit to a chemical test, none will be given. Charges of driving under the influence of alcohol may still be brought against the individual, however, based on other evidence.

(b) *Quantitative chemical tests of blood, urine, and other body fluids.* These tests shall be conducted by qualified medical personnel according to methods prescribed or approved by the Surgeon General or by the designated authority of the state in which the installation is located (for tests conducted outside military jurisdiction).

(c) *Quantitative chemical breath testing.*

A chemical breath testing device is an instrument which uses photoelectric or other sophisticated physical or chemical methods to quantitatively determine blood-alcohol concentrations. Instruments in this category include but are not limited to the following devices: Alco-analyzer Gas Chromatograph, Alco-tector, Breathalyzer, Gas Chromatograph Intoximeter and the Photo Electric Intoximeter. These instruments are not TOE equipment, but are normally locally procured. Breath tests are performed by qualified personnel (AR 190-5) using a quantitative chemical breath testing device approved by designated authorities of the state in which the installation is located in accordance with procedures established by such authority. In the absence of specified state operating procedures for the uses of chemical breath testing devices, the following apply:

1. Observe person to be tested for at least 20 minutes prior to collection of the breath specimen, during which period the person must not have ingested alcoholic beverages or other fluids, regurgitated, vomited, eaten or smoked.

2. Verify calibration and proper operation of the instrument by use of a control sample immediately prior to the test.

3. Comply with operational procedures set forth in the current instructional manual of the manufacturer for the instrument in use.

4. Perform preventive maintenance in accordance with procedures recommended in the manufacturer's current instructional manual.

(6) *Section V—Video tape motion picture voice recordings.* Mark (X) the appropriate blocks and enter required information in reference to the individual operating the camera/recording device. No recordings/photographs will be taken secretly or in any manner in which the subject, given normal perception, could not understand that recordings/photographs were being made. Still photographs and audio tape recordings may be used effectively. These visual and audio recording devices may be used with or without the permission of the subject. It is not necessary to warn the subject of rights in order to record the subject's image, sounds and motions with any conventional still or motion picture camera, video or audio tape recorder, or any combination of these. If, however, any questions are asked of the subject, or if the subject is requested to do anything *while being recorded*, the subject must be fully advised of all rights.

(7) *Section VI—Supplementary data.* Enter specific information concerning witnesses and passengers in the suspect's vehicle. List military police, when appropriate, if they do not appear elsewhere on the form. Use unit addresses for all military personnel. In the "Condition" column, enter the phrase that best describes the individual concerned: "evidence of intoxication," "appeared sober," "unknown," etc.

c. Blood Alcohol Concentration Standards (AR 190-5). For administrative and enforcement purposes, certain concentrations of alcohol in a person's blood are presumed to cause certain levels of intoxication. These levels may be modified, depending on the policies of the host state or country. These standards in no way change the rules of evidence in judicial or nonjudicial proceedings under the UCMJ.

(1) 0 to 0.05 percent alcohol by weight in blood = not intoxicated.

(2) More than 0.05 percent but less than 0.10 percent alcohol by weight in blood = not necessarily intoxicated or unintoxicated . . . other evidence must be used to determine if the person was under the influence of alcohol.

(3) 0.10 percent or more alcohol by weight in blood = under the influence of intoxicating liquor.

★d. Investigative Phase. In addition to completing the DD Form 1920, military police obtain as much information as is reasonably obtainable in the investigation phase. Areas to be investigated are: when, where, and with whom the suspect drank; how much liquor and of what type the suspect consumed; the manner in which the suspect operated the vehicles; conditions surrounding the accident and/or apprehension; and physical or other conditions of the suspect which might explain the unusual behavior or apparent intoxication. The provisions of AR 190-30 and AR 195-2 must be adhered to when developing information to support an apprehension for this offense.

★e. Frequently the suspect will exhibit one or more signs of drug or alcoholic influence, such

as the strong odor of liquor (although some liquors are relatively odorless), slurred speech, use of profanity, sloppy appearance, unsteadiness on his feet, and generally irrational behavior. Ordinarily, if these symptoms or appearances are due to alcohol or drugs, the suspect is drunk (para 191, MCM 1969). In his car or on his person there may be bottles of intoxicants. Many drunken drivers who have entered the dangerous driving stage do not exhibit such obvious symptoms. Any of the many symptoms which appear to be related to intoxication may be due to some chronic or acute illness or physiological condition (diabetes, shock, amnesia, nervous disorders, speech disorders, muscular diseases, and so on). If there is any indication that the suspect is suffering from an illness, medical authorities should be contacted immediately.

★f. After it has been decided that the driver is under the influence of intoxicants, he should never be permitted to drive the vehicle. His property or provisions should be safeguarded and the vehicle driven or towed with the driver's consent, or otherwise protected in accordance with local policy. The subject is then transported to the MP station in the latter's vehicle. Local SOP, coordinated with the local staff judge advocate, will prescribe specific procedures for each post, camp, or station.

6-17. Other Violations

Attention to those principal violations which increase congestion must not preclude consideration of others which do not occur as frequently, but which collectively can become quite important. Among these violations are—

- a.* Failure to signal turns or stops.
- b.* Oversize vehicle or loads above legal limits.
- c.* Blocking of sidewalks or alleys.
- d.* Alighting from vehicle on the street side.
- e.* Depositing debris on the roadway.
- f.* Improper backing.
- g.* Obstructing a driver's view.
- h.* Bicycle violations.

CHAPTER 7

PROCEDURES FOR STOPPING VIOLATORS OF TRAFFIC LAWS

Section I. IDENTIFICATION, PURSUIT, AND APPROACH OF VIOLATORS

7-1. Identification

a. When a violation has been observed, the military police identify the violator's vehicle by noting the license number, make, color, or other easily identifiable marks. This will insure that, should the patrol lose sight of vehicle due to heavy traffic, the military police will later be able to identify the vehicle. This identification also provides evidence for subsequent administrative or disciplinary action deemed appropriate by the commander.

★*b.* The identification of military vehicles is nearly the same as the identification of privately-owned vehicles. The MP records the following:

- (1) The type of vehicle.
- (2) The bumper markings or military license plate.
- (3) Additional information to include, USA number, road clearance number (if used), vehicle classification, number of occupants, sex or other identifying features.

★*c.* Upon identifying the vehicle, the MP should check the stolen vehicle list. If the vehicle is stolen, this will give the military police time to plan what action will be necessary to protect themselves upon stopping the violator.

★7-2. Pursuit of the Violator

The most important consideration of the pursuit is safety of the military police and the public. To begin the pursuit, the patrol enters the flow of traffic swiftly, yet safely. Overtaking the violator's vehicle is done as quickly as possible but not in a reckless manner. The patrol notifies the military police station by radio when pursuit begins and when the pursued vehicle is stopped. All pertinent information such as make of vehicle, license number, number of occupants and their sex, and location must be reported. If an MP is injured, this information can assist others in apprehending the violators.

7-3. Stopping the Traffic Violator

Selection of the place where the violator is to be

stopped is largely based on safety considerations; the place should be sufficiently large to allow vehicles to park as described below. Signalling the violator to stop can ordinarily be accomplished by moderate use of lights and horn, although in some cases it may be necessary to use the siren or even to pull alongside the violator and give oral directions. Care should be taken when using the siren because some drivers become excited and confused. Some drivers react unexpectedly and without due caution which, in turn, endangers other drivers, to include the military police patrol. When the violator has been stopped, the military police vehicle is parked approximately 10 to 12 feet (1 car length) to the rear, and offset 3 feet to the left of the stopped violator's vehicle (fig 7-1). With the patrol vehicle in this position, the MP is protected to a degree from oncoming traffic while alongside the violator's vehicle, and in the event the violator attempts to ram the patrol car, evasive action can be taken to avoid being struck. When leaving the vehicle, warning lights are left on to alert other drivers of impending danger. When it becomes necessary to stop a violator on a major highway or freeway, both vehicles are pulled off the driving surface and onto the shoulder of the road as far as possible to avoid being struck by moving traffic.

7-4. Approach to the Traffic Violator's Vehicle

★*a. Vehicle Approach by Two-Person Patrol.* Depending on existing conditions, one of the three following methods may be used in approaching the violator's vehicle:

- (1) *Normal approach.* The driver and rider approach the violator's vehicle from the left and right respectively (fig 7-1 and 7-2). The MP on the passenger side stops at the right rear of the violator's vehicle. From this position the MP can observe the occupants of the vehicle and can act as a protective cover for the military police driver. The military police driver proceeds to the front edge of the driver's (violator's) door and upon checking the rear seat and floor, keeps

the violator in sight at all times. While speaking to the violator, the military police driver stands approximately 2 feet from the vehicle and in line with the front edge of the driver's (violator's) door, facing the violator. This position prevents this MP from being struck by the door if it is suddenly opened and enables the MP to observe the violator's movements and oncoming traffic.

(2) *Possible dangerous violator.* The MP driver and rider approach the violator's vehicle from the left and right respectively as in (1) above. The MP driver will stop just to the rear of the violator's door, facing the vehicle. This MP will stay back of the rear edge of the driver's (violator's) door. This will keep the violator at a disadvantage and give the MP the advantage if danger should arise. From this position the MP

can observe any actions of the occupants of both the front and rear seats (fig 7-2).

(3) *Heavily traveled streets.* On heavily traveled streets where approach from the left side would be hazardous to the MP and other traffic, and under some other conditions that make a left-side approach inadvisable, approach may be made from the right side. The MP driver should pause just to the rear of the right rear window to check the rear seat and floor. This MP then takes a position at the front edge of the right front door, facing the rear of the vehicle. This will tend to disconcert the violator because most drivers (violators) expect the MP to approach from the left side. The MP rider will assume a position where assistance can be given if the need arises.

★b. *Vehicle Approach by a Single Patrolman.*

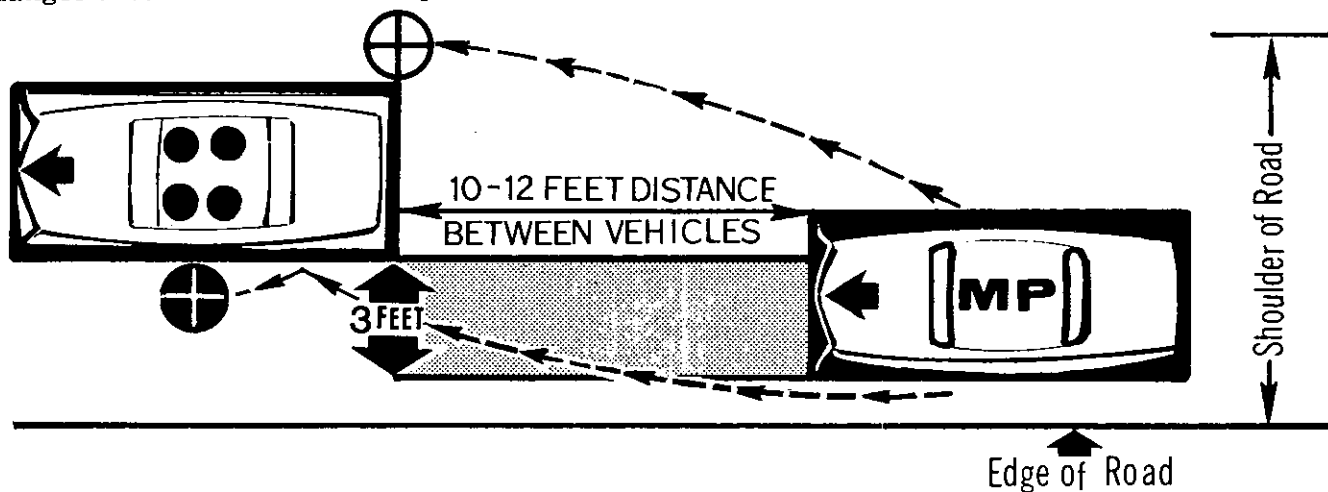

LEGEND



-  DRIVER MILITARY POLICEMAN
-  PASSENGER MILITARY POLICEMAN
-  VEHICLE OCCUPANTS

Figure 7-1. Correct position of the MP sedan in relation to the violator's vehicle, and approach to the violator's vehicle.



LEGEND

- ⊕ DRIVER MILITARY POLICEMAN
- ⊕ PASSENGER MILITARY POLICEMAN
- VEHICLE OCCUPANTS

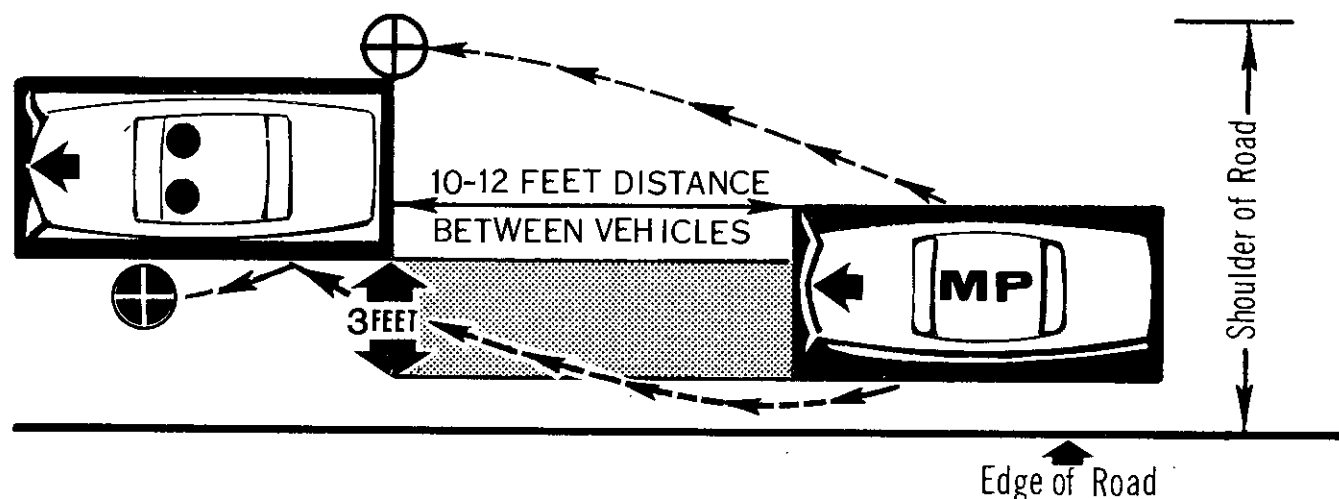
Figure 7-2. Correct approach to the violator's vehicle and position of MP when both the front and rear seats are occupied.

The method of approach to the violator's vehicle will change when military police are patrolling alone. When alone, upon stopping the violator, the MP exits the vehicle, walking up to the violator's vehicle, stopping long enough to observe the back seat and floor. The MP then proceeds to the rear edge of the violator's door. When there are occupants in the rear seat, the MP stands at a location approximately center of the violator's vehicle; this will allow an unobstructed view of both the front and rear seats.

★*c. Violator's Exit From Vehicle.* In situations where it is necessary to have the violator dismount, the MP opens the driver's (violator's) door, if traffic conditions allow, moving backwards with the swing of the door. The violator is required to move around the front of his vehicle,

with the MP following, and is directed to stand on the curb or sidewalk at the right front of the violator's vehicle. If the traffic conditions are such, and the vehicles are parked in a manner which would endanger both the MP and the violator, both exit their vehicles from the right side, away from the line of traffic. Whether exiting from the right or left, caution is always used when approaching the violator to insure the safety of the military police.

7-5. Procedures for Stopping Known Felons

★*a.* While military police are on routine patrol, sooner or later, they will come into contact with known fugitives. The patrol may recognize a wanted criminal or observe the license number of a stolen or wanted vehicle. In such a

case, the military police must immediately draw a distinction between prudence and foolhardiness. The suspected felon must be handled with care.

b. Upon making contact with the sighted vehicle of a suspected felon, the patrol must notify the radio dispatcher/desk sergeant at once (A, fig 7-3), giving the following information:

(1) The identification of the patrol unit.

(2) The location of the contact.

(3) The description of the car and the license number. If the stop is a result of a message warning the patrol to be on the "look out" for a suspect, the patrol should check to insure that the message is still in effect. The direction of travel and the name of the last street crossed should be repeated at intervals during the pursuit to permit the dispatcher and other police vehicles to map the course of travel and to hasten the arrival of the supporting units. The suspected vehicle should be followed until help arrives or assistance is known to be close at hand. While trailing the suspected automobile, the patrol should be alert for sudden stops, turns, or other evasive tactics.

★c. Before the attempt to halt the suspect can be made, the pursuing patrol must select a suitable stopping site (B, fig 7-3). Sites near alley entrances, openings between buildings, vacant lots, and other easy escape routes must be avoided. At night a well-lighted site will enable the pursuing patrol to observe whether or not the suspect is disposing of any evidence or weapon. When a suspect vehicle is stopped on a highway, the apprehending MP must exercise the same care the MP would in effecting a traffic stop to prevent endangering other motorists. If an off-the-road parking area is not available or the situation calls for an immediate stop, a level stretch of roadway in full view of the general public and traffic should be selected. Also, the emergency dome light or flashers should be left in operation. A location which is familiar to the patrol will help. The patrol will be able to direct additional assistance to the spot more quickly, and will be in a better position to make an apprehension if the occupant attempts to flee.

★d. After the stopping site has been decided upon, the military police should overtake the suspect. The patrol must be careful to guard

against any evasive action. The patrol vehicle, emergency light and siren operating, is driven almost abreast with the suspect's car until the front door of the police car is in line with the rear door of the wanted vehicle (C, fig 7-3). About 8 to 10 feet should be allowed between the two cars. Care must be exercised during this maneuver to avoid over-shooting the vehicle and to prevent the suspect from swerving into the police car.

★e. When the suspected felon has been signaled to the curb and parked, the patrol follows the wanted motorist to the designated location, parking about 10 feet to the rear in an offset position to the left of the suspect car with the front end angled toward the center of the street (D, fig 7-3). This position gives the military police maximum visibility and the use of the vehicle's engine block as a protective shield. Then, the MP, with weapon drawn, but without a round chambered, leaves the patrol vehicle from the left door. The MP assumes a position next to the left front fender of the MP vehicle. Extreme caution must be maintained. The suspect is kept under constant observation. At night, if a spotlight is available, it should be adjusted to concentrate its beams into the interior of the suspect's car. The headlights are also used to provide further illumination. The flashing emergency light should be left on to assist the supporting units to find the location of the stopped car and to warn oncoming traffic of a hazard in or near the roadway.

★f. The senior MP must assume immediate command of the situation (E, fig 7-3). The senior MP commands, in a loud, clear voice—"MILITARY POLICE, YOU ARE UNDER APPREHENSION! TURN OFF YOUR MOTOR AND DROP YOUR KEYS ON THE GROUND!" Even though the military police are in a military police vehicle and uniformed, this forceful command will serve to remove any doubt as to identity, purpose and ability of the MP. If the suspect is known to be armed, the MP weapon should be ready for use. The pistol should be removed from its holster only when its use is imminent and justified. (See FM 19-5 for specific instructions on the use of force.) The senior MP then orders the suspect to place both hands on top of his head, the palms of both hands against the windshield, or both hands

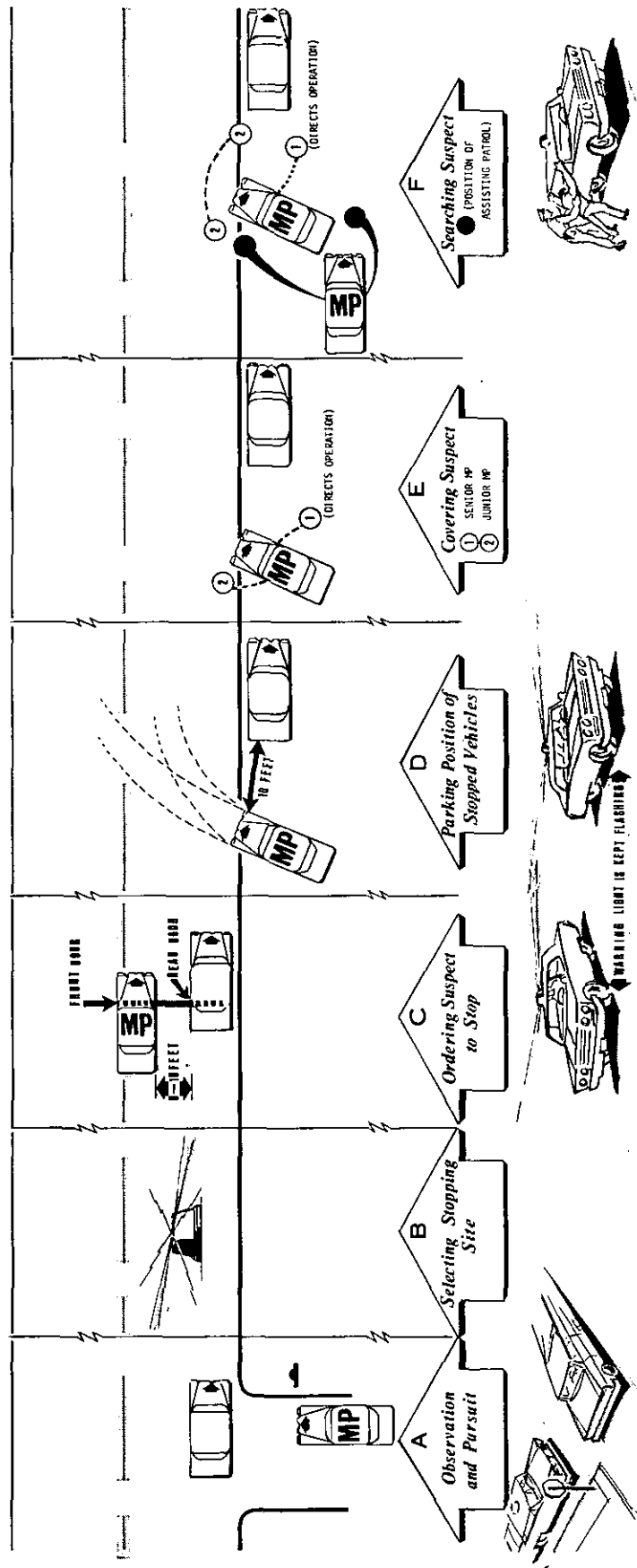

Figure 7-3. Stages in stopping the felony suspect.

FM 19-25

and arms out of the left front window, hands empty where they may be observed. Any three of these positions may be employed at the discretion of the senior MP. If there are several occupants in the car, a combination of these orders may be used. The driver and front seat passenger may be directed to place their open hands against the windshield while the occupants of the rear seat are ordered to place their hands on top of their heads. The situation will dictate the method to employ. It must be remembered that the purpose of these precautionary measures is to immobilize or restrict the movements of the suspects and to keep their hands in sight at all times. Further, it is important that the senior military policeman is in charge of the situation at all times.

g. If help arrives at the scene, the assisting patrol parks its vehicle behind the first patrol's vehicle. Then, the assisting patrol is briefed on the situation and assumes the position shown in F, figure 7-3. The presence of the second patrol must be made known to the suspect. This may be accomplished by having the senior MP instruct the assisting patrol to cover the curb side of the suspect's vehicle or by some other remark meant to be heard by the suspect driver which will leave no doubt as to the presence of

the additional help. Revealing the presence of the assisting patrol reduces the possibility of a sudden attack. With the arrival of help it is imperative that only the senior MP from the first patrol direct the operation. His command of the situation should be clear and complete. His bearing, words and actions must all reiterate the certainty of his purpose.

h. When removing suspects from the automobile, the stopped vehicle containing one occupant is ordered—"DRIVER OPEN THE CAR DOOR AND GET OUT WITH YOUR HANDS UP!" After the suspect has been removed from the automobile he is ordered to *keep* his hands up or resting on his head. He is then ordered to assume the wall search position against the car. The junior MP acts as guard while the senior MP enters the suspect's vehicle from the right hand side and checks the interior for other suspects, weapons, contraband, or other evidence. Upon completion of this cursory field search, the car is locked. The prisoner is then given a thorough search before being handcuffed and transported to the provost marshal's office. If there is more than one occupant in the suspect's car, assistance should be used when the occupants are ordered to get out of the car. However, the covering and searching procedures remain the same.

Section II. DEALING WITH VIOLATORS

7-6. Dealing With the Violator

a. When dealing with a violator, the military policeman maintains the highest degree of military courtesy and bearing. If the violator is an officer a salute is rendered. Military titles, "Sir" or appropriate civilian terms will be used at all times.

b. The military policeman greets the violator, identifies himself, and informs the violator of the reason that he was stopped, and the action to be taken (i.e., warning, citation, etc.). An example is—

"Good morning, Sir, I am Pvt Doe of the Post Military Police. I stopped you because you were driving 30 mph through a 20 mph zone. I am going to issue you an Armed Forces Traffic Ticket. May I see your driver's license, vehicle registration, and ID card (if appropriate), please?"

c. Normally, the violator may offer excuses,

rationalize his action or admit his guilt. The military policeman should allow the violator to talk. This will allow relief of the tension that normally builds up in an individual when he is stopped by the military police.

d. Extreme care must be exercised to insure that the rights of the traffic offender are not violated. The guidelines to follow are—

(1) Do not ask such questions of the violator as, "Were you speeding? Why were you speeding? Didn't you see the stop sign?" etc.).

(2) If it is necessary to ask questions, first warn the individual of his rights (Article 31, UCMJ).

(3) When the military policeman has reason to believe the violator is suspected of committing an offense other than the traffic offense, he immediately warns the violator of his rights (Article 31, UCMJ).

7-7. Enforcement Action

a. Next, the military policeman takes the appropriate enforcement action without wavering because of excuses or "reasons" for the violation, or by letting the violator's personality or persuasion change his intended action. The action is completed when the violator is allowed to proceed, or in the case of a serious violation is apprehended and accompanied to the military police station.

b. When the appropriate action is complete, the violator's documents are returned to him one by one; an example is—

"Sir, here is your ID card, here is your license, and here is your registration. This is an Armed Forces Traffic Ticket, would you please note the instruction on the reverse side. Thank you, sir. Good morning."

c. If the violator is permitted to proceed under his own recognizance, the military policeman assures that the violator's vehicle returns safely into the flow of traffic. Ideally, the violator's vehicle should be allowed to enter the flow of traffic without police control when a safe opportunity occurs. When traffic is so heavy as to preclude this, the military policeman safely stops traffic to allow the vehicle to proceed safely.

7-8. Referral of Minor Offenses and Uniform Violation Notices to US District Courts

a. AR 190-29 prescribes basis objectives and procedures implementing the Federal magistrate system by the Department of the Army. The provisions of the regulation apply to all US Army installations situated within the judicial district of a United States District Court.

b. The US magistrate system provides the Department of the Army with the means to process and dispose of certain categories of minor offenses by mail. Under this system, US magistrates and district courts will, by local court rule, preset fines for the bulk of minor violators who do not contest the charge nor wish to have a court hearing, to pay their fines by using mail-in, preaddressed, franked envelopes furnished to them with violation notice, DD Form 1805.

c. Installation commanders are encouraged to refer all minor traffic offenses, committed by military personnel, to the appropriate US magistrate/district court. Nontraffic related minor offenses committed by military personnel will not

be referred to these courts. They will be governed by the provisions of the Uniform Code of Military Justice.

d. Minor offenses, as used in this regulation, (AR 190-29), refer to those offenses for which the authorized penalty does not exceed imprisonment for a period of 1 year, or a fine of not more exceed imprisonment for a period of 1 year, or than \$1,000 or both (18 USC 3401 (f)). This does not include violations of post traffic regulations, which are prosecuted under UCMJ, but does include violations of those provisions of state traffic laws which are made applicable to the military reservation pursuant to provisions of section 13 of title 18, United States Code (Assimilative Crimes).

(1) In these applicable cases, the law enforcement personnel will issue DD Form 1805, Violation Notice, in each instance where referral to the US magistrate is deemed appropriate, or as directed by appropriate installation or provost marshal policy.

(2) The local District Court rules will specify the offenses which may be brought before a US magistrate.

(3) The US Magistrate District Court rules are applicable to military personnel as well as civilians on property over which the US has criminal jurisdiction.

7-9. Implementation of the United States Magistrate-District Court System

a. The objectives of the US magistrate system are to provide—

(1) Efficient, minimal commitment of judicial and clerical time through a procedure which centralizes the collection of fines, the scheduling of hearings (when violators request them), and the keeping of records.

(2) A simple but sure method of accounting for fines collected and tickets issued.

(3) Convenience to the public.

(4) Better enforcement of minor offense laws.

b. *Court Appearances.*

(1) *Mandatory appearances.* As required by the Administrative Office of the United States Courts, each District Court will determine by local court rule those offenses requiring mandatory appearance of violators. Installation provost

VIOLATION NOTICE FILED IN UNITED STATES DISTRICT COURT | 25 OFFICER NO. | DATE OF NOTICE | 10 JULY 71 | CASE NO. | 12971

VIOLATION CHARGED 1 IF THIS BOX

VIOLATION NOTICE FILED IN UNITED STATES DISTRICT COURT | 25 OFFICER NO. | DATE OF NOTICE | 10 JULY 71 | CASE NO. | 12971

VIOLATION CHARGED 1 IF THIS BOX

VIOLATION NOTICE FILED IN UNITED STATES DISTRICT COURT | 25 OFFICER NO. | DATE OF NOTICE | 10 JULY 71 | CASE NO. | 12971

VIOLATION CHARGED 1 IF THIS BOX

VIOLATION NOTICE FILED IN UNITED STATES DISTRICT COURT | 25 OFFICER NO. | DATE OF NOTICE | 10 JULY 71 | CASE NO. | 12971

VIOLATION CHARGED 1 IF THIS BOX

ISSUING OFFICER'S COPY

DMV COPY

CVB COPY

VIOLATION CHARGED

I CERTIFY THAT THE BELOW DESCRIBED VEHICLE AND OR PERSON DID VIOLATE APPLICABLE LAWS OR REGULATIONS OF THE STATES OR ITS AGENCIES.

OFFICER'S SIGNATURE: *John C. Roe*

VIOLATION CHARGED

TRAFFIC: PARKED, OVERTIME, PARKED IN RESTRICTED ZONE

NON-TRAFFIC: EXCEEDED SPEED, LIMIT BY DRIVING, OTHER

VISIBILITY: DAY, NIGHT, FOG/RAIN/SNOW, LIGHT, HEAVY, MEDIUM, DRY, WET, SNOW, ICE

IF AN ACCIDENT EXCEEDS \$1000: PROP. DAMAGE, PERSONAL INJURY, ADM. HOSP., NOT ADM. HOSP.

AGAINST OWNER OF THIS VEHICLE

Color of Vehicle: Green State: Georgia Driver's Permit No: 256812 No: 6353181

Make of Vehicle: Ford Body Type: 2Dr HT Address: 1811 South 133rd St, Centerville, Ga. City: Centerville State: Ga.

DATE OF BIRTH: 12/3/45 SEX: M F HEIGHT: 6'1" WEIGHT: 190

VIOLATION NO.: 12971 STATE: Ga. TAG NO.: EKE-1573 LAST NAME: Smith FIRST NAME: Alfred INIT: M VIOL LOC: 651 FINE: \$2,000

1 IF THIS BOX IS CHECKED YOU MUST APPEAR IN COURT AT ABOVE ADDRESS

2 CHECK THIS BOX IF YOU WISH TO APPEAR

3 COURT CLERK'S INITIALS HERE AND CHECK IN BOX BELOW WILL INDICATE CASE WAS CLOSED AND DOCKETED UPON RECEIPT OF PAYMENT. PERSONAL CHECK ASSUMED UNLESS "X" HERE

VIOLATOR MUST DO

1 **2** or **3**

1 PRINT YOUR NAME & ADDRESS IN SPACES AT THE BOTTOM OF THIS FORM.

2 MAIL WITHIN 7 DAYS. IN THIS POSTAGE-FREE ENVELOPE, CHECK OR MONEY ORDER FOR AMOUNT OF THE FINE WHICH THE COURT HAS SET OR THIS OFFENSE. PAYMENT WILL SIGNIFY THAT YOU DO NOT TEST THIS CHARGE REQUEST A COURT RING.

3 IF BOX "A" HAS NOT BEEN CHECKED YOU MAY AUTHORIZE THE COURT OR ITS OFFICERS TO DISPOSE OF THIS VIOLATION BY MAIL AS FOLLOWS:

Figure 7-4A. DD Form 1805, Violation Notice.

marshals will coordinate with local magistrates of district courts and secure a court-approved list of offenses requiring mandatory appearance of violators before the local US magistrate. General guidelines governing mandatory appearance offense categories include—

- (a) Indictable offenses.
- (b) Offenses resulting in accidents.

(c) Operation of a motor vehicle while under the influence of intoxicating alcohol or a narcotic or habit-producing or other mind-altering drug, or permitting another person, who is under the influence of intoxicating alcohol or a narcotic or habit-producing or mind-altering drug to operate a motor vehicle owned by the defendant or in his custody or control.

(2) *Voluntary appearances.*

(a) Requested by violators at the time violation notice, DD Form 1805, is issued.

(b) Law enforcement officials issuing violation notice, DD Form 1805, will refer violators for hearings before US magistrates in each instance where a hearing is requested by the violator.

(3) *Provost marshals.* Provost marshals will provide enforcement personnel with necessary information to facilitate scheduling violators to appear before US magistrates. Box B of the Violation Notice, DD Form 1805, will be marked by the issuing military policeman for each violator requesting hearing. Additionally, procedures set forth in paragraph 7-10 will be accomplished by the official issuing the violation notice.

(4) Requested by violators by mail.

(a) Voluntary appearance procedures are also available for violators who are not present at the time a violation notice is issued (i.e., parking violations) or who subsequently decide to voluntarily appear before a US magistrate rather than pay the fine indicated in the violation notice, DD Form 1805.

(b) Violators, who use the mail-in procedure to voluntarily appear before a US magistrate, must follow the instruction in Box B of the violation notice, DD Form 1805 (violation copy). The violator will be notified by the clerk of the district court of the time and place to appear for the scheduled hearing.

7-10. Preparing the Violation Notice

a. General. The heart of the US magistrate system is a four-ply ticket designed to provide legal notice to the violator and all other records needed by the court, law enforcement authorities and, if appropriate, the state motor vehicle departments. The DD Form 1805 is

printed on chemically carbonized paper and prenumbered in series for accounting control. The violation notices will be bound in groups of 25 tickets per book and prenumbered in series. These books will be issued through the Army Adjutant General Publications channels to installation law enforcement agencies. Accountability for books issued will be maintained by the appropriate service-centralized issuing authorities. Installation or Army provost marshal offices are responsible for maintaining accountability for the tickets, both issued and stocks on hand (fig 7-4A, 7-4B).

b. Issuing the Violation Notice.

(1) *Information.* The information to be written on the violation notice depends primarily on two things—

(a) The type of violation—parking, moving, or non-traffic, and

(b) Whether the offense requires an appearance in court.

(2) *Mailable fine offenses.*

(a) The military policeman writes the four part Violation Notice before removing it from the book. The amount of the fine for the particular offense must be recorded in the lower right corner of the ticket. This amount will always be predetermined by the US magistrate and provided to the duty military policeman by the provost marshal. If the violation notice is issued for a parking violation and the offender is absent, all entries concerning the violator will be left blank. The fourth copy (court-addressed envelope) will be issued to the violator, or placed on the violator's vehicle, if it is a parking violation. Copies 1, 2, and 3 will be returned to the provost marshal's office for disposition. Copies 1 and 2 will be forwarded with a transmittal form to the appropriate US District Court. *Military law enforcement agencies will not accept or otherwise collect any fines or keep track of fines paid or unpaid. Further, they will take no action concerning nonpayment delinquencies except where warrants are subsequently issued for the violator concerned by appropriate court authorities.*

(b) The US magistrate will provide installation PM with a list denoting the amount of fines for specific minor offenses. These lists must be detailed and provide adequate information to determine those offenses which require mandatory court appearances as distinguished from those offenses which will permit the violator to mail in his fine.

★(3) *Mandatory court appearance offenses.* The mail-in fine procedure will not apply in

Remove Tape, Pass
 Adhesive To Clean
 Smooth Dry Surface

1) **DO NOT SEND CASH BY MAIL. USE A PERSONAL CHECK OR MONEY ORDER MADE PAYABLE TO CLERK, U.S. DISTRICT COURT. WRITE THE VIOLATION NUMBER ON THE FACE OF YOUR CHECK OR MONEY ORDER.**

2) **IF YOU FAIL TO RESPOND WITHIN SEVEN DAYS TO THE INSTRUCTIONS ON THE VIOLATION NOTICE, OR FAIL TO COME TO COURT AT A TIME SCHEDULED FOR YOU TO APPEAR, YOU MAY BE SERVED WITH A SUMMONS OR WARRANT ORDERING YOU TO APPEAR, AND THE COURT MAY INCREASE YOUR FINE OR IMPOSE ADDITIONAL PENALTIES.**

3) **IF YOU PREFER TO PAY IN PERSON YOU MAY COME TO THE ADDRESS ON THIS ENVELOPE, OR TO**

CLERK U.S. DISTRICT COURT
 (SAME ADDRESS AS BELOW)
 FOR OFFICIAL COURT BUSINESS



POSTAGE AND FEES PAID
 UNITED STATES COURTS

CLERK, UNITED STATES DISTRICT COURT

Figure 7-4B. DD Form 1805 (Mail-in Envelope).

these cases, therefore, the violation notice will be processed differently. The MP will check Box "A" on the violation notice for all mandatory court appearance offenses. Based upon established instructions from the district court ((1), above), the MP will fill in the name and location of the magistrate before whom the violator must appear. (This goes (fig 7-4A) on the line below "United States District Court.") The MP will enter the date and time of the appearance in the space provided. The MP will not indicate any amount in the box marked "Fine." For each mandatory appearance case, the applicable provost marshal will forward copies one and two of the violation notice (within 24 hours) to the magistrate designated for the appearance. Copy three will be retained for file in the installation provost marshal's office. Copy four will be given to the violator. Further record keeping, the docketing of what happens at the hearing or at any additional proceedings, and the record of the case's disposition will be the responsibility of the magistrate concerned. Provost marshals will coordinate with appropriate magistrates/district courts to determine the disposition for all traffic cases in order to post driver records as required by AR 190-5.

(4) *General guidance.* General guidance concerning the preparation of the violation notice is provided in c, below.

★c. Information which is required when DD Form 1805 is issued.

- (1) All violations will require—
 - (a) The identification number of the MP preparing the form.
 - (b) Date of notice. (This is also the violation date unless otherwise shown.)
 - (c) Description of violation, including place and time if applicable.
 - (d) Violation code number and issuing location code number.
- (2) Parking offenses will require the above items (1) and the following:
 - (a) Vehicle description (make, color, body type).
 - (b) Licensing state.
 - (c) Auto license number.
 - (d) If the violator is present, the following information is included:
 1. Driver's permit number.
 2. Driver's address.
 3. Driver's name, rank, SSAN, and unit if the subject is in the military. If the subject is a civilian, enter status (e.g., "Dependent," "DAC," or simply "Civilian"). This information will be entered at the bottom of the form, below the subject's name.
- (3) All the information of (1) and (2)

above is required for moving violations *plus* the following:

- (a) Birth date and sex of driver.
- (b) Race (if it appears on driver's permit).
- (c) Height and weight.
- (4) Non-traffic offenses require the information listed in (1) *plus* the following:
 - (a) Person's name.
 - (b) Violator's address.
 - (c) Violator's birth date and sex.
 - (d) Also, if applicable, the race, height, and weight is added.

(5) On all *ailable disposition offenses*, the amount of the fine (collateral) must be shown.

(6) All *andatory court offenses* require the appropriate information listed above and also the following:

- (a) The place of court (i.e., magistrate court address).
- (b) The date and time of appearance (if known by officer).
- (c) Check the at position "A."

7-11. Written Warnings

The military policeman may be required to issue written warnings for those violations and/or under conditions which are outlined by local command policy. Written warnings, using the Armed Forces Traffic Ticket (DD Form 1408) serve as a record and as a basis for other military police or command actions. The warning can be useful enforcement tool, but prescribed procedures must be closely followed to prevent the military policeman from assuming the duties of the commander and the courts. Several written warnings to an individual, viewed collectively, can indicate either a disregard for traffic regulations and traffic safety, or an inadequately trained driver. On copy number 2 of the warning ticket, the military policeman enters the circumstances which prompted him to issue a warning rather than a citation. In either case, normally, the unit commander should be formally notified when three or more written warnings have been issued to a member of his command within a period of 6 months.

7-12. Related Action

As in other traffic duties the military policeman performs other actions while stopping a traffic violator. This includes checks for stolen vehicles, pass and leave documents, license and registration, and other such actions as may be directed.

7-13. Witnesses

For serious violations the names and addresses of all personnel who witnessed the violation should be secured and recorded. It may be necessary in some circumstances to request written statements from witnesses. In such cases the military policeman prepares a detailed written statement of his observations. It must be remembered that the MP's duty does not end with preparation and filing of his report. He must be prepared to testify in court. His written statement will be of considerable value to the counsel preparing the case for trial.

7-14. Protection of Property

a. It is the responsibility of the military police to protect the property of each person apprehended so that it may be returned to the individual in the condition in which it was received. To provide protection to both the military policeman and the person apprehended, all property is inventoried and a chain of custody maintained.

b. When, for a cogent reason, a vehicle must be impounded by military policemen, the provisions of local policy are strictly adhered to. Considerations in forming local policy should include the extent of Federal jurisdiction, liability which may be incurred by the military when moving or storing a vehicle which has been seized; place of seizure, and conditions under which the vehicle entered the military reservation.

7-15. Reports

All enforcement actions of the military police are reported to the military police headquarters by written reports. The military police patrol report is used to record a summary of all patrol activity to include traffic enforcement. Other traffic reports include—

a. The Armed Forces Traffic Ticket (DD Form 1408) form is used by all services to report traffic violations. Normally, a book of these forms, numbered consecutively, is issued to the military policeman and must be accounted for. They may be used to report the following traffic violations—

- (1) Speeding.
- (2) Improper turns.
- (3) Disobeying a traffic control device.
- (4) Improper passing.

- (5) Improper lane use.
- (6) Following too close.
- (7) Failure to yield.
- (8) Other violations (usually listed in local SOP).

b. The Military Police Report (DA Form 19-32) is completed when the offense is serious. Examples of types of offenses reported on this form include drunken driving, failure to stop for military police, driving without a license and

reckless driving. It is not normal procedure to complete a DA Form 19-32 on a violation that is reported on an Armed Forces Traffic Ticket.

c. The use of DA Form 19-32 as a letter of transmittal for DD Form 1408 is recommended in those cases where offenses must be reported to a command away from the installation where the violation occurred. Only the heading and offense blocks of DA Form 19-32 need be completed, accompanied by a comment in the "Remarks" section, to see attached DD Form 1408.

PART THREE
TRAFFIC CONTROL IN THE THEATER OF OPERATIONS
CHAPTER 8
GENERAL PRINCIPLES, PLANNING, AND SUPERVISION

8-1. General Principles

a. The primary movement of men and material in a theater of operations is on the ground. Increasing numbers of motor vehicles have provided additional ground mobility, but have compounded the control problems of the commander. One of the major tools the commander has available for use in ground mobility control is the military police unit.

b. While the general principles of traffic control presented for posts, camps, and stations are valid in the theater of operations, their implementation and techniques of traffic control take on a new and expanded meaning.

c. The basic principle of traffic control in the theater of operations is the insurance that the authorized road traffic moves efficiently, on schedule, with a certainty of arrival at the intended destination.

d. In part two of this manual emphasis was placed on the activities of the military policemen working alone or in pairs, since most traffic control actions conducted at a post, camp, or station require only one or two military police on the task. Ideally, traffic control in the theater of operations requires that a team of three or more military police be used for each task.

8-2. Supervision in a Theater of Operations

★*a.* Provost marshal supervision of traffic control operations in a Division, Corps, and COMMZ does not materially change from those requirements stated previously in this manual. The basic principle of smooth and efficient traffic flow is embraced in the traffic circulation plan issued by a highway traffic headquarters. In theater of operations, the G4 (ACofS, Logistics) provides the traffic circulation plan from which the provost marshal or traffic officer in the headquarters prepares the traffic control plan.

★*b.* Major commands (TAACOM, Corps, or Division) have the capability of providing a

highway traffic headquarters to regulate scheduled movement on all highways in the area for which it has responsibility. The highway traffic headquarters has, organic to it or furnished, personnel who can advise its officer in charge on highway regulation matters. For example, the Military Police representative plans for and advises on traffic control matters while the Engineer representative plans for and advises on matters concerning road capacity and durability.

c. The highway traffic headquarters produces the traffic circulation plan, issues instructions which regulate scheduled traffic movements, coordinates scheduled movements with higher and adjacent headquarters, and monitors those movements on the highways in its area of responsibility. This headquarters is a regulating agency which supervises scheduled movements, e.g., the march table provides information needed to control traffic by identifying units that will pass over specific portions of a route at given times and dates.

★*d.* After the traffic circulation plan is completed, and march orders and tables are issued, the responsibility for traffic control rests with subordinate commanders. The provost marshal at division level or military police traffic control personnel of military police units in Corps or COMMZ assist in the control of traffic. Normally, supervision of the traffic control activities of scheduled movements rests with the commander, but he is assisted by the provost marshal and the military police. Military police on traffic control posts report the progress of traffic to the highway traffic headquarters. Major changes in traffic circulation made by military police are reported immediately to traffic headquarters. Such changes are normally coordinated with traffic headquarters *prior* to execution and are based upon prior approved plans. Changes made in emergencies, i.e., emergency rerouting, are executed and re-

ported immediately. Normally, such changes made without approval of traffic headquarters are minor and have no great impact on the overall circulation and control plans.

e. The following is a guide to the relationship between the military police and the road user:

(1) The commander of troops using the road is responsible for tactical situations that may arise.

(2) Commanders of units not complying with traffic regulations or schedules will be advised of the applicable regulations. If the commander elects not to comply with the cited regulations, the military police will assist him to the extent of their ability and, as soon as possible, will report the incident to the military police unit, and make a permanent record of the incident.

(3) Whenever possible, military police will assist personnel performing highway regulation duties. Close coordination and cooperation are essential.

★(4) Procedures for handling refugees and local inhabitants on the roads will be published by the military police unit. Civil affairs units normally have responsibility for these persons, but military police units will take necessary action to control the roads. Provisions for tactical interrogation of refugees and local inhabitants for information of military intelligence interest should be addressed in military police unit SOP.

8-3. Preparation

Individual preparation on the part of the military policeman in the theater of operation follows the same general line of operations within a post, camp, or station. While the general pattern is the same, some of the specifics vary. In place of military police leather equipment, the military policeman wears the same field equipment as other soldiers. To distinguish him from other soldiers, he wears the military police brassard, and his helmet is marked according to AR 670-5. Those military police assigned traffic-type duties will also be equipped with luminous sleeves and vests. These identify the individual to both US forces and US allies as a policeman responsible for the control of traffic. Other equipment, such as flashlights, automatic weapons, vehicles, and communication equip-

ment, is prescribed by TOE for each military police unit.

8-4. Theater of Operations Planning

a. Many of the planning principles and factors applicable to post, camp, or station operations are also applicable (chap 2 through 7) in a theater of operations. Large military installations and complexes or towns and cities within the theater require the same or similar considerations.

★*b.* The traffic control plan provides guidelines for the commander and the highway traffic headquarters with information as to how the military police can assist commanders in the control of traffic in a given geographical area. Safety, though a lesser consideration in the control of combat traffic, must not be forgotten. Many of the efficient traffic control techniques add safety features which also make movement efficient. Traffic control posts expedite movement of traffic and eliminate conflicting vehicular flow and similar hazards.

8-5. Briefing

a. The briefing of the military policeman is of primary concern in his preparation for traffic control duty. This briefing may be conducted in the format of an operation order (for detail, see FM 101-5); it may be a published order supplemented by oral instructions; or it may be simply an oral order. Its extent is determined by the situation. While it is highly desirable for all military police involved in a task to receive the same briefing, frequently, due to security, time, or space restrictions, only the team and squad leaders can be briefed. Then, these leaders will insure that their military police are briefed on their duties. The briefing should follow this format:

(1) *General.* Title or general description of the task.

(2) *Maps.* Maps, overlays, strip maps, and sketches that are necessary for the task are presented.

(3) *Task organization.* The military police task organization, describing the assignment and designation of each individual man and team is explained.

(4) *Traffic and road situation.* This is a

summary of the traffic control plan, the highway regulation plan, the refugee movement plan; and the applicable results of route reconnaissance are presented.

(5) *The enemy situation.* This portion includes a summary of present enemy activity in the area, what can be anticipated in the immediate future, and the possibility of nuclear, chemical, biological, or air activity.

(6) *Weather information.* The weather information is restricted to that which has a direct effect on the use of the road, such as expected precipitation, cloud cover, temperature, wind, and periods of light and dark.

(7) *Friendly situation.* This includes the location of those units which can render assistance or service. These include ordnance units for wrecker service, medical units for emergency aid, and adjacent or nearby units that can reinforce the military police. Included in the friendly situation are all points and units whose locations the military police need to know to perform their function. This information usually is presented on a map or overlay.

(8) *Mission.* The mission which the military police will perform is spelled out in detail. It answers the questions WHAT, WHEN, WHERE, and sometimes WHY tasks must be accomplished.

(9) *Specific tasks.* Each squad, team, and individual is told the specific tasks he is expected to do and how it will be done.

(10) *Annex to written orders.* The coordinating instructions are applicable to two or more individuals or teams. Examples of such an instruction would be changes to the SOP, emergency rerouting instructions, straggler and refugee disposition, and similar information. When the military police duties involve movement schedules, appropriate instructions are published or may be issued as an annex to written orders.

(11) *Logistics.* Information is furnished concerning resupply, maintenance, water sources, and meal planning.

(12) *Signal.* An excerpt of the SOI that is to be used by the military police will be issued. It will contain radio call signs, frequencies, and authentication tables.

(13) *Command post.* Normally, the last item of a briefing is the announcement of the location of the military leaders and commanders involved in the mission to be accomplished.

b. The preceding subparagraph presents most areas of interest to the military policeman detailed to perform a mission; however, it may be necessary to issue some of the above information and instructions and other special considerations as annexes to written orders or as a special briefing. When military police perform repetitive or continuous duties, a printed collection of information and instruction may be issued to the military policeman as an SOP.

8-6. General

Normally, a military police unit is not assigned an exclusive functional mission such as traffic control. Rather, the military police unit provides military police functions and activities on an area basis. The military police platoon is the basic unit of employment by the company. Platoons are normally assigned an area of responsibility on a mission type order with supplementary instructions.

8-7. Planning for Employment of a Platoon

a. Upon receipt of orders the platoon leader analyzes the order and makes an estimate of the situation (FM 101-5).

b. Particular areas of traffic interest to the platoon leader include—

- (1) The assigned mission of the platoon.
- (2) The positions or activities that the military police company has specifically directed.
- (3) The results of route and area reconnaissance.
- (4) The anticipated road use.
- (5) The intelligence reports and predictions of enemy activity.
- (6) The availability of traffic control equipment which would affect the platoon manpower.
- (7) The equipment and the number of military police available.

c. Squad and team integrity is maintained whenever possible.

d. The platoon leader issues detailed oral orders to the squad and team leader. These orders follow the briefing format presented in paragraph 8-5 (also the operation order in FM 101-5).

FM 19-25

8-8. Duties of the Platoon Leader and Platoon Sergeant

a. The platoon leader and platoon sergeant must be capable of relieving each other. A platoon command post is established at a critical traffic post or other position where either the platoon leader or sergeant is located while the other is patrolling the platoon area.

b. Constant checking, supervising, and adjusting of traffic control activities are the principal duties of the platoon headquarters. These include—

(1) Evaluating personnel and equipment status against the requirements of assigned duties.

(2) Adjusting traffic control to changing traffic conditions.

(3) Directing military police activities during an enemy attack.

c. The platoon headquarters is the principal source of information on traffic control. It must keep the parent unit informed of platoon commitments and current capability.

8-9. Squad

Military police assigned to traffic control duties are normally employed as squads. Escorts and defile duties lend themselves to the employment of an entire squad. TCP and motor patrols each usually employ a team; however, when assigning tasks, the platoon leader assigns elements of the squad to adjoining posts or areas to maintain unit integrity and facilitate control.

CHAPTER 9

TRAFFIC CONTROL POSTS

Section I. ORGANIZATION AND EQUIPMENT

9-1. General

Traffic Control Post (TCP) is a point located on the ground where the military police control traffic. The selection of the location of the TCP is made by the military police unit or by military police planners at a higher headquarters. The TCP is established only where it is necessary for the control of traffic, to expedite it, and to prevent congestion. While performing its principal function the TCP also acts as a security point and performs other military police functions.

9-2. Organization

a. A type TCP team is composed of a senior military policeman and three other military policemen. Often there will be more than four military policemen assigned to this duty. The team must be provided with the means of traffic control, communications, and security for continuous operations.

b. When organizing a traffic control post the key word "METT" may be used as a guide for making an estimate of the situation. (For details on making an estimate of the situation, see FM 101-5.)

(1) M stands for Mission to be accomplished. While the mission may be simply stated as "establish a TCP," there may be many induced tasks, such as the TCP acting as a counterguerilla post.

(2) The E stands for the Enemy and his capability. Enemy capability must be considered and counter action must be evaluated.

(3) The first T introduces the consideration of the Terrain. The primary consideration is given to the road net, including bypass roads and holding areas.

(a) When estimating the influence of terrain, the following list will serve as a guide (for detail, see FM 7-11):

1. Observation and fields of fire.
2. Concealment and cover.
3. Obstacles.
4. Key terrain features.
5. Avenues of approach.



Figure 9-1. Correct stance assumed by a military policeman while directing traffic in the theater of operations.

(b) While not listed as an element of terrain, weather is another important consideration that affects the organization of a TCP. The weather often has a direct influence on the use of roads and is an important consideration in security.

(4) The last T is used to call attention to the Troops available; this is often a limiting factor.

c. Considering all the factors, tasks are assigned to each individual and equipment is allocated to accomplish the mission. Using the four man teams as the type TCP, task assignment considerations would involve—

(1) The assignment of one man to actually control the flow of traffic. His position in the roadway or intersection is determined in the same way as an individual engaged in point control. When he is not engaged in actual control of traffic, or during periods of attack, he will be located in a defensive position close to the roadway.

(2) All around security is provided by assigning one man at a security post. The selection of the site of this post will be based on the terrain. If possible, this individual should be located where he can cover the military policeman performing traffic control and serve as an observer over likely avenues of approach. A means of signaling and communication must be established between this post and other members of the team.

(3) The senior military policeman of the team maintains control of all classified or sensitive material such as maps, codes, and schedules. He directs the control of communication at the site. Persons seeking more detailed information than can be given by other team members are directed off the traveled roadway to the senior military policeman.

(4) The fourth member of the team is normally located at a rest position in the immediate vicinity of the senior military policeman. This member is only engaged during an attack or other emergency. While the principal task of this military policeman is to rest and prepare for duty, his location adds strength and security to

the position of the senior military policeman. An item which can give added security to the TCP is the Listening Post Surveillance Service AN/PPS-14. *Use:* A small, lightweight, man-carried surveillance device capable of annunciating the presence of intruders before they are detectable by the unaided senses of friendly personnel responsible for perimeter defense.

d. A traffic control post should have as many of the following physical characteristics as possible:

(1) A good location for communication. This is very important when radios are the means of communication used by the TCP.

(2) A position from which the senior military policeman can readily control and supervise the other military policemen.

(3) A position which offers good defense, to include cover and concealment.

(4) A location with sufficient area to park vehicles and to hold individuals such as stragglers.

9-3. Equipment

a. Ideally, every TCP should be equipped with several means of communication. As a minimum, it will have a radio and should have a telephone if practicable.

b. Dependent on the mission, the military police unit and the area of operation, automatic weapons may be issued to the TCP. The location of an automatic weapon is based on the METT. Often, to strengthen the team position, an automatic weapon is located with the senior military policeman.

c. Signs are tools of traffic control used in the theater of operation as well as in post, camp, and station conditions. The principles of temporary sign posting outlined in paragraph 4-18 are applicable. A supply of temporary traffic control signs and CBR warning signs should be available at a TCP.

d. Other material such as POL, water, rations, and tools must be available to a TCP. See appendix D for a checklist of equipment.

Section II. FUNCTIONS OF A TCP

9-4. Functions of a TCP

a. The primary mission of any TCP in a theater of operation is traffic control which insures that traffic moves to its destination without

delay or congestion, according to routine and scheduling instructions and in compliance with traffic rules and regulations.

b. Each TCP must serve as an information

post. This not only involves the capability of giving directions to those who have a need for them but also includes supplying information on road conditions, enemy activity in the area, and information issued by higher headquarters for dissemination to the road users. The military police should gather from the road user as much information as possible without interrupting traffic, and forward it to the next higher headquarters. The TCP also reports information of nuclear, biological, and chemical (NBC) activity. To perform this function every military policeman should be familiar with the NBC basic report (FM 3-12).

c. Like other types of military police activity, traffic control posts can be invaluable for gathering intelligence. By observing and reporting movements, the actions of the area's inhabitants, and by questioning road users, the military police add to the intelligence gathering activities of the Army. A positive contribution to counterintelligence effort is made by the military police enforcement of passive defense measures which include light lines, convoy discipline, and vehicle security. In all these activities, the military police attempt to deny information to the enemy.

d. The TCP is a natural counterguerrilla post. While not capable of withstanding strong and prolonged attack, the traffic control post can serve as a temporary block to guerrilla activity. The location of a TCP, with reasonable defense and good communications, effectively denies the use of that area for a surprise guerrilla movement. Its ability to gather information and intelligence is useful in locating guerrillas as the first step to their elimination. A well-organized TCP may serve as a base to organize forces to defend against an attack and prepare to counter-attack. The armored car, in conjunction with other appropriate patrol vehicles, provides a means to patrol areas between TCP and to serve as a reaction force to protect static TCP.

e. Checkpoints (para 4-5 and 11-1) are a specialized function of military police; however, each traffic control post performs some of these functions—

(1) Checking convoy clearances to insure proper use of the road.

(2) Inspection of a questionable vehicle or convoy concerning its authority to travel, its destination, and the equipment or cargo to insure compliance with current orders.

(3) When appropriate, traffic control posts may be colocated with highway regulation points where movement control personnel exercise highway regulation procedures over scheduled traffic using the road. Such consolidation of facilities will not only permit a quick and easy interchange of information and instructions between traffic control and highway regulation personnel, but will, through the reduction of locations along the road where traffic is halted for control and regulation purposes, facilitate the movement of traffic over the road.

f. All traffic control posts serve a secondary function as straggler control points. The personnel assigned to a TCP will perform those straggler control duties outlined in FM 19-5. A straggler holding area will be designated within the TCP area.

g. The military police assigned to traffic control will implement the movement plan for refugees within their area. The principal duty of the personnel of a TCP in refugee control is to insure that refugees use only the road assigned to them and do not interfere with military movements.

9-5. Holding Areas

When establishing a TCP, the senior military policeman organizes a tentative holding area, an area where traffic can be moved off the road in case of attack, congestion, or while awaiting the proper time to clear the TCP. General principles for establishing a holding area are—

a. The density and dispersion of vehicles within the holding area will depend on the tactical situation.

b. It must be located with easy exits and entrances to the roadway.

c. The surface of the area should be firm enough to sustain the weight of military vehicles.

d. In organizing the area—

(1) Vehicles should be parked in a manner that will allow the first vehicles in to be the first vehicles out.

(2) Roadways should be established to allow ease in moving selected vehicles out of the area.

e. The area should be large enough to allow dispersion and if possible concealment from casual air or ground observation.

f. The military police should prepare a defense for the holding area by uniting all road users into a team to establish a coordinated defense in case of enemy attack.

g. When it is practicable, the senior military policeman is located in the vicinity of the holding area.

h. For large holding areas, it is necessary to develop a control plan. The simplest method of control is to use a subdivision system. To utilize this system the following steps should be taken—

(1) Make a map or sketch of the area showing the trails, road net, and major obstacles. If available, a 1:25,000 map should be used.

(2) Outline the holding area on the map or sketch.

(3) Divide the area on the map or sketch into equal subdivisions, approximately 250 meters square, and assign a letter to each subdivision.

(4) On the ground erect signs showing the outline of each area.

(5) Develop a traffic flow plan, record it on an overlay of the holding area map, and erect signs to assist the road users in understanding the plan.

(6) Maintain a count by number, size, and unit designation of each vehicle in the lettered subdivision.

9-6. Rerouting

a. Rerouting of traffic is normally the responsibility of the military police unit or higher headquarters. The TCP must be prepared to initiate minor rerouting and to implement planned rerouting.

b. Since traffic rerouting affects the traffic plan, its implementation must be coordinated. The following is a guide for coordination:

(1) When time permits, rerouting, no matter how minor, will be approved by the next higher headquarters prior to being placed in effect.

(2) The TCP may reroute the traffic that affects only that TCP, provided travel time is not increased by more than 5 minutes.

(3) Adjoining TCP can reroute traffic during emergencies if the change is coordinated with the area patrols and travel time is not increased more than 5 minutes.

(4) Platoon leaders and platoon sergeants

may direct an emergency rerouting of traffic within their area if the travel time is not increased by more than 8 minutes.

(5) When emergency rerouting of traffic affects two platoons or larger units, the controlling headquarters of the units involved must direct the change.

c. Each TCP must be capable of functioning under a rerouting situation. The following considerations apply:

(1) TCP personnel must know the area and vicinity of their position so that they can utilize the best roads for rerouting.

(2) Equipment for a TCP will include sufficient material to properly mark the rerouting.

(3) Strip maps of the rerouting will be prepared by the military police at the TCP if not prepared by MP headquarters.

(4) During an emergency it may be necessary to establish temporary TCP to provide for an efficient rerouting. In this situation the principles for establishing a TCP which were outlined in paragraph 9-2 may have to be modified because of insufficient personnel and equipment.

d. The MEASLE map system (para 12-12) may be used in rerouting. During combat when COMSEC requirements must be met, this is not a secure method for passing information. Secure communications equipment or secure operational codes developed from classified COMSEC publications are the only acceptable means for sending information by radio or telephone in time of combat.

9-7. Role of a TCP During a Nuclear Attack

a. The traffic control point must constantly maintain passive defense measures to minimize the effects of a nuclear attack. The preparation of the position and plans for the defensive positions of road users are made by the team working as a unit. The TCP must maintain a passive defense posture and take those steps outlined in FM 21-41 to reduce the effects of a nuclear attack.

b. When a nuclear attack has occurred, the TCP will submit an NBC report as soon as practicable, with followup reports when possible, to the military police headquarters. The senior military policeman will prepare to activate the planned straggler collecting area. The TCP will

take initial steps to activate the holding area and prepare to reroute traffic; however, every effort should be made to keep traffic moving on the routes currently in use.

c. A TCP will displace only an order. If fallout occurs, the prepared defensive position will provide protection. Personnel will prepare to resist enemy efforts to exploit the nuclear attack.

9-8. Straggler and Refugee Movement Control

a. Provisions for the movement control of stragglers and refugees are incorporated within the traffic control plan by assigning special added duties to traffic control posts and to motor patrols.

b. During conventional and nuclear warfare the control of stragglers and refugees is a problem requiring the development of contingency plans to control their movements. The shock of war upon civilians and troops can generate the mass movement of refugees rearward from the

forward areas. There can also be a mass movement forward if there is a nuclear attack to the rear of combat lines. If these movements are not properly handled, they can impede the efficient movement of other traffic. Civil affairs officers can assist in the relocation and control of refugees who desire to return to their homes and devastated communities. The provost marshal coordinates the refugee movement control plan with the civil affairs officer.

9-9. Special Operations

The effects of weather, terrain, natural barriers, and different types and intensities of warfare are considered by the provost marshal in the formulation of the traffic control plan. Appropriate guidance concerning factors to consider in special operations is found in chapter 13 of this manual. When developing traffic control plans for special operations, appropriate manuals about arctic, desert, river crossing operations, etc., should be considered.

CHAPTER 10

TRAFFIC PATROLS

Section I. ORGANIZATION AND EQUIPMENT

10-1. General

The military police motor patrol is normally the predominant means of traffic control. Knowledge of the area, combined with the mobility and good communications of the motor patrol, provide a versatile tool for use by the military police unit in its role as an element of command control.

10-2. Organization

a. A type motor patrol is a team of three military policemen. Under normal operating conditions this team is capable of 12 hours continuous duty in 24 hours. Within the 12 hours, time is allocated for meals and first echelon vehicle and radio maintenance.

b. The senior military policeman normally rides in the right front seat of the vehicle to provide for control and observation.

c. The driver performs the principal task of driving; however, he may also assist in observation and reconnaissance.

d. The radio operator/recorder maintains constant monitoring of the MP radio net. This duty includes responsibility to prepare, send, and receive radio transmissions, record reconnaissance information, complete NBC reports, draft patrol reports, record instructions, post patrol maps and provide flank and rear security observation for the patrol.

e. Nothing in the foregoing is intended to prohibit the driving of the patrol vehicle by any member of the patrol for reasons of necessity or advisability.

10-3. Equipment

a. *Vehicles.* The sedan, 1/4-ton, 1/2-ton and 3/4-ton trucks and light armored vehicles are well suited to meet military police patrol requirements. The radios provided in military police TOE are designed to fulfill operational requirements. To assist the driver during night operations, or periods of reduced visibility, there are several items of STANO equipment available; these are—

(1) *AN/PAS3, Binocular, Electronic.*

Use: Its primary mission is to permit vehicle operation during darkness without use of visible light, while other missions are to detect infrared sources, locate and read road signs and perform other closeup tasks at night.

(2) *SU-50, Binocular, Electronic (Goggles).*

Use: This is a lightweight, face-mounted, passive night vision device for performing individual tasks during the hours of darkness, utilizing ambient radiation. It is designed for short-range close-in viewing for driving tracked or wheeled vehicles, reading maps and other documents, and other individual tasks may also be used with AN/PAS-8. (See appendix I, STANO equipment.)

b. *Weapons.* Military police patrol members carry their individual weapons which may be augmented with an automatic or a crew-served weapon if necessary. Additional fire support is achieved by the use of grenades.

c. *Other Equipment.* Other equipment is shown in the "equipment checklist" for a military police patrol (app D and I).

Section II. FUNCTIONS AND METHODS FOR PATROLLING

10-4. Functions of a Military Police Traffic Patrol

a. The primary function of the military police traffic patrol is to provide traffic control within

its assigned area. Additionally, it has the mission of maintaining contact with TCP and other military police activities in its area. Traffic patrol contacts serve to assist the military police head-

quarters to coordinate the military police effort. A patrol in the theater of operations enforces traffic regulations in a manner similar to that of a post, camp, or station patrol (chap. 5). Local instructions will prescribe the detail in which reports on traffic control will be submitted. For instance, within the field army area, accidents that do not involve loss of life will often require only the identification of the participants and the time, date, and location of the accident. When military police are operating as part of a NATO (North Atlantic Treaty Organization) force, they will use the NATO Standard Offense Report in appendix E.

b. Additional motor patrol functions include—

(1) Performing as a TCP during emergencies when congestion arises or when ordered by the military police unit.

(2) Encouraging the road users, by the presence and activity of the patrol, to voluntarily comply with the traffic regulations.

(3) Gathering current road information and reporting it to military police headquarters for use in planning. While designated patrols are dispatched for certain traffic control or route reconnaissance, all military police patrols perform traffic control and route reconnaissance functions. Like the TCP, the patrol gathers all available information.

(4) Performing intelligence functions as outlined in paragraph 9-4.

(5) Performing counterguerrilla operations.

(a) The patrol activities serve to deny routes of communications to the guerrillas.

(b) The patrol, while performing its traffic control mission, is oriented to initiate, within its capabilities, offensive action against guerrillas.

(c) The mobility of the patrol allows it to aid other military police when under attack by a guerrilla element. Military police unit plans should provide for the assembly of military police patrols to provide unity of action against a guerrilla force.

(d) Motor patrols may act as flank elements or may be used to move to the rear of a guerrilla force during offensive operations (FM 31-16).

(6) Deploying temporary checkpoints or roadblocks (chap. 11).

(7) Functioning as a mobile straggler collection point. It is also a normal mission for

mobile patrols, particularly those equipped with 3/4-ton vehicles to provide transportation of stragglers from a TCP to a straggler collecting point.

(8) Insuring that refugees use the roads assigned to them and do not use those roads assigned only for military use.

(9) Serving as relief for other military police, and performing administrative functions such as resupply and ration distribution.

(10) Acting as escorts and providing physical and personnel security when so directed.

(11) Checking traffic signs and insuring that guide signs have not been changed by enemy or guerrilla forces to divert traffic into vulnerable areas.

10-5. Motor Patrol Methods

a. *General.* In determining patrol assignments the military police headquarters evaluates the task, applying the principles of METT outlined in paragraph 9-2.

b. *Area Patrols.*

(1) *Unprogramed area patrol.* Most patrol instructions prescribe an area that includes major roads with or without TCP. The mission of an unprogramed area patrol does not specify an assigned route or a time schedule, but permits the patrol free movement throughout its assigned area. Normally, a requirement is placed on the patrol to coordinate with all other MP posts and activities within the area; however, coordination with adjoining patrols is not programed or scheduled.

(2) *Programed area patrol.* The activities of the programed area patrol are scheduled, planned and programed in advance. Programing should include scheduling of time for main route patrolling, coordination with TCP and adjoining patrols, performing as a TCP when necessary and providing time for free movement. Programing must not prescribe a regular pattern.

(3) *Combination patrols.* This is the most common method used in accomplishing the patrol task, since this allows flexibility of action. The usual method is to combine the unprogramed area patrol technique with the programed area patrol technique. This achieves a balance between control and freedom of action.

c. *Route Patrol.* This type patrol activity restricts the military police to a specific route

which is constantly patrolled. This patrolling may be conducted on schedule or may be unscheduled. The main supply route (MSR) is usually the only route that will receive this type of patrolling. Normally, one of the following conditions require the use of this type of patrolling:

(1) A lack of military police to establish necessary TCP on the route.

(2) Circumstances or incidents that lead to congestion and other traffic problems. Included are: refugees on the route, limiting road factors (bridges, short defiles, etc.), or a high accident rate.

(3) As a means of enforcing the requirements of highway regulation, this is necessary to insure that movements have proper authorization to use the road (Movement Credit).

(4) As a part of the rear area security plan. Usually this is employed only as a part of a special operation.

10-6. Aircraft in Traffic Control Patrolling

The use of rotary and fixed-wing aircraft is practical in performing traffic control, either alone or in conjunction with ground military police elements.

a. Rotary wing aircraft provides the most effective means by which military police can perform the route and area reconnaissance of large areas for overall traffic control planning and implementation of the traffic control plan. Routes may be checked in detail to determine the particular control that is necessary. Critical defiles, bridges, intersections, and traffic control complexes may be observed both while in flight and after landing at the location. This is essentially the same service which is provided by a ground motor patrol except that an aerial patrol can cover a much larger area and more routes, with greater flexibility. Aerial traffic control also includes continual ground and aerial coverage of all militarily usable routes within the military police area of responsibility. They are thereby able to maintain current information on alternate and bypass routes and areas that are not occupied.

b. Traffic control patrols can be accomplished by the use of a combination of ground vehicles and rotary wing aircraft. General or area traffic control is accomplished rapidly and effectively by the aircraft, with emphasis on patrolling the

sparsely populated areas and little used routes. Populated areas, frequently used routes, and main supply routes are patrolled by surface vehicles. This combination of patrolling gives the required credibility and responsiveness to the route and area traffic information system. When the aircraft patrols find areas of traffic congestion or traffic violations, they can direct the ground patrol to that location. (See para 6-6e for methods in measuring traffic speeds from aircraft.)

c. Rotary wing aircraft are well suited for aerial column control; i.e., providing guidance and assistance to the commander of troops or convoys in a march formation. In this role, the aircraft are used primarily for visual observation and secondarily for communications relay. Airborne military police observers can assist commanders by selecting suitable bypasses around obstructions and by locating lost elements and directing them back to the march route. Traffic control points can be established, augmented, or relieved with a minimum of delay and units operating over cross-country routes may be more closely and effectively supervised.

d. Highways marked at 176' intervals, as discussed in paragraph 6-6e, are a great assistance in controlling convoys because a march unit commander can be quickly informed when his trail units are exceeding the maximum catchup speed. Also, the convoy commander can be provided speed computation tables to compute the speed of the convoy as it passes through marked zones. (For additional information in the use of aircraft in traffic control operations, see FM 19-4.)

10-7. Water Patrols

Traffic control is an important military police function on water routes. Continuous boat traffic on navigable waterways and at ports and harbors presents an additional requirement for traffic control. Military police use water patrols to accomplish this traffic control mission. If assigned to a water patrol, the military policeman receives training in the following:

a. Boat operations.

b. Customs, regulations, if pertinent (host country).

c. Techniques of boat patrolling to include—

- (1) Boarding procedures.
- (2) Water safety.

FM 19-25

- (3) Marine firefighting.
- (4) Fire prevention.
- (5) Marine chart and map reading.
- (6) Operation of certain marine devices which will be outlined in local SOP (FM 55-15).

d. STANO equipment to aid the patrol performing water patrol duty can greatly assist the military police in locating and detecting water crafts. This equipment is—

- (1) Electromagnetic Intrusion Detector (EMID).

Use: This hand-emplaced item is used to detect the movement of personnel, powered and unpowered small boats, and vehicles with very low false alarm rates.

- (2) Patrol Electromagnetic Intrusion Device (PEMID).

Use: The PEMID is designed for use by patrols to detect intrusion of personnel and watercraft. This device provides line sensor intelligence data on intruder movement without alerting the intruder.

CHAPTER 11

OPERATION OF CHECKPOINTS, ROADBLOCKS, DEFILES, AND DISMOUNT POINTS

11-1. Function of Checkpoints

Military police establish checkpoints when necessary to insure proper route use, vehicle use, and to inspect cargoes.

a. Checkpoints are established at main entrances to reserved routes or routes which require "movement credit." (Drivers and certain convoys are given orders to use a dispatch route, or are given a movement credit allowing them to use certain portions of a highway or route.)

b. Military police are posted at checkpoints to assist drivers by directing them to their destinations or to their units when they become lost or take the wrong routes.

c. Checkpoints are established to prevent the local population from supplying the enemy with weapons, ammunition, food, medical supplies, or other items of military use.

d. Checkpoints help control and suppress blackmarket operations by limiting the transportation of illegal goods.

e. Security is one of the main factors to consider in checkpoint operations in a theater of operations. V-100 armored cars, can be used effectively to provide this security. Principles of traffic control post security are applicable to checkpoint security (see para 9-2).

11-2. Operation of Checkpoint

a. A checkpoint should be established at a position where oncoming traffic will approach the checkpoint after negotiating a sharp curve or hill. This hides the military police, thus denying the approaching drivers a chance to make a U-turn, or take other evasive action to avoid the checkpoint. The safety of the personnel operating the checkpoint is also a consideration in site selection (fig. 11-1).

b. Every effort should be made to inform the road user that checkpoints are in operation. This will encourage voluntary compliance with

the highway regulations. However, *the exact location of the checkpoint should never be given* (fig. 11-2).

c. The checkpoint should provide an area where vehicles can be moved off the road when necessary.

d. The approach lanes are outlined with traffic cones, wooden stakes, or other clearly visible markings.

e. Signs should be posted identifying other requirements, e.g., "turn off headlights."

f. A barrier such as a wooden pole or gate should be used to prevent vehicles from progressing beyond the checkpoint until allowed to proceed by checkpoint control personnel.

g. A military police patrol vehicle should be available to pursue vehicles or individuals who fail to stop at the checkpoint or who turn around when they see the checkpoint.

h. Military police should be on the alert for and report new methods used to bypass the checkpoint or to conceal unauthorized items.

11-3. Roadblocks

In the theater of operations, police roadblocks can be used in conjunction with checkpoints, to canalize vehicles and personnel into the checkpoint. Roadblocks are temporary and are established as a part of an emergency plan or for some special purpose. The general guidelines for operation of a roadblock in the theater of operations is the same as at posts, camps, or stations, except for the following increased defensive requirements:

a. Canalization of personnel on foot is established in open areas. With appropriate warning signs, field of fire, concertina, or other barbed wire, personnel can be canalized as required.

b. Defensive positions are established at the checkpoint to provide all-around security. Per-

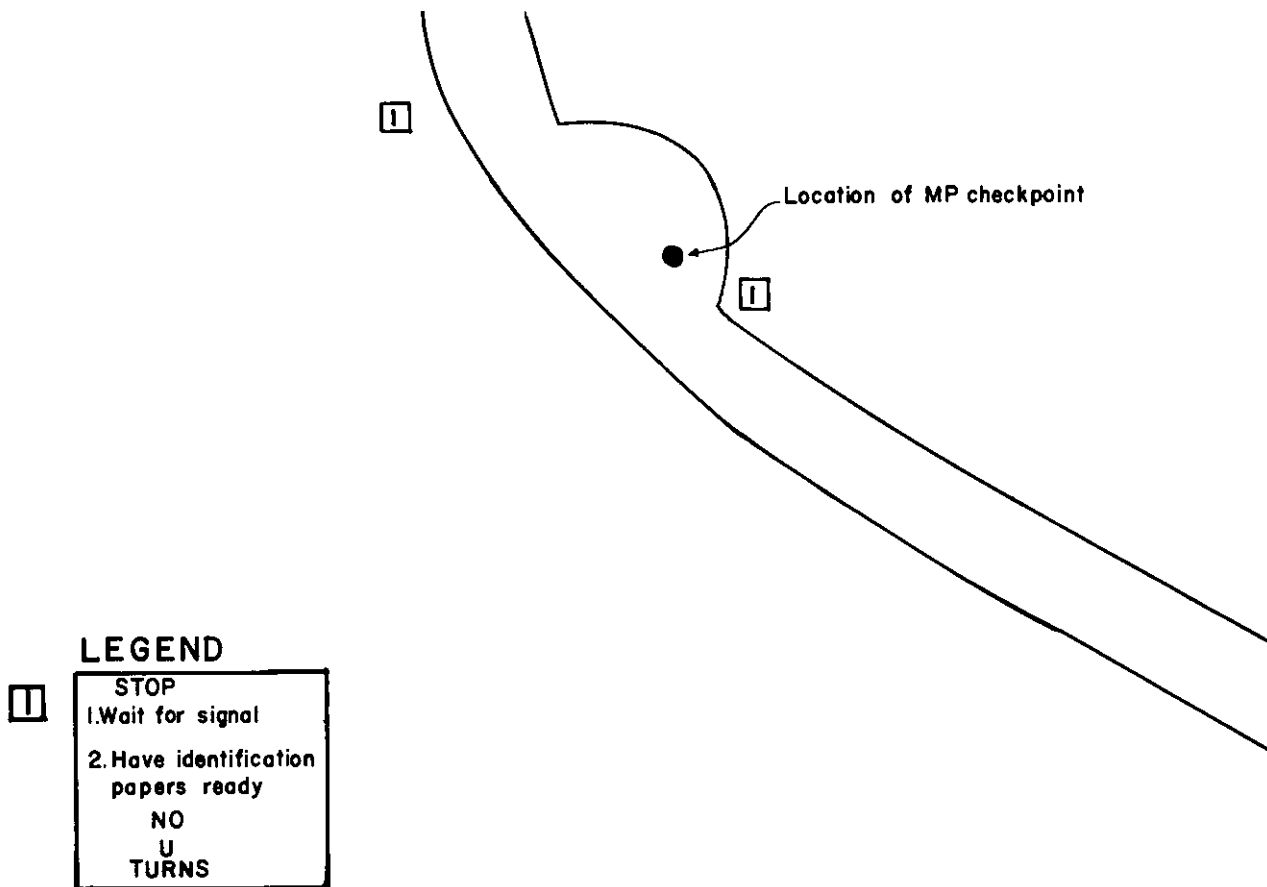

Figure 11-1. Location of a checkpoint.

sonnel assigned security duties should be concealed and equipped with the following:

- (1) Adequate weapons.
- (2) A portable means to block vehicle movement.
- (3) Radios or other communication equipment.

c. Communication must be maintained with the military police unit and the patrols operating in the vicinity of the roadblock. Wire or signals with a radio backup should be the primary internal communication among the different posts and activities of a roadblock.

d. An example of a roadblock is shown in figure 11-3 with the necessary equipment outlined in appendix D.

11-4. Definition—Defiles

For traffic purposes a defile is defined as a natural feature or a man-made structure or obstacle which restricts the traffic flow to one-way traffic

at a given time. Examples of a defile would include a damaged stretch of road, a narrow bridge or causeway, a path through a woods or narrow valley, or a street on which structures restrict movements to one-way traffic.

11-5. General Principles

The principles of traffic control at construction sites and detours (para 4-10 and 4-12) are valid with modifications for the theater of operations. Because movement is restricted, a defile offers the enemy an ideal target for the maximum disruption of military operations. Every effort must be made to pass all movements through the defile in the shortest possible time and to insure that concentrations of troops and vehicles are not permitted in the immediate vicinity of a defile. Traffic control in the vicinity of a defile must be absolute; direction of the traffic control is vested in the senior military policeman at the defile who must have a thorough knowledge of the area and conditions in the defile.

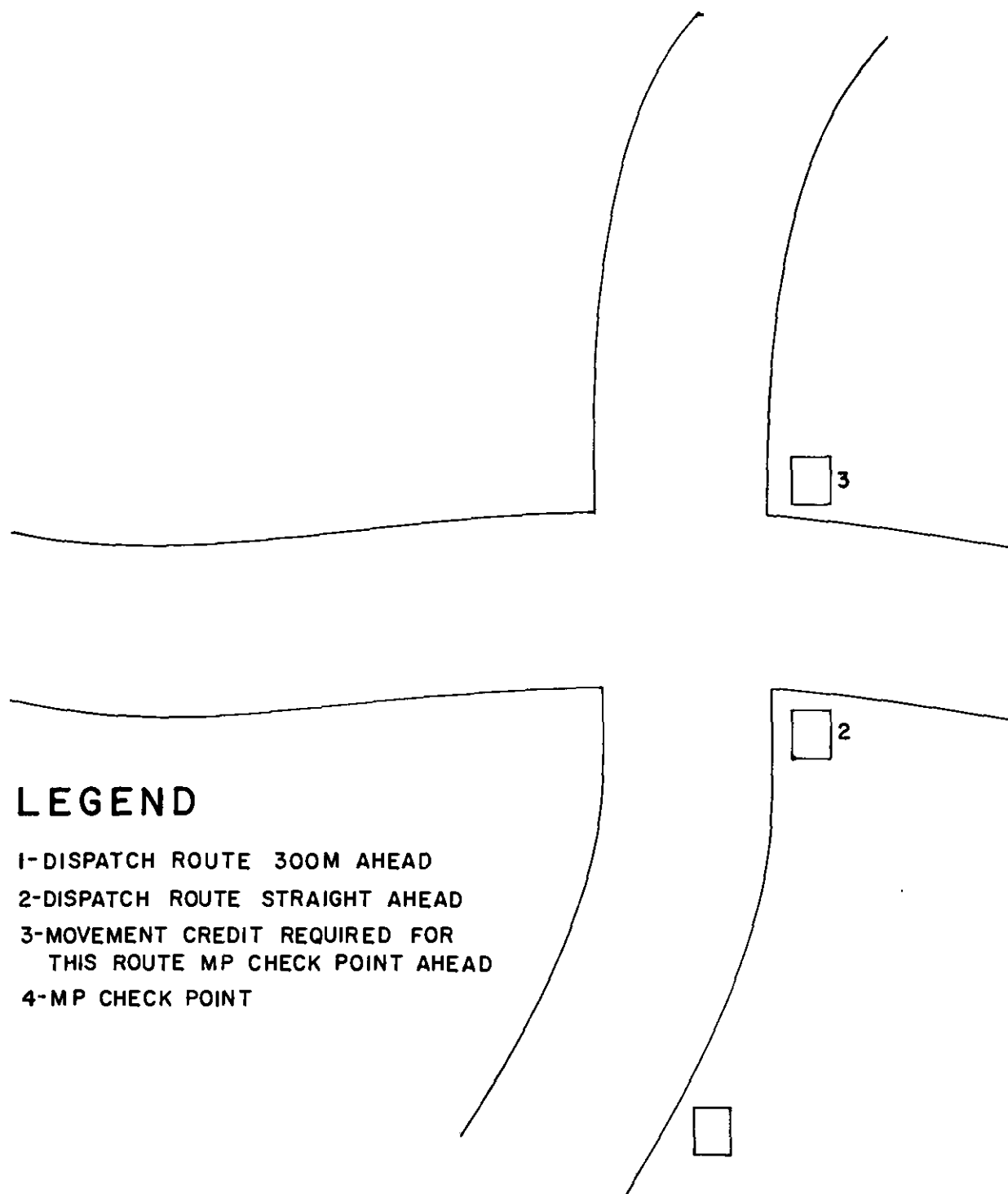

Figure 11-2. Example of signing a checkpoint.

11-6. Operation of a Defile

a. All control techniques outlined in chapter 4 may be used at a defile. However, the most common technique is to use a military policeman at each end of the defile with a motor patrol

circulating through the defile and the surrounding area.

b. Within the limits of security, maximum use is made of signs to reduce the need for military police personnel.

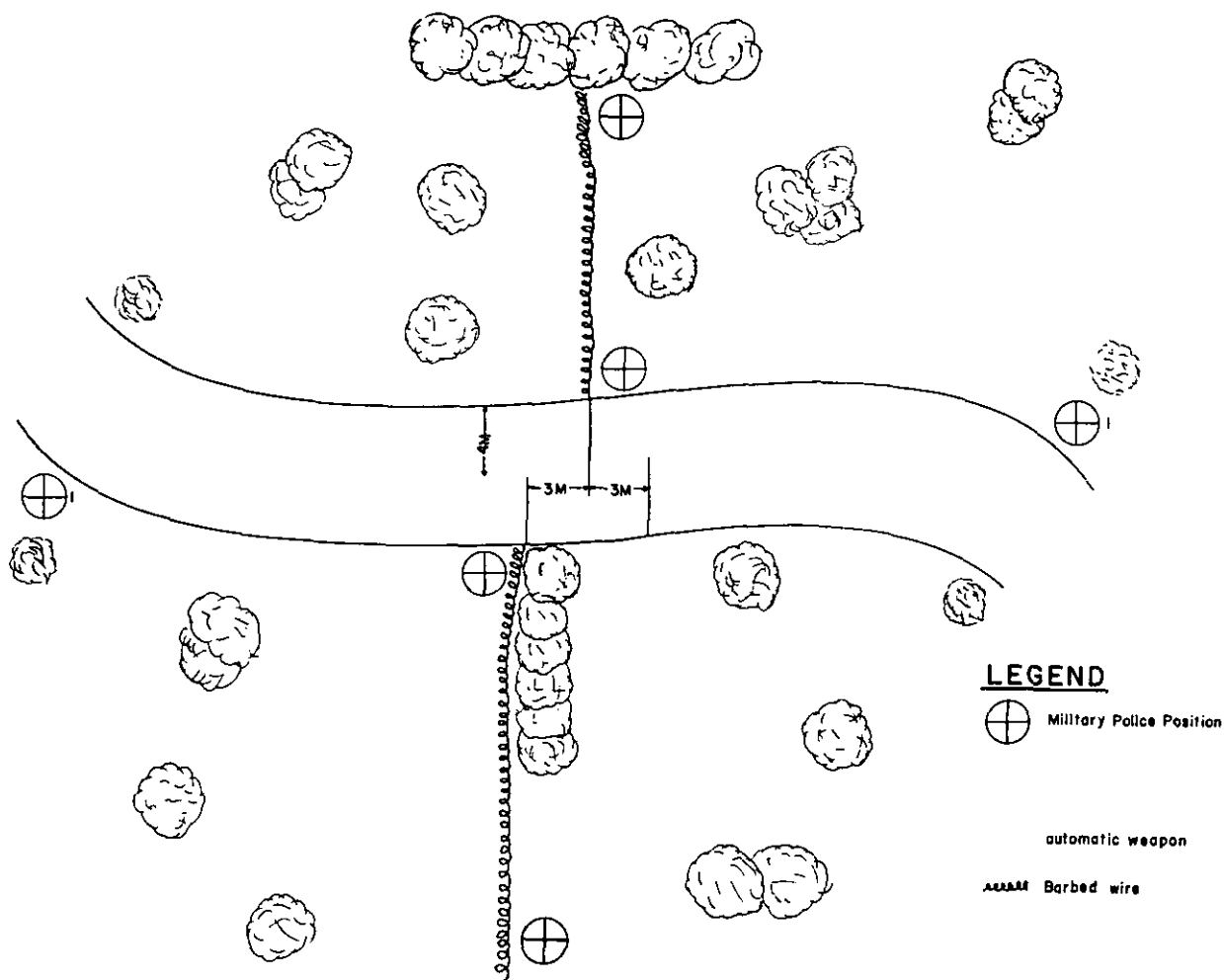

Figure 11-3. Example of a type roadblock.

c. Holding areas will be established at each end of a defile. During periods of enemy air superiority or probable nuclear attack, a series of holding areas are established 2 to 3 km from the defile.

d. Each military police position must be developed to provide for defense. The number of security positions will be based on the requirements and military police personnel available. The senior military policeman will make visual detailed reconnaissance of the area and an estimate of the situation using METT. Following this action a traffic control and security plan is developed. This plan is constantly examined to uncover areas for improvement.

e. Controls used or prepared for use at a defile will include at least two of the following independent techniques:

(1) Visual: The use of military police to observe the entire defile.

(2) Telephones should be used whenever possible between the ends of the defile and the turnouts. Defile control frequently generates a large volume of communication which, if radio were used exclusively, would become a source of intelligence to the enemy and would overload the military police radio net.

(3) Flag method. 4-12f(1).

(4) Rider method. 4-12f(4).

(5) Lead and/or follow method. 4-12f(3).

(6) Radio located at the ends and all turnouts in the defile.

11-7. Equipment

a. A means must be available to the military police to clear the defile of disabled vehicles and minor obstacles. If possible, the military police

unit will arrange for the use of a wrecker. When circumstances do not permit the use of a wrecker, the military police must be prepared to utilize field expedients (FM 20-22).

b. A detailed list of equipment needed for a defile operation is shown in appendix D.

11-8. Military Police

Military police in the theater of operations establish dismount points to—

a. Direct traffic at the main entrance to a headquarters. A duty that may be closely associated with this function is the control of stragglers and refugees that may have wandered into the area. When large masses of pedestrian traffic are encountered close to a main artery or intersection, it must be controlled closely, or rerouted. In such a case, stragglers may try to slip through the area. Refugees, sympathetic to the enemy's causes, and guerrillas, posing as refugees, represent a potential threat to the headquarters.

b. Enforce light, noise, communication, and movement discipline to prevent the enemy, guerrilla, or partisan forces from capitalizing on intelligence gained by violation of these principles.

c. Provide security for the headquarters by restricting from the area unauthorized personnel and vehicles. During the hours of daylight, personnel will be positively identified by official documents, whereas, during the hours of darkness, the challenge will be used as the initial identification. A search will be conducted of all vehicles (e.g., boats in river or crossing operations, bicycles and other forms of native transportation used by local nationals, vehicles of friendly allied forces) and personnel to locate explosives and prevent casualties and destruction in the headquarters area. Indigenous police forces, civil or military, can assist with the interpretation and translation of the local national language and with searches and detention, whether the dismount point is joint, combined, or US. Communication is an important feature of the dismount point because of the need to identify visitors to the staff sections and the rapid dissemination of the notification of an attack in the immediate area. Communications for this purpose is normally tied to the dismount point from the various staff sections and the security force.

d. Provide information and guidance to authorized personnel concerning the location of various sections in the headquarters area. This can be accomplished verbally, as in oral direction; physically, as in leading or escorting an individual to the area (useful during the hours of darkness), or by offering a controlled sketch or strip map; visually, by posting signs during the various conditions of visibility by use of infrared or light intensification devices and/or engineer tape during the hours of darkness; or by a combination of any of the preceding.

11-9. Considerations for Selection of the Location of a Dismount Point

a. Dismount points are normally accessible to main arteries or main supply routes. They must be located so as to provide maximum coverage of a variety of duties. Its close proximity to the command post established this point as an ideal information post. Also, due to its proximity to the main artery or roads it can serve as a straggler or refugee control or collection point.

b. It should be located in an area where cover and concealment are naturally available to prevent detection because the normal terrain features are disturbed. Cover and concealment of vehicles will limit the enemy's intelligence gathering capability by denying him knowledge of the number of vehicles and the size of the headquarters he has confronted.

c. The dismount point should be situated on level terrain with adequate parking areas within walking distance from the headquarters in the proximity of major intersections and where terrain can be navigated easily reducing the possibility of any vehicular congestion.

d. Parking areas should be on grassy or paved surfaces with overhead cover, if possible, to limit dust clouds when vehicles pass over dirt or sodded areas. This will also keep to a minimum the tracks made in soft earth or mud.

e. The intersection to the main road and the parking area should be separated enough to screen the headquarters from direct fire weapons by using natural terrain barriers such as depressions, slopes, and trees.

11-10. Organization of a Type Dismount Point

A dismount point should be divided into three functional portions as follows:

a. *Traffic Control at the Intersection of the Main Road to the Headquarters.* The military policeman at this point performs the same functions as at any TCP and in addition insures that only authorized vehicles and personnel enter the access road. His additional duties may be to assist in straggler and refugee control.

b. *Traffic Control at the Parking Area to Insure Maximum Effective Utilization of the Area.* The military policeman may also be required to search all vehicles and personnel entering the parking area and check authorization and documentation of those vehicles departing the parking area.

c. *Security Position at the Main Entrance to the Headquarters Area.* This position is organized to offer protection to the other military policemen on the dismount point as well as perimeter security. Military police at this location insure only authorized personnel enter the headquarters area.

11-11. Priorities of Traffic Movement

Priorities are established to insure that essential movements are made. Priorities are necessary where the road net will not accommodate all of the traffic which desires to use it. The enforcement of movement priorities is a function of military police traffic control personnel.

11-12. Types of Movement Priorities

a. Specific movement priorities are given for a specific move or operation. They are announced by the military police unit after receipt from higher headquarters. Such priorities list types of vehicles, supplies, personnel, or combination of these, and their order of priority. An example of a specific priority list is shown in figure 11-5.

b. General movement priorities are routine guides to traffic control personnel, highway traffic regulating personnel, and commanders of units using the roads. In the absence of specific instructions to the contrary, military police will apply

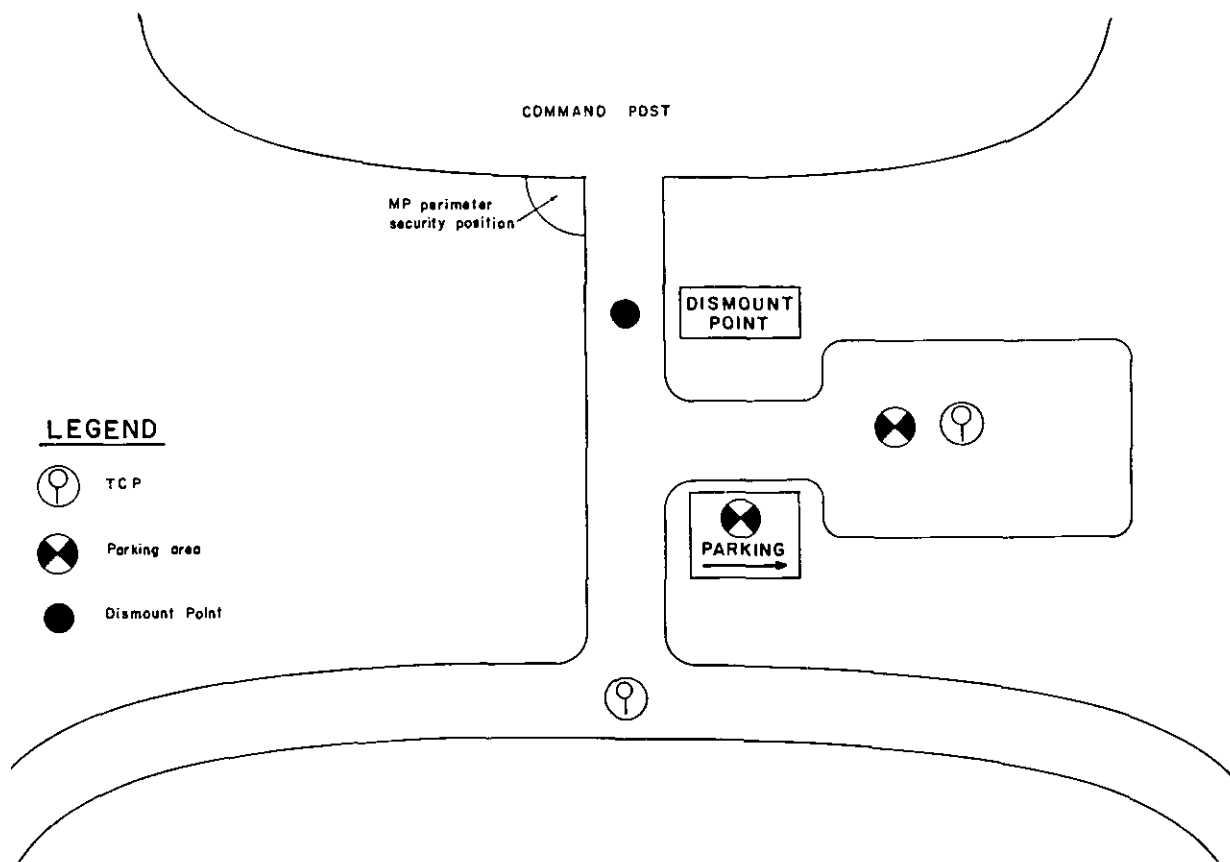

Figure 11-4. Example of a type dismount point.

HEADQUARTERS
24th Military Police Group
APO 999
US FORCES

MOVEMENT PRIORITIES:

Effective 260001 March 68 till 272400 March 68

1. The following priorities of movement will be enforced by military police traffic control personnel through the 24th Military Police Group Area.

Vehicles with movement credit 15-USM-09

Ambulances East bound

Tankers (gasoline, oil, and fuel) West bound

Red and White Disk vehicle

2. General priorities outlined in FM 19-25.

THOMAS
Col

Official

Sean
S3

Figure 11-5. Example of daily specific movement priorities announcement.

the following general priorities with on-the-spot changes that are required to keep essential traffic moving in an orderly, efficient manner:

(1) Forward-moving traffic has priority

over traffic moving to the rear.

(2) Forward-moving loaded vehicles have priority over empty vehicles moving in any direction.

CHAPTER 12

RECONNAISSANCE

Section I. TRAFFIC RECONNAISSANCE (STANAG 2015, 2151, SOLOG 53)

★12-1. General

a. There are two types of traffic reconnaissance; traffic control reconnaissance, and route reconnaissance. Traffic control reconnaissance is the gathering of information which will provide a base for the traffic control plan. Route reconnaissance is primarily a function of the engineers who conduct the reconnaissance to secure technical information, such as road construction, load capacities, and bridge restrictions. The military police will conduct route reconnaissance as an emergency measure only when there are no engineers available. The route reconnaissance conducted by the military police is restricted to the minimum information necessary to determine the qualities of the road as they apply to traffic control. It is usually called a "hasty route reconnaissance" in comparison to the "deliberate reconnaissance" performed by the engineers (FM 5-36).

b. The military police motor patrol is charged with the function of constantly conducting a traffic control reconnaissance. If it becomes necessary for the military police patrol to conduct a route reconnaissance, it should be assigned as its primary duty. A route reconnaissance report forwarded to higher headquarters will include appropriate recommendations for the control of traffic. Route reconnaissance summaries will be forwarded in a timely manner to appropriate intelligence officers for further dissemination as required.

c. The summaries of the results of traffic control reconnaissance and the route reconnaissance within their area of assignment should be available to all military police patrols and TCP. All information of an intelligence nature gathered by MP reconnaissance (e.g., deliberate damage to roadways or bridges) should be reported to intelligence personnel as rapidly as possible.

12-2. Methods of Reconnaissance

a. *Ground Reconnaissance.* Reconnaissance

should be made on the ground over the actual terrain to be traveled. This reconnaissance provides a detailed examination of road features and limitations which are not obtainable by any other method. However, ground reconnaissance is time consuming, and it may be difficult for a reconnaissance group to evaluate a route which has a heavy flow of traffic or is subject to enemy attack.

b. *Air Reconnaissance.* Air reconnaissance has the advantage over ground reconnaissance in that the use of aircraft permits a rapid coverage of extensive areas and of specific points where traffic problems exist. The observer can move quickly to areas that need his attention (identifying and countering possible ambushes), and he can switch rapidly from one road to another without interfering with, or being impeded by, surface activity. The helicopter is ideally suited for this type of reconnaissance. A disadvantage is the inability to make a close examination of specific road features and limitations. To assist in the air reconnaissance an item of STANO equipment called the KS-100 handheld, still picture camera can be used. This camera, using polaroid type black and white and color film packs, provides a quick-response, aerial reconnaissance photography capability for nonsurveillance type military aircraft observers. It will provide intelligence spot reports and other related military information. For additional items of STANO equipment, see appendix I.

c. *Air-Ground Reconnaissance.* An air-ground reconnaissance combines the best feature of the ground and air methods. A portion of the team travels in a helicopter and the remainder in a surface vehicle.

(1) The leader of the reconnaissance team located in the helicopter proceeds ahead of the ground group to locate areas or situations that require detailed examination by the ground group. He also searches the area parallel to the route of advance for alternate routes and re-

connoiters roads that cross or intersect the road traversed by the ground group. A survey of the surrounding area may be accomplished as part of a counter guerrilla effort.

(2) The effectiveness of the air-ground reconnaissance team depends mainly on effective radio communications. Should radio communications fail or be impossible because of security restrictions, the aircraft can land near the surface vehicle and the two groups can confer.

(3) An added advantage of the air-ground method is that the two groups are mutually supported for security. Each group should be alert for and warn the other group of impending danger along the route of advance. In some instances, one air reconnaissance group may coordinate and supervise several ground reconnaissance groups.

★*d. Map Reconnaissance.*

(1) *General.* Maps and aerial photographs may help traffic control planning personnel to visualize the layout of an area and the relative locations of roads, bridges, key installations, and facilities. This method is also useful in making tentative traffic control plans prior to the time that an area can be entered by a reconnaissance team. Maps and overlays are used for recording road and traffic information. In every case, the most accurate and up-to-date maps should be used in conjunction with the latest aerial photographs. In the continental United States, these maps are available through the Defense Mapping Agency Topographic Center, 6500 Brooks Lane, NW; Washington, DC 20315. In oversea areas, these maps may be procured through the engineer services. The maps include such information as road classification, terrain features and potential obstacles which can aid military police in assisting the movement of supplies and equipment. It should be remembered in cross-country movement that terrain consists of variable elements, which alone or in combination with the weather, can impede the movement of these supplies and equipment.

(2) *Consideration in a map reconnaissance.* The primary factors which should be considered in a map reconnaissance are routes of travel, terrain features, extent of vegetation cover, and variations in land forms and heights of natural features. These can all facilitate or hinder traffic movement. Although soil conditions may not be directly detectable on a map, they are still a necessary consideration and to some extent can be identified through terrain features. For example, a swampy area can usually be assumed

to be a hindrance to wheeled vehicles due to poor soil conditions. Grades, or slopes, that might slow traffic, are easily identifiable by using the contour lines on the map. The following factors, which can be used to determine the trafficability of terrain, include—

(a) Evaluation of slope and soil for cross-country movement.

(b) Effects of forest on cross-country movement.

(c) Special terrain features.

(d) Characteristics of terrain types.

(e) Evaluation of drainage features.

(f) Road and route classification. (Of questionable value if taken solely from a map.)

(3) *Additional information.* Military police should not rely solely on the use of maps and aerial photographs for traffic control reconnaissance when ground or air reconnaissance is possible. Conditions, as shown on the map, may have changed since the printing of the map or may be misinterpreted.

12-3. Organization

a. When the military police are to perform reconnaissance, the team should be organized similar to the type motor patrol discussed in paragraph 10-2.

b. In addition to the equipment normally found with a motor patrol the reconnaissance team should be equipped with the following:

(1) Compass.

(2) Measuring tape.

(3) Sketch pads.

(4) Colored pencils.

(5) Overlay materials.

(6) Detail maps and overlays of the area.

12-4. Briefing

The briefing of a reconnaissance team will follow the briefing outlined for traffic control duty in a theater of operations (para 8-5). In addition the briefing will include the following:

a. The exact purpose of the reconnaissance mission.

b. When the reconnaissance is to be conducted for a specific move, the briefing will include information on the date/time of the movement, the number, types, weights, and characteristics of vehicles involved, the organization of the movement, and tentative plans for its control.

c. The route, possible alternate routes, and areas to be reconnoitered.

d. The difficulties the military police have

previously encountered in the area as well as specific traffic problems.

e. The location of installations within the reconnaissance area.

f. Coordination with local police.

★g. The amount of information to be gathered, when the reconnaissance must be completed, and how the report should be submitted. Usually the report will be submitted in overlay form, however, information of immediate tactical value must be reported immediately.

12-5. Traffic Control Reconnaissance

Normally a traffic control reconnaissance team will gather the following types of information:

a. Location and characteristics of road obstructions.

b. State of road repair or construction.

c. Driving time and actual distance between various points.

d. Location, characteristics, and condition of potential alternate routes and bypass routes.

e. Location and characteristics of potential TCP and holding areas.

f. Location of potential ambush areas.

g. Location and characteristics of area that may be used for defensive positions for both road users and military police traffic control personnel.

h. Location and possible bypasses of contaminated areas.

i. Information on the current traffic flow to include who is using the road, numbers and types of vehicles, and areas of congestion. An estimate of the maximum possible traffic volume without congestion should be made. This will be expressed by the estimated number of 2½-ton trucks passing a point during a 1-hour period of time. The point selected for making this estimate should be a major intersection, restricted bridge, or defile along the route.

j. Information about current traffic control measures, to include:

(1) The location of traffic control personnel, periods of the operation of control points, and the mission of control points.

(2) The location, condition, and effectiveness of traffic control devices and signs.

k. Locations of possible communication sites for the military police.

l. Location of military units and facilities in the area.

12-6. Traffic Control Reconnaissance Report

a. This makes specific recommendations

about the traffic control measures required at particular locations. If the report and information is to be of value, the military police must know what each traffic and route reconnaissance symbol means, and how the information can affect the use of traffic control methods and devices.

★b. An explanation of the symbols used for route reconnaissance maps or overlays (fig 12-1) is shown in FM 5-36. The route classification system is as follows:

(1) *Types of roads.*

(a) (X) *All-weather*—Any road which, with reasonable maintenance, is passable throughout the year to a volume of traffic never appreciably less than its maximum good weather capacity. This type of road has a waterproof surface and is only slightly affected by rain, frost, thaw, heat, and flooding. At no time is it closed to traffic due to weather effects other than snow or flood blockage. The following are examples of this category: concrete; bituminous; brick; or stone.

(b) (Y) *Limited all-weather*—Any road which, with reasonable maintenance, can be kept open in bad weather to a volume of traffic which is considerably less than its normal good weather capacity. This type of road does not have a waterproof surface and is considerably affected by rain, frost, or thaw. The following are examples of this category: crushed rock or waterbound macadam; gravel or lightly metaled surface.

(c) (Z) *Fair weather*—A road which becomes quickly impassable in bad weather and which cannot be kept open by normal maintenance. This type of road is seriously affected by rain, snow, frost, or thaw. The following are examples of this type: natural or stabilized soil, sand or clay, cinders, or disintegrated granite.

(2) *Route classification formula.* The route classification formula is developed from notations expressed in the standardized sequence of minimum roadway width, route type, lowest military load classification, and obstructions if present. The formula briefly describes a specific route and is used together with a route reconnaissance overlay. If an obstruction appears in the route classification formula, it is necessary to refer to the route reconnaissance overlay in order to determine its exact nature. The overlay may also show bypass possibilities. Examples are shown below:

(a) 20 ft Y 50 describes a limited all-weather route with a minimum traveled way of 20 feet and a load limit of class 50 vehicles.

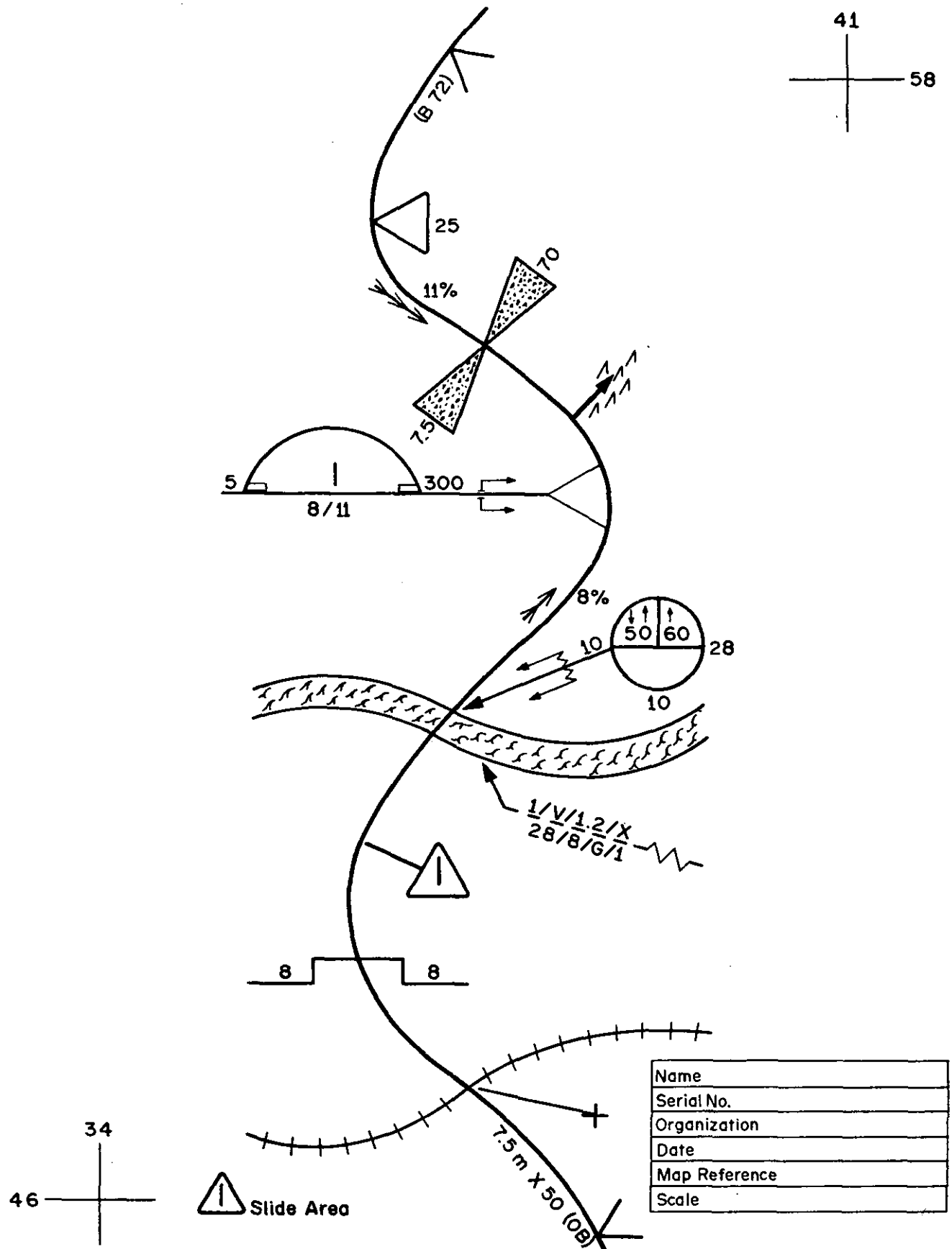

Figure 12-1. Example of a route reconnaissance report.

★(b) 20 ft Y 50 (OB) “(OB)” indicates an obstruction along the route. Obstructions are defined as—

1. Overhead clearances less than 4.3 meters (14 ft).
2. Traveled way widths less than those prescribed for the type of traffic flow.
3. Grades of 7 percent or more.
4. Curves with a radius of curvature of 30 meters (100 ft) or less.
5. Ferries.
6. Fords.

(c) 20 ft Y 50 (T) “(T)” represents snow blockage.

(d) 20 ft Y 50 (W) “(W)” represents flooding.

(3) *Causeways, snowsheds, and galleries.* Although these structures are not often encountered in a route reconnaissance, when they constitute an obstruction to traffic, they should be included in the route reconnaissance report. Limit the data to necessary clearance space, and load carrying capacity. If possible, support the information with photographs or a sketch of each structure. Also, if possible, include descriptive information which will help the engineers evaluate the structures and decide if their removal or strengthening is necessary.

(a) A causeway is a raised way across wet or unstable ground.

(b) A snowshed is a shelter offering protection from snow, such as a long structure over an exposed part of a road or railroad.

(c) A gallery is a sunken or cut passageway with cover or protection overhead on the sides. In a combat area, a gallery may be important not only because it may be an obstruction, but because it may afford protection.

★c. Road characteristics are expressed by symbols in the following order: limiting factors, width, construction material, and, if desired, length. Symbols for road characteristics are shown in figures 12-2 and 12-3.

(1) *Limiting factors.* The symbol A is used if there are no limiting factors. The symbol B means one or more limiting factors. A question mark in parentheses (?) means an unknown limiting factor. A V-like symbol on a map or overlay represents the terminal points of the road sector (fig 12-1). Figure 12-2 shows limiting factors, their criteria, and symbols representing them.

(2) *Width.* The roadway is expressed in meters followed by a slash, with the width of the roadway and shoulders combined, as 14/16.

(3) *Construction materials.* See figure 12-3 for these symbols.

(4) *Length.* This may be shown, if desired, in parentheses at the end of a road classification formula.

Limiting factor	Criteria and traffic control effect	Symbol
Sharp curves	Sharp curves with radius less than 100 ft (30 m) cause some slowing of convoy traffic and will be reported as obstructions. This may not allow proper turning space for tractor and trailers, or other long vehicles, and require defile control.	c
Steep gradients	Steep gradients, 7% or steeper, cause some slowing of convoy traffic. Gradients steeper than 7% and excessive changes in gradients will also be reported as obstructions. This may require control measures at the top and on downhill lanes to control the speed of descent and insure proper vehicle distances.	g
Poor drainage	Inadequate ditches, crown/camber, or culverts; culverts and ditches blocked or otherwise in poor condition. This may call for a bypass or rerouting to be established in the event of flooding.	d
Weak foundations	Unstable, loose or easily displaced material. Only vehicles of a certain weight class may be allowed to pass, and heavier vehicles rerouted. <i>Note.</i> Determined only by engineers.	f
Rough surface	Bumpy, rutted, or potholed to an extent likely to reduce convoy speeds. All weight classes may be able to pass over this area, but heavier vehicles may cause traffic to bottleneck and backup. Heavier traffic may need to be rerouted.	s
Excessive camber or superelevation	Falling away so sharply as to cause heavy vehicles to skid or drag toward the roadside. This could call for defile control to be established.	j

Figure 12-2. Criteria for determination of limiting factors.

Symbol	Material	Normal road type
k	Concrete -----	Type (X); generally heavy duty.
kb	Bituminous or asphaltic concrete (bituminous plant mix) -----	Type (X); generally heavy duty.
p	Paving brick or stone -----	Type (X); generally heavy duty.
pb	Bituminous surface on paving brick or stone -----	Type (X) or (Y); generally heavy duty.
rb	Bitumen-penetrated macadam; waterbound macadam with superficial asphalt or tar cover -----	Type (X) or (Y); generally medium duty.
r	Waterbound macadam, crushed rock, or coral -----	Type (Y); generally light duty.
l	Gravel or lightly metaled surface -----	Type (Y); generally light duty.
nb	Bituminous surface treatment on natural earth, stabilized soil, sand-clay, or other select material -----	Type (Y) or (Z); generally light duty.
n	Natural earth, stabilized soil, sand-clay, shells, cinders, disintegrated granite, or other select material -----	Type (Z); generally light duty.
v	Various other types not mentioned above -----	(Indicate length when this symbol is used.)

Note. In addition to the symbols shown above, the symbol "b" (bituminous surface) may be used alone when the type of bituminous construction cannot be determined.

Figure 12-8. Symbols for types of surface materials.

(5) *Additional information.* The civil and military designation of the road, cover and concealment, possibilities of movement off the road, and similar information are indicated by appropriate symbolic notation on an accompanying map or overlay.

(a) A 5.0/6.2k. This formula describes a road with no limiting characteristics or obstructions, a minimum roadway of 5.0 meters, a combined width of roadway and shoulders of 6.2 meters, and a concrete surface.

(b) B gs 4/5 1 (OB). This formula describes a road with limiting characteristics of steep gradients and a rough surface; a minimum traveled way of 4 meters and a combined width of 5 meters; gravel or lightly metaled surface; and obstructions, (s).

(c) B c (f?) 3.2/4.8 p (4.3km) (OB) (T). This formula describes a road with limiting characteristics of sharp curves and unknown foundation; a minimum traveled way of 3.2 meters and a combined width of 4.8 meters; paving brick or stone surface; 4.3 kilometers long; with obstructions (f?) (s); and subject to snow blockage. For detailed information concerning route reconnaissance and map overlay symbols, see FM 5-36 and FM 55-15.

(d) A 7 + 7/20 k. This formula describes a dual road with each traveled way 7 meters wide and with an overall width of 20 meters including shoulders. It is constructed of concrete and has no limiting factors.

d. Based on this information, the traffic control reconnaissance report should contain specific recommendations concerning the loca-

tion of traffic posts and establishment of motor patrols.

(1) When recommending specific locations for traffic control posts, the following items should be specified:

(a) Should a TCP be established pending the erection of signs?

(b) What will be the period of time that the TCP will be operational?

(c) Is a temporary TCP necessary during a construction phase?

(d) Is a TCP necessary to direct traffic around a contaminated area?

(e) The number of men to be assigned to a TCP team and items of special equipment required for the TCP should be specified.

(f) The above recommendations are based on the following considerations:

1. TCP are recommended only where absolutely necessary.

2. Signs and other devices are used in place of military police when possible.

3. The use of a patrol to service the area is being evaluated.

(2) The following points must be considered in the establishment of motor patrols:

(a) What size of patrol and kind of equipment is necessary?

(b) What areas and routes are to be patrolled?

(c) What method of patrolling should be used?

(d) Are there areas and points that require special patrol considerations?

Section II. TRAFFIC MAPS

12-7. General

Maps (used with overlays when appropriate) provide an excellent means for recording and

portraying road and terrain use. Also, maps can be used to depict the effectiveness of traffic regulation and control.

12-8. Traffic Circulation Map

The traffic circulation map is maintained by highway traffic headquarters. It is a graphic representation of the traffic circulation plan. The circulation map is normally composed of an issued map with one or more overlays portraying the pertinent information mentioned in paragraph 12-6. The traffic circulation map is not usually found below the platoon headquarters level. When information must be extracted from this map and passed to the individual military policeman, overlays are used. Much of the information found on this map, such as road information, was originally computed by the individual military policeman.

12-9. The Traffic Control Map

This map, which is maintained by the military police units and higher headquarters, is composed of an issued map with overlays. The traffic control map shows—

a. Information concerning traffic regulation and circulation necessary for traffic control.

b. The locations of all military police traffic control positions and patrol areas. (Other military police positions should also be shown when they are a source of assistance during traffic control operations.)

c. The locations of highway regulating positions and devices.

d. The locations of service facilities which assist highway movement. These would include POL points, motor maintenance facilities, and medical service facilities, etc.

12-10. The Unit Location Map

This map/overlay combination shows the location of all units, facilities, and activities in an area. It is normally maintained at MP unit headquarters.

12-11. The Reconnaissance Map

This map or overlay is prepared by the military police who conduct a reconnaissance. A master reconnaissance map is maintained by the military police unit showing the results of reconnaissance in the area.

12-12. Traffic Control Team Map

a. The senior military policeman or noncommissioned officer in charge of a traffic control function will be equipped with a map/overlay that will portray a combination of information found on the maps discussed previously. This information will be restricted to that affecting the area of responsibility of the traffic team and the area immediately bordering it. Information that applies throughout the area, such as light restriction, dispatch routes, etc., is not portrayed on this map/overlay.

b. Basic information included on the map/overlays issued to the military police traffic control team includes—

- (1) Traffic flow.
- (2) Traffic regulations.
- (3) MP positions, activities, and facilities.
- (4) Vehicle holding area.
- (5) Vehicle service facilities.
- (6) Military police communication positions.
- (7) Road restrictions and route classification.

(8) Bridge classification and bypasses.
 (9) Appropriate portions of division plans.
 (10) Location of units, installations and facilities.

c. In addition to map and overlays the military police teams are often provided with strip maps to be used in giving direction to the road user. This is normal under static conditions or during preplanned operations. Strip maps are used to pass specific instructions to road users, such as direction to crossing sites, holding areas and supply complexes.

d. Another map or overlay that is often provided to the military policeman assigned to traffic functions is the "measle map" (fig 12-4). The name "measle map" is derived from the dotted or spotted appearance of the map. This map or overlay assigns a reference number or letter to each intersection of importance. By use of this reference, the military police can accurately locate and report information. The measle map may be modified so that roads instead of intersections are assigned as reference points. Also, the artillery reference point system can be modified for this use (FM 6-40).

Section III. ESCORTS**★12-13. Traffic Escorts in Theaters of Operation**

Methods used for escorts in a theater of operation are similar to those performed on a post, camp, or station (para 5-9 and 5-10) with the

exception that, at times, military police perform escorts in an area of heavy enemy or guerrilla activity. Normally, personnel traveling in individual vehicles other than convoys provide their own security. If traveling in a convoy, security

will be provided by, or for, the entire convoy. The military police provide information to the convoy commander and aid him in the conduct of the convoy security plan when required.

★12-14. Modified Empty Truck Method

The military police presently use the four basic methods as stated in chapter 5. A type of escort used with a great deal of success in emergency situations is called the modified empty truck method. With the modified empty truck method, each planned traffic control post is equipped with a vehicle (usually ¼-ton truck) and radio. Should, for example, ten critical points (bridges, intersections, etc.) exist along a given route, twelve vehicles will be required to support the convoy. The NCOIC of the military police force departs with the personnel who will operate the TCP and proceeds in front of the convoy, insuring that each man on each TCP knows his mission. He posts the TCP at the preplanned, critical locations and posts himself at the final location. The military police force is careful not to travel too far in advance of the convoy for security and safety reasons (normally not more than 2 minutes). At the time of departure of the convoy, the officer in charge of the military police force escorts the convoy at a preplanned speed, while the NCOIC insures that the TCP's are located in their places and properly perform their mission. When the NCOIC notes road junctions, accidents, or other things which may impede the normal progress of the convoy, he shifts the TCP or, if possible, establishes new ones. The lead (OIC) vehicle maintains radio contact with each TCP and the trail vehicle. An NCO in the trail vehicle assists in the control of the convoy and insures when the convoy passes each point; the TCP's follow at the rear of the trail vehicle in the convoy. This method not only provides secure traffic control force movement but the personnel who had been used at TCP provide additional security force to the convoy.

12-15. Aircraft in Conjunction With Traffic-Escorts

Military police traffic escorts, for added efficiency and traffic safety, can be augmented by the use of rotary- or fixed-wing aircraft. They are of particular value for escorting traffic over rough terrain, and providing early warning of traffic problems to the convoy. The military police on the ground respond to situations reported from the air. Rotary-wing aircraft may also be used to place military police on traffic control posts, to relieve them or, move them

ahead to other posts. Armed rotary-winged aircraft, working in conjunction with the ground escort vehicles, may provide an additional element of security to the traffic escort and the convoy while assisting the traffic escort in its traffic control mission.

★12-16. Convoy Escorts

a. The mission of convoy escort details is to insure the security and efficient movement of the convoy.

b. Concept of operation.

(1) Under normal conditions, military police units provide convoy escort/security forces on an area basis to the motor transport service. When it has been determined by the TAACOM or Corps commander that the rear area threat required dedication or military police assets for convoy protection of transportation truck units engaged in line-haul operations, military police units, augmented by Team FZ, Armored Vehicle Squad, or combination thereof, may be placed in direct support of or attached to the motor transport service. The composition of such support (i.e., armored vehicle squads, platoons, or companies) will depend on the commander's priorities, enemy threat, availability of resources, size of the motor transport unit to which attached, or placed in direct support and the needs of the motor transport service.

(2) Direct support versus attached.

(a) Military police units placed in direct support of a motor transport unit are provided by the senior military police headquarters (TAACOM or Corps) on a mission support basis and remain under the operational control of the parent military police headquarters while performing such missions.

(b) Attached military police units are provided by the senior military police headquarters (TAACOM or Corps) and during the period of attachment to the motor transport service are operationally controlled by that unit and operate in accordance with pertinent motor transport service operating directives and SOP. Such attachment is accomplished on orders of a competent authority (commander, TAACOM, Corps) and extends for either a specific time period or until completion of a specific operation, at which time the attached military police resources revert to the operational control of the parent military police brigade.

(3) Command and control.

(a) In transportation line-haul operations, the officer or noncommissioned officer in command of a column is responsible for its actions

during a movement. The column commander issues orders to initiate the march and insures that instructions contained in standing operating procedures and march orders are carried out.

(b) There are two types of control exercised in military motor movements; organizational and area control. Organizational control is always exercised during motor movements by the commander of the organization or unit using the road. In this capacity, the commander of an organization or unit making a motor move is responsible for insuring observance of local security measures. Commanders having area jurisdiction may superimpose their control on organizational control to assure orderly and effective movement. Area control is normally planned, implemented, and supervised by the appropriate traffic headquarters for highway regulations and by the area military police for traffic control. It is employed only to the extent necessary to assure orderly and effective movement of vehicles over the highway system.

(c) In developing the movement plan or order, the commander directing a convoy highway movement must take into consideration the situation that exists or may be expected to exist along the route of movement and the resources that can be made available for security purposes. In consonance with the guidance cited above, a support group commander, for example, has several options for insuring the security of motor columns moving within or through his area of responsibility.

1. When the tactical threat is negligible, the area commander may feel that line-haul operations moving through his area require no security measures other than the normal road patrols and route security measures performed by military or civil police or other security forces within the area (area security measures) and the self-defense capability of the transport unit employing its organic rifles, machine guns, and grenade launchers (organizational security measures). When motor transport service units or vehicles operate without an escort and are

MAP:FRANKFURT
1:100,000; SHEET:T-3

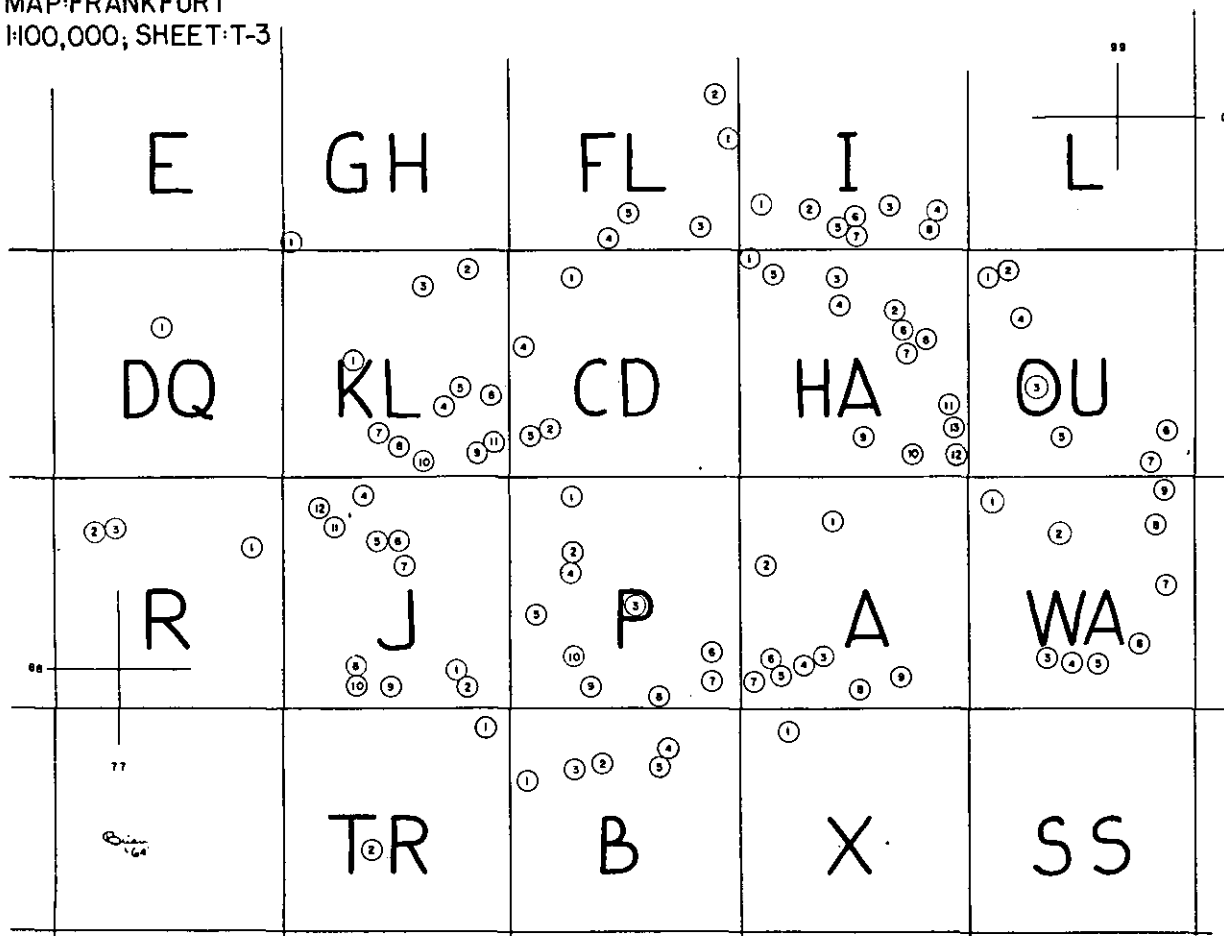

Figure 12-4. Example of a "measle map" overlay.

not attached to a using agency but provide transport in a direct support role, command and control of the motor transport unit or of a motor transport column and its serials or march units, or of a group of vehicles remain with the truck unit commander or the designated motor transport commander and his representatives at their respective levels as appropriate.

2. Where there is potential limited tactical threat to movement, the area commander may direct the senior military police headquarters to provide convoy escort forces in direct support of or as an attachment to the motor transport service unit executing the movement.

3. When a motor transport unit is provided a military police convoy escort force on an attached basis, command and control of that motor transport convoy remains—in the absence of any orders or operating directives to the contrary—with the designated motor transport commander at all times. In the event of attack, the security escort commander conducts defensive and/or retaliatory action as directed by the designated motor transport commander. The convoy commander will normally task the MP security force commander for technical advice and assistance in developing the security plan for the convoy.

4. When a tactical threat is the paramount consideration, the responsible area commander may deem it advisable to assign full responsibility for the security of convoy movements to the tactical security force rather than the transportation unit. In such a tactical circumstance, the transportation unit commander would be tasked by the tactical security force commander with the responsibility for local security of transportation unit vehicles. Because transportation truck units have a limited organic security capability and would be forced to degrade their cargo carrying capability to provide their own internal security, military police convoy escort/security forces must be placed in direct support of or attached to the motor transport service when such a threat condition exists. Under these circumstances, tactical units, such as an armored cavalry unit, would be responsible for clearing and securing a given route and military police forces would provide the dedicated security for convoys moving along that route.

12-17. Road Classification According to Enemy Action

Roads within the theater of operation are classified according to the amount of enemy activity

or action anticipated and the estimated risks involved to personnel and equipment using the road. This classification is best accomplished by the use of a color code; the three basic colors used are green, yellow, and red. However, *color designations must not be used as a substitute for current intelligence*. The tactical operations center must be consulted frequently so that current, valid intelligence is always used.

a. Green Road. A road generally free from enemy activity; military personnel normally are permitted to travel unarmed on this road.

b. Yellow Road. A road upon which there is a risk of enemy activity. Along this type road, the pattern of enemy activity will take the form of sniping at vehicles and hit-and-run attacks. In an area with guerrilla activity, the majority of roads and routes will be yellow. In addition to providing security the military police will also enforce the following procedures:

(1) All military personnel traveling the road will be armed.

(2) All military vehicles will carry a minimum of two men.

(3) Vehicles should be required to be close enough to each other to render mutual assistance but not so close that a small ambush force can attack all vehicles. This is normally accomplished by checkpoints or TCP forming individual vehicles into provisional convoys.

c. Red Road. A road lying within the combat area or subjected to such enemy activity that it requires offensive action by combat troops to reduce the enemy. For additional details, see FM 31-23.

12-18. Action During Attack

In the theater of operation, the possibility of attack always exists. If and when an attack occurs, at the outset immediate and positive action is taken to neutralize the enemy and gain the offensive. This can be obtained by the following methods:

★*a.* Vehicles should not be stopped but should clear the kill zone. Vehicles that have not entered the kill zone will stop outside the area. Personnel should dismount and take defensive positions.

★*b.* When under attack, security personnel must immediately take positive action to neutralize the attacking forces under supervision of the security force commander.

c. Personnel who have cleared the kill zone will dismount and, if possible, establish defensive positions as a base of fire.

★*d.* Personnel in vehicles that are stopped or

disabled in the kill zone will dismount and form a base of fire. Armored vehicles may be brought into the kill zone to serve as a base of fire.

★*e.* Requesting artillery or air support must be coordinated by a staff officer, convoy commander or security commander. If a request for a fire mission is received from an unknown observer, time may be lost in establishing his identity. All information should be coordinated with the artillery or aerial supporting units during the planning stage, and all requests for supporting artillery fires should be submitted as outlined in FM 6-40. Coordination must include call signs, radio frequencies, convoy start time, time schedule, checkpoint and size of march elements. Further, coordination may include the types of ammunition to be fired under various conditions, the number of rounds to be fired at a given target and the establishment of "No fires

zones." The most important of all is the person calling for and adjusting artillery fire; he must know how to read a map, operate a radio and adjust artillery fire. Another element of fire support which should be planned is the use of attack helicopters with aerial field artillery (AFA) capability. These attack helicopters can be either on alert status or overhead while the convoy is en route (chap 3 and 4, TM 55-311).

f. The attack element will immediately launch an attack on the enemy. Tactics to be employed are generally small unit tactics. The attack element must coordinate its movement by signals or radio. An attack should normally be made from only one direction so as to prevent an interunit clash.

g. The appropriate headquarters will be informed by radio of all enemy action as rapidly as possible.

CHAPTER 13

SPECIAL OPERATIONS

Section I. RIVER-CROSSING OPERATIONS

13-1. River-Crossing Operations

The purpose of a river crossing is to move the advancing force across a river obstacle as rapidly and as efficiently as possible, so that it may either continue its attack to destroy the enemy or seize objectives that will protect the crossing of the remainder of the force. River crossing operations require absolute control and maximum security. The military police provide the commander with a means to control traffic involved in the operation. The military police personnel engaged in this type operation will be located in three areas, which will modify normal traffic control functions. These areas are the crossing area, the near side to the rear of the crossing area, and the far side (fig 13-1). (For details, see FM 31-60.)

13-2. Traffic Control at River Crossings

a. Military police on traffic control duties at river crossings will insure that—

- (1) Only authorized movements take place.
- (2) Authorized movement is controlled to insure complete compliance with orders and regulations.

★(3) All vehicles clear the engineer regulating points. An Engineering Regulating Point (ERP) is a location where engineer personnel supervise traffic prepared to cross to insure that each vehicle meets the class, width and height restrictions of the bridges, rafts or ferries at the crossing sites. Vehicles will be directed to the appropriate crossing site.

★(4) Priorities are honored.

b. Plans will be formulated to divert traffic in emergencies. These plans will be understood by all military police.

c. Although control of military police will be decentralized by areas, the entire military police effort must be fully coordinated.

d. Prior to the assault military police will rely on telephones. After the assault has begun and radio silence has been lifted, radio communication will be used.

13-3. The Near Side

a. The near side to the rear of the crossing area (fig 13-1) is the area from the division rear boundary to the traffic regulating line (*b*, below). The objective of traffic control in this area is to provide an orderly, continuous movement to the crossing areas. Special traffic control procedures or control measures are listed below.

b. A traffic regulating line is selected for each phase of the river-crossing operation. It indicates the forward limit of traffic regulation and control responsibility of the commander having overall control of the operation. This normally would be located immediately to the rear of assault battalions to relieve the assault commanders of responsibility for traffic in their rear. Other traffic regulating lines may be established to facilitate the control of vehicular density throughout the division and to indicate the forward edge of corps area of responsibility.

c. Staging areas are located far enough from the river to allow the maximum use of alternate routes to crossing sites. They are located and employed to handle traffic entering the assault unit's area. Military police assigned to the vicinity of the staging area will—

(1) Provide traffic control between the staging areas.

(2) Insure that all vehicles clear the ERP.

(3) Enforce all orders and regulations with emphasis on movements.

(4) Advise the staging area commander, when requested, on the internal organization of the staging area as it affects traffic control.

(5) Assist in providing security, refugee control and straggler control.

d. Holding areas are located on the near and far side of the river just outside of the crossing area. The holding areas are located off the road and maintain the continued flow of traffic by preventing undue congestion of vehicles in the crossing area. Military police establish and op-

erate holding areas as outlined in paragraphs 13-6, 13-7, and 9-5 (fig 13-2).

13-4. Crossing Area

a. The crossing area is the responsibility of the crossing area commander. Military police are attached to the crossing area commander for the operation.

b. Dispersal areas, where vehicles can be halted and dispersed, are defined zones within the crossing area in proximity to the crossing means. These areas may be operated by the military police for the crossing area commander. Dispersal areas operate as holding areas. However, every effort is made to conceal the areas from the enemy and to disperse the vehicles, reducing the attractiveness of the target. The use of the dispersal area eliminates congestion on the crossing access road by providing temporary storage of the crossing traffic when the traffic has been disrupted or there has been a reduction in the crossing means. Vehicles are dispatched from the dispersal area to the crossing site in accordance with the capability of the reduced crossing means. The military police employed in the dispersal area operate under and are in constant communication with the crossing area commander.

13-5. Far Side

On the far side, precise traffic control prevents the massing of vehicles, thus facilitating the maximum use of the existing road nets; therefore, military police must be present immediately following the assault units. This traffic control is then accomplished by TCP and motor patrols at holding areas and at critical crossroads or road junctions.

13-6. Bridges and Crossings

Military police normally establish traffic control at bridges and crossing sites in a theater of operations. Sometimes in CONUS, military police may be required to establish traffic control at bridges or crossing sites under the following conditions:

a. When severe weather conditions have damaged the crossing site.

b. Where crossings have been destroyed by acts of sabotage.

c. In support of field training exercises.

13-7. Control Exercised at Bridges and Crossing Sites

Military police enforce traffic rules and regulations, including speed, vehicle interval limit,

crossing limitations, and defile control during special crossings at bridges and at other crossing sites. When necessary, holding areas are established on access roads approximately 1 to 5 km from the crossing site (fig 13-2).

13-8. Vehicle and Bridge Capacity Classifications

a. Classification of vehicles and bridges by allowable capacity simplifies the decision for determining whether a given vehicle can safely cross a bridge. Such classifications are determined by the engineers. The guidelines for using the classification information posted on vehicles and bridges is contained in FM 5-36.

★b. Generally, the classification is represented by a class number, which does not indicate weight, but rather the effect that a vehicle has on a bridge. The class number is shown on signs erected by the engineers at the beginning of each bridge or crossing site (fig 13-3A and 13-3B). The width limitation shown in figure 13-3B is only found on one-lane bridges.

c. Classification numbers assigned to vehicles are whole numbers ranging from 4 through 150. Figure 13-4 indicates the methods that are used to portray vehicle classification.

13-9. Types of Bridge Crossings.

There are two types of crossings:

a. *Normal Crossings.* Normal crossings may be made whenever the vehicle class number is equal to or less than the bridge class number. Existing convoy discipline must be imposed on the vehicles making a normal crossing. A minimum vehicle spacing of 27 meters and a maximum speed of 25 miles per hour are the main limitations imposed during a normal crossing. These are two types of normal crossings: normal one-way, and normal two-way.

(1) *Normal one-way.* This type of crossing is permitted when the vehicle class number is equal to or less than the number posted on a single-lane bridge or the one-way class number of a two-lane bridge. If a one-way crossing is made on a two-lane bridge, the vehicle should be driven down the center of the bridge.

(2) *Normal two-way.* This type of crossing is permitted when the vehicle class number is equal to or less than the two-way class number of a multilane bridge. Two-way traffic may be maintained with this type of crossing.

★b. *Special Crossings.* Special crossings are classified as caution crossings and risk crossings. A special crossing is one in which the bridge class number is less than that of the veh-

icle. A special crossing may be authorized by military authority under exceptional operating conditions or by local civil authorities if appropriate.

(1) A caution crossing is a bridge crossing where vehicles with a classification up to 25 percent above the posted bridge loadings are allowed to proceed cautiously across the span. A caution class number is obtained by multiplying the normal crossing class number of either a single lane or multilane nonstandard military bridge by 1.25. For standard prefabricated bridges, the vehicle class number must not exceed the published caution bridge class number. During a caution crossing, the vehicle remains on the center line of the bridge; maintains a 50

meter interval from the vehicle in front; and does not exceed a speed of 13 KPH (8 MPH), stop, accelerate, or shift gears on the bridge.

(2) A risk crossing may be made only on prefabricated fixed or floating bridges and in the gravest emergencies where excessive losses will otherwise result. An Engineer officer must inspect the bridge (for signs of failure) after each risk crossing. All damage must be repaired before traffic can resume. The vehicle will remain on the center line of the bridge, not exceed a speed limit of 5 KPH (3 MPH), be the only vehicle on the bridge, and not stop, accelerate, or have its gears shifted. (Tanks, on risk crossings,

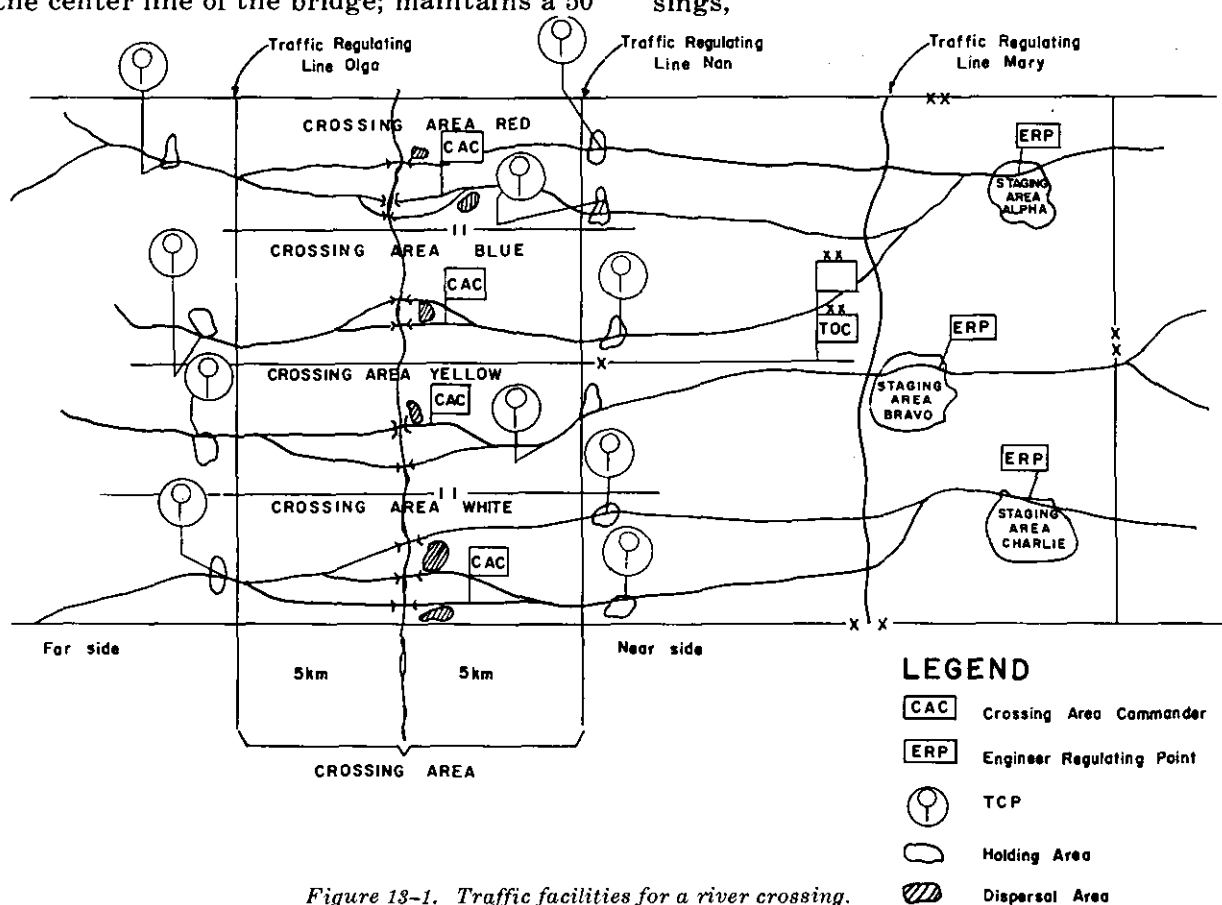
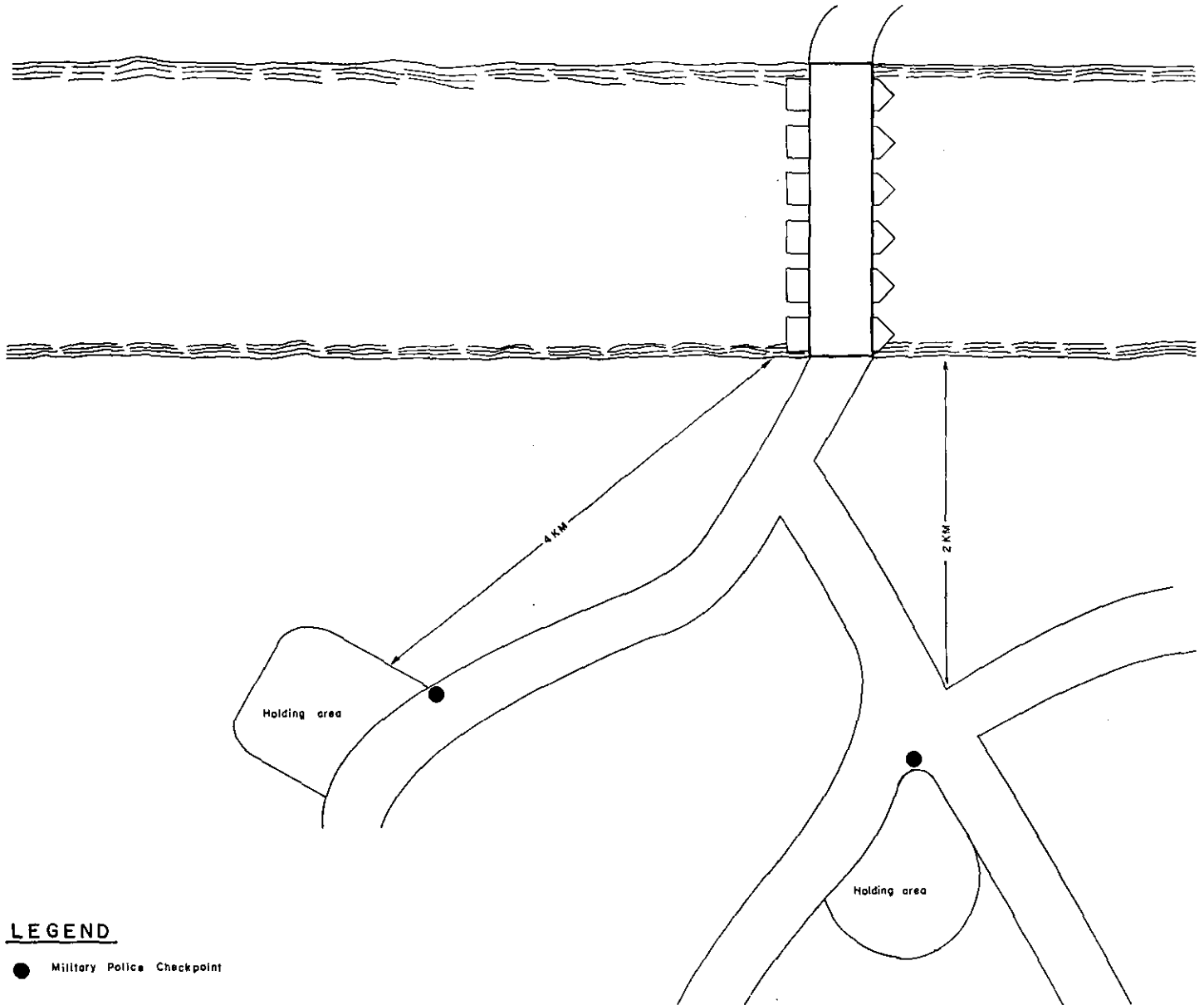

Figure 13-1. Traffic facilities for a river crossing.



LEGEND

● Military Police Checkpoint

★Figure 13-2. Location of holding areas.

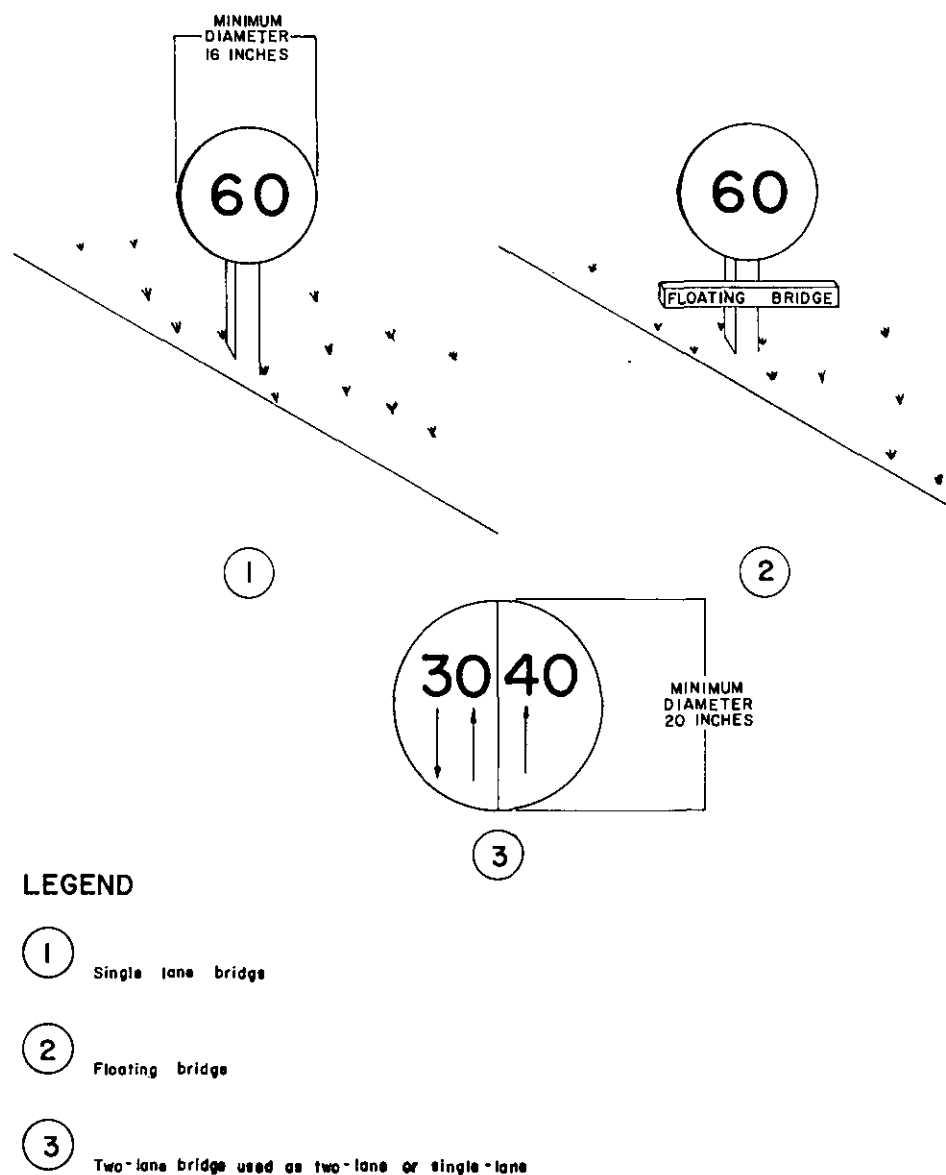

Figure 13-3A. Example of bridge classification signs.

must be steered by using their clutches only.) Risk crossings are permitted only when the vehicle class number does not exceed the risk class for the bridge (fig. 13-5).

13-10. Fords and Other Crossings

a. A ford is a shallow section in a stream or other body of water where the physical characteristics of the bottom and the approaches permit the passage of personnel and vehicles. Fords are classified according to their crossing potential for foot, wheeled, and tracked movements. Military police on traffic control duty at a ford should be fully briefed on the crossing potential

and the trafficability characteristics of the ford. For details, see FM 5-36.

b. Other crossing means include tunnels and ferries. For details, see FM 5-36.

13-11. Crossing Site Operations

a. A type employment of military police at a crossing site is shown in figure 13-6.

b. Activities of the military police are directed by an officer or noncommissioned officer who is located close to the crossing site. When an engineer element is present, the military policeman

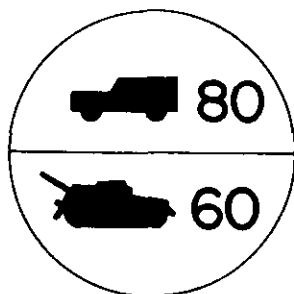

1 Limiting wheeled vehicle class and limiting tracked vehicle class

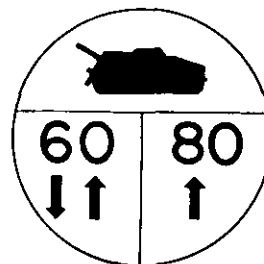
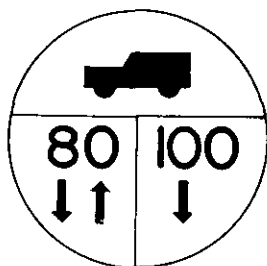

2 Combination of dual class and two-way bridge class signs

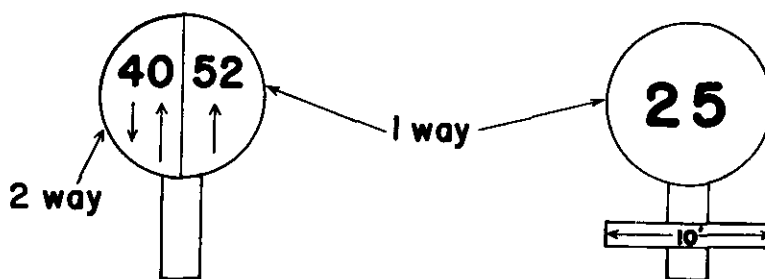

Figure 19-3B. Example of bridge classification signs.

The combination dual class and two-way bridge class signs are normally found mounted together, one above the other.

in charge should be located with the engineer in charge.

c. Instructions for the military police at the site will include information concerning priority for use of the crossing and limitations on other than normal crossing.

d. Communications will connect all military police positions. Telephones are the principal means of communication, supported by radio and connecting motor patrols.

e. Permanent classification signs are erected by the engineers. The temporary signs on bridges,

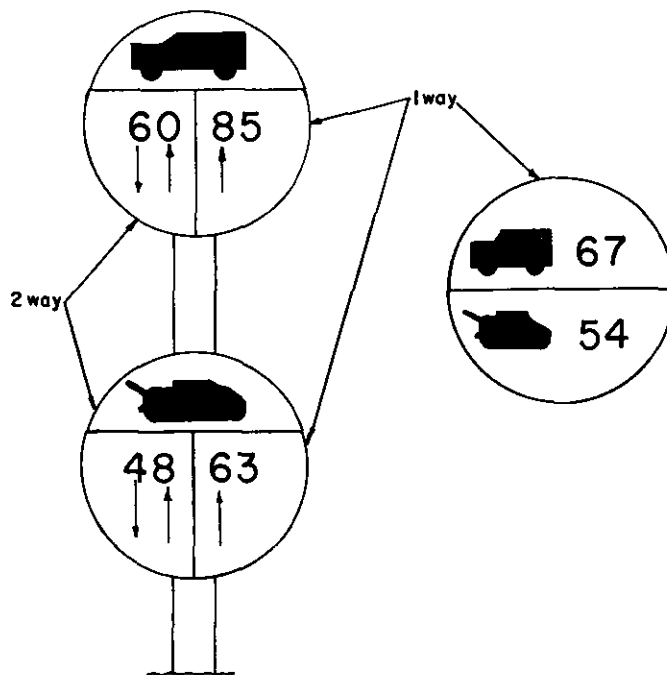
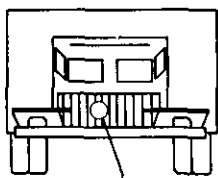
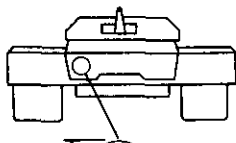

Figure 61—Continued.



WHEELED VEHICLES



TRACKED VEHICLES

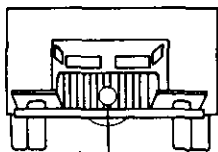

COMBINATION CLASS

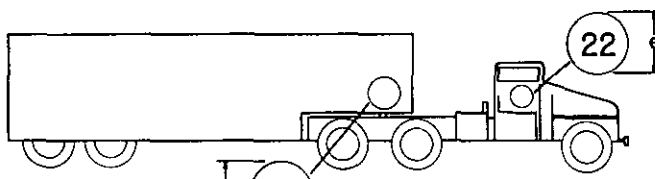

COMBINATION VEHICLE

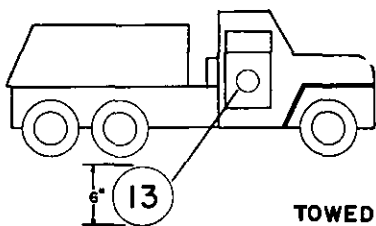

TOWED VEHICLE

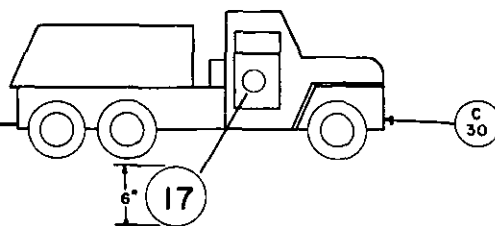

Temporary sign

Figure 13-4. Example of methods for portraying vehicle classification.

Table III. Floating Bridges

1. Type of bridge	2. Transportation required ¹	3. Construction Party ² /Construction Time ³ (hours)		4. Main crew (No men)	5. Load classes ⁴					6. Traffic capacity and vehicular distance for safe crossing in daylight (except as otherwise noted) ⁵											
		Stream width (meters)			Caution crossing ⁶	Risk crossing ⁷															
		Up to 80	80-160			Stream velocities in meters per second (mps)	Stream velocities in meters per second (mps)														
		1 Plat	1 Plat	1 Sqd	1 1.6	2 2.3	3 3.6	4 4.9	5 6.2	6 7.6	7 9.0	8 10.4	9 11.8	10 13.2	11 14.6	12 16.0	13 17.4	14 18.8	15 20.2	16 21.6	
2. Footbridge, aluminum	1 2 1/2-ton truck and 1 2 1/4-ton pole trailer per 77.4 meters of bridge.	1 Plat	1 Plat	1 Sqd	1.6	2.3	3.6	4.9	6.2	7.6	9.0	10.4	11.8	13.2	14.6	16.0	17.4	18.8	20.2	21.6	400 vehicles per hr 30 meters distance between vehicles. ¹⁶
3. Light tactical bridges	2 2 1/2-ton truck and 1 2 1/4-ton pole trailer per 14.4 meters of bridge.	1 Plat	2 Plat	1 Sqd	1.6	2.3	3.6	4.9	6.2	7.6	9.0	10.4	11.8	13.2	14.6	16.0	17.4	18.8	20.2	21.6	400 vehicles per hr 30 meters distance between vehicles. ¹⁶
4. M16 ¹⁰ /Hosi bridge	1 5-ton truck per 4.9 meters of bridge.	1 Co	2 Co	1 Sqd	1.6	2.3	3.6	4.9	6.2	7.6	9.0	10.4	11.8	13.2	14.6	16.0	17.4	18.8	20.2	21.6	400 vehicles per hr 30 meters distance between vehicles. ¹⁶
5. Class 60 floating bridge	Reinforced	1 Co	2 Co	1 Sqd	1.6	2.3	3.6	4.9	6.2	7.6	9.0	10.4	11.8	13.2	14.6	16.0	17.4	18.8	20.2	21.6	400 vehicles per hr 30 meters distance between vehicles. ¹⁶
	Normal	1 Co	2 Co	1 Sqd	1.6	2.3	3.6	4.9	6.2	7.6	9.0	10.4	11.8	13.2	14.6	16.0	17.4	18.8	20.2	21.6	400 vehicles per hr 30 meters distance between vehicles. ¹⁶
6. M4 floating bridge (limited standard)	Reinforced	1 Co	2 Co	1 Sqd	1.6	2.3	3.6	4.9	6.2	7.6	9.0	10.4	11.8	13.2	14.6	16.0	17.4	18.8	20.2	21.6	400 vehicles per hr 30 meters distance between vehicles. ¹⁶
	Normal ¹²	1 Co	2 Co	1 Sqd	1.6	2.3	3.6	4.9	6.2	7.6	9.0	10.4	11.8	13.2	14.6	16.0	17.4	18.8	20.2	21.6	400 vehicles per hr 30 meters distance between vehicles. ¹⁶
7. Mobile Assault Bridge/Ferry (MAB) (MFABF)	Reinforced ¹³	1 Co	2 Co	1 Sqd	1.6	2.3	3.6	4.9	6.2	7.6	9.0	10.4	11.8	13.2	14.6	16.0	17.4	18.8	20.2	21.6	400 vehicles per hr 30 meters distance between vehicles. ¹⁶
	Normal	1 Co	2 Co	1 Sqd	1.6	2.3	3.6	4.9	6.2	7.6	9.0	10.4	11.8	13.2	14.6	16.0	17.4	18.8	20.2	21.6	400 vehicles per hr 30 meters distance between vehicles. ¹⁶
8. Amphibious river crossing equipment (ARCE)	1 Amph big veh per 8.0 meters of brg exclusive of 8.0 meters ramp at each end of brg & 2 amph ramp carriers or 1 ST tractor w/25-ton low bed tr.	1 Co	2 Co	1 Sqd	1.6	2.3	3.6	4.9	6.2	7.6	9.0	10.4	11.8	13.2	14.6	16.0	17.4	18.8	20.2	21.6	400 vehicles per hr 30 meters distance between vehicles. ¹⁶

Figure 13-5. Float bridge load classes for various crossings.

KEY

Class for wheeled and tracked vehicles
 Class for wheeled vehicles
 Class for tracked vehicles

1 Transportation for bridge equipment only. Additional needed for any construction equipment required, and for troops.
 2 Average for retread tracks and continuous daylight assembly. Allowances are required for specific situation and the longer spans.
 3 Includes unloading and assembly only in daylight. Does not include conversion from high to low, additional to water entry configuration for the ARCE units. Time is based on use of retread tracks and no delays. Average time with 2 assembly sites.
 4 Based on abutment at levels within 12-in of floating bridge deck level.
 5 Vehicle anywhere on bridge deck between curbs. Speeds up to 40 kph permitted, but 24 kph recommended. Vehicle spacing, 30 meters.
 6 Center of vehicle within 12 in of bridge centerline. Maximum speed 13 kph. Vehicle spacing 50 meters. No stopping, accelerating, or gear shifting.
 7 Center of vehicle within 9 in of bridge centerline with guide. Maximum speed 5 kph. One vehicle on bridge. No stopping, accelerating, or gear shifting.
 8 Traffic capacities are for all traffic moving forward or rearward.
 9 Reduce capacity 20 percent for currents of 3 to 5.6 mps.
 10 Ratings based on 18-bolt curbs (166k in) in 22-bolt wide superstructure.

11 50-ton tanks having tread widths of 143 inches or more may cross safely up to 2.3 mps.
 12 Ratings based on use of reinforcing position in end span and 18-bolt between curbs (166k in) in 22-bolt wide superstructure.
 13 Ratings based on use of double deck and spars, 100 percent reinforced floating section and 20-bolt between curbs (185 in) in 24-bolt wide superstructure.
 14 Depending on length of bridge and general conditions.
 15 Only MAB crews are required, plus bank and access road preparation as needed.
 16 Based on ideal approach and ramp angle conditions.

(Ratings are tentative)

(Ratings are tentative)

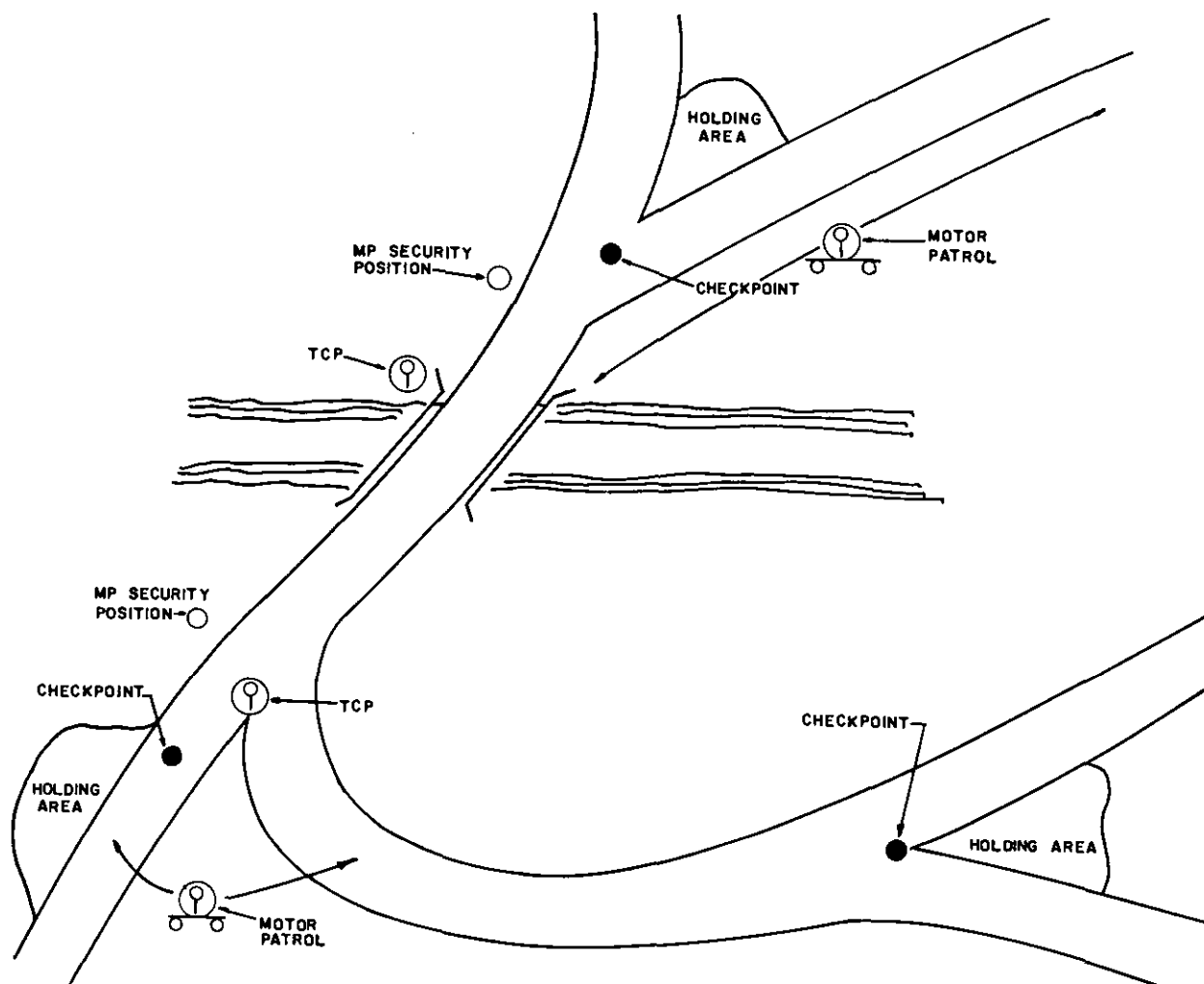

Figure 13-6. Example of a type employment of military police at a crossing site.

to include bridge class, are also the engineers' responsibility.

13-12. Riverine Operations

a. Riverine areas are land environments dominated by water routes. They may contain an extensive network of rivers and canals. Populated areas and commercial centers are normally concentrated along water routes to take advantage of boats, the primary means of transportation in the area.

b. Traffic control, a military police function, is important in riverine operations because the generally poor road networks and numerous small canals hinder combat and combat support elements. Water traffic control and reconnaissance follow the same principles applied to control and reconnaissance on land routes or during

river-crossing and amphibious operations. For additional information, see FM 19-50 and FM 31-75.

13-13. Amphibious Operations

Military police traffic control personnel land early during amphibious assault operations. Their mission is to facilitate the movement of personnel and equipment from the beachhead.

13-14. Principles of Beachhead Traffic Control

a. Traffic control on the beachhead assists the commander in continuing the operation by eliminating delays and congestion.

b. Maximum dispersion is enforced.

c. Personnel and equipment are moved off the

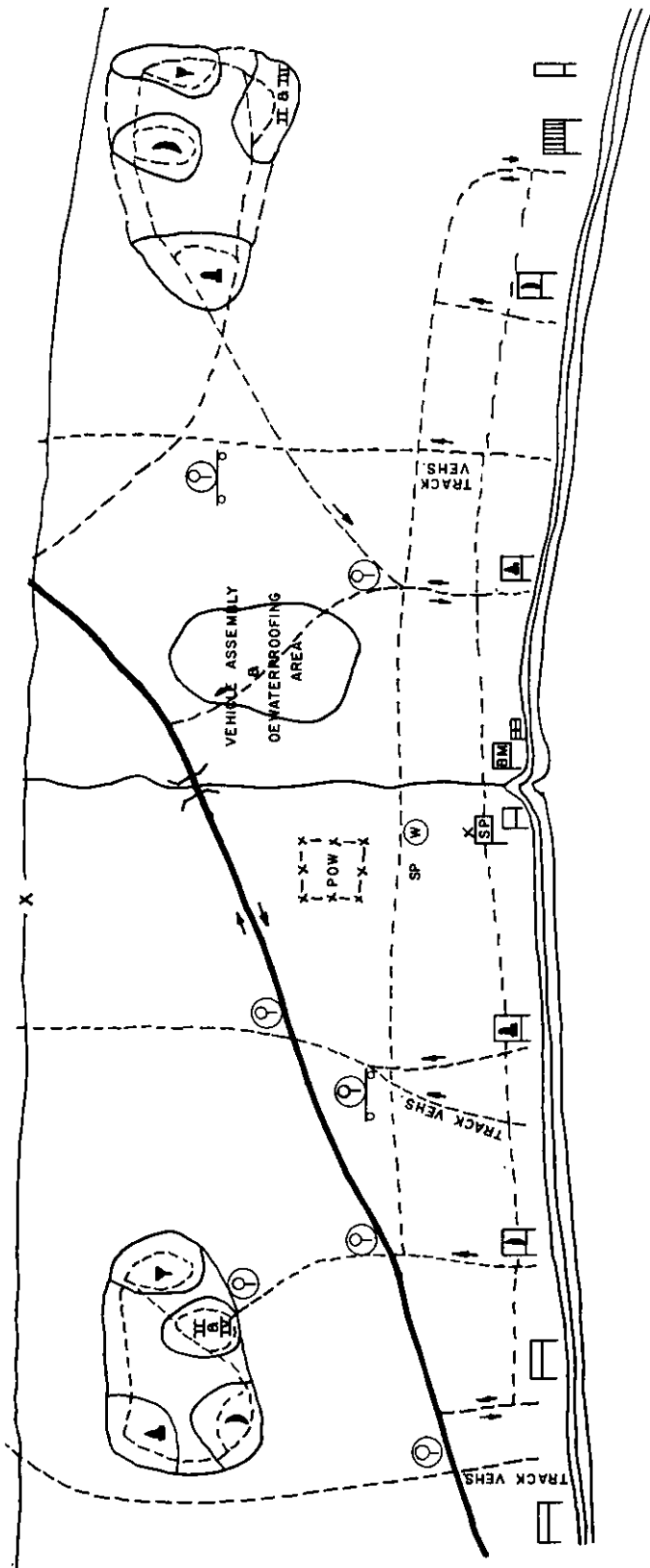

NOTE: SEE FM 5-144

Figure 13-7. Sketch of a beach traffic circulation plan.

beach area without delay, according to the commander's plan.

d. Maximum use is made of direction and control signs.

e. Vehicle drivers and other personnel will be directed to use roads and trails that exist or are outlined in figure 13-7.

f. All military police positions will act as information posts.

g. All military police patrols will conduct continuing route and area reconnaissance.

13-15. Inherent Problems of Amphibious Operations

a. Landing areas may or may not have roads.

Engineer, transportation, and military police units will establish trails and roads where none previously existed. This is accomplished by signs and engineer tape.

b. The area of assault will not have received a ground reconnaissance prior to the landing. This restricts the information available to the military policeman.

c. The area is normally subjected to enemy fire.

d. Landing areas are characterized by congestion and road users who are not familiar with the area.

e. For detailed information on amphibious operations, see FM 31-11 and 31-12.

Section II. OTHER SPECIAL OPERATIONS

13-16. Airborne Operations

Military police elements will accompany the initial assault force. The duties these military police have, in addition to traffic control, include other theater of operations such as straggler control, security of the headquarters, and handling of prisoners of war.

13-17. Traffic Control Techniques in Drop Zones and Airheads

The traffic control techniques used in the drop zone and the airhead are adaptations of conventional military police techniques with increased emphasis on security considerations, both for the security of the military police and for the traffic they are controlling. Normally, initial military police elements do not use reflectorized equipment because it may reveal their position to the enemy. Standard signs and sign making equipment are not used, but are replaced by small improvised cloth signs that are prepared in advance of the drop and issued to the individual military policeman. As the airhead is expanded, and the number of vehicles inside it increases, regular traffic patterns and traffic control duties emerge.

13-18. Desert Operations

Traffic control operations and principles are the same for desert operations as for other operations except as modified below:

a. The individual must continually be con-

scious of the physical environment of the desert, specifically, exposure to the sun, changes in temperature, water consumption, and dehydrations. The military policeman on traffic control duty must evaluate the effect of the environment on his capability to perform duty.

b. The desert is characterized by a lack of developed roads, camouflage, and cover. Since all vehicles will leave tracks in the desert, only designated routes can be used.

c. The lack of terrain features requires the military policeman to understand land navigation and act as a reference point for other personnel navigating over the desert.

d. The major movement of troops will be by mechanized means which, with the lack of navigation reference points, will require a large commitment of military police to traffic control duties.

e. Security considerations during desert operations are affected by—

(1) *The lack of camouflage and cover.* When military police prepare their position, they must camouflage the position and all material used or distributed in preparing the position. Material for cover must normally be transported to positions.

(2) *The great distance which light travels.* Enforcement of blackout regulations is a major military police function.

f. The adverse effect of the desert on vehicles

and personnel requires military police to be prepared to perform desert rescue functions.

g. At the normal command post (CP) or supply complex one dismount point is established; however, during desert operations both CP and supply complexes are characterized by multiple entrances thus requiring multiple dismount points. (For information on the operation of dismount points, see para 11-8, 11-9, and 11-10.)

h. For detailed information on desert operations, see FM 31-25.

13-19. Jungle Operations

The jungle area is normally characterized by lack of roads and restricted vehicle traffic. Traffic control is therefore extremely critical and is directed to insuring that movement is by schedule.

a. Techniques of traffic control in jungle operations are similar to other operations. Usually there are many defiles and crossing sites that require traffic control.

b. Prescribed distances and intervals must be rigidly maintained to prevent damage to the limited road net.

c. Jungle growth offers the enemy an excellent opportunity to utilize guerrilla tactics, thus increasing the security requirements for military police traffic control.

d. For detailed information on jungle operations, see FM 31-35.

13-20. Northern and Mountain Operations

a. The environment is a major factor in military northern and mountain operations. One must know how to survive in this environment (FM 31-70).

b. Because of the environment (snow and cold), maintenance of equipment is of paramount importance.

c. Mobility is restricted by adverse weather and terrain. Once movement and momentum have been achieved every effort must be made to maintain them.

d. Traffic control operation remains basically the same in the northern environment except as modified by the need to withstand the climate. Because of the climate, an active "buddy system"

should be employed by personnel assigned to traffic duty.

e. Reflectorized signs should be used behind the light line and luminous signs forward of the light line. When erecting temporary signs the military policeman should insure that they do not blend with the terrain or ground cover.

f. All single lane roads will have turnouts to reduce delays and congestions. Such turnouts will be well-marked and permitted only at designated places. When vehicles must pass on a narrow road, the vehicle being passed should come to a complete stop on the dangerous side of the road. The passing vehicle should then proceed around the stopped vehicle on the safer side (fig. 13-8).

g. The adverse effect of the climate requires that military police be prepared to perform rescue functions.

h. For details of northern operations see FM 31-70 and FM 31-71. For details of mountain operations, see FM 31-72.

13-21. NBC Operations

The potential threat of nuclear, biological or chemical attack is present during warfare of every intensity. Traffic control planning must provide the capability to reroute traffic around actual or anticipated contaminated areas. Contingency plans must state priorities for the types of traffic to be allowed into the contaminated areas. Methods for preventing unauthorized access to the areas, requirements for the use of protective equipment, and coordinating instructions which deal with the responsibilities, authority and jurisdiction of US forces and local police. These considerations also apply to contingency planning for the support of local governments in CONUS during disaster operations.

13-22. Platoon NBC Activity

The platoon headquarters is normally equipped with a radiological monitoring instrument and a chemical detection kit. This equipment is usually carried by an element of the platoon headquarters on patrol. By such an assignment, the military police unit achieves area coverage in reporting chemical and radiological contamination. This action may relieve the military police company of furnishing survey teams to the damage control center.

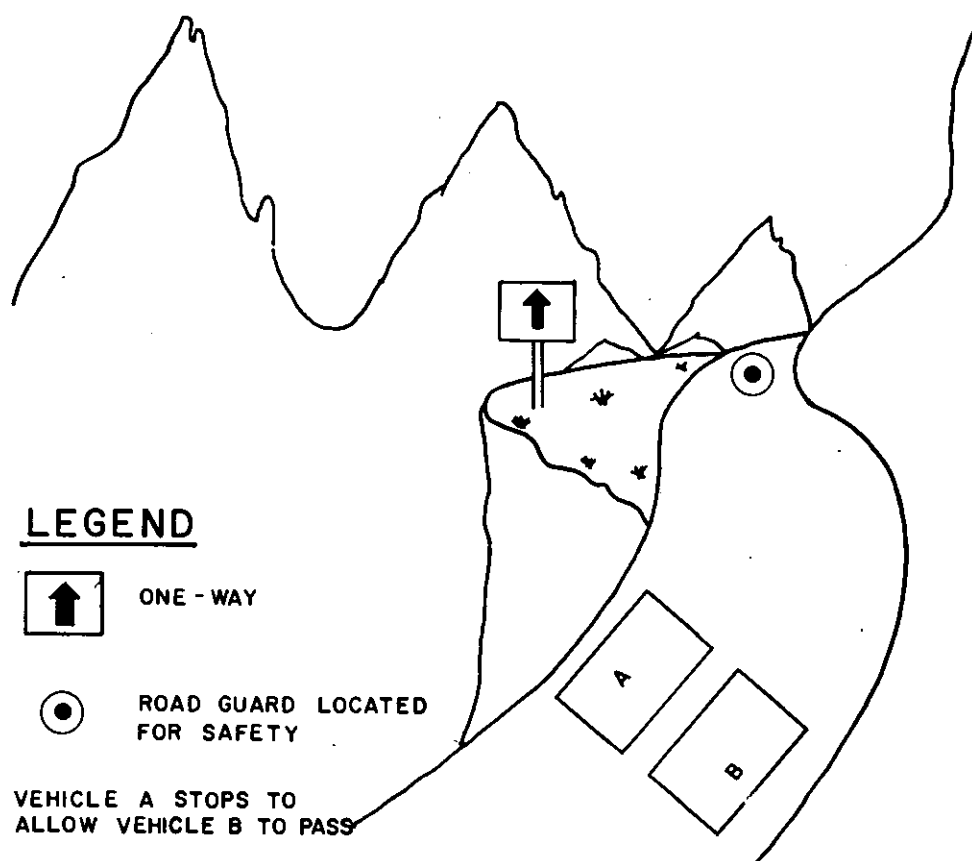

Figure 13-8. Example of a vehicle passing on a narrow mountain road.

13-23. Operation Under Blackout Conditions

a. Blackout conditions will be announced in the appropriate operation order. These conditions increase requirements for strict control of the traffic flow and traffic regulation, as well as creating a security problem.

b. The blackout conditions discussed herein are not total blackout, but are defined as "movement by night with lights which cannot be spotted by enemy observation, but which enable collisions to be avoided by showing the position of the vehicle to other road users." (STANAG No. 2024, Ed. 2.)

c. Depending upon security requirements, the military policeman may use the flashlight baton or wear the reflectorized sleeves and cross straps as an aid to controlling traffic. The operation order will specify those signs that are to be illuminated. Primary emphasis is given to danger and warning signs needed to prevent accidents, and signs that warn of a choice or change in direction. Requirements for illumination are as follows:

(1) The sign will be provided with an upper mask which will prevent detection of the light

from above. An observer flying higher than 150 meters must not be able to see the light or its reflection.

(2) The light will be oriented so that it is visible on the ground at a minimum distance of 100 meters and readable at a distance of 30 meters.

d. Vehicles operating under blackout conditions will meet the following requirements:

★(1) Vehicle lights will indicate the width of the vehicle from either the front or the rear.

(a) Vehicles with 3 or more wheels will display two white or yellow lights at the front and two red lights at the rear.

(b) Motorcycles without sidecars may be equipped with a single headlight and a single rear light.

(2) Vehicle lighting should be diffused. The lighting devices will be provided with effective masks to prevent the lights from being seen from above.

★(3) The lights shall be visible at a minimum horizontal distance of 50 meters and maximum of 300 meters.

(4) Vehicles traveling in convoy will meet the lighting requirements by displaying—

(a) Two white or yellow lights at the front of the first vehicle of each element.

(b) Two red lights at the rear of the last vehicle of each element.

(c) At least one light at the rear of each vehicle to permit the driver of the following vehicle to judge the proper distance. (Refer to paragraph 10-3 for items of STANO Equipment for night operation and blackout driving.)

13-24. Reduced Lighting

Military police may also be required to operate during "reduced lighting" conditions. Under these conditions the brightness of all exterior and interior lights is reduced. Specific requirements will be published by higher headquarters, and will vary with the situation (STANAG No. 2024, Ed. 2.). Refer to appendix I.

★Section III. PASSAGE OF LINES

13-26. General

a. A passage of lines is an operation in which an incoming unit attacks through a unit that is in contact with the enemy. The unit in contact remains in place and supports the incoming unit until its fires are masked. The unit passed through may then remain in place or may be committed to other action. The incoming unit must have priority for use of routes and facilities.

★b. A passage of lines is executed for various reasons. Some include to relieve an overcommitted or depleted unit, to rest a unit by providing fresh troops to continue the attack or to comply with a commander's stated operation exposure guide. The unit in contact furnishes all possible aid to the attacking unit.

13-27. Route Priority and Traffic Control

During passage of lines or similar operations involving the movement of divisions through each other, a joint traffic headquarters must be formed. Normally, the traffic headquarters of the two divisions would combine to form a separate joint element for the operation. The traffic headquarters would become part of the division tactical operations center (DTOC) of that division controlling the movement throughout the operation. Military police of the two divisions augment each other and respond directly to the instructions, priorities, and changes issued by the joint traffic headquarters. During joint traffic headquarters operations, procedures are es-

13-25. Legal Consideration

In a theater of operations the laws and customs of the nations within the theater must be considered in traffic control planning. In low intensity warfare and in operations governed by status of forces agreements and treaties, traffic control planning should be responsive to the needs of the host country. After conflict, our armed forces may govern the nations we occupy until civilian governments are established. When the civilian governments are established, traffic control planning is coordinated with legal and civil affairs personnel to insure that military policemen are aware of the traffic laws they enforce and of the jurisdiction they have over local national personnel.

established to identify both responsibility for control during initial operations and circumstances when control passes from one division to another. The joint traffic headquarters coordinates the control of units moving into and out of the area. This includes—

- a. Routes to be used and priorities for their use.
- b. Responsibility for traffic control.
- c. Location of assembly areas.
- d. Provision of guides for incoming units.
- e. Common use of transportation.

13-28. Traffic Headquarters

a. Division establishes priorities for the control of tactical and administrative movement by means of the division traffic headquarters. The traffic headquarters is composed of transportation, provost marshal, engineer, and communications-electronic (C-E) representatives. It is responsible for planning, coordinating, consolidating, scheduling, and routing all division traffic requirements.

- b. The G4 has the primary staff responsibility for movement control within the division.
- c. The transportation officer is responsible for division traffic regulations. He is primarily responsible for the operation of the traffic headquarters.
- d. The engineer representative advises the traffic headquarters on the condition, capabilities, and limitations of the road net.
- e. The division provost marshal advises the division traffic headquarters and the comman-

der and his staff on circulation, movement, and traffic control within the division area.

f. The division C-E officer advises the division commander and his staff on C-E matters and, through the division signal battalion, provides communication support to the traffic headquarters.

g. The division civil affairs officer advises the division traffic headquarters and the division commander and his staff on the control and care of refugees as they relate to traffic control problems.

h. The traffic headquarters is located near or within the division tactical operations center (DTC) as the situation requires and communicates directly with the G3 and the DISCOM commander. It continuously provides the G3 necessary traffic information for tactical plans and operations, concurrently providing the DISCOM commander necessary information and support to integrate division logistic requirements into the tactical scheme of maneuver. The traffic headquarters, based on the commander's priorities, integrates the administrative and tactical movement requirements

into a flexible and responsive traffic control system utilizing the following:

- (1) Commander's priorities.
- (2) Tactical movement requirements.
- (3) Administrative movement requirements.
- (4) Highway regulation plan.
- (5) Circulation control plan.

i. Commander's priorities change with the situation and become the overriding operational influence in all division movement control. Tactical movements are designed to support the scheme of maneuver, while combat and combat service support activities develop administrative movement requirements. The integration of these movements is reflected in the traffic regulation plan, while the traffic control plan indicates how these movements will be enforced.

j. Members of the traffic headquarters maintain close liaison with the DTC, the DISCOM, and the traffic headquarters of higher and adjacent headquarters to insure incorporation of all essential highway movements into the division traffic regulation plan.

APPENDIX A

REFERENCES

A-1. Field Manuals

- 1-15 Aviation Battalion, Group, and Brigade.
- 1-80 Aerial Observer Techniques and Procedures.
- 1-100 Army Aviation Utilization.
- 3-10 Employment of Chemical and Biological Agents.
- 3-12 Operational Aspects of Radiological Defense.
- 3-15 Nuclear Accident Contamination Control.
- 5-15 Field Fortifications.
- 5-20 Camouflage.
- 5-34 Engineer Field Data.
- 5-36 Route Reconnaissance and Classification.
- 6-135 Adjustment of Artillery Fire by the Combat Soldier.
- 7-11 Rifle Company, Platoons and Squads.
- 19-1 Military Police Support, Army Divisions and Separate Brigades.
- 19-4 Military Police Support, Theater of Operations.
- 19-5 The Military Policeman.
- 19-10 Military Police Operations and Administration.
- 19-15 Civil Disturbances and Disasters.
- 19-20 Military Police Investigations.
- 19-26 Military Police Traffic Accident Investigation.
- 19-30 Physical Security.
- 19-50 Military Police in Stability Operations.
- 20-22 Vehicle Recovery Operations.
- 21-6 Techniques of Military Instruction.
- 21-11 First Aid for Soldiers.
- 21-26 Map Reading.
- 21-30 Military Symbols.
- 21-31 Topographic Symbols.
- 21-40 Chemical, Biological, Radiological, and Nuclear Defense.
- 21-41 Soldier's Handbook for Chemical and Biological Operations and Nuclear Warfare.
- 21-60 Visual Signals.
- 21-75 Combat Training of the Individual Soldier and Patrolling.
- 21-150 Combatives.
- 23-30 Grenades and Pyrotechnic Signals.
- 24-18 Field Radio Techniques.
- 24-20 Field Wire and Field Cable Techniques.
- 24-21 Field Radio Relay Techniques.
- 30-5 Combat Intelligence.
- 30-10 Terrain Intelligence.
- 31-11 Doctrine for Amphibious Operations.
- 31-12 Army Forces in Amphibious Operations.
- 31-16 Counter guerrilla Operations.
- 31-22 U.S. Army Counterinsurgency Forces.
- 31-25 Desert Operations.
- 31-35 Jungle Operations.
- 31-60 River Crossing Operations.
- 31-70 Basic Cold Weather Manual.
- 31-71 Northern Operations.
- 31-72 Mountain Operation.
- 31-85 Rear Area Protection (RAP) Operations.
- 41-10 Civil Affairs Operations.
- 55-10 Army Transportation Movements Management.
- 55-15 Transportation Reference Data.
- 55-30 Army Motor Transport Operations.
- 57-35 Airmobile Operations.
- 61-100 The Division.
- 101-5 Staff Officers' Field Manual: Staff Organization and Procedure.

A-2. Technical Bulletin

- 55-46-1 Standard Characteristics (Dimensions, Weight and Cube)

for Transportability of Military Vehicles and Other Out-size/Overweight Equipment.

A-3. Technical Manuals

- 3-220 Chemical, Biological, and Radiological (CBR) Decontamination.
- 5-210 Military Floating Bridge Equipment.
- 5-216 Armored Vehicle Launched Bridge.
- 5-277 Bailey Bridge.
- 5-312 Military Fixed Bridges.
- 19-251 Traffic Control Studies.
- 21-300 Driver Selection and Training (Wheeled Vehicles).
- 21-305 Manual for the Wheeled Vehicle Driver.
- 55-310 Motor Transport Operations.
- 55-311 Convoy Security in Stability Operations.
- 55-312 Military Convoy Operations in CONUS.

A-4. Army Regulations

- 34-1 United States Participation in NATO Military Standardization, Research, Development, Production, and Logistic Support of Military Equipment.
- 55-162 Permits for Oversize, Overweight, or Other Special Military Movements on Public Highways in the Contiguous States and the District of Columbia of the United States.
- 190-5 Motor Vehicle Traffic Supervision.
- 190-7 Physical Security Standards for Protection of Presidential Aircraft.
- 190-8 Off Post Military Police Activities.
- 190-9 Military Absentee and Deserter Apprehension Program.
- 190-12 Military Police Working Dogs.
- 190-15 Traffic Accident Investigation.
- 190-16 Carrying Deadly or Dangerous Weapons Aboard Commercial Aircraft
- 190-22 Search, Seizure, and Disposition of Property.

- 190-29 Minor Offenses and Uniform Violations Notices Referred to U.S. District Courts.
- 190-45 Records and Forms.
- 190-46 Provost Marshal Activities.
- 195-10 Military Police Criminal Investigative Activities.
- 310-25 Dictionary of United States Army Terms.
- 310-50 Authorized Abbreviations and Brevity Codes.
- 380-5 Safeguarding Defense Information.
- 385-10 Army Safety Program.
- 385-40 Accident Reporting and Records.
- 385-55 Prevention of Motor Vehicle Accidents.
- 600-40 Apprehension, Restraint, and Release to Civil Authorities.
- 670-5 Male Personnel.
- 708-1 Cataloging and Supply Management Data.

A-5. DA Pamphlets

- 108-1 Index of Army Motion Pictures, and Related Audio-Visual Aids.
- 310-series Military Publication Index Series.

A-6. International Agreements

- STANAG 2010 Standardization of Bridge Classification Markings.
- 2012 Military Route (Itiner- aire) Signing.
- 2021 Computation of Bridge, Raft and Vehicle Classifications.
- 2024 Military Road Traffic Lighting Regulations.
- 2025 Basic Military Road Traffic Regulations.
- 2151 Road Network—Definitions and Characteristics.
- 2154 Definitions and Regulations for Military Motor Movements by Road.
- SOLOG 55 Military Road Traffic Lighting Regulations.

A-7. Miscellaneous Publications

Manual for Courts-Martial, United States,
United States Government Printing Office,
Washington, D.C.

Uniform Vehicle Code. National Committee
on Uniform Traffic Laws and Ordinances,
Washington, D.C.

Manual on Uniform Traffic Control Devices
for Streets and Highways Public Roads
Administration. United States Govern-
ment Printing Office, Washington, D.C.

Model Traffic Ordinance. National Committee
on Uniform Traffic Laws and Ordinances,
Washington, D.C.

APPENDIX B

HAND SIGNALS

B-1. General

The hand signals prescribed in this appendix are based on Annex C, STANAG 2025 (Edition No. 2) 22 June 1962. These signals are applicable within the continental United States and with member nations of the North Atlantic Treaty Organization; however, they may require modification when used with personnel of other nations not signatories of NATO. The military policeman directing traffic assumes the stance prescribed in paragraph 3-4c of this manual as his basic stance. All hand signals are given from this stance. Each signal is discussed in the following paragraphs.

B-2. To Stop Traffic

To stop traffic within NATO countries the military policeman raises both arms horizontally, palm upward, and faces in one of the directions



Figure B-1. NATO signal to stop traffic approaching from the front and rear of the military policeman.



Figure B-2. Military policeman stopping traffic approaching from the right.

FM 19-25

from which traffic is approaching and is to be stopped. This signal is used to stop traffic approaching from the front or from the rear of the military policeman.

B-3. To Stop Traffic From the Right

To stop traffic from the right, the military policeman, keeping his feet in place, turns his face to the right, and looks carefully at the traffic to insure his signal can be understood and complied

with. His right arm is thrust to the right and upward, bent slightly at the elbow. The military policeman's fingers and thumb are extended and joined; the palm is flat and the entire hand is clearly visible to oncoming traffic. (The elbow should be at eye-level so that the hand is clearly above the headgear.)



Figure B-3. Military policeman stopping traffic approaching from the left.



Figure B-4. Military policeman stopping traffic from the front.



Figure B-5. Military policeman stopping traffic approaching from the rear.

B-4. To Stop Traffic From the Left

To stop traffic from the left, the military policeman, keeping his feet in place, turns his face to the left, looks carefully at the traffic to insure



Figure B-6. Military policeman stopping traffic approaching from the right and left.

that his signal can be understood and complied with, and then he thrusts his left arm upward, bending it slightly at the elbow. The military policeman's fingers and thumb are extended and joined, the palm is flat, and the entire hand is clearly visible to oncoming traffic. (The elbow should be at eye-level so that the hand is clearly above the headgear.)

B-5. To Stop Traffic From the Front

To stop traffic from the front, the military policeman raises his left arm smartly to the front, keeping the fingers and thumb extended and joined, and the palm of the hand facing toward the traffic so that the entire hand is clearly visible to oncoming traffic. (The elbow should be at eye-level so that the hand is clearly above the headgear.)

FM 19-25

B-6. To Stop Traffic From the Rear

To stop traffic from the rear, the military policeman bends the left knee slightly, twists his body to the right without moving his feet, and turns his head and eyes to the right and rear. He then thrusts his right arm outward and upward, fingers and thumb extended and joined; palm flat, the entire hand clearly visible to traffic. The



Figure B-7. Military policeman bringing traffic through from the right.

right hand is used because traffic normally approaches the rear of the military policeman from the right.

Note. The normal NATO signal to stop traffic from the front or rear is the front or rear of the military policeman's body.

B-7. Changing the Flow of Traffic

Traffic is normally stopped from the military policeman's right first by using the signal outlined in figure B-2. While maintaining the hand signal to stop traffic from the right, the military policeman executes a signal to stop traffic from his left as outlined in figure B-3. After traffic is stopped from the right and left, the military policeman turns his body to his right or left so that he faces the traffic that he has just stopped. (The determination to turn either right or left is made by the military policeman so that he may face the stopped traffic that has the largest normal volume.) While making this turning motion, the military policeman lowers his arms to a horizontal so that when he has completed the turn, his arms are horizontal, palms faced upward, see figure B-1.

B-8. Bringing Traffic Through From the Right

When bringing traffic through from the right, the military policeman will normally start traffic moving through his position from the right. He turns his head and eyes smartly to the right. The right hand is then moved from the stop position (fig. B-2) in a 180° arc across the front of his body. The right hand is then dropped smartly along his side.

Note. If the driver fails to respond to the signal it will be repeated as necessary.

B-9. Bringing Traffic Through From the Left

After having started the traffic from his right, the military policeman turns his head and eyes smartly to the left. He then brings his left arm from the stop position (fig. B-2) and in a 180° arc across the front of his body. The left hand is then dropped smartly along his side.

Note. If the driver fails to respond to the signal, it will be repeated as necessary.



Figure B-8. Military policeman bringing traffic through from the left.

B-10. Right Turns From the Military Policeman's Left

When drivers want to make right turns from the military policeman's left, the military policeman looks both to the left and to the left rear. Then, with the left arm fully extended out from the shoulder, he points with his first two fingers to the vehicle that is to turn, moves the arm in a sweeping motion to the left (the driver's right and the military policeman's rear). He points his fingers as far to the rear as his body structure permits without turning his body or moving his feet.

Note. If the driver fails to respond to the signal, it will be repeated as necessary.

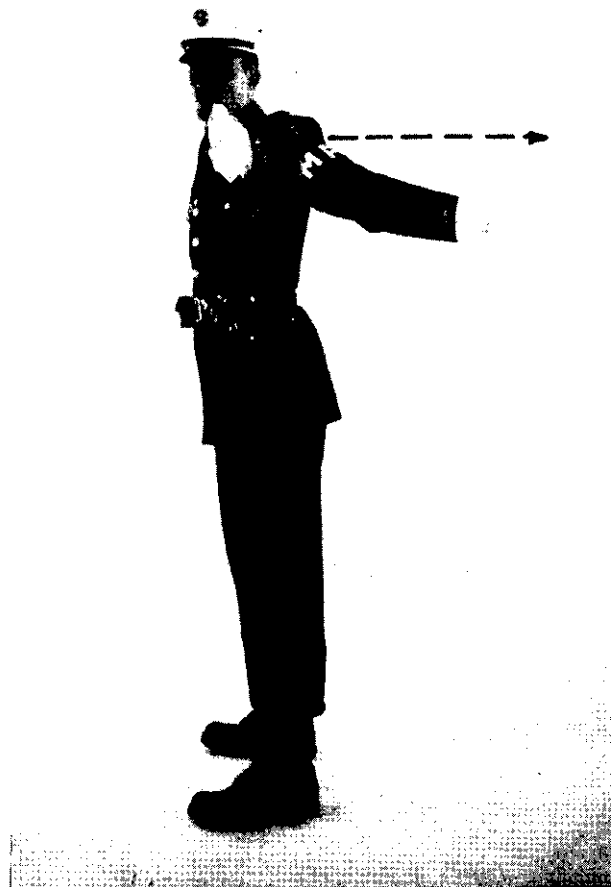

Figure B-9. Military policeman directing traffic from his left to make a right turn.

FM 19-25

**B-11. Right Turns From the Military
Policeman's Right**

The military policeman will look both to the right and to the front, then with the right arm fully extended from the shoulder, he points with his first two fingers to the vehicle that is to turn and in a sweeping motion indicates the direction the driver is to go (the driver's right and the military policeman's front).

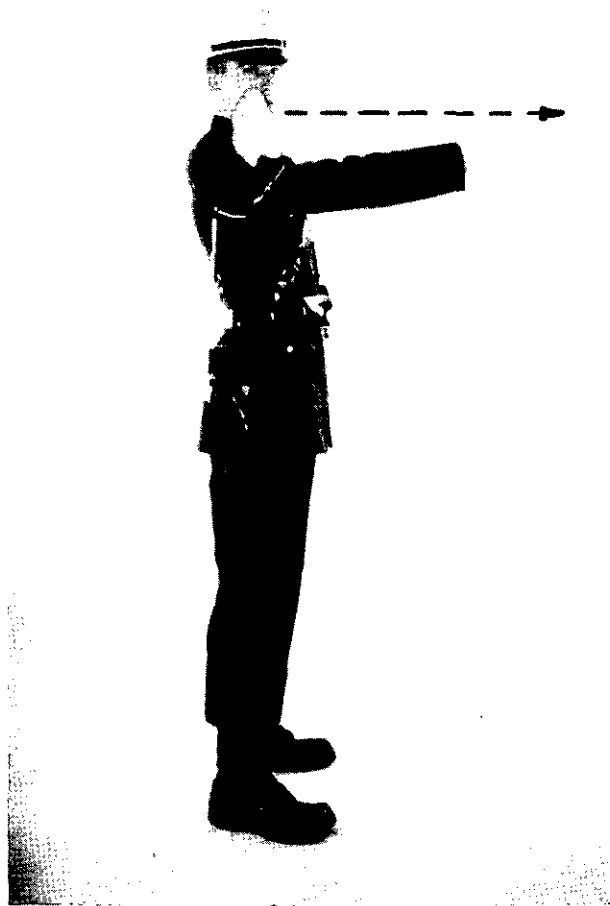

Figure B-10. Military policeman directing a driver on his right to make a right turn.

**B-12. Right Turns From the Military
Policeman's Front**

The military policeman looks to both the left and right as well as to his front prior to giving the signal. With his left arm fully extended from his shoulder, he points his first two fingers at the vehicle that is to make the turn and moves his arm to his left in a sweeping motion (the driver's right and the military policeman's left side).



Figure B-11. Military policeman directing traffic from his front to make a right turn.

**B-13. Right Turn From the Military
Policeman's Rear**

The military policeman looks to both the right and left as well as his rear prior to executing a signal. With the right arm fully extended out from the shoulder, he points his first two fingers at the traffic that is to make the turn, moves his right arm to its left in a sweeping motion (the driver's right and the military policeman's left) and directs the traffic in the direction that it is to move.



Figure B-11a. Side view of a military policeman directing traffic from his front making a right turn.



Figure B-12. Military policeman directing traffic from his rear to make a right turn.

FM 19-25

B-14. Left Turns

Left turns are directed and controlled by using the reverse of the method described for right turns.

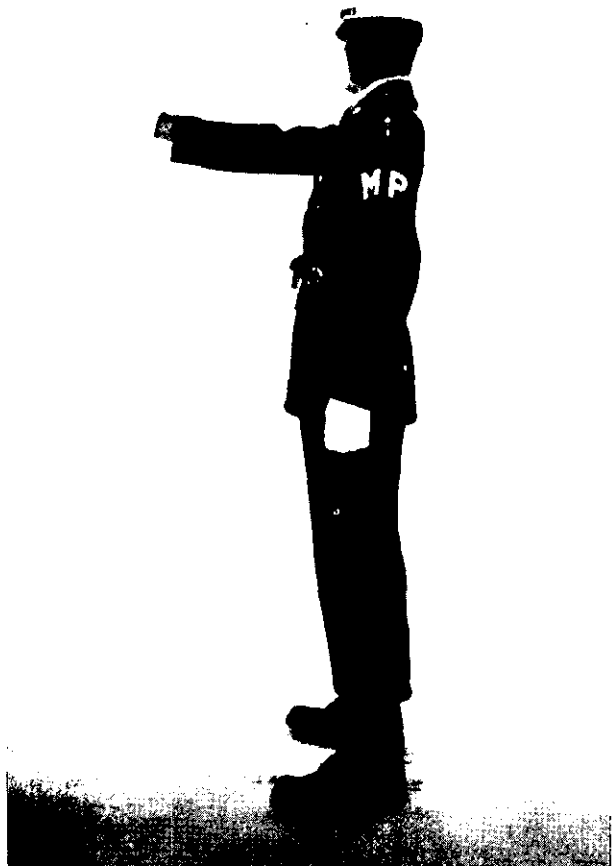

Figure B-13. Military policeman stopping traffic from his right to permit a left turn.

B-15. Allowing Traffic From the Left to Make a Left Turn

A military policeman directing traffic from his left to make a left turn looks to his right and extends his right arm straight out from the shoulder to his front, the palm is faced toward the traffic making the turn, fingers extended and joined, figure B-13. When the traffic approaching from the military policeman's right has stopped, the military policeman turns his head toward the traffic making the left turn, extends his left arm straight out from his shoulder toward the traffic making the turn, fingers extended and joined, and in a sweeping motion he folds his left arm across his body, figure B-13a. It may be necessary to stop traffic in the US by using the signal prescribed in figure B-2.

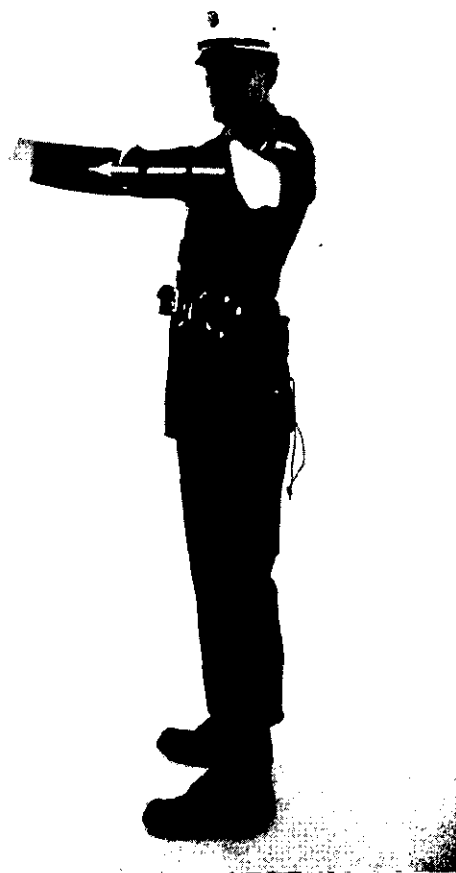

Figure B-13a. Military policeman allowing traffic from his left to make a left turn.

B-16. Military Policeman Directing Traffic to Make a Left Turn From His Right

A military policeman directing traffic approaching from the right to make a left turn, insures that traffic from the front and rear is stopped. After looking both to his right and to his rear and stopping traffic from the left in the manner prescribed in figure B-3, the military policeman fully extends his right arm straight out from the shoulder, first two fingers extended and joined and points to the traffic to make the turn, then, in a sweeping motion, he moves his arm to the right (the driver's left and military policeman's right rear). He points as far as his body structure will permit without turning the body or moving his feet, figure B-14. When the driver has completed the turn, the military policeman may permit traffic from his left to assume a go flow phase.



Figure B-14. Military policeman directing traffic from his right to make a left turn.

B-17. To Speed the Flow of Traffic

To speed up military traffic, the hand is raised above the head in a clenched fist and the arm is bent at the elbow. The fist is then quickly raised and lowered above the shoulder in a vertical plane. To speed up civilian type traffic within the continental United States, the military policeman repeats the appropriate go signal for the direction of the traffic as shown in figure B-3.



Figure B-15. Military policeman signalling military traffic to accelerate.

FM 19-25

B-18. To Slow Traffic

To slow down traffic, both military and civilian, the military policeman extends his arm horizontally, then moves it slowly up and down in a vertical plane.



Figure B-16. Military policeman signalling traffic to decelerate.

B-19. Military Policeman Directing a Vehicle to a Specific Point

When it is necessary for the military policeman to direct a vehicle to a specific point within an intersection or along the roadway, he signals the driver by pointing his first two fingers at an imaginary mark on the ground approximately where the military policeman desires the driver to stop his vehicle (fig. B-17). This is used when preparing traffic to make a conflicting or left turn.



Figure B-17. Military policeman pointing to an imaginary spot on the ground where he desires the vehicle to stop.

B-20. Directing Traffic With a Baton

Stopping traffic from the front—During night operations, the military policeman may use a baton for traffic direction. He stops traffic by raising the baton to face level and moves it back and forth in front of his face in an approximately 45° arc.



Figure B-18. Military policeman with a baton, signaling approaching traffic to stop.

B-21. Stopping Traffic From the Rear

While directing traffic from his right or left, and wanting to stop a vehicle approaching from his rear, the military policeman turns at the waist, keeps his feet in place, holds the baton at face level, and with his arm fully extended at the shoulder, waves the baton back and forth in front of his face at a 45° arc.



Figure B-19. Military policeman with a baton signaling traffic that is approaching from his rear to stop.

FM 19-25

B-22. Stopping Traffic From the Right

The military policeman with a baton and signaling traffic approaching from his right to stop, keeps his right arm fully extended and cants the baton to allow the signal to be more easily seen by the drivers. The military policeman then moves the baton back and forth in front of his face at a 45° arc, making certain the baton is held at face level.



Figure B-20. Military policeman with a baton signalling traffic that is approaching from his right to stop.

B-23. Stopping Traffic Approaching From the Left

When stopping traffic approaching from the military policeman's left, he turns at the waist at a 45° angle and faces the traffic, keeps his feet in place, and at the same time, brings his right arm directly across in front of his body. He keeps the baton at face level and moves it back and forth in front of his face at a 45° arc.



Figure B-21. Military policeman with a baton signaling traffic that is approaching from his left to stop.

B-24. Directing Traffic To Go From the Right

To direct traffic to go from his right, the military policeman, using a baton, extends his right arm out from his body to the right. Canting the baton slightly to the left so that the light may be visible to the driver, he turns on the light and drops his right arm in a sweeping motion 90° arc. He turns the light off when it has completed its arc.

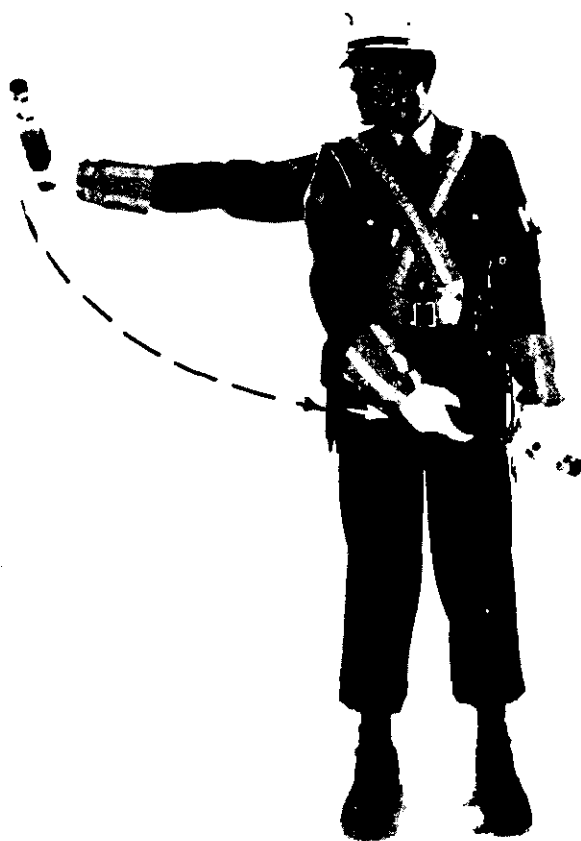

Figure B-22. Military policeman with a baton directing traffic to go from the right.

B-25. Directing Traffic To Go From the Left

To direct traffic to go from his left, the military policeman, using a baton, raises his right arm across his body canting the baton slightly to the right. He turns on the light so that the driver may see it and then drops his right arm across his body until it hangs naturally by his side where he turns off the light.



Figure B-23. Military policeman with a baton directing traffic to go from the left.

FM 19-25

B-26. Stopping Traffic From the Right

The military policeman stops the traffic from the right by the method discussed in paragraph B-22 and figure B-20, stopping traffic from the right. Then he sweeps his arm to the position shown in figure B-24, directing the left turn.



Figure B-24. Military policeman using a baton to stop traffic from the right prior to permitting a left turn for traffic from the left.

B-27. Left Turn From the Left With the Baton

When directing traffic from his left to make a left turn, the military policeman turns his head toward the traffic waiting to turn left. He then extends his left arm straight out from his shoulder. With the baton canted slightly to the front, and keeping his arm fully extended, he brings it to the front as a signal for the driver to make his turn. The military policeman then turns off the baton upon completion of the cycle.



Figure B-25. Military policeman using a baton to direct traffic from the left to make a left turn.

B-28. Right Turn From the Right With the Baton

When directing traffic from his right to make a right turn, the military policeman looks to his right, extends his right arm straight out from his shoulder. With the baton turned on and canted slightly to his front, and keeping his arm fully extended, he brings it to the front as a signal for the driver to make the turn.



Figure B-26. Military policeman with a baton directing traffic from his right to make a right turn.

B-29. Directing Traffic Using a Flashlight

Military police may use a flashlight to direct tactical vehicular movements. Figures B-27 through B-30 may be used as a guide to instruct personnel in the proper signals using the flashlight.



Figure B-27. Go signal using an ordinary flashlight.



Figure B-28. Stop signal using an ordinary flashlight.



Figure B-29. Left turn signal using an ordinary flashlight.



Figure B-30. Right turn signal using an ordinary flashlight.

APPENDIX C

TABLE OF COMMON TRAFFIC VIOLATIONS

Category SPEED		
Offense title	Explanation of offense	Remarks
Speeding	In excess of the posted speed limit or at a speed not reasonable and prudent under existing conditions. (Driving too fast for road conditions).	
Driving Too Slow	Driving below the minimum posted speed, or impeding traffic, under conditions when it is not reasonable and prudent to do so.	
Category TURNS		
Offense title	Explanation of offense	Remarks
Executing U-Turn On Roadways.	Prohibited unless authorized by traffic signs.	
Improper Turn	Wide turn at intersection, turn from the wrong lane, or other unsafe turn under existing conditions.	
Category PASSING		
Offense title	Explanation of offense	Remarks
Passing in No Passing Zone.	When proper road signs are posted and roadways are marked.	
Passing On Left	When the left side of the roadway is NOT clear of oncoming traffic or the roadway is not visible well ahead to the driver of passing vehicle.	
Passing On Right	Under conditions described in "Passing On Left," also passing on the right when prohibited by traffic laws and/or signs or when the passing would involve leaving the pavement.	See local SOP to insure that passing on the right is not prohibited.
Category STOP		
Offense title	Explanation of offense	Remarks
Failure to Stop For Stop Sign.	When the operator fails to observe stop sign or fails to come to a complete stop.	This may also include stopping beyond the stop line.
Failure to Stop For Stopped School Bus.	When loading or unloading, vehicles coming from either direction must come to a full stop until bus resumes motion or its driver signals motorist to proceed.	Vehicles upon a divided highway may not have to stop when the school bus is on a separated roadway. Check local traffic regulations and SOP.
Failure to Yield Right-of-Way.	At intersections when proper traffic signs are posted, failure to yield to the vehicle on the right, or vehicle entering first.	
Failure to Make Special Required Stops.	Railroad grade crossing, exits from driveways, and private roadways.	Check local SOP and traffic laws.

FM 19-25

Category TRAFFIC CONTROL DEVICES

Offense title	Explanation of offense	Remarks
Failure to Comply With Signal of MP or Policeman.	Same as title of the offense.	
Failure to Obey Traffic Control Devices.	Traffic signal, special road signs, etc.	

Category PARKING

Offense title	Explanation of offense	Remarks
Improper Stopping	Stopping on the roadway so as to block traffic; stopping so as to block two lanes of traffic; or stopping in a prohibited zone or area.	
Illegal Parking	Parking in space marked for no parking. Also improper parking, such as across yellow lines which separate parking spaces and cross walks or too close to fire hydrants, etc.	Check local SOP and traffic laws.

Category ADMINISTRATIVE REGULATION

Offense title	Explanation of offense	Remarks
Improper Use of Sound Device.	Use of a horn, bell, etc., so as to create a disturbance, or in a posted "Quiet Zone" without cause.	
Failure to Comply With Vehicle Equipment Laws.	Where prohibited by laws and regulations, the use, mounting, or displaying of colored lights, the equipping of a vehicle with muffler cutouts, sirens, whistles, etc., or the failure to equip a vehicle with required equipment.	
Operating a Vehicle Without Valid Registration and/or Displayed License Plate(s).	Failure to comply with appropriate civil laws.	
Operating Motor Vehicle With Defective Equipment.	Headlights, tail lights, brake lights, turn signals, muffler, horn, brakes.	
Overloading Vehicle	Failure to comply with regulations or appropriate vehicle TM.	
Failure to Comply With Post Vehicle Regulations.	Failure to comply with Post Registration and inspection requirements; the failure to maintain in force the required minimum vehicle insurance; failure to notify the PM of change of vehicle status (new state license, etc.).	
Driving Without a Valid Operator's Permit.	Failure to obtain permit or driving after suspension, revocation or withdrawal of driving permit (license).	
Permitting Unlicensed Operator to Operate Vehicle.	To be charged against owner when a non-owner driver is charged with the preceding offense.	
Driving a Vehicle With Obscured Vision.	Excessive snow or ice on windshield; unauthorized stickers on windows; any object inside the vehicle which may obscure the operator's vision, and inoperative windshield wipers.	
Improperly Secured Vehicle.	Failure to comply with regulations requiring vehicles to be secured by prescribed methods.	Check local SOP.

Category
ACCIDENTS

Offense title	Explanation of offense	Remarks
Leaving or Fleeing the Scene of an Accident.	Failure to stop, make identity known and render aid to injured.	Usually referred to MP CID.
Inattention	Not giving full time and attention to driving.	Usually connected with an accident.
Misjudging Clearance ...	The act of driving too closely while passing, entering or approaching a vehicle, person, or object.	
Following Too Closely ..	Not maintaining a safe stopping distance, considering the speed of the vehicles and condition of the highway, behind the vehicle ahead.	

Category
MISCELLANEOUS

Offense title	Explanation of offense	Remarks
Improper Backing	The rearward movement of a vehicle that cannot be made with reasonable safety and without interfering with other traffic. With military vehicles, failure to use a guide.	Check local SOP.
Improper Signal	Failure to give a proper signal prior to making a turn, stopping, passing, and starting.	
Drunken Driving	When the operator has consumed enough liquor or drugs to impair the rational and full exercise of his mental and physical faculties to affect his ability to control the vehicle he is operating.	
Driving the Wrong Way On a One-Way Street.	Failure to comply with posted road signs and/or road markings.	
Driving On Wrong Side of Roadway.	Failure to keep vehicle to the right side of the roadway or in the proper traffic lane.	
Reckless Driving	Operating a motor vehicle in a heedless and dangerous manner which may endanger lives or property.	
Failure to Dim Lights ...	Failure to dim lights to oncoming vehicles and at any time when within certain defined areas.	

APPENDIX D

EQUIPMENT CHECKLIST

D-1. Suggested Checklist of Organizational and Expendable Equipment

	TCP	Motor patrols	Platoon headquarters	De-file	Es-cort	Road blocks	Check-point	Hold-ing area	Cross-ings	Dis-mount point
Vehicle	1	1	1	*1	X	X	X	*X	*X	X
Radio AN/VRC	1	1	1	*X	X	X	X	*X	*X	
Radio AN/PRC	*			*		*	*	*	X	*
Water (gal.)	5		^b 5	5		5	5	5	5	
"C" ration (per ind)	2	1	1	2		2	2	2	2	
MP packet ^h	1	1	1	1		1	1	1	1	
Compass	1	1	1		1			*1		
First aid kit	1	1	1	1	1	1	1	1	1	1
Wristwatch	1	1	1	1	1	1	1	1	1	1
Telephone	*		^c	*X		3	*	*	X	X
Wire (WD-1)	*		^c	X		X	*	*	X	X
Baton (per ind)	1		1	1		1	1	X	X	1
Flashlight (per ind)	1	1	1	1	1	1	1	1	1	1
Shovel (D-handle)	^d 1		^b X	^d 1		^d 1	^d X	^d X	^d X	^d X
Pick	^d 1		^b X	^d 1		^d 1	^d X	^d X	^d X	^d X
Chain				1		1	1	1	1	
Rope	1	1	1	1	1	1		1	1	1
Fire extinguisher		1	1	1	1	1	1	1	1	1
Wrecker				*1	1			*1	1	
Cross straps and sleeves, and vest	PER INDIVIDUAL DIRECTING TRAFFIC									
Decontaminating apparatus (portable)			^b					*1		
Staple hammer or hammer	1	1	1	1		1	1	1	1	*1
1 doz rr flares		1	1	1	1	1	1	1	1	*1
Grenade fragmentation	4	4	4	4	X	X	4	X	X	X
Grenade phosphorous		4	4		X	X			X	X
Cook set fld	*1		^b	*1		*1	*1	*1	*1	
Sand bags	X		^{b*}	X	X	X		*X	*X	
Detector kit chemical			1							
Panel market set			1		1	1		1	*X	
Radiac Meter 1M/93	1	1	*1	1		1	1	1	*1	
Radiac Meter 1M/174			1							
Launcher rocket 3.5					*1	X			X	X
Gun machine 7.62		1	1	*1	X	X	*1	*1	X	X
Lantern elec	*1		^b				*1	*1	*1	*1
Flags red				X		*	*	*	*	*
Barbed wire			*X			X			X	*X
Ax			X	X		X		1	1	*
Traffic cones	X			*		*	*	*	*	*
Additional equipment		^f	^e							

X-Number determined by military police unit.

*-If needed.

^a May be substituted for vehicle w/radio if communication can be established with an MP position that has contact with the MP CP.

^b At the Platoon CP.

^c At the Platoon CP when connected by wire to other positions or units.

^d If vehicle is not assigned to this position.

^e May be used to channelize traffic.

^f When used for a reconnaissance patrol, see para 12-6.

^g May be used in place of wire communication.

^h See paragraph D-3, below.

D-2. Sign Checklist

	Com- pany basic load ^g	TCP	Motor pa- trols	Pla- toon head- quarters	De- file	Es- cort	Road blocks	Check- point	Hold- ing area	Cross- ings	Dis- mount point
Hazard signs -----	50			5	X					^b	
Warning MP activity ahead ^a -----		^b			4			4	^b	^b	^b
MP activity -----		1			2		2	2	1	2	1
Detour -----		2	5	10	^b		^b			^b	
Directional discs -----	100	5	5	20	5		^b		^b	5	^b
Route guide signs -----	50		^c 5	^c 10	^c 2			^c 2		^c 2	
Instruction signs ^d -----					^e			^e	^e	^e	^e
Contamination ^f :											
Chemical -----	50			20							
Nuclear -----	50			20							
Biological -----	20			5							

X—Number to be determined by military police unit.

^a See figure 11-2.
^b When required.

^c Per route.

^d Locally made.

^e Normally will be required.

^f Usually only assigned with monitoring and detection equipment.

^g Basic load maintained in addition to signs issued to platoon and position.

D-3. Sample MP Packet Content List

- Traffic Control Team Map.
 - Extract of SOI (when equipped with radio).
 - Authentication table.
 - Frequencies and call signs.
 - Codes.
 - Message book.
 - Overlay paper.
 - Measle map.
 - Pencils.
 - Strip maps.
 - Forms; reports of traffic violations.
- Instruction packet usually includes extracts of the traffic control plan and highway regulations.

D-4. Information Reference Material Checklist for PCS.

- a. Map of the installation showing building numbers.
- b. Strip maps showing the main facilities and primary roads.
- c. A post telephone book of units and activities.
- d. A map of the surrounding community.
- e. A directory of the areas of principal interest surrounding the installation.
- f. A copy of the installation traffic regulations.
- g. A copy of the local state traffic laws (usually what is issued to personnel applying for a driver's license).
- h. A list of the operating hours of post facilities which can be issued to individuals just arriving at the installation.
- i. A copy of FM 19-26, and FM 19-25.

APPENDIX E

NATO STANDARD OFFENSE REPORT

NATO—UNCLASSIFIED

STANDARD LAYOUT FOR OFFENCE REPORT TO BE USED BY NATO TRAFFIC CONTROL

PERSONNEL

PRESENTATION STANDARD DE LA FICHE D'INFRACTION A EMPLOYER PAR LES
AGENTS DE CIRCULATION DE L' OTAN
OFFENCE REPORT / FICHE E' INFRACTIONThis form will be sent through the normal military channels to the driver's Commanding Officer.
Cette fiche sera transmiss par la voi hiérarchique á l'autorité dont dépend le conducteur en faut.

1. Date, time, place of offence†		/	Date, heure et lieu de controle†

2. Driver's name†	Nationality	(if military) Rank, Service No.* & Unit	
Nom du conducteur†	Nationalité	(pour les militaires) Grade, No Matricule* et Unité	
		(if civilian) address of employer	
		(pour les civils) adresse de l'employeur	

3. Name of vehicle commander†	Nationality	(if military) Rank, Service No.* & Unit	
Nom du Chef de la voiture†	Nationalité	(pour les militaires) Grade, No Matricule* et Unité	
		(if civilian) address	
		(pour les civils) adresse	

4. Particulars of vehicle checked / Caracteristiques du véhicule contrôlé.			
a. Make / Marque			
b. Type / Type			
c. Registration No / No Matricule			
d. (Address of unit or civil owner)			
(Affectation du véhicule ou adresse du propriétaire)			

5. Offense observed		Infraction constatée	
(Detailed statement of evidence to be given)		(Constat détaillé)	
(x)			
-----		-----	
6. Action taken		Mesures prises	
(x)			
-----		-----	
7. Name, rank, service No & Unit		/	Nom, grade, No Matricule et Unité
of traffic control policeman†			de l'agent de circulation†
signature:			
(Person rendering the report)			Witnessed:
de l'argent établissant la fiche)			Témoigné par:

NOTE: † All names will be written in block letters.

Tous les noms propres seront écrits en capitales d'imprimerie.

x Further details may be added on the reverse side.

Tous details supplémentaires pourront étre indiqués au dos.

* French Officers had no Service No.

Les Officiers francais n'ont pas de No Matricule.

NATO—UNCLASSIFIED

Figure E-1. NATO standard offense report.

APPENDIX F

NATO ROADWORK—DEFINITIONS AND CHARACTERISTICS

(STANAG 2151, 16 October 1963)

Section I. DEFINITIONS

F-1. The Basic Military Road Network

a. The basic military road network includes all routes designated in peacetime by the host nations to meet the anticipated military movements and transport requirements, both allied and national.

b. The basic network should already, in peacetime, have sufficient capacity and be equipped with the necessary facilities.

F-2. A Military Road Maneuver Network

a. A military road maneuver network is the road system required by a commander for the conduct of a specific operation and for the required logistical support for that operation.

b. It is built up from the corresponding basic military road network, the routes of which form the framework of the military maneuver nets, taking into consideration such additions or alternatives as may be required by circumstances and the needs of the command. This network is defined and controlled (allotment of movement credits) by the military authorities, national or allied, according to the breakdown of responsibilities in the theater of operations (communication zone, rear and forward combat zones).

F-3. Axial Routes

Axial routes. This term denotes the routes running through the rear area and into the forward area. They are identified by odd numbers and shown on overlays by unbroken lines.

F-4. Lateral Routes

Lateral routes. This term denotes the routes which run parallel to the *frontline*, and feed into or cross axial routes. They are identified by even numbers and shown on overlays by broken lines.

F-5. Traffic Flow

Traffic flow is the total number of vehicles passing a given point in a given time. Traffic flow is expressed as vehicles per hour (VPH).

F-6. Road Capacity in Vehicles or Tons

The road traffic which may use a road is variable. The maximum capacity either for the flow of vehicles or for the tonnages carried are important data for transportation planning. These maximums are defined below:

a. The road capacity in vehicles is the maximum number of vehicles that can pass over a particular road or route in the same direction within a given time. It is generally expressed in vehicles per hour (VPH). The road capacity cannot be greater than the maximum traffic flow at its most restricted point.

b. The road capacity in tons is the maximum number of tons which can be moved over a particular road or route in the same direction within a given time. It is generally expressed in tons per hour and is the product of VPH and the average payload of the vehicles using the route (e.g. 200 VPH x 3T. = 4 600 tons per hour).

c. Complementary remarks. Estimates of traffic flows and/or tonnage capacity should take into account the existing conditions. They may include—

(1) Road characteristics (terrain, type of roadway, number of lanes available, road maintenance, rated tonnage capacity of the weakest bridge).

(2) Military traffic regulations (density, speed limits, direction of traffic).

(3) Types of vehicles employed.

(4) Movement conditions (by day, by night, lighting and/or weather conditions).

F-7. A Controlled Route

A controlled route denotes a route the use of which is subject to traffic or movement restrictions ("Movement Credit" mentioned below is defined in STANAG 2154)(also see para F-19 and F-20 below).

a. A supervised route is a roadway over which control is exercised by a traffic control authority by means of traffic control posts, traffic patrols or both. A "Movement Credit" (STANAG 2154) is required for its use by a column of 10 or more vehicles or by any vehicle of exceptional size or weight.

b. A dispatch route is a roadway over which full control, both as to priorities of use and the regulation of movement of traffic in time and space is exercised. A "Movement Credit" is required for its use by any independent vehicle or group of vehicles regardless of number or type.

c. A reserved route is a controlled route the use of which is—

(1) Allocated exclusively to a particular authority or formation, e.g., route reserved for the 10th Division, or

(2) Intended to meet a particular requirement, e.g., route reserved for evacuation.

F-8. An Open Route

An open route is a route for the use of which no "Movement Credit" is required.

F-9. A One Way Road

A one way road is a road on which vehicles may move in one direction only at a particular time.

F-10. A Signed Route

A signed route is a route of one of the above categories along which a unit has placed, on its own initiative, for its exclusive use, and under the conditions prescribed by the command or the maneuver regulations, directional signs which include the identification symbol of the unit concerned.

F-11. Route Where Guides Are Provided

The term *route where guides are provided* denotes a route included in one of the above categories on which a unit has placed, under its own initiative, for its exclusive use, and under the conditions prescribed by the command or the maneuver regulations, guides responsible for showing the vehicles of that unit the direction they are to follow. These guides direct the personnel and vehicles of their own formation but do not give any indication to personnel and vehicles of other units who must respect the common signing and regulations.

F-12. Prohibited Route

Prohibited route or prohibited section of route is a route or section of route over which traffic is prohibited, whatever its nature.

Section II. CHARACTERISTICS**F-13. Characteristics**

The characteristics of a route are in particular—

- a. The width of the traveled way.
- b. The clearance of obstacles (e.g., tunnels, bridges, etc.)
- c. The class of loads which can be accepted in accordance with STANAG 2021 (Edition No. 2).

F-14. Widths

a. The various widths of a road are illustrated in STANAG 2151.

b. The number of lanes is determined by the width of the traveled way; i.e., the subdivision of the traveled way to allow the movement of a single line of vehicles. Taking into account the width of a normal vehicle and the space required

on either side of that vehicle, the width of the lane required for the movement of one column is normally estimated at 3.50m (11 1/2 feet) and 4m (13 feet) for a tracked combat vehicle. A single lane road can only be used in one direction at any one time.

c. The traffic flow is determined by the number of lanes.

(1) A route or road is *single flow* when it allows a column of vehicles to proceed and in addition, isolated vehicles to overtake or to pass in the opposite direction, at predetermined points. It is desirable that the width of a single flow road be equal to at least 1 1/2 lanes.

(2) A route or road is *double flow* when it allows two columns of vehicles to proceed simultaneously. It is essential that the width of a double flow road be equal at least to 2 lanes.

Traffic flow possibilities	Road widths for normal vehicles only	Road widths for tracked combat vehicles
Isolated vehicles of appropriate width only and in one direction only.	At least 11½ ft (3.50m).	At least 13 ft (4m).
Generally one way only; no overtaking or passing in opposite direction.	Between 11½ ft and 18 ft (3.50m and 5.50m).	Between 13 ft and 19½ ft (4m and 6m).
Single flow -----	Between 18 ft and 23 ft (5.50m and 7m).	Between 19½ ft and 26 ft (6m and 8m).
Double flow -----	Over 23 ft (7m) -----	Over 26 ft (8m).

d. In the light of the above definition, the traffic possibilities can be shown in the above table.

F-15. Height

The height allowed for clearing overhead obstacles is that which separates the traveled way from a line drawn horizontally under the summit of the overhead obstacle. It is a definite limit prohibiting the use of a route to all vehicles which exceed that height, with or without a load.

F-16. Class

- ★a. *Route.* Normally, the lowest bridge military load classification number, regardless of vehicle type or conditions of traffic flow, determines the military load classification of a route.
- b. *Network.* The class of a network is fixed in relation to the minimum route classification in that network.

F-17. Categories

To facilitate movement those routes included in a low class network but over which heavier equipment can be moved are regrouped in broad categories:

- Average traffic routes ----- Class 50
- Heavy traffic routes ----- Class 80
- Very heavy traffic routes ----- Class 120

F-18. Composition of the Military Road Network

Whenever possible, the basic military road network is composed of average routes (Class 50) and includes a certain number of heavy traffic routes and few very heavy traffic routes.

F-19. Movement Credit (STANAG 2154)

a. A movement credit is the time allocated to one or more vehicles to move over a supervised, dispatch or reserved route. It includes the indication of time at which the first and last vehicle of the columns are scheduled to pass:

- (1) The entry point, i.e., the point where the column enters the controlled route.

(2) The exit point, i.e., the point where the column leaves the controlled route.

b. Identification of columns and movement credit.

(1) Each column will be identified in accordance with STANAG 2027, i.e., blue flag on leading vehicle, green flag on last vehicle. In addition, when the movement is being carried out at night, the commander (driver) of the leading vehicle will carry a torch giving a blue light and the commander (driver) of the last vehicle a torch giving a green light.

(2) Additionally, each column will be identified by a number known as "movement number" or "identification serial number" which is allocated at the same time as the "movement credit" by the authority organizing the movement. This number will identify the column during the whole of the movement.

(3) The number will be placed on both sides and, if possible, on the front of the lead vehicle, and last vehicle of the column so as to be clearly visible. It will be composed of—

(a) Two figures indicating the day of the month on which the movement is due to commence.

(b) Three or four letters indicating the authority organizing the movement. The first two letters will be the national symbols shown in STANAG 1059 (Edition No. 2).

(c) Two figures indicating the serial number allocated by the authority responsible for the movement.

(Example: Identification 03-BEA-08 will indicate that Column No. 8 will be moved by a Belgian authority on the 3d day of the current month.)

(d) The elements of a column may be identified by adding a letter behind the movement number.

F-20. Armbands for Movement Control Personnel (Not Traffic Control) (STANAG 2159))

a. The NATO Armed Forces agree that distinguishing armbands shall be used to identify all Movement Control Personnel who come into

personal contact with forces being moved by road, rail, air, or any other agency.

b. It is agreed that the armband will be red, approximately 16½ inches (42 cm) long and 3½ inches (9 cm) wide, with a yellow wheel with eight spokes, 3 inches (7.5 cm) in diameter. It will normally be fastened by four hooks or dome fasteners, 1 inch (2.5 cm) apart.

c. The standard armband will be worn on duty in accordance with the uniform regulations of the country concerned but in such a way that the wheel can be clearly seen. Staff officers may wear normal staff armbands if that is the usual practice of the countries concerned.

APPENDIX G

MOTOR VEHICLE EXAMINATION

G-1. Military Police

a. Patrols check for stolen vehicles and vehicles involved in hit-and-run accidents or involved in other crimes. When military police observe such vehicles, they conduct a complete examination of the vehicle to insure its proper identification and look for evidence. The following paragraphs relate the methods used in the conduct of a vehicle examination under those circumstances.

b. Prior to conducting a vehicle examination, record the following:

- (1) Location of the vehicle.
- (2) Date of examination.
- (3) Time of the examination.
- (4) Personnel making the examination.
- (5) Circumstances surrounding the examination (status of the vehicle as reported). What crime was the vehicle used for? This will be the key to the type of evidence the military police are searching for.

G-2. Examining the Exterior Surface

Each portion of the vehicle must be examined in a systematic manner. This is accomplished as follows:

- a. Front end includes—
 - (1) Bumper.
 - (2) Grille.
 - (3) Headlights.
 - (4) Front portion of the hood.
 - (5) Windshield.
- b. Left side includes—
 - (1) Left front fender.
 - (2) Door.
 - (3) Windows.
 - (4) Rear fender.
- c. Right side same as b above.
- d. Rear portion includes—
 - (1) License plates.
 - (2) Bumper.
 - (3) Trunk.
 - (4) Taillights.
 - (5) Rear window.
- e. Top portion includes—
 - (1) The roof.
 - (2) Top portion of the hood.
 - (3) Top of trunk lid.
- f. Under the vehicle.
 - (1) Tires.
 - (2) Undercarriage.

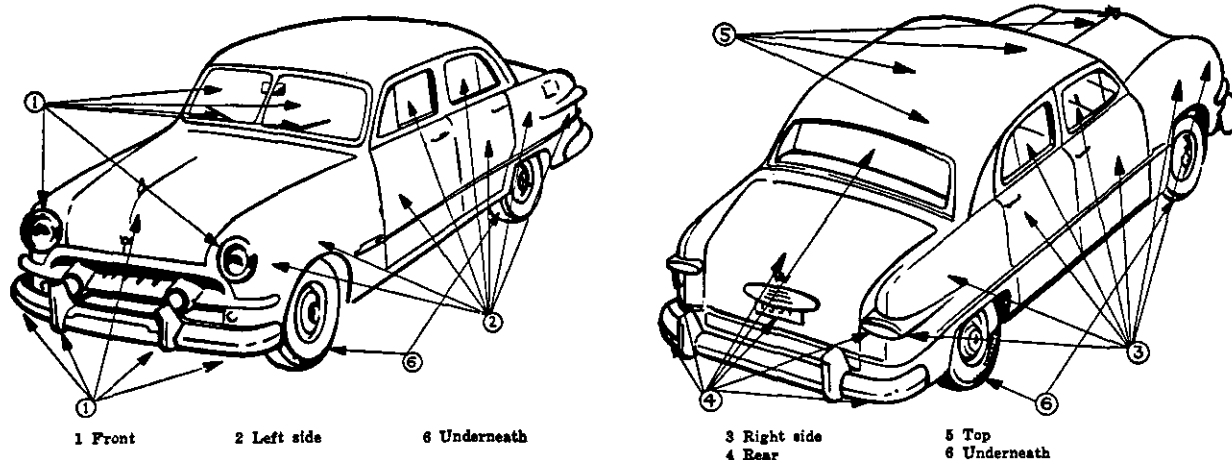

Figure G-1. Motor Vehicle examination points.

FM 19-25

G-3. Examining the Interior

a. Record motor and body number, make, year, model, etc.

b. Take speedometer mileage totals.

c. Check to see if the foot and emergency brakes are operating and note their condition.

d. Note whether gas gauge was operating, and check the contents of the gas tank.

e. Check to see if the horn is operating.

f. Check recent servicing stickers (lubrica-

tion, oil change, and inspection stickers, etc.). Note date and mileage recorded on the stickers.

g. Check evidence of ownership, registration, or insurance that may be in the vehicle.

h. Remove, tag, list, and secure all personal property. (If owner is present, all personal property not required as evidence should be returned to him. He should receipt for property that will be held by military police. If owner is not present, personal property should be inventoried in the presence of witnesses and promptly stored in a military police evidence room with a copy of the witnessed inventory attached thereto.)

APPENDIX H

UNITS OF MEASURE AND CONVERSION

H-1. English System of Linear Measure

12 inches	1 foot
36 inches	1 yard
3 feet	1 yard
1,760 yards	1 mile statute
2,026.8 yards	1 mile nautical
5,280 feet	1 mile statute
6,080.4 feet	1 mile nautical
63,360 inches	1 mile statute
72,963 inches	1 mile nautical

H-2. Metric System of Linear Measure

1 millimeter	0.1 centimeter	0.0393 inch
10 millimeters	1.0 centimeter	0.3937 inch
10 centimeters	1.0 decimeter	3.937 inches
10 decimeters	1.0 meter	39.37 inches
10 meters	1.0 dekameter	32.81 feet
10 dekameters	1.0 hectometer	328.1 feet
10 hectometers	1.0 kilometer	0.62 mile
10 kilometers	1.0 myriameter	6.21 miles

H-3. Kilometers to Miles

	<i>Rough</i>	<i>Exact</i>
1 kilometer 0.6 miles	(0.62 miles)
5 kilometers 3 miles	(3.10 miles)
10 kilometers 6 miles	(6.20 miles)
25 kilometers 15 miles	(15.50 miles)

H-4. Meters to Yards

	<i>Rough</i>	<i>Exact</i>
1 meter 1 yard	(1.09 yards)
5 meters 5 yards	(5.47 yards)
10 meters 11 yards	(10.94 yards)
25 meters 27 yards	(27.35 yards)
50 meters 55 yards	(54.70 yards)
75 meters 82 yards	(82.05 yards)

H-5. Meters to Feet

	<i>Rough</i>	<i>Exact</i>
1 meter 3 feet	(3.28 feet)
5 meters 16 feet	(16.40 feet)
10 meters 33 feet	(32.81 feet)
25 meters 82 feet	(82.00 feet)

H-6. Yards to Meters

	<i>Rough</i>	<i>Exact</i>
1 yard 1 meter	(0.91 meter)
5 yards 5 meters	(4.57 meters)

	<i>Rough</i>	<i>Exact</i>
10 yards 9 meters	(9.14 meters)
25 yards 23 meters	(22.85 meters)

H-7. Kilometers per Hour to Miles per Hour

<i>KPH</i>	<i>MPH</i>	<i>Exact conversion</i>
5 KPH 3 MPH	(3.1 MPH)
10 KPH 6 MPH	(6.2 MPH)
15 KPH 10 MPH	(9.3 MPH)
20 KPH 13 MPH	(12.4 MPH)
25 KPH 15 MPH	(15.5 MPH)
30 KPH 18 MPH	(18.6 MPH)
35 KPH 20 MPH	(21.7 MPH)
40 KPH 25 MPH	(24.9 MPH)
50 KPH 30 MPH	(31.0 MPH)
60 KPH 35 MPH	(37.2 MPH)
70 KPH 43 MPH	(43.4 MPH)
80 KPH 50 MPH	(49.7 MPH)
90 KPH 55 MPH	(55.9 MPH)
100 KPH 60 MPH	(62.1 MPH)

H-8. Conversion Factors

a. United States, British, and Metric Units.

<i>Multiply</i>	<i>by</i>	<i>to obtain</i>
Acres 43,560	Square feet
Acres 4047	Square meters
Centimeters03281	Feet
Centimeters3937	Inches
Cubic centimeters06102	Cubic inches
Cubic centimeters001	Liters
Cubic feet 1728	Cubic inches
Cubic feet02832	Cubic meters
Cubic feet03704	Cubic yards
Cubic inches 16.39	Cubic centimeters
Cubic inches0005787	Cubic feet
Cubic meters 35.31	Cubic feet
Cubic meters 1.308	Cubic yards
Cubic yards 27	Cubic feet
Cubic yards7646	Cubic meters
Feet per minutes01136	Miles per hour
Feet per second5921	Knots
Feet per second6818	Miles per hour
Inches 2.540	Centimeters
Inches08333	Feet
Kilometers6214	Miles
Kilometers5396	Miles (nautical)
Knots 1.152	Miles (per hour)
Knots 1	MPH (nautical)
Meters 100	Centimeters
Meters 3.281	Feet
Meters 39.37	Inches

FM 19-25

<i>Multiply</i>	<i>by</i>	<i>to obtain</i>
Meters	1.094	Yard
Miles	5280	Feet
Miles	63,360	Inches
Miles	1.609	Kilometers
Miles8684	Miles (nautical)
Miles	1760	Yards
Miles (nautical)	6080	Feet
Miles (nautical)	1.1516	Miles
Miles per hour	88	Feet per minute
Miles per hour8684	Knots
Square centimeters1550	Square inches
Square feet	929	Square centimeters
Square feet	144	Square inches
Square inches	6.452	Square centimeters
Square inches006944	Square feet
Square meters	10.76	Square feet
Square meters	1.196	Square yards
Square miles	640	Acres
Square miles	2.590	Square kilometers
Square yards0002066	Acres
Square yards	9	Square feet
Square yards	1296	Square inches
Square yards8361	Square meters
Yards	3	Feet
Yards	36	Inches
Yards9144	Meters

b. Chinese.

<i>Multiply</i>	<i>by</i>	<i>to obtain</i>
Chang	10.49	Feet

<i>Multiply</i>	<i>by</i>	<i>to obtain</i>
Chi	12.59	Inches
Chih	14.094	Inches
Chun	1.259	Inches
Feng1259	Inches
Hou0013	Inches
Li0126	Inches
Tsun	1.409	Inches

c. Japanese.

Bu12	Inches
Cho	119	Yards
Jo	3.31	Yards
Ken	1.99	Yards
Ri	2.44	Miles
Rin012	Inches
Shaku994	Feet
Shaku	11.93	Inches
Sun	1.2	Inches
Tan245	Acres
Tsumbo	3.953	Square feet

d. Russian.

Arshin	28	Inches
Dessiatina	2.7	Acres
Duim	1	Inches
Foute	1	Feet
Milya	4.64	Miles
Saszhen	7	Feet
Verst663	Miles

APPENDIX I

SURVEILLANCE, TARGET ACQUISITION AND NIGHT
OBSERVATION (STANO) EQUIPMENT

I-1. STANO Equipment

a. The surveillance, target acquisition and night observation (STANO) system is composed of those means and material organic to or in support of the Army in the field to include other services associated with information gathering and presentation capabilities to find the enemy or facilitate night operations.

b. The STANO items of equipment are designed to improve the general detection, identification of enemy forces during periods of limited reduced visibility. The primary goal of STANO is to improve the responsiveness, speed, accuracy, timeliness, and flexibility of the commander and staff in making decisions.

c. While it is obvious from the foregoing that the *primary* application of STANO is oriented to combat situations, it is equally obvious that appropriate items of STANO equipment would be extremely useful in traffic control operations, for example, in locating ambushes, the security of roadblocks and checkpoints, dismount points, the security patrol of sealed off areas, both within and on the perimeters; the prevention of mistakes by the identification of friendly and hostile elements; and many similar uses. These items are as follows:

- (1) AN/PAS, Binocular, Electronic.

Use: Primary mission is to permit vehicle operations during darkness without use of visible light. Secondary missions are to detect infrared sources, locate and read road signs, and perform other close-up tasks at night.

- (2) SU-50. Binocular, Electronic (Goggles).

Use: A lightweight, face-mounted, passive night vision device for performing individual tasks during the hours of darkness, utilizing ambient radiation. Designed for short-range, close in viewing for driving tracked or wheeled vehicles, reading maps and other documents, and

other individual tasks. May also be used with AN/PAS-8 (see (4), aiming light mounted on rifle to enhance accurate night firing, e.g., against located identified snipers) without conventional aiming.

- (3) Binocular, infrared, M18.

Use: General observation at night using an infrared source of energy. It is a handheld instrument for viewing those portions of the environment illuminated by the infrared source.

- (4) AN/PAS-8, Light, Aiming, Infrared.

Use: To provide a portable infrared aiming light to be used for the accurate night firing of military rifles. It is mounted to the rifle and used in conjunction with the SU-50 Binoculars (see (2) above).

- (5) AN/PVS-2, Night Vision Sight, Individual Served Weapons (Starlight Scope).

Use: This is as a handheld, night observation device for detecting friendly and hostile operations. Secondary mission is to provide a means for accurate aimed fire of individual or crew served weapons.

- (6) AN/PVS-3, Night Vision Sight, Miniaturized (Miniscope).

Use: Primary mission is for surveillance as a handheld, passive, night vision device. Secondary mission is to enable users to aim rifle fire accurately when the AN/PVS-3 is bracketed to the rifle.

- (7) AN/TVS-4, Night Vision Sight, Tripod Mounted (Night Observation Device, Medium Range).

Use: Usually emplaced on the best available vantage point overlooking the terrain of interest, it is used for sector and perimeter defense. It utilizes starlight and moonlight for completely passive viewing, to observe terrain and detect, identify, and observe friendly or hostile elements. The device may be tripod- or vehicle-mounted.

- (8) Periscope, M19 and Periscope M24.

Use: These devices are utilized during the night driving of armored vehicles with hatches closed. Infrared headlamps on the vehicle "illuminate" the scene. Visible images are viewed through eyepieces.

(9) AN/TVS-3, Searchlight, General Purpose, Xenon, 20KW.

Use: A searchlight for area illumination, sector or perimeter defense, and control of firepower.

(10) Searchlight, Handheld, DC, AN/USS-6, 28V, Under 10 Amps, 280W.

Use: In either mounted or dismounted operations, the device provides an invisible light source for short-range surveillance. Used with the night vision binoculars, it can be used to raise the light level sufficiently to detect and recognize targets at extended ranges under heavily overcast conditions.

(11) Searchlight Set, Infrared, AN/ASS-2.

Use: A helicopter device to provide large area illumination at several times moonlight level at extended altitudes. Proper use of this airborne searchlight can extend the range of aerial and ground passive night vision devices by increasing the ambient light level.

(12) AN/VSS-3, Searchlight (SLT), Infrared (1KW).

Use: This vehicle-mounted device provides for various uses, extending from perimeter and area illumination (visible mode) to extending the range of infrared and passive viewers. It can be rapidly switched from infrared to the visible mode, for the benefit of troops not equipped with viewing devices.

(13) Searchlight, Xenon, Infrared (2.2KW).

Use: To provide a visible or an infrared light assist for troops in tanks, jeeps, helicopters, or towers. It can be rapidly switched from one mode to the other, as necessary.

(14) Viewer, Infrared, AN/PAS-7.

Use: To provide a handheld thermal detection and imaging device for nighttime use to detect and recognize personnel targets at short-range. This viewer will be of particular benefit to patrols for ambush detection and will be employed by squad and team leaders when the ambient light is insufficient to permit the functioning of intensification-type devices.

(15) Listening Post Surveillance Device, AN/PPS-14.

Use: A small, lightweight, man-carried surveillance device capable of annunciating the presence of intruders before they are detectable by the unaided senses of friendly personnel responsible for perimeter defense.

(16) Patrol Electromagnetic Intrusion Device (PEMID).

Use: The PEMID is designed for use by patrols to detect intrusion of personnel, vehicles, and watercraft. This detection provides line sensor intelligence data on intruder movement without his knowledge of being detected.

(17) Self-Orienting Seismic Intruder Detector (SOSID).

Use: This item is a self-contained seismic intrusion detector capable of detecting seismic disturbance, and performing signal signature analysis in order to isolate those disturbances that are caused by moving vehicles or personnel.

(18) KS-100 Handheld, Still Picture Camera.

Use: This camera, using polaroid types black and white and color film packs, provides a quick-response, real-time, aerial reconnaissance photography capability for nonsurveillance type military aircraft observers. It will provide intelligence spot reports and other related military information.

I-2.

Only a partial listing of STANO equipment which is currently available has been listed which are considered applicable to traffic control operations. New and improved STANO material is continually being developed; as this equipment is modified, improved, and supplemented with new equipment, commanders should integrate these added capabilities with the tactics and techniques necessary for field exploitation. Field Manual 20-60 provides guidance in the utilization of many of these items of equipment. Field manuals of the 31-series also provide appropriate guidance. FM 31-100 (Test) is programmed for publication in FY 71. It is envisioned that this FM will supersede FM 31-36 (Test). The preceding list was extracted from an initial draft of FM 31-100 (Test).

INDEX

	Paragraph	Page		Paragraph	Page
Airborne operations	13-16	13-11	Delays in traffic	3-1a(5)	3-1
Aircraft:			Desert operations	13-18	13-11
Traffic escorts	12-15	12-9	Desk sergeant	2-6, 7-5b	2-3, 7-4
Traffic monitoring	6-6e	16-9	Detour:		
Airheads, traffic control	13-17	13-11	Signs	4-10b, 4-11	4-10, 4-11
Amphibious operations	13-13	13-9	Supervisor	2-4b(3)	2-2
Assimilative crimes	7-8d	7-7	Traffic control	4-12	4-11
Area Traffic control	1-2g	1-2	Disaster control	2-19, 4-20d	2-8, 4-20
Baton	3-4b, app B	3-4, B-1	Dismount points:		
Beachhead traffic control	13-14	13-3	Post, camp or station	4-9	4-9
Blackout conditions	13-23	13-13	Theater of operations	11-8, 10	11-5
Bridge:			Dispatch route	1-2f(2)	1-2
Caution crossing	13-9b(1)	13-3	Double flow	F-14c(2)	F-2
Classification	13-8	13-3	Drop zones, traffic control	13-17	13-11
Crossings	13-6	13-3	Drunk driving	6-16	6-11
Holding areas	13-7	13-3	Duty officer	2-7	2-3
Normal crossings	13-9a	13-3	Enforcement:		
Risk crossings	13-9b(2)	13-3	Action	7-7	7-7
Special crossings	13-9b	13-3	Drunk driving	6-16	6-11
Briefing:			Driving too slow	6-11	6-10
Point control	3-2, 8-5	3-1, 8-2	Lane use	6-12	6-10
Reconnaissance	12-4	12-2	Parking	6-9, -10 -14	6-10, 6-11
Checkpoints:			Pedestrian violations	6-15	6-11
Post, camp or station	4-5, 6	4-5	Speeding	6-6	6-2
Theater of operation	11-1, 2	11-1	Turning movement	6-13	6-11
Civil defense road signs	4-20d	4-20	Policies	6-4	6-2
Classification:			Preventive	1-6c	1-3
Bridge	13-8	13-3	Selective	1-6d, 6-3	1-3, 6-1
Signs	4-15, 13-8c	4-17, 13-3	Engineer regulation point (ERP)	13-2a(3)	13-1
Traffic	1-2c	1-1	Equipment:		
Vehicle (fig. 13-4)	13-8	13-3	Checklist	D-1, -2	D-1, D-2
Road	12-17	12-7	Information reference		
Route	1-2f, 12-6b(2)	1-1, 12-3	material	D-4	D-2
Commander, role in traffic control	1-9	1-4	MP packet	D-3	D-2
Consideration in traffic planning	2-11	2-5	MP traffic control	3-2b, 5-3, 9-3	3-3, 5-1, 9-3
Controlled route	1-2f	1-1	Motor patrol	5-3, 10-3	5-1, 10-1
Convoy escort:			Point control	3-2b	3-3
Post, camp or station	2-4b(4)	2-2	Signs	4-14	4-17
Theater of operations	12-15, 12-16	12-9	Traffic control post	3-2b, 9-3	3-3, 9-3
Counter guerrilla, TCP	10-4b(4) (5)	10-2	Escorts:		
Critical point	1-2i	1-2	CONUS	5-9	5-4
Crossings:			Convoy	2-4b(4), 12-15, -16	2-2, 12-9
Bridge and others	13-2, 13-3, 13-6	13-1, 13-3	Methods	5-10, 12-13, -16	5-4, 12-8 -9
Fords	13-10	13-5	Sensitive material	2-4b(4)	2-2
Types:			Supervisor functions	2-1b, 12-16b	2-1, 12-9
Caution	13-9b(1)	13-3	Theater of operations	12-13, 16	12-8, 9
Normal	13-9a	13-3	Estimate of situation	9-2	9-1
Risk	13-9b(2)	13-3	Ford, traffic control	13-10	13-5
Special	13-9b	13-3			
DD Form 1805	7-9	7-7			
Defiles	11-4, -7	11-2, 11-4			

FM 19-25

	Paragraph	Page		Paragraph	Page
G-4 (ACofS, logistics)	8-2a	8-1	One-way operation, construction	4-12	4-11
Goals of point control of traffic	3-1b	3-1	and detours	2-12	2-5
Guide signs	4-15c,	4-17,	One-way routes, principles ...		
	4-18f	4-18	Streets	2-12	2-5
Hand signals	3-4, app B	3-4, B-1	Open route	1-2f(4)	1-2
Highway regulation	1-2b	1-1	Organizational traffic control	1-2h	1-2
Safety	1-2n	1-2	Organized military movements	1-2c(1)	1-1
Traffic control	1-2d	1-1	Overlay, reconnaissance:		
Traffic headquarters	1-10d(2)	1-4	Parking	2-16	2-8
Holding area	9-5	9-3	Permanent	4-3	4-1
Defiles	13-2	13-1	Traffic control operation	4-1-4-4	4-1-4-4
TCP	9-5	9-3	Patrol supervisor	2-5	2-3
Indigenous traffic	1-2c(3)	1-1	Pedestrian control	2-15	2-7
Installation parking	4-2	4-1	Point control:		
Intersection traffic control (fig. 3-2)	3-1, 3-3	3-1, 3-3	(See traffic, point control		
Jungle operations	13-19	13-12	also.)		
Law, traffic	1-8, 7-7b	1-3, 7-7	Coordination	9-2	9-1
Legal considerations (theater of operations)	13-25	13-14	Definition	9-1	9-1
Light line	13-20,	13-12,	Ground orientation (fig. 3-2)		3-3
	13-23	13-13	Hand signals	3-4,	3-4,
Lighting, reduced	13-24	13-14	App B	B-1	B-1
Map:			Night	3-4b	3-4
Holding area (fig. 13-2)	9-5h(1)	9-4	Preparation	3-2	3-1
Measle	9-6d	9-4,	Rules	3-1c	3-1
	12-12	12-7	Safety equipment	3-2b	3-3
Reconnaissance	12-2d,	12-2,	School crossings	3-8	3-8
	12-11	12-7	Preventive enforcement	1-6c	1-3
Traffic circulation (fig. 13-7)	8-2,	8-1,	Prohibited route	1-2f(5)	1-2
	12-9	12-7	Protection of property and equip-		
Traffic control (fig. 3-1)	12-9	12-7	ment	7-13	7-11
Traffic control team (fig. 3-2, 3-6)	12-12	12-7	Provost marshal staff responsi-		
Unit location	12-10	12-7	bilities	1-10f	1-4
Military police, desk sergeant	2-6	2-3	Pursuit of violators	7-2	7-1
Duty officer	2-7	2-3	Radar	6-6b	6-3
Military traffic	1-2c	1-1	Rear area:		
Minor offenses, referred to U.S. district courts	7-8	7-7	Damage control	9-7, -8	9-4, 9-5
Mirror box	6-6d	6-5	NBC	9-8	9-5
Motorcycle patrols	5-5c	5-3	Reconnaissance:		
Motor patrols:			Air-ground	12-2c	12-1
Checkpoints	11-1, -2	11-1	Air	12-2b	12-1
Counter guerrilla	10-4b(5)	10-2	Ground	12-2a	12-1
Equipment	5-3	5-1	Map	12-2d	12-2
Functions and mission	5-1	5-1	Reduced lighting	13-24	13-14
Post, camp or station	5-9	5-4	Refugee control	9-8	9-5
Road reconnaissance	12-2a	12-1	Safety	5-7	5-3
Theater of operations	10-4	10-1	Registration of privately-owned		
Motor vehicle examination	App G	G-1	vehicles	5-8	5-4
Mountain operations	13-2	13-1	Regulatory signs	4-15a,	4-17,
Movement, credit priorities	1-2e,	1-1,	4-18d	4-18	4-18
	11-1a,	11-1,	Rerouting traffic by TCP	4-12, 9-6	4-11, 9-4
	11-11, -12,	11-6	Reserved route	1-2f(3)	1-2
	F-19	F-3	River crossings, traffic control	13-1, -2, -3	13-1
NATO standard offense report	E-1	E-1	Riverine operations	13-12	13-9
Northern operations	13-20	13-1	Road capacity	F-6	F-1
Nuclear attack, action of TCP	9-7	9-4	Road characteristics	12-6c	12-5
NBC operations	13-12, -22	13-12	Roadblocks	4-7	4-7
			Road classification by enemy		
			action	12-17	12-10
			Route classification formula	12-6b	12-3
			Route designations:		
			Axial	F-3	F-1
			Controlled	F-7	F-2

	Paragraph	Page		Paragraph	Page
Dispatch	1-2f(2), F-7b	1-2, F-2		Baton or flashlight	3-4b, app B 3-4, B-1
Lateral	F-4	F-1		Circulation map	12-8 12-7
Open	1-2f(4), F-8	1-2, F-2		Circulation plan	1-2i 1-2
Prohibited	F-12	F-2		Cones	3-2b(4) 3-3
Reserved	1-2f(3), F-7c	1-2, F-2		Delay	3-1a(5) 3-1
Signed	F-10	F-2		Enforcement	1-6 1-3
Supervised	1-2f(1), F-7a	1-1, F-2		Education	1-5 1-3
Rules of point control of traffic	3-1c	3-1		Engineering	1-4 1-3
Selective enforcement	1-6d, 6-3	1-3, 6-1		Flow system	1-2k, 3-1a(4), F-5 F-1
Signs	4-13—4-20	4-17— 4-19		Indigenous	1-2c(3) 1-1
Airborne operation	13-17	13-11		Management	1-2m 1-2
Checkpoints	4-6	4-5		Military	1-2c 1-1
Civil defense	4-20d	4-20		Planning	1-7 1-3
Classification	4-15	4-17		Point control:	
Construction	4-10, 5-7c(4)	4-10, 5-3		Goals	3-1b 3-1
Detours	4-10b, 4-11	4-10, 4-11		Preparation	3-2 3-1
Effective use	4-16	4-17		Rules	3-1c 3-1
Erection	4-18	4-17		School crossings	3-8 3-8
Fords	13-10	13-5		Reconnaissance report	12-6 12-3
Guide	4-15c, 4-18f	4-17, 4-18		Regulating line	13-3a 13-1
Northern operations	13-20	13-12		Signals	4-20 4-19
Reassurance	4-H			Studies	3-1a(3) 3-1
Reconnaissance (fig. 13-3, 13-6)		13-5, 13-9		Violation	6-1 6-1
Regulatory	4-15a, 4-18d	4-17, 4-18		Stopping violators	7-3 7-1
Standard	4-17	4-17		Table of violations	App C C-1
Warning	4-15b, 4-18e	4-17, 4-18		Traffic control:	
Signals:				Airheads	13-17 13-11
Baton	3-4, app B	3-4, B-1		Area	1-2a 1-1
Flashlight	3-4, app B	3-4, B-1		Beachhead	13-14 13-9
Hand	3-4, app B	3-4, B-1		Detour	4-12 4-11
Traffic	2-17, 4-20	2-8, 4-19		Devices	2-17, 3-1a(2) 3-1
Manual operation	4-20a	4-19		Disasters	2-4b(2) 2-2
Single flow	F-14c(1)	F-2		Drop zones	13-17 13-11
Special events	2-18	2-8		Emergency entrances	3-8b 3-8
Speed, measure devices	6-5	6-2		Fords	13-10 13-5
Zone establishment	2-13	2-5		Map	12-9 12-7
Staff judge advocate	1-10i	1-5		Posts (TCP)	9-1 9-1
Stopping known felons	7-5	7-4		River crossings	13-1, -3 13-1
Traffic violators	7-3	7-1		Special events	2-18 2-8
Straggler control	9-8	9-5		Supervision	2-2, -3, -4 2-1, 2-2
Street lighting	2-14	2-6		Traffic law enforcement	6-2 6-1
Supervised route	1-2f(1)	1-1		Transportation officer	1-10j 1-5
Support command	1-11	1-5		Uniform vehicle code and model traffic ordinance	1-8c 1-4
Temporary parking	4-4	4-1		Units of measure and conversion	App H H-1
Temporary signs, rules of erection	4-18	4-18		U.S. magistrate system	7-7b 7-1
Traffic	1-2a	1-1		V-100 armored car	9-2, 11-1e, 12-16 12-9
				VASCAR	6-6c 6-5
				Warning signs	4-15b, 4-18e 4-17, 4-18
				Whistle	3-5 3-4
				Written warnings	7-11 7-11

By Order of the Secretary of the Army:

W. C. WESTMORELAND,
General, United States Army,
Chief of Staff.

Official:

VERNE L. BOWERS,
Major General, United States Army,
The Adjutant General.

Distribution:

To be distributed in accordance with DA Form 12-11 requirements for Military Police Traffic Control.