

D101.26

MHI
Copy 3

FM 12-4

S. Deposit

FIELD MANUAL

DIVISION/SEPARATE BRIGADE ADJUTANT GENERAL

Documents Department
St. Louis Public Library

DEC 30 1972
15,355

St. Louis Public Library

HEADQUARTERS, DEPARTMENT OF THE ARMY
SEPTEMBER 1972

FOREWORD

Field Manual 12-4 provides procedural guidance, a philosophy of service, command/staff relationships, and concepts of management and operations to the division and separate brigade adjutant general (AG). This manual introduces the adjutant general company, and the division support command division data center (DDC), which replaces the adjutant section of the division administration company and the ADP support of the administrative machine branch within the personnel services division (PSD), respectively.

The division adjutant general company is organic to the division support command (DISCOM) and is the organization containing the resources with which the division AG performs his functional duties as a division special staff officer, division headquarters administrator, and division-wide personnel and administrative services monitor, coordinator, and operator. When appointed, he functions as the division rear officer-in-charge (OIC). The division AG has operational control of functional operations of the AG Company, and is supervised and directed by the division Chief of Staff. He receives policy guidance and general staff supervision from the ACofS, G1 personnel, and the CofS as desired by the division commander. The DISCOM commander provides the AG Company with data processing support, certain administrative and logistical services, special courts-martial jurisdiction (enlisted personnel only), non-technical training, and movement support.

The division AG section has been redesignated as the "office of the AG." This title denotes the division AG and *all* of his functional operations, which includes the administrative services division (ASD), the postal division, the special services division (SSD) the personnel services division (PSD), the replacement detachment (when augmented), and the band. The designation of the personnel service division has been changed to the personnel services division, to better describe the PSD mission.

The AG company has no organic replacement detachment or automatic data processing (ADP) capability. When replacement organizations are not provided to the division by Corps or Field Army support elements, a replacement detachment may be provided by augmentation. ADP support is provided to the division AG by the division data center (DDC), which is organic to HHC, DISCOM. When the division logistics system (DLOGS) is not implemented within the division, there is no DDC, and the division AG is provided ADP capability by the augmentation of an administrative machine branch (AMB) in the personnel services division (PSD). A band is organic to the AG company and is the functional responsibility of the division AG.

Personnel and administrative direct support functions performed by the division AG and his functional elements remain essentially the same, with the exception of the addition of the band.

There is no essential change to the mission, organization, or functions of the separate brigade AG. The separate brigade AG continues to operate within the administration company environment.

FIELD MANUAL }
 No. 12-4 }

HEADQUARTERS
 DEPARTMENT OF THE ARMY
 WASHINGTON, DC, 29 September 1972

DIVISION/SEPARATE BRIGADE ADJUTANT GENERAL

	Paragraph	Page
CHAPTER 1. INTRODUCTION		
Section I. General	1-1-1-5	1-1
II. Philosophy	1-6	1-2
CHAPTER 2. RELATIONSHIPS, RESPONSIBILITIES, AND CONCEPTS		
Section I. Relationships	2-1-2-3	2-1
II. Responsibilities	2-4-2-6	2-2
III. Concepts of Management and Operation	2-7-2-9	2-4
CHAPTER 3. ADJUTANT GENERAL COMPANY (DIVISION)		
Section I. Organization and Mission	3-1-3-6	3-1
II. Functions	3-7-3-14	3-5
CHAPTER 4. SEPARATE BRIGADE ADJUTANT GENERAL SECTION, ADMINISTRATION COMPANY	4-1 and 4-2	4-1
5. FIELD AND COMBAT OPERATIONS		
Section I. General Considerations	5-1-5-3	5-1
II. The Division or Separate Brigade Rear	5-4-5-17	5-3
III. Special Emphasis Areas	5-18-5-25	5-15
CHAPTER 6. PERSONNEL SUPPORT SYSTEM	6-1-6-6	6-1
7. AUTOMATIC DATA PROCESSING SUPPORT	7-1-7-3	7-1
APPENDIX A. REFERENCES	A-1-A-6	A-1
B. RELATED REFERENCE MATERIAL FOR THE ADJUTANT GENERAL COMPANY COMMANDER	B-1-B-7	B-1
C. VEHICLE USAGE AND MAINTENANCE FACTORS (AG COMPANY)		C-1
D. SYMBOLS RELATING TO FIGURE 5-2		D-1
E. TENTAGE INFORMATION		E-1
INDEX		Index-1

CHAPTER 1

INTRODUCTION

Section I. GENERAL

1-1. Purpose

The purpose of this field manual is to:

a. Provide doctrinal and procedural guidance for the division or separate brigade adjutant general (AG) to assist him and his personnel in fulfilling their personnel and administrative service responsibilities to commanders and personnel of organizations served.

b. Furnish field commanders and staff officers at various levels of administration and echelons of command within the division or separate brigade with information pertaining to the mission, duties, and functions of the AG and his relationship to supported organizations.

c. Serve as a guide for division/separate brigade adjutants general and as a supplement to formal training and acquired experience.

1-2. Scope

The scope of this manual encompasses a philosophy of AG service; adjutant general relationships, responsibilities, and concepts of operation; the adjutant general company and the separate brigade adjutant general section organization, mission, and functions; and an explanation of the division and separate brigade personnel support system. It discusses the mission, duties, and responsibilities of the AG peculiar to the field and combat operational environment, and certain special emphasis subjects in the AG area of responsibility.

1-3. General Application

a. This manual is applicable to conditions of a garrison or field situation involving:

(1) General war, to include consideration of, and protection from, nuclear munitions, and chemical, biological, and radiological (CBR) agents, and operations in nuclear, chemical, or biological environments.

(2) Limited war.

(3) Cold war, to include stability operations.

b. Army regulations have been promulgated to cover in detail the technical application of the doctrine, concepts of operations, and systems outlined in this manual.

1-4. Explanation of Terms

For the purposes of this manual, the following explanation of terms apply:

a. *Administration.* The management and execution of all military matters not included in tactics and strategy primarily in the field of logistics and personnel management; and the internal management of units. The organization commander is responsible for the administration of his command.

b. *Administrative Services.* Those elements of administration which are provided to the commander and his staff at any given level within the division/separate brigade to assist them in their internal management of administrative matters involving classified document security control; correspondence, records, forms, official mail, and publications management; reports control; and printing and local reproduction actions and control. The division/separate brigade adjutant general is a staff advisor, supervisor, and operator of headquarters administrative services at his headquarters level, and is also a staff advisor to the division or separate brigade commander on administrative services at subordinate levels.

c. *Personnel and Administrative (P&A) Services.* A general, broadly inclusive term which describes the total range of services provided by the division/brigade AG and his subordinate elements (divisions). These services assist the commander and his staff at all levels within the command in performing this duties of personnel

FM 12-4

management and actions, morale and personal services, and unit administration.

d. Personnel Services. The total range of administration which pertains to AG provision of personnel actions, personnel management advice and assistance, and personnel records keeping services to supported commanders, their staffs, and their assigned and attached personnel.

e. Postal Services. The total range of services which provide US Army personnel with ordinary and accountable mail services; to include mail receipt and delivery, mail directory service, and patron services (money order and postal stamp stock sales).

f. Special Services. A term used to denote a functional grouping of certain morale and welfare services. The term normally includes entertainment, service club, library, crafts, sports, and rest, leave, and recreation; and embraces those personnel services established and controlled by military authorities and designed to contribute to the physical and mental effectiveness of military personnel and authorized dependents and civilian employees.

Section II. PHILOSOPHY

1-6. Philosophy of Adjutant General Service

The philosophy of AG service in the division and separate brigade embodies, in general, the following principles:

a. The AG provides direct support personnel and administrative (P&A) services to all commanders, their staffs, and their personnel, as designated by the division/separate brigade commander.

b. Effective P&A services must be furnished to each individual of the staff and line, regardless of operational or administrative obstacles encountered.

c. Rapid, accurate, and professionally competent response by the AG to P&A direct support requirements within the purview of his responsibility is essential to the successful accomplishment of the unit mission at all levels within the division/separate brigade.

d. Support actions taken by the AG and his operating personnel bear directly upon the morale, efficiency, and welfare of each supported member, regardless of the simplicity of the task

g. Division. A division is a tactical organization and, for the purposes of this manual, is also the first subelement of the office of the adjutant general within:

(1) the adjutant general company, (i.e., personnel services *division*, and postal *division*;) or

(2) the adjutant general section, administration company separate brigade.

1-5. Recommended Changes and Comments

Users of this publication are encouraged to submit recommended changes and comments to improve the publication. Comments should be keyed to the specific page, paragraph, and line of the text in which the change is recommended. Reasons should be provided for each comment to insure understanding and complete evaluation. Comments should be prepared on DA Form 2028 (Recommended Changes to Publications) and forwarded direct to the Commanding Officer, US Army Combat Developments Command Personnel and Administrative Services Agency, Fort Benjamin Harrison, Indiana 46249.

to be accomplished, or the rank/status of the member concerned.

e. The unit commander at every level is relieved, to the maximum extent possible, of his administrative burden relative to P and A services by the AG.

f. Automatic data processing (ADP) equipment, available in the division data center (DDC) is utilized throughout the organization personnel and administrative (P&A) support system whenever such use is authorized and deemed economically and operationally feasible.

g. There are no "unimportant" personnel matters.

h. Personal interest, meticulous attention to detail, and conscientious application of AG resources to all P&A tasks is an AG "way of life" and must predominate as a central concept of AG service. The PERSONAL in PERSONNEL is maintained, regardless of the distance separating P&A services from those who are served.

i. A "business as usual" attitude cannot be condoned by the division or separate brigade AG.

Every action possible must be taken to reduce waiting time for the individual and speed the handling of personnel actions. An interim response to any personnel question asked by an individual should be furnished within 24 hours.

j. An AG keeps himself informed on the characteristics and operations of the organization to which he is assigned. His knowledge exceeds the superficial depth; it includes as a minimum, considerable familiarity with the division or separate brigade mission, role, organization, control facilities, the roles of commanders and their staffs at various levels, and the specific manpower and material characteristics of the com-

bat, combat support, and combat service support elements of the organization. The AG constantly strives to remain abreast of changes which affect the division or separate brigade, and develops the ability to relate logically and professionally the impact of such changes to his personal and functional capability to provide personnel and administrative services to the organization. The extent to which the AG is able to do this proportionately reflected in the efficiency of operations under his supervision, and in the finesse and expertise with which he provides P&A services to supported commanders and their assigned and attached personnel.

CHAPTER 2

RELATIONSHIPS, RESPONSIBILITIES, AND CONCEPTS

Section I. RELATIONSHIPS

2-1. General

The staffs of the division and separate brigade follow traditional patterns of a headquarters structure, as outlined in FM 101-5, with coordinating and special staff members to carry out prescribed duties and responsibilities. The staff of the separate brigade at the "S" level (S1, S2, S3, S4, S5) is considered to be a "general" staff for the purposes of this manual. The AG is a member of the special staff in both the division and the separate brigade. The title "adjutant general" is given to the adjutant of a commander having a general staff and is limited to officers of the Adjutant General's Corps (AGC). Officers of other branches who fill the position of AG are given the duty title "acting adjutant general." The staff position and relationships of a particular AG may vary in scope and degree with the desires of the division or the separate brigade commander. There are command staff relationships that apply to each type organization which are influenced by the organizational arrangements of the command; e.g., the division is authorized an adjutant general company in the DISCOM and the adjutant general is assigned to that company; the separate brigade is authorized an administration company in the support battalion, of which the adjutant general section is a part, and the adjutant general is assigned to that section.

2-2. The Division Adjutant General

a. General. In the division, the AG advises and assists the division commander and exercises operational and supervisory responsibilities in the functional areas of personnel and administrative services for all assigned and attached elements of the division. As the division special staff personnel and administrative services representative, he is supervised and directed by the division chief of staff and receives general (coordinating) staff supervision in personnel support matters

from the assistant chief of staff, G1, personnel. For guidance in performing his mission, the AG uses regulations and policies emanating from Department of the Army, intervening commands, and technical channels; policies, priorities, and desires of the division commander (whether received directly from the commander, through the chief of staff, or the assistant chief of staff, G1, personnel); and so far as is possible, the requirements and desires of commanders of organizations supported by his functional operations. When regulatory requirements or other directives are in conflict with the desires of directing staff officers and commanders, the AG will advise the party(ies) concerned, and then follow the direction of the responsible commander or staff officer. As the senior assigned member of the division adjutant general company, the AG supervises the company commander; however, he does not command the company.

b. Relationships with the General (Coordinating) Staff. The AG relationship to the general staff is that of an operator to coordinator, or doer to planner, although the AG also plans internally for his functional personnel and administrative services operations. Within overall plans and policies formulated by the general staff offices, the AG carries out operations charged to his area of responsibility. Once policies are established and implemented by the general staff, the AG operates without further reference to the general staff. When matters arise which deal with an exception or change to policy, or are not covered by policy at all, the AG provides his views and recommendations to the general staff section having primary interest, coordinates with the chief of staff, the assistant chief of staff, G1, personnel, and requests guidance for future operations.

c. Relationship With the Special and Personal staff. The relationship of the AG to other special and personal staff officers is that of lateral equal-

FM 12-4

ity. The extensive range of AG activities touches upon many of the special and personal staff functions, thus enabling the AG to assist the special and personal staff in the conduct of their operations and resolving their problem areas. The relationship of the AG to the special and personal staff can best be described as one of "service," but is also one of coordination and cooperation in problems of mutual concern and interest.

d. Relationship to the DISCOM Commander. The division AG, his entire functional operation, and the division adjutant general company (chap 3 for details) are organic to the DISCOM. The AG employs his personnel and administrative expertise, equipment, and functional operations within the office of the adjutant general as directed by the division chief of staff to provide personnel and administrative direct support to the entire division, to include all assigned and attached units. The division AG exercises operational control of all personnel and administrative (P&A) operations of the AG company functional areas for the division CofS. He receives policy guidance and general staff supervision from the ACofS, G1, personnel, and the CofS as desired by the division commander. The DISCOM commander provides the AG with data processing support, certain administrative and logistical services, special courts-martial jurisdiction for enlisted personnel, nontechnical training, and movement support. The AG may be designated by the division commander as the officer in charge of the division rear. In this role, the AG responds to the DISCOM commander in tactical, security, movement, and training matters, and insures that the rear tactical activities are controlled and integrated into the support command

rear area security and damage control plans and operations. For details on field and combat operations see chapter 5.

e. Relationship With Units and Personnel Served. See paragraph 2-6b.

2-3. The Separate Brigade Adjutant General

In the separate brigade, the AG is a special staff officer to the brigade commander and advises him on personnel, administrative, and related matters. The AG coordinates with other special (coordinating) staff members of the separate brigade staff and with remaining special and personal staff members in the same manner as does the division AG. The separate brigade AG is directed, controlled, and coordinated by the separate brigade executive officer. The AG and his entire section (with all P&A functional services to the separate brigade) are assigned to the administration company of the separate brigade support battalion. Within this organizational framework, the separate brigade adjutant general provides personnel and administrative support to all elements of the brigade (less finance), including centralized personnel and administrative services and replacement support. During tactical operations the administration company and its special and personal staff sections and other brigade elements may be under the tactical control of the adjutant general when located in a rear element of the brigade trains and designated as officer in charge (OIC) by the brigade commander. The adjutant general performs the duties of such office for the separate brigade support battalion commander in the same manner as does the division adjutant general for the DISCOM commander.

Section II. RESPONSIBILITIES

2-4. General

The adjutant general of the division or separate brigade is responsible to provide administrative, postal, special, and personnel services (and band services-divisions only) to the command. He occupies a critical position within the organization. He directs, controls, and coordinates elements and functions which impact directly upon the morale and efficiency of each assigned member and upon the state of training and combat readiness of the organization. As a member of the special staff, he exercises operational and

supervisory jurisdiction in the functional areas of personnel and administrative services as delineated in FM 54-2, FM 61-100, and FM 101-5. Within varied operational environments, the AG performs the duties of a special advisor to the division or separate brigade commander, the general, special, and personal staff, commanders of assigned and attached units of the division and the separate brigade; he is a supervisor and operator of functional personnel and administrative combat service support for the division commander; and when designated, is an officer in charge of a rear element. The AG also may be

required to assume civilian personnel functions and some comptroller responsibilities as a part of his overall responsibility.

2-5. Responsiveness

The adjutant general must be particularly responsive to the following:

a. Command personnel and administrative operational requirements under changing conditions.

b. Requirements of the division or separate brigade commander, his personal, general, and special staff, and his subordinate commanders, for information, advice, and recommendations.

c. Personnel and administrative service support requirements of subordinate command groups and individual members.

d. Requirements for liaison with other commands.

e. Tactical control and operational requirements related to his role as officer in charge of a rear echelon.

2-6. Specific Responsibilities

a. *Special Staff.* As a special staff officer, the AG provides information, makes estimates, prepares plans and orders relating to P&A services, and supervises the execution of such plans and orders; makes recommendations; assists the general staff; exercises technical supervision over AG activities in subordinate elements of the command; establishes liaison with AG elements in higher and adjacent commands; plans, supervises, and conducts technical training for the activities under his jurisdiction; and authenticates official correspondence "for the commander." The AG performs the functions outlined in FM 101-5; however, the commander may add other related functions to this list or assign certain of these functions to other staff sections. The AG performs his designated functions within broad policy determined by the general staff and approved by the commander. In his role as a special staff officer, the AG has wide spread influence within the organization and the impact of his actions reach as far as the Department of the Army in certain instances, e.g., replacement requisitioning.

b. *Personnel and Administrative Functional Services.* The AG provides essential personnel and administrative services to the entire division

or separate brigade. He implements the personnel support system (for details see chap 6) to acquire, maintain, and provide personnel statistics and other information, accomplish personnel actions, maintain personnel records, and assist commanders of assigned and attached organizations with their personnel management responsibilities. Within his functional areas of responsibility, the AG performs specific personnel and administrative services for each individual in the division or separate brigade on a continual, cyclic, or "as required" basis. He utilizes available resources (men and materiel) in conjunction with management tools (regulations, standard operating procedures, policy guidance, command direction) to provide necessary direct support services. The AG relieves supported commanders of routine personnel and administrative duties through the establishment and maintenance of direct lines of communication to the organizations served consistent with intervening command desires, prerogatives, and priorities: He apportions his resources to meet tactical conditions, and when required, decentralizes his services through the use of special techniques, lateral staff coordination, and direct commander contact. The AG must continually perform critical analysis (examination, evaluation, validation) of all data/information received before permitting it to be incorporated into the AG operating elements which support the division or separate brigade. The efficiency of AG operations depends heavily upon effective communications, accurate reporting from supported organizations within the division or separate brigade, available P&A expertise, and on higher, lateral, and lower headquarters' speed and accuracy in responding to personnel and administrative requirements.

c. *Officer in Charge of the Rear Element.* The division and separate brigade rear elements normally are commanded and controlled by the appropriate combat service support commander through his command post. However, when the rear is echeloned and situated in a manner which isolates the administrative elements of the command from the balance of the division or separate brigade, the adjutant general may be designated as OIC of the rear. As such, he is responsible for tactical control, security, and movement of the rear in accordance with the desires of the responsible combat service support commander, as well as the efficiency and timeliness of the operations of the administrative elements of the rear.

d. Orientations. The adjutant general is responsible to orient all commanders, staff officers, other supervisors and leaders, and personnel and administrative technicians throughout the organization on the concepts, doctrine, general procedure, and structure of the personnel support system, to include the centralized personnel records facility in the personnel services division (PSD). Emphasis should be placed on the nature and characteristics of automatic data processing or manual operations used; what it does for each individual, and their commanders and staffs in areas of personnel management, personnel actions, status reporting, recordskeeping, and military pay; the criticality of absolute accuracy in the unit morning report or other personnel status reports employed; the far reaching effects of erroneous data within the personnel support system, particularly the impact of such errors

on the system's ability to respond to command and individual needs; and how the system impacts upon the efficiency of each soldier and the organization's ability to perform its mission. Orientations should include an example and an explanation of the interfaces between the adjutant general company functional personnel and administrative elements, the support command division data center, and the finance company in the division; and the adjutant general section and the finance section of the administration company in the separate brigade. All officer, warrant officer, noncommissioned officer personnel and specialists working within the personnel support system at all levels throughout the organization should be thoroughly indoctrinated on supporting ADP facility operations and on the contents of DA Pam 600-8, which contains specific procedures on how to handle personnel and related actions, and reports.

Section III. CONCEPTS OF MANAGEMENT AND OPERATION

2-7. Management and Operational Concepts of the AG

a. General. The AG prepares for operations through adequate planning, accomplishes the workload in an efficient and timely manner, and checks and follows through to insure such accomplishment. The AG has flexibility in distributing his workforce and functions; the TOE does not organize the AG section or company down to the exact duty position for each individual within the functional divisions, nor does it establish fixed locations for items of equipment. Regulatory material provides the AG with specific procedures in most of his functional operations. The basic internal organization of division and separate brigade AG operational elements is influenced by the number of operating personnel spaces, equipment, and the requirements of the command. The AG allocates P&A functions to subelements under his control and assigns specific supervisory operational jurisdiction to specific individuals to insure the performance of all functional responsibilities. Each AG function is assigned as some individual's responsibility, and continuing internal review and followup techniques are employed through standing operating procedures (SOP) to insure these responsibilities are correctly carried out. The assignment of functions, the assignment of personnel and equipment to carry out these functions, and the estab-

lishment of followup techniques to insure completion are separate but interdependent personal acts of the adjutant general.

b. Delegation of Authority. Responsibility for a task is accompanied by the necessary authority to accomplish that task. Authority within AG operational areas is decentralized to the maximum extent possible to the functional element(s) or individual(s) responsible for the actual performance of the operation. Such decentralization does not restrict controls over policy, or the standardization of procedures, which are necessary to insure each functional element or individual contributes to the overall mission of the AG divisional or separate brigade operation. Limitations on delegation of authority are imposed only to assure that the basic policies of the adjutant general are coordinated and accomplished. Authority is not delegated until policies are completely delineated and explained; certain matters take on special significance because of possible repercussion if the case is mishandled. Centralization of authority, however, can result in overworked supervisors and frustrated subordinates. Control is exercised from the top level of management throughout the AG area of responsibility through attention to problems of exceptional importance rather than through a thorough review of routine actions of subordinates. Delegation of discretionary authority to subordinates at the risk of a few mistakes is

the better choice to the retardation of effective performance through unnecessary direct supervision, "redtape," and review from the "top." However, delegation of authority is made only when the supervisor is confident that the subordinate is competent to exercise such authority. Fullest benefit from this principle is realized only when a high state of training and professional ability is present in the organization at every level of supervision, and direct workers are inspired with a sense of service and dedication to duty.

c. Span of Control. The number of direct subordinates that one supervisor can effectively manage is limited by the complexity of the work, the capability of the individuals concerned, distance between the manager and subordinates, and available time. Much depends upon the type of work to be done and the individual(s) involved. For example, Department of the Army guidance on span of control within personnel offices furnishes a general rule-of-thumb of one supervisor to no more than ten direct subordinates.

d. Allocation of Workload. Grouping like or related activities and jobs in the AG organization produces greater efficiency and is accomplished except where responsiveness to the supported organization or staff officer will be hampered by such action. It is a poor policy to allocate functions purely upon the ability or skill of a particular person, for the loss of that person can seriously disrupt operations. The AG and his subordinate chiefs assign functions to the lowest possible level, insure that functions are not exempted from the chain of command, and assign functions based upon known or normal workloads. The workload is divided carefully so that experienced, capable, and energetic personnel are not overburdened, while other less capable personnel are not fully employed. Continual training is critical to the attainment and maintenance of this balance.

e. Shifts in AG Functions. Regardless of location, the AG performs essentially the same operations; however, certain workloads vary considerably between garrison and field (combat) situations. For example, casualty reporting in garrison is a relatively infrequent task. Under certain circumstances, MOS testing and redeployment assumes major proportions in garrison, or in the field during peacetime; however, in combat these actions are discontinued sometimes

completely or sharply reduced. Awards and decorations activities expand rapidly in proportion to the intensity of combat operations, and the AG becomes involved deeply in replacement operations, special services, postal operations, and staff coordination in matters directly related to personnel status reporting. The AG plans and is prepared throughout his area of responsibility to react quickly and efficiently to operational changes and to provide for certain AG functions to expand while contracting others, without creating a requirement for augmentation of personnel expertise or equipment to the AG operation. Chapter 5 discusses in detail the field and combat operations of the division and separate brigade AG.

f. Exceptions to AG Operating Procedures. Exceptions are established by the division or separate brigade AG which result in changes to day-to-day operational procedures within his subelements by his reservation of certain functions (e.g., the AG may assign the function of authenticating routine orders to a subelement but may reserve certain actions for his own signature.) When the AG reserves a large number of actions for himself which exceeds the basic organizational concept of the TOE, it affects the organization of subelements under his supervision. He requires more clerical and midmanagement assistance and draws upon existing authorizations to satisfy his requirements. As a general rule, the division and separate brigade AG and his division (subelement) chiefs do not become involved directly with the functions of operating activities; this interferes with their capability to perform the critical management actions of supervising, coordinating, controlling, directing, and planning. Notwithstanding the foregoing principle, certain duties and activities are expected to undergo reorganization by the AG and his subelement chiefs in response to the emphasis placed on various subject areas by the division or separate brigade commander.

g. Guide for Authentication. Except for combat orders, the authentication of directives and orders normally is restricted to commanders and adjutants general or their assistants. For the utmost efficiency, the AG establishes a *fixed pattern* whereby he reserves certain authentications for himself and delegates other signature authority to his assistants. Normally, the division AG authorizes each commissioned and warrant officer in the AG section to sign, as assistant or acting assistants AG, those actions which fall

FM 12-4

under the signer's functional responsibilities, e.g., the personnel actions branch chief would have the delegated authority to sign "for the commander" as the assistant adjutant general those routine personnel actions handled by SOP in his branch. This delegation is authorized formally by special orders appointing each officer and warrant officer as an assistant or acting assistant AG.

h. Rules of Authentication. The division and separate brigade AG usually reserves for himself the authentication of:

- (1) General Orders.
- (2) Major numbered directives (regulations, circulars, and memorandums).
- (3) Important single directives and letters.
- (4) Staff directives.
- (5) Instructions from the commander ("The commanding general directs . . .").
- (6) Correspondence or messages to higher headquarters in the following circumstances: the incoming reference has been signed by the AG of the higher headquarters; it is desired to indicate that the division or separate brigade has emphasized the matter; fault is admitted, errors are explained, or the command is exposed to censure; sensitive matters (security, political) are discussed; commendation or praise is given; or controlled subjects are covered.
- (7) Inter- or intraheadquarters staff papers discussing a subject of personal interest of the commanding general.
- (8) Correspondence or messages to lower headquarters in the following circumstances: it is desired to indicate emphasis has been given the communication, the subject involves censure or commendation, or controlled subjects are covered.

(9) Certain disapproved personnel actions, except those designated by the division commander for his personal signature. Subordinate chiefs, down to branch level, may be authorized to disapprove personnel actions in their functional areas except for unusual cases, those which bear the personal recommendation or support of a subordinate commander, or wherein disapproval is an exception to normal policy.

i. Matters Which Receive the AG's Personal Attention. The division and separate brigade AG normally takes a personal interest in the follow-

ing actions or reserves them for his personal attention:

(1) Coordination of all matters relating to P&A services raised by the division or separate brigade commander, chief of staff, separate brigade executive officer assistant chief of staff, G1, personnel, and other staff section chiefs; and important matters raised by subordinates of the above individuals.

(2) Coordination of all major policy questions raised by division or separate brigade staff sections and all conflicts that reach staff section chief level.

(3) Handling of the headquarters administrative executive functions, which may include policies involved in maintaining the division and separate brigade headquarters standing operating procedures, policy files, headquarters procedures manual; operations of the headquarters suspense and correspondence control and record system (when designated by the commander as an AG function); staff "action office" policy (When designated by the commander as an AG function); editorial and publications policies, efficiency rating system for staff officers and commanders of the division, and handling of classified material problems.

(4) Coordination of matters relating to office space and equipment with the headquarters commandant (in garrison) and the AG company commander or administration company commander (in the field) concerning equipment and enlisted men assigned to duty with the office of the adjutant general.

j. Matters Reserved for AG Personal Decision, Coordination, Investigation and Staffing. Operationally, the AG usually reserves for himself the giving of information or the making of decisions regarding the following:

(1) Overall allocation of replacement personnel. (After consultation with the ACofS, G1, personnel).

(2) Suspension of favorable personnel actions on individuals under investigation (upon request from the responsible commander).

(3) Any matter concerning key staff officers and major subordinate commanders.

(4) Disciplining of officers assigned to the office of the AG.

(5) The elimination, demotion, etc., for cause, of officers, warrant officers, and senior noncommissioned officers, or other enlisted men

holding sensitive positions within the organization.

(6) The commission of felonies, presence of scandals, occurrences of serious offenses, riots, security breaches, and racial disturbances which touch upon AG operations.

(7) Line-of-duty cases in which the ruling was "line of duty, *No.*"

(8) Congressional and presidential interest actions.

k. Matters Requiring Personal AG Handling. In the following situations, the AG handles or personally supervises the handling of matters on correspondence concerning:

(1) Failure to classify, loss, or errors in the custody of classified documents (includes loss of MOS test materials).

(2) Editorial controversies, involving division or separate brigade publications.

(3) Board reports assessing pecuniary liability.

(4) Errors or alleged errors made by the AG element.

(5) Postal losses (mail or financial).

(6) Dereliction of office or negligence of duty on the part of any individual assigned to the AG area of responsibility, regardless of grade or position.

(7) Sensitive correspondence of interest to the general staff, the chief of staff and the commanding general.

2-8. Management and Use of ADP Resources

a. General. Supporting ADP resources may be organic to the office of the AG or available from the DISCOM. In either event, it is essential that users at the functional operating level within the office of the AG (e.g., personnel management branch or composite team) understand and appreciate how the personnel system operates when it is supported by ADP. A cohesive working relationship must exist between the functional element user and the personnel performing data processing actions in order to extract the maximum from both elements. Without this relationship, optimum use of ADP facilities is doubtful. The watchwords in this instance are cooperation, coordination, and training.

b. Systems Managers. When one manager controls both the personnel and data processing

operation systems, management is simplified; under these conditions, the manager is sufficiently familiar with the operations of both systems and insures that both operations are contributing the maximum possible to the effective overall operation of the personnel and data processing operations. If a systems manager is not sufficiently familiar with the operation of the office of the AG or the support ADP he must make it a specific point to learn both operations. Effective utilization of the resources of both systems will make the manager's overall job much easier and will provide more responsive and accurate information and service to all users of the system and to those working within the system.

c. Working Level Supervisors. Working level enlisted, warrant, and commissioned supervisors should familiarize themselves with all inputs provided by their particular operation to the ADP/personnel systems and the outputs generated. General working knowledge should be supplemented by personal contact with operating personnel in the ADP activity or in the personnel office, so that when a problem arises it can be resolved as soon as possible without causing a major crisis.

d. Individual Workers. The individual worker is the key to the success or failure of the personnel/ADP system. If the individual worker is not trained properly and does not accomplish his duties in a professional manner, the system is bound to fail or be disrupted sufficiently to cause problems and additional work. Detailed instructions on the procedures in the personnel/ADP system is necessary. The resulting informal coordination and ability to resolve problems should prove beneficial to all concerned. A program of "job interchange" for short periods at the worker level between personnel and ADP system direct workers is a method which can be implemented to orient new individuals who have been recently assigned.

e. Orientation Tours. A chronic problem area in the personnel services functional element user area is the lack of appreciation and complete knowledge at the direct worker and first-line supervisor level as to how information they provide to the DDC becomes a finished product for command/staff use (e.g., how the information they furnish is converted to data, processed by the computer, transposed to machine listings, verified, and distributed to users). Orientation tours of the ADP operation by direct workers

FM 12-4

and supervisors will resolve the large majority of problems which exist due to this lack of knowledge. Tours must include detailed step-by-step explanations of how information is converted into computer acceptable media, how information is stored and updated, how cut-off dates affect the flow of information to the user, where problems can and do occur, and suggestions to users within the technical and functional areas as to what can be done to resolve them. A tour of ADP facilities, when immediately reinforced with a tour and orientation at the functional element level, benefits personnel and enhances their professional knowledge and capability. Daily observation and familiarization with the specific operations of the functional element which interface with various facets of the ADP facility will provide the worker first hand information which he can relate to his daily job effort.

f. Garbage In-Garbage Out (GIGO). The term "GIGO" is a standard statement in the data processing profession. It means that the quality and reliability of information put into a data processing system has a direct relationship to the result (product) turned out by the system. GIGO applies to data processing and to any other system which stores information for response and use. An irrefutable axiom is that the accuracy of information entered into a system will directly affect the accuracy of the output of the same system and indirectly affect the individual or operation to which it pertains, e.g., if the name or social security number of an individual is entered incorrectly on an individual record, the individual may not receive proper credit or be notified of an action that affects him. When this occurs in matters concerning pay or an action that affects the individual's personal or professional life, such as the crediting of wages earned to an individual's social security account eligibility or application for OCS, or for promotion, the seeds of a definite future problem are planted.

g. Errors in Data Handling. Errors can be entered into the personnel system in many ways. Some of the most common are:

(1) *Transcribing errors.*

(a) These occur when a direct worker copies down incorrect information when preparing a form or document which is to be used as data input and the error is not discovered when the information is checked or verified. This may be caused by:

(b) Honest error; e.g., when two letters or numbers are transposed.

(c) Haste or laziness; e.g., when the personnel specialist thinks something might be wrong but is either too busy or too lazy to verify the information.

(d) Deliberate mistake; e.g., when a deliberate falsification of a record is made for some reason.

(e) Illegibility errors; e.g., these errors are caused by poor handwriting and/or printing which requires guessing and results in substitution of improper numbers or letters.

(2) *Verification errors.* These occur when the work performed is not checked and verified to insure that erroneous information has not been entered into the system.

(3) *Keypunch errors.* These errors are similar to the transcribing errors described in (1) (a) above except that they are made when the information is being keypunched from a source or input document.

(4) *Computer error.* This type of error is the one that is blamed most, but occurs least. Genuine machine errors do occur but the electronic circuits of the computer do not make mistakes as frequently as believed. Most errors that are attributed to the "computer" can be traced to errors in data preparation (accuracy of input). One reason computer error is blamed so often is that users believe that the computer is supposed to check for errors during a processing run. The errors that the computer checks for are those that insure the circuits of the computer did not lose any of the information being processed (validity checks). These checks are not to determine whether the information entered into the system was originally correct or not. The computer cannot think and can only check the information it processes for validity against the information that was provided—not against what it should be.

2-9. Effects of Strategic and Tactical Tailoring on AG Operations

The division and separate brigade have a fixed command, staff and combat and administrative support structure (called the base. A selected number of infantry, airborne, airmobile, infantry mechanized, or tank combat battalions may be assigned to the division or separate battalion base as required by the mission and operational environment. The determination of the types and numbers of battalions to be assigned to the division or separate brigade prior to deployment in

an area of operations is called strategic tailoring. External tactical tailoring may be accomplished by field commanders if required after the organization is deployed. This may include transfer of units, augmentation with additional units, or detachment of selected elements. Internal tactical tailoring, the organization of combat elements within the division or separate brigade to meet changing combat or other conditions, may also be employed. Tactical tailoring actions may create changes in the arrangement of personnel and administrative functional elements within the AG area of responsibility. Assignments, reassignments, attachments, and detachments of units

and individuals, and the resultant shift of P&A services operated by the AG in response to these changes, may affect the adequacy of communications, the flow of personnel replacements, data, and other information, and the efficiency with which the organizational personnel support system can respond. The AG remains aware of changing conditions which forecast tactical tailoring, and through standard operating procedures (SOP) and contingency planning, is prepared to meet P&A support requirements of individuals and units affected. Continual and close liaison with the ACofS, G1, personnel and the ACofS, G3, operations assists the AG in this anticipatory task.

CHAPTER 3

ADJUTANT GENERAL COMPANY (DIVISION)

Section I. ORGANIZATION AND MISSION

3-1. Organization

a. The adjutant general company is organized as shown in figure 3-1. It consists of a company headquarters and the office of the adjutant general.

b. Company headquarters is organized as shown in figure 3-2. It consists of administration, supply, mess, and maintenance.

c. The *office of the division adjutant general* is organized as shown in figure 3-3. It consists of an administrative services division, postal division, special services division, personnel services division, and band; it is augmented by a replacement detachment, additional band personnel, and an administrative machines (ADP) capability, as required.

3-2. Mission

a. *Adjutant General Company.* The mission of the adjutant general company is to provide cen-

tralized personnel and administrative (P&A), postal, and special services, (less finance services), to all personnel and units assigned or attached to the division; to promote and maintain the morale and esprit de corps of troops by providing suitable music for military formations, light concerts, and recreational activities; and to provide an element of the division headquarters rear.

b. *Company Headquarters.* The mission of the company headquarters is to provide the unit level command element and personnel for unit and personnel administration, food service, supply, and organizational motor and weapons maintenance in support of the assigned and attached individuals of the company.

c. *Office of the Adjutant General.* The mission of the office of the adjutant general is to provide direct support personnel, administrative, postal, special, and band services to all assigned and attached organizations of the division, and when

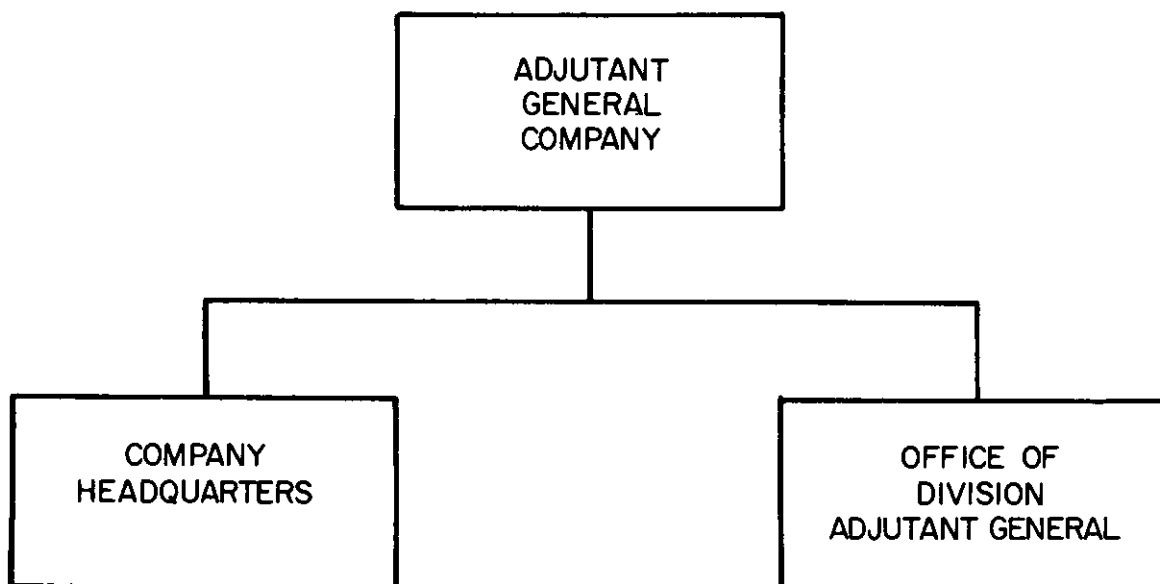

Figure 3-1. Adjutant general company.

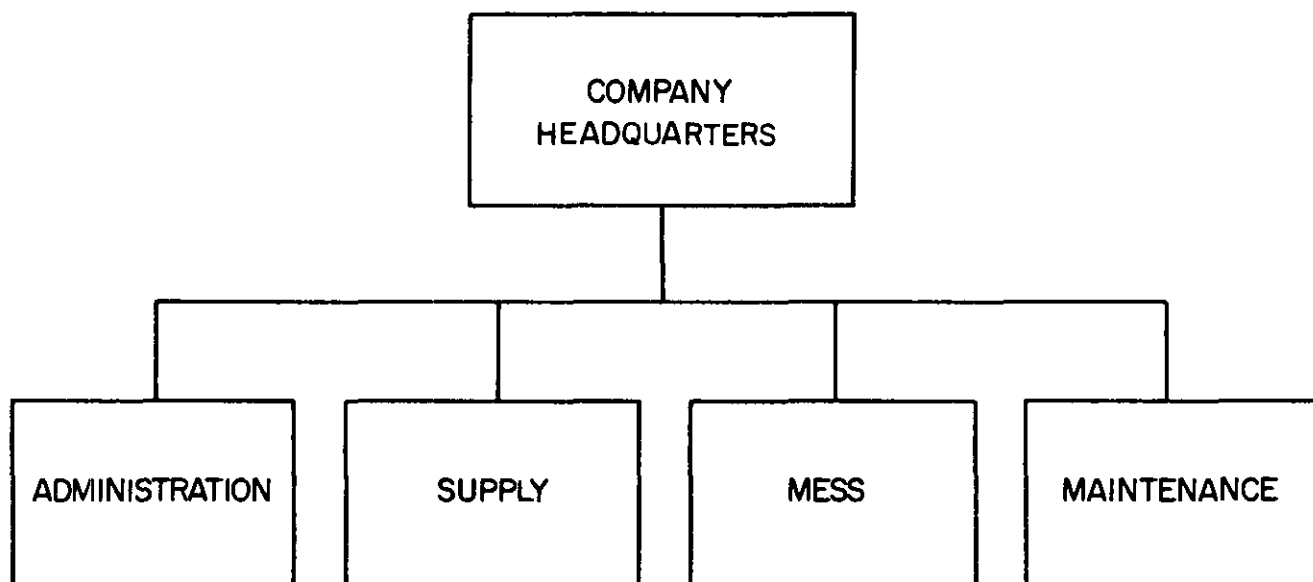
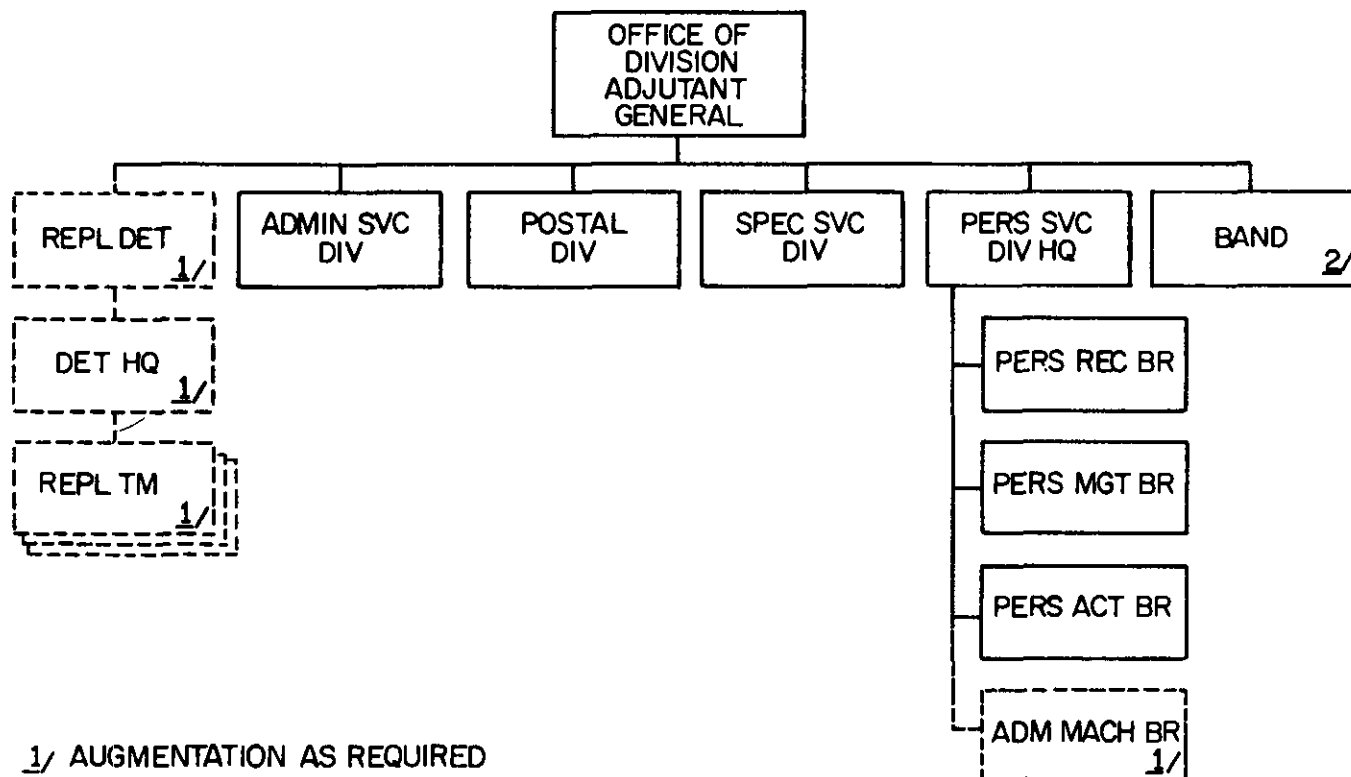

Figure 3-2. Company headquarters, adjutant general company.



1/ AUGMENTATION AS REQUIRED

2/ ADDITIONAL PERSONNEL AUGMENTATION AS REQUIRED

Figure 3-3. Office of the division adjutant general.

designated for such duty, provide tactical, security, and movement control for the division rear. (The term "office" as used herein includes the

headquarters of the office of the adjutant general and all functional elements (divisions and the band) under the direct supervision of the AG).

3-3. Assignment

The adjutant general company is organic to the division support command.

3-4. Capabilities

The capabilities of the adjutant general company (at full strength) include:

- a. Adjutant general special staff support to the commanding general, his staff, and commanders of divisional assigned and attached units and their staffs.
- b. Centralized personnel services for personnel and units assigned or attached to the division when directed by the division commander.
- c. Decentralized personnel services for personnel and units assigned or attached to the division when directed by the division commander.
- d. Cyclic on-site personnel and administrative services through the use of special purpose teams.
- e. Administrative, postal, and special services to all divisional elements.
- f. Logistical support of and plans for tactical security of the elements assigned to the adjutant general company.
- g. Direct support to the adjutant general company functional elements in the form of unit level personnel and administrative support, mess facilities, supply, weapon, and motor vehicle maintenance, and limited transportation.
- h. Production of military and dance music and participation of the band in radio or TV small music combinations and stage shows.
- i. Engagement in effective, coordinated defense of the unit area or installation.
- j. Performance of organization maintenance on organic equipment.

3-5. Limitations

The limitations of the adjutant general company include:

- a. Dependence upon the division data center (DDC, HHC, DISCOM) or other data processing unit (DPU) for automatic data processing (ADP) support of the office of the adjutant general and its direct support functional P&A elements. An administrative machines branch is augmented to the personnel services division only when other ADP support is not available.
- b. Dependence upon army/corps support replacement facilities and organizations for direct replacement support except when specifically authorized by Department of the Army to implement the augmentation of an organic replacement detachment.

3-6. Employment

- a. Company headquarters, the office of the division adjutant general, and the functional elements of the office of the division adjutant general are normally located in the division rear. The AG company is employed in a centralized configuration except when echelonment requires that the administrative services division operate concurrently in both division rear and division main (chap 5 for details). All elements of the office of the adjutant general may be used to furnish detached or decentralized services as required.
- b. Figure 3-4 provides a schematic field layout (centralized) for the adjutant general company. Appendix D provides information on the normally authorized tentage for the adjutant general company (tent, kitchen, flyproof, M-1948; tent, general purpose, small and medium; and tent, frame type, maintenance, medium). Further details on erecting, striking, and folding tentage are contained in FM 20-15.

AG COMPANY DEPLOYMENT

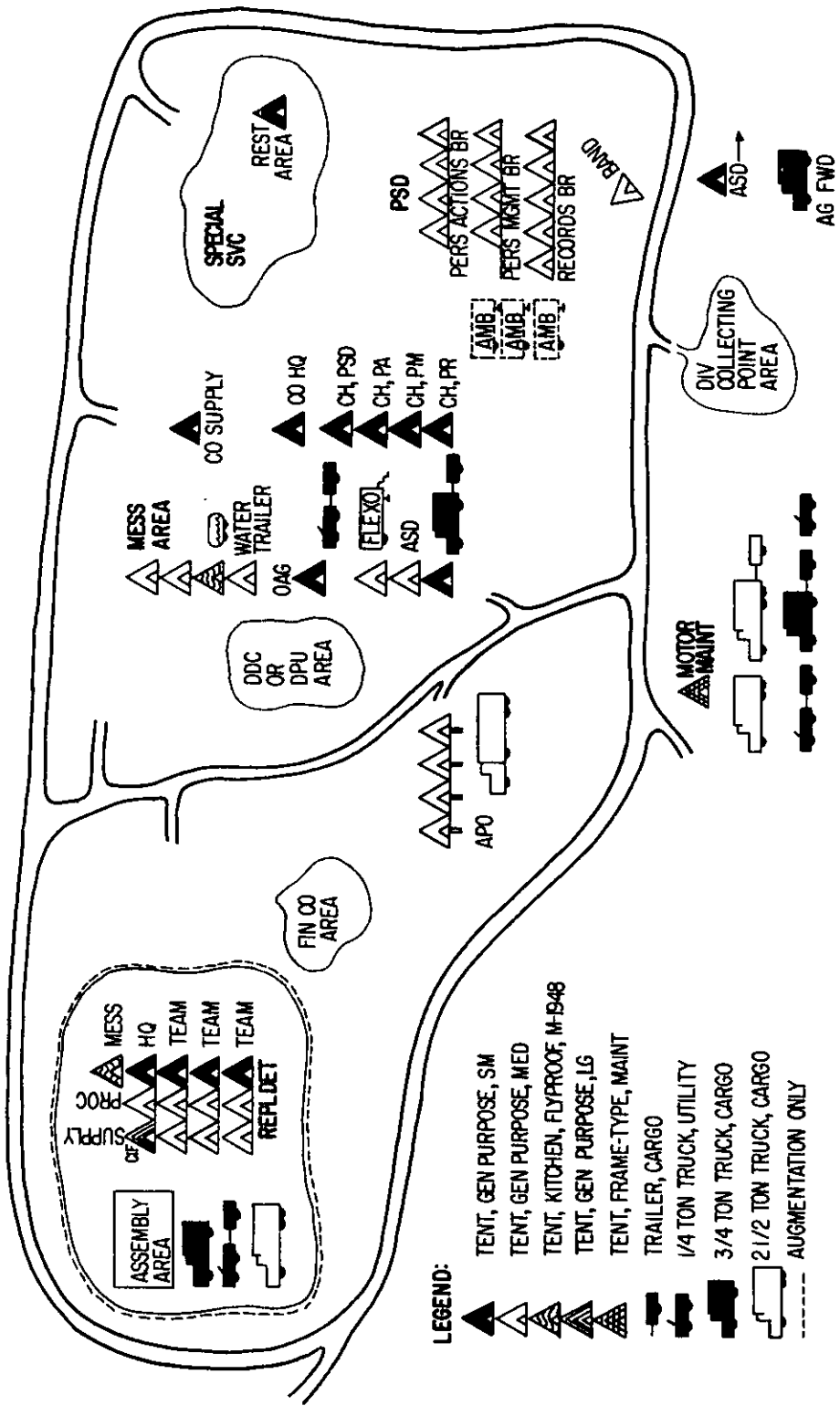

Figure 3-4. Field Layout-AG Company.

LEGEND:

- TENT, GEN PURPOSE, SM
- TENT, GEN PURPOSE, MED
- TENT, KITCHEN, FLYPROOF, M-1948
- TENT, GEN PURPOSE, LG
- TENT, FRAME-TYPE, MAINT
- TRAILER, CARGO
- 1/4 TON TRUCK, UTILITY
- 3/4 TON TRUCK, CARGO
- 2 1/2 TON TRUCK, CARGO
- AUGMENTATION ONLY

Section II. FUNCTIONS

3-7. AG Company Headquarters

The adjutant general company headquarters performs unit level functions of administration, training, and logistical support for all assigned members of the company. The task of the company commander and his personnel of the company headquarters is the same as other company-sized organizations except for the uniqueness of command-staff relationships normally found in headquarters type units where large technical staffs are supported. The following specific functions are performed by the AG company headquarters:

a. Unit Administration. Company headquarters administration includes office management (preparation of reports, military correspondence, orders, rosters, and records, maintenance of unit functional files, unit postal activities) and management of company headquarters personnel (selection for duties, on-the-job training, job rotation, and job performance counseling).

b. Training. Unit and individual training includes all aspects of mandatory training prescribed for company sized units of the division, as directed by the DISCOM commander. This segment of training does not include office of the adjutant general functional element technical training, which is performed by each functional element under the supervision of the AG.

c. Supply Operations. The company supply function requisitions, receives, stores, issues, and turns in organizational and individual equipment and supplies; assures that all equipment required by appropriate TOE or MTOE and common tables of allowance is on hand or on requisition and in a serviceable condition; maintains required records pertaining to equipment and supplies; and assists the commander in maintaining supply economy. Pertinent publications on unit level supply procedures and records are:

(1) (AR 710-2) Materiel Management for Using Units, Support Units, and Installations.

(2) (DA Pamphlet 700-2) Commander's Supply and Maintenance Handbook.

(3) Appropriate organizational equipment publications: technical manuals, technical bulletins, lubrication orders, and supply bulletins.

d. Dining Facility. The company headquarters normally operates one unit-type dining facility

in direct support of the operational personnel of the functional elements of the office of the adjutant general, company headquarters, and certain transient personnel. A consolidated dining facility may be operated in coordination with other organizations. Separate dining facilities may be operated (e.g., officer dining facility, noncommissioned officer dining facility, enlisted dining facility). In the field situation, after coordination with all commanders concerned is accomplished, the OIC of the division rear may elect dining facility consolidation, establish separate dining facilities, or permit each unit within the rear to operate its own dining facility. The adjutant general company commander supervises only his own dining facility except when appointed as the headquarters commandant of division rear; in this instance he is responsible for the proper supervision and efficient operation of all dining facilities. Pertinent references in unit level dining facility operations are:

(1) (TM 10-405) Army Mess Operations.

(2) (TM 10-415) Operations of Garrison Mess Equipment.

(3) (AR 30-1) The Army Food Service Program.

e. Transportation.

(1) The TOE for the adjutant general company authorizes vehicles to company headquarters and certain functional elements of the office of the adjutant general. Organic vehicles are for immediate operational needs and are insufficient to provide transportation to displace the entire company at one time. Additional transportation to move the company is requested as required, from the DISCOM commander.

(2) Although company headquarters or the functional element concerned has first priority on use of their designated vehicles, transportation must be pooled and trips consolidated through a dispatch system to insure optimum vehicle usage. The dispatch system operates under the supervision of the motor sergeant. For further flexibility, the company qualifies a pool of vehicle operators in each functional element of the office of the adjutant general to meet contingencies. As a general rule, selected personnel in grade E4 and below should be driver qualified on at least two vehicles.

(3) Vehicle usage and maintenance factors for authorized vehicles in the AG company are

contained in appendix D. This is suggested usage and may be modified as authorizations for vehicles increase or decrease.

f. Maintenance. The company headquarters provides organizational maintenance of equipment not specifically assigned to and used solely by one individual or one element (e.g., individual and crew-served weapons); organizational maintenance of equipment that the using individual or functional element of the office of the adjutant general is not technically qualified to maintain (e.g., vehicles); and dissemination and follow-up of maintenance instructions to insure enforcement of procedures and preparation of reports which apply throughout the life cycle of authorized and used equipment. Operator maintenance is the user's responsibility. The company is authorized personnel and tools for the performance of organizational maintenance on wheeled vehicles, power generation equipment, and weapons. *Tools and test equipment required for the performance of organizational maintenance are provided by TOE authorization, and are based on the types and quantities of equipment items provided by TOE and the functions authorized to be performed at organizational maintenance level. Repair parts allowances are also based on the number and types of equipment provided by TOE and specific repair functions authorized for performance by organizational maintenance personnel. Repair parts stockage is established and maintained in accordance with procedures of AR 710-2.* Company supply and maintenance personnel maintain these authorized amounts through preparation and submission of requests for replacement parts as company stocks are used and demand factors are established. The company keeps the maintenance records prescribed by appropriate regulations. Pertinent field manuals, technical manuals, and regulations on company level maintenance procedures and records are:

(1) (FM 29-2) Organization Maintenance Management.

(2) Technical manuals (organizational maintenance) pertaining to each piece of equipment authorized (e.g., vehicles, generators, telephones) DA Pam 310-4 is an index of publications pertaining to maintenance of equipment. The unit commander uses this publication to identify and requisition the technical manuals (TM) not on hand, but required to provide maintenance support for his maintenance personnel.

(3) (TM 38-750) The Army Maintenance Management System (TAMMS). This TM provides the unit commander guidance on specific procedures in the maintenance of records on equipment (e.g., vehicle logbooks).

(4) *FM 29-30-1 describes the organization and functions of the division maintenance battalion, the support services provided to units of the division, and how such services are obtained. FM 29-35 provides similar coverage on maintenance support operations in separate brigades.*

(5) Army Regulations:

(a) (AR 710-2) Materiel Management for Using Units, Support Units, and Installations.

(b) (AR 725-50) Requisitioning, Receipt, and Issue System.

(c) (AR 735-11) Accounting for Lost, Damaged, and Destroyed Property.

(d) (AR 750-1) Army Materiel Maintenance Concepts and Policies.

g. Transient Support.

(1) When augmented replacement detachment or provisional facilities are not available to the office of the adjutant general, the adjutant general company provides troop control and minimum essential logistical support (billeting and messing) for transients (replacement, returned-to-duty, rest and recuperation, TDY, and rotating personnel) while they are present in the AG company awaiting various stages of in-or-out processing or transportation. Administrative requirements which are unprogrammed (e.g., emergency personnel actions involving transients' personal affairs (to include finance) are referred by the AG company commander to the appropriate adjutant general functional element for accomplishment or further coordination. Coordination is also established between the company headquarters and the personnel services division (PSD) personnel management branch as to transient availability and notification for further processing and movement. Only in instances when it is absolutely necessary should transients be used by the company commander for detail duties while they are awaiting processing or transportation. Transients should not be used on details unless there is no other available manpower source, and the detail must be completed in a short period of time. No transient should be placed on a detail which is not commensurate with his rank and status.

(2) When a replacement detachment, spe-

cial services rest facility, or other organization is provided by higher support headquarters, TOE augmentation, or provisional action, billeting and troop control of transients are provided by such elements. Processing continues to be the responsibility of the functional element of the office of the adjutant general primarily concerned. Separate dining facilities are not normally established; cook personnel are available to the AG company from the replacement detachment TOE to supplement AG company cook personnel in proportion to numbers of transients projected or on hand. However, when deemed appropriate, messing arrangements and equipment may be subdivided as possible to provide better transient messing support and to respond to overriding requirements for separate dining facilities.

(3) Further details on special services functions are provided in paragraph 3-11 and chapter 5, and on replacement detachment functions in paragraph 3-13.

h. Duties of Company Headquarters Personnel:

(1) *Company commander.* The company commander:

(a) Commands all enlisted personnel assigned or attached to all elements of the adjutant general company, exercises company discipline, enforces law, maintains order, and administers unit punishment as required. He is the immediate commander exercising jurisdiction for nonjudicial punishment under Article 15, UCMJ for enlisted personnel. The division commander exercises court martial and nonjudicial punishment jurisdiction over all officers of the adjutant general company.

(b) Administers the personnel actions and affairs of individuals of his company. This includes enlisted promotions, reductions, disciplinary actions, leaves, separations, reclassification actions, awards and decorations, and reporting of personnel change-data on assigned and attached personnel in accordance with existing directives. A branch or division chief may initiate a favorable or unfavorable personnel action on an individual who is assigned to the company, but who works under his immediate supervision. When this occurs, the action is furnished to the company commander for his recommendations/concurrence/other comments, since many times the off-duty, out-of-office conduct of an individual may have a bearing upon the final action. Conversely, the company commander

seeks the recommendations/concurrence/other comments of the respective branch or division chief when he initiates a personnel action on a member of his company to insure he has a clear picture of the individual's efficiency and conduct on the job.

(c) Coordinates with the AG functional element chief on actions taken by him or his company headquarters personnel which affect the professional or personal status of an individual assigned or attached for primary duty to such functional element.

(d) Prepares training programs, schedules training periods in coordination with the office of the AG functional elements, and details supervisors and instructors. Since instructor personnel are not specifically included with the assigned strength of company headquarters, instructor tasks may be assigned by the company commander to functional element personnel. Detail of enlisted personnel assigned for duty to a functional element as instructors must be coordinated with the element concerned, and disputes resolved by the adjutant general. Selection of officer personnel for instructor duties must be coordinated with the adjutant general.

(e) Prompt and accurate payment of unit personnel is a joint responsibility between the servicing finance officer and the unit commander. To insure that personnel are promptly and accurately paid, the unit commander is responsible for:

1. Providing a class A agent officer when necessary.

2. Answering questions for subordinates regarding pay matters and referring difficult or technical questions to the finance officer.

3. Reviewing and approving, if authorized under the conditions specified in AR 37-125, enlisted member's request for a partial payment for emergency reasons. The commander should consider the two-payday concept of the Joint Uniform Military Pay System—Army (JUMPS—Army) i.e., payment on the 15th and the last day of the month, and approve the request only when the emergency stated on the request indicates that a hardship exists which will result in privation to the member or his dependents. Except for partial payments requested in accordance with AR 37-125, a partial payment may not be approved in an amount which will exceed the amount of pay due the member from Finance Center, US Army (FCUSA) at the end of the month in which the request is made.

4. Making final approval or disapproval of subordinates' requests for emergency payment of withdrawals from the Savings Deposit Program.

5. Reviewing and approving or disapproving all advance of pay requests for enlisted members in pay grade E1 through E6.

6. Preparing, as required, a letter of transmittal for transmission of pay data through the unit personnel officer to the servicing finance company. A copy of each daily morning report entry reflecting a change in a member's pay account is listed and attached to the letter of transmittal.

7. Contacting the finance officer whenever a member of the unit reports that a paycheck has not been received from Finance Center, US Army. The finance officer will determine the proper action to be taken in each instance. Detailed information on pay responsibilities should be obtained from the servicing finance office and DA Pam 35-1.

(2) *First sergeant.*

(a) The 1SG is primarily concerned with company headquarters functions of company level administration, mess, maintenance, supply, transportation, and transient control. However, he must remain alert to company headquarters mission-related activities which impact upon the ability of the AG functional elements to perform their missions. In this connection, he establishes and maintains close and harmonious relationships with all functional element noncommissioned officer supervisors in divisions within the office of the AG and his own company headquarters. The company 1SG is required to deal daily at noncommissioned officer level with NCOs of equal or senior rank: (the SGM, PSD is an E9 and functionally controls a major segment of the company's enlisted strength; E8s head the PR and the PM branches of the PSD, and an E8 supervises enlisted personnel in the ASD. The company 1SG, the SGM of PSD, and other division and company headquarters NCOs should develop an approach to company headquarters and functional mission responsibilities in an atmosphere of cooperation and coordinate closely to insure that both missions are completed harmoniously, with a minimum of mutual interference. Planning for the judicious use of enlisted personnel in both the functional and company headquarters environment should be done jointly and sufficiently in advance to preclude conflict at the noncommissioned officer level. Irreconcilable con-

flict where an individual is "absolutely required" for two simultaneous duties should not occur where careful planning, cross-training of subordinates, and daily cooperation and coordination have been applied by the noncommissioned officers in the company. An excellent way functional division NCOIC personnel can assist the company 1SG is to become personally involved by participating actively in company mission-related activities, such as billet and area inspections, details, supervision of their personnel in the maintenance of organizational and personal clothing and equipment, surveillance of the off-duty conduct and personal affairs ("troubles") of enlisted personnel, and in general, train, correct, and control their personnel on a daily basis. The 1SG can assist the functional element NCOIC by adjusting details, inspection schedules, etc., to meet unprogramed requirements imposed on the functional element by higher authority.

(b) Directs clerical and administrative operations in the company headquarters.

(c) Holds noncommissioned officer's call to disseminate orders, items of information, and company business items to his subordinate enlisted leaders and to the noncommissioned officers in charge of functional elements of the office of the adjutant general.

(d) Supervises and inspects duties performed by subordinate noncommissioned officers of the company in the mess, supply, and motor maintenance areas.

(e) Advises the company commander on matters relative to troop welfare in terms of assignment, reassignment, promotion, privileges, discipline, training, mess, supply, and maintenance.

(f) Indoctrinate new personnel of the company in military courtesy, customs of the service, and local regulations.

(g) Assists the company commander in the scheduling of military training (less functional element technical training within the office of the AG).

(h) Assists the company commander in inspection of barracks, kitchens, other unit areas, and personnel. Makes notes of observed discrepancies and initiates appropriate corrective action.

(3) *Company clerk.* The company clerk performs the duties enumerated for his MOS in AR 611-201 and DA Pam 600-8. He assists the company commander and the first sergeant in the accomplishment of company headquarters administrative requirements. He performs clerical

tasks such as typing, preparation of morning reports reflecting new and changed personnel data, preparation of non-judicial punishment forms and personnel actions, and maintains files. He also acts as the unit mail clerk.

(4) *Mess Steward.* The mess steward supervises the cooks, dining facility operation, food preparation, maintains mess records and prepares mess reports. The first cooks, cooks, and cooks' helpers physically prepare the rations for troop consumption and nourishment. The first cooks act as shift leaders when required. For further details, see AR 570-2 and AR 611-201.

(5) *Supply sergeant.* The supply sergeant supervises the activities of the supply clerk and armorer who requisition, receive, store, maintain, and issue supplies and equipment for the unit, and maintain the clothing, equipment, and arms records. For further information, see AR 611-201.

(6) *Motor sergeant.* The motor sergeant supervises the vehicle mechanics who maintain and repair motor vehicles and trailers assigned to the company, and the power generator operator/mechanic. The power generators provide electrical current for operation of equipment such as motor vehicle maintenance tool kits, band instruments, office machines, printing presses, and light sets, all of which are essential to the accomplishment of the unit mission. For further information on the positions of motor sergeant, vehicle mechanics and power generator operator see AR 611-201.

(7) *Class A agents.*

(a) Class A agents are appointed on division special orders or letter orders to act as agents for the finance officer for the purpose of making payroll payments to personnel of the unit.

(b) Specific instructions concerning responsibilities and duties of class A agents are contained in FM 14-8.

3-8. Office of the Division Adjutant General

a. *General.* The office of the division adjutant general reacts to requirement of the division commander, coordinates with the division general, special, and personal staff, and provides supervision, direction, and control of personnel and administrative (P&A) and band services functions performed by the office of the adjutant general functional elements in support of division-wide assigned and attached units.

b. *The Division Adjutant General.* The divi-

sion adjutant general is responsible to the division chief of staff for the technical operations of his office in providing direct personnel and administrative services support to the division, and for the direct supervision of the AG company commander. Specific details on AG responsibilities and duties are in chapter 2, and in (1) through (13) below. The AG:

(1) Advises on plans, policies, and procedures on personnel and administrative support to elements of the divisions.

(2) Recommends to the division Assistant Chief of Staff, G1, Personnel, policies for the allocation of individual and unit replacements, and issues their assignment instructions pursuant to policy.

(3) Operates the general administrative system for the command, to include internal headquarters administrative procedures, publications management and records management.

(4) Supervises reproduction, distribution, records management, and reports and forms control operations for the entire division.

(5) Operates the decorations and awards program for the command to include administrative processing of recommendations.

(6) Prepares replies to inquiries from Members of Congress and other governmental and civic organizations for signature of the division commander or as provided by the division SOP.

(7) Operates a complete postal service to include dispatch of outgoing mail, delivery of incoming mail to designated areas within the division, and provides registry, stamp, money order, and directory service.

(8) Insures that adequate recreational, morale, and welfare services under his supervision are available to all troops in the division.

(9) Insures that elements of the division that are detached temporarily from it receive adequate personnel and administrative support.

(10) Coordinates as necessary, administrative support of the division reenlistment and career counseling activities, may include supervision of field programs related to commissioned officer, warrant officer, and enlisted personnel procurement.

(11) In planning, coordinating, directing, and controlling the various operations of the AG

FM 12-4

functional divisions of the adjutant general company, he:

(a) Persistently seeks ways and means to increase the effectiveness and efficiency of AG functional areas.

(b) Maintains continuing liaison with the division staff, and with commanders and staffs of supported units. Such liaison is essential to an understanding of current requirements, and to facilitate the provision of the type and degree of AG support needed at all levels.

(c) As coordinated and directed by the chief of staff, maintains liaison with AGs and other appropriate staff members of higher and adjacent headquarters, particularly other divisions in order to explore mutual problems, exchange lessons learned, and benefit from difficulties encountered by others.

(d) Is constantly alert to probable changes in command strength and unit composition, geographical dispersion of division elements, mission assignment, and other related factors that have direct effects upon requirements for personnel and administrative support. Anticipating such changes enables the adjutant general to adapt the capabilities of the adjutant general company promptly to changing conditions.

(e) Directs the technical operations of the P&A functional elements under his control to provide continuous support to units of the division. The personnel services division (PSD) provides teams capable of furnishing custodial personnel recordskeeping support to organic battalion-size or larger units when these units are detached from the parent organization. The postal division provides postal service to major elements of the parent organization when dispersion of such elements makes it impractical for an army post office (APO) to provide service. When the headquarters is echeloned, the administrative services division and the personnel services division *both* support this fragmentation.

(f) Plans personnel and administrative procedures so as to minimize any adverse effect on the training or tactical missions of the command.

(g) Designs operational procedures to relieve the division commander, his staff, and subordinate commanders of detailed personnel and administrative recordskeeping and reporting without infringing upon command prerogatives.

(h) Takes the initiative in solving ad-

ministrative problems and provides specific assistance to subordinate commanders when the need arises. An example of such assistance is the training of division clerical personnel. A further example may be seen in the periodic visits by specialist teams to units of the division for personnel management, personnel action, and records maintenance support.

(i) Insures that "in-house" operational procedures provide for decentralization of authority to the lowest practicable level within the functional elements of the adjutant general company. He may delegate authority for actions within his areas of interest and include authority to sign the communication or document announcing the action, but in so doing, he must not usurp command prerogatives.

(j) Insures that the personnel and administrative functional elements of the adjutant general company comply with established priorities.

(k) Is responsive to the requirements of the adjutant general company commander, who must provide security, tactical, training, and logistical support of the assigned and attached officers and enlisted personnel who perform the functional personnel and administrative direct support services for the division.

(12) Assigns specific duties to the executive officer and to the officer in charge of the adjutant general forward element, when established.

(13) When acting as officer in charge of the division rear, is responsible for:

(a) Rear area security and damage control requirements related to his role.

(b) Requirements for communication facilities between the division rear and the division main command post.

c. Executive Officer. The executive officer may perform office management, plans, and technical training functions for the adjutant general. His activities encompass primarily the technical personnel and administrative functions of the adjutant general company, and may also relate to division-wide personnel and administrative functions within the total framework of the division personnel service support system. Specifically, the executive officer—

(1) Supervises the leave and pass program for the personnel assigned and attached to adjutant general company functional divisions. This program is closely coordinated with the adjutant general company commander.

(2) Monitors the assignment and reassignment of personnel to and from the adjutant general company functional divisions.

(3) Monitors the maintenance and police of facilities occupied by the functional divisions, including availability and serviceability of property and equipment authorized those elements.

(4) Prepares office memorandums and instructions relating to internal office matters, including any that may be prescribed by the adjutant general.

(5) Conducts organizational surveys of functional divisions or subelements thereof to insure that the management principles employed provide maximum operational effectiveness, supply economy, and proper utilization of personnel.

(6) Prepares and coordinates schedules for movement and employment of the band in support of division requirements.

(7) Assumes operational supervision of certain functional division areas designated by the adjutant general and conducts studies, surveys, and investigations when directed to do so.

(8) Serves as an alternate top secret control officer when properly designated as such.

(9) Operates the adjutant general forward element at the main command post when so directed by the division adjutant general.

(10) Prepares the functional division standing operating procedures (SOP) for garrison and field situations, and for operation of the division rear when the adjutant general is the OIC of the rear, and monitors the preparation of the functional division SOP.

(11) Monitors the overall office of the AG interfunctional operating personnel technical proficiency training program with special attention to the cross-training of personnel.

(12) Represents the adjutant general as required in matters which are coordinated with the adjutant general company commander, the division support command, the division data center (or other ADP support element), the finance company, and other elements. Routine day-to-day direct coordination may be authorized between the appropriate adjutant general functional division and the division data center or other ADP support and the finance company.

(13) Monitors the preparation and conduct of the training program for personnel staff noncommissioned officers, personnel data report-

ing specialists and other clerical personnel throughout the division.

(14) Coordinates adjutant general participation in command post and field exercises, and in the conduct of training and command inspections.

(15) Serves as operations officer to the adjutant general at the division rear when so designated.

(16) Plans, sets up, and relocates the division rear, when the AG is the OIC, or coordinates the AG functional elements portion of the rear with the AG company commander when the AG is not the OIC.

d. Secretary-Steno. The secretary-steno performs required clerical tasks, receives dictation, and typing for the AG and the AG Executive Officer. Included in his duties is the typing of intra-office memos and directives, and executive type correspondence, (such as replies to Congressmen and reports). He is also the driver of the vehicle assigned to the office of the AG.

3-9. Administrative Services Division (ASD)

a. General. The administrative services division (ASD) is primarily a service agency for the general and special staff sections of the division headquarters, and a technical assistance agency for the subordinate units of the command. It performs those office services and administrative management functions which relieve other headquarters staff elements of routine administrative workloads. To provide these services the administrative services division is authorized medium-volume reproduction equipment, facilities for volume storage of classified material, and equipment for volume handling of written communications. As a technical assistance agency, the administrative services division establishes and monitors command-wide programs for records management, reports control, forms control, printing control, publications supply, and administrative and clerical personnel training.

b. Organization. The ASD is typically organized as shown in figure 3-5. Figure 3-6 provides a typical ASD operation to include a suggested breakout of personnel resources in a H-series TOE.

c. Concept of Operations and Procedures.

(1) The administrative services officer allocates personnel within the administrative services division from his authorized available re-

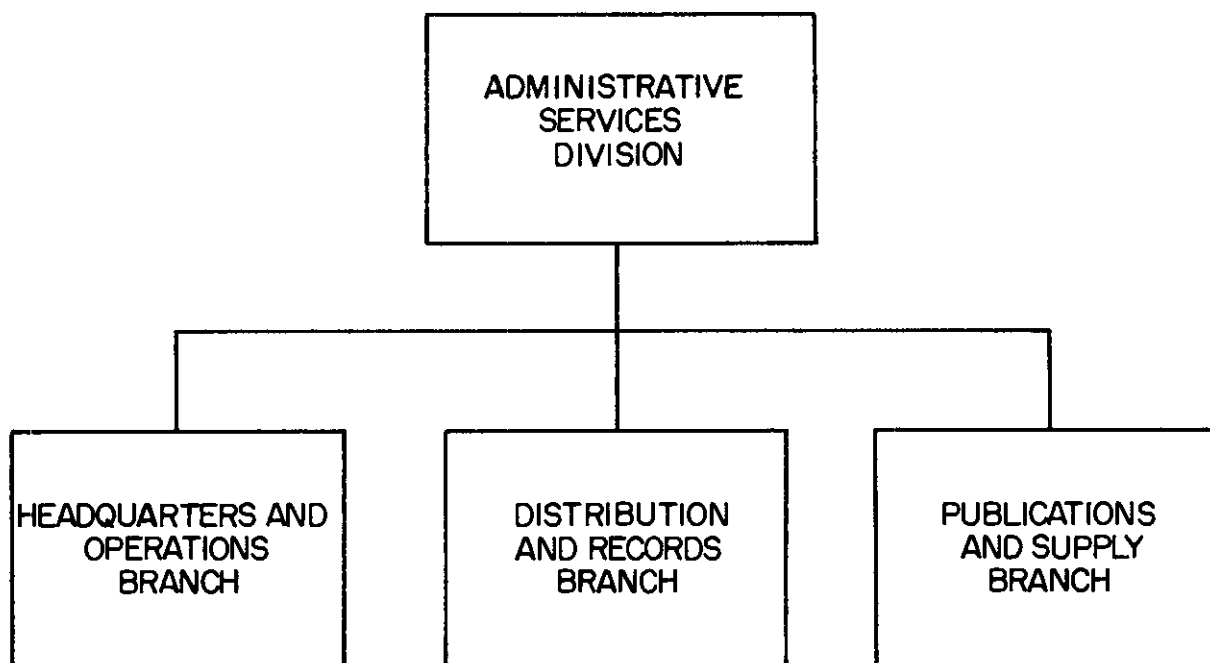

Figure 3-5. Administrative services division (ASD).

sources. This allocation may be based on the echelonment of the division headquarters, workload factors (e.g., quantities of classified and unclassified material handled), location and extension of the lines of communication, or the scope of the administrative support provided to the headquarters staff elements.

(2) The administrative services officer supervises the activities of his functional elements, coordinating their activities with the operational requirements of the adjutant general, and the headquarters staff elements. He establishes functional standing operating procedures (para *d*, (1)(*a*) below) to insure accuracy, efficiency, and expediency in providing administrative services.

(3) Normally, either the administrative services officer or his commissioned assistant perform the additional duties of records management officer, top secret control officer, publications control officer, division publications (supply) officer, and reports control officer. They are assisted in the administration of these functions by their assigned noncommissioned officers and specialists. Technical advice and assistance are provided to supported commanders and their staffs within the division in the areas of records management, publications control and supply, printing control, and clerical and administrative personnel training. Periodic inspections and visits are made to subordinate divisional units by ASD

personnel at the direction of the adjutant general to assist units in complying with applicable directives in the administrative services areas.

(4) The administrative services officer or his assistant normally authenticate outgoing correspondence (as a function of headquarters correspondence control) and orders and publications (as a function of headquarters publications control), excluding correspondence authenticated by the personnel services division, or which the commanding general, chief of staff, or adjutant general authenticate personally. Policy and procedure concerning correspondence and routine orders authentication is contained in AR 340-15 and AR 310-10, respectively. See also paragraph 2-7*g* and *h* of this manual. Information concerning preparation and authentication of combat orders (pertaining to strategic or tactical operations and attendant administration in the field) is prescribed in FM 101-5. Policy concerning release of technical correspondence (para 2-3*c* and *f*, AR 340-15) is determined by the division commander. All AGC officers assigned to elements of the office of the adjutant general are designated on orders as assistant adjutants general. Officers of other branches of service who are assigned to duty positions within elements of the office of the adjutant general are designated on orders as acting assistant adjutants general. Officers of other staff elements may be authoriz-

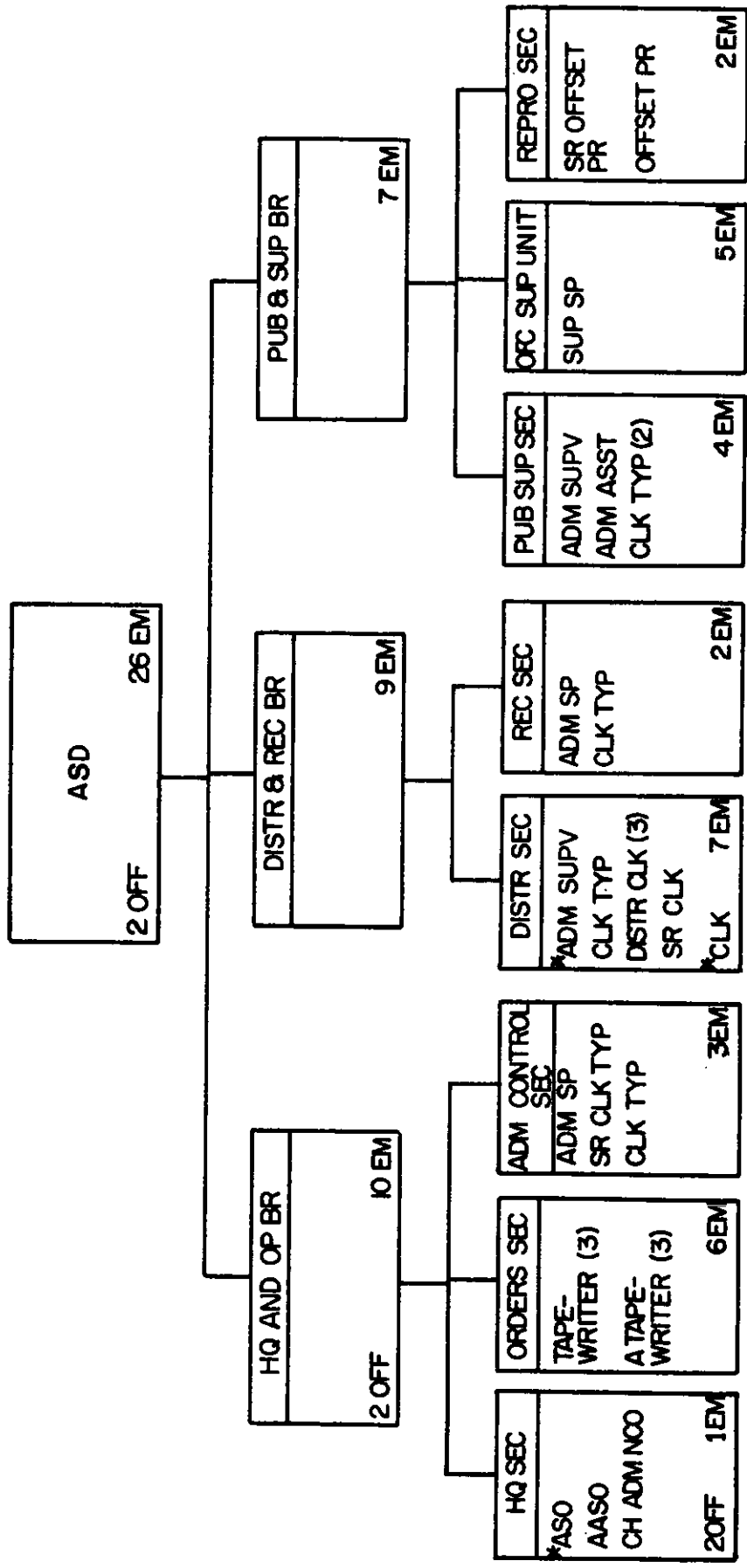

* AG FORWARD ELEMENT STAFFING

Figure 3-6. Typical ASD operation.

FM 12-4

ed to authenticate specific categories of routine correspondence or forms (AR 340-15). AR 600-11 provides details on the authority of armed forces personnel to perform notarial acts. The administrative services officer provides the administrative controls necessary for the AG to account for and to keep updated the headquarters reference files on what signatory authority is delegated to whom, and for what specific purposes.

(5) When the division headquarters is echeloned, the administrative services officer or his assistant may be designated by the adjutant general as officer-in-charge of the adjutant general forward element when the AGXO is not so designated.

d. Functions.

(1) *Headquarters and operations branch.* This branch operates the division headquarters publications control program (to include forms control), establishes the division reports control program, operates the headquarters correspondence management program, and prepares and maintains administrative reports for the office of the adjutant general. Specifically, this branch:

(a) Prepares the ASD SOP. In general, the ASD SOP contains an explanation of the division policy and procedural guidance on security control, records and forms management, mail management, printing and reproduction services, publications management, reports control and correspondence management. It can contain an AG mail and pickup and delivery schedule, a routing guide, and information on preparation of routine orders and procurement of printing and duplicating services available locally or through contractual arrangement. Specifics which can be contained in the ASD SOP (or published in single-subject staff memorandums) include: references which apply to ASD operations; organization of the ASD (to include AG Forward elements); examples of signature blocks of the CG, ADC, CofS, and AG; information as to what types of correspondence are reserved for the personal signatures of the CG, ADC, CofS, and AG; guidelines on preparation, coordination, routing, and dispatch of correspondence through the ASD distribution center; local policy on preparation of division directives (pamphlets, circulars, memorandums, supplements, bulletins); hours of ASD operations and telephone numbers; policy on centralized copying services; policy on reproduction services (types offered, and number and type of masters required for reproduction equipment in terms of number of copies expected

by requestors); how reproduction services are obtained; location and hours of operation of the classified correspondence repository; policy on the filing system used; and a listing of sample addressees frequently used by offices and commands preparing correspondence. Although the ASD SOP is basically for internal AG use, the AG may find it beneficial to provide copies to the general and special staff as well. The ASD SOP should be under continual review, and changes should be issued as quickly as they arise, in order that the SOP does not become a "file-and-forget" publication.

(b) Prepares multiple original copy correspondence (that correspondence which is prepared in the original for multiple addressees and which requires the original or facsimile signature of the originator on each copy) and routine orders formats for reproduction, to include action on orders requests submitted by the personnel services division. Flexowriters, or other authorized ADPE typewriters, are used to prepare orders pertaining to personnel. The punched paper tape by-product is preserved and delivered daily to the personnel services division for ultimate forwarding to the division data center (or other servicing DPU) for an automated personnel records file update. Figure 3-7 depicts a typical orders publication process.

(c) Establishes and monitors the division publications control and reports control programs.

(d) Edits, controls, and approves headquarters publications, to include forms. Figure 3-8 depicts a typical forms/publications control function. AR 310-1 provides policies on publications and forms control.

(e) Operates the headquarters reports control system. Figure 3-9 depicts a typical headquarters reports control system.

(f) Operates headquarters correspondence control for the command in accordance with local ASD standing operating procedure (SOP); reviews and authenticates selected command correspondence. Correspondence control should include the application of principles contained in DA Pam 1-10 and AR 340-15; a check to insure that all interested staff elements have seen the correspondence; that a file copy for return to the preparing staff agency is present and marked, and that suspense files (if any) have been adjusted to reflect current status.

(g) Prepares and maintains office of the adjutant general administrative reports (less personnel reports).

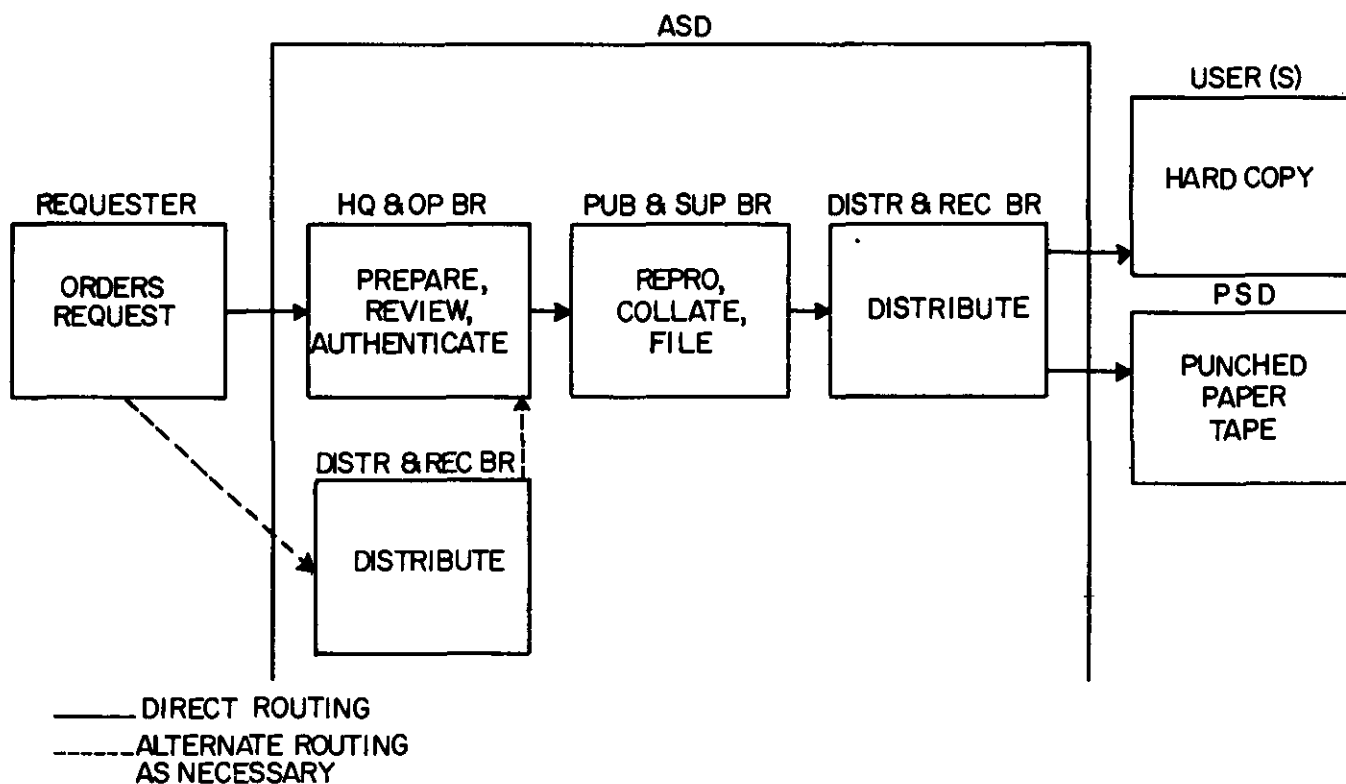

Figure 3-7. Typical ASD orders publication process.

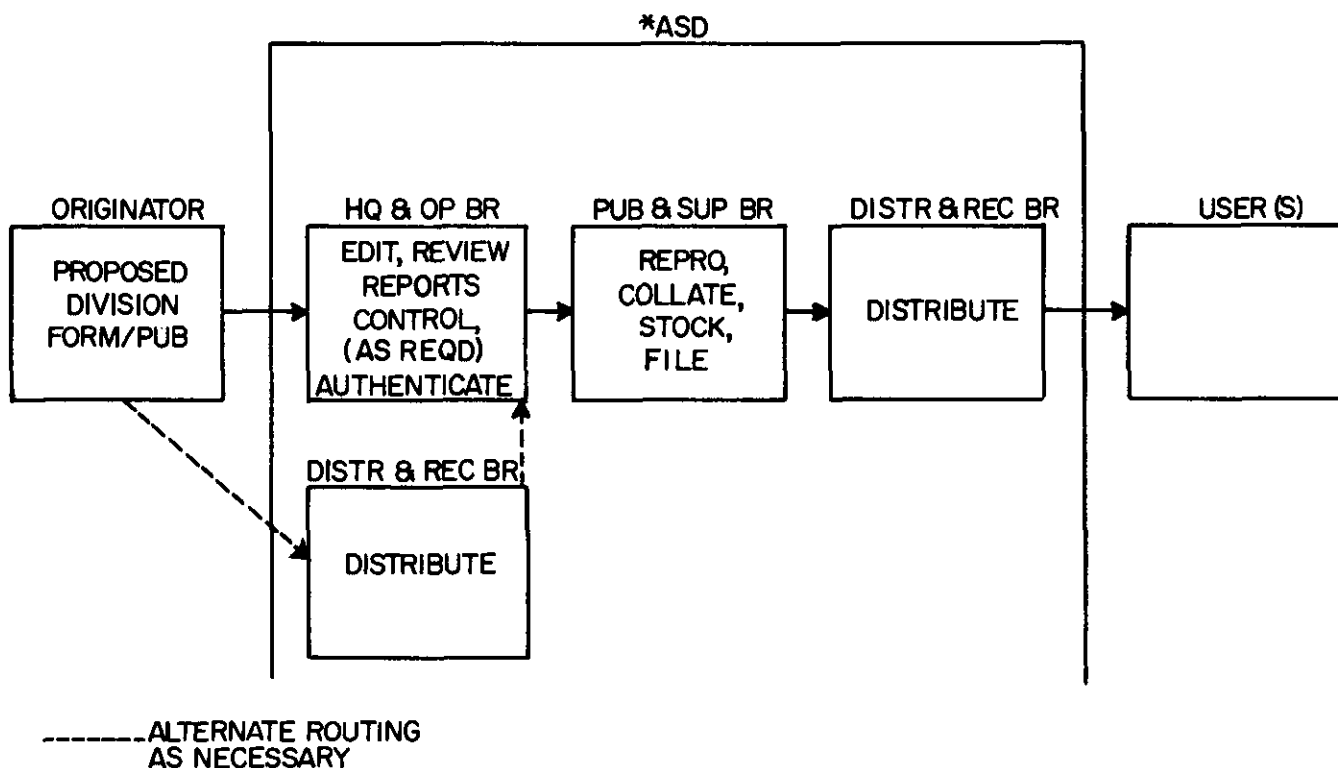
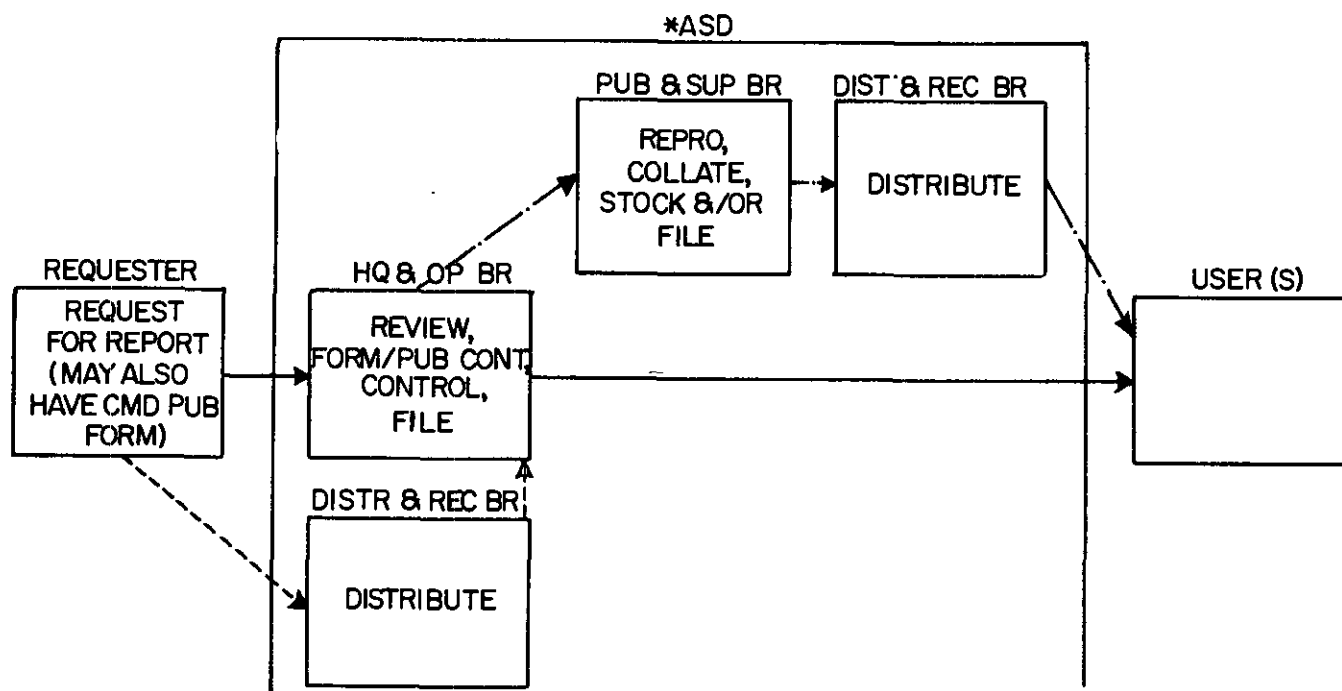

Figure 3-8. Typical forms/publications control function.



* FOR ALL DIVISION-WIDE REPORTS REQUIRING CONTROL IAW AR 335-15, REQUESTS MAY INCLUDE A COMMAND FORM REQUIRING FORMS CONTROL.

——ALTERNATE ROUTING AS NECESSARY

—WHEN PUBLICATION OF A COMMAND FORM OR DIRECTIVE IS REQUIRED.

Figure 3-9. Typical ASD reports control system.

(h) Conducts administrative review, for administrative correctness and completeness only, of reports of investigation referred to it. AR 15-6 contains an appendix which can be used for such administrative checks.

(i) Informally controls per diem and travel funds for the office of the adjutant general.

(j) Performs administrative services division clerical functions.

(k) Establishes and operates a division clerical and administrative personnel training program.

(l) Maintains workload and production statistics for use in determining adequate branch manning and equipment levels.

(2) *Distribution and records branch.* This branch operates the division headquarters central distribution center, establishes and monitors the division records management program, provides headquarters top secret and other control and storage, and coordinates requirements for classified couriers. Assigned personnel of this branch deliver correspondence by foot messenger to division headquarter's sections (forward and rear) only. Distribution made outside of the head-

quarters is performed by a motor messenger provided by the signal battalion. The branch must be constantly aware of the location of divisional elements to operate an effective distribution system. Specifically, this branch:

(a) Receives, controls, assigns proponentcy (action agency) as required, and distributes all official publications and correspondence (except electrically transmitted messages) entering or leaving the division area of operations through the ASD, regardless of classification. Figure 3-10 depicts a typical distribution operation.

(b) Coordinates with the division telecommunications center in the receipt, control and delivery of electrically transmitted messages which are intended for the office of the adjutant general.

(c) Maintains the correspondence suspense control system for the office of the adjutant general.

(d) Establishes and monitors the division records management program, which includes the areas of correspondence management; mail management; document reproduction control; and files maintenance, management, and disposition.

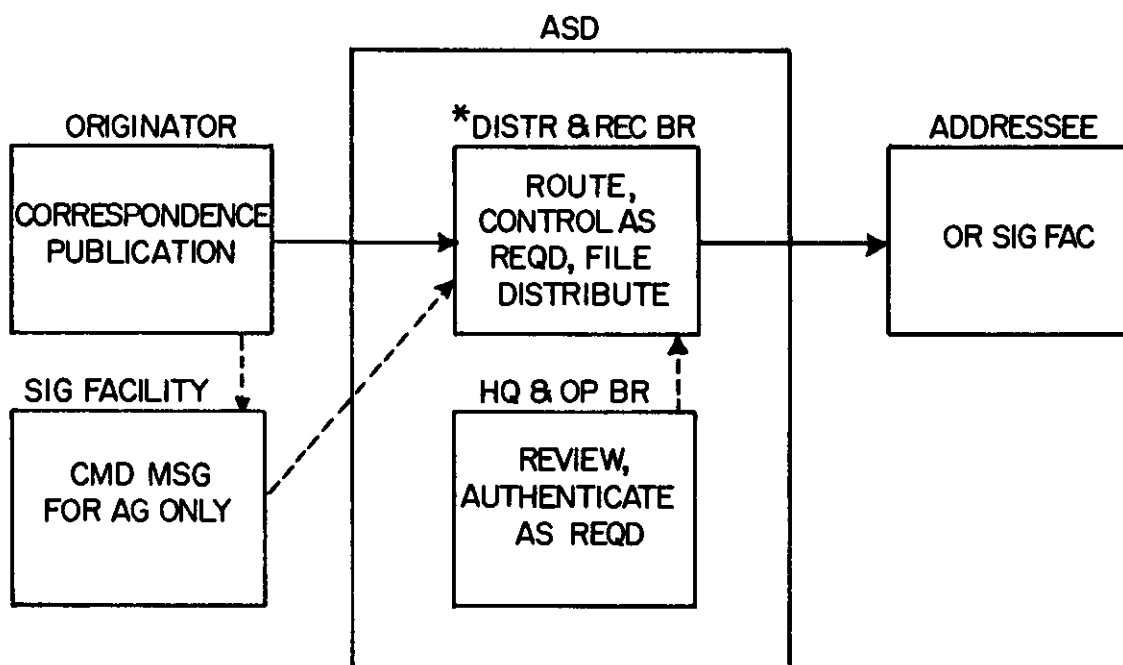

* DISTRIBUTION AND RECORDS BRANCH FUNCTIONS AS A DIVISION CENTRAL CLEARING FACILITY FOR CORRESPONDENCE REFERRED TO IT (LESS COMMAND MESSAGES) ENTERING AND EXITING THE DIVISION. THIS BRANCH ROUTES, CONTROLS, AND DISTRIBUTES OFFICAL CORRESPONDENCE FOR DIVISION STAFF ELEMENTS AND SUBORDINATE COMMAND, TO INCLUDE ORGANIC, ATTACHED, OR OTHER COMMANDS WITHIN THE DIVISION AREA OF OPERATIONS.
 ---- ALTERNATE ROUTING AS NECESSARY

Figure 3-10. Typical ASD distribution operation.

A typical ASD files transfer function is at figure 3-11.

(e) The following references pertain to the Records Management functions:

1. AR 340-1, Records Management,

Program Policies and Procedures.

2. AR 340-2, Maintenance and Disposition of Records in TOE Units of the Active Army and the Army Reserve.

3. AR 340-3, Official Mail.

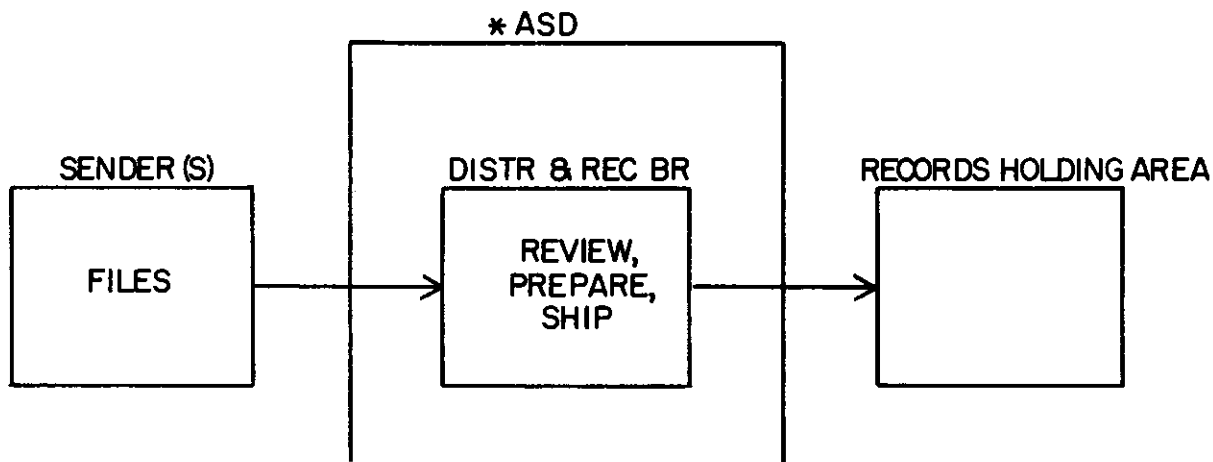

* RECEIVES AND CONSOLIDATES SCHEDULED FILES FOR ALL DIVISION ELEMENTS. FILES HAVE NORMALLY BEEN CONSOLIDATED AT BATTALION LEVEL.

Figure 3-11. Typical ASD files transfer function.

FM 12-4

4. AR 340-5, Correspondence and Mail Management.

5. AR 340-10, CENTO and NATO Correspondence.

6. AR 340-11, Office Symbols.

7. AR 340-18-series, The Army Functional Files System (TAFFS). This regulation provides basic guidance to the division records management officer.

8. AR 340-25, Mailing Instructions and Addresses for Certain US Army Elements and Activities and Certain U.S. Citizens Outside Continental United States.

9. AR 340-16, Safeguarding "For Official Use Only" Information.

10. AR 345-20, Release of Information and Records from Army Files.

11. AR 345-60, Release of Information Pertaining to Disciplinary Actions.

12. AR 380-5, Safeguarding Defense Information.

(f) Operates and maintains the headquarters top secret and classified control repository, to include the classified records accounting system. (For details see AR 380-5.) Retention and storage of classified documents may be decentralized to separate staff elements or subordinate units when adequate classified storage facilities exist and the requirement otherwise warrants. Proper classified document custodians and alternates must be appointed on appropriate orders for each element or unit operating a decentralized classified storage facility.

(g) Coordinates with the ACofS, G2, Intelligence, and commanders concerned, toward useful methods of training and inspection of subordinate facilities with the continuous objective of improving security.

(h) In coordination with the ACofS, G2, Intelligence, prepares and executes the headquarters classified document destruction and evacuation plans.

(i) Maintains a file of all personnel authorized access to the headquarters classified storage repository for the purpose of working there, perusing classified material, and/or receiving and delivering such material to elements of the division. This list is provided or verified by the ACofS, G2, Intelligence.

(j) Operates a courier system and maintains a roster of all division personnel authorized to perform classified courier duties.

(k) Maintains the file of headquarters security container combinations.

(l) Maintains workload and production

statistics for use in determining adequate branch manning and equipment levels.

(3) *Publications and supply branch.* This branch provides headquarters reproduction and supply services for certain publications, operates and maintains office of the adjutant general central reference library, and provides office supply and maintenance support to office of the adjutant general. Specifically, this branch:

(a) Provides reproduction services to the headquarters, and emergency or special purpose reproduction support to subordinate units when necessary. Figure 3-12 depicts a typical ASD reproduction services function.

(b) Stocks, controls, and distributes all headquarters publications and blank forms. The method and frequency of distribution are determined by local requirements.

(c) Normally consolidates and forwards all division requisitions for higher headquarters publications and forms.

(d) Maintains close coordination with the installation publications stockroom.

(e) Determines distribution of all initial and resupply (requisitioned) issues of publications and forms received from installation publications stockroom or higher headquarters. Figure 3-13 depicts a typical ASD publications supply function.

(f) Normally maintains a 90-day stock level of current headquarters publications and forms.

(g) Maintains a reasonable number of complete headquarters publications reference sets for issue to units which may be attached to the division.

(h) Monitors command compliance with procedures of the pinpoint distribution method for DA publications.

(i) Operates the pinpoint distribution of DA publications for the headquarters.

(j) Determines distribution of DA publications received under the command distribution method. This is a method for initial distribution of publications, and initial distribution and resupply of Department of the Army and other forms prescribed for departmental use, through the system of installations publications stockrooms and oversea publications centers established and operated in the field as prescribed by AR 310-1.

(k) Maintains the headquarters standard distribution formula for publications.

(l) Maintains property records for the office of the adjutant general.

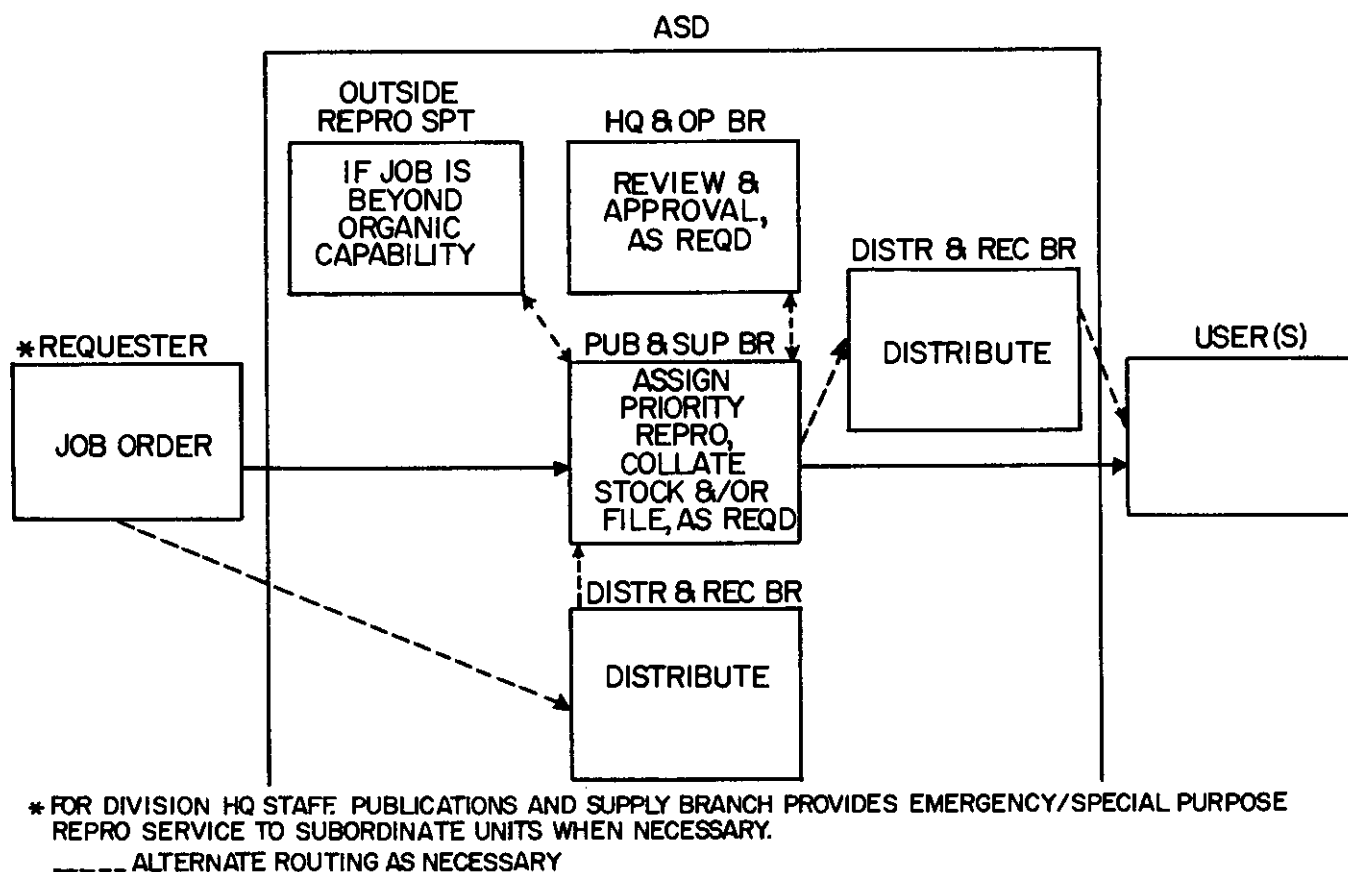

Figure 3-12. Typical ASD reproduction services function.

(m) Maintains a reasonable stock level of office supplies used by the office of the adjutant general, and processes maintenance work requests for the office of the adjutant general office equipment. Figure 3-14 depicts a typical ASD office of the AG supply and maintenance service function.

(n) Establishes and operates the division printing and duplicating control program in accordance with AR 310-1.

(o) Maintains production and workload statistics for use in determining adequate branch manning and equipment levels.

(p) Operates and maintains the adjutant general central reference library.

3-10. Postal Division

a. *Mission.* The mission of the postal division is to provide division level postal technical services and advice, and to operate an Army post office (APO) when postal services to the division are not provided by the United States Postal Service. These services include mail receipt, dis-

tribution, and dispatch; money order, stamp and stamped paper sales; insured, certified, registered and directory services, and advice and assistance to commanders who operate unit mail rooms. These services are provided in accordance with instructions contained in publications of the United States Postal Service, AR 65-1, AR 65-75, and implementing instructions issued by the theater army commander.

b. *Organization.* The postal division is organized as shown in figure 3-15. It consists of an office of the postal officer, three functional branches (the patron services branch, operations branch, and directory services branch); and a variable number of APO numbered units.

c. *Concept of Operation and Procedures.*

(1) The postal officer is the postal operations expert for the division and is responsible to the division adjutant general for the efficient operation of the postal division. He coordinates all postal functions within his postal branches, advises the adjutant general and commanders on

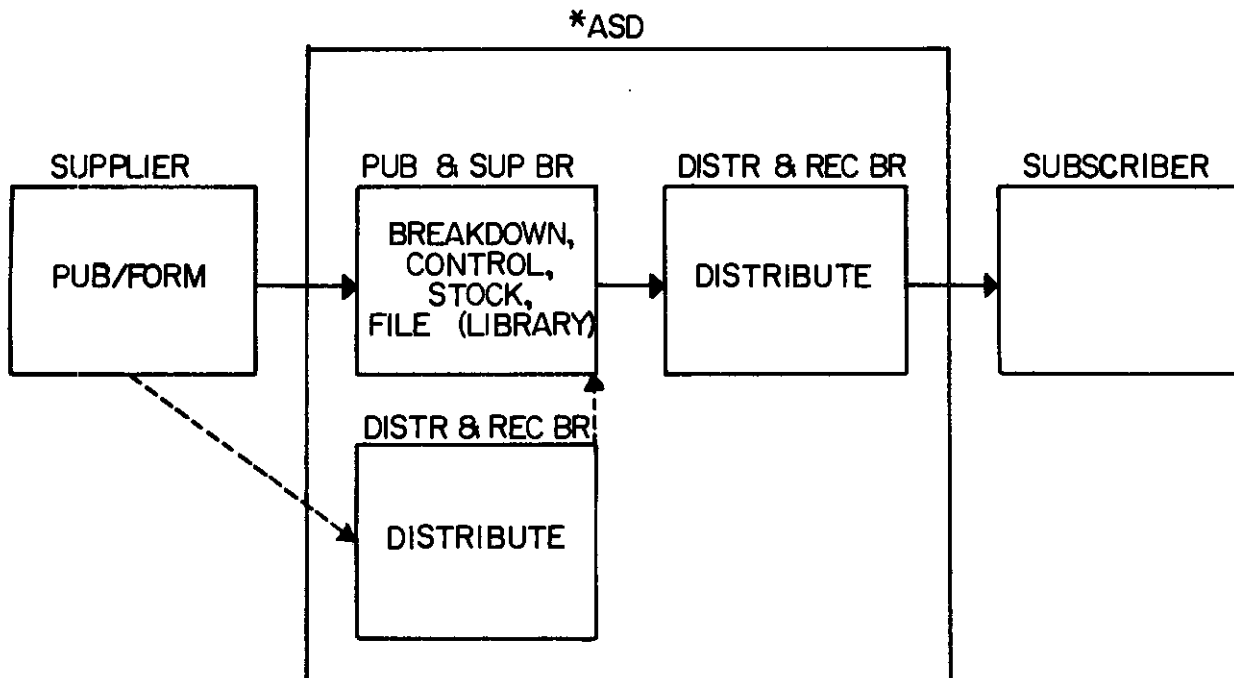

* THOSE FORMS/PUBS RECEIVED IN BULK (INITIAL DISTRIBUTION) FROM HIGHER COMMANDS OR INSTALLATION PUBLICATIONS STOCKROOM (NOT PINPOINT DISTRIBUTION OF DA PUBLICATIONS). RESUPPLY REQUISITIONS FROM DIVISION STAFF AND SUBORDINATE COMMANDS ARE FILLED OVER-THE-COUNTER (FROM LIMITED STOCKAGE), OR BY A CONSOLIDATED REQUISITION TO THE ISSUING HQ, OR INSTALLATION PUBLICATIONS STOCKROOM, AS DETERMINED BY LOCAL POLICY.
 ----ALTERNATE ROUTING AS NECESSARY

Figure 3-13. Typical ASD publications supply function.

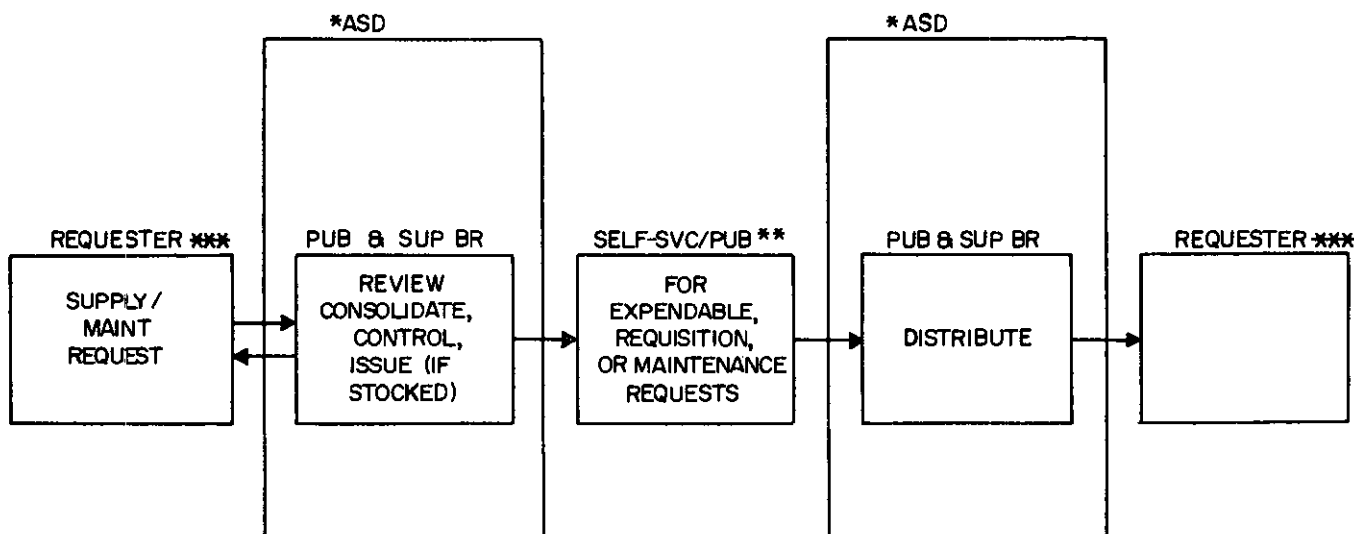

* PUBLICATIONS AND SUPPLY BRANCH MAINTAINS AN ADEQUATE STOCK OF OFFICE SUPPLIES AS DETERMINED BY EXPERIENCE.

** SELF SERVICE SUPPLY CENTER (SSSC) OR "COUNTRY STORE" / REQUISITION POINT

*** OFFICE OF AG, ASD, PSD, POSTAL DIV, SPEC SVC DIV, BAND, AND REPL DET.

Figure 3-14. Typical ASD office of the AG supply and

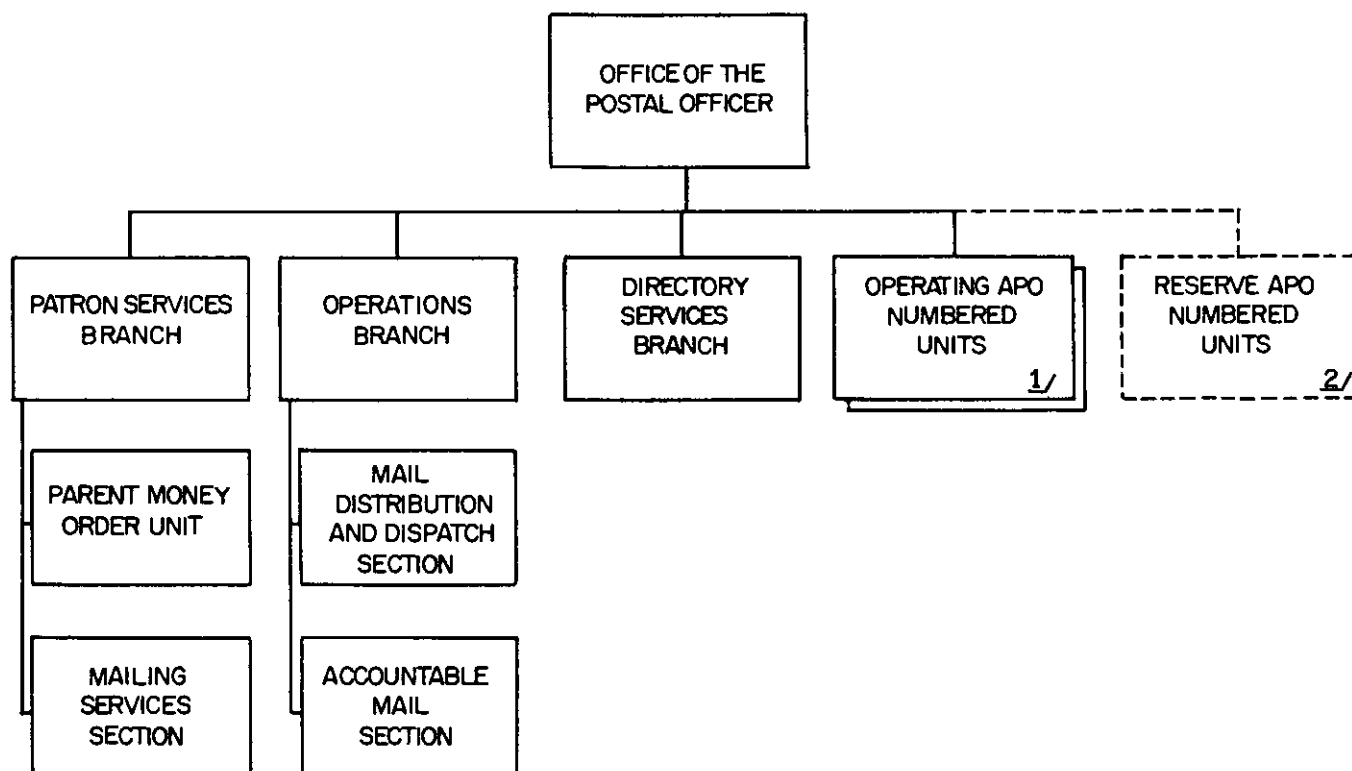

1/ A MINIMUM OF TWO APO NUMBERED UNITS ARE PROVIDED WHEN AN APO IS ESTABLISHED.

2/ THE NUMBER OF RESERVE APO NUMBERED UNITS TO BE MAINTAINED FOR AN APO IS DETERMINED BY THE THEATER ARMY COMMANDER.

Figure 3-15. Postal Division.

postal matters, and is responsible for safeguarding postal funds and accountable postal equipment. He uses as his regulatory guides, postal publications of the US Postal Service, AR 65-1, AR 65-10, and AR 65-75, implementing instructions issued by overseas commanders (when applicable) and local SOP.

(2) The postal officer and his operating personnel are key individuals to the maintenance of high morale within the division. Delayed or lost mail items have a serious impact on the individual morale and effectiveness of each assigned soldier. With this constantly in mind, the postal officer and his operating personnel take every feasible action within the purview of postal regulations to insure that mail pickup and delivery, and other individual postal services, are provided within the division area with an absolute minimum of delay, inconvenience, and worry to the soldier served.

(3) Figure 3-16 provides a typical mail distribution flow chart for a division. Division post-

al personnel pick up incoming mail and deliver outgoing mail for all divisional assigned and attached units served. Incoming mail and outgoing mail is received and delivered as appropriate at a postal regulating detachment or base post office assigned to a field army support command or a theater army logistical command.

(a) *Incoming mail.* Incoming mail received by the division APO postal operating personnel is usually received "broken down" by unit (separated into ties by unit designation) in accordance with a mail distribution scheme (a document which indicates the APO through which mail is received by organizations and activities authorized to use military mail service in certain areas). The mail distribution scheme is used by military post offices and postal concentration centers to effect the most correct distribution, dispatch, and routing of military mail, worldwide. Information on division units served contained in the mail distribution scheme is based upon input furnished by the division postal officer. It is imperative that his information is

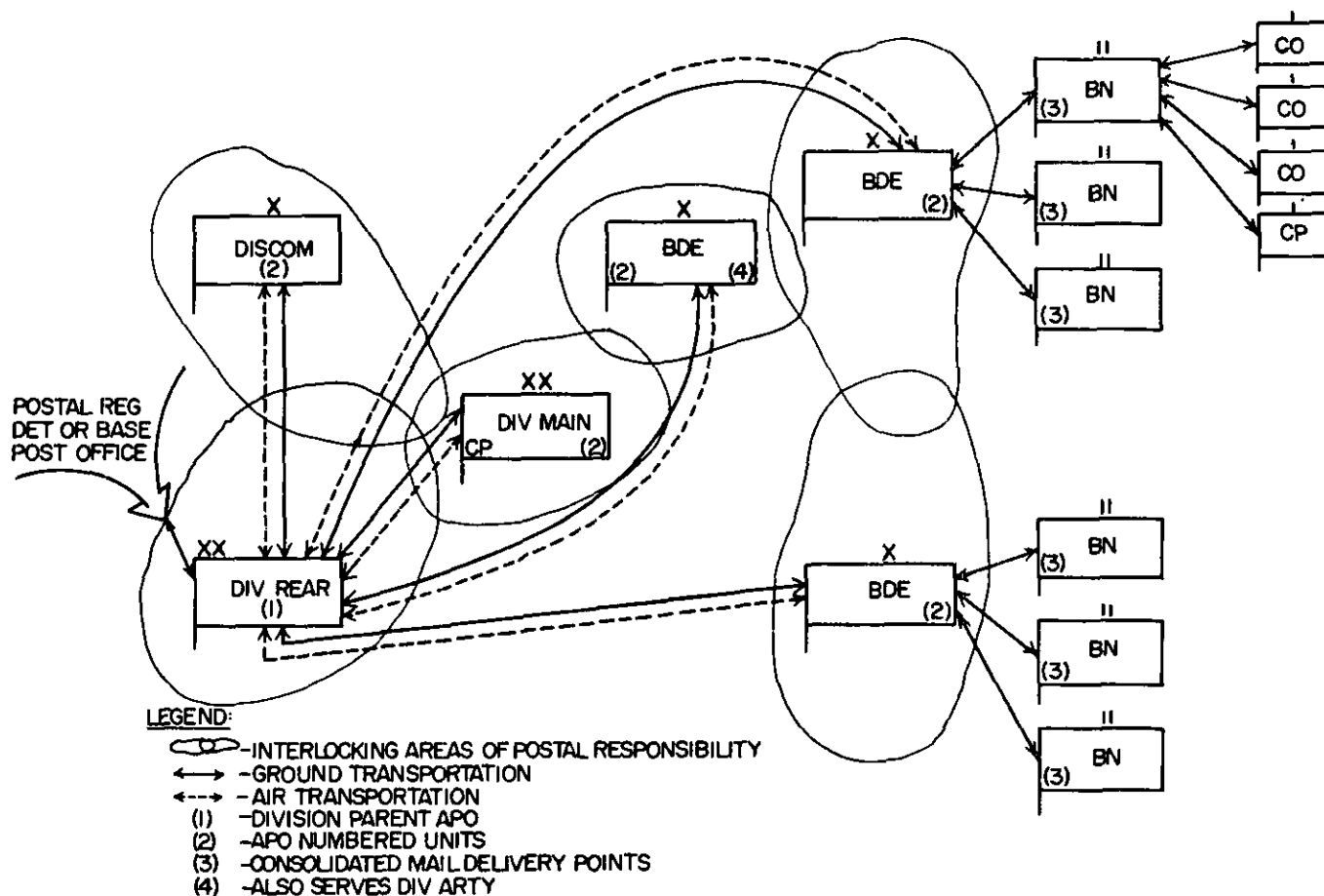

Figure 3-16. Typical mail distribution flow, division.

current at the servicing military mail terminal to permit accurate routing of mail to the division by the most direct means. Designated mail clerks of units served by the division APO pick up mail designated for individuals in their units at the division parent APO (usually located in the division support or division rear area) or at an operating APO numbered unit which is located in a readily accessible and frequently visited area (usually in a division support, brigade, or division artillery area). The division postal officer is responsible for delivery of mail to the division APO and to all operating APO units. The commanders of units served are responsible for pickup and delivery of mail to individuals through controlled mail processes and facilities (usually a unit mail room) in accordance with AR 65-75, implementing theater headquarters instructions, and regulatory guidance provided by the division adjutant general through his postal officer.

(b) *Outgoing mail.* The processing and

routing of outgoing mail is the exact reverse of the processing and routing of incoming mail, except casualty mail, which receives special handling. AR 65-1 provides information on the handling of casualty mail. The handling of mail for personnel evacuated to field army medical units requires that the division postal officer coordinate with the S1 of the supporting medical brigade. (Depending upon the intratheater evacuation policy, large influx of patients or unit movement, patients will be transferred from one medical facility to another within the evacuation chain. Evacuation and combat support hospitals therefore do not retain patients long enough to receive and deliver mail. The staffing and administration of the hospital is designed for assigned personnel mail support only. The flow of information and the system of evacuation does not provide the losing field army medical unit with information upon which mail can be re-directed.)

(c) *Transportation.* Vehicles organic to the postal division are used to move both incoming and outgoing mail between the division parent APO and its servicing postal regulating detachment or base post office. The division postal officer is provided transportation (ground or air) by division support elements when his requirements exceed those organic to him, to move mail between the division parent APO and APO operating units deployed throughout the division area. Units served provide their own organic transportation (individually or pooled) to move mail between the APO operating units and the unit mail facilities. Unit mail clerks deliver mail to individuals. The postal officer coordinates closely with the division AG on his transportation requirements. The division AG coordinates with the division aviator officer, and the division ACofS, G3, Operations to insure he has up to date information on troop deployment and ground and air movement capability to move the mail.

(d) *Patron services.* Patron services (sale of stamps, stamped paper, and money orders) are provided at the parent APO and at each numbered APO operating unit. When required, mobile patron services are provided by the postal officer on a preannounced schedule at designated points for limited periods of time anywhere they are needed in the division area. Under most circumstances in a combat area, sales of stamps and paper are not a major problem; military personnel are permitted to mail letters out of a theater of operation without charge. However, the mailing of packages and registered, insured, and certified matter, and the purchasing and cashing of money orders, are vital patron services required on a continuing basis by personnel in units served.

(e) *Replacement mail.* The postal officer coordinates with the personnel management branch, PSD for information on incoming replacements, and when possible, earmarks mail for these personnel for delivery to replacements at the replacement processing facility supporting the division headquarters upon their arrival in the division area.

(4) *Ground defense.* In addition to performing their functional postal duties, personnel of the postal division cooperate with the commander of the area in which they are located to provide assistance in the ground defense of their position, when required.

d. *Functions.*

(1) *Office of the postal officer.* The office of the postal officer is responsible to the division AG for the overall operation of the postal division, and provides supervision of the operation of the division APO. This office processes claims and inquiries, selects military personnel for designation as the army postal clerk or assistant army postal clerks, conducts inspections of unit mailrooms (see AR 65-75 for details), prepares reports, arranges mail transportation schedules, and handles all other administrative matters for which the postal division is responsible. Security of mail, particularly of registered mail, is an administrative matter of primary importance.

(2) *Patron services branch.* The patron services branch issues and cashes money orders; sells postage stamps and stamped envelopes, posts mail, and furnishes information to patrons.

(3) *Operations branch.* The operations branch receives, distributes, and dispatches accountable and ordinary mail to and from appropriate postal activities and all units served by the division APO. Outgoing mail to be routed through customs is labeled, sacked, and processed. Pouch records, mail distribution schemes, and the APO location lists are maintained by this branch.

(4) *Directory services branch.* The directory services branch maintains current locator information and furnishes required directory services for mail of personnel authorized to use the Army Postal Service. Initial decks of postal directory cards and a card for each subsequent gain or loss are furnished by the division data center (or other ADP facility servicing the division), through coordination with the records branch, PSD division to the directory services branch, to maintain an updated mail directory. The branch also monitors undeliverable mail returned by unit mail clerks to verify the accuracy of the addressee and address indicated thereon.

e. *Duties of postal personnel.*

(1) The postal officer and assistant postal officer direct the activities of the postal division. The postal division handles all incoming official and personal mail for the division. One of the postal division officers is designated as the custodian of postal effects (COPE). The COPE has the responsibility for all accountable postal equipment, postal forms and stock, and public monies derived from the postal sales and services (see AR 65-1 for details). The assistant postal

FM 12-4

officer assists the postal officer particularly in the areas of accountable mail (registered and certified) and in the operations of outlying or mobile postal teams or offices.

(2) The postal NCO, assistant postal NCO, and the postal supervisors provide the technical expertise and first line supervision over the enlisted postal direct workers. These NCOs supervise the primary subelements of the post office such as window operations, the accountable mail section, and the mail distribution and dispatch section.

(3) The postal and window clerks perform the actual mail and money handling inherent in postal operations.

3-11. Special Services Division

a. General. The special services division provides certain recreational, morale, and welfare services to divisional troops. This includes the procurement and issue of recreational supplies and equipment, procurement of recreational supporting services from resources outside the division, and the organization and supervision of a comprehensive special services program within the division.

b. Organization. The special services division is organized functionally on the basis of responsibilities of the division special services officer, the recreation supervisor, and the physical activities specialist.

c. Concept of Operations and Procedures.

(1) *Garrison operations.* In garrison, the division is satellited on a post for support and usually is provided permanent recreational and athletic facilities; libraries; craft shops; entertainment workshops; movies; "live" shows; civilian personnel to staff service clubs and non-appropriated funds to supplement appropriated funds for purchase of recreational supplies and equipment and for paying part-time sports officials and employees. A major part of the effort of the special services division in garrison is devoted to organizing and supervising athletic programs. Under garrison conditions, the operational tasks of the division special services officer consists mainly of planning, coordinating, and controlling the use of post morale and welfare activities by division personnel.

(2) *Field operations.* In the field, division special services responsibilities increase in importance and in scope. In addition to his opera-

tional responsibilities for all recreational activities of the division, the special services officer may establish, operate, or supervise the operation of rest camps and rest areas. An increase in special services activities is usually required during periods of decreased combat activity.

(3) Special services units organic to field army may be available by attachment or other arrangement to support divisions. These units provide soldier entertainment, movies, libraries, and sports activities.

(4) Mobile units such as bookmobiles, clubmobiles, craftmobiles, and showmobiles may also be available from theater support resources.

(5) "Live" professional entertainment groups tour theaters of operations and may be scheduled to visit divisional areas when the situation permits.

(6) *Duties of special services personnel.*

(a) The special services officer assists the adjutant general in developing plans and policies governing special services, and organizes and supervises the operations of comprehensive and diversified special services programs and facilities. He has the responsibility to procure and distribute movie films, projection equipment, athletic equipment, and table games, assure the adequacy of the sports and athletic programs and library services, organize sports events and competition, arrange live entertainment, and supervise the maintenance of special services facilities.

(b) The recreation supervisor organizes, supervises, coordinates, and technically assists in entertainment, sports, library, and arts and crafts programs. He assists the special services officer in continuous appraisal of recreational operations and training. He determines requirements, assigns duties and coordinates activities of special services rest areas and camps, the effectiveness of special services operations, adequacy of recreation facilities, and additional equipment required to meet unusual or added recreational programs and activities. He performs liaison between staff and operating and support elements to improve effectiveness of special services operations; and collects, prepares, and distributes material and data pertaining to special services operations. He coordinates and disseminates publicity and promotional material to obtain maximum participation in special services activities; and prepares administration and technical reports on special services matters to

include events, available talent, accountability and maintenance of equipment. He supervises the activities of the enlisted personnel in the special services office, coordinates with the AG company first sergeant on matters pertaining to his enlisted subordinates, and participates in company level inspections and formations.

(c) The clerk typist maintains the special services division office files and types correspondence including reports, equipment requisitions, and schedules as designated by the recreation supervisor in the special services office.

(d) The physical activities specialist accomplishes the coordination required to schedule athletic events and tournaments, organizes teams and intramural leagues, acquires coaches, and makes arrangements for clinics for umpire/referee personnel. He is responsible for insuring the marking of athletic fields, acquiring and arranging training for life guards, and the maintenance of athletic grounds, buildings, or facilities, such as swimming pools and handball courts.

(e) The supply clerk requisitions, stores, issues, maintains and repairs athletic equipment such as baseball, basketball, softball, handball, volleyball, ping pong, and tennis equipment, and distributes pocket books and movie films. Among other miscellaneous items, he should stock table games, weightlifting sets, bowling shoes and balls, boxing gear, and film projection and audio equipment with spare parts.

3-12. Personnel Services Division, (PSD)

a. General. The personnel services division (PSD) performs a central role in the division personnel support system for the division commander and his staff in the operation of the division personnel management program; taking or securing action on personnel service support matters which are the prerogative of the division commander; furnishing appropriately arranged personnel information to designated command and staff recipients; reporting to higher headquarters required information on matters such as personnel losses and replacement requirements; and furnishing personnel and administrative support and information to subordinate unit commanders within the division which is necessary for them carry out their personnel management responsibilities. For details on the role of the PSD in the division personnel support system, see chapter 6.

b. Concept of Operations.

(1) *Supervision.* The PSD is under the su-

pervision of the chief, PSD, who directs operations of the PSD for the AG through his branch chiefs. The PSD functional branches (personnel records branch, personnel management branch, and personnel actions branch) are delegated the necessary operational and signatory authority "FOR THE COMMANDER" to carry out the military personnel management and routine action services required to operate the division personnel support system.

(2) *Responsiveness.* All operating personnel of the PSD are immediately responsive to the division adjutant general, and make available to him any information he desires so that he can make decisions or furnish information and advice promptly and accurately. The PSD is also directly responsive to brigade, battalion, and company commanders within the division. Automatic data processing capabilities of the supporting ADP facility are used by the PSD to the maximum extent possible to insure a high degree of responsiveness to division-wide personnel support requirements, and requirements of higher headquarters.

(3) *Centralization.* The personnel records for all assigned and attached members of the division and the majority of personnel services expertise are at one central location in the PSD. This results in greater uniformity and accuracy in recordskeeping, consolidates filing and transport requirements for such records, conserves manpower, reduces technical training requirements, permits the assignment of definitive functional duties to personnel specialists within limited ranges, permits a higher degree of accuracy in personnel services, and complements the availability of ADPE.

(4) *Relief of commanders of an administrative burden.* The PSD accomplishes as many personnel actions at division headquarters level as possible to reduce personnel administration at unit level. The PSD exists to increase the efficiency of the division and to alleviate the administrative burden on unit commanders; however, it is neither intended nor designed to interfere in any way with the authority and prerogatives of unit commanders.

(5) *Monitoring personnel utilization.* The PSD monitors the utilization of personnel throughout the division for the division commander through the use of centralized records

repositories and updated personnel status files based upon reports from supported commanders.

(6) *Personnel management and accounting.* Procedures prescribed by AR 680-4 (Personnel Management and Accounting—Card Processors—RCS AG 552 (ACRONYM: PERMACAP)) apply to personnel management operations. (DA Pam 600-8 contains details on both PERMACAP and non-PERMACAP procedures of a military personnel office.) In the case of the PSD within a division under PERMACAP, the DDC provides ADP support to the PSD (see chap 7 for details). When the DDC is not authorized, the PSD should be augmented by an administrative machines branch (AMB) to provide ADP support. Availability of ADP permits mechanization of personnel operations, and the production of periodic machine-prepared personnel rosters and strength reports which are used by supported staff officers and commanders as media to support their recommendations and decisions. Functional branches of the personnel services division process personnel data changes received from supported units via the morning report and other media to the supporting ADPU to maintain up-to-date ADP files on all personnel of the division.

(7) *Postal directory support.* The servicing DPU provides a by-product directory card to the postal officer to support his mail directory service function. These postal directory cards notify the postal officer of divisional personnel gains, losses, and intradivisional transfers. Postal directory cards are transmitted by the DPU through the PSD headquarters to the postal officer on a daily basis.

(8) *Finance company support.* The PSD is responsible for collecting and transmitting pay change information to the finance company and providing notification of separations of members and/or reassignments. PSD will forward the copy 4 of each morning report, together with documents related to pay entries thereon and any other appropriate documents, to the finance company no later than 1000 hours of the day following preparation or receipt, as appropriate. Prior to transmission, each pay entry on the morning report is verified with attached documents to insure the inclusion of documents, when required. The finance company has the responsibility for military pay administration under JUMPS—Army, the maintenance of personal finance records (PFR), the accomplishment of pay actions, and response to pay complaints. Detailed infor-

mation on PSD responsibilities should be obtained from the servicing finance company and AR 37-104-2.

(9) *Orders preparation.* Routine orders requests pertaining to individuals are prepared by the personnel services division (PSD) and submitted to the administrative services division (ASD) for final typing, review, authentication, reproduction and distribution. The ASD uses Flexowriter or other authorized ADPE typewriters to prepare these orders. The by-product punched paper tape produced by the ASD is preserved and delivered to the PSD for ultimate delivery to the servicing DDC or AMB on a daily basis for the purpose of updating automated personnel status files. This action is a part of the PERMACAPS and provides the majority of personnel data changes to the personnel card files in the DDC.

(10) *Echelonment.* When the division is echeloned, most individuals assigned to the PSD operate at the division rear. Selected functional branch personnel may work at the AG forward facility at the division main CP. Personnel sections of attached nondivisional units normally operate as a part of the PSD. Personnel sections of units supporting the division may, at the discretion of the commanders concerned, operate as a part of the PSD.

(11) *Multi-functional service and assistance (support) teams.* These teams should be established by the PSD to extend specific personnel services to the division external to the centralized PSD operating environment. The chief of each functional branch in the PSD is responsible for the technical supervision of the personnel performing duty on the team, and either delegates to team members, or takes final action himself on routine matters for which the team is responsible.

(12) *Composite team.* A composite team is an internally organized segment of the PSD at direct worker level. The mission of the composite team is to provide complete personnel services for specific units in a centralized configuration. As far as possible, all composite teams are staffed identically, and each team serves approximately an equal number of personnel. The number of composite teams within a PSD will vary based on the operational requirements. For further detail on the organization and concept of operations of the composite teams, see c(2) below.

(13) *Special purpose teams.* Special purpose

teams may be formed when it becomes necessary to group certain individuals from the PSD together for a specific purpose. Organization and size of a special purpose team will depend upon the mission of the team. Examples of special purpose teams are support, incoming personnel processing, outgoing personnel processing, and personal affairs teams. In combat, special purpose teams may be formed to provide quick-reaction, on-the-spot assistance to brigade or battalion commanders after a battle, in preparing casualty reports or recommendations for awards.

(a) *Forward area support team (FAST).*

A FAST is composed of personnel from each branch of the PSD and selected AG, finance, medical, and staff judge advocate representatives as required. The FAST provides specialized assistance of a personnel support nature to a unit at the unit location on a temporary basis. The FAST is especially useful to the AG when a unit is remotely located or prevented from permitting its members to visit the division headquarters for centralized service. The FAST normally has the capability to handle personnel management, personnel action, personnel records, and routine medical, finance, and legal matters. Applicable personnel records accompany the team for the period of its absence from its centralized post of duty. The size of the FAST depends upon its mission, e.g., a FAST can be organized to provide a personnel records check, reaccomplish emergency addressee forms, check or administer immunizations, prepare allotments and check personal financial records, issue ID tags and cards, sell money orders and stamps, and provide legal advice. A designated officer and NCO supervise and control the FAST while it is on its period of detached duty. Supervisory duties are normally rotated. The FAST is moved by surface or air transportation as required and as available. The success of the FAST is dependent upon the ability of the PSD to schedule, coordinate, and time the arrival of the FAST at a location when the supported unit will be in the best position to receive FAST services. Prior planning is absolutely essential for optimum personnel services to individuals assigned to the unit supported by the FAST.

(b) *Support team.* A support team is composed of personnel from each branch of the PSD which accompanies a unit detached from the division. The team may also have military pay specialists from the finance company. Prior to movement an SOP or memorandum of instructions governing team composition, operations,

and movement is issued by the chief, PSD. In the preparation of this publication, the chief, PSD, coordinates with the finance officer for information pertaining to the finance clerks accompanying the team. Orders are issued which direct the detachment and specify the organic and personnel and administrative reports required. Selected team members are briefed and their impending mission by the chief, PSD.

(c) *Incoming personnel processing team.*

The personnel processing of replacements is an important part of total replacement processing. Inprocessing should be performed in the replacement detachment servicing the division except when there are too few replacements to warrant dislocation of the inprocessing team to that location from the composite team or functional branch area. The incoming replacement processing team should be thoroughly trained in its duties in order to perform accurately and efficiently the complete initial processing procedures. This will enable unit commanders to utilize replacements upon arrival and eliminate a number of subsequent visits to the PSD to complete details. The incoming replacement processing team is under the supervision of the chief, PSD PM branch, and is organized from representatives furnished by the PM, PR, and PA branches in the PSD, the finance company, a representative from the staff judge advocate (SJA), and medical personnel. From information on the number of replacements to be processed, the chief, PM branch determines the number of NCOs and specialists required to accomplish the inprocessing. (A requirements formula which recommends the number of clerical personnel to be used to process replacements is in DA Pam 600-8.) During the inprocessing of replacements a unit of assignment is determined; all personnel records are audited and corrected, and personnel information for receiving commanders is procured and prepared. An officer assigned to the replacement detachment is appointed to sign documents requiring a witnessing or certifying officer. When the numbers of replacements to be processed do not warrant the formation of a special incoming replacement processing team, replacements should be processed in the composite team at the PSD. When the division is not authorized a replacement detachment and there is no provisional or other AG company replacement organization available, the division will be supported by a replacement regulating organization organic to a Corps or Army Support Brigade. When this is the case, the chief, PSD, should

FM 12-4

make arrangements to process replacements at the supporting replacement regulating organization, by use of the division PSD incoming personnel processing team. Procedures on processing incoming personnel are in DA Pam 600-8.

(d) *Outgoing personnel processing team.* The outprocessing team is under the supervision of the chief, personnel records branch, PSD. Personnel who are assigned to the composite teams or functional branches are used as team members. Direct worker supervision and responsibility for the organization of the team rests with the processing unit supervisor of the records branch. The composition of the outprocessing team is dependent upon the workload. The processing unit supervisor should provide a team which can complete outprocessing of individuals in one day. A records team leader normally is designated as the outprocessing team supervisor and the team must include both records and pay specialists. The teams should plan for outprocessing on a daily basis due to the large number of troops served. Each day's workload represents individuals from units throughout the division and will entail the processing of records maintained by one or more of the composite teams in the PSD. In order to reduce the number of personnel reporting to the PSD for outprocessing and to minimize the difficulties in routing and scheduling, an outprocessing team is provided. The outprocessing team should be furnished facilities in or near the PSD or the replacement detachment. There may be occasions when the workload justifies the outprocessing team functioning *with* a battalion, (e.g., processing an entire company which has been alerted to move). The team should be held responsible for insuring that all personnel records leaving the PSD are complete and current. Care must be exercised that any individual being outprocessed is not cleared from the division until all his military accounts are settled, that he provides postal authorities with change of address cards, and that he has all his records, to include his PFR and complete medical and dental records. Specific procedures on outprocessing of personnel are contained in DA Pam 600-8.

(e) *Personal affairs team.* The personnel actions branch is responsible for the organization and control of personal affairs teams. Teams are organized to provide simultaneous service for each battalion and separate company by assigning a team member for each company size unit. A representative of the personnel actions branch should be placed with each battalion to answer

inquiries of the other team members while also processing a company size unit. Alternate team members must be designated in advance to provide service during leave or other absences of the assigned team members. All divisions are responsible for maintaining a readiness capability of varying degrees dependent upon the division mission and station. Accordingly, emphasis should be given by the Chief, PSD to operating procedures which will minimize the time required for officer and enlisted personnel to complete their personal affairs. Commanders can expect that the PSD provides continual assistance to their assigned and attached personnel so that final processing of personal affairs will not hinder the unit if an emergency situation arises. The PSD determines which personal affairs are appropriate to the division's mission and station, and provides for the preparation and periodic review of documents pertaining to those affairs, in anticipation of an emergency situation. Specific procedures on personal affairs for personnel on active duty and surviving dependents of decreased personnel are contained in DA Pam 600-8.

c. *Organization.* The personnel services division (PSD) is organized into a headquarters and three functional branches. Figure 3-17 depicts basic organizational elements of the PSD. Internal tailoring of the PSD organization by the Chief, PSD may be effected to meet specific requirements peculiar to the current situation, operational environment, available buildings or other shelter, and desires of the division commander. Two basic methods of operation of the PSD are normally adopted, with variations. These methods are *functional branch configuration* and the *composite team configuration*. The composite team concept is considered to be the best implementation of personnel services division resources to provide direct personnel support services to elements of the division. Branch chiefs are delegated authority to take final action on routine matters for which their function is responsible, subject to established policy. Exceptions to established policy are referred to the division personnel officer in PSD headquarters, who may take final action or seek the guidance of the division adjutant general, based upon standard operating policy and procedure.

(1) *Functional branch configuration.* Figure 3-17 depicts a typical functional branch configuration. Each branch has assigned functions to perform, and accomplishes its routine and spe-

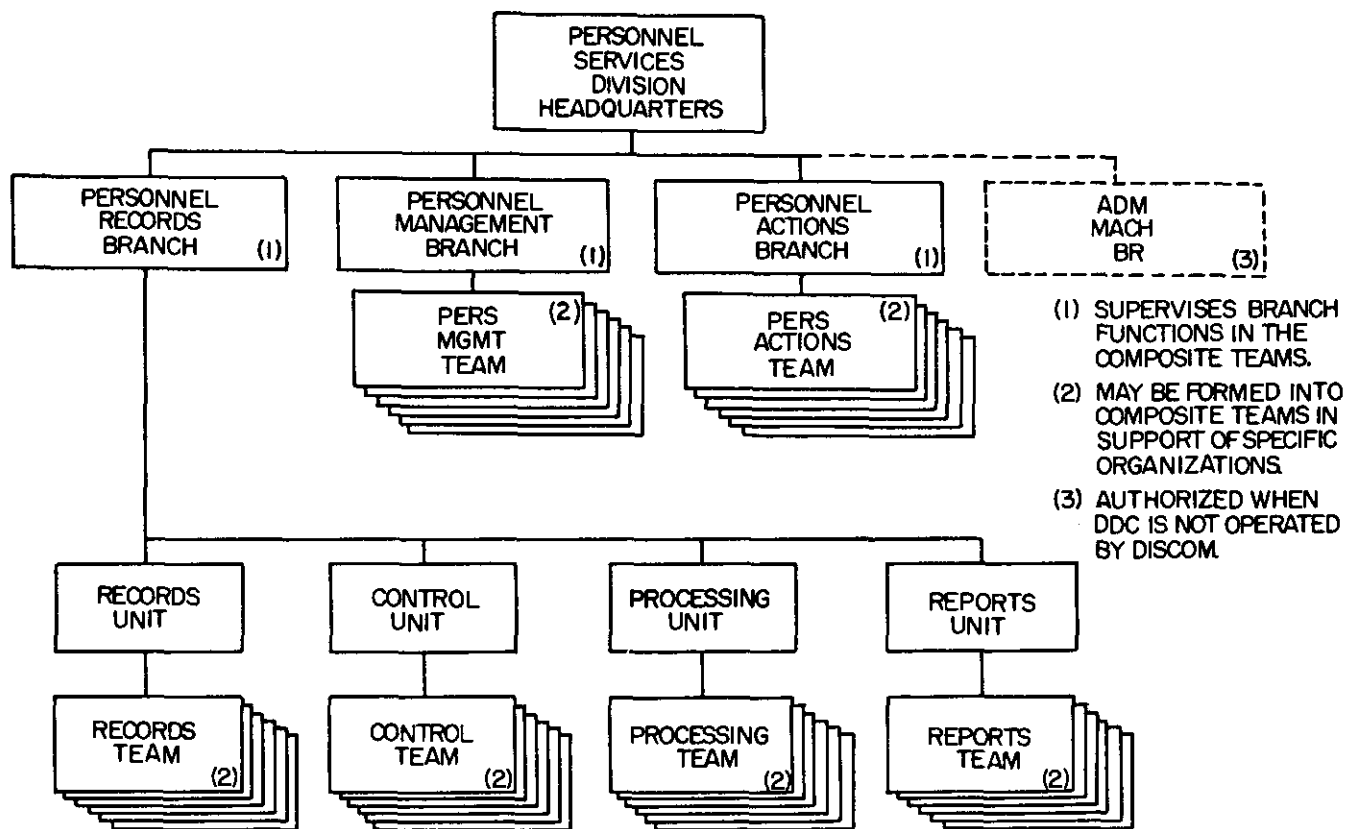

Figure 3-17. Personnel services division (PSD).

cial personnel and administrative direct support tasks in a consolidated, branch configuration. So far as geography and office space will permit, all branch personnel, from the branch chief down to the clerk typist, work as closely together as possible. Coordination with other branches of the PSD is normally effected by the branch headquarters, although routine matters may be coordinated directly between direct workers (specialists and clerks) of the various branches, (e.g., the PM branch management specialist may coordinate directly with the appropriate PR branch records specialist to obtain personnel records data or other information on an individual being considered for promotion to facilitate special orders request preparation). The functional branch configuration provides for:

(a) Effective and visual supervisory control by the branch chief and his branch level noncommissioned officers.

(b) Short lines of communication between branch headquarters level supervisors and direct workers within the branch on dissemination of policy and other work directives.

(c) Good control of the flow of administrative matters and action documents pertaining to the branch mission.

(d) An effective means of quickly checking the status of any action relevant to the branch mission.

(e) Quick subordinate-to-supervisor (and vice versa) response on sensitive matters.

(f) A limit to the range of skills and knowledge required of each specialist thereby minimizing detrimental effects of high turnover of branch personnel.

(g) Ease of cross-training (interbranch) of experienced personnel specialists and clerks.

(h) Increased skill and output of individuals assigned to the branch by permitting concentrated attention to all branch functions in a controlled branch environment.

(i) Greater standardization in maintaining and providing records and actions.

(2) *Composite team configuration.*

(a) *General.* See figure 3-18, for a typical organization of the PSD which uses the com-

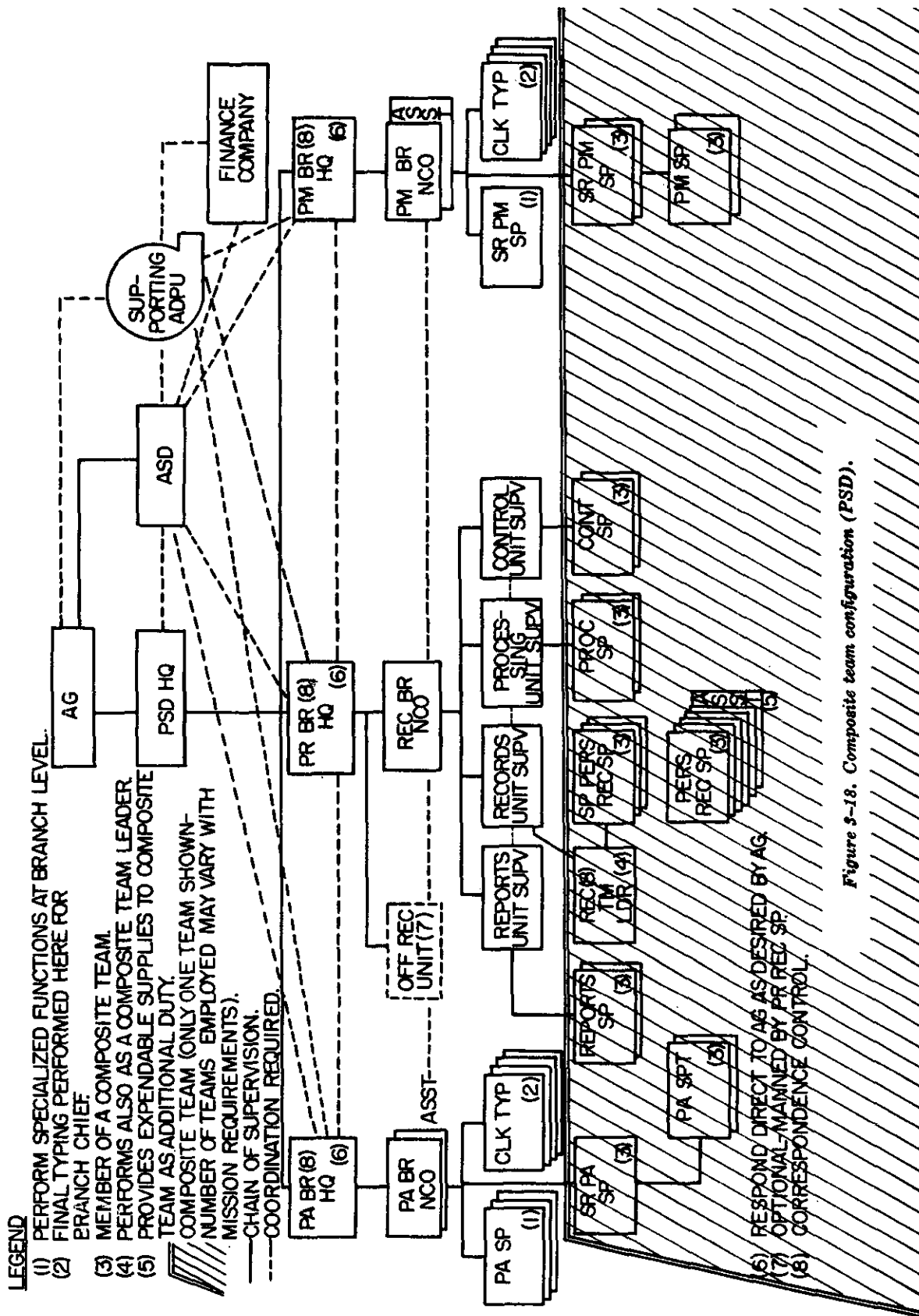

Figure 3-18. Composite team configuration (PSD).

posite team configuration. As with the functional branch configuration, there are variations which may be locally applied by the division adjutant general. Basically, this configuration retains the branch headquarters as a control, coordinating, and special functions facility under the chief, PSD; and provides a functional team from each branch to serve in composite team areas (e.g., PM, PA, and PR branch functional teams are organized in a composite and are assigned to work together in a centralized location in direct support of specifically designated divisional assigned or attached units). Support is provided "long range" (when a composite team remains as an integral part of the centralized PSD operation), or "short range" (when elements of the composite team, or the entire composite team, detaches from the PSD and supports specified divisional units at their respective locations). Task direction and control is always exercised over functional specialists and clerks in composite teams by their functional branch control headquarters. Physical control of the functional specialists in the composite team, regardless of their functional branch affiliation, is exercised by the senior enlisted member of the composite team (usually the records team leader, who also is a member of the functional personnel records branch team at composite team level). Physical control of all composite team members is necessary because of their multiple functional, training, security, and housekeeping duties which require their presence in areas other than at their composite team. A typical example of how this operates is when a specialist in a composite team receives direction from his branch headquarters to report for guard duty or other detail, and at that particular time he also has an important functional action to perform in the composite team relating to his branch mission. The direction of this specialist comes from the functional branch headquarters. The composite team leader is kept informed. Priorities are established for the specialist by his branch headquarters, and he follows direction from that level. The use of an appointment system at composite team level will permit the specialist to provide appropriate functional services in his absence by coordination with a fellow specialist who will be present.

(b) *Composite team grouping.* Each composite team serves a specific group of units which represent approximately one-seventh of the division. These unit-divisions are designated by the chief, PSD. A suggested Armored, Infantry, or

Infantry (Mechanized) division grouping as follows:

COMPOSITE TEAM	UNITS
1	HHC, Division, HHC, DISCOM, AG Co, Fin Co, S&T Bn, Maint Bn, Med Bn
2	MP Co, Avn Bn, Sig Bn, Engr Bn
3	3 Bde HHC, 2 Maneuver Bns
4	3 Maneuver Bns
5	3 Maneuver Bns
6	Cav Sq, 2 Maneuver Bns
7	HHB, Div Arty and all Arty Bns

(c) *Advantages of Composite team configuration:*

1. *Adapts to space limitations.* The PSD will operate best in one building. If it is not possible to obtain a single building of adequate size, a division into smaller units will be necessary. Composite team divisions provide greater flexibility for the personnel officer in utilization of space available because each composite team can be separated from the others. A composite team may be housed in two medium-size general purpose tents in the field and the organizational structure remains intact.

2. *Provides for organizational integrity.* All routine functions of personnel management and administration for a divisional unit are performed within a composite team. A company commander visiting the PSD needs only to visit one location and talk with a limited number of personnel specialists to gain a complete understanding of the services available to his unit. The personnel specialists are able to provide more efficient and prompt service when they are able to devote their undivided attention to a unit. For example, a PM specialist in a composite team can develop a thorough understanding of the unique requirements of a specific battalion due to the continuous assignments and classification actions he performs, and he will have a good basis for understanding the priorities established by the battalion commander he serves.

3. *Simplifies the routing of source documents.* A number of source documents must be used by personnel specialists in more than one functional branch. The routing of such documents to large functional branch organizations results in a complex transmittal pattern, delay, or loss. A source document will less likely be lost after arrival in a composite team, and delay in taking action on the document (e.g., records posting, request for orders, preparation of personnel data change cards) should be at a minimum, because

FM 12-4

all functional team members concerned are present in close proximity with one another.

4. *Facilitates direction by the branch chief.* Each functional team includes an NCO or senior specialist and thereby provides a channel for the branch chief's technical supervision of his function in each composite team. This functional supervision insures uniformity of procedures and application of policies throughout the PSD, e.g., the PA branch chief can implement a new DA directive or a division command policy on elimination of board actions by providing instructions to seven senior PA specialists, one in each composite team. The PA specialists can in turn share this information on a lateral coordination basis with other PA specialists and with the PM and PR specialists at composite team level as a matter of general information.

5. *Simplifies the responsibilities of intermediate supervisors.* The noncommissioned officer or senior specialist in each composite team provides a specialized personnel service to a fixed number of divisional units. This arrangement eliminates confusion over the scope of his responsibilities, and permits him to develop a close working relationship with a limited number of subordinates and personnel staff NCOs in battalions and brigades.

6. *Clarifies the point of contact for personnel staff NCOs.* A personnel staff NCO in a battalion or a brigade should experience no difficulty in understanding the organization of the PSD or finding his precise contact on any matter, because almost all of his personnel support is represented in one composite team. A personnel staff NCO deals directly with a functional team member in a composite team on routine matters involving reports, processing, control, personnel actions, or personnel management, unless the matter pertains to the making of policy, introducing a new procedure, or handling a sensitive personnel action.

7. *Simplifies internal communications.* Requests for information, assistance and various personnel records pose a problem similar to that of routing source documents. An organization providing for independent functional branches would present a serious obstacle to necessary coordination whereas the composite teams physically group the personnel specialists who must work together.

8. *Provides for detachments.* The PSD must be capable of responding to changing conditions, and one such case is a requirement to provide direct second echelon personnel support

(a personnel office) to units detached from the division. In this event, a support team may be separated from the composite team without hindrance to the composite team because the detached personnel specialists will have worked continuously with the same records.

9. *Broadens experience and training.* The experience and training of personnel specialists are expanded since they are not isolated in specialized areas to the exclusion of other areas of responsibility (e.g., personnel records specialists are directly associated "on the ground" in the same team with actions and management specialists). This provides a better base for the training of higher rated specialists and potential personnel staff noncommissioned officers (PSNCO) for assigned and attached organizations.

d. *Response to Units and Individuals.* It is reasonable to expect that commanders and their personnel who submit personnel actions will be concerned about the prevalence of an impersonal attitude in the PSD. Their initial concern will become aggravated in direct proportion to the time interval between an inquiry or application and the PSD response or action. Upon receipt of a personnel action request in the PSD, an acknowledgment card (DA Form 209) (Delay, referral or follow-up notice) should be dispatched to the requesting individual. This DA Form 209 should state that the action has been received and should specify a date that a final reply may be expected. All personnel assigned to the PSD should appreciate the fundamental nature of a service organization and be aware of the concern of commanders and requesting individuals that they receive good service.

e. *Procedures.* DA Pam 600-8 contains definitive guidance on the functions of a military personnel office which may be applied across the spectrum of the PSD, to include specific procedures in personnel management, personnel actions, personal affairs (including dependent affairs), personnel recordskeeping, rosters and reports, and the information and operation of special purpose teams.

f. *Communications.*

(1) *Internal routing of correspondence.* The size of the PSD, regardless of its configuration into functional branches or composite teams, presents problems of control of correspondence. Two important considerations when preparing a routing scheme are the physical layout and the rela-

tive experience of key personnel. Alternative routing plans which may be adopted are:

(a) The distribution of all incoming communications is made by the branch chief at branch headquarters. This alternative may be best when shortages are severe or inexperienced key personnel are handling action correspondence for the branch chief at composite team level or specialized branch headquarters level. It is an undesirable method under normal conditions.

(b) Distribution of all incoming communications pertaining to composite team level actions is made direct to the composite team. This alternative reduces the handling of all routine matters by the branch chief and applies the "management by exception" principle which releases the branch chief and his key NCOs for supervisory duties.

(c) A combination of (a) and (b); above. This can be advantageous when selected matters of significance (e.g., Congressionals, correspondence personally signed by commanders) can be routed to branch, and the more routine actions are routed directly to teams.

(d) Assignment of experienced specialists to the headquarters, PSD or the ASD to function as identification, action, and routing personnel on all matters involving PSD functional branch or composite team action. When this alternative is adopted, the workload on the remaining personnel specialists is increased because there are no TOE or augmented personnel spaces authorized to support the action, however, the accuracy and responsiveness gained by placing personnel specialists in HQ, PSD or ASD may offset the disadvantage of loss of operating manpower in the functional branch or the composite team. This alternative should seldom be employed, for the TOE provides spaces for individuals whose task it is to learn and accomplish routing. Personnel resources should not be diverted from valid primary duties to a job someone else should be doing, except for temporary, training purposes.

g. Functions.

(1) *Personnel services division headquarters.*

(a) The division personnel officer directs and controls the operations of the PSD and supervises the activities of the three branch chiefs in the personnel records, personnel management, and personnel actions branches. He is immediately available and responsive to the adjutant general and advises and assists supported staff officers

and commanders throughout the division. He makes his branch chiefs available to the adjutant general, other staff officers, and commanders on a direct coordination basis, and the branch chiefs keep the division personnel officer informed. The position of the division personnel officer requires an aggressive and thorough application of personnel expertise and a sincere and dedicated attitude toward the many demanding requirements inherent to the personnel support system.

(b) The PSD headquarters coordinates with other supporting elements within the division headquarters level which provide personnel support services; e.g., the ASD which prepares routine orders pertaining to individuals and produces paper tape by-products for ADP applications of personnel status change actions; the DDC (or other supporting DP facility) which furnishes statistical personnel reports and rosters for dissemination by the PSD to commanders and their staffs within the division; and the finance office, which administers the division military pay program. Normally, channels of communication to these and other support elements are direct from the functional branch to the supporting element, unless specific instances arise where the division personnel officer must personally become involved. Statistical personnel reports and rosters prepared by the DDC are furnished to the branches, which make distribution after the products are subjected to a quality and accuracy check.

(c) The PSD headquarters provides limited internal distribution for its PSD branches, to include records management assistance; however, the PSD headquarters depends upon the ASD for classified document control, procurement and distribution of office supplies, and publications and blank forms in direct coordination with PSD branches.

(d) The assistant personnel officer may perform office management, plans, and technical training functions for the division personnel officer. His activities encompass primarily the technical personnel and administrative functions of the PSD; however, he may be detailed to duties involving specific personnel actions of a sensitive nature, officer actions, and coordination with the adjutant general company headquarters on administrative and logistical requirements of operational personnel of the PSD. Specifically, he monitors the assignment and reassignment of personnel to and from the PSD; monitors the maintenance and police of facilities occupied by the branches and composite teams, including the

FM 12-4

availability, maintenance, and serviceability of property and equipment authorized those elements; insures the readiness of the PSD headquarters and branches to move to a field location and perform in that environment. He prepares office memorandums and instructions relating to internal PSD affairs common to all assigned members; conducts organizational surveys of branches and subelements thereof to insure that the management principles employed provide maximum operational effectiveness, supply economy, and proper utilization of personnel; assumes operational supervision of certain branch areas on order of the division personnel officer and conducts studies, surveys, and investigations when so directed to do; monitors the preparation of the branch standing operating procedures (SOP) for garrison and field situations; monitors the preparation and conduct of technical proficiency training programs for personnel specialists within the PSD and conducts liaison visits and orientations on PSD functions for supported unit adjutants, personnel staff noncommissioned officers, first sergeants, unit clerks, and commanders.

(e) The clerk-typist maintains the office files, types correspondence and reports, and distributes correspondence, orders, and other directives to the PSD subactivities and consolidates and prepares requisitions for supplies and publications from all elements of the PSD.

(2) *Personnel records branch.* The personnel records branch is organized to provide a headquarters, a records unit composed of up to seven teams, and three separate units for the functions of control, processing, and reports.

(a) Records personnel are grouped in teams in accordance with the units whose personnel records they service. Such an arrangement allows detachment of records teams when required, facilitates the matching of records for outprocessing, and permits strength control of records specialists through unit identity. Records personnel maintain the officer and enlisted records (officer records may be maintained separately). Health records (including dental records) are maintained in accordance with AR 40-403. Pay records are maintained by the finance company of the units for which the PSD has responsibility. Included are qualification records and other documents maintained in the military personnel records jacket (MPRJ). (See AR 640-10 for details.) Records specialists prepare and transmit reports of change to Department of the Army in accordance with DA policy. Recorded

information is also furnished to other PSD branches and staff officers on a need-to-know and a right-of-access basis. Requests for information from individuals who have no established right-of-access are referred to the chief of the records unit.

(b) Control personnel operate a suspense file of all recurring personnel actions. They notify the action elements of suspense requirements and monitor accomplishment of the actions concerned. These actions are coordinated with the DDC (or other ADP support facility) and suspense items are programmed for ADP application.

(c) Processing specialists from the personnel records branch (in close coordination with those of the personnel management branch, the finance company, and the supporting replacement processing element) screen and process incoming records and make proper internal distribution of all records. When these specialists are processing records pertaining to reported casualties, they coordinate their actions with the personnel actions branch and the finance company.

(d) Reports specialists receive, control, verify, consolidate, and transmit morning reports and all other personnel and administrative reports. These specialists develop, control, maintain, and furnish personnel statistical information and personnel data as required. They transmit personnel status changes to other elements of the PSD, and coordinate personnel status changes with the DDC (or other DPU supporting elements) for updating punched card files maintained by that facility which form the basis for periodic rosters and reports to commanders of divisional organizations and their staffs.

(e) *Duties of branch personnel.*

1. The chief and assistant chief of the records unit direct the activities of the handling (maintenance, storage, and transmission) of all personnel records (field 201 file and qualification records) for all officer, warrant officer, and enlisted personnel of the division. In conjunction with the personnel records function, these officers direct their subordinates in the updating of the statistical data bases maintained in the supporting data processing facility, and the prompt preparation and submission of pay change data to the finance company. These officers are the custodial officers for the records as required by AR 600-200 AR 640-2.

2. The records branch NOC supervisor supervises subordinate unit NOCs who, in turn, supervise their respective units: the records unit, processing unit, reports unit and control unit.

The records unit supervisor also supervises and controls the records team chiefs whose records teams are responsible for performing physical records maintenance duties. The processing unit supervisor controls and supervises the out processing of personnel and their records and in coordination with the personnel management branch assists with the inprocessing of personnel and their records. The reports unit supervisor consolidates, distributes, reviews, and transmits statistical report and source document input received from subordinate elements of the division (such as the M/R) and those reports and documents emanating from the records teams. The control unit supervisor maintains suspenses on personnel actions and individual reports, and controls "flagging action" cases (except for officers) to insure prompt release, termination, or other appropriate disposition. These NCOs, together with the records team chiefs, supervise the major portion of the personnel functional operations which impact upon the data processing system supporting the PSD.

3. The records team leader supervises the daily activities of individual personnel records team members involved in personnel records maintenance. He reviews: reports of change to officer and enlisted qualification records maintained at HQDA, required documents to be included in the TAG and OPO personnel files, and personnel change-data for feeder-type reports to the ADP facility. When detached from the PSD, the team chief serves as an interim personnel sergeant or section chief until his team forms the nucleus of the newly organized personnel section under a specified PSNCO and S1.

4. The personnel records specialists and their assistants perform the physical actions required to maintain and update the personnel files, prepare reports, and update the data base. Among the more common and frequent tasks performed are typing, filing, coding data processing cards, and reconciling discrepancies on the ADP output (rosters of exception, qualification rosters, suspense rosters, and personnel information rosters). DA Pam 600-8 contains details on these rosters.

(3) *Personnel management branch.* The personnel management branch accomplishes all personnel management functions not specifically assigned to other elements of the PSD. This branch performs classification and reclassification actions pertaining to military personnel and administers Army testing; assigns and reassigns personnel; processes oversea levies and voluntary applica-

tions for oversea service; prepares reports on passenger space requirements, and issues port call instructions; is responsible for POR (preparation of overseas replacement) processing; processes applications and selects personnel for training, schooling, and special assignments and details; fixes personnel authorizations from TOE, determines MOS requirements and overages, adjusts MOS overstrengths, and submits personnel requisitions; coordinates supporting replacement activities and supervises replacement processing teams; monitors utilization of personnel within the division; identifies personnel to be considered for separation before their ETS (expiration term of service); administers the PSD portion of the enlisted evaluation system; handles all matters pertaining to appointments, promotions, reduction, and demotions of assigned personnel; makes sample surveys of military personnel; develops, maintains and furnishes MOS strength and statistical information as required; prepares reports on eligibles for promotion and personnel surpluses as required; administers matters pertaining to redeployment and rotation of officer and enlisted personnel as well as dependents; processes advance oversea returnee lists and oversea returnee rosters; and closely coordinates the receipt, flow, and assignment of replacements with the division.

(a) *Duties of personnel management branch personnel.*

1. The personnel management officer advises the AG and the chief PSD on personnel management matters pertaining to the division. He directs the activities of the office which include all MOS actions, utilization and assignment, testing, promotions and reductions, travel, inprocessing, and AOR/surplus reporting. He acts as the classification authority for the commander, and as the TCO per AR 600-200.

2. The personnel management supervisor and his assistant assist the personnel management officer, provide technical expertise, and supervise the personnel management specialists in the performance of their duties. They review correspondence and reports, monitor assignments and MOS actions, distribute and monitor use of promotion allocations, and provide technical MOS instruction for their subordinates. They assure that internal office tasks are performed efficiently and coordinate the activities of personnel management branch elements with other PSD operations as required.

3. The personnel management specialists and clerk typists perform manual and physical

FM 12-4

routine actions required of the branch; maintain office files, type correspondence including reports and preparation of indorsements/comments for management actions. Management specialists research, review, and recommend appropriate courses of action for various types of personnel management actions within their purview of activity. They interview personnel, and compute and compile data for reports.

(4) *Personnel actions branch.* The personnel actions branch is responsible for all personnel actions that have not been specifically assigned to some other branch in PSD. When authorized to do so, this branch processes and takes final action on all matters pertaining to eliminations, separations, resignations, retirements, reenlistments, extensions, deaths, transfers, identification media, requests for excess leave, emergency leave, and leave to visit foreign countries. It provides advice and assistance and handles all matters pertaining to service benefits and personal affairs of military personnel and their dependents; processes all cases pertaining to marriage, legitimization or adoption of children, and civil-legal proceedings (in coordination with the division staff judge advocate); processes actions pertaining to branch transfer and details of officers, extension and declination of active duty for reserve personnel, and officer preference statements; insures timely, correct preparation and submission of officer efficiency reports and photographs; assists personnel in obtaining travel clearances, passports, and visas; insures that immunizations and periodic and special medical examinations are taken and prepares medical report forms required; insures control of personnel actions in security and investigative cases; administers the life insurance and soldier voting program; processes applications for identity and privilege cards for dependents of military personnel. The personnel actions branch processes applications of an individual nature and insures their proper staffing and screening, operates the division casualty reporting system (to include processing of casualty reports, maintaining master casualty files, and supervising the preparation of correspondence concerning casualty information). Casualty reporting functions are closely coordinated with the DDC or other servicing ADP facility. The personnel actions branch operates the awards program for the division by processing recommendations, preparing citations, announcing awards in orders and maintaining historical awards files. This branch also coordinates replies to inquiries received from members of Congress,

civic organizations, and other persons of the civilian community.

(a) *Principal duties of the personnel actions branch operating personnel:*

1. The personnel actions officer keeps the AG and the Chief, PSD informed on subject areas within his purview. He directs the activities of his branch, coordinates the activities of his branch with other elements of the PSD, serves as an organizer of boards, and processes personnel actions and personal affairs matters.

2. The personnel actions supervisor (NCO) assists the personnel actions officer by reviewing the appropriateness and correctness of cases prior to approval, signature, and dispatch; supervises the personnel actions specialists, and provides advice, MOS training, and technical assistance to his subordinates.

3. The personnel actions specialists and clerk typists perform the daily administration tasks required to accomplish the mission of this element. The personnel actions specialists review requests and draft their recommended courses of action in the form of forwarding indorsements or replies. They research files, records, and regulations to determine the proper disposition of cases received by the office. The clerk typists maintain the office files and type personnel actions, forms, certifications, and statements.

3-13. Replacement Detachment

a. *Mission.* The mission of the replacement detachment is to receive and control, provide essential logistical support (billeting and messing), and administratively process transient personnel (replacements, RTD, R&R&, TDY and rotatees) awaiting various stages of in-or-out processing or transportation. Administrative processing is a responsibility of the functional element of the Office of the Adjutant General primarily concerned.

b. *Organization.* The replacement detachment is organized into a headquarters and three replacement teams as shown in figure 3-19.

c. *Concept of Operations.*

(1) The replacement detachment operates under the direct supervision of the adjutant general and coordinates closely with the personnel records and personnel management branches of the PSD, the AG company, and the supply and transport battalion of the DISCOM.

(2) The adjutant general directs the location of the replacement detachment and insures that the selected area is large enough to contain

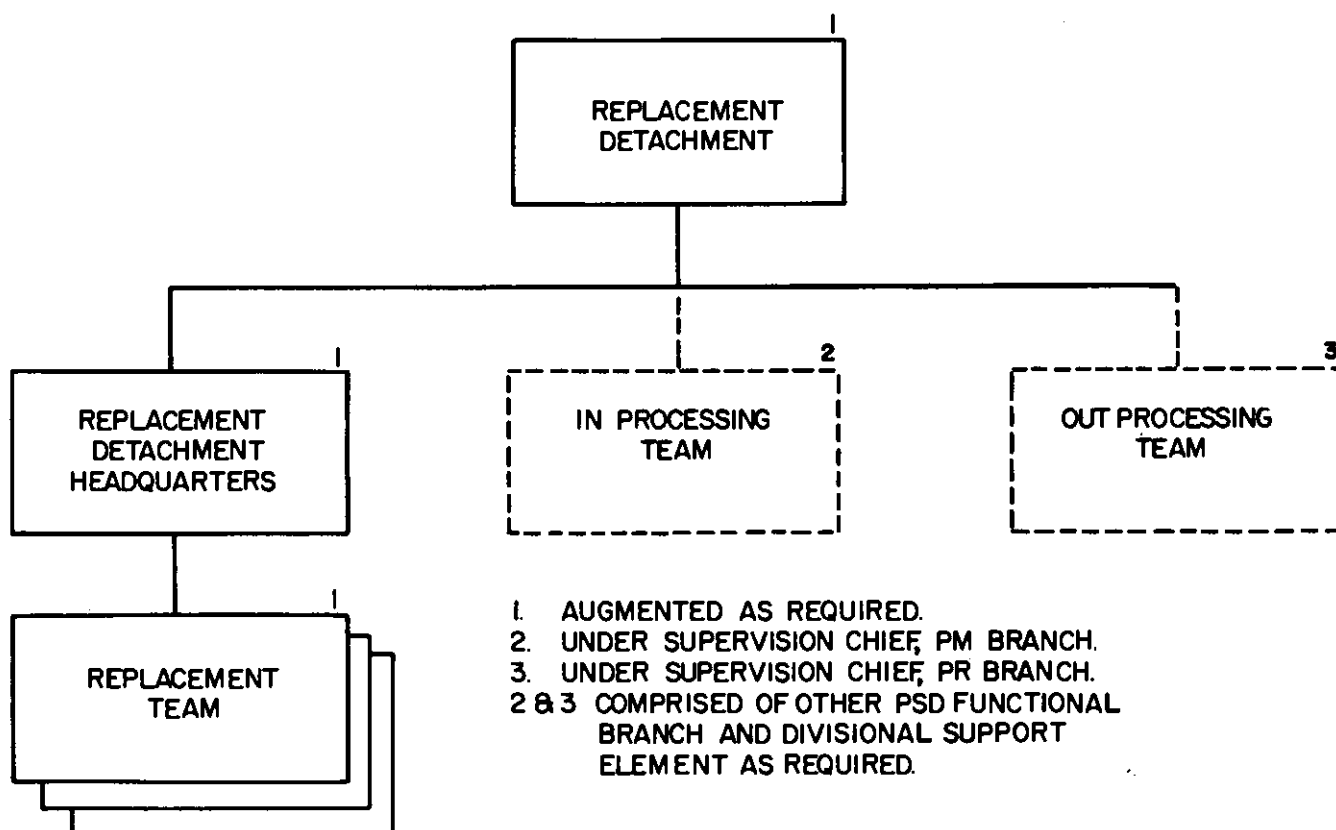

Figure 3-19. Replacement detachment.

a subarea for each replacement team. The adjutant general company commander provides any available permanent or semipermanent physical facilities to the detachment.

(3) The replacement detachment is normally the initial reception and departure point for all types of arriving transient personnel: replacements, returned-to-duty personnel (returnees from hospital emergency leave, and confinement), and those individuals departing as a result of rotation, elimination, separation, leave or extended periods of TDY.

(4) The adjutant general provides physically separate transient areas in which different classes of transient personnel (replacements, R&R, RTD, rotatees) may be billeted and processed.

(5) The PM branch, PSD, coordinates transportation requirements for incoming transient personnel and the PR branch, PSD for outgoing transient personnel with the AG company, replacement detachment, S&T battalion, and the gaining organization as applicable.

d. Procedures. The following general proced-

ures apply to processing replacements, returned-to-duty personnel, and rotatees, and may be supplemented as the need is recognized:

(1) The replacement detachment is separated from the other elements of the adjutant general company within the division rear. The detachment should contain assembly areas for troops arriving and departing, and should have sufficient covered areas to permit processing in bad weather. The detachment must be allotted an area that is large enough to contain a subarea for each replacement team. Each subarea should have sufficient space to accommodate proper dispersal and camouflage.

(2) Immediately prior to arrival of new replacements in the replacement detachment area, the division commander should be apprised by the adjutant general of the impending arrival (particularly large or highly specialized groups) so that the division commander may, at his option, personally welcome them to the division or direct someone to do so for him. Replacements are oriented on such matters as the history and accomplishments of the division; replacement detachment facilities; messing hours; processing

FM 12-4

to be accomplished; length of stay; how to handle personal problems which arise; mail; and available support facilities such as the post exchange, barber shop, post office, bath, etc. *POR processing accomplished in CONUS is not repeated.* (For details on POR processing see AR 612-2). Established policy should provide for the chaplain, medical officer, provost marshal, and other selected staff officers to participate briefly in the orientation of replacements when possible.

(3) Replacements are administratively processed by a PSD inprocessing team composed of personnel representing functional elements of the PSD, the finance company, and other selected special staff elements (e.g., SJA, surgeon) and representatives of the DISCOM central issue facility (CIF). When customs or baggage inspection actions are required, qualified military police may be added to the inprocessing team. The team is established by SOP and operates under the supervision of the personnel management branch chief, PSD. During their administrative processing, a check of replacement equipment, clothing, and weapons (if any) is made for quantity and serviceability; missing or defective items are replaced through arrangements with the CIF. The composition of the inprocessing team and actions taken to administratively process replacements are flexible matters which may be modified by the adjutant general to meet specific in processing requirements. Included in the organization and capabilities of the inprocessing team is the ability to displace and go to distant points on call to inprocess replacements at battalion or company level, and to process large organizations up to company size, if required.

(4) Normally, replacements are billeted separately from RTD and rotatee personnel. Movement of transient personnel in or out of the division is coordinated with the personnel management branch chief, who maintains division gain and loss statistics. Replacements, returned-to-duty personnel, or rotatees should be processed and moved to units of assignment or out of the division as expeditiously as possible. No transient should be held in the replacement detachment for longer than 48 hours unless dictated by operational necessity: such exception should be reported to the AG with reasons. Unless otherwise directed by the AG, processing should be accomplished on a first-in, first-out basis. In this connection, however, the detachment and processing personnel must always avoid creating an impression of impersonal handling and must pa-

tiently and expertly attend to all transient needs in a cheerful attitude of service. For many newly assigned replacements, this will be their first Army "home." Every effort must be made to instill a sense of pride and belonging in each new replacement.

(5) The replacement detachment acts as a holding agency for replacements and departing personnel until assignment orders or other instructions have been received by the replacement detachment headquarters from the personnel management branch of the PSD. Replacement and RTD personnel are provided transportation by the division supply and transport battalion, or by means provided by gaining units. Escort personnel, normally an NCO, should be provided by gaining units to escort new replacements to their new unit. If this is not possible due to distance, one replacement is designated as a group leader until arrival of replacements in the new unit. A followup check is made by the personnel management branch or the replacement detachment headquarters (as appropriate) to insure that they reach their intended destination within the division. In overseas theaters, rotatee personnel are furnished transportation to the general support replacement battalion which is responsible for their further processing.

(6) So far as is possible, returned-to-duty personnel are returned to their former units of assignment if their physical profiles permit.

(7) Under normal circumstances, the assignment of fatigue and supervisory details is as follows: Priority 1: replacements; priority 2: RTD personnel; priority 3: rotatees. Since minimizing stay time of transients in the detachment is critical to its successful operation, and since details are a most unwelcome imposition to the transient himself, it should be division policy that transient personnel will not be employed for details unless the task is essential, no other personnel are available, and the AG personally approves. This policy does not apply to perimeter defense plans for the division rear echelon.

(8) Processing and movement schedules are planned to insure that a maximum of rest is afforded replacements to preclude their arrival at their ultimate unit of assignment in a physically exhausted state.

e. When a field army operated replacement activity is not available, liaison must be maintained with servicing facilities of the Medical Brigade

to identify, assist, and supervise the return of division personnel to their units from both an inpatient and outpatient status.

3-14. The Division Band

a. Mission. The mission of the band is to provide military and recreational music as a part of the morale and personnel services program of the division.

b. Concept of Operations. The adjutant general executive officer coordinates the scheduling, movement, and employment of the division band throughout the division. The band may be used to support any military formation or recreational function in the division, consistent with its capability and availability. The band participants in military formations (e.g., change of command ceremonies), social and recreational functions (e.g., dances, pregame ceremonies at sports events), and may also provide musical entertainment for local populations as a part of the mili-

tary-civic action program (e.g., concerts, musical support for dance or drama). AR 220-90 contains details as to general policies; technical supervision and other responsibilities; personnel and training requirements; and equipment, facilities, ceremonial music, inspection and reports information for military bands. FM 12-50 provides detailed doctrine on formations, movements, field music, and ceremonies pertaining to band operations.

c. Employment. The division band will be employed as directed by the adjutant general. In addition to furnishing music, the band may be employed to provide security for the DISCOM and/or division rear command post; or perform such other combat, combat support, or combat service support tasks as the division commander may direct the adjutant general to provide. The band should not be fragmented or assigned to continuous duties which will preclude periodic rehearsal to maintain musical proficiency.

CHAPTER 4

SEPARATE BRIGADE ADJUTANT GENERAL SECTION,
ADMINISTRATION COMPANY

4-1. General

a. *The Separate Brigade Administration Company.* The separate brigade adjutant general section is organic to the administration company, support battalion. The administration company is allocated on the basis of one per support battalion for separate armored, infantry (mech), infantry, airborne, and light infantry brigades.

(1) The administration company comprises the brigade rear, and provides personnel and administrative support for the brigade, including centralized personnel services for all organic or attached units of the brigade. It provides logistical support, and tactical security for personnel assigned or attached and company level personnel and administrative support for personnel assigned to the company.

(2) It has the capability to receive, control, and administratively process up to 100 individ-

uals at any given time through its replacement element. These may be any combination of transients, to include replacements, hospital returnees, or rotatees. The separate brigade adjutant general supervises and controls the replacement operation.

(3) The administration company is dependent upon various organizations within the support battalion for communications, medical support, and certain organizational maintenance. Within its organizational structure, it contains company headquarters, inspector general, information, staff judge advocate, *adjutant general*, *replacement*, and finance support services capability.

(4) Individuals in the administration company can engage in effective, coordinated defense of the unit area or installation.

b. *Organization.* Figure 4-1 presents the or-

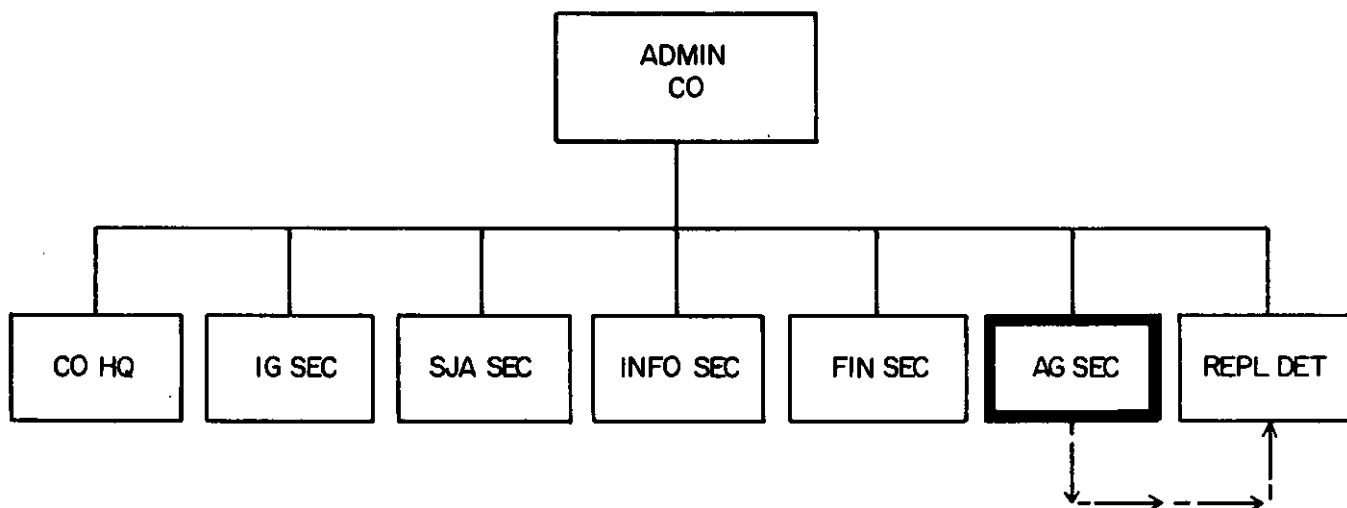

LEGEND:

--->--- STAFF SUPERVISION,
DIRECTION AND CONTROL.

Figure 4-1. Administration company, separate armored, infantry, and infantry (mech) brigade.

FM 12-4

ganization of the administration company in the armored, infantry, and infantry (mech); the airborne, and the light infantry separate brigades. Further information on the administration company is in chapter 1 and FM 54-2.

4-2. The Separate Brigade Adjutant General Section

a. Organization. The separate brigade adjutant general section is organized as shown in figure 4-2. It consists of an AG section headquarters, administrative services division, postal division, and personnel services division. It has attached replacement detachment capability from the administrative company.

b. Mission. The mission of the separate brigade adjutant general section is to provide brigade level direct support P&A services to the assigned and attached personnel of the separate brigade.

c. Assignment. The separate brigade adjutant general section is organic to the administration company. The administration company functions as a carrier unit, in addition to other staff elements, for the adjutant general section head-

quarters, all functional divisions of the adjutant general section, and assigned and attached personnel and equipment.

d. Capabilities. The capabilities of the adjutant general section include:

- (1) Adjutant general staff support to the brigade commanding general, the brigade staff, and commanders of assigned and attached units and their staffs.
- (2) Centralized personnel services for personnel and units assigned or attached to the brigade.
- (3) Decentralized personnel services for personnel and units assigned or attached to the brigade when directed by the brigade commander.
- (4) Cyclic on-site personnel and administrative services to all brigade elements.
- (5) Administrative, postal, and special services to all brigade elements.
- (6) Assistance in effective, coordinated defense of the administration company area as required.

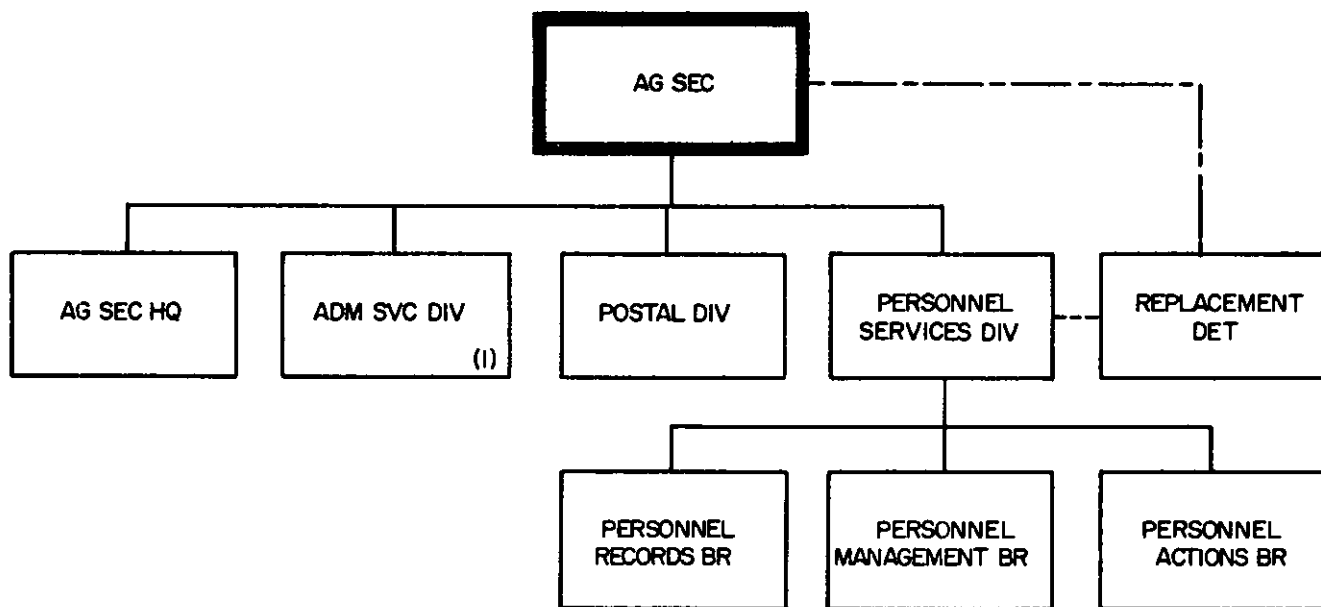

LEGEND:
 - - - - - SUPERVISION AND CONTROL
 - - - - - COORDINATION
 (I) PROVIDES SPECIAL SERVICES

Figure 4-2. Separate brigade adjutant general section.

(7) Replacement support to all elements of the brigade.

e. Limitation. The separate brigade adjutant general section is not authorized automatic data processing equipment nor does it have access to such capability within the organic structure of the separate brigade. Unless ADP to support the AG is authorized by special augmentation, or is made available from sources external to the brigade, the brigade adjutant general provides personnel and administrative direct support services by manual methods to the brigade.

f. Employment. The adjutant general section is employed as a part of the administration company in the brigade rear, less those elements of the administrative services division and the personnel services division designated by the adjutant general to be located at the main command post in support of the commanding general, his staff, and commanders forward of the main command post. The AG may situate himself at the main or rear command post as operational conditions require; however, his normal duty station is

with the adjutant general section in the rear command post.

g. Command and Staff Relationships. Command and staff relationships which apply to the separate brigade AG are depicted in figure 4-3.

(1) *Separate brigade executive officer.* Exercises supervision, direction, and control of the separate brigade adjutant general, less tactical, security, and movement aspects when the adjutant general performs functions as the officer-in-charge, brigade rear.

(2) *Separate brigade S1.* Exercises general (coordinating) staff responsibility and supervision in personnel support matters at the discretion of the brigade executive officer.

(3) *Separate brigade adjutant general.* Works directly for the brigade executive officer and coordinates staff and personnel and administrative direct support services and functions relating to his duties with supported elements of the brigade, both command and staff. When so directed, the adjutant general may supervise the administration company commander and the re-

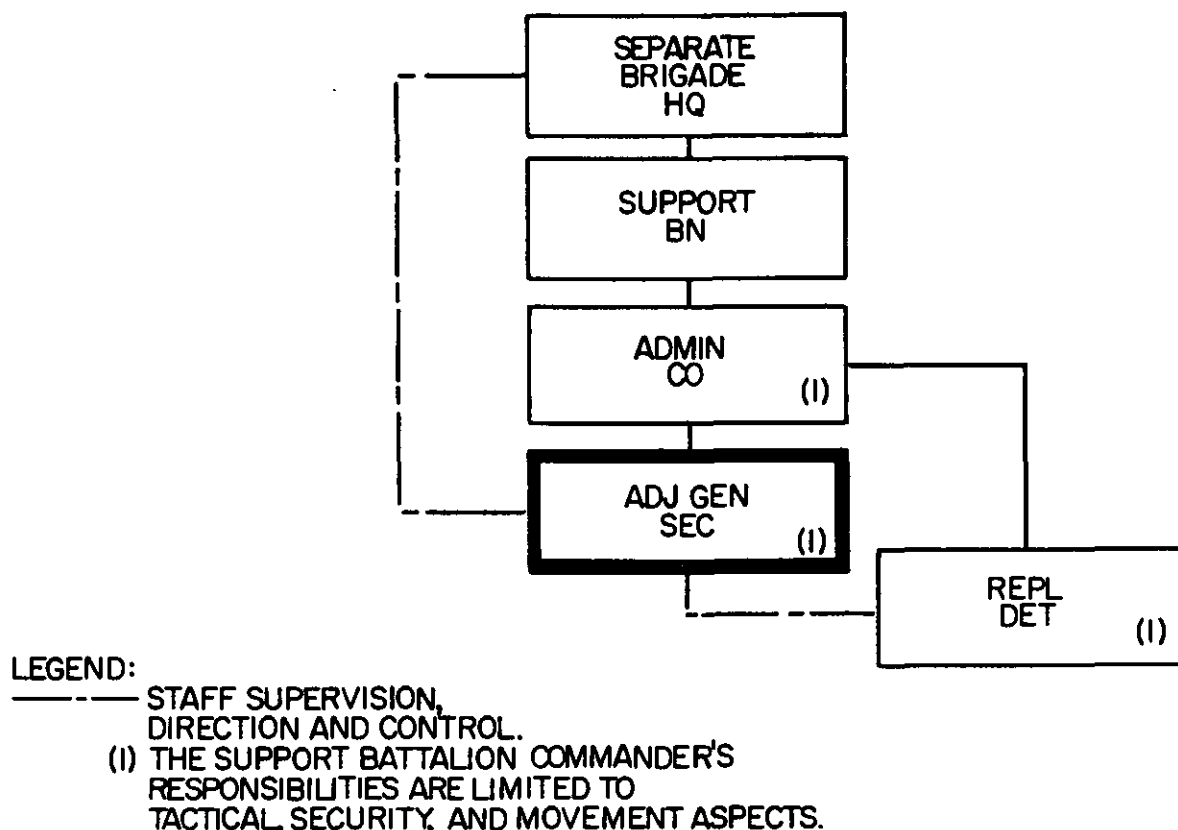

Figure 4-3. Separate brigade AG section command and staff relationships.

FM 12-4

placement detachment commander. When the brigade AG is designated as the officer-in-charge (OIC) of the rear, he is responsible to the support battalion commander for tactical control, security, and movement of the rear command post.

(4) *Separate brigade administration company commander.* Provides the brigade adjutant general section with unit level personnel and administrative support, mess, housing, tactical training, supply, weapons, and vehicle maintenance support. When so directed, performs as headquarters commandant of the brigade rear under the supervision of the OIC, brigade rear.

(5) *Support battalion commander.* Provides tactical, security and movement aspects of the administration company when the company comprises the brigade rear.

h. Functions. Except where command/staff relationships discussed above reflect a difference from division adjutant general operations (chap 3) with respect to staff supervision, responsibility, or functional operations, the functions of the separate brigade adjutant general section are the same as those of the office of the division adjutant general and its functional divisions. Support provided the separate brigade adjutant general by the administration company commander is essentially the same as that provided the office of the adjutant general by the adjutant general company commander in the division. Details are in chapter 3. Procedures employed by the separate brigade adjutant general in implementation of the personnel support system (less ADP) are as described in chapter 6. The following differences which affect personnel authorizations and P&A functions apply in the separate brigade when compared to the operations of the office of the division adjutant general:

(1) *Principal additional duties of AG officers:* In the airborne and light infantry separate brigades, the AG performs the additional duty of separate brigade postal officer. In all separate

brigades, the administrative services officer performs the additional duty of separate brigade special services officer.

(2) *Automatic data processing support:* There is no ADP support for the separate brigade adjutant general functional divisions or for the separate brigade personnel support system. All operations are manual.

(3) *Band:* There is no band authorized in the separate brigade.

(4) *Replacement support:* Unlike the division, which has the augmented replacement capability only, the separate brigade adjutant general section has operational control and direct supervision over the replacement detachment which is organic to the administration company.

(5) *Troops supported:* The separate brigade adjutant general section is organized to provide direct personnel and administrative support services to the numbers of troops shown below:

- (a) Separate armored, infantry, or infantry (mech) brigades: 4,500.
- (b) Separate airborne brigade: 4,000.
- (c) Separate light infantry brigade: 3,900.

i. Field and Combat Operations. See chapter 5. Within the modifications imposed by the operational environment, personnel and equipment authorizations, and the desires of the separate brigade commander, the separate brigade adjutant general section and its functional elements may be deployed in a field or combat operation in the same manner as the office of the division adjutant general. When the separate brigade adjutant general is designated as the separate brigade rear OIC, his position and responsibilities within the separate brigade rear are essentially the same as those of the division adjutant general in the division rear. Chapter 5 may be used as a guide by the separate brigade adjutant general in meeting certain of his field and combat responsibilities.

CHAPTER 5

FIELD AND COMBAT OPERATIONS

Section I. GENERAL CONSIDERATIONS

5-1. General

When the division or separate brigade is echeloned in tactical and field operations, and adjutant general functions are moved from garrison to the field, the division and separate brigade AG will normally echelon his operations between the main and rear command posts. He may incur the responsibilities of the officer-in-charge, division or separate brigade rear, for tactical control, security, deployment, and movement of the rear. Specific duties of the AG (in addition to his technical staff and P&A functional responsibilities) may include: selection and layout of the rear; defense organization; area damage control; rear area security; and physical security. These subjects are discussed in paragraphs 5-4 through 5-17.

5-2. Echelonment of a Division or Separate Brigade Headquarters

a. In a garrison situation, the division or separate brigade headquarters usually occupies a large building or several adjoining buildings. The physical arrangement of staff offices and other headquarters activities is the responsibility of the division G1 or the separate brigade S1. In a combat situation, division or separate brigade headquarters is seldom maintained as a complete entity in one general location. Security and the need for command and control close to the combat elements frequently demand that certain activities be performed relatively near the "front", others at intermediate distances, and others near the rear of the division or separate brigade area. The command and staff elements of the headquarters are normally echeloned (divided) into three headquarters installations: main, alternate and rear. The main is the principal facility through which the commander exercises command and control. An alternate command post insures continuity of operations in the event the main should become inoperable. Ele-

ments of the staff not required to assist the commander in the control of tactical operations are normally assigned to an administrative area, which then constitutes the "rear."

b. When the commander echelons his headquarters, he creates a requirement for individuals who are to be in charge of each echelon. Under simplest circumstances, the headquarters is divided into two parts—that portion most directly concerned with the conduct of tactical operations and under the division or separate brigade commander, and that portion concerned with administrative (including logistical) support of the division or separate brigade and under the tactical control of the support element (DISCOM or support battalion) commander.

c. When the division or separate brigade rear is separated from support elements by terrain or distance, the division or separate brigade commander specifically establishes a rear element and announces this establishment and its OIC by routine orders. (Whether or not the division or separate brigade rear is located some distance from the support elements, an OIC may be designated to provide unity of command for the rear installation and to plan for, coordinate, and supervise the tactical aspects of the rear operations). Separation of personnel and administrative services from other combat service support elements occurs to permit division/separate brigade logistical support activities to keep pace with combat elements moving forward. Personnel and administrative support elements do not require the same close proximity to supported troops. In the division, when logistical support elements are separated from personnel and administrative support elements, the division data center (DDC) in HHC, DISCOM (which provides the division adjutant general with automatic data processing support) is split and operates in two areas. Chapter 7 discusses the DDC split concept in further detail. In the separate

FM 12-4

brigade, personnel and administrative operations continue to be performed manually.

d. Figure 5-1 illustrates a possible echelonment and establishment of a division headquarters during tactical operations. The same principles apply to a separate brigade on a scaled down basis, except the alternate CP in the separate brigade is normally the CP of a designated maneuver battalion. (Brigade boundaries are designated based upon terrain, enemy dispositions, brigade mission and capabilities, and other considerations, and can shift fairly often. The location of CPs can be affected by terrain and enemy, as well as other factors.) The division rear, if not part of the support command CP, is found farther to the rear, normally in the division service area. It may also remain in the corps rear area during periods of fluidity, threat from enemy air or guerrilla forces, or rapid friendly advancement.

5-3. Adjutant General Forward

In a field and combat situation, the adjutant

general main body of support services are located at the division or separate brigade rear. An adjutant general forward element may be recommended by the AG to the Chief of Staff, (in coordination with the ACoS, G1, Personnel), and if approved, is established by the adjutant general to provide direct administrative services support to the division and separate brigade commander and their staffs, and to establish and maintain liaison with supported and supporting organizations.

a. *Functions.* Functions of the AG forward elements are as designated by the chief of staff and the adjutant general on a flexible basis. The normal functions to be performed will include: administrative support to the general staff; personnel management and actions; reporting; and courier and liaison support services. AG forward may, within this framework, be involved to some degree in strength and casualty reporting; awards and decorations; procurement of specific information upon which to base personnel management actions; distribution and control of cor-

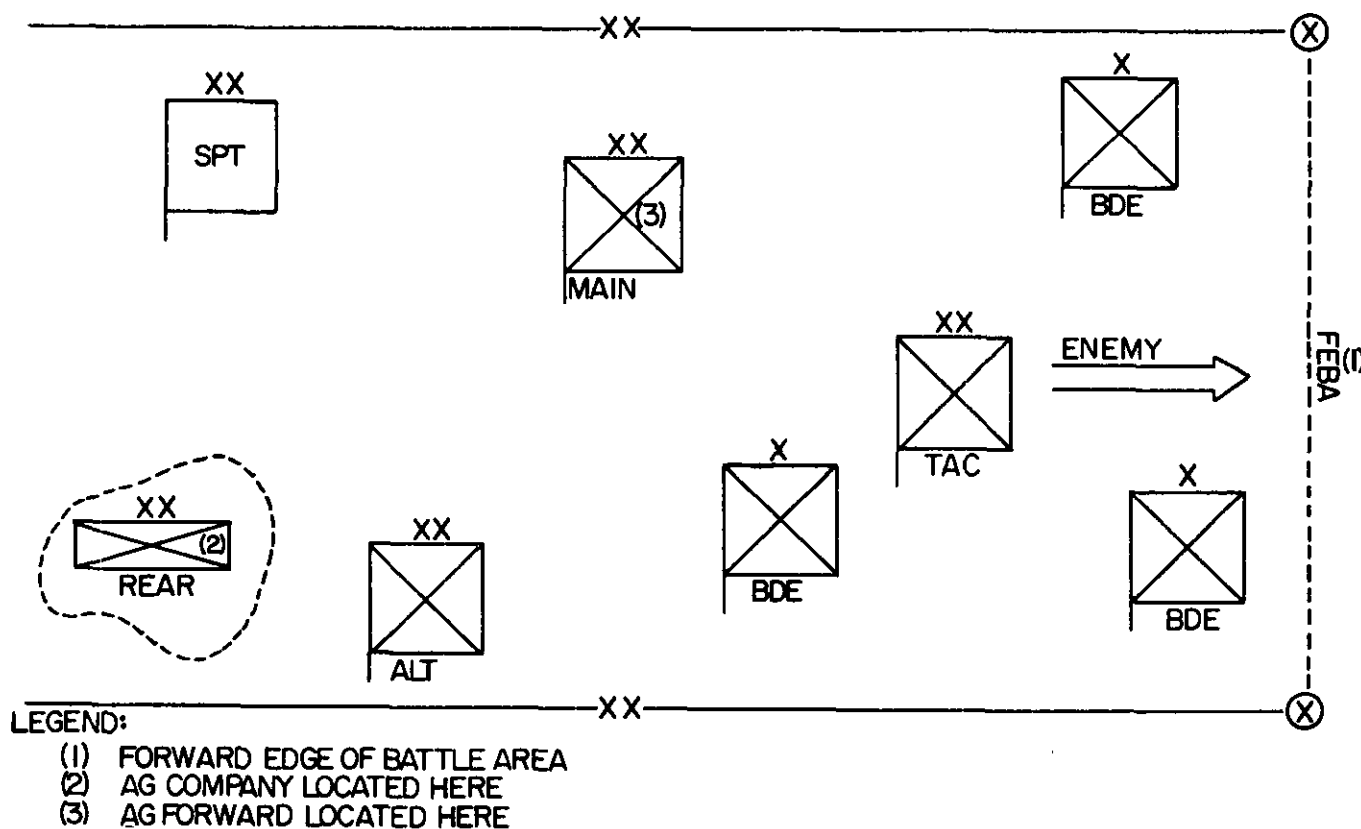

Figure 5-1. Echelonment and Establishment of a Division During Tactical Operations.

respondence; (less messages) authentication of outgoing correspondence, messages, and selected directives; safeguarding and control of classified information; handling of routine orders; maintaining and issuing publications; directing classified courier operations; message procurement and control on AG functional matters; operation of reproduction devices; preparation of station lists from situation maps; compiling lists of units eligible for combat credits; insuring adequate postal services through a forward postal facility; providing publications supply and reference services; preparing, editing, and authenticating communications and directives (other than operational) which cannot be issued by the rear; acting upon emergency personnel matters; controlling replacements as required; and any other matter designated by the AG.

b. Location. For efficient and effective operations, the AG forward element should be located with or near the forward signal communications

center, which is responsible for receiving, distributing, and dispatching messages. Adjacent location and close coordination between AG forward and the signal communications center facilitate rapid recording and dispatch of communications concerning functional areas of responsibility under the jurisdiction of the adjutant general.

c. Staffing. Top-quality personnel are assigned to the AG forward element to represent the adjutant general at the main command post. Personnel are usually drawn against authorizations in the administrative services division, and operate on two 12-hour shifts. Recommended minimum staffing is: one major, AGXO, or one captain, assistant AG, one E6 administrative supervisor, one E5 administrative specialist, one E4 clerk/typist, and one E3 clerk, general, and selected personnel specialists from the PSD in proportion to the involvement of the AG forward element in personnel actions and personnel management.

Section II. THE DIVISION OR SEPARATE BRIGADE REAR

5-4. General Considerations

When the division or separate brigade rear is established, the officer-in-charge organizes for combat operations under the same considerations as does the tactical commander. Specific factors involved are:

a. The tactical nature and characteristics of the division or the separate brigade maneuver elements, and how these factors apply to the division rear.

b. The relationship between the United States and the country where operations are progressing, e.g., native friendliness or hostility; the likelihood of active guerrilla operations, the presence and assistance of friendly indigenous police, armed forces, scouts, etc., and similar practical matters relating to such relationships.

c. Impact of geographic proximity of the rear to supported units in terms of the capability to communicate, and replacement support.

d. Selection of location and layout of the rear.

e. Requirements for the position of the perimeter depth of defenses, preparation of field fortifications and alternate defense positions suitable to rear terrain features.

f. Dispersion of rear elements based on calculated risk factors, consistent with ability to maintain walking contact and unit functional integrity.

g. How well the rear command element can move, defend itself, and communicate.

h. Rapidity of division movement.

i. Enemy capability (air, airborne, guerrilla).

j. Size of available forces in the rear.

k. Collocated or closely situated support or combat divisional or nondivisional elements.

5-5. Selection of Site

The officer in charge of the rear chooses several possible sites within the general location designated by the division G1/separate brigade S1. The major considerations by the OIC in the final selection of a site include: adequacy of space; cover and concealment; drainage; internal and external accessibility (roads, trails, paths, aerial access); security and defensive capability; communications; and internal layout. These subjects are discussed in subsequent paragraphs of this section.

5-6. Cover and Concealment

The selected area should afford cover camouflage and concealment opportunities. The presence of a heavy belt of vegetation on the perimeter of the area is important for screening the bivouac area from hostile observation; however, such a condition may also hamper effective perimeter defense unless efforts are devoted to its selective reduction.

5-7. Characteristics of Good Internal Accessibility

A suitable internal road or trail network which is capable of accommodating large trucks and vans to all segments of the area is characteristic of a site with good internal accessibility. Additional considerations are:

a. The network should have several entrances and exits, negotiable turns for large trucks and vans, and a one-way traffic circulation with convenient access to the motor park and to a dismount point.

b. The roadways should not require much field engineering or maintenance beyond the capabilities of largely unskilled division or separate brigade rear personnel. Engineer support may be completely unavailable.

c. Particular attention should be paid to road surfaces and to trails; streams, ditches, or creeks which cross the internal road network; dry creekbeds which may mean danger of a washout (flash flood) during heavy rains or quick thaws; dangerous curves or steep or infirm shoulders or roadside; and possibilities of blocking roads or trails. Even though a one-way traffic plan should normally be enforced, roads or trails should not be subject to complete blocking by manmade or natural obstacles. Heavy rains also produce deep mud; winter weather may mean much snow and ice; and such conditions must be anticipated and considered.

5-8. Characteristics of Good External Accessibility

Proximity to the main supply route (MSR) with good routes from the proposed area is characteristic of a site with good external accessibility. Additional considerations are:

a. The availability of alternate routes between the MSR and the rear area; possibility of maintaining safe, two-way traffic; and proximity of the area to facilities of other activities.

b. Nearby high ground for a radio relay station.

c. Ground suitable for a landing strip for the division's light planes and helicopters.

d. Nearby training areas (within walking distance).

e. An area suitable for weapons training (a range).

f. Availability of bath and shower points.

g. Reasonable proximity to higher echelon signal facilities which may be used to supplement division communications between forward and rear as required.

h. Locations near installations or facilities which are potential nuclear or nonnuclear air-targets (e.g., fuels or ammunition dumps or depots, installations heavily defended by friendly anti-aircraft guns, and areas where flak may fall) should be avoided.

5-9. Security and Defensive Capabilities

In addition to satisfying operational requirements, the position chosen for a division or separate brigade rear site should be suited to adequate security and defense against guerrillas, partisans, and direct enemy attack. Lack of overall defense factors may cause an otherwise excellent position to be discarded. For example, domination of the position by high hills likely to be held by guerrillas or partisans, from which they could direct mortar and aimed fire, would preclude the use of an otherwise suitable position.

5-10. Communications

Availability of communications is extremely important in the consideration of an area to be used as a rear site. Location of the division or separate brigade rear is normally in the division or separate brigade area of operations. The AG may use FASCOM (Field Army Support Command) communications to enhance the efficiency and responsiveness of his services, when such communications are made available to him. However, communications for the rear are normally provided by the organic division or separate brigade signal unit. See figure 1-3.

5-11. Internal Layout

The internal layout of the rear is patterned at each new site as closely as possible to that of the previous site. Lessons learned from prior ex-

perience should minimize the need for experimentation by trail-and-error. For example, the PSD of the AG company is normally close to the finance company and the administrative services division is normally next to the signal communications center. Internal arrangement of the rear, based on previously developed SOP, is determined by the following principles and requirements:

a. Elements should be grouped according to the supporting functions they perform and to separate the larger, more independent elements. Elements which have considerable internal traffic (e.g., the PSD) should be allocated sufficient space and accessibility to main internal routes to accommodate the traffic they will attract.

b. The replacement detachment should be carefully located so as to enhance replacement morale, insure their effective participation in security operations, and offer a minimum of disruption of replacement processing. The replacement detachment should be separated from the other rear elements. The space assigned should allow for training, messing facilities, and a shower point, for up to 300 personnel; for proper dispersal of the shelter-half tents, or other shelter for 100 men per replacement team (with accommodations for a probable overflow); and for an area in which truckloads of replacements may mount and dismount readily.

c. The dismount point should be located at the primary entrance and exit where the internal road network meets the feeder route to the MSR. Its location should permit vehicles to be headed in the direction of the visitors' motor park, and should not conflict with the perimeter defense plans. The dismount point should also be a sentry post.

d. The visitors' motor part should have enough space for vehicles to park and be adequately dispersed. It should be close to the dismount point, have good concealment, and have a roadbed capable of sustaining considerable vehicular movement and weight during inclement weather.

e. The arrangement of the motor park should permit dispersion of vehicles, suitably concealed. The ground should be capable of sustaining vehicular traffic of considerable density. The motor park should be convenient to the internal road net which leads to the functional operations within the area and should have sufficient space for shel-

ter and passive defense accommodations for motor pool personnel.

f. The rear headquarters should be located near the dismount point and convenient to the internal road net. The rear OIC, the ASD, the signal communications center, and such individuals or units of the provisional command as the OIC decides as necessary are located here. The rear headquarters serves as the tactical command post when defense plans and operations are executed.

g. The APO should be located close to the dismount point to facilitate the flow of traffic it will attract, and near the ASD.

h. The band should be situated in an area which will minimize the effect of noise of instrument practice on functional operations.

i. Figure 5-2 is a schematic (suggested) layout of the rear. This figure presents only one possible arrangement and applies to the division rear. It may be modified as required, or scaled down to fit the requirements of the separate brigade rear.

5-12. Final Selection of a Site

A thorough ground reconnaissance should be made of the sites chosen by map reconnaissance, and the officer in charge and his quartering party should visit the area selected on the map. Once an area has been selected, ground reconnaissance completed, and the features of the area evaluated, the internal sites of division rear elements are determined and marked with signs. The officer in charge has sketches prepared on the area, showing the approximate sites of division rear echelon elements, the traffic circulation plan, dismount points, the perimeter guard posts, motor parks, and the proposed defense plan (if time permits). The sketches should show the locations and directions of fire for crew-served weapons. Signs showing the telephone code designations of elements and guides may be placed in appropriate places along the march route. A strip map showing the route of movement should be prepared for use by individuals who may be in charge of movement serials of rear displacements and by the drivers of vehicles. The spot is elected where the quartering party will meet the head of the column and guide it into the bivouac area. The officer in charge and the quartering party then makes final plans for locating the separate

FM 12-4

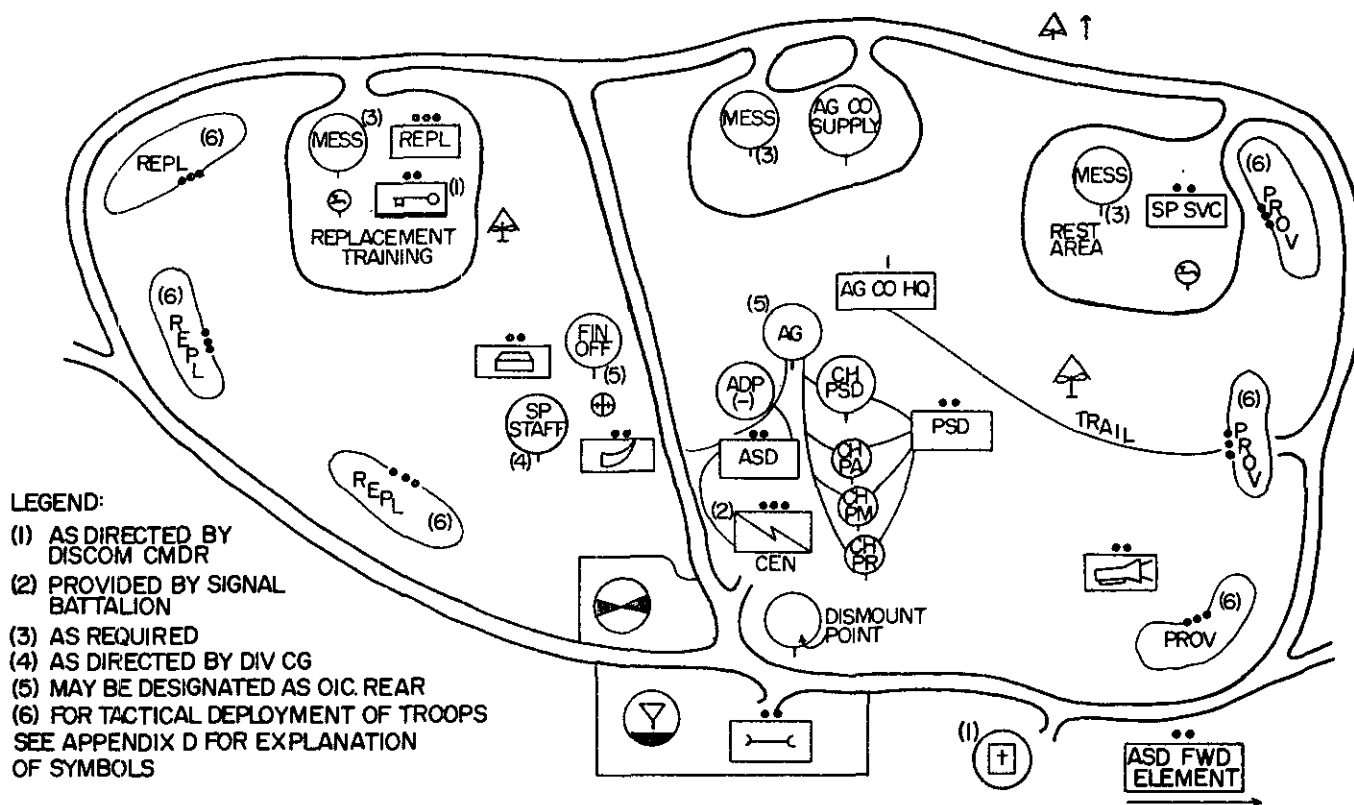

Figure 5-2. Layout of the division rear.

elements at the preselected sites within the rear as soon as the column arrives at the position.

5-13. Defense Planning and Organization

a. Planning. Before actual echelonment occurs, the officer in charge of the rear appoints a planning staff to assist in planning, organizing and later executing the defense plan. This staff consists of the designated headquarters commandant of the rear (normally the adjutant general company commander, administration company commander, or finance company commander as designated by the OIC) and other officers of the special staff elements which are to be situated in the division or separate brigade rear. Together with this planning staff, the officer in charge considers the following factors in establishing a rear defense:

(1) Capabilities of troops and weapons must be carefully assessed. This includes the availability of replacements in the replacement detachments, troops in the division or separate brigade rest areas, their state of training and arms, and the combat capabilities of other units or agencies attached or adjacent to the division or separate

brigade rear. The tactical plan must include alternate or contingency plans to provide for fluctuating numbers of troops who may be available for tactical employment.

(2) Primary missions of division and separate brigade support elements in the rear must be evaluated. The amount of primary mission effort must be determined which can be directed to meet tactical requirements, and at the same time, minimize strain and disruption upon functional missions of rear elements concerned.

(3) The amount of communications capability which should be devoted to tactical operations must be assessed. Wire is laid and telephones installed at desired locations in the defense perimeters and at outposts. The communications net established for functional and operational purposes also serves for tactical control purposes. Wire is the primary means of communication within the area. Alternate locations for telephones are established to serve the tactical purpose when the need arises.

(4) The possibility of enemy guerrilla actions, commando raids, airmobile or airborne assaults, and other attacks must be taken into

account. The defense plan against enemy threats must be complete. It should identify all possible enemy approach routes and concealed areas which enemy forces may occupy to deliver direct or indirect fire. The map coordinates of each of these possible target areas should be recorded so that air strike or artillery can be quickly and accurately called in.

(5) *Civil affairs.* In addition to operational and security requirements, the impact of the introduction of the rear to the civilian populace or community adjacent to the installation must be considered. The resultant increase in personnel and congestion of traffic creates new problems of discipline and control. Normally, disciplinary and civil affairs considerations are coordinated with the division or separate brigade ACoS G1 and ACoS, G5 and S1 and S5 respectively, and with the civil affairs staff element.

b. Organization.

(1) The OIC, division or separate brigade rear is responsible to the support element commander (DISCOM or support battalion) for tactical control, security, and movement of the rear.

(2) All personnel, by rank and precedence within rank, of all units and staff elements assigned or attached to the division or separate brigade rear are responsible to the rear OIC to support integrated plans for area defense and damage control. Tactical requirements prescribed by the OIC *are in addition* to technical operations and functions, which may or may not be controlled by the rear OIC in accordance with division or separate brigade policy and SOP.

(3) Each unit and staff element within the division or separate brigade rear is responsible to provide its own local and internal security.

(4) The division or separate brigade rear consists of individuals who must spend the majority of their time at their administrative or operational worksites. These individuals should be organized into company-sized provisional units for defense. Such organization permits flexible strength expansion in the provisional units and equally flexible assignment of defense sectors and defense functions. Organizing the elements of the rear and assigning personnel into provisional units involve the following considerations:

(a) The principal defense plan and organization should be based upon the number of persons who will typically be present. Plans for expansion evolve from that point. The defense

plan must not depend upon unreliable assumptions, such as the presence of a number of replacements or the availability of personnel in a rest camp.

(b) Deciding how individuals should be assigned to defensive and security tasks is one of the more difficult tasks for the OIC. For example, permitting personnel who are regularly assigned to the same unit or section to operate as a tactical team under their own supervisory personnel has advantages in ease of control, confidence, and higher morale of the personnel concerned; but such a grouping of personnel may disrupt unacceptably the primary mission of their functional section or unit. All personnel of the same section or unit may be lost for training at the same time, or a large number of casualties may be suffered if an attack strikes hard at this particular provisional unit. It is difficult to determine in advance just how many members should be required for defense as a percent of the total force. Only when the rear is operational can the defense plan be made completely realistic. At that time each section chief should know his operating workload, capabilities and how many persons he needs in order to keep abreast of this workload. It is probable that the main defensive alert must be maintained and the greater number of troops will be used at night, during which time most of the members will probably have completed their assigned functional duties. As a practical solution, 25 percent of the personnel can be engaged in defensive alert activities during daylight hours and 50 percent during the hours of darkness. However, these percentages will vary depending upon the number of personnel in the rear echelon and upon the imminence of attack. During actual attack, 100 percent of the able-bodied personnel can expect to be engaged in defensive operations.

(c) The layout of the division rear echelon and defense positions should be planned so that personnel need not travel long distances to reach defense positions. So far as is possible, defense sectors assigned to particular provisional units should be adjacent to work areas of unit members.

(d) Appointment of qualified officers, noncommissioned officers, and specialists to key positions in each provisional unit should not be based upon rank alone. Within reason, key positions must be filled by individuals whose abilities are best suited for the job. Additionally, key positions must be filled by persons who normal-

ly can be expected to be present in the rear if an attack should occur. This may preclude assigning field grade staff officers to key defense responsibilities, but their advice and planning assistance will always be utilized.

(e) An equitable distribution of personnel with combat experience or training should be provided in each provisional unit. Replacement personnel and experienced soldiers in the rest camp are combat trained and should be assigned to defensive duties in that portion of the overall defense perimeter closest to them. They may also be assigned to augment the strengths of other provisional units.

(5) The defense organization should provide for a rear command post and control group and for provisional company-size units. Figure 5-3 contains a chart of a defense organization that could be used. Because of the uncertainty as to the number of individuals available in the rear at any one time, considerable flexibility is essential to the defense organization.

(6) The OIC must make provision for train-

ing, rehearsal, and no-warning practice of the defense organization on a repetitive basis, despite the pressures of daily workload and functional missions, and the routine of administrative crises.

5-14. Perimeter Defense

a. Principles of Perimeter Defense.

(1) The perimeter defense, as established and manned, must permit continued efficiency in the functional operations of the division or separate brigade rear.

(2) Perimeter defense is a defense with no exposed flanks. It is characterized by the placement of troops and weapons along the outer boundary of the defense area. Figures 5-4, 5-5, and 5-6 are examples of types of perimeter defenses, variations, and steps to take in establishing a perimeter defense.

(3) Provisional company-sized units are formed by the division or separate brigade rear OIC to man the perimeter. Each unit is assigned a sector or specific tactical function. Each unit

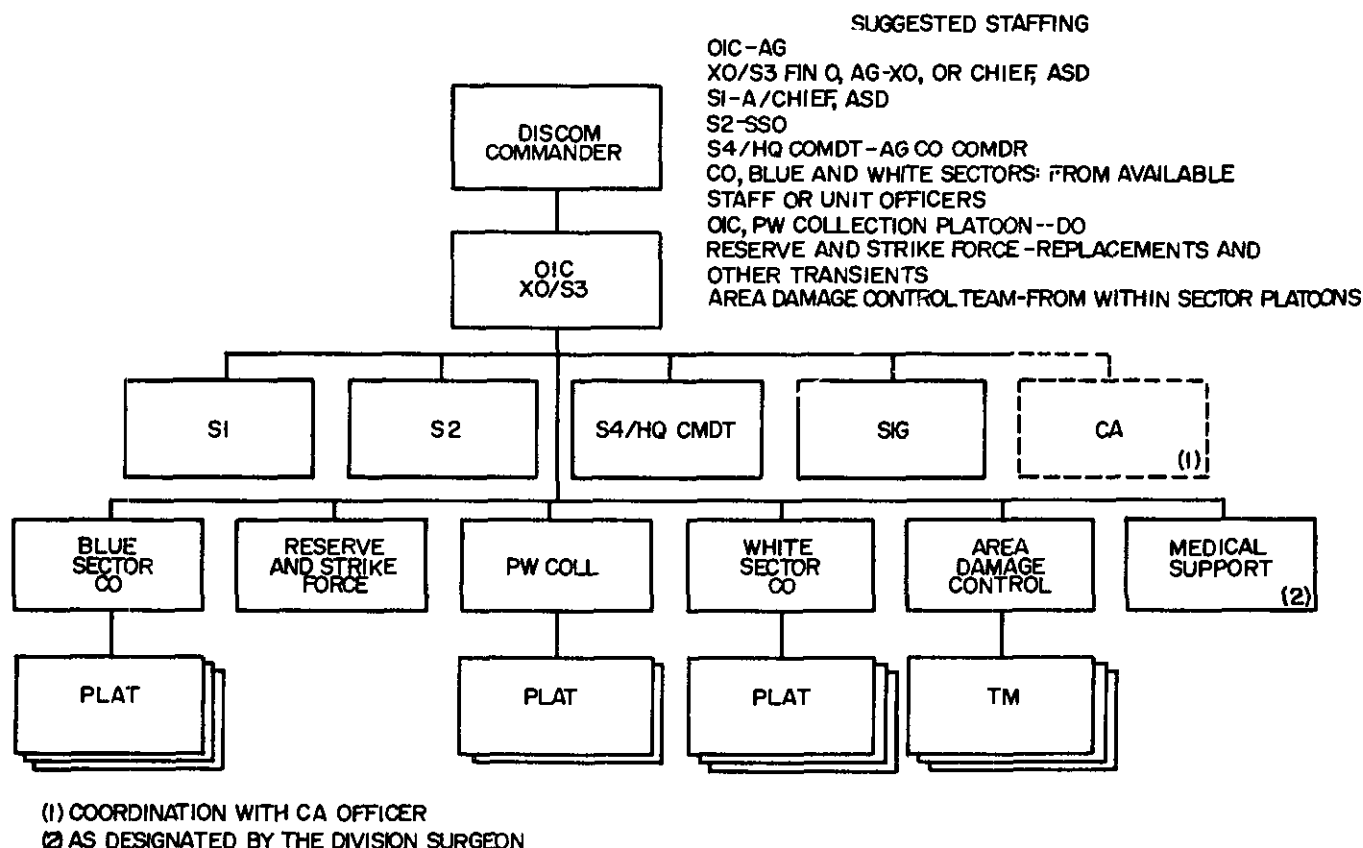

Figure 5-3. Type provisional organization of a division or separate brigade rear.

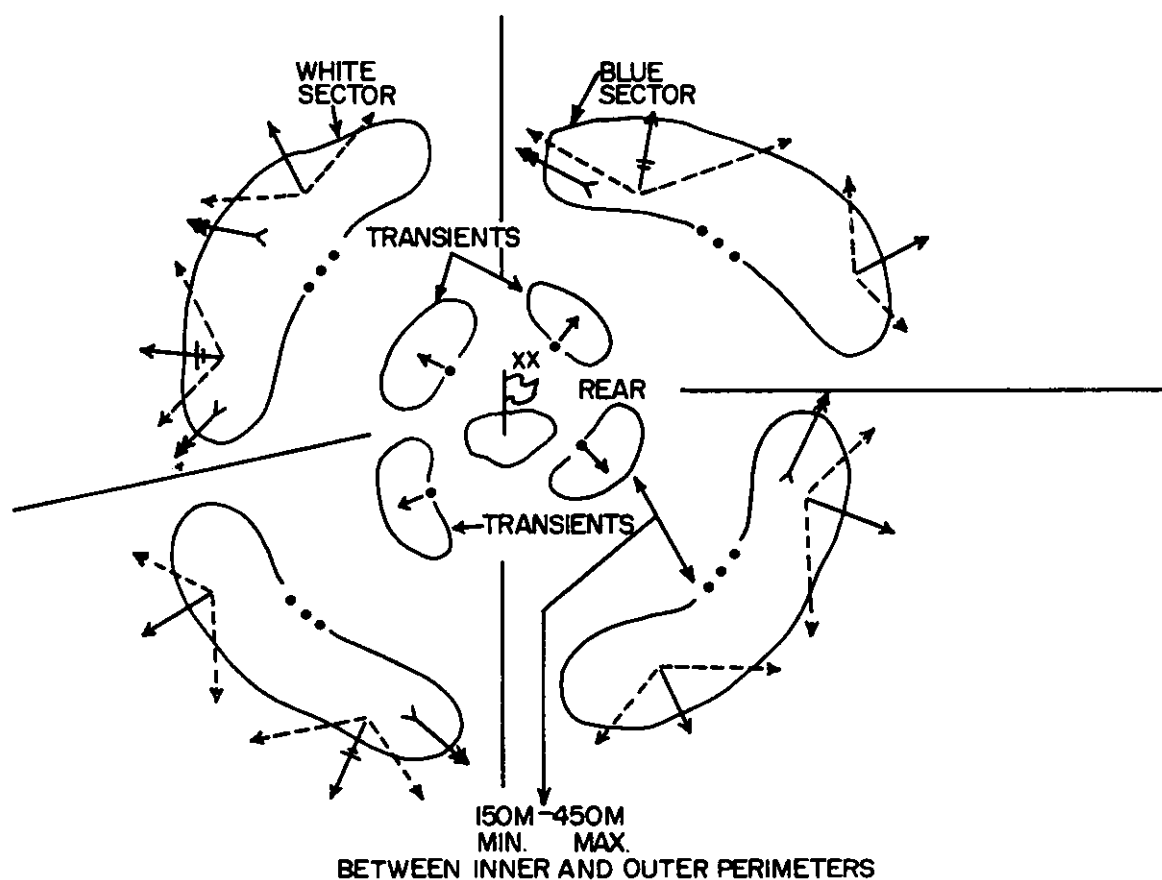

Figure 5-4. Type perimeter defense of division rear.

reassigns portions of its sector or functions to designated platoons and squads. Some platoons or squads may be placed on the outer perimeter, some on the inner perimeter, and some on outpost duty in the sector. Such an arrangement gives depth to the position, makes control easier, and allows the inner perimeter units to give support to those on the outer perimeter. Another suitable arrangement for a perimeter defense is the assignment of one or more provisional company-size units to the outer perimeter and outpost duty and one or more of the same size to the inner perimeter. This method has the advantage of keeping the provisional units intact rather than dividing their platoons between the outer and inner perimeters. To these basic arrangements, variations and combinations may be made.

(4) Certain principles regarding distances and frontages must be observed. The outer perimeter should not be closer than 150 meters (approximately 500 feet) to the inner perimeter. This prevents the inner perimeter from coming under the same enemy small-arms fire as the outer perimeter. The maximum distance between

the inner and outer perimeters should be about 450 meters (approximately 1500 feet); otherwise, inner perimeter fires cannot lend effective support to the outer perimeter. In open terrain, a rear echelon perimeter of approximately 3,000 meters in circumference can be adequately defended; however, in close terrain and conditions of limited visibility, the size of the perimeter should be reduced.

(5) The shape of the perimeter will vary according to the terrain. Perimeters in jungle areas will usually be elliptical to conform to the trail. It is natural that a perimeter on a hill conform to the contour of the hill. Generally, the terrain, best observation, and fields of fire will determine the shapes of perimeters. When possible, the perimeter should be tied into some natural obstacle, such as a river. This allows the commander to concentrate most of his forces in the direction of the most likely attack. Regardless of how secure a natural obstacle might seem, the commander should not be lulled into a false sense of security. The aggressor may choose to attack from the most unlikely avenue of approach to

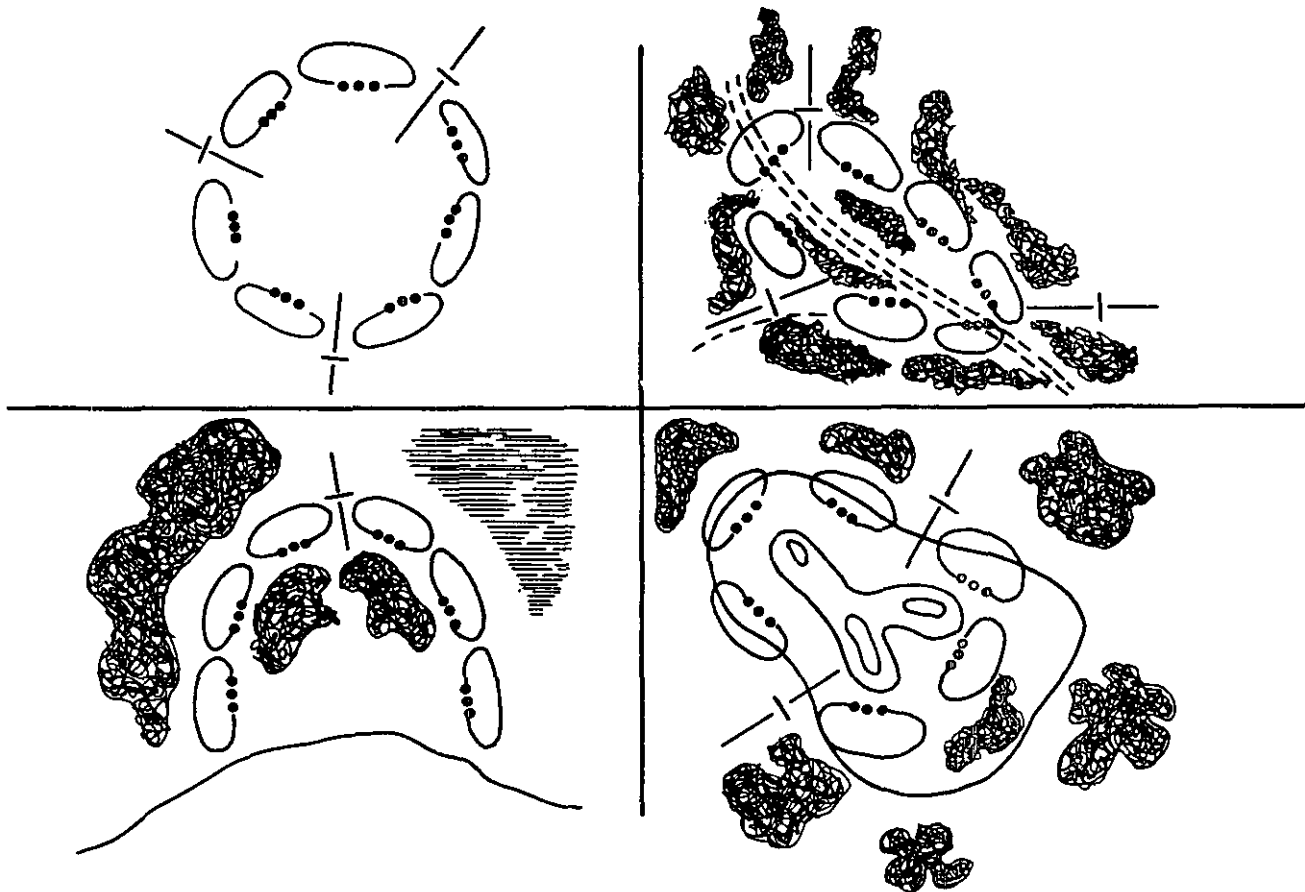

Figure 5-5. Variations of perimeter defenses.

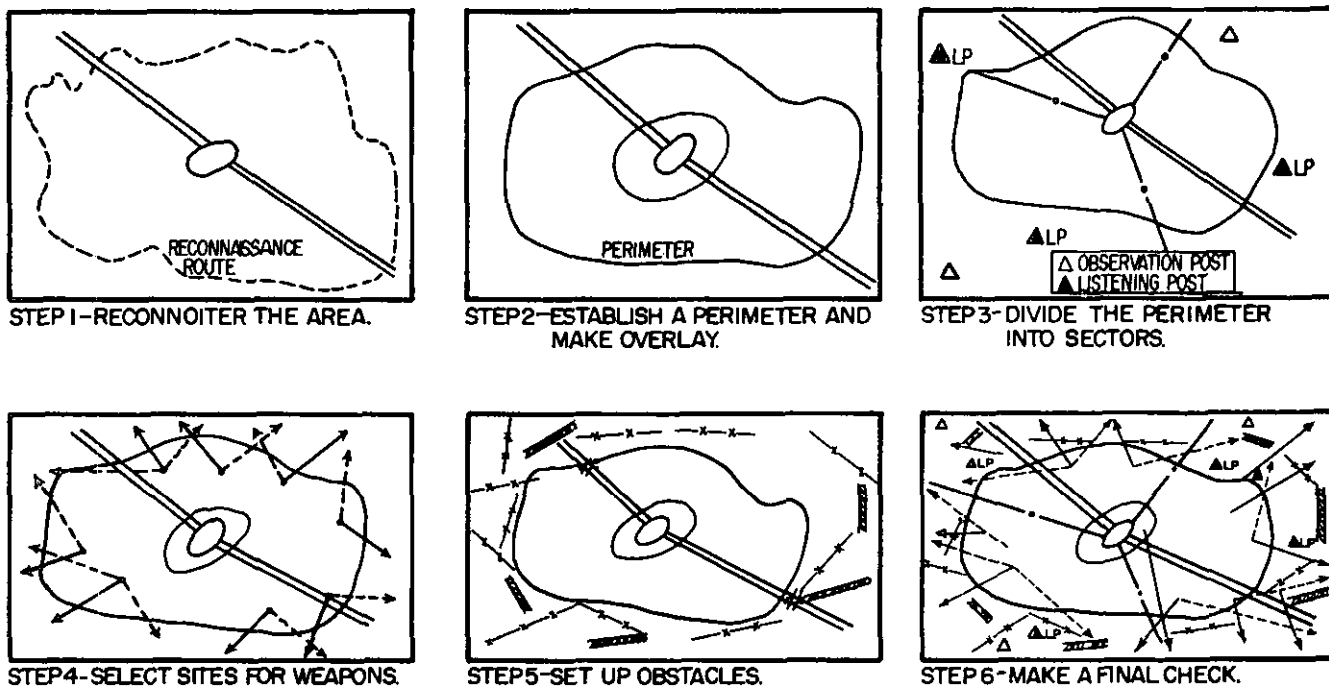

Figure 5-6. Steps in establishing a perimeter defense.

gain the advantage of surprise. Therefore, some security force should man the unlikely avenues of approach to insure that all approaches to the perimeter are covered.

(6) Machineguns normally are used on the outer perimeter. Although they are more effective when employed in pairs, it may be necessary to use them singly to achieve interlocking bands of grazing fire around the perimeter. Whether used singly or in pairs, each machinegun is assigned a final protective line and a sector of fire. The number of machineguns available limits their emplacement on the inner perimeter; however, if fields of fire are restricted on the outer perimeter, it may be advantageous to place the guns on the inner perimeter. Machineguns, if placed on the inner perimeter, are given only a principal direction of fire. They may be positioned to fire into gaps between the units on the outer perimeter. There is no simple solution or means whereby these machineguns can be issued to a provisional unit or to an individual for day-by-day use. The continual need for automatic weapons on the perimeters demands that some type of weapons-rotation system be devised (even though a provisional unit is charged with sector responsibility). Alternative positions for these weapons must be designated. Alternative positions are usually the second or third best positions in the immediate vicinity of the primary position, when the primary position is no longer suitable. The primary and alternative positions should be connected by covered routes. All of the machinegun crews must constantly be prepared to move rapidly to support the scheme of defense. Effective communications must exist so that information and instructions can be transmitted without delay.

(7) To gain information about the enemy, it is necessary to patrol continuously and aggressively. Using the existent structure of the provisional units, both foot patrols and mounted patrols should be established and assigned sectors of responsibility and reconnaissance duties.

(8) Observation posts and listening posts should be established around the entire perimeter to cover the possible avenues of approach. The primary consideration in selecting the site for an observation post is the view it affords; however, other factors such as communications, cover and concealment, and routes to and from the division rear echelon tactical command post should also be considered. Observation posts are established at a distance within control (sight

and sound) of the outer perimeter, in order to be able to give the command early warning of an approaching aggressor. These positions are manned by two or more men during the day. Listening posts are used at night or under conditions of reduced visibility to alert the main body of an approach. They are used in greater numbers than observation posts and are positioned to prevent the enemy's unannounced approach to the main battle positions. Listening posts are usually manned by two men and are sited wherever necessary to prevent a surprise approach. They are usually located 100 to 300 meters beyond the outer perimeter, seldom more than 400 meters, and not so far from the outer perimeter as the observation posts. The actual distance will depend upon the degree of visibility each night. Listening posts are usually recalled at daybreak and manned at evening twilight. Alternate positions should be prepared to counteract possible guerrilla intelligence activities.

(9) Mechanical aids should be used, such as wire, boobytraps, trip flares, battlefield illumination, security-tape minefields, antipersonnel and warning napalm mines attached to tripwires, and any other aids which would prevent surprise attacks upon the perimeter.

(10) The amount of movement within the perimeter at night depends upon how well the unit is trained and how good the enemy's infiltration tactics are. The construction of connecting trenches, consistent with the time available and the danger of enemy attack, will facilitate necessary movement.

(11) Perimeter defense is conducted much like other defenses—when the aggressor gets within the range of small arms, the outer perimeter weapons begin to fire. If and when he reaches the assault position, final protective line fires are called for. If he succeeds in penetrating the outer perimeter, units on the inner perimeter do everything possible to contain the penetration, and the reserve force counterattacks. Counterattack plans must be prepared and rehearsed for each possible route and direction of attack. Units on the outer perimeter should be used in the counterattack only when there is reasonable certainty that the aggressor is not capable of attacking in the area from which the units are withdrawn. When this expedient is used, a security force of at least a squad should remain in the area.

b. *Steps.* (See fig 5-6.) Steps in the organiza-

FM 12-4

tion of personnel for a perimeter defense and conduct of actions are as follows:

(1) The first step in establishing a perimeter defense is to make a physical reconnaissance of the area to be defended. The following points should be considered during the reconnaissance: Is the perimeter defendable by the means available? What are the natural terrain features on which the defense might be anchored? Do fields of fire exist for available weapons? What are the most likely avenues of approach for the enemy's best capability in guerrilla, airborne, and armor operations? How will the terrain affect the perimeter, the distances between the inner and outer perimeters, or the size of a defendable perimeter? Where are the logical sites for observation posts and listening posts? What are the areas of responsibility for foot patrol or mounted patrol activity?

(2) After a reconnaissance has been made, the next step is to prepare an overlay of the actual perimeter to be defended, based on an evaluation of the terrain observed during the reconnaissance. Next, observation posts and listening posts must be spotted on the overlay along the most likely routes of aggressor advance to provide for adequate warning of an attack from any quarter. (Terrain between observation posts and listening posts should be covered by patrols at dusk, dawn, and during periods of poor visibility. Patrols should cover assigned areas at different times by different routes to avoid ambush.) Perimeter guards must be established as the last possible warning of attack. They should be posted at intervals along the perimeter where they can see or detect aggressor activity. Distances between guard posts may be greater during the day and less at night, depending upon whether or not the terrain is open.

(3) The next step in preparing a perimeter defense is locating on the overlay the positions and sectors of fire of machineguns and their fields of fire. Finally, security minefields, mechanical aids, and obstacles should be accurately recorded on the overlay.

(4) The overlay provides an excellent means for checking the completeness of the defense plan. As soon as the plan is adopted, realistic training must be conducted to insure that all personnel can function effectively under the plan.

(5) Continuous effort should be made to improve the perimeter defense, once it has been established. This can be done by—

(a) Carefully evaluating the positions based on fields of fire observation, concealment, obstacles, and communications.

(b) Constructing camouflaged trenches (with overhead cover, adequate depth, firing steps, and irregular direction) to facilitate movement between positions and to lessen effects of enemy fire.

(c) Siting automatic weapons on the flanks of a unit to provide final protective fires in front of a unit and to afford maximum coverage of gaps between units.

(d) Constructing protected and concealed bunkers.

(e) Locating tactical, supplementary, and protective wire with regard to the best final protective line for automatic weapons.

(f) Constructing dummy emplacements.

(g) Establishing defiladed routes for supplies and reinforcements.

(h) Burying or sandbagging wire lines.

(i) Insuring that ammunition and other essential supplies are distributed and stored properly.

(j) Recording the exact location of minefields.

(k) Assigning sectors of responsibility to provisional units. Avenues of approach must not be split between units; e.g., a road should never be used as a sector boundary. One unit must be responsible for both sides of the road, trail, or other likely approach route.

(l) Scheduling and carrying out rehearsals, particularly on counterattack plans.

(6) There are many other safeguards not necessarily part of perimeter defense, yet closely alined. The primary missions of the technical and administrative units must be kept in mind, and must not be abandoned to take up defensive positions at every rumor of guerrilla and infiltrator activity in the vicinity. The OIC, however, must be kept well informed of the situation.

5-15. Area Damage Control

a. Explanation of Terms.

(1) *Area damage control.* Measures taken to avoid or minimize the effects of an enemy mass destruction attack, or natural disaster on administrative support operations.

(2) *Mass destruction weapons.* Mass destruction weapons are those nuclear, chemical, biological, or radiological means that may be used against concentrations of personnel or materiel

to accomplish large-scale devastation or neutralization.

b. Area Damage Control Planning. The purpose of area damage control planning is to prescribe the procedures, organization, and placement of activities to minimize the effects of damage, whether from enemy or natural causes. The planning for rear area damage control must include consideration of actions to be taken before, during, and after the disaster strikes. This planning is broken down into measures taken before an attack (phase I) and measures taken during and immediately after an attack (phase II).

c. The Support Command/Battalion Plan. The division support command commander and the separate brigade support battalion commander include the rear in the area damage control portion of the rear area security plan when the rear is located in the division support area. He anticipates the damage that could occur in the rear area, prescribes the protective placement and dispersion of units, formulates the procedures to be followed, and assigns damage control missions to subordinate activities. The support command area damage control plan or SOP is published to standardize procedures and provide guidance in preparing subordinate plans. Included in this SOP are the designation of damage control forces and the actions they must take.

(1) *Designation of damage control forces.* Each divisional support activity must provide resources for its own damage control functions. As an additional measure, the support command area damage control plans include the designation and formation of *damage control forces* to aid activities that are so severely damaged that they cannot help themselves. These control forces consists primarily of combat service support units or elements thereof and designated engineer elements. Damage control parties that form these units may be used for area damage functions in their own units, but their primary function in the event of calamity is to reinforce other units or installations if the situation warrants and if directed by the support element commander.

(2) *Actions of damage control parties.* Even though an attack has occurred, operations must resume. The restoration of operations involves maintaining or restoring control, evacuating casualties, isolating danger areas, and reducing personnel and materiel losses.

d. Unit Damage Control Plans. The OIC of the rear must insure that the rear has an established and workable damage control plan or SOP. The plan prescribes measures to be taken to minimize the effects of damage occurring in the area and sets forth in detail the equipment and troops that will be dispatched to assist other activities and units, in accordance with approved damage control plans and the SOP of the support command or battalion. The rear damage control SOP prescribes the actions that are taken if the activity is severely damaged or disabled. For example, the SOP includes provision for rosters to facilitate casualty and straggler search or checkoff. Locations of troops and work areas are designated and posted for efficient rescue or search operations. The SOP includes a provision that in the event of a disaster the surviving senior commander in the rear will carry on damage control and mission accomplishment activities.

e. Damage Control Teams. The division or separate brigade rear must organize and man several control and assessment teams (CAT) to carry out damage control functions. These teams must be equipped, trained, and ready for operations at all times.

(1) *Damage control party.* The support command/battalion area damage control plan may require the rear echelon to establish one or more damage control parties to assist other activities or units that have been damaged. If so, it will prescribe the personnel, equipment, supplies, and duties of the damage control parties. Each party should consist of an incident officer (commander), one or more officer assistants, and sufficient enlisted personnel to accomplish the following:

(a) Establish an incident post at the scene of damage.

(b) Conduct a radiological survey.

(c) Determine the extent of damage and amount and type of assistance required and report to the support command.

(d) Command all damage control squads dispatched to the damaged area.

(e) Coordinate with medical personnel in treating and evacuating casualties.

(f) Arrange for necessary administrative support, such as emergency food, clothing, and water.

(2) *Light rescue squads.* Two or more light rescue squads should be organized and equipped to assist in the rescue and removal of casualties,

FM 12-4

first aid, and decontamination. Normally, the light rescue squad is not employed outside the rear echelon. Each squad should consist of at least one noncommissioned officer and six other enlisted men. Squad equipment varies, depending upon its availability, but should include the following: one truck, 3/4-ton; three picks; three shovels; two axes; one hacksaw; one decontaminating apparatus, portable, 1 1/2 quart; six kits, protective ointment; one ladder; one crowbar; one first-aid kit, vehicular; two litters; four blankets; one kit, chemical agent detector; and one can, chlorinated lime, 20-pound.

(3) *Labor squads.* Two or more labor squads (one officer and approximately 20 enlisted men each) should be organized to help in decontamination, salvage, and repair operations. These squads also search for casualties and clear the area of debris. They will use such equipment as is available after the attack. If possible, each squad should be equipped with and have personnel trained in the use of decontaminating materials.

(4) *Radiological survey parties.* Radiological ground survey parties should be organized and trained. Each ground survey party consists of two individuals, a monitor and an assistant. Each team will use one radiacmeter IM-174/PD which are used to detect and measure the rate of gamma radiation is in the area.

(5) *Personnel radiological detection teams.* One team (a monitor and an assistant) should be formed to detect radiation doses received by individuals. A dosimeter (radiacmeter, IM-93/UD) is available for this purpose.

(6) *Chemical agent detection team.* One team consisting of three men should be organized and trained to detect the presence of chemical agents and in the use of the chemical agent detector kit. This kit is designed to detect the presence of and to assist in the identification of toxic chemical agents. The kit is used to determine when it is safe for personnel to remove their protective masks following a chemical attack, for reconnaissance in an area suspected of contamination, and for testing immediately following decontaminating operations.

(7) *Firefighting team.* In addition to the above teams, a firefighting team should be organized, staffed and trained. Equipment required will vary, depending on availability and local conditions.

(8) *Relationship of damage control to security operations is as follows:*

(a) Security operations and damage control measures are related activities of the rear. Personnel from some source must man security positions and damage control teams. Basic passive defense for security is also basic defense against damage; e.g., dispersion, emplacements. Organization for tactical operation also must provide skeleton organization for damage control operations. Damage control teams in operation must be able to contribute toward tactical objectives. Command responsibilities for carrying out damage control operations rests with the same individuals as do tactical operations; i.e., with the rear OIC and his provisional unit commanders.

(b) Minimum damage control activities and security operations can be carried on simultaneously by the rear. For example, reserve tactical forces inside the perimeter may conduct damage control missions while the outer perimeter is actively engaged with the aggressor. In most cases the active defense against attack in progress will receive the major effort of all elements.

(c) Tactical training of rear personnel includes damage control operations as an integral part of instruction. Provisional platoons, squads, and individuals should receive practical application training and be assigned duties in the countermeasures and procedures of damage control, particularly radiological survey, decontamination, rescue, and firefighting.

5-16. Rear Area Security

Rear area security concerns the measures taken to minimize the effects of enemy actions which constitute threats to units, activities, and installations in the rear area.

a. In the combat zone, rear area security is a function of territorial control. Its operations differ from area damage control in that rear area security is essentially an operational matter oriented mainly on enemy forces or actively hostile elements of some type. Its purpose is to prevent hostile forces from overtly or covertly disrupting, diverting, or destroying friendly units and installations. A major effort of rear area security may be the finding and destroying of enemy forces operating in friendly rear areas. As a minimum, rear area security includes local security of units and installations. Enemy operations and threats that endanger a command as

a whole become operational matters and are beyond the scope of rear area security operations.

b. Since rear area security is a part of territorial control, it becomes the responsibility of the commanders charged with territorial responsibility. In the event that the division or separate brigade rear is located outside the division or separate brigade area, it is responsive to the control of the commander of the territory in which located.

c. Security of that part of the rear area in which the combat service support units and installations of the division or separate brigade are located is the responsibility of the support command/battalion commander. The rear area security system is based on local security provided by each unit and installation, along with assistance to the overall rear area security mission. The division or separate brigade rear is capable of defending its own area but is incapable of participating in any active manner in the overall area security mission. Since the support command/battalion area would normally be divided into manageable segments which would include several units and installations, the rear OIC establishes appropriate liaison and cooperates with adjacent units as directed by the support command/battalion commander.

5-17. Physical Security

Rear defense and damage control planning are interrelated and developed concurrently. The division/separate brigade rear must be geared to minimize the effects of enemy mass destruction action, as well as of airborne, infiltration, and guerrilla attacks, and to deal with more than

one of these aggressor actions at one time. The damage control plan provides for the physical security of personnel and equipment by dispersion, occupation of shelters or trenches, and other means.

a. *Dispersion.* The OIC of the rear decides the balance required between dispersion and control, and between protection and operational and defensive readiness. This balance may include a calculated risk in order that the mission can be accomplished. At the time the rear defense plan is developed, the need to disperse personnel and equipment is considered; and troops, equipment, and activities are assigned positions in the rear area. Because of this dispersion, damage is minimized if an attack should occur.

b. *Protective Means.* Protective means include foxholes for individuals, emplacements for weapons, revetments and cuts for vehicles and other equipment, light cut-and-cover shelters for the command post and communications equipment, and collective protectors for defense against CBR attack. The terrain in the area may contain natural geographic features such as caves, steep hills, or cuts, and manmade structures such as local defense air raid shelters, mines, tunnels, and other underground installations which can be used to protect supplies and personnel from nuclear weapons, heavy artillery, or a mass bombing attack. Defensive structures are prepared for protection against nuclear weapons. During and following the use of nuclear weapons, there is usually danger from fallout. One of the best shielding materials is earth; a deep foxhole satisfactorily shields against initial gamma radiation if provided with an earth cover.

Section III. SPECIAL EMPHASIS AREAS

5-18. Impact of Field and Combat Operations

A shift to the field impacts to some degree on all AG functional operations. Unless carefully planned, frequently practiced, and efficiently executed, a move to a field location and subsequent relocations in the field can significantly impede progress within AG operational elements and degrade the quality of P&A direct support to supported units and individuals. AG planning for a move to the field must be thorough, well-coordinated with the appropriate general (coordinating) and special staff and with the DISCOM commander, and complete in its considerations

of impact upon internal AG operations and supported organizations. Careful analysis of projected operational environments in relation to P&A services will provide the AG with a sense of direction to facilitate his planning, selection of priorities, shifts of functional operating elements, execution of the actual move, and organization "on the ground" in the field location for sustained P&A support operations. Although all direct support P&A services represent varied degrees of criticality at different time (none are relegated to unimportant status), certain subject areas gain in sensitivity and emphasis when a division or separate brigade is moved to the

field and tactically employed. These subject areas are: personnel strengths; casualty reporting; replacement operations; awards and decorations; special services; postal operations; and ADP support. Coordination requirements are intensified by combat conditions between AG functional divisions and finance, graves registration, provost marshal, medical, DISCOM supply and transportation elements, and personnel and administrative activities at higher, lateral, and lower levels. Personal contact with supported and supporting units on routine administrative matters is less frequent. The transition from garrison to field and combat conditions tests the capability of the adjutant general to plan, communicate, coordinate, and execute effectively his direct support P&A responsibilities in a field location, and the adaptability of AG operational personnel and equipment to field conditions. In addition, the transition invariably increases the workload and pressure on supporting communications and ADP facilities.

5-19. Personnel Strength

a. General. The division G1 and the separate brigade S1 are responsible to their respective commanders for providing information concerning strengths within the command, and for accomplishing staff actions to maintain strengths. In fulfilling their responsibilities, these coordinating staff officers make continuous estimates of strength for present and future situations and exercise overall responsibility for the replacement function within the command.

b. Strength Reports.

(1) *Personnel Daily Summary (PDS).* The division G1 and the separate brigade S1 obtain information on the status of the command strength through the receipt of reports from subordinate units and estimate future strengths by making a loss estimate (using recent experience or loss rate tables provided by FM 101-10-1 and/or FM 101-10-3). They employ the most expedient communication means and the personnel daily summary (PDS) or some similar device to procure and convey information promptly to interested commanders and their staffs on the current status of personnel strength in the command. The PDS contains unit designations, authorized, assigned and previously reported strength, daily loss data, gains, and other remarks. An example of the PDS is contained in FM 101-5. The adjutant general receives morning reports (or morning report feeder data), casualty reports, other reports, and verified per-

sonnel data rosters from the same subordinate units which report to the division G1 or the separate brigade S1. Information in the reports and rosters received by the adjutant general partly duplicates the information contained in the PDS, and is in considerably greater detail. Individual personnel change data normally flows from the reporting unit to the personnel services division where reports are prepared (by coordinated ADP or manual processes) in accordance with PERMACAP or non-PERMACAP procedures (see DA Pam 600-8 for details). Rosters and reports are furnished by the AG as required to the commanding general, his staff, supported commanders and their staffs, and higher headquarters, as prescribed. The division G1 or separate brigade S1 periodically check PDS data against records maintained by the adjutant general to insure the greatest degree of PDS accuracy. Differences are reconciled among the G1, AG, and the reporting unit commander. Users must understand the basic difference between PDS "immediate" operational data and AG "after the fact" statistical personnel data is the as of times of the reports.

(2) *Periodic Personnel Report.* The division G1 or separate brigade S1 assembles the periodic personnel report and submits it to the commander either on a schedule or on call. The report recapitulates summary personnel data and personnel activities in the command. It contains unit strength data, significant items in the fields of personnel management; morale, discipline, law and order; headquarters management; and other miscellaneous information. This report forms the basis of the operational report (for details, see AR 525-15). Much of the data listed in the periodic personnel report comes from adjutant general records in the PSD, i.e., strengths by unit, gains, losses by category, replacement information, and awards and decorations. An example of the periodic personnel report is in FM 101-5.

(3) *Other Strength Measures.* A division or separate brigade commander whose many missions in garrison, field, or combat may include fire base, base camp, or other diversionary and housekeeping duties, will frequently express the desire for a realistic assessment of true "fighting" strength, especially as concerns the maneuver units. Since every unit's present-for-duty strength is continually degraded by PCS losses, the sick, absentees such as leave, TDY, and AWOL personnel, or men on lengthy detail and

special duty, various measures of fighting or "foxhole" strength can result in an alarming, and possibly quite accurate, picture of combat readiness. The wise AG will consider the construction of a foxhole strength assessment, and will discuss and plan it with the G1/S1 and maneuver unit commanders. The essence of such a measure is the decision whether certain types of absentees or ineffectives should be excluded from effective strength. Since authorized strengths of various maneuver units differ rather widely, it is normally best to express and compare effective strengths as percentages of authorized strengths *in the combat MOS* so that tank, infantry, mechanized, and armor units may be examined together with reasonable validity. Such a report is often received by the G1/S1, as frequently as once weekly in fluid personnel situations; but the AG should have considerable interest in it as another measure of replacement problems. Additionally, if his commander should base his "sales pitch" to higher headquarters on such data, or tend to give more credence to foxhole strength reports than to the PDS or to PERMACAP data, the AG and G1 must be harmoniously prepared to discuss apparent discrepancies and stress the special features of the various data compilations.

(4) Communications must be established and kept open between the adjutant general, subordinate reporting commanders, and the division G1, or separate brigade S1. The efficient management of personnel resources is heavily dependent upon accurate, up-to-date personnel data.

(5) References on personnel strength and accounting are:

(a) AR 680-1, Morning Report and Personnel Data Change Report RCS AG 546.

(b) AR 680-4, Personnel Management and Accounting, Card Processors PERMACAP.

(c) AR 600-10, The Army Casualty System (see para 5-20).

(d) FM 101-5, Staff Officers' Field Manual.

(e) FM 101-10-1, Organization, Technical and Logistical Data. (Unclassified)

(f) FM 101-10-3, Organization, Technical and Logistical Data. (Classified)

(g) DA Pam 600-8, Military Personnel Office Management and Administrative Procedures.

5-20. Casualty Reporting

a. Casualty reporting is one of the most exact-

ing administrative tasks performed in the Army. It has an importance and immediacy not found in other administrative functions because of its far reaching effects on the morale of both military personnel and the civilian populace, its impact on the Army image, and its connection with other functions of Army administration. When a soldier becomes a casualty, the Army must notify his next of kin as swiftly as possible (through appropriate channels) and furnish facts with *complete accuracy*. The division and separate brigade adjutant general casualty operation must check all reports and be meticulously accurate in every detail to insure that information forwarded to higher headquarters is totally correct.

b. The division G1 or separate brigade S1 prepares plans to establish a casualty reporting system and furnishes precombat instructions and procedures to be followed at all levels throughout the command. The division or separate brigade adjutant general operates the casualty reporting system for the command. During the formulation of instructions and procedures, the adjutant general assists the G1/S1 in preparing guidance which will insure the highest degree of casualty reporting accuracy throughout the command. The most important single factor is to be prepared *prior to combat action*, at all echelons of command throughout the division and separate brigade, with an effective casualty reporting system which is simple, and accurate, and rapid.

c. Units report casualties to the adjutant general in accordance with AR 600-10 theater implementing instructions, and local SOP and directives. These reports, when processed and transmitted by the AG:

(1) Furnish complete data on casualties for use in notifying higher headquarters, and the notification of emergency addresses.

(2) Provide data for settling pay, insurance, pension, and disability claims.

(3) Provide various DA, theater army, and subordinate headquarters agencies with information necessary to compile loss rate tables (see FM 101-10-1 and FM 101-10-3 for details) and estimated requirements, and to facilitate personnel strength accounting and replacement flow.

d. A casualty branch will be required in combat as a separate organizational entity within the PSD in both the division and the separate brigade. Although the personnel actions branch provides the basic staffing for the casualty re-

FM 12-4

porting function, personnel may be drawn from other elements of the PSD as required to expand casualty reporting and administration capability. Casualty reporting operations are coordinated by the PSD with the postal, finance, surgeon, provost marshal, graves registration, and chaplain functions to insure thorough checks of all related data which is directly or indirectly connected with a battle or nonbattle casualty. The adjutant general implements the AG forward element at the division or separate brigade main command post as the connecting link between reporting tactical commanders and the PSD; for liaison with forward medical and graves registration activities; and for control and checking of casualty information. The AG forward establishes direct liaison with the division tactical operations center (TOC) and obtains and furnishes releasable operations to the adjutant general which helps to forecast casualty trends. This technique provides the AG casualty reporting function at the rear additional time to prepare administratively for casualty reporting and facilitates accuracy in the reporting of mass casualty situations.

e. The adjutant general provides casualty reporting procedures as required to commanders of assigned and attached units within the division and the separate brigade to insure the highest degree of reporting accuracy. He reports instances of erroneous individual reporting of casualty information to the responsible commander, identifies the cause of the error, and takes prompt corrective action in coordination with the commander concerned to preclude recurrences.

f. The adjutant general must be intimately familiar with coordinating staff elements who also deal in casualty information, and normally base their data on separate reports. The G3/S3, in his daily command briefing on operations in combat, can be expected to mention numbers of men killed or wounded in a given contact and *operational* time period (e.g., as of 0600). The commander and chief of staff can be expected to follow such TOC-received data with the greatest interest, and to retain and ask questions about the data. This will cause the G1 to coordinate closely with the G3, and perhaps force him to assemble his own "operational" casualty data daily. Such data can be extremely useful to commanders and staffs. However, all users must understand the basic differences between immediate operational data (which could be considered as fragmentary or "frag" reports) and AG cas-

ualty data. A striking example is the soldier correctly reported as killed in action via operational channels within an hour of his death, but who does not become a KIA in AG casualty data until sometime later when identification is made. Also, higher headquarters which maintain monthly casualty totals will encounter discrepancies as the result of month-end casualties, if their system artificially counts a casualty as having occurred on the date the report was received there, not on the date it happened. It is the AGs responsibility to be the resident expert and educator on all such complications as they may exist under differing systems.

g. AG casualty reporting personnel in the PSD must be thoroughly familiar with, and able to instruct others in: personnel identification, graves registration, casualty evacuation channels, location of servicing hospitals, and records and personal property disposition procedures. They should have working knowledge of the army mortuary affairs, survivor assistance, and escort of remains programs. References which pertain to these functions are:

AR 600-10, The Army Casualty Reporting System;

AR 606-5, Identification of Personnel (Identification Cards, Tags, and Badges); AR 640-25 and AR 640-30, Photographs; TM 10-286, Identification of Deceased Personnel; AR 606-15, Preparation of Fingerprint Record; AR 640-20, US Army Intelligence Badges and Credentials.

AR 638-30, Disposition of Remains—Graves Registration Organization and Functions in Support of Military Operations; AR 638-40, Care and Disposition of Remains; FM 10-63, Handling of Deceased Personnel in Theaters of Operations; and

DA Pam 638-1, Escorting Deceased Army Personnel.

5-21. Decorations and Awards

a. The division G1 or separate brigade S1 is responsible for making advance plans for combat and to establish a decorations and awards policy. The adjutant general assists by formulating plans, writing procedures, and operating the decorations and awards system for the command. As in the casualty reporting system, precombat instruction and meticulous attention to detail is indispensable to effective operation of the decorations and awards system.

b. A decorations and awards branch will be required in combat as a separate organizational entity within the PSD. The AG forward element should be tasked to provide liaison between recommending commanders in combat brigades and battalions (where the bulk of recommendations will be developed) and the PSD, where they will be processed to final form. Continual attention must be devoted to the accuracy of recommendations for decorations and awards. They must be factual, eye-witnessed, events or accomplishments, appropriate to the decoration or award recommended, and expeditiously processed.

c. AR 672-5-1 contains details on the Army Awards program; AR 672-5-2 provides illustrations of awards.

5-22. Special Services

a. *General.* Special services take on significant emphasis in the field and in combat situations. Morale and recreational benefits are never more important and necessary to the division mission than under combat conditions. The division G1 and separate brigade S1 are responsible for general (coordinating) staff supervision, and the adjutant general is the principal operator of the special services program.

b. *Unit Rest Camps.*

(1) Unit camps can be set up in the unit or division rear area by the unit concerned. The unit commander is responsible for providing the operating personnel and essential accommodations (messing, sleeping, bathing) from within his command. Religious, finance, and American Red Cross services and recreational activities are provided by the appropriate agencies; e.g., the American Red Cross—writing materials, cigarettes, toothpaste, candy, etc.; the division special services officer—recreational equipment, paperbound books, small crafts materials, and musical instruments; and the chaplain—religious support. Normally the rest camp is in or near the division or separate brigade rear, and its operations are under the supervision of the special services officer. The camp usually is staffed by personnel levied from elements of the division or separate brigade and attached troops.

(2) In a more static combat situation where base-camps or rear areas of relative permanency are the rule, the division or separate brigade may improve upon the unit rest camp concept by constructing, equipping, and operating a company-size standdown area. Semipermanent facilities for billeting, mess, showers, clothing issue,

and recreation may be available, and the recreation facilities could well include an entertainment stage for live shows and movies; a snack bar featuring hamburgers, beer, and soft drinks; a swimming pool; a volleyball/basketball court; a branch of the open mess (club) facility; and any other feature available which will give the combat soldier a welcome respite from war.

c. *Rest Areas.* Rest areas are established by division or separate brigade directives to provide rest and rehabilitation for battalion-sized units. Responsibility for operation of facilities for rest areas normally is assigned to the rear-area OIC (usually the division or separate brigade adjutant general), who tasks his special services officer with supervision and operation. The size and condition of the area and the availability of personnel will govern the numbers and types of personnel utilized to operate a rest area. Operating overhead personnel are levied from various elements of the division and are supplemented by personnel from units resting in the area. In addition to housing, messing, and bathing facilities, services include dispensaries; exchanges; barbershops; postal services; clothing and equipment exchanges; and finance, religious, and special services.

d. *Mobile Special Services Units.* Mobile units such as bookmobiles, clubmobiles, craftsmobiles, and showmobiles may be available within the theater of operations to the adjutant general, and may be attached to the division or separate brigade. While attached, mobile units are supervised by the special services officer, who insures that units are scheduled so that remote and isolated divisional and brigade units receive prime consideration; that they are on site and available in troop unit locations during the soldiers' free time; and that they receive tactical protection, administrative services, and logistical support.

5-23. Postal Service

The division G1 or separate brigade S1 has general staff responsibility to prepare plans for postal services in field to combat environments, and the adjutant general operates the postal system in accordance with US Postal Service and Army regulations. Efficient postal operations enhance the morale of all individuals of the command. Under tactical conditions, the AG postal division provides complete postal services (sales of money orders, stamp stock and stamp paper, delivery of official and personal incoming mail to individuals and units served, and acceptance and dispatch

FM 12-4

of outgoing mail) for all assigned and attached units of the division. Further details on postal operations are in paragraph 3-10, chapter 3.

5-24. Replacements

a. General. Division and separate brigade operations are organized to provide for the centralized control of replacements at the division or separate brigade rear, from the time they report for reassignment within the command until they are delivered to the ultimate units of assignment. The goal of the replacement system must be optimum response to using commanders. Principal planners of the replacement operation are the division G1, and the separate brigade S1. The adjutant general assists in planning, and supervises and operates the replacement system for the command.

b. Duties and Responsibilities.

(1) The division G1 and the separate brigade S1 are concerned primarily with:

(a) Preparing and maintaining a continual estimate of the replacement situation, including unit replacements, and advising the commander and staff thereof. As necessary, they submit estimates to higher headquarters.

(b) Formulating replacement policies concerning requisitions and reports, allocation and distribution, procurement; and assignment and reassignment.

(c) Coordinating replacement matters with other staff sections, higher headquarters, and subordinate units.

(d) General staff supervision of the adjutant general's replacement operations.

(e) Allocating replacements to units, based on priorities established by the division or separate brigade commander.

(2) The adjutant general, as the principal operator is responsible for directing replacement operations and has operational control of the replacement system's operating units.

(3) The division G3, and the separate brigade S3 recommend priorities concerning the allocation of individual replacements and, in coordination with the G1, or S1, as appropriate, recommend the assignment of unit replacements.

(4) The division G4, or separate brigade S4 coordinates the availability of supply facilities and transportation in replacement operations. In coordination with the G3/S3, he recommends assignment of logistic support tasks for individual and unit replacements. Elements of DISCOM carry out approved logistic support assignments, e.g., the supply and transport battalion provides the central issue facility (CIF) and transportation of replacements to ultimate units of assignment.

(5) Other special staff officers provide recommendations for assignment of replacements in their branch of service or specialties; e.g., the division surgeon assists in the determination of assignment of medics.

c. Replacement Operations. Details on replacement operations are contained in paragraph 3-13, chapter 3. Under garrison conditions, a replacement detachment operates primarily for in-processing and as an overnight holding detachment for newly assigned personnel, pending their assignment to a unit. Under tactical conditions, a replacement detachment may be required to receive, mess, train, orient, and process replacements to their assigned organizations, and to command and control replacements when required as a reserve and/or strike force of the division or separate brigade rear.

5-25. Automatic Data Processing Support

The division data center (DDC), or an augmented administrative machine branch provides the division adjutant general with ADP support, as required. There is no ADP capability in the separate brigade. Details on the division DDC are in chapter 7.

CHAPTER 6

PERSONNEL SUPPORT SYSTEM

6-1. General

The personnel support system in the division and separate brigade is designed to provide accurate and efficient personnel services for commanders, their staffs, and the individual soldier. The system implements the concept of centralized personnel recordskeeping, personnel management support, and personnel actions processing; and uses automatic data processing equipment (or manual processes when automatic data processing equipment is not available) to provide P&A services as required to all assigned and attached organizations of the division or separate brigade. Techniques employed by the personnel support system are designed to assist commanders at all levels within the division or separate brigade to resolve personnel management problems, obtain and distribute replacements, facilitate personnel status reporting, alleviate administrative workloads in the supported unit, and increase the responsiveness of personnel support throughout the supported organization. The system relies heavily upon the ability of all participants to accurately report personnel status and changes, and to coordinate personnel support requirements, actions, and responses. It demands conscientious attention to detail and the meticulous evaluation of reports, information, and statistics.

6-2. Organization

Personnel support system is organized on four levels of command in the division and three levels of command in the separate brigade. These are:

a. The Division. Division headquarters; the brigade level, including division artillery and support command; the battalion or squadron; and the company, battery, or troop.

b. Separate Brigade. Separate brigade headquarters; the battalion; and the company.

6-3. Concept of Operations

a. Command Participation. Commanders at all echelons operate the personnel support system

as outlined in figure 6-1. Under normal circumstances, the division or separate brigade adjutant general establishes direct lines of communication between AG functional elements and supported organizations, by-passing those commanders in the intermediate chain of command. This facilitates the handling of routine personnel matters for those commanders supported without intervening processing and delays. However, any intermediate commander in the chain of command may interject himself into the administra-

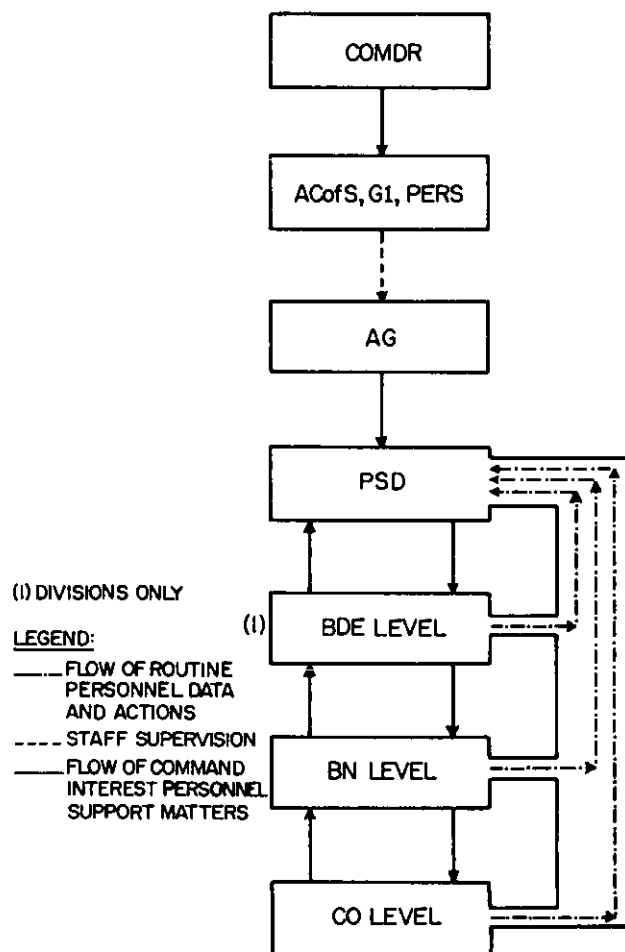

Figure 6-1. Personnel support system.

FM 12-4

tive chain between his subordinate commander and the adjutant general at any time he deems such action appropriate, or he may establish policy on certain types of personnel actions and order them to be processed through his headquarters for review and subsequent forwarding to the adjutant general for administrative processing and action, e.g., officer actions. Normally, a commander who exercises this prerogative does so for a limited time and number of actions since his headquarters is not designed to be in the administrative chain and lacks the time or depth in personnel expertise to conduct sustained personnel operations. Each supported commander down to and including company level establishes a direct administrative line of communication with the adjutant general to permit the expeditious flow of personnel management and actions matters to and from the AG functional element performing the particular service. The adjutant general provides P&A services in response to each commander's desires and priorities; within the purview of doctrine, regulations, and procedures; and as directed by the division or separate brigade commander.

b. Division and Separate Brigade Level.

(1) *Coordinating staff supervision.* The division G1 is responsible for general (coordinating) staff supervision of all personnel matters in the division, except for the administration of military justice, which is performed by the staff judge advocate. The separate brigade S1 exercises similar staff supervision over personnel support matters at the discretion of the brigade executive officer.

(2) *Combat service support elements.* The division and separate brigade combat service support commanders (division support command and separate brigade support battalion) provide command-wide personnel and administrative services through their adjutant general company and administration company adjutant general section, respectively.

(3) *Adjutant General.* The adjutant general is the chief operator of the personnel support system at division and separate brigade headquarters level. He provides division-wide and separate brigade-wide personnel administration, vital personnel status reports and statistics (based upon input from supported units and higher headquarters), other personnel services directed by the division or separate brigade commander which are deemed essential to the morale and well-being of all personnel, and technical training associated

with personnel support systems. The adjutant general implements the capability of his functional personnel support facilities within the adjutant general company (in the division) and the AG section of the administration company (in the separate brigade) to coordinate with organizational personnel support elements throughout the supported organization. His principal personnel support facility is the personnel services division (PSD); however, other AG elements are also employed (e.g., the administrative services division for the publication of special orders).

(4) *Personnel services division (PSD).*

(a) A PSD is organic to the adjutant general company in a division and the adjutant general section of the administration company of a separate brigade. The PSD is normally delegated the operational authority for handling military personnel management and personnel administration matters on which the division or separate brigade commander is authorized to take final action. The PSD performs a central role in the personnel support system by serving for the AG as the executive agency of the division or separate brigade commander and his staff in personnel support matters. The PSD:

1. Exercises, within command policy, the division or separate brigade commander's authority in personnel matters.

2. Monitors the utilization of personnel throughout the division or separate brigade to insure sound personnel management practices and procedures.

3. Furnishes statistical data on current and projected personnel strengths.

4. Assigns and reassigns personnel in accordance with established priorities to meet unit requirements.

5. Prepares detailed and summarized informational personnel reports and statistics for use by divisional and separate brigade units and higher headquarters.

6. Assumes custodial responsibility for individual personnel records.

7. Provides technical advice to commanders and their staffs on personnel management, actions, and administration matters.

8. Provides functional training and orientations for adjutants, PSNCOs, and company clerks.

(b) Detailed information on the functions of the division and separate brigade PSD is contained in chapter 3 and 4, and information c

procedures implemented by the PSD as a military personnel office are in DA Pam 600-8.

c. Divisional Brigade Level.

(1) *Brigade Commander.* Except when organized as a separate brigade, the brigade is not an administrative headquarters. The brigade commander exercises overall personnel management and personnel administration responsibilities for his command, but does not normally enter detailed personnel management and personnel administration channels which flow directly from the personnel services division to the supported battalions or companies under his command. The brigade commander supervises only those personnel matters of significance or current importance to him, whether passing to or through the brigade from his subordinate commanders or from higher headquarters, and those generated by his own headquarters. Normally, the brigade commander enters into administrative channels in the processing of officer and other selected personnel actions, at his discretion or at higher headquarters direction. The division adjutant general provides the brigade commander with personnel data and information on his subordinate units' authorized and current strengths, shortages, overages, known gains, and known losses to assist him in his responsibilities.

(2) *Brigade S1.* The brigade S1 is the intermediate level personnel administrator. As such, he maintains normal staff contact in personnel matters with his counterparts in assigned/supported battalions. This liaison permits the S1 to keep his commander informed of personnel problems, trends, and accomplishments within the brigade. He is assisted by the brigade personnel staff NCO. When the brigade is detached from the division and a support team is attached to the brigade from the personnel service division to serve as its personnel section, the brigade S1 performs the duties of personnel officer.

(3) *Brigade personnel staff NCO.* The brigade PSNCO assists the S1 with personnel matters concerning individuals assigned to the brigade headquarters and headquarters company. He provides technical advice and assistance to battalion PSNCOs only concerning the personnel policies of the brigade commander, and on actions that are required by policy to pass through the brigade headquarters.

d. Battalion Level.

(1) *Battalion commander.* The battalion commander exercises overall personnel manage-

ment and personnel administration responsibilities of his headquarters and all subordinate assigned and attached company-sized elements of the battalion.

(2) *Battalion S1.* The battalion S1 is the intermediate organization level personnel administrator. He supervises the personnel and administrative activities of the battalion and keeps the commander informed of personnel problems, trends, and accomplishments. His specific duties are enumerated in FM 101-5. Personnel and administrative actions not requiring command attention are processed from companies within the battalion directly to the PSD. In these instances, the PSNCO is kept informed by the unit 1SG. The battalion S1 performs as the battalion personnel officer when the battalion is detached from the division or separate brigade and is provided a special support team by higher headquarters for this purpose.

(3) *Battalion personnel staff NCO.* The battalion PSNCO assists company first sergeants and clerks with personnel matters through *personal* liaison with those individuals. The battalion PSNCO is the first consolidating element in the administrative personnel management and action process. Actions from companies within the battalion are normally consolidated by the PSNCO and forwarded to the PSD for necessary action. The battalion PSNCO is a coequal of the brigade PSNCO except in personnel matters or actions forwarded through the brigade headquarters.

e. Company Level.

(1) *Company commander.* The company commander is the primary personnel manager. His assistants are his executive officer, first sergeant, and company clerk in his headquarters, and his platoon leaders, and platoon sergeants, and squad leaders. The company is the lowest administrative headquarters in the chain of command. It is the level having the most direct contact with the soldier and is the initial point of contact for a soldier with a problem or a request for some type of personnel action. All personnel actions initiated by the soldier are channeled through his company orderly room. If the action is not initiated correctly and expeditiously by the company commander, it may not be acted upon promptly and efficiently at other administrative levels. Specifically, the company commander:

(a) Is responsible for the proper utilization of his assigned personnel based on their military occupational specialties (MOS), train-

FM 12-4

ing, experience, desires, and the needs of the organization. He is aided in this area by the advice and assistance of the battalion PSNCO, the battalion S1, and the PSD. All assignments, reassignments, and changes of duty position made by the company commander should be in the best interests of the Army, the unit, and the soldier. All status changes must be rapidly reported to the PSD.

(b) Is responsible for the initiation of reclassification action when he determines a soldier to be inefficient, better qualified in a higher military occupational specialty, or physically incapable of performing duty in his primary MOS.

(c) Authenticates the unit morning report and other personnel documents, and takes action on and forwards personnel actions in accordance with Army regulations.

(2) *Company clerk.* The company clerk is frequently the only contact many soldiers have with the Army's personnel support system. Therefore, he should be a mentally mature soldier, motivated and trained to assist each individual with his problem.

(a) The company clerk prepares the unit morning report, maintains morning report suspense and card files on all personnel of the unit, and prepares personnel actions or requests their preparation at the PSD as prescribed by DA Pam 600-8. He obtains information from personnel records, maintains the company files, and helps members of the company make appointments with the PSD and the finance company. (These appointments are coordinated through the battalion PSNCO). The company clerk prepares unit orders; charge sheets and allied papers for courts-martial; commander's recommendations for board actions to eliminate undesirable soldiers; flags for records of personnel under charges or investigation; and other miscellaneous correspondence and forms as directed by the company commander, executive officer, or first sergeant.

(b) The company clerk relies heavily on advice and assistance from the PSD. He receives guidance and information on preparation of personnel actions from the battalion PSNCO and DA Pam 600-8.

6-4. The Personnel Staff NCO (PSNCO)

a. *General.* A PSNCO is the principal liaison agent between his organization and direct support personnel and finance activities at division or separate brigade headquarters level. The

PSNCO must be a well-trained and carefully selected individual. His responsibilities form a key part of the personnel support system. He functions as a staff advisor to the organization commander and staff on personnel matters. He is provided to assist brigade and battalion commanders in accomplishing their personnel management and administrative responsibilities.

b. *Orientation.* The newly assigned PSNCO must receive a thorough orientation in the operations of the PSD and finance elements of the organization. His familiarity with the division and separate brigade direct support personnel and finance activities and his understanding of his own role in the personnel support system are extremely important. The PSNCO is a *technician*, and as such a *technical extension* of the PSD. The PSD keeps the PSNCO informed of new and changing personnel procedures and policies. Except for formal training by Department of the Army schools, the PSNCO is normally trained by the division or separate brigade adjutant general, in coordination with the appropriate organization commander. His training by the AG includes summaries of experience and techniques found successful by other PSNCO in similar circumstances (see para 6-5b for further details on PSNCO training).

c. *Employment.* Detailed duties of the PSNCO are contained in DA Pam 600-8. His employment should follow these guidelines. Essential P&A services may be sacrificed or degraded in terms of quality if the PSNCO is given additional duties which interfere with his primary function, such as assistant battalion sergeant major or chief clerk for the staff. If the PSNCO is lost to other functions, companies normally experience proportionate difficulty in handling essential administration pertaining to individuals, thus creating potential problem areas which may also affect PSD operations adversely.

6-5. Procedures to Increase Productivity

These division or separate brigade AG can take certain actions to increase productivity and efficiency at all levels and echelons throughout the personnel support system, and thereby provide more accurate and responsive personnel services for supported commanders, their staffs, and the individual soldier. These include:

a. *Visits to the PSD.*

(1) *Commanders and their staffs.* The adjutant general should encourage commanders and

their staffs to visit to PSD to be briefed on the functions and operations of the PSD; its functional branches and support teams. As understanding of the personnel support system will increase the capability of commanders and staff personnel to use efficiently the system thereby decreasing the frustrations and disappointments for both the supported commander and the individual.

(2) *Individuals seeking service.* The appointment system should be used to admit individuals to the PSD for purposes of completion of an individual personnel action or to answer an individual inquiry. The use of the appointment system will require an inquiry into the reason for the PSD visit by subordinate commands and commensurately reduce personnel traffic to, within, and from the PSD. When troops visit the PSD, their time is lost to the unit. Studies have indicated that on some operational days, two to three hundred soldiers may visit a central personnel facility in the division for one reason or another, and that approximately 90 percent of these inquiries could have been handled *in the company* if certain procedures were implemented at that level. These include:

(a) *Standing operating procedures.* Comprehensive and understandable SOP for company level personnel will increase efficiency and reduce use of the system for repetitive inquiry on routine problem areas.

(b) *Informal correspondence and telephone calls.* Use of informal correspondence on routine matters, formal requests for information, or telephone calls in the more urgent case, will greatly reduce nonessential personnel traffic, and provide the unit commander a means of control over the flow of data to and from his organization.

(c) *Specialized functional support teams.* Use of specialized support teams from the PSD is a highly desirable technique which takes the support to the unit and provides service to the commander "at home." These teams, if properly coordinated at special and personal staff level, can include records, management, actions, replacement, legal, administrative, medical, and financial personnel, who can handle many routine actions at the unit location and resolve problems and questions for soldiers without their having to

APPOINTMENT FORMAT			
(Last Name, First Name, Initial)		(SSN)	(Unit)
Appointment with:	(Name)	Location (Bldg nr)	Date & Time
Reason for appointment: _____			
(Signature of First Sergeant)		(Signature of Personnel Staff NCO)	
Time left unit	Time arrived PSD	Time left PSD	Time returned unit
_____ Signature of Team Leader PSD			
THIS FORM MUST BE PRESENTED TO FIRST SERGEANT			

Figure 6-2. Appointment form for PSD visit.

FM 12-4

(HEADING)

SUBJECT: Request for information _____ (Date)

CG, _____ Division
ATTN _____

(Last name, first name, initial) (Grade) (SSN)

Request the following information be provided on/for the above named soldier:

(Initials of Co Clerk or 1SG) _____ (Signature of Requester)

1st Ind

TO: FROM: CG, _____ Division DATE: _____

() Requested information is not available at this headquarters. It is being requested from: _____

by this office and will be provided to you upon receipt. Estimated time to obtain this information is _____ days.

() Requested information is furnished below:

(Signature & Title)

Figure 6-3. Sample inquiry form letter.

depart from the unit at all. A 15- or 20- minute contact at the unit can save one or two (or more) days of lost time when the soldier travels to and from the PSD for the same service.

b. Functional Training. Training of personnel, both officer and enlisted, in the fundamentals, objectives, and procedures of the personnel support system is of primary importance to the division and separate brigade AG.

(1) *Officer personnel.* Each officer assigned to the office of the adjutant general in the divi-

sion and the adjutant general section in the separate brigade should be periodically rotated in his duty assignments in order to provide him with a working knowledge of as many AG functional areas as possible. Adjutants of supported organizations should be invited and scheduled into the functional areas on a cyclic basis for orientation training to insure that they are properly qualified and acquainted with the personnel support system and how it functions in support of their particular organizations. The AG should pay particular attention to keeping Regular Army AG

officers who are serving in combat arms duty positions, and Reserve AG officers on active duty as enlisted men, abreast of significant "AG" news and personnel functions and systems changes.

(2) *Enlisted personnel.* The PSNCOs and company clerks within the division and separate brigade comprise a key and integral part of the personnel support system. These personnel should be closely screened, evaluated, trained, and provided to supported organizations by the PSD in all cases where workable techniques can be applied. All company clerks and PSNCOs should perform at least 2 weeks in training within the PSD to insure they acquire a thorough knowledge of the centralized personnel system and how it operates in support of their assigned organizations. The PSD should function as a PSNCO and personnel specialist training center for the division. A well-calculated and planned, cyclic program should be established with the objective to train and rotate personnel noncommissioned officers and specialists to duty positions out of the PSD into support organizations, and into the PSD from supported organizations. Such a program will:

(a) Provide to efficient NCOs and specialists within the personnel support system at all levels within the PSD and supported organizations the opportunity for promotion and increased professional potential and expertise (e.g., a good E4 or E6 in the PSD should be given every opportunity to compete for grades E5 or E7 at the company, battalion, and brigade levels; the E5 and E7 in the supported organizations should have the opportunity to compete for grades E6 and E8 in the PSD.)

(b) Increase overall personnel support system efficiency. An experienced, PSD-trained PSNCO and company clerk can successfully handle many "on the ground" personnel problems in the unit to the satisfaction of supported individuals, thereby reducing the volume of actions referred to the PSD. A well trained and experienced PSNCO or company clerk is also more adept at identifying and properly handling personnel problems which are administrative emergencies or potentially explosive situations.

(c) Provide additional time which can be spent at the unit to upgrade the quality of services provided by the PSNCO or company clerk; this time is utilized by the PSD in further personnel training, development of a higher degree of functional proficiency, and reduction of response time of the PSD to organizations supported.

(d) Enhance individual and collective morale throughout the division or separate brigade.

(3) *All personnel.* All officer and enlisted personnel working within the personnel support system should be encouraged to avail themselves of Department of the Army periodicals and US Army Adjutant General School non-resident instructional materials which will keep them informed and to become better qualified.

6-6. Procedural Guidance

Department of the Army Pam 600-8 provides complete procedural guidance in:

a. Responsibilities and functions of commanders and supervisory personnel as key personnel managers in relation to personnel management and personnel administration matters.

b. Techniques of organization, management, and control of the personnel services division.

c. Internal organization and operation of the personnel services division.

d. Steps which must be taken by the personnel manager to train required operating personnel in the personnel services division.

e. Actual step-by-step procedures (to include formats, examples, verbiage, and regulatory references) for:

(1) *Personnel management.* Reclassification; evaluation; testing; special assignments; levies; requests for training; assignment and reassignment; preparation, verification and use of personnel information rosters; requisitioning of officer and enlisted personnel; promotion and lateral appointments; oversea reassignment roster processing; dependent travel; special forces and airborne training; retesting in the Army classification battery; and language proficiency testing.

(2) *Personnel actions.* Suspension of favorable personnel actions; casualty reporting; survivor assistance; line of duty and misconduct investigations; appointment in the regular army; processing officer applications and declinations for extension of service on active duty; extension of enlistments and current periods of active duty; applications for Army officer candidate school; discharge (expiration terms of service) and immediate reenlistments; discharge and release from active duty; applications for retirement; recommendations for discharge because of unfitness, unsuitability, or misconduct; request for change

of name, birth data, and social security number; preparation, processing, and recording of officer efficiency reports (both officers on active duty for training (ACDUTRA) and active duty officers and RA enlisted personnel with reserve officer or warrant officer status; requests for excess or non-CONUS leave; requests for military identification cards; medical examinations; notification, followup, and recording of immunizations; and request for branch transfers (officers).

(3) *Personal affairs.* Issuance of uniformed services identification and privilege cards; processing elections of options under the retired serviceman's family protection plan; issuance and termination of certificates of eligibility for mortgage insurance; maintenance of personnel readiness files (applicable to units on USARSTRIKE troop lists); benefits, rights, and personal affairs for dependents of deceased military personnel.

(4) *Military pay administration.* Responsibilities and duties of the personnel officer, coordination with the finance officer, personnel records check procedures involving the PFR and MPRJ; military pay administration in the unit.

(5) *Records.* Inprocessing and outprocessing of records; records control; preparation, screening and maintenance of personnel suspense cards; processing source documents of information; verification of military personnel rosters; initiation and maintenance of qualification records; sample surveys; preparation, maintenance and disposition of emergency data forms; preparation and processing of armed forces security questionnaire; preparation of extracts of morning reports and military records of previous convictions; administrative actions resulting from absence without leave or desertion; processing requests for ID tags; identification of alien personnel; preparation and recording of enlisted conduct and efficiency ratings; maintenance of the personnel data card.

(6) *Administrative support.* Document routing; distribution of orders; reports control.

(7) *Rosters and reports.* PERMACAP and non-PERMACAP rosters and reports, to include data bases for each category of rosters and reports.

CHAPTER 7

AUTOMATIC DATA PROCESSING SUPPORT

7-1. General

a. This section provides information and doctrine on the division data center's organization, mission, assignment, capabilities, employment, staff and command relationships, concept of operations, and functions, to guide the division adjutant general in procurement of ADP support for his functional operations when ADP equipment is not under his direct supervision and control.

b. The division adjutant general is furnished automatic data processing support from the division data center (DDC), HHC, DISCOM, when the DDC is authorized in the division. When it is not authorized, the division adjutant general company is augmented by an administrative machine branch of the PSD.

7-2. Division Data Center

a. Organization. The division data center (DDC) is organized as shown in figure 7-1. It contains an office of the DDC (ADPS operations officer), an ADP management and planning section, a systems maintenance section, an ADP operations section, a files maintenance and document control section, and an equipment maintenance section.

b. Mission, Assignment, and Capabilities.

(1) *Mission.* The mission of the DISCOM DDC is to provide automated data processing service to support the division logistics system (DLOGS) and the personnel management and accounting card processor system (PERMACAPS) in the accomplishment of personnel, pay, and selected logistic functions to include maintenance reporting and management. This mission includes ADP support to the functional personnel and administrative services elements under the staff supervision and direction of the division adjutant general.

(2) *Assignment.* The division data center is organic to the headquarters and headquarters company, division support command.

(3) *Capabilities.* The division data center has the following capabilities:

(a) Installs, operates, and maintains automatic data processing equipment and associated equipment organic to the unit.

(b) Provides operational automatic data

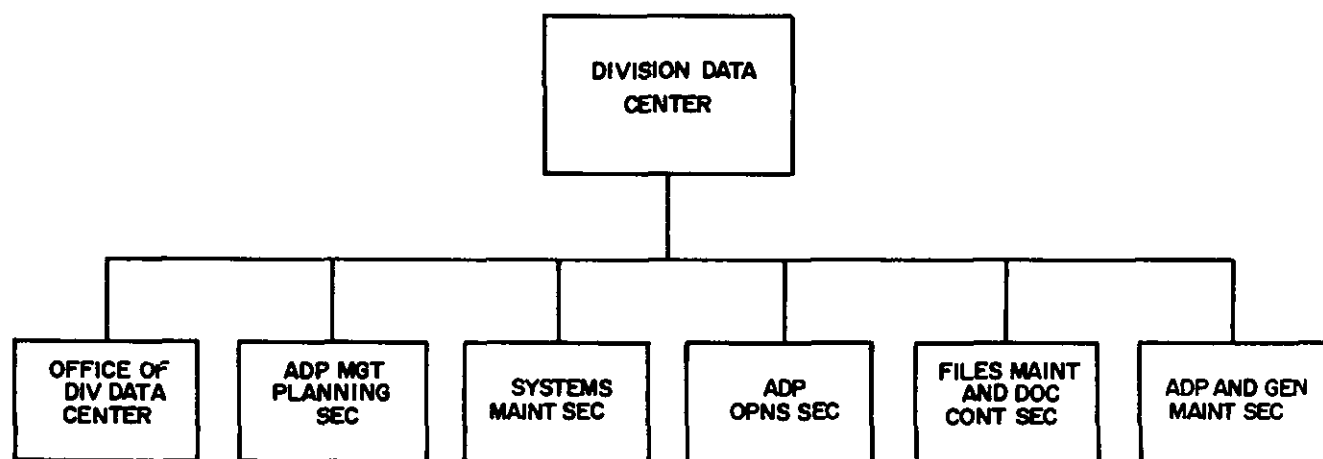

Figure 7-1. Division data center.

FM 12-4

processing support for personnel, pay, and selected logistics functions of the division.

(c) Operates, as required, as a centralized facility in one location or as a decentralized (split) facility in two separate locations.

(d) Contains personnel and equipment to operate on a two-shift basis.

(e) Performs organizational maintenance on ADP equipment and generators.

(f) Is fifty percent mobile in organic vehicles.

c. Employment. The division data center is capable of operating in both garrison and field environments. In a garrison operation, the division data center operates as a single, centralized entity. In field operations, the division data center is split, with one element located in the division rear to provide ADP support for personnel and pay functions and the other element located in the main support area to provide ADP support for selected logistic functions. The exception to this rule is when the division rear is collocated with the HQ DISCOM in the main support area. When the division data center is split, personnel and equipment assets are divided to assure that each computer complex is capable of providing adequate and efficient service to major users (one of whom is the division adjutant general).

d. Command and Staff Relationships.

(1) *DISCOM commander.* The DISCOM commander commands and controls the division data center and coordinates its use with all major users through his DDC ADPS operations officer in accordance with organizational policies outlined in paragraph 1-7, AR 18-1.

(2) *Adjutant general.* The adjutant general is a major user of the DDC. He provides input directly to the DDC within policies established by DA and the division commander and as implemented by the DISCOM commander. Output is received directly by adjutant general functional elements from the DDC for appropriate checks and distribution to product users as required. Conflicts in policies concerning input, output, and other support furnished the adjutant general by the DDC are resolved between the adjutant general and the DISCOM commander.

(3) *Split concept employment control.* When the DDC is split in a field or combat situation, the DDC element which performs the personnel and pay functions operates in the vicinity of the division rear under the direct supervision and control of the OIC, division rear.

(4) *DDC ADPS operations officer.* This officer supervises DDC operations for the DISCOM commander and maintains close liaison with major users. He resolves operating, programing, work-flow, and associated problems with major functional users of the division on a direct coordination basis. Conflicts are referred to the DISCOM commander by the DDC ADPS operations officer, and to the adjutant general by his functional element users.

(5) *Functional element chiefs, office of the adjutant general.* Division and branch chiefs of the office of the adjutant general coordinate their ADP support needs directly with the DDC ADP operations officer. They also receive and check output from the DDC and effect distribution to division staff and command elements.

e. Concept of Operations.

(1) *General.* Whether the DDC is in a split or consolidated configuration, it furnishes ADP support incident to requirements of the office of the adjutant general and its functional elements in personnel and administrative direct support matters. DDC support includes application of programs prescribed by the personnel management and accounting card processor (PERMACAP) system (see AR 680-4 and DA Pam 600-8) and other programs and tasks prescribed by the DISCOM commander.

(2) *Input.* The division data center, through its ADP operations section, performs the data reduction which applies to personnel (and pay) functions by keypunching from hard-copy documents to card machine input media. The adjutant general company has the capability to produce certain personnel input transactions on paper tape through use of the automatic typewriter (by-products of special orders). The DDC converts paper tape to card input or uses it for direct input to the ADPE. Personnel and pay input is handcarried to the DDC by AG company personnel (and the finance company personnel since no data transceiving capability is authorized these users).

(3) *Output.* After the input has been processed, output (reports, cards, etc.) is returned to the AG Company (or finance company). Each functional element user provides a screening capability to insure output is correct and complete. Users are also responsible to coordinate related files maintenance and document control to resolve input, processing, and output errors. Methods of distributing recurring and special reports

may be mutually agreed upon which are advantageous to supported divisional units, the functional elements of the office of the adjutant general, and the DDC.

(4) *Principal personnel function.* In the personnel function, field army data processing activity (DPA) interface cards are created during the update of the division personnel management and accounting card processor (RCS AG-552) (Acronym PERMACAP) files which are maintained in the DDC for the division adjutant general. These cards contain information for updating the officer and enlisted personnel data banks at Department of the Army. The DDC coordinates with the division adjutant general in transmitting these cards to the DPA for further processing and transmission to DA. The technical requirements concerning the DPA interface with the DDC are contained in Army Regulations 680-4 (PERMACAP). Feeder data to support the preparation and maintenance of PERMACAP files is received on a cyclic basis from the PSD, office of the adjutant general.

(5) *Military pay.* Members of the division are paid under JUMPS—Army. The DDC converts the hard copy transaction to JUMPS—Army punch card input format and furnishes these cards to the division finance officer who verifies transactions and transmits them through AUTODIN facilities to the Finance Center, US Army Finance Support Agency (USAFSA), Fort Benjamin Harrison, Indiana, for computation of military pay. Individuals are subsequently paid according to prearranged selected options, to include individual's election to be paid once or twice each month by either cash or check for each payment. He may elect to receive mid-month and end-of-month payments and also have monies accrue in his account payable on demand by the local finance officer.

f. Functions.

(1) *Office of the DDC section.* This section is the control element of the center. It consists of the ADPS operations officer, and the administrative personnel and facilities by which he exercises control over the DDC. The ADPS operations officer serves as the principal advisor to the DISCOM commander on all matters pertaining to ADP operations in the division. This section performs the following functions:

(a) Exercises management and operational control over all DDC operations and insures proper allocation of resources to accomplish the DDC mission.

(b) Develops policies to insure efficient and effective utilization of DDC personnel and equipment.

(c) Plans, coordinates, and performs administrative and logistical activities necessary to support the DDC.

(d) Coordinates with user activities, implements policies of higher headquarters, and advises the DISCOM commander.

(2) *ADP management and planning section.* This section consists of the deputy chief/operations officer of the DDC, accounting machine supervisor, and general clerk. It is responsible for control of manual files maintenance, document control, general scheduling, and reports generation within the DDC. The ADP management and planning section functions are to:

(a) Coordinate and establish scheduling of functions and processing of workload for the DDC.

(b) Coordinate the receipt of input and the distribution of output for the DDC.

(c) Exercise supervision over all card files.

(d) Provide supervision over general systems design and programing.

(e) Coordinate the activities of the systems maintenance section and the files maintenance and document control section.

(3) *Systems maintenance section.* This section is composed of the senior systems analyst and programers. It is responsible for design and programing of all special one-time reports required by the division, and for accomplishing program changes directed by higher headquarters. The systems maintenance functions are to:

(a) Perform systems analysis and programing for the DDC.

(b) Implement DA directed modifications to DA developed programs.

(c) Research, design, and program local systems and reports.

(d) Maintain all program and run instructions within the DDC.

(4) *Files maintenance and document control section.* This section is composed of analysts and specialists in the personnel, pay, and logistics functional areas. It monitors and controls the flow of input to the DDC and conversely, the machine output from the DDC to the systems users. The functions of this section are to:

FM 12-4

(a) Provide detailed control of all files and documents internal to the DDC.

(b) Maintain all card files in the DDC.

(c) Coordinate with supported units to insure proper operation of the total system.

(d) Check for erroneous data generated by the system and assist users and system maintenance personnel in determining problems and corrective measures required.

(e) Maintain all record input to the DDC to include scheduling, logging, and editing.

(f) Release all record output from the DDC to include scheduling, logging, and editing.

(g) Monitor work flow of production runs through the DDC.

(5) *ADP operations section.* This section is composed of data processing technicians, and ADP and associated equipment operators. The chief of this section is responsible for the daily operations of the ADPE within the DDC, and has supervisory control over card punch, machine operations and equipment maintenance. He is further responsible for detailed scheduling of machine operation and for training of operator personnel. The functions of this section are to:

(a) Conduct a two-shift operation.

(b) Schedule the daily workload of the user in each function, based on a general schedule provided by the ADP management and planning section.

(c) Tailor the strength of each shift of each computer complex to meet anticipated workloads.

(d) Insure proper utilization and maintenance of the computer equipment and determine changes in processing as required.

(e) Conduct training of operators in the proper methods of machine and systems operation.

(f) Operate the central processor and ADP peripheral and auxiliary equipment required to produce the user reports.

(g) Perform data reduction of user hard copy input to machine readable form.

(6) *ADP and generator maintenance section.* The personnel in this section are those required to perform DDC equipment maintenance. This section operates in close coordination with the ADP operations section. Its functions are to:

(a) Provide generator produced electrical power for the DDC when needed.

(b) Maintain all ADP equipment within the DDC.

(c) Maintain all generators assigned to the DDC.

(d) Coordinate with contract engineer provided by manufacturer to assist in proper operation and maintenance of ADP equipment in the DDC.

7-3. Reference

Army Regulation 18-1 contains the details of objectives and policies for Army Information Systems.

APPENDIX A

REFERENCES

A-1. Army Regulations (AR)

15-6	Procedures for Investigating Officers and Boards of Officers Conducting Investigations.
18-1	Policies, Objectives, Procedures, and Responsibilities.
30-1	The Army Food Service Program.
37-103	Finance and Accounting for Installations; Disbursing Operations.
37-104-2	Finance and Accounting for Installations; Military Pay and Allowance Procedures.
37-125	Finance and Accounting for Installations; Pay and Allowances Administration.
40-403	Health Records.
65-1	Army Postal Operating Instructions.
65-10	Use of Army Postal Service.
65-75	Unit Mail Service.
220-90	Army Bands.
310-1	Publications, Blank Forms, and Printing Management.
310-10	Orders.
340-1	Records Management—Program Policies and Procedures.
340-2	Maintenance and Disposition of Records in TOE Units of the Active Army and the Army Reserve.
340-3	Official Mail.
340-5	Correspondence and Mail Management.
340-10	CENTO and NATO Correspondence.
340-11	Office Symbols.
340-15	Preparing Correspondence.
340-16	Safeguarding 'For Official Use Only' Information.
340-18-1 through-16	The Army Functional Files System (TAFFS).
340-25	Mailing Instructions and Addresses for Certain US Army Elements and Activities and Certain US Citizens Outside CONUS.
345-20	Release of Information and Records From Army Files.
345-60	Release of Information Pertaining to Disciplinary Actions.
380-5	Safeguarding Defense Information.
525-15	Operational Reports—Lessons Learned.
570-2	Organization and Equipment Authorization Tables—Personnel.
600-8	Military Personnel Offices.
600-10	The Army Casualty System.
600-11	Authority of Armed Forces Personnel to Perform Notarial Acts.
600-200	Enlisted Personnel Management System.
606-5	Identification Cards, Tags, and Badges.
606-15	Preparation of Fingerprint Record.
611-201	Enlisted Military Occupational Specialties.
611-203	Enlisted Military Occupational Specialties.
612-2	Preparing Individual Replacements for Oversea Movement (POR) and US Army Oversea Replacement Station Processing Procedures.
614-100	Officers.

FM 12-4

638-30	Graves Registration Organization and Functions in Support of Major Military Operations.
638-40	Care and Disposition of Remains.
640-2	Qualification Records and Management Data Reporting.
640-10	Individual Military Personnel Records.
640-20	US Army Intelligence Badges and Credentials.
640-25	Photographs.
640-30	Photographs.
672-5-1	Awards.
672-5-2	Illustrations of Awards.
680-1	Morning Report and Personnel Data Change Report.
680-4	Personnel Management and Accounting, Card-Processors (PERMACAP).
710-2	Material Management for Using Units, Support Units, and Installations.
725-50	Requisitioning, Receipt, and Issue System.
735-11	Accounting for Lost, Damaged and Destroyed Property.
750-1	Army Material Maintenance Concepts and Policies.

A-2. DA Pamphlets (DA Pam)

1-10	Improve Your Writing.
35-1	Pay Guide for Small Unit Commanders.
310-4	Index of Technical Manuals, Technical Bulletins, Supply Manuals (types 7, 8 and 9) Supply Bulletins, and Lubrication Orders.
350-52	Company Administration Programed Text: Mess Management.
350-55-1	Company Administration Programed Text: Supply Management.
600-8	Military Personnel Officer Management and Administrative Procedures.
608-2	Your Personal Affairs Handbook.
638-1	Escorting Deceased Army Personnel.
700-2	Commander's Supply and Maintenance Handbook.

A-3. Field Manuals (FM)

5-15	Field Fortifications.
5-20	Camouflage.
8-15	Medical Support in Divisions, Separate Brigades, and the Armored Cavalry Regiment.
10-63	Handling of Deceased Personnel in Theaters of Operation.
12-50	The Military Band.
14-8	Class A Agent Officer.
20-15	Pole and Frame Supported Tents.
21-30	Military Symbols.
29-2	Organization Maintenance Management.
29-30-1	Division Maintenance Battalion.
29-35	Maintenance Support in Separate Brigades.
54-2	The Division Support Command and Separate Brigade Support Battalion.
61-24	Division Communications.
61-100	The Division.
100-10	Combat Service Support.
101-5	Staff Officers' Field Manual: Staff Organization and Procedure.
101-10-1	Organizational, Technical, and Logistical Data (Unclassified Data).
(S) 101-10-3	Organizational, Technical, and Logistical Data—Classified Data (U).

A-4. Tables of Organization and Equipment (TOE)

12-7	Adjutant General Company, Support Command (Armored, Infantry, and Infantry (Mech) Divisions).
12-27	Adjutant General Company, Support Command Airmobile Division.

12-167 Administration Company, Separate Airborne Brigade.
12-177 Administration Company, Separate Armored, Infantry, and Infantry
(Mech) Brigades.
12-197 Administration Company, Separate Light Infantry Brigade.

A-5. Technical Manual (TM)

10-286 Identification of Deceased Personnel.
10-405 Army Mess Operations.
10-415 Operation of Garrison Mess Equipment.
38-750 The Army Maintenance Management System (TAMMS).

A-6. Other Pertinent References

DODPM Department of Defense Military Pay and Allowances Entitlements Manual.

APPENDIX B

RELATED REFERENCE MATERIAL FOR THE ADJUTANT GENERAL COMPANY COMMANDER

B-1. Army Regulations (AR)

10-5	Organization and Functions—Department of the Army.
71-7	Military training aids and Army Training Aid Center System.
220-55	Field and command post exercises.
310-25	Dictionary of United States Army Terms.
310-50	Authorized abbreviations and brevity codes.
350-25	Civil affairs and civil-military operations training.
350-30	Code of conduct.
350-225	Survival, evasion, and escape training.
360-81	Command Information Program objectives and policies, publication, and Armed Forces radio and television.
385-63	Regulations for firing ammunition for training, target practice, and combat.
600-20	Army command policy and procedure.
600-30	Human Self Development Program.
600-55	Motor vehicle driver—selection, testing and licensing.
600-200	Enlisted personnel management system.

B-2. DA Pamphlets (DA Pam)

16-5	Character guidance discussion topics—duty—honor—country.
16-10	Duty—honor—country. (Contents: Heritage. Marks of greatness. Common sense. Marriage. Honesty. Truth.)
16-11	Duty—honor—country. (Contents: Sacrifice. Personal freedom. Patience. Practical wisdom. Reputation.)
40-5	Training in first aid and emergency medical treatment.
*108-1	Index of Army motion pictures and related audio-visual aids.
165-5	Character guidance discussion topics—Our Moral Heritage.
165-6	Character guidance discussion topics; Our Moral Heritage.
165-9	Character guidance discussion—Our Moral Heritage.
165-10	Human self-development discussion topics—Our Moral Heritage.
310-1	Index of administrative publications.
310-2	Index of blank forms.
310-3	Index of doctrinal, training, and organizational publications.
750-1	Commander's guide of preventive maintenance indicators.

B-3. Field Manuals (FM)

5-15	Field fortifications.
5-20	Camouflage.
7-10	The rifle company, platoons, and squads.
7-30	The Infantry Brigades.
8-35	Transportation of the sick and wounded.

*Instructor's Film References, available at film libraries, list up-to-date comments on, and changes to, training films.

FM 12-4

10-63	Handling of deceased personnel in Theaters of Operations.
19-30	Physical security.
21-5	Military training management.
21-6	Techniques of military instruction.
21-10	Field hygiene and sanitation.
21-11	First aid for soldiers.
21-13	The Soldier's Guide.
21-15	Care and use of individual clothing and equipment.
21-18	Foot marches.
21-20	Physical readiness training.
21-26	Map reading.
21-30	Military symbols.
21-31	Topographic symbols.
21-40	Chemical, biological, radiological and nuclear defense.
21-41	Soldier's handbook for defense against chemical and biological operations and nuclear warfare.
21-60	Visual signals.
21-75	Combat training of the individual soldier and patrolling.
21-76	Survival, evasion and escape.
22-5	Drill and ceremonies.
22-100	Military leadership.
23-8	US Rifle—7.62mm, M14 and M14A1.
23-9	Rifle 5.56MM, M16A1.
23-31	40mm grenade launcher, M203 and M79.
23-67	Machinegun 7.62mm, M60.
23-71	Rifle marksmanship.
30-5	Combat Intelligence.
31-22	US Army Counterinsurgency Forces.
31-23	Stability operations, US Army doctrine.
31-35	Jungle operations.
33-5	Psychological operations—techniques and procedures.
41-10	Civil affairs operations.
57-35	Airmobile operations.
100-5	Operations of Army forces in the field.
100-10	Combat service support.
105-5	Maneuver control.

B-4. Technical Manuals (TM)

10-286	Identification of Deceased Personnel.
11-5805-201-12	Operator and Organizational Maintenance Manual, Including Repair Parts and Special Tool Lists: Telephone Set TA 312/PT (TO31W1-2PT-291).
11-5805-201-12	Operator and Organizational Maintenance Manual Including Repair Parts and Special Tools Lists: Telephone Set TA 312/PT.
21-300	Driver Selection and Training (Wheeled Vehicles).
21-301	Driver Selection, Training, and Supervision Tracked Vehicles.
21-305	Manual for the Wheeled Vehicle Driver (AFM 77-2).
21-306	Manual for the Tracked Combat Vehicle Driver.
55-310	Motor Transport Operations.
57-220	Technical Training of Parachutists.

B-5. Army Subject Schedules (ASUBJSCD)

3-20	Individual and Unit CBR Training.
5-3	Maps, compass, aerial photograph reading and elementary field sketching.
7-12	Antiinfiltration and counter guerrilla training.

7-51	Basic Airborne refresher training.
7-58	Drop zone assembly.
12-1	The military band.
12-3	Data processing unit operations.
12-4	The Special Services Company.
12-70A10	MOS technical training of Clerk (MOS 70A10).
12-71B20	MOS technical training of Clerk-Typist (MOS 71B20 and 71B30).
17-1	Marches and assembly areas.
21-12	Survival, evasion and escape.
21-15	Code of conduct.
21-22	Marches and bivouacs.
21-37	Physical readiness training.
29-4	Preventive maintenance—unit training.
29-6	Small unit defense.
30-37	Organization of the Army.
55-44	Air Movement Schedule.

B-6. Training Aids

a. Film Bulletins (FB)

5-85 Camouflage Dummies and Decoys (14 min).

b. Training Films (TF)

3-3289	Individual Protection Against CBR Attack (23 min).
5-3718	Basic Map Reading—Part I: Map Symbols (20 min).
5-3719	Basic Map Reading—Part II: Grid Distance and Elevation (29 min).
5-3720	Basic Map Reading—Part III: Direction, Orientation, and Location without a Compass (30 min).
5-3721	Basic Map Reading—Part IV: Direction and Orientation and Location with a Compass (30 min).
5-3722	Basic Map Reading—Part V: Photos and Photomaps (31 min).
7-2634	Jungle Operations—Part I: How to live in the jungle (19 min).
7-3734	Drill and Ceremonies—Part I: Squad Drill (21 min).
7-3903	Drill and Ceremonies—Part II: Platoon Drill (15 min).
8-1691	General effects of heat on man (21 min).
8-2292	First Aid—Part I: Major wounds and fractures (33 min).
8-2588	First Aid—Part III: Burns (14 min).
8-3021	First Aid—Part IV: Resuscitation, mouth to mouth, mouth to nose (23 min).
21-1973	Escape (45 min).

c. Graphic Training Aids (GTA)

3-1-7	CBR Decontaminants.
3-4-5	Defense against CBR Attack, with instructor's notes.
3-7-2	Things to do under nuclear, biological, or chemical attack.
5-1	Concealment and Camouflage.
5-2-2	Elementary Map Reading.
7-1-9	Rifle Marksmanship.
8-5	This is Shock.
9-1-135	Preventive Maintenance—Wheeled Vehicles.
9-6-34	Rifle 5.56mm M16E1 Nomenclature and cycle of operation.
9-6-35	M79 Grenade Launcher.
9-608	Rifle 7.62mm, M14.
9-6-36	M60 Machine Gun 7.62mm.
21-1	Code of Conduct.
21-39	Components of Physical Fitness.

FM 12-4

d. Transparencies (T)

12-101 (1-12) US Army Code of Conduct—Articles I through VI

e. Training Devices (DVC)

5-1 Map Reading Trainer.

5-3 Model Set Terrain: Training Aid w/Chest.

8-4 War-Would Mouflage Set.

B-7. Common Tables of Allowance (CTA)

23-100-6 Ammunition, rockets, and missiles for unit training-active Army and Reserve components.

APPENDIX C

VEHICLE USAGE AND MAINTENANCE FACTORS
(AG COMPANY)

	Quantity	Annual Maint Manhrs per Each Mtr Veh	Total Maint Manhrs per Mtr Vehicle	USAGE FACTORS
AG Section HQ Truck, utility ¼-ton	1	194	194	Provided the Division AG in order to facilitate the control necessary over the AG subordinate elements. Frequently the dispersion of the AG offices is such that an organic vehicle is necessary. Additionally, the AG must coordinate with other staff officers and subordinate commanders over a wide area. As the officer-in-charge of the rear echelon, the AG will be provided the mobility he requires to accomplish his mission. This vehicle, combined with one of the ¼-ton vehicles in ASD (operating on a pooled basis) will provide transportation to the PSD. One of the most vital functions performed will be the regular transportation of PERMACAP documents from the PSD to the DDC. All vehicles in the AG Co, with the exception of the semi-trailer for the flexwriters, will afford and contribute to the transportation of guard details, manning of defensive positions, and reserve forces.
Trailer, ¼-ton	1	128	128	Will transport supplies and equipment for the AG Section.
Truck, utility, ¼-ton	1	194	194	Provides transportation for the AG Company Commander, aiding him in fulfilling his command and control responsibilities. The AG Company Commander will be responsible for directing the company's defense functions.
Trailer, ¼-ton	1	128	128	Transports supplies and equipment for the AG Company command element.
Truck, cargo, 1 ¼-ton	1	Unk	Unk	Provided to facilitate the maintenance function by carrying tools and personnel to and from the location of any assigned vehicle which may be in need of repair. Will also transport power generator maintenance personnel.
Trailer, ¼-ton	1	128	128	Transports tool sets, other maintenance equipment, and vehicle/generator parts.
Truck, utility, ¼-ton	1	194	194	Will provide pooled transportation for several staff officers in accomplishing their responsibilities. These officers are the Special Services Officer, Postal Officer, and Band Officer. Will also provide transportation for unit mail clerk.
Trailer, ¼-ton	1	128	128	Will transport supplies and equipment belonging to the supported staff element(s).
Truck, cargo, 2 ½-ton	2	321	642	Will be pooled for use by all elements of the AG Company, including company level supply and mess, transportation of replacements and band, and requirements in support of special services, postal and personnel management.
Trailer, 1 ½-ton	1	128	128	Provides additional transportation vehicle for supplies and equipment.
Trailer, tank, 400-gal.	1	128	128	Transports water for mess operations.

<i>AG Section HQ</i>		<i>USAGE FACTORS</i>	
<i>AG Section HQ</i>	<i>Quantity</i>	<i>Annual Maint Manhrs per Each Mtr Veh</i>	<i>Total Maint Manhrs per Mtr Vehicle</i>
Chassis, trailer, generator	1	96	96
<i>Admin Services Division</i>			
Truck, cargo, 1½-ton	2	Unk	Unk
Trailer, ¾-ton	1	128	128
Semitrailer, van, Expandable, 6-ton	1	160	160
<i>Postal Division</i>			
Truck, van, shop 2½-ton	1	326	326
Trailer, 1½-ton	1	128	128

Transports 30KW generator.

Will be separated by virtue of the fact that the ASD will provide both forward and rear AG elements. The vehicles will aid in the pick-up and delivery of messages, correspondence, official mail and publications. On a pooled basis, the ¾-ton in the rear area will also be used by the PSD and the Personnel Management, Personnel Records, and Personnel Actions Officers.

Will provide transport equipment of the ASD and PSD, such as field safes, file cabinets, desks, tents, tables, and typewriters.





Provides the inclosed working area and transportation for the ADPE Typewriters (Flexowriters). Prime mover for this semitrailer will be provided by the Division Supply and Transport Branch.



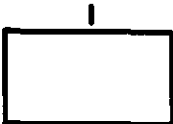

Will be the prime mover of all incoming and outgoing mail in the division. The shop van provides security and protection from the elements for this mail.



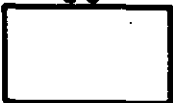



Transports postal and office equipment such as tents, desks, safes, and scales and distribution racks/cases.

APPENDIX D

SYMBOLS RELATING TO FIGURE 5-2 (FM 12-4)

	<u>SYMBOL</u>	<u>DESCRIPTION</u>
1.		HQ AG CO HQ
2.		HQ FIN CO HQ
3.		DIV DATA CENTER MINUS (SPLIT CONCEPT)
4.		LOCATION OF SPECIFIC STAFF MEMBER(S) OR FUNCTIONS
5.		SECTION OR FUNCTIONAL DIVISION

	-FIN OPERATIONS
ASD	-ADM SVC DIV
PS	-PSD
	-CENTRAL ISSUE FACILITY
	MAINTENANCE (MOTOR PARK)
	BAND
	-POSTAL

- 6.  GRAVES REGISTRATION
- 7.  PETROLEUM FUELS
- 8.  PARKING
- 9.  SHOWER
- 10.  HELICOPTER LANDING
- 11.  TO NEAREST AIR STRIP
- 12.  PLATOON DEFENSIVE AREA

APPENDIX E

TENTAGE INFORMATION

TENT, KITCHEN, FLYPROOF, M-1948*

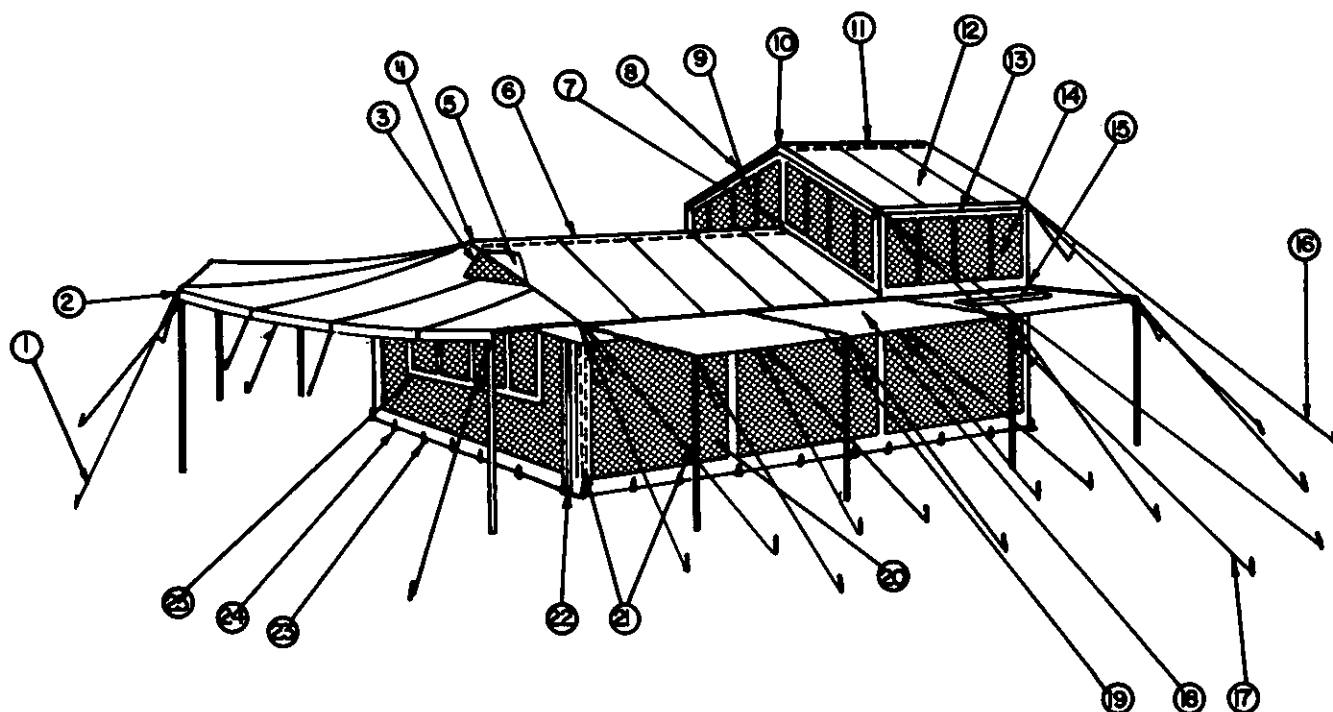

- | | | |
|---|--|--|
| 1 Eave line | 9 Front stack ventilator screen | 18 Sidewall awning section |
| 2 7-foot tentpole | 10 12-foot 3-inch tentpole | 19 Awning slide fastener |
| 3 Front ventilator screen | 11 5-foot 11- $\frac{1}{4}$ -inch solid ridge pole | 20 Tent screen |
| 4 9-foot tentpole | 12 Roof stack | 21 6-foot 2-inch tentpole |
| 5 Front ventilator flap | 13 Stack side flap | 22 Entrance opening slide fastener |
| 6 11-foot 10-inch jointed ridge pole | 14 Stack side screen | 23 16-inch tent pin |
| 7 Spindle of 11-foot 10-inch ridge pole | 15 Sidewall ventilator opening | 24 Footstop |
| 8 Front stack ventilator flap | 16 Guy line | 25 Service window opening slide fastener |
| | 17 24-inch tent pin | |

Figure E-1. Tent, kitchen, flyproof, M-1948.

*For detailed instructions on erecting, striking, and folding tents see FM 20-15.

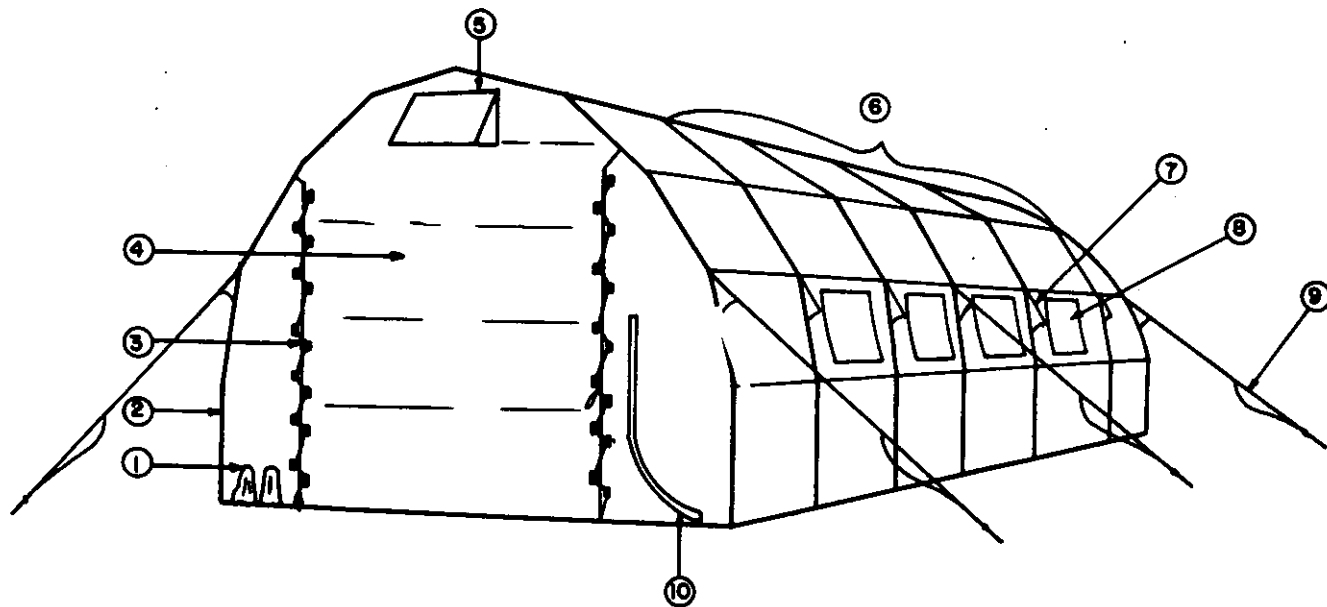

- | | | | |
|---|---------------------|----|-----------------------|
| 1 | Heater duct sleeves | 6 | Intermediate sections |
| 2 | End section | 7 | Guy line sleeve |
| 3 | Lacing line | 8 | Window |
| 4 | Vehicle door | 9 | Guy line assembly |
| 5 | Ventilator | 10 | Personnel door |

Figure E-8. Tent frame-type, maintenance, medium light metal.

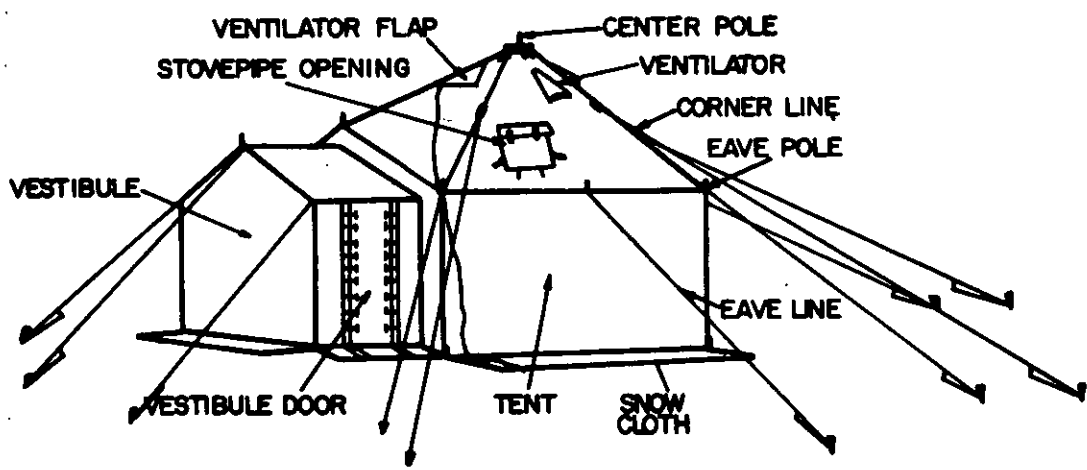
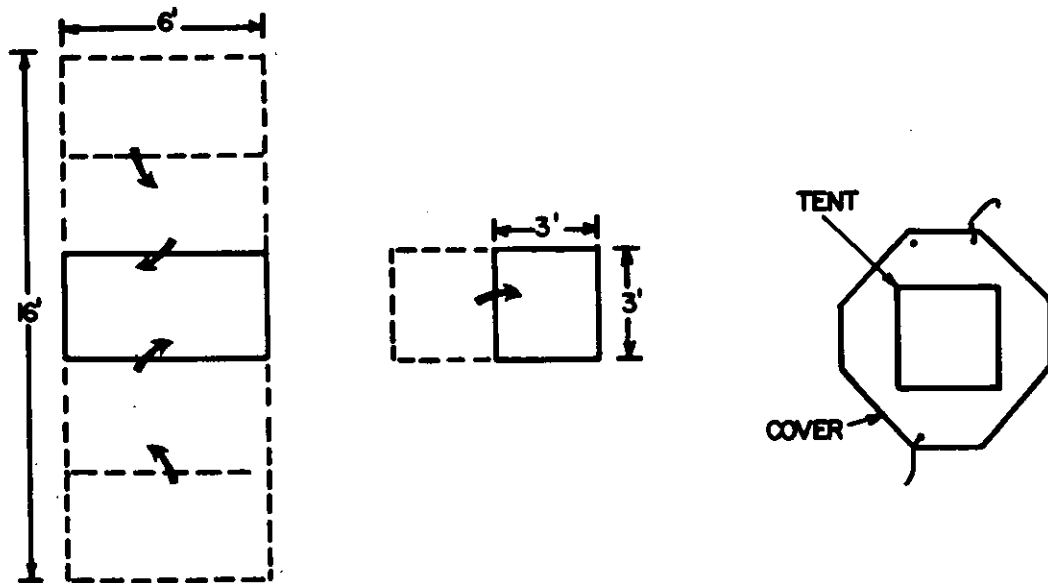
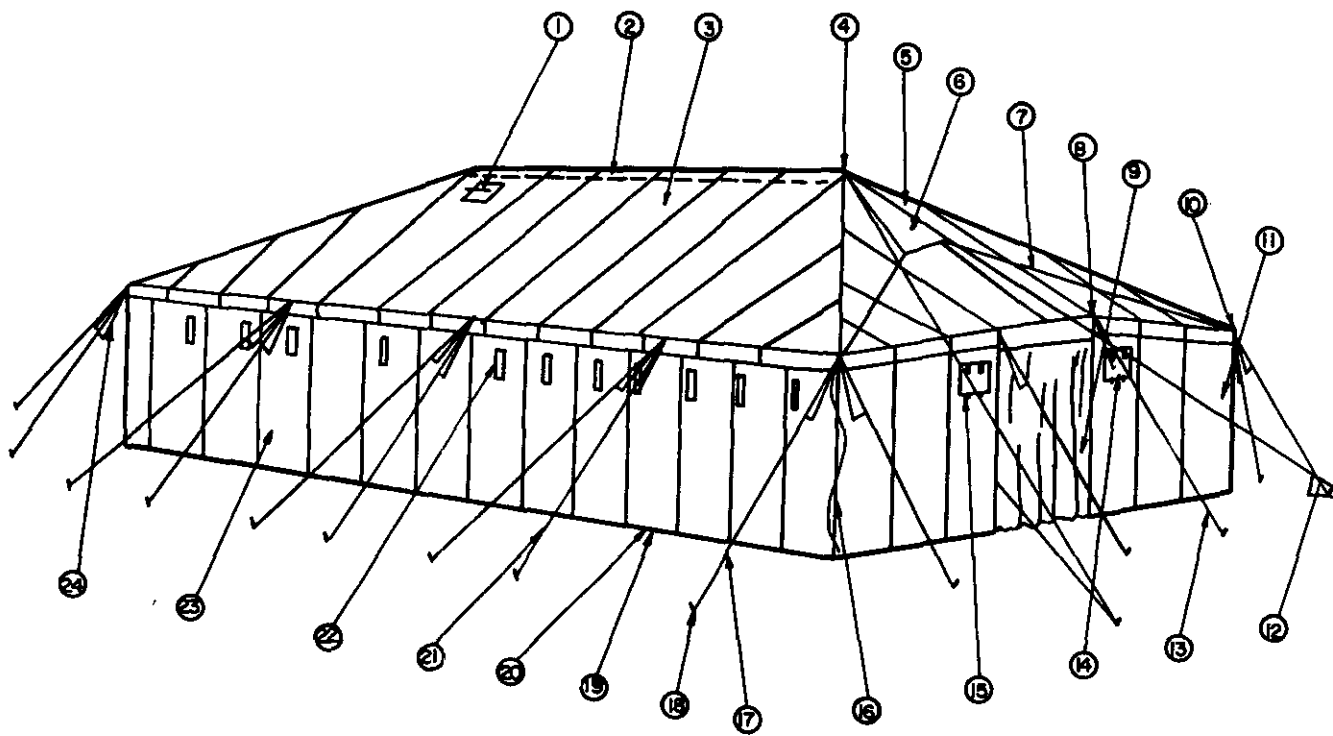

Figure E-3. Tent, general purpose, small.



- | | | |
|------------------------|---|---|
| 1 Stovepipe opening | 10 Eave pole | 18 24-inch wood tent pin, or 12-inch steel tent pin |
| 2 Ridge pole | 11 End wall | 19 Footstop |
| 3 Side roof | 12 Ridge guy line | 20 16-inch wood tent pin, or 9-inch aluminum tent pin |
| 4 Center pole | 13 Door eave line | 21 Side eave line |
| 5 End roof | 14 Care and maintenance instructions flap | 22 Tie tape |
| 6 Ventilator | 15 Erection instructions flap | 23 Sidewall |
| 7 Ventilator flap line | 16 Slide fastener | 24 Tent slip |
| 8 Door pole | 17 Corner eave line | |
| 9 Door curtain | | |

Figure E-4. Tent, general purpose, medium.

INDEX

	Paragraph	Page
Adjutant general:		
Administrative services	1-4b	1-1
Command relationship	2-2a, d	2-1, 2-2
Philosophy of service	1-6	1-2
Responsibilities and duties	2-4, 2-5, 2-6a, b, 2-7i, j, k, 3-8b, 6-3b	2-2, 2-3, 2-6, 2-7, 3-9, 6-2
Separate brigade	2-3, 4-2g	2-2, 4-3
Staff relationship	2-1, 2-2	2-1
Adjutant general company:		
Assignment	3-3	3-3
Capabilities	3-4	3-3
Employment	3-6	3-3
Functions	3-7, 3-8, 3-9, 3-10, 3-11, 3-12, 3-13, 3-14	3-5, 3-9, 3-11, 3-19, 3-24, 3-25, 3-36, 3-39
Limitations	3-5	3-3
Mission	3-2	3-1
Organization	3-1	3-1
Adjutant general forward	5-3	5-2
Administration	1-4a	1-1
Administration company	4-1, 4-2	4-1, 4-2
Administrative machine branch	3-5a, 3-12b, 7-1	3-3, 3-25, 7-1
Administrative review	3-9d	3-14
Administrative services	1-4b, 3-8b, 3-9	1-1, 3-9, 3-11
Administrative services division	3-9	3-11
Administrative services officer	3-9c	3-11
ADP (see Automatic data processing)		
ADPE (see Automatic data processing equipment)		
Alternate command, post	5-2a, d	5-1, 5-2
APO (see Postal services)		
Area damage control	5-15	5-12
ASD (see Administrative services division)		
Authentication	2-7g, h, 3-9c	2-5, 2-6, 3-11
Automatic data processing	2-6d, 2-8, 3-5a, 3-8c, 3-12b, 7-1, 7-2, 7-3	2-4, 2-7, 3-3, 3-10, 3-25, 7-1, 7-4
Automatic data processing equipment	1-6f, 3-9d, 7-2	1-2, 3-14, 7-1
Band	3-14, 5-11k	3-39, 5-5
Brigade headquarters	5-2	5-1
Capabilities, adjutant general company	3-4	3-3
Casualty reporting	5-20	5-17
CBR agents (see Chemical biological, and radiological agents)		
Central reference library	3-9d	3-14
Certified mail (see Patron services)		
Chemical, biological and radiological agents	1-3, 5-15	1-1, 5-12
Classified documents	3-9d	3-14
Command staff relationship	2-1, 2-2d, 2-3, 4-2g, 7-2d	2-1, 2-2, 4-3, 7-2
Company commander	1-6e, 3-7h, 4-2g, 6-3e	1-2, 3-7, 4-3, 6-3
Composite team	3-12b	3-25
Congressional inquiries	3-8b, 3-12g	3-9, 3-33
COPE (see Custodian of Postal effects)		
Correspondence (see also Authentication)	3-9c, d	3-11, 3-14
Custodian of Postal effects	3-10e	3-23

FM 12-4

	Paragraph	Page
Damage control team	5-15e	5-18
Decorations and awards	5-21	5-18
Defense	5-9, 5-13, 5-14	5-4, 5-6, 5-8
Delegation of authority	2-7b, g, 3-8b	2-4, 2-5, 3-9
Direct workers	2-8d, e	2-7
Directory services branch	3-10d	3-23
DISCOM (<i>see</i> Division support command)		
Distribution and records branch	3-9d	3-14
Division	1-4g	1-2
Division chief of staff	2-2d	2-2
Division data center	3-12b, 5-2c, 7-1, 7-2	3-25, 5-1, 7-1
Division/separate brigade		
Rear:		
Area damage control	5-15	5-12
Communications	5-10	5-4
External accessibility	5-8	5-4
General	5-4	5-3
Internal accessibility	5-7	5-4
Layout	5-11	5-4
Security and defense	5-9, 5-13, 5-14, 5-16, 5-17	5-4, 5-6, 5-8, 5-14, 5-15
Selection of site	5-5, 5-6, 5-12	5-3, 5-4, 5-5
Division support command	3-3, 7-2b	3-3, 7-1
Division support command commander	2-2d, 2-5b	2-2, 2-3
Echelonment	3-12b, 5-1, 5-2, 5-3	3-25, 5-1, 5-2
Employment of adjutant general/administration company	3-6, 4-2f	3-3, 4-3
Executive officer	3-8c, 3-14b, 4-2g	3-10, 3-39, 4-3
Finance support	3-12b, 7-2e	3-25, 7-2
Flexowriter	3-9d, 3-12b	3-14, 3-25
Forms control	3-9d	3-14
Forward area support team (FAST)	3-12b	3-25
Functional branch configuration (PSD)	3-12c	3-28
Functions	2-7a, d, e, f, j, 2-8, 3-7, 3-8, 3-9, 3-10, 3-11, 3-12, 3-13, 3-14, 6-6	2-4, 2-5, 2-6, 2-7, 3-5, 3-9, 3-11, 3-19, 3-24, 3-25, 3-36, 3-37, 6-7
Garrison v. field operations	2-7e	2-5
General staff	2-2b, 2-5b, 2-6a, 3-8b, 6-3b	2-1, 2-3, 3-9, 6-2
Incoming mail (<i>see</i> Mail receipt)		
Incoming personnel processing team	3-12b	3-25
Insured mail (<i>see</i> Patron services)		
Interface, adjutant general and finance companies	2-6d, 3-12b	2-4, 3-25
Mail (<i>see</i> Postal services)		
Main command post	5-2a	5-1
Maintenance	3-7f	3-6
Messages	3-9d	3-14
Mission, adjutant general company	3-2a	3-1
Money orders (<i>see</i> Patron services)		
Morning report	3-12b	3-25
Office of the division adjutant general	3-8	3-9
Office of the Postal officer	3-10c, d	3-19, 3-23
Operations (<i>see</i> Functions)		
Operations branch—ASD	3-9d	3-14
Operations branch—Postal	3-10d	3-23
Orders	3-9c, d, 3-12b	3-11, 3-14, 3-25
Orientations	2-6d, 2-8e, 3-13d	2-4, 2-7, 3-36
Outgoing mail	3-10c	3-19
Outgoing personnel processing team	3-12b	3-25

	Paragraph	Page
Patron services	3-10 <i>c, d</i>	3-19, 3-23
PERMACAP (<i>see</i> Personnel management and accounting)		
Personal affairs	6-6 <i>e</i>	6-
Personal affairs team	3-12 <i>b</i>	3-25
Personnel actions branch	3-12 <i>b, g, 6-6e</i>	3-25, 3-33, 6-7
Personnel and administrative services (<i>see also</i> Personnel services and personnel support system)	1-4 <i>c, 1-6, 2-2a, 2-5c, 2-6b, 3-8b, 3-12</i>	1-1, 1-2, 2-1, 2-3, 3-9, 3-25
Personnel management and accounting	3-12 <i>b, 7-2b</i>	3-25, 7-1
Personnel management branch	3-12 <i>g, 6-6e,</i>	3-33, 6-7
Personnel procedures	3-12 <i>e, 6-5, 6-6</i>	3-32, 6-4, 6-7
Personnel records branch	3-12 <i>b, g</i>	3-25, 3-33
Personnel reports	5-19 <i>b</i>	5-16
Personnel services (<i>see also</i> Personnel and administrative services and Personnel support system)	1-4 <i>d, 2-8, 3-12, 5-19, 5-20, 5-21</i>	1-2, 2-7, 3-25, 5-16, 5-17, 5-18
Personnel services division	3-12, 5-11 <i>a, 5-19, 5-20, 5-21, 6-3b, 6-5a</i>	3-25, 5-5, 5-16, 5-17, 5-18, 6-2, 6-4
Personnel staff NCO	6-4	6-4
Personnel strength	5-19	5-16
Personnel support system (<i>see also</i> Personnel services and Personnel and administrative services)	2-6 <i>b, 3-12, 6-1, 6-2, 6-3, 6-4, 6-5, 6-6</i>	2-3, 3-25, 6-1, 6-4, 6-7
Philosophy of adjutant general service	1-6	1-2
Postal officer	3-10 <i>c, e</i>	3-19, 3-23
Postal services	1-4 <i>e, 3-8b, 3-10, 3-12b, 5-23</i>	1-2, 3-9, 3-19, 3-25, 5-19
Printing control	3-9 <i>d</i>	3-14
Property records	3-9 <i>d</i>	3-14
PSD (<i>see</i> Personnel services division)		
Publications control	3-9 <i>c, d</i>	3-11, 3-14
Publications and supply branch	3-9 <i>d</i>	3-14
Rear command post	5-2 <i>a</i>	5-1
Rear echelon officer in charge (OIC)	2-5 <i>e, 2-6c, 3-8b, 5-1, 5-2c, 5-4, 5-5, 5-11f, 5-12, 5-13, 5-14, 5-15d, 5-17</i>	2-3, 3-9, 5-1, 5-3, 5-5, 5-6, 5-8, 5-13, 5-15
Records management	3-9 <i>c, d</i>	3-11, 3-14
Recreation (<i>see</i> Special services)		
Replacement detachment	3-12 <i>b, 3-13, 5-11b</i>	3-25, 3-36, 5-5
Replacement operations	3-5 <i>b, 3-12b, 3-13, 5-24</i>	3-3, 3-25, 3-36, 5-20
Replacement regulating organization	3-12 <i>b</i>	3-25
Reports control	3-9 <i>c, d</i>	3-11, 3-14
Responsibilities, adjutant general	2-4, 2-5, 2-6 <i>a, b, 2-7i, j, k, 3-8, 6-3b</i>	2-2, 2-3, 2-6, 2-7, 3-9, 6-2
Rest areas	3-11 <i>c, 5-22b, c</i>	3-24, 5-19
Security	5-16, 5-17, 5-19	5-14, 5-15, 5-16
Separate brigade, adjutant general section	4-1 <i>a, 4-2</i>	4-1, 4-2
Service teams	3-12 <i>b</i>	3-25
Signal communications center	5-3 <i>b</i>	5-3
Span of control	2-7 <i>c</i>	2-5
Special purpose teams	3-12 <i>b</i>	3-25
Special services	1-4 <i>f, 3-8b, 3-11, 5-22</i>	1-2, 3-9, 3-24, 5-19
Special staff relationship	2-2 <i>c, 2-3, 2-5b, 4-2g</i>	2-1, 2-2, 2-3, 4-3

FM 12-4

	Paragraph	Page
Staff	2-1, 2-2a, c, 2-4, 2-5b, 2-6a, 3-4a, 5-19, 5-20b, 5-21	2-1, 2-2, 2-3, 3-3, 5-16, 5-17, 5-18
Stamps (<i>see</i> Patron services)		
Standing operating procedures (SOP)	3-8c, 3-9d	3-10, 3-14
Strategic tailoring	2-9	2-8
Supervisors	2-8c, e	2-7
Supply, adjutant general company	3-7c, 3-9d	3-5, 3-14
Support team	3-12b	3-25
Tactical tailoring	2-9	2-8
Teams:		
Composite team	3-12b	3-25
Damage control	5-15e	5-13
Forward area support	3-12b	3-25
Incoming personnel processing	3-12b	3-25
Outgoing personnel processing	3-12b	3-25
Personal affairs	3-12b	3-25
Service	3-12b	3-25
Special purpose	3-12b	3-25
Support	3-12b	3-25
Top Secret control	3-8c, 3-9c, d	3-10, 3-11, 3-14
Training	2-8c, d, 3-7b, 3-8c, 3-9d, 6-5b	2-7 3-5, 3-10, 3-14, 6-6
Transient personnel (<i>see also</i> Replacement detachment)	3-7g	3-6
Transportation	3-7e, 5-7	3-5, 5-4
Vehicles (<i>see also</i> Transportation)	3-7e	3-5
Workload	2-7d, e	2-5

By Order of the Secretary of the Army:

Official:

VERNE L. BOWERS
Major General, United States Army
The Adjutant General

BRUCE PALMER, JR.
General, U.S. Army
Acting Chief of Staff

Distribution:

To be distributed in accordance with DA Form 12-11 requirements for Division/Separate Brigade Adjutant General.