

WWW.SURVIVALEBOOKS.COM

YOUR LAST LINE IN DEFENSE AND SURVIVAL

CHECK OUT OUR WEBSITE SOME TIME FOR PLENTY OF ARTICES ABOUT SELF DEFENSE,
SURVIVAL, FIREARMS AND MILITARY MANUALS.

<http://www.survivalebooks.com/>

Thank you for purchasing our ebook package.

DEPARTMENT OF THE ARMY TECHNICAL MANUAL

ORGANIZATIONAL MAINTENANCE MANUAL
INCLUDING REPAIR PARTS AND SPECIAL TOOLS LISTS
FOR

RIFLE, 7.62-MM, M14, W/E

(1005-589-1271)

RIFLE, 7.62-MM, M14A1, W/E

(1005-072-5011)

BIPOD, RIFLE, M2

(1005-711-6202)

HEADQUARTERS, DEPARTMENT OF THE ARMY

AUGUST 1972

ORGANIZATIONAL MAINTENANCE MANUAL

INCLUDING REPAIR PARTS AND

SPECIAL TOOLS LISTS

RIFLE, 7.62-MM, M14, W/ E

RIFLE, 7.62-MM, M14A1, W/ E

AND BIPOD, RIFLE, M2

This manual is current as of 27 June 1972

			Paragraph	Page	Illust fig
CHAPTER	1.	INTRODUCTION			
Section	I.	General	1-1	1-4	3
	II.	Description and data	1-5	1-7	3
CHAPTER	2.	ORGANIZATIONAL MAINTENANCE INSTRUCTIONS			
Section	I.	Service upon receipt of materiel	2-1	2-2	9
	II.	Repair parts, special tools. and equipment	2-3	2-4	9
	III.	Lubrication instructions		2-5	10
	IV.	Preventive maintenance checks and services		2-6	10
	V.	Troubleshooting.....	2-7	2-8	11
	VI.	Maintenance of firing mechanism		2-9	13
	VII.	Maintenance of stock assembly		2-10	16
	VIII.	Maintenance of hand guard assembly		2-11	16
	IX.	Maintenance of operating rod and connector assembly		2-12	17
	X.	Maintenance of bolt assembly		2-13	19
	XI.	Maintenance of barrel and receiver group		2-14	19
	XII.	Maintenance of the stabilizer assembly M 14A1 Rifle)		2-15	21
	XIII.	Maintenance of rifle bipod		2-16	22
CHAPTER	3.	MAINTENANCE OF MATERIEL USED IN CONJUNCTION WITH MAJOR ITEMS			
Section	I.	General		3-1	
	II.	Maintenance of blink ammunition firing attachment with breach shield		3-2	23
	III.	Maintenance of grenade launcher and grenade launcher sight		3-3	24
	IV.	Maintenance of winter trigger kit		3-4	25
	V.	Maintenance of Bayonet-Knife. M6		3-5	25
A PPENDIX	A.	REPERENCES.....	A-1	A-4	26
Appendix	B.	MAINTENANCE ALLOCATION CHART			
Section	I.	Introduction	B-1	B-3	29
	II.	Maintenance allocation chart			
APPENDIX	C.	ORGANIZATIONAL MAINTENANCE REPAIR PARTS AND SPECIAL TOOLS LIST			
Section	I.	Introduction	C-1	C-6	33

* The manual supersedes TM 9-1005-223-20, 19 May 1967, including all changes.

	Paragraph	Page	Illust fig
II.	Repair Parts List	36	
	Major groups and assemblies	39	1
	Firing mechanism	40	2
	Operating rod and connector group	41	3
	Bolt assembly	41	4
	Barrel and receiver group	42	5
	Winter trigger kit	42	6
	Combination tool	43	7
III.	Special Tools List	38	
	Tools and equipment for unit replacement	43	7, 8
	Organizational tools and equipment (For Armorer's use)	43	8
IV.	Federal Stock Number and Reference Number Index	44	

CHAPTER 1 INTRODUCTION

Section I. GENERAL

1-1. Scope

This manual contains instructions for organizational maintenance personnel responsible for performing maintenance on 7.62-MM R-file, M14, M14A1, Rifle Bipod, M2, and accessories as allocated by the Maintenance Allocation Chart (MAC).

1-2. Forms and Records

Maintenance forms, records, and reports which are to be used by maintenance personnel at all maintenance levels are listed and prescribed by TM 38-750.

1-3. Destruction of Material to Prevent Enemy Use. Refer to TM 750-244-7.

1-4. Reporting of Errors

Reports of errors, omissions, and recommendation for improving this publication user is encouraged. Reports should be submitted on DA Form 2028 (Recommended Changes to Publications) and forwarded direct to; Commanding General, US Army Weapons Command, ATTN: AMSWE-MAS /SP, Rock island, Illinois 61201.

Section II. DESCRIPTION AND DATA

1-5. Description

a. The 7.62-MM Rifle, M14 or M14A1, (figs 1-1 through 1-9) is a light-weight air-cooled, gas

operated , magazine fed, shoulder fired. It is used primarily for semiautomatic or full automatic fire.

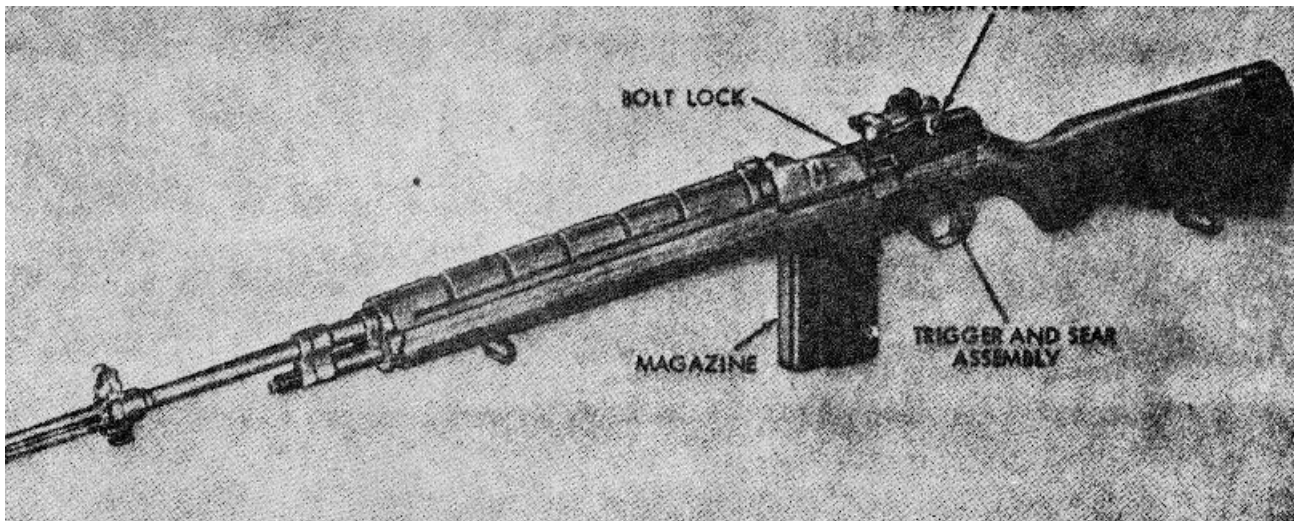

Figure 1-1. 7.62-MM Rifle. M14-left view.

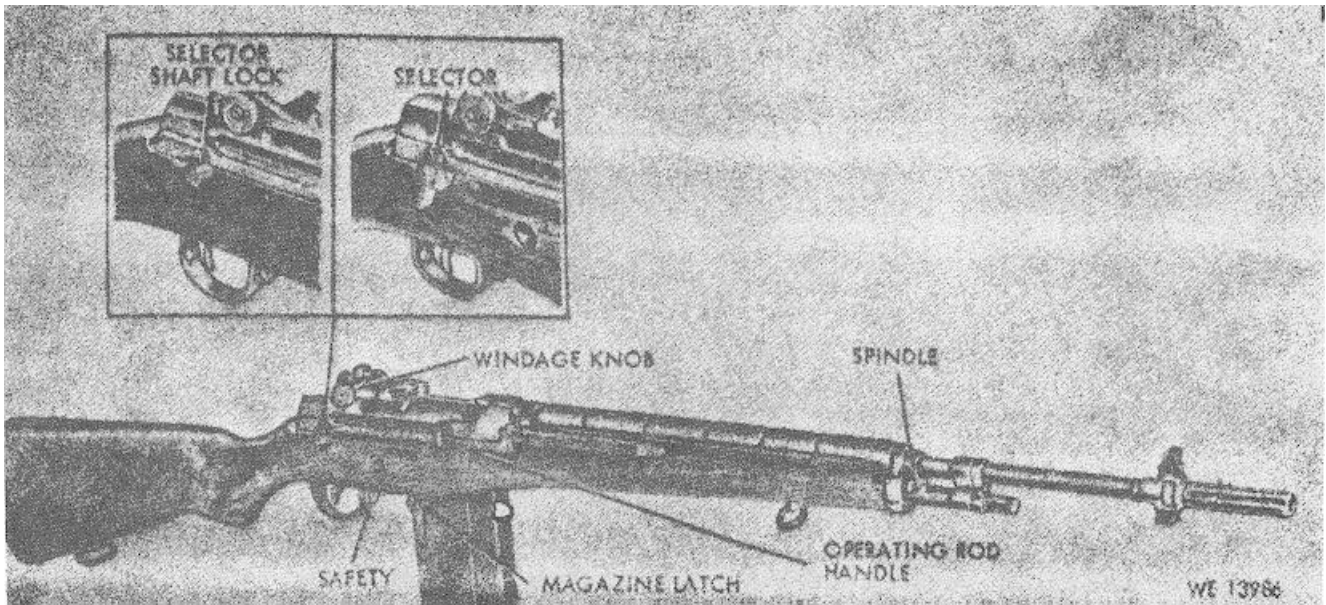

Figure 1-2. 7.62-MM Rifle, M14-right view.

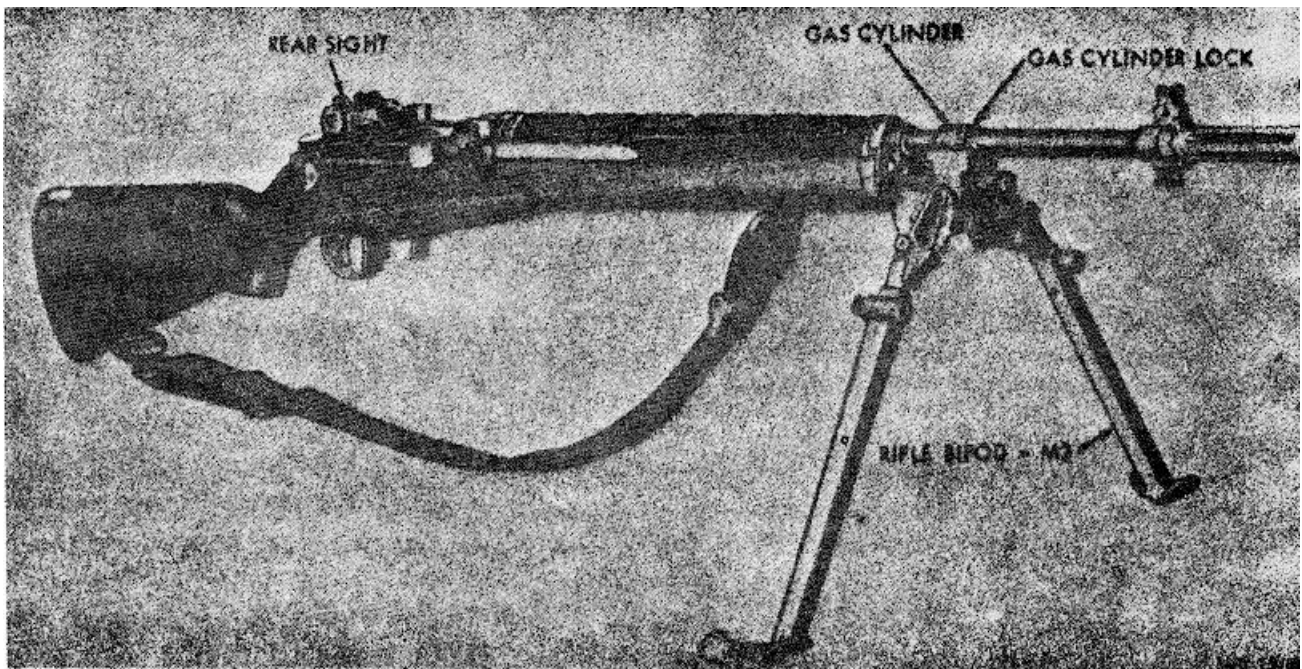

Figure 1-3. 7.62-MM Rifle, M14 with bipod.

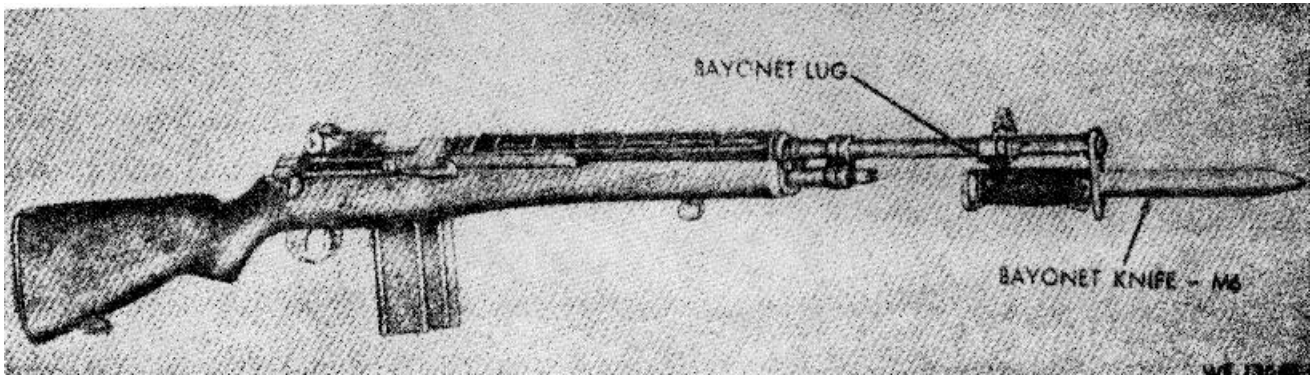

Figure 1-4. 7.62-MM Rifle ,M14 and Bayonet-Knife, M6.

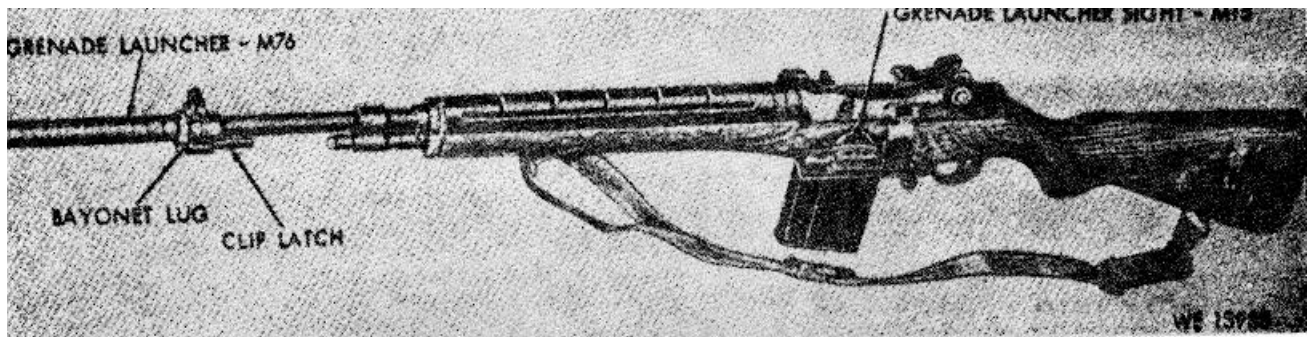

Figure 1-5. 7.62-MM Rifle ,M14 and accessories.

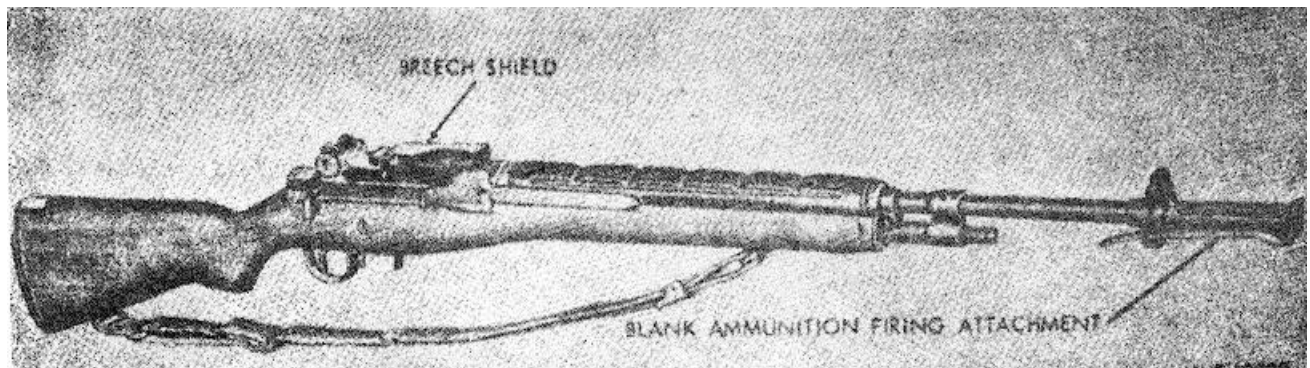

Figure 1-6. 7.62-MM Rifle ,M14 and blank ammunition firing attachment and breech shield.

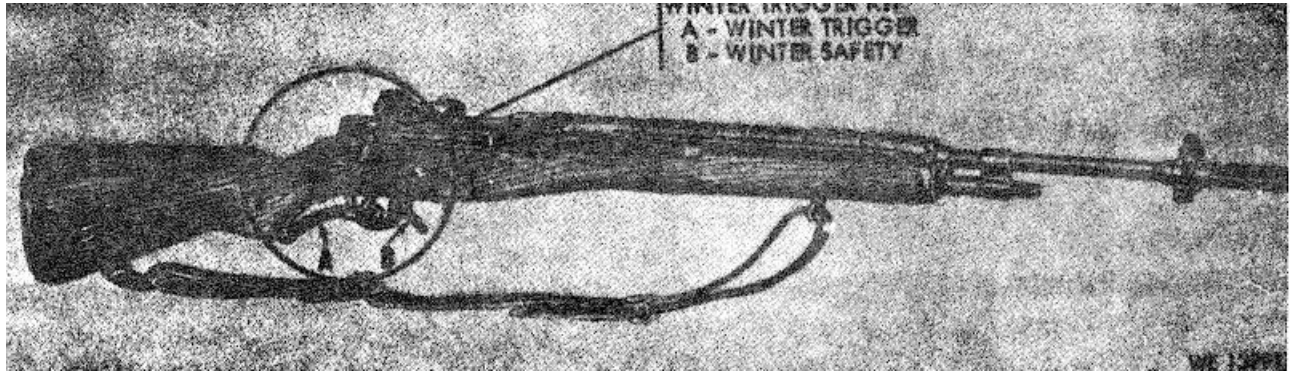

Figure 1-7. 7.62.-MM Rifle M14 with winter rigger kit.

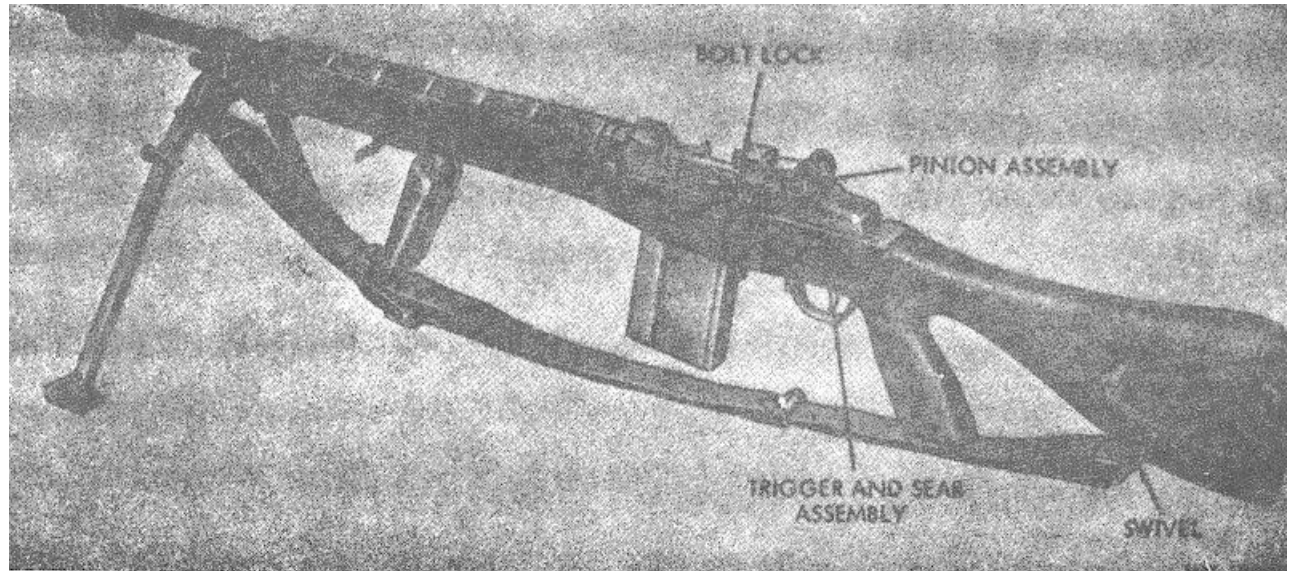

Figure 1-8. 7.62-MM Rifle M14A1-left view.

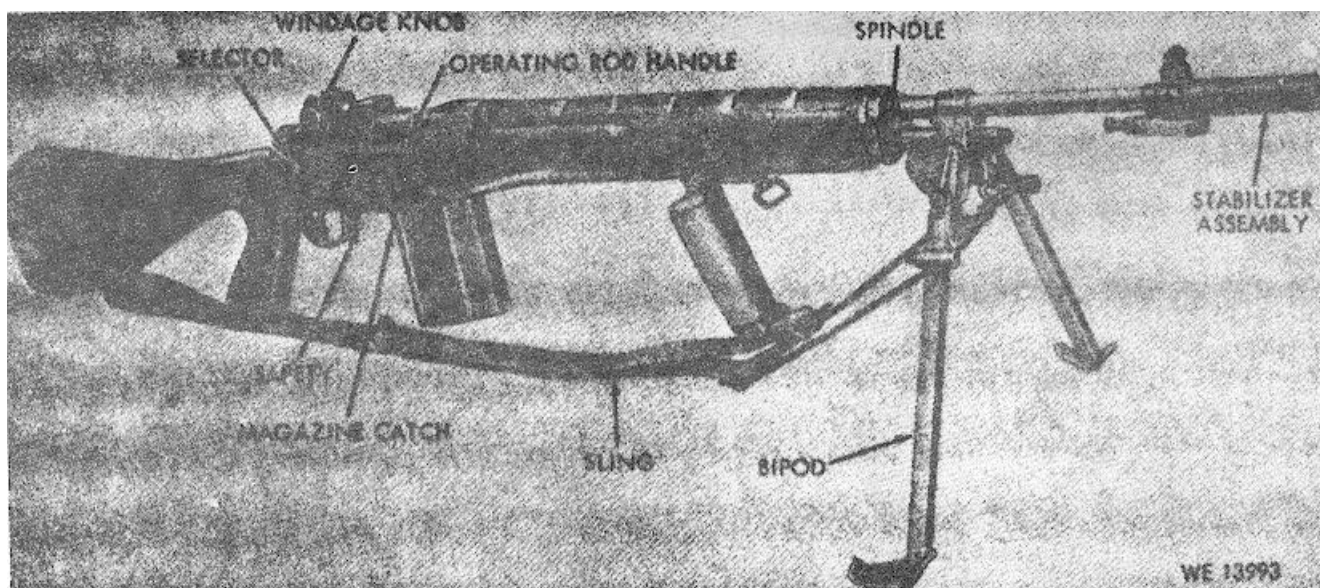

Figure 1-9. 7.62-MM-Rifle M14A1-right view.

b. The Rifle Bipod, M2 (fig 1-10) is a light weight portable, folding mount which is assembled to the gas cylinder of the rifle.

e. The Bayonet-Knife Scabbard, M8A1 (fig 1-11) serves as a carrier for the bayonet-knife when it is not installed to the rifle.

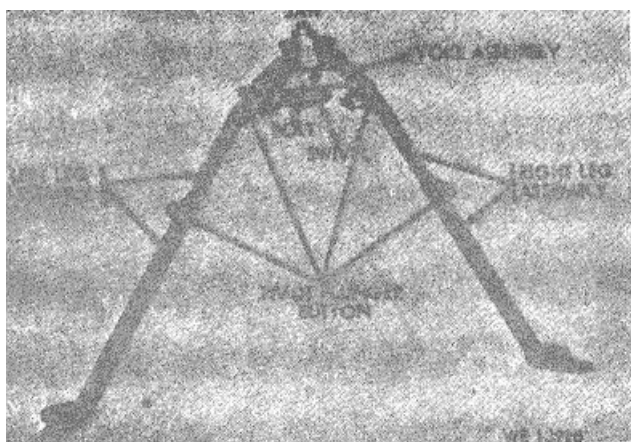

Figure 1-10. Rifle Bipod, M2.

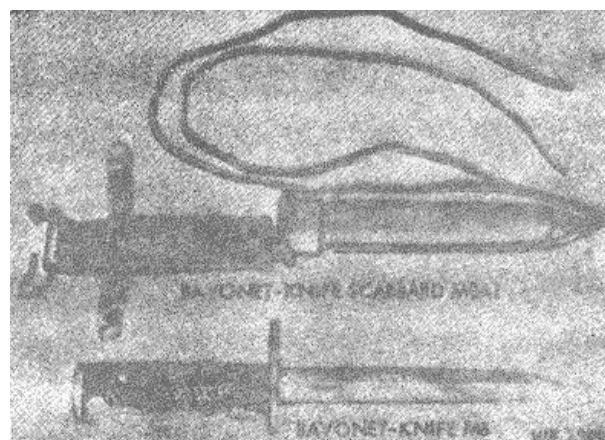

Figure 1-11. Bayonet-Knife M6 end Scabbard M8A1.

c. Grenade Launcher Sight, M15 (fig 1-5) is used in conjunction with the Grenade Launcher, M76, (fig 1-5) when launching grenades from the 7.62-MM Rifle, M14. It consists of mounting scale plate and sight bar assembly. The mounting plate is attached to the left side of the stock by two screws. The sight bar assembly is attached to the mounting plate.

f. The blank ammunition firing attachment consists of the M12 firing attachment and the M3 breech shield (fig 3-1). It is used to fire blank ammunition. The blank firing attachment has an orifice tube which slides into the muzzle opening of the flash suppresser. It is secured by the bayonet lug and a spring clip latch. The shield is secured to the cartridge guide by a guide lug with a spring plunger.

d. Bayonet-Knife, M6 (fig. 1-11) is used in conjunction with Rifle, M14 for close combat. It connects to the bayonet lug of the flash suppresser and a close loop in the handle encircles the flash suppresser.

g. The winter trigger kit M5 is used in cold weather or arctic operation of rifles. The winter trigger kit (fig 1-7) is assembled to the stock assembly with screws.

1

1-6. Tabulated Data

Refer to TM 9-1005-223-10 for tabulated data not listed below.

Chamber pressure (amx) ----- 50,000 psi

Weight (M14 w/e and loaded magazine)-----10.1 lb approx

Weight (M14A1 w/e and loaded magazine) -----13.12 lb approx

1-7. Administrative Storage

Refer to TM 740-90-1.

CHAPTER 2

ORGANIZATIONAL MAINTENANCE INSTRUCTIONS

Section I. SERVICE UPON RECEIPT OF MATERIEL

2-1. Inspecting, Servicing, and Installation Instructions

When equipment is first received by the using organization, inspect all assemblies, subassemblies, and accessories to certify that they are properly assembled, secured, cleaned, correctly adjusted, and lubricated. Check all tools and equipment against the basic issue item list in TM 9-1005-223-10 to make sure

every item is present, in good condition, clean and correctly assembled. If any, make a record of missing parts and malfunctions. The shipping containers should be retained for possible reuse. For installation of components of the 7.62-MM Rifles M14, M14A1 and accessories, refer to pertinent chapters in this manual. 2.-2. Inspection and Service Refer to table 2-1.

Table 2-1. Inspection and Service,

Step	Action	Reference
1	Unpack	
2	Clean	
3	Check for missing parts	Para 2-1
4	Check for damaged parts	
5	Lubricate	Para 2-5
6	Perform operational check	

Section II. REPAIR PARTS, SPECIAL TOOLS, AND EQUIPMENT

2-3. General

Repair parts, special tools, test, and support equipment are listed in appendix C.

2-4. Maintenance Supplies and Materials Table 2-2 lists lubricating, cleaning, maintenance materials, and their stock numbers that are authorized for maintenance of the rifles. Pertinent authorized documents are the proper requisitioning authority for these maintenance

expendable supplies and materials. The maintenance level column indicates the lowest category of maintenance authorized to utilize the particular item. The maintenance level codes used are:

Code	Explanation
C	Operator / crew
O	Organizational Maintenance

Table 2-2. Maintenance Supplies and Materials

Federal no.	Description	Maintenance level
8020-244-0153	BRUSH, ARTIST: METAL FERRULE, FLAT, CHISEL EDGES, 7/16 W, 1-1/8 LG, EXPOSED BRISTLE.	O
7920-205-2401	BRUSH, CLEANING, TOOL AND PARTS: RD, 100 PERCENT TAMPICO FIBER, 1-1 / 16 AT FERRULE BRUSH DIA, 2-7 / 8 CLEAR OF BLOCK BRUSH LG.	O
6850-965-2332	CARBON REMOVING COMPOUND: (P-C-111) (5 GAL PAIL)	O
6850-224-6657	CLEANING COMPOUND, RIFLE BORE: (RBC)	C
6850-224-6663	8 OZ CAN	O
5350-221-0872	1 GAL CAN	O
6850-281-1985	CLOTH, ABRASIVE: CROCUS, FERRIC OXIDE AND QUARTZ, JEAN-CLOTH-BACKING, CLOSED COATING, 9 W, 11 LG, 50 SH-SLEEVE (CA)	O
9150-754-0063	DRY CLEANING SOLVENT: (SD) (1 GAL CAN)	O
8010-221-0611	GREASE, RIFLE: (1 LB CAN)	O
9150-273-2389	LINSEED OIL, RAW: (1 GAL CAN)	C
9150-231-6689	LUBRICATING OIL, GENERAL PURPOSE: (PL SPECIAL)	C
9150-292-9689	4 OZ CAN	C
	1 QT CAN	O
	LUBRICATING OIL, WEAPONS: (LAW) FOR BELOW ZERO OPERATIONS (1 QT CAN)	O
7020-205-1711	RAG, WIPING: COTTON FOR GENERAL USE (50 LB BALE)	O

Section III. LUBRICATION

2-5. General

a. This section is intended to describe special lubrication instructions for the organizational personnel.

b. When performing maintenance, all parts of the weapon subject to friction or movement must be properly lubricated with a grade of oil recommended for the temperatures being encountered.

c. Always apply a light application of lubricant

to all parts requiring lubrication. However, excess lubricant must be removed with a suitable cloth or swabs.

d. Bear in mind that past experience, varying weather conditions and the extent which the equipment is used must be evaluated. From this evaluation the frequency of lubricant application may be most accurately determined.

Section IV. PREVENTIVE MAINTENANCE

2-6. General

a. This section contains organizational instructions for performing the periodic preventive maintenance checks and services required to maintain the rifle and auxiliary equipment.

b. To insure that the equipment is ready for

operation at all times, it must be thoroughly inspected so that defects may be discovered and corrected before contributing to equipment failure. The necessary preventive maintenance checks and services to be performed are contained in TM 9-1005-223-10 and in table 2-3.

Table 2-3. Organizational Preventive Maintenance Checks and Services

Q--Quarterly
 Total man hours required:

sequence number	Item to be inspected procedure	Work time
1	Rifle, M14 and M14A1 Wipe dry to remove oil, dirt, and foreign matter.	.100
2	Magazine. (Check magazine for damage, rust, missing parts, and functioning.	.033
3	Stock Assembly. Inspect for cracks, chips, looseness, missing screws, protective coating, and overall good condition.	.050
4	Operating Rod and Connector Assembly.033 Inspect for damage and for proper functioning.	
5	Bolt Assembly. Remove and inspect for excessive wear and cracks. Clean and lubricate.	.100
6	Barrel and Receiver. Inspect for unusual wear, damage, and cleanliness.	.050
7	Stabilizer Assembly. Check for proper installation and unusual wear.	.017
8	Bipod . Check functioning. locking action, and for visual damage.	.033
9	Blank Ammunition Firing Attachment Inspect for proper installation, damage, and cleanliness.	.017
10	Sight. Check for damage. missing or loose parts and functioning.	.033
11	Bayonet-Knife Check for damage, missing or loose parts. Check blade for chips, rust, sharpness and for proper installation.	.033

Section V. TROUBLESHOOTING

2-7. General

This section contains troubleshooting information for locating and correcting malfunctions which may develop in the weapon.

2-8. Troubleshooting

Table 2-4 is intended as a guide for troubleshooting.

The table does not cover all possible malfunctions that may occur. However, it includes the more common malfunctions. Additional data on troubleshooting is contained in TM 9-1005-223-10. Malfunctions which are not listed will be reported immediately to direct or general support personnel for remedial action.

Table 2-4. Troubleshooting

Malfunction	Probable cause	Corrective action
1. Ammunition does not load freely into magazine	<ul style="list-style-type: none"> a. Damaged magazine. b. Defective ammunition. c. Wrong caliber of ammunition. 	<ul style="list-style-type: none"> a. Replace. b. Replace. c. Check grade and nomenclature. Use proper caliber of ammunitions.
2. Magazine difficult or does not seat into magazine well	<ul style="list-style-type: none"> a. Damaged magazine. b. Ammunition improperly loaded into magazine. c. Undersized/over-sized magazine. 	<ul style="list-style-type: none"> a. Replace magazine. b. Remove/reload magazine. c. Replace magazine,
3. Bolt fail to lock.	<ul style="list-style-type: none"> a. Ammunition seated chamber. seated in chamber. b. Defective extractor. c. Dirty bolt assembly. d. Defective operating rod or spring. 	<ul style="list-style-type: none"> a. Make sure that ammunition is b. Replace extractor. c. Clean, oil or repair. d. Replace.
4. Failure to fire	<ul style="list-style-type: none"> a. Bolt open or not fully closed. b. Defective firing pin. c. Defective ammunition. d. Defective bolt assembly. e. Firing mechanism defective. 	<ul style="list-style-type: none"> a. Close bolt fully. b. Replace. c. Replace ammunition. d. Repair bolt assembly. e. Repair firing mechanism.
5. Short recoil.	<ul style="list-style-type: none"> a. Defective gas piston. b. Gas cylinder plug defective or loose. c. Spindle valve improperly set. d. Dirty weapon. e. Defective ammunition. f. Cylinder gas port not alined with gas port of barrel 	<ul style="list-style-type: none"> a. Replace. b. Tighten or replace. c. Set spindle valve to open (12 o'clock) position. d. Clean and lubricate. e. Replace ammunition. f. Tighten as cylinder lock.
6. Failure to feed.	<ul style="list-style-type: none"> a. Short recoil. b. Magazine not loaded properly. magazine. c. Defective magazine. 	<ul style="list-style-type: none"> a. Refer to short recoil. b. Reload ammunition into c. Replace magazine.
7. Failure to extract	<ul style="list-style-type: none"> a. Spindle valve closed. b. Short recoil. c. Defective extractor or bolt assembly. d. Ruptured or damaged ammunition. in chamber. case. 	<ul style="list-style-type: none"> a. Set spindle valve to open position. b. Refer to short recoil. c. Repair and clean bolt assembly. D. Remove ammunition or defective
8. Failure to eject	<ul style="list-style-type: none"> a. Defective ejector or spring or bolt assembly. b. Short recoil. 	<ul style="list-style-type: none"> a. Repair and clean bolt assembly. b. Refer to short recoil.
9. Failure to cock	<ul style="list-style-type: none"> a. Defective trigger and sear assembly. 	<ul style="list-style-type: none"> a. Clean or replace trigger and sear assembly.
10. Legs of bipod fail to remain in	<p>RIFLE BIPOD</p> <ul style="list-style-type: none"> a. Damaged leg assembly. desired position. for repair. b. Worn plunger or spring. for repair. 	<ul style="list-style-type: none"> a. Evacuate bipod to direct support b. Evacuate bipod to direct support
11. Bipod yoke assembly jaw does not retain proper torque when installed to rifle.	<ul style="list-style-type: none"> a. Worn yoke assembly. b. Bolt or swivel defective. 	<ul style="list-style-type: none"> a. Evacuate bipod to direct support. b. Evacuate bipod to direct support for repair.

Section VI. MAINTENANCE OF FIRING MECHANISM**2-9. General**

a. This section contains repair instructions for the firing mechanism.

NOTE

A white arrow on an illustration indicates disassembly and a black arrow denotes assembly.

b. Removal. Refer to figures 2-1 thru 2-3.

c. Disassembly. Refer to figures 2.2 thru 2-3.

d. Cleaning. Remove excess lubricant and contaminants from metal parts with a clean cloth or brush saturated with dry cleaning solvent (SD) or rifle bore cleaning compound (RBC). Wipe dry with a clean cloth.

e. Inspection. Inspect all components for excess wear, installation and for other visual damage. Check hammer spring for weakness, breaks and distortion.

f. Repair. None.

g. Assembly. Refer to figures 2-1 through 2-3.

h. Installation. Refer to figures 2-1 through 2-3.

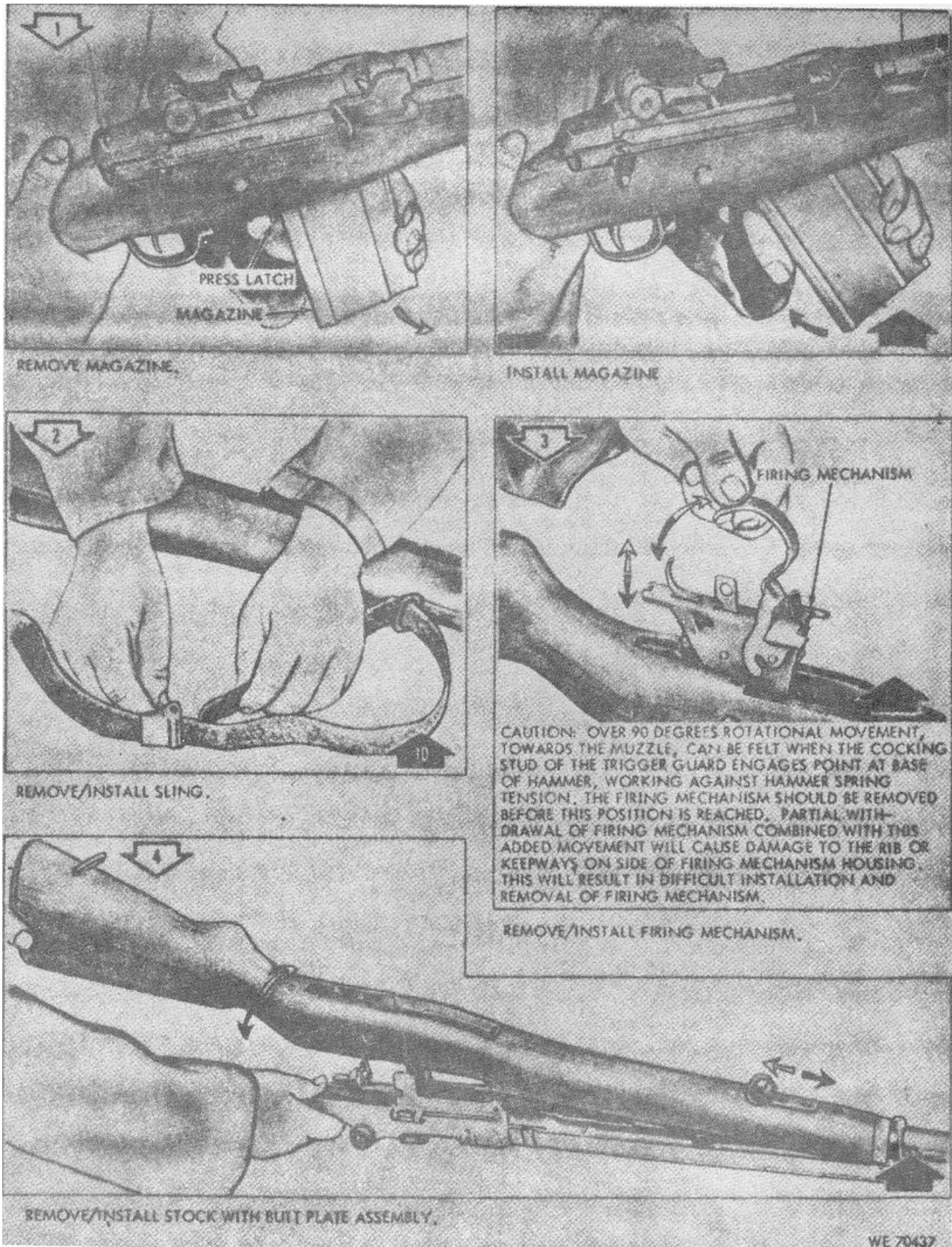

Figure 2-1. Disassembly/assembly of rifle components-partial exploded view.

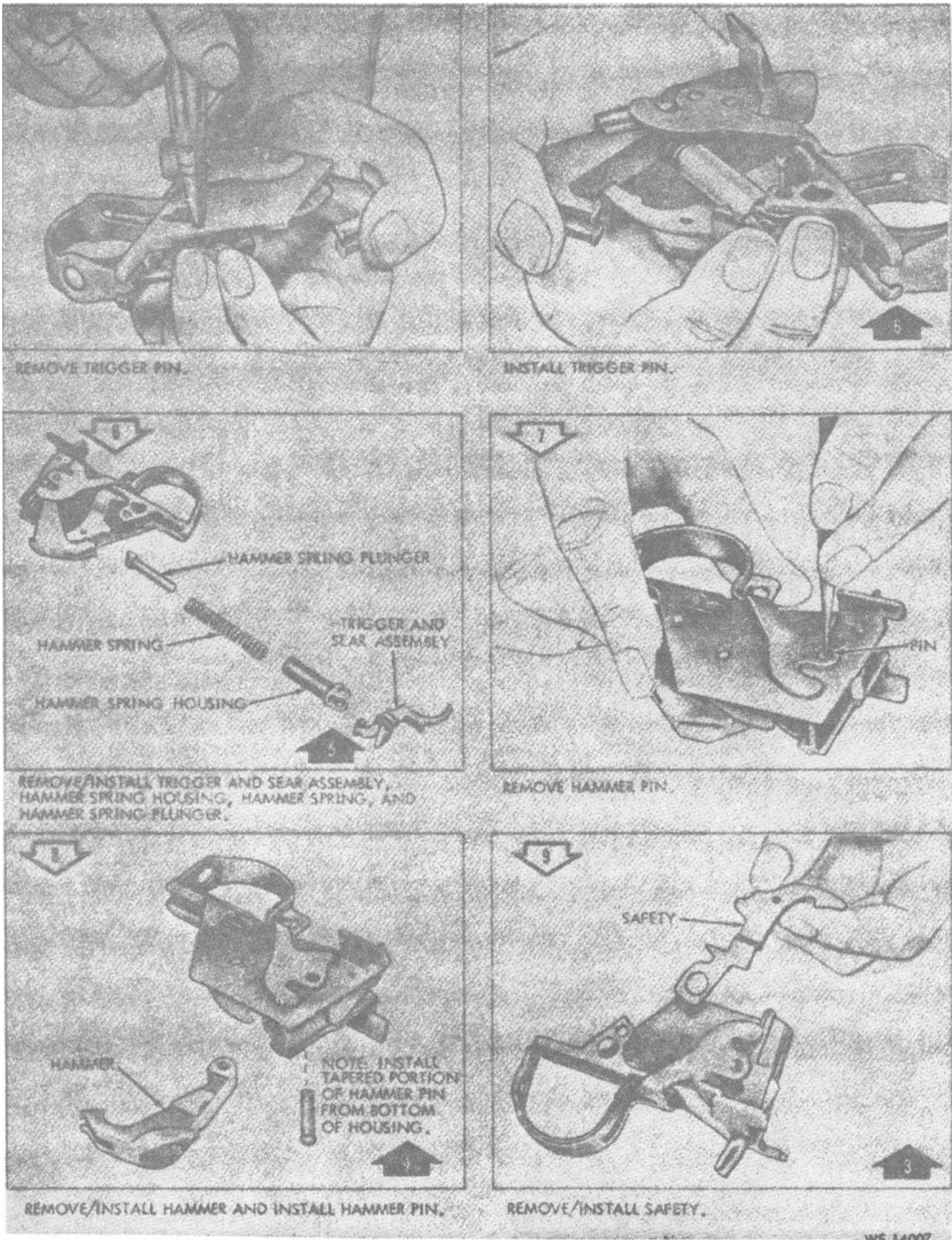

Figure 2-2. Disassembly /assembly of firing mechanism.

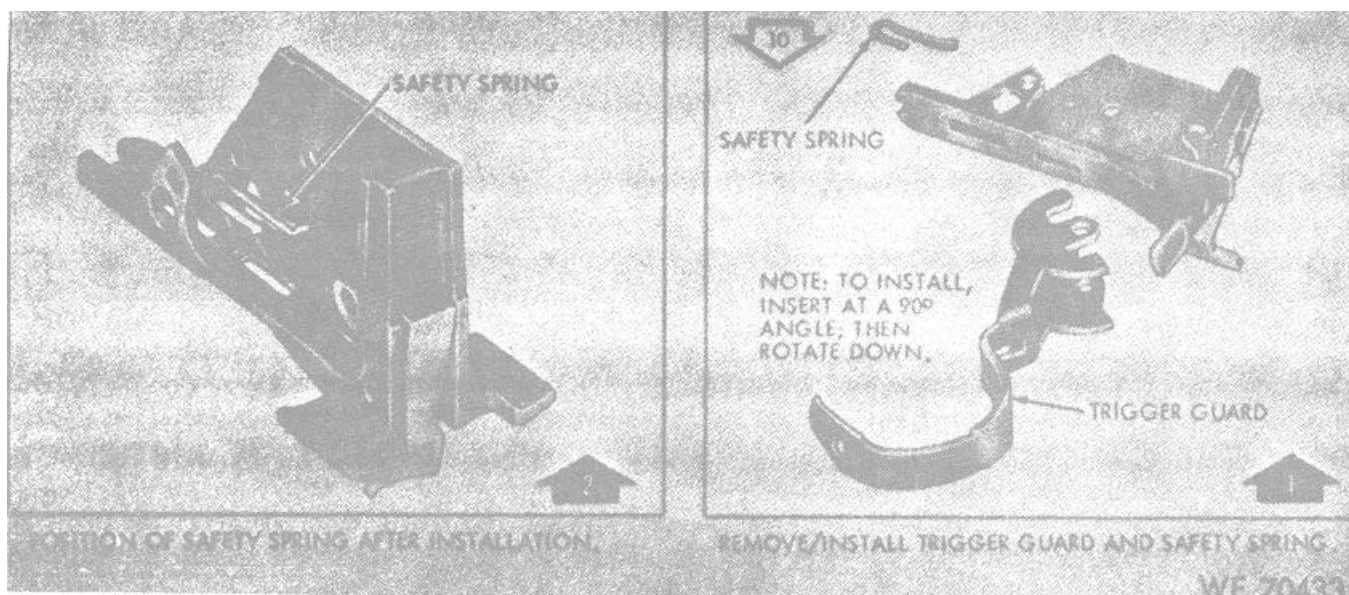

Figure 2-3. Disassembly/assembly of firing mechanism.

Section VII. MAINTENANCE OF STOCK ASSEMBLY

2-10. General

This section contains repair instructions for stock assembly.

- a. Removal/installation. Refer to TM 9-1005-223-10.
- b. Repair. None. Evacuate damaged stock assembly to direct support.

Section VIII. MAINTENANCE OF HAND GUARD ASSEMBLY

2-11. General

This section contains repair instructions for the hand guard assembly.

- a. Removal/Installation. Refer to figure 2-4.

- b. Cleaning. Clean hand guard assembly with a clean cloth.
- c. Inspection. Check for visual damage.
- d. Repair. Replace the damaged hand guard assembly.

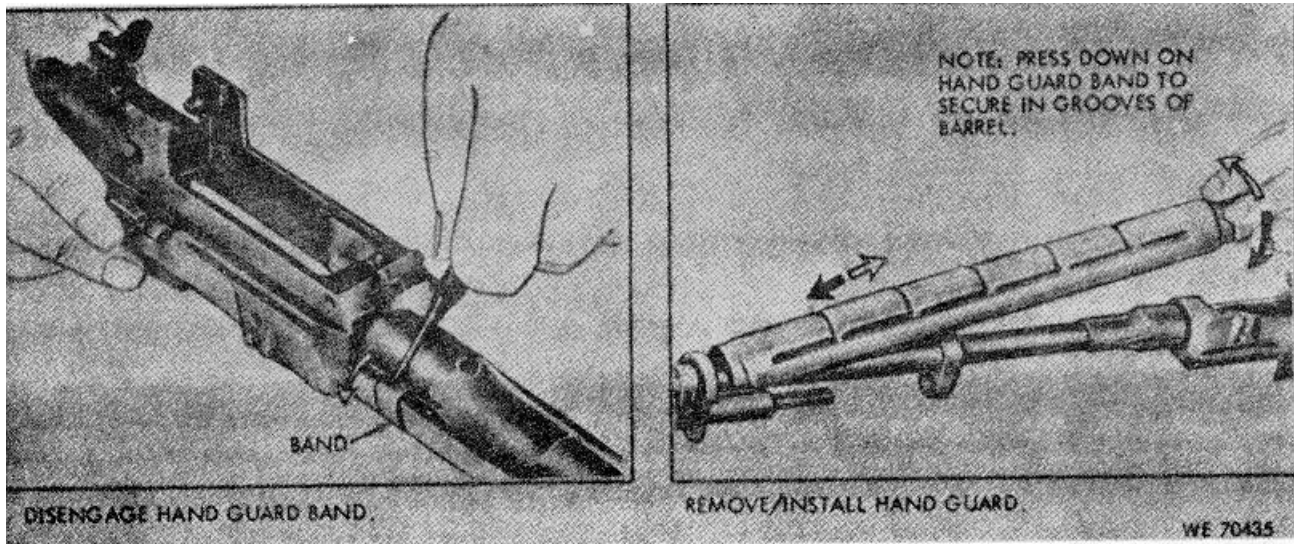

Figure 2-4. Remove/install hand guard.

Section IX. MAINTENANCE OF OPERATING ROD AND CONNECTOR ASSEMBLY

2-12. General

This section contains maintenance instructions for the operating rod and connector.

- a. Removal/installation. Refer to figure 2-5.
- b. Cleaning. Refer to paragraph 2-9d.

c. Inspection. Inspect parts for damage and operating rod spring for breaks and tension.

d. Repair. Replace the damaged or missing operating rod spring only.

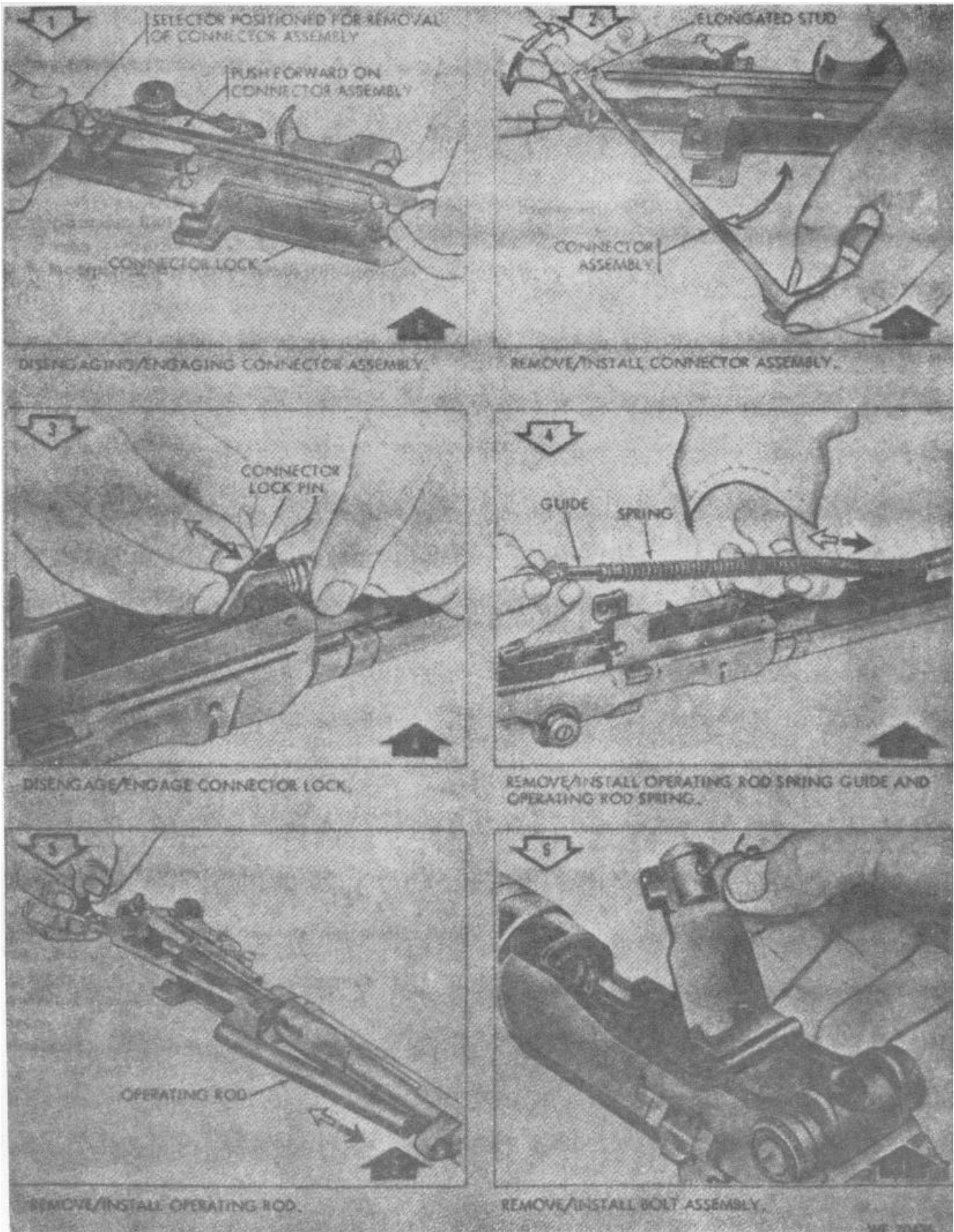

Figure 2-5. Remove/install operating rod and connector assembly.

Section X. MAINTENANCE OF BOLT ASSEMBLY

2-13. General

This section contains maintenance instructions for the bolt assembly.

a. Removal. Refer to figures 2-5, 2-6, and to TM 9-1005-223-10.

b. Installation. Refer to figure 4. Use the combination tool (fig. 7) and apply a downward force on the ejector while holding down on the extractor to secure inner parts of the bolt.

c. Cleaning. Refer to paragraph 2-9d.

d. Inspection. Inspect for damage, missing parts and for proper functioning.

e. Repair. Repair consists of replacing damaged or missing parts.

NOTE

When installing the bolt assembly, make certain it is not interchanged between other rifles. Interchangeability of a bolt assembly requires usage of a headspace gage authorized for direct and general support maintenance.

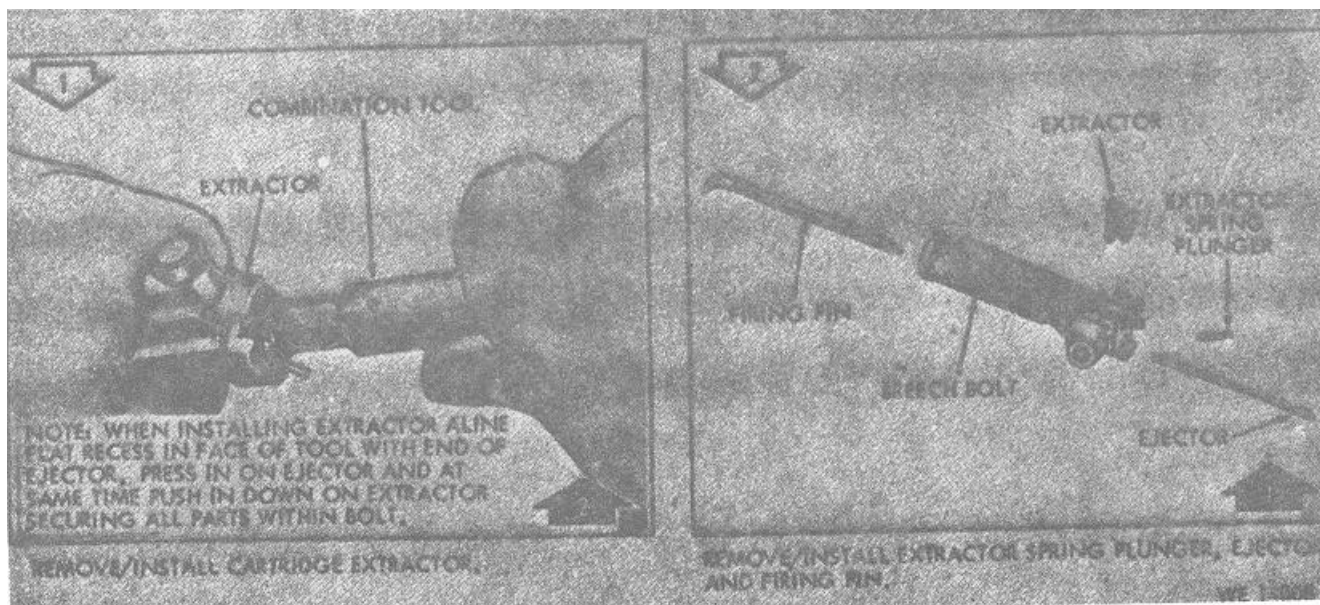

Figure 2-6. Remove/install cartridge extractor and components .

Section XI. MAINTENANCE OF BARREL AND RECEIVER GROUP

2-14. General

a. This section contains maintenance instructions for the barrel and receiver group.

b. Removal/installation. Refer to figures 2-7 and 2-8 and TM 9-1005-223-10.

c. Cleaning. Refer to paragraph 2-9d.

d. Inspection. Inspect barrel and receiver assembly for barrel obstruction, abnormal wear

and missing or damaged components. Check to insure that parts are assembled, adjusted, and function properly.

e. Repair. Replace missing or damaged parts of the barrel and receiver assembly to the extent authorized in the MAC as an organizational maintenance function.

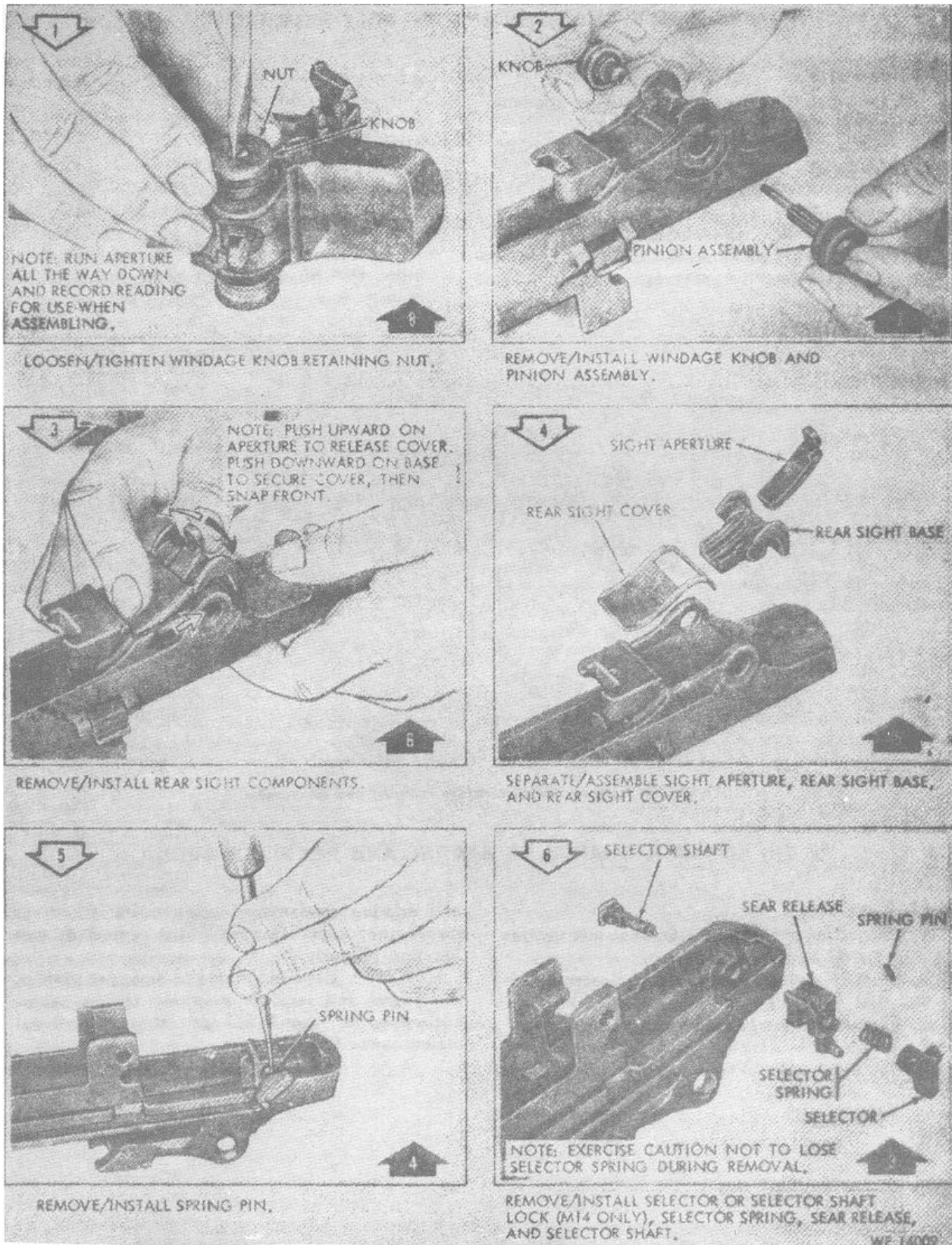

Figure 2-7. Remove / install component of the barrel and receiver assembly.

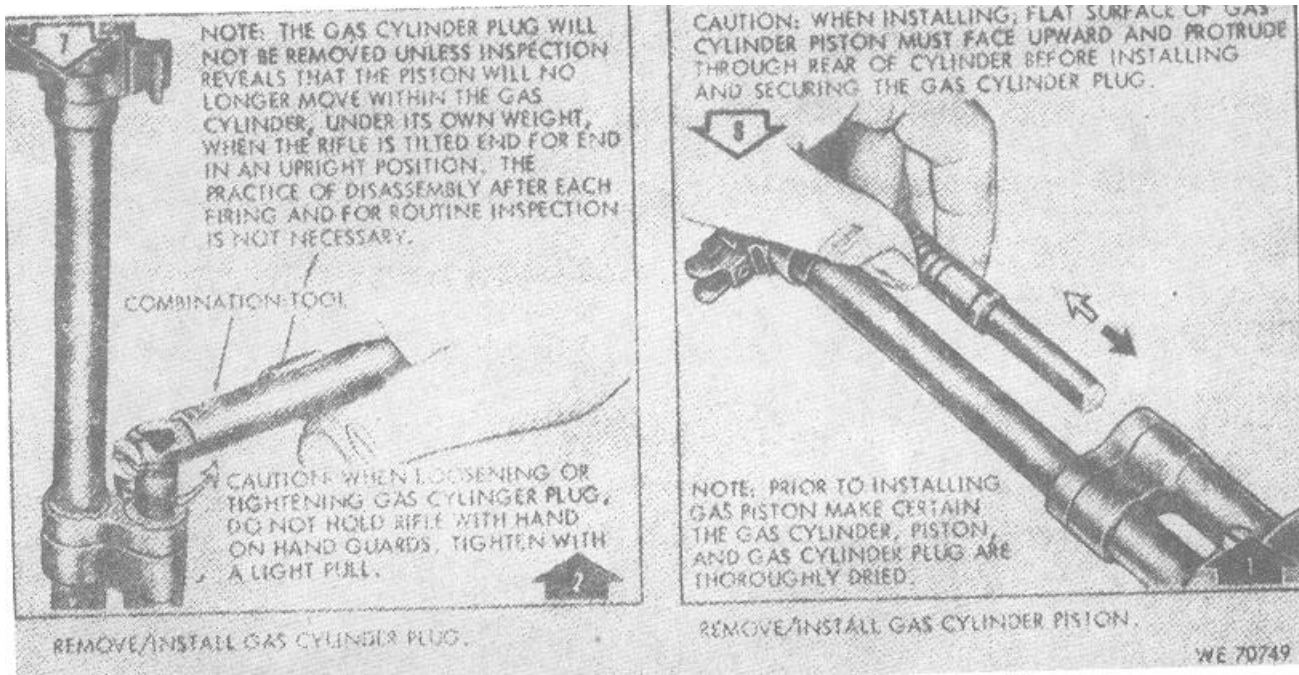

Figure 2-8. Remove/install gas cylinder and piston.

Section XII. MAINTENANCE OF THE STABILIZER ASSEMBLY (M14A1 RIFLE)

2-15. General

- a. This section contains maintenance instructions for the stabilizer assembly.
- b. Removal/ installation. Refer to figure 2-9 and TM 9-1005-223-10.
- c. Cleaning. Refer to paragraph 2-9d.

- d. Inspection. Inspect for visual damage and missing parts.
- e. Repair. Remove damaged stabilizer assembly and refer to direct support maintenance for remedial action.

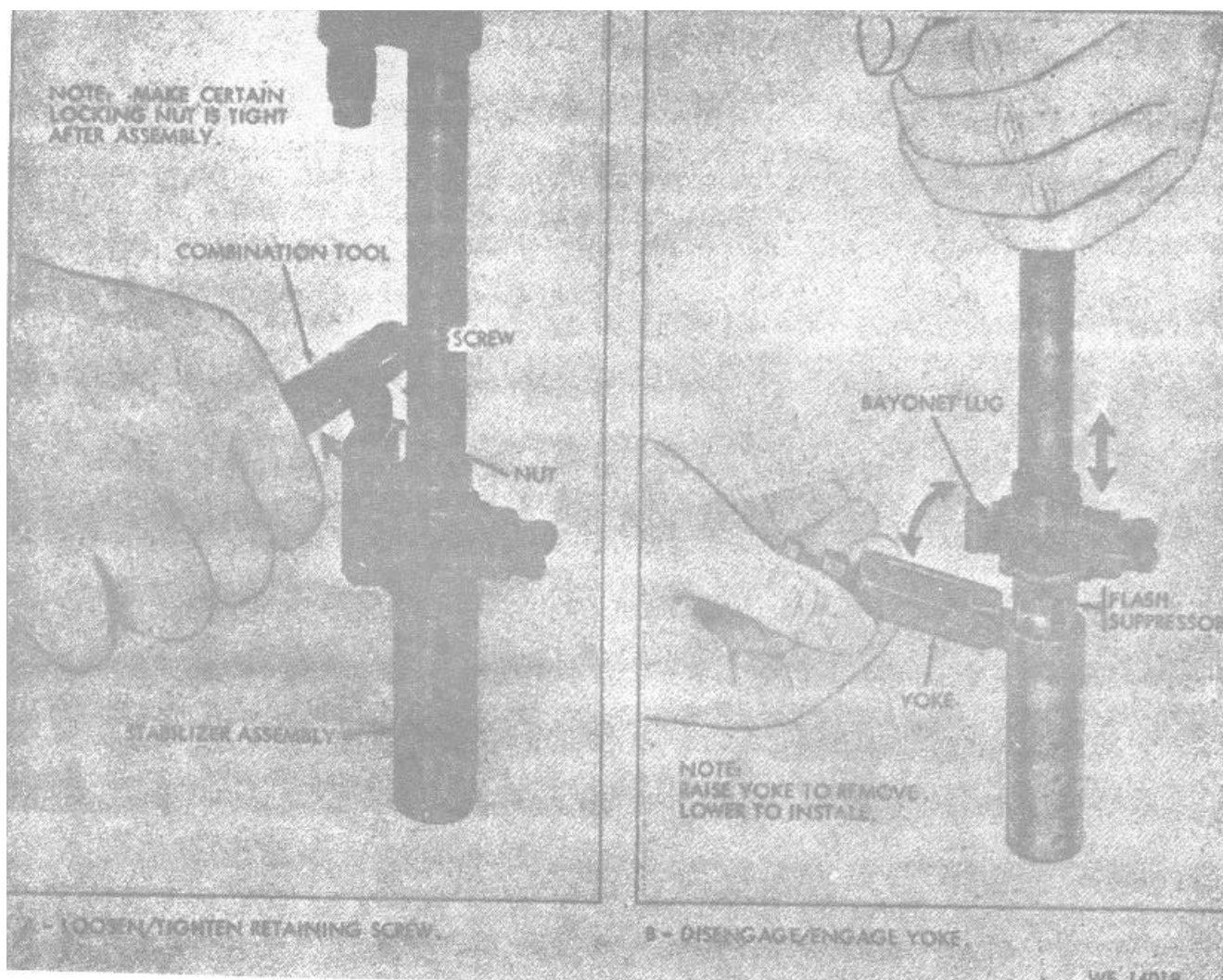

Figure 2-9. Remove/ install stabilizer assembly.

Section XII. MAINTENANCE OF RIFLE BIPOD

2-16. General

a. This section contains maintenance instructions for the Rifle Bipod, M2 (fig 1-10).

b. Cleaning. Refer to paragraph 2-9d.

c. Inspection. Check yoke jaw, pivot plunger and legs assemblies for proper operation, wear and for other visual damage.

d. Repair. Replace bipod or refer to direct support maintenance for remedial action.

CHAPTER 3

MAINTENANCE OF MATERIEL USED IN
CONJUNCTION WITH MAJOR ITEMS

Section I. GENERAL

3-1. Scope

This chapter contains maintenance instructions for the Blank Ammunition Firing Attachment, M12 with Breech Shield, M3 (for M14 Rifle);

Grenade Launcher, M76; Grenade Launcher Sight, M15; and Bayonet-Knife, M6.

Section II. MAINTENANCE OF BLANK AMMUNITION FIRING ATTACHMENT WITH BREECH SHIELD

3-2. General

a. This section contains maintenance instructions for the blank ammunition firing attachment with breech shield.

b. Removal/installation. Refer to figures 3-1 and 3-2.

c. Cleaning. Refer to paragraph 2-9d.

d. Inspection. Inspect for visual damage and for proper installation.

e. Repair. Evacuate damaged blank firing attachment and breech shield to direct support.

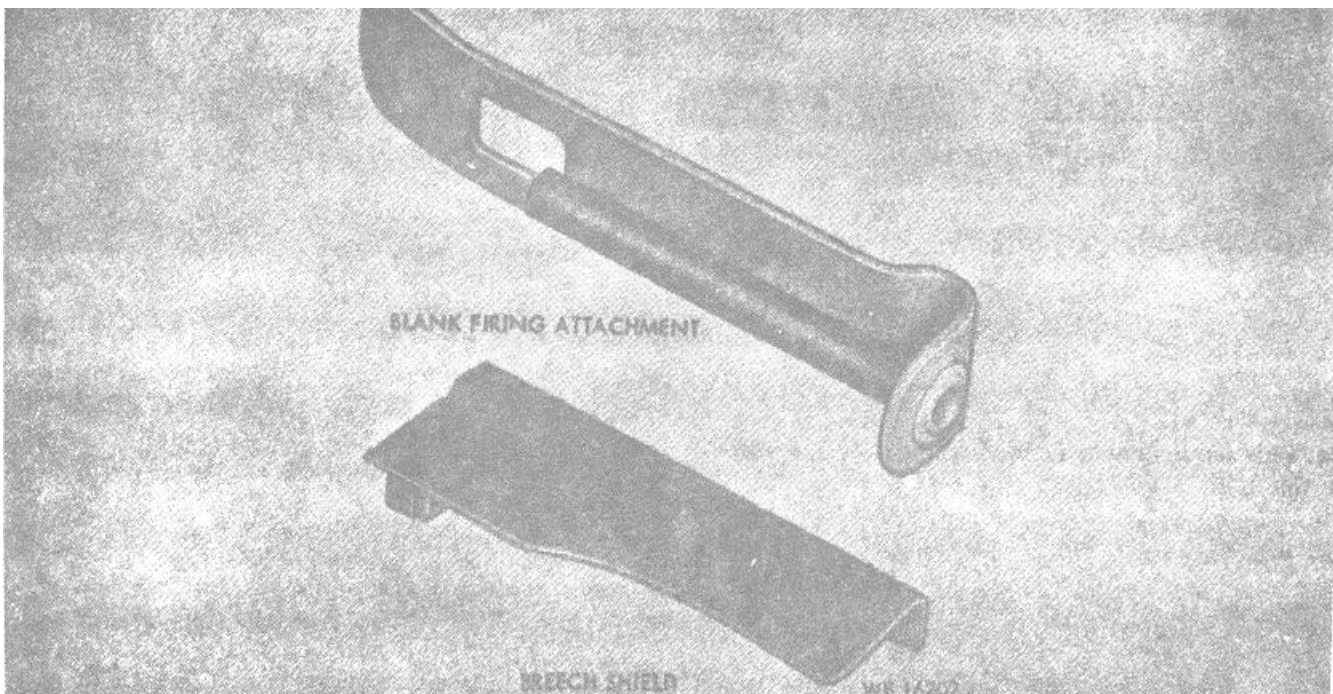

Figure 3-1. Blank ammunition firing attachment and breech shield.

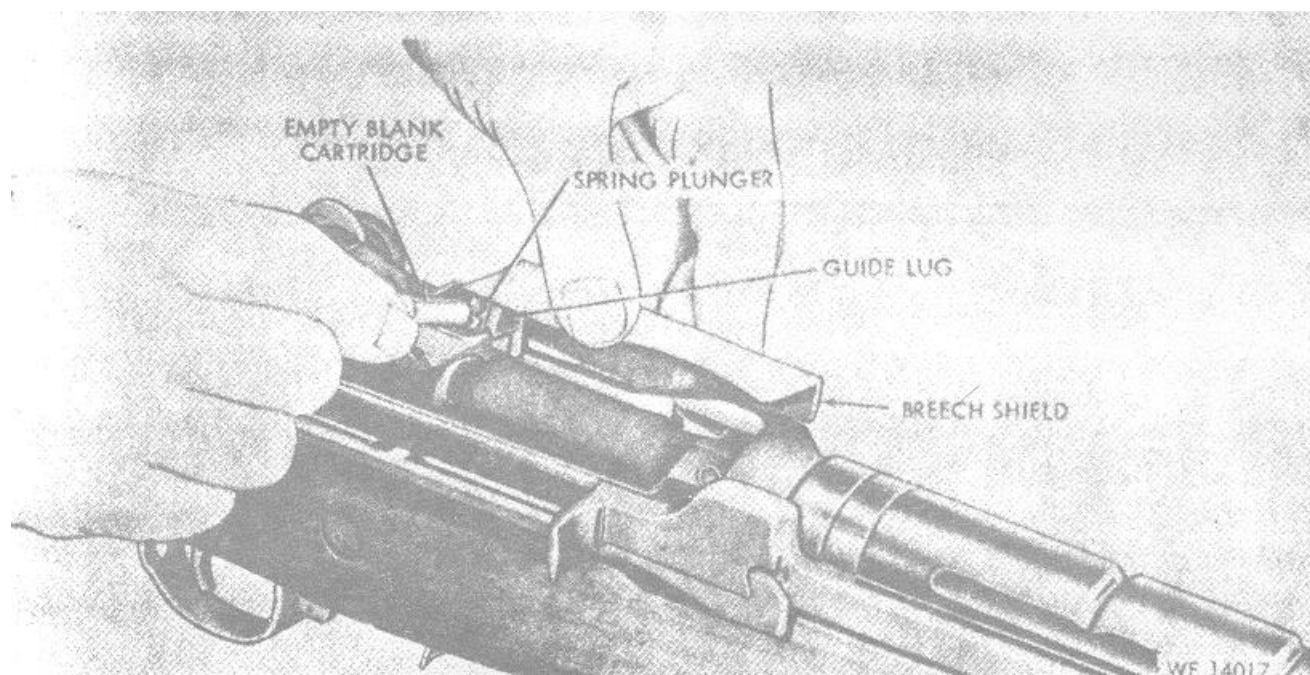

Figure 3-2. Remove/install breech shield.

Section III. MAINTENANCE OF GRENADE LAUNCHER AND REINADI LAUNCHER SIGHT

3-3. General

a. This section contains maintenance instructions for the Grenade Launcher, M76 and Grenade Launcher, M15.

b. Removal/ installation. Refer to figure 3-3 and TM 9-1005-223-10.

c. Cleaning. Refer to paragraph 2-9d.

d. Inspection. Inspect for visual damage.

e. Repair. Replace damaged grenade launcher or grenade launcher sight.

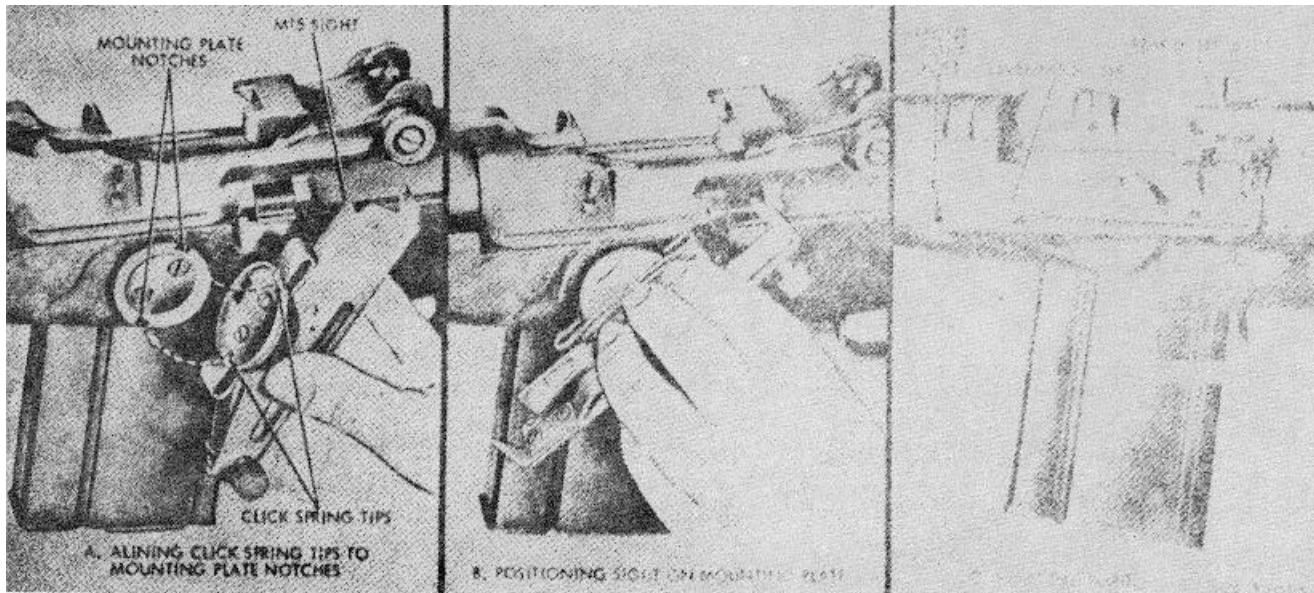

Figure 3-3. Remove/Install Sight, M15 on rifle.

Section IV. MAINTENANCE OF WINTER TRIGGER KIT

3-4. General

- a. This section contains maintenance instructions for the Winter Trigger Kit, M5 (fig. 6).
- b. Cleaning. Refer to paragraph 2-9d.

c. Inspection. Inspect for rust, missing parts, and for visual damage.

d. Repair. Repair consists of replacing screws, washers, and winter safety (fig 6).

Section V. MAINTENANCE OF BAYONET-KNIFE, M6

3-5. General

- a. This section contains maintenance instructions for Bayonet-Knife, M6 (fig. 1-11).
- b. Refer to TM 9-1005-237-15P for assembly / disassembly instructions.
- c. Cleaning. Refer to paragraph 2-9d.

d. Inspection. Inspect latching lever lugs in the handle of the bayonet for burs. Inspect for missing parts and for other visual damage.

e. Repair. None. Refer bayonet-knife to direct support or general support.

APPENDIX A

REFERENCES

A-1. Publication Indexes

Consult each new issue of the following for the latest changes or revisions to publications listed In this appendix or for new publications on the material covered in this manual.

Military Publications:

Index of Administration Publications.....	DA Pam 310.1
Index of Blank Forms.....	DA Pam 310-2
Index of Supply Catalogs and Supply Manuals (excluding types 7, 8, and 9).....	DA Pam 310-6
Index of Technical Manuals, Technical Bulletins Supply Manuals (types 7, 8, and 9) Supply Bulletins, Lubrication Orders	DA Pam 310-4
Index of Doctrinal, Training, and Organizational Publications.....	DA Pam 310-3
US Army Equipment Index of Modification Work Orders	DA Pam 310-7

A-2. Identification List

The following identification listings pertain to this materiel:

Ammunition and Explosives (Class 1305 Ammunition through 30-MM).....	SC 1305 / 30 / IL
--	-------------------

A-3. Forms

The following form pertains to this materiel:

Recommended Changes to Publications	DA Form 2028
---	--------------

A-4. Other Publications

a. Ammunition.

Ammunition, General	TM 9-1300-200
Care, Handling, Preservation and Destruction of Ammunition	TM 9-1300-206
Identification of Inert Ammunition And Ammunition Components	AR 385-65
Small Arms Ammunition.....	TM 9-1305-200

b. General

Accident Reporting and Records	AR 385-40
Administrative Storage of Equipment	TM 740-90-1
Authorized Abbreviations and Brevity Codes.....	AR 310-50
Basic Cold Weather Manual.....	FM31-70
Dictionary of United States Army Terms.....	AR 310-25
Military Symbols.....	FM 21-30
Military Training Management	FM 21-5
Operator's Manual, Rifles, 7.62-MM, M14, Rifle, 7.62-MM, M14A1 and Rifle Bipod, M2	TM 9-1005-223-10
Organizational, DS, GS, and Depot Maintenance Repair Parts and Special Tools List: Bayonet-Knife, M4, M5, MSA1, M6, and M7, with Bayonet-Knife M8A1	TM 9-1005-237-15P
Organization, Policies, and Responsibilities for Maintenance Operations	AR 750-5
Procedures for Destruction of Equipment in Federal Supply Classifications 1000, 1005, 1010, 1015, 1020, 1030, 1055, 1090, and 1095 to Prevent Enemy Use.....	TM750-244-7
Regulation for Firing Ammunition for Training, Target Practice. and Combat	AR 385-63
Techniques of Military Instructions	FM 21-6
The Army Maintenance Management System (TAMMS)	TM 38-750
Worldwide Ammunition Reporting System 4(WARS): Reports Control System CSGLD-1322 (R1) (MIN).....	AR 700-22

c. Property Accountability.
Materiel Management for Using Units, Support Units
and InstallationsAR 710-2

APPENDIX B

MAINTENANCE ALLOCATION CHART

Section I. INTRODUCTION

B-1. General

This Maintenance Allocation Chart designates overall responsibility for the performance of maintenance functions on the identified end item or component.

B-2. Maintenance Functions

Maintenance functions will be limited to and defined as follows:

a. Adjust. Maintain within prescribed limits by bringing into proper or exact position, or by setting the operating characteristics to specified parameters.

b. Align. To adjust specified variable elements of an item to bring about optimum or desired performance.

c. Calibrate. To determine and cause corrections to be made or to be adjusted on instruments or test measuring and diagnostic equipment used in precision measurement. Consists of comparisons of two instruments, one of which is a certified standard of known accuracy, to detect and adjust any discrepancy in the accuracy of the instrument being compared.

d. Inspect. To determine the serviceability of an item by comparing its physical, mechanical and / or electrical characteristics with established standards through examination.

e. Install. The act of emplacing, seating, or fixing into position an item, part, module (component or assembly) in a manner to allow the proper functioning of an equipment / system.

f. Overhaul. That maintenance effort (service / action) necessary to restore an item to a completely serviceable/ operational condition as prescribed by maintenance standards (e.g., DMWR) in pertinent technical publications. Overhaul is normally the highest degree of maintenance performed by the Army. Overhaul does not normally return an item to like new condition.

g. Rebuild. Consists of those services/actions necessary for the restoration of unserviceable equipment to a like-new condition in accordance with original manufacturing standards. Rebuild is the highest degree of materiel maintenance applied to Army equipment. The rebuild operation includes the act of

returning to zero those age measurements (hours, miles, etc.) considered in classifying Army equipment / components.

h. Repair. The application of maintenance services (inspect, test, service, adjust, align, calibrate, replace or other maintenance actions welding, grinding, riveting, straightening, facing re machining, or resurfacing) to restore serviceability to an item by correcting specific damage, fault, malfunction, or failure in a part, subassembly, module / component / assembly, end item or system.

i. Replace. The act of substituting a serviceable like-type part, subassembly, module (component or assembly) in a manner to allow the proper functioning of an equipment/ system.

j. Service. Operations required periodically to keep an item in proper operating condition, i.e., to clean, preserve, drain, paint, or to replenish fuel / lubricants / hydraulic fluids, or compressed air supplies.

k. Test. To verify serviceability and to detect incipient failure by measuring the mechanical or electrical characteristics of an item and comparing those characteristics with prescribed standards.

l. Symbols. The uppercase letter placed in the appropriate column indicates the lowest level at which that particular maintenance function is to be performed.

B-3. Explanation of Format.

Purpose and use of the format are as follows;

a. Column 1, Group Number. Column 1 lists group numbers, the purpose of which is to match components, assemblies, subassemblies, and modules with the next higher assembly.

b. Column 2, Functional Group. Column 2 lists the next higher assembly group and the item names of components, assemblies, subassemblies, and modules within the group on which maintenance is authorized.

c. Column 3, Maintenance Function. Column 3 lists the eleven maintenance functions defined in B2 above. Each maintenance function required for an item shall be specified by the symbol among

those listed in d below which indicates the level responsible for the required maintenance. Under this symbol there shall be listed an appropriate work measurement time value determined as indicated in e below.

d. Use of Symbols. The following symbols shall be used to prescribe work function responsibility:

- C-Operator / Crew
- O-Organization
- F-Direct Support
- H-General Support
- D-Depot

e. Work Measurement Time. The active repair time required to perform the maintenance function is included directly below the symbol identifying the category of maintenance. These figures were developed under conditions corresponding to those that

are normal for TOE units operating in the field. The skill levels used to obtain the measurement times are approximate of those in typical TOE units. Active repair time is the average aggregate time required to restore an item (subassembly, assembly, component, module, end item or system) to a serviceable condition under typical field operating conditions. This time includes preparation time, fault isolation / diagnostic time and QA / QC time. It also includes the time required to perform specific maintenance functions identified for the tasks authorized in the maintenance allocation chart. This time is expressed in man-hours carried to one decimal place (tenths of hours).

f. Column 4, Tools and Equipment. This column shall be used to specify, by code, those tools and test equipment required to perform the designated function.

g. Column 5, Remarks. Self-explanatory.

SECTION II. MAINTENANCE ALLOCATION CHART
Rife 7.62-MM m14, M14A1, Rife, Bipod M2 and Grenade Launcher M76 Sight M15

(1) Group No.	(2) Functional Group	(3) Maintenance functions										(4) Tools and equipment	(5) Remarks	
		Inspect	Test	Service	Adjust	Align	Calibrate	Install	Replace	Repair	Overhaul			Rebuild
1	Magazine	C 0.1	..	C 0.1	C 0.1	C 0.1	..	D 0.5			
2	Firing Mechanism	C 0.1	F 0.1	C 0.1	C 0.1	O 0.1	F 0.1	D 0.2			
3	Sock Assembly	C 0.1	..	C 0.1	C 0.1	F 0.1	F 0.2	D 0.1			
4	Hand Guard Assembly	C 0.1	..	C 0.1	O 0.1	O 0.1			
5	Operating Rod & Connector Assembly	C 0.1	..	C 0.1	C 0.1	O 0.1	O 0.1	D 0.1			
6	Bolt Assembly	C 0.1	..	C 0.1	C 0.1	O 0.1	O 0.1	D 0.1			
7	Barrel Receiver Group	C 0.2	..	C 0.1	..	F 0.1	O 0.1	O 0.2	D 0.2			
8	Stabilizer Assembly	C 0.1	..	C 0.1	C 0.1	F 0.1	F 0.1	D 0.1		Combi- nation Tool (7790679)	
9	Bipod, Rifle	C 0.1	..	C 0.1	C 0.1	O 0.1	F 0.2	D 0.3		Combi- nation Tool (7790679)	
10	Blank Ammunition Firing Attachment w / Breech	C 0.1	..	C 1.0	C 0.17	O 0.17					
11	Grenade Launchers M76 w / Grenade Launch Sight	C 0.1	..	C 0.1	F 0.2	O 0.1					
12	Slings, Small Arms Webbing M1, M14 only	C .017	..	C .017	C .017	O .017					
13	Bayonet-Knife	O 0.1	..	C 0.1	F .017	F .02	H 0.2	D 0.3		
14	Scabbard	O 0.1	..	C 0.17	O .017					

**APPENDIX C
ORGANIZATIONAL MAINTENANCE REPAIR PARTS
AND SPECIAL TOOLS LIST**

Section I. INTRODUCTION

C-1. Scope

This appendix lists repair parts, special tools and equipment required for the performance of organizational maintenance of the Rifles, 7.62MM, M14 and M14A1.

C-2. General

This Repair Parts and Special Tools List is divided into the following sections:

a. Repair Parts List-Section II. A list of repair parts authorized at the organizational level for the performance of maintenance. It also includes parts which must be removed for replacement of the authorized parts. Parts lists are composed of functional groups in ascending numerical sequence, with the parts in each group listed in figure and item number sequence.

b. Special Tools List-Section III. A list of special tools, test and support equipment authorized for the performance of maintenance at the organizational level.

c. Federal Stock Number and Reference Number Index-Section IV. A list, in ascending numerical sequence, of all Federal stock numbers appearing in the listings, followed by a list, in alphanumeric sequence, of all reference numbers appearing in the listings. Federal stock number and reference numbers are cross-referenced to each illustration figure and item number appearance.

C-3. Explanation of Columns

The following provides an explanation of columns found in the tabular listings.

a. Source, Maintenance, and Recoverability Codes (SMR).

- (1) Source Code. Indicates the source for the listed items.

Source codes are:

Code	Explanation
P	Repair parts, special tools, and test equipment supplied from the GSA/ DSA, or Army supply system. and authored for use at indicated maintenance categories
P2	Repair parts, special tools, and teat equipment which e procured and stocked for insurance purposes because the combat or military essentiality of the end item dictates that a minimum quantity be available in the supply system.
P9	Assigned to items which are NSA design controlled: unique repair parts, special tools, zest. measuring, and diagnostic equipment which are stocked and supplied by the Army COMSEC

Logistic System and which are not subject to the provisions of AR 380-41.

P10	Assigned to items which are NSA design controlled: special tools, test, measuring, and diagnostic equipment for COMSEC support which are accountable under the provisions of AR 380-41, and which are stocked and supplied by the Army COMSEC Logistic System.
M	Repair parts, special tools and test equipment which are not procured or stocked as such in the supply system but are to be manufactured at indicated maintenance levels.
A	Assemblies which are not procured or stocked as such but are made up of two or more units. Such component units carry individual stock numbers and descriptions. ore procured and stocked separately, and can be assembled to form the required assembly at indicated maintenance categories.
X	Parts and assemblies that are not procured or stocked because the failure rate is normally below that of the applicable end item or component. The failure of such part or assembly should result In retirement of the end item from the supply system.
X1	Repair parts which are not procured or stocked. The requirement for such items will be filled by the next higher assembly or component.
X2	Repair parts, special tools and test equipment which are not stocked and have no foreseen mortality. The indicated maintenance category requiring such repair parts will attempt to obtain the parts through cannibalization or salvage. The item may be requisitioned, with exception data, from the end item manager for immediate use. Ib Major assemblies that are procured with PEMA funds for initial issue only as exchange assemblies at DS and GS level. These assemblies will not be stacked above DS and GS level or returned to depot supply level.

NOTE

Cannibalization or salvage may be used as a source of supply for any items source coded above except those coded X1 and aircraft support items as restricted by AR 700-42.

(2)Maintenance Code. Indicates the lowest category of maintenance authorized to install the repair part and/ or use the special tool or test equipment for each application. Capabilities of higher maintenance categories are considered equal or better. Maintenance codes are:

Code	Explanation
C	Crew / operator
O	Organizational maintenance
F	Direct support maintenance
H	General support maintenance
D	Depot maintenance

(3)Recoverability (Code). Indicates whether unserviceable items should be returned for recovery or salvage. Items not coded are non-recoverable.

Recoverability codes are:

Code	Explanation
R	Repair parts assemblies and components), special tools and test equipment which are considered economically repairable at direct and general support maintenance levels. When the item is no longer economically repairable, it is normally disposed of at the GS level. When supply considerations dictate, some of these repair parts may be listed for automatic return to supply for depot level repair as set forth in AR 710-1. When so listed, they will be replaced by supply on an exchange basis.
S	Repair parts, special tools and test equipment, and assemblies which are economically repairable at DS and GS activities and which normally are furnished by supply on an exchange basis. When items are determined by a GSU to be uneconomically repairable, they will be evacuated to a depot for evaluation and analysis before final disposition.
T	High dollar value recoverable repair parts, special tools and test equipment which are subject to special handling and are issued on an exchange basis. Such items will be repaired or overhauled at depot maintenance activities only. No repair may be accomplished at lower levels.
U	Repair parts, special tools and test equipment specifically selected for salvage by reclamation units because of precious metal content, critical materials, high dollar value, or reusable casings or castings.

b. Federal Stock Number. Indicates the Federal stock number assigned to the item and will be used for requisitioning purposes.

c. Description. Indicates the Federal item name and a minimum description required to identify the item. The last line indicates the reference number followed by the applicable Federal Supply Code for Manufacturer (FSCM) in parentheses. The FSCM is

used as an element in item identification to designate manufacturer or distributor or Government agency, etc., and is identified in SB 708-42 Items that are included in kits and sets are listed below the name of the kit or set with quantity of each item in the kit or set indicated in front of the item name.

d. Unit of Measure (U/M). Indicates the standard or basic quantity by which the listed item is used in performing the actual maintenance function. This measure is expressed by a two character alphabetical abbreviation, e.g., ea, in, pr, etc., and is the basis used to indicate quantities and allowances in subsequent columns. When the unit of measure differs from the unit of issue, the lowest unit of issue that will satisfy the required units of measure will be requisitioned.

e. Quantity Incorporated in Unit. Indicates the quantity of the item used in the breakout shown on the illustration figure, which is prepared for a functional group or an assembly. A "V" appearing in this column in lieu of a quantity indicates that no specific quantity is applicable, e.g., shims, spacers, etc.

f. 15-Day Organizational Maintenance Allowances.

(1) The allowance columns are divided into four subcolumns. Items authorized for use are identified with an asterisk in the allowance column opposite the first appearance of each item. Subsequent appearances have the letters "REF" in the allowance columns.

(2) Subsequent changes to allowance lists will be accomplished in accordance with AR 710-2. In addition, the major commands will be authorized to approve reductions in stockage allowances (range and quantity). If additional items are considered necessary, recommendation should be forwarded to Commanding General, US Army Weapons Command, ATTN: AMSWE-MAS / SP, Rock Island, Illinois 61201, for exception or revision to the allowance list.

g. Illustration. This column is divided as follows:

(1) Figure Number. Indicates the figure number of the illustration on which the item is shown.

(2) Item Number. Indicates the callout number used to reference the item on the illustration.

C-4. Special Information

a. Usable on codes are included in Column 3. Uncoded items are applicable to all models. Identifications of the usable on codes used in this publication are:

Code	Used On
A	M14
B	M14A1

b. Action change codes indicated in the left-hand margin of the listing page denote the following:

- N-Indicates an added item.
- C-Indicates a change in data.
- R-Indicates a change in FSN only.

e. The illustrations in this manual are identical to those published in TM 9-1005-223-34. Only those parts assigned a maintenance code "0" are listed in the tabular listing. Only illustrations containing organizational authorized items appear in this manual.

C-5. How to Locate Repair Parts,

a. When Federal stock number or reference number is unknown.

(1) First. Using the table of contents determine the functional group within which the repair part belongs, This is necessary since illustrations are prepared for functional groups and listings are divided into the same groups.

(2) Second. Find the illustration covering the group to which the repair part belongs.

(3) Third. Identify the repair part on the illustration and note the illustration figure and item number of the repair part.

(4) Fourth. Using the Repair Parts Listing, find the functional group to which the repair part belongs and locate the illustration figure and item number noted on the illustration.

b. When Federal stock number or reference number is known:

(1) First. Using the Index of Federal Stock Numbers and Reference Numbers find the pertinent Federal Stock number or reference number. This index is in ascending FSN sequence followed by a list of reference numbers in ascending alphanumeric sequence, cross-referenced to the illustration figure number and item number.

(2) Second. Using the Repair Parts Listing, find the functional group of the repair part and the illustration figure number and item number referenced in the Index of Federal Stock Number and Reference Numbers.

C-6. Abbreviations

<i>Abbreviations</i>	<i>Explanations</i>
dia.....	diameter
fl-fil-hd	flat fillister head
hex-socket	hexagon socket
non-std.....	non-standard
o/a	over all
od	outside diameter
phos-ctd.....	phosphate coated
S	steel
stk.....	stock
UNF	Unified fine thread

Section II. REPAIR PARTS LIST

ACT ON CODE	(1) SOURCE MAINT AND RECOV CODE			(2) STOCK NO. MEAS	(3) DESCRIPTION Reference Number & Mfr Code Usable on Code	(4) UNIT OF	(5) QTY INC IN UNIT	(6) 15-DAY ORGANIZATIONAL MAINTENANCE ALW				(7) ILLUSTRATION	
	(a) Source	(b) MAINT	(c) RECOV					(a)	(b)	(c)	(d)	(a) Figure No.	(b) Item No
								1-5	6-20	21-50	51-100		
N R	P	C		1005-628-9048	MAJOR GROUPS AND ASSEMBLIES MAGAZINE, CARTRIDGE: 20 CARTRIDGE CAPACITY 7790183 (19204)	EA	1	*	*	*	*	1	1
	P	O		1005-856-2108	GUARD ASSEMBLY, HAND, FIBER GLASS: 7791286 (19204)	EA	1	*	*	*	*	1	2
	P	O		1005-072-5376	SLING, SMALL-ARMS: 1101003819204	EA	1	*	*	*	*	1	3
	P	O		1005-072-5386	PLUG, RECOIL PAD: STOCK ASSY, RIFLE 7791674 (19204)	EA	2	*	*	*	*	1	4
	P	O		5315-819-4501	FIRING MECHANISM PIN, TRIGGER: 7791367 (19204)	EA	1	*	*	*	*	2	1
	P	O		1005-587-8419	TRIGGER AND SEAR ASSEMBLY: 7267090 (19204)	EA	1	*	*	*	*	2	2
	P	O		1005-600-8887	SPRING, HELICAL COMPRESSION: , .063 STK DIA 0.361 FREE OD 2.50 FREE O/A LG, 20 COILS HAMMER 6008887 (19204)	EA	1	*	*	*	*	2	4
	P	O		5315-501-3668	PIN, STRAIGHT HEADED: FL-FIL-HD, PHOS-CTD, 0.187 MAX DIA, 3/4 LG UNDER HD, HAMMER 5013668 (19204)	EA	1	*	*	*	*	2	6
	P	O		1005-554-6015	SAFETY, SMALL ARMS: CATCH TYPE HOLDING DEVICE, 0.197 DIA 5546015 (19204)	EA	1	*	*	*	*	2	8
	P	O		1005-587-8414	SPRING, SAFETY: 7267080 (19204)	EA	1	*	*	*	*	2	9
	P	O		1005-587-8413	OPERATING ROD AND CONNECTOR GROUP SPRING, OPERATING ROD: 7267079 (19204)	EA	1	*	*	*	*	3	3
	P	O		1005-953-9504	BOLT ASSEMBLY EXTRACTOR, SMALL ARMS CARTRIDGE: 7791578 (19204)	EA	1	*	*	*	*	4	1
	P	O		1005-587-8381	EJECTOR CARTRIDGE WH SPRING: 7267015 (19204)	EA	1	*	*	*	*	4	2
	P	O		1005-600-8618	PLUNGER, EXTRACTOR SPRING: 6008618 (19204)	EA	1	*	*	*	*	4	3
P	O		1005-921 5248	PIN, FIRING: 11686413 (19204)	EA	1	*	*	*	*	4	4	

Section II. REPAIR PARTS LIST - Continued

ACT ON CODE	(1) SOURCE MAINT AND RECOV CODE			(2) STOCK NO. MEAS	(3) DESCRIPTION		(4) UNIT OF	(5) QTY INC IN UNIT	(6) 15-DAY ORGANIZATIONAL MAINTENANCE ALW				(7) ILLUSTRATION	
	(a) Source	(b) MAINT	(c) RECOV		Reference Number & Mfr Code	Usable on Code			(a) 1-5	(b) 6-20	(c) 21-50	(d) 51-100	(a) Figure No.	(b) Item No
C	P	O		1005-999-3399	BARREL AND RECEIVER GROUP		EA	1	*	*	*	*	5	1
	P	O		1005-731-2737	PINION ASSEMBLY, REAR SIGHT ELEVATING: 11010363 (19204)		EA	1	*	*	*	*	5	2
	P	O		1005-600-8868	KNOB: WINDAGE, REAR SIGHT 7312737 (19204)		EA	1	*	*	*	*	5	3
	P	O		1005-600-8868	APERTURE SIGHT: 6008868 (19204)		EA	1	*	*	*	*	5	3
	P	O		5315-051-6891	PIN, SPRING: S,PHOS-CTD, 5/64 NOM DIA, 3/8 LG MS 16562-107 (96906)		EA	3	*	*	*	*	5	4
	P	O		1005-587-8408	SELECTOR: AUTOMATIC AND SEMIAUTOMATIC FIRING 7267071 (19204)		EA	1	*	*	*	*	5	5
	P	O		1005-587-8420	LOCK, SELECTOR SHAFT: S, 0.260 ID, 0.028 OD, 0.056 THK 7267172 (19204)		EA	1	*	*	*	*	5	5
	P	O		1005-587-8415	SPRING, SELECTOR: 7267081 (19204)		EA	1	*	*	*	*	5	6
	P	O		1005-587-8400	PLUG, GAS CYLINDER: 7267053 (19204)		EA	1	*	*	*	*	5	9
	P	O		5305-042-6426	SETSCREW: HEX-SOCKET, NONSTD PT, 0.092 MAX DIA, 0.070 LG, S, PHOS-CTD, NO. 6-40UNF-3A, 1/4 LG 7790300 (19204)		EA	1	*	*	*	*	5	11
	P	O		1005-775-0364	WINTER TRIGGER KIT TRIGGER,ASSEMBLY, WINTER: MS 7790808 (19204)		EA	1	*	*	*	*	6	1
	P	O		5305-990-6435	SCREW, TAPPING, THREAD FORMING: 7791415 (19204)	A	EA	2	*	*	*	*	6	2
	P	O		1005-010-5022	WASHER, HINGE RETAINING: TRIGGER ASSEMBLY 7791237 (19204)	A	EA	1	*	*	*	*	6	3
	P	O		1005-778-0580	SAFETY, WINTER: 7790903 (19204)	A	EA	1	*	*	*	*	6	5
	P	O		5315-597-5086	PIN, SPRING:S, PHOS-CTD, 1/16 DIA, 3/8 LG MS 16562-98 (96906)		EA	1	*	*	*	*	7	1
P	O		4933-780-1982	BLADE, SCREWDRIVER: S PHOS-CTD, 0.220 W, 0.527 LG 30 DEG BLADE ANGLE 7790786 (19204)		EA	1	*	*	*	*	7	2	

Section III. SPECIAL TOOLS LISTS

ACT ON CODE	(1) SOURCE MAINT AND RECOV CODE			(2) STOCK NO. MEAS	(3) DESCRIPTION Reference Number & Mfr Code Usable on Code	(4) UNIT OF	(5) QTY INC IN UNIT	(6) 15-DAY ORGANIZATIONAL MAINTENANCE ALW				(7) ILLUSTRATION	
	(a) Source	(b) MAINT	(c) RECOV					(a)	(b)	(c)	(d)	(a) Figure No.	(b) Item No
								1-5	6-20	21-50	51-100		
C	P	O		1005-288-3565	TOOLS AND EQUIPMENT FOR UNIT REPLACEMENT SWAB, SMALL ARMS CLEANING: COTTON, 2-1/2 SQ (1000 IN PKG) 5019316 (19204)	PG		*	1	2	4		
	P	C		1005-556-4174	BRUSH, CLEANING, SMALL ARMS: BORE 5564174 (19204)	EA		*	1	2	4		
	P	C		1005-650-4510	CASE, SMALL ARMS CLEANING ROD: 6267754 (19204)	EA		*	*	1	1		
	P	C		1005-654-4058	SLING, SMALL ARMS: M1 WEBBING 6544058 (19204)	EA		*	1	1	1		
	P	O		1005-690-8441	BRUSH, CLEANING, SMALL ARMS: CHAMBER 7790463 (19204)	EA		*	1	1	2		
	P	C		1005-726-6109	ROD SECTION, CLEANING, SMALL ARMS: 7266109 (19204)	EA		*	*	1	1	8	1
	P	C		1005-726-6110	SWAB HOLDER SECTION, SMALL ARMS CLEANING RO: 7266110 (19204)	EA		*	1	1	2	8	2
	P	C		1005-791-3377	CASE, LUBRICANT: 7790995 (19204)	EA		*	*	1	1		
	P	C		4933-768-0211	COMBINATION TOOL: 7790768 (19204)	EA		*	1	1	2	7	--
	P	O		1005-722-8907	ORGANIZATIONAL TOOLS AND EQUIPMENT FOR ARMORERS USE) THE 15-DAY LEVEL IS NOT APPLICABLE ENVELOPE: FABRIC, 2-BUTTON, 4-7/8 X 3 7228907 (19204)	EA		*	*	*	*		
N	P	O		4933-628-9700	REFLECTOR., GUN BARREL: 7790138 (19204)	EA		*	*	*	2	8	3
	P	O		4933-652-9950	EXTRACTOR, RUPTURED CARTRIDGE CASE: 7790352 (19204)	EA		*	*	2	2	8	4
	P	O		4933-690-3497	PLIERS, LOCK NUT, FLASH SUPPRESSOR: 7790493 (19204)	EA		*	*	*	2	8	5
	P	O		4933-856-2561	ALIGNMENT, TOOL: FLASH SUPPRESSOR 7799705 (19204)	EA		*	*	*	1	8	6

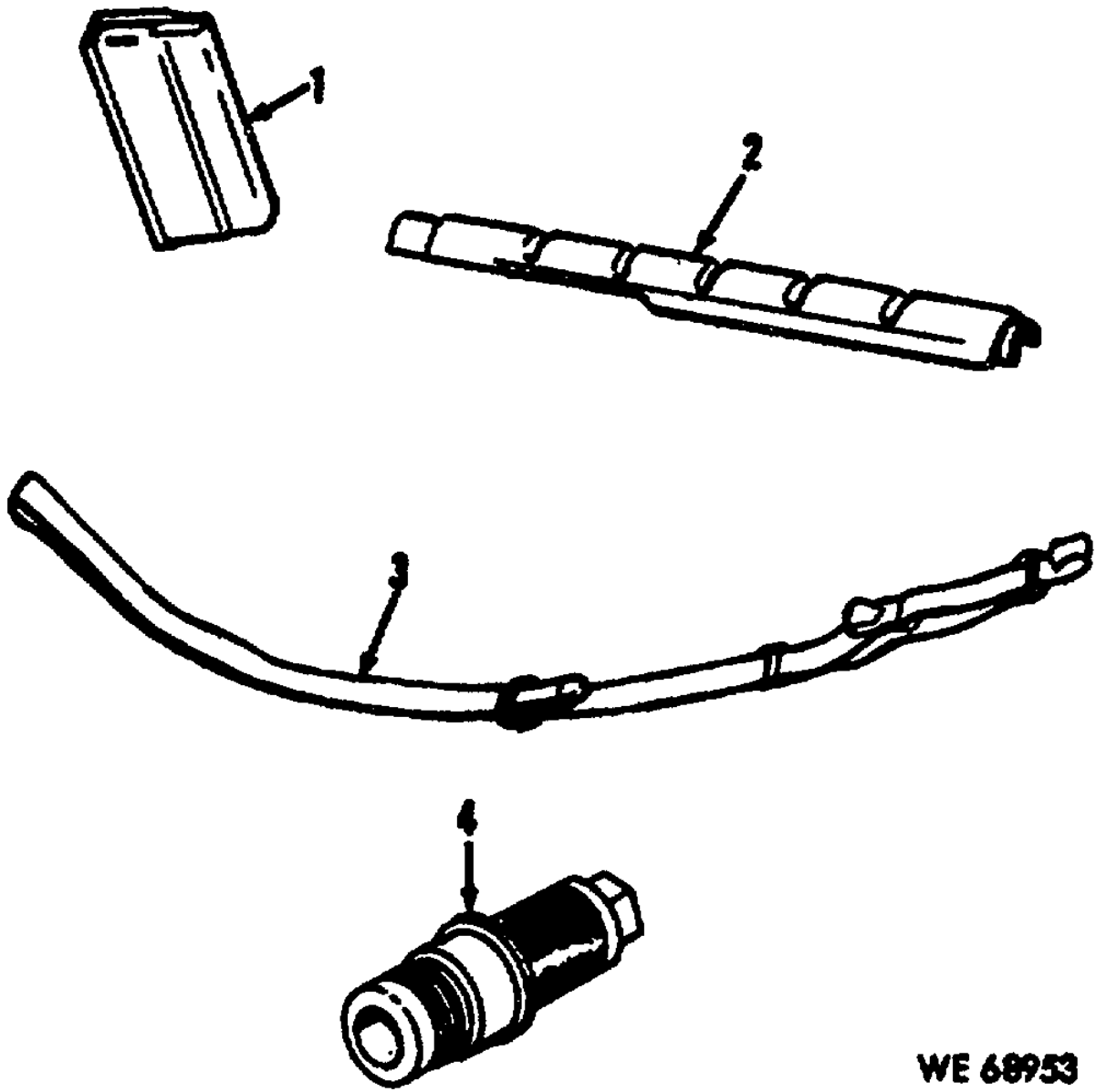

WE 68953

Figure 1. Major groups and assemblies.

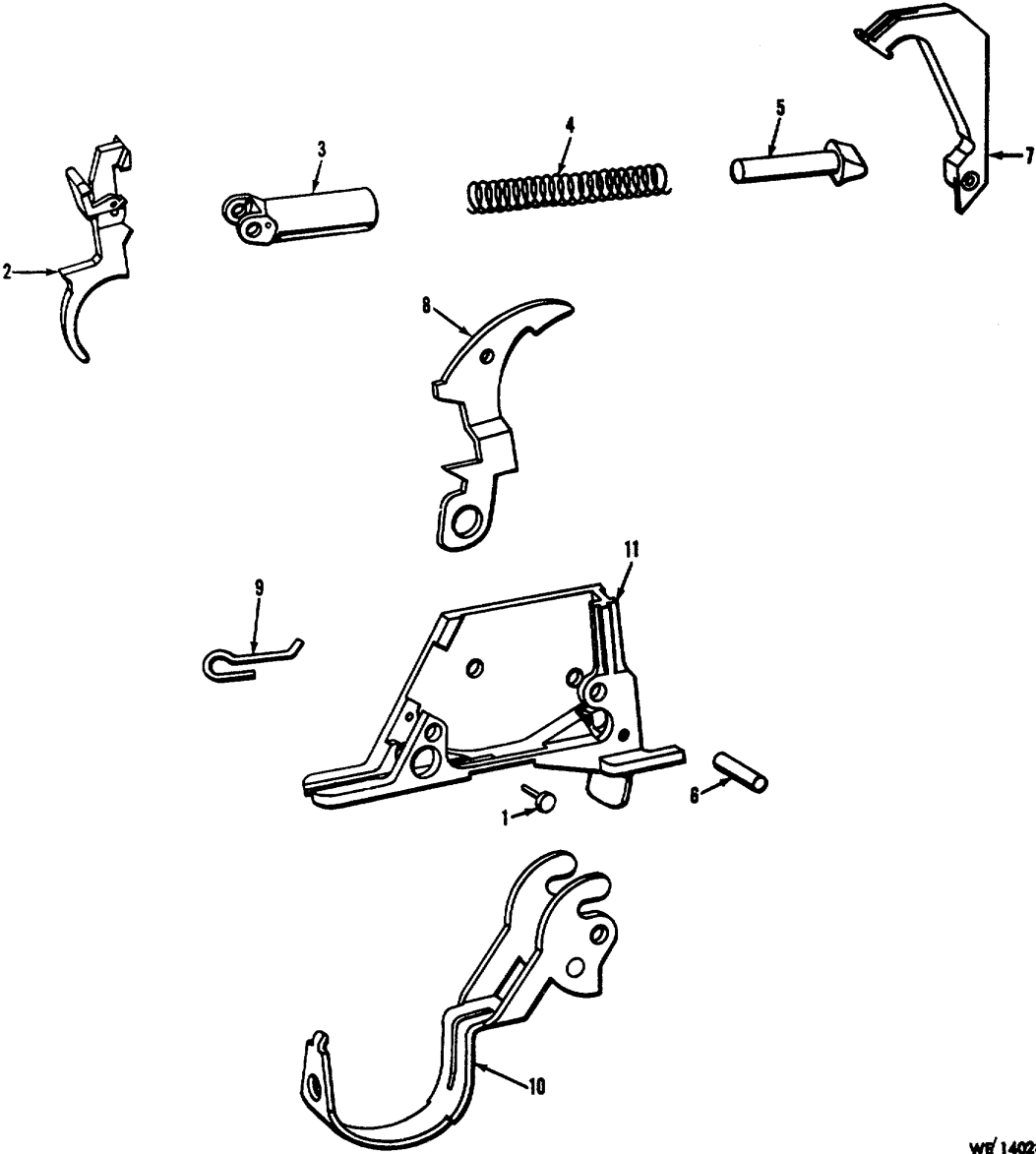

WE 14021

Figure 2. Firing mechanism-exploded view

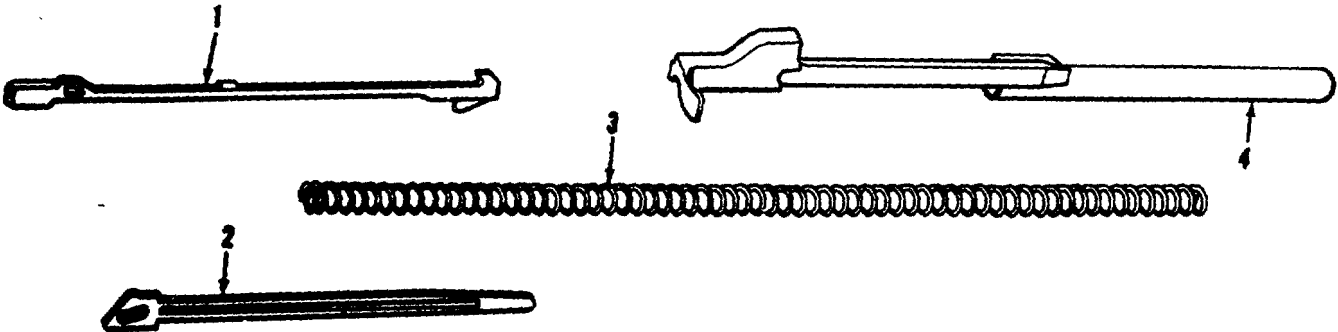

WE 14029

Figure 3. Operating rod and connector group-exploded view.

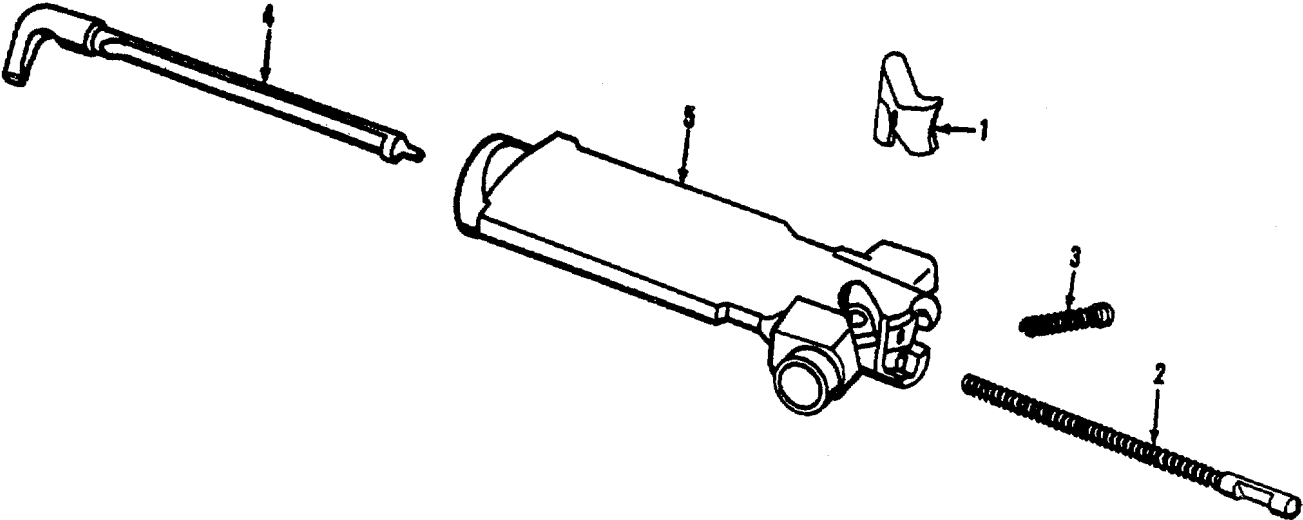

WE 14030

Figure 4. Bolt assembly- exploded view.

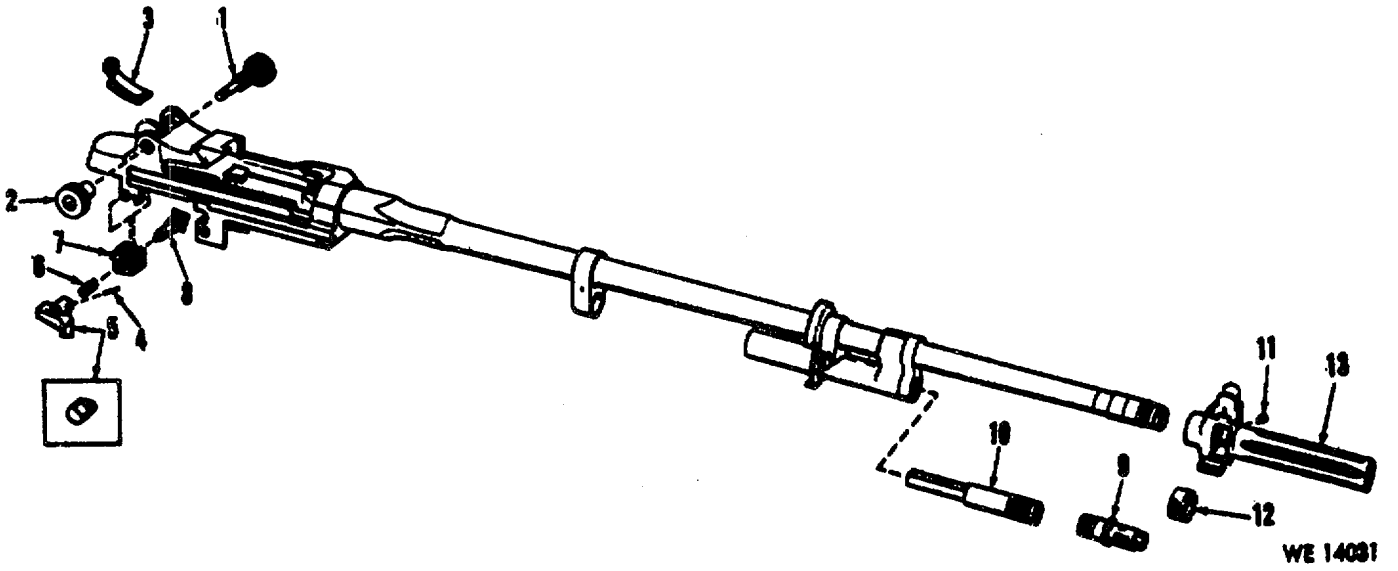

Figure 5. Barrel and receiver group-exploded view.

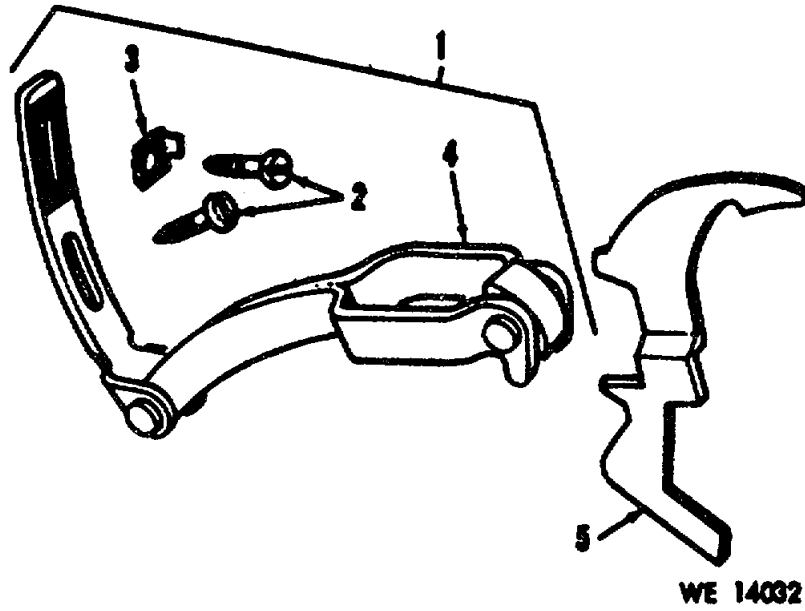
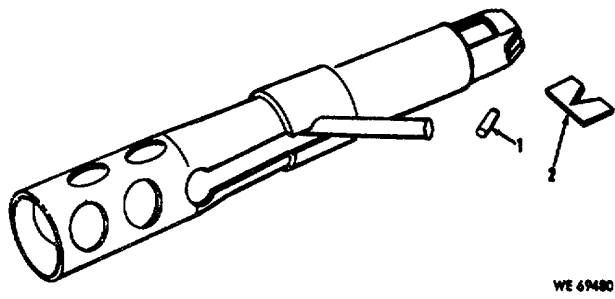
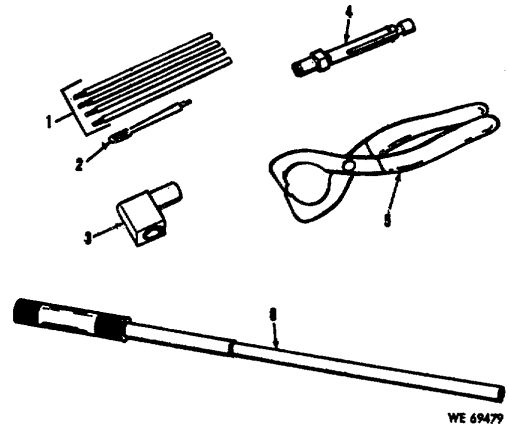

Figure 6. Winter trigger kit-M14 Rifle-exploded view.



WE 69480

Figure 7. Combination tool-exploded view.



WE 69479

Figure 8. Tools and equipment.

Section IV. FEDERAL STOCK NUMBER AND REFERENCE NUMBER INDEX

NATIONAL STOCK NUMBER INDEX							
STOCK NUMBER	FIG.	ITEM	STOCK NUMBER	FIG.	ITEM		
1005-010-5022	6	3	1005-731-2737	5	2		
1005-072-5376	1	3	1005-775-0364	6	1		
1005-072-5386	1	4	1005-778-0580	6	5		
1005-554-6015	2	8	1005-856-2108	1	2		
1005-587-8381	4	2	1005-921-5248	4	4		
1005-587-8400	5	9	1005-953-9504	4	1		
1005-587-8408	5	5	1005-999-3399	5	1		
1005-587-8413	3	3	4933-628-9700	8	3		
1005-587-8414	2	9	4933-652-9950	8	4		
1005-587-8415	5	6	4933-690-3497	8	5		
1005-587-8419	2	2	4933-768-0211	7	-		
1005-587-8420	5	5	4933-780-1982	7	2		
1005-600-4618	4	3	4933-856-2561	8	6		
1005-600-8868	5	3	5305-042-6426	5	11		
1005-600-8887	2	4	5305-990-6435	6	2		
1005-628-9048	1	1	5315-051-6891	5	4		
1005-726-6109	8	1	5315-501-3668	2	6		
1005-726-6110	8	2	5315-597-5086	7	1		
5315-819-4501	2	1					

REFERENCE NO.	MFR CODE	FIG. NO.	ITEM NO.	REFERENCE NO.	MFR. CODE	FIG. NO.	ITEM NO.
MS 16562-107	96906	5	4	7267090	19204	2	2
MS 16562-98	96906	7	1	7267172	19204	5	5
11010038	19204	1	3	7312737	19204	5	2
11010363	19204	5	1	7790138	19204	8	3
11686413	19204	4	4	7790183	19204	1	1
5013668	19204	2	6	7790300	19204	5	11
5546015	19204	2	8	7790352	19204	8	4
6008618	19204	4	3	7790493	19204	8	5
6008868	19204	5	3	7790768	19204	7	-
6008887	19207	2	4	7790786	19204	7	2
7266109	19204	8	1	7790808	19204	6	1
7266110	19204	8	2	7790903	19204	6	5
7267015	19204	4	2	7791237	19204	6	3
7267053	19204	5	9	7791286	19204	1	2
7267071	19204	5	5	7791367	19204	2	1
7267079	19204	3	3	7791415	19204	6	2
7267080	19204	2	9	7791578	19204	4	1
7267081	19204	5	6	7791674	19204	1	4
7799705	19204	8	6				

By Order of the Secretary of one Army:

Official:

VERNE L. BOWERS

Major General, United States Army

The Adjutant General

BRUCE PALMER, JR.
General, U. S. Army
Acting Chief of Staff

Distribution:

To be distributed in accordance with DA Form 12-40, (qty rqr block no. 140) Organizational maintenance requirements for Rifle, 7.62-MM, M14.

☆U.S. GOVERNMENT PRINTING OFFICE: 1993 - 342-421/80490

RECOMMENDED CHANGES TO EQUIPMENT TECHNICAL PUBLICATIONS



THEN... JOT DOWN THE DOPE ABOUT IT ON THIS FORM, CAREFULLY TEAR IT OUT, FOLD IT AND DROP IT IN THE MAIL!

SOMETHING WRONG WITH THIS PUBLICATION?

FROM: (PRINT YOUR UNIT'S COMPLETE ADDRESS)

DATE SENT

PUBLICATION NUMBER

PUBLICATION DATE

PUBLICATION TITLE

BE EXACT... PIN-POINT WHERE IT IS

PAGE NO.

PARA-GRAPH

FIGURE NO.

TABLE NO.

IN THIS SPACE TELL WHAT IS WRONG AND WHAT SHOULD BE DONE ABOUT IT:

TEAR ALONG PERFORATED LINE

PRINTED NAME, GRADE OR TITLE, AND TELEPHONE NUMBER

SIGN HERE:

DA FORM 2028-2 JUL 79

PREVIOUS EDITIONS ARE OBSOLETE.

P.S.—IF YOUR OUTFIT WANTS TO KNOW ABOUT YOUR RECOMMENDATION MAKE A CARBON COPY OF THIS AND GIVE IT TO YOUR HEADQUARTERS.

