

FMFM 6-4

Marine Rifle Company/ Platoon



U.S. Marine Corps

PCN 139 000475 00

DEPARTMENT OF THE NAVY
HEADQUARTERS UNITED STATES MARINE CORPS
WASHINGTON, D.C. 20380

17 February 1978

FOREWORD

1. PURPOSE

This publication, FMFM 6-4, Marine Rifle Company/Platoon, sets forth doctrine, tactics, and techniques for operations and training conducted by Marine rifle companies and platoons. It is made available to other Services for information and use as desired.

2. SCOPE

This Manual provides information on the employment of the rifle company and platoon in the following operations: amphibious operations, helicopter-borne operations, offensive combat, defensive combat, patrolling, auxiliary operations, and counterinsurgency operations.

3. SUPERSESION

FMFM 6-4, Marine Rifle Company/Platoon, dated 1 April 1974.

4. CHANGES

Commanding General
Doctrine Division (C 42)
Marine Corps Combat Development Command
2042 Broadway Street Suite 210
Quantico, VA 22134-5021

5. CERTIFICATION

Reviewed and approved this date.

BY DIRECTION OF THE COMMANDANT OF THE MARINE CORPS



J. C. FEGAN
Lieutenant General, U.S. Marine Corps
Commanding General
Marine Corps Development and Education Command
Quantico, Virginia

DISTRIBUTION: TFD

PCN 139 000475 00

User Suggestion Form

From:

To: Commanding General, Doctrine Division (C 42), Marine Corps Combat Development Command, 2042 Broadway Street Suite 210, Quantico, Virginia 22134-5021

Subj: RECOMMENDATIONS CONCERNING FMFM 6-4, *MARINE RIFLE COMPANY/PLATOON*

1. In accordance with the foreword to FMFM 6-4, which invites individuals to submit suggestions concerning this FMFM directly to the above addressee, the following unclassified recommendation is forwarded:

<u>Page</u>	<u>Article/Paragraph No.</u>	<u>Line No.</u>	<u>Figure/Table No.</u>
-------------	------------------------------	-----------------	-------------------------

Nature of Change: Add
 Delete
 Change
 Correct

2. Proposed new verbatim text: (Verbatim, double-spaced; continue on additional pages as necessary.)

3. Justification/source: (Need not be double-spaced.)

Note: Only one recommendation per page.

(reverse blank)

FMFM 6-4

MARINE RIFLE COMPANY/PLATOON

TABLE OF CONTENTS

CHAPTER 1. GENERAL		<u>Page</u>
Section I.	INTRODUCTION	
<u>Paragraph</u>		
1101	General	1
1102	Missions	1
1103	Characteristics	1
1104	Employment	2
Section II.	ORGANIZATION AND DUTIES	
1201	Rifle Company	3
1202	Rifle Platoon	3
1203	Weapons Platoon	4
1204	Duties of Personnel	4
Section III.	ORGANIZATION FOR COMBAT	
1301	General	7
1302	Methods of Employment	8
1303	Task Organization	9
Section IV.	COMMAND AND CONTROL	
1401	Command	11
1402	Communications	12
1403	Principles of War	16
1404	Estimate of the Situation	18
1405	Troop Leading Procedure	22
1406	Combat Plans and Orders	25
1407	Combat Records and Reports	29
Section V.	INTELLIGENCE AND COUNTERINTELLIGENCE	
1501	General	32
1502	Collection of Information	33
1503	Processing and Use of Combat Intelligence	36
1504	Dissemination	37
1505	Counterintelligence	37
1506	Intelligence Training	38
1507	Amphibious Operation	39
1508	Helicopterborne Operations	41
Section VI.	LOGISTICS	
1601	General	42
1602	Supply	42
1603	Motor Transport	44

1604	Medical	
1605	Services	44
		44
CHAPTER 2.	AMPHIBIOUS OPERATION	
Section I.	INTRODUCTION	
2101	General	
2102	Concepts	47
		47
Section II.	PLANNING	
2201	General	
2202	Fundamentals of Amphibious Planning	49
2203	Planning Sequence	49
2204	Planning Aids	50
2205	Plan of Attack	51
2206	Amphibious Training	51
		53
Section III.	EMBARKATION	
2301	General	
		56
Section IV.	REHEARSAL AND MOVEMENT TO OBJECTIVE AREA	
2401	Rehearsal	
2402	Movement to Objective Area	57
		57
Section V.	SHIP-TO-SHORE MOVEMENT	
2501	General	
2502	Characteristics of the Ship-to-Shore Movement	63
2503	Organization	63
2504	Control of the Ship-to-Shore Movement	63
2505	Landing Categories	67
2506	Serial Numbers	70
2507	Landing Plan	71
2508	Debarkation	72
2509	Ship-to-Shore Sequence	79
2510	Transfer Operations	82
2511	Over the Horizon Standoff	84
		86
Section VI.	CONDUCT OF THE ASSAULT	
2601	General	
2602	Helicopterborne Assault	87
2603	Waterborne Assault	87
		91
Section VII.	AMPHIBIOUS RAIDS, DEMONSTRATIONS, AND WITHDRAWALS	
2701	General	
2702	Amphibious Raids	94
2703	Amphibious Demonstration	94
2704	Amphibious Withdrawal	95
		95

FMFM 6-4

CHAPTER 3.	OFFENSIVE OPERATIONS	
Section I.	INTRODUCTION	
3101	General	97
3102	Fundamentals of Offensive Tactics	97
3103	Phases of the Attack	98
3104	Distribution of Forces	100
3105	Forms of Offensive Maneuver	102
Section II.	MOVEMENT TO CONTACT	
3201	General	106
3202	Route Column	107
3203	Tactical Column	111
3204	Approach March	118
3205	Assembly Area	119
Section III.	DAYLIGHT ATTACK	
3301	General	121
3302	Tactical Control Measures	121
3303	Preparation for the Attack	127
3304	Plan of Attack	127
3305	Scheme of Maneuver	128
3306	Fire Support Plan	132
3307	Conduct of the Attack	144
3308	Consolidation	146
3309	Exploitation	147
3310	Reserve Rifle Platoon	148
3311	Reserve Rifle Company	150
Section IV.	NIGHT ATTACK	
3401	General	152
3402	Tactical Control Measures	153
3403	Plan of Attack	155
3404	Conduct of the Attack	160
3405	Consolidation	161
Section V.	TANK-INFANTRY ATTACK	
3501	General	162
3502	Mutual Protection	162
3503	Methods of Attack	162
3504	Plan of Attack	165
3505	Conduct of the Attack	166
3506	Consolidation	167
Section VI.	MECHANIZED INFANTRY ATTACK	
3601	General	168
3602	Methods of Attack	168
3603	Plan of Attack	169
3604	Conduct of the Attack	172
3605	Consolidation	172

FMFM 6-4

Section VII.	ATTACK OF FORTIFIED AREAS	
3701	General	
3702	Special Considerations	173
3703	Plan of Attack	173
3704	Conduct of the Attack	175
		176
Section VIII.	ATTACK OF BUILT-UP AREAS	
3801	General	
3802	Basic Considerations	177
3803	Phases of Attack	177
3804	Plan of Attack	179
3805	Conduct of the Attack	179
		182
Section IX.	RIVER-CROSSING OPERATIONS	
3901	General	
3902	Concept	183
3903	Crossing in Assault Amphibious Vehicles	183
3904	Crossing in Boats	184
		185
Section X.	INFILTRATION	
31001	General	
31002	Plan of Attack	187
31003	Conduct of the Attack	187
31004	Subsequent Operations	188
		189
Section XI.	HELICOPTERBORNE UNITS IN SUBSEQUENT OPERATIONS ASHORE	
31101	General	
31102	Concepts	190
31103	Planning	190
31104	Assault	190
31105	Night Operations	194
31106	Helicopterborne Training	194
		195
CHAPTER 4.	DEFENSIVE OPERATIONS	
Section I.	INTRODUCTION	
4101	General	
4102	Types of Defense	197
4103	Basic Definitions and Control Measures	197
4104	Defensive Echelons and the Battle Area	198
4105	Basic Rifle Company Missions	199
4106	Fundamentals of Defense	200
		201
Section II.	SECURITY FORCES	
4201	General	
4202	Covering Force	203
4203	General Outpost	203
4204	Combat Outpost (COP)	203
4205	Local Security	203
		206

Section III.	AREA DEFENSE	
4301	General	208
4302	Frontline Rifle Company	208
4303	Frontline Platoon	214
4304	Weapons Platoon	219
4305	Reserve Platoon	225
4306	Conduct of the Defense	227
4307	Reserve Rifle Company	229
Section IV.	PERIMETER DEFENSE	
4401	General	233
4402	Rifle Company	233
4403	Rifle Platoon	234
4404	Weapons Platoon	235
Section V.	REVERSE SLOPE DEFENSE	
4501	General	236
4502	Rifle Company	236
4503	Rifle Platoon	236
4504	Weapons Platoon	237
Section VI.	DEFENSE OF BUILT-UP AREAS	
4601	General	239
4602	Rifle Company	239
4603	Rifle Platoon	240
4604	Weapons Platoon	240
Section VII.	DEFENSE OF A RIVER LINE	
4701	General	241
4702	Rifle Company	242
Section VIII.	MOBILE DEFENSE	
4801	General	244
4802	Forward Forces	244
4803	Reserve	245
4804	Security Forces	245
CHAPTER 5.	PATROLLING	
Section I.	INTRODUCTION	
5101	General	247
5102	Patrolling as Part of Combat Operations	247
Section II.	PATROL TYPES	
5201	General	248
5202	Reconnaissance Patrols	248
5203	Combat Patrols	250
5204	Raid Patrols	251
5205	Ambush Patrols	253

FMFM 6-4

Section III.	PATROLLING RESPONSIBILITIES	
5301	General	
5302	Command and Staff Action	257
5303	Command Aspects of Patrolling	257
		259
Section IV.	PLANNING AND PREPARING PATROLS	
5401	General	
5402	Patrolling in Counter guerrilla Operations	261
5403	Patrol Helicopterborne Procedures	261
		263
Section V.	ADVANCED PATROLLING TECHNIQUES	
5501	General	
5502	Patrol Bases	264
5503	Thrust Line and Thrust Point Systems	264
		266
CHAPTER 6.	COUNTERINSURGENCY	
Section I.	INTRODUCTION	
6101	General	
6102	The Approach to Counterinsurgency	271
6103	Organization	272
6104	Counterinsurgency Programs	273
6105	Counterinsurgency Forces	274
		274
Section II.	COUNTERGUERRILLA OPERATIONS	
6201	General Considerations	
6202	Police Operations	276
6203	Security Measures	278
6204	Intelligence	280
6205	Combat Operations	281
6206	Denial of Support	284
		284
		291
CHAPTER 7.	DOMESTIC EMERGENCIES	
Section I.	INTRODUCTION	
7101	General	
7102	Crowds and Mobs	293
		294
Section II.	DISTURBANCES	
7201	General Considerations	
7202	Planning and Training	295
7203	Riot Control Formations	296
7204	Operations	298
		298
		306
CHAPTER 8.	AUXILIARY OPERATIONS	
Section I.	INTRODUCTION	
8101	General	
8102	Scope	311
		311

Section II.	RELIEF OPERATIONS	
8201	General	313
8202	Relief in Place	314
8203	Passage of Lines	316
Section III.	RECONNAISSANCE IN FORCE	
8301	General	318
8302	Planning	318
8303	Conduct	318
Section IV.	RETROGRADE OPERATIONS	
8401	General	319
8402	Withdrawal Action	321
8403	Delaying Actions	326
8404	Retirement	328
Section V.	MINE WARFARE	
8501	General	330
8502	Basic Concepts	330
8503	Tactical Classification of Minefields	331
8504	Planning and Siting	332
8505	Standard Pattern Minefield	332
8506	Manual Laying of Minefields	335
8507	Reports and Records	340
8508	Breaching Operations	343
Section VI.	NUCLEAR, BIOLOGICAL, AND CHEMICAL DEFENSE	
8601	General	345
8602	Defense Personnel	345
8603	Training	345
8604	Nuclear Warfare	347
8605	Chemical Operations	348
8606	Biological Operations	349
Section VII.	BIVOUACS	
8701	General	350
8702	Selection of Site	350
8703	Organization of Site	351
8704	Security	351
APPENDIXES:		
A	Typical Oral Operation Orders	355
B	Characteristics of Weapons and Equipment	375
C	Overlay Techniques	377
D	Special Techniques for Counterguerrilla Operations	383
E	Casualty Care and Evacuation in the Platoon Line	397
LIST OF REFERENCES		405
INDEX		407



CHAPTER 1

GENERAL

Section I. INTRODUCTION

1101. GENERAL

This Manual discusses the functions of a Marine rifle company and platoon in offensive and defensive operations. It is the basic company manual and is to be used in conjunction with FMFM 6-3, Marine Infantry Battalion; FMFM 6-5, Marine Rifle Squad; and other appropriate manuals of the FMFM series.

1102. MISSIONS

a. The primary mission of the Marine rifle company and platoon is to locate, close with, and destroy the enemy by fire and maneuver or to repel his assault by fire and close combat.

b. The primary mission of the weapons platoon of the rifle company is to provide supporting direct and indirect fires (including close-in antitank fires and demolitions) for maneuvering or defending elements of the rifle company.

1103. CHARACTERISTICS

a. The rifle company is the basic maneuver element of the infantry battalion and is capable of performing a variety of combat missions. Its basic organization permits the formation of internal temporary task organizations. It can control additional combat, combat support, and combat service support elements in accomplishing specific tasks.

b. The rifle platoon is the basic maneuver element of the rifle company. Its characteristics are essentially those of the rifle company.

Par. 1104

FMFM 6-4

c. The weapons platoon is the basic fire support element of the rifle company. Its organization and equipment permit maximum flexibility, control, and ease of employment in support of the rifle platoons.

1104. EMPLOYMENT

a. Rifle Company.--The rifle company normally operates as a maneuver element of the infantry battalion although it can be employed independently for short periods when appropriately reinforced. The company is the nucleus to which appropriate supporting fires, maneuver to positions from which component for the accomplishment of a particular mission.

(1) In the attack, the company's rifle platoons, assisted by organic and/or external supporting fires, maneuver to positions from which they can close with and destroy the enemy.

(2) In the defense, the rifle company defends as part of the battalion and exceptionally as an independent force. It organizes to deny the enemy access to terrain by destroying him with the planned fires of all available weapons and close combat. The company can operate as part of the area defense or the mobile defense.

b. Rifle Platoon.--The rifle platoon usually fights as part of the rifle company. When circumstances dictate, it can be appropriately reinforced to operate independently for limited periods (e.g., patrol actions).

(1) In the attack the platoon's rifle squads, assisted by organic and/or external supporting fires, maneuver to positions from which they can close with and destroy the enemy.

(2) In the defense the rifle platoon defends as part of the rifle company. Assisted by nonorganic planned fires, it organizes to deny the enemy access to terrain by use of organic fires and close combat.

c. Weapons Platoon.--The weapons platoon provides a main source from which rifle platoons may be reinforced for specific operations.

(1) In the attack, the platoon provides the maneuver elements of the company with machinegun, 60mm mortar, and rocket fire support as well as close-in antitank defense and limited demolition support.

(2) In the defense, the weapons platoon defends as part of the rifle company. Its machinegun section, augmented by the fires of weapons not organic to the rifle company, establishes the principal component of the company's final protective fires. The assault section integrates rocket fire support and close-in antitank defense into the company's defensive fires. The 60mm mortar section provides close and continuous fires in support of the company in defense.

Section II. ORGANIZATION AND DUTIES

1201. RIFLE COMPANY

The Marine rifle company is organized to ensure effective control and flexibility of employment. It has a triangular organization built around three maneuver elements (rifle platoons) and one fire support element (weapons platoon). The activities of the subordinate units are controlled and coordinated by a company headquarters. (See fig. 1.)

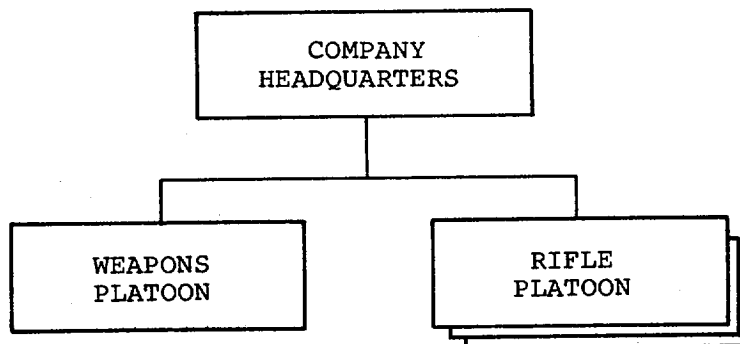

Figure 1.--Marine Rifle Company.

1202. RIFLE PLATOON

The platoon has a triangular structure composed of three rifle squads. Each squad is a balanced group consisting of three fire teams; one rifleman within each fire team will be assigned to carry the M16/M203 grenade launcher system. (See fig. 2.)

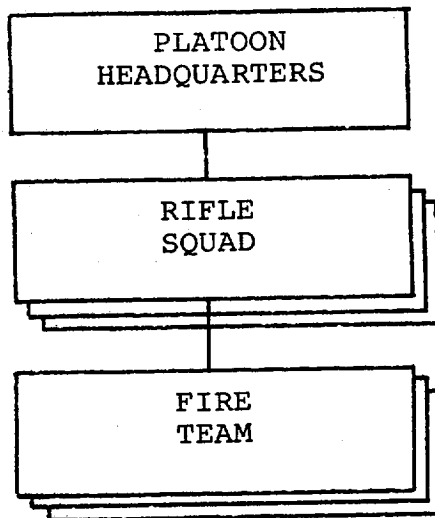

Figure 2.--Rifle Platoon.

Par. 1203

FMFM 6-4

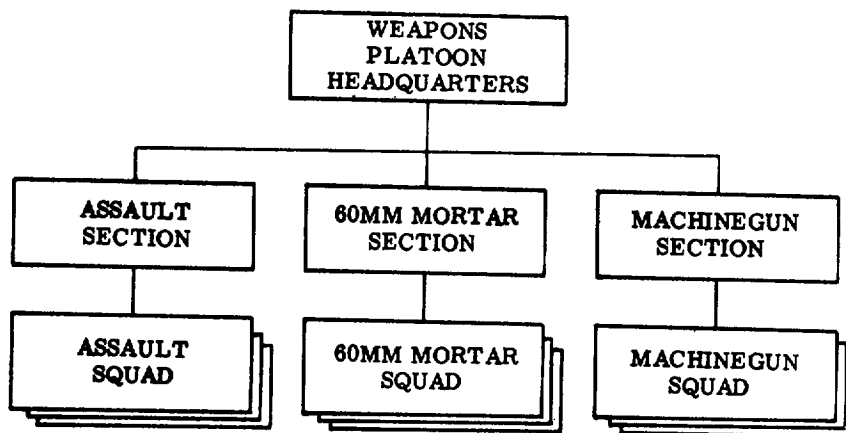

Figure 3.--Weapons Platoon.

1203. WEAPONS PLATOON

The weapons platoon is the fire support element of the rifle company. It provides the company with organic machinegun, 60mm mortar, and rocket fire support and antitank defense. A weapons platoon headquarters controls and coordinates the fires of the machinegun, mortar, and assault sections. The machinegun section is composed of three machinegun squads of two teams each. Each team employs one machinegun. The 60mm mortar section consists of three mortar squads, with each squad employing one 60mm mortar. The assault section has three assault squads. Each squad consists of one four-man multishot portable flame weapon/light antitank assault weapon (MPFW/LAAW) team and one two-man LAAW team each possessing a limited capability for demolition support. (See fig. 3.)

1204. DUTIES OF PERSONNEL

a. Company Headquarters Personnel

(1) Company Commander.--The company commander is responsible for everything his company does or fails to do in combat and in garrison. He is responsible for the training, combat efficiency, discipline, administration, and welfare of his company.

(2) Executive Officer.--The executive officer is second in command of the company. He performs such duties as are assigned to him by the company commander. He supervises the activities of the company headquarters both in garrison and in combat. He keeps abreast of the tactical situation in combat and assumes command of the company in the company commander's absence.

(3) First Sergeant.--The first sergeant is the senior enlisted man in the company. He assists the company commander by performing such duties as are assigned. He is the principal enlisted assistant to the company commander in supervising the administration of the company. In combat, the first sergeant operates the company command post under the general supervision of the executive officer in the absence of the command group. He closely supervises the members of the service group in supporting combat operations.

(4) Gunnery Sergeant.--The gunnery sergeant assists the company commander by performing such duties as are assigned. He is the principal enlisted assistant to the company commander in supervising the training of the company. He ensures that high standards of police and sanitation are maintained in the company area. He assists the company commander in training and in combat by supervising the displacement, positioning, and arrangement of the command group when it operates separately from the command post. He assists, and his duties complement those of the first sergeant.

(5) Chief Clerk

(a) The chief clerk is the company administrative chief. He performs his duties under direct supervision of the first sergeant in garrison or in combat when company administration is performed in the field. He is assigned to and directly supervised by the officer in charge of the battalion administrative center when such a center is established.

(b) The chief clerk allocates administrative work to the company's administrative personnel and supervises its proper preparation.

(6) Supply Sergeant

(a) In garrison, the company supply sergeant operates the company supply room. He is directly responsible to the company commander for drawing and issuing supplies, organic property, and camp property. He maintains supply records of all items on charge to the company and ensures that the on-hand quantities of serviceable equipment are in accordance with current allowances. He further performs first echelon maintenance of organic property on charge to the company which is not in the hands of the troops.

(b) In combat, the supply sergeant operates a supply distribution point at the company command post. He requisitions the supplies and equipment necessary to sustain the company in combat from the battalion service platoon. He divides and issues supplies as directed.

(7) Administrative Personnel.--The administrative clerk and the administrative man perform company administration in garrison and in combat as directed by the chief clerk.

(8) Messenger

(a) In garrison, the company messenger is supervised by the first sergeant and may be employed in light clerical duties such as company mail clerk. The company messenger performs additional duty as vehicle driver when the battalion provides vehicles without drivers in support of the company.

(b) In combat, the company messenger functions in a dual capacity in the command group as a messenger and as a radio operator. When not employed as the messenger link to the battalion, he normally carries the company tactical radio for the company commander.

b. Rifle Platoon Headquarters

(1) Platoon Commander.--The platoon commander is responsible to the company commander for the training, combat efficiency, discipline,

administration, and welfare of his platoon. Everything the platoon does or fails to do in garrison or in combat is the platoon commander's responsibility. He is also responsible for the first echelon maintenance, safeguarding, and economical use of all equipment on charge to the platoon and its individual members.

(2) Platoon Sergeant.--The platoon sergeant, as second in command, performs the duties assigned by the platoon commander. He assumes command in the absence of the platoon commander. He assists in all aspects of supervision and control of the platoon.

(3) Platoon Guide.--The platoon guide performs such administrative functions as the platoon commander may direct. He is directly responsible to the platoon commander for the supply and timely resupply of the platoon in combat and maintains a casualty record. He also prevents straggling when the platoon is moving in training and in combat operations.

(4) Platoon Messengers.--The messengers are employed as the platoon commander directs. In combat, the messengers provide messenger communications between the rifle company headquarters and the rifle platoon commander and also between the platoon and its squads and attached or supporting elements.

c. Weapons Platoon Headquarters

(1) Weapons Platoon Commander

(a) The weapons platoon commander is responsible for the training, combat efficiency, discipline, administration, and welfare of his platoon. He is also directly responsible for the first echelon maintenance, safeguarding, and economical use of all equipment on charge to the platoon and its individual members.

(b) In combat, the weapons platoon commander makes timely recommendations to the company commander concerning the most efficient employment of the platoon and its subordinate elements. He exercises direct control over his platoon to the degree consistent with the methods of employment of its elements.

(2) Weapons Platoon Sergeant

(a) The weapons platoon sergeant, as second in command, performs the duties assigned by the platoon commander. He assumes command in the absence of the platoon commander. He assists in all aspects of supervision and control of the platoon.

(b) The platoon sergeant further performs such administrative functions as the platoon commander may direct. He is responsible to the platoon commander for the supply and timely resupply of the platoon in combat compatible with the method of employment and maintains a casualty record. He also prevents straggling.

(3) Weapons Platoon Messenger.--The weapons platoon messenger is employed as the platoon commander directs and is used to establish and maintain messenger communications with the company headquarters and with the subordinate elements of the platoon.

Section III. ORGANIZATION FOR COMBAT

1301. GENERAL

The basic rifle company organization does not contain medical or communication personnel, forward observers, forward air controllers, naval gunfire spotters, motor transport equipment, and other specialists and equipment necessary for combat operations. The rifle company must be augmented by additional personnel and equipment prior to entering combat. Certain augmentations such as medical, communications, and forward observers are required for combat missions. Other specific missions would require the rifle company to be augmented by additional units such as reconnaissance, LVT's, tanks, etc.

a. Standard Augmentations.--The parent infantry battalion's SOP's usually specify what organic medical, communications, and motor transport augmentation will be assigned to the rifle companies. The company commander exercises tactical control over the augmentation personnel and is responsible for their billeting, messing, and general military training. The parent organization (headquarters and service (H&S) company) is responsible for providing the individual equipment (including special equipment and weapons), conducting specialty training, and administration.

(1) Medical.--Normally, each rifle company is augmented by a medical team of 11 corpsmen from the battalion medical platoon during combat. A lesser number may be assigned while in garrison. The corpsmen are then usually further assigned by the company commander to subordinate company units--three with each rifle platoon, one with the weapons platoon, and the senior corpsman with the company command group.

(2) Communications.--The majority of communication equipment used by the rifle company is furnished and maintained by the battalion communication platoon. Company personnel, however, normally operate the radio equipment and install the wire communication systems. The battalion communication platoon usually furnishes one wireman to assist the company and one radio operator who operates on the battalion tactical net.

(3) Motor Transport.--All motor transport equipment used by the rifle company must be provided by external sources. Normally, the parent infantry battalion provides each rifle company one 1/4-ton, 4x4 truck with trailer and two light infantry weapons carriers (Mules). The rifle company normally has to furnish the drivers.

(4) Forward Observers.--Forward observer teams from the 81mm mortar platoon and supporting artillery units are assigned for major training exercises and combat operations to the rifle company by infantry battalion and artillery unit SOP's.

(5) Forward Air Control (FAC) Party.--A forward air control party may be assigned to the rifle company for training exercises and is generally assigned to an attacking company during combat operations. The assignment is made by the battalion from its organic tactical air control party (TACP).

Par. 1302

FMFM 6-4

(6) Naval Gunfire Spotters.--Naval gunfire spot teams from the shore fire control party (SFCP) may be assigned to the rifle company for amphibious training exercises and during combat operations.

(7) Other Organic Battalion Support.--The infantry battalion has the capability to provide additional communications, antitank and 81mm mortar fires, and other support, such as surveillance radars and night observation devices, to rifle companies from organic sources. The decision to provide such support would depend on the individual rifle company's mission and the mission of the battalion as a whole.

b. Combat, Combat Support, and Combat Service Support.--There exists within the Marine Corps a wide variety of combat, combat support, and combat service support units that could support the rifle company. Normally, such support is not assigned directly to the rifle company, but is rather assigned to the parent infantry battalion who then determines the requirements for further assignment to the companies. The rifle company is capable of employing and controlling such supporting units.

(1) Combat units are considered to be those units organic to the infantry regiments.

(2) Combat support units organic to the Marine division are the artillery, reconnaissance, combat engineer, tank, and assault amphibian battalions.

(3) Combat service support units organic to the Marine division are found in the headquarters battalion.

(4) Force troops and aviation units may be either combat support or combat service support units depending on the type support or service provided.

1302. METHODS OF EMPLOYMENT

a. Methods.--There are three methods of employment of supporting units, each method differing in the tactical, administrative, and/or logistic relationships between the supporting and supported units.

(1) General Support.--General support is that support which is given the supported force as a whole. When a unit is employed in general support of an infantry command, it supports the entire force rather than a specific subordinate unit. The supporting unit leader retains tactical, administrative, and logistic control of his unit.

(2) Direct Support.--Direct support is a mission requiring a force to support another specific force and authorizing it to answer directly the supported force's request for assistance. A supporting element is in direct support when its leader is given responsibility for control of the support rendered to a specified supported command. The direct support element receives its request for assistance (which the direct support leader will translate into a mission and assign the subject mission to his unit) from the supported unit commander. The supporting element leader exercises tactical control by taking action to accomplish the mission assigned by the supported unit commander. Administrative and logistic control is retained by the supporting unit from which the supporting element originated. For example, a Dragon section is placed in direct support of a rifle company.

The company commander has the use of Dragon and assigns missions to the section. Tactical control of the squads is exercised by the section leader. The antitank assault platoon from which the section originated is responsible for administrative and logistics control of the squad.

(3) Attachment.--Attachment is the placement of units or personnel in an organization where such placement is relatively temporary. When an element is attached to an infantry unit, the infantry unit commander assumes tactical, logistic, and administrative control of the attached element. His responsibility for attached elements is the same as for organic subordinate units. Attachments to lower units are never made arbitrarily, but must meet a specific tactical requirement for the duration of attachment.

b. Operational Control.--In organizing for combat, the commander may find it necessary or desirable to place units or elements under the operational control of other units. Operational control may be defined as those functions of command involving the composition of subordinate forces, the assignment of tasks, the designation of objectives, and the authoritative direction necessary to accomplish the mission. Operational control should be exercised by the use of the assigned normal organizational units through their responsible commanders or through the commanders of subordinate forces established by the commander exercising operational control. It does not include such matters as administration, discipline, internal organization, and unit training, except when a subordinate commander requests assistance. (The term is synonymous with operational command.)

c. Combination of Methods.--A commander may use a combination of methods to suit a particular tactical situation. An element may be attached to a subordinate command. The remaining portion of the unit from which the attached element is derived may be used in general support. For example, one machinegun squad could be attached to a rifle platoon while the remaining two squads in the machinegun section remain in general support of the company.

1303. TASK ORGANIZATION

a. General.--Task organization is the assignment to a responsible commander of the means with which to accomplish a specific mission. In organizing the battalion for a specific combat mission, the battalion commander may attach additional units to the rifle company. Attachments are not made arbitrarily, but are effected to provide the company commander with the means and degree of control over those means which the battalion commander deems necessary to the success of the company's mission. By attaching units to the rifle company, the battalion commander has temporarily organized the rifle company for conducting a specific operation. In so doing, he has task organized the battalion internally into the task components he believes necessary for the accomplishment of the battalion mission.

b. Rifle Company Reinforced.--When attachments are made to the rifle company's basic tactical organization, the company is a reinforced company. The reinforced company is a temporary task component of the battalion organized to execute a specific mission or operation. It tactically groups units under the control of one company commander for the planning and conduct of the operation. The rifle company is the infantry nucleus upon which the additional elements of its task organization are imposed.

Par. 1303

FMFM 6-4

c. Company Task Organization.--Both the rifle company and the reinforced rifle company are capable of internal task organization. In organizing the company or company reinforced for a specific combat mission, the company commander carefully evaluates the support requirements of his rifle platoons. Close examination of their contemplated missions and an evaluation of the methods of employment for the weapons platoon and attached units largely determine the need for task organization. The company commander provides the rifle platoon with the fire support means and degree of control necessary for the accomplishment of its mission. The nature of the operation often dictates the formation of task components within the company. By attaching units to the rifle platoon, the company commander tactically groups units under the platoon commander for the planning and conduct of the mission he assigns the platoon. The reinforced platoon thus formed is a task component of the company for the operation.

d. Rifle Platoon Reinforced.--When attachments are made to the rifle platoon, the platoon is reinforced. The reinforced platoon is a temporary organization for the conduct of a specific mission or operation. The company commander tactically groups units under one platoon commander for the conduct of the operation.

Section IV. COMMAND AND CONTROL

1401. COMMAND

a. General.--The military definition of command as contained in JCS Pub. 1, Department of Defense Dictionary of Military and Associated Terms, is: "The authority which a commander in the military service lawfully exercises over his subordinates by virtue of rank or assignment. Command includes the authority and responsibility for effectively using available resources and for planning the employment of, organizing, directing, coordinating, and controlling military forces for the accomplishment of assigned missions. It also includes responsibility for health, welfare, morale, and discipline of assigned personnel." The commander exercises his command authority by prescribing policies, missions, and standards through the existing chain of command and ensuring that these policies, missions, and standards are fulfilled by personal supervision and inspection. In turn, subordinate commanders and commanders of attached units issue the necessary directives and guidance to ensure the company commander's orders are carried out. Initiative and self-reliance are encouraged at all levels by allowing maximum latitude consistent with existing policies and procedures. The chain of command is always utilized to the fullest extent possible.

b. Control Facilities.--The primary control facility within the rifle company is the command post (CP). On occasion, however, the company commander may elect to control tactical operations from an observation post (OP).

(1) Command Post.--The CP is a central point from which the company operations are directed. In garrison, the company CP usually is the company office. In combat and during training exercises, the company CP is normally located in a covered and/or concealed position to the rear of the forward rifle platoons in the general vicinity of the reserve platoon. Operations within the CP are divided into two functional areas.

(a) Command Group.--The command group consists of those personnel in the company headquarters and supporting arms representatives who perform those command and staff functions necessary for the efficient planning, direction, and control of combat operations. This group directs and controls the fires and maneuver of the rifle company.

(b) Service Group.--The service group consists of those personnel in the company headquarters and service support personnel attached to the company who perform the necessary administrative and logistics support functions in support of the company.

(2) Observation Post.--During tactical operations, the company commander may elect to control operations from an OP. This is any vantage point from which he can physically observe the tactical operations on the battlefield. Only those members of the command group whose presence is required are physically located at the OP. The remainder take covered and/or concealed positions in the vicinity of the OP within communicating distance or remain at the CP. In defensive situations, supporting arms representatives may operate from separate OP's in order to most effectively control their fires.

Par. 1402

FMFM 6-4

1402. COMMUNICATIONS

a. General.--The company commander must have sufficient communications to provide the continuous capability to command assigned forces; to control and coordinate movement, supporting fires, and logistics support; and to collect and disseminate information. This requires that he have the means to maintain continuous communications with each of his subordinate and supporting units, with higher headquarters, and with adjacent units. The company utilizes a combination of radio, wire, messenger, visual, and sound communications. The four fundamental requirements for effective communications are reliability, security, speed, and flexibility. Radio and messenger are the primary means of communication for offensive operations involving rapid and extensive movement. These are supplemented by visual and sound signals. Wire and messenger are usually the primary means of communication in defense. Radio backs up the wire service and is employed when service is interrupted or when directed by higher authority. For detailed information on communications, see FMFM 10-1, Communications.

(1) Responsibility for Communications.--Responsibility for communications is a function of command. The company commander is responsible for the installation, operation, and maintenance of the company communication system and for its efficient functioning as part of the battalion system. He ensures that his subordinates are properly trained to execute the required communication duties.

(2) Types of Communications.--Communication means are classified into two types: telecommunications and physical communications. While the term telecommunications is generally associated with rapid high-capacity electrical or electronic communication means such as wire and radio, it also includes visual and sound communications. Physical communications include mail and messenger service.

(3) Communication Organization.--Communication personnel and equipment are provided to the rifle company, as required, from the communication platoon, headquarters and service company.

(4) Communication Training.--Essential training for key non-communication personnel who operate or utilize the rifle company communication resources is essential and must include:

- (a) Fundamentals of radio-telephone procedure.
- (b) Fundamental operation of assigned equipment.
- (c) Procedures necessary for maintaining physical and transmission security.
- (d) Procedures and techniques necessary to maintain effective communications in an electronic warfare environment.
- (e) Message drafting techniques.
- (f) Familiarization with the communication requirements of the unit and the resources available to satisfy these requirements.

b. Telecommunication Systems

(1) Radio.--The rifle company has access to the following radio nets:

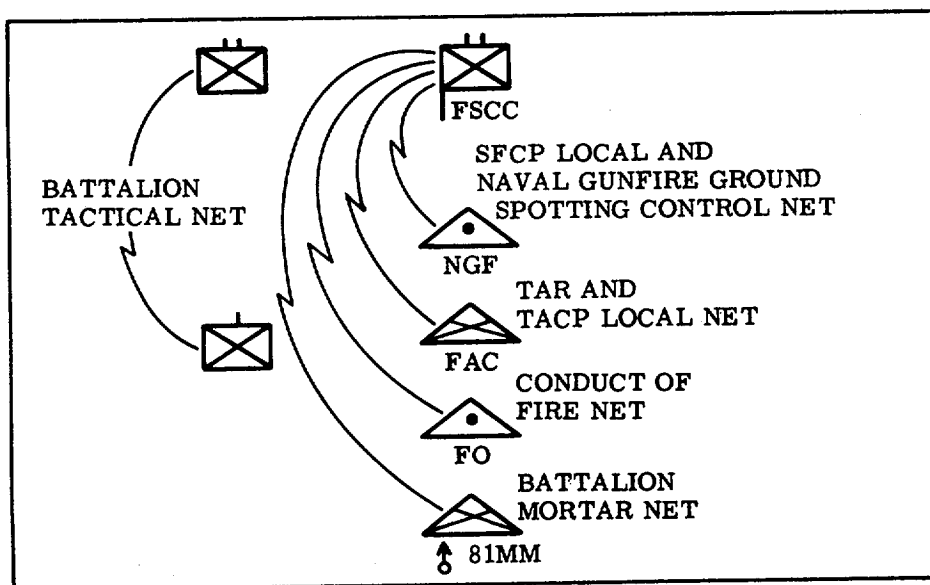

Figure 4.--Radio Communications: Rifle Company to Infantry Battalion.

(a) Battalion Tactical Net (VHF).--The battalion tactical net provides a means to exercise command and control of subordinate units. Stations on the net include the battalion commander (when absent from the command post), the battalion command post, rifle companies in the battalion, the battalion tactical-logistical (TAC-LOG) group, and the 81mm mortar platoon fire direction center (FDC). The antitank assault platoon, the service platoon, and attached and supporting units enter as required. (See fig. 4.)

(b) Rifle Company Tactical Net (VHF).--The rifle company tactical net provides the company commander with a means for exercising command and control of subordinate units of the company. Stations on the net include the company commander, the company executive officer, the three rifle platoon commanders, and the weapons platoon commander. Attached or supporting units may be directed to enter the net. (See fig. 5.)

(c) Rifle Platoon Tactical Net (VHF).--The rifle platoon tactical net provides the platoon commander with a means for exercising tactical control over subordinate units of the platoon. This is a special purpose net which will be activated when required for the coordination of platoon activities. Stations on the net include the platoon headquarters, rifle squads, and fireteams (as required).

(d) Battalion Mortar Net (VHF).--The 81mm mortar forward observer team provides the company commander access to a station on the battalion mortar net. Its primary function is to permit the mortar forward observer to initiate fire requests. In an emergency when contact on the battalion tactical net is lost, the mortar net may be used by the company commander to maintain communications with the battalion commander via the battalion fire support coordination center (FSCC).

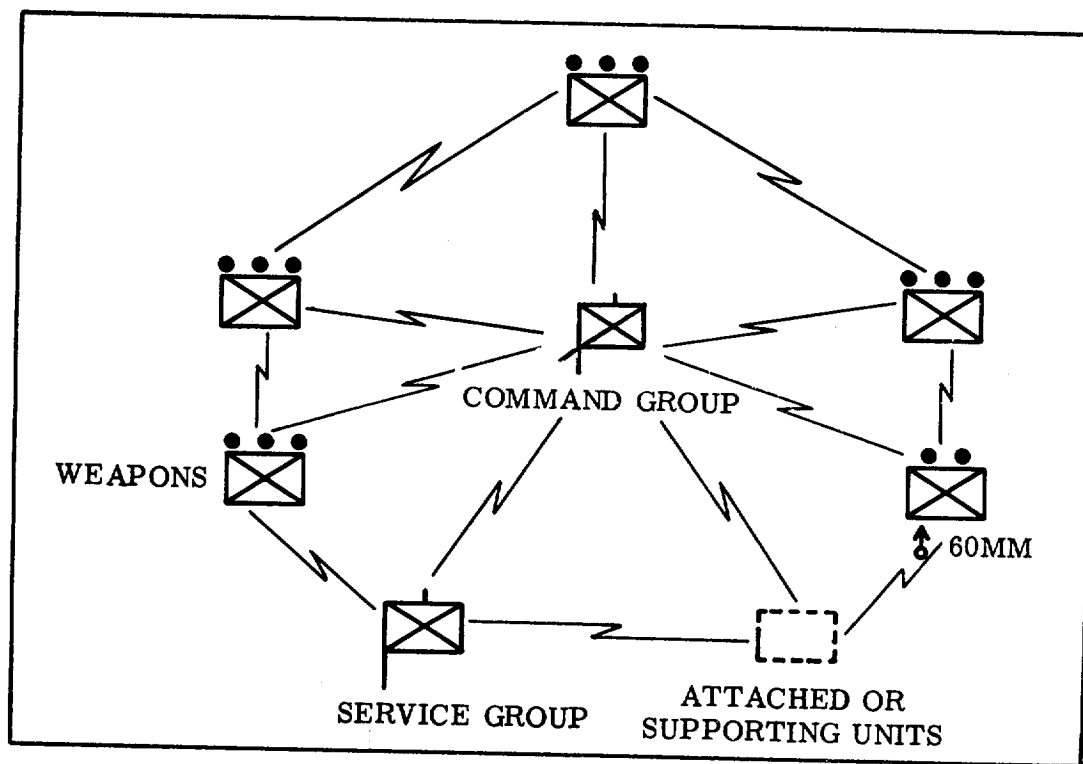

Figure 5.--Company Tactical Radio Net.

(e) Artillery Conduct of Fire Net (VHF).--The artillery forward observer team provides the company commander access to a station on the artillery conduct of fire net. The artillery forward observer team operates a station on the conduct of fire net for initiating fire requests in support of the company. In an emergency, the company commander may use this net to communicate with the battalion command post.

(f) Tactical Air Request Net (HF)/Helicopter Request Net (HF) and the Tactical Air Control Party Local Net (VHF).--When a forward air control party operates with the rifle company, the party operates a station on the tactical air request net/helicopter request net and the tactical air control party local net. The company commander may use either of these nets to communicate with the battalion command post in an emergency, since the battalion air liaison officer maintains stations on these nets in the infantry battalion FSCC.

(g) Naval Gunfire Ground Spot Net (HF/VHF) and the Shore Fire Control Party Local Net (VHF).--The naval gunfire spot team, when operating with the infantry company, activates two radio nets: the naval gunfire ground spot net, which is used to call for and adjust naval gunfire, and the shore fire control party local net. Both nets are guarded by the naval gunfire liaison team at the infantry battalion FSCC. Therefore, the company commander, in an emergency, has two or more alternative means of communicating with the battalion command post.

(h) Medical Evacuation Common Net (HF/VHF).--This net provides a means of coordination between the requesting units, evacuation helicopters/vehicles, and medical facilities engaged in medical evacuation.

(2) Wire.--Rifle companies are usually issued manpacked wire dispensing equipment. Current tables of equipment authorize the company to maintain eight soundpower telephones and eight wire reels as organic equipment. In defensive situations, particularly at night, the rifle company establishes a wire communication net for intracompany communications linking the following stations:

- (a) Company observation post (command group).
- (b) Company command post.
- (c) Three rifle platoons.
- (d) Weapons platoon.
- (e) 60mm mortar section.
- (f) Attached units.

(3) Visual.--Visual signals include air panels, pyrotechnics, grenades, marking rounds, lights (flashlights, strobe, etc.), flags, mirrors, tracer ammunition, and arm-and-hand signals.

(a) Instructions from higher headquarters prescribe the use of visual signals in ground-to-air communications and the control of supporting fires. The establishment of codes by higher headquarters does not prevent prearranged use of other visual signals within the rifle company and platoon as required for the control of operations.

(b) Visual signals employed by the company and platoon in controlling operations are prearranged. Operation orders include the meaning and effects of such signals including special arm-and-hand signals specifically devised for the operation.

(c) Standard arm-and-hand signals are an effective communication means at rifle company level and below. The training of subordinate unit leaders at all levels within the company is mandatory to the effective use of the system. See FMFM 6-5, Marine Rifle Squad, for details.

(4) Sound.--Sound signals are primarily used for alarms to warn of air; nuclear, biological, and chemical (NBC); tank; or ground attack. Whistles, horns, gongs, small arms, or other noise makers may be used in sound signalling. Their use is usually prescribed in SOP's but does not preclude the prearranged use of special sound signals in combat operations.

(5) Messenger.--Messengers provide a secure and reliable means of communication. The T/O provides for a total of eight messengers--two in each rifle platoon headquarters and one each in company headquarters and weapons platoon.

(a) The company headquarters messenger usually carries the company commander's portable VHF-FM radio that would be on the company tactical net. When messenger communications are required with the battalion, he is employed as the messenger.

Par. 1403

FMFM 6-4

(b) One messenger from each rifle platoon headquarters is habitually detailed to the company command group. The platoon messengers provide a pool permitting reliable messenger communications between the company and the rifle platoons. The remaining rifle platoon messenger is retained in the platoon headquarters to provide messenger communications from platoon headquarters to company command group. He further provides intraplatoon communications to the rifle squads and elements attached or in support of the platoon. Messengers are frequently rotated between the company command group and the rifle platoon headquarters as the locations of either group change significantly. Frequent rotation provides each headquarters with messenger service familiar with the locations of and routes to the respective echelons. Reliability and speed of service are enhanced.

(c) The location and employment of the weapons platoon messenger will be determined largely by the platoon method of employment and the location of the platoon commander. Each situation is evaluated to provide the best balance of intraplatoon communications and contact with the company commander.

1403. PRINCIPLES OF WAR

a. General.--The principles of war are fundamental truths governing the prosecution of war. The principles of war are guidelines to be used by a commander to effectively apply the combat power of the Marine company or platoon to aid in the accomplishment of the assigned mission. The effective application of these principles is essential to the proper exercise of command and the conduct of war. Although combat leaders have studied the principles, it is not enough to name them in sequence, but rather to know when and how to relate them to the combat environment. The principles of war are included here to provide a review for the commander to be used when applying doctrine contained in this manual.

b. Principles

(1) Objective.--The objective of a military force is the goal or aim, usually expressed as a mission, for which the force was constituted. This principle is overriding; it is applicable to any operation at any level of command. The objective of a force can be stated in either broad or precise terms depending upon the nature of the goal. Each element of an infantry unit contributes to the attainment of the objective of the larger unit of which it is a part. For example, when the objective of a battalion has been defined, all elements of the battalion must be assigned objectives that facilitate the attainment of the battalion objective. Success in combat is measured by the accomplishment of the mission.

(2) Offensive.--By the offensive, the commander can impose his will on the enemy, set the pace and course of battle, exploit enemy weaknesses, and meet unexpected developments. Even in the defensive, the commander must be alert to regain the initiative by offensive counteractions. Aggressiveness, flexibility of mind, and the ability to make rapid, reasoned decisions are required to apply fully the principle of the offensive. In defense, the commander can often best accomplish his mission by offensive action.

(3) Simplicity.--Simplicity demands that detailed, simple plans be adopted in every military operation. It is, of course, a relative term

because all actions in war are essentially complex. Simplicity will be especially important on the nuclear battlefield, where the full use of available means will require close control and coordination and where plans must be as simple as the situation will permit. Detailed, simple plans lead to coordinated, timely execution.

(4) Unity of Command.--Unity of command is the establishment of a single authority. This is the best means of ensuring unity of effort, which implies a singleness of purpose and cooperation by all elements of the command.

(5) Mass.--Mass demands that superiority of combat power be attained at the critical time and place for a decisive purpose. This superiority is both qualitative and quantitative. Combat power is primarily a combination of firepower and maneuver, which is applied at the right place and time for a decisive purpose. The use of nuclear weapons by enemy forces will require greater dispersion for passive defense; therefore, a greater stress must be placed on the application of mass from the point of view of time rather than space. Violation of this principle exposes the command to the risk of piecemeal defeat even by an inferior enemy.

(6) Economy of Force.--Economy of force requires that sufficient force be applied at other than the decisive time and place to permit mass to be applied at the point of decision. These two principles--economy of force and mass--are so closely related that they cannot be considered singly. Application of the two principles requires a sound estimate of what is sufficient elsewhere to permit the attainment of decisive superiority at the decisive time and place. "Sufficient" is the key. It connotes the application of the force necessary to accomplish the purpose, and not the application of as little force as possible.

(7) Maneuver.--Maneuver requires that all military resources be brought to bear in the accomplishment of the objective. Correct application of the principle of maneuver requires not only the full use of combat power at the decisive time and place but includes the movements of elements of combat power (including combat service support) to the area of operations. Application of this principle is a function of command at all levels. At the highest level, it usually means the movement of men, means, and supplies to an area of operations, and at the lowest level it means the positioning of troop units and fires to destroy the enemy.

(8) Surprise.--Surprise connotes striking the enemy when, where, or in such a manner that he is unable to counter effectively. The achievement of surprise is not necessarily dependent upon misleading the enemy as to intentions, such as, for example, concealing from him an intention of attacking. He may know from the situation that he will be attacked; yet the attacker may achieve surprise by the time, place, direction, size or composition of forces, or tactics employed.

(9) Security.--Security provides readiness for action or counter-action and is enhanced greatly by flexibility. Flexibility in mind, organization, and means contributes to security. Its attainment embraces all measures designed to avoid being surprised or interfered with seriously, and the retention of freedom of action. Security does not imply undue caution and avoidance of all risks, for bold action is essential to success in war. When security is provided, unexpected developments will not seriously interfere with the attainment of the mission.

c. Application.--The principles of war act as a checklist for the commander in order to apply combat power effectively and reduce his unit's vulnerability. A review of military history will demonstrate that those commanders who have adhered to those principles have most often enjoyed success on the battlefield. There have been, of course, exceptions to the rule; however, these exceptions prove the rule that any attempt to rigidly apply all the principles to all battlefield environments may lead to defeat. The commander should recognize the need to apply the principles as flexibly as all other tactical principles, based on the circumstances with which he is confronted. Flexibility in the application of principles is as important as flexibility in the application of combat power on the battlefield. No commander can rigidly follow the examples provided by doctrinal resources, but must modify them according to his mission, the situation, and the terrain over which he is fighting.

1404. ESTIMATE OF THE SITUATION

On being assigned a mission, the commander is faced with determining the best way to accomplish it. A systematic method of selecting the course of action which offers greatest possibility of success has been developed and time-tested to aid the commander. The problem solving process used in arriving at a decision is called the estimate of the situation. The more formal estimates used by commanders of units with a staff capability may be too cumbersome for the rifle company unit leader. His estimates are mental and without staff aid. Estimating the situation is a continuing process. The estimate upon which his initial course was based is continually reviewed as the situation develops. This process may culminate in revision or rejection of the initial course of action. Once a decision is reached and the unit is committed to action and as new facts become apparent, the commander evaluates such facts to determine whether he should continue his current course of action or adopt a new course. The estimate provides for the logical and orderly examination of the mission, enemy, terrain and weather, and the troops and fire support available in developing the course of action offering the greatest possibility of success. The estimate is often referred to by the term "METT." METT is formed by the first letters of each consideration. The course of action selected from the application of METT to the unit situation is translated into a concise statement of what the unit will do. It answers the questions Who?, What?, When?, Where?, How?, and Why?

a. Mission.--The mission assigned is a clear, concise statement of the tasks to be performed. It must be carefully examined and thoroughly understood as it is the basis for all actions of the unit until it is accomplished. The mission may be assigned in its entirety by higher authority, may be deduced in part by the commander concerned, or exceptionally, may be developed entirely on his own initiative.

(1) Deduced Mission.--The commander will frequently be assigned a mission in such simple terms as "attack and seize Hill Y." When he studies the terrain and general situation, he determines that Hill X intervenes between his unit and Hill Y, his assigned objective. He further determines that the enemy occupies Hill X and dominates his area of operation and logistical approaches to Hill Y. He may logically deduce that it will be necessary for him first to seize Hill X in accomplishing the assigned mission. The seizure of Hill X becomes a deduced mission for his command, and he must include that task in his announced plan. The deduced mission is that portion of the overall stated task (normally translated in the unit

commander's order as intermediate objectives) which is developed on the commander's initiative and which results from such needs as:

- (a) To increase observation of the final objective.
- (b) To secure firing positions which will accommodate the displacement forward of supporting weapons.
- (c) To increase fields of fire from which the support element (base of fire) may more effectively support the seizure of the assigned objective by the maneuver element.
- (d) To offer the commander a position to confirm or reject the initial concept for the seizure of the assigned objective, based on a more complete and accurate estimate of the situation.
- (e) To serve as a control measure enabling the commander to better control and coordinate the attack.

(2) Implied Mission.--The mission may be developed entirely by the commander concerned. At company and platoon level, the opportunities for developing the stated task of the unit are relatively rare and are usually confined to units performing advance guard and advance party functions for larger march units. A company commander assigned the advance guard mission for a larger march unit at times may find it necessary to deploy from the march column formation and attack to ensure the uninterrupted advance of the march column. It is implicit in his assignment as advance guard that he has the prerogative to do so on his own initiative. Similarly, the advance party platoon commander of that same company has the same prerogative implicit in his assignment as advance party. The actual stated attack mission of both march elements is developed entirely by the respective commanders within the broad guidelines of their assignments to ensure the uninterrupted advance of the larger march units following them.

b. Enemy.--A careful analysis of the enemy situation is made to establish as much detailed information concerning him as time permits. Such information is derived from many sources. At the company and platoon level, information is obtained from the senior headquarter's operation order, intelligence reports and summaries, and individual and subordinate unit reports. Information obtained is often confirmed or amplified during the commander's reconnaissance troop leading step. All available information is assimilated and mentally sifted to provide as much detail of the enemy situation as possible. As much of the following information as possible is important to the development of sound plans:

- (1) Strength.
- (2) Composition.
- (3) Location.
- (4) Weapon types.
- (5) Tactical dispositions.
- (6) Combat efficiency.

- (7) Capabilities.
- (8) Recent significant activities.

c. Terrain and Weather.--The terrain and weather affect all planned actions of the rifle company and platoon. The effects of weather and terrain are studied from both friendly and enemy viewpoints. Rifle units take full advantage of the terrain in closing with the enemy. Both present and predicted weather can have an effect upon visibility, movement, trafficability, and fire support. Most often the primary concerns of unit leaders at company and platoon level are the military aspects of the terrain and the degree of visibility permitted by the weather. The military aspects of the terrain are considered as follows:

(1) Observation and Fields of Fire.--Observation is the ability of the unit to see the enemy locations. It assists in gaining information about the enemy, in accurately directing fire on him, and in controlling troops. Fields of fire are the areas that a weapon or group of weapons can cover and are essential to the effective employment of direct fire weapons. The commander considers the available observation and fields of fire both from friendly and enemy points of view. He employs available friendly observation and fields of fire to maximum advantage in delivering fire upon the enemy. Schemes of maneuver are developed which avoid areas in which the enemy can employ his weapons against friendly units with the greatest effect.

(2) Cover and Concealment.--Cover is protection from enemy fire; concealment is protection from enemy observation. The commander evaluates the available cover and concealment as it affects both his unit and the enemy. He considers cover from the standpoint of protection from flat trajectory, high angle, and nuclear fires. Though his primary concern in evaluating concealment is protection from ground observation, he is careful to consider protection from air observation commensurate with the importance placed on it by the nature of the operation and the security considerations of higher headquarters. Terrain features which provide cover also provide concealment from ground observation. Areas such as woods may provide concealment but little or no cover, especially from indirect fire weapons. Such terrain may amplify the secondary blast effects of nuclear fires.

(3) Obstacles

(a) Obstacles are either natural or artificial features which prevent or impede military movement. To be effective, obstacles must be covered by fire and observation. Natural obstacles include the following:

- 1 Unfordable streams.
- 2 Swamps.
- 3 Steep slopes.
- 4 Lakes.

(b) The commander is careful to consider the use of artificial obstacles in support of his own operations. He evaluates the effects

of enemy employment of artificial obstacles on his plans. Artificial obstacles include the following:

- 1 Those resulting from nuclear fires.
- 2 Areas subjected to chemical attack.
- 3 Minefields.
- 4 Barbed wire.
- 5 Roadblocks.
- 6 Antitank ditches.

(c) All effects of obstacles to friendly and enemy movements of foot troops and wheeled and tracked vehicles are evaluated as they pertain to the particular operation.

(4) Key Terrain.--Any locality or area, the seizure or retention of which affords a marked advantage to either combatant, is key terrain. At company and platoon level, the advantage gained from key terrain is primarily related to the superiority in observation and fields of fire inherent in that particular feature. As a result, key terrain is usually associated with dominant terrain in a company or platoon area of operation. In built-up areas, particular structures within the area may provide observation and fields of fire. The commander studies the terrain features within and adjacent to his zone or area to determine their effect on his unit's operation.

(5) Avenues of Approach

(a) An avenue of approach is terrain that provides a relatively advantageous route by which a force of a particular size may reach a key terrain feature. A desirable avenue of approach provides the following advantages:

- 1 Observation and fields of fire for the using unit.
- 2 Cover and concealment from the defender's observation and fire.
- 3 Minimum obstacles.
- 4 Ease of movement.
- 5 Sufficient maneuver space for the using unit.
- 6 Rapid access to key terrain.

(b) The attacking company commander focuses his attention on those avenues of approach which he anticipates can accommodate platoon size forces. The platoon commander's interest is focused on avenues which will accommodate squads or the entire platoon. A close evaluation of avenues of approach is of particular importance to small unit leaders. Schemes of maneuver are largely determined by the avenues of approach. The defending commander studies the terrain to determine those avenues of approach available to the enemy which lead into key terrain or into his flanks or rear.

Par. 1405

FMFM 6-4

d. Troops and Fire Support Available.--Consideration is given to the effective personnel strengths of the rifle units to be employed in the operation and the fire support available to them.

(1) Deficiencies in the personnel strengths of subordinate units may influence the formation for the attack or defense. In ensuring the impact of the assault, it may be necessary to use larger quantities of understrength subordinate rifle units in the assault echelon to provide adequate troop strength. In the defense, a greater employment of understrength rifle units forward may be necessary to produce a reasonable volume of small arms fire.

(2) The fire support available from all sources is carefully evaluated. Consideration is given to the employment of organic and nonorganic direct and indirect fires. Operation orders of the next higher echelon provide information concerning the support available and the degree of control over the supporting fires retained by the superior commander. Consideration is given to all supporting fires as the basis for developing a fire support plan which provides for the integrated employment of all types of fire in covering the advance of maneuver elements.

1405. TROOP LEADING PROCEDURE

Troop leading procedure is the logical sequence of action the commander follows while receiving, preparing for, and executing an assigned mission, and making best use of his time, facilities, and personnel. As discussed in this paragraph, troop leading procedure is appropriate for all troop leaders within the company for all types of operations.

a. Receipt of Mission

(1) Company Commander

(a) The rifle company commander frequently receives a battalion warning order which permits early planning and initial preparation for the operation. Included in the warning order is information pertaining to issuance of the battalion operation order. Based on the battalion warning order, the company commander initiates a warning order to his subordinates and decides who will accompany him to receive the battalion operation order. He normally takes the following individuals with him:

- 1 Weapons platoon commander.
- 2 Artillery forward observer.
- 3 Leaders of attached and direct supporting units.
- 4 Company messenger with the company tactical radio.

(b) Realizing that time is usually at a premium, the company commander takes the necessary equipment (binoculars, map, and notebook) and selected leaders to assist in formulating plans. The executive officer is left to prepare the company for combat and comes forward with the rifle platoon commanders to a designated location to receive the company commander's operation order. In instances where the executive officer's presence with the company is not required to continue preparation for the operation, he may accompany the commander throughout the receipt of mission and subsequent troop leading steps.

(2) Rifle Platoon Commander.--The rifle platoon commander receives his mission from the company commander's operation order. The company order is normally an oral order. The platoon commander is summoned to a company vantage point from which a terrain orientation is conducted. The company commander points out the salient features of the terrain on which operations are to be conducted. The entire party is then withdrawn to a more covered and concealed position for issuance of the company order. At the conclusion of the company operation order, the platoon commander is prepared to conduct his troop leading steps. Proper preparation for receipt of the company order provides for the following:

(a) When the platoon is not in direct enemy contact, the platoon sergeant, time and duties permitting, should accompany the platoon commander to receive the company order and through the succeeding troop leading steps.

(b) The platoon continues preparation for the operation under control of the platoon guide or continues current operations under control of the platoon sergeant.

(c) The platoon messenger accompanies the platoon commander as primary means of communication with the platoon.

(3) Weapons Platoon Commander.--The weapons platoon commander accompanies the commander to receive the battalion operation order, when the situation permits. After receipt of the battalion order, the company commander may direct the weapons platoon commander to accompany him on his reconnaissance or to conduct a separate reconnaissance. When a separate reconnaissance is conducted, the weapons platoon commander prearranges a subsequent meeting with the company commander to submit recommendations. Based on the battalion order, the company commander's concept of operation, and his own reconnaissance, the weapons platoon commander prepares recommendations for the employment of his platoon. His recommendations are incorporated into the company operation order. The weapons platoon sergeant and messenger join the weapons platoon commander to receive the company order. The platoon sergeant then accompanies the weapons platoon commander through the remaining troop leading steps. The messenger provides the primary communication means with the platoon.

b. Troop Leading Steps.--The troop leading steps are a logical and orderly process for making the best use of time, facilities, and personnel in preparing for and executing an assigned mission. Depending on circumstances, the level of command, and the type of operations, some steps may be accomplished before others. In urgent situations, all steps may not be necessary or possible. The degree of consideration for each step may vary in accordance with the operation. Time is usually the governing factor in the application of the steps. The steps discussed here are appropriate for all leaders in the rifle company.

(1) Begin Planning

(a) Use of Available Time.--To ensure that subordinates are provided sufficient time for planning, the commander plans the best use of available time. The interval of time between receipt of the operation order and the time at which it is to be executed is subdivided. The commander sets aside a portion of the time for his own reconnaissance and planning and must reserve adequate time for planning and reconnaissance on

Par. 1405

FMFM 6-4

the part of his subordinates. In instances where troop movements and planning cannot be conducted concurrently, a portion of the available time must be reserved for the movement of troops to the location from which the commander intends to initiate operations.

(b) Begin the Estimate.--The commander makes a preliminary estimate of the situation based on the content of the order received from the next senior echelon and the terrain as seen from the vantage point and map, aerial photo, or terrain sketch. (See par. 1404.)

(c) Make a Preliminary Plan.--A tentative plan is developed as a basis for future planning. Its basis is the preliminary estimate just completed. Reconnaissance will often require alteration or rejection of the preliminary plan.

(2) Complete Arrangements for the Following:

(a) Movement of the Unit.--Sufficient information is provided to the subordinate responsible for controlling the movement. (See par. 1406c.)

(b) Reconnaissance.--Planning for the reconnaissance includes consideration of the route, persons to accompany the commander, and specific instructions to selected supporting and attached leaders concerning their roles in the reconnaissance. The route is usually planned to effect a prearranged schedule of meetings with adjacent and supporting unit leaders for the purpose of coordination. (See par. 1406c.)

(c) Issuance of the Order.--Subordinate leaders are notified of the time and place at which the commander will issue his order. Notification is usually effected after the vantage point has been selected. Messengers accompany the commander on reconnaissance for this purpose. (See par. 1406c.)

(d) Coordination.--Most adjacent and supporting unit leaders with whom coordination is desired are present when the higher echelon order is received. The commander confers with them and establishes times and locations at which to coordinate plans. The reconnaissance route and schedule are strongly influenced by these prearranged meetings.

(3) Make a Reconnaissance

(a) On his reconnaissance, the commander continues the estimate process in accordance with his terrain analysis and the enemy strengths, locations, and dispositions. He revises his preliminary estimate in conformity with new information gained. His preliminary plan is altered accordingly.

(b) He selects a vantage point from which he intends to orient his subordinates on the terrain. Once the vantage point is selected, subordinates are notified of the time and place at which his order will be issued.

(c) Coordination is effected in accordance with the prearranged schedule.

(4) Complete the Plan

- (a) The commander receives recommendations.
- (b) The estimate is completed and a decision is made.
- (c) The commander prepares his operation order reflecting the decision.

(5) Issue the Order

(a) At the appointed time, subordinate commanders are oriented on the terrain from the vantage point.

- (b) The commander issues his operation order.

(6) Supervise

(a) The commander supervises subordinate planning and preparation.

(b) Supervision is continuous throughout the conduct of the operation and is a key means of making the commander's presence felt on the battlefield.

1406. COMBAT PLANS AND ORDERS

The commander's decision is translated into action through the issuance of plans and orders which provide instructions and information to subordinate units. Combat plans and orders are those pertaining to operations and administration in the field as distinguished from routine orders associated with the Marine Corps directives system. This paragraph includes only those plans and orders commonly used at battalion level and below.

a. Standing Operating Procedure.--SOP's are sets of instructions covering those features of operations which lend themselves to a definite or standardized procedure without loss of effectiveness. They prescribe methods and techniques for particular tactical and administrative units of the command which the commander desires to make routine. The established procedures are applicable, unless otherwise directed, in a particular case. Thus, the flexibility necessary in special situations is preserved.

b. Operation Order.--An operation order is the expression of the manner in which the commander's decision will be implemented to accomplish the mission. It sets forth the situation, mission, decision, plan of action, and method of execution. The operation order converts the commander's decision into a plan of action, gives direction to the efforts of the command, and provides specific instructions to subordinate elements of the command. The order sets forth the who, what, when, and where of the commander's decision, together with enough of the how and why to ensure intelligent compliance. Operation orders may be either written or oral. (See app. A.)

(1) Written Orders.--Written orders may be promulgated by message or other convenient form. The orders are issued directly to subordinate commanders or their representatives. Orders may be transmitted by electrical means, messenger, and/or liaison officer. Written orders are rarely used at the company level. When time permits, the battalion commander will normally use a written order in issuing instructions to his

companies. This is particularly true where the order contains considerable detail and requires precision in execution (e.g., a landing operation or a raid).

(2) Oral Orders.--An oral order is the most direct and satisfactory method of communicating the commander's decision to subordinate units. This method is most commonly used by company and platoon commanders. In a rapidly changing situation and in matters that are simple in nature, the battalion commander frequently issues oral orders.

(3) Techniques.--Clarity, simplicity, and timeliness are essentials of an operation order. Clear, concise sentences are most easily understood. In the interest of simplicity, commanders and leaders at each echelon should closely evaluate and issue only those facts received from a higher headquarters that are pertinent to their own subordinate unit leaders. The order must be issued in a timely fashion, sufficiently in advance of the time of execution to permit subordinate planning. Oral orders should be delivered in positive, direct, and confident tones using aggressive and forceful language.

(4) Format.--A standard form has been developed for an operation order in accordance with Standardization Agreement (STANAG) 2014. Use of the standard form promotes clarity and brevity. It presents information and instructions in a logical, easily assimilated manner, and serves as a checklist to help ensure that no important item has been overlooked. The sequence shown in figure 6 is used by commanders at all echelons. Paragraph numbers and paragraph titles shown are not normally stated in oral orders.

(5) Annexes.--An annex is a document appended to and forming a part of a complete plan, order, or other document. It pertains to a particular type of activity or subject, and may be prepared in any form appropriate to the subject matter. Annexes contribute to the brevity and clarity of the parent order by removing from it voluminous details or those which are not of general interest. The company commander refers to appropriate annexes in determining the details of his unit organization and employment in the operation. Where annex information is provided, reference is made to it in the body of the battalion operation order.

(6) Attachments.--The battalion operation order may specify attachments to the rifle company in one of three ways. The company commander determines what attachments will be made to his company by consulting one of the following:

(a) Task Organization Annex.--Each task grouping which is to receive a tactical mission in the execution portion of the order may be shown along with its component elements in an annex to the battalion operation order.

(b) Task Organization Entry.--An entry preceding paragraph 1 of the order may show the components of a task grouping as in an annex.

(c) Execution Paragraph.--Attachments to the rifle company may be shown in the execution subparagraph of the battalion operation order.

1. SITUATION

- a. Enemy Forces.--(Situation, capabilities, indications.)
- b. Friendly Forces.--(Missions and locations of higher, adjacent, and supporting units.)
- c. Attachments and Detachments.--(Units attached to or detached from the issuing unit by higher headquarters and effective times.)
- d. Commander's Evaluation.--(An optional subparagraph that may be used to present the commander's evaluation of the situation.)

2. MISSION

(State the mission of the issuing unit. The stated mission includes the missions assigned by higher echelon and may state missions deduced by the commander of the issuing unit. Missions are stated in the order of their expected accomplishment.)

3. EXECUTION

(The first subparagraph gives a summary of the scheme of maneuver and fire support plan of the tactical plan, but does not specifically designate the units accomplishing the tasks. The succeeding subparagraphs assign missions to each organic and attached unit in logical sequence. The next to last subparagraph designates the reserve and its assigned mission. The last subparagraph lists the coordinating instructions common to two or more subordinate units.)

4. SERVICE SUPPORT

(Supply, evacuation, transportation, service, personnel, and miscellaneous information are included in the paragraph.)

5. COMMAND AND SIGNAL

- a. (Signal instructions and information.)
- b. (Command posts, location of commander.)

Figure 6.--Operation Order Format.

c. Warning Order.--Warning orders give advance notice of an order or action to follow. Their purpose is to provide subordinates with maximum time available in preparation for the contemplated operation or action. A warning order contains as much information as is available and such instructions as are necessary at the time. Warning orders normally take the forms of brief oral or written messages and adhere as closely as possible to the sequence of the standard form. Operational warning orders are used extensively at battalion and company level.

(1) The company commander's use of a warning order is usually prompted by receipt of a warning order or operation order from battalion, probable employment of his reserve, or probable changes in the employment of subordinate units.

(2) The platoon commander issues warning orders on receipt of warning orders from the company or as otherwise appropriate in alerting subordinates to new situations requiring their consideration and planning efforts.

d. Overlay Operation Order.--An overlay type operation order is one in which as much of the information and instructions as possible are shown graphically on overlay paper. The overlay is amplified with a brief written portion using the standard form. The overlay order permits rapid preparation, promotes brevity, and increases clarity since recipients can see as well as read what is intended. The battalion commander makes frequent use of this type order in changing situations.

e. Fragmentary Operation Order.--Fragmentary orders are issued when the time element precludes issuance of a complete order. They are designed to ensure continuous action as a situation develops or as decisions are made. Fragmentary orders omit elements found in a complete order which have not changed since issuance of the last complete order or are unavailable or incomplete at the time of issue. Fragmentary orders follow the sequence of the related standard order. At a minimum, they contain paragraphs 2 and 3 of the standard order but can include information contained in the other paragraphs. The battalion commander uses the fragmentary order extensively in fast moving situations. Fragmentary orders are supplemented by visits, messages, and other fragmentary orders until the action is completed or a complete order is issued.

(1) Company Use.--The rifle company commander relies extensively on use of the fragmentary order. When the company mission results from receipt of a fragmentary order from battalion, the company commander employs the fragmentary form in assigning tasks to his subordinates. He may use the fragmentary order when there is insufficient time for the preparation of a complete order. The company commander finds the fragmentary order particularly useful as a control means in offensive operations involving deduced missions for the company. Having deduced that it will be necessary to seize Hill X in order to accomplish his assigned mission of seizing Hill Y, the company commander issues a complete order assigning tasks for the seizure of X. On seizing X and when prepared to continue operations, he then issues a fragmentary order assigning tasks to continue operations in order to seize Hill Y. Using the fragmentary order in conjunction with the succeeding terrain objectives permits the company commander to reestablish positive control prior to initiating the next phase of the operation. Both the initial order and a subsequent fragmentary order make the company's ultimate mission perfectly clear.

(2) Platoon Use.--The platoon commander makes extensive use of the fragmentary order. His use of the order is prompted by receipt of a fragmentary order from the company or insufficient time to prepare a complete order. He may also employ the fragmentary order as a control means in operations involving deduced missions. In such cases, his employment of the order conforms to that described above for the company commander.

f. Administrative/Logistics Order.--The administrative/logistics order is an order covering administrative and logistic support details for tactical operations. At company level and below, such information is contained in paragraph 4 of the operation order. At battalion level, the administrative and logistic data may be so detailed and voluminous as to preclude including them in the body of the operation order. The company

commander refers to the administrative/logistics order to extract information for his own order pertaining to the following:

- (1) Materiel and services (supply, transportation, services, labor, etc.).
- (2) Medical evacuation and hospitalization.
- (3) Personnel.
- (4) Civil-military cooperation.
- (5) Miscellaneous.

g. Combat Plan.--A plan may be either administrative or tactical in nature. There is a basic difference between an order and a plan. An order carries with it the obligation of immediate execution or execution at the time prescribed therein. A plan is based on assumptions, and the anticipated time or circumstances of its execution are tentatively stated. A plan is normally issued well in advance of the prescribed action and is executed when prescribed conditions are met or on order or signal. A plan, when ordered executed, becomes an order.

h. Outline Plan.--An outline or draft plan is a preliminary plan covering the mission, concept, basic undertakings, and scope of operations. Outline plans are prepared and issued to provide subordinate commanders a basis for concurrent and coordinate planning. Outline plans are sometimes employed at battalion level as planning guidance in preparation for amphibious, helicopterborne, and air movement operations.

1407. COMBAT RECORDS AND REPORTS

Combat records and reports are important aids to efficient unit operations. Proper utilization of essential reports aids in planning and supervising operations. They are designed to keep information available for present and future operations and to record the unit's activities for historical purposes. The infantry battalion commander, with the aid of his staff, is responsible for maintaining certain combat records and forwarding reports to higher echelons. A major portion of the information included in his combat records and reports is obtained from various reports required of the rifle companies. The rifle company commander is responsible for the timely submission of such combat reports as the battalion commander may direct. Battalion SOP's and/or operation plans and orders provide detailed information concerning submission of reports.

a. Personnel Status Report.--The purpose of the personnel status report is to provide the battalion commander and his staff with information of the personnel situation as it affects the combat efficiency of each of his subordinate commands. The company commander is responsible for its preparation and submission. The report reflects the officer and enlisted strengths and casualties for the period covered. It may contain information as to prisoners of war captured and evacuated. It is usually submitted daily. The statistical data on which it is based is maintained at the company command post.

b. Operational Situation Report (SitRep).--As changes in the company tactical situation develop, the company commander makes reports of the

existing situation to the battalion. Any information affecting the company's tactical dispositions or ability to accomplish its mission is included. Enemy activities affecting the company's tactical dispositions, casualties sustained, and logistic deficiencies, when they endanger accomplishment of the assigned mission, are of tactical concern and may be included in the operational situation report. Routine logistic requirements are reported and/or requested by other means. Operational situation reports are normally made as changes occur but may be of a periodic nature in static situations or at the discretion of the battalion commander. For further details, see FMFM 3-1, Command and Staff Action.

c. Intelligence Reports.--The rifle company is an information collection agency for the infantry battalion. It is frequently given specific collection missions in the battalion operation order. Battalion SOP's or operation orders prescribe special measures to expedite the reporting of vital information. Information concerning the enemy, terrain, and shell reports are proper subject matter for intelligence reports and are reported as they occur in order of urgency. Reports are transmitted in the clear and are assigned message precedences in SOP's or operation orders which indicate the degree of urgency of their content. Leaders at all echelons have a continuing responsibility for the timely, complete, and accurate reporting of information concerning the enemy.

(1) Procedure.--Information must be reported as rapidly, accurately, and completely as possible and includes as much of the following as can be determined (SALUTE report):

- (a) Size of enemy units.
- (b) Activity.
- (c) Location.
- (d) Unit reporting.
- (e) Time.
- (f) Equipment.

(2) Urgency.--The content of the information contained in the report will indicate its relative importance to the tactical situation. Vital information is that which is likely to have an immediate serious effect on the battalion tactical situation and usually includes the following:

- (a) Reports of initial contact with the enemy.
- (b) Tank, mechanized, or motorized forces.
- (c) Hostile counterattacks.
- (d) Sightings of enemy aircraft or guided missiles.
- (e) Indications of nuclear, biological, or chemical weapons employment.

d. Shell Reports (ShelRep) and Crater Analysis.--Shell reports and crater analysis are among the best sources of counterfire information and,

Rec by _____ (Initials of Writer)		<u>S2, 1st Bn, 11th Marines</u>				<u>1258</u>		<u>1</u>		
Section I. SHELREP MORTREP BOMREP (Designate which)										
A	B	C	D	E	F	G	H	I	J	K
From	Position of Observer	Mag or grid az of sound, flash, furrow or ft-path origin	Time from	Time to	Area shelled	Nr, caliber (or size), and type of weapon	Nature of fire	Nr and type of shells	Time of flash to bang	Damage (remarks)
OP#1	365478	1438 m	1250	1255	?	2/?	?	18/?	8 Secs	?
Section II. Location of Hostile Weapon						Section III. Counterfire Action				
L	M	N	O	P	Q	Fill in				
From and time	Grid reference and accuracy	Means of locating	Time active	Nr, caliber (or size), and type of weapon	Remarks	Time of fire	Fired by	Nr of rd fuze and projectile	Remarks (effect)	
Radar Sec	478675 100 Meters	Radar	1255	2/?	Area Shelled 490650	1300	4th Bn, 11th Mar	36 FZ 50% FQ 50% VT	Under surveillance OP#1	

Figure 7.--Artillery Counterfire Information Form.

if possible, should be submitted immediately, even during the actual shelling, so that a fire mission, search, or surveillance of the origin of enemy shelling can be requested by company or battalion headquarters. The personal risk involved in requiring shell report teams to take and report crater analyses is often necessary for the effective neutralization of enemy artillery, rocket, or mortar fire. Personnel from forward observer teams are trained to take and report crater analyses. However, every rifle platoon should have personnel trained to take crater analyses, obtain shell fragments identification, submit sound azimuth reports and flash-to-bang reports, and trained in the proper use of the artillery counterfire information form (ACIF) used for transmitting these reports. (See fig. 7.) The artillery forward observer is best qualified to conduct the training; however, other well qualified instructors are available from any fire support unit.

e. Platoon Responsibility.--The platoon commander is responsible for the timely submission of the various types of reports mentioned in this paragraph. He submits such reports to the company as they occur. A notable exception is the personnel status report. The platoon commander does not prepare a personnel status report but provides information to the company commander, as required, for incorporation into the company personnel status report.

Section V. INTELLIGENCE AND COUNTERINTELLIGENCE

1501. GENERAL

a. Intelligence.--Intelligence is the product resulting from the collection, evaluation, analysis, integration, and interpretation of all available information which concerns one or more aspects of foreign nations or areas of operations and which is immediately or potentially significant to military planning and operations.

b. Combat Intelligence.--Combat intelligence is that knowledge of the enemy, weather, and geographical features required by a commander in the planning and conduct of tactical operations.

c. Information.--Information is unevaluated material of every description, including that derived from observations, reports, rumors, photographs, and other sources which, when analyzed, may produce intelligence.

d. Intelligence Process.--The intelligence process consists of the steps by which information is assembled and converted into intelligence and the resulting product made available to users. These steps are generally grouped into four phases:

(1) Direction.--Direction is the determination of intelligence requirements, preparation of a collection plan, issuance of orders and requests to information collection agencies, and a continuous check on the productivity of collection agencies.

(2) Collection.--Collection is the systematic procurement and selection of information pertinent to a given intelligence problem.

(3) Processing.--Processing is the phase whereby information becomes intelligence through evaluation, analysis, integration, and interpretation.

(4) Dissemination.--Dissemination is the conveyance of intelligence in suitable form (oral, graphic, or written) to agencies needing it.

e. Elements of Combat Intelligence

(1) Weather.--The rifle company normally receives weather reports from the infantry battalion. They include forecasting information concerning temperatures, cloud conditions, visibility, storms, surface winds, and precipitation. The information provided permits the company commander to evaluate the effects of weather upon planned tactical operations.

(2) Light Conditions

(a) The battalion S-2 can provide information concerning the phases of the moon and times for sunset, sunrise, nautical twilight, moonrise, and moonset. This information can affect tactical operations and is valuable in scheduling attacks, movements, and patrols.

(b) The beginning of morning nautical twilight (BMNT) and the ending of evening nautical twilight (EENT) occur when the sun is 12 degrees below the horizon. Masking terrain and vegetation, fog, and haze will shorten the periods of twilight visibility. However, under good conditions and in the absence of other illumination, at BMNT and EENT the general outlines of objects can be seen, vision is limited to less than 400 meters, ground movement is not difficult, close coordination between individuals is facilitated, and the enemy can be approached within about 400 meters unobserved. When the sun is 0-6 degrees below horizon (civil twilight), sufficient light is available for normal daytime activities including observed artillery fire and close air support when weather and terrain are not limiting factors.

(3) Geographical Features.--The military aspects of terrain and hydrography are major concerns in the commander's estimate of the situation and are important intelligence requirements in the planning and conduct of tactical operations. The concern is not only with those aspects that aid in accomplishing the mission, but how those aspects affect the enemy's capabilities as well.

(4) Enemy.--Reliable information concerning the enemy strengths, locations, dispositions, and activities influences operational planning. Of particular interest to the company and small units is information concerning enemy positions and locations of automatic weapons, mortars, tanks, and antitank weapons, as well as the locations of minefields and obstacles.

1502. COLLECTION OF INFORMATION

The need for information concerning the terrain in the area of operations and the enemy forces is a continuing one. On receipt of a specific mission, the battalion commander often finds that there are gaps in the information he has available. Some informational gaps must be answered in order for the battalion commander to make a sound tactical decision, conduct a maneuver, or avoid being surprised. Occasionally, the company commander and platoon commander may require answers to fill informational gaps.

a. Essential Elements of Information (EEI).--The items of information which are considered most critical and must be answered are termed the commander's essential elements of information.

(1) Company and Platoon EEI's.--The rifle company and platoon are generally concerned with the enemy forces directly opposing them as to locations, dispositions, strengths, and armament. Terrain information may occasionally be deemed critical. Care is taken to limit the number of EEI's to those that are critical. Inclusion of nice-to-know items obscures and weakens the collection effort.

(2) Battalion EEI's.--Battalion EEI's are directive in nature and the rifle companies endeavor, within their capabilities, to provide information which contributes to answering them.

b. Collection Planning.--At the company and platoon level the greatest problem encountered in the collection of information is the limited time available from the receipt of an order to its execution. To compensate, rifle company and platoon commanders continually stress the importance of reporting information and remain aware of the capabilities of all

means available for gaining information. In determining his own EEI or on receiving EEI from higher echelons, commanders determine what sources may likely provide the desired information.

(1) Enemy.--The source of much of the information relating to combat intelligence is the enemy himself. The quantity and types of information concerning the enemy's activity are limited by the means available to detect and observe them and his ability to mask his actions.

(a) Prisoners of War.--Prisoners of war are one of the most valuable sources of information concerning the enemy. The interrogation of prisoners of war is normally conducted by trained interrogators. The rifle company commander makes specific requests for information to the battalion. When the tactical situation prohibits the rapid evacuation of prisoners, tactical interrogation, utilizing locally available interpreters, may be conducted by the capturing company. Such interrogations seek information of immediate tactical value. Information produced by untrained interrogators is frequently unreliable; therefore, untrained interrogators should not be used, if possible. As most prisoners are captured by small units in contact with the enemy, small unit leaders and commanders ensure that all personnel understand and apply the techniques for handling prisoners of war outlined in FMFM 6-5, Marine Rifle Squad. The platoon and/or company commanders ensure that all prisoners are tagged and that the required information is shown on each prisoner's tag prior to evacuating them. Tag information includes the date/time of capture, the place of capture, circumstances of capture, and the unit making the capture.

(b) Enemy Documents and Material.--Captured documents are an important part of the intelligence collection effort. In many cases, enemy unit designations are more valuable in order of battle studies if the precise location and time of capture are known. Documents are tagged and show the same general information as is required for captured prisoners. Enemy dead and prisoners of war are lucrative sources of information and documents. When documents are removed from a prisoner of war, care is taken to ensure that future interrogators are able to associate the documents with the prisoner from whom they were taken. Documents are evacuated to the rear with the prisoner from whom removed. Captured enemy material, though generally not of immediate tactical value, may provide valuable technical intelligence. The collection of both documents and material is ensured only by appropriate training and supervision of small units and individual Marines.

(c) Enemy Shelling.--Observed enemy artillery and/or mortar fire and the analysis of resulting craters are a source of information frequently available to the small unit. Detailed instructions concerning shelling report procedures are contained in FMFM 6-5, Marine Rifle Squad, or FMFM 7-4, Field Artillery Support. (See fig. 7.)

(2) Maps and Photographs.--Maps and photographs are of value to all rifle unit leaders as sources of information concerning the geographical aspects of the area of operations. Planning includes considering the use of maps of special or larger scale than normal, blowups of available scales, or pinpoint photography of particular objectives. Such requests are made to the battalion S-2.

(3) Higher Echelons.--Higher echelons may be able to assist in answering the EEI's of small units. Platoon and company requests for information to their respective higher echelons should be as specific as possible.

(4) Indigenous Personnel.--Indigenous personnel who have been within enemy controlled areas may be valuable sources of information, particularly concerning terrain. They also may have knowledge of enemy installations and activities.

c. Collection Agencies

(1) Rifle Company.--The rifle company plays a vital role in combat as a collection agency. Being in close contact with the enemy and often the first friendly unit to cross previously held enemy terrain, the rifle company gains considerable information about the enemy's strength, location, and armament; trafficability of the terrain; and status of bridges and key facilities. In addition, company elements capture prisoners, documents, and material. Small units are the first to be contacted by line crossers and defectors and are the initial targets of, and defense against, enemy reconnaissance efforts.

(2) Individual Marine.--The individual Marine is the most valuable single information collection agency available at the rifle company level. His value is directly proportional to the training and supervision he receives. An understanding and appreciation of his role in the intelligence process and training and supervision in the techniques of collecting, handling, and reporting information have a direct bearing on the value of the following:

(a) Patrolling.--Patrolling is the primary means of obtaining information at the company level. To obtain maximum results, it is important that patrols be carefully briefed concerning the EEI which they are endeavoring to provide. The value of a patrol is directly related to the ability of the patrol to report what it has observed in meaningful terms. The company commander ensures this by adequately debriefing patrols on their completion.

(b) Observation Posts.--Observation posts provide visual coverage of a considerable area with a minimum expenditure of personnel. They are able to render detailed reports of events occurring within their sectors of observation and to recount the sequence of those events, permitting recognition of the relationships existing between various occurrences.

(c) Listening Posts.--Listening posts are essentially local security elements, but may provide information of value concerning enemy movements, sounds, and lights in their vicinity. The employment of listening posts in coordination with electronics and other surveillance devices such as seismic intrusion devices and starlight scopes should be considered to provide the most complete results.

(d) Forward Observer Teams.--Forward observer teams from various supporting arms are valuable sources of information concerning the enemy and terrain. They are carefully briefed on appropriate EEI's.

(e) Ground Surveillance Radar Teams.--Ground surveillance radar teams from the battalion may be attached to or operate in the vicinity of the rifle company or platoon. The company commander and platoon commander coordinate with them to ensure that information of interest obtained by the team is made available.

Par. 1503

FMFM 6-4

(f) Air Observation.--Observation aircraft may occasionally support the battalion. An air observer may be employed to support the company, a platoon, or patrol for a specific mission on request to the battalion S-2.

(g) Optical, Mechanical, and Electronic Devices.--The infrared telescope assembly weapon sight, starlight scopes, seismic intrusion devices, and surveillance radars available from the battalion increase the night surveillance capabilities of the observation posts, listening posts, and patrols. Tactical remote sensors in support of the battalion may be requested to increase the surveillance capabilities.

d. Collection Effort.--After selecting those sources and agencies most suitable to secure the required information, the commander designates specific missions and specific questions to be answered. Orders and requests for the collection of information which are given in generalities will result in answers that are vague and incomplete.

1503. PROCESSING AND USE OF COMBAT INTELLIGENCE

a. General.--Processing of intelligence is accomplished by judging the credibility of collected information, drawing pertinent inferences from an analysis thereof, and when appropriate, interpreting such inferences in the perspective of planning.

b. Processing.--Processing, the task of converting information into intelligence, involves three steps:

(1) Recording.--Recording information serves to provide a record of events for subsequent study. The vast majority of information received at the company and platoon level can be carried in the commander's head, a small notebook, or indicated on his tactical map. Retaining the carbon copies of messages relaying collected information to the battalion will often suffice. Recording should act as an aid rather than a hindrance.

(2) Evaluation.--In evaluating information, rifle company unit commanders are most concerned with the reliability of its source or agency and its accuracy. Reliability is based on a background knowledge of each source or agency. Such items as the training and experience of personnel manning an observation post or the past performance of certain individuals on patrol should be considered. Accuracy means, "What is the probable truth of the information?" The most reliable method of judging the accuracy of information is to compare it with other information. In so doing, the following questions should be considered:

(a) Is the reported fact or event at all possible?

(b) Is the report consistent within itself?

(c) Is the report confirmed by information from other sources?

(d) Does the report agree or disagree in any way with other available information, particularly information whose accuracy is known?

(3) Interpretation.--The interpretation of information attempts to determine its significance and to arrive at conclusions relating to the

effect of this information on the enemy's capabilities and friendly operations. If, after carefully evaluating the information available to him, the commander is able to gauge the enemy's strength, location, and the general nature of his activity, he can apply this information to determine the enemy's ability to affect friendly operations. Terrain and weather conditions are then considered with respect to both friendly and enemy viewpoints.

c. Responsibility.--The functioning of the intelligence process and the availability of adequate combat intelligence are a command responsibility. As there are no designated intelligence personnel at the company level, the rifle company commander and platoon commander perform their intelligence functions by providing timely and accurate information to their respective higher echelons and by using information collected and the intelligence provided by the battalion in order to arrive at a decision, to conduct planning, to execute a maneuver, or to avoid being surprised.

1504. DISSEMINATION

a. Battle Dissemination.--The basic requirement of dissemination is to provide the information to those who need it in time to be of use to them. At the company level and below, most dissemination takes place by personal contact. Radio, wire, or messenger may also be available. Rifle company officers ensure that information which is deemed critical is transmitted and received by appropriate communication means.

b. Intelligence Summary (INTSUM's).--The INTSUM provides a summary of the intelligence situation covering a specific period (usually 6 hours). It contains information/intelligence on significant enemy activity, estimated losses in personnel and material, new units and personalities, obstacles, administrative activities, weather and terrain conditions, capabilities and vulnerabilities, and a conclusion concerning the meaning of enemy activities in relation to the overall situation.

1505. COUNTERINTELLIGENCE

a. General.--Counterintelligence measures at the company level consist of denying the enemy information concerning friendly forces and the terrain, detecting his efforts to obtain such information, and deceiving or misleading him as to friendly capabilities, location, and intentions. Measures applied for one purpose frequently accomplish others. For example, patrol activities may be used to deny, to detect, and to deceive concurrently, while camouflage can be used to deny and deceive.

b. Denial Measures.--Counterintelligence emphasis at the company level and below is placed on denying the enemy information and neutralizing his efforts to gain information concerning friendly forces.

(1) All personnel are instructed on their behavior if captured to ensure that no information of intelligence value comes to the enemy by interrogation.

(2) Letters, personal papers, photographs, and other information which could prove of value to the enemy are collected prior to an action. Particular care is taken to ensure that personnel moving forward of friendly lines do not have material of this nature in their possession.

Par. 1506

FMFM 6-4

(3) Camouflage, noise, and light discipline are enforced, and available cover or concealment are utilized when the unit is exposed to possible enemy observation.

(4) The challenge and password are properly used.

(5) Bivouacs, assembly areas, fire support bases, patrol bases, etc., are policed to ensure that no maps, messages, or other material of possible intelligence value are left behind.

(6) Specific instructions are issued on safeguarding military information and equipment, including the emergency destruction of documents (shackle sheets) and equipment (radio crystals) of value to the enemy, when capture is imminent.

(7) All personnel should receive instruction in correct voice radio communication procedures to avoid disclosing information.

(8) Care must be taken that refugees, line crossers, and other civilians in or passing through the area, see and hear as little as possible of friendly operations. A good enemy agent will seldom be detected through casual observation. All civilians must be treated as though they are potential enemy agents until cleared by higher authority.

1506. INTELLIGENCE TRAINING

a. Basic Objectives.--In combat, the rifle company is often so busy fighting or reorganizing that they neglect or disregard critical aspects of the intelligence process. The collection, handling, and reporting of information of potential intelligence value must be an automatic, reflex action by all Marines regardless of rank or assignment. To this end, all personnel should be indoctrinated with their individual importance and responsibility in accomplishing the following:

(1) Collecting and reporting information concerning an actual or potential enemy and the area of operations.

(2) Denying information of friendly forces to unauthorized persons.

b. Training of the Individual Marine.--Every Marine who has occasion to observe significant facts concerning the enemy in the area of operations is a potential intelligence source. He should be taught what to look for and to recognize what he sees. Likewise, every individual has certain counterintelligence responsibilities; therefore, training must also be conducted in that aspect of denying information to the enemy. All officers and enlisted men should receive training in the following subjects:

(1) Intelligence Subjects

(a) Nature and purpose of combat intelligence and counter-intelligence.

(b) Secrecy discipline.

(c) Defense against hostile efforts toward subversion and espionage.

(d) Handling of prisoners of war, enemy deserters, civilians, evaders and escapees, and captured documents and material.

(e) Use of countersigns.

(f) Shelling reports.

(g) Enemy identifications; e.g., uniforms, insignia, and recognition of mechanized vehicles, aircraft, and ships.

(h) Actions in the event of possible espionage, subversion, or sabotage.

(i) Characteristics of the projected area of operations; nature and attitude of the civilian populace.

(2) Related Subjects

(a) Map and aerial photo reading.

(b) Use of available means of communication.

(c) Observation and reporting; emphasis on accurate reporting of facts.

(d) Camouflage.

(e) Survival, evasion, resistance to interrogation, and escape.

(f) Code of conduct.

c. Integration of Intelligence Training.--It is difficult to simulate in training those combat conditions in which prompt, accurate, and complete information of the enemy becomes a vital necessity. However, realism should be stressed throughout all aspects of intelligence training. The use of aggressors helps improve realism and makes the commander and troops conscious of the enemy as a real opposing force. Maximum advantage should be taken of field exercises in which the enemy is represented by actual troops in order to inject realism into intelligence training. Careful integration of the intelligence training program with other training enhances the value of both the intelligence and the non-intelligence training.

1507. AMPHIBIOUS OPERATION

a. General.--In planning for an amphibious operation, the rifle company is completely dependent upon higher headquarters for intelligence. This dependence in no way relieves the company commander of the responsibility for initiating requests to the S-2 for information required to conduct operations ashore. See FMFM 2-1, Intelligence, for details concerning intelligence in the amphibious operation.

b. Basic Requirements.--Basic intelligence requirements at all echelons of the command emphasize the enemy situation, hydrographic conditions, landing beaches, weather conditions, and terrain. The company commander carefully reviews each of these requirements to determine

specific items of information desired and makes his requirements known to the battalion landing team (BLT) S-2.

(1) Enemy Situation.--Information concerning the enemy situation is often extremely vague, particularly early in the planning of an amphibious operation. The company commander requires information relating to the specifics of the enemy situation ashore and in his zone of action.

(2) Hydrographic Conditions.--The company commander's interest in the hydrographic conditions of the objective area generally centers around troop indoctrination and training and his own planning. The tide level relative to the beach gradient greatly influences the beaching of landing craft. A falling tide may cause craft to ground far off the beach proper, compelling the troops to wade a great distance to shore.

(3) Light Conditions.--Light conditions in the objective area are of significance in planning. (See par. 1501e.)

(4) Landing Beaches.--The configuration and characteristics of the beach are of interest to the company commander in planning.

(a) Configuration.--The configuration of the landing beach; i.e., straight, convex, concave, or combinations of these, will have considerable bearing on the type of fire the enemy may be able to deliver. A straight beach to some degree eliminates flanking or enfilade fire, while a concave beach permits the defender to utilize enfilade and interlocking fires. A straight beach lends no decisive advantage to either the attacker or defender. A convex beach may be of advantage to an attacker since it invites dispersion of hostile defensive fires and prevents effective enfilade fires.

(b) Characteristics.--The beach gradient provides a basis for estimating the effects of enemy beach obstacles. A long flat beach permits the installation of obstacles. A steep beach lessens their effectiveness and extent. Precipitous beach slopes can be negotiated by foot troops and provide some cover from direct enemy fire. Narrow beaches benefit the attacker as well, permitting him to reach concealment and cover soon after landing. Woods or bluffs close to the beach can be an advantage provided they do not greatly impede the advance of equipment or restrict naval gunfire or air support. Since all types of landing craft have sloping bottoms, the slope of the gradient determines how far offshore grounding occurs. The greater the grounding distance from the beach, the longer the troops are exposed to hostile fire and the more complex the problem of unloading equipment and supplies.

(5) Weather and Terrain.--The rifle company commander is interested in such items as the frequency of morning ground fogs and astronomical data. Key terrain features that mask observation from points inland or prevent ground observation, natural and artificial obstacles, concealment and cover, as well as avenues of approach are studied. Where there is no dominant terrain inland, defensible manmade features such as antitank ditches, railroad banks, or small villages may have increased significance. Sand dunes, sea walls, shell holes, bomb craters, and built-up areas provide cover from direct fire, while grasslands, cultivated areas, built-up areas, and woods provide excellent concealment.

c. Intelligence Coordination.--Coordination with the BLT S-2 should be effected early in planning. Requirements for maps, charts, and aerial photography should be made known and the commander's EEI's reviewed to ensure that no confusion or misunderstanding exists as to the information required. The assault companies are often responsible for providing initial information concerning beach obstacles, enemy dispositions and strength, etc., to the BLT. Here too, coordination as to exact information required and priority are established.

1508. HELICOPTERBORNE OPERATIONS

a. General.--The intelligence requirements of the rifle company in the helicopterborne operation are basically the same as for other operations and emphasize terrain intelligence requirements related specifically to the landing zone and landing sites within the zone.

b. Enemy.--Special emphasis in helicopterborne operations is placed on the enemy's capability to:

(1) Redispose forces in the landing zone prior to the assault, with particular attention to armor and air defense means.

(2) Attack helicopterborne forces during landing and reorganization.

(3) Reinforce the attacking or defending force.

(4) Employ civilians and quasi-military forces to interfere with the landings.

(5) Employ mines or similar hazards in landing sites.

c. Terrain.--Adequate terrain intelligence is needed to select landing sites and assembly areas and to plan for the seizure and defense of objectives. The nature and extent of the obstacles to enemy movement, particularly armor, are evaluated before preparation of barrier plans.

(1) Sources of Terrain Intelligence.--Prior to a helicopterborne operation, the rifle company commander requests maps of the objective area, small and large-scale aerial photography, aerial reconnaissance reports, terrain studies, descriptions of obstacles, and large-scale terrain models.

(2) Landing Zone Data.--Information concerning the landing zone required to support planning and operations includes the following:

(a) Descriptions of prominent terrain, unusual natural or manmade formations, bodies of water, or other landmarks that aid in the orientation of disembarking troops.

(b) Information concerning surface materials present and soil trafficability within the sites is obtained. The former is related to the temporary loss of visibility or possible injury to troops and the latter to vehicular, troop, and logistic mobility. Loose dirt and sand may cause temporary loss of pilot visibility and temporary blindness of troops. Ashes blown into the eyes of pilots or troops will cause temporary incapacitation. Fire hazard is created in dry grasslands by hot exhaust gases.

Par. 1601

FMFM 6-4

Section VI. LOGISTICS

1601. GENERAL

The company commander has command responsibility for the logistics functions of the company and for the proper use of all supplies and equipment. The company commander exercises his responsibility through a small supply section. The section carries a prescribed load and handles the internal distribution of supplies for the company. The receipt of supplies and their internal distribution are performed by the supply sergeant. His logistics functions in combat operations are closely supervised by the company first sergeant or gunnery sergeant. The general supervision of administrative and logistics matters is normally accomplished by the executive officer.

1602. SUPPLY

a. The company distribution point is the local point for the receipt and issue of supplies. The distribution point is located within the company command post. Supplies are not stored at the distribution point but are issued as soon as possible after receipt. The distribution point should have as many of the following desirable characteristics as possible:

- (1) Facilitates supplying the platoons.
- (2) Located near a good road or trail to the rear.
- (3) Provides adequate space.
- (4) Is easily identifiable.
- (5) Provides concealment from aerial observation.
- (6) Affords cover from flat trajectory fire.

b. The rifle company employs two techniques of distribution in receiving and issuing supplies:

(1) Unit Distribution.--Unit distribution is a technique in which the agency issuing the supplies delivers them to the using unit. For example, when the battalion resupplies the rifle companies by delivering the items to the company distribution point, the company is being supplied by unit distribution. The rifle company normally receives supply support from the infantry battalion service elements by unit distribution.

(2) Supply Point Distribution.--Supply point distribution is a technique requiring the using unit to draw supplies from a distribution point and transport them to the unit's location for use. For example, if the platoons pick up required supplies at the company's distribution point, the company is dispensing supplies utilizing the supply point distribution technique. The rifle company normally employs this technique in providing logistic support to its platoons. On occasion, particularly when the company is assigned several motor transport vehicles, the supply point distribution technique may be employed by the battalion in supporting the

company. The battalion distribution technique may be a matter of unit SOP, may be contained in the battalion administrative/logistics plan, or may be contained in paragraph 4 of the battalion operation order.

c. Supply requirements are submitted to the battalion S-4 by informal, routine requests. Requests are based on the anticipated expenditure of supplies in supporting the company for one combat day. The company commander prescribes the supply load to be transported by the company and requisitions supplies accordingly. The prescribed load consists of the types and quantities of supplies prescribed by the company commander for the supply support of the platoons. The prescribed load is not a fixed quantity and may change to meet new tactical and/or logistics conditions. Prescribed loads for the rifle company are often established by the battalion. Establishing the prescribed load is influenced by the following:

- (1) Mission.
- (2) Enemy.
- (3) Terrain.
- (4) Weather.
- (5) Transportation.
- (6) Ease of resupply.

d. Aerial resupply by helicopter or fixed-wing aircraft may be requested when the existing tactical and logistics situations warrant. Timely requests are submitted to the S-4. The battalion administrative/logistics order usually mentions available logistics air support.

(1) Resupply by helicopter requires that key members of the company be well trained in the procedures for selecting and marking the landing site, disengaging externally loaded supplies from the aircraft, and the use of basic signals in directing the helicopter. Fleet Marine Force unit SOP's require units at company/battery level to train specified numbers of enlisted personnel in these procedures in cooperation with helicopter units.

(a) Local criteria for selecting and marking sites are covered in SOP's.

(b) Basic procedures for disengaging externally loaded supplies are simple and require minimum training time. The helicopter is directed by hand signals until its external cargo is resting firmly on the ground. The nylon lifting ring is then detached from the aircraft lifting apparatus.

(c) See FMFM 3-3, Helicopterborne Operations, and FMFM 6-5, Marine Rifle Squad, for details concerning hand signals for directing helicopters and detaching their cargo loads.

(2) Aerial delivery of supplies by parachute from fixed-wing aircraft is usually employed when no other means of resupply is compatible with the existing tactical and logistics situation of the rifle company. An area of suitable size is marked in accordance with the unit SOP covering

Par. 1603

FMFM 6-4

ground-to-air communications or instructions received from the infantry battalion. The accuracy of the drop and pilot's ease in locating the drop area are enhanced by the use of smoke. The smoke drift provides the pilot with current information concerning surface wind direction and speed.

1603. MOTOR TRANSPORT

a. The rifle company has no organic motor transport and relies on the infantry battalion for such support. The company's normal combat support requirements are provided for by the assignment of vehicles organic to the infantry battalion and are usually assigned in accordance with the battalion SOP. The motor transport requirements of the rifle company are largely determined by the company's prescribed load and the supply distribution technique established by the battalion commander for the operation.

b. The truck company, headquarters battalion, is the first echelon of command possessing the capability of transporting the entire rifle company in wheeled vehicles. Timely requests for this type support are submitted to the battalion S-4.

1604. MEDICAL

A medical team of 11 corpsmen is normally assigned to the rifle company. The team provides first aid for casualties and prepares them for evacuation, ensures that preventive medicine is practiced by making recommendations to the unit commanders concerning rigorous programs of field sanitation and personal hygiene, and provides immediate treatment of minor ailments. Field ambulance service and casualty evacuation procedures are contained in the battalion SOP or in the administrative/logistics order. Emergency casualty evacuation, special medical assistance, and other medical matters not specifically covered in battalion SOP's or administrative/logistics orders are requested through the S-4. See FMFM 4-5, Medical and Dental Support, for details.

1605. SERVICES

a. Maintenance.--Maintenance varies from minor preventive operations to highly specialized and technical repairs. Maintenance performed by the Marine Corps is grouped into three broad categories. For the purpose of providing flexibility and identifying the categories with elements of Marine Corps organization, the categories are subdivided into five echelons, numbered consecutively.

(1) Organizational Maintenance.--Maintenance performed by a using organization on its own equipment is known as organizational maintenance.

(a) First echelon maintenance is performed by equipment operators. This level of maintenance is primarily preventive in nature, and its effectiveness depends upon frequent inspection and supervision at all levels within the rifle company. Maintenance of weapons and equipment organic, assigned, or attached to the rifle company is limited to first echelon.

(b) Second echelon maintenance is performed by specially trained personnel provided for that purpose in the using organization. The infantry battalion performs second echelon maintenance of organic equipment.

(2) Intermediate Maintenance.--Intermediate maintenance is authorized and performed by designated maintenance activities in direct support of using organizations.

(a) Third echelon maintenance units are authorized to carry a larger assortment of parts, assemblies and subassemblies, and more precise tools and test equipment than the infantry battalion. They also support lower maintenance echelons by providing technical assistance, mobile maintenance teams, and repair parts. Third echelon maintenance is performed by the force service support group (FSSG).

(b) Fourth echelon maintenance is performed by units organized as semifixed shops to serve lower maintenance echelons within a geographical area. Their principal function is to repair subassemblies, assemblies, and major items for return to lower echelons. Fourth echelon maintenance is performed by the FSSG.

(3) Depot Maintenance.--Depot maintenance is the fifth echelon. Depot maintenance units perform major overhaul or completely rebuild items evacuated to them. Fifth echelon maintenance is performed by Marine Corps logistics support bases.

(4) Disposition of Equipment.--Maintenance above first echelon is requested through the battalion S-4. Equipment requiring maintenance other than first echelon is repaired by mobile maintenance teams or evacuated to the battalion. Further determination of the maintenance echelon required to repair the equipment is done at the battalion level. When the equipment requiring maintenance is immobilized, the infantry battalion then arranges for its evacuation or on site repair.

b. Salvage.--Salvage operations include search, recovery, removal, and disposition of abandoned or captured supplies, material, property, and equipment. The rifle company has continuing responsibility for clearing salvage from the area in which it operates. During periods of relative inactivity in combat, the immediate company area is searched, and collected salvage is deposited on the line of drift designated in the battalion administrative/logistics order.

c. Other Services.--There are many other services available to the rifle company. Those mentioned in the battalion administrative/logistics order will be provided as outlined therein. Services not mentioned are requested through the S-4. Services available include:

- (1) Field messing.
- (2) Fumigation and bath units.
- (3) Cobbler shop service.
- (4) Field exchange units.
- (5) Construction units.

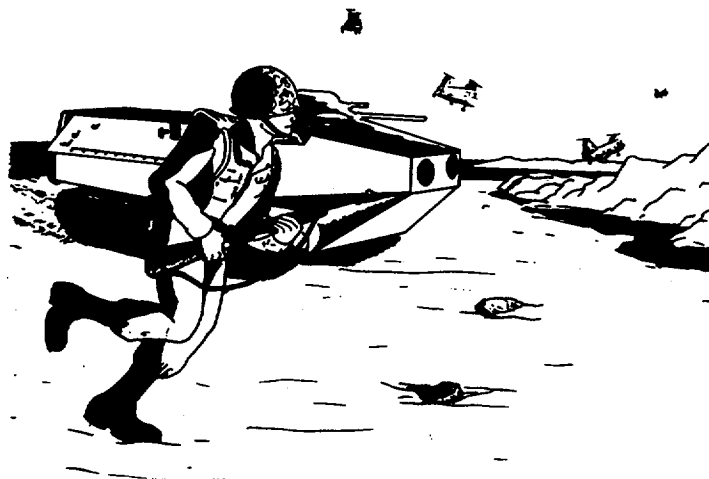

CHAPTER 2

AMPHIBIOUS OPERATION

Section I. INTRODUCTION

2101. GENERAL

This chapter discusses the amphibious operation as it primarily concerns the rifle company's planning and conduct of operations as part of the battalion landing team. In isolated situations, the rifle company may be employed in independent amphibious operations. The techniques for conducting amphibious landings in connection with independent operations are very similar to those employed by assault companies in larger landings.

2102. CONCEPTS

a. General.--An amphibious operation is an attack launched from the sea by naval and landing forces embarked in ships or craft, involving a landing on a hostile shore. It is conducted for the purpose of prosecuting further combat operations, obtaining a site for an advanced naval or air base, or to deny the use of an area or facilities to the enemy.

b. Characteristics.--The amphibious operation integrates sea, air, and land forces in a concerted military effort. The force is balanced and capable of striking at a selected site within the enemy defense system. The salient limiting characteristic of the attacking forces is the necessity for building up combat power ashore from initial zero to full power in the face of certain natural forces including seas, surf, and features of hydrography not normally encountered in land warfare. The massing of troops and materiel, their movement to the objective area, and the landing impose unique tactical and logistics problems.

c. Sequence.--The pattern of an amphibious operation is a well defined sequence of events or activities. The general pattern is a succession of phases which may overlap in time, but occur in the following sequence:

(1) Planning.--The period extending from receipt of the initiating directive to embarkation. Planning, however, is a continuing process and overlaps other phases.

(2) Embarkation.--The period during which the forces, with their equipment and supplies, are embarked in the assigned shipping. This phase commences the operational phases of the amphibious assault.

(3) Rehearsal.--The period during which the prospective operation is rehearsed for the purposes of:

(a) Testing the adequacy of plans, the timing of detailed operations, and the combat readiness of participating forces.

(b) Ensuring that all echelons are familiar with plans.

(c) Testing communications.

(4) Movement.--The period during which various components of the amphibious task force move from points of embarkation to the objective area. The movement may proceed via rehearsal, staging, and/or rendezvous areas and terminates with the arrival of the components of the amphibious task force at assigned positions in the objective area.

(5) Assault.--The period between the arrival of the major assault forces of the amphibious task force in the objective area and the accomplishment of the amphibious task force mission. The Marine Corps concept of the amphibious operation places primary emphasis on helicopterborne assault techniques, complemented, as required, by surface assault utilizing assault amphibious vehicles and landing craft. Helicopterborne amphibious assault enables the landing force to achieve a rapid buildup of combat power by expeditiously landing the assault elements with their equipment and supplies.

d. Termination.--The amphibious operation is terminated when specific conditions contained in the initiating directive are met. Usually one of these conditions is that the landing force must be firmly established ashore.

Section II. PLANNING

2201. GENERAL

a. Planning for the amphibious operation differs from normal operational planning for land warfare in the manner in which it is conducted and in the degree of detail involved. The assault of a defended littoral is a special form of attack conducted to overcome a well-developed and coordinated defensive system manned by an enemy who may have had months, or even years, to plan and develop his defenses. To ensure success, the attacker must fully exploit the means available; i.e., helicopter support, supporting weapons, and combat service support. Normally, the rifle company commander is not told how or in what manner his mission is to be accomplished; however, during planning, the BLT commander may make certain decisions that are ordinarily left to the rifle company commander in land combat such as formation for the attack.

b. Planning for amphibious operations is conducted in inverse order. That is, the first step in amphibious planning is to determine what physical objectives must be taken in order to accomplish the mission. Next, a scheme of maneuver is developed that will seize these objectives. That scheme determines the plan for landing which, in turn, determines the plan for debarkation. Finally, the plan for debarkation is used to determine the embarkation plan.

2202. FUNDAMENTALS OF AMPHIBIOUS PLANNING

a. General.--Amphibious planning is concurrent, parallel, and detailed. These features distinguish amphibious planning procedures from those of land warfare. The differences arise from the complex nature of the operation and a requirement for the totally integrated participation of forces from two or more Services.

b. Concurrent Planning.--Concurrent planning is conducted at all echelons of the same command and by corresponding echelons of different commands. Concurrent planning not only saves time, it also permits the early detection of problems at all echelons in order that they may be resolved quickly and allow the orderly continuation of the planning process. The BLT commander ensures that tentative decisions and plans and other information are made available to his subordinate units.

c. Parallel Planning.--Close and continuous coordination necessary between corresponding naval and troop echelons is termed parallel planning. The necessity for parallel planning arises from the need to coordinate two or more Services in a common effort. At the BLT level, such planning cannot begin until certain basic decisions have been announced by higher echelons.

d. Detailed Planning.--When the commander amphibious task force (CATF) determines that he can support the concept of operations ashore, detailed planning commences. The BLT commander and his subordinate commanders plan the details of their schemes of maneuver ashore, fires in support of the schemes, and movements from ship-to-shore (landing plans) which will establish forces ashore in the combat postures dictated by maneuver and fire support requirements.

2203. PLANNING SEQUENCE

a. The planning sequence begins at BLT level with receipt of a directive or planning memoranda, which may be disseminated from the next higher command, normally the regimental landing team (RLT). This directive contains information such as the date and hour of the landing expressed in terms of D-day and H-hour, regimental and higher objectives, assignment of the BLT's mission, its tentative landing formation, and its zone of action, or tactical area of responsibility. Combined with other information available from higher authority, this provides the BLT commander with a basis for commencing planning. The planning sequence varies with the scope and magnitude of the operation. The BLT commander usually follows a simple form of planning sequence.

(1) Upon receipt of a directive or planning memoranda, the BLT commander issues planning guidance to his staff and subordinate commanders. He announces his policies, assumptions, and general intentions with respect to the projected operation. He may propose possible courses of action as a guide for preparing staff estimates. He establishes a planning program to assist the staff and his subordinate commanders. In the program, specific tasks, the sequence of their accomplishment, and deadlines for their completion are assigned to the staff sections.

(2) It is the operations officer's (S-3) responsibility to formulate courses of action and to examine the feasibility of the courses of action that will best accomplish the assigned mission. Based upon the proposed courses of action, the staff members complete their estimates to determine which course of action they can best support.

(3) In formalizing the commander's estimate, a meeting is held consisting of the BLT commander, his staff, company commanders, and BLT supporting unit commanders. The S-3 presents the proposed courses of action and states a recommended priority. Other staff members and subordinate commanders are given the opportunity to comment on the significant aspects of each course within their respective purviews and make recommendations as to the best course of action from their viewpoints. The BLT commander asks questions and obtains additional information. The meeting culminates in completion of the BLT commander's estimate and the announcement of his decision.

(4) The commander elaborates upon his decision by issuing a concept. The concept, in refined form, is the basis for paragraph 3a of the BLT operation plan.

(5) The S-3 further develops the operation plan with the assistance of other staff members. He may publish an outline plan amplifying the commander's concept, or he may informally brief the company commanders and assign tentative missions to the rifle companies. At the same time, he may announce a planning schedule for preparation of the operation plan. The schedule establishes deadlines for submission of various recommendations, annexes, and components of the complete operation plan. The administrative/logistics and embarkation plans are developed concurrently with the operation plan.

b. The rifle company commander commences planning on receipt of his tentative mission from the S-3. The S-3 planning schedule will establish a deadline for the receipt of recommendations made by the company commander. Ideally, the company commander makes recommendations as to the company

formation for landing, as well as fire support requirements. Fire support recommendations are usually limited to fires required to support the company in the seizure of its initial BLT objective. The S-3 acts upon the company commander's recommendations within the limitations imposed on the BLT by the availability of landing means, naval gunfire, and air support. The basis for the company commander's recommendations is the company's tentative plan of attack.

2204. PLANNING AIDS

a. The rifle company commander and his subordinates are denied the opportunity for physical reconnaissance and are totally dependent upon the BLT for information and intelligence during the planning phase. Essential planning aids are made available to the company by higher headquarters as substitutes for reconnaissance in developing plans of attack, in training for the operation, and in briefing troops. Any of the items listed below may be useful as planning aids.

(1) Maps and Charts.--The BLT intelligence officer (S-2) provides the rifle companies with sufficient maps and charts for planning and use in combat.

(2) Aerial Photographs.--Aerial photos are a vital source of information concerning the objective area. The BLT S-2 provides the rifle companies with the best photo coverage available. Information concerning beach characteristics, terrain, and offshore obstacles and conditions are of interest to the company and platoon commanders.

(3) Shoreline Photographs.--When available, shoreline photographs or sketches are used to orient subordinate leaders at the company and platoon level. They present the details of the shoreline as it will be seen in the landing. Familiarity with the main features of the beach and the immediate surroundings permits subordinate leaders to orient themselves with respect to initial objectives while still embarked in landing vehicles or craft during the actual ship-to-shore movement.

(4) Area and Theater Studies.--Pertinent extracts from area and theater studies, provided by the BLT S-2, may furnish information of value to the company commander.

(5) Scale Models and Relief Maps.--Scale models and relief maps are invaluable in planning at company and platoon level. Models and relief maps should be three dimensional. Local production of sand table type models for briefing troops should be encouraged where other three dimensional aids are not readily available.

(6) Reports.--The BLT S-2 will provide the substance of reports from evaluated prisoner-of-war interrogations, resident experts on the area, underground sources, and other covert and clandestine sources, as appropriate.

b. Paragraph 1507 describes other intelligence information as it relates to the rifle company in the amphibious operation.

2205. PLAN OF ATTACK

a. General.--The rifle company plan of attack is a detailed plan for the seizure of one or more terrain objectives ashore. In both the

helicopterborne and waterborne amphibious assaults, it consists of the scheme of maneuver, the fire support plan, and the landing plan. The plan stresses simplicity and flexibility.

b. Tentative Plan.--The rifle company commander, having received a tentative mission, accomplishes a modified first troop leading step in arriving at a tentative plan.

(1) He makes a preliminary estimate of the situation based on the content of the planning aids, the S-2's intelligence estimate, current intelligence reports and summaries, and the tentative mission assigned.

(2) A tentative plan is formulated based on the decision reached in the preliminary estimate.

(a) The scheme of maneuver embodies a plan for maneuvering the rifle platoons once they are ashore as discussed in paragraph 3305.

(b) The fire support plan is a detailed plan for supporting the maneuver elements of the company by fire. It consists of the fires of organic, attached, and supporting weapons. Maximum use of organic fire support means is stressed. Supporting artillery fires are not available in the early stages of the landing. Naval gunfire and air support fill the gap until such time as the artillery is landed. Maximum use of organic fires decreases the company's naval gunfire and air support requirements and correspondingly reduces the danger of overtaxing the capabilities of these agencies. Fire support recommendations consisting of the fires not organic to the rifle company required to support the tentative scheme of maneuver are submitted to the S-3.

(c) Development of the tentative landing plan is initiated by determining the formation for landing the company which best supports the company's scheme of maneuver and planned employment of organic supporting fires. The frontal attack is the form of maneuver most often employed in seizing initial objectives after landing.

(3) The company commander's recommendations for landing the company are submitted to the S-3 in accordance with the planning schedule for preparation of the operation plan.

c. Revision of Plans.--The company commander's recommendations are integrated into the BLT operation plan. The S-3 makes adjustments as necessary and notifies the company concerning the details. The company commander's recommendations and subsequent adjustments thereto are reflected in the BLT operation plan as follows:

(1) Fires in support of the company's attack on initial BLT objectives are primarily reflected in the fire support appendix. When the company's fire support requirements are adjusted to meet overall BLT requirements, deficiencies may be partially compensated for by the attachment or direct support of weapons such as the Dragon. Attachments are reflected in the task organization annex. A study of the friendly situation subparagraph and the execution paragraph to the BLT operation plan will indicate units in direct support of the company. A detailed study of the operation plan and its annexes is mandatory to an understanding of the availability of fires to support the company's scheme of maneuver ashore. Where fires are not considered adequate to support

the tentative scheme of maneuver, the scheme of maneuver is revised to one which can be supported by the existing fire support means.

(2) Rough BLT landing documents are routed to the rifle company commanders for information and are used as a means of providing further information to the S-3.

(a) In the helicopterborne landing, a helicopter availability table is often provided to inform the company commander of the number and type of aircraft assigned to transport his company in the ship-to-shore movement.

(b) In the waterborne assault, a tentative landing diagram is supplied. A study of this document will point out any disparities between the company's recommended landing formation and scheduling and those which are best suited to overall BLT requirements.

(3) When the tentative landing documents are not in complete agreement with the company commander's recommendations, the tentative scheme of maneuver is revised to one which can be supported by the existing landing formation and wave scheduling of the company outlined.

d. Final Plan.--The rifle company commander assimilates all important information in the BLT operation plan when it is published. He makes any further adjustments to his initial estimate that are required and completes his plan of attack for the operation. Early dissemination of the company commander's complete plan in oral order form, consistent with security requirements, permits detailed rehearsal of the tactical plan ashore in the preparatory training of the unit. The BLT plan may be published in its entirety, or its associated annexes may be published separately as they are completed. In any case, operation planning documents are authenticated individually and are no longer tentative. Planning documents are effective for planning purposes on receipt.

2206. AMPHIBIOUS TRAINING

a. General.--Integral with the necessity for detailed plans in the amphibious operation is a requirement for specialized training to prepare the unit for this form of combat. The effectiveness of the training program is limited only by the imagination and energy of the rifle company's unit commanders. A complete training program involves individual and unit training in a variety of areas. This paragraph includes the debarkation training essential to the success of the ship-to-shore movement. See FMFM 3-2, Amphibious Training, for a detailed treatment of amphibious training.

b. Ground Combat.--Early in the planning phase of the amphibious operation, company officers institute a training program aimed at the progressive development of individual and unit skills in the types of ground combat anticipated. As more planning information is derived, training becomes more specialized until, in its final stages, actual rehearsals of company and platoon plans of attack ashore are conducted.

(1) Initial Training.--The amphibious assault is initiated by small units fighting independently in the landing zone or at the water's edge. Success depends primarily upon the ability of the small unit to take aggressive, independent action. Once it is known that an operation is in

prospect, a training program emphasizing small unit independent action and the development of small unit leadership skills is planned. The entire program is aimed at instilling boldness and aggressiveness in the individual and the unit.

(2) Subsequent Training.--As more information concerning the area of operations becomes available, the training program takes into account the terrain peculiarities of the area. For example, if the general nature of the terrain in the area of operations is wooded, the program should place some emphasis on combat in woods. Where the terrain inland is gentle, rolling, and reasonably open, the prudent unit commander can anticipate the extensive employment of tanks and, perhaps, mechanized attacks. Training in these operations is conducted. Later, as more specific information assigning missions, objectives, etc., for the operation becomes available, the training program is oriented to emphasize the tactics and techniques which will be involved in each task in which the unit may be a participant.

(3) Rehearsals.--Security considerations permitting, company officers plan and conduct detailed rehearsals of the company and platoon plans of attack ashore in the operation. Terrain similar to that expected in the unit's prospective zone of action is located. Objectives of similar characteristics are selected and known obstacles improvised. Orders are issued which duplicate the unit's actual plan of attack as closely as possible. Even when security requirements are very stringent, such training may be conducted if not specifically forbidden. The commander may plan the training exercise as a rehearsal of the actual operation, but deliberately refrain from informing subordinate leaders. Their lack of knowledge concerning the exercises's intent does not hamper its value as a training exercise; however, seemingly undue repetition and emphasis may endanger security. Several fairly similar training exercises aid in alleviating the difficulties imposed by security requirements. Troop briefings, conducted after embarkation, point out the similarities between the actual operation and the training exercises.

c. Training Aids.--The ship-to-shore movement requires specialized individual and unit training in the techniques employed in debarkation from assault shipping and in troop procedures while embarked in helicopters, landing craft, or assault amphibious vehicles. Maximum advantage must be taken of existing training facilities ashore in preparing individuals and units for their roles in the prospective ship-to-shore movement. Training facilities include:

(1) Helicopter Mockups.--Helicopter mockups can be constructed from locally available materials. A salvaged helicopter fuselage may serve the purpose. The use of a mockup provides practice in enplaning, use of safety belts, loading, stowing and lashing equipment, ditching procedures, and deplaning.

(2) Boat Mockups.--Most camps in which Fleet Marine Force infantry units of regimental strength are garrisoned are equipped with mockups of the LCVP for training purposes. Training mockups ashore are of great value in training troops in boat discipline, the positioning of boat team members in the craft, and in procedures for debarkation from the landing craft.

(3) Assault Amphibious Vehicles (LVT's).--A static assault amphibious vehicle may be used as a training aid in conducting troop instruction in boarding and debarking from LVT's. A mockup and a static LVT may be used to practice the transfer operations, when required.

(4) Dry Nets.--Camps equipped with boat mockups usually have a debarkation platform. A debarkation platform is a shore facility which simulates a ship's debarkation station. It consists of an elevated platform simulating the ship's deck, a debarkation net, and a boat mockup. It is designed to permit detailed troop instruction and practical exercise in debarkation procedures.

(5) Wet Nets.--Wet net facilities are any debarkation training facilities which permit boat teams to debark into waterborne craft. A wet net facility may consist of using the outboard debarkation stations of a ship which is tied up. It may be a structure similar to a debarkation platform which is located on a pier or barge. Such facilities most nearly simulate the actual debarkation. Practice operations with ships are considered the ultimate in wet net training.

Par. 2301

FMFM 6-4

Section III. EMBARKATION

2301. GENERAL

a. To a large extent, success of the amphibious operation is dependent upon the manner in which troops, supplies, and equipment are loaded aboard ships. Embarkation plans must provide for the rapid and orderly buildup of forces ashore in support of the landing plan and the scheme of maneuver.

b. Current doctrine governing the employment of the rifle company and its parent unit in the waterborne amphibious assault is far more flexible than was the case prior to the advent of nuclear weapons. One outgrowth of this flexibility is the requirement for an understanding of embarkation planning at the company level. Modern contingencies may dictate the embarkation of a single reinforced rifle company or, more probably, the embarkation of a BLT in several ships. In either case, the rifle company is an active participant in planning for embarkation. See FMFM 4-2, Amphibious Embarkation, for a detailed treatment of the subject.

Section IV. REHEARSAL AND MOVEMENT TO OBJECTIVE AREA

2401. REHEARSAL

a. General.--The decision to conduct an integrated rehearsal involving the major elements of the amphibious task force rests with the commander amphibious task force. This decision is made early in the planning. Integrated rehearsals involving all troops are desirable. Independent or separate rehearsals may be conducted by the BLT or its elements.

b. Modified Rehearsals.--While ashore, the rifle company, independently or as part of the BLT, may conduct rehearsals simulating the ship-to-shore movement without naval participation. Careful selection of the rehearsal area is made to employ terrain most resembling that of the actual objective area. An area where live ammunition can be fired is highly desirable. To test the ship-to-shore movement, troops are formed into heli-teams, boat teams, scheduled waves, etc., identical to the actual landing plan.

(1) In the rehearsal of the helicopterborne ship-to-shore movement, heli-teams are introduced into the landing site in accordance with the timing contained in the landing plan documents.

(2) When rehearsing the waterborne ship-to-shore movement, a line of departure to represent the actual line of departure is established. Boat teams, in scheduled waves and proper formations, move to a simulated beach line prior to deployment.

(3) Vehicles and equipment are phased into the problem as appropriate.

(4) Assault rifle companies may further test readiness for combat by continuing the rehearsal as a field exercise to seize terrain objectives in preparation for the actual operation. As the assault units enter the landing site or reach the simulated beach line, they deploy and attack initial objectives. The attack may be rehearsed in detail.

c. Critique.--A critique of the rehearsal is held to discuss mistakes made, flaws in the operation plan, and remedial actions to be taken. Detailed critiques of subordinate platoon and squad performances should be undertaken and corrections made at all levels.

2402. MOVEMENT TO OBJECTIVE AREA

a. General.--The movement to the objective area may be via rehearsal, staging, and/or rendezvous areas. The movement phase is completed when the components of the amphibious task force arrive in their assigned positions in the objective area. Since the voyage may take several weeks, shipboard organization must be efficient. The efficiency with which troop life aboard ship is organized and carried out will have a direct effect upon troop morale, physical fitness, training, and general well-being when they disembark. Full advantage of time and facilities aboard ship must be taken to further prepare troops for accomplishment of their mission. Preparations should include a physical conditioning program and a training program by which troops will be oriented, briefed, and rehearsed in procedures to be carried out at the objective. Major requirements of embarked troops include:

(1) Physical Conditioning.--All troops must be exercised daily to ensure that they will be physically fit for combat operations. Aboard ship, this is best accomplished by organized calisthenics. The schedule setting forth exercise periods should be coordinated with the ship's routine. Climbing ropes, cargo nets suspended from hatch coamings, and other such devices will aid materially in any program designed to preserve the physical fitness of embarked troops.

(2) Care of Equipment.--Climate conditions aboard ship require that extra precautions be taken in the care of weapons, supplies, and equipment. Dampness and salt water cause corrosion and deterioration to an extent beyond that usually experienced ashore. Equipment must be properly secured in such a manner as not to damage the ship or equipment. Weapons must be kept clean, dry, and where applicable, oiled.

(3) Combat Orientation and Briefing.--Once underway, troops are oriented and briefed on their destination, mission, and the plans for employment of their units. This briefing is a continuous process as new information is received regarding the enemy and conditions at the objective. Training aids, such as maps, photographs, and charts are of particular value when conducting briefings and assist the embarked troops in gaining a better understanding of the operation. Care is taken to point out similarities of the operation to previous training exercises and rehearsals.

(4) Training.--Training conducted while the ship is underway will be limited to those activities which do not interfere with the ship's operating schedule. Crowded conditions aboard ship require that shipboard routine be highly organized. Consequently, all training must be thoroughly planned and organized in order to avoid conflicting activities. The commanding officer of the ship may authorize the firing of weapons off the ship's deck. Such firing should be limited to familiarization and test firing. Test firing of automatic weapons should be accomplished as close to the time of arrival at the objective as possible to assure proper functioning during the landing attack.

(5) Recreation and Morale.--Available recreational facilities are fully utilized to assist in maintaining morale.

(6) Health and Sanitation.--The health, hygiene, and sanitation of all embarked troops is the responsibility of the commanding officer of troops. High standards of hygiene and sanitation are established and maintained by frequent inspections, continuous supervision, and detailed instructions. Special attention should be given to adequacy of ventilation in troop compartments; sanitation of troop galleys, mess spaces, compartments, showers, and heads; and personal hygiene of troops.

(7) Discipline.--The commanding officer of troops is responsible for the discipline and efficiency of embarked troops.

(8) Other Requirements.--These are other areas requiring positive preparation and action. See FMFM 4-2, Amphibious Embarkation, for detailed instructions. These include:

- (a) Command relationships afloat.
- (b) Messing and billeting.

- (c) Security, to include ship's guard.
- (d) Inspections of troop spaces and facilities.

b. Debarkation Planning.--During movement to the objective area and prior to any scheduled rehearsal, a debarkation plan is evolved and disseminated. Planning for debarkation is a mutual naval and landing force responsibility. Landing force responsibility in planning rests with the commanding officer of troops aboard each ship. Debarkation of troops and equipment in the shortest possible time requires timely preparations. See paragraph 2508 for information concerning the execution of debarkation.

(1) Debarkation of Helicopterborne Units.--Planning for the debarkation of helicopterborne units utilizes the landing plan documents as a basis and results in the detailed scheme for assembling and enplaning the rifle company to meet the requirements of the ship-to-shore movement. The debarkation plan provides detailed information concerning the following:

- (a) Location of the assembly area.
- (b) Control point location.
- (c) Routes from the assembly area to the control point.
- (d) Passenger manifesting procedures.
- (e) Loading point locations.
- (f) Routes from control point to loading points.
- (g) Use of guides.

(2) Debarkation of Waterborne Units.--Debarkation planning for waterborne units may involve debarkation utilizing landing craft or assault amphibious vehicles.

(a) Debarkation Via Landing Craft

1 Debarkation Schedule.--The debarkation schedule is a form which lists the debarkation stations, designates the boat teams to be debarked from each station in order of debarkation, and gives the sequence by type of the various landing craft to come alongside debarkation stations. The debarkation schedule is prepared jointly by the ship's commanding officer and the commanding officer of troops. It is usually prepared after the troops are embarked. It is distributed to all personnel responsible for control of debarkation. Debarkation schedules are not usually prepared for units landing in assault amphibious vehicles from landing ships. When troops landing in assault amphibious vehicles are initially embarked in other transports and require transfer to the landing ships carrying the assault amphibious vehicles, schedules are prepared. Debarkation required for effecting the transfer is incorporated into the ship's debarkation schedule. Figure 8 is an example of a debarkation schedule; instructions in the debarkation schedule are supplemented and clarified by a ship's diagram. (See fig. 9.)

2 Boat Team Organization.--The commanding officer of troops on board each ship is responsible for the detailed organization and

BOAT	RED 1	WHITE 3	BLUE 5	YELLOW 7	GREEN 9
1st	LCVP 2-3 BT 2-3	LCVP 2-5 BT 2-5	LCVP 2-7 BT 2-7	LCVP 2-1 BT 2-1	LCVP 2-9 BT 2-9
2d	LCVP 2-2 BT 2-2	LCVP 2-4 BT 2-4	LCVP 2-6 BT 2-6	LCVP 00-1 BT 00-1	LCVP 2-8 BT 2-8
3d	LCVP 3-3 BT 3-3	LCVP 3-5 BT 3-5	LCVP 3-7 BT 3-7	LCVP 3-1 BT 3-1	LCVP 3-9 BT 3-9
4th	LCVP 3-2 BT 3-2	LCVP 3-4 BT 3-4	LCVP 3-6 BT 3-6	LCVP 4-2 BT 4-2	LCVP 3-8 BT 3-8
5th	LCVP 4-1 BT 4-1	LCVP 4-3 BT 4-3	LCVP 4-5 BT 4-5	LCVP 4-4 BT 4-4	LCVP 5-1 BT 5-1
6th	LCVP 5-2 BT 5-2	LCVP 5-3 BT 5-3	LCVP 5-4 BT 5-4	LCVP 5-5 BT 5-5	LCVP 6-2 BT 6-2
7th	LCVP 6-1 BT 6-1	LCVP 6-3 BT 6-3	LCVP 6-5 BT 6-5	LCVP 6-4 BT 6-4	LCVP 6-6 BT 6-6
8th	LCVP 7-3 BT 7-3	LCVP 7-2 BT 7-2	LCVP 7-1 BT 7-1	LCVP 7-5 BT 7-5	LCVP 7-4 BT 7-4
		LCVP 00-2	LCVP 7-6 BT 7-6		
	RED 2	WHITE 4	BLUE 6	YELLOW 8	GREEN 10
<p>If sea conditions permit unloading from both sides of the ship, boat teams listed on the 2d, 4th, 6th, and 8th lines debark over port side, even numbered, debarkation stations.</p>					
		HATCH 1	HATCH 2	HATCH 4	
1st		LCM 1 1 TD-9	LCM 3 1 1/2 T 4x4	LCM 5 1 TD-9	
RAIL LOAD					
	WHITE 3 Davit	WHITE 4 Davit	BLUE 5 Davit	BLUE 6 Davit	
	None	None	None	None	

Figure 8.--Example of a Debarkation Schedule.

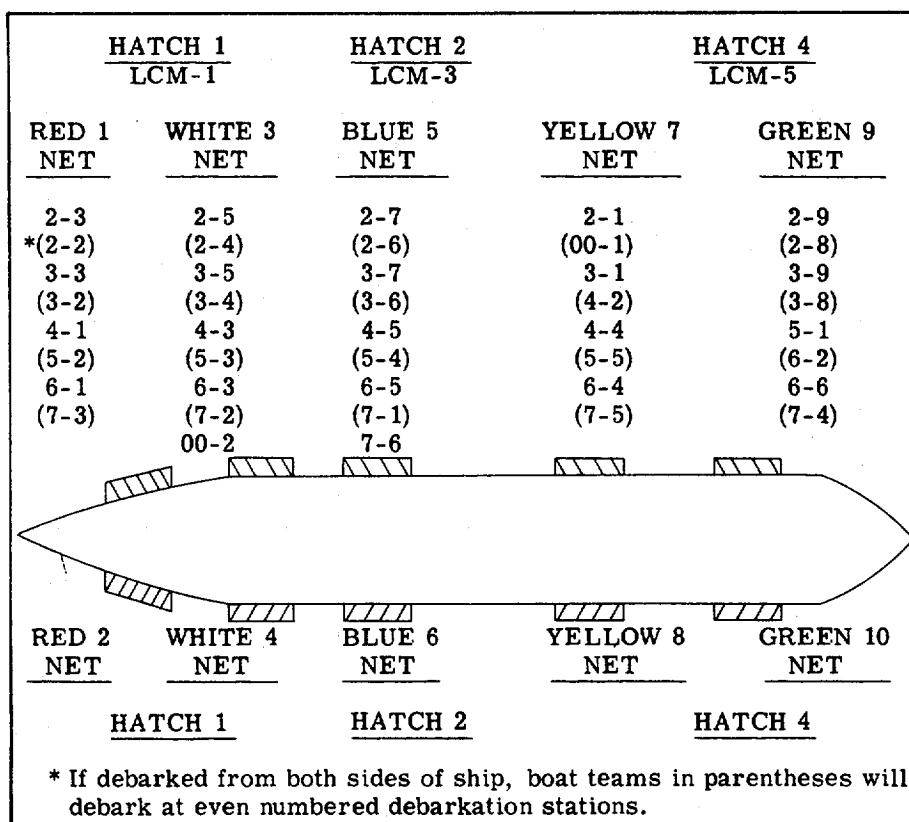

Figure 9.--Example of a Ship's Diagram.

orientation of boat teams. Such details are completed through the troop unit chain of command as soon as the debarkation schedule is published and before any scheduled debarkation drill or rehearsal. Each boat team must be organized internally and familiarized with ship's debarkation procedures. The landing craft and assault amphibious vehicle assignment table appendix to the landing plan annex specifies the structure of the boat teams. The boat team commanders are responsible for establishing their internal organization and orienting them with respect to debarkation. See FMFM 6-5, Marine Rifle Squad, for details concerning the internal organization of the boat team and the duties and responsibilities of key individuals including the boat team commander.

(b) Debarkation Via Assault Amphibious Vehicles

1 Assembly Area.--An area for assembling boat teams is designated.

2 Routes.--Routes are selected for the movement of boat teams from assembly areas to the vehicles.

3 Preloading.--Arrangements are described for preloading and stowage of crew-served weapons, equipment, and boat paddles in the vehicles.

Par. 2402

FMFM 6-4

c. Debarkation Rehearsal.--Debarkation rehearsals are conducted to test debarkation plans and to thoroughly acquaint troops and leaders with debarkation procedures. At least one rehearsal should include all man-packed equipment and weapons, including life jackets. Actual debarkation of troops may take place during integrated rehearsals of the operation.

d. Ships' Drills.--The commanding officer of troops ensures that troops are instructed in the procedures to be followed during ships' drills as soon as practicable after embarkation.

Section V. SHIP-TO-SHORE MOVEMENT

2501. GENERAL

This section discusses the organization and techniques employed in conducting the ship-to-shore movement of the rifle company. Marine Corps doctrine places primary emphasis upon the helicopterborne ship-to-shore movement as the means for firmly establishing the landing force ashore. Support and/or operational requirements ashore often dictate a need for waterborne assault in conjunction with the landing of helicopterborne forces. Both helicopterborne and waterborne ship-to-shore movements are discussed herein. The details of planning and executing the ship-to-shore movement are contained in FMFM 3-3, Helicopterborne Operations; FMFM 9-2, Amphibious Vehicles; and NWP 22-3, Ship-to-Shore Movement.

2502. CHARACTERISTICS OF THE SHIP-TO-SHORE MOVEMENT

a. The ship-to-shore movement is that portion of the assault phase of an amphibious operation which includes the deployment of the landing force from the assault shipping to designated landing areas. The movement is designed to ensure the landing of troops, equipment, and supplies at the prescribed times and places and in the formation required by the landing force concept of operations. The movement may be executed by waterborne means, by helicopter, or by a combination of the two. The rifle company is rarely moved ashore by a combination of means.

b. The ship-to-shore movement is the most critical part of the assault phase. The coordination and control of the diverse Navy and landing force participants in the ship-to-shore movement impose tasks of a scope unparalleled in other military operations. Success demands concurrent and parallel planning at all Navy and landing force echelons. The landing plan must leave no doubt as to what is intended.

c. The ship-to-shore movement commences on order of the commander amphibious task force and terminates when unloading of assault shipping is completed. The assault and initial unloading period is primarily tactical in nature and is totally responsive to requirements ashore. The general unloading period is primarily logistic in character and emphasizes speed and volume of unloading operations.

2503. ORGANIZATION

a. Rifle Company.--The tactical organization structured for the rifle company's assault is the organization for landing.

(1) Other elements of the landing force which are not part of the rifle company's tactical organization, but whose usefulness depends upon early initiation of their operations ashore, may be embarked and landed with the rifle company. These may be shore party elements, helicopter support team elements, artillery reconnaissance parties, advance elements of higher commands, liaison elements, and others. Boat or helicopter space is reserved for these elements.

(2) The reserve rifle company is organized for landing in a manner similar to that of an assault company. The reserve is not organized

Par. 2503

FMFM 6-4

for the assault of a specific beach or landing zone, but is prepared to land as an assault unit.

b. Terminology.--In order to understand the organization for landing, certain terms must be fully understood.

(1) Boat Space.--The space and weight factor used to determine the capacity of boats, landing craft, and assault amphibious vehicles. With respect to landing craft and assault amphibious vehicles, it is based on the requirements of one man with his individual equipment. He is assumed to weigh 240 pounds and to occupy 13.5 cubic feet of space.

(2) Boat Paddle.--The boat paddle serves to identify the boat team and aids in forming a wave in proper order. When directed by the boat team commander, the boat paddle handler displays the paddle. He removes the paddle after the line of departure is crossed, carries it ashore, and drops it on the beach above the high water mark to signify that his boat team has reached the beach. (See fig. 10.)

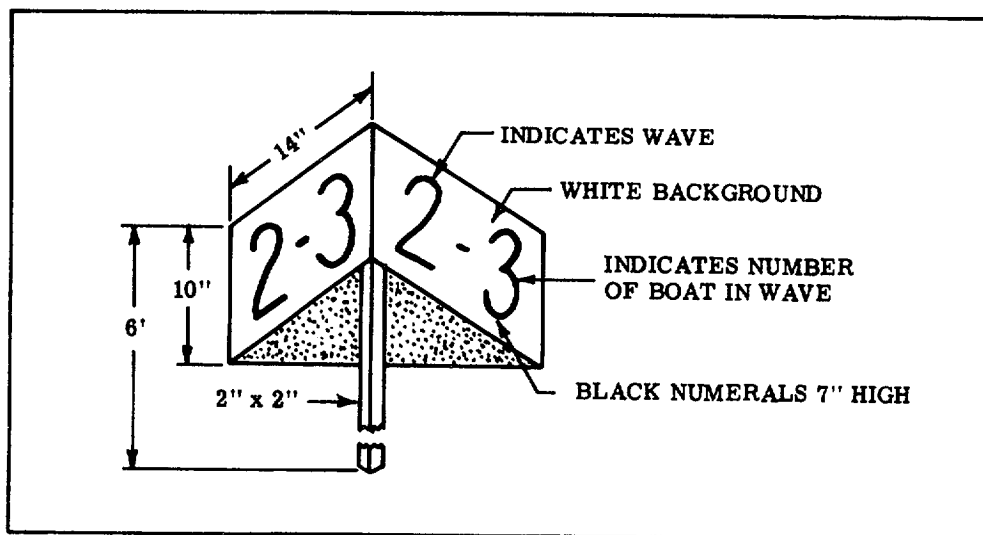

Figure 10.--A Typical Boat Paddle.

(3) Helicopter Space.--The space and weight factor used to determine the capacity of helicopters. It is based on the requirements of one man with his individual equipment which is assumed to be 240 pounds and 13.5 cubic feet of space.

(4) Boat Team.--The troops and their equipment loaded aboard one landing craft or assault amphibious vehicle for an amphibious assault. The senior member of the boat team is designated as boat team commander and is responsible for his boat team from the period when preparations for debarkation begin to the actual assault of the beach. Boat team organization is designed to provide for the execution of key functions in the rapid debarkation of troops and equipment. All unit leaders are trained in boat team organization and the functions of each key individual. The

details of boat team organization and functioning are contained in FMFM 6-5, Marine Rifle Squad. Boat teams are organized as follows:

(a) Landing Craft Boat Team

- 1 Boat team commander.
- 2 Assistant boat team commander.
- 3 Eight loaders (four deck loaders and four boat loaders).
- 4 Four net handlers.
- 5 Boat paddle handler.
- 6 Remaining troops and equipment.

(b) Assault Amphibious Vehicle Boat Team

- 1 Boat team commander.
- 2 Assistant boat team commander.
- 3 Remaining troops and equipment.

(5) Helicopter Team.--The troops and their equipment lifted in one helicopter at one time, commonly called a heliteam. The senior member of the team is designated heliteam commander and is responsible for the team from the commencement of preparation for debarkation to deplanement in the landing zone.

(6) Wave.--A formation of forces, landing ships, assault amphibious vehicles, or aircraft required to beach or land about the same time. A wave can be classified as to type, function, or order as follows: assault wave, boat wave, helicopter wave, numbered wave, on-call wave, and scheduled wave.

(a) Normally, waves land in the same approximate area under tactical control of a single commander.

(b) Every effort should be made to maintain tactical integrity of landing force units within teams and waves, consistent with the scheme of maneuver.

(7) Boat Group.--The basic organization of landing craft. One boat group is organized for each BLT (or equivalent) to be landed in the first trip of landing craft and amphibious vehicles.

(a) The boat group commander exercises command of the boat group through the boat wave commanders. During the ship-to-shore movement, the boat wave operates as a unit and is maneuvered by the boat wave commander. Individual waves within the boat group are numbered successively from front to rear as first wave, second wave, etc. The term "first wave" is that which leads the formation in its approach to the beach.

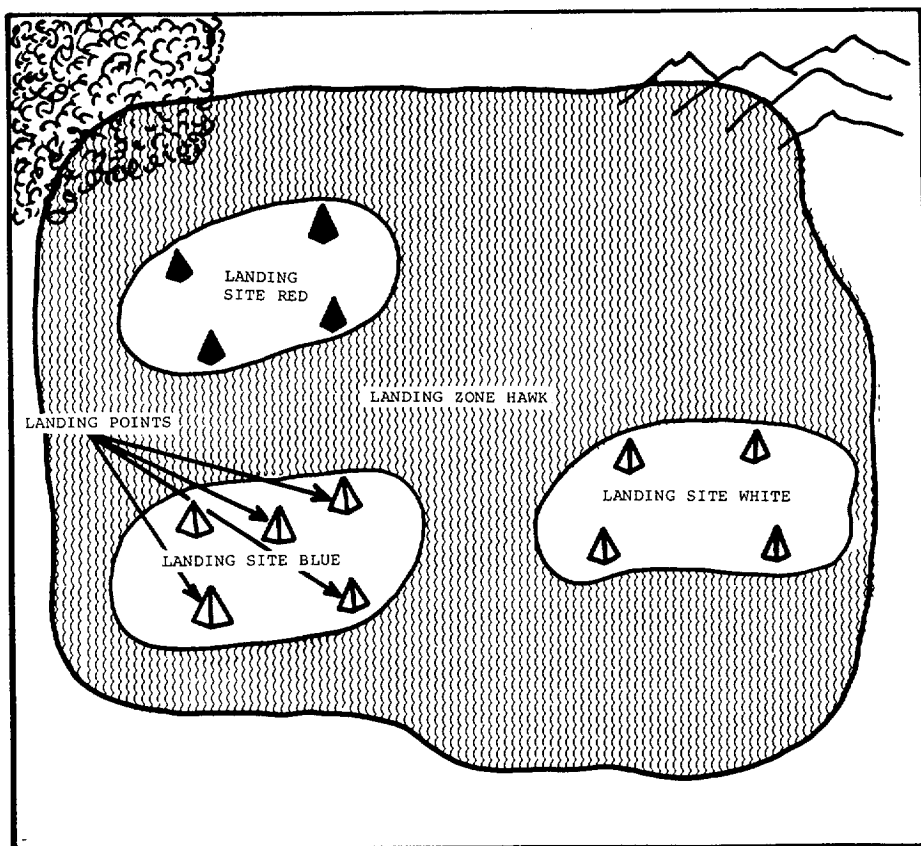

Figure 11.--A Typical Landing Zone.

(b) Since the landing craft of a single amphibious ship are not normally capable of landing an entire BLT, additional landing craft are provided from other ships. Regardless of source of the craft, the boat group functions as a unit until its last wave has landed.

(8) Landing Zone.--A specified ground area for landing assault helicopters to embark or disembark troops and/or cargo. A landing zone may contain one or more landing sites. Helicopterborne troop units of battalion or BLT size and smaller utilize a single landing zone. A landing zone is designated by a code name, usually the name of a bird. (See fig. 11.)

(9) Landing Site.--A designated subdivision of a helicopter landing zone in which a single flight or wave of assault helicopters land to embark or disembark troops and/or cargo. Landing sites are designated by color.

(10) Landing Point.--A landing point is a point within a landing site where one helicopter can land. A landing site contains one or more landing points. It may be designated by a two-digit number. Landing points are seldom prearranged as to their exact location on the ground, except in the conduct of administrative heli-lifts.

(11) Helicopter Lane.--A helicopter lane is a safety air corridor in which helicopters fly en route to or returning from the helicopter landing zone. It is used as a means to coordinate fire support on the ground and as a tactical control measure for the appropriate air control agency. The approach to the landing zone and retirement from it are usually made along the same lane at different altitudes. It is normally referred to as an approach and retirement lane.

(12) Landing Beach.--That portion of a shoreline usually required for the landing of a battalion landing team. However, it may also be that portion of a shoreline constituting a tactical locality, such as the shore of a bay, over which a force larger or smaller than a battalion landing team may be landed.

2504. CONTROL OF THE SHIP-TO-SHORE MOVEMENT

a. General.--The commander amphibious task force exercises overall control of the ship-to-shore movement. Separate control organizations are required for the surfaceborne and helicopterborne movements. The waterborne ship-to-shore movement is controlled by a central control officer until general unloading commences, at which time control is decentralized. The helicopterborne ship-to-shore movement is centrally controlled throughout its duration through the establishment of a helicopter coordination section (HCS) in the amphibious task force flagship and a helicopter direction center (HDC) in each helicopter transport group/unit.

b. Helicopter Control.--The control organization for the helicopterborne ship-to-shore movement is basically the same for all such movements; however, augmentation of certain control agencies is required in large scale, multideck operations.

(1) Tactical Air Control Center (TACC).--The TACC is embarked in the amphibious task force flagship and exercises overall control of aircraft in the amphibious objective area.

(2) Helicopter Coordination Section.--In multideck helicopterborne operations, the HCS, an integral part of the TACC, provides the central control agency for helicopter employment and coordinates operations conducted by subordinate helicopter direction centers.

(3) Helicopter Direction Center.--The HDC is the primary control agency for the helicopter transport group/unit commander and is normally embarked in his flagship. Basically, it controls helicopter movements within its assigned control area.

(4) Helicopter Coordinator (Airborne) (HC(A)).--The HC(A) is normally utilized for the initial assault and is responsible to the helicopter transport group/unit commander. The specific authority delegated to the HC(A) is contained in the landing force operation plan. The rifle company commander is briefed on the specific authority of the HC(A) when such authority is likely to affect the ship-to-shore movement of the company.

(5) Initial Terminal Guidance Teams.--Initial terminal guidance teams from force reconnaissance company or reconnaissance battalion, Marine division, provide terminal guidance to the landing zone for initial helicopter waves. The assault rifle company should be aware of these friendly operations in the area.

c. Waterborne Control

(1) Control Group.--Control of the movement of landing ships, landing craft, and assault amphibious vehicles from the transport and landing ship areas to landing beaches is exercised through a Navy control group. (See fig. 12.) The organization of the control group is based on the arrangement and number of landing beaches to be used. Control officers and control ships are designated by the amphibious task force and naval transport group commanders for their respective levels of command. The control organization parallels the landing force organization for landing and may include:

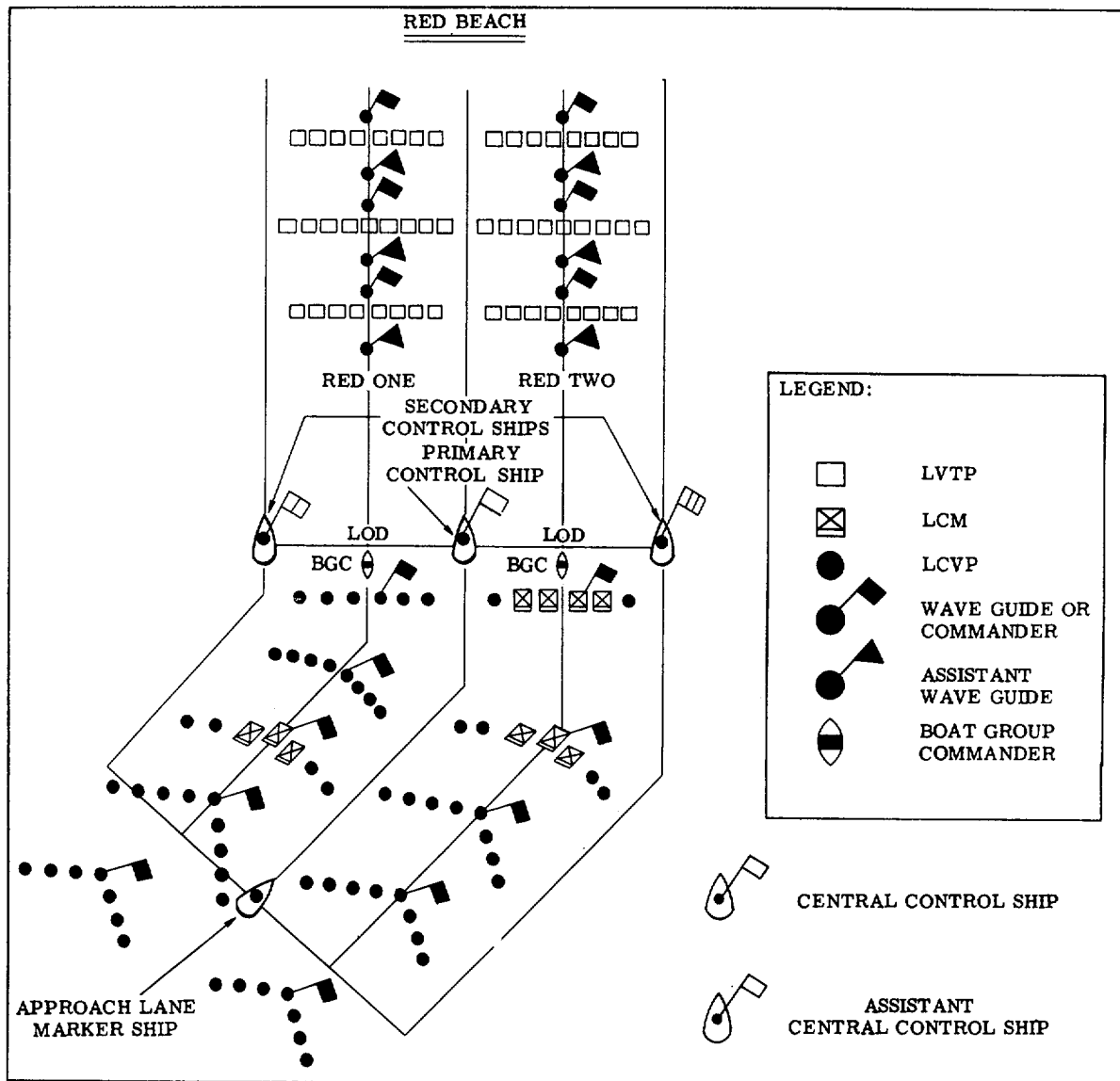

Figure 12.--Navy Control Organizations.

(a) The central (force) control officer, designated by the commander amphibious task force for overall coordination, embarked in the central control ship.

(b) Assistant central control officers embarked in assistant central control ships. They coordinate, as necessary, the movement of landing craft, assault amphibious vehicles, and landing ships to their respective beaches.

(c) A primary control officer designated for each transport organization landing an assault regimental landing team or equivalent formation. Primary control officers, embarked in primary control ships, control the movement of landing craft, assault amphibious vehicles, and landing ships to and from the beaches. When elements of an assault battalion landing team are to be landed over widely separated beaches, a primary control officer may be required for each beach.

(d) Secondary control officers embarked in secondary control ships and stationed on the line of departure (LOD) to assist the primary control officer.

(e) Approach lane control officers embarked in approach lane marker ships and stationed at the seaward end of the approach lanes. They control the movement of the waves between the seaward end of the approach lane and the line of departure. When assault amphibious vehicles are used in the ship-to-shore movement, they normally are launched near the line of departure and do not come under the control of the approach lane control officer.

(f) Boat group commanders embarked in landing craft are in command of all boats of their boat groups from the time the boats are lowered, or report, until their last organized wave has landed. Each boat group commander operates initially under the commanding officer of his respective assault transport. After reporting to the control organization, each boat group commander operates under the direction of the primary control officer until all waves of his boat group have landed. After all waves of the boat group have been landed, the boat group commander then becomes traffic control officer of the beach operation under the primary control officer and in cooperation with the beach party.

(g) Assistant boat group commanders embarked in landing craft. They assist the boat group commanders in their duties. When the last wave of his group has beached, each assistant boat group commander becomes the salvage officer for his beach and reports to the beachmaster.

(h) Wave commanders embarked in landing craft or assault amphibious vehicles. These officers form the waves and, under the direction of the boat group commander, control all subsequent movements of the waves. The senior troop officer in that wave is normally embarked in the same landing craft.

(i) Wave guides embarked in wave guide boats when assault amphibious vehicles are used. They assist in the navigation of assault amphibious vehicles to the beach.

(j) Casualty evacuation control officers initially embarked in control ships and, where the situation permits, transferred to specially

designed evacuation control ships located off the landing beaches. These officers control evacuation from their assigned beaches.

(2) Tactical-Logistical Group

(a) A TAC-LOG group is a temporary agency consisting of landing force personnel and established as required by the commanders of major echelons down to BLT level. A TAC-LOG group functions as the commander's staff liaison representatives for the principal purpose of advising corresponding Navy control officers of landing force requirements while the ship-to-shore movement is being executed. The TAC-LOG is not part of the Navy movement control organization.

(b) The TAC-LOG group of each echelon of the landing force is stationed in the same ship with the Navy control officer exercising control over the ship-to-shore movement of that echelon. LFM 02, Doctrine for Landing Forces, shows the relationship of the Navy control organization, landing force organization, and TAC-LOG group organization.

2505. LANDING CATEGORIES

a. Troops and Supplies.--The movement of troops and supplies in the ship-to-shore movement is arranged in the following five categories:

(1) Scheduled Waves.--Scheduled waves may consist of landing craft, assault amphibious vehicles, or helicopters loaded with those assault elements of the landing force, together with their initial combat supplies, whose time and place of landing are predetermined. After scheduled waves cross the line of departure, the landing proceeds without change, except in emergency. Waves commence landing at H-hour and continue for a relatively short period of time. Helicopterborne waves are landed in accordance with the helicopter employment and assault landing table.

(2) On-Call Waves

(a) On-call waves are elements of the landing force with their initial combat supplies, whose need ashore at an early hour is anticipated, but whose time and place of landing cannot be predicted accurately and is not specified. These elements are essentially those which are subject to an immediate emergency call.

(b) Helicopterborne on-call waves are held in readiness aboard ship.

(c) In waterborne landings, on-call waves are boated at or near H-hour and are held in instant readiness to respond to an order to land. When the situation permits, landing ships, as well as boats and assault amphibious vehicles, are employed to land on-call waves.

(d) The urgency that may attend the landing of an on-call wave may disrupt the landing of other on-call waves (scheduled waves, however, are disrupted only in a dire emergency). To preserve the high priority status of such units, their number is kept to the minimum consistent with the requirements of the landing force.

(e) The helicopter employment and assault landing table may list the helicopter on-call waves below the scheduled waves. Waterborne

on-call landing waves are listed in the assault schedule below the scheduled waves.

(3) Nonscheduled Units.--Nonscheduled units are the remaining units of the landing force equipped with their initial combat supplies, which are expected to land prior to the commencement of general unloading. This category usually includes most of the combat and combat service support elements not included in scheduled or on-call waves. The landing of nonscheduled units may be interrupted to permit the landing of floating dump supplies or other selected units, supplies, and equipment. The anticipated sequence of landing is determined during the planning phase and is shown in the landing sequence table. The landing sequence table serves as the basis for the landing of nonscheduled units by waterborne means. The landing sequence of nonscheduled units and equipment to be landed by helicopter is shown in the heliteam wave and serial assignment table.

(4) Floating Dumps.--Floating dumps are emergency supplies preloaded in landing craft or landing ships, primarily for resupply of surface landed forces.

(5) Prestaged Helicopter Lifted Supplies.--Emergency supplies are those supplies prestaged on LHA, LPH, or LPD type ships for resupply of helicopterborne forces.

(6) Landing Force Supplies.--Landing force supplies are those supplies remaining in assault shipping after initial combat supplies and floating dumps have been unloaded.

b. Free Boats.--Free boats are landing craft or assault amphibious vehicles reserved for the landing of a particular element whose time of landing is not scheduled. They remain in readiness until requested and are boated and move to the beach on request of the element embarked. Free boats are numbered consecutively 00-1, 00-2, etc., for each beach over which they are to be landed. Free boats are generally assigned to the BLT commanding officer and executive officer groups. Free boats restrict the utilization of a landing means until released and should be kept to a minimum.

c. Command and Control (C&C) Helicopter.--The commander of the helicopterborne unit may be provided with a C&C helicopter so that he can observe the activities and progress of his unit. The C&C helicopter is usually an observation type with excellent visibility. Some communication equipment is available in this type of helicopter. Additional equipment may be provided from ground unit assets.

2506. SERIAL NUMBERS

a. A serial number is an arbitrary number assigned to each unit or grouping including its equipment, which is embarked entirely in one ship, is to be landed as a unit on one beach or helicopter landing zone, and is to be landed at approximately the same time. They are a simple means of identifying troop elements and equipment. All troop and naval elements to be landed prior to commencement of general unloading are assigned serial numbers. The number assigned is not intended to imply a sequence of landing, but serves only to identify the element contained in the serial.

b. Early in planning, a block of consecutive serial numbers is allocated to the BLT. The BLT, in turn, allocates a consecutive portion of its block to each subordinate unit.

c. The BLT assigns serial numbers to its units, parts of units, or groupings being landed from its allocated block. The assignment of individual serial numbers is based on the organization for landing. The number of landing craft or assault amphibious vehicles in a serial may vary.

2507. LANDING PLAN

a. General.--The landing plan is a compendium which outlines the ship-to-shore movement and is the source of information from which the ship-to-shore movement is conducted and controlled. The plan is published as an appendix to the amphibious operations annex to the BLT operation plan. It is a compilation of the contents and forms required to move units, supplies, and equipment ashore at the proper place and time, and in the prescribed formation. The documents appear as tabs to the landing plan appendix.

b. Landing Formation.--The landing formation for an assault rifle company is largely based upon the plan of attack ashore and the availability of landing means.

(1) In the helicopterborne assault, helicopter availability permitting, the landing plan should provide for the landing of an entire assault rifle company from one wave of aircraft in the same landing site. The quantity of landing points in a site will generally be insufficient to permit all aircraft in the wave to touch down at individual points simultaneously. However, the time differential between the landing of the initial flight and the last flight unit within a wave is so small as to be of negligible tactical importance to the ground scheme of maneuver. When helicopter availability does not permit the enplanement and landing of an entire assault company, the scheme of maneuver must consider the differential in the scheduled landing times of the waves in which the company is to be landed.

(a) A column of platoons is an appropriate formation for landing when the landing site is very small, the enemy situation negligible, and helicopter availability requires landing the company in three or more waves. The leading platoon must seize and control the site.

(b) Two platoons abreast may be landed in the first wave as assault units. The remainder of the company lands in the succeeding waves. In using this formation, the scheme of maneuver provides for seizing and controlling the landing site employing the two leading platoons.

(c) Three platoons abreast is the preferred landing formation. It provides the company commander with the opportunity to assume almost immediate control of the company's major tactical elements and takes advantage of the flexibility of employment inherent in its triangular structure. Landing with three platoons abreast does not preclude the company from adopting any suitable attack formation.

(2) In the waterborne assault, the form of maneuver and the requirement for a rapid buildup of combat power ashore usually dictate that the rifle company land with at least two rifle platoons abreast. Further, the tactical elements of an entire assault rifle company are usually landed in the first two waves over the same portion of beach to preserve unit integrity. The S-3 provides the company commander with information as to the type of landing means to be employed. The company commander makes a determination as to his landing craft or assault amphibious vehicle requirements and their scheduling within the first two waves.

(3) Command echelons and crew-served weapons are spread loaded throughout the heliteams or boat teams comprising a wave. Machinegun and rocket squads are enplaned by weapon teams in separate aircraft, when possible.

c. Landing Documents for Helicopterborne Assault.--In the helicopterborne amphibious operation, landing documents are prepared to ensure optimum distribution of helicopter assets and to provide for landing units and equipment in accordance with the plan. The landing documents are a major source of information through which the helicopterborne ship-to-shore movement is controlled. This paragraph addresses the documents and forms prepared in planning a formalized helicopterborne ship-to-shore movement. The possible requirement for a more spontaneous landing should not be neglected. It is a preconceived plan for landing units or portions of units in support of the overall tactical plan, without preparation of formal landing documents, and is adopted when speed is of the essence. The landing of reserve units may often be spontaneous and responsive to the tactical situation ashore.

(1) Helicopter Availability Table.--This document is a tabulation of the number and types of helicopters available for a proposed helicopter operation. It lists the helicopter units, the number of helicopters available for the first and subsequent lifts, and the ships or landing zones from which the helicopters will operate. This table is prepared by the senior helicopter unit early in the planning phase, and is used as a basis upon which to determine the employment of available helicopters. Figure 13 is an example of a helicopter availability table.

HELICOPTER UNIT AND DESIGNATION	NUMBER OF A/C	A/C AVAILABLE NUMBER		MODEL	CARRIER	DECK LAUNCH CAPACITY	TENTATIVE LOAD PER A/C		REMARKS
		FIRST TRIP 90%	OTHER TRIPS 75%				TROOPS	CARGO	
HMM-163 (Ridgerunner)	21	18	14	CH-46	LPH-1	7	18	4,000	All external lift capable.
HMH-463 (Bomber)	24	22	18	CH-53	LPH-2	5	35	8,000	Equipped with aircraft recovery slings.
HML-267	24	22	18	UH-1E	LPH-3	10	4	1,000	10 armed.

Figure 13.--Example Helicopter Availability Table.

(2) Helicopter Employment and Assault Landing Table.--The employment and assault landing table includes the detailed plan for the movement of helicopterborne troops, equipment, and supplies. It is the landing timetable for the helicopterborne movement. The table provides the basis for the helicopter unit's flight schedules and is used by the air control agency as the basis for controlling the helicopterborne movement. The document is prepared jointly by the helicopter unit and the helicopterborne force. Figure 14 is an example of the helicopter employment and assault landing table.

(3) Heliteam Wave and Serial Assignment Table.--The heliteam wave and serial assignment table shows the tactical units, equipment, and supplies that are loaded into each helicopter in the assault waves. It identifies

Par. 2507

FMFM 6-4

Wave	Helicopter Unit & Flight No.	No./Model A/C	From To		Time			Destination			Troop Unit, Equipment and Serial External Loads
			Carrier (Origin)	Report (Load)	Load	Launch	Land	LZ	LS		
1st	ANVIL-1	10 CH46D/F	LPH-5	LPH-5	Pre-load	H-26	H-hr	Code Name	Color	Co A(-) (Rein) Ser 101	
2d	ANVIL-2	12 CH46D/F	LPH-5	LPH-5	H-18	H-16	H+5	Code Name	Color	Co B(-) (Rein) Ser 105	
3d	ANVIL-3	9 CH46D/F	LPH-5	LPH-5	H+21	H+25	H+46	Code Name	Color	Elms Co A, LIWC w/ Dragon Ser 102 Elms Co C, Ser 110	
4th	ANVIL-4	5 CH46D/F 6 CH46D/F	LPH-5	LPH-5	H+26	H+30	H+51	Code Name	Color	Elms Co B, 2 LIWC w/ Dragon Ser 106 Co C(-), 2 LIWC w/ Dragon Ser 111	

Figure 14.--Example Helicopter Employment and Assault Landing Table.

WAVE	HELITEAM FLIGHT SERIAL	PERSONNEL		SUPPLIES & EQUIPMENT	WEIGHT (4,200# MAX)		
		TROOP UNIT	NO.		PERS	EQUIP	TOTAL
1	ANVIL 101 100-1	1st Sqd, 1st Plat, Co A	13	1 MPFW (12#) 2 Rkt Clips (30#)	4,080	42	4,122
		Plat Sgt, 1st Plat, Co A	1				
		Aslt Tm, 1st Aslt Sqd, Wpns Plat	3				
			17				
	ANVIL 102 100-2	2d Sqd, 1st Plat, Co A	13	1 MPFW (12#) 2 Rkt Clips (30#)	4,080	42	4,122
		Plat Guide, 1st Plat, Co A	1				
		Aslt Tm, 1st Aslt Sqd, Wpns Plat	3				
			17				
	ANVIL 103 100-3	Plat Cmdr, 1st Plat, Co A	1	1 AN/PRC-75 (26#)	4,080	26	4,106
		Plat Radio Op, 1st Plat, Co A	1				
		Msgr, 1st Plat, Co A	1				
		Corpsman, 1st Plat, Co A	1				
		3d Sqd, 1st Plat, Co A	13				
			17				

(NOTE:) The heliteam flight serial is as follows:

ANVIL: Helicopter Squadron Radio Call Sign

1 Wave Number
0 Heliteam Position in the Wave

1 Troop Unit Serial Assign Number
0

1 Troop Unit Heliteam Number

Figure 15.--Example Heliteam Wave and Serial Assignment Table.

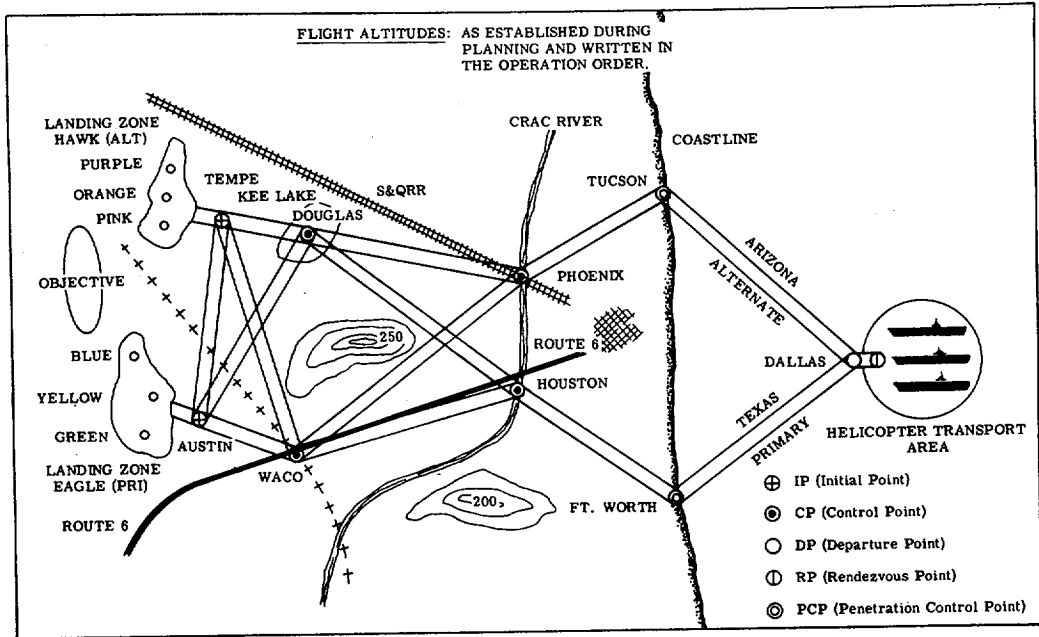

Figure 16.--Example Helicopter Landing Diagram.

each heliteam with an assigned serial number and the serial number with the flight and wave. The weight section serves as a check to ensure that maximum allowable helicopter payloads are not exceeded by the troop units. The explaining column assigns an explaining station to each heliteam. The rifle company consolidates and submits to the battalion S-3 (the issuing agency) its requirements based upon the scheme of maneuver, unit integrity, helicopter availability and dispersion of key personnel/crew-served weapons. Figure 15 is an example Heliteam Wave and Serial Assignment Table.

(4) Helicopter Landing Diagram.--The helicopter landing diagram is a graphic portrayal of the lanes to and from the landing zones and the helicopter transports or loading zones. It includes the helicopter transport area or loading zone, rendezvous points, departure points, penetration control points, control points, initial points, approach and retirement lanes, landing zones and sites, and such other information and remarks as are necessary for clarity. It is prepared by the helicopter unit. Figure 16 is an example of a helicopter landing diagram.

d. Landing Documents for Waterborne Assault.--Landing documents prepared by the BLT for the waterborne ship-to-shore movement vary in accordance with the operation. The importance to the rifle company commander of two documents merits detailed discussion. Other landing documents receive brief mention.

(1) Landing Diagram

(a) The landing diagram is the graphic means of illustrating the plan for the ship-to-shore movement. It is of particular value in informing the transport commander, boat group commander, boat personnel,

Par. 2507

FMFM 6-4

H-HOUR <u>0830</u>		Beach <u>RED-1</u>									
ASLT PLATS COS A AND B											
WAVE 1 H-HOUR	1-1 X*	1-2 X	1-3 X	1-4 X	1-5 X	1-6 X	1-7 X	1-8 X	1-9 X	1-10 X	
CO A (-) AND CO B (-)											
WAVE 2 H+4 Min	2-1 X*	2-2 X	2-3 X	2-4 X	2-5 X	2-6 X	2-7 X	2-8 X	2-9 X	2-10 X	
LEADING PLATS CO C AND 81MM MORT PLAT											
WAVE 3 H+8 Min	3-1 X*	3-2 X	3-3 X	3-4 X	3-5 X	3-6 X	3-7 X	3-8 X	3-9 X	3-10 X	
CO C (-)											
WAVE 4 H+12 Min	4-1 X*	4-2 X	4-3 X	4-4 X	4-5 X	4-6 X	4-7 X				
CO D											
WAVE 5 H+16 Min	5-1 X*	5-2 X	5-3 X	5-4 X	5-5 X	5-6 X	5-7 X	5-8 X	5-9 X	5-10 X	
H&S CO (-)											
WAVE 6 H+20 Min	6-4 0	6-2 0	6-1 0*	6-3 0	6-5 0						
LEGEND: X - LVTP 0 - LCVF * - Troop Wave Commander											

Figure 17.--Example Landing Diagram.

control personnel, and BLT subordinate commanders of the plan for tactically deploying the unit for landing. Figure 17 is an example of a landing diagram.

(b) The landing diagram is prepared by the S-3 as a tab to the landing plan appendix. It is prepared and promulgated at the same time as the BLT landing craft and assault amphibious vehicle assignment table.

(c) The landing diagram shows that:

1 The time of landing of each wave is given in terms of H-hour.

2 The waves are numbered from front to rear.

3 Each landing craft is assigned a boat number corresponding to the number of the embarked boat team. Landing craft within the boat wave are numbered from the center to the flanks of the wave, with the even numbers on the left and the odd numbers to the right.

4 Assault amphibious vehicles are numbered from left to right in each wave; i.e., in a BLT landing, with a front of 10 assault amphibious vehicles, the vehicle on the extreme left will be number one, the vehicle on the extreme right will be number ten. Each vehicle is identified by two numbers, the first indicating the wave, the second indicating the vehicle position in the wave. These numbers are separated by a hyphen. Thus, a vehicle numbered 2-3 would be the third vehicle from the left in the second wave.

5 A legend is utilized to show the type of craft. The diagram also shows the time of H-hour, the beach the unit is to land on, the number of waves, the units to be landed, and the formation of the waves for landing.

(2) Landing Craft and Assault Amphibious Vehicle Assignment

Table

(a) The landing craft and assault amphibious vehicle assignment table shows the assignment of personnel and materiel to each landing craft and assault amphibious vehicle and their assignments to waves for the ship-to-shore movement. Personnel, equipment, and supplies assigned to one craft or assault amphibious vehicle comprise a boat team.

(b) The table is consolidated and prepared for the BLT by the S-3. The rifle company commander submits a rough table to the S-3 for consolidation. Figure 18 is an example of a landing craft and assault amphibious vehicle assignment table.

CRAFT	PERSONNEL	BOAT SPACES	FORMATION
LVTP 1-1	Plat Comdr, 1st Plat, Co A	1	<u>Column</u>
	Msgr, 1st Plat, Co A	1	1-1
	3d Sqd, 1st Plat, Co A	13	x
	Sqd Ldr, 1st MG Sqd, Wpns Plat, Co A	1	1-2
	1st Tm, 1st MG Sqd, Wpns Plat, Co A	4	x
	Corpsman	1	1-3
		<u>21</u>	x
LVTP 1-2	Plat Sgt, 1st Plat, Co A	1	x
	Plat Guide, 1st Plat, Co A	1	1-5
	2d Sqd, 1st Plat, Co A	13	x
	2d Tm, 1st MG Sqd, Wpns Plat, Co A	4	1-6
	Corpsman	1	x
		<u>20</u>	1-7
LVTP 1-10	XO, Co A	1	1-10
	Gy Sgt, Co A	1	x
	Plat Sgt, 2d Plat, Co A	1	
	Plat Guide, 2d Plat, Co A	1	
	Msgr, 2d Plat, Co A	1	
	1st Sqd, 2d Plat, Co A	13	
	Corpsman	1	
	<u>19</u>		

Figure 18.--Example Landing Craft and Assault Amphibious Vehicle Assignment Table.

(c) In preparing the table, a boat space is considered to be the space occupied by one Marine and his individual combat equipment. Allowances of boat spaces for crew-served weapons, vehicles, and equipment are made. These items take up boat spaces; therefore, a smaller number of personnel are embarked in the same craft. Appendix B contains information relevant to allowances of boat spaces for weapons and equipment.

(d) The retention of tactical unity and the landing of subordinate units in tactical formations must be preserved within a wave formation. Where possible, crew-served weapons squads and sections are assigned to adjacent boat teams within a wave so that loss of one craft does not put the squad or section out of action ashore.

(e) The risk of heavy losses in command echelons is greatly reduced by distributing key personnel among two or more landing craft. Neither company commanders and executive officers nor platoon commanders and platoon sergeants are boated in the same boat team. Usually, the company executive officer is landed in the first wave and the company commander in the second.

(3) Approach Schedule.--A schedule is prepared by the transport commander in coordination with the BLT commander for the movement of each scheduled wave of the boat group from the rendezvous area to the line of departure, and thence to the assigned beach, so that the landing of each wave will be made at the prescribed time. See figure 19 for an example of an approach schedule.

WAVE	LEAVE RENDEZVOUS AREA	LEAVE LINE OF DEPARTURE	LAND
1	H-27 minutes	H-15 minutes	H-hour
2	H-25 minutes	H-13 minutes	H+2 minutes
3	H-19 minutes	H-7 minutes	H+8 minutes
4	H-13 minutes	H-1 minute	H+14 minutes
5	H-7 minutes	H+5 minutes	H+20 minutes
6	H-1 minute	H+11 minutes	H+26 minutes
7	H+5 minutes	H+17 minutes	H+32 minutes

Course from rendezvous area to line of departure 040°T, 035° MAG.
 Course from line of departure to beach 355°T, 350° MAG.
 Boat group commander: Lt WAVE, USN.
 Assistant boat group commander: Lt(jg) HATCH, USN.
 Primary control officer: LCdr BEAN, USN, embarked in LPR 89.

Figure 19.--Example Approach Schedule.

(4) Serial Assignment Table.--A serial number is assigned to all personnel, materiel, and vehicles to be landed from the same ship on one beach at the same time. The serial assignment table shows the serial number, the title of the unit, the number of personnel, the equipment, and the number and type of craft and/or assault amphibious vehicles required to boat the serial, as well as the ship in which the serial is embarked.

(5) Landing Sequence Table.--The landing sequence table incorporates the detailed plans for the ship-to-shore movement of nonscheduled units.

2508. DEBARKATION

a. General.--Debarkation procedures vary in consonance with the nature of the ship-to-shore movement to be conducted, the ship from which debarked, and the type of craft used. Debarkation may involve enplanement in helicopters, the use of assault amphibious vehicles, or off-loading via landing craft. The commanding officer of troops is responsible for expeditious debarkation. Debarkation planning is accomplished, and plans are tested by conducting rehearsals while moving to the objective area as discussed in section IV of this chapter.

b. Enplanement of Helicopterborne Units.--Enplanement of a helicopterborne unit is under the overall control of the ship's officers, assisted by the helicopter unit, the helicopterborne unit, and the ships' company personnel. Variations in deck and troop space configurations may result in differing detailed enplanement procedures, even among ships of the same class. General enplanement procedures are as follows:

(1) Troops are initially alerted and assembled in an assembly area located on the hangar deck. Heliteams are assembled and organized, passenger manifests prepared, life preservers buckled on, and all personnel readied for enplanement.

(2) From the assembly area, heliteams move to a control point, normally adjacent to the flight deck. It should be large enough to accommodate sufficient personnel for one complete deck launch. Coordination of troop movements from the assembly area to a control point is an important function of the troop debarkation officer and the combat cargo officer.

(3) From the control points, troops are led by flight deck guides (ship's company) to their respective helicopter loading points where they enplane under the supervision of the helicopter loading supervisor. The guides will pick up passenger manifests from the heliteam commander at the control point.

(4) During enplaning, consideration must be given to the safety of personnel and helicopters. Radio antennas which could become entangled in rotors must be dismantled or extreme caution used. Equipment such as weapons, entrenching tools, or other equipment attached to packs may damage the aircraft during the loading, en route, and unloading phases.

(5) Cargo is palletized, spotted, and rigged with slings as necessary.

(6) See FMFM 6-5, Marine Rifle Squad, for heliteam functioning and enplaning and deplaning procedures.

c. Debarkation of Waterborne Units.--The ship's commanding officer is responsible for preparing the ship for debarkation. The commanding officer of troops ensures the expeditious debarkation of embarked units to reduce the ship's vulnerability to enemy action. Debarkation is conducted by boat team organizations.

(1) Debarkation From Transports.--Troop units embarked in transports normally land in landing craft or are transferred to land in assault amphibious vehicles. Preparations for debarkation are begun during the final approach to the transport area. Debarkation stations are prepared by the ship's crew. Putting the proper landing craft alongside the appropriate debarkation station, lowering the landing net into the craft, dispatching loaded boats to rendezvous, and forming the landing craft in waves are Navy responsibilities. The composition of the boat team is as described in subparagraph 2503b(4). Boat team debarkation proceeds as follows:

(a) Preparations in Assembly Area.--Troop units remain in their compartments and boat teams are mustered and prepared for debarkation. Lashing of crew-served weapons and bulky equipment is undertaken. Each individual in the boat team is responsible for rigging individual equipment and weapons for debarkation. See FMFM 6-5, Marine Rifle Squad, for details.

(b) Movement From Assembly Area.--When the ship's debarkation officer calls the individual boat team to its debarkation station over the ship's public address system, the following are accomplished:

1 The boat team commander leads his boat team in single file over the assigned route to the debarkation station.

2 The boat paddle handler follows the boat team commander since the boat paddle assists in rapid identification of the boat team.

3 The assistant boat team commander is the last man to leave the assembly area. He ensures that all personnel and equipment assigned to the boat team clear the assembly area and arrive at the debarkation station.

(c) Preparation at Debarkation Stations.--On arriving at debarkation stations, the following is accomplished:

1 Boat team members rig shoulder weapons as described in FMFM 6-5, Marine Rifle Squad, without command from the boat team commander.

2 Deck loaders take positions forward or aft of the debarkation net.

3 Lashed equipment is distributed to the deck loaders.

4 The boat team is formed so as to permit debarkation in four files. Net handlers comprise the first rank. Boat loaders and the assistant boat team commander take up positions in the second rank.

5 The boat team commander reports the boat team to the Navy debarkation station officer.

6 The boat team commander positions himself forward or aft of the debarkation net in a position where he can positively control the debarkation of his boat team.

(d) Debarkation.--The boat team commander is in charge of debarking his team. On order from the Navy debarkation station officer, he orders his team to debark.

1 Men go over the side in ranks of four. The net is used to full capacity, 12 men on the net at one time. The four men in each rank keep abreast of each other by glancing to the right and left, allowing the slowest man to set the pace. While descending, hands are on the vertical. Ranks descend and step into the landing craft, making certain that their feet are firmly planted on the craft's deck before releasing the net. As each man enters the boat, he takes up his assigned position and assists the man in front of him in unslinging his weapon.

2 The first two four-man groups into the craft are the net handlers and boat loaders. Initially, the net is held taut and away from the craft's gunwale by the boat crew. When net handlers are in the landing craft, they relieve the boat crew.

3 The assistant boat team commander supervises the loading of troops and equipment in the craft.

4 The remainder of the boat team debarks with the two deck loaders as members of the last group.

5 The boat team commander checks to ensure that all personnel and equipment in the boat team are debarking and descends the net as a member of the last group.

(e) Lowering Equipment.--Lowering lines and guidelines are provided by the transport. In training at dry and wet net facilities ashore, the lines are provided by the unit conducting the training. Each line has a steel hook spliced in one end. Equipment is lowered simultaneously with troop debarkation as follows:

1 The guideline is hooked in the eye of the lashing line located at the heavy end of the equipment and the lowering line at the light end.

2 The free end of the guideline is lowered to the boat loaders in the landing craft.

3 The deck loaders commence lowering the piece of equipment. As it is lowered, the boat loaders keep the guideline taut. This keeps the equipment from bumping against the side of the ship.

4 When a piece of equipment has been lowered, the lashing line eyes are disengaged from the hooks on the lowering line and guideline.

5 The hook on the guideline is engaged with the lowering line hook, and the deck loaders pull the hook end of the guideline up to the debarkation station. Thus, the guideline is in proper position for use on the next piece of equipment. The process continues until all equipment is lowered.

6 At the conclusion of lowering, guidelines and lowering lines are retrieved, coiled, and turned over to the ship's personnel at the debarkation station.

d. Debarkation From Landing Ships.--Infantry units debark from landing ships in assault amphibious vehicles. The composition of the LVT boat team is as described in subparagraph 2503b(4). Preparation for debarkation must be complete. LVT debarkation differs from landing craft training as follows:

(1) Preparations in Assembly Area.--Individual preparations proceed as previously described, supervised by the boat team commander.

(a) Crew-served weapons and equipment are not lashed but preloaded and properly stowed in the LVT.

(b) Shoulder weapons are not slung in the fashion described for debarking from transports but are slung normally or carried in the hands.

(2) Movement From Assembly Area.--Moving the boat team from the assembly area to its appropriate assault amphibious vehicle and boarding the vehicle are easily accomplished. The boat team commander has previously reconnoitered the route and assigned troop positions for boarding the LVT. The vehicle is boarded while on the tank deck or in the well deck of the landing ship and before it becomes waterborne. When the order to load is passed over the ship's public address system, the following are accomplished:

(a) The boat team commander leads his boat team in single file to the LVT. Troops are arranged to file from the assembly area in inverse order of debarking from the LVT.

(b) The assistant boat team commander is last to leave the assembly area and ensures that all personnel and equipment clear the assembly area.

(c) On reaching the LVT, the boat team boards.

(d) The boat team commander supervises the loading.

(e) When all personnel and equipment have been loaded, the boat team commander informs the LVT crew chief.

(f) The boat team members brace themselves as the LVT starts down the ramp or well deck of the landing ship.

2509. SHIP-TO-SHORE SEQUENCE

a. Helicopterborne

(1) When directed, helicopters comprising the first assault waves are readied and spotted on the flight deck of the assault ships. On signal, crews and troops enplane and the helicopters are launched.

(2) Flights of helicopters rendezvous about their parent ship and proceed as waves to the landing zone or to a previously designated

wave rendezvous point where flights from several ships rendezvous to form a single wave.

(3) At the control point, the helicopter wave leader reports his wave to the appropriate air control agency. The wave then proceeds via the designated approach lane to the landing zone. En route, escort aircraft rendezvous with the wave to provide protection from enemy ground fire, aerial cover, and support by fire. Helicopter coordinator(s) (airborne) may also assist in guiding the wave to its destination.

(4) Upon reaching the landing zone, troops deplane and helicopters return to the ships to refuel and to enplane subsequent serials. Subsequent waves follow the same general procedure.

(5) While helicopter waves are en route to and from the landing zone, troop and cargo serials still aboard ship are placed in readiness to be moved.

b. Waterborne

(1) Assault Amphibious Vehicles

(a) Ships launch amphibious vehicles from the assault amphibious vehicle launching circle located immediately seaward and to the flank of the line of departure. In the event assault amphibious vehicles cannot immediately cross the line of departure, they are assigned maneuver areas to seaward, where they maneuver at slow speeds in a series of flanking movements.

(b) Assault amphibious vehicles land the surface assault elements of the landing force and their equipment in a single lift from assault shipping to inland objectives and conduct mechanized operations ashore. If the scheme of maneuver dictates that the troops and equipment be discharged on the beach and the LVT's return to the ships, they will do so by proceeding to a designated flank of the boat lane and returning seaward keeping clear of incoming waves. Vehicles landed subsequent to the first wave must maneuver to keep clear of troops and equipment landed earlier.

(2) Landing Craft

(a) Loaded boats of the scheduled waves proceed from the ship to a rendezvous area. The rendezvous is normally located 500 to 1,000 meters from the ship in the direction of the approach lane marker ship. Wave commanders form their waves at the rendezvous. While in the area, waves circle slowly in assigned localities.

(b) Waves depart the rendezvous area for the line of departure on order of the boat group commander and in accordance with the approach schedule. The entire boat group normally moves as a unit with a short interval separating waves. During periods of good visibility, waves proceed in a closed wedge formation. Where visibility is poor, wave formation is a column. Distances between boats in a wave are in consonance with the visibility. Boat speed is regulated so that the boat group arrives at the line of departure at the proper time.

Par. 2510

FMFM 6-4

(c) If the boat group is not to cross the line of departure immediately, it circles by waves clear of the line of departure under control of the boat group commander.

(d) Boat wave formations and maneuvers en route to the beach are controlled by wave commanders. The formation prescribed in the landing diagram is adopted prior to beaching. During the last 1,000 meters of the approach, boats proceed at maximum speed. Upon beaching, a designated crew member lowers the ramp. After landing the boat team, the craft's ramp is raised and the boat retracts and clears to a designated flank of the boat lane.

2510. TRANSFER OPERATIONS

a. Ship-to-Ship Transfers.--It may become necessary to transfer personnel from one type shipping (LPA, LKA, etc.) to another (LPH, LPD, LST, etc.) upon arrival in the objective area. The transfer may be effected close to shore or some distance at sea. It is a time-consuming operation that must be executed as expeditiously as possible.

(1) When troops are transferred from a transport to a landing ship, they are normally delivered administratively by landing craft or helicopter.

(2) Troops board the landing ship by climbing the sides on debarkation nets. Once aboard, they assemble by boat teams in accordance with the landing craft and assault amphibious vehicle assignment table.

(3) Boat teams are guided to their assigned assault amphibious vehicles by the vehicle crews. All heavy gear is then stowed in the vehicles.

(4) If the transfer is effected several hours or several days prior to the landing, boat teams are thoroughly oriented as to assembly area locations and specific routes from assigned areas to vehicles. Teams are thoroughly rehearsed in moving to assigned vehicles in minimum time. When the transfer is effected immediately prior to the landing, boat teams are loaded into the vehicles on being guided to them by the crew members.

(5) If billeting is required, the troops are assigned billeting space. Such may be the case when the transfer is effected more than a few hours prior to the landing.

b. Transfers at a Transfer Line.--Fringing reefs, sandbars, or other offshore obstacles may prevent beaching by landing craft. The slow speed of assault amphibious vehicles does not permit the rapid buildup of combat power ashore when the vehicles are required to make frequent and lengthy trips from ship to shore. Therefore, a transfer area seaward of enemy small arms range, which is navigable to landing craft, is used to transfer troops and cargo from landing craft to assault amphibious vehicles. The economy and speed of the landing craft are exploited in delivering loads from the ships to the transfer area. In shuttling troops and cargo to beaches inaccessible to landing craft, the amphibious capabilities of the vehicles are best realized.

(1) Transfer operations are controlled by the Navy control organization. The control ship takes station near a line designated as the

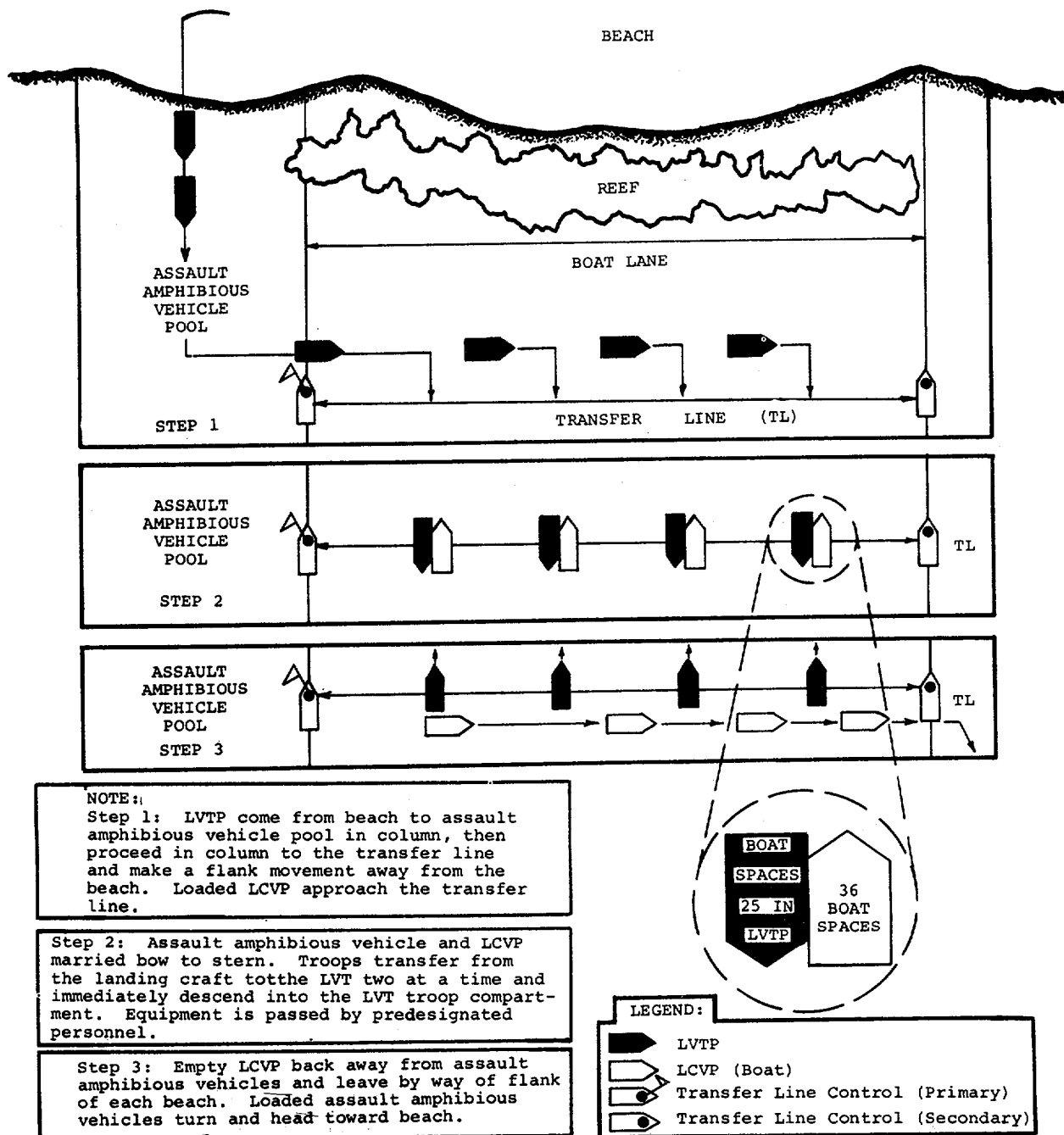

Figure 20.--Schematic Diagram of Transfer Operations.

transfer line. Assault amphibious vehicle representatives and a representative from the major troop unit being transferred are located with the Navy control officer. Careful planning and training before the operation are necessary for proper control and execution of transfer operations.

(2) Transfers of this type are effected only when necessary and usually do not involve assault units or other units landed in scheduled waves. The rifle company may be involved in this type transfer as a reserve element of the regimental landing team or, in some instances, as a reserve company of the assault BLT. In either case, the transfer operation is conducted as shown in figure 20.

2511. OVER THE HORIZON STANDOFF

a. General.--In certain combat environments, the deployment of amphibious shipping close in shore in the amphibious objective area may unduly hazard the forces involved. Extensive mining of coastal waters, a significant enemy surface-to-surface missile capability, desire for tactical surprise, or other local conditions may dictate the launching of an amphibious assault from considerable distance at sea. The ship-to-shore movement of helicopterborne forces in this type of assault presents no unique problems as the speed and range of the helicopter are sufficient to permit assault landings from extended distances. The landing of waterborne forces from a standoff posture requires the adoption of techniques which demand timing, seamanship, and training. The techniques employed involve the underway launch of assault amphibious vehicles and loaded landing craft. The procedure is advantageous in that it avoids a long, slow water transit while minimizing the duration of exposure of launching ships to hostile action. The delivery of fresh troops and fully fueled assault amphibious vehicles to the line of departure may constitute a tactical advantage when landed ashore.

b. Underway Launch

(1) The line of departure is located in a swept lane parallel to the beach and is marked with buoys.

(2) Well deck configured landing ships steam toward shore in a swept lane, turn at or near the line of departure, and launch loaded assault amphibious vehicles and/or landing craft while underway.

(3) Given adequate water depth and sea room, such a launch can be executed at high speeds.

(4) Launch intervals depend upon ship speed and on desired spacing between vehicles.

(5) Intervals in the approach of landing ships to the line of departure are dictated by the timing of assault waves.

Section VI. CONDUCT OF THE ASSAULT

2601. GENERAL

a. This section discusses the conduct of the amphibious assault using both helicopterborne and waterborne means. FMFM 3-3, Helicopterborne Operations, contains detailed information concerning the helicopterborne amphibious assault. LFM 02, Doctrine for Landing Forces, provides additional detail of the amphibious assault.

b. The helicopterborne amphibious assault commences with the touchdown of the leading helicopters of the first wave in the landing zone. The waterborne assault is initiated with the crossing of the line of departure by the first scheduled wave of assault amphibious vehicles or landing craft. The assault ashore of the waterborne rifle company commences with the debarkation of troops from the first assault amphibious vehicle or landing craft.

2602. HELICOPTERBORNE ASSAULT

a. General.--The initial wave is composed mainly of assault rifle units, reinforced as necessary to provide the combat power required for clearing the landing sites and the landing zone of enemy elements. Although the scheme of maneuver is dependent upon many other factors, the initial assault forces are normally assigned responsibility for clearing sectors of the landing site. (See fig. 21.)

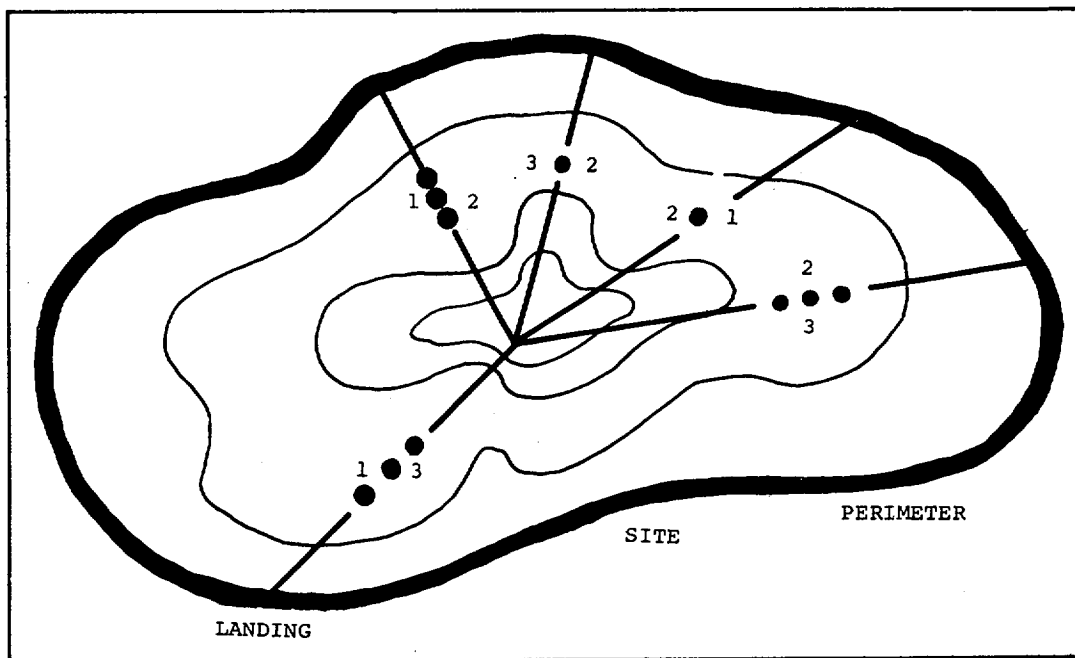

Figure 21.--Landing Site Showing Platoon and Squad Sectors.

Par. 2602

FMFM 6-4

b. Assault Rifle Platoon.--The assault rifle platoon effort initially consists of separate squad actions in assigned portions of the platoon sector to establish control and clear the sector of enemy resistance.

(1) The platoon sector is divided into squad sectors. Each squad is responsible for clearing its sector. Initially, control of the platoon is decentralized to the squad leaders. Consequently, aggressiveness and initiative at small unit level are emphasized.

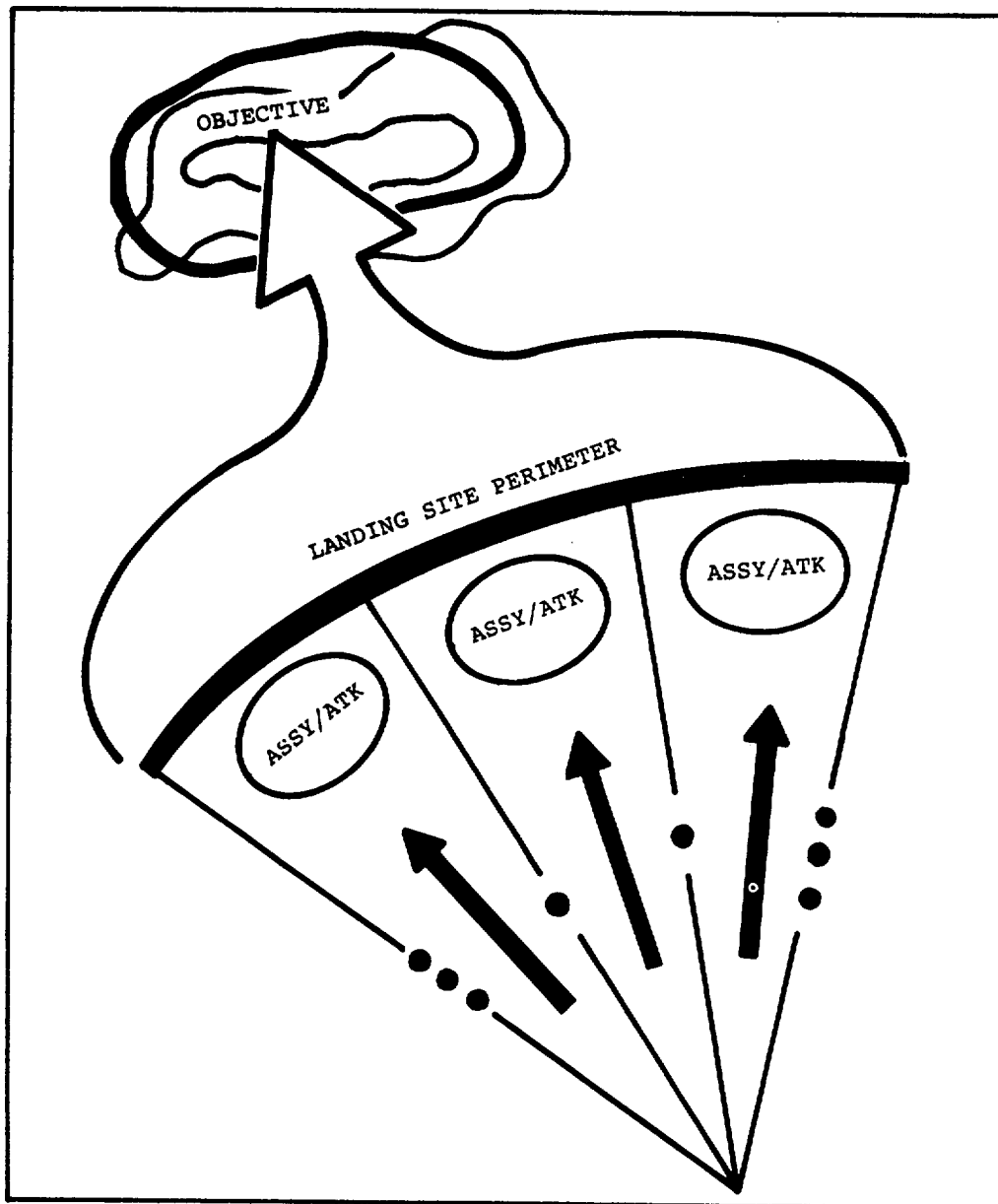

Figure 22.--Typical Platoon Actions on Landing.

(2) Key terrain within the platoon sector is assigned as an objective and is seized in the course of clearing the sector. When that portion of the landing site perimeter does not consist of key terrain, the platoon deploys and conducts a preplanned attack to seize objectives beyond the landing site perimeter. (See fig. 22.)

(3) The seizure of objectives on or beyond the landing site perimeter permits the platoon to dominate avenues of approach into the site from that direction. Control of these objectives also prevents enemy small arms interdiction of the landing.

c. Assault Rifle Company.--The assault rifle company lands in its assigned landing site in one or more waves, clears the landing site of enemy resistance, and seizes terrain objectives which control the site. Based upon the formation for landing, the company commander usually lands in a wave which allows him to gain control of at least two rifle platoons in their ground actions. The executive officer is left in charge of loading and lands with one of the last heliteams in the company.

(1) The primary concern of the company commander is to rapidly gain control of his subordinate units without causing loss of momentum in the attack. Immediately upon landing, the company commander continues his estimate of the situation. Revision of the estimate is based on reports from his assault platoon commanders and a brief personal reconnaissance. He is concerned with whether his attack is proceeding according to plan or whether a new plan of attack must be instituted in face of a changed situation.

(2) Helicopter availability permitting, an assault rifle company lands with three platoons abreast in a single wave and may thereafter attack in any formation. It is common to employ all three platoons in uncovering the landing site immediately upon landing. The employment of three platoons may not be necessary when the landing site is very small, the enemy situation is extremely light, and the terrain permits effective control of the site with a smaller force. Figure 23 illustrates some of the initial attack formations which may be adopted by the company in uncovering the site when the company is landed in a single wave. Platoons which the company commander does not plan to commit initially in uncovering the landing site are held in reserve in the immediate vicinity of the site.

(3) Helicopter availability may not permit an assault company to land three platoons in a single wave. The attack formation is again determined by the size of the landing site, the enemy situation, and the terrain in the vicinity of the site. The platoon or platoons landed in the assault secure the landing site and protect the landing of the remainder of the company.

(4) The assaults of two rifle companies in adjacent landing sites within the same landing zone may be coordinated. One company may be charged with the responsibility for clearing the portion of the landing zone lying between two nearly contiguous landing sites. By acting in concert to seize terrain dominating the two sites, enemy entry into both sides from a particular direction may be controlled by one unit. Active patrolling and coordination of fires on the boundaries between the two adjacent companies ensure control of both landing sites.

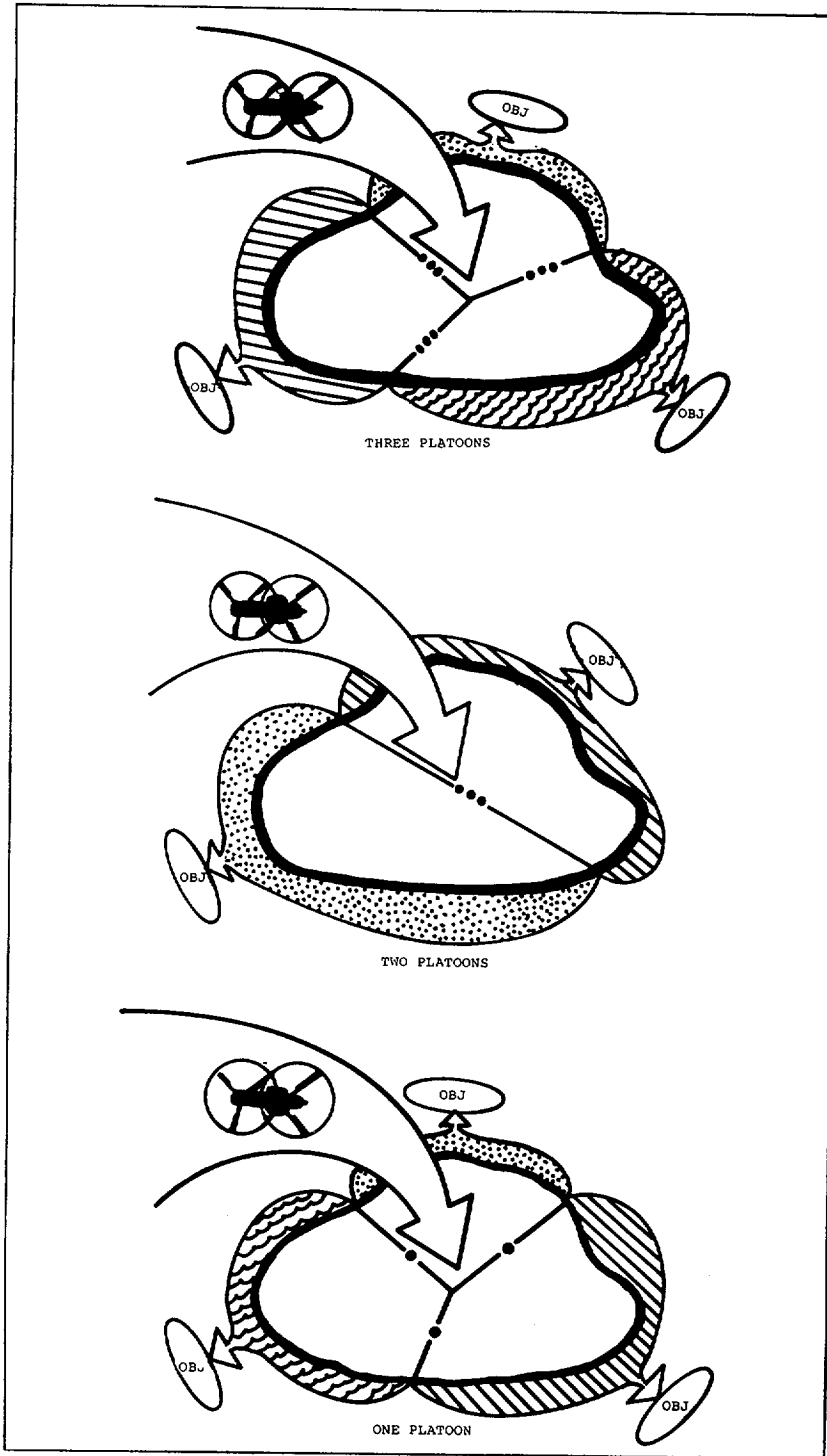

Figure 23.--Typical Attack Formations, Assault Rifle Company.

2603. WATERBORNE ASSAULT

a. Preparation for Landing.--As the line of departure is crossed, each boat team commander prepares his boat team for rapid debarkation from the landing craft or vehicle.

(1) The boat paddle is unrigged from the display position by the boat paddle handler.

(2) The boat team commander orders protective covers removed from weapons and weapons are locked and loaded. Cartridge belts and helmet chin straps are fastened. The boat team members assume low positions when prepared to debark.

(3) During the run into the beach, the boat team commander may have the opportunity to orient subordinate tactical unit leaders with respect to the landing beach and terrain features in the vicinity. Often, the beach and its surroundings are obscured by the smoke and dust of battle.

(4) When the wave is within 100 meters of the beach, the boat team commander alerts the team and the members face forward and brace themselves for the shock of landing.

b. Debarkation Procedure.--Assault units in landing craft debark on order when the craft beaches. Unless the scheme of maneuver dictates otherwise, assault amphibious vehicles arriving at the beach proceed inland to the first available cover. Debarkation proceeds as outlined below.

(1) Debarkation From Landing Craft

(a) Troops use only the cleated sides of the ramp. As a safety measure, no one steps over the forward edge of the ramp. When debarking, men move quickly down the ramp, and when the water becomes sufficiently shallow, double time to the first available cover. At no time will men stand on the gunwale and jump.

(b) The boat paddle is carried ashore and dropped by the handler above the high watermark.

(c) The troops in the assault remove life jackets at the first available cover above the high watermark.

(2) Debarkation From LVT's.--As LVT's beach and on signal from the boat team commander, troops remove life preservers and pass them to the front of the LVT. Rounds are then chambered in the weapons, the weapon remaining on safe.

c. Assault Rifle Platoon.--The reinforced platoon is normally boated in the same wave and lands simultaneously to ensure a rapid buildup of firepower. The landing craft or assault amphibious vehicles transporting the platoon are adjacent to each other in the wave to facilitate the rapid establishment of control by the platoon commander upon debarking.

(1) Based upon available intelligence of the beach area and the mission of the platoon, squads may be assigned independent objectives on the beach or portions of the platoon objective. Squad objectives are normally key terrain features or enemy fortified emplacements located in the immediate vicinity of the beach.

(2) The principles of attack in land combat remain valid, but the initial stages of combat in the amphibious operation emphasize the following:

(a) There is a requirement for independent and aggressive action by the squads until control is gained by the platoon commander.

(b) Squads assigned objectives inland immediately destroy any enemy in the immediate vicinity of the beach before proceeding inland. Squads assigned objectives on the beach assault and destroy or neutralize them as soon as possible after landing.

(3) The platoon commander's primary concern is to gain control of his platoon. He makes a continuous estimate of the situation to determine whether his plan of attack is proceeding as planned or whether the situation has changed to an extent requiring a new plan of attack. The platoon commander adheres to the principle of initially destroying enemy resistance on the beach in his zone of action. In so doing, he adopts one of the following courses of action:

(a) Diverts the minimum subordinate units required to destroy or neutralize resistance on the beach and continues the attack toward the platoon objective with the remainder of the platoon.

(b) Formulates a new plan of attack employing all or a greater part of his platoon to subdue the resistance on the beach.

(c) In situations where all squads have bypassed resistance on the beach and are successfully attacking the platoon objective, the platoon commander may continue the attack and report the location, type, and estimated strength of the bypassed enemy to the company commander.

d. Assault Rifle Company.--An assault rifle company usually lands in the first two troop waves ashore. The company executive officer normally lands in the first wave with the assault platoons in order to establish control and to coordinate the activities of the assault platoons until control can be passed to the company commander. The company commander normally lands in the second wave with the forward observers (FO's), attachments such as the Dragon and engineers, and the reserve platoon.

(1) The executive officer is joined by a messenger from each assault rifle platoon on landing and immediately selects a vantage point from which he can communicate and ensure control of the company's attack until such time as the company commander is able to regain control. By observation, personal reconnaissance, and reports from the rifle platoons, the executive officer formulates an estimate of the situation as a basis for briefing the company commander concerning the tactical situation when control is passed to him. In instances when early requirements for non-organic fire support can be foreseen, forward observers and forward air control personnel may be landed with the executive officer to request and control air and naval gunfire support in support of the assault rifle platoons.

(2) The primary concern of the company commander is the rapid establishment of control over all his subordinate units without causing a loss of momentum in the attack of the assault platoons. Immediately upon landing, the company commander continues the estimate of the situation.

His estimate is based on reports from the assault platoon commanders and the executive officer as well as a brief personal reconnaissance. As was the case with the platoon commander, he is concerned with whether the attack is proceeding according to plan or whether a new or modified plan of attack must be instituted in the face of a changed situation.

e. Reserve Platoon.--The reserve platoon provides the company commander with a degree of flexibility in his attack. It is employed to ensure success of the attack or to maintain momentum. However, it may be ordered to accomplish or be prepared to accomplish other specific missions. Appropriate missions for the reserve platoon of an assault rifle company in the waterborne amphibious assault include one or more of the following:

- (1) Eliminating enemy resistance remaining on the beach or elsewhere in the company zone of action that has been bypassed by the assault platoons.
- (2) Ensuring success of the assault platoons by attacking from a new direction.
- (3) Assuming the mission of one of the assault platoons.
- (4) Protecting the company flanks.
- (5) Reinforcing the attack by fire.

Section VII. AMPHIBIOUS RAIDS, DEMONSTRATIONS, AND WITHDRAWALS

2701. GENERAL

Amphibious raids, demonstrations, and withdrawals are lesser included amphibious operations which may involve the participation of an entire landing force or selected elements thereof. Major differences between these operations and the amphibious assault are the intended purpose of the operation and the normal lack of retention of a landing force on a hostile shore.

2702. AMPHIBIOUS RAIDS

a. General.--An amphibious raid is a landing from the sea on a hostile shore involving swift incursion into, or temporary occupancy of, an objective and followed by a planned withdrawal. Raids may be independent operations or support other operations such as another landing, a land campaign, or an air or naval operation.

b. Organization and Command.--The principles of organization and command relationships applicable to the amphibious assault generally apply to amphibious raids. Accordingly, overall command of the raid is vested in the commander amphibious task force.

c. Planning.--The BLT or a larger force possess staffs capable of planning an amphibious raid. Raiding forces smaller than a BLT are provided a planning staff. Frequently, the parent BLT from which the raiding force is drawn provides the planning staff for the force. Under certain circumstances, the planning staff may be furnished from other sources. Normally, the staff conducts planning functions only and is not part of the raiding force.

d. Friendly Guerrilla Support of Amphibious Raids.--The decision to employ friendly guerrillas in assisting the amphibious raid is based upon careful consideration, utmost trust of their leader, and the reliability of the guerrilla units. Only the planning details essential to their own operation are provided to them. Guerrilla assistance may be either covert or overt in nature.

(1) Covert Operations

(a) Civil disturbances may be directed against the enemy which will cause him to:

- 1 Misdirect his forces.
- 2 Change policy.
- 3 Dilute his combat power.

(b) Sabotage is one of the guerrilla's most effective weapons. Properly employed, sabotage:

- 1 Reduces the enemy's war potential and morale.

missions. 2 Forces the enemy to divert troops to security

(c) Guerrilla forces may provide effective screens to the front and flanks of the raiding force or conduct prelanding reconnaissance. During the raid, they may act as guides; after the raid, they may assist in evasion and escape.

(2) Overt Operations

- (a) Ambush.
- (b) Raids.
- (c) Attacks in force.

2703. AMPHIBIOUS DEMONSTRATION

a. General.--The amphibious demonstration is an operation conducted for the purpose of deceiving the enemy by a show of force or by a minor attack with the expectation of influencing the enemy in a course of action unfavorable to himself. The amphibious demonstration is designed primarily to deceive the enemy as to the time, place, or strength of the main attack. It normally includes a preparation and other supporting fires but does not involve the commitment of a landing force ashore.

b. Participation.--The rifle company's participation in an amphibious demonstration usually involves:

- (1) Simulating debarkation of assault troops and equipment.
- (2) Providing boat teams or portions of boat teams to ride in landing craft in the waterborne demonstration.
- (3) Providing heliteams for a helicopterborne amphibious demonstration. When landing zones and adjacent areas are not occupied by the enemy, heliteams may actually debark from the helicopters for a short period.

2704. AMPHIBIOUS WITHDRAWAL

An amphibious withdrawal is a withdrawal of forces by sea in naval ships or craft from a hostile shore to preclude their loss or to retract them for employment elsewhere. The amphibious withdrawal may be forced or voluntary. The actions preceding the withdrawal normally involve some form of retrograde movement common to land combat. The amphibious withdrawal begins with the initial defense of the debarkation area and terminates upon embarkation of covering forces.

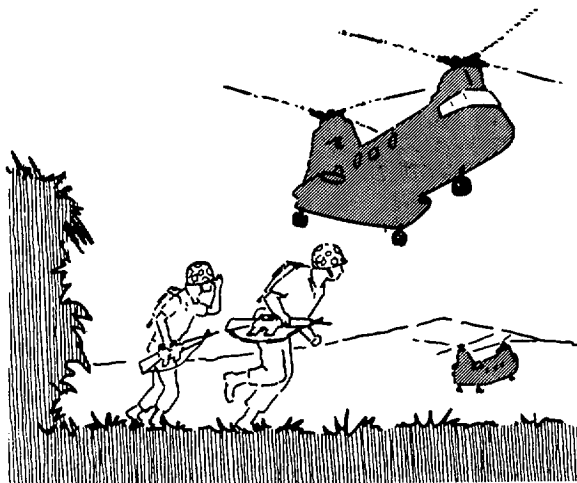

CHAPTER 3

OFFENSIVE OPERATIONS

Section I. INTRODUCTION

3101. GENERAL

This chapter discusses the basic principles employed at company and platoon level in gaining contact with the enemy and attacking him. It includes the tactics and techniques to be used by the company commander and the platoon commander in applying the principles of offensive land combat. The special considerations applying to warfare in jungle, deserts, and mountains are not included but may be found in FMFM 8-1, Special Operations, or in appropriate Army Field Manuals of the 31 series. For doctrine on riverine operations, see FMFM 8-4, Doctrine for Navy/Marine Corps Joint Riverine Operations, and for doctrine on antiguerrilla warfare, see FMFM 8-2, Counterinsurgency Operations.

3102. FUNDAMENTALS OF OFFENSIVE TACTICS

The fundamentals of offensive tactics are the general rules which evolved as commanders applied the principles of war to accomplish offensive missions. The fundamentals do not replace the principles of war, but rather adapt the application of the principles to current doctrine, organization, and state of the art of war.

a. Gain and Maintain Contact.--This fundamental of offensive tactics is applicable when a force is not in contact with the enemy or when the enemy is attempting to move toward or away from the force.

b. Develop the Situation.--Developing the situation is closely allied to gaining and maintaining contact and consists of those actions necessary to determine the strength, location, composition, and disposition

of the enemy that has been encountered. A commander must know what he is fighting.

c. Exploit Known Enemy Weakness.--In situations created by opposing maneuvering forces, each seeking a tactical advantage, the commander avoids enemy strength and reacts with maximum speed to take advantage of known enemy weaknesses to enhance success. Weakness from faulty dispositions, poor morale, insufficient support, or tactical error, as well as a weakness in numerical strength, should be exploited.

d. Seize or Control Key Terrain.--The successful accomplishment of the offensive mission is often dependent upon the early control or neutralization of key terrain. However, to be an advantage, the possession of key terrain must be exploited.

e. Retain the Initiative.--A paramount objective of the commander in the offense is to seize and retain the initiative.

f. Neutralize Enemy Capability to React.--Every effort is made to disrupt and neutralize the enemy's capability to react to the commander's tactical dispositions and maneuver. Isolation of the battlefield and destruction of, or interference with, enemy support and reinforcement actions reduce his responsiveness, reduce risk, enhance the security of friendly forces, and assist in gaining and retaining the initiative.

g. Advance by Fire and Maneuver.--The attack is characterized by fire and maneuver, combined and controlled to create a preponderance of combat power that culminates in a powerful and violent assault in the decisive area.

h. Maintain the Momentum of the Attack.--Once the attack is launched, every effort is made to gain and maintain momentum until the objective is secured; flexibility and speed in the employment of combat power are paramount.

i. Concentrate Superior Combat Power at the Decisive Time and Place.--Successful offensive action requires the massing of superior combat power at the decisive place and time and the rapid application of this power to destroy the enemy.

j. Exploit Success.--Because combat power is relative, commanders exploit any information, tactical success, or advantage that accrues during the attack. Speed of action and reserve combat power are required.

k. Provide for the Security and Integrity of the Force.--Security is necessary whether a force is in bivouac, on the march, or in combat. All units are responsible for their own security, regardless of the security provided by other units.

3103. PHASES OF THE ATTACK

Generally, the attack is planned and executed in three phases: the preparatory phase, the conduct phase, and the consolidation and reorganization phase.

a. Preparatory Phase.--During this phase, preliminary operations are executed which tactically dispose the force to conduct the attack. These include:

(1) Movement to, and concentration of forces in, the forward area prior to the attack (the assembly areas). The commander determines the probability of contact with the enemy. It is his estimate of the probability of contact which determines a formation offering reasonable security to the movement and the speed at which the movement may be conducted. The probability of contact may be considered as follows:

(a) Contact Remote.--The probability of contact is sufficiently slight that administrative considerations outweigh tactical concerns. Limited security is employed and the movement may be conducted rapidly, in nontactical formation, using any type mobility.

(b) Contact Improbable.--The probability of contact with the enemy forces of sufficient strength to cause the unit to deploy has increased to a point at which administrative and tactical considerations govern the situation. Additional security is required as the movement continues. Units are tactically grouped but not fully deployed except for security elements.

(c) Contact Imminent.--The probability of contact with an enemy of sufficient strength to cause complete deployment of the unit for combat has influenced the commander's estimate to the degree that he considers readiness of the unit for tactical employment the paramount consideration. Forward elements may be fully deployed in combat formation.

(2) Final preparation of attack echelon (reorganization, resupply, rest, reconnaissance, plans and orders, training, orientation, coordination, maps, security, rehearsals, etc.).

(3) Development of the enemy position and intensification of intelligence operations.

(4) Execution of deception plan, including feints and demonstrations.

(5) Fires before the attack may be completed and preparation fire initiated as scheduled (to include chemical and nuclear fires and assessment of damage created).

(6) Completion of preparations for relief in place or passage of lines as required.

b. Conduct Phase.--The conduct of the attack involves three separate stages in which "the impulse of force in a decisive direction" is advanced:

(1) Assembly area to line of departure.

(2) Line of departure to final coordination line.

(3) Movement from the final coordination line to the objective.

c. Consolidation and Reorganization.--The purpose of the consolidation and reorganization is to prepare the attacking force for future action. When possible, the seizure of the objective should be followed by immediate continuation of the attack or exploitation of success obtained.

(1) Consolidation.--Consolidation pertains to all measures taken to organize and strengthen a newly captured position as it may be used

against the enemy; initially, a hasty defensive posture is assumed to ward off possible counterattacks. Thereafter, the unit takes necessary action to occupy the objective or, following minimum essential reorganization, to continue the attack depending on its mission. Emphasis is placed on security, displacing and positioning of forces, fire planning, reconnaissance, and reorganization; but these actions should not unnecessarily slow the momentum of the attack if it is to be continued. Reconnaissance elements and motorized or helicopterborne forces maintain contact with the enemy, keep him off balance, and obtain information. Fires beyond the objective protect the reorganization and break up counterattacks.

(2) Reorganization.--Reorganization includes all measures taken to restore order in a unit after combat and to maintain its combat effectiveness in order to prepare the force for further attack or pursuit of the enemy. Reorganization is continuous but is given special emphasis upon seizure of the objective. It includes reporting of unit location and status to higher headquarters, redistribution of personnel, evacuation, resupply, and restoration of control and communications.

d. Flexibility

(1) The interaction and reaction of events and conditions on the battlefield make it necessary for combat units to adapt their actions rapidly to the current situation. This flexibility is especially important in offensive operations where situations created by opposing maneuvering forces seeking a tactical advantage require the commander to modify his plans to meet significant changes and to react with utmost speed. Success in the attack may well hinge on a commander's willingness and ability to modify his original plan.

(2) To achieve the desired flexibility in his plan of attack, the commander must, at least mentally, plan for contingencies in the following situations:

- (a) Continuation of the attack.
- (b) Exploitation.
- (c) Pursuit.
- (d) Failures of the attack on intermediate or final objectives.
- (e) Enemy counterattack.
- (f) Redesignating the main and supporting attack.
- (g) Reconstitute a new reserve force as soon as possible, after employment.

3104. DISTRIBUTION OF FORCES

a. General

(1) Offensive action imposes three different tasks on the commander. They are directly related to the manner in which the commander divides the available combat power in organizing for the attack. The tasks to be accomplished are as follows:

- (a) Locate and hold the enemy in place.
- (b) Maneuver to gain a tactical advantage.
- (c) Attack at the decisive time and place and destroy the enemy.

(2) These tasks are normally accomplished by apportioning the available combat power to the following:

- (a) Main attack.
- (b) Supporting attack.
- (c) Reserves.

b. Main Attack.--The main attack contains the greatest concentration of combat power. Its purpose is to secure the decisive objective and destroy or cause the destruction of the enemy force. The main attack is the commander's bid for victory. The following are primary characteristics of the main attack:

- (1) Directed against a decisive objective.
- (2) Launched on a narrow front.
- (3) Allocated the preponderance of combat power and fire support.
- (4) Reserves positioned to exploit success.

c. Supporting Attack

(1) The supporting attack is conducted in conjunction with the main attack. It is apportioned the combat power necessary to accomplish its mission and is designed to support the main attack as outlined below:

- (a) Holds the enemy in position and/or destroys him.
- (b) Deceives the enemy as to the locations of the main attack.
- (c) Induces the enemy to dissipate his fire support and prematurely shift or commit his reserves.

(2) The differentiation between main and supporting attacks is seldom indicated in the commander's order. This approach provides flexibility to the commander's plan. The supporting attack is characterized by the following:

- (a) Directed against objectives, the seizure of which supports the main attack.
- (b) Conducted on a broader front than the main attack.
- (c) Maximum available firepower is employed forward.

Par. 3105

FMFM 6-4

(d) Few reserves.

(e) May be an attack by fire for small units.

(3) Unexpected developments may cause the commander to shift the weight of his attack. The supporting attack then becomes the main attack. Modifications to the plan of attack involve reapportioning supporting fires and shifting reserves to exploit the unexpected success of the supporting attack.

d. Reserves

(1) The primary mission of the reserve is to enter offensive action at the proper place and moment to accomplish the assigned mission, or exploit success. The reserve must be large enough to exploit success, yet its size should not materially weaken the main attack forces. The reserve should be located in a position from which it can move rapidly to points of probable employment. The initial strength of the reserve varies. Some of the factors influencing the initial size of the reserve are:

(a) Contemplated missions of the reserve.

(b) Forces available.

(c) Type maneuver planned.

(d) Terrain.

(e) Possible hostile reactions.

(f) Clarity of the situation.

(2) When the situation is relatively clear and enemy capabilities are limited, the reserve may constitute a small fraction of the command. When the situation is obscure, the reserve may initially consist of the bulk of the command, prepared for immediate employment at any point as the situation develops. Employment of the reserve at the decisive moment is the commander's principal means to influence the action. Quite often the commander's most difficult and important decision is concerned with time, place, and circumstances of committing the reserve. (See par. 3305g.)

3105. FORMS OF OFFENSIVE MANEUVER

a. General.--Offensive maneuver is the movement made to place combat power in an advantageous position with respect to the enemy, to close with him, and to destroy him. Although maneuver is made with respect to the enemy, the ability to maneuver is closely related to battlefield initiative. The initiative lies with the attacker so long as he retains freedom of action to select the time and place of the engagement. In the final analysis, the tactical advantage being sought through maneuver is the disposition of the friendly force in such a manner as to facilitate the destruction of the enemy.

(1) The commander may orient his attack on the front, flank, or rear of the enemy. Helicopterborne operations that place forces on the enemy's flanks or in his rear can be used during all forms of maneuver.

(2) The basic forms of maneuver are the envelopment, the penetration, and the frontal attack. The frontal attack and the single envelopment are the primary forms of maneuver employed by the company and the platoon. The double envelopment, turning movement, and encirclement are the variations of the envelopment that may be employed by larger units.

(3) The mission of the unit, characteristics of the area of operations, disposition of opposing forces, and relative combat power of opposing forces are analyzed to determine the best form of maneuver. Normally, terrain, time available, friendly dispositions, ability to support the attack, and the enemy situation are the principal factors in determining the form of maneuver.

(4) Terrain, especially, exerts a decisive influence on the selection of the form of maneuver employed by the company or platoon. The interrelationship of terrain features, particularly their relationship to the decisive objective, will directly affect the commander's ability to employ his combat power appropriately. The availability of suitable avenues of approach into and within a position may limit the choices of maneuver. Whenever possible, selected avenues of approach avoid enemy defensive strength.

b. The frontal attack is a form of maneuver in which the attacker strikes the enemy all along his front by the most direct route. The frontal attack is used to overrun and destroy or capture a weaker enemy in position or to fix an enemy force in position in support of a main attack conducted elsewhere. Subordinate units of a force conducting a frontal attack are not restricted to be on line or conducting frontal attacks themselves. During a frontal attack, the commander seeks to create or take advantage of conditions that will permit a more decisive penetration or envelopment of the enemy defensive positions. The frontal attack is the form of maneuver most often employed by the rifle company and platoon. (See fig. 24.)

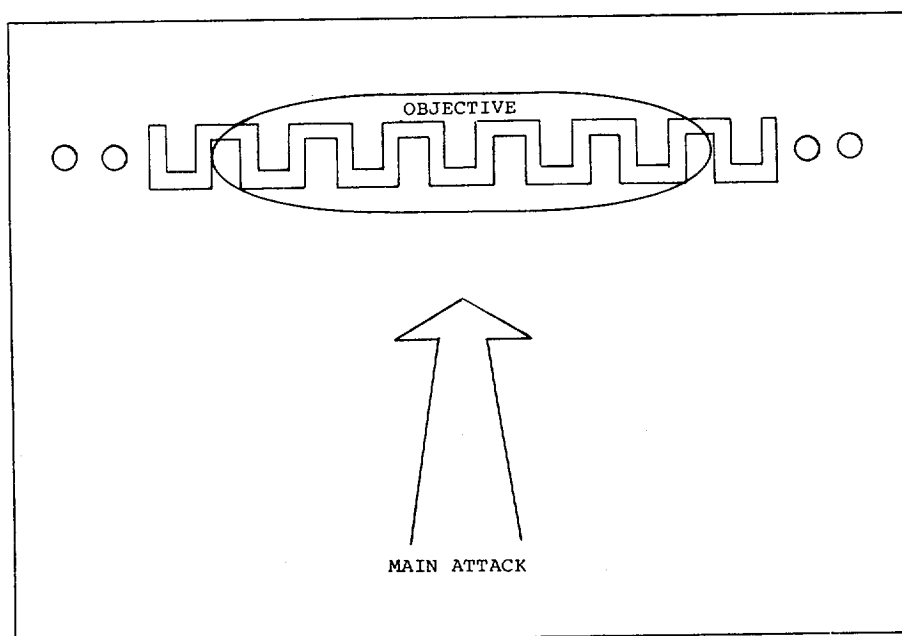

Figure 24.--Frontal Attack.

Par. 3105

FMFM 6-4

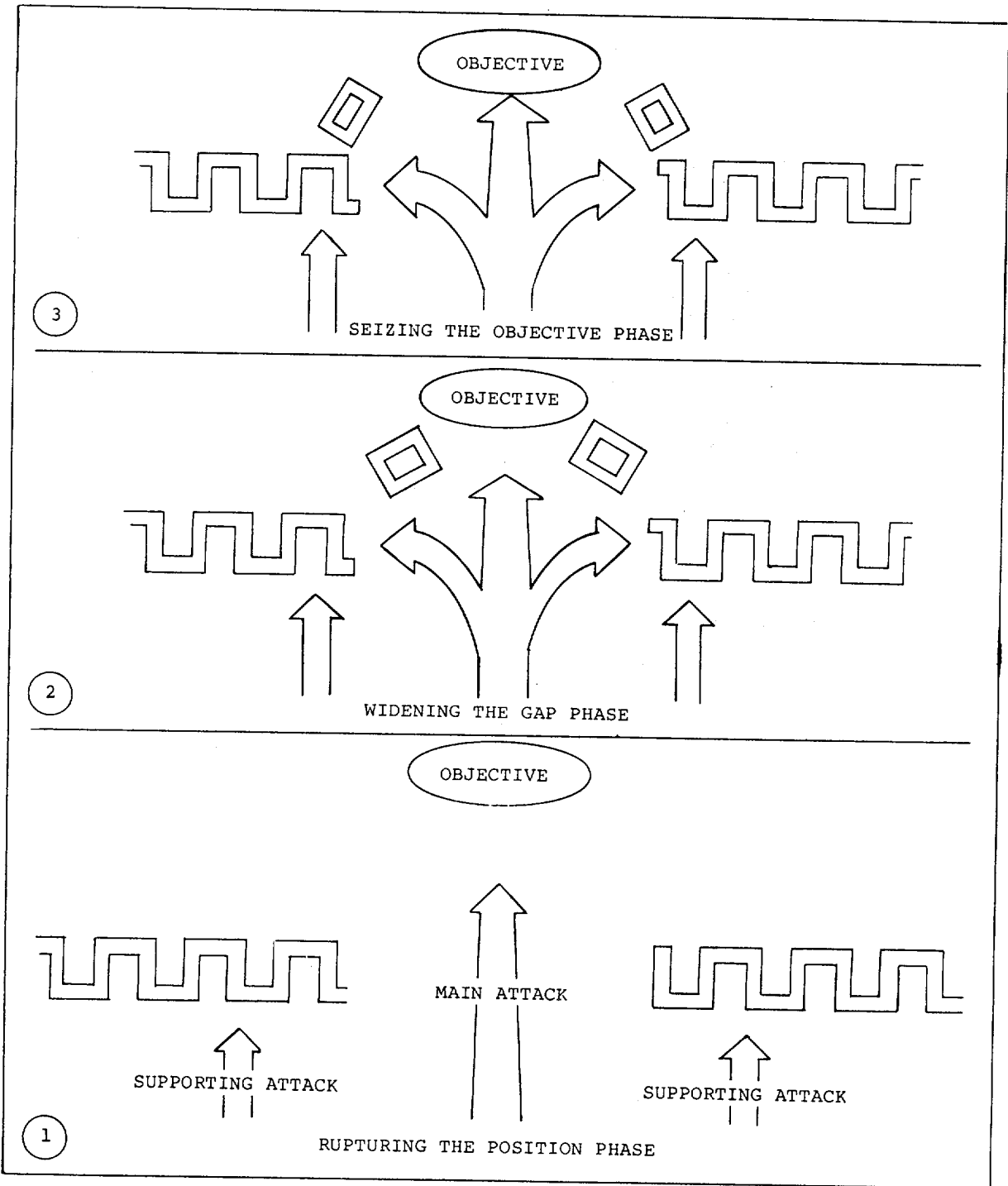

Figure 25.--Three Phases of the Penetration.

c. In the penetration, a powerful main attack passes through the enemy defensive positions on a narrow front while one or more simultaneous supporting attacks exert pressure on a broad front to deceive the enemy and hold him in place. The penetration begins with rupturing the enemy defensive positions to make a gap through them to the enemy rear. The next step is the widening of the gap to permit the employment of additional forces. The final step is the seizing of objectives in the enemy rear that destroy the continuity of the enemy defense. With the employment of helicopters, a penetration may be accomplished by landing a helicopterborne force behind the enemy defensive positions and rupturing them from the rear. While a planned penetration is seldom feasible for a rifle company or platoon, a frontal attack may develop into a penetration. The rifle company and platoon may also take part in a penetration by a larger unit. (See fig. 25.)

d. In the envelopment, the enveloping attack passes around or over the main enemy defensive positions to seize objectives in the enemy's rear. The envelopment causes the enemy to fight in two or more directions, and its success depends on surprise, mobility, and the ability of supporting attacks and deception to hold the enemy in place. In the ground envelopment, the enveloping attack is directed against an assailable flank, a flank that can be circumvented without fighting a major engagement. When committed, the enveloping attack moves rapidly and avoids strong enemy defensive positions to seize assigned objectives in the enemy rear. A vigorous supporting attack holds the enemy in position and prevents him from maneuvering against the enveloping attack. The reserve normally follows the enveloping attack, but the commander is alert to exploit success of the enveloping or supporting attacks. Fire support is used to help hold the enemy in place and prevent his maneuvering against the enveloping attack. Objectives for the enveloping attack are picked to subject the enemy to destruction in position from the flank or rear. Helicopters, which provide the means of delivering fresh troops on or near assigned objectives, may be used to make a vertical envelopment over the main enemy defensive positions. Both the rifle company and platoon are capable of conducting the single envelopment. (See fig. 26.)

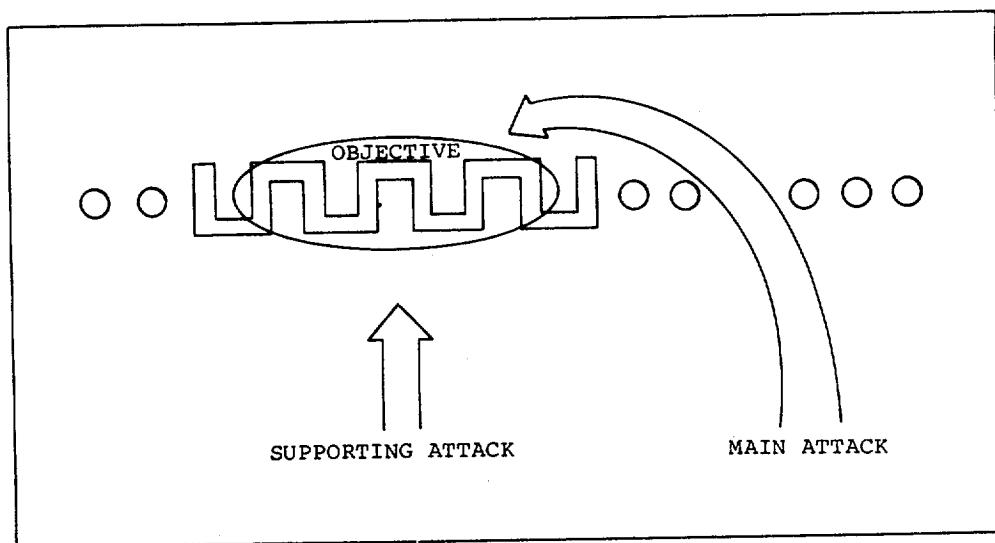

Figure 26.--Envelopment.

Section II. MOVEMENT TO CONTACT

3201. GENERAL

a. Movement to contact is a tactical movement to establish initial contact with the enemy or to reestablish contact which has been lost. It is terminated when physical contact with the enemy is gained or when the march units go into assembly areas to prepare for combat. The unit commander conducting the movement organizes his unit to provide for:

- (1) Rapid movement.
- (2) All-around security.
- (3) Retention of control of the main body.
- (4) Ease of control.

b. The rifle company may conduct the movement to contact as part of the infantry battalion or, in some instances, as an independent force. In either case, the movement may be an uncovered movement or a covered movement.

(1) An uncovered movement to contact is made by the leading element of a force with the mission of gaining or regaining ground contact with the enemy. Information of the enemy and terrain may not be available from friendly ground units to the front. Reconnaissance by the advancing forces must be intensified to compensate for a lack of security elements provided by other forces.

(2) A covered movement to contact is made when adequate security is provided by other forces. A unit usually makes a covered movement to contact for the purpose of relieving or operating with forces already in contact with the enemy.

c. A movement to contact may be made utilizing any means of mobility but generally adopts some form of march column. In conducting a march, certain preparations must be made to ensure that the movement takes place with minimum confusion and delay.

(1) A warning order containing the below information should be issued to allow subordinate units maximum time for preparation:

- (a) Units to be moved.
- (b) Method of movement.
- (c) Time the movement is to start.
- (d) Destination.
- (e) Purpose of the movement.

(2) A reconnaissance of the prospective route is undertaken when the situation and time available permit. The march column commander

prescribes the composition of the reconnaissance party and the extent of the reconnaissance effort. Both depend upon the method of movement, the size of the march column, the enemy situation, and the subsequent missions of the units moved. Some of the purposes of the reconnaissance are to:

- (a) Gain detailed information concerning the characteristics of the route, its length, actual or potential obstacles, and a realistic estimate of the rate of advance permitted by the route.
- (b) Determine the number of guides, guards, and direction markers required and the locations at which they should be posted.
- (c) Determine the amount of engineer support required to make the route passable.
- (d) Locate suitable bivouacs, if necessary.

(3) A march order initiating the movement is issued. It may consist of a short oral briefing followed by a concise, oral order designating the route, destination, schedule, rate of march, formation, and other control measures not covered by unit SOP, or the complexity of the movement may require a more formal treatment of the order in written form which includes overlays, maps, and march tables. The rifle company commander employs the oral march order exclusively whether the company comprises a march element of a larger march column or whether the rifle company commander is the march column commander. Annotations on maps and/or overlays are used to fix march routes.

3202. ROUTE COLUMN

a. General.--When contact is remote, administrative considerations govern and the movement is made in route column. Administrative grouping of foot march elements and administrative loading of troops and equipment into vehicles for motor, rail, helicopter, or other transportation are effected to take advantage of rapid movement and ease of control. The route column regroups tactically when the column commander's estimate of the probability of contact changes from remote to improbable. Units may move by various means over different routes. For instance, a battalion might proceed by rail and its organic motor transport may proceed by one or more roads. As a general rule, the infantry battalion will move on one axis in the movement to contact.

b. Administrative Foot March.--An administrative foot march is made when no enemy interference except by aircraft or long-range weapons is anticipated. Units are administratively grouped for ease of control and speed of movement. Security elements are negligible or nonexistent. The normal formation for a foot march is a route column with one file moving on each side of the road, but it may be a column of threes or fours. The march column commander designates the formation.

(1) Organization for the March.--A command executing a march is basically organized into march units and, as necessary for control, into serials or march columns.

(a) A march unit is a unit of command which moves and halts at the command of a single commander. The march unit usually corresponds to one of the smaller units such as a platoon or company.

(b) A march serial consists of one or more march units organized under the senior officer and given a specific numerical or alphabetical designation to facilitate control. The march units of a serial normally possess the same march characteristics and are governed by the same set of instructions. A serial is usually a battalion or larger unit, but may be a company if the battalion is marching alone.

(c) A march column is composed of the elements of a command moving over the same route. To facilitate control, a column commander is designated. The order of march within the march column is dependent upon the mission, terrain, and probable order of commitment of subordinate units. A column is normally a regiment or larger unit, but may be a battalion if it is marching alone.

(2) Control and Coordination.--The column commander establishes initial control of the march by designating control measures in his march order. To facilitate control, the commander provides for advance and quartering parties, guides, marking of routes, and traffic control. Control measures normally used are described below:

(a) The start point is any designated place at which a column or element thereof is formed by the successive arrival of its various subdivisions and comes under the control of the commander ordering the movement.

(b) The release point is a clearly defined point on a route at which specified elements of a column revert to the command of their respective commanders.

(c) Other critical points may be selected. A critical point is a selected point along the route of march used for reference in giving instructions or any point along the route of march where interference with the troop movement may occur.

(d) A time is prescribed at which the head or tail of the column is to pass the start point and critical points.

(e) Other control measures are used and include the order of march, locations of assembly or bivouac areas, and command posts, as well as communications to be employed on the march.

(3) March Procedures.--Experience has taught that certain march procedures contribute to the well being of the individual Marine and, as a result, to unit proficiency. These procedures include the following:

(a) The normal pace is 30 inches. A pace of 30 inches and a cadence of 106 steps per minute will establish a correct rate of march for most march columns. In order to establish the correct rate, a pace setter is selected. The pace setter is an experienced individual, carrying the same load as the majority of the men, who marches from 4 to 10 meters in advance of the column under the supervision of the officer marching at the head of the column. The pace setter's primary duty is to maintain the rate of march prescribed by the column commander. The proper rate of march is established as the pace setter adjusts his pace and cadence to obtain the prescribed rate. Minor changes in the rate at the head of the column become greatly magnified by the time they are reflected in the rear, resulting in an accordion effect through the column. To reduce the accordion

effect, gradual changes in pace and cadence rather than abrupt alterations should be used in adjusting the rate of march. The order of march should be rotated periodically so that the same units and individuals do not always march at the rear. The most heavily laden units march near the head of the column.

(b) Distances between units and individuals in the march units should be sufficient to promote march efficiency and to minimize the effect of accordion action. When marching on roads, the distances between individuals may vary from 2 to 5 meters to provide dispersion and sufficient space for marching comfort. In an administrative foot march, the distances between companies and platoons may vary from a few meters through the column to 100 meters between companies and 50 meters between platoons to permit vehicles to pass.

(c) Night marches are characterized by closed formation, more difficult control, and slower rates of march. March routes require more detailed reconnaissance and marking. Control is increased primarily by reducing distances between individuals and units. Guides may be increased over those normally used, depending upon the route selected.

(d) During a march, halts are made at regular intervals to rest personnel and to adjust equipment. Halts are regulated by the march order. All units in the column should be halted at the same time. Company and platoon commanders inspect their troops and equipment during halts. Under normal conditions, a 15-minute halt is made shortly after the march commences to adjust equipment. Following the first halt, a 10-minute halt is made after each 50 minutes of marching.

(4) Security.--In the administrative foot march, the probability of ground contact with the enemy is considered remote. Passive security measures against ground attack and both passive and active measures against air attack are taken in planning the march. Passive measures include the use of concealed or protected routes, night marches, increased interval between march elements, and dispersion when attacked. Active measures include the designation of air sentinels to give warning and the use of organic and attached weapons in defense.

c. Administrative Motor March.--An administrative motor march is the controlled movement of troops in motor vehicles when ground contact with the enemy is not anticipated. The march may be conducted using any type vehicles including tanks, trucks, or assault amphibious vehicles, but is generally performed utilizing a 2½-ton, 6x6 cargo truck. In the administrative march, troop units and their equipment are loaded into the vehicles in administrative groupings. Those passive and active security measures against ground and air attack described for foot marches generally apply to the motor march.

(1) Types of Motor March.--There are three basic types of motor marches which may be utilized in transporting units administratively in the route column:

(a) Close Column.--A close column is one in which the elements are formed as compactly as practicable. Vehicles follow at the least distance which safety, traffic conditions, and the tactical situation permit. This type of column is adopted when a road net must be used to its maximum capacity, when passing through congested areas where maximum control

is required, or for night marches under blackout conditions when visual contact must be maintained between vehicles.

(b) Open Column.--An open column is one in which the elements are widely separated for passive defense and driving safety. Intervals between vehicles should be large enough to permit overtaking vehicles to enter the column when necessary. This type is the best possible compromise between the requirements for maximum route use and tactical dispersion between vehicles. Column control is not as effective as in the close column, but far superior to that of infiltration. Open column marching also reduces fatigue and dust conditions.

(c) Infiltration.--Infiltration is accomplished by dispatching individual vehicles or small groups of vehicles over a specified route, thus giving the march the appearance of casual traffic. This type march reduces interference with other traffic to a minimum. It is used primarily to provide maximum secrecy, deception, and dispersion. Much less control is possible and drivers must be given extensive briefing as to routes, speeds, and traffic restrictions.

(2) Preparation for the March.--Preparation for a motor march is similar to that for a foot march. However, since motor marching is considerably more complex and sensitive to route conditions than is foot marching, more preliminary planning is normally required prior to the execution of a motor march.

(a) A warning order is issued. The purpose and format of this order are similar to the foot march warning order. Somewhat more lead time is given in order to prepare the vehicles for movement.

(b) The amount of reconnaissance effort required depends primarily upon the availability, detail, and reliability of road maps of the area to be traveled. In training areas within the United States, up-to-date and accurate road maps with complete road information are normally available. Therefore, in these areas, the route reconnaissance effort may consist of simply driving the proposed route to verify map mileage figures, to locate any recent detours, and to check proposed rest halt locations on the route for suitability. In combat zones, road information of the rear areas may be comparable to that found in the United States; while in the forward combat area, such information may be so limited that a detailed and extensive route reconnaissance will be required.

(c) As in the foot march, a march order is issued for movements of personnel and equipment from one location to another in a stated length of time.

(3) Entrucking

(a) An entrucking point is the location where a convoy or column, or element thereof, halts for the boarding of personnel. Normally, it is easier to move trucks than troops and their equipment. Therefore, an entrucking point should be selected which requires a minimum of foot marching by the troops. The entrucking point should afford a suitable area for the method of entrucking used and should have ready access to the proposed motor march route. There are many methods of entrucking. These range from detailed preloading plans covering the exact personnel and equipment for each truck, and the exact spot within the entrucking point that each

truck will be loaded, to the hasty move where each truck is loaded in rotation with no previous planning. The method to be used depends on the time available, loading conditions, and the troop leaders' ingenuity.

(b) Individual equipment such as packs and bedding rolls should be loaded aboard the same trucks as the troops in order to avoid loss and confusion in unloading. When trailers are available, they should be used for baggage and equipment and for loading mechanical mules when the march is to be conducted over hard surfaced roads. The mechanical mules are not designed for extensive operation on hard surfaced roads.

(4) Execution of the Motor March.--There are two methods of executing a motor march:

(a) In the single lift method either the open or closed column or infiltration may be used.

(b) The shuttling method is one in which the same vehicles make repeated trips to move troops and supplies.

(5) Halts.--Halts are made for rest, personal comfort and relief, refueling, messing, allowing other traffic to pass, checking vehicles and equipment, etc. Halts may be prescribed by higher echelon orders or by route regulating instructions. When the choice is left to the column commander, a halt of 15 minutes should be made at the end of the first hour. Thereafter, a 10-minute halt every 2 hours is advisable. One-half hour to an hour is normally prescribed for messing and refueling halts.

3203. TACTICAL COLUMN

a. General.--When the column commander's estimate of the probability of contact with the enemy changes from contact remote to contact improbable, he becomes more concerned with the security of the column. Subordinate units within the column are tactically grouped and adequate security to the front, flanks, and rear of the column is provided. If available, helicopters provide transportation for positioning, relieving, and advancing security elements and for aerial observation. The tactical column normally ends in the occupation of an assembly area in which preparations for an attack are made. During the movement, the enemy situation may cause a deployment into an approach march formation or attack formation from the tactical column.

b. Tactical Foot March.--The formation for conducting a tactical foot march is a staggered column of twos. The column is divided into a main body and security elements. With the exception of its tactical organization, the tactical march is conducted as generally described for the administrative foot march in subparagraph 3202b. Figure 27 shows the organization for a typical tactical march.

(1) Main Body

(a) The bulk of the forces comprising the column are tactically grouped in a column which advances on the assigned axis or route of march.

(b) The column formation for the main body permits ease of control and reasonably secure and rapid movement of the force.

(c) The main body provides its own flank security.

(2) Advance Guard

(a) An advance guard is a security detachment that precedes and protects the main body of the march column when it is in a tactical march formation. The advance guard provides for the uninterrupted

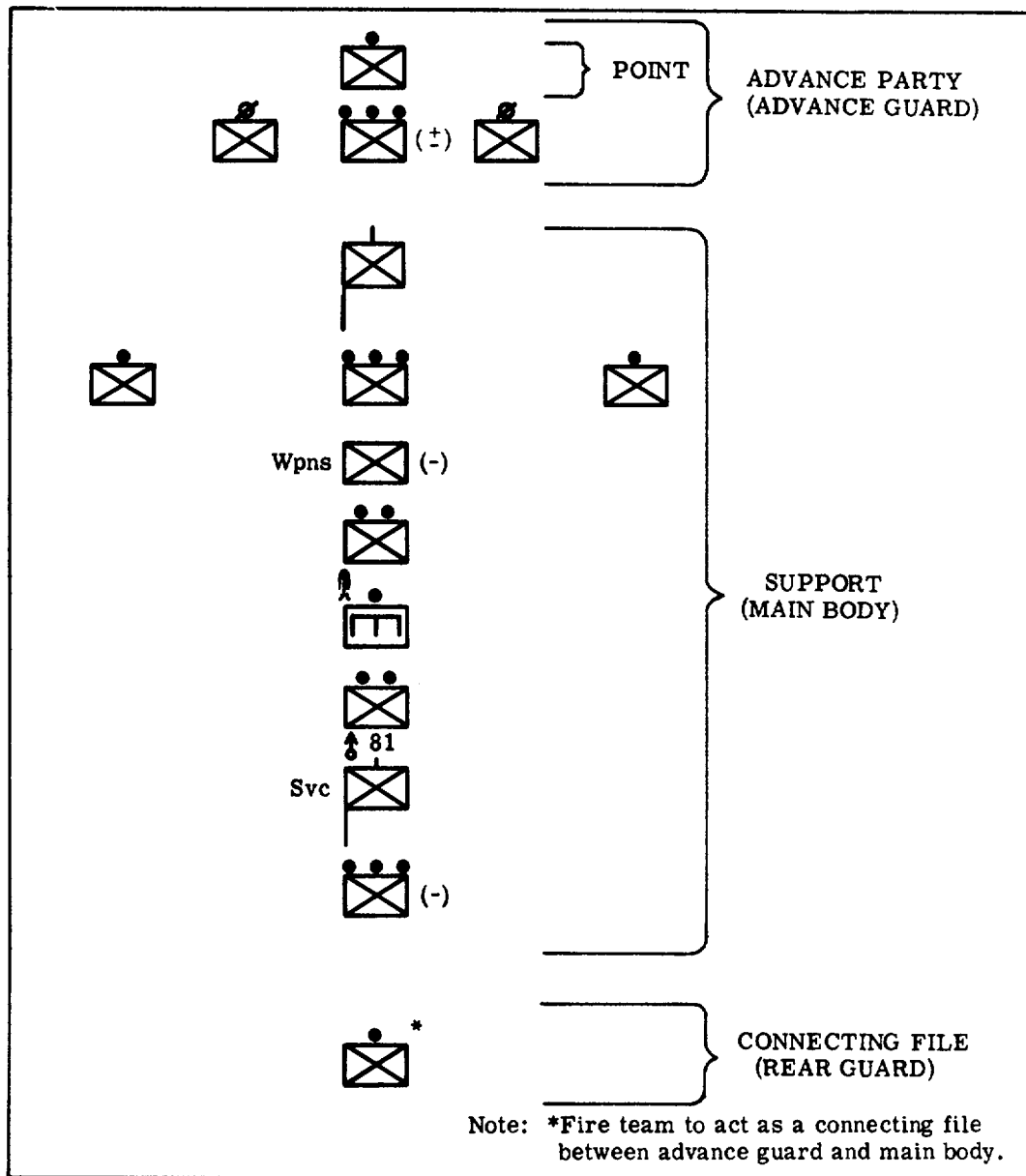

Figure 27.--A Typical Tactical March Column.

advance of the main body. Should the enemy be encountered in such strength as to require deployment of the main body or a portion of it, the advance guard covers the deployment.

(b) The advance guard company is subdivided from front to rear into a point, an advance party, and a support. Flank patrols are dispatched by both the advance party and the support to protect the flanks of their respective elements during the march.

(c) The advance guard for a rifle company marching alone is composed of one rifle platoon, acting as advance party. The advance guard for the rifle company does not contain a support.

(d) The advance guard function for a rifle platoon moving alone is performed by a squad or fire team size security element which precedes the platoon.

(e) The support is the maneuvering element of the advance guard. It comprises the largest part of the advance guard, reinforces the actions of the advance party, and furnishes patrols to protect its flanks.

(3) Advance Party

(a) The advance party is sent forward by the advance guard company and constitutes the reconnoitering element for the support. It accomplishes its security mission by providing and supporting a point and by furnishing its own immediate flank security.

(b) The advance party is generally a force of reinforced platoon strength which drives back enemy patrols and eliminates minor resistance. If enemy strength is such that the advance party is unable to destroy or dislodge him, the advance party covers the deployment of the support.

(4) Point.--The point is a squad size detachment sent forward by the advance party to give rear elements warning of enemy activity to the front. The point confines its activities to the axis of march in reconnoitering to the front and immediate flanks. It engages and drives back small, hostile parties encountered on the march route. When larger enemy units are encountered, the point develops the situation until stopped and covers the deployments of the larger units within the advance guard.

(5) Rear Guard.--The rear guard consists of a rear point and the rear party. The rear guard has no support and is large enough to protect the rear of the tactical column. It relieves the main body of the necessity for engaging in battle, protects the main body, and preserves its freedom of action. The rear guard for a rifle company marching alone normally consists of a rifle squad acting as rear point.

(6) Flank Guards

(a) Each major subdivision of the march column establishes security detachments which protect the flanks of the unit while on the march. A flank guard moves abreast of the main body of the march column and on a route parallel to it. It occupies successive key terrain features covering the routes of hostile approach into the march route of the column.

(b) The flank guard prevents the enemy from bringing effective flanking fire or observation to bear on the main body. Its mission requires it to engage the enemy as necessary. Decisive engagements should be avoided, but the flank guard is expected to fight as long as necessary to prevent exposure of the march column.

(c) The flank guard must move rapidly over greater distances in shorter periods of time than the march column. Often the terrain over which the flank guard moves is much more difficult than that of the march route taken by the column. Frequent relief of the flank guard is necessary. Relieving units station themselves ahead of the flank guard and relief is effected as the flank guard passes through.

(d) The flank guard regulates its movement on the rate of march of the main body. There are three basic techniques of movement which may be employed by the flank guard. The technique selected is dependent upon the rate of march of the main body, the enemy situation, and the terrain.

1 When the main body moves with a slow rate of advance, the flank guard advances by alternate bounds and occupies blocking positions dominating likely avenues of approach into the flank.

2 When movement of the main body is interspersed with frequent, short halts, the flank guard advances by successive bounds and occupies positions blocking avenues of approach into the flank.

3 A constant rate of advance by the main body normally requires the flank guard to advance by continuous movement in an appropriate combat formation.

(7) Security During Halts.--Security of the main body during halts in the march is ensured by the employment of security elements and march outposts.

(a) Consistent with the terrain, the advance guard, rear guard, and flank guards continue to perform their security missions by any combination of the following:

1 Occupying blocking positions located on dominant terrain which permit control of the avenues of approach into the halted main body.

2 Patrolling.

3 Establishing march outposts.

(b) March outposts are observation posts and patrols established for the protection of a command during a halt in a march. The march column commander further augments the security arrangements described in subparagraph (7)(a) by establishing march outposts as required to ensure the security of the command.

(8) Connecting Elements

(a) Contact between the various elements of the tactical march column is the responsibility of the larger unit. The commanders of

larger units establish connecting files or connecting groups to maintain contact with small units dispatched by them in the performance of security missions.

(b) Connecting files are individuals who march in the gaps between security elements and the larger units establishing them to maintain contact and relay messages and information between the two. When small units are charged with the same responsibilities, they are referred to as connecting groups. Connecting groups are usually of fire team size. They are reconstituted after each action involving their parent unit since they rejoin the latter on its commitment.

(c) The primary mission of a connecting file or group is to report the location and situation of the unit with which the file or group is maintaining contact. It may have a secondary mission to report information of its parent unit to the commander of the unit with which it is maintaining contact.

(d) Flank connecting files or groups that maintain contact with units guard or patrol on the flanks. Formation for flank connecting elements permits lateral extension. Connecting files use extended intervals between individuals. Connecting groups use the wedge or skirmishers right (left) formation to maintain contact between units.

(e) Individuals or fire teams used to maintain visual contact between elements in the tactical column are called column connecting files or groups. Connecting elements within the column, regardless of their size, normally use a column formation. They expand and contract this formation as necessary to maintain contact. Visual contact is maintained with the units being connected and within the connecting element itself.

c. Tactical Mechanized March.--Ordinarily, the rifle company conducts mechanized marches as part of the infantry battalion when the battalion moves as a mechanized column marching alone or as part of larger forces. The rifle company may move as a separate mechanized or motorized column when it is properly reinforced and the situation dictates its employment in rapid movements requiring independent action for short periods of time.

(1) Organization

(a) A force of the type required to conduct a mechanized march is task organized and contains the combat, combat support, and combat service support elements necessary to accomplish the mission. The force is a balanced task grouping of tanks and infantry with trucks and LVT's for mounting the infantry.

(b) The mechanized tactical march is organized into a main body, advance guard, and other security elements in the same manner as to the tactical foot march. The security elements are vehicle or helicopter transported and are deployed ahead of and to the flanks of the main body. The majority of the tanks in the task organization are well forward in the formation.

(c) The march column is organized to sustain rapid and uninterrupted movement. The bulk of the combat power is retained in the main body during movement to permit its rapid employment on contact. Care is taken to ensure that tactical units in the main body are mounted in

vehicles of similar cross-country mobility characteristics. If avoidable, a rifle company in the main body should not be partially mounted in assault amphibamphibious vehicles and partially in trucks as the flexibility of the company's employment is greatly reduced. Security elements, particularly the point and flank guard units, are mounted in light vehicles.

(d) The advance guard is a highly mobile task organization of tanks and mechanized infantry. Other support may be included in its task organization such as engineer and antitank units. The advance guard task organization should provide a concentration of firepower with a sustained combat capability, grouped under one commander. The flank protection for an advance guard unit is usually provided for by flank guard units of the main body. Figure 28 is a diagram of a typical advance guard rifle company task organization.

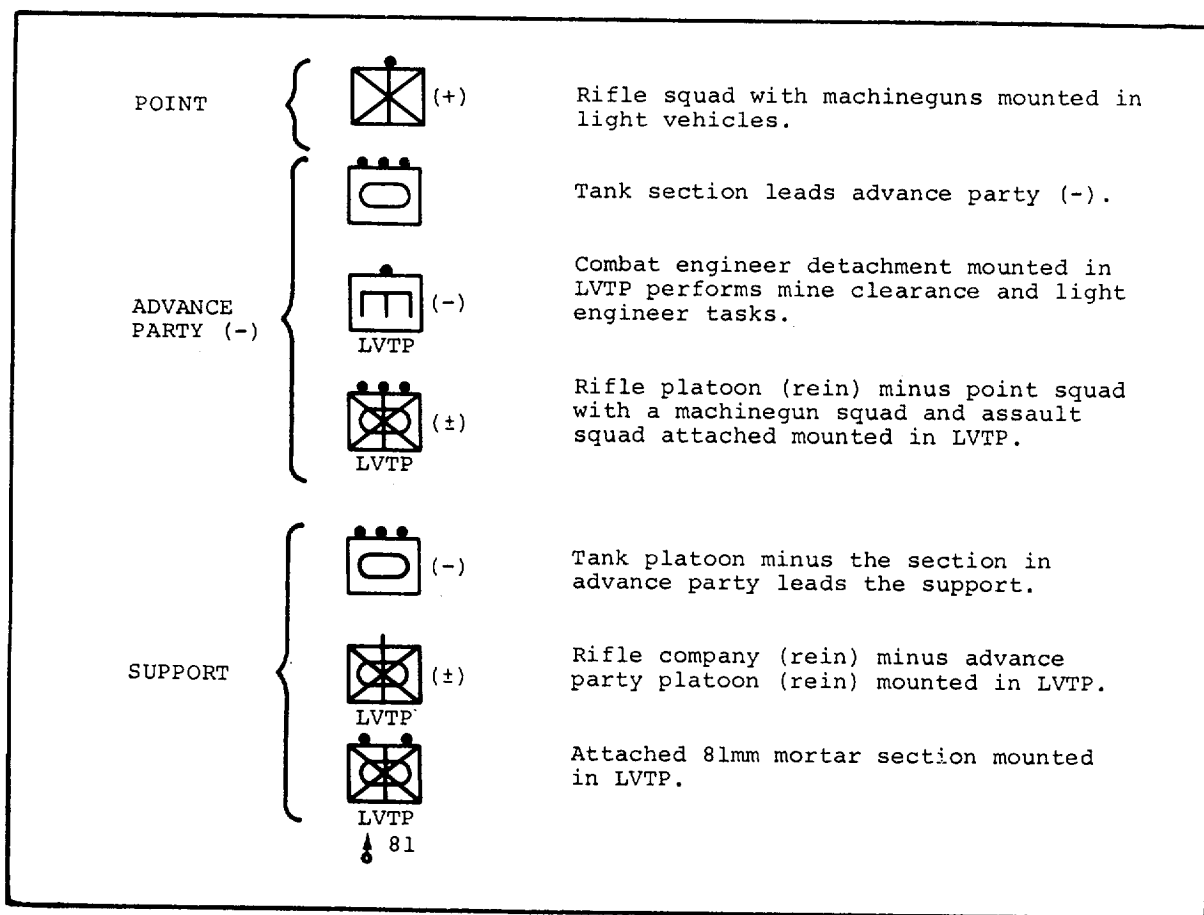

Figure 28.--A. Typical Advance Guard Task Organization for Mechanized March.

(e) The advance party is a task organization of infantry, tanks, combat support, and combat service support elements necessary to provide the infantry mobility. The advance party establishes a point, usually mounted in light vehicles, which precedes the advance party by a short time interval. When the availability of vehicles or enemy activity does not permit mounting the point in light vehicles, the point precedes the advance party in other vehicles. The point and advance parties normally do not deploy elements to the flanks, but rely on observation and reconnaissance by fire for security.

(f) In some situations, the infantry battalion may be organized for mechanized movement on two axes. The battalion usually moves in two parallel columns within supporting distance of each other. Reconnaissance elements range ahead of the columns at considerable distances. Mechanized task organizations are formed to provide separate advance parties for each column. Contact is maintained between columns. Both columns are covered by a common rear guard.

(2) Conduct of the March

(a) The march moves as rapidly as the situation permits. The various echelons of the advance guard take rapid and aggressive offensive action to develop the situations encountered during the march.

(b) The point moves by bounds or alternate bounds along the march route in advance of the remainder of the advance party. The point may conduct extensive reconnaissance by fire with machineguns mounted on vehicles and other automatic weapons to develop the situation rapidly when the enemy is encountered or when his location is suspected.

(c) The advance party, minus the units comprising the point, follows the point at a time interval of about 2 minutes when the point is lightly mounted. Tanks are rarely employed with the point, but follow the point as leading element of the advance party in most cases. Rifle elements may ride the tanks as close-in protection when the column is extended and/or the terrain is close. The remaining rifle elements of the advance party are tactically grouped and mounted in assault amphibious vehicles which follow the tanks.

(d) The support follows the advance party at a time interval of about 5 minutes. It is task organized and tactically grouped with the tanks well forward. The tanks are closely followed by rifle units tactically mounted in assault amphibious vehicles.

(e) The main body follows the advance guard at a prescribed time interval and is mounted in assault amphibious vehicles or trucks. Tanks are well forward in the column.

(f) The rear guard follows the main body and is usually a task organization of tanks and mechanized infantry trailing the main body by a prescribed time interval. Its task organization is similar to the advance party. A rear point is established which follows the rear guard by bounds from one point of good rearward observation to the next.

(g) Flank guards are mounted in light vehicles and travel assigned routes parallel to the route of march for the main body. They are normally established by the march column commander and provide flank

security for the entire march column including the advance and rear guards. In difficult terrain when parallel routes for light vehicles are not available, the flank guards may be positioned, relieved, and advanced by employing helicopters. The helicopterborne positioning, relief, and advancement of flank guards is scheduled and controlled by the march column commander.

d. Tactical Motorized March

(1) Formation.--When the enemy's ability to seriously impede movement on the road net is considered slight and contact is improbable, a motorized column may be formed to conduct a tactical march.

(2) Organization

(a) The organization of the motorized march is very similar to that of the mechanized march except that the advance guard, the entire main body, and the rear guard are mounted in light vehicles.

(b) The vehicles comprising the entire motorized march column or vulnerable portions of the column may be hardened to provide additional protection against small arms fire. Additionally, troop elements mounted in each vehicle of the column or mounted in vehicles whose positions are particularly vulnerable may be tactically arranged within vehicles to defend against enemy ambush. Appendix D to this manual describes procedures for hardening motor vehicles and for tactically arranging the troops mounted in a vehicle to take effective counterambush action.

3204. APPROACH MARCH

a. General.--As the column commander's estimate of the probability of contact with the enemy changes to contact imminent, the march column increases its readiness for combat. Units in the main body are task organized and tactically grouped for immediate deployment from the march column. Tactical considerations in the organization of the column outweigh other considerations. Continued movement forward in the tactical column may develop the enemy situation sufficiently for the main body to deploy directly from the column and seize selected objectives, or the enemy situations may be developed so as to result in a partial deployment from the column. The partial deployment increases the march column's readiness for combat as it approaches a location from which to attack decisively. For example, the battalion is marching along in an uncovered movement to contact. The battalion commander may further increase his readiness for combat by ordering the advance guard to continue the march in a deployed, combat formation. The main body follows the deployed company in column to a location from which the battalion initiates the attack.

b. Rifle Company.--The rifle company may participate in the approach march as part of the battalion or as an independent force.

(1) When the rifle company marches as part of the battalion, it may be employed as the advance guard or as part of the main body. In employing the rifle company as part of the battalion main body, the considerations are essentially those of the tactical march.

(2) A rifle company employed as the advance guard in the approach march may conduct itself as described in paragraph 3203 for advance guards, or it may move in a deployed combat formation. The battalion

commander may elect to increase his readiness for combat by deploying one or more companies to protect the further forward movement of the column. In such cases, the advance guard company continues to move forward completely prepared for combat in a fully deployed combat formation. The formation selected is largely determined by the area which must be cleared to ensure the uninterrupted advance of the march elements following in trace. Leading platoons, employing scouting elements and utilizing cover and concealment, clear assigned areas of the march axis.

(3) A rifle company conducting an independent, uncovered movement to contact or moving independently from the battalion assembly area to the company attack position or line of departure may employ approach march techniques. When contact is imminent and the rifle company is moving independently, the company usually moves in column behind a rifle platoon deployed for combat. In short movements from the assembly area to the attack position or line of departure, the company may move in its initial attack formation.

c. Rifle Platoon.--When the rifle platoon is part of a deployed advance guard, it moves forward completely prepared for combat and fully deployed. The formation selected is determined by the area to be cleared, the nature of the terrain, and the rate of movement desired. A leading platoon utilizes maximum cover and concealment in its movements. Scouting elements move at the limit of visibility and within supporting distance of the forward squads to prevent surprise. These elements are under direct control of the rifle platoon commander.

3205. ASSEMBLY AREA

a. General.--The covered movement to contact normally terminates in the occupation of an assembly area. The assembly area is an area in which a command is assembled preparatory to further action.

b. Characteristics.--Desirable characteristics of an assembly area include the following:

- (1) Cover and concealment.
- (2) Adequate space for the dispersion of troops, equipment, and vehicles.
- (3) Ease of access and egress.
- (4) Adaptable to antimechanized defense.
- (5) Located beyond the effective range of enemy mortar and light artillery fires when possible.

c. Organization.--The rifle company occupies an assembly area which is normally designated by the battalion commander. In the assembly area, elements of the company are dispersed to the maximum practicable extent to reduce vulnerability to enemy fires. The company takes maximum advantage of the available cover and concealment. Camouflage discipline is employed. Elements of the company are dispersed to permit all-around defense, and security is posted to prevent surprise ground or air action. Antitank weapons, obstacles, and roadblocks are positioned to provide protection against armor.

d. Preparations.--In the assembly area, preparations for combat are commenced. They are as complete and detailed as the available time and the situation permit. Preparations include the following:

- (1) Weapons are checked, vehicles fueled.
- (2) Additional ammunition is drawn and distributed.
- (3) Equipment not required in the operation is staged for later disposition.
- (4) Special equipment needed for the operation is drawn and issued.
- (5) Troops are allowed to rest to the maximum extent possible consistent with security and preparations for the attack.
- (6) Maps or map substitutes are issued.
- (7) Units attached for the operation may join the command.
- (8) Communication equipment is checked for serviceability and frequencies and call signs are issued.
- (9) Specialized training and rehearsal may be conducted.

Section III. DAYLIGHT ATTACK

3301. GENERAL

a. The attack is characterized by fire, maneuver, and close combat. The purpose of this section is to provide the rifle company commander and his subordinate commanders with guidance in planning for, executing, and controlling the fire, maneuver, and close combat inherent in the attack of the rifle units during daylight.

b. When the daylight attack is planned, the battalion commander assigns missions to the rifle company, usually expressed in terms of terrain objectives to be seized, control measures, and designation of attached and/or supporting units.

(1) The rifle company may be all or a part of the main attack, the supporting attack, or the reserve of the infantry battalion. The company may be foot mobile, mechanized, or helicopter transported in the attack. When it is a reserve element of the battalion, it may utilize any form of mobility.

(2) The rifle platoon normally attacks as part of a coordinated company action. When appropriately reinforced, it may be employed for short periods of time as an independent force. Using the fires of organic, attached, and supporting weapons to neutralize the enemy, the platoon maneuvers its squads to positions from which to assault the enemy.

3302. TACTICAL CONTROL MEASURES

Infantry battalion, rifle company, and rifle platoon commanders control the maneuver elements of their respective units in the attack by utilizing required control measures. To give subordinate echelons maximum freedom of action, the minimum control measures necessary to ensure that the attack progresses in the desired manner are prescribed. Some of the more frequently used control measures are described below and illustrated in figure 29.

a. Zone of Action.--A zone of action is a tactical subdivision of a larger area the responsibility for which is assigned a tactical unit. It is designated by boundaries on one or both flanks, a line of departure, and a final objective. A unit is free to maneuver and fire throughout its assigned zone in accomplishing its mission. When the commander of a unit desires to enter or fire into the zone of an adjacent unit, he coordinates the matter with the adjacent unit commander and notifies the next higher commander of the action. A unit is not required to clear enemy resistance from its assigned zone of action unless specifically directed. Enemy resistance which does not jeopardize the accomplishment of the unit's mission may be bypassed, provided such action is promptly reported to the next higher commander. When a commander issues oral orders unaccompanied by overlays, the zone of action is described as a frontage measured along the line of departure and boundaries designated along terrain features or the flank of an adjacent unit. A zone of action should include at least one adequate approach to the objective.

b. Boundaries.--Boundaries defining a zone of action extend forward only as far as the particular situation requires and to the rear of the line

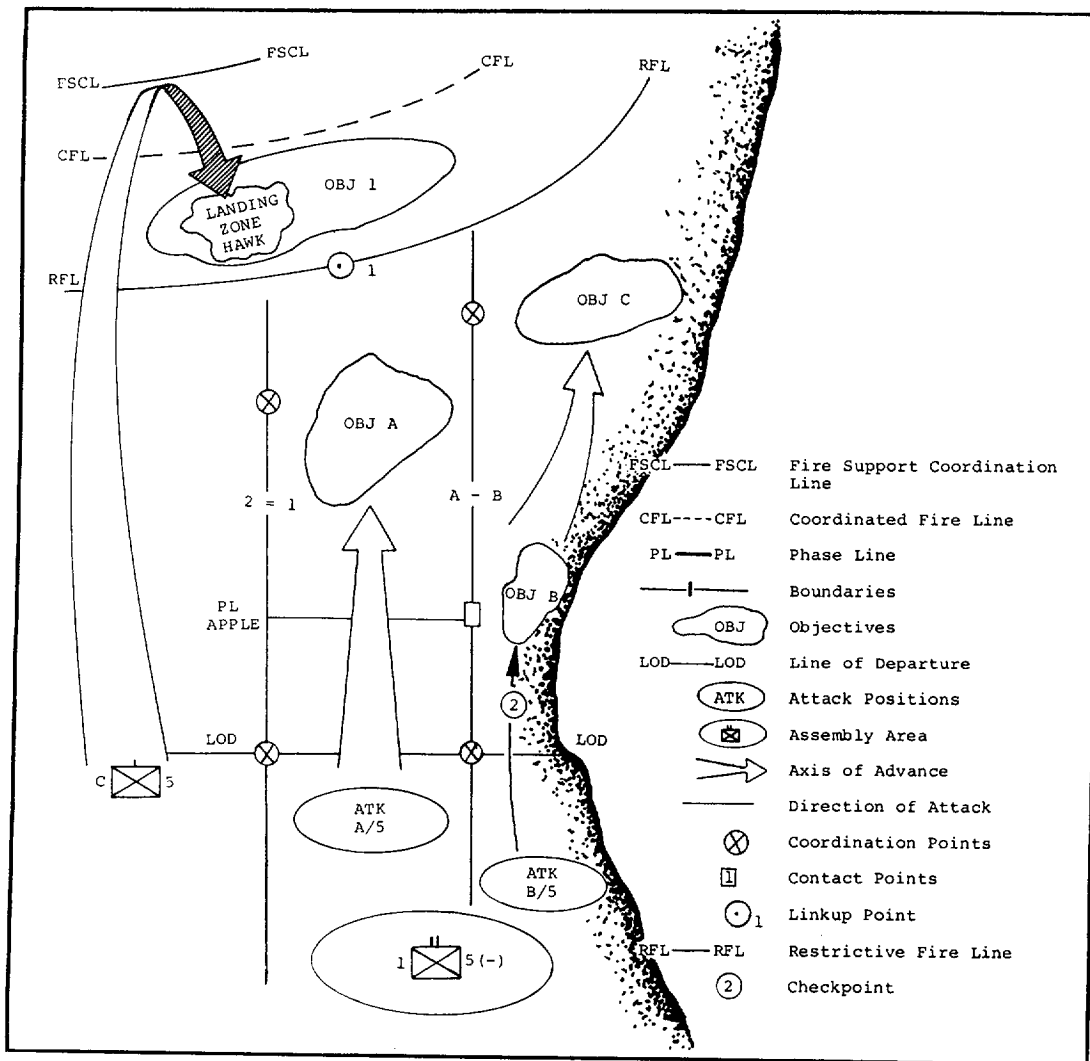

Figure 29.--Control Measures.

of departure a sufficient distance to accommodate the responsible unit's logistic and command facilities. Boundary lines are usually drawn along easily recognizable terrain features in such a manner that division of responsibility for key terrain is avoided. If one flank is exposed, the commander does not normally designate a boundary on that flank. The commander then determines the width of his zone by analyzing the mission, his mobility, and the ability of his unit to maneuver in the zone without risk of defeat. The presence and locations of reconnaissance elements on the flank further determine the width of the zone of action.

c. Line of Departure (LOD).--The line of departure is a line designated to coordinate the beginning of an attack. Desirably, it should be easily recognizable on the ground, generally perpendicular to the direction of the attack, under control of friendly units, and not subject to direct fire or observation by the enemy. For units not in contact, a line of

departure is normally based upon terrain. When the line of departure cannot be fixed on terrain as in a passage of lines, forward friendly dispositions (FFD) may be designated as the line of departure; i.e., LOD is FFD. The present major positions (PPos) of the unit may be designated as the line of departure; i.e., LOD is PPos.

(1) The time of attack is usually prescribed in the battalion order unless the company is attacking independently. It is the time at which the leading elements of the attacking platoons must cross the line of departure. In conjunction with the line of departure, the time of attack ensures the company or platoon commander that his attacking element and fire support elements are coordinated at the commencement of the attack.

(2) In some instances, the line of departure specified by the battalion commander may be unsuitable for elements of the company. The company commander may select and use a company line of departure in the vicinity of that prescribed for the battalion. In such instances, the company commander must adjust the time of the attack across the line of departure he selects. The leading attack elements of the company must cross the battalion line of departure at the time prescribed in the battalion order.

(3) When the line of departure is a line held by another unit already in contact, coordination is required to ensure the uninterrupted passage of lines and minimize the time that a lucrative target may be offered. Speed and secrecy must be emphasized in guiding the attacking elements.

d. Attack Position.--The attack position is the last concealed and covered position short of the line of departure which is occupied by an attacking unit. It is the location where final coordination, last-minute preparations, and deployment into the initial attack formation are effected. It should be occupied for the minimum time necessary.

(1) A halt in the attack position is made only when final preparations cannot be completed in the assembly area or during movement from the assembly area. Any unnecessary delay in the attack position needlessly exposes the unit to enemy fires and may reduce the degree of surprise.

(2) The attack position is normally selected by the company commander except when close control is desired by the battalion commander. An attack position offers concealment and cover, is easily recognizable on the ground, permits radio communications to the battalion, and is large enough to accommodate the company when it is dispersed in its initial formation.

e. Axis of Advance.--An axis of advance is a line of advance extending in the direction of the enemy that indicates the general direction along which attacking elements will move. It should extend only as far as this form of control is essential to the overall plan. Normally, it is depicted by a broad arrow from the line of departure to the objective, following an avenue of approach. The axis of advance conveys to the commander to which it is assigned, that his unit is expected to attack along the axis and not allow small enemy forces to delay the advance to and seizure of the objective. It further indicates that the commander may maneuver his forces and place his fires freely to either side of the axis to avoid obstacles, to engage the enemy, or to bypass enemy forces of such strength that could not threaten his security or jeopardize the accomplishment of his mission.

The commander should ensure that such deviation does not interfere with adjacent units, that his unit remains oriented to the objective, and that the location and size of the bypassed enemy forces are reported to higher headquarters. In mechanized operations, this control measure is most frequently used against light, disorganized, or discontinuous enemy resistance, such as may be encountered in the exploitation or pursuit where the need for a closely coordinated attack does not exist.

f. Direction of Attack.--A direction of attack is a specific direction or route which the main attack or center of mass of the unit will follow. The terrain along the direction of attack must be cleared of effective enemy resistance. Because of its restrictive nature, a direction of attack is normally used only when a commander must maintain close control over the maneuver of subordinate elements to accomplish a closely coordinated scheme of maneuver. It is often used to designate the direction of a counter-attack. A direction of attack is depicted graphically by an unlabeled arrow or is described orally with relation to identifiable terrain features or by magnetic azimuth.

g. Phase Line (PL).--A phase line is a line utilized for control and coordination. It is usually located on an easily recognizable terrain feature and extends across a zone of action. Phase lines are used to control the forward movement of units. Units report arrival at and, at times, clearance of phase lines but do not halt unless ordered to do so. A phase line may be used to limit the advance of attacking elements.

h. Objective.--An objective is a locality or geographical feature to be captured or reached in the course of an attack or during movement. Assigned objectives must be seized and controlled.

(1) Objectives may be:

(a) Terrain which dominates all or the major portion of the company or platoon zone of action or axis of advance and which, if occupied by the enemy, would jeopardize the accomplishment of the mission.

(b) Terrain from which a subsequent coordinated attack will be launched.

(c) Terrain required for purposes of controlling the attack as in areas where observation is limited or where distances involved require displacements of supporting weapons.

(2) Terrain features selected as objectives should have as many of the following characteristics as possible:

(a) Easily recognizable on the ground.

(b) Provide for convergence of effort.

(c) Within effective range of indirect fire support.

(d) Of such size as to be controlled by the unit after seizure.

(3) The number of objectives selected should be the minimum required to maintain control, coordination, and the progress of the attack in the manner desired by the commander.

i. Final Coordination Line.--The final coordination line is a line used to coordinate the ceasing and shifting of supporting fires and the final deployment of the assault echelon in preparation for launching an assault against an enemy position. It is located as close to enemy positions on the objective as assaulting troops can move before becoming dangerously exposed to friendly supporting fires. It should be recognizable on the ground and be within 150 meters of enemy positions on the objective. Ideally, the final coordination line should offer concealment and cover, although it should be cleared quickly. When a requirement exists for two or more elements of a unit to assault simultaneously, elements of the assault echelon may be halted momentarily to await the arrival of other elements.

(1) When enemy positions are known and supporting fires can be carefully planned in advance, the company commander may select a tentative final coordination line while planning the attack. He normally does so for objectives on which simultaneous assaults by two or more platoons are planned.

(2) The rifle platoon commander selects tentative final coordination lines for attacks in which the company does not plan coordinated assaults.

(3) Often a tentative final coordination line cannot be designated ahead of time. The final coordination line is selected by the assault element leader during the attack when a tentative line has not been designated. He may also adjust the location of the final coordination line when a tentative line has been previously designated.

j. Restrictive Fire Line (RFL).--The restrictive fire line is a line established between converging friendly forces (one or both may be moving) that prohibits fires or effects from the fires across the line without coordination with the affected force. The RFL is utilized to regulate all supporting fires and airstrikes occurring between forces involved in linkup operations. Neither of the forces involved requests or delivers supporting fires or strikes across the RFL without prior clearance from the other. As the linkup becomes imminent, the RFL is moved as close to the stationary force as possible to allow maximum freedom of action and maneuver of fire support to the linkup force. As the distance between forces is narrowed, coordination of supporting arms becomes more critical. Therefore, the loss of air and naval gunfire in the phases of the linkup is inevitable and the commander must be prepared for restricted use of his supporting artillery and, finally, total reliance upon organic weapons. At this point in the linkup, and thereafter, the responsibility for fire support coordination for the force as a whole must be clearly established. The RFL is selected by the fire support coordinator (FSC) in conjunction with the recommendations of the supporting arms representatives, taking into consideration the plan of operations and the plan of supporting fires. It is reviewed and approved by the commander or his designated representative. As the linkup progresses, it is reviewed, changed, or modified in the same manner as the original line.

k. Coordinated Fire Line (CFL).--The coordinated fire line is a line beyond which conventional surface fire support means (mortars, field artillery, and naval gunfire ships) may fire any time within the zone of the establishing headquarters without additional coordination. Artillery and/or ships do not fire short of the CFL except on request of the supported infantry commander. Beyond the CFL supporting fires may be delivered at any

time without danger to friendly troops. The infantry commander is responsible for selecting the exact location of the CFL and solicits recommendations from his supporting artillery commander and artillery liaison officers. Location of the CFL is based on such factors as the scheme of maneuver, patrol plans, and troop safety.

l. Fire Support Coordination Line (FSCL).--The fire support coordination line is used to coordinate tactical air support with ground combat operations. Short of the FSCL, aircraft do not attack ground targets except on request/approval of the appropriate infantry commander; beyond the FSCL, targets may be engaged without specific clearance. The FSCL is established by the commander landing force in consultation with the ground element and tactical air commanders. When an infantry force is deployed beyond the FSCL, an FSCL is established around the detached force. Selection of the FSCL is based on the scheme of maneuver, troop safety, terrain, weather, and type of attack aircraft; it should be easy to identify both on a map and from the air.

m. Base Unit.--A base unit is that unit within a formation upon which the remainder of the formation guides for speed and direction of movement. It is assigned by the commander of the formation of which it is a part. During daylight hours, the unit with the most difficult terrain to cross or the heaviest enemy resistance in its zone of action is normally assigned as a base unit. At night, or under conditions of reduced visibility, the base unit is usually that unit which can most easily maintain its direction and speed. In a column, the base unit is the leading element of the formation.

n. Checkpoints.--Checkpoints are reference points used to facilitate control. Checkpoints may be selected throughout the zone of action or along an axis of advance or direction of attack. By reference to them, a subordinate commander may rapidly and accurately report his successive locations, and a higher commander may designate objectives, line of departure, assembly areas, or other localities to subordinate commanders. For security, random numbering of checkpoints is essential. Checkpoints are particularly useful in fast-moving mounted operations.

o. Contact Points.--Contact points are easily recognized points designated between units where the commander desires the units to make physical contact. Contact points may also be used to delineate areas of responsibility in specific localities when boundaries are obviously unsuitable; e.g., between elements of a flank guard. Contact points may be used during the consolidation of an objective to designate where units will coordinate the organization of the position.

p. Linkup Point.--A linkup point has primary application in the composite helicopterborne/surface-landed operation, but may be used on other occasions as indicated by the situation. Linkup points are selected at which physical contact between the two forces will occur. These points are mutually agreed upon and should be readily recognizable to both forces. They are located where the routes of advance of the linkup force intersect the security elements of the stationary force. Alternate linkup points are established. Enemy action may force linkup to occur at places other than those planned. The number of linkup points established depends upon the capability of the stationary force, the number of routes being used by the linkup force, nature of terrain, and enemy threats to the operation. Troops manning the points, as well as the units contacting them, must be familiar

with procedures for mutual identification and plans for the rapid passage of the advancing units. Assistance by the stationary force includes removing obstacles established to hinder enemy movement, providing guides, and reserving assembly areas for the reorganization of linkup forces.

q. Tactical Area of Responsibility (TAOR).--A tactical area of responsibility is a defined area of land for which responsibility is specifically assigned to the commander of the area as a measure for control of assigned forces and coordination of support. A commander assigned a TAOR is responsible for the positive control and coordination of all activities within its periphery. TAOR's are employed when conditions of wide unit separation require a distinction between tactical localities which are to be seized and/or defended and the extensive intervening areas which need only be maintained under reconnaissance and surveillance or security.

(1) All fire or maneuver conducted within the TAOR, or whose effects impinge upon it, is coordinated with the commander of the force assigned the TAOR.

(2) The boundary outlining the periphery of the TAOR is located on recognizable terrain and includes terrain features essential to operations of the organization.

3303. PREPARATION FOR THE ATTACK

a. Where feasible, each echelon within the chain of command issues warning orders in order to permit subordinate echelons to conduct early planning and to initiate preparations for the attack. The warning order is usually fragmentary and contains the following information:

- (1) Time of attack.
- (2) Mission.
- (3) Preliminary plan for employment.
- (4) Information pertaining to the issuance of the attack order.
- (5) Necessary administrative instructions.

b. Upon receipt of a warning order, the company commander and platoon commanders carry out the troop leading steps contained in paragraph 1405 and ensure that as many of the preparations for combat contained in paragraph 3205 as possible are carried out.

3304. PLAN OF ATTACK

The plan of attack consists of the scheme of maneuver and a fire support plan. In arriving at the plan of attack, the scheme of maneuver and fire support plan are developed concurrently, based on the commander's estimate of the situation. The available supporting fires are planned to support the scheme of maneuver. The commander ensures that his scheme of maneuver and fire support plan are mutually compatible and capable of being supported logistically and with communications.

3305. SCHEME OF MANEUVER

The scheme of maneuver is the commander's plan for employing his subordinate, attached, and supporting units, other than fire support units, to accomplish the mission. The scheme of maneuver includes provisions for:

a. Distribution of Forces.--Paragraph 3104 contains a brief, general discussion of the distribution of forces.

(1) The rifle company commander distributes his forces to a main attack, a supporting attack, and a reserve. Attacking echelons, fire support echelons, and reserves are specifically designated in the attack order. Usually, the supporting attack is an attack by fire while the main attack is composed of one or more rifle platoons maneuvering to seize assigned terrain objectives.

(2) The rifle platoon commander distributes his forces to the main and supporting attacks. Maneuvering squads and fire support units are specifically designated in the platoon attack order. The rifle platoon does not normally designate a reserve, but preserves a degree of flexibility in the attack by the judicious selection of attack formations. The supporting attack is normally an attack by fire from a designated base of fire and/or fires from external agencies, while the main attack is composed of one or more rifle squads maneuvering to positions from which to assault assigned objectives.

b. Form of Maneuver.--The form of maneuver selected for the attack is largely predicated upon the avenues of approach to the assigned objective and the cover and concealment offered by those avenues. Both the rifle company and the rifle platoon may employ either the frontal attack or the single envelopment in daylight attack.

c. Formation.--The initial attack formation is the disposition of subordinate units as they cross the line of departure. The formation is changed as required during the conduct of the attack. The company commander and the platoon commander plan to employ sufficient combat power to ensure success. Formations are selected which, when combined with the available fire support, provide the margin of superiority in combat power necessary to accomplish the mission.

(1) The company commander determines how many rifle platoons he will use in the attack echelon and how many will be retained in reserve. There are no fixed conditions which determine the most appropriate formation for a given situation.

(a) A formation of one platoon in the attack and two platoons in reserve provides limited firepower to the front and a strong reserve. It may be appropriate when information concerning the enemy is vague or when the company is attacking with one or both flanks exposed. The formation may be utilized when only a single, narrow avenue of approach is available or when attacking to seize a deep objective. The reserve platoons may follow the attacking platoon in company column or they may be positioned abreast to protect one or both exposed flanks of the company. The formation provides infinite variety in the positioning and movement of the reserve platoons and gives the company commander maximum flexibility in maneuver and control.

(b) Two platoons in the attack and one platoon in reserve provide moderate firepower to the front while retaining a reserve large enough to influence the action. This formation may be appropriate when relatively detailed information of the enemy is available.

(c) When three platoons are employed in the attack echelon, the company lacks a reserve with which to influence the action. This formation provides maximum firepower to the front and may be appropriate when a wide area must be cleared rapidly or when the enemy situation is known and the company is attacking in a wide zone of action.

(2) The rifle platoon commander selects an initial attack formation; however, he may be able to foresee changing to other formations as the attack progresses. The choice of formations is affected to a great degree by the available avenues of approach. It is also influenced by the need for security, control, flexibility, and speed. Proximity of the objective may be a factor in selection of the formation. On occasion, the platoon commander prescribes the initial formations within his rifle squads. Formations used by the platoon are:

(a) Platoon Column.--The platoon column facilitates control and favors action to the flanks. It employs minimum firepower forward and is used when speed and control are governing factors and when visibility is limited. It is suitable for advancing through narrow, covered avenues of approach with maximum speed and control.

(b) Platoon Wedge.--The platoon wedge facilitates control, provides good all-around security, and is an extremely flexible formation. It permits the delivery of reasonable firepower to the front or flanks. The wedge is used when the enemy is known to be in the area, but his exact dispositions and strengths are not clear. Additionally, terrain and visibility may require dispersion of the platoon. The wedge tends to prevent the bulk of the platoon from becoming prematurely engaged and permits flexibility in the employment of the squads when contact with the enemy is established.

(c) Platoon Vee.--The platoon vee facilitates movement into the platoon line formation. The vee provides excellent firepower to both the front and the flanks. It is used primarily when the enemy's strength and locations to the front are known. The formation is easily controlled, provides good all-around security, but is less maneuverable than the wedge.

(d) Echelon.--The echelon formation is difficult to control. As a consequence, movements in the echelon are slow and the formation is difficult to maneuver. It provides heavy firepower to the front and in the direction of echelonment. It is used primarily in protecting an exposed flank. The formation may be echeloned to the right or left.

(e) Line.--The line formation allows the platoon to develop maximum firepower forward. It is difficult to control and maneuver and is most often used in the coordinated assault of all three squads.

d. Control.--In developing the scheme of maneuver, plans for controlling the maneuver elements are considered. Each maneuver element is basically controlled by being given a specific mission prescribing its role in the scheme of maneuver. Missions assigned to attacking platoons and maneuvering rifle squads are usually expressed in terms of terrain objectives

to be seized. Company and platoon commanders control the attack by using the tactical control measures described in paragraph 3302. Only the minimum necessary control measures are imposed in order to preserve freedom of action by subordinate commanders. Both the company and platoon commanders continue to control their respective organizations during the attack. The company commander usually accomplishes this by establishing a vantage point from which he can observe his units and communicate with them. The platoon leader does not normally operate from an OP but selects a position in his platoon formation from which he can best control his attack. Both commanders have assistants that they use in controlling the attack. (See par. 1204.)

e. Continuation of the Attack.--When the attack is to be continued beyond the initial objective, the company commander and the platoon commander make preliminary plans for continuing the attack while formulating the initial plan of attack. Preliminary planning reduces the time required for reconnaissance and troop leading after seizure of the initial objective. The preliminary plan for continuing the attack embodies the essential elements of any plan of attack. Portions of it may be included in the initial attack order to clarify the commander's intention when they serve to complement the basic plan. It is continuously refined as the estimate of the situation on which it was based is altered during the conduct of the initial attack. After the initial objective is seized, the preliminary plan and its refinements are the bases for issuing a fragmentary order implementing a continuation of the attack to seize deeper objectives.

f. Consolidation.--Consolidation is the organization and strengthening of a newly captured position and includes the reorganization of the successful attacking units.

(1) The company commander considers plans for the consolidation of the objective in formulating his scheme of maneuver. The responsibility of the rifle platoons for defending the assigned objective or the assigned portion of the objective is normally implicit in the assignment of their attack missions. For example, a platoon assigned the mission, "attack and seize the left half of objective A," need not be assigned the further mission of consolidating that portion of objective A. The company commander provides specific consolidation instructions only when necessary to clarify or further delineate the platoon's responsibility in that regard. The company consolidation plan designates general position areas and assigns missions to organic and attached weapons over which the company commander has control. When necessary, it may also direct changes in the method of employment of supporting weapons. Proper positioning of the reserve to support consolidation or for continuation of the attack is planned. The company commander contributes to the early reorganization of his unit by planning for and issuing instructions regarding timely resupply, vehicular movement, casualty reporting and evacuation, as well as movement and general location of the command post and security measures.

(2) The rifle platoon commander, even in the absence of specific consolidation instructions, assigns consolidation missions to each rifle squad and attached unit. The plan includes both routine or SOP type security measures, special instructions for security, and preparations to facilitate future actions. The security measures provide for the designation of general position areas, the rapid emplacement of automatic weapons in the best available position to cover reorganization, specific missions for attached weapons, and all special security precautions. Reorganization

is accomplished on the objective by evacuating casualties, reassigning personnel, redistributing and replenishing the ammunition supply, and doing everything possible to prepare the platoon for further combat.

g. Plan for Use of Reserves

(1) The rifle company commander plans to withhold a reserve when the situation permits. Its initial location is often a covered or concealed area a short distance behind the line of departure. The commander plans subsequent, identifiable locations to maintain the reserve far enough forward to ensure its availability, but far enough to the rear to stay out of the attacking platoons' fire fights. The reserve displaces from one location to another on order of the company commander. The company commander may place all or part of the reserve in the zone of the rifle platoon expected to make the best progress, or he may echelon all or part of it toward an exposed flank. If a large gap develops between attacking platoons, he may direct the reserve to follow between them. Appropriate missions include one or more of the following:

- (a) Attack from a new direction.
- (b) Assume the mission of an attacking platoon.
- (c) Protect one or both flanks of the company.
- (d) Mop up a position which has been overrun or bypassed by attacking platoons.
- (e) Maintain contact with adjacent units.
- (f) Protect the reorganization of the attacking platoons.
- (g) Support the attacking platoons or adjacent units by fire.

(2) The rifle platoon does not normally designate and withhold a reserve. An attacking rifle platoon preserves its flexibility by using formations which withhold at least one squad from initial contact with the enemy to the front. Advancing the rear squad forward by bounds from one covered or concealed position to the next prevents it from being subjected to enemy fires directed at the leading squad or squads. The squads in the platoon formation move well within supporting distances of one another. The rear squad or squads in the formation are available for employment as maneuver elements or to reinforce the fires of the leading squads. Employing scouts forward of the leading squad or squads and advancing the platoon from cover to cover behind the scouts may be necessary to further preserve the platoon's flexibility. In these situations, the platoon commander must be able to observe and control both the scouts and leading squads in order to make continuing estimates.

h. Security.--Security of his unit is the continuing responsibility of each unit leader in the rifle company. Security measures are planned against enemy air and ground action. Security measures are designed to provide warning in time to permit the necessary deployment of forces or other actions to meet the threat.

(1) The company may attack with one or both flanks exposed. The company commander may position all or part of his reserve to protect an exposed flank. Combat patrols from the reserve may be planned to cover likely avenues of approach into the flank. Reconnaissance patrols, provided with rapid communication means, may be used as flank security elements. Connecting groups which periodically report the location of the flank of an adjacent unit add a degree of security by keeping the company commander informed regarding the situation on the flank.

(2) The close-in security of the command post is provided by personnel available at the command post under the general supervision of the executive officer. The security of the command post is increased when it is located near reserve elements of the company. When the command group operates from an observation post, the gunnery sergeant takes appropriate close-in security measures utilizing command group personnel.

(3) The rifle platoon commander provides for unit security in the attack by the selection of appropriate attack formations, observation, and the employment of scouting elements. Timely and accurate reports of enemy sightings from all levels enable him to make sound estimates for appropriate action.

(4) The weapons platoon commander concerns himself with close-in security of weapons under his control in the attack. He selects firing positions which offer cover or concealment and, where possible, are located in the vicinity of rifle units. Security of weapons units attached to the rifle platoons are the planning responsibilities of the rifle platoon commanders.

3306. FIRE SUPPORT PLAN

In offensive operations, the proper utilization of available fire support is essential to the most efficient and economical accomplishment of the mission. The fire support plan as an element of the plan of attack supports the scheme of maneuver and is developed concurrently with it. The fire support plan includes targets to be engaged, time of delivery of fire, duration of fire, types of fires and weapons to be used, communications, and time of displacement. The plan is based on the scheme of maneuver, information received from higher headquarters, the terrain, information concerning the enemy, and recommendations from fire support unit leaders and forward observers. In developing a fire support plan, such items as the nature of the target, effects desired, weapons capabilities, and availability of ammunition are considered. In general, the fire support plan provides for planned fires to neutralize known and suspected enemy positions in support of the maneuver elements.

a. Prearrangement of Fires.--Effective fire support planning is predicated upon the close integration and coordination of the fires which each fire support agency can deliver in support of the attack. The degree of prearrangement of these fires is classified as follows:

(1) Preplanned Fires.--Preplanned fires are fires for which firing data is prepared in advance. They may be either scheduled or on call fires.

(a) Scheduled fires are preplanned as to location and time of firing and are usually delivered as preparation fire.

(b) On call fires are preplanned as to location only and are fired on request. These fires are planned on known and suspected enemy locations to cover the movement to the objective, the assault, and the consolidation.

(2) Targets of Opportunity.--Fires on targets of opportunity cannot be prearranged and are requested and fired as new targets appear in areas not covered by preplanned fires.

b. Sequence of Delivery.--In offensive operations, supporting fires are normally planned for and delivered in the following sequence:

(1) Fires prior to the preparation are controlled by higher echelons and include registration fires preparatory to supporting the attack.

(2) Preparation fires consist of an attack by fire on hostile positions through the delivery of a system of scheduled fires prior to, during, and after the attacking echelons have crossed the line of departure. The preparation is coordinated with the scheme of maneuver and is designed to destroy or neutralize enemy installations likely to interfere with the attack, gain superiority over hostile counterfire means, disrupt hostile command and communication systems, and isolate the battle area. Higher commanders usually determine whether a preparation will be fired as well as its duration.

(3) Fires in support of the attack are delivered to assist the movement toward the objective and the assault. All types of weapons are employed in firing on call missions covering known or suspected enemy installations which might affect the maneuver. These fires aid in gaining fire superiority for each successive objective and include fires on targets of opportunity.

(4) Fires to support consolidation of the objective are planned as on call fires to cover logical enemy avenues of approach into the objective and assembly areas which might be used to organize a counterattack. Their purpose is to disrupt his counterattack preparations in the assembly areas and to break up his attack. On call fires are supplemented by fires on targets of opportunity as they appear.

c. Planning Assistance.--The weapons platoon commander, the 81mm mortar forward observer, and the artillery forward observer are the company commander's principal assistants in fire support planning. They make recommendations to the company commander concerning the employment of the fire support agencies at their disposal.

(1) The weapons platoon commander implements the company commander's decision by preparing and issuing an attack order derived from the mission assigned to the weapons platoon. The mission assigned by the company commander usually incorporates the recommendations of the weapons platoon commander.

(2) The forward observers implement the company commander's decision by initiating the requests for fires. Fires requested normally include prearranged fires desired by the company commander and fires requested by the rifle platoons which are approved by the company commander.

d. Company Fire Planning.--Company fire planning involves the use of all available fires, including those of organic, attached, and supporting weapons.

(1) Preparation Fires.--Preparation fires are normally planned at higher echelons. The rifle company commander integrates the fires of weapons over which he has control into these preparation fires. In addition, he makes recommendations to the battalion concerning targets to be included in the preparation.

(2) Fires in Support of Attack.--The company commander plans fires in support of the attack which cover the forward movement of maneuver elements and the assault on the objective. Fires in support of the attack usually consist of a combination of direct fires and on call indirect fires. Provision is made for delivery of the greatest concentration of fires on the objective just prior to the assault. Often the fires available cannot effectively engage all known or suspected enemy positions simultaneously. In such cases, it may be necessary to plan fires designed to successively neutralize enemy positions likely to have the greatest effect on the accomplishment of the mission during various stages of the attack. These fires are planned on call and delivered at appropriate times during the attack. On call fires desired by the attacking platoons are approved or disapproved by the company commander. Approved requests for fires are relayed to the appropriate agencies.

(3) Fires to Support Consolidation.--On call fires are planned to cover the consolidation of objectives. Likely enemy avenues of approach into the objective and probable assembly areas are determined from ground and map reconnaissance. Fires are planned to deny their use to the enemy. The rapid and timely displacement of organic, attached, and supporting weapons to new positions from which to support the consolidation is planned.

(4) Unit in Contact Support.--Fire support from a unit in contact may be made available to an attacking rifle company passing through or around its position. The attacking company commander coordinates with the unit commander and integrates the additional fires into his plan.

(5) Supporting Arms Representative's Responsibility.--As the rifle company commander's chief representatives for supporting arms, the artillery and mortar FO's and the battalion NGF spotter, if available, are responsible for planning and advising in the application of their fire support means. The company commander points out the hostile targets on the ground, expressing his desires as to destruction or neutralization necessary to accomplish the company's mission. He also indicates illumination or smoke requirements, special patterns or effects on the ground, and the desired degree of prearrangement for supporting fires. Target assignments are made within the capabilities of each supporting arm available. Requests for prearranged fires, when approved by the company commander, are submitted to the liaison officers of the respective supporting arms in the infantry battalion FSCC for approval and to the appropriate unit control agency (fire direction center (FDC), combat information center (CIC)).

(a) The rifle company commander approves the individual list of targets prepared by the supporting arms representatives, forward observers, and spotters, ensuring that they meet his expressed desires and those of his platoon commanders prior to submission to the FSCC for integration with other requests.

(b) The supporting arms representatives generally ascertain through concurrent planning that their fire support agencies can or cannot provide the desired fires contained on the list of targets, and whether additional reinforcing means will be available.

(c) The submitted list of targets contains the target descriptions, coordinates, altitudes, sizes of areas, and appropriate remarks. Any requirements for groups or series of fires may be included or arranged with the liaison officer and supporting arms agencies in order to fulfill foreseen or probable requirements for on call fires to cover a particular combat action of the company and/or its elements. These prearranged groups and series of fires preclude lengthy transmissions of requests for several individual targets. (See FMFM 7-4, Field Artillery Support.)

(d) Coordination and integration of the requested fires are effected in the infantry battalion FSCC and the supporting arms control agencies and are forwarded successively to higher echelons for approval. Upon final approval, a completed fire support plan, including the approved company fire support request, is disseminated to elements of the landing force. The FSCC is responsible for advising the company commander of approval or disapproval of his request. Supporting arms representatives, additionally, inform the company commander of approved fires and their target numbers upon receipt by them.

(e) The supporting arms representatives remain near or accompany the company commander throughout the action in order to ensure rapid and responsive fire support. Where the necessity to occupy a vantage point as a position for observation of the company's entire zone of action precludes this, the supporting arms representatives remain in contact with the infantry commander by wire and/or radio.

(6) Platoon Commanders' Responsibilities.--Platoon commanders may request prearranged fires to augment platoon fire support plans. This is particularly significant when a platoon's plan of attack involves the seizure of platoon intermediate objectives. The company commander, upon approving the requested prearranged fires, consolidates them with his own requests and forwards the request as discussed in the preceding paragraph. Platoon commanders are informed of the approval or disapproval of their fires and target numbers.

(7) Control of Fires.--The company commander's fire support plan includes adequate means for controlling the fires supporting the attack. Control means include radio, messenger, and wire communications, and the use of visual signals for calling, checking, or shifting fires.

(a) Direct fire weapons are usually controlled by the use of visual signals, but instructions may be delivered by radio, wire, or messenger.

(b) Indirect fires are controlled by use of the company communication system and forward observer radio or wire nets. The company commander exercises centralized control of indirect fires when the scheme of maneuver dictates. He may decentralize control when the requirements imposed by the scheme of maneuver are less stringent. For example, when the planned scheme of maneuver requires a closely coordinated attack, on-call fires are centrally controlled by the company commander. He calls,

shifts, and checks the fires by direct instructions to the forward observers during the attack. When the scheme of maneuver requires less coordination, less centralized control is exercised. The company commander informs his platoon commanders concerning the details of the fire support plan. Prearranged target locations and their identifying numbers are published in the company attack order. The platoon commanders may then request delivery of planned fires as necessary in conducting their attacks. The company commander monitors the requests and, if he approves them, directs the appropriate forward observer to initiate the fire request. In employing decentralized control, the platoon commander's requests are disapproved when the company commander determines that the fires will endanger units adjacent to the requesting platoon. The company commander and the platoon commanders may call fires on targets of opportunity at any time during the attack regardless of the control employed.

(8) Close Air Support.--The availability of air support is prescribed in the battalion attack order. A forward air control team may operate with the command group of an attacking rifle company. The forward air controller assists the company commander in planning airstrikes against suitable targets. Targets include gun positions, armor and other vehicles, troop concentrations, strongly defended positions, pillboxes, and defended roadblocks. Close air support missions are classified as preplanned or on call.

(a) Preplanned missions are conducted in accordance with an appropriate fire plan in advance of the attack. These missions are usually planned at battalion or higher level. However, the company commander, in planning fire support, may see a requirement for and request an airstrike in support of his attack.

(b) On call missions are air missions to meet specific requests for immediate air attack which arise during the course of battle and cannot be planned in advance. They may be conducted by aircraft awaiting a mission at an airfield (ground alert), on board an aircraft carrier (deck alert), or in the air over the battlefield (air alert). Suitable targets are determined by the company commander on the advice of the forward air controller and the forward observers. The forward air controller requests the strike and directs the aircraft to the target.

e. Rifle Platoon Fire Planning.--The rifle platoon commander's fire plan involves the use of organic, attached, and supporting weapons to support his scheme of maneuver.

(1) The fires of company and higher echelons are planned to support the platoon's attack by neutralizing enemy positions while the platoon maneuvers to close with the enemy. These fires, announced in the company order, are considered by the platoon commander to determine whether they will adequately support his scheme of maneuver. He may request additional prearranged fires to augment the fires of higher echelons. For example, when the platoon commander selects an intermediate objective, he may request mortar or artillery targets be prearranged to support his attack. His requests are submitted to the company commander by radio or messenger. If the company commander and the fire support coordination center approve the requests, the platoon commander is notified of the target numbers assigned these fires. The platoon commander uses the assigned target numbers in subsequent requests for the delivery of prearranged fires.

(2) The platoon commander plans the fires of all attached weapons, as well as those weapons in direct support. His primary concern is to provide close-in and responsive fire support to his maneuver elements as they close with the opposing force. The platoon commander exercises fire control and assigns fire missions and general firing positions to an attached unit. His decisions, in this respect, are largely influenced by the scheme of maneuver, enemy dispositions, fields of fire, and observation. Weapons most likely to be attached to the rifle platoon are 60mm mortars, machineguns, LAAW's, and MPFW's. The platoon commander will assign fire missions to a unit in direct support of his platoon; however, the remaining aspects of tactical control are exercised by the supporting unit commander. Weapons most frequently found in direct support of a rifle platoon are mortars, Dragons, and tanks.

(a) Machineguns are positioned near the line of departure and support the maneuver elements when the nature of the terrain affords observation and fields of fire over the objective and the avenues of approach to it. It may be necessary for the machineguns to accompany the maneuver elements to positions forward of the line of departure from which they can deliver effective fire. If fields of fire and observation are extremely limited, the machineguns may accompany the maneuver elements all the way through the objective as assault weapons.

(b) A platoon commander may employ an assault squad from a base of fire position, or it may be assigned to move with the maneuver element until firing positions are uncovered from which suitable targets may be engaged. When there is no armor threat, the LAAW's fire on other appropriate targets.

(c) An attached 60mm mortar squad may be positioned in proximity to the line of departure or assigned to move with the squad(s) comprising the maneuver element. Positions are selected near the line of departure only when the mortar squad, from that position, can deliver continuous and effective supporting fires without excessive displacements. The platoon commander must position himself to allow him to function as a forward observer and to control the fires of the mortar(s). When suitable firing positions are not available near the line of departure and/or when nonorganic fires are sufficient to ensure initial fire superiority for the maneuver elements, the mortar squad frequently moves with the maneuvering rifle squads in the attack. When the mortar section is in direct support of a rifle platoon, the platoon commander will control the section's fires by assigning fire missions.

(3) Firing missions and general locations for weapons are designated for each attached unit in consolidating the objective. Consolidation missions are assigned in the attack order. Prior liaison with direct support unit leaders will determine the general positions from which they can best support the consolidation. Routes of displacement to positions should permit rapid movement, cover and concealment, and early occupation of positions covering dangerous avenues of approach.

(4) The platoon commander plans to control his fire support by making timely requests for prearranged fires to the company commander, by keeping organic and attached fire support units within reasonable communicating distance, and by relying heavily on visual signals. The platoon sergeant may be employed to coordinate and control supporting fires. Generally, direct fires are controlled by prearranged visual signals and

indirect fires by timely calls via the company communication system. When the company plan of attack requires close coordination of the attacking platoons, the company commander usually retains strict control over the delivery of indirect fires. When less close coordination of attacking platoons is required, the platoon commanders are provided with detailed information concerning the company fire support plan, including prearranged artillery and mortar target locations and identifying numbers. Platoon commanders request delivery of planned fires as necessary. Platoon commanders request fires on targets of opportunity as they appear.

f. Weapons Platoon Fire Planning.--The weapons platoon commander performs the troop leading procedures described in paragraph 1403. His preliminary fire support planning is focused upon making an estimate of the situation as a basis for the submission of recommendations to the company commander. Detailed planning commences on receipt of the company order and involves weapons employed in general support.

(1) The weapons platoon commander's basic recommendations propose the methods of employment for the machinegun section, the assault section, and the 60mm mortar section. His recommendations may include general information concerning weapons position areas, fire control, displacements, and consolidation considerations.

(a) Machineguns may be employed in general support when positions are available near the line of departure which afford observation and fields of fire over the avenues of approach and/or the initial company objective. When the enemy situation is indefinite, the machineguns may be positioned in general support to cover the advance of the rifle platoons. They are prepared to fire on predesignated target areas and/or at targets of opportunity. They fire when directed by the company commander. When enemy dispositions and locations are known, the situation usually requires the continuous engagement of known and suspected enemy locations from commencement of the attack until fires are masked. General support is the preferred method of employment, as it provides the company commander maximum flexibility in the application of machinegun fire in support of the attack.

(b) Machineguns are attached to the rifle platoons when fields of fire and observation do not exist near the line of departure or when the closeness of the terrain is likely to isolate an attacking platoon. Close terrain provides extremely limited fields of fire, resulting in a requirement for close-in support of the rifle platoon. Attachment is the method which provides the rifle platoon commander maximum control of close-in machinegun fire. Attachment is appropriate when a rifle platoon attacks alone or attacks with an exposed flank which cannot be otherwise protected. Attachment is also warranted when probable displacements are likely to physically remove a machinegun unit beyond effective communication distance and control of the section.

(c) LAAW's are normally retained in general support whenever possible. LAAW's may be attached to the rifle platoons when they cannot provide adequate fire support and/or antitank protection from general support positions. In close terrain, attachment to the rifle platoons may be required.

(d) The 60mm mortar section is ideally employed in general support. When it has been determined that effective supporting fires cannot

be delivered in support of an attacking platoon while the weapons platoon commander retains tactical control, a mortar squad or squads may be attached to that platoon. When one rifle platoon has an established priority for supporting fires, which can be provided by the section under the control of the weapons platoon commander, the mortar section may be placed in direct support of that platoon. Remaining considerations relating to the 60mm mortar employment are similar to those stated for the machinegun.

(2) Detailed planning includes the selection of firing positions, targets to be engaged, and fire control as well as the selection of general position areas from which to support consolidation of the objective. When the company plans operations involving closely coordinated maneuvers by the rifle platoons, many details of fire support planning at the weapons platoon level must await issuance of the company commander's order. The order may contain amplifying instructions pertaining to fire control and consolidation. Information concerning other planned fires is contained in the company commander's order. Adjustment of the weapons platoon commander's preliminary fire support plan may be necessary to avoid needless duplication of fires. Further, the weapons platoon commander ordinarily coordinates with the rifle platoon commanders after receipt of the company order. One of the purposes of coordination is to establish times and locations at which attached weapons units and their leaders report to the rifle platoons. For these reasons, the weapons platoon commander formulates his detailed plan after receipt of the company commander's order.

(3) The following elements of fire control apply specifically to machineguns but also apply to antitank weapons when employed in a fire support role:

(a) Weapons unit leaders are informed of the time to open fire. Generally, they open fire just prior to or at the time of the attack.

(b) To gain surprise and establish fire superiority quickly, general support weapons open fire simultaneously either on a prearranged signal or at a specified time. When a signal is used, it is described in the weapons platoon commander's order.

(c) Rates of fire are established and announced in the weapons platoon commander's order. Normally, machineguns open fire at the rapid rate and maintain that rate until fire superiority is established. The sustained rate is usually sufficient to maintain fire superiority once it is established.

(d) Lateral and overhead safety limits are determined. Depending upon the company scheme of maneuver and the locations of firing positions, one or both safety limits may be applicable. Safety limits are usually determined and described with relation to identifiable terrain features.

g. Tactical Employment of Machineguns.--The basic unit for the tactical employment of machineguns is the machinegun squad. Of all weapons available to the company commander, the machinegun is capable of delivering the greatest volume of flat trajectory small arms fire. The basic offensive mission of machinegun units is to support the advance of the attacking rifle platoons by fire.

(1) Machinegun fires delivered in offensive combat fall into one or more of four general tactical classifications:

(a) Close support fires are those delivered against enemy positions directly opposing the advance of the attacking platoons.

(b) Long-range fires are fires delivered against targets located beyond the hostile position directly opposing the advance. Machinegun fires are often shifted to deeper targets when close support fires are masked by maneuvering rifle units.

(c) Flank protection fires are machinegun fires which protect an exposed flank of the rifle platoon or rifle company.

(d) Machineguns are employed in the consolidation of objectives by firing to protect the rifle platoons against counterattack.

(2) The machineguns may be assigned either point or area targets. At battle ranges, the machinegun is essentially an area fire weapon and should be assigned point targets only when weapons of greater precision are not available. Targets are assigned to the machinegun squad and not to a single gun whenever possible.

(3) The best position on the ground from which the mission can be accomplished is the primary position for the machinegun squad. Any other position from which the same mission can be fired is an alternate position. Machineguns move to alternate positions when enemy action renders the primary position untenable or when it becomes otherwise unsuitable for continuing the fire mission. An alternate position should be sufficiently removed from the primary position to minimize the effects of enemy fires directed at the primary position. Supplementary positions are necessary when it is anticipated that a machinegun unit may be required to fire a mission in addition to or in lieu of its primary mission. The supplementary position is a position from which a mission other than the primary mission can be accomplished. Firing on enemy troops attacking the flanks or rear of the assigned defense area may be designated as supplementary missions. All three firing positions should offer as many desirable characteristics as possible. Seldom will any position offer all of them and some compromises must be made. The accomplishment of the mission is the most important consideration. A firing position should have as many of the below listed characteristics as possible:

- (a) Fields of fire.
- (b) Observation of friendly maneuvering units.
- (c) Direct fire without premature masking.
- (d) Cover and/or concealment.
- (e) Covered routes for occupation and resupply.
- (f) Sufficient space for dispersing the weapons.
- (g) Availability and accessibility of alternate positions.
- (h) Local security.

(4) When machinegun fires are masked or are shortly to become masked, it is necessary to displace them to new locations. Displacements

are made as rapidly as possible and take maximum advantage of covered and/or concealed routes. Machineguns are displaced by echelon or as a unit depending upon the tactical situation.

(a) Machineguns are displaced by echelon when the tactical situation requires the uninterrupted fire support of attacking rifle elements. At least one machinegun squad remains in position and fires while the others move forward to new firing positions. Once the advanced squad or squads are in new firing positions and prepared to continue their support, the rear unit or units move forward to new positions. Machineguns are normally displaced by squad units.

(b) When an objective is seized, the machineguns have completed their initial primary fire support mission and must either displace to support the consolidation or shift to new targets and continue to support from the same positions. Since machinegun fires protecting against counterattack are extremely important, machineguns are usually displaced as a unit to consolidate the objective.

h. Tactical Employment of LAAW's.--LAAW's are usually positioned to cover avenues of approach that enemy armor could use to disrupt the attack. The LAAW is the close-in antitank defense weapon organic to the company. When the enemy armor threat is slight or avenues of approach for armor are limited, LAAW's may be effectively employed in supporting the attack by firing on appropriate targets within range. The assault squad is the basic unit of tactical employment. The two assault teams of a squad are normally employed in proximity to each other and cover the same avenue of approach. Numerous avenues of approach for armor or limited observation and fields of fire may justify splitting the assault squads in the assignment of separate fire missions by teams. Observation and fields of fire over the avenues of approach for armor or designated targets largely dictate the positioning of LAAW's.

(1) Because enemy reaction to the launcher's backblast makes frequent position changes necessary, alternate positions assume almost equal consideration with primary positions. Desirable characteristics for a LAAW position are outlined below:

- (a) Fields of fire.
- (b) Observation of friendly troops.
- (c) Cover and/or concealment.
- (d) Covered routes for occupation and resupply.
- (e) Available and accessible alternate positions.
- (f) Safety clearance for backblast.
- (g) Local security.

(2) When the assault section/squad fires become masked or are shortly to become masked, or when their weapons are out of effective range, displacement is made as rapidly as possible, taking maximum advantage of covered and/or concealed routes.

i. Tactical Employment of 60mm Mortars.--It must be remembered that the 60mm mortar was not returned to the Marine Corps to replace the need for any other weapon in use at the time of its return. The 60mm mortar was returned to provide the company commander with a weapon which could be used to supplement nonorganic, high-angle fires. When comparing the capabilities of the 60mm mortar with those related high-angle fire weapons, its primary advantage is found in the mortar's rapid response in engaging "targets of opportunity." It is also apparent that the destruction and/or neutralization effect of this weapon does not favorably compare with heavier indirect fire weapons.

(1) Weapons Selection.--Time permitting, weapons providing the most suitable effect on a given target will be employed, thus ensuring achievement of the desired effect on the target. It is for this reason that the 60mm mortar has limited application in delivering prearranged fires. The ability of the 60mm mortar to accompany the maneuver elements of the rifle company causes it to be ideally suited to respond rapidly to targets of opportunity. These mortars are committed to on call missions only when nonorganic fires are incapable of meeting such requirements within the desired time frame. The commitment of the 60mm mortar to scheduled missions reduces the flexibility of the mortar to respond to targets of opportunity. It must be remembered that only a limited amount of ammunition may be carried by a mortar section and resupply of a company in the attack is an ever-present problem. It is for this reason, as well as consideration of the limited effect of the 60mm mortar round, that it will rarely be assigned to deliver scheduled fires.

(2) Targets.--The 60mm mortar is suitable for employment against the same general type of targets in the attack as is the 81mm mortar. The high explosive (HE) round does not have a penetrating capability and should not be employed against hardened or fortified targets. Point targets within 900 meters of the guns may be engaged effectively. Because of the problem of ammunition supply, and resupply, the 60mm mortar is fired at known targets and is normally not employed against suspected targets, as is the 81mm mortar.

(3) In the Attack.--In the attack, the 60mm mortar is extremely flexible in achieving firing positions which afford the weapon and its crew adequate cover and concealment. Because of its low silhouette, this weapon presents a reduced target to the enemy. Folds and relief in the terrain will normally provide the weapon with adequate protection against flat trajectory fires. In offensive operations, such as movement to contact or combat patrols where the direct lay or handheld techniques are frequently employed, firing positions may be exposed. Considerations in establishing a permanent firing position in support of the attack are as follows:

(a) No less than 35 meters between squads to provide passive security against incoming fires.

(b) As close as feasible to the line of departure and not further than 300 meters to its rear, to exploit the weapon's limited range to the maximum extent.

(c) Mask clearance of overhead obstructions, natural or artificial, must be considered to ensure safety and maximum area coverage.

(d) Covered routes of supply and communications, and routes between primary and alternate positions.

(4) Displacement.--When the mortar section is employed in general or direct support, displacement in the attack is normally ordered by the company commander through the weapons platoon commander. However, if displacement is necessary and the company commander is not available, the weapons platoon commander orders displacement on his own initiative. In the attached role, the mortar squad(s) will be displaced on order of the rifle platoon commander.

(a) Time of Displacement.--Displacement is ordered when friendly troops mask the fire of the mortar(s), when displacement will increase observation and potential target selection, before assault units outdistance the effective range of the mortars, or when all known lucrative targets are beyond the effective range of the mortar.

(b) Method of Displacement

1 Section

a Echelon.--When a requirement exists for continuous fire support, the section will conduct an echelon displacement. Depending on the circumstances, one squad may displace while the other two remain in firing positions, or two squads may displace while one squad remains in position. During periods of the attack where there are no fire missions for the mortar section, the weapons platoon commander, acting through the section leader, takes advantage of lull in fire support requirements to order the displacement of one or more squads to new firing positions. This facilitates the delivery of effective supporting fires when fire missions are once again received.

b Unit.--When a mortar section can no longer effectively deliver supporting fires from its primary position, and the speed with which a displacement can be effected is of primary concern, the section will normally displace by unit. Such is frequently the case when the displacement is conducted to support consolidation of an objective. Displacements in this situation are normally initiated when the mortar fires are masked by the assaulting infantry. It is mandatory that heavier weapons be available to pursue the enemy by fire and deliver initial fires in support of consolidation during the section's displacement.

2 Squad.--Because there is only one 60mm mortar contained within each mortar squad, the terms echelon and unit displacement have virtually no application. The attached mortar squad is employed as close as practical to the point of infantry action. This is accomplished by ordering displacements to keep the mortar within supporting range of the attacking squads, to ensure that fires in support of consolidation are rapidly available.

(c) Displacement Planning.--Displacement will be planned to take place under the cover of nonorganic supporting weapons and at a time when it is anticipated enemy contact will be the lightest. Displacements should be planned to take place so as to ensure maximum fires are available to support consolidation.

j. Displacement Instructions.--The commander details his instructions for displacement of all crew-served weapons with his unit, organic or attached, in his operation order. The following instructions are included:

Par. 3307

FMFM 6-4

(1) Method.--Displacement by unit or by echelon is directed. If displacement is accomplished by echelon, the order states which units will remain in place to cover the initial displacement.

(2) Time and/or Signal.--This is used to initiate the displacement.

(3) Route.--Definite routes are assigned for all units to ensure efficient and rapid displacement.

(4) Objective.--The displacement objective is normally the next position for firing. Sufficient room for dispersion should be available in order to minimize the effects of enemy fire.

3307. CONDUCT OF THE ATTACK

a. General.--The attack is conducted aggressively, closing rapidly with the enemy in order to keep him off balance until the objective is seized. Leaders at all echelons make continuing estimates of the situation in order to remain flexible and alter plans as required by new and unforeseen situations.

b. Movement From Assembly Area.--Under most conditions, the company commander and platoon commanders control movement from the assembly area. Concurrent completion of troop leading steps and movement from the assembly area may be necessary. Under such circumstances, movement forward from the assembly area toward the line of departure may be made under control of the executive officer or the first sergeant and the platoon guides.

(1) Company Considerations.--The rifle company times its departure from the assembly area so that movement to and across the line of departure is continuous except when an attack position is used. When an attack position is used, the movement is timed to permit the occupation of the attack position for the minimum period consistent with effective coordination and control of the attack. Movement from the assembly area or the attack position across the line of departure is regulated so that the leading elements of the company cross at the time of the attack. The order of march should facilitate deployment into the initial attack formation or occupation of the attack position, as appropriate. The rifle company may move forward using multiple routes to facilitate deployment while on the move. Weapons platoon elements and attached weapons may precede the company in order to occupy firing positions when security is provided by rifle elements.

(2) Rifle Platoon Considerations.--The rifle platoons may move forward from the assembly area under the company control on a single route, or each platoon may move on a separate route. If an attack position is used, the platoons occupy assigned areas and maintain security in their initial attack formations. When an attack position is not used, deployment into initial attack formations is accomplished during movement from the assembly area. All forward movements are ordered by the company commander and timed so that leading elements of attacking platoons cross the line of departure at the time of the attack.

(3) Weapons Platoon Considerations.--Weapons platoon elements, accompanied by appropriate security elements, may move forward from the

assembly area or attack position in advance of the company to occupy firing positions in the vicinity of the line of departure. When initial firing positions are in proximity to each other, the weapons units usually move over one route. Widely separated firing positions may necessitate movements on multiple routes.

c. Advance by Fire and Maneuver.--At the time of the attack, the attacking platoons cross the line of departure and move rapidly toward their assigned objectives. Their movements take maximum advantage of the cover and concealment offered by the avenues of approach to the objective and the protection afforded by supporting fires. If effective enemy resistance is encountered en route to the objective, attacking platoons close rapidly by conducting fire and maneuver, assault, and destroy the enemy. When the enemy resistance encountered does not affect the accomplishment of the mission, the rifle platoon bypasses the resistance and notifies the company commander. The platoon commander's decision to bypass the enemy position is made with due regard for the tactical control measures imposed by the company commander. Normally, platoons not stopped by enemy fire continue to advance even though adjacent units are halted. The advance can then outflank enemy positions holding up adjacent units, thus permitting the delivery of flanking fires and maneuver against the enemy's flanks and rear.

(1) Company Commander.--The company commander keeps abreast of the attack in progress by observation and communications with his platoon commanders and attached and supporting unit leaders. Throughout the attack, he coordinates the movement of all elements of his company including attachments and the fires of supporting weapons. The reserve is displaced as appropriate to maintain it in suitable positions from which it can be rapidly committed. The company commander anticipates situations requiring the possible commitment of his reserve and plans accordingly. As flank security requirements of the company change during the attack, the company commander adjusts security measures. He orders timely displacements of the command group to maintain effective control of the attack. The command post displaces as the company commander directs to permit continuous logistic and administrative support of the attack. The company commander acts upon the recommendations of supporting weapons unit leaders in ordering timely displacements to support the attack echelon.

(2) Rifle Platoon Commander.--The platoon commander selects the position in the platoon attack formation from which he can best observe and control the squads. He continually revises his estimate of the situation as the attack progresses and employs fire and maneuver as appropriate. He coordinates the fire and maneuver of the leading squad or squads when enemy resistance is encountered en route to the objective. When more than one squad is required to overcome the resistance, the platoon commander initiates further fire and maneuver by issuing fragmentary orders. When the tactical control measures imposed by the company commander permit, it may be possible to bypass the enemy positions. When a position is bypassed, the company commander is notified.

(3) Weapons Platoon Commander.--The weapons platoon commander locates himself where he can best assist the company commander. He is usually near the company commander where he can observe the advance of the rifle platoons and can communicate with the elements of the weapons platoon employed in general support. Throughout the attack, the weapons platoon commander makes timely recommendations to the company commander concerning

employment of his platoon. He recommends changes in the methods of employment to meet changed situations. He also informs the company commander of the need for displacement and recommends methods of displacement. The platoon sergeant directly supervises the employment of general support elements of the platoon through the section leaders. He further arranges timely resupply of ammunition in keeping with the existing status of on-position supplies for general support elements of the platoon.

d. Assault.--The distance from the objective at which the assault commences is influenced by the safety limits for supporting fires and the casualty producing effects of enemy fires. A final coordination line is selected which permits assault elements to deploy into the assault formations as close to the objective as possible without taking excessive casualties from enemy fires or undue hazard from supporting fires. A tentative final coordination line may be designated in the attack order. The exact location from which the assault is launched is determined by the assault element leader. When a coordinated assault by two platoons is planned, the company commander selects the location. Supporting fires on the enemy positions increase in intensity as the assault elements approach the final coordination line. Whenever possible, assaulting units deploy in assault formations and launch the assault without a halt at the final coordination line. The assault moves at a rate consistent with the visibility, slope of the objective, ground conditions, state of troop training, and physical condition of assault troops. The assault's momentum is maintained until assaulting units clear the enemy positions and move over the objective far enough to delivery fire on withdrawing enemy elements and to protect against counterattack.

(1) Rifle Platoon.--Assaulting squads of an attacking rifle platoon are formed in squads abreast upon reaching the final coordination line. The platoon may assault with one, two, or all three rifle squads depending upon the situation. The assault is initiated on order or signal. The assault signal at platoon level and above is usually a visual signal. The rifle squad's actions in the assault are described in FMFM 6-5, Marine Rifle Squad.

(2) Supporting Fires.--The shifting or ceasing of supporting fires is effected after commencement of assault fires and is normally controlled by the company commander. As the assault is launched, fires that endanger assaulting units are ceased or shifted. Generally, indirect fires are ceased or shifted first and direct fire weapons continue to fire until masked by the assault.

e. Pursuit by Fire.--The assaulting units pursue the withdrawing enemy with small arms, mortar, artillery, or naval gunfire. Units plan and request supporting fires on withdrawing forces in order to continue the pursuit by fire on forces which have reached positions defiladed from small arms. The pursuit by fire begins for each unit as soon as that unit's objective has been seized. Fire on individuals and units withdrawing prior to seizing the objective is part of the attack or assault. The pursuit by fire may continue simultaneously with the initial stages of consolidation and ceases when the withdrawing enemy elements have been destroyed or no longer present targets.

3308. CONSOLIDATION

a. General.--Consolidation commences as soon as the objective is seized. Consolidation plans contained in the attack order are revised as

necessary. When the attack is to be continued beyond the initial objective, the halt on the initial objective is as short as possible. Consistent with orders from the next higher echelon, the duration of the halt varies from a minimum of the time required for issuance of orders to subordinate units to that required for a thorough reorganization and resupply.

b. Security Measures.--The first considerations of the commander after seizing the objective, and while the pursuit by fire is being conducted, are to ensure that he holds his gains and that he does not miss any opportunity that will facilitate future actions. To protect the objective, he takes all actions necessary to defeat an enemy counterattack.

(1) The company commander's most immediate concerns are the dispositions of the leading rifle platoons and the timely displacement of organic, attached, and supporting weapons to preselected position areas from which they can repulse a counterattack. The reserve may be positioned to protect an exposed flank or to extend the depth of the position. Local security and patrols are employed to the front and flanks to maintain contact with the enemy and with adjacent units. Fire plans in support of the position are improved and redistribution of weapons and units is accomplished as personal reconnaissance dictates.

(2) The rifle platoon commander's most pressing initial concerns are the dispositions of the squads which conduct the assault and the displacement and positioning of the base of fire, if employed. The platoon's security precautions are preplanned and are included in the attack order. However, after a personal reconnaissance, the platoon commander redistributes his squads and/or attached weapons and requests changes in fire support from the company.

c. Reorganization.--Reorganization is continuous throughout the attack and during consolidation. It includes the reassignment of personnel to key billets made vacant by casualties, reestablishment of the chain of command, and redistribution of ammunition. During reorganization after seizure of the objective, the situation, strength, and ammunition status are reported to the next higher commander. Casualties are evacuated. Enemy information is reported and prisoners of war are handled in accordance with the battalion SOP.

(1) When necessary, the company commander may relieve one or both of the frontline platoons of responsibility for a position so that they may be withdrawn to covered or concealed positions to reorganize.

(2) In many instances, the rifle platoon's frontage on the objective is relatively narrow and the use of three squads to hold the position is not necessary. This is particularly true when the platoon objective is assaulted by either one or two rifle squads. Base of fire squads or squads not previously committed in the attack may be employed to relieve frontline squads. Relieved squads are withdrawn to the first available cover to reorganize.

3309. EXPLOITATION

a. General.--Exploitation is the following up of gains to take full advantage of success in battle. It is designed to destroy the enemy's ability to reconstitute an organized defense or to engage in an orderly retrograde movement. Exploitation ranges from that of pursuing small local

forces to the pursuit of large enemy forces. It is characterized by rapid advances against lessening resistance. Its purpose may be to take an objective deep in the enemy's rear or to pursue a retreating enemy force.

b. Company Exploitation

(1) When the company participates in an exploiting action, it may be mounted or dismounted. In either case, exploitation is characterized by rapid movement. Helicopters may be profitably used to lift an exploiting force to prevent enemy withdrawal, or to attack positions to the enemy rear or flanks. Operations are quickly executed to exploit the mobility and flexibility of the helicopter.

(2) Employment of mechanized infantry or motorized march columns for rapid movement are excellent methods of exploiting success. Particular emphasis is placed on the organization for combat, logistic support, and security required. Normally, the company participates as part of a larger force in this type of operation.

c. Pursuit.--Physical pursuit is undertaken by higher echelons when the enemy is no longer able to maintain his positions and endeavors to escape destruction by retreat. The decision to physically pursue the enemy rests with the battalion commander or higher echelons. It may be defined as an offensive action against a retreating enemy employing direct pressure or a combination of direct pressure and encirclement intended to annihilate him. The enemy is afforded no opportunity to reorganize his forces for defense.

(1) The rifle company participates in the pursuit as part of a larger force. It may function to maintain direct pressure by continuing to attack as ordered or it may be a participant in tactical movements to reestablish contact with the enemy. The rifle company, appropriately supported by some means of rapid mobility, may participate in tactical movements and attacks as part of the encirclement. The encirclement seizes objectives on the axes of enemy retreat to prevent his escape and permit his destruction between the two forces.

(2) The infantry battalion may conduct localized physical pursuit within its area of operation. When the battalion conducts limited physical pursuit, an appropriately reinforced rifle company may comprise the entire direct pressure or encircling force.

3310. RESERVE RIFLE PLATOON

a. General.--At least one rifle platoon is withheld from action as the company reserve whenever possible. The reserve is available for employment at a decisive moment. The opportunities for decisively committing the reserve are usually of extremely short duration and require timely decisions and rapid reactions. It is incumbent upon the reserve platoon commander to be thoroughly aware of the company plan of attack and to keep abreast of the company's situation in the attack. When rapid changes in the situation can be foreseen, it may be necessary to locate the reserve platoon commander with the company command group to ensure rapid reaction.

b. Primary Missions.--The reserve is most frequently committed at a decisive moment to ensure the success of the attack or to maintain its

momentum. Preferably, the company commander commits his reserve against enemy weakness to exploit an advantage gained by the attack. The company commander commits the reserve by fragmentary order, notifies the battalion, and reconstitutes a reserve as quickly as possible. Appropriate tasks may include one or more of the following:

(1) Attack From a New Direction.--The company commander commits his reserve to maintain or regain momentum of the attack, maneuvering the reserve against the enemy flank or rear.

(2) Assume the Mission of an Attacking Platoon.--When an attacking platoon has become disorganized or ineffective because of casualties, the reserve platoon may be used to replace it. If possible, the reserve should be committed from a new direction rather than through the disorganized platoon in contact. A successful attack by the reserve may restore lost momentum to the company attack. When circumstances require attacking through the platoon in contact, the rapid movement of subordinate units in gaps between the other platoon's major dispositions is stressed.

(3) Protect One or Both Flanks.--Normally, the reserve protects the company's exposed flanks utilizing combat patrols. The company commander may prescribe the size of combat patrols used to protect the flanks. He usually controls them through the reserve platoon commander and coordinates their movements with the actions of the attacking platoons. Splitting the reserve platoon into two combat patrols, each protecting one flank of the company, materially reduces the rapidity with which the reserve can be committed to the attack. When the terrain permits, the reserve platoon may move successively to positions from which the exposed flank can be covered. Other terrain situations may dictate echelonment of the reserve platoon or part of it to cover the flank.

(4) Mopup Operations.--The reserve platoon or its elements may be used to eliminate pockets of enemy resistance in the company zone of action which have been bypassed by the attacking platoons. In fast moving situations, reserves may be committed to clear the enemy from positions on the objective which have been bypassed.

(5) Maintain Contact With Adjacent Units.--The reserve platoon maintains contact between its parent company and adjacent companies. It may also be assigned to maintain contact between widely separated platoons of the same company. The reserve platoon commander establishes connecting groups to maintain contact between widely separated platoons of the same company. The reserve platoon commander establishes connecting groups to maintain contact between units. The connecting groups may serve as scouting elements for the reserve platoon when it advances in the gap between the attacking platoons.

(6) Protect Reorganization.--The reserve platoon or its elements may be employed in a variety of roles to protect reorganization of the attacking platoons:

- (a) Protect an open flank.
- (b) Complete a company perimeter defense.
- (c) Outpost and patrol the front and flanks of the reorganization.

Par. 3311

FMFM 6-4

(d) Assume the defensive mission of one or both leading platoons.

(7) Support By Fire.--The reserve platoon may be employed to support attacking platoons or adjacent units by fire when an increased application of small arms fire is sufficient to ensure the success of the attack. The reserve is committed in a fire support role only when fire alone is sufficient to maintain the momentum and decisiveness of the main attack.

c. Reserve Positioning.--The reserve is positioned where it can best perform its assigned missions. The company commander prescribes the initial location and plans subsequent, easily identifiable locations.

(1) General Considerations.--The initial position is often a covered or concealed area immediately in the rear of the line of departure. The assignment of certain reserve missions may dictate another location. The reserve is advanced by bounds from one covered or concealed location to the next as the attack progresses. Its positioning permits its availability but does not involve it in the fire fights of the attacking platoons. Reserve platoons displace forward to new positions on order from the company commander. When the terrain affords concealed or covered routes, the reserve may be ordered to follow in trace of a particular unit at a specified distance. The distance is predicated upon enemy observation and effective fields of fire.

(2) Additional Considerations.--The company commander may place a reserve platoon in the zone of action of the attacking platoon expected to make the best progress. This ensures its availability to influence the action and reduces the reaction time to a minimum. The company commander may direct the echelonment of the reserve platoon to protect an exposed flank. When a large gap exists between attacking platoons, the reserve may follow between them at a specified distance or by bounds to ensure adequate scouting of a broad zone of action.

3311. RESERVE RIFLE COMPANY

a. General.--The reserve rifle company is located in a position from which it can move rapidly to points of probable employment. As the attack progresses, it is kept within reinforcing distance of the attack echelon. The battalion commander directs the initial and subsequent positioning of reserves. The battalion commander plans the employment of his reserve to exploit success.

(1) The battalion order may include more than one contingent mission for the company. The company commander makes detailed plans for each contingency and disseminates them to his subordinates.

(2) The rifle company, as all or part of the battalion reserve, may be assigned one or more of the following missions:

(a) Attack to exploit enemy weakness or friendly success such as a rupture of an enemy position.

(b) Attack from a new direction upon an enemy position which has halted or threatens to halt the advance of the attacking echelon.

(c) Operations against the hostile rear to extend an envelopment or exploit a successful envelopment.

(d) Assume the mission of an attacking company.

(e) Eliminate enemy resistance bypassed by the attacking echelon or subsequently developed to the rear of the attacking echelon.

(f) Protect the battalion's flanks and rear.

(g) Maintain contact with adjacent units.

(h) Assist adjacent units when such action favors the accomplishment of the battalion mission.

b. Conduct.--During the attack, the battalion commander may require the reserve company commander to accompany him until the reserve is committed. He also may require the company commander to make recommendations concerning subsequent locations or to otherwise assist in the preparation of plans for employment of the company.

(1) The company commander, whether physically located with the battalion commander or with his company, keeps himself informed of the battalion situation at all times. He seeks information by maintaining close contact with the battalion, monitoring the battalion tactical net, and by personal reconnaissance. He anticipates missions likely to be assigned and prepares plans accordingly. Subordinates are kept informed.

(2) The reserve company is normally committed by a battalion fragmentary order. The order may or may not relate to a previously prepared plan.

(3) When committed, a reserve company is automatically relieved of reserve missions unless otherwise directed.

Section IV. NIGHT ATTACK

3401. GENERAL

a. General.--Night attacks are a normal part of operations and become increasingly important as enemy firepower increases. Night attacks are employed to achieve one or more of the following purposes:

- (1) To achieve tactical surprise.
- (2) To complete or exploit a prior success.
- (3) To maintain pressure against the enemy.
- (4) To avoid heavy losses which would likely result from daylight attacks conducted under the same conditions.
- (5) To compensate for an inferiority in combat power.
- (6) To seize terrain considered vital to the conduct of subsequent daylight operations.

b. Plans.--Although the plan for a night attack should be as simple as possible, the attack order may be lengthy and detailed because of the unusual number of specific control measures and special instructions which are necessary. In conjunction with the order, a thorough day and night terrain orientation is of the utmost importance. The plan for a night attack must include preparation, employment, distribution, and maintenance of night-viewing devices and surveillance equipment.

c. Characteristics

(1) Night combat generally is characterized by a decrease in the ability to place aimed fire on the enemy; a corresponding increase in the importance of close combat, volume of fire, and the fires of fixed weapons which are laid on definite targets or target areas by daylight; and difficulty in the maintenance of control, direction, and contact. Utilization of night sights and viewing devices can minimize these problems. Despite these difficulties, the night attack gives the attacker a psychological advantage in that it magnifies the defender's doubts, apprehensions, and fear of the unknown.

(2) The difficulties of night attack are further reduced by adequate planning and preparation and by thorough training in night operations. Normally, more time is required to plan and coordinate a night attack than a daylight attack. Thorough ground and/or air reconnaissance both day and night, by leaders of all echelons, is highly desirable. Because of difficulties in control, the scheme of maneuver for a night attack should be simple.

d. Types.--Night attacks may be classified as illuminated or non-illuminated operations.

(1) The illuminated attack is planned using the general techniques of daylight attacks and employing fire support and illumination.

The degree to which daylight techniques are employed in the scheme of maneuver is predicated upon the condition of visibility resulting from the use of illumination.

(2) The nonilluminated attack is conducted by stealth to maintain secrecy and achieve surprise in closing with the enemy before he discovers the attack. A complete plan of fires and illumination is developed to support the attack. The fires and illumination are not employed until the attack is discovered by the enemy.

e. Applicability.--This section deals primarily with the techniques employed by the rifle company and platoon in the nonilluminated operation. Certain of the techniques may be applicable to other forms of night attack. This section treats specifically the rifle company's planning and conduct of the night attack by stealth when the company attacks alone or as part of the infantry battalion.

3402. TACTICAL CONTROL MEASURES

a. General.--The degree of visibility largely determines the measures taken to ensure control. The reduced ability to control maneuver normally requires the company to move generally in columns and lines over open terrain. Easily identifiable terrain features are used as control measures whenever possible. Terrain features not easily identifiable in darkness are marked by artificial means; e.g., engineer tape. Control measures emphasized in a night attack are:

(1) Assembly Area.--The assembly area is normally assigned by the battalion commander. It may be closer to the line of departure than for a daylight attack.

(2) Release Points.--A release point is a point(s) at which a higher commander releases control of a unit to its commander. The battalion commander designates the company release point, the company commander designates the platoon release point, and the platoon leader designates the squad release point. Platoon and squad release points are located to provide a gradual deployment during movement to the probable line of deployment. They should be located far enough back to allow attacking units to complete their lateral movement before reaching the probable line of deployment, yet far enough forward to permit centralized control as long as possible.

(3) Attack Position.--An attack position is normally designated but seldom used in a night attack. The attack position should be in defilade but need not offer as much concealment as in daylight; it should permit easy entrance and exit. The company occupies the attack position only for the minimum time required to receive final instructions, to ensure coordination and/or to pick up special equipment.

(4) Point(s) and Line of Departure.--The company commander normally selects a specific point(s) of departure where the company will cross the line of departure.

(5) Routes.--The company commander selects the route to be used from the company release point to the platoon release point(s); the platoon leader selects the route from the platoon release point to the squad release point(s). Normally, selection in both cases is made on the basis of

observation of the area from a position to the rear of the line of departure. The route from the platoon release point to the squad release point is usually announced as a direction. The routes from the squad release point to the probable line of deployment are also announced as directions for squad movement. Guides are normally used to assist in the movement to the probable line of deployment.

(6) Probable Line of Deployment.--The probable line of deployment, normally selected by the battalion commander, is the location on the ground where the company commander plans to complete final deployment prior to moving out with platoons on line. The probable line of deployment should coincide with some terrain feature(s) visible at night. It should be generally perpendicular to the direction of the attack and as close to known enemy positions on the objective as it is estimated the company can move without being detected. If the enemy has obstacles in front of his position, the probable line of deployment should be on the enemy side of the obstacle, if feasible. The company commander selects the probable line of deployment if the battalion commander does not do so.

(7) Zones of Action and Objectives.--The company is normally assigned a zone of action and, in addition, may be assigned a direction or azimuth of attack. The company objective for a night attack is usually smaller than for a daylight attack so that the company can clear it in a single assault. The company commander usually assigns platoon zones of action by designating a portion of the probable line of deployment and an objective for each platoon. The frontage of 80 to 100 meters is considered adequate for each platoon. A rifle company would then have a frontage of 200 to 300 meters, depending on the number of platoons which were coordinated in the assault. Platoon objectives should also be small enough to be seized and cleared in a single assault. Assigned objectives should be designated by unmistakable terrain features. Intermediate objectives are not normally assigned for night attacks.

(8) Limit of Advance.--A limit of advance is a terrain feature easily recognized in the dark (stream, road, edge of woods, etc.) beyond which attacking elements will not advance. It is far enough beyond the objective to allow security elements room to operate. The limit of advance may be prescribed by the battalion or company commander.

(9) Time of Attack.--Often, an attack is made late at night so that initial objectives can be seized by daylight and the attack continued at that time. If the objective is relatively deep, or if the company mission requires immediate continuation of the attack, the attack may begin early at night and continue to the final objective during darkness. If the objective is to be seized and held, it also may begin early at night.

(10) Other Control Measures.--Additional measures which may be used to facilitate control in a night attack include:

(a) Use of an azimuth, mortar or artillery marking rounds, or tracers to assist in maintaining direction.

(b) Use of guides and connecting files.

(c) Designation of a base element on which other units base their movement.

(d) Use of radar, night-vision devices, binoculars, and flashlights with colored filters.

(e) Prescribing intervals and distances to be maintained between individuals, squads, and platoons.

(f) Identification of leaders and friendly troops by use of luminous buttons or tape, white armbands, etc.

(g) Use of radio. This means of control is normally restricted until after the attack is discovered. The company commander may use wire and/or messengers for communications with his platoon leaders.

(h) Pyrotechnics may be used as emergency control signals, but their indiscriminate use may alert the enemy.

b. Reconnaissance.--If possible, all leaders reconnoiter during daylight, dusk, and darkness. Reconnoitering during different conditions of light ensures maximum familiarity with the terrain. The company commander normally limits the size of reconnaissance patrols and prescribes other limitations on reconnaissance essential to the maintenance of secrecy. Night-vision devices should be used to assist in reconnaissance and to detect the enemy use of such equipment.

c. Surprise and Secrecy.--Positive measures are taken to ensure secrecy and increase surprise. In addition to limitations on reconnaissance patrolling, the movement of vehicles and weapons is held to a minimum. Light and noise discipline is rigidly enforced. Registration of weapons is avoided or accomplished in a way which will not indicate intentions to the enemy. A technique which may be utilized is to fire the registration adjustment over an extended time. Significant change in any type of activity is avoided.

3403. PLAN OF ATTACK

a. General.--The plan of attack is much more detailed and comprehensive than for the daylight attack and requires considerably more time to develop. Close coordination between adjacent units and with available fire support agencies is required at the lowest echelons.

b. Scheme of Maneuver.--The scheme of maneuver provides for the employment of subordinate, attached, and supporting units other than fire support units in the conduct of a frontal attack. Figure 30 is a schematic diagram of a typical scheme of maneuver for the rifle company.

c. Formation

(1) To assist in control, the column formation is used as far forward as practicable. If possible, deployment of the rifle squads in squad line is delayed until the company is within assaulting distance of the enemy positions. The principal considerations in the selection of a formation are visibility, distance to the objective, and anticipated enemy reaction. Based upon these considerations, the company normally crosses the line of departure either in a column of platoon columns or in a line of platoon columns. Generally, the single file formation is avoided.

(a) If visibility is poor, distance to the objective is great, or early contact with the enemy is not expected, the company may

Par. 3403

FMFM 6-4

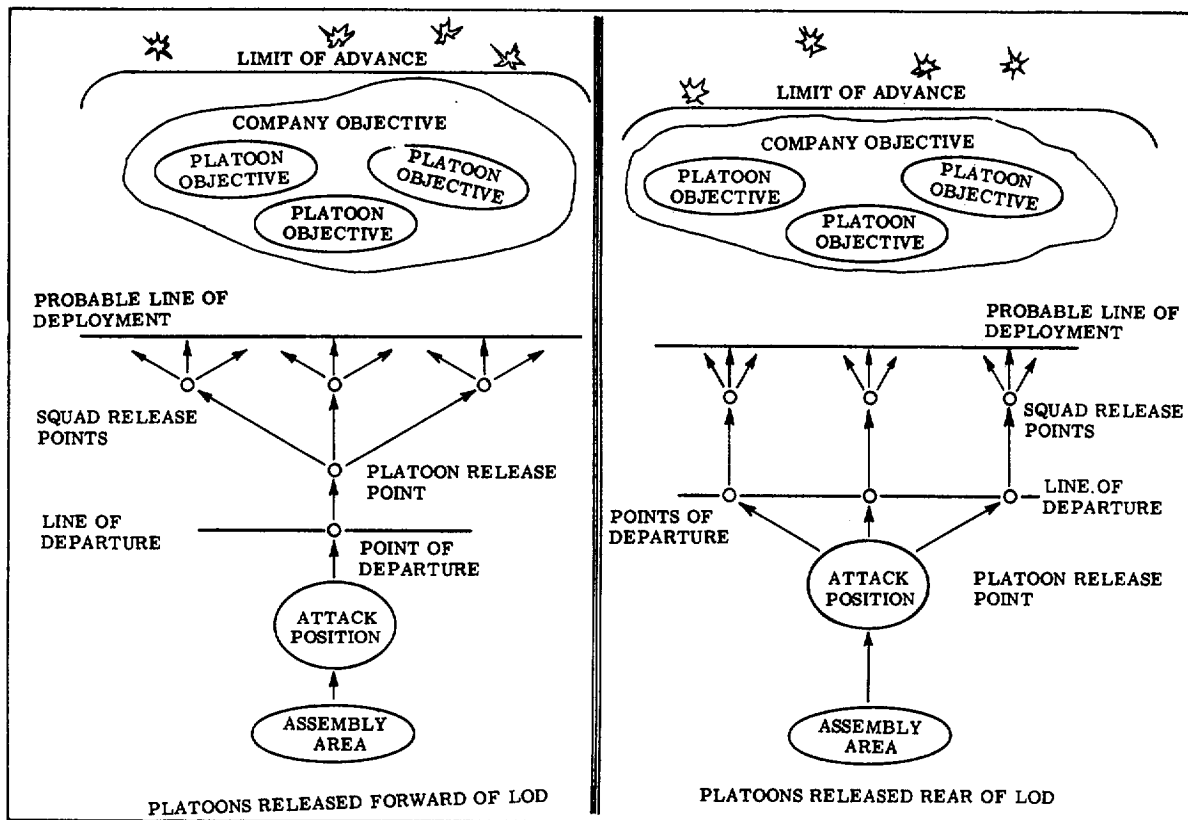

Figure 30.--Rifle Company Night Attack.

cross the line of departure in a column using one point of departure. This formation is retained until the platoon release point is reached unless enemy action forces earlier deployment.

(b) If visibility permits control of a more open formation, the distance to the objective is short, or early contact with the enemy is expected, it may be desirable to advance from the line of departure in a company line of platoon columns using three points of departure.

(c) If the company is in contact with the enemy and the distance to the objective is short, it will be necessary to have the leading squads move forward from their positions in squad line. In this case, the line of departure is, in effect, the probable line of deployment.

(2) The company commander normally employs all three rifle platoons in the assault. Under conditions of reduced visibility, the effective use of a reserve as a maneuver element is extremely difficult because of the difficulties of control and coordination. A reserve is withheld only when the company zone of action is extremely narrow or when there is a dangerously exposed flank or rear. If a reserve is designated to provide flank or rear security, the company commander may direct it to follow the attacking echelon closely, or he may leave it on the line of departure and have it brought forward on signal.

d. Communications.--The use of radio is normally restricted until after the attack is discovered or until deployment on the probable line of deployment is effected. The company tactical radio net usually invokes radio listening silence until the platoons are finally deployed or are positively discovered. Radio brevity codes may be employed to report readiness at the line of deployment. The principal means of communications within the company and platoon during movement to the probable line of deployment is by messenger.

e. Patrolling and Security.--Patrols are normally sent out before a night attack to reconnoiter the routes forward, to secure release points, and to gather knowledge of the terrain and information about the enemy. In addition, selected patrol members will act as guides to facilitate ease of movement. A patrol of from four to six men is generally sent from each platoon. The platoon leader will brief the platoon patrol leader on the route forward from the platoon release point to squad release points, the location of squad release points, and the platoon position on the probable line of deployment. The platoon leader may give specific instruction on the positioning of patrol personnel on the probable line of deployment so these personnel can aid the platoon in deploying. Platoon patrol leaders are briefed by the company commander on the route forward to the platoon release point, on terrain and enemy information desired, on locations of all platoon positions on the probable line of deployment, on actions to be taken in case the enemy is encountered before reaching (or on) the probable line of deployment, the guide system he desires, and on anything else that will assist in the accomplishment of their mission. The platoon patrols will normally be consolidated into a single company patrol with the company commander designating one patrol leader to coordinate the efforts of the platoon elements. The company commander may direct patrol leaders to leave some members of their patrols to secure the probable line of deployment while the remainder return to act as guides. The designated company patrol leader will normally remain at the platoon release point where he can best control the platoon patrols and coordinate the guide effort. Designated platoon patrol members (guides) will meet their platoons at the platoon release point and guide them to the squad release points and then to the probable line of deployment. Frontal and flank security is provided during the movement from the line of departure to the probable line of deployment. The size of these security elements varies with the amount of detailed information available on the enemy, the terrain, and likely enemy counteraction. The distance at which these security elements operate depends primarily on the commander's ability to control them.

f. Rehearsal.--The company commander should rehearse his plan of attack over similar terrain during daylight, and at dusk, if possible. This rehearsal is used to complete plans, ensure that all members of the unit are thoroughly familiar with the plan of attack, and to gain self-confidence in the nonilluminated method of attack. Unit commanders make corrections and adjust plans as necessary.

g. Fire Support Plan.--Night attacks may or may not be supported by fire depending on the degree of surprise to be achieved. In an attack against a well organized position where the possibility of achieving surprise is remote, preparation fires, fires in support of the attack, and fires to support the consolidation are employed. Use of supporting fires under these circumstances closely parallels a daylight attack. In an attack against a hastily organized position where the possibility of surprise is good, fires in support of the attack and fires to support the

consolidation are planned but are employed only when it becomes necessary. Even though the attack is to be made by stealth, complete plans are made for supporting fires and illumination. Weapons are positioned and registered, but their fires are normally placed on call and delivered on order of the company commander. When more than one company comprises the attack echelon, the battalion commander may prescribe conditions under which supporting fires and illumination may be requested.

(1) Fire Planning

(a) Fire planning for the night attack is essentially the same as for attacking in daylight. Registration is held to a minimum and coincides with other normal fires in the same general area so as not to sacrifice surprise.

(b) Indirect fire weapons are registered and all firing data completed in daylight.

(c) Direct fire weapons such as tanks and machineguns are positioned and laid on targets during daylight. Provisions are made to displace them forward over predesignated routes to predetermined positions on the objective from which to support the consolidation.

(d) Whenever possible, coordination is effected to employ the weapons of forward units to support the attack. When attacking through another company, the company commander coordinates with the company in contact and incorporates its machineguns and other suitable direct fire weapons into his planned fires. Normally, the unit in contact places these fire support elements in direct support of the attacking company until seizure of the objective.

(e) Machineguns organic to the attacking company are attached to and move with the rifle platoons. Their employment in the assault increases the assault fire capabilities of the rifle platoons. Moving with the company ensures their immediate availability en route and during the consolidation. When the distance from the line of departure to the objective is short and weapons are not available from other companies, organic machineguns may be emplaced in the vicinity of the line of departure to provide direct fire support.

(f) The assault section closely follows the attack to predesignated positions on the objective from which to support the consolidation. LAAW's do not ordinarily support the attack by fire.

(g) The 60mm mortar section normally will be employed in general support and will follow in trace of one of the attacking platoons, usually with the weapons platoon (-). During the assault, the company commander may have the section established in positions in the vicinity of the probable line of deployment to provide illumination and possibly engage targets of opportunity under illumination. The mortars will move to the objective immediately after seizure and engage targets of opportunity during pursuit by fire and consolidation. When nonorganic supporting fires are insufficient to ensure fire superiority for the attacking company, the mortars may be positioned near the line of departure to provide continuous fire support throughout the attack. This employment is contingent on the availability of firing positions within supporting range of known targets or danger areas.

(2) Illumination Planning

(a) The battalion commander normally determines the degree of illumination to be provided. During the attack by stealth, illumination is not employed during the advance to the probable line of deployment. During the assault, direct illumination by searchlights and flares may be used to blind and confuse the enemy. Illumination used to aid in consolidating the objective is normally limited to indirect illumination. Battlefield illumination may be furnished by the employment of ground signals, mortars, artillery, naval gunfire, aircraft flares, and searchlights.

(b) Illumination by searchlight is divided into classes--direct and indirect. Positioning is accomplished during daylight. It can be employed in three ways (see fig. 31):

1 With direct illumination, the lights occupy positions which permit a direct line of sight coverage of the objective. The light produced approximates daylight.

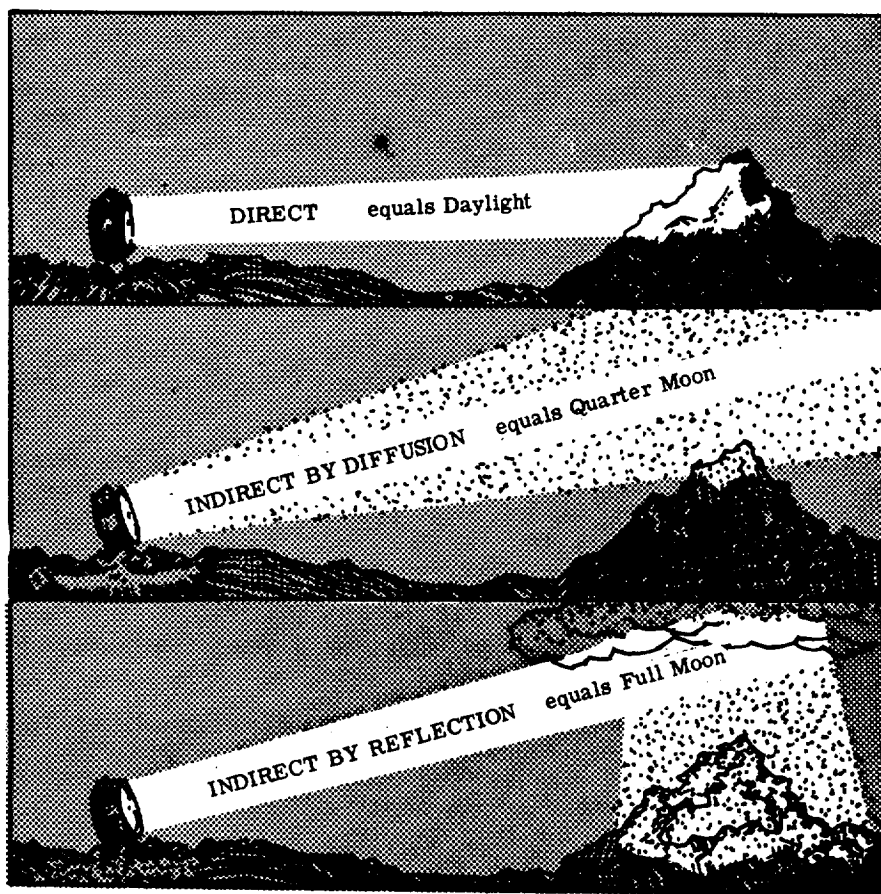

Figure 31.--Searchlight Employment.

2 Illumination by diffusion is indirect lighting which approximates the intensity of a quarter-moon. The beam is directed at a minimum elevation above the ground which causes the area beneath and to the flanks of the beam to be illuminated by the light diffused from atmospheric particles.

3 Illumination by reflection is another means of indirect lighting. It approximates that of a full moon. The searchlight beam is directed against low-lying clouds. The area illuminated receives light reflected from the clouds as well as diffused light.

3404. CONDUCT OF THE ATTACK

a. Attack Position.--Guides are used and routes are marked as necessary to aid movement into the attack position or to the line of departure when an attack position is not used. The company occupies the attack position for the minimum time needed to effect final coordination and last minute instructions. Returning members of the security patrol usually rejoin their respective platoons in the attack position after reporting to the company commander.

b. Movement to Platoon Release Point.--The company commander leads the company to the platoon release point. Platoon commanders march at the heads of their units to facilitate control. Frontal, flank, and rear security is maintained. Once the line of departure is crossed, movement is continuous and the rate of advance is slow enough to permit silent movement.

c. Advance to Probable Line of Deployment.--Movement is continuous through the platoon release point. When released, the platoons proceed on separate routes to the squad release point and then to the probable line of deployment. Each platoon provides forward, flank, and rear security elements.

(1) The company command group usually follows closely in trace of one of the rifle platoons to a predesignated position in the vicinity of the probable line of deployment.

(2) The assault section follows the company command group to a predesignated location short of the probable line of deployment when not employed in protecting a flank from an armor threat.

(3) Enemy elements encountered are eliminated as silently as possible during the approach to the probable line of deployment.

(4) Flare discipline is employed during the entire movement to the probable line of deployment.

(5) If the movement is positively discovered, the platoons are released and move on their independent routes to the probable line of deployment. They deploy from the platoon column as necessary to overcome enemy resistance on their respective routes.

d. Actions at the Probable Line of Deployment.--On arriving at the probable line of deployment, the squads deploy in line formation with fire teams as skirmishers. Enemy elements which may endanger deployment are eliminated as silently as possible just prior to arrival of the squads. Guides and security patrol members assist in the deployment and rejoin their squads.

The platoon commanders report their completed deployments and readiness to continue the operation to the company commander by radio brevity codes and/or messenger. Flare discipline is usually employed at the probable line of deployment.

e. Movement Forward.--Movement forward of the probable line of deployment commences on order of the company commander. The company commander may employ a radio brevity code, messenger, and/or movement of the base platoon to initiate further movement. The company continues the advance by moving silently forward in line without firing, but does not normally employ flare discipline forward of the probable line of deployment. When the attack is discovered, the assault is begun on signal from the company commander.

f. Assault.--Scattered firing by the enemy must not be construed as a loss of surprise and the company committed to a premature assault. The assault is normally initiated by the company commander. Unmistakable visual signals and voice commands are used. The authority to signal the assault because of enemy action may be delegated to the platoon commanders at the company commander's discretion. The assault is conducted aggressively. The importance of developing a large volume of fire is emphasized. Assault fire must establish the fire superiority normally provided for by other fires in daylight. Tracer ammunition may be used to aid accuracy and to demoralize the enemy. The company commander calls for supporting fires to isolate the objective and for available illumination. The assault is carried forward to the far military crest of the objective or to another prescribed limit short of the limit of advance.

3405. CONSOLIDATION

Consolidation is conducted in a manner similar to that for daylight operations. The reduced visibility must be taken into consideration when assigning defensive sectors. Also, the lack of visibility may require that the organized mopup of enemy forces be delayed until daylight. However, immediate action must be taken against enemy forces interfering with the consolidation.

Section V. TANK-INFANTRY ATTACK

3501. GENERAL

a. The speed, maneuverability, and communication facilities of tank units permit the rapid massing of mobile firepower at a locally decisive point. Tanks are employed with infantry in a balanced tank-infantry team to exploit the mobility, firepower, speed, and shock action of the tank to the maximum. The infantry elements provide close-in protection for the tanks from enemy antitank weapons and tank-killer teams. The tanks and infantry complement each other through mutual support and cooperation which emphasize the offensive capabilities of each arm. The separation of tanks and infantry is limited to the time and distance within which they are mutually supporting.

b. Terrain is the greatest limitation in the employment of tanks. Swamps, dense woods, steep slopes, and unfordable bodies of water slow or stop tank movement; however, minimum engineering efforts may sometimes overcome obstacles considered impassable by the enemy. The tanks' engine and track noise often give warning of their presence making tactical surprise difficult to achieve. A degree of surprise may be obtained, however, by utilizing the tanks' speed and maneuverability to advance rapidly under the cover of artillery fire, air support, or naval gunfire. Additionally, surprise may be realized by utilizing the least favorable avenue of approach for armor and attacking from an unexpected direction.

c. Tank units may be attached to, placed in direct support of, or placed in general support of infantry units. See paragraph 1302 for a discussion of these methods of employment. When employed with a rifle company, the tank unit is normally in direct support. The size of the supporting tank unit varies with the terrain, enemy situation, friendly situation, mission, etc., but will normally be a platoon of five tanks or a section of two or three tanks. Tanks should not be employed in less than sections.

d. The supporting tank unit commander is responsible for establishing the initial liaison with the supported unit commander. Thereafter, it is the responsibility of both commanders to maintain close and continuous coordination throughout the planning and attack.

3502. MUTUAL PROTECTION

Each element of the tank-infantry team provides a degree of mutual protection to the other element. The tank provides direct fire support with its main armament and machineguns. It is also capable of breaching wire entanglements and antipersonnel minefields. The tank, however, is not capable of fully protecting itself against enemy tank-killer teams because of its limited visibility. The accompanying infantry must provide this protection and generally uses one or a combination of the methods shown in figure 32, consistent with the nature of the terrain.

3503. METHODS OF ATTACK

a. General.--Whether the tanks are attached or in direct support, the rifle company commander uses any combination of three methods of attack

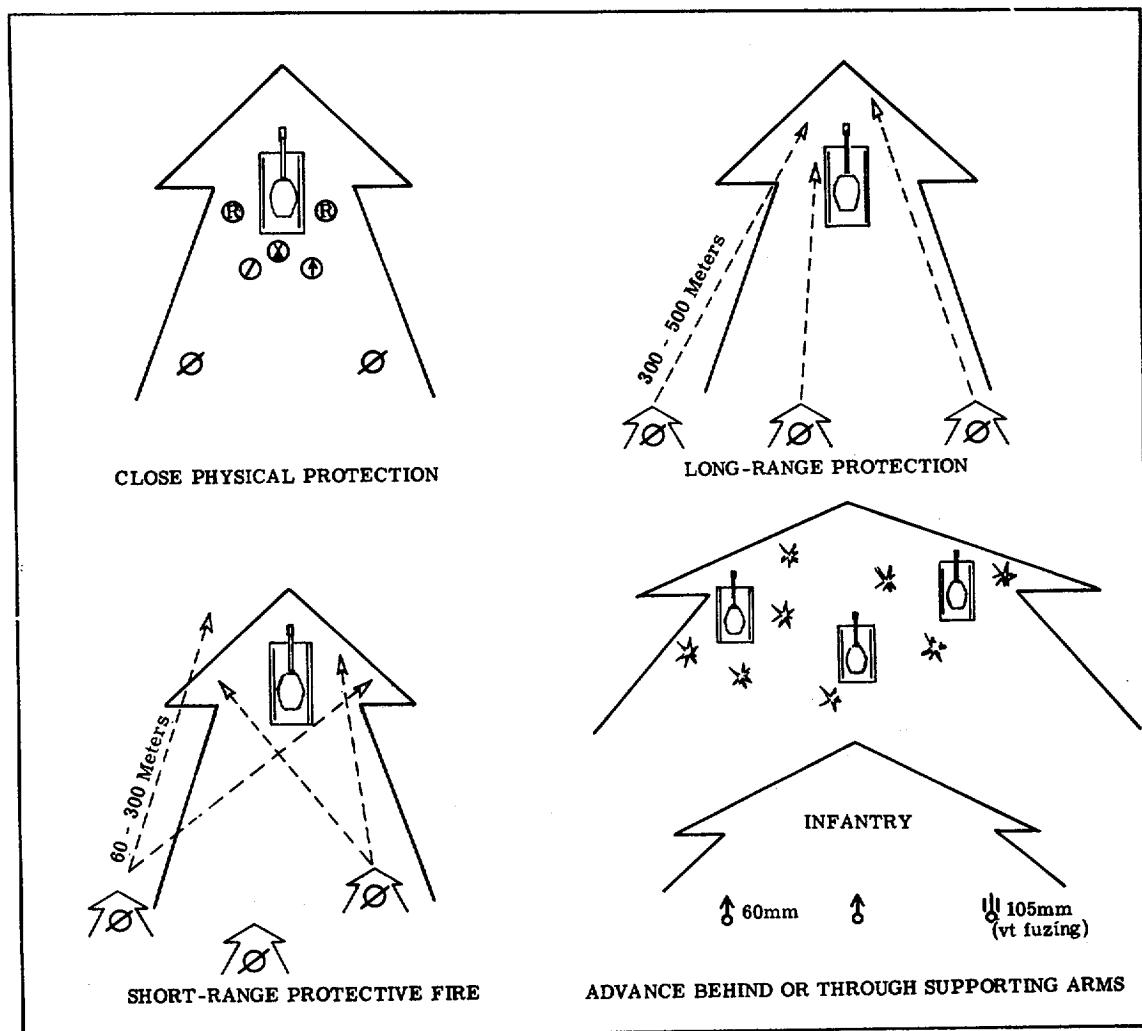

Figure 32.--Tank Protection Measures.

in employing the tanks. The three methods are the single axis attack, the converging axis attack, and support by fire. The combination of methods employed in the attack and the techniques of their application are varied to take maximum advantage of the tank's mobility, firepower, speed, and shock action. The three methods are appropriate for the rifle company or platoon.

(1) Single Axis Attack

(a) When maneuver, visibility, and fields of fire are restricted, the tanks and the infantry usually advance together within

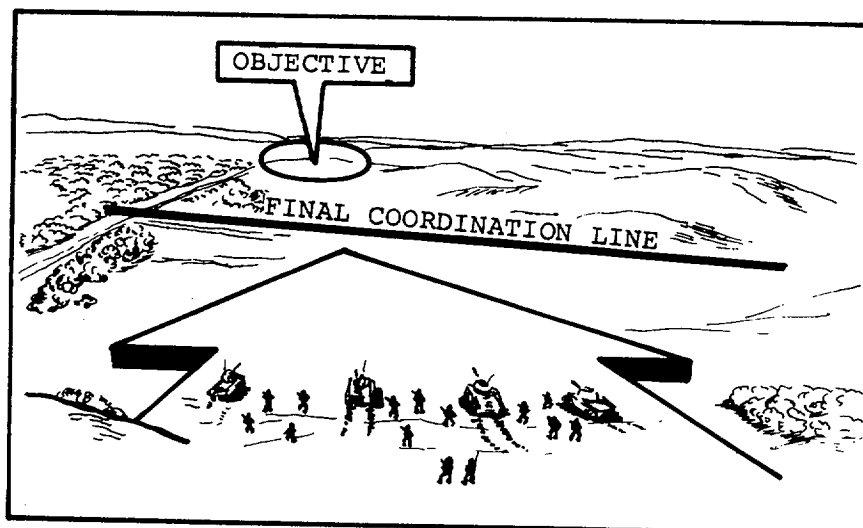

Figure 33.--Single Axis Attack.

mutually supporting distance of each other. Preferably, the tanks precede the infantry at the same speed. As the advance progresses, the relative positions of the tanks and infantry are adjusted according to the terrain and the enemy situation. This technique permits close coordination and maximum mutual support but sacrifices the speed and mobility of the tanks. Consequently, the shock action of the tanks is decreased and their vulnerability to enemy counteraction is increased.

(b) When good visibility and fields of fire are available, the tanks may initially support the advance of the infantry by fire. As the infantry approaches the final coordination line, the infantry commander orders the tanks forward for the assault. The movement of the tanks may be so timed that they pass through the infantry and assault under artillery and mortar air bursts. The infantry assault closely follows. The movement of the tanks may also be timed to join the infantry at the final coordination line for a simultaneous assault of the tanks and the infantry. The tanks lead the assault to take maximum advantage of their firepower and shock action and to prevent the infantry from masking their fires. In either case, proper timing must prevent prolonged halts at the final coordination line. (See fig. 33.)

(2) Converging Axes Attack.--Two different axes are used by the tank-infantry team to approach a common objective in attacking on converging axes. The adoption of the converging axes method depends primarily on the availability of suitable avenues of approach for the tanks and the infantry. Normally, the tanks follow the terrain most appropriate for their employment, while the infantry advance follows an axis offering cover and/or concealment. The tanks initially support the infantry advance by fire. The movement of the tanks is timed so that they assault the objective slightly in advance of the infantry to take maximum advantage of their shock effect. Tanks and infantry may also assault at the same time. When both axes are suitable for the employment of tanks, tank-infantry teams may also attack on each axis. One axis contains a force which is predominantly infantry supported by tanks. The other axis employs a force of tanks supported by

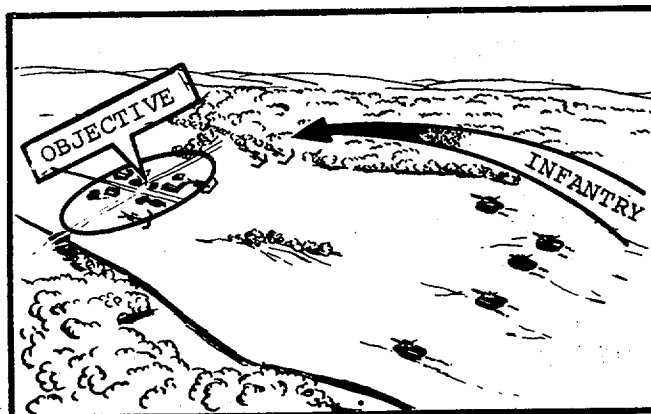

Figure 34.--Converging Axes Attack.

a minimum force of infantry. The converging axes attack is the preferred method as it achieves maximum firepower and shock action. It is economical in the use of troops and equipment and forces the enemy to fight simultaneously in two directions. Coordination of the assault presents the greatest difficulty. (See fig. 34.)

b. Support by Fire.--The support by fire method consists of an infantry attack to seize the objective while the tanks support the attack by fire. Having the tanks support by fire is the least desirable method for their employment and is used only when conditions exist which preclude their physical presence in the assault. This method is adopted when obstacles exist which must be uncovered in the attack to protect breaching parties, or when the attack includes the seizure of terrain impassable to tanks. In attacks of this type, the infantry loses the mobility, shock action, and close support of the tanks. The infantry is unsupported in the assault when the tanks cease or shift fire. The tanks are not available on the objective to cover the consolidation.

3504. PLAN OF ATTACK

a. General.--The plan of attack for the tank-infantry team is similar to that for the daylight attack in that it embodies a scheme of maneuver and fire support plan. They are developed concurrently, based on the infantry commander's estimate of the situation.

b. Scheme of Maneuver.--The scheme of maneuver is formulated from the considerations discussed in paragraph 3305 for the daylight attack and a consideration of the methods of tank-infantry attack. The rifle company commander and the unit leader of the attached or supporting tank unit conduct a joint reconnaissance. During the reconnaissance, the tank unit leader makes specific recommendations to the company commander concerning tank employment from the standpoints of terrain, the enemy situation, and the number and types of tanks available. The company commander incorporates the recommendations of the tank unit leader into his estimate of the situation, completes the estimate, and arrives at a decision. His decision includes the method or combination of methods of attack for the tank-infantry team. Whenever practicable, the company commander retains the tank unit in a general support role and plans his maneuver to take maximum advantage of

the shock action and firepower attained by the employment of tanks in mass. Where the company zone of action is too restricted to facilitate the movement of massed armor, tanks may be placed in direct support of the attacking rifle platoon(s). In such a case, a joint reconnaissance is made by the unit leaders involved prior to arriving at the plan of attack.

c. Fire Support Plan.--Fire support planning for the tank-infantry attack proceeds generally as described for the daylight attack in paragraph 3306. Certain special fire support considerations are involved in the employment of the tank-infantry team.

(1) Fires must be planned to protect the tanks from enemy tank-killer teams. These fires may be any combination of small arms and artillery or mortar time fire. Machineguns may be effectively employed in protecting tank movements. Their range materially reduces the number of displacements necessary to continuously support the tanks. Fires to protect and cover tank movements are particularly important when the scheme of maneuver requires the tanks to traverse ground not previously uncovered by the infantry advance.

(2) Fire planing must provide for the destruction or neutralization of known and suspected enemy antitank weapons. Fire plans must be flexible enough to provide for the immediate engagement of enemy antitank weapons positions disclosed during the attack.

(3) The fire support plan employs the fire and maneuver capabilities of tanks to the maximum. Fires from the tank's main armament and its machineguns are incorporated into the fire support plan. Tanks may participate in preparation fires, fires in support of the attack, assault fires, and fires to support consolidation. The relative effectiveness of their fire support is directly related to the method or methods of attack required by the scheme of maneuver.

3505. CONDUCT OF THE ATTACK

a. General.--The attack is conducted aggressively to close with the enemy as rapidly as possible with a combined force of tanks and infantry. Ideally, the tanks lead the infantry through the assault of the objective.

b. Movement from Assembly Areas.--The techniques employed in assembling and moving the tank-infantry team to the line of departure may vary.

(1) The tank-infantry team may be formed and occupy a common assembly area. When the terrain permits and the assembly area is close to the line of departure, the team moves forward to and across the line of departure in its initial attack formation. When routes to the line of departure are limited and/or the assembly area is remote from the line of departure, the tank-infantry team moves forward to an attack position in an approach march formation. Deployment into the initial attack formation is effected in the attack position.

(2) The tank and infantry components of the team may occupy separate assembly areas. The respective commanders, having effected coordinated planning, may arrange to move their respective components from separate assembly areas to a common attack position at which the tank-infantry team is physically formed. Such movements require execution sufficiently in advance of the attack to effect close coordination in the attack position.

This technique is usually employed at the company level when the prospective plan of attack is simple and under company control.

c. Advance and Assault.--The advance by fire and maneuver and the assault are conducted as described in paragraphs 3307 and 3502. Care is taken to ensure the coordinated advance and assault of the infantry and tank elements comprising the team.

3506. CONSOLIDATION

a. Consolidation is conducted in the manner described for the daylight attack in paragraph 3308. The tanks are withdrawn from their points of furthest advance in the assault to hull defilade positions on the objective. The tank unit's consolidation missions are assigned prior to commencement of the attack. The tank unit leader predesignates positions on the objective from which to accomplish the assigned consolidation missions.

b. In some situations, the presence of tanks on the objective may permit the rifle unit commander to withdraw the major portion of the rifle unit to covered positions for reorganization. The firepower afforded by the tanks in consolidation may be sufficient to defend the objective when augmented by adequate infantry to provide close-in protection for the tanks. This is of particular value when an early continuation of the attack is planned.

Section VI. MECHANIZED INFANTRY ATTACK

3601. GENERAL

a. The mechanized company may be employed independently or as part of a battalion mechanized force to accomplish one or more of the following missions:

- (1) Rapid seizure of deep objectives.
- (2) Envelopment and seizure of enemy positions.
- (3) Pursuit and/or cutoff of withdrawing enemy.
- (4) Exploitation of battalion successes.
- (5) Linkup with helicopterborne forces.

b. In the amphibious operation, the company normally lands as part of a larger force whether it conducts independent mechanized operations ashore or participates as part of a larger mechanized force.

c. The purpose of this section is to provide the rifle company commander and his platoon commanders with guidance in planning and executing the coordinated mechanized attack. Vehicle availability and planned employment on dismounting may require alteration of the techniques discussed.

3602. METHODS OF ATTACK

a. General.--The mechanized rifle company is a balanced fire and maneuver team composed of tanks, assault amphibious vehicles, and the rifle company. The entire grouping is controlled by the rifle company commander from the commencement of planning until the team is dissolved on order from higher headquarters. Similarly, the rifle platoon and its supporting assault amphibious vehicles are a balanced maneuver team. In some instances, tanks may be placed in support of the platoon to permit fire and maneuver at platoon level. In organizing the rifle company for the mechanized attack, the company commander is normally directly supported by a platoon of tanks, a platoon of assault amphibious vehicles, and a command vehicle. He normally retains the tanks and the command vehicle under his control and apportions the assault amphibious vehicles in direct support of the platoons. When possible, apportionments to the attacking echelon are sufficient to tactically mount one attacking rifle squad in each assault amphibious vehicle. The weapons platoon and the reserve rifle platoon are mounted in the remaining vehicles. Desirably, the entire rifle company is mounted in vehicles of similar land mobility characteristics.

b. Same Route.--In the mechanized attack, mounted infantry and tanks both advance simultaneously or the infantry may follow the tanks by bounds. (See fig. 35.) The tanks lead using their firepower to prevent undue exposure of the assault amphibious vehicles. The tanks and infantry may advance in any formation within mutual supporting distance.

c. Multiple Routes.--In some situations, it may be necessary or desirable for mechanized infantry and tanks to move on two routes. This is

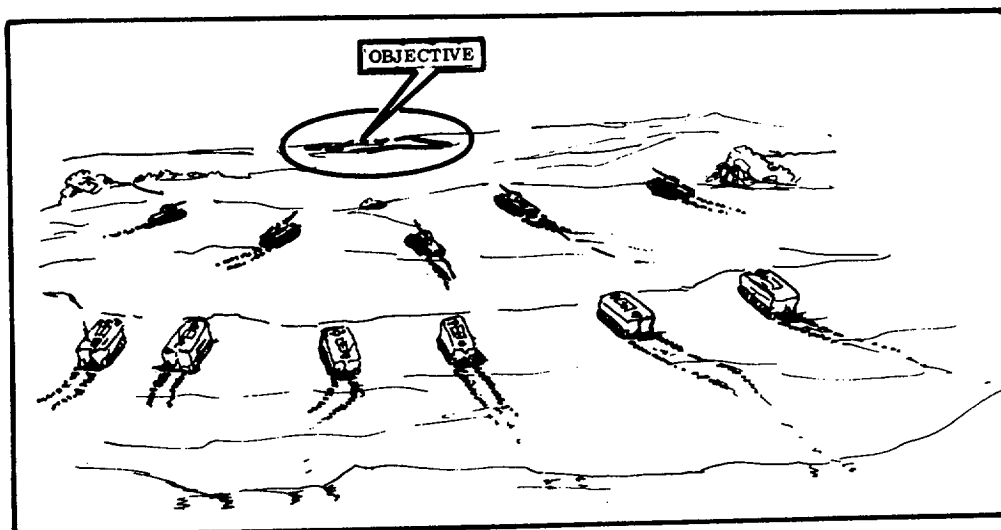

Figure 35.--Mounted Infantry and Tanks Advancing.

usually the case when exploiting the amphibious capability of the assault amphibious vehicle in crossing streams, rivers, lakes, etc. In such cases, the tanks support the attack by fire and join the infantry as soon as practicable. Once the infantry and tanks are reunited, the attack continues on a single route. When a single avenue of approach is too narrow to accommodate the entire attack echelon, tanks and mounted infantry may advance on multiple routes in closing with the enemy. Normally, a maximum of two routes are used in the advance. Tanks and infantry advance on both fronts.

3603. PLAN OF ATTACK

a. General.--The plan of attack for mechanized operations is similar to the daylight attack.

b. Scheme of Maneuver.--The scheme of maneuver is developed generally as discussed in paragraph 3305 for the daylight attack and a consideration of the methods of mechanized infantry attack. The following considerations are important in formulating the scheme of maneuver:

(1) Enemy.--Enemy defenses have considerable effect on the selection of routes and on the ability to move mounted in the attack. Enemy armor, antitank defenses, and positions with overhead cover are particularly important. Mounted movements in proximity to enemy covered positions are not practicable due to the relative ineffectiveness of air burst artillery and mortar fire in neutralizing them. Dismounted action forward of the line of departure is usually required to destroy or neutralize enemy armor, antitank defenses, and obstacles prior to initiating action at the assigned objective. Against hastily prepared positions with weak antitank defenses, however, mounted movement may be practicable all the way to the objective.

(2) Terrain.--Terrain is considered with respect to its trafficability for tracked vehicles and for wheeled vehicles logistically

supporting operations. Also, close terrain may force the infantry to dismount in order to provide the necessary close-in protection.

(3) Control.--The attack is controlled by adequate communications, affording subordinate leaders effective control of supporting vehicles, the selection of appropriate formations, and the use of tactical control measures.

(a) Vehicle Control.--Each rifle squad leader assumes tactical control of the vehicle in which his squad is mounted. The rifle platoon commander maintains tactical control over the three vehicles in which his platoon is mounted. The company commander normally exercises control from his assault amphibious vehicle.

(b) Communications.--Communications in the attack consist of radio and visual signals. Each assault amphibious vehicle is equipped with a radio set. The company tactical net is established utilizing the radios in appropriate vehicles during the mounted stages of the attack and reverts to the conventional net on dismounting.

(c) Formations.--The formations employed by the rifle company and the rifle platoon during dismounted stages of the attack are identical to those employed in the normal daylight attack. The formations employed when mounted in assault amphibious vehicles are similar:

1 Company Formations.--The considerations in selecting an attack formation are basically the same as for dismounted attack. The formation normally used when mounted is two platoons in the attack and one in reserve. A column formation is used more frequently for mechanized attack than for a dismounted attack. The mechanized rifle company often attacks to seize deep objectives when the enemy situation is relatively obscure. When necessary and when vehicles are available, all three platoons may be employed in the attack echelon. The weapons platoon and the reserve rifle platoon are seldom tactically mounted as their employment normally involves movement to a specified location by vehicle and dismounted action on commitment.

2 Platoon Formations.--The mechanized rifle platoon may employ various formations during mounted stages of the attack. The vehicle in which the platoon commander rides is normally the lead vehicle of the formation and is the base vehicle for movements in changing formations.

(d) Tactical Control Measures.--Special considerations are involved in the selection and/or use of certain tactical control measures. Tactical control measures not normally used in other forms of attack are required in the mechanized attack. Control measures not discussed are used in their normal manner; e.g., checkpoints and phase lines have the same significance.

1 Axis of Advance.--The company is normally assigned an axis of advance in the mechanized attack and may assign axes to the attacking platoons.

2 Zone of Action.--The company may be assigned a zone of action. A mechanized rifle company is rarely required to clear a zone. The company commander may assign zones of action to attacking platoons even

when the company is assigned an axis of advance. Zones are wide enough to permit vehicle maneuver and are considerably wider than for other attacks.

3 Intermediate Objectives.--Intermediate objectives tend to slow the attack and negate the mechanized capability of rapid and steady advance. They are designated less frequently in mechanized attack than in other forms of attack.

4 Dismount Area.--The company commander designates a dismount area forward of the line of departure in which his attacking platoons dismount from assault amphibious vehicles and immediately continue the attack on foot. The dismount area may be short of the final coordination line, at the line, or on the objective. It should be a concealed or covered area, if possible, and it should be located as far forward as the terrain and the enemy situation permit. In selecting the dismount area, the company commander estimates how far forward the attack echelon can move mounted before becoming vulnerable to effective enemy counteraction. He also considers the support afforded by the tanks and other fires as well as the terrain. The area selected during planning is tentative and may be changed during the attack. The dismount area is located on the objective only when tanks accompany the advance and it is estimated that enemy strength can be effectively neutralized by fire.

c. Fire Support Plan.--Since the movement of the mechanized attack echelon is rapid, detailed planning and coordination of supporting fires are essential to permit the timely delivery, shifting, and ceasing of fires. The plan provides for maximum delivery of fires during the period in which the infantry is active in the dismount area and just prior to the assault. Flexibility of the fire support plan is mandatory to meet unforeseen situations. Fire support planning proceeds generally as described in paragraph 4306 for the daylight attack and includes the additional considerations listed below:

(1) Protection Fires.--Since the tanks normally lead the mounted advance of the infantry, protecting the tanks by fire is a primary concern in fire support planning. Fires to protect the assault amphibious vehicles are a lesser, but important, requirement.

(a) Time Fire.--When the tanks lead the assault amphibious vehicles by sufficient distance, artillery and mortar air bursts may be used to protect the tanks. These fires should not be used to protect assault amphibious vehicles.

(b) Vehicle Fires.--The machineguns mounted in the cupolas of the assault amphibious vehicles may provide sufficient protective fires for the tanks. Their effectiveness is largely dictated by the terrain and the distance at which the tanks are leading the mounted infantry. The cupola machineguns may also be employed in mutual support between assault amphibious vehicles.

(2) Weapons Platoon.--The depth of the maneuver forward of the line of departure usually prevents the effective employment of the machinegun section during the mounted advance. The availability of tanks markedly decreases the importance of the assault section as an antitank defense means. For these reasons, the planned employment of the weapons platoon in the mechanized attack is limited to actions following its arrival in the dismount areas or other forward locations which it can effectively

Par. 3604

FMFM 6-4

support the attack. Normally, the assault section is employed only in consolidation unless its demolition capability is to be exploited.

(3) Tank Fires.--The fire support plan exploits the fire and maneuver capabilities of the tanks to the maximum. Tank fires are incorporated into the fire support plan.

(4) Neutralization Fires.--The destruction or neutralization of known and suspected antitank weapons must be provided for. The flexibility of the plan must permit the immediate engagement of enemy antitank weapons located during the attack.

(5) Screening Smoke.--The use of smoke is considered in screening the mounted advance and activities in the dismount area.

3604. CONDUCT OF THE ATTACK

a. Movement forward and across the line of departure is continuous. If a halt in the attack position is necessary, it should be as short as possible. The movement from the attack position to the line of departure is made in the initial attack formation.

b. Movement forward of the line of departure is made as rapidly as the terrain, speed of the vehicles, and the use of supporting fires permit.

c. During the advance the infantry dismounts for action when the situation requires. The infantry also dismounts to provide close physical protection for the tanks and assault amphibious vehicles when passing through close terrain, then remounts and continues the mechanized advance.

d. Upon reaching the dismount area, the vehicles halt under available cover and the infantry dismounts. The attack then continues as a dismounted daylight attack or as a tank-infantry attack.

3605. CONSOLIDATION

a. After seizing the objective, the attacking force consolidates in much the same way as in a daylight attack or tank-infantry attack. The assault amphibious vehicles are ordered forward from the dismount area to a covered area in the immediate vicinity of the objective or to hull-defilade positions from which they can provide machinegun fire. Some assault amphibious vehicles may be positioned to provide security to the flanks and rear.

b. As in the tank-infantry attack, the availability of firepower on the objective may permit rifle units to be withdrawn to covered positions for reorganization. Close-in protection requirements for the tanks and assault amphibious vehicles usually govern the rifle unit strength which may be withdrawn.

Section VII. ATTACK OF FORTIFIED AREAS

3701. GENERAL

a. Fortifications provide a base for offensive operations or a series of strong defensive positions for the protection of vital areas. They cause the attacker to mass and present a profitable target. The attacker's task of reducing fortifications results in dissipation of his combat power, thereby making him vulnerable to counterattack.

b. Fortified works of some nature are invariably constructed when military forces have a defensive mission. Depending upon the time and resources available for their construction, they may range in complexity from simple, hastily prepared log or earth bunkers constructed from locally available materials to permanent concrete and steel emplacements with fixed embrasures or steel turrets, intricate underground passages, and elaborate troop quarters.

c. This section discusses the tactics and techniques employed by the rifle company and the rifle platoons when participating in the attack of a fortified area consisting of mutually supporting bunkers and formidable obstacles.

3702. SPECIAL CONSIDERATIONS

a. General.--The attack of a fortified area is difficult and requires special consideration. The defender has the advantage of protection against all types of fire, prepared obstacles, carefully planned fires, and thoroughly rehearsed counterattack plans. For these reasons, fortified areas are normally bypassed by the main attacking forces and are contained by minimum forces. Actions to reduce the bypassed area may include seige or an attack from the rear.

b. Enemy Weaknesses.--There are certain disadvantages to defending a fortified area. The attacker must take maximum advantage of enemy weaknesses in planning and executing his attack. These weaknesses include:

(1) Lack of Mobility.--Each emplacement or bunker within a fortified area is permanently established and cannot be relocated or altered to meet changing situations.

(2) Openings.--Emplacements are weakest at and near the embrasures, air vents, and doorways leading in and out of them.

(3) Lack of Visibility.--A single embrasure in an emplacement can normally cover a 60-degree sector of observation and fire. The number of embrasures which can be constructed per emplacement is limited because the strength of overhead cover decreases correspondingly with the increase in the number of embrasures. This lack of visibility requires emplacements to depend upon each other for mutual support. The ability of a fortified area to maintain a coordinated defense depends upon the mutually supporting emplacements remaining intact. The defense becomes progressively less effective as emplacements are neutralized or captured.

c. Basic Principles.--The attack of a fortified area usually follows the basic principles of the daylight attack but may employ night

principles to exploit successful daylight attack or to seize key bunkers prior to daylight. The character and extent of the defense normally dictate the degree of special preparation necessary for the attack and whether it is initiated in daylight or in darkness. Greater than normal emphasis is placed on the following:

(1) Zones of Action.--Since the penetration is the normal form of maneuver employed by larger units in attacking a fortified area, the rifle company and rifle platoon are directed to clear their zones of action, particularly when participating as part of the main attack. This is done to eliminate enemy interference in rear of the main attack which might affect forces assigned to widen the gap or exploit the penetration. Zones of action assigned the rifle company and the platoon are narrower than normal. Specific frontages will be determined by the mission, the enemy situation, number of bunkers to be cleared, the number of troops, types and amount of special equipment available, etc.

(2) Missions.--Missions assigned the rifle company and the rifle platoon involve clearing their specified zones of action and seizing terrain objectives. A sequence for the reduction of known bunkers is normally assigned to insure that:

(a) Fortifications which are mutually supporting are attacked simultaneously.

(b) Maximum mutual support between attacking units is maintained.

(c) A maximum number of emplacements are attacked from the rear or from a blind side.

(d) The zone of action is cleared.

(3) Mass.--A primary purpose of a fortified area is to cause the attacker to mass and present lucrative targets. Plans for the attack must minimize this danger, consistent with the accomplishment of the mission.

(4) Information.--Detailed intelligence is required upon which to base training, rehearsals, and plans. The essential elements of information require efforts at all levels to determine the following:

(a) Exact location and extent of individual fortifications.

(b) Locations and numbers of embrasures, field of fire, and types of weapons therein.

(c) Locations of entrances, exits, and air vents in each emplacement.

(d) Directions of fire and types of fixed weapons.

(e) Extent of underground fortifications.

(f) Locations of natural and artificial obstacles.

(g) Locations of weak spots in the defense.

(h) Location of reserves.

(5) Planning.--Planning and preparation are centralized at the company level for decentralized execution by the rifle platoons. Plans are detailed, concurrent, and parallel.

(6) Captured Positions.--Unless required for use by the attacker, captured enemy armament and fortifications are moved or destroyed to prevent their use by the enemy if recaptured.

(7) Task Organization.--Each attacking unit within the infantry battalion, including the rifle squad, is task organized to accomplish its mission. The rifle company may be reinforced with tanks, engineers, and/or Dragons and MPFW's. The platoon (and squad) may also be reinforced as necessary by the above and weapons from the company weapons platoon. The use of demolitions and MPFW's during the attack of fortified positions is most advantageous.

3703. PLAN OF ATTACK

a. General.--At company and platoon level the plan of attack is a scheme of maneuver integrated and coordinated with a fire support plan similar to the daylight attack. The special considerations discussed in paragraph 3702 are incorporated into the estimate of the situation, as appropriate.

b. Scheme of Maneuver.--The scheme of maneuver at both the company and platoon level is normally a frontal attack immediately preceded by obstacle breaching operations. It provides for:

- (1) Breaching obstacles to provide clear approaches for assault elements.
- (2) Seizing mutually supporting emplacements simultaneously, if possible.
- (3) Reduction of emplacements within the zone of action in the sequence prescribed by the next higher echelon.
- (4) Seizure and consolidation of assigned terrain objectives.
- (5) Designation of both company and platoon reserves with the additional mission of protecting the flanks and rear of the penetration.

c. Fire Support Plan.--Fire support planning is very similar to planning for the daylight attack but is more detailed and comprehensive. Fire support usually commences with an intense preparation. Fire support elements of both the rifle company and rifle platoon participate in the preparation to cover concurrent obstacle breaching operations conducted by maneuver elements.

(1) Company level fire support planning must provide fires which are closely integrated with the support requirements of the attacking platoons and adjacent units. The company commander ensures that his fire support plan provides for:

- (a) Adequate support of obstacle breaching operations conducted by the attacking platoons.

Par. 3704

FMFM 6-4

(b) Simultaneous engagement of all known or suspected enemy positions and embrasures capable of firing in support of the emplacements under attack.

(c) Delivery of previously coordinated fires in support of adjacent units as required by the respective schemes of maneuver.

(d) Mutual support between attacking platoons.

(2) Platoon level fire support planning provides for the close fire support of obstacle breaching and assault elements. Within his fire support capabilities, the platoon commander plans for the simultaneous engagement of known and suspected enemy positions and embrasures capable of firing in support of the emplacements under attack. Additional fires are requested from the company commander and, when approved, are prearranged with the appropriate fire support unit. Mutual support between attacking squads and with adjacent platoons is arranged as necessary. A diversity of targets usually requires the platoon commander to employ machineguns, rockets, and MPFW's by teams rather than squads. This is particularly true of machineguns and rockets when the platoon withholds a reserve.

d. Rehearsal.--The entire plan of attack is rehearsed in detail when time permits. Leaders at all echelons are thoroughly familiarized with the plan of attack, its sequence, and its timing. Unit commanders make corrections and adjust plans as necessary.

3704. CONDUCT OF THE ATTACK

a. The attack usually commences with an intense air, naval gunfire, and artillery preparation. During the preparation, routes are cleared of obstacles to permit the passage of attacking squads. Assault elements advance as rapidly as possible under available supporting fires. Direct fire weapons engage the embrasures and other openings in the emplacements. Close supporting fires are directed toward supporting the advance of assault units to positions from which to assault and destroy assigned emplacements. Fires are continued as long as troop safety permits and are shifted or ceased by prearranged visual signal. Assault units approach assigned emplacements from a blind side, assault, and destroy them employing white phosphorous and demolitions. If the fortifications are protected by wire, wire breaching elements accompany the assault and clear routes through the wire. FMFM 6-5, Marine Rifle Squad, describes the assault of a single emplacement.

b. Consolidation is conducted generally as described in paragraph 3308 for the daylight attack. Supporting weapons may displace to new positions from which to support a continuation of the attack. Attacking platoons consolidate their respective emplacement areas and continue the attack until the final objective is seized. Reserve squads of attacking platoons and the reserve platoon take the necessary steps to prevent captured emplacements from being reoccupied in the wake of the attack. Battalion reserves may ultimately assume this responsibility. On seizure of the final objective, the attacking companies and platoons consolidate their gains while other forces widen the gap created. Other units may attack through the consolidating units to exploit the penetration.

Section VIII. ATTACK OF BUILT-UP AREAS

3801. GENERAL

The attack of a built-up area assumes specialized characteristics not normally associated with the conventional attack. Such attacks may be equated to the amphibious operation in that they require semi-independent actions of small units and extremely detailed planning to offset the difficulties imposed by the nature of the operational environment. The purpose of this section is to provide the rifle company commander and his subordinates with guidance in the planning and execution of the attack in a built-up area. The type construction encountered in the area may require a blending of the techniques discussed here with those of the daylight attack and the attack of fortified areas.

3802. BASIC CONSIDERATIONS

a. Certain general definitions are basic to a discussion of combat in built-up areas. (See fig. 36.)

(1) Built-Up Areas.--A built-up area is any group of buildings designed for habitation or for commercial purposes such as a village, town, or city. A built-up area may become a battle area because its location controls routes of movement or because it contains valuable industrial or political installations.

(2) Block-Type Construction.--Block-type construction is that type construction in which few or no gaps exist between buildings such as in business districts or large towns or cities.

(3) Detached or Semidetached Building Areas.--These are areas of towns and cities in which the buildings are spaced relatively close together as in residential areas with a high density of individual and duplex buildings.

(4) Isolated Housing Areas.--Isolated housing areas include villages, hamlets, suburban houses, or other small clusters of buildings which are surrounded by large, open areas.

(5) Critical Areas.--Critical areas are locations within a built-up area that may require special coordination to overcome. Open areas between buildings, superhighways, wide streets, railroads, and other terrain features which provide the enemy an advantage in observation and fire may become critical areas. Buildings bordering these terrain features are included in the critical areas.

(6) Key Building.--A key building is a structure which contains an important governmental agency or public utility or is one of distinct cultural, political, or historical value. City halls, telephone exchanges, telegraph offices, waterworks, transportation facilities, hospitals, museums, and cathedrals are examples of key buildings. Plans for seizure of such structures provide for minimum damage to the facilities housed therein.

b. The general construction of a built-up area imposes tactical considerations of a specialized nature on both the attacker and defender. These are discussed below primarily as they affect the attacker.

(1) Control.--Buildings in a built-up area interfere with radio communications. Wire and messengers are frequently the only reliable means. Because of restrictions on communications and observation, control is difficult and is decentralized. Initiative of small unit leaders assumes added importance.

(2) Military Aspects of Terrain.--The military aspects of the terrain hinge upon unusual characteristics which are unique to built-up areas.

(a) Observation and Fields of Fire.--Observation and fields of fire are restricted to the narrow lanes provided by streets and alleys. Observation is further restricted by the use of smoke or by the dust and smoke created during the fighting; therefore, it may be necessary to seize some of the taller buildings for use as observation posts. The rubble and debris resulting from destruction of buildings severely restricts existing fields of fire.

(b) Cover and Concealment.--Built-up areas offer excellent cover and concealment for both the attacker and the defender. The defender has an important advantage in that the attacker must expose himself to move through the area. The effectiveness of the cover depends upon the density of the buildings and the nature of their construction. Buildings with basements or two or more stories offer good overhead cover from supporting arms fire.

(c) Obstacles.--Buildings set close together in geometric patterns present obstacles to both troops and vehicles. Streets, particularly in block-type construction areas, are relatively easy to barricade and cover by fire. Rubble created by air, naval gunfire, artillery, and direct fire weapons may constitute obstacles to the progress of the attack.

(d) Key Terrain.--Key terrain in built-up areas includes strongly constructed buildings or groups of buildings which cover good avenues of approach, bridges, and hubs of underground sewerage and subway systems.

(e) Avenues of Approach.--The best avenue of approach in terms of cover and concealment is often through existing buildings. Streets, alleys, and underground sewerage and subway systems constitute avenues of approach which invite movement, but are readymade fire lanes and killing zones for enemy direct fire weapons. Vehicle movement is restricted to streets and alleys where they are subject to ambush.

(3) Fire Support.--Poor observation with its resulting limitations on adjustment of fire and the proximity of friendly and enemy forces in contact renders indirect fire support difficult. Direct fire weapons normally provide the bulk of the close fire support during the attack. The attacker must use supporting weapons carefully and consider the possibility of creating obstacles to his own advance or hindering the maneuver of higher or adjacent units.

(4) Security.--Basements, underground passages, and upper floors create a requirement for security above and below as well as to the front, flanks, and rear.

(5) Night Operations.--Under cover of darkness, streets can be crossed more safely and small patrols can infiltrate between defended areas

or defended buildings. These patrols may perform reconnaissance missions or conduct combat operations to eliminate enemy positions. Large scale night operations are avoided. Small local night attacks may position units for daylight operations, secure buildings or areas required for continued daylight operations, or eliminate enemy strongpoints.

3803. PHASES OF ATTACK

a. The attack of a built-up area is divided into three phases:

(1) Phase I.--Phase I is designed to isolate the built-up area by seizing terrain features which dominate the approaches. Because enemy defenses or terrain obstacles may prevent complete isolation, the attacker must secure positions outside the built-up area from which he can support entry into it and its step-by-step seizure. This phase of the attack is planned and conducted in a manner similar to other attacks.

(2) Phase II.--Phase II consists of the advance to the edge of the built-up area and the seizure of a foothold. Normally, this foothold consists of the seizure of buildings on its near edge which deny the enemy observation and direct fire on the attacker's approaches to the town. The planning and conduct of this phase are much the same as for attacks of strong defensive positions and may assume many of the characteristics of an attack against a fortified area.

(3) Phase III.--Phase III consists of the advance through the built-up area to clear it of enemy. During this phase the attack assumes its more specialized characteristics. It ends when the entire built-up area is cleared.

b. Phase I may be accomplished concurrently with phases II and III by large forces. There is no discernible pause following completion of phase II before phase III is initiated. As the planning and conduct of phases I and II are similar to other attacks, the remainder of the discussion in this section is devoted to phase III, clearance of the built-up area.

3804. PLAN OF ATTACK

a. General.--The plan of attack consists of the scheme of maneuver and a fire support plan which emphasizes the use of direct fire weapons in the close support of attacking echelons. As in other attacks, the scheme of maneuver and the fire support plan are developed concurrently. The tactical considerations resulting from the peculiarities of the built-up area are included in the estimate of the situation.

b. Scheme of Maneuver.--The scheme of maneuver is closely integrated with the fire support plan and emphasizes mutual support between adjacent attacking units.

(1) Rifle Company.--The rifle company commander is usually required to attack frontally within a zone of action, which must be cleared. The company is normally assigned key buildings, groups of buildings, or blocks of buildings as objectives, and in turn, plans to assign groups of buildings or single large buildings as platoon objectives. When an objective extends to a street, only the near side of the street should be included. Each building within the zone of action must be entered and

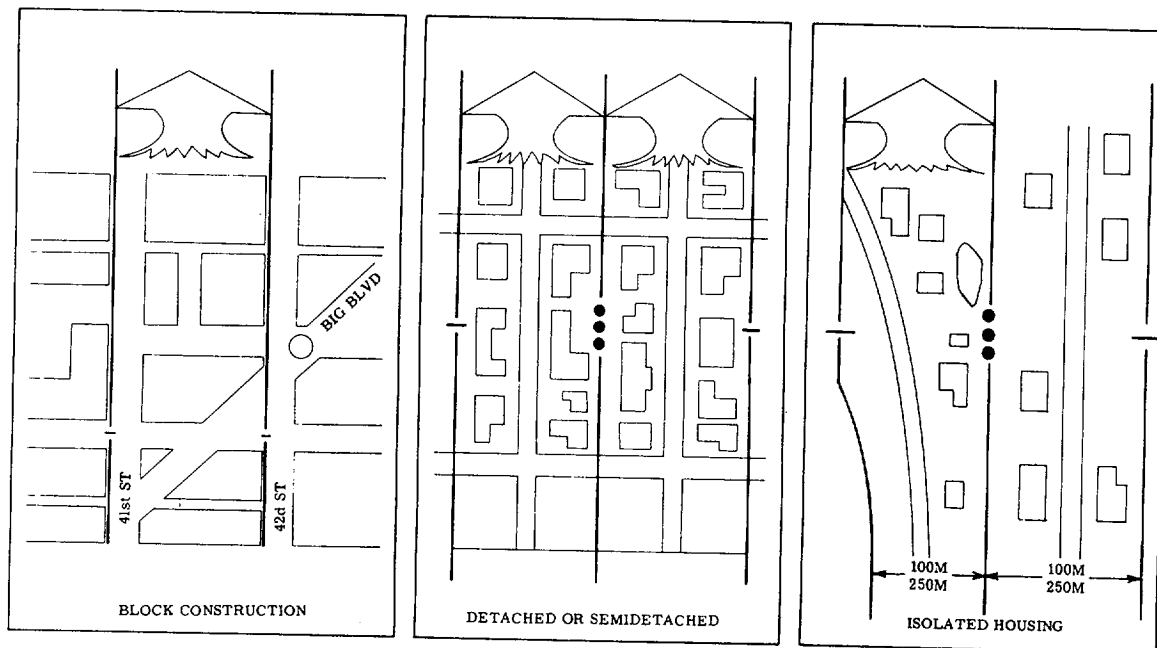

Figure 36.--Typical Company and Platoon Frontages.

searched in order to be assured that the enemy is cleared. Phase lines may be employed to enhance control and regulate the advance of attacking platoons.

(a) Formations.--The attack formation depends upon the width and depth of the zone of action, the type construction of the area, and anticipated enemy resistance. Normally, the rifle company employs two platoons in the attack and one in the reserve. The reserve protects the flanks and rear of the company.

(b) Frontages.--Frontages assigned to the rifle company depend upon the enemy strength, size of buildings, and the type construction of the area. In isolated housing areas, the company may be assigned normal frontages. In areas of detached and semidetached construction, the company frontage consists of two streets including all buildings fronting on both streets. In block-type construction, the rifle company is assigned a zone of action one block wide inclusive of the street on one flank and exclusive of the street on the other. Figure 36 shows typical frontages for the rifle company and platoon and provides guidance to the company commander in assigning zones of action to attacking platoons.

(2) Rifle Platoon.--The rifle platoon commander plans to attack frontally to clear the assigned zone of action. The platoon is normally assigned groups of buildings or single large buildings as platoon objectives. Correspondingly, the platoon commander assigns individual buildings or portions of large buildings as squad objectives. Numbering buildings within the platoon zone of action facilitates the assignment of objectives and simplifies reports of their seizure.

(a) Formations.--The rifle platoon normally designates and withholds a reserve and employs two squads in its attacking echelon, particularly when attacking in block-type construction or in areas of detached and semidetached construction. In isolated housing areas, the platoon attack formations may assume the character of those used in other attacks.

(b) Frontages.--Frontages assigned attacking rifle platoons may vary, depending primarily upon the type construction characteristic of the area under attack. Figure 36 shows typical platoon frontages for the various type constructions. The frontages assigned the rifle squads are also determined largely by the type construction encountered. In isolated housing areas squad frontages are normal. In areas consisting of detached and semidetached buildings, a squad is normally assigned a frontage sufficient to include the buildings fronting on one side of the street. In block type construction, squad frontages are assigned consistent with the building or portion thereof assigned the squad as an objective. In some instances a direction of attack may be assigned to ensure entry into the building at the desired location.

c. Fire Support Plan.--Fire support planning is similar to planning for the daylight attack but relies more extensively on the use of direct fire weapons in close support of the attack. Indirect fires are primarily planned to engage deeper targets and to screen the attack with smoke. Mutual support between adjacent squads and platoons is required and integration of schemes of maneuver with mutual fire support requirements is planned in detail. (See fig. 37.)

(1) Support.--Tanks; Dragons; and tube launched, optically tracked, wire command link, guided missile system (TOW) platoons are attached to or support the rifle company and increase its direct fire support capability. Vehicle mounted weapons are restricted to movement in streets and alleys and must be protected by infantry. Restricted observation and fields of fire require their employment from positions well forward in the attack.

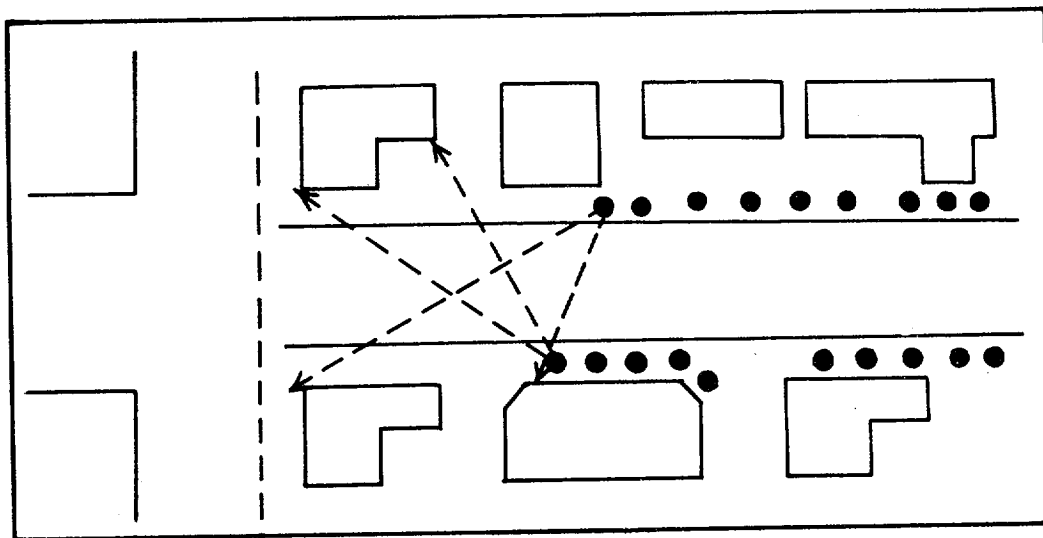

Figure 37.--Mutual Support.

Par. 3805

FMFM 6-4

(2) Automatic weapons and machineguns are positioned to create killing zones down streets and across open areas. Their fires are coordinated with the scheme of maneuver to ensure ceasing or shifting fires when attacking units are crossing or otherwise employing the zones.

(3) LAAW's are normally attached to the rifle platoons and, in addition to their antimechanized role, are used to breach buildings and street barricades.

(4) 60mm mortars are positioned to cover potential withdrawal routes and avenues which might be used to reinforce the area.

3805. CONDUCT OF THE ATTACK

a. Phase III of the attack may be either a systematic block-by-block, house-to-house reduction of the built-up area or a rapid advance through the town with clearance of specific critical areas and key buildings. In either case, the rifle company normally attacks to seize assigned objectives in a systematic manner, when committed.

b. Direct fire weapons engage known and suspected enemy locations in support of searching parties and covering parties entering and clearing individual buildings. FMFM 6-5, Marine Rifle Squad, describes the techniques of house-to-house fighting employed by searching and covering parties.

c. Consolidation takes place as each unit objective is seized. Attention is given to placing weapons in firing positions to cover all avenues of approach. Plans are made or completed for the continuation of the attack. The three dimensional nature of security must be stressed during consolidation. Avenues of approach from above and below the objective share equal importance with those from the front, flanks, and rear. Consolidation plans must provide appropriate coverage of these approaches.

Section IX. RIVER-CROSSING OPERATIONS

3901. GENERAL

a. This section discusses the roles of the Marine rifle company and its rifle platoons as a part of larger forces in the attack of a river line. It provides the rifle company officer with guidance in planning and executing the river crossing. The purpose of a river-crossing operation is to move an attacking force rapidly across a river obstacle so that it may continue its attack to seize assigned objectives. The characteristics and restrictions peculiar to this type operation are as follows:

- (1) Specialized equipment and personnel are required.
- (2) Limited areas suitable for crossing often tend to canalize the attack.
- (3) Control of units is complicated by the nature of the obstacle itself, the restrictions imposed by space, and the employment of combat support units requiring detailed command coordination.
- (4) Tactical courses of action are limited, since deployment and firepower are restricted while the troops are astride the river.
- (5) Once forces are committed to action, it is difficult to deviate from the initial plan.

b. There are two general types of river crossings, hasty and deliberate.

(1) Hasty Crossing.--A crossing is termed hasty when it can be conducted as a continuation of the attack, with a minimum loss of momentum, by the same large forces which executed the advance to the river line. A hasty crossing is normally conducted when enemy defenses on the far bank are weak or when bridges or fords are captured before the enemy has a chance to destroy them. This type of crossing is characterized by speed, surprise, and minimum concentration of personnel and equipment. It is made with the crossing means available and requires prior planning to include necessary task organization and allocation of crossing means.

(2) Deliberate Crossing.--The deliberate crossing is characterized by some delay, more detailed preparations and planning, and the employment of extensive and specialized crossing means in the face of a determined enemy defense.

3902. CONCEPT

a. In a river crossing the effectiveness of the river as an obstacle is reduced through surprise and deception and by the speed of the attack and buildup of combat power on the hostile shore. Tactical deceptions such as feints and demonstrations are coordinated by higher echelons to confuse and mislead the enemy.

b. A river crossing is usually made on a wide front to facilitate dispersion, rapid crossing, and deception. The size of the initial wave is limited solely by the available crossing means and sites.

Par. 3903

FMFM 6-4

c. When possible, assault units cross in helicopters and/or assault amphibious vehicles and seize relatively deep objectives. The surface units rapidly link up with the helicopterborne forces. When helicopters and/or assault amphibious vehicles are not available or their use is not feasible, the assault units cross in boats. In this case, they have limited mobility and are assigned initial objectives close to the river.

d. The attacker must rapidly seize objectives on the far bank and clear it so that rafts, bridges, and other crossing means may be constructed. When attacking units cross in helicopters or assault amphibious vehicles to seize deep objectives, the river line clearing task is normally assigned to reserve forces.

3903. CROSSING IN ASSAULT AMPHIBIOUS VEHICLES

a. General.--The assault amphibious vehicle may be employed in both the hasty crossing and the deliberate crossing. Normally, an assault amphibian platoon supports the rifle company in a river crossing. The infantry/tractor team may cross the river and seize objectives close to the far side employing techniques similar to those described for the amphibious assault. It may also be organized to cross and conduct mechanized attacks against deep objectives and/or linkup with helicopterborne forces.

b. Planning.--The company commander and the assault amphibian platoon commander conduct a joint reconnaissance to select routes forward and suitable sites for the tractors to enter and leave the water, to determine conditions of the river and its bank, and to locate underwater obstacles. The company commander selects and designates a portion of the near bank for each platoon to enter the water. Based on the downstream drift and the planned scheme of maneuver, he selects and designates an area on the far bank at which each platoon will land. The rifle platoon commanders reconnoiter jointly with vehicle crew chiefs to confirm routes and select specific sites at which each vehicle will enter the water within the assigned portion of the near bank. Where necessary and appropriate, a specific landing point for each vehicle on the far shore is selected.

(1) Amphibious Technique.--When the rifle company effects a river crossing to seize close objectives, the amphibious technique is employed. The company is organized into boat teams, embarked in assault amphibious vehicles, and crosses in whatever formation for landing the company commander selects. The assault companies normally cross in waves and do not rely on shuttling. When the waves are landed on the far shore, troops disembark and attack as described in chapter 2 for the amphibious operation. Tanks and Dragons may support by fire until other crossing means become available. The machinegun section may initially support the crossing by fire from the near bank and, when fires are masked, mount vehicles and cross to new positions on the far shore.

(2) Mechanized Crossing.--When the rifle company crosses a river to seize deep objectives and/or effect linkup with helicopterborne forces, it is normally organized as described in section VI for mechanized infantry attack. The mechanized rifle company plans its crossings in the manner described above, seizes initial objectives, and when joined by the tanks, attacks mechanized to seize the deep objectives.

c. Conduct of the Attack.--The initial attack on the far bank of the river is conducted as described for the amphibious operation in chapter 2 and may continue as described elsewhere in this chapter.

(1) Movement forward from the assembly area is continuous and is conducted rapidly over multiple routes. An attack position is seldom used. The near bank of the river is normally designated as the line of departure.

(2) The company commander initially controls the crossing from a vantage point on the near bank. He crosses immediately after the successful crossing of the first wave. When the initial wave is heavily opposed, the reserve may cross at a lightly defended site and attack the enemy flank or rear.

3904. CROSSING IN BOATS

a. General.--An assault rifle company crossing by boat usually has the initial mission of seizing terrain from which to prevent the enemy's delivery of effective direct small arms fire on the crossing site. Boat crossings are normally made under conditions of reduced visibility. Boats are provided from external sources.

b. Planning.--The company commander and as many subordinate leaders as possible, to include boat team commanders, reconnoiter the ground as the situation and available time permit. They make every effort to ensure that their reconnaissance activities do not compromise the secrecy of the operation. Items of particular concern during the reconnaissance are routes forward, the attack positions, boat positions and launching sites, and condition of the banks and the river. An engineer officer usually assists the company commander during this period, making recommendations and providing technical assistance. The company commander selects a portion of the near bank where each platoon will begin its crossing and designates landing areas on the far bank. The platoon commanders select the specific launching site for each of their boats and landing sites on the far bank.

(1) Attack Position.--The battalion commander normally selects the company attack position. It is generally the location where troops and the boats are brought together. The company commander assigns portions of the attack position to each.

(2) Boat Positions.--The company commander and supporting boat unit commander decide where to position the boats in preparation for the crossing. Normally, they are placed in the attack position close enough to the river to permit easy carry by the platoons. When the attack position is more than 300 meters from the river, boat positions closer to the river are selected. Boats for each platoon are placed directly in rear of their launching sites.

(3) Crossing Means.--An attacking rifle company is normally supported by sufficient assault boats to permit crossing without shuttling. Except for rubber boats authorized for the force reconnaissance company and the reconnaissance battalion of the Marine division, rubber boats are not available in the Fleet Marine Force. The boats above can carry a total of seven persons including the coxswain. It is anticipated that when a river crossing requires the use of rubber boats (assault boats), they will be provided by the U.S. Army or other external sources. They may be provided with or without boat crews. When boat crews are not assigned, the company commander conducts special training in boat handling operations.

(4) Engineer Support.--Coordination with supporting engineers is essential at all times during the operation. The engineers position the boats, furnish crews, and provide technical assistance. They may furnish guides to assist the boat teams in reaching the boats when the rifle company commander directs. An engineer crew of three men normally operates each assault boat, with two in the bow and one in the stern. The coxswain steers and has technical control of the boat. The infantry boat team commander has tactical control of the boat and directs the tactical maneuvering of the boat to its landing site. The engineer crew assists the boat team in embarking, paddling, and debarking. After the boat team debarks, the engineer crew returns the boat to the near bank for subsequent use.

(5) Formation.--The company usually crosses and assaults with three platoons in the first wave. No reserve is retained when its movement in time to influence the action cannot be ensured. After seizure of initial objectives, the company commander designates a reserve and alters the formation for continuing the attack.

(6) Rehearsal.--Whenever time, terrain, and equipment permit, full-scale rehearsals are conducted to closely simulate the crossing. If conditions do not permit a full-scale rehearsal, the company commander requests assault boats for dryland training. The training should include designating paddlers and nonpaddlers, carrying the boats, and simulating launching, loading, and debarking.

c. Conduct of the Attack

(1) Boat teams are organized and all plans and orders for the crossing are completed in the assembly area. The movement from the assembly area to the attack position is made on foot. It is made as rapidly and with as much secrecy as possible. The order of march is designed to permit continuous movement into and out of the attack position. Engineer guides meet the platoons in the attack position and guide them directly to their boats. The boat teams halt no more than momentarily as they pick up their boats and move into the water. They launch and load their boats, then paddle across the river without a halt and with maximum speed. They do not fire their weapons while crossing. Riflemen either paddle or hold weapons for those who do paddle. When they reach the far bank, they debark and attack as in the amphibious operation.

(2) The company commander remains on the near bank where he can best observe the action as the first wave crosses. As soon as the first wave has crossed, debarked, and cleared the far bank, he orders the second wave to cross. He crosses with the command group in the second wave.

Section X. INFILTRATION

31001. GENERAL

a. Tactical infiltration is a form of penetration in which an attacking force moves by stealth through the enemy defenses without rupturing the position. Infiltration may be accomplished by dismounted infantry, helicopterborne forces, and-exceptionally, by mechanized forces. It involves the movement of forces into the enemy rear by small groups, their assembly, and the preplanned attack of one or more objectives. The purpose of the infiltration is to deploy strong forces in the enemy rear for decisive tasks while exposing only small forces to enemy fires during the passage through the enemy defenses. The rifle company usually participates in tactical infiltration as part of the battalion attack. The infiltrating company may constitute all or part of the battalion main or supporting attacks.

b. The purpose of this section is to provide guidance to the rifle company officer in the general principles of planning and conducting the attack by infiltration. Other operations such as the raid and reconnaissance in force may be conducted by infiltration.

31002. PLAN OF ATTACK

a. General.--An infiltration is an operation involving a relatively long period of time and requires detailed planning and thorough briefings. The terrain used should limit the enemy's observation and use of surveillance devices. Woods, swamps, and broken ground are best suited for infiltration. Conditions of reduced visibility increase the chances of success.

b. Basic Considerations.--In addition to the nature of the terrain, certain basic considerations are an integral part of the decision to conduct the attack by infiltration.

(1) Enemy.--The enemy dispositions must present a dispersed force with gaps existing between units. Even so, it may be necessary for higher echelons to conduct deceptions and diversionary measures against an alert enemy.

(2) Objective.--Objectives for infiltration are key terrain features which, when seized, restrict the movement of enemy reserves or isolate his defensive positions.

(3) Control.--Infiltration is difficult to control and coordinate. Deviations from plans are difficult to coordinate during the operation. Close coordination must be effected between fire support agencies, infiltration forces, and forces conducting linkup. The nature of the operation dictates maximum dissemination of information.

c. Scheme of Maneuver.--The scheme of maneuver involves the infiltration of platoon or squad size groups through the enemy defenses along predesignated infiltration lanes. The groups rendezvous at prescribed points in the enemy rear and conduct a previously planned and coordinated attack to seize the assigned objective. The planning, preparation, and conduct of each infiltration group is the same as for a separate patrol until the

Par. 31003

FMFM 6-4

rendezvous point is reached. The attack after rendezvous is conducted as described in sections III and IV of this chapter.

d. Control Measures.--Certain control measures not normally used in other attacks are employed to control infiltration.

(1) Infiltration Lanes.--Infiltration lanes extend through known or likely gaps in the enemy defenses and indicate the directions and widths of the areas allocated to infiltration groups. Each group is assigned a separate lane.

(2) Rendezvous Points.--Rendezvous points are locations concealed from possible enemy detection where infiltration units are to assemble at a prescribed time. They are secured by the first groups arriving and are used to rendezvous infiltrating units prior to the attack. Both primary and secondary rendezvous points are normally designated. The rendezvous point may be used as an attack position or a separate attack position may also be designated.

(3) Time of Infiltration.--Time of infiltration is the time at which infiltration is commenced and is selected to take advantage of reduced visibility. It is the time at which infiltration groups cross the line of departure, enter infiltration lanes, and infiltrate. The attack is timed to best support the plans of higher headquarters.

(4) Other Control Measures.--Other control measures such as checkpoints, direction of attack, restrictive fire lines, etc., may be directed.

(5) Fire Support Plan.--Fire support planning proceeds in a manner similar to that of other attacks. Fires are not normally planned in the infiltration lanes but may be preplanned on call to support movements from the rendezvous to the attack position or to provide deception. The weapons platoon elements are attached to the rifle platoons for infiltration as teams or squads. Plans may require their detachment after rendezvous to support the company attack.

31003. CONDUCT OF THE ATTACK

a. At the time of release, infiltration groups move forward from their respective release points under control of group leaders. These are covered movements, timed to pass through friendly forces and cross the higher headquarter's line of departure at the time of infiltration.

b. The infiltration groups move by stealth through the infiltration lanes to the rendezvous points. Artillery fires are used as necessary to distract the enemy. The groups avoid contact by withdrawing or moving around the enemy. FMFM 6-5, Marine Rifle Squad, contains additional information relating to infiltration groups.

c. At the rendezvous points, groups assemble and attack preparations are completed. Final preparations compensate for unsuccessful infiltration by missing groups. The company may rendezvous at a single point or it may rendezvous at several platoon points.

d. The company may move forward from a company rendezvous point to a single attack position on one route or it may move in multiple routes

from platoon rendezvous points to platoon attack positions. Rifle companies employ raid or attack techniques depending on the operation planned.

31004. SUBSEQUENT OPERATIONS

a. Attack Operations.--In attack operations the objective is normally retained. If so, it is consolidated and defended against counter-attack. In the consolidation, emphasis is placed on the perimeter defense as most objectives seized by infiltration are in enemy rear areas. A link-up with other forces may require special consideration and attention after consolidation. Visual and sound recognition signals, radio communications, and fire controls must be effected to prevent engagement of friendly linkup forces.

b. Raid Operations.--The objective is not retained once the raiding force has accomplished the task assigned. The attacking force withdraws either to a clandestine assembly area or to friendly lines. Normally, additional raids or attacks are conducted from the clandestine assembly area. A withdrawal to friendly lines may be made by helicopter or by exfiltration.

Section XI. HELICOPTERBORNE UNITS IN SUBSEQUENT OPERATIONS ASHORE

31101. GENERAL

This section primarily concerns the rifle company in the planning and conduct of helicopterborne operations as part of the infantry battalion. A suitably reinforced rifle company is capable of independent helicopterborne operations; however, the rifle company and/or its subordinate elements may utilize the helicopter as a means of mobility in accomplishing a wide variety of missions.

31102. CONCEPTS

a. In offensive combat, helicopters are employed to provide mobility and to accomplish rapid troop movement, logistic support, and exploitation of supporting fires. The rapid concentration of forces at a decisive place and time is the paramount aim. Helicopterborne forces are not employed in assault landings against heavily defended areas; however, helicopters may be used to transport assault troops to a nearby undefended area from which the defended area may be attacked. Helicopterborne forces avoid meeting the main enemy strength in the initial assault by landing in areas which are either undefended or are lightly defended.

b. The greatest single threat to helicopterborne forces is the threat of an enemy counterattack with armor. Helicopterborne forces are physically removed from other friendly forces and have a limited antitank capability. In the event the enemy has an armor capability, plans should provide for an early linkup by a ground force having an antitank capability.

31103. PLANNING

a. General.--As in planning for the amphibious assault, the helicopterborne operation ashore involves concurrent, parallel, and detailed planning. The planning period may involve several days or weeks, or it may consist of a matter of hours during which plans are made to employ a helicopterborne force in ground combat. The basic nature of the helicopterborne operation prevents personal reconnaissance on the part of unit commanders. To this extent, the troop leading procedures are modified and the information usually gained by personal reconnaissance is obtained by the use of whatever planning aids and information the infantry battalion can provide.

b. Planning Sequence.--The planning sequence normally begins at the battalion level with receipt of the battalion mission. The sequence varies with the scope and complexity of the operation, but it is usually very similar to the form for the amphibious assault. The planning sequence commences with the formulation of the battalion's scheme of maneuver and fire support plan. Once these are known, the battalion commander selects the primary and alternate landing zones which best support the battalion's plan after considering the advice of the helicopter unit commander. The helicopter unit commander considers the aviation aspects such as obstacles, approaches, wind direction, etc., in making his recommendations. He also selects approach and retirement lanes and control points for the helicopters which permit direct movement, precise timing, coordination, and aircraft economy. The rifle company commander commences planning on receipt of the

battalion warning order. The company commander is also informed concerning attachments to the company for the operation and the availability of helicopters. Based on the scheduled employment on landing, a loading plan is formulated to prescribe the proper enplanement of troops and equipment.

c. Landing Documents.--From the standpoint of control, the movement of a helicopterborne force from the location at which it is enplaned to the landing zone may be equated to the ship-to-shore movement in the amphibious assault. The control organization must be provided with detailed information concerning the employment of the helicopters and the troop units involved. In the amphibious operation, the landing documents described in paragraph 2507c must be prepared to support the written plan for the helicopterborne force. In fast moving operations ashore, time may not permit the formal preparation of these plans; however, the battalion S-3 must consider all information required by these documents and disseminate their substance to the lifted units.

d. Plan of Attack.--The plan of attack consists of the scheme of maneuver, a fire support plan, and the landing plan.

(1) Scheme of Maneuver.--The scheme of maneuver selected will depend on the tactical situation anticipated, the assigned mission, the helicopter availability, etc. However, any scheme adopted must accomplish the following: first, the scheme must establish immediate tactical control over subordinate units; and second, gain control over the landing site and those terrain features that dominate the landing site. One problem frequently encountered in helicopterborne operations is that of troop orientation on the ground. It is often difficult for helicopterborne troops to orient themselves on the ground when landing in unfamiliar terrain. This problem may be alleviated somewhat by a thorough map and aerial photograph study prior to the operation and by the helicopter crew informing the heli-team commander of the helicopter heading on landing. The helicopter crew should also inform the heli-team commander of any enemy activity noted in the area.

(2) Fire Support Plan.--The fire support plan provides for maximum effects in the employment of organic and attached weapons in addition to air, artillery, and naval gunfire support. The helicopterborne assault may take place beyond the ranges of artillery and/or naval gunfire support; therefore, air support may be the primary means employed by higher echelons to influence the action until such time as mortars and artillery are landed and prepared to fire. Heavy burdens are placed on available fire support agencies in providing fires to cover the approach, landing, and retirement of the helicopter waves requiring careful consideration in selection of initial supporting fires.

(3) Landing Plan.--The landing plan is very similar to that of the amphibious assault. The plan preserves the tactical integrity of the assault platoons and lands the company in the formation and sequence which best support the scheme of maneuver and fire support plan. (See pars. 2507 and 2602.)

e. Loading Plan.--As in the amphibious assault, a plan is developed which provides for embarking assault units in a manner which supports the landing plan. The plan includes passenger manifesting, organization of the helicopter loading site, and enplanement.

(1) Passenger Manifest.--An accurate record must be made of who is on which aircraft. This record must include the passenger's name, grade, and service number and be coupled with the aircraft side number. There are many methods of preparing such a manifest; however, one such method that has wide field acceptance is to have each heliteam member fill out the required information on a piece of paper such as a prepared manifest tag, a baggage tag, or even a page from a notebook. These individual pieces of paper are collected and placed into an envelope marked with the helicopter side number and given to the troop loading assistant or flight deck guide.

(2) Organization of the Loading Site.--A loading site from which troops ashore are lifted by helicopter is organized to provide an assembly area for troops, a control point, ready circles, and loading points for the helicopters. The battalion air liaison officer or forward air controller and battalion headquarters personnel normally control loading from a loading site. When more than one site is established, the group of loading sites comprises a loading zone. Figure 38 is a schematic diagram of a loading site. Normally, a rifle company is lifted from one loading site. In most operations, the control organization for the loading site is provided by the battalion. Company officers should not lose sight of the fact that in fast moving situations, the rifle company may be required to establish and operate loading sites from time to time in support of their operations.

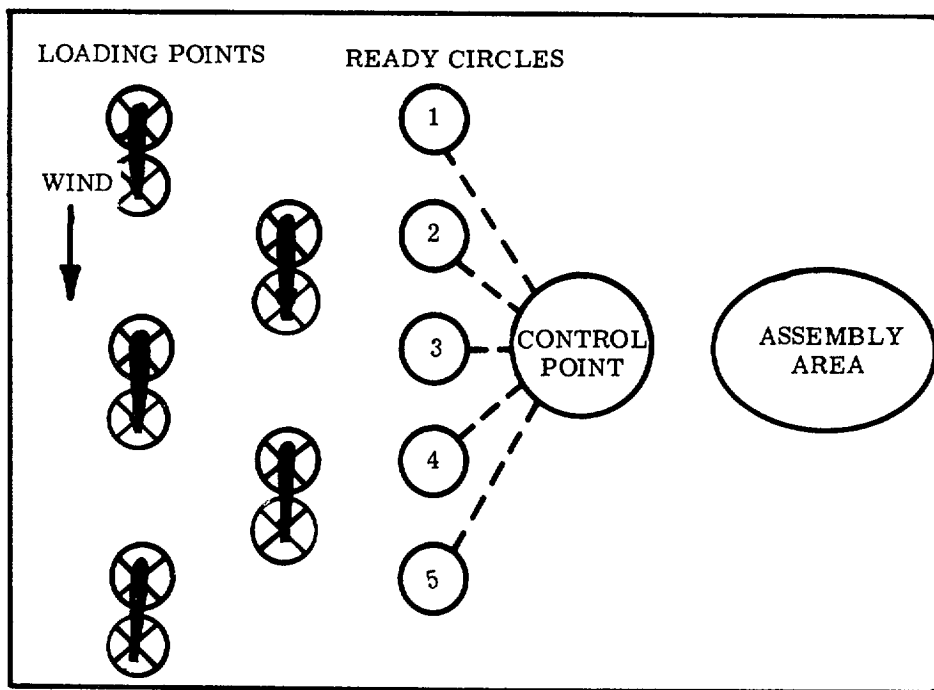

Figure 38.--Schematic Diagram of a Loading Site.

(a) Assembly Area.--The assembly area is that locality set aside within the loading site to assemble troops and make preparations for the lift. It should be centrally located with relation to the control point and ready circles. The unit to be lifted is organized into heliteams, passenger manifest tags are distributed and prepared, and preparations for combat are completed in the assembly area.

(b) Control Point.--The control point is a location within the loading site at which heliteams are positioned for enplanement. It should be near the assembly area. Just prior to the arrival of the helicopters, a number of heliteams equal to the number of loading points is summoned from the assembly area and reports to the control point. Heliteam manifest tags are collected from the heliteam commanders at the control point when troop loading assistants are not provided at the ready circles. One heliteam is then dispatched to each ready circle or to each loading point when ready circles are not used.

(c) Ready Circles.--The ready circles are alert points near the loading points from which heliteams are called for enplaning. They should be located close to the loading points and clearly marked by numbered stakes, flags, or other means. Easily identifiable ready circles obviate the necessity for stationing control personnel at the ready circles. On signal from the control point, heliteam commanders rapidly lead their teams to the aircraft and enplane them. When control personnel troop loading assistants are provided at the ready circles, heliteam commanders turn the manifest tags over to them on arrival at the circles. In small unit lifts and when other control means are adequate, ready circles may be dispensed with.

(d) Loading Points.--A loading point is a location within a loading site at which one helicopter enplanes a heliteam. Eight to 10 points is a practical limit to the number that can be controlled within a single loading site with loading points at least 100 feet apart for the loading of medium helicopters and 200 feet apart for heavy helicopters.

(e) Control.--Control of those functions concerned primarily with troop readiness and preparation for the lift are responsibilities of the lifted unit and involve those actions accomplished prior to reaching the loading points. Those functions concerned with enplaning passengers and safely delivering them to the landing zone are helicopter unit responsibilities.

1 Troop Loading Officer.--The battalion air liaison officer or forward air controller is usually stationed at the loading site control point and acts as troop loading officer. He ensures that loading is accomplished in accordance with the plan and maintains a record of the progress of the lift. By previous liaison, he has established the suitability of the selected site with such advice and assistance as may be necessary from the helicopter unit. In conducting uncomplicated loading operations from a single loading site, he usually functions as helicopter loading zone control officer as well as troop loading officer. In this capacity, he maintains communications with the helicopters and controls helicopter traffic in the loading site.

2 Helicopter Loading Zone Control Officer.--In complex loading operations, a helicopter loading zone control officer is assigned to the loading zone by the helicopter unit. He is the representative of the helicopter unit commander and is responsible for the following:

Par. 31104

FMFM 6-4

a Providing advice and assistance to the troop unit commander during planning.

b Controlling helicopter traffic in the loading zone.

c Maintaining communications as required and directed.

d Effecting liaison with the troop loading officers.

e Supervising troop enplanement at the loading points.

3 Loading Supervisor.--The loading supervisor at each loading point is usually the crew chief of the aircraft. He is responsible to the pilot and ensures the aircraft is ready to load and assists the troops in loading. He notifies the pilot when the troops are properly loaded.

4 Troop Loading Assistant.--When a large number of loading points comprise the loading site and ready circles are not well marked, the troop loading officer may provide an assistant stationed at each ready circle. His specific duties include the following:

a Collecting the passenger manifest tags and recording the helicopter side number on the manifest group. These actions constitute a passenger manifest which is retained until the lift is completed.

b Ensuring that weapons are unslung and that equipment is held properly before dispatching troops to helicopter loading point.

c Dispatching troops from the ready circle to helicopter loading point.

31104. ASSAULT

The assault proceeds as described in paragraph 2602 for the amphibious assault of helicopterborne units.

31105. NIGHT OPERATIONS

a. The planning and execution of a night landing is essentially the same as for a daylight operation; however, combat power will be built up at a considerably slower rate. Landing points are spaced farther apart. Unloading is slowed by restricted visibility and the greater separation of helicopters in flight.

b. Landing points must be marked with lights so that the pilots may find them and be assured that the point is unoccupied. Normally, assault heliteams do not immediately execute preplanned attacks to clear the landing site until they are first assembled and reorganized in preplanned assembly areas. Guides are normally provided to lead heliteams to the assembly areas by either the landing site control team or previously landed heliteams. Once tactical control has been established, preplanned offensive action may be taken to secure the landing site for succeeding waves. A slower rate of

activity must be accepted in loading helicopters at night. Fewer helicopter loading points are normally used. Dim or red-tinted lights are used in the vicinity of the loading site in order to preserve night vision and preserve secrecy. The loading site is organized the same as for daylight operations with the following special considerations:

(1) Helicopter loading points are suitably marked with identification lights for the pilots. The helicopter unit provides and installs the light system.

(2) Routes from the assembly area to the control point and from the control point to the ready circles are as short as possible. The lifted troop unit marks the routes with tapes or other suitable identification.

(3) Ready circles are located further away from the loading points and are marked for easy identification. Loading supervisors or troop loading assistants lead the heliteams from the ready circles to the loading points for enplaning.

31106. HELICOPTERBORNE TRAINING

The proper indoctrination and training of Marines in the techniques of the helicopterborne assault are continuing responsibilities of rifle company officers. Technical assistance and advice necessary to supplement the training may be obtained from the battalion air liaison officer and the helicopter unit. All personnel to be transported by helicopter should be indoctrinated in heliteam functioning and in enplaning and deplaning procedures. See FMFM 6-5, Marine Rifle Squad, for heliteam functioning and enplaning and deplaning procedures.



CHAPTER 4

DEFENSIVE OPERATIONS

Section I. INTRODUCTION

4101. GENERAL

a. The Marine rifle company in the amphibious assault and subsequent operations ashore may be required to assume a defensive posture either on order of higher authority or when forced by enemy action. However, when a unit in combat ceases to move for any reason for any period of time, it is in fact assuming a defensive posture.

b. This chapter introduces the concepts of defensive combat and discusses the rifle company's role in the defense. Its purpose is to provide rifle company officers with guidance in planning and executing the missions assigned in the course of defensive operations. The chapter includes a general discussion of defensive concepts and techniques relating to large units. This discussion serves only to place the roles of the rifle company and platoon in appropriate perspective within the framework of defensive operations. Air defense by the rifle company consists primarily of passive defense measures and is more appropriately covered in the battalion SOP's.

4102. TYPES OF DEFENSE

a. General.--The two basic types of defense are the area defense and the mobile defense. They are the opposite extremes of defensive operations. The most suitable form of defense in a given situation may incorporate elements of both.

b. Area Defense.--This defense is oriented toward the retention of specific terrain. In this type of defense, forward positions are strongly

held and emphasis is placed upon destroying or repulsing the enemy forward of a specific battle area. The bulk of combat power is committed in the forward area with the principal objective of destroying the enemy or counter-attacking to gain control over lost portions of the forward area. Section III of this chapter describes the company and platoon roles in the area defense.

c. Mobile Defense.--The mobile defense is conducted by divisions and larger forces. It is based upon skillful use of maneuver and concentrated fires to destroy the enemy. Minimum combat power is employed forward to warn of impending attack, delay and disorganize the enemy, and to canalize his attack into areas suitable for counterattack by a reserve. The bulk of the available combat power is retained in a strong, mobile reserve, positioned for offensive action with the principal objective of destroying the enemy. Section VIII of this chapter provides additional background in mobile defenses and describes the roles of the rifle company and platoon therein.

4103. BASIC DEFINITIONS AND CONTROL MEASURES

The defense requires the use of terminology and tactical control measures peculiar to this form of combat as well as the specialized application of control measures associated with offensive combat.

a. Definitions

(1) Battle Area.--The battle area is that area assigned a forward committed unit in which its forward forces and reserves are located for the accomplishment of the defensive mission.

(2) Forward Edge of the Battle Area (FEBA).--The foremost limits of a series of areas in which ground combat units are deployed, excluding the areas in which the covering or screening forces are operating, designated to coordinate fire support, the positioning of forces, or the maneuver of units.

(3) Gap.--A break in the continuity of the tactical dispositions of units that cannot be covered by small arms fire caused by terrain, enemy action, or by the size of an area of responsibility assigned to a unit.

(4) Interval.--A break in the continuity of the tactical dispositions of units that can be covered by small arms fire.

b. Control Measures

(1) Boundaries.--Boundaries define the area of a unit's responsibility and delineate areas within which units may fire and maneuver with maximum freedom in the defense. Lateral boundaries divide the defensive frontage of a forward unit between subordinates according to the natural defensive strength and relative importance of the defense areas. Boundaries are located to avoid division of responsibility for the defense of key terrain features or avenues of approach. Every effort is made to give forward units equal defensive tasks within their capabilities. The forward or rearward extensions of a lateral boundary indicate the limits of territorial responsibility when such limits are not otherwise delineated. A rear boundary is often used to indicate the extent of rearward responsibility.

(2) Coordinating Points.--Coordinating points on boundaries fix locations at which a higher commander requires adjacent subordinate commanders to coordinate their defenses. A coordinating point is located at or near a terrain feature which is easily recognizable on both the ground and the map. Commanders of adjacent units or their representatives coordinate at these points and determine whether the area between their units should be covered by fires, barriers, physical occupation, or a combination of these means. When subordinate commanders believe that a coordinating point should be relocated, they recommend a change to the commander who designated it.

(3) Assembly Areas.--Assembly areas are general locations designated for occupation by reserves not employed in blocking positions. Locations selected are based primarily on the reserve mission and mobility, cover and concealment provided, and the availability of routes of entry and exit.

(4) Blocking Positions.--A blocking position is a location organized to deny the enemy access to a given area or prevent his further advance in a given direction.

4104. DEFENSIVE ECHELONS AND THE BATTLE AREA

Defensive echelons include the security echelon, the forward defense echelon, and the reserve echelon. Each forward company and larger unit possesses the capability of employing organic elements in all three echelons. Defensive forces are initially distributed to security forces, forward forces, and reserve forces. These forces are disposed in three areas: the security area, the forward defense area, and the reserve area. (See fig. 39.)

a. Company Battle Area.--The rifle company battle area is that defensive area organized by a single frontline rifle company. It encompasses that portion of the battalion forward defense area included within the forward edge of the battle area, the company's lateral boundaries, and the limit of company boundary extension rearward from the FEBA. The frontage and depth shown in figure 39 represent those attainable under ideal terrain conditions.

b. Company Security Area.--The company security area is that portion of the battalion security area within the company lateral boundaries forward of the FEBA. It extends forward 400 to 500 meters to the limit of forward extension of the company's lateral boundary. The company local forward security operates within this area. This area is not reserved to their exclusive use and may be used by the security elements of higher headquarters.

c. Company Forward Defense Area.--The forward defense area for the rifle company is that portion of its battle area which the frontline platoons are assigned to defend. It includes the portion of the battle area bounded laterally by the company boundaries, forward by the FEBA, and the rearward extent of supplementary positions required by the frontline platoons.

d. Company Reserve Area.--The company reserve area is that portion of the company battle area not assigned to the frontline platoons. The reserve platoon prepares primary and supplementary positions within this area from which to accomplish its defensive missions.

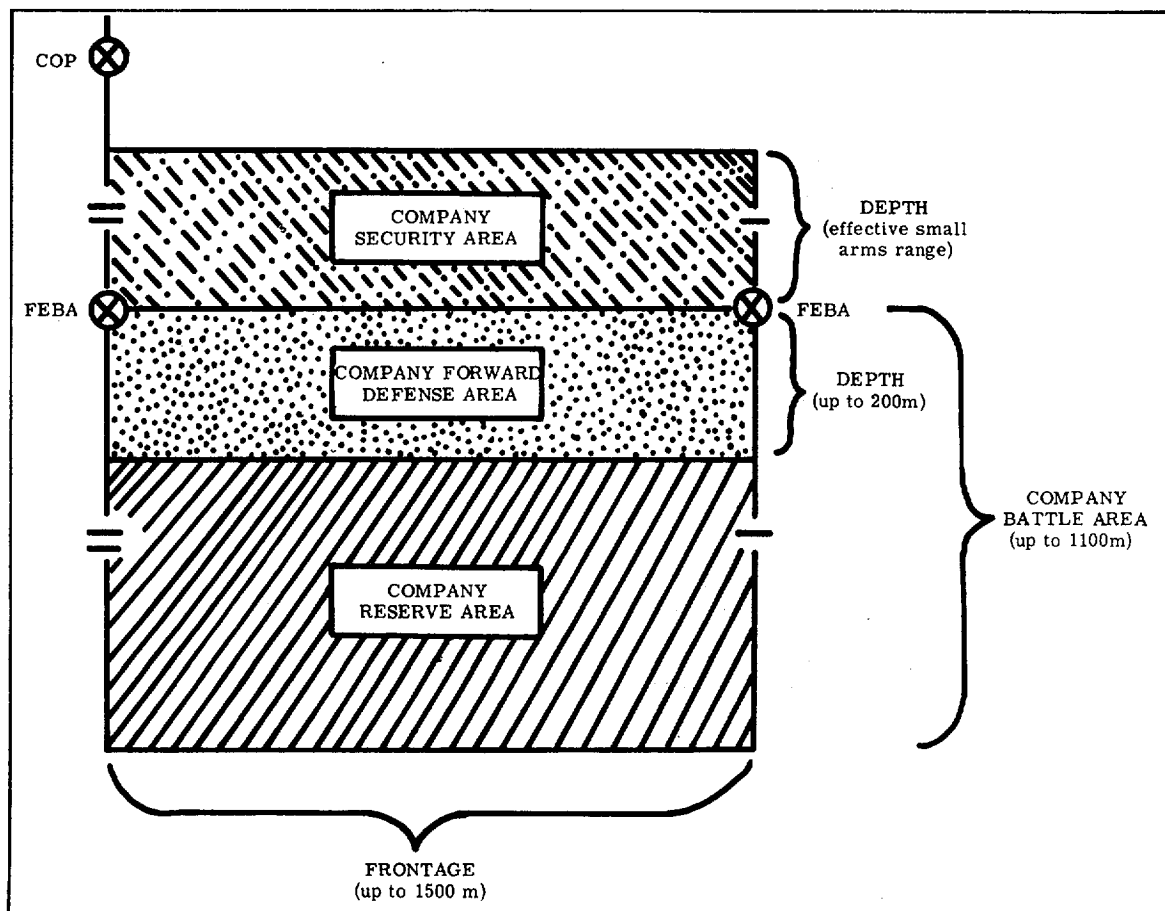

Figure 39.--Defensive Areas.

e. Higher Echelons.--The forward battalions and larger units employ the three defensive echelons and delineate the areas of their initial disposition in the same manner as described above.

4105. BASIC RIFLE COMPANY MISSIONS

a. Rifle Company Mission.--The basic mission of the rifle company in defense is to repel the enemy assault by fire, close combat, and/or counterattack. It may defend as part of a larger unit defense or as an independent force.

(1) A frontline rifle company defends by destroying or stopping the enemy by fire forward of the battle area and destroying or repelling him by close combat if he reaches it. In certain situations, reserve elements of the company counterattack to destroy or eject the enemy if he penetrates the battle area.

(2) A reserve company may be assigned a variety of missions which are discussed later in this chapter. Basically, it blocks or canalizes enemy penetrations of the battalion battle area or counterattacks to destroy or eject the enemy.

b. Rifle Platoon Mission.--The mission of the rifle platoon in defense is to destroy or repel the enemy assault by fire and close combat. It normally defends as a part of the rifle company and not as an independent unit.

(1) A frontline platoon defends its assigned area by destroying or stopping the enemy by fire forward of the battle area and by destroying or repelling him by close combat if he reaches it.

(2) The reserve platoon of a frontline rifle company adds depth to the defense. It supports the frontline platoons by fire and destroys or ejects the enemy if he penetrates the company battle area. Occasionally, the destruction or ejection of the enemy is accomplished by counterattack.

(3) The basic employment of the rifle platoons in a reserve company may be to block or counterattack. The rifle platoons organize and defend assigned positions which block or canalize enemy penetrations of the battalion battle area. When not employed to block the enemy, they participate in counterattack operations to destroy or eject the enemy.

c. Weapons Platoon Mission.--The mission of the weapons platoon in the defense is to provide close and continuous machinegun, 60mm mortar fire support and close-in antitank defense for the rifle company. The weapons platoon of a reserve rifle company supports the reserve blocking mission by augmenting the defensive fires of the rifle platoons with machinegun and 60mm mortar fire support and by providing machinegun and 60mm mortar fire support for the company's attack echelon and close-in antitank defense for the rifle company.

4106. FUNDAMENTALS OF DEFENSE

Rifle company unit commanders plan, organize, and conduct the defense by applying certain fundamentals. These considerations do not have equal influence nor are they equally emphasized at different command levels in a given situation. Further, they may not apply to the same extent in different situations. The unit commander decides the degree to which each will affect his defense.

a. Proper Utilization of Terrain.--The defender takes maximum advantage of the terrain by placing troops and weapons in positions which offer good observation, fields of fire, concealment and cover, and which control enemy avenues of approach. Responsibility for the defense of key terrain and avenues of approach is not divided but assigned to one unit.

b. Security.--The commander adopts security measures to offset the attacker's advantages of initiative and flexibility and to cause him to attack under unfavorable conditions. He uses active and passive measures to protect his unit against ground observation and surprise from any direction.

c. Mutual Support.--The commander obtains mutual support by positioning units so they can reinforce each other by fire or movement. In situations where gaps exist between units, he emphasizes coordinated surveillance, timely exchanges of information, coordinated fires, final protective fires, and patrolling.

d. All-Around Defense.--The commander organizes his defensive position so he can defend from any direction. He does so by planning and organizing primary and supplementary positions.

e. Defense in Depth.--The company commander organizes a defense in depth to preserve the integrity of the defense. A shallow defense is vulnerable to a concentrated attack at any point. Fires are planned throughout the depth of the defensive area. The platoon commander attains depth by organizing supplementary positions and shifting fire into threatened areas.

f. Coordinated Barrier Planning.--Barrier planning includes considerations for the employment of a series of natural and artificial obstacles to restrict, delay, block, or stop the movement of enemy forces. Routes must be available for use by security elements during withdrawal, by patrols, and by the maneuver element of counterattacking forces. Barriers are covered by fire and are particularly important when defending on wide frontages.

g. Coordinated Fire Planning.--The fires of infantry weapons, artillery, naval gunfire, and the use of close air support are carefully planned. These fire plans are closely coordinated with the barrier plan. The fire support plan provides for the following:

(1) Bringing the enemy under fire as soon as he comes within effective range.

(2) Subjecting him to increasingly heavier fire as he approaches the battle area.

(3) Breaking up his assault by fires immediately in front of the battle area.

(4) Destroying him or ejecting him by fires within the battle area should he succeed in penetrating it.

h. Flexibility.--The company commander achieves flexibility by withholding a reserve to be employed in blocking or counterattacking enemy penetrations and by centralizing control of his supporting fires. Maintaining an adequate communication system is imperative. The platoon commander's flexibility is achieved by controlling and shifting fires and by the preparation of supplementary positions.

i. Maximum Use of Offensive Action.--A spirit of offense must be maintained. Troops must be psychologically conditioned to shift rapidly from the defense to the offense. In many situations there are opportunities to regain the initiative by local offensive action in the conduct of combat patrols and limited objective attacks.

j. Dispersion.--Company unit leaders ensure that units and individuals are sufficiently dispersed to avoid excessive casualties. At the rifle company level no attempt is made to disperse as a passive defense against nuclear weapons. Such dispersion weakens the company's effectiveness disproportionately to the protection gained and invites defeat in detail for lack of mutual support.

k. Time.--Time available for planning and preparation is considered in selecting a form of defense.

Section II. SECURITY FORCES

4201. GENERAL

The security echelon includes security forces established by various command levels from the landing force to the frontline rifle company. This section discusses the distribution and operation of security forces, the roles of the rifle company as part of the security forces established by higher headquarters, and the security responsibilities of the rifle company in defensive combat.

4202. COVERING FORCE

A covering force is normally established by higher headquarters to provide security forward of the general outpost (GOP). It has the mission of delaying the enemy forward of the general outpost for a specified period to provide time for the preparation of defensive positions, to disorganize the attacking enemy forces, and to deceive the enemy as to the location of the battle area. The rifle company operates as an element of the infantry battalion when it functions as part of the covering force.

4203. GENERAL OUTPOST

a. General.--The MAF commander normally prescribes the approximate location of the general outpost. The Marine Division provides the forces for the general outpost and controls it. There is no prescribed organization for this outpost. It should be a balanced task organization of combined arms with the necessary logistic support.

b. Missions.--The general outpost warns of the enemy approach and provides time for the forward forces to prepare positions in the battle area. It covers the withdrawal of reconnaissance forces when they are operating to its front, prevents enemy ground observation of the battle area, delays the enemy advance within its capability, and deceives him as to the true location of the battle area.

c. Conduct.--The general outpost accomplishes its mission by observation and fire, use of obstacles and demolitions, aggressive patrolling and reconnaissance, delaying action, tactical deception, and when necessary, close combat.

d. Company Employment.--The rifle company operates as part of the infantry battalion on the general outpost. It is normally assigned a wide frontage and a delaying action mission. Delaying actions are discussed in paragraph 8402. Platoon positions should permit long-range observation and fire. The assigned frontage is usually too wide to permit withholding a reserve.

4204. COMBAT OUTPOST (COP)

a. General.--The combat outpost is a security echelon consisting of a series of outguards covering the foreground of the positions of the regiment in the battle area.

b. Mission.--The primary mission of the combat outpost is to provide early warning and information of the advance of the enemy, to provide a

counterreconnaissance screen, and to deny the enemy close ground observation of the battle area. Within its capabilities, the combat outpost delays and disorganizes the enemy and attempts to deceive him as to the true location of the battle area. It does not engage in close combat. The combat outpost provides target information for fire support agencies.

c. Composition.--The strength and composition of the combat outpost varies with distances involved, enemy situation, weather, and terrain. For each forward battalion in the battle area, it can vary in strength from a rifle platoon reinforced with machineguns and rockets to a rifle company reinforced with mortars, Dragons, tanks, and reconnaissance elements. Artillery and mortar fires are usually provided from their positions within the battle area through forward observers located with the combat outpost.

d. Location.--The combat outpost is normally located on key terrain 1,000 to 2,400 meters forward of the FEBA. Its location should be within supporting distance of the forward battalions. Ideally, its location should:

- (1) Afford long-range observation and fields of fire.
- (2) Provide obstacles to the front and flanks.
- (3) Provide cover and concealment on positions.
- (4) Provide covered and concealed routes of withdrawal.
- (5) Deny the enemy close ground observation of the battle area.
- (6) Be within supporting distance of the battle area.

e. Control.--Control of combat outposts may be exercised through the reserve or forward battalion commanders depending on the situation and the organization providing the bulk of the forces. If the majority of the combat outpost forces are provided from the forward battalions, the forward battalion commanders will normally exercise control. If the bulk of the combat outpost forces are from the reserve battalion, either the reserve or forward battalion commander may exercise control. In the latter case, the COP elements may be attached to the forward battalions.

f. Organization.--The combat outpost is organized in the same manner regardless of its size and composition. Figure 40 shows an example combat outpost organization on a battalion front.

(1) The forces comprising the combat outpost are disposed laterally in a series of outguards varying in strength from a fire team to a reinforced squad. Outguards are positioned near the topographical crest on terrain offering long-range observation and fields of fire covering the avenues of approach into the battle area. Preferably, adjacent outguards are within visual distances of each other.

(2) The outpost commander provides for local security with sentinels, listening posts, warning devices, and patrols. When observation is limited, he employs patrols extensively between adjacent outguards.

(3) Patrols forward of the combat outpost establish and maintain contact with the general outpost. When the general outpost withdraws, the combat outpost commander employs patrols forward to gain and maintain

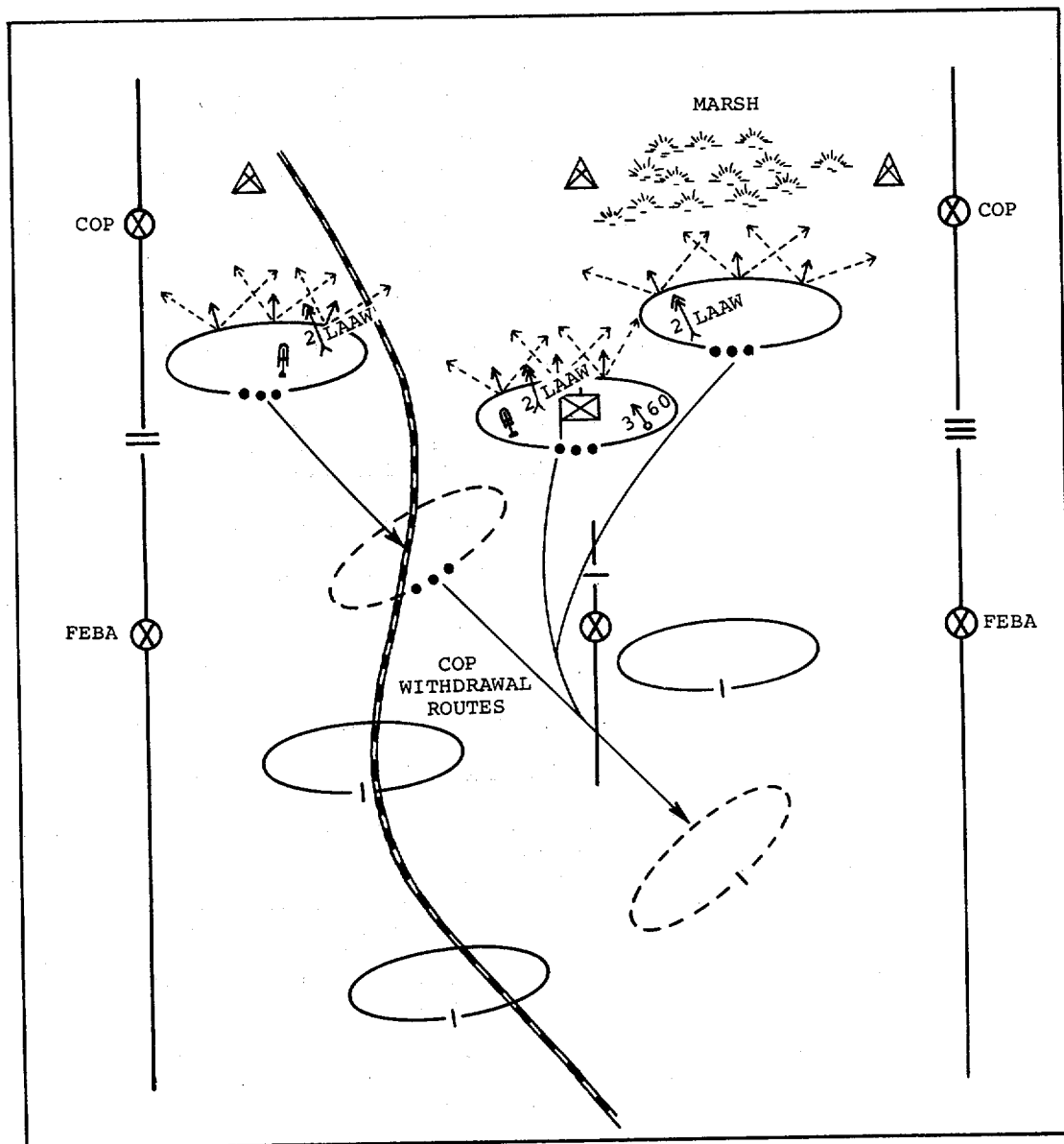

Figure 40.--Example Organization of a Combat Outpost.

contact with the enemy and to request and adjust naval gunfire, airstrikes, and artillery and mortar fire. Patrolling is intensified during periods of reduced visibility.

(4) The outpost commander prepares a withdrawal plan and coordinates his plan with the frontline units concerned. The withdrawal plan provides for an orderly withdrawal of the outguards on predetermined routes to successive delaying positions. The withdrawal plan is designed to maintain fires of frontline units. The techniques for conducting withdrawals and delaying actions are discussed in paragraphs 8402 and 8403.

(5) The outpost commander's fire plan provides for the engagement of enemy forces anywhere they are detected. Fires are planned well forward, immediately in front of, within, and to the flanks and rear of the outpost positions. Fires within the outpost include fires planned between outguards to protect their flanks and fires within outguard positions which are delivered after their evacuation to cover the withdrawal. Fires in rear of the outguards support their withdrawal to delaying positions and the successive delaying actions.

g. Conduct.--The combat outpost maintains contact with the general outpost and covering forces to its front and assists in their withdrawal. Early contact with the enemy is gained and maintained by the use of patrols, security detachments, and observers who bring the enemy under long-range fire and provide information to the forward battalions. The combat outpost subjects the enemy to an increasing volume of fire as he approaches the outpost position unless, for purposes of deception and surprise, it waits until an unsuspecting enemy presents a more profitable target. The combat outpost resists until the strength and proximity of the enemy require its withdrawal. Withdrawal is then made over previously selected routes and is covered by planned fires from the battle area. Contact is maintained with the enemy at all times by a combination of patrols and observation. After the enemy has been defeated and he is forced to withdraw, the combat outpost is reestablished. (See fig. 40.)

h. Withdrawal.--COP's do not normally become decisively engaged since their forces are usually assigned other missions later in the defense (reserves, blocking positions, counterattack forces, etc.). Provisions must be made for the orderly withdrawal of COP's prior to becoming decisively engaged. The withdrawal may be on order of the controlling headquarters or, in some cases, at the discretion of the outpost commander.

4205. LOCAL SECURITY

a. Forward Security.--While the security of that portion of the battalion security area to the rear of the combat outpost is the responsibility of a forward battalion, that responsibility is discharged in part through the assignment of a security area to each frontline company. The company commander, in providing for the forward security of his company within the assigned security area, ensures the forward local security of the battalion.

(1) Local forward security consists of sentinel posts, patrols, and listening posts. Security elements operate within small arms supporting distances of units on the FEBA on the nearest terrain features allowing observation of the company front. The company commander normally directs each frontline platoon to provide forward local security. He may assign the mission to his reserve platoon. The company commander specifies the number of security posts to be established in front of each frontline platoon, consistent with the frontages assigned, the terrain, and the visibility. The platoon commander normally specifies the personnel strength of each security post and its general location. Security posts consist of from two to four members, depending upon the planned duration of their operation and/or the sector of observation assigned. At night, listening posts, supplemented by patrols, are established on likely avenues of enemy approach.

(2) As the enemy approaches, the forward local security elements give warning and observe to determine enemy strength, actions,

and routes of approach. They avoid combat and withdraw to the battle area as the enemy closes.

b. Local Security.--Units are responsible for the security of their own command and administrative installations. At the platoon and company level, this is normally done through the selection of locations with or near subordinate tactical units, supplemented with the personnel of the headquarters or administrative unit. The platoon CP usually is located at or near a rifle squad defensive position; company headquarters at or near the reserve platoon with headquarters personnel providing part or all of the local security.

c. Rear Area Security.--A reserve company may be assigned contingency missions to provide rear area security forces. This normally requires protecting rear areas and installations against attack by airborne and helicopterborne forces, guerrillas, and infiltrators. Protection is provided by the establishment of a surveillance and warning system, preparing necessary defensive positions, and reliance on the mobility of the security forces in meeting one or more of several different contingencies.

d. Flank Security.--Information concerning the situation on an exposed flank and in gaps between adjacent units is a tactical requirement at all command levels.

(1) Exposed flanks are secured by locating reserves to block principal approaches from the flanks. Flank security is enhanced by employing patrols and security posts.

(2) Gaps between adjacent units are covered by adherence to the fundamentals of mutual support and use of barriers. They are closed by obstacles and mutually supporting fires. Supplementary positions affording observation and fields of fire for elements of a frontline platoon aid in securing the gap. Positioning the reserve to cover a wide gap may be necessary. Gaps between frontline platoons and companies require the extensive use of security posts, patrols, and warning devices therein to prevent infiltration when visibility is reduced, even though mutual fire support exists.

e. Special Surveillance Devices.--When operating from a static defensive perimeter, maximum use should be made of seismic intrusion detectors, starlight scopes, and Xenon searchlights, when these devices are available, in order to detect enemy movement around the position.

Section III. AREA DEFENSE

4301. GENERAL

a. The area defense is a relatively compact defense in its basic form and is characterized by a strongly held forward defense area. When it becomes impossible to apply the fundamentals of defense to the maximum because of a hostile nuclear threat, major terrain difficulties, or unit mission, variations of the area defense may be adopted.

(1) Extended defense is a variation of the area defense which stresses depth and flexibility through the withholding of a large reserve. Forward forces are widely separated and provide limited mutual support. Generally, the smallest forward units separated beyond mutually supporting distances are infantry battalions. On occasion, the battalion may be required to separate companies beyond effective mutual support of small arms fire.

(2) Linear defense is a variation of the area defense requiring a maximum employment of forces forward with a small reserve. It is characterized by strong mutual support between forward units, limited depth, and minimum flexibility. The linear defense is employed when defending a wide area and is a suitable variation for the rifle company and larger units.

(3) Perimeter defense is a variation of area defense which disposes a unit to meet attack from all directions simultaneously. It is a suitable defense for use by the rifle company. A discussion of perimeter defense is contained in section IV of this chapter.

b. The purpose of this section is to provide the rifle company officer with guidance in the employment of the rifle company, rifle platoon, and weapons platoon in area defense. The basic tactics and techniques discussed apply to all variations of the area defense.

4302. FRONTLINE RIFLE COMPANY

a. General.--The battalion commander's defense order provides sufficient guidance to ensure that the frontline rifle company organizes and conducts the defense in accordance with the battalion plan. The battalion defense order specifies the company's battle area, security area, and the general trace of the FEBA by assigning boundaries and coordinating points as discussed in paragraphs 4103 and 4104.

b. Plan of Defense.--The rifle company's plan of defense consists of a scheme of maneuver and a fire support plan with its concomitant consideration of barriers. The company commander develops his defense plan from the battalion defense order, the estimate of the situation, and consideration of the fundamentals of defense discussed in paragraph 4106. The scheme of maneuver, the fire support plan, and barriers are considered concurrently, since they are interdependent elements.

(1) Scheme of Maneuver.--In the defense, the rifle company's scheme of maneuver is the planned disposition of the platoons in the battle area. Occasionally, counterattack plans are a portion of the defensive scheme of maneuver. The counterattack is discussed in paragraphs 4305 and 4307.

(a) The company commander analyzes the terrain and envisions the rifle squad positions required to adequately cover the avenues of approach leading into the key terrain features within his battle area. He considers the general frontages squads are capable of defending under existing terrain conditions, which in turn is the basis for establishing the width of the platoon defense areas. The anticipated extent of squad supplementary positions is his primary consideration in determining the depth of a forward platoon's defense area.

(b) The company commander considers the retention and probable positioning of a reserve, consistent with the requirement for adequate forces to defend the FEBA. Probable positions for the reserve support the FEBA units by fire, protect key terrain features in the rear, and/or control the most dangerous approaches through the company battle area. Appropriate missions for the reserve and its employment are discussed in paragraph 4305.

(c) The requirement for squads on the FEBA, the fundamentals of defense, and the need for retention of a reserve to provide depth are incorporated into the company commander's estimate of the situation. The decision concerning distribution of forces in the company battle area is made. The company commander then plans platoon defense areas consistent with his decision. He does not divide responsibility for defending an avenue of approach, but assigns the approach and the terrain that dominate it to one platoon. Frontline platoon defense areas are assigned by indicating the trace of the FEBA, a frontage measured along the FEBA with respect to an identifiable feature or the flank of an adjacent platoon, and a depth behind the FEBA. The limit of the platoon's responsibility forward usually includes the entire depth of the company security area and is prescribed as a distance in meters. The reserve platoon is assigned a primary position and supplementary positions in the reserve area from which to accomplish its defensive missions. When the terrain within the company battle area requires the employment of three rifle platoons on the FEBA, the company commander selects supplementary positions to protect his flanks and rear and plans to shift frontline platoons to counter such threats.

(2) Fire Support Plan.--The fire support plan for a frontline rifle company is coordinated and integrated with the planned fires of the battalion. The coordinated fire plan is designed to bring the enemy under long-range fire with air, naval gunfire, mortars, and artillery. It holds him under an increasingly heavy volume of close defensive fire as he approaches the battle area and stops his assault with an intense barrier of final protective fires immediately in front of the battle area. Fires within the battle area are planned to destroy the enemy if he penetrates the area and to support counterattacks. The plan includes the fires of all available organic, attached, and supporting weapons on targets of opportunity and prearranged fires that can be delivered under any condition of visibility. Fires are integrated with the barrier system to provide fire coverage of obstacles.

(a) The final protective fires of the organic machineguns and mortars are the rifle company commander's initial concern in planning fires to stop the enemy assault. During reconnaissance, the company commander provides his weapons platoon commander with general planning guidance concerning position areas and directions for the final protective lines. This information is based upon prospective locations of the frontline rifle platoons, coordinated mutual support with adjacent companies, best use of

terrain, and a sound foundation in the defensive employment of machineguns. Paragraph 4304 discusses the tactical employment of machineguns in the defense. The weapons platoon commander, within the scope of the planning guidance received, selects the general primary and alternate positions and the final protective line for each machinegun squad. He also selects a general position area for the 60mm mortar section and appropriate targets and FPF's. These determinations constitute his major recommendations to the company commander. The weapons platoon commander further recommends supplementary missions and positions from which they can be accomplished. The recommendations approved by the company commander are the substance of missions assigned to the machinegun and mortar section by the weapons platoon commander.

(b) Final protective fires are prearranged barriers of fire designed to protect friendly troops by impeding enemy movement across defense lines or areas. They are coordinated with other fires and with natural and artificial obstacles. Final protective lines are positioned to cover gaps and dead spaces in the final protective fires of the machineguns. Normally, these fires are planned to cover dangerous avenues of approach into the battle area and break up enemy assaults against friendly positions on the FEBA. They are usually planned so that the near edge of the impact area is not more than 200 meters forward of the FEBA. They take priority over all other fire missions. Artillery and mortar final protective fires are fired on order of the company commander whose battle area is protected by them. When delivered, they are fired continuously at maximum rate until ordered discontinued by the company commander. The battalion commander designates the general locations of the mortar and artillery final protective fires. The company commander, when allocated a final protective fire, specifies its exact location to the forward observer. The final protective fire is then registered. Figure 41 indicates the widths of final protective fires for various weapons and units.

(c) Indirect fire weapons fires are planned to cover areas in which targets are likely to appear. These fires are planned throughout the security area forward of the FEBA and within the battle area itself. They may include fires for any of the following purposes:

WEAPON	UNIT	WIDTH OF FPF
60mm Mortar	Squad	50 Meters
60mm Mortar	Section	150 Meters
81mm Mortar	Squad	50 Meters
81mm Mortar	Section	100 Meters
81mm Mortar	Platoon	400 Meters
105mm Howitzer	Battery	200 Meters
155mm Howitzer	Battery	300 Meters
8-Inch Howitzer	Platoon	160 Meters

Figure 41.--Final Protective Fire Widths.

- ments.
- 1 Support withdrawal of forward local security elements.
 - 2 Cover likely avenues of approach.
 - 3 Cover areas which direct fire weapons cannot reach.
 - 4 Cover gaps between platoons.
 - 5 Cover likely target areas.
 - 6 Limit penetrations.
 - 7 Support counterattacks.

(d) Small arms fire coverage is afforded by the assignment of platoon defense areas. The company commander specifically ensures that adequate small arms coverage of the gaps between adjacent platoons is afforded. He may require these areas to be covered by the fires of the reserve platoon, machineguns located with the reserve, or by indicating the general direction of a machinegun squad's final protective line.

(e) Antitank defense is normally afforded by tanks and TOW's employed in general support of the battalion. They cover the most dangerous avenues of approach for armor into that portion of the battalion's battle area. These weapons are positioned within the company battle area by the battalion commander. The company commander coordinates with them and affords them the close-in protection of his rifle units. The weapons platoon's assault section provides close-in antitank defense and fire support for the frontline rifle company. The details of its employment in defense are covered in paragraph 4304.

(f) The specifics of the company fire support plan are forwarded to the battalion in the form of a fire plan sketch or overlay. Subordinate commanders are informed concerning important details of the fires available to them. Figure 42 is a typical rifle company fire plan.

(3) Barrier Plan.--Barrier planning at company level is an integral part of fire support planning and is treated separately here only for ease of discussion. A barrier plan is normally originated by higher headquarters. It includes a coordinated series of obstacles to canalize, restrict, delay, or stop enemy ground movement. The intent is to slow or stop his movements in particular directions in order to hold him in planned fields of fire for maximum periods of time. The use of barriers and obstacles is closely integrated with the rifle company fire plan. Barriers are coordinated with the disposition of units and plans for the movements of friendly forces during the defense in order to avoid interference.

(a) The frontline rifle company makes extensive use of barbed wire entanglements classified as tactical, protective, or supplementary depending upon their use.

1 Tactical wire entanglements are designed to break up attack formations and to hold the enemy in areas covered by the most intense defensive fires. They are sited along the friendly sides of machinegun final protective lines. They may extend across the entire front of a position and normally have a high priority of construction.

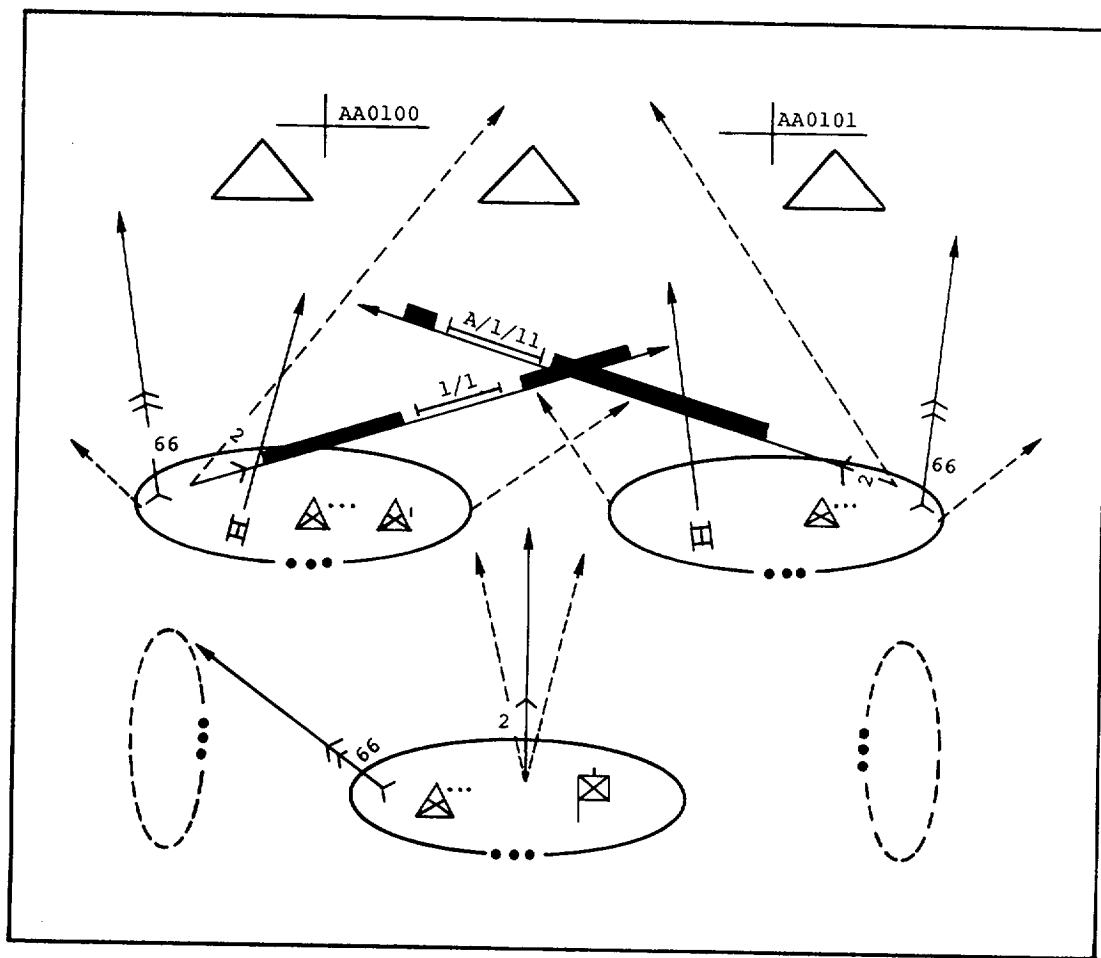

Figure 42.--Typical Rifle Company Fire Plan.

2 Protective wire entanglements are located to prevent surprise assaults from points close to the defensive positions. They are close enough to be observed day and night and far enough from friendly positions to keep the enemy beyond normal hand grenade range. Protective wire is normally positioned from 50 to 75 meters from friendly positions.

3 Supplementary wire entanglements are used to break up the patterns of tactical wire, thus deceiving the enemy as to the locations of final protective fires. They are also used to connect platoon defense areas when gaps exist. Supplementary wire may be used in any locality to canalize enemy movement into areas covered by intensive fires.

(b) The battalion or higher headquarters normally coordinates the use of extensive obstacles such as antitank ditches and minefields. The battalion commander may authorize the company commander to lay protective minefields across likely avenues of approach within the company security area or battle area. These minefields provide local protection against infiltration and small armor or infantry attacks. The rifle company's role

in mine warfare is discussed in FMFM 6-5, Marine Rifle Squad, which also describes the techniques employed in laying mines.

c. Priority of Work.--Many of the tasks involved in organizing a defensive position are carried on concurrently, but the company commander establishes priorities for the completion of various tasks and may, due to the enemy situation, specify times for their completion. Though camouflage is continuous, the priority of work may include special precautions to be taken regarding camouflage. The following is a typical sequence of the most important priorities:

- (1) Establish security.
- (2) Position automatic and crew-served weapons.
- (3) Clear fields of fire and determine ranges to probable target locations.
- (4) Prepare weapons emplacements and individual positions.
- (5) Plan, coordinate, and plot available fire support.
- (6) Install tactical and supplementary wire.
- (7) Lay and bury wire communication nets.
- (8) Prepare other obstacles including minefields and protective wire.
- (9) Prepare alternate positions for weapons.
- (10) Prepare supplementary positions.

d. Control.--The effectiveness of the planned defense is directly related to the company commander's ability to control subordinate units and supporting fires. The plan of defense provides for establishing and maintaining effective control means.

(1) The company commander selects and prepares one or more observation posts which give the best possible view of the battle area, the avenues of approach, and the company's flanks. The gunnery sergeant receives general guidance from the company commander as to internal arrangement and selects and supervises the preparation of positions within the site. The company observation post is manned by members of the command group at all times.

(2) The company command post site is located in the rear portion of the company reserve area. Preferably, it is situated in defilade and is concealed from ground and air observation. A position offering covered routes forward and to the rear facilitates supply of the frontline platoons and evacuation of casualties.

(3) The company installs a complete wire communication net. Wire communications are preferred to radio for security reasons. Wire net communications are supplemented by maintaining the company tactical radio net on listening silence. When wire failure occurs, the radio net is substituted in contacting affected stations. Messengers and visual signals further augment communications.

(4) The infantry battalion establishes and maintains a battalion wire net permitting wire communications between the rifle company commander and the battalion command post. The company's wire line is in direct contact with the battalion switchboard. The switchboard arrangement facilitates communications with the battalion commander and individual members of the executive staff. The battalion tactical radio net is activated and operates in accordance with the communication SOP and instructions promulgated in the battalion defense order.

(5) The company commander prescribes visual signals to control his final protective fires. He normally retains the authority to order delivery of final protective fires. Though the frontline platoons maintain physical possession of the signalling devices, the platoon commander is authorized to employ them only with the approval of his request by the company commander. In circumstances where the company commander is unable to gain sufficient observation of the frontline platoons to make accurate estimates of the situation in their defense areas, authority to order the final protective fires may be delegated to platoon commanders.

(6) Control of the forward security elements is normally exercised through the frontline rifle platoon commanders. Occasionally, when a security post or listening post is established to observe a particularly dangerous avenue of approach, the company commander may control it through wire communications or a visual, sound, or pull wire signalling expedient.

e. Organization of the Ground.--The organization of the ground begins when the company arrives in the area and continues as long as the position is occupied. When the organization of the ground must be accomplished while the force is in contact with the enemy, defense against attack and organization of the ground are conducted concurrently. Maximum use of available fires is planned to support the organization of the area. Smoke may be effective in denying the enemy observation of the work.

4303. FRONTLINE PLATOON

a. General.--A frontline platoon is assigned a platoon defense area within the company battle area to organize and defend. The company commander delineates the trace of the FEBA and assigns the platoon a frontage measured along the FEBA in meters from a reference point on the terrain or the flank of an adjacent platoon. A distance from the FEBA to the rear is also described. (See fig. 43.)

(1) Frontage.--On ideal terrain, the platoon may be assigned a maximum frontage of 750 meters; however, normal frontages are much smaller. It physically occupies up to 450 meters under ideal conditions and must cover the remainder by fire. Boundaries or coordinating points are not normally assigned.

(2) Depth.--The depth of a platoon defense area is the distance between squad primary positions and the rearward extension of their supplementary positions. It may be up to 200 meters.

(3) Security Area.--The rifle platoon is assigned a portion of the company security area forward of the FEBA. It normally extends forward to effective small-arms range. The platoon posts forward security elements in this area and ensures its coverage by fire.

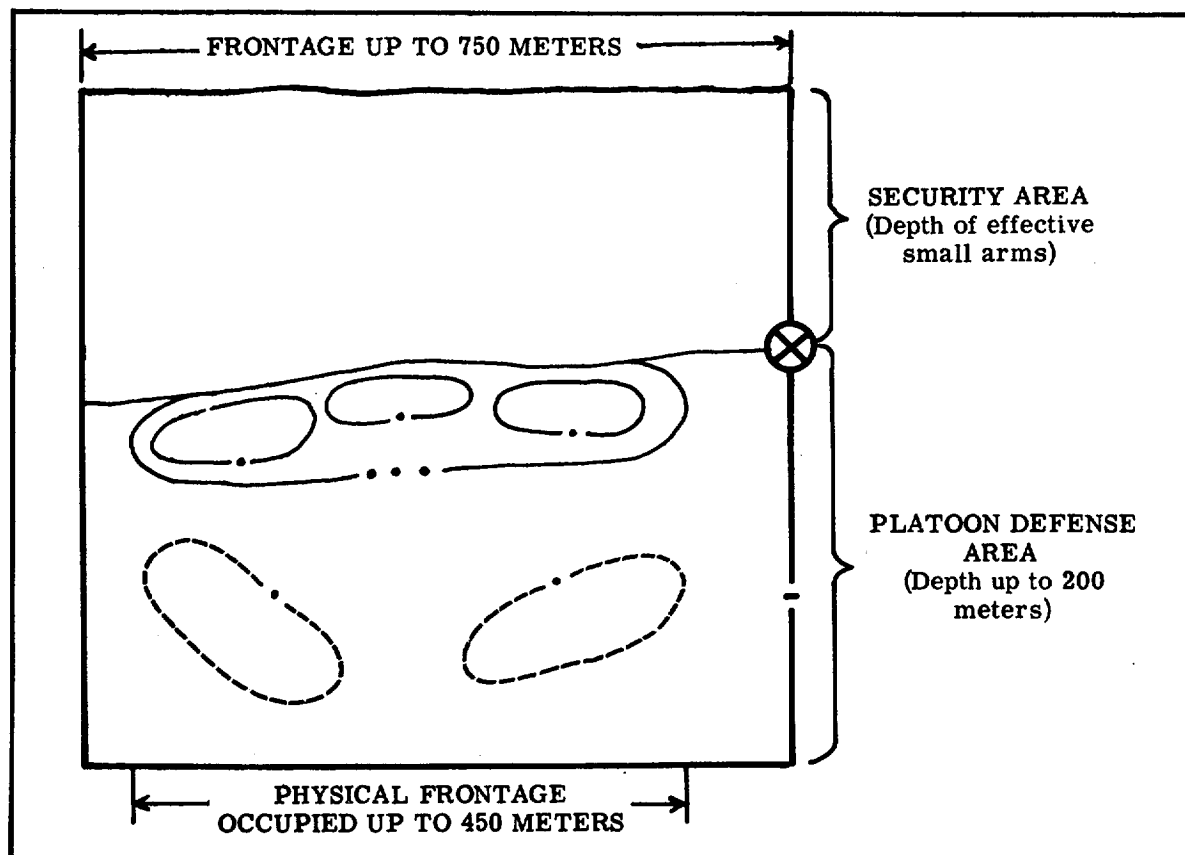

Figure 43.--Frontline Platoon Defense Area.

b. Plan of Defense.--The platoon commander's plan of defense consists of a scheme of maneuver and a concurrently developed fire support plan which is integrated with the fire support and barrier planning of the rifle company. Basically, the platoon's plan of defense consists of assigning each rifle squad a position on the terrain and a sector of fire. The plan of defense results from the platoon commander's estimate of the situation and consideration of the fundamentals of defense discussed in paragraph 4106.

(1) Scheme of Maneuver.--The scheme of maneuver provides for assigning each rifle squad a primary position on the terrain within the defense area. The positions are generally abreast and face in the general direction of expected enemy attack. The platoon commander selects supplementary positions to protect the flanks and rear of his platoon. A squad position is indicated by pointing out on the ground the general trace of the line to be physically occupied and the flanks of the position.

(a) Primary positions are selected which afford the best observation and fields of fire over the avenues of approach into the platoon defense area. They are normally located on the forward military crests of the key terrain features. The selection of squad primary positions must

further consider the requirements for mutual support between adjacent squads and the protection of crew-served weapons positioned within the platoon's defense area. Squad positions must be mutually supporting. The primary, alternate, and supplementary positions for crew-served weapons in the defense area are always afforded close-in protection by rifle units. Primary and alternate crew-served weapons positions are included within the primary defensive positions of the rifle squads.

(b) Supplementary positions for the rifle squads are selected as required to protect the flanks and rear of the platoon primary position and the supplementary positions for crew-served weapons. Supplementary positions afford good observation and fields of fire covering avenues of approach into the flanks and rear of the platoon defense area. Terrain permitting, covered routes for movement between primary and supplementary positions are selected.

(2) Fire Support Plan.--The rifle platoon commander is provided with information concerning machinegun final protective lines (FPL's), barriers, and the locations of final protective fires planned by higher headquarters. His defensive fire plan is integrated with the plans of higher headquarters.

(a) Once a squad primary position is determined, the platoon commander selects the squad sector of fire. The three squad sectors overlap and cover the entire portion of the company security area for which the platoon is responsible. The sectors of fire of the flank squads extend in front of adjacent platoons and overlap the sectors of their flank squads to provide mutual support. When an interval exists between adjacent platoons, the squads flanking on the interval are positioned so that the two platoons' flanks are drawn back (refused) to provide maximum mutual support and flanking fire in the interval between them. When a gap exists between adjacent platoons, proper coverage is accomplished by use of indirect fire and local physical security methods. (See figs. 44 and 45.)

(b) The platoon commander, in order to best coordinate his fires with the company fire plan, selects general firing positions and principal directions of fire for specific automatic rifles and grenade launchers organic to the rifle squads. Normally, the rifle squad leader makes these assignments. In most platoon defensive situations, the final protective fires of the company's machineguns contain small gaps or dead spaces which are not covered by mortar or artillery final protective fires. These gaps and dead spaces are concerns of the platoon commander in integrating his fires with the fires of higher headquarters. He plans to assign the principal directions of fire for automatic rifles and/or grenade launchers to cover them by fire. Their fires augment the final protective fires of the company by sealing the gaps and dead spaces.

(c) The platoon commander prepares a fire plan sketch or overlay and submits it to the company commander for approval. Figure 46 is a typical fire plan sketch. The sketch or overlay includes the following:

- 1 Squad primary positions and sectors of fire.
- 2 Positions and principal directions of fire for all automatic rifles.
- 3 Location of platoon observation post.

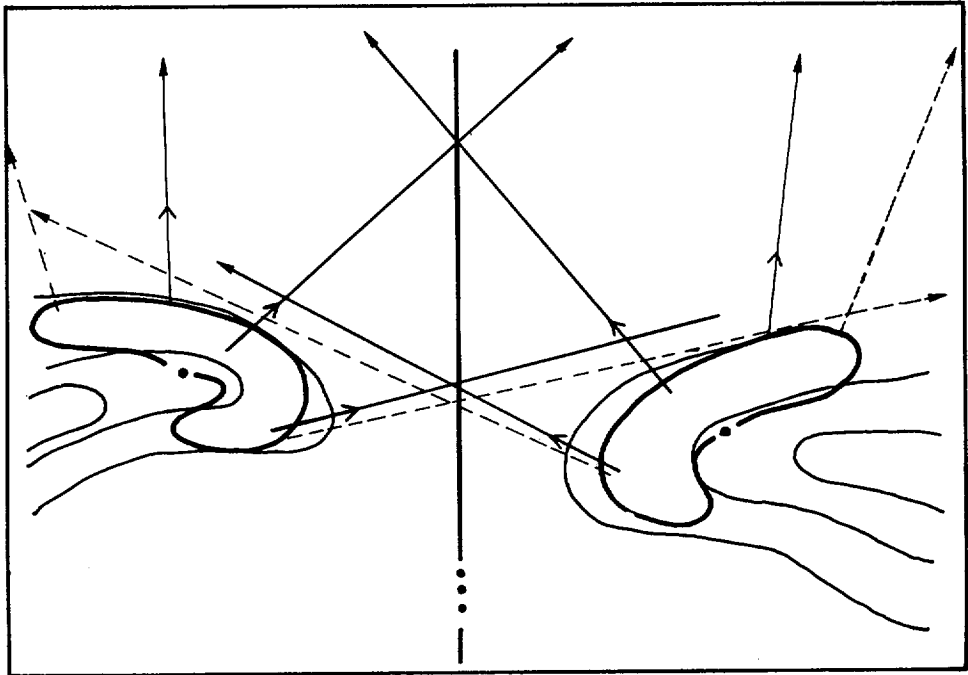

Figure 44.--Mutual Support in an Interval.

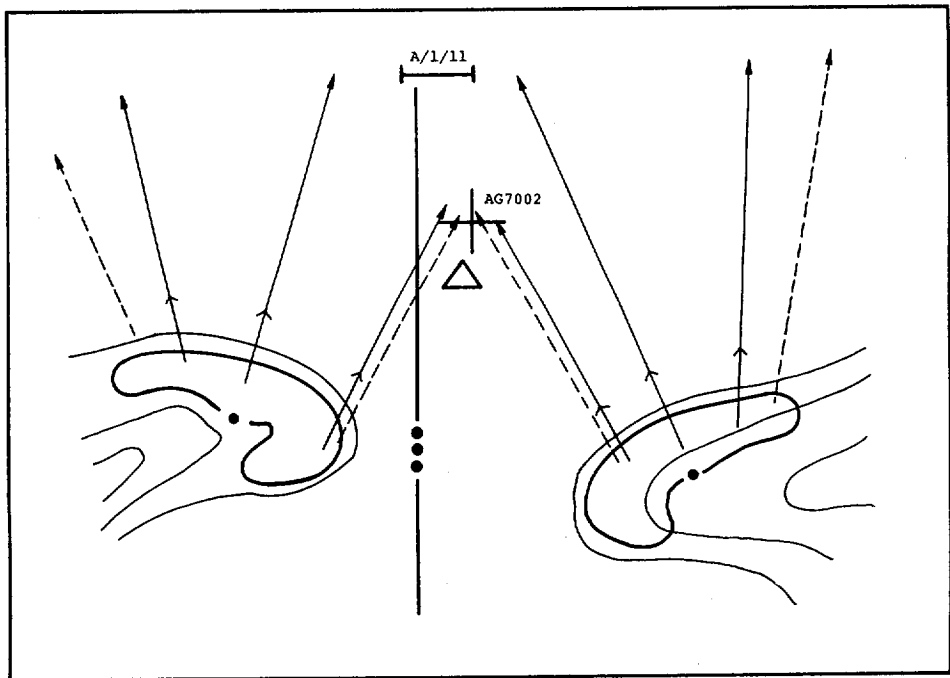

Figure 45.--Coverage for a Gap.

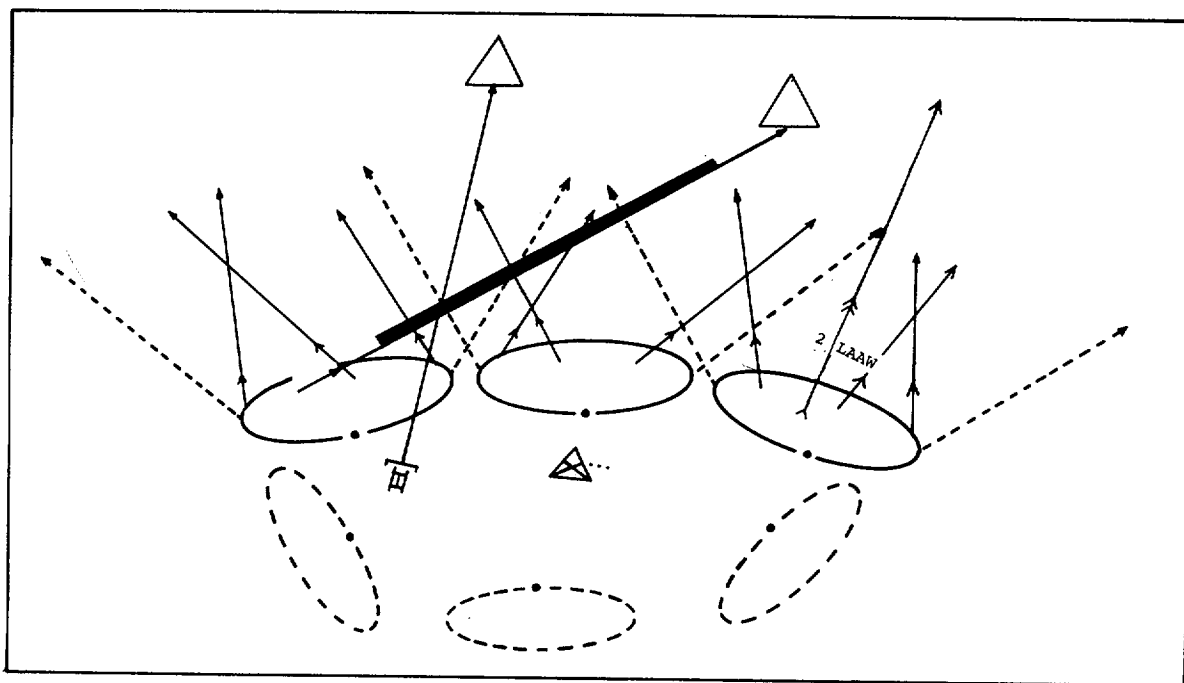

Figure 46.--Platoon Fire Plan Sketch.

4 Position and principal direction of fire of grenade launcher when assigned by platoon commander.

5 Positions and final protective lines (FPL's) or principal directions of fire for machineguns located in the platoon defense area (includes sectors of fire for attached guns).

6 Positions and principal directions of fire of other crew-served weapons in the platoon defense area (includes sectors of fire for attached weapons).

c. Control.--The effectiveness of the platoon's defense is dependent upon the platoon commander's ability to control organic units and their fires and to request additional fire support.

(1) The platoon headquarters employs a combined command post/observation post to control the defense selected by the platoon commander. It provides the best available observation of the platoon defense area, the avenues of approach into it, and the platoon's flanks. The platoon sergeant assists the platoon commander in controlling the platoon from this location. Restrictive terrain may require the preparation of more than one observation post. In this circumstance, the platoon commander locates the command post/observation post so that he can observe the majority of the positions or the most dangerous avenues of approach. The platoon sergeant is positioned to observe and control other important but less dangerous locations in the defense area.

(2) The platoon maintains a telephone station on the company wire communication net. It is supplemented by monitoring the company tactical radio net.

(3) When the time, situation, and availability of telephones permit, the platoon commander establishes a platoon wire communication net, linking the platoon's command post/observation post, the rifle squads, and the sentinel posts or listening posts on a common circuit. Sufficient telephones are usually available initially to establish wire communications between the platoon command post/observation posts and the security posts. When wire communication nets are inoperative or have not been established, the platoon commander employs visual signals, messenger, sound signals, and signalling expedients in controlling the platoon.

(4) The platoon commander ensures complete dissemination of important visual signals such as those prescribed for controlling final protective fires. The platoon commander ensures sufficient control of signalling devices to be certain that final protective fire signals are employed only on approval of the company commander, except in those cases where the authority to order delivery of final protective fires is vested in the platoon commander.

d. Organization of the Ground.--The task of organizing the ground is begun immediately upon arrival of the platoon in the defense area and is continued throughout the period of its occupancy. Work commences in accordance with the priority of work established by the company commander. Top priorities for the rifle platoon normally include the following, in order of importance, and are prescribed in the platoon commander's defense order:

(1) Post security.

(2) Position automatic rifles and grenade launchers and assign sectors and principal directions of fire.

(3) Clear fields of fire and determine ranges to probable target locations.

(4) Prepare positions.

(5) Other tasks in the priority assigned by the company commander.

4304. WEAPONS PLATOON

a. General.--In the defense, the weapons platoon provides the rifle platoon with close and continuous machinegun fire support and close-in anti-tank defense. The weapons platoon commander positions himself near the company commander and uses wire, messengers, and visual signals in controlling elements of the platoon.

(1) Machineguns.--The machinegun section is a major fire support agency in providing fires to stop the enemy assault immediately in front of the battle area. In a well-organized defense, the majority of the rifle company's final protective fires are delivered by the machinegun section. Its positions and fires are planned primarily for this purpose.

(2) LAAW's.--The assault section provides close-in antitank protection for the rifle company and, in the absence of an armor threat, augments other fires by providing close-range fire support for the rifle platoons. In the defense, its fires are planned in advance for delivery from previously prepared positions.

(3) Mortars.--The 60mm mortar is assigned positions and fire missions to provide continuous close fire support to the rifle company. Targets are preplanned in connection with support of close defensive fires and fires within the battle position, and FPF's are planned to supplement machinegun FPF's.

b. Recommendations.--The weapons platoon commander either conducts his reconnaissance with the company commander or is directed to conduct it separately. In either case, the company commander provides him with guidance in planning the employment of the weapons platoon. Guidance includes prospective positioning of the rifle platoons, the trace of the FEBA, general position areas for weapons, general final protective lines for machineguns, final protective fires for the 60mm mortars, and avenues of approach to be covered by rocket launchers. The company commander may specify the exact final protective lines for machinegun units providing mutual support to an adjacent company or covering the gap between adjacent platoons. Within the scope of instructions provided by the company commander, the weapons platoon commander selects a primary and an alternate position, a specific final protective line or principal direction of fire, and a sector of fire for each machinegun squad. For each assault squad, he selects covered waiting positions, primary and alternate positions, and a sector of fire. His selections are the substance of recommendations made to the company commander for the primary defensive employment of the weapons platoon. While on reconnaissance, the weapons platoon commander also selects supplementary positions, as necessary, from which the machineguns may perform other defensive missions. The weapons platoon commander will also select a section firing position for the 60mm mortar section to include at least one alternate position. Supplementary positions are selected only infrequently. Recommended targets will be selected based on nonorganic fire support preplanned on available avenues of approach, and general guidance received from the company commander. Final protective fire locations will be influenced by the presence of dead space or gaps remaining in FPL's after nonorganic fires have been planned.

c. Fire Support Plan.--In the defense, the company commander normally retains the weapons platoon in general support of the company. He exercises control of the platoon through the weapons platoon commander for the most effective defensive employment of his unit. The weapons platoon commander ensures its effectiveness by preparing a detailed plan consistent with the recommendation accepted by the company commander. The weapons platoon commander formulates his fire support plan from his estimate of the situation, the fundamentals of defense discussed in paragraph 4106, and a sound knowledge of the tactical employment of machineguns and 60mm mortars in the defense.

(1) Machinegun Tactical Employment.--The basic unit of machinegun employment in defense is the squad. Machineguns employed on the FEBA are normally employed by squad. Each gun of the squad is assigned the same mission. Normally, it is necessary to employ all three squads of the machinegun section on the FEBA in order to achieve the desired coverage. Machinegun defense in depth is gained by positioning a machinegun squad

with the reserve platoon to support the frontline platoons by fire. Such a situation may be obtained only when adequate fire support can be provided by the employment of two machinegun squads on the FEBA.

(a) Machineguns on FEBA.--Machinegun squads employed on the FEBA are normally assigned a final protective line and a sector of fire. Both machineguns of the squad fire the same general final protective line and sector of fire from positions a minimum of 35 meters apart. Under some circumstances, it may be necessary to split some squads in order to provide effective machinegun coverage. A machinegun squad is split when each of its guns has been assigned a different firing mission; i.e., a different final protective line or principal direction of fire and sector of fire. A machinegun squad is split only when necessary and, when split, the two guns should be employed as close to each other as the machinegun fire plan will permit for ease of control and supply. The perimeter variation of defense or defense in mountains, heavy woods, or jungle may necessitate splitting machinegun squads.

1 Final Protective Lines.--Effective final protective fires are characterized by flanking, interlocking, and grazing fires. Maximum flanking fire is desirable. The more frontal the fire, the less effective the coverage of the company front. Interlocking fire adds to the effectiveness of the fire plan by reducing the number of gaps in the final protective lines and provides mutual support between adjacent units. Final protective lines are located to obtain maximum grazing fire. Grazing fire is fire in which the trajectory of the bullets does not rise above the height of a man standing. On flat or uniformly sloping terrain, machinegun fire is grazing to a maximum range of 700 meters from the gun. Figure 47 shows the proper technique for graphically portraying final protective fire and gaps in its grazing fire on an overlay or sketch.

2 Sector of Fire.--A sector of fire is assigned each machinegun squad. It designates the area of responsibility within which the squad engages targets of opportunity when the enemy approaches within range. A machinegun sector of fire does not normally exceed 800 mils (45 degrees). It is desirable that adjacent machinegun squad sectors overlap. (See fig. 47.) Preferably, the final protective line comprises the near boundary of the sector. It may be located within the sector when the grazing fire is slightly more frontal than desirable and machinegun fire coverage closer to the FEBA is required.

3 Principal Direction of Fire.--When the terrain does not permit planning effective final protective lines, machineguns on the FEBA may be assigned principal directions of fire covering dangerous avenues of approach. In such situations, the principal direction of fire may fall within the sector of fire or comprise either of its boundaries.

(b) Machineguns in Rear of FEBA.--When adequate machinegun final protective fires are obtainable employing two machinegun squads on the FEBA, it may be desirable to add defensive depth by positioning a machinegun squad with the reserve platoon. These machineguns may be split and are assigned principal directions of fire and sectors of fire which best support the frontline platoons. Their fires may cover wide gaps between adjacent frontline platoons, and/or they may support the forward units from positions permitting overhead fire. (See fig. 48.)

Par. 4304

FMFM 6-4

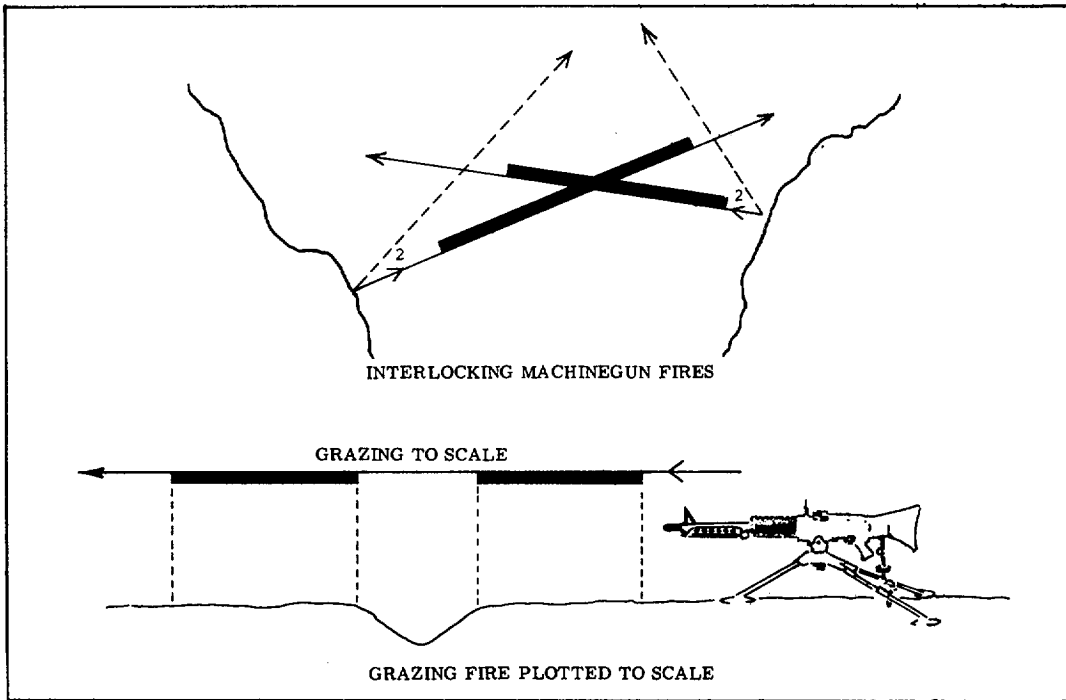

Figure 47.--Machineguns on the FEBA.

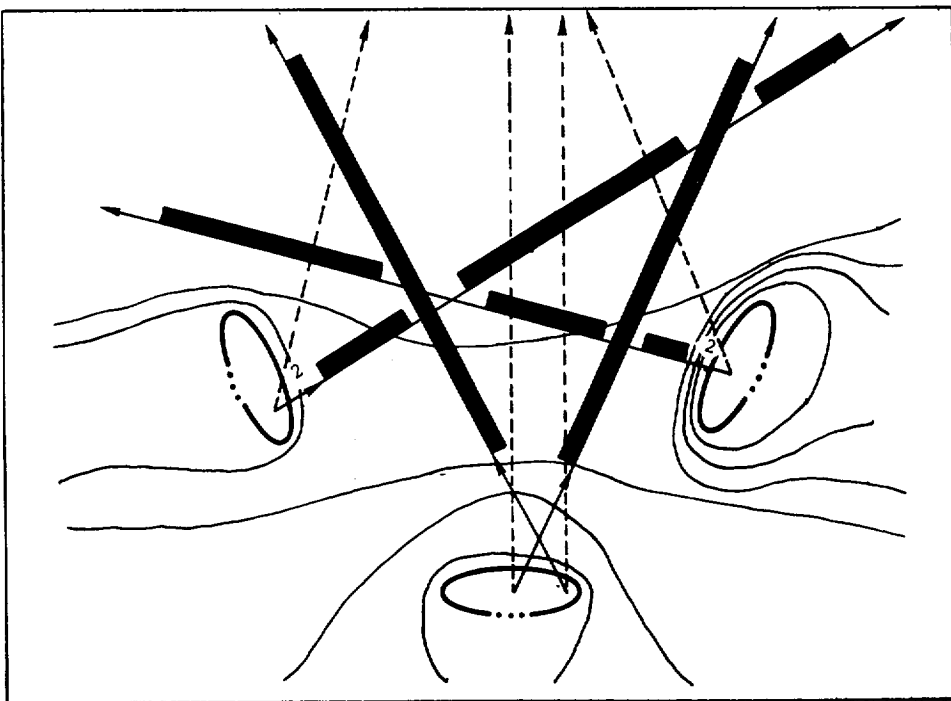

Figure 48.--Machineguns Split and Positioned with Reserve Platoon.

(c) Machinegun Laying Technique.--Both guns of the machinegun squad fire generally the same mission. The guns are assigned positions separated by at least 35 meters. The base gun is laid on its final protective line or principal direction of fire by compass azimuth. When properly laid, a visual reference point is located on the terrain. The second gun of the squad is laid on the appropriate line by using the visual reference point. The process is repeated for boundaries to the squad sector of fire. The firing data of the two guns differs slightly because of their difference in position, but both machineguns of the squad are performing essentially the same mission.

(d) Communications.--Whenever possible, the machinegun squad's primary positions are provided with sound power telephone communications on the company wire net. Wire is laid to alternate and supplementary positions, time permitting. Messengers are used when wire communications are inoperative or have not been installed.

(2) Rocket Tactical Employment.--The assault squad is the basic unit for the tactical employment of the rocket launcher. Because of their short range they are normally positioned with the frontline platoons to provide close-in antitank defense. The weapons platoon commander normally uses a messenger to communicate with assault squads.

(a) Position.--The location of the best observation and fields of fire covering the avenues of approach for armor dictate the positioning of assault squads. A primary and several alternate firing positions are prepared from which each avenue of approach can be covered. Covered waiting positions on the reverse slopes are prepared. When the armor threat develops, the squad moves by covered routes to the previously prepared positions.

(b) Sectors of Fire.--Each assault squad is assigned a sector of fire to ensure that all avenues of approach for armor are covered and to provide overlapping areas of antimchanized responsibility. The size of the sector is limited only by the available observation and fields of fire. The assignment of a sector of fire does not preclude firing at targets outside the sector. When the squad is employed as a unit, both assault teams are assigned the same sector. When the squad is split, the two teams may be physically located in proximity but are responsible for separate sectors. Fire planning should avoid splitting assault squads except when absolutely necessary.

(c) Employment in Depth.--Assault squads may be employed with the reserve platoon to add depth, flank protection, and all-around defense against armor. When other antitank weapons adequately cover the dangerous approaches into the frontline platoons, the assault squads cover the less dangerous approaches to avoid excessive duplication of fires.

(3) 60mm Mortar Tactical Employment

(a) Accomplishment of Missions.--In the defense, the mortar section is normally employed in the general support role. Final protective fires of a single mortar cover an area of approximately 50 by 50 meters. A final protective fire may be located within 60 meters of the FEBA. Thus, the 60mm mortar can cover small gaps or dead space in the machinegun final protective fires close to the FEBA. The company commander coordinates the fires of the 60mm mortars with the 81mm mortars. Targets over 500 meters

forward of the FEBA are normally covered by the 81mm mortar. The 60mm mortar fires are normally withheld until the enemy enters the security area and is engaged by close defensive fires. Because of the 60mm mortar's limited silhouette, it is possible to locate the weapon near the FEBA, and still afford the weapon and its crew adequate cover and concealment. In the defense, firing positions should be located between 150 and 300 meters to the rear of the FEBA. When possible, the three mortars of a section are emplaced as a section, thereby simplifying control and ammunition resupply.

(b) Fire Control

1 Communications.--The primary means of communication in the defense is wire. Sound power telephones provide communications between the section leader at the OP and the gun position. In the event the section leader is not physically located near the company commander or the weapons platoon commander, wire should be laid to provide the section leader with constant communications to the company CP.

2 Approval of Missions.--The company commander will normally approve fires on targets located in the security area before they are delivered. In no case would this authority be delegated beyond the weapons platoon commander.

3 Sectors of Observation.--In the event it becomes necessary to man two or more OP's for the purpose of controlling mortar fires throughout the entire security area, the company commander must ensure that the area is covered by overlapping sectors of observation. The company commander would accomplish this by assigning, in his defense order, FO's in addition to the mortar section leader. Rifle platoon commanders logically would be assigned to act as FO's under these circumstances and would normally call for and control fires from their CP/OP.

4 Sectors of Fire.--Mortar squads are not assigned sectors of fire but are expected to be able to provide coverage throughout the entire company security area.

5 Rate and Duration of Fires.--In the absence of any instructions, the normal rate of fire is nine rounds per minute for the first 2 minutes and six rounds per minute thereafter for the duration of final protective fires. The section leader will normally specify the number of rounds to be expended on each target. The company commander may set the number of rounds to be fired for FPF's and targets in his defensive order, keeping in mind ammunition on hand, nonorganic support available, anticipated resupply schedule, area to be covered, and enemy activity.

(4) Supplementary Missions.--Both the machinegun squad and the assault squad may be positioned and employed in performing supplementary missions in defense.

(a) Machineguns.--Machinegun squads employed on the FEBA or in the reserve area prepare supplementary positions from which to cover sectors of fire different from their primary sectors. Such missions are usually contingent upon an enemy penetration of an adjacent unit or a front-line platoon. Fires are delivered into the penetrated area to limit its expansion or to protect the exposed flank and rear of the company.

(b) Rockets.--Assault squads prepare supplementary positions from which to perform various contingency missions. Assault squads, whose primary missions are to cover avenues of approach to the FEBA, may be required to prepare supplementary positions from which to cover avenues into the flanks and rear of the company. Assault squads usually support the defense by fire from planned supplementary positions when an armor threat fails to develop.

(c) 60mm Mortars.--Supplementary positions are infrequently established for a 60mm mortar squad/section. However, fires within the battle area are planned to support frontline rifle units when they are forced to move to supplementary positions.

(5) Fire Control Signals.--The weapons platoon commander ensures dissemination of fire control signals down to the lowest echelon. Signals for commencing and ceasing the final protective fires are vital to effective defense. Other signals may be used in controlling close defensive fires, manning alternate positions, or in controlling movement of the assault section from covered waiting positions to firing positions.

4305. RESERVE PLATOON

a. General.--The reserve rifle platoon is normally positioned in the rear of the frontline platoons to provide depth to the company defense. The company commander assigns the reserve platoon a primary position and one or more supplementary positions from which to accomplish its mission. The reserve moves from one position to another on order of the company commander.

b. Location and Organization.--The reserve platoon is located on the best available defensive terrain in the company reserve area from which it can accomplish the assigned missions. It is positioned no closer than 150 meters from the forward edge of the reserve area so as to avoid enemy fires directed at the frontline platoons. It organizes its positions in generally the same manner as the frontline platoons. The entire platoon normally occupies the primary position initially. Supplementary positions are prepared for occupation by the entire platoon. Only dire necessities imposed by difficult terrain should require the preparation of separated squad positions.

(1) Fire Plan.--Fire planning for the reserve platoon is essentially the same as that for a frontline platoon consistent with the reserve's mission, except final protective fires are not normally planned.

(2) Control.--The reserve platoon commander locates a command post/observation post within the primary position from which he can best observe and control the fires of the platoon. Terrain permitting, he should be located so that he can observe the frontline platoons and the company's flanks and rear.

(a) The reserve platoon maintains a telephone station on the company wire communication net and operates its tactical radio on listening silence. The radio is employed if wire communications fail.

(b) The platoon commander communicates with subordinate units by messenger, visual signal, and personal contact.

c. Mission.--The reserve platoon may be assigned more than one mission. When the company commander assigns more than one mission, he establishes a priority for their accomplishment. The prospective employment of the reserve is planned in advance; however, its execution is contingent upon the enemy situation.

(1) Support Frontline Platoons by Fire.--The reserve platoon may be assigned the mission of supporting the frontline platoons by fire and is positioned where it can support the forward platoons by firing into the gaps between them and on their flanks and rear. The reserve position is organized within effective range of the frontline platoons' primary positions. The width of the company's battle area may require the preparation of more than one position to accomplish the mission in different portions of the company area.

(2) Limit Penetrations.--The company commander determines the probable areas of enemy penetration and assigns the reserve platoon positions from which to limit them. The reserve platoon occupies terrain from which it can block the enemy's advance. The frontline platoons aid in limiting the penetration by placing fire across its base and flanks. Previously planned indirect fires are delivered to augment the fires of the reserve platoon and frontline units. Every effort is made to prevent the enemy from reinforcing the penetration or reorganizing within the penetrated area. (See fig. 49.) When the reserve platoon is engaged in limiting a penetration, the counterattack to eject the enemy is executed by the reserve of a higher echelon.

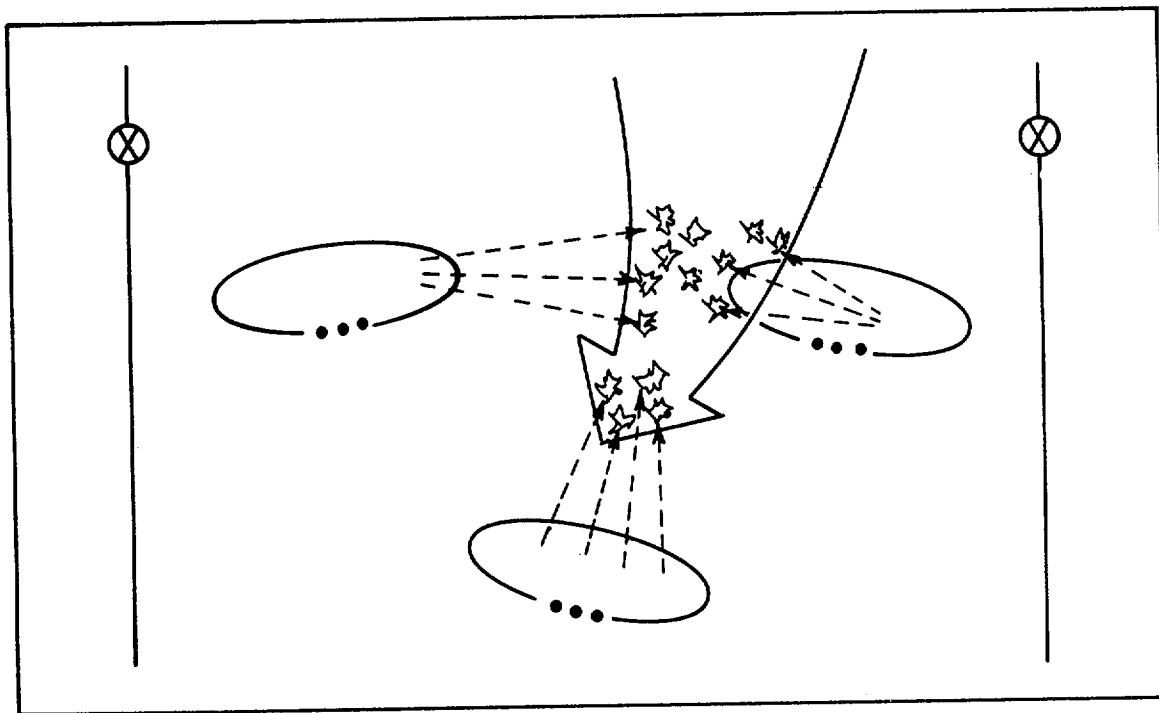

Figure 49.--Limiting a Penetration.

(3) Protect the Company's Flanks and Rear.--To complete all-around defense, the reserve platoon prepares positions to protect the company's flanks and rear. The company commander designates specific avenues of approach into the rear area that the reserve platoon is to block. Positions are prepared which permit fire coverage of these avenues. The positioning of the reserve in protecting the flanks of the company must be coordinated with supplementary positions of the frontline platoons and adjacent units. The company commander coordinates with adjacent companies. The reserve platoon commander coordinates with affected platoons from his company and adjacent companies. The reserve platoon occupies the positions, on order from the company commander, to protect the company's flank when a penetration has occurred in an adjacent area.

(4) Security and Surveillance.--The company commander may assign the reserve platoon security and surveillance missions. They may include providing the forward local security elements for the company, security of unoccupied portions of the battle area, and security of an exposed flank. The security missions may require the establishment of sentinel posts, listening posts, and security patrols. Security elements are located to cover avenues of approach, routes of movement, and key terrain. In addition, patrols may be used to maintain contact with adjacent companies or as means of communications between security elements.

(5) Counterattack.--The reserve rifle platoon seldom executes the counterattack. The counterattack is a limited objective attack designed to destroy the enemy in a penetration or eject him from it and to regain control of the penetrated portion of the battle area. Only when plans for limiting a prospective penetration depend upon barriers, indirect fires, and the fires of frontline units and do not involve the reserve platoon can the rifle company plan a counterattack to eliminate a penetration. The reserve platoon provides the frontline rifle company with limited counterattack means. Counterattack plans are prepared in detail and rehearsed. The reserve platoon commander prepares or assists the company commander in the preparation of counterattack plans. Counterattack plans are based upon detailed reconnaissance and careful coordination with units occupying positions in the area of the expected penetration. A counterattack is conducted in generally the same manner as any other attack. Paragraph 4307 provides additional guidance in preparing counterattack plans.

4306. CONDUCT OF THE DEFENSE

a. Daylight Defense

(1) The conduct of the combat outpost is described in paragraph 4204.

(2) Forward observers search for targets for indirect fire weapons and call for and adjust their fire. Tanks and antitank weapons open fire on appropriate targets when the enemy comes within effective range. When the enemy apparently knows the location of the FEBA, all weapons along the FEBA open fire as he comes within their effective ranges. When it appears that the enemy is probing to locate the positions, all but a few specified fires may be withheld until he is well within effective rifle range. Then all weapons along the FEBA engage appropriate targets within their sectors of fire. When the enemy attacks without armor, the defender's tanks, antitank weapons, and rocket launchers may engage such targets as crew-served weapons, vehicles, and groups of personnel. Leaders

actively control the fires of their units to ensure that all fires are effective. They move their weapons to alternate or supplementary firing positions as required.

(3) The rate of fire increases as the enemy approaches the FEBA. If the attacking force includes tanks as well as infantry, the tanks are engaged by antitank weapons and artillery, while small arms fire, mortars, and artillery are directed at the attacking infantry. Every effort is made to separate the tanks and infantry. The company commander moves his assault squads to positions to reinforce the antitank fires in a threatened area as required.

(4) When the enemy is repelled, he is pursued by all available fire. If he breaks contact, companies in the battle area reestablish local security and send patrols forward to regain contact. The defender delivers harassing and interdiction fires in areas where the enemy is likely to be regrouping. Platoons along the FEBA reorganize, evacuate casualties, redistribute and resupply ammunition, and strengthen their defenses.

(5) During the conduct of the defense, all leaders keep their next higher commander informed of the situation at all times. Aggressive leadership on the part of all leaders is essential. Fire team leaders assist squad leaders in the control of squads, particularly in fire control. During the conduct of the defense, leaders move from place to place so that they can influence the action through personal leadership.

(6) When the enemy continues his advance through the close defensive fires, the platoon commander in the threatened area requests final protective fires. Upon receiving such requests, the company commander will normally order the final protective fires. When the order to fire the final protective fires is given, the company delivers maximum fires along with the machinegun, mortar, and artillery final protective fires. Automatic riflemen fire on their principal directions of fire. Riflemen and grenadiers fire within their sectors. Grenadiers assigned principal directions of fire cover them. Elements to the flanks of the platoon reinforce their fires. The company commander calls for the fires of indirect fire weapons that are not firing final protective fires to reinforce the fires in the threatened area.

(7) When it appears that a penetration of the company's portion of the FEBA is probable, the commander moves the reserve to positions from which it can block the penetration and/or support threatened units by fire. If the penetration or threat is in the area of an adjacent company, he positions his reserve to protect the endangered flank.

(8) When the enemy assault reaches the position, the defender repels him by fire, grenades, and close combat. All available antitank weapons engage enemy tanks. Individuals along the FEBA continue firing until forced to take cover to protect themselves and their weapons from the crushing action of the tanks. They resume their firing positions and continue to fight as soon as the tanks pass. Tanks that penetrate the forward area are engaged by antitank weapons that are positioned in depth.

(9) When the platoon defense area is penetrated or is threatened from the flanks or rear, the platoon commander may adjust his defenses by moving men and weapons from the least engaged area into supplementary positions to meet the threat. He calls for the fires of all weapons which

can profitably engage targets within the penetration. Fires are also placed across the base of the penetration to prevent the enemy from reinforcing it. The company normally attempts to limit a penetration of the forward platoons with the reserve and to destroy the enemy by fire. The reserve platoon may be ordered to counterattack and eliminate the penetration.

b. Night Defense

(1) At night the company relies on patrols, listening posts, and surveillance devices to detect an advance or infiltration. If the company contracts its defense position at night, it ensures surveillance of the gaps created on its flanks. The security elements report the advance of the enemy and call for illumination and supporting fires. They withdraw before they become engaged in close combat.

(2) Illumination is used extensively to expose the enemy as he approaches the frontline platoon areas. Platoon commanders normally request permission from the company commander to fire illumination. It is the responsibility of the company commander to inform adjacent units of his intent to use illumination. As a general rule, weapons are not fired until targets are visible. Fires are opened only on order of leaders. All leaders maintain rigid fire control to prevent indiscriminate firing which results in needless expenditure of ammunition and premature disclosure of positions. Leaders may direct some weapons to fire at flashes and, in some instances, at sounds. Crew-served weapons fire with predetermined firing data or by using artificial illumination.

(3) When it has been determined that the enemy is commencing his assault, the platoon commander requests final protective fires in the threatened area. Illumination continues at an increased rate and the defense is conducted in generally the same manner described for defense in daylight. Automatic riflemen fire on their principal directions of fire. Riflemen fire within their sectors except as otherwise directed by their fire team leaders. Grenadiers assigned principal directions of fire cover them. Hand grenades are used to supplement other fires as the enemy nears the position. Other aspects of the conduct of the defense at night are generally the same as for the conduct during daylight.

4307. RESERVE RIFLE COMPANY

a. General.--A forward battalion generally withholds a reserve of one or more rifle companies in the area defense. They are suitably disposed within the battalion reserve area to perform their assigned tasks. In general, if the enemy penetrates the battle area, the battalion commander uses his reserve to limit the penetration. When there is a reasonable chance of success for counterattacking forces, a counterattack is launched to destroy or eject the enemy and restore the battle area. The decision to counterattack is made by the battalion commander.

b. Missions.--A reserve rifle company may be assigned one or more of the following tasks:

- (1) Block or canalize an enemy penetration.
- (2) Launch a counterattack.
- (3) Protect the battalion flanks and rear.

(4) Perform rear area security and surveillance missions as discussed in paragraph 4205.

(5) Relieve a frontline company.

(6) Support the frontline companies by fire.

(7) Assist in preparing positions for frontline companies.

(8) Provide the combat outpost as discussed in paragraph 4204.

c. Blocking Positions.--The battalion commander designates blocking positions in the battalion reserve area. The positions are located to limit penetrations of the battalion battle area. Others may be located to block avenues of approach into the battalion's battle area from the flanks and rear. The battalion commander specifies the priority of their construction and designates the blocking positions or assembly area to be occupied initially by the reserve company.

(1) Blocking positions are organized generally in the same manner as the positions of frontline companies. A blocking position may vary in size from reinforced platoon to a reserve company location. A reserve company may initially occupy designated blocking positions or it may be assigned an assembly area from which to meet various contingency missions. Each blocking position is oriented toward limiting an enemy penetration of a particular avenue of approach. Squad supplementary positions are prepared to protect the flanks and rear of each blocking position organized.

(2) Machineguns employed in the blocking positions are assigned principal directions of fire and sectors of fire covering the most dangerous avenues of approach rather than final protective lines. Machinegun squads emplaced in a suitably located blocking position may support the frontline companies by fire. These supporting fires are normally delivered in the gaps between adjacent frontline companies. The fires are prearranged through close coordination with the frontline companies concerned.

(3) Assault squads perform their defensive blocking missions by organizing positions generally as discussed in paragraph 4304. When an armor threat is not apparent, they may support the blocking positions with close-in fire support.

(4) The 60mm mortar section, when employed from a blocking position, is assigned targets that assist in blocking the most likely avenues of approach. The 60mm mortar, as in the case of the machinegun, may also be employed to fill gaps which exist on the FEBA between adjacent frontline units. These fires are normally planned on-call in coordination with the frontline unit commanders.

d. Counterattack.--The battalion commander directs and supervises the preparation of battalion counterattack plans. A reserve company is normally part or all of the counterattack maneuvering force. Some counterattack plans may require the reserve company to block the penetration with one reinforced platoon and maneuver with the remainder of the company as part or all of the counterattack maneuvering force. The counterattack capability of the battalion reserve is neither dissipated against minor enemy successes nor employed against overwhelming odds.

(1) Each battalion counterattack plan usually assigns the maneuvering force a line of departure, direction of attack, and an objective.

(2) The counterattack scheme of maneuver is very similar to that of any attack. The direction of attack and line of departure assigned by the battalion commander are located so that the attack is directed against a shoulder or flank of the penetration. The initial success of the counterattack isolates the enemy in the forward portion of the penetrated area.

(3) Fire support planning for the counterattack is slightly more complex than fire support plans for other attacks. All fires within the penetrated area are controlled by the maneuvering force commander once the counterattack is launched. Fire support planning for the counterattack includes:

(a) Fires to support the maneuvering force.

(b) Fires across the base of the penetration to destroy enemy forces attempting to reinforce the penetrated area or attempting to withdraw from it.

(c) Fires within the penetrated area to prevent the enemy from expanding his foothold or reorganizing.

(4) When the reserve rifle company participates in a counterattack, the original plan usually requires slight revisions by fragmentary

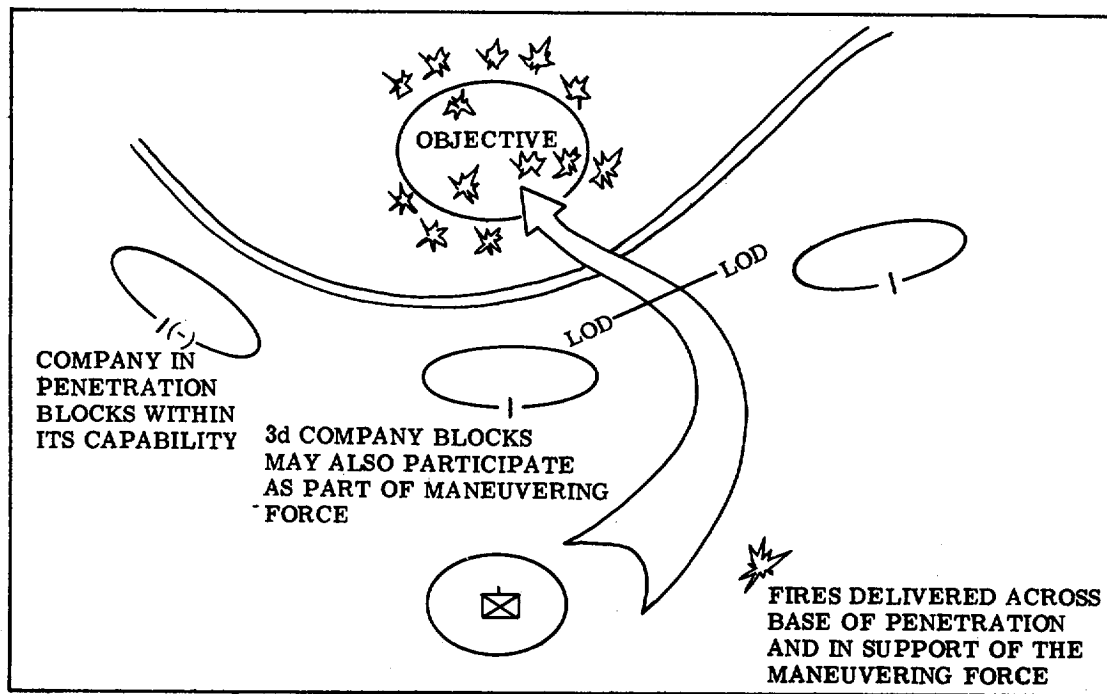

Figure 50.--Typical Counterattack (Schematic).

Par. 4307

FMFM 6-4

order to conform to the existing situation. Seldom does the actual penetration conform in every detail to the assumptions upon which the battalion plan was based.

(5) Once the enemy has been destroyed or ejected from the penetration, the maneuvering force may be ordered to assume responsibility for defense of that area or to resume its reserve missions in the battalion reserve area. When the counterattack is only partially successful, the force consolidates the ground gained. Figure 50 is a schematic of a typical counterattack.

Section IV. PERIMETER DEFENSE

4401. GENERAL

The perimeter defense is a variation of the area defense in which the defending unit is disposed to meet attacks from all directions simultaneously. The rifle company may defend a portion of the battalion perimeter. It may be required to organize a company perimeter when it is separated from the remainder of the battalion. A rifle company perimeter defense is appropriate when the company is separated by enemy action, the terrain, or the company's mission. In some instances, the battalion may adopt the extended form of area defense. Separation of the frontline companies may require each of them to organize a separate perimeter even though the company performs its defensive mission as part of the battalion. This section discusses the perimeter variation of area defense. Since this defense has many of the characteristics of other area defense variations, only the peculiarities of the perimeter are discussed in detail. The purpose of the discussion is to provide the rifle company officer with guidance in the planning and conduct of perimeter defense. A sound foundation in the principles of area defense is presupposed.

4402. RIFLE COMPANY

a. Battalion Perimeter.--The rifle company's participation in the battalion perimeter defense is very similar to its participation in the compact variation of area defense discussed in section III. The battalion perimeter consists of a series of mutually supporting platoon positions organized to take advantage of the observation and fields of fire afforded by commanding terrain.

(1) The frontline rifle company is assigned a normal frontage. It draws back (refuses) its flanks to tie in with and effect maximum mutual support with adjacent units. This requires the company to defend with three platoons forward more often than is the case in compact area defense.

(2) The reserve rifle company is employed in much the same manner as in compact area defense. It retains its primary functions of blocking and/or counterattacking penetrations. In the perimeter defense, a reserve company may perform a security mission similar to its employment as a combat outpost. It usually establishes separate outguards to cover the avenues of approach into the battalion perimeter. Extensive patrolling is planned to maintain contact with the outguards. Other patrols range beyond the outguards to establish and maintain contact with the enemy. Outguards and patrols in the affected areas are withdrawn when the enemy attacks in force.

b. Company Perimeter.--In the company perimeter defense, the rifle company is physically disposed to meet attack from all directions simultaneously. The fundamentals of defense are applied to the maximum possible extent.

(1) The perimeter defense established by a rifle company consists of a perimeter and a reserve area. Each of the platoons is assigned a portion to organize and defend. The reserve may consist of one rifle squad from one of the rifle platoons reinforced by elements of the weapons

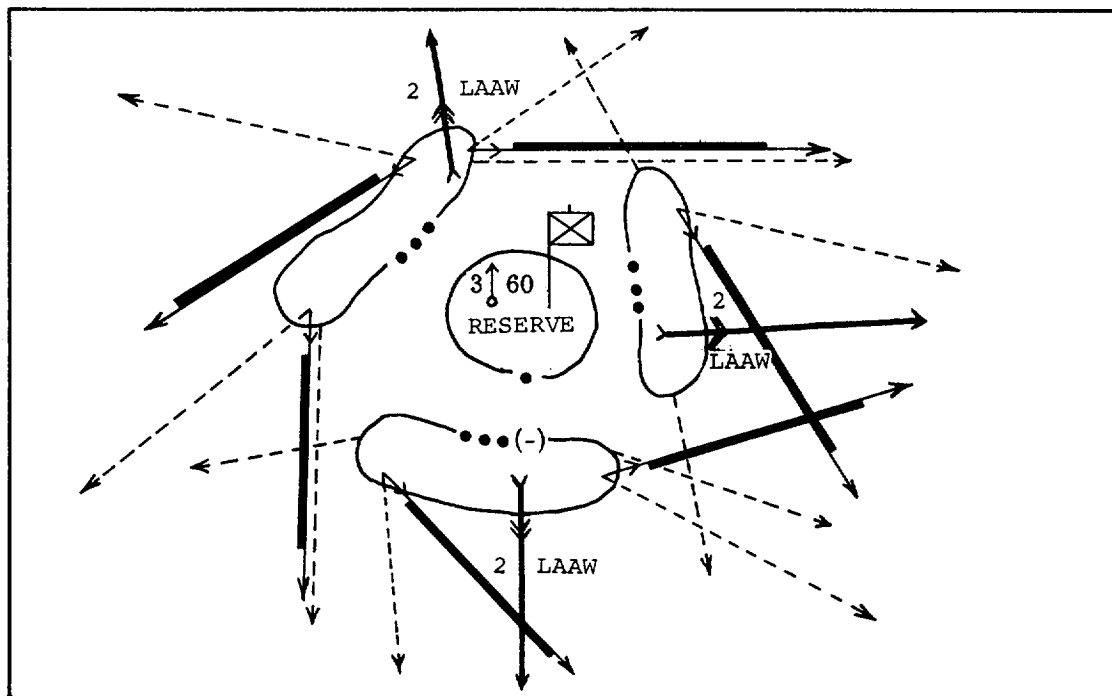

Figure 51.--Rifle Company in Perimeter Defense.

platoon and the company command post acting as riflemen. When the full strength of all three platoons is required on the perimeter, the reserve consists of elements of the weapons platoon, elements of the company command post, and/or elements of the least committed rifle platoon. In some instances, an entire rifle platoon may be withdrawn from the perimeter temporarily to counterattack.

(2) The frontages of the company and the platoons are normal, except that the company front is approximately circular rather than linear. The company commander assigns platoon defense areas in accordance with the importance of the avenues of approach and the observation and fields of fire available. Platoons covering the most dangerous avenues of approach are assigned narrower frontages. Security and coverage of gaps between platoons are as discussed in sections II and III, this chapter. Figure 51 is a schematic of a typical company perimeter.

(3) The conduct of the perimeter defense is generally the same as described in paragraph 4306 except that the reserve normally counterattacks to destroy or eject enemy penetrations and restore the perimeter.

(4) Patrols are used to establish and maintain contact with the enemy.

4403. RIFLE PLATOON

The organization of the platoon frontline defensive position or reserve position in the battalion perimeter is the same as discussed in

section III. The platoon participates in the company perimeter defense in essentially the same manner as discussed in paragraph 4303. The perimeter variation assumes the following characteristics affecting the platoon's dispositions and employment:

a. The company front is circular rather than linear with adjacent platoons tied in with each other.

b. Gaps between platoons are generally reduced.

c. One squad of a frontline platoon may be initially withdrawn from the platoon commander's control and retained and employed as part of the company reserve. The frontage assigned to the platoon is reduced accordingly.

d. A frontline platoon or portions of that platoon occupying the portion of the perimeter not under attack or under very light attack may be used as a counterattack force to destroy a penetration.

4404. WEAPONS PLATOON

The employment of the weapons platoon in the perimeter defense is basically the same as discussed in paragraph 4304. The special considerations discussed in this paragraph apply equally to its participation in the battalion and company perimeter unless otherwise noted.

a. Machinegun Section.--The generally circular trace of the FEBA makes it difficult to obtain flanking and interlocking final protective lines. The machinegun squads are normally split in the perimeter defenses to gain increased flanking and interlocking fires. Each machinegun team is assigned an individual final protective line and sector of fire. Interlocking fires are achieved whenever possible, consistent with the best flanking and grazing fire attainable. The two machinegun teams from a squad are positioned in physical proximity to one another whenever possible, even though they are firing separate missions. Their proximate positioning enhances fire control and supply.

b. Assault Section.--In the company perimeter defense, the assault section prepares positions as described in paragraph 4304 for compact area defense. Its covered waiting positions are usually located in the reserve area. The assault section is often organized as riflemen to act as part of the company reserve. The assault section leader may be designated commander of the reserve.

c. 60mm Mortar Section.--The mortar section will be centrally located within the perimeter to enable it to fire in support of all platoons located on the perimeter. When this is not possible, the mortar squads will be positioned individually to increase the total area of coverage.

Section V. REVERSE SLOPE DEFENSE

4501. GENERAL

a. A reverse slope defense is one organized on the portion of a terrain feature that is masked by a crest from enemy direct fire and ground observation from the front. All or any part of the forces on the FEBA may be on the reverse slope, depending on the terrain in the area to be defended. A successful reverse slope defense depends on the control of the crest by fire or physical occupation. The company commander may direct the occupation of a reverse slope position under the following conditions:

(1) When the forward slope is untenable because of enemy fire.

(2) When the forward slope has been lost or not yet gained.

(3) When the terrain on the reverse slope gives better fields of fire than the forward slope.

(4) To avoid a dangerous salient or reentrant.

(5) When possession of the forward slope is not essential for observation.

(6) To assist in achieving deception and surprise.

b. In a reverse slope defense, the frontline platoons in the battle area are protected from enemy ground observation and direct fire. Enemy indirect fire weapons normally must deliver unobserved fires which reduce their effectiveness. When the enemy has been deceived as to the true situation, he may advance to close contact before he realizes he has discovered the battle area. The defender may effectively employ deception measures such as dummy positions on the forward slope. Two major disadvantages are the difficulty of maintaining observation of the enemy and the restricted range for direct fire weapons. Without observation, the effectiveness of friendly direct and indirect fires is limited. Obstacles and minefields on the forward slope cannot be covered by direct fire weapons. If the enemy seizes the crest, he has the advantage of attacking downhill while a counterattack to eject him must move uphill.

4502. RIFLE COMPANY

The reverse slope is generally organized as a compact area defense applying the fundamentals of defense. (See fig. 52.) Observation and security groups are established on or just forward of the topographical crest to provide observation over the company's entire front. These groups may vary in size from two men to a rifle squad. They may be reinforced with machineguns and tanks. At night security groups are strengthened to prevent infiltration and surprise. If the company is part of the battalion reverse slope defense, the observation and security groups may be controlled by the battalion commander.

4503. RIFLE PLATOON

a. The frontline rifle platoons are located within effective small arms range of the crest. Squads on the reverse slope are positioned to

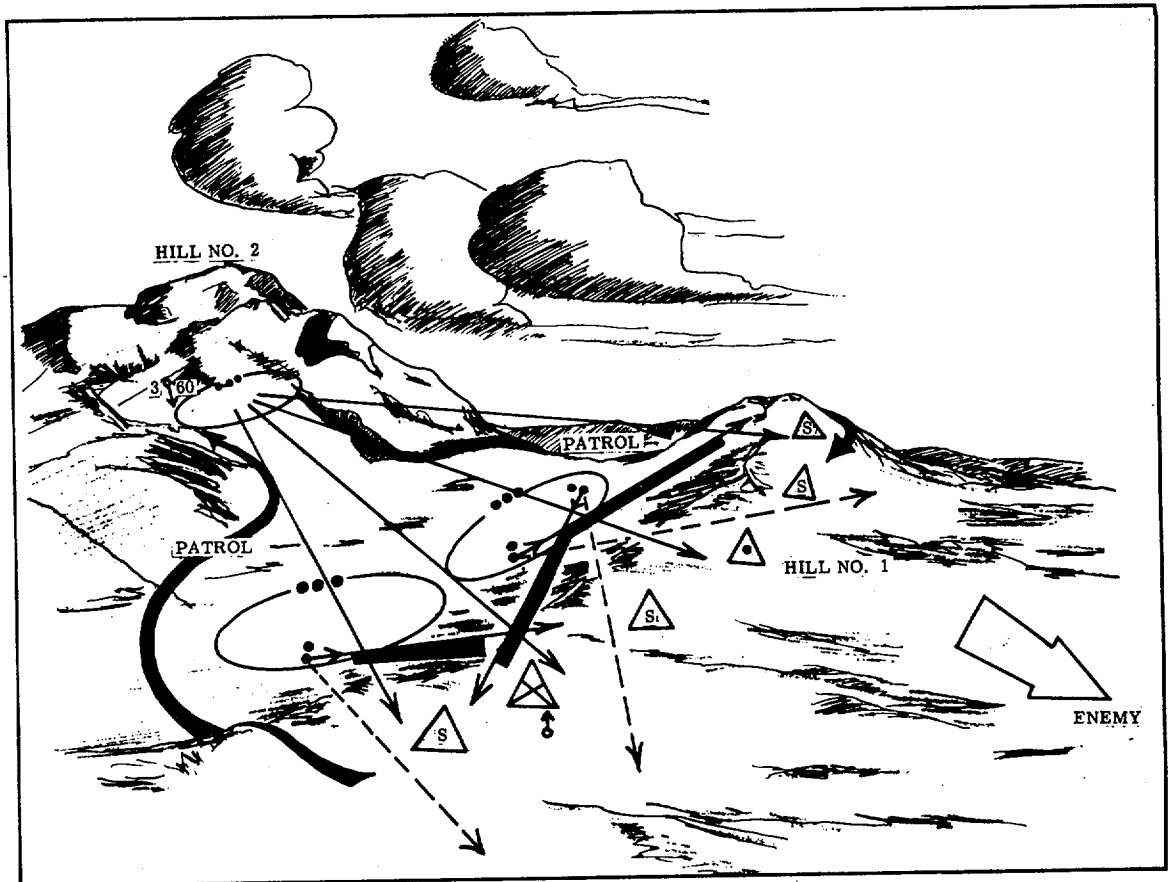

Figure 52.--Reverse Slope Defense.

permit the delivery of maximum fire on the crest and the ground between the crest and the FEBA. The fire plan for the frontline platoon is formulated in a manner similar to the forward slope defense.

b. The reserve platoon occupies the next high ground to the rear of the FEBA and organizes positions on the military crest from which to support the frontline platoons by fire. The reserve platoon usually provides the observation and security groups operating in the company's security area. In addition to counterattacks to destroy or eject enemy penetration of the FEBA, the reserve platoon may be employed in counterattacks forward of the FEBA to regain control of the topographical crest. The crest is essential to effective observation.

4504. WEAPONS PLATOON

a. The employment of the weapons platoon in reverse slope defense is very similar to its employment in the defense of a forward slope.

(1) Machineguns are placed where they can deliver the most effective surprise fire as the enemy crosses the crest. Sectors of fire provide maximum coverage of the ground between the FEBA and the crest.

Par. 4504

FMFM 6-4

Final protective lines are designated and organized as in forward slope defense.

(2) Assault squads may be employed more extensively in their fire support role. The bulk of the antitank defense is provided by heavier weapons positioned near the reserve platoon.

(3) The 60mm mortar section will be assigned a series of targets to deny the enemy access to the crest of the hill. Final protective fires are planned in relation to machinegun final protective lines as in the normal defensive role.

b. Final protective fires are normally placed along the crest of the hill to deny it to the enemy. When the FEBA is as much as 400 meters back of the crest, it may be more advisable to locate the final protective fires closer to the FEBA than to the crest. In this case, targets are planned both on and short of the crest to keep the enemy under fire as he advances toward the planned final protective fire areas.

Section VI. DEFENSE OF BUILT-UP AREAS

4601. GENERAL

a. The use of a built-up area in the organization of a defense depends upon such factors as its size, its location in relation to the overall defensive area, and whether it affords increased protection. Localities constructed of flammable materials provide little protection and may become a hazard to the defender. Buildings of masonry construction can be developed into fortified defensive positions or strong points.

b. The area defense is employed when defending a built-up area. The fundamentals of defensive combat are generally the same as for the defense of any other area. The principal difference lies in the degree of emphasis placed on certain fundamentals.

(1) The cover and concealment available and limited observation require that special attention be given to all-around defense and mutual support to counter enemy infiltration.

(2) Added emphasis is placed on barriers in barricading the streets to deny the enemy ease of movement.

(3) Surveillance of the flanks and rear is intensified, and the defense must be flexible enough to permit defense in any direction to protect against encirclement.

4602. RIFLE COMPANY

A frontline rifle company may be assigned a frontage of two to four city blocks and a depth of two to three blocks. An average city block is approximately 175 meters wide. The frontage is less in areas of block-type construction, multistory buildings, and underground passages. Tanks and Dragons are employed in support of the defense to cover the most dangerous avenues of armor approach. They are usually employed well forward in conjunction with barricades along the FEBA. The requirement for their employment well forward in close coordination with the rifle elements generally requires that such weapons be attached to or placed in direct support of the rifle company. Restricted observation and the short ranges afforded by the area for antitank weapons may require the rifle company commander to decentralize control by attaching them or placing them in direct support of the frontline platoons. When streets entering the company defense area are numerous, tanks and antitank weapons are employed under company control and positioned in depth. The frontline rifle company normally employs two platoons forward and one in reserve. The three dimensional aspect of the defense is stressed. The company battle area is vulnerable to attack from above or below if these approaches are not guarded. Generally, the company FEBA is established along one side of a wide street or open area. The final protective fires, though much closer to friendly positions than normal, are prepared in the usual manner. Streets entering the FEBA are barricaded. The barricades are defended by antitank weapons and rifle units. Subterranean approaches into the company battle area from the front are barricaded and defended. Surface, subsurface, and probable overhead approaches into the flanks and rear are barricaded and placed under surveillance. Contingency plans are prepared for their defense.

Par. 4603

FMFM 6-4

4603. RIFLE PLATOON

Rifle platoons along the FEBA are assigned frontages of up to two city blocks and a depth of one city block, depending upon the character of building construction. Large, strongly constructed buildings such as court-houses, post offices, or public utility buildings may require occupation and defense by an entire platoon. Specific fire teams or individuals are assigned to devote special attention to security and defense against entry into the platoon area from the flanks, rear, overhead, and underground. The platoon's flanks are normally secured by physical contact with adjacent units.

4604. WEAPONS PLATOON

The weapons platoon is normally employed in general support. Its basic employment is very similar to its employment in other defenses.

a. Machinegun Section.--The machinegun section performs its normal defensive role, providing final protective fires for the frontline rifle company. The machineguns are positioned on or near ground level to achieve maximum grazing fire down the axis of a wide and generally uniformly sloped street. Falling debris can clog the street sufficiently to block the planned grazing fire. An examination of the building heights, projections into the street, and width of the street aids in determining probable points at which falling debris may block final protective fires. Primary and alternate positions are selected which minimize the number and size of gaps in the final protective fires likely to result from obstruction of the street.

b. Assault Section.--The rocket launchers (LAAW and MPFW) are positioned so as to command street intersections in depth within the company defense area. They can be located inside and/or on top of buildings in order to take maximum advantage of observation and fields of fire. When employed inside a building, appropriate safety considerations must be made for the backblast launch effects (loose objects, structure of building, personnel, etc.). Alternative firing positions should be designated for each launcher.

c. 60mm Mortar Section.--The 60mm mortar section is employed from a central firing position which affords the best coverage of avenues of approach leading into the area. FPF's are assigned to supplement machine-gun final protective lines, much as in a position defense.

Section VII. DEFENSE OF A RIVER LINE

4701. GENERAL

a. Rivers constitute obstacles to an attack and natural lines of resistance for defensive and delaying action. The use of a river as an obstacle often compensates for numerical inequality or enables the commander to practice economy of force by assigning abnormally wide frontages to some units while massing his main forces for action elsewhere. The defense of a river line is conducted using the same fundamentals employed in other forms of defensive combat. The presence of the obstacle increases the capabilities of the defending forces.

b. Defense of a river line requires aggressive reconnaissance by all agencies. The reconnaissance is both technical and tactical and includes careful consideration of the terrain as it affects the actions of the enemy and the defense. Engineer reconnaissance determines the most probable crossing sites so that these can be defended in force. Other considerations are the banks and approaches to the banks; width, depth, and current of the river; topography of the adjacent terrain; and the road net on both sides of the river. Engineer reconnaissance also determines the bridges and fords to be destroyed and the means required for their destruction. Tactical reconnaissance on the friendly side of the river determines suitable defensive positions, positions for reserves, and routes to be used by mobile reserves in counterattacking successful crossings. Reconnaissance on the enemy side of the river gains early information of the strength, composition, disposition, routes, and rate of advance of hostile forces and determines the locations of local enemy assembly areas for troops, bridging equipment, and probable crossing sites.

c. Covering forces remain on the enemy's side of the river to maintain contact with the enemy, delay his advance, and determine his assembly positions and probable crossing sites. When forced to retire, these elements withdraw across the river. Timely measures are taken to destroy the crossings after the last elements have withdrawn, or at such earlier time as may be necessary to prevent the crossings from being seized by the enemy. Positive measures must be taken to ensure the complete destruction of all bridges and fords which cross the river to prevent them from falling intact into the hands of the enemy. Unless specifically forbidden by higher authority, any bridge or ford may be destroyed to keep it from falling into enemy hands.

d. Commanders at high levels may employ the mobile defense when adequate forces are not available to occupy the assigned frontage, when the enemy has a nuclear capability, when the enemy is capable of launching a crossing at several large sites, or when a counteroffensive is to be initiated by the defending force. The mobile defense along a major river is designed to canalize the attacker and destroy him by counterattack while his forces are astride the river. This type defense is organized with units deployed in strongpoints across the forward defensive area and a reserve deployed in depth. Strongpoints across the forward defensive area are organized on terrain which controls the avenues of approach from the river.

e. When the enemy is to be stopped at the river line, the area defense is utilized. The major portion of the defending force is disposed

along or near the riverbank, and all means are taken to prevent the enemy from crossing the river. The defensive structure is similar to a conventional area defense. However, with the river serving as an effective obstacle in front of the defensive position, wider frontages may be assigned to defending units. The location of the forward edge of the battle area may be along the riverbank, in rear of the riverbank, or a combination of the two, depending upon the defensive characteristics of the terrain along the river. Where the river is an effective obstacle and the terrain permits good fields of fire, the forward edge of the battle area is placed on the near bank of the river. If the terrain at the riverbank is unsuitable for the organization of defensive positions, the forward edge of the battle area is moved back from the river to obtain improved fields of fire. It is desirable that the defense be close enough to the river so that the near bank can be covered by small arms fire.

4702. RIFLE COMPANY

a. In the mobile defense of a river line, the rifle company may be employed as an element of the forward forces. When suitably reinforced, it may be assigned the mission of establishing a strongpoint in the forward defense area, or it may participate as part of the battalion in the organization and defense of a battalion strongpoint. Strongpoints are prepared to accept temporary encirclement. The rifle company organizes a separate strongpoint utilizing the principles of perimeter defense discussed in section IV. When organizing a portion of the battalion strongpoint, the principles of compact area defense apply. The rifle company participates in the battalion attack when the battalion is part of the reserve. The company may be helicopterborne, mechanized, or motorized to provide it with the necessary mobility.

b. The rifle company normally operates as part of the battalion when large forces defend a river line by area defense. The principles applied in other forms of the area defense apply to the rifle company. The additional considerations incorporated into the defense plan for defending a river line are:

(1) When the FEBA is along the riverbank, the frontline platoons are positioned to cover the most probable crossing sites.

(2) When the FEBA is in rear of the riverbank, the frontline platoons are positioned to cover the most dangerous avenues leading from the river.

(3) A reserve platoon is retained whenever possible.

(4) Supplementary positions for the reserve are more numerous to provide depth in areas of likely enemy crossing and to permit defense against helicopterborne attack.

(5) When the FEBA is along the riverbank, fire support assumes the following characteristics:

(a) Machinegun sectors of fire cover dangerous crossing sites and the avenues of approach to them.

(b) Final protective lines are established which graze the river or its far bank.

(c) Antitank weapons are positioned to cover likely crossing sites for amphibious vehicles and their avenues of approach to the far bank of the river.

(d) Final protective artillery and mortar fires are normally planned on the far bank at probable crossing sites.

Section VIII. MOBILE DEFENSE

4801. GENERAL

The purpose of a mobile defense is to destroy the enemy. Minimum forces are positioned in the forward defense area to warn of impending attacks and block or impede the enemy advance or canalize it into pre-selected killing zones. Killing zones are located along favorable enemy avenues of approach. They are selected on the basis of adequate natural obstacles, sufficient size to allow employment of all supporting fire, routes for moving supporting fires, and routes for maneuver of the reserve. The reserve is made up of the bulk of the mobile combat power available and is positioned to take offensive action at a time and place chosen by the defender. Although the objective of the mobile defense is destruction of the enemy rather than retention of specific terrain features, proper use of terrain and organization of key localities are essential. Only by taking full advantage of terrain in the positioning of forward forces is the necessary economy of force realized. The rifle company may participate as a part of the forward defense force, the reserve, or the security force.

4802. FORWARD FORCES

a. General.--The forward defense area is that portion of the division sector in which the forward defensive positions are located. Normally, the size of the forward defense area is based on considerations such as the area required by units to accomplish their missions, the capability of the units to prevent infiltration, and their ability to maintain surveillance over the area.

b. Strongpoints.--A strongpoint is normally a defensive position organized by a battalion or company in the forward defense area. Its mission is to slow down, divert, repel, or destroy the advancing enemy. It provides information from which the location of the enemy's main attack, strength, and direction of advance can be determined. It may serve as a pivot of maneuver for offensive action or as a base for security and reconnaissance forces. Battalion or company strongpoints employ area defense or one of its variations. Although positions are primarily oriented to defend against attacks from the front, strongpoint reserves must prepare numerous supplementary positions to which troops may be moved rapidly to meet a threat from any direction. Maximum emphasis is placed on the fundamentals of all-around defense and flexibility. Strongpoints may also employ a perimeter defense, particularly those established by rifle companies.

(1) If the mission is to block or impede, a unit organizing a strongpoint may adopt a formation suited to hold specific terrain. It must be capable of carrying out its mission even when isolated for limited periods.

(2) When the mission is that of canalizing enemy movement, the strongpoint is organized so it can maintain observation and fire on the approaches into its position. The strongpoint may organize a series of blocking and delaying positions throughout its area in accordance with the overall plan for influencing the movement of the enemy force. When required by its mission, the company conducts a delaying action or participates in the battalion delaying action. Paragraph 8403 contains a discussion of the delaying action.

4803. RESERVE

The reserve is comprised of the combat units of the division not employed in the forward defense area and other combat units which may be attached to the division. Rifle companies of the reserve may be required to prepare blocking positions, although these positions are not normally occupied. Normally, they occupy assembly areas near blocking positions, taking special precautions to remain concealed from enemy air and ground reconnaissance. Companies in the reserve area are responsible for their own security and may be charged with maintaining surveillance over designated localities.

a. The rifle company unit commanders prepare the necessary plans for employment in accordance with the battalion plans. They reconnoiter possible routes over which the company may move as well as the areas in which their units may be committed.

b. The rifle company, as part of the reserve, is oriented for employment in an offensive role even though it may be assigned the additional mission of preparing blocking positions. It remains concealed and, when committed, attacks as part of the infantry battalion.

4804. SECURITY FORCES

Security forces in the mobile defense may include aviation and reconnaissance units furnished by division, force, and wing. A general outpost may not always be established by a division. When a general outpost is not employed, the functions of other reconnaissance and security forces are emphasized. Rifle companies in the forward defense area provide for their own local security and maintain surveillance over approaches leading into the battle area. Patrol bases may be established when the battalion area of responsibility for surveillance is large. Chapter 5 discusses patrol bases in detail.



CHAPTER 5

PATROLLING

Section I. INTRODUCTION

5101. GENERAL

This chapter discusses the command aspects of patrolling required by the company commander and the platoon commander. It further describes the roles of patrolling in combat operations and establishes guidance for the effective use of patrolling as a part of combat operations. Basic patrol organization and techniques are discussed in FMFM 6-5, Marine Rifle Squad, and FM 21-75, Combat Training of the Individual Soldier and Patrolling. This chapter provides guidance and amplifies certain patrolling techniques.

5102. PATROLLING AS PART OF COMBAT OPERATIONS

A patrol is a detachment sent out from a unit to perform a specific reconnaissance or combat mission. The surest means of establishing and maintaining security; gaining information; and contacting, harassing, or damaging the enemy is through aggressive patrolling. Whether on a nuclear battlefield or hunting guerrillas, the importance of patrolling cannot be overemphasized. Patrols are limited only by the ingenuity with which they are employed and the skill and aggressiveness of their members. Successful operations against guerrillas are accomplished through conducting aggressive small unit patrols. Extensive and aggressive patrolling provides one of the most effective information gathering agencies available to the commander of a company size tactical unit.

Section II. PATROL TYPES

5201. GENERAL

a. Patrols are classified by the type mission performed: reconnaissance or combat. The principal difference is in actions at the objective. Either type of patrol may be short or long-range and may be foot mobile, motorized, helicopterborne, airdropped, or amphibious.

(1) Short-range patrols operate in the dispatching unit's area of influence for short periods of time and over relatively short distances.

(2) Long-range patrols operate in the dispatching unit's area of influence and area of interest. They may be extended in time, distance, or both.

b. There are two steps in organizing a patrol: general organization and special organization.

(1) General organization is the organization of a patrol into major subdivisions, or elements, and a patrol headquarters if necessary. The elements are determined by the nature of the mission--reconnaissance or combat.

(2) Special organization is the subdivision of patrol elements into specific teams required by the mission.

5202. RECONNAISSANCE PATROLS

a. General.--Reconnaissance patrols are normally conducted by small units and are characterized by stealth, patience, and maximum use of concealment. A reconnaissance patrol attempts to reach its objective, accomplish its mission, and return to friendly positions without being detected by, or engaging, the enemy.

b. Definition.--A reconnaissance patrol is a patrol which collects timely and accurate information which is vital to the commander in making tactical decisions.

c. Missions.--The mission of a reconnaissance patrol is to collect or confirm information about the enemy and/or terrain. For example:

(1) About the enemy: the location and disposition of enemy forces, enemy strength at a certain location, type of unit, what equipment, weapons, uniform, what is his activity?

(2) About the terrain: location of key terrain features, observation and fields of fire, cover and concealment, obstacles and mines, condition of structures, roads, bridges, avenues of approach/egress.

d. Types.--There are two types of reconnaissance patrols, depending on the mission: the point reconnaissance and the area reconnaissance.

(1) Point reconnaissance is conducted to gain information about a specific location or a small specified site, usually a known or suspected enemy position or activity.

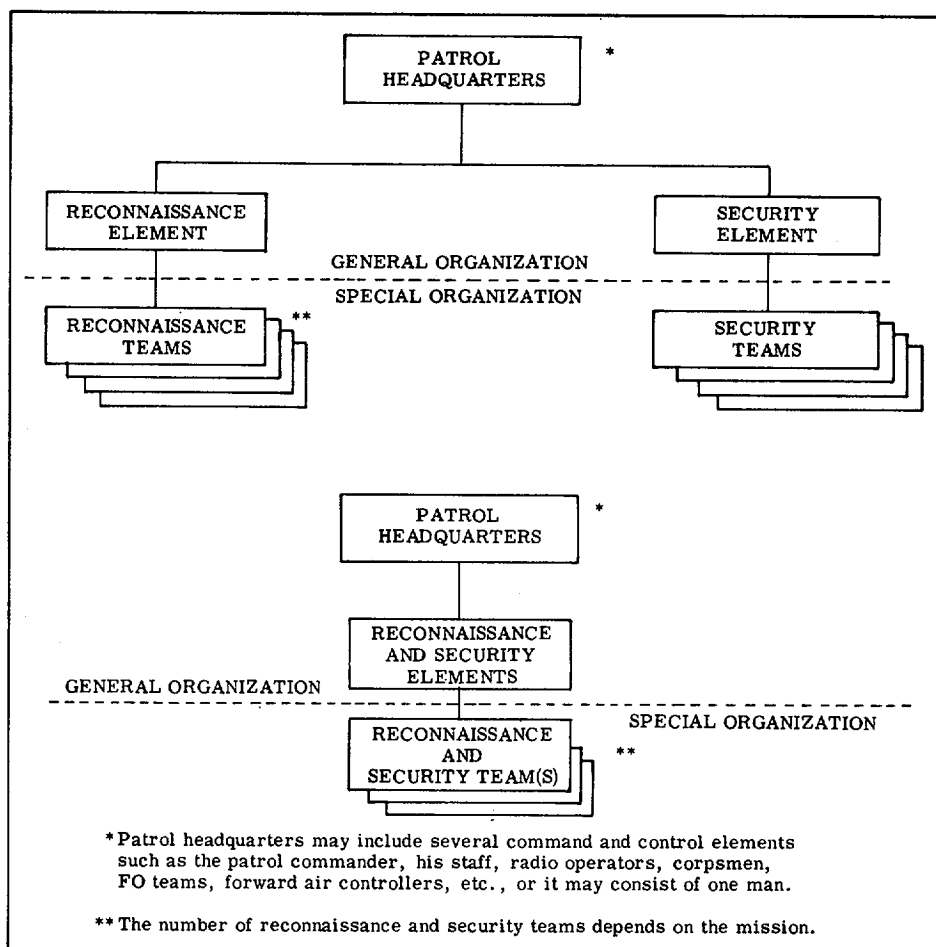

Figure 53.--Example Organization of a Reconnaissance Patrol.

(2) Area reconnaissance is conducted within defined boundaries or other limited features to gain information about an extended area or several locations within an area. Maximum freedom of action within the assigned area is given the reconnaissance unit.

e. Organization.--Reconnaissance patrols are organized generally into elements and specially into teams according to the mission with which the patrol has been tasked.

(1) General organization divides the patrol into a reconnaissance element, a security element, and when necessary, a patrol headquarters. The reconnaissance element reconnoiters or maintains surveillance over the objective. The security element secures the objective rallying point, provides early warning of enemy approach into the objective area, and protects the reconnaissance element. A patrol headquarters is established when it is necessary for control purposes.

(2) Special organization subdivides the elements into teams according to the mission for which the element was organized. (See fig. 53.)

Par. 5203

FMFM 6-4

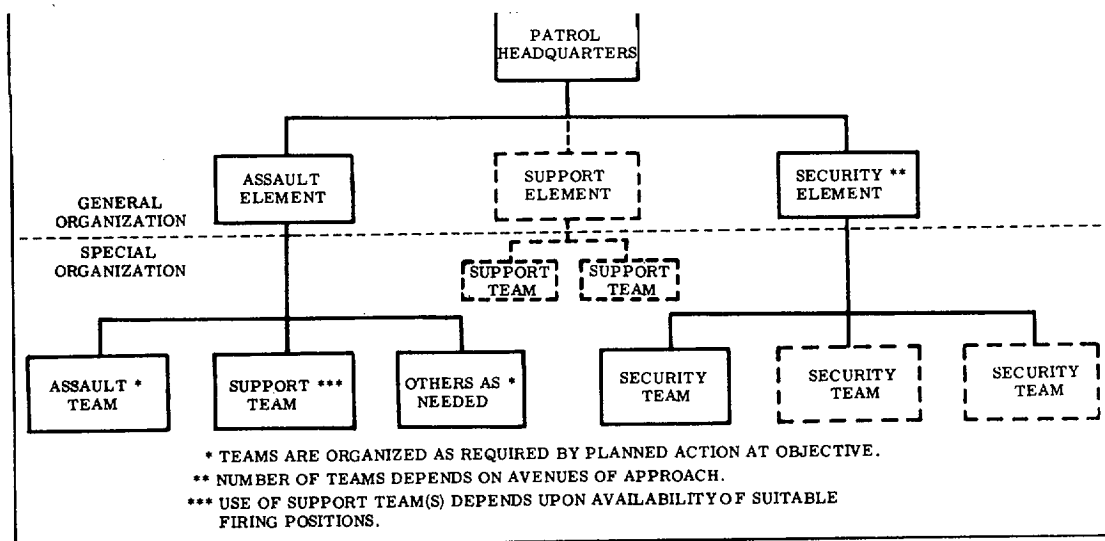

Figure 54.--Example Organization of a Combat Patrol.

5203. COMBAT PATROLS

a. Purpose.--Combat patrols provide security, establish and/or maintain contact with friendly and enemy forces, deny the enemy access to terrain, and harass, destroy, or capture enemy personnel, equipment, and installations. Combat patrols also collect and report all information whether or not it is related to the assigned mission.

b. Organization.--A combat patrol is organized into elements and a separate patrol headquarters. (See fig. 54.) These elements include the following:

(1) Assault Element.--The assault element engages the enemy at the objective by fire and maneuver, such as an assault team and a support team, or operates in the immediate area of the objective, such as demolition teams, search teams, and prisoner teams.

(2) Security Element.--The security element provides security for the patrol en route to and from the objective, secures the objective rally point, and isolates and provides early warning at the objective.

(3) Support Element.--A support element is organized when the patrol leader wants to use his support in a separate mission other than that of the assault element and/or it is not feasible for the assault element leader to control the support unit(s).

(4) Patrol Headquarters.--A patrol headquarters is organized for command and control and to provide general support for the patrol. The size and composition of the patrol headquarters depends on the mission.

c. Missions.--Combat patrols perform a variety of missions and derive their names from specific missions performed. The principal types of combat patrols are:

(1) Raid Patrols.--Raid patrols destroy or capture enemy personnel and equipment, destroy installations, or liberate personnel. (See par. 5204.)

(2) Ambush Patrols.--Ambush patrols conduct ambushes of enemy patrols, carrying parties, foot columns, and vehicle convoys. (See par. 5205.)

(3) Security Patrols.--Security patrols screen flanks, areas, and routes. In a static situation they prevent enemy infiltration and provide security against surprise. They protect a moving unit by screening flanks, the area through which the unit will pass, and the route over which the unit intends to move. Once a security patrol contacts the enemy, its conduct is similar to that of a raid patrol. Security patrol organization includes a support team to provide maximum flexibility in the event of enemy contact. The organization of other teams depends upon the known enemy situation and anticipated contacts.

(4) Contact Patrols.--Contact patrols establish and/or maintain contact to the front, flanks, or rear. They are used to contact friendly or enemy forces when their definite locations are not known. They maintain contact once it has been established. Contact may be physical or visual. A contact patrol's special organization and equipment depend upon the known enemy situation and anticipated enemy contact. For example, contact patrols between adjacent units making contact at designated points are usually small and relatively lightly armed. On the other hand, a patrol sent out to establish contact with an enemy force is organized, armed, and equipped to overcome the resistance offered by his light screening forces and ensure contact with the main enemy force. If contact with the enemy is made, the patrol must not become decisively engaged.

(5) Economy of Force Patrols.--Economy of force patrols establish roadblocks to retard enemy movement or prevent reinforcement, seize key terrain to deny the enemy access to an area, cover the withdrawal of a force to deceive or delay the enemy, and block enemy interference with friendly major efforts elsewhere. An economy of force patrol attacking a defended objective is organized, armed, and equipped in the same manner as a raid patrol. Its actions at the objective differ from those of a raid patrol only in that it retains and defends the objective.

(6) Search and Attack Patrols.--Search and attack patrols have the mission of seeking out and attacking targets of opportunity. When a patrol is smaller in size than the rifle squad, it is considered to lack the capability for engaging in decisive combat and is considered a harassing patrol. It attacks by fire only (supporting arms; i.e., artillery, air). When squad size or larger, a search and attack patrol decisively engages targets within its capability and is considered a destruction patrol.

5204. RAID PATROLS

a. General.--A raid is a surprise attack upon an enemy force or installation which results in the attacking force withdrawing after accomplishing its mission. Surprise, firepower, and violence of action are the keys to a successful raid. The size of the raid patrol is the minimum which can reasonably be expected to accomplish its mission and evacuate its own casualties.

b. Planning.--Thorough planning is essential to the success of a raid. Detailed, advance information of the enemy, including night dispositions, is obtained. Reconnaissance patrols may reconnoiter near the objective to select routes to the objective, a practicable probable line of deployment (PLD), positions suitable for small arms support, tentative rally points, and withdrawal routes. It may be necessary to dispatch other patrols to clear selected routes of mines, obstacles, and enemy security elements.

(1) Organization.--The commander of the raiding patrol organizes his unit into an assault, a security, and when appropriate, a support element. A support element is normally formed when suitable firing positions are available. Each element is organized and equipped to accomplish specific tasks in the overall mission. The size and composition of each element depend upon the tasks to be accomplished and the resistance expected at the objective.

(2) Routes of Advance and Withdrawal.--The route of advance and withdrawal should be concealed and, when possible, be over terrain which the enemy may consider impassable. Enemy security detachments along or near selected routes should be noted, but bypassed if possible. If this is not possible, predesignated advance security elements may precede the raiding force and silently dispose of enemy security detachments located along selected routes. Plans are made to employ security teams and prearranged fires in keeping withdrawal routes open.

(3) Fire Support Plan.--A complete and detailed fire support plan is prepared even though the fires may not be used. Supporting fires are planned to isolate the objective, support the assault, to prevent or limit hostile counterattacks, and to aid security teams in keeping the routes of withdrawal open. The use of fires at the outset decreases the degree of surprise, but is usually required in raiding a strong enemy position.

(4) Isolation of the Objective.--The two key factors to be considered in isolating the objective are the terrain in the area of operations and the enemy capability to reinforce or react. Complete isolation of the objective for prolonged periods is normally impractical. Isolation is usually accomplished through the use of indirect fire support and the security element organized for this specific task. The raid patrol accomplishes the assigned mission in minimum time. The planned length of stay on the objective is carefully weighed against the time it normally requires the enemy to react with supporting weapons.

(5) Rehearsals.--When possible, the raid patrol rehearses on terrain and under light conditions similar to those expected during the raid. Weapons to be employed in the actual raid are test-fired. Rehearsals for night raids are conducted initially during daylight and then at night. Rehearsals simulate all conditions and cover all phases of the raid. All participating and supporting elements are thoroughly briefed before rehearsals commence.

c. Actions at the Objective.--The patrol is halted at the objective rallying point. If a different return route is planned, a rendezvous point should be established on or near that route. This rendezvous point must provide concealment, be easily recognizable, and free from the enemy. The patrol leader establishes security and makes a reconnaissance. The purpose of the reconnaissance is to pinpoint the objective and confirm or alter plans. The assistant patrol leader remains with the patrol. He is ordered

to take appropriate action should the reconnaissance party fail to return. The patrol leader returns and alters or confirms the raid plan. The elements and teams are then dispatched to their respective positions. So far as possible, their movements are arranged and coordinated so that all reach their positions at about the same time. This improves the patrol's capability for decisive action if prematurely detected by the enemy.

(1) Security Element.--The security element secures the objective rallying points, gives early warning of enemy approach, blocks avenues of approach into the objective area, and prevents enemy escape from the objective area. As the assault elements move into position, the security element informs the patrol leader of observed enemy activity, but fires only if detected or on order. The security element covers the withdrawal of the assault element to the objective rallying point and withdraws on order or on a prearranged signal.

(2) Support Element.--The support element moves into position so that it can neutralize the objective and cease or shift fire when the assault is launched. It normally covers the withdrawal of the assault element from the immediate area of the objective, withdrawing itself on order.

(3) Assault Element.--The assault element deploys far enough in advance to permit immediate assault if detected by the enemy on the objective. As supporting fires lift or shift, the assault team(s) assaults, seizes, and secures the objective and protects demolition teams, search teams, and other teams while they work. On order, the assault element withdraws from the objective. If the raid is supported by artillery and mortars, the patrol leader, who is usually located with the assault element, orders supporting fires shifted as in any assault. Essential messages which must be received and understood by every member of the assault element, such as "assault" and "withdraw," are transmitted by visual means. Prearranged visual signals may be required for shifting supporting fires back into the objective to cover the withdrawal once it is commenced.

(4) Rallying Point.--At the objective rallying point, the assistant patrol leader takes charge of accounting for all patrol members. Plans are made to protect the rallying point with supporting fires during its occupancy. The objective rallying point is a location at which the patrol is accounted for while still near enough to the objective to facilitate the recovery of missing persons. If a rendezvous point is used for regroupment of the patrol, the same criteria and actions apply as for the objective rally point.

5205. AMBUSH PATROLS

a. An ambush patrol is a combat patrol whose mission is to establish and execute an ambush and to harass, destroy, or capture personnel or equipment or any combination thereof. Planning for ambush patrols must first consider if the ambush is a deliberate ambush or an ambush of opportunity. The primary difference between these ambushes is that the deliberate ambush is a specific action planned against a specific target, whereas the ambush of opportunity attacks the first suitable target passing through the planned ambush site.

b. An ambush is a surprise attack from a concealed position upon an enemy who is either moving or temporarily halted. It can be used either offensively or defensively, in the destruction and/or harassment of the enemy. The conduct of a successful ambush encompasses destruction of men and material and a lessening of the morale and overall effectiveness of the

enemy. Through thoughtful and carefully planned usage of the ambush, useful information is gathered, security is strengthened, and a minimum of men and material is tied up in so doing.

c. The fundamentals of a successful ambush are surprise, coordinated violent fires, and control. Careful planning, based on good intelligence and including thorough rehearsals, are essential for these fundamentals to be accomplished. The following factors are considered:

(1) Selection of the Ambush Site.--In selecting the ambush site, a careful reconnaissance is made using maps, aerial photographs, and when possible, personal reconnaissance. Consideration is given to the availability of usable natural obstacles. For example, a good location along a particular route is one with a steep cliff or swamp on one flank and good positions from which to deliver a heavy volume of fire on the other. The absence of natural obstacles can be compensated for by substituting minefields and road craters or establishing killing zones with the Claymore antipersonnel weapon. Tricks or ruses are employed to lure the enemy into the ambush. Road signs may be placed to confuse enemy columns. Feints or raids may be employed in order to attract the enemy to the desired ambush location. Key terrain, cover and concealment, and available fields of fire are fully utilized in preparation of the site.

(2) Route To and From the Ambush Site.--The route to and from the ambush site is carefully selected in order to ensure secrecy in occupying the position and speed and security during the withdrawal. Maximum cover and concealment are considered in selection of routes. Elements of a larger patrol can also be effectively "dropped off" at a predesignated location to establish an ambush site, without compromising their location or the mission of the original patrol. After entry into the ambush area, the route followed by the ambush patrol is carefully screened to remove all evidence of its passage. In planning the withdrawal, alternate routes are selected to reduce the probability of enemy forces blocking the withdrawal. Security is posted to the rear as well as to the flanks to cover the patrol's movement during all phases of the ambush, including withdrawal.

(3) Communications and Control.--A successful ambush depends on good signals. Effective control is impossible without the following: a signal to alert the patrol to the enemy, a signal to commence fire (characterized by violence of action), a signal to cease fire, and a signal to withdraw. All these signals should have alternates and should be further tested in the ambush site. Communications to higher headquarters must include codes to avoid disclosing to the enemy any information which he might be able to use.

(4) Rehearsal of Participating Troops.--Rehearsals for the ambush operation are conducted on terrain similar to that of the planned site and include all participating personnel. Subordinate leaders, weapons crews, and security elements are briefed concerning the exact sequence of events of the ambush and their duties. Equipment is checked and weapons are test fired at the rehearsal.

(5) Camouflage Measures.--Camouflage discipline is extremely important in the ambush. Personnel and weapons must blend with the surrounding area and all residue resulting from preparation of the site must be removed. Once the position is camouflaged, personnel must not move unnecessarily. Patience and absolute silence are required to avoid premature disclosure of the ambush.

(6) Coordinated Fires.--All weapons, including mines and demolitions, must be positioned, and all fires, including artillery and mortars, must be coordinated to achieve the following:

(a) The isolation of the killing zone to prevent escape and/or reinforcement.

(b) The surprise delivery of a large volume of highly accurate and concentrated fires into the killing zone. These fires must inflict maximum damage immediately following the signal to commence fire in order to achieve optimum surprise. The lifting of these fires must be equally precise. Speedy search and consolidation procedures must be implemented before the enemy has the chance to react. Fire support to cover the withdrawal is planned.

(7) Use of Patrol Elements

(a) An ambush patrol is organized in the same manner as other combat patrols to include a patrol headquarters, an assault element, a support element, and a security element. The assault and support elements are the attack force, and its purpose is to destroy the enemy. The force may be broken down and assigned various secondary missions; demolition teams, search teams, and prisoner of war teams may be included.

(b) The security element of an ambush patrol secures the objective rallying point and provides security for the ambush force by blocking avenues of approach into the flanks and rear of the site. Additional teams within the security element are organized to patrol the withdrawal route, when appropriate.

(8) Use of Support Element.--The organization of a separate support element is often desirable in ambush operations to make maximum use of available firepower. The assault element's firepower complements the support element fires until the assault element's killer teams sweep the objective.

(9) Effectiveness.--The degree of effectiveness of ambush operations is directly related to the state of troop training in ambush techniques. Some of the primary training deficiencies which may contribute to reduced effectiveness of ambushes are:

(a) Premature disclosure of ambush site by noise.

(b) Tendency to shoot high.

(c) Premature disclosure of ambush position by failure to remove evidence of passage in the area or movement by individuals when enemy is approaching.

(d) Poor fire control.

(e) Patrol leader improperly positioned to control his elements.

(f) Lack of all-around security.

(g) Weapons failures.

Par. 5205

FMFM 6-4

- (h) Poor communication plan.
- (i) Poor fire distribution.
- (j) Improper use of signals.

Section III. PATROLLING RESPONSIBILITIES

5301. GENERAL

Although the commander is responsible for the patrolling effort of his organization, he cannot personally accomplish all details of his patrolling responsibilities. Many of the following functions related to the patrolling effort are delegated to staff officers and subordinate commanders:

- a. Training.
- b. Selection of patrol leaders.
- c. Formulation of patrol missions.
- d. Issuance of patrol orders.
- e. Coordination.
- f. Control measures.
- g. Support.
- h. Supervision.
- i. Debriefing.

5302. COMMAND AND STAFF ACTION

a. Training.--Valid patrolling techniques can best be learned through practical field exercises. Classroom instruction, map, and sand-table exercises are valuable aids in teaching patrolling principles, and are employed in conjunction with practical field exercises. The battalion operations officer (S-3) maintains staff cognizance over training. He is assisted by the intelligence officer (S-2) and works closely with the company commanders in preparing training programs and exercises to ensure proper training in the principles and techniques of patrolling.

b. Selection of Patrol Leaders.--In training, commanders rotate duty as patrol leader among their noncommissioned officers and junior officers to ensure equal training experience. In combat, the commander furnishing a patrol normally selects the patrol leader. In so doing, he considers the experience and leadership abilities of available officers and noncommissioned officers. Consistent with assigned missions, he ensures rotation of patrol leaders to avoid continued use of a selected few.

c. Formulation of Patrol Missions.--The S-2 plans and recommends missions for reconnaissance patrols. The S-3 plans and recommends missions for combat patrols. The battalion commander considers the capabilities of each type of patrol and approves the assignment of patrol missions.

d. Issuance of the Patrol Order.--The patrol leader is issued an order, either oral or in the standard five-paragraph operation order format, providing him with the instructions, information, and guidance he requires to plan, prepare for, and accomplish the patrol mission. Only one primary

mission is assigned each patrol. Alternate and secondary missions may be assigned. The mission is clearly stated, thoroughly understood, and within the capabilities of the particular patrol.

(1) Orders for patrols are sometimes issued by the battalion commander, but are usually issued by the staff officer having cognizance for the particular type patrol.

(2) The S-2 provides an intelligence briefing as required.

(3) Other staff officers (S-1, S-4) may give briefings on matters related to their areas of staff responsibility.

e. Coordination.--Coordination is accomplished by the staff and the patrol leader. The three general areas of coordination are between the staff members and with the staffs of other units, between the staff and the patrol leader, and between the patrol leader and units or personnel immediately affected by the patrol's operation. Coordination frequently overlaps to ensure that it is complete, continuous, and properly accomplished. This is particularly true of long-range patrols, since the dispatching unit's area of influence and interest may overlap those of other units.

f. Control Measures.--The commander is limited in controlling a patrol and in influencing its actions after it has departed. The degrees of control and influence must be planned and included in the patrol's order. Control is exercised as follows:

(1) A specific time of departure may be given to prevent congestion in an area, reduce possibility of contact between patrols, and provide strict control. Time of departure may be stated in general terms, such as "leave after dark" or "leave before daylight."

(2) Information obtained by a reconnaissance patrol may lose its value if not received by a certain time, or future operations may hinge upon the results achieved by a combat patrol. A patrol may be required to accomplish its mission at or within a certain time. For example, it may be required to destroy a communication center at or by a certain time in order to assist a planned attack. When the commander places time restrictions on a patrol, he must provide for the possibility that, despite its best efforts, the patrol may not accomplish the mission and comply with the time restrictions. When he places time restrictions on a patrol, he must state whether accomplishment of the mission or meeting the time limitation has priority. Normally, a time of return is stated in general terms.

(3) The general patrol route may be prescribed through the use of checkpoints. Normally, a report is made upon reaching each checkpoint. The exact route is seldom prescribed, except in route reconnaissance or when very close control of patrol movement is required.

(4) The communication plan specifies reports required and methods of their transmission. Radio is usually the most effective means. Field wire may be used when the distance is short. The type of radio employed is determined by anticipated maximum transmission distances, availability of radios and qualified operators, and method of patrol movement. Simple, prearranged brevity codes are used to reduce transmission time and decrease the possibility of compromising the patrol's mission. Pyrotechnics may also be used, but increase the probability of detection.

g. Support and Supervision.--The S-3 arranges for effective supporting fires. The supply officer provides equipment not available within the patrol's parent unit. The S-2 and S-3 arrange for specially qualified personnel such as demolitions specialists, guides, interpreters, and terminal guidance personnel. Supervision is exercised by all commanders and staff officers concerned. They actively supervise all phases of patrol planning and preparation.

h. Debriefing.--Battalion directed patrols are debriefed by the appropriate staff officer(s). The patrol report form shown in figure 55 is used to ensure orderly and complete debriefing. The form is standard among NATO countries and its use is required (STANAG No. 2003). Debriefing techniques vary. One effective debriefing method requires the patrol leader to give a narrative account of the patrol from departure to return. Each patrol member then contributes any additional information he has. The debriefer asks the patrol leader questions to secure desired information not otherwise gained. All patrol members then are offered the opportunity to add pertinent information relating to the question.

5303. COMMAND ASPECTS OF PATROLLING

a. Patrol Authority.--Patrols are normally dispatched and controlled by the battalion. The company commander maintains overall responsibility for patrol personnel provided by his unit. He checks, rehearses, and additionally briefs patrols from his company even though he is not the initiating authority. When a company commander dispatches company patrols, his patrol plan is coordinated with appropriate staff officers at the battalion level. This ensures a unified patrolling effort throughout the battalion area.

(1) Normally, battalion directed patrols are briefed and debriefed by the appropriate staff officer. The patrol leader informs the company commander of matters on which he was briefed or debriefed by the battalion staff.

(2) In combat operations, it is not always possible for the appropriate staff officer to individually brief and debrief each battalion directed patrol. In such cases, the company commander is provided with the necessary information to ensure proper briefing or debriefing of battalion initiated patrols from his company.

b. Company Authority.--Company directed patrols, for the most part, consist of those the company commander requires to maintain contact between elements of the company, between the company and adjacent units, and those necessary to provide security or reconnaissance of importance to the company commander.

c. Counter guerrilla Patrol Authority.--The authority to conduct patrols is decentralized as much as practicable. Although overall patrolling policy and the requirement for certain special patrols may be determined by higher headquarters, the extensive patrol activity and rapid reaction to the tactical situation required in counter guerrilla operations make it desirable to delegate patrol authority to lower echelons. Battalions, companies, or platoons may be assigned patrol authority. The delegation of specific authority is determined by the terrain, the guerrilla activity, coordination problems, and troop availability. The control of the patrolling effort under decentralized authority is improved by the assignment of operational areas of responsibility to the battalion and

PATROL REPORT					
(OMIT HEADING(S) NOT APPLICABLE)					
(DESIGNATION OF PATROL)	(DATE)				
TO:					
MAPS:					
A. SIZE AND COMPOSITION OF PATROL	(DESCRIPTION OF THE TERRAIN--DRY, SWAMPY, JUNGLE, THICKLY WOODED, HIGH BRUSH, ROCKY, DEEPNESS OF RAVINES AND DRAWS; CONDITION OF BRIDGES AS TO TYPE, SIZE, AND STRENGTH; EFFECT ON ARMOR AND WHEELED VEHICLES.)				
B. TASK					
C. TIME OF DEPARTURE					
D. TIME OF RETURN					
E. ROUTES (OUT AND BACK)	(STRENGTH, DISPOSITION, CONDITION OF DEFENSE, EQUIPMENT, WEAPONS, ATTITUDE, MORALE, EXACT LOCATION, MOVEMENTS, AND ANY SHIFT IN DISPOSITION; TIME ACTIVITY WAS OBSERVED; COORDINATES WHERE ACTIVITY OCCURRED.)				
F. TERRAIN					
G. ENEMY					
H. ANY MAP CORRECTIONS	(INCLUDING ASPECTS OF NUCLEAR, BIOLOGICAL, AND CHEMICAL WARFARE.)				
J. MISCELLANEOUS INFORMATION	(ENEMY PRISONERS AND DISPOSITION; IDENTIFICATIONS; ENEMY CASUALTIES; CAPTURED DOCUMENTS AND EQUIPMENT.)				
K. RESULTS OF ENCOUNTERS WITH ENEMY					
L. CONDITION OF PATROL INCLUDING DISPOSITION OF ANY DEAD OR WOUNDED					
M. CONCLUSIONS AND RECOMMENDATIONS	(INCLUDING TO WHAT EXTENT THE TASK WAS ACCOMPLISHED AND RECOMMENDATIONS AS TO PATROL EQUIPMENT AND TACTICS.)				
<table style="width: 100%; border: none;"> <tr> <td style="width: 33%; border-top: 1px solid black; border-bottom: 1px solid black;">SIGNATURE</td> <td style="width: 33%; border-top: 1px solid black; border-bottom: 1px solid black;">GRADE/RANK</td> <td style="width: 33%; border-top: 1px solid black; border-bottom: 1px solid black;">ORGANIZATION/UNIT OF PATROL LEADER</td> </tr> </table>			SIGNATURE	GRADE/RANK	ORGANIZATION/UNIT OF PATROL LEADER
SIGNATURE	GRADE/RANK	ORGANIZATION/UNIT OF PATROL LEADER			
N. ADDITIONAL REMARKS BY INTERROGATOR					
<table style="width: 100%; border: none;"> <tr> <td style="width: 33%; border-top: 1px solid black; border-bottom: 1px solid black;">SIGNATURE</td> <td style="width: 33%; border-top: 1px solid black; border-bottom: 1px solid black;">GRADE/RANK</td> <td style="width: 33%; border-top: 1px solid black; border-bottom: 1px solid black;">ORGANIZATION/UNIT OF INTERROGATOR TIME</td> </tr> </table>			SIGNATURE	GRADE/RANK	ORGANIZATION/UNIT OF INTERROGATOR TIME
SIGNATURE	GRADE/RANK	ORGANIZATION/UNIT OF INTERROGATOR TIME			
O. DISTRIBUTION					

NOTE: The letter "I" is not used.

Figure 55.--Patrol Report Form.

its subordinate units. Coordination of patrol activity within assigned areas is required to avoid patrol clashes and to permit the immediate pursuit of guerrillas from one area to another. Although patrol authority is decentralized, all patrol activity is reported to higher headquarters.

Section IV. PLANNING AND PREPARING PATROLS

5401. GENERAL

A unit commander is responsible for the patrolling effort of his unit regardless of the directing authority. For patrols initiated by higher authority, the unit commander concerned takes prompt action to designate the patrol leader. An assistant patrol leader may be designated or his selection may be left to the discretion of the patrol leader. The unit commander must be aware of the information contained in the briefings and patrol orders issued to patrol leaders by appropriate staff officers. In combat operations, the unit commander may be directed to brief and issue the patrol order. (See fig. 56.) The unit commander assists the patrol leader in the completion of his plan, aids in the coordination of details, arranges additional support desired by the patrol leader, supervises rehearsals, and conducts an inspection of the patrol with the patrol leader prior to the patrol's departure. For company directed patrols, the platoon commander usually designates the patrol leader. The company commander briefs the patrol leader and the assistant patrol leader on the enemy situation and issues the patrol order. Rehearsals and inspections are accomplished under the direct supervision of the platoon commander. The steps to be followed in planning for a patrol are based on the troop leading steps. A detailed discussion of planning steps is contained in FMFM 6-5, Marine Rifle Squad.

5402. PATROLLING IN COUNTERGUERRILLA OPERATIONS

a. General.--Patrols are carefully planned in order to ensure success against guerrillas. Deception is used to a much greater extent than in normal combat operations. Since the guerrillas maintain informers throughout the civilian population, it is difficult for patrols to depart for operations without being detected. In countries where both paramilitary forces and Marine units are operating against the guerrillas, careful planning is required to prevent mutual mistaken identity between friendly forces. In counter guerrilla operations, identification of the enemy is much more difficult than in conventional operations as the guerrilla often disguises himself as a civilian.

b. Special Considerations.--The fundamentals of patrolling apply in counter guerrilla operations. However, special techniques that apply to counter guerrilla operations have been developed and added to the fundamentals.

(1) Patrols are all-purpose and have a general mission--to capture, kill, or harass the enemy; to obtain and report information; and to win support of the people. Each patrol is assigned a specific task involving accomplishment of one or more elements of the general mission. However, all elements are undertaken to the maximum extent possible consistent with accomplishment of the specific mission assigned.

(2) Most counter guerrilla patrols operate in difficult terrain for extended periods of time and are required to transport more equipment than in conventional operations. This additional equipment is necessary in order to maintain troop health and combat efficiency.

PATROL ORDER	
1.	SITUATION (as it affects the patrol)
a.	Enemy forces: Weather, terrain, identification, location, activity, strength.
b.	Friendly forces: Mission of next higher unit, location and planned actions of units on right and left, fire support available for patrol, missions and routes of other patrols.
c.	Attachments and detachments.
2.	MISSION (what the patrol is going to accomplish and the location or area in which it is to be done)
3.	EXECUTION
a.	The overall plan--the fire support plan--and missions of elements, teams, and individuals in the objective area.
b.	Other missions, not in the objective area, for elements, teams, and individuals. Included are such tasks as navigation, security during movement, and security at halts.
c.	Coordinating instructions.
(1)	Times of departure and return.
(2)	Primary and alternate routes.
(3)	Departure and reentry of friendly areas.
(4)	Organization for movement.
(5)	Actions at danger areas.
(6)	Actions on enemy contact
(7)	Rallying points and actions at rallying points.
(8)	Actions in objective area.
(9)	Debriefing.
(10)	Other actions.
(11)	Rehearsals and inspections.
4.	SERVICE SUPPORT
a.	Rations.
b.	Arms and ammunition.
c.	Uniform and equipment (state which members will carry and use).
d.	Method of handling wounded and prisoners.
5.	COMMAND AND SIGNAL
a.	Signal.
(1)	Signals to be used within the patrol.
(2)	Communication with higher headquarters--radio call signs, primary and alternate frequencies, times to report, and special code to be used.
(3)	Challenge and password.
b.	Command.
(1)	Chain of command.
(2)	Locations of leaders at various times--during movement, at danger areas, at the objective.

Figure 56.--Format for Patrol Order.

c. Training.--Long arduous patrols under primitive conditions are representative of patrol actions in counter guerrilla operations. The training program requires developing a high degree of proficiency in the following:

- (1) Physical and mental conditioning.
- (2) Techniques of raids and ambushes.
- (3) Long-range patrol operations.
- (4) Tracking and land navigation.
- (5) Immediate action drills.
- (6) Countermeasures to detect and evade guerrillas.
- (7) Survival techniques.

- (8) Advanced first aid and preventive medicine measures.
- (9) Fieldcraft and improvisation.
- (10) Cross-training in communications and crew-served weapons.

5403. PATROL HELICOPTERBORNE PROCEDURES

a. General.--The nature of patrolling missions requires landing zone insertion and extraction procedures which differ from normal ground unit helicopterborne operations. These differences are made necessary by virtue of the small size of most patrols, the requirement for speed and stealth, and the need to move from the landing zone as quickly as possible.

b. Insertion.--Patrol insert landing zones are not occupied, secured, and/or defended as in normal helicopterborne assault operations. An initial en route rally point near the landing zone is established by the patrol leader. Immediately upon landing, each heliteam proceeds directly to this point, where the entire patrol organizes and departs on its route of march as quickly as possible. If the insert is opposed by a significant enemy force, the patrol leader should be prepared for an immediate extraction and/or insertion into an alternate landing zone.

c. Extraction.--Extraction procedures are designed to provide the patrol leader with a quick and safe exit from his area of operation. Use of proper landing zone briefs and landing zone identification systems (GAIL system for night extracts) will ensure a smooth extraction. (See FMFM 3-3, Helicopterborne Operations.) A landing zone brief should include the following information:

- (1) Unit identification.
- (2) Unit location.
- (3) Landing zone description. Size, enemy positions, and obstacles are desired information for the pilot.
- (4) Landing zone marking. Mirrors, panels, smoke, and lights are common methods of marking landing zones.
- (5) Recommended approach direction.
- (6) Enemy fire description. Type and location of last enemy fire received and direction of expected enemy fire are desired by the pilot.
- (7) Helicopter return fire. Direction and distance the helicopter is cleared to return fire is needed by the pilot for ground unit safety.

Section V. ADVANCED PATROLLING TECHNIQUES

5501. GENERAL

Experience in the conduct of patrolling operations has shown that certain techniques contribute to the overall effectiveness of patrols. This section contains guidance in the employment of techniques which have proven useful in training, controlling, and conducting patrols. The techniques discussed herein supplement the patrol tips contained in FMFM 6-5, Marine Rifle Squad. The purpose of this section is to provide the company officer with guidance in the application of techniques which improve the effectiveness of the unit's patrolling effort. They include:

- a. The establishment of patrol bases.
- b. The use of the thrust line and thrust point systems of coordinates in patrolling.

5502. PATROL BASES

a. General.--When engaged in combat operations, the battalion commander may require elements of the rifle company to operate from patrol bases. The establishment of patrol bases is most common in counter guerrilla operations, but may be directed in conventional combat, when appropriate. These are temporary bases from which platoons, squads, or smaller units conduct reconnaissance and/or combat patrols. The bases are carefully sited and are not usually occupied for more than 48 hours. The aim in establishing a patrol base is to secretly occupy a protected position with the minimum of orders. The location for the base is normally planned in advance, either by map and photo inspection or by ground or aerial reconnaissance. The planned site is tentative until reached, reconnoitered, and confirmed by the patrol leader.

b. Deception.--A patrol base is secretly occupied. Generally, it depends upon the secrecy of its location for security. Secrecy is maintained by employing deception maneuvers. Deception plans include the following considerations:

- (1) If possible, the march to the probable base site is conducted at night.
- (2) The primary and alternate routes avoid centers of population and enemy activity.
- (3) Local inhabitants met by the patrol in remote areas are detained, when necessary.
- (4) Inhabitants of areas that cannot be avoided are deceived by marching the patrol in a direction other than the intended direction to the base site.
- (5) The route to the tentative base site is selected by the use of photos, maps, and ground and aerial reconnaissance when practicable.
- (6) The departure of patrols from a base area is often difficult to conceal if it is under observation by local villagers who can count the

number of Marines, follow them, and determine their direction of travel. Suggested techniques for patrols to employ where movement under observation is unavoidable include:

(a) Dispatch elements of a patrol at periodic intervals, about half an hour, in different directions. Later, the patrol can rally in a secure area and continue its mission.

(b) Two patrols can pass as one by combining and then separating when remote from visual observation. One element can detach itself and remain in ambush for a brief period to see if they are being followed.

(c) Strict security procedures are essential when employing these deception techniques since small patrols are particularly susceptible to guerrilla ambush.

c. Security of Patrol Bases.--Planning for patrol bases must include both passive and active security measures.

(1) Passive Security Measures.--Passive security measures center around the selection of terrain for the patrol base. Terrain selected and occupied as a patrol base should:

(a) Be in an area considered of little tactical value and where there is not likely to be any enemy activity.

(b) Be in an area where there is ample concealment, preferably where there is dense vegetation.

(c) Be in an area remote from human habitation.

(d) Be in an area near but not on a source of water.

(e) Be in an area that is not swampy or on steep slopes.

(f) Avoid ridgelines and topographical crests except as necessary to maintain communications.

(g) Avoid roads, trails, and valleys that may be natural lines of drift.

(2) Active Security Measures

(a) Reconnoiter patrol base sites prior to occupation.

(b) Establish perimeter defense, outposts/listening posts with adequate communication systems.

(c) Plan withdrawal, if required, to include multiple withdrawal routes.

(d) Enforce camouflage, noise, and light discipline.

d. Establishment of Patrol Bases.--Planning for patrol bases should be detailed, including individual actions to be taken while the base is being established. FM 21-75, Combat Training of the Individual Soldier and Patrolling, includes a suggested detailed step-by-step occupation of a platoon sized patrol base. Generally, this procedure is as follows:

(1) The forces to occupy the patrol base do not enter the site until it has been scouted and the patrol base commander has checked the site for suitability.

(2) Upon entering the patrol base site, forces immediately form a perimeter defense, dispatch local patrols around the perimeter, establish outposts/listening posts, and dig in if necessary.

(3) Security is paramount at all times. Movement within the base is held to a minimum, silent signals are used to alert personnel, and smoke from cooking fires is strictly controlled. Other passive and active security measures are carried out.

5503. THRUST LINE AND THRUST POINT SYSTEMS

a. General.--The thrust line/thrust point systems of reporting locations may be used by patrols of short range and duration when regular encoding is not feasible. Use of these systems aids in rapid communications and eliminates the requirement for employing regular radio codes.

b. Precautions.--It should be noted that neither of these systems is as secure as the regular encoding system. A trained enemy will be able to "break the system" with little trouble if he is able to identify any point transmitted. When using thrust points or thrust lines, changes are required frequently and use of one or two lines or points continually should be avoided.

c. Thrust Line.--The thrust line is defined as a coordinate system for identifying the location of points on a map or aerial photograph. The location of any point is described with relation to the thrust line.

(1) The thrust line is established on a map or photograph by the use of two known features or one known feature and an azimuth. One feature is designated as the base point. A line drawn from the base point to the second feature, or from the base point on a predetermined azimuth, is the thrust line. (See fig. 57.)

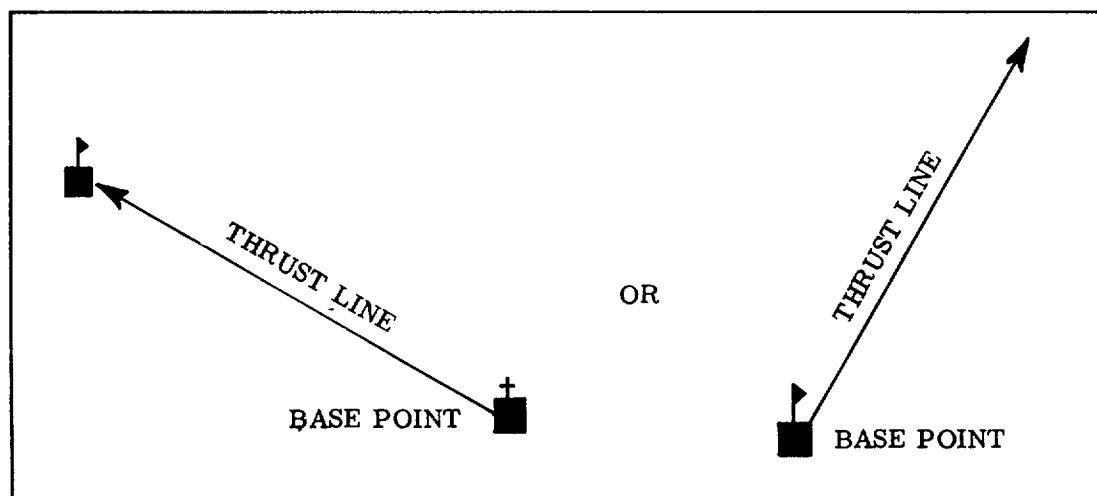

Figure 57.--Thrust Lines.

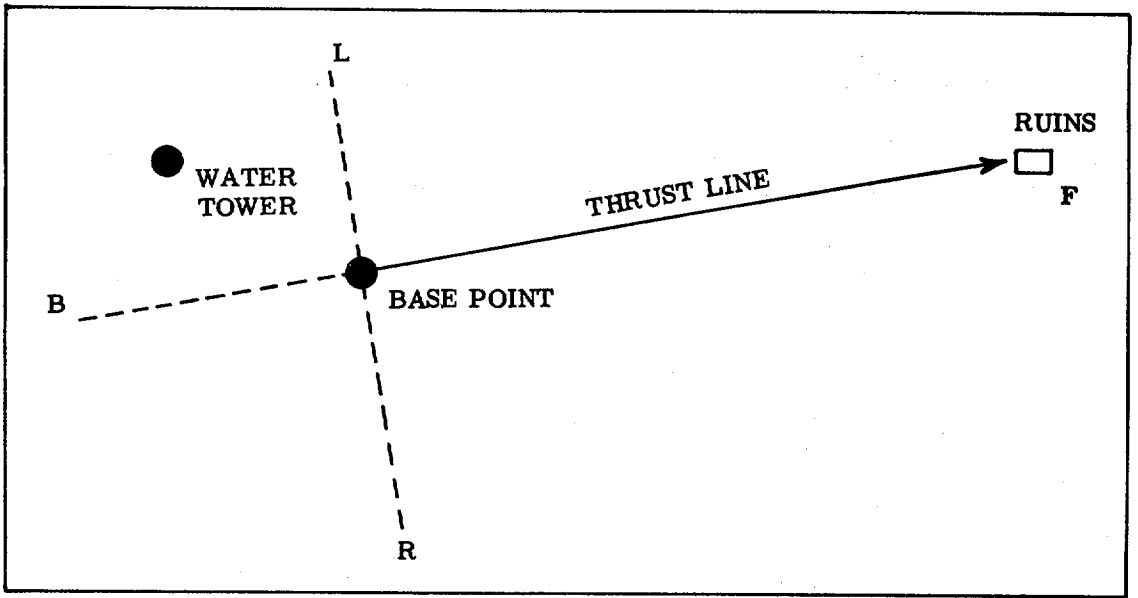

Figure 58.--Thrust Line System.

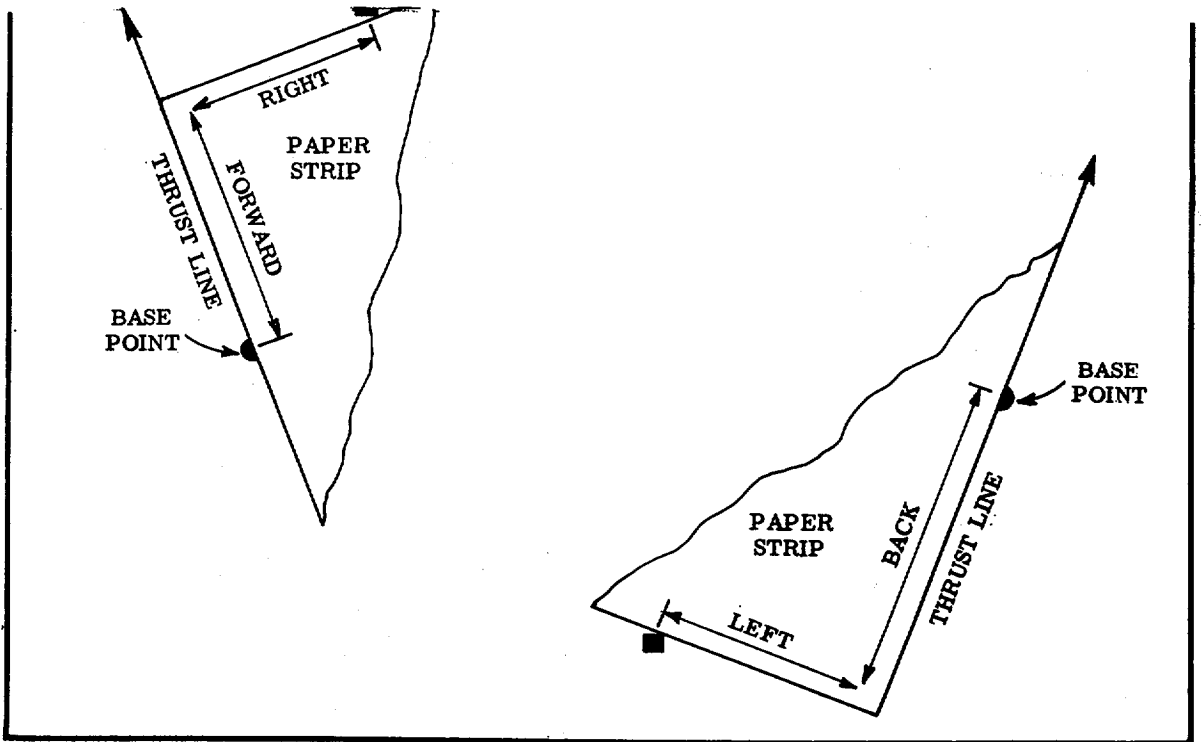

Figure 59.--Locating Points from Thrust Lines.

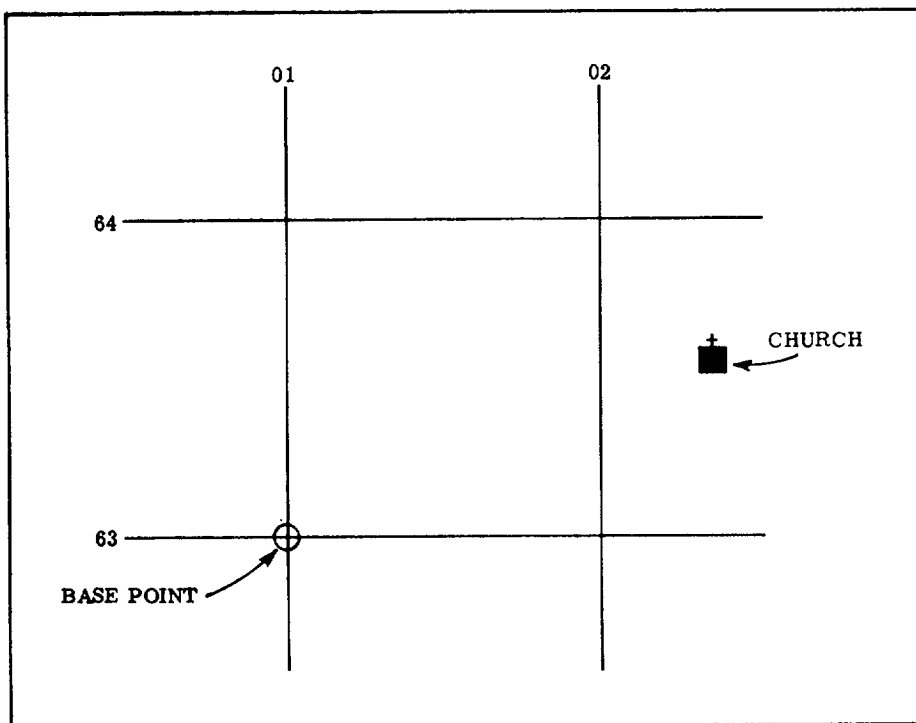

Figure 60.--Thrust Point System.

(2) Once the thrust line has been established, the location of any point can be described by its distance forward (F) or back (B) from the base point and its distance right (R) or left (L) from the thrust line. The map reader assumes that he is standing at the base point facing the direction of the thrust line. Right and left remain constant. In figure 58, the water tower is back from the base point and left from the thrust line.

(3) Distances forward or back from the base point are measured along the thrust line. Distances right or left from the thrust line are always measured perpendicular (90 degrees) from the thrust line. These distances are always stated in units of horizontal ground distance, hundreds of meters; therefore, they are most easily determined by the use of the paper strip and graphic scale. Position the paper strip and make tick marks as shown in figure 59.

(4) After making the tick marks on the paper strip, use the graphic scale to measure the distance in meters. Then convert these distances to the required unit of measure for thrust lines, hundreds of meters. A feature located 1,340 meters forward from the base point and 970 meters left from the thrust line would be reported as "F13.40, L9.70."

(5) The representative fraction (RF) of an aerial photograph must be determined before thrust lines can be used on the photo. Knowing the photo RF, you measure the distances on the photo in millimeters (photo distance) and convert them to meters (ground distance) by using the RF formula. Then convert the distances to hundreds of meters.

d. Thrust Point.--The thrust point identifies a given point on a map where one preselected north-south grid line intersects one east-west grid line.

(1) The intersection of one north-south and one east-west grid line is selected as the base point. Distances right (R), left (L), up (U), or down (D) are measured along the north-south or east-west grid lines. These distances are always stated in horizontal ground distances, same as the thrust line system. (See fig. 60.)

(2) To identify the church shown in figure 60, which is located 1,300 meters right of base point and up 550 meters, it would be reported as "R1.3, U.55."



CHAPTER 6

COUNTERINSURGENCY

Section I. INTRODUCTION

6101. GENERAL

This chapter provides information and guidance in solving the problem of countering an insurgent movement. Although it is discussed in terms of U.S. agencies operating in a foreign country at the invitation of their government, the principles apply equally to countering domestic insurgency. This chapter provides guidance in the probable roles of the rifle company and its elements in counterinsurgency operations.

a. Background

(1) International communism has won a succession of victories in its struggle for world domination. Presently, over 1 billion people and over 13 million square miles of the earth's total land mass are under control of Communist regimes.

(2) While occupying the attention of the free world through pressure and threat of overt military action along the periphery of the Iron and Bamboo Curtains, the Communists have concentrated their efforts on the seizure of power in selected nations through insurgent means.

(3) Using their established worldwide subversive apparatus, indigenous cadres, fronts, and fellow travelers, they have exploited a wide variety of techniques ranging from civil war, revolution, terrorism, and guerrilla warfare to psychological and subversive political action. They

have taken advantage of the upsurge of nationalistic desires for self-government in colonial areas and have capitalized on inexperience in self-government of new nations. Allying themselves with budding national independence movements and popular front governments, the Communists have scored notable successes and have gained considerable public support. Their insurgency movements promise material betterment and achievement of nationalist aspirations in a wide variety of situations and areas. The primary and ultimate objective of the Communists has been, and remains, the subversion and seizure of governments in all target areas. Communist strategy and tactics in the form of the so-called "peoples war" waged by "revolutionary warfare" have evolved through trial and error.

b. U.S. Advisors

(1) The primary responsibility for conducting counterinsurgency operations basically rests with the local government. Insurgent warfare is an intimate affair normally fought between antagonists of similar ethnic backgrounds. The massive intrusion of force by an external power, unless carefully applied through the local government, can negate the power of such government to control the affairs of the nation. However, carefully applied aid and support, including the judicious military and civilian use of advisory groups to provide assistance and advice in countering an insurgency, have proven feasible and successful.

(2) The focal point for the coordinated operation of U.S. Government agencies abroad is the "country team." It consists of the senior member of each of the U.S. Government agencies in the host country and is under the leadership of the U.S. Ambassador or principal U.S. diplomatic officer. The country team is not meant to be a substitute for the Ambassador. It is not a parliament or committee operating by consensus or majority rule. It is the senior advisory body to the Ambassador and comprises the staff through which he carries out his responsibilities. The country team analyzes the problems of the host country and recommends solutions thereto. One of the primary responsibilities of country teams in nations facing an insurgency is assisting the host government in formulating plans and programs to counter or prevent the development of such a problem. The scope of recommendations which may be made to host governments is broad and includes the use of military and police action in coping with the guerrilla, the use of psychological and intelligence capabilities, and environment improvement programs for correcting social and economic deficiencies. Positive results in the worldwide struggle against "revolutionary warfare" can be obtained through use of country teams, missions, and mobile training teams.

6102. THE APPROACH TO COUNTERINSURGENCY

a. The problem of counterinsurgency is part of the larger problem of modernization in the newly developing countries. Some of these countries have only recently obtained political independence. Others are just emerging into economic and social development. Still, others are ruled or controlled by oligarchies which, in order to maintain their own favored positions, resist the efforts of the masses to gain economic and social betterment. In the past, the problem of countering an insurgency has been viewed primarily as an internal security problem and has been handled by military and police action. The prevention of modern insurgency demands political, economic, social, and psychological development. Military support of a civic action program is a major preventive measure and a significant factor in defeating an insurgency.

b. Counterinsurgency operations consist largely of constructive efforts, while conventional operations are essentially destructive in character. The military cannot make its full contribution unless the people are persuaded that the government intends taking steps to meet their aspirations. Extensive national development programs are instituted to eliminate the causes of dissent. Unless the legal government aspires to goals more appealing to the people than those proposed by the insurgents and convinces the people of its intent to implement them, the revolutionary forces are at a decided advantage. The military counterinsurgency effort must aim at severing the insurgents from their bases of popular support. The insurgent must be opposed by the amplification of his own tactics, offensive actions executed in a mobile, discriminatory, and flexible fashion. The counterinsurgency objective is not achieved solely by the elimination of the guerrilla element. All counterinsurgency operations must specify appropriate roles, missions, and tasks for the political, economic, military, police, social welfare, and information services of the nation.

6103. ORGANIZATION

a. National Internal Security Committee (NISC).--A national internal security committee or its equivalent is established at the national level to provide a coordinated approach to the planning and direction of the counterinsurgency effort. The NISC would be roughly equivalent to the Cabinet in the United States. In general, it would be composed of the Chief of State/Head of Government, Ministers of the various departments such as the Minister of Justice, the heads of the armed forces, the national intelligence organization, and other organizations at the same level of government.

b. Area Security Coordination Center (ASCC).--An initial step in the establishment of a counterinsurgency program in a given area is the formation of an area security coordination center. It is a headquarters which provides overall planning, coordination, and direction of the counterinsurgency effort at all lower geopolitical levels. It consists of representation from the following:

- (1) Local civil government.
- (2) Military.
- (3) Police.
- (4) Paramilitary.
- (5) Intelligence organization.
- (6) Economic and information agencies.

c. Civil-Military Advisory Committee (CMAC).--A civil-military advisory committee is established at a lower geopolitical level to act in an advisory capacity to the ASCC. They consider both short- and long-range effects of all proposed actions, being particularly alert for a boomerang effect from any proposal. Members are deliberately chosen from divergent levels of the society that have responsibility and influence. They are not expected to rubberstamp proposals forwarded for their consideration. They advise the modification of actions considered by them to be of doubtful effect. The inclusion of the ranking military officer, the political head of the area, and the civil police chief as members of this body ensure that their unified decisions are carried out with dispatch.

Par. 6104

FMFM 6-4

6104. COUNTERINSURGENCY PROGRAMS

a. Counterinsurgency programs are divided into three main areas:

(1) Counter guerrilla operations to neutralize the guerrilla element of the insurgency movement.

(2) Population and resources control to detect and neutralize the insurgency apparatus and operations in the community, sever popular support of the guerrilla, and provide a secure physical and psychological environment for the population.

(3) Environmental improvement to better the social, economic, and political climate. Military forces contribute to national development through civic action.

b. Broad general direction and overall coordination of counter-insurgency programs are exercised at the national level with maximum decentralization. Emphasis is placed on operational freedom and initiative at the regional and local levels. Local authority is vitally necessary to ensure successful and swift exploitation of local opportunities and rapidly changing circumstances.

c. The three counterinsurgency programs are closely coordinated with one another in planning, development, and execution. In practice, one program is largely dependent upon partial success of another to achieve progress. Intelligence and psychological operations form a vital part of all three programs.

6105. COUNTERINSURGENCY FORCES

a. Military

(1) The local armed forces perform the primary function of seeking out and destroying the guerrilla military formations. They also furnish training, organizational, and logistic support to other counter-insurgency elements as required.

(2) Indigenous armed forces establish coastal, air, waterway, and border security as necessary, close air support, surveillance, and training missions as appropriate.

b. Police

(1) The national police perform police and internal security duties and exercise law enforcement, intelligence, and countersubversive duties as directed by the ASCC. They relieve military units of internal security duties in pacified (cleared) areas.

(2) Regional, state, provincial, municipal, and local police are armed, uniformed police whose main function is normal law enforcement in areas not under national police jurisdiction. They assist national police and support operations of the local ASCC.

(3) Special police are recruited and trained for special tasks such as civil guards for factories, mines, plantations, ranches, and railroads. Special police may man outposts or police posts in isolated

villages. They may further be involved in limited patrol actions or special operations such as raids, ambushes, or searches.

(4) Border police (guards) are police-type organizations responsible for the control and regulation of the movement of persons and material across political or tactical boundaries.

c. Paramilitary Forces

(1) Self-defense units maintain security of villages and hamlets and guard headquarters, bridges, and other vital installations. These units are made up of local volunteers and organized into platoons or squads. They man outposts, patrol perimeters of the community, and are capable of limited offensive action. They are armed and may be uniformed.

(2) Civil defense groups are similar to self-defense units in mission, organization, and capabilities. They are usually nonuniformed and unpaid and are usually a part-time, volunteer force. Armed militia are organized at the town, village, and hamlet levels and are trained by the armed forces to combat overt insurgent activities within the community. They also protect local inhabitants, provide guides, maintain surveillance, and otherwise support counterinsurgency operations in the community.

(3) The roles of organized civil and self-defense forces are significant. The basis for a large proportion of military offensive actions is dependent on intelligence gathering and other services provided by these forces. The psychological effect of local civilian inhabitants in the role of part-time soldiers, capable of preventing insurgent occupation of the outlying villages and localities, assists the government in securing the support of the population as a whole.

d. National Intelligence/Security Agencies.--Intelligence operations against the insurgent organization and countersubversion intelligence functions within the government and civil population are coordinated with the area security coordination center and performed by national intelligence and security agencies.

e. Other Assets

(1) Press, radio, and other public information media cooperate with national and military information and psychological operations.

(2) Selected civilian organizations and agencies (youth groups, labor union, civic, and industrial organizations).

Section II. COUNTERGUERRILLA OPERATIONS

6201. GENERAL CONSIDERATIONS

The introduction of Fleet Marine Forces into a counterinsurgency environment in response to a request for assistance from a host country anticipates their employment primarily in counter guerrilla operations.

a. Mission

(1) The mission of counter guerrilla operations is to subvert, kill, or capture the guerrilla force and prevent the resurgence of the resistance movement. The accomplishment of this mission usually requires the successful accomplishment of the following operations:

(a) Police operations.

1 Population control.

2 Security of troops, installations, communities, and lines of communication.

(b) Combat operations.

1 Harassment of the guerrilla force.

2 Offensive operations to destroy the guerrilla forces and the enemy infrastructure.

(c) Assistance in a program of civil improvement.

(d) Denial of sponsoring power support.

(2) Since the probable guerrilla force reaction to tactical pressure is movement to another area or hiding until counteraction has lessened, commanders must not consider the force destroyed merely because opposition has halted.

(3) Terrain, as a tactical objective, means little to guerrillas until the size and organization of the force begin to parallel that of a conventional force. Commanders must orient their efforts continually toward the destruction of the enemy and not on terrain. Terrain can usually be yielded by the guerrilla force with little or no tactical loss.

b. General Principles.--Preventing the formation of a resistance movement is much easier than dealing with one after it is formed. Likewise, destroying such a movement is much easier during its early stages than when it has reached more advanced stages of development. However, specifically identifying the resistance elements in the early stages is often extremely difficult. Counter guerrilla operations must include:

(1) Control of the civil populace to sever guerrilla support.

(2) Aggressive offensive action and imaginative leadership.

(3) Secrecy and surprise in tactical movements.

- (4) Continuous pressure against the guerrilla.
- (5) Counterintelligence.
- (6) Superior mobility.
- (7) Small unit leadership.
- (8) Security of key installations.
- (9) Rapid reaction to contact with the enemy.
- (10) Imaginative psychological operations program.

c. Area Responsibility

(1) The scope and nature of a commander's mission may emphasize political, economic, and social considerations to a greater extent than in conventional operations. A military unit engaged in counter guerrilla operations is normally assigned a specific area of operation. Whenever military considerations permit, the area encompasses a political subdivision of the affected locality. The assignment within a political subdivision ensures assistance from the civil authorities and, therefore, releases military personnel for purely military tasks. Such an assignment is effected to make maximum use of the following:

- (a) Civil administrative agencies.
- (b) Police and paramilitary forces.
- (c) Intelligence nets.

(2) Political subdivisions seldom provide optimum military areas of operations. In most cases, the boundaries of assigned areas are dictated by military considerations. The principles governing the assignment of unit boundaries are the same in counter guerrilla operations as in conventional warfare.

(3) The infantry battalion is normally assigned an area of responsibility. The battalion commander assigns specific sectors of responsibility to subordinate rifle companies. The company commander may assign sectors to his platoons. He assigns tasks or missions to further the accomplishment of the company mission. The size of the subsector assigned depends on the mission, the terrain, the nature of the guerrilla force, and the troops available. In an underdeveloped, rugged area which is under the effective control of the guerrilla force, the subsector of responsibility may be much smaller than in the more populated areas where the friendly force or neither force exercises effective control. The size of the area assigned to the battalion may be too large to be cleared concurrently by the rifle companies. In this case, the battalion commander establishes a priority for the clearance of his area and assigns sectors of responsibility to the subordinate units accordingly. The sector assigned a rifle company is no larger than the unit can clear and/or control without large groups of enemy regrouping elsewhere in it.

d. Mobile Combat Bases

(1) The rifle company establishes a combat base within its sector from which to operate. Although it may establish more than one such

base, whenever possible, the company operates from a single base to facilitate security and control.

(2) A combat base is the focal point for tactical operations against the guerrilla. It includes the company command post, the reaction force (reserve), and the combat support and service support elements necessary to sustain operations. The base is positioned to facilitate tactical operations.

(3) A combat base is essentially a bivouac organized within a perimeter defense. Obstacles are prepared to augment the defense. Local security is established and continuously maintained beyond the perimeter. The basic perimeter defense force and the local security are organized from locally available units other than reaction forces. The base is completely mobile and must be relocated periodically to reduce the enemy's effectiveness in locating and isolating it.

e. Reaction Forces.--Each battalion and rifle company assigned an area or sector of responsibility maintains a reaction force. A reaction force is a highly mobile reserve to be used in local reaction to contact with the guerrilla force. The rifle company normally retains a rifle platoon as its reaction force. It is positioned to augment the defense of the combat base perimeter and may provide additional local security when not active in its primary role.

f. Static Security Posts

(1) A static security post is any organized security system for the protection of fixed critical military or civil installations, or critical points along lines of communications such as terminals, tunnels, bridges, and road or railway junctions. They are utilized, as necessary, to adequately secure the assigned area of operations against guerrilla attack. The size of the post depends on the mission, the size and characteristics of the hostile force, the attitude of the civil populace, and the importance of the area being secured. It may vary from a two-man bridge guard to a reinforced company securing a key communication center or civilian community. Static security posts in remote areas are larger than those nearer supporting forces.

(2) The organization of a static security post varies with its size, mission, and distance from reinforcing units. In any case, such outposts are organized for self-protection and the protection of the installation. Reliable communications are established between remote static security posts and the parent unit base. The parent unit is prepared to counterattack with reserves or reaction forces to assist the outpost.

(3) Indigenous personnel, other than paramilitary personnel, are not allowed to enter the defensive positions. Those living in the immediate vicinity are closely screened. Friendly civilians may be helpful in warning of the approach of guerrilla units.

6202. POLICE OPERATIONS

a. General.--Police operations are those operations conducted primarily to effect population control and the security of military troops and installations, key communities, and lines of communication. Units engaged in counter guerrilla operations are normally required to deal with

the civil population in assigned areas. A battalion commander may be given the authority and responsibility for exercising military control over the civil populace in his area, or he may be required to coordinate with a civil administration having responsibility for population control. In either case, the rifle company commander ensures the maximum possible liaison and cooperation with the agencies responsible for attaining the objectives of police operations within the company's sector. The objectives of police operations are:

- (1) Isolate the guerrilla force from its civilian support.
- (2) Prevent interference with friendly operations by the civilian population.
- (3) Secure military troops, installations, and lines of communication from guerrilla attack.
- (4) Secure civilian installations and communities from guerrilla attack.
- (5) Solicit the active support of the civil population for the friendly cause.

b. Use of Civilians in Police Operations.--The effective conduct of police operations normally requires numbers of personnel far beyond the capability of the military unit responsible for these operations. It is imperative that maximum effort be made to organize, train, and utilize available civilian sympathizers in the area. Trained civilian cadres assist in the administration of population control and security of the area. Rifle company officers and noncommissioned officers frequently supervise the training programs established for organizing civilian assistance.

c. Population Control.--Rigid population control and stern administrative measures are imposed by higher echelons on a populace which is collaborating with guerrilla forces. Controls and restrictions are relaxed on a populace in direct proportion to its efforts to cooperate. The sincere will of the civilians to oppose guerrilla force coercion is adequately supported. The basic objective is to isolate the guerrilla force from the populace. Administrative measures imposed to suppress an unfriendly populace and minimize its ability to collaborate with hostile guerrilla forces may include the imposition of martial law. Vigorous enforcement and stern punishment are applied to carry out administrative measures. Half-heartedness or any other sign of laxness breeds contempt and defiance. Violators are apprehended and justly rapidly punished. The guerrilla force may initiate violence in communities which are earnestly cooperating with friendly forces to provoke unjust retaliation against these communities. Any unjust or misplaced punishment at the hands of the friendly force is vigorously exploited by the guerrillas.

- (1) In enforcing the population control policies of higher echelons, elements of the rifle company may be required to establish roadblocks in cooperation with the police. Roadblocks are employed to control the movements of civilian and illegal goods, to apprehend members of the guerrilla force, and to check the adequacy of other controls such as the use of identification passes. They are established as surprise checks and are organized to either halt or pass traffic as desired. Roadblocks are normally located where there is sufficient space for the assembly of people

under guard and for the parking of vehicles for search and investigation. Small units are concealed in the vicinity to apprehend those attempting to avoid the checkpoint. Elements of the company must be trained and rehearsed so as to be capable of establishing a roadblock in a short period of time at any hour. The processing of personnel, and vehicles at the roadblock, is as rapid and efficient as possible. The attitude of the personnel conducting the operation is impersonal. The search is thorough. FMFM 6-5, Marine Rifle Squad, provides a discussion of individual and vehicle search.

(2) The rifle company or its elements may participate in search and seizure. Search and seizure operations are conducted to screen a built-up area, village, or large watercraft; apprehend guerrilla force members; and uncover and seize illegal arms, communication means, medicines, and other items of a critical nature. A search and seizure operation may be conducted at any time and may be used as a preventive measure against the accumulation of critical items by the population. The operation is conducted as a controlled inconvenience to the population and should sufficiently irritate and frighten the populace so they do not collect restricted items, harbor guerrilla force leaders, nor support them. Conversely, the operation must not be so severe as to drive the civilians into collaboration with the guerrilla force because of resentment. Appendix D describes search and seizure techniques.

6203. SECURITY MEASURES

a. Unit and Installation Security.--In areas threatened by a guerrilla force, security measures must be taken to safeguard military personnel, military and civilian installations, and key communities. Vigilant security and sound defensive measures not only minimize losses, but tend to discourage guerrilla force operations.

(1) Unit Security.--Unit security is a command responsibility. All elements of a military unit must be thoroughly briefed concerning known or suspected guerrilla forces. Security measures are employed on the march, during halts, and while in the combat base. Troops in rear areas may acquire a false sense of security and relax their vigilance even though the guerrilla threat is comparable to that of forward areas. Unit commanders must exercise methodical supervision to maintain security discipline. Since guerrilla operations may be spasmodic, long, quiet periods further tend to reduce security vigilance. Supply discipline must be strictly enforced. It must be emphasized that supplies lost, traded, or thrown away will be recovered by the guerrillas and used against friendly forces. Arms and equipment must be salvaged from battle areas and from civilians.

(2) Installations.--Command posts and administrative support installations are secured from guerrilla attacks and sabotage. Special attention is given to the security of arms, ammunition, and equipment. To economize on manpower, it is important to select sites for command posts and installations that readily lend themselves to defense. Installations are grouped together so that they may be guarded as a unit. To further conserve personnel, maximum use is made of obstacles, alarms, illumination, searchlights, and restricted areas. Fields of fire are cleared and field fortifications are constructed for guards and security forces. The guard or security system is supplemented by a vigorous patrol system. Rigid security means are enforced on native labor to include screening, identification, and supervision as defenses against sabotage within installations. The security routine is altered frequently to prevent guerrilla forces

from obtaining detailed, accurate information concerning the composition and habits of the defense.

b. Security of Lines of Communication.--Rifle company elements may participate in securing the lines of communication in an assigned area.

(1) Railways.--Within areas threatened by hostile guerrilla forces, security measures are taken to protect railway rights-of-way, designated installations, repair and maintenance crews, and rail traffic. Important installations such as bridges, underpasses, tunnels, water towers, marshalling yards, and roundhouses are secured. The right-of-way and an area within 300 meters of the tracks may be declared and posted as a restricted zone. Civilian inhabitants living within this zone are evacuated and unauthorized persons are prohibited from entering. Underbrush and thick forests are cleared from both sides of the roadbed. Static security posts may be established along the right-of-way. Frequent patrols are conducted along the routes and to the flanks to discourage trespassing in the restricted zone, to detect mines and sabotage along the roadbed, and to give warning of guerrilla activities. Armored railroad cars may be used to supplement patrolling. Railway inspection, maintenance, and repair crews are provided with armed security detachments to defend them against guerrilla attack. When passing through areas of likely ambush, security detachments conduct reconnaissance by fire to the flanks until the danger area is passed. Flamethrowers may be used to advantage in this role. For added protection, an engine pushing cars loaded with rocks and earth may be run ahead of important trains. Other techniques may be devised to counter guerrilla interdiction. Rifle units guarding the right-of-way integrate their communication systems with the administrative railway communication system

(2) Highways.--Highways through hostile guerrilla areas are secured by the methods discussed above for the security of railway rights-of-way. Lone vehicles and convoys not capable of providing their own security are grouped together and escorted through danger areas by armed security detachments. All traffic through danger areas is controlled by traffic control stations. Appendix D provides guidance in organizing convoys to counter ambushes.

6204. INTELLIGENCE

a. General

(1) The conventional intelligence and counterintelligence procedures outlined in chapter 1 are generally applicable to the Marine rifle company in counterguerrilla operations. Certain aspects, however, require increased emphasis, particularly in the areas of locating the guerrilla and in counterintelligence measures to deny him information concerning friendly operations and to deceive him as to intentions. In order to exist, guerrilla units must have intelligence to achieve surprise and to negate the superior numbers and firepower of the counterguerrilla force. Guerrillas continually seek out spies and informers, usually within the civilian populace, to provide information on movements, dispositions, operations, weapons, and habits of the counterguerrilla force.

(2) The nature of guerrilla warfare, together with the sympathetic or forced support of the guerrilla by the local population, creates intelligence and counterintelligence obstacles that can be overcome only by patient determination and resourcefulness.

(3) The nature of the operational area determines the applicability of conventional intelligence techniques and the degree of modification they may require. For example, in areas where population is sparse, foot tracks on trails and food supply are particularly important. In a heavily populated area, pass systems and extensive surveillance measures are required to ferret out the guerrilla from the civilian populace.

b. Intelligence Requirements.--The rifle company and platoon are most concerned with locating the guerrilla force or elements thereof. The nature of guerrilla warfare reduces the ability to observe and report. Increased emphasis must be placed on obtaining information from the civilian population.

(1) Collecting Information.--Planning by the commander includes consideration of all potential sources of information and the means available at both company and higher echelons to exploit them. Additionally, thorough training and constant emphasis for all personnel in observing and reporting information, no matter how insignificant the information might seem, is mandatory. All personnel and tactical units must be provided with clear, concise, and simple tactical EEI's. They must be told what to look for, where to look for it, and to report promptly.

(2) Guerrilla Force.--Intelligence required concerning the guerrilla force may include, but is not limited to, the following:

(a) On Contact With Guerrillas

1 Where contacted (date, time, location).

2 Number of guerrillas with descriptions such as race, sex, dress. Were they carrying packs or food?

3 How were they armed (weapons seen and estimated from volume of fire)?

4 If guerrillas were sighted on the move or observed withdrawing, in what direction were they moving?

5 Distinguishing scars or features on enemy dead which may aid in identifying them.

(b) Indications of Guerrillas in Area

1 When and where were indications found and what did they consist of?

2 How many guerrillas made the tracks, were at the abandoned camp site, attacked the village, etc.?

3 What direction were the guerrillas moving in?

(c) Routes of Suspected or Known Guerrilla Movement.--Particular attention is paid to terrain features which may canalize guerrilla movement such as fords, dikes, ridgelines, trails, and stream junctions.

(d) Relationship Between Guerrilla and Civil Population

1 Women whose husbands or children whose father cannot be located or identified may indicate membership in the guerrilla organization as well as family support of him and the organization.

2 The guerrillas' food supply may be coming from the civilian population. Recent harvests of which portions cannot be properly accounted for and checkpoints revealing civilians with excessive amounts of food, clothing, or other supplies of potential value to the guerrillas which cannot be satisfactorily explained are examples.

3 Guerrilla force methods of operations may be noted by the absence of normal village activity or absence of certain individuals immediately preceding a guerrilla attack. These indicate prior knowledge of the attack. Departure of certain civilians from the village or friendly camp prior to the unit being ambushed or attacked indicates active support of the guerrilla.

(e) Locations of Guerrilla Camps.--Areas likely to serve as guerrilla hideouts usually have the following characteristics:

1 Difficulty of access as in mountains, jungles, marshes, and extensive or inundated rice paddies.

2 Concealment from air reconnaissance.

3 Covered withdrawal routes.

4 Located within one day's foot movement from small civilian settlements which could provide food, intelligence information, and warning.

5 Adequate water supply.

6 Evidence of newly cleared or cultivated areas in sparsely inhabited areas.

7 Evidence of fortification or preparation of weapons' emplacements.

c. Sources of Information.--In addition to the sources of intelligence information noted in chapter 1, the following have particular importance in counter guerrilla operations:

(1) Indigenous Armed Forces and Police.--These organizations have the advantage of long and close association with the country and its people. In addition to information, they may supply guides and interpreters as well.

(2) Agents and Informers.--These are of greatest value when handled by specialist personnel. When company elements are contacted by an agent or potential informer, higher headquarters should be notified. In making immediate tactical use of an informer, possibly as a guide, care is exercised to ensure that his long-range potential value is not lost.

(3) Surrendered and Captured Guerrillas.--Prisoners should be interrogated by trained personnel as soon as possible after capture or

surrender. If trained interrogators are not available within reasonable distance or time, local interrogation may be conducted providing the local interrogator is familiar with the rudiments of interrogation procedures. Information gained from them is relayed quickly. In certain circumstances, surrendered guerrillas may be used to guide friendly forces to enemy camps or supply dumps.

(4) Aerial Imagery Reconnaissance.--Aerial photography may be of limited value due to the guerrillas' aptitude for camouflage; however, he may be located by use of aerial infrared imagery detection which detects hot spots such as vehicles and campfires. Infrared is equally effective at night.

d. Counterintelligence.--Guerrilla forces depend primarily upon secrecy and surprise to offset the superior combat power of the counter-guerrilla force. The degree of surprise depends upon the effectiveness of the guerrilla intelligence operation. Intensive efforts are made to reduce the effectiveness of that system. At the company level, deception techniques and security of information provide the most effective means.

(1) Security of Information.--The guerrilla force is rarely able to obtain all the information it needs on a particular subject from one source. It relies on small bits of apparently insignificant data, which, when pieced together, indicate a possible course of friendly action. For example, meat being put out to thaw may indicate a very early breakfast, which, when coupled with the palletizing of water cans the day before, indicates the use of helicopters. In this regard, all personnel should be constantly aware of civilians observing their activities.

(2) Deception.--Deception must be incorporated into every plan and used in all operations. The following general principles apply:

(a) Do not alter dispositions or daily routines too suddenly.

(b) Tactical cover and deception plans are devised and exposed to guerrilla intelligence to disguise the purpose of preparations and movements; for example, a propaganda leaflet drop in one area, followed by an attack in another, or wearing footgear treads of local pattern over boots to preclude identification of the combat boot print.

6205. COMBAT OPERATIONS

a. General.--Combat operations are those military operations conducted against a guerrilla force or elements of the underground. If any portion of the assigned area of a unit is under effective control of the guerrillas, priority must be given to these operations to harass and destroy the guerrilla force. Normally, the presence of civilians within the area of operations dictates the continued conduct of police operations concurrently with combat operations against the guerrilla force. Combat actions against guerrilla forces are extremely decentralized until sizable guerrilla elements have been located. Even then, operations are centralized only to the degree necessary to effect the destruction of the located enemy force. A continuous distribution of force in depth is necessary.

b. Harassment.--At the start of combat operations against a guerrilla force, the location of the enemy is not known. Normally, an extended

program of harassment by the military force is necessary to locate the guerrilla force, maintain pressure against him, and gain knowledge of the terrain. Once the area under the control of the guerrilla force has been definitely determined, harassment operations are restricted to this area. They are conducted primarily by the use of reconnaissance patrols to locate him. Combat patrols raid known and suspected enemy bases, installations, and outposts and ambush his patrols in deliberate or chance encounters. During harassment, the rifle company operates from the combat base in its subsector. The rifle platoons may operate from patrol bases as necessary. Chapter 5 contains a discussion of patrol bases.

(1) Reaction

(a) When a guerrilla element is located during harassing operations, the patrol making contact engages the enemy and destroys him or, in a larger encounter, maintains contact with the enemy and requests assistance from the rifle company. This unit rapidly deploys its reaction force to engage and destroy the guerrilla force. When the contact is known to exceed the capability of company reaction to destroy it, higher echelon reaction forces are deployed. Often, the immediate reaction to hastily discovered guerrilla forces consists primarily of a pursuit. In such cases, efforts are made to envelop the enemy force and cut it off from the rear. Once the escape of the guerrilla force has been blocked, it may be destroyed by the pursuing force. The mobility required to conduct such a pursuit is provided by ground vehicles, helicopters, and accelerated foot movement.

(b) Throughout operations, the company commander continually establishes guerrilla force capabilities within his subsector for various situations and prepares plans for decisive reaction to each assumed enemy action. These plans are simple, prepared in detail, and rehearsed. To be effective, these plans are based on the best possible intelligence of the area and the enemy force. Since the guerrilla is most active during the hours of darkness, it must be assumed that most reaction operations will be conducted during the same period. A current list of possible guerrilla targets within the subsector is maintained. Common targets may include important road and railroad junctions, defiles, bridges, homes of important persons, key military and police installations, key communities, public utilities, public gathering places, and commercial establishments.

(c) For simplicity, reaction to sizable, consolidated enemy forces is called offensive operations and is discussed separately in paragraph 6205c.

(2) Patrolling and Patrol Bases

(a) Patrol bases are temporary bases established throughout the subsector of a company from which platoons and squads of the unit conduct patrols to harass the enemy. The techniques for organizing and establishing patrol bases are discussed in paragraph 5502.

(b) Patrolling involves all types under all conditions of terrain, weather, and visibility. Chapter 5 provides guidance in organizing patrols. Basic patrolling techniques are found in FMFM 6-5, Marine Rifle Squad.

c. Offensive Operations.--Once a sizable guerrilla force has been definitely located, priority of all available combat power is given to

eliminating the enemy. Offensive operations normally require a friendly force much larger than the located guerrilla force. The infantry battalion and rifle company may conduct offensive operations or participate in the conduct of such operations by larger units. In large-scale offensive operations, high echelon reaction forces (reserves) are normally the basic offensive units employed. Offensive operations are planned in great detail. Troops are well briefed and rehearsed. Since the immediate application of combat power is usually necessary to effectively engage and destroy a located guerrilla force before it disperses, emphasis is placed on the use of helicopterborne forces for the conduct of these operations. The encirclement of a guerrilla force usually offers the most effective means of fixing it in position and destroying it. However, if lack of time, inadequate forces, or the terrain prevent or do not favor an encirclement, it may prove successful to conduct surprise attacks against the enemy and follow them up immediately with aggressive pursuit. The techniques for the conduct of these operations are discussed in the following paragraphs.

(1) Combat in Urban Areas

(a) Since built-up areas are the most unfavorable terrain for an overt combat element of a guerrilla force, it will not normally choose to fight in these areas until it has reached the latter phases of its organizational development and has strength and capability comparable to the conventional force. However, underground elements in cities and towns may incite organized rioting, seize portions of urban areas, erect street barricades, and resist attempts to enter the area. Nonparticipants caught in the area are usually held as hostages. The objectives of these operations may be solely to conduct resistance, or more probably, to commit the counter guerrilla force to actions against the civil population which result in a gain of sympathizers for the guerrilla force and make it appear that it is promoting a popular cause. When an urban area has been seized by guerrillas, action is taken to eliminate or eject them as soon as possible to prevent an apparent success or victory by the guerrilla force, to maintain popular support for the friendly cause, and to free troops for use elsewhere.

(b) The tactics employed in reducing a barricaded, built-up area resemble the conventional tactics normal to street and house-to-house fighting. A cordon is established to surround and seal the barricaded area. The cordon is established at the next street or road out from the barricaded area which offers good visibility, fields of fire, and ease of movement. All unauthorized persons are cleared from the intervening area. Announcements are made to the insurgents that the area will be attacked at a given time unless they lay down their arms, return their hostages safely, and surrender. During the period between the time of the announcement and the time of the attack, a show of force in the vicinity of the barricaded area assists in impressing upon the insurgents the hopelessness of defending against the forthcoming attack. Tanks and assault amphibious vehicles, with their inherent massiveness, are very good show of force weapons.

(2) Encirclement

(a) Of all offensive actions open to a counter guerrilla force, the encirclement offers the greatest possibility of fixing a guerrilla force in position and achieving decisive results. By the same token, it is one of the most difficult operations to conduct. The rifle company

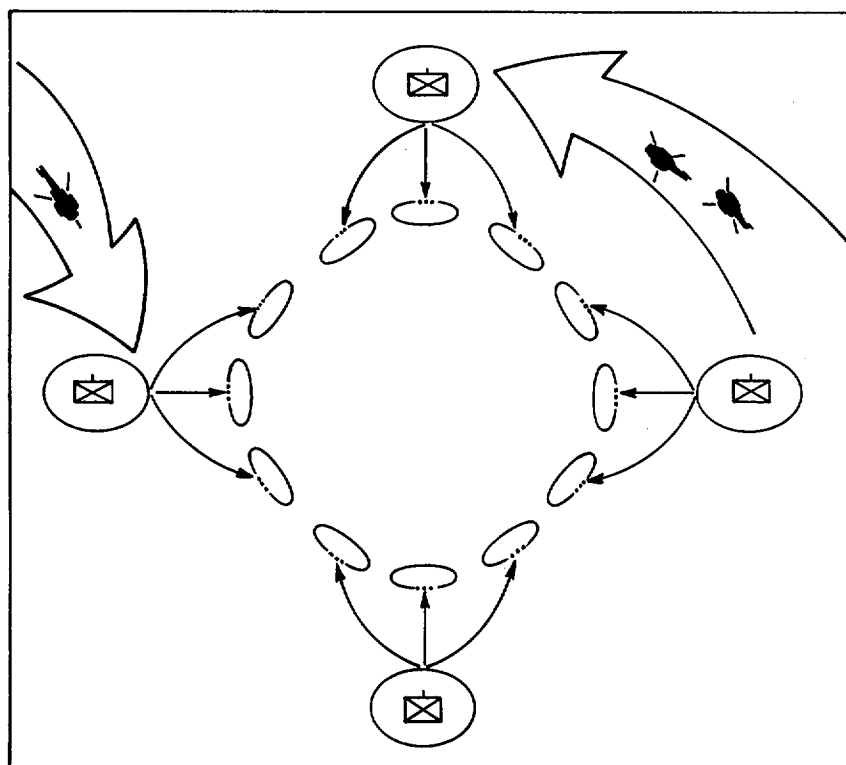

Figure 61.--Initial Encirclement.

may conduct an encirclement or participate in an encirclement conducted by a larger force. The encirclement requires a high relative preponderance of friendly troops. However, firepower, aerial reconnaissance, surprise, and the use of strong, mobile reserves can substantially lessen the troop requirement.

(b) The planning and execution of an encirclement are aimed at sudden, complete encirclement and surprise. Normally, maximum security and surprise can be gained by occupying the line of encirclement during the hours of darkness. The encirclement should be completed by daylight.

(c) The initial encircling movements are executed rapidly. (See fig. 61.) Maximum use of helicopterborne units contributes speed to the early phases of the encirclement. Upon arriving on the predesignated line of encirclement, units organize defensive positions and establish unit security. It is preferable that the entire line of encirclement be occupied simultaneously. When simultaneous occupation is not possible, the best escape routes are covered first. Large guerrilla units react immediately and violently when they realize they are encircled. The guerrillas probe for gaps and attack weak points to force a gap. Escape routes may be deliberately established as ambushes. Throughout the encirclement, the guerrillas continuously attempt to escape from the area either individually or in small parties. Difficult terrain is not considered a barrier to guerrilla forces.

(d) Strong, mobile reaction forces are positioned behind the line of encirclement ready for immediate movement to any portion of the line threatened by a guerrilla breakout in large operations. When the rifle company conducts an independent encirclement, all three platoons are normally employed on foot after their initial dispositions in the area.

(e) Following the initial encirclement, the capture or destruction of the guerrilla force is conducted methodically and thoroughly. This may be accomplished in any of the following ways:

1 Enticement to Surrender.--This method utilizes psychological warfare techniques, such as broadcasts, leaflets, show of force, etc., to persuade the encircled force to surrender. Historically, this technique has proven effective and should not be discounted.

2 Construction of the Encirclement.--In this technique, operations consist of a simultaneous controlled contraction of the encirclement. As the line is progressively shortened, units are removed from the line and added to the reserve forces. Against small guerrilla forces, the entire encircled area may be cleared by progressive contraction; however, against larger forces, it is more probable that at some point the contraction will reach a "critical mass," requiring action other than further contraction. (See fig. 62.)

3 Dividing the Area.--This technique is accomplished by successively splitting the guerrilla force into smaller units until destruction of the unit has been completed. It may be used in conjunction with the contraction of the encirclement after "critical mass" has occurred. (See fig. 63.)

4 Hammer and Anvil.--The hammer and anvil is an effective technique for annihilating the enemy after an encirclement has been contracted. This technique utilizes two forces--one to hold the enemy in position (the anvil), and one to force the guerrilla against the anvil element by offensive action and annihilate it with crushing pressure (the hammer). Either element may effect the actual destruction, but the majority of it will usually be accomplished by the force composing the hammer element. The anvil element blocks the guerrilla withdrawal and is most effective when located on, or immediately in the rear of, a natural terrain obstacle. Emplacement of the hammer element can best be accomplished by helicopter-borne units. It is desirable to emplace the hammer forces as late in the operation as possible in an effort to gain surprise and thus effect greater confusion among the guerrillas on discovery of the strong thrust being made against them.

5 Variations.--Variations of the operations described above include the following:

a Rabbit Hunt.--The "rabbit hunt" is a very effective technique for finding and destroying elements of a guerrilla force known to be in a relatively small area. It involves the use of three forces (see fig. 64):

(1) The hunting element begins on one boundary of the area to be cleared and advances parallel to a "direction of beat" in line formation. It methodically searches the area and either destroys the guerrilla or pushes him deeper into the area.

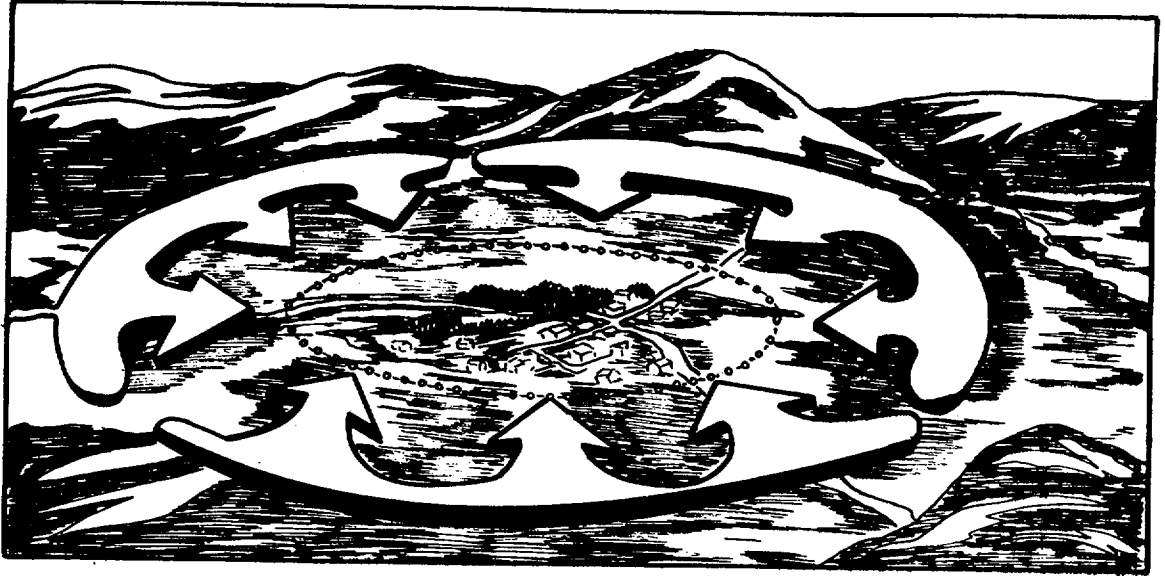

Figure 62.--Contraction of the Encirclement.

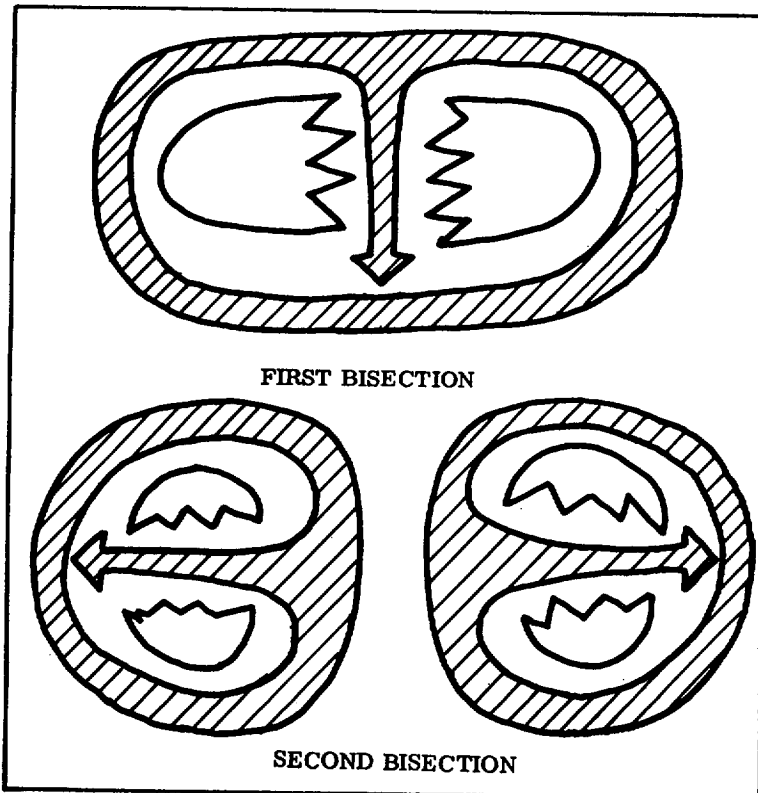

Figure 63.--Dividing the Area.

Par. 6205

FMFM 6-4

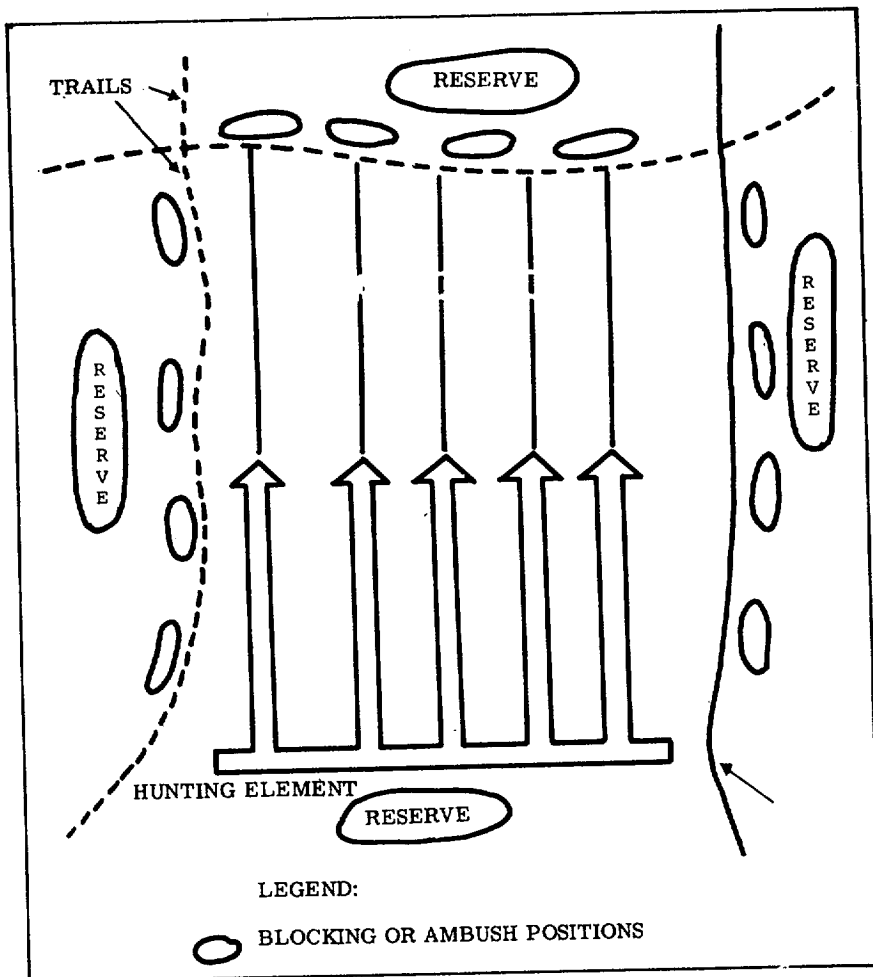

Figure 64.--Rabbit Hunt.

(2) The blocking or ambush force occupies positions around the entire area to be cleared except the side occupied by the hunting element. It engages the enemy attempting to withdraw from the pressure of the advancing hunting element.

(3) Adequate reserves are located behind both the hunting element and the blocking or ambush force ready for employment if the enemy attempts to make a concerted breakout at any point around the area.

b Fire Flush.--An effective variation of the "rabbit hunt" is the "fire flush." In this variation, the blocking or ambush force encircles an area approximately 1,000 meters square and awaits the enemy withdrawal from intense saturation indirect fire and/or attack by tactical air support. For security, the friendly troops occupy their ambush positions coincidentally with the limitation of the bombardment

or as close thereto as is possible. The "fire flush" is an effective technique in keeping the guerrilla on the move in a large area. The larger area is divided into smaller 1,000 meter (plus or minus) square areas, some or all of which are periodically surrounded and flushed out.

c Conventional Attack.--In the late stages of its development, a guerrilla force reaches a point in size, organization, training, and equipment which approximates the combat power of a conventional force. Such a force can be expected to gain extensive control over large areas.

(3) Pursuit (Sweep).--When contact is made with a guerrilla force, the most probable reaction of the guerrillas is to inflict maximum casualties on friendly forces without becoming decisively engaged and then flee the scene of action. This method of operation dictates that military forces operating against guerrilla forces be particularly adept in the conduct of pursuits. A pursuit is the maintenance of contact with, and the continuation of offensive action against, a fleeing enemy. It may be conducted by any size force. Often, the unit making the initial contact with guerrillas requires rapid reinforcement to maintain pressure against them, envelop them, and effect their destruction. A force conducting a pursuit is normally organized into two elements, the direct pressure force and the encircling force. The direct pressure force pursues the enemy and maintains constant offensive pressure on him as he withdraws. The encircling force, employing superior mobility, conducts local envelopments to cut him off and destroy him. The rifle company participates in the conduct of a pursuit by a larger force.

6206. DENIAL OF SUPPORT

a. Operations are initiated simultaneously with other counter-guerrilla operations to deny guerrilla elements the benefit of safe havens across international boundaries and support by an external sponsoring power. These operations require effective measures to secure extensive land, border, or seacoast areas and prevent communications and supply operations between the sponsoring power and the guerrilla forces.

b. The rifle company may be assigned missions of preventing ingress/egress across a boundary or shoreline in a particular locality as a part of concurrent combat operations against guerrilla forces.



CHAPTER 7

DOMESTIC EMERGENCIES

Section I. INTRODUCTION

7101. GENERAL

a. Introduction.--Widespread public disturbances threaten effective government functioning; lower public morale; and destroy public relationships, confidence, and progress. This chapter provides guidance in the procedures for suppressing domestic emergencies, both foreign and national, and the control of mobs and riots. The term domestic emergency includes any or all of the following emergency conditions:

(1) Civil Defense Emergency.--A domestic emergency disaster situation resulting from devastation created by an enemy attack and requiring emergency operations during and following attack. It may also be proclaimed by appropriate authority in anticipation of an attack.

(2) Civil Disturbances.--Group acts of violence or disorder prejudicial to public law and order.

(3) Major Disaster.--Any flood, fire, hurricane, or other catastrophe which, in the determination of the President, is or threatens to be of sufficient severity and magnitude to warrant disaster assistance by the Federal Government to supplement the efforts and available resources of state and local governments in alleviating the damage, hardship, or suffering caused thereby.

(4) Natural Disaster.--All domestic emergencies except those created as a result of enemy attack or civil disturbance.

b. Definitions

(1) Crowd.--A crowd is a large number of persons, temporarily congregated. Generally, the members of a crowd think and act as individuals and are without organization.

(2) Demonstration.--A demonstration is an assembly of persons usually motivated by a common goal and exhibiting sympathy either with or against authority. Political, economic, and social conditions or movement are prime motivators for most demonstrations.

(3) Insurrection.--Insurrection consists of an act of revolt against civil or political authority, or the established government.

(4) Mob.--A mob is a crowd whose members, under the stimulus of intense excitement or agitation, lose their sense of reason and respect for law, and follow leaders in lawless acts.

(5) Riot.--A riot is a breach of the peace characterized by violence and involving three or more persons in furtherance of a common goal.

7102. CROWDS AND MOBS

a. Causes of Disturbances.--The causes of disturbances arise from a variety of social, political, or economic factors. Conditions following disasters may generate violent disturbances among people because of the fear of further catastrophic actions. Also, the absence of authority or the inability or failure of authorities to exercise their responsibilities may cause a disturbance.

b. Transformation of a Crowd Into a Mob.--A crowd develops into a mob when all or most of its members have been instilled with a purpose and with an intent to carry out their purpose, regardless of the consequences.

c. Mob Actions

(1) Members of mobs are limited only by their ingenuity, the training of their leaders, their weapons, supplies, equipment, and materials. Leaders may be trained enemy agents who are determined to create turmoil. The degree of violence depends upon factors such as the composition of a mob, the number of people involved, location, cause of the disturbance, and the weapons available.

(2) Mob actions may include verbal abuse in the form of obscene remarks, taunts, ridicule, and jeers. Objects may be thrown at troops from various vantage points such as windows and roofs of buildings. Objects or vehicles may be rolled against troops and buildings set afire to block the advance of troops or create confusion or diversion. Leaders of the mob may direct that weapons be fired against troops, inciting the mob to more daring and violent action.

Section II. DISTURBANCES

7201. GENERAL CONSIDERATIONS

Instigators of civil disturbances attempt to create a breakdown in the normal functioning of a society. The artful use of a mob as a tool has become a trademark of these individuals in an endeavor to blackmail authorities into granting their demands. A mob howling through the streets not only causes physical destruction, but irreparably damages the mystique of government or authority, which has, by either incapacity or incompetence, allowed the situation to develop. Unjust or misplaced punishment to counter civil disturbances is normally exploited by the instigators to gain sympathizers and strengthen their cause.

a. Relations With Civilian Authorities.--Military assistance to civilian authorities is rendered by the armed forces when such assistance is requested or directed in accordance with executive orders and the law of the land. The military commander cooperates to the fullest possible extent with local authorities unless such cooperation interferes with the accomplishment of his mission. In making his resources available to civilian authorities, a military commander is subject to no authority except that of his superiors. The commander is guided by the principle of suppressing violence without undue force and may not undertake assistance on his own unless:

(1) The overruling demands of humanity compel immediate action to prevent starvation, extreme suffering, or property loss.

(2) Local resources are clearly inadequate to cope with the situation.

b. Liaison.--The commander maintains liaison with civilian authorities in order to attain maximum cooperation and coordination in providing military aid and assistance. Because a civil disturbance is primarily a law enforcement problem, the commander should, at the earliest possible time, establish liaison with civilian law enforcement agencies. Liaison is established for the following purposes:

(1) Preservation of law and order.

(2) Custody of offenders.

(3) Documentation of evidence.

(4) Traffic control.

(5) Information of intelligence value.

(6) Care of injured.

(7) Evacuation, housing, and feeding.

(8) Protection, isolation, and decontamination of key areas or facilities.

c. Public Information.--Because of the sensitivity of public information relating to the employment of Federal military forces in a civil disturbance emergency, public relations aspects of military activities assume great importance and should be actively encouraged and supported.

d. Military Use in Foreign Areas.--The use of United States military forces in foreign civil disturbances is dependent upon the conditions under which that force is introduced into the country. In an area occupied as a result of belligerency, the establishment and maintenance of law and order are the responsibilities of the military commander until such time as directives, agreements, or treaties, promulgated by the United States Government, alter or modify them. In areas where United States military forces are established as a result of consent or mutual agreement, action during disturbances is taken within the scope of the instructions under which the commander operates within the country.

7202. PLANNING AND TRAINING

a. General.--The mission of troops during civil disturbances is normally to restore and maintain order. This is usually accomplished by dispersing unauthorized or prohibited assemblages and demonstrations of people and by patrolling the area to prevent further assemblage. During operations to restore order in a large center of population, Marines establish road or area blocks, disperse crowds, employ riot control agents, and patrol designated areas. They may also be used as a security force or reserve. The successful execution of such missions depends upon planning, thorough training, adequate intelligence information, a sound tactical plan of operation, coordinated action of individuals and units, and bold, aggressive leadership.

b. Purpose and Extent of Planning.--Planning provides for actions to be taken before, during, and after disturbances. A Marine unit preparing for riot control duty passes through two general phases, the planning and training phase and the alert phase. Rifle company planning is responsive to the plans of the next higher command.

(1) The planning and training phase encompasses all preparations made prior to the company being alerted. Included in this phase are preparation of the following:

- (a) Company alert plan and standing operating procedures.
- (b) Reconnaissance of areas and routes.
- (c) Tentative plans for probable areas of disturbance.
- (d) Procurement and rehearsals with riot control devices and equipment.
- (e) Instructions in riot control operations.

(2) The alert phase may be of short duration or may be an extended period. During this phase, the unit is fully prepared and ready to move. Vehicles are loaded and in formation. Marines are habitually in the prescribed uniform and have immediate access to their equipment. Weapons, ammunition, riot control agent munitions, and supplies are issued.

When the company is not ordered to move immediately, personnel are allowed as much rest as possible. They are thoroughly briefed on the situation and probable mission.

c. Company Alert Plan.--The rifle company prepares a detailed alert plan, based upon the area alert plan or the battalion alert plan. The alert plan brings the company to a state of operational readiness which enables it to perform assigned missions promptly.

(1) The alert plan may be employed in the event of fire, disaster, attack, movement, tactical operation, or civil disturbance.

(2) The alert plan is based upon local conditions. It is revised as a result of experience gained by rehearsals or as necessary to conform to changes in the battalion's alert plan. The alert plan includes:

- (a) Authentication of the alert order.
- (b) Manner of alerting the unit during both duty and non-duty hours.
- (c) Uniform.
- (d) Weapons.
- (e) Ammunition.
- (f) Riot control agent munitions.
- (g) Organizational and individual equipment.
- (h) Supplies.
- (i) Vehicles.
- (j) Formation of march column.
- (k) Special equipment.
- (l) Security.
- (m) Tactical and administrative details.
- (n) Briefing of troops.
- (o) Issuance of operation order.

d. Contingency Plans.--Tentative plans are prepared to deal with disturbances which might arise in various assigned localities. Each plan accounts for the peculiarities of the particular area and includes:

- (1) Assembly area and routes thereto.
- (2) Locations of road blocks.
- (3) Observation posts.

Par. 7203

FMFM 6-4

- (4) Tactical plan.
- (5) Patrol plan.
- (6) Temporary quarters for billeting and feeding.

e. Training.--Riot control training is combat training. Marines must be convinced of the need for this type of training and the importance of riot control. Training stresses physical and mental conditioning as well as proficiency in employing the tactics, techniques, and equipment used in riot control operations. Therefore, each commander must determine the need for training in each area based upon the prior training and experience of his personnel and the degree of proficiency already obtained by his unit. To assist commanders in this regard, FM 19-15, Civil Disturbances and Disasters, contains further guidance in civil disturbance training.

7203. RIOT CONTROL FORMATIONS

a. General.--Certain formations have been developed for use by the rifle platoon and the rifle company in taking offensive action against mobs or in defending against the actions of a mob. Smartness and precision in their execution have a psychological effect on a mob. The formations include the following:

(1) Line

(a) The line is employed for blocking or pushing a mob and is continuous without gaps with the flanks anchored to obstacles or protected by reserve units.

(b) As a defensive formation, the line is used to hold mobs or deny access to restricted streets or areas.

(2) Echelon.--The echelon is employed to force rioters away from an obstacle, such as a wall of a courtyard or building, or to direct their movements in a certain direction.

(3) Wedge

(a) The wedge is employed to split a mob into segments.

(b) The wedge may be modified to provide all-around security when required.

b. Control

(1) Cadences

(a) The normal cadence for movement into and assembly from all riot control formations is double time.

(b) The normal cadence for movement of troops while in any riot control formation is quick time. While in the on-guard position, the cadence is approximately 60 steps per minute. Cadence may be increased or decreased at the discretion of the unit commander to meet varying situations.

(c) A unit may be ordered into or assembled from riot control formations from the halt or while marching. As each man reaches his proper position, he faces in the direction of the unit's intended advance and comes to a halt. He remains at the halt in the high port position and awaits further orders.

(2) Interval and Distance.--The normal intervals and distances between men in riot control formations are one pace.

(3) Signals.--Arm-and-hand signals are used in conjunction with oral commands when noise and other distractions may prohibit the unit from hearing oral commands. The signals for riot control formations are identical to those used in signalling combat formations.

c. Platoon Formations.--Initial riot control formations are formed from the platoon close column. Subsequent changes in formation may be effected from the initial formation. In forming riot control formations from the column, the platoon commander moves out to the right or left of his platoon and faces it when giving his commands. Unless he specifies otherwise, the formation is formed immediately to the front of the column. The platoon commander pauses between preparatory commands and commands of execution to permit each squad leader to issue a preparatory command to his squad.

(1) Platoon Line

(a) Command.--"PLATOON AS SKIRMISHERS, MOVE."

(b) Execution.--Immediately following the platoon commander's preparatory command, the squad leaders command, "FOLLOW ME." At the platoon commander's command of the execution, the second squad moves to the front and forms a skirmish line. At the same time, the first and third squads move forward to their left and right respectively, form squad lines individually, close, and dress on the second or base squad. (See fig. 65.)

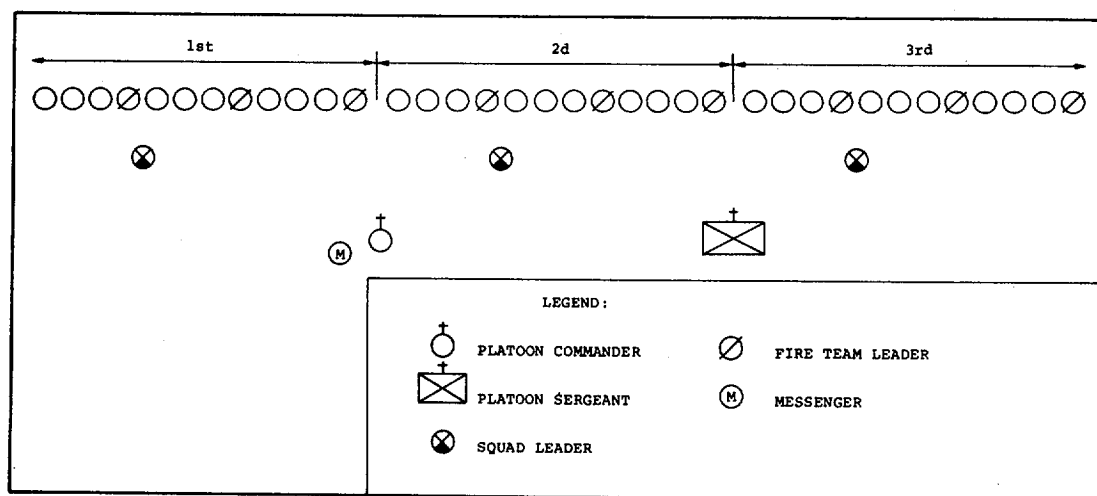

Figure 65.--Platoon Line.

Par. 7203

FMFM 6-4

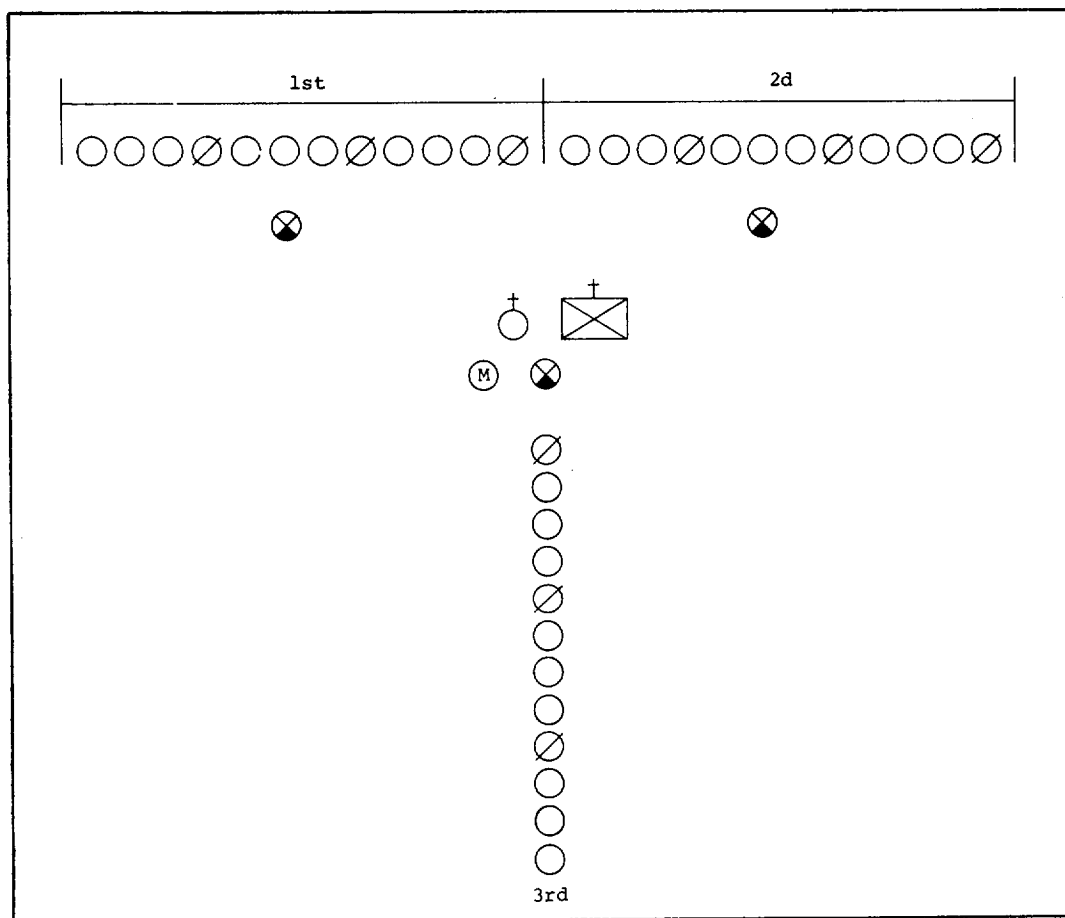

Figure 66.--Platoon Line With One Squad in General Support.

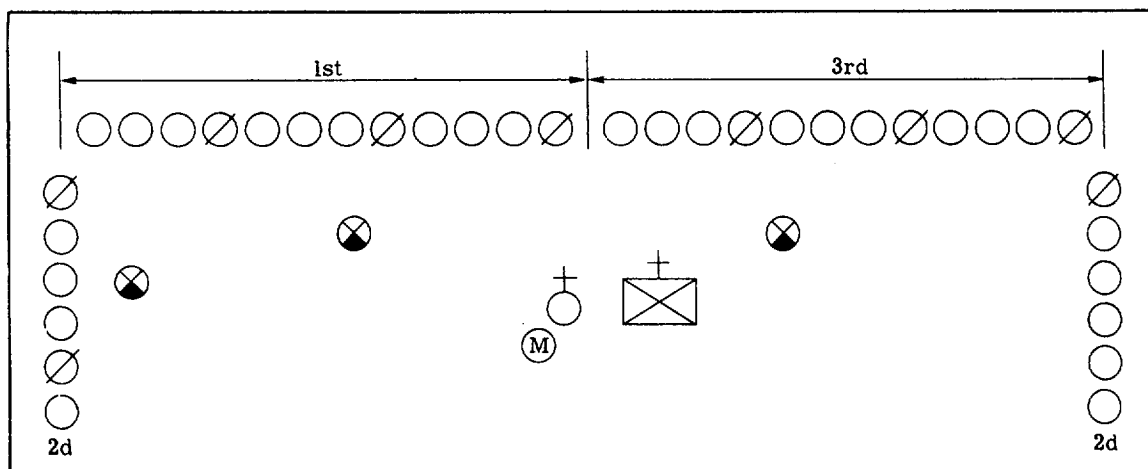

Figure 67.--Platoon Line With Squad in Lateral Support.

(2) Platoon Line With Support.--The three formations with support are general, lateral, and close. Whenever the command for establishing a riot control formation contains the phrase "IN SUPPORT," without modification, it means that the support squads are to remain in general support.

(a) Command.--"PLATOON AS SKIRMISHERS, SECOND SQUAD IN SUPPORT, MOVE."

(b) Execution.--The first and third squads execute the line while the second squad remains in column. The first squad is base squad. (See fig. 66.)

(c) Command.--"PLATOON AS SKIRMISHERS, SECOND SQUAD IN LATERAL SUPPORT, MOVE."

(d) Execution.--The first and third squads execute the line, the second squad forms into a column of twos. After the line has been formed by the first and third squads, the squad leader of the second squad moves each column of his squad out to the platoon's flanks. The columns close on the ends of the line already formed and face the direction of the platoon's advance. (See fig. 67.)

(e) Change in Formation.--Similarly, the second squad may be committed from general to lateral support at any time by the platoon commander. He commands, "SECOND SQUAD, LATERAL SUPPORT, MOVE."

(f) Rejoining the Line.--To have the second squad join the line from either general or lateral support, the platoon commander commands, "SECOND SQUAD, EXTEND THE LINE, LEFT (RIGHT)," indicating to which flank the second squad is to move into line. The second squad leader commands, "SQUAD AS SKIRMISHERS, LEFT (RIGHT)." On the command, "MOVE," the second squad establishes a line formation on the directed flank of the existing line.

(g) Command.--"PLATOON AS SKIRMISHERS, SECOND SQUAD IN CLOSE SUPPORT, RIGHT (LEFT, CENTER), MOVE."

(h) Execution.--The first and third squads execute a line formation. The second squad forms a similar line in the rear of the leading line and closes in. The second squad is positioned right, left, or center of the leading line as directed by the platoon commander. The men in the supporting line cover the intervals between men in the leading line. (See fig. 68.)

(i) Two Support Squads.--In instances where a restricted or narrow front is necessary or desired, two squads may be used in each of the general, lateral, or close support formations.

(j) Assembling the Support Squads.--To assemble the support squads from any position to general support, the platoon commander commands, "SQUAD(S), ASSEMBLE, MOVE." The squad(s) return to the column(s) in rear of the line.

(3) Echelon Right

(a) Command.--"PLATOON ECHELON RIGHT, MOVE."

Par. 7203

FMFM 6-4

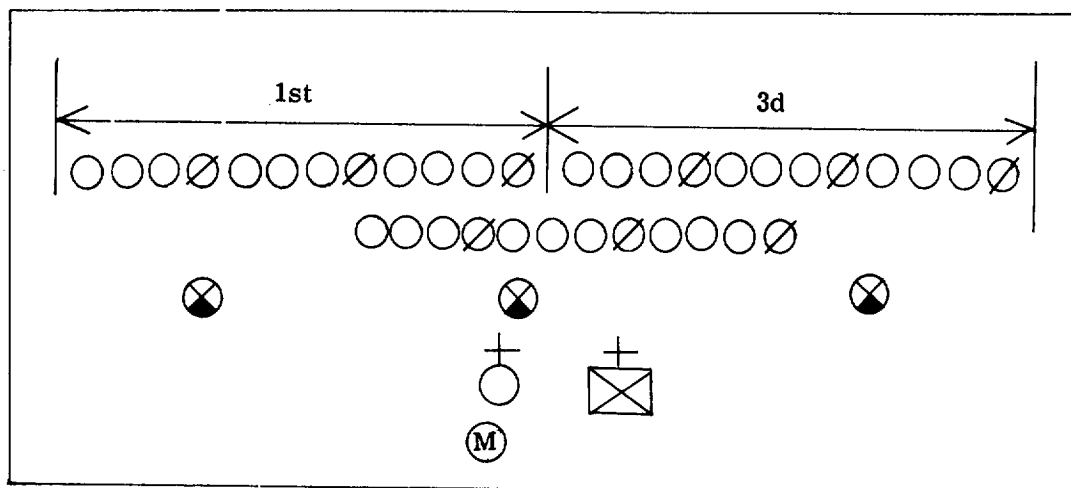

Figure 68.--Platoon Line With Squad in Close Support Center.

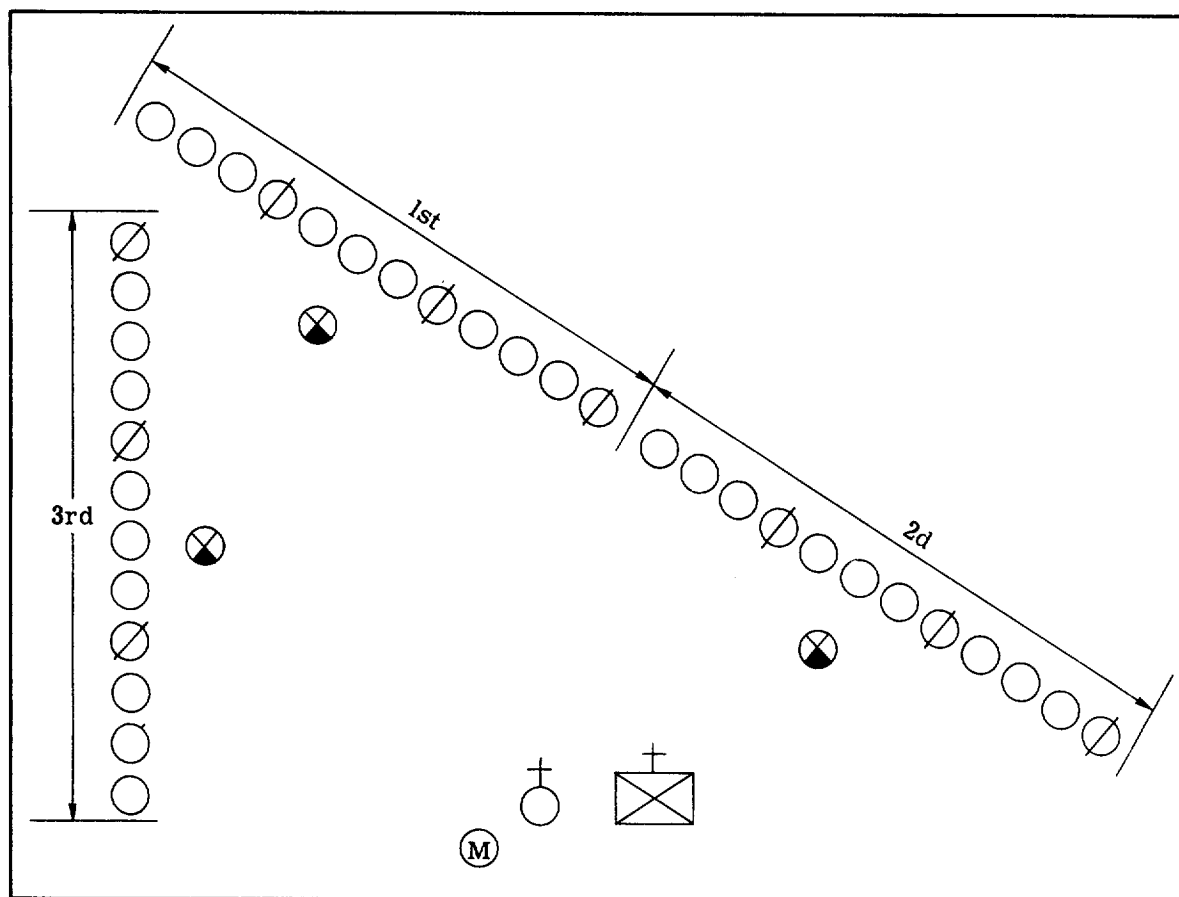

Figure 69.--Platoon in Echelon Right With One Squad in Lateral Support, Left.

(b) Execution.--Immediately following the platoon commander's preparatory command, the squad leader of the first squad commands, "FOLLOW ME." The squad leaders of the second and third squads command, "STAND FAST." At the command of execution, the first squad moves out and executes an echelon right at the location designated. As each squad clears the column, the next successive squad moves out individually and extends the echelon already formed by the preceding squad(s).

(4) Echelon Left

(a) Command.--"PLATOON ECHELON LEFT, MOVE."

(b) Execution.--The platoon echelon left is formed in the same manner as the echelon right except in inverse order. The third squad is the base squad and the remaining squads extend the echelon in inverse sequence.

(5) Echelon With Support.--A squad or squads may be used in general, lateral, or close support with the echelon right or left in the same manner as with the line. (See fig. 69.)

(6) Wedge With Squad in Support

(a) Command.--"PLATOON WEDGE, SECOND SQUAD IN SUPPORT, MOVE."

(b) Execution.--Immediately following the preparatory command, the squad leaders of the first and third squads command, "FOLLOW ME." The squad leader of the second squad commands, "STAND FAST." The first and third squads form the left and right sides of the wedge respectively, the second squad may either remain in column or form a column of twos. (See fig. 70.)

(7) Wedge With Squad in Lateral or Close Support.--Generally, it is impractical to form a platoon wedge with more than one squad in support. One squad may be employed in close or lateral support in the same manner as with the line or echelon formations.

d. Company Formations.--The company commander may form his weapons platoon into a fourth rifle platoon when the use of crew-served weapons is not anticipated in the control of a civil disturbance. The company commander orders the company into riot control formations from the column. If he does not indicate a location for the formation in the preparatory command, the company forms immediately in front of the leading platoon.

(1) Company Line in Depth

(a) Command.--"COMPANY AS SKIRMISHERS IN DEPTH, MOVE."

(b) Execution.--Immediately following the preparatory command, each platoon commander gives the command, "PLATOON AS SKIRMISHERS." The squad leaders follow with their respective commands to their squads to form the platoon line. At the command of execution, each platoon establishes a platoon line immediately to its front. (See fig. 71.) Should the company commander desire a more formidable formation, he gives the command, "SECOND PLATOON, CLOSE SUPPORT, MOVE."

Par. 7203

FMFM 6-4

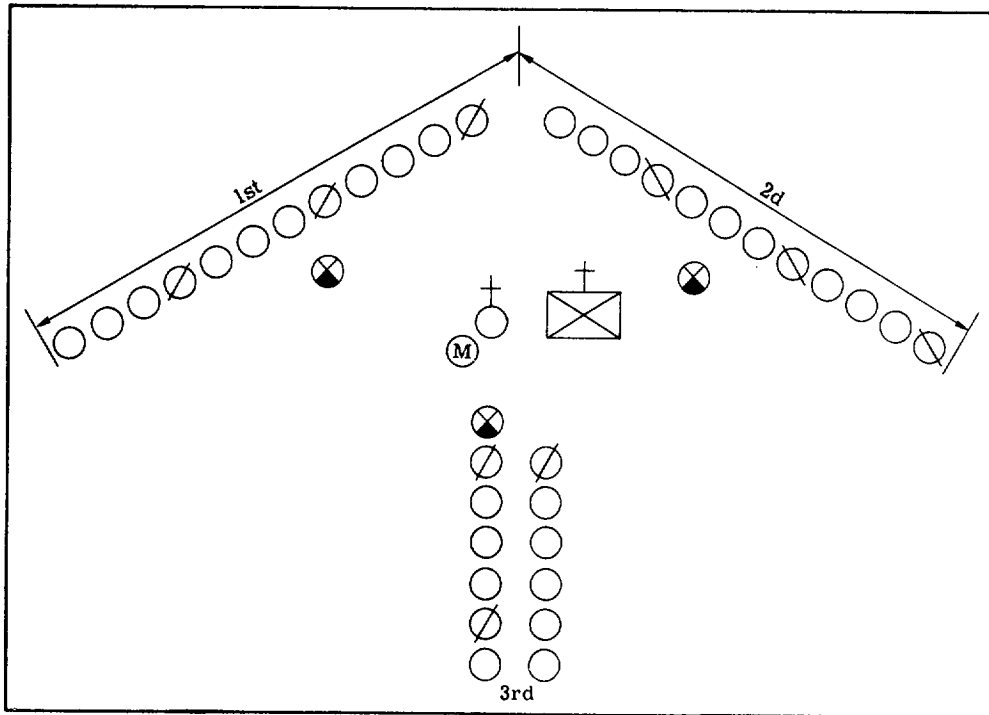

Figure 70.--Platoon Wedge With One Squad in General Support.

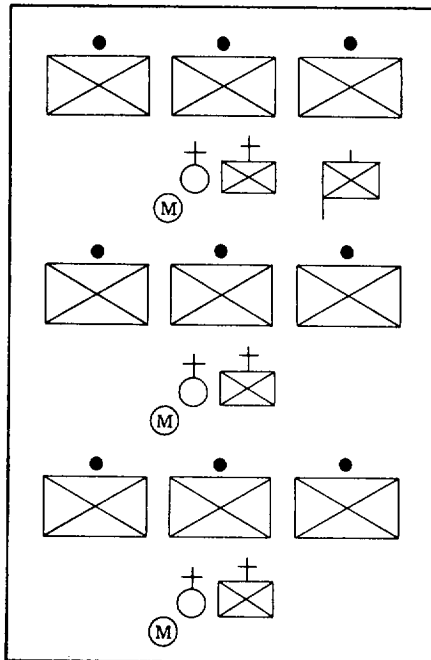

Figure 71.--Company Line in Depth.

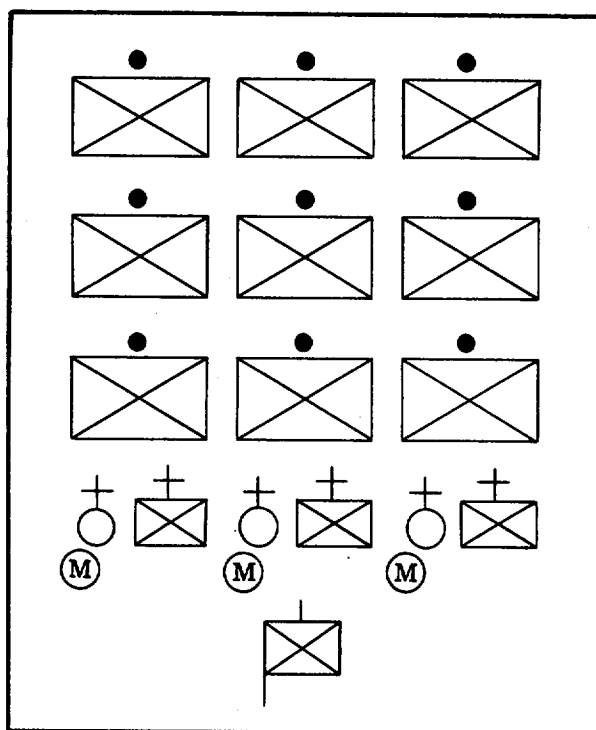

Figure 72.--Company Line in Mass.

The second platoon moves forward and covers the intervals between the men of the leading platoon and automatically assumes the same position as the men of the leading platoon, which will normally be the ON GUARD position. The third platoon then moves forward to occupy the position vacated by the second platoon.

(2) Company Line in Mass

(a) Command.--"COMPANY SKIRMISHERS IN MASS, MOVE."

(b) Execution.--The platoons each form a line individually, and the second and third platoons close on the first platoon without further command. (See fig. 72.)

(3) Company Line With Support.--In company formations, the first platoon normally forms the assault element and the second and third platoons are used in support. Should the weapons platoon be employed as a rifle platoon, the commander's power and flexibility are increased. The support platoons can be employed in the same manner as the support squads in platoon formations. Some variations of a company with support are illustrated in figure 73.

(4) Company Echelon and Wedge.--The company echelon and wedge are formed in the same manner and with the same variations as the company line. (See fig. 74.)

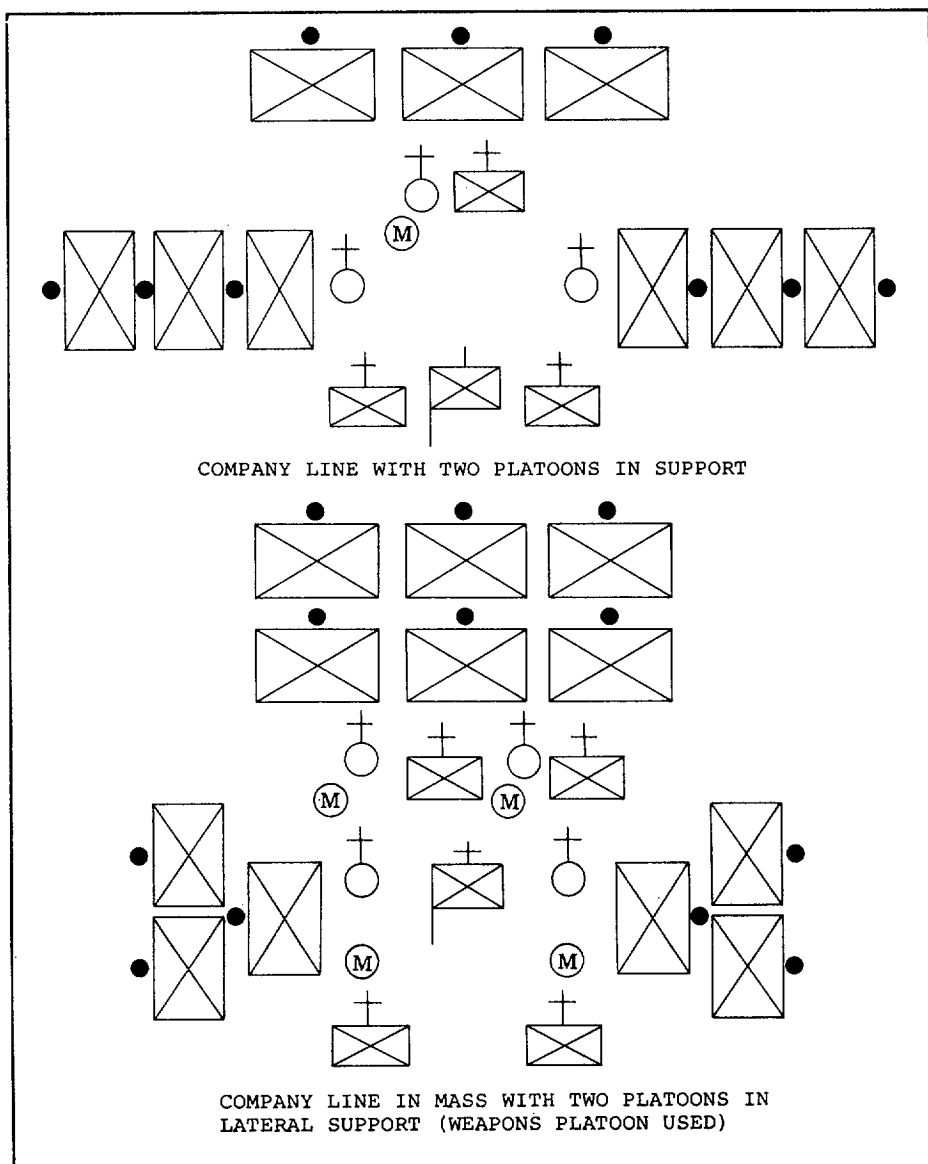

Figure 73.--Company Line With Support.

7204. OPERATIONS

a. General

(1) The tactics and techniques for quelling civil disturbances are selected to fit the conditions of each disturbance. When Marine units are committed to restore order, there must be no hesitation, particularly when in view of the rioters. The plan of action should be followed forcibly and with determination.

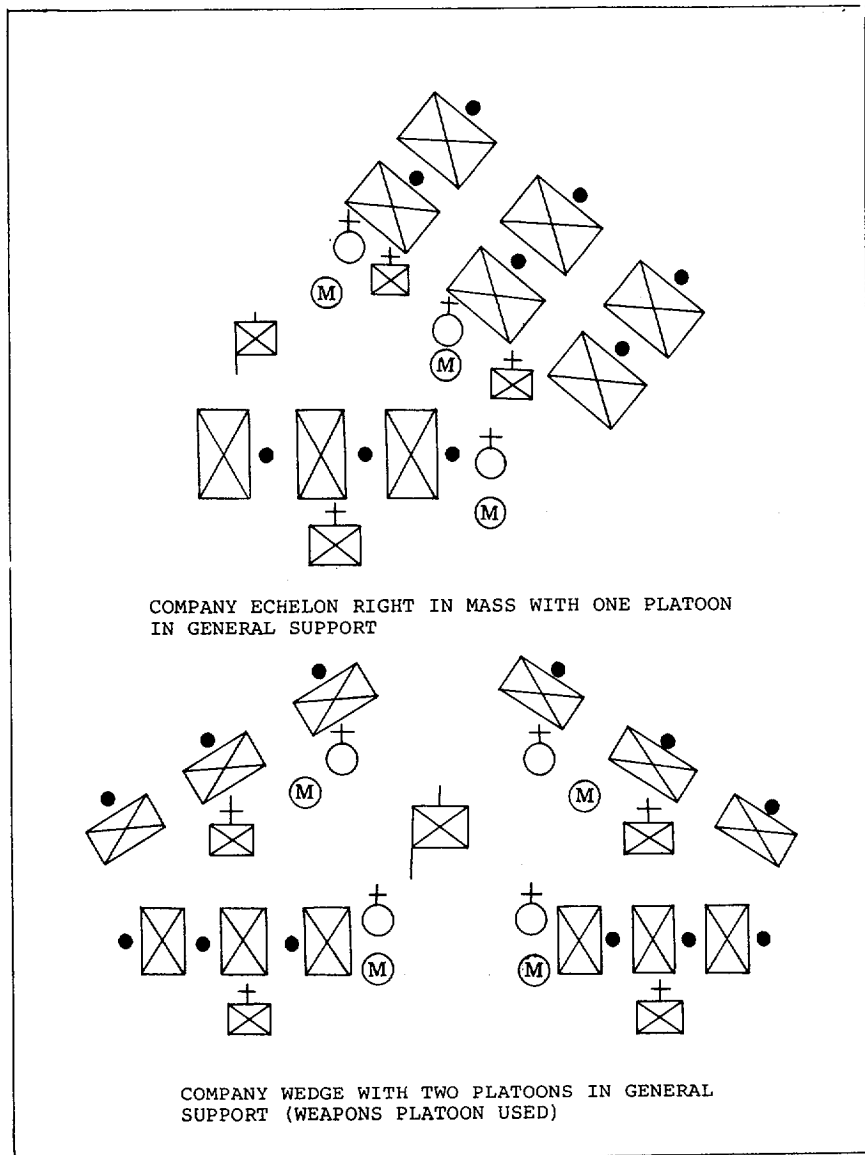

Figure 74.--Company Echelon and Wedge With Support.

(2) In some cases, mobs may be dispersed without violence if handled firmly and tactfully. On the other hand, unnecessary violence or arrogance on the part of the troops may cause the mob to take violent action against the troops.

b. Initial Action

(1) Initial action normally consists of blocking a mob along a selected line short of its objective and emplacing the necessary road

blocks, presenting a display of military strength. A proclamation is issued ordering the people to disperse immediately and return peaceably to their homes. The necessary instructions as to routes to be taken and time limitations are promulgated to the people.

(2) When the mob retires, Marine units follow at the speed of retirement. When these units reach a predesignated line they halt and motorized patrols continue the pursuit and patrol the area to prevent reassembly.

(3) If the members of the mob do not obey the proclamation, other measures must be employed.

c. Employment of Force.--The following measures may be applied in any order deemed appropriate by the responsible commander:

(1) Show of Force.--To use the show of force to the greatest advantage against mobs, Marine units should make a surprise, formidable appearance. To ensure this, the following procedures are used:

(a) Units dismount from vehicles and assemble at some point beyond sight of the mob. This point must be as near the mob as practicable to save time, and yet far enough from the scene to ensure secrecy.

(b) Fix bayonets, lock, and load all weapons.

(c) March in column formation to a point at a reasonably safe distance from but within plain view of the mob.

(d) Halt and remain in formation. Marines hold their weapons at high port while the commander delivers the proclamation. Following this, the commander informs the mob that it has a specified time in which to comply with the order to disperse.

(e) If the mob does not comply within the specified time, the commander then employs whatever measures are necessary to disperse them.

(f) Any advance toward the Marine units is stopped before it reaches a unit's position.

(2) Riot Control Formations.--Riot control formations are employed as appropriate.

(3) Employment of Water.--High pressure water systems such as fire hoses and mobile water cannons may be used.

(4) Use of Chemical Agents.--Nontoxic chemical agents are employed in dispersing mobs.

(5) Employment of Firepower.--The decision to employ firepower in halting or dispersing a mob is made by the senior commander prior to committing units to a show of force. Firepower is employed in two ways:

(a) Selected marksmen are designated in each squad and thoroughly instructed. They fire on order as required by the situation.

(b) Full firepower from an entire unit may be employed.

d. Route of Escape.--Excessive pressure is not placed against the mob if no route of escape is open to them. Routes of escape are planned and pointed out to the mob. The greater the number of routes open to the people the sooner they can be dispersed.

e. Defensive Operations.--Defensive actions consist of establishing a line on the ground at a designated distance from the troops. The mob is ordered not to cross the line. Marine units apply the necessary force to carry out this order.



CHAPTER 8

AUXILIARY OPERATIONS

Section I. INTRODUCTION

8101. GENERAL

Auxiliary operations are combat-related or assist the efficient conduct of offensive or defensive combat operations discussed elsewhere in this manual. Some of the operations discussed are passive in themselves but are conducted concomitant with combat operations. Others are preludes to combat or are its aftermath.

8102. SCOPE

a. The purpose of this chapter is to provide guidance in the planning and conduct of certain additional activities that may be essential to success of rifle company operations in a combat zone. They are grouped in this chapter only for convenience of organization and not as matters of less importance to the combat commander.

b. The chapter includes a discussion of the following:

- (1) Relief operations.
- (2) Reconnaissance in force.
- (3) Retrograde operations.
- (4) Mine warfare.
- (5) Nuclear, biological, and chemical defense.

Par. 8102

FMFM 6-4

(6) Bivouacs.

(7) Special operations are not discussed in this manual. Refer to FMFM 8-1, Special Operations, for detailed information on these subjects.

Section II. RELIEF OPERATIONS

8201. GENERAL

a. Material presented in this section agrees with applicable portions of STANAG 2082. A relief operation is the replacement of one unit by another. A relief may be effected as part of the tactical plan, to ensure that the initiative is maintained, or to conserve the strength and effectiveness of the relieved unit. The rifle company may participate in a relief as a unit or it may effect reliefs within the company when the reserve platoon relieves another rifle platoon. Relief operations consist of two types, relief in place and passage of lines.

b. Certain basic considerations are common to all types of reliefs. The following are required:

(1) Preparation of detailed plans and their close coordination between all echelons of the relieving and relieved units. The incoming unit becomes thoroughly familiar with existing plans. Liaison personnel are exchanged.

(2) The time or circumstances under which the relieving commander assumes responsibility for the mission of the unit being relieved is established precisely by higher authority.

(3) Commanders of relieving units are afforded the opportunity for thorough reconnaissance. Reconnaissance should include inspection of existing defenses, relief routes, entrucking, detrucking, and turnaround points, and command and observation installations.

(4) Arrangements are made for the control of units moving into and out of the area.

(a) Routes to be used and priority of their use.

(b) Responsibility for traffic control.

(c) Location of entrucking, detrucking, and turnaround points.

(d) Guides.

(5) The unit being relieved transfers to the relieving unit all information and intelligence concerning the enemy and the area of operations. Any essential element of information required by the relieving unit is obtained by the unit being relieved.

(6) All fire support requested and delivered in the area is controlled through the commander responsible for the area.

(7) A written report of the transfer of responsibility for a minefield is prepared and signed by both the relieved and relieving unit commanders. It includes a certification that the relieving unit commander has been informed of all mines within his area and that he assumes responsibility for them. The report is forwarded to the first common superior of the relieved and relieving units.

Par. 8202

FMFM 6-4

8202. RELIEF IN PLACE

a. General.--A combat operation in which, by direction of higher authority, all or part of a unit is replaced in a combat area by the incoming unit. The responsibilities of the replaced elements for the combat mission and the assigned zone of operations are transferred to the incoming unit. The incoming unit continues the operation as ordered.

(1) Secrecy is essential in preparing for and conducting a relief. Darkness and reduced visibility help to preserve secrecy; therefore, reliefs are made more frequently at night than during daylight. The relief is conducted as rapidly as possible, consistent with secrecy and control.

(2) During a relief, units are particularly vulnerable to enemy fires. To avoid a concentration of troops, platoons may be relieved one at a time unless a particular situation requires all company elements to be relieved at once.

b. Planning the Relief.--Plans are as detailed and complete as time permits and include the considerations discussed below:

(1) Preceding the relief, the incoming company commander and platoon commanders conduct a daylight reconnaissance of the area, routes, and locations at which guides will be provided to incoming units. They familiarize themselves with defensive dispositions and plans, the terrain, and the enemy situation. The outgoing company commander makes necessary plans for conducting his part of the relief. He normally remains with his unit; therefore, he designates representatives to reconnoiter the outgoing route, guide locations, and the new area to be occupied, as appropriate.

(2) The commander of the incoming company and his platoon commanders take liaison personnel forward with them on their reconnaissance and arrange to leave them on the positions to be occupied. The liaison personnel keep informed of all changes occurring after the reconnaissance. When practicable, liaison personnel from the outgoing unit remain on the position long enough to further orient the newly committed unit commanders.

(3) Commanders of the incoming and outgoing units arrange for the mutual exchange of weapons which cannot be easily moved or whose removal would disrupt the effective delivery of fires, based upon the authority included in the relief order of the battalion commander. Outgoing units normally leave excess ammunition, field fortification material, wire lines, range cards, and minefield records on position. In the exchange of crew-served weapons, three possibilities or methods are presented and require careful analysis to determine which should be used:

(a) Retention of weapons by both units.

(b) Mutual exchange of all weapons.

(c) Partial exchange of weapons (baseplates, tripods, etc.).

(4) To simplify control and reduce the number of guides, the incoming rifle company commander normally attaches weapons crews to the rifle platoons in whose areas their positions are planned. The outgoing

rifle company commander usually does the same. Attachments during the relief are generally made for the movement only.

(5) The guides reconnoiter and mark relief routes in advance. The incoming and outgoing companies use different routes to facilitate control and dispersion. The activities of the guides are supervised to ensure efficiency and avoid unnecessary delays. An incoming company is usually guided by its own personnel to the rear of the battle area of the outgoing company. From this point forward it is guided by personnel of the outgoing company. Movement should be continuous even when changing guides. Personnel of the outgoing company guide their units during the entire movement to the rear.

(6) Normal activities are simulated as much as practicable. Local security elements are normally maintained by the outgoing unit and are usually the last elements of that unit to be relieved. The relief is not mentioned in the clear over electrical means of communications. The size and activities of reconnaissance parties are limited, and the movement of vehicles is restricted. Light and noise discipline is enforced.

(7) The relief order follows the sequence of the standard operation order and includes the following:

- (a) The times for the relief to begin and end.
- (b) The time or condition for exchanging responsibility for the area.
- (c) Routes.
- (d) Attachments.
- (e) March formations.
- (f) The designation and location of crew-served weapons, equipment, and supplies.
- (g) Security measures.
- (h) Action to be taken in the event of hostile action during relief.
- (i) The requirement for periodic reports to be submitted by subordinate leaders during the conduct of the relief.

c. Conduct of the Relief.--The relief is effected as follows:

(1) In time for the prescribed relief, the incoming company moves forward from the company release point. Guides lead the platoons from the platoon release point to their squad release points where other guides lead the squads to their positions. The incoming and outgoing squad leaders then relieve a fire team at a time until the relief is completed. Enough time is allowed for each man of the incoming squad to be thoroughly oriented by the man he is relieving.

(2) As each squad is relieved and the squad leader has been relieved of responsibility for the position, the squad moves directly from its assembly area to the platoon assembly area. When the platoon commander

is relieved of responsibility for his defense area, he joins his platoon and moves it to the company assembly area without further delay. When the company commander is relieved of responsibility for the company area, he rejoins his company. Throughout the conduct of the relief, commanders at all levels are responsible for the dispersion and security of their units.

d. Passage of Command.--The outgoing unit commander is responsible for the defense of his assigned sector until command passage. The moment when command is to pass is determined by mutual agreement between the two unit commanders unless directed by higher headquarters. It normally occurs when subordinate commanders have assumed responsibility for their sectors and the incoming unit commander has sufficient communication facilities in operation to exercise control over his entire sector.

8203. PASSAGE OF LINES

a. General.--In a passage of lines, an incoming unit attacks through and/or around a unit which is in contact with the enemy. Elements of the unit passed through remain in position and provide support to the attacking unit until their fires have been masked. A passage of lines may be conducted to:

- (1) Maintain the momentum of an attack.
- (2) Change the direction of attack.
- (3) Exploit an enemy weakness by an attack with the reserve.

b. Areas of Passage.--When possible, the areas selected for the actual passage of lines should be the unoccupied areas between elements of the unit in position or on its flanks. This procedure reduces confusion and facilitates control by lessening the intermingling of the personnel of both units. Additionally, it reduces the vulnerability to enemy fires which exists in areas of high troop density. Movement from the assembly area through the area of passage and into the attack is continuous. Attack positions are not used.

c. Planning Procedures.--The commander of the unit to execute the passage of lines makes early contact with the commander of the unit in position to coordinate, as a minimum, the following details:

- (1) Exchange of intelligence.
- (2) Exchange of tactical plans to include fire support and communication plans.
- (3) Arrangements for detailed reconnaissance by elements of the attacking unit, or limited reconnaissance when time is a critical factor.
- (4) Measures for security of both units during the passage.
- (5) Selection of areas and routes of passage.
- (6) Provisions for guides for each squad size unit from the unit in position if the tactical situation permits.
- (7) Establishment of priorities for the use of routes and provision for movement control.

(8) Extent, type, and control measures for fire support to be provided by the unit in position.

(9) Extent of logistic support to be provided by the unit being passed through and procedures for continued support subsequent to the attack. This support includes the use of areas and facilities and the measures for the evacuation of casualties and prisoners of war.

d. Passage of Command.--The commander executing the passage assumes responsibility for the zone of action at a time mutually agreed upon with the commander of the unit in position, unless the time has been specified by higher echelon. When responsibility is transferred prior to the attack, the unit making the passage controls the elements of the unit in position that are in contact with the enemy at the time of transfer.

Section III. RECONNAISSANCE IN FORCE

8301. GENERAL

The reconnaissance in force is a limited objective operation conducted to discover and test the enemy's dispositions and strengths or to develop other intelligence. It is essentially an attack designed to produce enemy reaction and disclose his positions and strengths. The rifle company participates as part of the battalion when the battalion comprises the reconnaissance force of a higher headquarters. A suitably reinforced rifle company may conduct the reconnaissance in force for the battalion or higher headquarters.

8302. PLANNING

a. The reconnaissance in force is employed to develop enemy information rapidly. The commander, in considering the decision to reconnoiter in force, weighs the urgency of the additional information sought against the efficiency and speed of other collecting agencies. Reconnaissance in force may prematurely divulge the contemplated plan of action or risk a general engagement under unfavorable conditions. It is seldom justified when the loss of the reconnaissance force would seriously hamper subsequent operations. For this reason, the rifle company reconnoiters in force only when authorized by higher echelons.

b. Reconnaissance in force may be planned as a limited objective attack to seize specific terrain objectives, or it may be a phased advance along an axis to successively probe a series of terrain features.

c. The reconnoitering force is of sufficient size to cause the enemy to react and thereby disclose his locations, dispositions, strengths, planned fires, and planned use of local reserves. Once the enemy makes the disclosures intended by the commander ordering the reconnaissance, the reconnoitering force executes a preplanned withdrawal to break contact with the enemy. Planning for the conduct of a reconnaissance in force is very similar to the planning involved in daylight attack or mechanized attack. Fires are planned to assist the withdrawal. The withdrawal is discussed in section IV of this chapter.

8303. CONDUCT

The reconnaissance in force is conducted in a manner similar to a dismounted attack or a mechanized attack, depending upon its depth. In the dismounted reconnaissance, the rifle company attacks to seize designated terrain objectives as in any other daylight attack. In the mechanized reconnaissance, a mechanized rifle company, supported by tanks, advances on an assigned axis of advance and attacks a series of deep objectives. Restrictions are normally placed on the reconnaissance commander to avoid decisive engagement. The commander ordering the reconnaissance is prepared to exploit success or to assist in extricating the reconnaissance force if it becomes heavily engaged. On order of the higher commander, the reconnaissance force conducts a withdrawal or remains in contact and awaits relief or a new mission.

Section IV. RETROGRADE OPERATIONS

8401. GENERAL

A retrograde operation is any movement of a command to the rear or away from the enemy. It may be forced by the enemy or it may be made voluntarily. Such movements are classified as withdrawals, retirements, or delaying actions. Since any retrograde operation is dependent upon the situation and plan of action involving the force as a whole, proper execution is carried out in accordance with plans and orders of higher echelons. The withdrawal of platoons and companies can, therefore, be accomplished in the manner prescribed by orders of the battalion. These orders may be fragmentary and may be issued by staff officers in the name of the commander when there is not adequate time for detailed planning. The movement may be made by foot, vehicle, helicopter, or a combination of these means.

a. Types.--Retrograde operations are classified by three basic types:

(1) Withdrawal action in which all or part of a force is disengaged from the enemy to initiate other action.

(2) Delaying action in which a force trades space for time while inflicting maximum punishment on the enemy without becoming decisively engaged.

(3) Retirement in which a force avoids combat under existing conditions by conducting an orderly withdrawal according to its own plan and without pressure by enemy forces.

b. Purpose.--Retrograde movements are conducted to achieve one or more of the following purposes:

(1) Draw the enemy into an unfavorable situation.

(2) Permit the use of a force elsewhere.

(3) Avoid combat under unfavorable conditions.

(4) Gain time without fighting a decisive engagement.

(5) Disengage from combat.

(6) Avoid destruction by a superior enemy force.

c. Basic Considerations.--The commander ordering the retrograde considers the following:

(1) Terrain must be exploited to the maximum. Good observation and fields of fire are sought to permit engaging the enemy at long ranges. Maximum use is made of concealment and cover. Natural obstacles are supplemented with minefields and other artificial obstacles to strengthen defenses, protect exposed flanks, and delay the enemy. Emphasis is placed on denying avenues of approach and key terrain features to the

enemy. Efforts are made to canalize the enemy and force him to mass so he can be destroyed by fires.

(2) Demolitions and obstacles are employed to the maximum extent practicable in order to delay and disorganize the enemy advance. In planning use of demolitions, guidance is provided concerning the time or conditions under which demolitions are fired. A demolition firing party is designated and, when appropriate, guards are provided to prevent premature firing or seizure by enemy infiltrators. Care is exercised to ensure that demolitions do not hamper future operations in the area.

(3) Because retrograde operations are usually more difficult to control than other operations, plans and orders are in greater detail. The responsibility for executing the plans is often decentralized. As the course of action cannot be predicted with accuracy, plans are flexible. Alternate plans are prepared as time permits. Leaders at all echelons must be thoroughly familiar with the concept of the operation so they can make sound decisions if they lose contact with higher commanders. Retention of the initiative is important. Close combat is avoided unless required to accomplish the mission.

(4) Ground and air transportation is used, when possible, to move units rapidly. Detachments left in contact and covering forces normally have transportation priority. Special measures are needed to control traffic at critical points.

(5) Plans are made to ensure that civilian refugees do not hinder the operation by blocking withdrawal routes. Higher headquarters normally help in planning for the handling of refugees. Military material that cannot be evacuated is destroyed.

(6) Close cooperation and coordination are required when a withdrawing force passes through a friendly unit. Plans include measures for mutual recognition, routes to be used, points of passage, responsibility for zone, and priority of routes in the rear. The withdrawing unit passes through as quickly as possible to reduce the period of concentration. The withdrawing unit commander is responsible for notifying the unit in position when the last withdrawing element has passed.

(7) Security is obtained in retrograde operations through passive and active measures, including:

- (a) Maintaining normal radio patterns.
- (b) Providing front, flank, and rear security for withdrawing units.
- (c) Maintaining normal supporting fires and patrols.
- (d) Displacing during periods or conditions of reduced visibility.

(8) Morale considerations take on added importance during retrograde operations. Aggressive spirit is retained and full advantage taken of all opportunities for offensive action. Forceful leadership is emphasized in order to suppress rumors, keep men informed, and to maintain strict discipline and control.

8402. WITHDRAWAL ACTION

a. General

(1) In a withdrawal action, the company (or elements thereof) disengages from combat in order to position itself for employment elsewhere. The company may participate in a withdrawal as part of a larger force, on its own, or direct the withdrawal of certain of its subordinate platoons.

(2) Withdrawals are classified as either withdrawals under enemy pressure or withdrawals without enemy pressure. Withdrawals without enemy pressure are favored over withdrawals under enemy pressure as they provide more freedom of action, facilitate deception, and reduce the effectiveness of enemy observation and fires. In either type, contact is maintained with the enemy to deceive the enemy, to provide security, and to prevent a rapid enemy advance. Units lightly engaged may be withdrawn by helicopters.

(3) The commander ordering a withdrawal designates the location to which troops move and the action to be taken after the withdrawal. Although withdrawals are normally conducted in a direction generally perpendicular to the line of contact, on occasions, a limited lateral movement may be considered.

(4) During the withdrawal, limited objective attacks or counterattacks can be conducted to facilitate disengagement and keep the enemy off balance.

b. Planning for a Withdrawal

(1) Upon receipt of an order to execute a withdrawal, the commander follows the normal sequence of planning. The plan of withdrawal includes a scheme of maneuver and a plan of fire support. Both are developed concurrently and are closely integrated. In addition to the essential details of security, logistic support, and communications, it also includes all or most of the following:

- (a) New location of rear positions or assembly areas.
- (b) Sectors of withdrawals and/or routes of withdrawal for subordinate units.
- (c) Time of withdrawal and sequence of withdrawal of all subordinate units. If the exact time is not known, planning is based on H-hour.
- (d) Composition and mission of detachments left in contact (DLIC).
- (e) Location and composition of ambush.
- (f) Planned employment of supporting fires.
- (g) Tactical cover and deception measures.
- (h) Designation of control measures for coordination; i.e., phase lines, checkpoints, initial points, release points, rallying points.

- (i) Instructions for the movement of logistic installations to the rear.
 - (j) Evacuation of casualties.
 - (k) Provisions for evacuation and/or destruction of specific supplies and equipment.
 - (l) Traffic control measures and instructions relative to priority of movement.
 - (m) Alternate plans.
 - (n) Preparation of limited attack or counterattack plans to aid in disengagement of heavily engaged units.
- (2) Planning for the withdrawal should allow sufficient time for subordinate commanders to conduct daylight reconnaissance of routes, terrain, and new positions.

c. Withdrawal Without Enemy Pressure

(1) Concept.--The withdrawal without enemy pressure is executed with all possible stealth. It is conducted during periods of reduced visibility, natural or artificial, with maximum use of deception measures to deceive the enemy as to our intent. Upon execution, the main body of forward committed units withdraws to the rear, under the cover of the detachments left in contact. They simulate the normal activities of the unit by their fire, patrolling, and other deceptive means. In preparation for a withdrawal without enemy pressure, the battalion commander may prescribe special tactical measures such as limited objective attacks and raids to confuse and disrupt the enemy. Figure 75 is a schematic diagram of a withdrawal without enemy pressure.

(2) Planning

(a) When the company commander receives the battalion order, he issues a warning order immediately and starts his planning in accordance with the troop leading steps. He makes maximum use of available daylight for reconnaissance.

(b) The leaders of the company frequently cannot reconnoiter the new position personally. Since the company executive officer will be employed to command the detachments left in contact, the company commander normally directs the weapons platoon commander to command a reconnaissance detail for the new area. This detail consists of at least one representative from each rifle platoon, usually the platoon guide or platoon sergeant. Based on guidance from the company commander, the weapons platoon commander selects platoon defense areas and weapons positions and makes appropriate plans pertaining to the organization of the new position. The rifle platoon representatives prepare plans for the organization of their new platoon defense areas.

(c) The company commander may designate platoon assembly areas for the withdrawal and platoon routes to the company assembly area. Platoon assembly areas are normally immediately in rear of each platoon position. The company commander designates a portion of the company

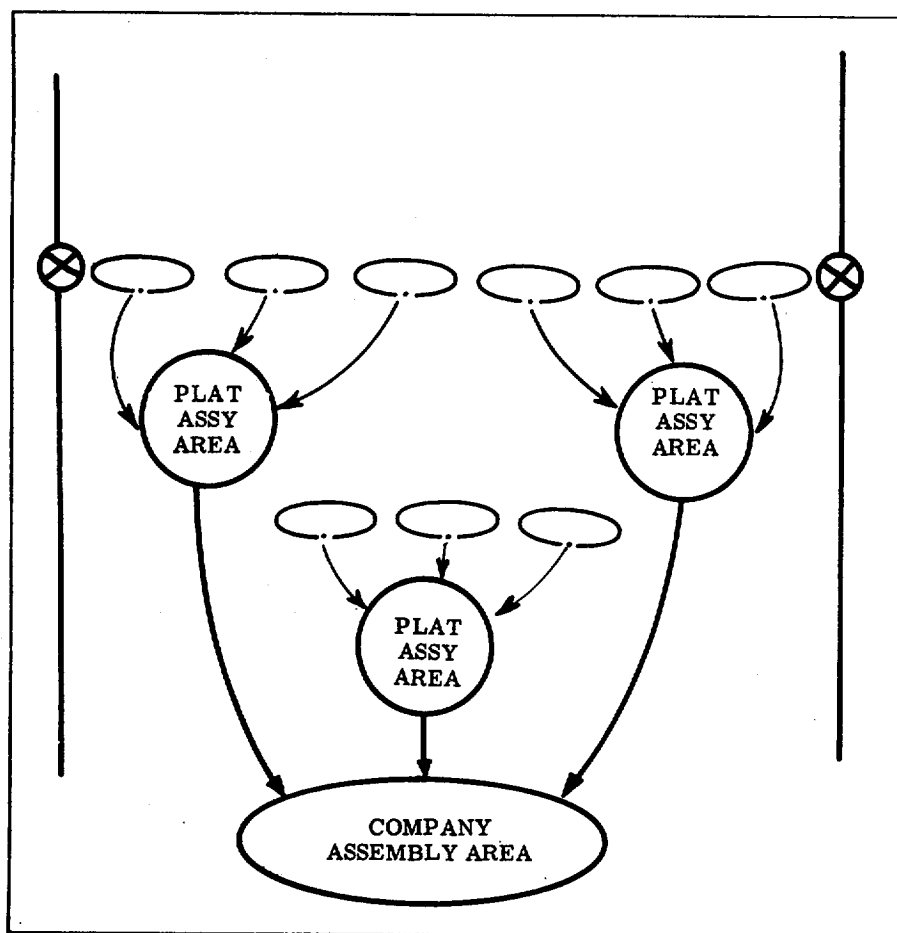

Figure 75.--Withdrawal Without Enemy Pressure (Schematic).

assembly area for each platoon. He specifies security measures to be taken in the company assembly area.

(d) The platoon commander designates squad assembly areas and routes to the platoon assembly area.

(e) Routes and assembly areas may be marked for ease of identification at night, if it can be done without compromising secrecy.

(f) To facilitate control during the withdrawal, weapons platoon elements are normally attached to the rifle platoon in whose area they are located. Attachments are normally effective only for the withdrawal.

(3) Detachments Left in Contact

(a) The detachments left in contact protect the withdrawal of the main body by deception and resistance. The strength of the detachments usually does not exceed one-third of the company's rifle strength,

plus about one-half of the weapons platoon. Normally, one rifle squad is left in each frontline platoon area. As a platoon withdraws, the squad left in place adjusts positions as necessary to cover the most dangerous enemy approaches into the platoon defense area and provides close-in protection for weapons platoon elements. A squad from the reserve platoon may patrol the company rear area or block a dangerous approach into the flank or rear.

(b) The crew-served weapons remaining in the area of the forward rifle company are attached to the detachments left in contact for their protection and the protection of the withdrawing main body and to provide normal fires to deceive the enemy.

(c) Tanks and Dragons may be withdrawn, under battalion control, before the main body withdraws. The battalion commander, as an alternative, may require that they remain with the detachments left in contact if there is a definite threat of enemy armor, or if deception is jeopardized by moving them. Tanks and Dragons remaining with the detachments left in contact are normally attached thereto and withdraw immediately before or at the same time as other elements of the detachments.

(d) A rifle squad leader commands each platoon detachment. Control of the detachments left in contact is assumed by the executive officer at a specified time or on order from the company commander. Similarly, the detachments from the entire battalion are commanded by an officer designated by the battalion commander. He assumes control as designated in the battalion operation order.

(4) Conduct

(a) The rearward movement of all rifle company elements, less the detachments left in contact, begins simultaneously at the designated time. Fire teams move to squad assembly areas, squads move to platoon assembly areas, and platoons move to the company assembly area. Column formations are normally used for ease of control. The movement is made quietly and rapidly. Consistent with the battalion plan and the reconnaissance made by platoon commanders, each platoon may be sent immediately to the rear as it arrives at the company assembly area. Sometimes the entire main body of the company may be assembled before any element is sent to the rear, although such halts are avoided if possible. Every effort is made to maintain continuous movement.

(b) The detachments left in contact cover the company's withdrawal. The company commander provides additional close-in security with small detachments to the front and rear of the main body and elements to block routes into the flank. The main body normally maintains radio listening silence. It may use wire lines along the route for communications with the battalion commander.

(c) At the specified time or on order, the detachments left in contact withdraw simultaneously. Squads normally move directly to the company assembly area where all are assembled. Before withdrawing, the detachments spoil wire lines by removing sections of the wire. The company detachments left in contact designate small groups to provide security for the movement from the assembly area to the rear. The time of withdrawal generally is prescribed by the higher commander. This should permit the detachments left in contact to join the main force prior to daylight.

d. Withdrawal Under Enemy Pressure

(1) Concept.--A withdrawal under enemy pressure is avoided whenever possible. If such a withdrawal is required, and the company is on the FEBA, a covering force is used to provide security for the withdrawing elements. Forward units withdraw intact and detachments are not left to cover the withdrawal. Success of the withdrawal under enemy pressure depends, in great part, upon at least temporary local air superiority and effective employment of covering forces.

(2) Planning

(a) It is desirable for all leaders to reconnoiter withdrawal routes, sectors, and subsequent positions, but time normally permits only limited reconnaissance. Reconnaissance parties may be used to reconnoiter successive positions. The company commander issues a fragmentary warning order as soon as possible to facilitate subordinate concurrent planning. Fragmentary orders are issued as plans are formulated.

(b) The company commander assigns each frontline platoon a sector, assembly area, and general route of withdrawal so he can coordinate and control their movement. The sectors of withdrawal for frontline platoons extend as far to the rear as it is anticipated the platoons will be required to move deployed for combat. Usually, this is no farther than the location of the company covering force, but it may be farther for platoons whose withdrawal cannot be covered by this force.

(c) The assembly areas are normally located in defilade to the rear of the company covering force. When the withdrawal of a frontline platoon cannot be covered by the company covering force, it may be necessary to locate the assembly area for that platoon to the rear of the battalion covering force. The assembly area for the company covering force is normally the company assembly area.

(d) Routes are designated from the platoon assembly areas to the company assembly area or a subsequent position, as appropriate. The routes pass around the flanks to the rear and offer as much concealment and cover as possible, consistent with the speed of the movement and the battalion plan.

(e) The covering force may have to be split so that elements are located where they can best cover the withdrawals of the frontline platoons. When the covering force is too far to the rear or flank to cover the withdrawal of the company covering force, the company commander may have the withdrawing rifle platoons occupy successive covering positions. Company organic weapons are attached to the platoons in whose areas they are located.

(f) The platoon commanders determine the probable order of withdrawal of elements of their platoons, and they may select tentative rallying points along the route of withdrawal.

(3) Conduct

(a) Depending upon the situation, the commander may order all forward units to withdraw at the same time, or he may order the least engaged forward units to withdraw first. The decision whether to withdraw

the most heavily or least heavily engaged unit first is a difficult one. To withdraw the most heavily engaged units first may subject the entire command to encirclement or destruction. To withdraw the least heavily engaged units first may result in the loss of all or part of the most heavily engaged units. The decision must ultimately be based on determining which plan best contributes to the overall accomplishment of the mission and which best preserves unit integrity. Supporting fires and smoke are used and a limited objective attack may be executed to extricate heavily engaged units.

(b) The company withdraws on order. If elements of the company are heavily engaged, the company commander usually orders the least engaged frontline platoons to withdraw first. If enemy pressure is about equal along the front, he may order all frontline platoons to withdraw at the same time by using fire and maneuver.

(c) Control of the platoon at all times is essential. The enemy situation dictates which of the tentative rallying points is used. The platoon sergeant may withdraw with or ahead of the initial elements of the platoon so that he can supervise the reestablishment of control of the platoon elements at the rallying point or can supervise the occupation of a subsequent position. Withdrawing elements pause at the rallying point only long enough to reestablish control. When the platoon withdraws using fire and maneuver, the position is thinned out gradually. Remaining automatic weapons are usually withdrawn last after other elements are far enough to the rear to be protected from enemy direct fire. Withdrawing units do not mask the fires of covering forces to the rear. Platoons assemble in platoon assembly areas and move immediately to the company assembly area, in rear of the battalion covering force.

e. Helicopterborne Withdrawal.--A withdrawal by helicopter is conducted much in the same manner as the withdrawals described above. However, additional assembly areas and helicopter loading areas are designated. As units assemble in the rear under the protection of the covering force, combat outpost, or detachments left in contact, they embark rapidly aboard helicopters. When units become helicopterborne, the remainder of their movement is actually conducted as a retirement rather than a withdrawal.

8403. DELAYING ACTIONS

a. General

(1) A delaying action is an operation in which a unit trades space for time and inflicts maximum casualties on the enemy without becoming decisively engaged in combat. Although the underlying principle of a delaying action is to gain time without fighting a decisive engagement, the company may be forced to accept close combat or a higher commander may order it to improve the overall situation.

(2) A delaying force consists of a security echelon, forward defense echelon, and a reserve. A rifle company may occupy the forward area, act as all or part of the security force, or it may be part of the battalion reserve. When extreme frontages are assigned, the battalion reserve may provide the security echelon.

(3) The mission may direct the delaying force to hold the enemy beyond a definite line until a stated time. The reason for the action is normally announced. The delaying force may conduct the operation from a single position or successive positions.

(4) During the conduct of the action, the delaying force maintains contact with the enemy. It delays to the maximum between, as well as on, successive positions. It takes advantage of all obstacles and employs maximum fire at long range.

b. Organization of Delaying Positions

(1) When selecting the exact location of a delaying position, the commander picks a position which incorporates the following characteristics:

(a) Good observation and fields of fire. The delaying force can normally develop long-range fires from positions on topographical crests. If a long delay on one position is required, consideration should be given to organizing the terrain to permit mutual support by flat trajectory weapons.

(b) Concealed routes of withdrawal.

(c) Obstacles to the front and flanks.

(d) Maximum concealment for the forces on the delaying position.

(e) Cross-compartment defense organization.

(2) The company commander normally is assigned an initial delaying position and a sector of withdrawal. The company frontage can be greater than in a defensive situation because, unlike the defense, the delaying action is usually conducted for a prescribed and relatively short period of time. Often, the company commander must use three platoons forward to cover the assigned frontage adequately. He retains a reserve, if possible, to provide flexibility and depth. The company organizes the extended frontage by accepting larger gaps between platoons, not by increasing the areas physically occupied by platoons over the maximum acceptable for a defense. The company commander covers the gaps between platoons with indirect fires, patrols, observation, and obstacles.

(3) The company commander designates platoon areas as he does for the defense, except that the forward edge of the platoon positions is normally on or near the topographical crest to provide long-range fires and observation and to facilitate withdrawal. The company organizes the ground indirect fires, patrols, observation, and obstacles.

(4) Weapons platoon elements are usually attached to the rifle platoon in whose area they are positioned. The rifle platoon commander places organic and attached weapons where they can obtain long-range fields of fire.

(5) The company commander normally prescribes platoon sectors of withdrawal. He designates as many subsequent platoon delaying positions as are required to control the company's action. The delaying positions

block key approaches and take advantage of natural and artificial obstacles. If the assigned frontage allows him to retain a reserve, he uses it as the company covering force.

(6) Platoon commanders select additional delaying positions within their assigned sectors. They are generally located so that the first elements of the platoon to withdraw from a position can occupy the next one to the rear to cover the withdrawal of the remainder of the platoon.

c. Conduct

(1) Permission to withdraw forward forces from a battalion delaying position must normally be obtained from the battalion commander. Consequently, the company commander keeps the battalion commander informed of the situation at all times to prevent frontline platoons from becoming so heavily engaged that they cannot be withdrawn effectively.

(2) By using long-range fires, every effort is made to stop the enemy's leading elements. An effective delaying action will force the enemy into the time-consuming task of deploying his forces to attack the delaying position.

(3) Normally, forward forces withdraw, on order, before they become engaged in close combat. The same principles as a withdrawal are applied.

(4) As the platoons withdraw from initial positions, they continue to delay in their assigned sectors. The first platoon elements to withdraw move rapidly to and occupy the next position to the rear, normally under the supervision of the platoon sergeant. These elements cover the withdrawal of the remainder of the platoon. The platoon may move by bounds to the first delaying position to the rear or move by alternate bounds and occupy two successive positions to the rear. The platoon fights to delay the enemy at each successive position, withdrawing only to avoid close combat. It withdraws in this manner until it passes the covering force of a higher unit. Then the platoon may assemble to continue its movement to the company assembly area or a subsequent delaying position, as appropriate.

(5) The company commander coordinates the actions of his withdrawing platoons. Consistent with instructions from the battalion commander, he orders his forward platoons to withdraw in time to prevent them from being cut off by an enemy force. When he has retained a reserve, he repositions it to block enemy penetrations and protect the flanks and rear. He uses patrols to maintain contact with adjacent units, provide flank security, and block enemy threats from the flanks. If the enemy withdraws from the attack, the company maintains contact and reoccupies the forward positions, if possible.

8404. RETIREMENT

a. A retirement is a retrograde movement in which a force withdraws without enemy pressure. It may be made following action or when no contact with the enemy has been made. In a withdrawal, the movement becomes a retirement after the main forces have broken contact with the enemy and march columns have been formed.

b. The rifle company executes the retirement with the infantry battalion as part of a larger force. The company makes maximum use of cover and concealment and avoids undue concentration as it retires, particularly when the estimated enemy nuclear threat is great. The battalion adopts a march formation in which the rifle company or its elements may perform security missions or march as part of the main body.

Section V. MINE WARFARE

8501. GENERAL

a. The tactical requirement for dispersion imposed by the prospect of combat in a nuclear environment and also the rapid pace of modern conventional warfare result in separation of units in depth and the development of large gaps between adjacent units. The threat of their exploitation by mobile enemy forces demands means of denying, limiting, or slowing his attempts to penetrate these gaps. Landmine warfare, when boldly and intelligently employed, can act as a powerful deterrent to enemy mobility. Landmines are an effective weapon in denying frontal and flank approaches, increasing rear installation security, and in obstructing gaps between units.

b. Minefields are used to delay, canalize, harass, and demoralize the enemy. Included in barrier plans, they are used to supplement other obstacles and weapons. The portability and weapon effect of each mine provides the commander with effective obstacles, particularly when mines are sown in fields of reasonable density.

c. The density of a minefield is expressed as the number of mines of any one type per linear meter of minefield trace or front where mines are laid by hand or machine. Density may also indicate the number of mines by type per square meter or minefield when mines are dropped from aircraft or scattered by hand or machine. Mine density is a measure of the degree of obstacle effectiveness in a minefield. A high density indicates more mines in a field than would be present if the density were lower. Normally, the density desired is directly related to the type and scale of enemy movement which the minefield is intended to deter and the tactical purpose it is designed to accomplish. For practical purposes, the depth of a minefield is not considered in determining its density.

8502. BASIC CONCEPTS

a. Methods of Employment.--There are three methods of installing a minefield: deliberate, hasty, and special technique. Deliberate minefields are those laid according to a standard pattern with the mines buried. Hasty minefields are laid without pattern and usually with the mines unburied. Special technique minefields are those laid with special purpose mines requiring specific techniques or adaptation of standard mines to unusual situations which differ from normal minefield installation. Hasty or deliberate methods may be employed in protective and defensive minefields.

b. Authority to Employ.--The authority to employ minefields is vested in battalion and higher commanders. It may be specifically delegated to the next lower commander, when the situation warrants. Normally, the authority to lay mines is held by the highest commander whose operations may be affected by the mines. Mine employment at each command echelon must be consistent with the overall concept of operation, probable future missions, and available resources.

c. Coordination of Information.--It is imperative that information concerning mine warfare operations be disseminated to subordinate and adjacent units, as well as higher authority. Proper use of reporting and

recording procedures and effective liaison with affected units contribute to coordination. Accurate and timely records and reports are mandatory.

d. Obstacles.--Their ability to inflict casualties and damage vehicles establishes mines as an excellent active obstacle. Minefields are integrated with demolition projects and artificial and natural obstacles to create effective barriers to the enemy advance.

8503. TACTICAL CLASSIFICATION OF MINEFIELDS

The basic tactical classification of minefields is in accordance with the purpose of their employment. These are protective, defensive, barrier, nuisance, and phony. Minefields may also be identified according to the type of enemy movement to be obstructed; for example, antipersonnel, antitank, anti amphibious, and anti airborne minefields. Moreover, mining activity may be described according to the type of terrain in which mines are employed; for example, route mining, beach mining, river mining, and field mining. The identification of minefields in accordance with their purpose or the type terrain in which mines are installed does not alter the basic tactical classification. Thus, a barrier minefield may include segments of route mining, field mining, and river mining; and an anti amphibious minefield may serve as a protective, defensive, barrier, or nuisance minefield.

a. Protective Minefield.--A protective minefield is one which is simple, shallow in depth, and narrow in frontage. It is employed to assist a unit in local close-in protection.

(1) Antitank and antipersonnel mines, flares, and flame mines may be used. Chemical mines and antihandling devices are not employed in protective fields.

(2) Protective minefields are sited across the most likely enemy avenues of approach. They are located within range of organic weapons of the employing unit but beyond enemy hand grenade range. Protective minefields are removed by the installing unit unless responsibility is transferred to a relieving unit; in which case a "report of transfer" is submitted to the appropriate command. The company may be delegated the authority to employ protective and phony minefields.

b. Defensive Minefield.--A defensive minefield is one employed to defeat or limit penetration into or between company defensive areas, to strengthen or link other obstacles, and to reinforce defensive areas themselves.

(1) To achieve maximum effectiveness, defensive minefields must be covered by observation and fire.

(2) Location of mines are part of the coordinated fire support plans.

(3) Density, location, and type of mines will be determined and support from engineer units usually will be utilized in laying.

c. Barrier Minefields.--The barrier minefields are employed to canalize, disrupt, and delay the enemy attack. Normally, barrier minefields are laid in considerable depth. Authority to employ is reserved by division or higher commanders.

d. Nuisance Minefields.--Nuisance minefields are employed to delay and disorganize the enemy and to hinder his use of an area or route. Since the hazard presented to friendly troops by nuisance minefields may restrict future maneuver, only the highest commanders are authorized to employ nuisance minefields.

e. Phony Minefield.--A phony minefield is an area of ground used to simulate a minefield with the object of deceiving the enemy. Its purpose is to deceive the enemy when he has become mine conscious.

(1) A phony minefield may be employed by any commander who has the authority to use the type minefield simulated.

(2) Its composition may include phony mines or may have the earth disturbed and the area littered with evidence of mining. Real mines are not used.

(3) Fire coverage of a phony minefield is the same as that provided for the simulated minefield.

8504. PLANNING AND SITING

a. Siting of Minefields.--Primary consideration and priority in siting is given to blocking likely avenues of enemy approach, particularly when short-term use is contemplated, or time, material, and effort are critical. Minefields are sited in such a manner that they are anchored to other natural or artificial obstacles whenever possible. Mines are employed by types in accordance with trafficability of the terrain and the nature of the enemy threat. Whenever possible, they are located so that they can be covered by fire or are accessible to mobile fire support teams.

b. Siting of Lanes and Gaps.--Mines must contribute to the destruction and delay of the enemy with minimum hazard to the user. Minefields must conform to the plan of the commander responsible for large scale maneuver and must be sited to allow the unit protecting the field and adjacent units to execute operational plans such as patrolling, attacking, and counterattacking. For this reason, lane and gap locations and sizes, together with provisions to close or relocate them, are incorporated into the original design of the mined area.

(1) The general locations of lanes and gaps should be given to the commander of the laying unit by the tactical commander establishing the field. Lanes and gaps are skillfully sited so that their locations are not easily determined by the enemy. Their trace should be irregular and should not follow established roads or paths. Efforts should be made to deceive the enemy as to their locations.

(2) The locations of lanes and gaps are changed periodically to prevent enemy detection and subsequent ambush of friendly patrols. In minefields having a high density of small, nonmetallic mines, locations for future lanes and gaps should be determined before the field is installed so that metallic mines may be laid in those areas. This assists in relocation of the mines by using a mine detector.

8505. STANDARD PATTERN MINEFIELD

a. General.--United States mine warfare doctrine requires the use of a standard pattern a majority of the time. When time, logistic

support, or sufficient personnel are not available, nonstandard or scattered patterns may be authorized. A prescribed standard pattern affords the following advantages:

- (1) Speed and efficiency in laying mines.
- (2) Thorough coverage and adequate mine density.
- (3) Ease of recording.
- (4) Rapid clearing of the minefield.
- (5) Facilitates training of personnel.

b. Mine Cluster

(1) The basic unit of deliberate, manually laid minefields is the standard cluster pattern. Figure 76 shows a typical cluster pattern minefield consisting of a minimum of three regular strips of mines and one irregular strip. The irregular strip or "irregular outer edge," when laid, is always on the enemy side of the minefield. Regular strips are lettered in alphabetical order beginning with the one nearest the enemy.

(2) A cluster may consist of one mine or as many as five mines of certain types. When more than one mine is used, the additional mines are placed within a 2-pace radius of the base mine. Only one antitank mine is placed in a cluster and it is the base mine. When no antitank mine is used, an antipersonnel mine, preferably metallic, becomes the base mine.

(3) A mine strip consists of two rows of mine clusters. In a manually laid field, row number one is nearest the enemy and is parallel with the strip centerline at a distance of 3 paces. Row number two is parallel to and 3 paces from the centerline on the friendly side. The clusters in row number two are staggered so that they lie between the clusters in row number one. Clusters are numbered consecutively from the first cluster in row number one to the first cluster in row number two throughout the strip, so that all clusters in row number one have odd numbers and those in row number two have even numbers. (See fig. 76.)

(a) Tripwire actuated antipersonnel mines are always placed in row number one, no more than one to a cluster and no closer than one in every third cluster. Tripwires should point toward the enemy from the strip centerline and should be no closer than two paces to another cluster, tripwire, or safety line.

(b) The minimum distance between adjacent strip centerlines is 18 paces. Strips need not be parallel with one another and may have as many turning points (changes of direction) as desired. Each segment of a strip (change of direction) is numbered consecutively starting with one at the strip marker stake indicating the turning point.

(c) The irregular outer edge (IOE) is used to confuse the enemy as to the pattern and spacing of mines in the regular strips. The use of IOE is largely dictated by the time allowed for construction of the minefield and the terrain of the laying site. The irregular strip consists of short sections of a regular trace with a varying number of clusters in each section. The number of mines in the IOE is about one-third the total

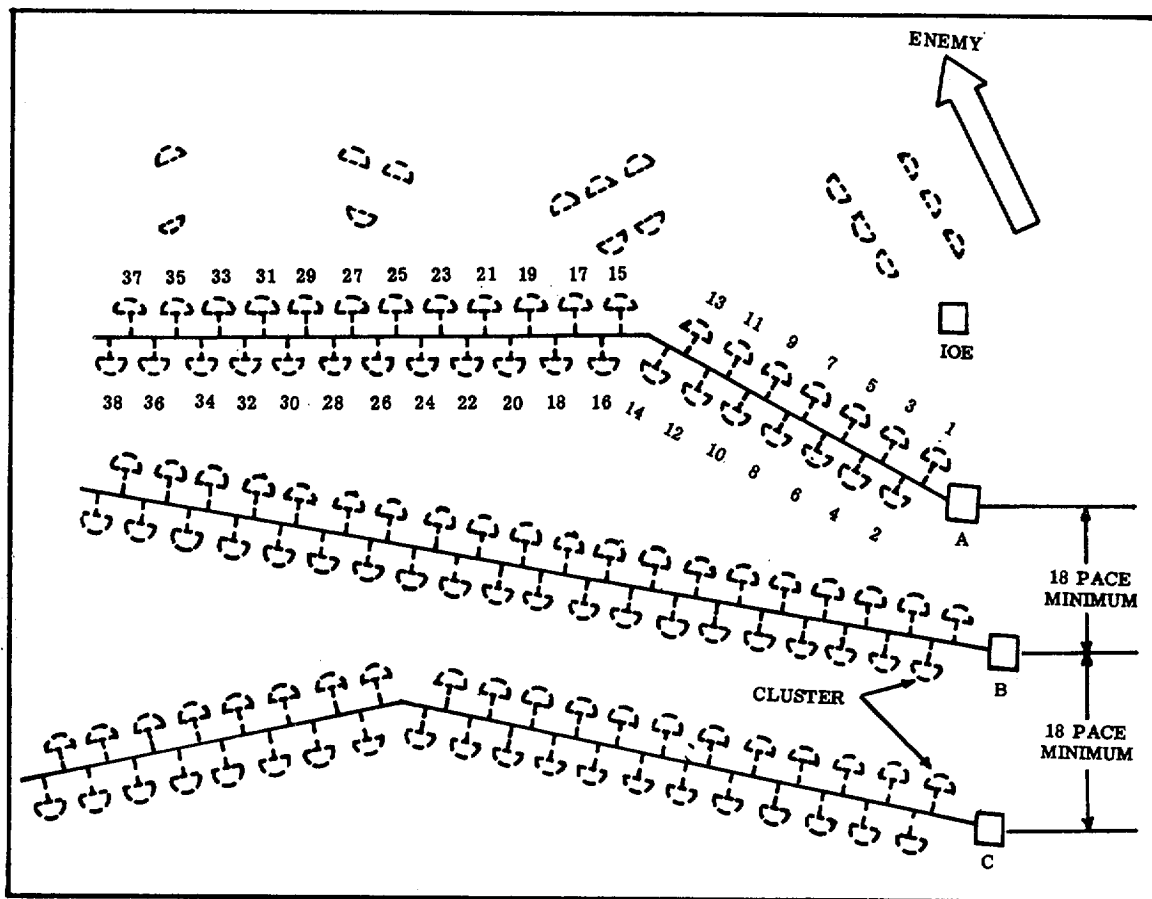

Figure 76.--Method of Numbering Clusters in a Mine Strip.

number of antitank mines laid in a regular strip. The number of mines in each cluster of the IOE may be varied as desired within the limits described in subparagraph b, above.

(4) The standard row and strip are used in a manner most suitable for the situation. Single strips may be used as needed; for example, in perimeter security, roadblock, and route mining. However, the typical minefield should be used whenever feasible and time permits.

c. Minefield Lanes and Gaps

(1) A minefield lane is a safe path or route through a minefield. Lanes through friendly fields are 8 meters wide for one-way vehicle traffic and 16 meters wide for two-way vehicle traffic.

(2) A minefield gap is that portion of a minefield in which no mines have been laid. The purpose of a gap is to enable a friendly force to pass through the field in a tactical formation. Gaps are of specified widths, seldom less than 100 meters.

Personnel	Officer	NCO	Enlisted	Equipment
Supervisory Personnel	1	1	-	Officer: Map, lensatic compass, notebook, and DA Form 1355 NCO: Map, notebook, and lensatic compass
Siting Party	-	1	3	Stakes or pickets, sledges, Hammers, tracing tape on reels, and nails to peg tape
Marking Party	-	1	2	Barbed wire on reels, pickets, Marking signs, lane signs, wire cutters, gloves, and sledges
Recording Party	-	1	2	Sketching equipment, lensatic compass, DA Form 1355, map and metric tape
1st Laying Party	-	1	6 to 8	Notebook for squad leader, picks, shovels, and sandbags
2d Laying Party	-	1	6 to 8	Same as 1st laying party
3d Laying Party	-	1	6 to 8	Same as 1st laying party
TOTALS	1	7	25 to 31	

Figure 77.--Platoon Organization and Equipment for Minefield Laying.

8506. MANUAL LAYING OF MINEFIELDS

a. Organization for Laying Minefields.--The platoon is the basic unit for installing a standard pattern minefield. The organization shown in figure 77 will serve as a guide for a typical platoon mine laying operation.

(1) Duties of Personnel

(a) The platoon commander as officer in charge (OIC) is responsible for the entire operation of the laying unit. When laying commences, he makes a report of initiation to the headquarters authorizing the field. At the site, the officer in charge indicates the traces of mine strips and marking fences, the location of dumps for mines and materials, the landmarks, and the location and marking of lanes. He indicates the cluster composition to each laying party NCO, including tripwire actuated mines, verifies the completed minefield record, and reports the completion of laying. The officer in charge submits progress reports during the laying operation which may be required by his headquarters.

(b) The platoon sergeant acts as the second in command of the laying unit. He tells each laying party NCO where to lay mines with

antihandling devices, if any, and establishes traffic tapes between strips. He keeps a record of mines initially placed in dumps or aboard trucks and verifies the arming by collecting safety pins and clips from laying party NCO's. He has these safety devices buried within one-third meter to the rear of the strip marker at either end of each strip. He assigns additional duties to siting, marking, recording, and laying personnel, as required. He supervises the removal of safety line tapes and the laying of traffic tapes, and has excess spoil and other indications of mine laying removed when directed by the officer in charge.

(2) Siting Party.--As directed, the siting party places boundary stakes or pickets at the beginning and end of each mine strip and additional stakes at points where strips change direction. It lays tracing tape between boundary stakes and stakes out the centerline of each strip. The party tapes lanes, safety lanes, and traffic paths as directed. Upon completion of assigned tasks, the siting party augments other parties as directed.

(3) Laying Parties.--Each laying party is assigned the installation, arming, and camouflaging of all mines on a strip or portion of a strip. Upon completion of the initial task, each party is assigned additional strips or portions of strips. As directed, laying parties establish mine dumps and unload mines from trucks.

(4) Recording Party.--The recording party obtains the necessary reference data and makes out DA Form 1355. (See par. 8507e.) The party also installs intermediate markers, when used. When possible, the recording party records critical distances in meters; i.e., distances from lane and strip markers to landmarks, distances between strip markers, and extent of field.

(5) Marking Party.--As directed, the marking party erects marking fences and signs and, if applicable, marks lanes. Upon completion of assigned tasks, it augments other parties as directed.

b. Laying Out the Field

(1) Orders to the officer in charge of the laying unit specify the type and classification of the minefield to be installed. They also state the proposed location, width, density, and depth of the field, the types of mines to be used, the amount of fence, and the existing obstacles to which the field can be anchored. On receipt of such orders, the officer in charge makes a map study and a personal reconnaissance of the site, accompanied by the platoon sergeant. On reconnaissance, he determines the locations of each mine strip, locations of landmarks for referencing, location of the fence, and additional details such as locations for mine dumps and approach routes. He prepares a sketch of the field which shows these details and determines the number of mines that will be required. He arranges for mines to be drawn and issues oral orders, using his minefield sketch to explain his plan to his NCO's. The pace is used as the unit of measurement in laying the minefield. All minefield components are spaced in multiples of 3 paces except the spacing of mines within a cluster. All minefield components are installed by the use of paces.

(2) Arriving at the site with his siting and marking parties, the officer in charge proceeds to the inner (rear) right-hand boundary of the field, determined by facing in the direction of the enemy. He indicates the

starting point of the rear strip and his siting party drives a boundary stake to mark this location. He then designates a starting point for the marking party at least 20 paces to the right and indicates, by reference to his minefield sketch and specific terrain features, the trace (location and direction) of the marking fence. The marking party immediately begins to install fence pickets. When the field is to be fenced only on the flanks and rear, they begin at the indicated point and work clockwise. When all pickets are installed, the marking party encircles the field with a single strand of barbed wire and, when it is in place, installs the second strand.

(3) From the boundary stake of strip C, the officer in charge paces in the direction of the enemy and establishes the starting point of strip B, keeping in mind that the centerlines of the strips should not be parallel and at least 18 paces apart. Two men of the siting party drive a stake at the starting point of strip B and the remaining two men begin to lay tape between the two stakes. The tape is fastened to the ground at frequent intervals to prevent movement. This procedure is followed until the right-hand boundary stakes of the three-lettered strips and the IOE have been installed, with varying distances between each.

(4) At the right-hand boundary stake of the irregular edge, the officer in charge gives his minefield sketch to the siting party NCO and instructs him on siting the mine strip centerlines. The NCO and one other man immediately begin setting stakes at turning points to indicate the trace of the IOE, followed by the centerline laying team. Tape reels are left where tapes run out. On reaching the left-hand boundary of the IOE, the siting party NCO establishes the left-hand boundary stake of strip A and stakes out this strip. The procedure is followed until all strip centerlines are taped. Stakes are driven flush with with ground at turning points.

(5) While the IOE is being taped, the recording party begins obtaining reference data for preparation of the minefield record, starting from the landmark designated by the officer in charge and working behind the siting party. The amount of detail obtained by the recording party depends on the classification of the field and the orders of the commander authorizing its installation.

(6) As soon as the laying parties arrive at the site with the mines, they establish mine dumps behind the field at approximately 150-meter intervals. (See fig. 78.) This work is supervised by the platoon sergeant. Mine crates are taken from trucks to dumps where the antitank mines are uncrated and stacked. Other type mines are left in their crates but crate lids are removed. Fuzes and detonators are placed in separate boxes; fuzes of one type are not mixed with fuzes of another type.

(7) When the siting party completes the staking of centerlines, it installs safety line tapes, lane tapes, and traffic tapes in that order. Traffic tapes are needed to reduce the amount of walking by laying party personnel when obtaining mines from dumps and to assist in camouflage by reducing the amount of traffic on strip centerlines. Traffic tapes are laid approximately perpendicular to the minefield trace at about 100-meter intervals. Tapes to mark safety lanes for vehicles and patrols also can be utilized as traffic tapes. The traffic pattern of mine laying personnel is counterclockwise along the boundary, traffic, centerline, or lane tapes. Figure 79 shows the tape layout of a minefield.

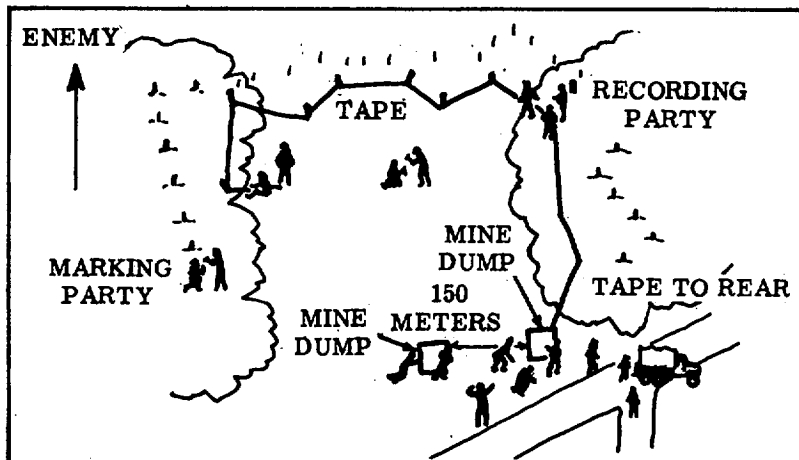

Figure 78.--Laying Out Strip A and Establishing Mine Dumps.

c. Laying a Regular Strip

(1) From orders of the officer in charge, each NCO in charge of a laying party knows the cluster composition of the strip his party is to lay and any variations in cluster composition. When the centerline tape for a regular strip has been installed, the NCO in charge of the party assigned to lay that strip designates all of his party as layers, except two men who are to fuze the mines. Layers pick up a maximum load of cluster base mines. The fuzers carry all the fuzes and detonators.

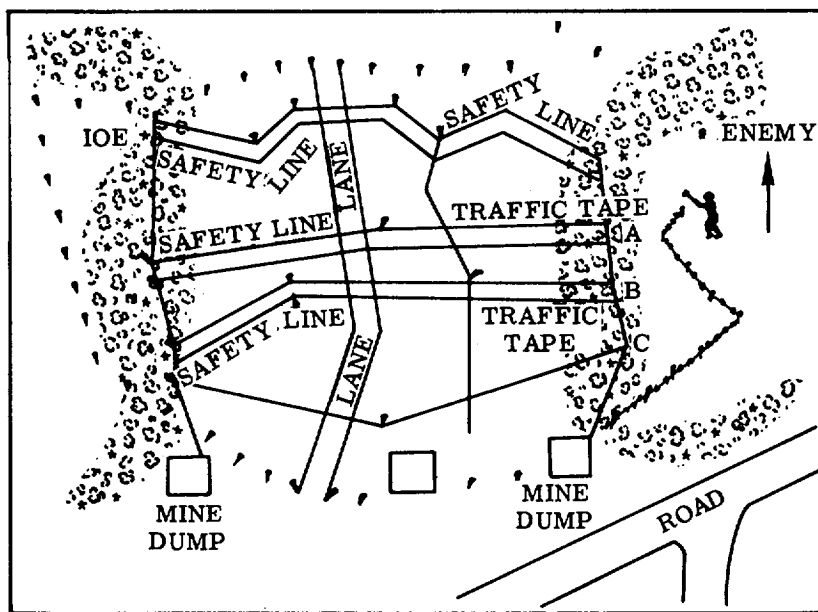

Figure 79.--Minefield Layout by Tape.

(2) The NCO then goes to the right-hand boundary stake of the strip and forms his layers in two columns to his rear, 6 paces apart. The NCO then steps off along the centerline; he stops at 3 paces. With his right arm pointing in the direction of the enemy, he indicates the placement of the first mine. The NCO next steps off the next 3 paces and, with his left arm, indicates the friendly side of the strip. The first layer on that side places a mine on the ground. As the initial load of mines is laid, each layer returns to the nearest mine dump for another load. Fuzers work behind layers inserting fuzes and/or detonators (minus safety clips) in the antitank mines and placing the arming dial, on mines so equipped, on "safe." Fuze safety clips are turned over to the NCO. This procedure is followed until the left-hand boundary stake of the strip is reached. Then, the NCO orders layers to obtain antipersonnel mines from a mine dump and tells them the number and types of mines to be placed next to the base mine of each cluster. As antipersonnel mines are being placed, the NCO proceeds along the strip placing all mines in each cluster where he wants them. He places a spool of tripwire next to each mine that is to be tripwire actuated. He indicates antitank mines which are to be equipped with antihandling devices by turning them upside down.

(3) When all mines are fuzed, layers return to the starting point for shovels. Each man is assigned to dig holes for all mines in one cluster. Spoil from the holes in one cluster is placed in a sandbag and left beside one of the holes. Each digger checks the positioning of mines in the holes but leaves the mines beside holes. Diggers anchor tripwires with nails or stakes and wrap loose ends around fuzes. When digging has progressed at least 25 meters from the starting point, the arming operation begins. One man arms all the mines in a cluster, beginning with the mine farthest from the centerline and working back. He places mines in holes, attaches tripwires, covers and camouflages each mine, removes safety clips, then places sandbags containing spoil on the centerline tape opposite the base mine of the cluster. Individuals arming mines keep their feet toward the centerline and stay at least 25 meters from other personnel at all times. When a cluster contains a mine to be equipped with an antihandling device, the cluster is usually left unarmed until all clusters within 40 meters are armed and all personnel are a safe distance away. Mines located in lanes are not buried. They are placed there to prevent confusion in keeping the cluster numbers straight. The holes are filled in and the mines are carried to the lane entrance. Fuzers give their safety clips to the NCO who verifies the count. After all mines are armed and concealed, the NCO checks the strip and organizes his party to pick up sandbags, tapes, and debris. Upon completion of this task, he turns over the safety clips to the platoon sergeant who assigns him other duties such as installing another strip, if required.

d. Installing the IOE

(1) The officer in charge informs the NCO of the laying party assigned to the IOE of the total number of mines to be installed and indicates the areas where the heaviest concentrations of clusters are to be laid. The NCO then decides on the composition of each cluster. Unlike the clusters in the regular strip, clusters in the IOE differ from each other in type and number of mines.

(2) The procedure followed is basically the same as that described in subparagraph 8506c, but the NCO does not have a mine laid at every 3-pace interval. Along the less likely avenues of enemy approach,

he may have only a few clusters installed at widely spaced intervals. In areas affording the enemy logical routes of approach, he may have clusters installed at regular 3-pace intervals. Generally, he omits about two-thirds of the clusters.

8507. REPORTS AND RECORDS

a. General.--Mine warfare may be flexibly employed; however, reporting and recording are mandatory in all its phases. Reports and records are made on all minefield laying and alteration activities. Minefields are reported and recorded to inform commanders of mined areas which may affect future operations, to expedite the transfer of responsibility for minefields from one unit commander to another, and to facilitate the removal of the minefield by friendly units.

(1) A minefield report is any message or communications, normally verbal, concerning either friendly or enemy mining activities.

(2) A minefield record is a written record of pertinent information concerning a minefield. It is normally prepared by the recording party of the laying unit on DA Form 1355 and is signed by the officer in charge of the laying unit.

b. Minefield Reports.--Three informal reports are made on every minefield laid by friendly troops. These reports are classified secret.

(1) Report of Intention to Lay.--Any commander having the authority to install a minefield must make an immediate report of his intention to lay a field to the next higher commander before initiating laying operations. The report of intention to lay may be made by any secure means. The contents and format of this report, arranged in a manner to facilitate transmission by electrical means, is illustrated in figure 80.

(2) Report of Initiation of Laying.--When the commander of the laying unit is ready to begin operations, he informs the next higher commander. This report is forwarded to the commander authorizing the field and is posted on situation maps.

(3) Report of Completion of Laying.--Immediately after completion of the laying, the laying unit commander informs, by any secure means,

EXPLANATION OF CONTENTS	LETTER DESIGNATION	DATA
Tactical Objectives	ALPHA	
Types of Mines	BRAVO	
Number and Types of Lanes, if known	CHARLIE	
Coordinates of Minefield	DELTA	
Estimated Starting and Completion Time and Dates	ECHO	

Figure 80.--Report of Intention to Lay.

EXPLANATION OF CONTENTS	LETTER DESIGNATION	DATA
Changes in Information Submitted in Intention to Lay Report	ALPHA	
Total Number and Type of AT & AP Mines Laid	BRAVO	
Date & Time of Completion	CHARLIE	
Method of Laying Mines (Hand, Mach.)	DELTA	
Details of Lanes & Gaps Including Their Markings	ECHO	
Details of Perimeter Marking	FOXTROT	
Overlay Showing Perimeter, Lanes, and Gaps	GOLF	
Laying Unit and Signature of Ind. Authorizing Laying of Field	HOTEL	

Figure 81.--Report of Completion of Laying.

the next higher commander. This report is normally followed by DA Form 1355. The report of completion of a protective minefield is usually forwarded no higher than division level. See figure 81 for content and format of this report.

c. Progress Reports.--These are reports submitted by the commander of a unit installing a large field to keep the higher headquarters informed of the amount of work completed. This is a matter of command SOP.

d. Report of Transfer.--A report of transfer is a written report which transfers the responsibility for a minefield from the commander of a unit which is responsible for the field when the unit is relieved to the relieving unit commander. A report of transfer must be signed by both the relieved and relieving commanders. It must include a certificate stating that the relieving unit commander has been shown on the ground or otherwise informed of all mines within his zone of responsibility, and that he assumes full responsibility for such mines. The report of transfer is forwarded to the next higher commander having authority over both the relieved and relieving unit commanders. (See sec. II.)

e. DA Form 1355 Minefield Record

(1) Preparation of the standard minefield record form is the responsibility of the commander of the laying unit. It is signed by him and forwarded to the next higher headquarters as soon as possible. When completed, DA Form 1355 is classified secret. Minefield records can easily be circulated on a need to know basis. Minefield and boobytrap records are marked "SPECIMEN" when used for training purposes. (See fig. 82.)

Par. 8507

FMFM 6-4

SECRET (when completed)

MINEFIELD RECORD										Copy No. _____	
(FM 20-3)										Sheet _____ of _____ Sheets.	
Authority for Laying: _____			Date & Time: Start: 25100 Oct 68 Completion: 30100 Oct 68		Minefield No: LXX(LNF)-15-E Map Name and Scale: Tolboville 1:25,000					Sheet No. for Name: 6561	
Laying Unit: 1 Co. 3rd Bu 7th Marines			Officer in Charge: PG Knowse 1st Lt 082445216		Recorder: Ben Sarte Sgt 2nd Lt						
LANDMARKS						INTERMEDIATE MARKERS					
No. Co-ordinates Description						No. Description					
34 2677 B-1						1 Three Steel Pickets wrapped with					
34 2674 SW Corner Building (Brick)											
Description of Boundary Fence: Standard											
No. of Strips: _____ Description of Strip Markers: Stakes Driven Flush											
ANTI-TANK MINES						ANTI-PERSONNEL MINES					
Type		Type		Type		Type		Type		Type	
No.		No.		No.		No.		No.		No.	
34				0		0		112		112	
Total AT Mines		Total AP Mines		Anti Hoo/Die Device		M14		M249		Total AP Mines	
34		0		0		112		112		112	
Total		310		310		15		620		310	
Total		310		310		15		620		310	
NOTES											
Lane Entrance: Marked By 3 stakes of tracking tape wrapped around bottom of fence picket.											
Lane Exit: Marked by one wooden stake driven flush alongside fence picket.											

DA FORM 1355

REPLACES EDITION OF 1 JUN 58 WHICH IS OBSOLETE.

SECRET (when completed)

Figure 82.--Minefield Record With Minimum Information.

(2) DA Form 1355 consists of a single, printed sheet, the upper half for tabular data and the lower half for a scale sketch of the field. Instructions for completing the forms are printed on the reverse side. Maximum length of the field to be recorded on one form is 400 meters at a scale of 1 centimeter equal to 10 meters.

8508. BREACHING OPERATIONS

a. Information as to the location and size of a minefield may come from many sources.

b. Individual mines and boobytraps are most often detected by visual means, by probing, or by electrical detection. Knowledge of the mine habits of a particular enemy often aids in locating his mines. The following are likely locations for mines:

- (1) Potholes, road patches, or soft spots in surfaced roadways.
- (2) Under the edges of road surfacing at the junction of the surfacing and the road shoulder.
- (3) On road shoulders where mines are easily laid and camouflaged.
- (4) At locations which block logical bypass routes around a blown bridge or cratered road.
- (5) Around the edges of craters and ends of damaged bridges or culverts. Antipersonnel mines are sometimes placed in craters if the craters are likely to be used as shelter from enemy artillery fire or air bombing.
- (6) In barbed wire entanglements, wire fences, and similar obstacles. In any other type of obstacle such as abandoned vehicles or among felled tree trunks or limbs across roads or trails.
- (7) Near any unusual object which may have been placed by the enemy for his own use such as a minefield marker.
- (8) In places where it is natural to drive a vehicle such as turnouts, parking lots, in front of entrances to buildings, narrow defiles, and airfield runways.
- (9) Near bodies or souvenir materials such as pistols, field glasses, and bottles of liquor.
- (10) In likely bivouac or assembly areas and in buildings suitable for use as command or observation posts.

c. There are four general courses of action which may be resorted to in countering a mined area:

(1) Bypassing mined areas is usually the best course of action. This may be accomplished by either circumventing the mined area on the ground or by helicopterborne movement over the mined areas. In some situations, circumvention on the ground may be impossible because of terrain characteristics, time limitations, or the possibility of being canalized into disadvantageous areas or positions.

(2) Hasty breaching is an assault tactic which is sometimes necessary when the tactical situation does not permit time to reconnoiter and bypass, clear, or deliberately breach the obstacle. It involves blasting with demolitions and shoving rollers, flails, and disabled vehicles

through minefields to create mine-free lanes. It is a course of action usually selected only during fast-moving operations. Mine clearing devices suitable for use in hasty breaching are tank-pushed, mine-clearing rollers and linear explosive charges. Artillery and mortar fire and air strikes are expedient breaching techniques. The resulting gaps are not usually completely mine-free and may sensitize the field, making it more dangerous.

(3) Deliberate breaching of minefields is a major operation requiring extensive planning, specially trained personnel, and positive methods of locating and removing each mine. Individual mines are located using portable and vehicular-mounted mine detectors and mine probes. Mines are marked and are then destroyed in place, removed by rope, or where required, by hand. Lanes are marked as they are cleared.

(4) Minefield clearance is the removal or destruction of all mines in a minefield and is normally done on areas which are not under enemy observation or fire. Minefield clearance is an extension of deliberate minefield breaching and employs the same materials and techniques. Whenever possible, minefield clearance is accomplished in daylight and under favorable weather conditions. Speed is secondary to thoroughness in minefield clearance operations.

Section VI. NUCLEAR, BIOLOGICAL, AND CHEMICAL DEFENSE

8601. GENERAL

The rifle company is required to be prepared to operate effectively in all geographical areas and under all conditions of warfare including situations short of war, limited war, and general war. The latter includes a conflict in which the entire spectrum of NBC weapons may be used. However, any of the three conditions may result in the employment of radiological, biological, and chemical contaminants without resorting to the blast effects of nuclear weapons. In such warfare, coverage of wide areas with toxic chemical agents, biological agents, or radioactive materials can be expected. The varied weapons available in these fields are capable of producing mass casualties and extensive damage. Commanders must ensure action to protect personnel, arms, equipment, and supplies from the effects of NBC weapons and agents if the combat mission is to be successfully executed. Training and readiness measures are implemented to provide individuals and units with effective defensive procedures.

8602. DEFENSE PERSONNEL

a. Assignment.--Marine Corps tables of organization provide billets in certain organizations for NBC defense personnel. In Fleet Marine Force companies, batteries, squadrons, and larger size commands for which the tables do not include such billets, a minimum of one officer and four enlisted assistants are normally assigned NBC defense duties in unit SOP's as additional duty. Current Marine Corps orders establishing NBC defense policies direct such assignments.

b. Duties.--NBC defense personnel assist the commander in NBC defense by performing the staff functions of planning and supervising training, operations, logistic support, and intelligence. The special tasks for these billets include:

(1) Conducting surveys, monitoring, detecting, identifying, and decontaminating NBC agents and munitions.

(2) Training, supervising, and controlling others in the performance of the tasks listed above.

8603. TRAINING

a. General.--Two levels of training are necessary in NBC defense. Defense personnel must have a level of training requisite to their assignments, and all Marines must be capable of self-protection to a degree permitting them to accomplish their missions during and/or after NBC attack.

(1) Defense Personnel.--Training to qualify personnel for the billets described in paragraph 8602 is provided at the U.S. Army Chemical Corps School, Ft. McClellan, Alabama; the U.S. Navy School Command, Treasure Island, San Francisco, California; and at local schools conducted by major commands. Most major subordinate commands of the Fleet Marine Force conduct NBC defense schools to train personnel for instructional duties and defense billets.

(2) Individual.--The training of the individual Marine in NBC defense procedures is a command responsibility. It is an inherent responsibility of command and devolves upon the rifle company and platoon.

b. Proficiency Standards.--The 1500 series of Marine Corps orders prescribes the attainment of certain levels of proficiency in NBC defense, both for individuals and units.

(1) Individual.--Each Marine must be able to:

(a) Put on and adjust the protective mask properly within 9 seconds following an alarm or recognition of NBC attack.

(b) Recognize, by appearance or effects, the existence of NBC hazards, and take protective action.

(c) Recognize NBC attacks, methods of delivery, and alarms, and take appropriate protective action.

(d) Perform simple decontamination of his person, personal equipment, individual weapon and position, and/or crew-served weapon.

(e) Perform first aid for NBC injuries.

(f) Recognize all standard marking signs which indicate NBC contaminated areas.

(g) Cross or bypass contaminated areas with minimum danger to himself.

(h) Maintain individual protective equipment.

(i) Perform his mission during friendly or enemy employment of nuclear or chemical weapons within the limitations imposed by the attack.

(j) Maintain a high order of health, personal hygiene, and sanitary discipline as a protective measure against biological operations.

(k) Take the maximum protective measures against the effects of nuclear weapons, especially radiological fallout.

(l) Be familiar with the basic capabilities and characteristics of radiac instruments.

(2) Unit.--Each unit must be able to:

(a) Decontaminate its equipment.

(b) Cross, bypass, or function in contaminated areas, decontaminating where necessary.

(c) Take action as required by unit SOP when local alarm is given.

(d) Determine the presence of NBC hazards and take proper action.

- (e) Operate its detection and protective equipment.
- (f) Exploit friendly nuclear and chemical fire support, directly or indirectly.
- (g) Sustain an enemy NBC attack with minimum interference in the performance of its assigned mission.
- (h) Maintain a high order of sanitation to minimize vulnerability to biological attack.
- (i) Report attacks promptly and properly.
- (j) Maintain its defense equipment.
- (k) Carry out field expedient methods of determining ground zero location, height of burst, elevation of top and bottom of nuclear cloud, and angular width of the nuclear cloud.

c. Material.--NBC defense equipment should be used in training. The protective mask should be carried routinely as individual equipment and used during training exercises. NBC defense property is periodically inspected to determine serviceability. The inspection of chemical items is prescribed in the 10010 series of Marine Corps orders as to serviceability standards, technical information, and modification instructions for specific items. Beta and gamma detection devices are tested weekly to ensure that the equipment is ready for operational use. The calibration interval of detection devices is 6 months.

8604. NUCLEAR WARFARE

a. General.--Nuclear warfare is characterized by sudden and drastic changes in the tactical situation. This demands an alert and flexible system of command with firm, centralized planning, decentralized execution, and a doctrine that stresses initiative and flexibility by subordinate commanders. All commanders must be prepared to act instantly and aggressively and in the absence of orders. To provide for contingencies, advance planning, including the use of a complete unit SOP, must be routine.

b. Leadership.--This type of warfare places great demands on the individual Marine and the combat leader, particularly the small unit leader. The individual Marine must be trained to control his fears in order to prevent panic and to ensure his aggressive reaction. Leadership roles of the platoon and company commander demand rapid and independent action arising from the greater dispersion of units. Emphasis is placed on decentralization of authority. The company officer is called upon to make decisions formerly made by officers of higher rank and greater experience. They must be prepared to cope with situations which tax their knowledge, judgement, initiative, and courage to the utmost.

c. Protective Measures.--Protective measures are either active or passive. Active measures include the destruction or neutralization of enemy nuclear delivery means and the destruction of enemy nuclear weapons. Passive protection falls into two categories, defense against the detection of friendly troop dispositions by the enemy and defense against the effects of enemy nuclear fires.

(1) Defense against enemy detection of troop dispositions may be accomplished through the use of appropriate counterintelligence measures. These measures include tactical dispersion, frequent and rapid movement, use of camouflage and concealment, and movement and operations during periods of low visibility. Tactical deceptions, use of dummy equipment, communication security, and the proper employment of security forces contribute materially to the counterintelligence effort.

(2) Defense against the effects of a nuclear detonation may be accomplished by tactical dispersion, cover afforded by digging, armor protection, taking advantage of the shielding afforded by terrain, and by using protective covering on the exposed parts of the body. FM 21-40, Chemical, Biological, Radiological, and Nuclear Defense, provides detailed instructions on unit operations during a nuclear attack.

d. Action After Nuclear Attack.--Commanders ensure that their units are prepared to withstand an enemy nuclear attack. This requires indoctrination of individuals and the preparation and rehearsal of SOP's to cover foreseeable situations. In the event of a strike, the following actions are taken in the priority dictated by the situation:

- (1) Determine losses of personnel and equipment.
- (2) Notify higher headquarters of the situation.
- (3) Ensure or reestablish command control.
- (4) Accomplish the assigned mission.

8605. CHEMICAL OPERATIONS

a. General.--The effective use of protective equipment is the first line of defense against chemical agents. It is essential that all personnel be trained in the use of protective equipment and in the first aid measures required to minimize injuries from chemical agents. The effectiveness of protective measures is dependent upon the ability of the individual to recognize the presence of a chemical hazard, his ability to use available protective equipment, and on speed of action.

b. Standard Procedures for Protection Against Chemical Attack.--The following is a relatively simple, standard set of individual procedures which are effective against chemical attack. These procedures should be followed when chemical or biological attack is imminent, or after such attacks have been initiated. When the enemy attacks with chemical or biological agents, take the following actions without command:

- (1) Stop breathing.
- (2) Take cover (use poncho).
- (3) If liquid falls into eyes, flush with water.
- (4) Put on mask, clear, and breathe.
- (5) Remove liquid from skin.
- (6) Flush skin with water.

- (7) Apply protective ointment to skin.
- (8) Decontaminate or remove contaminated clothing.
- (9) If nerve agent symptoms appear, use nerve agent antidote injector.
- (10) Attach used syrettes to pocket.
- (11) Remain masked until "all clear" is sounded.
- (12) Continue mission.

8606. BIOLOGICAL OPERATIONS

a. General.--The variety of agents available in the field of biological operations precludes a resume of the physiological effects or symptoms. The defense against biological attack is based upon planning, training, and supervision on the small unit level until the unit is molded into an alert and cautious force with an avid regard for any unusual activity in the forms of sprays, bombs, shells, aerosols, and actions of individuals or groups. There is no device available for the immediate detection of a biological agent. This is done through the efforts of medical teams and requires a long, tedious process. The unit commander cannot wait until an attack or agent is identified. He ensures that protective measures are taken and that the protective equipment available to the unit is effectively employed. A list of suggested items that assist in the defeat of a biological attack follows:

- (1) Protective Equipment.--The protective mask and normal clothing offer good protection against biological agents.
- (2) Immunization.--Prescribed shots taken regularly as scheduled help increase body resistance.
- (3) Sanitation and Body Hygiene.--A clean body and sanitary quarters help prevent the spread of germs. Clean living habits, sleep, exercise, and a good diet guard the health.
- (4) Decontamination.--The body should be scrubbed thoroughly and frequently with soap and water in any situation where the use of biological agents is likely.
- (5) Food and Drink.--Only approved food and drink should be taken; these must be obtained from protected sources.
- (6) Restricted Areas.--Quarantined buildings and areas must be avoided.
- (7) Intelligence.--Personnel should be alert to note and report suspicious activities and materiel. Biological agents may be delivered by clandestine means.
- (8) Rumors.--Repeating or exaggerating rumors should be avoided.

Section VII. BIVOUACS

8701. GENERAL

Adequate shelter contributes to the future combat efficiency of units in the field. It is essential that units in a combat zone be provided with the best shelter available consistent with the tactical situation. In the forward areas of the combat zone, troops at rest are provided with shelter tents or hastily improvised shelters. When thus quartered, the rifle company is in bivouac. Bivouacs are used only when tactically necessary and/or when other facilities are not available.

8702. SELECTION OF SITE

a. Prior to the arrival of the rifle company, a quartering party selects the specific bivouac site. The company commander furnishes the quartering party with general guidance as to the proposed area, internal arrangement, and security considerations. When the bivouac has been previously designated a battalion bivouac, the company's quartering party comprises a portion of the battalion quartering party which precedes the battalion and prepares the area for bivouac. The rifle company quartering party normally consists of the executive officer, the gunnery sergeant, and one representative from each platoon to organize the platoon area and guide the platoon into its assigned location.

b. The selection of the specific bivouac site is governed by both tactical and sanitary considerations. Tactical requirements always have priority over other considerations and include the following:

- (1) Sufficient space for dispersion of the company.
- (2) Concealment from ground and air observation.
- (3) Ease of security.
- (4) Defensible terrain in the immediate surrounding areas.

c. Sanitation measures and maximum troop comfort enhance morale and combat efficiency. The bivouac site selected must have as many of the following desirable sanitation and comfort features as possible:

- (1) Ample water supply for drinking, bathing, and washing clothes.
- (2) Grass covered area.
- (3) Well drained, elevated, and fairly level site.
- (4) Shaded in hot weather.
- (5) Windbreaks in cold weather.
- (6) Accessible to a good road.
- (7) Not occupied by other units within the preceding 2 months.

(8) Removed from mosquito breeding areas, native habitations, and other unsanitary areas.

8703. ORGANIZATION OF SITE

a. When the bivouac site has been selected and prior to the arrival of the company, the quartering party performs the following functions:

- (1) Selects areas within the bivouac site for each platoon.
- (2) Determines the number and composition of outposts necessary for security of the bivouac.
- (3) Marks unit areas and posts guides.
- (4) Selects galley site near the road, as near the water supply as possible, and with adequate drainage.
- (5) Establishes heads on the side of the bivouac opposite and downgrade from the galley.

b. On arrival of the company in the bivouac site, the platoons are guided to their assigned areas, and the bivouac is established as follows:

- (1) Security is provided as necessary.
- (2) An interior guard is organized.
- (3) Work details are assigned prior to arrival of the company in the bivouac site. On arrival in the site, they commence:
 - (a) Digging heads.
 - (b) Setting up the galley.
 - (c) Preparing wet and dry garbage pits.
 - (d) Procuring fuel, water, etc., as required.
- (4) Troops not otherwise assigned tasks commence pitching shelter tents. Figure 83 shows a typical rifle company bivouac.

8704. SECURITY

a. The rifle company may provide for the security of its bivouac or may be assigned the mission of establishing security for the battalion in bivouac. In either case, the security system established is similar.

b. Tactical security is established as a series of outposts, detached posts, and patrols to maintain surveillance and provide early warning of the enemy's approach. If the enemy situation warrants, outposts may be expanded into a perimeter defense of the bivouac site.

(1) The organization of an outpost is similar to that of the combat outpost in defensive combat. It is normally organized into a support, outguards, security posts, and patrols. The support is the principal echelon of resistance in the outpost and consists of the reinforcing weapons

Par. 8704

FMFM 6-4

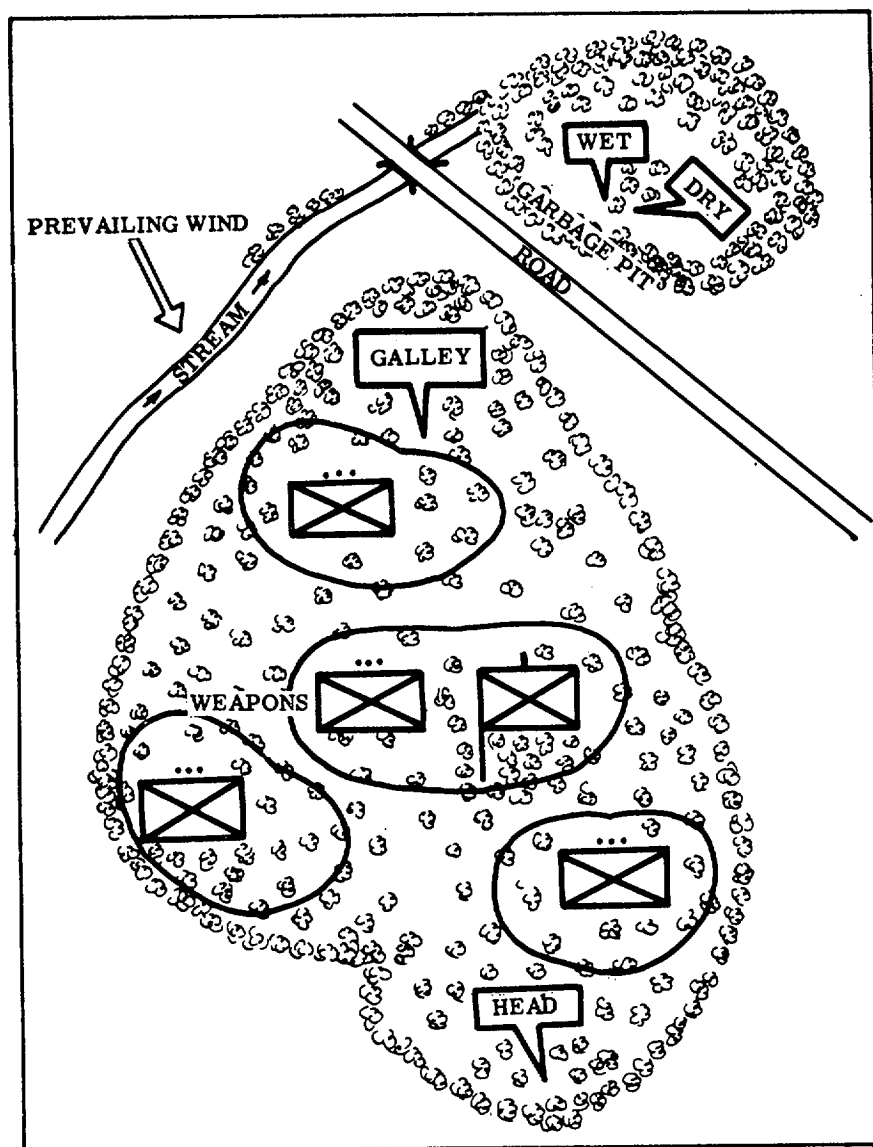

Figure 83.--Bivouac Organization.

emplaced within the outguard locations. They cover likely avenues of approach and protect the bivouac site with flanking fire. (See fig. 84.) The outguards are positioned on terrain which affords long-range observation and fields of fire covering the avenues of approach to the bivouac site. They establish security posts as necessary to maintain unit security. Patrols are extensively employed between adjacent outguards, between outguards and their security posts, and between outposts to further enhance security.

(2) Detached posts are located on terrain dominating dangerous avenues of approach beyond the limit of observation afforded by outposts.

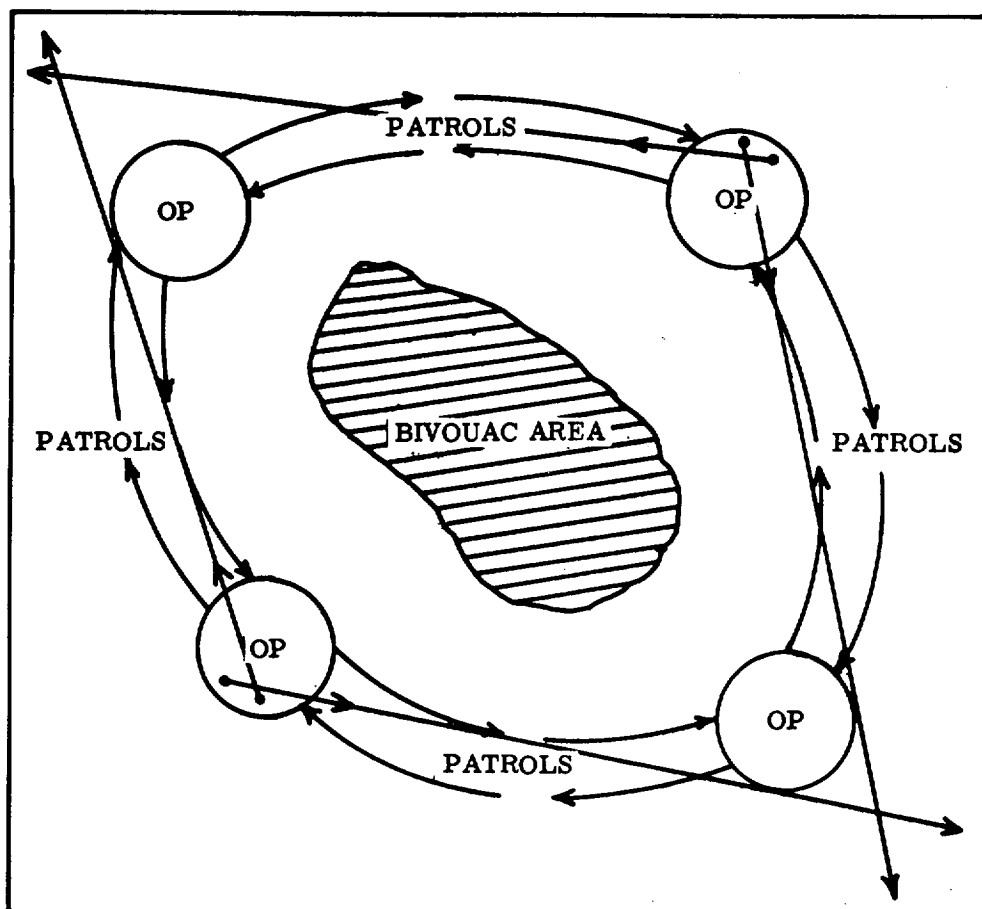

Figure 84.--Bivouac Security.

Positioning and organization of detached posts are undertaken when the terrain proximate to the bivouac site affords avenues for the rapid incursion of mechanized forces or armor. A detached post is similar in organization to an outpost except that its supporting weapons are assigned sectors of fire covering the avenue of approach.

c. Internal security involves the establishment of a small interior guard to prevent pilferage of supplies and to enforce sanitary discipline. Sentries are posted at the supply dump, the galley, the water point, and within each platoon area. The supply dump and galley sentries primarily prevent pilferage. The remaining posts enforce rigid sanitary measures throughout occupation of the bivouac.

APPENDIX A

TYPICAL ORAL OPERATION ORDERS

I. RIFLE COMPANY ATTACK ORDER

Orientation: (Refer to fig. 85.) Break out your maps. Our approximate location is coordinates 873736. On the map you can see Hill 326 at coordinates 886720. That is Battalion Objective A. Also on the map note the high ground at coordinates 882723. That ground is Company Objective 2. Note the hard surface road to our left. That road is Route #1. About 750 meters to our front you can see some high ground with a grove of trees on it just to the right of Route #1. In that grove of trees is a cemetery. The map shows a dirt road running southwest from Route #1 along that high ground. The high ground extending beyond the cemetery to the dirt road and southwest of Route #1 for 100 meters is Company Objective 1. Note the first ridge line about 350 meters to our front. That ridge line is Phase Line Green. The company left boundary is about 30 meters into the woods on the left.

TAKE NOTES.

1. SITUATION

- a. Enemy Forces.--An estimated 12 to 15 enemy riflemen supported by several automatic weapons are reported well dug in on Objective 1. Air observers report a reinforced squad position on Objective 2 and prepared positions for about eight men on Phase Line Green. Patrols have reported an AT-AP minefield extending across Route #1 from coordinates 874733 to 878733.
- b. Friendly Forces.--Battalion attacks to seize Belfair Crossroads before dark. Company "C" is on our left; our right flank is open. Eight VF/VA aircraft on 10-minute strip alert available for support. Priority of fires Battery "A," 1/11 to our battalion. 81mm Mortar Platoon is in general support of the battalion.

2. MISSION

Company "D" attacks at 1250 on a frontage of 600 meters right of the company left boundary; seizes Objectives 1 and 2; and on my order, continues the attack and seizes Battalion Objective A.

3. EXECUTIONa. General

- (1) We will conduct a frontal attack with two rifle platoons up initially. One platoon will attack on the left and seize Objective 1. One platoon will attack simultaneously on the right, clear its zone of action to Phase Line Green, and after seizure of Objective 1, on order, continue the attack to seize Objective 2. One rifle platoon, initially in reserve, will protect the company's right flank. On my order, the company will continue the attack to seize Battalion Objective A.

App. A

FMFM 6-4

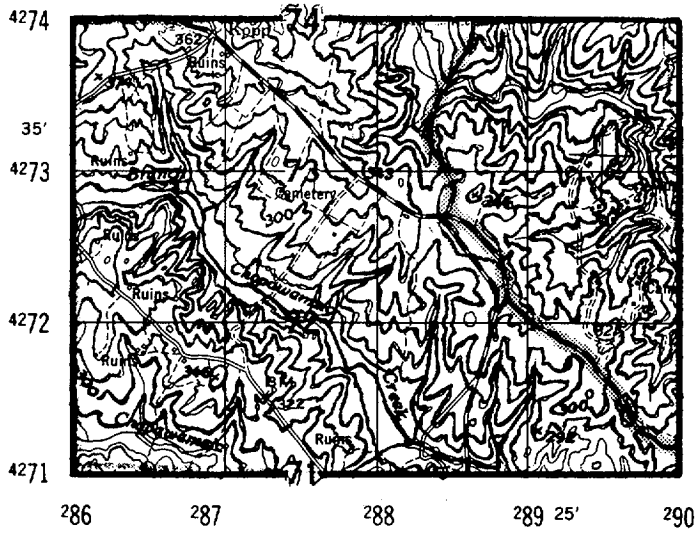

Scale 1:50,000

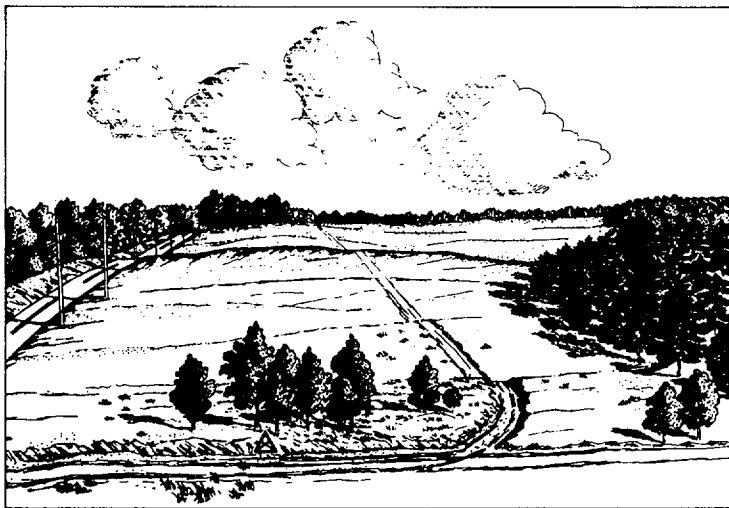
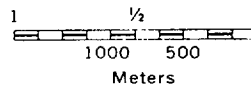

Figure 85.--Daylight Attack Map and Terrain Sketch.

(2) I have planned two targets on Objective 1 on call: target AB105 at coordinates 878729; target AB106 at coordinates 877728. 81mm Mortar target 101 is on call on Objective 2.

- b. 1st Platoon.--With one assault squad attached; attack on a frontage of 300 meters right of the company left boundary and seize Objective 1. Be prepared to continue the attack on order.
- c. 3d Platoon.--With one machinegun squad and one assault squad attached; attack on a frontage of 300 meters right of 1st Platoon; clear your zone of action to Phase Line Green and, on order, continue the attack to seize Objective 2. Be prepared to continue the attack on order.
- d. Weapons Platoon.--Attach one assault squad to each rifle platoon. Attach one machinegun squad to 3d Platoon. Machinegun Section minus; general support; from positions this vicinity, support by fire the attack on Objective 1 until fires are masked. 60mm Mortar Section; general support. Be prepared to support the attack on Objective 1. Prepare to displace to Phase Line Green and to support continuation of the attack on Objective 2.
- e. 2d Platoon.--With one assault squad attached; company reserve; follow in trace of 3d Platoon at the limit of visibility but not further than 200 meters; protect the company right flank and be prepared to assume the missions of either attacking platoon.
- f. Coordinating Instructions
 - (1) LOD, this trail; no reconnaissance forward.
 - (2) Base unit, 1st Platoon until seizure Objective 1, then 3d Platoon.
 - (3) Maintain security, especially in the woods.

4. SERVICE SUPPORT

- a. Prescribed ammunition load is a basic allowance for all weapons and two grenades per man.
- b. Service Group carries an additional basic allowance.
- c. Replenish to prescribed load after seizure Objectives 1 and 2.
- d. Battalion Aid on Route #1, 700 meters to our rear.
- e. POW's will be handled in accordance with the battalion SOP.

5. COMMAND AND SIGNAL

- a. Red smoke and red star clusters to 1st Platoon as signals. Green smoke and green star clusters to 3d Platoon.
- b. I will be here initially and follow 1st Platoon to Objective 1. Will move to Objective 2 when it is seized.

ANY QUESTIONS? TIME IS NOW 1210. MOVE OUT!

App. A

FMFM 6-4

II. RIFLE PLATOON ATTACK ORDER

Orientation: (Refer to fig. 85.) Note the hard surface road to our left. That road is Route #1. About 750 meters to the front you can see some high ground with a grove of trees on it just to the right of Route #1. The map shows a dirt road running southwest from Route #1 on the high ground. That high ground, its extension to the dirt road and to the southwest for 100 meters, is Company Objective 1. About 350 meters from here you can see a ridge running across the company front, that ridge is Phase Line Green. The portion of the ridge in our zone of action is Platoon Objective A. Note the woods on our left and the woods to the right front. The left boundary of the platoon zone of action is 30 meters into the woods on the left. My map shows high ground 800 meters to the right front of Objective 1. That high ground is Company Objective 2. The battalion objective is beyond that about another 600 meters.

TAKE NOTES.

1. SITUATION

- a. An estimated 12 to 15 enemy with several automatic weapons are well dug in on Objective 1. I estimate that four to six riflemen are dug in on Objective A. A minefield extends across Route #1, into the woods on the left in the vicinity of the draw short of Objective A.
- b. Company "D" attacks to seize Objectives 1 and 2 and continues the attack, on order, to seize the battalion objective. Company "C" is on our left. 3d Platoon attacks on our right; clears its zone of action to Phase Line Green; and on order, continues the attack to seize Objective 2. Eight VG/VA aircraft on 10-minute strip alert are available for support. Artillery and the battalion's 81mm mortar platoon are also supporting the attack. In addition, the machineguns and 60mm mortars of the weapons platoon are in general support of the company.
- c. 1st Assault Squad, Weapons Platoon, attached effective 1210.

2. MISSION

1st Platoon attacks at 1250 on a frontage of 300 meters right of the left boundary; seizes Objective A; and on my order, continues attack and seizes Objective 1. Be prepared to continue the attack on order.

3. EXECUTIONa. General

- (1) We will attack initially with one rifle squad to envelop Objective A from the right. After moving the remainder of the platoon up, continue the attack on my order and seize Objective 1 by a frontal attack with two rifle squads.
- (2) For the initial attack on Platoon Objective A, two rifle squads will provide a base of fire and the assault squad is in general support. When we attack Objective 1, one rifle squad and the assault squad will provide a base of fire. The company's machineguns also support by fire, the attack on Objective 1 from the

vicinity of the line of departure until their fires are masked. Artillery and mortar on call targets are planned on Objective 1 as follows: AB105 at coordinates 878729 and AB106 at 877728. The attack aircraft, as well as the 60mm mortars, will be used against targets of opportunity as the attack progresses.

- b. 1st Squad.--Attack and seize Objective A through woods on right. On seizure of Objective A, lay down a base of fire on Objective 1.
- c. 2d Squad.--Occupy positions vicinity of the LOD on the left and be prepared, on my command, to lay down a base of fire to support 1st squad's envelopment of Platoon Objective A. On order, follow in trace of 1st squad to rear left of Platoon Objective A and be prepared to continue the attack to seize the left portion of Objective 1 on order.
- d. 3d Squad.--Initially occupy a position vicinity of the LOD on the right of the 2d Squad and be prepared to lay down a base of fire on my command to support the attack on Platoon Objective A. On order, follow in trace of the 2d Squad to right rear of Platoon Objective A and be prepared to continue the attack to seize the right portion of Objective 1 on order.
- e. Assault Squad.--On order, follow in trace of 3d Squad to rear of Objective A. General support; from positions, left portion Objective A, reinforce 1st Squad's base of fire by firing on covered emplacements.
- f. Coordinating Instructions
 - (1) LOD is this trail; no reconnaissance forward.
 - (2) For the attack on Platoon Objective A, the base of fire will fire only on my command and will not fire into the treeline on the right or to the left of that fence; both squads' sectors of fire cover the entire objective and cease fire on the signal for the assault to commence. 1st squad leader is assault commander and designates the final coordination line.
 - (3) I'll issue a fragmentary order and provide additional coordinating instructions for the attack on Objective 1 after we seize Platoon Objective A.
 - (4) Maintain security when moving through the woods.

4. SERVICE SUPPORT

- a. Carry two grenades per man and basic allowance per weapon.
- b. Ammunition resupply after seizure Objective 1.
- c. Platoon corpsmen with 1st and 2d Squads.
- d. Battalion Aid 700 meters to rear on Route #1.
- e. Prisoners of war will be handled in accordance with battalion SOP.

App. A

FMFM 6-4

5. COMMAND AND SIGNAL

a. Signal:

- (1) Signal to commence the assault and cease the base of fire for Platoon Objective A is red smoke. For Objective 1, the assault commences and the base of fire ceases (the company's machine-guns will shift fires) on a red star cluster.
- (2) Hand and arm signals will be used to displace the base of fire on Platoon Objective A and on Objective 1.

b. I will be with the 2d Squad during the attack on Objective A.

ANY QUESTIONS? TIME IS NOW 1230. MOVE OUT!

III. RIFLE PLATOON FRAGMENTARY ATTACK ORDER

1. SITUATION

We are receiving small arms fire from Objective 1. Company C on our left and 3d Platoon on our right are generally abreast of us and continuing to attack.

2. MISSION

At my signal, the platoon continues the attack to seize Objective 1 and is prepared to continue the attack on order.

3. EXECUTIONa. General

- (1) We will attack frontally to seize Objective 1 with two rifle squads. One rifle squad, our assault squad, and the company's machineguns will lay down a base of fire.
- (2) I have requested artillery high explosive fires on target AB105 to precede our attack.

b. 1st Squad.--From present positions, continue base of fire on Objective 1. On signal, cease fire and displace down Route #1 to cemetery on Objective 1.

c. 2d Squad.--At my signal, attack on a frontage of 80 meters and seize left half of Objective 1. Consolidate from Route #1 right 80 meters and protect assault squad in your sector.

d. 3d Squad.--At my signal, attack on a frontage of 80 meters and seize the right half of Objective 1. Consolidate from 2d Squad right 80 meters and refuse your right flank.

e. Assault Squad.--From present positions, support by fire, the attack on Objective 1. On signal, displace by unit to Objective 1 down Route #1 and consolidate with 2d Squad. Priority of fires to Route #1.

f. Coordinating Instructions

- (1) LOD is the topographical crest of this hill (Platoon Objective A).
- (2) Second Squad is the base squad.
- (3) Final coordination line is on a line roughly parallel with that rock on the forward slope of Objective 1. I will signal for the assault to commence.
- (4) Base of fire. Do not fire below that rock and cease fire on signal for the assault to begin. Don't fire outside zone of action.

4. COMMAND AND SIGNALa. Signal

- (1) Watch me for the signal to begin the attack. We move out immediately following the completion of the artillery fire on the objective.
- (2) Otherwise, no change. Remember. Watch for the red star cluster to cease the base of fire and commence the assault.

- b. Command.--I will move initially in the center behind the attacking squads. Platoon Sergeant coordinate the base of fire.

ANY QUESTIONS? TIME IS NOW 1314. MOVE.

IV. RIFLE COMPANY FRAGMENTARY ATTACK ORDER

1. SITUATION

- a. Friendly Forces.--Five-minute air preparation Battalion Objective A commencing at 1525. Artillery target AB1160 at coordinates 886721 and target AB1170 at coordinates 886720 planned on call on Objective A.

2. MISSION

Company "D" continues the attack at 1530; seizes Objective A. Be prepared to continue the attack on order.

3. EXECUTIONa. General

- (1) The company continues the attack from present positions with two platoons abreast and one in reserve and seizes Battalion Objective A by frontal attack.
- (2) Battalion has ordered an artillery preparation of the objective from 1505-1525. This will be followed by a 5-minute air preparation commencing at 1525. Artillery/81mm mortar on calls are

App. A

FMFM 6-4

also planned: target AB1160 at coordinates 886721 and target AB1170 at coordinates 886720.

- b. 1st Platoon.--With one machinegun squad and one assault squad attached; attack on a frontage of 300 meters right and inclusive of Route #1; seize left half Objective A. Be prepared to continue the attack on order.
- c. 2d Platoon.--With one machinegun squad and one assault squad attached; attack through 3d Platoon on a frontage of 300 meters; seize right half Objective A.
- d. Weapons Platoon.--Attach one machinegun squad and one assault squad to each rifle platoon. Be prepared to assume control all weapons when reverted to general support in consolidation of Objective A. 60mm Mortar Section in general support. Support the 1st and 2d Platoon attacks on Objective A from 3d Platoon's position.
- e. Reserve, 3d Platoon.--Remain present position initially. Support by fire attack of 2d Platoon through your positions until fires are masked. Follow in trace of 2d Platoon at limit of visibility, but not further than 200 meters. Protect company right flank. Be prepared to assume the mission of either attacking platoon.
- f. Coordinating Instructions
 - (1) LOD is present position, 3d Platoon.
 - (2) Base unit, 1st Platoon.
 - (3) The tentative final coordination line is the draw 150 meters forward of Battalion Objective 1. Each attacking platoon signal when you are ready to begin the assault.
 - (4) 2d and 3d Platoons coordinate passage of lines.

5. COMMAND AND SIGNAL

- a. Signal.--No change. 1st Platoon use red star clusters to signal for beginning the assault. 2d Platoon get green star clusters from the 3d Platoon and use them to signal beginning of your assault.
- b. Command.--I will be on Objective 2 initially and move in trace of 1st Platoon to Battalion Objective A.

ANY QUESTIONS? TIME IS NOW 1500. MOVEOUT!

V. RIFLE COMPANY DEFENSE ORDER

Orientation: (Refer to fig. 86.) Break out your maps. Our approximate location is coordinates ----- . The direction we are facing is east. The ridge we are located on runs generally north and south. The east (forward) military crest of the ridge is the trace of the FEBA. The hard surface road running into the FEBA from the east is Route #8. The stream which parallels the FEBA is John's Branch. Note the bridge on Route #8 spanning the branch. Note the powerline trail leading into the left front. Our

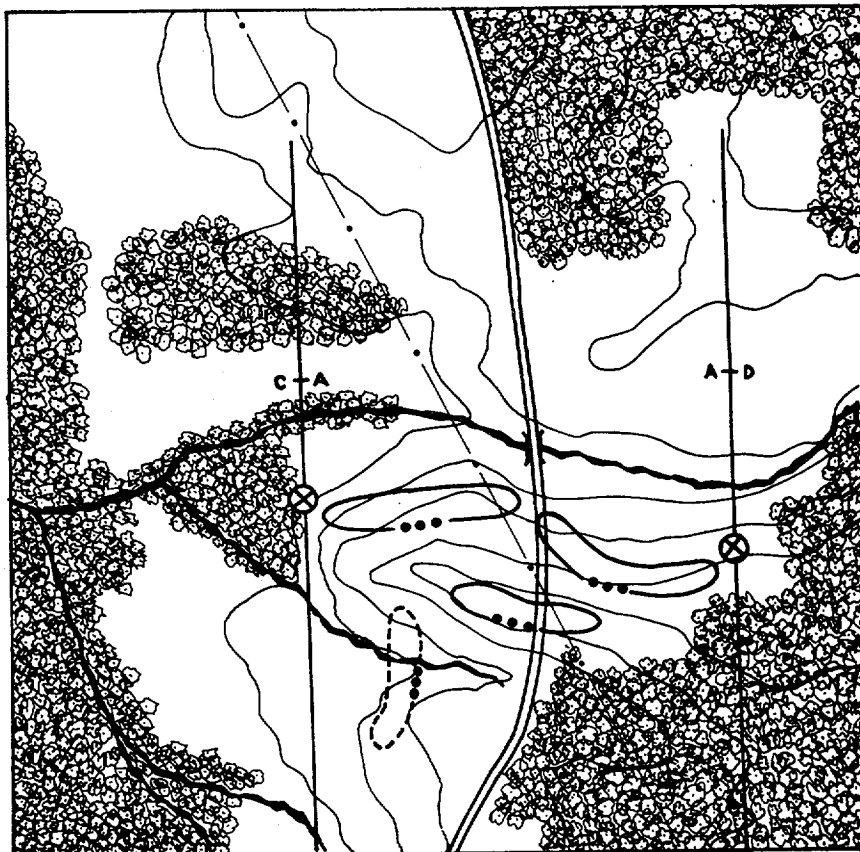

Figure 86.--Defense Sketch Map.

right boundary is 500 meters right of Route #8. Both boundaries extend to the forward military crest of the next ridge to our front. The company rear boundary is 500 meters to the rear of the FEBA. The forward defense area extends 200 meters to the rear of the FEBA.

TAKE NOTES.

1. SITUATION

- a. Enemy Forces.--An estimated enemy regiment has been reported operating in this general area. Increased enemy patrol activity westward has been reported. Air observers report evidence of enemy tanks operating 10 miles to the east.
- b. Friendly Forces.--Our battalion defends the high ground astride Route #8. Company C defends our left and Company D our right. 3d Battalion, which is in regimental reserve, have established the combat outpost 1500 meters to our front and will destroy the bridge after withdrawal. 1st Battalion, 10th Marines, is in general support of the regiment. The 81mm mortar platoon is in general support of the battalion.

App. A

FMFM 6-4

2. MISSION

Company "A" occupies and defends the center portion of the battalion battle area.

3. EXECUTIONa. General

- (1) We will defend on the forward slope with two rifle platoons up and one in reserve.
 - (2) The weapons platoon is in general support of the company and supports the rifle platoons by fire. We have one 105mm artillery battery FPF on Route #8 at grid coordinates -----, and 81mm mortar FPF's #6 and #7 ----- and ----- respectively. The company's 60mm mortar FPF's will be used to fill gaps or dead spaces after we get our machinegun FPL's established.
- b. 1st Platoon.--Occupy and defend the left portion of the company battle area from the company left boundary to, but exclusive of, Route #8.
 - c. 2d Platoon.--Occupy and defend the right portion of the company battle area from and inclusive of Route #8 to the right boundary.
 - d. Weapons Platoon.--General support. Machinegun Section provide FPL's from company left flank across 1st Platoon's front to the powerline and from both flanks of 2d Platoon north and south across 2d Platoon's front. Assault Section occupy positions 1st Platoon area covering the powerline trail and positions 2d Platoon area covering Route #8. 60mm Mortar final protective fires will fill dead space or gaps existing in final protective lines.
 - e. Reserve--3d Platoon.--Occupy primary position on the high ground to our rear; support frontline platoons by fire; be prepared to limit enemy penetration on axis Route #8 by fire. Prepare a supplementary position covering the stream bed and draw to the left rear; be prepared to limit by fire penetration of company left flank from that position.
 - f. Coordinating Instructions
 - (1) Maintain 50 percent alert during hours of darkness and minimize movement on position.
 - (2) Frontline platoons establish and report locations of security posts.
 - (3) Reserve platoon provide fire team patrols to recon company security area. Patrol leaders report to CP at 1400 for patrol orders.
 - (4) Submit fire plan overlays by 1700.

- (5) Priority of work:
 - (a) Local security out.
 - (b) Position weapons.
 - (c) Clear fields of fire.
 - (d) Prepare positions--two-man foxholes.
 - (e) Tactical and supplementary wire. Frontline platoons assist weapons units to install.
 - (f) Protective wire.
 - (g) AT/AP mines.
- (6) Camouflage discipline continuous on arrival in area.
- (7) Complete preparation of positions by 1700.

4. SERVICE SUPPORT

- a. Engineer equipment and fortification material delivered on position by 1300.
- b. Draw an additional half allowance of ammo and tomorrow's rations at the CP.
- c. Pick up sound power phones for platoon wire nets at CP.
- d. Evacuate casualties to CP.

5. COMMAND AND SIGNAL

- a. Signals on my order only:
 - (1) Commence final protective fires--green star cluster and voice.
 - (2) Cease final protective fires--red star cluster and voice.
- b. Company wire net will be laid as primary communication means. Come up on radio if wire fails. Provide guide for wireman to your CP/OP's.
- c. My OP will be here at the vantage point.
- d. CP is in woods edge on Route #8 behind reserve platoon.
- e. The challenge is Bald and the password is Sparrow. The alternate is Gold Eagle.

ANY QUESTIONS? TIME IS NOW 1200. MOVE OUT!

App. A

FMFM 6-4

VI. RIFLE PLATOON DEFENSE ORDER

Orientation: (Refer to fig. 86.) The direction we are facing is east. We are standing on the FEBA which runs generally north and south along the military crest of this high ground. Note the ridge line to our front. The forward military crest of that ridge is the forward limit of our security area. Note the powerline trail to our front and the draw to our right front. The stream to the front that parallels the FEBA is John's Branch. Note the bridge on Route #8 spanning the Branch. Note the wood line to our left flank. Our left boundary is exclusive of that wood line. The hard surface road on our right is Route #8. Our right boundary is exclusive of that road. Our rear boundary is 200 meters to the rear of the FEBA.

TAKE NOTES.

1. SITUATION

- a. An enemy regiment has been reported operating in this general area. Increased enemy patrol activity has been reported and we can anticipate an attack. Air observers have reported evidence of tanks operating 10 miles to our front.
- b. Our company occupies and defends the center portion of the battalion battle area. 2d Platoon is on our right and Company C is on our left, in the woods. The 3d Platoon is in company reserve and will be sending out patrols to our front after 1400. Elements of the 3d Battalion have established the combat outpost 1500 meters to our front. Weapons platoon is in general support with one machinegun squad and one assault squad in our defense area. An artillery battalion is in general support of the regiment.

2. MISSION

This platoon occupies and defends the left portion of the company forward defense area.

3. EXECUTIONa. General

- (1) We will occupy our positions and defend with three rifle squads abreast on the forward slope. Squad supplementary positions will be prepared to protect both flanks of the platoons.
 - (2) We have a machinegun FPL extending from the left flank across our front to the power line. The assault squad positioned in our area will cover the power line trail. In addition, 81mm mortar FPF's #6 and #7 are planned on the power line in our portion of the security area as indicated here on my map. The company's 60mm mortar FPF's will be used to fill any gaps or dead spaces after we get established.
- b. 1st Squad.--Occupy and defend in the left portion of the platoon defense area a position extending from 50 meters this side of our left boundary, right 150 meters. Sector of fire: left limit--that large dead tree (point), right limit--five fingers left of the double power pole to your right front. Establish two-man

sentinel post in the trees beyond John's Branch. Establish two-man listening post in the tree line this side of the Branch at dusk. Prepare a supplementary position to your left rear facing north.

- c. 2d Squad.--Occupy and defend in the center portion of the platoon defense area a position extending from the left portion of this nose, right to and exclusive of the powerline. Sector of fire: left limit--junction of the cedar tree line and tree line to our front (point), right limit--where Route #8 crosses the ridge line to our right front. Establish two-man sentinel post in tree line south side of powerline trail on topographical crest of the hill to the front.
- d. 3d Squad.--Occupy and defend in the right portion of the platoon defense area a position extending from and inclusive of the powerline trail right to but exclusive of the road. Sector of fire: left limit--the double power pole 75 meters to your front, right limit--the bridge over John's Branch. Establish two-man listening post in brush line east of John's Branch at dusk. Prepare a supplementary position along the high ground this side of the powerline facing south.
- e. Coordinating Instructions
 - (1) Maintain 50 percent alert during the hours of darkness commencing at 1800. Movement out of foxholes after dark only on order.
 - (2) Submit squad fire plan sketches by 1600.
 - (3) Locations of specific AR's and PDF's to be pointed out on the terrain after my order.
 - (4) Report when security posts detect enemy.
 - (5) Withdraw security posts on my order only.
 - (6) Secure sentinel posts and establish listening posts at 1830.
 - (7) Relieve sentinel posts every 4 hours and listening posts every 2 hours.
 - (8) Priority of work.
 - (a) Sentinel posts out.
 - (b) Position weapons.
 - (c) Clear fields of fire.
 - (d) Prepare positions--two-man foxholes.
 - (e) Assist weapons units in installation of tactical and supplementary wire.
 - (f) Protective wire.
 - (g) Lay AT/AP mines.

App. A

FMFM 6-4

(9) Camouflage continuous upon arrival. Evacuate excess spoil. Vary routes to positions.

(10) Complete preparation of positions by 1700.

4. SERVICE SUPPORT

- a. Pick up engineer equipment and fortification materials at my CP/OP at 1300.
- b. At 1300 send one man each squad my CP to assist guide as working party.
- c. Draw additional ammo and tomorrow's rations before dark at my CP.
 - (1) 50 rounds per rifle.
 - (2) 250 rounds per automatic rifle.
 - (3) 12 rounds for grenadier.
- d. Pick up sound power phones for security posts at my CP/OP.
- e. Platoon corpsman with CP/OP and 1st Squad.
- f. Evacuate casualties to company CP.

5. COMMAND AND SIGNAL

- a. Signals
 - (1) Commence final protective fires--green star cluster and voice.
 - (2) Cease final protective fire--red star cluster and voice.
 - (3) SOP pull wire signals for security posts if net fails.
- b. Platoon wire net will be laid to squad leaders and security posts as primary communications means. Squads use messenger if wire fails.
- c. My CP/OP will be on the high ground in immediate rear 2d Squad. Company CP behind 3d Platoon in edge of woods near road.
- d. Platoon Sergeant behind 1st Squad at dark.
- e. The challenge is Bald and the password is Sparrow. The alternate is Gold Eagle.

ANY QUESTIONS? TIME IS NOW 1240. MOVE OUT!

VII. RIFLE COMPANY MARCH ORDER

Orientation: (Refer to fig. 87.) Break out your maps. We are presently located at coordinates 821774. Note the hard surface road running southwest. That road is Route #8. The start point is the junction of Route #8 and this dirt trail. Note the stream crossing the hard surface

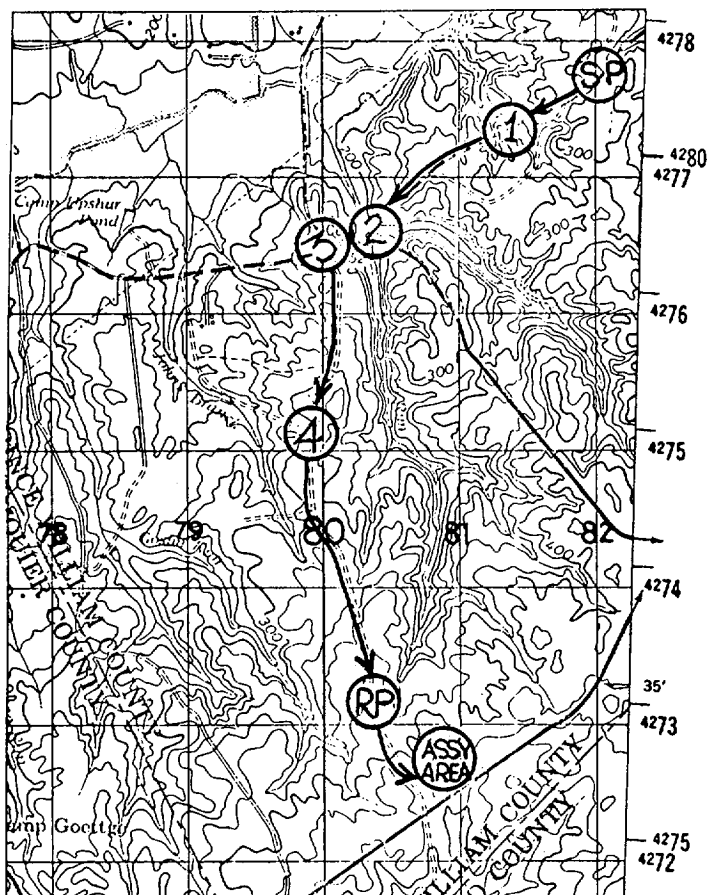

Figure 87.--March Route Map.

road in grid square 8177. That is Checkpoint 1. Checkpoint 2 is the road junction at coordinates 803766. Approximately 200 meters west of Checkpoint 2 a secondary road junctions with Route #8. That is Checkpoint 3. Continuing south on the dirt road there is another road junction at coordinates 799751. That is Checkpoint 4. Approximately 1,000 meters south of Checkpoint 4 there is a bend in the road at coordinates 803732. That bend is the release point. Coordinates 808727 is Assembly Area Delta.

TAKE NOTES.

1. SITUATION

- a. Enemy Forces.--The enemy has broken contact and is withdrawing to the south. He has established roadblocks of unknown strength to interdict the road net leading south. Our aircraft have spotted remnants of enemy armor and infantry moving southwest.
- b. Friendly Forces.--Our battalion will move on foot in tactical column to Assembly Area Alfa, Bravo, Charlie, and Delta; prepare to conduct further operations in clearing enemy pockets to the southwest.

App. A

FMFM 6-4

There are screening elements to the front about 5,000 meters. Company "C" follows 600 meters to our rear at the head of the main body. B Battery 1/10 is in direct support.

- c. Attachments and Detachments.--1st Section, Dragon Platoon, and 1st Section, 81mm Mortar Platoon, attached at 0900 today.

2. MISSION

Our company is the advance guard for the battalion.

3. EXECUTION

a. General

(1) We will move out in a tactical column along the assigned march route to assembly area DELTA. One platoon moves as advance party and the remainder of the company follows in column as the support.

(2) I have arranged for the following on call targets: target AB103 at checkpoint 3, coordinates 800765; target AB104 at checkpoint 4, coordinates 799751; and target AB105 on the hill mass located at coordinates 793747.

b. 1st Platoon.--With one machinegun squad and one assault squad attached; advance party. Revert to rear platoon of the support on my order.

c. 2d Platoon.--Follow in trace of 1st Platoon at 300 meters as lead platoon of the support.

d. Dragon Section.--General support of the advance guard with priority of fires to the advance party. Follow 2d Platoon.

e. Weapons Platoon.--Attach one machinegun squad and one assault squad to 1st Platoon. Weapons Platoon minus and 60mm Mortar Section; general support. Follow Dragon Section.

f. 81mm Mortar Section.--General support. Follow Weapons Platoon.

g. 3d Platoon.--Follow in column behind the 81mm Mortar Section. Provide squads as right and left flank security under company control.

h. Coordinating Instructions

(1) Start time--1100.

(2) Start point--Junction Route #8 and dirt trail.

(3) March route--southwest on Route #8 to Checkpoint 3 and then south on dirt road to march objective.

(4) Rate of march--106 paces/minute. Advance party regulate.

(5) March distances within support:

- (a) Between units--50 paces.
- (b) Between individuals--5 paces.
- (6) Report arrival at checkpoints.
- (7) Advance party report arrival at release point, deploy, and clear march objective.
- (8) March objective--Assembly Area Delta.
- (9) Connecting groups and security elements rejoin platoons upon commitment.
- (10) Enforce noise discipline.
- (11) Maintain all-around security.
- (12) Post two air sentinels per platoon.
- (13) Confirm all march control measures from my map before you leave.

4. SERVICE SUPPORT

- a. Carry basic allowance of ammunition for all weapons.
- b. Service group transport additional basic allowance of ammunition for crew-served weapons.

5. COMMAND AND SIGNAL

- a. Connecting group contact with advance party from leading platoon of support.
- b. Monitor the company tactical net commencing at 1045.
- c. Command group moves at the head of the support. I will move with the command group.
- d. Service group move behind weapons platoon.

ANY QUESTIONS? TIME IS NOW 0950. MOVE OUT!

VIII. RIFLE PLATOON MARCH ORDER

Orientation: (Refer to fig. 87.) Look at my map and follow along as I point out certain features. This hard surface road running southwest is Route #8. Note where this trail meets Route #8. That is the start point. The stream that crosses Route #8 here is Checkpoint 1. See this road junction here? The road junction is Checkpoint 2. The secondary road junction here is Checkpoint 3. Now, moving south on the secondary road, the road junction here is Checkpoint 4. See the bend in the road here? That bend is the release point. Note the area here to the left of the secondary road. That is Assembly Area Delta, the march objective. Our march route is from start point here, southwest along this hard surface road to Checkpoint 3, and then south along the dirt road.

App. A

FMFM 6-4

TAKE NOTES.

1. SITUATION

- a. The enemy has broken contact and is fleeing south. We can expect enemy roadblocks along the road net. Our aircraft have spotted remnants of enemy armor and infantry moving southwest.
- b. Our company is advance guard for the battalion. Elements of Reconnaissance Battalion will be screening us about 5,000 meters to the front. 2d Platoon follows us at 300 meters as leading element of the support. 60mm Mortar Section; general support. B Battery 1/10 is in direct support of the company.
- c. 1st Machinegun Squad and 1st Assault Squad, Weapons Platoon, attached 20 minutes ago.

2. MISSION

Our platoon is the advance party.

3. EXECUTIONa. General

- (1) We will move out in a tactical column along the assigned march route to the release point, deploy on my order, and clear the march objective. One squad moves as the point and the remainder of the platoon follows in column.
- (2) The Company Commander has arranged for the following call targets: target AB103 at checkpoint 3, coordinates 800765; target AB104 at checkpoint 4, coordinates 799751; and target AB105 on the hill mass located at coordinates 793747. I have requested that the 60mm mortar section stand by to provide fire on target AW101 on the ridge at coordinates 804738.

b. 1st Squad.--Point Squad.

c. 2d Squad.--Follow in trace of 1st Squad at 200 meters.

d. Machinegun Squad.--General support of the platoon. Follow 2d Squad.

e. Assault Squad.--General support of the platoon. Follow Machinegun Squad.

f. 3d Squad.--Follow Assault Squad. Provide two scouts each flank under my control as flank security.

g. Coordinating Instructions

- (1) Start time--1100.
- (2) Start point--junction Route #8 and dirt trail.
- (3) March route--as I described.

- (4) Rate of march--106 paces per minute. 2d Squad leader is pacer.
- (5) March distances with advance party minus:
 - (a) Between units--10 paces.
 - (b) Between individuals--5 paces.
- (6) Point report arrival at checkpoints.
- (7) Point report arrival at release point.
- (8) All units be prepared on order to deploy and clear march objective.
- (9) Enforce noise discipline; troop silence; no yelling by unit leaders.
- (10) Maintain all-around security. Assign sectors of observation; one air sentinel each rifle squad less point.
- (11) Confirm all march control measures from my map before you leave.

4. SERVICE SUPPORT

- a. Carry basic allowance of ammunition for all weapons. Draw ammunition here at 1040.
- b. Platoon corporals will march with me and 3d Squad.

5. COMMAND AND SIGNAL

- a. Communications: arm-and-hand signals until we make contact; connecting files to point on my order.
- b. I will move at the head of 2d Squad.

ANY QUESTIONS? TIME IS NOW 1020. MOVE OUT.

APPENDIX B

CHARACTERISTICS OF WEAPONS AND EQUIPMENT

1. WEAPONS CHARACTERISTICS											
Weapon	Model	Ammunition						Effective Range Meters	Burst Effect	Rate of Fire Rds Per Minute	Boat Spaces
		Basic Allowance			Unit Package Data						
		Wpns Rounds	Section Rounds	Co/Btry Rounds	Quantity Rounds	Weight Pounds	Cube CuFt				
Pistol, Auto Cal. .45	Ctg Ball M1911	21	X	714	2,000	106	0.90	50	X	10	X
Rifle, Cal. 7.62mm M14	Ctg Ball 5-Rd Clip M59	100	X	14,200	840	68	0.90	460	X	30	X
Rifle, Cal. 7.62mm M14 (Mod)	same	500	X	13,500	same	same	same	same	X	40-60	X
Machinegun 7.62mm M60	same linked	1,000	6,000	6,000	800	75	0.91	1,100	X	Sustained --100 Rapid--200	X
Rifle, Cal. 5.56mm M16	Ctg Ball M193	280	X	47,320	1,440	59.0	0.85	460	X	Semi--45-65 Auto--150-200	X
Launcher, Grenade, M79	Ctg 40mm HE	24	X	216	72	58	1.70	375	5-Meter Radius	Aimed--5-7 Pointing--7-9	X
Grenade, Hand	Frag M26	X	X	300	25	51	1.30	40	15-Meter Radius	X	X
Grenade, Hand	Illum MK1	X	X	25	25	39	1.50	40	55,000 cp for 25 Sec.	X	X
Grenade, Rifle	HEAT M28	2 per Launcher	X	68	10	50.8	3.11	91	Penetrates 9-in. Armor	X	X
Mortar, 60mm M19	HE M49A2 WP M302 Illum M83	24	72	72	10	51.2	1.02	1,800	20x10 Meters	Max-30 Sust-18	1
Mortar, 81mm M29	Ctg HE M362	24	48	X	3	53.5	1.33	3,000	30x20 Meters	2	2
Antitank Rocket, 66mm HE M72	Rocket 66mm HEAT	1	X	X	15	120	7.05	Point Tgt --325 Moving Tgt --250	Penetrates 11-in. Armor	1-Rd per Wpn Launch Exp.	X
Howitzer 105mm	Ctg HE M1	115	X	690	2	120	2.03	11,000	15-Meter Radius	1	11
Howitzer 155mm	Proj. HE M107	80	X	480	8	797	6.63	14,600	25-Meter Radius	1	X
M202 MPFW	M74 Incend Rocket Clip	X	X	X	4 per Clip	15.1	X	200	X	X	X

2. EQUIPMENT CHARACTERISTICS					
Equipment	Square	Cube	Weight (Empty)	Boat Spaces	
Truck, Utility, 1/4 ton, 4x4, M38A1 (Jeep)	65	463	2,700	17	
Truck, Utility, 1/4 ton, 4x4, M151A1	58	253	2,273	15	
Carrier, Light Weapons, M274 (Mechanical Mule)	43	81	900	11	
Trailer, Amphibious, 1/4 ton, 2 WH-1, M100	44	161	550	11	
Truck, Ambulance, 1/4 ton, 4x4, M170	72	513	3,000	19	
Truck, Cargo, 3/4 ton, 4x4, M37	118	1,031	5,917	31	
Trailer, Cargo, 3/4 ton, 2 WH-1, M101	78	527	1,520	20	
Truck, Ambulance, 3/4 ton, 4x4, M43	121	1,010	7,154	32	
Truck, Cargo, 2 1/2 ton, 6x6, M35	216	2,054	13,000	56	
Trailer, Cargo, 1 1/2 ton, M105	105	866	2,400	27	

APPENDIX C

OVERLAY TECHNIQUES

1. GENERAL

Overlays provide a rapid and easily understood means by which the commander or his staff may express an operational plan, concept, or friendly or enemy situation. Standardization of technique is essential if tactical information is to be relayed without misunderstanding. Guidelines for the pictorial representation of tactical situations are established in this appendix.

2. MILITARY SYMBOLS

a. Colors.--Colors in conjunction with military symbols denote the following:

- (1) Blue or Black.--Friendly units and activities.
- (2) Red.--Enemy units and activities. If this color is not available, enemy symbols are outlined with double black lines.
- (3) Yellow.--Friendly or enemy areas of chemical, biological, or radiological contamination.
- (4) Green.--Manmade obstacles.

b. Units and Installations

(1) Geometric figures form the basic symbols to represent units and installations. Future or proposed locations of units or installations are shown by broken lines. Examples of the more common figures are as follows:

(a) A unit:



(b) A headquarters or command post:
(staff is always to the left.)



(c) An observation or security post:







(d) A single purpose, logistical installation:













(2) To show the size of a unit, the appropriate size indication is placed on top of the basic symbol as follows:

App. C

FMFM 6-4

(a) Fire Team		(f) Battalion	
(b) Squad		(g) Regiment	
(c) Section		(h) Brigade	X
(d) Platoon		(i) Division	XX
(e) Company		(j) Corps	XXX

(3) To show the type unit being represented, a symbol is placed inside the basic figure as follows:

(a) Infantry		(f) Reconnaissance	
(b) Armor		(g) Medical	
(c) Assault Amphibious Vehicle/Unit		(h) Motor Transport	
(d) Artillery		(i) Shore Party	
(e) Engineer		(j) Amphibious	

(4) To indicate a particular unit or installation, place the unit's own designation (in accordance with its size symbol) to the left of the symbol with higher echelons of command to the right of the symbol. Slashes separate command echelons. To avoid cluttering the symbol, known units in the chain of command may be omitted.

Example: 3d Plat, Company "A", 1st Bn, 6th Marines, 2d Mar Div 3  A/6

c. Weapons

(1) Symbols are also used to indicate the type and location of a weapon or group of weapons. When a weapon symbol appears on a map or overlay, the base of the shaft indicates the location of the weapon.

(2) Most weapons are derived from the following basic symbols:



Basic Infantry Weapon



Basic Artillery Weapon

(a) If the weapon has a high trajectory, a  is placed at the base of the weapon.

(b) A weapon which is a flat trajectory, antitank weapon has a  placed at the base of the shaft.

(c) If the weapon is primarily for air defense, a  is placed at the base of the shaft.

(d) A weapon which is a rocket projector or launcher has a  placed at the head of the shaft.

(e) If the weapon is also a tracked, self-propelled vehicle, a  is placed below the weapon symbol.

(3) Generally, the number and caliber of weapons are indicated by placing the number of weapons to the left of the symbol and the caliber to the right of the symbol.

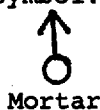

Mortar



Antitank rocket launcher



Dragon



Tow





Howitzer



A group of four tracked, self-propelled 155mm cannons

3. CONTROL MEASURES

a. Lines of control or coordination are drawn and labeled as shown below:

- | | |
|--|---|
| (1) Fire support coordination line | FSCL ————— FSCL |
| (2) Restrictive fire line | RFL ————— RFL |
| (3) Light line | LL ————— LL |
| (4) Line of departure | LOD ————— LOD |
| (5) Line of departure is present positions | LOD/PP  LOD/PP |
| (6) Line of departure is forward friendly dispositions | LOD/FFD  LOD/FFD |
| (7) Phase line with code name | PL
GREEN ————— PL
GREEN |

- | | |
|---------------------------------|--------------------|
| (8) Coordinated fire line | CFL CFL |
| (9) Probable line of deployment | PLD PLD |
| (10) Final coordination line | FINAL CL FINAL CL |

b. Control points are drawn on the selected terrain feature and identified as follows:

(1) A checkpoint consists of a circle enclosing a selected terrain feature with a number, letter, or code name placed inside the circle.



(2) A coordinating point is shown by drawing a circle on the selected terrain feature and placing an "X" in the center. Coordinating points are used in conjunction with boundaries to designate defensive areas.

Example:

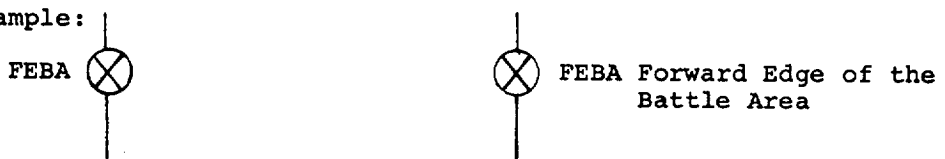

(3) A contact point is shown by drawing a square with a number placed inside.



4. FIRE PLANS

a. Sector of Fire

(1) Representation of a sector of fire is shown by two arrows composed of broken lines:

Example:

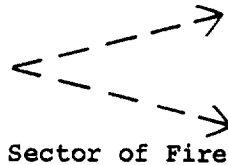

(2) A weapon symbol is normally used in conjunction with the symbol for a sector of fire. The base of the symbol indicates the weapon's position.

Examples:



Automatic Rifle



Machinegun

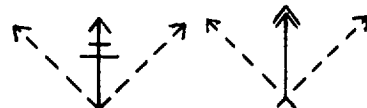

Heavy Machinegun



Rocket Launcher

b. Direction of Fire

(1) A principal direction of fire is represented by a solid arrow. To prevent confusion with similar symbols, the symbol representing a principal direction of fire is always shown together with the appropriate weapon symbol.

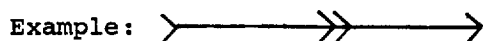

Principal direction of fire for an antitank rocket launcher.

(2) Symbols for sectors of fire and principal directions of fire are often combined.

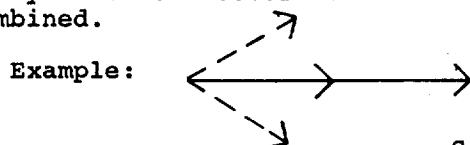

Sector of fire and principal direction of fire for a machinegun.

(3) A special principal direction of fire symbol is used to indicate final protective lines. Heavily shaded portions along the principal direction of fire symbol indicate areas of grazing fire.

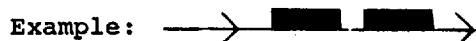

Final protective line for a single machinegun.

(4) The final protective line symbol is usually combined with the sector of fire and weapon symbols.

Examples:

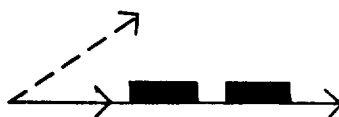

A final protective line and sector of fire for a single machinegun (machinegun team).



A final protective line and sector of fire for a machinegun squad (two machineguns).

c. Targets

(1) Point targets of less than 100 yards

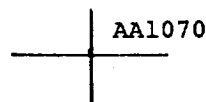

(2) Linear targets

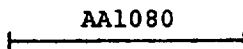

App. C

FMFM 6-4

(3) Area targets



(4) Rectangular targets

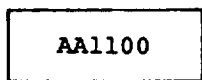

d. Final Protective Fire

A/1/10



(FPF assigned Battery A, 1st Battalion, 10th Marines)

APPENDIX D

SPECIAL TECHNIQUES FOR COUNTERGUERRILLA OPERATIONS

1. GENERAL

This appendix contains techniques for use in counter guerrilla operations which supplement established tactical procedures. It includes counterambush preparations for motorized units, immediate action drills for small units, and village search procedures.

2. COUNTERAMBUSH TECHNIQUES FOR MOTORIZED UNITS

a. General.--Experience in fighting terrorists and guerrillas has shown that they favor the ambush wherever the situation permits. The ambush of units traveling in motor convoy is not difficult and can be very costly if measures have not been taken to prepare vehicles and occupants before contact. This section contains information concerning techniques for the preparation of vehicles and their occupants for counterambush action when motorized.

b. Characteristics of Vehicular Ambushes.--A convoy is never safe from guerrilla ambush. Experience has shown that no set patterns of likely areas for ambush such as ravines, defiles, heavily wooded, or jungle covered areas can be established. Ambushes are equally likely to be set in villages or in flat terrain which offers a minimum of cover and concealment. The following additional characteristics are most often encountered:

(1) The ambush lasts the minimum time necessary to accomplish the mission.

(2) The ambush occurs in two phases, a short period of heavy fire followed by an assault of the ambushed vehicles to capture equipment, complete the annihilation of personnel, and to destroy vehicles.

(3) The basic ambush weapons are small arms. These may be augmented by machineguns, rocket launchers, and recoilless rifles.

(4) Electrically detonated mines to disable vehicles and cause personnel casualties are used. These mines may consist of artillery shells and mortar rounds as well as conventional mines.

c. Preparation of Vehicles.--Occupants traveling in vehicles must have all-around observation and fields of fire and be able to throw or fire grenades without hindrance. They must be able to debark from the vehicle rapidly with minimum restriction. For these reasons the configuration of vehicles such as the M35, 6x6 cargo truck must be altered. The following measures may be taken to "harden" a vehicle to provide its occupants with a degree of protection.

(1) Canvas, bows, windshields, and doors are removed.

(2) The tailgate is lowered to a horizontal position. A piece of pipe, wood, or metal may be affixed to the vehicle in a vertical position

extending above the driver's head to prevent decapitation if wire is stretched across the road.

(3) Sandbags are placed on the floorboards and bed of the vehicle. For the M35, 6x6 truck, a single row of sandbags, stacked five layers high down each side of the truck above the layer in the bed of the truck, provides protection from most small arms. A total of 70 to 100 sandbags are required for each truck. This load plus troop and equipment weight permits off-highway operation without undue wear on the vehicle. A wooden bench or packs rigged down the middle of the bed provide the troops with seats. (See fig. 88.)

(4) Sections of scrap armor plate may be used to reinforce sandbags in the bed of the vehicle.



Figure 88.--Hardened Vehicle.

d. Organization of Occupants.--Encounters with a guerrilla ambush are sudden, short, and so unexpected that the opportunity to inflict casualties upon him is lost if troops are not organized and well drilled to take immediate offensive action. The organization of a rifle squad as occupants of an M35, 6x6 truck is as follows:

(1) The squad leader is vehicle commander. A commander is designated for each vehicle. He is positioned in the bed of the vehicle where he can best control the squad and driver reaction to the ambush.

(2) An assistant driver is seated in the cabin with the driver. He should be able to operate the vehicle and should be prepared to aid the driver in controlling the vehicle. He remains with the vehicle after debarkation to act as close protection for the driver and vehicle. He does not accompany maneuvers executed by the occupant squad.

(3) Four corner sentries are positioned in the bed of the vehicle. The two at the front observe an arc of 90 degrees from the front to each side. When possible, each sentry should be armed with an automatic rifle. These sentries fire immediately from their positions within the vehicle, should the vehicle be ambushed. Their fire covers the debarkation of the occupants should the vehicle be halted in the ambush killing area. They also assist in convoy control by notifying the vehicle commander of any disruption of the convoy formation.

(4) If a machinegun team is traveling with the occupant squad, it should be positioned facing out the rear of the vehicle and be prepared to expeditiously debark, bringing fire to bear on the enemy and covering the debarkation of the four corner sentries.

(5) The remaining occupants are positioned in the bed of vehicle, each facing outboard.

(6) The maximum number of men in the bed of a hardened M35, 6x6 truck should not exceed 13. (See fig. 89.)

e. Convoy Commander.--The convoy commander positions himself where he can best control the convoy. He should not, however, position himself in the lead vehicle. He designates a second in command and a vehicle commander for each vehicle. He briefs them thoroughly before departure. Briefing by the convoy commander before departure is detailed and explicit. All drivers and vehicle commanders are present. The briefing includes:

(1) Formation: close column, open column, or infiltration.

(2) Timings.

(3) Route.

(4) Speed.

(5) Order of march (organization of vehicles).

(6) Maintenance of contact.

(7) Procedure when contact is lost and action on vehicle breakdown.



Figure 89.--Organization of Occupants of Hardened 6x6 Truck.

(8) Distribution of subordinate units.

(9) Appointment of vehicle commanders.

(10) Actions on ambush.

(11) Action in danger areas (dismounted sweeps or use of reconnaissance by fire).

f. Action on Contact.--Whatever the precautions and preparations, the ambush is nearly always an unexpected encounter. Counterambush drills are simple courses of action designed to deal with the problem of the unexpected encounter. They call for immediate, positive, offensive action. The action on ambush is to drive through the ambush area or stop before running into it, then to attack the enemy immediately from flank or rear.

(1) When vehicles are fired upon:

(a) Drivers attempt to drive through the killing zone.

(b) Sentries return fire immediately.

(c) When vehicles are clear of the killing zone, they are halted. Occupants dismount and take immediate offensive action against the enemy positions.

(d) Subsequent vehicles approaching the killing zone halt short of the zone. Occupants disembark and take immediate offensive action against the enemy positions.

(2) If hardened vehicles are forced to halt in the killing zone, all available weapons are used to return fire immediately. Occupants remain in the vehicles. On the first perceptible slackening of enemy fire, occupants disembark. When riding in a "soft" vehicle and caught in a killing zone, occupants disembark immediately. In both cases, occupants disembark under the covering fires of the four corner sentries, who initially remain aboard. The occupants then deploy to the side directed by the vehicle commander and take the enemy under fire to cover the disembark of the four sentries.

(3) After disembarking, if no cover is available, an immediate frontal assault against the enemy should be employed. The most logical course of action after disembarking is to take cover, immediately build up a base of fire, and employ a maneuver element against the enemy ambush positions. Speed of execution is all important.

g. Tactical Considerations.--The most effective counteraction to ambushes is a flanking attack by elements not in the killing zone quickly followed by relentless pursuit of the enemy. Attention must be given to the following considerations:

(1) In actions when no troops have entered the killing zone, the convoy commander launches an immediate flanking attack on the enemy position, using supporting fires from machineguns and mortars.

(2) In actions where a portion of the vehicles are ahead and out of the killing zone and the remainder are halted short of the zone, the portion which has not yet entered the killing zone initiates the flanking attack. If the convoy commander is not present, the senior vehicle commander takes command and directs the attack. Troops in vehicles which are ahead of the killing zone disembark and, under the command of the senior vehicle commander, return to the vicinity of the killing zone and exploit the situation.

(3) The best way in which an armored vehicle can assist in counter-ambush action is by moving into the killing zone to engage the enemy at short range. In this way it can give good covering fire to the flanking attack or provide protection for those troops caught in the killing zone.

(4) It is possible that the convoy commander may be killed, wounded, caught in the killing zone, or positioned on the wrong side of the zone. It is essential that all commanders know their responsibilities for organizing and directing the counterambush action. This is clearly stated in unit convoy orders and emphasized at briefings.

(5) The techniques outlined above are practiced repeatedly until the reaction procedures become a predrilled response permitting immediate, positive action on ambush.

h. Vehicle Unloading Drill.--When a vehicle is forced to halt in the killing zone of an ambush, the disembarkation of occupants must be organized and predrilled. On order or signal, the response must be immediate and each man must act swiftly to move to his proper position. Confusion is

thus overcome and immediate offensive action against the enemy is more likely to be effective. When the vehicle is halted, actions are as follows:

(1) If the vehicle is hardened, the vehicle commander takes appropriate action as set forth in subparagraph f(2) above. He then commands, "DEPLOY RIGHT (OR LEFT)," to indicate the direction in which occupants are to assemble after dismounting.

(2) Sentries throw smoke grenades and open fire immediately on the ambush positions. The grenadier, if one is aboard the vehicle, fires on the ambush position.

(3) Occupants, under cover of fire from the sentries, dismount over both sides of the vehicle and move to the side of the vehicle indicated in the command. As few occupants as possible attempt to dismount over the tail gate of the vehicle.

(4) As soon as the occupants have dismounted, the sentries dismount under covering fire from troops on the ground.

(5) The driver and assistant driver dismount in the direction indicated by the vehicle commander.

(6) When all occupants are out of the vehicle, action is taken in accordance with paragraph f(3).

3. IMMEDIATE ACTION DRILLS

a. General.--The guerrilla normally seeks contact with organized units only under favorable tactical circumstances; e.g., ambushes. When contact is made under less favorable circumstances, the guerrilla attempts a rapid withdrawal. In either case, small unit encounters with guerrillas are likely to be sudden, violent, and of short duration. Inaction or slow reaction results in excessive losses or the loss of an opportunity to punish the guerrilla unit. Contact is often made at close range, particularly when operating in jungle, temperate zone forests, woods, or heavy brush. Immediate action drills aid small units in reacting quickly and properly.

(1) Immediate Action.--Immediate and aggressive offensive action against guerrillas is fundamental to success in counter guerrilla warfare. In the performance of their combat missions against guerrillas, small rifle units employ immediate action drills and conventional tactics.

(a) Immediate Action Drills.--Immediate action drills are predrilled, prerehearsed reactions to contact or anticipated contact with the enemy and are used by small units operating in close terrain. They are similar to the conventional battle drills discussed in FMFM 6-5, Marine Rifle Squad. Immediate action drills are most frequently employed by rifle platoons and squads during the conduct of foot patrols and dismounted movements in close terrain against guerrillas. These actions may also be used against conventional forces in close terrain.

1 The variety of drills is limited only by the imagination and initiative of the small unit leader and the state of training of the unit. It is impractical to develop drills covering every contingency; however, it is important to develop a drill for each of the most frequently

occurring situations. The response to a given situation must not be stereotyped, as the enemy may ultimately capitalize upon rigid adherence to the same tactics.

2 Immediate action drills stress simplicity, aggressiveness, and rapid execution. They demand alertness and a high state of individual training. Drills are of little value to a unit in which the individual Marine lacks proficiency in the fundamental combat skills.

(b) Conventional Tactics.--In open terrain, conventional small unit tactics, battle drills, and patrolling techniques are usually required.

(2) Troop Leading Procedures.--The conventional troop leading procedures relate to the seizure of terrain and the destruction of a relative static enemy. The procedures by which the small unit leader arrives at a course of action in combat operations against guerrillas often are a parallel but abbreviated form of conventional troop leading.

(a) The unit leader makes a continuing estimate of the situation during his unit's movement; e.g., patrol. Prior to contact with the enemy, the estimate is normally limited to the following:

1 Consideration of the terrain and the visibility.

2 Selection of the most suitable immediate action drill to undertake in the event of a chance encounter; i.e., meeting engagement.

3 Selection of the most suitable counterambush maneuver.

(b) Once contact with the enemy has been established or is imminent, the leader completes his estimate by rapidly determining the nature of the encounter. He then conveys his decisions to the unit by prearranged signal. The signal initiates the immediate actions of the unit.

b. Freeze and Hasty Ambush.--The freeze and hasty ambush is a drill designed to deal with the meeting engagement. The drill is undertaken when the small unit has sighted guerrillas approaching but has not yet been seen by them. Immediate action is taken to ambush the guerrillas when they approach moving on a trail different from that used by the Marine unit or when the approach is on the same trail.

(1) Freeze.--When the guerrillas are sighted, the unit is halted by silent signal such as an arm and hand or other prearranged special signal. Each member of the unit relays the signal to individuals more remote from the originator than he and freezes in his tracks with his weapon in a firing position.

(2) Different Trails.--If the guerrillas are approaching on a route different from that of the Marine unit, the unit remains on the trail in a freeze position. The unit leader signals commence firing when the guerrillas present suitable targets.

(3) Same Trail.--On initially sighting the enemy, the freeze is executed. The individual making the sighting indicates the number of enemy by silent signal and then moves off the trail. Each individual relays the signal and moves off the trail on the same side used by the originator.

It is essential that the entire unit move to the same side of the trail. Speed of execution and silent movement are mandatory. Any unnatural sound may cause the guerrillas to turn and flee. Each man takes up a firing position facing the direction of enemy approach. The unit leader initiates the ambush by firing his weapon. In the event the guerrillas sight any unit member, that individual fires and springs the ambush.

c. Immediate Assault.--The immediate assault is a tactic used during an unexpected encounter at close quarters. It is a predrilled response to situations in which the guerrillas and the Marine unit become aware of each other at the same time. The immediate assault drill is a rapidly executed frontal assault.

(1) The drill is usually initiated by the first member of the unit who sights the enemy. He fires at the enemy and shouts a prearranged signal indicating the direction of the encounter; e.g., "enemy front (left, right), charge."

(2) The signal is repeated by each individual.

(3) The unit adopts the line formation. The line is oriented in the indicated direction of contact. A predesignated subordinate unit is withheld from the line to protect the flanks and rear.

(4) The unit leader sounds a prearranged assault signal.

(5) The assault is pressed forward until halted by the unit leader, usually when the guerrillas are no longer in sight.

d. Counterambush Drill.--There is no generally accepted immediate action for foot troops when ambushed. Adherence to the principle of security in avoiding an ambush is easier than escape from one. When ambushed, violent and concerted reaction is required to prevent annihilation. Small units must have a prearranged plan, known to every man, that allots a specific immediate action to each individual in accordance with his location and function in the formation.

(1) Entire Unit in Killing Zone

(a) It is seldom possible to find covered or concealed positions within the killing zone from which to exchange fire with the enemy. The unit may execute the immediate assault in the direction indicated by the unit leader. The direction indicated is normally what appears to be the weakest point in the ambush and is a prearranged counterambush drill.

(b) The unit may initially execute a preplanned movement to a position outside the killing zone indicated by the unit leader. The position is normally one which provides cover and/or concealment and is the location from which a subsequent drill is undertaken to eliminate the enemy.

(2) Leading Element in Killing Zone.--When only the foremost elements of the unit are caught in the killing zone, an immediate encircling attack is executed.

(a) Elements within the ambush indicate the nature and location of the ambush by prearranged signal; e.g., by voice, "ambush front (left, right)," or by whistle or other signals.

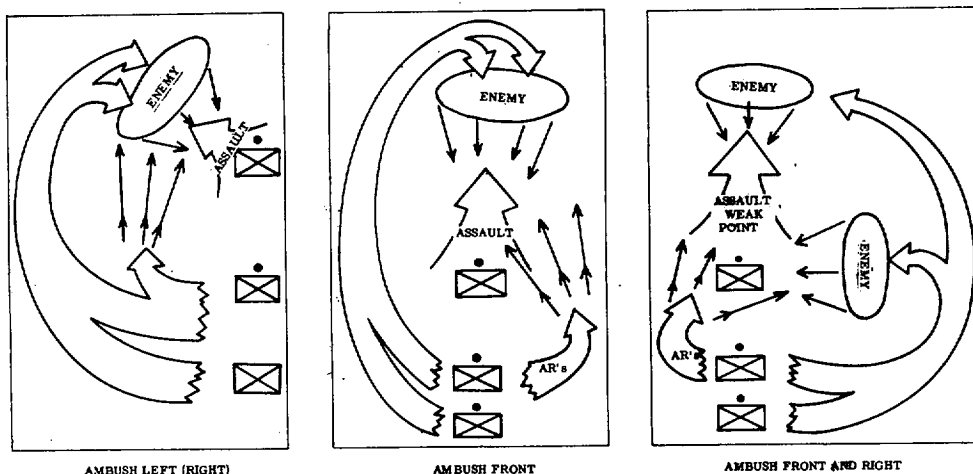

Figure 90.--Encircling Attack.

(b) Ambushed elements execute the immediate assault.

(c) Previously determined base of fire elements from subordinate units not yet engaged assume base of fire positions. These fires simultaneously support encircling maneuver elements and the units in the killing zone.

(d) The encircling attack units move out in a prearranged envelopment of the enemy flank and/or rear. (See fig. 90.)

(e) Whenever possible, the enemy rear is enveloped. The assault by the encircling units drive the enemy into the fires of the base of fire elements.

4. SEARCH TECHNIQUES

a. General.--In counter guerrilla operations, the rifle company must have the capability to effectively seize and thoroughly search villages. This section provides the company and platoon commander with the techniques of village seizure, clearing, and search operations. The attack of a fortified village is not treated herein.

b. Seizing and Searching Friendly or Neutral Villages.--The ability to seize and search a village results in the capture of guerrillas, reduces their effectiveness, and encourages the cooperation of the local population. The objective is to develop methods of capturing or killing guerrillas in a friendly or neutral village without alienating or harming residents or damaging their property.

(1) Principles.--Villages and hamlets vary from place to place and the details of procedure may vary, but the principles remain constant. The principles of village seizure and search are these:

(a) Reasons for the Operation.--A village clearing operation is never undertaken for its own sake alone. It derives from some specific

aim. The aim may be psychological warfare, a show of force and support, or apprehending guerrillas based on intelligence information received. Patrols are never sent into villages with vague, general orders, with neither the patrol leader, nor his troops, nor the villagers themselves being clear on the precise aim of the intrusion. This results in a wide scale of effects, ranging from ineptitude and a laughing guerrilla to excesses and a village population driven to resentment.

(b) Know Your Enemy.--Every enemy develops a behavior pattern which varies from district to district, and from time to time, often as a reaction to the methods of the military's efforts. Knowledge of this behavior pattern is one of the most important weapons in the commander's armory. He must study it, watch for variations, and keep abreast of it constantly. Typical questions are:

1 Where do guerrilla groups live? In the villages? On the edge of the village? 500-1,000 meters outside the village?

2 If living in the villages, do they disperse or live concentrated?

3 If living concentrated, do they favor any particular location; e.g., near fringing jungle, etc.?

4 How are they fed? Do they come together for meals? Do they eat dispersed in individual huts?

5 What are their alarm arrangements?

6 What are their security arrangements?

7 What get-away techniques do they favor? Dispersion among villagers? Escape individually or in small groups?

(c) The Village.--The following questions should be answered:

1 Size? What shape? How many huts?

2 Fortifications? Where? What type?

3 Tunnels?

4 Location? Open country, jungle all around, on edge of jungle, etc.?

5 Livestock, dogs, poultry, pigs, cows, buffalo?

(d) The Villagers.--The following questions should be answered:

1 Number?

2 Ethnic group or groups?

3 Religion or religions?

4 History of relations with guerrillas?

- 5 Industry? Rice, timber, etc.?
- 6 Where are the young men?
- 7 Where do the guerrillas normally hide weapons? In roof thatch? In double walls? In pits outside the house? In the fields?
- 8 Are the villagers sympathetic to the guerrilla? Terrorized? Apathetic?
- 9 Are any elements progovernment?

(e) A Well-Rehearsed Procedure.--Search and seizure operations are combat operations and, like other operations, require planning and training. The final plan is a welding together of a number of familiar, well-known procedures. The plan varies from place to place. The individual procedures will vary little. Attempts to improvise procedures on the spot invite failure. A company must be trained for this operation.

(2) Organization.--A rifle company may conduct search operations independently or as part of a larger unit. The tactical organization for conduct of operations is as follows:

(a) General Organization.--The first step is to designate a blocking or cordon force, an assault force, and a headquarters group. Unit integrity is maintained to the maximum extent possible.

(b) Special Organization.--The two forces are further organized into subordinate elements. The blocking or cordon force is organized into a blocking element, security element, and mobile reserve. The assault force may be organized into the following elements as appropriate:

- 1 Reconnaissance team.
- 2 Search teams.
- 3 Civilian control and interrogation team.
- 4 Prisoner-of-war team.
- 5 Fire support team.

(3) Execution.--There are three main steps in seizing and searching a village:

(a) Isolation.--The first step is the isolation of the village. This is the task of the blocking or cordon force. It is necessary to seal off escape routes to prevent the guerrillas from leaving the village prior to its seizure, and to prevent persons outside from warning or reinforcing those in the village.

1 The village is surrounded by a cordon, the blocking element of the blocking force. These troop units approach by as many different routes as possible. Secrecy, noise discipline, and light discipline are paramount. Surprise is required. When the troops are close to their line of encirclement, they double time to their final positions. The aim

must be to try to surround an area before the inhabitants realize what is happening. A cordon established in darkness needs to be as continuous as possible, but it can be thinned out after daylight as long as close observation between individuals or observation posts is maintained. Normally, it is impossible to maintain a continuous cordon for any length of time due to the large number of troops required. If necessary, cordon troops should dig in and/or take advantage of natural cover.

2 If there is a chance hostile elements from outside may attempt to interfere with the search, it may be necessary to use a security element of the blocking force to prevent their approach toward the cordon. At all costs, such persons must be prevented from joining the inhabitants of an area under search.

(b) Seizure.--The second main step is seizing the village. The seizure is accomplished after the cordon is established.

1 The officer in command informs the villagers by banner, loudspeaker, or through the leader of the community of the following:

a The area is to be searched.

b A house curfew is in force and all inhabitants are to remain indoors, or all inhabitants are to gather at a central point for searching.

2 On signal from the commander, the assault force enters the village, crossing the cordon perimeter at as many points as possible. The troops avoid using known gates and paths to avoid boobytraps and bear pits.

3 Once in the village, the assault troops fire only at known enemy targets, their object being to clear the village as quickly as possible. Houses are not entered at this stage. The fire support teams may be assigned fire positions sighted along possible escape routes. During the assault, a minimum of two men may be positioned at each house or likely hiding place to prevent any guerrilla movement or fire from inside.

4 As soon as the village has been seized, the commander moves his headquarters to the village to organize the detailed search.

(c) Village Search.--The third main step is searching the village. The commander assigns areas for search. There must be a system of search whereby every house is thoroughly searched for any hiding place, hidden weapons, entrances to underground tunnels, etc. In addition, each team must be supported by a fire unit. It must be remembered that the bulk of the villagers may be neutral, and because of this, there must be no indiscriminate firing. Units fire only when fired upon.

1 When searching a building with inhabitants inside, the first action required is to get everyone into one room. When searching, imagination is needed but every effort must be made to avoid causing wanton and unnecessary damage. When a house has been searched, it must be marked accordingly. Persons awaiting search must not be able to move into a building marked as searched.

2 When it is decided to search inhabitants in one central area, the villagers are segregated into one group of women and children and

a second group of men. Both groups are guarded. It will be necessary to have one person remain in every house so that he or she can be present when the house itself is searched. If this is not done, the owner is in a position to deny knowledge of anything incriminating that is found and to claim that it had been planted.

3 A great problem in all search operations is the accusation of theft and looting which is often made against the troops. In small searches, it may be possible to obtain a signed certificate from individual householders that nothing has been stolen, but in a large search this is likely to be impossible.

4 The prisoner-of-war team(s) are responsible for erecting any cages (compounds) required, guarding persons inside, and acting as escort troops for suspects found by the search teams. Separate cages must be provided for men, women, and suspects, and must be out of sight of each other. Children must not be regarded automatically as innocent, since they may have been trained to be hostile by parents and teachers. As a general rule, if under 12 years of age, children should be kept with women.

5 Interrogation is of greatest importance, but this must be regarded as a specialist task. The interrogator should be a member of the battalion intelligence section attached to the company for the operation.

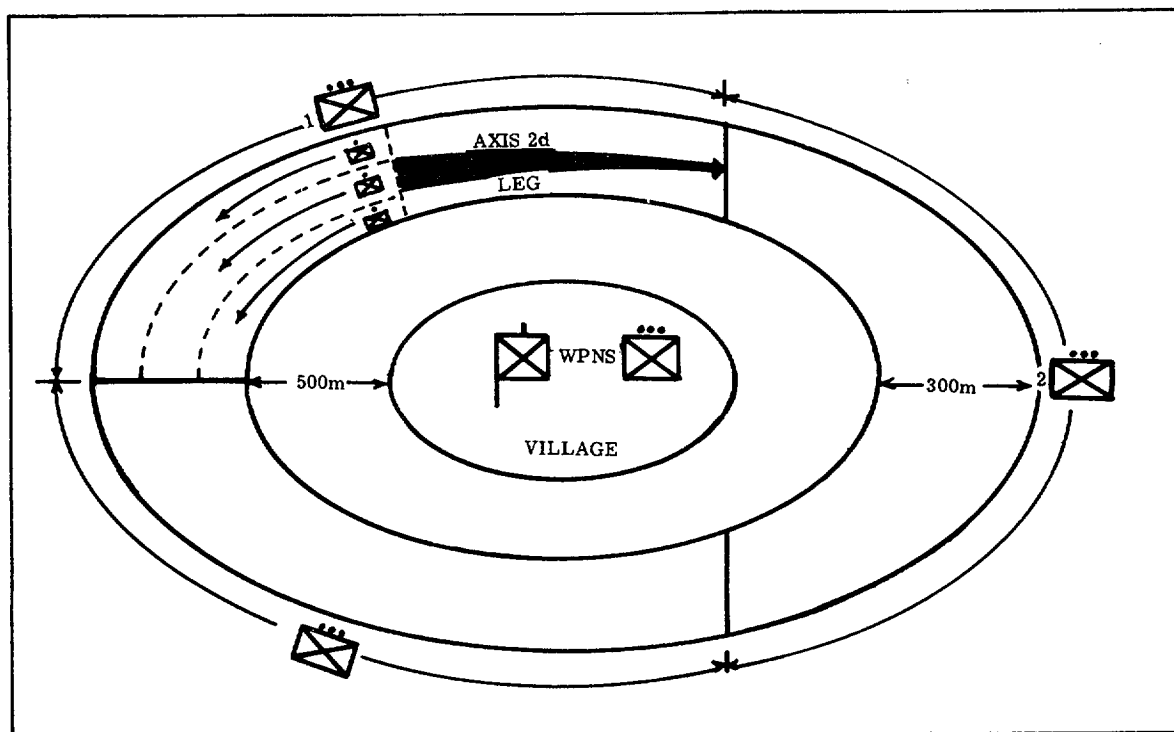

Figure 91.--Perimeter Search.

(d) Perimeter Search.--House search and interrogation completed, there remains the task of searching for possible external camps. The perimeter is divided into sections. Company headquarters remains in the village in radio contact with the searching platoons. Each platoon sweeps its assigned section by a two-leg traverse on the broadest possible front. (See fig. 91.) The blocking force joins in this maneuver; If the country is jungle or heavy woods, the frontages are reduced and the sweep repeated in four legs.

APPENDIX E

CASUALTY CARE AND EVACUATION IN THE PLATOON LINE

1. GENERAL

A medical team of 11 corpsmen is assigned to and operates with each rifle company in training and in combat. The company medical team is distributed as follows: the senior corpsman, designated the company corpsman, is assigned to company headquarters; the other 10, designated platoon corpsmen, are attached to platoons, normally one to the weapons platoon and three to each rifle platoon.

a. Casualty care in the platoon zone of action is the responsibility of the platoon commander. To assume that responsibility, the platoon commander must be aware of the facilities for casualty care and evacuation. He must also be able to plan for their proper use in combat. Not only does the ultimate welfare of the casualty call for efficient care and evacuation, but the performance and record of the platoon in present and subsequent engagements will be greatly influenced by proper handling of casualties. The loss of effectives among highly trained combat troops, when they are utilized for removal of the wounded because proper planning did not provide for litter bearers from supporting elements, may result in a disastrous lack of firepower when it is most needed in the attack.

b. Facilities for casualty care and evacuation in the forward zone of action consist of the following: the individual Marine and his buddy, platoon corpsmen, litter bearers from various sources, jeep ambulances from the battalion medical platoon, and most often, helicopters. The capability, availability, and employment of each of these facilities will be discussed in some detail.

2. INDIVIDUAL MARINE AND HIS BUDDY

During the training period, the platoon commander will ensure that all personnel are instructed by battalion medical personnel in basic first aid for battle wounds. Further, the individual Marine should be taught that, if wounded, he must remain calm. If his wound is minor, he or his buddy should apply a battle dressing and continue to deliver fire until the action lessens. If more seriously wounded, he should make his way, if able, to a place of relative safety and have the word passed for the platoon corpsman. If unable to move, his buddy may assist him. Such movement should be out of the direct line of fire. The ability of a buddy to give aid is dependent on the tactical situation.

3. PLATOON CORPSMEN

a. Hospital corpsmen are assigned from the battalion medical platoon on the basis of three per rifle platoon. They are as much a part of the platoon as any other member; however, corpsmen have not had as complete training as the combat infantryman and, initially, may require more tactical guidance and leadership from the platoon commander and his subordinate leaders. The platoon corpsman is a well trained technical assistant; he has been through Naval recruit training, 12 weeks of instruction in hospital

corps school, and 5 weeks special instruction at a field medical service school. On joining the platoon, he must be made a part of the team. The platoon corpsman, to properly and efficiently carry out his duties, must have the confidence and backing of the platoon commander in matters that deal with his technical specialty.

b. During the development of the attack, battalion corpsmen assigned to rifle platoons are normally positioned one to each squad. The corpsman assigned to the weapons platoon, initially, is positioned with the platoon command group. In both cases, however, the platoon commander may desire to position his corpsmen differently, based on his estimate of the situation and scheme of maneuver.

4. PLATOON CORPSMAN DUTIES PRIOR TO AND DURING THE ATTACK

Prior to and during the attack, the corpsman will:

a. Consult with the platoon commander on the objective of the attack, the terrain features involved, possible routes of evacuation, the availability of litter bearers and the position he will take in the attack formation.

b. Remove or direct removal of casualties to a place of relative safety where the corpsman can administer such first aid as indicated. This does not mean removal from the platoon zone of action, but only to a place protected by terrain features from direct aimed fire. In this connection, it is emphasized that it is neither necessary nor desirable that a corpsman expose himself recklessly to direct aimed fire to go to the assistance of a casualty in an exposed position. Covering fire, smoke screen, or employment of a tank for a shield may need to be used in making medical evacuations under fire. Usually, if the assault is moving, the corpsman will be ordered to delay until the casualty lies behind the advance. These precautions are not only for the preservation of the corpsman, but for the casualty as well, lest he become a target during evacuation over fire-swept terrain.

c. While giving first aid, the platoon corpsman will decide whether or not the condition of the casualty is serious enough to demand evacuation. If in the corpsman's judgment the condition of the casualty so demands, he will direct the casualty to the route of evacuation or, if litter bearers are necessary, will contact the litter squads by voice, runner, platoon radio, or field phone. The platoon commander must be aware that certain types of casualties demand high priority of evacuation if they are to have the best chance of survival (penetrating wounds of the abdomen, etc.), and that the corpsman's judgment should be adhered to on such occasions, whenever the tactical situation allows.

5. COMPANY CORPSMAN

a. While the corpsman assigned to a rifle company headquarters is not a part of a rifle platoon, he may play an important role in evacuation from a platoon zone of action by prompt dispatching of litter bearers when needed. He will also secure replacement platoon corpsmen and supplies when necessary.

b. It is mandatory that this corpsman be briefed by the rifle company commander on anticipated platoon activities if he is to properly plan for

litter bearers, plan evacuation routes, and secure facilities for evacuation to the rear.

6. LITTER BEARERS

Litter bearers are sometimes assigned from battalion headquarters, with such personnel as messmen, clerks, or bandsmen often being utilized. Stretcher teams are usually stationed with the corpsman at rifle company headquarters. Many variations occur, however, and it is to be emphasized that this source of litter bearers should not be taken for granted, and that in planning his attack, the platoon commander must assure himself of an adequate number of litter teams. Eight men per rifle company are considered adequate unless unusually heavy casualties are anticipated. Other sources of litter bearers are:

a. Members of the Rifle Platoon.--This source is mentioned only to be discouraged, although it will be well recognized that in an emergency or through poor planning, this is the only source available at times. Utilization of platoon personnel may result in a disastrous lack of firepower when it is most needed during the attack.

b. Members of the Reserve Platoon.--Here again it is recognized that in an emergency, this source must be employed. However, to rely on this source is not good practice because in the attack, when large scale casualties occur, the reserve platoon will usually be committed to action. In a moving situation, the reserve platoon is used to maintain contact with adjacent units, as a flank or rear guard, and for numerous other tactical duties. If the platoon is used for casualty evacuation, the company commander may be caught short handed.

c. Native Laborers.--Availability of native laborers for litter bearers depends on the local situation. Natives have been used for carrying rations, water, and ammo forward on litters and for evacuation of personnel on the return trip. Careful planning and supervision must be maintained.

(1) Many times, casualties who would demand litter carry, as judged by civilian standards, must make their way on foot and may do so without further injury. The platoon corpsman is the best judge of the patient's ability in this regard. Care must be taken in the administration of morphine by nonmedical personnel to ensure against making a litter case out of an ambulatory casualty.

(2) Litter bearers are vital from the standpoint of the survival of the casualty, in the maintenance of good morale, and most of all, to prevent loss of firepower to the assaulting platoons. Provisions for litter bearers must be included in plans.

7. AMBULANCES

An ambulance is normally available at battalion headquarters and it functions as far forward as the terrain and enemy activity will permit to prevent prolonged carrying of litters. When these vehicles are called forward, explicit instructions must be given as to routes taken and the exact location to which they are to proceed. Inasmuch as these vehicles frequently draw enemy mortar and artillery fire, they should not be brought up to an area under direct observation of the enemy. Casualties can and should travel by any conveyance available returning to the battalion aid

station or command post area from the front when ambulances are not immediately available.

8. HELICOPTER EVACUATION

a. Evacuation by helicopter is, of course, the ideal evacuation method. However, they should be used with discretion as their number is usually limited and they draw enemy fire when observed. This type of evacuation is available day and night at the rifle company level. Inasmuch as helicopters usually bypass the battalion aid station after picking up a casualty in the rifle company zone, care should be exercised that minor wounded are not evacuated by this means lest their ultimate return to duty be extended, and helicopters thereby used needlessly.

b. Helicopters are normally requested through battalion, but the platoon and rifle company commanders should be aware of their availability under all circumstances.

c. In those cases where the platoon commander has the capability or may be required to call in a helicopter for casualty evacuation, a landing site in the immediate area must be located and cleared. Flat open spaces and hilltops are good locations, provided that all-around security can be established. It is imperative that physical security be provided out to the effective range of small arms fire, if at all possible. When patrolling in the jungle highlands, a landing site may have to be cleared by the platoon. Tools likely to be used would be chain saws, hatchets, K-bars, entrenching tools, and explosives such as TNT and C-4. In extreme cases, where single and double canopy exists, casualties may have to be evacuated by hoisting as the helicopter hovers overhead. This necessitates extremely accurate map reading and communications with the helicopter. For normal operations when the helicopter approaches the landing site, the platoon commander should throw a smoke grenade to mark his position and show the pilot the direction of the wind. The platoon commander should also inform the pilot of the friendly position and the enemy position and situation. Particularly in a debris-strewn landing site, a Marine should direct the helicopter in, signalling where it is clear for the aircraft to land in the site. All Marines in the platoon should be trained in directing helicopters into a landing site, requesting medical evacuation helicopters from the company commander and communicating with the pilot over the radio. Radio communications are particularly important in night operations. Because of the inherent danger in night evacuation, the seriousness of the wound must be considered. It might be advantageous to wait until first light to evacuate the casualty. If night evacuation is necessary, it is preferable to form a triangle with flashlights or small fires to outline a landing point for the helicopter. Unit SOP's may be established so that the apex of the triangle indicates the direction in which the nose of the helicopter will point when setting in the zone and also the best direction for takeoff. Do not shine lights on the helicopter as it approaches, since this may confuse the pilot in addition to making a better target for the enemy. It is obvious that excellent signals and communications are essential for night evacuation by helicopter.

9. BATTALION AID STATION

a. The next medical echelon to the rear is the battalion aid station, having two medical officers and 21 hospital corpsmen. They are equipped with one jeep ambulance which works as far forward as possible. The

function of the battalion aid station is to give further first aid, check continued hemorrhage, re-bandage where indicated, apply splints if needed, and give supportive therapy for shock in the form of plasma and serum albumen in order to put the seriously wounded casualty in condition to withstand further evacuation.

b. This station also serves as a holding point for minor casualties, heat prostrations, minor psychiatric cases, and others, in which a return to frontline duty is anticipated in a matter of 24 to 36 hours.

10. CASUALTY HANDLING METHODS

a. The platoon commander is briefed for the attack by the rifle company commander; the company corpsman should be present at this conference to advise on the need for, and the availability of litter bearers, jeeps and helicopters, and details of routes of evacuation.

b. The platoon corpsmen should be present when the squad leaders of the platoon are briefed. The position of the corpsmen in the assault will be decided upon, routes of evacuation discussed, and a place selected for the collection of casualties for evacuation to the rear. Information regarding the availability of litter bearers will be passed on to the corpsmen and squad leaders.

c. When a casualty occurs as the attack develops, the wounded man, if possible, will make his way back to a relatively protected spot and the word quietly passed for one of the platoon corpsmen who will go forward to give first aid. The necessity for passing the word back quietly and efficiently is important. Loud shouting for a corpsman by all the men in the vicinity may have a demoralizing effect on green troops. Incidents have occurred when inexperienced troops have actually panicked because of frenzied shouting of the whole squad for a corpsman to take care of a single casualty. The call for a corpsman is sometimes passed by code or the corpsman's name.

d. If there is heavy firing in the area to be traversed by the corpsman, the platoon commander may prevent the corpsman's going forward until a reasonable chance of success is apparent.

e. After giving first aid, the corpsman will make a recommendation to the platoon commander on the disposal of the casualty.

f. If litter carry is indicated, the corpsman will contact the litter bearers by voice, runner, or by the use of the platoon radio or field phone. If the situation is such that jeep ambulances can be brought forward with relative safety, the platoon commander shall inform the rifle company commander, who will order the ambulances up and assume responsibility for their employment. If the patient's condition demands helicopter evacuation, the platoon commander shall so inform the company commander, who will decide on the advisability of bringing a helicopter into the area and communicate the request to battalion if affirmed.

g. If evacuation is interrupted by enemy interdiction, casualties will be collected in a relatively safe spot and company headquarters informed of the situation. If large-scale casualties occur and their care is beyond the capabilities of the platoon corpsmen and assigned litter bearers, these facts will be made known to company headquarters and assistance will be requested.

11. CASUALTY CARE AND EVACUATION ON PATROL MISSIONS

Under no other circumstances is detailed planning so necessary to ensure adequate casualty care and evacuation as for patrol actions. When a casualty occurs on a patrol, several courses of action are open to the patrol leader:

a. Take the casualty along with the main body of the patrol. Such action will be taken when the wound is minor, when the patrol is nearing its objective, when return route of the patrol is not to be along the route of original advance, or when the route of evacuation is too insecure to send him back or leave him at a collecting point with attendants.

b. Leave casualty or casualties at designated rally points along the route of advance. This method is indicated when the patrol is to return shortly over the same route and sufficient personnel can be left with the casualties to ensure reasonable protection. This method may also be used if supporting elements have the capability of coming out to collecting points to accomplish evacuation.

c. Evacuation by motor transport or ambulance if route is secure.

d. Evacuation by helicopter if this means is available. The patrol leader should consider the following factors in deciding which method or combination of methods will be utilized on any given patrol:

- (1) Mission.
- (2) Size of patrol.
- (3) Estimated enemy contact.
- (4) Distance patrol will probably advance from a base line and route of return.
- (5) Expected duration of a patrol.
- (6) Ability of supporting elements to come to the relief of the patrol should heavy casualties be taken.
- (7) Whether or not supporting elements are to move up to consolidate position of contact.
- (8) Efficiency of communications.
- (9) Availability of helicopters and efficiency of their use under the anticipated circumstances.

e. Methods may change as the patrol action develops, but adequate planning will facilitate proper casualty care under all but the most unusual circumstances.

12. CASUALTY CARE AND EVACUATION IN THE DEFENSIVE SITUATION

a. In the ideal defensive situation, where all units are tied in, communications to higher echelons are open and close liaison has been established with all supporting units, casualty care and evacuation should

be at its highest peak of efficiency. Platoon commanders must ensure, however, that all available means mentioned heretofore are in readiness day and night. When action is light, there is time to take stock of the health of the platoon and to inaugurate such measures indicated to prepare it for further offensive action. Minor wounds and complaints are attended, and the borderline cases of physical unfitness may be evacuated from the platoon.

b. In other defensive actions, where the platoon is occupying an extended front or required to defend isolated outposts, casualty care can be a serious problem. All facilities outlined under the care and evacuation during the assault must be considered for use and their employment planned for. It is particularly important that in the defense of isolated outposts, the most protected area in the perimeter of defense be utilized as a collecting point for casualties and higher echelon notified of such an accumulation of ineffectives.

FMFM 6-4

LIST OF REFERENCES

1. JOINT PUBLICATIONS



JCS Pub 1, Department of Defense Dictionary of Military and Associated Terms

2. FLEET MARINE FORCE MANUALS



FMFM 1-1, Close Combat
 FMFM 1-2, Marine Troop Leaders Guide
 FMFM 2-1, Intelligence
 FMFM 3-1, Command and Staff Action
 FMFM 3-2, Amphibious Training
 FMFM 3-3, Helicopterborne Operations
 FMFM 4-2, Amphibious Embarkation
 FMFM 4-5, Medical and Dental Support
 FMFM 6-3, Marine Infantry Battalion
 FMFM 6-5, Marine Rifle Squad
 FMFM 7-4, Field Artillery Support
 FMFM 8-1, Special Operations
 FMFM 8-2, Counterinsurgency Operations
 FMFM 9-1, Tank Employment/Antimechanized Operations
 FMFM 9-2, Amphibious Vehicles
 FMFM 10-1, Communications

3. U. S. NAVY PUBLICATIONS

NWP 22-3(), Ship-to-Shore Movement

4. U. S. ARMY FIELD MANUALS

FM 7-10, The Rifle Company, Platoons, and Squads
 FM 7-20, The Infantry Battalions
 FM 17-1, Armor Operations
 FM 19-15, Civil Disturbances
 FM 20-32, Mine/Countermine Operations at the Company Level
 FM 20-60, Battlefield Illumination
 FM 21-18, Foot Marches
 FM 21-30, Military Symbols
 FM 21-40, Chemical, Biological, Radiological, and Nuclear Defense
 FM 21-48, Planning and Conducting Chemical, Biological, Radiological (CBR), and Nuclear Defense Training
 FM 21-75, Combat Training of the Individual Soldier and Patrolling
 FM 31-21, Special Forces Operations, U.S. Army Doctrine
 FM 31-50, Combat in Fortified and Built-Up Areas
 FM 31-60, River-Crossing Operations

5. ARMY PUBLICATIONS

AR 320-5, Dictionary of United States Army Terms

FMFM 6-4

6. STANDARDIZATION AGREEMENTS

STANAG 2014, Operation Orders, Annexes to Operation Orders and
Administrative/Logistic Orders
STANAG 2020, Operational Situation Reports

FMFM 6-4

INDEX

	<u>Paragraph</u>	<u>Page</u>
A		
Aerial imagery reconnaissance -----	6204c(4)	284
Ambulances -----	App E	399
Ambush patrols -----	5205	253
Amphibious demonstration -----	2703	95
Amphibious operations		
Concepts -----	2102	47
Conduct of the assault -----	2601	87
Embarkation -----	2301	56
Movement to the objective area -----	2402	57
Planning -----	2201	49
Raids, demonstrations, withdrawals -----	2701	94
Rehearsal -----	2401	57
Ship-to-shore movement -----	2501	63
Amphibious raids -----	2702	94
Amphibious withdrawal -----	2704	95
Approach march -----	3204	118
Approach schedule -----	2507d(3)	78
Area defense -----	4102b,	197
	4301	208
	4306	227
Conduct -----	4303	214
Frontline platoon -----	4302	208
Frontline rifle company -----	4305	225
Reserve platoon -----	4307	229
Reserve rifle company -----	4304	219
Weapons platoon -----	6103b	273
Area security coordination center (ASCC) -----	3205	119
Assembly area -----	3302d	123
Attack position -----	8101	311
Auxiliary operations -----	8701	350
Bivouacs -----	8501	330
Mine warfare -----	8601	345
Nuclear, biological, and chemical defense -----	8203	316
Passage of lines -----	8301	318
Reconnaissance in force -----	8202	314
Relief in place -----	8201	313
Relief operations -----	8401	319
Retrograde operations -----	3302e	123
Axis of advance -----		
B		
Barrier plan -----	4302b(3)	211
Base unit -----	3302m	126
Battalion aid station -----	App E	400
Biological operations -----	8606	349
Bivouacs -----	8701	350
Organization of site -----	8703	351
Security -----	8704	351
Selection of site -----	8702	350

FMFM 6-4

	<u>Paragraph</u>	<u>Page</u>
Boundaries		
Defensive -----	4103b(1)	198
Offensive -----	3302b	121
Breaching operations -----	8508	343
Built-up areas, attack of -----	3801	177
C		
Casualty care and evacuation in the platoon line -----	App E	397
Casualty handling methods -----	App E	401
Checkpoints -----	3302n	126
Chemical operations -----	8605	348
Civil disturbances -----	7201	295
Crowds and mobs -----	7102	294
Domestic -----	7201a	295
Foreign -----	7201d	296
Operations -----	7204	306
Planning and training -----	7202	296
Riot control formations -----	7203	298
Civil-Military Advisory Committee (CMAC) -----	6103c	273
Classification of minefields		
Barrier minefield -----	8503c	331
Defensive minefield -----	8503b	331
Nuisance minefield -----	8503d	332
Phony minefield -----	8503e	332
Protective minefield -----	8503a	331
Collection agencies -----	1502c	35
Collection of information -----	1502	33
Combat		
Operations, counter guerrilla -----	6205	284
Outpost -----	4204	203
Patrol -----	5203	250
Plans and orders -----	1406	25
Records and reports -----	1407	29
Command and control -----	1401	11
Communications -----	1402	12
Company corpsman -----	App E	398
Conduct of the assault -----	2601	87
Helicopterborne -----	2602	87
Waterborne -----	2603	91
Conduct of the attack		
Built-up area -----	3805	182
Daylight -----	3307	144
Fortified area -----	3704	176
Infiltration -----	31003	188
Mechanized-infantry -----	3604	172
Night -----	3404	160
Tank-infantry -----	3505	166
Conduct of the defense -----	4306	227
Consolidation		
Daylight -----	3308	146
Mechanized-infantry -----	3605	172
Night -----	3405	161
Scheme of maneuver -----	3305f	130
Tank-infantry -----	3506	167

FMFM 6-4

	<u>Paragraph</u>	<u>Page</u>
Contact points -----	3302o	126
Control measures -----	App C	379
Control, ship-to-shore movement -----	2504	67
Coordinated fire line (CFL) -----	3302k	125
Converging axes attack -----	3503a(2)	164
Counterambush for motorized units -----	App D	383
Counterattack -----	4305c(5)	227
Counter guerrilla operations -----	6201	276
Combat operations -----	6205	284
Denial of support -----	6206	291
Intelligence -----	6204	281
Police operations -----	6202	278
Security measures -----	6203	280
Counterinsurgency -----	6101	271
Approach -----	6102	272
Civil disturbances -----	7201	295
Counter guerrilla operations -----	6201	276
Forces -----	6105	274
Organization -----	6103	273
Programs -----	6104	274
Counterintelligence -----	1505	37
Covering force -----	4202	203

D

Daylight attack -----	3301	121
Conduct of the attack -----	3307	144
Consolidation -----	3308	146
Exploitation -----	3309	147
Fire support plan -----	3306	132
Plan of attack -----	3304	127
Preparation for the attack -----	3303	127
Reserve rifle company -----	3311	150
Reserve rifle platoon -----	3310	148
Scheme of maneuver -----	3305	128
Tactical control measures -----	3302	121
Debarkation -----		
Amphibious vehicles -----	2402b(2) (b)	61
Helicopterborne units -----	2402b(1)	59
Landing craft -----	2402b(2) (a)	59
Rehearsal -----	2402c	62
Schedule -----	2402b(2) (a) <u>1</u>	59
Deduced mission -----	1404a(1)	18
Defense -----		
Built-up area -----	4601	239
Fundamentals -----	4106	201
River line -----	4701	241
Defensive echelons and the battle area -----	4104	199
Defensive operations -----	4101	197
Area defense -----	4301	208
Basic definitions and control measures -----	4103	198
Basic rifle company missions -----	4105	200
Defense of a river line -----	4701	241
Defense of a built-up area -----	4601	239
Fundamentals -----	4106	201
Mobile defense -----	4801	244

FMFM 6-4

	<u>Paragraph</u>	<u>Page</u>
Defensive operations (continued)		
Perimeter defense -----	4401	233
Reverse slope defense -----	4501	236
Security forces -----	4201	203
Types of defense -----	4102	197
Delaying actions -----	8403	326
Denial of support -----	6206	291
Direction of attack -----	3302f	124
Direction of fire -----	App C	381
Dissemination of intelligence -----	1504	37
Distribution of forces -----	3104	100
Domestic emergencies -----	7101	293
Civil disturbances -----	7201	295
E		
Economy of force, principle of war -----	1403b(6)	17
Embarkation -----	2301	56
Encirclement -----	6205c	286
Estimate of the situation -----	1404	18
Exploitation -----	3309	147
F		
Final coordination line -----	3302i	125
Fire plans -----	App C	380
Fire support coordination line (FSCL) -----	33021	126
Fire support plan, offensive operations -----	3306	132
Forms of offensive maneuver -----	3105	102
Envelopment -----	3105d	105
Frontal attack -----	3105b	103
Penetration -----	3105c	105
Fortified areas, attack of -----	3701	173
Forward forces -----	4802	244
Freeze and hasty ambush -----	App D	389
Frontal attack -----	3105b	103
Frontline platoon -----	4303	214
Frontline rifle company -----	4302	208
Fundamentals of defense -----	4106	201
Fundamentals of offensive tactics -----	3102	97
G		
General outpost -----	4203	203
H		
Hammer and anvil -----	6205c(2)(e) <u>4</u>	288
Harrassment, counter guerrilla -----	6205b	284
Helicopter		
Availability table -----	2507c(1)	73
Employment and assault landing table -----	2507c(2)	73
Heliteam wave and serial assignment table -----	2507c(3)	73
Landing diagram -----	2507c(4)	75
Training -----	31106	195

FMFM 6-4

	<u>Paragraph</u>	<u>Page</u>
Helicopter control -----	2504b	67
Coordination section (HCS) -----	2504b(2)	67
Coordinator (Airborne)(HC(A)) -----	2504b(4)	67
Direction center (HDC) -----	2504b(3)	67
Initial terminal guidance teams -----	2504b(5)	67
Tactical air control center (TACC) -----	2504b(1)	67
Helicopter evacuation -----	App E	400
Helicopterborne units in subsequent operations ashore --	31101	190
Assault -----	31104	194
Concepts -----	31102	190
Night operations -----	31105	194
Planning -----	31103	190
Training -----	31106	195

I

Illumination planning -----	3403g(2)	159
Immediate action drills -----	App D	388
Implied mission -----	1404a(2)	19
Infiltration -----	31001	187
Intelligence -----	1501	32
Amphibious operation -----	1507	39
Counter guerrilla operations -----	6204	281
Counterintelligence -----	1505	37
Helicopterborne operations -----	1508	41
Reports -----	1407c	30
Training -----	1506	38

L

Landing categories -----	2505	70
Landing craft and assault amphibious vehicle assignment table -----	2507d(2)	77
Landing documents		
Helicopterborne -----	2507c	73
Waterborne -----	2507d	75
Landing plan -----	2507	72
Landing sequence table -----	2507d(5)	79
Lanes and gaps -----	8505c	334
Limit of advance -----	3402a(8)	154
Line of departure (LOD) -----	3302c	122
Linkup point -----	3302p	126
Litter bearers -----	App E	399
Local security -----	4205	206
Logistics		
Medical -----	1604	44
Motor transport -----	1603	44
Services -----	1605	44
Supply -----	1602	42

M

Machinegun, tactical employment -----	4304c(1)	220
Maneuver, principle of war -----	1403b(7)	17

FMFM 6-4

	<u>Paragraph</u>	<u>Page</u>
Maneuver, offensive -----	3105	102
Envelopment -----	3105d	105
Frontal attack -----	3105b	103
Penetration -----	3105c	105
Manual laying of minefields -----	8506	335
Mass, principle of war -----	1403b(5)	17
Mechanized infantry attack -----	3601	168
Conduct -----	3604	172
Consolidation -----	3605	172
Methods -----	3602	168
Plan -----	3603	169
Messenger, communications -----	1402b(5)	15
Methods of attack		
Mechanized infantry -----	3601	168
Tank-infantry -----	3503	162
Military symbols -----	App C	377
Mine cluster -----	8505b	333
Mine warfare -----	8501	330
Basic concepts -----	8502	330
Breaching operations -----	8508	343
Tactical classification of minefields -----	8503	331
Manual laying of minefields -----	8506	335
Planning and siting -----	8504	332
Reports and records -----	8507	340
Standard pattern minefield -----	8505	332
Missions		
Rifle company/platoon -----	1102a	1
Weapons platoon -----	1102b	1
Mobile defense -----	4102c,	198,
	4801	244
Motor march, administrative -----	3202c	109
Movement to contact -----	3201	106
Approach march -----	3204	118
Assembly area -----	3205	119
Route column -----	3202	107
Tactical column -----	3203	111
Movement to objective area -----	2402	57
Mutual protection -----	3502	162

N

National Intelligence/Security Agencies -----	6105d	275
National Internal Security Committee (NISC) -----	6103a	273
Night attack -----	3401	152
Conduct of the attack -----	3404	160
Consolidation -----	3405	161
Plan of attack -----	3403	155
Tactical control measures -----	3402	153
Types -----	3401d	152
Night defense -----	4306b	229
Night operations, helicopterborne -----	31105	194
Nuclear, biological, and chemical defense -----	8601	345
Biological operations -----	8606	349
Chemical operations -----	8605	348
Defense personnel -----	8602	345

	<u>Paragraph</u>	<u>Page</u>
Nuclear warfare -----	8604	347
Training -----	8603	345
O		
Objective		
Control measure -----	3302h	124
Principle of war -----	1403b(1)	16
Offensive maneuver -----	3105	102
Offensive operations -----	3101	97
Attack of built-up areas -----	3801	177
Attack of fortified areas -----	3701	173
Daylight attack -----	3301	121
Distribution of forces -----	3104	100
Forms offensive maneuver -----	3105	102
Fundamentals -----	3102	97
Helicopterborne units in subsequent operations		
ashore -----	31101	190
Infiltration -----	31001	187
Mechanized infantry attack -----	3601	168
Movement to contact -----	3201	106
Night attack -----	3401	152
Phases -----	3103	98
River crossing operations -----	3901	183
Tank-infantry attack -----	3501	162
Offensive, principle of war -----	1403b(2)	16
On-call waves -----	2505a(2)	70
Operations, civil disturbances -----	7204	306
Organization and duties		
Rifle company -----	1201	3
Rifle platoon -----	1202	3
Weapons platoon -----	1203	4
Organization, combat		
Combat, combat support, and combat service support--	1301b	8
Standard augmentations -----	1301a	7
Organization of bivouac site -----	8703	351
Overlay techniques -----	App C	377
P		
Paramilitary forces -----	6105c	275
Passage of lines -----	8203	316
Patrolling -----	5101	247
Advanced patrolling techniques -----	5501	264
Counter guerrilla operations -----	5402	261
Patrol types -----	5201	248
Planning and preparing -----	5401	261
Responsibilities -----	5301	257
Thrust line and thrust point systems -----	5503	266
Patrol bases -----	5502	264
Patrol types -----	5201	248
Ambush -----	5205	253
Combat -----	5203	250
Raid -----	5204	251
Reconnaissance -----	5202	248

FMFM 6-4

Penetration -----	3105c	105
Perimeter defense -----	4401	233
Personnel, duties of		
Company headquarters -----	1204a	4
Rifle platoon headquarters -----	1204b	5
Weapons platoon headquarters -----	1204c	6
Phase line (PL) -----	3302g	124
Phases of attack		
Conduct -----	3103b	99
Consolidation and reorganization -----	3103c	99
Flexibility -----	3103d	100
Preparatory -----	3103a	98
Plan of attack		
Built-up areas -----	3804	179
Daylight -----	3304	127
Fortified areas -----	3703	175
Infiltration -----	31002	187
Mechanized-infantry -----	3603	169
Night -----	3403	155
Tank-infantry -----	3504	165
Planning, amphibious operations -----	2201	49
Aids -----	2204	51
Fundamentals -----	2202	49
Plan of attack -----	2205	51
Sequence -----	2203	50
Training -----	2206	53
Police operations -----	6202	278
Population control -----	6202c	279
Preparation for the attack -----	3303	127
Principles of war -----	1403	16
Probable line of deployment -----	3402a(6)	154
Processing and use of combat intelligence -----	1503	36
Protective wire -----	4302b(3)(a) <u>2</u>	212

R

Rabbit hunt -----	6205c(2)(e) <u>5a</u>	288
Raid patrols -----	5204	251
Receipt of mission -----	1405a	22
Reconnaissance in force -----	8301	318
Reconnaissance patrols -----	5202	248
Rehearsal -----	2401	57
Release point(s) -----	3402a(2)	153
Relief in place -----	8202	314
Relief operations -----	8201	313
Reserve -----	4803	245
Platoon in defense -----	4305	225
Rifle company -----	3311	150
Rifle platoon -----	3310	148
Use of, plan -----	3305g	131
Restrictive fire line (RFL) -----	3302j	125
Retirement -----	8404	328
Retrograde operation -----	8401	319
Delaying actions -----	8403	326
Withdrawal actions -----	8402	321
Reverse slope defense -----	4501	236

	<u>Paragraph</u>	<u>Page</u>
Rifle company		
Attack order -----	App A	355
Battle area -----	4104a	199
Built-up area defense -----	4602	239
Characteristics -----	1103a	1
Command and control -----	1401	11
Defense order -----	App A	362
Employment -----	1104a	2
Forward defense area -----	4104c	199
Fragmentary order -----	App A	361
Frontline -----	4302	208
Intelligence -----	1501	32
Logistics -----	1601	42
March order -----	App A	368
Missions in the defense -----	4105	200
Perimeter defense -----	4402	233
Reserve area -----	4104d	199
Reserve in defense -----	4307	229
Reverse slope defense -----	4502	236
River line defense -----	4702	242
Security area -----	4104b	199
Task organization -----	1303	9
Rifle platoon		
Attack order -----	App A	358
Built-up area defense -----	4603	240
Characteristics -----	1103b	1
Defense order -----	App A	366
Employment -----	1104b	2
Fragmentary order -----	App A	360
Frontline -----	4303	214
March order -----	App A	371
Mission in the defense -----	4105b	201
Perimeter defense -----	4403	234
Reverse slope defense -----	4503	236
River-crossing operations -----	3901	183
Concept -----	3902	183
Crossing in assault amphibious vehicles -----	3903	184
Crossing in boats -----	3904	185
Rocket, tactical employment -----	4304c (2)	223
Route column -----	3202	107
S		
Scheduled waves -----	2505a (1)	70
Scheme of maneuver		
Helicopterborne units -----	31103d (1)	191
Offensive operations -----	3305	128
Search techniques -----	App D	391
Sector of fire -----	App C	380
Security forces -----	4201	203
Combat outpost -----	4204	203
Covering force -----	4202	203
General outpost -----	4203	203
Local security -----	4205	206
Mobile defense -----	4804	245

FMFM 6-4

	<u>Paragraph</u>	<u>Page</u>
Security measures, counter guerrilla operations -----	6203	280
Security, offensive operations -----	3305h	131
Security, principle of war -----	1403b(9)	17
Serial assignment table -----	2507d(4)	79
Serial numbers -----	2506	71
Shell reports (ShelRep) and crater analysis -----	1407d	30
Ship-to-shore movement -----	2501	63
Characteristics -----	2502	63
Control -----	2504	67
Debarkation -----	2508	79
Landing categories -----	2505	70
Landing plan -----	2507	72
Organization -----	2503	63
Over-the-horizon standoff -----	2511	86
Sequence -----	2509	82
Serial numbers -----	2506	71
Terminology -----	2503b	64
Transfer operations -----	2510	84
Ship-to-shore sequence		
Helicopterborne -----	2509a	82
Waterborne -----	2509b	83
Simplicity, principle of war -----	1403b(3)	16
Single axis attack -----	3503a(1)	163
Standard pattern minefield -----	8505	332
Supplementary wire -----	4302b(3) (a) <u>3</u>	212
Surprise, principle of war -----	1403b(8)	17
T		
Tactical area of responsibility (TAOR) -----	3302q	127
Tactical column -----	3203	111
Advance guard -----	3203b(2)	112
Advance party -----	3203b(3)	113
Flank guard -----	3203b(6)	113
Point -----	3203b(4)	113
Rear guard -----	3203b(5)	113
Tactical control measures -----	3302	121
Tactical wire -----	4302b(3) (a) <u>1</u>	211
Tank-infantry attack -----	3501	162
Conduct of the attack -----	3505	166
Consolidation -----	3506	167
Methods of attack -----	3503	162
Mutual protection -----	3502	162
Plan of attack -----	3504	165
Task organization -----	1303	9
Terrain and weather -----	1404c	20
Thrust line and thrust point systems -----	5503	266
Transfer operations -----	2510	84
Transfers at a transfer line -----	2510b	84
Troop		
Leading procedure -----	1405	22
Leading steps -----	1405b	23
Loading assistant, helicopterborne units -----	31103e(2) (e) <u>4</u>	194
Loading officer, helicopterborne units -----	31103e(2) (e) <u>1</u>	193

FMFM 6-4

U

Unity of command, principle of war -----	1403b(4)	17
Urban areas, combat -----	6205c(1)	286

V

Visual communications -----	1402b(3)	15
-----------------------------	----------	----

W

Warning order -----	1406c	27
Waterborne control -----	2504c	68
Weapons platoon		
Built-up area defense -----	4604	240
Characteristics -----	1103c	2
Employment -----	1104c	2
In the area defense -----	4304	219
Perimeter defense -----	4404	235
Reverse slope defense -----	4504	237
Withdrawal action -----	8402	321

Z

Zone of action -----	3302a	121
----------------------	-------	-----