

Military Operations on Urbanized Terrain (MOUT)

FM 90-10

Headquarters

Department of Army

Washington, DC, 15 August 1979

FM 90-10
Military Operations
on Urbanized Terrain
(MOUT)

Table of Contents

CHAPTER 1... INTRODUCTION

Urbanization

Characteristics of Urban Warfare

CHAPTER 2... OFFENSE

How the Enemy Defends

Planning the Attack

The Offensive Battle

Corps

Division

Brigade

Battalion Task Force

CHAPTER 3... DEFENSE. How the Enemy Attacks

Planning the Defense

The Defensive Battle

Corps

Division

Brigade

Battalion Task Force

CHAPTER 4... COMBAT SUPPORT

Field Artillery

Engineer

Army Aviation

Tactical Air

Air Defense

Military Police

Chemical

Communications

CHAPTER 5... COMBAT SERVICE SUPPORT

Support Organization

Logistical Functions

Noncombatants

Civil Affairs Operations

Refugee Control

APPENDIX A... Urban Terrain Analysis

APPENDIX B... Weapons Effects And Employment

APPENDIX C... How To Select And Prepare Defensive Positions In Built Up Areas

APPENDIX D... Employment Of Obstacles And Mines In Built Up Areas

APPENDIX E... Demolitions. APPENDIX F... Armored Forces In Built Up Area

APPENDIX G... How To Attack And Clear Building

APPENDIX H... References And International Agreements.

CHAPTER 1

Introduction

Tactical doctrine stresses that urban combat operations are conducted only when required and that built-up areas are isolated and bypassed rather than risking a costly, time-consuming operation in this difficult environment. Adherence to these precepts, though valid, is becoming increasingly difficult as urban sprawl changes the face of the battlefield. The acronym MOUT (Military Operations on Urbanized Terrain) classifies those military actions planned and conducted on a terrain complex where manmade construction impacts on the tactical options available to commanders. Commanders must treat the elements of urban sprawl as terrain and know how this terrain affects the capabilities of their units and weapons. They must understand the advantages and disadvantages urbanization offers and its effects on tactical operations.

Urban combat operations may be conducted in order to capitalize on the strategic or tactical advantages which possession or control of a particular urban area gives or to deny these advantages to the enemy.

Major urban areas represent the power and wealth of a particular country in the form of industrial bases, transportation complexes, economic institutions, and political and cultural centers. The denial or capture of these centers may yield decisive psychological advantages that frequently determine the success or failure of the larger conflict. Villages and small towns will often be caught up in the battle because of their proximity to major avenues of approach or because they are astride lines of communications that are vital to sustaining ground combat operations.

During offensive operations, commanders must seek to achieve a favorable mobility differential over the defender, to retain momentum, and to avoid a protracted and costly urban battle. Built-up areas are obstacles to maneuver; hence, isolation and bypass, which neutralize their value to the defender, are the goals of urban offensive operations.

Conversely, the defender must seek to integrate the elements of urban sprawl into his defensive scheme to slow, block, or canalize the attacker and enhance weapon effectiveness. The attack or defense of a built-up area should be undertaken only when significant tactical or strategic advantage accrues through its seizure or control.

Urbanization is a complex, multifaceted process influenced by many factors including a nation's cultural development, its economic resources, and its industrial capacity. Although its form varies from region to region, urbanization is characterized by a general pattern of changes in land usage and the spread of manmade features across natural terrain.

Tactical terrain analysis has traditionally considered some elements of the urban environment such as the allocation of land to agriculture or forestry and the distribution of railway or road networks. However, the focus has been on natural terrain elements. In Europe and other urbanized areas of the world, increased awareness of the effects of manmade features on the overall tactical scheme is necessary. How urban terrain elements impact on operations is an important consideration in determining our tactical options.

For the small-unit tactical commander, the physical layout of a buildup area and structural characteristics of its buildings are critical planning considerations. [Appendix A](#) provides a detailed discussion of these factors and the combat characteristics of various types of built-up areas for offensive and defensive operations. For commanders at battalion level and above, the size of a built-up area, the support network of lines of communication, and the urban pattern formed by a complex of built-up areas assume added importance.

BUILT-UP AREAS

The following discussion uses the central European setting to describe these aspects of urbanization. With minor modifications, it is applicable to other urban areas throughout the world.

A built-up area is a concentration of structures, facilities, and population which form the economic and cultural focus for the surrounding area. There are four categories:

Large Cities

(Population Greater than 100,000.)

Most typical of the urbanization process is the increasing number of large and still-growing large cities. In Europe, other than the Union of Soviet Socialist Republics (USSR), there are approximately 375 cities with populations in excess of 100,000. The Federal Republic of Germany (FRG) has 49 cities with populations exceeding 100,000 and 4 cities of over 1 million. Large cities frequently form the core of a larger, densely populated urban complex consisting of the city, its suburban areas, and small towns. Such complexes have the appearance of a single, large, and continuous city containing millions of people and occupying vast areas of land. The illustration on the following page depicts major complexes that exist in FRG. The Rhine-Ruhr complex stretches west to Aachen and south to Bonn and contains over 12.5 million people concentrated in 13,000 square kilometers. The Rhine-Main complex includes Frankfurt Darmstadt, Mainz, Mannheim, and Karlsruhe; it contains over 4 million people in 7,000 square kilometers. To the southeast, greater Stuttgart (2 million people in 3,000 square kilometers) will soon merge with Rhine-Main. These urban centers encompass 10 percent of FRG's total land area and approximately one-half of its total population.

Towns and Small Cities

(3,000 - 100,000.)

Within the FRG there are approximately 235 small cities/towns with populations from 3,000 - 100,000. In many cases these areas are located along major lines of communications and situated in river valleys. Similar to larger cities, these areas are continuing to expand and will eventually form new combinations or merge with existing ones.

Villages.

(Less than 3,000.)

In the FRG there are approximately 21,000 built-up areas with populations of less than 3,000. In most cases these villages are agriculturally oriented and are usually distributed among the more open cultivated areas of Germany. In the average brigade sector in the FRG there are 25 of these villages. The average distance between them is only 3.5 kilometers.

Strip Areas

These built-up areas generally form connecting links between villages and towns. They are also found along lines of communications leading to larger complexes. Although the size and population of strip areas vary, they normally assume a long thin linear pattern.

Major Urban Complexes

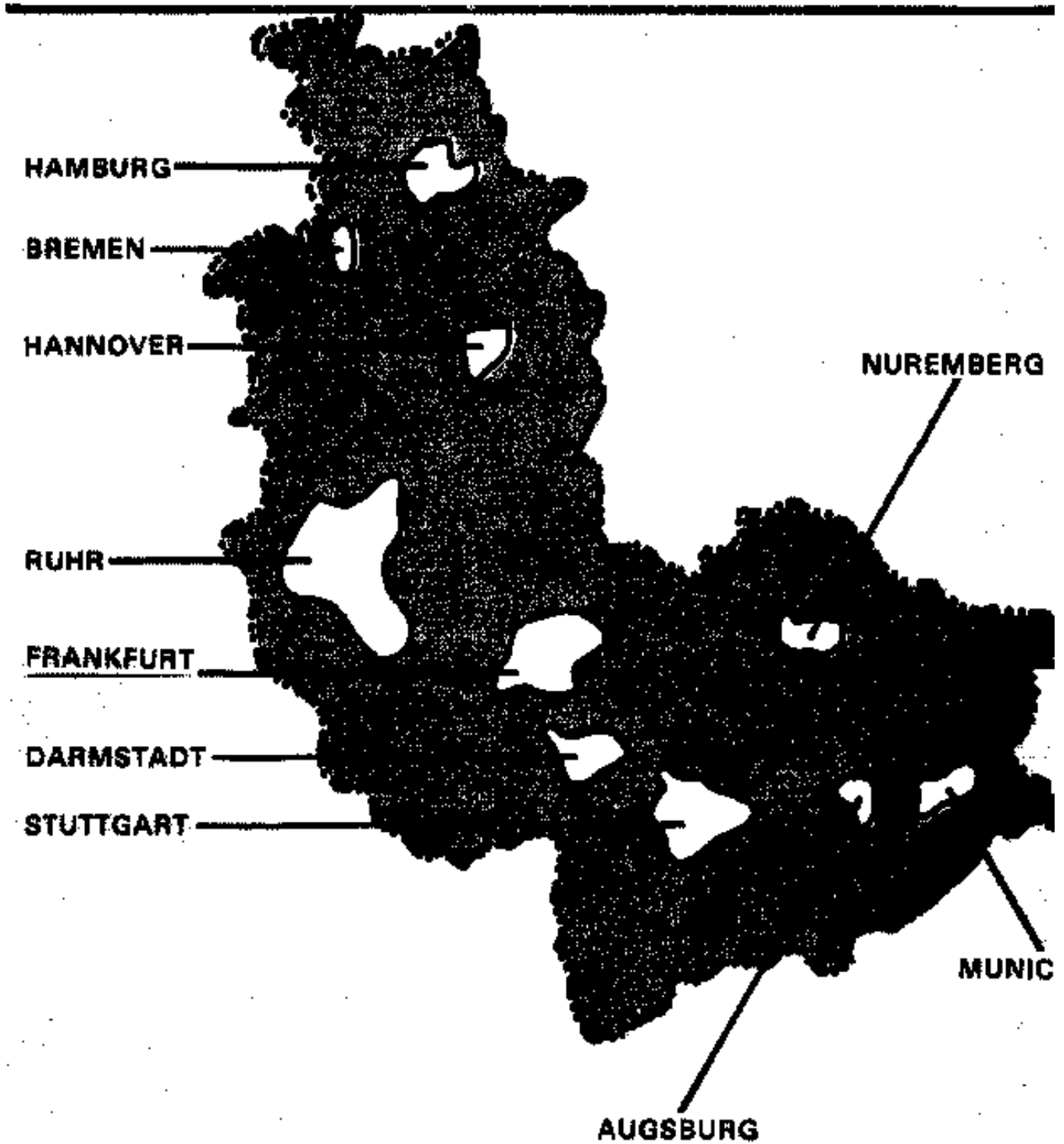

Figure 1-3. Major Urban Complexes.

BUILDING AND STREET PATTERNS

The physical layout of built-up areas is of tactical significance. Five basic building and street patterns which impact on fire support and maneuver schemes recur throughout western Europe. [Appendix](#) provides a detailed analysis of the tactical implications of each pattern. For ease of reference, they have been identified by form and assigned a letter designation. The following table briefly summarizes the general characteristics of each pattern.

TYPE GENERAL CHARACTERISTICS

- A. Dense, Random Construction Typical old inner city construction with narrow winding streets radiating in an irregular manner from a central area. Found within cities, towns, and villages. Buildings are located close together and frequently along the edge of roadways.
- B. Closed-orderly Block Common to central areas of towns and cities. Wider streets forming generally rectangular patterns with buildings frequently forming a continuous front along a block. Inner block courtyards are common.
- C. Dispersed Residential Area Normally contiguous to Type B areas. Consists of row houses or single dwellings with yards gardens, trees, and fences. Street pattern is normally rectangular or curving.
- D. High-rise Area Typical of modern construction in larger towns or cities. Consists of multi apartments, separated large open areas and one-story buildings. Wide streets are laid out in rectangular patterns.
- E. Industrial/Transportation Older complexes may be found within Type A and B areas. New construction normally consists of low, flat-roofed factory and warehouse buildings. Generally located on or along the major rail and highway routes of the urban complex.

LINES OF COMMUNICATION (LOC)

A vast network of modern highways, all-weather roads, railroads, and canals connect the FRG's built-up areas. These LOCs permit rapid access to virtually all areas in western Europe. Areas formerly considered to be terrain-restrictive for movement can now be rapidly traversed. Modern four-lane highways, capable of accommodating thousands of heavy vehicles, crisscross NATO-Europe. Frequently, these highways bypass the larger cities, or at least avoid the congested centers most built-up areas. There is a limitation, however, inherent in these lines of communication. They are often built across terrain that is relatively impracticable for vehicular traffic movement, and are heavily dependent on a system of bridges, ramps, and overpasses. If these systems can be destroyed the LOCs may then become virtually useless and an obstacle in themselves.

URBAN PATTERNS

The combination of built-up areas, lines of communication, and natural terrain results in the formation of basic urban patterns that impact on tactical operations.

Hub Phenomenon

Central to any urban pattern is the hub or built-up area. Although it may vary in size from village to major urban complex, the effects of a hub remain constant. For the defender, the hub may serve as the pivot or anchor of his defense or as an element of a defense in depth. As shown, the hub is an obstacle which blocks the attacker's advance. Where adjacent natural terrain permits, a hub will normally be bypassed.

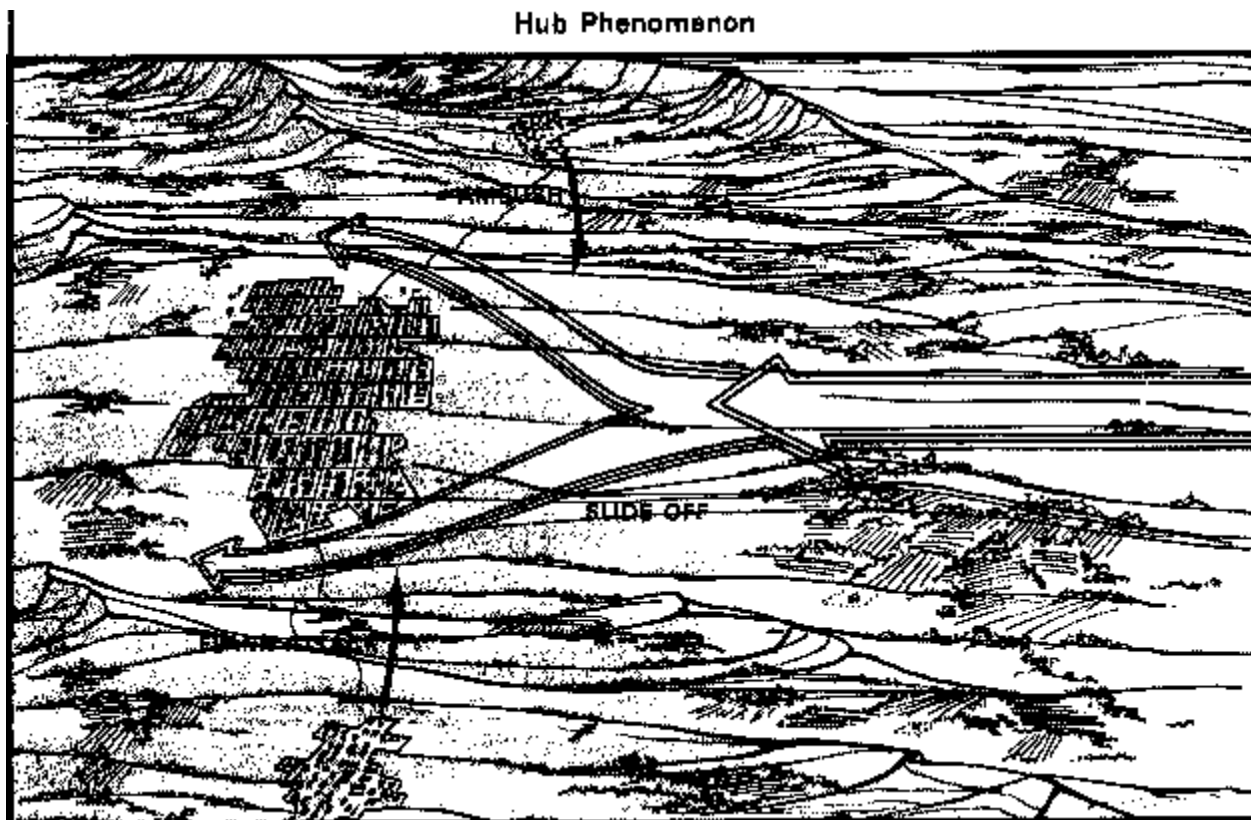

Figure 1-6. Hub Phenomenon.

This requires a change in direction of advance and may reduce offensive momentum and cohesion. As the attacker slides off the leading edge of the hub and begins his bypass operation, his vulnerability to flank attacks and ambushes along the new axis of advance increases.

Where adjacent natural terrain is unsuitable for mounted operations, the hub may be developed as a defensive strongpoint. The decision to attack will require significant forces and could result in time consuming, intensive close combat in the built-up area.

Satellite Pattern

This is a common pattern with its central hub and relatively dependent, dispersed, smaller built-up areas. It is typical of the village-town-small city pattern found within a brigade or perhaps division sector. Lines of communication tend to focus on the central hub, with most taking the form of farm and forest or secondary roads. Seldom will more than one major communications route pass through the central hub of the satellite pattern. The natural terrain and cultivated portions throughout the area are relatively homogeneous. Operations on urbanized terrain find built-in mutual support in this pattern. Outlying or satellite urban centers support the principal urban area at the hub by providing:

Re supply and evacuation routes for the defender.

Reinforcement routes for the defender; avenues of approach for the attacker.
Mutually supporting battle positions for the defender.
Multiple exit links from the hub for the attacker.

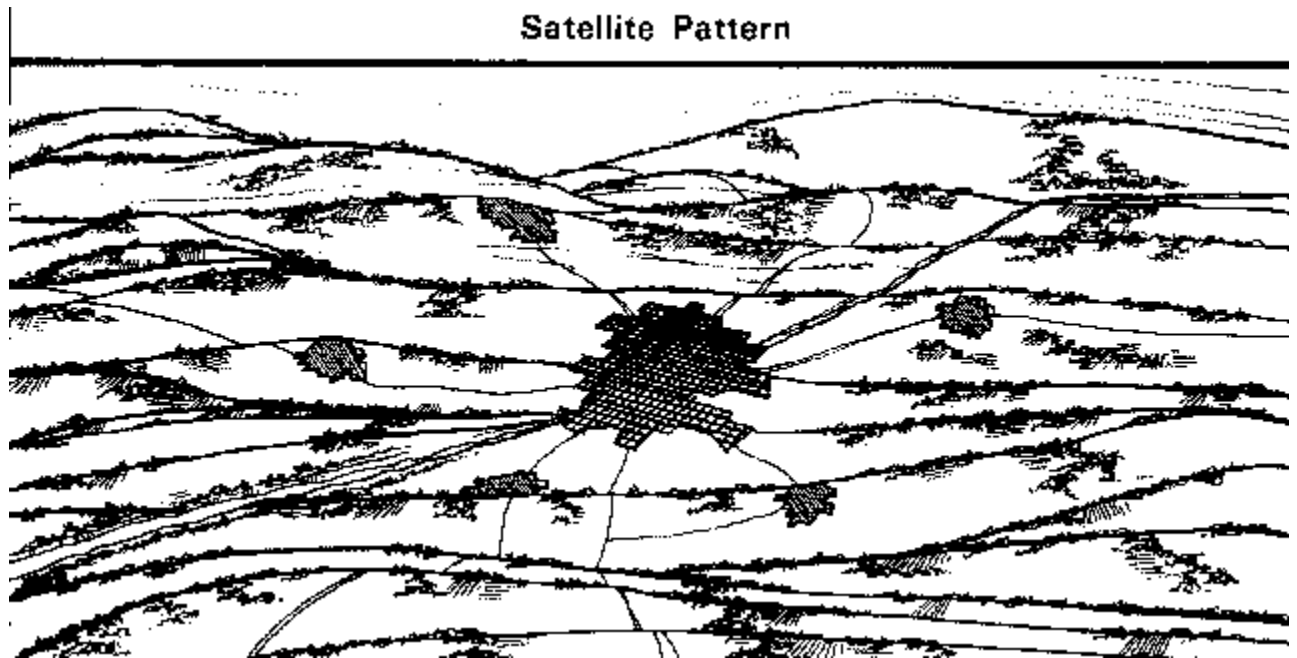

Figure 1-7. Satellite Pattern.

Network Pattern

Similar in initial appearance to the satellite pattern, the network is vastly more complex and diverse. It represents the interlocking of the primary hubs of subordinate satellite patterns and most often occurs at division or higher levels. Formed primarily of towns and cities, its elements are more self-sufficient and less supportive of each other, although a dominant hub may exist. Major lines of communication within a network are more extensive than in a satellite pattern and take a rectangular rather than convergent form. The natural terrain within a network may be more varied than that contained in a single satellite array. The tactical effects on offensive operations are: to cause delay, in that attacking units must fight their way through a maze of manmade features that provide defensive obstacles; and, to make bypass difficult because natural contiguous terrain frequently is impracticable for mounted operations (e.g., steep slopes, rivers, and heavily forested areas). This pattern provides depth to the defense.

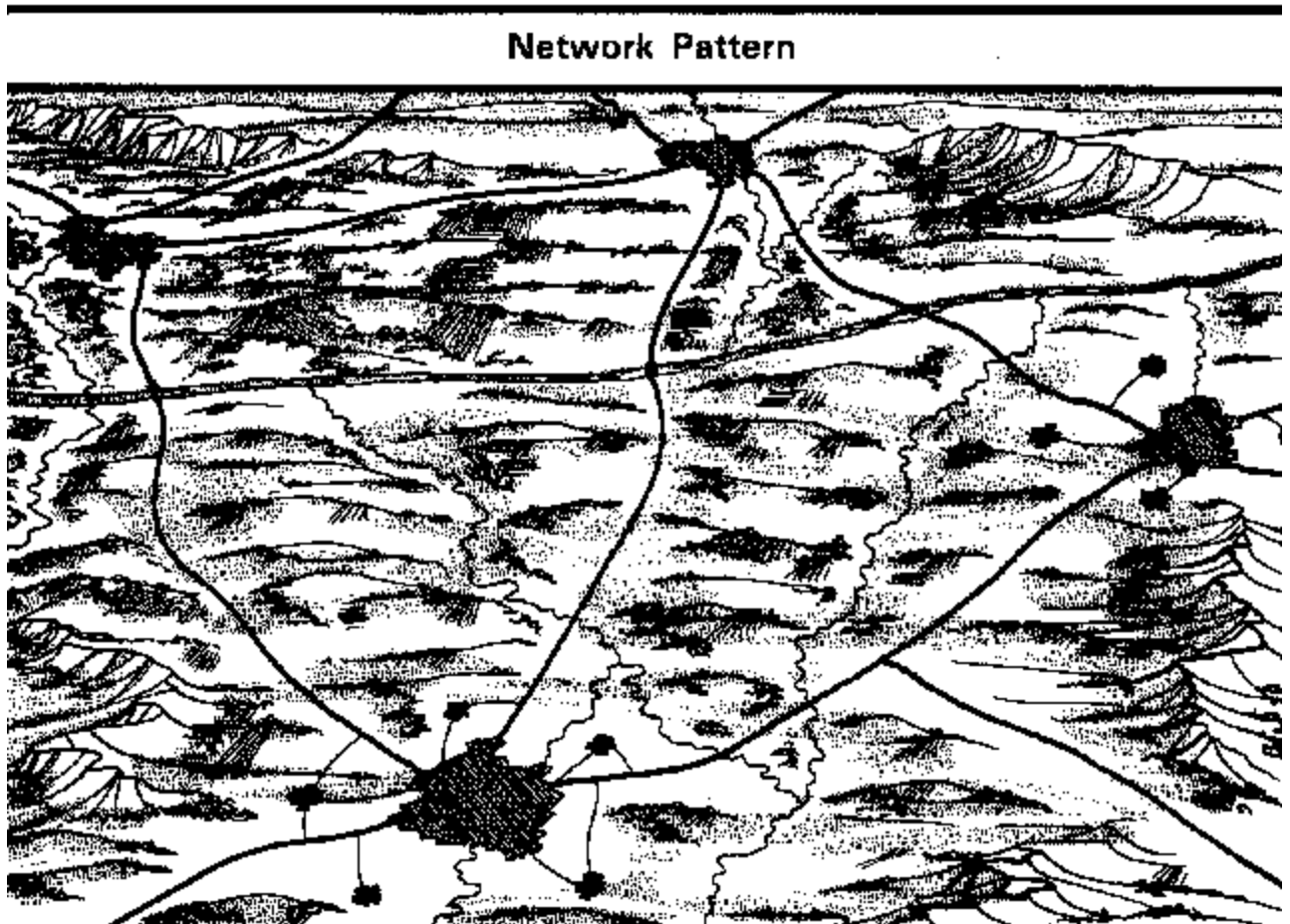

Figure 1-8. Network Pattern

Linear Pattern

A sub-element of the basic geometric patterns, the linear array may form one ray of the satellite pattern or be found along connecting links between the hubs of a network. Most frequently, the linear array results from the stringing of minor hubs along a confined natural terrain corridor such as an-elongated valley approach. It may also occur along the banks of a water course or manmade communications route. To the defender, this pattern facilitates the development of a series of strong defensive positions in depth. To the attacker, it presents a series of decision points, delaying his canalized forces and requiring repetitive deliberate attacks. This pattern is frequently found within a battalion zone of responsibility, although it may extend in width and depth throughout a brigade area.

Segment or Pie Slice Pattern

This pattern may occur as a subset of either the satellite or network patterns or within a major hub. It is characterized by the splitting of an urban area by dominant natural terrain such as a river or by manmade features such as roads, railways, and canals. When such a division of other patterns occurs, it may influence the assignment of boundaries and other control measures or attack objectives. It may also bear directly on the organization of the terrain and task organizations. This pattern may be detected on urban terrain at any level of command.

PATTERN EFFECTS

In addition to the basic blocking action which may be caused by the hub phenomenon, other effects can be associated with these patterns.

The Funnel-Fan Effect

This effect normally occurs at battalion or brigade level when a hub is located between terrain features that are unsuitable for mounted operations. Passage of units into the area results in the concentration of forces, a loss of momentum, and canalization. Beyond the hub, forces are required to spread or fan out before full combat power can again be developed. In each case this effect favors defense and hinders offense. It causes an accordion action in units moving through the hub, with increased difficulties in command and control and reduced operating effectiveness. A similar effect on maneuver takes place when the attacker must penetrate an urban network on a narrow front between hubs.

The Funnel Effect

Funnelling or concentration and canalization of forces may occur without the immediate fanning. Again, this effect most frequently occurs at battalion or brigade level when a linear pattern is encountered. It favors the defender by limiting the number of maneuver elements that may be applied against a series of hubs that must be confronted in succession. Greater reliance must be placed by the attacker on indirect and long-range weapon systems. At the same time, it reduces maneuver options available to the defender and routes available for his combat service support elements.

Segment or Pie Slice Pattern



Figure 1-9a . Segment or Pie Slice Pattern

Funnel-Fan Effect



Figure 1-9b Funnel-Fan Effects

TACTICAL IMPLICATIONS

Urbanization is gradually changing the face of the battlefield. Traditional avenues of approach are being blocked and narrowed by manmade features. Urban areas are growing along lines of communications and expanding across the adjacent terrain. This trend is resulting in the concentration of built-up areas and road networks along natural corridors bounded by forests, slopes, marshes, and bodies of water.

The following example illustrates an effect of this process on military operations on urbanized terrain:

The Meiningen Corridor is a broad, high-speed approach permitting armor forces some freedom to maneuver. Throughout the corridor, however, there are a number of villages and towns flanked by restrictive terrain. To the defender, this corridor offers an in-depth system of instant battle positions in the succession of villages spaced from 2 to 4 kilometers apart. Mutual support can be achieved throughout this corridor by integrating village battle positions with adjacent natural terrain obstacles and positions. To an attacker, the corridor's urban features represent a series of manmade obstacles. Advancing forces that attempt to bypass individual villages and towns are susceptible to flank attacks. The attacker may be required to conduct frequent combined arms attacks which greatly reduce offensive momentum and increase battle losses.

CHARACTERISTICS OF URBAN WARFARE

Some general characteristics of military operations on urbanized terrain apply to both offensive and defensive operations. Although they are discussed in subsequent chapters, they are presented here in capsule form because of their importance to an understanding of urban warfare.

The decision to attack or defend an urban complex can result in massive damage and destruction. Constraints on firepower to insure minimum collateral damage within its built-up areas can be expected. Combat operations may be hampered by the presence of civilians in the battle area. Concern for their safety can seriously restrict the combat options open to the commander. The necessity to provide life support and other essential services to civilians can siphon off a substantial amount of military resources and manpower. A hostile population may also impose a serious security problem. Success may well be measured by how we accomplish our mission while minimizing destruction of buildings and alienation of

the population. On the urban battlefield, advantages and disadvantages in the areas of mobility, cover, and observation tend to even out for attacker and defender. Initially, however, the defender has a significant tactical advantage over the attacker because of his knowledge of the terrain.

Unlike deserts, forests, and jungles which confront the commander with a limited variety of fairly uniform, recurring terrain features, the urban battlefield is composed of an ever-changing mix of natural and manmade features. Frequently, commanders of larger forces will have units fighting on open terrain, on terrain within built-up areas, and on a complex where these two distinct terrain forms merge.

Urban sprawl expands the scope of the commander's terrain analysis and influences the organization and positioning of forces, weapons employment, and maneuver. The dominant role of armor and mechanized infantry on open terrain is balanced by the requirement to fight in that portion of the urban environment which favors the employment of infantry supported by other arms. Manmade features dispersed in varying densities provide increased cover and concealment while frequently restricting observation and fields of fire. These features are also obstacles to maneuver and are to be avoided by an attacker and used by the defender.

Urbanized terrain normally offers numerous avenues of approach for mounted maneuver well forward of and leading to urban areas. In the proximity of its built-up areas, however, such routes generally become convergent and restrictive. Bypass may be blocked by urban sprawl and the nature of adjacent natural terrain. Avenues of approach within built-up areas are determined by street patterns, building arrangements, open areas, and underground systems. Mounted forces are restricted to streets, alleys, and open areas between buildings. Dismounted forces maximize available cover by moving through buildings and underground systems, along edges of streets, and over roofs. Fighting within a built-up area is characterized by a three-dimensional battle. In addition to fighting the enemy at street level, fighting may also be conducted on roofs and in the upper stories of buildings and below street level in sewer systems, subways and other underground structures. Assets and resources may be required to deny, retain, secure, or monitor each dimension. It cannot be assumed that the enemy is not there.

Weapons employment and target-acquisition ranges are greatly reduced by urban features. On the approaches to urban areas, visibility frequently extends to less than 1200 meters. Within built-up areas, targets will generally be exposed for brief periods, frequently at ranges of less than 100 meters. These limitations induce close, violent combat between opposing forces, placing great reliance on automatic weapons, rocket launchers, hand grenades, and hand-emplaced high explosives.

Urban features also increase the difficulty of maintaining effective communications. Tactical radios, the backbone of command and control networks, will be extremely range-limited within built-up areas. Operating from, within, or through urban areas isolates and separates units. Frequently, operations are reduced to a series of small-unit battles. Greater dependence is placed on the individual soldier's and small-unit leader's initiative, skill, and fortitude.

In possibly no other form of combat are the pressures of battle more intense. Continuous close combat, high casualties, the fleeting nature of targets, and fires from a frequently unseen enemy produce severe psychological strain and physical fatigue particularly among small-unit leaders and soldiers.

In combination, the general characteristics of urban warfare make it more difficult to apply basic tactical fundamentals and maintain control. Military operations on urbanized terrain require detailed planning that provides for decentralized execution.

SUMMARY

Urbanization impacts on military operations by adding the element of urban sprawl to the existing terrain complex. It does not change basic tactical doctrine, but requires that commanders understand how these elements may affect the capabilities of their units and weapons.

Built-up areas must be treated as terrain factors during the planning for and conduct of all military operations on urbanized terrain. Those providing tactical or strategic advantages to a defender will be integrated into his overall defensive scheme. Regardless of their size or configuration, built-up areas are obstacles to maneuver along the lines of communication or route of advance for at least one portion of an attacking force. Their value as an obstacle should be neutralized by isolation and bypass whenever feasible. Built-up areas should be attacked only when no other alternative is available.

CHAPTER 2

Offense

Man made features on the urbanized battlefield influence offensive operations at each level of command. To the battlefield commander, a single built-up area may be the dominant terrain feature in his assigned zone of responsibility and may limit alternative courses of action and dictate the nature of combat to be waged. To the brigade and higher commanders, the elements of urban sprawl are factors to be evaluated throughout the decision process.

Units operating on urbanized terrain may conduct or participate in a movement to contact, an exploitation or pursuit, and hasty and deliberate attacks. Although urbanization affects all offensive operations, its greatest influence is felt during the attack.

This chapter summarizes Threat force doctrine for the defense of built-up areas, describes US planning considerations for urban offensive operations, and provides examples of how the offensive battle may be conducted.

HOW THE ENEMY DEFENDS

This section describes why and where the enemy defends and examines those aspects of his defense that are different from our own. It covers the organization, planning, and conduct of the defense to include his use of the combined arms in the defense. The enemy recognizes the political and military importance of the urbanization phenomenon. Threat commanders realize the importance of not only defending built-up areas, but also of incorporating them into the overall defensive plan. The enemy always attempts to establish his defense well forward of an urban area in order to engage and defeat the attacker on the approaches to and flanks of the built-up area.

The enemy reverts to the conduct of defense within a built-up area only when:

Attacking forces break through defenses organized on the approaches and threaten the built-up area proper.

The built-up area has especially great political, strategic, or economic importance.

It is necessary to defend a built-up area which is a seaport or other critical communication/transportation complex.

ORGANIZATION OF THE DEFENSE

The categories of built-up areas contained in Threat literature differ slightly from those described in [chapter 1](#) and provide guidelines for the organization of his defense. Smaller towns and villages of rural areas are incorporated into his defense as strong points in accordance with standard defensive doctrine. It is only for those operations conducted in the more populated urban- areas that modified techniques are described. The following figure shows how the Threat classifies built-up areas by population and estimated perimeter.

Classification of Built Up Areas

POPULATION SIZE ESTIMATED CLASSIFICATION PERIMETER

100,000+	Large	25 kms
50,000 to 100,000	Average	15 kms to 25 kms
> 50,000	Small	15 kms

In order to provide commanders sufficient room to maneuver, urban areas are normally included as part of a larger defensive zone. The tactics and weapon systems used are dependent on the characteristics of the central built-up area and the terrain adjacent to it. The key defensive concept is to draw the attacking force into preplanned kill zones and destroy them.

The task of defending an urban area is normally allocated to a motorized rifle division (MRD). The MRD deliberate defense is organized with a security zone and a main defensive belt. Mutually supporting strong points are echelon in depth. Natural and manmade obstacles, as well as the smaller built-up areas are incorporated in the defense to impede the advance of the attacking forces and to canalize them. The figure on the following page illustrates the basic organization of the terrain when the defense of a built-up area is required. The specific frontages and depths of the defending forces are determined by the complexity of the urban terrain, the enemy, and the forces and fire support available to the defender.

Security Zone

The role of the security zone is not changed on the urban battlefield. Forces are organized to halt or delay the attacker and cause him to deploy early. A motorized rifle division will normally employ its second-echelon motorized rifle regiment (MRR) in this zone which may extend up to 30 km forward of the main defensive belt. The task of deceiving the attacker as to the location of the main defenses is aided by the restrictive nature of the urban terrain and the presence of small built-up areas which may be integrated into the defensive scheme. The battle in the security zone is fought by motorized rifle companies reinforced with AT weapons, artillery, tanks, and engineers.

Main Defensive Belt

This zone, which may extend up to 15 km in depth, is the backbone of the defense. It is normally organized in two echelons with the built-up area located within the second echelon.

Forces in the first echelon will normally consist of two MRRs deployed across a zone 20 to 30 km wide. Each MRR will deploy security elements forward of this zone to slow and canalize the attack force. The mission of the first echelon is to defeat the attack forward of the built-up area. A strongpoint defense integrating urban features and frequent local counterattacks is employed to destroy or repulse the attacker. The first-echelon MRRs will have designated secondary positions on the flanks of and within the built-up areas.

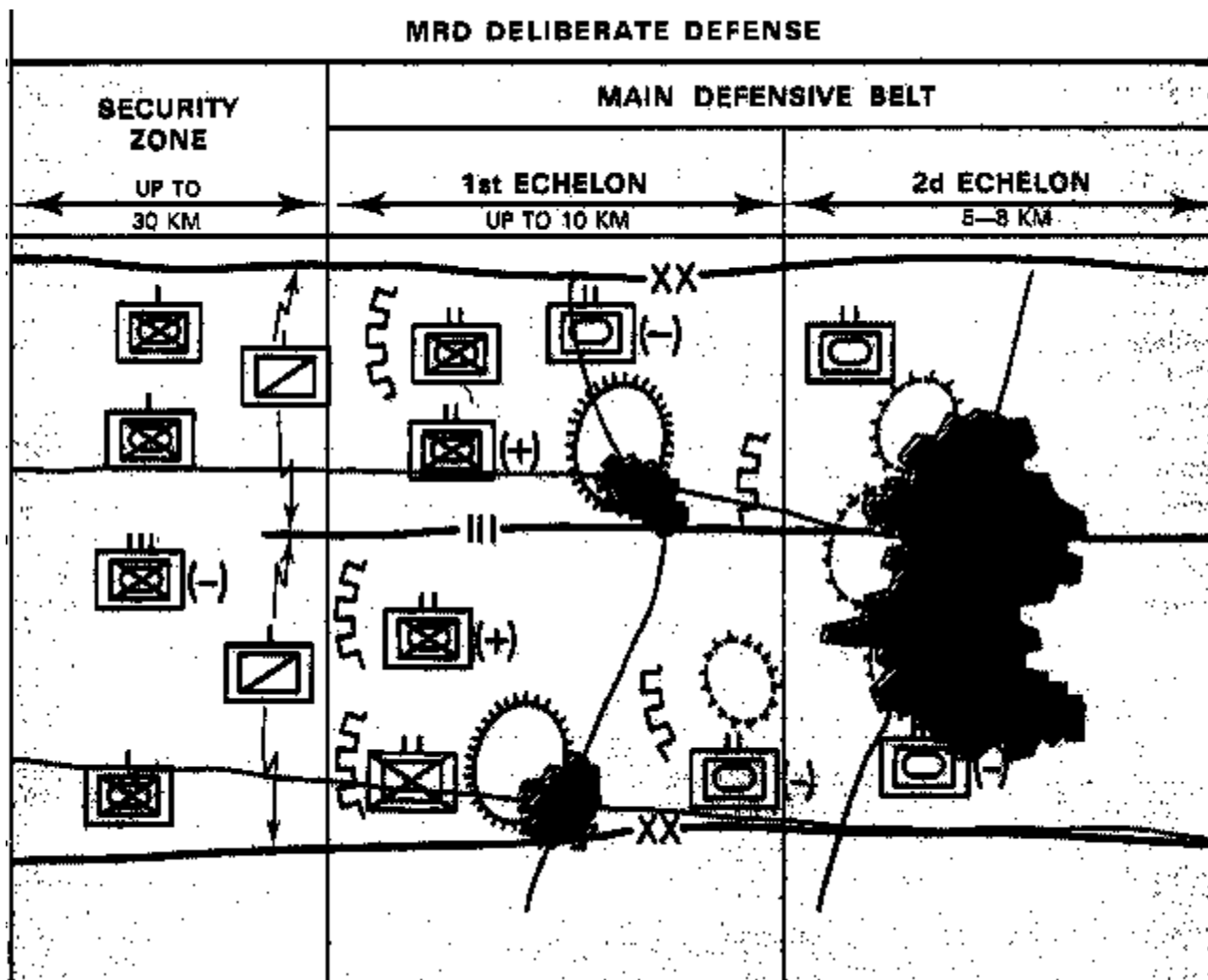

Figure 2-3. MRD DELIBERATE DEFENSE

Following withdrawal of forces from the security zone, the second echelon MRR will prepare defensive positions within the built-up area for itself and the first-echelon MRRs. The medium tank regiment will be retained under division control and deployed primarily on the flanks of the built-up area. Elements of this regiment will normally be used to reinforce the first-echelon MRR on the main avenue of approach. If it is necessary to defend within the built-up area, only a small portion of the available force is used to hold its central area. The MRRs of the division establish their defensive positions on the approaches to the built-up area whenever possible. Since it is unlikely that lengthy preparation time for such operations will be available, the initial defense may be organized based on a detailed map study with only limited personal reconnaissance at the lower levels of command. The layout of the built-up area, the type of structures available, the time of the year, and the climate are important considerations in the planning of the defense. The defensive battle in the main defensive belt is a combined arms battle fought by the motorized rifle battalion.

COMBINED ARMS UN THE DEFENSE OF A BUILT-UP AREA/ Motorized Rifle Battalion (MRB)

Enemy doctrine for the defense of built-up areas emphasizes the importance of the combined arms concept. Motorized rifle units provide the basic element of his urban combat force structure. The enemy MRR is the most effective unit for combat in the built-up area because of its inherent mobility, armor protection, and rapid capability to adapt buildings and other structures for defense or as shelters against the effects of nuclear weapons. It coordinates closely with units from other arms, some of which will attach elements, and others of which will be placed in will be reinforced by other branches depending on the requirements and conditions expected in various parts of the built-up area. As a rule the MRB defends as part of the larger, regimental-size unit. It may defend on a main or a secondary avenue of approach and/or be in the first or second echelon or in the reserve.

If the attack penetrates, the MRB must inflict maximum losses, stop further forward movement, and create favorable conditions for the second echelon or regimental reserve to counterattack.

A MRB on the main avenue of approach and in the first echelon:

Receives the main attack of attacking forces.

Inflicts decisive damage on the assaulting forces to prevent a breakthrough by tanks and infantry.

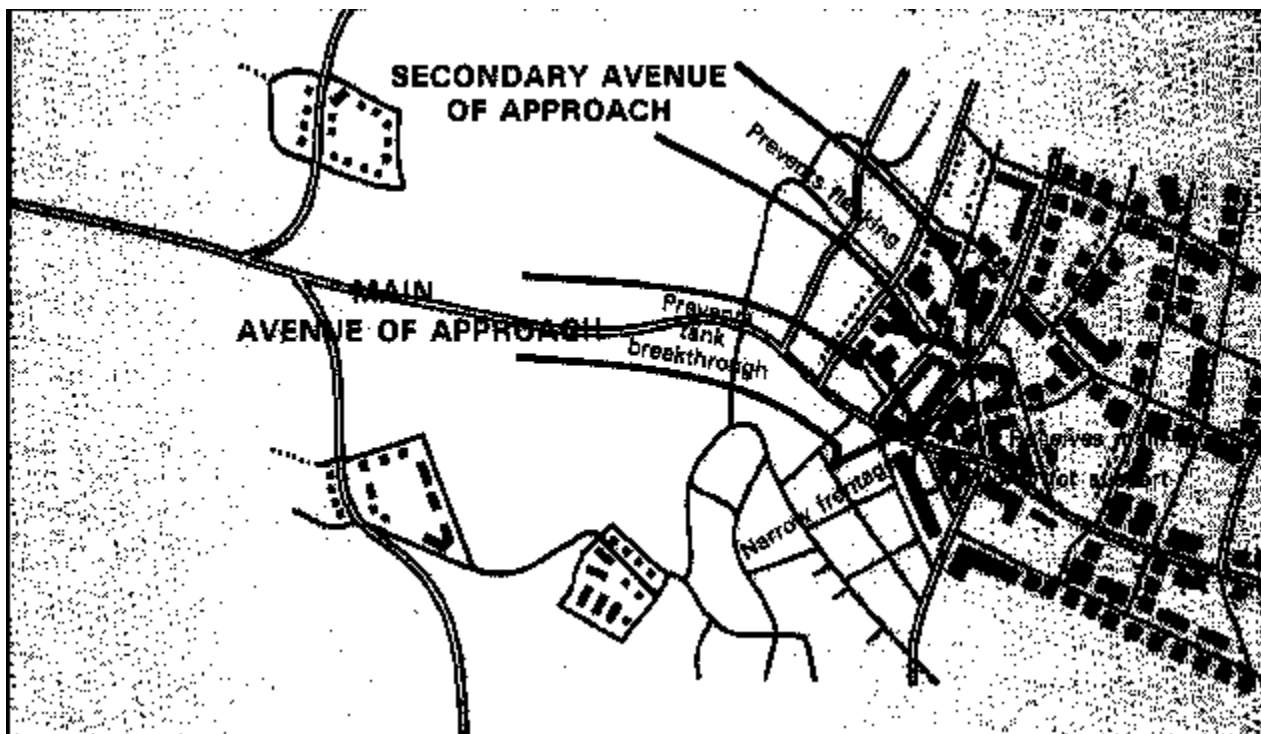

Figure 2-4. Secondary Avenue of Approach

The MRB in the first echelon covers a narrower front and receives greater reinforcements than one in the second echelon. It will be supported by most of the artillery of the next higher command.

A MRB in the second echelon or on a secondary avenue of approach:

Prevents flanking/rear maneuvers.

Holds defended sites and prevents further advances by an attacker that has penetrated the built-up area.

Conducts counterattacks to restore positions of the battalions in the first echelon.

MRB defenses are generally organized in two echelons to provide greater depth and reserves. Company Strong points are prepared for perimeter defense and constitute the basis of the battalion defensive position. The reserve is located in a separate strong-point. Ambush locations are established in the gaps between strong points. Numerous firing positions for mortars, artillery, and antitank weapons are designated. The rear service area is selected to capitalize on the cover and concealment afforded by the built up area. Dummy strong points are constructed to deceive the attacker. Positions for securing and defending entrances/exits to underground structures and routes of communications are established. Combat security positions are prepared in front of the defensive position of a first-echelon battalion.

The Reserve:

Reinforces/replaces battalions in the first echelon.

Covers breaches caused by enemy nuclear weapons.

Holds sites deep within the defensive positions whose retention is vital to the overall defense.

Extinguishes or contains fires that endanger friendly forces or limit their operations.

Conducts rear area security and defeats air-landed forces that are inserted in the rear.

Battalion Defensive Area

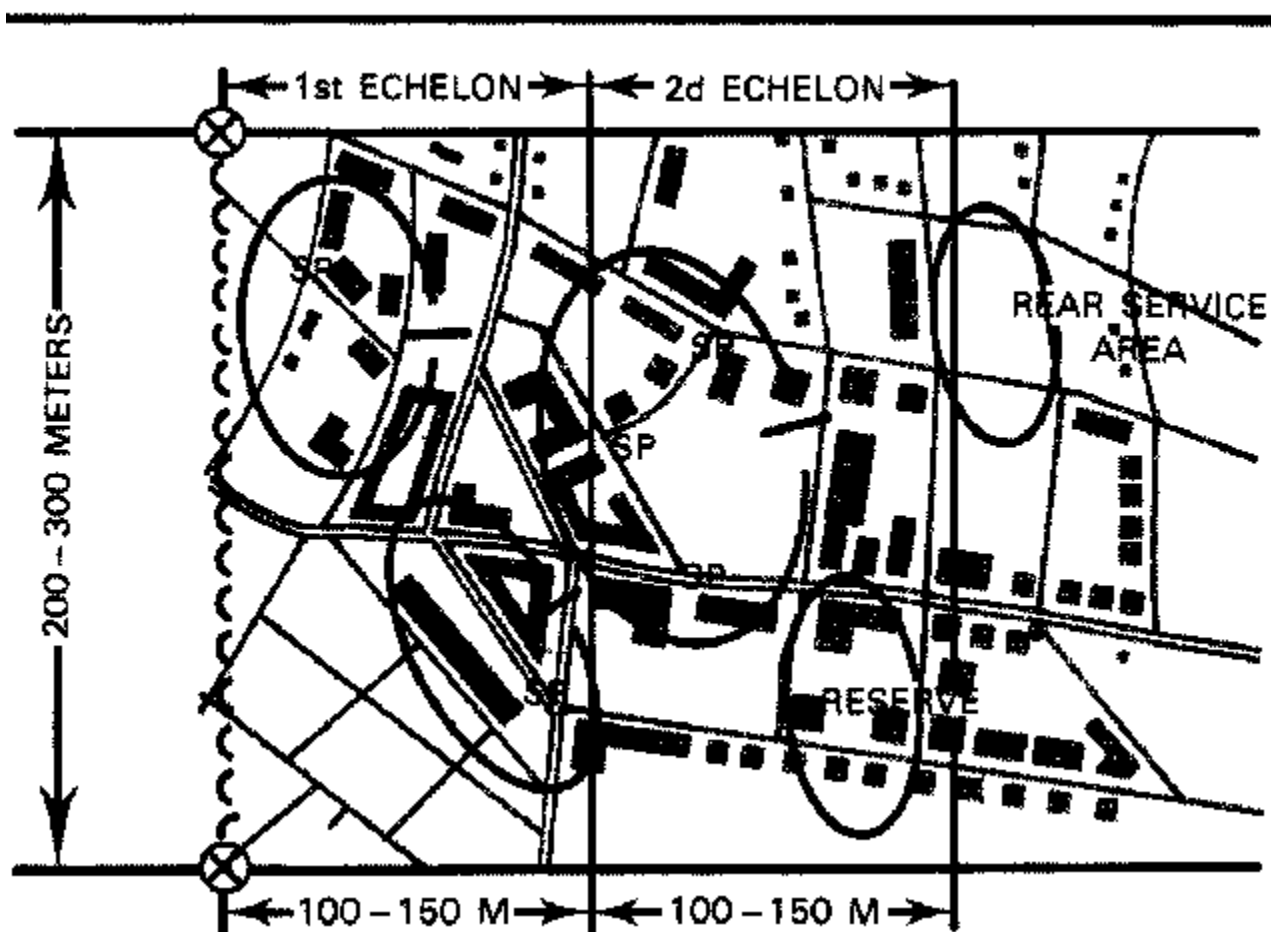

Figure 2-5. Battalion Defensive Area

Within a built-up area, a company may defend with mutually supporting fires several buildings prepared for perimeter defense. Each platoon defends one or two buildings within a company strongpoint or a floor of a large building that is defended by a company.

Strong points constitute the basis of each defensive position. They are usually prepared in solidly constructed buildings located at intersections, entrances to public squares and parks, or adjacent to bridges, and with observation and prepared fields of fire appropriate to the weapons available. Fires are coordinated between strong points. They offer personnel protection against weapons of mass destruction. Communication trenches are prepared within strong-points. In addition, ambushes are set up in the gaps between positions, and wooden structures or other buildings which hinder fields of fire are razed. Fire planning for infantry weapons requires a combination of flanking, interlocking, and layered fires of all types. Weapons are emplaced to provide fires on the approaches to a defensive area, on the flanks, and in the battalion rear. Fires are tied in with artificial and natural obstacles to cover open areas completely.

Particular attention is paid to antitank fire planning within the built-up area. The enemy recognizes that there will be limited opportunities to place effective fires on the tanks within the city; therefore, weapon positions are carefully selected. Ambushes are prepared along main avenues of armor advance.

Tanks are routinely attached to a MRB for employment in ambushes or to reinforce antitank defenses. They may operate as "roving guns" or be positioned in strongpoints; and, they may be used in ambushes where they are employed primarily against attacking tanks and along expected routes of the main attack.

Artillery carries out most of its missions by firing by direct lay. Artillery units are regularly attached to maneuver companies and platoons.

Mortars of all caliber's, with their high-angle fires, ease of transportability, and high rate of fire, are considered to be highly effective in built-up areas.

Chemical defense elements may be attached to the MRB. They perform radiological and chemical reconnaissance in order to detect the effects of NBC weapons employed by the attacker and to determine the degree and limits of contamination.

Smoke agents are used extensively to conceal the maneuver of men and weapon systems between Strong points, defensive areas, and separate buildings that do not have concealed or underground routes between them. Also they deny the attacker observation and aimed fires.

Nuclear weapons may be used against the attacker's nuclear delivery means and concentrations of forces on the approaches to the city, or against troops who attempt to encircle or bypass the built-up area, or against an attacker who has seized part or all of a built-up area if there are not other weapons available to destroy him.

Engineers attached to the MRB perform standard engineer tasks.

Party-Political Work.

The enemy views this as critical to fulfilling the assigned combat mission, the creation of a successful defense, and the regaining of the initiative. Political indoctrination is achieved by timely explanation to personnel of the mission and procedures for its accomplishment. Indoctrination of soldiers, NCOs, and officers in patriotism, courage, and tenacity in defending the built-up area is basic to the party-political efforts.

All fighting men are told that no one has the right to leave the defended location without a specific order to do so. Party members are distributed throughout the fighting units. There must be an "active member" in every separate group of fighting men. He conducts party-political indoctrination and provides the example in combat. Based on the commander's guidance and decision, the Deputy Commander for Political Affairs plans the party-political support for the combat missions. The underlying assumptions to this plan are:

Every defended building must be a fortress inaccessible to the attacker.

The force which possesses the stronger moral qualities (e.g., coldness, endurance, and resourcefulness) and knows procedures for fighting in a city will win.

BASIC DEFENSIVE CONSIDERATIONS

The enemy's defense of a built-up area is centrally controlled by the commander, preferably from a command observation post from which he can view the area and communicate with his forces. All available means of reconnaissance are used to determine where the attacker will strike and the location of his main effort. Once this is determined, maximum firepower is continually massed on the approaching attacker.

Dummy positions and alternate strong points are also used along the attacker's avenues of approach. Gaps created in the defense are immediately covered by massive fires of all types. During an attacker's artillery preparation, combat equipment and forces are kept in standby readiness in protected positions. When the preparation is lifted, the forces move forward and occupy primary defensive positions from which to repulse the attack.

Company strong points constitute the basic element of the built-up area defensive structure. Companies may also occupy a salient on an open flank or behind one of the companies in the first echelon. Every effort is made during the defense to separate infantry from tanks so that tanks may be attacked and destroyed at short ranges by antitank weapons. Antitank ambushes are prepared at each level. Counterattacks are habitually launched to regain lost positions before the attacker has the opportunity to prepare hasty defenses.

PLANNING THE ATTACK

This section describes urban offensive operations and provides detailed considerations to be applied by US commanders during planning. Readers must understand how the enemy defends and be familiar with US offensive planning as discussed in organizational How-to-Fight manuals.

The attack of a built-up area, regardless of its size and the level of command involved, should be considered only as the last resort, and only when major advantage accrues to the attacker through its seizure or control.

Attacks against built-up areas may be launched to:

Gain a Critical Objective. Selected built-up areas will be attacked to gain a critical objective or to deny an advantage to the enemy. The objective may be:

A vital bridge.

Transportation facilities that are required to sustain future combat operations.

Strategic industrial or vital communications facilities.

Rupture the Defense. The enemy will frequently prepare built-up areas as strong points to gain favorable defensive advantages. The elimination of selected strong points may be required in order to break through his defensive system.

Facilitate Future Operations. Built-up areas will frequently preclude bypass. Commanders will have to overcome those obstacles that restrict or control their avenues of approach in order to continue the attack.

Deal the enemy a decisive psychological blow.

Attacks against built-up areas will be avoided when:
The area is not required to support future operations.

Bypassing is tactically feasible.

The built-up area has been declared an "open city" to preclude civilian casualties or to preserve cultural or historical facilities.

Sufficient combat forces are not available to seize and systematically clear the built-up area.

Offensive operations must be tailored to the urban environment based on a detailed analysis of each urban terrain setting, its types of built-up areas, and existing structural forms. The following general considerations apply to the four basic categories of built-up areas described in [chapter 1](#).

Large Cities (Population greater than 100,000)

The decision to attack a large city or major urban complex normally may be made at levels above corps, based primarily on political and strategic considerations. Such vast areas are difficult to defend or attack in their entirety. The battle will proceed from the attack of smaller built-up areas leading to the central complex and will involve major forces. It will evolve as a series of coordinated combat-in-cities actions fought at small-unit level. Elements of the attack force may be required to conduct the whole range of military operations: attack-defense-retrograde during the battle.

Towns and Small Cities (3,000-100,000)

The decision to attack a town or small city will normally be made by corps or division commanders. The allocation of major forces and significant time are required to secure such objectives. Civilian casualties and significant collateral damage to structures usually accompany urban operations, requiring commanders to consider the political and psychological consequences before attacking. A hasty attack by heavy, mobile forces against weak points on the flanks or rear of the town or small city is preferred. Where well-established defenses exist, a deliberate attack may be required.

Villages (3,000 or less)

Team and task force commanders operating over urbanized terrain will frequently encounter villages that inhibit speed and restrict maneuver along their avenues of approach. These small built-up areas may be prepared by the enemy as strong points and integrated into his defensive scheme. If it is necessary to destroy resistance within a particular village, division/brigade commanders must bring overwhelming force to bear on the strongpoint and suppress mutually supporting positions. Adequate forces must be employed to carry the assault quickly with the objective of securing the whole village in the confusion of the initial assault. House-to-house fighting may be required but is costly in casualties and time. Night attacks may be required to gain entry into the village if it is not possible to suppress or obscure the defenders' weapons, or if concealed routes to the village are not available.

Strip Areas

Defended strip developments must not be permitted to slow the momentum of team and task force attacks. Although their length and density vary, they are not easily bypassed, and therefore the alternative of not attacking seldom exists. Strip areas should normally be penetrated at their narrowest point by a fast-moving armor-heavy force supported by suppressive fires and smoke obscuration.

If the enemy does not withdraw after the penetration, these areas must be cleared by follow-on forces.

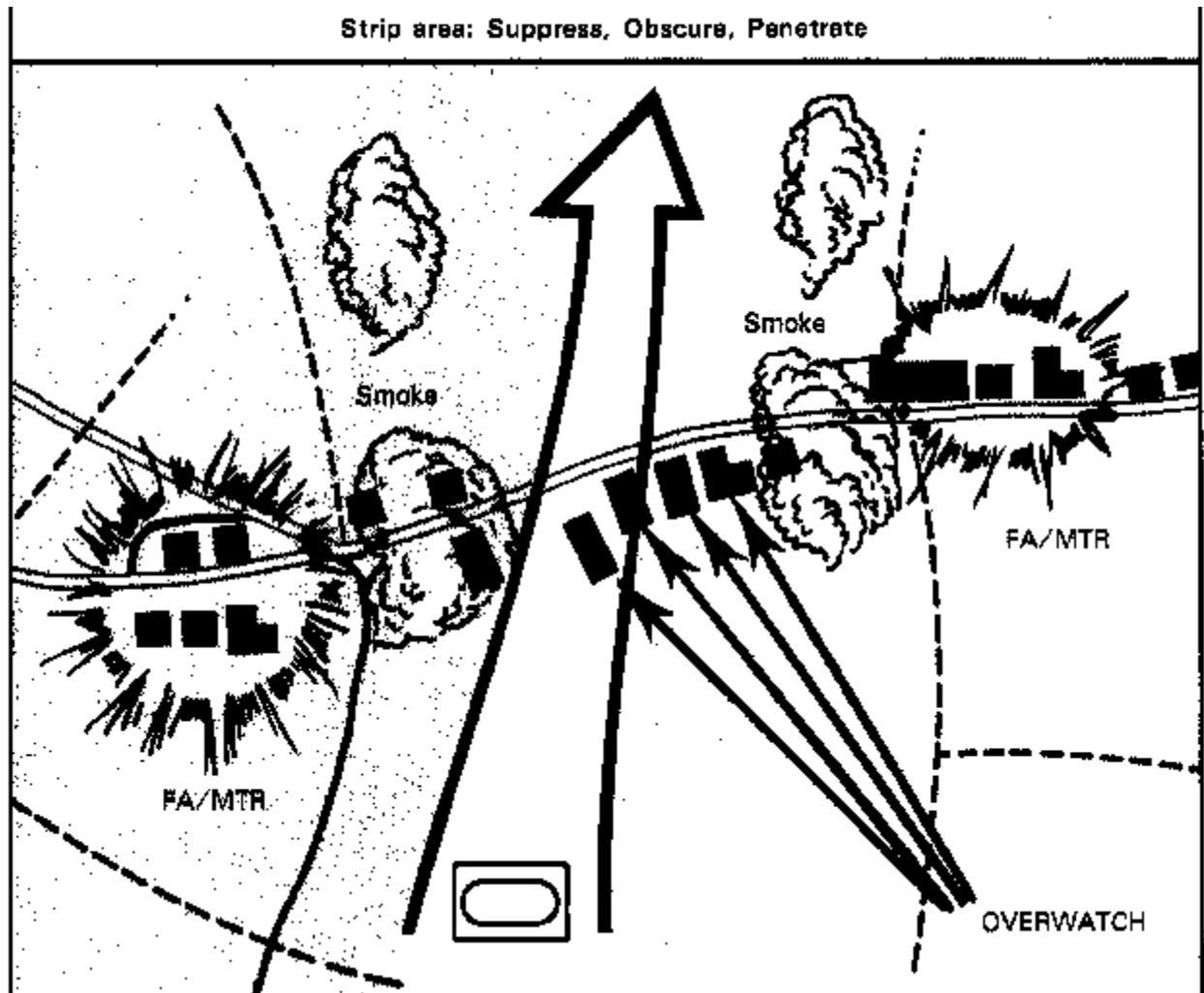

Figure 2-9. Strip area: Suppress, Obscure, Penetrate.

FUNDAMENTALS OF THE OFFENSE

The six fundamentals of the offense, contained in FM 100-5, Operations, and associated with specific organizational tasks and techniques in the How-to-Fight series of manuals, are applicable to offensive operations on urbanized terrain. Commanders must understand urban characteristics, the advantages and disadvantages they offer, and how they impact on mobility and weapons effectiveness.

See the Battlefield

No environment other than jungles or woods provides the degree of concealment found on the urbanized battlefield. The limited depth the battalion and company commanders can see is further reduced. On natural terrain adjacent to built-up areas, observation seldom extends beyond the 1200m range. On the approaches to and within built-up areas, observation may be limited to one block, or one building, or one room. Reconnaissance elements, frequently operating on foot and using infiltration techniques, are more important than ever. Not only do they find the enemy, but they also provide valuable reaction time and maneuver space.

Masking effects of the terrain and concealment offered by built-up areas make it easier for the enemy to hide his command and control elements, as well as combat support and combat service support units. The effectiveness of ground surveillance, infrared, --and visual/optical target-acquisition devices is reduced. Aerial photos may provide great detail and display every abnormality or alteration to the terrain. They are blind, however, to what is located within individual buildings. Increased emphasis must be placed on electromagnetic devices and the use of long-range air and ground reconnaissance. The armored cavalry squadron is particularly well suited for the task of finding the enemy, identifying weakness, and providing detailed terrain information.

Although the advantage of knowing the terrain lies initially with the defender, this advantage can be reduced through aggressive reconnaissance at each level of command. The same factors which provide concealment to the enemy also enable ground reconnaissance to be extended. Knowledge of how the enemy normally defends on urbanized terrain and the effects that the terrain has on his weapons and mobility guide the commander's efforts to see the battlefield.

Concentrate Overwhelming Combat Power

Mobility restrictions imposed by urbanized terrain make it difficult to concentrate ground maneuver forces quickly. Commanders must seek to achieve concentration on terrain which avoids built-up areas. When bypass is not possible and the attack of a built-up area is required, deception as well as mass becomes critical.

Although the defender has the planning advantage, the same mobility restriction limits his ability to reinforce or shift forces. The urban terrain also offers the attacker enhanced concealment during maneuver.

Limited - objective attacks, which fix defenses or cause the enemy to dissipate forces by early reaction, contribute to concentration. Concentration should be provided for during the planning phase, by allocating added combat support, particularly engineer and field artillery, to the main effort. During the attack, field and air defense artillery, as well as attack helicopters from corps and offensive air support, provide flexible, responsive elements of combat power which may be massed with less regard to mobility restrictions. OPSEC with its various sub-elements is critical on urban terrain which by its nature spreads defenses and makes it difficult for the defender to identify the attacker's main effort.

Suppress Enemy Defensive Fires

The urbanized battlefield provides the defender increased, readily available cover as well as concealment for weapon systems at all levels. Its obstacle characteristics may also increase the attacker's vulnerability by canalizing mounted maneuvers. At the same time, the terrain frequently offers the attacker concealment for dismounted maneuver and denies the defender long-range observation or fields of fire. The attacker is most vulnerable to enemy fires during the initial phase of securing a foothold in a built-up area. Defensive weapons, operating from the protection of structures that provide mutual support with prepared fields of fire, must be suppressed or destroyed.

At battalion and company level, there is an increased requirement for direct, rather than indirect, fire suppression. With reduced engagement ranges, this requirement may be satisfied in part by organic weapons. The use of field artillery in the direct fire role may be required to suppress gunners in hardened positions. Extensive use of smoke also may be required to conceal movement. The intensity of close combat and reduced direct fire ranges within built-up areas will require continuing suppressive fires and smoke obscuration. Increased dependence must be placed on the coordinated use of electronic support measures and electronic countermeasures to locate enemy emitters and to suppress and jam these acquisition and control devices. Where effective suppression by fires or electronic means cannot be accomplished, night/limited visibility operations may be required to reduce the defender's advantages.

Shock, Overwhelm, and Destroy the Enemy

Division lead elements must possess the combat power to attack as soon as a weakness is found or created. Enemy defenses well forward of built-up areas must be ruptured and penetrated if bypass is to be achieved. Commanders should seek to conduct a hasty attack, simultaneously enveloping the defender's flanks and rear. However, the size of a large urban complex or the extent of enemy defenses may deny the option of conducting a hasty attack. A deliberate attack breaking through a prepared defensive position is costly and usually results in heavy casualties and a protracted battle which forward-looking planning seeks to avoid.

Once the momentum of the attack has been gained, commanders must maintain that momentum until the defense has lost its cohesion. Enemy resistance is bypassed or destroyed by fires to preclude heavy casualties and loss of momentum. Stalled attacking forces maintain pressure by fires, while reserves bypass the resistance and continue the attack. The attacker must cause events to happen faster than the defender can react to them. The enemy must be denied the opportunity to consolidate defenses and must be destroyed or isolated before he can occupy built-up areas.

Attack the Enemy Rear

Enemy defenses will usually consist of strong points and obstacles arrayed laterally and in depth over the most likely avenues of approach. After disrupting the initial urban defenses, the attacker must secure critical objectives and seek to drive into the enemy rear to find and destroy his control headquarters, combat support, and combat service support units. The attack and isolation of forward defenses disrupt combat service support functions. It also demands that the defender employ his combat support elements, thus aiding the attacker in locating and destroying them. At battalion and company level, infantry forces, infiltrating by stealth or under conditions of limited visibility, should be employed to attack key command, control, and support installations. The division commander should consider utilizing air mobile assets and heavy reconnaissance elements to conduct rear area operations throughout the attack to find and destroy the enemy command and control facilities. The splintering of the defense, along with the disruption of command and control and destruction of support capabilities, will cause the defense to collapse.

Provide Continuous Mobile Support

Although urban battles are viewed predominantly as small-unit, combined arms actions, continuous combat support and combat service support are required. Tanks and artillery provide the infantry with destructive firepower to defeat prepared defenses. Combat engineers breach obstacles to enhance mobility. Field artillery, attack helicopters, and offensive air support disrupt the enemy command and control network and destroy his support units. Air defense artillery helps protect the entire force. Forward replenishment of supplies and contact maintenance teams help sustain momentum. Military police provide vital traffic control and area security in the division rear. Electronic warfare and intelligence units obtain information about the enemy needed by commanders. Communications units provide for its timely dissemination.

[Chapters 4](#) and [5](#) provide details pertaining to combat and combat service support.

PLANNING CONSIDERATIONS

Attack planning on the urbanized battlefield follows the general process described in organizational How-to-Fight manuals. The following specific considerations take on added importance during the analysis of the situation and development of the commander's concept for the attack. The offensive may take the form of either a hasty or deliberate attack.

Hasty Attack

A hasty attack is conducted when the enemy has not established strong defensive positions and attacking forces can exploit maneuver to overwhelm the defense. Three tasks are essential to its success:

Locate a weak spot or gap in enemy defenses.

Fix forward enemy elements.

Rapidly move through or around the gap or weak spot to be exploited.

Because a hasty attack is conducted to capitalize on opportunities as they present themselves, commanders should not expect to execute these tasks in the same order on all occasions. For example, advanced elements of the task force may be engaged with forward enemy elements when it becomes apparent that a weak point exists in their defenses. In another instance, a reconnaissance force may discover the location of a gap and subsequently be ordered to seize it to prevent enemy reinforcement. In any case, however, speed is essential; for if momentum is lost, the hasty attack will fail.

An urban area is an obstacle to tactical maneuver, and in that respect the hasty attack in MOUT is conducted somewhat differently than in open terrain. The congestion and incomplete intelligence characteristic of urban fighting will frequently require the attack to move through, rather than around, the fixing force. Techniques of control and coordination become extremely important to prevent unnecessary congestion at the edge of the urban area. In addition, commanders must insure that only those troops and resources necessary are committed to the fixing force, with the balance of combat power committed to the main effort of the hasty attack.

On-order, follow-on missions should be assigned to forces making a hasty attack so that, once the attack objective is secured, the force is prepared to respond to any contingency.

Deliberate Attack

A deliberate attack is necessary when enemy defenses are extensively prepared, when the urban obstacle is extremely large or severely congested, or when the advantage of surprise has been lost. It may be divided into three basic phases: isolation, assault, and clearance. Although not necessarily sequential in their execution or totally interdependent, the use of these implied phases facilitates the identification of specific tasks to be accomplished, the allocation of resources, and the preparation of plans.

Phase I is designed to isolate the objective by controlling avenues of approach into and out of the built-up area. Armor-heavy forces, supported by ATGM and field artillery, are well-suited to the task of isolating the built-up area from reinforcement and re-supply by securing dominating terrain and utilizing direct and indirect fires. This phase does not involve combat in cities, although some units may be required to eliminate defenses.

The battle to isolate a built-up area is fought on the natural terrain adjacent to it. Where the terrain precludes ground maneuver to isolate the objective, long-range surveillance and fires, attack helicopters, and offensive air support may be required. Failure to isolate the built-up area effectively before the assault begins, may require, in the long run, more casualties and time to secure the complex. The psychological impact that isolation causes on defending forces, coupled with the fact that the enemy must now decide if he wants to expend resources to reinforce or conduct a breakout, adds to the confusion of battle and makes complete isolation an important consideration.

Phase II consists of an assault to rupture the defenses and secure a foothold on the perimeter of the built-up area from which attacks to clear the area may be launched. An envelopment, assaulting defensive weaknesses on the flanks or rear of the built-up area, is preferred; however, a penetration may be required. The following basic actions are included in Phase II:

Fix the Defense. Balanced forces representative of the major organization are used to fix the enemy defense and draw his attention away from the main attack. Feints are highly effective as diversionary supporting attacks. The force should be provided adequate assets to portray convincingly the main attack and to continue the attack on order if the feint penetrates the defensive system. Other limited-objective or deception operations may be conducted to fix the enemy when sufficient assets to conduct a feint are not available. Additionally, the enemy can be fixed by fires.

Conduct the Assault. Mobility, shock action, and massed firepower are required to secure a foothold and rupture established defenses. During a penetration or envelopment, assault forces are task-organized with armor, infantry, and engineers to rupture the defense effectively.

Over watching direct fires, along with indirect suppression and obscuration, help the attacker secure a foothold in the built-up area. Once within the highly restrictive urban terrain, the role of the infantry becomes dominant.

Regardless of the form of maneuver used, mobility and suppression are required to maintain the momentum of the assault forces. Small-unit, combat-in-cities actions may be required to dislodge defenders and consolidate the foothold area.

Phase III is predominantly a clearance action which may consist of a systematic building-by-building, block-by-block advance through the entire area; or it may be a rapid advance through a lightly defended section to secure a critical objective, with a subsequent detailed clearance of the area by a follow-on unit. This phase is characterized by decentralized, small-unit actions, and it requires detailed planning to offset the difficulties of control.

Frequent commitment and reconstitution of reserves, particularly at TF/Co team level, is common during this phase since strongpoint defenses are repeatedly encountered. Reserves should parallel the composition of the main attack to facilitate commitment where necessary. The reserve must be mobile and prepared to react immediately to various contingencies.

During a hasty attack of a built-up area by units in contact or moving to contact, there may be no clear distinction between these phases. All actions may be accomplished by elements of covering or reconnaissance forces or by leading brigades with Phases I and II conducted concurrently and followed immediately by Phase III. If a hasty attack of a well-defended built-up area fails or is not possible, a deliberate attack sacrificing momentum and requiring detailed planning and the allocation of major resources will be necessary. During a deliberate attack, the phases will normally be accomplished sequentially.

Urban Information Requirements

In addition to knowing where the enemy is and in what strength, commanders must also know how he usually defends a built-up area and the approaches to it. Specific terrain information is required to maximize weapon effectiveness in this special environment and to minimize the effects of unfavorable terrain characteristics on maneuver and control. The following additional information is required:

Natural terrain adjacent to a built-up area that supports the enemy's defense, or that which will provide attacking forces with over watching positions.

Cover and concealed routes to the built-up area and to objectives within the built-up area.

Critical objectives within the built-up area that provide decisive tactical advantages.

Tactical characteristics of the buildup area and its structures.

Information about the population will frequently assist in determining where to attack, what firepower restrictions may be imposed, and what areas within the urban complex must be avoided to minimize destruction of life-support facilities and civilian casualties.

Typical Attack Zones by Type Built-up Areas. (Meters)

A) Portrayed are typical zone widths for elements of 150-200 a main attack in various types of built-up areas described briefly in [Chapters 1](#).

B) 200-300 The highly restrictive nature of the urban terrain reduces mobility, observation, and fields of fire, and complicates all command and control functions. These factors, coupled with the need to concentrate combat power, necessitate reducing the width of attack zones assigned to units.

C) 300-400 Within an urban area, typical widths will be significantly less than those experienced on open

terrain. During the attack, a company team will seldom be assigned a zone greater than one to two blocks in width.

D) This will vary based on enemy defense and type 300-500 of built-up area.

E) Actual zone dimensions can only be determined by detailed analysis of the urban terrain complex as described in [appendix A](#).

Limited Visibility Operations

Limited visibility and night attacks are essential elements of the offense within an urbanized area. As described in other How-to-Fight manuals, such operations may be conducted to achieve surprise or exploit earlier success. On the urban battlefield, they are most frequently required to rupture strong defenses, minimize enemy mutual support, and maintain momentum. Difficulties with command and control, navigation, coordination of fires, and identification of friendly forces are compounded on urbanized terrain. Other problems are:

Restrictive terrain increases opportunities for elements of a unit to become lost or separated.

Limited avenues of approach, rubble and other obstacles decrease the chances for a large unit to achieve surprise.

At brigade and division level, limited visibility conditions are exploited to cover the movement of major units and supplies. Battalion task forces use limited visibility conditions to extend reconnaissance and infiltration or to attack occupied objectives. Typical night or limited visibility operations at unit levels within a built-up area include:

Attacks across an open area to seize a strongpoint or building.

Ambush patrols to engage infiltrators.

Raids or night combat patrols to achieve a limited objective.

Reconnaissance patrols to develop intelligence.

Control Measures

The coordination and control of forces and fires is greatly complicated by the restrictive nature of the urban environment. It is facilitated, however, by a detailed plan with explicit control measures for decentralized execution at the lowest level. The control measures most frequently used within a built-up area are:

Objectives. While dominant features that provide observation or physical control over access routes through or around the built-up area remain important, additional consideration must be given to its facilities and manmade objects. Communication networks, whether vehicular, rail, nautical, or telephonic/telegraphic, play an increasingly significant role.

Initial objectives to gain a foothold are usually located on the outer edge of the built-up area; and, when occupied, they provide concealment and cover for the attacking forces.

Team/company-size objectives are generally one to two blocks in depth. Their exact size is determined by the nature of the built-up area. An intermediate objective may be assigned by any commander when its seizure is essential to the accomplishment of the mission. When an enemy cannot be bypassed, the assignment of intermediate objectives will frequently be required. When feasible, final objectives are located on the exit side or beyond the built-up area.

Phase Lines. Phase lines are routinely employed to regulate the advance of attacking forces. They may also be used in lieu of objectives. Principal streets, rivers, and trolley and railroad lines which are easily identified are appropriate for use as phase lines.

Boundaries. At brigade level and below, boundaries are habitually used to control fires and designate areas of responsibility. They are normally established in alleys or within a block of buildings to insure that both sides of a street are included in the zone of one unit.

Checkpoints and Contact Points. Street corners, buildings, railway crossings, bridges, or other easily identifiable features may be designated as checkpoints or contact points. These points facilitate reporting locations and may identify specific points where the commander desires units to make physical contact.

Security

Threat forces emphasize spoiling attacks and infiltration of the flanks and rear of attacking forces. Frequently the enemy will position individuals and small units in concealed locations to perform stay-behind missions. Built-up areas provide the defender excellent cover and concealment while limiting the attacker's observation. The requirement to maintain the continuity of the attack results in bypassing isolated pockets of resistance which further complicates security problems. It is necessary to increase overall security precautions for attacking forces while operating in highly restrictive areas. Also, it is essential to provide security forces to escort combat service support and combat support units and to monitor, patrol, and guard possible infiltration routes. Additionally, measures must be taken to guard against sabotage, guerrilla warfare, and intelligence-gathering by a hostile population.

Attachments

Frequently, company teams, platoons, and squads will be isolated and will have to fight for extended periods with what resources they have. In order to reduce reaction time, maintain flexibility, and overcome communications difficulties, it may be necessary to attach combat support and combat service support elements to a task force, a team, and sometimes to platoons, thus permitting decentralized execution at the lowest level.

THE OFFENSIVE BATTLE

This section provides examples of how the offensive battle may be conducted on urbanized terrain. Each example is designed to illustrate specific tactical considerations from the perspective of differing command levels. The examples flow from the basic corps situation and should be studied in the sequence presented as part of the overall scheme of maneuver.

GENERAL SITUATION

An attempted penetration of the 10th (US) Corps sector has been blunted well forward in the main battle area with heavy losses inflicted on the attacking first echelon units. Prisoners and captured documents indicate that the corps is opposed by a combined arms army consisting of four divisions. Elements in contact, identified as units of two motorized rifle regiments, are preparing hasty defensive positions in depth. Aerial reconnaissance has detected defensive positions being prepared in a broad band 40 to 80 kilometers north of the present line of contact and the rearward movement of combat formations. Intelligence indicates that:

The two first-echelon divisions are at less than 80% effectiveness and are being withdrawn through. The second echelon elements of the second-echelon divisions are preparing a main defensive belt. The stalled attack was a supporting attack for the enemy general offensive.

SPECIAL SITUATION

Corps Hasty Attack

The 10th (US) Corps commander has been directed to initiate offensive actions as soon as possible. His planning for the offense is directed at the basic requirement of rupturing the enemy's hastily prepared defensive belts. His plan must also provide for the passage of sufficient forces into the rear area to destroy the enemy and create an exploitable situation once the rupture has been accomplished. In analyzing the terrain, the commander focused on those natural and manmade features that would affect the maneuver of brigade-size and larger units or provide tactical objectives. Of primary interest to him are major terrain compartments, communications networks, and built-up areas. Each of these features can impact on his tactical options.

As shown, the terrain complex in the corps zone consists of a rural-urban mix. On the eastern boundary, rolling foothills reach an elevation of 230 meters and limit access into the corps zone to one minor avenue of approach along a hard-surface road and secondary rail line. An unimproved dirt and gravel road net is available, but permits only limited north-south movement by tracked and wheeled vehicles. To the west, the Herz Mountains, which rise to elevations in excess of 600 meters, represent a major obstacle to lateral maneuver. Within this basin, the central complex consists of two basic compartments tied to land use and urban development.

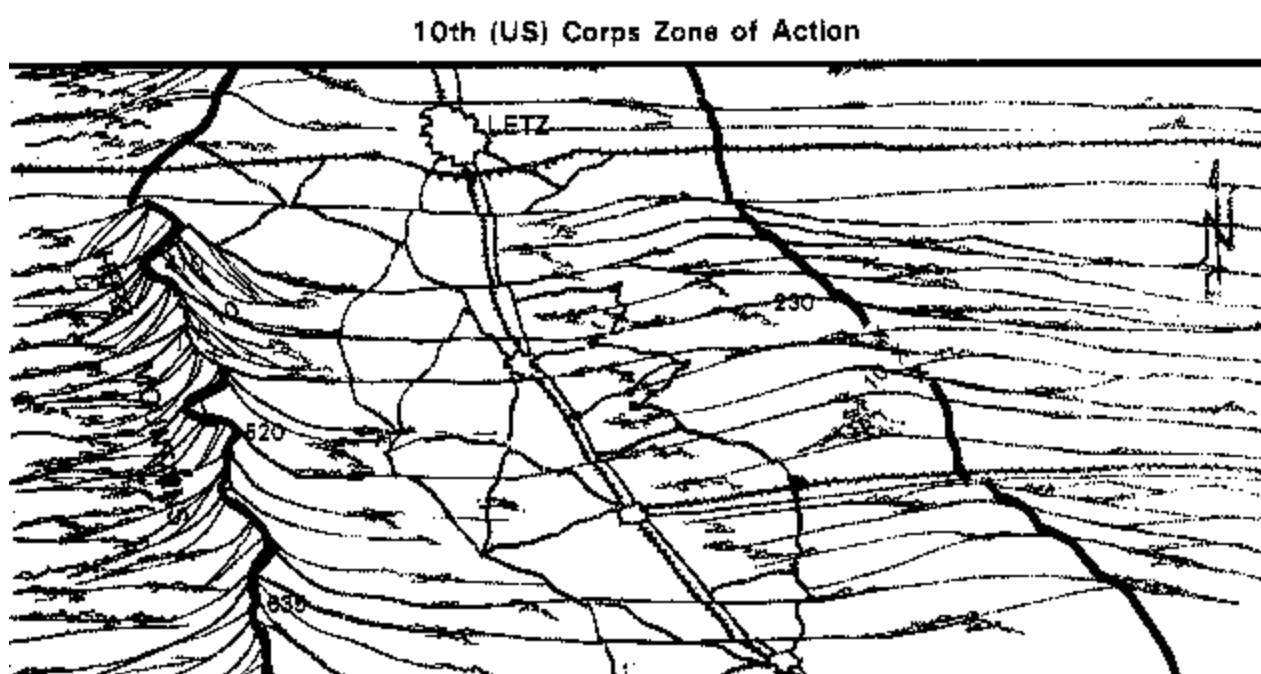

Figure 2-18 10th (US) Corps Zone of Action

The eastern compartments encompass a growing commercial and light industrial complex with numerous villages and small towns. A network of secondary and improved hard-surface roads is available for the movement of heavy wheeled vehicles. Cross-country mobility is restricted. Visibility is limited by terrain, hedgerows, and wood lots to an average of 1200 - 1500 meters. Long-range observation may be obtained from isolated dominating hills.

The western compartment is an agricultural belt supplying both the local region and the northern industrial complexes. Scattered small villages predominate throughout the area. Cross-country mobility for tracked vehicles is excellent during this season; however, wheeled vehicle movement is restricted to the secondary rural roads.

These two distinct compartments come together along a major north-south rail and road network which joins the LIMSPACHPUR communications corridor at the town of LETZ and continues north into the region's principal industrial complex. Rural and secondary road nets from both the east and the west converge on the small towns which stretch along this route. Light industrial complexes sit beside modern high-rise developments throughout the region.

LETZ, with a peacetime population of close to 40,000, is a major transportation hub and an obstacle to corps-level maneuver. It must be secured with major facilities intact in order to sustain the corps offensive to the north.

North of LETZ, the terrain assumes a more uniform nature with rolling farmland, interrupted by small villages and scattered stands of woods, giving way to a broad corridor through forested foothills. No dominant terrain features exist in this area other than the man-made lines of communication to the north. Cross-country mobility is excellent.

Based upon the corps commander's knowledge of the enemy and the analysis of the terrain, he derived the following conclusions:

Retention intact of both the LIMSPACH-PUTS rail line and the town of LETZ, with its transportation modes, is important to the enemy if he is to sustain his defense and resume the attack. In any case, it is highly probable that he will attempt to retain LETZ as long as possible and destroy its critical facilities only if necessary. To do this, the enemy will have to deny any major penetration bypassing the town to the north, as well as local isolation of the defenders in the built up areas. The location of defensive works currently being constructed indicates that both the town and the rail line will be encompassed in the 2d echelon of his main defensive belt (MDB). The identification of two MRRs in the security zone indicates that up to two MRDs deployed laterally across the corps zone may be assigned responsibility for establishing the MDB. Given the enemy's normal tactics, LETZ will most likely be included entirely within the sector of one MRD, with a second MRD deployed westward toward the Herz Mountains. The development of a second defensive belt north of LETZ will require significant time and effort since no major terrain feature is available.

Commander's Actions

A review of the status of corps units shows that the armored cavalry squadron and elements of one division sustained significant losses during the conduct of the active defense. In addition, the equivalent of one attack helicopter company was rendered ineffective.

Although logistical support available to the corps remains adequate, no additional maneuver resources are available. The corps commander reallocated elements of the 32d Mech Division to his other units to replace losses and retained its remaining mech-heavy brigade under corps control.

The distribution of natural land forms and urban features within the corps zone favors conducting the major effort in the west. For this to succeed, sufficient force must be applied in the central and eastern regions to fix the defenses and maintain the ability to react to detected defensive weaknesses. The concept formulated by the corps commander calls for a hasty attack from present positions with two divisions and a mechanized brigade abreast.

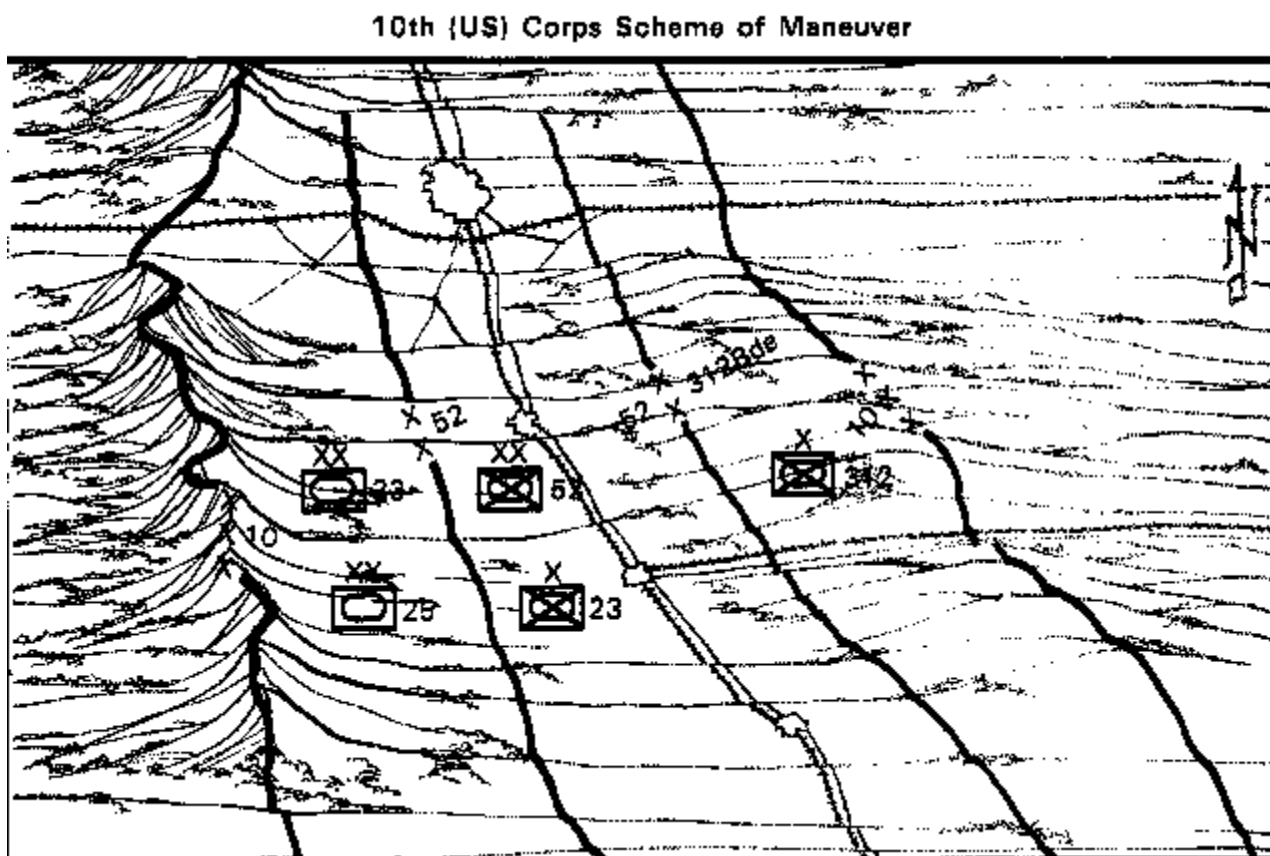

Figure 2-20 10th (US) Corps Scheme of Maneuver

The 23d Armored Division will conduct the main attack in the west, followed in zone by the 25th Armored Division. The 52d Mech Division will conduct a supporting attack on the east in a zone centered on LETZ and the major communication network. The 3d Brigade, 32d Mech Division, will follow in the zone of the 52d Div, and be prepared for attachment to the 52d Div or for commitment to the west or east. The 312 Sep Mech Brigade will attack along the eastern boundary. Although the corps commander would prefer to envelop a weak defensive flank, his scheme of maneuver provides for a penetration to rupture the defenses if required.

His concept of the operation and scheme of maneuver match the operational capabilities of available forces to the terrain and their designated objectives while offering him the following alternatives: To attack a weakness if the enemy chooses to concentrate his defenses; and to concentrate forces for a penetration at the time and place of his choice if the enemy disperses his forces.

The corps commander is aware that speed and momentum are important considerations. To him LETZ is a critical objective. A successful penetration, if achieved, will enable him to bypass the town with armored units and may force the enemy to retire from LETZ without the use of follow-on forces. If the enemy does not withdraw, it will be necessary to clear the town-which could result in costly, time-consuming fighting. The 52d Mech Division is positioned to accomplish this task without interrupting the momentum of the main attack.

SPECIAL SITUATION 2 Division Hasty Attack

As part of the corps offensive, the 52d Mech Division is moving north, led by a reconnaissance force consisting of its armored cavalry squadron and a balanced task force from the reserve, supported by field artillery and engineers. The division's main body is deployed with two brigades abreast. The reserve brigade follows in the zone of the western brigade.

The division lead elements, which have been in contact with security forces from the 322d MRR, report increasing heavier resistance in the form of antitank fires from prepared company-size strong points and local counterattacks by tanks. Aerial reconnaissance confirms that a defensive network controlling avenues of approach into the town is being prepared within LETZ and on adjacent terrain. Although the movement of tank forces to the west has been reported by corps, all indications are that the enemy intends to defend LETZ.

Trafficability throughout the division zone is excellent for tracked vehicles. A network of secondary roads is available to support the wheeled vehicles of the division and its combat service support requirements.

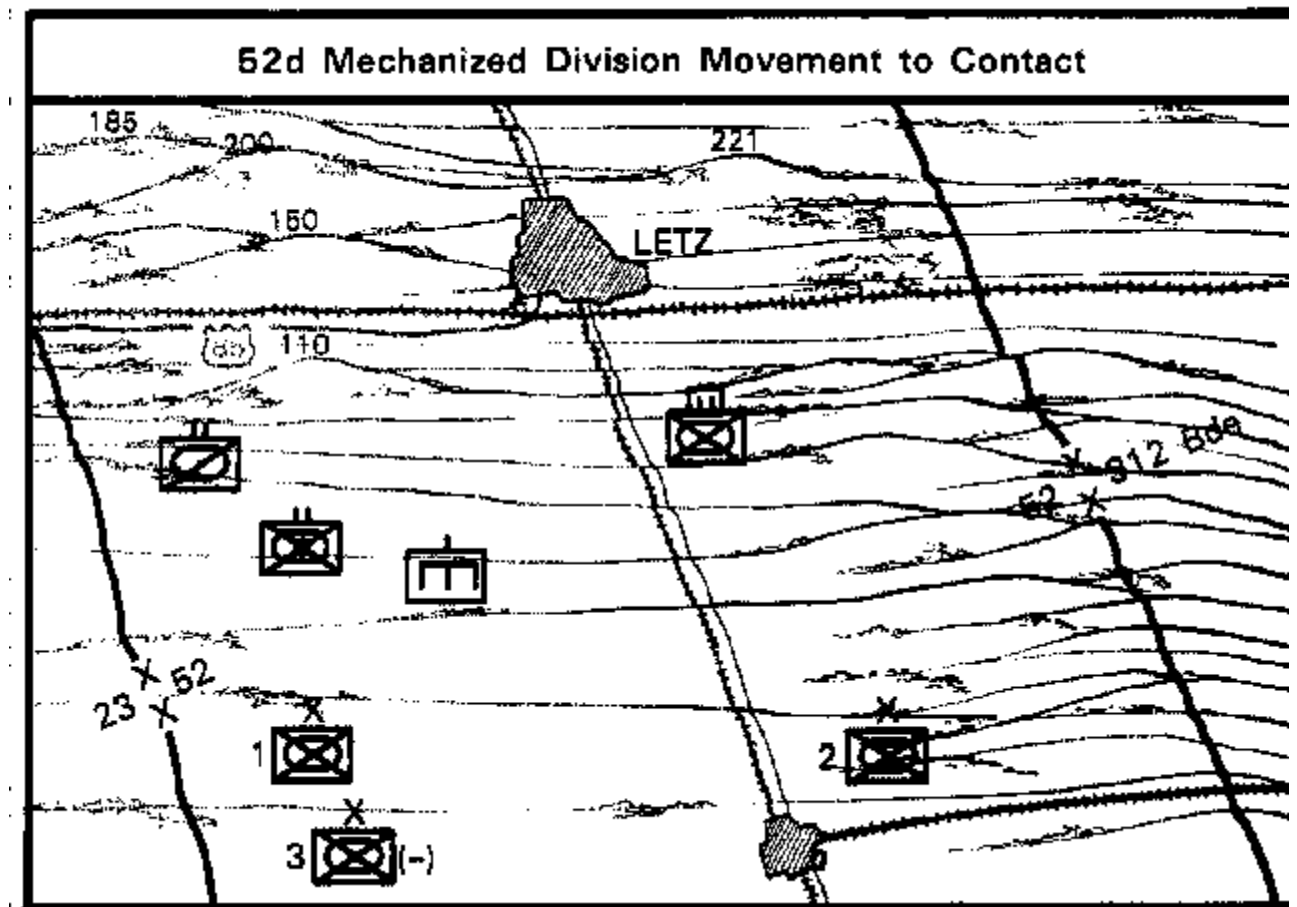

Figure 2-21 52d Mechanized Division Movement to Contact

Commander's Actions

Based on his mission of securing LETZ, the division commander identified two specific tasks. The first was to isolate the town by securing terrain on its flanks and to its rear. If required, the isolation phase would be followed by an attack to secure key installations in LETZ and clear it of organized resistance. In light of the developing situation, the commander had decided to pass his lead brigades through the security forces and conduct a hasty attack against terrain objectives adjacent to LETZ. He directs: The balanced 1st Brigade to secure hills 185 and 200 northwest of LETZ and the main highway leading north from town to block withdrawal from or reinforcement of the town.

The mech-heavy 2d Brigade to secure hill 221 and the wooded area east of LETZ to block withdrawal from or reinforcement of the town and to link up with the 1st Brigade to the north of LETZ.

The mech-heavy 3d Brigade to follow in the zone of the 1st Brigade and be prepared to secure hills 150 and 110 west of LETZ.

The ACS to protect the western flank against armor counterattacks.

The FSCOORD to reinforce the fires of the 1st and 2d Brigades DS artillery battalion with two battalions from the attached FA Brigade and to assign the priority for fires and attack helicopters to the 1st Brigade.

The division commander's concept provides that the attacking forces avoid the built-up area initially by targeting them against terrain features which control access to LETZ. It also positions his major elements for a subsequent attack of the built-up area if required. Even limited success in either brigade sector will enable the commander to support fully such an attack. He has retained his options as to when and where to penetrate the urban defenses, if required, and is well disposed to repel an enemy counterattack or prevent reinforcement.

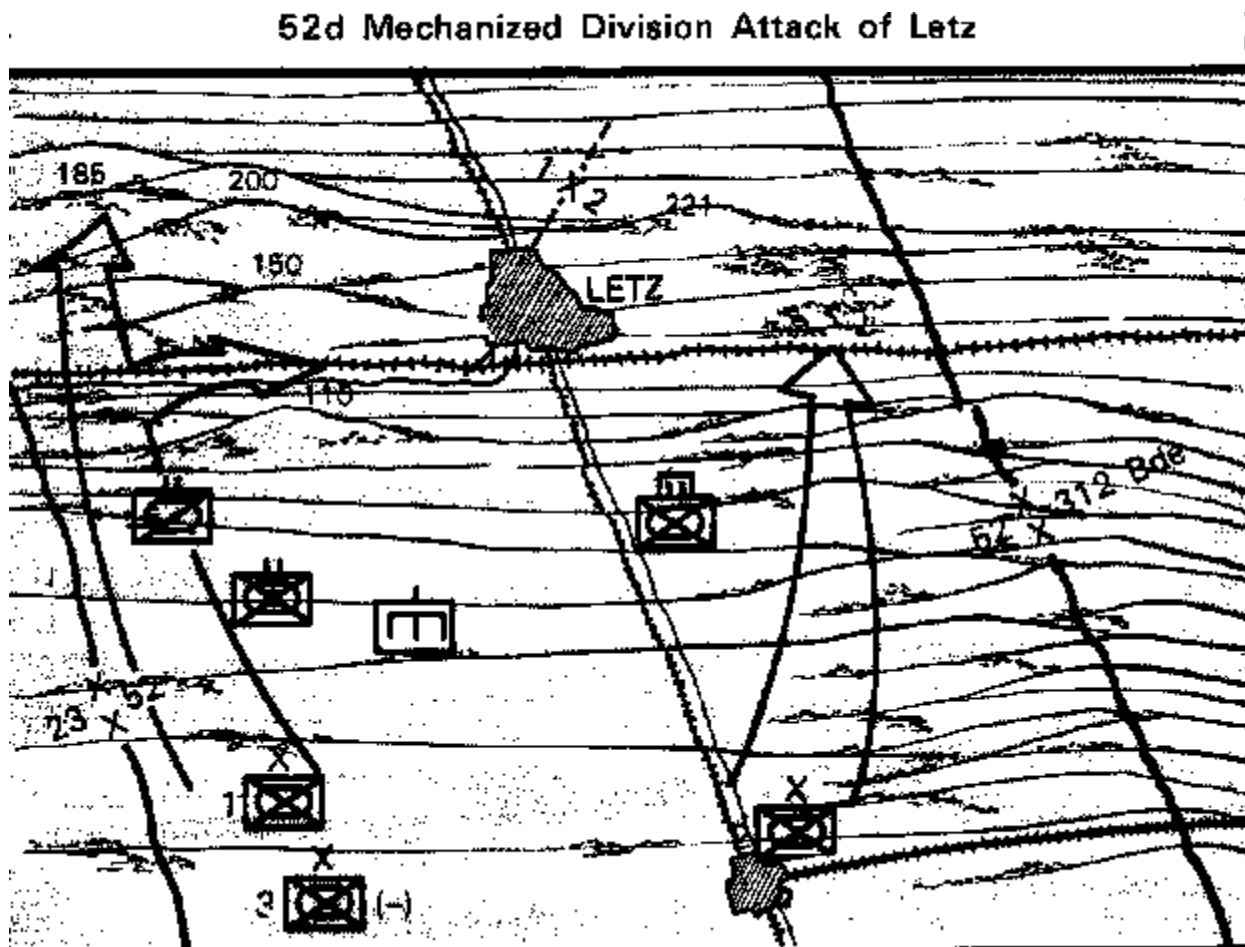

Figure 2-22 52d Mechanized Division Attack of Letz

Options left to the enemy commander are considerably reduced. He does not know if LETZ will be attacked or bypassed. A stubborn defense on the terrain adjacent to the built-up area would make LETZ vulnerable to a rapid penetration. A concentration of forces within LETZ could enable the attacker to rupture his flank defenses and turn his rear. An attempted withdrawal, forfeiting the advantages of prepared defenses, could be costly if not precisely executed.

SPECIAL SITUATION 3

Brigade Hasty Attack

As the division attack continued against heavy resistance, the corps main attack in the west penetrated the enemy's main defensive belt. Rather than risk being encircled, enemy defenders are attempting to withdraw north from the town of Letz. Radio intercepts indicate that a reinforced motorized rifle battalion has been assigned the mission of covering the withdrawal of the main body and destroying key facilities within the town.

The division commander issued a frag order directing the 3d Brigade to conduct a hasty attack on Letz to secure the rail yards and be prepared to clear the town of enemy resistance. The division commander further advised that the rail yards should be secured quickly before the enemy has an opportunity to destroy them. The 1st and 2d Brigades are to continue their attacks, maintaining maximum pressure on enemy forces and completing the isolation of the town by linking up north of Letz.

Intelligence reports indicate that enemy forces are occupying prepared defensive positions on the outskirts of town and within the town itself. They are reported to be well equipped with medium and heavy antitank weapons. The main road leading into the town from the south is heavily mined.

3d Brigade lead elements, advancing steadily, secured their initial objective, hills 110 and 150. Prisoners taken by 3d Brigade elements confirm that the estimated reinforced motorized rifle battalion in Letz has the mission of covering the withdrawal of main body elements and destroying key installations within the town.

The limited map coverage of the town itself was supplemented by aerial photos of the central railway complex and major routes into and through the town. Data compiled from the interrogation of refugees helped round out a picture of the urban defensive network. A city map, obtained by corps from the territorial forces, provides locations of key municipal facilities.

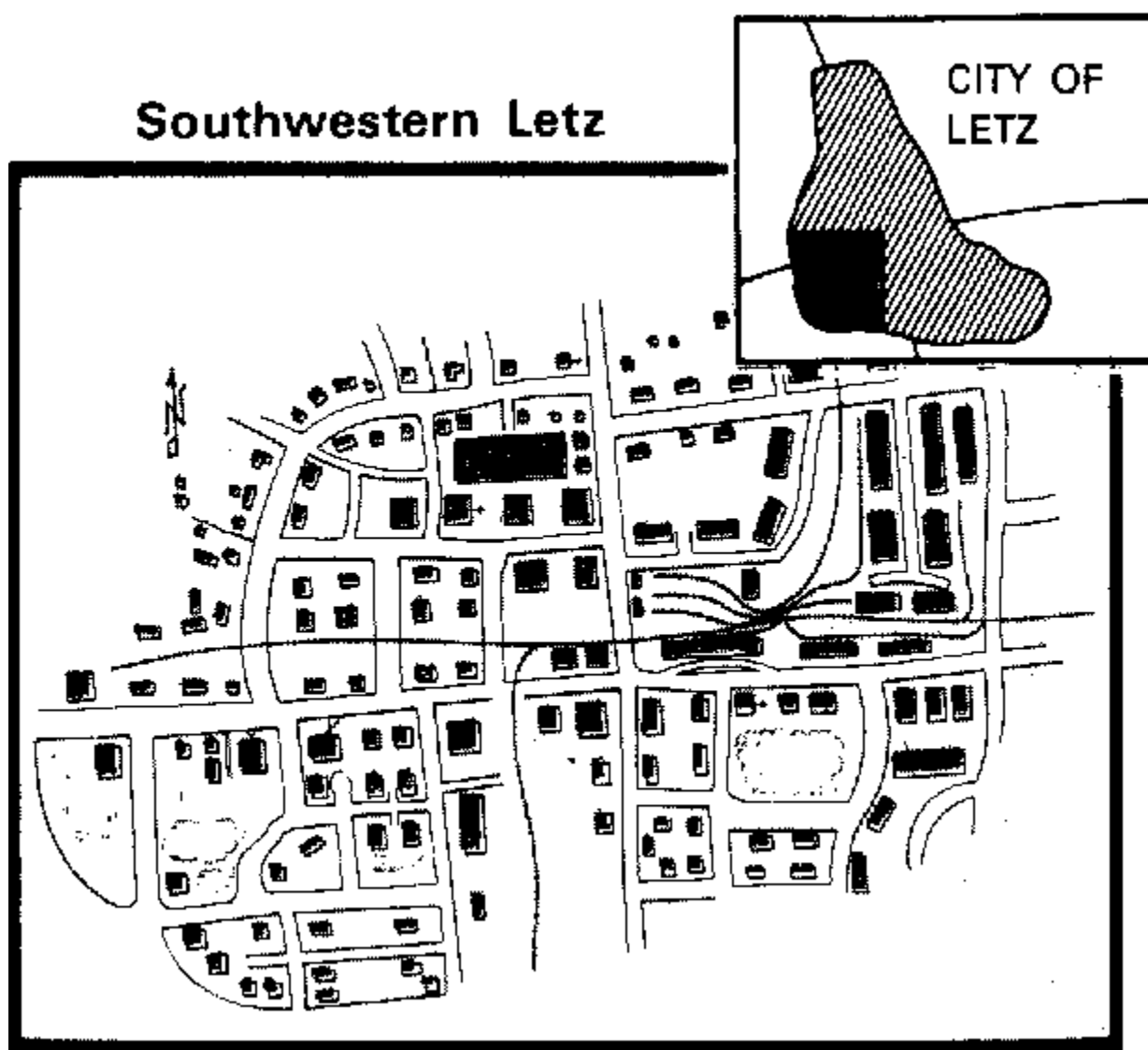

Figure 2-23 Southwestern Letz

Commander's Actions

Based on available information about the town and its surroundings, the 3d Brigade commander believes that the best avenue of approach is from the west. The enemy forces appear to have oriented their defense to the south, and an attack from the west should strike the enemy on his flank. Terrain along the major rail and highway system leading into the town from the west provides sufficient room for the attacking forces to maneuver. Many of the buildings in the western and southwest sector of the town have a low profile, making them easy to smoke. The establishment of a foothold in the western sector of the town also opens the most direct route to the railroad yards.

Based on his assessment of the situation, the brigade commander outlined his general concept for the conduct of the operation.

"The Brigade has basically three tasks. We must establish a foothold in the town of Letz; we must then secure rail yards; and, finally, we must be prepared to clear the town of enemy resistance. The most critical task is to secure the rail yards as quickly as possible before enemy forces have an opportunity to destroy them. I recognize that the rail yards are situated deep within the town and that a foothold should first be established on the edge of the town. But because of the critical and time-sensitive nature of securing the rail yards, I want to insure that the momentum of our attack is maintained throughout both phases (establishing the foothold and securing the rail yards).

"Highway 85 appears to be the most direct route to the rail yards, and there appears to be sufficient maneuver room on both sides of the highway for it to serve as our main route of advance. Two mech-heavy task forces will make a coordinated attack on Letz and establish a foothold two-to- three blocks deep on the north and south sides of Highway 85. The task force in the southern zone should have responsibility for Highway 85 and for keeping it open. An alternate route of advance should be identified in the northern task force zone in the event that Highway 85 cannot be kept open. The third task force is to follow in the zone of the southern task force.

"At this point, I want to keep all options open to me. If little or no enemy resistance is encountered by either of the lead task forces in the foothold, then we will continue the attack to secure the rail yards, and the rear area task force will assume its position in the foothold. If the foothold is well-defended, the rear task force is to be punched through the foothold to secure the rail yards.

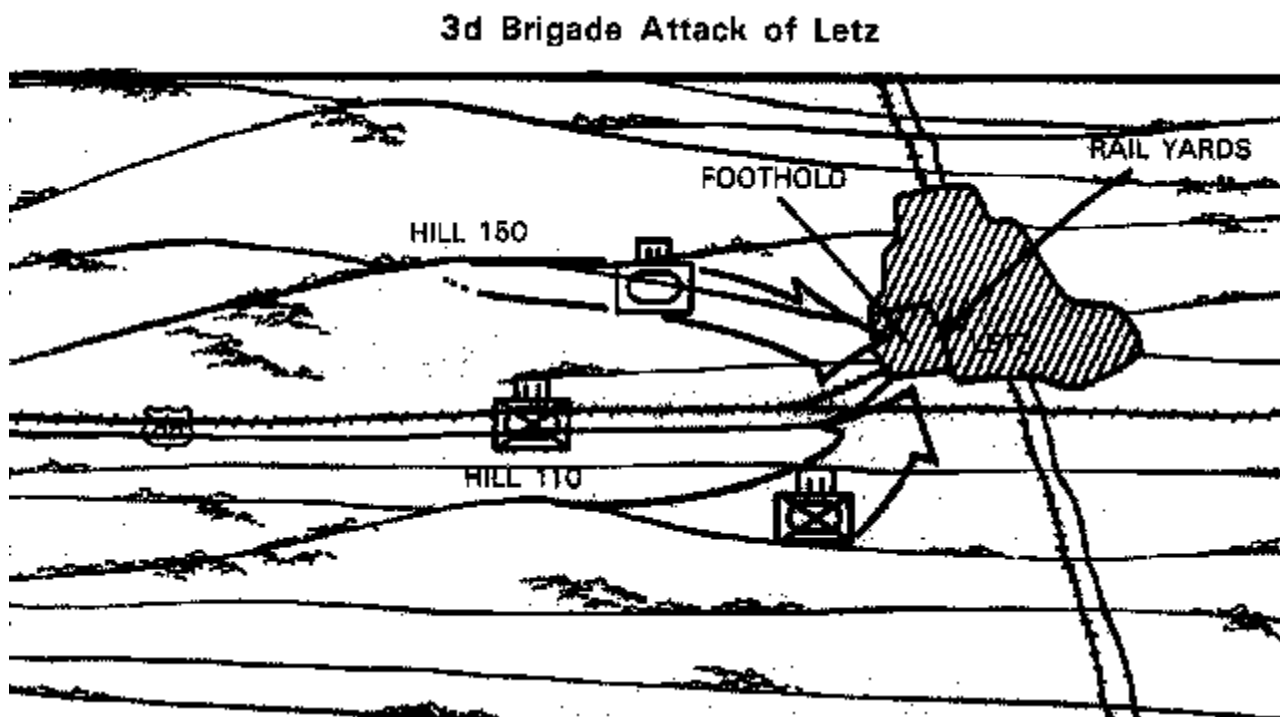

Figure 2-24 3d Brigade Attack of Letz

"Once the rail yards are secure, a systematic clearance of the town will be conducted and each task force will be assigned a zone to clear.

"S3, get with division and tell them that I want our DS engineer company attached to us for the duration of this operation, and I want an additional engineer company allocated to us. We also should have another artillery battalion to reinforce our DS battalion.

"I want to keep one mech platoon in bde reserve to serve as a reaction and security force. Request some aircraft so that we can air assault the platoon into the city if necessary. The platoon should be capable of making a rooftop landing."

The division, upon receiving the requests from the brigade S3, approved them and allocated the brigade six lift aircraft for the possible air assault.

Based on the brigade commander's general concept and guidance, there is no need to change the task organization, and the brigade remains task organized as follows:

TASK ORGANIZATION: 3D BRIGADE

TF 1-5	TF 1-82	TF 1-81	BDE CONTROL
1-5 Arm (-)	1-82 Mech (-)	1-81 Mech (-)	1/B/1-82 Mech
A/1-81 Mech	B/1-5 Arm	A/1-5 Arm	1-42 FA (DS)
B/1-82 Mech (-)	2/C/52 Engr	D/52 Engr	3-35 FA
			(Reinf 1-42FA)
1/C/52 Engr			C/52 Engr (-)
			2/B/23d CEWI
			C/1-441 ADA
			(Vulc)

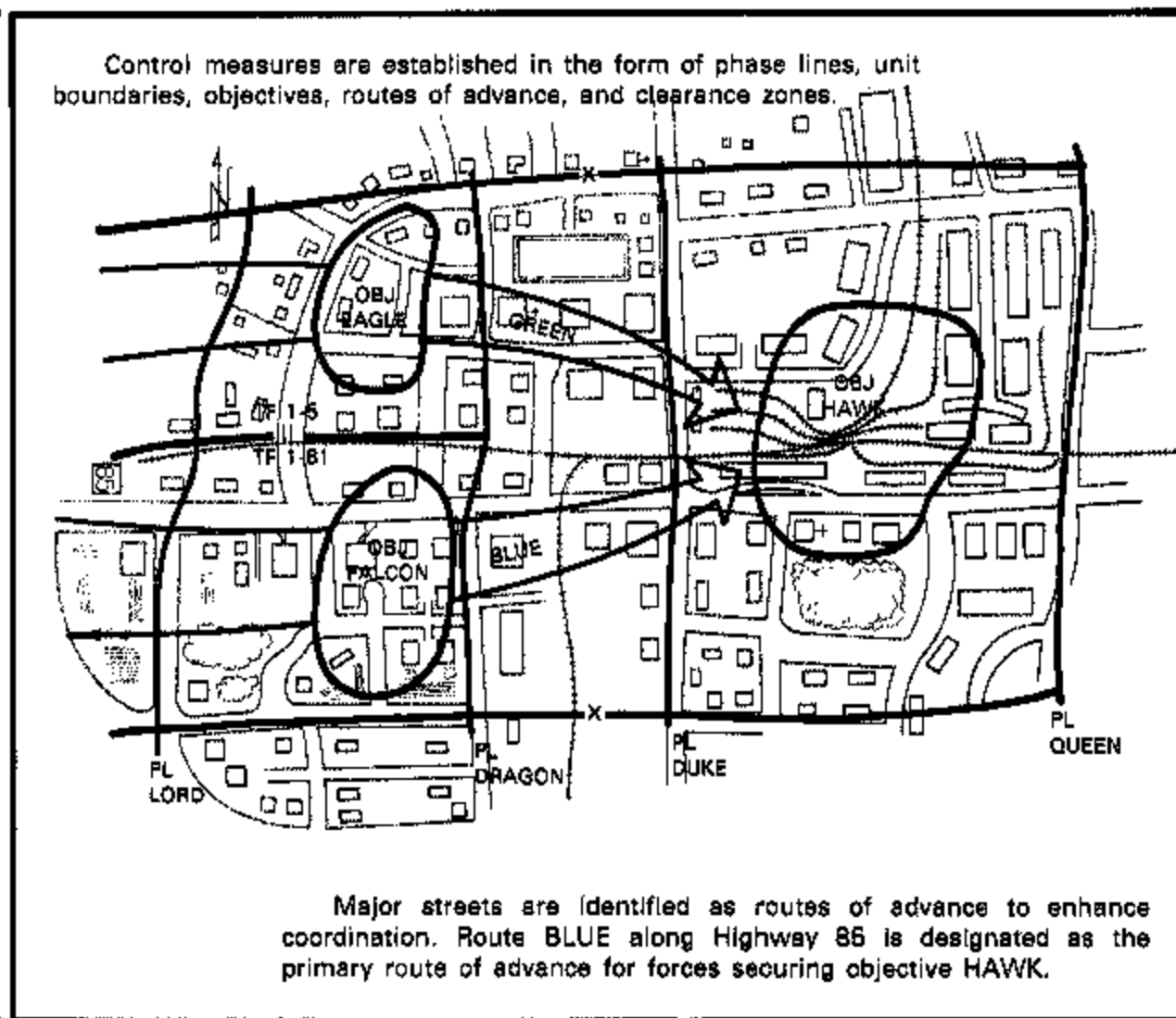

Figure 2-25 3D BRIGADE TASK ORGANIZATION

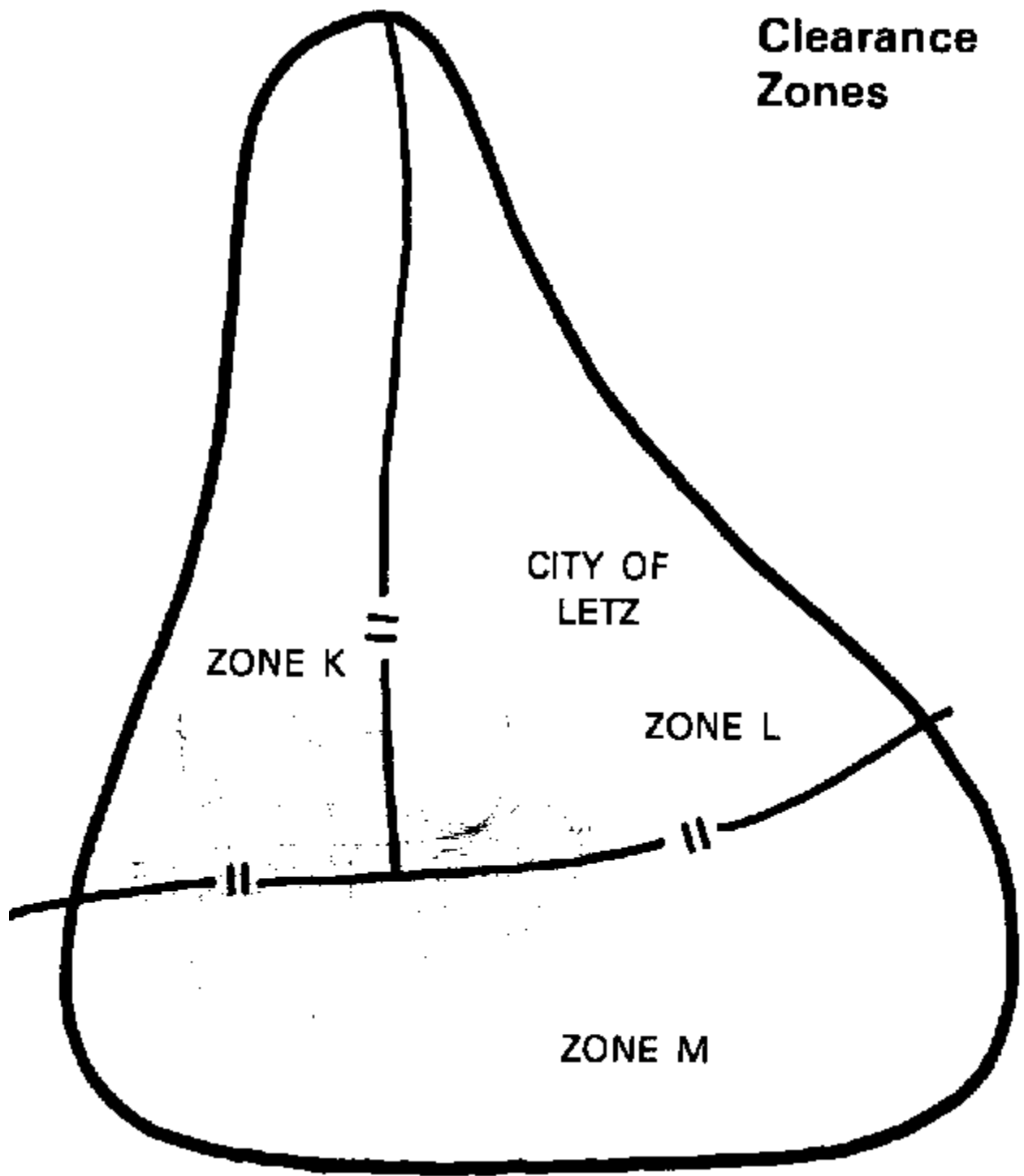

Figure 2-26 Clearance Zones

TF 1-5 Armor

- * Attack at H-hour to secure objective EAGLE.
- * Be prepared to continue the attack to secure objective HAWK.
- * Be prepared to release one mech-heavy team to TF 1-82 and assist passage of TF 1-82 elements along route GREEN.
- On order, conduct systematic clearance in zone.
-

TF 1-81 Mech

- * Attack at H-hour to secure objective FALCON.
- * Be prepared to continue the attack to secure objective HAWK.
- * Be prepared to release one mech-heavy team to TF 1-82 and assist passage of TF 1-82 elements along route BLUE.
- * On order, conduct systematic clearance in zone.

TF 1-82 Mech

- * Follow TF 1-81 in zone on route BLUE.
- * Be prepared to assume TF 1-81 position on objective FALCON or 1-5 position on objective EAGLE.
- * Be prepared to pass through lead elements and conduct attack to secure objective HAWK.
- * On order, conduct systematic clearance in zone.

The brigade commander provided the following specific guidance to his commanders and staff:

"The key to the success of this attack is a rapid advance and close coordination. Report the crossing of each phase line and the securing of assigned objectives. Do not initiate a systematic clearance of the foothold areas until objective HAWK is secured.

"At H-5, artillery is to engage known enemy positions with HE and provide smoke to cover the advance of attacking elements. Artillery fires will be lifted at the discretion of the lead task forces. Lead elements should attempt to close within 200 meters of enemy positions prior to lifting smoke in order to reduce the effectiveness of enemy antitank weapons. Caution will be exercised in the use of HE artillery to avoid unnecessary rubble, particularly along routes of advance.

"If necessary, the DS artillery battalion is prepared to provide, through coordination with the brigade FSO, up to two howitzer sections to assist in reducing strong points. The requesting task force must provide a guide and security for these sections if employed.

"Nuclear weapons will not be used. Non-persistent irritating munitions may be used to assist in clearing buildings; however, artillery or mortar chemical rounds will not be used without prior approval from my CP.

"Because of collateral damage restrictions, municipal buildings will not be fired upon unless developed and used by the enemy as defensive positions. Six tac air sorties have been allocated to the brigade for the attack. The aircraft are prepared to deliver precision munitions on call. Remember that collateral damage must be minimized.

"Phase line Dragon is an initial limit of advance for TF 1-5 and TF 1-81.

"Priority of fires will go to TF 1-81 initially, and upon passage of phase line Dragon, priority of fires will shift to the lead task force. Task forces are not to fire across common boundaries to the rear of phase line Dragon without prior coordination. Once lead elements have passed forward of phase line Dragon, the rear task forces may not engage targets forward of phase line Dragon without prior clearance.

"One platoon from A Company, 1-82 Mech, will be retained under brigade control as a reaction and security force. The platoon will be prepared to conduct air mobile operations throughout the zone, and contingencies for the platoon will include rooftop landings. Task forces occupying positions in the foothold will be prepared to release a company team to reinforce the lead task force securing objective HAWK.

"Brigade trains will remain in present locations and be prepared to move on 30 minute's notice. The maintenance collection point will displace along Highway 85 to the vicinity of phase line Lord once objective FALCON is secured. Brigade supply route is Highway 85.

"Attack elements remain on listening silence prior to initial contact with enemy forces. TF 1-82 will monitor the command nets of TF 1-5 and TF 1-81. Once the foothold is secured, retransmission sites should be established in elevated positions to reduce FM communication difficulties anticipated within the built-up area on brigade command and control nets. Try to use wire communications within the town. Intact civilian communication systems may also be available to supplement tactical systems.

"CEVs should be positioned well forward to gain maximum effectiveness from their blowdown capability against enemy strong-points. Engineers will also be positioned well forward to clear enemy mines and obstacles.

"The brigade TAC CP will be located initially in the proximity of TF 1-81 CP. TF 1-82 will establish a jump TOC with the brigade headquarters to insure close coordination. TF liaison personnel will collocate with the brigade main CP initially."

SPECIAL SITUATION 4

Task Force Attack to Secure Foothold

Task force 1-81 has just closed on hill 110 against light enemy resistance. Only a few casualties have been sustained. The task force commander has been alerted to conduct a hasty attack against the town of Letz to establish a foothold. He has, in turn, alerted his company team commanders. His present task organization consists of three mech-heavy company teams.

Enemy forces within Letz in the TF 1-81 zone are estimated to consist of reinforced platoon or a company minus. Intelligence reports indicate that defenders are well armed with antitank weapons. The types of antitank weapons which the enemy has available are believed to include wire-guided missiles, RPG-7s, SPG-9s, and possibly T12s. Their wire-guided missiles require a minimum of 500 meters for the enemy gunners to gain control of the missiles once they have been fired. Friendly forces should expect the enemy to employ the antitank weapons from inside buildings and from other well-concealed positions. The defenders are also reported to have tanks which they will use in the defense.

The terrain between TF 1-81 and the outskirts of town is slightly rolling. There is sufficient relief in the terrain to provide some cover and concealment from positions in the town; and lightly wooded areas will provide some additional concealment from direct observation.

Once the initial penetration of the town is made, attacking forces will be able to take advantage of the cover and concealment provided by buildings. The area within the TF zone in the town is primarily residential. Many houses have yards and gardens. The houses are spaced far enough apart to allow for sufficient maneuver room for attacking elements throughout most of the zone. The civilian population has reportedly moved out of the area into the central part of the city.

Commander's Actions

The task force commander makes an assessment of the situation and briefs his staff on his general concept of the operation:

"Our tasks are to conduct a rapid advance from our present positions to the town of Letz, penetrate the enemy defenses of the town in zone, and secure objective FALCON. At this point we must be prepared either to continue the attack to secure objective HAWK or to assist TF 1-82 with a passage of lines along

route BLUE. After HAWK has been secured, we will then begin a systematic clearance of our assigned zone.

"During the initial assault, a mech-heavy company team will attack along route BLUE and a mech company minus will attack along a parallel axis to the south of route BLUE. An armor-heavy company team will provide over watching direct fire support until advancing elements have closed on the initial enemy positions. The armor-heavy team will then follow along route BLUE with the mission of keeping route BLUE open. The scout platoon will screen the TF's southern flank during the attack and while in position in the foothold.

"If we are ordered to continue the attack to secure objective HAWK, we will proceed on a narrow front along route BLUE with the pure mech company minus, the mech-heavy team, and the tank-heavy team, in that order. If substantial resistance is encountered to the point that the lead elements become decisively engaged, follow-on elements will deploy laterally and maintain the momentum of the attack on alternate attack routes, if necessary, bypassing enemy pockets of resistance."

Based on the task force commander's concept and guidance, the following task organization is developed, requiring only minor changes.

TASK ORGANIZATION: TF 1-81 MECH

TEAM BRAVO	C COMPANY	TEAM TANK	TF CONTROL
B/1-81 Mech	C/1-81 Mech (-)	A/1-5 Armor (-)	Scout Platoon
2/A/1-5 Arm	2/D/52 Engr	3/C/1-81 Mech	Redeyen Sect
1/D/52 Engr	1 TOW Section	1 Redeye Team	Hv Mtr Plt
1 TOW Sect	1 Redeye Team		D/52 Engr (-)
1 Redeye Team			

Command and Control

In order to insure effective command and control during the conduct of the operation, the following control measures are utilized:

Unit boundaries are established within the foothold area.

An additional phase line is included (PL Jack) to insure that all major streets running laterally within the task force zone are readily identifiable for reporting procedures.

Buildings are assigned letter and number identifiers. Letters used do not correspond to units involved in the attack for security reasons. Numbers used are sequentially away from the attacker to facilitate progress reports during the attack.

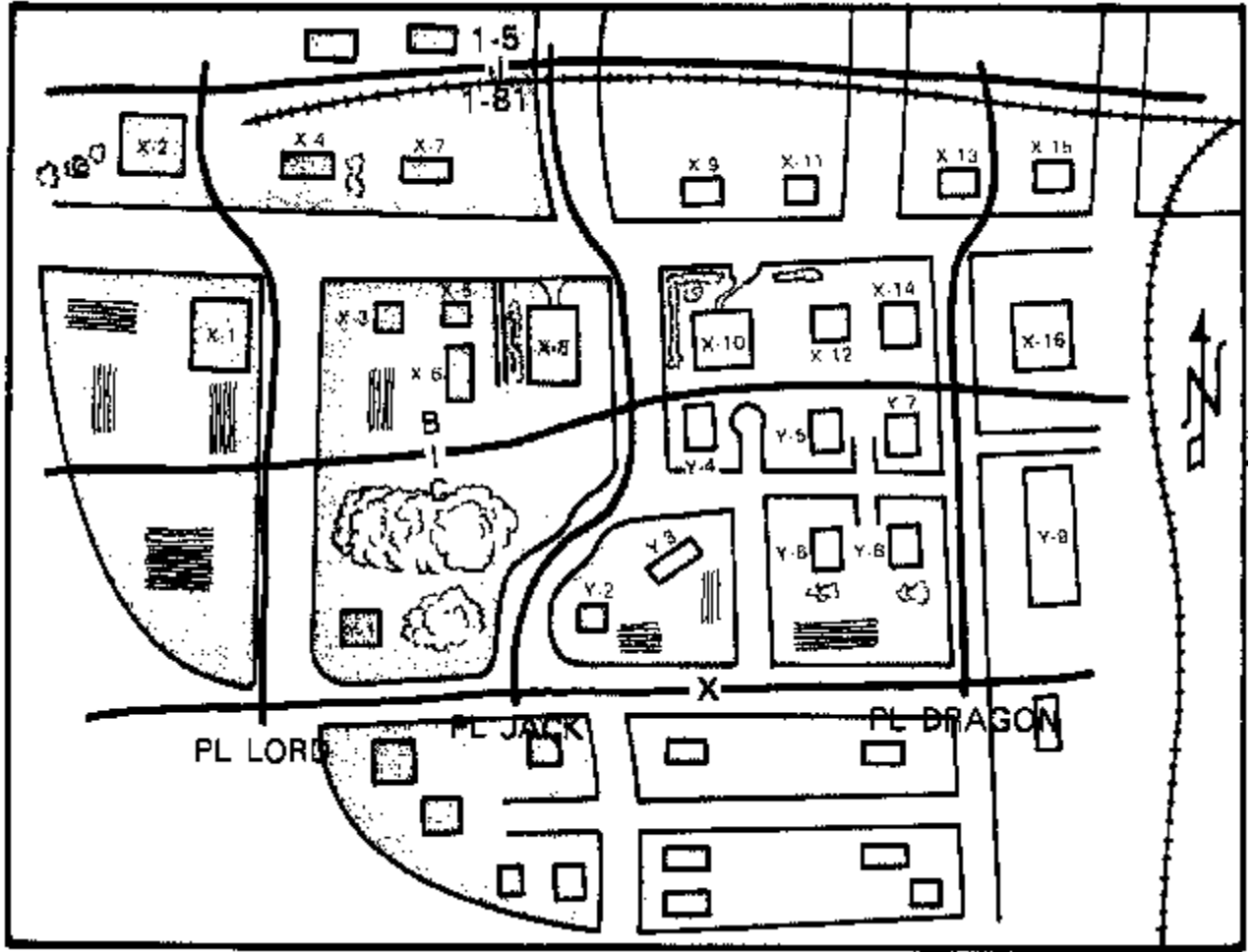

Figure 2-29 TF 1-81 Mech Task Organization

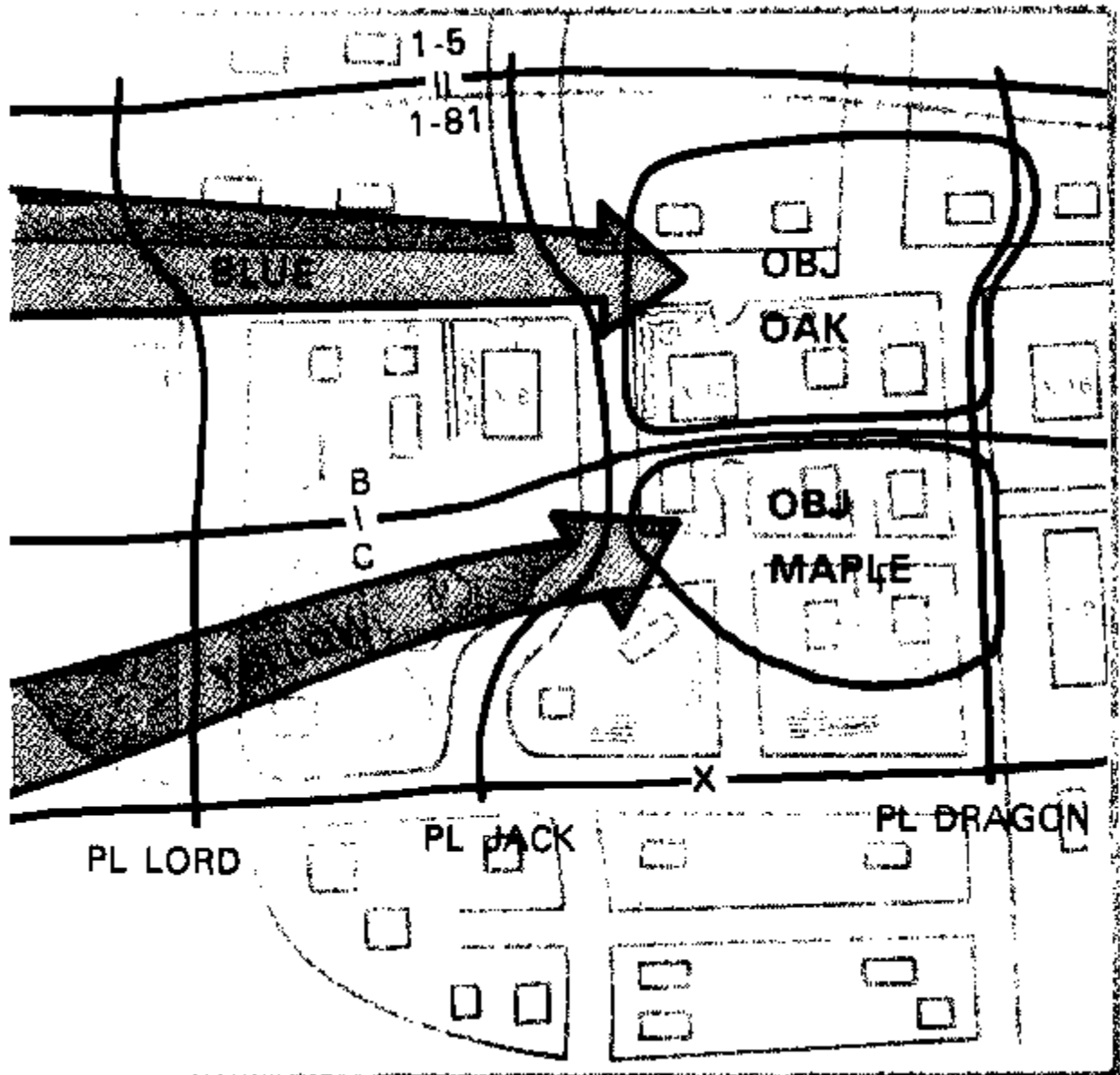

Figure 2-30

An additional route of advance, route YELLOW, is established.
Routes of advance are identified.
Company/team objectives are assigned.

The following missions are assigned:

Team B:

- * Attack along route BLUE to secure objective OAK.
- * Be prepared to assist passage of elements from TF 1-82.

- Be prepared to continue the attack to objective HAWK.

C Company:

- * Attack along route YELLOW to secure objective MAPLE.
- Be prepared to continue the attack of objective HAWK.

Team Tank:

- * Initially, provide over watching direct fires in support of the attack until lead elements reach the town and direct the lifting of fires.
- * On order, follow Team B along route BLUE.
- Be prepared to assist passage of TF 1-82 elements.

Scout Platoon:

- * Screen southern flank.

The task force commander provided the following guidance to his commanders and staff:

"Our mission is to conduct a rapid advance on the town of Letz and secure objectives OAK and MAPLE. During the advance, expect all elements to make maximum use of available cover and concealment, and, at the same time, the advance must be conducted swiftly to reduce exposure time to enemy defenders.

"Although maximum use of smoke will assist in covering our advance on the town, it should be expected that dust signatures from tracked vehicles and exhaust signatures from some of the tanks, together with the noise factor, will alert the enemy once the attack is under way. It is, therefore, of greatest importance, once the attack is started, that elements advance on the town as rapidly as possible.

"Artillery forward observers should call for fires on known or suspected enemy positions and should make maximum use of smoke to cover the advance until lead elements have closed to within a minimum of 500 meters from enemy positions. Smoke should then be shifted and maintained at no more than 500 meters ahead of lead elements as they advance toward their objectives.

Although civilians are not supposed to be in the area, care must be exercised when engaging targets. Yet, there should be no hesitation when engaging known or suspected enemy positions. Once an area has been cleared of enemy forces, however, I expect absolute respect for the integrity of civilians and their property.

"Priority of fires will go to team Bravo. FOs will be cautioned about unnecessary rubbing, especially along routes of advance. If TF 1-82 is passed through us, no targets will be engaged forward of our positions without prior coordination, once their lead elements have passed ours. Direct coordination is authorized.

"Our trains will remain at their present location until the foothold is well established, at which time they will displace forward along route YELLOW.

"Listening silence will be maintained until initial contact with enemy forces is made. I want our signal people to establish a retransmission site in an elevated position within the foothold area as soon as possible. Maximum use will be made of wire once we are within the town. We may later be able to use the civilian communications system to supplement our own.

"My CP will follow Team Bravo. Our liaison officer will collocate with brigade."

SPECIAL SITUATION 5

Task Force Secures Critical Objective

Task force 1-82 had just closed on its initial objective in the vicinity of hill 150 when the TF commander received the order from brigade for the attack on the town of Letz. In analyzing his mission, he determined that he would be required to follow TF 1-81 into the foothold area and that he would then have to be prepared to assume positions in the foothold or pass through the foothold to secure objective HAWK.

Commander's Actions

Based on the general situation (see situation 4) and after analyzing courses of action available to him, the TF commander developed the following general concept which he outlined to his staff:

"Our mission is to follow TF 1-81 and be prepared to assume positions in the foothold or to pass through the foothold to secure objective HAWK. I want the task force organized for maximum speed and flexibility. In the event that we are ordered to maintain positions in the foothold, I want the order and manner in which we will deploy clearly defined. If we are ordered to pass through the foothold, the momentum and flexibility of the attack must be maintained. Enemy pockets of resistance are to be bypassed. We can police them up after objective HAWK has been secured. I want to insure that alternate routes of advance to objective HAWK are identified."

"S3, check with brigade and see if we can move along two avenues of advance into the foothold: along route BLUE behind IF 1-81, and along route GREEN behind TF 1-5. This would put us in a better position to respond to the various contingencies that we must plan for. If we can use two routes of advance, want a pure mech company on route BLUE followed by a mech-heavy team and a tank-heavy team on route GREEN. Have the scout platoon screen forward along both routes and maintain contact with the brigade lead task forces."

The task force S3 asks brigade if routes of advance, other than route BLUE, can be used by TF 1-82 elements moving into the foothold area and also beyond the foothold area toward objective HAWK. Brigade approves the use of route GREEN, but wants to be kept closely informed as to which routes are being used by which elements during the conduct of the operation. Based on task force commander's general concept of operation and guidance, the task force is organized as follows:

TASK ORGANIZATION

A COMPANY	TEAM CHARLIE	TEAM TANK	TF CONTROL
A/1-82 Mech	C/1-82 Mech (-)	B/1-5 Armor(-)	Scout Platoon
1/2/C/52 Engr	2/2/C/52 Engr	1/C/1-82 Mech	2/C/52Engr
1 TOW Sect		1/B/1-5 Armor	Redeye Sect
1 Redeye Tm		1 TOW Sect	Hv Mtr Plt
1 Redeye Tm			

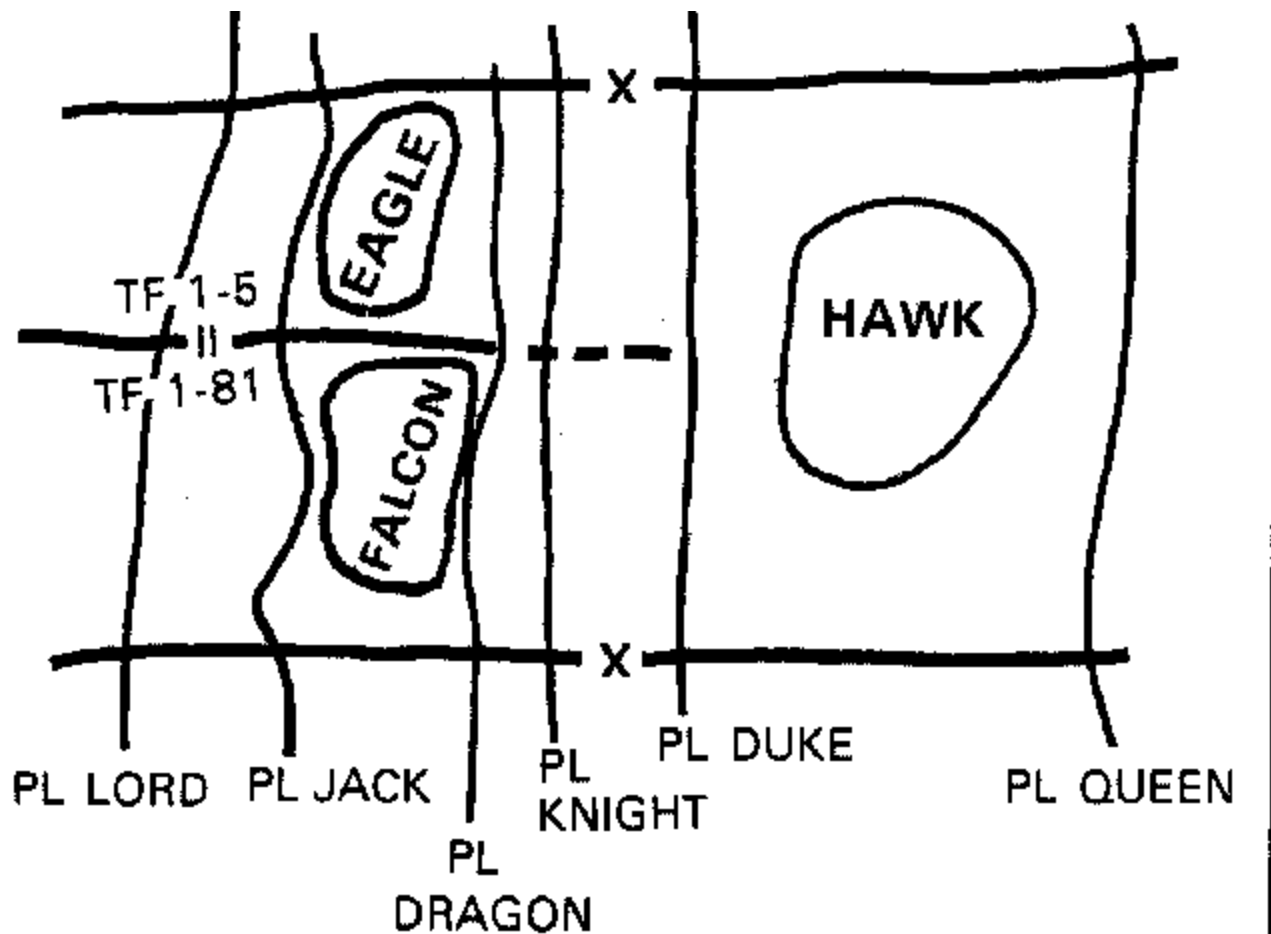

Figure 2-32 Control Measures

Control Measures

Control measures are established forward of phase line Dragon to provide better command and control for securing objective HAWK.

An additional phase line, PL Knight, is established; an on-order company/team boundary is established between PL Dragon and PL Duke; and buildings to and around objective HAWK are numbered. Primary routes of advance, BLUE and GREEN, are supplemented by alternate routes of advance, YELLOW and WHITE, to objective HAWK.

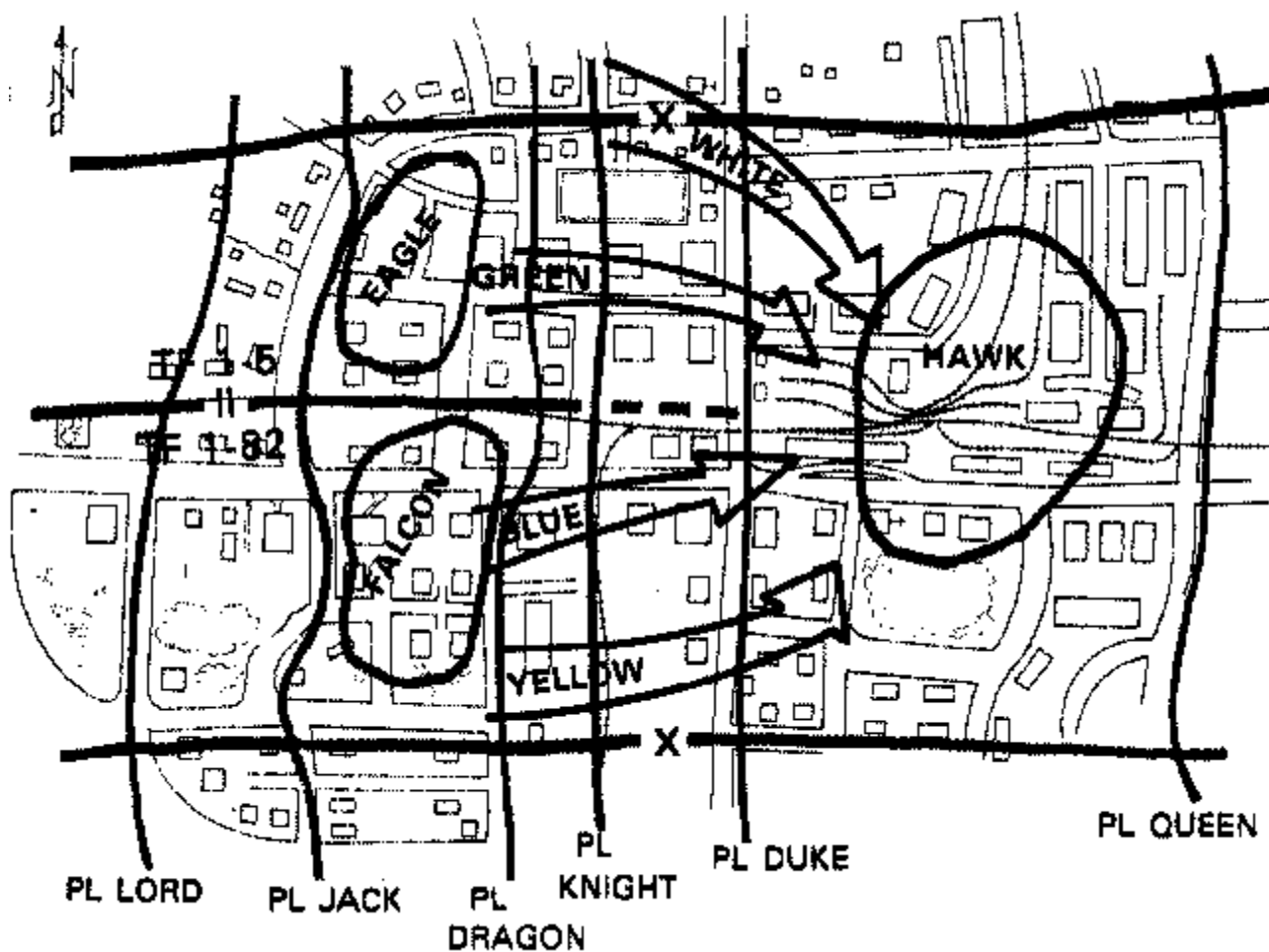

Figure 2-33 Routes of Advance

Company/team objectives are identified in the rail yard area and include buildings which are adjacent to and which dominate the rail yards. Objective boundaries will serve as fire coordination lines.

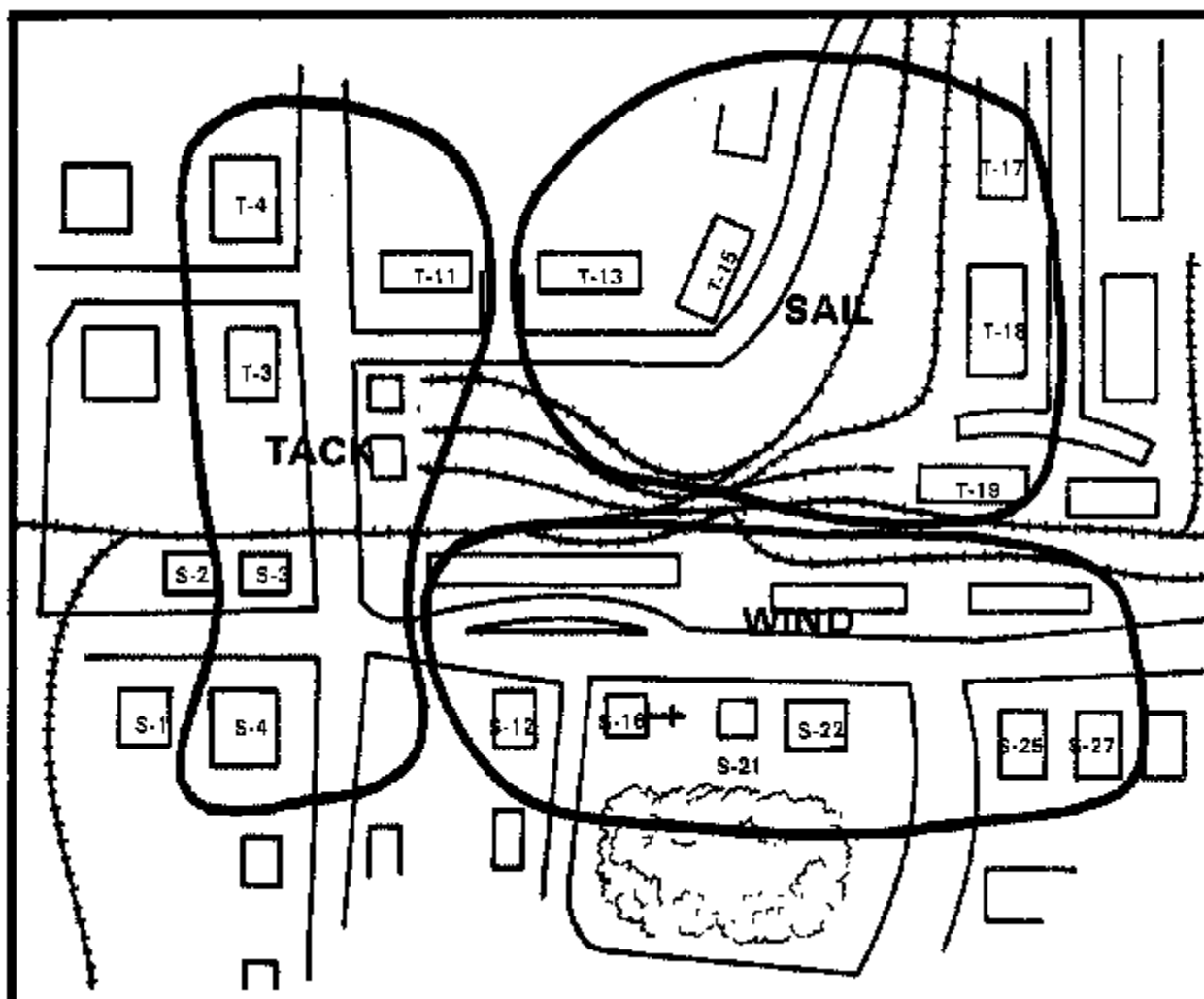

Figure 2-33 Company/Team Objectives

Task force elements are assigned specific missions:

A/1-82 Mech:

- * Follow TF 1-81 Mech into foothold along route BLUE
- * Be prepared to assume positions in foothold.
- * Be prepared to pass through TF 1-81 and attack along route BLUE to secure objective WIND.
- * On order, conduct systematic clearance in zone.

Team Tank:

- * Follow A/1-82 Mech into the foothold along route BLUE.
- * Be prepared to assume positions in foothold.
- * Be prepared to follow A/1-82 along route BLUE to secure objective TACK.
- On order, conduct systematic clearance in zone.

Team CHARLIE:

- * Follow TF 1-5 into foothold along route GREEN.
- * Be prepared to assume positions in foothold.
- * Be prepared to pass through TF 1-5 and attack along route GREEN to secure objective SAIL.
- * On order, conduct systematic clearance in zone.

Scout Platoon:

- * Screen forward of the TF along routes GREEN and BLUE.
- Be prepared to screen northern or southern flank of foothold area.

The two lead task forces of the brigade have successfully secured the foothold but only after defeating stiff enemy resistance. Enemy forces are now in the process of falling back to alternate defensive positions deeper within the city, but have left forces in contact to try to contain the foothold. The brigade commander issued FRAG orders for TF 1-5 and TF 1-81 to hold their positions in the foothold and to assist passage of TF 1-82 elements. He orders TF 1-82 to pass through the lead task forces and continue the attack to secure objective HAWK. The priority of fires is shifted to TF 1-82. He reminds the commanders of TF 1-5 and TF 1-81 that, upon passage of TF 1-82 lead elements, no targets are to be engaged forward of phase line DRAGON without prior coordination with TF 1-82. He tells the brigade 53 to have the reserve platoon prepared to load the aircraft for an air assault into the town on 2-minute notice.

Commander's Actions

The commander TF 1-82 issues FRAG orders to his company/team commanders to pass through the lead task forces in the foothold area and continue the attack along designated routes of advance to secure assigned objectives in and around the rail yards. All elements are to report progress by phase lines and are to report any changes in routes of advance. The scout platoon is to screen the southern flank.

As the task force continues the attack, lead elements find that enemy forces have rubble buildings along route GREEN and that the route is impassable to tracked vehicles. When the commander of team CHARLIE is advised of this situation, he swings out to route WHITE and continues the advance. As A/1-82 Mech lead elements near the rail yards, they come under increasingly heavy enemy fire.

Enemy defenders are occupying the hotel and city hall to the southeast of the rail yards. The hotel is approximately 10 stories high, and the enemy defenders are able to control the surrounding area by fire from inside the hotel, effectively halting the advance of A/1-82. The commander of A/1-82 reports his situation to the task force commander who, in turn, requests from brigade that the reserve platoon be air assaulted to the top of the hotel building. The brigade commander concurs and authorizes the commitment of the brigade reserve platoon.

The commander of ALPHA/1-82 is advised of the air assault and is told to get into position to lay down a heavy base of fire against the hotel as the first aircraft approaches the building. ALPHA/1-82 elements assume covered and concealed positions to the west and southwest of the hotel and lay down a heavy base of fire with their organic weapons. As the first aircraft lands on top of the building, enemy return fire from the building starts to diminish and ALPHA/1-82 elements assault the building on the ground. Enemy forces within the building readily surrender. Task force elements then proceed to secure their assigned objectives.

SPECIAL SITUATION 6

Systematic Clearance of Built Up Area

The 3d Brigade notifies division headquarters that the rail yards are secure and that a systematic clearance of the town will begin shortly. The brigade S3 asks the division G3 if any additional units will be available to the 3d Brigade to assist with clearing operations. The division G3 replies that 1st and 2d Brigade elements have just been able to link up to the north of Lets, and they will not be available for clearing operations in the town. The division G3 also advises the 3d Brigade that a civil affairs team and the personnel from the division G5 office will be reporting to the 3d Brigade CP to advise the brigade commander on matters pertaining to the civilian population and the local civilian government. Intelligence reports indicate that several pockets of enemy resistance remain even though enemy forces are attempting to withdraw completely from the town. It is not expected that they have sufficient force to attempt a breakthrough operation. Civilians in the area have reported that enemy forces have planted mines and booby traps throughout the area. Generally speaking, the civilian population has been extremely cooperative with friendly forces, but they have expressed considerable concern about the destruction within the town resulting from military operations and have requested that every effort be made to avoid further destruction.

The brigade commander assigns each task force a sector of the town to clear.

Task Force Clearance Zones

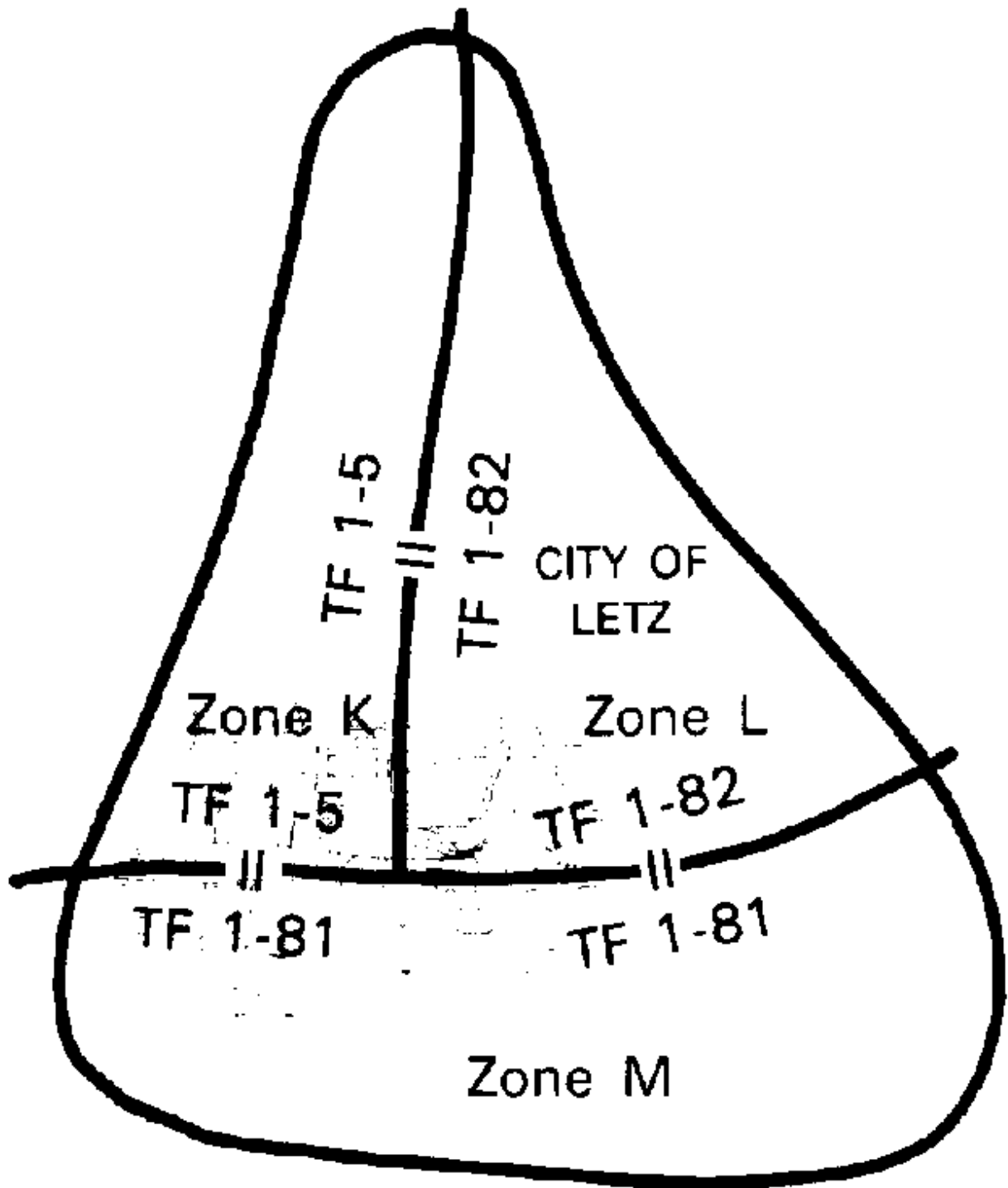

Figure 2-35 Task Force Clearance Zones (previous page)

The brigade commander calls his task force commanders together to brief them on how the clearing operations are to be conducted.

"A brigade prisoner of war facility will be established in the vicinity of the rail yards and manned by the military police. All prisoners of war are to be immediately evacuated to the facility.

"The safety of civilians in the area is of great concern to me. During the conduct of the clearing operations, indiscriminate and random firing is to be avoided. The integrity of civilians and their property is to be respected.

"Indirect fires are not to be utilized during the clearing operations unless permission to do so is granted by my CP. Heavy direct fire weapons should only be used as a last resort. Tear agents may be used against known or suspected enemy positions.

"It can be reasonably expected that mines, booby traps, and unexpended munitions will be encountered by our troops. They should constantly be alert for these hazards. When feasible, these items are to be marked and bypassed, initially. If they cannot be bypassed, engineers will assist in disposing of them. Caution your troops about the hazards of booby traps and unexpended munitions.

"Your troops should expect enemy soldiers on the roofs of buildings, at ground level, and below ground level in sewer systems and underground garages. They cannot afford to assume that the enemy is not there.

"I will retain the platoon I now have in reserve to serve as a security/reaction force throughout the zone. My CP will be located in the vicinity of the rail yards. I expect my CP to be kept closely informed concerning your progress during the clearing operations."

The Company Team Battle

This section has provided examples of how units from corps through battalion task force may attack on the urbanized battlefield. It focused on the factors the commander must consider in developing his offensive plan in this environment. Details pertaining to the conduct of the company team battle within the built-up areas of the urbanized battlefield are provided in the appendices to this manual.

SUMMARY

Know the characteristics of urbanized terrain and the advantages and disadvantages it offers both the attacker and the defender.

Bypass built-up areas when possible in order to maintain attack momentum and lessen casualties.

Attack a built-up area only as the last resort, and only when major advantage accrues through its seizure or control.

Attack where the enemy is weak--hit his flanks and rear simultaneously.

Rapid, detailed planning by participating commanders is required to allow decentralized execution and limit command and control problems during the battle.

Employ the combined arms team to provide a mutual shielding of vulnerabilities.

Dissipate the enemy's strength by causing him to react to demonstrations, feints, or ruses.

Concentrate overwhelming combat power to force a quick and violent disruption of the defenses, envelop the built-up area, and move rapidly to the enemy's rear.

Maneuver over approaches to a built-up area must be obscured by smoke and protected by over watching fires.

Where possible, reduce strong points with fires only, keep moving, and secure them with follow-on forces.

Cut lines of communications and defeat the enemy through isolation.

Attack at night to gain surprise or to take objectives whose assault during daylight would be too costly.

Once momentum has been gained, the attack must be continuous until defenses have been splintered.

CHAPTER 3

Defense

Defensive operations on urbanized terrain are conducted in accordance with the fundamentals and principles contained in FM 100-5, Operations, and the How-to-Fight series of manuals. The general characteristics of the urban environment described in chapter 1 and appendix A influence the conduct of the defense at each command level.

This chapter supplements other doctrinal manuals by describing how the enemy may attack on urbanized terrain and how the defense is planned, organized, and conducted.

HOW THE ENEMY ATTACKS

This section supplements the threat offensive doctrine sections of other How-to-Fight manuals by describing how the enemy may attack built-up areas on the urbanized battlefield. It also discusses his organization for combat and use of the combined arms team in this environment.

Threat force structure and offensive tactics incorporate the concepts of mass, maneuver, and speed. Daily offensive rates of advance of 60-100 kilometers are expected during nuclear operations, and 30-60 kilometers under conventional conditions. To achieve these significant rates, to maintain offensive momentum, and to avoid presenting lucrative targets for nuclear weapons, speed and bypass operations are emphasized in overcoming natural and manmade obstacles.

When it is necessary to attack a built-up area, the following basic concepts govern the deployment of forces at division level:

A surprise attack from the line of march, based on detailed advanced reconnaissance, is the preferred form of attack.

Deliberate attacks from positions in contact may be launched if initial operations fail to make progress.

Day and night attacks are used to maintain constant pressure on the defender.

Smoke, darkness, and limited visibility conditions are exploited to conceal movement.

Command and control is decentralized to the maximum extent possible.

The combined arms team is integrated at motorized rifle company level.

The decision to attack a city or town may be based on tactical, strategic, or political considerations; and it is normally made at army level or above. Threat forces may attack built-up areas to:

Secure political, industrial, logistical and communications facilities.

Destroy defending forces within a built-up area.

Gain passage through an urban area that cannot be bypassed.

The results of urbanization and its effects on offensive operations are recognized and planned for by Threat commanders. The following table shows how they classify built-up areas by using population and perimeter size. Their doctrine stresses that offensive formations attacking across highly developed regions may encounter at least one large built-up area every 40 to 60 kilometers, with one or two small built-up areas contained in every 200 to 300 square kilometers of battle area. The numerous small villages and clusters of structures that restrict and even block avenues of approach are treated as potential strong-points to be isolated and neutralized or destroyed by lower-level units.

Classification of Built-Up Areas

SIZE ESTIMATED

POPULATION	CLASSIFICATION	PERIMETER
100,000	Large	25 kms
50,000 to 100,000	Average	15 kms to 25 kms
< 50,000	Small	15 kms

SURPRISE ATTACK

A surprise attack envisions a rapid, bold movement from the line of march by a strong advance detachment to secure an undefended or lightly defended built-up area. It seeks to avoid a costly, protracted street-by-street, house-to-house battle and permit attacking forces to continue beyond the area without reducing offensive momentum. The surprise attack seeks to preserve vital facilities such as bridges, railroads, airfields, key industrial complexes, and utilities.

The following figure illustrates how a motorized rifle division (MRD) might conduct a surprise attack with a reinforced M battalion (MRB) in the role of the advance detachment. The size of an advance detachment is determined by the size of the built-up area and expected resistance.

The advance detachment moves rapidly and attempts to avoid contact with defensive forces on the approaches to the objective. If little or no resistance is encountered, the advance detachment seizes the most important objectives (buildings) and key streets, splitting the area into isolated pockets of resistance, and destroys them piecemeal. Hasty defenses are organized to defeat counterattacks by the defending forces or to destroy defenders attempting to escape through the built-up area.

Airborne or helicopter-landed forces may support the advance detachment by sealing off flanks or the rear of the objective. These forces may also be employed as the advance detachment around or in the built-up area. An advance detachment operating outside the range of forward artillery receives intensified reconnaissance and close air support from high-performance aircraft and helicopter forces.

If the surprise attack fails, the advanced detachment is normally directed to seize a foothold in the outskirts or to seize an adjacent key terrain feature and wait for the main body to arrive.

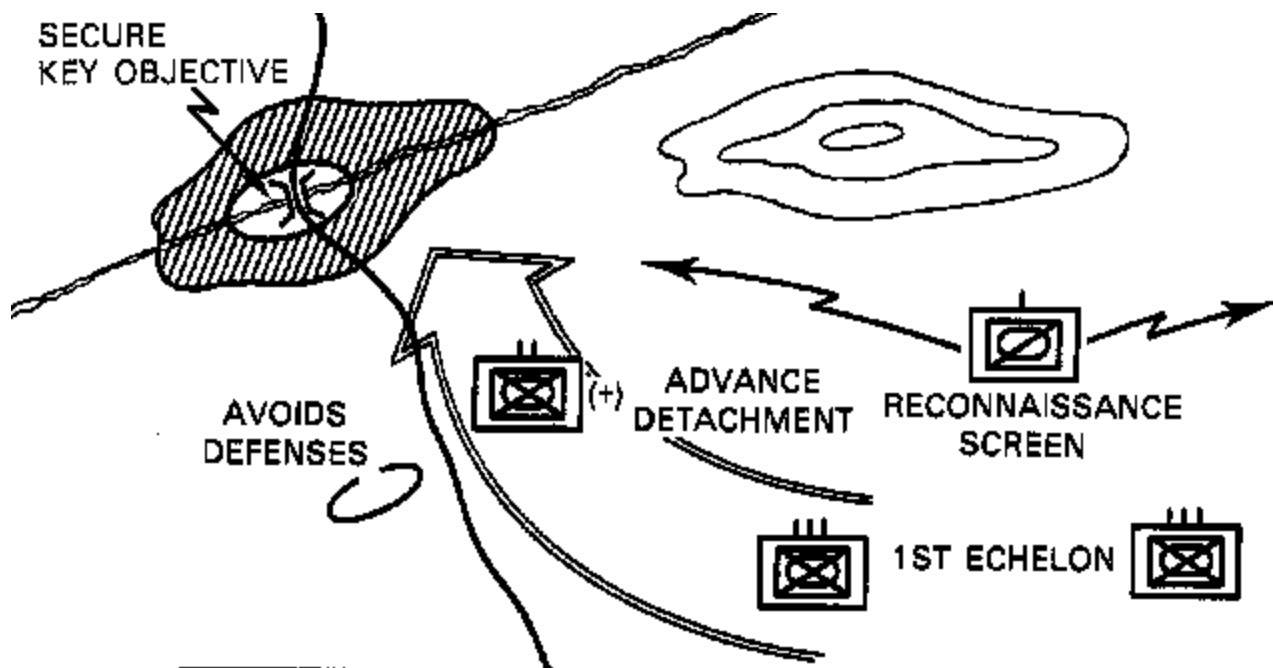

Figure 3-3a Secure Key Objective

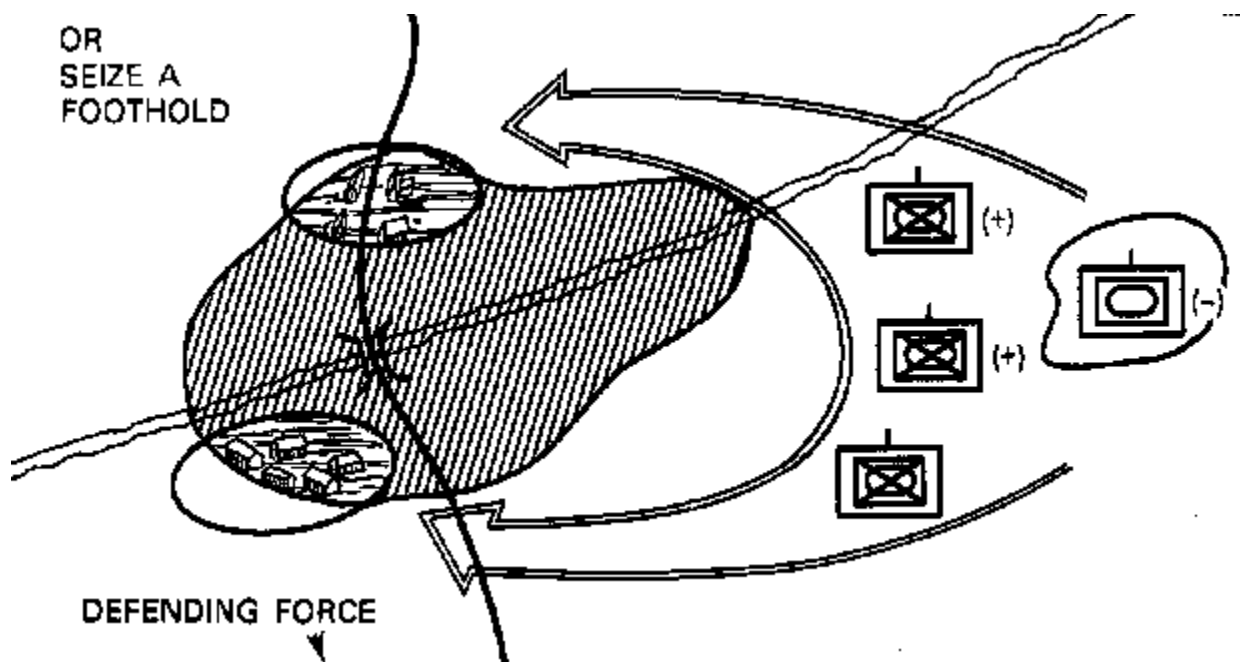

Figure 3-3b Seize A Foothold

DELIBERATE ATTACK

A deliberate attack is conducted when the surprise attack has failed or when intelligence indicates a city is well defended. This attack involves larger forces, requires more detailed planning, and has a greater weight of artillery, mortar, and rocket fires than a surprise attack. The deliberate attack is characterized by:

Isolation of the objective.

Extensive reconnaissance.

Intense pre-assault bombardment.

Assaults to secure a foothold and key objectives.

Reconnaissance

Advanced reconnaissance activities include the study of large-scale maps, aerial photographs, and background intelligence reports. These data are updated by tactical intelligence from long-range reconnaissance patrols, agent reports, and electronic intelligence. Heli-borne and airborne units may supplement ground reconnaissance and are normally targeted against specific key points in the urban area. Reconnaissance functions are also frequently conducted by infiltrators disguised as refugees. Infiltrators or reconnaissance detachments may operate in the objective area for several days before an assault. Active reconnaissance may include the use of local residents to provide current essential information of the defender's activities. Raids by reconnaissance teams may be mounted for the purpose of capturing prisoners and documents. In some cases, raid/reconnaissance teams may be tasked to destroy selected critical facilities and defending forces prior to a deliberate attack.

Reconnaissance tasks include the determination of:

Defensive dispositions on approaches to objectives.

Covered positions leading to flanks or rear of the objective.

Location and strength of defensive strong points.

Main routes through the built-up area.

Key objectives (buildings) that dominate the area.

Underground passages that can be utilized by assaulting forces.

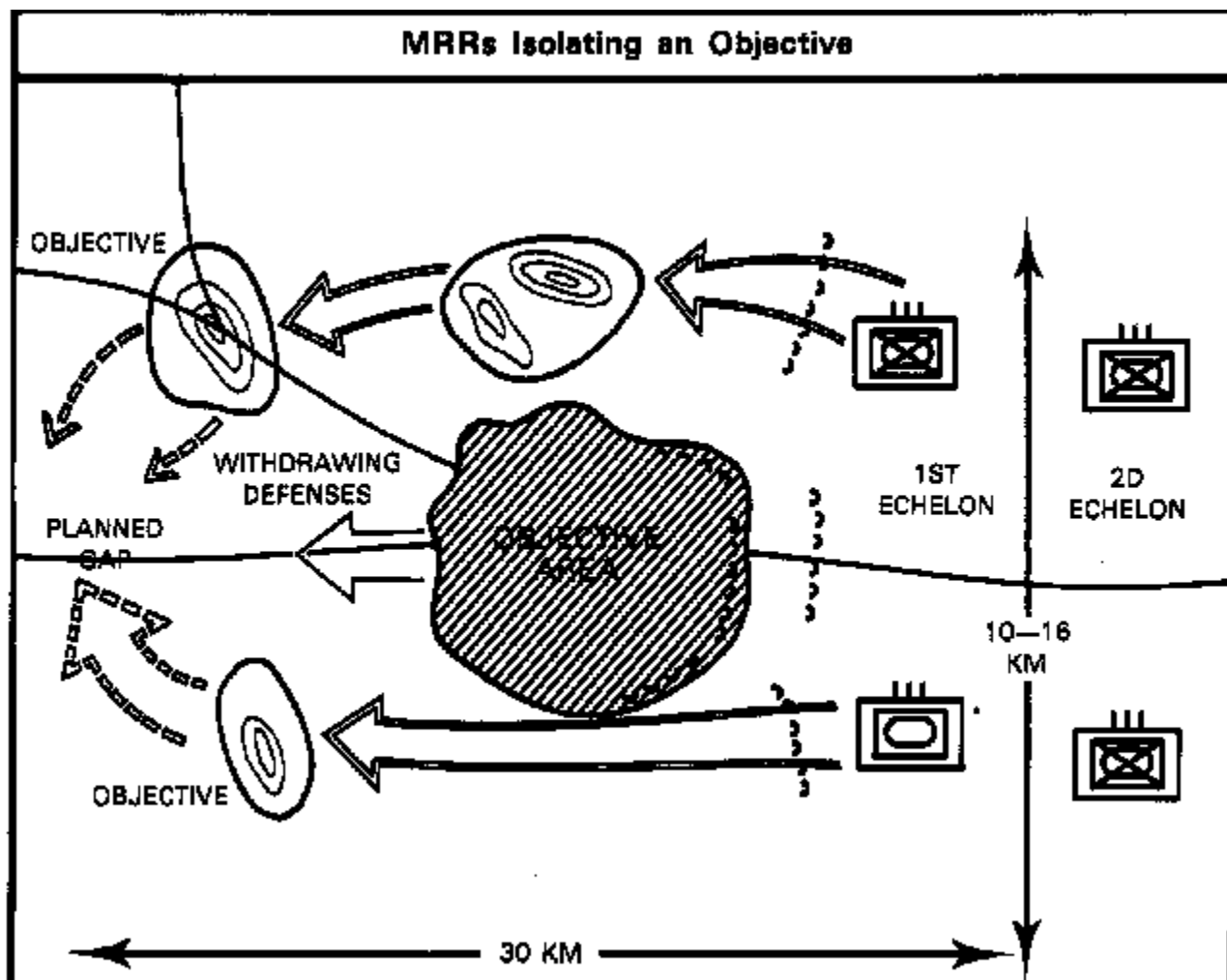

Figure 3-4. MRRs Isolating an Objective

- Command post, reserves, weapon positions, and supply locations.

Isolation

The preceding figure depicts first-echelon regiments of a motorized rifle division (MRD) isolating an objective area in order to deny reinforcement/resupply of defenders and block escape routes. Occasionally, an intentional exit may be permitted to entice defenders into open terrain where they can be attacked. After isolating the area, second-echelon forces may conduct a siege operation while first-echelon forces break contact and continue their advance. If the attacker's timetable permits, siege operations are preferred to avoid a costly direct assault and destruction of facilities needed to support future operations.

Bombardment

The deliberate attack is normally preceded by howitzer, mortar, rocket, and air bombardment. The intensity of the preparation is determined by the strength of defensive forces, the type building construction, and the density of fires required to suppress observation and fires.

First priority of fires is allocated to the main attack to destroy AT weapon positions and strong points on the area's edge. Artillery attached to assaulting units normally does not participate in the bombardment, but is reserved for direct fire employment against strong points on the outskirts and for support within the built-up area.

Other goals of the bombardment are to destroy or disrupt:

Communications.

Heavy weapon positions.

Command posts.

Tall structures that permit observation.

Troop emplacements.

Threat forces fully appreciate that heavy bombardments may affect their mobility, but consider reduced mobility an acceptable tradeoff for destruction of defending forces. Incapacitating or nonpersistent lethal chemical fires may be employed during bombardment to inflict casualties and preclude destruction of key facilities. Smoke will normally be employed during artillery preparations to suppress the defenders while threat forces negotiate obstacles on the approaches and within the built-up area.

Assault

Habitually, simultaneous attacks are made on the flanks and rear to capture specific objectives and to splinter defenses. Frontal assaults are avoided and will be conducted only when an objective cannot be isolated or flanked.

During or immediately after preparatory fires, engineers move forward under the cover of smoke and high explosives to neutralize barriers and breach minefields on routes into the city. First-echelon assault groups attack to secure a foothold 2-3 blocks in depth. After securing the initial foothold and rupturing the outer defenses, the first echelon may continue to attack, or the second echelon is passed through the foothold and attacks along designated routes from one objective to another.

The attack within the built-up area is characterized by bold, rapid movements to secure assigned objectives. Buildings along the route are not routinely searched or secured unless resistance is strong. Bypassed defenders are left for elimination by following echelons or the reserve. If the leading echelon is stopped or slowed, the following echelons or reserve may be committed around engaged forces and continue to the objective.

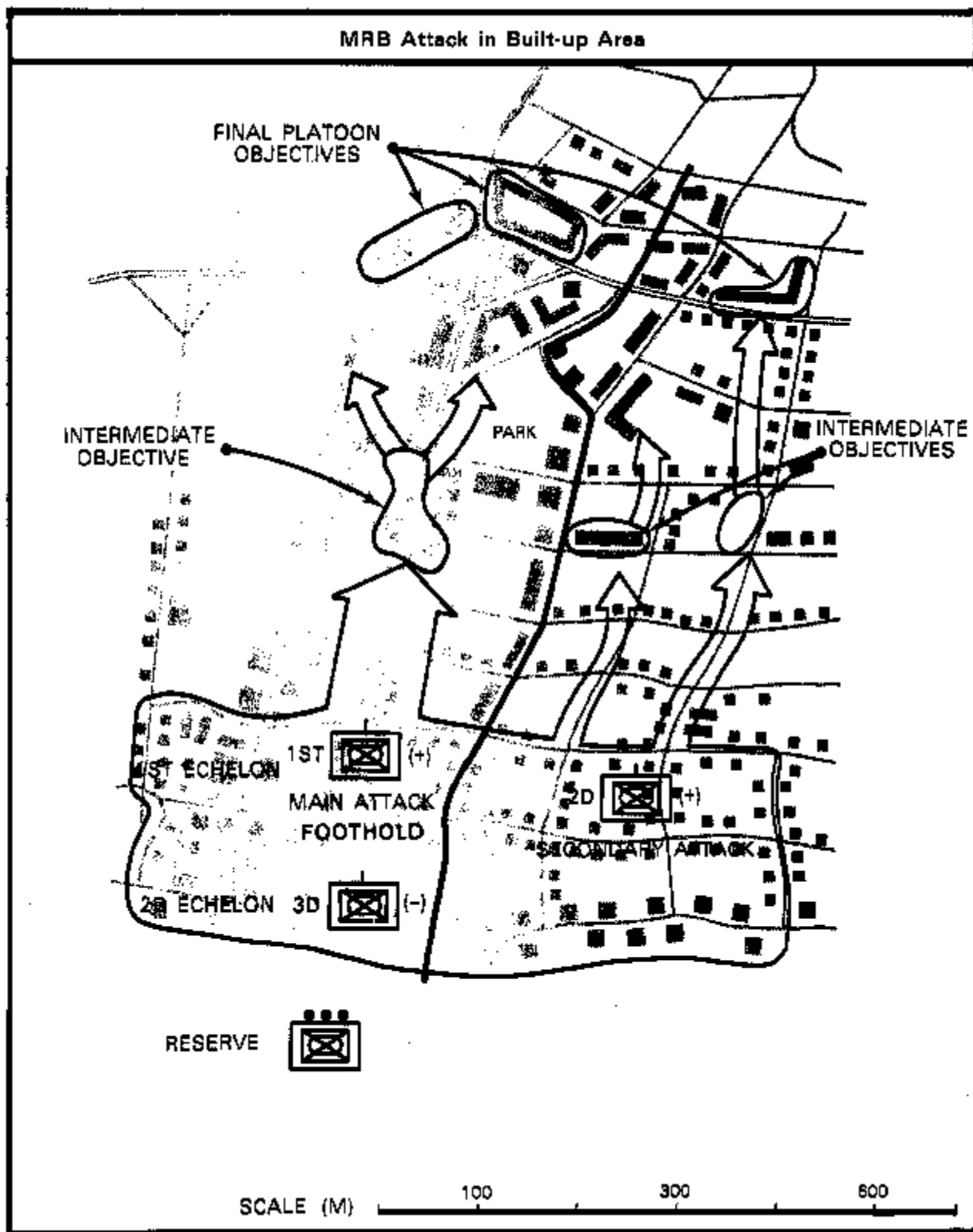

Figure 3-6 MRB Attack in Built-up Area

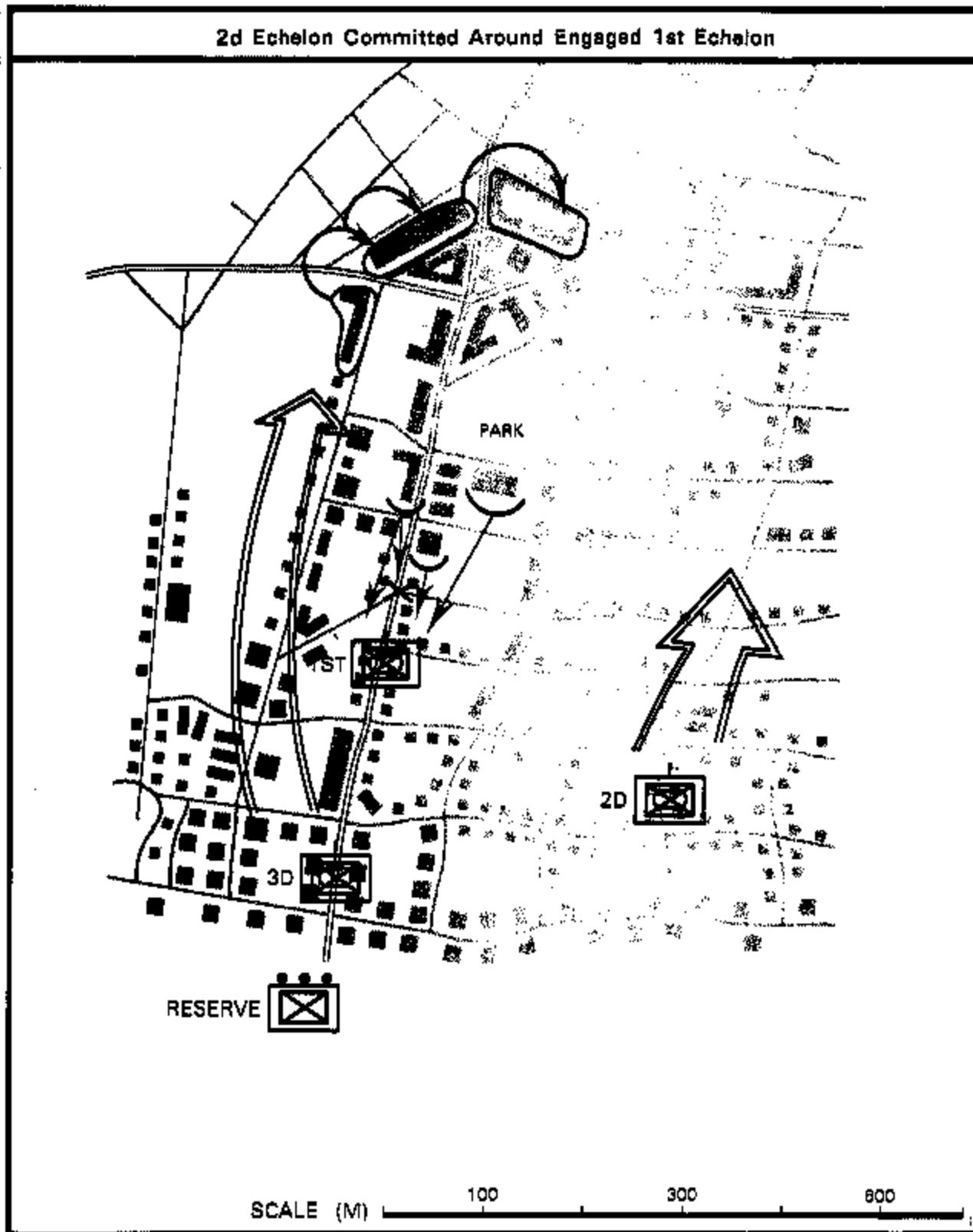

Figure 3-7. 2d Echelon Committed Around Engaged 1st Echelon

Detected weaknesses in the defense are exploited by aggressive mounted attacks. Infantry mounted on tanks, in BMPs, or trucks fire while moving rapidly along streets to assigned objectives. Tactical doctrine stresses the use of underground routes in the attack. Such routes that cannot be used are blocked or mined to prevent infiltration into the attacking force's rear.

In the assault of an objective, Threat forces isolate the position by fire or by securing adjacent buildings. Isolation is stressed to prevent defenders from escaping to a rearward position and to deny reinforcement. Attached artillery and tanks are habitually used to suppress defensive fires and to breach walls to provide entrances for assaulting infantry. Assaulting infantry avoid advancing along streets where they would be exposed to effective defensive fire. They seek surprise by attacking the objective from the flank or rear. Routes to the objective may consist of available underground passages such as subways, tunnels, and sewers, or passages blasted through intervening building walls. Once the assault of an objective begins, supporting fires shift to upper stories and to adjacent buildings. Assaulting infantry aggressively clear, in sequence, ground floor, basement, stairways, and each ascending floor. Once secured, the position is immediately prepared to repel counterattacks.

Round-the-clock operations are stressed to maintain uninterrupted momentum of the attack and to reduce casualties. Night operations against built-up areas are conducted to:

Bypass outlying villages being used as battle positions.

Seize initial objectives on the edge of the built-up area when there is a requirement to attack across open ground.

Attack across open areas (broad streets, parks, between buildings).

Seize strong points that are heavily defended.

Reduce street obstacles that are well protected by mines and covered by fires.

Exploit successes of daylight operations by keeping pressure on the defense.

Reconnaissance units may attempt to infiltrate night objectives to achieve detailed information and to guide assault forces to their objectives. The difficulty of night navigation in restrictive terrain and in the proximity of opposing forces requires a simple maneuver plan with close, easily recognized objectives. Assault groups normally attack in one echelon with units deployed on line. Surprise is achieved by withholding fire support until after the infantry assault has been detected. Once the attack has been unmasked, artillery illuminates the objective. Attached tanks and artillery join assault forces and suppress defensive fires with direct fires.

When surprise cannot be achieved, night assaults may be preceded by direct artillery/tank fires against strongly defended buildings. Direct support artillery and mortars seal off the objective area to prevent defenders from withdrawing or being reinforced. Illumination is fired to guide forces, illuminate objectives, and to dazzle the defender's night vision devices.

After securing assigned objectives and eliminating significant defensive opposition, assault groups normally establish defensive positions beyond the built-up area and prepare to continue the attack. Detailed clearance operations are normally passed to following units or to security formations.

ORGANIZATION FOR COMBAT

The size and composition of the force allocated to seize a built-up area is determined by the area's size, shape, type of buildings, street patterns, and strength of defending forces. Attacking forces are not evenly distributed around the built-up area, but are employed over the most favorable avenues of approach.

Generalized attack zones for motorized rifle units are:

Division 4 to 6 kilometers

Regiment 2 to 3 kilometers

Battalion 400 to 600 meters

Company 200 to 300 meters

The figure below depicts the second-echelon motorized rifle regiments of a motorized rifle division conducting a deliberate attack. The 1st MRR, designated as the main attack force, is moving with three motorized rifle battalions (MRBs) in column. This formation is normally employed when defenses are organized in depth or when the city is configured in an elongated pattern.

The 2d MRR is organized with two MRBs in the first echelon, one MRB (-) in the second echelon, and a MR company as the reserve. Thi formation is normally employed when defenses are organized on the city's edge or when attacking a shallow built-up area.

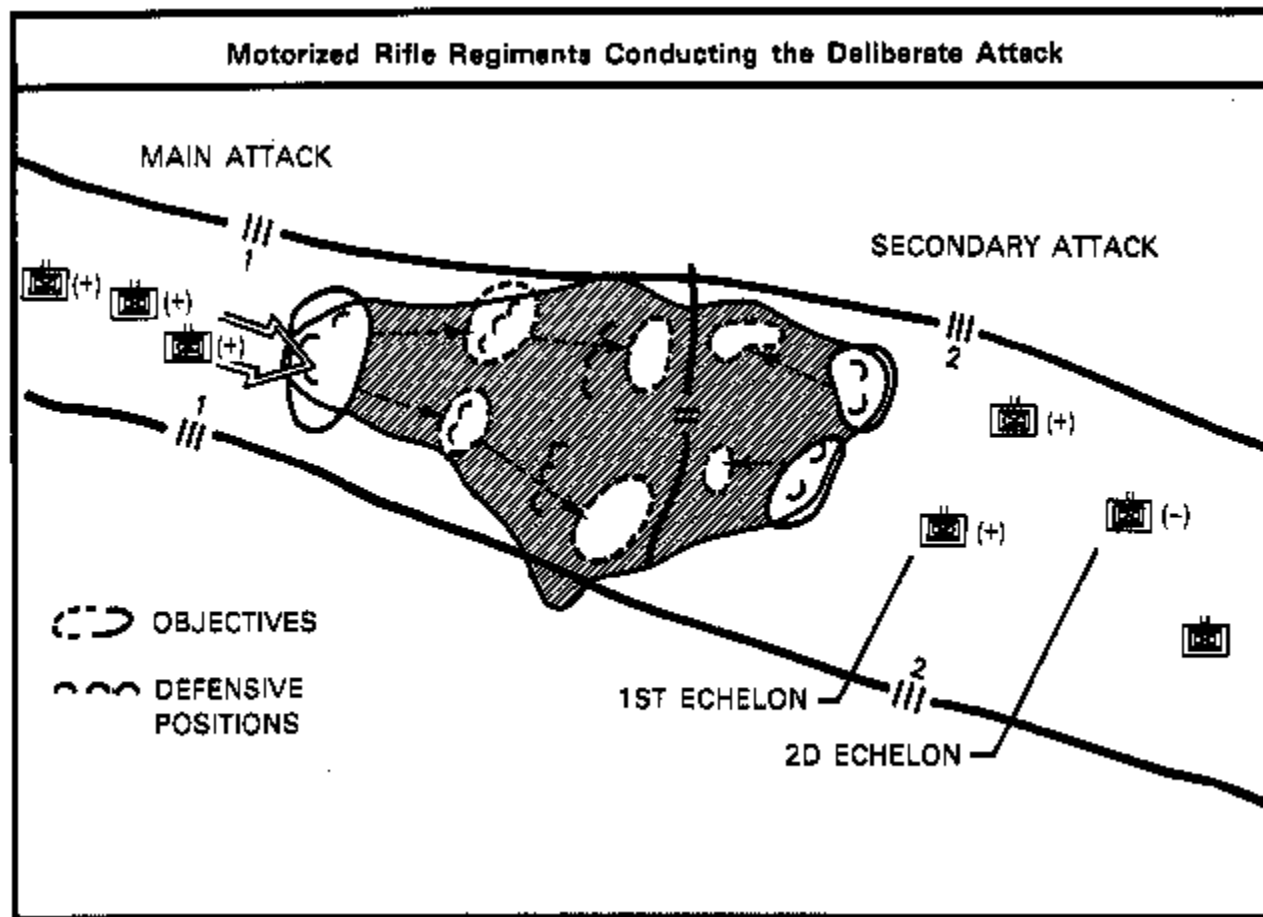

Figure 3-9 Motorized Rifle Regiments Conducting the Deliberate Attack

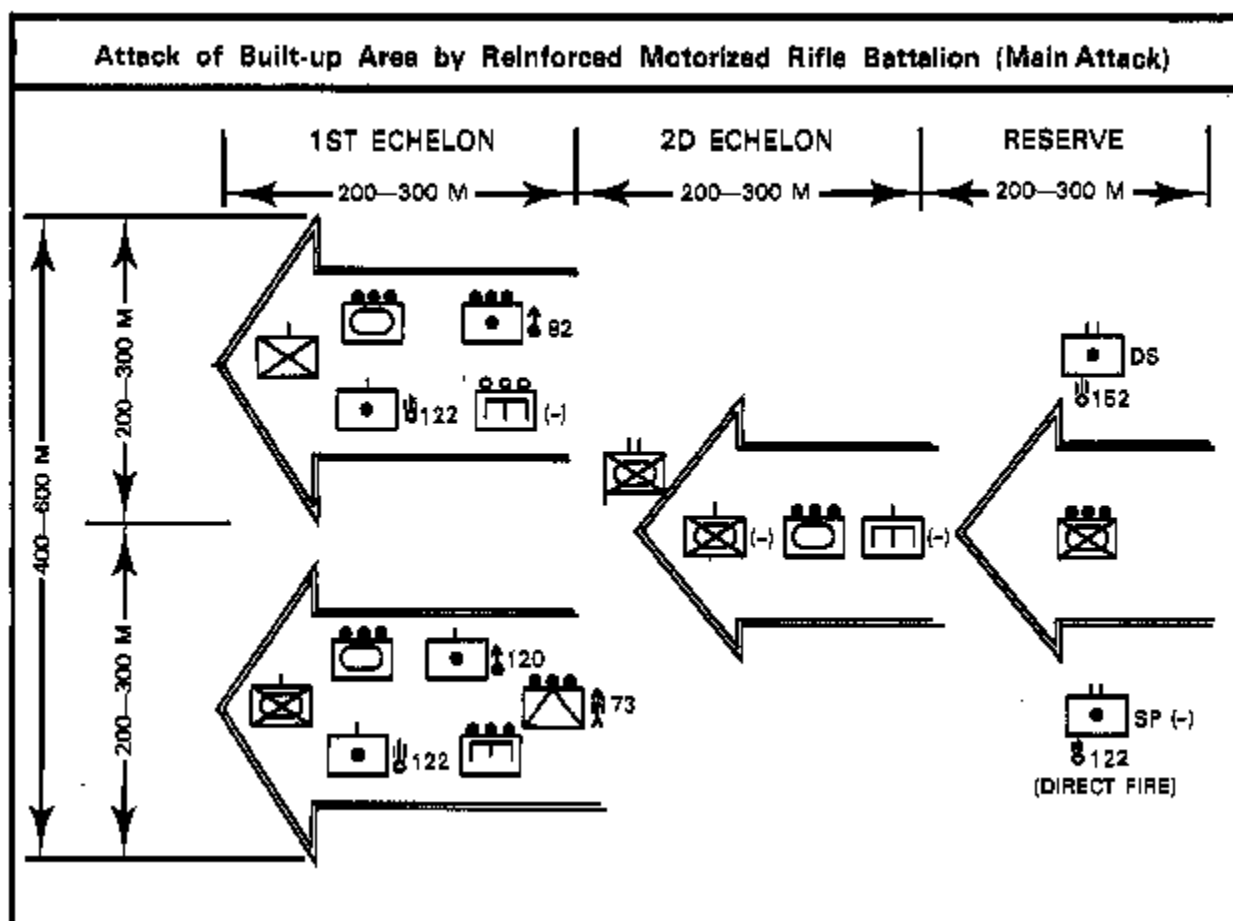

Figure 3-10 . Attack of Built-up Area by Reinforced Motorized Rifle Battalion (Main Attack)

The basic unit in built-up area warfare is the reinforced MRB. The above figure illustrates a type first-echelon MRB (assault detachment) designated as the main attack force. The battalion is reinforced by attaching a tank company, a battery of SP artillery for direct fire, one company of engineers, and one NBC reconnaissance section. An additional artillery battalion is normally placed in direct support for indirect fire missions in the battalion's zone. Missions normally assigned to a MRB making the main attack in the first echelon include:

- Seize intermediate objective(s) on city's edge.
- Attack along primary (main) routes to secure deep objectives and key facilities in zone.

Second-echelon MRBs are also reinforced with tanks, artillery, and engineers. This arrangement provides for rapid replacement of the first echelon without time-consuming reassignment of units during the battle.

Missions normally assigned a second-echelon MRB include:

- Reinforce first echelon.
- Be prepared to assume first-echelon mission.
- Provide replacements to first-echelon units which have lost combat effectiveness.

Reduce bypassed defense positions.

Reserve MRBs are prepared to:

Pass through either echelon and attack to take advantage of a defensive weakness.

Protect flank.

Conduct fire fighting and debris clearance missions as required.

Motorized rifle companies (MRCs) may be designated as assault groups. MRCs conducting the main attack are normally reinforced with a tank platoon, an artillery battery, chemical and flame thrower units, and an engineer platoon. Frequently, MRB antitank gun platoons will be attached to the MRC making the main attack.

Attachments to the MR company are further attached to platoons, providing each platoon with at least one tank or artillery weapon and a share of engineers. These attachments allow decentralized/independent operations by platoons in seizing specific objectives. Frequently, these attachments may be made down to squad level.

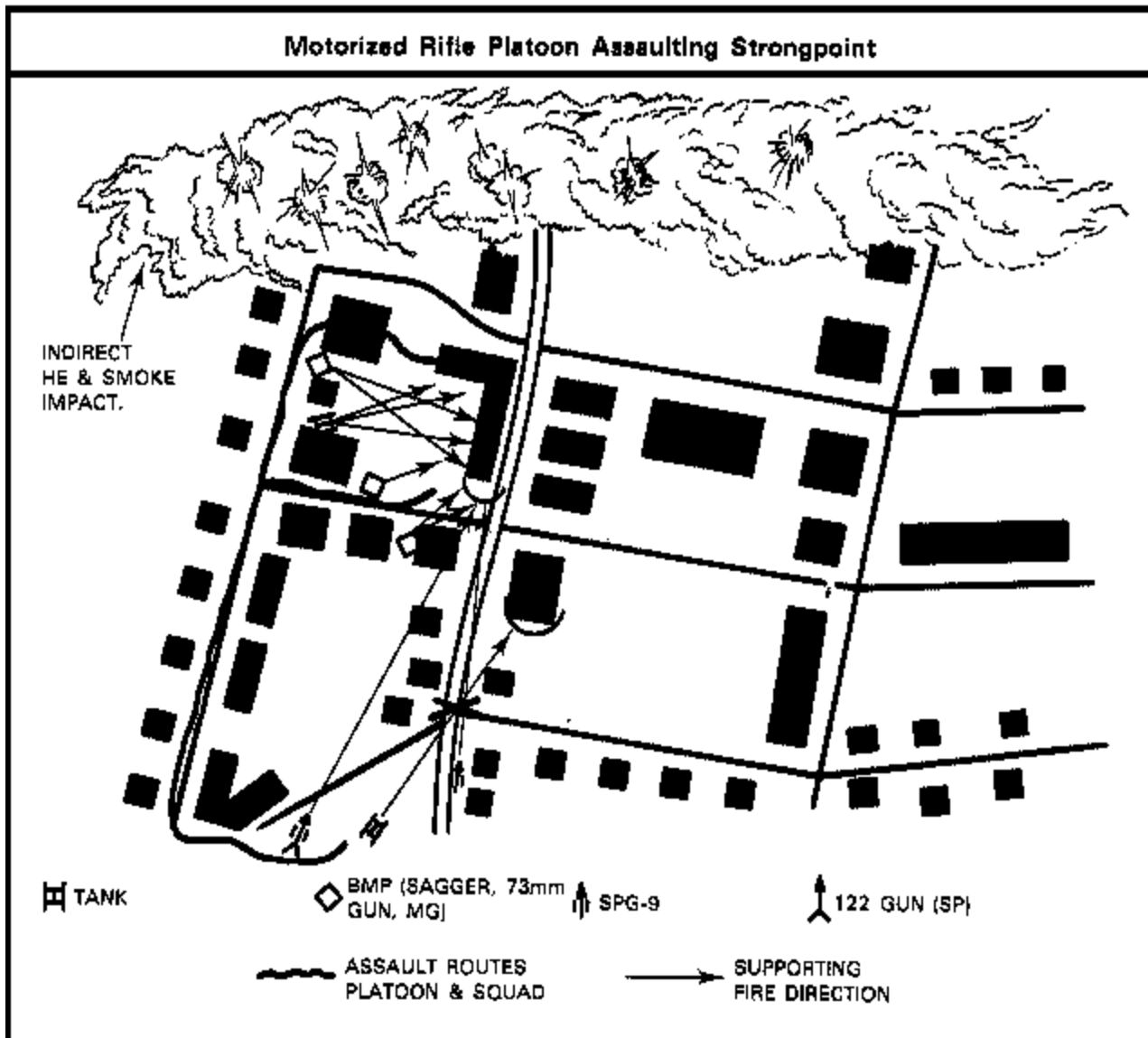

Figure 3-11 Motorized Rifle Platoon Assaulting Strongpoint.

Tanks

Tanks supporting MR companies may be employed as a platoon, in sections, or singly with an MR squad. Generally, a rifle squad provides close-in security for each tank, relying on the tank for protection and fire support. Tanks also support the attack by firing on suspected positions, smashing barricades, and engaging opposing armor.

Artillery

The difficulty of centralized fire control and the decreased effectiveness of indirect fires within built-up areas is recognized. For these reasons, over 50 percent of the available artillery may be attached and employed in a direct fire role to create breaches in buildings, walls, and barricades. Within the built-up area, SP artillery weapons are frequently attached to infantry platoons/squads. The artillery commander normally collocates with the MRB commander.

Mortars

Mortars cover avenues of enemy troop movements, such as street intersections and alleys. Mortar firing positions are placed behind walls or inside buildings close to their targets.

Engineers

Engineers are attached to MR platoons and squads with the following missions:

Breach obstacles on approaches to the city.

Clear passages through rubble and barricades.

Destroy individual buildings.

Block or clear underground passages.

Clear or lay mines as required.

Division and Regimental Artillery

Massed fire from heavy batteries of the division and regimental artillery groups is used against large buildings, strong enemy fortified positions, and in a counter fire role. Other missions for these groups include interdiction and destruction of enemy supply installations, headquarters, and communication centers.

BASIC OFFENSIVE CONSIDERATIONS

Threat doctrine stresses the following offensive fundamentals which should be considered when planning the defense of a built-up area.

Built-up areas not essential to overall success of offensive operations will be bypassed and isolated if possible. When an attack is required, Threat forces will attempt to secure key built-up areas by a surprise attack from the march before defenses have been established.

The deliberate attack is characterized by isolating the objective area, conducting an intense pre-assault air and artillery bombardment, and by multiple assaults on the flanks and rear of the area to be secured. Combined arms assault groups orient on securing objectives and will bypass and isolate centers of resistance. Detailed clearance of each building is normally assigned to follow-on units.

MR companies are reinforced with tanks, artillery, antitank guns, and engineers. MR companies are expected to operate independently. The majority of organic artillery is attached to assaulting units and employed in a direct fire role.

Underground systems are considered to be key avenues of approach. Tall structures that are likely observation posts are high-priority artillery targets.

The enemy will accept isolation of attacking units and heavy losses to secure assigned objectives and to maintain attack momentum.

PLANNING THE DEFENSE

This section describes US defensive doctrine for operations on urbanized terrain and provides detailed considerations to be applied by commanders during planning. Readers must be familiar with defensive planning as outlined in organizational How-to-Fight manuals and understand how the enemy attacks.

DEFENSIVE OPERATIONS

Commanders at each level must decide how best to integrate manmade features into their overall scheme. In some cases, commanders may be directed to defend a built-up area, a line of communications, or an industrial complex whose retention provides significant advantage within the framework of the defensive plan of a higher level commander. The decision to defend such an area may also be made because of specific tactical advantages accruing to the defender assigned responsibility for an area. In all cases, the elements of urban sprawl must be analyzed in conjunction with natural terrain in order to determine how to enhance weapons effectiveness to slow, block, canalize, and destroy the enemy.

Built-up areas, like forests, hills, or other terrain features, may be incorporated in the plan for the defense of an urban area in order to:

Control avenues of approach. Avenues of approach in urban areas are frequently interrupted by built-up areas scattered across the terrain. These built-up areas may provide a portion of the defensive grid for the combined arms team. In some cases, the location of a built-up area on the urban terrain complex may effectively deny bypass to major elements of an attacking force. At lower levels of command, this may favor the use of villages or small towns as strong-points. At the other extreme, major urban complexes may be so large that they cannot be totally avoided.

Act as a combat multiplier. Built-up areas are obstacles to a mechanized force. Passage through such areas can be blocked, canalizing enemy forces into open terrain interlaced with anti-armor fires and reinforced with mines and other obstacles. When urbanization significantly restricts mounted maneuver or when sufficient mechanized forces are unavailable, the integration of the elements of urban sprawl into the defense may provide a combat multiplier for the defender.

Conceal forces. Technological advances have significantly improved tactical imagery and sensor devices. However, when employed against built-up areas, their effectiveness is greatly reduced. In addition, urban features frequently offer cover and concealment to the defender with a minimum expenditure of preparation time. Such features may be suitable for use as battle positions within the overall defensive scheme.

Retain key transportation centers. The requirement to shift and concentrate major combat forces and supplies rapidly over an extended battle area may demand the retention of the hubs of main road and railroad networks.

Deny strategic/political objectives. Industrial or economic complexes may be incorporated in the defense for their strategic value, while political/cultural centers may provide psychological/national morale advantages.

Built-up areas will normally not be utilized as part of the urban defensive plan when:

Sufficient combat strength is not available for defense.

The built-up area does not support the overall defensive concept.

Terrain adjacent to the built-up area permits the enemy to bypass it.

Structures within the built-up area do not afford adequate protection for the defender.

The complex is dominated by adjacent terrain that offers an attacker significant observed fire advantages over the defender.

The built-up area is declared an "open city" for humanitarian and political reasons or to protect valuable structures.

Planners should seek to avoid combat within built-up areas while recognizing that this may not always be possible. They should also seek to integrate into the overall defensive scheme those built-up areas which provide the commander defensive advantages.

FUNDAMENTALS OF THE DEFENSE

The fundamentals of the defense do not change on the urban battlefield. To apply them, commanders must understand the characteristics and components of urban sprawl, the advantages and disadvantages they offer, and how they impact on the capabilities of units and weapons during the conduct of the defense.

Understand the Enemy

The first part of this chapter supplements Threat data provided in other source documents by describing how the enemy may attack on urbanized terrain. When planning an urban defense, commanders at each level must place themselves in the enemy's position, view the battlefield from his perspective, and fit his concepts, formations, and weapons to the terrain. This estimate enables the defender to narrow the list of tactical options available to the attacker and identify his most probable courses of action. See the Battlefield

Once the commander has organized the defense to counter the variety of attack options available to the enemy, he must aggressively seek to learn where the enemy is, how he is organized, which way he is going, and in what strength.

Although the characteristics of urbanized terrain may complicate the intelligence collection effort, the advantage lies initially with the defender. Commanders at all levels must know the terrain over which they will conduct the defense. Reconnaissance, surveillance, and target-acquisition resources must be applied as far forward as possible along likely avenues of approach to provide data to higher commanders.

Security forces operating from covered and concealed positions in depth complement electronic warfare support measures and tactical imagery activities by limiting the enemy's ground reconnaissance and infiltration capabilities.

On the urban battlefield, the attacker must forfeit, at least in part, the advantages of cover and concealment in order to move and mass; his routes of advance are limited and more clearly defined, enhancing the defender's target-surveillance capability; and he must use increased communications to coordinate the concentration of his forces, which reduces his ability to achieve surprise.

The defender must use his knowledge of the terrain and enemy to see the battlefield more accurately than the enemy, to prevent surprise, and to maximize reaction time for maneuver forces.

Concentrate at the Critical Times and Places

The ability of the defender to concentrate rapidly throughout the battle area may be limited by restrictive terrain. In order to maintain a favorable mobility differential over the attacker, the commander must use his knowledge of the terrain. Routes must be selected, reconnoitered, and prepared for the forward and lateral

movement of forces to be concentrated. The obstacle value of the urban terrain complex must be reinforced to slow the attacker.

Detailed movement data and explicit traffic control plans are essential. Lines of communication which are dependent on bridges, overpasses, or tunnels should not be used unless suitable bypasses are available. Weather or land usage patterns, as well as other manmade features, may limit the mobility of armored and mechanized forces. Greater reliance must be placed on an initial positioning of forces which accepts risk zones along the least probable avenues of approach. These zones may be covered primarily by air or ground screening forces and fires. On urbanized terrain, it is more difficult to recover from an erroneous decision which concentrates maneuver elements too early or at the wrong place. In this maneuver-restrictive environment, increased emphasis on the use of artillery and attack helicopters as the first increments of concentration is required. As the battle progresses, the commander's intimate knowledge of the terrain is used to maintain the mobility advantage.

Fight as a Combined Arms Team

A detailed analysis of the urban-terrain complex provides the basis for allocating and organizing available forces to accomplish the defensive mission. Cross-reinforcement of maneuver elements will normally be required in order to match unit capabilities to the terrain mix. In the more open portions of the urban environment, armored and mechanized forces may play the dominant role. As the density of manmade features increases, the employment of mechanized or dismounted infantry, supported by armor and engineers, becomes increasingly important. If it is necessary to fight within a built-up area, the role of infantry supported by other arms becomes dominant. Field and air defense artillery, air cavalry, and attack helicopters are employed throughout the battle area to maximize the combined arms team's effectiveness, multiply its combat power, and enhance its survivability.

Exploit the Advantages of the Defender

The already significant advantages of the defender become more pronounced on the urbanized battlefield. A common thread running through the discussion of the application of these fundamentals is the defender's familiarity with the terrain. Every action by the attacker is made more difficult because he must feel his way through this complex of manmade and natural terrain features. The defender can prepare the ground in advance, build and reinforce obstacles, and select firing positions and observation posts, many of which require improvement only. He can reconnoiter and improve routes between battle positions to shift forces and to supply them. Mutually supporting positions are often readily available. This pattern of favorable positions should enable the commander to strike the enemy repeatedly, slowing and disrupting him, inflicting losses, and making him vulnerable to multiple, violent, local counterattacks. In many areas, terrain restrictions may enable attacks by fire alone.

PLANNING CONSIDERATIONS

Defensive planning on the urbanized battlefield follows the process described in organizational How-to-Fight manuals. The basic roles of the covering force, main battle, and rear areas remain unchanged. The following specific considerations assume added importance.

Organization of the Battlefield.

On the urbanized battlefield, the defender fits his forces to the ground by utilizing the terrain to take maximum advantage of its natural and manmade features. Urban sprawl adds strength to the active defense by providing covered and concealed positions and restricting the attacker's mobility and observation. Dismounted infantry can contribute to this defense by occupying battle positions or strong points around

which the mobile battle is fought. In restrictive urban terrain, dismounted forces may be required in order to find the enemy, deny him the ability to close without being detected, and then fight the close-in battle. If the retention of a built-up area is required, the defense may assume the characteristics of a position defense organized in depth and supported by strong mobile forces.

Covering Force Area (CFA). The urban area defense begins with mobile combined arms covering forces deployed well forward of the main battle area (MBA).. Company team and task force battle positions are organized in depth to control approaches to the main battle area, with emphasis placed on using natural and manmade features which offer cover and concealment or restrict opposing force maneuver. Small villages and strip areas may be incorporated in the defensive scheme in the same manner as other terrain features. Increased engineer support is required to reinforce the obstacle nature of the terrain and maintain withdrawal and attack routes. Mixed caliber artillery contributes to deception in this environment where it is difficult for the enemy to see the battlefield and assists the CFA commander in maintaining the continuity of the defense from successive positions. The air defense artillery umbrella must extend over the CFA to deny the enemy the use of aerial observation and attack assets. Air cavalry and attack helicopters should be employed throughout the CFA, taking advantage of the terrain which limits detection by ground surveillance and screens aerial maneuver.

The transfer of the enemy by the covering force must not result in an easing of pressure or allow the enemy to gain momentum. Once detailed coordination has been accomplished, the restrictive nature of the urban terrain complex, its obstacles, and readily available defensive positions may facilitate the actual hand off.

Main Battle Area (MBA). The defending commander must be aware of the impact that urbanization of the terrain within the MBA will have on his ability to defend. Consideration should be given to the restrictive or compartmentalized areas caused by the urbanization process and to the advantages or disadvantages which the areas may offer the defender. It is possible that some of these areas may fall within risk areas which provide the enemy with covered and/or concealed infiltration routes into the MBA. In such cases, responsibility for risk areas must be clearly delineated between adjacent units. If the urban terrain includes villages, small towns, and strip areas, it might be advantageous to incorporate these features within company/team or task force battle positions. Such features can provide excellent cover and concealment to defending forces and are frequently mutually supportable.

As previously noted, it may become necessary to designate a built-up complex within the MBA as critical to the defense of the urban area. When this situation arises, it is imperative to initiate the defense of the urban area as far forward as possible to facilitate the defense of the built-up area and to avoid a protracted combat-in-cities battle.

The figure below portrays typical defensive sectors for company/team organizations assigned a defend mission in various types of built-up areas. With less restrictive missions, these typical widths may be extended. Final sector dimensions are defined based on a detailed analysis as described in appendix A.

Figure 3-17. Typical Company Team Defensive Sectors by Type Built-up Area

- A 300-500 Meters
- B 400-600 Meters
- C 500-800 Meters
- D 500-900 Meters
- E 700-1100 Meters

Commanders should consider the potential value of urban features as obstacles to attacking forces. Frequently urban areas sit astride, or otherwise dominate, high-speed avenues of approach into and through the MBA. If urban areas cannot be bypassed easily, they may reduce the momentum of the enemy's attack

and his ability to maneuver. In these instances, the defending commander must be prepared to capitalize on the situation. Conversely, the defending commander must also appreciate the limitations which urban areas can place on his own ability to maneuver, particularly during active defense operations.

A primary concern to commanders defending a built-up area is to avoid becoming isolated by enemy forces. In planning the defense, the commander can normally make two assumptions concerning this matter. The first assumption is that although the built-up area may not occupy terrain which is dominant, it normally has dominant terrain adjacent to it on at least one side. The second assumption is that, doctrinally the enemy will attempt to bypass and isolate a built-up area by securing the adjacent dominant terrain before the built-up area itself is directly attacked. Therefore, the defending commander must integrate surrounding dominant terrain into his defensive scheme in order to preclude being bypassed and isolated. Should the defense of an urban area develop to the point that operations within the built-up area itself are required, the defending commander must consider the nature of the built-up area and the characteristics which are unique to fighting there. The nature of the built-up area includes such aspects as the size of the area, the type of construction used for buildings, the density of the buildings, and the street pattern or layout of the built-up area. These aspects may vary considerably from one part of the built-up area to another, but each will impact in some way on the manner in which the defense of the area is conducted.

Built-up areas generally degrade command and control by reducing the capability of direct observation of subordinate units and by interfering with radio communication. Zones of responsibility are compressed into relatively small areas with shorter unit frontages.

Maneuver room is restricted, placing a greater reliance on infantry-heavy forces. Fields of fire and observation are also reduced, leading to violent, independent small-unit actions at close quarters. The battle within a built-up area can be expected to be multidimensional. It may be fought simultaneously above the ground, on roof tops, in buildings, at street level, and below the ground in sewers and subway systems. Rear Area. The functions and organization of the division rear area are not significantly changed in an urban environment. Within larger urban areas, mobility may be restricted by damage to and along lines of communication from air or artillery attacks. Detailed traffic control may be required to maintain the forward and rearward flow of combat service support elements. Additionally, the ever present threat of attack by small elements infiltrating through the MBA or from air assault forces increases. Internal security and self-defense responsibilities expand because of the limited availability of and reduced mobility of reserves.

When the MBA defense is organized around brigade battle areas, security during logistical movements and for combat support units located outside these battle areas becomes increasingly critical. If brigade support areas are located behind battle areas, additional coordination may be required to establish priority for security and movement between the various brigade, division, and corps support elements.

Limited Visibility Operations

The defender on the urban battlefield must be prepared to counter enemy attacks launched at night or under other conditions of limited visibility. Within built-up areas, the attacker may use such conditions to attempt to extend his reconnaissance, infiltrate friendly positions, cross open areas, or secure limited objectives. To help defend against such operations, the following basic measures may be employed:

Shift defensive positions and crew-served weapons to alternate positions just before dark to reduce chances for surprise and to deceive the enemy as to their exact location. A squad or fire team can often be shifted to an adjacent building and provide the same cover on an avenue of approach.

Occupy or patrol open areas between units which are covered by observed fire during daylight.

Employ radar, remote sensors, and night observation devices on the best night avenues of approach.

Use nuisance mines, noisemaking devices, tangle foot tactical wire, and LPs on secondary avenues of approach for early warning.

Place LPs for security outside of buildings being used as strong points or battle positions.

Plan illumination over the entire sector, integrating artillery/mortar flares, trip flares, and hand-projected flares.

Command and Control

Urban warfare places a heavy strain on the command and control apparatus. Command of subordinate units and the control of fires is complicated by restrictive terrain, the proximity of opposing forces, reduced communications capabilities, and the numerous small, isolated battles that may be fought simultaneously throughout the urban complex.

The primary control measures used are battle areas, battle positions, and sectors. Phase lines, checkpoints, and restrictive fire control measures may also be used to simplify reporting and control.

Timely and accurate situation reports are more critical to the commander in this environment. Distances between forces on the urban battlefield are reduced; an unreported breakthrough may splinter defensive cohesion and seriously jeopardize the entire defense. Commanders must constantly be informed of critical actions to enable rapid assessment and reaction. Commanders should be located well forward and within FM (secure) ranges of committed forces.

An in-depth, well-thought-out concept of defense provides the latitude for repositioning uncommitted units and quickly integrating them into the defense.

Achievement of an integrated, flexible, and responsible command and control system will require: A detailed, but simple, centralized concept for conducting the defense. Subordinate units will be given restrictive missions and finite control measures where necessary.

Although told exactly what to do- how to accomplish assigned tasks will be left to subordinate units (decentralized execution).

Decentralized execution may require attachment of combat support and combat service support assets.

Commanders insure accomplishment of assigned tasks in an orderly fashion by establishing priorities and deadlines.

THE DEFENSIVE BATTLE

This section provides examples of how units from corps through battalion task force may defend on an urbanized battlefield. The urbanized terrain offers certain benefits and problems for the defender to consider in developing his defensive plan. A keen awareness of the urban environment and how it can affect the battle is stressed for all levels of command. In order to reduce the amount of repetitive general information, each special situation flows from the preceding material. Therefore, they should be read in sequence. General planning considerations and procedures described in detail in organizational How-to-Fight manuals are not repeated here.

GENERAL SITUATION

Strategic intelligence sources indicate that enemy units are preparing to initiate offensive operations. All

available information points to the fact that an attack crossing the international boundary on a wide front is imminent. The commander, 10th (US) Corps, along with other allied commanders has been directed to implement standing defense plans immediately.

The mission of the 10th (US) Corps is to establish covering forces along the international boundary and defend in sector.

This Corps is a forward-deployed organization consisting of the following major combat units:

23d Armored Division

52d Mechanized Division

203d Armored Cav Regt

312th Mech Inf Bde (Sep)

The 10th (US) Corps is opposed by the 6th and 8th Combined Arms Armies. It is estimated that their combined first-echelon forces will consist of three motorized rifle and two tank divisions, with three motorized rifle and one tank division in the second echelon. The front's second echelon includes a tank army and mobilizing combined arms army element.

It is estimated that the enemy will attempt to penetrate the corps defenses on a narrow front once beyond the border region in order to pass second-echelon forces into the corps rear area. Although the enemy may be required to secure selected urban areas for use as logistical bases to support the offensive drive, it can be expected that first-echelon forces will attempt to bypass urban areas and leave the attack of those built-up areas to second-echelon forces.

SPECIAL SITUATION 1

Corps Defense Plan

During the development of the corps defense plan, specific consideration was given to land use patterns, major lines of communication, and physical terrain forms. Each of these elements impacts upon defensive operations, and, when properly utilized, may offer significant advantages by adding to the combat power of the defender.

The following figure portrays the primary terrain features and lines of communication within the corps sector. The border area consists of a 5-10 kilometer-deep band of heavily forested rolling foothills cut by narrow valleys. The main crossing points for motorized forces are along Route 4 and the four regional highways.

10th (US) Corps Defensive Sector

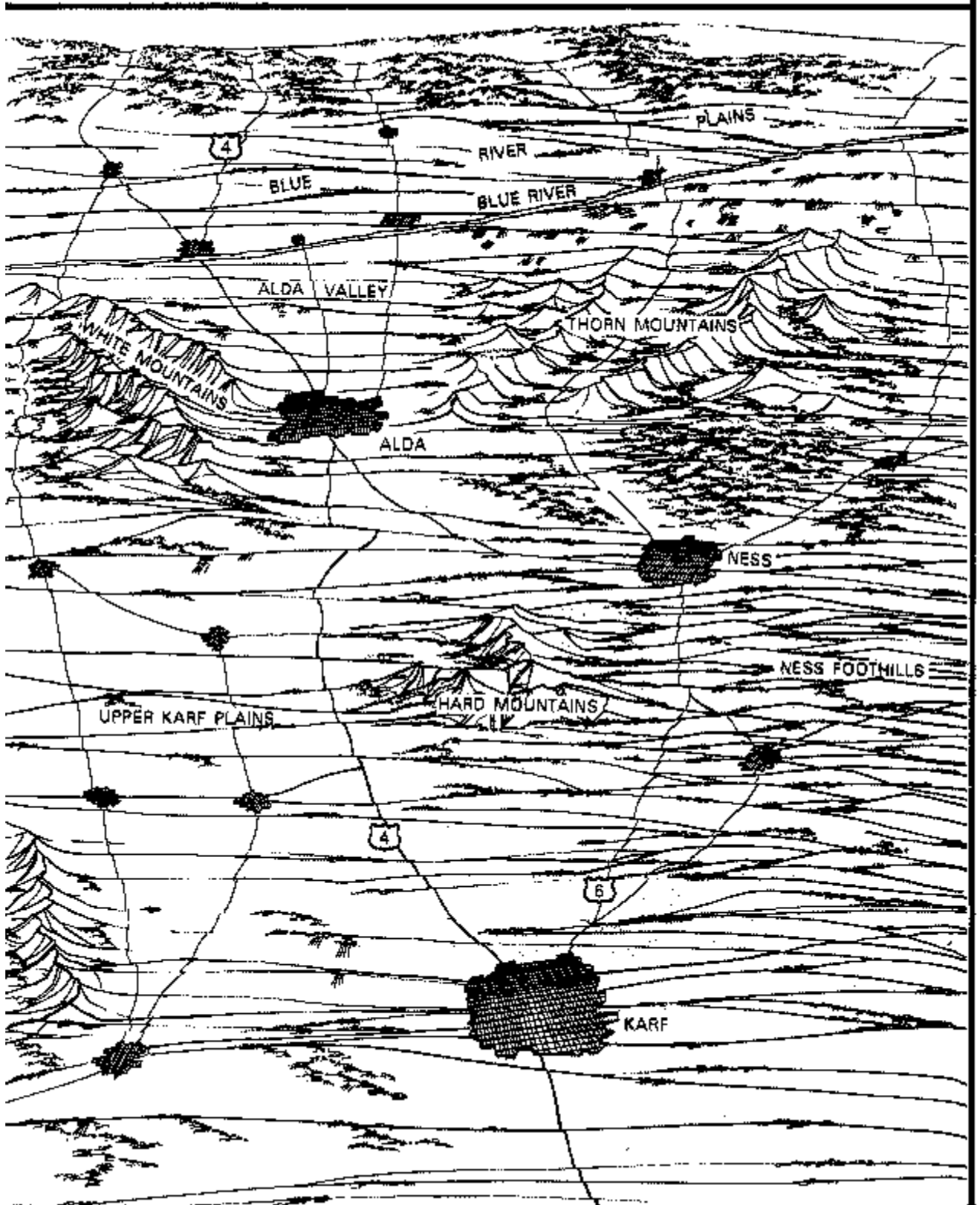

Figure 3-21 10th (US) Corps Defensive Sector

South of the foothills lies the broad, gently rolling Blue River Plains. No significant natural obstacles to maneuver exist except the Blue River itself which is ford-able at selected crossing sites. The defense in this area requires armor-heavy forces and must be conducted from battle positions arrayed in depth on the best available terrain.

In order to cross the Blue River and carry his attack to the south, the enemy will be required to displace and reposition combat support units, particularly field artillery and short-range air defense systems. South of the Blue River, the countryside begins to climb toward the White and Thorn Mountains. The generally rolling, compartmentalized terrain favors the defender. In the west, the Alda Valley is a natural corridor leading through the hill country and into the upper Karf Plains.

Southwest of the valley and along the corps western boundary, the White Mountains are a major obstacle to maneuver above battalion level. In the east, the regional road net provides access through the Thorn Mountains to the southern plains area.

National Route 4, connecting Karf and Alda and continuing north through the Alda Valley to the border, is the principal line of communications in the corps sector.

The Blue River Plains, Upper Karf Plains, and the Ness Foothills encompass approximately 55 percent of the land area and are primarily agricultural regions with limited industrial development. Almost 30 percent of the corps area is forested, with wood production centered in the White and Thorn Mountain regions. Approximately 10 percent of the land area in the corps sector is allocated to urban/industrial uses. Numerous small villages are found throughout the sector, with an average density of 8-9 villages per 100 square kilometers. This density increases to as high as 12 villages per 100 square kilometers along the central Blue River Plains, Alda Valley, and National Routes 4 and 6. The mountain regions and border area are sparsely settled.

Urban areas of particular interest to the corps commander are the two regional towns of Alda and Ness. In the west, Alda, with a population of approximately 80,000, sits astride the most likely high-speed avenue of approach into the corps sector. It includes large areas of urban sprawl radiating from the town along road nets leading north and south and toward the foothills of the White and Thorn Mountains. Alda and its adjacent terrain constitute a significant obstacle which would be extremely difficult for major forces to bypass. Integrating the built-up area of Alda into the corps plan for defense in depth offers significant tactical advantage.

Ness, in the east, is slightly larger than Alda and represents another primary communications hub along an avenue of approach. However, its nonrestrictive adjacent terrain would easily enable an attacker to bypass the town with first-echelon forces. The last major obstacle to southerly movement in this area is located north of Ness in the Thorn Mountain passes. Based on these considerations, Ness is considered to be of minimal value to the corps defense.

To the south is Karf, a major urban complex with a total population well in excess of one million. Because of its large size and lack of readily exploitable resources, Harf is not considered to be an immediate tactical objective and would probably be bypassed.

The figure on the next page portrays the major avenues of approach identified during the analysis of terrain. The corps commander's concept provides for the conduct of an active defense in sector with the covering force battle fought north of the Blue River by the on-line divisions. Although the Blue River is fordable at selected sites throughout its length, its steep banks and paralleling flood plains will restrict and slow attacking units. The excellent defensive terrain in the area will facilitate the handoff of the enemy to the brigades in the main battle area.

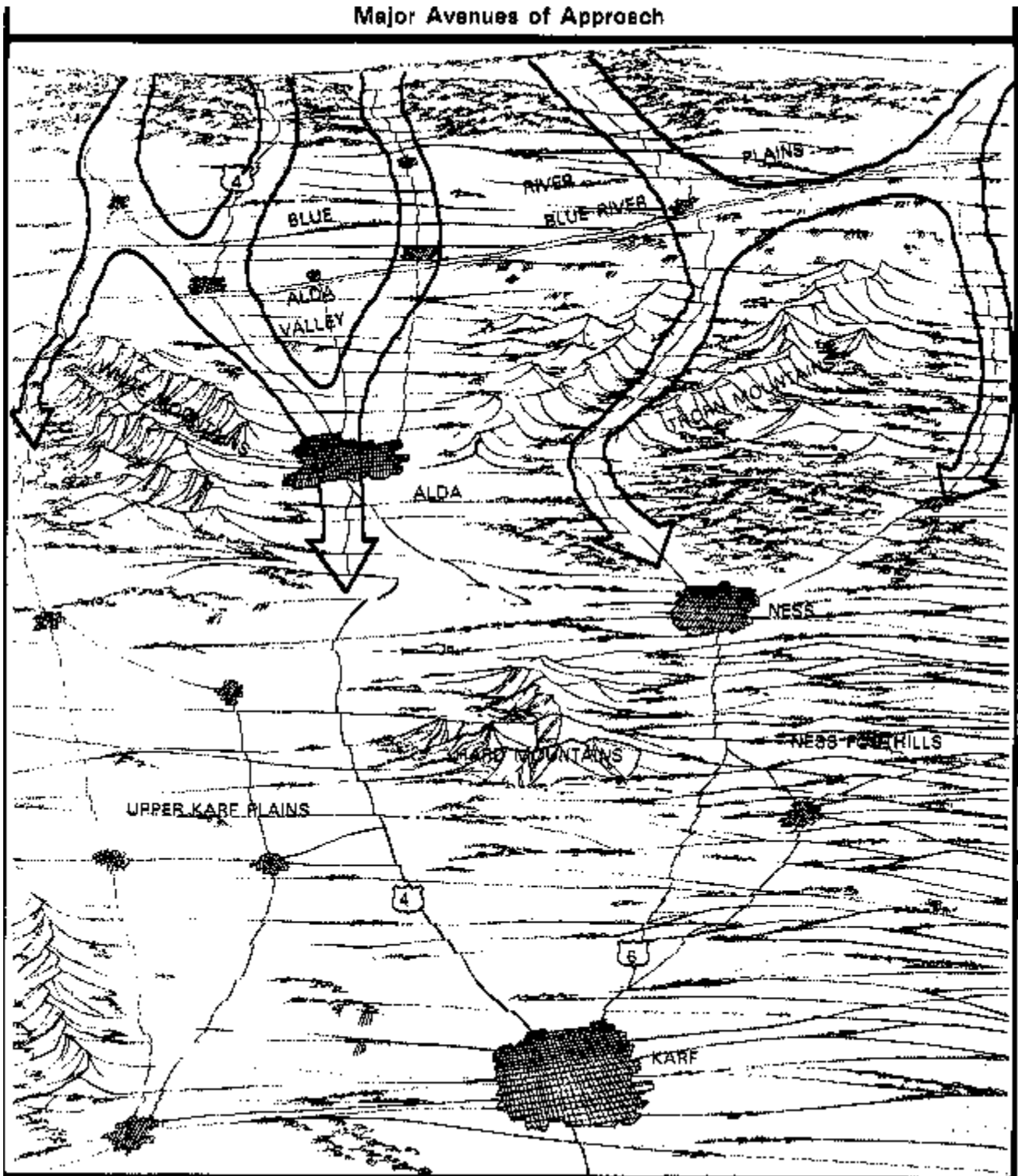

Figure 3-23 Major Avenues of Approach

To assist in the conduct of the covering force and main battle area operation, the following corps assets have been allocated to the forward divisions.

The figure on the next page depicts the basic organization of the terrain for the corps defensive battle. The majority of the corps combat and combat support units are garrisoned within the corps sector. Preplanned initial position areas and movement routes of all units have been reconnoitered by key personnel at platoon level and above. Total movement and preparation time varies from less than 12 hours for forward maneuver elements to approximately 3 days for selected corps combat service support units. It is anticipated that all units will be in position and operational prior to the initiation of the attack. The selection of battle positions and areas is based upon a detailed analysis of Threat capabilities, doctrine, and the terrain in the corps sector. Forces are fitted to the best available terrain in order to service the anticipated target array. In many cases, the cover, concealment, and fields of fire offered by small built-up areas provide significant tactical advantages in the development of the overall defensive network. The retention of such areas is not of significance to the corps. Alda, however, because of its location along the major line of communications in the corps sector and its relationship to adjacent dominating terrain, is critical to the corps defense and must be retained.

The basic goals embodied in the corps plan are to defeat attacking first-echelon armies as far forward as possible in the corps sector, to gain time for reinforcements to arrive, and to create favorable conditions for initiating offensive actions.

SPECIAL SITUATION 2

Division Defense Plan

The mission of the 23d Armored Division includes three basic tasks. The division must conduct covering force operations north of the Blue River, defend in sector, and retain the town of Alda. To assist the division, the corps commander allocated additional maneuver, field artillery, and engineer units to the division and placed an attack helicopter company OPCON to it.

As shown in the [figure3-27](#), the sector of the 23d Armored Division consists of three basic geographic regions (i.e., the Blue River Plains area, the uplands of the White and Thorn Mountains, and the Upper Kar Plains). Superimposed upon and influencing the tactical characteristics of each of these subdivisions are urban terrain features. Division planning for the conduct of the defense must consider the entire terrain package before allocating forces for the accomplishment of its basic tasks.

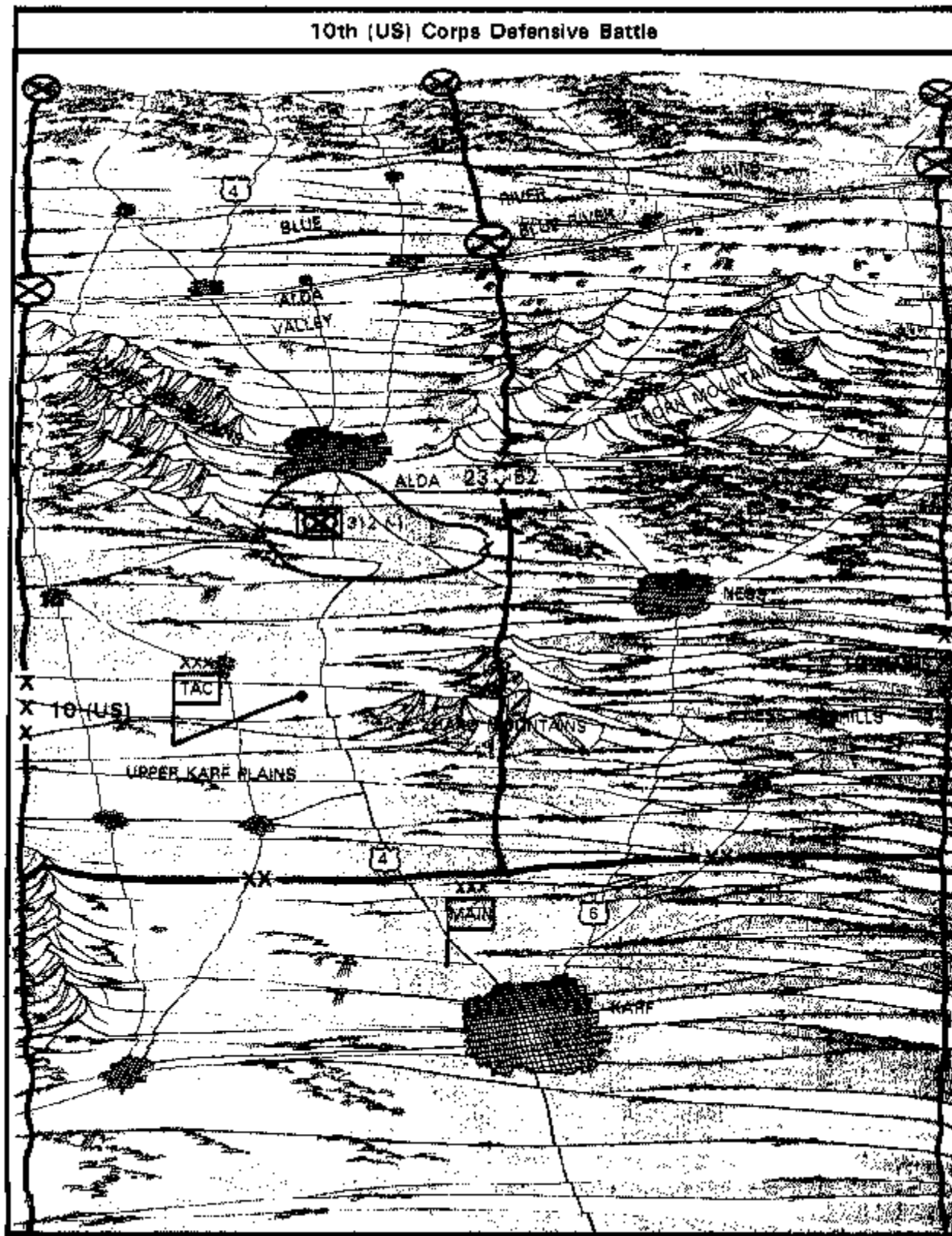

Figure 3-25. 10th (US) Corps Defensive Battle

The Blue River Plains area is a broad agricultural belt bounded on the north and south by uplands and split into two segments by the Blue River, a natural obstacle.

In the north, a band of heavily forested, sparsely populated, rolling hills extends along the international border. This area is cut by numerous small valleys which provide avenues of approach leading into the plains. Maneuver by formations larger than battalion size is restricted to the main communication routes where the national and regional highways cross the border.

While the terrain characteristics along the border favor the defender, this advantage is neutralized, at least in part, by the ability of the enemy to apply massive, preplanned fire support at any point and time under the protection of a fully coordinated air defense umbrella.

Between the border uplands and the Blue River, the gently rolling countryside offers only minor changes in relief with low ridge lines and isolated knolls rising 10-30 meters above the surrounding plains. Tributaries of the Blue River flow from north to south through shallow valleys cut into the plains.

Dotting this northern plains area are numerous small, relatively self-sufficient villages surrounded by garden plots, small, dense wood lots, and agricultural tracts divided by hedgerows and irrigation systems. The rural, fair-weather road net will support light vehicular traffic, and off-the-road mobility for mechanized forces is excellent throughout most of the year. Although multiple avenues of approach penetrate this entire network, maneuver formations may frequently be split or diverted by the requirement to bypass built-up areas.

Observation and fields of fire from these villages and low ridges throughout the area are excellent, and in many cases extend beyond 2000 meters. Single family dwellings ringing the rural villages frequently provide easily prepared fighting positions suitable for use during the flow of the active defense.

The density of built-up areas increases along the hard-surface, all-weather road net converging in the small regional towns. These roads, which will support heavy vehicular and mechanized traffic, can easily be cut by demolitions, thus reinforcing the obstacle value of the built-up areas.

The combination of natural terrain and manmade features in the northern plains area favors the employment of armor-heavy forces, fighting from battle positions arrayed laterally and in depth. The small built-up areas should be integrated where possible in the defense as obstacles to derive full value from the cover and concealment they afford.

South of the river, the plains rapidly give way to rolling hills and ridgelines dominating valleys that carry run-off from the mountains to the river. In this area, the central portion of the division sector is traversed by the Alda Valley, a broad, heavily wooded natural corridor which gradually narrows as it passes through the mountain area and onto the Upper Karf Plains. To the south and west of the valley, the foothills of the White Mountains severely restrict the mobility of mechanized forces. In the eastern portion of the sector, gently rolling foothills and small valleys form terrain compartments which complicate coordinated large-scale maneuver.

Throughout this southern portion of the plains area, built-up areas are concentrated along the major Road nets. When coupled with the canalizing effect of the increasingly restrictive terrain, this array of manmade features provides balanced forces the opportunity to confront the attacker repeatedly with obstacles and mutually supporting defensive positions in depth. In order to cross the Blue River, he will be required to displace his combat support and combat service support units from initial positions north of the border, thus increasing their vulnerability.

The largest commercial/industrial centers on the plains are located along the Blue River in the small towns that have grown at the sites where the national and regional road nets cross. The river is the only major obstacle to maneuver on the plains. Its steep banks and associated flood plains limit tactical crossings to selected fording sites or to existing bridges unless extensive engineering effort is expended. Most fording sites are located in the vicinity of rural built-up areas.

The White and Thorn Mountain ranges rise to elevations in excess of 300 meters, separating the northern division sector from the Upper Karf Plains. Heavily forested mountains form another natural obstacle.

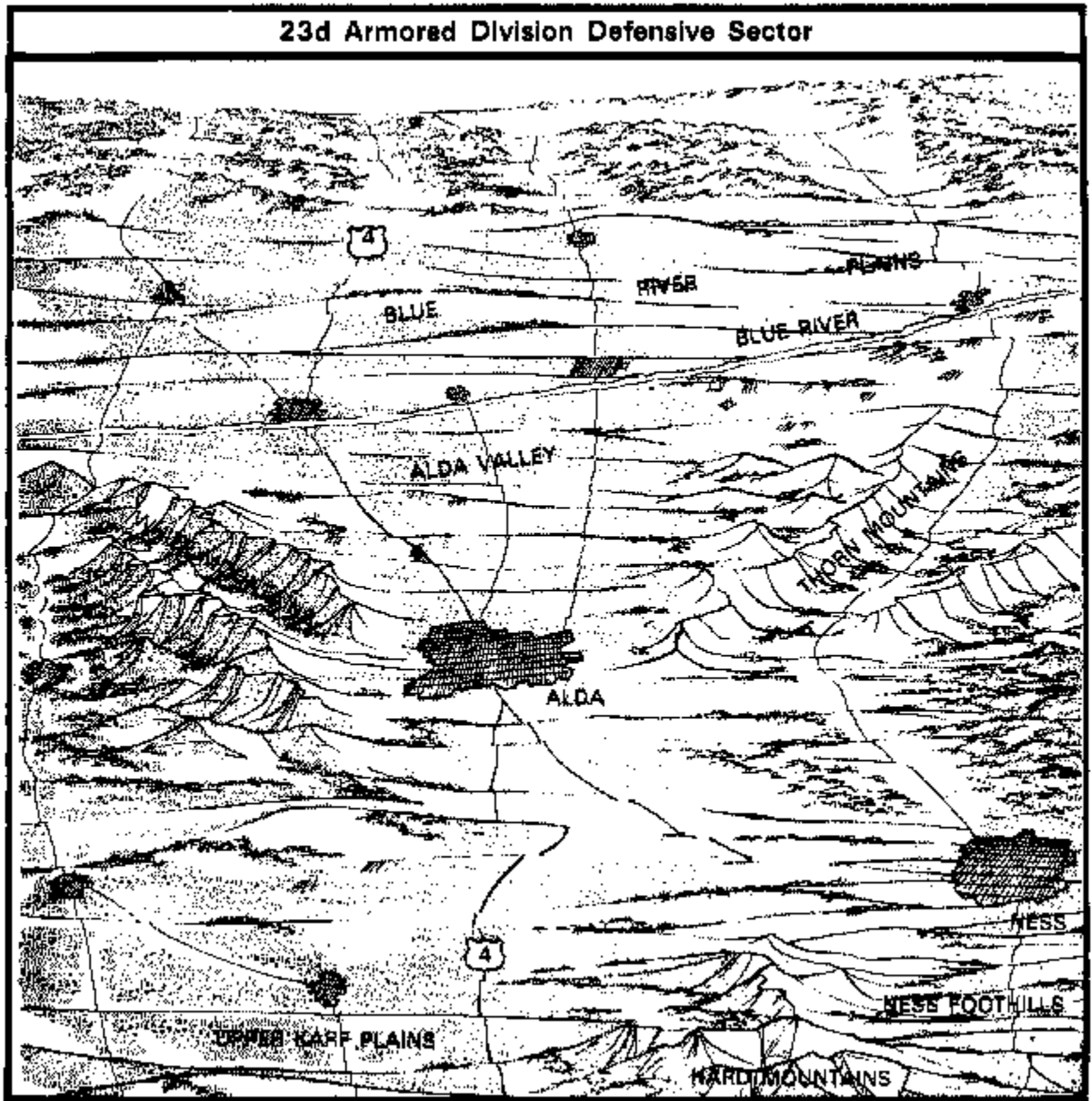

Figure 3-27 23d Armored Division Defensive Sector

They are sparsely populated with isolated communities supporting the forest industry. Few hard-surface, all-weather roads exist, and off-the-road trafficability for any type of vehicle is poor. The small villages block and further restrict maneuver by sitting astride the intersections of the inferior road nets and natural terrain corridors.

The Upper Karf area consists of a broad irregular plain cut and interlaced by streams and small valleys. Local relief is extremely varied with isolated hills standing up to 75 meters above adjacent flatlands. Primarily an agricultural area, it offers excellent cross-country mobility. Its rural road net converges on small towns which are tied together by the regional highway system. Like the Blue River Plains, this area favors the employment of tank-heavy forces.

The following figure portrays the major avenues of approach leading to the Upper Karf Plains.

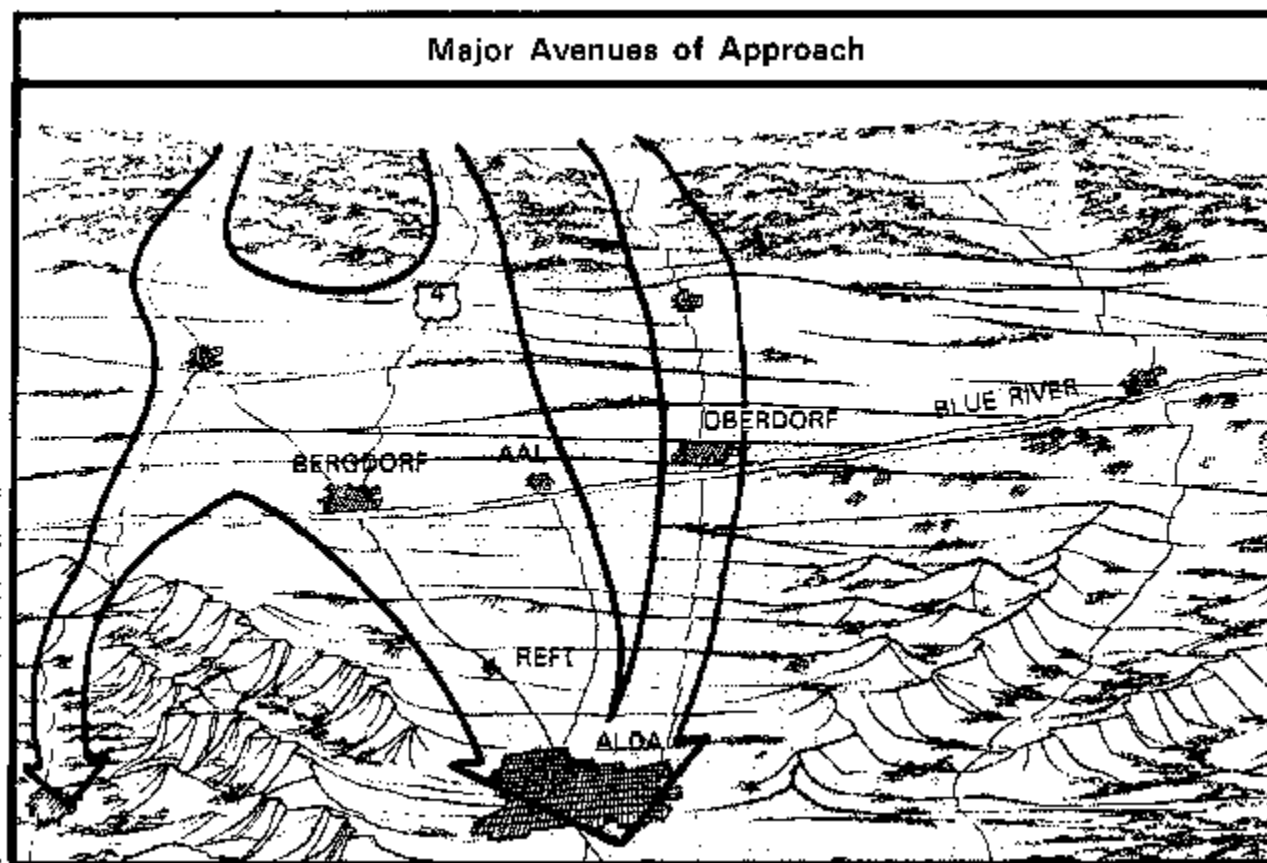

Figure 3-28 Major Avenues of Approach

During his analysis of the urban characteristics of the terrain, the division commander focuses his attention primarily on the regional towns along the main avenues of approach in the sector. Unlike the smaller villages, which may play an important role as obstacles and fighting positions during the flow of the battle but seldom warrant retention, the larger built-up areas may provide significant advantages to the defender. If the enemy cannot bypass and must fight through these towns, his momentum will suffer. Such delay will contribute to the overall mission of gaining time for reinforcements to arrive and will increase target time on columns backed up by these bottlenecks.

The location of the town in relation to the adjacent terrain and probable enemy avenues of approach, its size, physical layout, the structural characteristics of its buildings, its commercial and industrial assets, and its population are basic considerations involved in this analysis.

Bergdorf and Oberdorf, on the principal crossing sites over Blue River, and Reft, located north of ALDA on Route 4, warrant special consideration.

Forces defending either of the river towns could effectively control the railroad and highway bridge networks during the withdrawal of the covering force and deny these crossings to enemy lead elements once the bridges are destroyed.

The terrain in the vicinity of Bergdorf favors an initial defense along the river with the integration of the town in a battle position. The newer industrial and commercial area on the north bank of the river is a significant obstacle suitable for defense by mechanized forces. In spite of the current stay-in-place policy, some civilians will have to be evacuated from likely areas of intense combat. National authorities in each town will be required to designate prepared shelters for such contingencies.

Oberdorf in the eastern portion of the sector offers few advantages to the defender.

Smaller than Bergdorf, its newer construction has spread north and south from the river along the regional roadnet. Agricultural processing plants and storage areas north of the river provide some concealment, but little or no cover. The older town center sits astride crossings over the river, limiting maneuver and fields of fire. The town can easily be bypassed and isolated by using other fording sites along the river. The best defensive terrain controlling crossing sites in this area is located on the foothills south of the river.

Reft is located south of Bergdorf where the valley begins to narrow for its climb through the Alda Gap. It is nestled in the low foothills controlling the major avenue of approach along Route 4. If the division is to retain ALDA without getting involved in a major city battle, the attack must be stopped in the vicinity of Reft and its associated terrain complex.

The figure below portrays the organization of the terrain for the defense.

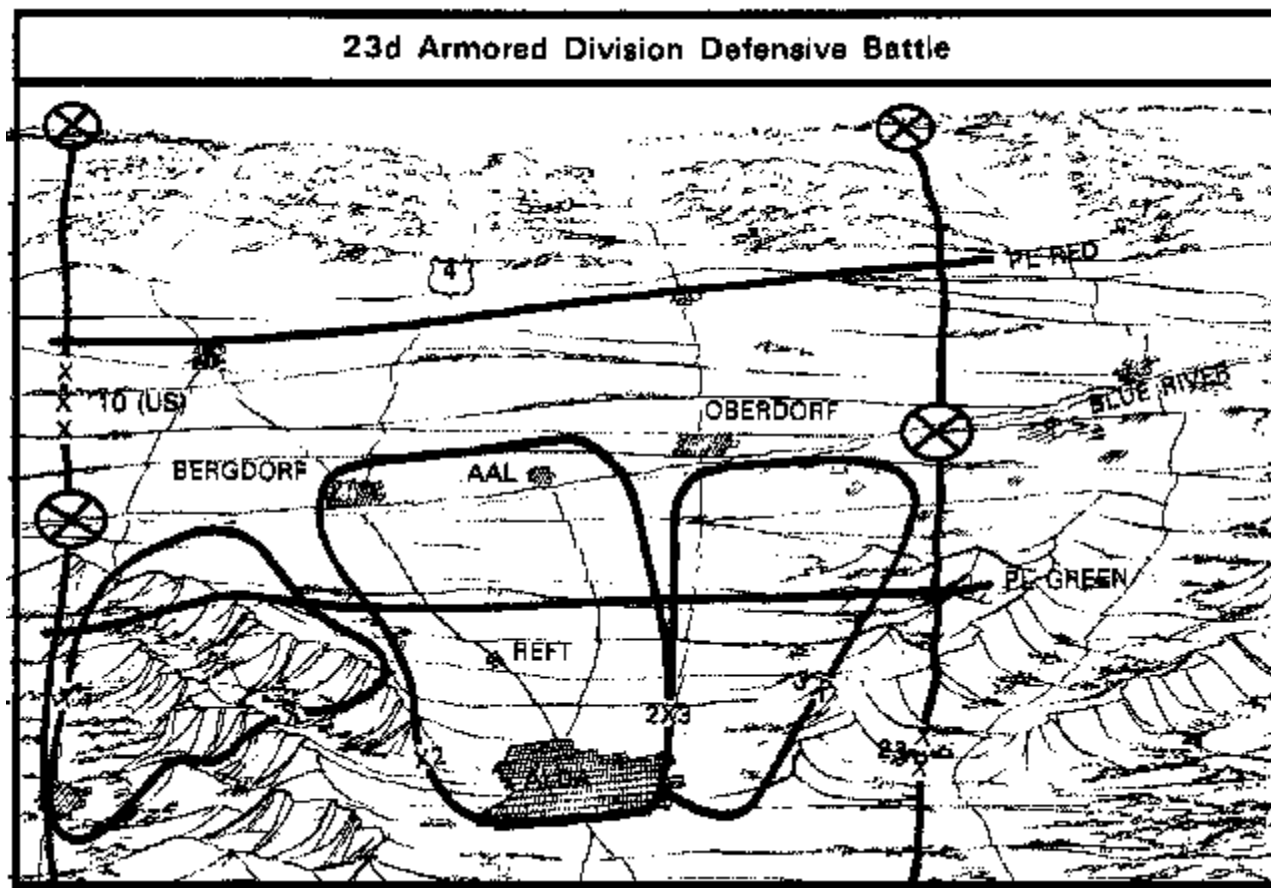

Figure 3-29 23d Armored Division Defensive Battle

The division commander's concept calls for the conduct of covering force operations north of the Blue River under division control. Forces allocated to the covering force battle include the 1-203d Armd Cav Sqdn, TF 2-135, and the divisional Cav Sqdn, all of which are garrisoned in the border area. In addition, the 2d and 3d Brigades are tasked to provide one armor-heavy task force to the covering force. Fire support is provided by the three battalions of the 71st FA Brigade, the divisional general support FA battalion, and a Vulcan battery. Engineer support is provided by the 502d Engineer Battalion augmented by one divisional engineer company.

It is anticipated that the hand off of enemy elements to the brigades in the main battle area will take place in the vicinity of RL Red.

Each brigade has been assigned battle areas fitted to the terrain along the primary avenues of approach in the division sector.

Maneuver elements allocated to the brigades for the conduct of the defense include:

1st Bde	2d Bde	3d Bde
1 Mech Bn	2 Mech Bn	2 Mech Bn
1 Armor Bn	3Armor Bn	2 Armor Bn

Upon completion of covering force operations, the corps maneuver elements will be positioned under brigade control in positions that add depth to the defense. This will insure that forces are in place to block routes converging on Alda as the brigades shift south into the excellent defensive terrain along the valley corridor and foothold regions.

The division commander emphasized the following factors:

"The priority for engineering effort will be to counter mobility operations in the 2d Brigade sector with obstacles established in depth and covered by long-range fires and ATGM. The obstacle value of the Blue River must be reinforced. Its bridges should be retained as long as possible, but destroyed as the fight shifts into the MBA. Major obstacles can also be created along National Route 4, which is heavily dependent on elevated spans and its tunnel network, and along road nets passing through built-up areas.

"The numerous small built-up areas throughout the sector are obstacles which offer easily prepared defensive positions controlling much of the trafficable terrain. They can frequently be incorporated in battle positions or used as bases of fire to support limited objective, low-level counterattacks.

"South of RL Green, the nature of the terrain and increased urbanization will tend to compartmentalize the attacker and cause him either to mass and slow his advance or to break up his formations along minor avenues of approach. In the 2d Brigade area, Reft and its adjacent terrain represent a major obstacle which must be retained as long as possible.

"If it is necessary to fight to retain Ada, success will depend mainly on our ability to control the dominating terrain adjacent to the town. It is anticipated that the enemy will attempt to bypass Alda on the west along the narrow corridor between the town and foothills. Any attempt to pass through Alda itself would destroy the momentum of his first-echelon forces. The positioning of the corps reserve and the nature of the terrain in the 3d Brigade sector make it doubtful that he could effect a bypass east of Alda.

"Refugee control and infiltration may be major problems in the Alda area. PSYOP teams and territorial forces operating in the Division planning for the defense provides sufficient forces and control measures for the accomplishment of each major task. The defense is continuous in nature and conducted in depth throughout the sector. town will be under the operational control of the 2d Brigade to insure that their planning provides for the organization of civilian control areas corresponding to the tactical defense sectors."

SPECIAL SITUATION 3

Brigade Defense Plan

The defensive mission of the 2d Brigade, 23d Armored Division, includes several tasks. The brigade must provide one tank-heavy task force to the covering force, assist elements of the covering force in a rearward passage of lines in the vicinity of RL Red, defend in its assigned battle area, and retain the city of Alda.

Intelligence sources indicate that Alda is an initial enemy objective and that the enemy must secure the city to serve as a logistics base in support of further operations.

Urbanization within the brigade battle area is moderately dense and consists of numerous small villages, strip areas, and towns in addition to the city of Alda. New growth, in the form of light industrial centers and modern residential areas, can be found in most of the villages and small towns. The city of Alda includes

large new areas built on its outskirts. Several of these built-up areas, when considered in conjunction with other terrain features in the valley, will have an impact on military operations.

Six of the small towns are prominent enough to be considered of some importance to the defense. The brigade commander and his staff evaluated them based on two primary criteria. The first is the obstacle effect which they may have against enemy forces. The second criterion is based on how well they lend themselves to being defended.

Bergdorf. Sits astride the most likely high-speed avenue of approach leading into the brigade area and controls bridges over the Blue River. Dominant terrain features on the east and west sides of the town and south of the river enhance the defense of the town. The town cannot be easily bypassed.

Aal. Sits astride the second most likely avenue of approach into the brigade area. It controls bridges over the Blue River; however, surrounding terrain does not lend itself to the defense of Aal proper. Good defensive terrain which controls routes out of Aal are located to the south and southwest of the town.
Kant. Sits astride the most dangerous avenue of approach. It can be bypassed without great difficulty unless significant engineer effort is dedicated to the emplacement of counter mobility obstacles.

Reft. Sits astride the most dangerous avenue of approach. Terrain on east and west side of Reft precludes easy bypass and enhances the defensive potential of the area.

Lerl. Sits astride the most dangerous avenue of approach but can be easily bypassed.

Barg. Sits astride a less threatening avenue of approach and offers some defensive value.

In order to avoid a protracted battle within Alda, brigade planning for the defense seeks to defeat the attack as far forward in its assigned battle area as possible.

Terrain forward of the brigade battle area is primarily an open and rolling agricultural zone. In the northern portion of the battle area, the Blue River runs across the brigade battle area, with bridges located at the towns of Bergdorf and Aal. The river is fordable with difficulty between these towns except at a developed crossing site midway between them. To the west of Bergdorf and to the east of Aal, the river banks are too steep to provide suitable crossing sites. The low hill masses along the south side of the river provide excellent observation and long-range fields of fire to the north. Avenues of approach in this portion of the battle area are limited to the corridors passing through these hills.

South of this area, the Alda Valley narrows and becomes increasingly restrictive as it climbs toward Alda and the pass through the southern mountains. Trafficability throughout the brigade battle area is fair-to-good along primary and secondary all-weather roads. There are also several loose-surface roads throughout the area which can support limited numbers of tracked vehicles except during periods of excessive precipitation.

The brigade commander is primarily concerned with those avenues of approach which can support at least an enemy battalion-size force. The following figure depicts the most likely avenues of approach forward of and within the brigade battle area identified during the analysis of the terrain.

The most threatening avenue of approach into the area passes through Bergdorf along Route 4. The second most likely avenue of approach is through Aal. Forces along this route can turn to the southwest toward Kant or continue south along the high ground of the valley

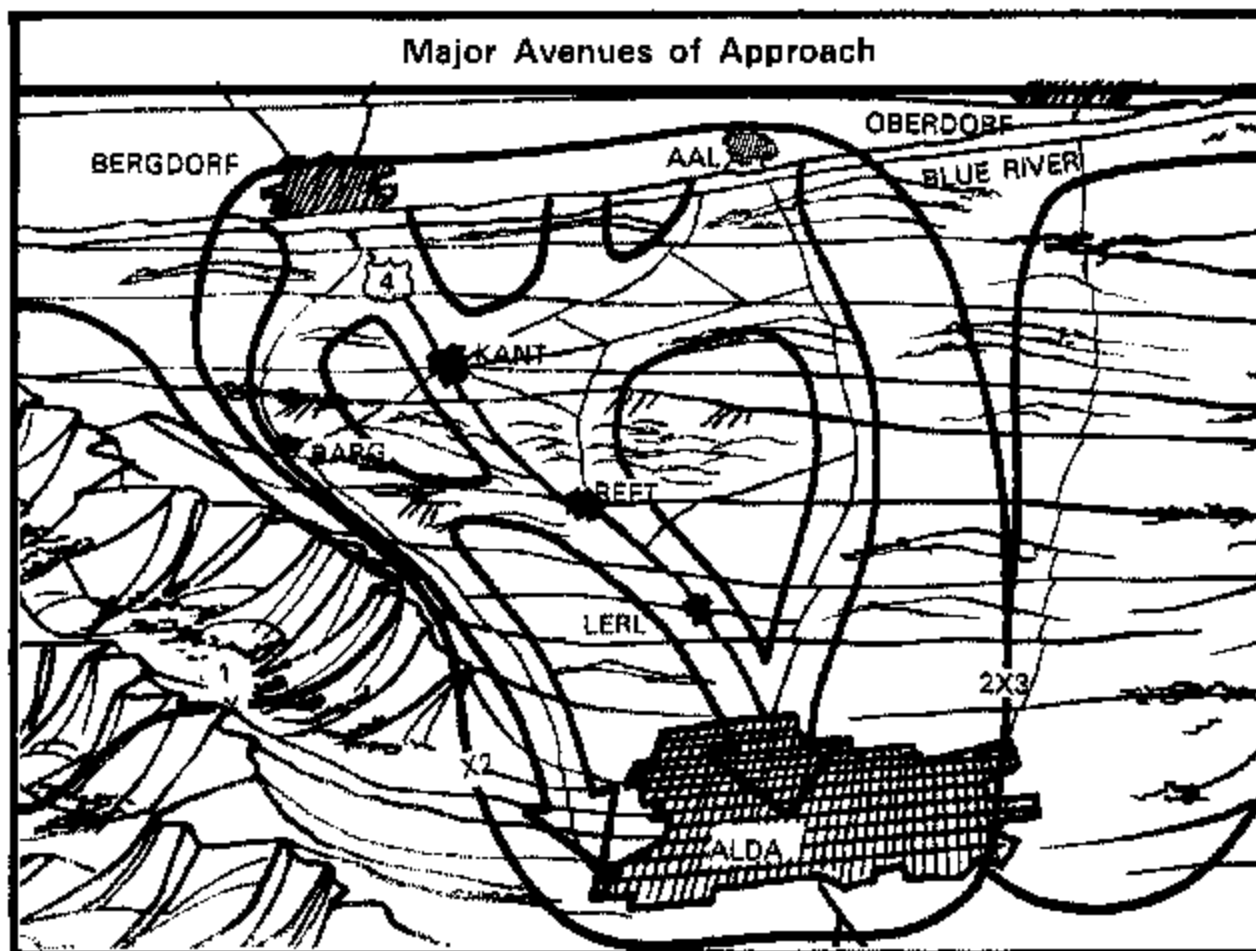

Figure 3-32. Major Avenues of Approach.

Once committed to this southerly route, any subsequent change in direction would be extremely difficult. A minor avenue of approach also passes along the western foothills leading to Alda. South of Barg this route becomes highly restrictive for armor and for maneuver above company level. Having analyzed his mission, the enemy, the terrain, and the courses of action available to him, the brigade commander briefs his staff on his general concept for the defense within the assigned battle area.

"The Blue River which runs across our area is a natural obstacle to attacking enemy forces and will serve as a good point for the covering force to complete its handoff of the battle to the main battle area forces. The town of Bergdorf sits astride the major high-speed avenue of approach into the Alda Valley and also controls bridges over the Blue River.

"For these reasons we should make maximum use of Bergdorf in our defensive planning. I also want to insure that other built-up areas which enhance our defensive capabilities are used to our fullest advantage. Those towns and villages which are astride likely avenues of approach and serve as obstacles to enemy forces must be fully developed to slow or halt the advancing enemy elements. They must be denied the opportunity to gain momentum south of the initial defensive positions.

"The terrain forces the main avenues of approach to converge in the vicinity of the town of Kant. Counter mobility obstacles will be required in the town and east of it. Field artillery, attack helicopter, and close air support will play an important role in this area. If this is properly planned and coordinated, we will

gain additional time to service targets. We should make every effort to halt the enemy advance forward of Reft. If we permit the enemy to penetrate beyond this point, we will have an extremely difficult time retaining Alda.

"In planning this operation I want to establish a battalion-size battle area in the northeast section of our brigade battle area. The task force assigned to this battle area will have the responsibility of preventing an enemy penetration through its assigned area. Task force battle positions should be established along the Blue River, keying on the primary avenue of approach through Bergdorf and covering potential crossing sites on the river. Insure that optimum use is made of dominant terrain along the south side of the river. "Additional task force battle positions are to be planned and prepared in depth throughout our battle area where they can most effectively influence the battle. One task force reinforced with engineers will occupy a battle area encompassing the town of Reft with the mission of retaining the town and halting the enemy advance north of that town. If the enemy is successful in penetrating to that point, I want at least two other task force positions prepared to support the defense in and around Reft. Task force battle positions and task force sectors within the city of Alda must also be identified early to insure that civil affairs, national authority, and ground tactical planning are fully coordinated. Even with a stay-in-place policy, evacuation of personnel from the northern and western portions may be necessary.

"Upon completion of the covering force battle, our task force and TF 2-135 will pass to our control. We will also pick up additional engineer assets in the form of the 502d Engr Bn (Corps) (-), reinforcing fire from two battalions of the 71st FA Bde, and OPCON of an attack helicopter company.

"Position the attack helicopter company in an assembly area in the vicinity of Bergdorf with priority for employment to the TF in that area. Upon passage of RL Green, priority will shift to the TF defending the Reft area. Priority for fire support will pass in the same manner."

"Our TAC CP will locate well forward with an initial position in the vicinity of Bergdorf."

2d BRIGADE TASK ORGANIZATION				
TF 1-11	TF 1-12	TF 1-13	TF 1-92	TF 1-93
1-11 Arm (-) A/1-92 Mech 1/B/23d Eng 2 GSR TM 1 REMS TM	1-12 Arm (-) B/1-92 Mech 1 GSR TM	1-13 Arm (-) A/1-93 Mech 1 GSR TM	1-92 Mech (-) A/1-11 Arm B/1-12 Arm 1 GSR TM	1-93 Mech (-) A/1-13 Arm D/23 Arm (-) 2 GSR TM 1 REM TM
TF 2-135	Bde Control			
2-135 Mech (-) A/1-18 Arm 2 GSR TM 1 REMS	2/B/23d CEWI 1-51 FA (DS) 2/611th FA (Reinf 1-51 FA) 2-71 FA (Reinf 1-51 FA) 2/A/1-440 ADA		TF 502 (DS) 502d Engr Bn (Corps) (-) B/23d Engr (-) (OPCON) A/115 AH Bn (OPCON)	

Figure 3-34a 2d Brigade Task Organization

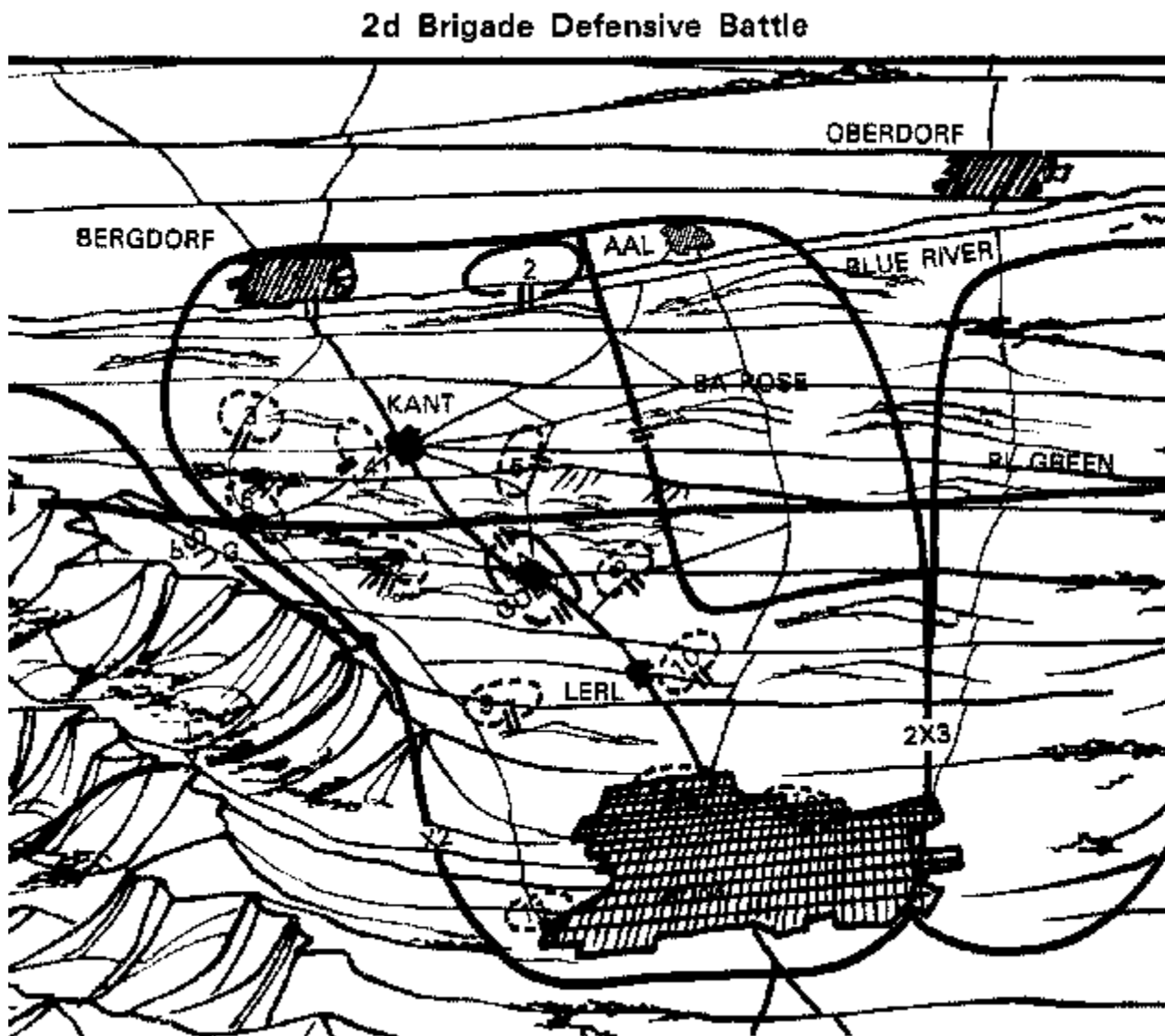

Figure 3-34 2d Brigade Defensive Battle

Missions assigned for the defensive battle with the brigade battle area are as follows:

1-11 Armor:

- * Occupy and defend BP 1.
- * Prepare the bridges over the Blue River in Bergdorf for destruction.
- * Prepare BP 4.
- * Reconnoiter BP 6, 9, and 12.

1-12 Armor:

- * Upon release from the covering force defend BP 5.
- * Prepare BP 10.
- * Reconnoiter BP 12.

1-13 Armor:

- * Occupy and defend BA Rose.

- * Prepare the bridges over the Blue River in Alda for destruction.
- * Be prepared to occupy BPs 10 and 13.

1-92 Mech:

- * Occupy and defend BP 2.
- * Prepare BP 8.
- * Reconnoiter BP 13.

1-93 Mech:

- * Occupy and defend BA Gold.
- * Prepare BP 11.

2-135 Mech:

- * Upon release from the covering force occupy and defend BP 3.
- * Prepare BP 7.
- * Reconnoiter BP 6, 9, and 11.

A/115 AH:

- * Upon release from the covering force occupy an assembly area vicinity of BI 3 with priority of employment to TF 1-11.
- * Be prepared to occupy an assembly area vicinity of BA Gold.
- Upon passage RL Green, priority of employment will be to TF 1-93.
-

SPECIAL SITUATION 4

Battalion Task Force Defense Plan

Task force 1-93 has been assigned the mission of defending from Battle Area Gold and retaining the small town of Reft. As the order was issued, the 2d Brigade commander emphasized the importance of BA Gold to the overall brigade defensive plan once south of RL Green.

"Your battle area contains the best defensive terrain along the valley approach to Alda. Its rolling, wooded nature provides repeated opportunities to confront the attacker from planned defensive positions. In most cases, concealed routes will be available to assist in repositioning forces in depth. The retention of Reft is essential. If we can stop the enemy on the favorable terrain north of the town, we can avoid a protracted and costly battle for Ada and the pass to the southern plains area."

"To strengthen the overall defense, I will position task forces in BPs 7 and 8. If the attacker tries to redirect his efforts to the east to avoid you, he will be confronted not only by defenders in BP 8 but also by the forces in BA Rose. If he shifts to the west, forces in BP 7 and the rugged terrain along the western slopes will effectively stop him. Either move will expose a vulnerable flank to you."

"Once we are south of RL Green, you will have priority for fire support and for the employment of the attack helicopter company OPCON to the brigade."

"I want to destroy enough attacking forces north of the town to allow for the initiation of limited counterattacks. Be prepared to receive the attachment of a tank-heavy company team from TF 1-12 for such use in your battle area. I don't feel it is necessary to develop a strong-point in the town since the terrain on its flanks can be readily tied into the built-up area defenses. Make sure the forces in the town organize positions in depth. They must be prepared to defeat mounted or dismounted attacks and hold the town with only limited reinforcement initially."

Task force 1-93 consists of two mechanized companies and one tank company. In addition to the priorities for fires established by the brigade commander, an engineer company and a Vulcan platoon are attached for the defense. The task force maneuver units will be uncommitted prior to the enemy's crossing of RL Green. The initial defensive battle fought along the Blue River will provide adequate time for the organization of the task force battle area.

Task force planning for the defense is based on a detailed analysis of the terrain and personal reconnaissance of the area by key personnel. As indicated, the terrain in

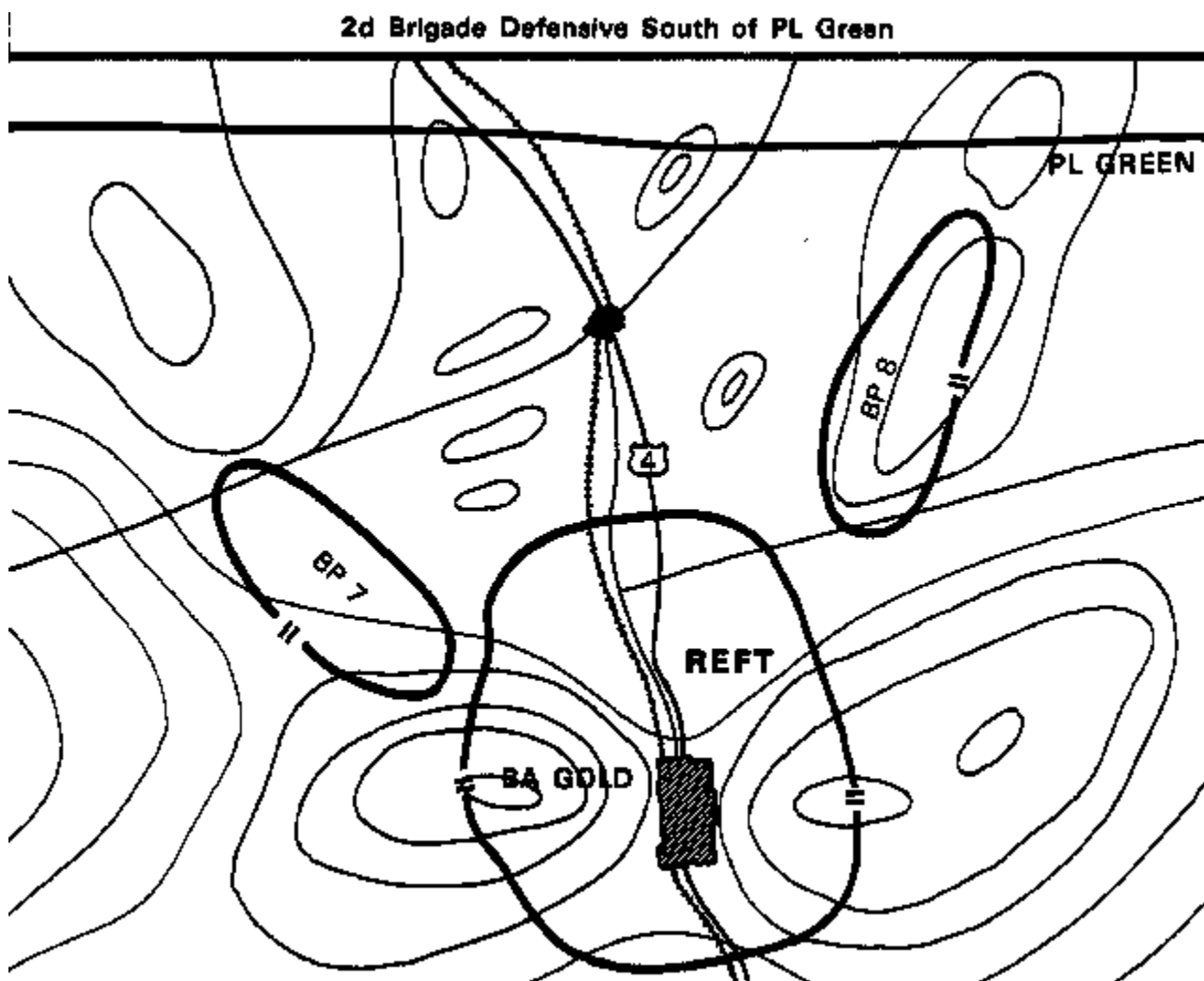

Figure 3-36 2d Brigade Defensive South of PL Green

the northern portion of BA Gold is a gently-rolling, wooded valley paralleling the communications network. Successive platoon and company positions are available in depth throughout this area. Closer to Reft, wooded hills lead eastward to the shoulder of the Alda Valley. A mixture of small wood lots, orchards, and open fields used for grazing and garden crops are pieced together in a patchwork pattern. Fair-weather, loose-surface roads lace the area and allow for the maneuver or repositioning of light wheeled or tracked vehicles. The repeated pattern of open fields and tree lines provides excellent fields of fire from concealed positions for anti-tank and direct fire weapons. The western portion of the battle area contains a long, low hill mass overlooking Route 4 and the valley

approaches from the north. Lightly wooded along their base, the hills rise to form a gentle rolling ridge leading from Reft and Route 4 to the west.

Reft is a small industrial and agricultural center that has almost doubled in size over the past decade. Its current peacetime population is approximately 10,500. The town's depth along a north-south axis is approximately 2500 meters. Its width in the central region is slightly more than one kilometer.

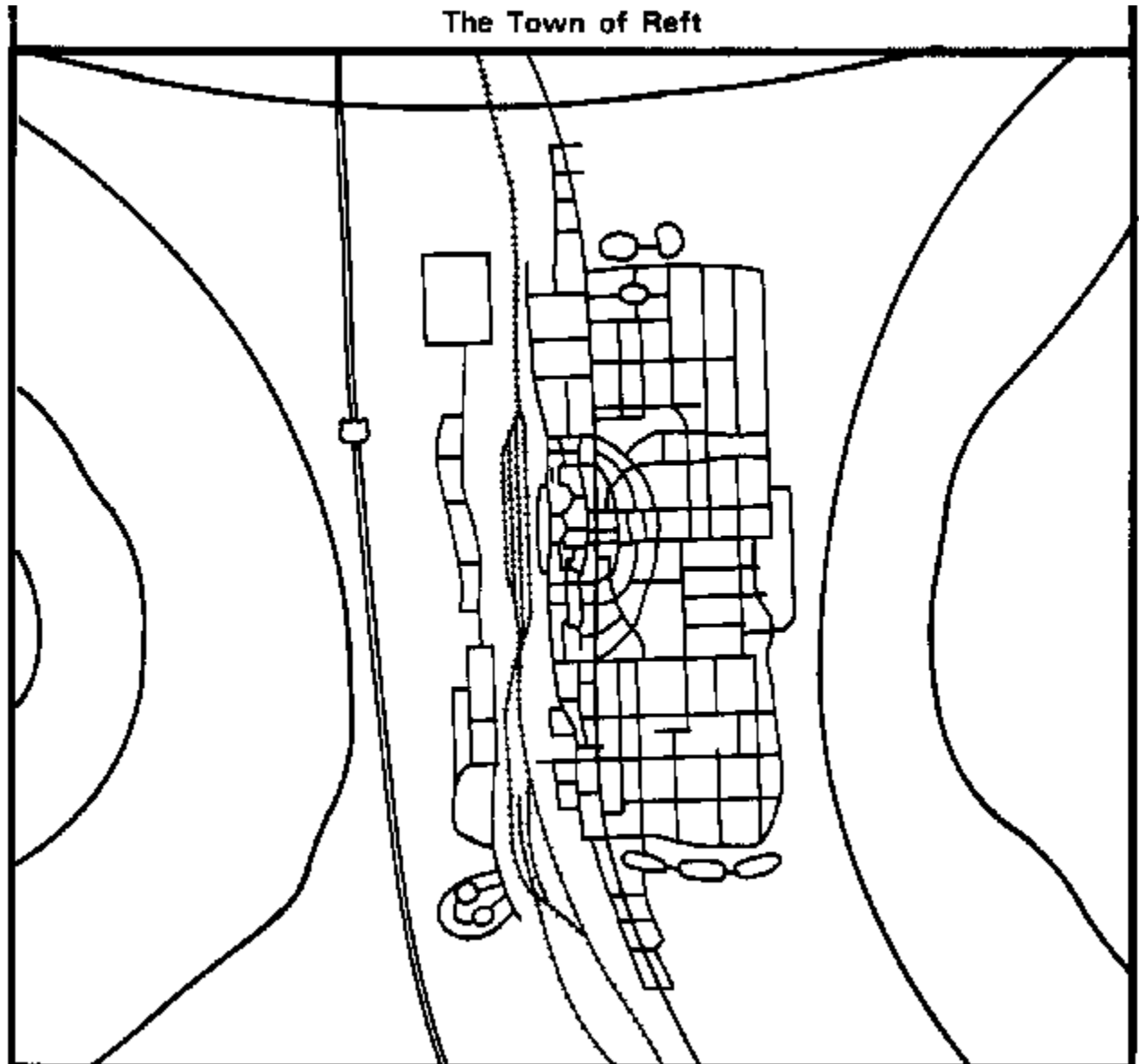

Figure 3-37 The Town of Reft

The old part of the town has retained its village characteristics with narrow winding streets and closely packed buildings. The newer growth extends in all directions from the central core. To the west, there is an industrial complex consisting of small factories and low warehouses. A fuel storage facility occupies the area between the rail lines and the new Route 4. The major highway system bypasses Reft on the west, with interchanges located north and south of the town. Ringing the remaining portion of the town is a new residential area with individual and multiple family dwellings laid out in a rectangular pattern. The few

high-rise buildings in the town are located along its northern fringe.

In planning for the defense of this critical area, the task force commander stressed the following basic factors.

The town is a major obstacle. Its growth over the past years has effectively blocked the narrow terrain corridor leading to the south and the Alda Pass through the White/Thorn Mountain complex.

The terrain adjacent to the town is well suited for the organization of a strong defense supporting that established within the built-up area.

The configuration of the Alda Valley forces the main avenues of approach to converge north of the town.

The town cannot be easily bypassed.

Forces within the task force battle area can be re-deployed along pre-selected routes.

Any attempt to penetrate the defense of the built-up area will be costly in manpower as well as time and will cause the attack to lose momentum.

Based on his analysis of the overall situation, the task force commander outlined his basic concept for the defense of the battle area:

"The terrain consists of three basic compartments which merge on the outskirts of the town along the central valley. Long-range fields of fire are available from the low hills which overlook the valley floor from the east and the west, and to a lesser degree from the town itself. I want a mech-heavy team weighted with the preponderance of our TOWs defending in the western portion of the valley. A balanced team with a couple of additional TOW sections should be able to take care of more restrictive eastern portions of the area. The remaining mech company, reinforced with a tank platoon, should be assigned responsibility for the town and its approaches."

The commander task organized his forces as follows:

TASK ORGANIZATION: TF 1-93

TEAM A	TEAM B	TEAM TANK	TF CONTROL
A/1-93 Mech (-)	B/1-93 Mech	A/1-13 Armor (-)	Scout Plt
1-A/1-13 Armor	2/A/1-13 Ar	3-A/1-93 Mech	Hvy Mort Plt
4 TOW Sec	2-D/23 Engr	2 TOW	2 GSR TM
1 REMS TM			
Redeye Tm	Redeye Tm	Redeye Tm	Redeye Sec (- D/23d Engr (-

The following depicts the basic organization of BA Gold.

Team A will be deployed in the west with its tank platoons operating along the valley corridor west of Route 4. Forward positions will be located to insure maximum coverage of the valley approaches with other positions in depth.

Team B will defend forward of and, if necessary, in the town of Reft.

Team Tank will defend in the east on the restrictive terrain which blocks the minor routes bypassing the town and favors a defense with mobile direct-fire weapons and light antitank weapons positioned in depth.

The scout platoon will screen the risk area between BA Gold and task force battle position 8. South of RL Nail, the platoon will be prepared to occupy positions along the east flank or assemble in the vicinity of Reft as the TF reserve.

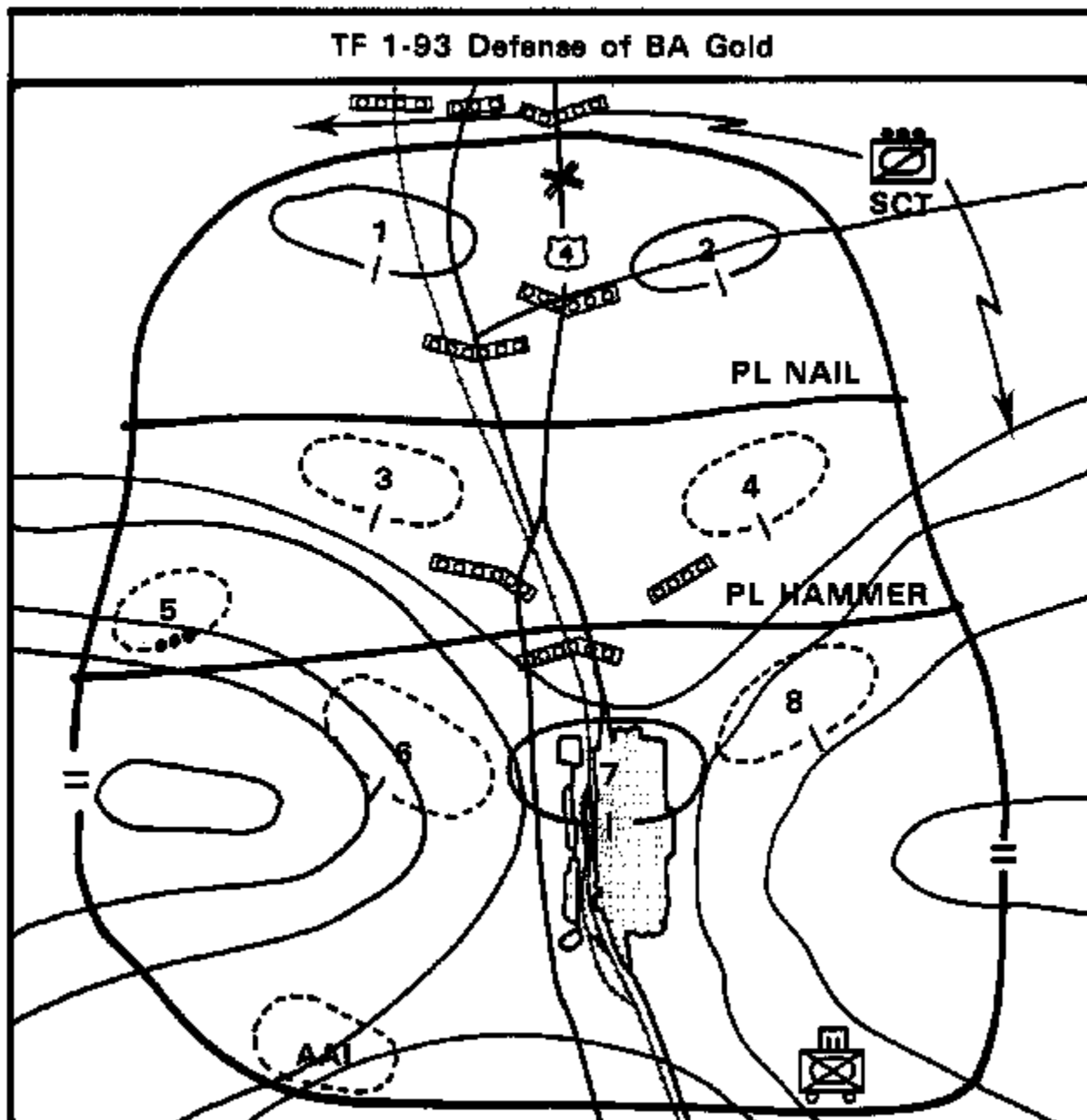

Figure TF 1-93 Defense of BA Gold

The task force commander provided the following specific guidance:

"Priority for engineer effort will be given to the development of obstacles to support our long-range ATGMs and tanks. Close-in obstacles, defensive wire, and mines are the responsibility of each platoon with technical advice from the engineers, if required. The brigade engineers will emplace counter mobility obstacles along the valley north of the battle-area. I want these closely coordinated to insure they support our initial positions."

"Within the battle area, each weapon position must be selected to take advantage of natural obstacles. Where none exists, obstacles must be developed in order to slow the enemy and provide maximum target servicing time. I want high-speed avenues of approach interrupted at frequent intervals where the obstacles can be integrated with mines or natural obstacles and covered by long-range fires. Prepare the Route 4 overpass north of town for destruction on order.

"Position the ground surveillance radar and remote sensors to give as much advanced warning as possible and to serve as eyes for our indirect fire weapons if the attacker uses smoke to cover his advance.

"Develop a fire plan which integrates the fires of team and task force mortars with field artillery. Priority of fires will be to the scout platoon initially. Plan suppressive fires and smoke throughout the defensive area to increase the effectiveness of our direct fire systems. On order, shift the priority of fires to Team B. If the battle draws into the town, use artillery on the flanks and concentrate on the use of our organic mortars in Reft.

"Upon the brigade's passage of RL Green, priority for the employment of its attack helicopter company and fire support will pass to us. Coordinate with the helicopter company as soon as possible. It can occupy assembly area 7, southwest of BP 6. I am most concerned with the areas immediately north of our TOW fans for each battle position.

"Plan close air support missions at likely points of concentration beyond our range and look specifically at the requirement for precision-guided munitions at key points within Reft.

"Coordination of the fires of our organic antitank weapons and tank fires must be accomplished at each level. This requires not only the careful selection of positions for each weapon, but also designation of specific areas of responsibility for each weapon.

The figure below portrays the task force plan for the organization of the defense in the critical southern portion of Battle Area Gold. Within Reft, the task force commander has established a clearly defined defensive sector for Team B. Teams A and

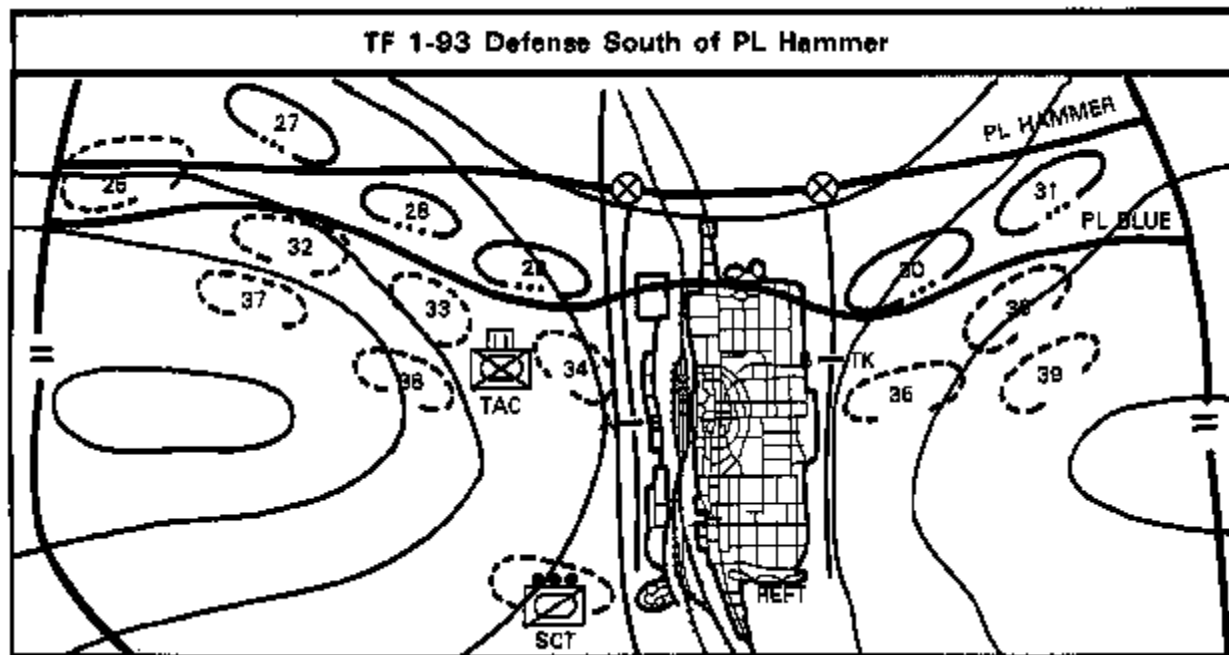

Figure 3-40 TF 1-93 Defense South of PL Hamme

Tank will defend from battle positions selected to defeat enemy attempts to bypass the town. South of RL Hammer units may become decisively engaged as the attack threatens the outskirts of the built-up area. RL Blue will be used to coordinate the positioning of forces within and on the flanks of Reft for the defense of the town. During this phase of the battle, the scout platoon will be positioned west of the town and along the Route 4 communications line as the task force reserve. Planning also provides for the initiation of local counterattacks from the west by elements of Team A or by a tank-heavy team from TF 1-12, if attached. The figure below depicts the basic organization of Reft for the defense. Control measures, to include report lines and platoon sectors, are used to control the battle. In addition, key buildings and principal thoroughfares will be assigned numeric designations.

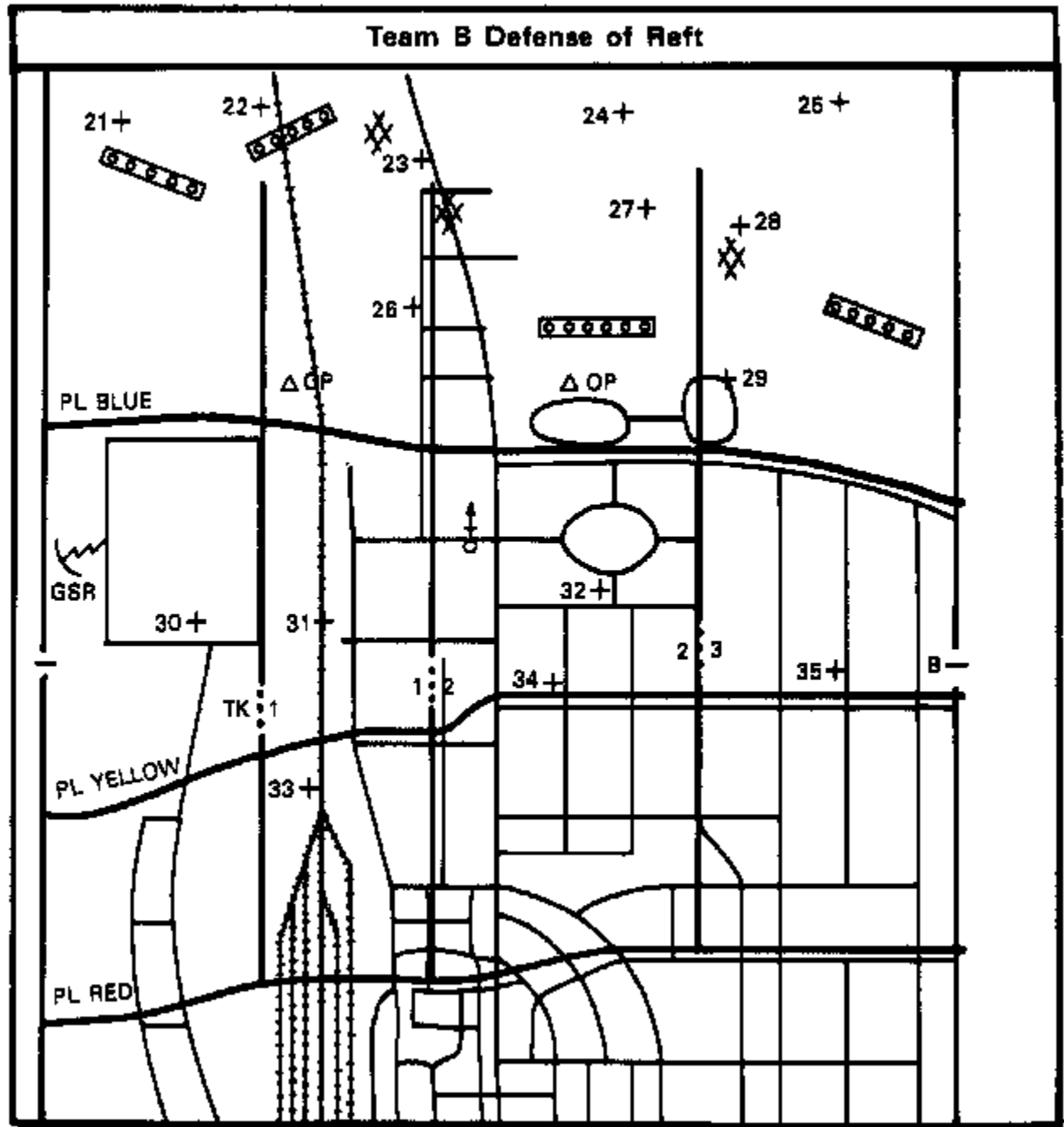

Figure 3-41 Team B Defense of Reft

The task force commander provided the following additional guidance:

"Team B may experience some FM communications problems, particularly if they withdraw toward the central section of the town. In any case, I want maximum use made of wire during this portion of the defense. Use radio as a backup, and only if absolutely necessary.

"At the northern limits of Reft, the open terrain and dispersed buildings allow for the deployment of

dismounted infantry supported by their carriers, tanks, and TOWs. If we are forced to fight in the central part of the town, its narrow streets and densely packed buildings may limit our ability to maneuver or position the carriers. In this case, consideration should be given to dismounting weapons in order to emplace them where they can best support ground operations.

"Although there is no requirement to strongpoint the town, have Team B prestock rations, water, and ammunition in prepared platoon positions in depth throughout the town to minimize re supply requirement during the critical initial stages of the battle. Also, have them collect as much fire fighting equipment as possible to include sand in fortified positions.

"Rubble, particularly in the older part of town, may prevent resupply or medical evacuation by vehicle. Be prepared to provide manpack loads to platoon positions and to use litters for the initial evacuation of casualties from fighting positions to platoon medical collection points.

"Locate the TAC CP with Team A initially where we can best see and control the action. It will displace to Reft only if effective communications cannot be maintained with Team B.

"I want to plug up this corridor as long as possible so that we can slow the enemy attack at every opportunity and hit him again and again with all our organic weapons plus field artillery, attack helicopters and close air support.

The Company Team Battle

This section has provided examples of how units from corps through battalion task force may defend on the urbanized battlefield. It focused on the terrain aspects of urban sprawl and the advantages and disadvantages the commander must consider in developing his defensive plan in this environment. Details pertaining to the conduct of the company team battle within the built-up areas of the urbanized battlefield are provided in the appendices to this manual.

SUMMARY

Include small built-up areas as obstacles in the defensive scheme when significant advantage accrues to the defender.

Avoid combat within built-up areas when feasible.

Establish defenses as far forward of a built-up area as possible if its retention is required.

Integrate adjacent terrain into the defense of a built-up area.

Use security forces operating in depth to limit enemy ground reconnaissance and infiltration.

Provide a detailed, but simple, centralized concept for the defense.

Use restrictive missions and detailed control measures to facilitate decentralized execution.

Provide priorities and deadlines for the accomplishment of assigned tasks.

Attach combat support and combat service support units to the lowest level possible.

Employ the combined arms team to maximize individual unit capabilities.

Use the defender's knowledge of the terrain.

CHAPTER 4

COMBAT SUPPORT

Military operations on urbanized terrain require special considerations pertaining to the provision of combat support. For example, field artillery and close air support, unless carefully coordinated, may actually prove counterproductive if collateral damage and rubble resulting from their employment impede subsequent maneuver. Increased engineer support is essential in both offense and defense; mobility and counter mobility functions are especially critical. Signal support is basic to all combat operations. When fighting within a built-up area, the maintenance of effective and continuous communications may be difficult at echelons above company. On the urban battlefield, opposing forces are frequently hidden and protected by the readily available built-up terrain features. Close, violent combat requiring detailed coordination of combat support may be the norm.

The impact of urban terrain characteristics is most evident during the battle in built-up areas. This chapter supplements other doctrinal manuals by describing considerations applicable to combat support activities during offensive and defensive operations on urbanized terrain.

FIELD ARTILLERY

The missions of the field artillery are not changed by the urban battlefield. Positioning is critical because of mobility restrictions, limited availability of suitable areas, masking of fires by urban features, security, and enemy counter battery. Within built-up areas, the direct fire role may take on added importance along with a more frequent use of the reinforcing mission.

OFFENSE

The force commander, after recommendation from his FSCOORD, makes the decision regarding the firing of a FA preparation in support of the maneuver to isolate the built-up area. The high probability of creating severe obstacles to future operations within the built-up area must be weighed. In addition, the requirement to preserve key facilities, such as civil communications, for future use must be considered. Initially, the FA destroys enemy front line fortifications by massing heavy FA fires, neutralizes enemy artillery and observation by firing programs of targets, provides interdiction by creating obstacles, and covers the maneuver force's advance with smoke and fire.

When the brigade gains a foothold in the built-up area and begins to move through it, the FA moves forward by echelon to positions just outside the built-up area or within its large open areas such as parks. Consideration must be given, however, to the fact that these areas will be targets for enemy counter battery /air. The batteries are positioned away from tall buildings and other masks. The effectiveness of FA during this phase may be limited because of restricted observation, masking, hard enemy cover, and the proximity friendly troops to the enemy. During the attack the maneuver commander at battalion, company, or platoon level may be confronted with hard targets that cannot be neutralized by organic or other supporting weapons. At this time a FA battery may provide one or two howitzer sections, depending on the situation, for direct fire. After the mission the howitzer sections return to the battery. If they do not, ammunition resupply may be a problem, and the field artillery's ability to mass will be decreased. In addition, there is the risk of losing individual howitzers. The supported maneuver units may become isolated and unable to extract heavy equipment and howitzers.

Besides continually neutralizing enemy artillery, rooftops and upper story windows are engaged with HE, fuze VT and Time, as well as smoke, to prevent enemy observation. Harassing and interdiction fires

are used to prevent enemy movement in the streets and to deny rooftop observation, construction improvement, and use of withdrawal routes. During the advance through the built-up areas, FA frequently supports the maneuver elements of high-angle fire. However, because of the proximity of friendly and enemy troops, these fires require careful coordination.

DEFENSE

Initially, FA is located in battery position areas on the outskirts of the built-up area facing the enemy's approach. From these locations the FA engages the enemy at maximum range along avenues of approach. The object of these fires is to disrupt and slow the enemy attack and to separate enemy armor and infantry, thereby enhancing the effectiveness of friendly direct fire weapons.

At the appropriate time, FA displaces rapidly along predetermined primary and alternate routes to positions behind the built-up area. Once positioned, FA supports the fighting that will take place within the built-up area.

FA COMMUNICATIONS

The characteristics of built-up areas require that special consideration be given to the establishment and maintenance of FA fire direction communication nets. The range capabilities of FM radios which depend on line-of-sight may be significantly reduced. Site selection for antennas is critical. The use of relay stations or retransmission devices will frequently be required in order to maintain effective radio communication between FIST teams and fire direction centers. In many cases, forces may have to depend on the use of field wire nets that will be difficult to install and maintain. Because of these difficulties, appropriate supplementary signals, particularly pyrotechnic devices, are used to initiate, stop, or shift planned fires. (See COMMUNICATIONS, page 4-8.)

WEAPONS AND MUNITIONS

The 155 mm self-propelled howitzer offers its crew mobility and limited protection in built-up areas. It is effective because of its rate of fire and the 155mm projectile's ability to penetrate concrete (38 inches). The 8-inch howitzer has a slow rate of fire, but its projectile has excellent penetration capabilities (56 inches of concrete). The crew must work in the open and is vulnerable to all types of enemy fire. The howitzer itself carries only three complete rounds and would have to be augmented with ammunition carried on another vehicle.

Artillery HE ammunition with concrete-piercing fuze provides an excellent means of penetrating reinforced concrete. Chemical rounds may clear a built-up area without destruction or may be used to canalize the enemy into a built-up area. High explosive, fuze quick, achieves excellent results against troops in the open. High explosive, fuze delay, bursts .05 seconds after impact and is good for penetrating light or medium bunkers and fortifications with overhead cover. High explosive, fuze time or variable time, is recommended for keeping OPs off rooftops and for discouraging movement in the open. Shell smoke obscures the enemy's vision, but troops should not move behind a smoke screen without some cover. ICM is effective against troops on rooftops and in the open. White phosphorous will start fires and is effective against materiel.

ENGINEER

During MOUT, divisional engineers may be attached in order to support dispersed maneuver elements (e.g., one engineer company to each committed brigade, one platoon to each battalion task force, and a squad to each company team). The majority of engineer manual labor tasks, however, will have to be completed by units with reinforcing engineer heavy equipment support and technical supervision. Frequently a divisional combat engineer company is reinforced by an engineer company of a corps combat engineer battalion assigned to the division.

Engineers perform the following missions during offensive operations:

Conduct technical reconnaissance to determine the location and type of enemy obstacles and minefields and make breaching recommendations.

Assist and train infantry units in preparation and use of demolitions for breaching structures or other obstacles.

Clear barricades and heavy rubble with earth-moving equipment to assist forward movement.

Destroy fortifications and strong-points that cannot be reduced with the maneuver unit's organic means with fires from the Combat Engineer Vehicles (CEVs) or hand-emplaced demolitions.

Use CEVs to destroy structures or clear rubble from routes of ingress/egress.

Clear minefields.

Priorities for the installation of mines by engineer elements are:

AT mines on armor avenues of approach.

AP mines.

Boobytraps.

NOTE: Authority for use of booby traps rests with division.

Engineers perform the following missions during the defense of a built-up area:

Construction of essential obstacles and provision of technical advice to infantry units in the preparation of other obstacles using local materials where possible, to the front, flanks, and throughout the built-up area. Priority is given to construction of anti armor obstacles on concealed and covered approaches to the defended area. Streets are barricaded to halt tanks at the optimum employment range of antitank weapons, to restrict/stop the movement of tanks and infantry, to separate attacking dismounted infantry from tanks, and to assist in the delay by inflicting casualties on the attacker. AT mines, with anti-handling devices, are employed with AP mines around and within obstacles and are covered with fires to make reduction costly and time-consuming.

Rubbling of buildings.

Preparation and execution of demolition missions as required.

Assist in selection and preparation and maintenance of routes to rearward positions.

Maintenance of counterattack and re-supply routes.

Engineers must also be prepared, when required, to fight as infantry.

SUPPORT

ARMY AVIATION

When using Army Aviation in support of MOUT, consideration is given to the enemy air situation, enemy air defense capabilities, terrain characteristics within and adjacent to the built-up areas, and the availability of Army or Air Force suppression means.

Army Aviation support of operations within built-up areas includes:

- * Aerial fire support (guns, missiles, rockets, grenades, flares);
- * Lift for assault operations;
- * Relocation of combat or combat support units;
- * Re supply operations;
- * Observation;
- * Operation of sensory devices; and
- * Radio retransmissions.

Missions for Army Aviation in support of built-up area offensive operations include:

Air assault operations to secure key terrain adjacent to the built-up area and to secure key objectives within the built-up area when the area is lightly defended or when enemy fires have been suppressed.

Employment of aerial weapons at long ranges to support maneuver units within or adjacent to the area.

Combat service support, command and control, communications, and intelligence operations.

Missions for Army Aviation during defensive operations of a built-up area include:

Employment of anti armor aerial weapons at long ranges on approaches to the city or within the built-up area using terrain flight/pop-up techniques.

Rapid insertion or relocation of personnel (e.g., anti armor teams and reserves).

Rapid concentration of forces and fires to meet unexpected enemy maneuver or movement of forces to rearward positions.

Combat service support, command and control, communications, and intelligence operations.

TACTICAL AIR SUPPORT

During MOUT, tactical air support can provide the ground commander with selective and discriminating fire support. Cluster bomb units, rockets, cannons, laser guided bombs, and electro-optically guided missiles are particularly suited for engaging hard targets.

The employment of tactical air support is dependent upon the following considerations:

The rubble and debris resulting from air attacks may increase the defender's cover while creating significant obstacles to movement of attacking forces.

The proximity of opposing forces will often require the use of precision-guided munitions and/or the temporary retirement of the forces in contact when supported by tactical air. The use of air weapons may be restricted by the presence of civilians or requirements to preserve key facilities within the built-up areas.

Limited ground observation will normally dictate that airborne FACs control strike aircraft in built-up areas if enemy air defense will allow.

The effects of weather will always be a factor. During offensive operations, offensive air support (OAS) is employed:

To support the isolation of the built-up area by interdicting entry and exit routes.

To support attacking units by reducing enemy strongpoints with precision-guided munitions.

To conduct tactical air reconnaissance and provide detailed intelligence of enemy dispositions, equipment, and strengths.

During defensive operations OAS is employed:

To strike attack positions/formations and other concentrations of enemy forces outside the built-up area.

To destroy attacking formations as they approach the built-up area.

To provide precision-guided munitions support of counterattacks against fallen strong points.

AIR DEFENSE

Basic air defense doctrine will not change when operating in special environments such as built-up areas. The fundamental factors of mix, mass, mobility, and integration are applicable to the solution of the air defense problem in built-up areas.

The following factors apply to the employment of air defense units in built-up areas:

The enemy ground force's ability to maneuver is degraded in built-up areas; however, enemy air will continue to operate unimpeded.

Built-up areas are static, easily located, and provide vulnerable targets for enemy high-altitude and tactical fighter-bombers. Additional targets such as principal LOCs, road and rail networks, including river bridges, radiate from built-up areas in today's potential battlefield.

The lack of good firing positions for long-range air defense missile systems in the urban environment may limit the number of deployed weapons. Weapon systems may have to be winched or airlifted into position. Long-range systems can provide air defense cover from positions on or outside of the suburban ring.

Because the built-up environment will decrease line-of-sight capability, the commander must be prepared to change normal positioning requirements and control procedures. When communication relays are not used, line-of-sight is required between ADA elements.

Limited visual and electronic observation and close-in radar masks prevalent within built-up areas degrade the effectiveness of AD fires. Radar operators must, therefore, be trained to operate in extreme electronic clutter conditions.

Radar masking and degraded communications will reduce early warning time for both AD and non-AD units. AD control measures must be adjusted to permit responsive air defense within these reduced warning parameters.

MILITARY POLICE

MP operations in urban areas require continuous liaison and coordination with civilian authorities for the maintenance of law, order, and security.

Urban roads, waterways, and railroad terminals are usually critical choke points in the MSRs that sustain the battle. MPs are responsible for route reconnaissance, selection of alternate routes, convoy escort, and security of these vital LOCs.

MPs also secure critical civil installations (e.g., communication centers, government buildings, water and electrical supply sources, and sewer and subway systems). Employment of unattended ground sensors will assist in this task.

Refugee control, an inherent urban area problem, will be accomplished by MPs in close cooperation with civilian authorities. Also, straggler control operations may be necessary; enemy prisoners of war, detained by maneuver units or at critical installations, will be evacuated under MP escort as soon as possible. see [chapter 5](#) for further details.

CHEMICAL

Although the U.S. has rejected first-use of chemical weapons, friendly forces must understand their potential uses on the urbanized battlefield. Chemical munitions are area coverage weapons that can effectively penetrate strong points, bunkers, and buildings used for defense in built-up areas. Built up areas tend to maintain higher chemical concentrations than the equivalent strikes in open or wooded areas. The employment of chemical agents can neutralize or destroy large numbers of defensive forces without damaging structures and equipment. This is especially critical in a built-up area where the criterion for success is often the capture of a structure or facility intact.

The multiple rocket launchers organic to Threat divisions are ideally suited for employing large concentrations of chemical agents against built-up areas. Threat forces may use chemical agents to neutralize a built-up area so that it can be bypassed. Defending forces must take specific defensive measures to minimize advantages accruing to an attacker using chemical agent.

Chemical support may be required from smoke generator units for both offensive and defensive operations in built-up areas. In the offense, smoke can support the maneuver of combat elements and/or deception operations. Smoke employed in the defense obscures enemy air and ground observation, thereby limiting the accuracy of enemy fires and target intelligence.

Sometimes obscuration using smoke pots, generators, or artillery smoke munitions should be considered to cover the withdrawal of defending forces or the movement of attacking forces. Artillery-delivered white phosphorus also may be effective on enemy forces by causing casualties and fires. Smoke should not be used when it degrades the effectiveness of aimed fires from friendly forces.

The use of smoke in built-up areas is affected by terrain considerations. Buildings cause wind patterns to be extremely complex. When covering a built-up area with a smoke haze or a blanket, it is essential that all buildings be covered. Failure to obscure tall buildings, towers, and steeples will provide enemy observers with reference points for placement of fires within the built-up area.

Maneuver units may also use smoke grenades to provide a hasty screen to conceal movement across streets and alleys or for signaling. M203-launched smoke grenades can be used to mark targets for attack helicopters or tactical air.

When authorized, riot control agents, such as CS and CN, can be used to drive enemy troops from prepared positions or, in the persistent form, to deny areas to enemy occupation. Riot control agents are incapacitating, with no lasting casualty effects. Therefore, they are effective when the avoidance of civilian casualties is a planning consideration. Against an enemy well trained in chemical defense, however, riot control agents will not be overly effective.

NOTE: The incendiary effects of both WP and the base ejection munitions in the litter and debris of the built-up area must be considered.

COMMUNICATIONS

MOUT poses special problems for all communications operations. Built-up areas distort radio wave propagation, and the limited availability of uncongested lines of communication make it difficult to move and install fixed station and multi-channel systems. Communications difficulties are particularly intense within built-up areas.

Frequency modulated (FM) and very high frequency (VHF) radios that serve as the principal medium for command and control will have their effectiveness reduced in built-up areas. The operating frequencies and power output of the sets demand a line-of-sight between antennas. Line-of-sight at street level is not always possible in built-up areas. Amplitude modulated (AM) high frequency (HF) sets are less affected by the line-of-sight problem because operating frequencies are lower and power output is greater. HF radios are not organic to the small units that will conduct the clearing operations. How can this be overcome? Retransmit the FM and VHF signals.

Retransmission stations in aerial platforms could provide the most effective means if they are available. Most likely, organic retransmission sets will have to be used. The antennas should be hidden or blend in with the surroundings so they won't be landmarks for the enemy to home in on. They can be concealed by water towers, existing civilian antennas, and steeples.

Wire can be laid while friendly forces are in static positions, but careful planning is necessary. Existing telephone poles can be used to raise wire lines above the streets. Ditches, culverts, and tunnels can be used to keep the wire below the streets. If these precautions are not taken, tracked and wheeled vehicles will constantly tear lines apart and disrupt communications. Alternate lines must be laid.

Messengers provide security and flexibility; however, once the battle begins, messenger routes must be carefully selected to avoid any pockets of enemy resistance.

Visual signals, such as arm-and-hand signals, take on added importance in this environment. They are excellent for calling for fire, lifting or shifting fire, and for indicating the seizure of buildings. Pyrotechnics, smoke, and marking panels are also excellent means for communicating, but they must be well coordinated and fully understood by air and ground forces. The noise of combat in built up areas makes it difficult to use sound signals effectively.

The seizure or retention of existing communications facilities must be included in planning. Every effort should be made to prevent damage or destruction of these facilities. The local telephone system is already in place and tailored to the city or town. Its use by our forces provides immediate access to wire communications with overhead and buried cable. This helps overcome the problems encountered with

radio and provides a cable system less susceptible to combat damage. Local media, such as newspapers, radio stations, and TV stations, provide communication with the local populace after the level of combat declines. Intact police or taxi communication facilities are also a possibility for a radio system tailored to the city with retransmission facilities already in place.

OTHER COMMUNICATIONS CONSIDERATIONS

Consider a few more steps that should be taken within the built-up area: park radio-equipped vehicles inside buildings for cover and concealment and dismount radio equipment and install it inside buildings (in basements, if available); place generators against buildings or under sheds to increase noise absorption and provide concealment; install wire through buildings which are still intact if they provide a good route; place antennas on roof slopes away from the enemy and knock holes in walls below rooftop level for directional antennas.

CHAPTER 5

Combat Service SUPPORT

The combat service support (CSS) functions of arming, fueling, fixing, and manning weapons and weapon systems do not change during military operations on urbanized terrain. Forward support for the combat forces continues to be the basic concept governing CSS operations. No significant changes in doctrine or organizations are required. However, the characteristics of the urban battlefield and the nature of urban combat may impact on how CSS is provided.

Urbanized regions normally contain a well-developed distribution system designed to provide products and services to even their smallest population centers. Major portions of this network of highways, rail lines, airfields, ports, pipelines, and storage facilities may be available to assist in the movement of personnel, supplies, and equipment to the battle area.

Built-up areas will frequently provide suitable locations for the deployment of CSS organizations. Such areas offer excellent cover and concealment and may contain easily adaptable maintenance, storage, and medical facilities. At the same time, rubble or damaged built-up areas may be obstacles along lines of communication which are vital to the efficient functioning of CSS elements. The close and continuous nature of urban combat may modify specific logistical requirements and capabilities as the dominant role shifts from armor and mechanized formations to infantry supported by other arms.

The presence of large population groups within the battle area, whether under a stay-in-place policy or as refugees, will increase civil affairs support requirements and may demand special security measures. This chapter describes basic considerations applicable to combat service support activities during offensive and defensive operations on urbanized terrain. Emphasis is placed on those operations conducted in and around built-up areas, since it is here that the most significant impact on current CSS procedures and techniques is felt.

SUPPORT ORGANIZATION

The division support area (DSA), occupied by the division support command (DISCOM) and many of the attached corps CSS units, is the hub of CSS activities. As in other environments, the DSA must be located as far forward as possible. Since CSS units will be high-priority targets for the enemy, they should normally be dispersed throughout the numerous small built-up areas in the battle area in order to reduce their vulnerability to detection and attack. This dispersion may complicate command and control, but these disadvantages will normally be outweighed by the increased security, cover, and concealment afforded by built-up areas.

When using built-up areas as support bases, fire protection and physical security become increasingly important considerations. Supplies must be protected both from enemy attack and theft. All classes of supply are subject to pilferage. Rations, fuel, small arms and their ammunition, and medical supplies are the most susceptible items.

Unit trains may also be located in the smaller built-up areas in the forward battle area to take maximum advantage of the cover and concealment.

Field trains will normally be collocated a brigade support area (BSA) along the main supply routes if adequate space is available for dispersion. The size of the combat trains may be increased to provide greater maintenance, ammunition, and medical support capabilities as far forward as possible.

LOGISTICAL FUNCTIONS

During the attack or defense of a built-up area, support elements will normally move supplies and equipment as far forward as possible with increased emphasis placed on unit distribution. Supply requirements will also vary from those encountered during operations in other tactical environments.

SUPPLY CLASSES

Class I (Subsistence)

Increased difficulty may be met in delivering prepared meals to forward elements. Vehicular delivery within the built-up area may be impracticable because of rubble, dispersal of forces in buildings and structures, and the proximity of opposing forces. Where the isolation of units or sub elements is probable, the stockage of an additional day or two of combat rations at platoon or company level or in the combat trains may be required. Water re-supply may also be difficult. Local water sources, if available, must be tested and carefully monitored to detect contamination before internal consumption. There will be an increased requirement, particularly during defensive operations, for portable water containers to allow dispersed stockage at small-unit level.

Class II (Individual Equipment)

Urban operations have little impact on Class II requirements other than those problems relating to delivery to individual level.

Class III (POL)

Increased use of unit distribution and the conduct of sustained dismounted operations in the built-up area will reduce tactical vehicle fuel requirements at maneuver unit level. However, this decrease may be balanced by increased fuel requirements for engineer and power-generating equipment attached to or operating with the forward units. Again, an increased availability of small, portable fuel containers may be required where vehicular delivery is impracticable. The dispersed storage of fuels throughout a built-up area also increases the fire hazard.

Class IV (Construction Materials)

The availability of barrier material to construct counter-mobility obstacles and reinforce the restrictive nature of terrain in built-up areas is particularly critical during defensive operations. Use of local materials to include the selective rubbleing of structures in the defensive area reduces supply requirements and the concurrent demand they place on the transportation system. The requirement to stockpile sand in individual fighting positions as a fire-fighting aid is a priority task that must be accomplished in the preparation of the defense.

Class V (Ammo)

Arming weapon systems for the urban battle requires a detailed consideration of the possible change in roles of each system, the composition of basic loads, forward stockage capabilities, and re-supply procedures.

Attacking a built-up area may result in changes in ammunition required supply rates (RSR). There will be an increase in artillery and mortar ammunition requirements if it is necessary to provide sustained isolating and interdiction fires in addition to preparatory and suppressive fires. There may also be a requirement to change the mix of artillery fuzes in basic loads to insure the availability of time and variable time fuses.

Increased quantities of smoke munitions of all types will be needed at each level to obscure maneuver. Demolition materiel takes on added importance in order to clear obstacles and breach structures along with the use of antipersonnel and antitank mines as part of obstacle preparation. Ammunition requirements for the combat engineer vehicle demolition gun and for tank over watch fires may also increase. Within the built-up area, consumption rates for small arms ammunition, hand grenades, and light antitank weapons increase. Each of these factors may contribute to a requirement to redistribute allocated resources or to establish controlled supply rates (CSR) not normally experienced. Ammunition supply mini points may be required throughout the battle area.

Similar considerations apply to the defense. The defender has a significant advantage in being able to plan and estimate specific ammunition requirements for each portion of his assigned area. Prestocking selected Class V items in defensive positions during preparatory stages can reduce re-supply difficulties anticipated during the battle.

During offensive or defensive operations, throughput shipments of ammunition to battalion field trains should be used whenever possible. Movement of ammunition to unit level may require a combination of vehicle transport and manpack.

Class VI (Personal Items)

Competing priority transportation requirements may limit the availability of personal demand items. The provision of sundry packs with ration resupply should be used whenever possible.

Class VII (End Items)

As in other tactical environments, the requirement for and availability of major end items cannot be easily forecast. Maximum emphasis should be placed on forward repair rather than end item replacement.

Class VIII (Medical)

The isolation of units and intensity of small-unit battles in built-up areas may increase the requirement for medical supplies. Evacuation difficulties may require in-place treatment and increase the demand for first aid items such as dressings, splints, and protective or cleansing ointments.

Class IX (Repair Parts)

Forward repair and maintenance operations may create the requirement to stock high-usage repair parts within unit trains to insure rapid repair of weapon systems and tactical vehicles.

Class X (Nonmilitary)

Support of civil affairs units may require the stockage and distribution of supplies to be provided the local populace.

TRANSPORTATION

Adequate road networks are available throughout the urban battlefield for the movement of supplies, equipment, and personnel forward to division and brigade support areas. It may be necessary to restrict selected roads to military traffic when civil support and refugee control operations compete for available routes. In many cases, railroad systems will also be available for the transportation of heavy or bulky classes of supply such as ammunition. Aviation assets, operating from dispersed civil or military airfields, may provide for the movement of priority lightweight items.

Transportation operations forward of the DSA or BSA may be more complicated. Built-up areas can become significant obstacles to vehicular movement because of rubble and other battle damage. Route maintenance is a priority task for engineer units. Bypassed pockets of resistance and ambushes pose a constant threat along supply routes. Route patrols and observation posts may be required to provide security, but these activities are expensive in terms of manpower. Armed convoys or the substitute of

lightly armored vehicles for trucks may be required for the movement of critical supplies. Resupply by helicopter or US Air Force aircraft should also be considered. The air defense threat and the proximity of opposing forces will normally preclude their routine use in forward areas. Helicopters are ideal for emergency resupply and for the movement of high-priority items to the combat trains. Forward of the combat trains, it may be necessary to break supplies down into small loads to be transported by hand.

MAINTENANCE

Equipment should be repaired as far forward as possible by unit or direct support maintenance company teams. Recovery operations should be limited to the movement of disabled equipment to guarded sites selected along supply routes or to the combat trains. Within built-up areas, rubble may preclude the evacuation of vehicles and heavy equipment. On-the-spot repair may be required. Cannibalization of non-repairable equipment may also be required where end-item re-supply is not possible. These factors increase the importance of diagnostic training for operators and crews in order to insure that the correct parts and maintenance personnel are sent forward.

HEALTH SERVICES

The same restrictions that impact on transportation operations may preclude vehicular or aerial evacuation of casualties within built-up areas. Litter bearers will normally be needed to move wounded to a point where they can be further evacuated by ground or air ambulance. Litter relay teams may be required along lengthy evacuation routes to conserve energy and expedite evacuation. Litter bearers will normally have to be drawn from combat units. These personnel must be trained in techniques for moving casualties to ground level from underground systems or from the upper floors of buildings. The limited availability of medical aidmen, coupled with the physical separation of small-unit elements within built-up areas, may limit the initial treatment of casualties to first aid administered by non-medical personnel or self-treatment measures.

GRAVES REGISTRATION

As with medical treatment, the evacuation of remains from a built-up area is a major problem. During sustained operations, litter bearers may also be required for this task. Once evacuation has been accomplished, standard processing and burial procedures are applicable.

FM 10-63, Handling of Deceased Personnel in Theaters of Operations, contains additional information on graves registration procedures.

NONCOMBATANTS

The presence of a large concentration of civilians confined within a comparatively small area can significantly inhibit tactical operations. The initiation of hostilities may result in mass civilian casualties, disruption of essential life support facilities, and operations.

Refugees attempting to escape over roads may seriously impede or block movement over routes required by the military. Combat service support units will frequently find lines of communication clogged with vehicles and pedestrians. The presence of civilians will often restrict the application of fires. Selected areas may be designated as no-fire areas to prevent civilian casualties. Other areas can be limited to small arms and grenades, with prohibitions on air strikes, artillery, and mortars. Target acquisition and the direction of fire missions will be complicated by the requirement to determine the identity of personnel targets. Flame weapons must be judiciously employed or prohibited in areas that may contain civilians. The presence of local civilians and mass movements of refugees influence the location and type of obstacles that may be employed. Minefields are coordinated with designated refugee routes or guarded until the passage of refugee- is complete. Boobytraps and flame obstacles are not emplaced until the evacuation of civilians is complete. Buildings occupied by civilians or facilities that provide essential life services (e.g., hospitals) are not mined or destroyed.

Increased security and special security considerations are required to preclude:

Civilians from being used as cover by enemy forces or as agents.

Pilferage of supplies and theft of weapons or vehicles.

Sabotage.

Civilians from passing through or lodging in defensive areas.

The limits of authority of commanders at all levels over government officials and the civilian populace must be established and well understood. A commander must be afforded that degree of authority necessary for him to accomplish his mission; however, the host government's concern and responsibility for its populace and territory will affect the commander's latitude in conducting military operations. In secure areas, where the host government can function effectively, the commander's authority in civil-military matters may be very limited. In less secure areas, where the host government may be only partially effective, the commander may be called upon to assume greater responsibility for the safety and well-being of the civilian populace. Operations within highly populated areas may require diversion of men, time, equipment, and supplies for humanitarian reasons. If host government agencies collapse, the drain on military resources could become substantial. The disruption of government-provided civilian health and sanitary services will also sharply increase risks of disease and the possibility of epidemics among civilians and military forces.

If they become panic-stricken, refugees may exceed the host government's ability to control them, thus requiring minor US force augmentation or the commitment of a large force to protect life, property, and to restore order. In addition to peacekeeping, there may be requirements for the forces to secure vital host government facilities.

CIVIL AFFAIRS (CA) OPERATIONS

CA activities include both governmental and operations. Governmental support operations are conducted by the US military to aid and assist allied governments and populations or to establish a military government in occupied enemy territory. Governmental support activities include the advice and assistance provided by selected CA specialists; the extensive involvement of CA and other military units in support of a friendly or allied government and populace; and the exercising of legislative, executive, and judicial authority over occupied enemy territory. Governmental support operations are usually conducted by CA units organized under a single CA command. CA command support includes procuring local goods and services for military use, reducing civilian interference in military operations, and assisting the commander in fulfilling his moral and legal obligation to the local government and civilian populace. Command support is normally provided by the attachment of CA command support units to the supported tactical, administrative, or logistical command.

Both types of CA operations may be conducted in an area at the same time. The presence of CA governmental support units will normally reduce the responsibility that CA command support units and their supported commands have for assisting the host government. Additionally, CA governmental support units will serve as an interface between the host government and CA command support and other military units.

In the event a fully effective civil government is not functioning in a built-up area, combat/combat service support commanders may be temporarily responsible for administering essential civil activities until the civil government is reestablished or until responsibility can be given to CA governmental support units. These activities are normally performed by those civil affairs elements attached to combat/combat service support units. Where friendly and effective local government organizations exist, they are used to assist in civil affairs activities. See FM 41-5, Joint Manual for Civil Affairs, and FM 41-10, Civil Affairs Operations, for further discussion.

REFUGEE CONTROL

The control of refugee movements in combat operations is a Military Police responsibility. Measures for controlling civilian refugees are contained in TC 19-7, Straggler and Refugee Control. The most important principle in refugee control is reliance on the host government forces (military/civilian) wherever possible. Frequently, US forces will be totally committed to fighting and therefore unable to provide such support or will have limited refugee control capabilities.

If the host government is incapable of performing this mission, US forces (combat/combat service support) may be required to conduct any or all of the following refugee control measures (TC 19-7):

Enforcing stand fast orders or prohibiting other unauthorized movements.

Searching and taking custody of enemy agents or other hostile personnel discovered among refugees.

Screening refugees for suspicious activities, such as detection of infiltration by guerrillas, enemy agents, and escaping members of the hostile armed forces.

Performing traffic control on designated refugee routes.

Escorting refugee columns when so directed.

Directing or diverting refugee columns to secondary roads and through areas not utilized by military elements.

Performing police duties, such as traffic control or security, at refugee assembly areas, collecting points, and centers or camps, when directed.

Enforcing prescribed restrictive measures, such as curfews, identification and pass systems, restricted areas, restraining lines, no-passage lines, checkpoints and roadblocks, travel permits or manifests, licensing or registration of vehicles or prohibitions on the use of vehicles, priorities of movement, and limits on personal belongings.

TREATMENT OF CIVILIANS

The standards for the treatment of civilians by US forces are established by laws and regulations. These rules are summarized below:

Provide medical care to sick or wounded civilians, within immediate capabilities.

Do not use coercion in questioning or interrogating civilians.

Treat all captives (military/civilian) humanely.

In all circumstances, civilians are entitled to respect for their persons, their honor, their family rights, their religious convictions and practices, and their manners and customs. They shall at all times be humanely treated and shall be protected against all acts of violence or threats.

PROTECTION OF CIVILIAN PROPERTY

**Cultural and humanitarian property should not be attacked or destroyed. This category includes:
Churches.**

Art, science, or public service buildings.

Historical monuments.

Hospitals.

Schools and orphanages.

These places are considered protected property so long as they are not used by the enemy for military purposes at the time of friendly tactical operations.

When applying firepower in a built-up area, only military targets may be attacked. Mass bombardments (air/artillery) are tactically counter-productive (reduces mobility and provides better cover). They also alienate the population whose support in achieving tactical and strategic objectives is required.

Built-up areas present many opportunities for looting. Soldiers must understand that the taking of "souvenirs" is looting or stealing. As men acquire loot, they discard needed equipment which results in an overall loss of combat efficiency.

No matter how well-trained or well disciplined a unit may be, troops will loot unless precautions are taken in advance and violators are promptly and appropriately punished. Looting detracts from the soldier's alertness, increases his vulnerability and that of his unit, and reduces his initiative and efficiency. Such actions may delay the progress of the attack and alienate the population.

APPENDIX A

Urban Terrain Analysis

This appendix supplements [chapter 1](#) by providing a detailed analysis of the tactical characteristics of built-up areas. It is of specific interest to commanders at levels from platoon through brigade.

Terrain analysis is fundamental to offensive and defensive planning on any battlefield. It provides a basis for organizing forces and for determining how the area of operations impacts on the capabilities of available units and weapons. [Chapter 1](#) provided a general description of the urban battlefield in terms of the size of built-up areas, major type lines of communication, and the urban patterns formed by a complex of built-up areas. The ground maneuver commander requires additional details pertaining to the physical layout of a built-up area and the structural characteristics of its buildings.

PHYSICAL LAYOUT

The physical layout of a village, town, or city generally represents a historical composite of the area's urban development. Within western Europe and other regions colonized by European nations, five basic building and street patterns recur. While small rural villages are fairly homogeneous in nature, most urban areas contain a mix of these basic patterns. Each pattern impacts on maneuver and fire support schemes. For ease in presentation and subsequent reference, they have been identified by form and assigned a letter designation.

Each pattern is evaluated in terms of the following combat characteristics for offensive and defensive operations:

Mobility. The ability to move vehicles and infantry in relation to structures, open spaces, streets, and rubble.

LETTER

FORM DESIGNATION

Random Construction A

Closed-Orderly Block B

Dispersed Residential Area C

High Rise Area D

Industrial/Transportation E

Fields of Fire/Observation. Restriction of fields of fire and observation along streets, across spaces between buildings, and from upper floors of buildings.

Obstacles. Obstacle construction potential in relation to the following:

Time to construct.

Labor requirements.

Materiel requirements.

Obstacle value.

Cover/Concealment. Protection from direct and indirect fires is determined by the composition and strength of each area's structural materials. Concealment depends on the proximity of structures, the potential amount of rubble, and the density of battle haze that can be developed.

Fire Hazard. The potential for fire is determined by type construction and proximity of one building to another. Each area is evaluated for the following fire hazards:

Isolated fires - restricted to a single building or a part of a building.

Area fires - consume from one building up to an entire block. Generally this type of fire is contained by streets.

Fire storms - the most violent and dangerous fire, capable of consuming large areas rapidly, creating wind storms and intense heat. Fire storms are generally uncontrollable.

Explosion hazard - present in areas containing fuel and chemicals.

Command and Control. The built-up area's effect upon:

Coordination of fire and maneuver.

Means of communication.

DENSE, RANDOM CONSTRUCTION (TYPE A)

This type of construction is found in the center of villages, towns, and large cities. Generally, it is the only type construction in small villages of 3,000 or less inhabitants. However, in the larger built-up areas, it is not uncommon to find a number of these areas connected by newer construction.

Dense, random construction is the oldest of the five basic patterns. As shown in chapter 1 (page 1-4), its buildings are located close together along the edges of narrow winding streets.

Tactical Evaluation

The following evaluation applies to both offense and defense:

Mobility. Movement of infantry, although difficult, is not considered to be a significant disadvantage. Infantry can move along streets, through holes in walls, and over roofs. Extensive underground sewers and utility tunnels are frequently found in these areas and are normally large enough to permit transit by individual soldiers. Movement of trucks, APCs, SP artillery, and tanks is considerably restricted by narrow, twisting streets. After rubble, the streets will require extensive clearing to permit vehicular movement.

Fields of Fire/Observation. This is the most restrictive area for fields of fire and observation. Weapon ranges and observation distances seldom extend more than 100 meters along streets that average 7 meters in width. These narrow streets limit tank turret traverse and do not allow for minimum ATGM ranges. Deployment of heavy direct-fire weapons may also be limited by buildings and narrow streets. These short fields of fire and observation distances necessitate assigning small defensive sectors to defending units, thus requiring large numbers of troops to establish a position defense. The principal weapons employed in this area are small arms, grenades, LAWs, Claymores, and mortars.

Obstacles. Narrow streets with buildings constructed directly off the street edge facilitate construction of all types of obstacles. Even a few overturned cars or trucks in a narrow street can create an effective obstacle to armor or other vehicular passage. Demolition of structures will also provide rubble for instant obstacles as shown above.

Type A construction is the most readily adaptable obstacle area of all. With little troop effort, time, and material requirements, these areas can be turned into one large obstacle.

Cover/Concealment. Buildings provide numerous concealed positions for infantry. Armored vehicles can find isolated positions under archways or inside small industrial or commercial structures. Thick masonry, stone, or brick walls offer excellent protection from direct fires.

Overhead protection from indirect fires and plunging small arms fire is poor. Most roofs are constructed of wood or tile materials and most ceilings and floors are wood or plaster--offering little protection.

Adequate overhead protection is normally found in the basements of most of these buildings.

Underground systems provide excellent protection and frequently allow movement between battle positions and sections within the built-up area.

Fire Hazard. There is considerable danger from fires in a fixed defensive system. The roofs of these closely spaced buildings normally are constructed of wooden rafters supported by light shingles. Fire extinguishers, sand, or water must be immediately available to put out even the smallest fire before the entire built-up area is destroyed by a fire storm.

Command/Control. The restrictive arrangement of buildings and streets will normally limit combat actions to a series of squad and platoon battles from one building to another. Coordination between units is difficult because of reduced visibility and the masking of radio communications.

Because of the restrictive terrain, tanks and other direct-fire weapons are difficult to control while in support of infantry forces.

CLOSED-ORDERLY BLOCK

(TYPE B)

Closed-orderly block areas are normally found in the central areas of medium-size towns and large cities. These areas consist of residential and commercial type buildings. Buildings often form continuous fronts for as much as a city block, and each block normally contains an inner court. Streets in this area are normally wider than Type A areas, averaging 26 meters in width and are normally laid out in a rectangular pattern (see chapter 1, page 1-4).

Tactical Evaluation for Defense

Mobility. Infantry attacking this area must move:

Along streets.

Through breached building walls or underground systems.

Over roofs.

Vehicular movement is limited to streets by the substantial buildings. These wide streets, however, may allow high-speed movement of tracked and wheeled vehicles. Large quantities of demolitions are required to create impassable rubble in the streets. These areas, unlike Type A areas, provide sufficient maneuver space for the employment of heavy direct-fire weapons in support of the defense.

Fields of Fire/Observation. Fields of fire and observation ranges extend to approximately 350 meters and are sufficient for heavy direct-fire weapons to support infantry. ATGM minimum ranges are not a disadvantage in most areas. Streets and open areas generally permit mutually supporting fires to be established. Observation of indirect fires will be limited by numerous tall buildings.

Obstacles. Unlike Type A areas, significant labor, time, and material will be required to construct obstacles in streets and around defensive positions (buildings). The well-ordered, usually right-angled street patterns permit the control of obstacles by fires.

Cover/Concealment. The heavy construction found in most walls and ceilings provides excellent protection against direct and high-angle fires. A considerable amount of time, demolitions, and labor will be required to breach walls for firing ports and to construct infantry passageways through walls. Cellars selected for shelters must be evaluated for their ability to withstand the weight of a collapsing building.

In some cases, cellar ceilings will have to be reinforced, requiring additional resources and time. Cellars also provide personnel excellent protection against the initial effects of radiation.

Underground systems are normally extensive in these areas and can provide storage areas, protection, and passageways for infantry. The defender must locate all underground systems and evaluate their contribution to the defensive concept. Those underground systems not used must be blocked or troops must be committed to control them.

As in Type A areas, armored vehicles will have few covered/concealed positions.

Fire Hazard. As in Type A areas, there are great fire hazards. If this type area must be defended, considerable resources must be expended to lessen the dangers of fire and provide fire fighting equipment and materials.

Command/Control. Functions of command and control are improved over Type A areas. The orderly

system of buildings and street patterns normally provides extended weapon ranges. Throughout these areas, mutually supporting fires are usually possible.

Tactical Evaluation for Offense

Mobility. For attacking infantry, the interiors of buildings provide excellent covered and concealed movement routes. However, tremendous amounts of labor and explosives are required to breach a succession of walls and ceilings. Infantry advancing through unfamiliar underground systems require time for careful reconnaissance and planning.

Armored vehicles are restricted to streets. If streets are barricaded or blocked by rubble, mobility is severely restricted until they are cleared.

Fields of Fire/Observation. As in the defense, structures permit mutual support between attacking infantry units. Heavy direct-fire weapons support is restricted to existing streets. In most cases, heavy weapons will have to be positioned well behind advancing infantry units. Flanking fires can normally be accomplished along straight street sections, in parks, and other open spaces.

Observation of indirect fires will be limited by structures and smoke. Excessive use of artillery in this type area will create rubble-further limiting vehicular mobility and reducing heavy direct-fire support. The limitations on fields of fire and visual observation necessitate the assignment of small, narrow attack zones and a high density of troops in each zone.

Obstacles. Street barricades require significant resources and time to reduce. Usually these obstacles will be covered by defensive fires. Bypassing these obstructions is difficult because of the unbroken rows of buildings. Infantry units must clear well beyond the obstacles to neutralize defensive fires, permitting the obstacles to be reduced with earthmoving equipment and/or explosives.

Cover/Concealment. Advancing along streets is an open invitation to disaster and must be avoided whenever possible. Effective cover and concealment are offered by the interiors of buildings.

Armored vehicles, however, are restricted to streets and are exposed targets in most cases. Limited protection can be achieved by using buildings as a mask.

Fire Hazard. Since the attacker is not fixed in position (as in the defense), he can avoid burning structures. The attacker may avoid attacking some areas by starting area fires and forcing the defender to leave his position.

Command/Control. Block-long, multistoried buildings require successive and mutually supporting attacks by squads and platoons, complicating the command and control of supporting direct fires.

Command and control of maneuvering infantry is further complicated by reduction of radio ranges.

Observation and control of indirect fires is degraded by buildings, smoke, and reduced radio ranges.

DISPERSED RESIDENTIAL AREA

(TYPE C)

These areas are normally contiguous to Type B areas and are found on the outer edges of villages or in the suburbs of larger urban areas.

These areas consist of row houses or single dwellings with yards, trees, gardens, and fences. The street pattern is normally rectangular or gently curving. Street widths average 14 meters. However, buildings are normally set back 6-8 meters from the roadway, providing an effective street width approximating 30 meters (see [chapter 1](#)).

Tactical Evaluation for Defense

Mobility. Infantry is generally unrestricted. Underground utility systems are normally too small to be used. Subways, when present, will offer protected and concealed routes between areas and positions.

Numerous routes are available for vehicular movement between buildings and on numerous streets.

Rubble will be the principal hindrance to mobility.

Fields of Fire/Observation. Weapon ranges are often reduced to less than 250 meters by winding streets, but rectangular street patterns will, in many cases, provide extended weapon ranges. Throughout these

areas mutually supported fires are usually possible. Forward observers can direct fires accurately from forward ground-level positions or from tall buildings.

Obstacles. Gaps between houses can be closed with overturned vehicles, wire, mines, cratering charges, or fallen trees. Obstacles in the streets will be of little value since, in most cases, they can be easily bypassed. To establish effective obstacles in this area, considerable time, labor, and materials will be required.

Cover/Concealment. Crew-served weapon positions can be concealed behind hedges, fences, walls, and in houses. Frequently, walls will have to be reinforced for adequate protection against heavy direct fire weapons. When using houses, overhead protection will vary. Positions on the first and second floors will generally require reinforcement with additional overhead protection. Positions in basements usually provide excellent protection from indirect fires and the initial radiation effects from nuclear weapons. There is little danger of being buried by rubble while occupying one or two-story structures. These areas provide frequent opportunities to conceal and protect tanks and APCs inside of or behind buildings. Numerous alternate firing positions may be selected/prepared throughout the area.

Fire Hazard. There is no danger of area fires or fire storms. Isolated fires in a single structure can be contained with fire extinguishers, or forces can shift to an alternate position.

Command/Control. The well-ordered arrangement of this type of development facilitates command at all levels. Despite visibility restrictions, the coordination of all fires is not significantly impeded. Radio transmissions in this area are only slightly degraded.

Tactical Evaluation for Offense

Mobility. Armor and infantry approaches are numerous throughout these areas. Deployment of forces is restricted only where structures are surrounded by high thick walls. Tanks and infantry will have to use fire and maneuver in house-to-house combat. Frequently, smoke and suppressive fires will be required to cross open areas or streets. Rubble will have little effect on mobility.

Fields of Fire/Observation. The defender can prepare fields of fire, the attacker can not. Buildings, hedges, bushes, walls, and other obstructions limit the effectiveness of small arms, ATGMs, and heavy direct support weapons. Observation of in-direct fire is limited until tall structures can be secured. Frequently, tanks and ATGMs will be limited until tall structures can be secured. Also, tanks and ATGMs will be limited to short-range engagements down streets and between houses.

Obstacles. Although bypass is possible, obstacles of all types in streets and between buildings reduce an attacker's mobility. Mines hidden between obstacles present a particular hazard for armored vehicles.

Cover/Concealment. Attacking infantry can find cover once they have penetrated a building. Between buildings infantry must use the cover afforded by walls and fences and the concealment of hedges.

Normally, infantry cannot advance until defensive fires have been suppressed with fires or obscured by smoke.

Armored vehicles gain cover by moving from one building to the next while protected by overwatching fires from other vehicles.

Fire Hazard. The dangers of fire are of little consequence to the attacker; burning structures are simply bypassed.

Command/Control. The building density and resultant terrain restrictions will not seriously affect command and control. Radio coordination of fires is not degraded, but observation is limited until tall structures are secured. Close air and attack helicopter support is possible in areas where observation posts have been established.

HIGH-RISE AREA (TYPE D)

As depicted on page 1-5, Type D areas generally consist of multistoried apartment buildings, separated by large open areas such as parking lots, recreation areas, parks, and individual one-story buildings.

Rarely are there unbroken rows of houses facing the street in this type area. This modern trend is most

frequently found in medium-size and large city residential developments.

Tactical Evaluation for Defense

Mobility. Covered routes of movement for infantry are found only within building complexes.

Underground systems are generally too small for use or are inaccessible. Establishing covered routes requires digging communication trenches between buildings. Rubble will not hamper vehicular or foot mobility because of the wide spaces between buildings. Tanks, APCs, and other vehicles have few restrictions on mobility and can move over wide streets or through numerous open areas.

Fields of Fire/Observation. Small arms and machinegun grazing fire can be employed effectively throughout the area. Mutually supporting fires can be established between buildings. Maximum weapon ranges can be achieved by positioning weapons in upper stories. ATGMs can fire out to significant ranges. Forward observers can effectively control indirect fires.

Obstacles. Construction of obstacles between buildings requires exorbitant amounts of material, time, and labor. However, obstacles can be constructed in the proximity of buildings and throughout the first floor to slow infantry attacks. Mines are effective obstacles in the open areas between buildings.

Cover/Concealment. Within taller buildings, protection is provided from indirect fires, except on the top floors. Positions on these floors must be improved by reinforcing the walls and ceilings. Protection from small arms fire is afforded by building walls. However, these walls will have to be reinforced with sandbags to provide protection against heavy direct-fire weapons.

Armored vehicles will find cover and/or concealment behind buildings or in entranceways to underground garages.

Basements provide excellent protection from all fires, including nuclear.

Fire Hazard. Area fires are precluded by the distance between buildings. Escape routes for rapid withdrawal from buildings must be established and marked.

Command/Control. Excellent observation and radio communications facilitate command and control of forces and fires throughout this area.

Tactical Evaluation for Offense

Mobility. The open spaces between buildings expose an attacker as he attempts to close on objectives (buildings). However, these open spaces do facilitate the forward movement of heavy weapons such as tanks and artillery to support infantry assaults. Defensive fires must be suppressed by all available means prior to movement of infantry or armored vehicles. Infantry and armored vehicles must rapidly cross open areas after defensive gunners have been suppressed by fire or their vision obscured with smoke.

The principle of no movement without covering fires must be observed in this area. For movement inside of buildings, it may be necessary to breach walls and ceilings with explosives.

Fields of Fire/Observation. Fields of fire and observation are excellent. Mutual support between infantry and heavy direct-fire weapons is often possible.

Obstacles. In this area, mines are a particular hazard to the attacker. They will normally be covered by grazing fires and will require skilled coordinated efforts by infantry, tanks, and engineers to advance successfully. The techniques for breaching minefields in this area are the same as those for natural terrain. Great quantities of explosives will be required to breach physical obstacles on lower floors, walls, and ceilings within each building.

Cover/Concealment. Cover and concealment are not available to the attacker until he secures adjacent buildings. Therefore, attacking forces rely on relentless heavy covering fire, continuous smoke, and rapid movement from one objective (building) to the next. If the situation permits, night attacks provide a greater degree of concealment for operations in this area and should be considered to improve chances for success and to reduce casualties.

Fire Hazard. Fires are of no appreciable hindrance to attacking forces.

Command/Control. Command and control functions outside of buildings are not reduced by terrain.

Communication with fire support units and maneuver units is not restricted outside of buildings.

Company-size attacks are possible in these areas.

INDUSTRIAL/TRANSPORTATION

(TYPE E)

The older industrial/transportation areas, located in proximity of the center of medium-size towns and larger cities, retain essentially the same characteristics as Type A and B areas. The newer industrial/transportation areas are generally located on or near the edge of towns and cities. These areas principally consist of low, flat-roofed factory buildings, warehouses, railroads, and supply depots (see chapter 1, page 1-5).

Tactical Evaluation for Defense

Mobility. Infantry routes are available through and between buildings. Frequently, underground routes are available and each must be evaluated for its utility. Armored routes exist over the road network and through large factory buildings. Spacing of buildings reduces rubble restrictions to all movement.

Fields of Fire/Observation. Numerous positions are available inside and outside of buildings. Fields of fire are available to the front and flanks, permitting mutual support between buildings. Quite often, these areas are situated on the city's outskirts, permitting excellent fields of fire over approaches to the built-up area.

Obstacles. Open areas and spaces between buildings will require tremendous resources and time to construct effective infantry obstacles. These gaps can be more effectively closed with mines and covered by fires.

Armored obstacles can be constructed with local materials ((e.g., in a rail yard, railroad cars can be pushed together and overturned to delay tanks and APCs).

Cover/Concealment. Infantry and armor can gain a degree of protection from direct fires by occupying positions within buildings. Little protection from indirect fire is offered by building roofs. Concealment can be gained by positioning crew-served weapons, tanks, and APCs inside of buildings. Open, shed-type transportation facilities offer little protection from enemy observation and fires--avoid them.

Fire Hazard. Stockpiling of fuel and combustible chemicals is common to industrial/transportation areas--avoid them. Isolated fires will be common in this area.

Command/Control. The usually good line-of-sight and predominantly low and widely spaced arrangement of buildings facilitate command/control of fires. Radio communications may be slightly degraded by the masking effect of buildings in these areas.

Tactical Evaluation for Offense

Mobility. The variety of building types provides numerous infantry approaches. In industrial areas, movement will be from building to building. In open transportation facilities, advancing infantry are largely dependent on supporting fire or smoke to cover movement. Streets and vacant areas allow ample maneuver space for armored vehicles.

Fields of Fire/Observation. Excellent fields of fire prevail throughout the entire area for all weapons. Observation over the entire area facilitates the employment of indirect fires and close air support. Smoke obscuration may be significant in fuel storage areas and a detriment to directing accurate fire.

Obstacles. Mines and concealed demolition charges in buildings are serious obstacles encountered in this area. Wide spacing of buildings and other open areas normally permits the attacker to bypass any rubble.

Cover/Concealment. An attacker will be confronted with the same conditions in this area as found in Type D areas. A form of concealment can be achieved by suppressive fires and the skillful employment of smoke as forces cross open areas.

Fire Hazard. Isolated fires can be easily bypassed.

Command/Control. Open spaces, excellent observation, lack of effective obstacles, and excellent communication facilitate command and control of combined arms.

TYPES OF BUILDINGS AND THEIR TACTICAL SIGNIFICANCE

The design and construction of buildings are influenced by climate, available materials, function, and cultural development of the region. This section describes nine types of buildings that are common to central Europe. Because there are numerous hybrid construction methods and the possibility exists of different type buildings being adjacent or sharing a common wall, distinct tactical evaluations for the attack and defense of each type building are not practical. General factors to be considered by the commander in evaluating a building include:

The protective value (cover) afforded by its walls, ceilings/floors, and roofs.

The ease with which it may be demolished by enemy fire or intentionally rubble to provide an obstacle or fighting position.

The availability of internal lines of communication and the effort required to breach exterior walls.

The time, effort, and material required positions in the building.

The potential fire hazard to its defenders.

Type 1. Wood and Timber Frame Construction

Most farm buildings and those buildings constructed prior to the late 19th century are classified as Type 1. Their wooden rafted ceilings and weak exterior walls offer little protection from indirect or direct weapons fire. Internal communication routes are excellent since their lightly constructed walls are easy to breach; however, significant reinforcement is required to provide protective cover if such buildings are to be used as defensive positions. Within larger built-up areas, Type 1 buildings present the greatest fire hazard.

Type 2. Masonry Construction

Buildings with strong walls of brick or natural stone constructed in the 19th and early 20th century are classified as Type 2. These buildings, typified by the old town hall, are commonly found in the central areas of towns and cities. They generally contain from two to four stories with wooden rafted ceilings and lightly constructed tile roofs. Presenting less of a fire hazard than wood and timber frame structures, Type 2 buildings are frequently suitable as defensive positions. While internal communication routes are excellent, external walls are difficult to breach without heavy weapons or demolitions.

Type 3. One- or Two Family Dwellings

Family dwellings constructed of solid or insulating bricks or of cinder blocks with ceilings of reinforced concrete are classified as Type 3. Such buildings frequently contain strongly constructed basements. Type 3 buildings offer significant protection and require little reinforcement if used as defensive positions. Because of their construction, fire hazards are minimal. If demolished, significant rubble offering protection to the defender or creating an obstacle to the attacker is generated.

Type 4. Prefabricated One-Family Dwellings

Prefabricated family dwellings assembled with pre-cast and light building materials are classified as Type 4. In most cases, only the cellars or basements are strongly constructed. Unlike Type 3 dwellings, these buildings require significant reinforcement if they are to be used as defensive positions. They also constitute a fire hazard in a fixed defense. Rubble produced by their destruction creates an effective

obstacle and additional cover for ground-level defensive positions.

Type 5. Office Building

Building Types 5 through 8 are comprised of multistory office and apartment buildings. For the purpose of classification and subsequent evaluation, each category is divided into those buildings of six stories or less and high-rise structures in excess of six stories. Multistoried office buildings, with their steel frame and reinforced concrete construction, are normally characterized by large expanses of plate glass which offer little protection.

Apartment buildings, while similar in size, generally have smaller glass areas and loadbearing reinforced concrete exterior walls which provide greater protection.

Type 6. High Rise Office Building

Type 7. Apartment Building

Type 8. High Rise Apartment Building

Type 9. industrial/Warehouse Buildings

Buildings common to newer industrial and warehouse complexes are classified as Type 9. While the type construction may vary considerably, steel framing and the use of lightweight materials for exterior walls and roofs are normal practices. Reinforced concrete floors/ceilings are frequently used in multistory buildings.

APPENDIX B

Weapons Effects And Employment

This appendix supplements organizational How-to-Fight manuals by providing data and considerations pertaining to the employment and effectiveness of ground maneuver unit organic weapons on the urban battlefield.

Major US Army weapon systems are currently being tested to determine effects (penetration/breaching) upon various types of construction materials. Test results and employment considerations will be incorporated in this appendix when available.

The characteristics of built-up areas and the nature of urban warfare impact on both the effectiveness of our weapons and how they may be employed. The following basic factors, acting in various combinations, must be considered by commanders during offensive or defensive operations.

Relative locations of the firer and the target. Both the firer and the target may be inside or outside buildings. Either one may be inside a building while the other is outside. In addition, both the firer and the target may be inside the same or separate building.

Structural configuration of buildings. The basic classes of structures encountered in built-up areas can generally be classified as concrete, masonry, or wooden. However, any one structure may include a combination of these materials. All buildings offer concealment even though the degree of protection (cover) varies with the material used. In some cases, the structure itself may have to be targeted before personnel in it can be attacked.

Firing ranges and angles. Engagement ranges may vary from point-blank to the maximum effective range of a weapon. Minimum arming ranges and troop safety from back blast or fragmentation effects must be considered. Depression and elevation limits for selected weapons may create dead space. Target engagement from oblique angles, either vertical or horizontal, demands increased marksmanship skills.

Visibility limitations. Added to weather conditions that limit visibility are the urban factors of target masking and increased dead space caused by buildings or rubble. Obscuration from smoke and dust, concealment offered by shaded areas, rubble, and manmade structures influence visibility.

THE M16A1 RIFLE

During the urban battle, the M16A1 is suitable for the engagement of targets in the open or those behind the light cover of doors, shutters, ceilings, and wooden or plaster walls. Its automatic capability makes it an excellent assault rifle for clearing buildings and close-quarter combat.

The penetrating power of its 5.56mm round against other material targets is limited as illustrated in the following figure.

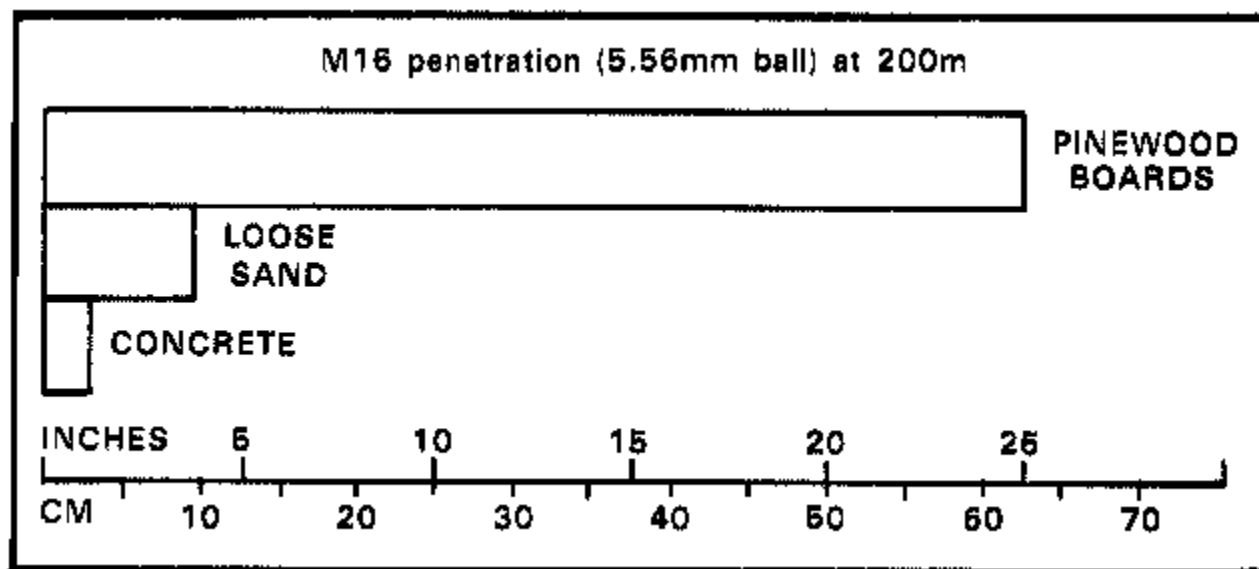

Figure B-2. M16 Penetration (5.56mm Ball) at 200m

Although close combat is a dominant characteristic of urban combat, the ability to kill small fleeting targets located in windows, loopholes, or bunker apertures is required. The M16A1 rifle in the semiautomatic mode provides the accuracy required for this task. To take maximum advantage of the cover offered by manmade features, particularly while advancing through built-up areas, riflemen must be trained to fire from either the right or left shoulder and to engage small targets from oblique angles at and above street level.

When fighting inside buildings, the automatic fire mode and quick fire technique (see FM 23-9, M16A1 Rifle and Rifle Marksmanship) should be used. A series of 3-round bursts provides effective suppression and a more efficient use of ammunition than one long burst. Quick fire is the most effective engagement technique at close quarters.

CAUTION: Remember the M16 round will penetrate wood and plaster. Make sure that no friendly troops are on the other side of interior walls.

Within built-up areas, reduced ambient light and strong shadow patterns of varying density limit the effectiveness of night vision and sighting devices. The use of aiming stakes in the defense and of the pointing technique in the offense, both using 3-round bursts, are night firing skills required of all urban fighters.

Because of the reduced engagement ranges common to the urban battlefield, the M16A1 can also be used as a highly efficient sniper weapon. In this environment, the sniper is both a casualty producer and an intimidating psychological weapon. In addition to covering obstacles, dead space, and gaps in planned fires, the sniper should be assigned target engagement priorities. The following priority is recommended:

- Tank commanders.
- Direct fire support weapons crewmen.
- BMP commanders.
- Crew-served weapons personnel.
- Officers.
- Forward observers.
- Other personnel.

In the urban environment as elsewhere, the Browning caliber .50 machinegun and the 7.62mm M60 machinegun provide high volume, long-range, automatic fires for the suppression or destruction of targets. Structural material penetration capabilities for each weapon are summarized in the following tables.

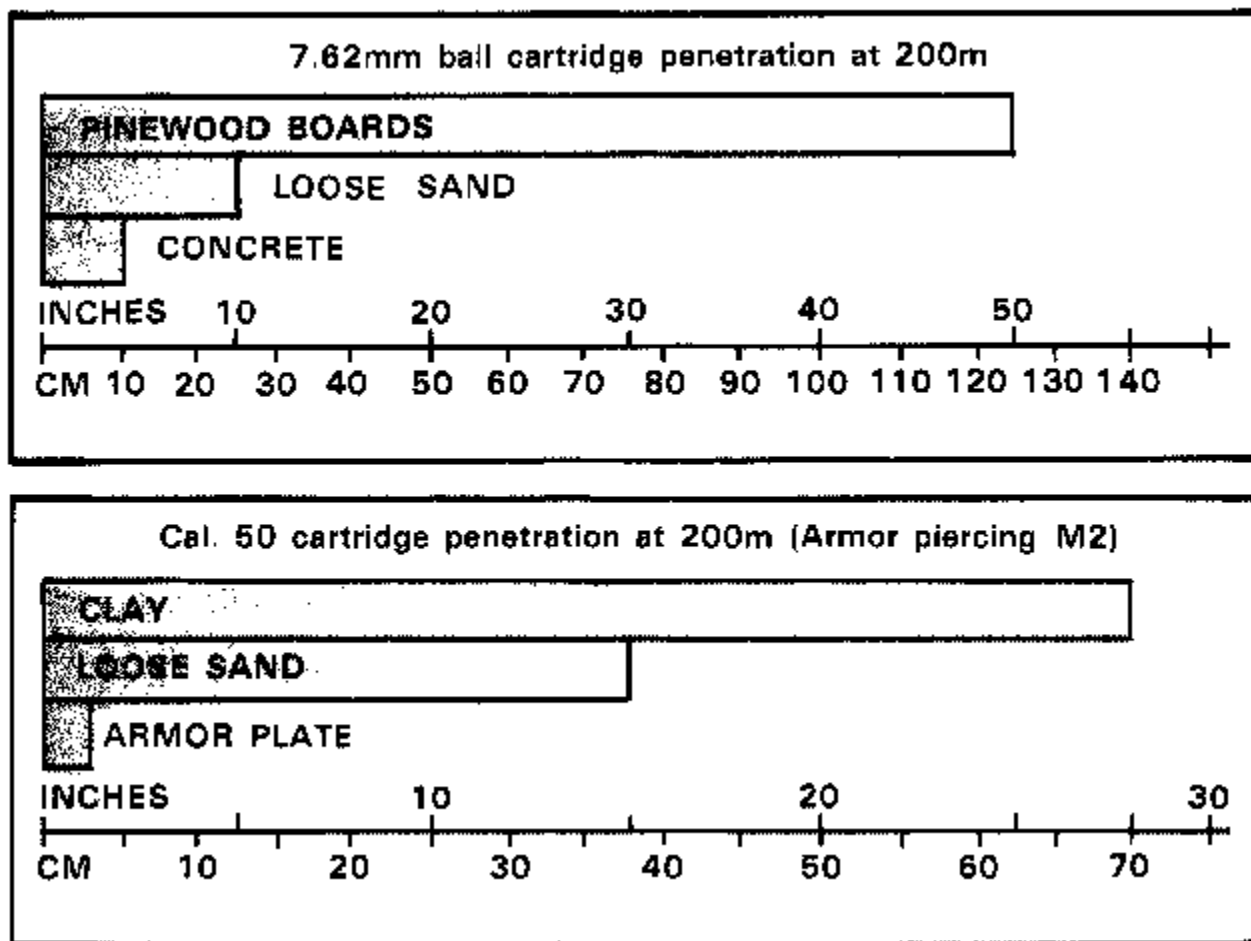

Figure B-3. Machinegun

The primary consideration impacting on the employment of machineguns within built-up areas is the limited availability of long-range fields of fire. Although machineguns should be emplaced at the lowest level possible, grazing fire at ground level -is frequently obstructed by rubble.

The .50 caliber machinegun will normally be employed in its vehicular mount during both offensive and defensive operations. If necessary, it can be mounted on the M3 tripod mount for use in the ground role or in the upper level of buildings. When mounted on a tripod, the .50 caliber machinegun can be used as an accurate, long-range sniper weapon and can supplement M16 sniper fires.

During room-to-room combat, the M60 machinegun can be fired from either the shoulder or the hip to provide a high volume of assault and suppressive fires. The use of the long sling to support the weapon and ammunition is preferred.

Because of their reduced range and penetrating power, M60 machineguns are less effective than caliber .50 machineguns. However, their greater availability and light weight make them well suited to augment heavy machinegun fire, or to be used in areas where caliber .50 machineguns cannot be positioned, or as

a substitute when heavy machineguns are not available.

M203 DUAL PURPOSE WEAPON (DPW)

The DPW, which consists of the M16A1 rifle and an attached 40mm grenade launcher, provides a means for suppressing or neutralizing targets that are located in dead space or defilade and for projecting a variety of grenades to extended ranges.

Its special capabilities are a function of the type grenade used.

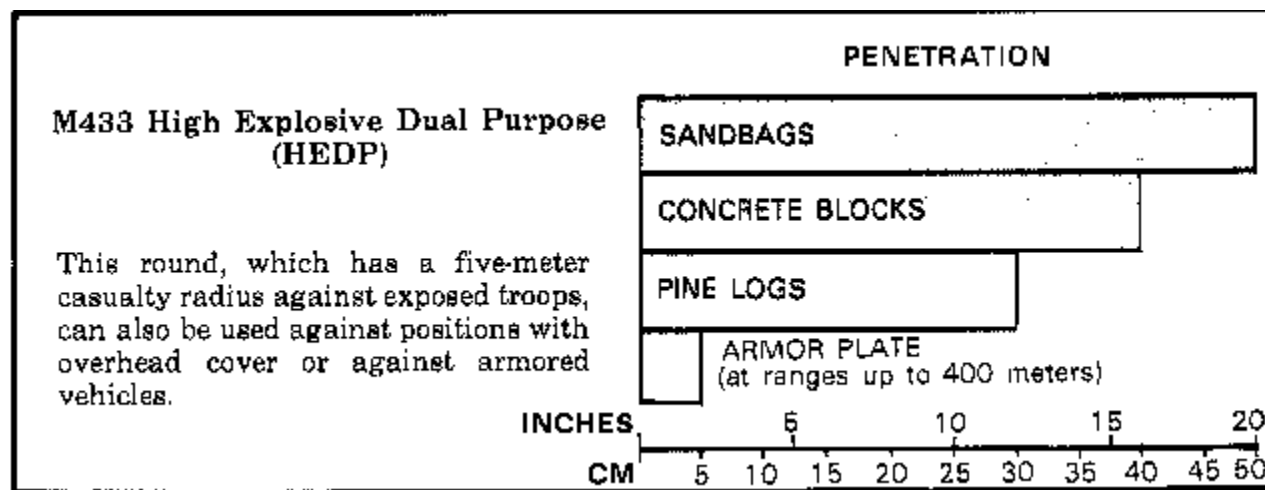

Figure B-4. M433 High Explosive Dual Purpose (HEDP)

M651E1 Tactical CS

Effective in driving the enemy from bunkers, buildings, subways, or sewers using a tactical agent (CS), the round has some incendiary characteristics. It could be a fire hazard when used in buildings.

M583 White Star Parachute

Is an effective signal and a battlefield illuminant that can be placed 300 meters forward of the squad position to illuminate an area 200 meters in diameter for a period of 40 seconds.

XM585 Star Clusters

Are red, white, and green; used for signaling. CAUTION - The green star cluster may appear white in bright sunlight.

XM635 Ground Smoke

Is used for spotting locations; not used for screening. Available in red, yellow, and green.

Significant characteristics of the M203, 40-mm Grenade Launcher, are:

Range at which a .5 probability of target hit can be expected:

Area Target (fire team size) 350m

Point Target-Window 125m

Bunker Aperture 50m

Vehicles/Emplacements 200m

Maximum Range 400m

Minimum Safe Firing Range Combat 31m

Minimum Arming Range 14-28m*

*This must be considered in close-in firing to insure that round will explode.

Within a built-up area, the M203 DPW provides the commander a highly accurate means of attacking point targets and defensive positions with a variety of munitions and the minimum exposure of his

grenadiers. It can also be used to suppress heavy weapons and antitank gunners and to disable enemy armored vehicles when other antitank weapons are not available. In addition, since there is no back blast, the launcher can be fired from enclosed areas without taking special safety precautions.

HANDGRENADES

A variety of hand grenades are available to the urban fighter.

M67 Fragmentation

Used chiefly to help clear rooms, they are thrown through windows or doors prior to entry. Used with the M213 time fuze, the grenade should be "cooked off" for two seconds to deny the enemy time to throw it back.

M34 WP Smoke Hand grenade

M34 WP Smoke Hand grenade These grenades are most often used to destroy flammable objects, to drive the enemy from wooden structures, or to create smoke screens to conceal movement.

CAUTION: The M34 has a 35m bursting radius.

ABC M/A3 CS Riot Control Grenade

These may be used to drive enemy troops out of fortifications when civilian casualties or collateral damage constraints are considerations.

AN-M8HC White Smoke and M18 Colored Smoke Grenades

These grenades may be used to screen squad or individual movement; to supplement screening provided by artillery, mortars, or smoke pots; and to mark locations or provide visual signals.

FLAME WEAPONS

M2 Flame thrower and M202A1

Multi shot Rocket Launcher (FLASH)

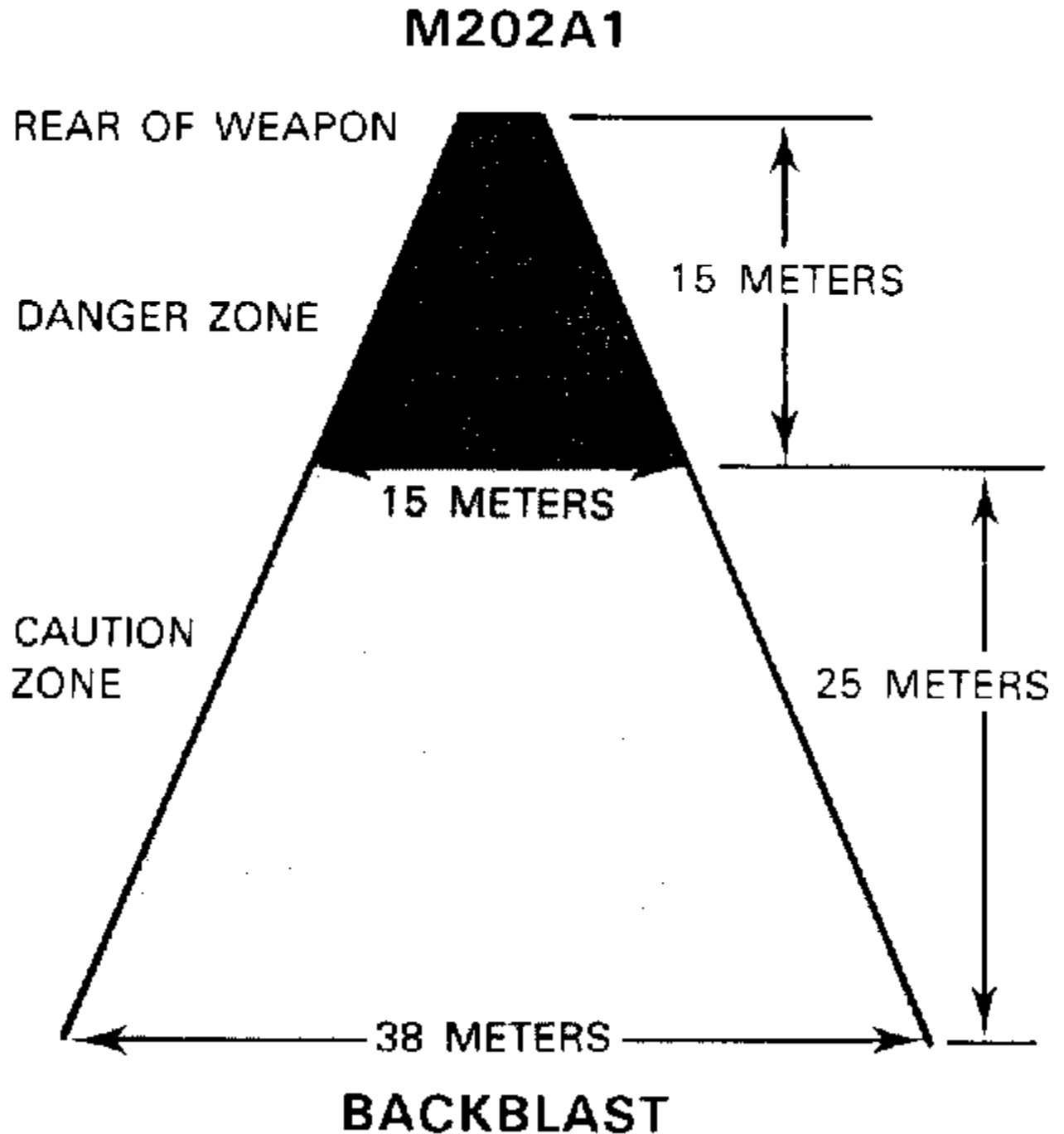

Figure 4-5. M202A1

Flame weapons are characterized by both a physical and a psychological casualty-producing capability. Flame need not be fired with pinpoint accuracy and can be controlled in order to limit collateral damage. The .M2 flame thrower has a short effective range (20 to 50 meters), but requires no special back blast preparation. The M202 flash can be used at greater ranges (20 to 200 meters for point targets, 20 to 500 meters for area targets), but has a back blast which must be considered.

Flame weapons are employed to:

Destroy enemy personnel in buildings or in open areas.

Suppress RPG-Sappers and other weapons.

Force armor crews to "button up."

NOTE: When fired from inside of rooms, the LAW safety requirements apply (see antitank weapon section)

Significant characteristics of the M202A1 are:

Area Target (fire team size) 500m

Point Target 200m

Stationary Vehicle or 200m

Uncovered Position Bunker

Aperture 200m

Bunker Aperture 50m

Ranges at which a .5 probability of target hit can be expected:

Minimum Arming Range 6-13m

Bursting Radius of Rocket Warhead 20m

Flame weapons used against fortified positions should be aimed directly at the aperture. Even if the round or burst misses, enough of the flaming material will enter the position to cause casualties. Against troops behind a barricade, the M2 flame thrower can be fired in a traversing burst to cover a wide frontage. Blind angle burst may be fired without exposing the gunner and exploit the splattering effect of the thickened fuel.

Bursts of fuel fired without ignition (wet shots) can be fired with the M2 to be ignited with a subsequent shot to create an intense fireball. This technique is effective in destroying captured equipment or in killing enemy soldiers in sewers and basements. If the enemy has established a position in a wooden building, the building can be burned down. Flame is also effective when fired on the back deck of tanks or at their vision blocks.

Thickened fuel is difficult to extinguish, and therefore a commander must ascertain what will burn before he employs flame. Limits imposed on collateral damage, either political or tactical, will be the most serious constraint to use of flame. Commanders must also insure that soldiers using flame weapons are provided adequate security.

ANTITANK WEAPONS: TOW, DRAGON, LAW, and 90mm RCLR

Antitank weapons may perform a dual-purpose role in urban combat. While they are designed and employed primarily to defeat enemy armor, they may also be used when required to attack structures or fortified targets.

Antitank Role

The general employment considerations for antitank weapons contained in organizational How-to-Fight manuals are applicable to offensive and defensive operations or urbanized terrain. Within built-up areas, special attention must be given to restrictions on fields of fire and mobility.

TOWs and DRAGONs provide over watch antitank fires during the attack of a built-up area and an extended-range capability for the engagement of armor during the defense. Within built-up areas, they are best employed from the upper stories of buildings in order to attain long-range fields of fire. Their minimum firing range of 65 meters may limit firing opportunities in the confines of densely built-up areas. When fired from street level, rubble or other obstacles may interfere with missile flight. At least 3.5 feet (1.1 meters) of vertical clearance over such obstacles must be maintained.

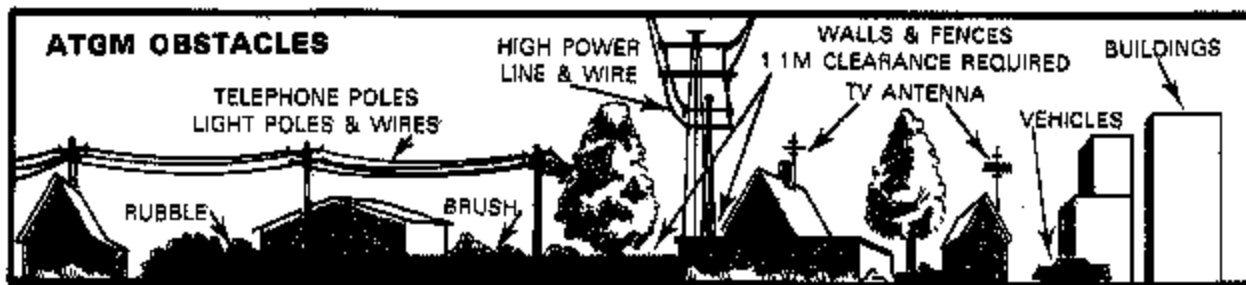

Figure B-6. ATGM OBSTACLES

The maximum depression and elevation limits of the TOW mount may also result in dead space and preclude the engagements of close-in targets.

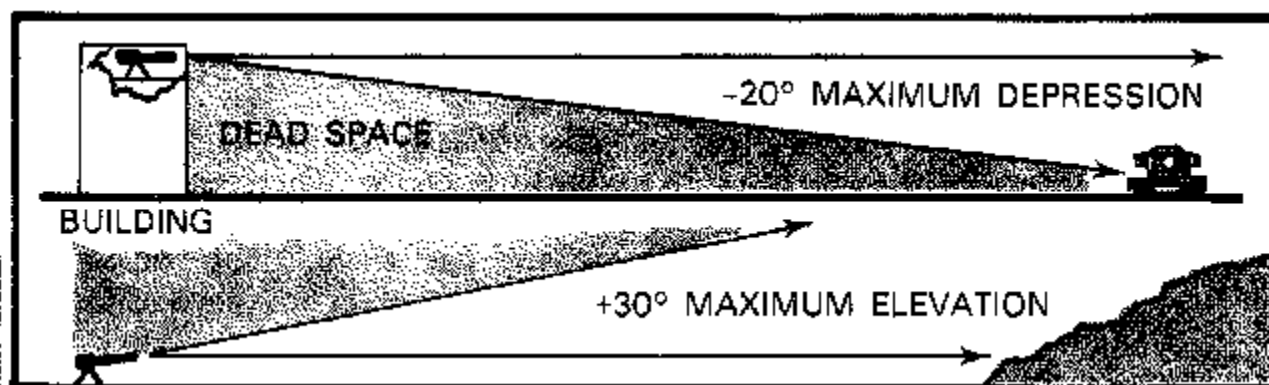

Figure B-7a Maximum Depression and Elevation Limits

The DRAGON is lightweight and easily moved or shifted from one position to another within the same building or between buildings. When deciding whether to dismount TOWs, the commander must weigh the advantage of gaining longer range fires against the disadvantage of losing mobility. While the TOW is man portable, considerable effort and time will be required to move the launcher and missiles from position to position. In many cases, the best technique may be to reallocate TOWs to task forces operating on the periphery of the built-up area, rather than to those within it.

LAWs, DRAGONs and 90mm RCLRs, because of their light weight and mobility, can attain effective short-range shots by firing from the upper stories of buildings or from flanking positions. These engagements are targeted against the more vulnerable parts of the tank and catch the tank in a situation where it cannot counter fire.

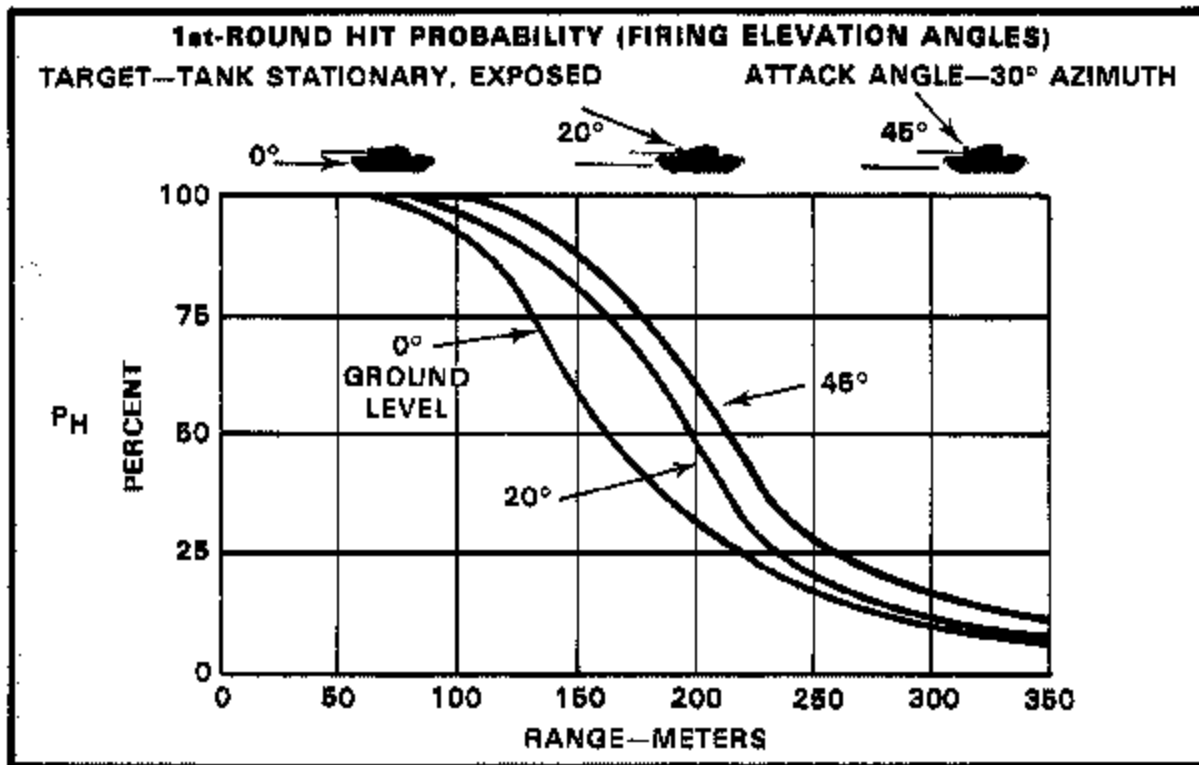

Figure B-7b 1st-Round Hit Probability.

Elevated firing positions also increase the first-round hit probability as shown. Firing down at a tank from an angle of 20 degrees increases the chance of a hit by 2/3 at 200 meters. A 45-degree angle doubles the first-round probability of a hit when compared to a ground level shot. Since the LAW warhead is less lethal than those of the other antitank weapons, multiple hits are necessary. LAWs should be used in volleys, pairs, or sequences.

Back blast. Back blast is an important limiting factor when employing antitank weapons in the restrictive terrain of the urban battlefield. The following tables outline back blast data for antitank weapons fired in the open.

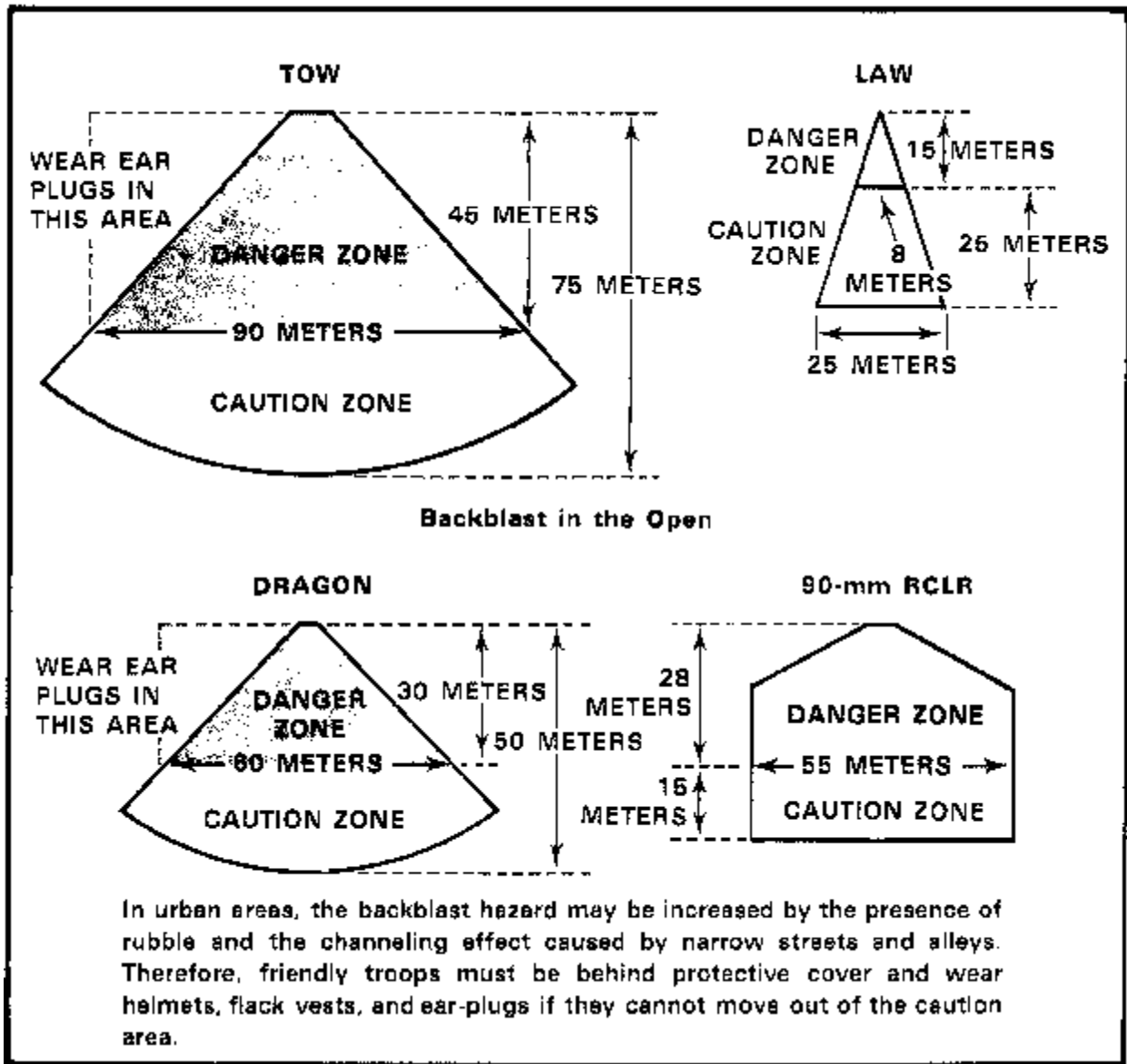

Figure B-8. Back blast Hazard

Firing from Enclosed Areas. None of the antitank weapons described here can be fired from an unvented or completely enclosed room. To be fired from inside a building, the following conditions must be met. The enclosure must be of sturdy construction with a ceiling at least 7 feet (2.1 meters) high.

Minimum floor sizes by weapon and type construction are as shown below:

WEAPON	FRAME	MASONRY
TOW	6 x 10	6 x 6
DRAGON	4.5 x 5	3 x 6
90mm RCLR	4.5 x 5	3 X 6
LAW	2 x 3.5 Min 1.3 to back Wall	

In all cases there must be 20 square feet (2 square meters) of ventilation to the rear of the weapons. An open door will normally provide adequate ventilation.

All small loose objects and window/door glass must be removed from the firing area.

Combustible material must be removed from behind the weapon. Curtains and overstuffed furniture out of the blast area should be left in place to help absorb sound.

For ATGMs, the following vertical clearances between the bottom of the launch tube and the firing aperture are required.

WEAPON VERTICAL CLEARANCE

TOW 6 in/15 cm

DRAGON 9 in/23 cm

Everyone in the room must be forward of the rear of the weapon and must wear helmets and earplugs.

Anti-structure Role

The most important tasks to be performed against structures are the neutralization of fortified firing positions and personnel/weapon systems behind barriers. Antitank weapons can be used in this role; none, however, is as effective as heavy direct-fire weapons (tank/artillery) or standard demolitions. The following table summarizes in general terms the penetration capability of antitank weapons against various structural materials common to built-up areas.

DEPTH OF PENETRATION (FEET/METERS)

WEAPON	EARTH	REINFORCED	STEEL
CONCRETE			
TOW	8/2.6	4/1.3	1.33/.4
DRAGON	9/2.6	4/1.3	1/.3
LAW	6/1.9	2/.6	.67/.2
90mm HEAT	3.5/1.1	2.5/.8	.83/.3

NOTE: Penetration does not necessarily imply a concurrent destruction of the structural integrity of a position. Testing is being conducted to develop effects data for deployed weapons and those under development.

Against sandbagged emplacements, antitank weapons should be aimed at the center of the firing aperture. Even if the round does not go through the aperture, the bunker's walls are usually easiest to penetrate at the apertures.

Against structures, antitank weapons should be aimed about 6 inches below or to the side of a firing aperture. This will increase the spilling effect and thereby enhance the probability of killing soldiers behind the wall.

Wall breaching is another urban combat task for which antitank weapons may be used. Breaching operations are designed to improve mobility by providing access to building interiors without using existing doors or windows. Breaching techniques may also be used to create loopholes for weapon positions or to allow hand grenades to be thrown into defended structures. As a guideline, breach holes for troop mobility should approximate 24 inches (60cm) in diameter. Loopholes should be approximately 6 inches (20cm) in diameter.

None of the antitank weapons organic to maneuver battalions will provide a one-shot wall-breaching capability. To breach walls, a number of shots should be planned.

The use of antitank guided missiles (ATGMs) to breach or destroy structural targets or fortifications, although possible, is inefficient because of the high cost and limited availability of missiles. These weapons should be reserved for use against armored vehicles.

Although the penetration data for the LAW appears promising, it is not an effective breaching weapon. Test data indicates that it cannot, even with multiple shots, create a man-size breach hole.

Wall breaching is much more efficiently accomplished by heavy direct-fire weapons or demolitions (see [appendix E, Demolitions](#)).

MORTARS

Terrain masking by buildings on the urban battlefield is an important fire support consideration. While all fires are masked to some degree, mortars are the least affected of all because of their high-angle trajectory.

Mortars are most often the main indirect-fire support for forward teams in built-up areas. The requirements for indirect fires close to forward elements often preclude the use of supporting artillery because of the obstruction of tall buildings. Normally, mortars are employed in general support and emplaced within or near an occupied position of the task force reserve. Mortar positions with adequate mask clearance may be limited within built-up areas. Also, difficulty may be encountered in finding positions which provide suitable hard stand. Occasionally, when the depth of the task force defensive area is quite shallow or when suitable firing positions are not available within the task force area, mortars may be positioned behind the reserve.

If there is nothing but concrete in the mortar platoon's area, mortars can be fired using sandbags as a buffer under the base plates and curbs as anchors or braces. Aiming posts can be placed in dirt-filled cans or supported by sandbags. The minimum range for 900 meters of the 107-mm mortar will also be an important positioning constraint.

In planning target concentrations, priorities are given to streets and other open areas as well as to areas containing lightly constructed buildings. Because of the excellent cover normally afforded defending troops in a built-up area, air burst concentrations may be planned much closer to friendly positions than in other situations. Incendiary fires are planned in detail and are most effective against enemy forces in Type A and B areas.

Extensive use of mortar illuminating fires can be planned for the hours of darkness. However, the masking effect of buildings also impacts on the use of illumination. It will often be necessary to plan illumination so that friendly positions are in shadows and enemy positions are lighted.

APPENDIX C

How To Select And Prepare Defensive Positions In Built-up Areas

This appendix provides "how to" guidance for the:
Selection of defensive positions in built-up areas.
Preparation of buildings as defensive positions.
Selection of defensive positions for armored vehicles.

POSITION SELECTION

Analysis of the type of area in which the building is located and the individual characteristics of the building is basic to selecting a building as a defensive position (appendix A). As a minimum, leaders consider the following factors to determine a building's suitability for defense:

- Cover.
- Fields of Fire.
- Covered Routes.
- Concealment.
- Dispersion.
- Fire Hazard.
- Observation.
- Preparation Time.

Cover

Select buildings that provide protection from direct and indirect fires. Reinforced concrete buildings with three or more floors provide suitable protection. Buildings constructed of brick, block, or other light material must be reinforced for sufficient protection. One- or two-story buildings without a strongly constructed cellar are vulnerable to indirect fires and will require construction of overhead protection for each firing position. (See appendix A for comparative building protection.)

Covered Routes

Defensive positions should have at least one covered route that permits re-supply, medical evacuation, and reinforcement or withdrawal from the building. This route may be established:

- Through walls of adjacent buildings.
- Through an underground system.
- Through communication trenches.
- Behind protective buildings.

Dispersion

Avoid establishing a position in a single building when it is possible to occupy two or more buildings that will permit mutually supporting fires. A position in one building, without mutual support, is vulnerable to bypass, isolation, and eventual destruction by assaults from any direction.

Observation

The building should be of sufficient height to permit observation of adjacent defensive sectors.

Fields of Fire

To prevent isolation, positions should be mutually supporting and capable of firing in all directions. Clearing fields of fire may require destroying adjacent buildings with explosives and bulldozers.

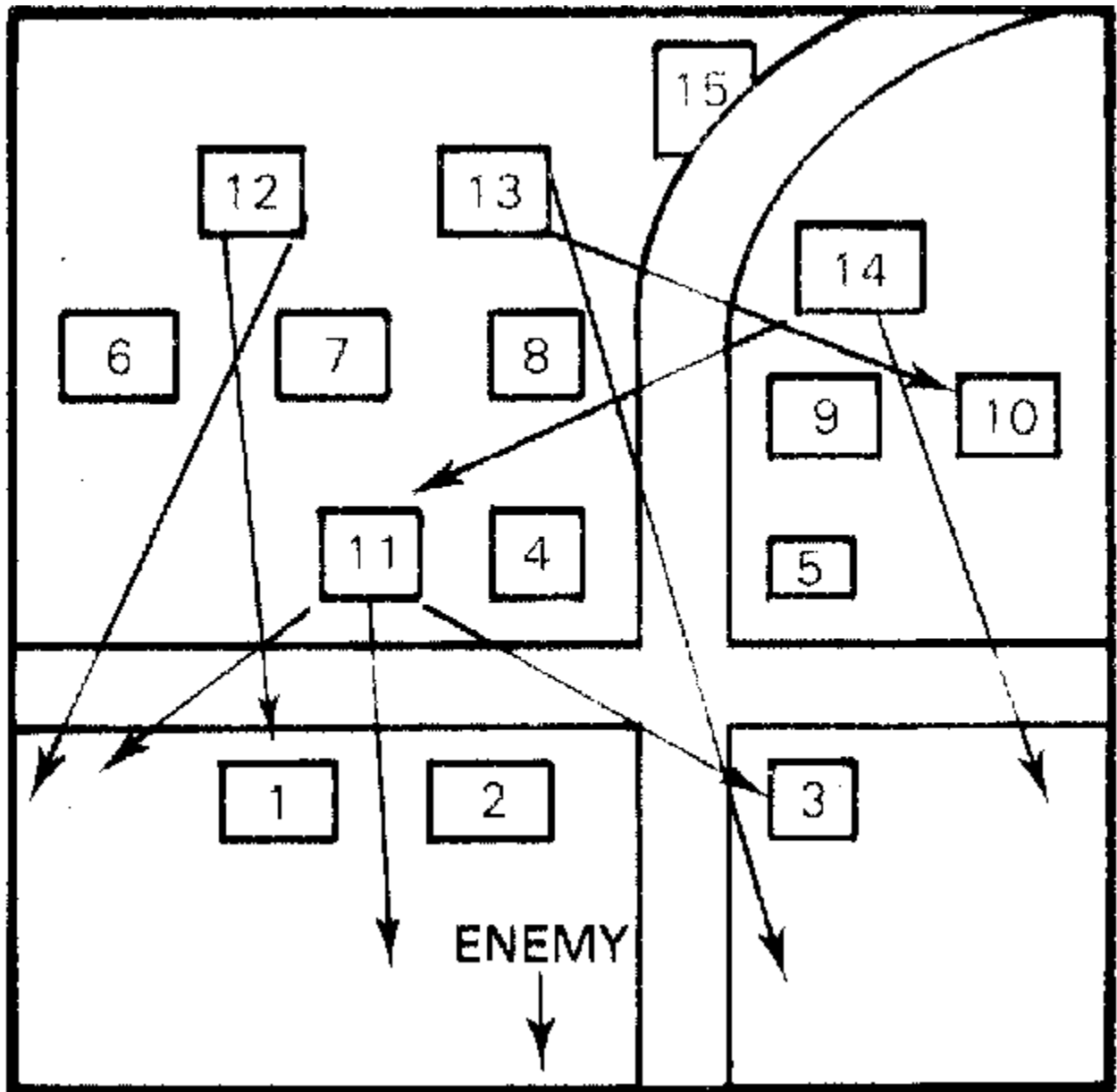

Figure C-2. Fields of Fire

Concealment

Avoid selecting buildings that are obvious defensive positions. For example, in the preceding figure, buildings 1, 2, and 3 are not selected because they are located on the village edge and will probably be targets of direct fire weapons. Buildings 4 and 5 are not selected because of their exposed corner locations. Buildings 6 through 10 are not selected because of their exposed location along the edge of an open area. Each of these buildings may be subjected to long-range direct fires. Buildings 11 through 15 are concealed by other buildings and should provide protection against direct fires and offer the best

position for engaging advancing enemy with surprise fires. In certain situations, requirements for security and fields of fire will require the occupation of exposed buildings. In such cases, additional reinforcing construction is necessary to provide suitable protection.

Fire Hazard

Avoid older, Type 1 buildings (appendix A) found in Areas A and B. This type of building represents the greatest fire hazard in built-up areas. If these structures must be occupied, extensive efforts are required to reduce the dangers of fire.

Time

Time to prepare the defense may be the most critical factor in selection of building positions. Buildings that require extensive reinforcement with sandbags, time consuming fire prevention measures, fields of fire clearance, and other manual labor requirements should be avoided. Conversely, buildings located in desirable areas that require minimal construction and improvement will probably become the main center of defense.

PREPARATION OF BUILDINGS

Each weapon is assigned a primary sector of fire to cover enemy approaches to the position. Alternate positions that over watch the primary sector are also selected. Building characteristics permitting, alternate positions are selected in an adjacent room on the same floor. Where possible, several alternate positions for each weapon are selected. Each weapon is assigned a supplementary position to engage attacks from any direction. Each weapon is assigned a Final Protective Line (FPL).

PREPARATION OF WEAPON POSITIONS

To avoid establishing a pattern of always firing from windows, loopholes are prepared in the wall.

Loopholes

Several loopholes are generally required for each weapon (primary, alternate, and supplementary position), but the number of loopholes should be kept to a minimum because they may weaken walls and reduce protection. Loopholes are made by punching or drilling holes in walls. Blasting loopholes, unless done by experts, generally results in an exaggerated hole that can easily be seen by the enemy. The figure below illustrates where loopholes may be placed. The general rule to follow in preparing loopholes is to place them where they are concealed and where they are unexpected.

Loopholes are cone-shaped to enable engagement of targets above and below the firer's position and to reduce the size of the exterior aperture. The edges of a loophole,

Loophole Location

In missing or removed roof tile.

In wall.

Between boards in window shutters.

In chimneys.

Concealed under eaves.

Behind vines.

Behind bushes.

In dark areas of sign.

In bottom of doors.

In mail drops or concealed by name plates.

especially in brick walls, splinter when hit by bullets. Where possible, protective linings, such as an

empty sandbag held in place by wire mesh, will reduce splintering effects. When not in use, loopholes are covered with sandbags to prevent the enemy from firing into or observing through them.

Loopholes are also prepared in interior walls and ceilings of the building to enable fighting within the position when necessary. Interior loopholes should over watch stairs, halls, and unoccupied rooms. Interior loopholes are concealed by pictures, drapes, or light furniture. Loopholes in floors permit the defender to engage enemy personnel on lower floors with small arms and/or to drop grenades. These holes must be covered when not in use.

Protection

Although walls provide frontal protection, they should be reinforced with sandbags or furniture filled with dirt. Each position should have complete overhead and perimeter protection. Protection is increased by proper firing through loopholes. Avoid firing directly through a loophole. Use the wall as protection and fire at an angle.

The following figures portray types of weapon positions in buildings.

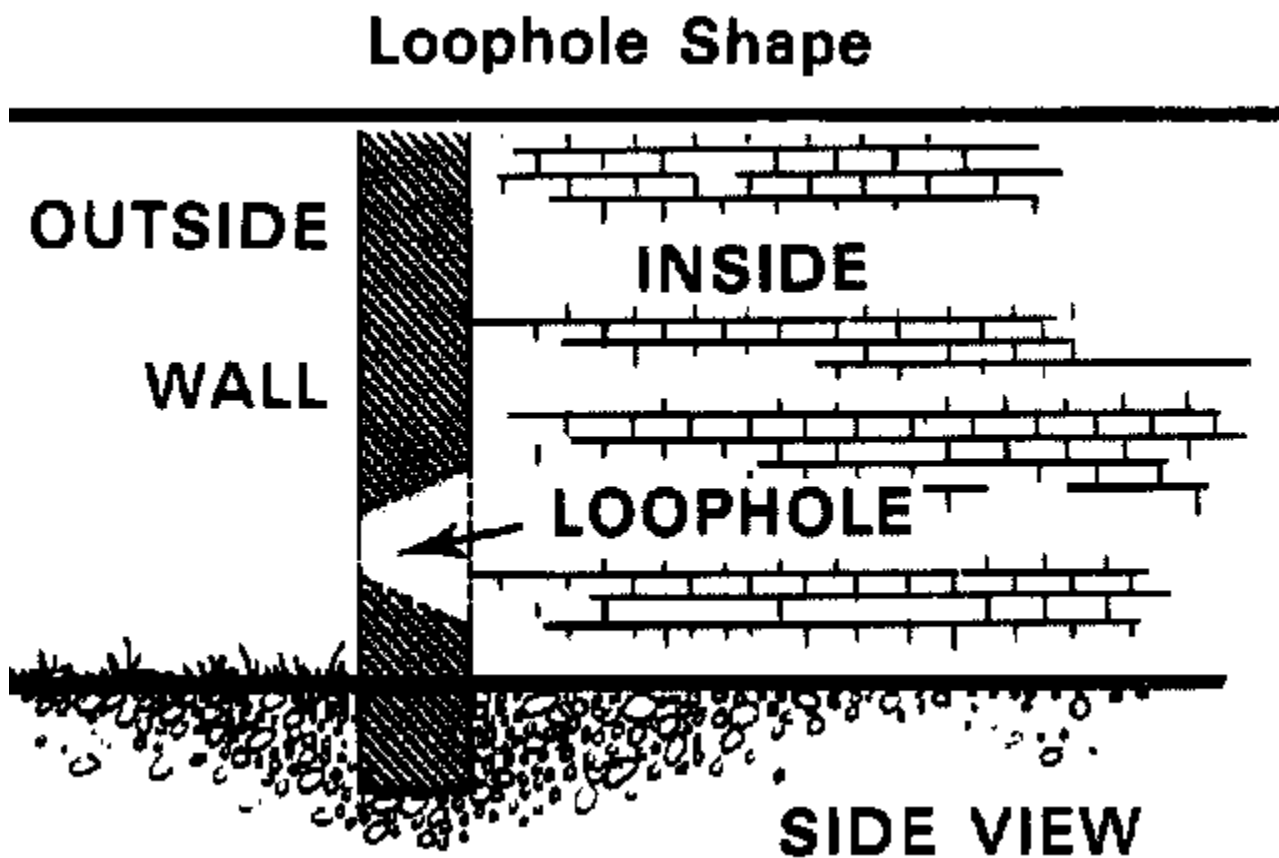

Figure C-4a Side View

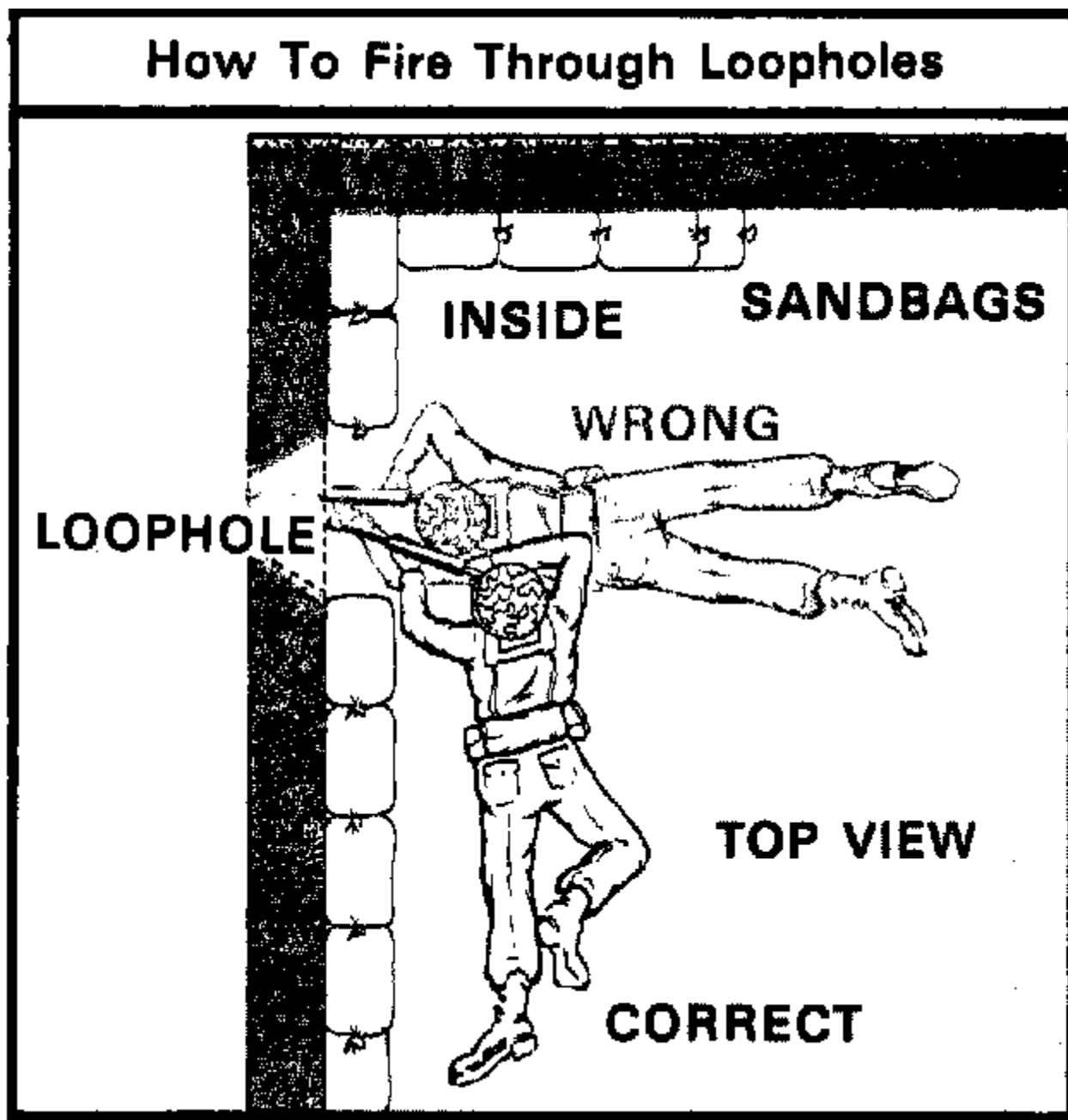

Figure C-4b Top View

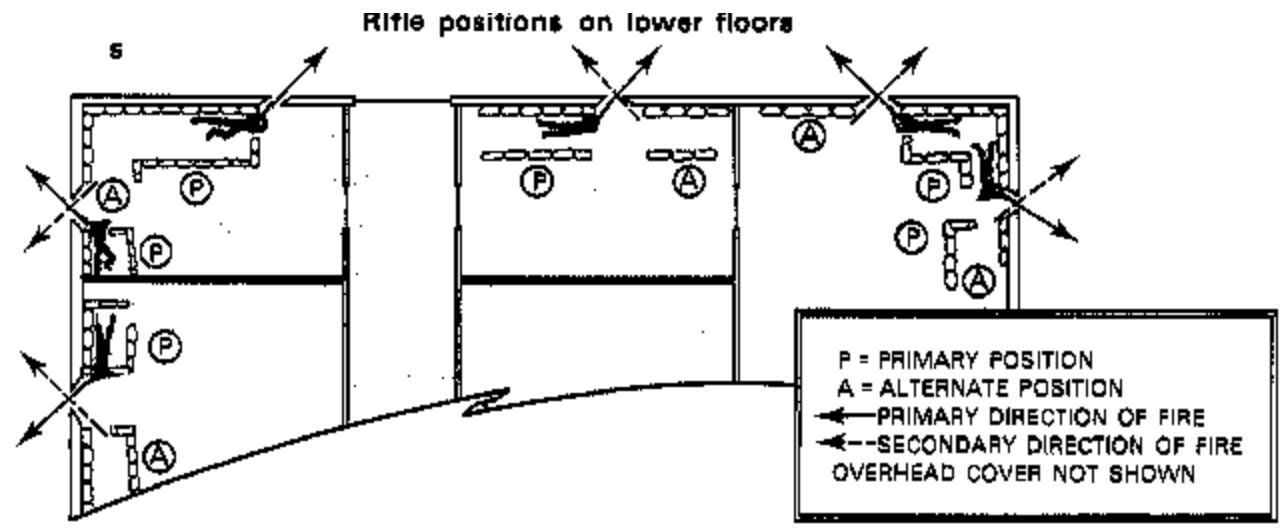

Figure C-4c Rifle Positions on Lower Floor

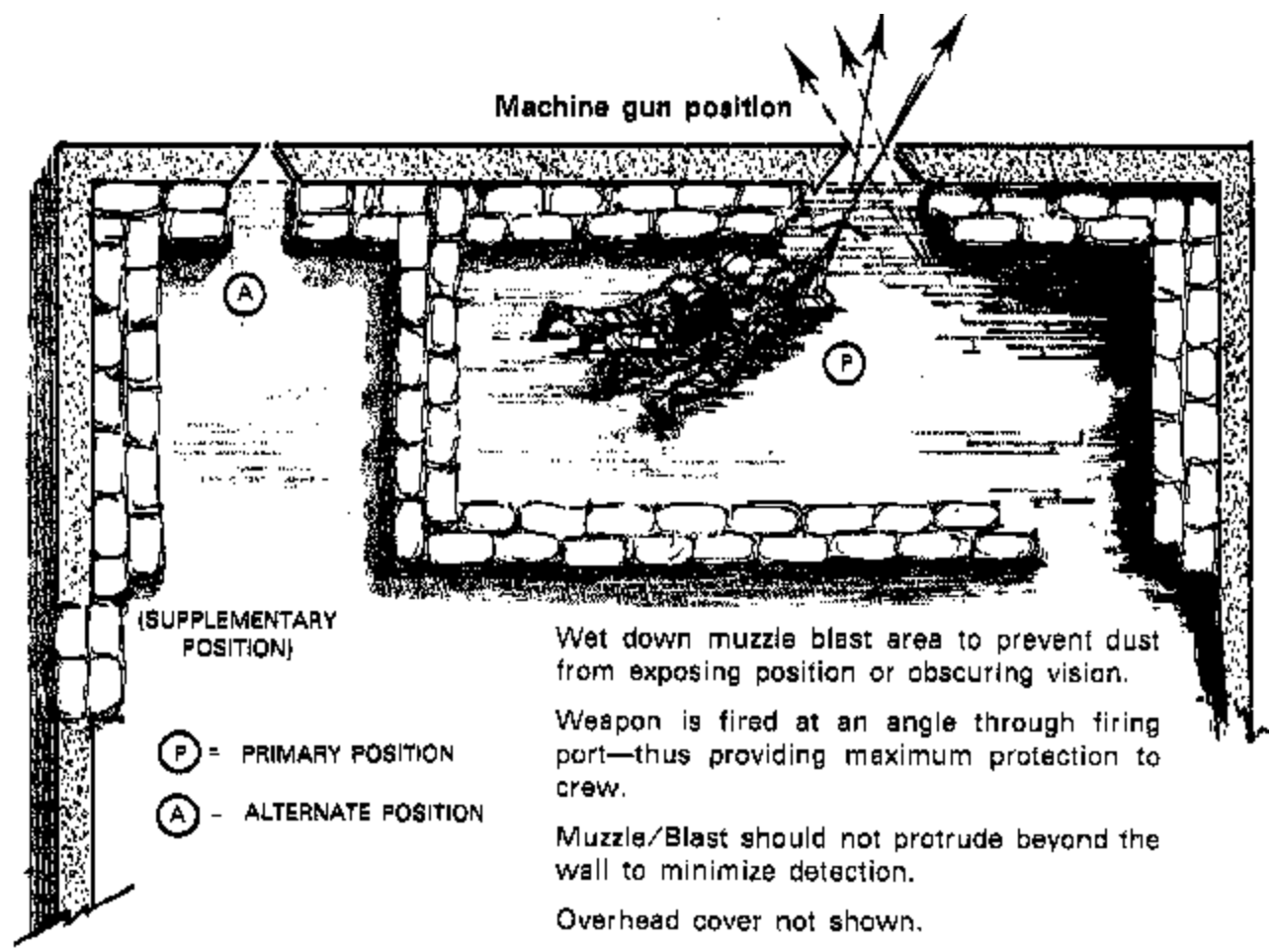

Figure C-5a Machine Gun Position

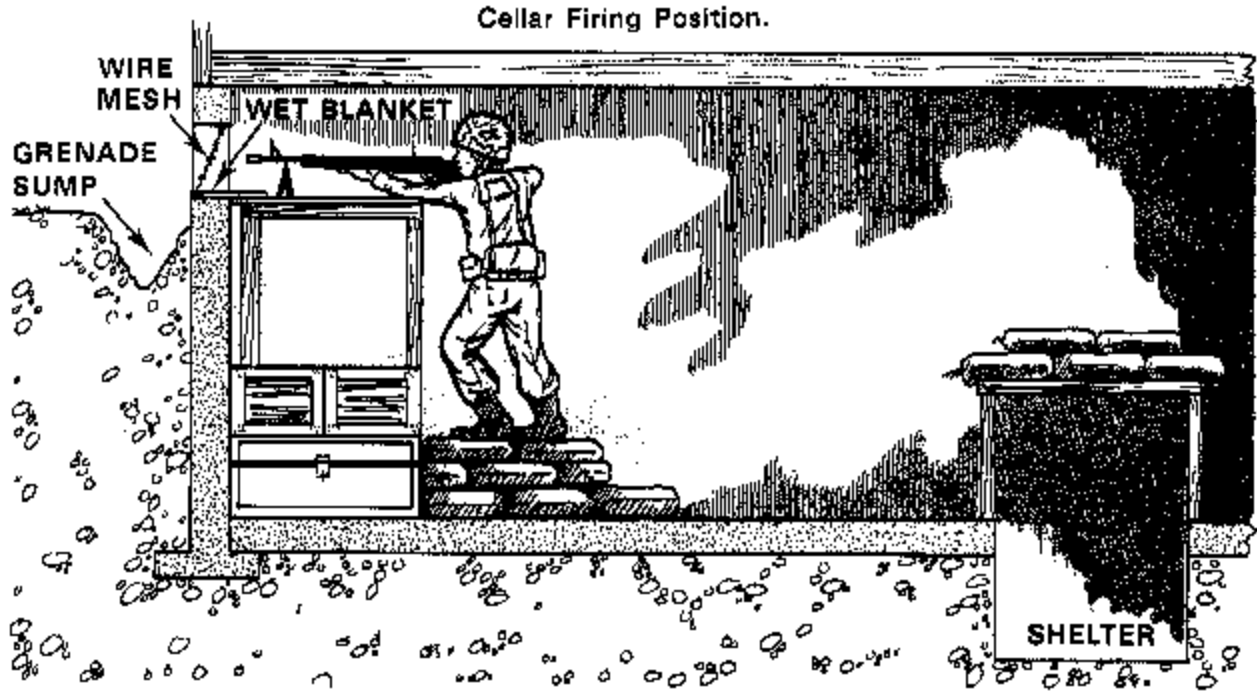

Figure C-5b Cellar Firing Position

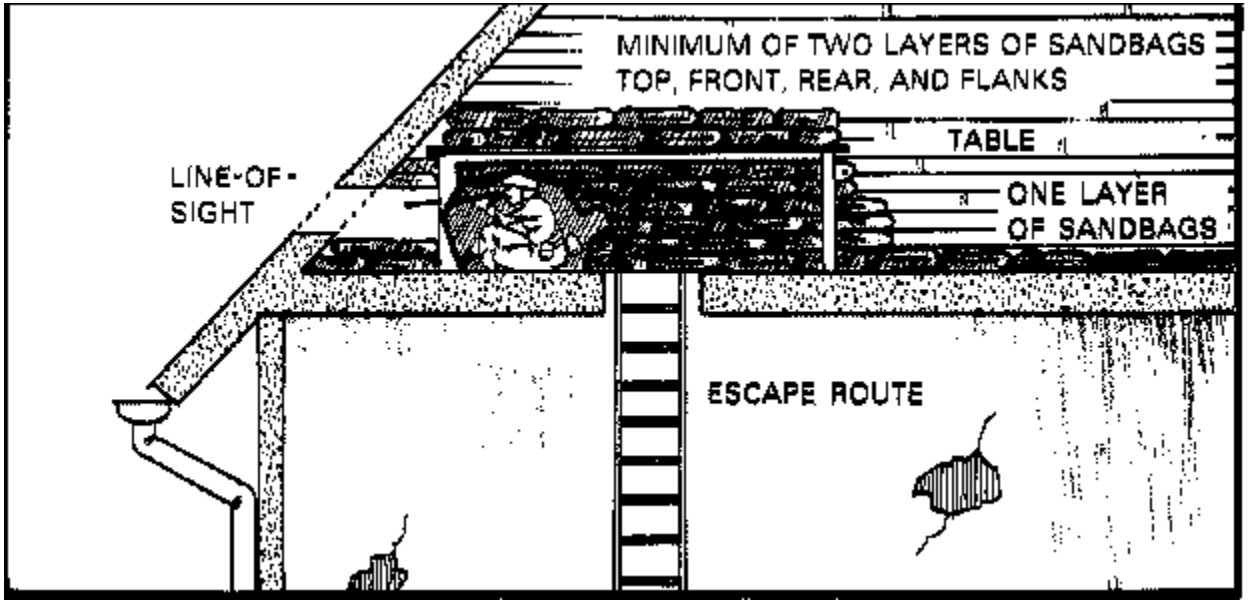

Figure C-6a Attic Position

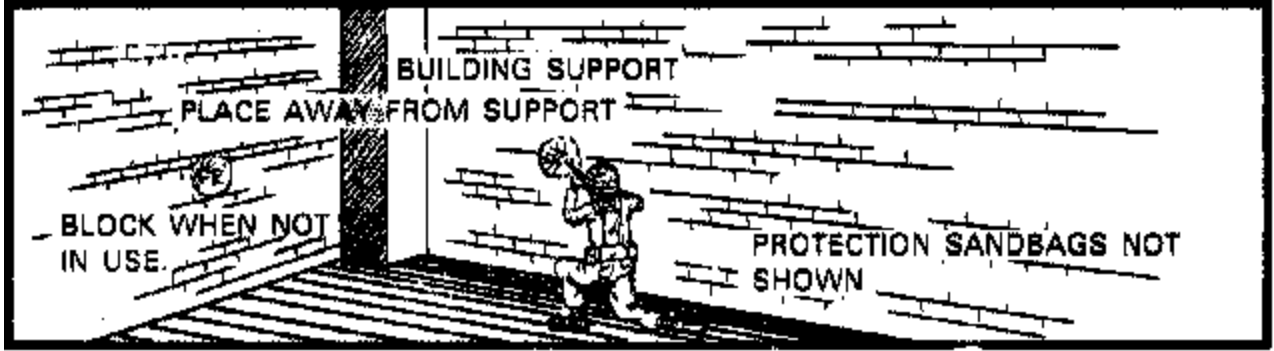
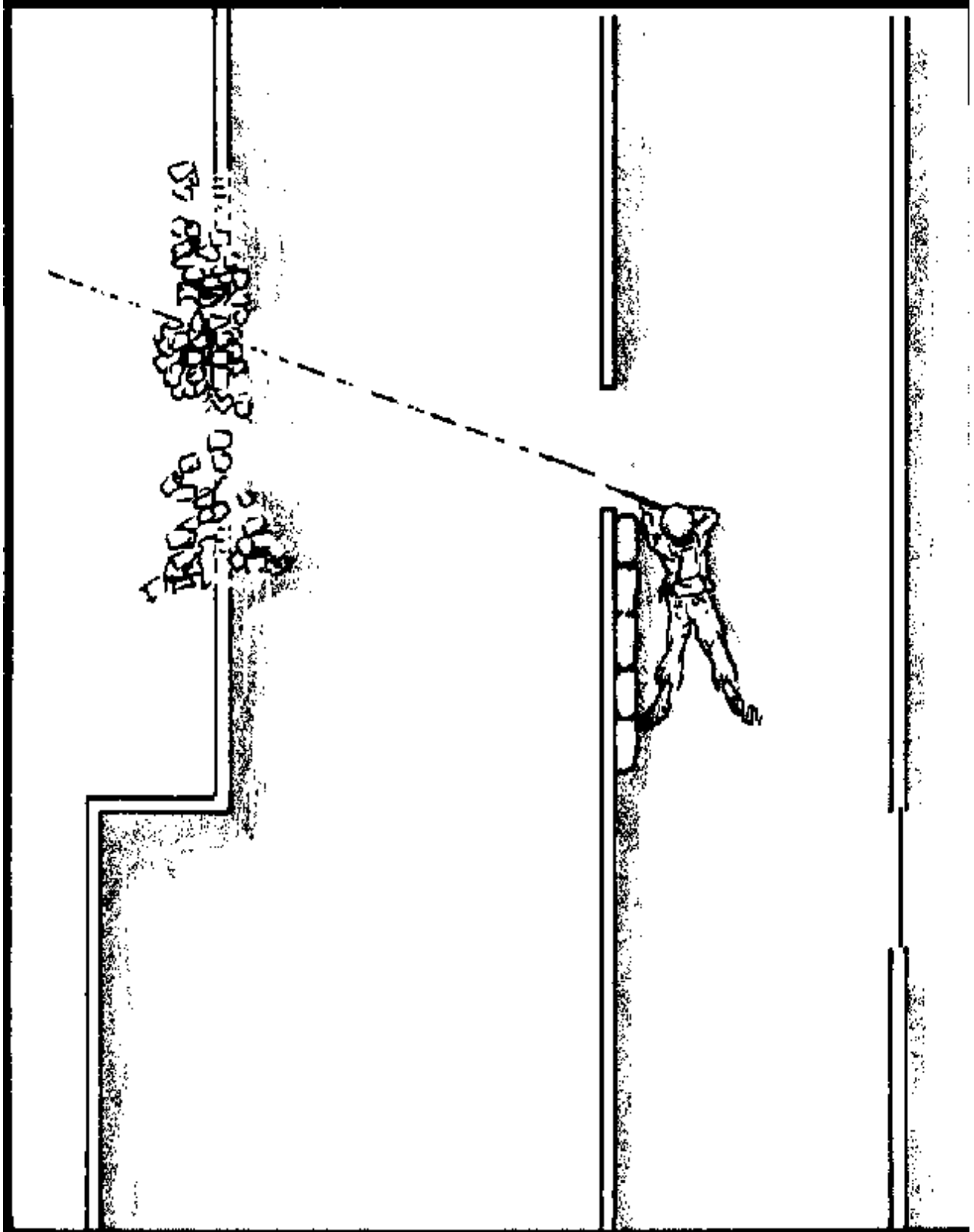

Figure C-6b Corner Firing Position.

Figure C-6c Interior Wall Position (on next page)

Interior Wall Position



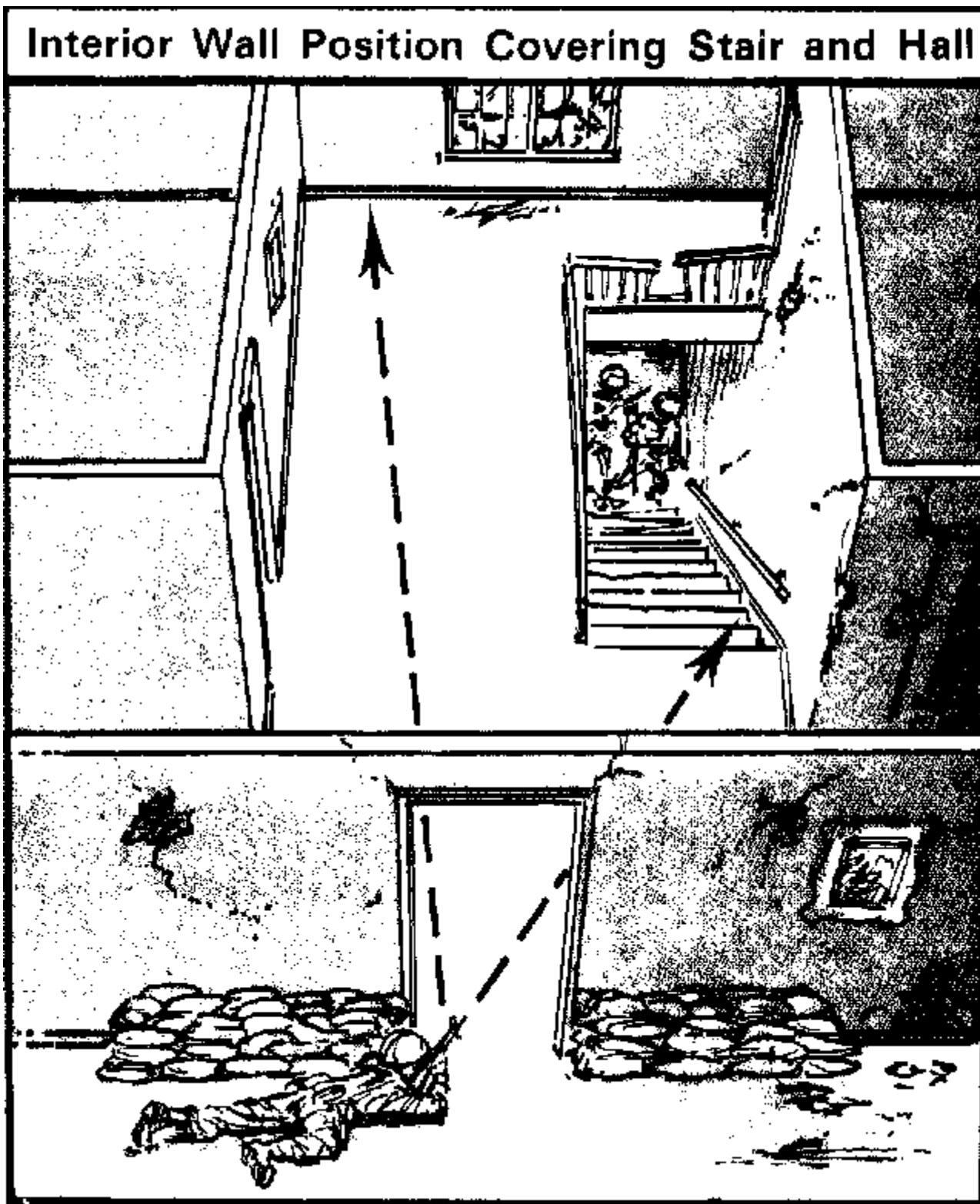

Figure C-6d Interior Wall Position Covering Stair and Hall

Window Positions

When using window positions, soldiers use the wall on either side of the window to provide a protected kneeling or standing position. To provide the ability to fire downward from upper floors, tables or similar objects placed against the wall should provide sufficient elevation. When using an elevated platform it must be positioned to prevent the weapon from protruding through the window. Prone positions do not always permit sufficient freedom for firing at widely varying angles or at targets above the position.

Window Position



Figure C-7a Window Position

OTHER CONSTRUCTION TASKS

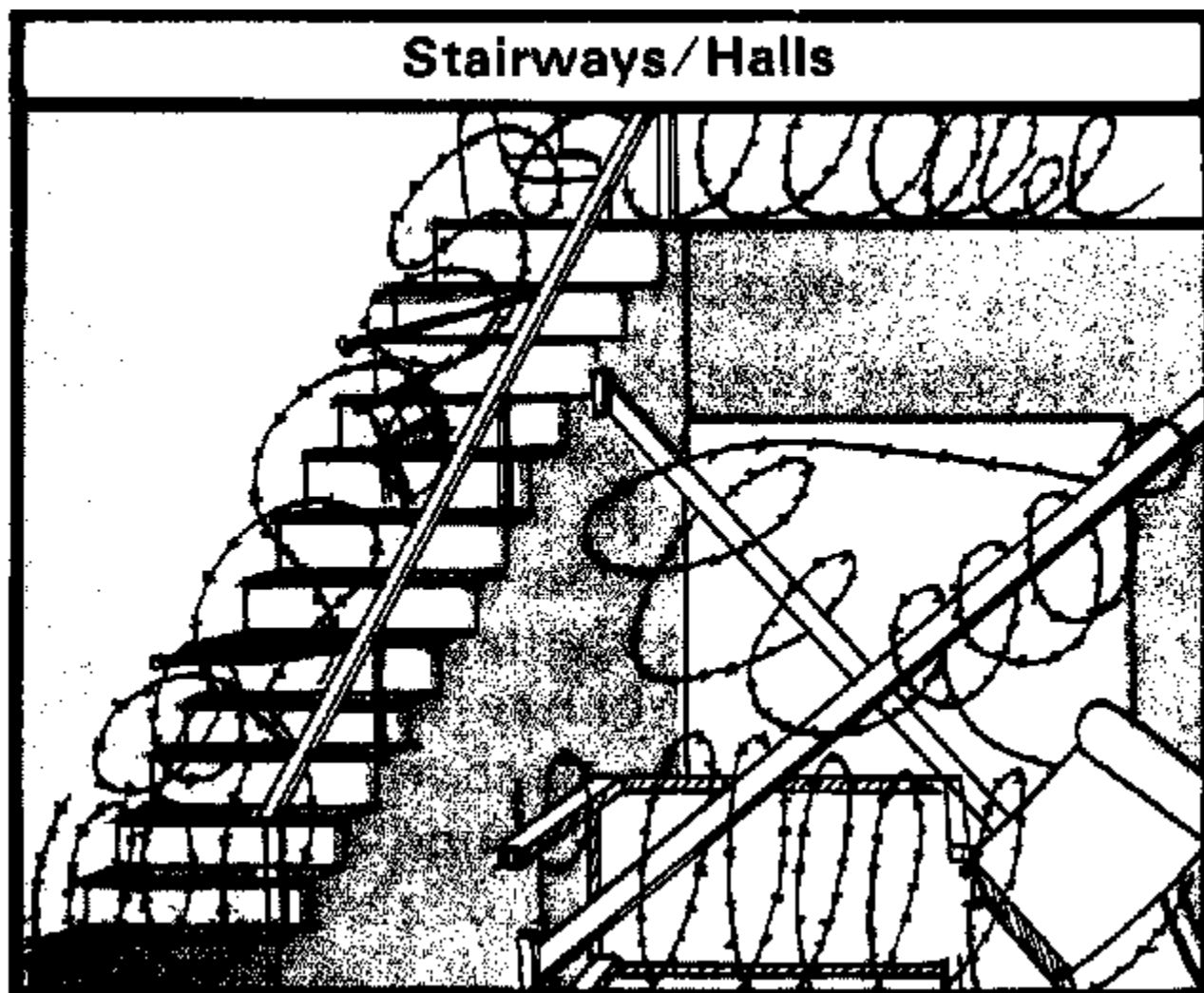

Figure C-7b Stairways/Hall

Ground Floors

All doors not used by defenders are locked, nailed shut, and blocked with furniture or sandbags. Outside doors are booby trapped by trained engineers, or other trained personnel.

Hallways not required for the defender's movement are blocked with furniture and tactical wire.

Stairs not essential to defense are blocked by furniture and tactical wire or removed. Boobytraps are employed as required.

Windows. All glass is removed and the windows not used are blocked with boards or sandbags. Walls are reinforced with sandbags to gain additional protection.

Floors. If there is no basement, foxholes are dug into the floor for additional protection against heavy direct-fire weapons.

Ceilings are reinforced with supports to withstand the weight of rubble from upper floors.

Unoccupied rooms. Rooms not required for defense are blocked with tactical wire and small Booby traps.

Basements

The basement requires preparation identical to the first floor. Any underground system not used by the defender that may provide enemy access to the position must be blocked.

Upper floors

The upper floors require essentially the same preparation as ground floors. Windows are not blocked, but covered with wire mesh. The wire is loose at the bottom to permit dropping of grenades by the defender, while blocking grenades from being thrown in windows.

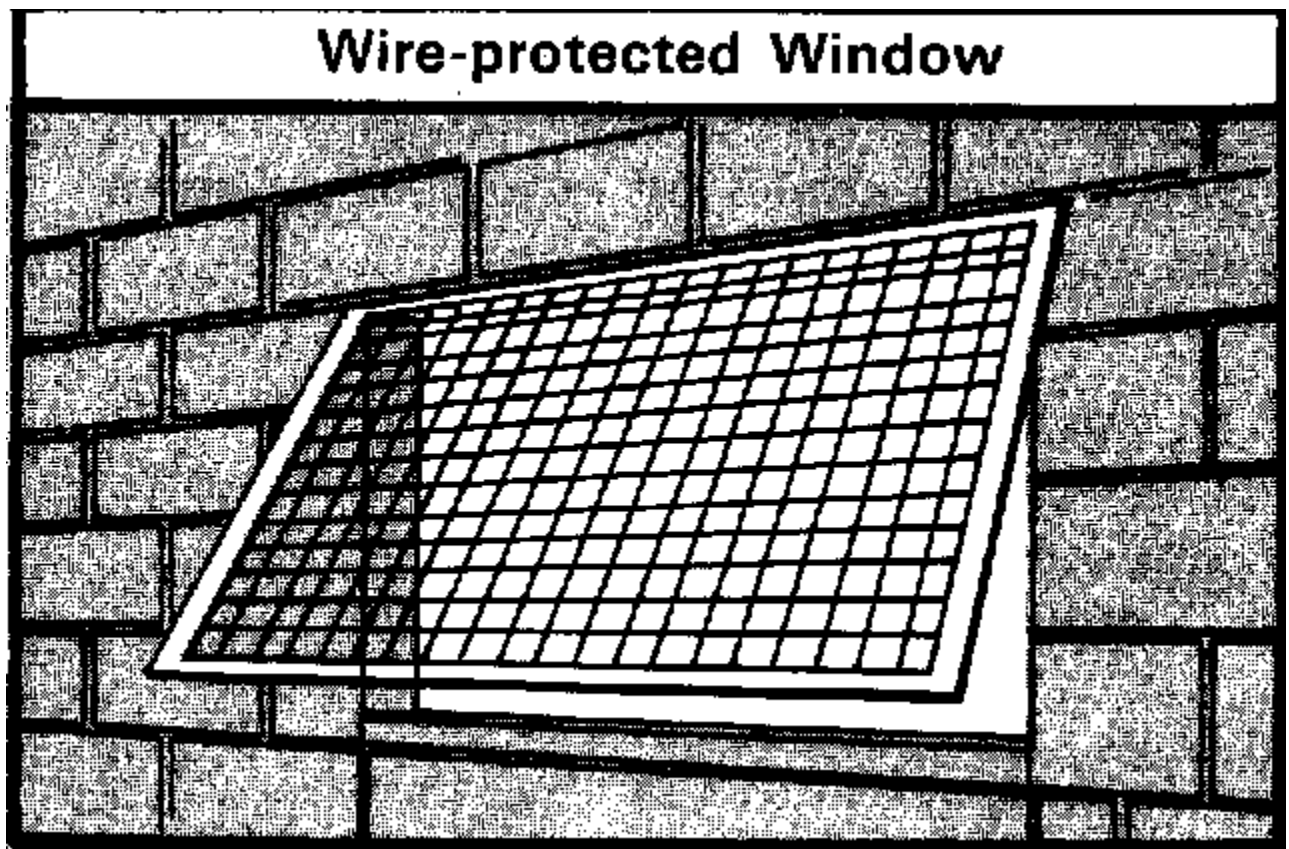

Figure C-8. Wire-protected Window

Interior Routes

Sufficient routes are required to permit defending forces to move within the building to engage enemy forces in any direction. Additionally, escape routes are planned and constructed to permit rapid evacuation of a room or the building. Small holes are made in walls to permit movement between rooms. These holes are concealed behind furniture and blocked with sandbags when not in use. Movement between floors is accomplished by knocking holes in ceilings/floors and using ropes or a ladder that can be quickly installed or removed. Once the defender has withdrawn to upper floors, these holes are blocked with timbers and furniture. Building evacuation routes are clearly marked for day and night identification. All personnel are briefed and practice evacuation over different routes.

Fire Prevention

Buildings that have wooden floors and rafter ceilings will require extensive fire prevention measures. The attic and other wooden floors are covered with approximately one inch of sand or dirt. Buckets of water or sand are positioned for immediate use. Water basins and bathtubs are filled as a reserve for fire fighting. All electricity and gas are turned off. In Areas A and B firebreaks are created by destroying buildings adjacent to the defensive position. In other types of buildings, fire fighting material (dirt, sand, fire extinguishers, and blankets) should be located on each floor for immediate use.

Communications

Telephone lines are laid to the building through adjacent buildings, through underground systems, or buried in shallow trenches. Radio antennas are concealed by locating them among civilian TV antennas, up the side of a chimney, steeple, or by placement out a rear window away from enemy observation. Telephone lines within the building are laid through walls and floors.

Rubbling

Rubbling a part of the building provides additional cover and concealment for weapon emplacement. Rubbling should be attempted only by skilled engineers.

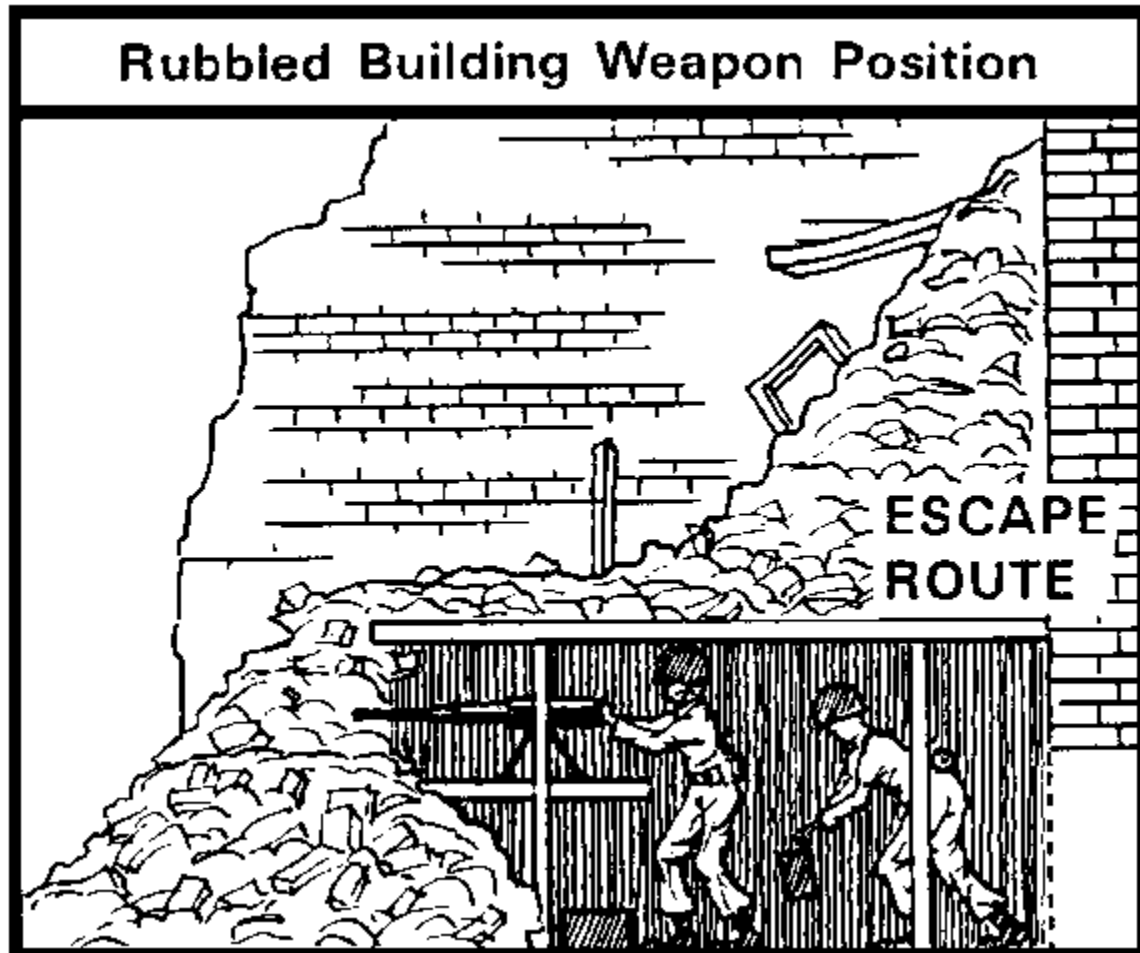

Figure C-9a Rubbled Building Weapon Position

Roofs

Positions in flat-roofed buildings require anti-helicopter obstacles. Roofs accessible from adjacent structures are covered with tactical wire and guarded. Entrances to the building from the roof are blocked.

Exterior structure

Any structures on the outside of a building that would assist scaling to gain access to upper floors or to the roof are removed or blocked with tactical wire.

Obstacles

Obstacles are positioned adjacent to the building to stop tanks and delay infantry (See appendix D).

Buildings in proximity to the defensive position that provide cover for enemy infantry movements or are suitable weapon positions are:

Destroyed.

Mined/booby trapped.

Filled with barbed wire.

Blocked at doors and windows.

Combinations of the above.

Fields of fire

Fields of fire are improved around the defensive position as time permits. Selected buildings may be destroyed to enlarge fields of fire. Obstacles to ATGM flight are cleared as required.

TANK/APC POSITIONS

The factors of cover, concealment, fields of fire, etc. considered in selecting other defensive positions are also applicable when selecting positions for combat vehicles. In addition, the physical layout of the built-up area, the condition of its structures, and the amount and type of rubble present directly influence the selection process. Within a built-up area, tank and APC positions can be classified in general terms as hull-down or hide positions.

Hull-down positions utilize any type physical barrier available, such as low walls or piled-up rubble, to protect the vehicle by reducing its target silhouette.

Hide positions, as the name implies, are used to deny the enemy direct observation of a tank or APC until it is time for target engagement. In some cases it may be possible to hide a vehicle within a building to gain additional cover and concealment. However, caution must be exercised to insure that building floors will support the vehicle.

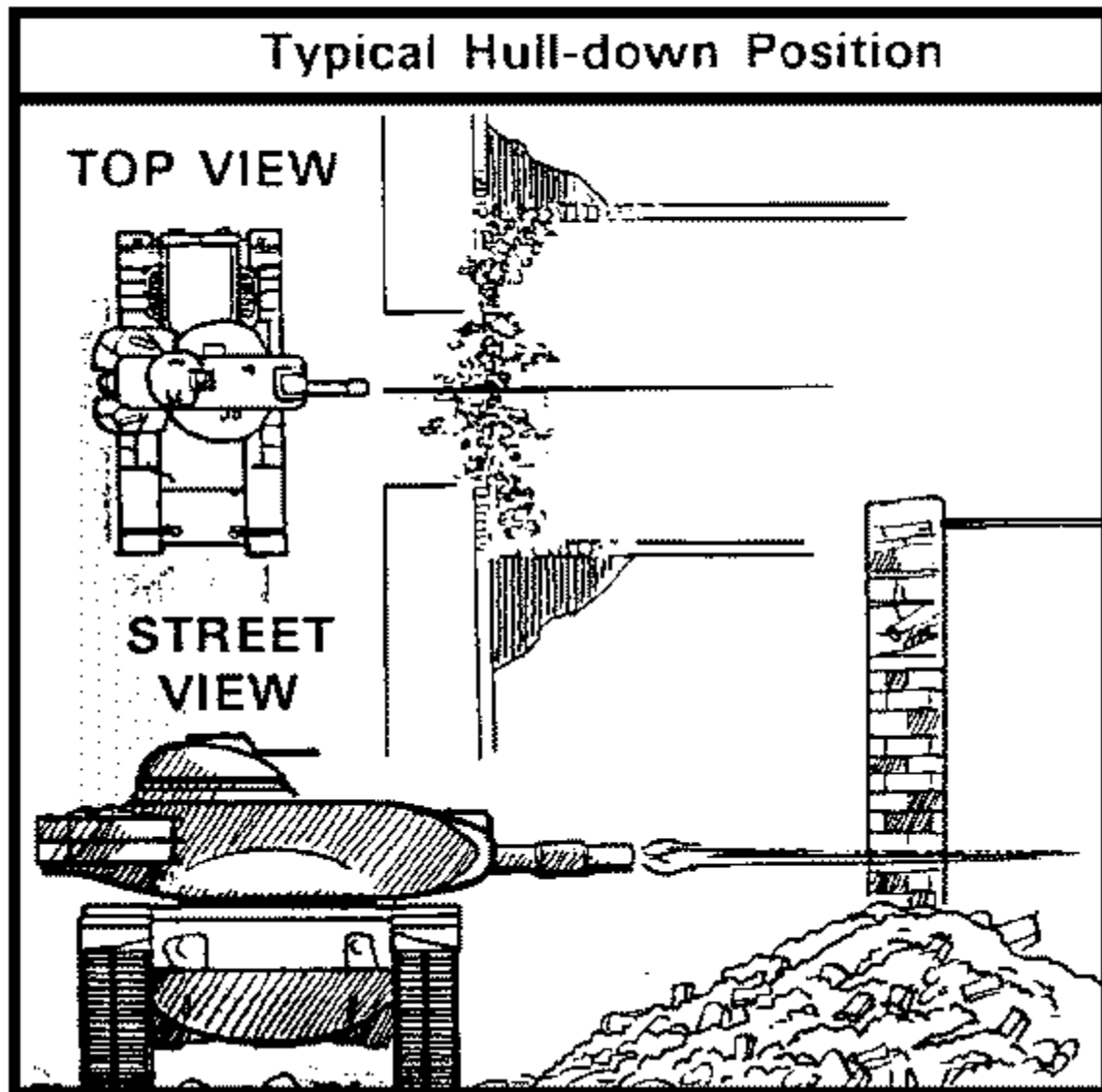

Figure C-9b Typical Hull-down Position

NOTE: Engineers may be required to evaluate the floor strength and to prepare an entrance and exit for the vehicle.

Building hide positions may also serve as firing positions if the structure will withstand firing overpressures and probable enemy return fires.

Normally, vehicles will be hidden behind structures within the built-up areas and moved to a prepared, hull-down firing position as necessary. Camouflage, particularly overhead screening, is required when hide positions are to be occupied for any significant period of time. Because the vehicle crew cannot see advancing enemy forces from a hide position, observers from the section or nearly dismantled units are needed to select targets and control the movement of the vehicle from its hide position to a firing position. Routes from each firing position to alternate hide or firing positions should be selected and prepared in advance.

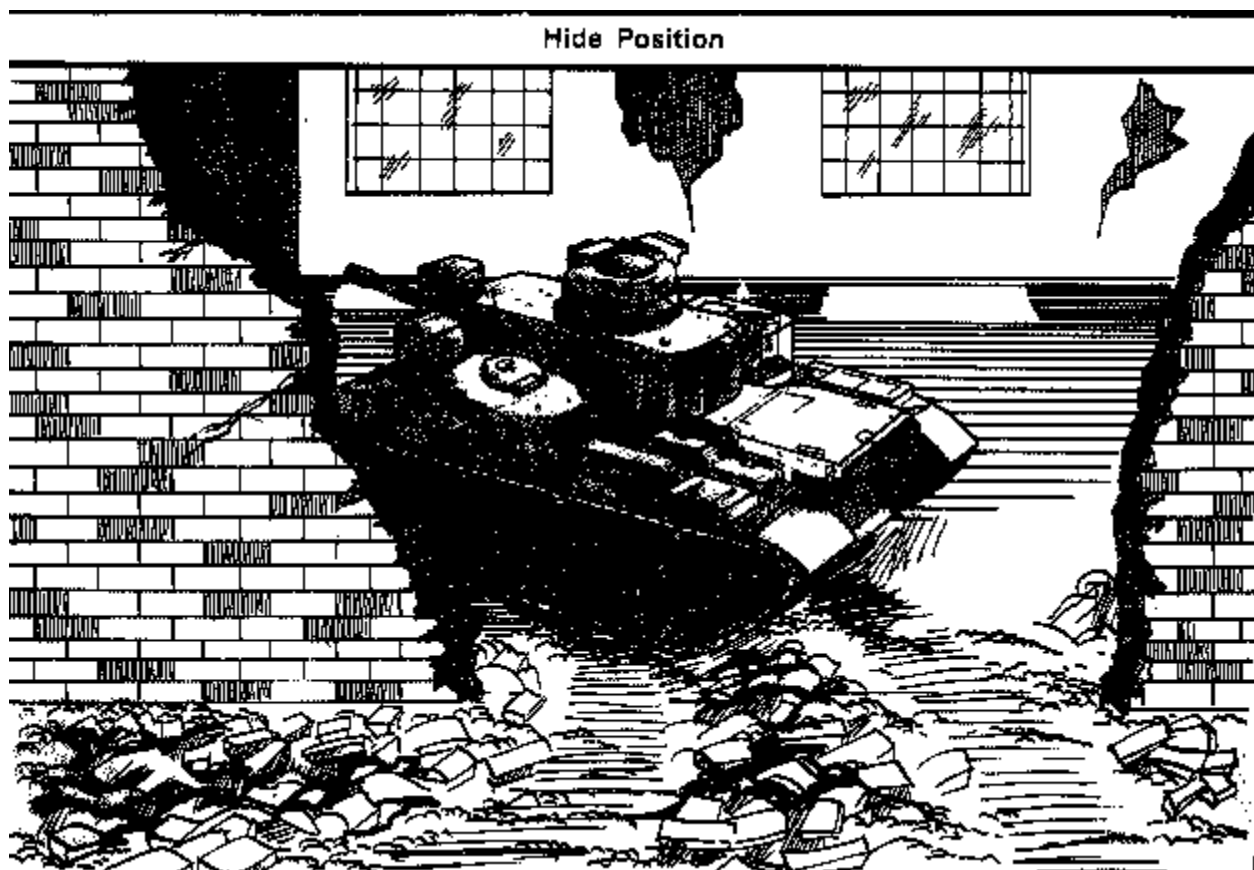

Figure C-10 Hide Position

As indicated in appendix A, narrow winding streets and limited fields of fire may restrict the effective use of tanks or APCs in Type A built-up areas (dense, random construction). Type B areas, on the other hand, with their closed-orderly block layout and rectangular pattern of wider streets, offer greater possibilities for the employment of these combat vehicles. Extended fields of fire may be established along main thoroughfares. Hide positions are available in courtyards, alleys, and side streets. The construction of hull-down firing positions at street intersections and the use of smoke to screen movement will frequently be required.

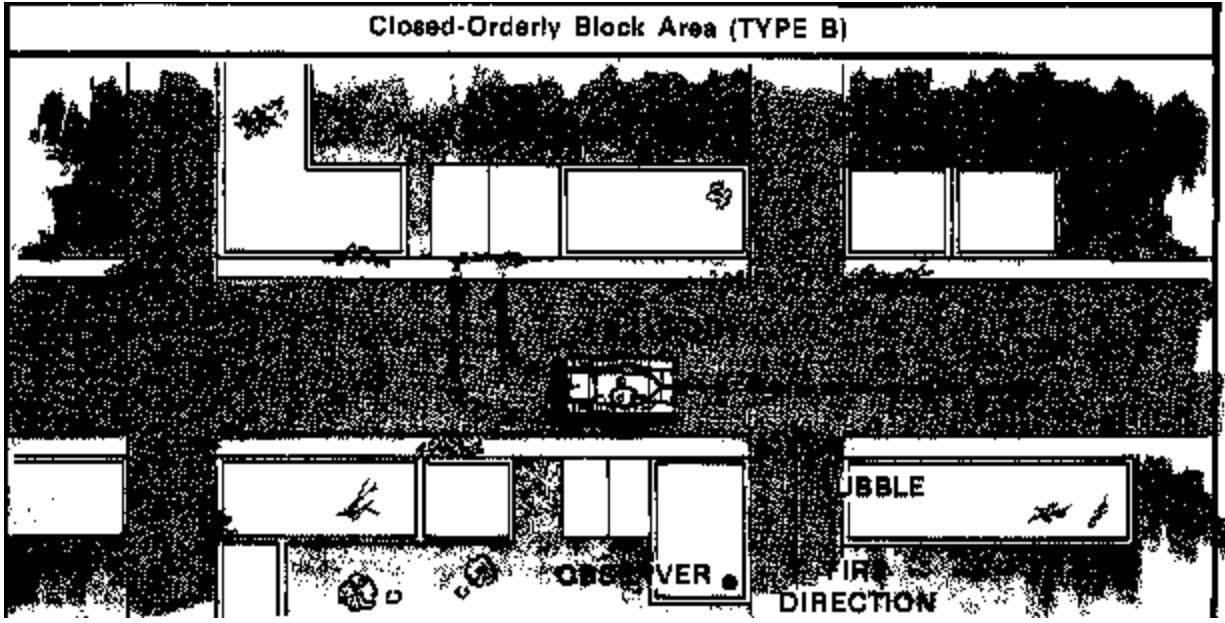

Figure C-11 Closed-Orderly Block Area (TYPE B)

The other categories of built-up areas provide many possibilities for employing tanks and APCs. A wide variety of hide and firing positions are frequently available. In many cases it is possible to establish mutually supporting fields of fire between adjacent positions.

The following illustrations show typical defensive positions for Type C, D, and E built-up areas.

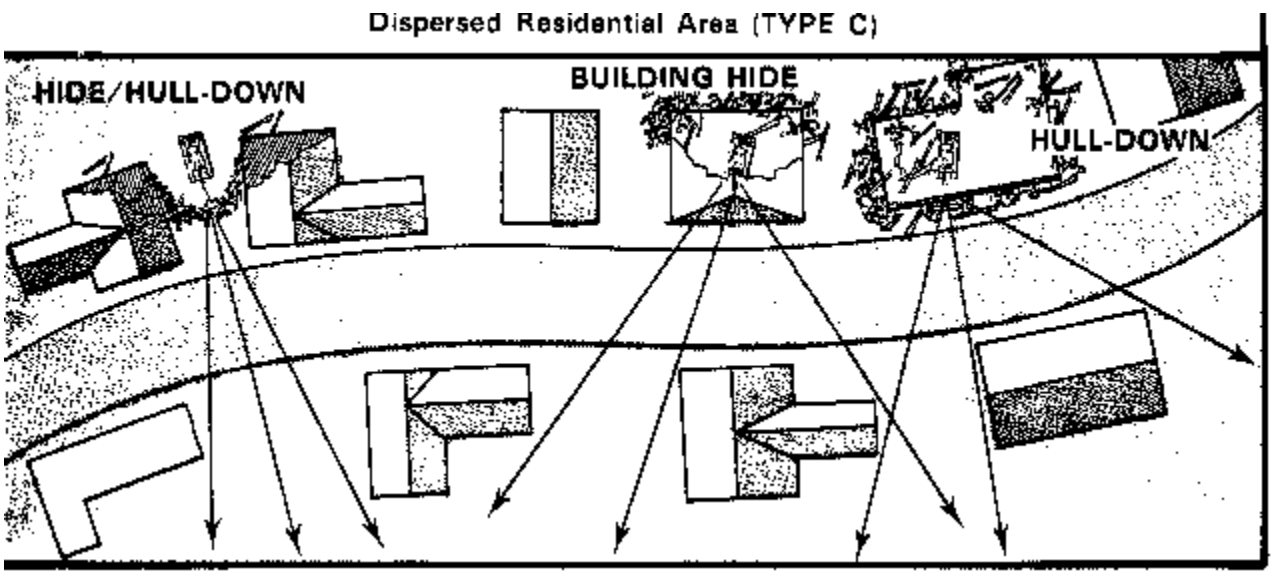

Figure C-11 Dispersed Residential Area (TYPE C)

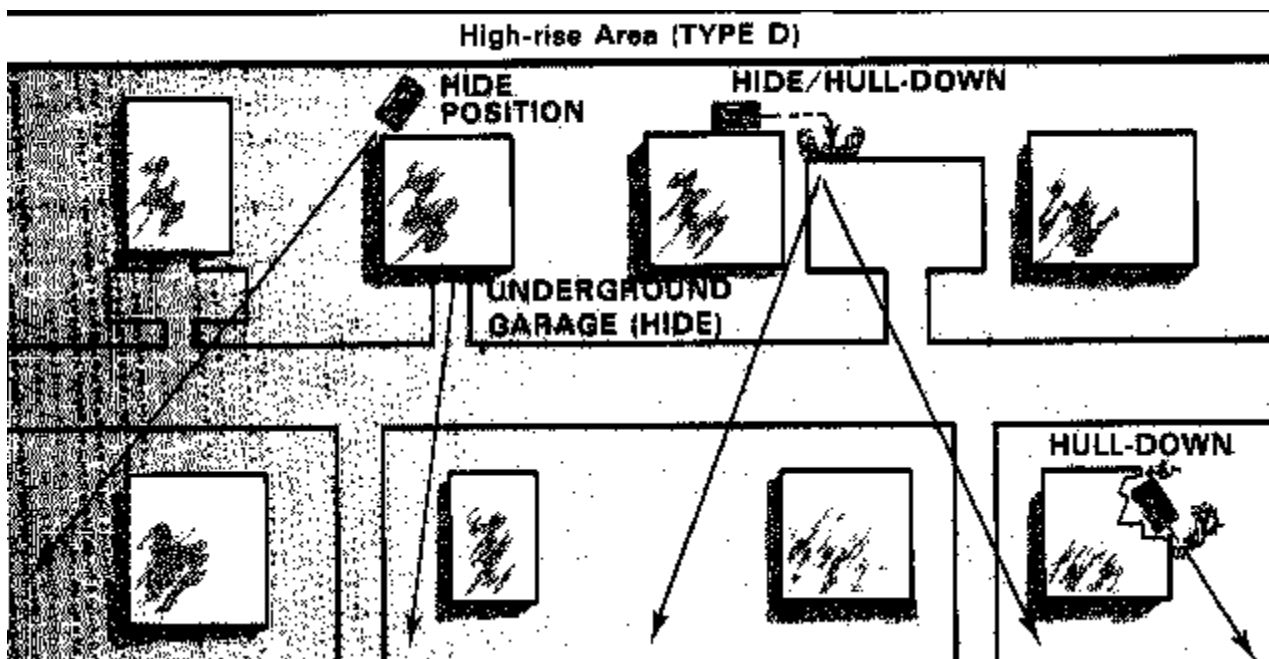

Figure C-12 High-rise Area (TYPE D)

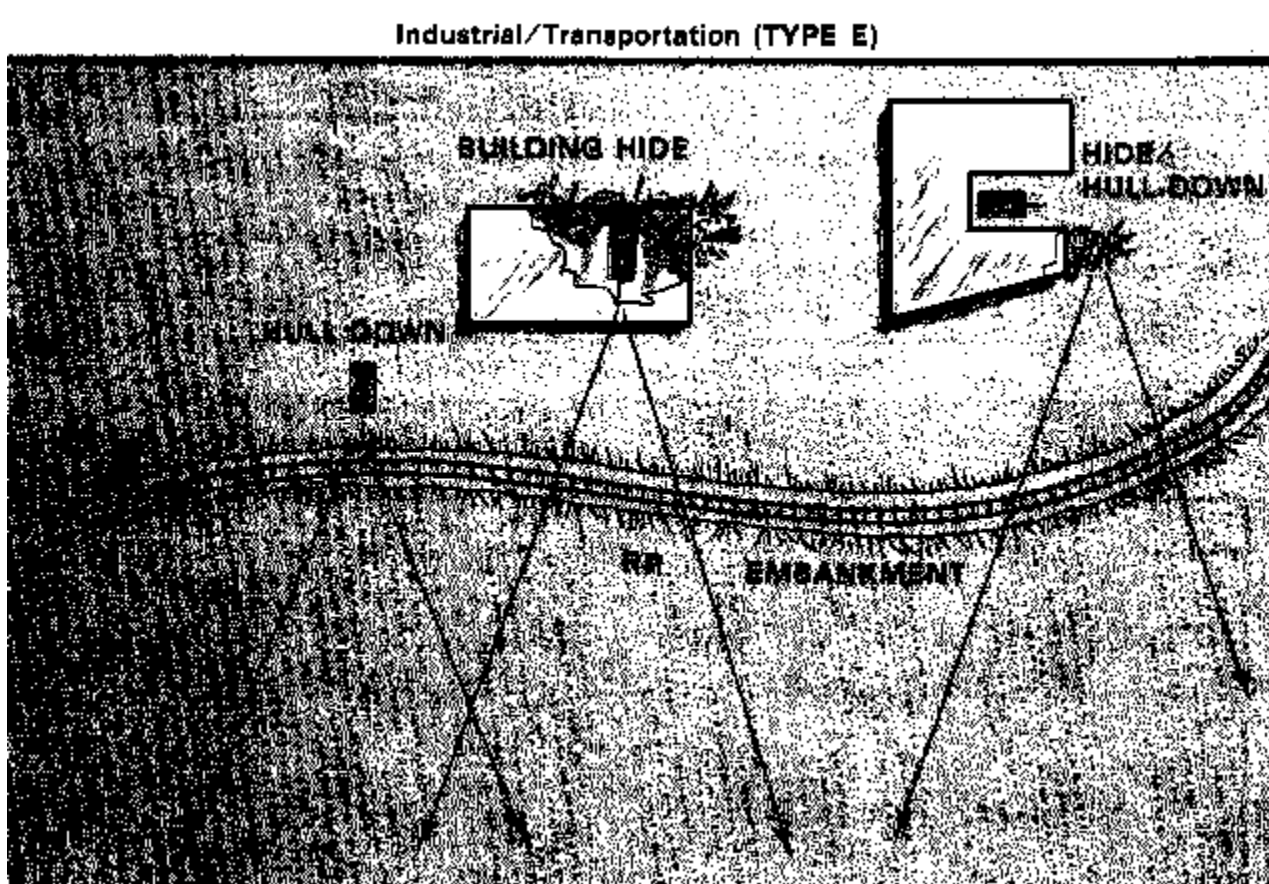

Figure C-12b Industrial/Transportation (TYPE E)

APPENDIX D

Employment Of Obstacles And Mines

This appendix describes how to prepare obstacles in the five types of built-up areas.

DENSE, RANDOM CONSTRUCTION (TYPE A) and CLOSED-ORDERLY BLOCK (TYPE B)

Antipersonnel Obstacles are constructed to block infantry approaches through or over:

Underground systems.

Streets.

Buildings.

Roofs.

Backyards.

Dead spaces in the defender's observation

Underground Systems are blocked by:

Destruction with explosives.

Barbed tape/wire.

Boobytraps.

Exits from underground systems that would provide the enemy positions an advantage within or behind the defense are denied as indicated.

Block Exits From Underground Systems

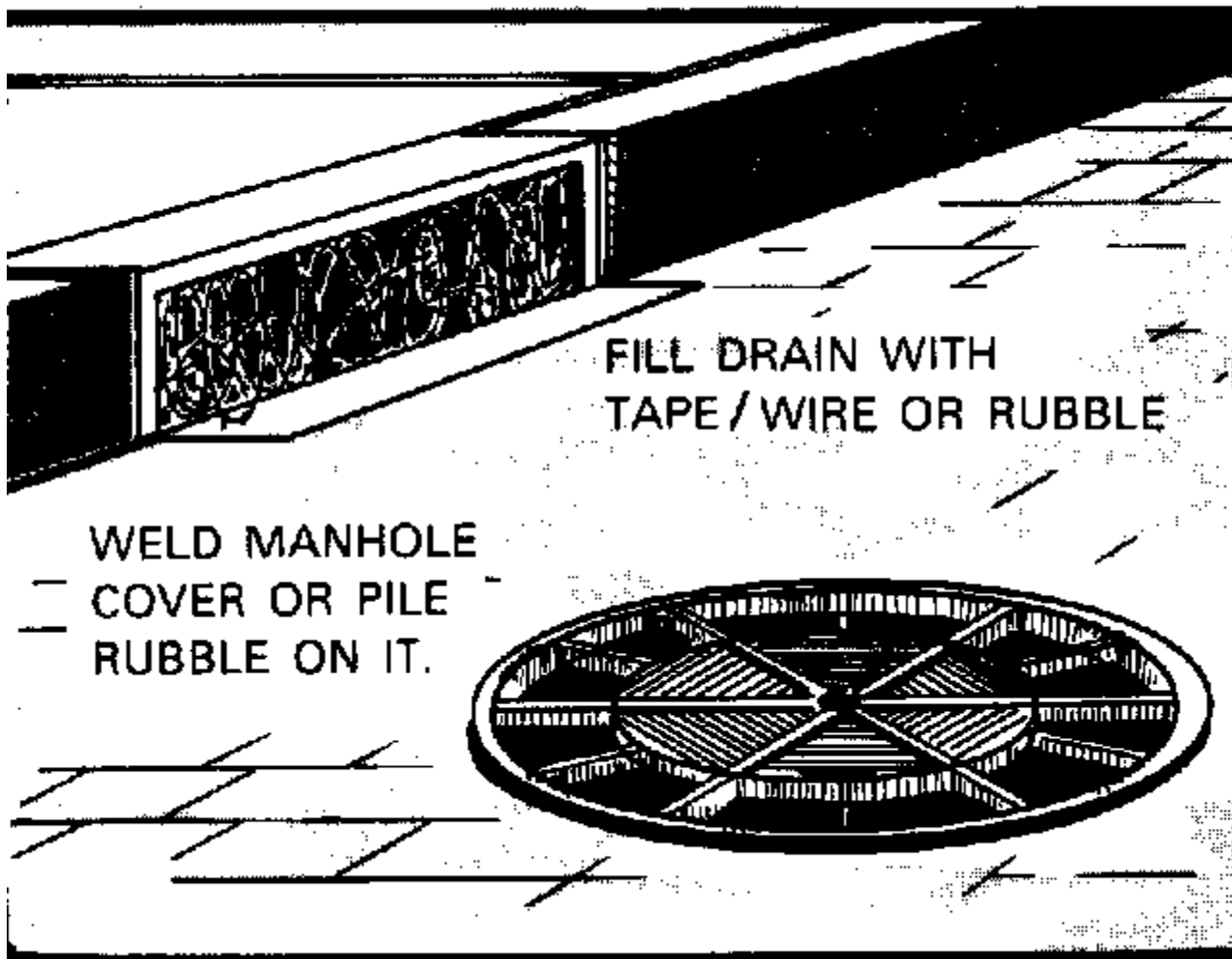

Figure D-1a Block Exits From Underground System

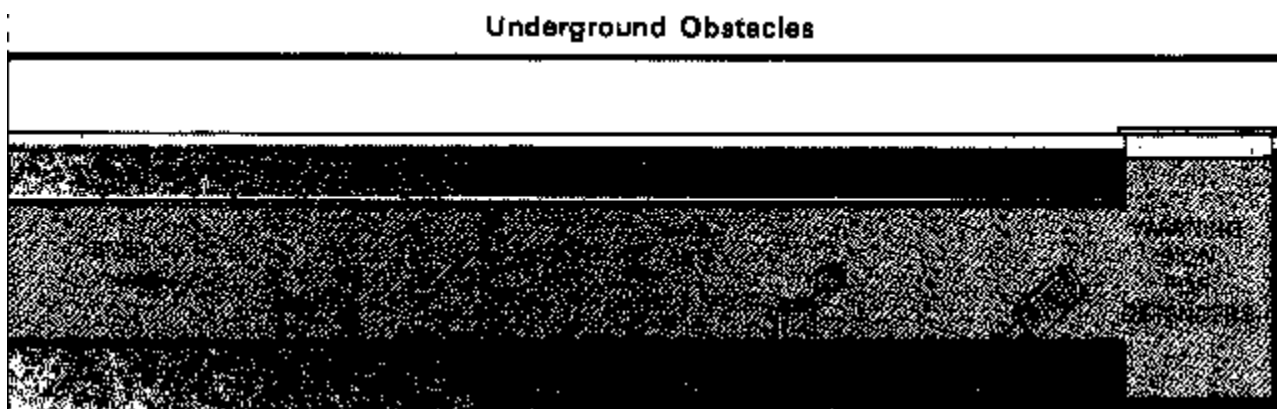

Figure D-1b Underground Obstacles

Street Antipersonnel Obstacles are constructed with antipersonnel mines, barbed tape/wire boobytraps, and exploding flame devices.

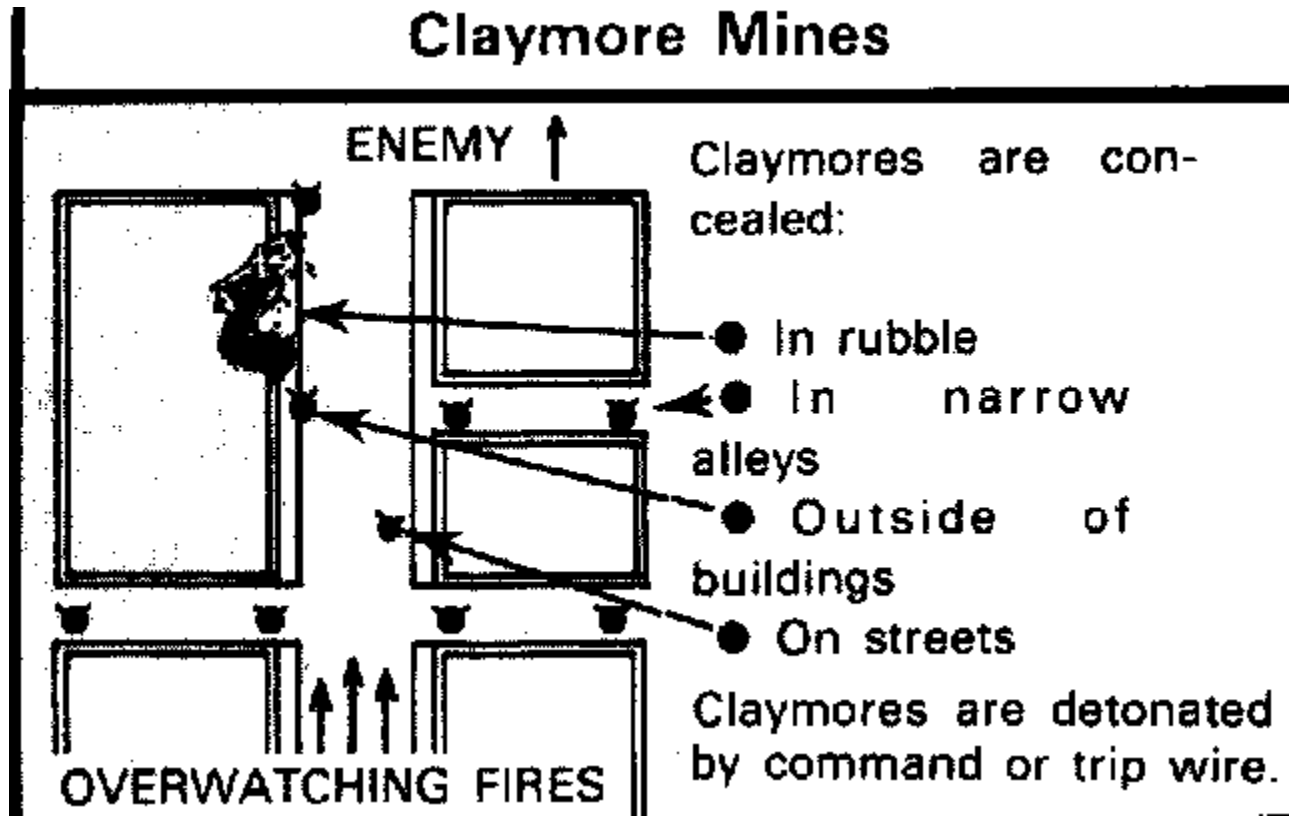
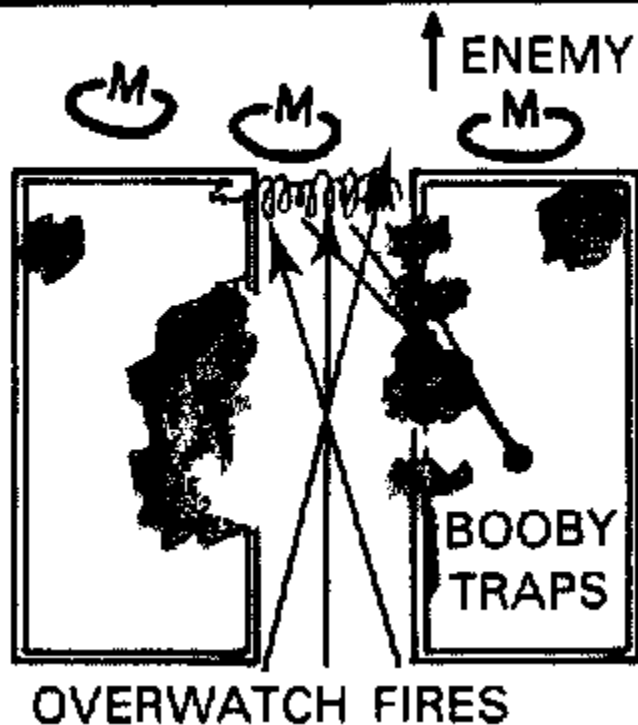

Figure D-2a Claymore Mines.

Wire Obstacles and Boobytraps



- Mines are dug into street and concealed with street material or covered with rubble.

- Phony mines (painted lids) may be employed in the open.

- Cover obstacle with fire.

Figure D-2b Wire Obstacles and Boobytraps.

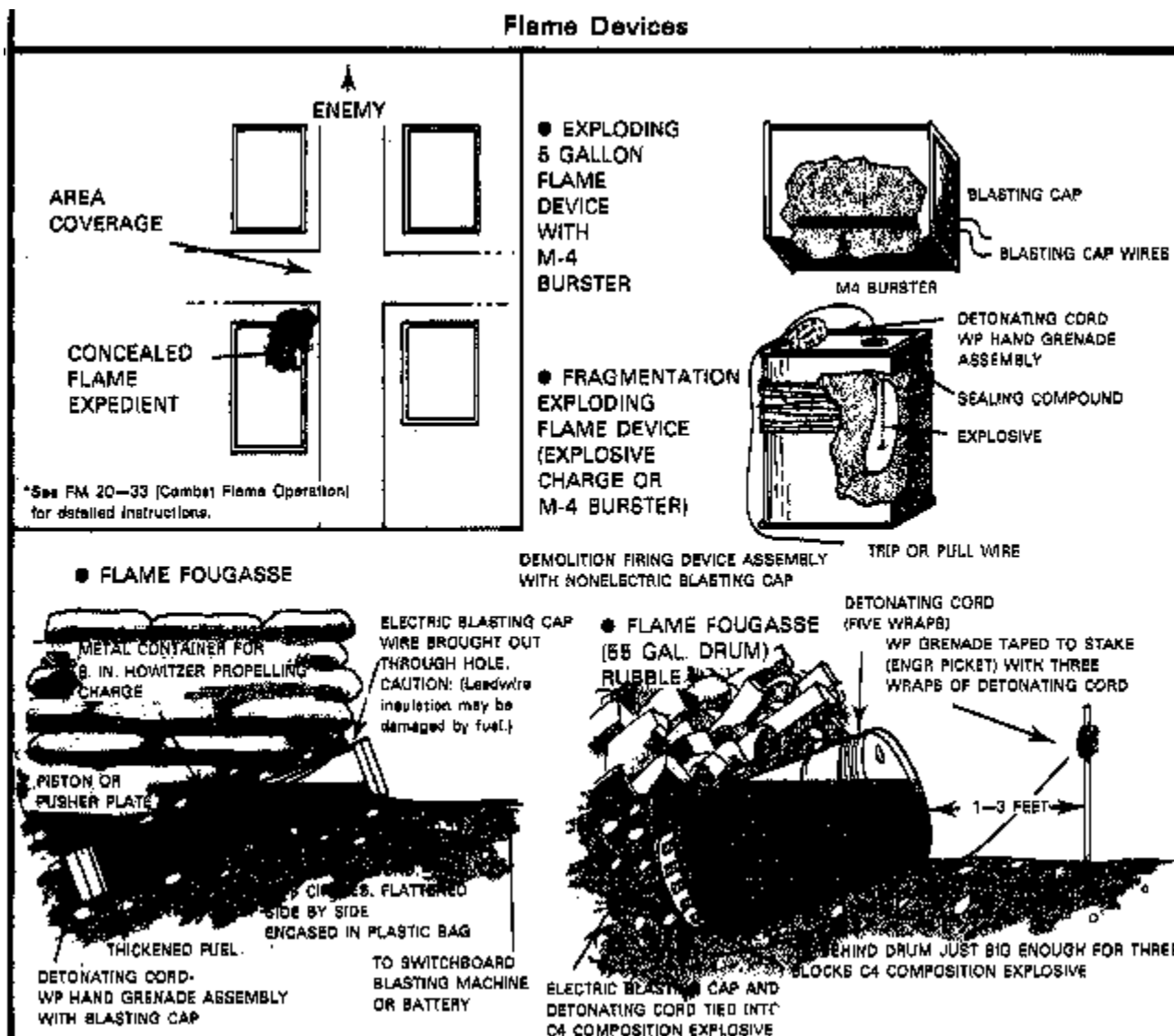
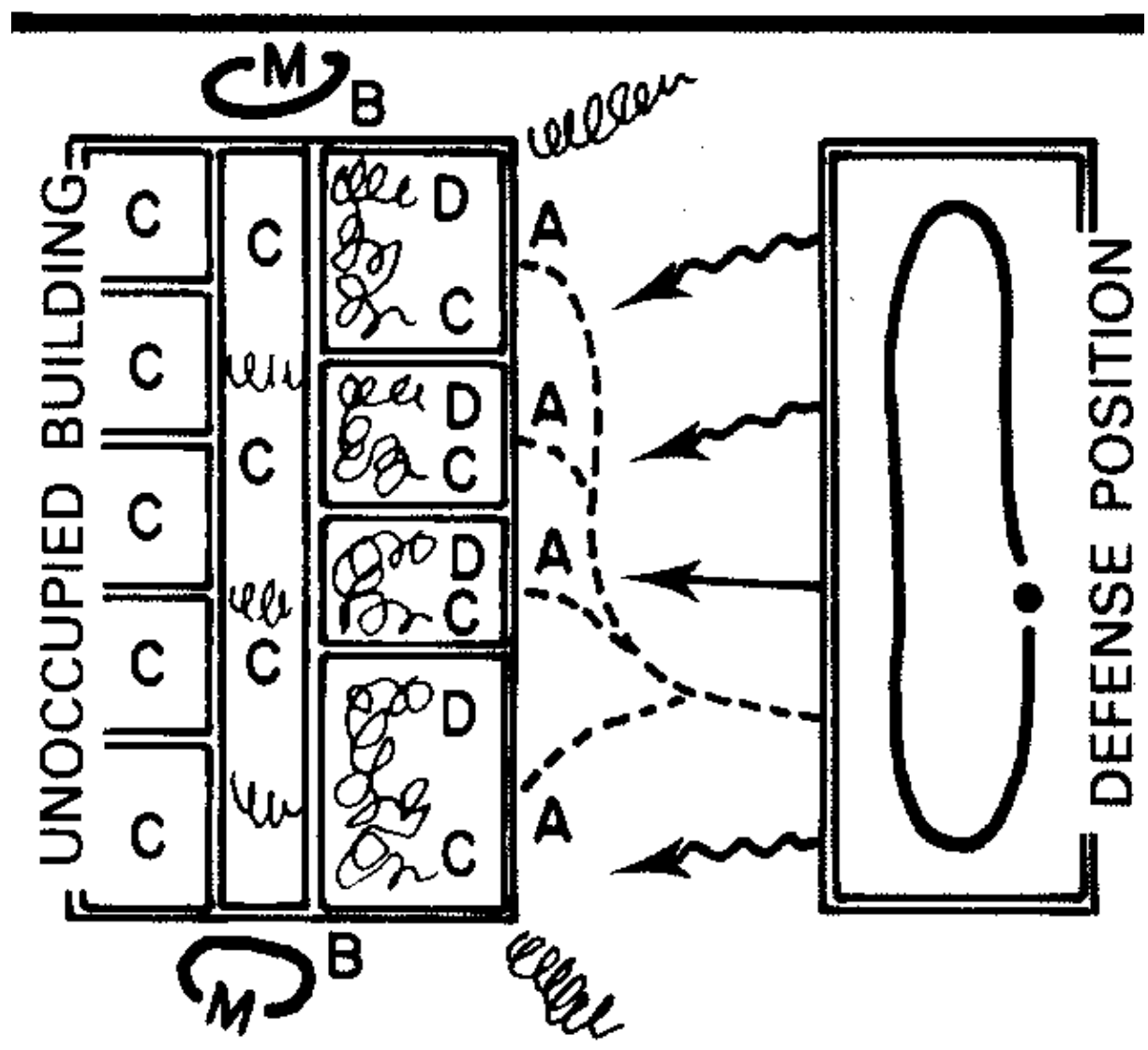

Figure D-2c Flame Devices

Building Obstacles are constructed to deny enemy infantry covered routes or weapon positions in the proximity of defensive positions. They may be developed by destroying the building with explosives or flames, constructing wire obstacles within the building, using booby traps, or preparing the building as an explosive/flame trap to be ignited after enemy forces have occupied it.

Building Obstacle



A—BOARD UP WINDOWS

B—BLOCK DOORS

C—BOOBYTRAPS

scribble—TAPE / WIRE

D—CLAYMORE (CONCEALED)

----—BURIED CLAYMORE WIRES

Figure D-3a Building Obstacle (previous page)

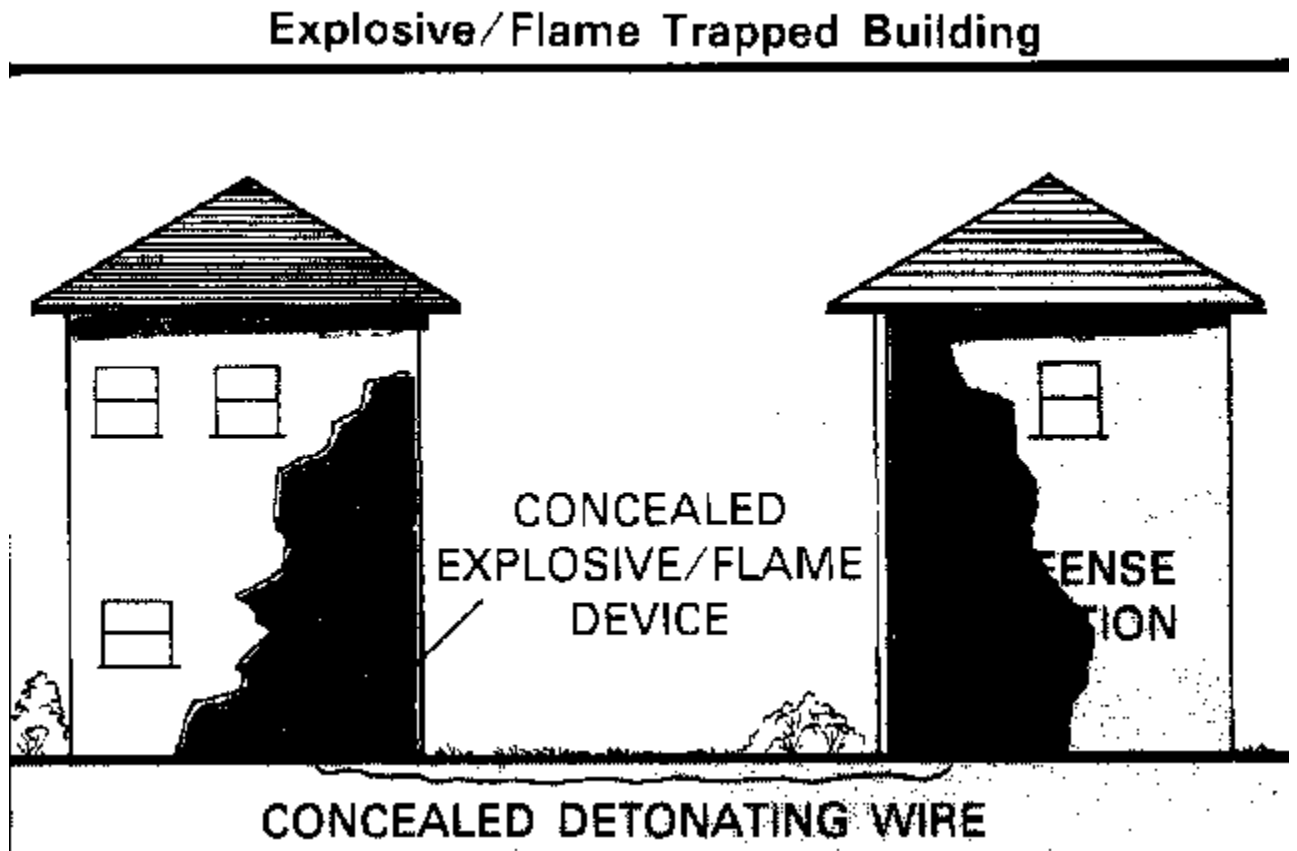
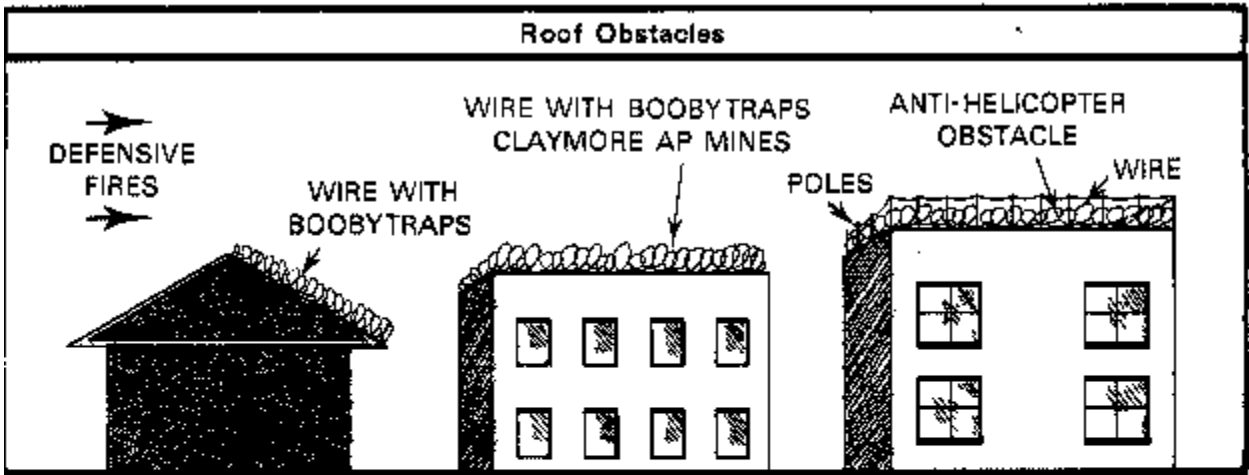

Figure D-3b Explosive/Flame Trapped Building

Dead space obstacles are designed to inflict casualties and restrict infantry movement in areas concealed from observation and protected from direct fires.

Vehicle Obstacles. Enemy tanks, BMPs, and direct fire support weapons (artillery/AT guns) are restricted to streets. The following illustrations depict types of vehicle obstacles:



Dead space obstacles are designed to inflict casualties and restrict infantry movement in areas concealed from observation and protected from direct fires.

Vehicle Obstacles. Enemy tanks, BMPs, and direct fire support weapons (artillery/AT guns) are restricted to streets. The following illustrations depict types of vehicle obstacles:

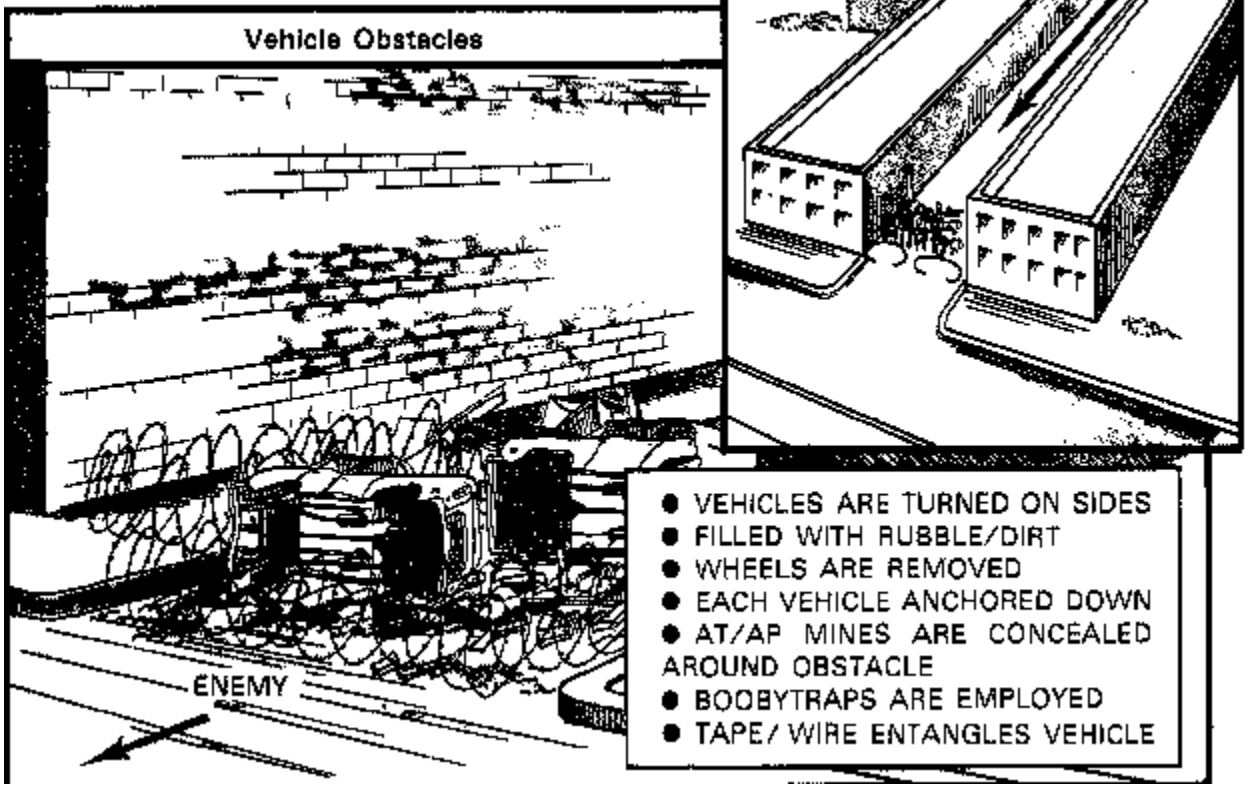

Figure D-4. Roof and Vehicle Obstacles

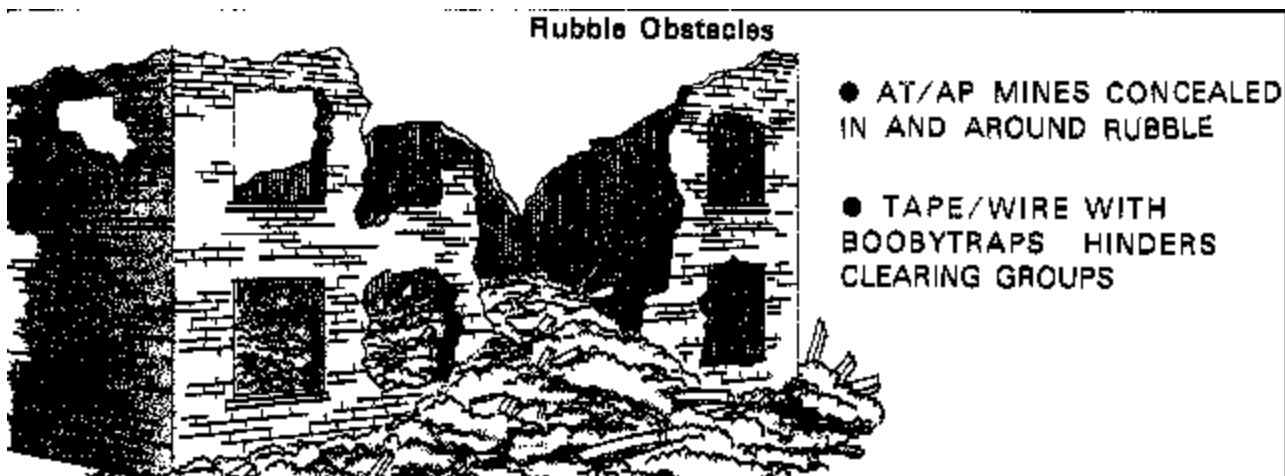

Figure D-5a Rubble Obstacle

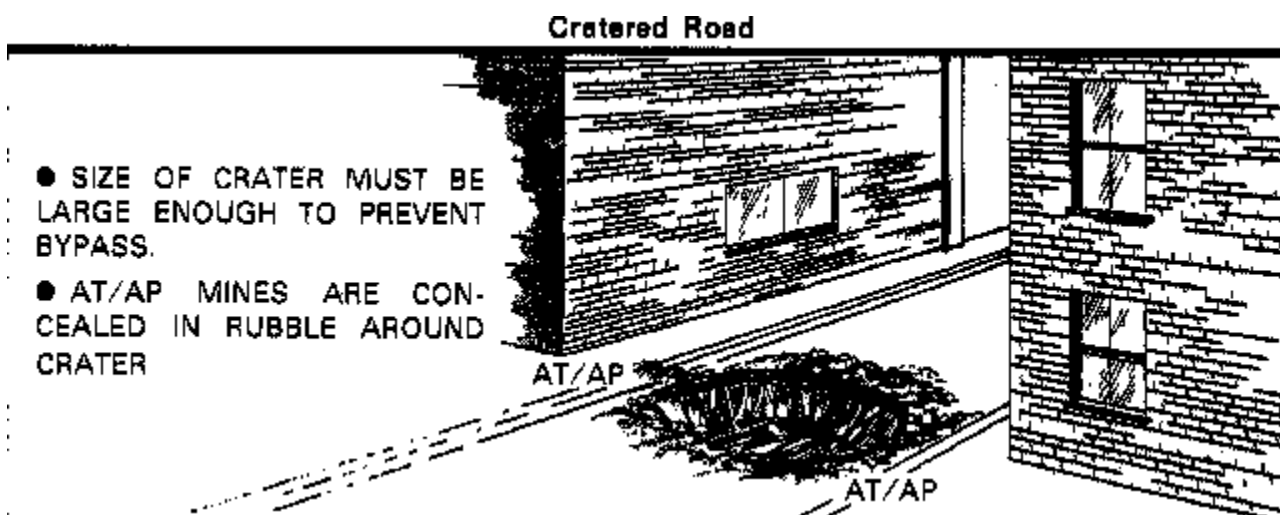

Figure D-5b Cratered Road

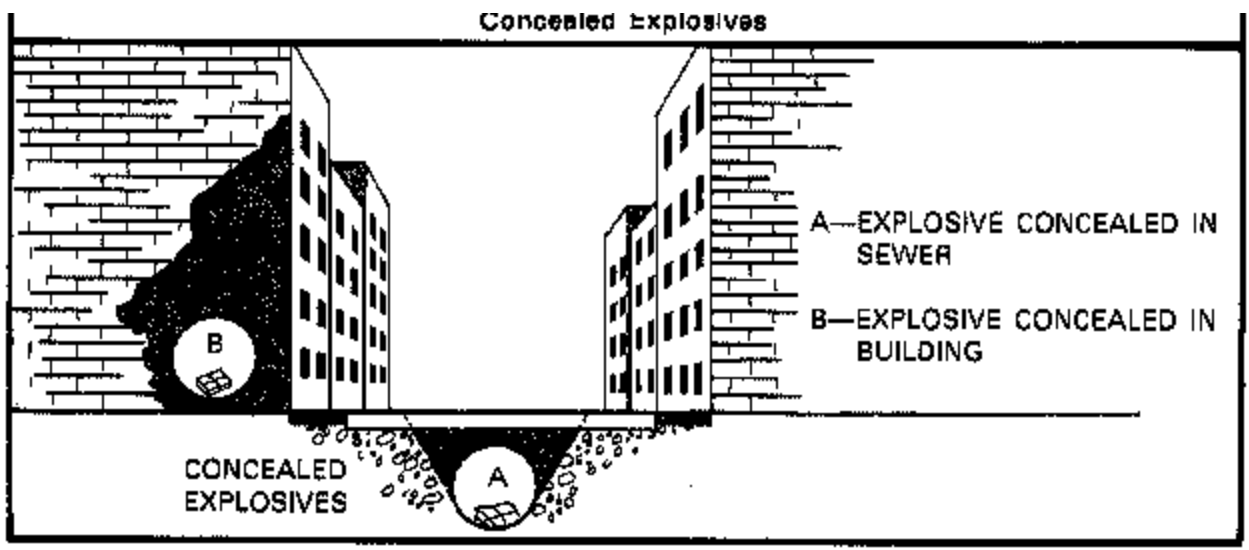

Figure D-5c Concealed Explosive

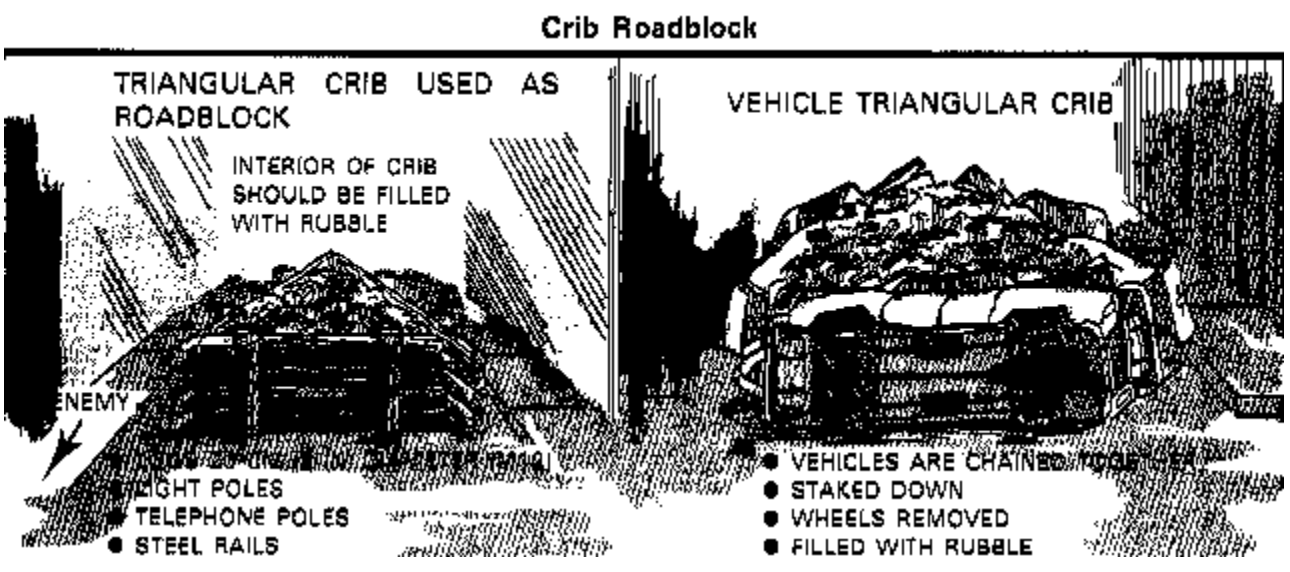

Figure D-6a Crib Roadblock

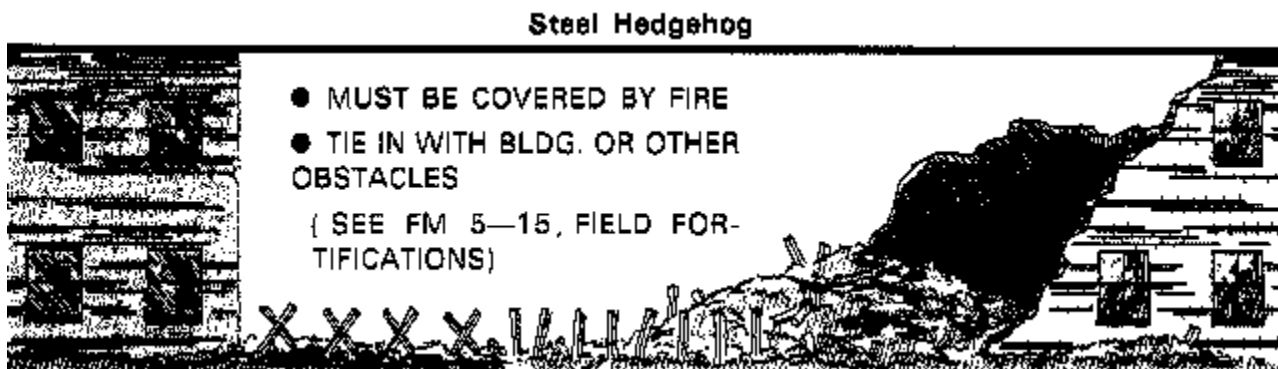

Figure D-6b Steel Hedgehog

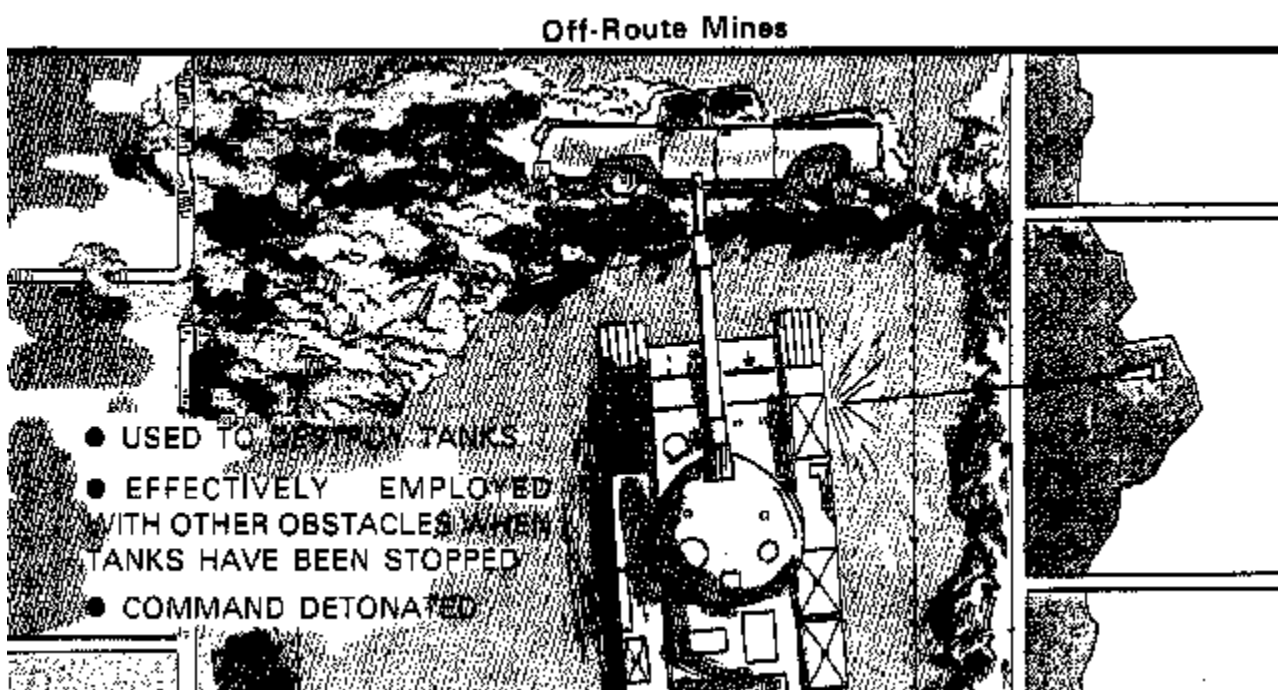

Figure D-6c Off-Route Mines

DISPERSED RESIDENTIAL AREA (TYPE C)

Obstacles in this area are constructed to reduce infantry mobility through houses, between houses, and in open areas. Barbed tape/wire and AP mines/booby traps are the most effective antipersonnel obstacles in this area.

Anti armor obstacles are designed to prevent armored vehicles from moving between houses and along streets. Street barriers will be of little use because of the relative ease of bypassing them. Antitank mines are the most effective vehicle obstacles in this area.

The figure below depicts types of anti armor and antipersonnel obstacles that are suitable for this area.

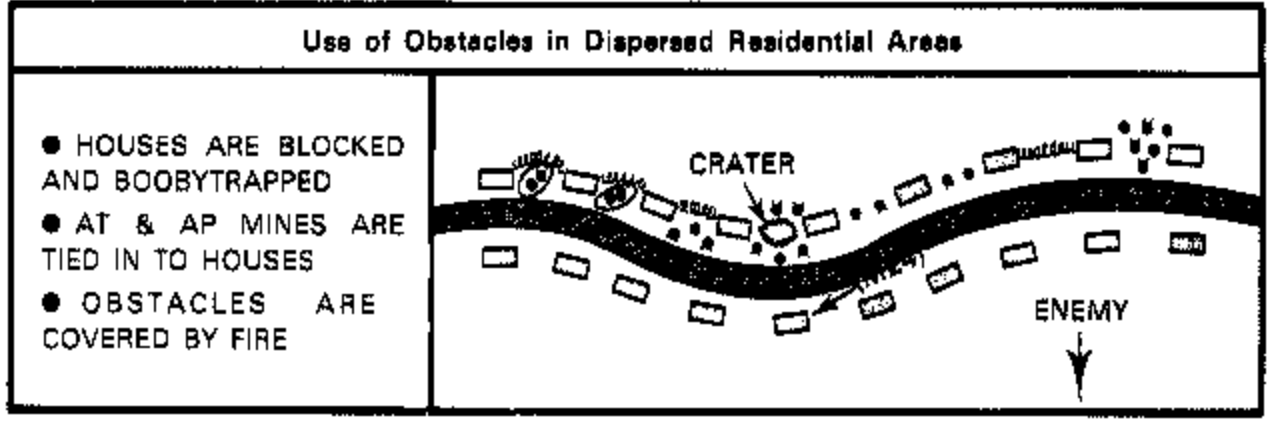

Figure D-7. Use of Obstacles in Dispersed Residential Areas

HIGH-RISE AREA (TYPE D) and INDUSTRIAL/TRANSPORTATION AREA (TYPE E)

The open areas that are generally found in these areas will require hasty minefields similar to those recommended for high-rise areas.

The numerous open areas between widely spaced buildings will require significant labor and barrier materials. The most effective obstacle in this area will be hasty AT/AP minefields.

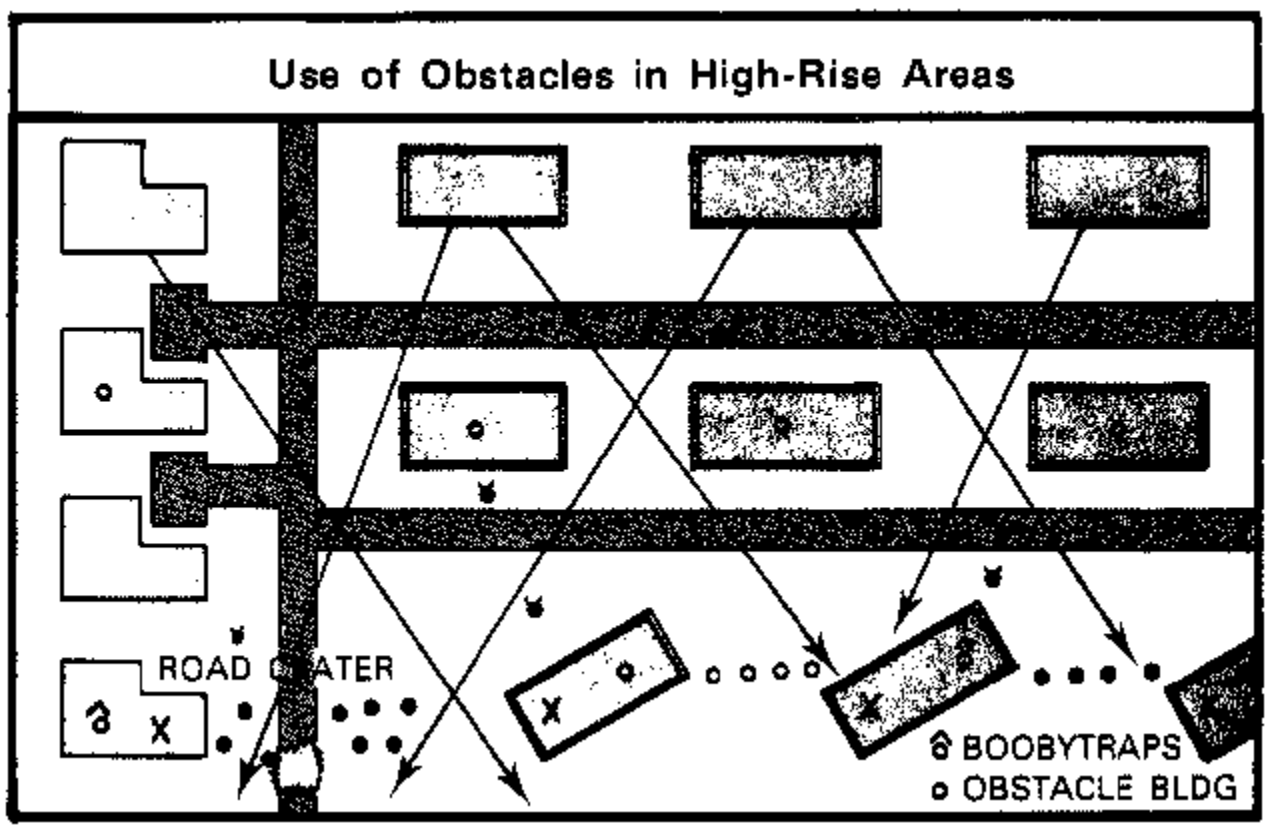

Figure D-7b Use of Obstacles in High-Rise Areas

APPENDIX E

Demolitions

This appendix describes general techniques for the employment of breaching materials. FMs 5-25, Explosives and Demolitions, and 5-34, Engineer Field Data, provide detailed information. Frequently, infantrymen will be required to employ explosives and demolitions without engineer assistance. The most common demolition requirement for assaulting infantry is the breaching of walls, ceilings, and floors. Complicated destruction/denial missions should only be attempted by skilled combat engineers.

BREACHING EXTERIOR WALLS

One of the most difficult demolition operations is the breaching of masonry and reinforced concrete walls. When faced with a requirement of this nature, C-4 is the ideal explosive for the infantry soldier. Normally, buildings have walls 61cm (2 feet) or less in thickness. Assuming that all outer walls are constructed of reinforced concrete, a good rule of thumb for breaching is to tie or tape 4.5 kg of C-4 on a pole, place it against the target between waist and chest height, and detonate. This will normally blow a hole large enough for a man to get through. If his charge is not elevated at least one wall thickness above the base of the wall, the charge will not create the desired effect.

Breaching Wall With C-4

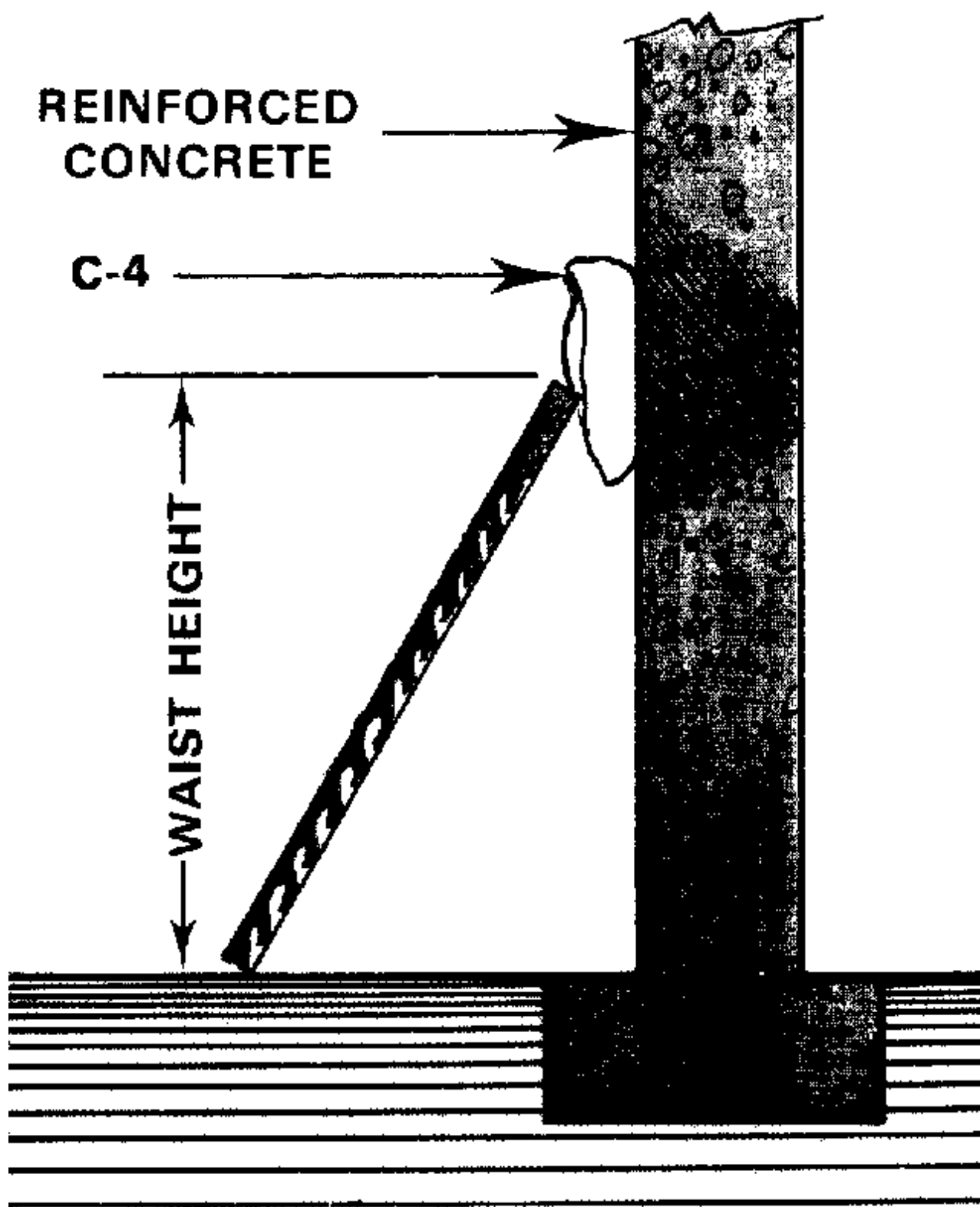

Figure E-1. Breaching Wall With C-4 (previous page)

Metal reinforcing bars will not be cut by this charge. Once exposed, they can easily be removed by using the following rule of thumb for cutting reinforcing bar:

Less than 2.5cm (1''): use .5kg (1 lb) of TNT.

2.5cm (1'') and over, but less than 5.1cm (2''): use .9kg (2 lbs) of TNT.

NOTE: Before attempting to cut reinforcing bar, hand grenades should be thrown into the opening created by the breaching charge.

BREACHING INTERIOR WALLS

Holes can be readily blown in interior walls by using C-4 or Flex-X. Although Flex-X explosives have adhesive backing, additional means must be taken to secure charges to the walls. When using C-4, one block should be cut into three equal parts. They should be placed on the wall at an equal distance, from neck to knee height. The charges should be primed with detonating cord or three electric blasting caps to obtain simultaneous detonation.

With Flex-X there are four sheets per package. Use two sheets placed against the wall at mid chest and mid thigh height. Prime in the same manner as with C-4. When emplaced as described, these charges will effectively blow a hole in an interior wall (not concrete) large enough for a man to get through.

NOTE: When using time fuse, care must be taken by the members of the search team to insure that enough time is available to get out of the room and take cover. The overpressure caused by the explosion in a room can cause casualties.

Breaching with C-4

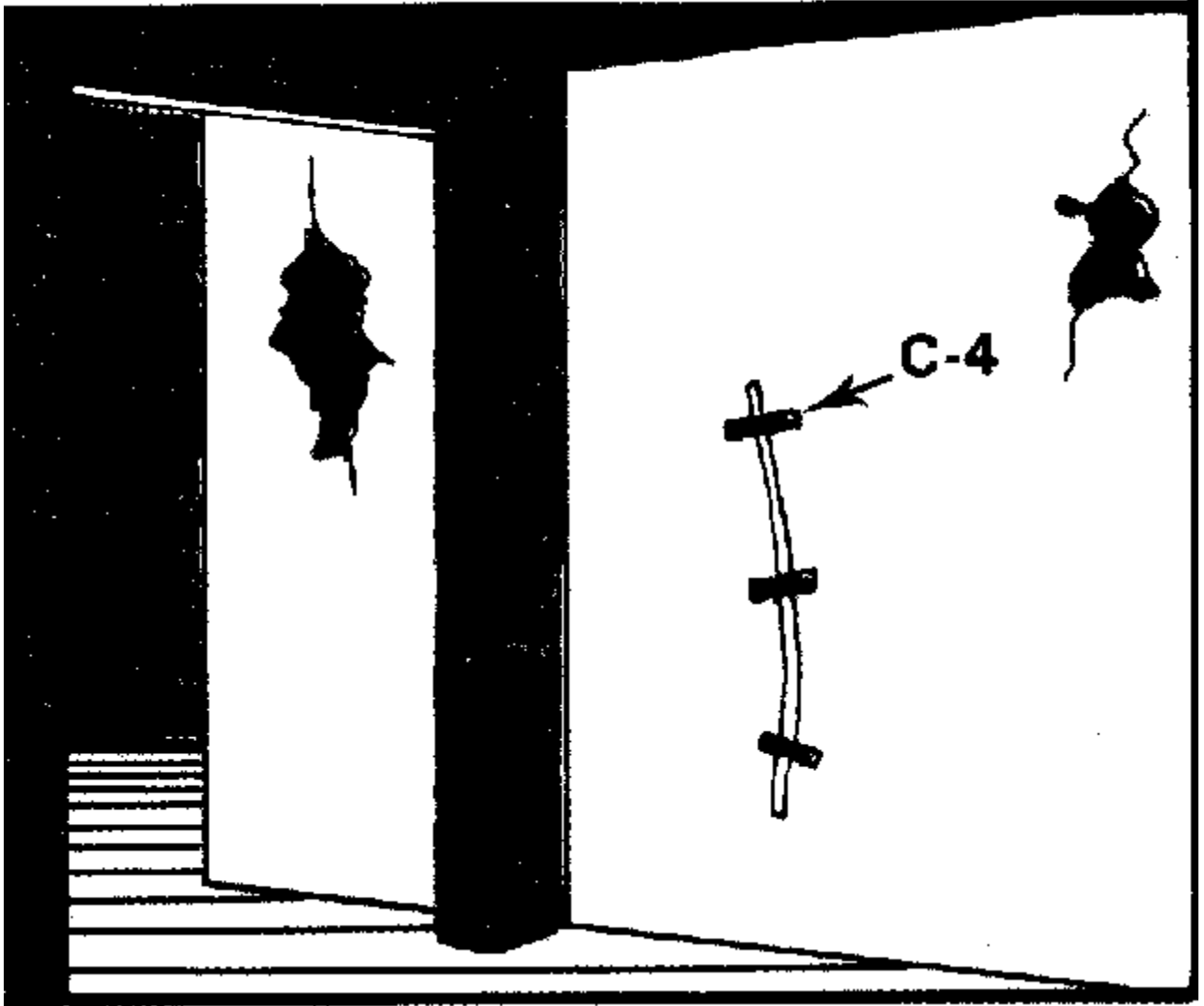

Figure E-2a Breaching With C-4

CLAYMORE MINE

The claymore mine contains .67kg of C-4 explosive. It can knock doors down, breach thin walls, and destroy minor obstacles in a building.

When using claymore mines to breach interior walls, tamping material such as sandbags should be used to increase their effectiveness and reduce the amount of explosive force directed to the rear.

Breaching with Claymore (C-4)

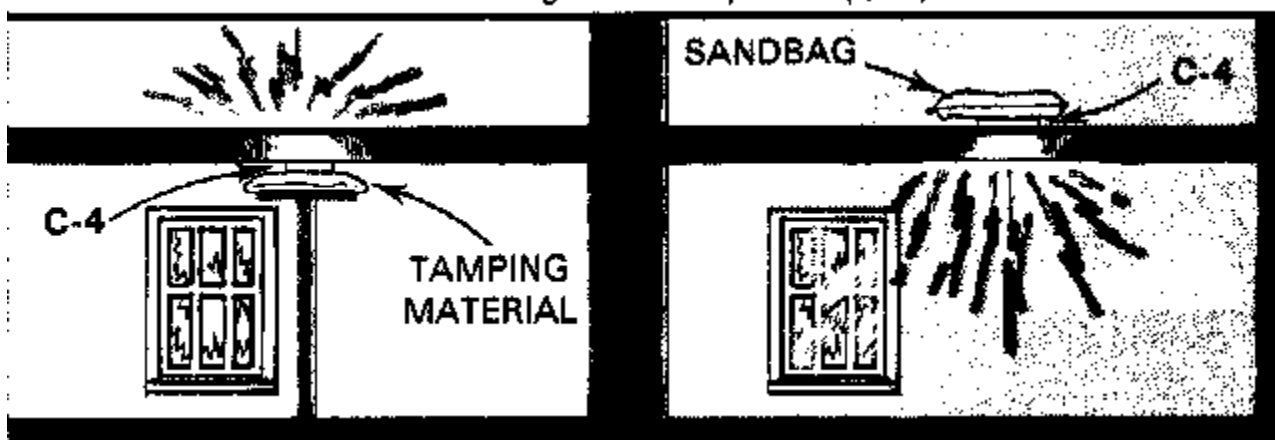

Figure E-2b Breaching with Claymore (C-4)

SAFETY CONSIDERATIONS

The greatest danger to personnel from demolitions is the debris and fragments thrown by the explosion. Leaders must insure that measures are taken to protect personnel and equipment from injury or damage. The distances listed below indicate the minimum safe distances from bare charges for persons in the open.

EXPLOSIVE IN		SAFE DISTANCE IN METERS
KILOGRAMS	POUNDS	
1-12	1-27	300
13.5	30	311
18	40	342
22.5	50	369
45.0	100	465

NOTE: These distances will be modified in combat when troops are in other buildings, around corners, or protected by intervening walls.

Demolitions Do's and Don'ts

DO NOT: Take chances.

Handle explosives carelessly.

Divide responsibility for explosive work.

Mix explosives and detonators.

Carry explosives or caps in pockets.

DO: Keep the blasting machine under the control of a NCO.

Wear helmets at all times while firing explosives.

Handle misfires with extreme care.

Clear the room and get people protected when blowing interior walls.

Prepare some charges, minus detonators, beforehand to save time.

Carry enough demolitions for your needs.

Use C-4 to breach hard targets (masonry construction)

APPENDIX F

Armored Forces In Built-up Areas

This appendix supplements material presented in chapters 2 and 3 of this manual by providing fundamental considerations for the employment of armored forces in built-up areas.

Our forces, particularly armored forces, have been trained to avoid built-up areas whenever possible; however, because of the rapid expansion of urban areas, this option may no longer be feasible. Tank crews must expect to fight in built-up areas as an integral part of the combined arms team, providing their firepower and shock action to dislodge and destroy the enemy.

The characteristics of operations in built-up areas will normally preclude the employment of pure armor or armor-heavy task forces. The inner city, with its narrow and/or rubble-clogged streets, limits or severely canalizes armor movement. Further, armor operating independently can easily be forced to button up, thus reducing observation and heightening the prospect of ambush by close-range ATGM fires. Finally, the traverse of the main armament may be limited by structures (except the M551) and cannot be sufficiently depressed or elevated to fire into basements or upper stories of buildings.

TANKS IN THE DEFENSE

In the defense of a built-up area, armor is employed with the security forces on approaches. Tanks will be employed to take maximum advantage of the long range of their main armament. In addition to their integration and employment with security forces, they may be positioned on the edge of the built-up area in mutually supporting positions with concealed routes of withdrawal. Tanks are normally retained under centralized control to provide flexibility in meeting armor threats on avenues of approach.

Upon withdrawal to the inner defense, tank fires are integrated with all other AT fires. Their positions must offer cover and concealment, be mutually supporting, and, ideally, have covered and concealed routes of movement between positions.

An important additional mission for tanks in the defense of built-up areas is their employment in over watch of barricades and obstacles along the periphery of the built-up area and in depth. Since the defensive battle will be fought primarily from strong points dispersed in depth, armor offers a significant direct fire, heavy-weapon supporting capability for these strong points.

Control of tanks is generally retained at company team level, and only in exceptional cases are tanks attached to platoons. Finally, tanks are attached to infantry-heavy reserves to support counterattacks or other reserve missions.

TANKS IN THE ATTACK

Where the adjacent terrain permits, armor-heavy or balanced forces conduct envelopment and isolation of a built-up area. Armor-heavy forces are also suited for overrunning a small lightly defended built-up area. In the attack of a built-up area, tanks over watch the infantry's initial assault until an entry into the area has been secured. Tanks must receive mutual support from infantry organic weapons to suppress enemy strong points and ATGMs while they move into position to fire their main armament.

Tanks support infantry by:

Providing shock action and firepower.

Neutralizing or suppressing enemy positions with smoke, high explosives, and automatic weapons fire as infantry closes with and destroys the enemy.

Smashing through street barricades or reducing barricades by fires.

Reducing or making untenable enemy strong points by fire.

Taking under fire other targets designated by the infantry.

Establishing roadblocks.

Infantry supports armor by:

Locating targets for engagement by tank weapons.

Suppressing and destroying AT weapons with mortars, automatic weapons, and grenades.

Assaulting positions and clearing buildings.

Providing local security for tanks at night or during other periods of reduced visibility.

APPENDIX G

How To Attack And Clear Buildings

This appendix provides "how to" guidance for:

The conduct of the attack in built-up areas.

The clearance of defended buildings

HOW TO ATTACK IN BUILT-UP AREAS

This section provides examples of how the battle is conducted in various types of built-up areas. These illustrative actions are based on application of tactical fundamentals.

Because the commander is driven by the requirement to maintain momentum, he must retain the initiative. Upon gaining enemy contact he maintains that contact and provides additional security, if required, while aggressively seeking the enemy's weakness, whatever it may be. He rapidly initiates several actions simultaneously. He directs suppressive fires to neutralize the enemy's ability to react and provide mutual support; he concentrates forces to overwhelm the enemy at a selected spot; and he commits them in fire and maneuver to assault the enemy.

The following combat vignettes are provided:

Commitment of a company team to seize a strongpoint.

Reduction of an enemy strongpoint in Type A area.

Company team attack in Type D area.

Infantry platoon attack in Type C area.

Air mobile assault of a tall apartment building in Type D area.

COMMITMENT OF A COMPANY TEAM TO SEIZE A STRONGPOINT

The 1st Platoon leader reported to his team commander that his platoon has been stopped by heavy fires from apartment building 1 (illustration on following page). The platoon leader has requested indirect fires and engaged the enemy position with fires from an attached tank. However, he is unable to bypass. The team commander directed the platoon leader to provide a base of fire for the employment of the 3d Platoon on the flank. The 3d Platoon moved to the vicinity of buildings 2, 3, and 4 and prepared to assault the enemy strongpoint. After achieving fire superiority from supporting weapons, the 3d Platoon attacked and cleared the enemy strongpoint. See the latter part of this appendix for clearance of buildings.

Seizing a Strongpoint

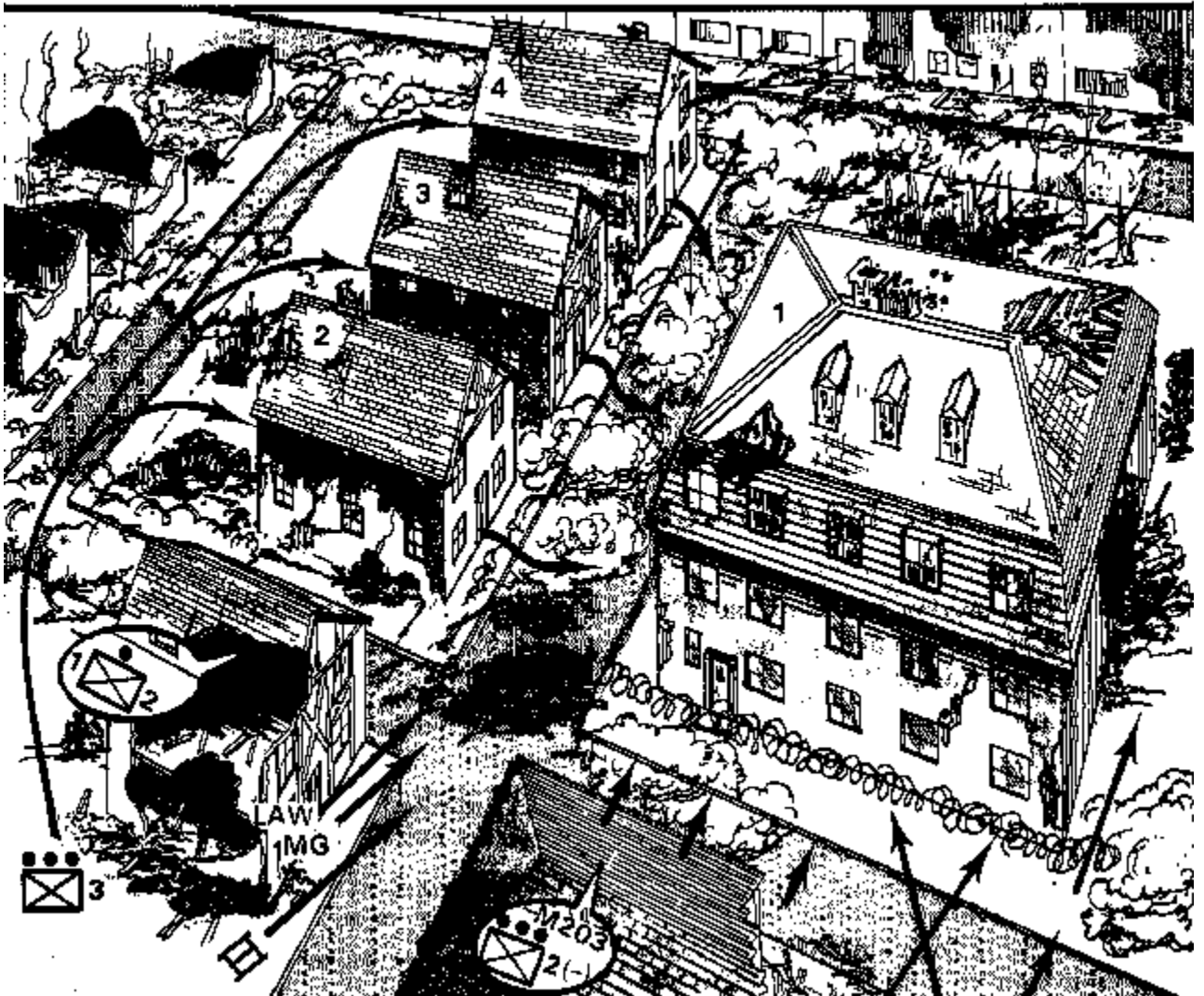

Figure G-2. Seizing a Strongpoint

The following summarizes the actions taken in this situation. Remember, after securing an enemy strongpoint, immediately prepare for a counterattack.

- 1st Platoon provided over watching fires.
- Strongpoint was isolated by indirect/direct fires.
- All weapons were employed to suppress defensive fires.
- Smoke was used to conceal movement across streets.
- Defeated enemy position was immediately prepared to repel possible counterattack.

REDUCTION OF ENEMY STRONGPOINT IN AREA A

In this situation, the 3d Platoon has been stopped by an enemy-prepared position in building 2 (illustration opposite). It appears that the enemy strongpoint has mutual support from adjacent buildings along the entire block. This area is a high fire hazard area. The company commander employed machinegun tracers and white

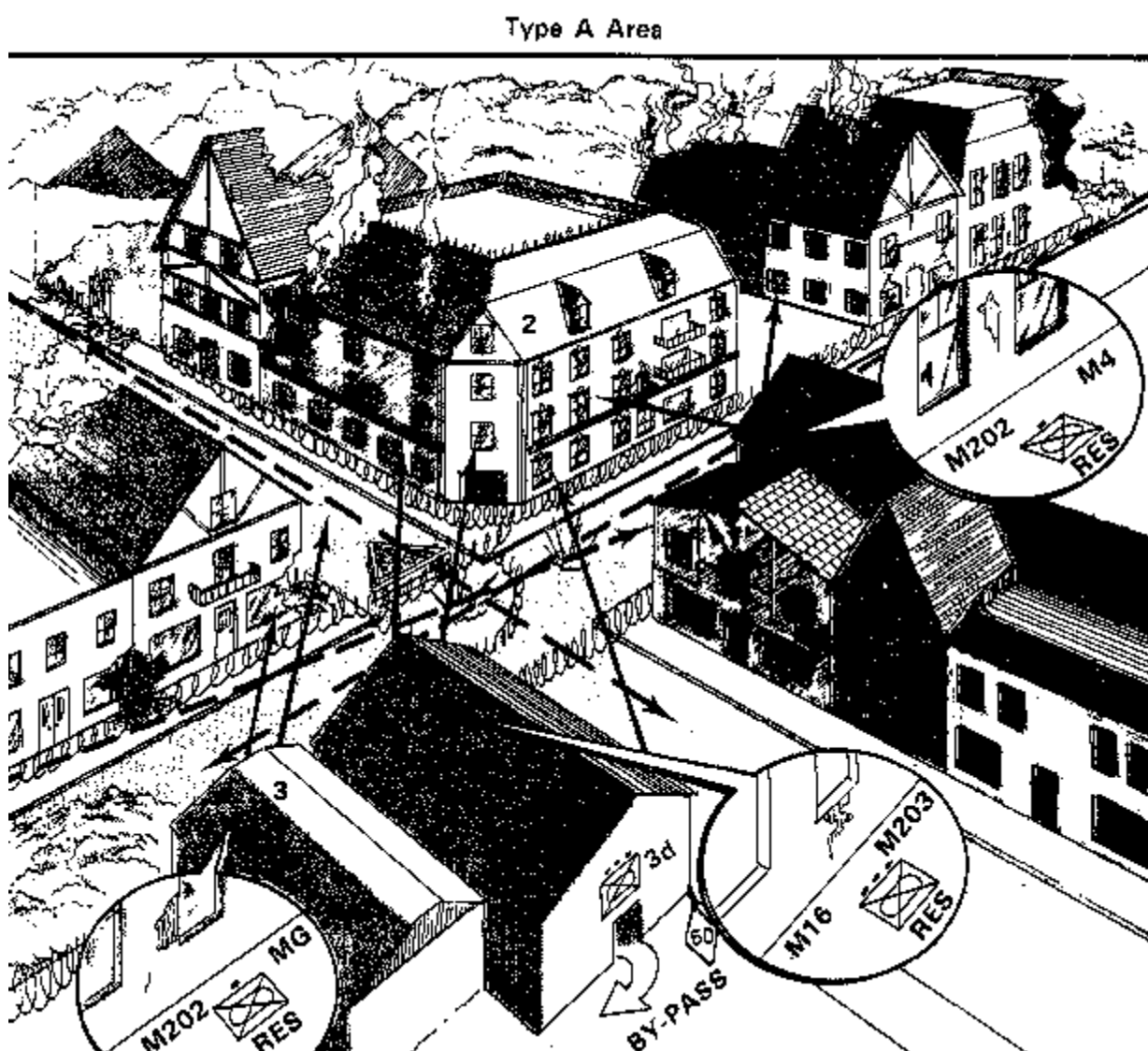

Figure G-3. Type A Area

phosphorous mortar fires onto rooftops. Multiple purpose flame weapons (M-202) were employed from buildings 3, 4, and 5. Other indirect fires and automatic weapons confined to suppress the strongpoint.

The company commander assigned his reserve the mission of containing the enemy position while the team (-) bypassed and continued the attack. Combat actions are summarized as follows:

3d Platoon maintained pressure until reserve arrived.

Enemy strongpoint was reduced by fires.

Tracers, WP, and flame weapons were employed.

Reserved contained--while 3d Platoon bypassed and continued the attack.

Excessive casualties were avoided by not assaulting this well-prepared position.

Team A, reinforced with a tank platoon, is attacking an enemy strongpoint organized within the apartment building. The objective has been isolated by indirect fires to the rear and by small arms fire on both flanks. Movement in this area is covered by over watching fires and/or concealed by smoke. Combat engineers, accompanied by the 3d Platoon, were able to place a breaching explosive as indicated in the figure. After breaching the walls in four places, the 3d Platoon cleared the strongpoint. The actions in this situation are summarized as follows:

Strongpoint was isolated by mortar and artillery fires.
All movement was concealed by smoke.
Over watching weapons suppressed enemy gunners.
Assaulting forces used cover as much as possible while moving.

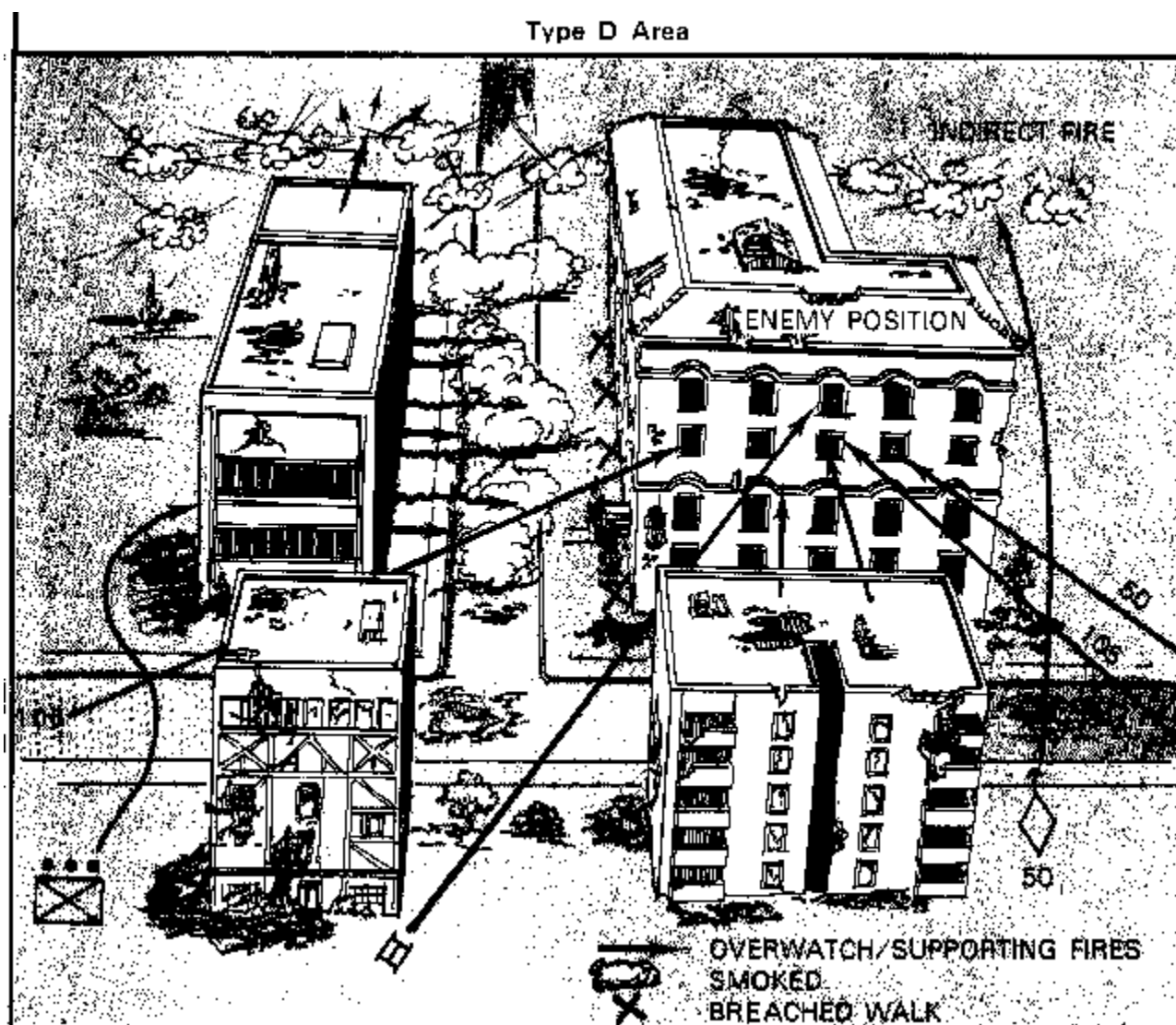

Figure G-4. Type D Area.

INFANTRY PLATOON ATTACK IN TYPE C AREA

The 3d Platoon has encountered two family dwellings lightly defended as indicated below. The platoon leader employed the 1st and 2d squads to support and over watch the 3d squad's assault on building #1. The platoon leader supported the assault with automatic weapons fire, multiple purpose flame weapons (M-202), and LAWs. Organic team mortars were used to isolate the area from reinforcement or withdrawal, to collapse roofs, start fires, and to provide smoke to conceal fire and maneuver within the platoon.

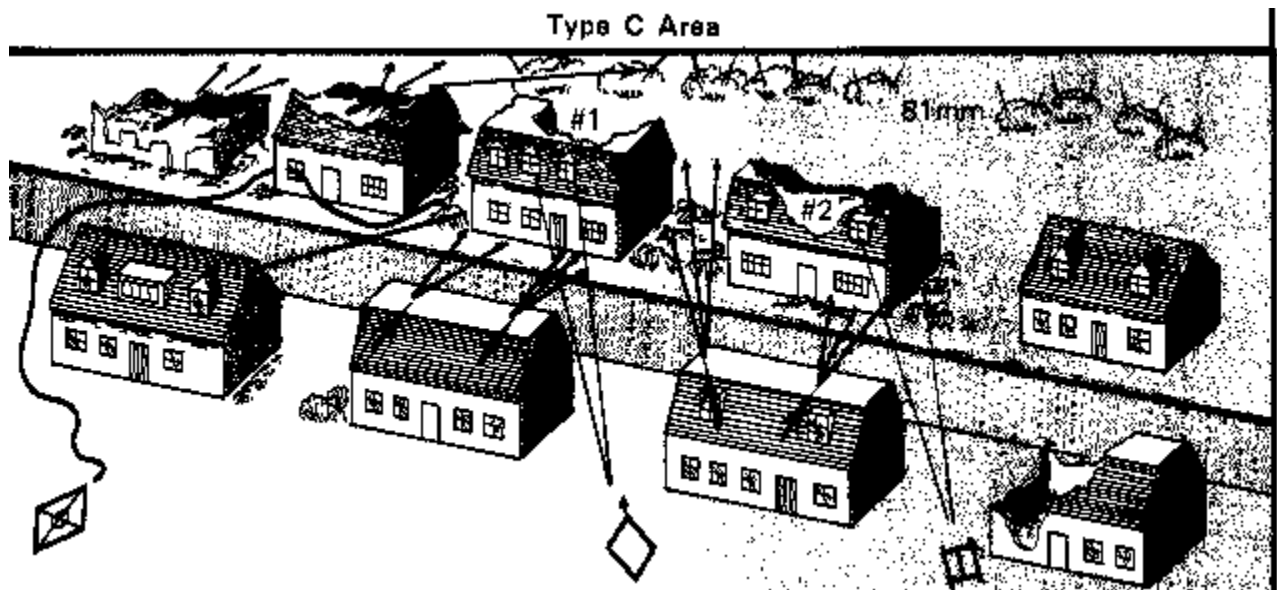

Figure G-5a Type C Area

AIRMOBILE ASSAULT OF A TALL APARTMENT BUILDING

In this situation, Team A has isolated the objective and was able to suppress antiaircraft fires within the immediate area. Brigade is coordinating antiaircraft suppression along corridors leading into this building. Enemy ground fires within the objective are suppressed with all available fires. The open area around the building would make a ground assault too costly. The commander employed the 3d Platoon, by squad, from a secure pickup point to the apartment building rooftop by helicopter. The 3d Platoon cleared the building from the top, down. The helicopter flew in and out of the objective area over known safe corridors. Summary of actions:

Enemy ADA and small arms fires must be suppressed.

Never use same air route more than once.

Pick up in secure area.

Know strength of roof.

Airmobile Assault

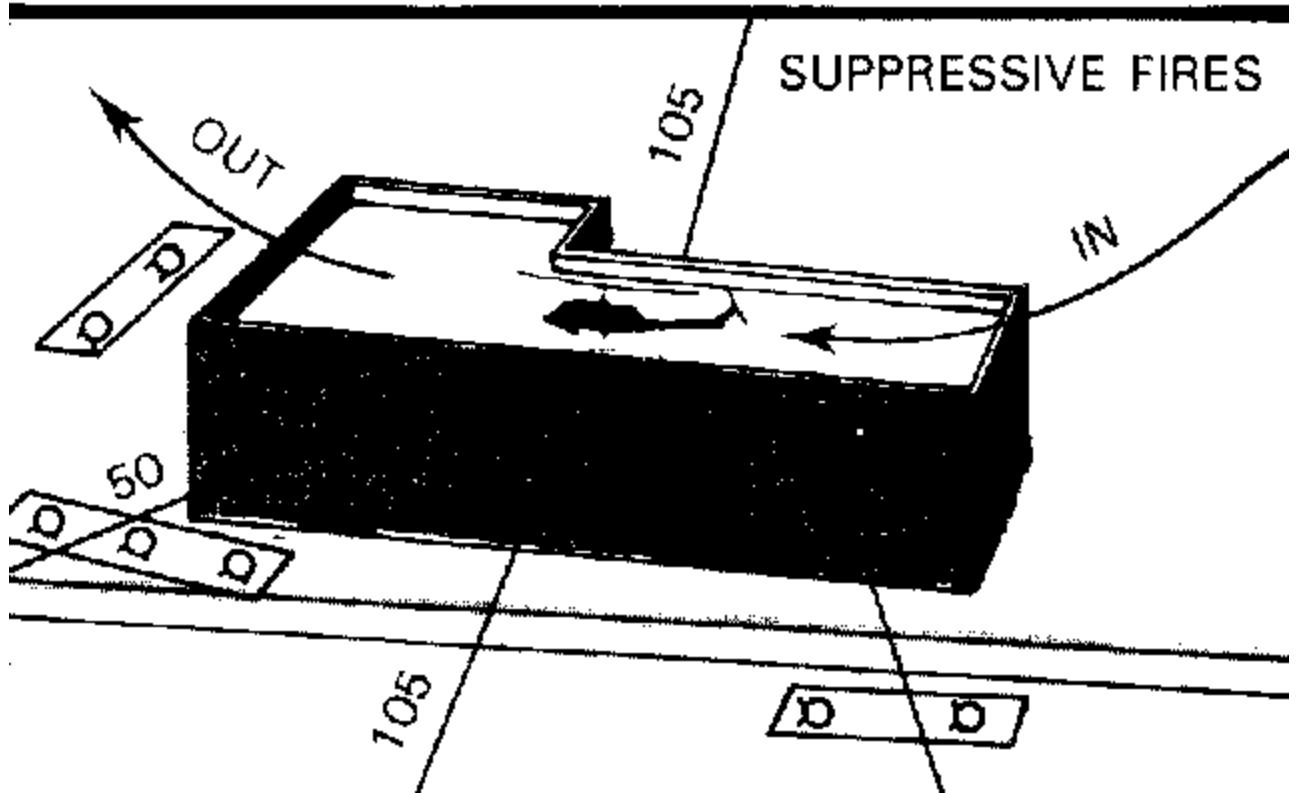

Figure G-5b Air mobile Assault

HOW TO ATTACK AND CLEAR DEFENDED BUILDINGS

Regardless of a structure's physical characteristics or type urban area, there are four interrelated requirements for attacking and clearing a defended building. They are:

- * Fire support.
- * Assault.
- * Movement.
- * Reorganization.

Proper application and integration of these requirements reduce casualties and hasten accomplishment of the mission. The degree of application of some requirements is determined by the type building to be attacked and by the nature of adjacent urban terrain. For example, numerous open spaces in Type D and E areas require increased fire support to suppress/obscure enemy gunners while infantry units move across open terrain. Conversely, in Type A and B areas numerous covered routes will decrease fire support requirements.

FIRE SUPPORT

Fire support and other assistance to enhance the advance of the assault force are provided by an Over watch force. This assistance includes:

- * Suppressing/obscuring enemy gunners within objective building(s) and adjacent structures.
- * Isolating the objective building(s) with indirect/direct fires to prevent enemy withdrawal, reinforcement, or counterattack.
- * Breaching walls en route to and in the objective structure.
- * Destroying enemy positions with direct-fire weapons.

- * Securing cleared portions of the objective.
- * Providing replacements for the assault force.
- * Providing re-supply of ammunition and explosives.
- Evacuation of casualties and prisoners.
-

The size of the over watch force is determined by:

- * Type and size of objective building(s).
- * Adjacent terrain--open or covered approaches.
- * Organization and strength of enemy defenses--what firepower is required to suppress/obscure enemy gunners.

Depending on the situation, the over watch force may consist of only one infantry fire team, with M-60 machineguns, grenade launchers, and M202 multi shot flame weapons, to support another fire team's assault. In situations involving a larger assault force, a platoon or company, reinforced with tanks, engineers, and self-propelled artillery, may be required to support movement and assault by an adjacent platoon or company. Upon seizure of objective buildings, the assault force reorganizes and may be required to provide over watching fires for the displacement or assault by the over watching force.

Technique of Fire

Each weapon is assigned a target or area to cover. Individual small arms place fires on likely enemy weapon positions--loopholes, windows, roof areas. Snipers are best employed in placing accurate fire through loopholes or engaging long-range targets. M203s and M202s direct their fires through windows or loopholes.

LAWs are employed to penetrate walls constructed of light material, barricades, and window barriers on the ground level of structures. Tank main guns engage first-floor targets and breach walls for attacking infantry. Tank machineguns engage suspected positions on upper floors and in adjacent structures. In addition to destroying or weakening structures, tank main gun projectiles create casualties by hurling debris throughout the interior of structures. Artillery and mortars use delayed action fuzes on rooftops to cause casualties among defenders within the structure by high-explosive, shrapnel, and falling debris effects

MOVEMENT

The assault force (squad-platoon-company) minimizes enemy defensive fires during movement by:

- * Using covered routes:
- * Through underground structures.
- * Through or behind secured buildings.
- * Through streets (rubble, vehicles, etc.).
- * Moving only after defensive fires have been suppressed or obscured.
- * Moving at night or during other periods of reduced visibility.
- * Selecting routes that will not mask friendly suppressive fires.
- * Crossing open areas (streets, space between buildings) rapidly under the concealment of smoke and suppressive fires provided by over watching forces.
- * Moving on rooftops that are not covered by enemy direct fires.

In lightly defended areas, the requirement for speed may dictate moving through the streets and alleys without first clearing all buildings. Under these circumstances, the maneuver element should employ tanks, if available, to lead the column, closely followed and supported by infantry. If the infantry is mechanized, it should remain mounted until forced to dismount. It should remount to cross open areas. When dismounted, rifle elements move along each side of the street with leading squads keeping approximately abreast of the lead tanks. When not accompanied by tanks, rifle elements move in single file along one side of the street under cover of fires from supporting weapons. They are well dispersed

and move quickly. Each man in the leading element is detailed to observe and cover a certain area, such as second-floor windows on the opposite side of the street.

Individual movement techniques are contained in TC 7-1, Rifle Squads.

ASSAULT

The assault force, regardless of size, attempts to close on the flank(s) or rear of an objective building. If the building is located on a street with numerous adjacent buildings under enemy control and an envelopment is not feasible, a frontal attack is required. Alternatively, the assault force can initially clear nearby buildings and then attack the final objective simultaneously from the front and flanks.

In the following example, the assault force has been organized into two teams; each team is assigned an entry point on the ground floor. Preferably, entry is gained through walls breached by explosives or gun fire. Assault teams avoid windows and doors as entry points because they are usually covered by fire or booby trapped.

Immediately prior to the assault, suppressive fires are increased on the objective and continue until masked by advancing forces. Once masked, such fires are shifted to upper windows and continue until assault forces have entered the building. At this time, supporting fires are shifted to adjacent buildings to prevent enemy withdrawal or reinforcement. Assault teams close on the building rapidly; however, prior to entry through a breached wall, window, or smashed door, a hand grenade is thrown inside. Immediately after the explosion, assault teams enter and spray the interior with automatic fire.

Once inside the building, the first task is to cover with automatic weapons the staircase(s) leading to upper floors and the basement; and, secondly, to seize rooms that overlook approaches to the building. These actions are required to isolate enemy forces within the building and to prevent reinforcement from the outside. Previously designated teams clear each ground floor room and then the basement.

Room Clearance

A searching team (two-man minimum) is assigned to clear one or more rooms. When entering a room avoid using door handles. Knock the door open with automatic-fire and throw a hand grenade into the room. After detonation, one man quickly enters, sprays the room with automatic fire, and takes up a position where he can observe the entire room. At this time, a second man enters and conducts a systematic search.

Avoid clearing each room in a repetitive manner. For example, as shown, rooms 1 and 5 were cleared as previously described. Rooms 2 and 3 were cleared by blasting a hole through the wall, throwing in a grenade, entering the room, and conducting a search, as previously described.

1. Shoot Door Open.

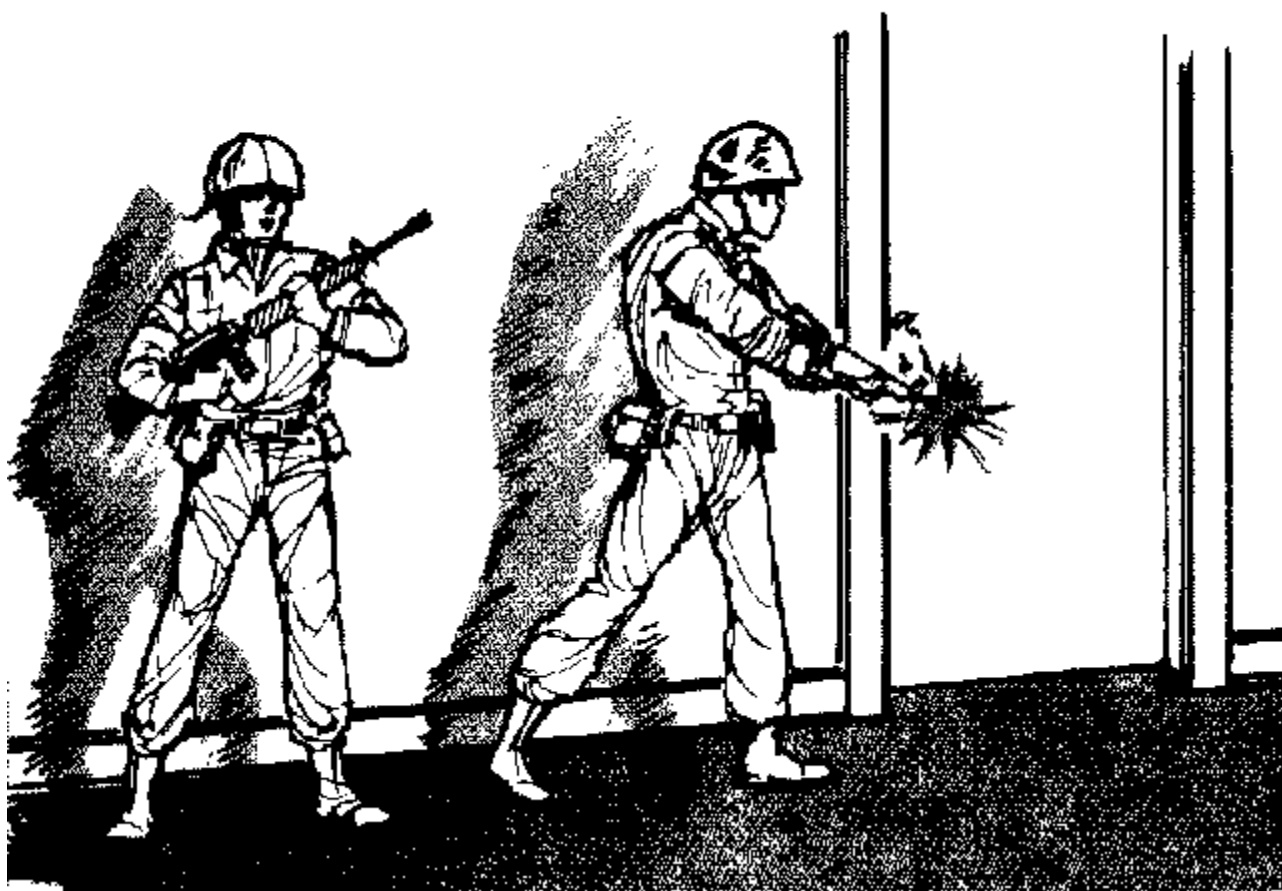

Figure G-8a Shoot Door Open

2. Toss Grenade.

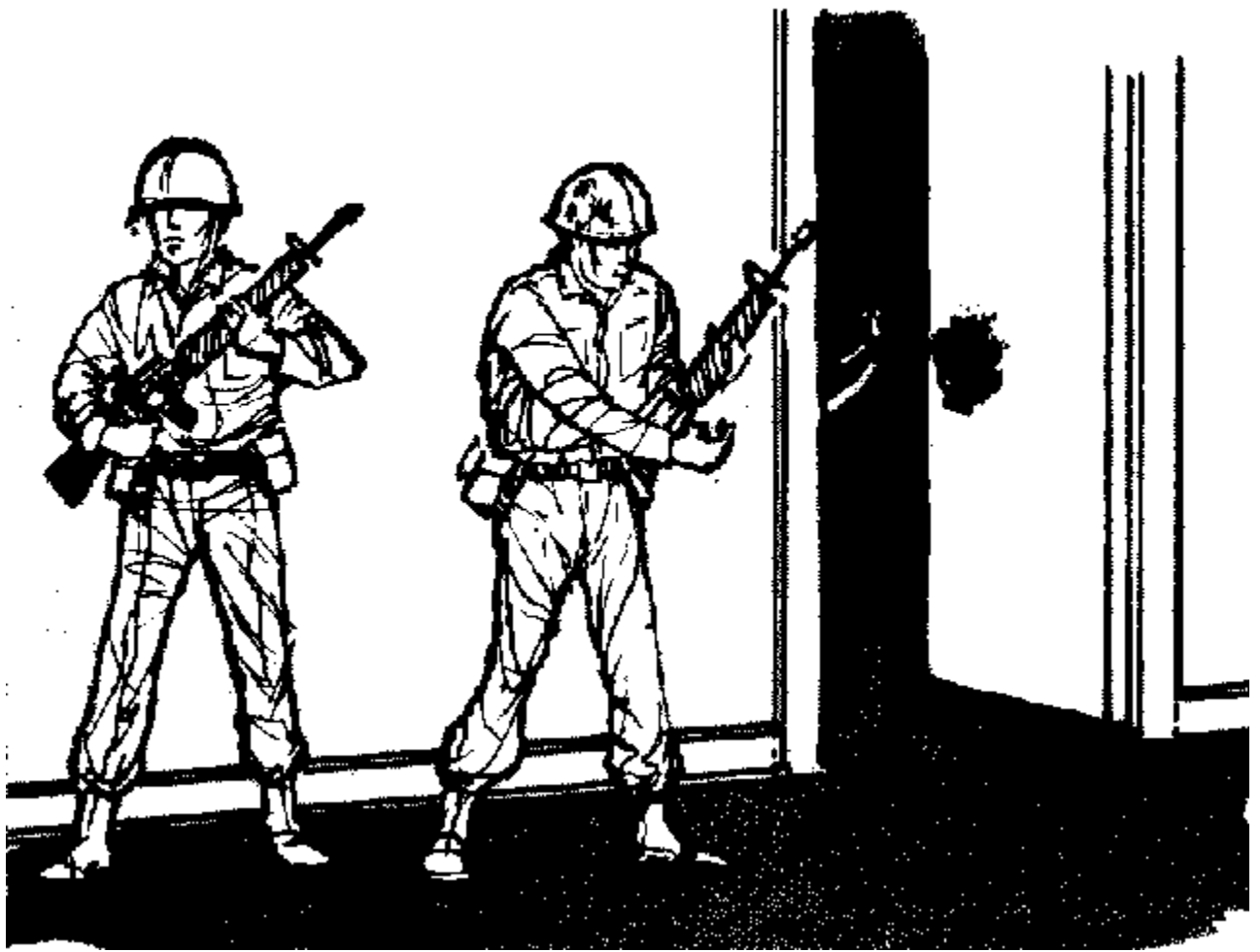

Figure G-8b Toss Grenade

3. Enter Firing and Search Room.



Figure G-8c Enter Firing and Search Room

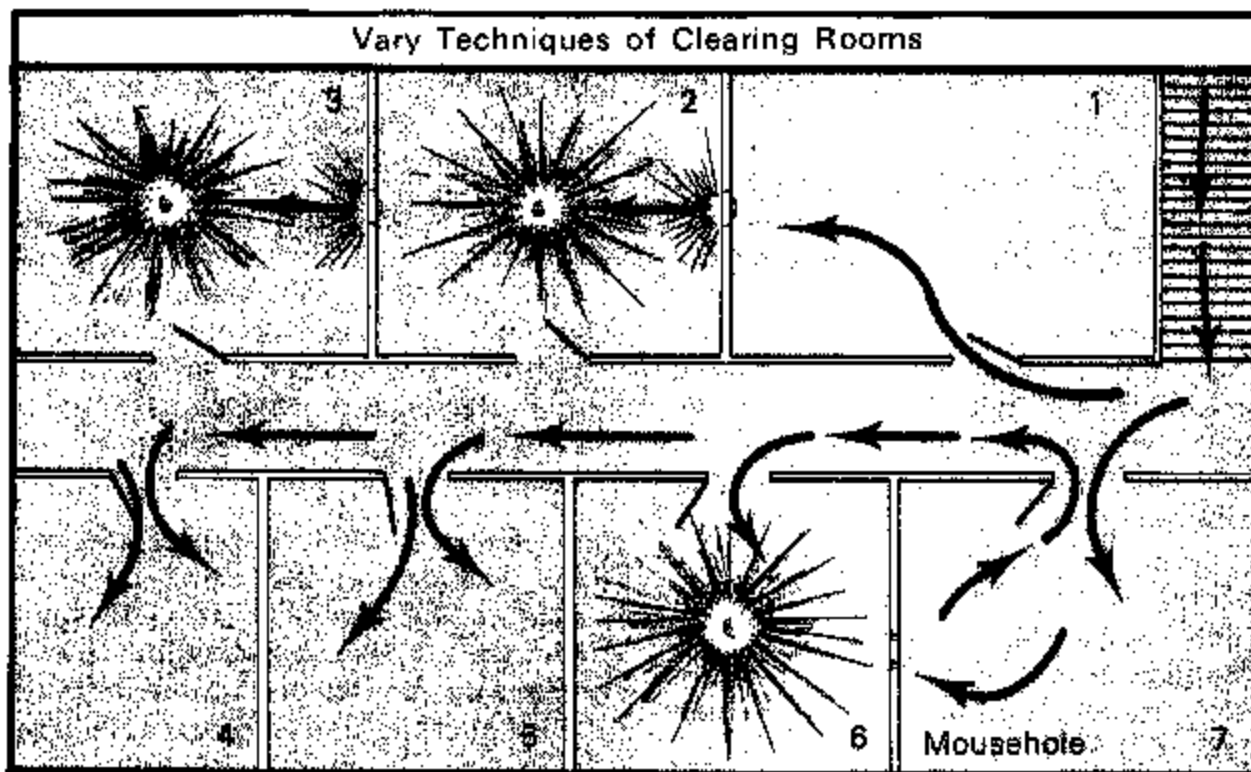

Figure G-9a Vary Techniques of Clearing Room

In room 7, an enemy "mouse hole" between rooms 6 and 7 was discovered behind a sofa. A grenade was thrown in the mouse hole; room 6 was then entered through the door and searched. Room 4 was entered by firing through the door, throwing grenade, and then searching. As rooms are cleared, doors are left open, and a predetermined mark (chalk, tape, aerosol spray) is placed on the door jamb or over the door.

Basement

If there is a basement, it should be cleared as soon as possible, preferably concurrent with clearance of the ground floor.

Securing Upper Floors

Frequently, stairways will be blocked with barbed wire and booby trapped. Stairs are usually covered by enemy fires, and entry into the stairwell can easily be denied by defenders throwing grenades into the stairwell. Avoid stairways whenever possible. Select room(s) that have ceilings intact and place an explosive charge against the ceiling. The resultant explosion should kill or stun defenders and provide uncontested access to the next floor. After securing an initial foothold, the remainder of the floor is cleared.

Clear Basement

- Fire through door.
- Toss grenade(s).
- Enter firing.
- Search carefully.
- Guard underground routes.

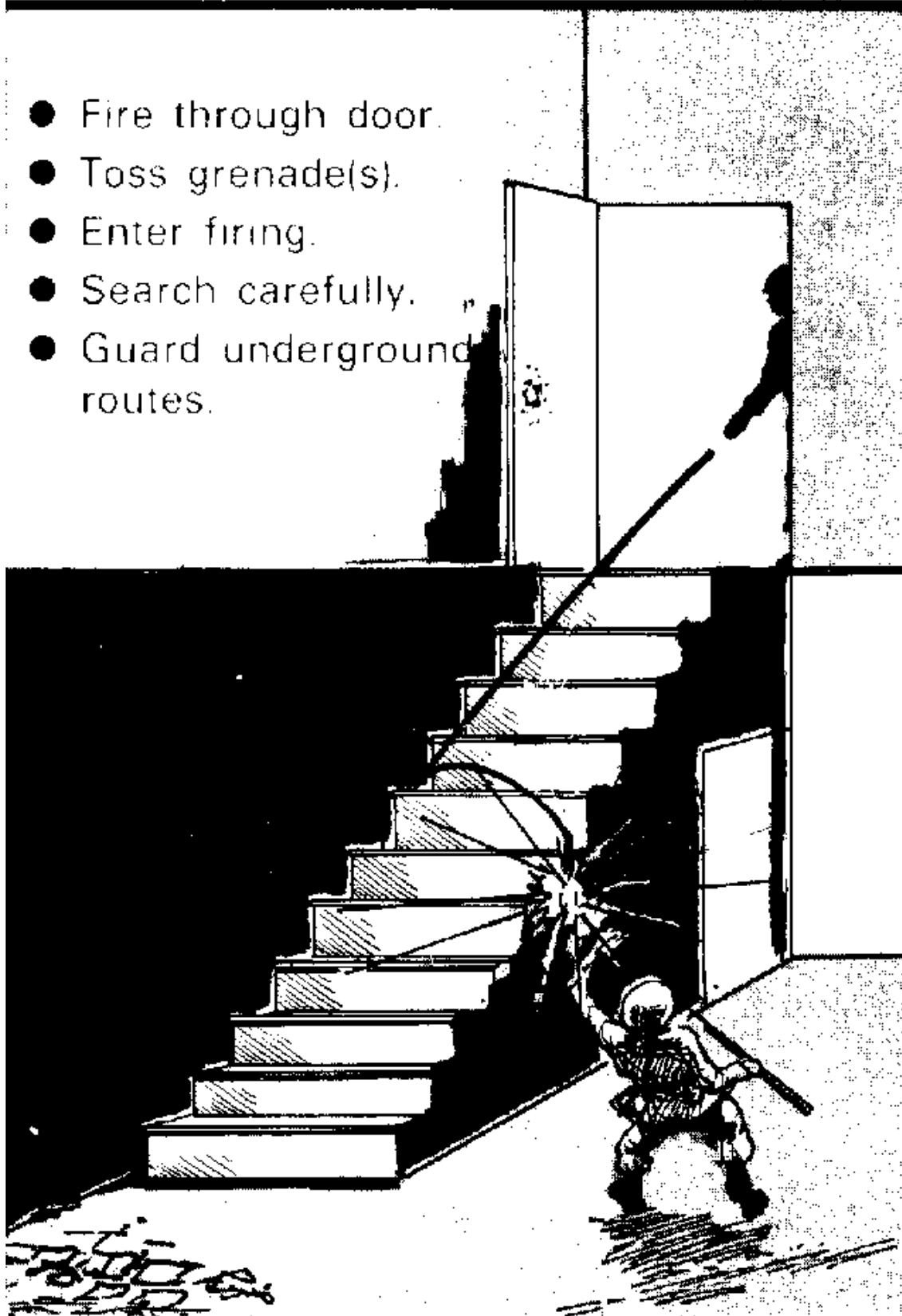

Figure G-9b Clear Basement (previous page)

Occasionally, buildings can be cleared from top to bottom. In block type construction (Area B), assault forces may outflank an enemy position by seizing an adjoining structure, breaching through the walls in upper stories, and clearing downward, floor by floor. Stairs are guarded by friendly security elements, but not used. Entrance to lower floors is gained by breaching the floor/ceiling with explosives and/or using lowering rope to enter the lower floor. Enemy mouse holes to lower floors are used only after a grenade has been dropped into the lower room. After detonation, a search team enters and clears the room.

In situations where assault forces are masked from enemy fires, access to the top floor or middle floor may be gained by using fire escapes, downspouts, grappling ropes, or ladders. If a middle floor is reached, assault teams clear that floor first, then upper floors, and finally lower floors.

Where to enter a specific building is one of the critical decisions for platoon and squad leaders. The normal rule of thumb is to enter at the highest level possible to minimize the amount of upstairs fighting and to avoid enemy heavy-weapons positions, which will usually be located on lower levels.

Other considerations which will affect the decision on the point of entry are the availability of access means to upper stories and the cover and concealment in the area. Often a squad or platoon leader will have to evaluate the relative risks of scaling the side of a building or clearing upward from the ground floor. Clearing from the bottom up may be the most frequent method in isolated, detached construction.

REORGANIZATION

In a captured building, reorganization of the assault force to repel enemy counterattacks must be rapid. After securing a floor (bottom, middle, or top floor), selected members of the assault force will be assigned to cover potential enemy counterattack routes to the building. These sentinels alert the remainder of the assault force to approaching enemy forces and place a heavy volume of fire on the enemy. These riflemen cover/guard:

- * Enemy mouse holes connecting adjacent buildings.
- * Covered routes to the building.
- * Underground routes into the basement.
- * Approaches over adjoining roofs.

As the other members of the assault force complete search requirements, they are assigned defensive positions. After the building has been completely cleared, the following actions are taken during reorganization:

- * Replenish and/or redistribute ammunition.
- * Mark building to indicate to friendly forces that the building has been cleared.
- * Cover advance of over watch force or assume over watch mission and support assault on another building.
- * Treat and evacuate wounded.

If the building is to be occupied for any period of time, start development of a defensive position.

Assault Fundamentals

The following fundamentals are to be considered when assaulting buildings:

- * Each soldier must know his responsibilities and his role in the over watch or assault force.
- * Close and continuous coordination is required between the over watching and assaulting forces.
- * Each assault member must know his entrance point into the objective building.
- * When conducting the initial entrance into a building, avoid using doors and windows. Use explosives or shell holes to gain entry.
- * Make intelligent use of cover.
- * Avoid windows, door, and hallways. Streets and open space between buildings are killing zones.

- * Use suppressive fires, cover, and smoke when moving through these areas.
- * Use buildings adjacent to the objective to mask enemy fires in the final assault.

Grenades.

Avoid, unless absolutely necessary, throwing grenades at upper windows or upstairs; they may bounce back. Use grenades before entering the building, basement, and all rooms.

Vigorously throw grenades into rooms so they carom about, denying the enemy an opportunity to throw them back.

- * Use automatic fire when entering and clearing a room.
- * Do not open doors by hand or attempt to kick them open. Shoot the door open by firing several rounds through the lock or blow the door in with explosives.
- * In buildings with lightly constructed interior walls/floors use M16 and M60 fires to clear rooms by firing through walls, ceilings, and floors. M60 machineguns with their heavier bullet are very effective in this role.
- * Avoid set patterns of clearing; vary entry methods from room to room and floor to floor.

Boobytraps.

Be constantly alert for them in doors, windows, halls, stairs, and concealed in furniture.

Do not attempt to deactivate them; mark for later disarming by trained engineers.

Use previously cleared routes where possible.

If the booby trap must be removed by untrained personnel, evacuate building; destroy in place with explosives, re-clear the building.

Assault and room-clearing teams should consist of at least two soldiers.

Avoid initial entry of building through middle floors; clear up or down; keep the procedure simple.

Reorganize assault teams for defense of captured buildings immediately.

APPENDIX H

References And International Agreements

Department of the Army Pamphlet 25-30 should be consulted frequently for latest change or revision of references given and for new material on subjects covered in this manual.

COMBAT

TC 7-1 The Rifle Squads

FM 7-7 The Mechanized Infantry Platoon and Squad

FM 7-8 The Light Infantry Platoon and Squad*

FM 7-10 The Rifle Company, Platoons and Squads

FM 7-20 The Infantry Battalion

FM 17-50 Attack Helicopter Operations

FM 17-95 Cavalry

FM 23-9 M16A1 Rifle and Rifle Marksmanship FM 71-1 The Tank and Mechanized Infantry Company Team

FM 71-2 The Tank and Mechanized Battalion Task Force

FM 71-100 Armored and Mechanized Division Operations

FM 71-101 Infantry, Airborne and Air Assault Division Operations*

FM 100-5 Operations

*To be published

ARMY AVIATION

FM 1-5 Instrument Flying and Navigation For Army Aviators

COMBAT SUPPORT.AIR DEFENSE

FM 44-1 Air Defense Artillery Employment

FM 44-3 Chaparral/Vulcan Employment

FM 44-23 Redeye Employment

ENGINEER

FM 5-15 Field Fortifications

FM 5-20 Camouflage

FM 5-25 Explosives and Demolitions

FM 5-34 Engineer Field Data

FM 5-36 Route Reconnaissance and Classification. FM 20-32

Mine/Countermine Operations At the Company Level

FM 20-33 Combat Flame Operations

FM 90-7 Denial Operations and Barriers*

*To be published

FIELD ARTILLERY

FM 6-20 Fire Support In Combined Arms Operations

NUCLEAR, BIOLOGICAL, CHEMICAL

FM 3-10 Employment of Chemical Agents

FM 3-12 Operational Aspects of Radiological Defense

FM 3-50 Chemical Smoke Generator Units and Smoke Operations. FM 21-40

NBC Defense

FM 21-41 Individual NBC Defense

COMMUNICATIONS AND ELECTRONICS

FM 11-50 Combat Communications within the Divisions

FM 21-60 Visual Signals

FM 24-20 Field Wire and Field Cable Techniques

FM 32-1 Signal Intelligence (SIGINT) (U)

FM 32-6 SIGSEC Techniques

INTELLIGENCE.FM 30-5 Combat Intelligence

FM 30-10 Military Geographic Intelligence (Terrain)

FM 30-17 Counterintelligence Operations

FM 31-100 Surveillance, Target Acquisition and Night Observation (STANO) Operations

FM 90-2 Tactical Deception

FM 30-40 Handbook on Soviet Ground Forces

MILITARY POLICE

FM 19-1 Military Police Combat Support, Divisions and Separate Brigades

TC 19-7 Straggler and Refugee Control. FM 19-40 Enemy Prisoners of War Civilian Internees, and Detained Persons

COMBAT SERVICE SUPPORT

FM 8-15 Medical Support in Division, Separate Brigade, and the Armored Cavalry Regiment

FM 8-35 Evacuation of Sick and Wounded

FM 10-63 Handling of Deceased Personnel in Theaters of Operations

FM 21-10 Field Hygiene and Sanitation

FM 21-11 First Aid for Soldiers

FM 27-10 The Law of Land Warfare

FM 33-5 Psychological Operations. FM 38-1 Logistics Management

FM 41-10 Civil Affairs Operations

FM 54-2 The Division Support Command and Separate Brigade Support Battalion

FM 100-10 Combat Service Support

FM 101-10-1 Staff Officers Field Manual: Organizational, Technical, and Logistical Data, Unclassified Data

FM 101-10-2 Staff Officers Field Manual: Organizational, Technical, and Logistical Data Extracts of Non- Divisional Tables of Organization and Equipment

SPECIAL OPERATIONS

FM 19-15 Civil Disturbances. FM 20-60 Battlefield Illumination

FM 41-5 Joint Manual For Civil Affairs

FM 41-10 Civil Affairs Operations

ARMY REGULATIONS (AR)

FM 100-26 The Air-Ground Operations System

AR 310-25 Dictionary of United States Army Terms

AR 310-50 Authorized Abbreviations and Brevity Codes

IMPLEMENTED AND RELEVANT INTERNATIONAL STANDARDIZATION AGREEMENTS.PART I

The international standardization agreement implemented by FM 90-10 is as follows:

NATO CENTO ABCA

STANAG STANAG QSTAG TITLE

STANAG 2868 Land Force Tactical
Doctrine (ATP-35)

PART II

International standardization agreements relevant to FM 90-10 are as follows:

NATO CENTO ABCA

STANAG STANAG QSTAG TITLE

STANAG 2002 2002 QSTAG 501 Markings of Contaminated
or Dangerous Land Areas.STANAG 2003 2003 Patrol Reports by Army
Forces

STANAG 2014 2014 QSTAG 506 Operation Orders

STANAG 2029 2029 QSTAG 514 Method of Describing
Ground Locations, Areas,
and Boundaries

STANAG 2088 2088 QSTAG 182 Battlefield Illumination

STANAG 2099 2099 Fire Coordination in the
Land/Air Battle

STANAG 2112 Radiological Survey

STANAG 3736 Offensive Air Support
Operations (ATP-27)