

WWW.SURVIVALEBOOKS.COM

YOUR LAST LINE IN DEFENSE AND SURVIVAL

CHECK OUT OUR WEBSITE SOME TIME FOR PLENTY OF ARTICES ABOUT SELF DEFENSE,
SURVIVAL, FIREARMS AND MILITARY MANUALS.

<http://www.survivalebooks.com/>

Thank you for purchasing our ebook package.

**BASIC TELEVISION LIGHTING
AUDIO AND SCENERY**

(BROADCASTING)

PUBLIC AFFAIRS

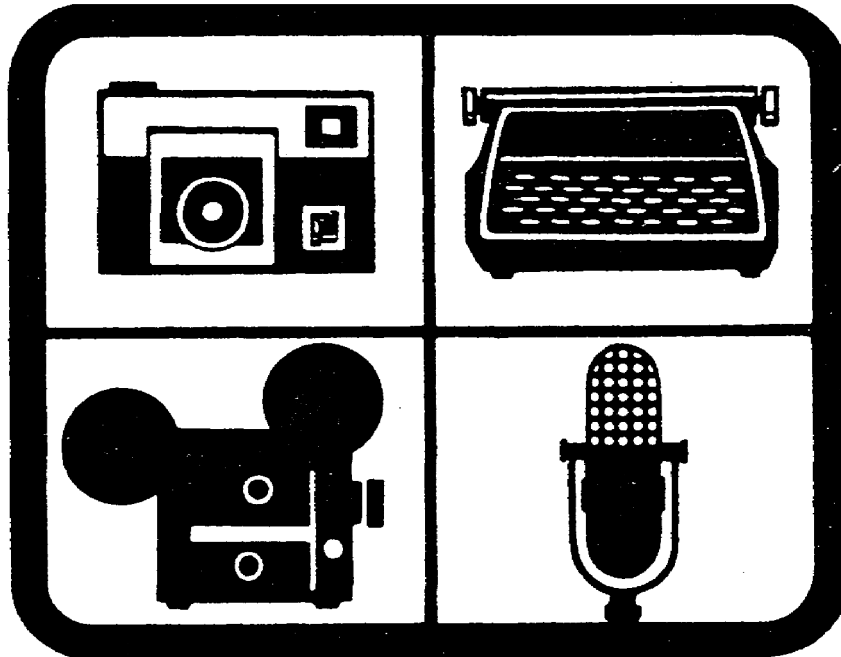

THE ARMY INSTITUTE FOR PROFESSIONAL DEVELOPMENT
ARMY CORRESPONDENCE COURSE PROGRAM

**A
I
P
D**

READINESS/
PROFESSIONALISM



THRU
GROWTH

MOS 71R SKILL LEVELS 1 AND 2

BASIC TELEVISION LIGHTING, AUDIO AND SCENERY

Subcourse DI0370
October, 1987

Army Public Affairs Center
Fort George G. Meade, Maryland

Ten Credit Hours

GENERAL

The Basic Television Lighting, Audio, and Scenery part of the Broadcast Journalist 71R Skill Level 1 and 2 Subcourse, is designed to introduce Army broadcasters to an entry level understanding of three point lighting techniques, microphones used in various productions and related audio equipment and television scenery/backgrounds. This subcourse is presented in three lessons.

ADMINISTRATIVE INSTRUCTIONS

SUBCOURSE CONTENT

This subcourse contains three lessons, each related to the fundamental tasks of television lighting, audio and scenery for the Army Broadcaster. These lessons will provide a basic knowledge and understanding of the different phases of basic television lighting, audio and scenery.

Supplementary Requirements:

This lesson may be taken without any prerequisites.

Material Needed: You will need paper and T No. 2 pencil to complete this subcourse. No other materials are needed.

Reference. No supplementary references are needed for this subcourse.

GRADING AND
CERTIFICATION INSTRUCTIONS

Ten credit hours will be awarded for successful completion of this subcourse..

Task: In these lessons, you will first become familiar with basic lighting techniques and the requirements used for setup of simple television sets. Secondly, you will learn the two-categories and five types of microphones, their characteristics and usage. The functions of the two types of audio boards and related equipment. And finally, the role scenery, properties and set dressings play in the television environment.

Conditions: Given the material presented in this subcourse.

Standards: Demonstrate a basic knowledge and understanding of the fundamental techniques of lighting, lighting equipment, and the three-point-lighting method. Know the types of microphones, their characteristics and how they are used. And, the important role television scenery plays in the visual portion of a TV program.

TABLE OF CONTENTS

SECTION	Page
TITLE PAGE.....	i
TABLE OF CONTENTS.....	iii
Lesson 1: BASIC TELEVISION LIGHTING.....	1
Learning Event 1: Technical Objectives.....	1
Learning Event 2: Aesthetics.....	5
Learning Event 3: Lighting Instruments.....	6
Learning Event 4: Three-point Lighting.....	9
Learning Event 5: Controlling Light.....	11
Practice Exercise.....	15
Answers to Practice Exercise.....	16
Lesson 2: INTRODUCTION TO BASIC AUDIO.....	17
Learning Event 1: Sound Theory.....	17
Learning Event 2: Microphones.....	17
Learning Event 3: Electronic Characteristics.....	19
Learning Event 4: Categories of Microphones.....	21
Learning Event 5: Microphone Placement.....	23
Learning Event 6: Kinds of Microphones.....	24
Learning Event 7: Acoustics.....	28
Learning Event 8: Accessories.....	29
Learning Event 9: Console Functions.....	32

Learning Event 10: Control Consoles.....	32
Learning Event 11: Related Equipment.....	36
Learning Event 12: Glossary.....	40
Practice Exercise.....	43
Answers to Practice Exercise.....	44
Lesson 3: Basic Scenery.....	45
Learning Event 1: Scenery.....	45
Learning Event 2: Property.....	46
Learning Event 3: Studio Backgrounds.....	47
Practice Exercise.....	51
Answers to Practice Exercise.....	52

BASIC TELEVISION LIGHTING

INTRODUCTION TO LIGHTING

Lighting for television is not only an art, it's also a science. The art of television lighting is creating certain moods and effects with lighting techniques. The science is the application of specific technical rules.

The broadcast journalist needs to be aware of these differences because they will affect the quality of the work in both studio and field production.

Television cameras will not reproduce a quality picture without proper lighting. Your eyes need much less light to see than does a television camera. Outside, the sun, moon and even stars provide illumination. Inside, table lamps, overhead lights, recessed lights and other lighting fixtures provide illumination. However, when you start to control illumination for the purpose of creating special moods or for technical reasons, you are involved in lighting for television.

TECHNICAL OBJECTIVES

The first thing you need to consider when learning the basic concepts of television lighting are the technical requirements of the television system itself. There are two basic objectives you must be concerned with: Quantity and Quality of light.

Quantity

In order for the television camera to see the subject, there must be enough illumination/light. A TV camera requires considerably more light than the human eye. If the overall light level is too low, you get what is called a "noisy or snowy picture, or none at all. When the picture is noisy, it looks grainy -- Similar to a photograph that has been enlarged a great deal.

Another aspect of the quantity of light is the intensity of the shadows in the scene. A television system can accommodate a contrast range, of NOT more than twenty times darker than the brightest element of the scene.

LESSON 1/Learning Event 1

If shadows are darker than 20: 1 there will be reproduction problems for the camera. For example put yourself in a dark room and have a flashlight available. You will be able to find any object in the room. But a television camera in the same room, under the same conditions, would not be able to identify a thing. That's because your eyes have a contrast ratio of 160 to 1, but a camera only has a ratio of 20 to 1.

With too much light, subjects have an appearance of glowing or "blooming". This, when seen on television, shows a washed out appearance. Obviously both situations are unacceptable.

Light Meter. The most common method of finding out if a scene or subject has enough light to reproduce a good quality television image, is by measuring the amount of light falling on or reflected by the scene or subject. This is done with the aid of a light meter. The meter measures light by allowing light to strike a light sensitive strip or cell which produces a small electric current. The amount of current produced is directly proportional to the amount of light entering the meter. A lot of light produces more current and a little light less current. The current in turn moves a needle over a printed scale. (Fig. 1-1)

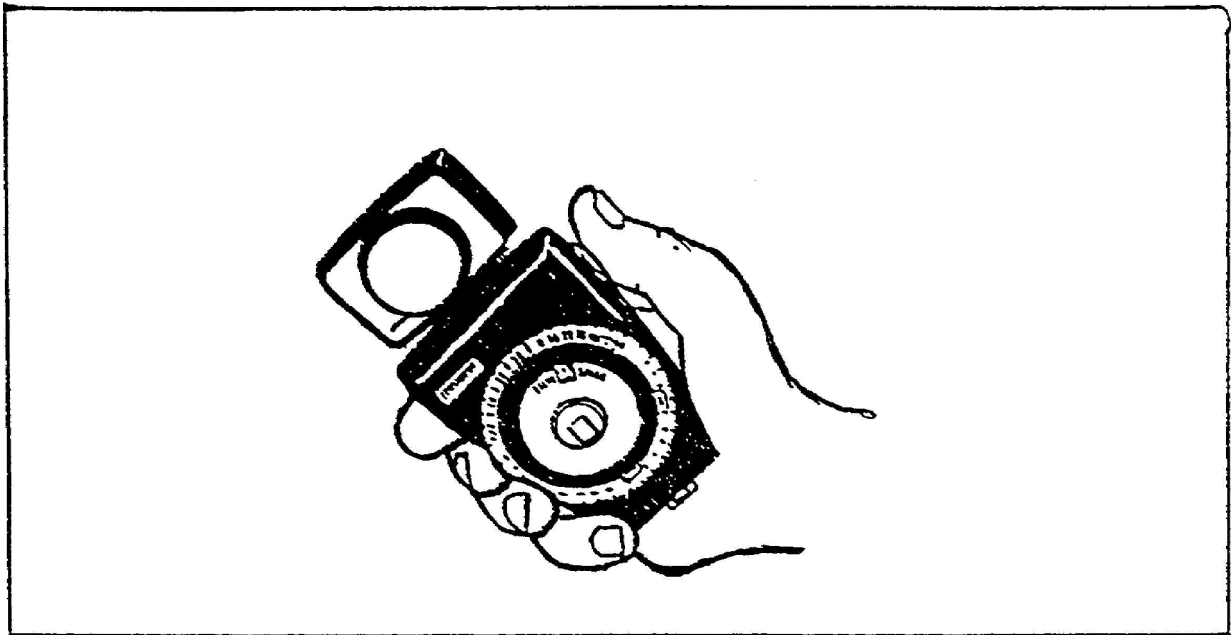

Figure 1-1
Light Meter

LESSON 1/Learning Event 1

The scale is calibrated to indicate how much light is entering the meter. The scale is normally calibrated in footcandles but may also be marked in lumens (which are equal to footcandles). The footcandle scale is normally used in television.

Quality

Let's take a look at the second technical consideration. The quality of light refers to the color temperature of the light source. Color temperature is properly termed "Kelvin Temperature." This refers to the amount of red, yellow and blue-white quality in the light, and is expressed in "degrees Kelvin". Do not confuse color temperature with footcandles. Footcandles measure the intensity of the light, not its color temperature.

Color cameras may be balanced to any color temperature. But, the television industry has set 3,200 degrees Kelvin as the standard for studio lighting. The outside color temperature from the sun on a bright day is rated at 5,600 degrees Kelvin. This standard may not always be consistent, because clouds filter the sun's light and create a different color temperature. Different color temperatures will cause unpredictable color distortions. Such distortions might produce purple faces. Mixing lights of different color temperatures will produce other technical problems. Most quartz halogen bulbs used in television produce 3,200 degrees of color temperature. DO NOT try to use stage lights from a theater. Stage lights use a different color temperature, and will throw the color TV cameras off balance. Using lights other than those designed for 3,200 degrees Kelvin will cause engineers many problems.

There are many different makes and models of light meters with multiple options and functions. When you start to work with a light meter, take the time to read the operating instructions and become familiar with the meter. A little practice in reading the meter and you will have the technique in no time.

LESSON 1/Learning Event 1

Measuring Light. There are two methods of measuring the light in your studio.

- a. Incident
 - b. Reflected
1. Incident light reading. Measuring the actual light falling on the subject is called "incident" light measurement. To take an incident light reading, a light meter is held near the subject, but the top of the light meter pivots, and should be facing the light source. The meter measures the amount of light falling on the subject. The incident light meter reading is the most commonly used method in television (Fig. 1-2).

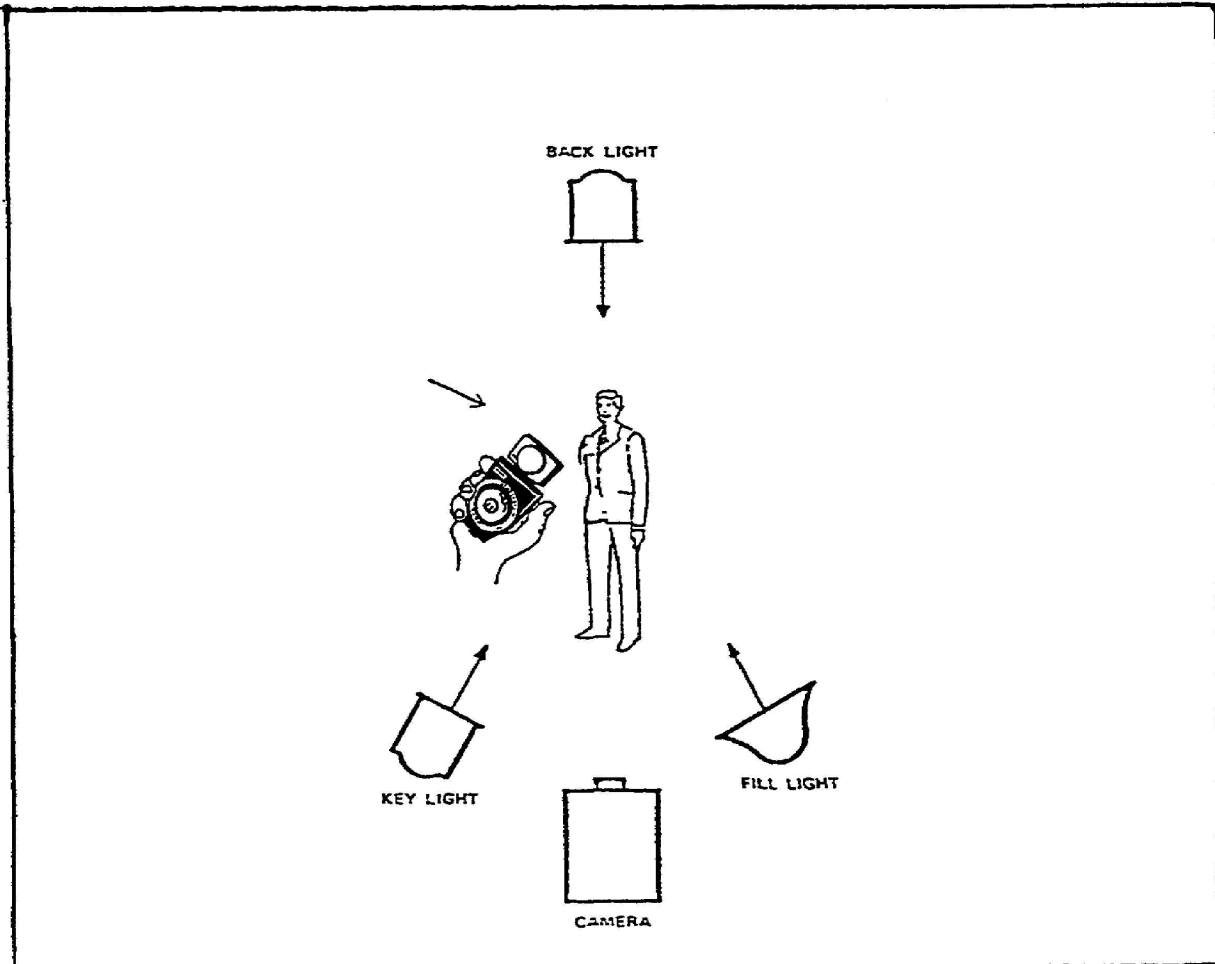

Figure 1-2
Incident light measurement

2. Reflected light reading. The second method of measuring light is called a "reflected" light reading. A reflected light meter reading measures the amount of light reflected from the subject.

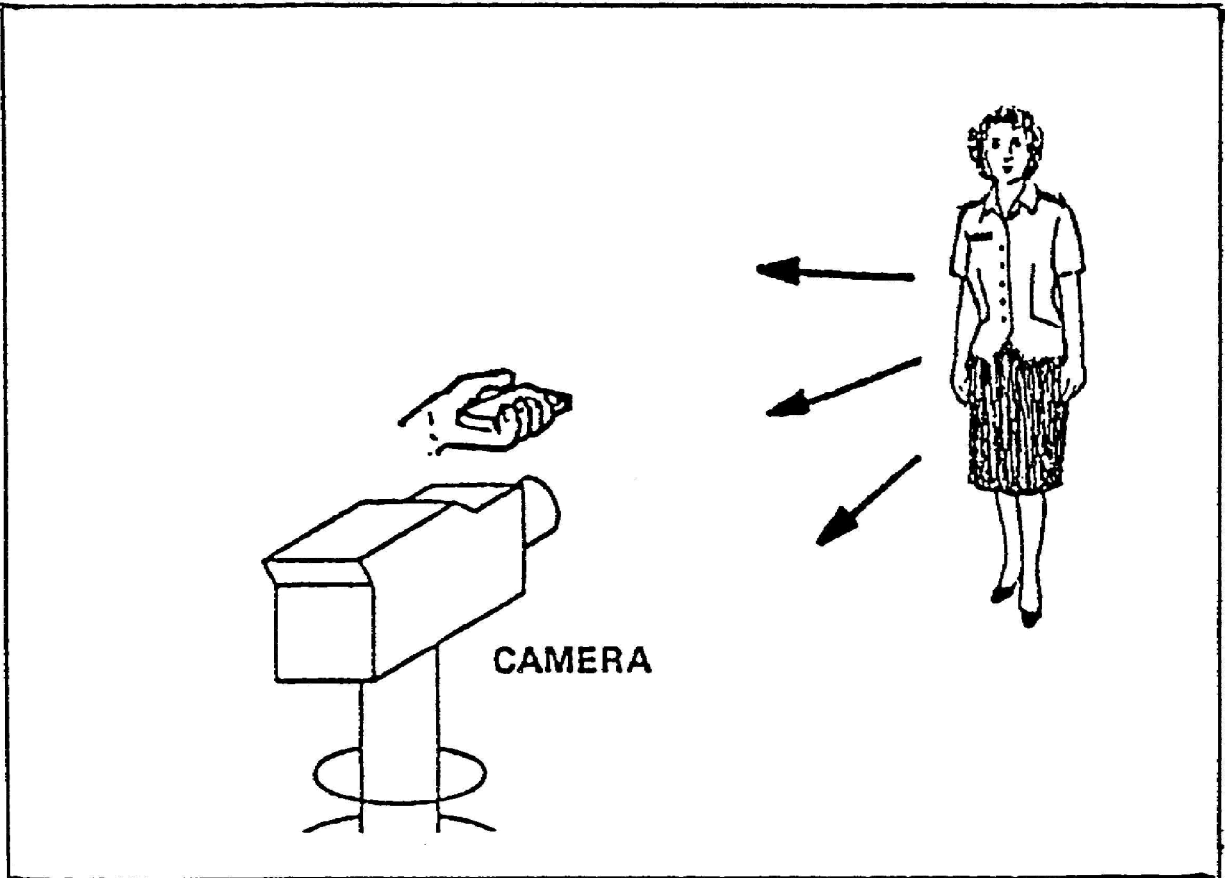

Figure 1-3
Reflected light measurement

The reflected meter reading is used in television primarily when the overall scene is composed of dark colors. (Fig. 1-3)

AESTHETICS

The needs of a lighting technician do not end once the technical requirements of lighting the set have been met. Certain aesthetic or non-technical objectives are mood, form or dimension, and directing attention.

Mood

Using shadows and different light levels discreetly will set the mood of a program or scene, and even the time of day, when necessary. Every scene has some sort of mood to convey. Usually, the set and lighting should work hand in hand to accomplish this effect.

Dimension or Form

Television is currently a two-dimensional medium. In the future, there may be 3-dimensional hologram TV. Right now the TV screen has only height and width, but there are ways to create the illusion of the third dimension "depth," with effective lighting. While we need to be careful of creating harsh shadows, we need some shadows to create form. By using backlight on a subject we separate objects in the foreground from subjects in the background. This technique gives the illusion of depth and dimension.

Directing Attention

Directing the viewer's attention can be done in a number of ways. The most obvious way is to use a "follow spot." A follow spot is a spotlight that keys in on a particular subject and follows that subject, directing the viewer's attention. Normally though, we will want to be a little more subtle. Using key and fill lights properly to direct attention will do the same thing without being so obvious.

Important Note: Each situation for lighting a set or scene is different. Separate illumination should be used for the background, foreground and subject at all times. Attention to each step of the lighting setup is needed to accomplish specific requirements. Take time when attempting these tasks. As a broadcast journalist, be aware of the objectives and how they apply to each project. The difference between excellent lighting and adequate lighting is the dedication, not the time spent.

LIGHTING INSTRUMENTS

There are two primary types of lights used in the three-point lighting method spotlight and the floodlight.

Spotlight

A lens spotlight provides a variable focus or beam spread of light (Fig 1-4). The light field is smooth, even, and

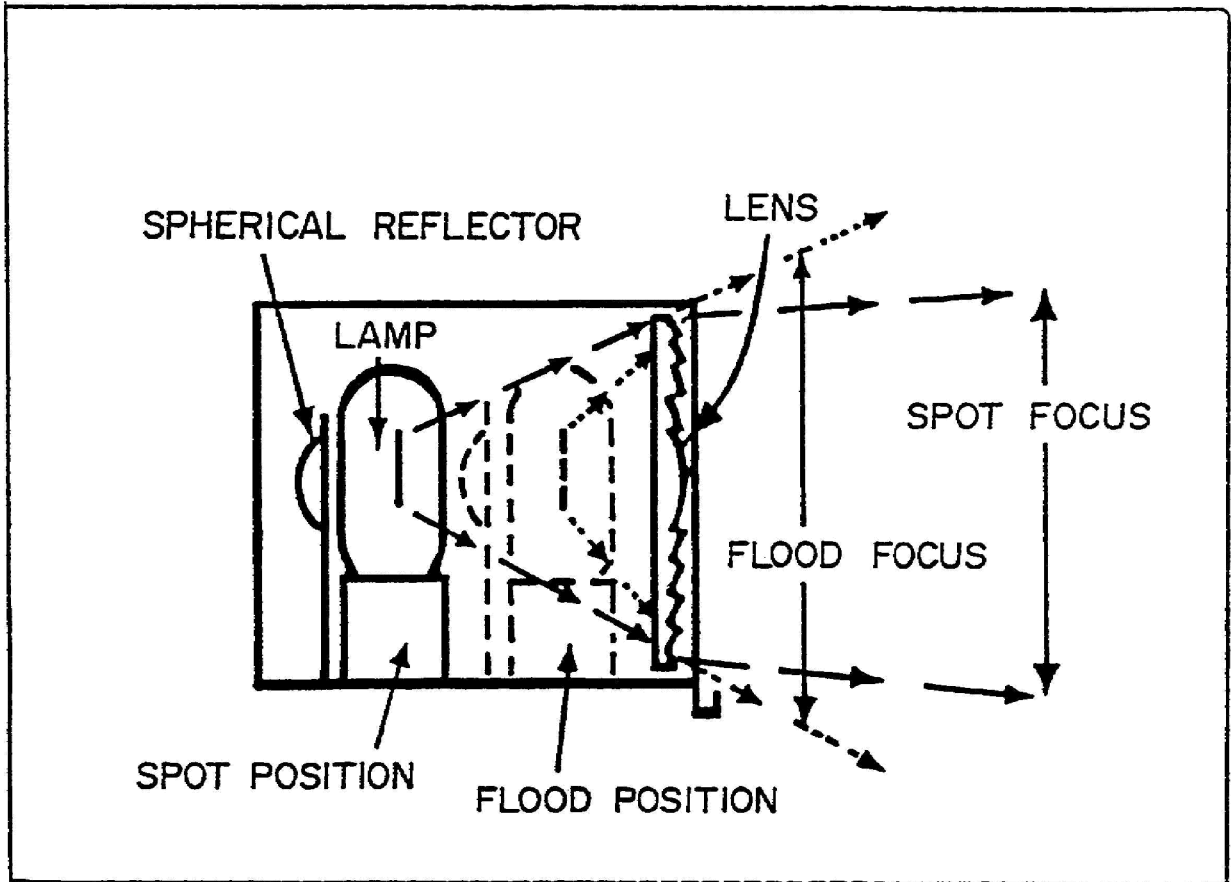

Figure 1-4
Spotlight

the outer edge of the spotlight beam is less intense than the center. They are very directional, have a highly polished reflector and a relatively thin, lightweight clear lens. They may be used in many situations such as key light, backlight and other spotlight applications.

Floodlights

The floodlight is a wide-angled "scoop" used to provide fill and base light with a very wide, diffused beam (Fig. 1-5). The bulbs are exposed inside a brush-finished reflector with no lens. Fiberglass scrim or metal mesh may be placed across the front in a special holder to dim the light.

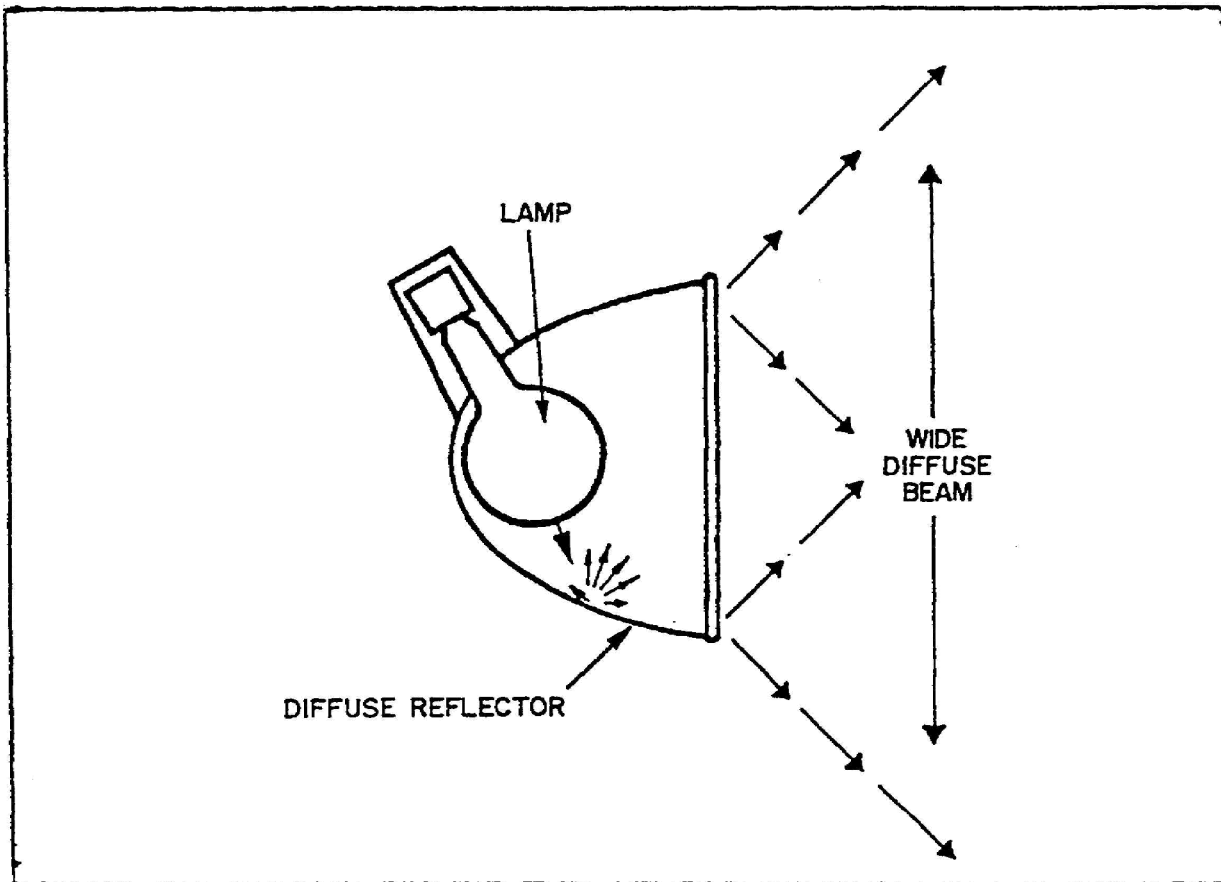

Figure 1-5
Floodlight (Scoop)

THREE-POINT LIGHTING

With all the information presented here, it may seem very difficult to provide light for television. However, following proven photographic lighting techniques makes the task manageable.

The methods for lighting all non-visual mediums such as motion picture photography and television originated from still photography. The basic three-point lighting format (Fig. 1-6) is still the basic photography layout.

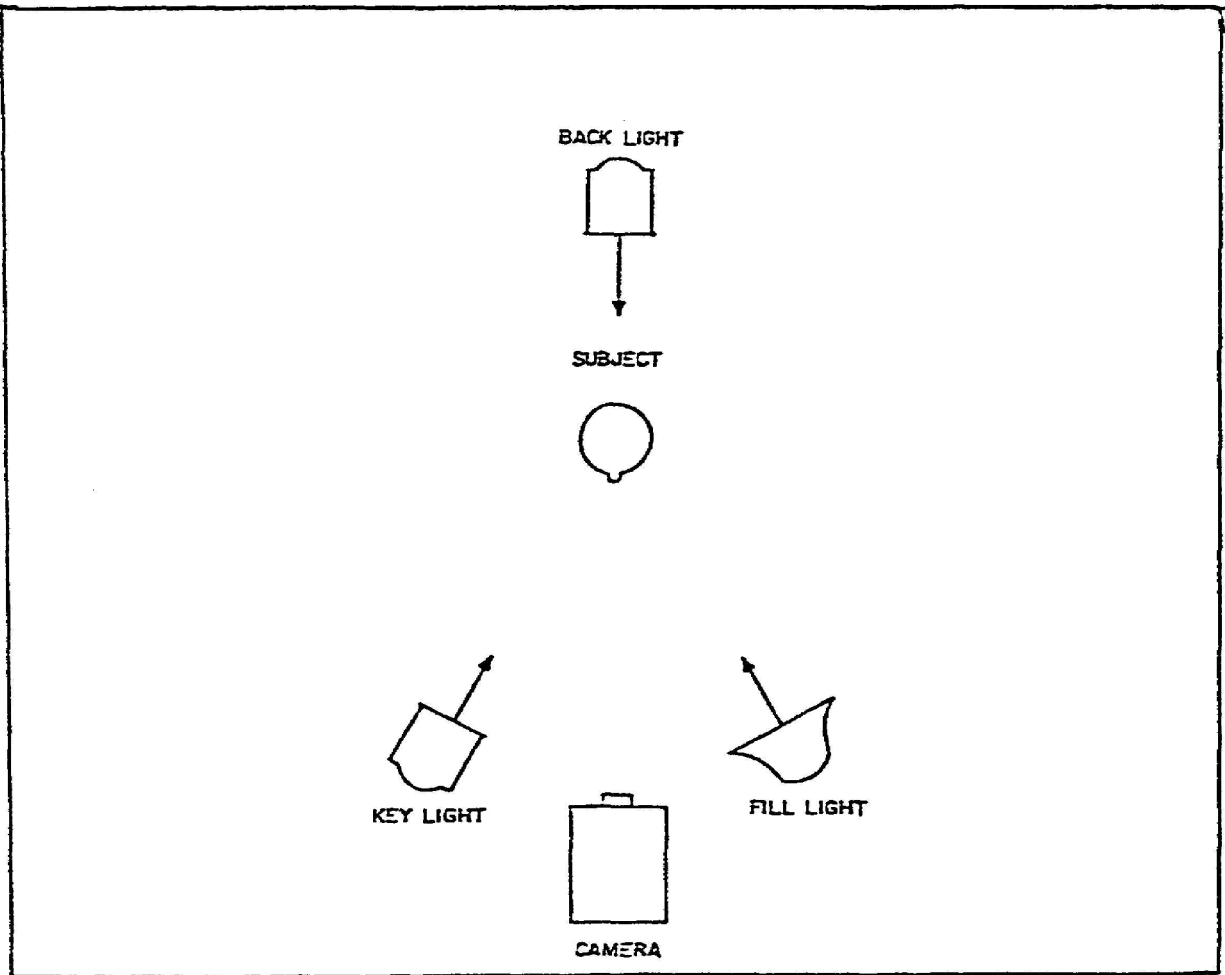

Figure 1-6
Three-point lighting

LESSON 1/Learning Event 4

Key Light. The key light is the primary source of illumination when setting three-point lighting, and should be set up first. Generally, the key light is placed at a 45-degree angle to the left or right of the camera and above. When lighting is natural, the light comes from above. So the key light should also be elevated above the level of the camera in relation to the subject. The main function of the key light is to bring out the basic shape of the main subject. The subject will have a very dark shadow. A key light or spotlight allows a great deal of directional control over the light source.

Backlight. The secondary light source is the backlight. The backlight is used to separate the subject from the background and provides the illusion of a third dimension -- depth. A spotlight or key light that has been shaded to prevent "flare" is always used for the backlight. Flare is the excess light that enters the camera lens when the backlight is not positioned properly. "Barn doors" must be used to prevent direct light from entering the camera lens. Barn doors are used to direct light coming from a lighting instrument. The doors shade the light itself on the top and bottom.

Once the key light and backlight have been set, the definition or dimension of the object should show quite well. But the fall-off area from the light to dark area is very fast. So we need to fill these areas in, and this is accomplished by using a fill light.

Fill Light. The fill light is the third light source and has a more diffused characteristic compared to the key light and backlight. In three-point lighting, a fill light or scoop is used to fill in the dark areas created by the key and backlight. The main function of a fill light is to reduce shadows. Don't eliminate all the shadows, because we need some shadows to create depth. The fill light should be placed opposite the key light at a 45-degree angle above the camera.

The ratio or contrast range of key light to fill light is best when kept to about 2:1. This means that the key light is twice as bright as the fill light. This reduces the contrast range or shadow density but still leaves enough shadow area to create, rather than eliminate, the three-dimensional effect.

CONTROLLING LIGHT

The lighting instruments themselves will hang from the ceiling on a series of pipes or battens called a "grid." These lights plug into a series of electrical outlets which are numbered and are attached to, or mounted in a strategic location, along the lighting grid.

The lights are fastened to the grid by a "C" clamp that is attached to an accordion-like device or telescoping pole, called a "pantograph." The C-clamp is a clamp that looks like a "C" -- with a locking bolt that is threaded through the open ends of the C clamp. Pantographs allow vertical (up and down) movement to vary the height of the light.

The electrical outlets in the grid connect to a central electrical "lighting patch panel" either in the same studio or another room. The patch panel is used to assign each individual light to a specific control or dimmer switch.

These in turn are connected to a dimmer bank of switches that are used to control a group of lights. This allows the technician to group lights together. Therefore, all fill lights are put on one bank, key lights on another, etc.

Lighting instruments have many physical sizes but they all produce two basic types of light:

- o Directional
- o Non-directional or diffused light

Remember that the object is not simply to turn all the lights on and point them toward the subject. The controls that are used to blend and shape lights to meet our technical and aesthetic objectives must now be put into practice. We will look at how we can control the intensity, direction and color of our light.

Intensity

There are several ways to control the brightness or intensity of the light falling on the subject. The most convenient way is by using dimmer circuits. These circuits work by reducing the amount of electrical current to the bulb. While dimmers are very convenient and easy to use, they have one major drawback. As the amount of electricity

LESSON 1/Learning Event 5

decreases, the filament of the bulb dims and color temperature changes, giving an increasingly reddish light. Most experts agree that we may dim a light to about 85 percent of its rated voltage. This decreases the color temperature about 200 degrees Kelvin without a noticeable change in color.

Beware of using dimmers, especially for light that falls on a subject's face or skin. Flesh tones are the only true way of adjusting color levels on a viewers set. If we alter that color in any way, our reference will be lost. And all the color levels, on all the television sets receiving the video picture, will end up out of adjustment.

Another way to reduce the light intensity is by increasing the distance between the subject and the light. Remember, as the distance increases, the angle, distribution and light intensity changes in direct proportion to the subject. Putting "screens" and "scrims" in front of your light also reduces the intensity of your light. Screens are used mostly on directional lights because they do not alter the hard directional light beam or affect color temperature. A scrim is made of translucent gauze or glass fiber material. The fiber diffuses the light beam and decreases light intensity.

Barn doors. Barn doors are adjustable metal shutters, resembling doors, that allow the operator to control the edge of the beam of light. The barn doors slip into a slot on the front of the lighting instrument (normally fresnels). Barn doors are used to shape the light. The doors come in two-and four-door varieties.

Some spotlights have a built in "lens" control that does the same thing as a set of barn doors but with more accuracy.

The lens control allows a very accurate amount of light to be targeted to a specific area.

Scrims and screens. Scrims and Screens are placed in front of a light source to soften and diffuse the light. One layer of scrim material will normally reduce light output by 50 percent. Thus, the scrim reduces light output and softens and diffuses the light. The scrim does not affect the color temperature of the light. If there is still difficulty in getting the right intensity, the wattage, not the voltage, of the bulb in the fixture is changed.

Direction

The directional control for lighting comes from the grids, clamps, and pantographs or other hanging devices in the studio. Lights may be hung and pointed in any direction.

Effects lighting. Lights coming through windows and doors may be used to highlight a specific area or object dictated by the script or setting. An "eye light" can add sparkle to a performer's eyes and teeth or small objects in dark corners. The effects lights are the last lights added to the set. These are added to correct deficiencies of the key, back and fill lights. Poor lighting should be corrected by adjusting or relocating the key or fill light already in place.

Color gels. Gels are available in a wide selection of colors. They are placed in front of the light in the same way scrims and screens are positioned. Color lighting is used sparingly in television because flesh tones are used as a color reference. Do not splash color on the subject unless there is a special reason, and then, only when the engineers have been informed. Color gels are used primarily to place color on cycloramas and/or sets.

Light for color television. A major consideration in lighting for color television is the color temperature of the lighting. Color cameras are normally balanced electronically for lighting that has a color temperature of 3,200 degrees Kelvin. Most tungsten-halogen or quartz-iodine bulbs are manufactured with this specific color temperature.

We are most interested in lights that affect skin tones of a subject. For this reason we will seldom, if ever, use color lights on a television subject. When the lights are on a dimmer, always try to maintain the color temperature of 3,200 degrees Kelvin (plus or minus 200 degrees).

Final check. The final check for determining adequate light levels may be made by viewing the results on the control room TV monitors. The engineers will indicate which level is the most technically accurate.

***** SAFETY WARNING *****

All television lights become extremely hot when they are used. You may receive serious burns if you are not careful. Be careful when you are adjusting barn doors, scrims, etc., after the lights have been on. After use lights remain extremely hot for about 5 to 10 minutes.

PRACTICAL EXERCISE

LESSON #1

BASIC STUDIO LIGHTING FOR
TELEVISION

SUBCOURSE No. DI0370

INSTRUCTIONS:

Review the material in this lesson. Answer the questions below by circling "T or F" next to each question. Compare your answers with the answer key on the next page. Ensure that you understand the lesson material and answers before proceeding to the next lesson.

- T F 1. There are two basic lighting objectives.
- T F 2. You can control the intensity, direction and the color of light in a studio.
- T F 3. The color temperature that is the industry standard is 3,100 degrees Kelvin.
- T F 4. Backlight, properly used, is the main contributing factor used to create the illusion of a third dimension.
- T F 5. The best lighting ratio for key light to backlight is 1:1.

ANSWER KEY

PRACTICE EXERCISE

LESSON #1

BASIC TELEVISION LIGHTING

SUBCOURSE No. DI0370

1. TRUE Page 1
2. TRUE Page 4
3. FALSE Page 5
4. TRUE Page 9
5. FALSE Page 9

INTRODUCTION TO BASIC AUDIO

SOUND THEORY

In this lesson, we will describe the fundamentals of sound and how it is transmitted. Let's begin with the theory of sound. Everything that takes the form of matter --solid, liquid or gas --is made up of micro bits of material called molecules. We can't see the molecules because of their size. These molecules stay approximately in the same location until they are disturbed. When this happens they collide.

During the collision, the molecules transfer energy to each other through whatever material they are made of --solid, liquid or gas. In sound theory, molecules continue to collide with each other until they make contact with the ear. The ear picks up the vibrations or pressure waves (energy) and channels the vibrations into the eardrum where they are converted into electrical signals. The brain then process the signals. The conversion from pressure wave to electrical information in the brain produces what we know as sound.

MICROPHONES

A microphone, like the ear, is a transducer that converts acoustical sound energy into electrical energy. The energy is then amplified and transmitted to a speaker. All microphones are basically the same. They all have their own housing, diaphragm, magnetic field and moving parts within that field. Until a sound wave is changed from the wave in the air to an electrical form, it can't be used electronically. This is the function of the microphone.

Microphones are classified by the way they change the sound waves into electrical energy. There are two components microphones must have to change sound energy into electrical energy:

1. a diaphragm, which vibrates in response to sound pressure
2. a generating element, which changes the physical vibrations of the diaphragm into usable electrical energy.

LESSON 2/Learning Event 2

According to their principles of operation, microphones are separated into two categories. They are:

1. pressure-operated microphones
2. velocity microphones

Pressure-Operated Microphones

There are several types of pressure-operated microphones: carbon, crystal or ceramic, and condenser or capacitor. When someone speaks into a pressure-operated microphone, the diaphragm vibrates in response to the air pressure from the sound (See Figure 2-1). These vibrations cause the voice coil to move back and forth within a magnetic field. The coil produces a fluctuating electric current which, when amplified and transmitted to a speaker, reproduces the exact sound the microphone picked up initially and makes the sound audible to the listener.

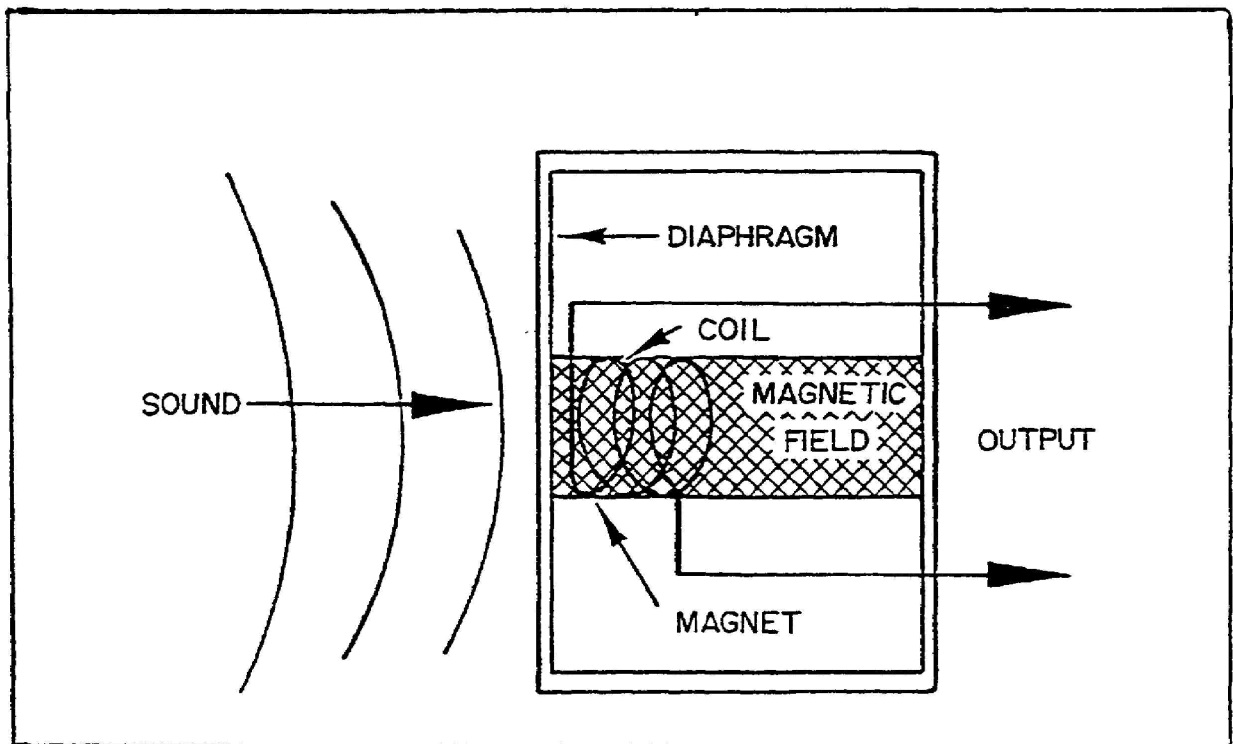

Figure 2-1
Pressure-operated microphone

Velocity Microphones

The velocity or ribbon microphone employs the moving conductor principle, in which a thin, flat piece of metal is suspended, so that it vibrates freely in a magnetic field. In this case, the ribbon element is the diaphragm. Again, a generating element changes the vibrations of the diaphragm into electrical energy (Fig. 2-2). The ribbon is not encased in a closed housing; it's exposed to the air on all sides. This type of microphone is very fragile. Any sharp, loud blast of air close to the microphone, may damage or even destroy it.

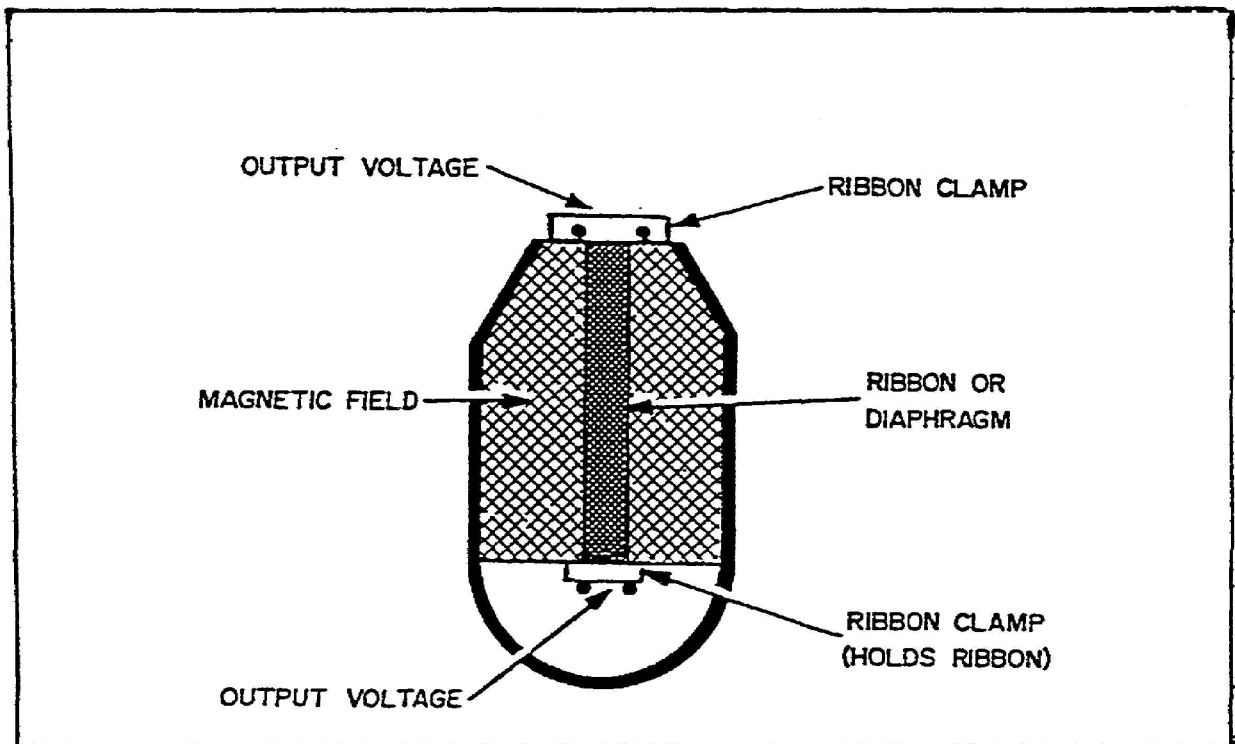

Figure 2-2
Velocity-operated microphone

ELECTRONIC CHARACTERISTICS

All audio broadcasting and/or recording begins with the use of a microphone. "Mike's" as they are commonly referred to, may be grouped into three classifications according to their directional pickup properties.

1. unidirectional (one direction)
2. bidirectional (two directions)
3. omnidirectional (all directions).

LESSON 2/Learning Event 3

Some mikes belong to only one class while others can be changed or adjusted to either of the other two. Microphones do not pick up sound equally from all directions. The pickup pattern of a mike will tell you how to best place the microphone or subject for optimum sound reception.

Unidirectional Microphones

The pickup pattern of the unidirectional microphone is, roughly, the shape of a heart or cardioid pattern. These microphones accept sound best at the 0 degree point with minimal response at the 180 degree point (Fig. 2-3).

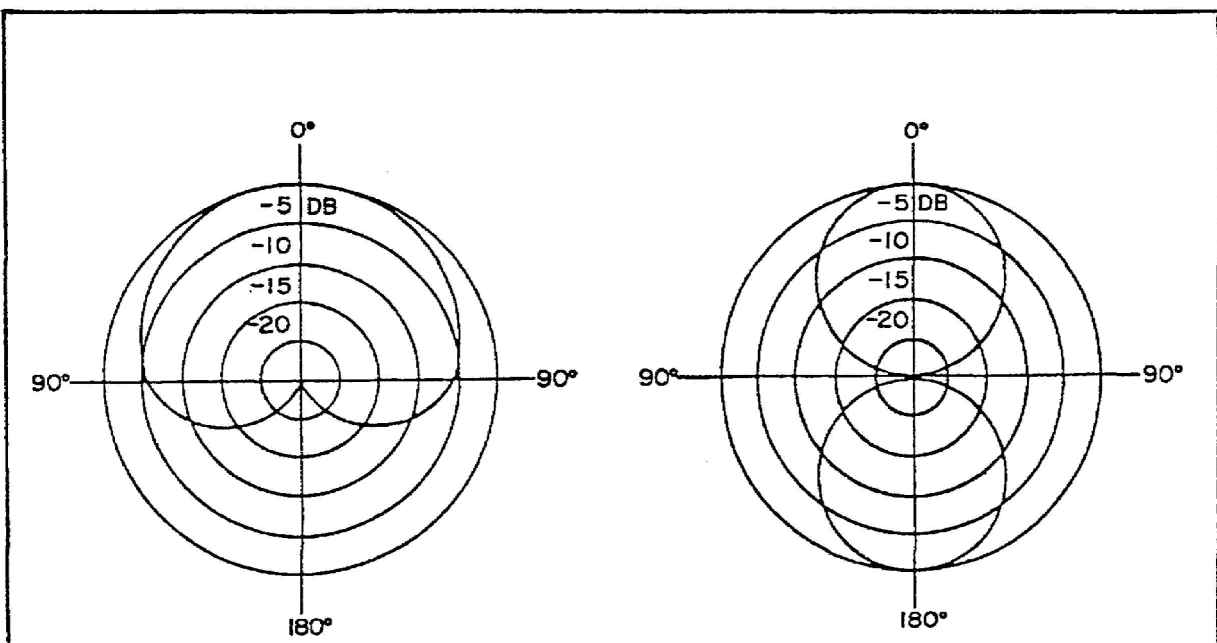

Figure 2-3
Unidirectional

Figure 2-4
Bidirectional

An example of the value of a unidirectional or cardioid microphone would be a singer performing with an orchestra. Let's say the singer uses a unidirectional mike. Its dead side may be turned toward an orchestra so the orchestra will not overpower the singer. Another example would be a speaker addressing a group. The unidirectional mike will only pick up the speaker talking. The side noise will not be heard, or if it is, it will be very faint. The unidirectional microphone must be pointed in the direction of the sound source for best results.

Bidirectional Microphones

This particular microphone has a figure eight type pickup pattern. The dead side of the microphone is on either side. This configuration accepts sound best at the 0 degree and 270 degree axis points or sides (Fig. 2-4). In radio, with two or more performers, the bidirectional microphone is usually preferred. When two or more people perform at a bidirectional mike, they not only feel less crowded. They have the advantage of playing to each other, thus giving them a feeling of natural, human interaction.

Omnidirectional

Omnidirectional mikes accept sound equally well from all directions without any loss. There are no variations in this pattern (Fig. 2-5). This microphone allows the performer to talk from any direction. The omnidirectional mike is particularly valuable for round table discussions and for voices in a group.

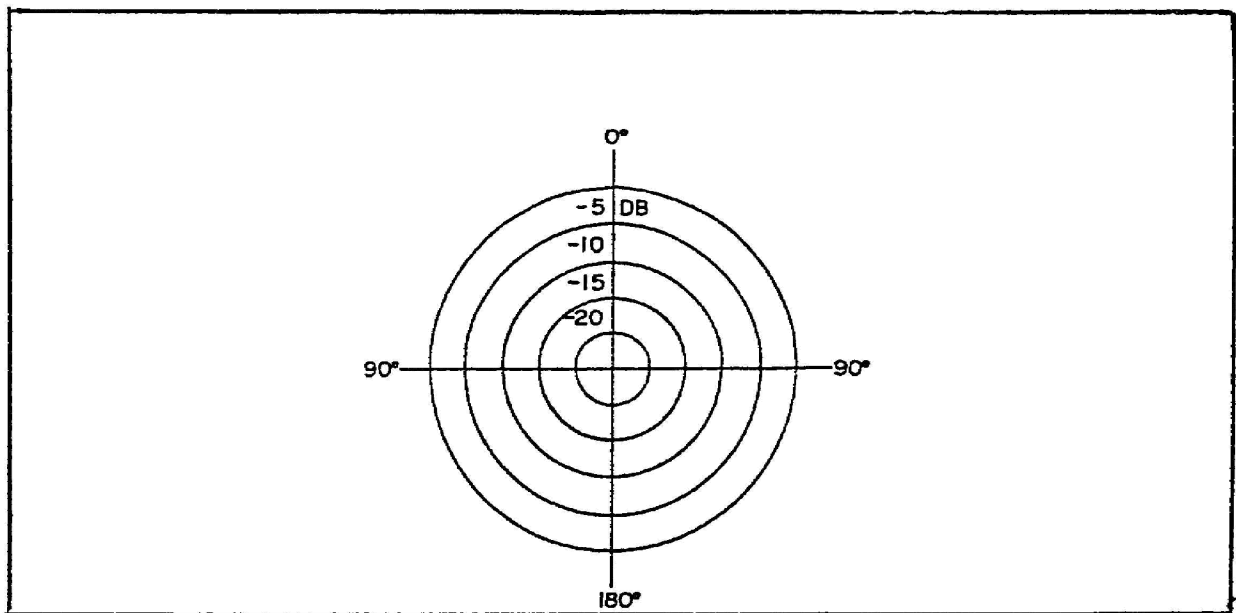

Figure 2-5
Omnidirectional

CATEGORIES OF MICROPHONES

There are two types of microphones: the dynamic and the velocity.

Dynamic

The most popular microphone in broadcasting is the dynamic microphone. The dynamic mike is the most ruggedly constructed of all the microphones. The dynamic microphone is used in all types of environments, both in studio and on remote assignments. This is because the dynamic mike has a low wind-noise characteristic. This trait and its dependability make the dynamic mike the most trusted of all microphones. The dynamic mike tends to favor high-frequency over low-frequency sounds. Because of its inherent high-frequency cutoff, the dynamic mike tends to accentuate sibilance in a person's voice. Sibilance is a hissing sound made when the letter "s" is pronounced. Dynamic mikes are pressure operated microphones.

Velocity

A close relative of the dynamic mike is the velocity microphone. This is the old standby for the broadcast and recording industry. The velocity or ribbon mike has a superb uniform frequency response between 20 to 20 thousand hertz. This may be seen with an audio test generator. The ribbon mike is extremely sensitive and should never be used outdoors. A strong wind may break the ribbon rendering the mike useless. The ribbon element is enclosed by a screen. The velocity microphone has a tendency, because it's so sensitive, to make performers "pop" their p's, b's and t's if they get too close to the mike. The explosive quality of these letters causes a very sharp, momentary increase in the pressure component of the sound wave. This may sound to the listener like a very small firecracker exploded in front of the microphone.

The velocity mike tends to favor low-frequency over high-frequency sounds. Consequently, a velocity mike may be used to deepen the voice. A unique characteristic of this mike is the closer the announcer gets to the microphone the deeper his voice will sound.

Condenser

The condenser or capacitor microphone is the mike that is chosen most by professionals. This microphone has the most exacting reproduction of sound with perfect uniformity and full-range response. The condenser mike is a pressure-operated microphone and operates on the storage of an

electrical charge which requires a battery or power supply. The head of the mike contains two plates. One plate is the diaphragm, the other is a heavy backplate. The backplate is insulated from the diaphragm and spaced parallel to its' rear surface. As sound waves enter the mike, the sound pressure causes a change in the spacing of the two plates. This varies the internal capacitance and the voltage of the battery or power supply to the signal current. The condenser mike, with its battery, has an extremely low electrical output and requires its own power supply. Because of its technical complexity and accuracy, it is one of the most expensive microphones to manufacture.

MICROPHONE PLACEMENT

Microphone placement in a radio studio is simple. The mikes are normally placed on a desk stand ready for use. Radio studio microphones are usually placed on a 45 degree angle, about four to six inches from the announcer's mouth. However, this is only a suggested guideline. As each announcer becomes more accustomed to a particular mike, they may want to move it around to get the best results for themselves.

Microphone placement is more critical for television if and when the mike is to be seen on-camera. The mike should not interfere with viewing the picture or distract the eye of the viewer by being in strange locations.

KINDS OF MICROPHONES

Lavalier Microphone

The most commonly used microphone in television is the lavalier (Fig. 2-6). The "lav" is always omnidirectional. When an announcer uses a lavalier, he talks across the mike rather than directly into it. Because it is omnidirectional

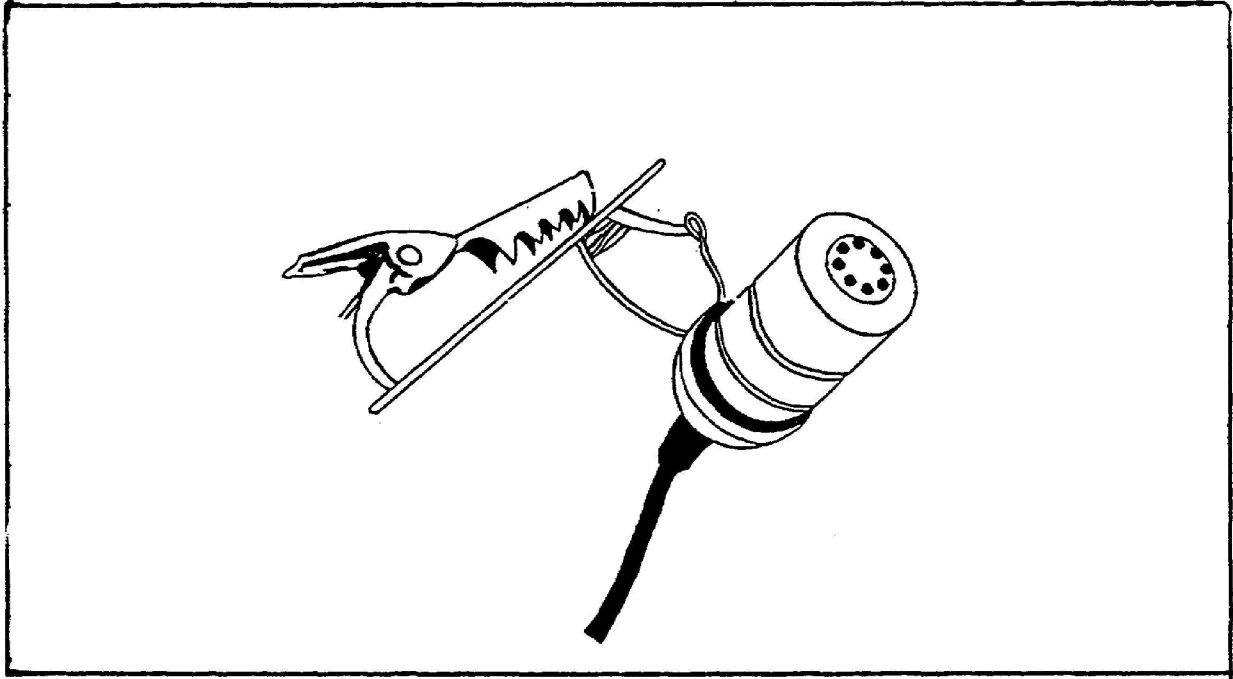

Figure 2-6
Lavalier microphone

the lav has a tendency to pick up studio noise and must be positioned properly to avoid this situation. Have the production personnel place the mike on the subject. The untrained guest who puts on his own microphone probably will position the lav where it looks best rather than for best sound pick up.

A good rule of thumb for positioning a Lavalier microphone is to place the mike in the direction the performer will face. For example, during interviews, the host and guest should face each other at about a 45 degree angle. The microphone should be attached to their lapels on the side where the host and guest face each other.

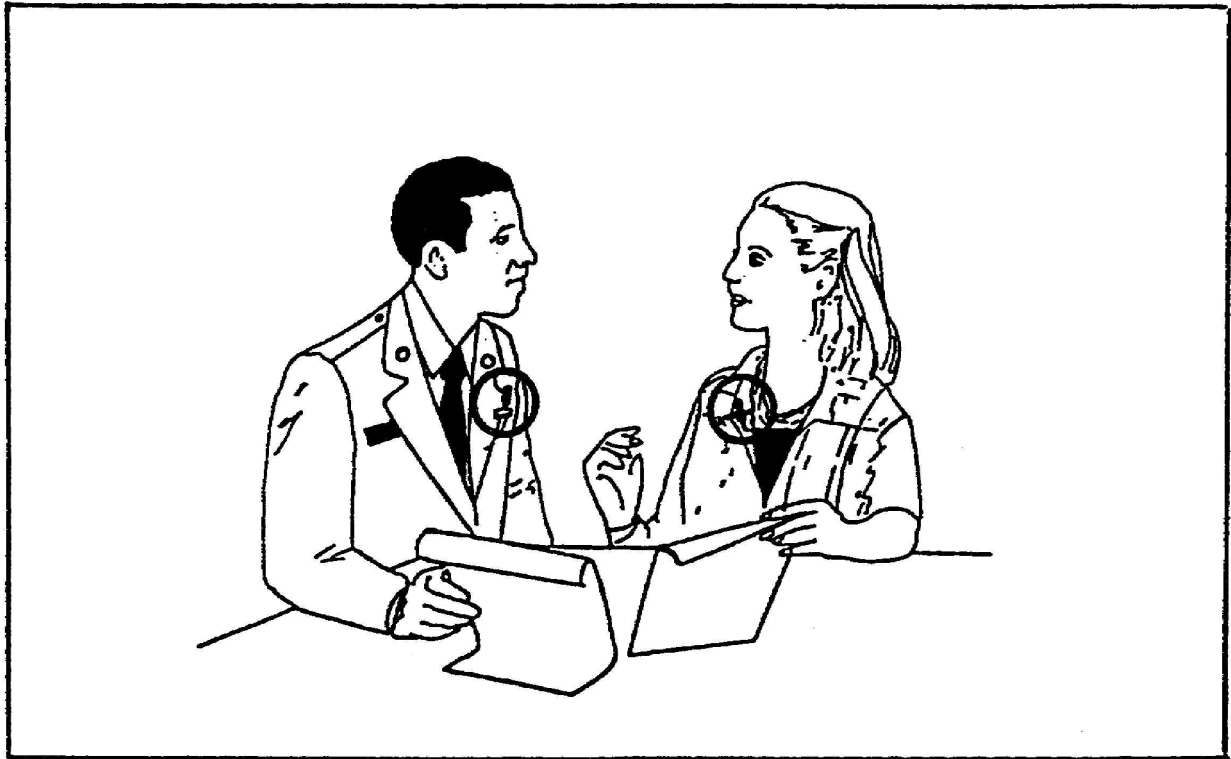

Figure 2-7
Lavalier placement

Do not place a lavalier microphone under a tie or clothing (Fig 2-7). This may result in muffled audio or extraneous clothing noise when the microphone rubs against the material.

The lavalier microphone is a good tool to use when movement is required on the set. For example, a weather report where movement is required by the weatherman from a sitting location to a standing location in the weather maps area. The lav is attached to his clothing which allows freedom of movement to the weatherman. This enables him freedom to move to the maps and back again to the set with a minimum of problems.

Desk Microphone

The desk microphone is attached to a small stand and placed on a desk or table top. The front of the mike should be pointed in the direction the announcer will normally face during the production (Fig. 2-8). Desk mikes are very sensitive to external noise. Announcers should be reminded not to tap or kick the desk.

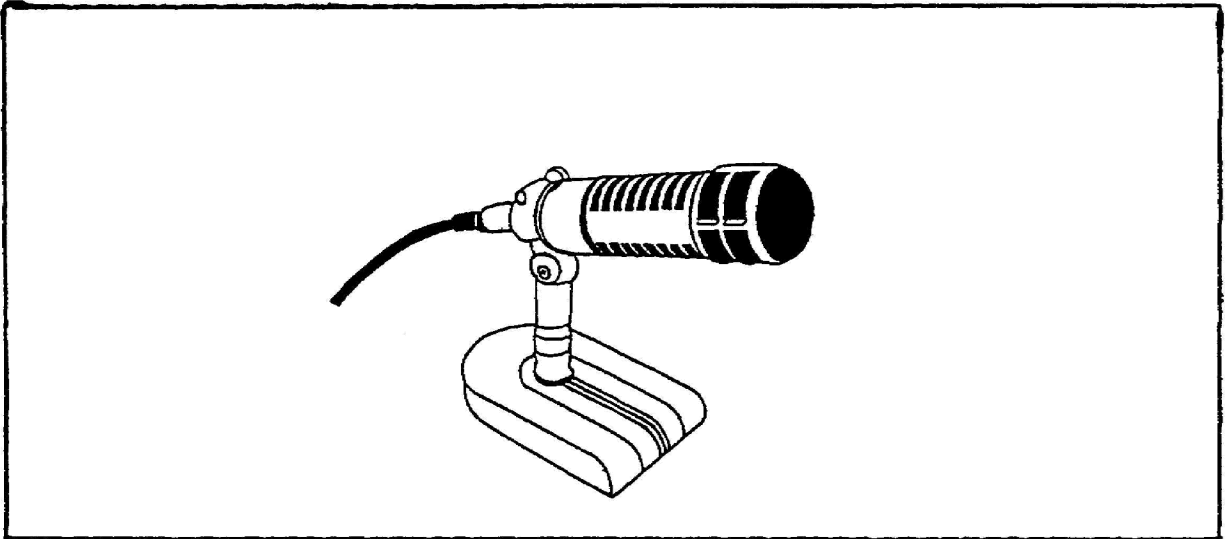

Figure 2-8
Desk microphone

Hand Microphone

The hand held microphone (Fig. 2-9) is commonly used by radio and television reporters for interviewing in the field

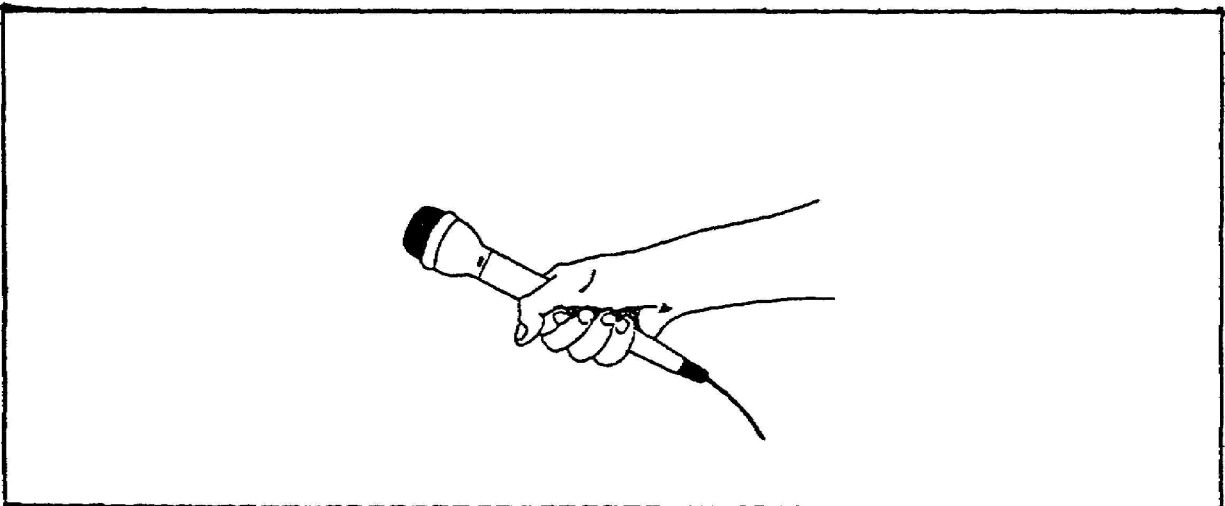

Figure 2-9
Hand microphone

LESSON 2/Learning Event 6

and by entertainers. The interviewer and performer have complete control over the positioning of the microphone, since they hand hold the mike. Because both news people and entertainers need to move around, this mike is an excellent choice.

Stand Microphone

This is basically a hand held microphone positioned on a tall stand and frequently used by singers or placed near musical instruments (Figure 2-10). The stand microphone is normally preset to the subject's height for ease of use.

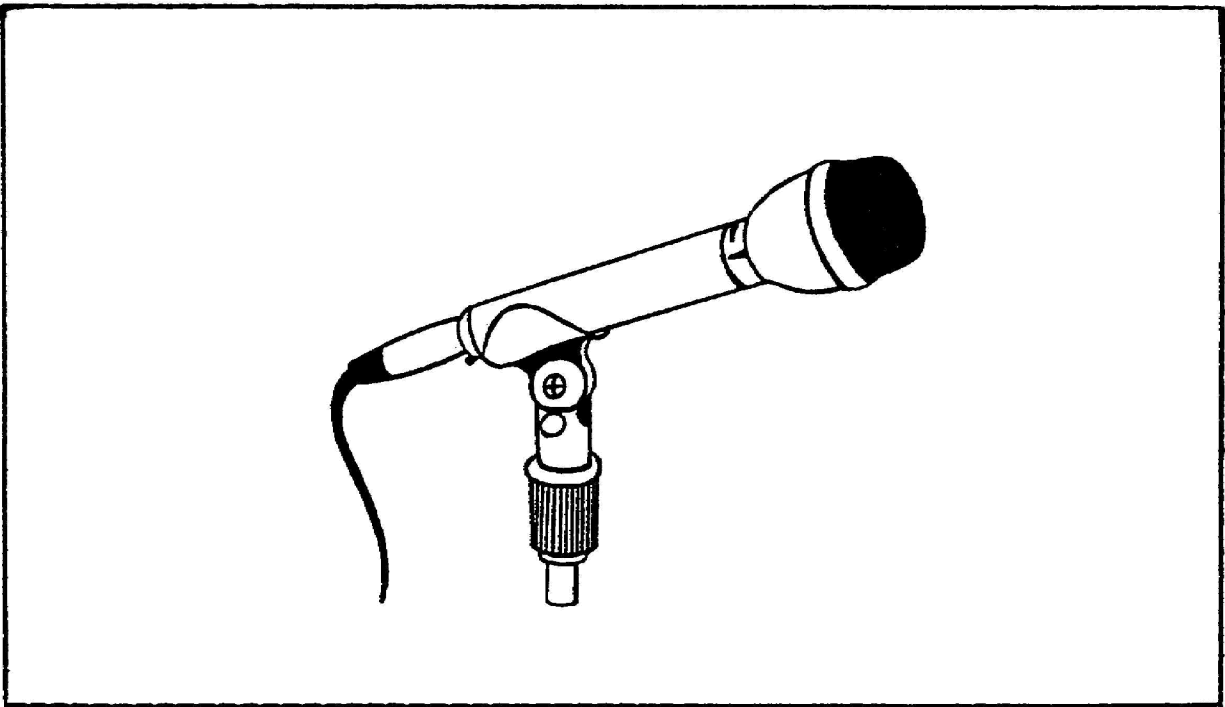

Figure 2-10
Stand microphone

Shotgun Microphone

The shotgun microphone is designed to pick up sound and not be in the picture. This is particularly useful when it is not possible to place a microphone on a speaker's lectern. The shotgun mike may be several feet from the speaker and still pick up acceptable audio. Because this mike is highly unidirectional, the shotgun locks in on the main source while eliminating most ambient or side noise. The shotgun

microphone is specifically designed to gather sound from the front and suppress sound at the sides and rear of the microphone (Fig. 2-11).

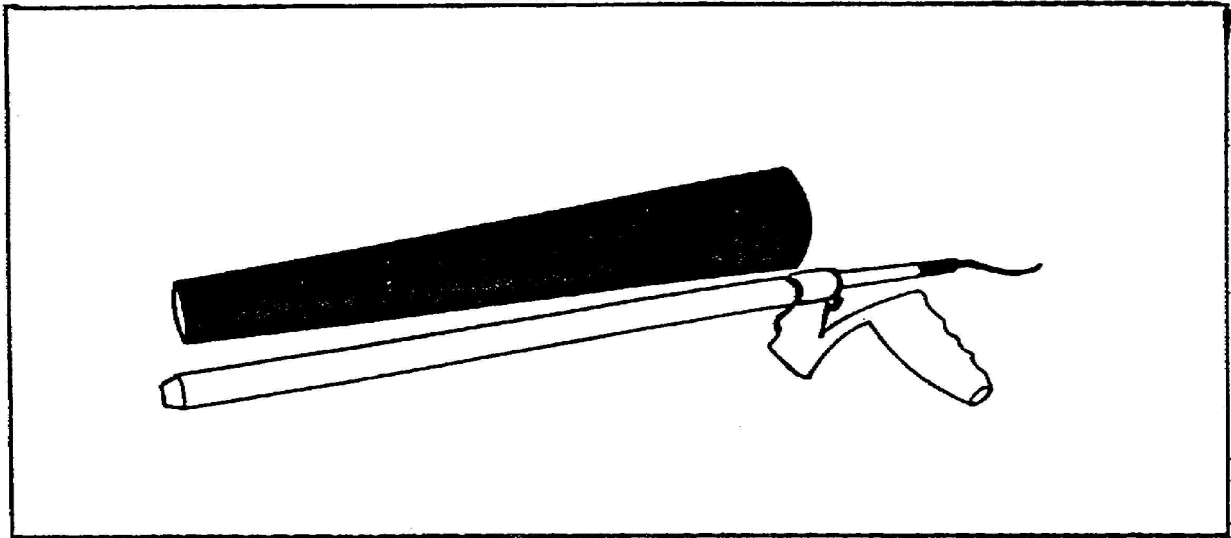

Figure 2-11
Shotgun microphone

ACOUSTICS

Most studios are acoustically controlled for recording. However, many recording situations will not be in the controlled environment of a studio. An empty room reflects sound and therefore, records differently than that same room filled with furniture; a small room sounds differently than a large room; inside acoustics are much different than outside.

For example, when covering an open-air speech where a large crowd is present, the main consideration should be recording the speech and keeping the ambient or outside noise from interfering. An omnidirectional microphone will pick up the speaker and the ambient sound. In this situation, a unidirectional microphone should be used, eliminating much of the ambient noise and keying in on the main speaker.

An interview conducted in a room that has a hollow sound presents other problems. Rooms with high ceilings or sparsely furnished and containing many hard surfaces will create this hollow effect by causing the sound waves to bounce off the hard surfaces. A bidirectional mike should be used here because this type of mike picks up sound best directly in front, and in back, with decreasing sensitivity at the sides. (See Fig. 2-4)

LESSON 2/Learning Event 7 and 8

When conducting an acoustical analysis, it is important to know the directional characteristics of the microphones that are available. The audio person must take all possible audio situations and problems into consideration. Examine the alternatives and then select the type microphone that will provide the best pickup for the specific situation.

ACCESSORIES

Professional mikes and cables use standard jacks or connector plugs called "Canon XLR" connectors or "Canon Plugs". The canon plug is a three pronged plug with male and female connectors. Generally most audio outputs, such as the microphone end, use the male plug while most inputs in the studio audio connector box use a female receptacle. When connecting these plugs, listen for a click which tells when they are joined. When taking them apart, be sure to release the safety lock or the wires may be pulled out of the connector.

Windscreens/Filters

Most microphones are sensitive to loud, sudden, sounds and wind noise. "Pop filters and screens" are used on mikes to diminish these sounds. Pop filters are built in electronically and are usually used in dynamic microphones. Windscreens are external attachments on any mike that cover the microphone. Pop filters and screens will not eliminate all the unwanted sound but they will help. They are excellent tools to use against unwanted distortion or loud sounds.

These filters slightly reduce the frequency response of a microphone (Fig. 2-12).

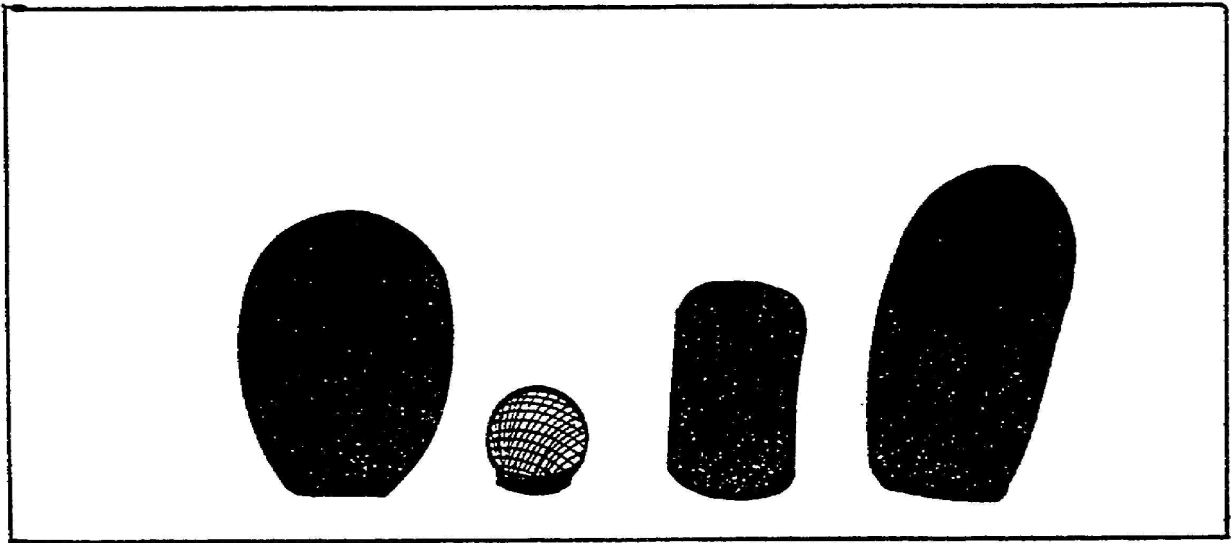

Figure 2-12
Windscreens

Connectors

Audio connector boxes are usually located low to the floor along the studio wall. These boxes usually will contain female receptacles. Connecting a microphone is easy. Just line up the pins to the female connector and push them together. To release a mike from a receptacle, push the release button. Use caution when inserting and removing a cable and handle the cable by the metal connector, NOT by the wire. Pulling on the cable may damage the wires inside. A little care will prevent a lot of problems.

Fig. 2-13 shows the different types of connectors that you may run into in a studio or field situation.

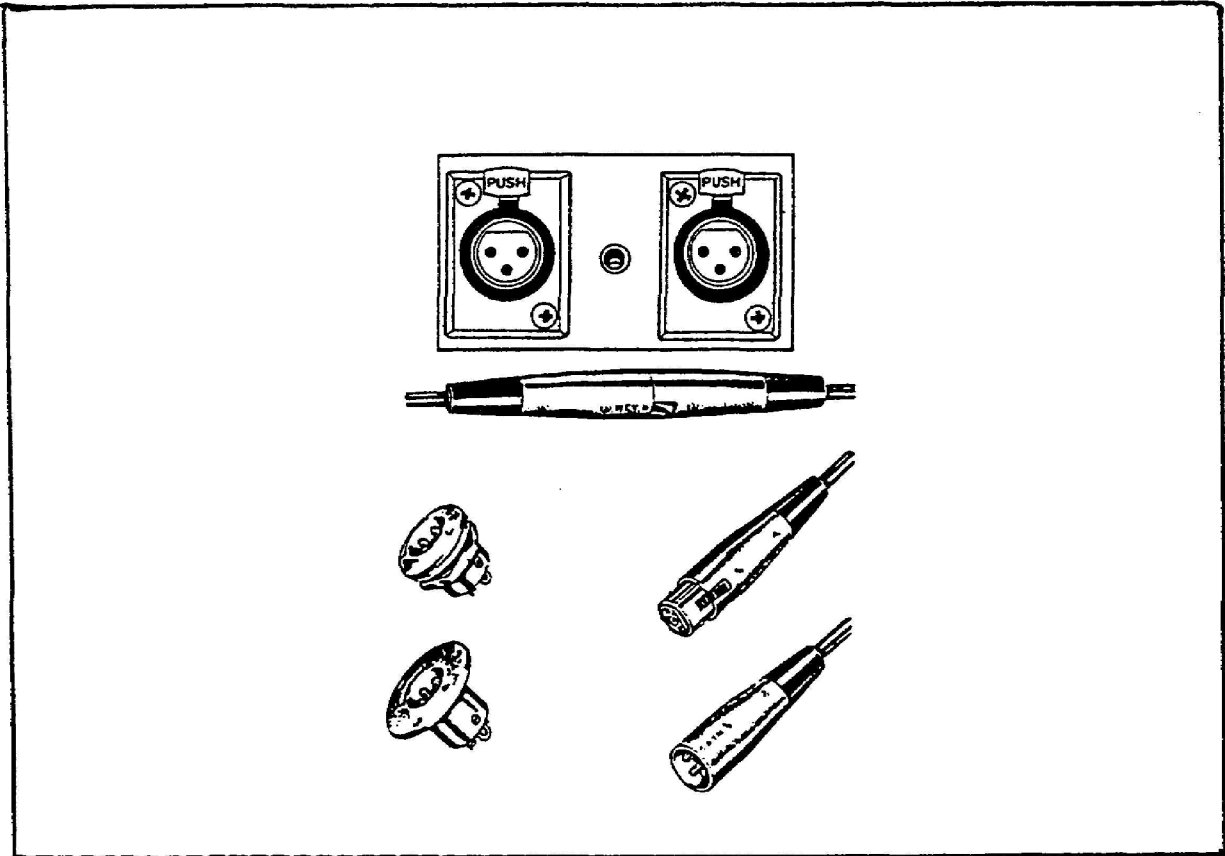

Figure 2-13
Connectors

Cables that are not in use should be neatly coiled. Be careful not to wrap them too tight or damage to the wires inside may occur. If cables or connectors are abused, they may not function when you need them. Before leaving for an assignment, always inspect the cables and connectors before you plug them into an input.

Make sure you have enough audio cable. You need to have a sufficient amount to allow for subject or crew movement and to keep it out of the camera view. It is important to have enough audio (mike) cable so it can be taped out of the way of traffic areas. When cables are run across the floor, tape them down so that no one will trip.

CONSOLE FUNCTIONS

All control consoles in the broadcast industry have the same basic similarities. Learn one control console thoroughly and be able to operate it properly and, in most cases, the other audio boards will be less difficult to operate. So take the time now at your earliest opportunity to learn audio operations and procedures.

An audio control console has three primary functions:

1. amplify sound
2. control sound
3. route sound

Amplify Sound

Amplification is accomplished when different levels of sound are received by a microphone, turntable, or tape playback sources. The audio levels are then amplified into a greater or usable sound without distorting the quality of that sound.

Controlling Sound

Sound is controlled through the use of potentiometers (pots) or faders that increase or decrease the level or intensity of the audio elements.

Routing Sound

This channels the sound by activating specific input program selector switches and turning or sliding the faders to a desired level. The sound is sent to a specific area left for Audition, the middle for Off and right for "On Air".

CONTROL CONSOLES

The operator sits in front of the audio board and operates the equipment. The audio console is an indispensable part of any audio system using more than one or two

"input sources". Input sources are items of equipment like mikes, turntables, etc., that are connected to the audio board. The console allows selection from a large number of audio inputs, allowing the operator to blend or mix those selected sources into a signal output. There are two basic types:

1. Traditional monaural/stereo console.
2. Modular mono/stereo console.

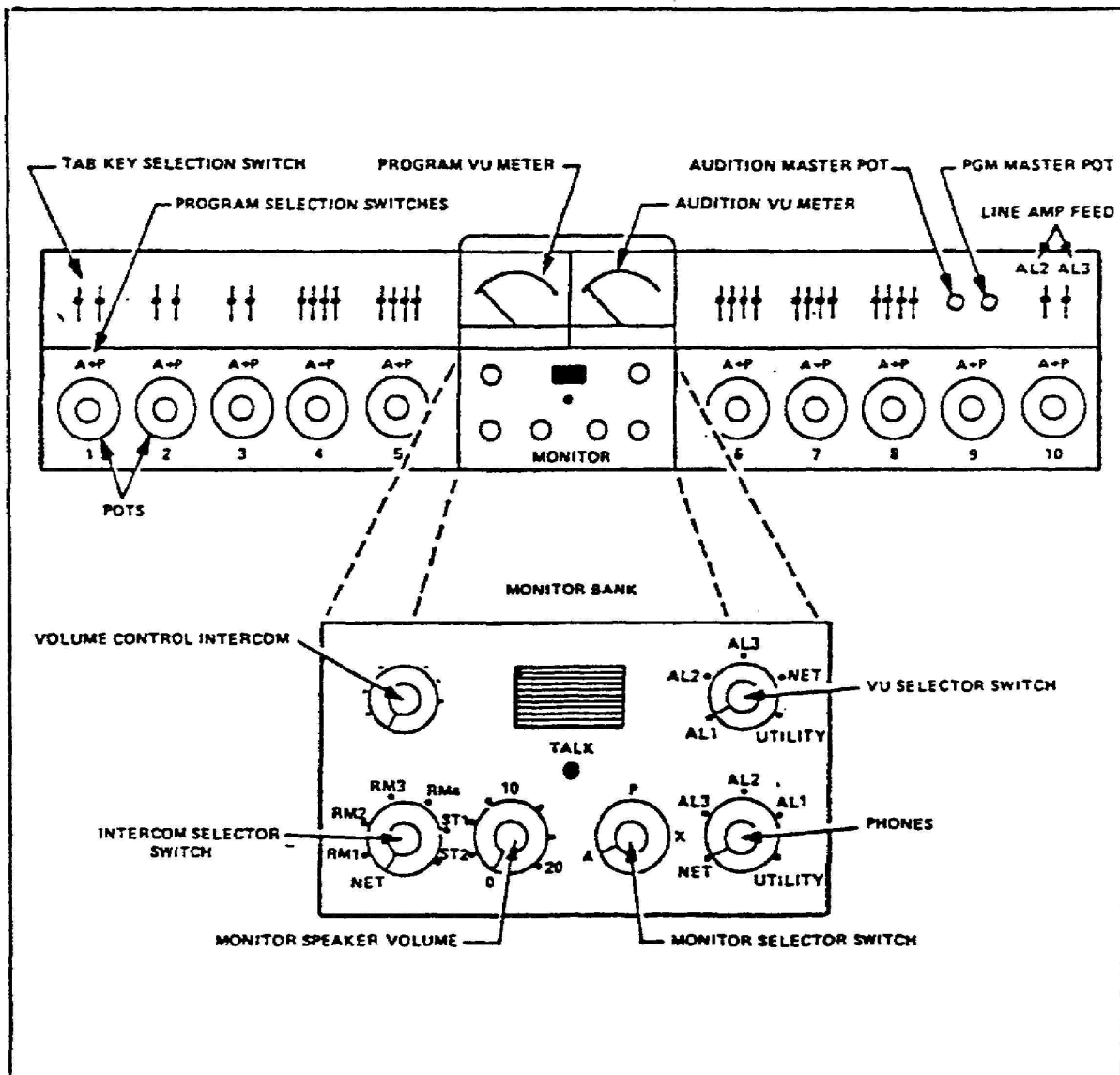

Figure 2-14
Traditional monaural/stereo console

Traditional Mono/Stereo Board

The front panel has a fixed placement of knobs, pots, switches, volume speaker controls, and one or two VU meters (Fig. 2-14). These are the older boards.

Modular Mono/Stereo Console

These are the most current audio boards. These have operating panels designed for specific applications. They have volume speaker controls, faders, mixer keys and VU (volume unit) meters (Fig. 2-15). However, "vertical linear faders" are used instead of the standard circular pots for mixing. A vertical pot is also called a linear fader.

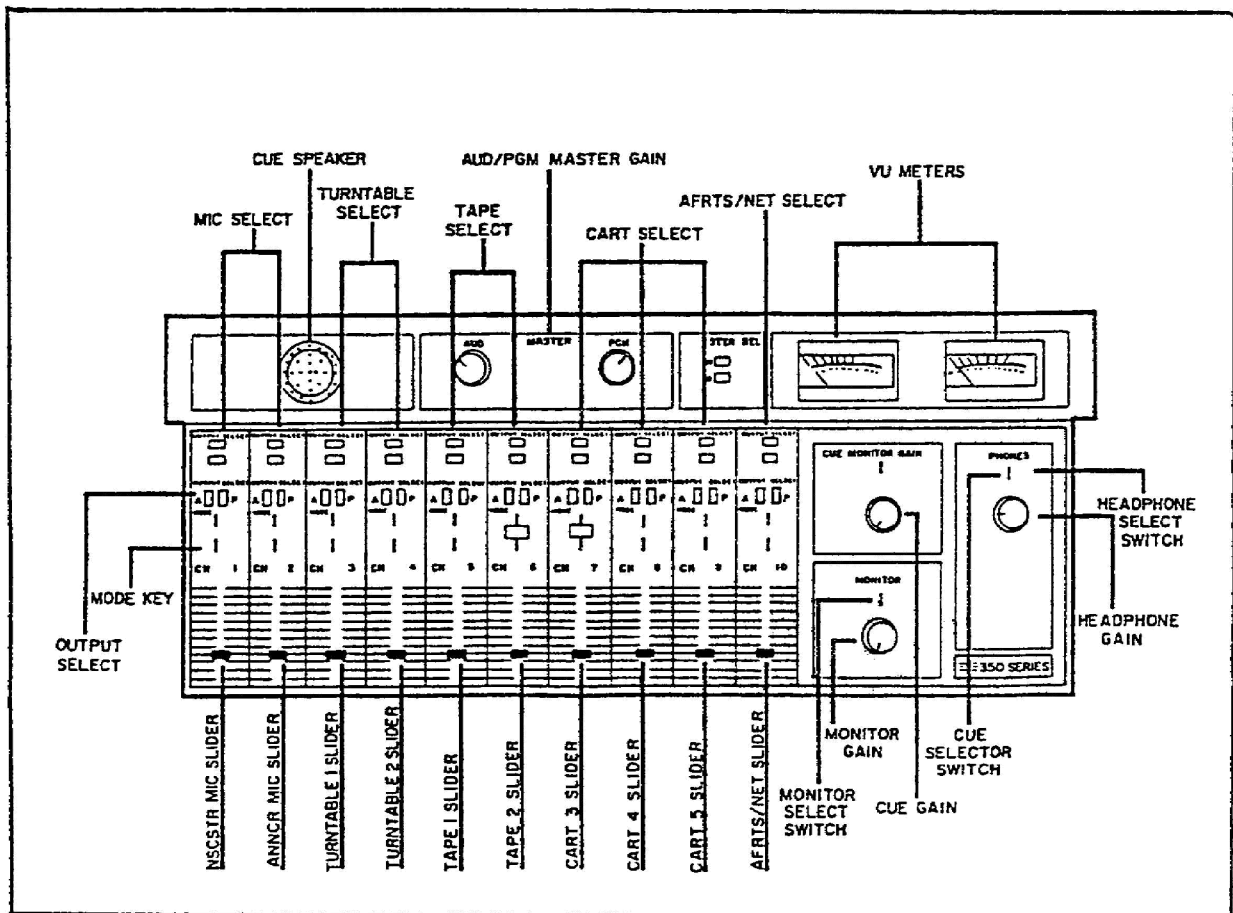

Figure 2-15
Modular mono/stereo

LESSON 2/Learning Event 10

The vertical faders appear on the console face as sliding knobs that are moved up and down to control the sound level or intensity. "Output channels" direct the sound to a specific location, i.e. PROGRAM, OFF or AUDITION.

VU Meter

Above the individual faders/pots or controls, right in front of the operator, is a large meter(s) called the "volume unit" or VU meter. The volume meter is an essential tool in dealing with audio levels or signals. It is impossible to determine how loud a sound is, or how loud we think the sound is without a VU meter to tell us. VU meters are expensive and delicate. All audio levels are set with the VU meter. Look at the VU meter (Figure 2-16). Notice there are two scales. The upper scale is read in volume units, from -20 to 0 and then +3. The zero mark is a representation of "decibels or db" with zero db equal to 100 percent modulation or audio without distortion. The newer VU meters have 0 to 100 on the top scale and the decibels on the bottom scale. Beyond zero, the scale is marked in red. Sound level readings in this area, should only be permitted momentarily because these readings indicate volume unit (VU) distortion in the audio signal.

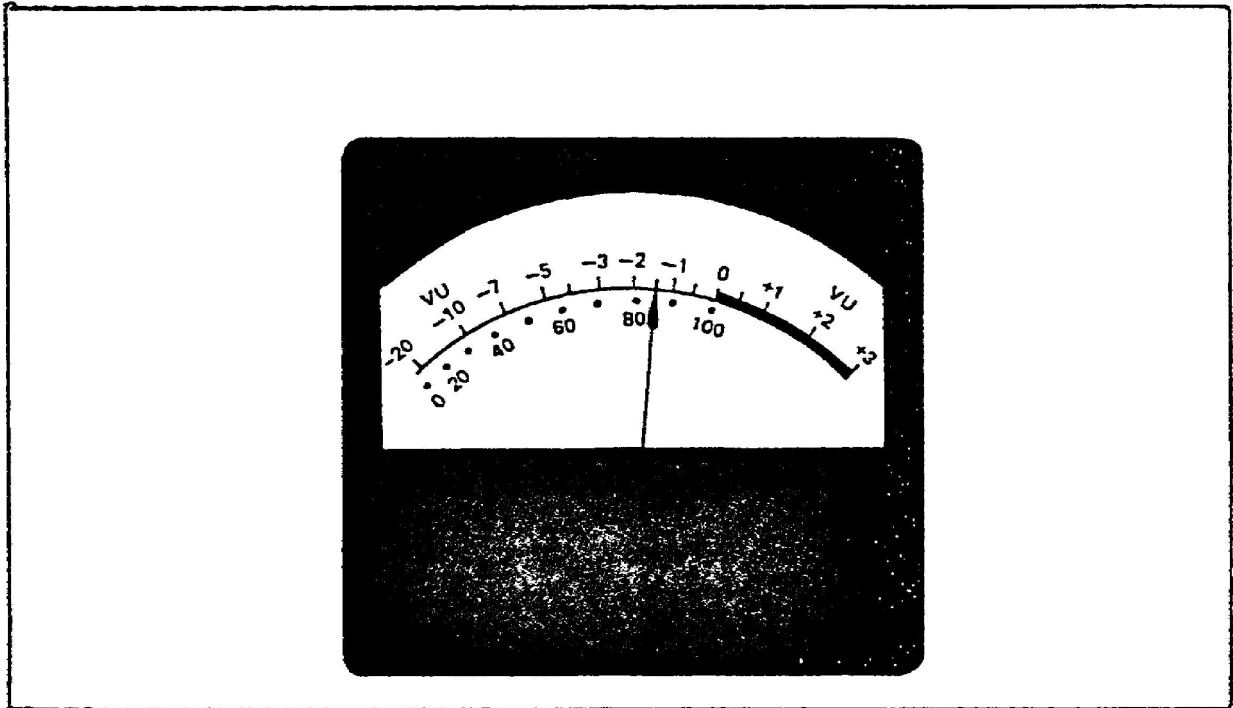

Figure 2-16
VU meter

The lower scale has a range from 0 to 100 and is a reflection of that percent of modulation. When the audio signal exceeds 100 percent modulation the scale indicates red. This is called "in the red" and is not a desirable place to be. When the needle is all the way to the right, we say "the needle is pegged". Pegging the needle may damage the needle mechanism by bending the needle. This will cause inaccurate readings. When the needle reading is down around the minus 20 mark, at the left, we say we're "riding in the mud". Riding in the mud means that the audio level is too low and should be brought up. The term "Riding Gain" refers to the amount of sound level or volume that the needle is measuring. Riding or monitoring gain with the VU meter then consists of watching the moving needle while adjusting the pot that controls the sound. The normal acceptable level for riding audio is between 80-100 per cent VU modulation and should read this at all times.

RELATED EQUIPMENT

Additional control room equipment includes turntables, cartridge and/or cassette tape recorders, speakers, clocks, remote controls and filters.

Turntables

A turntable is a high-quality record player that play records at speeds of 78, 45 and 33-1/3 revolutions per minute (rpm). The 78 rpm speed is seldom used today. The most common speeds are 45 and 33-1/3 rpm.

Tape Recorder

Audio tape recorders have three operating formats: reel-to-reel, cartridge and cassette. Entire programs, special events, and on-the-spot news items are recorded on tape, in these three formats for later insertion. Talks by inexperienced speakers may be taped and later "edited" to remove those embarrassing long pauses. The ease of editing, plus the ability to "erase" the tape and reuse it makes the tape recorder a requirement of good broadcast operations.

Reel-to-Reel. Tape recorders for broadcast use are operated at 3-3/4, 7-1/2 and 15 inches per second (ips). The

playback and recording heads on a tape recorder are the heart of the recorder. The three electromagnets are called heads. The tape heads are arranged in a line near the tape transfer mechanism. They are aligned from left to right: erase head, recording head and playback head. The tape recorder consists of:

1. A tape transfer mechanism which moves the tape from a feed reel, past the tape heads, to a take up reel at a constant speed. The constant speed is maintained by a capstan motor that pulls the tape through a pair of tangent wheels or rollers.
2. A speed-changing and start switch which allows the operator to change speeds. The speeds are either 3-3/4 to 7-1/2 or 15 ips and/or any combination of the three depending on the designs of the recorder/reproducer. The start switch is positioned to start the record/play back process and/or fast forward and reverse.
3. A recording amplifier to impress the sound onto the tape through the record head.
4. A play back amplifier to feed the sound from a previously recorded tape to the audio control board. The sound on the tape activates the play back head which in turn sends it to the play back amplifier.
5. An erase head or oscillator to clean unwanted, previously recorded sound from the tape. The erase oscillator operates the erase head which then erases the tape. This oscillator operates at a frequency above human hearing at about 25 kilohertz.

Cartridge Recorders/Reproducers. Cartridge machines use a plastic case containing a cartridge that has an endless tape loop. The tape rewinds itself as it is played back. An inaudible tone is placed on a tape by the operator for cueing purposes. This tone will rescue or stop the tape at any specific location on the tape the operator wants, automatically. In recent years, cartridge tapes have been used in place of turntables for playback of recorded transcriptions or records. This saves the records from repeated use when they first appear on music charts. News and sports announcers use cartridge tapes for recording on-the-spot events. Cartridges are also widely used in radio

and television for recording station identifications (ID's), program themes, sound effects, announcements and public service announcements (PSA's).

The cartridge tape recorder is designed to use a standard tape cartridge holding tape lengths of from 20 seconds to 31 minutes play time, at 7-1/2 ips. Cartridge tape uses the half-track format with program material recorded on one track and cue pulses recorded on the other. The cue portion of the tape has a pulse at the beginning of the program material to cue the tape. After the audio program material has played, the tape continues to roll silently through the cart until another cue tone is reached. The tape will then automatically stop. The cart may then be removed and played at a later time.

Cartridge tape may be bulk erased and re-used just like reel-to-reel tape. Cart machines are manufactured as either recorder/reproducers or as reproducers only. Storage racks are available for wall mounting or as mobile rotating stands that hold from 20 to 200 carts for studio use.

Cassette Recorder/Reproducer. The cassette recorder was originally designed for use in home entertainment. However, in recent years, they have been put to use in broadcasting by reporters for on-the-scene coverage, conducting interviews and as an audio cassette broadcast system.

Speaker

The control room speaker is an important guide to both operator and director. During a broadcast, the speaker reproduces what is on-the-air. During rehearsals, what is heard over the speaker is the basis for audio corrections and for the director's suggestions to the announcer or performers. The control room speaker may be turned up or down to a comfortable level in the control room. This does not affect what 's going over the air for broadcast or recording. There are normally two sets of speakers. The broadcast monitor speakers and the cue channel speaker.

Clocks

In radio and television, everything runs by the clock. For this reason, all clocks should be set properly. This

indicates a well run station to the listeners. Adequate consideration should be given to what clocks are used for and what types are available.

Round-face clocks are the most commonly used time instruments. They should be large enough to be read easily from anywhere in the studio. Large plain numerals and hands are a must. A 12-hour face is more desirable than a 24-hour face with small markings. A second hand is essential.

The second hand should move in one-second increments, rather than one smooth circular motion found on most household clocks. All clocks should be synchronized either by a master timer or by resetting once or twice a day as needed. It is not unusual for a majority of the non-essential clocks on a military installation to be set from times given over the radio or television. Don't confuse the listeners.

Clocks with a digital read-out have become extremely popular in recent years. The electronic read-out is preferable and generally more accurate. Some of these units may be used as clocks, standard counters, countdown timers, and stop clocks. However, some individuals can't visualize the remaining time in a program, the elapsed time or cue time, as readily as they can with the more familiar circular face clocks.

Timers

Timers are essential tools for good production work in broadcasting. They may range from a simple stop watch or photographer's timer, to an elaborate electronic timer capable of starting and stopping equipment. In broadcasting, it's generally preferred that the timer have at least start and stop capability without having to be reset to zero.

Remote Controls

Remote controls are switches that operate equipment located some distance from the audio control board. These controls allow the operator to function from a central location without having to physically touch the equipment. These remote controls are available from the equipment manufacturer.

TERMS

The following is a list of terms that will help the student better understand broadcast terminology.

Pots. Pots are the round knobs or linear (vertical) faders used to increase or decrease sound levels on an audio control board.

Inputs. Audio "inputs" to the console are normally "hardpatched," that is, permanently wired into the console. For example, mike number one and two will probably always be fed to their individual pot. The operator uses the selector key to determine if microphone number one or two will be in the audition or in the program mode and fed into the pots. Newer boards use a linear fader. This type of fader is a vertical attenuator or pot. The linear fader slides up and down a graduated scale. The strength of the signal increases in a linear or straight line output. The scale graduation has a closer tolerance.

Outputs. The next step is to determine where the signal is going. We normally have three choices: cue, audition or program. The cue system amplifier will let the operator hear the input signal. This signal does not reflect on the VU meter nor does it go out over the air. The cue system is solely for the operator to hear what is going to air. The cue system has its own lower quality speaker, and distinct sound. The speaker quality allows the operator to tell the difference between the on-air audio and the next source audio in cue.

Channel selector switch. Immediately above each pot is a three positioned switch. This switch directs the sound to the different audio channels. In the left position, the signal or audio is fed to the audition monitor/speaker channel. The middle position is off and in the far right position the channel is sent to the program or on-air output.

Terms continued

Audition/Program. The audition channel is primarily used to set up the next sound source. On many audio boards, the audition system will have the same quality as the program channel. In order for the operator to see the VU level reading in audition the operator must turn the audition/program monitor switch to the position that indicates audition VU monitor. Likewise, for the operator to monitor or hear the program information, this switch must be in the program channel.

Master Program Switch. The master program selector switch normally has only two positions; Off and Program. If the program is to be heard by the listener, the audio must be sent to the transmitter and this switch must be in the program position.

The master program level is predetermined and set. The engineer calibrates the signal to determine what the best audio output level of the console is to the transmitter. NEVER change this preset level unless directed to do so by an engineer or your supervisor.

Operating Techniques. Operating techniques refer to the operators ability to mix, blend and control sound sources. Let's make sure we are talking the same audio language for basic audio technique. "FADING" is opening and closing the pot. "CROSSFADE" is to reduce the level of an existing sound source while increasing the level of a second sound. "SEGUE" (pronounced seg-way) is an audio transition whereby the preceding sound is faded out and the following sound faded in immediately. "DOWN and UNDER" is the fading down of music to a low level for the entrance of a voice and then holding the music source at a low level. "UP and UNDER" is the gradual increase of music to a low level while an announcement is being made, usually being followed by "UP and FULL" when the announcement is concluded. "DOWN and OUT" is fading down the music to a low level for the entrance of a voice and then taking the music completely out. Remember, avoid crossfading with music vocals where the voice will be cut in either direction. Only use down and under, and up and under, etc., when vocals are needed for emphasis.

Terms continued

Patch Panel. In a control room that has a patch panel, patch bay, or patch board, the major pieces of equipment in the studio may be connected to the preceding unit through patching. A patch panel lets the operator or engineer connect or by-pass the output of one piece of equipment to the input of another through a system of standard jacks that are attached to short lengths of shielded cable with male plugs on both ends. The process is called "patching". The by-passing is always done from the "output" of the last good piece of equipment, around the bad piece of equipment, in line to the "input" of the replacement piece of equipment. This process will allow the broadcast process to continue. These interconnecting cables are called external patch cords.

Patch cords should always be in one of two places; hung up on a storage hook; or with both plugs inserted into the patch panel. Do not leave one end of a patch cord dangling. The cord may become damaged or become the source of unwanted static or noise in the audio system. Give frayed or damaged cords to maintenance personnel for repair. Keep only well maintained cords in the studio.

PRACTICE EXERCISE

LESSON #2

BASIC AUDIO

SUBCOURSE No. DI0370

INSTRUCTIONS:

Review the material in this lesson. Answer the questions below by circling the "T" or "F" next to each question. Compare your answers with the answers on the next page. Ensure that you understand the lesson material and answers before proceeding to the next lesson.

- T F 1. In a pressure-operated microphone, the diaphragm vibrates with the pressure from the sound and makes the voice coil move back and forth in a magnetic field.
- T F 2. The omnidirectional mike accepts sound quality from only one direction.
- T F 3. The most commonly used microphone in television is the lavalier.
- T F 4. Windscreens are externally mounted on the microphones and can help eliminate loud distortion.
- T F 5. All audio control consoles are similar.
- T F 6. When patching, patch from the input to the output.
- T F 7. When the channel selector switch is in the program position, the signal will be sent to the transmitter.

ANSWER KEY

PRACTICE EXERCISE

LESSON #2

SUBCOURSE No. DI0370

INTRODUCTION TO BASIC AUDIO

- | | | | |
|----|-------|------|----|
| 1. | TRUE | Page | 16 |
| 2. | FALSE | Page | 19 |
| 3. | TRUE | Page | 21 |
| 4. | TRUE | Page | 25 |
| 5. | TRUE | Page | 28 |
| 6. | FALSE | Page | 37 |
| 7. | TRUE | Page | 37 |

BASIC SCENERY

SCENERY

Television scenery plays a major role in the quality of the visual portion of a TV program. Guidelines applicable to other visual elements also apply to scenery, especially the concepts of contrast and detail.

Today, the emphasis is on simplicity when designing scenery. Scenery created for television should be symbolic rather than too realistic. Size, texture, color and location of sets are specifically adapted to what the television camera can see. The scenic environment, though important, remains secondary. However, broadcasters should know something about the design and construction of scenery and properties.

Scenery is divided into two categories. Simply put, all scenery either stands or hangs.

Standing Scenery

The most commonly used standing scenery units are known as "flats". Flats consist of a frame and muslin or canvas covering, plus tacks, glue, nails, screws and hinges as required. Standing flats should be high enough to prevent overshooting by the camera during wide-angle long shots. The height is usually 8 to 10 feet and the width may vary from 3 to 5 feet depending upon studio requirements. Scenery constructed today is much lighter than it was several years ago. Remember to make the scenery light enough to be assembled or disassembled with a minimum of time by one person. Paper-covered sheets, and plywood, or other construction materials serve this purpose very nicely.

Flats may be single, twofold, or threefold, with different horizontal dimensions and fold for storage. Flats may contain openings for doors or windows into which these units may be fastened. Sets may require miscellaneous standing units such as pylons (which look like three-sided pillars), step blocks, pedestal, platforms, plastic bushes and a variety of folding screens. All of these special set pieces are considered as standing scenery.

Hanging Scenery

Hanging scenery is either suspended from an arrangement of pipes, battens, grids, or from some other piece of standing scenery. The most versatile hanging background unit is the cyclorama.

A cyclorama is a large curtain that hangs down from the grids in sections. They usually come in three colors white, black and chroma key blue. Usually they cover three sides of a studio.

Other hanging scenery may include painted canvas drops, curtains which may be slid or traversed horizontally, drapes, murals and sometimes photomurals. The chroma key drop is a wide roll of blue canvas that is for "keying" Keying is electronically inserted information to the side or behind the announcer. The electronic insert adds support information for the announcer. Normally, this technique is used in newscasts for slides and videotapes.

PROPERTY

Studio sets are normally built from a number of separate, prefabricated scenic units, positioned and fastened together. Subsequently, they are dressed with appropriate furnishings, properties, drapes, etc., to create the total scenic effect. There are three types of properties:

1. stage properties, or props,
2. hand props
3. set dressings.

Stage Props

There are many types of stage properties, but the term generally refers to furniture: news desks, tables, lectern, chairs, etc.

Hand Props

Hand props consist of all items that are actually handled by people during a show. They include such items as ashtrays, telephones, typewriters, dishes, silverware, glasses, bottles and food.

Set Dressings

Set dressings are furnishings that normally give an apartment or set its distinguishing characteristics of locale, mood, etc. Set dressings also include pictures, draperies, bookcases, fireplace, lamps and chandeliers, indoor plants, and miscellaneous decorative items, etc.

STUDIO BACKGROUNDS

In preparing studio backgrounds, the main problem of contrast and layout are important to consider in the overall program. Before preparing the background or scenery for a program, broadcasters need to identify camera movement, whether or not the background will be seen in a close up, and what type of action will take place in front of the background. The background, as a general rule, should be darker than the foreground. A darker area tends to recede from the viewer while a lighter area tends to stand out. This gives greater separation or depth between background and subject. Separation is a feature which is always desirable for television transmission. If the background is not to be shown in a close up, the lines and designs may be coarse. But, if one area is to be seen close up, then more detail should be added to that particular area.

Contrast

Television lighting contrast is important. Backgrounds may be adjusted by varying color, material texture, or light intensity. The most important characteristics of any particular light are direction, intensity and quality.

All three characteristics will influence the reflective value of the backdrop but in no case should the contrast range exceed the limits of the television system of 20 to 1. The brightness of color is usually measured by how much light objects reflect.

LESSON 3/Learning Event 3

Highly reflective objects should never be included on TV as property or as part of a costume. If it is necessary to use a highly reflective surface, dull it with a special dulling spray. If dulling spray is not readily available, use soap or a solution of Epsom salts and stale beer (1 tablespoon of salt to 1 cup of stale beer). Spraying or brushing a shiny surface with this mixture will appreciably dull reflecting properties. Brasso will also dull very shiny objects. Just dab it on and let it dry.

Storage

Small station operations will be primarily concerned with non-dramatic local presentations. For this reason, the station wardrobe or costumes will be somewhere between nonexistent and very small. What there is, if anything, will probably be miscellaneous items occasionally necessary to correct clothing contrast problems.

We defined scenery at the beginning of this lesson using the terms "standing" and "hanging". In any case, if there is a lot of scenery, storage may be a problem. From the standpoint of availability, storage in the studio is best because some scenery is quite heavy. However, some scenery may require too much studio space when not in use. If so, operations personnel may have to move it into hallways or adjacent rooms or to a props and sceneries storage area. Wherever scenery is stored, it's best to have scene docks for the flats. A scene dock has slots into which the top and bottom edges of the flats slide for vertical storage like books in a bookcases. If there is no room for scene docks, scenery may have to be leaned against walls or stacked in layers. If necessary, it is best to reserve an area for each type of flat which will at least segregate singles, two folds, and three folds. Pile flats in flat horizontal layers, back to back to avoid damage. Space around the walls should be assigned specific types of flats. Drapes will be less apt to wrinkle or develop horizontal folds if they are hung on high racks. Costumes and set dressings should be stored in a prop room adjacent to the studio.

Flameproofing

Fire regulations require materials that are to be used for scenery to be flameproofed. This may be done by spraying or painting the scenery (either before or after it has been made or painted) with special FLAMEPROOFING chemicals. These chemicals are available from companies that deal in stage or scenery equipment or may be mixed at the studio from ingredients found in almost any grocery store. One formula commonly used is:

- a. 1 pound borax (sodium tetraborate)
- b. 1 pound sal ammoniac (ammonium chloride)
- c. 3 quarts water

WARNING

Although the scenery material may have been flameproofed, this does not mean that the scenery will not burn. Flameproofing only retards or slows the ignition process.

Issue Control

As with all station equipment and supplies subject to intermittent use, it is best that issue slips be completed by personnel requiring scenery or other material from storage. The issue slip should identify the material; show the length of time the material will be needed; and give the probable date of return. A suspense filing system is advisable so that the scenery and/or property custodian has information immediately available on the location and future availability of items. The custodian should establish controls for such supplies as paint, fabrics, and hardware. The reason for supply controls, other than avoiding waste, is to insure adequate inventory and sufficient lead time for planning, requesting, and purchasing.

PRACTICE EXERCISE

LESSON #3

SCENERY

SUBCOURSE No. DI0370

INSTRUCTIONS:

Review the material in this lesson. Answer the questions below by circling the "T" or "F" next to each question. Compare your answers with the answer key on the next page. Ensure that you understand the lesson material and answers before proceeding.

- T F 1. A cyclorama has many different pieces that cover only one wall.
- T F 2. The most commonly used standing units are flats.
- T F 3. The brightness of color is usually determined by the amount of light it reflects.
- T F 4. Studio settings are built from a number of separate prefabricated scenic-units, positioned and fastened together.
- T F 5. The best way to store flats is to put them all together one on top of the other.
- T F 6. Fire regulations require materials that are to be used as scenery to be flameproofed.
- T F 7. Issue control slips should be required of personnel requesting scenery and other materials from storage.

ANSWER KEY

PRACTICE EXERCISE

LESSON #3

SUBCOURSE No. DI0370

SCENERY

1. FALSE Page 42
2. TRUE Page 41
3. TRUE Page 43
4. TRUE Page 42
5. FALSE Page 44
6. TRUE Page 44
7. TRUE Page 45