

**TACTICAL
SINGLE-CHANNEL
RADIO
COMMUNICATIONS
TECHNIQUES**

DEPARTMENT OF THE ARMY

Approved for public release, distribution is unlimited.

Field Manual
No. 24-18

FM 24-18
HEADQUARTERS
DEPARTMENT OF THE ARMY
Washington, D.C. 30 September 1987

TACTICAL SINGLE-CHANNEL RADIO COMMUNICATIONS TECHNIQUES

TABLE OF CONTENTS

PREFACE	iv
CHAPTER 1 INTRODUCTION TO SINGLE-CHANNEL RADIO COMMUNICATIONS	1-1
CHAPTER 2 RADIO PRINCIPLES	2-1
Section I. Theory and Propagation	2-1
Section II. Types of Modulation and Methods of Transmission	2-7
CHAPTER 3 ANTENNAS	3-1
Section I. Requirement and Function	3-1
Section II. Characteristics	3-1
Section III. Types of Antennas	3-6
Section IV. Field Repair and Expedients	3-13
CHAPTER 4 PRACTICAL CONSIDERATIONS IN OPERATING SINGLE-CHANNEL RADIOS	4-1
Section I. Siting Considerations	4-1
Section II. Transmitter Characteristics and Operator's Skills	4-3
Section III. Transmission Paths	4-4
Section IV. Receiver Characteristics and Operator's Skills	4-5
CHAPTER 5 RADIO OPERATING TECHNIQUES	5-1
Section I. General Operating Instructions and SOI	5-1
Section II. Radiotelegraph Procedures	5-4
Section III. Radiotelephone and Radio Teletypewriter Procedures	5-6

DISTRIBUTION RESTRICTION: Approved for public release; distribution is unlimited.

* This publication supersedes FM 24-18, 13 December 1984.

CHAPTER 6 ELECTRONIC WARFARE	6-1
CHAPTER 7 RADIO OPERATIONS UNDER UNUSUAL CONDITIONS	7-1
Section I. Operations in Arcticlike Area	7-1
Section II. Operations in Jungle Areas	7-3
Section III. Operations in Desert Areas	7-6
Section IV. Operations in Mountainous Areas	7-7
Section V. Operations in Special Environments	7-8
CHAPTER 8 SPECIAL OPERATIONS AND INTEROPERABILITY TECHNIQUES	8-1
Section I. Retransmission and Remote Control Operations	8-1
Section II. Secure Operations	8-5
Section III. Equipment Compatibility and Netting Procedures	8-7
APPENDIX A POWER SOURCES	A-1
APPENDIX B IONOSPHERIC SOUNDER AN/TRQ-35(V)	B-1
APPENDIX C EXTENDED FREQUENCY RANGE, MULTIMODE FIELD RADIO SET AN/PRC-70	C-1
APPENDIX D TRANSCEIVER MULTIPLEXER (TD-1288()/GRC AND TD-1289()/GRC)	D-1
APPENDIX E STEERABLE NULL PROCESSING GROUP OL-275()/VRC	E-1
APPENDIX F NET RADIO INTERFACE	F-1
Section I. Purpose and Scope	F-1
Section II. Doctrine and Deployment	F-1
Section III. Operation	F-4
Section IV. Radio Set Control C-6709/G	F-14
APPENDIX G TIME ZONE CHART	G-1
APPENDIX H TIME CONVERSION TABLE	H-1
APPENDIX I CIRCUIT LOG AND OPERATOR'S NUMBER SHEET	I-1
APPENDIX J ELECTROMAGNETIC PULSE	J-1
APPENDIX K NBC PROTECTION	K-1
APPENDIX L TACTIC SINGLE-CHANNEL COMMUNICATIONS	L-1

APPENDIX M NEAR-VERTICAL INCIDENCE SKY-WAVE PROPAGATION CONCEPT	M-1
GLOSSARY	Glossary-1
REFERENCES	References-1
AUTHORIZATION PAGE	Authorization Page

PREFACE

Purpose and Scope

This manual provides information and guidance to all personnel who are involved with and use single-channel radio in tactical situations.

To ensure your understanding of all the material presented, this manual includes a brief discussion of radio fundamentals, antennas, and radio-wave propagation. It also covers procedures and techniques that have been used effectively during tactical operations to include: site selection and reliability factors; operation in the several transmission modes and under unusual conditions; field expedients; electronic warfare techniques and reporting; and other aspects of the practical applications of single-channel radio. There are other items pertinent to single-channel radio operations listed in the appendixes.

User Information

The proponent of this publication is HQ TRADOC. You are encouraged to submit comments and recommended changes to improve this manual. Submit your comments on DA Form 2028 (Recommended Changes to Publications and Blank Forms) and key them to the pages, paragraphs, and lines of text to which they apply. If DA Form 2028 is not available, a letter is acceptable. Provide reasons for your comments to ensure complete understanding and proper evaluation. Forward your comments to the Commander, United States Army Signal Center and Fort Gordon, ATTN: ATZH-DTL, Fort Gordon, Georgia 30905-5070.

The provisions of this publication are the subject of the following international agreement(s): STANAG 2019 (Military Symbols).

DISTRIBUTION RESTRICTION: Distribution authorized to U.S. Government agencies and their contractors to prevent valuable technical or operational information from automatic dissemination under the International Exchange Program or by other means. This determination was made on 10 December 1986. Other requests for this document will be referred to Commander, U.S. Army Signal Center and Fort Gordon, ATTN: ATZH-DTL, Fort Gordon, GA 30905-5070.

DESTRUCTION NOTICE: Destroy by any method that will prevent disclosure of contents or reconstruction of the document.

*This manual supersedes FM 24-18, 13 December 1984.

Whenever a word normally referring to a particular sex appears within this publication, it is intended to include both masculine and feminine genders.

CHAPTER 1

INTRODUCTION TO SINGLE-CHANNEL RADIO COMMUNICATIONS

1-1. Employment of Radio Communications

Mobility is one of the keys to success on the modern battlefield. All communications must be geared to support a combat force that must repeatedly move to survive and fight the enemy. The single-channel radio is the primary means of communication for command, fire control, exchange of information, administration, and liaison between and within units. The versatility of radio communications makes it readily adaptable to rapidly changing tactical situations. Radio is essential for communications over large bodies of water, territory controlled by enemy forces, and terrain where the construction of wire lines is impossible or impractical. It is also required for air assault operations.

1-2. Capabilities and Limitations

The capabilities of the single-channel radio make it flexible, securable, mobile, and reliable.

Radio communications facilities usually can be installed more quickly than wire communications. Thus, radio can be used as a primary means of communications during the initial stages of combat operations.

Once installed in a vehicle, aircraft, or ship, the equipment is ready for use and does not require reinstallation. Wire communications require reinstallation with each move.

Radio equipment is designed to meet mobility requirements and is used by airmobile, amphibious, mechanized, and dismounted units.

Radio lends itself to many modes of operation, such as radiotelephone, radiotelegraph, radio teletypewriter (RATT), visual presentation, and data.

All of the modes of operation are securable when required equipment is available.

Natural obstacles, minefields, and terrain under enemy control or fire do not limit radio to the same extent that they limit other means of communications.

By using special techniques, radio can interface with other communications means (net radio interface), be separated from the immediate vicinity of the user (remoting), and operate over extended distances (retransmission).

The limitations of single-channel radio must also be considered.

Radio is the most detectable means of electronic communications and is subject to intentional and unintentional electronic interference. Current Threat conditions require good electronic counter-countermeasures (ECCM) to include remoting techniques.

To be capable of operating together, radios must have common or at least some overlapping frequencies. They must transmit and receive the same type signal and must be located within operating range of each other with a clear transmission path.

Radio is the least secure means of communications, and it must be assumed that interception occurs every time a transmitter is placed in operation.

1-3. Tactical Applications

The extent to which radio is used in combat operations depends on the requirements for secrecy and surprise balanced against the urgency of communications. When surprise is important, radio operation is limited initially to those units already in contact with the enemy. In some instances, to increase deception and surprise, the operation of dummy stations may be directed by higher commanders. When a unit is moving into an area just prior to attack, it may be directed to maintain listening silence until the attack is launched. When a unit is already occupying a sector from which it is to launch an attack, and its radio stations are in operation, it may be directed to maintain normal radio operations without substantial change in traffic load until the attack is launched. If a unit is moved to another sector or is relieved by another unit, it may be required to provide dummy radio stations to continue operations until the attack is fully underway. Once the attack is launched, special restrictions on radio operations are generally removed.

CHAPTER 2

RADIO PRINCIPLES

Section I. Theory and Propagation

2-1. The Radio Set

Basic Components.

A radio set ([fig 2-1](#)) consists basically of a transmitter and a receiver. Other items necessary for operation include a source of electrical power and an antenna for radiation and reception of radio waves.

The transmitter contains an oscillator which generates radio frequency (RF) energy in the form of alternating current (AC). A transmission line or cable feeds the RF to the antenna. The antenna converts the AC into electromagnetic energy which is radiated into space. A keying device is used to control the transmission.

Normally, in single-channel radio operations, the receiver uses the same antenna as the transmitter to receive electromagnetic energy. The antenna converts the received electromagnetic energy into RF alternating current. The RF is fed to the receiver by a transmission line or cable. In the receiver the RF is converted to audio frequencies (AF). The audio frequencies are then changed into sound waves by a headset or loud speaker.

Separate antennas are used for transmitting and receiving in some single-channel radio installations.

NOTE: When two radio sets operate on the same frequency, with the same type of modulation, and are within operating range, communications between both sets is possible.

[Figure 2-1](#). Basic radio set.

Radio Transmitter.

The simplest radio transmitter consists of a power supply and an oscillator ([fig 2-2](#)). The power supply can be batteries, a generator, an alternating current power source with a rectifier and a filter, or, a direct current (DC) rotating power source. See [appendix A](#) for additional information on power sources. The oscillator, which generates RF energy, must contain a circuit to tune the transmitter to the desired operating frequency. The transmitter must also have some device for controlling the emission of the RF signal. The simplest device is a telegraph key, which is a type of switch for controlling the flow of electric current. As the key is operated the oscillator is turned on and off for varying lengths of time. The varying pulses of RF energy produced correspond to dots

and dashes. This method is used when transmitting international Morse code (IMC). This method is called continuous wave (CW) operation.

Figure 2-2. Block diagram of a simple radio transmitter (continuous wave/morse code operation).

Continuous wave (CW) transmitter. A radio transmitter is used to generate RF energy which is radiated into space. The transmitter may contain only a simple oscillator stage. Usually, the output of the oscillator is applied to a buffer stage to increase oscillator stability and to a power amplifier (**figure 2-3**) which produces greater output. A telegraph key may be used to control the energy waves produced by the transmitter. When the key is closed, the transmitter produces its maximum output. When the key is opened, no output is produced.

Figure 2-3. Block diagram of oscillator-RF amplifier CW transmitter.

Radiotelephone transmitter. To transmit messages by voice, you need a way to vary the output of the transmitter. This is accomplished by adding a modulator and a microphone (**fig 2-4**). When the modulating signal causes the *amplitude* of the radio wave to change, the radio is an *amplitude modulated* (AM) set. When the modulating signal varies the *frequency* of the radio wave, the radio is a *frequency modulated* (FM) set.

Figure 2-4. Block diagram of a radiotelephone transmitter.

Antennas.

After an RF signal has been generated and amplified in the transmitter, it is radiated into space by an antenna. At the distant station, a receiving antenna is used to receive the signal from space. An antenna consists of wires or rods designed for use with either a radio transmitter or a radio receiver. **Chapter 3** discusses antennas in detail.

Radio Receiver.

There are two general kinds of RF signals that can be received by a radio receiver. They are (1) modulated RF signals that carry speech, music, or other audio energy and (2) continuous wave signals that are bursts of RF energy conveying messages by means of coded (dot/dash) signals.

Detector. The process of recovering intelligence from an RF signal is called detection, and the circuit in which it occurs is called a detector (**fig 2-5**). The detector recovers the intelligence from the carrier and makes it available for direct use or for further amplification. In an FM receiver, the detector is usually called a discriminator.

Figure 2-5. Block diagram of a simple radio receiver.

Radio frequency amplifier. An RF signal diminishes in strength at a very rapid rate after it leaves the transmitting antenna. Many RF signals of various frequencies are crowded into the radio frequency spectrum. Therefore, some means must be used to both select and amplify the desired signal. This is accomplished by an RF amplifier (**fig 2-6**). It is included in the receiver to sharpen the selectivity (the ability to choose one frequency out of many) and to increase the sensitivity (the ability to respond to very weak signals). The RF amplifier normally uses tunable circuits to select the desired signal. It contains transistors, electron tubes, or integrated circuits (IC) to amplify the

Figure 2-6. Block diagram of a detector and an RF amplifier.

Audio frequency amplifier (**fig 2-7**). The signal level of the output of a detector, with or without an RF amplifier, is generally very low. To build up the signal level to a useful value that will operate headphones, a loudspeaker, a teletypewriter, or data devices (one or more AF amplifiers) are used in the receiver.

Figure 2-7. Block diagram of a complete radio receiver.

2-2. Radio Waves

Propagation Velocity.

Radio waves travel near the surface of the Earth and also radiate skyward at various angles to the Earth's surface (**fig 2-8**). These electromagnetic waves travel through space at the speed of light, approximately 300,000 kilometers (186,000 mi) per second.

Figure 2-8. Radiation of radio waves from a vertical/antenna.

Wavelength.

Wavelength is defined as the distance between the crest of one wave and the crest of the next wave. It can also be defined as the length of one complete cycle of the waveform. It is the distance traveled during one complete cycle. The length of the wave is always measured in meters.

Figure 2-9. Wavelength of a radio wave.

Radio Frequency.

The frequency of a radio wave is the same as the number of complete cycles that occur in one second. The longer the time of one cycle, the longer is the wavelength and the lower the frequency. The shorter the time of one cycle, the shorter is the wavelength and the higher the frequency (**fig 2-10**). Frequency is measured and stated in units called hertz (Hz). One cycle per second is stated as 1 hertz. Because the frequency of a radio wave is very high, it is generally measured and stated in thousands of hertz (kilohertz, kHz) or in millions of hertz (megahertz, MHz). One kHz is equal to 1000 cycles per second, and 1 MHz is equal to 1,000,000 cycles per second. Sometimes frequencies are expressed in billions of hertz (gigahertz, GHz). One GHz is equal to 1,000,000,000 cycles per second.

Frequency calculation. For practical purposes, the velocity of a radio wave is considered to be constant, regardless of the frequency or the amplitude of the transmitted wave. Therefore, to find the frequency when the wavelength is known, divide the velocity by the wavelength.

Formula: Frequency (hertz) = 300,000,000 (meters per second) / wavelength (meters)

To find the wavelength when the frequency is known, divide the velocity by the frequency.

Formula: Wavelength (meters) = 300,000,000 (meters per second) / frequency (hertz)

Figure 2-10. Comparison of two waves of different frequency.

Frequency bands. Within the radio frequency spectrum, radio frequencies are divided into groups or bands of frequencies as shown in [table 2-1](#). Most tactical radio sets operate within a 2 MHz to 400 MHz range within the frequency spectrum.

Table 2-1. Frequency band coverage.

Characteristics of the frequency bands. Each frequency band has certain characteristics which are reflected in [table 2-2](#). The ranges and power requirements shown are for normal operating conditions (proper siting and antenna orientation, and correct operating procedures). The ranges will change according to the condition of the propagation medium and the transmitter output power.

Table 2-2. Frequency band characteristics.

2-3. Radio Wave Propagation

There are two principal paths by which radio waves travel from a transmitter to the receiver ([fig 2-11](#)). One is by ground wave which travels directly from the transmitter to the receiver. The other is by sky wave which travels up to the ionosphere and is refracted (bent downward) back to the Earth. Short distance and all UHF and upper VHF transmissions are by ground waves. Long distance transmission is principally by sky waves. Single-channel radio sets can use either ground wave or sky wave propagation for communications.

Figure 2-11. Principal paths of radio waves.

Ground Wave Propagation.

Radio communications which use ground wave propagation do not use or depend on waves that are refracted from the ionosphere (sky waves). Ground wave propagation is affected by the electrical characteristics of the Earth and by the amount of diffraction (bending) of the waves along the curvature of the Earth. The strength of the ground wave at the receiver depends on the power output and frequency of the transmitter, the shape and conductivity of Earth along the transmission path, and the local weather conditions. The following paragraphs describe the components of a ground wave ([fig 2-12](#)).

Direct wave. The direct wave is that part of the radio wave which travels direct from the transmitting antenna to the receiving antenna. This part of the wave is limited to the line-of-sight (LOS) distance between the transmitting and receiving antennas, plus the small distance added by atmospheric refraction and diffraction of the wave around the curvature of the Earth. This distance can be extended by increasing the height of either the transmitting or the receiving antenna, or both.

Ground reflected wave. The ground reflected wave is that portion of the radio wave which reaches the receiving antenna after being reflected from the surface of the earth. Cancellation of the radio signal can occur when the ground reflected component and the direct wave component arrive at the receiving antenna at the same time and are 180° out of phase with each other.

Surface wave. The surface wave, which follows the curvature of the Earth, is that part of the ground wave which is affected by the conductivity and dielectric constant of the earth.

Figure 2-12. Possible routes for ground waves.

Sky-Wave Propagation.

Radio communications that use sky-wave propagation depend on the ionosphere to provide the signal path between the transmitting and receiving antennas.

Ionospheric structure. The ionosphere has four distinct layers (see [fig 2-13](#)). In the order of increasing heights and decreasing molecular densities, these layers are labeled D, E, F1, and F2. During the day, when the rays of the Sun are directed toward that portion of the atmosphere, all four layers may be present. During the night, the F1 and F2 layers seem to merge into a single F layer, and the D and E layers fade out. The actual number of layers, their height above the Earth, and their relative intensity of ionization vary constantly.

- **D region.** The D region exists only during daylight hours and has little effect in bending the paths of high frequency radio waves. The main effect of the D region is to attenuate high frequency waves when the transmission path is in sunlit regions.
- **E region.** The E region is used during the day for high frequency radio transmission over intermediate distances (less than 2,400 km (1,500 mi)). At night the intensity of the E region decreases and it becomes useless for radio transmission.
- **F region.** The F region exists at heights up to 380 kilometers (240 mi) above the Earth and is ionized all the time. It has two well-defined layers (F1 and F2) during the day, and one layer (F) during the night. At night the F region remains at a height of about 260 kilometers (170 mi) and is useful for long-range radio communications (over 2,400 km (1,500 mi)). The F2 layer is the most useful of all layers for long-range radio communications, even though its degree of ionization varies appreciably from day to day.

Figure 2-13. Average layer distribution of the ionosphere.

Regular variations of the ionosphere. The movements of the Earth around the Sun and changes in the Sun's activity contribute to ionospheric variations. There are two main classes of these variations: regular, which is predictable; and irregular, which occurs from abnormal behavior of the sun. The regular variations are classed as--

- **Daily:** caused by the rotation of the Earth.
- **Seasonal:** caused by the north and south progression of the Sun.
- **27-day:** caused by the rotation of the Sun on its axis.
- **11-year:** caused by the sunspot activity cycle going from maximum through minimum back to maximum levels of intensity.

Irregular variations of the ionosphere. In planning a communications system, the current status of the four regular variations must be anticipated. There are also unpredictable irregular variations that must be considered. They have a degrading effect (at times blanking out communications) which we cannot control or compensate for at the present time. Some irregular variations are listed below.

- **Sporadic E.** When it is excessively ionized, the E layer often blanks out the reflections back from the higher layers. It can also cause unexpected propagation of signals hundreds of miles beyond the normal range. This effect can occur at any time.
- **Sudden ionospheric disturbance (SID).** A sudden ionospheric disturbance coincides with a bright solar eruption and causes abnormal ionization of the D layer. This effect causes total absorption of all frequencies above approximately 1 MHz. It can occur without warning during daylight hours and last from a few minutes to several hours. When it occurs, receivers seem to go dead.
- **Ionospheric storms.** During these storms, sky wave reception above approximately 1.5 MHz shows low intensity and is subject to a type of rapid blasting and fading called "flutter fading." These storms may last from several hours to days, and usually extend over the entire Earth.

Frequency characteristics in the ionosphere. The range of long distance radio transmission is determined primarily by the ionization density of each layer. The higher the frequency, the greater the ionization density required to reflect radio waves back to Earth. The upper (E and F) regions reflect the higher frequencies because they are the most highly ionized. The D region, which is the least ionized, does not reflect frequencies above approximately 500 kHz. Thus, at any given time and for each ionized region, there is an upper frequency limit at which radio waves sent vertically upward are reflected back to Earth. This limit is called the critical frequency. Radio waves directed vertically at frequencies higher than the critical frequency pass through the ionized layer out into space. All radio waves directed vertically into the ionosphere at frequencies lower than the critical frequency are reflected back to Earth. Radio waves used in communications generally are directed towards the ionosphere at some oblique angle, called the *angle of incidence*. Radio waves at frequencies above the critical frequency will be reflected back to Earth if transmitted at angles of incidence smaller than a certain angle, called the critical angle. At the critical angle, and at all angles larger than the critical angle, the radio waves will pass through the ionosphere if the frequency is higher than the critical frequency. As the angle of transmission becomes smaller, an angle is reached at which the radio waves will be reflected back to Earth.

[Figure 2-14.](#) Sky wave transmission paths.

Transmission Paths. Sky-wave propagation refers to those types of radio transmissions that depend on the ionosphere to provide signal paths between transmitters and receivers ([fig 2-14](#)). The distance from the transmitting antenna to the place where the sky waves first return to Earth is called the *skip distance*. The skip distance is dependent on the angle of incidence, the operating frequency, and the height and density of the ionosphere. The antenna height, in relation to the operating frequency, affects the angle that transmitted radio waves strike and penetrate the ionosphere and then return to Earth. This *angle of incidence* can be controlled to obtain the desired area of coverage. Lowering the antenna height will increase the angle of transmission and provides broad and even signal patterns in an area the size of a typical corps. The use of near-vertical transmission paths is known as *near-vertical incidence sky-wave* (NVIS) (see [appendix M](#)). Raising the antenna height will lower the angle of incidence. Lowering the angle of incidence can produce a *skip zone* ([fig 2-15](#)) in which no usable signal can be received. This area is bounded by the outer edge of usable ground wave propagation and the point nearest the antenna at which the sky wave returns to Earth. In corps area communications situations, the skip zone is not a

desirable condition. However, low angles of incidence make long distance communications possible.

Figure 2-15. Low angle sky-wave transmission path.

When a transmitted wave is reflected back to the surface of the Earth, part of its energy is absorbed by the Earth. The remainder of its energy is reflected back into the ionosphere to be reflected back again. This means of transmission--by alternately reflecting the radio wave between the ionosphere and the Earth--is called *hops* ([fig 2-16](#)) and enables radio waves to be received at great distances from the point of origin.

Figure 2-16. Sky-wave transmission hop paths.

Maximum usable and lowest usable frequencies. Using a given ionized layer and a transmitting antenna with a fixed angle of radiation, there is a maximum frequency at which a radio wave will return to Earth at a given distance. This frequency is called the maximum usable frequency (MUF). It is the monthly median of the daily highest frequency that is predicted for sky-wave transmission over a particular path at a particular hour of the day. The MUF is always higher than the critical frequency because the angle of incidence is less than 90°. If the distance between the transmitter and the receiver is increased, the maximum usable frequency will also increase. Radio waves lose some of their energy through absorption by the D region and the portion of the E region of the ionosphere at certain transmission frequencies. The total absorption is less and communications more satisfactory as higher frequencies are used--up to the level of the MUF. The absorption rate is greatest for frequencies ranging from approximately 500 kHz to 2 MHz during the day. At night the absorption rate decreases for all frequencies. As the frequency of transmission over any sky-wave path is increased from low to high frequencies, a frequency will be reached at which the received signal just overrides the level of atmospheric and other radio noise interference. This is called the lowest useful frequency (LUF), because frequencies lower than the LUF are too weak for useful communications. It should be noted that the LUF depends also on the power output of the transmitter as well as the transmission distance. When the LUF is greater than the MUF, no sky-wave transmission is possible.

Ionospheric Sounder AN/TRQ-35(V) is an electronic device that enables operators to determine which frequencies are best to use at any particular time of day or night. See [appendix B](#) for a more detailed discussion of this equipment.

Section II. Types of Modulation and Methods of Transmission

2-4. Single-Channel Communications

Single-channel communications radio equipment is used primarily to transmit intelligence in the form of speech, data, RATT, or telegraphic code. Although sound can be converted to audio frequency electrical energy, it is not practical to transmit it in this energy form through the Earth's atmosphere by electromagnetic radiation. For example, efficient transmission of a 20-hertz audio signal would require an antenna almost 8,000 kilometers (5,000 mi) long. None of the above limitations apply when radio frequency electrical energy is used to carry the intelligence. Great distances can be covered, efficient antennas for radio frequencies are of practical lengths, and antenna power losses are at reasonable levels.

The frequency of the radio wave affects its propagation characteristics. At low frequencies (.03 to .3 MHz), the ground wave is very useful for communications over great distances. The ground wave signals are quite stable and show little seasonal variation. In the medium frequency band (.3 to 3.0 MHz), the range of the ground wave varies from about 24 kilometers (15 mi) at 3 MHz to about 640 kilometers (400 mi) at the lowest frequencies of this band. Sky wave reception is possible during the day or night at any of the lower frequencies in this band. At night, the sky wave is receivable at distances up to 12,870 kilometers (8,000 mi). In the high frequency band (3 to 30 MHz), the range of the ground wave decreases as frequency increases and the sky waves are greatly influenced by ionospheric considerations. In the very high frequency band (30 to 300 MHz), there is no usable ground wave and only slight refraction of sky waves by the ionosphere at the lower frequencies. The direct wave provides communications if the transmitting and receiving antennas are elevated high enough above the surface of the Earth. In the ultrahigh frequency band (300 to 3,000 MHz), the direct wave must be used for all transmissions. Communications is limited to a short distance beyond the horizon. Lack of static and fading in these bands makes line-of-sight reception very satisfactory. Antennas that are highly directional can be used to concentrate the beam of RF energy, thus, increasing the signal intensity.

2-5. Amplitude and Frequency Modulation

Both AM and FM transmitters produce RF carriers. The carrier is a wave of constant amplitude, frequency, and phase which can be modulated ([fig 2-17](#)) by changing its amplitude, frequency, or phase. Thus, the RF carrier "carries" intelligence by being modulated. Modulation is the process of superimposing intelligence (voice or coded signals) on the carrier.

[Figure 2-17.](#) Wave shapes.

Amplitude Modulation.

Amplitude modulation is defined as the variation of the RF power output of a transmitter at an audio rate. In other words, the RF energy increases and decreases in power according to the audio frequencies superimposed on the carrier signal.

When audio frequency signals are superimposed on the radio frequency carrier signal, additional RF signals are generated. These additional frequencies are equal to the sum and the difference of the audio frequencies and the radio frequency used. For example, assume a 500 kHz carrier is modulated by a 1 kHz audio tone. Two new frequencies are developed, one at 501 kHz (the sum of 500 kHz and 1 kHz) and the other at 499 kHz (the difference between 500 kHz and 1 kHz). If a complex audio signal is used instead of a single tone, two new frequencies will be set up for each of the audio frequencies involved. The new frequencies resulting from superimposing an AF signal on an RF signal are called sidebands.

As described above, when the RF carrier is modulated by complex tones such as speech, each separate frequency component of the modulating signal produces its own upper and lower sideband frequencies ([fig 2-18](#)). These additional frequencies occupy a band of frequencies called sidebands. The sideband that contains the sum of the RF and AF signals is called the upper sideband. The sideband that contains the difference between the RF and AF signals is called the lower sideband.

The space occupied by a carrier and its associated sidebands in the radio frequency spectrum is called a channel. In amplitude modulation, the width of the channel (bandwidth) is equal to twice the highest modulating frequency. For example, if a 5000 kHz (5 MHz) carrier is modulated by a band of frequencies ranging from 200 to 5000 cycles (.2 to 5 kHz), the upper sideband extends from 5000.2 to 5005 kHz. The lower sideband extends from 4999.8 kHz to 4995 kHz. Thus, the bandwidth is the difference between 5005 kHz and 4995 kHz, a total of 10 kHz.

Figure 2-18. Amplitude-modulated system.

Amplitude modulation generally is used by radiotelephone and radio teletypewriter transmitters operating in the medium and high frequency bands. The intelligence of an amplitude modulated signal exists solely in the sidebands.

Frequency Modulation.

Frequency modulation is the process of varying the *frequency* (rather than the amplitude) of the carrier signal in accordance with the variations of the modulating signals. The amplitude or power of the FM carrier does not vary during modulation ([see fig 2-17](#)).

The frequency of the carrier signal when it is not modulated is called the center or *rest* frequency. When a modulating signal is applied to the carrier, the carrier signal will move up and down in frequency away from the center or rest frequency.

The *amplitude* of the modulating signal determines how far away from the center frequency the carrier will move. This movement of the carrier is called *deviation*; how far the carrier moves is called the *amount of deviation*. During reception of the FM signal, the amount of deviation determines the *loudness* or volume of the signal.

The FM signal leaving the transmitting antenna is constant in amplitude, but varying in frequency according to the audio signal. As the signal travels to the receiving antenna, it picks up natural and manmade electrical noises that cause amplitude variations in the signal. All of these undesirable amplitude variations are amplified as the signal passes through successive stages of the receiver until the signal reaches a part of the receiver called the limiter. The limiter is unique to FM receivers as is the discriminator.

The limiter eliminates the amplitude variations in the signal, then passes it on to the discriminator which is sensitive to variations in the frequency of the RF wave. The resultant constant amplitude, frequency modulated signal is then processed by the discriminator circuit, which changes the frequency variations into corresponding voltage amplitude variations. These voltage variations reproduce the original modulating signal in a headset, loudspeaker, or teletypewriter.

Frequency modulation is generally used by radiotelephone transmitters operating in the VHF and higher frequency bands.

2-6. Methods of Transmission

Single Sideband.

It was stated in [paragraph 2-5](#) that the intelligence of an AM signal was contained solely in the sidebands. In fact, each sideband alone contains all the intelligence we need for communications.

Since this is true, it may be correctly inferred that one sideband and the carrier signal can be eliminated. This is the principle on which single sideband (SSB) communications is based. Although both sidebands are generated within the modulation circuitry of the SSB radio set, the carrier and one sideband are removed before any signal is transmitted ([fig 2-19](#)).

The sideband that is higher in frequency than the carrier is called the upper sideband (USB). The sideband that is lower in frequency than the carrier is called the lower sideband (LSB). Either sideband can be used for communications as long as both the transmitter and the receiver are adjusted to the same sideband. Most Army SSB equipment operates in the USB mode.

The transmission of only one sideband leaves open that portion of the RF spectrum normally occupied by the other sideband of an AM signal. This allows more emitters to be used within a given frequency range.

Single sideband transmission is used in applications where it is desired to--

- Obtain greater reliability.
- Limit size and weight of equipment.
- Increase effective output without increasing antenna voltage.
- Operate a large number of radio sets without heterodyne interference (whistles and squeals) from radio frequency carriers.
- Operate over long ranges without loss of intelligibility due to selective fading.

[Figure 2-19](#). Single-sideband system.

Radiotelegraphy (Continuous Wave Transmission).

Radiotelegraph information can be transmitted by starting and stopping the carrier by means of a switch or key. Each letter and number of a message is indicated by combining short and long pulses (dots and dashes) in groups according to a determined sequence or code. For example, if an operator wants to send the letter A, using international Morse code ([fig 2-20](#)), he or she would close the key for a fraction of a second (a dit), open the key for the same length of time, and then close it again for a period three times longer than the first (a dah). This process of transmitting information, called radiotelegraphy, is also called continuous wave transmission--or, more simply, CW.

Radiotelegraph information can also be transmitted by using a tone modulated radio wave. In tone transmission, the carrier is modulated at a fixed audio rate usually between .5 and 1 kilohertz. The carrier signal is again stopped and started to form dots and dashes. This is called modulated continuous wave or MCW. Because tone emission occupies a broader band, it may be used successfully against some types of jamming. However, the broad signal used in tone transmission is an easy target for radio direction finding equipment. Also, the distance range of a tone modulated transmitter is less than that of a nonmodulated CW transmitter of the same power output.

Manual radiotelegraph transmission has a limited traffic handling capacity. Consequently, its use is confined to lower echelons of the Army and special situations where the traffic load is light. It may also be used in isolated or remote locations if other means of communications are not available.

Figure 2-20. Continuous wave signal for the letter A.

Radiotelephony.

The microphone of a radiotelephone set converts voice or audio waves to weak electrical impulses. These impulses are strengthened by a series of audio amplifiers and are passed to a modulator. In AM transmission, the modulator provides the audio power necessary to modulate the RF amplifier. At the receiver, the modulated RF wave is demodulated, allowing only the audio component of the incoming signal to be reproduced by a loudspeaker or headset.

Radio Teletypewriter.

Radio teletypewriter transmission is possible over distances of up to several thousand miles. This type of transmission is often used in rapidly changing tactical situations where time does not permit installation of wire lines.

The teletypewriter itself consists of a transmitting keyboard and a receiving and printing mechanism. The depression of a key activates the transmitting mechanism that sends a series of electrical signals over the radio to a receiving device with the receiving radio. This device translates the signals into a mechanical action so the printer can select and print the proper character. Each key sends a different arrangement of pulses ([fig 2-21](#)) and the message may be printed in page form or on a tape. The teletypewriter keyboard contains the letters of the alphabet, basic numbers, and punctuation marks ([fig 2-21](#)). The machine also performs the function of carriage return, line feed, letter/number shift, and spacing.

In the special signaling code used for teletypewriter transmission, each character or signal is of uniform length and consists of five intervals of time. The units are equal in length and are known as either marking or spacing impulses. A marking impulse (mark) exists when current flows in the circuit and the selector magnets in the receiving printer are operated. A spacing impulse (space) is the open condition in the circuit when selector magnets in the receiving printers are not operated. Various combinations of marking and spacing impulses are used for different letters, numerals, and functions.

In the most commonly used method of operation, the teletypewriter signals a radio transmitter which, in turn, radiates on one frequency for the marking condition and on a slightly different frequency for a spacing condition. This type of operation, which is a form of frequency modulation, is called frequency-shift keying (FSK). The receiving mechanism converts the two frequencies, which are 850 hertz apart or 85 hertz apart depending on the transmitter used, to teletypewriter pulses. The pulses then cause the receiving teletypewriter to operate. The striking of a key on the transmitting teletypewriter will thus activate the receiving teletypewriter.

2-7. Radio Equipment

Most Army single-channel radio equipment is designed to operate in only one mode and one frequency band--for example, FM only, VHF (30 to 76 MHz), for the AN/VRC-12 series. Configurations using the AN/GRC-106 and -106A can operate in either AM or SSB mode from 2 to 29.999 MHz. The AN/PRC-70 is a new radio set that can operate multimode (FM, AM, or SSB) and in both HF and VHF bands (2 to 76 MHz). The AN/PRC-70 is described more fully in

Figure 2-21. Teletypewriter code character set and standard start-stop, five-unit code chart.

NOTE: The letters on the perforated tape will appear 6 characters in front of the actual perforations on the tape. This is necessary for alignment of the tape in the tape distributor.

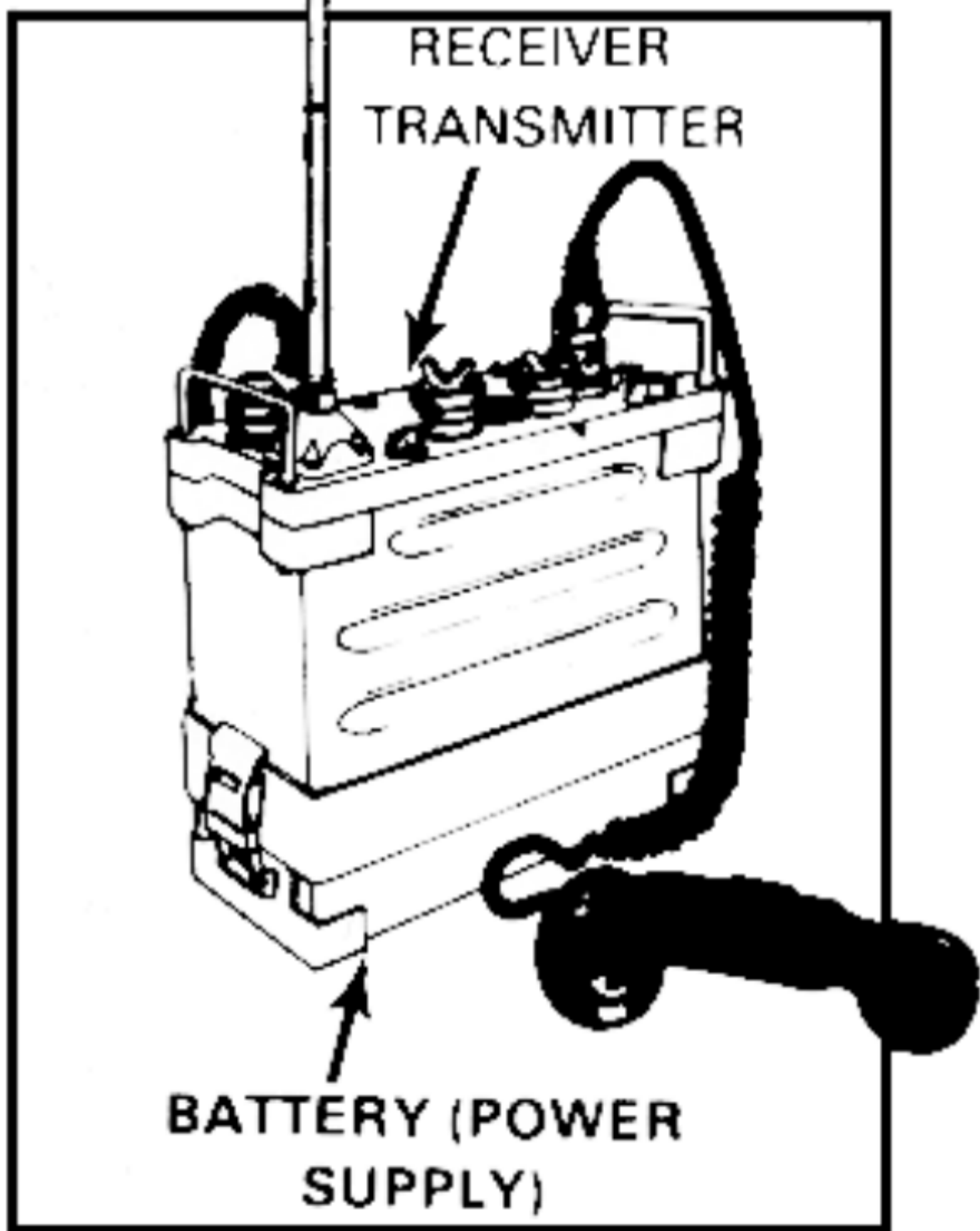

Figure 2-1. Basic radio set.

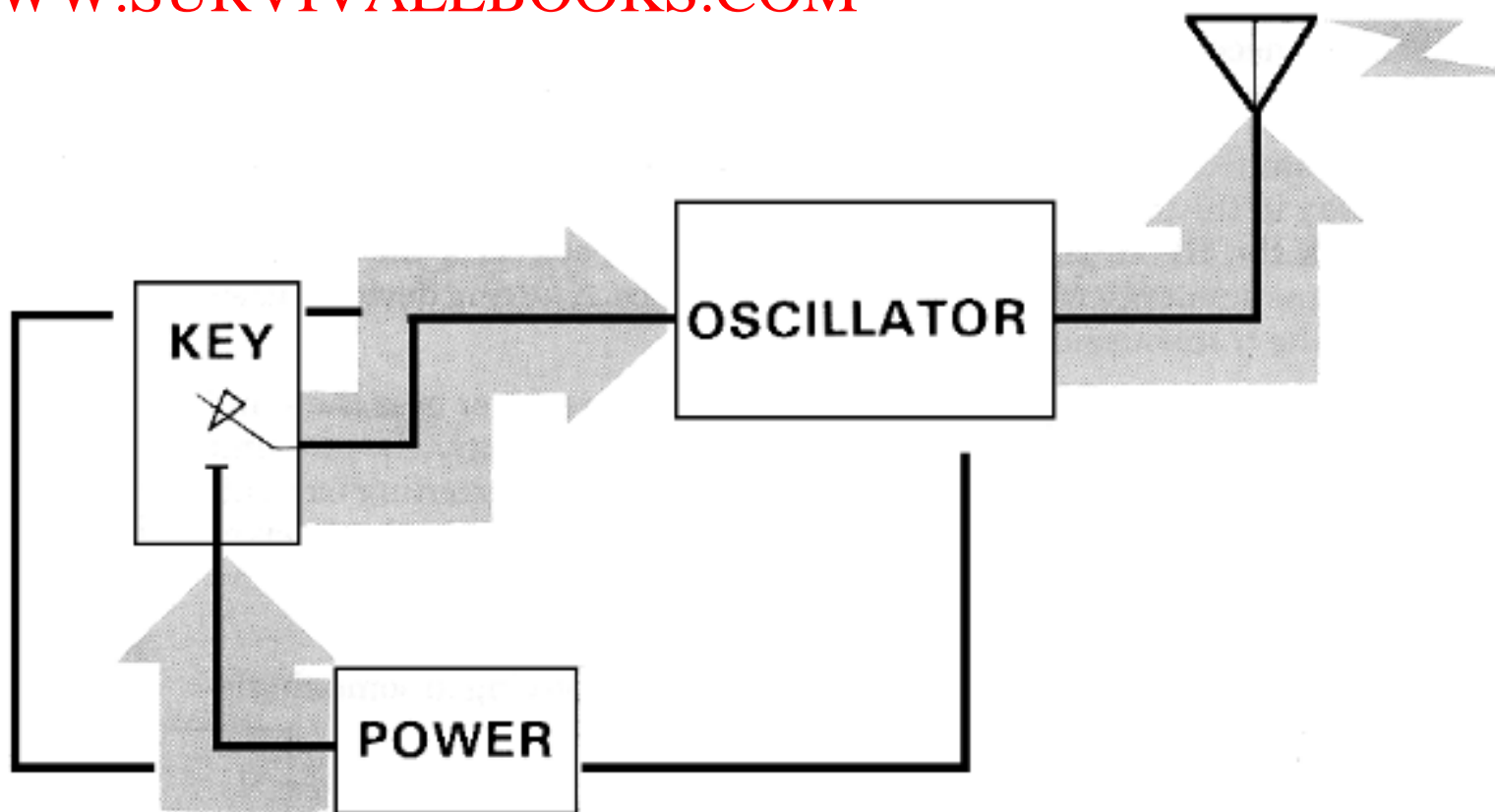

Figure 2-2. Block diagram of a simple radio transmitter (continuous wave/morse code operation).

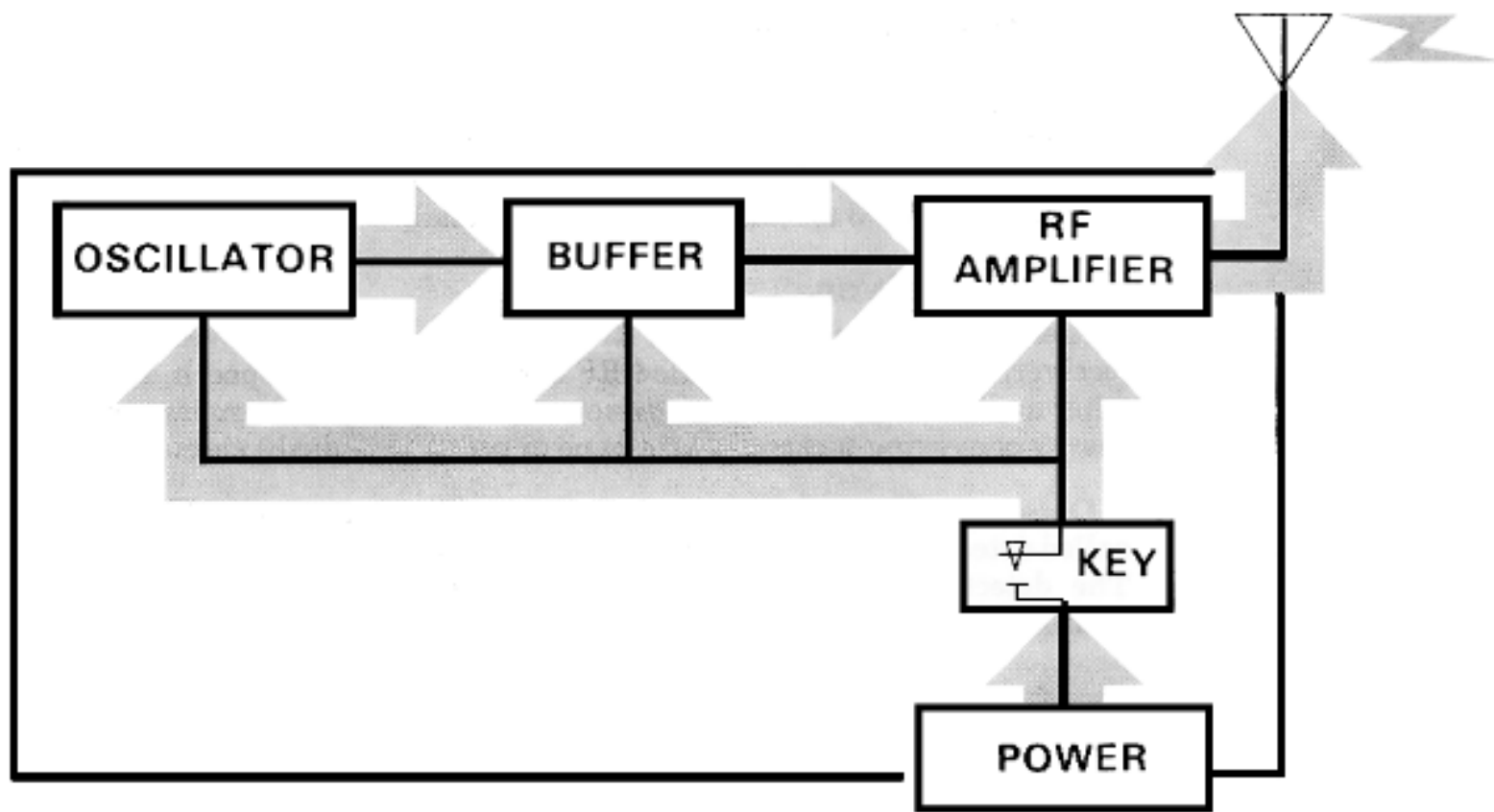

Figure 2-3. Block diagram of oscillator-RF amplifier CW transmitter.

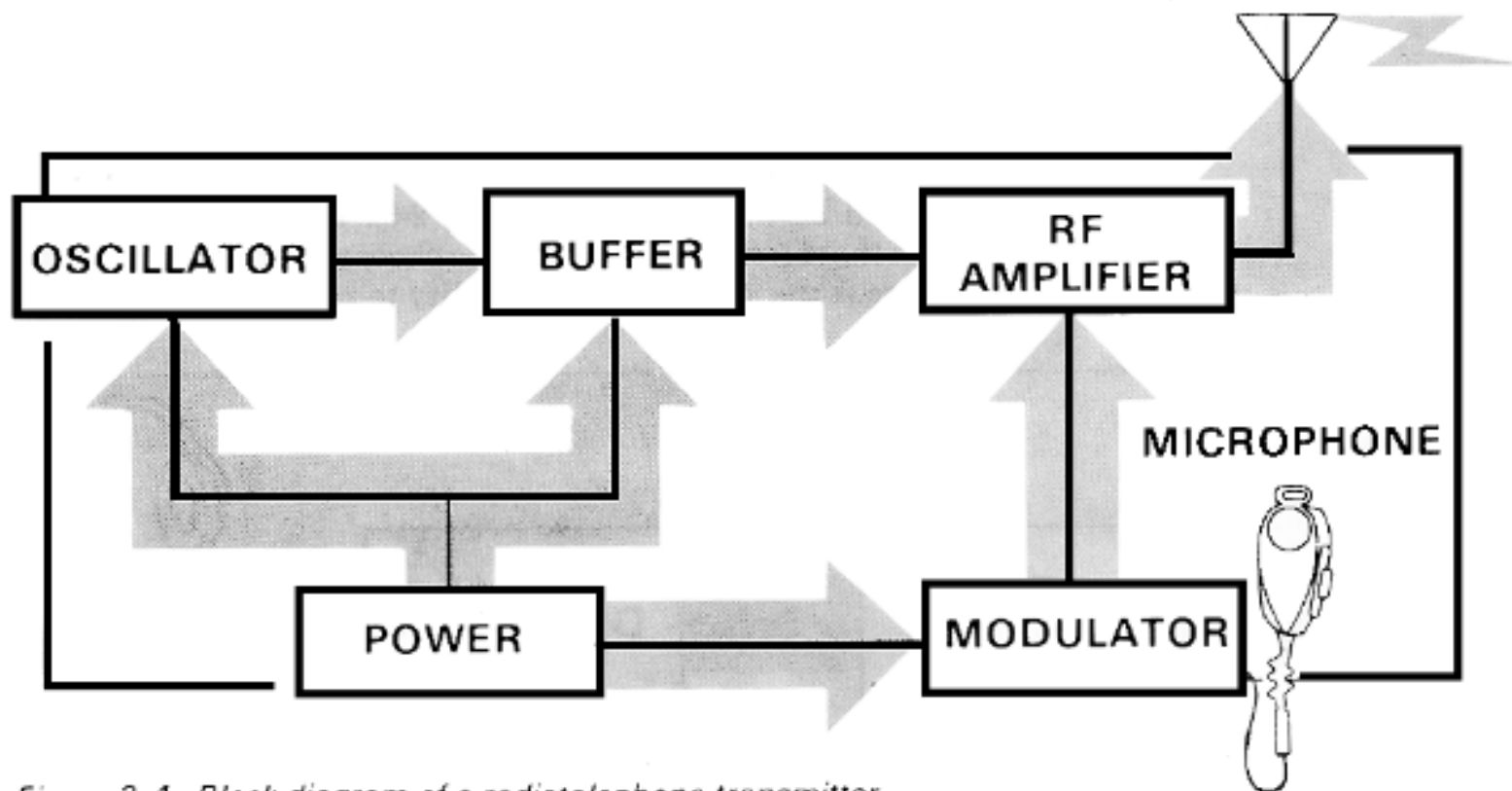

Figure 2-4. Block diagram of a radiotelephone transmitter.

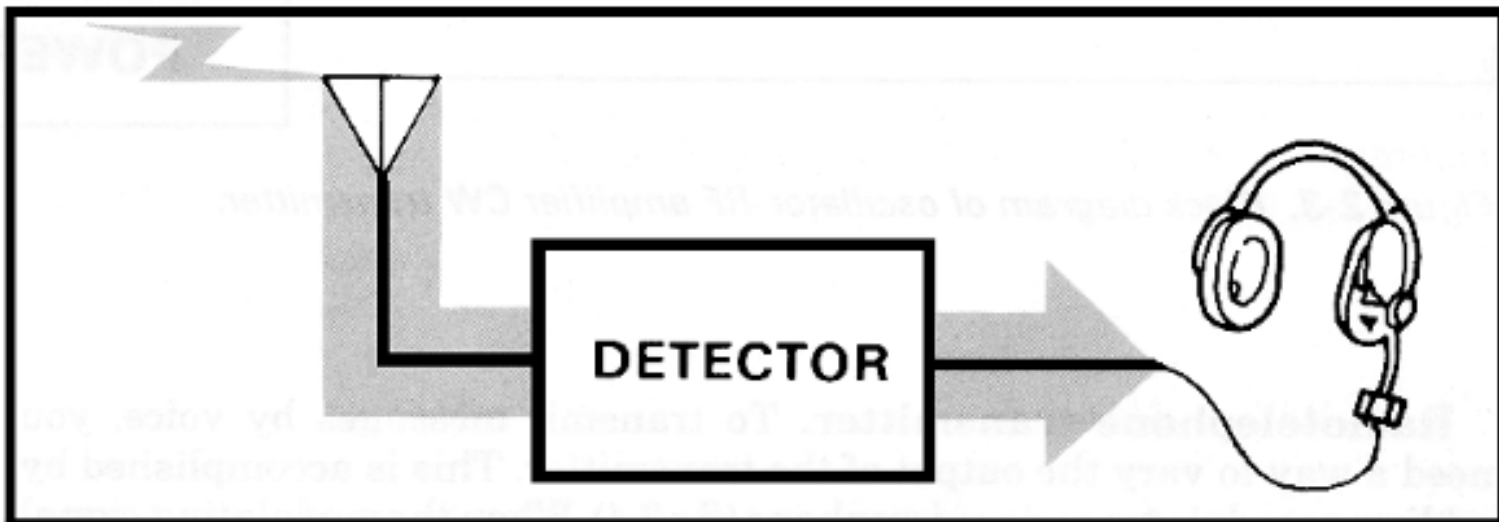

Figure 2-5. Block diagram of a simple radio receiver.

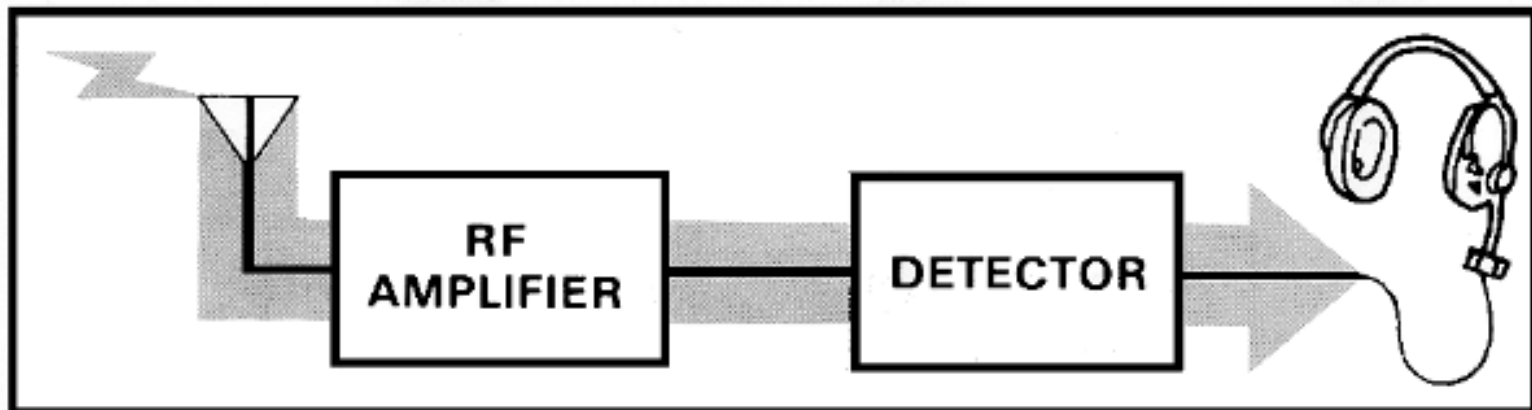

Figure 2-6. Block diagram of a detector and an RF amplifier.

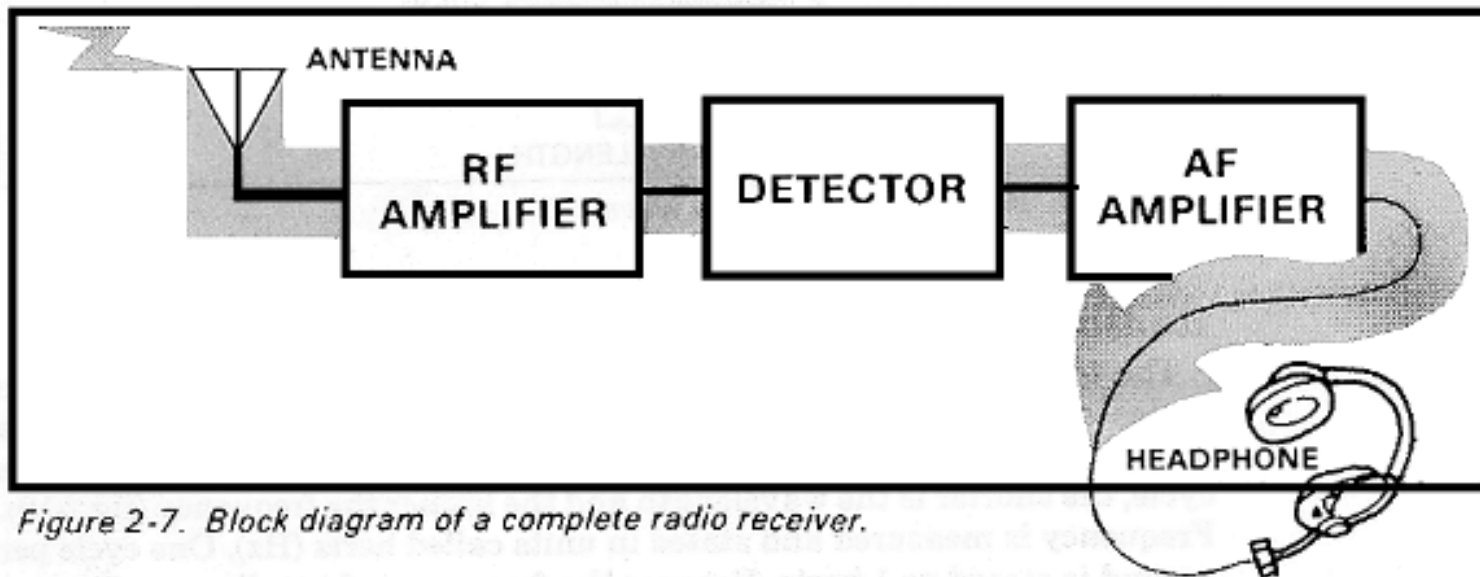

Figure 2-7. Block diagram of a complete radio receiver.

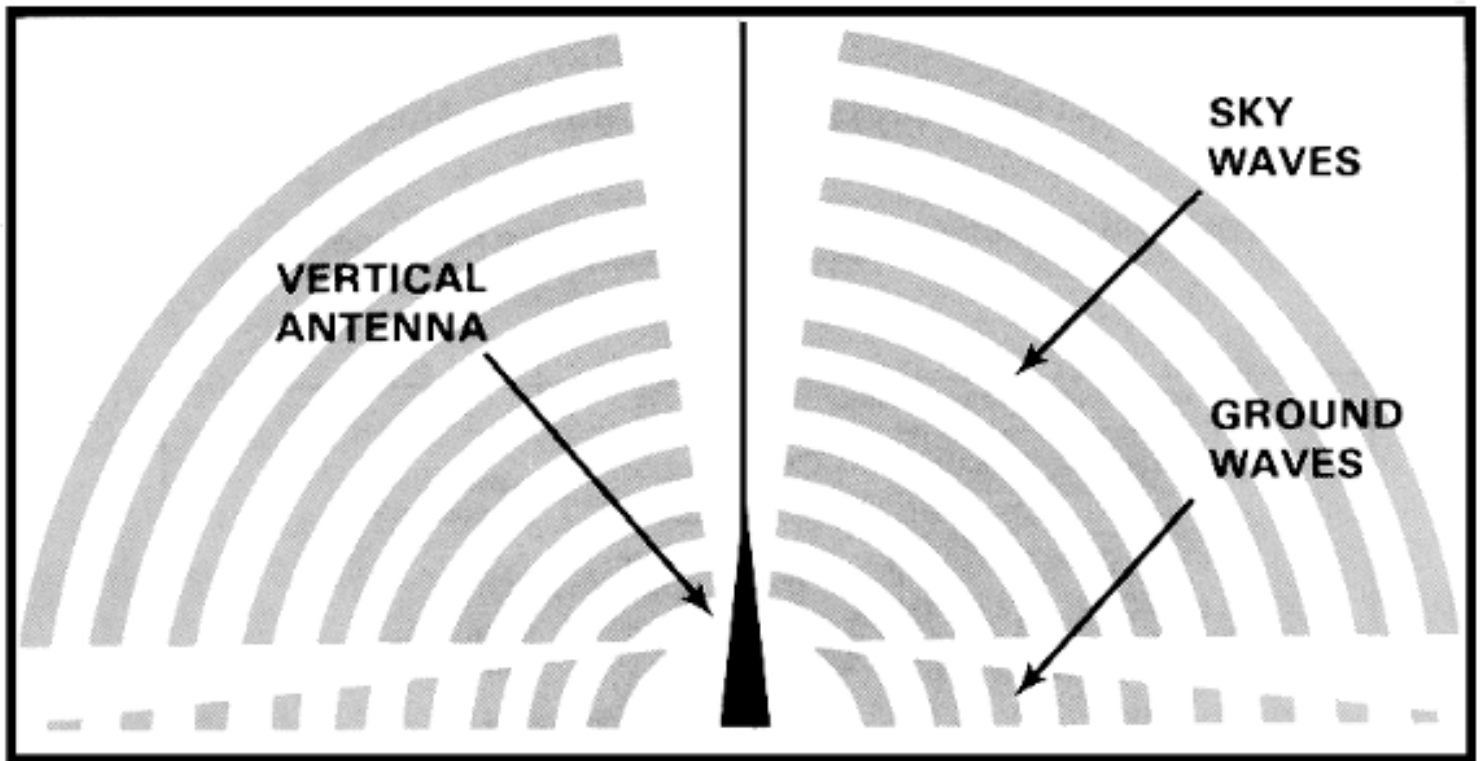

Figure 2-8. Radiation of radio waves from a vertical antenna.

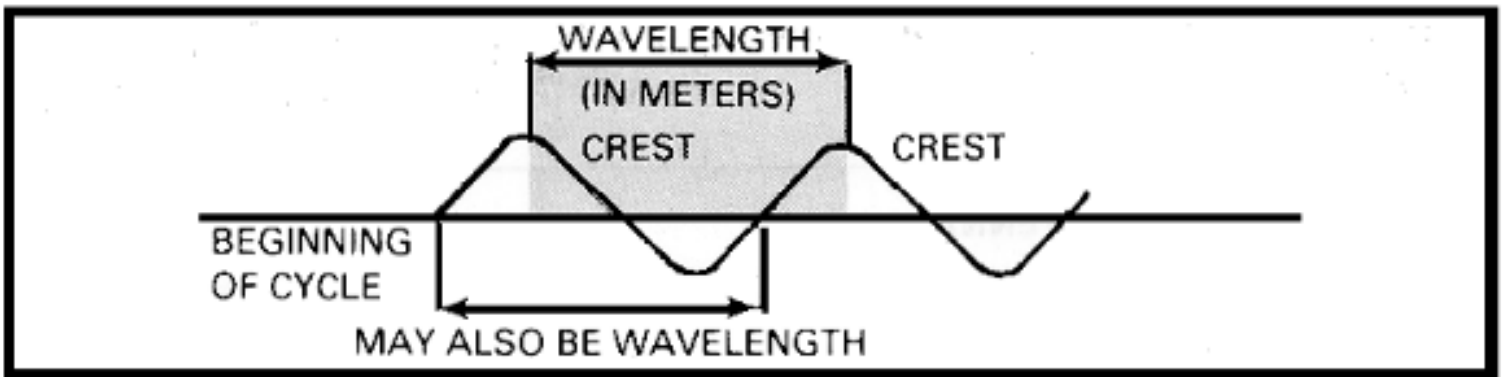

Figure 2-9. Wavelength of a radio wave.

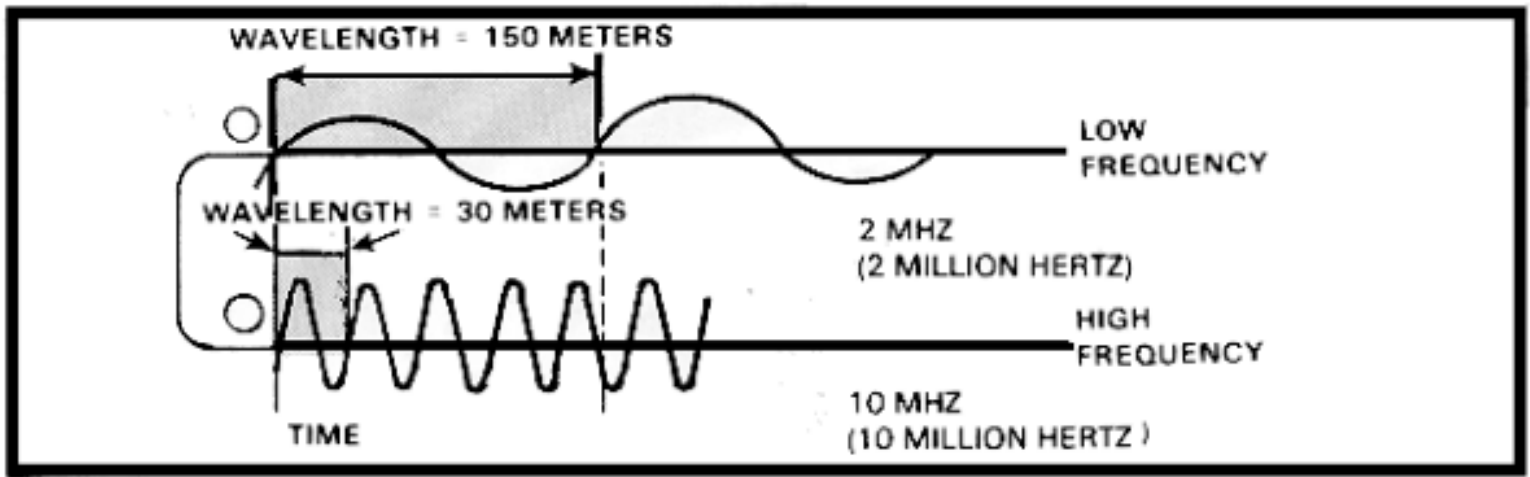

Figure 2-10. Comparison of two waves of different frequency.

Table 2-1. Frequency band coverage.

Band	Frequency (MHz)
Very low frequencies (VLF)	Below .03
Low frequencies (LF)	.03 to .3
Medium frequencies (MF)	.3 to 3.0
High frequencies (HF)	3.0 to 30
Very high frequencies (VHF)	30 to 300
Ultrahigh frequencies (UHF)	300 to 3000
Superhigh frequencies (SHF)	3,000 to 30,000
Extremely high frequencies (EHF)	30,000 to 300,000

Table 2-2. Frequency band characteristics.

Band	Range		Power Required (kW)		
	Ground wave	Sky wave			
	Miles	km			
LF	0 - 1000	0 - 1609	500 - 8,000	805 - 12,872	above 50
MF	0 - 100	0 - 161	100 - 1,500	161 - 2,415	.5 - 50
HF	0 - 50	0 - 83	100 - 8,000	161 - 12,872	.5 - 5
VHF	0 - 30	0 - 48	50 - 150	80.5 - 241	.5 or less
UHF	0 - 50	0 - 83	XXX	XXX	.5 or less

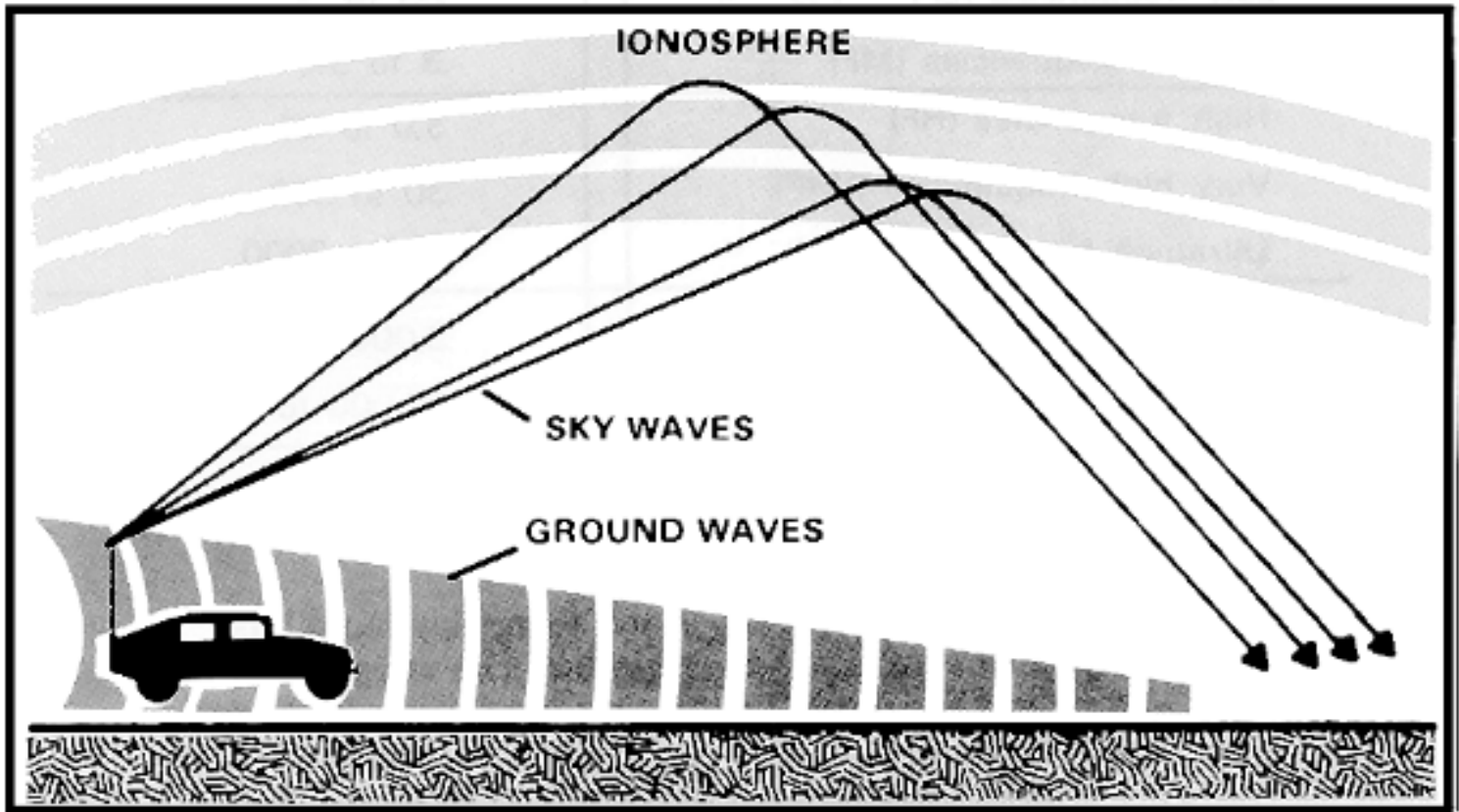

Figure 2-11. Principal paths of radio waves.

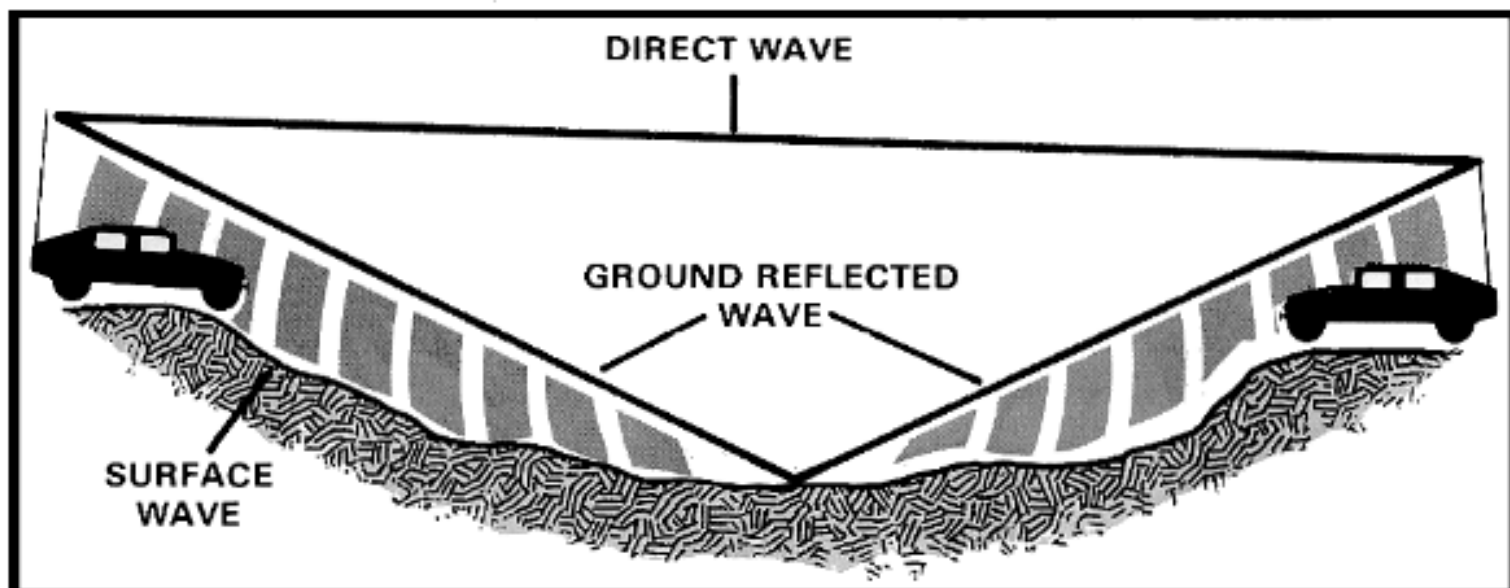

Figure 2-12. Possible routes for ground waves.

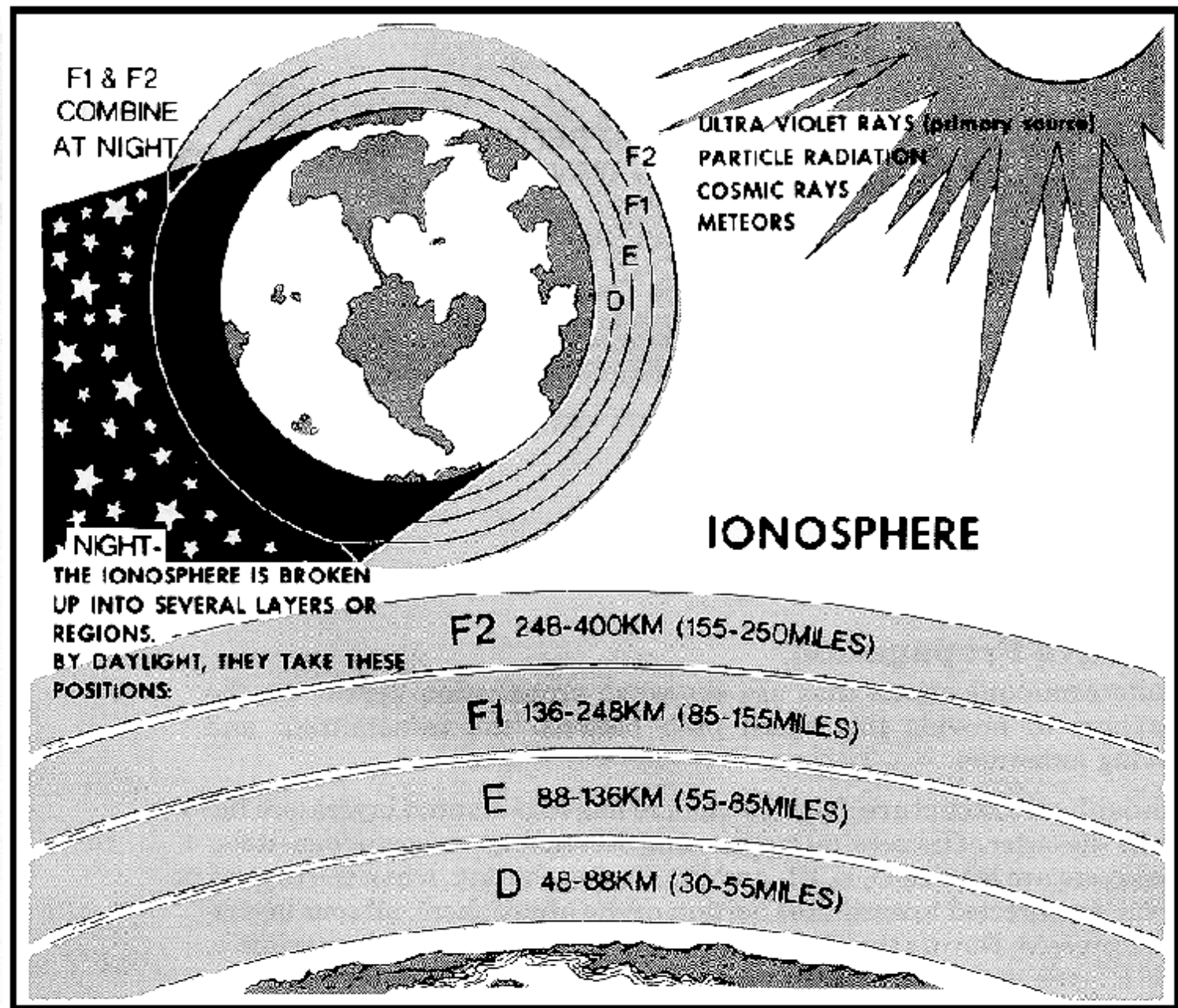

Figure 2-13. Average layer distribution of the ionosphere.

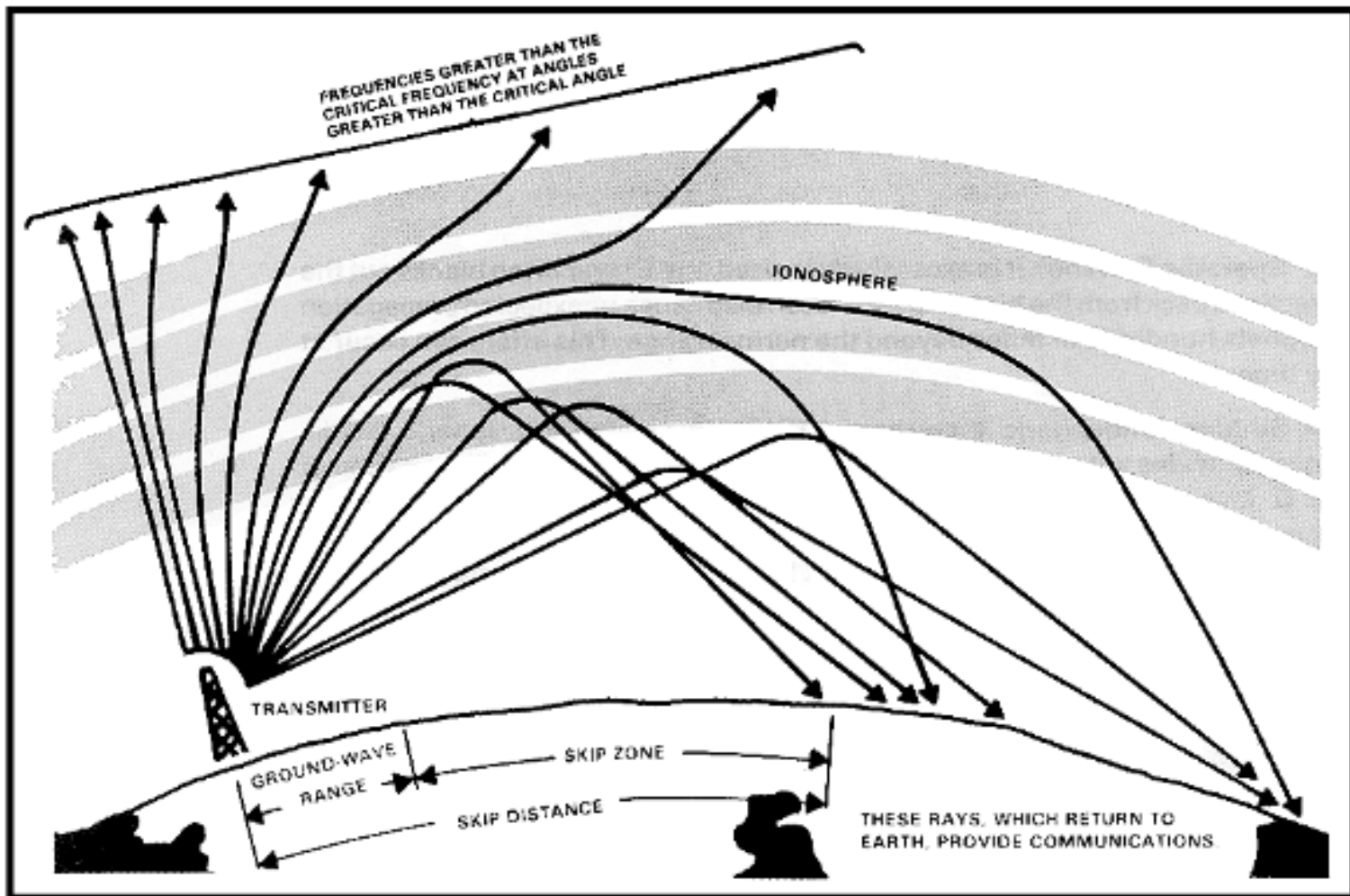

Figure 2-14. Sky wave transmission paths.

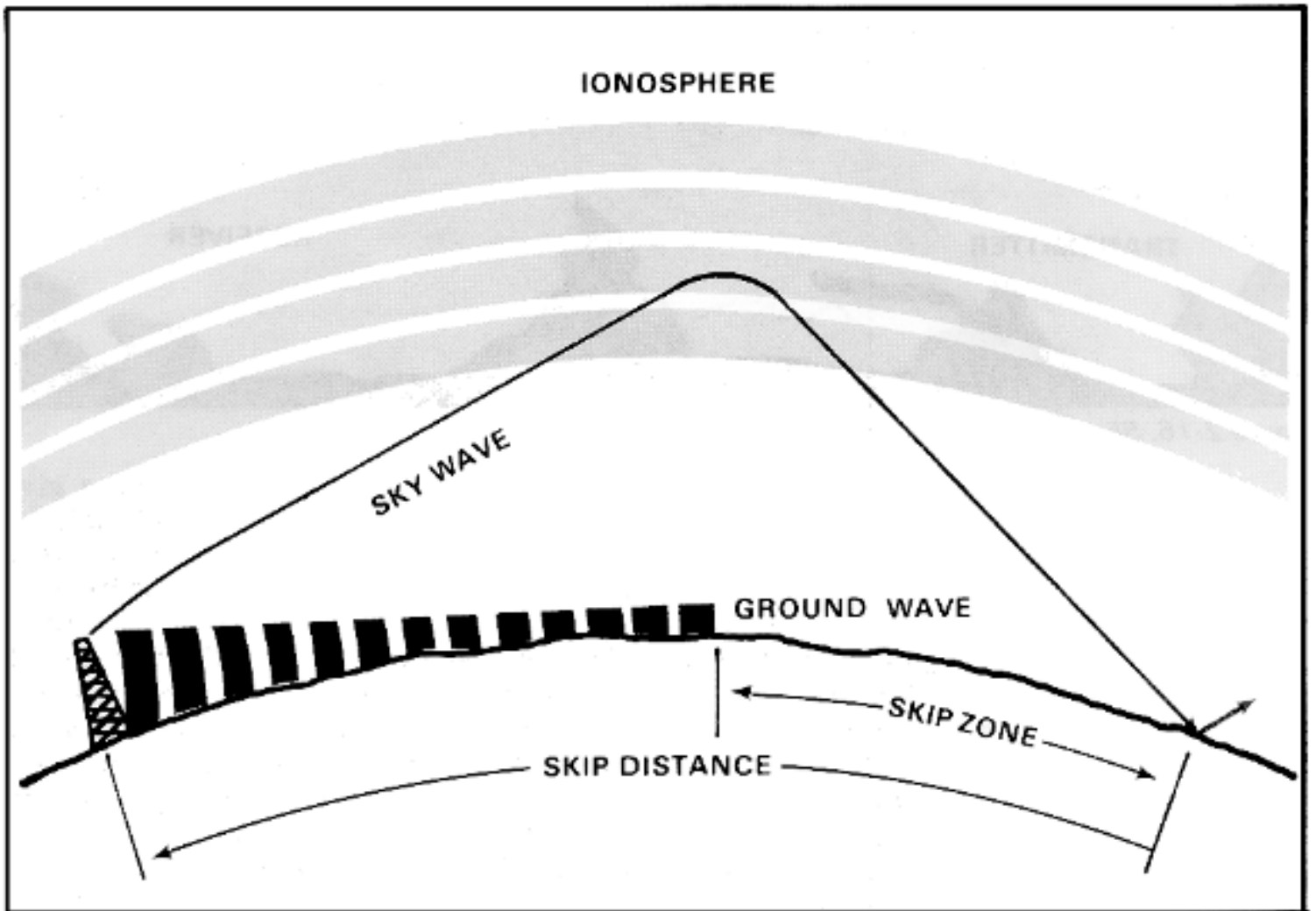

Figure 2-15. Low angle sky-wave transmission path.

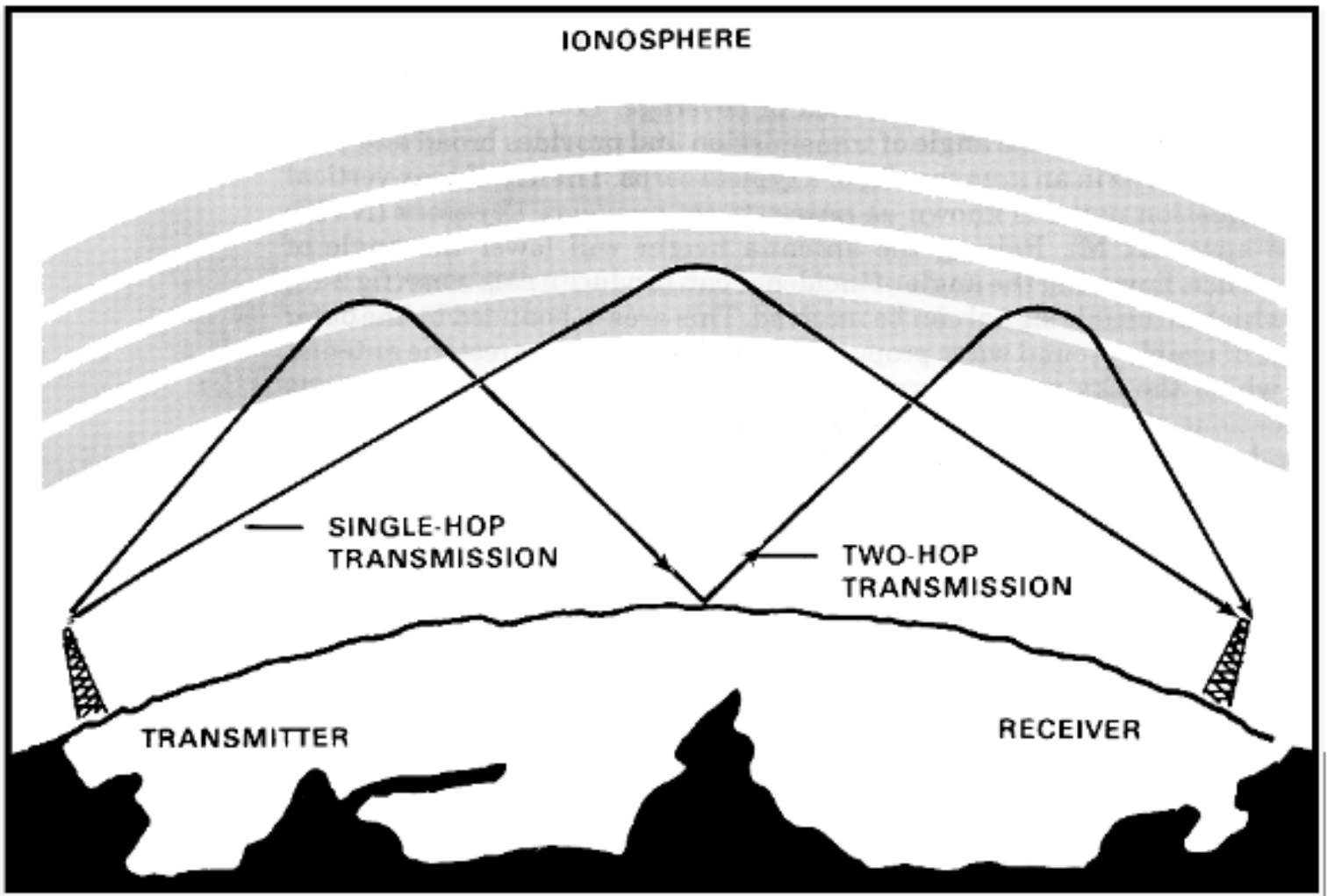

Figure 2-16. Sky-wave transmission hop paths.

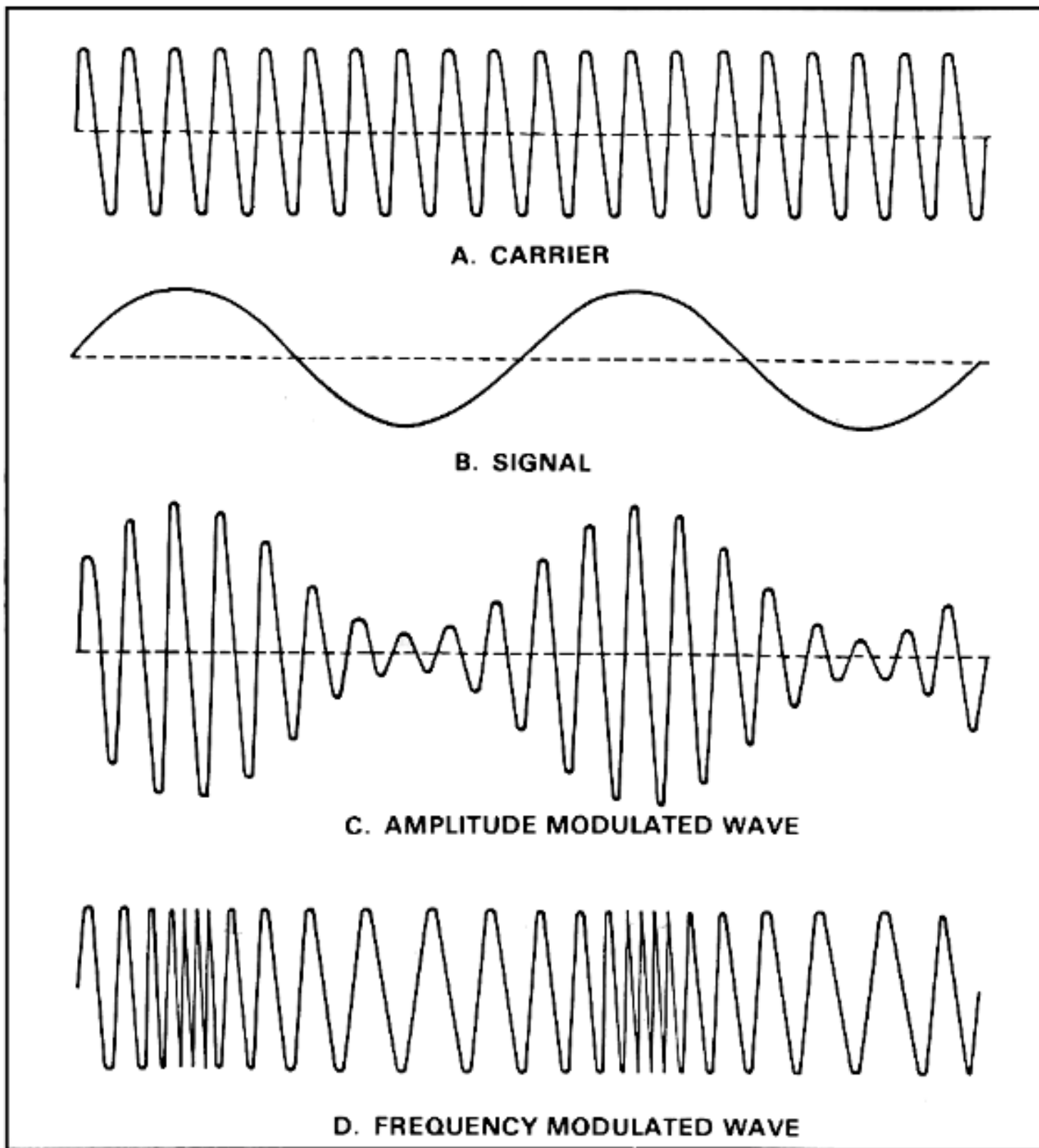

Figure 2-17. Wave shapes.

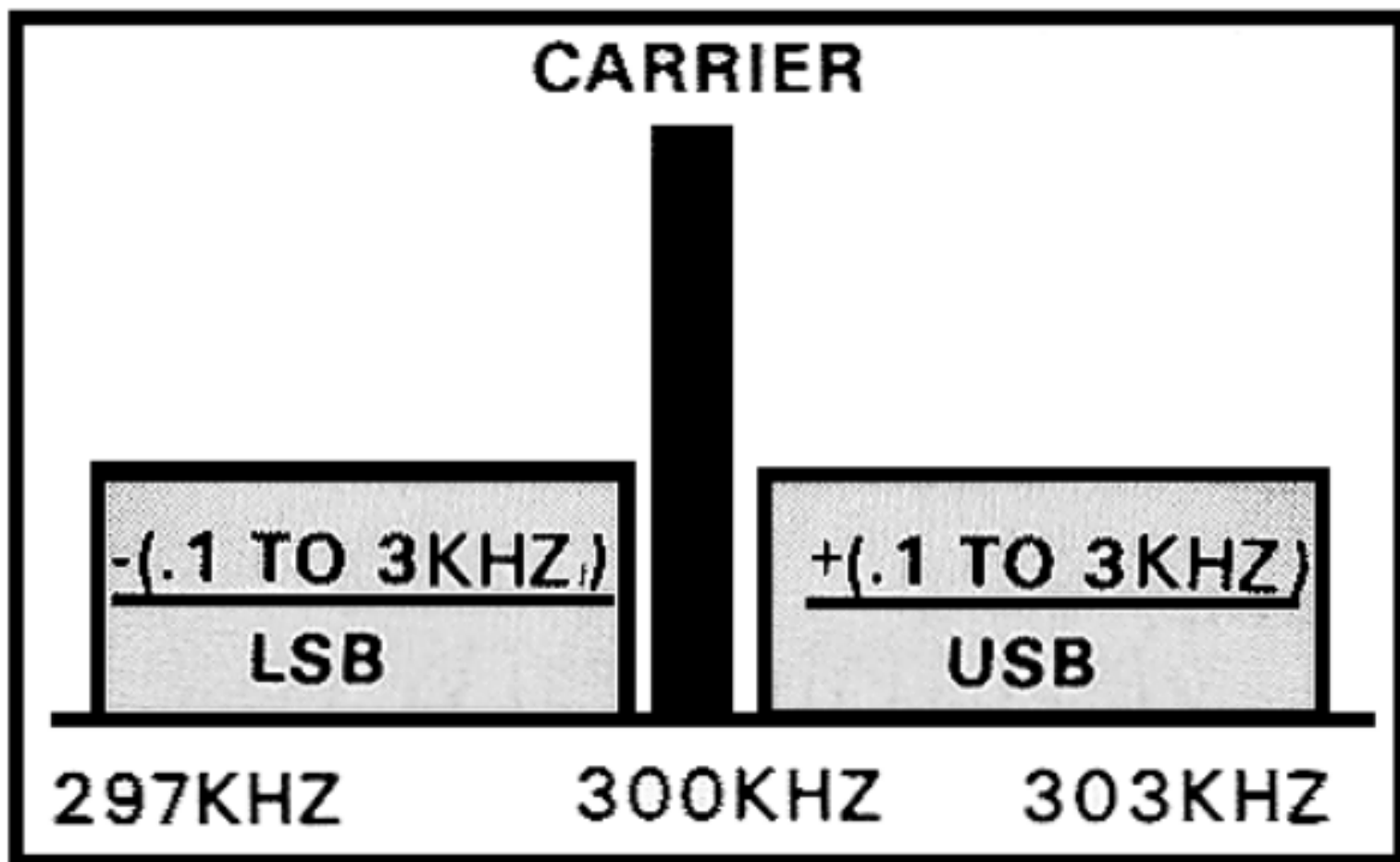

Figure 2-18. Amplitude-modulated system.

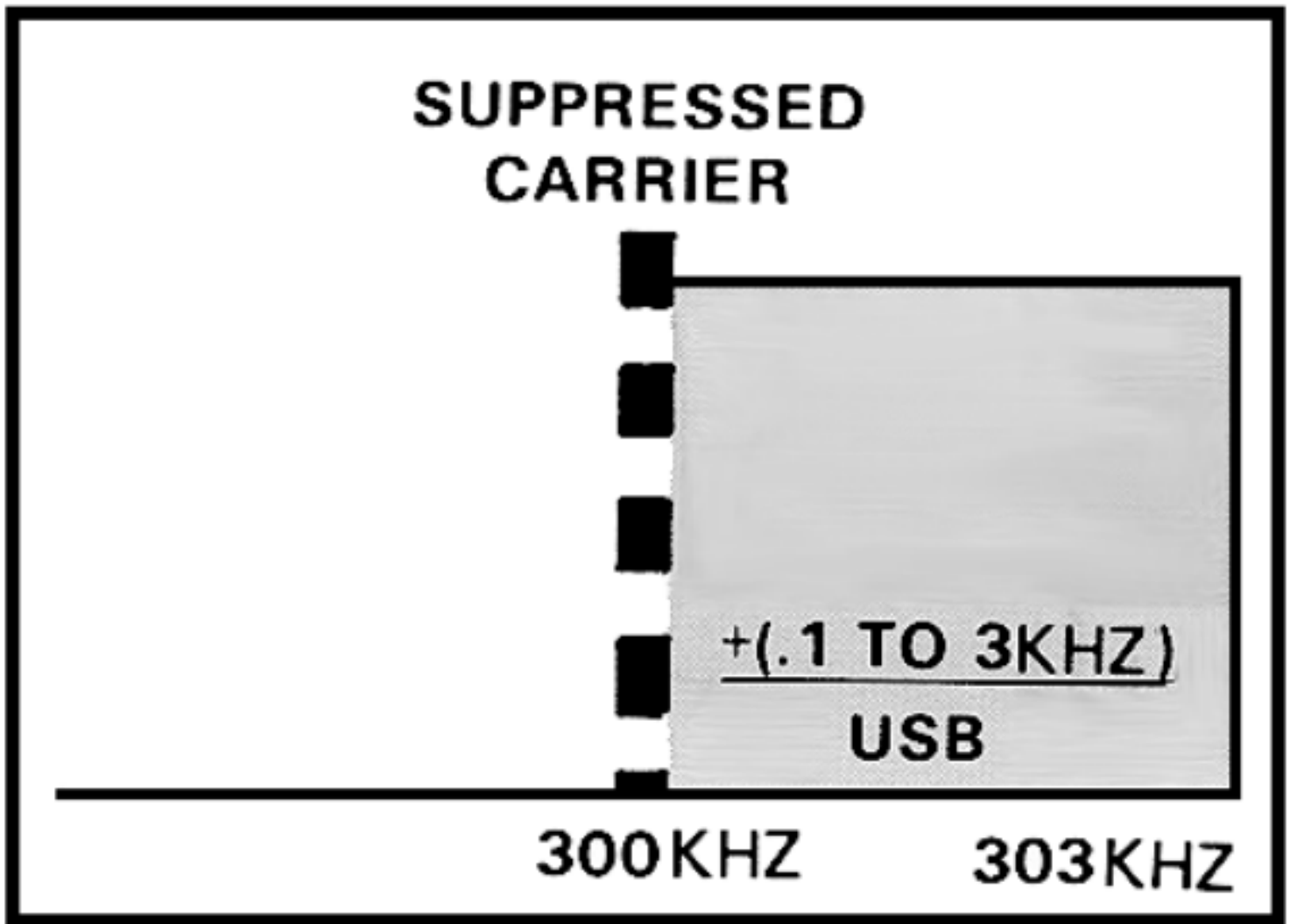

Figure 2-19. Single-sideband system.

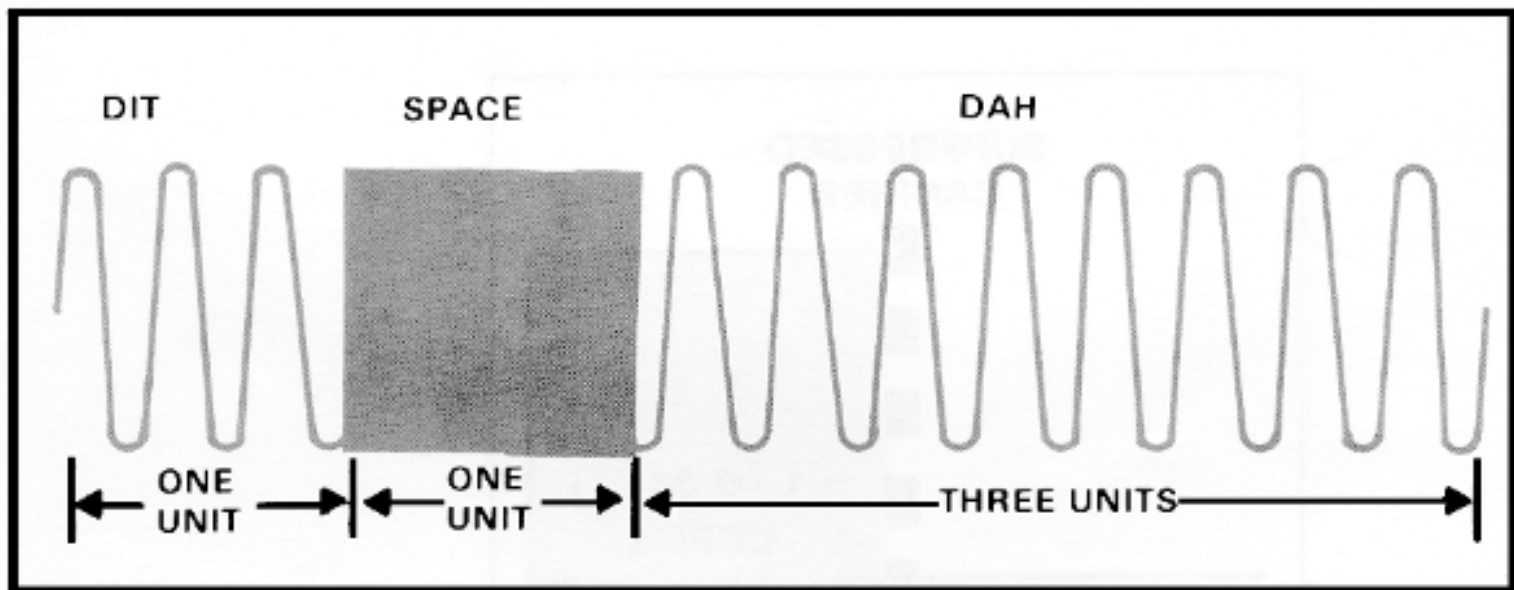
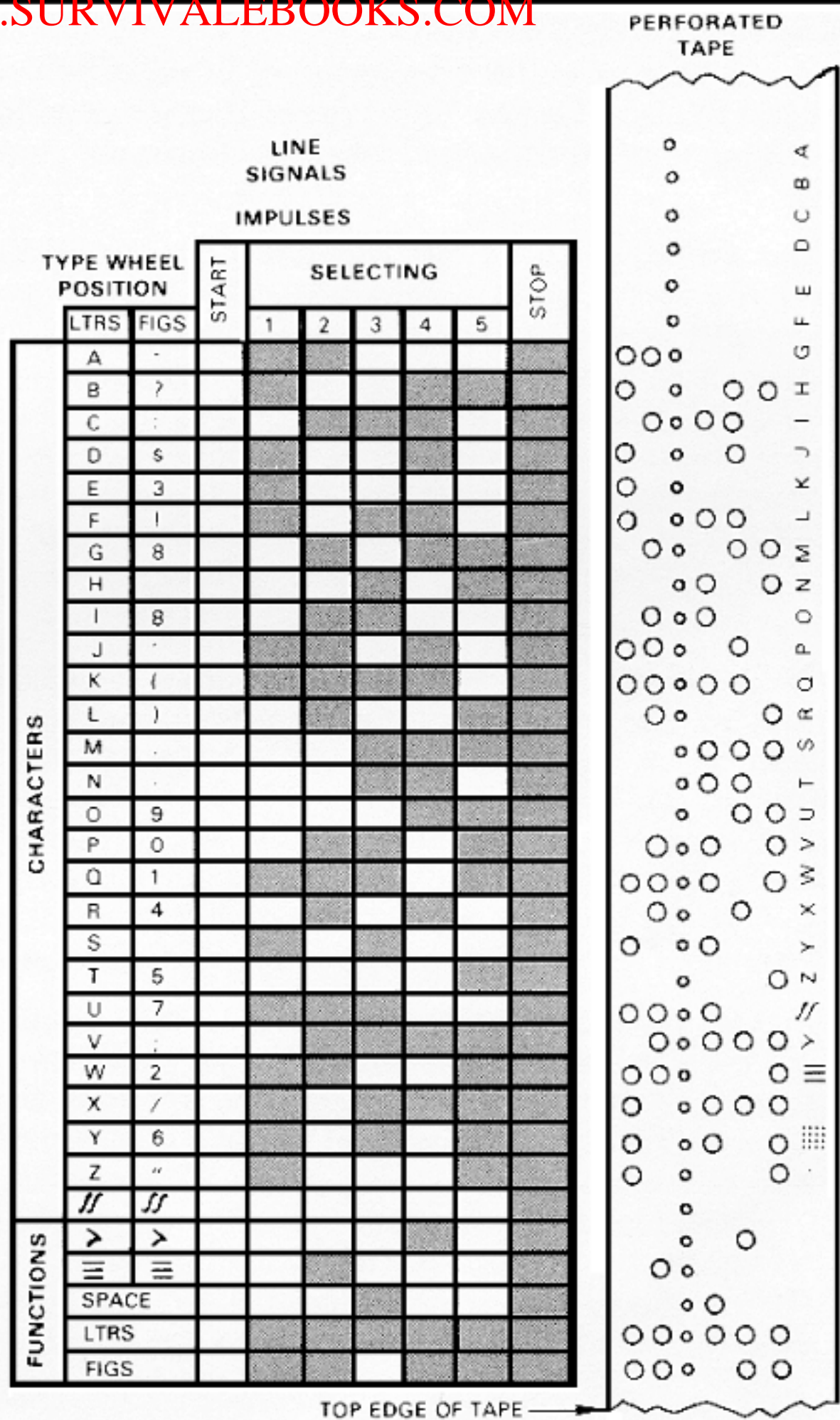

Figure 2-20. Continuous wave signal for the letter A.



⋮ IS PRINTED ON TT-76A/GGC AND TT-76B/GGC IN LTRS POSITION.

SIGNAL LENGTH IN MILLISECONDS. STANDARD SPEED 60 WORDS PER MIN

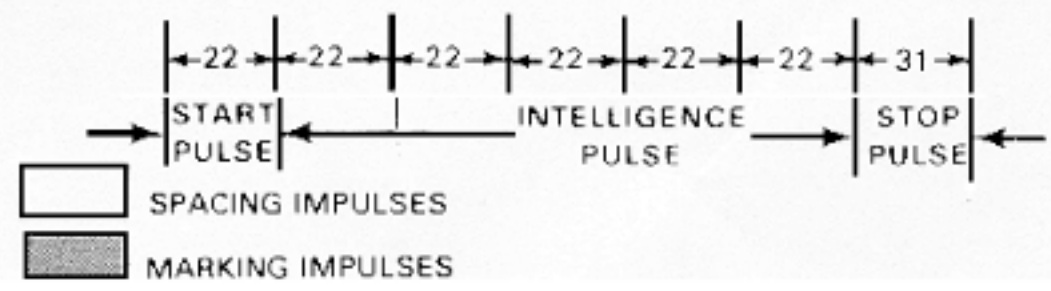

Figure 2-21. Teletypewriter code character set and standard start-stop, five-unit code chart.

CHAPTER 3

ANTENNAS

SAFETY WARNING

Be extremely careful when putting up, taking down, or moving antennas located near high voltage or commercial power lines. Antenna contact with these can and may result in electrocution or sever injury to personnel holding the antenna or the connecting guy wires and cables.

Section I. Requirement and Function

3-1. Necessity

All radios, whether transmitting or receiving, require some sort of antenna. Single-channel radios normally send and receive radio signals on one antenna. This is called one-way-reversible (OWR) or simplex operation. During duplex (DX) operation two antennas are used, one for transmitting and the other for receiving. In either case, the transmitter generates a radio signal. A transmission line delivers the signal from the transmitter to the antenna. The transmitting antenna sends the radio signal into space toward the receiving antenna. The receiving antenna intercepts the signal and sends it through a transmission line to the receiver. The receiver processes the radio signal so that it can either be heard or used to operate a recording device such as a teletypewriter ([fig 3-1](#)).

[Figure 3-1](#). Simple radio communications network.

3-2. Function

The function of an antenna depends on whether it is transmitting or receiving. A transmitting antenna transforms the output RF energy produced by a radio transmitter (RF output power) into an electromagnetic field that is radiated through space. In other words, the transmitting antenna converts energy from one form to another form. The receiving antenna reverses this process. It transforms the electromagnetic field into RF energy which is delivered to a radio receiver.

3-3. Gain

The gain of an antenna depends mainly on its design. Transmitting antennas are designed for high efficiency in radiating energy, and receiving antennas are designed for high efficiency in picking up energy. On many radio circuits, transmission is required between a transmitter and only one receiving station. In this case, energy may be radiated in one direction because it is useful only in that direction. Directional receiving antennas increase the energy pickup or gain in the favored direction, and reduce the reception of unwanted noise and signals from other directions. The general requirements for transmitting and receiving antennas are that they have small energy losses and that they be efficient as radiators and receptors.

Section II. Characteristics

3-4. Electromagnetic Radiation

Radiation Fields.

When RF power is delivered to an antenna, two fields are set up: one is an induction field, which is associated with the

stored energy; the other is a radiation field. At the antenna, the intensities of these fields are large and are proportional to the amount of RF power delivered to the antenna. At a short distance from the antenna and beyond, only the radiation field remains. This radiation field is composed of an electric component and a magnetic component ([fig 3-2](#)).

[Figure 3-2.](#) Components of electromagnetic waves.

The electric and magnetic fields (components) radiated from an antenna form the electromagnetic field. The electromagnetic field is responsible for the transmission and reception of electromagnetic energy through free space. A radio wave is a moving electromagnetic field that has velocity in the direction of travel, and with components of electric intensity and magnetic intensity arranged at right angles to each other.

Radiation Patterns.

The radio signals radiated by an antenna form an electromagnetic field having a definite pattern, depending on the type of antenna used. This radiation pattern is used to show the directional characteristics of an antenna. A vertical antenna theoretically radiates energy equally in all directions (omnidirectional); a horizontal antenna is mainly bidirectional. There are also unidirectional antennas. These antennas theoretically radiate energy in one direction. In practice, however, the patterns usually are distorted by nearby obstructions or terrain features.

The full- or solid-radiation pattern is represented as a three-dimensional figure that looks somewhat like a doughnut with a transmitting antenna in the center ([fig 3-3](#)). The upper pattern in the figure is that of a quarter-wave vertical antenna; the center pattern is that of a half-wave horizontal antenna, located one-half wavelength above the ground. The bottom pattern is that of a vertical half-rhombic antenna.

[Figure 3-3.](#) Solid radiation patterns from quarter-wave, half-wave, and vertical half-rhombic antennas.

3-5. Polarization

The polarization of a radiated wave is determined by the direction of the lines of force making up the electric field. If the lines of electric force are at right angles to the surface of the Earth, the wave is said to be vertically polarized ([fig 3-4](#)). If the lines of electric force are parallel to the surface of the Earth, the wave is said to be horizontally polarized ([fig 3-5](#)).

When a single-wire antenna is used to extract (receive) energy from a passing radio wave, maximum pickup results if the antenna is oriented so that it lies in the same direction as the electric field component. Thus, a vertical antenna is used for efficient reception of vertically polarized waves and a horizontal antenna is used for the reception of horizontally polarized waves. In some cases, the field rotates as the waves travel through space. Under these conditions, both horizontal and vertical components of the field exist and the wave is said to have elliptical polarization.

[Figure 3-4.](#) Vertically polarized signal.

Polarization Requirements for Various Frequencies.

At medium and low frequencies, ground-wave transmission is used extensively and it is necessary to use vertical polarization. Vertical lines of force are perpendicular to the ground, and the radio wave can travel a considerable distance along the ground surface with a minimum amount of loss. Because the Earth acts as a relatively good conductor at low frequencies, horizontal lines of electric force are shorted out and the useful range with the horizontal polarization is limited.

At high frequencies, with sky wave transmission, it makes little difference whether horizontal or vertical polarization is used. The sky-wave, after being reflected by the ionosphere, arrives at the receiving antenna elliptically polarized. Therefore, the transmitting and receiving antennas can be mounted either horizontally or vertically. Horizontal antennas are preferred however, since they can be made to radiate effectively at high angles and have inherent directional properties.

[Figure 3-5.](#) Horizontally polarized signal.

For frequencies in the very-high or ultra-high range, either horizontal or vertical polarization is satisfactory. Since the radio wave travels directly from the transmitting antenna to the receiving antenna, the original polarization produced at the

transmitting antenna is maintained as the wave travels to the receiving antenna. Therefore, if a horizontal antenna is used for transmitting, a horizontal antenna must be used for receiving.

Satellites and satellite terminals use circular polarization. Circular polarization describes a wave whose plane of polarization rotates through 360° as it progresses forward. The rotation can be clockwise or counterclockwise (see [fig 3-6](#)). Circular polarization occurs when equal magnitudes of vertically and horizontally polarized waves are combined with a phase difference of 90°. Depending on their phase relationship, this causes rotation either in one direction or the other (see [app L](#)).

[Figure 3-6](#). Circular polarized wave.

Advantages of Vertical Polarization.

Simple vertical half-wave and quarter-wave antennas can be used to provide omnidirectional (in all directions) communications. This is desirable in communicating with a moving vehicle. Its disadvantage is that it radiates equally to the enemy and friendly forces.

When antenna heights are limited to 3.05 meters (10 ft) or less over land, as in a vehicular installation, vertical polarization provides a stronger received signal at frequencies up to about 50 MHz. From about 50 MHz to 100 MHz, there is only a slight improvement over horizontal polarization with antennas at the same height. Above 100 MHz, the difference in signal strength between vertical and horizontal polarization is small. However, when antennas are located near dense forests, horizontally polarized waves suffer lower losses than vertically polarized waves.

Vertically polarized radiation is somewhat less affected by reflections from aircraft flying over the transmission path. With horizontal polarization, such reflections cause variations in received signal strength. An example is the picture flutter in a television set when an aircraft interferes with the transmission path. This factor is important in areas where aircraft traffic is heavy.

When vertical polarization is used, less interference is produced or picked up from strong VHF and UHF transmissions (television and FM broadcasts) because they use horizontal polarization. This factor is important when an antenna must be located in an urban area that has television or FM broadcast stations.

Advantages of Horizontal Polarization.

A simple horizontal half-wave antenna is bidirectional. This characteristic is useful in minimizing interference from certain directions.

Horizontal antennas are less likely to pick up man-made interference, which ordinarily is vertically polarized.

When antennas are located near dense forests, horizontally polarized waves suffer lower losses than vertically polarized waves, especially above 100 MHz.

Small changes in antenna location do not cause large variations in the field intensity of horizontally polarized waves when an antenna is located among trees or buildings. When vertical polarization is used, a change of only a few feet in the antenna location may have a significant effect on the received signal strength.

3-6. Directionality

Vertical receiving antennas accept radio signals equally from all horizontal directions, just as vertical transmitting antennas radiate equally in all horizontal directions. Because of this characteristic, other stations operating on the same or nearby frequencies may interfere with the desired signal and make reception difficult or impossible. However, reception of a desired signal can be improved by using directional antennas.

Horizontal half-wave antennas accept radio signals from all directions, with the strongest reception being received in a line perpendicular to the antenna (that is, broadside); and, the weakest reception being received from the direction of the ends of the antenna. Interfering signals can be eliminated or reduced by changing the antenna installation so that either end of the antenna points directly at the interfering station.

Communications over a radio circuit is satisfactory when the received signal is strong enough to override undesired

signals and noise. The receiver must be within range of the transmitter. Increasing the transmitting power between two radio stations increases communications effectiveness. Also, changing the types of transmission (for example, changing from radiotelephone to CW), changing to a frequency that is not readily absorbed, or using a directional antenna aids in communications effectiveness.

Directional transmitting antennas concentrate radiation in a given direction and minimize radiation in other directions. A directional antenna may also be used to lessen interception by the enemy and interference with friendly stations.

3-7. Ground Effects

Since all practical antennas are erected over the Earth and not out in free space, except for those on satellites, the presence of the ground will alter the free space radiation patterns of antennas. The ground will also have an effect on some of the electrical characteristics of an antenna. It has the greatest effect on those antennas that must be mounted relatively close to the ground in terms of wavelength. For example, medium- and high-frequency antennas, elevated above the ground by only a fraction of a wavelength, will have radiation patterns that are quite different from the free-space patterns.

Grounded Antenna Theory.

The ground is a good conductor for medium and low frequencies and acts as a large mirror for the radiated energy. This results in the ground reflecting a large amount of energy that is radiated downward from an antenna mounted over it. Using this characteristic of the ground, an antenna only a quarter-wavelength long can be made into the equivalent of a half-wave antenna. A quarter-wave antenna erected vertically, with its lower end connected electrically to the ground (fig 3-7), behaves like a half-wave antenna. Under these conditions, the ground takes the place of the missing quarter-wavelength, and the reflections supply that part of the radiated energy that normally would be supplied by the lower half of an ungrounded half-wave antenna.

Types of Grounds.

When grounded antennas are used, it is especially important that the ground has as high a conductivity as possible. This reduces ground losses and provides the best possible reflecting surface for the down-going radiated energy from the antenna. At low and medium frequencies, the ground acts as a sufficiently good conductor. Therefore, the ground connection must be made in such a way as to introduce the least possible amount of resistance to ground. At higher frequencies, artificial grounds constructed of large metal surfaces are common.

The ground connections take many forms, depending on the type of installation and the loss that can be tolerated. In many simple field installations, the ground connection is made by means of one or more metal rods driven into the soil. Where more satisfactory arrangements cannot be made, ground leads can be connected to existing devices which are grounded. Metal structures or underground pipe systems are commonly used as ground connections. In an emergency, a ground connection can be made by forcing one or more bayonets into the soil.

When an antenna must be erected over soil with low conductivity, treat the soil to reduce its resistance. The soil should be treated with substances that are highly conductive when in solution. Some of these substances, listed in order of preference, are sodium chloride (common salt), calcium chloride, copper sulphate (blue vitriol), magnesium sulphate (Epsom salt, and potassium nitrate (saltpeter). The amount required depends on the type of soil and its moisture content.

WARNING: When these substances are used, it is important that they do not get into nearby drinking water supplies.

Figure 3-7. Quarter-wave antenna connected to ground.

For simple installations, a single ground rod can be fabricated in the field from pipe or conduit. It is important that a low resistance connection be made between the ground wire and the ground rod. The rod should be cleaned thoroughly by scraping and sandpapering at the point where the connection is to be made, and a clean ground clamp should be installed. A ground wire can then be soldered or joined to the clamp. This joint should be covered with tape to prevent an increase in resistance because of oxidation.

Counterpoise.

When an actual ground connection cannot be used because of the high resistance of the soil or because a large buried ground system is not practical, a counterpoise may be used to replace the usual direct ground connection. The counterpoise ([fig 3-8](#)) consists of a device made of wire which is erected a short distance above the ground and insulated from it. The size of the counterpoise should be at least equal to or larger than the size of the antenna.

When the antenna is mounted vertically, the counterpoise should be made into a simple geometric pattern. Perfect symmetry is not required. The counterpoise appears to the antenna as an artificial ground that helps to produce the required radiation pattern.

[Figure 3-8.](#) Wire counterpoise.

In some VHF antenna installations on vehicles, the metal roof of the vehicle (or shelter) is used as a counterpoise for the antenna.

Small counterpoises of metal mesh are sometimes used with special VHF antennas that must be located a considerable distance above the ground.

Ground Screen.

A ground screen consists of a fairly large area of metal mesh or screen that is laid on the surface of the ground under the antenna. There are two specific advantages in using ground screens. First, the ground screen reduces ground absorption losses that occur when an antenna is erected over ground with poor conductivity. Second, the height of the antenna can be set accurately. As a result of this, the radiation resistance of the antenna can be determined more accurately (See TM 11-666, para 61).

3-8. Antenna Length

The length of an antenna must be considered in two ways. It has both a physical and an electrical length, and the two are never the same. The reduced velocity of the wave on the antenna and a capacitive effect (known as *end effect*) make the antenna seem longer electrically than it is physically. The contributing factors are the ratio of the diameter of the antenna to its length and the capacitive effect of terminal equipment (insulators, clamps, etc.) used to support the antenna.

To calculate the physical length of an antenna, use a correction of 0.95 for frequencies between 3.0 and 50.0 MHz. The figures given below are for a half-wave antenna.

$$\begin{aligned} \text{Length (meters)} &= 150 \times 0.95 / \text{Frequency in MHz} \\ &= 142.5 / \text{Frequency in MHz} \end{aligned}$$

$$\begin{aligned} \text{Length (feet)} &= 492 \times 0.95 / \text{Frequency in Mhz} \\ &= 468 / \text{Frequency in MHz} \end{aligned}$$

The length of a long-wire antenna (one wavelength or longer) for harmonic operation is calculated by using the following formula.

$$\text{Length (meters)} = 150(N-0.05) / \text{Freq MHz}$$

$$\text{Length (feet)} = 492 (N-0.05) / \text{Freq MHz}$$

Where N = number of half-wave lengths in the total length of the antenna.

For example, if the number of half-wavelengths is 3 and the frequency in MHz is 7, then:

$$\begin{aligned}
 \text{Length (meters)} &= 150(N-0.05) / \text{Freq MHz} \\
 &= 150(3-.05) / 7 \\
 &= 150 \times 2.95 / 7 \\
 &= 442.50 / 7 \\
 &= 63.2 \text{ meters}
 \end{aligned}$$

3-9. Antenna Orientation

Azimuth.

If the azimuth of the radio path is not provided, the azimuth should be determined by the best available means. The accuracy required in determining the azimuth of the path is dependent upon the radiation pattern of the directional antenna. If the antenna beam width is very wide (for example, 90° angle between half-power points, [fig 3-9](#)), an error of 10° in azimuth is of little consequence. In transportable operation, the rhombic and V antennas may have such a narrow beam as to require great accuracy in azimuth determination. The antenna should be erected for the correct azimuth. Great accuracy is not required in erecting broad-beam antennas. Unless a line of known azimuth is available at the site, the direction of the path is best determined by a magnetic compass. [Figure 3-10](#) is a map of magnetic declination, showing the variation of the compass needle from the true north. When the compass is held so that the needle points to the direction indicated for the location on the map, all directions indicated by the compass will be true.

[Figure 3-9.](#) Beam width measured on relative field strength and relative power patterns.

[Figure 3-10.](#) Magnetic declination over the world.

Improvement of Marginal Communications.

Under certain situations, it may not be feasible to orient directional antennas to the correct azimuth of the desired radio path. As a result, marginal communications may suffer. To improve marginal communications, follow the procedure presented below.

- Check, tighten, and tape cable couplings and connections.
- Retune all transmitters and receivers in the circuit.
- Check to see that antennas are adjusted for the proper operating frequency.
- Try changing the heights of antennas.
- Try moving the antenna a short distance away and in different locations from its original location.
- Separate transmitters from receiving equipment, if feasible.

Transmission and Reception of Strong Signals.

After an adequate site has been selected and the proper antenna orientation obtained, the signal level at the receiver will be proportional to the strength of the transmitted signal.

If a high-gain antenna is used, a stronger signal can be obtained. Losses between the antenna and the equipment can be reduced by using a high quality transmission line, as short as possible, and properly matched at both ends.

WARNING: Excessive signal strength may result in enemy intercept and interference or in your interfering with adjacent frequencies.

Section III. Types of Antennas

3-10. Tactical Considerations

Tactical antennas are specially designed to be rugged and permit mobility with the least possible sacrifice of efficiency. They are also designed to take abuse. Some are mounted on the sides of vehicles that have to move over rough terrain;

FM 24-18 CHAPTER 3 ANTENNAS
 others are mounted on tops of single masts or suspended between sets of masts. The smallest antennas are mounted on the helmets of personnel who use the radio sets. All tactical antennas must be easy to install. Large ones must be easy to take apart and pack and they must be easy to transport.

Several types of transmitting and receiving antennas are shown in [figure 3-11](#).

- A of the figure is a rhombic antenna.
- B is a half-wave Hertz antenna.
- C is an end-fed, vertical antenna, also called a whip antenna.
- D is a loop antenna that receives a strong signal in directions as shown and almost no signal in other directions.
- E is an antenna group OE-254/GRC which is an omnidirectional, biconical antenna designed for broadband operation.
- F is a long-wire antenna.
- G is a vertical half-rhombic antenna.
- H is a directional half-rhombic antenna.

[Figure 3-11](#). Types of antennas.

[Figure 3-11](#). Types of antennas (cont).

[Figure 3-11](#). Types of antennas (cont).

Most practical transmitting antennas come under one of two classifications, Hertz antennas or Marconi antennas. A Hertz antenna is operated some distance above the ground and may be either vertical or horizontal. A Marconi antenna operates with one end grounded (usually through the output of the transmitter or the coupling coil at the end of the feed line). Hertz antennas are generally used at higher frequencies (above about 2 MHz) while Marconi antennas are generally used at the lower frequencies. Marconi antennas, when used on vehicles or aircraft, operate at high frequencies. In these cases, the aircraft or vehicle chassis becomes the effective ground for the antenna.

3-11. The Hertz Antenna

The operation of the Hertz antenna is based on the fact that the wavelength to which any wire will electrically tune depends directly upon its physical length. The basic Hertz antenna is center fed and its total wire length is equal to approximately one half of the wavelength of the signal to be transmitted. This type of antenna, which is also known either as a doublet, a dipole, an ungrounded, or a half-wave antenna, can be mounted in either a vertical, horizontal, or slanting position. Two typical military half-wave, center-fed Hertz antennas are shown in figures [3-12](#) and [3-13](#). These antennas are used for transmitting and receiving frequencies from 2 to 30 MHz.

[Figure 3-12](#). Center-fed Hertz antenna with two upright supports.

[Figure 3-13](#). Center-fed Hertz antenna with three upright supports.

The Mast Base AB-155 is employed for upright supports with the centerfed doublet antenna. Refer to TM 11-5820-256-10. Antenna Group AN/GRA-50 can also be used to install a center-fed doublet antenna by using trees, buildings, or other existing means of support. Refer to TM 11-5820-467-15. For all practical purposes, the length (in feet) of a half-wave doublet antenna is determined by using the formula, 468 divided by the frequency in megahertz.

Employment.

The half-rhombic antenna is employed with the current VHF/FM family of radios. Because the half-rhombic antenna is very directional, its employment is restrictive in nature, usually providing only point-to-point communications.

Training.

The introduction of the half-rhombic antenna into the Army tactical inventory minimally impacts on the Army training program. The operators of VHF-FM radio nets are responsible for the installation, operation, and teardown of the

half-rhombic antenna in all applications. The fielding of the half-rhombic antenna does not require any additional support personnel. Half-rhombic antenna installation/training may consist of a short period of on-the-job training (OJT) conducted by the using unit.

3-12. The Marconi Antenna

If the lower half of a vertical Hertz antenna is replaced by an extensive conducting plane, no disturbance is caused in the propagated waves from the upper half. In other words, the remaining quarter-wave continues to radiate much in the same way as a half-wave antenna, providing a large conducting plane is used. The Marconi antenna is a practical form of this kind of radiating system in which the antenna proper provides one-quarter wavelength and the soil supplies the additional quarter-wavelength. The total effective (or electrical) length is then one-half wavelength.

The main advantage of the Marconi antenna is that, for any given frequency, it is physically much shorter than the Hertz antenna. This is particularly important in all field and vehicular radio installations. Typical Marconi antennas are the inverted L, the whip, the ground plane, and the modified ground-plane antennas.

3-13. The Whip Antenna

At the lower frequencies where wavelengths are longer, it is impractical to use resonant-length tactical antennas with portable radio equipment, especially with vehicular-mounted radio sets. Tactical whip antennas are electrically short, vertical, baseloaded types, fed with a nonresonant coaxial cable of about 52 ohms impedance ([fig 3-14](#)).

If the tactical whip antenna is to attain an efficiency comparable to that of a half-wave antenna, the height of the vertical radiator should be a quarter wavelength. However, this is not always possible, so the loaded whip is used instead. The loading increases the electrical length of the vertical radiator to a quarter wavelength. The missing quarter-wavelength of the antenna is supplied by the ground, a counterpoise, or any conducting surface that is big enough.

[Figure 3-14](#). Common types of whip antennas.

The whip antenna supplied with military radio sets is usually 4.5 meters (15 ft) long for the high-frequency tactical radio sets. The whip antenna used with the lightweight portable FM radios is 0.9 meters (3 feet) long for the semirigid steel tape antenna and 3 meters (10 feet) long for the multisection whip antenna. It is made shorter than a quarter-wavelength to keep it a practical length. (A quarter-wavelength antenna for 5.0 MHz would be over 14 meters (46 ft) long.) An antenna tuning unit, either built into the radio set or supplied with it, compensates for the missing length of antenna. The tuning unit varies the electrical length of the antenna to accommodate a range of frequencies.

Whip antennas are used with tactical radio sets because they radiate equally in all directions in the horizontal plane ([fig 3-15](#)). Since stations in a radio net lie in random directions and change their positions frequently, the radiation pattern is ideal for tactical communications.

When a whip antenna is mounted on a vehicle, the metal of the vehicle affects the operation of the antenna. As a result, the direction in which the vehicle is facing may also affect transmission and reception, particularly of distant or weak signals.

[Figure 3-15](#). Radiation pattern of a whip antenna.

[Figure 3-16](#). Best directivity of whip antenna mounted on vehicle.

A vehicle with a whip antenna mounted on the left rear side of the vehicle transmits its strongest signal in a line running from the antenna through the right front side of the vehicle. Similarly, an antenna mounted on the right rear side of the vehicle radiates its strongest signal in a direction toward the left front side ([fig 3-16](#)). The best reception is obtained from signals traveling in the direction shown by the dashed arrows on the figure.

In some cases, the best direction for transmission can be determined by driving the vehicle in a small circle until the best position is located. Normally, the best direction for receiving from a distant station is also the best direction for transmitting to that station.

There are times when a whip antenna mounted on a vehicle must be left fully extended so that it can be used instantly while the vehicle is in motion. The base mounted insulator of the whip is fitted with a coil spring attached to a mounting

bracket on the vehicle. The spring base allows the vertical whip antenna to be tied down horizontally when the vehicle is in motion and when driving under low bridges or obstructions. Even in the vertical position, if the antenna hits an obstruction, the whip usually will not break because most of the shock is absorbed by the spring base.

WARNING: When an antenna must be left fully extended while in motion, contact with overhead powerlines must be avoided. Death or serious injury can result if a vehicular antenna strikes a high-voltage transmission line. If the antenna is tied down, be sure the tip protector is in place.

[Figure 3-17.](#) Ground-plane antenna.

Some of the energy leaving a whip antenna travels downward and is reflected by the ground with practically no loss. To obtain greater distance in transmitting and receiving, it may be necessary to raise the whip antenna. However, when a whip antenna is raised, its efficiency decreases because it is further from the ground. Therefore, when we use a whip antenna at the top of a mast, we must supply an elevated substitute for the ground (ground plane).

3-14. The Ground-Plane Antenna

The ground-plane antenna is a whip antenna that includes radial elements which serve as the ground. The coaxial feeder is connected with the inner conductor feeding the vertical element (whip), and the braid of the coaxial cable is connected to the radials (the ground plane) to keep them at ground potential. The ground-plane antenna is a broad-tuned type that radiates efficiently over a wide range of frequencies.

[Figure 3-17](#) shows a ground-plane antenna presently used with tactical FM sets. It can be tuned by using the proper length of antenna sections in the vertical element and in the ground-plane elements. Refer to TM 11-5820-348-15.

[Figure 3-18.](#) Radiation pattern of V antenna.

3-15. The V Antenna

The V antenna consists of two wires arranged to form a V, with their ends at the apex (where the legs come together) attached to a transmission line ([fig 3-18A](#)). Radiation lobes off each wire combine to increase gain in the direction of an imaginary line bisecting the apex angle (See [fig 3-18A](#)). The pattern is bidirectional. Adding terminating resistors to the far end of each leg will make the pattern unidirectional (See [fig 3-18B](#)). For details on the angle and resistor values see TM 11-666, paragraph 89.

3-16. The Broadband Omnidirectional Antenna

The broadband omnidirectional VHF antenna system OE-254 ([fig 3-19](#)) is an improved tactical antenna that will replace the present antenna, RC-292. The antenna permits operation in the 30 to 88 MHz frequency range without the need to manually drop and retrieve the antenna each time the operating frequency is changed. The antenna system is being fielded for use with current tactical VHF-FM net radios. The antenna system is being issued on a one-for-one replacement for the RC-292.

This omnidirectional vertically polarized VHF antenna system--

- Operates in the 30 to 88 MHz range without any physical adjustments.
- Has input impedance of 50 ohms unbalanced with an average voltage standing wave ratio (VSWR) of 3:1 or less at RF power levels up to 350 watts.
- Is capable of being assembled and erected by one individual.
- Operates at a distance equal to that of the present antenna equipment RC-292.
- Meets the broadband and power handling requirements of the 2-port and 5-port transceiver multiplexer (See [appendix D](#)).
- Is capable of being used with the Steerable Null Processing Group OL-275()/VRC (SNAP-1) (See [appendix E](#)).

The antenna system ([Figure 3-19](#)) includes:

- A standard lightweight mast having a maximum height of 41 feet and 9 inches.
- A canvas carrying bag similar to that issued with antenna equipment RC-292. Assembly and erection procedures are provided with the bag.
- All necessary guying assemblies, stakes, base plate, tools, and other ancillary equipment required to make a complete antenna system.
- All necessary coaxial cables and cable adapters for Radio Sets AN/PRC-25 and AN/PRC-77 (series) and the AN/VRC-12 (family).

[Figure 3-19.](#) Broadband omnidirectional antenna system OE-254

3-17. The Directional VHF Log-Periodic Antenna

As the mobility of the Army increases, the need for extended range and directivity for the tactical radios in the field also increases. The Army has long awaited the advent of an effective electronic counter-countermeasures (ECCM) device/procedure that allows continued radio communications in a hostile electronic warfare (EW) environment. This need will be partially met by use of the log-periodic antenna (see [fig 3-20](#)). Use of the log-periodic antenna with nominal transmitter power output satisfies the need for extended range. Additionally, the use of the log-periodic antenna allows the use of reduced transmitter power with the resultant reduction of signals in all directions other than the antenna main beam. This satisfies the need of providing a degree of ECCM protection. Finally, the log-periodic antenna operates with the present VHF-FM tactical net radios (AN/VRC-12/PRC-25 series).

[Figure 3-20.](#) Log periodic antenna.

Operation.

The log-periodic antenna operates in the 30 to 88 MHz frequency range without any mechanical or electrical adjustments. This makes it a broadband antenna. It operates with power levels up to 250 watts and has a maximum of 2:1 VSWR at the RF input connectors over the frequency range. It presents a nominal input impedance of 50 ohms over the frequency range of 30 to 88 MHz.

Capabilities.

The log-periodic antenna is--

- Capable of being erected in a geographical area no greater than 18.3 meters (60 ft) in diameter.
- Capable of being mounted on a quick-erect mast on either a vehicle or a shelter.
- Capable of a mechanical azimuthal directional change within a 1-minute time frame.
- Capable of being assembled by two individuals in 20 minutes.
- Capable of being transported by manpack or tactical vehicle when fitted into two packages (one for the antenna and one for the mast).
- Capable of operation with either the 2-port or 5-port transceiver multiplexer.
- The antenna system operates with either horizontal or vertical polarization with the capability of changing polarization in less than 1 minute of time.

Antenna Assembly.

The antenna assembly consists of a collapsible frame which supports a log-periodic antenna assembly. No tools are required to reassemble the antenna for operation. The antenna is capable of being mounted on top of the mast, polarized either vertically or horizontally. The antenna system includes all necessary guying assemblies, stakes, base plate, tools, and other ancillary equipment required to make a complete antenna system. It also includes all necessary coaxial cables and cable adapters for Radio Sets AN/PRC-25 and AN/PRC-77 (series), and the AN/VRC-12 (family).

Mast Assembly.

The mast assembly is capable of being mounted on either a vehicle or on a shelter.

The log-periodic antenna is organic to battalion and higher level units for special applications. It is task assigned, where needed, to subordinate units within the battalion. Its primary usage is by forward units in command and intelligence nets to a higher headquarters. Because the log-periodic antenna is directional, its employment is usually restricted to point-to-point communications.

Organizational Maintenance.

Organizational maintenance is performed by operators of radio equipment at the echelons where radio operator MOSs are authorized and by the user at all other echelons where authorized. It includes--

- Performance of scheduled preventive maintenance services as directed by the technical manuals for organizational level.
- Forwarding all unserviceable components, cables, elements, etc., to the designated direct support activity for repair.
- Repair by replacing those faulty components that have been specified in the maintenance allocation charts (MAC) as replaceable at this level (for example, insulators, and cables).

3-18. The Half-Rhombic Antenna

The VHF half-rhombic antenna is a vertically polarized antenna which, when used with the current VHF-FM tactical radios, extends the range of transmission considerably and provides some degree of ECCM protection not offered by the current VHF-FM omnidirectional antenna. The current omnidirectional antennas, when employed in forward combat areas, transmit and receive signals equally in all directions and provide as strong a signal to the enemy EW units as they do to friendly units. The half-rhombic antenna, when properly employed, decreases VHF-FM radio susceptibility to hostile EW operations and enhances the communications ranges of the deployed radio sets. This effect is realized by directing the maximum signal strength in the direction of the desired friendly unit. It is made rugged enough to withstand the current doctrinal requirements of moving (erection and teardown) every 4 to 6 hours and be able to operate in the climatic conditions as stated in AR 70-38.

Operations.

The half-rhombic antenna operates in the 30 to 88 MHz frequency range without mechanical or electrical adjustments. It operates with power levels up to 200 watts and has a maximum of 2:1 VSWR over the entire frequency range. The antenna presents a nominal load impedance of 50 ohms over the frequency range 30 to 88 MHz.

Capabilities.

The half-rhombic antenna can--

- Be erected in a geographical area of 53 meters (175 feet) in diameter or less depending upon the frequency.
- Be mounted on any structure about 15 meters (50 feet) in height.
- Be capable of azimuthal directional change within 1 minute of time.
- Be installed by 2 individuals in 20 minutes or less.
- Be transported by manpack or tactical vehicle when fitted into a package.
- Operate with either the 2- or 5-port transceiver multiplexer.

Functional Description.

The half-rhombic VHF antenna is a high gain, lightweight, directional antenna capable of operation over the frequency range of 30 to 88 MHz without the need for physical tuning by the operator. The antenna and all the ancillary equipment (guys, stakes, tools, mast sections) can be packaged in a carrying bag for manpack or vehicular transportation. The AB-1244 mast assembly is used with the OE-303 half-rhombic antenna. The mast assembly ([fig 3-21](#)) consists of 12 tubular mast sections (five lower-mast sections, one mast transition adapter, five upper-mast sections, and antenna adapter), a mast base assembly and assorted ancillary equipment. When erected, the mast assembly is stabilized by a two-level, four-way guying system ([fig 3-22](#)). The weight of the half-rhombic VHF antenna including mast is approximately 18 kilograms (45 lb). This antenna handles radio frequency power levels up to 200 watts, matches a

nominal 50 ohm impedance with a VSWR of no more than 2: 1 over the entire frequency range of the antenna, and meets the operation, storage, and transit requirements as specified in AR 70-38. Nuclear survivability has not been considered during the building of this antenna; however, due to the density of antennas in the field, replacement of damaged antennas may be made in a timely manner if the situation warrants. The half-rhombic antenna may be used with the radio set alone or with the 2- or 5-port multiplexer. Connections to the antenna and radio sets are made with connectors and cables provided with the antenna. This antenna, due to its simplicity and light weight, may be installed by two individuals in a time of 20 minutes or less. The simplicity of this antenna also makes it much easier to maintain in a tactical environment.

[Figure 3-21.](#) OE-303 antenna mast assembly (AB-1244()/GRC).

[Figure 3-22.](#) Erected mast assembly, less antenna.

Unit Application.

In most instances, the half-rhombic antenna is used for special applications. It is task assigned as required. Its primary usage is by forward units on command control and intelligence nets to a higher headquarters. It must be available for use by units that habitually operate over extended distances from parent units and it must be available to units for special tasks or across the forward line of own troops (FLOT).

3-19. Near-Vertical Incidence Sky-Wave Antenna

The near-vertical incidence sky-wave (NVIS) antenna, AS-2259/GR is a lightweight sloping dipole omnidirectional antenna designed to operate in the 2- to 30-MHz frequency band ([fig 3-23](#)). It is employed with radio teletypewriter communications in a 0- to 483-kilometer (0- to 300-mile) range. The NVIS antenna is capable of operating with current AM/HF radio sets and will be an item of issue with the improved high frequency radio (IHFR). The antenna/coupler may be manually tuned at the antenna/coupler or remotely up to 61 meters (200 feet). Tuning time does not exceed 1 minute. The NVIS antenna is interchangeable with the AN/GRA-50 and the whip antenna when used with the above radio sets. Weight of the antenna is 5.44 kilograms (12 pounds) and it is constructed of chemical, biological resistant materials. It is horizontally and vertically polarized simultaneously and provides an omnidirectional pattern. The power handling capability is 1000 watts (PEP) or 500 watts (average). (See [Table 3-1](#) and [Figure 3-24](#).)

Maintenance is performed as outlined in AR 750-1. Organizational maintenance is performed by the Single-Channel Radio Operator, MOS 31C, at the echelons where this MOS is authorized and by the user at all other echelons where authorized. It includes performing scheduled preventive maintenance checks and services (PMCS) prescribed by organizational technical manuals, evacuating unserviceable repairable components to the designated direct support (DS) activity, and repairing by replacement of faulty components according to the MAC. DS will be performed by the Field Radio Repairer, MOS 29E. DS maintenance includes evaluation of faulty items received from organizational levels and performing repairs authorized at the DS level. Repaired items are returned to the user or replaced by a DX item. DS contact teams will repair on-site when possible to preclude the evacuation of items from the operating areas and to reduce the downtime of the HF system due to the antenna. There is no general support (GS) or depot maintenance.

See [appendix M](#) for a discussion of the near-vertical incidence sky-wave concept.

[Table 3-1.](#) Specifications of NVIS Antenna AS-2269/GR.

[Figure 3-23.](#) NVIS antennas, AS-2259/GR.

[Figure 3-24.](#) Physical configuration and coordinate location of elements of AS-2259/GR antenna.

3-20. The Dummy Antenna

Using a radiating antenna during tuning may reveal the location of a transmitter to enemy radio direction finders and may cause interference with other stations operating on the same frequency. To eliminate the possibility of unauthorized signals going on the air during tune-up, a dummy antenna should be used. This device acts as a load for the transmitter and absorbs the signal without radiating it into space. Dummy antennas normally consist of a noninductive resistor large enough to absorb the transmitter output and dissipate it as heat. Some dummy antennas also have an RF wattmeter to check RF power output of the transmitter.

Section IV. Field Repair and Expedients

3-21. Assessment of Damage

Antennas are sometimes broken or damaged, causing either a communications failure or poor communications. If a spare is available, there is no problem--replace the damaged antenna. When there is no spare, you may have to construct an emergency antenna. The following paragraphs are suggestions on repairing antennas and antenna supports and on constructing and adjusting emergency antennas. See also [paragraph 7-7](#).

3-22. Repair Techniques

Whip Antennas.

When a whip antenna is broken into two sections, the portion of the antenna that is broken off can be connected to the portion attached to the base by joining the sections as shown in [figure 3-25](#). Use the method illustrated in A, [figure 3-25](#), when both parts of the broken whip are available and usable. Use the method shown in B when the portion of the whip that was broken off is lost or when the whip is so badly damaged that it is not fit for use. To restore the antenna to its original length, add a piece of wire that is nearly the same length as the missing part of the whip. Then, lash the pole support securely to both sections of the antenna. Clean the two antenna sections thoroughly to ensure good contact before connecting them to the pole support. If possible, solder the connections.

[Figure 3-25](#). Emergency repair of broken whip antenna.

Wire Antennas.

Emergency repair of a wire antenna may involve the repair or replacement of the wire used as the antenna or transmission line; or, the repair or replacement of the assembly used to support the antenna.

When one or more wires of an antenna are broken, the antenna can be repaired by reconnecting the broken wires. To do this, lower the antenna to the ground, clean the ends of the wires, and twist the wires together. Whenever possible, solder the connection.

If the antenna is damaged beyond repair, construct a new one. Make sure that the length of the wires of the substitute antenna are the same length as those of the original.

Antenna supports may also require repair or replacement. A substitute item may be used in place of a damaged support and, if properly insulated, can be of any material of adequate strength. If the radiating element is not properly insulated, field antennas may be shorted to ground and be ineffective. Many commonly found items can be used as field expedient insulators. The best of these items are plastic or glass, to include plastic spoons, buttons, bottle necks, and plastic bags. Though less effective than plastic or glass but still better than no insulator at all are wood and rope, or both, in that order. The radiating element--the actual antenna wire-- should touch only the antenna terminal and should be physically separated from all other objects, other than the supporting insulator. [Figure 3-26](#) shows various methods of making emergency insulators.

[Figure 3-26](#). Improvised insulators.

Guys.

Lines used to stabilize the supports for an antenna are called guys. These lines are usually made of wire, manila rope, or nylon rope. If a rope breaks, it may be repaired by tying the two broken ends together. If the rope is too short after the tie is made, it can be lengthened by adding another piece of or a piece of dry wood or cloth. If a guy wire breaks, it can be replaced with another piece of wire. [Figure 3-27](#) shows a method of repairing a guy line with wood.

[Figure 3-27](#). Repaired guy lines and masts.

Masts.

Some antennas are supported by masts. If a mast breaks, it can be replaced with another of the same length. If long poles are not available as replacements, short poles may be overlapped and lashed together with rope or wire to provide a pole of the required length. [Figure 3-27](#) shows a method of making an emergency repair to masts.

3-23. Tips on Construction and Adjustment

Constructing the Antenna.

The best kinds of wire for antennas are copper and aluminum. In an emergency, however, use any type that is available.

The exact length of most antennas is critical. The emergency antenna should be the same length as the antenna it replaces.

Antennas supported by trees can usually survive heavy wind storms if the trunk of a tree or a strong branch is used as a support. To keep the antenna taut and to prevent it from breaking or stretching as the trees sway, attach a spring or old inner tube to one end of the antenna. Another technique is to pass a rope through a pulley or eyehook, attach the rope to the end of the antenna and load the rope with a heavy weight to keep the antenna tightly drawn.

Guys used to hold antenna supports are made of rope or wire. To ensure that the guys made of wire will not affect the operation of the antenna, cut the wire into several short lengths and connect the pieces with insulators.

Adjusting the Antenna.

An improvised antenna may change the performance of a radio set. Use the following methods to find out if the antenna is operating properly.

A distant station may be used to test the antenna. If the signal received from this station is strong, the antenna is operating satisfactorily. If the signal is weak, adjust the height and length of the antenna and the transmission line to receive the strongest signal at a given setting on the volume control of the receiver. This is the best method of tuning an antenna when transmission is dangerous or forbidden.

In some radio sets, the transmitter is used to adjust the antenna. First, set the controls of the transmitter in the proper position for normal operation; then, tune the system by adjusting the antenna height, the antenna length, and the transmission line length to obtain the best transmission output.

Impedance-matching a load to its source is an important consideration in transmissions systems. If the load and source are mismatched, part of the power is reflected back along the transmission line towards the source. This reflection not only prevents maximum power transfer, but also can be responsible for erroneous measurements of other parameters, or even cause circuit damage in high-power applications.

The power reflected from the load interferes with the incident (forward) power causing standing waves of voltages and current to exist along the line. The ratio of standing-wave maxima to minima is directly related to the impedance mismatch of the load; therefore the standing-wave ratio (SWR) provides the means of determining impedance and mismatch.

WARNING: Serious injury or death can result from contact with the radiating antenna of a medium- or high-power transmitter. Turn the transmitter off while making adjustments to the antenna.

The matching unit of the standing-wave Ratio Power Meter ME-165/G (see [fig 3-28](#)), provides a noninductive dummy load of 52 ohms and, when connected between the transmitter and its load, permits direct readings of the transmitter power output and the SWR between the transmitter and its load.

3-24. Field Expedient Omnidirectional Antennas

Vertical antennas are omnidirectional; that is, they transmit and receive equally well in all directions. Most tactical antennas are vertical; for example, the manpack portable radio uses a vertical whip as do the [Figure 3-28](#). Standing-wave Ratio Power Meter ME-165/G. vehicular radios in tactical vehicles. A vertical antenna can be improvised by using a metal pipe or rod of the correct length, held erect by means of guys. The lower end of the antenna should be insulated from the ground by placing it on a large block of wood or other insulating material. A vertical antenna may also be a wire supported

by a tree or a wooden pole ([fig 3-29](#)). For short vertical antennas, the pole may be used without guys (if properly supported at the base). If the length of the vertical mast is not long enough to support the wire upright, it may be necessary to modify the connection at the top of the antenna ([fig 3-30](#)).

[Figure 3-29.](#) Field substitutes for support of vertical wire antennas.

[Figure 3-30.](#) Additional means of supporting vertical wire antennas.

End-Fed Half-Wave Antenna

An emergency, end-fed half-wave antenna can be constructed from available materials such as field wire, rope, and wooden insulators. The electrical length of this antenna is measured from the antenna terminal on the radio set to the far end of the antenna ([fig 3-31](#)). The best performance can be obtained by constructing the antenna longer than necessary, and then shortening it, as required, until best results are obtained. The ground terminal of the radio set should be connected to a good Earth ground for this antenna to function efficiently.

[Figure 3-31.](#) End-fed half-wave antenna.

Center-Fed Doublet Antenna

The center-fed doublet is a half-wave antenna consisting of two quarter wavelength sections on each side of the center. Construction of an improvised doublet antenna for use with FM radios is shown in [figure 3-32](#).

Doublet antennas are directional broadside to their length, which makes the vertical doublet antenna essentially omnidirectional. This is because the radiation pattern is doughnut shaped (See [fig 3-3](#) for quarter-wave antenna which has a similar radiation pattern.). The horizontal doublet antenna is bidirectional (See [fig 3-3](#) for half-wave antenna).

[Figure 3-32.](#) Half-wave doublet antenna.

The length of a half-wave antenna may be computed by using the formula in paragraph 3-8. Cut the wires as closely as possible to the correct length because the length of the antenna wires is important.

A transmission line is used for conducting electrical energy from one point to another and it is used to transfer the output of a transmitter to an antenna. Although it is possible to connect an antenna directly to a transmitter, the antenna generally is located some distance away. In a vehicular installation, for example, the antenna is mounted outside and the transmitter inside the vehicle. A transmission line, therefore, is necessary as a connecting link.

Center-fed half-wave FM antennas can be supported entirely by pieces of wood. A horizontal antenna of this type is shown in [figure 3-33A](#); a vertical antenna in [figure 3-33B](#). These antennas can be rotated to any position to obtain the best performance. If the antenna is erected vertically, the transmission line should be brought out horizontally from the antenna for a distance equal to at least one-half of the antenna's length before it is dropped down to the radio set.

[Figure 3-33.](#) Center-fed half-wave antenna.

A similar arrangement for a short, center-fed half-wave antenna is shown in [figure 3-34](#). The ends of this antenna are connected to a piece of dry wood, such as a bamboo pole, and the bend in the pole holds the antenna wire straight. Another pole, or bundle of poles, serves as the mast.

[Figure 3-34.](#) Bent bamboo antenna.

[Figure 3-35](#) shows an improvised half-wave antenna. This technique is used primarily with FM radios. It is effective in heavily wooded areas to increase the range of portable radios. The top guy wire can be connected to a limb or passed over the limb and connected to the tree trunk or a stake.

[Figure 3-35.](#) Improvised vertical half-wave antenna.

3-25. Field Expedient Directional Antennas

The vertical half-rhombic antenna ([fig 3-36](#)) and the long-wire antenna ([fig 3-37](#)) are two field expedient directional antennas. These antennas consist of a single wire, preferably two or more wavelengths long, supported on poles at a height of 3 to 7 meters (10 to 20 feet) above the ground. The antennas will, however, operate satisfactorily as low as 1 meter (approximately 3 feet) above the ground. The far end of the wire is connected to ground through a noninductive resistor of 500 or 600 ohms. To ensure the resistor is not burned out by the output power of the transmitter, use a resistor rated at least one-half the wattage output of your transmitter. A reasonably good ground, such as a number of ground rods or a counterpoise, should be used at both ends of the antenna. The radiation pattern is directional. The antennas are used primarily for either transmitting or receiving high-frequency signals.

[Figure 3-36.](#) Vertical half-rhombic antenna.

[Figure 3-37.](#) Long-wire antenna.

The V antenna is another field expedient directional antenna. It consists of two wires forming a V with the open area of the V pointing toward the desired direction of transmission/reception (see [fig 3-38](#)). To make construction easier, the legs may slope downward from the apex of the V (this is called a sloping-V antenna) ([fig 3-39](#)).

The angle between the legs varies with the length of the legs in order to achieve maximum performance. Use [table 3-2](#) to determine the angle and the length of the legs.

When the antenna is used with more than one frequency or wavelength, use an apex angle that is midway between the extreme angles determined by the chart.

To make the antenna radiate in only one direction, add noninductive terminating resistors from the end of each leg (not at the apex) to ground. The resistors should be approximately 500 ohms and have a power rating at least one half that of the output power of the transmitter being used. Without the resistors, the antenna radiates bidirectionally, both front and back.

The antenna must be fed by a balanced transmission line.

For further information, see TM 11-666 paragraph 89.

[Table 3-2.](#) Leg Angle for V Antennas.

[Figure 3-38.](#) V antennas.

[Figure 3-39.](#) Sloping-V antenna.

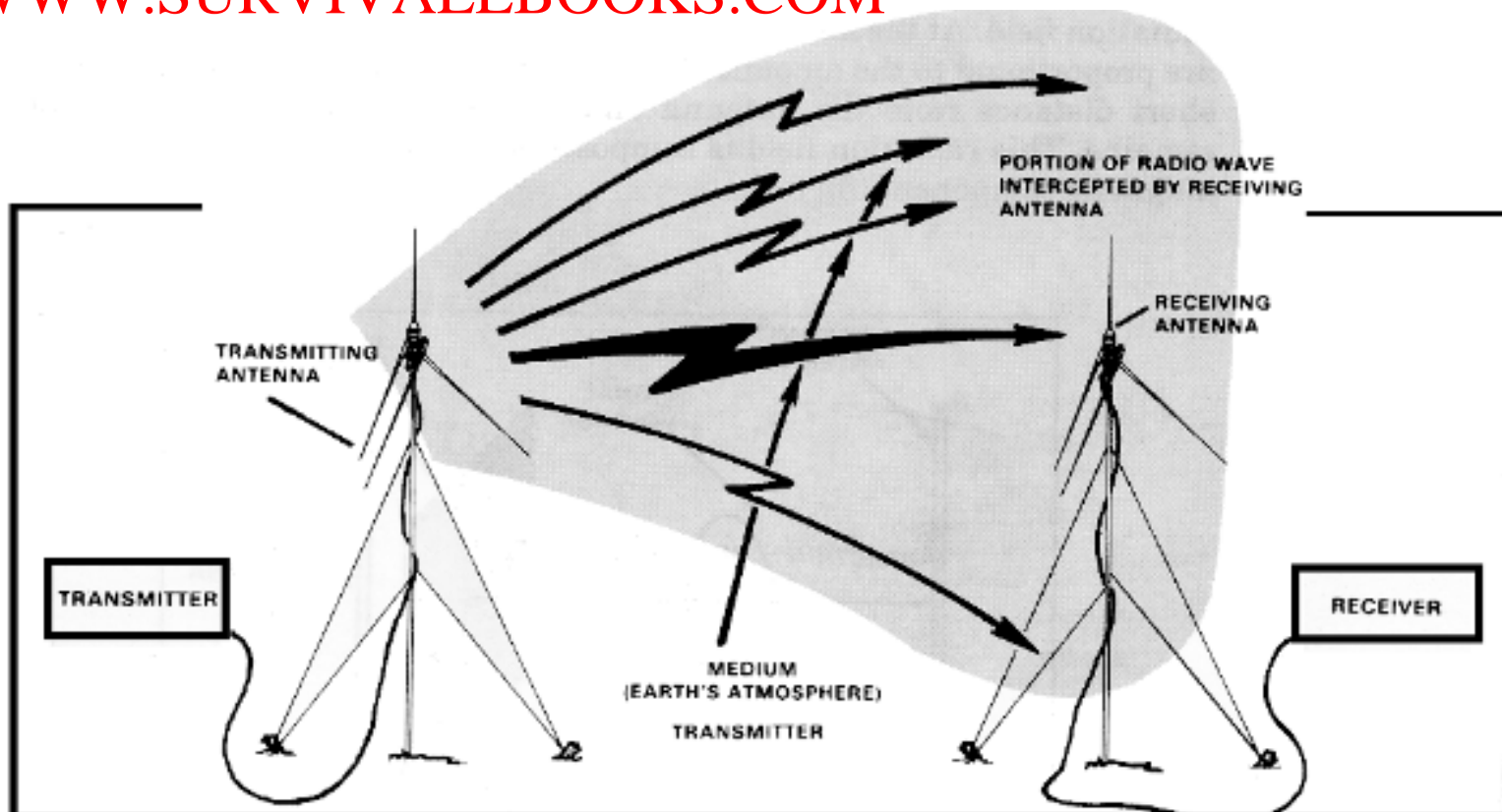

Figure 3-1. Simple radio communications network.

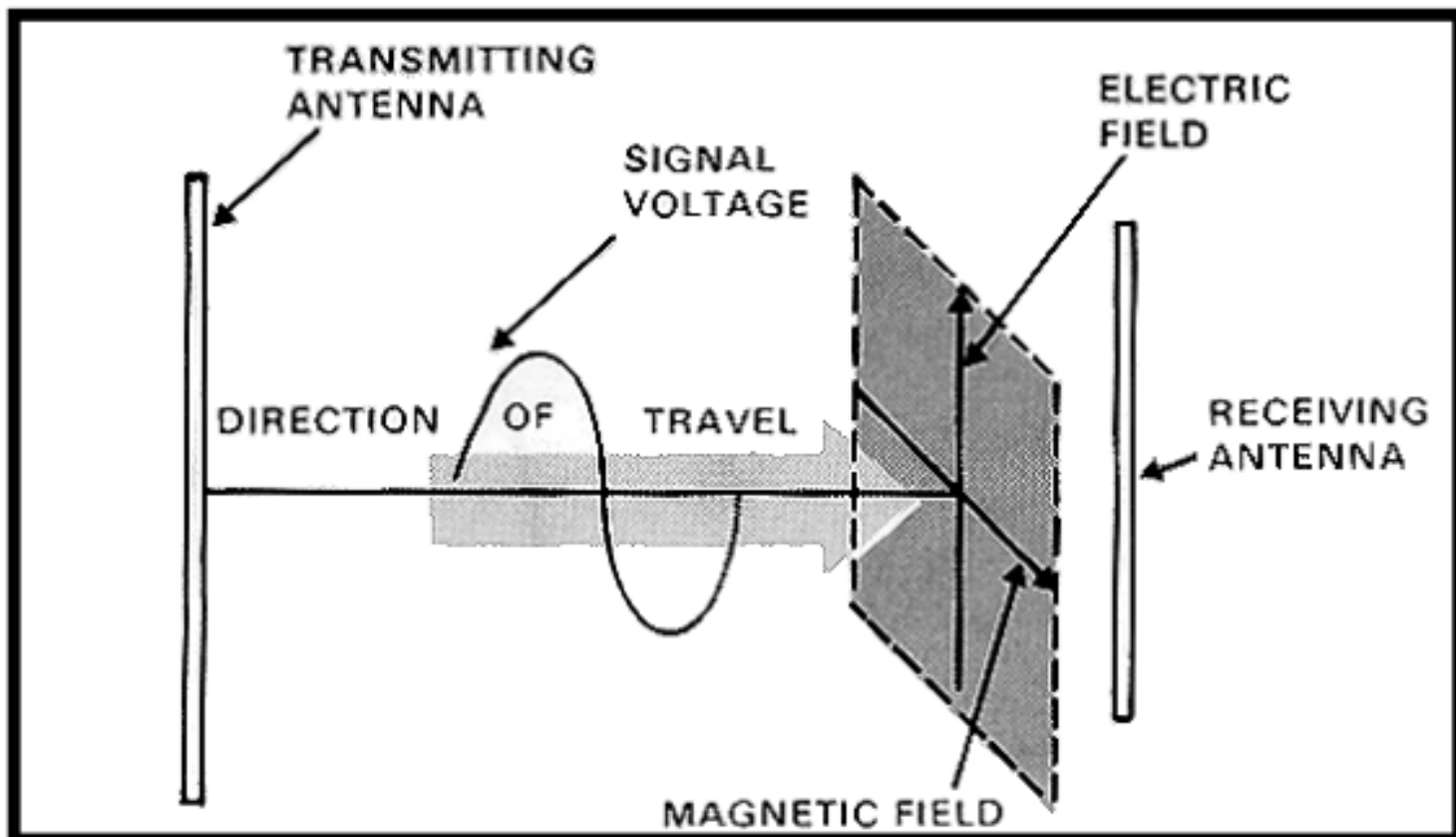

Figure 3-2. Components of electromagnetic waves.

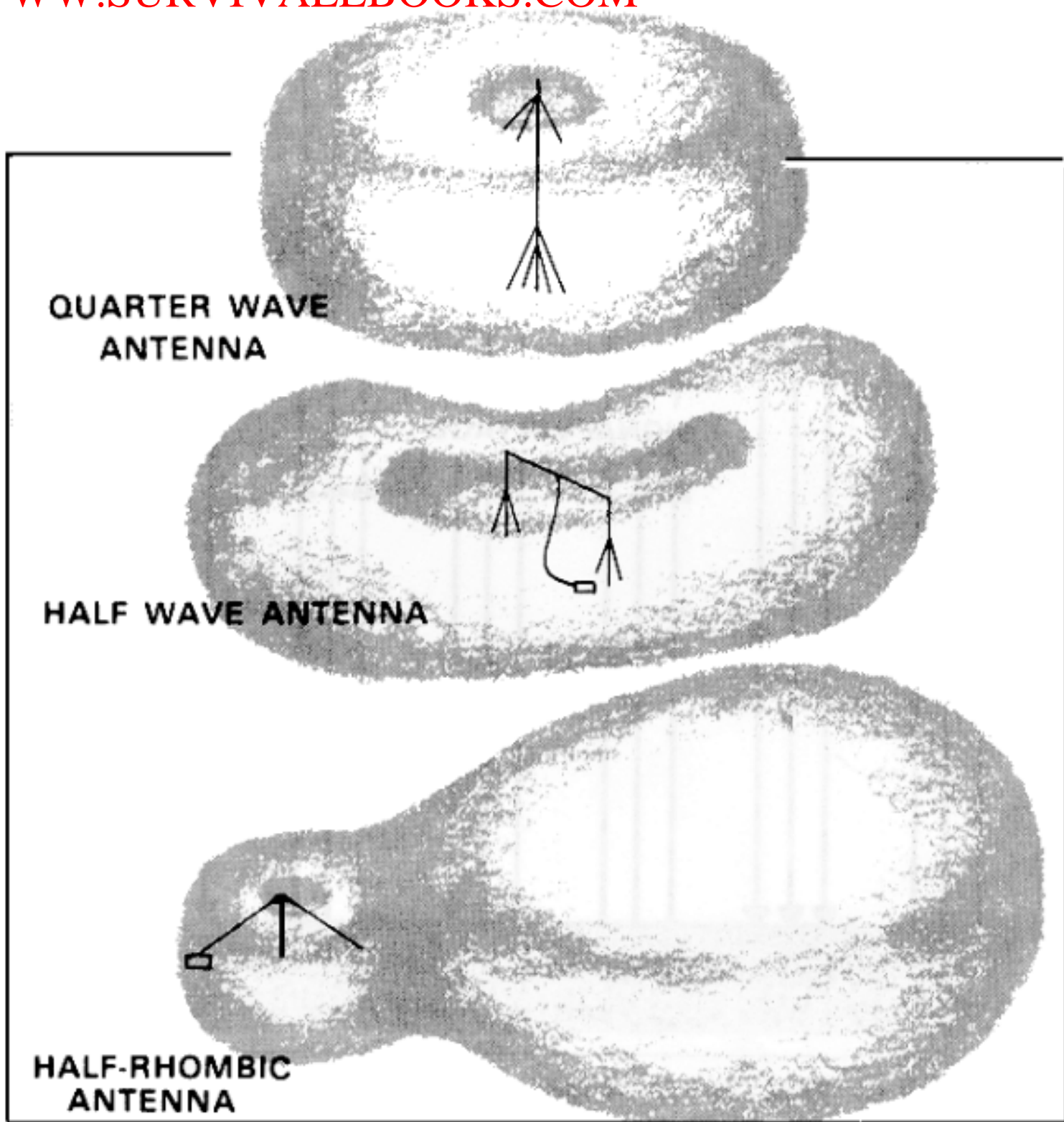

Figure 3-3. Solid radiation patterns from quarter-wave, half-wave, and vertical half-rhombic antennas.

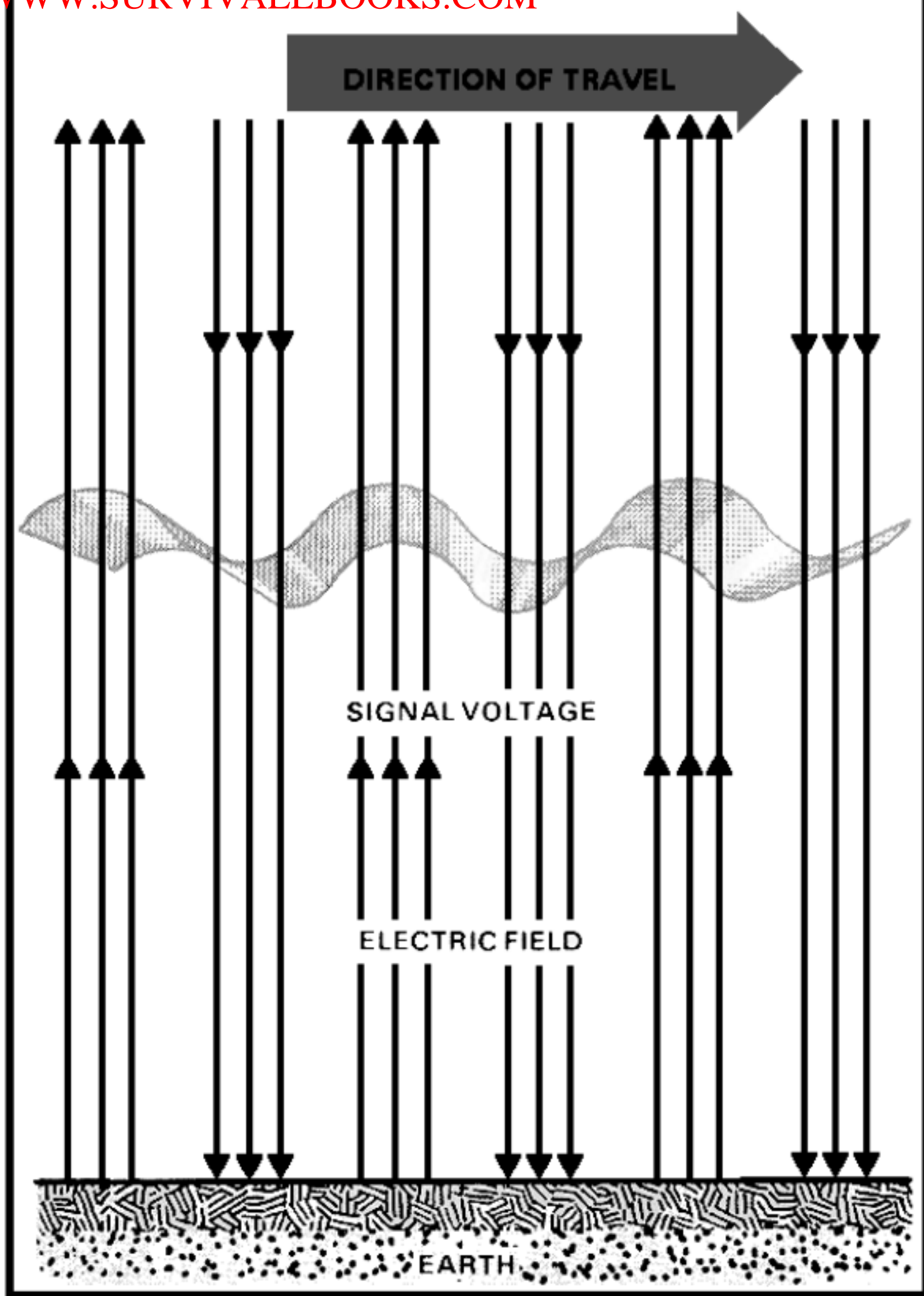

Figure 3-4. Vertically polarized signal.

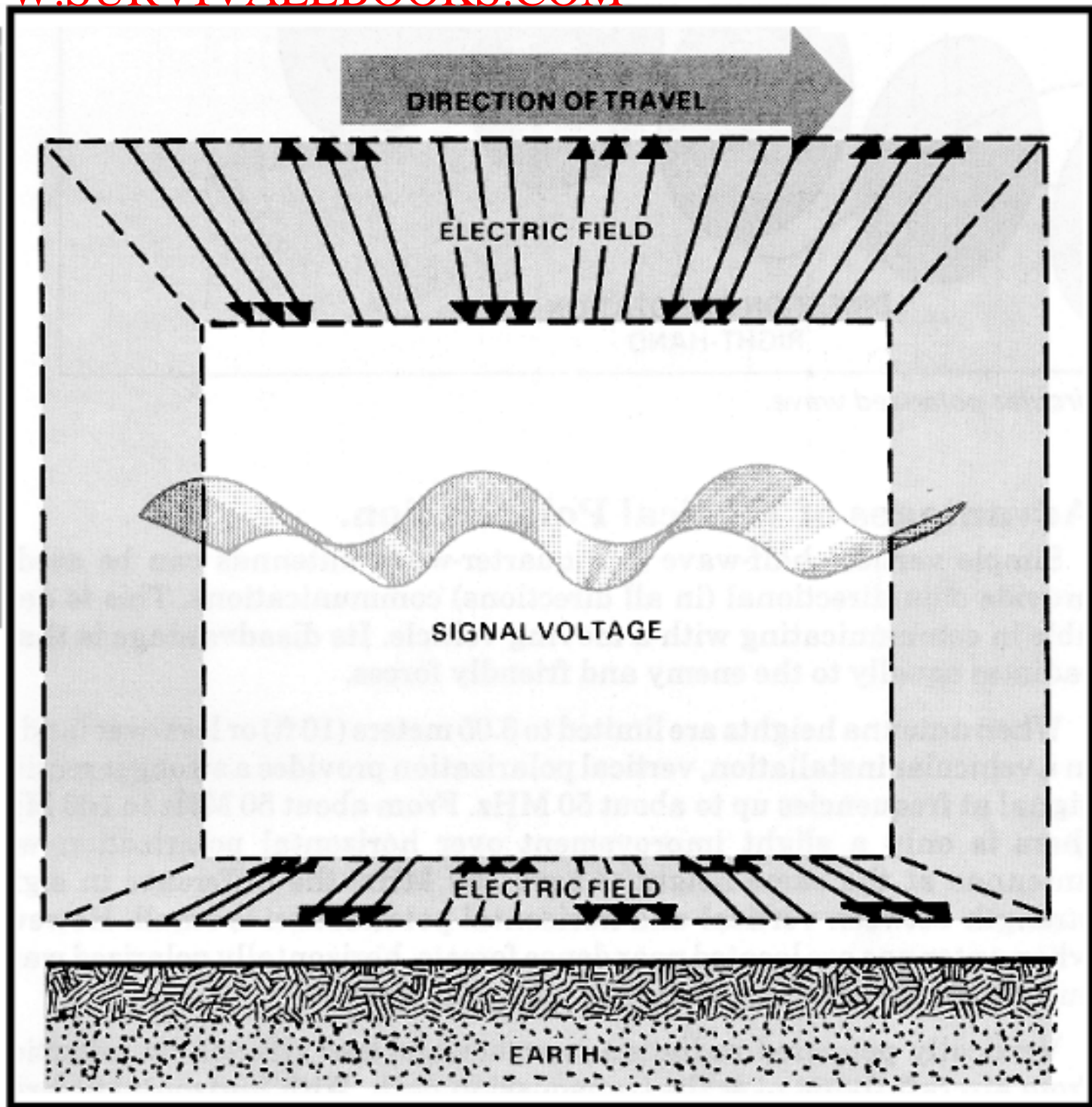

Figure 3-5. Horizontally polarized signal.

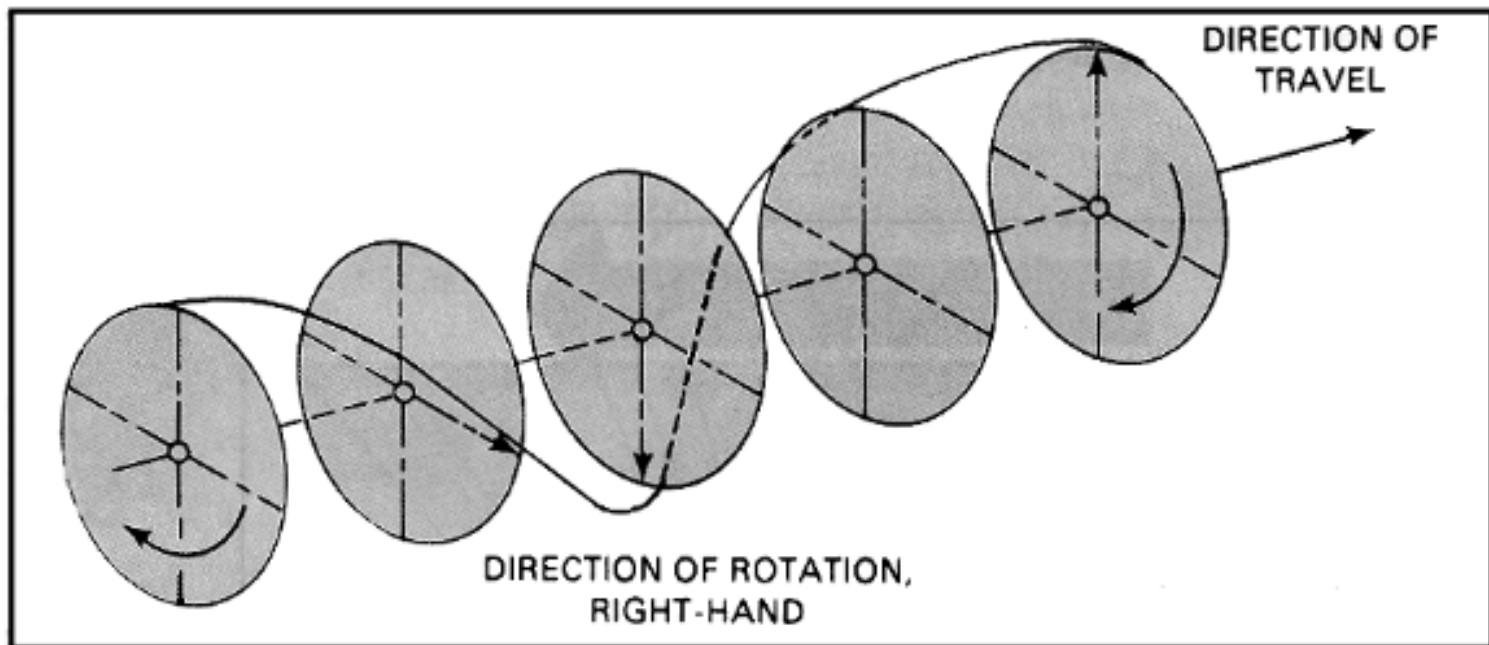

Figure 3-6. Circular polarized wave.

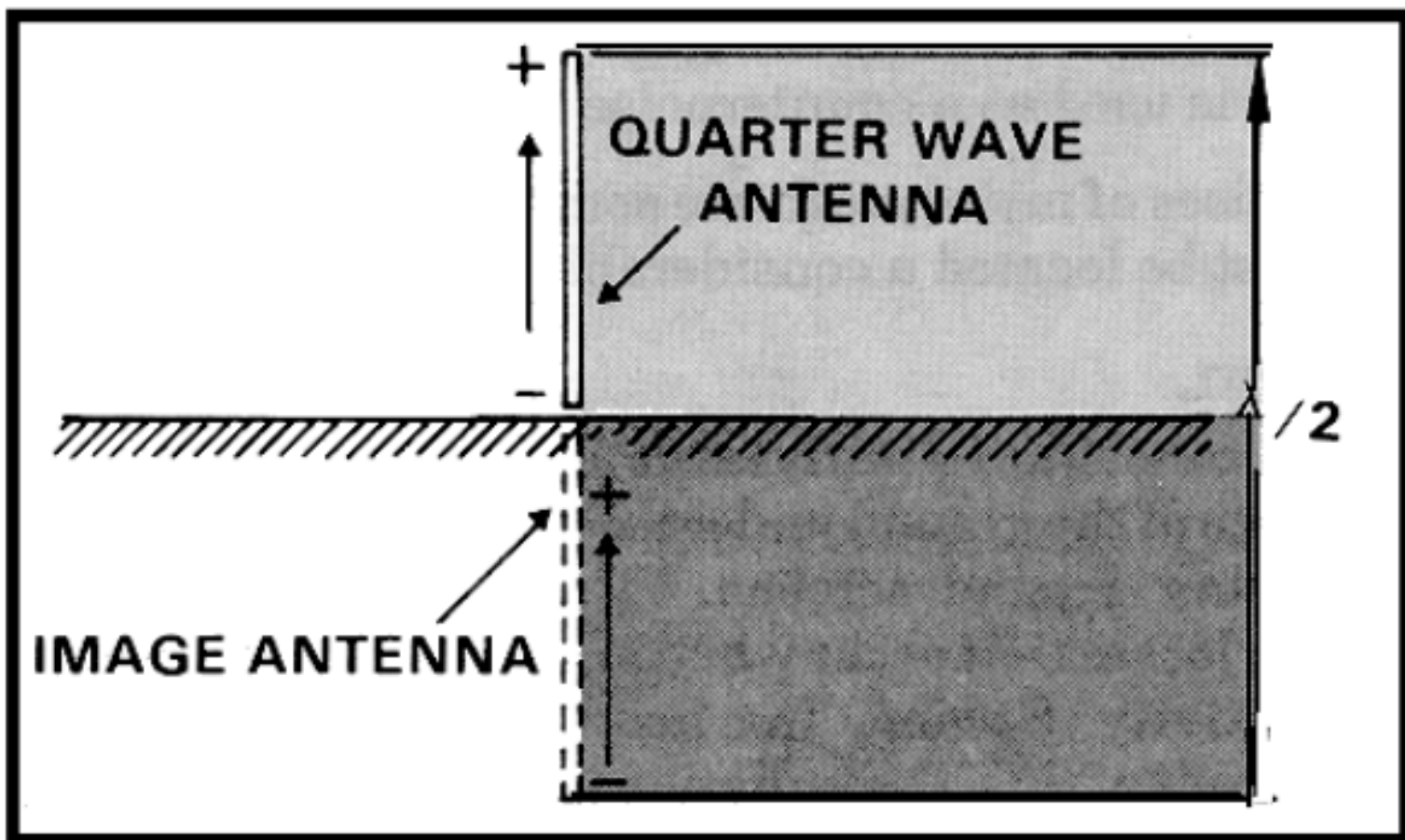

Figure 3-7. Quarter-wave antenna connected to ground.

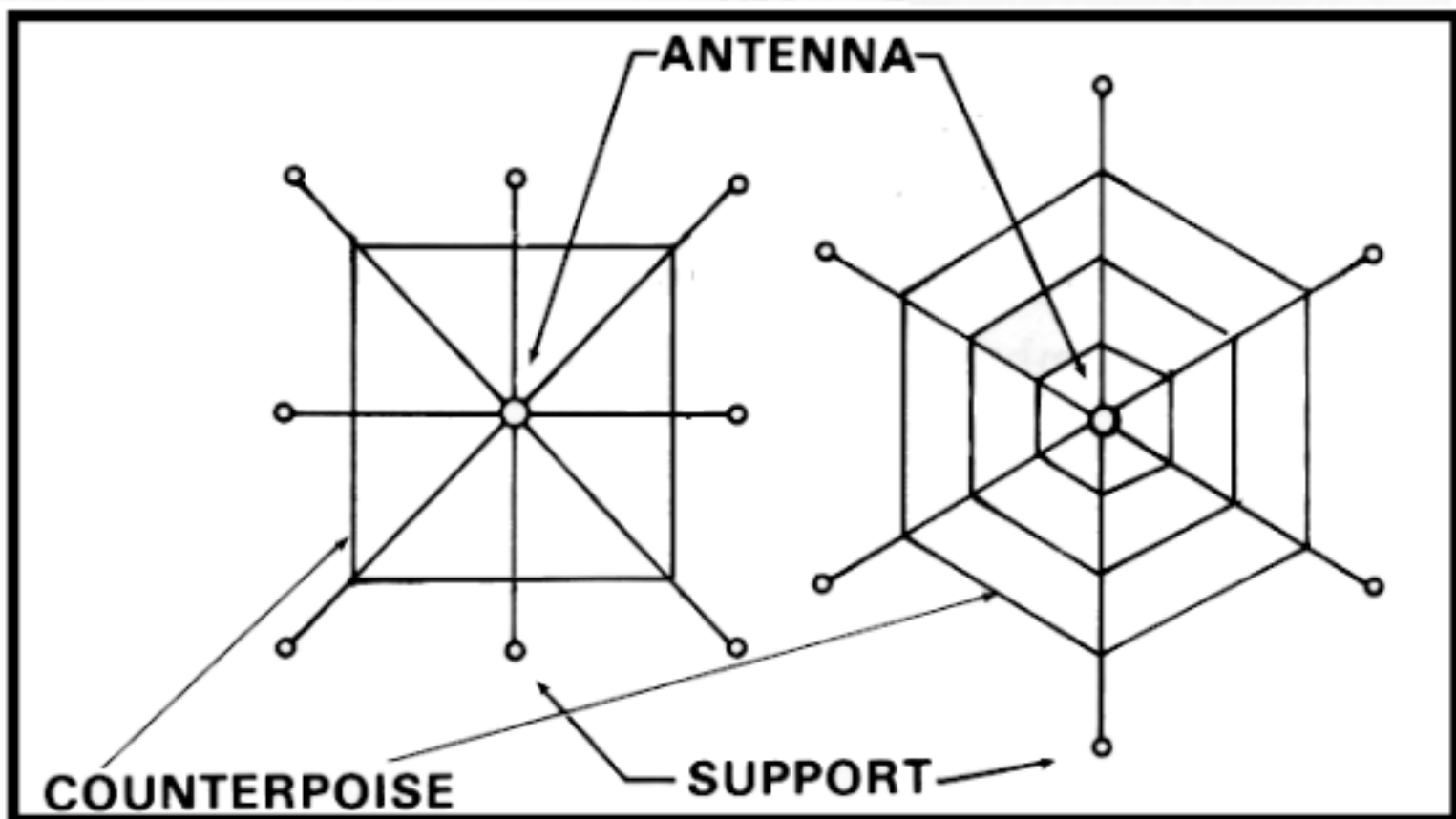

Figure 3-8. Wire counterpoise.

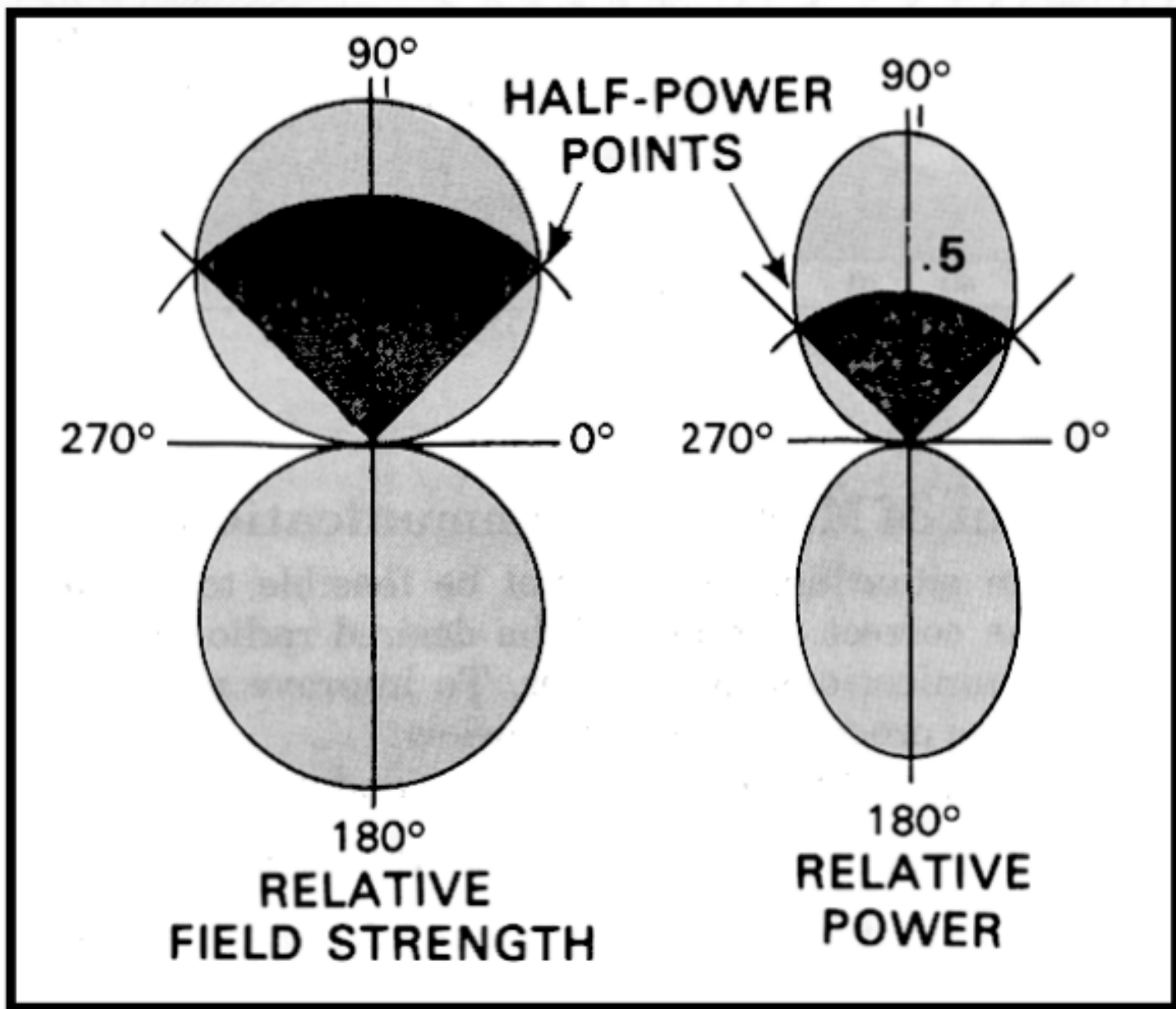

Figure 3-9. Beam width measured on relative field strength and relative power patterns.

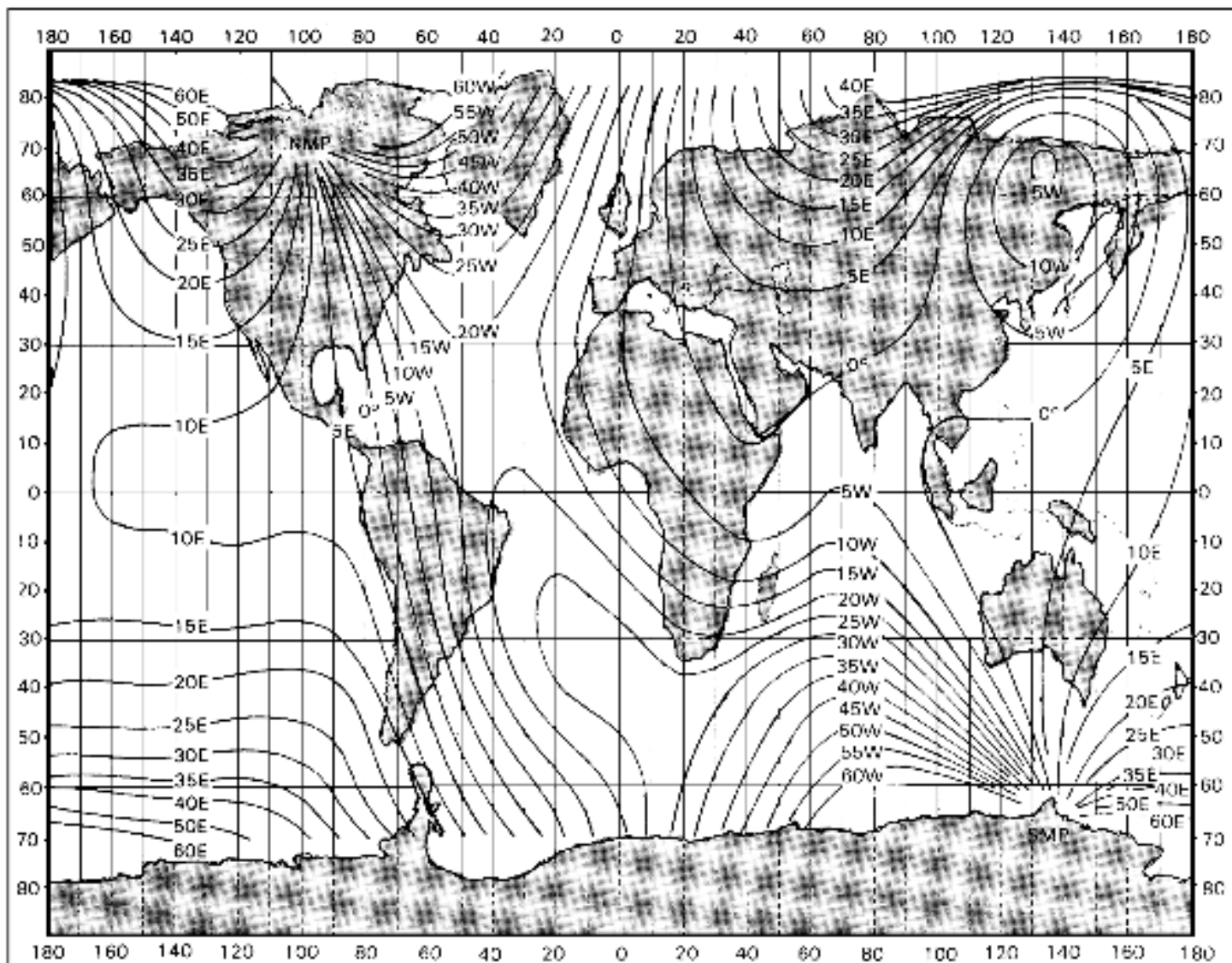

Figure 3-10. Magnetic declination over the world.

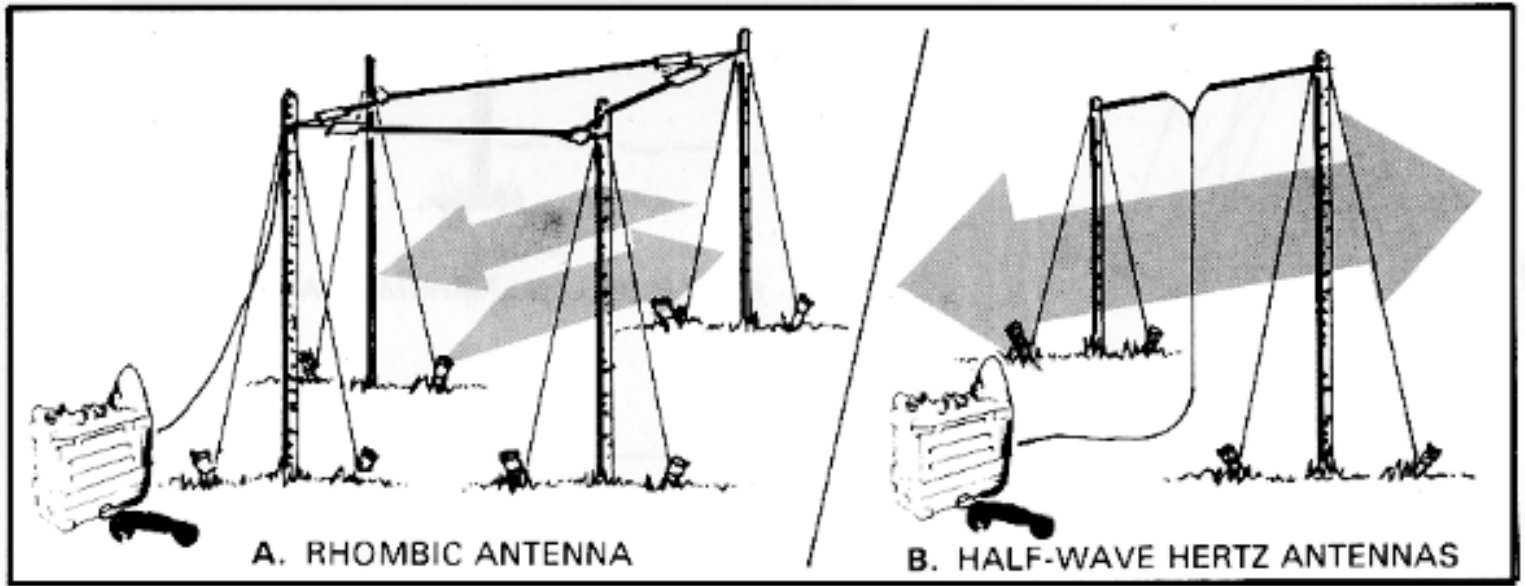

Figure 3-11. Types of antennas.

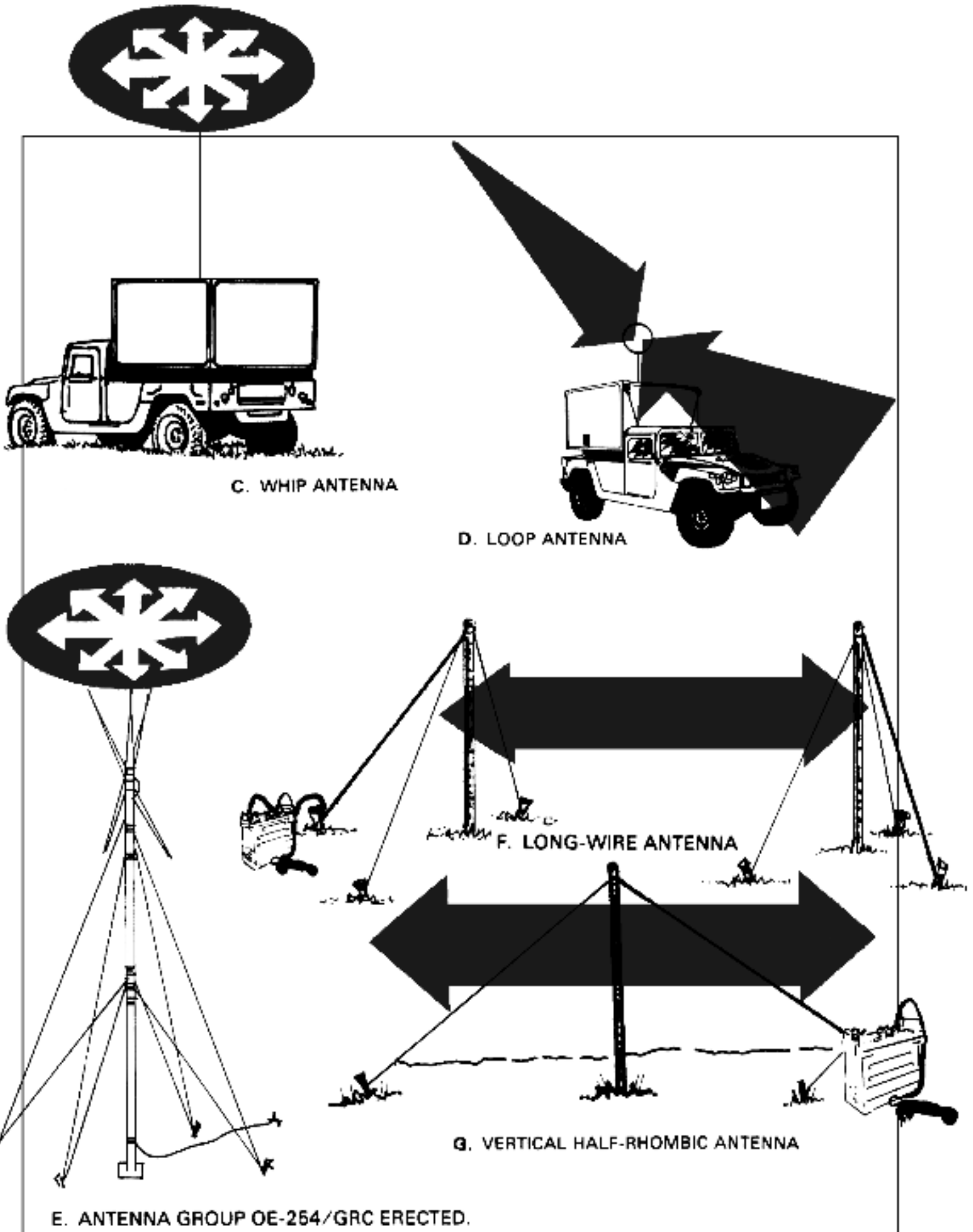

Figure 3-11. Types of antennas (cont.)

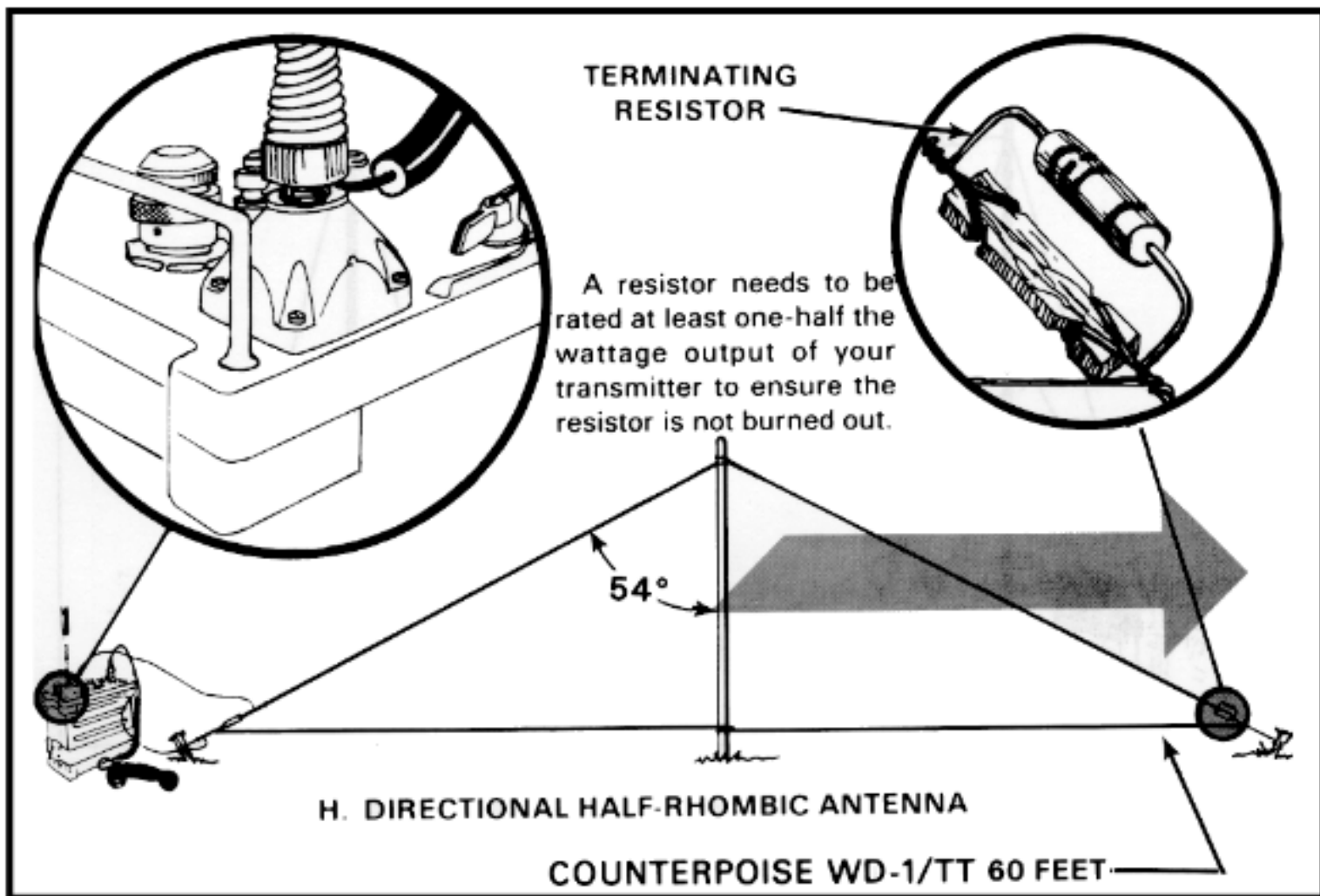

Figure 3-11. Types of antennas (cont).

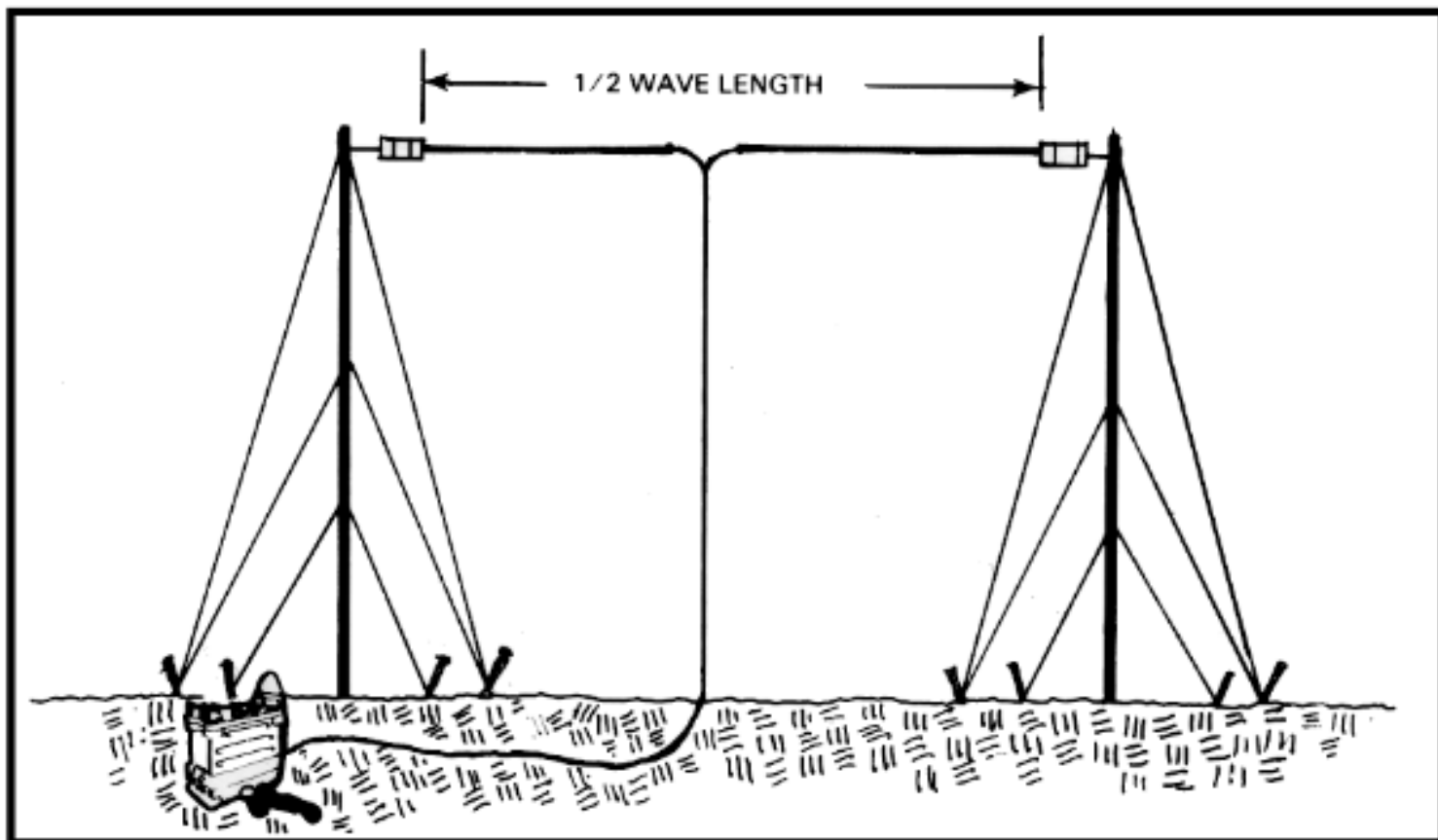

Figure 3-12. Center-fed Hertz antenna with two upright supports.

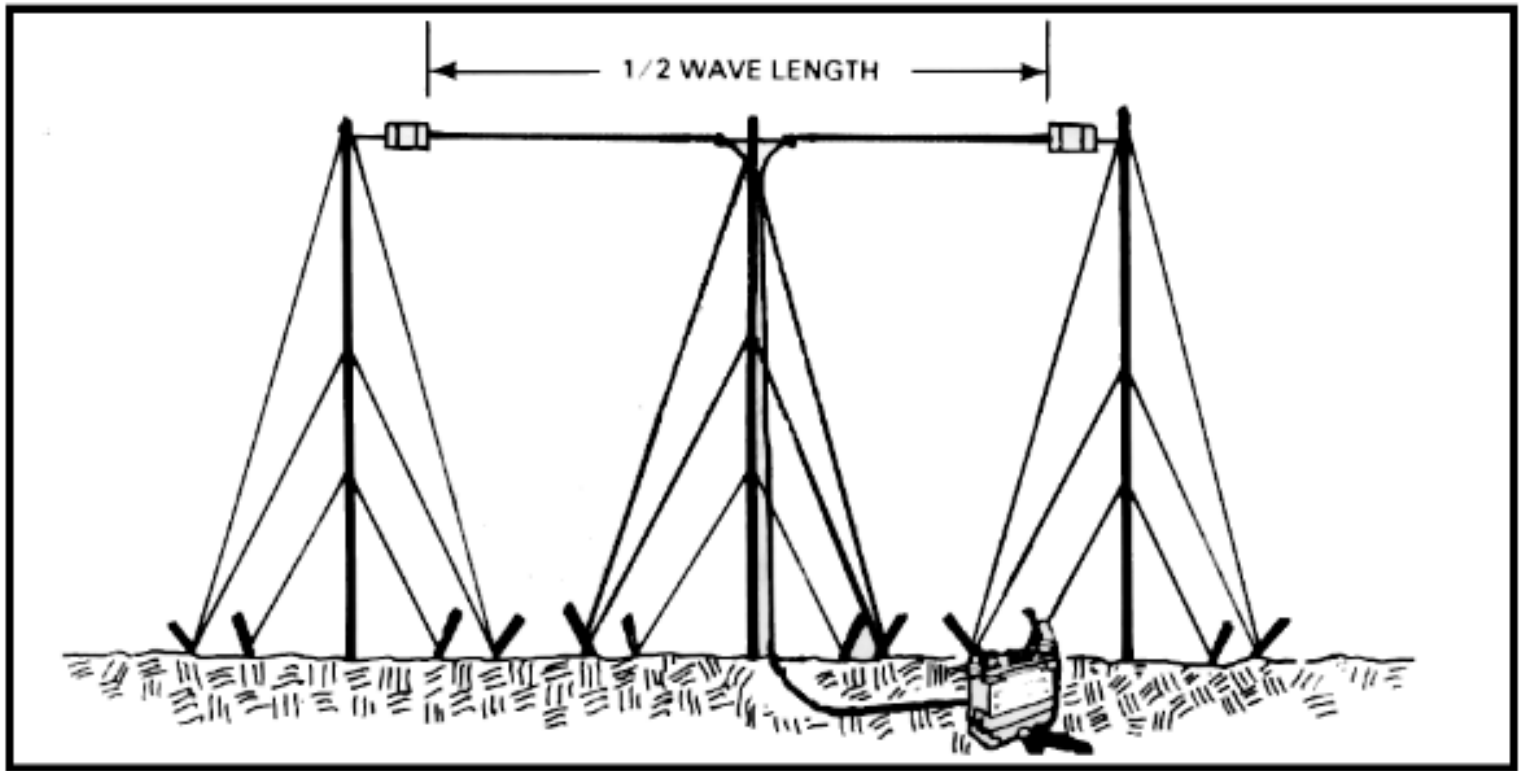

Figure 3-13. Center-fed Hertz antenna with three upright supports.

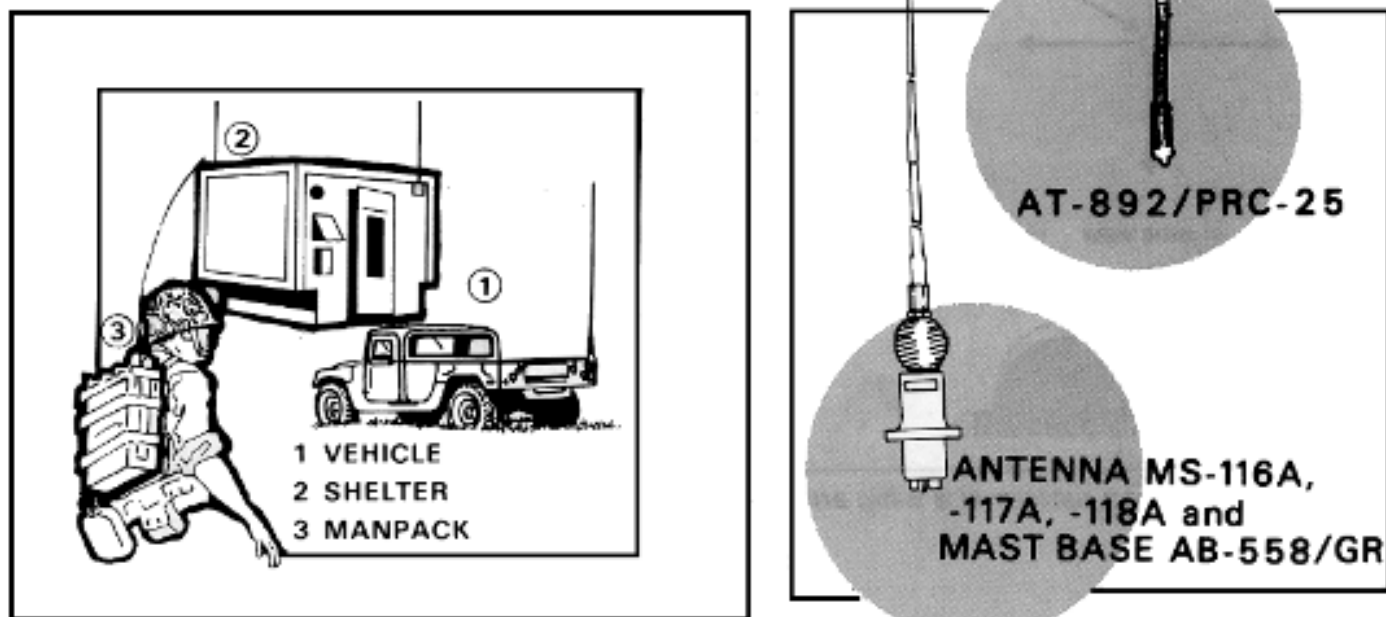

Figure 3-14. Common types of whip antennas.

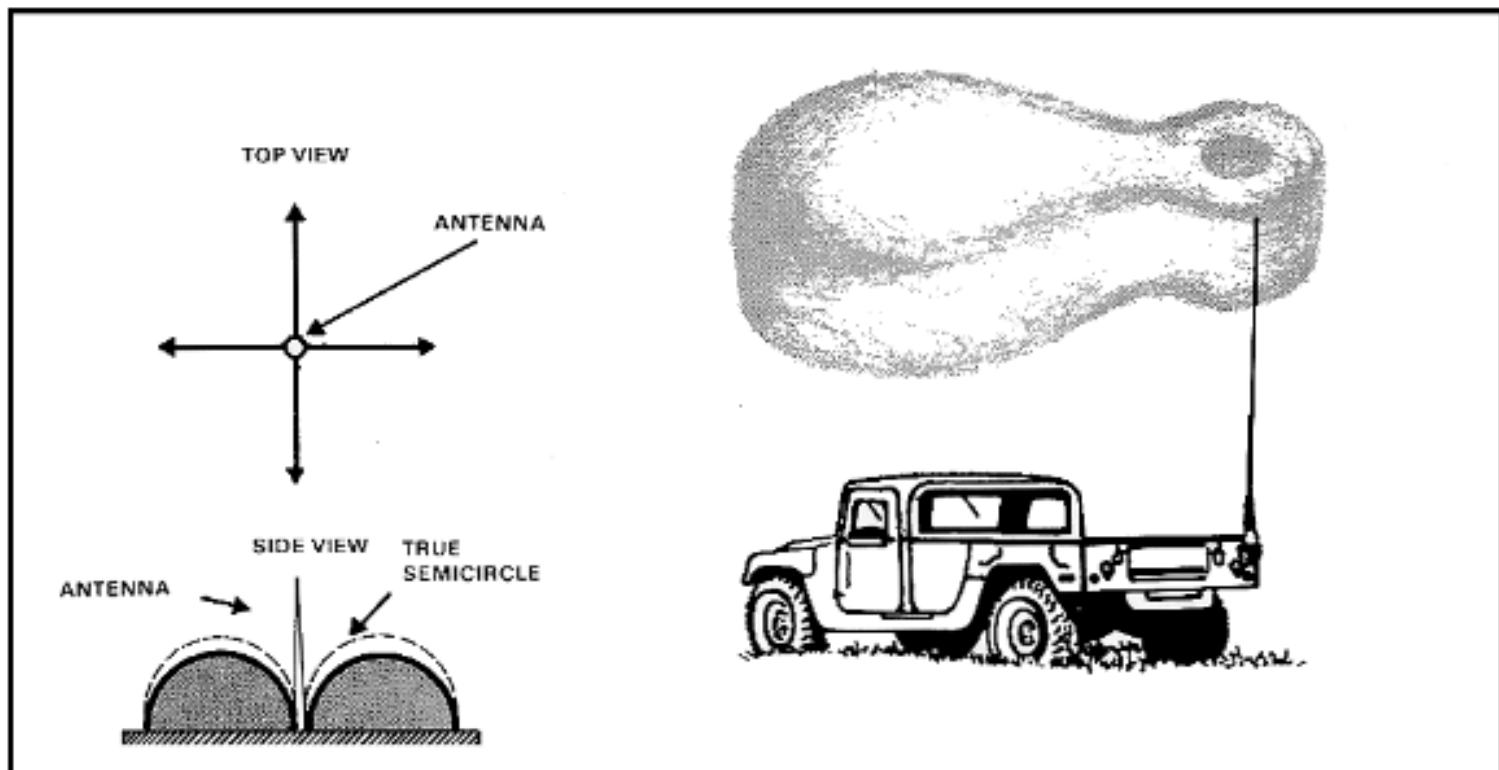

Figure 3-15. Radiation pattern of a whip antenna.

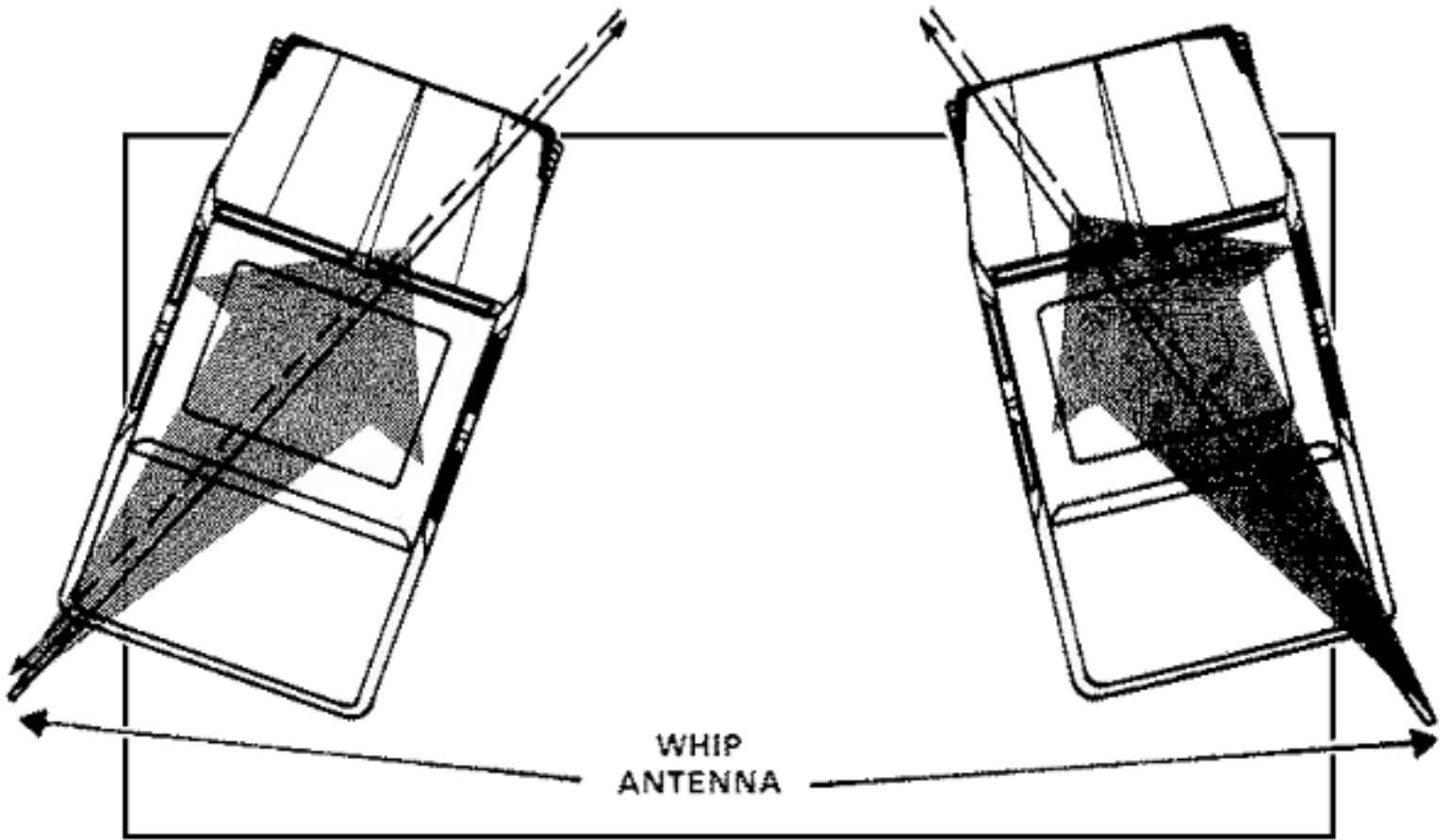

Figure 3-16. Best directivity of whip antenna mounted on vehicle.

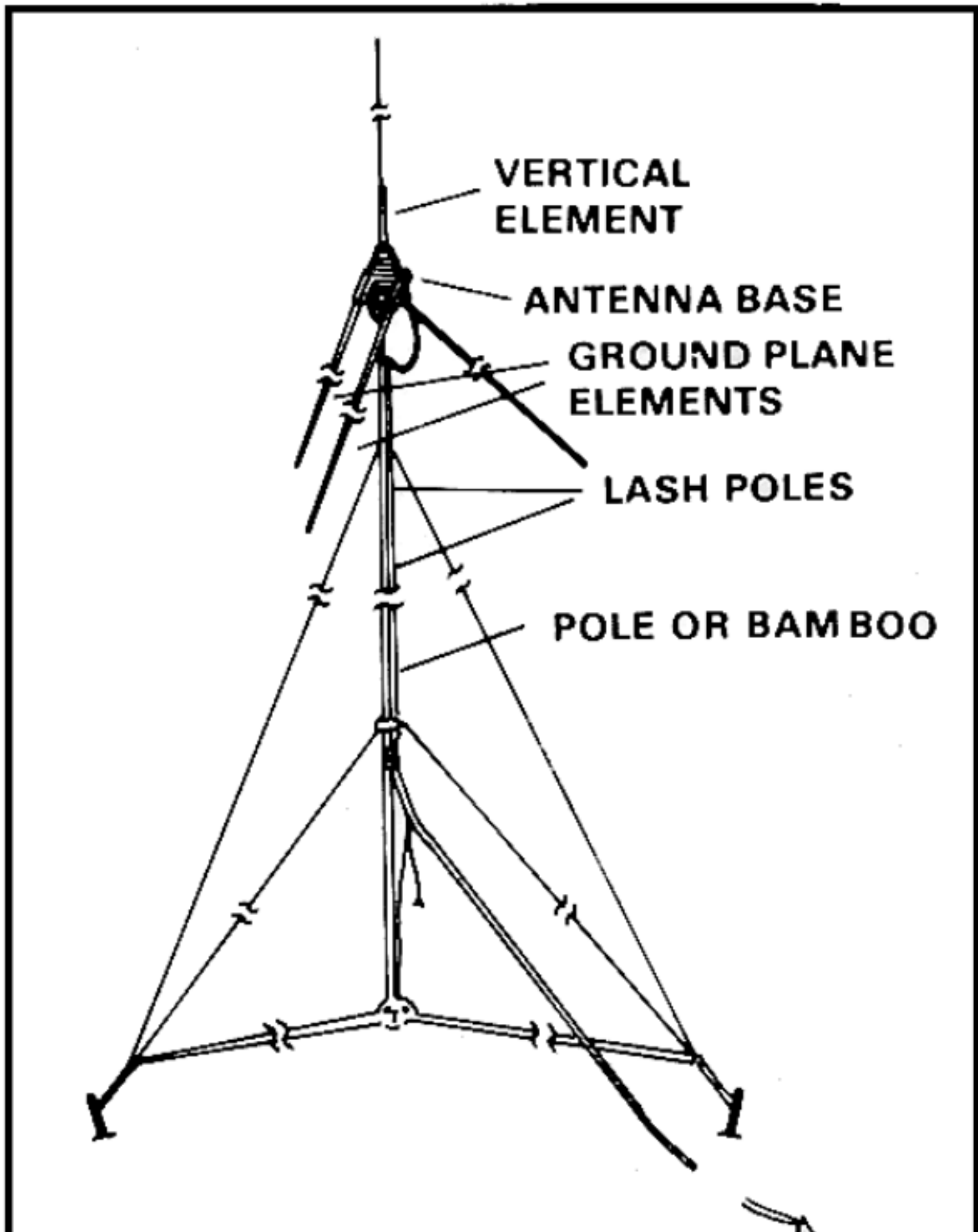

Figure 3-17

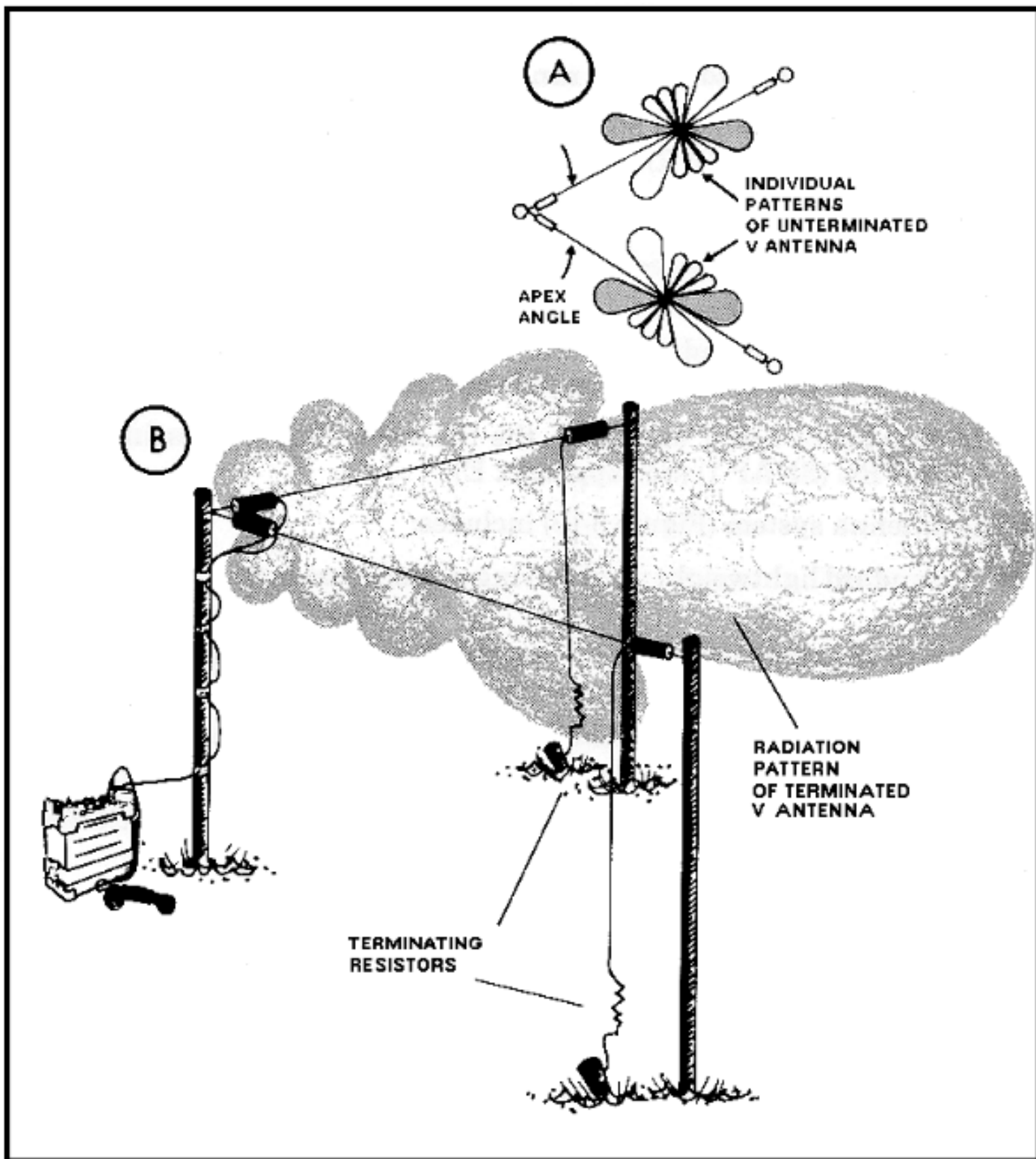

Figure 3-18. Radiation pattern of V antenna.

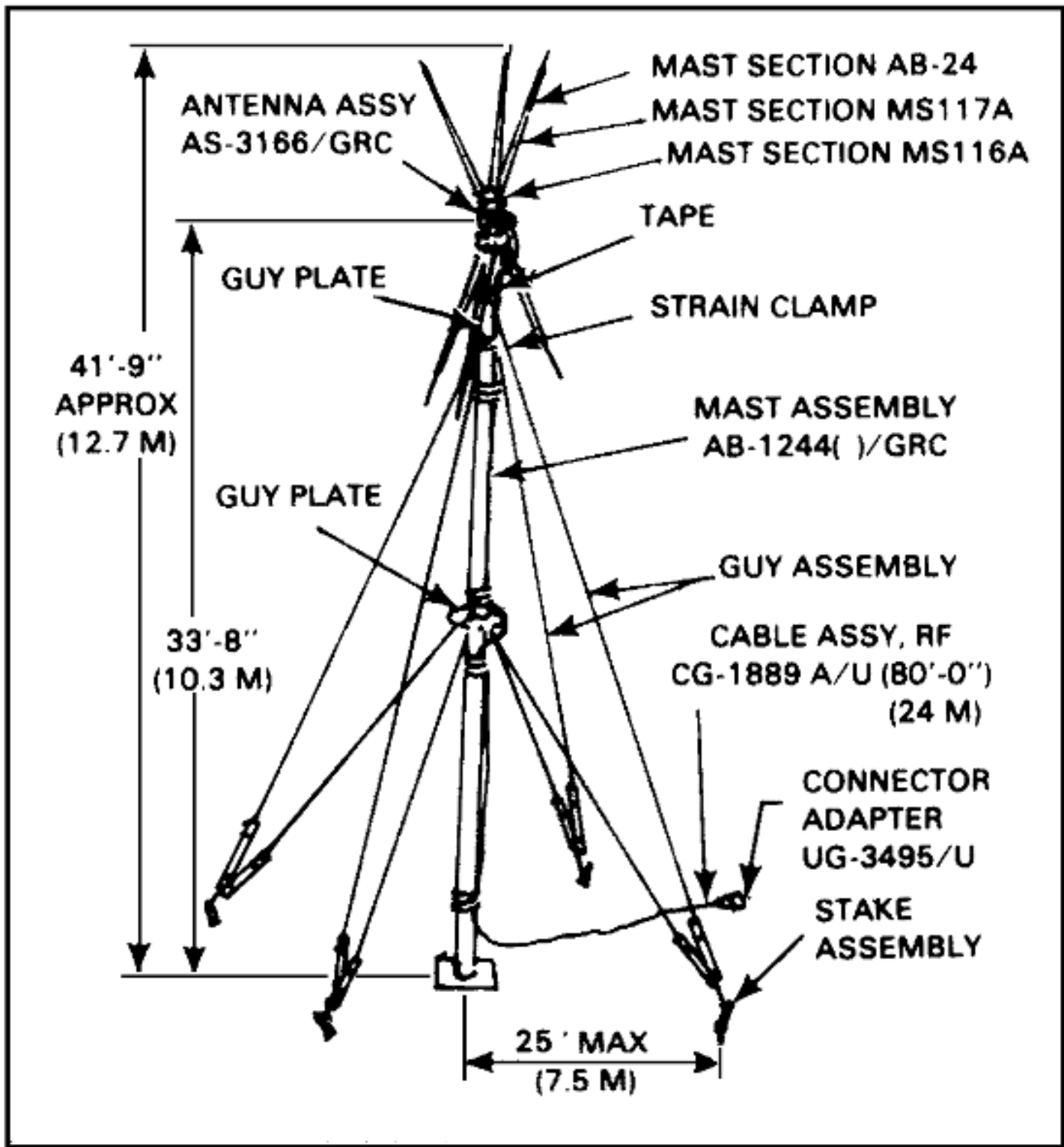

Figure 3-19. Broadband omnidirectional antenna system OE-254.

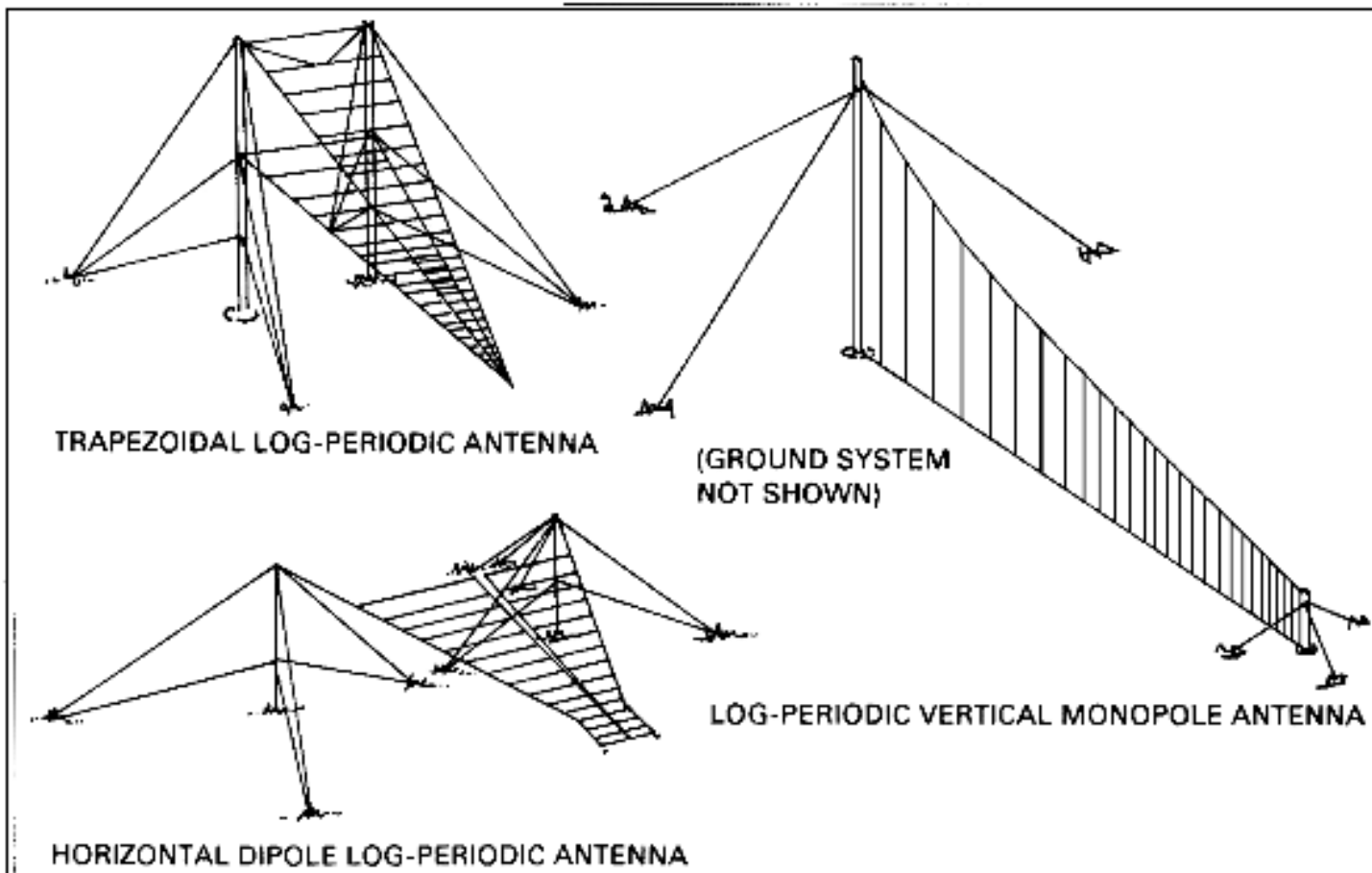

Figure 3-20. Log periodic antenna.

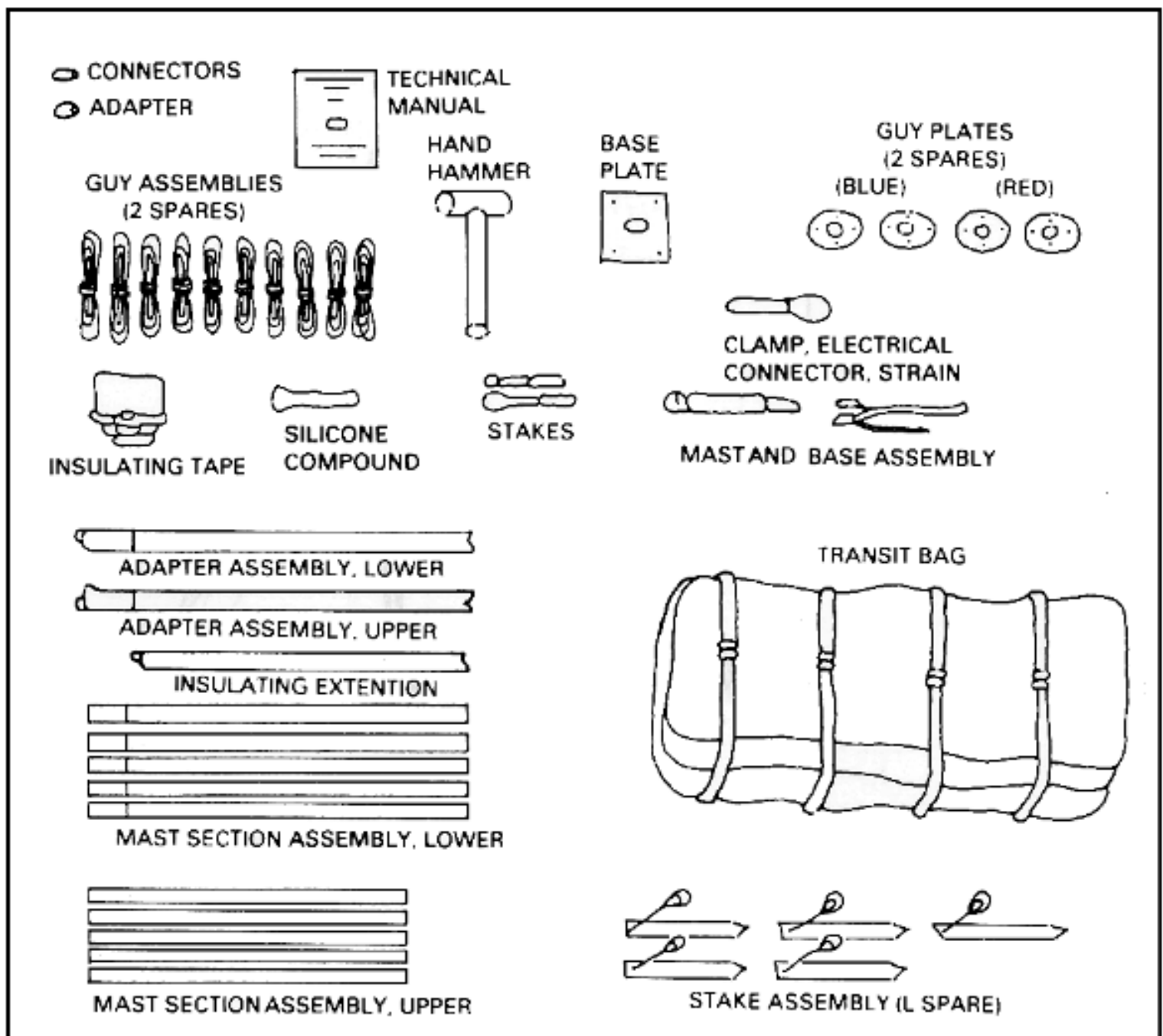

Figure 3-21. OE-303 antenna mast assembly (AB-1244()/GRC).

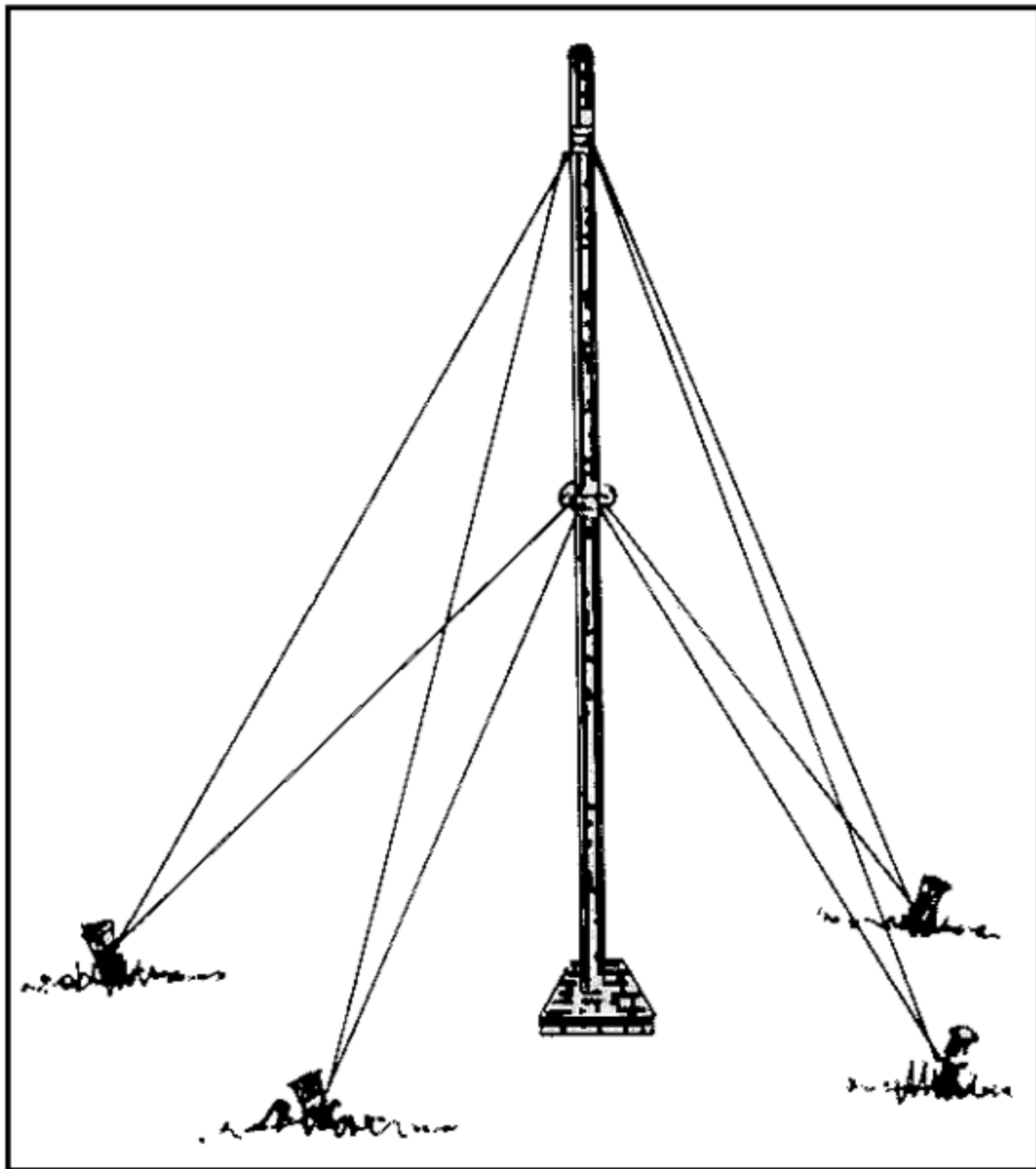

Figure 3-22. Erected mast assembly, less antenna.

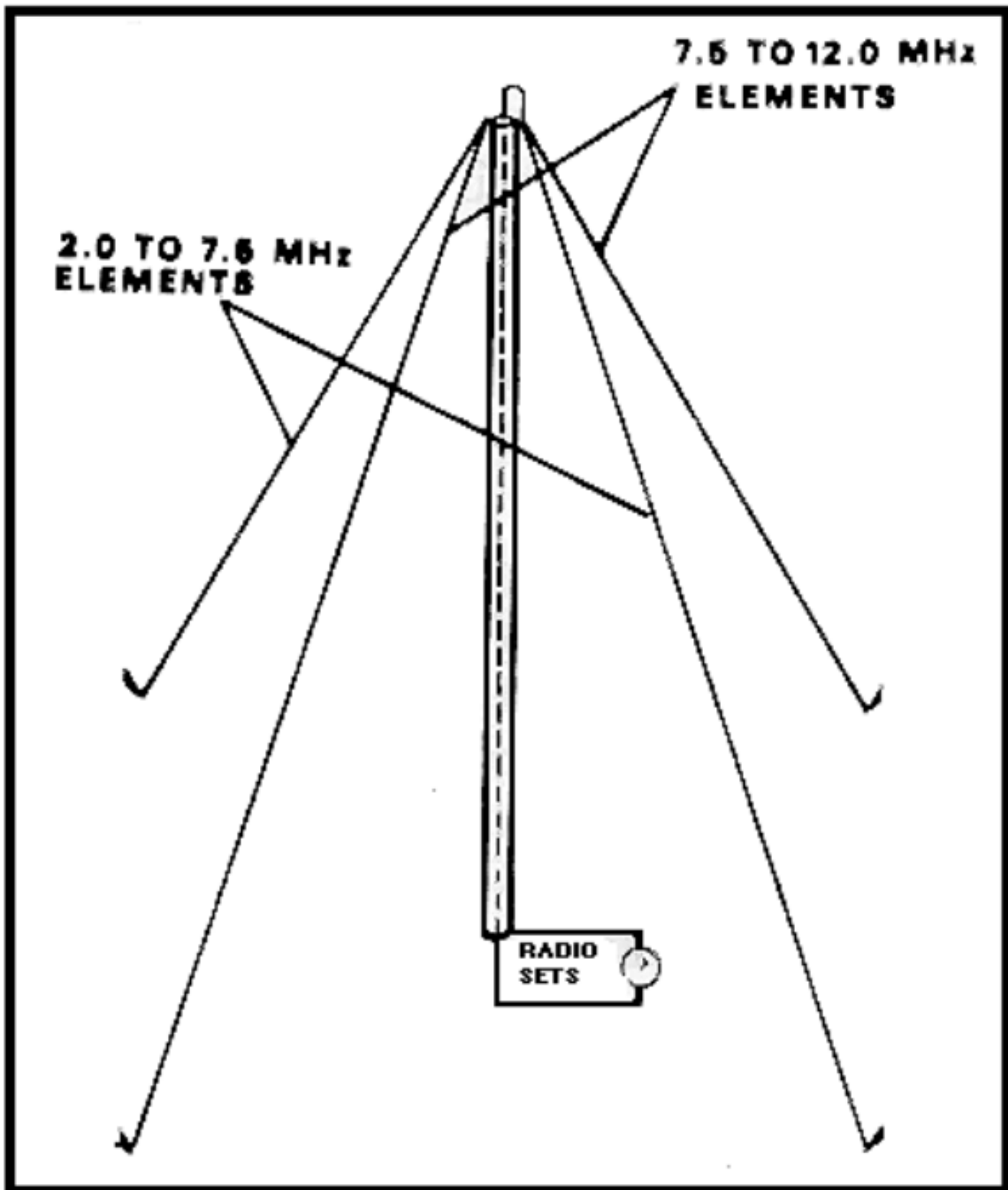

Figure 3-23. NVIS antenna, AS-2259/GR.

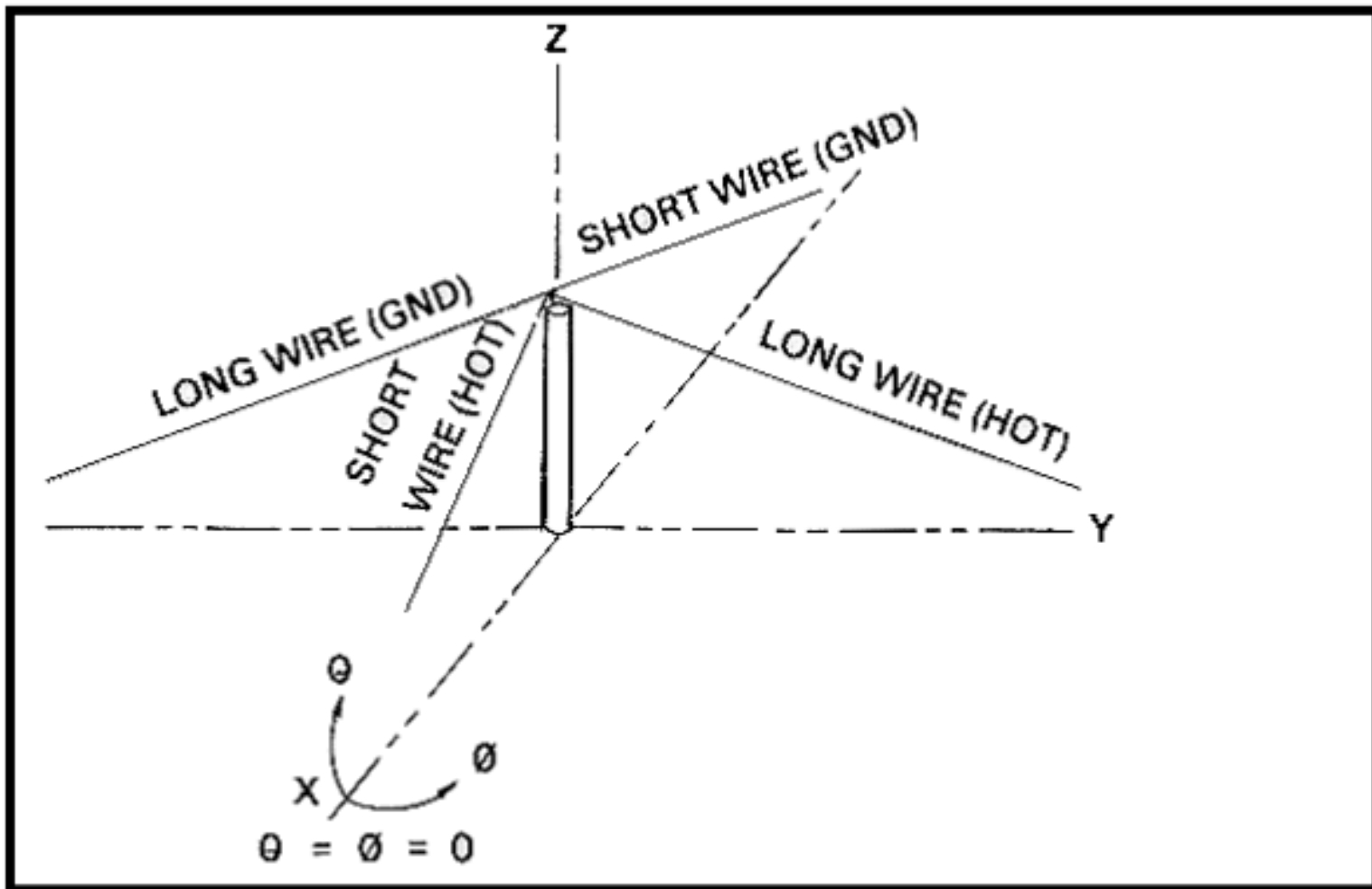

Figure 3-24. Physical configuration and coordinate location of elements of AS-2259/GR antenna.

Table 3-1. Specifications of NVIS Antenna AS-2259/GR.

Frequency range	2 to 12 MHz (NVIS mode) (2 to 30 MHz with antenna tuner)
Polarization	Horizontal and vertical simultaneously
Impedance	Requires coupler
Power handling capability	1000 watts PEP or 500 watts average
Gain	Comparable to dipole mounted horizontally 10 feet above same type ground
Radiation pattern:	
Azimuth	Omnidirectional
Elevation	Near-vertical incidence, typical
Input RF connector	$\frac{3}{8}$ -16 UNC2A x $\frac{1}{2}$ inch stud with ground strap on mast base
Wind and ice loading	60-MPH wind with no ice
Overall height	15 feet (4.6M)
Installed area	61 x 61 feet (18.6 x 18.6M)
Transit container	Canvas "tool roll"
Storage volume	0.44 Cu. feet (0.01 Cu. M)
Weight	12 pounds (5.44 kG)
Erection time	2 men, 5 minutes

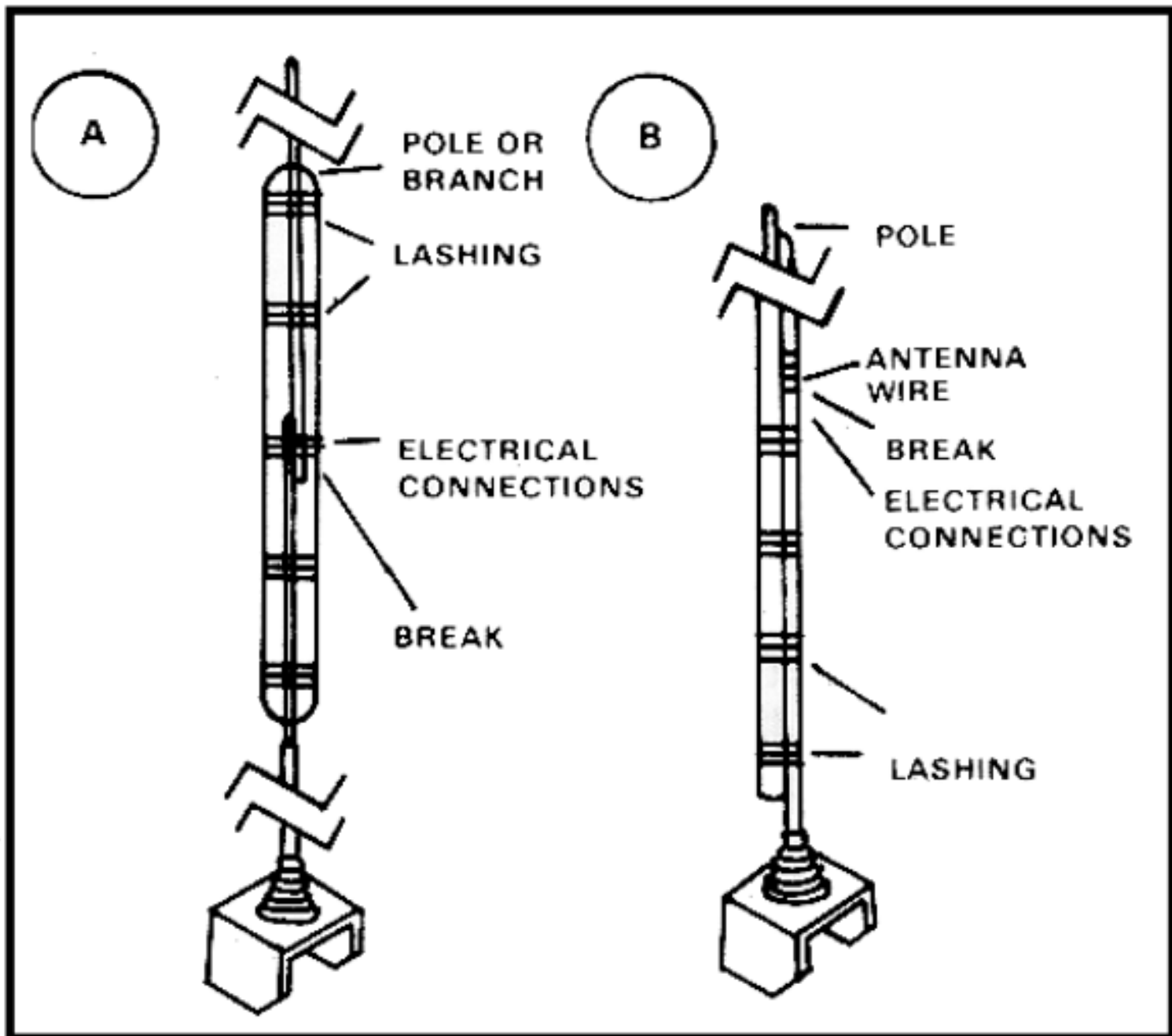

Figure 3-25. Emergency repair of broken whip antenna.

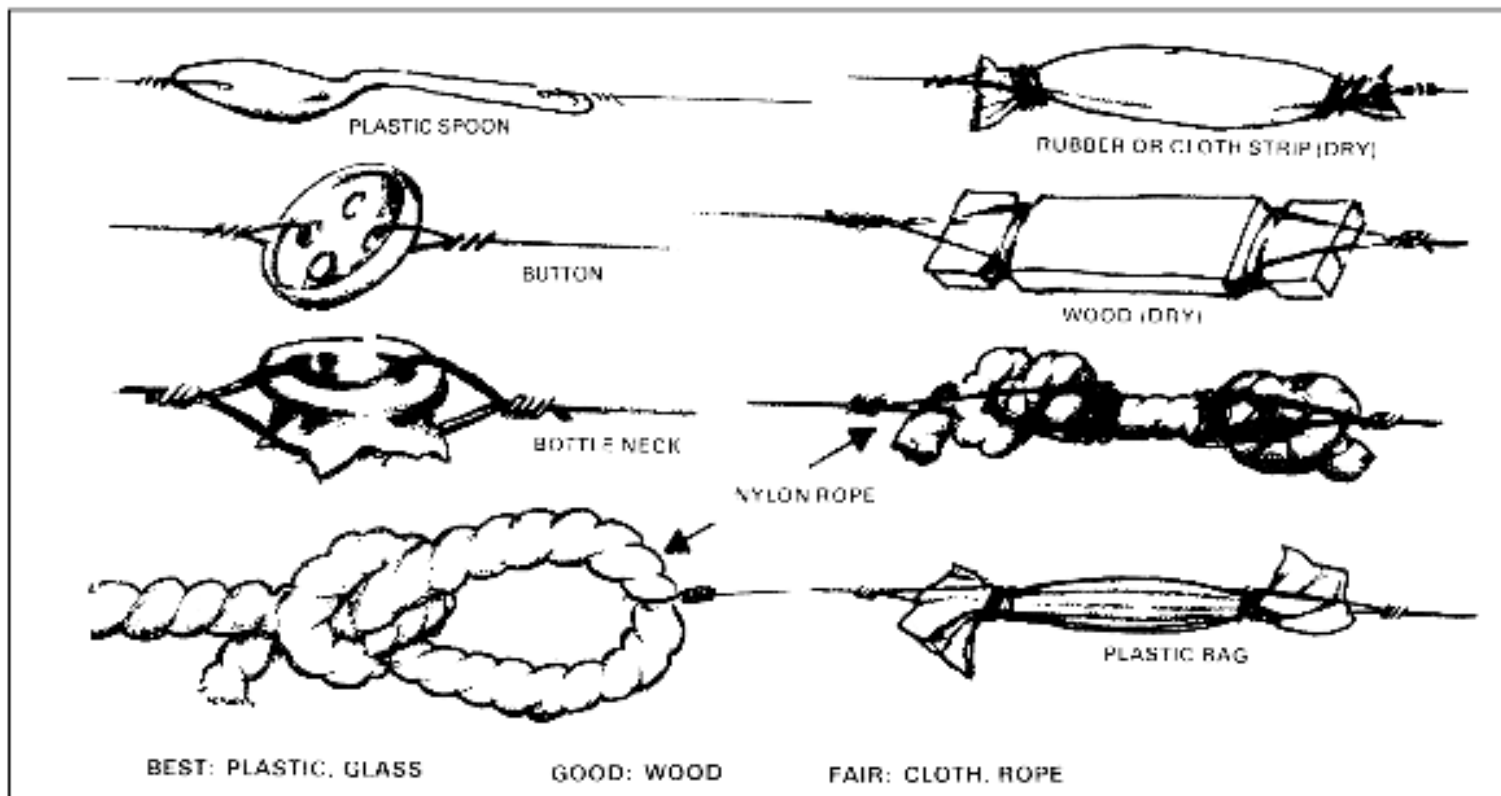

Figure 3-26. Improvised insulators.

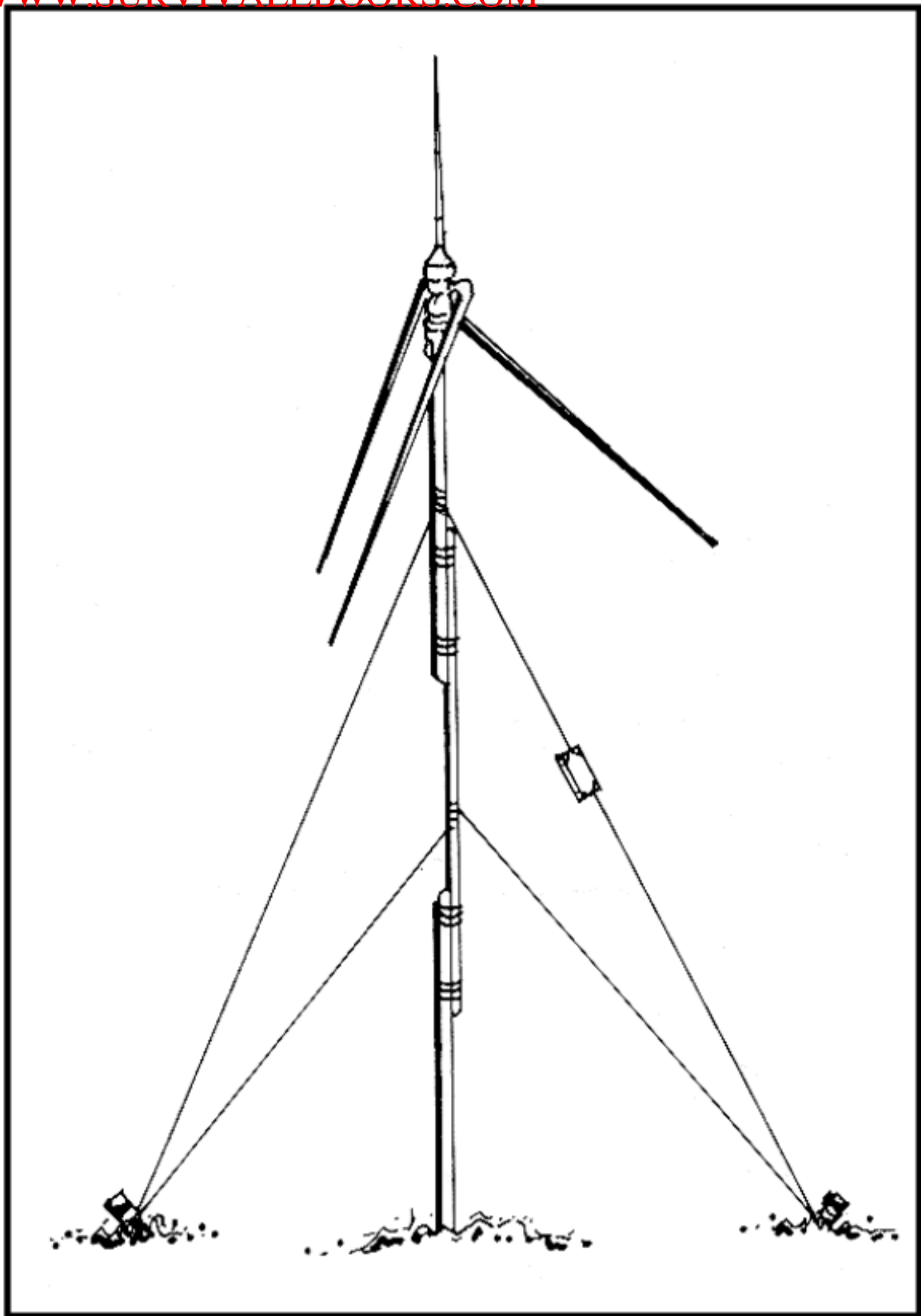

Figure 3-27. Repaired guy lines and masts.

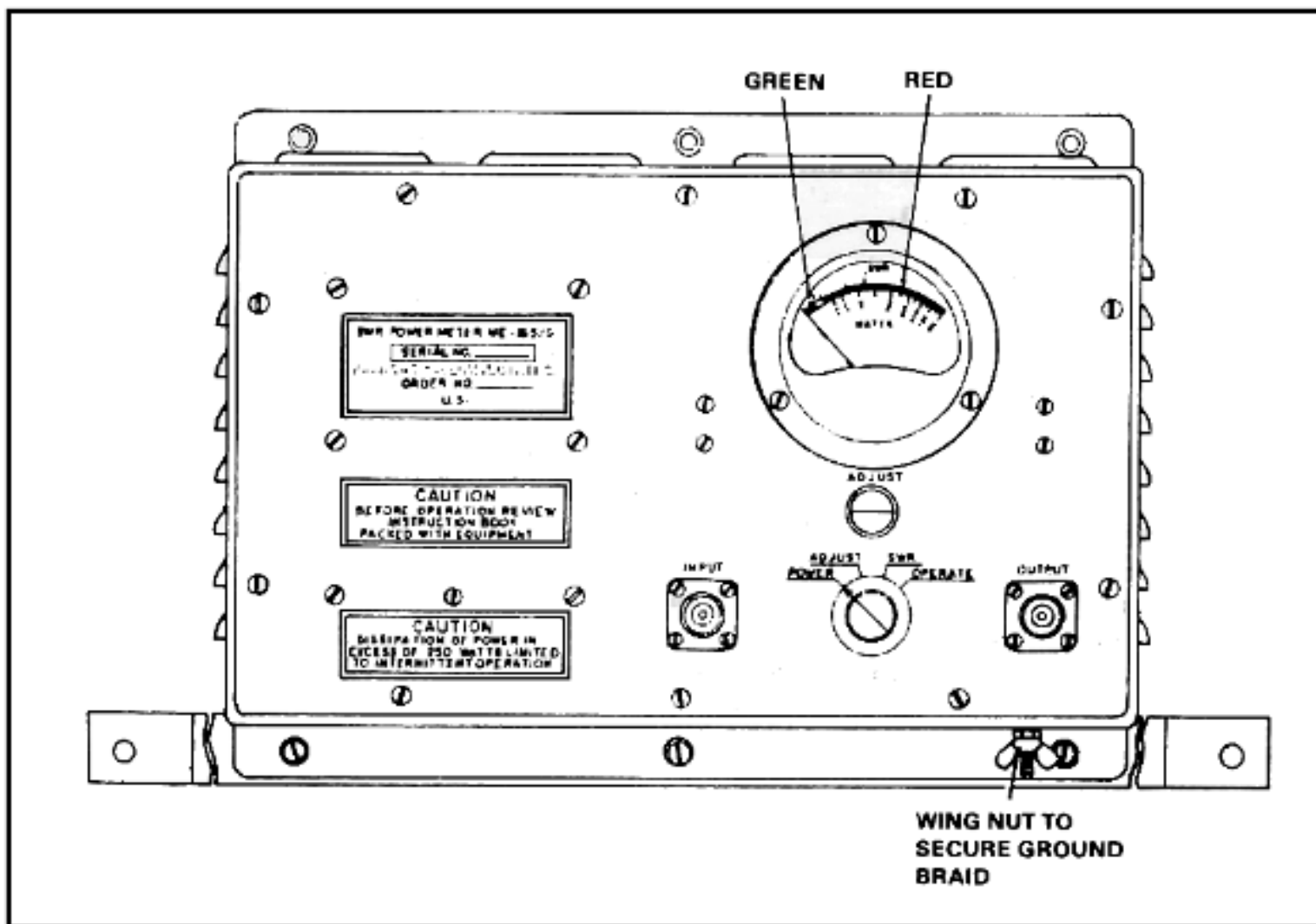

Figure 3-28. Standing-wave Ratio Power Meter ME-165/G.

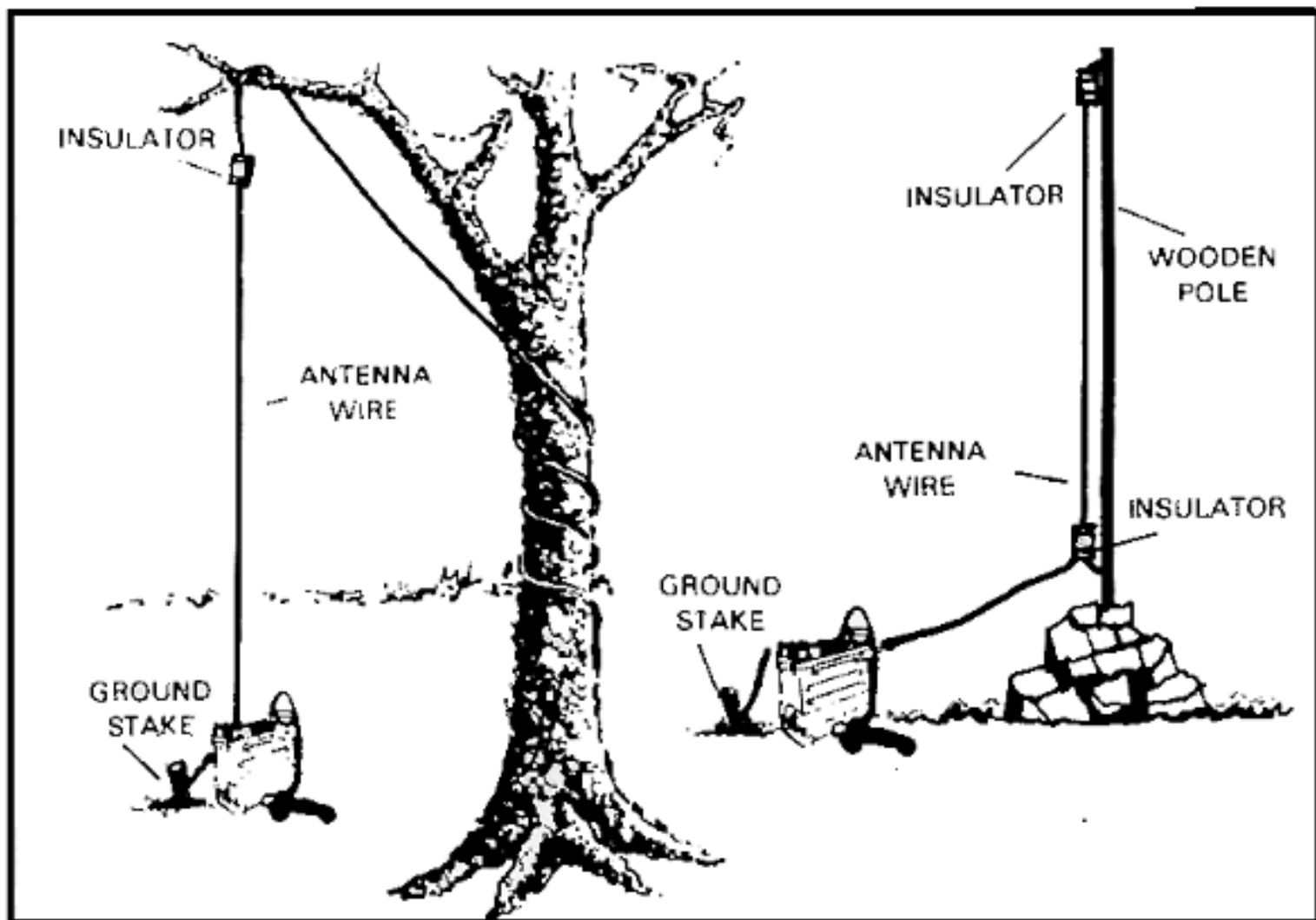

Figure 3-29 Field substitutes for support of vertical wire antennas.

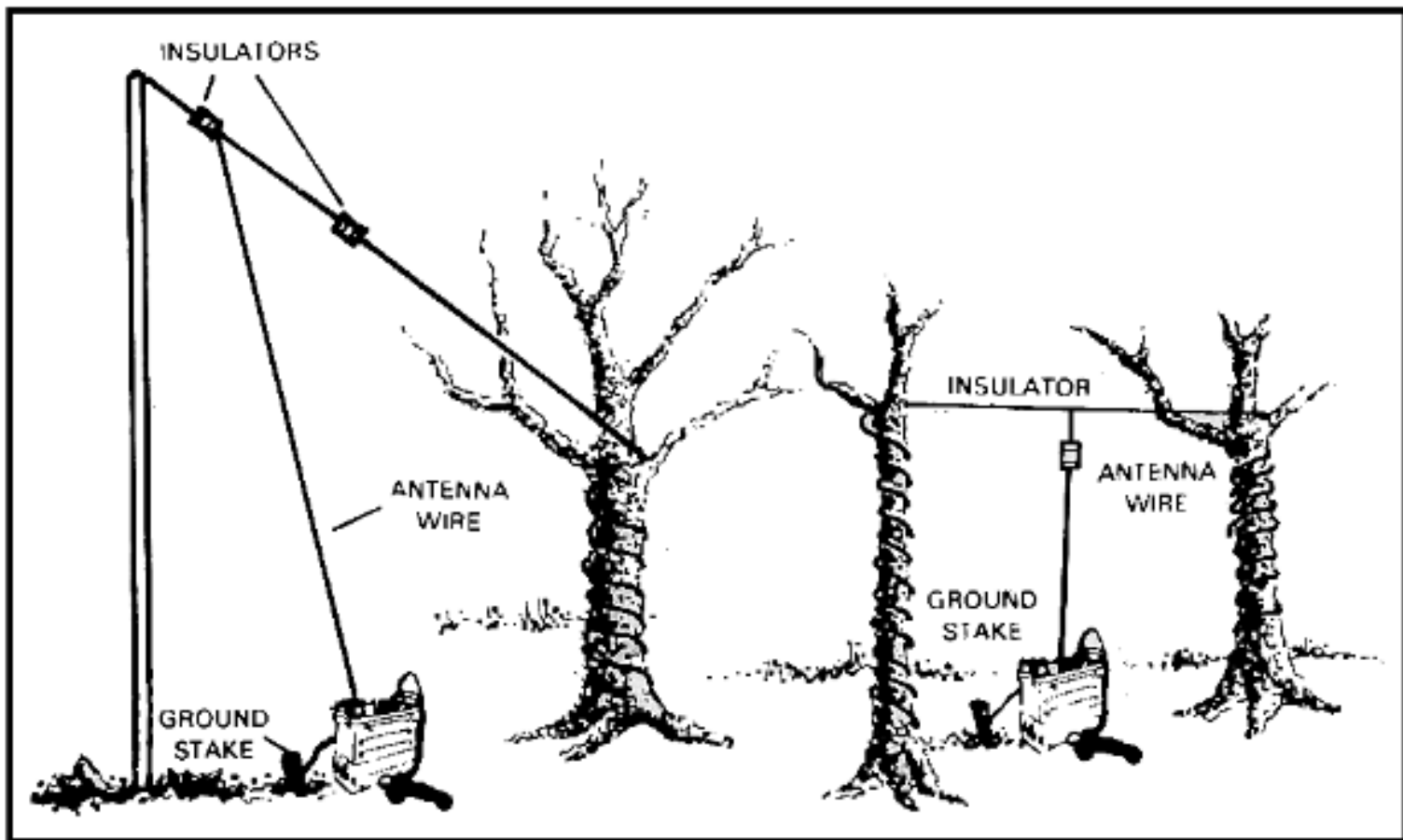

Figure 3-30. Additional means of supporting vertical wire antennas.

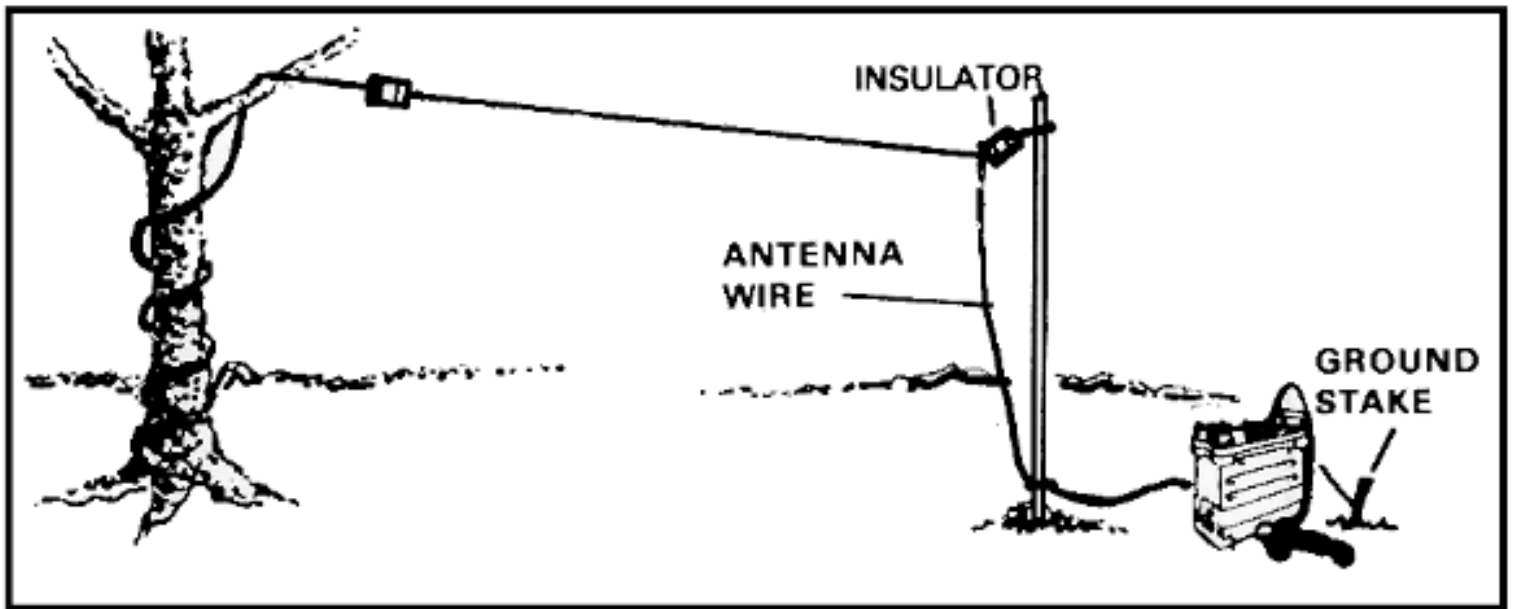

Figure 3-31. End-fed half-wave antenna.

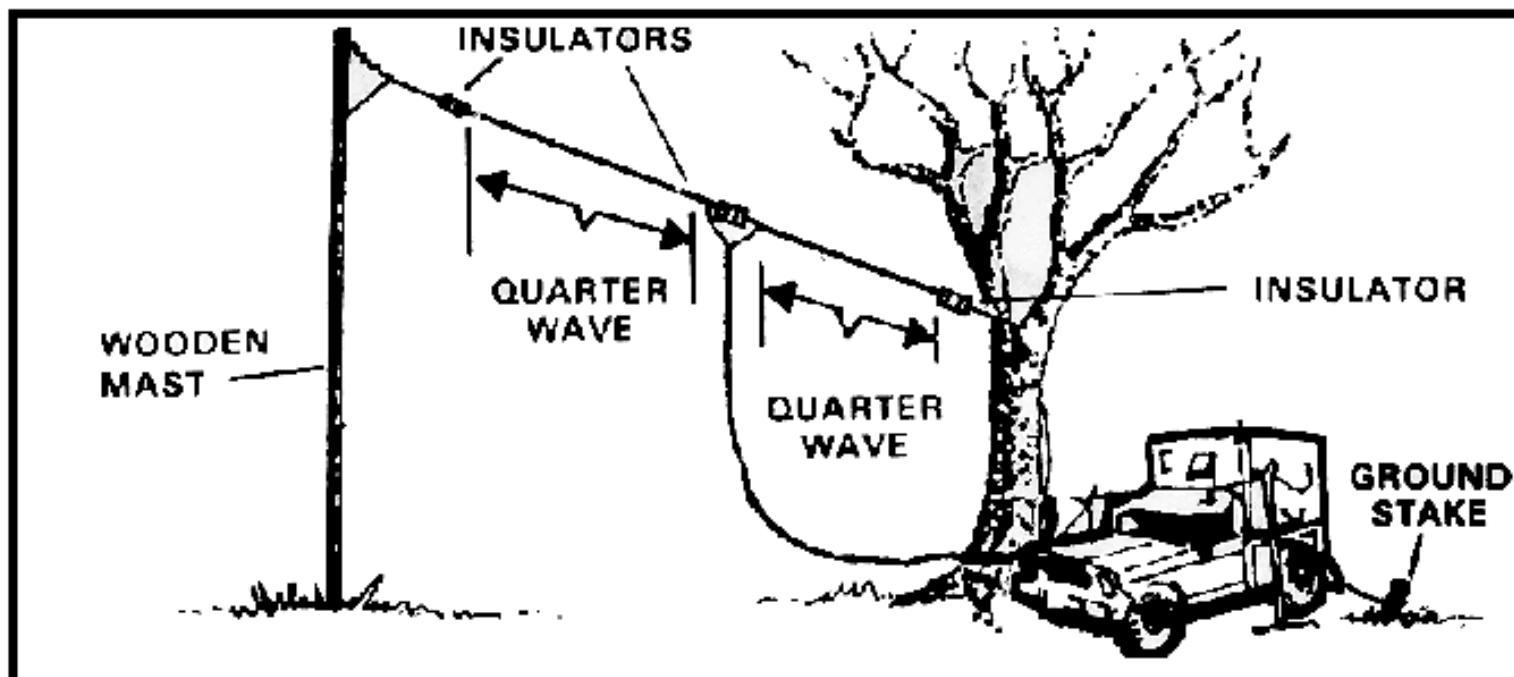

Figure 3-32. Half-wave doublet antenna.

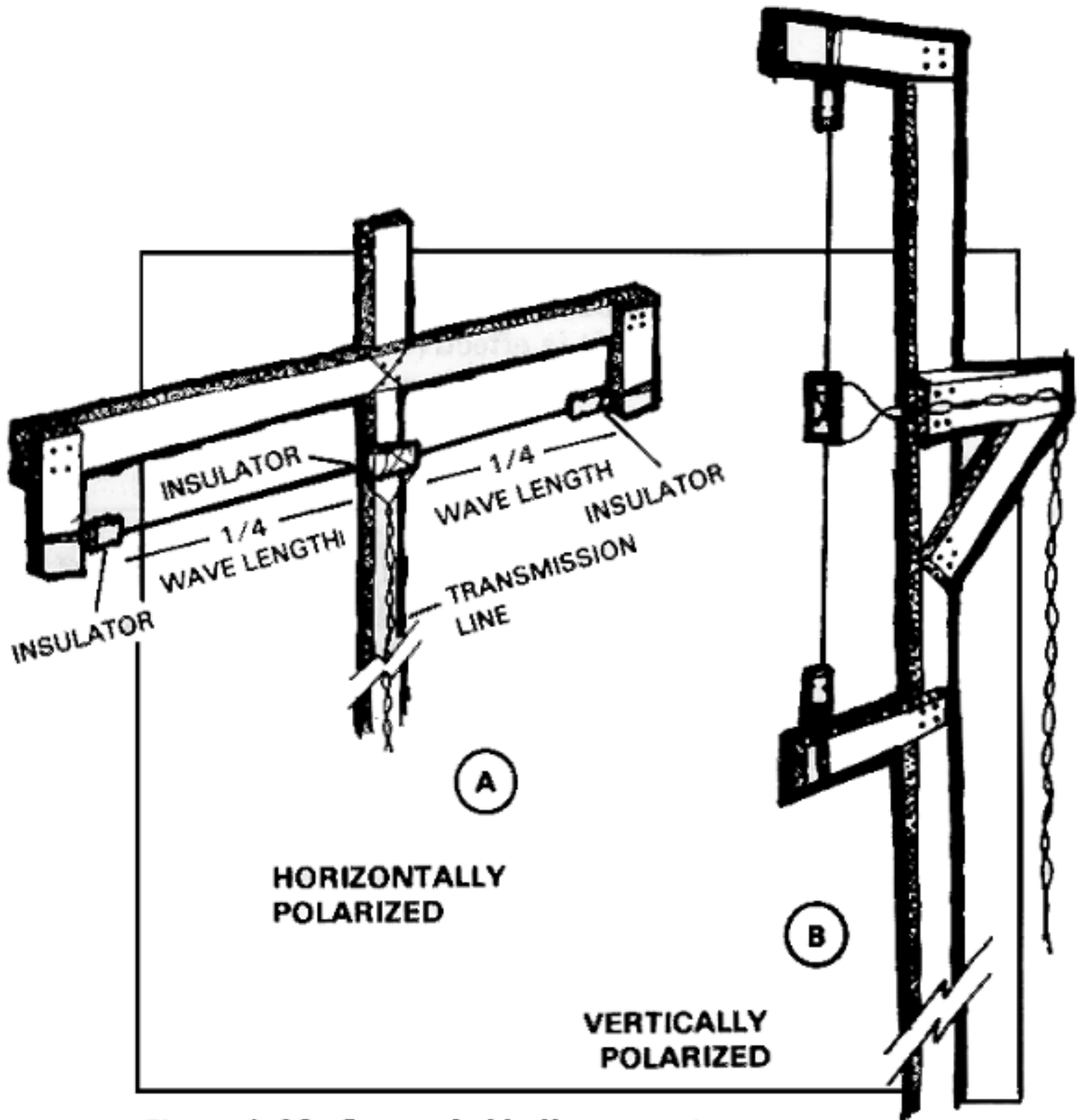

Figure 3-33. Center-fed half-wave antenna.

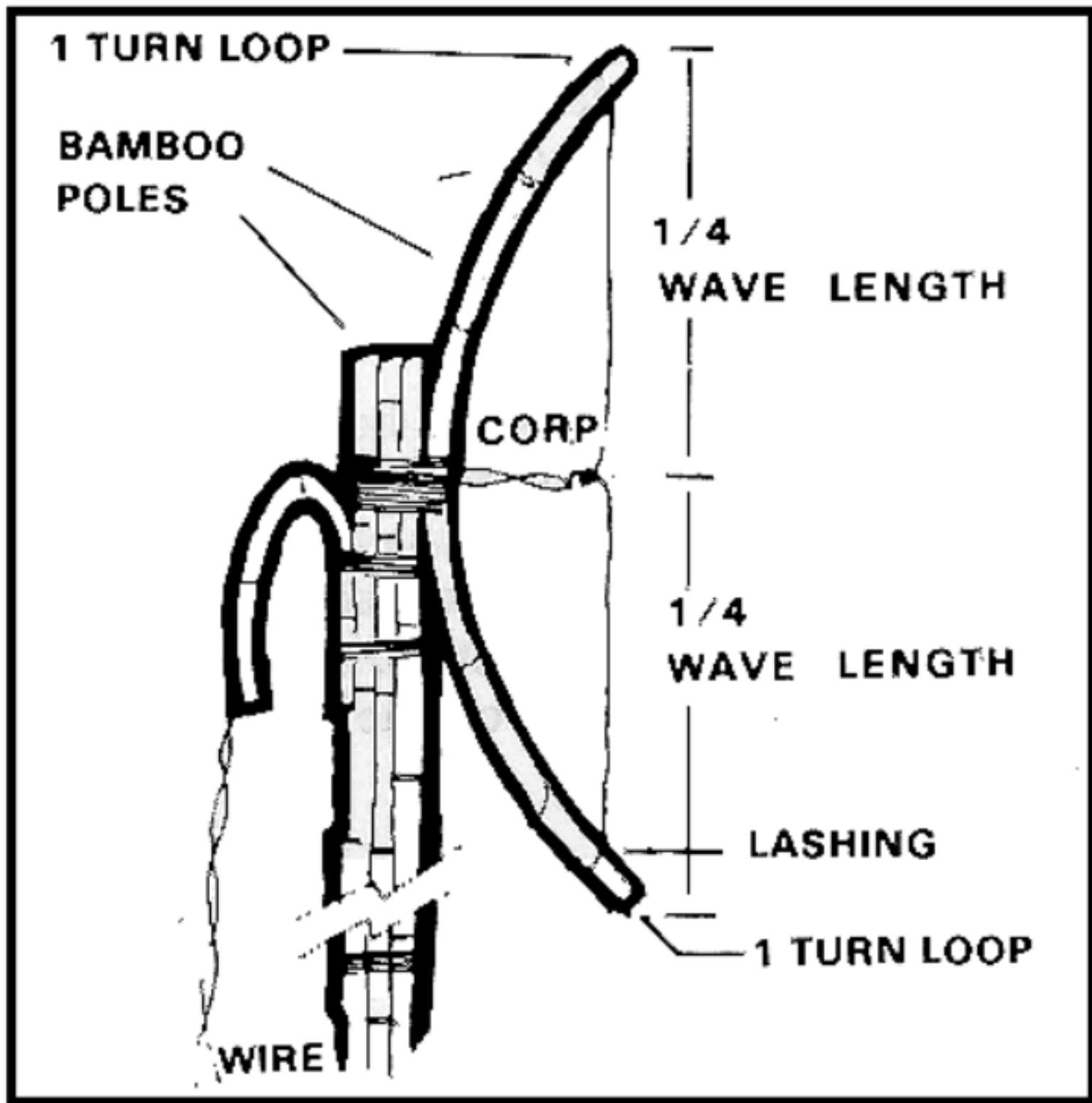

Figure 3-34. Bent bamboo antenna.

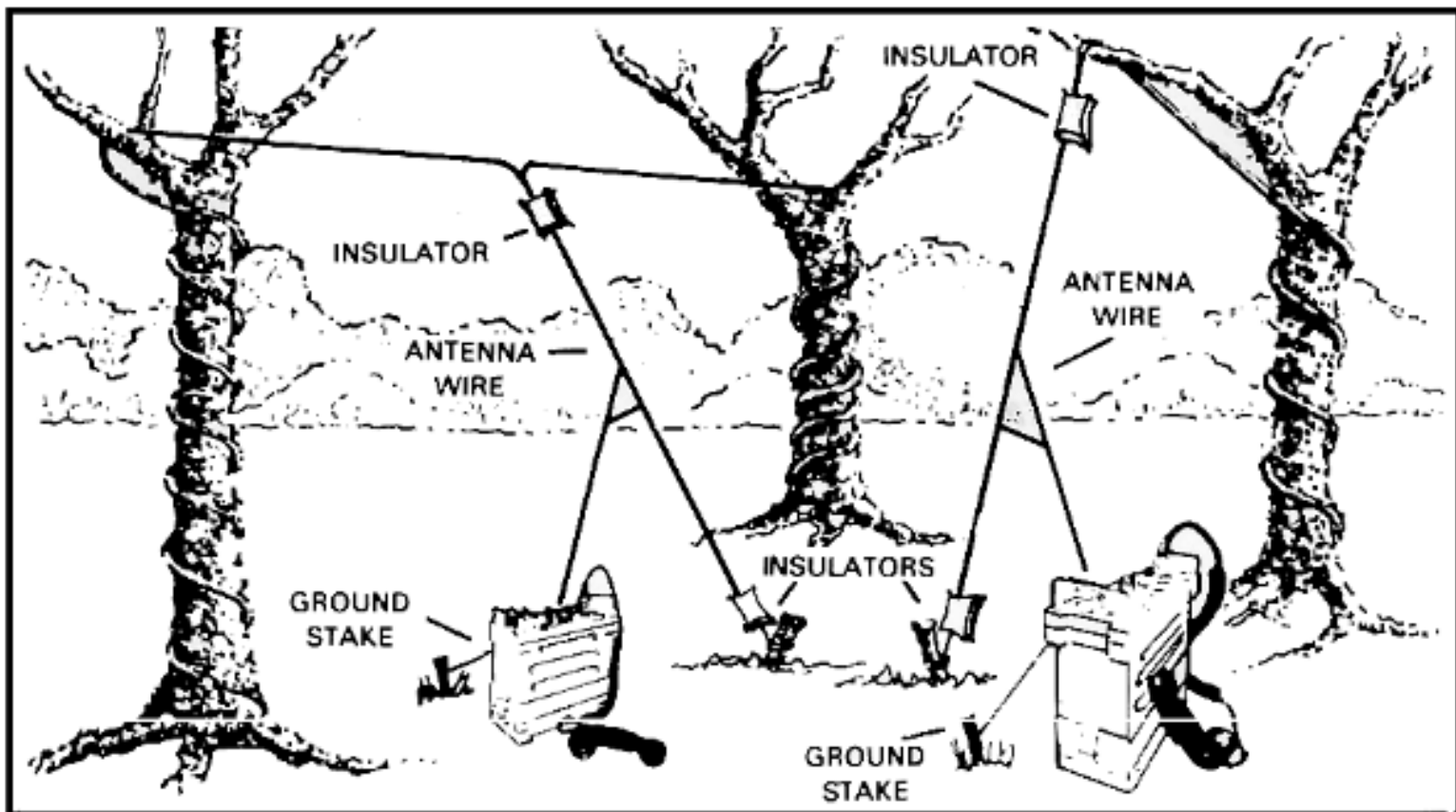

Figure 3-35. Improvised vertical half-wave antenna.

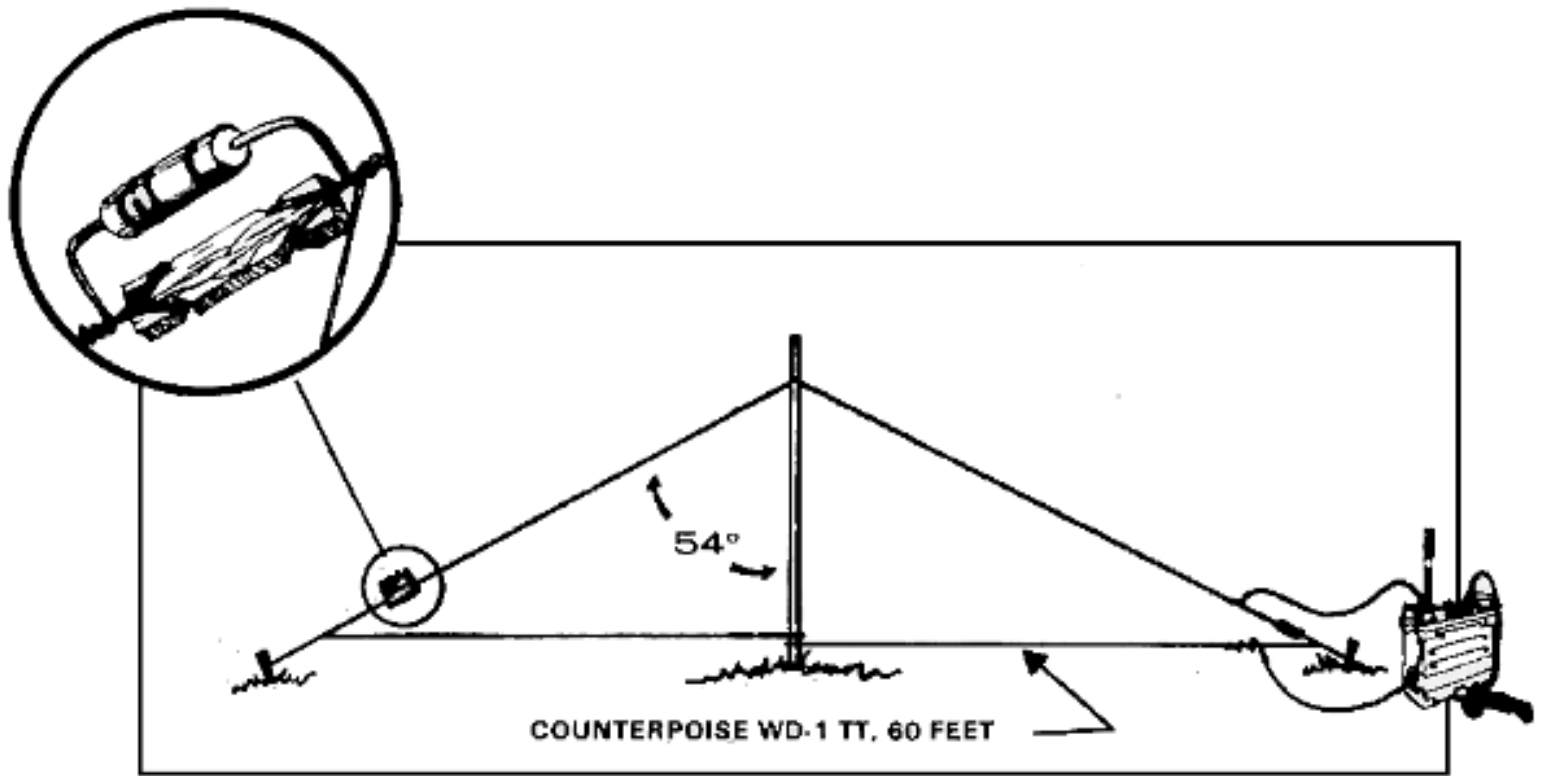

Figure 3-36. Vertical half-rhombic antenna.

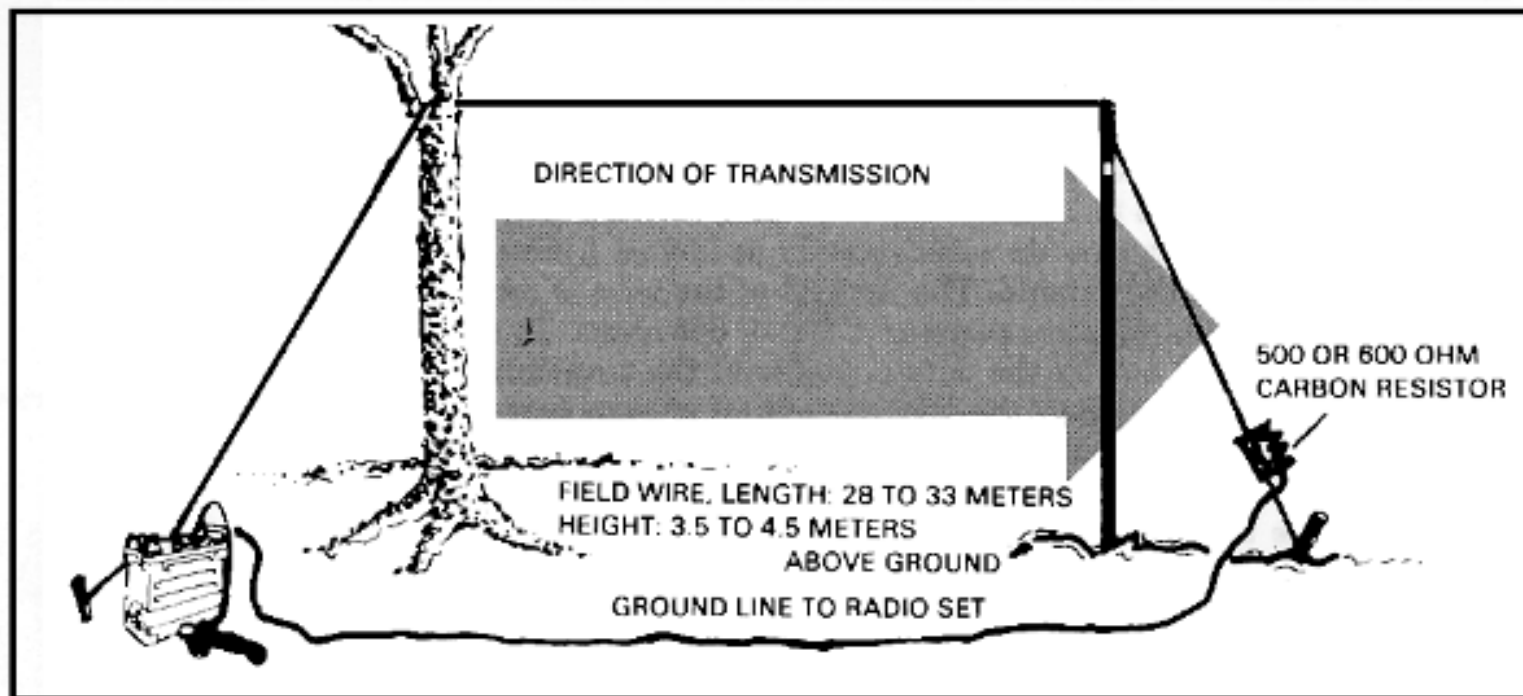

Figure 3-37. Long-wire antenna.

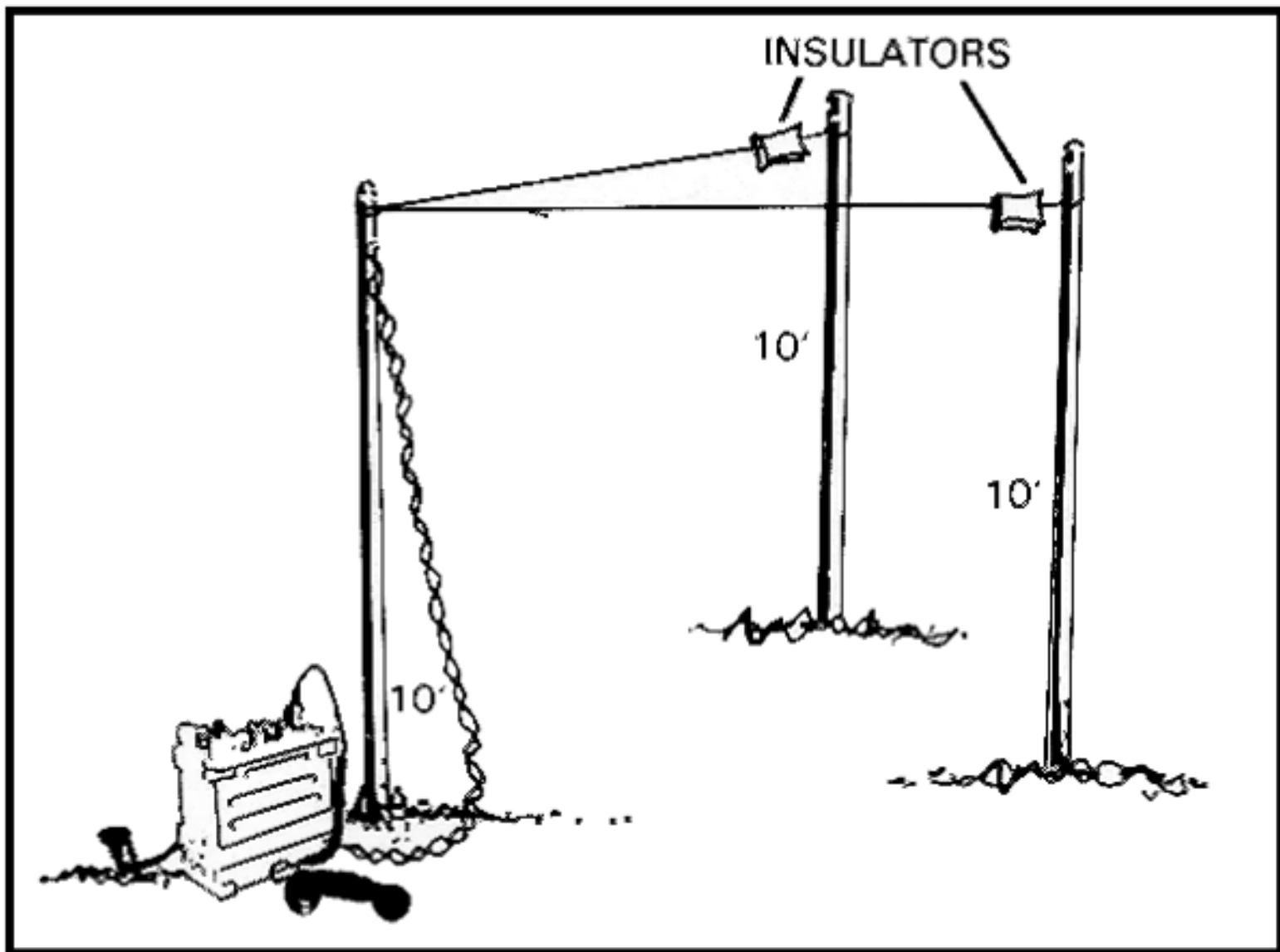

Figure 3-38. V antennas.

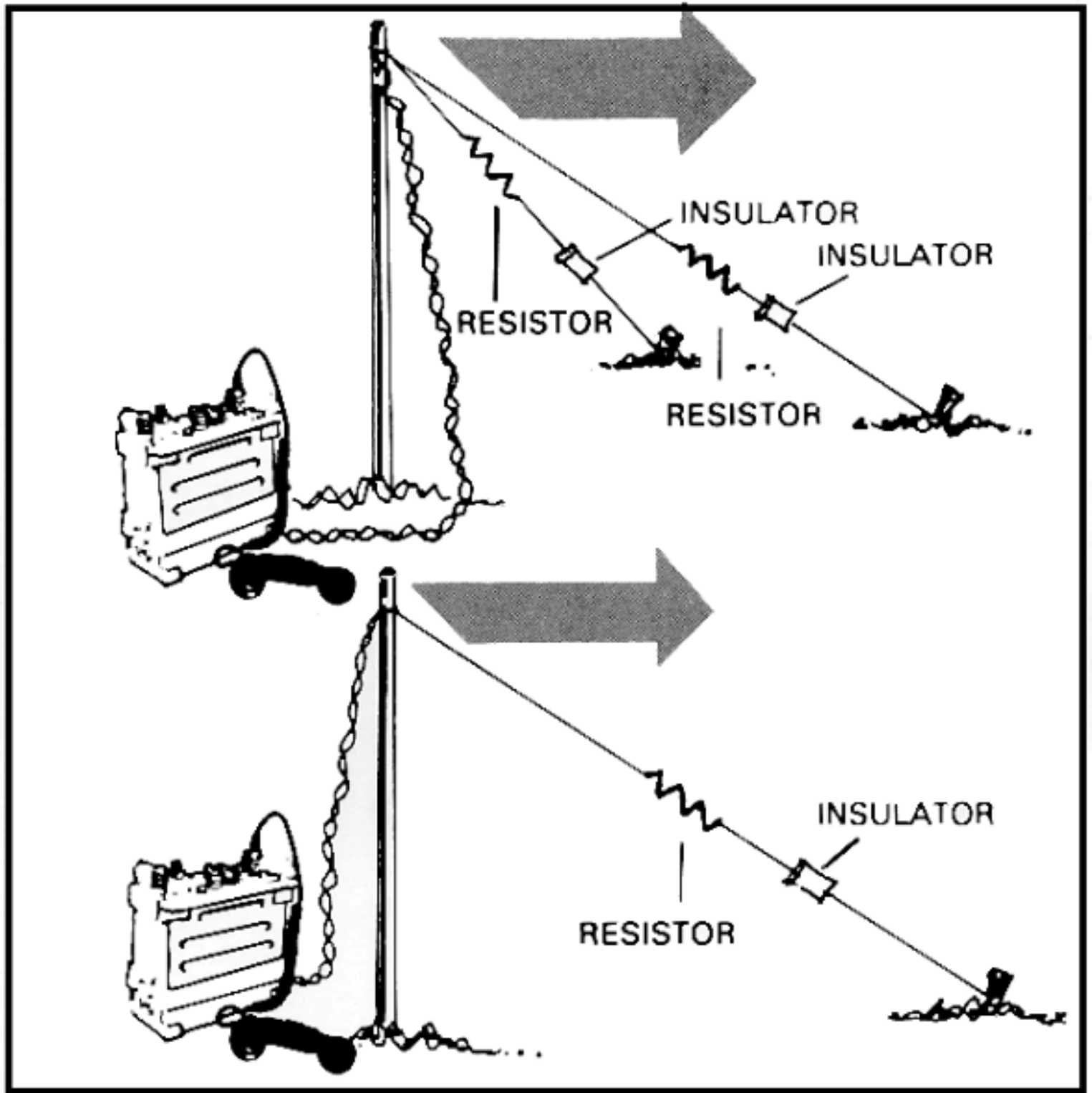

Figure 3-39. Sloping-V antenna.

Table 3-2. Leg Angle for V Antennas.

Antenna length (wavelength)	Optimum Apex Angle (degrees)
1	90
2	70
3	58
4	50
6	40
8	35
10	33

CHAPTER 4

PRACTICAL CONSIDERATIONS IN OPERATING SINGLE-CHANNEL RADIOS

Section I. Siting Considerations

4-1. Site Selection

The reliability of radio communications depends largely on the selection of a good radio site. Since it is very difficult to select a site for a radio that satisfies all the technical, tactical, and security requirements, we compromise and select the *best* site of all those available. It is also good planning to select both a primary site and an alternate site. If, for some reason, radio communications cannot be established and maintained at the primary location, the radio equipment can be moved a short distance to the alternate site.

Location.

A radio station must be located in a position that will assure communications with all other stations with which it is to operate and yet maintain a degree of physical and communications security. To obtain efficiency of transmission and reception, the following factors should be considered.

Hills and mountains between stations normally limit the range of radio sets. In mountainous or hilly terrain, select positions relatively high on the slopes ([fig 4-1](#)). Avoid a location at the base of a cliff or in a deep ravine or valley ([fig 4-2](#)). For operation at frequencies above 30 MHz, and whenever possible, select a location that will allow line-of-sight communications. Try to avoid locations which provide the enemy with a jamming capability, visual sighting, or easy interception.

[Figure 4-1](#). Good sites for radio communications.

Dry ground has high resistance and limits the range of the radio set. If possible, locate the station near moist ground, which has much less resistance. Water, and in particular salt water, greatly increases the distances that can be covered.

Trees with heavy foliage absorb radio waves, and leafy trees have more of an adverse effect than evergreens. Keep the antenna clear of all foliage and dense brush; but try to use available trees and shrubs for cover and concealment and for screening from enemy jamming.

Man-made Obstructions.

Do not select an antenna position in a tunnel or beneath an underpass or steel bridge ([fig 4-2](#)).

Transmission and reception under these conditions are almost impossible because of high absorption of RF energy.

[Figure 4-2](#). Poor sites for radio communications.

Buildings located between radio stations, particularly steel and reinforced concrete structures, hinder transmission and reception. You should, however, try to use buildings to camouflage your antenna from the enemy.

Avoid all types of pole wire lines, such as telephone, telegraph, and high-tension powerlines, when selecting a site for a radio station. Wire lines absorb power from radiating antennas located in their vicinity. They also introduce hum and noise interference in receiving antennas.

Avoid positions adjacent to heavily traveled roads and highways. In addition to the noise and confusion caused by tanks and trucks, ignition systems in these vehicles may cause electrical interference.

Do not locate battery-charging units and generators close to the radio station.

Do not locate radio stations close to each other.

Locate radio stations in relatively quiet areas. The copying of weak signals requires great concentration by the operator, and his or her attention should not be diverted by outside noises.

4-2. Tactical Requirements

Local Command Requirements.

Radio stations should be located some distance from the unit headquarters or command post that they serve. Thus, long-range enemy artillery fire, missiles, or aerial bombardment directed at the stations as a result of enemy direction finding will not strike the command post area.

Cover and Concealment.

The locations selected should provide the best cover and concealment possible, consistent with good transmission and reception. Perfect cover and concealment may impair communications. The permissible amount of impairment depends upon the range required, the power of the transmitter, the sensitivity of the receiver, the efficiency of the antenna system, and the nature of the terrain. When a radio is being used to communicate over a distance that is well under the maximum range, some sacrifice of communications efficiency can be made to permit better concealment of the radio from enemy observation.

Practical Considerations.

Manpack sets have sufficiently long cordage to permit operation from a concealed position (set and operator) while the antenna is mounted in the best position for communications.

Some sets can be controlled remotely from distances of 30 meters (100 feet) or more. The remotely controlled set can be set up in a relatively exposed position, if necessary, while the operator remains concealed.

Antennas of all radio sets must be mounted higher than ground level to permit normal communications.

Small tactical sets usually have whip antennas. These antennas are difficult to see from a distance, especially if they are not silhouetted against the sky. However, they have a 360° radiation pattern and are extremely vulnerable to enemy listening.

Avoid open crests of hills and mountains. A position protected from enemy fire just behind the crest gives better concealment and sometimes provides better communications.

All permanent and semipermanent positions should be properly camouflaged for protection from both aerial and ground observation. However, the antenna should not touch trees, brush, or the camouflage material.

Use one well-sited, broadband antenna to serve several radios. [Appendix D](#) describes a transceiver multiplexer (TD-1288(-)/GRC and TD-1289(-)/GRC) that will allow several radio sets to be connected to a single antenna with no degradation of performance. This will allow quicker set-up and tear-down times as well as reducing camouflaging time and materials.

Local Communications.

At brigade level and higher, contact must be maintained between the radio station and the message center at all times, either by local messenger or field telephone. The station should also be readily accessible to the unit commander and to staff members.

Section II. Transmitter Characteristics and Operator's Skills

4-3. Importance to Reliable Communications

In addition to proper siting, the reliability of radio communications also depends upon the characteristics of the transmitted signal. The transmitter and its associated antenna form the initial step in the transfer of energy to a distant receiver.

4-4. Operating Frequency

Ground-wave transmission is used for most field radio communications. The range of the ground-wave becomes correspondingly shorter as the operating frequency of the transmitter is increased through the applicable portions of the medium-frequency band (300-3000 kHz) to the high-frequency band (3-30 MHz). When the transmitter is operating at frequencies above 30 MHz, its range is limited generally to slightly more than line of sight. For circuits using sky-wave propagation, the frequency selected depends on the geographic area, season, and time of day.

4-5. The Transmitting Antenna and Power Output

For maximum transfer of energy, the radiating antenna must be the proper length for the operating frequency. The local terrain determines, in part, the radiation pattern and, therefore, affects the directivity of the antenna and the possible range of the set in the desired direction. If possible, several variations in the physical position of the antenna should be tried to determine the best operating position to radiate the

The range of a transmitter is proportional to the power radiated by its antenna. An increase in power output of the transmitter results in some increase in range, and a power decrease reduces the range. Under normal operating conditions, the transmitter should feed only enough power into the radiating antenna to establish reliable communications with the receiving station. Transmission of a signal more powerful than required is a breach of signal security, because the location of the transmitter may be more easily fixed by enemy direction-finding stations. Also, the signal may interfere with friendly stations operating on the same frequency.

CAUTION: Do not detune a transmitter to reduce power output. Operation with a detuned power output stage can cause damage to the transmitter.

4-6. Transmitting Operator's Skills

The skill and technical abilities of the operators at the transmitter and receiver play important parts in obtaining the maximum range possible. The transmitter, output coupling, and antenna feeder circuits must be tuned correctly to obtain maximum power output. In addition, both the radiating antenna and the receiving antenna have to be constructed properly with regard to both electrical characteristics and conditions of the local terrain. The operator is the main defense against enemy interference. The skill of the operator can be the final determining factor in maintaining command and control communications in the face of enemy efforts to disrupt it.

Section III. Transmission Paths

4-7. Characteristics of the Transmission Path

After the radio signal leaves the transmitting antenna, you must be concerned with the amount of radiated energy that is lost along the transmission path. Selecting the transmission path with the least radiation loss ensures that more energy will be transferred to the receiving antenna.

4-8. Conductivity of the Terrain

The type of terrain between two field radio sets determines ground conductivity and affects the ground-wave. Flat prairie country has high conductivity and there is little absorption of the ground-wave by the earth.

Large bodies of water also have high conductivity. Mountainous, rugged, and broken country usually has low conductivity. In areas where there are large mineral deposits, and in deep ravines and valleys, the ground-wave may be absorbed completely by the soil.

4-9. Location of the Antenna

Large terrain obstructions between the transmitting and receiving stations reduce the reliability of radio transmissions. When you are selecting a site location, select high ground on which to erect the antenna.

4-10. Distance Between Stations

Low-power radio transmitters of limited range must work with receivers located within their range. Higher power transmitters with correspondingly stronger ground and sky waves may reach receiving

stations with either or both of these waves, depending upon the distances between the transmitter and the receivers. When sky-wave propagation is used for communications, the skip distance must be considered. At times during the day or night on certain frequencies, the receiving station might lie within the skip zone and will not receive a signal from the transmitter.

Section IV. Receiver Characteristics and Operator's Skills

4-11. Sensitivity and Selectivity of the Receiver

When the transmitted signal reaches the receiver location, it arrives at a much lower power level than when it left the transmitter. The receiver must efficiently process this relatively weak signal to provide maximum reliability of communications.

Sensitivity is a term used to describe how well a receiver responds to a weak signal at a given frequency. A receiver with high sensitivity is able to accept a very weak signal and amplify and process it to provide a usable output (an output that can be fully understood or that can be used to operate a teletypewriter or other devices). The principal factor that limits or lowers the sensitivity of a receiver is the noise generated by its own internal circuits (for example, tube and resistor noise).

Selectivity is a term used to describe how well a receiver is able to differentiate between a desired frequency and nearby frequencies.

4-12. The Receiving Antenna

In field radio communications, the type, location, and electrical characteristics of the receiving antenna are not as important as they are for the transmitting antenna. The receiving antenna must be of sufficient length; be properly coupled to the input of the receiver circuit; and, except in some cases for HF sky-wave propagation, it must have the same polarization as the transmitting antenna.

4-13. Interference

Interference from Natural Sources.

There are four kinds of radio interference you can expect from natural sources.

- Atmospheric interference from electrical storms.
- Solar and cosmic interference from eruptions on the Sun and other stars.
- Precipitation static from charged particles (rain, sleet, snow, sand, smoke, or dust) in the atmosphere. Dry particles produce greater charges and more static than wet ones.
- Fading from disturbances in the medium through which radio waves are propagated.

Interferences listed above, except the last, appear in electronic equipment as disturbing noise. This noise shows up as sound in headphones and loudspeakers and as errors in the output of other terminal equipment. There is interference from natural sources at most frequencies, but it diminishes considerably as the frequency is increased. At very high frequencies these disturbances have very little effect on reception.

Man-made Interference.

Man-made interference is generated by electrical devices (such as arc welders), leakage on high-tension lines, television sets, vehicle ignition systems, and sparking brushes on motors and generators and other rotating machines. This interference may be intentional or unintentional. If the interference is intense enough, it will drown out or obscure communications.

Although man-made interference is best eliminated or minimized at its source, some improvements can be made at the receiver. The operator can often make tuning adjustments which will enable the signal to be read through the interference. The use of a directional receiving antenna will eliminate some of the interference if the source is not in the same direction as the transmitting station. In addition, specially designed antenna lead-in wire may eliminate or minimize man-made interference that would normally be picked up on the lead-in wire.

Radio noise waves coming from a man-made source tend to be vertically polarized. Therefore, a horizontally polarized receiving antenna will generally receive less noise than a vertically polarized antenna.

Mutual Interference.

When one communications system interferes with another, or when one particular unit within a given system interferes with other units in the same system, there is a condition of *mutual interference*.

Mutual interference may appear in several forms: noise, cross talk, and/or harmonic interactions. Some of the common conditions that cause mutual interference are--

- Spurious, undesired signals.
- Spurious receiver responses.
- Rf arcing in transmitters.
- Impedance mismatch in the antenna system.
- High-voltage pulse interference.
- Improper frequency assignments.

Interference originates from many local and distant sources. Frequency relationships, geographical location, faulty adjustment of equipment, and improper operating techniques are important factors contributing to mutual interference. Equipment and systems that are potential generators of mutual interference are radar, radio, radio aids to navigation, and telephones.

4-14. Receiving operator's Skills

Most communications receivers have adjustable controls that, when properly used, are designed to minimize the adverse effects of fading, noise, and interference. The proficient use of these controls, such as the noise limiter and one of the various types of filters, often will permit satisfactory reception of many messages that would otherwise be lost when noise and interference become excessive. On the other hand, maladjustment of these controls, through either ignorance or carelessness, can cause unsatisfactory operation. Therefore, the skill and technical proficiency of the receiver operator play a most important part in radio communications.

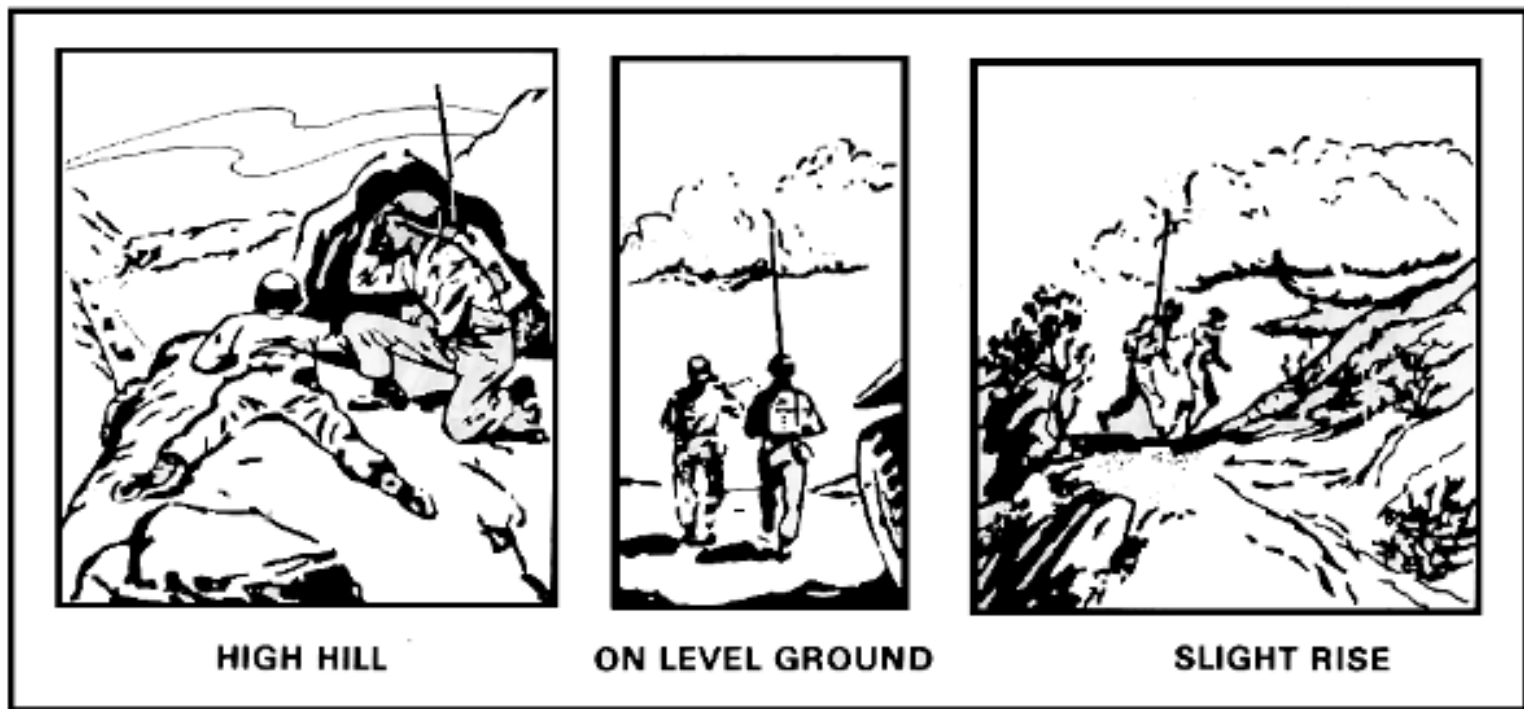

Figure 4-1. Good sites for radio communications.



HIGH TENSION LINES



UNDERPASSES



VALLEYS

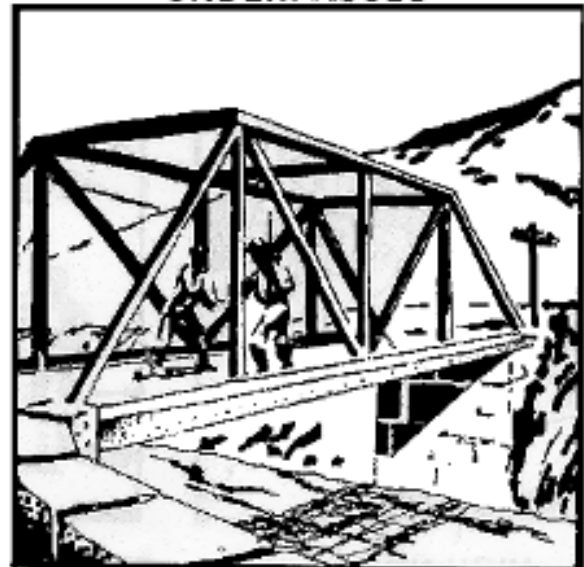

OVERHEAD STEEL BRIDGES

Figure 4-2. Poor sites for radio communications.

CHAPTER 5

RADIO OPERATING TECHNIQUES

Section I.

General Operating Instructions and SOI

5-1. Effective Operations

The tactical effectiveness of any communications equipment is no greater than the skill of the operators. By the same token, the most efficient communications within a net or command is attained when the operators habitually use the proper procedures in transmitting and receiving messages. This chapter was prepared to assist operators in improving their skills as communicators. It covers the use of the signal operation instructions (SOI), and the techniques that apply to the operation of radiotelegraph (international Morse code), radiotelephone (voice), and radio teletypewriter communications equipment and systems. Single-channel radio can be connected to the tactical telephone system by using net radio interface (NRI) techniques and procedures. They are presented in detail in [appendix F](#).

5-2. Operating Instructions

Instructions pertaining to radio communications are contained in the SOI and in standing operating procedures (SOP).

The SOI provides the organization of stations into nets, assigns call signs, designates net control stations (NCS), and assigns frequencies. It also provides information on changes to alternate frequencies and on authentication. In addition, the security procedures that must be used by radio operators in the command are included in the SOI supplemental instructions.

The SOP governs routine signal operations of a unit. Refer to FM 24-16 for additional information on the SOP and FM 24-35 for SOI.

5-3. Initial Preparation

Before you operate any radio set, get the equipment technical manual (TM) and carefully study the operating instruction. Refer to the panel diagrams, connections diagrams, and the paragraphs covering the description of components during the preliminary starting procedure. Make sure that the proper cables are connected to the proper panel connectors, and that the controls are correctly set. Even the most experienced operators should check their preliminary procedures against the TM references from time to time to insure accuracy and to avoid damage to equipment. Use the operational checklist and the

equipment performance checklist to determine what to do to remedy any problems encountered during starting procedures and operation. A time zone chart ([app G](#)) and a time conversion table ([app H](#)) are included in the back of this manual to assist you in understanding geographical, time zone, and conversion factors you may need during operation of radios and radio nets. Instructions for using DA Form 4158 (Operator's Number Sheet) is contained in [appendix I](#).

5-4. Steps in Operating Radio Sets

Radio sets issued to a unit vary in type according to the communications requirements of the unit. For example, some sets may be completely contained in one assembly, while others may consist of separate components that must be properly connected to assemble a complete radio set. The following steps are generally required in operating a radio set.

Check the Set for Completeness.

Make sure that all the necessary components and accessories are on hand and ready for use. Refer to the equipment basic issue items list in the TM. Never operate the transmitter without the antenna attached.

Inspect the Condition of the Knobs, Dials, Switches, and Controls.

Look for knobs, dials, switches, and controls that are loose on their shafts, bind when being operated, won't operate, or are damaged in any other way. Make corrections where possible or report the faulty condition. Make sure that all knobs and exterior parts are on the set. Immediately report any that are missing.

Check the Condition of Plugs, Receptacles, and Connectors.

Do not attempt to connect the set for operation until you are sure that the plugs and connectors are clean and in good condition and that the receptacles to which they must be connected are also clean and in good condition.

Check the Connections Diagrams.

The connections diagrams in the equipment TM show the type and number of cables required to interconnect the components of the radio set for each type of operation. The radio set may be damaged if cables are connected to the wrong receptacles.

If the connectors don't match, it is possible to physically damage the pins or sleeves of the connector.

If a cable is connected to a receptacle into which it fits but does not belong, it may cause serious electrical damage to the equipment and, in some cases, injury to the operator.

Make Sure of Dial, Switch, and Control Settings.

Some radio sets can be seriously damaged if the switches, dials, and controls are not set to the required initial settings before applying power or making the initial timing adjustments. Before applying power, check the equipment TM to be sure you performed all preliminary starting procedures. Be sure radios installed in vehicles are turned off before starting vehicle engine 80 as to avoid damage to radio equipment.

Follow the Starting Procedure.

The equipment TM covers, in detail, the proper procedure for starting the radio set. If there is a specific sequence for starting the set, it is described in the manual. Perform the operations in the proper sequence.

Apply Power.

After the proper connections are made and all switches are properly set, power may be applied to the set.

Allow the Set to Warm Up.

Radio sets usually require a warm-up period when first applying power in order to stabilize the equipment. In some cases, it is possible to damage a set by attempting to operate a set without allowing a warm-up period. Most sets are protected against such damage, but it is foolish to risk damage to a radio set by trying to put it on the air before it is ready.

Tune to the Desired Frequency (Channel).

Tune the transmitter to the frequency of the desired channel according to the procedures in the equipment TM. Use the methods that are given in the TM to check for correct tuning.

Check the Set for Normal Operation.

While the set is in operation, check the indicators frequently to be sure that the set is operating correctly. If anything unusual occurs during operation, investigate it immediately. When necessary, turn off the power to the set and refer to the operational checklist and the equipment performance checklist in the equipment manual. If the corrections given in the operational checklist and the equipment performance checklist will not correct the trouble, report the condition to the unit electronics maintenance shop. Make sure that the condition of the set and the action taken are properly recorded on the maintenance records.

Use the Proper Procedure to Turn Off the Set.

After operation (or if the set is being turned off because of improper operation) make sure that the controls, switches, and dials are properly set (this may not be required on some radios). Proceed to shut down the components of the set in the sequence specified in the equipment manual. Simple radios may require nothing more than turning the power switch to its off position, but more complex sets may require elaborate shutdown procedures.

5-5. Operating Hints

Use a handset or headset, rather than a loudspeaker, if the incoming signal is weak.

Make sure that the microphone or handset is in good condition. Speak directly into the microphone; speak slowly and distinctly.

Make sure that the vehicle's battery voltage (if radio set is vehicular-mounted) is within the correct range. Keep the engine running to charge the battery.

Move the set or the vehicle, if necessary, to improve reception.

Lack of communications or poor communications may be caused by--

- Too great a distance between radio sets.
- Poor choice of location (siting) at one or both ends of the circuit.

- Terrain--hills or mountains.
- Noise and interference.
- Not enough transmitter power.
- Defective equipment.
- Improper adjustment of equipment.
- Ineffective antenna.
- Improper frequency assignment.

Poorly maintained equipment and improper operation can be just as effective in preventing communications as excessive distance or mountainous terrain. To avoid problems, observe the following precautions at all times:

- Study the technical manuals for the equipment you are using. They provide complete operating instructions and maintenance procedures.
- Keep your radio set clean and dry.
- Handle your radio set carefully.

5-6. The SOI

The SOI is a communications security (COMSEC) aid designed to provide transmission security by limiting and impairing enemy intelligence collection efforts. The SOI does not provide security to the content of messages. The SOI will provide maximum benefits when used with approved cryptographic systems.

The SOI is a series of orders issued for technical control and coordination of a command or activity. It provides guidance needed to ensure the speed, simplicity, and security of communications. The classroom-training SOI is the KTV 1600 () Series for the fictitious 52d Infantry Division (Mech). It serves as a general format and prescribes communications doctrine and techniques which apply to all Army SOI.

The SOI remains the best means of security for nonsecured communications. The procedures and instructions in FM 24-35 implement Department of the Army policy set forth in AR 105-64. FM 24-35 provides the following:

- A detailed explanation of the centrally produced SOI program.
- Instructions for the preparation of data required for generation of centrally produced SOI.
- Instructions for the generation and production of a manually produced SOI.
- Examples of standardized supplemental instructions for Army SOI.

Section II. Radiotelegraph Procedures

5-7. Use of Radiotelegraphy

Radiotelegraphy is a system of telecommunications for the transmission of intelligence (or information) by international Morse code. It provides the most reliable radio communications over long distances and

under adverse conditions, but requires highly skilled operators. It is used between mobile units and as an emergency substitute for teletypewriter (TTY) communications. Details on radiotelegraph procedures are in ACP 124(). In addition to normal communication procedures, radiotelegraphy uses PROSIGNs, operating signals, and special abbreviations. Operating signals are listed in ACP 131(); authorized PROSIGNs and abbreviations are in ACP 124(). Although CW communications is necessarily slower than voice or teletypewriter communications, it has the advantage of being more readable in the presence of interference and jamming. CW signals can often be read clearly when voice and teletypewriter signals of the same strength are unreadable.

5-8. International Morse Code

Dots and dashes are used in various distinctive combinations to represent the letters of the alphabet, the numerals from 0 to 9, punctuation, and the procedure signs (prosigns). The dots and dashes of the Morse code are produced by keying a transmitter to transmit short and long signals. The dash is three times the length of the dot. The combination of dots and dashes that are used for a letter are spaced from each other by a period of time equal to the length of one dot. Letters are spaced from each other by a period of time equal to three dots and words are spaced by a period of time equal to seven dots.

5-9. Procedure Signs

Procedure signs (prosigns) are used on radiotelegraph and radio teletypewriter circuits to convey information, requests, orders, and instructions in a condensed standardized form. Prosigns represent single words or phrases in order to minimize transmitting time. Certain letters are transmitted "run together"--that is, without a space between the letters--and represent a phrase other than the letters. They are overscored (written with a line drawn over the top of them). For example, \overline{AR} is transmitted as if it were a single letter, not as two letters, and means "end-of-transmission."

Authorized PROSIGNs and their meanings are listed in [table 5-1](#).

[Table 5-1](#). Procedure Signs

5-10. Operating Signals

Operating signals are three-letter signals starting with the letter Q or the letter Z. They are used by CW operators and radio teletypewriter operators to expedite communications. Each Q-signal or Z-signal conveys the meaning of a number or words and, at times, a complete message. For example, ZFG means "This message is an exact duplicate of a message previously transmitted." Information on authorization of Q- and Z-signals is in ACP 131().

ACP 131() lists the meanings of Q- and Z-signals and provides instructions for their use. If it is not possible to provide each operator with a copy of ACP 131(), lists of commonly used signals should be prepared and provided to each operator. In no case should the operator be required to memorize all of the operating signals.

Operating signals are considered to be plain language, and they must be encrypted when used as a part of an encrypted message. They are an aid to communications security, since they are brief; but their meanings are common knowledge to many nations.

5-11. Transmission Techniques and Transmission Speeds

Each character shall be transmitted clearly and distinctly. The speed of transmission shall be governed by the prevailing conditions and the ability of the receiving operator.

Accuracy in transmission is far more important than speed. The difference in time required to send a message at 18 words per minute and the time required to transmit it at 25 words per minute is slight. Even this slight gain in time may be nullified by any added time required for repetitions.

The speed at which the receiving operator can copy without having to obtain repetitions is the speed at which the transmitting operator will transmit. When transmitting to more than one station in a net, the governing speed of the transmitting operator is that of the slowest receiving operator.

The speed of transmitting headings on manually operated circuits should be slower than the speed of transmission of texts.

Speed of transmission on automatic circuits is governed by traffic conditions and the reliable capacity of the equipment.

If necessary during specific periods, the net control station can prescribe the speed of transmission on a circuit or set certain qualifications which operators must meet.

When authorized by the net control station, speed keys may be employed on manually operated circuits if traffic conditions warrant and operator abilities permit.

Section III.

Radiotelephone and Radio Teletypewriter Procedures

5-12. Radiotelephony

Radiotelephony is a system of telecommunications that is normally used for short-range tactical communications and between mobile and air units. It provides rapid, person-to-person communications in highly mobile situations. However, radio transmissions are subject to enemy interference and afford little or no security to messages if a security device is not used with the radio set. Therefore, basic rules essential to transmission security are strictly enforced on all military radiotelephone circuits. Details on radiotelephone procedures are in ACP 125(). Just as radiotelegraphy makes use of PROSIGNS and operating signals, radiotelephony uses procedure words (PROWORDS) and procedure phrases. Authorized PROWORDS are covered later in this section.

Transmission Security.

The following basic rules are essential to transmission security and will be strictly enforced on all military radiotelephone circuits.

No transmission will be made if it is not authorized by the proper authority.

The following practices are specifically forbidden:

- Violation of radio silence.
- Unofficial conversation between operators.

- Transmission on a directed net without permission.
- Excessive tuning and testing.
- Transmission of the operator's personal sign or name.
- Unauthorized use of plain language.
- Use of other than authorized PROWORDS.
- Unauthorized use of plain language in place of applicable PROWORDS or operating signals.
- Association of classified call signs and address groups with unclassified call signs.
- Profane, indecent, or obscene language.

Call Signs.

Call signs are used in radio communications to identify a communications facility, a command, an authority, or a unit. There are two forms of call signs: complete call signs and abbreviated call signs.

Complete call signs consist of a letter - number - letter combination and a suffix and are used when--

- Entering a net in which you do not normally operate.
- When so requested by the NCS or another station in the net.

Abbreviated call signs are used at all other times.

EXAMPLES:

Complete Call Sign _____ A2D28

Abbreviated Call Sign _____ D28

If no confusion exists as to which operators are on the radio net, no call signs need be used.

5-13. Pronunciation of Letters and Numerals

To avoid confusion and errors during voice transmission, special techniques have been developed for pronouncing letters and numerals. These special techniques resulted in the phonetic alphabet and phonetic numerals.

The phonetic alphabet is used by the operator to spell difficult words and thereby prevent misunderstanding on the part of the receiving operator. The words of the phonetic alphabet, which is a word alphabet and not a code, are pronounced as shown in [table 5-2](#). The underscored portion indicates the syllable or syllables to be emphasized.

The phonetic alphabet is also used for the transmission of encrypted messages. For example, the cipher group CMVVX is spoken "CHARLIE MIKE VICTOR VICTOR XRAY."

Numbers are pronounced as shown in [table 5-3](#).

[Table 5-2.](#) Phonetic Alphabet

[Table 5-3.](#) Number Pronunciation Guide

Numbers are spoken digit by digit, except that exact multiples of thousands may be spoken as such. For

example, 84 is "AIT FOW ER," 2,500 is "TOO FIFE ZE RO ZE RO," and 16,000 is "WUN SIX TOUSAND."

The date-time group is always spoken digit by digit, followed by the time zone indication. For example, 291205Z is "TOO NIN-ER WUN TOO ZE-RO FIFE ZOO-LOO."

Map coordinates and call sign suffixes also are spoken digit by digit.

5-14. Procedure Words

To keep voice transmission as short and clear as possible, radio operators use procedure words (PROWORDS) to take the place of long sentences. The PROWORDS and their meanings are listed in [table 5-4](#).

5-15. Radio Teletypewriter

Radio teletypewriter communications is a system of telecommunications for transmitting information over radio (FSK mode) using direct action of a teletypewriter keyboard, perforated tape, or from electronic memory storage. This same information is received in the form of page copy, perforated tape, or both.

A big advantage of field radio teletypewriter operations is that through the use of one mobile radio teletypewriter set you have available all three modes of radio telecommunications systems--radiotelegraph, radiotelephone, and radio teletypewriter. Transmission is possible over distances up to several thousand miles.

Radio teletypewriter operators must be highly trained. Those operators possessing the additional skill identifier (ASI) for international Morse code must maintain their proficiency in radio telegraph operations. Radio telegraph operators must use IMC when the quality of the circuit drops below that required for radio teletypewriter communications.

Message format and the procedure for handling messages by radio teletypewriter are the same as prescribed for manual teletypewriter operations listed in ACP 126().

Table 5-1. Procedure Signs

PROSIGN	MEANING
<u>AA</u>	All After
<u>AA</u>	Unknown Station
<u>AB</u>	All Before
<u>AR</u>	End of Transmission
<u>AS</u>	Wait
<u>B</u>	More to Follow
<u>BT</u>	Long Break
<u>C</u>	Correct/Correction
<u>DE</u>	From
<u>EEEEEEEE</u>	Error
<u>F</u>	Do not answer
<u>FM</u>	Originator's sign
<u>G</u>	Repeat back
<u>GR (numeral)</u>	Group count
<u>GRNC</u>	Groups not counted
<u>HM (three times)</u>	Emergency silence
<u>II</u>	Separative sign
<u>IMI</u>	Repeat
<u>INFO</u>	Information addressee sign
<u>INT</u>	Interrogative
<u>IX</u>	Execute to follow
<u>IX (5-second dash)</u>	Executive signal
<u>J</u>	Verify with originator and repeat
<u>K</u>	Invitation to transmit/over
<u>NR</u>	Number
<u>O</u>	Immediate
<u>P</u>	Priority
<u>PT</u>	Call sign follows
<u>R</u>	Receipt/Roger
<u>R</u>	Routine
<u>T</u>	Transmit to
<u>TO</u>	Action addressee designator
<u>WA</u>	Word after
<u>WB</u>	Word before
<u>XMT</u>	Exempted addressee designator
<u>Z</u>	Flash

Table 5-2. Phonetic Alphabet

Letter	Word	Pronunciation	Letter	Word	Pronunciation
A	ALFA	<u>AL</u> FAH	N	NOVEMBER	NO <u>VEM</u> BER
B	BRAVO	<u>BRAH</u> VOH	O	OSCAR	<u>OSS</u> CAH
C	CHARLIE	<u>CHAR</u> LEE or <u>SHAR</u> LEE	P	PAPA	PAH <u>PAH</u>
D	DELTA	<u>DELL</u> TAH	Q	QUEBEC	KEH <u>BECK</u>
E	ECHO	<u>ECK</u> OH	R	ROMEO	<u>ROW</u> ME OH
F	FOXTROT	<u>FOKS</u> TROT	S	SIERRA	SEE <u>AIR</u> RAH
G	GOLF	GOLF	T	TANGO	<u>TANG</u> GO
H	HOTEL	HOH <u>TELL</u>	U	UNIFORM	<u>YOU</u> NEE FORM or <u>OO</u> NEE FORM
I	INDIA	<u>IN</u> DEE AH	V	VICTOR	<u>VIK</u> TAH
J	JULIETT	<u>JEW</u> LEE <u>ETT</u>	W	WHISKEY	<u>WISS</u> KEY
K	KILO	<u>KEY</u> LOH	X	XRAY	<u>ECKS</u> RAY
L	LIMA	<u>LEE</u> MAH	Y	YANKEE	<u>YANG</u> KEY
M	MIKE	MIKE	Z	ZULU	<u>ZOO</u> LOO

Table 5-3. Number Pronunciation Guide

Numeral	Spoken As
0	<u>ZE</u> RO
1	WUN
2	TOO
3	TREE
4	<u>FOW</u> ER
5	FIFE
6	SIX
7	<u>SEV</u> EN
8	AIT
9	<u>NIN</u> ER

PROWORD	EXPLANATION	EQUIVALENT TO PROSIGN
ALL AFTER	The portion of the message to which I have reference is all that which follows _____.	AA
ALL BEFORE	The portion of the message to which I have reference is all that which precedes _____.	AB
AUTHENTICATE	The station called is to reply to the challenge which follows.	
AUTHENTICATION IS	The transmission authentication of this message is _____.	

Table E-4. Procedure Words (cont)

PROWORD	EXPLANATION	EQUIVALENT TO PROSIGN
BREAK	I hereby indicate the separation of the text from other portions of the message.	<u>BT</u>
BROADCAST YOUR NET	Link the two nets under your control for automatic rebroadcast.	
CALL SIGN	The group that follows is a call sign.	<u>PT</u>
CORRECT	You are correct, or what you have transmitted is correct.	C
CORRECTION	An error has been made in this transmission. Transmission will continue with the last word correctly transmitted.	EEEEEEEE
	An error has been made in this transmission (or message indicated). The correct version is _____.	C
	That which follows is a corrected version in answer to your request for verification.	C
DISREGARD THIS TRANSMISSION—OUT	This transmission is in error. Disregard it. This PROWORD shall not be used to cancel any message that has been completely transmitted and for which receipt or acknowledgement has been received.	EEEEEEEE <u>AR</u>
DO NOT ANSWER	Stations called are not to answer this call, receipt for this message, or otherwise to transmit in connection with this transmission. When this PROWORD is employed, the transmission shall be ended with the PROWORD "OUT".	F

Table 5-4. Procedure Words (cont)

PROWORD	EXPLANATION	EQUIVALENT TO PROSIGN
EXECUTE	Carry out the purpose of message or signal to which this applies. To be used only with the Executive Method.	IX (5 sec dash)
EXECUTE TO FOLLOW	Action on the message or signal which follows is to be carried out upon receipt of the proword "EXECUTE". To be used only with the Delayed Executive Method.	IX
EXEMPT	The addressees immediately following are exempted from the collective call.	XMT
FIGURES	Numerals or numbers follow.	
FLASH	Precedence FLASH	Z
FROM	The originator of this message is indicated by the address designator immediately following.	FM
GROUPS	This message contains the number of groups indicated by the numeral following.	GR
GROUP NO COUNT	The groups in this message have not been counted.	GRNC
I AUTHENTICATE	The group that follows is the reply to your challenge to authenticate.	
IMMEDIATE	Precedence IMMEDIATE	O
IMMEDIATE EXECUTE	Action on the message or signal following is to be carried out on receipt of the word EXECUTE. To be used only with the Immediate Executive Method.	<u>IX</u>

Table 3-4. Procedure Words (cont)

PROWORD	EXPLANATION	EQUIVALENT TO PROSIGN
INFO	The addressees immediately following are addressed for information.	INFO
I READ BACK	The following is my response to your instructions to read back.	
I SAY AGAIN	I am repeating transmission or portion indicated.	<u>IMI</u>
I SPELL	I shall spell the next word phonetically.	
I VERIFY	That which follows has been verified at your request and is repeated. To be used only as a reply to VERIFY.	
MESSAGE	A message which requires recording is about to follow. Transmitted immediately after the call. (This PROWORD is not used on nets primarily employed for conveying messages. It is intended for use when messages are passed on tactical or reporting nets.)	
MORE TO FOLLOW	Transmitting station has additional traffic for the receiving station.	B
NET NOW	All stations are to net their radios on the unmodulated carrier wave which I am about to transmit.	
NUMBER	Station Serial Number	NR
OUT	This is the end of my transmission to you and no answer is required or expected.	<u>AR</u>
OVER	This is the end of my transmission to you and a response is necessary. Go ahead, transmit.	K

PROWORD	EXPLANATION	EQUIVALENT TO PROSIGN
PRIORITY	Precedence PRIORITY.	P
READ BACK	Repeat this entire transmission back to me exactly as received.	G
RELAY (TO)	Transmit this message to all addressees (or addressees immediately following this PROWORD). The address component is mandatory when this PROWORD is used.	T
ROGER	I have received your last transmission satisfactorily.	R
ROUTINE	Precedence ROUTINE.	R
SAY AGAIN	Repeat all of your last transmission. Followed by identification data means "Repeat _____ (portion indicated)".	<u>IMI</u>
SERVICE	The message that follows is a SERVICE message.	SVC
SIGNALS	The groups which follow are taken from a signal book. (This PROWORD is not used on nets primarily employed for conveying signals. It is intended for use when tactical signals are passed on nontechnical nets).	
SILENCE (Repeated three or more times).	Cease transmission on this net immediately. Silence will be maintained until lifted. (When an authentication system is in force, the transmission imposing silence is to be authenticated).	<u>HM HM HM</u>
SILENCE LIFTED	Silence is lifted. (When an authentication system is in force, the transmission lifting silence is to be authenticated).	

Table 5-4. Procedure Words (cont)

PROWORD	EXPLANATION	EQUIVALENT TO PROSIGN
SPEAK SLOWER	Your transmission is at too fast a speed. Reduce speed of transmission.	
STOP REBROADCASTING	Cut the automatic link between the two nets that are being rebroadcast and revert to normal working.	
THIS IS	This transmission is from the station whose designator immediately follows.	DE
TIME	That which immediately follows is the time or date-time group of the message.	
TO	The addressees immediately following are addressed for action.	TO
UNKNOWN STATION	The identity of the station with whom I am attempting to establish communication is unknown.	<u>AA</u>
VERIFY	Verify entire message (or portion indicated) with the originator and send correct version. To be used only at the discretion of or by the addressee to which the questioned message was directed.	J
WAIT	I must pause for a few seconds.	<u>AS</u>
WAIT-OUT	I must pause longer than a few seconds.	<u>AS AR</u>
WILCO	I have received your signal, understand it, and will comply. To be used only by the addressee. Since the meaning of ROGER is included in that of WILCO, the two PROWORDS are never used together.	

PROWORD	EXPLANATION	EQUIVALENT TO PROSIGN
WORD AFTER	The word of the message to which I have reference is that which follows ____.	WA
WORD BEFORE	The word of the message to which I have reference is that which precedes _____.	WB
WORDS TWICE	Communication is difficult. Transmit (transmitting) each phrase (or each code group) twice. This PROWORD may be used as an order, request, or as information.	
WRONG	Your last transmission was incorrect. The correct version is _____.	

CHAPTER 6

ELECTRONIC WARFARE

6-1. Importance to the Radio Operator

The radio operator has a vital position in every unit. Actions by the operator can either greatly aid or seriously hamper the accomplishment of the unit's missions. Any person, regardless of rank, who operates a radio must know what the consequences of his actions might be. If a radio is used properly, the unit will more easily accomplish its mission and its personnel will enjoy greater safety. If a radio is used improperly, the consequence may be the destruction of the unit.

Warfare today is not limited to just bombs and bullets. An important part of the commander's combat assets is the electronic warfare (EW) equipment that he can use to aid him and hinder the enemy.

6-2. Definition and Scope

Simply stated, EW is the military action involving the use of electromagnetic energy (radio frequency waves) to determine, exploit, reduce prevent hostile use of the electromagnetic spectrum (frequency bands) and actions which retain friendly use of the spectrum. EW includes three kinds of activities. The first, electronic warfare support measures (ESM), involves actions taken to search for, intercept, locate, record, and analyze radiated electromagnetic energy for the purpose of exploiting such radiation in support of military operations. Thus, ESM provides a source of information required to conduct the second EW action, electronic countermeasures (ECM). ECM involves actions taken to prevent or reduce effective use of the electromagnetic spectrum by the opposing force. The third part of EW, electronic counter-countermeasures (ECCM), involves actions taken to ensure effective use of the electromagnetic spectrum despite EW activity by the enemy. [Figure 6-1](#) illustrates the relationships of ESM, ECM, and ECCM.

On implementation of Joint Interoperability of Tactical Command and Control System (JINTACCS), the JINTACCS format will be the standard operational report used to report MIJI incidents. If JINTACCS has not been implemented, or in cases where JINTACCS is not available, use the current format in this manual.

NOTE: The JINTACCS format is in DA Pam 25-7, Annex 81 to chapter 3, pages 3-81-1 thru 3-81-13.

[Figure 6-1.](#) Electronic warfare functions.

6-3. Enemy EW Techniques Each radio operator must be aware of what the enemy will try to do. The enemy is well equipped to conduct EW and the different techniques he uses have specific purposes in his EW effort.

Interception.

The first thing that the enemy must do is intercept our radio signal. All he needs to do this is a radio receiver

that operates in the same mode and on the same frequency you are using to transmit. The mere fact that you are operating gives the enemy valuable information. It tells him that you are in the area. And, by the number of stations operating on the same frequency, he can estimate the size of the unit. If your net is operating in the clear, his language specialists can understand exactly what is said for even more information. When he analyzes the traffic pattern, he can figure out which station is the net control station (NCS) and identify the headquarters. Usually, in US forces, the NCS is the radio used by the operations officer/section of the highest headquarters operating in the net. By further traffic analysis, he can determine changes in the level of activity that could mean a movement or upcoming operation.

Radio Direction Finding.

Interception is only one of the many dangers that the radio operator will face. After the enemy knows that you are in the area, he will try to locate your position by using radio direction finding (RDF). A radio direction finder consists of a radio receiver, a directional antenna, and some other specialized equipment. With RDF equipment, the approximate azimuth (bearing) to a transmitting radio can be determined. One azimuth gives a general indication of direction. The intersection of two azimuths by different RDF stations is called a *cut* and gives a general indication of distance. The intersection of three or more bearings is called a *fix* and gives a general location. The ideal fix is the exact intersection of three or more bearings. However, exact intersection is seldom achieved. Terrain and weather conditions, together with variations in radio wave propagation characteristics, plus the inherent RDF equipment and operator inaccuracies, all tend to prevent an ideal fix. The fix that is obtained is called an actual fix. Although the actual fix may not be usable for immediate targeting purposes, it is more than enough for intelligence analysts to develop targeting data. Airborne direction finding is more accurate than ground-based direction finding but normally requires further analysis for targeting. RDF ability to intercept electronics equipment emissions and determine a bearing depends on the power output of the targeting transmitter and its antenna radiation patterns. Experience indicates RDF accuracy of 500-meter (547-yd) circular error probable (CEP) is considered a very good RDF fix. Normally, 50 percent of the CEPs are approximately 1,500 meters (1,640-yd) when the direction finder is located within 20 to 25 kilometers (12.4 to 15.5 mi) of the forward line of own troops (FLOT). Many Threat forces will fire on a 1,500-meter (1,640-yd) CEP if they have sufficient massed artillery, and further analysis of terrain and radio intercept can reduce the target area or identify an important target.

Jamming.

Threat forces employ a large number of RDF sets and communications intelligence (COMINT) analysts to exploit friendly use of the electromagnetic spectrum. The enemy's goal is to locate and destroy as many command, fire support, special weapons, and intelligence sites as possible during the first critical phase of the battle. He will continue to locate and destroy whenever possible; and when he locates sites that he cannot or does not want to destroy, these become his prime jamming targets. Jamming is an effective way to disrupt control of the battle. All it takes is a transmitter, tuned to your frequency, with the same type of modulation and with enough power output to override the signal at your receiver.

Jammers operate against receivers--not transmitters. There is equipment available which, when used with the AN/VRC-12 series radio sets, can counter the jamming threat of the enemy. See [appendix E](#) for more details.

There are many types of jamming signals that may be used against you. Some will be very difficult to detect and in some cases impossible. For this reason, an operator must always be alert to the probability of jamming and react accordingly when the radio has been silent for an inordinate amount of time. Others are quite clearly jamming signals. The more commonly used types are--

Random Noise	Random Pulse
Stepped Tones	Wobbler
Random Keyed Modulated CW	Tone
Rotary	Pulse
Spark	Recorded Sounds
Gulls	Sweep-through

Imitative Electronic Deception.

In addition to interception, RDF, and jamming, the enemy may use a compatible radio and a language expert to enter a friendly radio net. This is called imitative electronic deception (IED). The enemy IED experts are good and they are believable. If you permit them into your net, they will create confusion and destruction for your unit. They will have you shelling your own units, walking into ambushes, deploying to the wrong position, and making yourself a target.

6-4. Signal Security and ECCM

Now that you know what the enemy is going to try to do to you and how he plans to do it, you must also realize the effectiveness of his EW depends a lot on how effective we let it be. There is a saying that "You are your own worst enemy." In EW that is true because the less you do to protect yourself, the more the enemy can hurt you. This emphasizes the fact that a close relationship exists between ECCM and signal security (SIGSEC). Both of these defensive arts are based on the same principle. When the enemy does not have access to our essential elements of friendly information (EEFI), the less effective he becomes. The major impact of SIGSEC is to ensure that all friendly use of the electromagnetic spectrum is not exploitable by the enemy. ECCM are those actions taken to protect and ensure continued effective use of communications, surveillance, and acquisition devices from enemy ECM. SIGSEC techniques are designed to increase the security of our transmissions. ECCM techniques ensure you some degree of protection from enemy ECM and ESM measures. Both SIGSEC and ECCM should be preplanned and based on the enemy's ESM, ECM, and destructive capabilities.

SIGSEC Techniques.

SIGSEC techniques cover the areas of emission security (also called emission control or EMCON), transmission security, crypto security, and physical security. Each of these areas will protect you from one or more of the enemy's threats of interception, radio direction finding, jamming, imitative electronic deception, and destruction.

Emission security/control.

The first line of defense against enemy EW action, and the key to successful defense is control of electromagnetic emission. Radios and other emitters should be turned on only when required for the successful accomplishment of the mission. Enemy intercept analysts look for patterns which can be turned into usable information for the enemy commander. Making short transmissions, masking antenna locations, using directional antennas, and using the lowest possible power output are some of the actions that will protect you and your unit from enemy EW. Emission control can be total. All radios remain silent while the unit makes its tactical maneuver. It can be selective with some nets as directed nets and some nets as free nets. It can aid in deceiving the enemy, with some units on radio silence while others operate normally. EMCON should always be used and planned for. It is the first line of defense for a radio operator against interception and RDF. If the enemy does not know you are out there (because he can't pick up your radio transmissions), he cannot target you for destruction or for jamming.

Transmission security.

The second line of defense is transmission security (TRANSEC). TRANSEC has to do with what and how information is transmitted. A message transmitted in the clear is the enemy's greatest source of information. After the enemy has intercepted your radio transmission, his language specialists will extract all possible intelligence from it. He hopes to learn EEFI. These critical items of information that must be protected can be remembered by the key words SELDOM UP. Each letter indicates a class of information as listed below.

S trength _____	Number of personnel, size of unit
E quipment _____	Type, quantity, condition
L ogistics _____	Procedure for resupply, depots
D isposition _____	Where, what positions, map coordinates
O rganization _____	How, what, chain of command, forces structure
M ovement/Morale _____	Where, how, when/good-bad
U nits _____	Type, designation
P ersonalities _____	Who, where

Using TRANSEC is absolutely essential for the radio operator. When the radio must be used, keep transmission time to an absolute minimum (20 seconds absolute maximum: 15 seconds maximum preferred); preplan your messages to avoid compromising any essential element of information; and, if you must send EEFI items, use brevity lists, if possible, and also encrypt the message. These measures decrease your transmission, help protect you from RDF, and deny the enemy valuable information. Included under transmission security are the authentication procedures that must be followed to protect you from the enemy's imitative electronic deception. (See FM 24-35 for instructions on authentication procedures.) Every radio operator must be aware of the dangers of and guard against IED.

Crypto security.

Crypto security deals with codes, key lists, and communications security devices. This is the third line of defense for the radio operator. If you use a security device on your radio, the enemy will not get anything for his language specialists to work on. However, do not get a false sense of security. The need for emission control and transmission security still exists--probably more so; because, if the enemy can't get information, he might attempt to destroy or jam your station. Also, it is very important for all radio operators to use only authorized codes and to realize that using homemade codes is dangerous. Homemade codes offer no protection at all. Their use is not authorized and is a serious violation of security. This also includes trying to "talk around" a classified or sensitive piece of information. The enemy intelligence personnel are not fools, and trying something like "talking around" critical information does more harm than good. If critical information must be transmitted, it should be encrypted or sent by secure means. In a special situation where it is not possible to send by a secure means or to encrypt a message that must be sent, the possibility of what we will lose against what the enemy could gain must be weighed. Other factors, such as how fast the enemy could react to the information and what delaying the message for encryption could mean must also be considered.

Physical security.

Physical security is the fourth line of defense for the radio operator. Physical security means using common sense measures to protect your radio and related material, such as CEOIs and key lists, from unauthorized use and abuse. A radio is an important item of equipment; only well-trained and fully briefed personnel should use it.

Electronic Counter-Countermeasures.

ECCM techniques may be divided into two categories: preventive and remedial. Preventive ECCM are those procedures that can be used to avoid enemy ECM attempts. Remedial ECCM apply to jamming only; there are no remedial measures once you have been intercepted, detected, or deceived. ECCM procedures are covered in FM 24-33.

6-5. Capture Effect and Jamming Techniques

Capture Effect.

An inherent characteristic in FM communications is that a given station transmitting a signal will *capture* those receivers on the same frequency and in range for the receiver to detect the signal. This is the basis for *netted* communications for VHF FM radios. This FM capture effect is undesirable when receivers in a net are "captured" by a transmitter not in that net. This could be friendly interference or enemy interference. Friendly interference is usually unintentional whereas enemy interference is usually intentional.

Obvious Jamming.

We are mostly aware of obvious interference (jamming) by an enemy, such as stepped tones (bagpipes), random-keyed Morse Code, pulses, and recorded sounds. The purpose of this type of jamming is to block out reception of friendly transmitted signals and to cause a nuisance to the receiving operator. An operator usually can detect when the enemy is using this type of jamming against him.

Subtle Jamming.

This type of jamming is not obvious at all. With subtle jamming, no sound is heard from the receiver. The radio does not receive incoming friendly signals, yet everything seems normal to the operator. Subtle jamming takes advantage of design features of the AN/PRC-77 and AN/VRC-12 series radios. In order for an AN/PRC-77 to receive a signal in the "SQUELCH ON" mode (function switch in SQUELCH position) or an AN/VRC-12 series radio to receive a signal in the "NEW SQUELCH ON" mode, a 150-Hz tone must be on the received carrier signal. This 150-Hz tone is used to deactivate the squelch circuitry and allow the operator to hear the incoming message. In addition to this squelch feature, the AN/PRC-77 and AN/VRC-12 series radio receivers will lock onto the strongest carrier signal received and eliminate the reception of all other signals. For example, suppose you are operating an AN/PRC-77 in the "SQUELCH" mode or an AN/VRC-12 series radio in the "NEW SQUELCH ON" mode, and a strong, unmodulated (no 150-Hz tone) jamming signal appears on your frequency. If the jamming signal is stronger than any other signal on your frequency, the receiver will lock onto the jamming signal and will block out all others. Since there is no 150-hertz tone to deactivate the squelch, the receiver appears not to be receiving a signal. Neither is the call-light activated. In effect, the Threat jammers can block out the ability of these radios to receive a friendly transmission without the operator being aware that this is happening. This is called "SQUELCH CAPTURE" and is a subtle-jamming technique. Again, let us emphasize that with subtle jamming, everything appears normal to the operator. It should be noted that the operator should readily be able to detect the fact that he is being jammed in all other squelch positions.

6-6. Operator Actions

Radio operators must be able to determine whether or not their radios are being jammed. As was mentioned in the previous paragraph, this is not always an easy task. Threat jammers may employ obvious or subtle jamming techniques. These techniques may consist of powerful unmodulated or noise-modulated carrier

signals transmitted to the operator's receiver. Unmodulated jamming signals are characterized by a lack of noise. Noise-modulated jamming signals are characterized by obvious interference noises. If radio operators suspect that their radios are the targets of Threat jamming, the following procedures will help them to make this determination.

AN/PRC-77

The operator turns the function control from the SQUELCH to the ON position.

If no noise is present, this may indicate that the radio is being jammed by an unmodulated jamming signal. The operator should temporarily disconnect the antenna. If normal static noise returns with the antenna disconnected, there is a high probability that the radio is being jammed.

If a greater than normal level of noise or an obviously modulated signal is present, this may indicate that the radio is being jammed by a modulated jamming signal. The operator should temporarily disconnect the antenna. If normal static noise returns with the antenna disconnected, there is a high probability that the radio is being jammed.

If tests indicate the probability of jamming being present, the operator should follow local SOP to reestablish communications and also to initiate a MIJI report (see [para 6-7](#)) informing higher headquarters of the jamming.

AN/VRC-12 Series Radio

The operator turns the squelch control from the NEW SQUELCH ON to the NEW SQUELCH OFF position.

If no noise is present, this may indicate that the radio is being jammed by an unmodulated jamming signal. The operator should temporarily disconnect the antenna. If normal static noise returns there is a high probability that the radio is being jammed.

If a greater than normal level of noise or an obviously modulated signal is present, this may indicate that the radio is being jammed by a modulated jamming signal. The operator should temporarily disconnect the antenna. If normal static noise then returns there is a high probability that the radio is being jammed.

If tests indicate the probability of jamming being present, the operator should follow local SOP to reestablish communications and also to initiate a MIJI report (see [para 6-7](#)) informing higher headquarters of the jamming.

6-7. Meaconing, Intrusion, Jamming, and Interference (MIJI) Report

It must be reemphasized that, any time you suspect or know you are being jammed, or you know or suspect that the enemy is intruding on the net, you must report the incident immediately by secure means to higher headquarters. Such information is vital for the protection and defense of our radio communications.

Purpose of Field MIJI Reports.

Field MIJI reports serve two distinct purposes. First, initial MIJI reports facilitate battlefield evaluations of the enemy's actions or intentions and provide data for tactical countermeasures as appropriate. Second, complete and accurate follow-up reports ensure MIJI incidents are documented and evaluated on a national level, thus providing data for a continuing study of foreign electronic warfare capabilities and activities. To meet these diverse needs, field MIJI reports will be of two types.

- MIJI 1--An abbreviated initial report containing only those items of information necessary to inform

headquarters of the incident and enable them to initiate evaluatory/retaliatory actions as appropriate.

- MIJI 2--A complete follow-up report containing all details of the incident which will be forwarded to the Joint Electronic Warfare Center (JEWEC), San Antonio, Texas 78243 (message address is JEWEC SAN ANTONIO TX//OPM//).

Transmission of MIJI Reports.

MIJI reports may be transmitted over nonsecure electronic means when secure communications are not available, however, the textual content of the MIJI report will be secured by an off-line (manual) system. Reports will be prepared in the format outlined below. Brevity numbers pertinent to specific line item information are provided for some items. These brevity numbers must be encoded in the numeral cipher/authentication system prior to transmission.

The MIJI 1 Report.

This report is forwarded through the chain of command to the unit operations center by the operator who is experiencing the MIJI incident. A separate report is submitted for each MIJI incident.

Item 1 - Type report. When being transmitted over nonsecure communications means, the numerals 022 are encrypted as Item 1 of the MIJI 1 report. When being transmitted over secure communications means, the term MIJI 1 is used as Item 1 of the MIJI 1 report.

Item 2 - Type MIJI incident. When being transmitted over nonsecure communications means, the appropriate numeral preceding one of the items below is encrypted as Item 2 of the MIJI 1 report. When being transmitted over secure communications means, the appropriate term below is used as Item 2 of the MIJI 1 report.

- 1 Meaconing
- 2 Intrusion
- 3 Jamming
- 4 Interference

Item 3 - Type of equipment affected. When being transmitted over nonsecure communications means, the appropriate numeral preceding one of the terms below is encrypted as Item 3 of the MIJI 1 report. When being transmitted over secure communications means, the appropriate term below is used as Item 3 of the MIJI 1 report.

- 1 Radio
- 2 Radar
- 3 Navigational aid
- 4 Satellite
- 5 Electro-optics

Item 4 - Frequency or channel affected. When being transmitted over nonsecure communications means, the frequency or channel affected by the MIJI incident is encrypted as Item 4 of the MIJI 1 report. When being transmitted over secure communications means, the frequency or channel affected by the MIJI incident is Item 4 of the MIJI 1 report.

Item 5 - Victim designation and call sign of affected station operator. The complete call sign of the affected station operator is Item 5 of the MIJI 1 report over both secure and nonsecure communications

means.

Item 6 - Coordinates of the affected station. When being transmitted over nonsecure communications means, the complete grid coordinates of the affected station are encrypted as Item 6 of the MIJI 1 report. When being transmitted over secure communications means, the complete grid coordinates of the affected station are Item 6 of the MIJI 1 report.

The MIJI 2 Report.

This is a complete report containing all details of the MIJI incident. Due to the number of items which require encryption when the report is transmitted over a nonsecure circuit, it is recommended that the report be delivered by messenger whenever possible. Either the operations officer, intelligence officer, or the electronic warfare officer is responsible for ensuring that a complete message report of the incident is submitted to the Joint Electronic Warfare Center (JEWEC) within 24 hours of the incident.

Reference Material.

Refer to FM 24-33 for a more detailed treatment of MIJI 1 reports and to AR 105-3 for details on MIJI 2 reports.

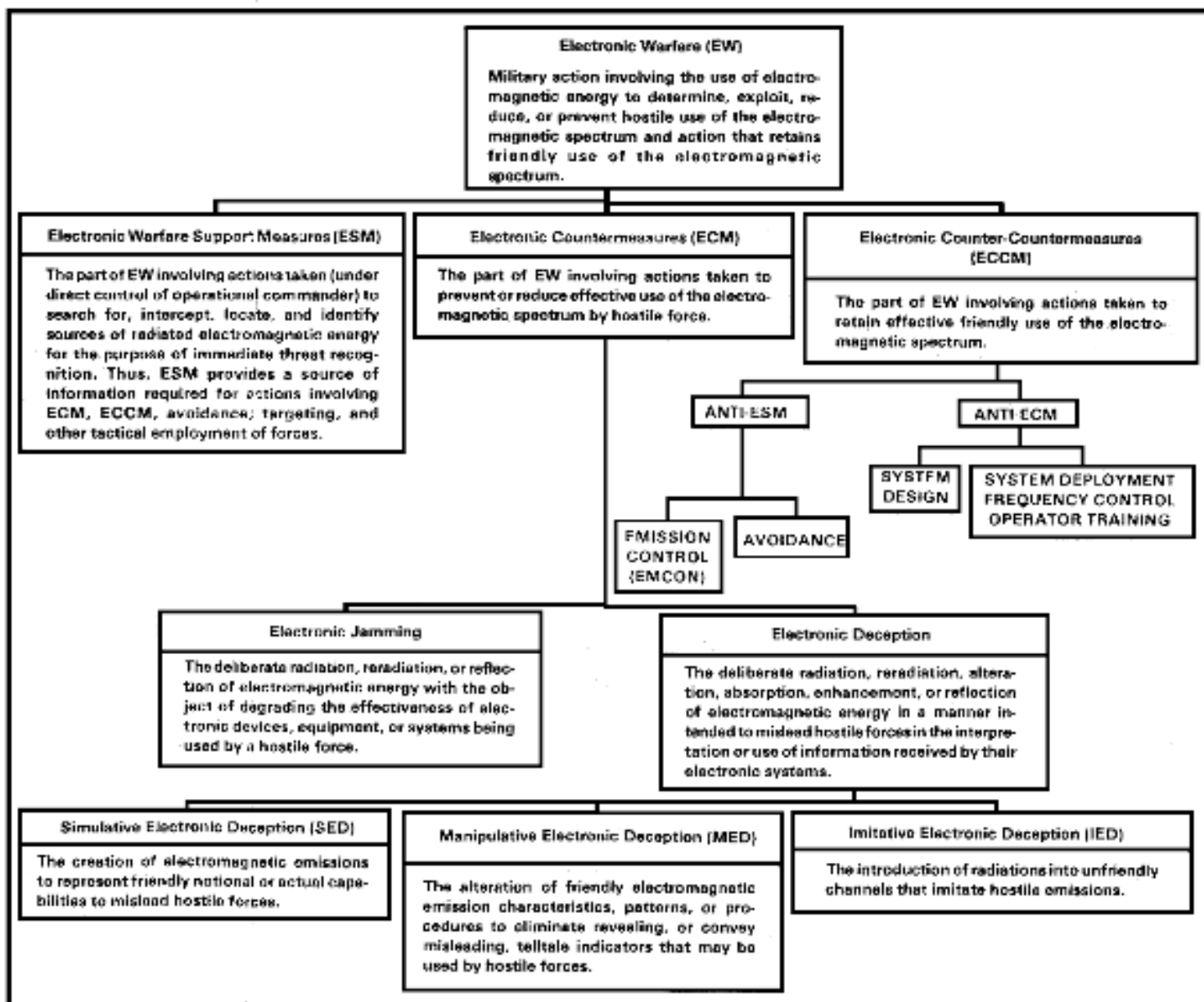

Figure 6-1. Electronic warfare functions.

CHAPTER 7

RADIO OPERATIONS UNDER UNUSUAL CONDITIONS

Section I. Operations in Arcticlike Areas

7-1. Capabilities and Limitations

Single-channel radio equipment has certain capabilities and limitations that must be carefully considered when operating in extremely cold areas. However, in spite of significant limitations, radio is the normal means of communications in such areas.

One of the most important capabilities of radio in arcticlike areas is its versatility. Vehicular-mounted radios can be moved relatively easy to almost any point where it is possible to install a command headquarters. Smaller, manpacked radios can be carried to any point accessible by foot or aircraft.

A limitation on radio communications that radio operators must expect in extremely cold areas is interference by ionospheric disturbances. These disturbances, known as ionospheric storms, have a definite degrading effect on sky wave propagation. Moreover, either the storms or the auroral (for example, Northern Lights) activity can cause complete failure of radio communications. Some frequencies may be blocked out completely by static for extended periods of time during storm activity. Fading, caused by changes in the density and height of the ionosphere, can also occur and may last from minutes to weeks. The occurrence of these disturbances is difficult to predict. When they occur, the use of alternate frequencies and a greater reliance on FM or other means of communications are required.

7-2. Techniques for Better Operations in Arctic-like Areas

Whenever possible, radio sets for tactical operations in arcticlike areas should be installed in vehicles to reduce the problem of transportation and shelter for operators. This will also help solve some of the grounding and antenna installation problems due to the climate.

Because of permafrost and deep snow, it is difficult to establish good electrical grounds in extremely cold areas. The conductivity of frozen ground is often too low to provide good ground wave propagation. To improve ground wave operation, use a counterpoise to offset the degrading effects of poor electrical ground conductivity. When installing a counterpoise, remember to install it high enough above the ground so that it will not be covered by snow.

In general, antenna installation in arcticlike areas presents no serious difficulties. However, installing some antennas may take longer because of adverse working conditions. A few tips for installing antennas in extremely cold areas are listed below.

- The mast sections and antenna cables must be handled carefully since they become brittle in very low temperatures.
- Whenever possible, antenna cables should be constructed overhead to prevent damage from heavy snow and frost. Nylon rope guys, if available, should be used in preference to cotton or hemp because nylon ropes do not readily absorb moisture and are less likely to freeze and break.
- An antenna should have extra guy wires, supports, and anchor stakes to strengthen it to withstand heavy ice and wind loading.

Some radios (generally older generation radios) adjusted to a particular frequency in a relatively warm place may drift off frequency when exposed to extreme cold. Low battery voltage can also cause frequency drift. When possible, allow a radio to warm up several minutes before placing it into operation. Since extreme cold tends to lower output voltage of a dry battery, try warming the battery with body heat before operating the radio set. This minimizes frequency drift.

Flakes or pellets of highly electrically charged snow is sometimes experienced in northern regions. When these particles strike the antenna, the resulting electrical discharge causes a high-pitched static roar that can blanket all frequencies. To overcome this static, antenna elements can be covered with polystyrene tape and shellac.

7-3. Maintenance Improvement in Arcticlike Areas

The maintenance of radio equipment in extreme cold presents many difficulties. Radio sets must be protected from blowing snow, since snow will freeze to dials and knobs, and blow into the wiring to cause shorts and grounds. Cords and cables must be handled carefully since they may lose their flexibility in extreme cold. All radio equipment and power units must be properly winterized. Check the appropriate TM for winterization procedures. A few tips for maintenance in arctic areas are listed below.

Power Units.

As the temperature goes down, it becomes increasingly difficult to operate and maintain generators. They should be protected as much as possible from the weather.

Batteries.

The effect of cold weather conditions on wet and dry cell batteries depends upon the following factors: the type and kind of battery, the load on the battery, the particular use of the battery, and the degree of exposure to cold temperatures. Check SB 11-6 and SB 11-30 for specific information.

Shock Damage.

Damage may occur to vehicular radio sets by the jolting of the vehicle. Most synthetic rubber shock mounts become stiff and brittle in extreme cold and fail to cushion equipment. Check the shock mounts frequently and change them, as required.

Winterization.

Check the TMs for your radio set and power source to see if there are special precautions for operation in extremely cold climates. For example, normal lubricants may solidify and permit damage or malfunctions. They must be replaced with the recommended arctic lubricants.

Microphones.

Moisture from your breath may freeze on the perforated cover plate of your microphone. Use standard microphone covers to prevent this. If standard covers are not available, improvise a suitable cover from rubber or cellophane membranes or from rayon or nylon cloth.

Breathing and Sweating.

A radio set generates heat when it is operated. When you turn it off, the air inside cools and contracts and draws cold air into the set from the outside. This is called *breathing*. When a radio breathes and the still-hot parts come in contact with subzero air, the glass, plastic, and ceramic parts of the set may cool too rapidly and break.

When cold equipment is brought suddenly into contact with warm air, moisture will condense on the equipment parts. This is called *sweating*. Before cold equipment is brought into a heated area, it should be wrapped in a blanket or parka to ensure that it will warm gradually to reduce sweating. Equipment must be thoroughly dry before it is taken back out into the cold air or the moisture will freeze.

Vehicular-Mounted Radios.

These radios present special problems during winter operations because of their continuous exposure to the elements. Proper starting procedures must be observed. The radio's power switch must be off prior to starting the vehicle; a particularly critical requirement when vehicles are slave started. If the radio is cold soaked from prolonged shutdown, frost may have collected inside the radio and could cause circuit arcing. Hence, time should be allowed for the vehicle heater to warm the radio sufficiently so that any frost collected within the radio has a chance to thaw. This may take up to an hour. Once the radio has been turned on, it should warm up for approximately 15 minutes before transmitting or changing frequencies. This allows components to stabilize. If a vehicle is operated at a low idle with radios, heater, and lights on, the batteries may run down. Before increasing engine revolutions per minute to charge the batteries, radios should be turned off to avoid an excessive power surge. A light coat of silicon compound on antenna mast connections helps to keep them from freezing together and becoming hard to dismantle.

Section II. Operations in Jungle Areas

7-4. Capabilities and Limitations

Radio communications in jungle areas must be carefully planned, because the dense jungle growth significantly reduces the range of radio transmission. However, since single-channel radio can be deployed in many configurations, especially manpacked, it is a valuable communications asset. The capabilities and limitations of single-channel radio must be carefully considered when used by forces in a jungle environment.

The mobility and various configurations in which single-channel radio can be deployed are its primary advantages in jungle areas.

Limitations on radio communications in jungle areas stem from the climate and the density of jungle growth. The hot and humid climate increases the maintenance problems of keeping equipment operable.

Thick jungle growth acts as a vertically polarized absorbing screen for RF energy that, in effect, reduces transmission range. Therefore, increased emphasis on maintenance and antenna siting is a must when operating in jungle areas.

7-5. Techniques for Better Operations in the Jungle

The main problem you may have in establishing radio communications in jungle areas is the siting of your antenna. Apply the following techniques to improve your communications in the jungle:

- Antennas should be located in clearings on the edge farthest from the distant station and as high as possible.
- Antenna cables and connectors should be kept off the ground to lessen the effects of moisture, fungus, and insects. This also applies to all power and telephone cables.
- Complete antenna systems, such as ground planes and dipoles, are more effective than fractional wavelength whip antennas.
- Vegetation must be cleared from antenna sites. If an antenna touches any foliage, especially wet foliage, the signal will be grounded.
- Vegetation, particularly when wet, will act like a vertically polarized screen and absorb much of a vertically polarized signal. Use horizontally polarized antennas in preference to vertically polarized antennas.

7-6. Maintenance Improvement in the Jungle

Because of moisture and fungus, the maintenance of radio sets in tropical climates is more difficult than in temperate climates. The high relative humidity causes condensation to form on the equipment and encourages the growth of fungus. Operators and maintenance personnel should check the appropriate TMs for any special maintenance requirements. Some techniques for improving maintenance in jungle areas are listed below:

- Keep the equipment as dry as possible and in lighted areas to retard fungus growth.
- Keep all air vents clear of obstructions so air can circulate to cool and dry the equipment.
- Keep connectors, cables, and bare metal parts as free of fungus growth as possible.
- Use moisture and fungusproofing paint (MFP) to protect equipment after repairs are made or when equipment is damaged or scratched.

7-7. Expedient Antennas for Use in the Jungle

Dismounted patrols and units of company size and below can greatly improve their ability to communicate in the jungle by using expedient antennas. While moving, you are generally restricted to using the short and long antennas which come with your radios. However, when you are not moving, these expedient antennas will allow you to broadcast farther and to receive more clearly. Keep this fact in mind; however, *an antenna that is not "tuned" or "cut" to the operating frequency is not as effective as the whips that are supplied with your radio.* Circuits inside the radio "load" the whips properly so that they are "tuned" to give maximum output. Whips are not as effective as a tuned doublet or tuned ground-plane (namely, RC-292 type), but the doublet or ground-plane *must be tuned* to the operating frequency. This is especially critical with low-power radios such as the AN/PRC-77.

Expedient 292-Type Antenna.

The expedient 292-type antenna was developed for use in the jungle and, if used properly, will increase your ability to communicate. In its entirety, it is bulky and heavy and is not generally acceptable for dismantled patrols and small unit operations. You can, however, carry only the mast head and antenna sections, mounting these on wood poles or hanging them from trees. Or, you can fabricate a complete expedient 292-type antenna ([fig 7-1](#)) using WD-1, wire, and other readily available material. You can use almost any plastic, glass, or rubber objects for insulators. Dry wood is acceptable when nothing else is available. See [figure 3-26](#) for types of insulators which may be used. Below are some points on making this antenna.

Use the quick-reference chart ([table 7-1](#)) to determine the length of the elements (1 radiating and 3 ground planes) for the frequency you will be using. Cut these elements ([fig 7-1A](#)) from WD-1 field wire (or similar wire). Cut spacing sticks ([fig 7-1B](#)) the same length. Place the ends of the sticks together to form a triangle and tie the ends with wire, tape, or rope. Attach an insulator to each corner. Attach a ground-plane wire to each insulator. Bring the other ends of the ground-plane wires together, attach them to an insulator ([fig 7-1C](#)), and tie securely. Strip about 3 inches of insulation from each wire and twist them together.

Tie one end of the radiating element wire to the other side of insulator C and the other end to another insulator ([fig 7-1D](#)). Strip about 3 inches of insulation from the radiating element at insulator C.

Cut enough WD-1 field wire to reach from the proposed location of the antenna to the radio set. *Keep this line as short as possible: excess length reduces efficiency of system.* Tie a knot at each end of this cable pair to keep it from unraveling. Identify *one* wire in the pair and tie a knot at each end to identify it as the "hot" lead. Remove insulation from the "hot" wire and tie it to the radiating element wire at insulator C. Remove insulation from the other wire and attach it to the bare ground-plane element wires at insulator C. Tape all connections and do not allow the radiating element wire to touch the ground-plane wires.

Attach a rope to the insulator on the free end of the radiating element and toss the rope over the branches of a tree. Pull the antenna as high as you can, keeping the lead-in routed down through the triangle. Secure the rope to hold the antenna in place.

At the radio set, remove about 1 inch of insulation from the "hot" lead and about 3 inches of insulation from the other wire. Attach the "hot" line to the antenna terminal (doublet connector, if so labeled). Attach the other wire to the metal case--the handle, for example. Be sure both connections are tight or secure.

Set up correct frequency, turn on set, and proceed with communications.

[Table 7-1](#). Quick Reference Chart

[Figure 7-1](#). Expedient 292-type antenna.

Patrol Antenna.

This is another antenna that is easy to carry and quick to set up ([fig 7-2](#)). The two radiating wires are cut to the length shown in [table 7-1](#) for the operating frequency. For the best results, the lead-in should extend at least 1.8 meters (6 ft) at right angles (give or take 30°) to the antenna section before dropping

The easiest way to set up this antenna is to measure the length of the radiating elements from one end of the lead-in (WD-1) and tie a knot at that point. The two wires are separated: one is lifted vertically by a rope and insulator, the other is held down by a rock (or other weight) and a rope and insulator. The antenna should be as high as possible.

Attach the other end of the lead-in to the radio set as described in the paragraph on the expedient 292-type antenna.

[Figure 7-2](#). Expedient patrol antenna.

Section III. Operations in Desert Areas

7-8. Capabilities and Limitations

Radio is usually the primary means of communications in the desert. It can be employed effectively in desert climate and terrain to provide the highly mobile means of communications demanded by widely dispersed forces. However, desert terrain provides poor electrical ground and counterpoises are needed to improve operation. (Refer to [chapter 3](#) for information on counterpoises.)

7-9. Techniques for Better Operations in the Desert

For the best operation in the desert, radio antennas should be located on the highest terrain available. Transmitters using whip antennas in the desert will lose one-fifth to one-third of their normal range due to the poor electrical grounding characteristic of desert terrain. For this reason, it is important to use complete antenna systems such as horizontal dipoles and vertical antennas with adequate counterpoises.

7-10. Equipment Considerations

Some radios automatically switch on their second blower fan if their internal temperature rises too high. Normally, this happens only in temperate climates when the radios are transmitting. This may disturb soldiers unaccustomed to radio operation in the desert environment. Operation of the second fan, however, is quite normal. RF power amplifiers used in AM and SSB sets are liable to overheat severely and burn out. Such equipment should be turned on only when necessary (signal reception is not affected). Since the RF power amplifiers take approximately 90 seconds to reach the operating mode, the SOP of units using the equipment should allow for delays in replying. Dust affects communications equipment such as SSB/AM RF power amplifiers and radio teletypewriter sets. The latter especially are prone to damage due to the vulnerability of the oil lubrication system (which attracts and holds dust particles). Dust covers, therefore, should be used whenever possible. Some receiver-transmitter units have ventilating ports and channels that can get clogged with dust. These must be checked regularly and kept clean to prevent overheating.

7-11. Batteries

Wet cell batteries do not hold their charge efficiently in intense heat. Electrolyte evaporates rapidly and should be checked weekly (more often, if warranted). Add distilled water as needed. Extra containers of distilled water should be carried in the vehicle. Maintenance of vehicle batteries beyond adding water

must be done only by authorized motor pool personnel according to applicable regulations (see FM 90-3). Dry battery supplies must be increased, since hot weather causes batteries to fail more rapidly.

7-12. Electrical Insulation

Wind-blown sand and grit will damage electrical wire insulation over a period of time. All cables that are likely to be damaged should be protected with tape before insulation becomes worn. Sand will also find its way into parts of items such as "spaghetti cord" plugs, either preventing electrical contact or making it impossible to join the plugs together. A brush, such as an old toothbrush, should be carried and used to clean such items before they are joined.

7-13. Condensation

In deserts with relatively high dew levels and high humidity, overnight condensation can occur wherever surfaces such as metals exposed to air are cooler than the air temperature. This condensation can affect such items as electrical plugs, jacks, and connectors. All connectors likely to be affected by condensation should be taped to prevent moisture from contaminating the contacts. Plugs should be dried before inserting them into equipment jacks. Excessive moisture or dew should be dried from antenna connectors to prevent arcing.

7-14. Static Electricity

Static electricity is prevalent in the desert. It is caused by many factors, one of which is wind-blown dust particles. Extremely low humidity contributes highly to static discharges between charged particles. Poor grounding conditions aggravate the problem. Be sure to tape all sharp edges (tips) of antennas to cut down on wind-caused static discharges and the accompanying noise. If you are operating from a fixed position, ensure that equipment is properly grounded. Since static-caused noise diminishes with an increase in frequency, use the highest frequencies that are available and authorized.

7-15. Maintenance Improvement in the Desert

In desert areas, the maintenance of radio sets becomes more difficult because of the large amounts of sand, dust, or dirt that enter the equipment. Sets equipped with servomechanisms are particularly affected. To reduce maintenance downtime, keep the sets in dustproof containers as much as possible. It is also important to keep air vent filters clean to allow cool air to circulate to prevent overheating.

Preventive maintenance checks should be made frequently. Also, you should keep a close check on lubricated parts of the equipment. If dust and dirt mix with the lubricants, moving parts may be damaged.

Section IV. Operations in Mountainous Areas

7-16. Capabilities and Limitations

Operation of radios in mountainous areas have many of the same problems as in northern or cold weather areas. Also, the mountainous terrain makes the selection of transmission sites a critical task. In addition, the terrain restrictions encountered frequently make radio relay stations necessary for good communications.

Because of terrain obstacles, radio transmissions will frequently have to be by line of sight. Also, the ground in mountainous areas is often a poor electrical conductor. Thus, a complete antenna system, such as a dipole or ground-plane antenna with a counterpoise, should be used.

The maintenance procedures required in mountainous areas are very often the same as for maintenance in northern or cold weather areas. The varied or seasonal temperature and climatic conditions in mountainous areas make flexible maintenance planning a necessity.

Section V. Operations in Special Environments

7-18. Radio Communications in Urbanized Terrain

Radio communications in urbanized terrain pose special problems. Some problems are similar to those encountered in mountainous areas. There are problems of obstacles blocking transmission paths. There is the problem of poor electrical conductivity due to pavement surfaces. There is also the problem of commercial power lines interference.

VHF radios are not as effective in urbanized terrain as they are in some other areas. The power output and operating frequencies of these sets require a line of sight between antennas. Line of sight at street level is not always possible in built-up areas.

HF radios do not require or rely on line of sight as much as VHF radios. This is true because operating frequencies are lower and power output is greater. The problem now is that HF radio sets are not organic to small units. To overcome this, the VHF signals must be retransmitted.

Retransmission stations in aerial platforms can provide the most effective means if they are available. Organic retransmission is more likely to be used. The antenna should be hidden or blended in with surroundings.

This will help prevent the enemy from using it as a landmark to "home in" his artillery bombardment. Antennas can be concealed by water towers, existing civilian antennas, or steeples.

Here are some other steps that should be taken within urbanized terrain:

- Park radio-equipped vehicles inside buildings for cover and concealment.
- Dismount radio equipment and install it inside buildings (in basement, if available).
- Place generators against buildings or under sheds to decrease noise and provide concealment (adequate ventilation must be provided to prevent heat buildup and subsequent failure of generator).

7-19. Radio Operations in a Nuclear, Biological, and Chemical Environment

One of the realities of fighting on the modern battlefield is the presence of nuclear weapons. Nearly everyone is aware of the effects of nuclear blast, heat, and radiation. The ionization of the atmosphere by a nuclear explosion will have degrading effects on communications because of static and the disruption of the ionosphere.

There is also another effect of a nuclear explosion that is even a greater danger to our radio communications. This effect is called electromagnetic pulse (EMP). EMP is a strong pulse of electromagnetic radiation, many times stronger than the static pulse generated by lightning. This pulse can enter the radio through the antenna system, power connections, and signal input connections. In the equipment, the pulse can break down circuit components such as transistors, diodes, and integrated circuits. It can melt capacitors, inductors, and transformers. EMP can destroy a radio.

Defensive measures against EMP call for proper maintenance, particularly the shielding of equipment. When the equipment is not in use, all antennas and cables should be removed to decrease the effect of EMP on the equipment. Effective grounding is a *must* to reduce effect of EMP. See [Appendix J](#), Electromagnetic Pulse (EMP).

EMP is a danger to our equipment: contamination is a danger to our personnel. In fact, contamination from any faction of the nuclear, biological, and chemical (NBC) environment has adverse effects on both equipment and personnel. [Appendix K](#) deals with this situation in more detail.

Table 7-1. Quick Reference Chart

OP FREQ IN MHZ	ELEMENT LENGTH (radiating element and ground-plane elements)
30	2.38m (7 ft 10 in)
32	2.23m (7 ft 4 in)
34	2.1m (6 ft 11 in)
36	1.98m (6 ft 6 in)
38	1.87m (6 ft 2 in)
40	1.78m (5 ft 10 in)
43	1.66m (5 ft 5 in)
46	1.55m (5 ft 1 in)
49	1.46m (4 ft 9 in)
52	1.37m (4 ft 6 in)
55	1.3m (4 ft 3 in)
58	1.23m (4 ft 0 in)
61	1.17m (3 ft 10 in)
64	1.12m (3 ft 8 in)
68	1.05m (3 ft 5 in)
72	.99m (3 ft 3 in)
76	.94m (3 ft 1 in)

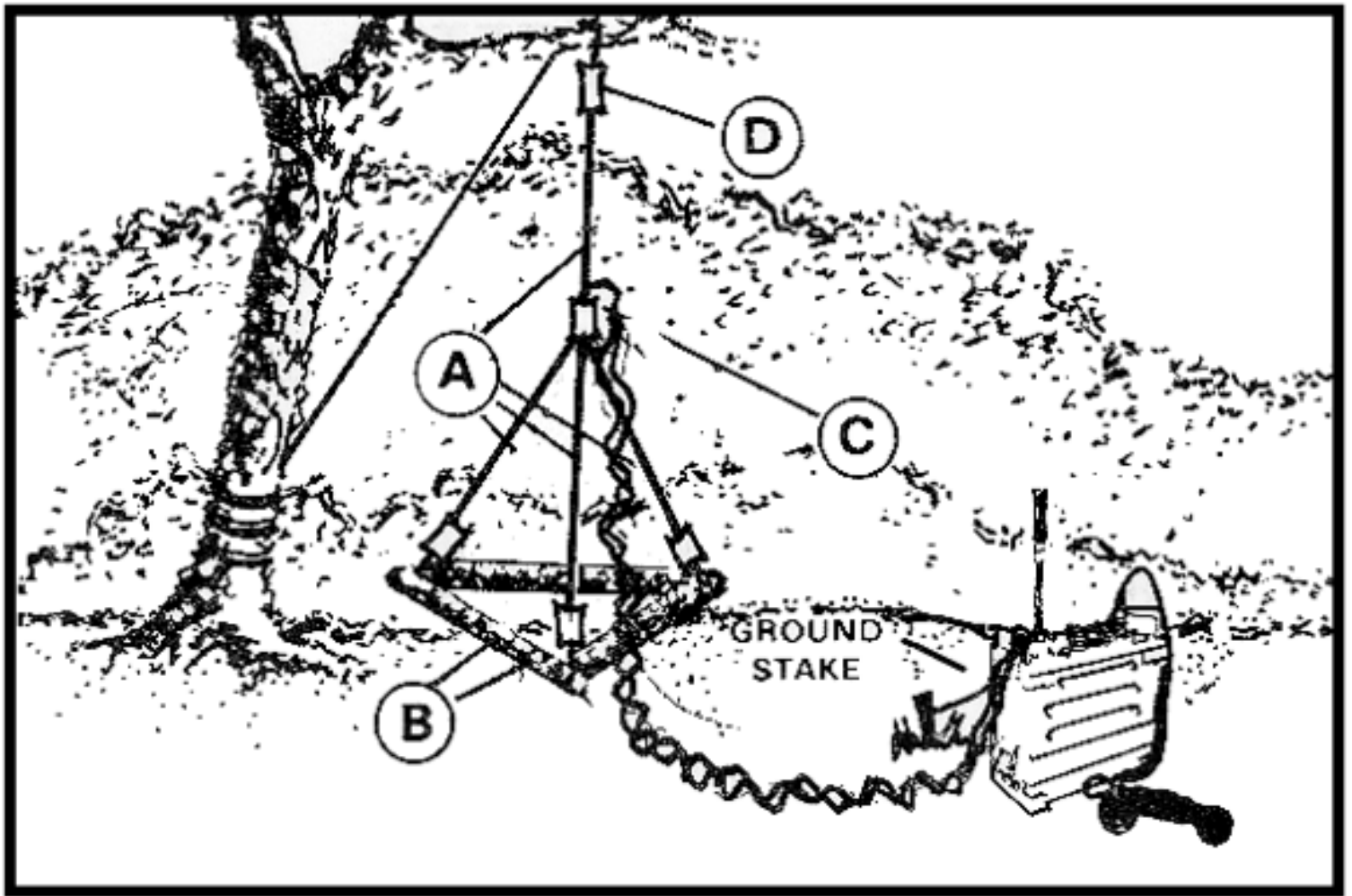

Figure 7-1. Expedient 292-type antenna.

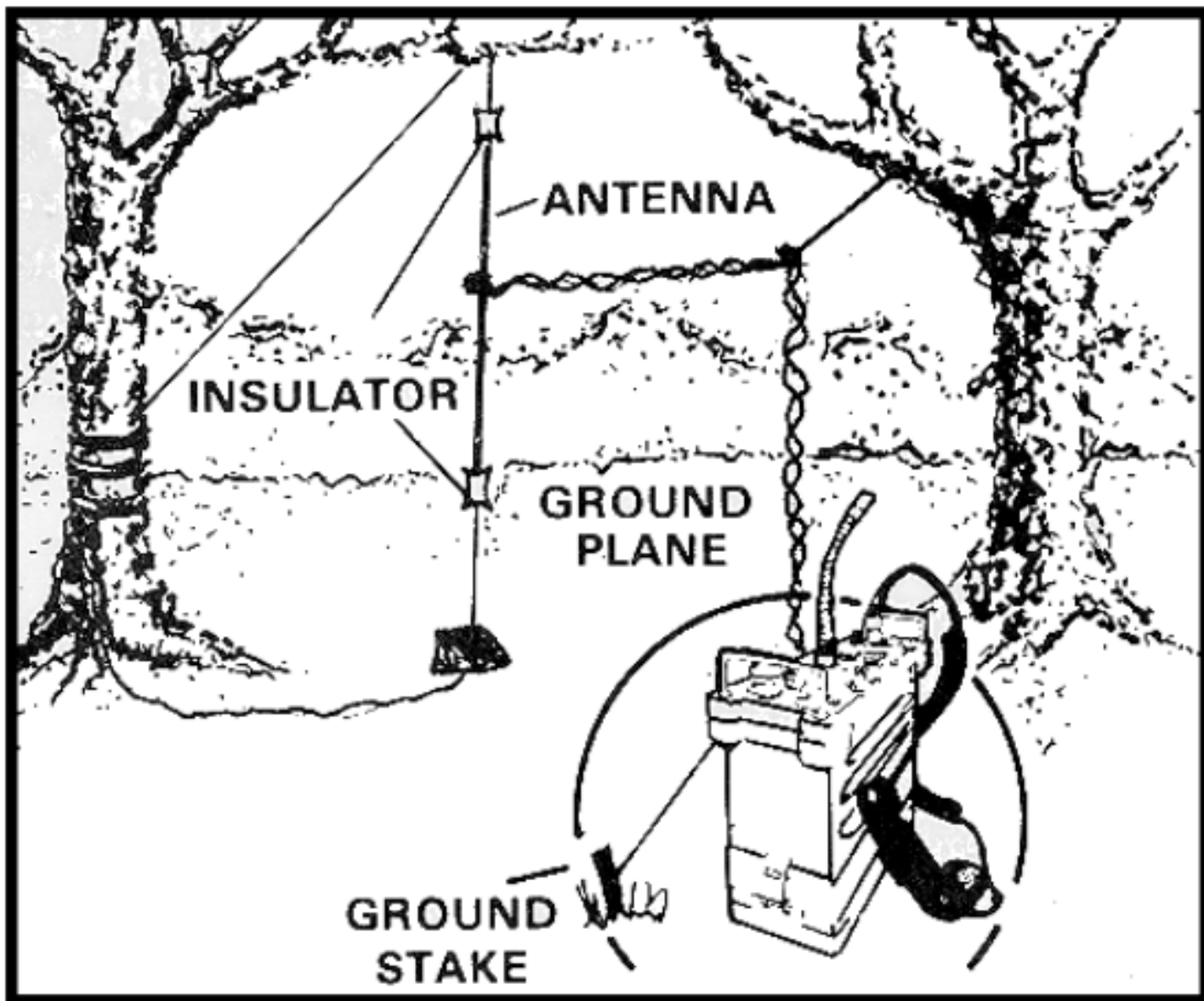

Figure 7-2. Expedient patrol antenna.

CHAPTER 8

SPECIAL OPERATIONS AND INTEROPERABILITY TECHNIQUES

Section I.

Retransmission and Remote Control Operations

8-1. Retransmission Operation for Radio Sets AN/VRC-45 and AN/VRC-49

Radio retransmission is an arrangement of two radios connected together to provide automatic retransmission of signals between two other radios that are too far apart to communicate directly with each other.

Special considerations.

Radio Sets AN/VRC-45 and AN/VRC-49 are radio configurations provided with Radio Set Control C-2299/VRC or RETRANS-Control C-10374/VRC for secure/nonsecure retransmission.

Frequency selection for retransmission.

To identify the radios involved in the retransmission operation, the retransmission site radios are identified as retransmission radios 2 and 3, and the distant radios as terminal radios 1 and 4. Radios 1 and 2 operate on one frequency; radios 3 and 4 on another frequency.

Frequencies selected for the receiver-transmitter units at the retransmission site must be such that the transmitting power of one radio will not interfere with the signals being received on the frequency of the other receiver-transmitter unit.

The frequencies selected will be at least 10 MHz apart.

Refer to your SOI and to TM 11-5820-401-10-1 to aid in selecting operating frequencies that will not cause interference problems.

Retransmission operation (nonsecure).

After the retransmission site radios are set up for retransmission, communications proceed automatically on a push-to-talk basis between the terminal radios.

Set the C-2299/VRC RETRANS switch to OFF.

When audio accessories are connected to the C-2299/VRC, set the C-2299/VRC RAD TRANS switch to position 1 to communicate through the receiver-transmitter connected to J701, and to position 2 to communicate through the other receiver-transmitter.

When the C-2299/VRC is connected to the radio-intercom system, the audio accessories connected to the control boxes must be used for radio communications. Set the MONITOR switch (on the AM-1780) to position A to communicate through "A" radio with terminal radio number 1, and to position 2 to communicate through "C" radio with terminal radio number 4.

Turn on and tune each receiver-transmitter to its assigned frequency. Establish a satisfactory squelch mode operation with each terminal radio before proceeding to use the radios for retransmission. Squelch is discussed in [paragraph 8-8](#).

Notify each terminal radio station to communicate directly with the other station; then set the C-2299/VRC RETRANS switch to ON. When the C-2299/VRC is used in the radio-intercom system, also set the AM-1780/VRC INSTALLATION SWITCH to RETRANS.

Communications between the terminal radios progress automatically. While communications are in progress, the CALL indicator of the receiving radio lights and the blower motor of the other radio should be heard operating.

When the audio accessory is connected to the C-2299/VRC, the retransmission can be monitored by setting it to position 1 during the time retransmission is in progress from terminal radio number 1 to terminal radio number 4, and to position 2 when retransmission is in progress in the opposite direction.

When the C-2299/VRC is in the radio-intercom system, monitor the retransmission using the ALL position of the control box MONITOR switches.

The setting of the VOLUME controls of the receiver-transmitter units has no effect on the signal between the retransmission site radios.

While the C-2299/VRC RETRANS switch is set to RETRANS and the AM-1780/VRC INSTALLATION switch to RETRANS, the retransmission site radios cannot be keyed for transmission.

When retransmission is completed, or to establish contact with the terminal radios, set the C-2299/VRC RETRANS switch to OFF. In the radio-intercom system, also set the AM-1780/VRC INSTALLATION switch to OTHER.

Retransmission operation (secure).

After the retransmission site radios are set up for retransmission, communications proceed automatically on a push-to-talk basis between the terminal radios.

Turn on and tune each receiver-transmitter to its assigned frequency. Set squelch to NEW ON.

Turn on and load (key) each TSEC/KY-57 with appropriate variables if secure communications are desired at the RETRANS site.

NOTE: In tracked vehicles, ensure AM-1780/VRC installation switch is set to OTHER.

Establish secure communications with distant terminals (Radio 1 to Radio 2 and Radio 3 to Radio 4).

Notify one terminal to communicate directly with the other; immediately set C-10374/VRC RETRANS switch to RETRANS.

Communications between the terminal radios progress automatically. While communications are in progress, the call indicator of the receiving radio lights and the blower motor of the other radio should be heard operating.

To establish contact with either terminal radio, set C-10374/VRC RETRANS switch to OFF and call using the appropriate radio set (2 to 1 or 3 to 4).

8-2. Remote Operation of the AN/VRC-12 Series Radios

Remote control of the AN/VRC-12 series radios can be provided by Radio Set Control Group AN/GRA-39. The AN/GRA-39 may be used to provide remote control of radio transmission and reception by the receiver transmitter units up to approximately 3.2 kilometers (2 miles). This equipment may also be used to provide net radio interface between the SB-22/PT switchboard and the receiver-transmitter units. Installation and operating instructions for the AN/GRA-39 are provided in TM 11-5820-477-12.

Connections.

Connect the AN/GRA-39 to the receiver-transmitter using Control Cable C-2329/GRA-39. Connect the field wires between the AN/GRA-39 control boxes.

Operation.

Tune the receiver-transmitter to the assigned frequency. Use the squelch or nonsquelch mode, as desired. Use push-to-talk operation to control the receiver-transmitter from the AN/GRA-39.

Refer to TM 11-5820-477-12 for procedures to use the AN/GRA-39 for remote control of the receiver-transmitter.

8-3. Remote Operation of Radio Teletypewriter Sets Equipped with Radio Set AN/GRC-106

The Control Group AN/GRA-6 provides a means for controlling and operating the AN/GRC-106 from a remote site. In addition, the AN/GRA-6 permits control of the AN/GRC-106 through a continuous circuit, and for two-way telephone communications and ringing between the remote and local control operators. The local control portion consists of Local Control Unit C-434/GRC and the remote portion consists of Remote Control Unit C-433/GRC. In addition to these basic components, the AN/GRA-6 includes Handset H-33/PT with a connector plug and a push-to-talk switch and a CW-189/GR carrying or storage container. Connections between the local and remote control positions are made by a pair of field wires connected to the DC entrance box. Both units are battery operated and are in individual weatherproof cases. All operating controls and indicators are on the front panels. The C-434/GRC is shelf-mounted at the cab end of the shelter and is semi-permanently wired into the shelter. The C-433/GRC and associated accessory items are stored in the shelter. Refer to TM 11-5820-489-10 for a more detailed description of the AN/GRA-6.

8-4. Remote Operation of Radio Set AN/GRC-26D

The Remote Switching Control C-1474/GRC controls the operation of the radio set from a remote site up to 16 kilometers (10 miles). The C-1474/GRC consists of binding posts and jacks in a metal housing. On the right panel are four sets of binding posts: ONE WAY, REMOTE TEL, REC DX, and LOCAL TEL. The XMTR ON switch is on the front panel, and six telephone jacks are on the left panel. The TTY SWITCH coaxial connector is below the telephone jacks. A bracket at the top of the unit is for mounting the unit.

The modified C-1474/GRC has three jacks and two connectors on the right panel. The jacks are labeled LOC TEL, REC DX, and ONE WAY OR SEND DX. The connectors are labeled REMOTE and TTY SWITCH. The XMTR ON switch is on the front panel. A bracket at the top of the unit is for mounting the unit.

8-5. Remote Operation of Radio Teletypewriter Set AN/GRC-46

The AN/GRC-46 set may be operated from a remote site by using Radio Set Control Group OA-1754/GRC and Radio Set Control AN/GRA-6. Maximum distance for remote control of the set is 3.2 kilometers (2 miles), and remote CW or FSK operation is possible.

CW mode.

Plug the RE-479/GRC (connector J101) into the T-195/GRC-19 AUDIO receptacle.

Remove FUSE 15 amp 24 volt fuse cap from the T-195/GRC-19. Substitute the modified fuse cap provided with the RE-479/GRC.

Insert connector P101 of the WS-16/U into the jack of the modified fuse cap.

Mount the SA-708/GRC at the remote site as convenient. Use the angle bracket as required.

Connect Telegraph Key KY-116/U to receptacle J1 on the SA-708/GRC with a cable assembly such as CX-1852/U.

Connect an appropriate two-conductor line (not exceeding 3.2 kilometers (2 miles)) between the LINE binding posts of the SA-708/GRC and the T-195/GRC-19.

At the local site, place the SERVICE SELECTOR switch of the T-195/GRC-19 at CW. At the remote site, set the FSK ON switch on the SA-708/GRC in the down (off) position. The set is now ready for operation.

FSK mode.

Remove the jumper wire connecting terminals E2 and E5 (TTY LINE) on the J-668/GR interconnecting box. Reconnect the jumper wire between terminals E3 and E4.

Insert one end of a suitable two-conductor line such as WD-1/TT (not to exceed 3.2 kilometers (2 miles)) into J-668/GR terminals E2 and E5. At the remote site, connect the other end of the line to a teletypewriter set. Use the binding posts prescribed for two-wire operation.

Connect one end of another two-conductor line (not to exceed 3.2 kilometers (2 miles)) to the J-668/GR terminals E4 and E5. At the remote site, connect the other end of the line to the LINE binding posts of the SA-708/GRC.

Install Radio Set Control AN/GRA-6 between the local and remote sites, as required. This provides a voice and FSK monitoring capability.

The RE-479/GRC is not used for remote FSK operation.

The SERVICE SELECTOR switch on the T-195/GRC-19 must be at VOICE/FSK. The SEND-RECEIVE-MARK HOLD switch on the teletypewriter shelf must be at RECEIVE. At the remote site, the FSK ON switch on the SA-708/GRC must be in the up (on) position during teletypewriter transmission and in the down (off) position for reception.

Section II. Secure Operations

8-6. Securing the AN/GRC-142 and -122 Series with the KW-7.

For information on secure operations with equipment, see TM 5815-334-10.

8-7. Securing the AN/GRC-26D and the AN/GRC-46 With the KW-7 ([Figs 8-1](#), [8-2](#), [8-3](#), [8-4](#))

Identifying dummy boxes.

Two dummy boxes are provided in the AN/GRC-26D. The upper dummy box (J-2597/GRC) is for the OWR DX-SEND TTY Loop and the lower one (J-2598/GRC) is for the DX-RECEIVE PONY Loop.

NOTE: Only one dummy box (J-2498/GRC) is provided in the AN/GRC-46. It is used for OW DX-SEND TTY operations.

Removing dummy boxes (J-2597/GRC) or (J-2498/GRC).

Disconnect W7, CX-9998/U cable from E1, E3 and E5 terminals.

Remove jumper wire from E2 and E4 terminals.

Remove cables from J4, J7, J3 and J8.

Loosen the captive screws on both sides of the dummy box and remove the dummy box.

Installing the TSEC/KW-7 (for OWR DX-SEND OPERATION).

Position the TSEC/KW-7 in mount provided and perform the following actions on the equipment rear panel.

Connect jumper wire between E2 and E4 terminals.

Connect W7, CX-9998/U cable to terminals E1 (black wire), E3 (green wire), and E5 (white wire); connect the other end of the W7 wire to the J11 terminal on the Control Radio Set C-1123/GRC (AN/GRC-26D only).

Connect W7, CX-9998/U cable to terminals E1 (black wire), E3 (green wire), and E5 (white wire); connect the other end of the W7 wire to the SYNC input terminal on the Interconnecting Box J-2491/GR (AN/GRC-46 only).

Connect W5 wire to the J4 connector (LOOP IN-2).

Connect W4 wire to the J7 connector (LOOP OUT-1).

Connect W6 wire to the J3 connector (LOOP IN-1).

Connect W3 wire to the J8 connector (LOOP OUT-2).

Connect W2 AC POWER Cable (part of KW-7) to the J1 AC power connector, and the opposite end to the AC wall socket.

Adjust the BIAS ADJUST knob on the Control Radio Set C-1123/GRC for a reading of 60 MA prior to typing on the teletypewriter set (AN/GRC-26D only).

Adjust the BIAS and LINE ADJUST knobs on the Interconnecting Box J-668/GR for a reading of 60 MA prior to typing on the teletypewriter set (AN/GRC-46 only).

Removing dummy box (J-2598/GRC, AN/GRC-26D only).

Disconnect W7a, CX-9998/U cable from E1, E2 and E3 terminals.

Remove W4 wire from the J8 connector.

Loosen the captive screws on both sides of the dummy box and remove dummy box.

Installing the TSEC/KW-7 (for DX-RECEIVE OPERATION ONLY).

Position the TSEC/KW-7 in the mount provided and perform the following actions on the equipment rear panel.

Connect W7a, CX-9998/U cable to terminals E1 (black wire), E2 (white wire), and E3 (green wire); connect the other end of the W7a wire to the J16 terminal on the Control, Radio Set C-1123/GRC.

Connect W4 wire from the DX Receive TT98 to the J8 connector (LOOP OUT-2).

Connect shorting plugs (dummy plugs) to the J7, J3 and J4 connectors.

Connect W2 AC power cable (part of KW-7) to the J1 AC power connector, and the opposite end to the AC wall socket.

[Figure 8-1.](#) Wiring diagram for nonsecure operations, AN/GRC-26D.

[Figure 8-2.](#) Wiring diagram for secure operations, AN/GRC-26D.

[Figure 8-3.](#) Wiring diagram for nonsecure operations, AN/GRC-46.

[Figure 8-4.](#) Wiring diagram for secure operations, AN/GRC-46.

Equipment Compatibility and Netting Procedures

8-8. FM Equipment Compatibility

Single-channel FM voice radio is the primary communications means used in practically all Army units. FM radio gives the tactical commander the quick, reliable, flexible communications support necessary to control the battle. The main family of FM radios used by the Army today includes the AN/VRC-12 series and the AN/PRC-77. With the fielding of the single-channel ground and airborne radio subsystem (SINCGARS), the Army will be using two families of FM radios. Also making its debut into the inventory is the extended frequency range, Multimode Field Radio Set AN/PRC-70. It is capable of operating FM, AM, or SSB over a frequency range of 2 to 76 MHz. It is further described in [Appendix C](#). The communications personnel of both Active Army and Reserve Components must be prepared to plan for and operate tactical FM radio nets containing all three families of radios. Today's Army finds Active and Reserve Components training together and operating together. The old and new generations of FM radios do interoperate, and all it takes is proper planning and training to make the nets work. The following paragraphs give some planning considerations for operating nets with both families of radios.

Frequency planning.

[Figure 8-5](#) shows a comparison between AN/VRC-12 series and SINCGARS-V radio sets. In addition to the extended range of SINCGARS-V, channel spacing problems must be anticipated when interfacing AN/VRC-12 and SINCGARS-V. The channel spacing for AN/VRC-12 is 50 kilohertz. The channel spacing for SINCGARS-V is 25 kilohertz. When interfacing is necessary, frequencies must end in 00 or 50.

Squelch.

The AN/VRC-12 series radios have the squelch capability of old squelch, new squelch or no squelch. The old squelch was for use with the AN/GRC-3 thru 8 series radios. The AN/PRC-77, AN/PRC-25 and SINCGARS-V radios have the capability of new squelch or no squelch. The AN/VRC-12 series radios should be used in new squelch or no squelch only.

Security.

The AN/PRC-25 has no capability for operations using secure equipment. The AN/PRC-77 and AN/VRC-12 series radios can be secured with Vinson or Nestor devices. SINCGARS-V can be secured with Vinson. Vinson and Nestor devices are not compatible, therefore, no interface is possible. Planners should attempt to exchange equipment if certain nets must be on-line secured, and leave other nets to use low-level encryption and authentication procedures. Regardless of which type of security system is used, all nets MUST USE proper radio procedures.

[Figure 8-5](#). Frequency comparison chart.

Compatibility chart.

The following chart ([table 8-1](#)) compares the important characteristics of the receiver-transmitter units which are the chief components of both old and new series of FM radios. Of particular importance are

frequency, channel spacing, squelch, and secure equipment capability.

[Table 8-1.](#) FM compatibility chart

8-9. AM Radio Operations

Equipment shortages or differences may cause serious problems for you. These problems can cause you to have to use one or two radio sets to pass all the traffic normally passed by a half dozen or more sets. It will help for you to remember that AM radios can pass traffic in either of three modes: voice, RATT, or CW. The following subparagraphs will help you to solve the problems just mentioned.

Design considerations for reduced assets

Alternate the radio between nets. Select the most important net to monitor and operate in. Enter the other nets only when necessary to pass traffic. Enter the other nets at preplanned times or notify the other stations by telephone or FM radio at unscheduled times.

Operate one AM radio in several nets using an established time schedule. The schedule should change every day and be randomly generated to preclude the enemy from analyzing your traffic pattern.

Preplan all messages by using brevity lists and codes as much as possible to shorten the amount of time actually spent on the air.

Use off-line teletypewriters of the telecommunications center to prepare teletypewriter tapes prior to submitting traffic to the RATT operator for transmission. This reduces the burden on the RATT operator and saves transmission time.

Use full-duplex (FDX) operation on equipment which has FDX capability. Much more traffic can be passed over FDX circuits than over half-duplex circuits, thereby reducing time required for passing traffic.

Transmit low priority traffic over alternate means, such as messenger or multichannel radio, if they are available.

Use one radio, if possible, for several individuals, staff sections, or units.

Establish a wire link with a distant station using the existing teletype-writer and secure device along with a Telegraph Terminal TH-5/TG or TH-22/TG when the radio or modem of a RATT system is defective. Speech-plus can also be provided using this technique by using Telegraph-Telephone Terminal AN/TCC-14 or AN/TCC-29.

Equipment considerations.

When different types of AM radios must work together in the same net, here are some suggestions which should help ensure communications.

SOI must include proper frequency assignments compatible to each type of radio equipment. All nets using two or more different AM radios are restricted to certain frequency ranges or modes of operation. (The various technical characteristics of all the AM radios currently in the Army inventory will be covered later in this chapter.) Frequency and mode assignments must be coordinated prior to joint operations when units with different AM radios may be involved together.

Radio planning ranges must be considered when planning nets. Certain AM radios have much more power than others, so planning ranges must be based on the least powerful radio's capabilities. Related to the distance factor is the type and polarization of antennas. Antennas must be properly polarized and correctly oriented. For extended ranges, a half-wave doublet antenna, such as the AN/GRA-50, should be used whenever time and terrain permit.

NOTE 1: When planning RATT operations with units with whom you do not normally operate, it is important that compatible speeds be selected. This is especially critical for units equipped with older generation teletypewriter sets, such as the TT-4, TT-98 and TT-76 teletypewriter-reperforator. These sets operate at speeds of 60, 66, 75, or 100 words per minute (WPM) depending on the worm gear installed in the set. The worm gear must be changed to be compatible with units operating at unlike speeds. Units who have mission support to North Atlantic Treaty Organization (NATO) and United States Army, Europe (USAREUR) units must ensure that 66 WPM gears are on hand and installed prior to deployment into these theaters since 66 WPM is the NATO/USAREUR standard.

FM 24-18 NOTE 2: When operating the AN/GRC-106, AN/GRC-122/142, and AN/VSC-2/3 with a whip antenna, the RF power output can be degraded on frequencies below 12 MHz. Additionally, prolonged keying of the radio set could cause damage to the amplifier. This is caused by a high SWR existing on low frequencies when the whip antenna is used. When operationally feasible, a doublet or other matched antenna should be used on low frequencies.

Various civilian radios with AM, CW, and SSB capabilities can be used provided prior approval is obtained. Under no circumstances will citizen's band procedures be used. When using civilian radio equipment, proper military procedures will be used.

Security considerations.

Some of the Army AM radios may be secured in the voice mode by using the KY-65. Most AM radios can be secured for RATT operation by using the TSEC/KW-7 or TSEC/KG-84 security devices. Some of the older radios have not been modified to accept the KW-7 at this time but can be altered to accept it as required. If time and situation permit, ensure that all your radios have been modified to accept security devices. When operating a nonsecured radio in voice or CW modes, it is essential to use codes or off-line encryption methods.

8-10. Technical Considerations

Old and new equipment.

Most active components use the newer families of SSB radios, whereas the Reserve Components have a combination of the older AM and the newer SSB equipment. The new equipment can work with the older equipment, but it takes just a little extra care to make it work correctly. The planner needs to know the technical characteristics of all the radio sets involved in order to plan the communications network properly. Table 8-2 is a comparison of technical characteristics of the AM radios in the Army inventory. (See the following Tables 8-3, 8-4, and 8-5.)

FM 24-18 [Table 8-2](#). AM radio technical characteristics.

FM 24-18 [Table 8-3](#). Technical capabilities of the AN/PRC-104

FM 24-18 [Table 8-4](#). Technical capabilities of the AN/GRC-193.

FM 24-18 [Table 8-5](#). Technical capabilities of the AN/GRC-213. **Netting old and new equipment.**

The most important technical characteristics to consider when netting two different radios are the type of tuning and type of emission.

As noted in [Table 8-2](#), the older radios have continuous tuning whereas the newer radios have detent tuning. The difference between these two is that detent-tuned radios can tune only to certain frequencies and cannot tune to the in-between frequencies to which the continuous-tuned radios can tune. The NCS should have a new series radio set to which all radios can tune. If the NCS does not have a new series radio set, the operator should direct a station with a new series radio to provide the signal to which all others tune. Check [Table 8-6](#) for compatible frequency ranges.

FM 24-18 [Table 8-6](#). AM radio frequency ranges.

Types of emission must match. In the CW mode, the type of emission for both old and new series radio sets is the same. In the FSK mode, the type of emission is the same. Only the way the carrier shifts is different, and this problem can be overcome. (See [paragraph 12](#).) The type of emission for voice, however, is different. The old series equipment uses double sideband (DSB) while the new series equipment uses SSB and compatible AM. Only the compatible AM mode of the new series radio can be used with the older equipment. SSB cannot be used to communicate with the older series equipment.

Another item of importance that must be taken into consideration when operating old and new series radio sets together is the difference in frequency ranges. The old series radio sets have a transmitting frequency range between 1.5 to 20 MHz, and a receiving frequency range between 0.5 to 32 MHz. The new series radio sets have a frequency range for transmitting and receiving from 2.0 to 29.999 MHz. So when operating between the old and the new series radios, the operating frequency must be within 2.0 to 20 MHz.

The most commonly used old series RATT sets are the AN/GRC-46 and the AN/GRC-26D. They are used by Reserve Components. The most commonly used new series RATT sets are the AN/GRC-142 and the AN/GRC-122 used by both Reserve Components and the active Army.

Characteristics of both old and new series equipment are listed in Table 8-7. (See Tables 8-3, 8-4, and 8-5.)

[Table 8-7](#). Characteristics of both old and new generation AM radio sets.

8-11. Modes of Operations

The AN/GRC-46 and the AN/GRC-26D operate in the AM (DSB), CW, and FSK (850 Hz shift) modes.

The AN/GRC-142/122 operates in the SSB (using upper sideband), AM voice, narrow frequency shift keying (NSK) (85 Hz shift), FSK (850 Hz shift), and CW modes of operation.

After establishing a compatible SOI net frequency, the following rules apply for netting old and new series radio sets for different modes of operations.

Voice operations (Table 8-8).

New series radio sets AN/GRC-142/122.

- Tune for normal voice operation.
- Change the SERVICE SELECTOR switch on the RT-662 or RT-834 from SSB/NSK to the AM position.
- Conduct normal voice operation.

Old series radio sets AN/GRC-46 and AN/GRC-26D.

FM 24-18

- Tune equipment as usual for voice operation.
- While receiving voice signal from a station in the net using a new series radio set, rotate the CONTINUOUS TUNING dial for clearest voice reception.
- Realign transmitter to receiver.
- Conduct normal voice operation.

[Table 8-8.](#) Voice tuning procedures. **CW operation (Table 8-9).**

New series radio sets AN/GRC-142/122.

- Tune radio set for normal operation.
- Change the SERVICE SELECTOR switch on the RT-662 or RT-834 to the CW position.

NOTE: In the CW mode, the transmitted RF signal is 2 kHz higher than the frequency indicated on the RT's (Receiver/Transmitter) MC and KC controls.

- Lower the operating frequency by 2 kHz on the RT-834/662. Key radio set with CW keying device and adjust beat frequency oscillator (BFO) control left or right for comfortable listening tone.
- Conduct normal CW operation.

Old series radio sets AN/GRC-46, AN/GRC-26D.

- Tune radio sets for normal CW operations.
- While receiving a CW signal from a station in the net using a new series radio set, rotate the CONTINUOUS TUNING dial on the receiver until a clear CW signal is heard.
- Realign transmitter to receiver.
- Conduct normal CW operations.

FM 24-18 [Table 8-9.](#) CW tuning procedures. **Radio teletypewriter operation.**

NOTE: Other than netting with the continuous tuning dial for voice and CW operations, the operator of the new series radio set was the only one that had to make changes in the normal

tuning procedures of his radio set. For RATT operations, both the operator of the old series and the new series radio sets must make changes from the normal tuning procedures. The primary reason is the position of the mark and space signals in relation to the carriers of the two types of equipment. Old series radio sets transmit the mark signal above the carrier and the space signal below the carrier. The new series radio sets transmit the mark signal below the carrier and the space signal above the carrier.

New series RATT sets AN/GRC-142/122.

- Tune RATT equipment as usual for normal RATT mode of operation.
- Change the service selector switch on the RT-662 or RT-834 to the FSK position.
- Change the REC switch on the modem (MD-522) from normal to reverse.
- Change the mode selector switch on the MD-522 to 850 Hz.
- When receiving a TTY signal, adjust the BFO on the MD-522 for reverse scope alignment. If necessary, adjust the Frequency Vernier to assist BFO scope alignment when tuning the receiver to the receive signal.
- Conduct normal RATT operation.

NOTE: When receiving a TTY signal from like equipment (new series radio to new series radio), the REC switch must go back to NORMAL in order to receive.

Old series radio teletypewriter set AN/GRC-46.

- Tune RATT equipment as usual for normal RATT mode of operation (Table 8-10).
- Change the service switch on the Converter CV-278 from normal to reverse.

FM 24-18

- Adjust the Receiver R-392 to the tuning signal of the AN/GRC-142/122, VSC-2, or VSC-3. Adjust until a mark 40 signal to the right of 0 is received on the (CV-278) converter.
- Realign transmitter to receiver.
- Conduct normal RATT operation.

[Table 8-10.](#) RATT tuning procedures.

NOTE: When operating secure RATT and you are not receiving, the teletypewriters may run open. To stop them from running open, return the SERVICE switch on the Converter CV-278 to the MARK HOLD position. On the CV-116 set the MARK HOLD switch back to the MARK HOLD position.

Old series radio teletypewriter set AN/GRC-26D.

- Tune RATT equipment as usual for normal RATT mode of operation (Table 8-11).
- Change the MARK HOLD switch on the converter (CV-116) from XTAL (left) (NORM) position to the XTAL (right) (REV) position.
- Adjust the Receiver R-390 to the tuning signal of the AN/GRC-142/122, VSC-2, or VSC-3. Adjust until a mark 50 signal to the right of 0 is received.
- Realign transmitter to receiver.

- Conduct normal RATT operation.

FM 24-18 [Table 8-11](#). RATT tuning procedures.

NOTE 1: When receiving a TTY signal from like equipment (old series radio to old series radio), the service switch on CV-278 or the MARK HOLD switch on CV-116 must go back to the normal operating position in order to receive.

NOTE 2: When operating secure RATT and you are not receiving, the teletypewriters may run open. To stop them from running open, return the SERVICE switch on the Converter CV-278 to the MARK HOLD position. On the CV-116 set the MARK HOLD switch back to the MARK HOLD position. 8-26

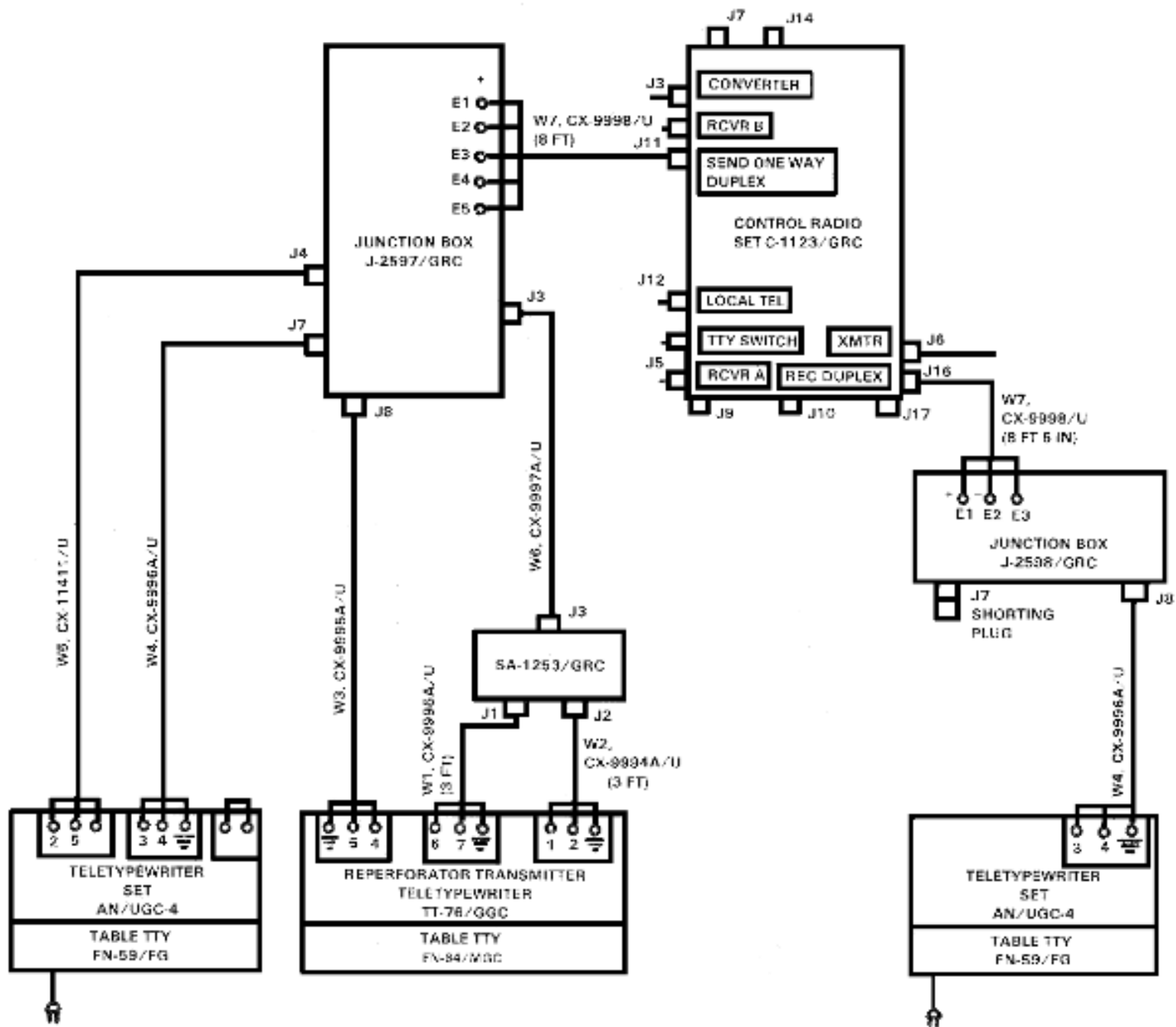

Figure 8-1. Wiring diagram for nonsecure operations, AN/GRC-26D.

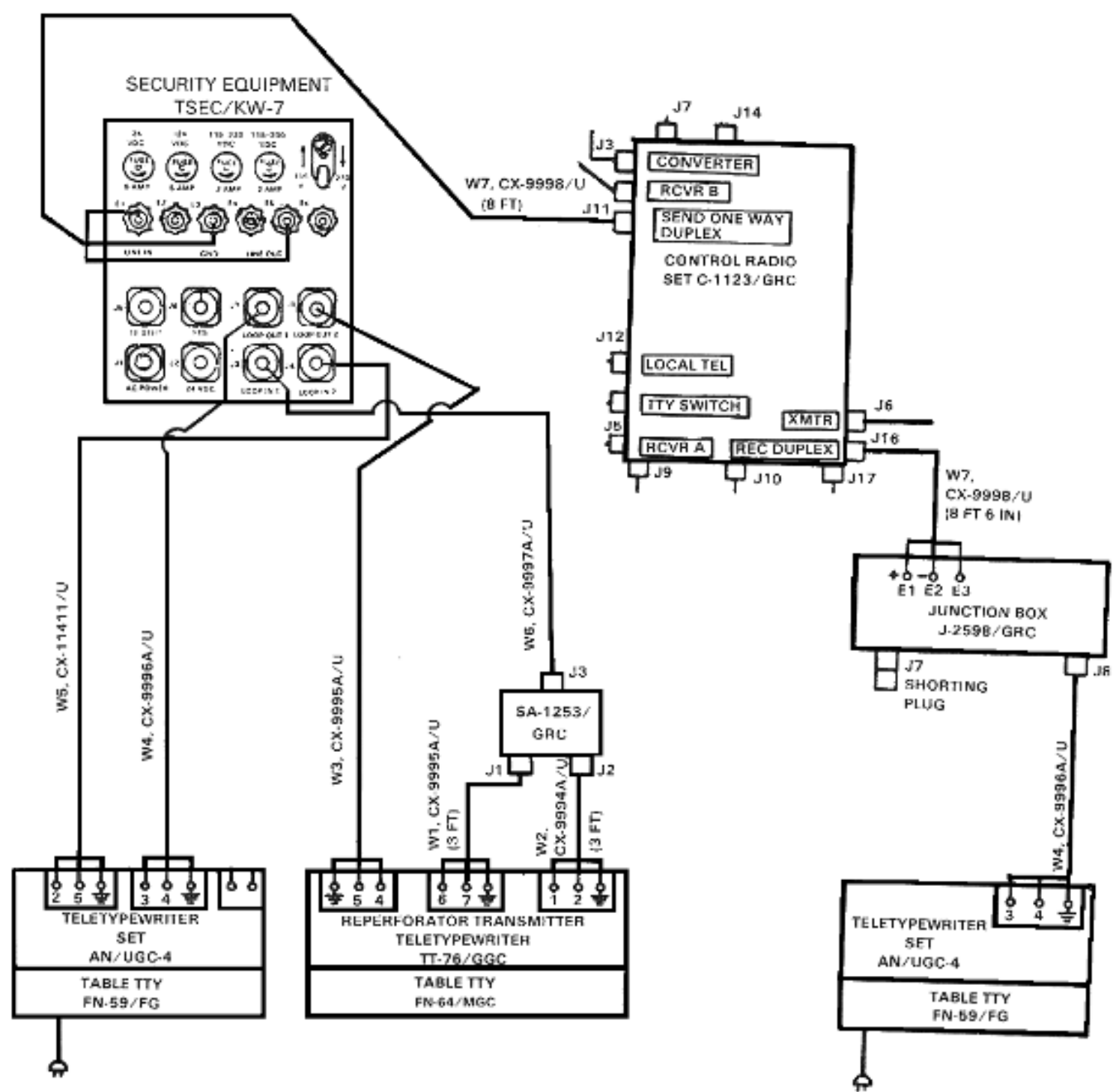

Figure 8-2. Wiring diagram for secure operations, AN/GRC-26D.

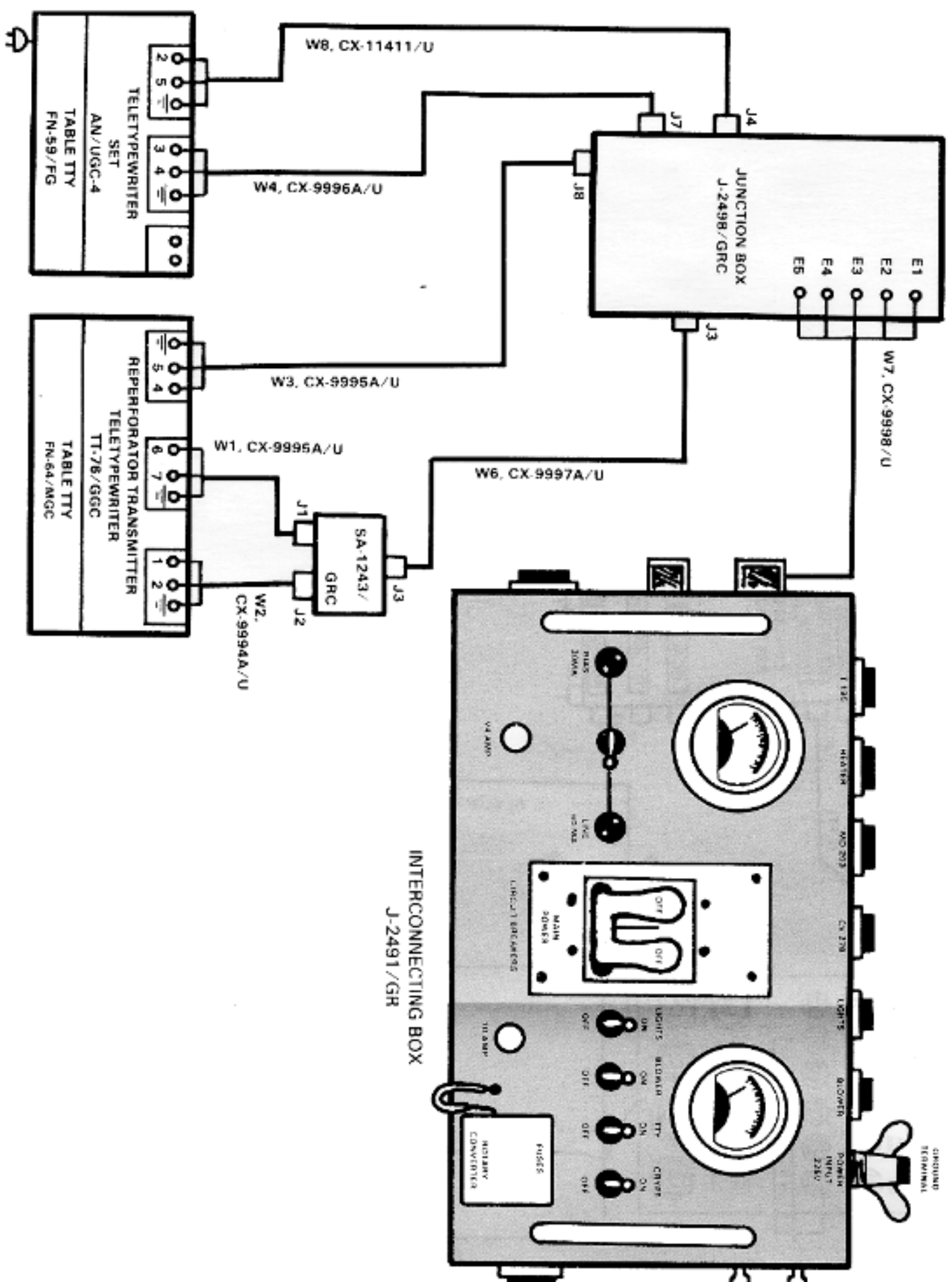

Figure 8-3. Wiring diagram for nonsecure operations, AN/GRC-46.

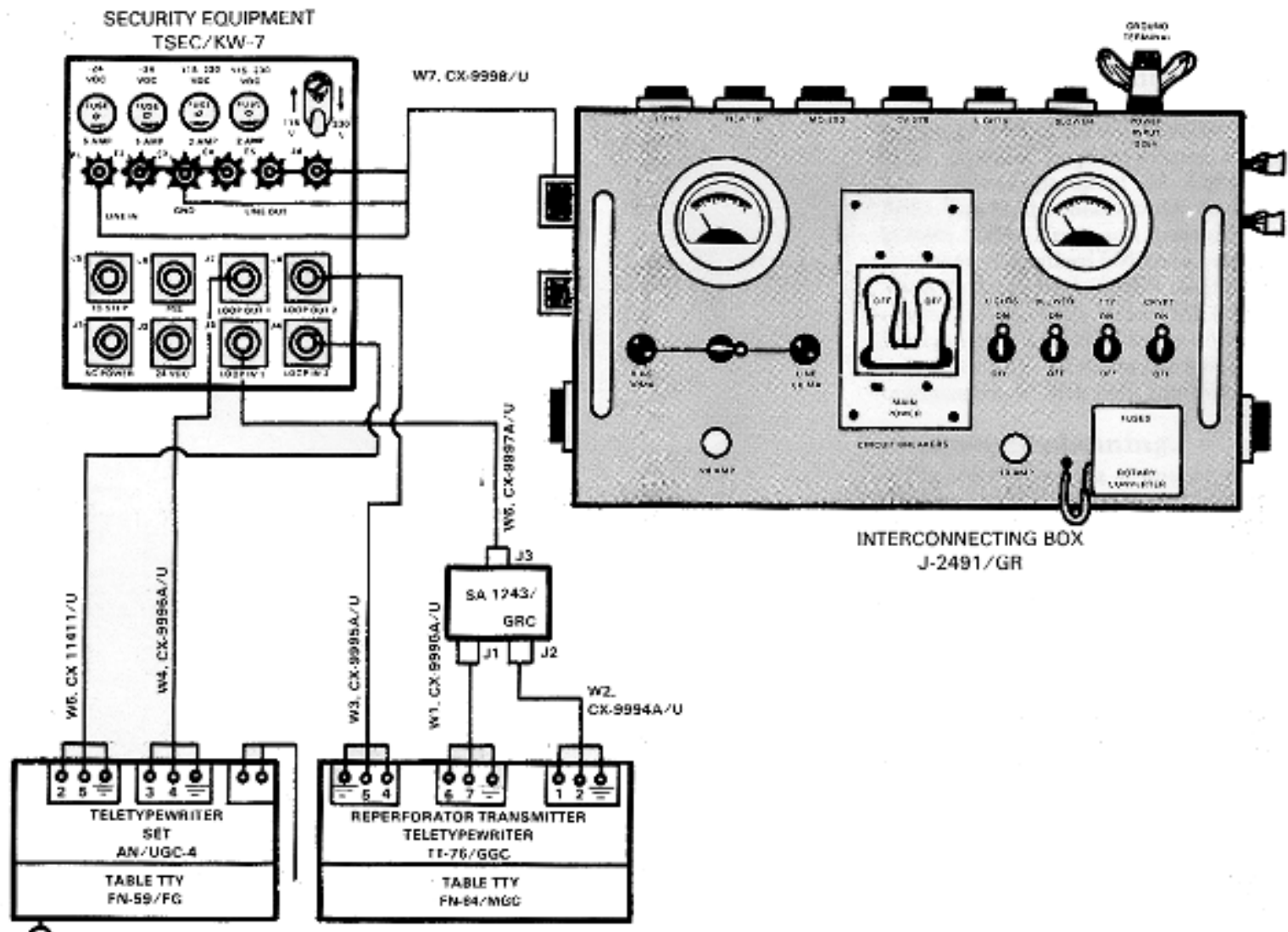

Figure 8-4. Wiring diagram for secure operations, AN/GRC-46.

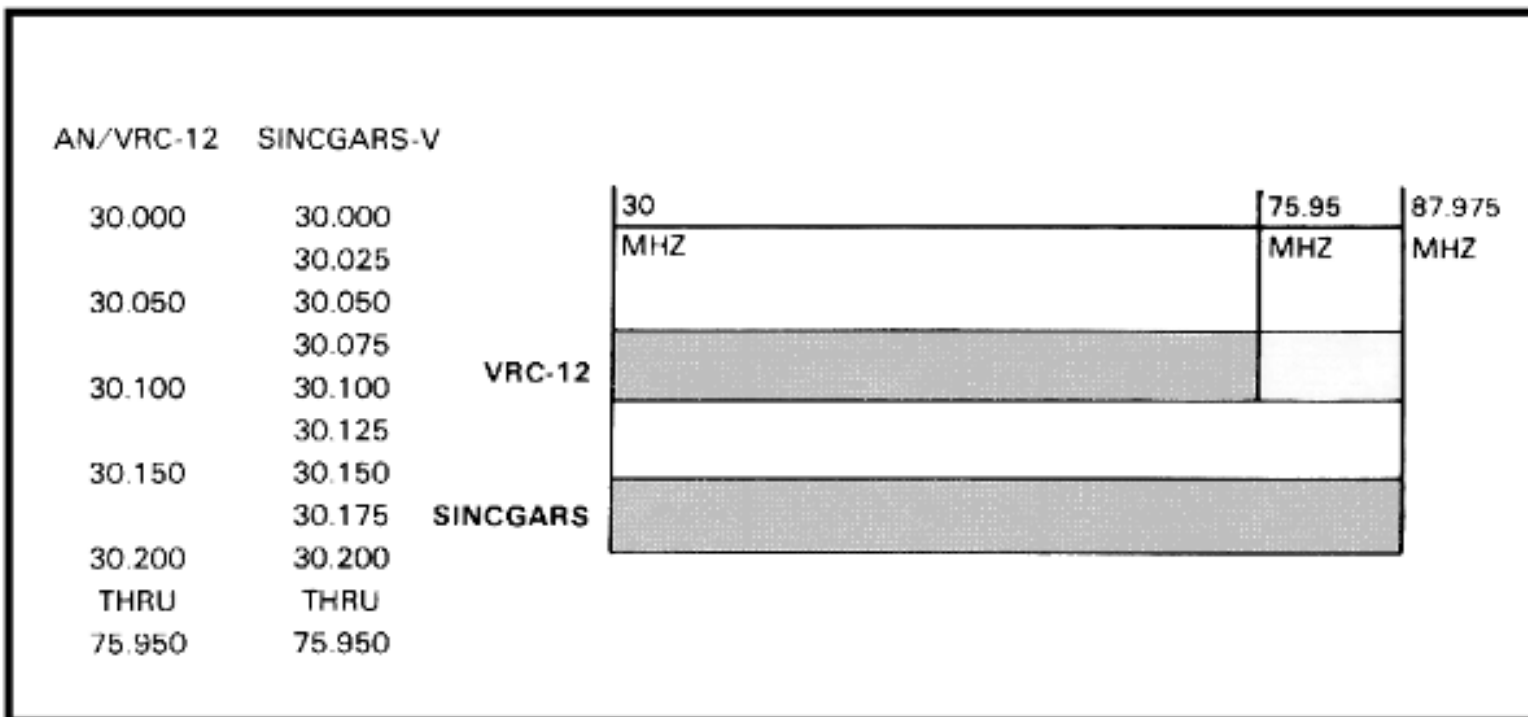

Figure 8-5. Frequency comparison chart.

Table 8-1. FM compatibility chart

RT Unit	Frequency (MHz) Coverage	Tuning	Channel Spacing	Power Output (WATTS)
RT-524	30-75.95	Detent	50 KHZ	35 (High) 8 (Low)
RT-246	30-75.95	Detent	50 KHZ	35 (High) 8 (Low)
RT-505 (PRC-25)	30-75.95	Detent	50 KHZ	2
RT-841 (PRC-77)	30-75.95	Detent	50 KHZ	2
RT-1439 (SINCGARS)	30-87.975	Detent	25 KHZ	32 uW (Low) 160 mW (Med) 4 W (High) 50 W (P Amp)
	Range (Miles)	Squelch	Using Unit	Security Equipment
RT-524	25 (High) 5 (Low)	New/Old/Off	All	KY-8/KY-38/KY-57
RT-246	25 (High) 5 (Low)	New/Old/Off	All	KY-8/KY-38/KY-57
RT-505 (PRC-25)	5	New/Off	All	None
RT-841 (PRC-77)	5	New/Off	All	KY-38/KY-57
RT-1439 (SINCGARS)	.2 (Low) 2.5 (Med) 5 (High) 22 (P Amp)	New/Off	All	KY-57

Table 8-2. AM radio technical characteristics.

	Nomenclature	Configurations	Types of Service	Tuning	Power Output	Planning Range
Old	AN/GRC-19	GRC-46, VRC-29 VSC-1	DSB Voice, CW, RATT	Continuous	100W	80 KM (50 mi)
	AN/GRC-41		DSB Voice, CW	Continuous	Voice 400W CW/RATT 450W	1600 KM (1000 mi)
	AN/GRC-26D		DSB Voice, CW, RATT	Continuous	CW/RATT 450W Voice 400W	1600 KM (1000 mi)
	AN/GRC-109		DSB Voice, CW	Continuous	10W 15W	121 KM (75 mi)
	AN/GRC-87	VRC-34	DSB Voice, CW	Continuous	Voice 7W CW 15W	16 to 50 KM (10 to 31 mi)
	AN/FRC-93		SSB Voice, CW	Continuous	100W 1000W (W/AM- 3979)	80 KM (50 mi)
New	AN/GRC-106	GRC-122, GRC-142 VSC-2, VSC-3	AN/SSB Voice, CW RATT FSK/NSK	Detent	Voice 400W CW-RATT 200W	80 KM (50 mi GW) 160 to 2400 KM (100 to 1491 mi)
	AN/PRC-47		SSB Voice, CW	Detent	High 100W Low 20W	
	AN/PRC-64A		DSB Voice, CW	Detent	Voice 1.5W CW 5W	24 KM (15 mi)
	AN/PRC-70		SSB Voice, CW	Detent	Voice 7.5W CW 30W	121 KM (75 mi) 4000 KM (2500 mi)
	AN/PRC-74	PRC-74A, PRC- 74B, PRC-74C	SSB Voice, CW	Detent	15W	40 KM (26 mi)
	AN/PRC-104 AN/GRC-213 AN/GRC-193	See Tables 8-3, 8-4, and 8-5.				

Table 8-3. Technical capabilities of the AN/PRC-104

Capability	Description
Frequency Range	2.0000 to 29.9999 MHz in 100 Hz increments. 280,000 possible frequency settings.
Operating Modes	SINGLE SIDEBAND (selectable USB or LSB). VOICE/CW. DATA. RECEIVE ONLY (VOICE AND DATA). This will allow you to receive. You cannot transmit in these modes.
RF Output Power	20 W (PEP).
RF Output Impedance	50-ohms, unbalanced - Output protected to infinite VSWR.
Antenna Tuning	Automatic to 1.5:1 VSWR in 3 to 12 seconds.
Power Requirements	20.0 to 32.0 V DC with input at 3.5 amp. (24.0 V DC) for transmit (typical); 200 ma for receive (typical).
Operating Temperature Range	-51°F (-46°C) to +160°F (+71°C).
Mean Time Before Failure	2500 hours.
Dimensions	12½" x 10½" x 2⅝" (DxWxH).
Weight	14 pounds including battery.

Table 8-4. Technical capabilities of the AN/GRC-193.

Capability	Description
Frequency range	2,0000 to 29.9999 MHz.
Frequencies	280,000.
Frequency spacing	100 Hz.
Modes of operation	USB, DSB, Voice, Data, CW, and TTY in Receive-Transmit or Receive Only.
RF output (power)	400 Watts PEP.
Data Transmission Rate	75 Baud (100 WPM on TT).
Tuning	Fully Automatic (6 seconds) after 1 minute warm-up.
Antenna Matching	AT-1011, AS-2259 (NVIS), Doublet, or field expedient long wire.
Primary Power	26.5 V DC (Standard 60 Amp system on M-151).
Current Drain	45 Amps at 400 Watts; less than 0.5 Amps in receive only.
Immersion	3 feet of water for 4 hours.
Remote Radio Set	Up to 2 miles with the AN/GRA-39B (modified).
Remoting Antenna	200 feet with the Tactical Antenna Siting Kit RF-4032.
Secure equipment	KG-84 (TTY)

Table 8-5. Technical capabilities of the AN/GRC-213.

Capability	Description
Frequency Range	2 to 29.9999 MHz in 100 Hz increments. 280,000 possible frequency settings.
Operating Modes	-SINGLE SIDEBAND (selectable USB or LSB). -VOICE/CW. -DATA. -RECEIVE ONLY (inhibits transmission operation).
RF Output Power	20 W (PEP).
RF Output Impedance	50 ohms, unbalanced. Output protected to infinite VSWR.
Antenna Tuning	Automatic to 1.5:1 VSWR in 3 to 12 seconds.
Power Requirements	24 to 32 V AC, 26.5 V DC nominal
Operating Temperature Range	-51°F (-46°C) to +160°F (+71°C).
Mean Time Before Failure	2500 Hours.
Dimensions	12.5" x 6.12" x 8.63" (WxHxD).
Weight	50 pounds.
Antennas	Whip, Slant Wire, Dipole, NVIS.

Table 8-6. AM radio frequency ranges.

Nomenclature	Frequency Range
AN/GRC-19 Transmit	1.5 to 20.0 MHZ
AN/GRC-19 Receive	0.5 to 32.0 MHZ
Transmitter T-368 *	1.5 to 20.0 MHZ
Receiver R-390 **	0.5 to 32.0 MHZ
AN/GRC-109 Transmit	3.0 to 22.0 MHZ
AN/GRC-109 Receive	3.0 to 24.0 MHZ
AN/GRC-87	2.0 to 12.0 MHZ
AN/FRC-93	3.4 to 5.0 MHZ 6.5 to 30.0 MHZ
AN/GRC-106	2.0 to 29.999 MHZ
AN/GRC-106(A)	2.0 to 29.9999 MHZ
AN/PRC-47	2.0 to 11.999 MHZ
AN/PRC-64A	2.2 to 6.0 MHZ
AN/PRC-70	2.0 to 75.999 MHZ
AN/PRC-74/74A	2.0 to 11.000 MHZ
AN/PRC-74B/74C	2.0 to 17.999 MHZ
IHFR AN/PRC-104, AN/GRC-213 and AN/GRC-193	2.0 TO 29.9999 MHZ
*T-368 is a component of AN/GRC-26D, AN/GRC-41, and AN/MRT-9	
**R-390 is a component of AN/GRC-26D, AN/GRC-41, AN/MRR-8, and AN/MRT-9	

Table 8-7. Characteristics of both old and new generation AM radio sets.

	Old Family	New Family
RT Unit	AN/GRC-19 T-195 R-392 AN/GRC-26 () T-368 R-390	AN/GRC-106 RT-662 or RT-834 (AN/GRC-106A) AM-3349 IHFR AN/PRC-104/GRC-213 AN/GRC-193 See Tables 8-3, 8-4, and 8-5.
Frequency Coverage	Transmit 1.5 - 20.0 MHz Receive 0.5 - 32.0 MHz	Transmit and Receive 2 - 29.999 MHz
Tuning	Continuous	Detent
Power Output	T-195 100 watts T-368 450 watts	400 watt
Channels	NA (continuous tuning)	Every 1 kHz (RT-662) Every 100 Hz (RT-834)
Modes of Operation	DSB Voice CW FSK (850 Hz shift)	SSB Voice, Compatible AM Voice NSK (85 Hz shift) FSK (850 Hz shift) Continuous wave (CW)
Security Equipment	KW-7 (RATT only)	* KW-7 (RATT only)

* TSEC/KG-84A to replace TSEC/KW-7

Table 8-8. Voice tuning procedures.

Old Radios	New Radios
1. Tune equipment as usual.	1. Tune for SSB voice operations.
	2. Change the service selector switch from SSB/NSK to the compatible AM position.

Table 8-9. CW tuning procedures.

Old Radios	New Radios
1. Tune equipment as usual.	1. Tune equipment for CW operation.
2. Lower the operating frequency by 1.5 KHz if using the AN/FRC-93.	2. Lower the operating frequency by 2 KHz.

Table 8-10. RATT tuning procedures.

AN/GRC-46, VSC-1, VRC-29	AN/GRC-142/122, VSC-2, VSC-3
1. Change the service switch on the CV-278 from normal to reverse.	1. Change the service switch on the RT-662 or RT-834 to FSK position.
2. Adjust the R-392 to the tuning signal of the AN/GRC-142/122, VSC-2, or VSC-3. Adjust until a mark 40 signal to the right of 0 is received on the CV-278 converter.	2. Change the REC switch on MD-522 from normal to reverse.
3. Tune the transmitter T-195 for a mark 40 reading to the right of zero (0) on the converter.	3. Change the mode selector switch on the MD-522 to 850 Hz.
	4. Adjust the BFO control on the MD-522 for reverse scope alignment. // necessary, adjust the FREQ VERNIER to assist BFO scope alignment when tuning the receiver to the receive signal.

Table 8-11. RATT tuning procedures.

AN/GRC-26	AN/GRC-142/122, VSC-2, VSC-3
<ol style="list-style-type: none">1. Change the MARK HOLD switch on the CV-116 converter from XTAL (left) (NORM) to XTAL (right) (REV).2. Adjust the R-390 to the tuning signal of the AN/GRC-142/122, VSC-2, VSC-3. Adjust until a mark 50 signal to the right of 0 is received on the CV-116 converter.3. Tune the T-368 for a mark 50 reading to the right of 0 on the converter.	<ol style="list-style-type: none">1. Change the service selector switch on the RT-662 or RT-834 to the FSK position.2. Change the REC switch on MD-522 from normal to reverse.3. Change the mode selector switch on the MD-522 to 850 Hz.4. Adjust the BFO control on the MD-522 for reverse scope alignment. <i>If necessary, adjust the FREQ VERNIER to assist BFO scope alignment when tuning the receiver to the receive signal.</i>

APPENDIX A

POWER SOURCES

A-1. Types

The power required to operate radio equipment may come from a variety of sources, such as commercial power, dry batteries, storage batteries, engine-driven generators, and rectifiers. Each type has certain advantages and certain limitations. Depending upon the application involved, these sources of power may be used individually or in combinations.

A-2. Commercial Power

Various values of AC and DC voltages can be obtained from commercial powerlines and used as primary power sources. The AC voltage sources range from the standard 115-volt, single-phase power source to the 2,300 volt, three-phase power used for industrial purposes. The primary DC voltage sources range from 28 to 440 volts. Power supplies designed for AC operation must not be connected to a DC source, since this will damage the power transformer. Also, equipment designed exclusively for a DC source will not operate on AC power.

A-3. Power Converters

Because of the wide variation in commercial power in various parts of the world, and because of the special power requirements of certain types of communications equipment, it is frequently necessary to make changes in the available power. It may be desired to convert AC to DC, or DC to AC. It may be necessary to provide 60-hertz current from a 25-hertz power source, step the voltage up or down, or convert single-phase power to multiphase power. Electronic converters, motor generators, or transformers may be used singly or in combination to effect these changes. The choice of equipment depends on the desired result and the available power sources.

Electronic converter.

Electronic converters are devices that change AC to DC, DC to DC, or DC to AC. There are no moving parts used in the conversion process. Instead, electronic devices such as transistors and electron tubes are used. Electronic converters that change AC or DC to DC are commonly called DC power supplies, while those that change DC to AC are called inverters.

Transformers.

Most AC devices for communications systems are designed to operate at 50 to 60 hertz from a 115- or 230-volt power source. In many areas, however, the available voltage is unsuitable for the operation of such equipment. Therefore, power transformers are used to increase or decrease the AC output voltage to

Solid state power inverters.

Solid state power inverters are used in power units that supply power requirements to both vehicular and conventional radio systems because they may be designed to operate from both AC or DC voltage inputs. They are highly versatile, and are capable of providing wide ranges of AC and DC voltage outputs. These inverters may be designed to produce AC outputs at the standard 60-hertz line frequency or at higher frequencies which facilitate the design of lighter and smaller power units, filtering systems, and associated equipment. These inverters may be designed to convert either AC or DC input voltages into a square wave pulse train, transforming this train to the desired voltage level. Where DC outputs are required, the inverter rectifies and filters this voltage to a smooth and ripple-free DC power source. Normally, these power units incorporate solid state voltage regulator circuits and protective circuitry designed to shut down the affected power sources during hazardous malfunctions of associated equipment.

A-4. Batteries

WARNING: Observe all warning labels on batteries. Severe injury or death may result if they are mishandled or disposed of incorrectly.

There are distinct advantages to be realized through the use of batteries as a source of electrical power for both radio communications equipment and test, measurement, and diagnostic equipment (TMDE). They allow complete mobility of the equipment involved and provide complete isolation from noisy power generating systems. Such systems produce electrical power which is often laden with transient spikes and pulses that tend to interfere with communications and prohibit accurate measurements. The recent breakthrough in battery design, development, and manufacture has produced a greater dependability and versatility of batteries as a source of power. Consequently, the military inventory of battery-powered equipment is steadily on the increase. Some of the items currently in use which use a variety of sizes and types of batteries are listed in [table A-1](#).

[Table A-1](#). Partial List of Items of Equipment That Use Batteries

The complete inventory of radio communications equipment is too extensive to list in this manual. The items cited above are mere illustrations of the general uses of batteries in radio equipment. The inventory of TMDE equipment using batteries as a source of power is comparably extensive. The installation and preventive maintenance procedures for batteries are given in the specific operator's manual for the equipment which uses them as a source of power. Therefore, no procedures are given in this manual.

A battery consists of a number of cells assembled in a common container and connected together to function as a source of electrical power. Batteries are widely used as power sources in portable radio communications equipment because of their inherent stability. Batteries are also widely used in TMDE. Modern technology has produced a wide range of batteries, each unique in itself in meeting some particular power requirement. Development of new and different types of batteries in the past decade has been so rapid that it is impossible to present a complete knowledge or description of them in this manual; however, some of the common types currently used in radio and TMDE are described below.

Mercury cells.

With the advent of small transceivers and miniaturized equipment, a very small battery was needed that was capable of delivering maximum electrical capacity per unit volume while operating in varying temperatures and at a constant discharge rate. The mercury battery, which is one of the smallest batteries, meets these requirements.

Lead-acid batteries.

The lead-acid battery is used extensively throughout the world. It is an electrochemical device for storing chemical energy until it is released as electrical energy. Active materials within the battery react chemically to produce a flow of direct current whenever current consuming devices are connected to the battery terminals. This current is produced by chemical reaction between the active material of the plates (electrodes) and the electrolyte (sulphuric acid). It is primarily used as a vehicle battery, but it can be, and is being used in larger communications equipment and shelters.

Nickel-cadmium batteries.

The nickel-cadmium batteries are far superior to the lead-acid type. Some are physically and electrically interchangeable with lead-acid types. Smaller units are designed to be used inside radio, TMDE, and electronic equipment. The nickel-cadmium and lead-acid batteries have capacities that are comparable at normal discharge rates, but at high discharge rates the characteristics of the nickel-cadmium batteries are far superior. They can deliver a large amount of power and can maintain an almost constant voltage level until discharged. They can stay idle in any state of charge for an indefinite time and keep a full charge when stored for long periods of time. They may be charged and discharged any number of times without any appreciable deterioration. Due to their superior capabilities, nickel-cadmium batteries are being used extensively in many military applications that require a battery with a high discharge rate. In many instances they are replacing lead-acid batteries in vehicles.

Zinc-carbon batteries.

Zinc-carbon is the most widely used type of battery. They are commonly called dry cells or dry batteries because the electrolyte used is in paste form and sealed, making it virtually impossible to spill. The ampere hour of these batteries is not a fixed value but varies with current drain, operating schedule, cut-off voltage, temperature, and battery storage techniques and duration. These batteries have four general areas of application: (1) radio, (2) general purpose, (3) flashlight and photo-flash, and (4) heavy duty industrial. The dry cells vary in chemical composition, depending on the application for which they are intended. Thus, a dry cell battery intended for radio applications contains a higher percentage of active electrochemical materials than a battery intended for photo-flash operation. This higher percentage of electrochemical materials increases the overall capacity of the battery, enabling it to remain in service longer than a similar size battery designed for photo-flash operation. Conversely, a battery intended for photo-flash applications contains a higher percentage of carbon which lowers the internal resistance and impedance of the battery enabling it to deliver the required higher current for a short duration. Although either of these classes of batteries will operate in another application, the most satisfactory results are obtained when each type of dry cell or battery is used in the application for which it was specifically designed.

Alkaline batteries.

The electrochemical system of both nonrechargeable (primary) and rechargeable alkaline cells comprises a zinc anode of large surface area, a manganese dioxide cathode of high density, and a potassium

hydroxide electrolyte. These batteries have low internal resistance, low impedance, and high service capacity. They are hermetically sealed. The nominal voltage of a single alkaline cell is 1.5 volts; however, the closed circuit voltage of an alkaline primary battery falls gradually as the battery is discharged. Consequently, the service hours delivered by alkaline/ manganese primary batteries are far greater than that of zinc-carbon batteries as the end point voltage is lower. Service capacity remains relatively constant as the discharge rate is varied and the capacity does not vary as much with current drain as it does in zinc-carbon batteries. The alkaline system operates with high efficiency under continuous or heavy duty and high drain conditions where as the zinc-carbon battery is unsatisfactory. Under certain conditions, alkaline batteries will provide as much as ten times the service of standard zinc-carbon batteries.

Lithium batteries.

The lithium-nickel halide battery represents a potential for a dense, high energy source of electric power. Extensive research is in process to develop this extraordinary, high current producing battery. Lithium is the Earth's lightest solid element, weighing only one-thirtieth as much as an equal volume of lead. It can, however, generate up to eight times as much electricity when coupled to a suitable cathode in the presence of a suitable electrolyte. Because of their high current producing capabilities, lithium batteries are being developed for use as power sources in electric cars and forklifts. Some lithium-type batteries have already been fielded for some types of Army radio equipment. For example, The BA-5590/U is used in the KY-57 (Vinson) and the BA-5598/U is available for use in the AN/PRC-25, -77, and -74 radio sets. Others are in the process of distribution.

Safety features. The battery is protected by a 3.5 ampere blow replaceable fuse in each 12-volt section to protect against excessive currents of external short circuits which could lead to overheating, cell venting, or rupture. This fuse should not be bypassed or replaced with a higher rated fuse. Each cell (ten per BA-5590/U) is designed with a venting device which releases internal cell pressure to ambient pressure if the internal pressure exceeds 350-450 psia. Venting will occur when pressures become excessive due to cells which have overheated (200-220°F) and serves to prevent the cell from rupturing. If a cell vents, sulfur dioxide gas will be released, which is a noxious eye and respiratory irritant. Irritation will occur long before toxic concentrations are reached and serves as an indication of its (SO₂) presence. This battery contains no radioactive material.

Precautions.

Storage. Bulk storage of BA-5590/U batteries should be in a well ventilated cool temperature facility (about 70°F). Refrigeration is not required. Battery life decreases with storage time and with increasing temperature. For this reason, temperatures above 130°F should be avoided if possible.

Handling. The BA-5590/U battery contains pressurized cells similar to aerosol cans. Therefore, under no circumstances should the battery be deliberately opened, crushed, punctured, disassembled or otherwise mutilated. Rupture of the cell could occur. The BA-5590/U battery should not be heated or incinerated, as overheating may produce internal pressure at a rate in excess of the venting capacity and could result in a cell or battery rupturing. Under no condition should the batteries be recharged. Such action could lead to venting, rupturing, or rupturing with fire.

Transportation. Shipment of the BA-5590/U battery is regulated by the Department of Transportation in 49 CFR 173.1015 in conjunction with 49 CFR 172.101 Hazardous Materials Table and DOT-E-7052

exemption for shipping of charged lithium batteries. 49 CFR 173.1015 addresses the shipping and general transportation of depleted lithium batteries.

Disposal. Batteries must be turned in to the local property disposal officer for disposal.

Overheating. In the unlikely event that an equipment operator detects the battery compartment becoming unduly hot, hears cell venting (hissing sound), or smells the irritating sulfur dioxide, he should immediately do the following:

- Turn off equipment.
- Do not remove the battery.
- Place equipment away from area of operation and, if possible, in a well ventilated fire protected area; allow 4 hours for battery to cool (battery should be cool to the touch).
- Carefully remove the battery from the equipment using available face and hand protection, such as safety shields, safety goggles, and protective clothing. Materials should not be picked up by hand. Use tongs or a scoop shovel.
- If the battery cannot be removed, leave the immediate vicinity of the equipment.
- Dispose of the battery properly if it can be removed.

Fire. In the event there are fires in which lithium batteries are involved, use a graphite powder, such as LITH-X or any other class D flammable metal fire extinguisher. If not available, these fires are generally extinguishable with water in sufficient amounts so as to flood the burning materials. This will not only tend to cut off air access to the fire, but will cool down the batteries and surrounding combustibles so that cell venting and burning are minimized. If many cells have ruptured, lithium metal may be exposed. Burning lithium metal may respond satisfactorily to treatment with water. However, if not, efforts should be aimed at preventing the spread of the fire to other combustibles while letting the lithium metal burn itself out. Carbon dioxide extinguishers will not extinguish burning lithium metal but will extinguish other combustible materials within or near the battery.

Voltage delay. If there is a delay in the operation of the equipment that exceeds 2 minutes, the battery should be replaced.

Battery removal. When equipment will not be used within 30 days, the battery should be removed from the equipment.

A-5. Engine-Driven Generator Units

DC engine-driven generators have output capacities of from 0.4 to 15.9 kW. AC engine-driven generators have output capacities of from 0.3 to 1,000 kW. In addition, there are certain special purpose generators that provide both AC and DC output.

Power unit noise reduction at forward area sites.

The procedure outlined below is designed to reduce power unit noise by approximately 90 percent and to increase survivability to direct fire.

Construct a dugout with adequate clearance along the sides and top to provide sufficient space for maintenance and ventilation of the engine-driven generator.

Locate the dugout preferably on a slight rise or hill so that accumulations of water and rain will be drained off. Dig drainage ditches leading away from the low side of the dugout.

Reinforce the sides of the shelter with sandbags, or a wooden or steel framework, to provide support and to prevent cave-ins.

Erect a roof of available material to provide protection from the weather. Allow space for a ventilator shaft to carry exhaust fumes away. (An exhaust system may be improvised by using flexible metal pipes or fiber carrying cases for artillery ammunition.) Ensure adequate space around the exhaust system for ventilation and cooling.

Drape empty sacks or canvas along the roof overhang to muffle generator noise.

Camouflage the dugout with available material that matches the surrounding terrain.

Power source substitution.

Power units that are recommended for specific equipment usually give the best results. In emergency situations, however, use any power unit of appropriate output voltage, current, wattage, and frequency. Sometimes spare equipment is available to provide additional output power. In such cases, it is recommended that only as many units be used as are required to carry the load.

In case of emergency, turn off all equipment and lights except those actually required to keep the circuits in operation.

Table A-1. Partial List of Items of Equipment That Use Batteries

Radio Sets and Controls		
AN/PRC-41	AN/PRC-74	AN/GRC-109
AN/PRC-41A	AN/PRC-77	AN/GRA-6
AN/PRC-47	AN/PRC-90	AN/GRA-39B
AN/PRC-64A	AN/PRR-9	AN/URC-10A
AN/PRC-70	AN/PRT-4	AN/URC-69
Satellite Communications Sets		
AN/TRC-156	AN/TSC-79	AN/TRR-30
Radar Set		
AN/PPS-5		

APPENDIX B

IONOSPHERIC SOUNDER

AN/TRQ-35(V)

B-1. Recognition of Propagation Path Outages

High frequency radio continues to play a critical role in the communications architecture for the near- and far-term needs of the Army. The reliability of the HF nets has been plagued by outages directly related to changes of the characteristics and conditions of the ionosphere which are unpredictable. The number of outages can also be increased by action of enemy radio electronic combat (REC) units. When outages occur, it is first necessary to recognize that one has occurred and then change frequencies to one which is capable of supporting the propagation over the path desired. The AN/TRQ-35(V) meets this need by displaying those frequencies which presently are propagating and also by displaying a summary of the amount of time each channel has been used in either the last 5 or the last 30 minutes, whichever is desired.

B-2. Capabilities

The AN/TRQ-35(V) has the capability of improving the connectivity and reliability of HF communications. The employment of the sounder system enables the frequency manager to determine those frequencies which actually are propagating and the mode or modes by which the propagation is accomplished. The spectrum analyzer portion of the sounder system allows the operator to determine which frequencies are being used and how busy they are. With this information, the operator can ascertain whether or not the transmissions should be received and whether or not multipath interference should occur. If it is determined that communications are possible but are not being achieved, an operator or equipment problem is probably occurring. If the operator finds that propagation paths will not support communications with the frequency assigned, the operator can select frequencies that avoid multipath interference, are presently propagating over the desired link, and are unused or have minimal use. A phenomenon, known as *sporadic-E ionization*, occurs occasionally and sometimes provides for the propagation of frequencies which would not be possible under ordinary circumstances. It also has the effect of preventing propagation of some of the frequencies which were or should be propagating at that time. The duration of the sporadic-E ionization can be very short or for fairly long periods of time. The AN/TRQ-35(V) has the distinct advantage of being able to display the effects of the sporadic-E ionization as it is occurring and to allow the operator to use its advantages and recognize its detrimental effects to other propagation paths. Frequency managers using this device will be able to select frequencies that will assure consistent and effective communications.

B-3. Propagation

There are two principal paths by which radio waves can travel from a transmitter to a receiver. One is by ground waves, which travel near the ground from the transmitter to the receiver, and the other is by sky waves which travel up to the ionosphere and are refracted (bent downward) back to the Earth. In the HF radio band, 2 to 30 MHz, both modes of propagation are used. The distance over which the signal is able to propagate via ground wave is primarily dependent upon the conductivity and the dielectric constant of the Earth for a given radio system. The ability to propagate by ground waves is best over sea water and poorest over deserts and through jungles. The ability of the ionosphere to refract radio waves is dependable upon the height of the ionized layers in the Earth's upper atmosphere, the density of the electrons in the layers, and the frequency and incidence angle of the radio waves. The electron density and height of the layers vary with the time of day, seasons of the year, and sunspot activity. Present methods for determining usable frequencies use predictions based on historical interpretation which shows cyclic trends in ionospheric conditions. There are sudden ionospheric disturbances in addition to the large excursions in the undisturbed ionosphere. All of these phenomena lead to very conservative frequency selections in order to achieve high predicted reliability probabilities. The result is that many usable frequencies are neither specified nor used and many outages occur which could be predicted.

B-4. Characteristics

Transmitter.

The T-1373/TRQ-35(V) transmitter transmits a CW signal which is swept linearly between 2 to 16 MHz or 2 to 30 MHz in 4 minutes and 40 seconds. The maximum power output is 100 watts (a selectable attenuation can reduce the power output to 10 W). If the diplexer is employed to allow the use of a common antenna with the communications transmitter, only 2 percent of the sounder transmitter power is coupled to the antenna and the remaining power is dissipated in an internal dummy load. The communications transmitter power output cannot exceed 2.5 kilowatts if the diplexer is to be used. Switches are provided in the transmitter to select a sweep ON or OFF at each 5-minute interval in the hour. Switches are also provided to enable blanking out of up to 16 frequencies in order to prevent interference to any critical links in either co-sited or adjacent receivers and to prevent interference to authorized frequencies such as distress and international time frequencies. A transmitter may be colocated with other communications equipment or may be completely detached as long as it has the required power source. Since its emission has a distinct electronic signature and the radiated output has a long time duration, it is an easily isolated and identifiable target. From the viewpoint of both physical and intelligence security, the transmitter should be detached from any major node as far as possible. The transmitter operates unattended after it has been initially programmed and time synchronized. The antenna used should be broadband and have a high take-off angle since most tactical HF communications use near-vertical incidence. The colocated transmitter may share the transmitter antenna of an HF communications transmitter but the sounder transmitter emitted power is then reduced to 2 percent of the available power. The sounder also is restricted by the characteristics of the communications transmitter antenna which may be narrowband and directional. This would identify the actual operating characteristics of the link involved but could affect the usefulness of the sounder system elsewhere in the operating area.

Receiver.

The R-2081/TRQ-35(V) receiver sweeps the HF spectrum in synchronism with the sounder transmitter. This allows the receiver to have an extremely narrow bandwidth which offers tremendous immunity to

interference from other users. A cathode-ray tube (CRT) display is used to provide a visual representation of the strength of the received signal and the time delay due to the propagation path. The display of time delay can be interpreted to determine the mode by which propagation is achievable. Propagation by more than one mode (known as multipath) normally results in interference which is exhibited as fading. The display of only one mode of propagation is desirable for selection of the optimum usable frequencies. The receiver can store and display data from up to three separate transmitters. A sounder receiver may be colocated with the HF communications receiver or operated completely detached. It may share an antenna with the colocated receiver or use a separate antenna. The antenna should be wideband and nondirectional if more than one transmitter is being used. After time synchronization and initial programming have been completed, no operational requirements exist except for interpretation of the displayed data.

Spectrum Monitor.

The R-2093/TRQ-35(V) spectrum monitor is an HF receiver, processor, and display system which presents a visual representation of the occupancy statistics of 6 kHz wide channels through the HF band. The entire HF spectrum is scanned every 11 seconds and results are compiled and updated in 5-minute and 30-minute time blocks. A width of either 100 kHz or 500 kHz is displayed around a selected center frequency and the resulting "histogram" depicts occupancy of each 6 kHz channel. Selection is provided for any of four different received power thresholds spaced by 10 dB and the resulting analysis shows the frequency of occurrence of the crossing of the selected threshold. The operator can select by pushbutton control, and view, received signal amplitude expressed in dBm and percentage of use for each 9,333 channels scanned. The operator can monitor any selected center frequency using internal speaker or headphones--selecting USB, LSB, AM, or FM. The spectrum monitor may be located wherever a power source and an antenna are available. No synchronization is required, so that the operator only is required to turn the monitor on and interpret the display. Colocation of the sounder receiver and spectrum monitor provides the operator with the necessary information to enable selection of the optimum frequencies from the viewpoint of received signal strength, lack of multipath occurrence, and unused or minimally used frequencies.

APPENDIX C

EXTENDED FREQUENCY RANGE, MULTIMODE FIELD RADIO SET AN/PRC-70

C-1. Use

Radio set AN/PRC-70 ([fig C-1](#)) is designed to provide special forces, ranger, and selected engineer units, reliable long- and short-range command and control communications, under all climatic conditions. This radio gives units operating behind enemy lines the capability of providing near real-time, secure tactical and/or strategic intelligence information to corps and theater.

[Figure C-1.](#) AN/PRC-70 Manpack.

C-2. Basic Components and Accessories

The AN/PRC-70 system consists of the basic receiver/transmitter, battery, and accessory kit. Additional ancillary/accessory items for use with this system are a mast assembly, retransmission cable, maintenance cable assembly, AC/DC power supply, and G-76 hand-cranked DC generator. A burst-data device, the Digital Message Device Group OA-8990 can also be used with the AN/PRC-70 system.

C-3. System Description

The AN/PRC-70 is an extended frequency range, multimode, manpack receiver/transmitter. It is designed to provide medium-to-long-range communications in CW, FSK, AM, FM, and SSB modes in the frequency range of 2 to 76 MHz. It has power output levels ranging from 1.8 to 5.6 watts in the low-power setting, and 21 to 42 watts in the high-power setting. The radio set is designed to be compatible with all standard Army HF and FM sets when utilizing appropriate modes and frequencies. Compatibility with standard voice security equipment provides the capability of secure communications in the FM mode. Additionally, burst communications can be accomplished in the CW and FSK modes by utilizing appropriate ancillary equipment. (For example, see [figure C-2](#), Coder-Burst Transmission Group AN/GRA-71.) Retransmission capability is provided by using two AN/PRC-70 radio sets in conjunction with an interconnecting cable (Retransmission Cable MK-456) designed for this purpose ([fig C-3](#)).

Battery.

The BB-542/U, a 2 ampere-hour (AH) sealed, fast-rechargeable NICAD battery, is for use with the AN/PRC-70 system. A special battery box is required to contain appropriate lithium batteries.

Power Supply PP-6148.

The PP-6148 is a portable, AC battery charger/power supply providing 0 to 10 amperes at 14 or 28 VDC from 115/230 volts, single phase, 50, 60, or 400 Hz AC power sources. This item is used to power the Radio Set AN/PRC-70 and to recharge NICAD batteries.

Direct Current Generator G-76.

This generator is a lightweight, hand-cranked generator providing 30 to 32 VDC output at a maximum of 200 watts developed at a cranking speed of approximately 80 RPM. This item will power the radio set directly for short-duration burst transmissions and will charge rechargeable NICAD batteries.

[Figure C-2.](#) Coder-Burst Transmission Group AN/GRA-71.

[Figure C-3.](#) Retransmission configuration.

Digital Message Device Group OA-8990()/P.

This device, which weighs two to three pounds including self-contained rechargeable batteries, is a hand-held, microprocessor-controlled message terminal designed to originate alphanumeric information in either free or 5-letter format. The device provides storage of 1,000 characters in transmit-partitioned memory, and 2,000 characters in the receive-partitioned memory. Messages may be edited, stored, and transmitted at 300 or 1200 BPS utilizing the American Standard Code for Information Interchange (ASCII) 7 bit code, audio FSK over HF, VHF, or UHF satellite radios. The unit features a 32-key standard typewriter style keyboard and a 16-character liquid crystal display. The device is powered by a rechargeable NICAD battery.

COMSEC.

Secure communications may be obtained by use of COMSEC devices when operating in both the VHF and UHF frequency ranges.

C-4. Operations

The Radio Set AN/PRC-70 is installed and operated by field radio operators in field environments within tactical and strategic communication nets as required by the mission assigned. Special signal operation instructions (SOI) are developed and specifically tailored to support these widely varying missions by type organizations and required net structures. Specific installation configurations are dependent upon the specific net requirements of these organizations. Power Supply PP-6148 instead of batteries may be selected to directly power a radio set installed in a semi-fixed installation. In support of special operations (SO) of short duration, lithium batteries may be chosen instead of rechargeable batteries.

Special Forces.

The Radio Set AN/PRC-70 is organic to the special forces (SF). Operational detachments employ the radio set to provide command and control communications to the special forces operational base (SFOB)/forward operational base (FOB). These operational bases are normally established in theater rear areas. Operational detachments/elements deploy deep behind enemy lines to conduct unconventional warfare (UW) and special operations missions. Additionally, special forces perform foreign internal defense (FID) missions. Special forces units normally install field wire antenna systems designed around required directional characteristics, and specifically selected to provide maximum gain to support both

medium (VHF-FM) and long-range (HF) communications requirements. SF message traffic is normally transmitted in the burst mode between stations operating within SFOB/FOB signal centers to a maximum of 36 deployed operational detachment elements at distances of up to 4000 kilometers. The blind transmission broadcast method of contact is normally employed.

Ranger Battalion and Long Range Reconnaissance Patrol Company.

The Radio Set AN/PRC-70 is organic to each ranger battalion and long range reconnaissance patrol company (LRRP) which are corps assets. These radios are employed to provide both short-range and long-range command and control communications between established headquarters base stations and deployed operational company/platoon/patrol in support of Army corps operations. Ranger and LRRP units normally install antenna systems designed to be erected rapidly and support short- to long-range communications.

Engineer (ADM) Company.

The Radio Set AN/PRC-70 is organic to atomic demolition munitions (ADM) engineer companies to provide near real-time secure command and control communications as required in support of the unique mission requirements of these units. Engineer units normally install antenna systems designed to be rapidly erected and to support their radio network communications.

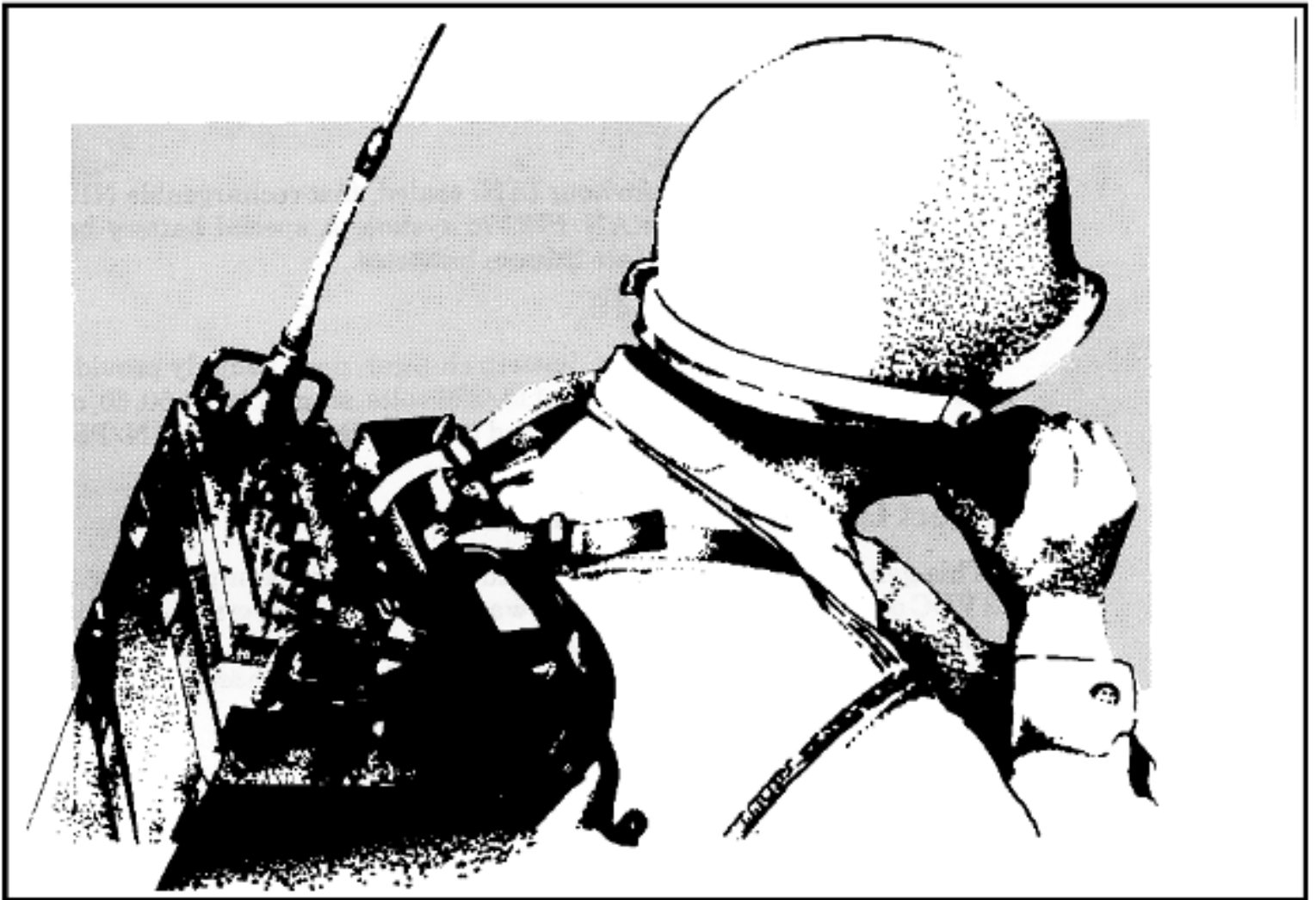

Figure C-1. AN/PRC-70 Manpack.

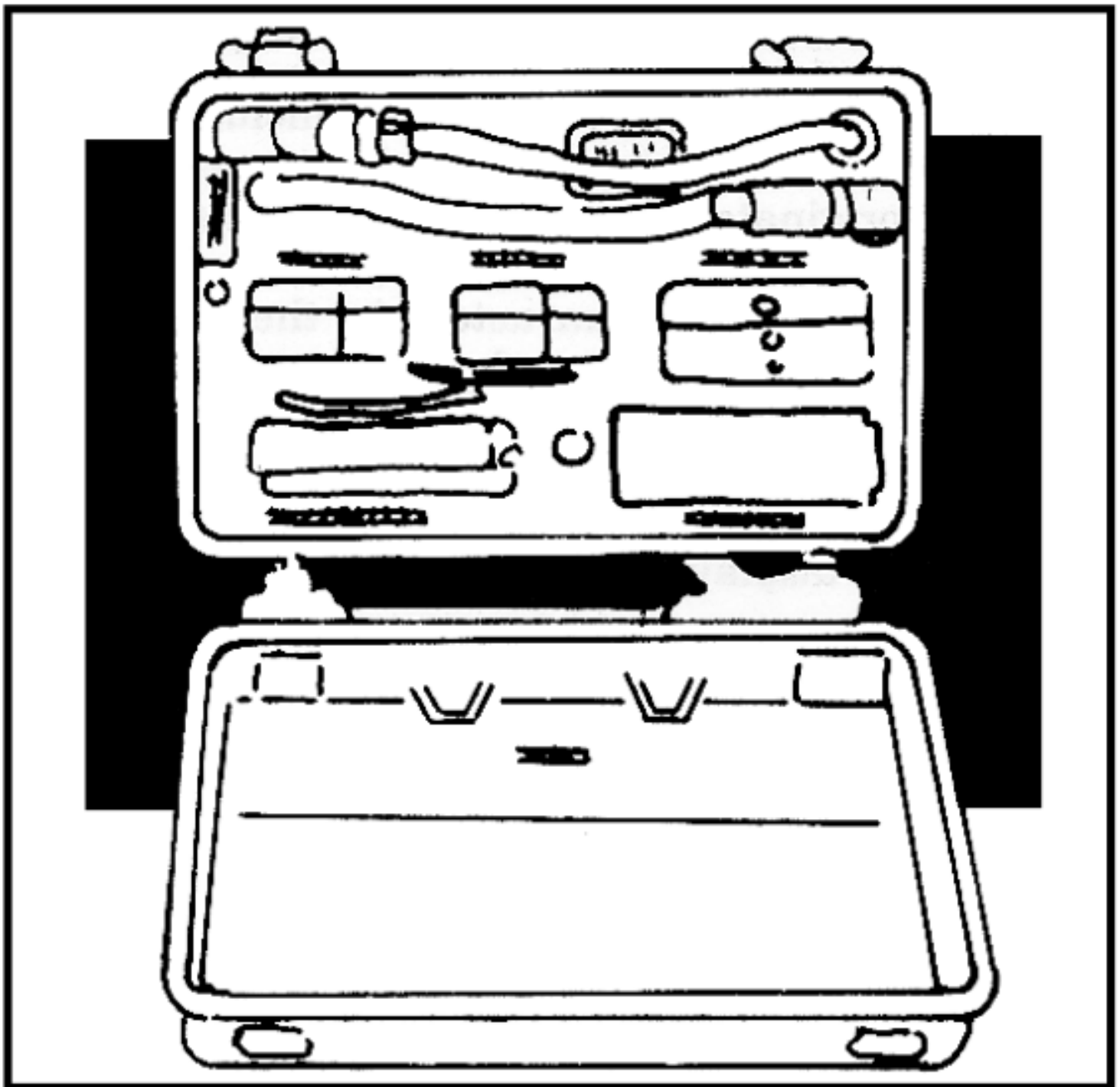

Figure C-2. Coder-Burst Transmission Group AN/GRA-71.

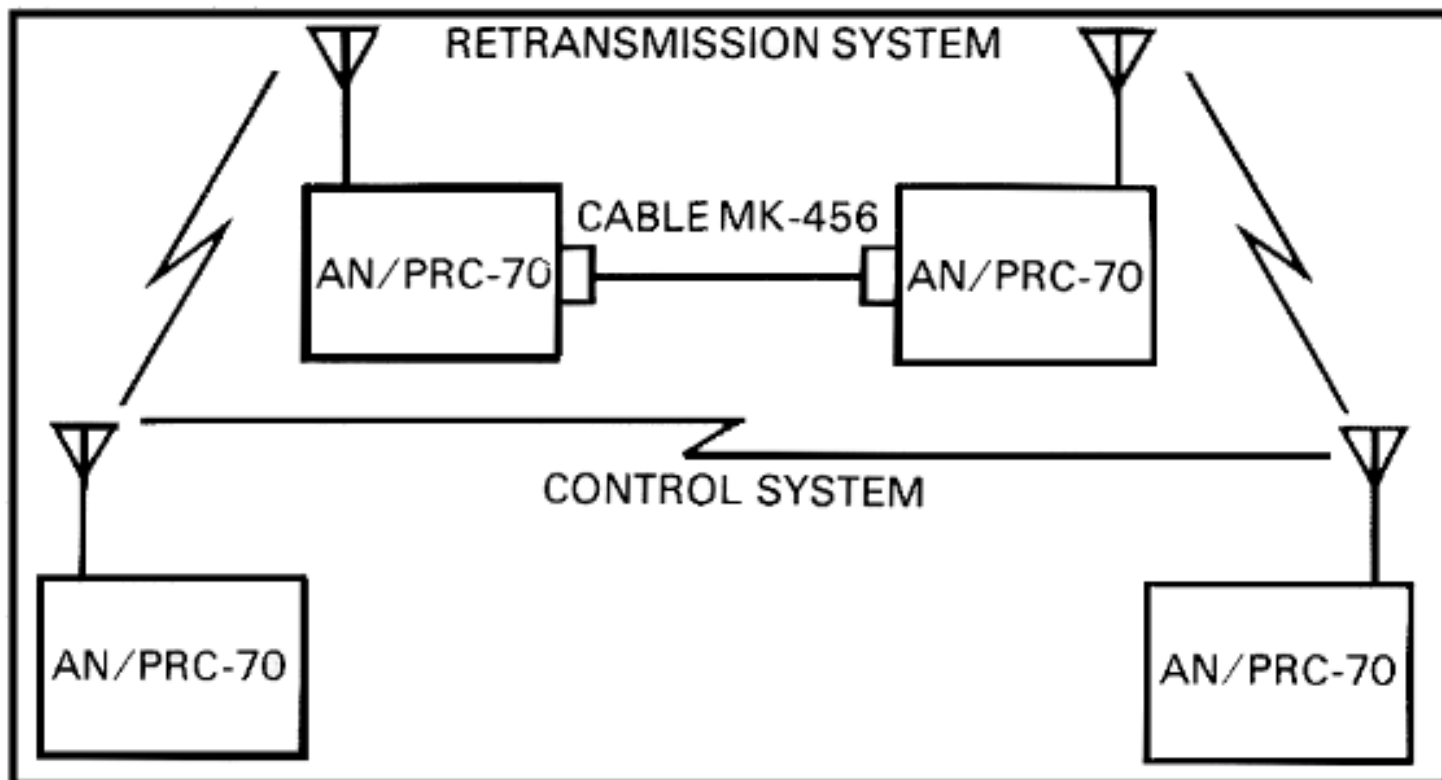

Figure C-3. Retransmission configuration.

APPENDIX D

TRANSCEIVER MULTIPLEXER (TD-1288()/GRC AND TD-1289()(V)/GRC)

D-1. Use and Application

Command and control of the combat, combat support, and combat service support unit is dependent on responsive communications. The communications system must be responsive, highly reliable, and be available to meet the requirements of the force. The transceiver multiplexer enables as many as five tactical combat VHF-FM radios to operate simultaneously at the same location with a single broadband antenna. The transceiver multiplexer equipment assists in the rapid employment of the tactical command post FM communications due to the decrease in the number of antennas required to be erected.

The transceiver multiplexer in no way impedes the normal function of the individual transceiver of the net configuration. The multiplexer is capable of passing any type traffic within the 30 to 88 MHz frequency range with no degradation of radio planning range.

The multiplexer is not affected by communications security and requires no physical security other than that required for the entire radio system.

Technically, the multiplexer reduces or eliminates interference between receivers and transmitters in the VHF systems. It also reduces or eliminates interference to and from other sensitive electronic equipment.

Tactically, the multiplexer decreases the installation/displacement time of the tactical command post due to the decreased command post area. There is no direct effect on the transceiver multiplexer by EW operations. The multiplexer is electromagnetic pulse protected by design.

D-2. Characteristics

The transceiver multiplexer--

- Contains filter modules which are interchangeable within the mounting base.
- Contains termination units for terminating unused channels that are interchangeable with filter modules. The termination units prevent impedance mismatch losses and/or spurious emissions from degrading the performance of operating channels.
- Contains visual tuning indicators for each individual filter module to provide tuning and monitoring each channel.
- Introduces no more than a 2-dB insertion loss into the communications circuit.
- Contains input and output characteristics compatible with the AN/VRC-12 series radio to include OE-254/GRC biconical antenna and any other broadband antenna (50 ohm impedance).

- Permits independent operation of transceivers separated in frequency by at least 5 percent (1.5 MHz at 30 MHz, 4.4 MHz at 88 MHz).
- Provides circuitry to allow for monitoring the forward and reflected power of each transceiver and for monitoring both high (0-60 watts) or low (0-6 watts) transmitter power in order to facilitate tuning when operating with low power radios.

D-3. Equipment

The transceiver multiplexer consists of either a two- or five-port unit. (See [fig D-1](#)).

[Figure D-1](#). Transceiver multiplexer.

D-4. Associated Equipment

Tactical net radio (AN/VRC-12, AN/PRC-77, and AN/PRC-70).

Antenna system OE-254/GRC (or any other broadband antenna under development in the 30-88 MHz range).

All necessary coaxial cables and cable adapters.

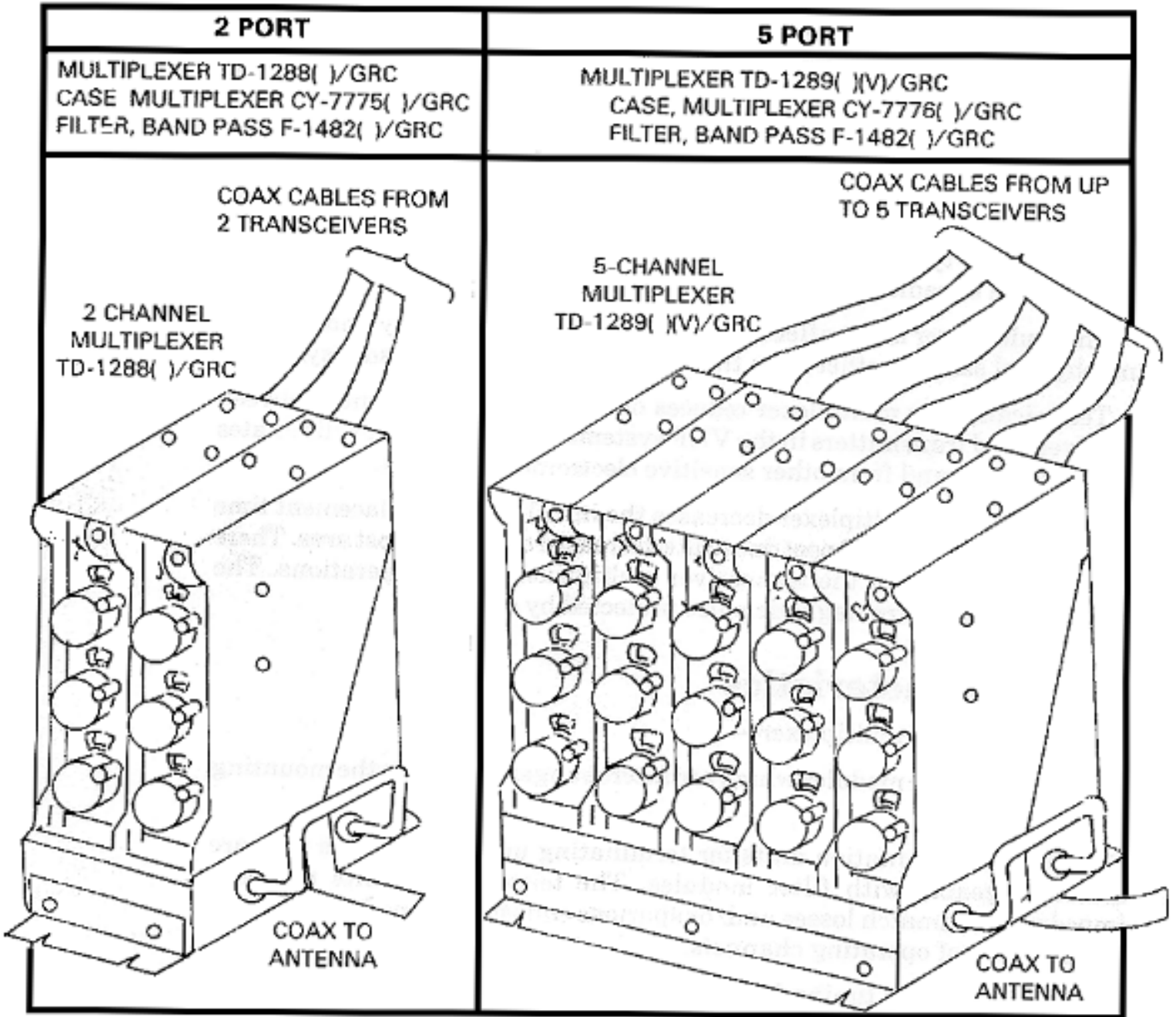

Figure D-1. Transceiver multiplexer.

APPENDIX E

STEERABLE NULL PROCESSING GROUP OL-275()/VRC

E-1. Use and Application

The present capability to counter the jamming threat is limited to operator techniques including manual frequency switching, use of terrain features to shield from jammer signals, and the employment of a limited number of directional antennas. These capabilities to counter the EW threat are inadequate to assure essential communications when intense jamming is encountered. Hence, the Steerable Null Processing Group OL-275()/VRC-- commonly called the SNAP-1--is needed to provide an ECCM capability for the AN/VRC-12 family of radios. The SNAP-1 is employed on essential command and control and fire support single-channel radio nets from platoon to division echelon in forward areas. Basic application includes the division command/operations net, brigade/group command/operations net, as well as those FM radios used by separate brigades in the command/operations nets. The SNAP-1 may be used with the SINCGARS equipment in the single-channel mode. A similar device, the SNAP-2, is being developed to be used with the SINCGARS equipment in the frequency-hopping mode.

The OL-275()/VRC consists of a Steerable Null Antenna Processor CP-1380/VRC (hence the name SNAP), Interconnecting Box J-3792/VRC, and Special Purpose Electrical Cable Assembly CX-13179/U ([fig E-1](#)). The SNAP-1 combines signals received by two standard VHF-FM antennas to create a radio reception pattern containing a null. The SNAP-1 installation kit includes the additional antenna. When employed as a part of a radio system (for example, with vehicular mount, radio, antennas, processing unit), the SNAP-1 becomes the antenna control system for the radio and must, therefore, interface and operate with the radio. Additionally, the SNAP-1 --

- Effectively eliminates an unwanted signal from the radio receiver automatically without interfering with the desired signal arriving from a different direction. A 35-dB reduction in the unwanted signal power is accomplished under most operating conditions. The SNAP-1 is capable of operating efficiently when the operator has no prior knowledge of the direction of either the unwanted or the desired signal.
- Is capable of operation on the move and while stationary. It is capable of effectively eliminating signals automatically from a stationary or moving jammer.
- Operates with current vehicular mounted VHF-FM radios and COMSEC equipment without requiring modification to the radios or the COMSEC equipment. The SNAP-1 permits normal cipher and plain text voice and data communications over the associated radio and COMSEC equipment.

- Is capable of passing the desired signal to the receiver from other VHF-FM transmitters whether or not the sending transmitter is equipped with SNAP-1.
- Has a bypass or override feature for use in a jam-free environment or when a failure occurs in the SNAP-1.
- Uses standard Army VHF-FM antennas (for example, the AS-1729 or the AS-2731).

[Figure E-1.](#) Components of OL-275()/VRC.

E-2. Features

Modes of Operation.

Automatic. Continuous closed-loop tracking of jammer. This enables it to be useful against a moving jammer, or with a moving receiver.

Manual. Permits cancellation of a jammer only slightly stronger than the desired signal. Coarse and fine adjustments are provided to eliminate co-channel interference and unintentional interference by a strong friendly signal.

Bypass. Permits bypassing SNAP applique while retaining channel light function.

Frequency Selector.

Permits direct setting of channel frequency.

Sum-Normal-Null Switch.

Permits manual selection of pattern nulling (jammed condition) or peaking (unjammed condition). The NORM position provides automatic selection based on the 150-Hz squelch tone on desired signals.

Channel Light.

Indicates presence of signal power in the channel, thus providing an indication of a jamming or interfering signal.

Meter.

Provides an indication of the null depth by monitoring energy of the in-phase component of the canceled signal.

Mounting Case.

The SNAP-1 is contained in a case similar to an R-442 case so as to make use of the existing vehicular mount (MT-1898).

E-3. Associated Equipment

The SNAP-1 operates with the following equipment:

- Two AS-1729 or two AS-2731 antennas.
- Interconnecting Box J-3792/VRC. (Included in Group.)
- Two antenna cables CG-1773.

- Two control cables CX-4722.
- Mount MT-1898.
- Special Purpose Electrical Cable Assembly CX-13179/U. (Included in Group.)
- COMSEC equipment, TSEC/KY-8, TSEC/KY-38, or TSEC/KY-57.
- AN/VRC-12 family of radios and AN/GRC-160 and AN/VRC-164.

[Figure E-2](#). Installation of the OL-275()/VRC.

STEERABLE NULL PROCESSING GROUP
OL-275()/VRC

STEERABLE NULL ANTENNA
PROCESSOR CP-1380/VRC

INTERCONNECTING
BOX J-3792/VRC

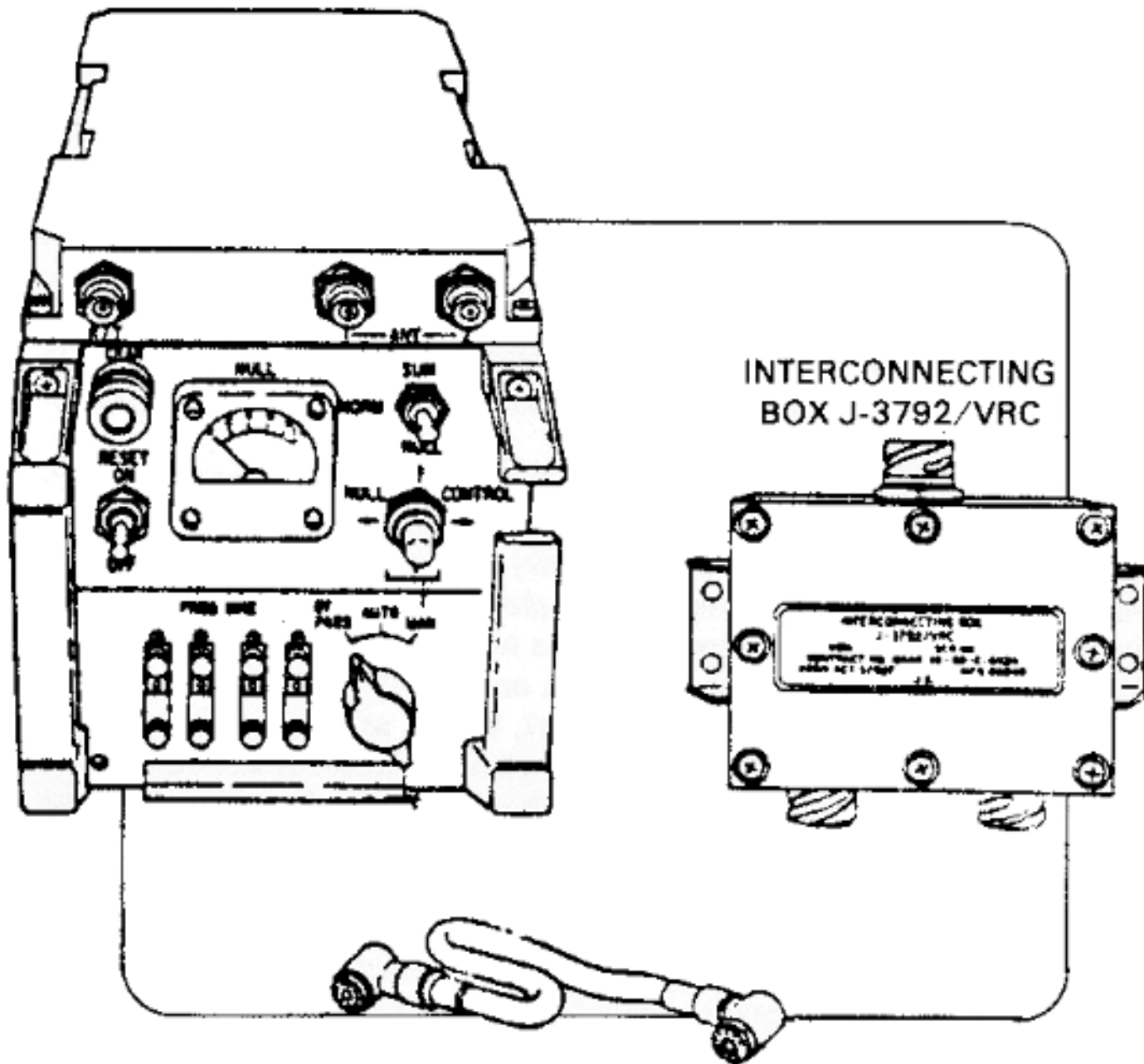

CABLE ASSEMBLY, SPECIAL
PURPOSE, ELECTRICAL
CX-13179/U (3 FT 0 IN)

Figure E-1. Components of OL-275(VRC).

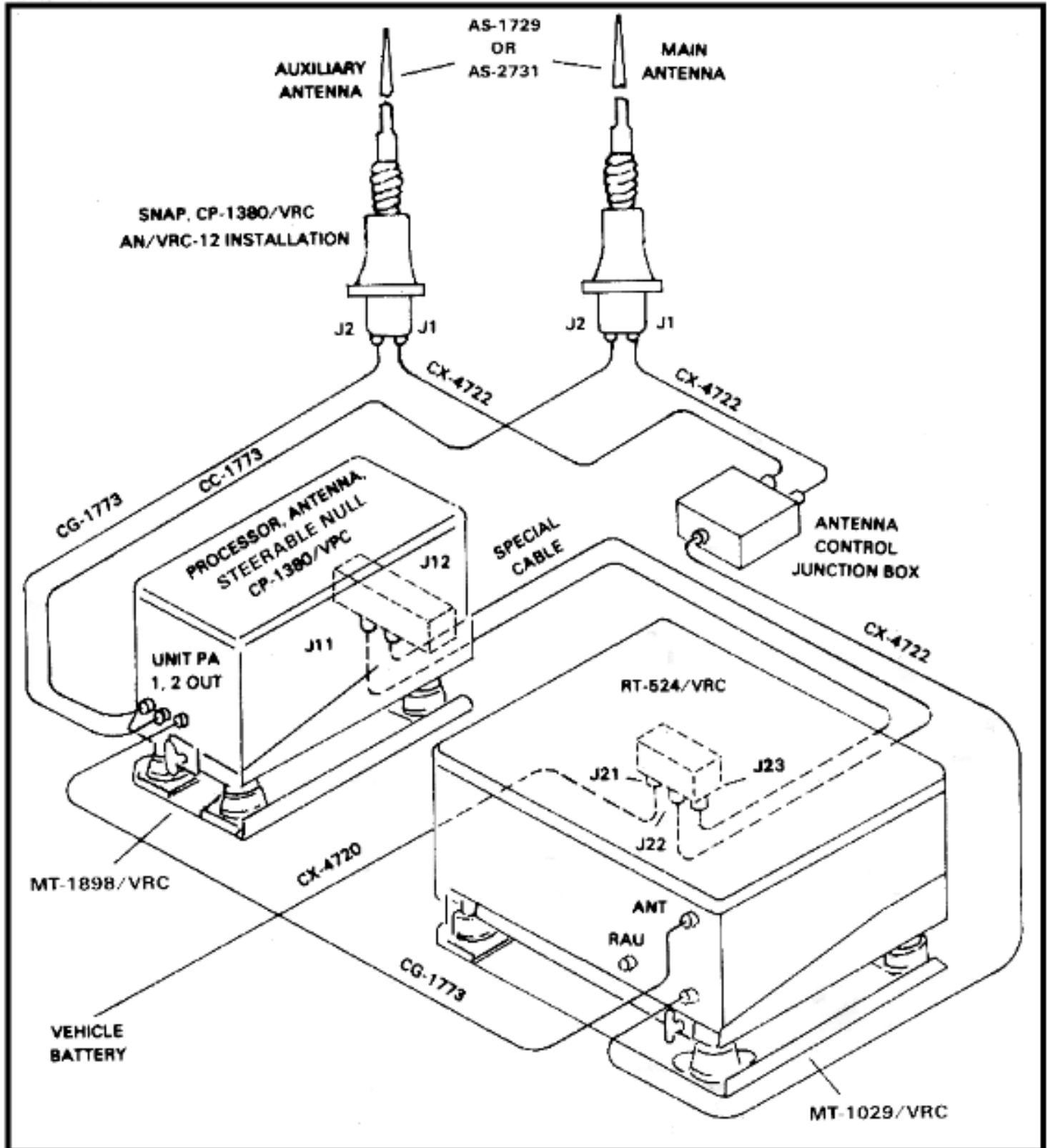

Figure E-2. Installation of the OL-275(V)/VRC.

APPENDIX F

NET RADIO INTERFACE

Section I. Purpose and Scope

F-1. Purpose

NOTE: The term radio-wire integration (RWI) is being replaced by net radio interface (NRI). The functions and operations remain the same, but the name change more closely reflects the service provided.

This appendix provides information on the doctrine and operation of TOE net radio interface facilities installed in tactical areas. Procedures for operation of nontactical, garrison type administrative NRI facilities may be developed by local commanders. It provides commanders, operators, and users of NRI facilities the information needed to use this capability effectively in a tactical setting. It may also be used to help personnel prepare for command post exercises and field training exercises. It will be a valuable aid when used with a unit's Army training and evaluation program (ARTEP).

F-2. Scope

[Section II](#) of this appendix provides information on the doctrine and deployment of NRI. [Section III](#) provides information to both the switchboard operator and the NRI operator on installation and operation of an NRI facility. [Section IV](#) provides information regarding Radio Set Control C-6709 which is designed to provide NRI with the automatic switches.

Section II. Doctrine and Deployment

F-3. Location of NRI

To carry out command and control responsibilities, a tactical unit commander must have all authorized means of communications readily available. The principal means of command and control are the tactical radio and telephone networks. Although each of these networks is a distinct, specialized means of communications, it is possible--and often required--to interconnect or interface them. This interface capability is provided by net radio interface equipment.

At corps level, a net radio interface station is located at--

- Main.

- Tactical command post.
- Corps support command.
- Area signal centers (ASC).

At corps level, NRI is installed and operated by the corps area signal battalion at each signal center. Commanders of all units serviced by the ASC are authorized to use the NRI facility.

At division level, a net radio interface station is located at--

- Main.
- Division support command.
- ASCs.
- Division artillery.

At division level, NRI is installed and operated by the division signal battalion. The NRI facility is available to the commanders of all units of the division.

F-4. Use of NRI

At corps level, NRI stations are used--

- By the commanding officer, corps staff, and other designated key personnel in the corps.
- For initial establishment of telephone service from the corps area communications system to using units.
- To keep commanders and staffs in contact with subordinate and higher headquarters, as required, during the displacement of command posts (CP).
- For emergency FM communication between elements in the corps area where there is a loss of telephone communications. At division level, NRI stations are normally used--
- To establish emergency communications between mobile FM radio stations and elements connected to the division area telephone system by telephone.
- To establish communications between FM radio stations separated by distances that are beyond the direct operating range of their FM radio sets.
- By the commanding general, division staff, and other designated key personnel in the division when operating from a mobile CP to contact division elements connected to the division area communications system.
- For initial establishment of telephone service from the division area communications system to using units.
- For voice communications between mobile combat elements in the division forward area and supporting division logistic elements in the rear area.
- For communications between low-flying Army aircraft operating in distant parts of the division area and airstrips of flight control elements connected to the division area communications system, when direct FM radio cannot be maintained.
- For communications between forward air controllers and the air liaison officer's communications facilities when these facilities are connected with the division area communications system.
- To keep commanders and staffs in contact with subordinate and higher headquarters, as required,

during the displacement of CPs.

- To connect two switchboards and to span a break in a wire line between units.
- For communications during river crossings.

F-5. NRI Equipment

The equipment authorized for NRI stations is based on the unit's mission. However, equipment authorized is normally designated as NRI equipment either by paragraph number or by section. Most NRI facilities use AN/VRC-12 series radio sets. The following paragraphs discuss equipment used for NRI:

Radio Control Set AN/GSA-7.

Radio Control Set AN/GSA-7 is a small, lightweight electronic switching device used to interconnect single-channel FM radio equipment with the local, push-to-talk telephone system. The radio control set can be used in wire-to-wire (via radio), wire-to-radio, or radio-to-wire communications up to a distance of 16 kilometers (10 miles).

Radio Control Set AN/GRA-39.

Radio Control Set AN/GRA-39 is a substitute item for the AN/GSA-7. The AN/GRA-39 may be used to provide remote control of a radio receiver-transmitter up to approximately 3.2 kilometers (2 miles). This equipment may be used to provide NRI between a Telephone Switchboard SB-22/PT and the receiver-transmitters.

Additional telephone systems and radio equipment.

Manual switchboards ([Figure F-1](#)).

- SB-22/PT.
- SB-86/P.
- SB-3082/GT.

[Figure F-1](#). Manual switchboards.

Manual switchboard configurations ([Figure F-2](#)).

- AN/MTC-1.
- AN/MTC-3.
- AN/MGC-9.
- AN/TTC-35.
- AN/TTC-23.
- AN/TTC-29.
- AN/MTC-7.

Automatic switch AN/TTC-38 (300- and 600-line). [Figure F-2](#). Switchboard configurations.

Radio equipment ([Figure F-3](#)).

- Radio Set AN/VRC-49 (2 ea RT-524/VRC receiver-transmitters).
- Receiver-Transmitter RT-524/VRC.
- Receiver-Transmitter RT-841/PRC-77.
- Receiver-Transmitter RT-505/PRC-25.
- Telephone Set TA-312/PT.
- Installation kits.
- Cable Assembly CX-7474 (for use with the AN/VRC-12 family).

[Figure F-3.](#) Radio equipment.

[Figure F-3.](#) Radio equipment (continued).

F-6. Security of an NRI System

NRI systems can be secured through the use of the Vinson secure equipment. (Secure wire line with KY-57s and HYX-57s.) Wire-line Adapter HYX-57 provides the interface for the KY-57 to a standard 2- or 4-wire transmission line, but it does not encrypt or decrypt. This is done by the KY-57. Distance between HYX-57s should be no greater than 16 kilometers (10 miles). If a secure wire line is required over a distance greater than 16 kilometers (10 miles), two HYX-57s can be placed back-to-back to double the range.

Security of an NRI system using the Nestor secure equipment (KY-38 and KY-8) ([Figure F-4](#)) is limited to secure radio. The wire line portion is not secure. Users of this type of NRI system must be aware of the security risk that the wire line adds. The enemy will associate call signs with unit or telephone numbers on the wire line. Long calls or trunk lines where possibility of hostile wire tapping exists must be used with caution.

The NRI station can call a radio station that has a KY-38 installed, whether the KY-38 is in the plain or cipher mode. The NRI stations cannot call a radio station with a KY-8 installed if the KY-8 is in the cipher mode. A station with either type of security equipment (KY-8 or KY-38) can call the NRI station by switching to the plain mode.

[Figure F-4.](#) KY-38.

Section III. Operation

F-7. Responsibility for NRI Systems

The operator of the NRI system is responsible for installing, operating, and maintaining an NRI facility that will connect the radio system and the telephone system. There are times when the commander and certain key personnel of the command elements must have access to both the telephone and the tactical radio systems through the NRI facility. This provides the commander with a more flexible means of command and control. The responsibility of the NRI operator does not stop at the NRI facility. When a problem occurs, the operator should be able to locate its source. That means the NRI operator must know what happens at the switchboards, automatic switches, NRI equipment, and the radio site.

F-8. Switchboards and Switches Used With the NRI System**SB-22/PT.**

The SB-22 ([Figure F-5](#)) is the simplest switchboard used with NRI. Connect a field wire pair to the binding posts on the back of the switchboard that match the line pack selected for NRI use. The other end of the pair goes to the NRI rig. The switchboard is not located in the NRI rig; it is usually the unit or area switchboard.

[Figure F-5.](#) SB-22/PT.

SB-86/P, AN/MTC-3, AN/TTC-23, and other similar units.

Use an extra switchboard cord such as the one on the SB-22, SB-86, or AN/MTC-1 type switchboard. If a switchboard cord is not available, use a PJ-051 ([Figure F-6](#)) three-conductor telephone plug and connect a piece of two-wire cable to the ring and tip of the plug. Connect the wires coming from the tip and ring of the plug to the binding posts of a TA-312 telephone. Position the telephone where the switchboard operator can reach it, and hang the plug where the operator can insert it into any jack on the board.

[Figure F-6.](#) Hookup.

SB-86/P configurations.

In a vehicle mounted configuration with more than one SB-86/P, such as the AN/MTC-3, set the TA-312 on top of one of the SB-86s. Allow the cable to hang so that the plug end can be inserted into any jack on either switchboard. Terminate the line from the NRI site on the binding posts of the TA-312. In an AN/MTC-3, for example, connect the line from the NRI site to spare binding posts A in the signal entrance box. Inside the shelter, at the binding post and jack panel, connect binding posts A to the TA-312 located on top of the switchboard.

AN/MTC-1 and AN/TCC-7 configurations.

In the AN/MTC-1, place the TA-312 on the table behind operator number 1. Run the cable overhead from the TA-312 binding posts and hang it where it can be plugged into any jack on position number 1. Terminate the line from the NRI site at the binding posts of the TA-312. In the AN/MTC-1, this can be done by connecting the line from the NRI site to the PHONE 1 MTA-4 binding posts in the power and signal entrance box of the AN/MTA-3. Inside the AN/MTA-3, connect a phone cable with a two-conductor plug to the TA-312 binding posts and insert the plug end into the PHONE 1 MTA-4 jack on the signal duct. Do not plug a phone into the PHONE 1 MTA-3 jack in the AN/MTA-4.

SB-3082/GT.

Net radio interface is possible through the SB-3082 ([Figure F-7](#)); however, it won't work on a push-to-talk basis. This means that the NRI operator must assist the call by using the push-to-talk switch on the NRI equipment handset to key the transmitter for the telephone subscriber. For NRI with the SB-3082, hook up the pair of wires from the NRI rig to one of the lines on the switchboard. Set the toggle switch on the NRI line to MAG. No special actions are required of the switchboard operator.

[Figure F-7.](#) SB-3082/GT.

Have the AN/TTC-38 switch attendant program the NRI line as to 20-Hz, 2-wire ringdown circuit using terminal code 34. This gives the dual-tone, multi-frequency (DTMF) telephone (TA-341) subscriber direct access to the NRI 20-Hz phone without assistance from the AN/TTC-38 operator. The AN/TTC-38 operator will have to assist on all calls originating from a radio station.

F-9. Switchboard Operator Sequence of Events

SB-86/P switchboard operator sequence of events (subscriber origination).

The subscriber signals the switchboard. A drop appears on the board. The switchboard operator plugs in an answer cord and answers. The subscriber asks for the NRI operator. The switchboard operator unplugs the answer cord from the subscriber's jack. If the subscriber's telephone is set for CBS, the signal will drop again and the buzzer will sound. The switchboard operator inserts the plug of the cord connected to the NRI telephone into the subscriber's jack. This will restore the signal, if it dropped, and connect the subscriber to the NRI rig. The switchboard operator cranks the TA-312 handcrank, picks up the handset, and waits for the NRI operator to answer. When the NRI operator answers, the switchboard operator hangs up the handset and processes other calls. When the call is completed, the NRI operator rings the switchboard to tell the switchboard operator to disconnect.

AN/MTC-1 and AN/TTC-7 switchboard operator sequence of events (subscriber origination).

The subscriber signals the switchboard. A light appears on all three positions. A switchboard operator plugs in an answer cord and answers. The subscriber asks for NRI. If operator number 2 or 3 answered the call, the operator will tell operator number 1 to pick up the NRI call on the number 1 board. Operator number 2 or 3 will unplug when operator number 1 plugs in. Switchboard operator number 1 plugs the telephone cord into the subscriber's jack, picks up the TA-312 handset, cranks the TA-312, and listens for the NRI operator to answer. Operator number 1 must tell the other operators not to plug into the circuit which is being used for NRI. A busy test of the subscriber's jack on position number 2 or 3 will not indicate busy; but, if an operator plugs into the circuit, the NRI call will be interrupted. The line can be checked using the handset of the TA-312. At the end of the call, the NRI operator signals the switchboard: the TA-312 buzzer sounds. Operator number 1 picks up the handset and is told by the NRI operator to disconnect.

SB-86, AN/MTC-1, and AN/TTC-7 sequence of events (radio origination).

The NRI operator signals the switchboard. The TA-312 at the switchboard buzzes. The switchboard operator picks up the TA-312 handset and answers. The NRI operator gives the switchboard operator the desired telephone number. The switchboard operator plugs the cord connected to the TA-312 into the desired subscriber's jack, cranks the TA-312, and listens to the TA-312 handset for the subscriber to answer. The switchboard operator replaces the handset on the phone and continues to handle other calls. Operator number 1 must tell the other operators not to plug into the telephone circuit which is receiving the NRI call. The NRI operator processes the call and rings the switchboard operator when the call is completed. The TA-312 in the switchboard rings, the switchboard operator picks up the handset, and is told to unplug the TA-312 cord from the switchboard.

F-10. NRI Equipment, Configurations, Hookups, and Procedures

The following information explains the connections for, and the operation of, NRI using the AN/GSA-7 ([Figure F-8](#)) and the AN/GRA-39 ([Figure F-14](#)). Use the AN/GRA-39 only if the AN/GSA-7 is not available. These instructions apply to an NRI system using the AN/VRC-49 radio. If you have only one RT-524, the following change to these instructions will apply. For a call originating from a telephone, the NRI operator will tune the NRI radio to the frequency of the desired station and instruct the radio station to tune to the NRI frequency. The NRI operator then returns the radio to the NRI frequency to complete the call.

[Figure F-8.](#) Radio Set Control AN/GSA-7.

[Figure F-9.](#) NRI hookup using the AN/GSA-7.

Using the AN/GSA-7.

NRI hookup. The following equipment will be needed: Radio Set Control AN/GSA-7, Telephone Set TA-312, Radio Set AN/VRC-49 or Receiver-Transmitter RT-524, and Handset H-33 or equivalent. The circled numbers are keyed to [Figure F-9](#).

Connect the two wires from the unit switchboard to the line binding posts of the AN/GSA-7. (1)

Connect the TA-312 to the same binding posts with a short pair of wires. (2) Set the switch on the TA-312 to LB.

Connect the CX-7474/W from the radio jack on the AN/GSA-7 to the RETRANSMIT R/W jack on the RT-524. (3)

Connect handset H-33 or equivalent to the PHONE jack. (4)

Set the C.O. POWER switch on the AN/GSA-7 to EXT. (5)

If using AC power, set the POWER SELECT switch to match the input voltage. (6)

Connect the AC or DC power cable (depending on the power source). Also see [Figure F-10](#). (7)

Connect the RC-292 (or the OE-254) or the whip antenna to the ANT jacks on both transmitters with coaxial cable. (8)

When using the whip, either on the vehicle or raised up on the AB-9(3), connect the antenna control cables between the ANT CONT jacks (9) on both RT-524s and the connectors on the base of the antennas ([Figure F-11](#)). When you use an RC-292 or OE-254, you don't use the control cable.

Do not remove the X-MODE covers. (10) The set won't work with the covers removed. [Figure F-10](#). Check polarity.

[Figure F-11.](#) Base of antenna AS-1729/VRC (whip). Connect a microphone to the C-2299. (16)

Set the POWER switches (13) on both RT-524s to LOW.

Set the SQUELCH switches (11) according to local directives.

Set the BAND switch, MC TUNE, and KC TUNE controls on RT-524 number 1 (12) to the assigned

NRI frequency. Read it in the window. Don't set RT-524 number 2 on the NRI frequency.

Turn the speaker switches to ON. (14)

Set the VOLUME controls to mid range. (15)

System testing. Set the OFF-AC-DC switch on the AN/GSA-7 to AC or DC depending on the power source. Allow warm-up time. ([Figure F-12.](#))

NOTE: If the radio keys and stays keyed, reverse the leads from the switchboard at the binding post on the AN/GSA-7.

[Figure F-12.](#) Line connections.

Turn the RADIO & MON/TEL switch to TEL-R to ring the switchboard. Release the switch. It will return to TEL-T. Use the handset of the TA-312 or the handset connected to the PHONE jack to talk to the operator. Request a ringback. The buzzer in your TA-312 should ring.

Turn the RADIO & MON/TEL switch to RADIO & MON-T. Check your CEOI for the frequency and call sign of a known operating station. Set the RT-524 number 1 on this frequency. Using the handset on the TA-312 or the handset connected to the PHONE jack on the AN/GSA-7, call the station for a communications check. If the station doesn't answer, set the power switch to HIGH and call again ([Figure F-13](#)). During transmission, a beep should be heard about every 5 seconds to remind the users that it is an unsecured NRI circuit.

When you finish the communications check, turn the POWER switch on the radio back to LOW, tune back to the NRI frequency, and set the switch on the AN/GSA-7 back to TEL-T.

Set the C-2299 to TRANS 2. Use the mike on the C-2299 and test RT-524 number 2.

[Figure F-13.](#) RT-524.

[Figure F-14.](#) Radio Set Control Group AN/GRA-39.

NRI call originating from a telephone subscriber.

NOTE: In the following discussion, you are presumed to be the 1-77 Infantry Battalion NRI operator. The commander of the 1-77 Infantry Battalion desires an NRI call to the commander A/1-77 Infantry Battalion. (Telephone subscriber does not have the radio call signs). Unclassified unit designators will not be linked with call signs.

When a call comes from a telephone network user, your TA-312 buzzer will buzz.

You can answer with either the TA-312 handset or the handset connected to the PHONE jack. Obtain the required information and tell the caller to stand by.

NRI OP: "SERVANT 134".

TEL SUB: "This is SERVANT 106, SERVANT 140 please."

NRI OP: "Roger--Wait--OUT."

NOTE: NRI operator determines necessary call signs and contacts requested party. In the event the requested party is not operating on your frequency, you must enter his net and request he meet you on your frequency.

NRI OP: "C46, this is A81--OVER."

RADIO SUB: "A81, this is C46--OVER."

NRI OP "This is A81, stand by for A46--OUT."

NOTE: NRI operator provides telephone subscriber with the necessary call signs and reminds him to use proper radiotelephone procedures.

NRI OP: "Sir, you are A46, your party is C46. You must use proper radiotelephone procedures. This circuit is not secure. Go ahead with your call--OUT."

Set the switch on the AN/GSA-7 to RADIO & MON-T.

Any one of three conditions will occur.

The telephone subscriber will be able to control the transmitter from his or her telephone set. This happens if the subscriber's telephone is set for local battery (LB) and is connected to the same switchboard as the NRI rig. In this condition, just monitor the call.

The second possible condition is that the transmitter will key as soon as the switch is moved to RADIO & MON-T for the telephone subscriber to talk and unkeyed by setting the switch to TEL-T for him to listen.

The third possible condition is that the subscriber will be unable to key the transmitter from his or her telephone set and it does not key when the AN/GSA-7 is set to RADIO & MON-T. This occurs if the AN/TTC-38, or SB-3082 switch is used, or if the call comes over a multichannel system. In this condition, leave the AN/GSA-7 switch in TEL-T. Key the transmitter with the switch on the TA-312 handset, or the handset connected to the PHONE jack, for the telephone subscriber to talk. Unkey it for the subscriber to listen.

NOTE: If you can find out beforehand what type telephone system is in your area (CB, LB, automatic switch), you should be able to tell how the transmitter is to be keyed.

Monitor the call. If feedback from the speaker causes erratic keying or squealing, turn off the speaker and monitor with the handset.

When the call is over, ring the switchboard operator and tell him or her to disconnect. Return the switch on the AN/GSA-7 to TEL-T.

NRI call originating from a radio station.

NOTE: In the following discussion, you are the brigade NRI operator. The B/1 -77 Infantry Communications Chief (radio subscriber) desires an NRI call to the 1st Brigade COMSEC Officer Unclassified unit designator will not be linked with call signs.

If necessary, the radio subscriber requests permission to leave his net.

Radio subscriber contacts the BDE NRI station on the BDE NRI frequency.

RADIO SUB: "W6T81, this is H8Q48--Request permission to enter net--OVER."

NRI OP: "H8Q48, this is W6T81--Identify your station--OVER."

RADIO SUB: "W6T81, this is H8Q48--Refer to Bravo Juliet--OVER."

NOTE: The NRI operator may elect to use abbreviated call signs once the station has been identified.

NRI OP: "Q48. this is T81--authenticate. Juliet Lima--OVER."

RADIO SUB: "T81, this is Q48--I authenticate, Whiskey--OVER."

NRI OP: "This is T81--Roger--OVER."

NOTE: In the event the requested party is not served by the NRI operator's switchboard, the full call sign and item number identifier will be given.

RADIO SUB: "This is Q84--Request contact with T36--OVER."

NRI OP: "This is T81 Roger--Wait--OUT."

NOTE: NRI operator determines switchboard designator and number and establishes contact with requested party.

SWBD OP: "SHAMROCK."

NRI OP: "SHAMROCK 167 please."

TEL SUB: "SHAMROCK 167."

NRI OP: "This is SHAMROCK 134. You have a radio call from H8Q48. Refer to Bravo Juliet. You are T36. You must use proper radiotelephone procedures. This circuit is not secure. Do you have any questions? Stand by--OUT."

NRI OP: "Q48, this is T81. Go ahead with your Call--OUT."

Switch the AN/GSA-7 to RADIO & MON-T. Refer to the previous sequence for difference in transmitter keying with CB, LB, or automatic switches.

When the call is completed, return the AN/GSA-7 switch to TEL-T. Ring the switchboard to tell him to disconnect the call.

Using the AN/GRA-39.

NRI hookup. The following equipment will be needed: Radio Set Control Group AN/GRA-39, Switchboard SB-22/PT, Radio Set AN/VRC-49 or Receiver-Transmitter RT-524, 18 Batteries BA-30/U, Connector U-182/U or Connector U-229/U, and 1 meter (about 3 feet) of 2-wire cable. Have your

repairman build a cable as follows: Connect one wire of the 1-meter (3-foot) cable to pin A and the other wire to pin C of the U-182 or U-229 connector. Strip the insulation from about 2 centimeters (3/4-inch) of the wires on the other end. The circled numbers are keyed to [Figure F-15](#).

NOTE: The connector is the same as the one on your RT-524 handset or mike.

Install four BA-30s in the SB-22 and six BA-30s in both the C-2328 and the C-2329.

Connect the WD-1 from the unit or area switchboard to a pair of line binding posts on your NRI SB-22. (1)

Insert the connector of the 2-wire cable to the audio jack on the C-2328. (2)

Connect one of the stripped wires of your homemade cable to the bottom binding post of the C-2328. (3)

Decide which line pack on the SB-22 is to be used for NRI. Connect the other stripped wire to one of the binding posts (4) that matches the selected line pack.

Run a wire (5) from the other binding post of the SB-22 to the top binding post of the C-2328.

Connect the C-2328 binding posts to the C-2329 binding posts. (19)

Connect the RADIO cable (6) on the C-2329 to the RETRANSMIT R/W jack on RT-524 #1.

Connect the mike to one of the audio connectors (7) on the C-2299.

Connect the coax cables from both RT-524s to both antennas. (8)

Connect both antenna control cables if you are using the vehicle whip. (9)

Set the SQUELCH on both RT-524s according to local directives. (10)

Set the RT-524 #1 BAND switch, MC TUNE, and KC TUNE controls to the NRI frequency. (11)

Turn both RT-524 speakers on. (12)

Adjust the RT-524 VOLUME controls during operation. (13)

Connect the SB-22 headset microphone to the SB-22 HEADSET connector. (14)

Set the SB-22 visual and audible alarm switch to AUD.

Turn on the C-2329. (16)

Set the C-2328 VOLUME control to mid range. (17) Make the final volume adjustment during operation.

Set both RT-524 power switches to LOW. (18)

NOTE: If the transmitter keys and stays keyed, reverse the two wires (4) and (5) connected to the NRI line pack on the back of the SB-22.

[Figure F-15](#). NRI hookup using the AN/GRA-39.

System testing. Check your SOI for the frequency and call sign of an operating station. Set the RT-524

Set the C-2328 switch to RAD.

Plug the switchboard operator's cord into the line pack used for NRI.

Put the headset on, squeeze the switch in the headset cord ([Figure F-16](#)), and using radio procedure call the radio station.

Release the switch to listen. Adjust the headset audio using the VOLUME control on the RT-524.

If the station does not answer, set the RT-524 on HIGH power and try again.

After completing the radio check, put RT-524 back on LOW power, unplug the operator's cord from the NRI line pack ([Figure F-17](#)), and plug into the line pack connected to the area switchboard. Set the switch on the C-2328 to TEL. Turn the handcrank on the SB-22 to signal the area switchboard. Ask the operator to give you a ringback.

[Figure F-16](#). Headset switch.

[Figure F-17](#). Switchboard connections for subscriber radio link, NRI. After the switchboard communications check, plug the SB-22 operator's cord into the operator's jack on the operator's pack.

Set the RT-524 #1 back on the NRI frequency.

Set the C-2299 RAD TRANS switch to 2. Using the mike on the C-2299, make a radio check with the same station. When you finish testing, set the C-2299 back on RT 524 #1.

NRI call originating from a telephone subscriber. (Call originates from a telephone. Refer to the AN/GSA-7 sequence for typical conversation.)

The drop on the line pack connected to the area switchboard will turn to white and the buzzer will sound.

Plug the operator's cord into the area switchboard line pack jack and, using the SB-22 handset, answer the call. Lock the cord switch in the middle position.

Obtain the required information from the caller. Tell the caller to stand by.

Check the SOI for the call sign and frequency.

Give the telephone caller his or her call sign and the call sign of the person being called, if necessary.

Set the RT-524 #2 to the frequency of the station being called.

Set the C-2299 to TRANS 2. Use the mike on the C-2299 and call the radio station.

When the radio station answers, tell the radio operator to tune to the NRI frequency and to call back. Set the C-2299 to TRANS 1.

When the radio operator calls back, answer the call by using the mike on the C-2299. Tell the operator to stand by for an NRI call.

Plug the cord of the line pack connected to the area switchboard into the jack on the NRI line pack and,

talking into the SB-22 headset mike, tell the telephone subscriber to go ahead. Tell the subscriber to use radio procedure and that the circuit is not secure.

Set the switch on the C-2328 to RAD. Monitor the call.

NOTE 1: If the telephone subscriber can't key the transmitter with the push-to-talk switch, key the transmitter for the subscriber by squeezing the switch on your headset cord.

NOTE 2: If the transmitter keys and stays keyed when the switch is set to RAD, the telephone subscriber probably has a common battery phone. If this happens, you can key the transmitter by setting the switch on the C-2328 to RAD when the telephone user talks and setting it to TEL when the user listens.

NOTE 3: If the sound from the speaker causes squealing or erratic keying, turn off the speaker and monitor the call through the headset.

When the call is finished, unplug the NRI line pack cord, set the C-2328 switch to TEL, ring the switchboard, and tell the operator to disconnect the line cords. Plug the SB-22 operator's cord into the jack on the operator's pack and wait for another call.

NRI call originating from a radio station. (Refer to the AN/GSA-7 sequence for typical conversation.)

The call will be heard on the RT-524 #1 speaker.

With the switch on the C-2299 at position TRANS 1, answer the call using the mike connected to the C-2299. Get the required information from the radio operator. Tell the operator to stand by.

Plug the SB-22 operator's cord into the jack on the line pack connected to the area switchboard. Turn the crank on the SB-22.

When the area switchboard operator answers, use the SB-22 headset mike. Tell the operator that you have an NRI call and give the desired number.

When the desired party answers, say that the line is not secure. Advise the party of the assigned call sign, to use radio procedures, and to stand by.

Plug the cord from the area switchboard line pack into the NRI line pack jack.

Use the mike connected to the C-2299 and tell the radio operator to go ahead with the call. Set the switch on the C-2328 to RAD. Monitor the call.

NOTE 1: If the telephone subscriber can't key the transmitter with the push-to-talk switch, key the transmitter for the subscriber by squeezing the switch on your headset cord.

NOTE 2: If the sound from the speaker causes squealing or erratic keying, turn off the speaker and monitor with the headset.

NOTE 3: If the transmitter keys and stays keyed when the switch is set to RAD, the telephone subscriber probably has a common battery phone. If this happens, you can key the transmitter by setting the switch on the C-2328 to RAD when the telephone user talks and setting it to TEL when he or she listens.

When the call is completed, unplug the NRI cord, ring the switchboard, and tell the operator to disconnect.

Plug the operator's cord into the jack on the operator's pack and wait for the next call.

Section IV. Radio Set Control C-6709/G

F-11. Typical Usage

The C-6709/G will extend push-to-talk control of a wire-connected radio set at the NRI station to 2-wire/4-wire telephone users. This will allow the telephone user to talk and listen to a remote radio user. Control tones generated by using the keyset of the 2-wire or 4-wire telephone will control the transmitter/receiver in the transmit or receive mode. The station operator at the manned NRI station will answer and extend calls by dialing into the 4-wire automatic system and will respond to and place calls to the radio user's system. At the conclusion of a call, the normal release signal will reset the equipment for another call. The control unit will be capable of being mounted in the vehicle that houses the radio equipment. Connection between the control and Radio Set AN/VRC-12 or any other radio set will be accomplished by means of standard cables shipped with the C-6709/G. The equipment will be powered by the vehicular battery through Radio Set AN/VRC-12 or an equivalent power source. [Figure F-18](#) shows the control unit, and [Figure F-19](#) illustrates a typical system.

[Figure F-18.](#) Radio Set Control C-6709.

[Figure F-19.](#) Typical C-6709 system.

F-12. Equipment Characteristics

The C-6709/G is in a waterproof enclosure with a cover held by four latches. The cover has an air relief valve for equalizing air pressure before opening. All controls and interconnections are on the front panel which is accessible when the cover is removed. The cover contains a small canvas bag used to store a spare lamp and fuse. A separate canvas bag is used to store cables, headset, and two mounting brackets used to mount the C-6709/G in a vehicle. [Table F-1](#) lists some electrical characteristics.

[Table F-1.](#) Electrical characteristics.

F-13. Mission of the System

Mode of Employment.

Radio Set Control C-6709/G will be used to provide integration facilities between 2- or 4-wire telephones and a push-to-talk radio system. A subscriber is connected to 4-wire central offices, and push-to-talk AN/VRC-12 type radio sets. Other type push-to-talk radios can be used with this device if

Purpose.

Radio Set Control C-6709/G is part of a reliable, high quality, automatic, electronic, 4-wire switching system. It is a lightweight, completely solid state, single-channel, attended radio set control device. The control provides a means for the telephone subscriber with a push-button telephone to control transmission and reception of a remote radio used in an NRI system.

System Applications.

The C-6709/G may be used with several radio sets, COMSEC devices, and telephone switching equipment ([Table F-2](#)).

[Table F-2.](#) Equipment compatible with the C-6709.

F-14. Location

This equipment is designed to be mounted in a vehicle along with the radio set with which it is being used. Space requirements are illustrated in [Figure F-20](#). When the C-6709/G is used with some radio sets (such as the AN/VRC-12), it uses the radio set power supply. In some cases, an external 24 volts DC power supply is needed. The C-6709/G is normally mounted so the operator has easy access to the radio set. The use of an external 24 volts DC power supply will be required when using any radio/crypto sets other than the AN/VRC-12. The connection for these radio/crypto sets will be made to a pair of binding posts on the front panel of the C-6709/G. The wire/cable and the connectors (for example, alligator clips for 24 volts DC vehicle battery) are not supplied as a component with the equipment when used with the list of radio/crypto sets other than the AN/VRC-12.

[Figure F-20.](#) Vehicle space requirements for C-6709.

F-15. Operation

Call originating from a radio station.

NOTE: In the following discussion you are the 1-77 Infantry Battalion NRI operator. The Commander, 1-77 Infantry Battalion desires an NRI call to the Commander A/1-77 Infantry Battalion. (Telephone subscriber does not have the Radio call signs.) Unclassified unit designators will not be linked with call signs.

You receive a call from a radio station. You will hear the call in your H-250 handset or H-325 headset microphone. You may hear the call over the radio speaker, if the radio set is so equipped.

RADIO SUB: "A81, this is A46--OVER."

If the C-6709/G has been placed in the proper standby condition, you need only to key the transmitter to answer the call. If you are using the H-250 handset, key the radio by depressing the push-to-talk (PTT) switch and unkey it by releasing the PTT switch. If you are using the H-325/TTC headset microphone, you key the radio by depressing key number 1 on the C-6709/G keysender and unkey by depressing key number 3. If the C-6709/G is not in the proper standby condition, you must place the C-6709/G MODE switch to the OPER position; this permits you to key your radio on and off. You next depress the

C-6709/G OPER CONNECT RADIO pushbutton; this connects the C-6709/G to the NRI transmitter-receiver. You may now key your radio on and off as outlined above.

NRI OP "This is A81--OVER."

NOTE: In the event the requested party is not served by the NRI operator s switchboard, the full call sign and item number identifier will be given.

RADIO SUB: "This is A46. Request contact with C46--OVER."

NRI OP: "This is A81--Roger--Wait--OUT."

You consult the SOI and telephone directory to determine the telephone number for the desired party.

You depress the C-6709/G OPER CONNECT SWBD pushbutton; this connects the C-6709/G to the automatic switchboard. The C-6709/G SVC REQ/BUSY lamp will come on and remain lit and you will receive a dial tone from the switchboard. You then key the number of the desired party on the keysender of the C-6709/G.

NOTE: If you misdial the number, depress the C-6709/G RLSE pushbutton; this disconnects the C-6709/G from the switchboard and places it in a standby condition. The C6709/G SVC REQ/BUSY lamp will go out. Again depress the C-6709/G OPER CONNECT SWBD pushbutton and proceed as above.

When the telephone is answered, get the desired party on the line and tell him or her there is an incoming NRI call. Because a telephone user doesn't usually have an SOI, you will have to give the subscriber the call sign to use. You and the subscriber now must determine the type of radio transmitter keying control the subscriber will use. If the subscriber is using a telephone handset that has a push-to-talk (PTT) switch, the SF (PTT) position of the C-6709/G MODE switch may be used. In this position the transmitter is keyed when the PTT switch is depressed and held, and is unkeyed when the PTT switch is released. If the subscriber has a telephone with a keysender, the DTMF 1/3 position of the C-6709/G MODE switch may be used. In this position, the transmitter is keyed when the subscriber presses key number 1 on the keysender and is unkeyed when key number 3 is pressed. The subscriber may choose, as an alternative, to use the AVOX position of the C-6709/G MODE switch. In this position, the transmitter is keyed when the subscriber is speaking and is unkeyed when he or she is silent. You must remember the type of transmitter control used. The switchboard subscriber is then told to stand by for the NRI call.

TEL SUB: "SERVANT 140."

NRI OP: "This is SERVANT 134. You have a call from A46. What type of telephone equipment are you using?"

TEL SUB: "TA-312."

NRI OP: "Your call is from A46. You are C46. You must use proper radiotelephone procedure. This circuit is not secure. Stand by--OUT."

You depress the C-6709/G OPER CONNECT RADIO pushbutton; this transfers the connection of the NRI operator from the switchboard subscriber to the radio transmitter.

NOTE: The C-6709/G SVC REQ/BUSY lamp will remain lit, indicating that the C-6709/G is still connected to the switchboard subscriber. Using the H-250 handset or H-325/TTC headset microphone, establish contact with the radio station. Tell the radio subscriber to then go ahead with the call.

NRI OP: "A46, this is A81. Go ahead with your call--OUT."

You set the C-6709/G MODE switch to the AVOX position.

NOTE: At this time the C-6709/G MODE switch will be set to one of the three positions, as determined by you and the switchboard subscriber.

You then depress the C-6709/G CALL CONNECT OPER IN pushbutton. This disconnects you from the switchboard subscriber, and connects the switchboard subscriber and the radio station to a common talk path within the C-6709/G. When the C-6709/G CALL CONNECT OPER IN pushbutton is depressed, you can monitor both sides of the NRI talk path. You cannot transmit to either party.

Monitor the NRI talk path to ensure that the switchboard subscriber can key the transmitter on and off and that good communications between the two parties has been established. If for some reason the switchboard subscriber cannot key the transmitter, you must set the C-6709/G MODE switch to the OPER position and key the transmitter on and off at the appropriate times for the switchboard subscriber. After a good NRI connection has been made, you must monitor to ensure proper radio procedure is being used.

NOTE: As long as the NRI call is in progress, the C-6709/G SVC REQ/BUSY lamp will remain lit.

When the NRI call has been completed and the switchboard subscriber hangs up the handset, the C-6709/G SVC REQ/BUSY lamp will go out, and the C-6709/G is automatically placed in a standby condition. When this occurs, you should place the C-6709/G MODE switch to the OPER position and depress the OPER CONNECT RADIO pushbutton. You are now ready to answer the next service request. If it is by radio, you need only key the transmitter to answer. If the request is by telephone, you need only to depress the C-6709/G OPER CONNECT SWBD pushbutton to answer. If the C-6709/G SVC REQ/BUSY lamp does not go out within a reasonable time, you should depress the C-6709/G CALL CONNECT OPER IN pushbutton. This will enable you to monitor the NRI talk path. If the call has been completed, you should then depress the C-6709/G RLSE pushbutton. This will disconnect the C-6709/G from the switchboard and place the C-6709/G into a standby position. You should then place the C-6709/G MODE switch to the OPER position and depress the OPER CONNECT RADIO pushbutton. You are then ready for the next service request, as outlined above.

Call originating from switchboard subscriber.

You receive a call from a switchboard subscriber. This is indicated on the C-6709/G by the audible alarm and flashing SVC REQ/BUSY lamp.

Depress the C-6709/G OPER CONNECT SWBD pushbutton. This connects you to the switchboard subscriber. The audible alarm will go off and the SVC REQ/BUSY lamp stops flashing and remains lit.

Answer the call by using the H-325/TTC headset microphone or H-250 handset. Obtain from the subscriber the individual or station the caller desires. Because a telephone user does not usually have a CEOI, you will have to look up the call signs and frequency and give the call sign to the subscriber. You and the subscriber will have to determine the type of radio transmitter keying control the subscriber will use. If the subscriber is using a telephone that has a push-to-talk switch, the SF (PTT) position of the C-6709/G MODE switch may be used. In this position the transmitter is keyed when the PTT switch is depressed and held, and is unkeyed when the PTT switch is released. If the subscriber has a telephone with a keysender, the DTMF 1/3 position of the C-6709/G MODE switch may be used. In this position, the transmitter is keyed when the subscriber depresses key number 1 on the keysender and is unkeyed when the subscriber depresses key number 3. Alternately, the subscriber may choose to use the AVOX position of the C-6709/G MODE switch. In this position the transmitter is keyed when the subscriber speaks and is unkeyed when he or she is silent. Remember the type of transmitter control used. Tell the switchboard subscriber to standby while the desired party is contacted by radio.

NRI OP: "SERVANT 134."

TEL SUB: "This is SERVANT 106, connect me with SERVANT 140."

NRI OP: "What type of telephone equipment are you using?"

TEL SUB: "TA-838."

NRI OP: "Roger--Wait--OUT."

Depress the C-6709/G OPER CONNECT RADIO pushbutton. This transfers you from the switchboard subscriber to the NRI radio receiver-transmitter. Note that the C-6709/G SVC REQ/BUSY lamp will remain lit, indicating that the C-6709/G is still connected to the switchboard subscriber. Set the radio to the frequency of the desired party. Place the C-6709/G MODE switch in the OPER position. You may now key the radio on and off. If you are using handset H-250, key the radio by pressing the PTT switch and unkey the radio by releasing the PTT switch. If you are using headset microphone H-325/TTC, the transmitter is keyed when you depress key number 1 on the C-6709/G keysender and is unkeyed when you depress key number 3.

NRI operator determines necessary call signs and contacts requested party. In the event the requested party is not operating on your frequency, you must enter his net and request he meet you on your frequency.

NRI OP: "C46, this is A81--OVER."

RADIO SUB: "This is C46--OVER."

NRI OP: "This is A81--Stand by for a call from A46--OUT."

Depress the C-6709/G OPER CONNECT SWBD pushbutton. This disconnects you from the receiver-transmitter and makes connection to the switchboard subscriber. Provide the telephone subscriber with the necessary call signs and remind him to use proper radiotelephone procedure.

NRI OP: "Sir, you are A46. Your party is C46. You must use proper radiotelephone procedure. This circuit is not secure. Go ahead with your call--OUT."

NOTE: At this time the C-6709/G MODE switch will be set to one of the three positions, as determined by you and the switchboard subscriber earlier.

Depress the C-6709/G CALL CONNECT OPER IN pushbutton. This disconnects you from the switchboard subscriber, and connects the switchboard subscriber and radio station to a common talk path within the C-6709/G. When the C-6709/G CALL CONNECT OPER IN pushbutton is depressed, you can monitor both sides of the NRI talk path. You cannot transmit to either party.

Monitor the NRI talk path to ensure that the switchboard subscriber can key the transmitter on and off and that good communications between the two parties has been established. If for some reason the switchboard subscriber cannot key the transmitter, you must set the C-6709/G MODE switch to the OPER position and key the transmitter on and off at the appropriate times for the switchboard subscriber. After a good NRI connection has been made, you must monitor to ensure proper radio procedure is being used.

NOTE: As long as the NRI call is in progress, the C-6709/G SVC REQ/BUSY lamp will remain lit.

When the NRI call has been completed and the switchboard subscriber hangs up the handset, the C-6709/G SVC REQ/BUSY lamp will go out. The C-6709/G is automatically placed in a standby condition. When this occurs, place the C-6709/G MODE switch to the OPER position and depress the OPER CONNECT RADIO pushbutton. You are now ready to answer the next service request. If it is by radio, you need only to key the transmitter to answer. If the request is by telephone, you need only to depress the C-6709/G OPER CONNECT SWBD pushbutton to answer.

If the C-6709/G SVC REQ/BUSY lamp does not go out within a reasonable time, depress the C-6709/G CALL CONNECT OPER IN pushbutton. This will enable you to monitor the NRI talk path. If the call has been completed, depress the C-6709/G RLSE pushbutton. This will disconnect the C-6709/G from the switchboard and place the C-6709/G into a standby condition. Place the C-6709/G MODE switch to the OPER position and depress the OPER CONNECT RADIO pushbutton. You are now ready for the next service request as outlined above.

NRI FACILITIES MUST CONNECT
TO SWITCHBOARDS!

MANUAL SWITCHBOARD

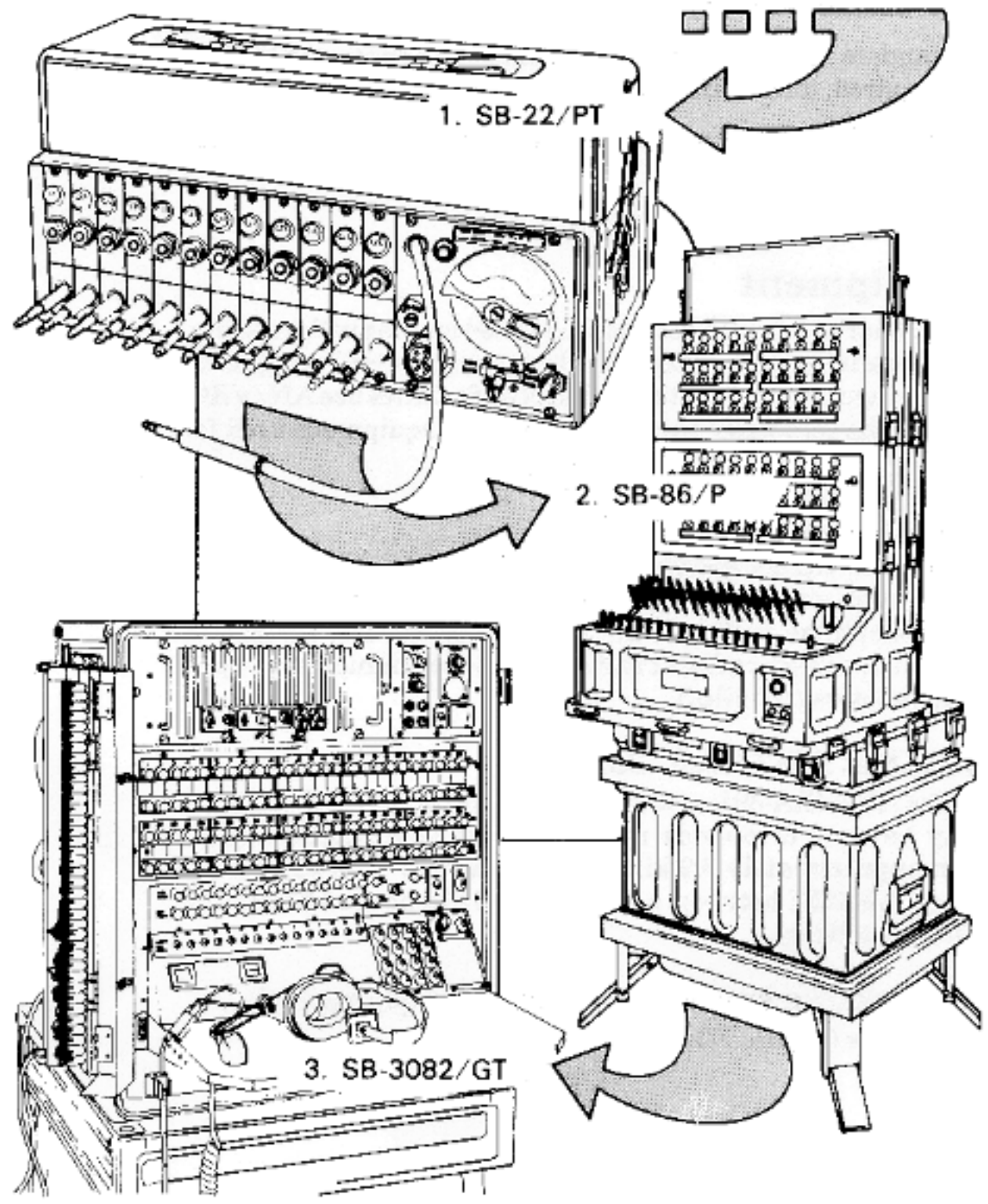
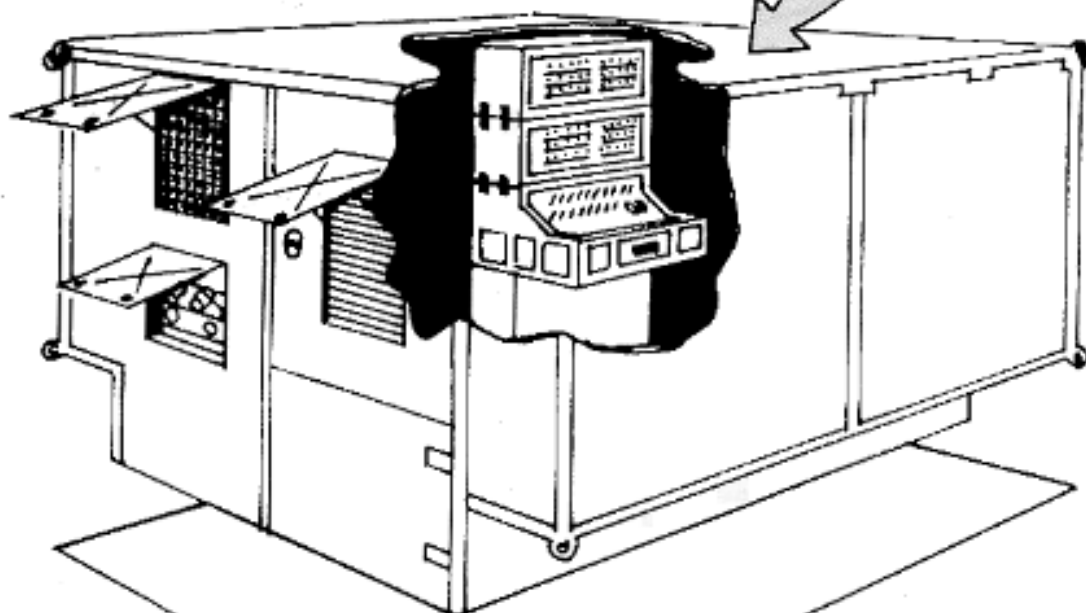

Figure F-1. Manual switchboards.

Automatic switch AN/TTC-38 (300- and 600-line).

THERE ARE MANY SWITCHBOARD CONFIGURATIONS



TYPE MANUAL SWITCHBOARD CONFIGURATION

. . . . BUT THEY'LL ALL
WORK FOR NRI

AUTOMATIC SWITCH

- AN/TTC-38 (300- AND 600-LINE)

Figure F-2. Switchboard configurations.

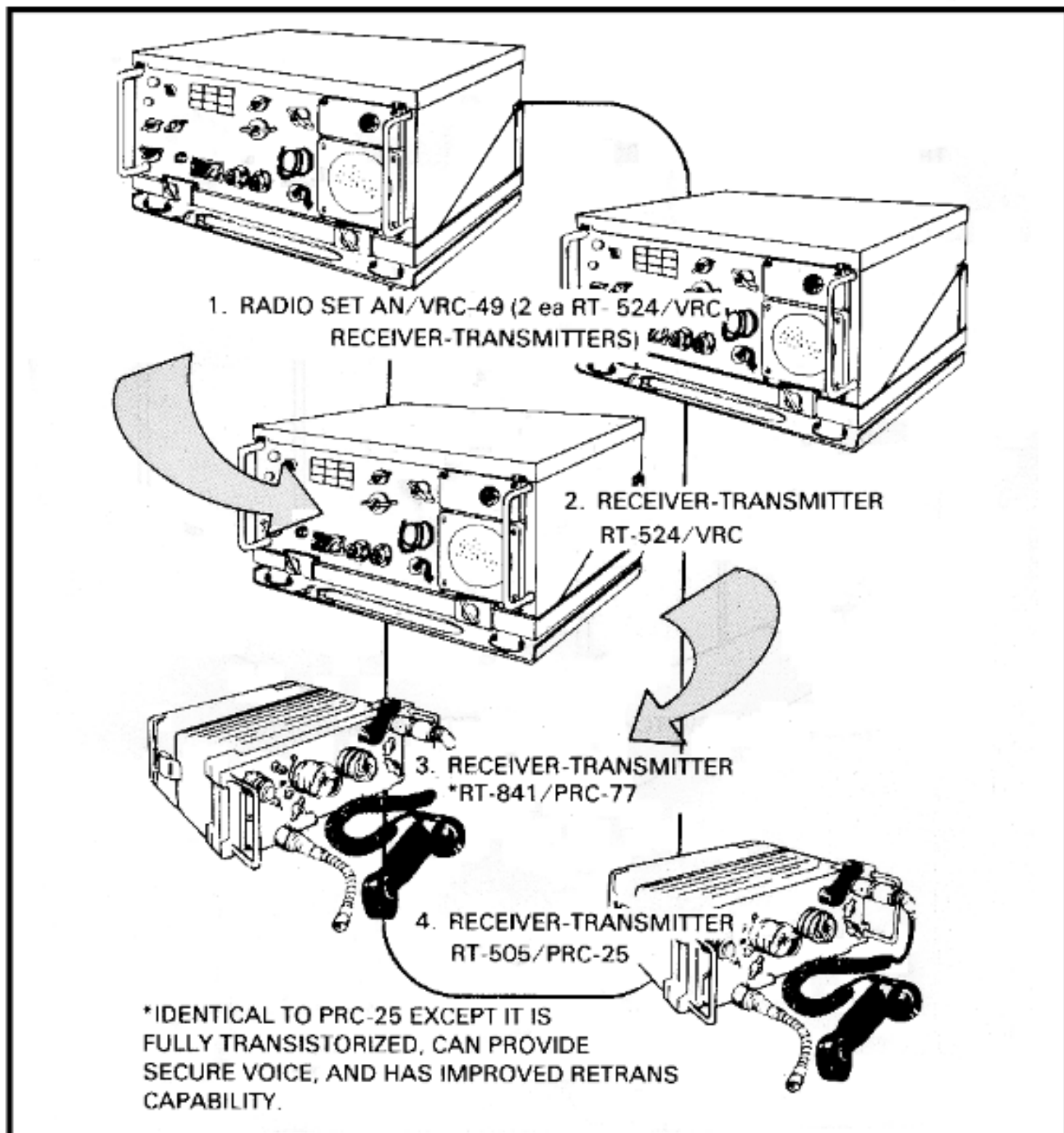
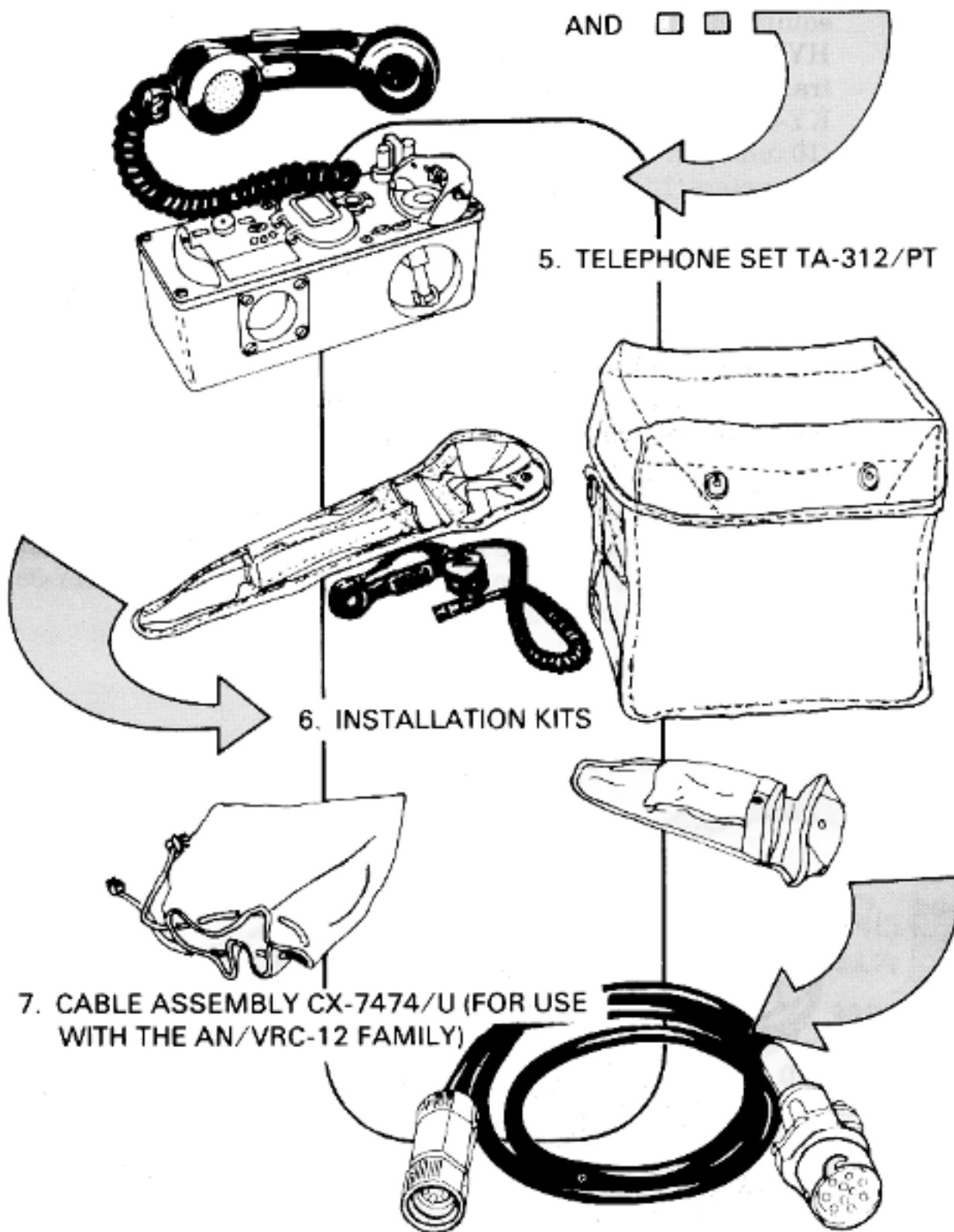

Figure F-3. Radio equipment.



NRI USING THE AN/PRC-77 OR AN/PRC-25 IN A VEHICULAR CONFIGURATION IS SIMILAR TO NRI USING THE RT-524 RECEIVER-TRANSMITTER. THE OPERATING INSTRUCTIONS IN SECTION III ARE BASED ON AN NRI SYSTEMING USING THE RT-524. SEE TM 11-5820-498-12 FOR MORE INFORMATION ON THE OTHER RADIO SETS.

Figure F-3. Radio equipment (continued).

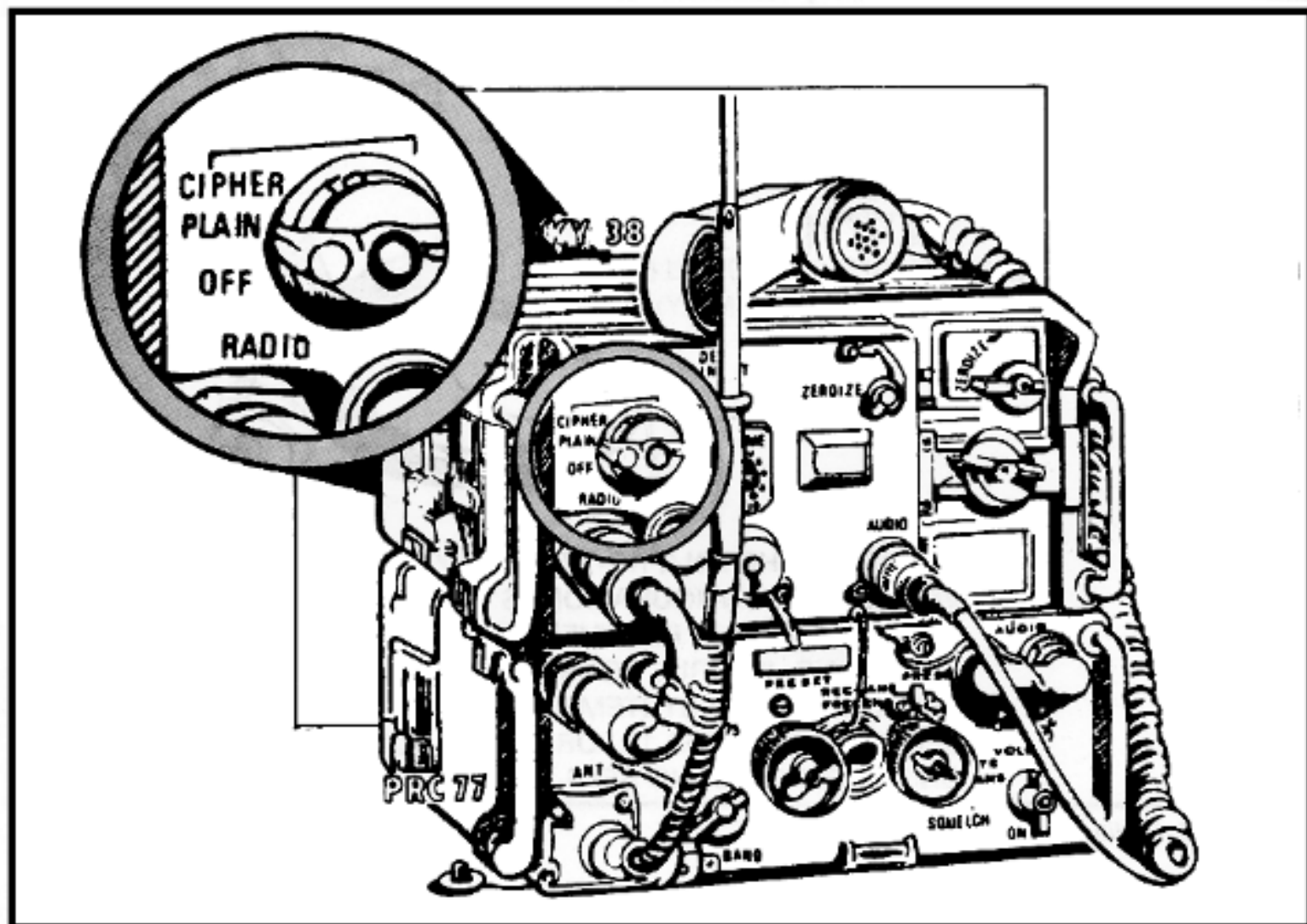

Figure F-4. KY-38.

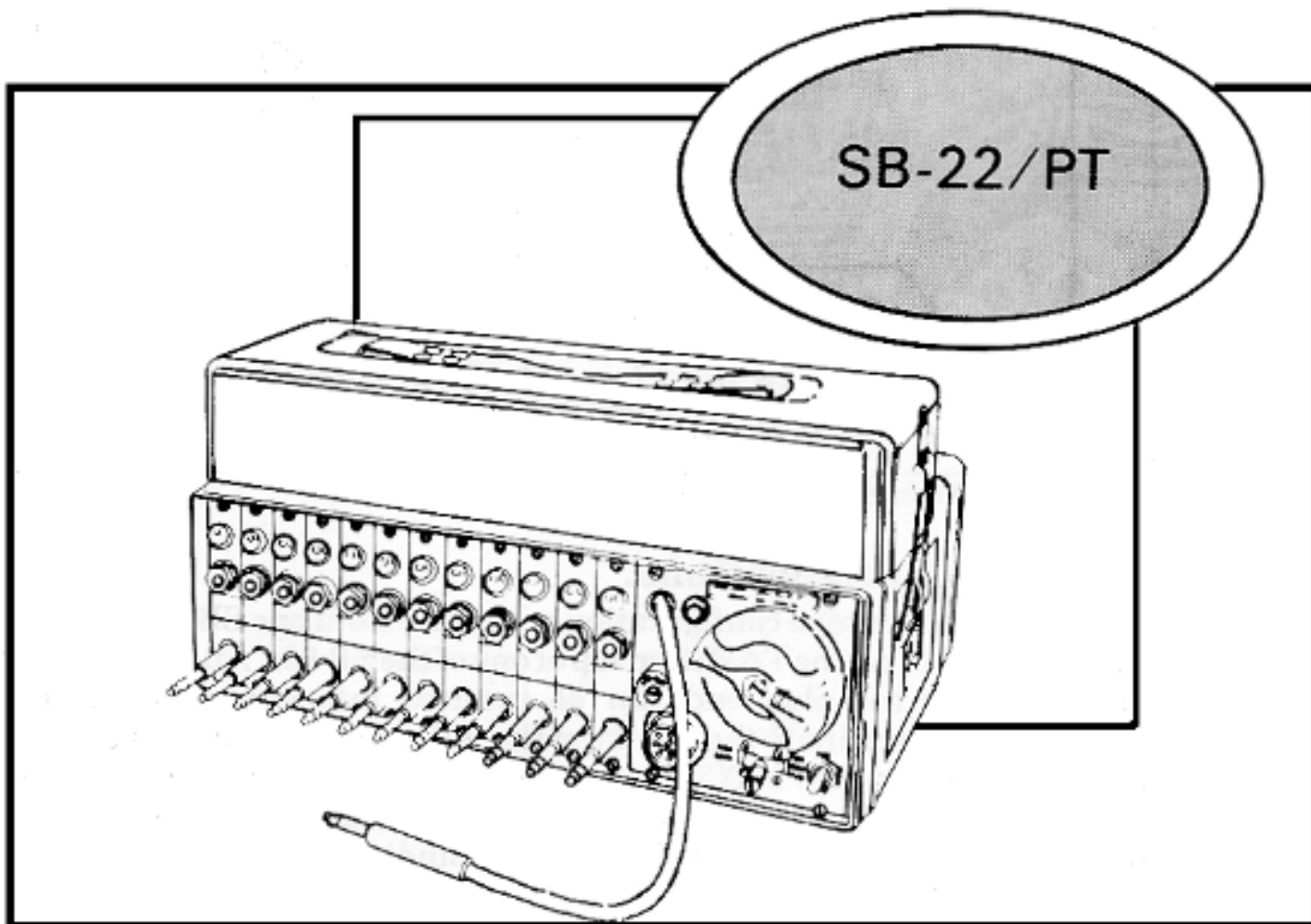

Figure F-5. SB-22/PT.

HERE'S HOW
TO DO IT!

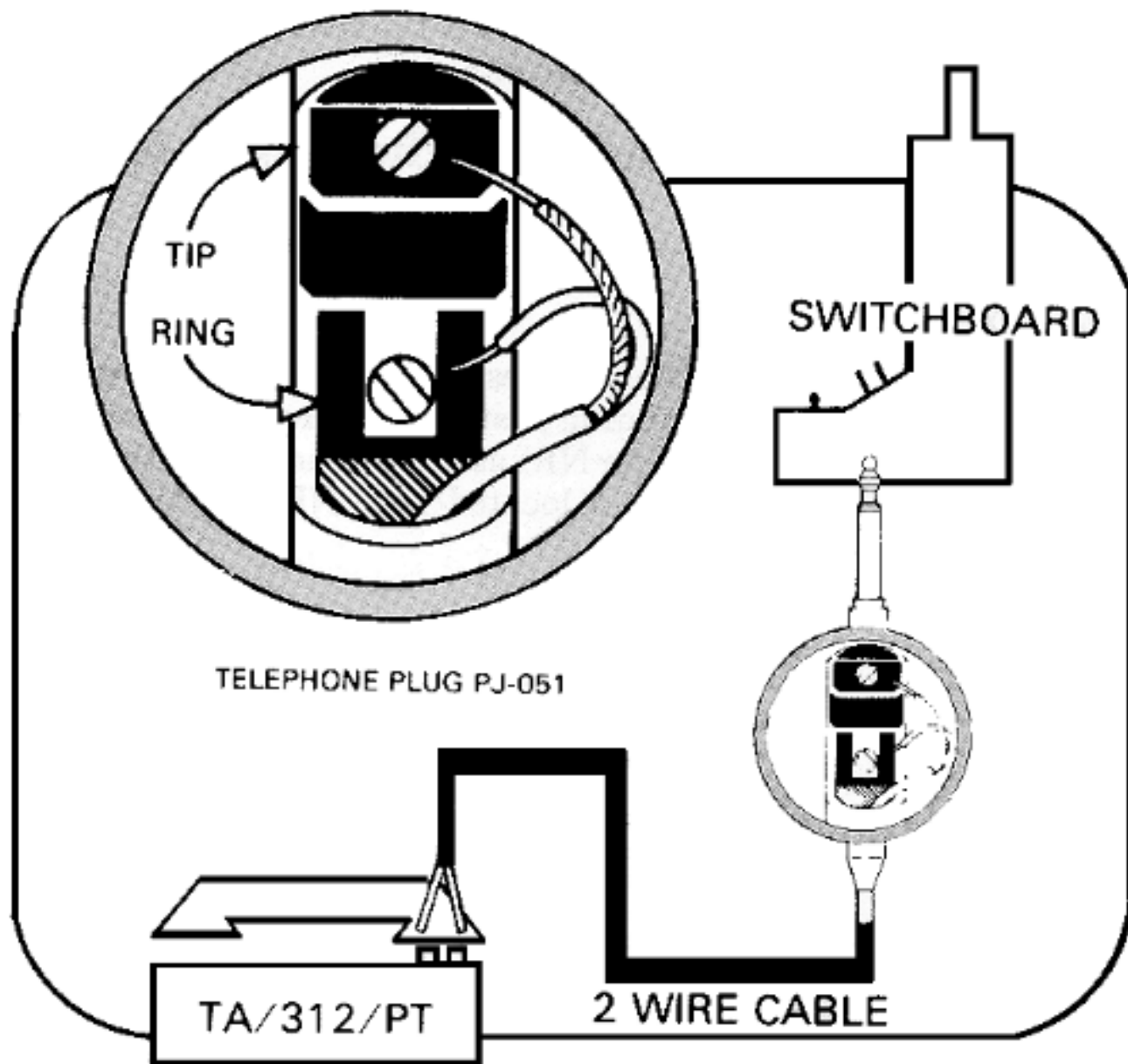

Figure F-6. Hookup.

NRI OPERATOR MUST
ASSIST TELEPHONE
SUBSCRIBER WHEN
SB-3082/GT IS USED.

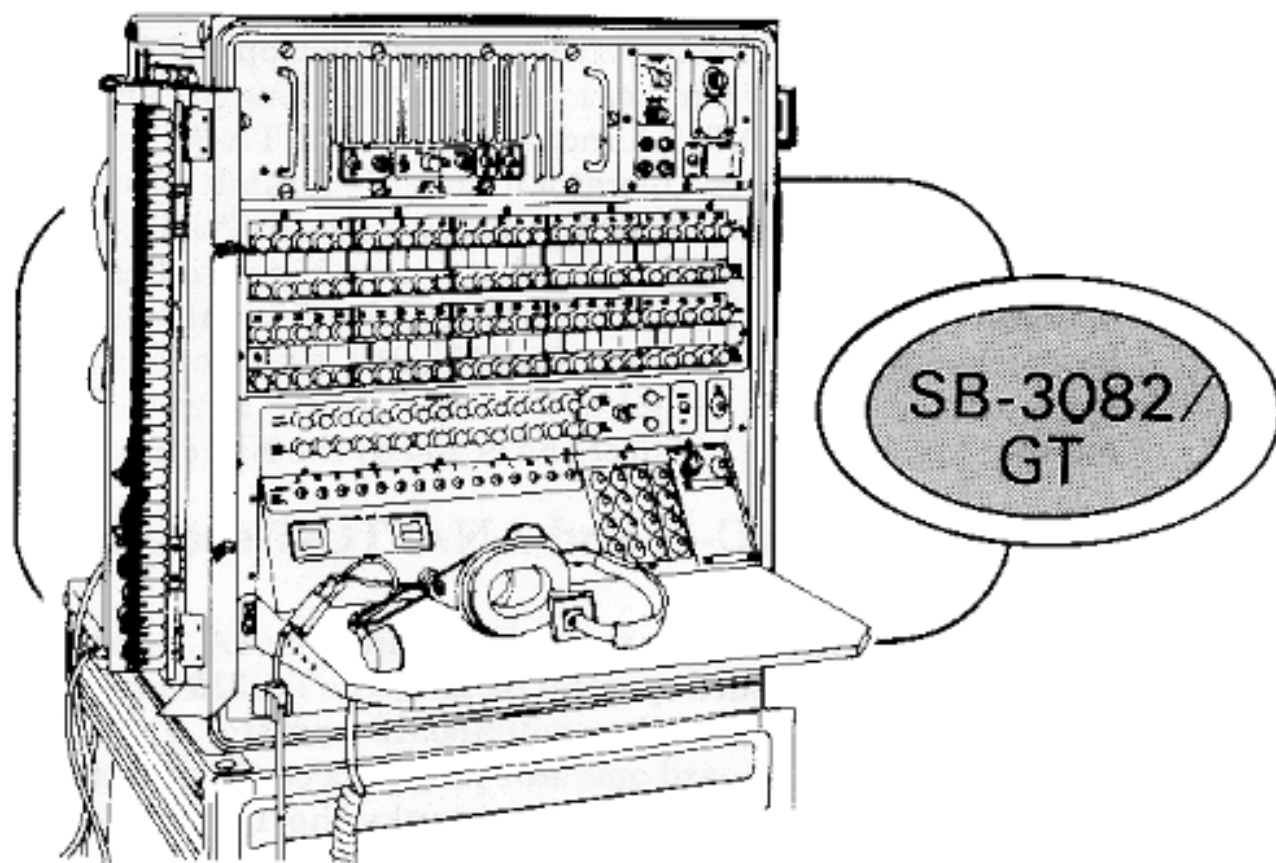

Figure F-7. SB-3082/GT.

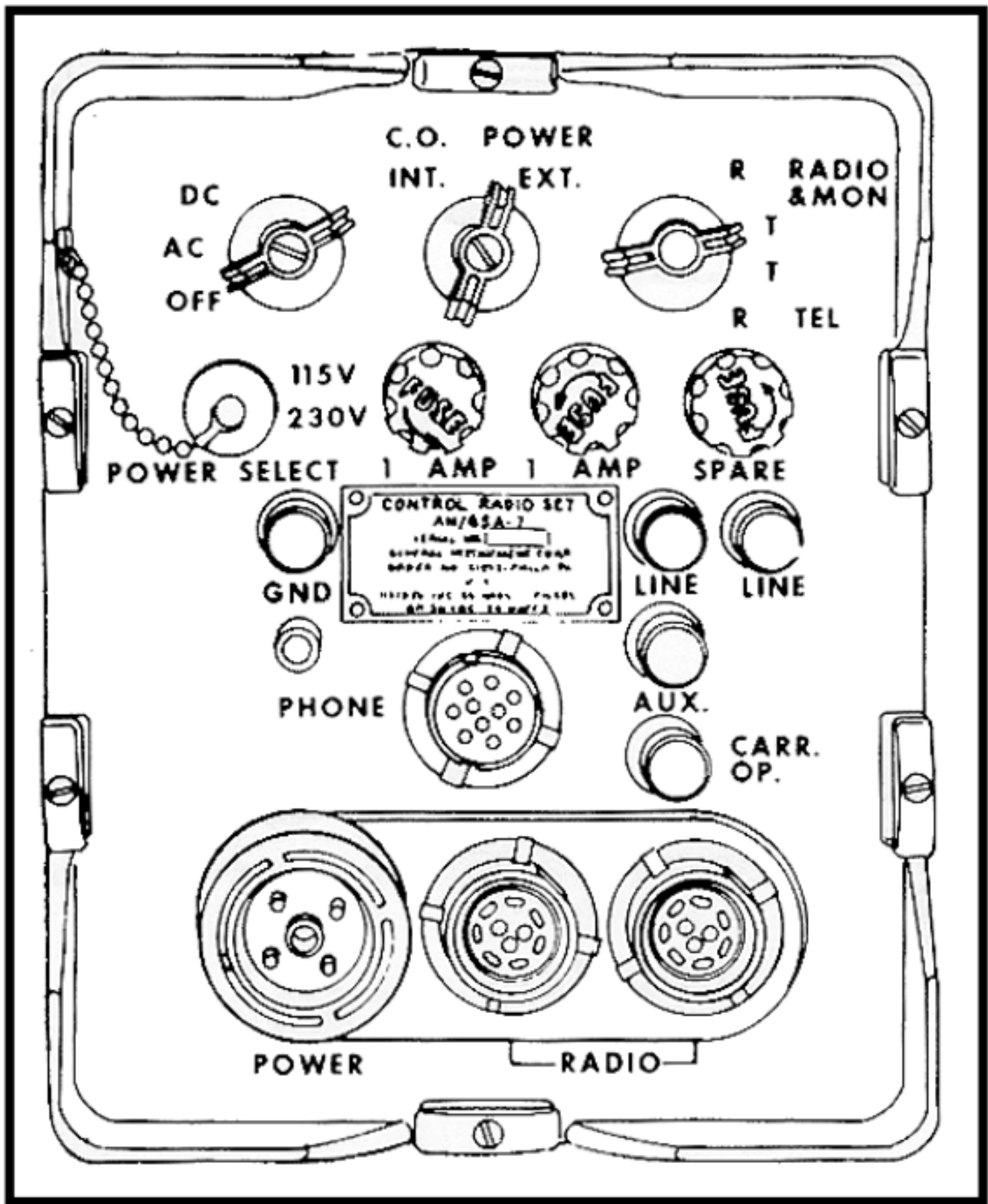

Figure F-8. Radio Set Control AN/GSA-7.

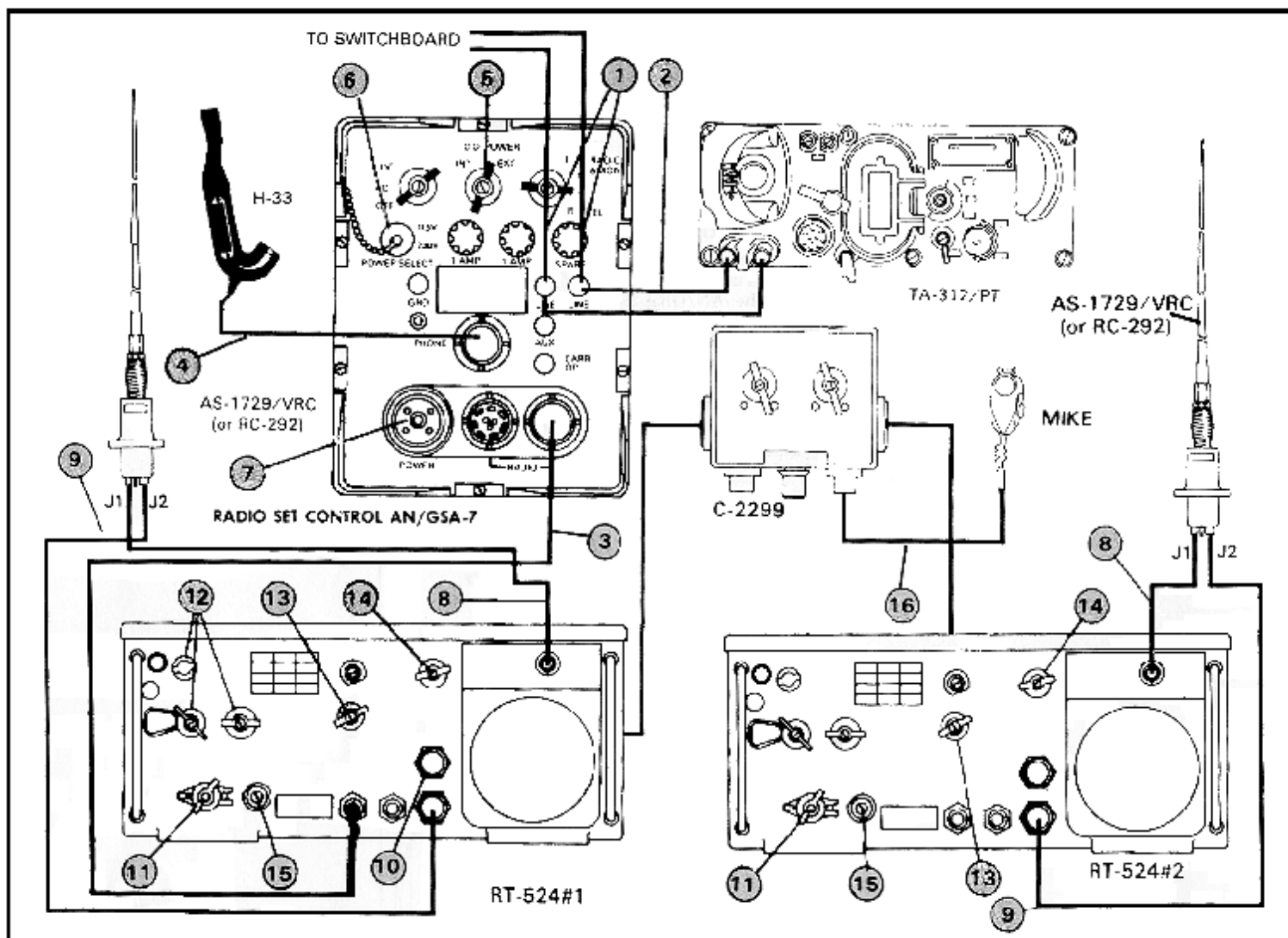

Figure F 9. NRI hookup using the AN/GSA-7.

WHEN USING DC POWER, CHECK
POLARITY. BLACK IS NEGATIVE,
WHITE IS POSITIVE.

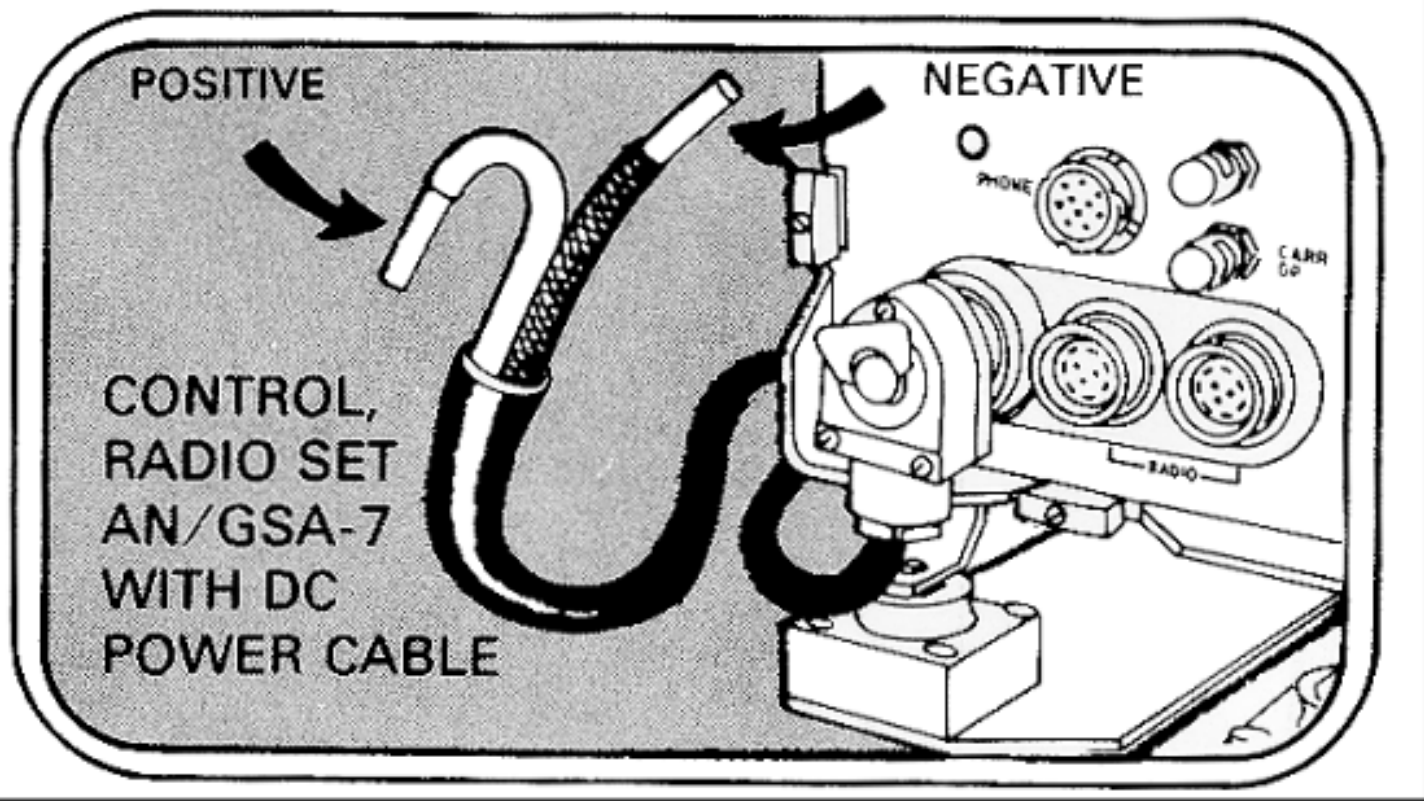

Figure F-10. Check polarity.

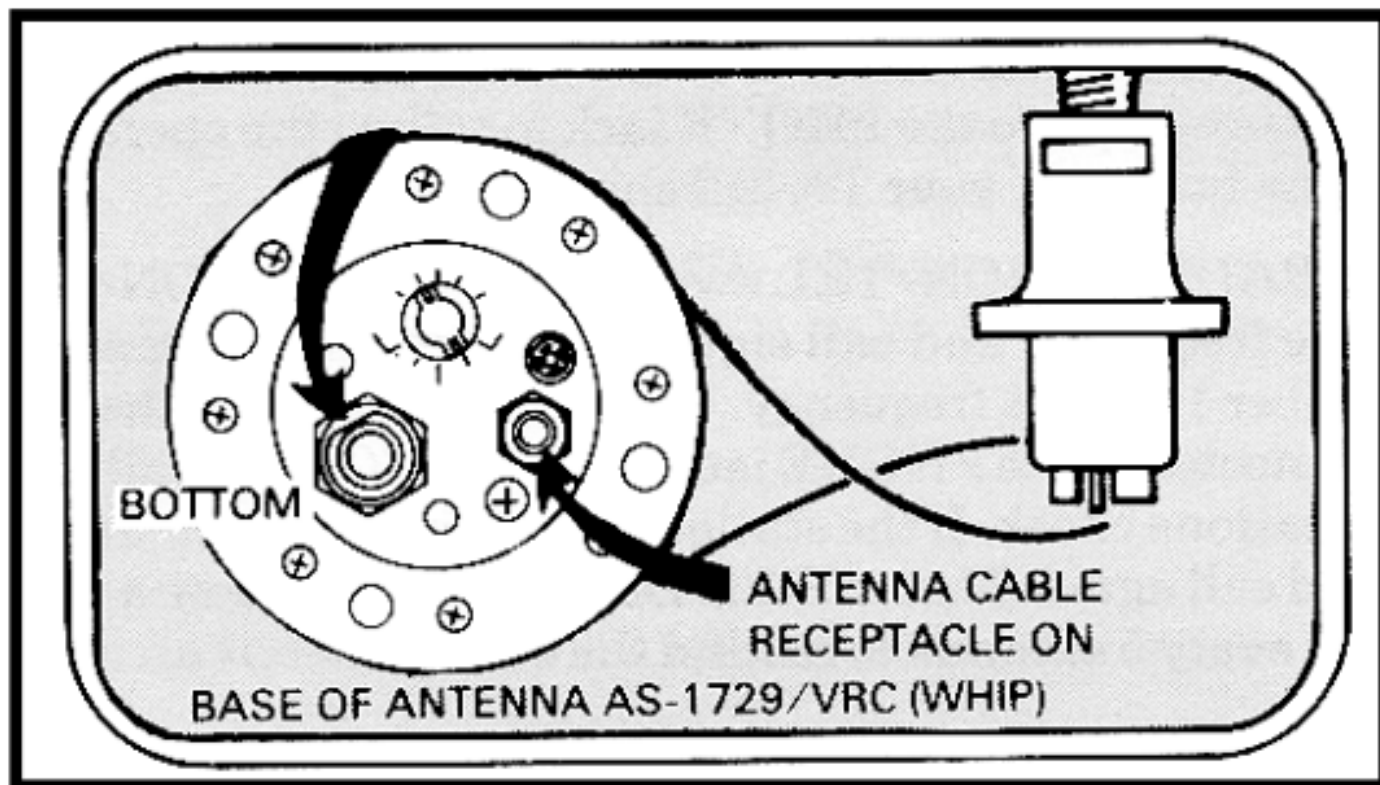

Figure F-11. Base of antenna AS-1729/VRC (whip).

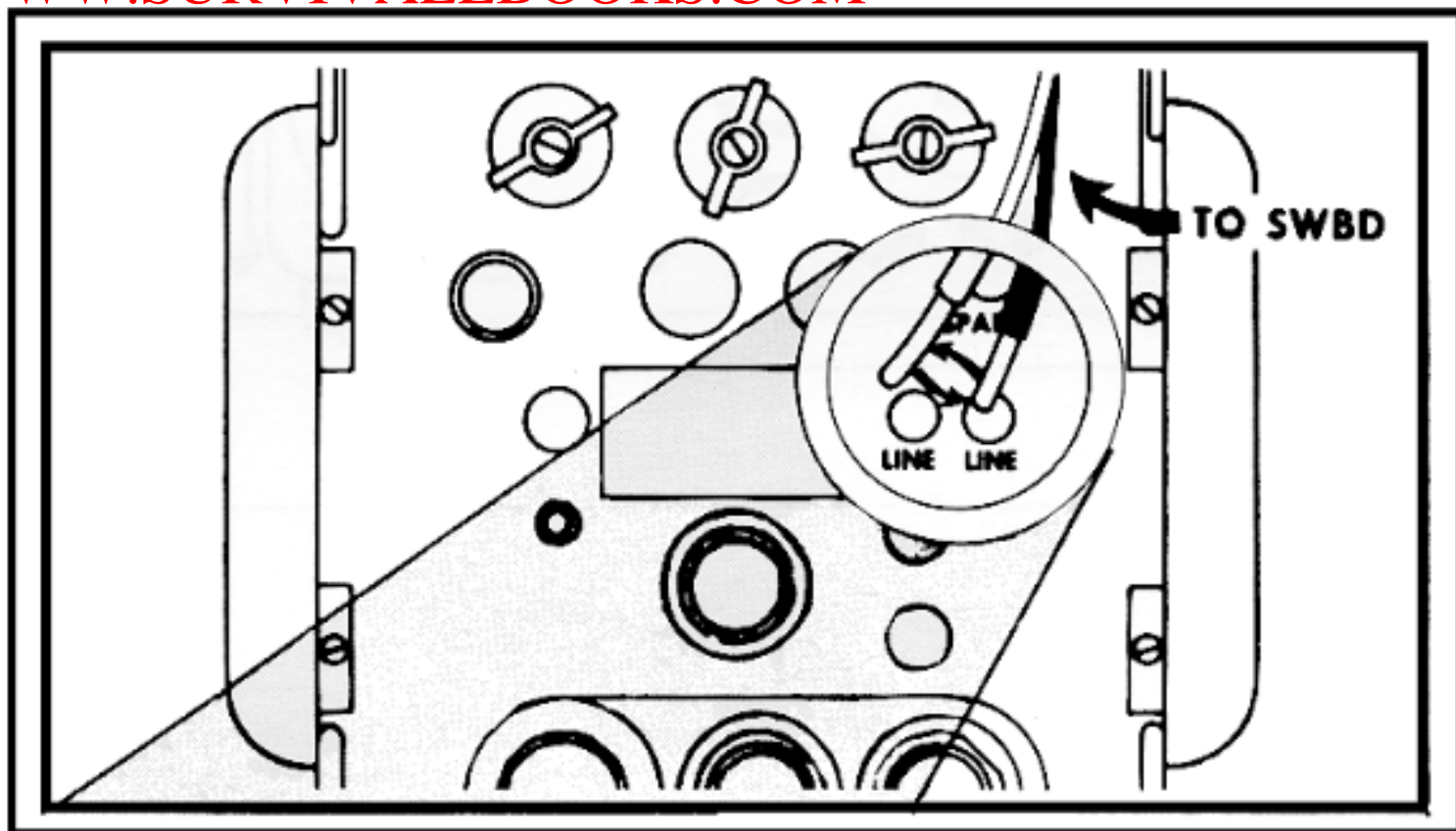

Figure F-12. Line connections.

USE HIGH POWER ONLY WHEN CONTACT
CANNOT BE MADE ON LOW POWER

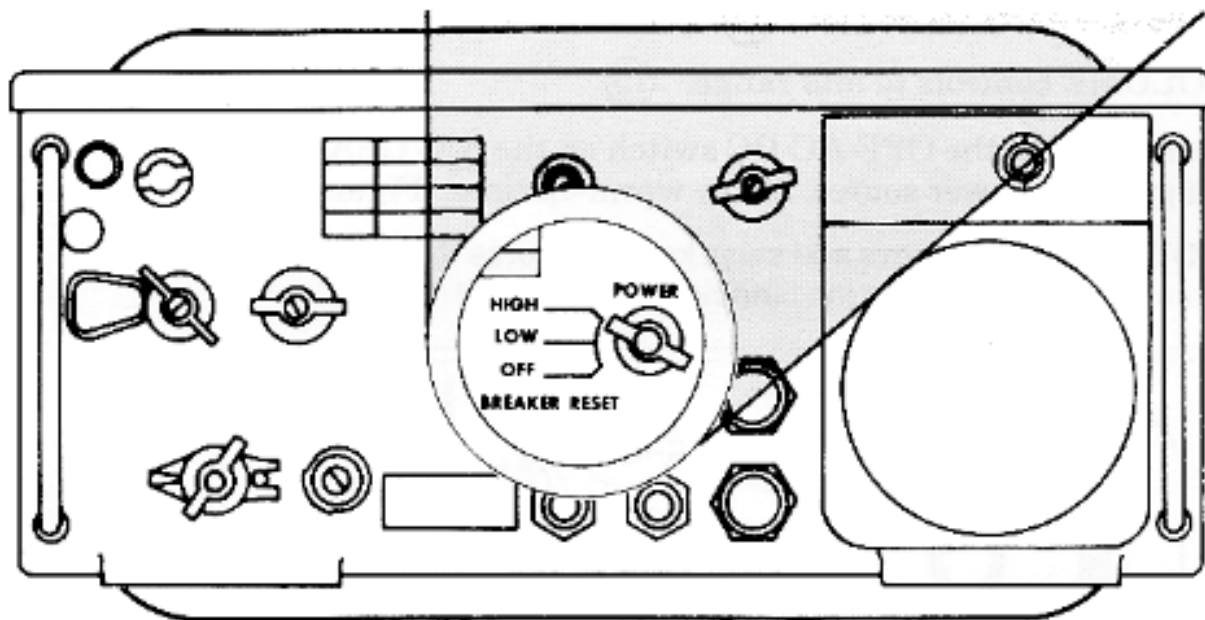

Figure F-13. RT-524.

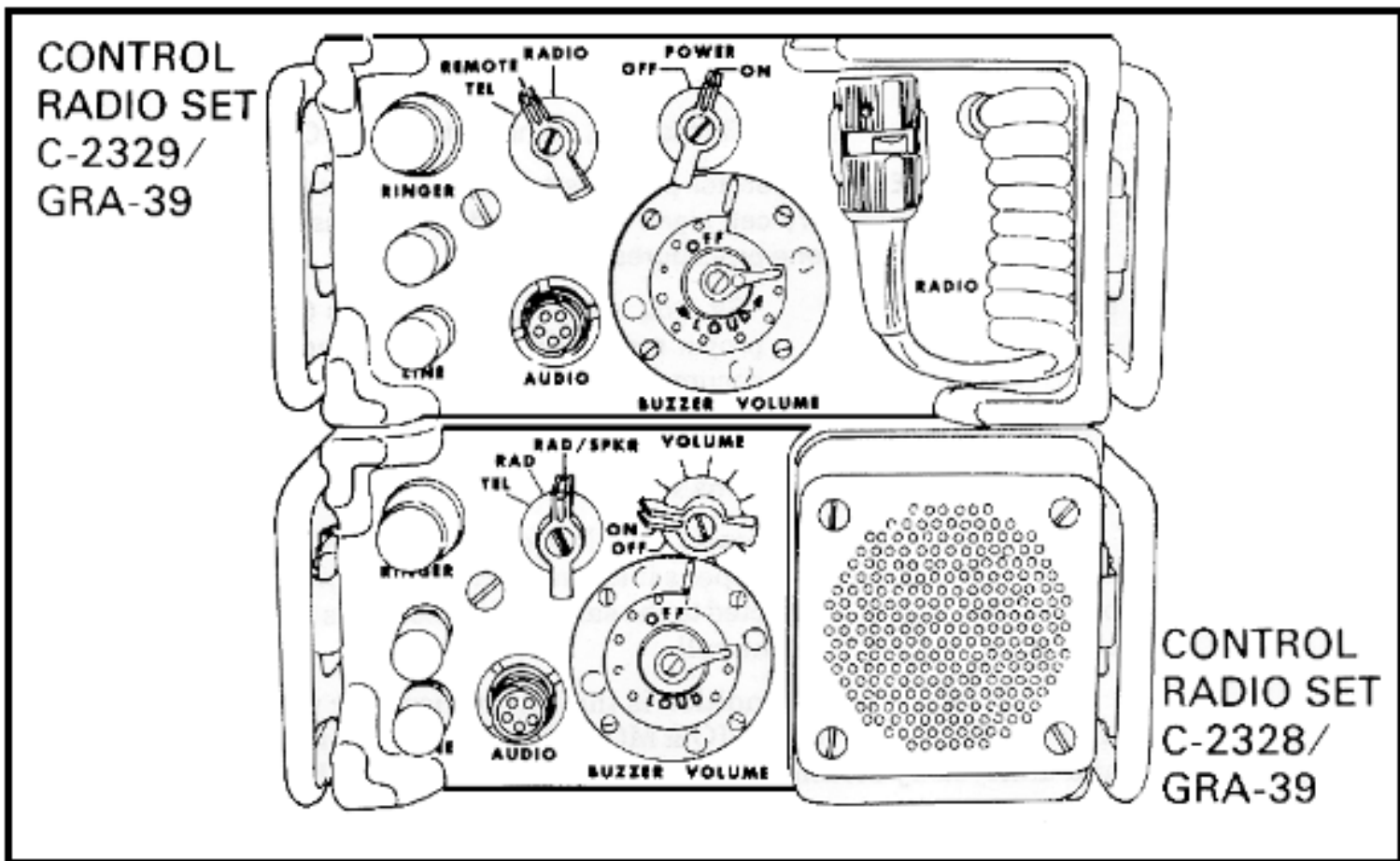

Figure F-14. Radio Set Control Group AN/ GRA-39.

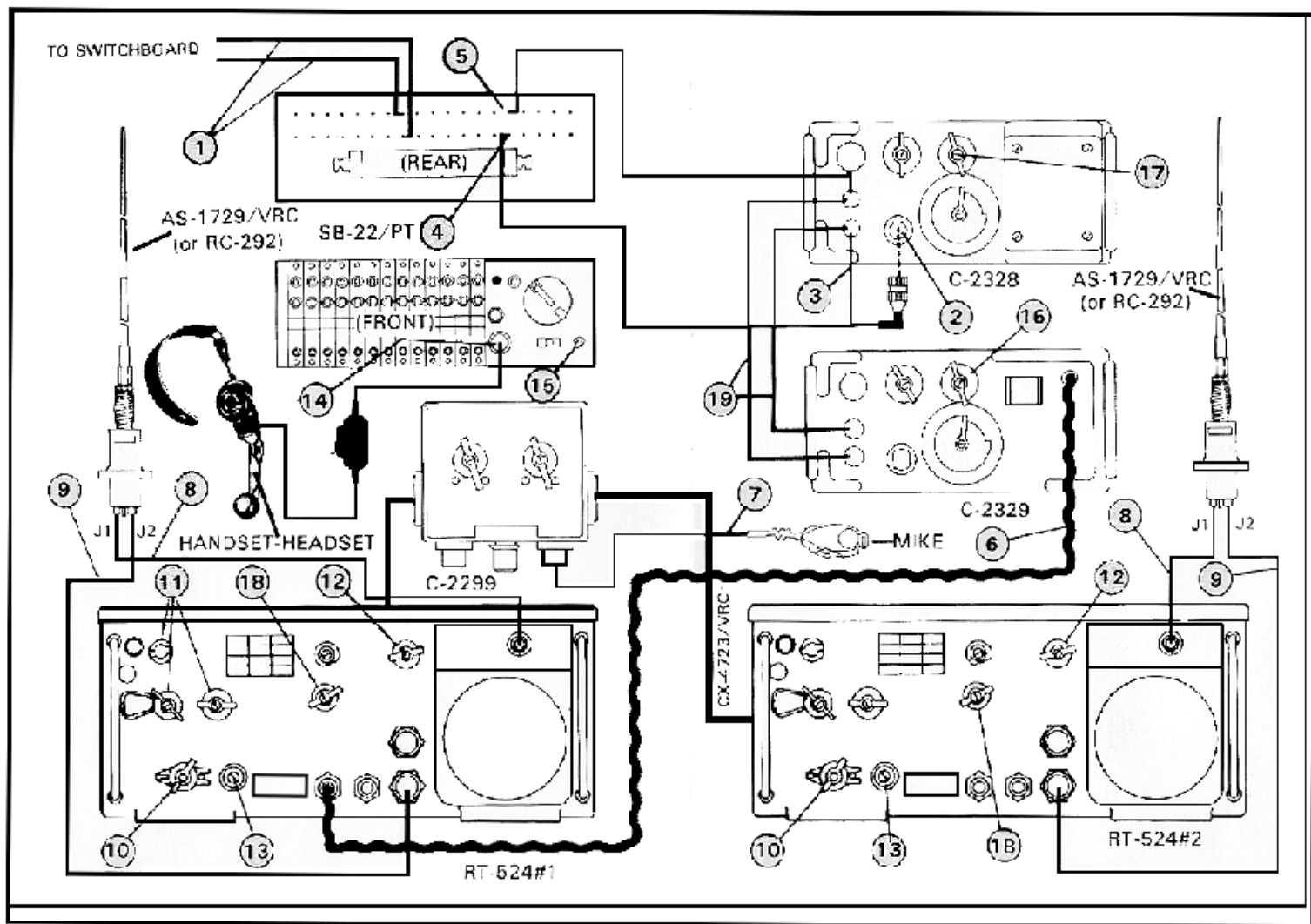
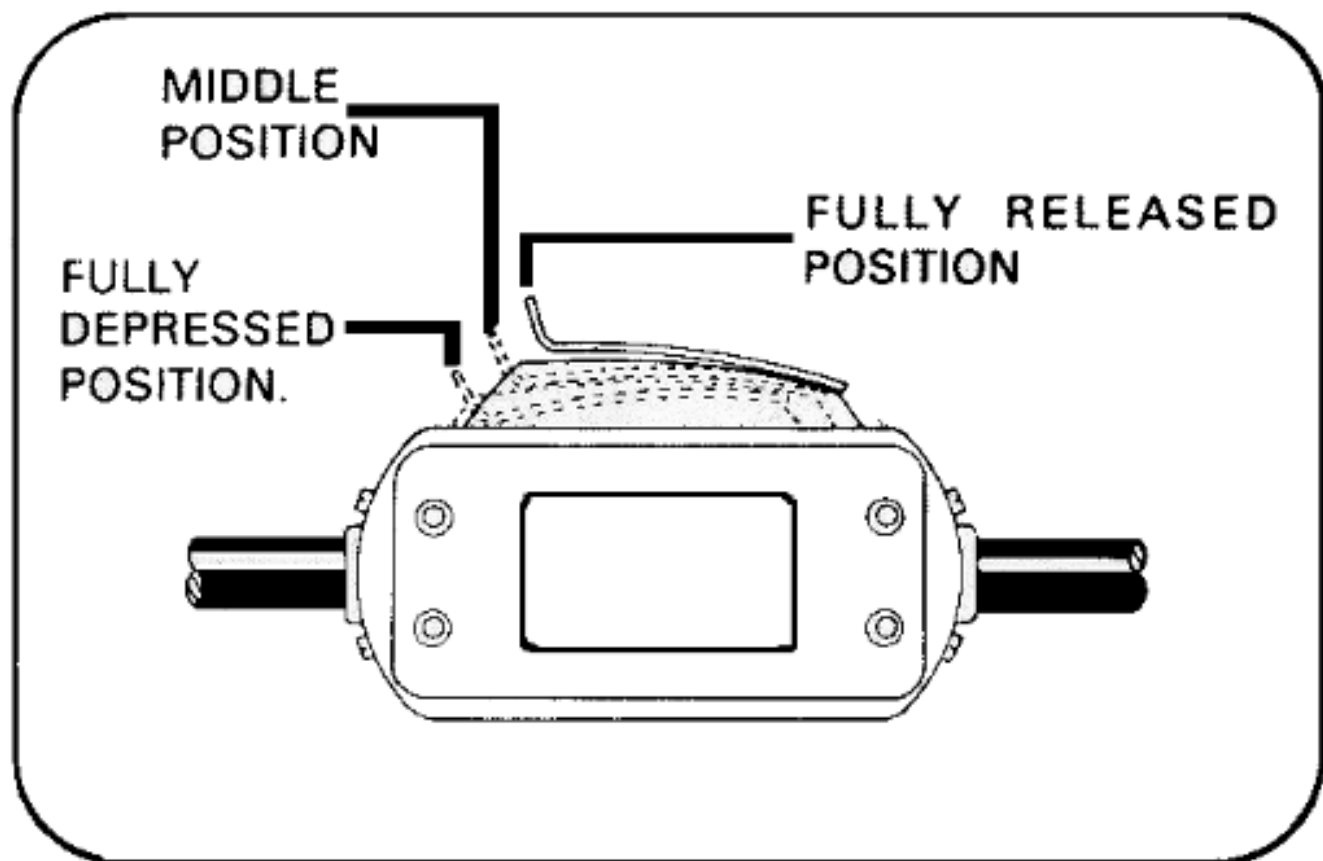

Figure F-15. NRI hookup using the AN/GR/ 35.



THE SWITCH IN THE HEADSET CORD IS A THREE POSITION SWITCH. THE FULLY RELEASED POSITION IS OFF. THE MIDDLE POSITION (IN WHICH IT CAN BE LOCKED) PERMITS TALKING AND THE FULLY DEPRESSED POSITION WILL KEY A TRANSMITTER CONNECTED TO IT.

Figure F-16. Headset switch.

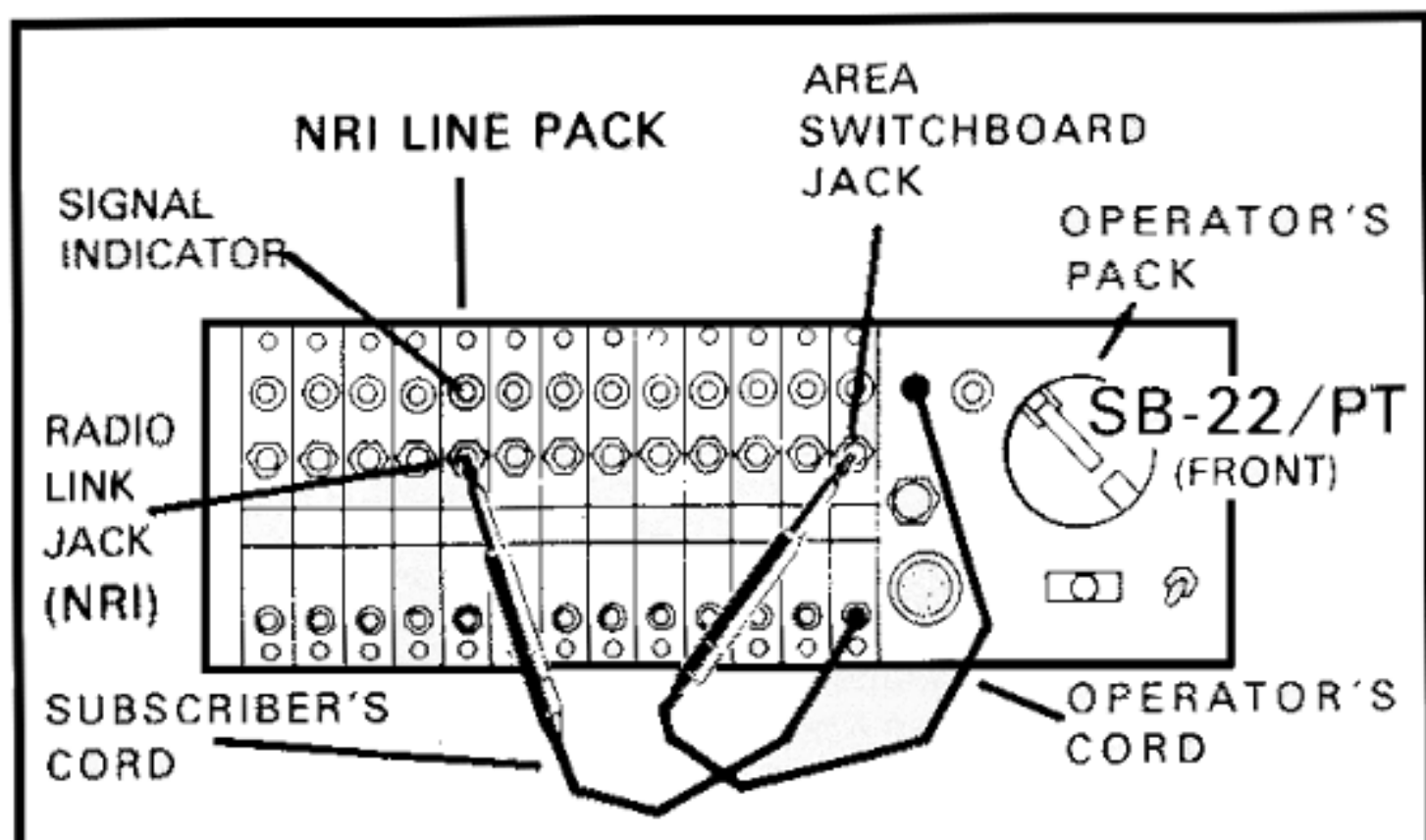

Figure F-17. Switchboard connections for subscriber radio link, NRI.

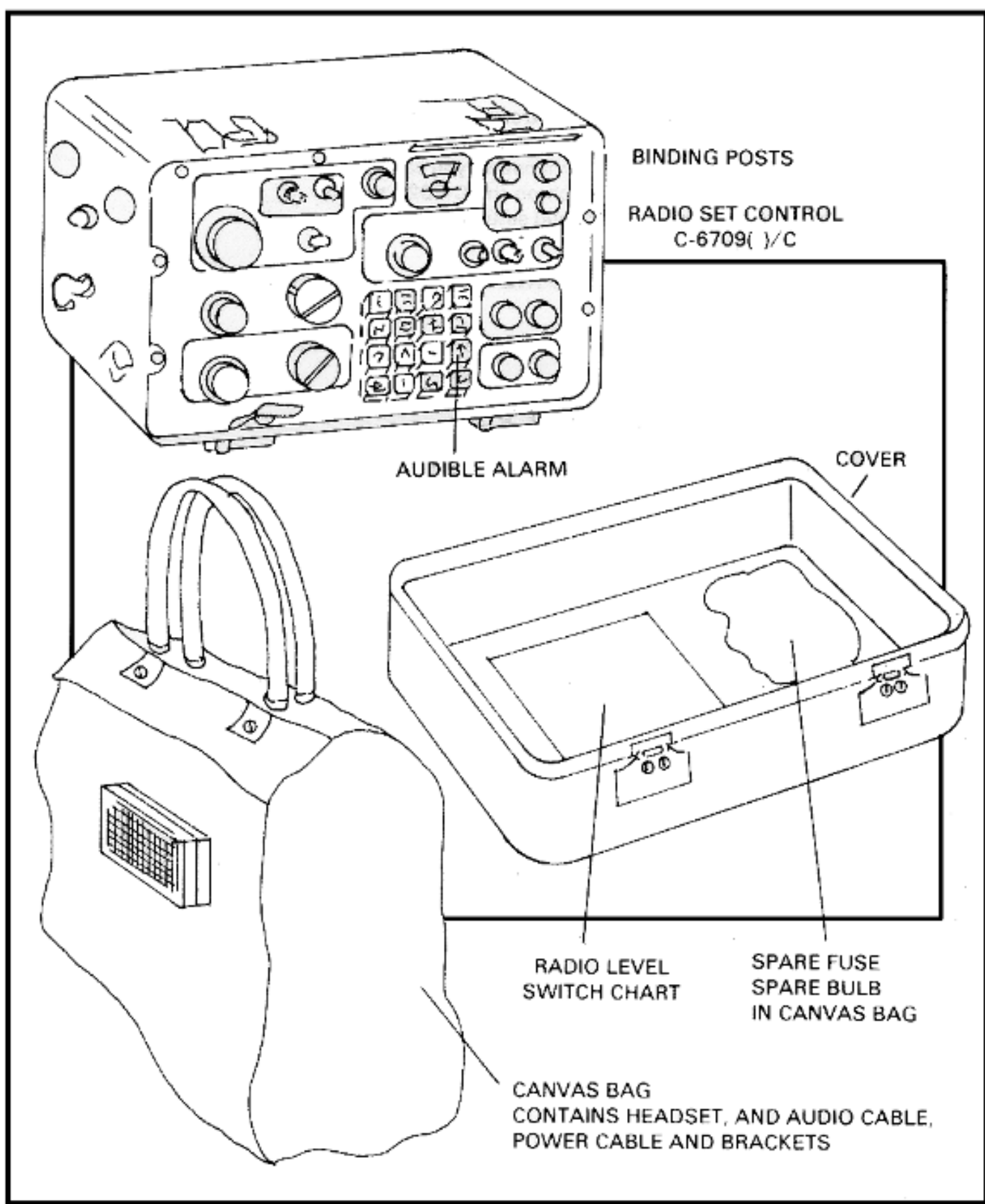

Figure F-18. Radio Set Control C-6709.

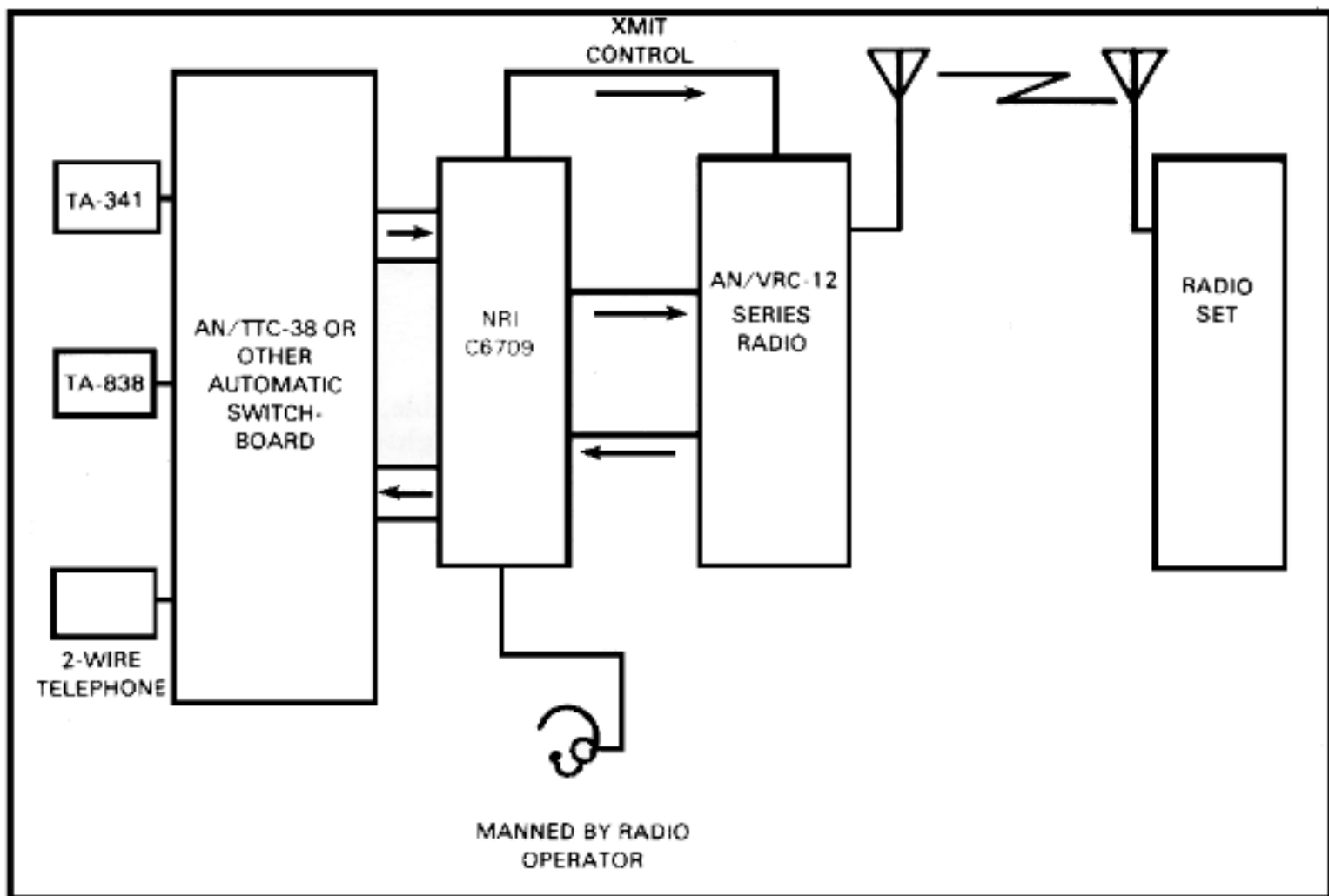

Figure F-19. Typical C-6709 system.

Table F-1. Electrical characteristics.

Input Signal Frequencies:	
Release	2600 Hz
Seize	2250 Hz
Acknowledge	570 Hz
Input Signal Levels	-30 dBm min.
Operating Power	24 VDC

Table F-2. Equipment compatible with the C-6709.

Radio Sets:		
AN/URC-93V	AN/PRC-70	AN/PRC-104
AN/SRC-20A	AN/PRC-77	AN/MRC-138
AN/SRC-21A	AN/VRC-12	AN/GRC-193
AN/GRC-106	AN/VRC-43 thru -49	
COMSEC Devices:		
TSEC/KY-65		
TSEC/KY-38		
TSEC/KY-57		
Telephone Central Office Electronic Switching Systems:		
AN/TTC-39	AN/TTC-38	
	SB-3614/TTC-41	
	SB-3865/AN/TTC-42	

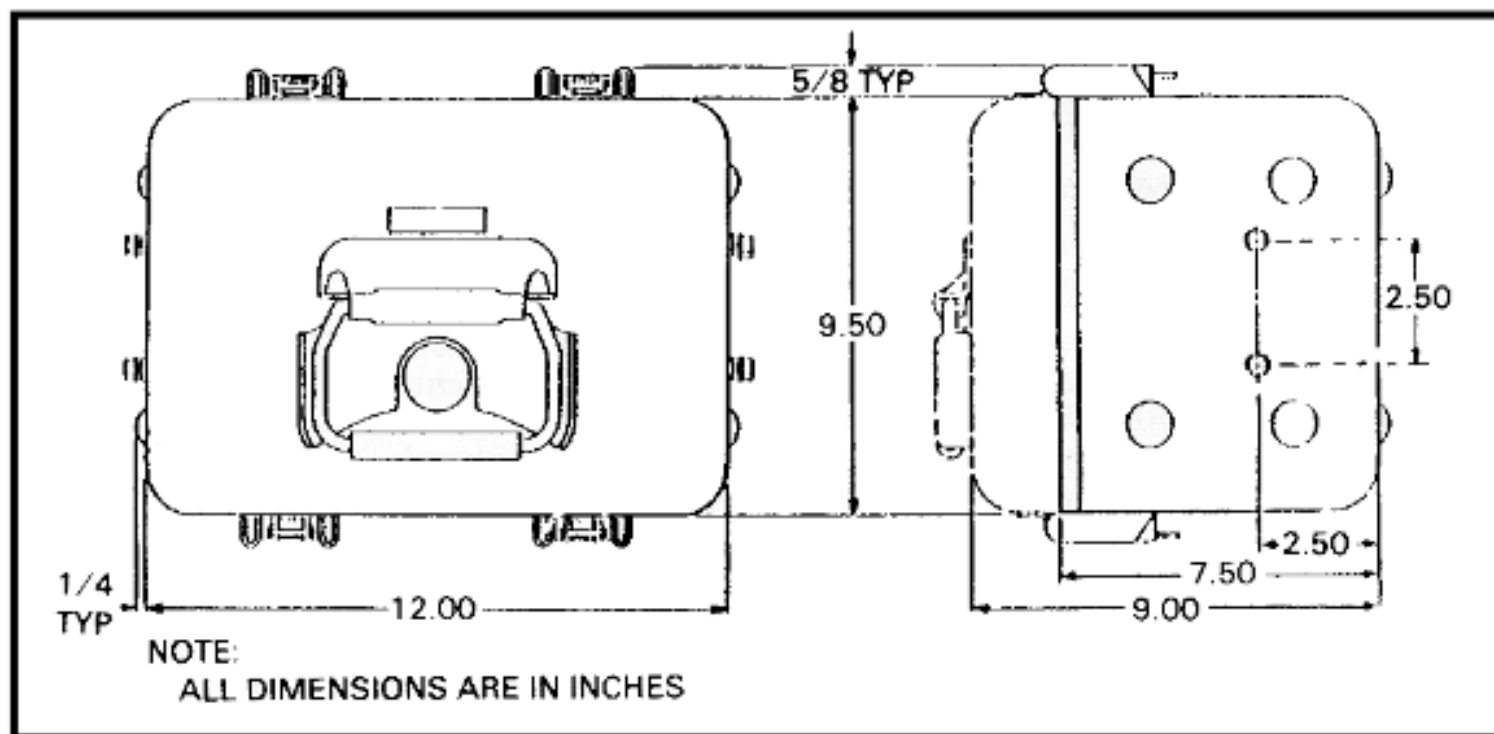

Figure F-20. Vehicle space requirements for C-6709.

APPENDIX G

TIME ZONE CHART

[Figure G-1.](#) Time Zone Chart

TIME ZONE CHART

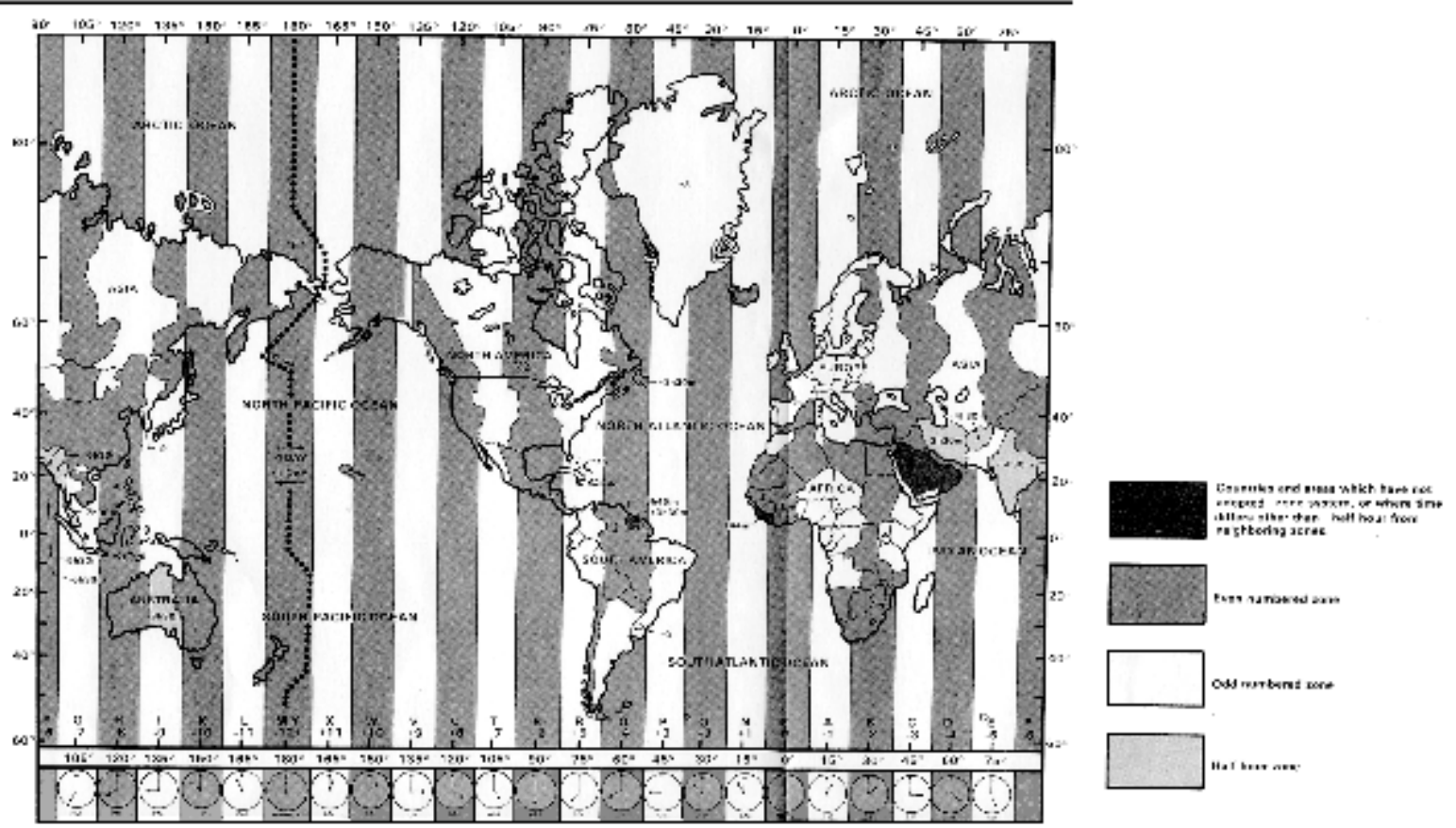

Figure G-1

APPENDIX H

TIME CONVERSION TABLE

[Figure H-1.](#) Time Conversion Table

A time conversion chart is used to convert local time in one zone to local time in any other zone. To construct your own time conversion chart, print the letter Z (Zulu), in the center of the next page in the space provided. However, any blank sheet of paper may be used for constructing your time conversion chart. To the right of the letter Z (Zulu), print the letters A (Alpha) through M (Mike), leaving out the letter J (Juliet). To the left of the letter Z (Zulu), print the letters N (November) through Y (Yankee). You now have the 25 time zone suffix letters in the order in which they represent the 25 world time zones. An easy rule to follow in constructing your own time conversion chart is: "NZA (the three letters that appear in the center of your paper) leave out the J (the letter of the alphabet that is not used)." Just remember this simple rule: **NZA AND LEAVE OUT THE J.**

When using your time conversion chart, there are two easy rules to follow: First, you **NEVER** count the time zone in which you are located; second, you add 1 hour for each time zone crossed when moving to your right and you subtract 1 hour for each time zone crossed when moving to your left. In more simple terms, **ADD** when going to the **RIGHT** and **SUBTRACT** when going to the **LEFT**. For example, if you were stationed in C (Charlie) time zone and needed to convert to Z (Zulu) time, you would start with the letter C. Do not count the C for this is the zone in which you are stationed. Then count the B, A and Z zones to your left (three) and subtract 3 hours from your local time, and the result will be GCT or Z (Zulu) time.

APPENDIX I

CIRCUIT LOG AND OPERATOR'S NUMBER SHEET

I-1. Purpose

The primary job of an operator is to send and receive messages as rapidly and accurately as possible. To perform that job effectively, the operator must also keep a record of messages sent and received and of other important events that happen during his tour of duty. DA Form 4158 (Operator's Number Sheet) is provided for this purpose and includes the circuit log and the operator's number sheet. The operator's number sheet is not normally used for FM radiotelephone nets.

The circuit log portion of DA Form 4158 is used to record opening and closing times, frequencies, frequency checks and frequency changes, traffic delays, and any incidents or conditions affecting circuit efficiency.

The operator's number sheet portion of DA Form 4158 is a record of messages transmitted and received. It tells the operator which number must be assigned to the next message and how many messages have been received.

I-2. Procedures for Filling Out the Circuit Log

In the *station-channel-net* block, line through the word *channel* when operating a radio net ([fig I-1](#)).

Under *station* your call sign is printed. The net call sign is printed following your call sign.

The *date* block is completed by filling in the day, month, and year.

[Figure I-1](#). Station-channel-net block.

The log sheet has three columns. The first is the *time* column. The hour of the day with zone letter suffix is entered in this column. The following ([fig I-2](#)) is an example.

[Figure I-2](#). Time column.

The *operator's* sign is completed by printing your personal sign. Your personal sign is normally your initials. [Figure I-3](#) shows an example with Kilo Watt as the operator.

[Figure I-3](#). Operator's sign.

The first entry in the *remarks* column is the operator on duty. To complete this entry, print your *rank*, *name*, and the words *on duty*. An example is shown in [figure I-4](#).

[Figure I-4](#). Remarks column.

In the *remarks* column, there are *mandatory entries* that you must make. Here is a list of *mandatory entries*:

- All opening and closing transmissions.

- Identifying portions of all messages sent or received by your station.
- Causes of delay.
- Frequency adjustments.
- Unusual occurrences:

--Procedure violations.

--Security violations.

--Interference with reception.

Mandatory entries are made as they occur.

The time column is filled in at the beginning of an action and at the end of that action. Refer to the log sheet in [figure I-5](#). A time was entered when the NCS starts to open the net (0702R) and again when the net is open (0708R).

[Figure I-5](#). Complete log sheet.

When recording messages, only identifying portions (message number, precedence, and date-time group, month and year) are normally used. This is controlled by the standing operating procedure of the unit. Example:

[Example I-1](#).

The entries on the log ([fig I-5](#)) at 0720R and 0725R indicate a cause of delay.

When an error is made, *do not erase*. To correct an error, line through the wrong portion and initial after it. Continue with the correct information. The log, [figure I-5](#), shows an error in the entry at 0730R.

The operator must make a closing entry at the end of the day (2400 hours) or when going off duty. The closing entry will be the operator's *signature* followed by the words OFF DUTY printed. The log, [figure I-5](#), shows a closing entry at 0738R.

A *new log* will be started at 0001 each day.

I-3. Procedures for Filling Out the Operator's Number Sheet

The operator's number sheet is a record of sent and received messages. It is used to assist in handling, recording, and checking traffic. The number sheet is helpful in assigning station serial numbers. (Station serial numbers are not normally used on FM radiotelephone nets.)

A new number sheet will be started each day at 0001 hours. A list of messages sent and received for each station is recorded. Messages that are recorded on the number sheet are noted by the date-time group of the message, time zone suffix followed by the operator's initials.

Enter call signs and date in blocks. **STATION CALL** is your call sign.

[Figure I-6](#). Call sign blocks.

NET CALL is the net call sign. **OTHER STATIONS CALL** will be call signs of other stations in the net. Example is shown in [figure I-6](#).

The columns under other stations call are used to record messages sent or received. [Figure I-7](#) shows an example of sent and received columns.

[Figure I-7](#). Sent/received blocks.

[Figure I-8](#). Completed operator's number sheet.

Procedures for recording traffic are given below.

- Procedures for recording *sent* messages:

- Assign numbers in order of handling.

- Each station will have its own sequence.

- Strike slant sign through number on operator's number sheet in sent column.

- Enter date-time group on operator's personal sign.

- Procedures for recording *received* messages.

- Strike slant sign through number sheet, after receipting for message, in the receive column.

- Enter date-time group and operator's personal sign.

- [Figure I-8](#) shows example of recording traffic.

LOG		
Enter opening and closing time, frequencies, frequency checks and frequency changes, traffic delays and any incidents or conditions affecting circuit efficiency. Remarks need not be confined to one line.		
STATION - CHANNEL - NET (Strike out words not applicable) D28 A2D		DATE 5 AUG 83
TIME	OPERATOR'S SIGN	REMARKS

Figure I-1. Station-channel-net block.

LOG		
Enter opening and closing time, frequencies, frequency checks and frequency changes, traffic delays and any incidents or conditions affecting circuit efficiency. Remarks need not be confined to one line.		
STATION-CHANNEL (Strike out words not applicable) D 28 A2D		DATE 5 AUG 83
TIME	OPERATOR'S SIGN	REMARKS
0700R	KW	

Figure 1-3. Operator's sign.

LOG

Enter opening and closing time, frequencies, frequency checks and frequency changes, traffic delays and any incidents or conditions affecting circuit efficiency. Remarks need not be confined to one line.

STATION: CHANNEL - NET (Strike out words not applicable)

DATE

D28 A2D

5 AUG 83

TIME	OPERATOR'S SIGN	REMARKS
0700R	KW	PFC KILO WATT ON DUTY
0702R	KW	A2D THIS IS D28 AUTHENTICATE CX OVER
		D28 THIS IS NI2D I AUTHENTICATE K
		AUTHENTICATE ES OVER
		A2D THIS IS D28 I AUTHENTICATE C
		AUTHENTICATE NB OVER
		A2D THIS IS V06D I AUTHENTICATE A OVER
0708R	KW	A2D THIS IS D28 OUT
0710R	KW	V06D THIS IS D28 ROUTINE OVER
		D28 THIS IS V06D OVER
		V06D THIS IS D28 MESSAGE NUMBER 1
		ROUTINE TIME 050700R AUG 83
0715R	KW	D28 THIS IS V06D ROGER OUT
0720R	KW	POWER FAILURE
0725R	KW	POWER RESTORED
0730R	KW	A2D KW A2D THIS IS D28 CLOSE
		DOWN OVER
		D28 THIS IS NI2D AUTHENTICATE AQ
		OVER
		A2D THIS IS D28 I AUTHENTICATE H
		OVER
		D28 THIS IS NI2D ROGER OUT
0735R	KW	D28 THIS IS V06D ROGER OUT
0738R	KW	PFC Kilo Watt OFF DUTY

Figure I-5. Complete log sheet.

Time	Operator's Sign	Remarks
0710R	KW	V06D THIS IS D28 MESSAGE NUMBER 1 ROUTINE TIME 050700R AUG 83

OPERATOR'S NUMBER SHEET

For use of this form, see FM 24-18; proponent agency is US Army Training and Doctrine Command.

Check off both sent and received numbers immediately and enter Date-Time Group and personal sign. Strike out word not applicable in heading "Sent/Received." "Other Stations Call" may be entered in "Sent/Received" block if only one column is required.

STATION CALL <i>D28</i>		NET CALL <i>A2D</i>		DATE <i>5 AUG 83</i>	
OTHER STATIONS CALL <i>N12D</i>		<i>TØ1D</i>		<i>VØ6D</i>	
SENT REC'D	SENT REC'D	SENT REC'D	SENT REC'D	SENT REC'D	SENT REC'D

Figure 1-6. Call sign blocks.

OPERATOR'S NUMBER SHEET					
For use of this form, see FM 24-18; proponent agency is US Army Training and Doctrine Command.					
Check off both sent and received numbers immediately and enter Date-Time Group and personal sign. Strike out word not applicable in heading "Sent/Received." "Other Stations Call" may be entered in "Sent/Received" block if only one column is required.					
STATION CALL <i>D28</i>		NET CALL <i>A2D</i>		DATE <i>5 AUG 83</i>	
OTHER STATIONS CALL <i>N12D</i>		<i>TØ1D</i>		<i>VØ6D</i>	
SENT REC'D	SENT REC'D	SENT REC'D	SENT REC'D	SENT REC'D	SENT REC'D

Figure 1-7. Sent/received blocks.

OPERATOR'S NUMBER SHEET

For use of this form, see FM 24-18; proponent agency is US Army Training and Doctrine Command.

Check off both sent and received numbers immediately and enter Date-Time Group and personal sign. Strike out word not applicable in heading "Sent/Received." "Other Stations Call" may be entered in "Sent/Received" block if only one column is required.

STATION CALL <i>D28</i>		NET CALL <i>A2D</i>		DATE <i>5 AUG 83</i>	
OTHER STATIONS CALL <i>N12D</i>		<i>TØ1D</i>		<i>VØ6D</i>	
SENT REC'D	SENT REC'D	SENT REC'D	SENT REC'D	SENT REC'D	SENT REC'D
<input checked="" type="checkbox"/> <i>050700R/KW</i>	<input checked="" type="checkbox"/> <i>050705R/KW</i>	<input type="checkbox"/>	<input checked="" type="checkbox"/> <i>050800R/KW</i>	<input checked="" type="checkbox"/> <i>050815R/KW</i>	<input type="checkbox"/>
<input checked="" type="checkbox"/> <i>050703R/KW</i>	<input type="checkbox"/>	<input type="checkbox"/>	<input type="checkbox"/>	<input type="checkbox"/>	<input type="checkbox"/>
<input type="checkbox"/>	<input type="checkbox"/>	<input type="checkbox"/>	<input type="checkbox"/>	<input type="checkbox"/>	<input type="checkbox"/>
<input type="checkbox"/>	<input type="checkbox"/>	<input type="checkbox"/>	<input type="checkbox"/>	<input type="checkbox"/>	<input type="checkbox"/>
<input type="checkbox"/>	<input type="checkbox"/>	<input type="checkbox"/>	<input type="checkbox"/>	<input type="checkbox"/>	<input type="checkbox"/>
<input type="checkbox"/>	<input type="checkbox"/>	<input type="checkbox"/>	<input type="checkbox"/>	<input type="checkbox"/>	<input type="checkbox"/>

Figure 1-8. Completed operator's number sheet.

APPENDIX J

ELECTROMAGNETIC PULSE

J-1. Detrimental Effects

During nuclear warfare, communications will be more critical to military operations than at any other time. Thus, every commander must understand the effects that nuclear detonations have on electronic equipment. Analysis of communications problems yields two distinct categories of detrimental effects:

- Degradation of the signal resulting from changes in the medium characteristics (a transient effect).
- System damage caused by radiation or from intense fields generated by gamma rays.

The first should be approached with an eye toward various or alternative post-effect countermeasures. The second must be minimized through prior planning and precautionary procedures. This appendix discusses the electromagnetic pulse (EMP), its effect on communications and electronics equipment, and protective measures to enhance the survivability of communications systems. Although an explanation of EMP can be quite technical, it is discussed in this appendix in nontechnical terms. The focus is on what commanders and communications personnel need to know about EMP and how they can best use measures to reduce the consequences that may result from it.

J-2. Characteristics of EMP

EMP is produced by the radiation from a nuclear burst. Of the gamma rays, X-rays, and neutrons which comprise nuclear radiations, gamma rays are the dominant cause of EMP. Gamma rays radiate outward from the burst and strip electrons from the atoms in the air. Because of the high energy of the original gamma rays, the electrons are projected away from the burst point at approximately the speed of light. Thus, a virtual wall of fast-moving electrons is generated as the radiation sweeps outward in an expanding spherical wave. This process creates a region of high charge and strong currents (called the *source* or *deposition* region) which may extend for several thousand meters from the point of burst for a small-yield, low-altitude detonation, to several thousand kilometers for a high-yield, high-altitude burst. Within this region, the charge separation and currents produce strong electric and magnetic fields; and, if the current density is unproportional, a broad bandwidth, high amplitude radio frequency electromagnetic pulse is radiated. The outer atmospheric burst (height of burst (HOB) more than 50 km) and the near-surface burst (HOB less than 2 km) are the only ones of concern to ground-based systems as far as EMP is concerned.

J-3. Strength of the EMP

The strength of EMP is best appreciated by comparing it to various electromagnetic energy generators. Several electromagnetic energy sources and associated power densities are listed below along with the power density needed to drive a typical radio receiver. Clearly, EMP can deliver to a radio receiver a

billion times the power necessary for reception. It is not difficult to understand the detrimental effect this can have. See [table J-1](#) for an energy-comparison chart.

[Table J-1](#). Electromagnetic energy comparison.

J-4. Frequency Analysis

A frequency analysis of EMP reveals frequency radiation from the extremely low frequency (ELF) band to the super high frequency (SHF) band. Most of the energy is concentrated in the high frequency (HF) and very high frequency (VHF) ranges.

J-5. Area Coverage

The relative source strength and area coverage of radiated fields for different heights of burst are summarized in [table J-2](#). These strengths are what a land-based communications system would experience. Where the source region is not touching the ground in some cases, the strength is low or has no effect.

[Table J-2](#). EMP strength and ground coverage.

J-6. Susceptibility

Modern communications and electronics equipment are increasingly susceptible to EMP due to the extensive use and application of microcircuits, semiconductors, and transistor technology. These devices normally cannot handle the voltage and current surges that result from EMP coupling. System, component, or subcomponent susceptibility can also be related to size and level of power handling capability. Normally, the smaller the individual component, the lower its power handling capability and, consequently, the greater its susceptibility.

J-7. EMP Protective Measures

Communications and electronics equipment in the inventory today has generally not been designed to withstand the effects of EMP and remain operational. To enhance its survivability and permit mission accomplishment, measures must be taken to reduce the vulnerability of communications equipment to EMP. While progress is being made in some cases to ensure EMP hardening in the procurement stage of future equipment, most communications equipment presently in the inventory will have to be used unhardened. Thus, measures to reduce vulnerability to EMP must be implemented by the users in the field. This responsibility requires commanders at all levels to incorporate SOPs and directives concerning methods of installation and operation of communications equipment to enhance survivability and mission accomplishment. During field exercises and tests, maximum emphasis should be placed on compliance with EMP related directives. These measures can only be effective if employed as routine actions.

Current demand for reliable communications is extremely high. Degradation of communications systems must be avoided and it is the responsibility of all personnel associated with communications to reduce EMP susceptibility as much as possible. Initially, all planning should provide for alternate means for passing priority traffic in an EMP environment. Since only a portion of a total communications system is likely to be affected by EMP, routing must consider the hardest systems for the highest priority traffic.

The capability to quickly repair and reintegrate damaged portions of the system with minimum confusion and maximum efficiency is of primary concern. All equipment not absolutely required in primary

systems should remain disconnected and stored within a sealed shelter or other shielded enclosure for protection from the EMP. This measure will reduce the likelihood of all equipment being simultaneously damaged by EMP and will provide for backup components to reinstall affected systems. Rigid operator/user training should be stressed for implementing reroute plans and equipment restoration.

To prevent or reduce "coupling" with the energy from EMP, wires and cables (to include output coaxial types) should be shielded and properly grounded. In addition, the lengths of cables should be kept as short as possible. Excess lengths of cables in use should never be left wound on a cable reel but should be taken off the reel and pulled out in a straight line to avoid having loops in the cables. When cables are not needed, or are installed for possible operation, they should not be connected to the equipment. Burying the cables a foot or more will reduce their exposure to EMP fields and subsequently reduce the collected energy. Power cables should be treated in a similar manner and the same protective measures taken. Shields on all cables should be physically connected to the grounding systems where provided on communications equipment.

Antennas and their connecting cables should be disconnected from radio sets when not in use. Selection of the proper antenna, to include operation required, size, installation, and polarization, should be paramount in planning procedures. Narrow bandwidth antennas requiring high power for operation reduces the EMP coupling effect.

Communications equipment should never use commercial power. All commercial power facilities are extremely susceptible to EMP and their use would provide a direct path to vulnerable communications components. Communications shelter doors, access panels, vents (if possible), and all other apertures should be kept closed or shielded to reduce the direct entry of EMP fields into the shelter. Honeycomb screens are available for vents which allow the vents to open during operation while simultaneously shielding against EMP.

Maintenance of communications equipment should be continuous. Although cables and wires with damaged shielding or connectors may be operational, they should be replaced to ensure that proper shielding is maintained. Power system filters should be checked periodically and repaired/replaced if necessary. Particular attention should be paid to a rapid repair capability, with necessary parts and facilities. Equipment spare parts should be checked periodically to ensure their level of fill conforms to established directives. Alternate or backup equipment should be tested periodically to ensure proper operation. Additional measures should not preclude the use of visual, sound, and extensive messenger services (air, motor, and foot) to replace systems rendered nonoperational by EMP damage.

All users of communications equipment and systems must remember that the EMP threat is real and the use of nuclear weapons on the battlefield of the future will require viable measures to enhance communications survivability and mission accomplishment.

J-8. Guidance

The following reference material provides guidance for EMP protective measures:

- FC 50-16.
- FC 50-17.

Table J-1 . Electromagnetic energy comparison.

Power Required/Energy Source	Power Density (Watts/Square Meter)
Typical Radio Receiver	1/1000
Typical Radio Transmitter	100
Directional Pulse Radar	1,000
EMP	1,000,000

Table J-2. EMP strength and ground coverage.

Source Region EMP			Radiated EMP	
Burst Altitude	Strength	Area (km ²)	Strength	Area (km ²)
Outer Atmosphere	NA*	0	High	1,000,000
Air	NA	0	NA	0
Near Surface	High	30	Low	50
Subsurface	High	Less than 1	NA	0
*Not applicable				

APPENDIX K

NBC PROTECTION

K-1. Contamination

The first step in dealing with contamination is to understand it as the deposit and/or absorption of harmful material on/or by personnel, material, or structures. Nuclear, biological, and chemical (NBC) contamination causes casualties and reduces the effectiveness of individuals and units and reduces their operational efficiency.

The adverse effects of contamination are minimized by any action taken to avoid and control exposure. There are three primary requirements for contamination avoidance.

Determining the Location of NBC Contamination.

By knowing the location of contamination the commander can incorporate that knowledge into his decision-making process. This is normally done by using remote and local NBC sensing detectors and monitors.

Collecting, Analyzing, and Disseminating NBC Information.

This will further enhance the decision-making process to assist in avoiding contamination.

Limiting the Spread of Contamination if it Becomes Necessary to Operate Around Contamination.

This will simplify operation. Protecting material and equipment with chemical agent resistant covers, paints, and/or devices will assist greatly in survivability on the air-land battlefield. Contaminated supplies and equipment must be segregated to limit the spread of contamination. Users are responsible for ensuring that damaged equipment is decontaminated before it is recovered and/or repaired. This also will limit the spread of contamination.

The next step in dealing with contamination is individual protection. Mission oriented protective posture (MOPP) levels exist for protection of individuals. Equipment and procedures must be developed with NBC contamination in mind to achieve maximum efficiency without sacrificing protection. When a chemical threat exists, the protective ensemble becomes the standard combat uniform as determined by the theater commander. A prolonged operational capability must be considered when developing equipment and procedures.

Collective protective devices/equipment must be used to provide for operations in a contamination-free environment.

K-2. Decontamination

The last step in the process is a decontamination operation. Contaminated soldiers must perform their own emergency decontamination using the M258A1 personal decontamination kit. Partial equipment decontamination may be performed using the M258A1 or the portable decontaminating apparatus, M11 spraying decontaminating solution number 2 (DS2). Note that DS2 is highly corrosive and would damage electronics. The M258A1 could be used to wipe flat surface areas but is not practical for keyboards and other electronic equipment faces where the decontaminant could come in contact with and damage the circuitry.

When decontaminating communications and radar equipment, the power supply must be disconnected to prevent injury to personnel and damage to the equipment. The best way to decontaminate such equipment is to use hot air. The metal parts of field telephones and radios exposed to blister agents and V-agents may be decontaminated with DS2. General procedures for metals, plastics, wood, and leather apply for comparable parts of communications and radar equipment. Extreme care must be exercised when using DS2 or soapy water on equipment with transistors. Indiscriminate use of decontaminants may corrode terminals or relays and render the equipment inoperable.

K-3. Guidance

The following reference material provides guidance for NBC protective measures:

FM 3-3.

FM 3-9.

APPENDIX L

TACTICAL SINGLE-CHANNEL SATELLITE COMMUNICATIONS

L-1. Need and Employment

Most of the satellite communications in today's military environment are multichannel. It is, in fact, more economical to process many voice channels over a single wideband satellite channel than to restrict the satellite to single-channel usage. However, there still exists a strategical need for single-channel operation in which satellite communications offer the best means of mission accomplishment.

Whereas ordinary means of communications are subject to varying degrees of radio direction finding (RDF), the satellite system can be used in such a manner as to deter enemy RDF success. The short transmission times of burst communications present less attractive jamming targets than do longer, continuous communications of regular nets.

Special forces and other users find that satellite communications fill their special needs more effectively than other means of communications. Therefore, the Army has developed a single-channel, ultra high frequency (UHF) manpack system to fill these needs. [Figure L-1](#) illustrates a basic manpack system concept of operations.

[Figure L-1.](#) Manpack system concept of operation.

The special forces and engineers concept is to deploy the manpacks with selected teams with net control at the forward operation bases of both the engineers and special forces groups. The rangers concept of operation is for the deployment of manpacks at the company headquarters/combat patrol bases with net control at the ranger battalion headquarters. (See [fig L-2](#) and [L-3](#) for concepts of employment.) The system can be used with the AN/PRC-70, AN/PRC-77, SINCGARS, and the AN/VRC-12 series radio sets for retransmission capabilities.

[Figure L-2.](#) Manpack system typical employments.

[Figure L-3.](#) Special Forces BCS concept of operation.

L-2. System Description

The manpack system is designed for low-echelon, highly mobile unit communications where units operate in either friendly or enemy territory at great distances from the home unit. The equipment can

operate in the on-the-move/line-of-sight (LOS) mode using 2 watts output power or in the at-halt/satellite (SAT) mode using 35 watts output power. It can transmit and receive in either voice or data format in either mode. The system complements the older tactical radios which operate in the high frequency (HF) spectrum and which are highly susceptible to enemy RDF and jamming as well as requiring relay-switching in order to operate over long distances. Furthermore, the manpack system requires less personnel training than does the older HF equipment and it requires no additional personnel at unit or support levels.

L-3. Equipment Description

Radio Set, AN/PSC-3() ([fig L-4\(a\)](#) and [\(b\)](#)) is a battery-operated, portable communications terminal employing an RT-1402()/G receiver/transmitter (RT) unit ([fig L-5](#)) which provides two-way communications in the frequency range of 225 MHz to 400 MHz in both SAT and LOS modes of operation.

[Figure L-4a.](#) AN/PSC-3() with OA-8990()/P DMDG.

[Figure L-4b.](#) Radio Set AN/PSC-3() components.

[Figure L-5.](#) Receiver/Transmitter RT-1402()/G.

The terminal uses a low-gain omnidirectional whip antenna for LOS operation while in motion. This antenna also enables reception of a satellite alert ringing signal while in LOS mode ([fig L-4b](#)). The set uses an AS-3567()/PSC-3 medium-gain antenna ([fig L-7](#)) for at-halt satellite communications. The terminal provides half duplex communications at 300 BPS and 1200 BPS biphase shift keying (BPSK), 2400 BPS synchronous BPSK, 16 KBPS frequency modulation (FM) and frequency shift.

[Figure L-6.](#) Hi- and low-gain (whip) antennas.

[Figure L-7.](#) Medium-gain antenna AS-3567()/PSC-3.

The vehicular net control station (NCS) AN/VSC-7 uses the basic AN/PSC-3RT unit installed in a C-11119()/VSC-7 control converter which is shock-mounted into a communications shelter or a military ground vehicle. Power to the NCS is derived from the vehicle's electrical system. It may also be used with a S-280 communications shelter mounted on an M-832 mobilizer. The power amplifier module in the control converter is blower-cooled to allow continuous key-down operation at temperatures up to 86ø C (155ø F). The NCS can serve up to 15 AN/PSC-3() terminals in a communications net with the selection of conference or individual call-codes available at the control converter front-panel. The NCS uses a high-gain (9 dB) AS-3568()/VSC-7 antenna and a low-gain whip antenna ([fig L-6](#)). The low-gain AS-3566()/G whip antenna is used for LOS operation and for CALL reception. The AS-3567()/PSC-3 medium-gain antenna, used for satellite relay operation, provides 6 dB gain in the frequency range of 240-318 MHz and 5.5 dB gain in the frequency range 318-400 MHz. Terminal characteristics include all features of the AN/PSC-3() and additionally provide--

- Operation from vehicle electrical system
- Transmission of selective or conference call signals
- Input-power conditioning
- Automatic transmission/reception mode changeover

- Electromagnetic interference protection against colocated transmitter(s)
- Continuous key-down operation
- High-gain (9 dB) antenna

The Digital Message Device Group (DMDG) OA-8990()/P is the major "used with" component of the AN/PSC-3 and AN/VSC-7 in the burst communications system (BCS). This hand-held device provides digital input to the radio for burst transmissions at data rates of 300 and 1200 BPS. It provides the operator with the ability to transmit in a few seconds what would normally take minutes in a standard CW mode. The DMDG microprocessor unit features a 32-key keyboard, a 16-character light emitting diode (LED) display, an HF modem, and a 1,020-character memory. Power is supplied by rechargeable Nicad batteries. Data rates are 300 or 1200 BPS using ASCII 6-bit code. Selection of bit rate for compatibility with the satellite is accomplished by an internal switch. The maximum DMDG weight will be 3.9 kilograms (8.0 lbs); maximum volume will be 3.7 cubic centimeters (225 cu in). Interface equipment used with but not part of the manpack system, such as TSEC/KY-57 and KY-65 secure voice applique devices, are current Army inventory assets and may be issued as dictated by mission requirement.

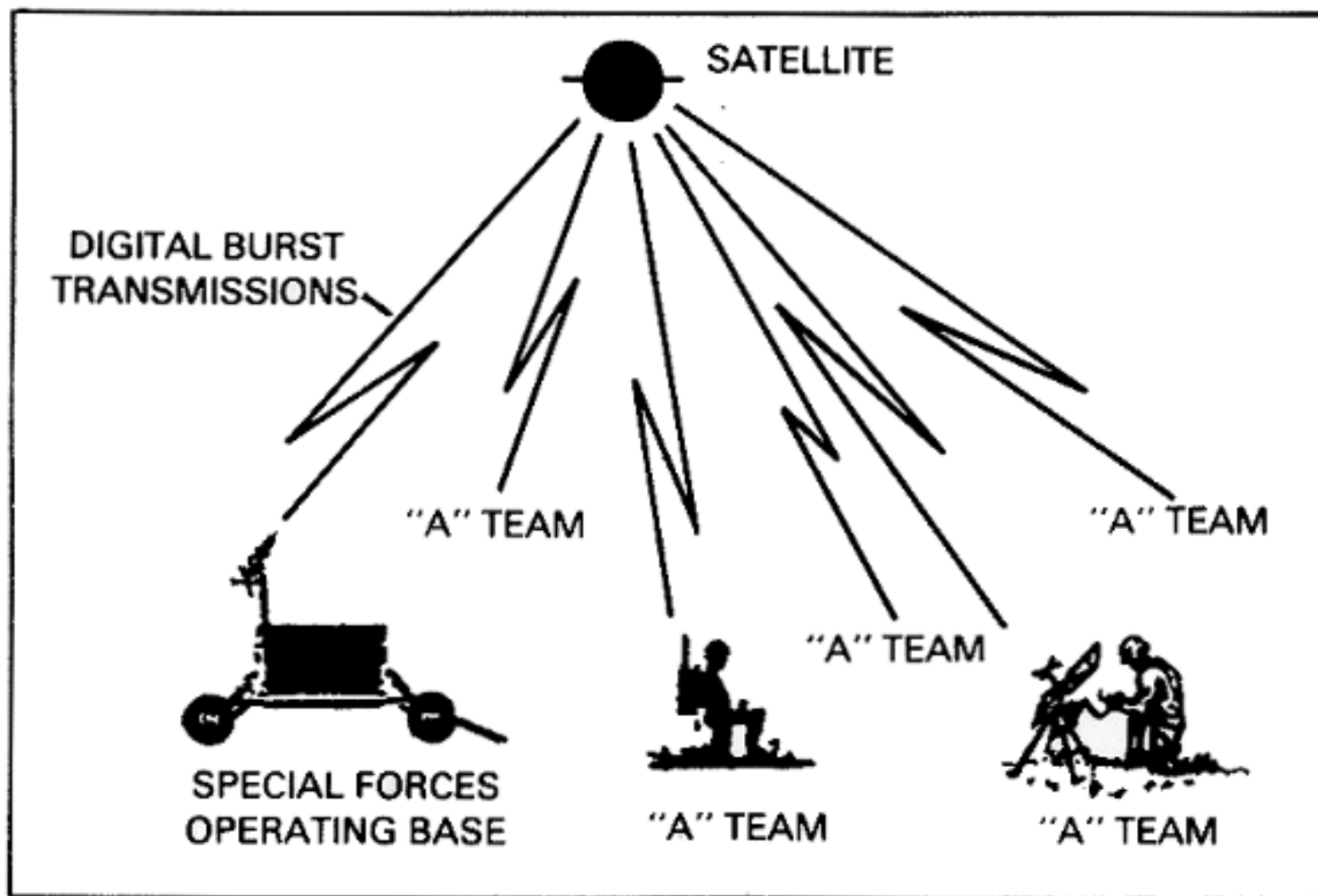

Figure L-1. Manpack system concept of operation.

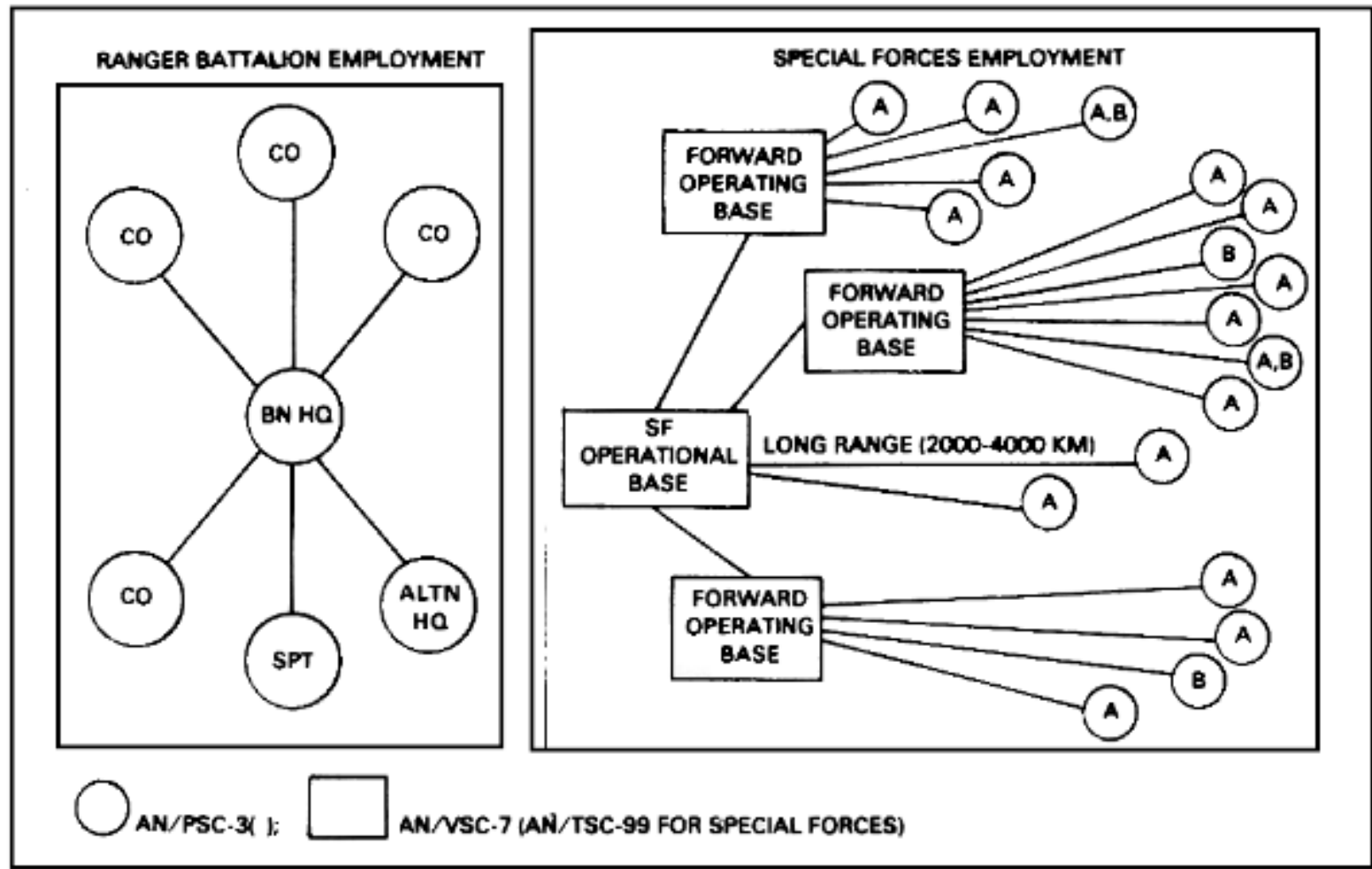

Figure L-2. Manpack system typical employments.

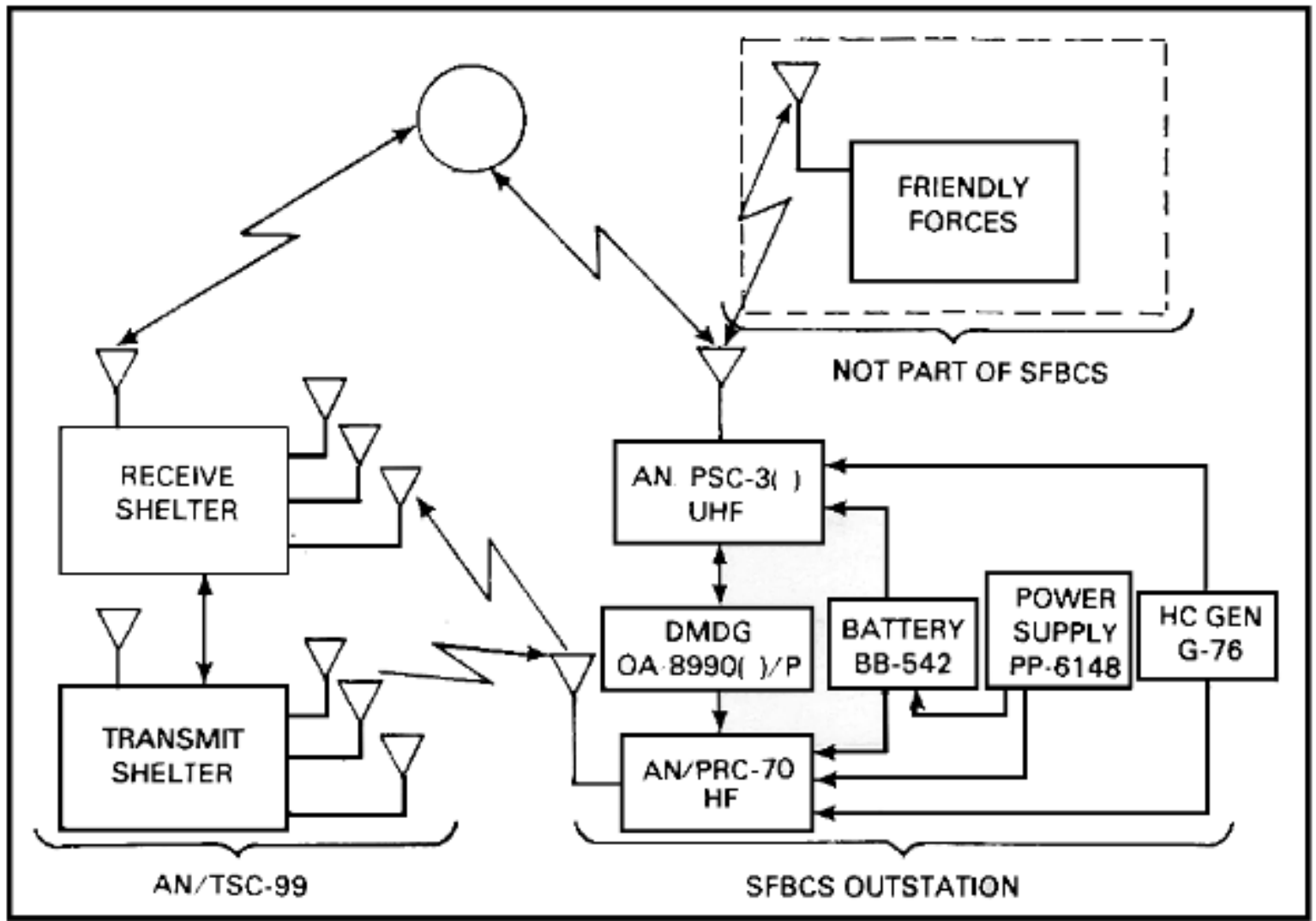

Figure L-3. Special Forces BCS concept of operation.

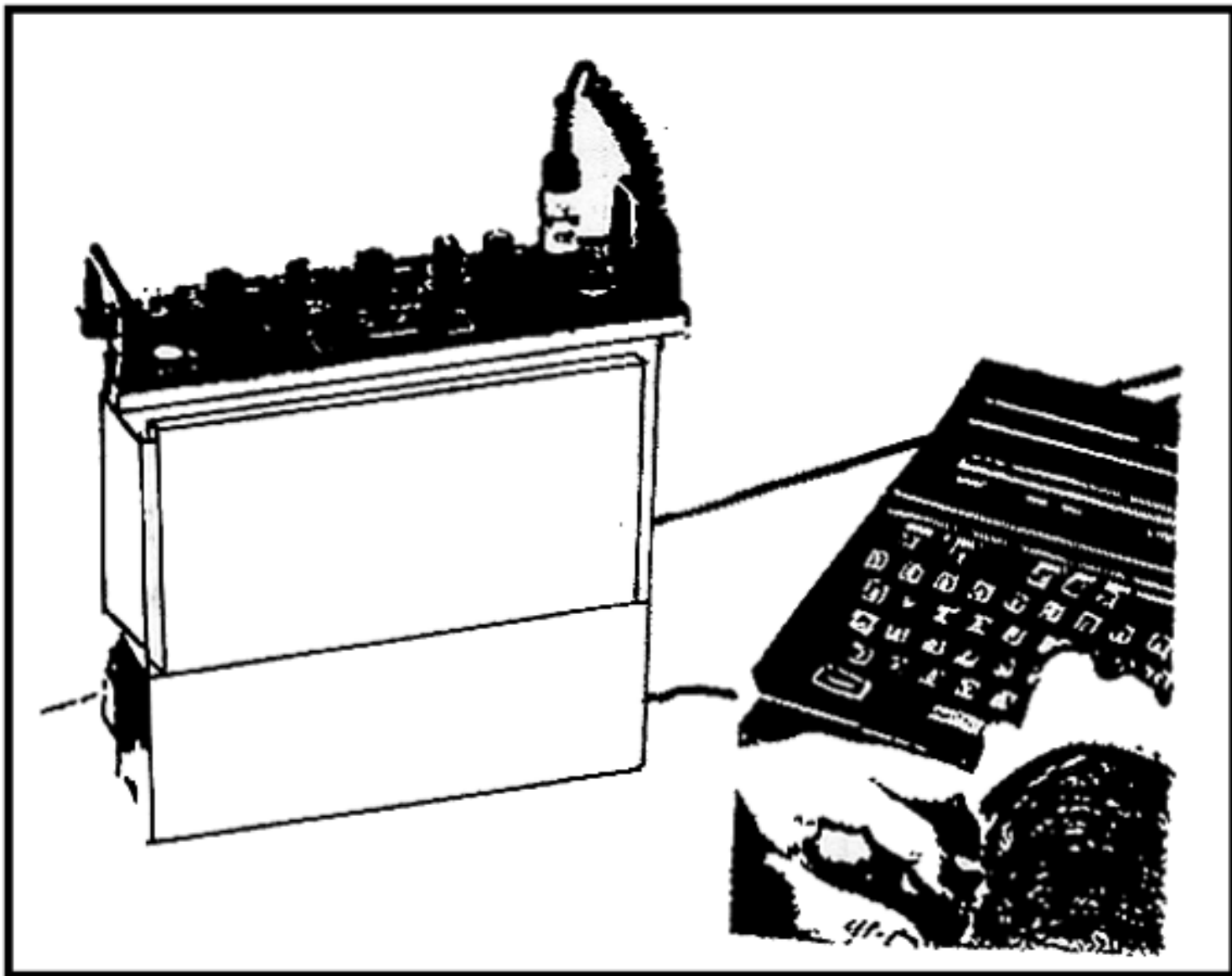

Figure L-4a. AN/PSC-3() with OA-8990()/P DMDG.

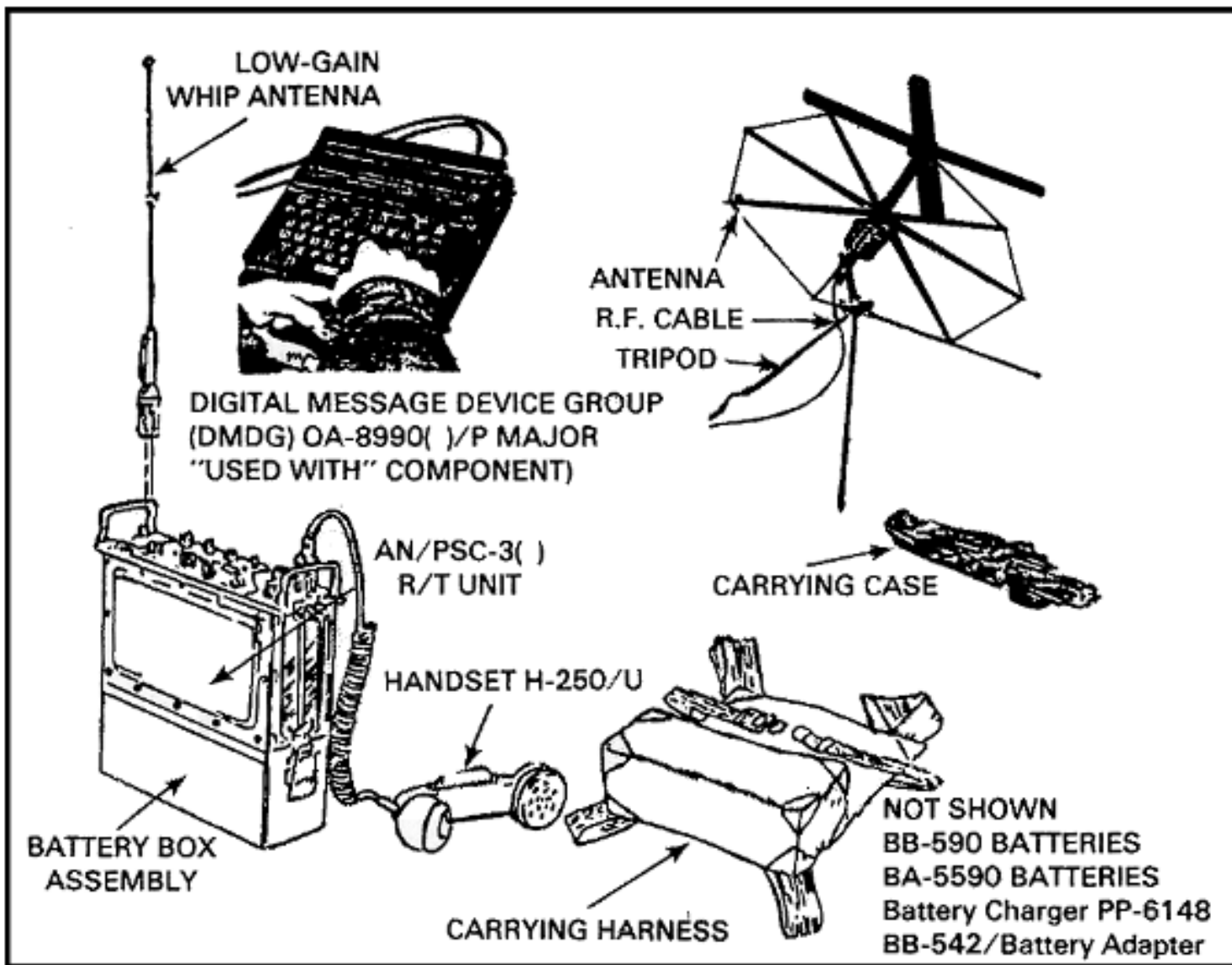

Figure L-4b. Radio Set AN/PSC-3() components.

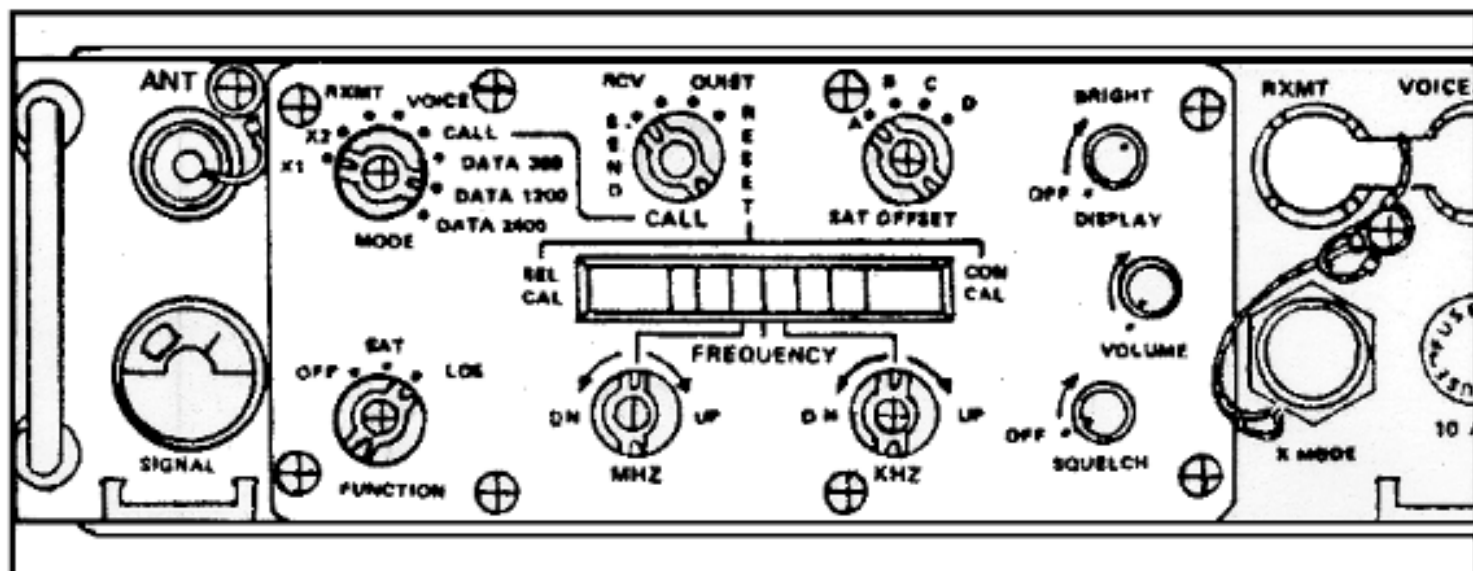

Figure L-5. Receiver/Transmitter RT-1402()/G.

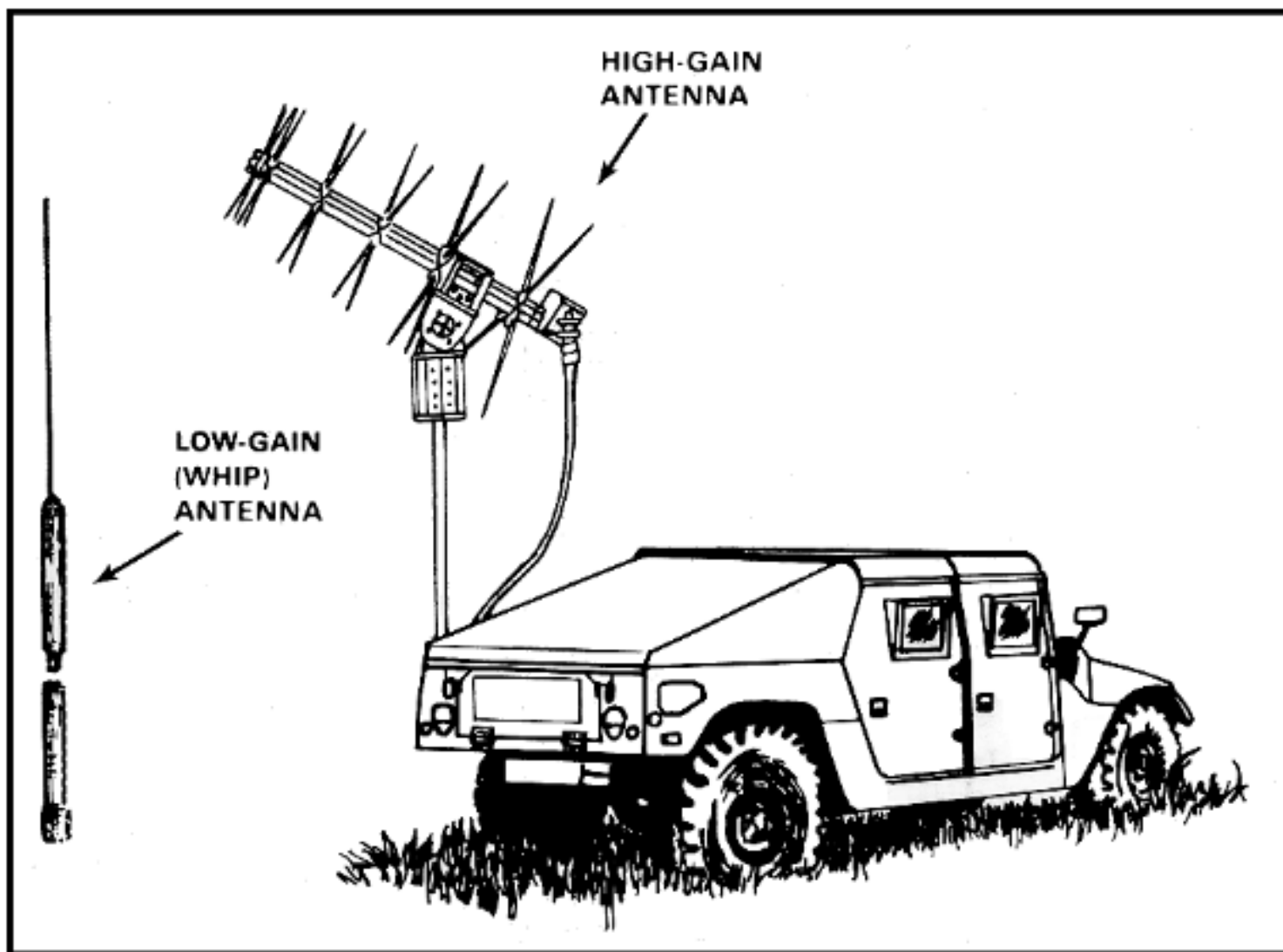

Figure L-6. Hi- and low-gain (whip) antennas.

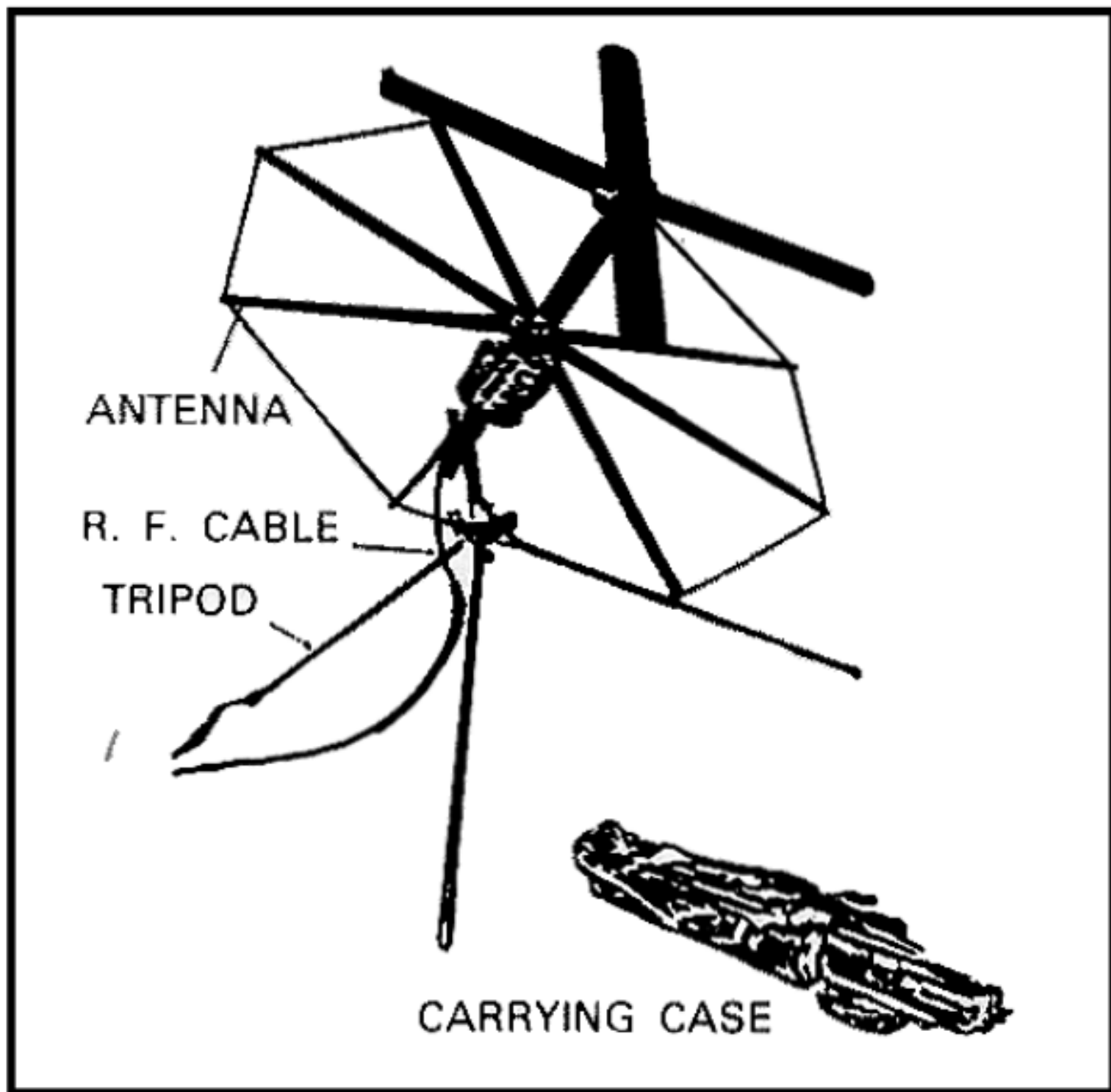

Figure L-7. Medium-gain antenna AS-3567()/PSC-3.

APPENDIX M

NEAR-VERTICAL INCIDENCE SKY-WAVE PROPAGATION CONCEPT

M-1. Evaluation of Communications Techniques

The standard communications techniques used in the past will not support the widely deployed and the fast-moving formations we intend to use to counter the modern threat. Coupling this with the problems that can be expected in deploying multichannel LOS systems with relays to keep up with present and future operation, high frequency (HF) radio and the near-vertical incidence sky-wave (NVIS) mode take on new importance. High frequency radio is quickly deployable, securable, and capable of data transmission. It will be the first, and frequently the only, means of communicating with fast-moving or widely separated units. It may also provide the first long-range system to recover from a nuclear attack. With this reliance on HF radio, communications planners, commanders, and operators must be familiar with NVIS techniques and their applications and shortcomings in order to provide more reliable communications.

M-2. Problems Encountered in Propagation of Radio Waves

Under ideal conditions, ground wave component of a radio wave becomes unusable at about 80 kilometers (50 mi) ([fig 2-12](#)). Under actual field conditions, this range can be much less, sometimes as little as 3 kilometers (2 mi). Sky waves, generated by standard antennas (for example, doublets) which efficiently launch the sky wave, will not return to earth at a range of less than 161 kilometers (100 mi). This can leave a skip zone of at least 80 to 113 kilometers (50 to 70 mi) where HF communications will not function. This means that units such as long-range patrols, armored cavalry deployed as advance or covering forces, air defense early warning teams, and many division-corps, division-brigade, division-DISCOM and division-DIVARTY stations are in the skip zone and thus unreachable by HF radio even though HF is a primary means of communication to these units.

M-3. Concept of Near-Vertical Incidence Sky-Wave Radiation

Energy radiated in a near-vertical incidence direction is not reflected down to a pinpoint on the Earth's surface. If it is radiated on too high a frequency, the energy penetrates the ionosphere and continues on out into space. Energy radiated on a low enough frequency is reflected back to earth at all angles (including the zenith), resulting in the energy striking the earth in an omnidirectional pattern without dead spots (that is, without a skip zone). Such a mode is called a near-vertical incidence sky wave (NVIS). The concept is illustrated in [figure M-1](#).

This effect is similar to taking a hose with a fog nozzle and pointing it straight up. The water falling back to earth covers a circular pattern continuously out to a given distance. A typical receive signal pattern for antenna AS-2259/GR is shown in [figure M-2](#), and the path length and incident angle are shown in [figure M-3](#). A typical elevation plane pattern is shown in [figure M-4](#). The main difference between this short-range NVIS mode and the standard long-range sky-wave HF mode is the lower frequency required to avoid penetrating the ionosphere and the angle of incident signal upon the ionosphere. In order to attain a NVIS effect, the energy must be radiated strong enough at angles greater than about 75 or 80 degrees from the horizontal on a frequency that the ionosphere will reflect at that location and time. The ionospheric layers will reflect this energy in an umbrella-type pattern with no skip zone. Any ground wave present with the NVIS signal will result in undesirable wave interference effects (such as, fading) if the amplitudes are comparable. However, proper antenna selection will reduce ground-wave radiated energy to a minimum, and this will reduce the fading problems. Ranges for the NVIS mode are shown in [figure M-3](#) for typical ionosphere height and take-off angles. Since NVIS paths are purely sky wave, the path losses are nearly constant at about 110 dB +10 dB. Relative gain performance of the AS-2259/GR NVIS antenna is shown in [figure M-5](#). This is significant for the tactical communicator because all the energy arriving at the receiving antenna is coming from above at about the same strength over all of the communications ranges of interest. This means the effect of terrain and vegetation (when operating from defiladed positions such as valleys) are greatly reduced, and the receive signal strength will not vary greatly.

[Figure M-1](#). Near-vertical incidence sky-wave propagation concept.

[Figure M-2](#). Near-vertical incidence sky-wave antenna typical azimuth plane pattern.

[Figure M-3](#). Path length and incident angle (near-vertical incidence sky-wave mode).

[Figure M-4](#). Typical elevation plane pattern.

[Figure M-5](#). Relative gain performance of AS-2259 antenna.

M-4. Assessment of Characteristics of Common Antennas

It is obvious that the Army needs short-range HF communications in the 2-30 MHz frequency band in the 1985-1990 time frame and beyond. The problem, however, is to obtain the required radiation characteristics. This is not difficult, because half-wave dipole antennas located from one-quarter to one-tenth wavelength above the ground will cause the radiated energy to be directed vertically ([fig M-6](#)). [Table M-1](#) shows the relative gain toward the zenith of the most common types of HF antennas. This table shows that the half-wave Shirley folded dipole ([fig M-7](#)) has the most gain towards the zenith (with the other dipoles being almost as good). The Shirley dipole is a good NVIS base station antenna, but it is limited to a band of frequencies within about 10 percent of the design frequency. The fan dipole ([fig M-8](#) and [table M-1](#)) performs almost as well, and it provides more frequency flexibility (for example, day, night, and transition period frequencies). For tactical communications, these dipoles can be easily deployed in a field expedient manner because they can be located close to the ground. For mobile or shoot-and-scoot type operations, vehicular-mounted antennas are required. This is the standard 5-meter (161/2-foot) whip bent down to a horizontal position ([fig M-9](#)). In this configuration, the whip is essentially an asymmetrical dipole (with the vehicle body forming one side) located close to the Earth. A

significant amount of energy is directed upward ([fig M-6](#) for typical pattern) to be reflected back by the ionosphere in an umbrella pattern. For use, while operating on the move, the whip antenna must be tied across or parallel to the vehicle or shelter. This configuration is like an asymmetrical open-wire line, and it also directs some energy upwards although with less efficiency. There are still no skip zones, but received signal levels are weaker than with the whip tied back as shown in [figure M-9](#).

[Table M-1](#). Summary of relative gain toward the zenith for field-expedient high frequency antennas (in dB)

[Figure M-6](#). Typical elevation plane patterns for half-wavelength antennas one-eighth wavelength or less above ground.

[Figure M-7](#). Half-wave Shirley folded dipole.

[Figure M-8](#). Fan dipole NVIS base station antenna.

[Figure M-9](#). Tying the whip antenna down.

M-5. Orientation of Antenna

Wire dipole antennas have always been sited so that the broadside of the antenna was pointed toward the receiving station(s). This is still the correct approach for long-haul paths. This antenna orientation is not necessary when using the NVIS mode. For NVIS operation, antenna orientation does not matter since all the energy is directed upward and returns to earth in an omnidirectional pattern. This means that the dipole should be erected at any orientation that is convenient at the particular radio site without regard to the location of other stations. This holds true except when operating in the region of the magnetic dip equator ([fig M-10](#)). When operating near the dip equator (such as, within 500 kilometers (311 mi)), the dipole antennas should be oriented in a magnetically north-south direction for greater receive signal levels for all NVIS path bearings. Antenna orientation broadside to the path direction must be retained near the dip equator and elsewhere for longer sky-wave paths.

M-6. Problems in Using the NVIS Concept

While use of the NVIS technique does provide beyond line-of-sight, skip-zone-free communications, there are some drawbacks in its use that must be understood in order to minimize them.

[Figure M-10](#). Magnetic dip equator.

Interference Between Ground Wave and Sky Wave.

Where both a NVIS and ground-wave signal are present, the ground wave can cause destructive interference. Proper antenna selection will suppress ground-wave radiation and minimize this effect while maximizing the amount of energy going into the NVIS mode.

High Take-Off Angles.

In order to produce radiation which is nearly vertical, antennas must be selected and located carefully in order to minimize the ground-wave radiation and maximize the energy radiated towards the zenith. This can be accomplished by using specially designed antennas such as AS-2259/GR or by locating standard dipole (doublet) antennas one-quarter to one-tenth wavelength from the ground in order to direct the

energy toward the zenith ([fig M-11](#)). A typical measured dipole pattern (power gain) is shown in [figure M-12](#).

Critical Frequency Selection.

As in all sky-wave propagation, there is a critical frequency (f_o) above which radiated energy will not be reflected by the ionosphere but will pass through it (TM 11-666). This frequency is related approximately to the angle of incidence.

[Figure M-11](#). Recommended dipole height for NVIS applications.

[Figure M-12](#). Measured radiation pattern of the 8-MHz 23-foot high unbalanced dipole.

This means that the useful frequency range varies in accordance with the path length. The shorter the path, the lower the MUF and the smaller the frequency range. In practice, this limits the NVIS mode of operation to the 2-to 4-MHz range at night and to the 4- to 8-MHz range during the day ([fig M-13](#)).

These nominal limits will vary with the 11-year sunspot cycle and they will be smaller during sunspot minimums (for example, 1985-86). This restriction of the frequency range is due to the physics of the situation and cannot be overcome. Some problems can be expected when operating on the NVIS mode in this portion of the HF spectrum.

The range of frequencies between the MUF and the LUF is limited, and frequency assignment may be a problem.

The lower portion of the band which supports NVIS is somewhat congested with aviation, marine, broadcast, and amateur radio which limits frequencies available.

Atmospheric noise is higher in this portion of the HF spectrum in the afternoon and night.

Man-made noise tends to be higher in this portion of the HF spectrum.

M-7. Advantages in Using the NVIS Concept

After the foregoing problems are overcome, there are many advantages in using the NVIS concept.

The tactical environment.

- There are skip-zone-free omnidirectional communications.
- Terrain does not effect 1088 of signal. This gives a more constant received signal level over the operational range instead of one which varies widely with distance.
- Operators are able to operate from protected, dug-in positions. Thus tactical commanders do not have to control the high ground for HF communications purposes.
- Orientation of doublets and inverted antennas become noncritical.

The EW environment

ù **There is a lower probability of geolocation.** NVIS energy is received from above at very steep angles, which makes direction finding (DF) from nearby (but beyond ground-wave range) locations more difficult.

ù **Communications are harder to jam.** Ground-wave jammers are subject to path 1088. Terrain features

can be used to attenuate a ground wave jammer without degrading the desired communication path. The jamming signal will be attenuated by terrain, while the sky-wave NVIS path 1088 will be constant. This will force the jammer to move very close to the target or put out more power. Either tactic makes jamming more difficult.

ù Operators can use low-power successfully. The NVIS mode can be used successfully with very low-power HF sets. This will result in much lower probabilities of intercept/detection (LPI/LPD). [Figures M-14](#) and [M-15](#) show results obtained in Thailand jungles and mountains with the 15-watt AN/PRC-74 operating on one SSB voice frequency (3.6 MHz) over a 24-hour period.

15-watt AN/PRC-74 operating on one SSB voice frequency (3.6 MHz) over a 24-hour period.

M-8. Conditions Under Which to Use the NVIS Concept

Near-vertical incidence sky-wave techniques must be considered under the following conditions:

- The area of operations is not conducive to ground-wave HF communications (for example, mountains).
- Tactical deployment places stations in anticipated skip zones when using traditional frequency selection methods and operating procedures.
- When operating in heavy wet jungle (or other areas of high signal attenuation).
- When prominent terrain features are not under friendly control.
- When operating against enemy ground-wave jammers and direction finders.

[Figure M-13.](#) Maximum usable frequencies in Vietnam.

[Figure M-14.](#) Communications success with the AN/PRC-74 as a function of time of day and antenna type over a 12-mile path in low mountains, spring and summer 1963.

[Figure M-15.](#) Communications success as a function of range for the AN/PRC-74 in mountainous and varied terrain--including jungle in Thailand.

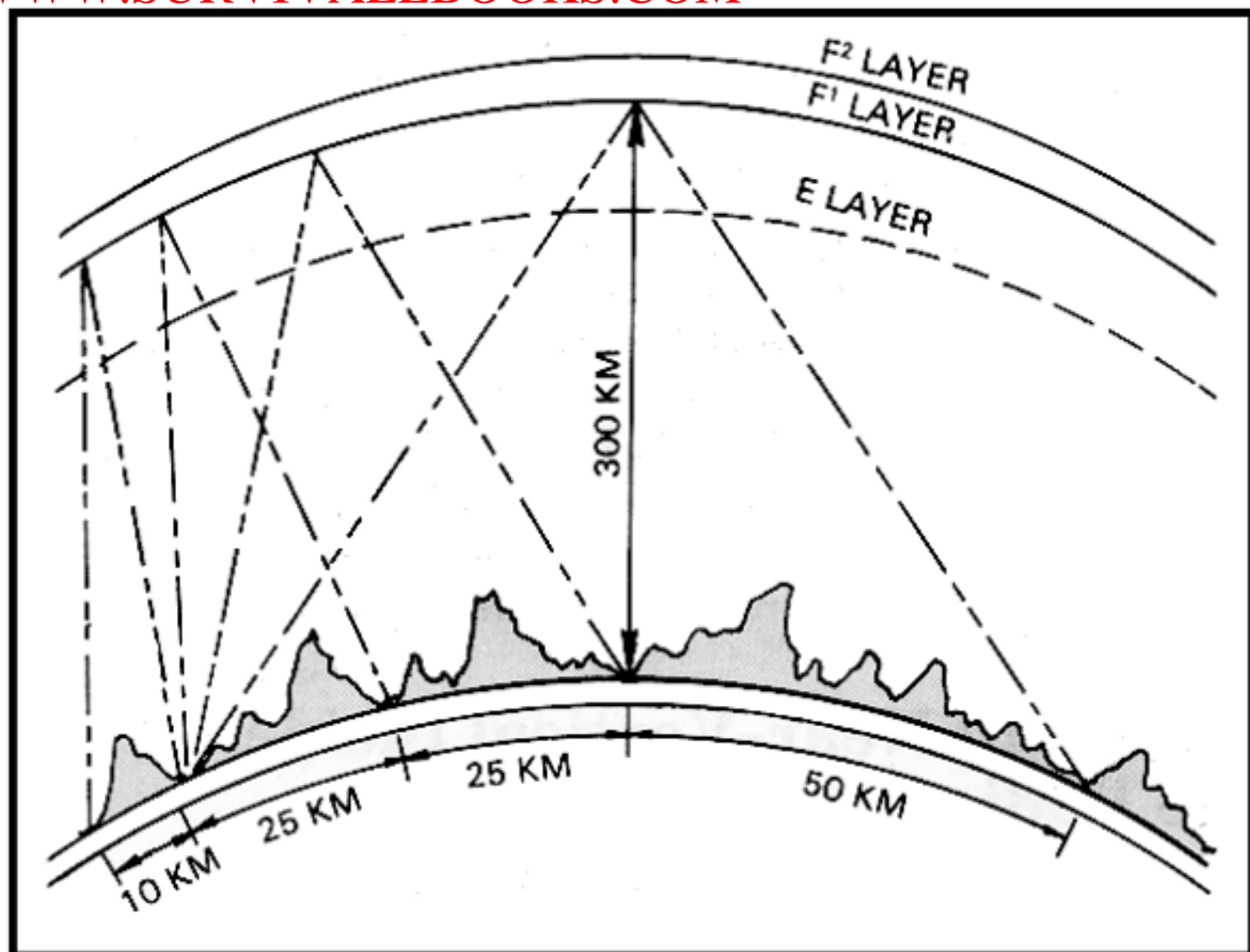

Figure M-1. Near-vertical incidence sky-wave propagation concept.

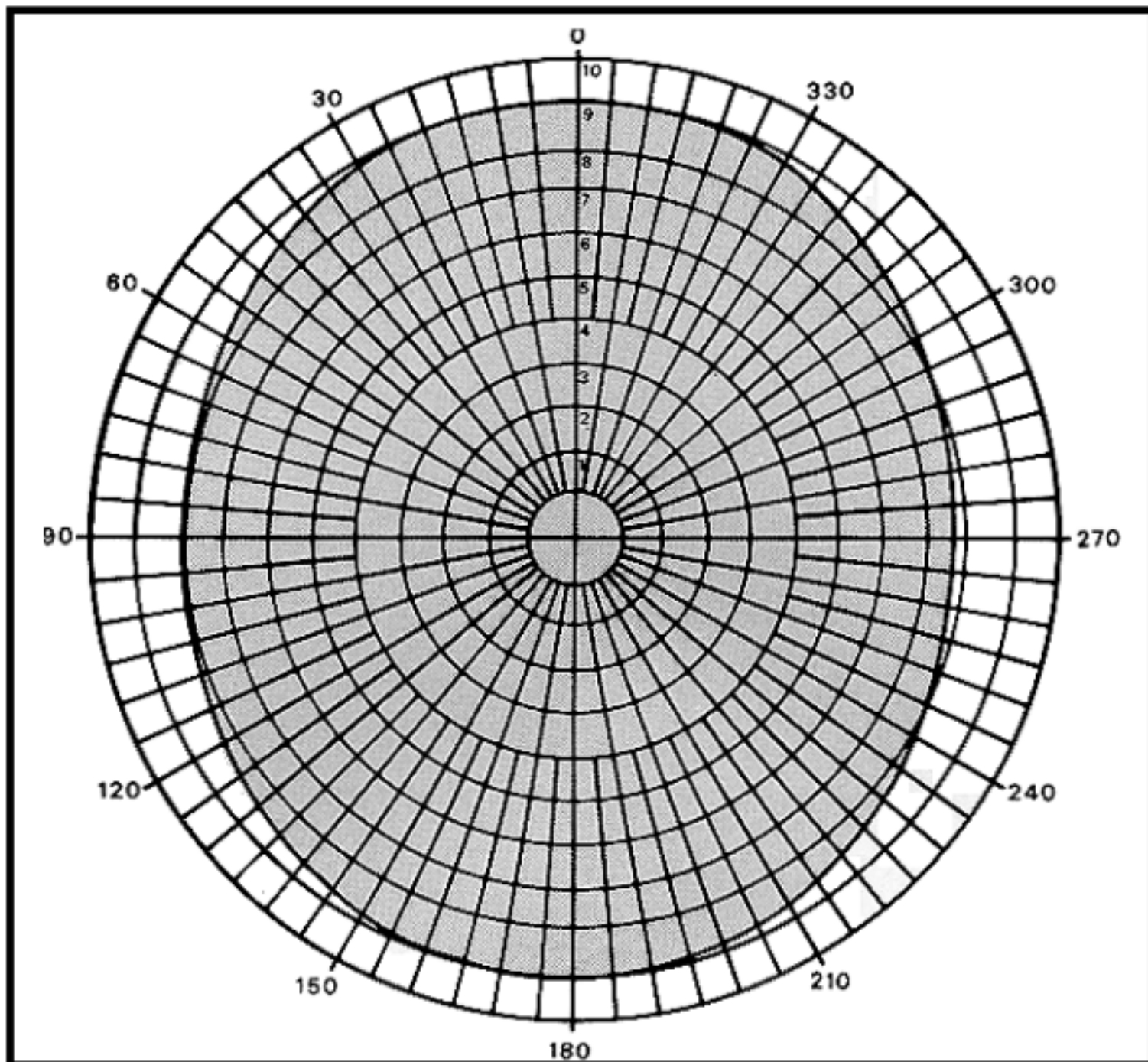
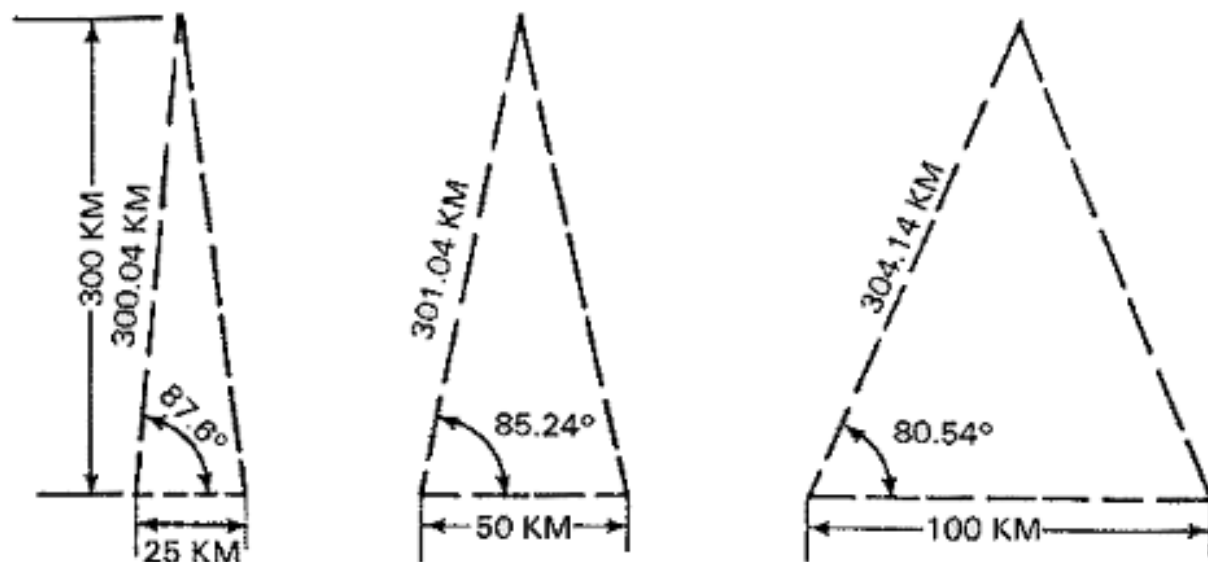

Figure M-2. Near-vertical incidence sky-wave antenna typical azimuth plane pattern.



GROUND RANGE Km	RADIO PATH LENGTH Km	RANGE VARIABLE $20 \text{ LOG } d$	V LOSS dB
25	600.5	55.57	0
50	600.08	55.59	0.02
100	608.28	55.68	0.11

NIGHT OR DAY ABSORPTION, TURN-AROUND, NORMAL ATMOSPHERICS.
 AVERAGE PATH LOSS (3 TO 5 MHz) = 110 dB + 10 dB.

Figure M-3. Path length and incident angle (near-vertical incidence sky-wave mode).

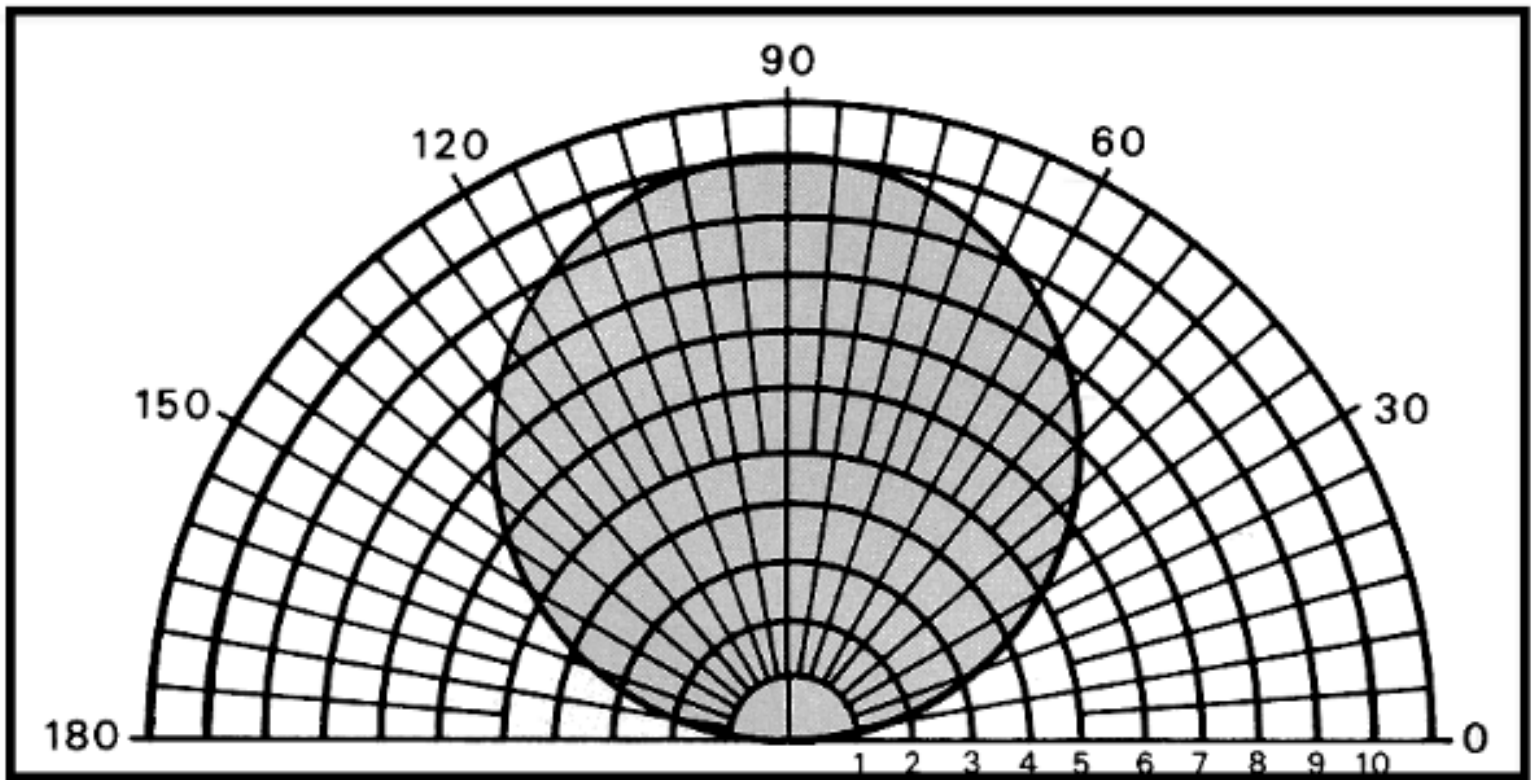

Figure M-4. Typical elevation plane pattern.

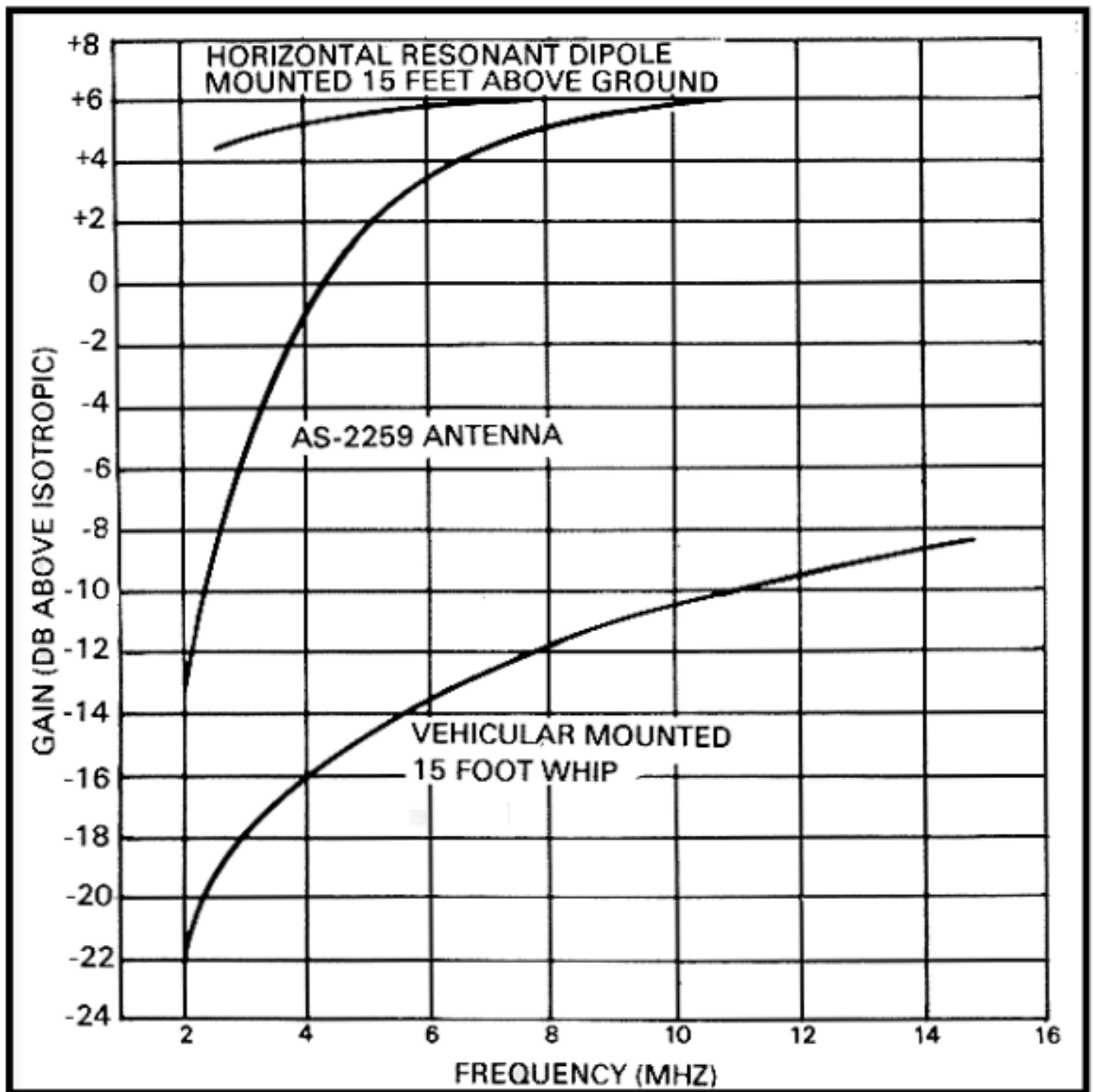

Figure M-5. Relative gain performance of AS-2259 antenna.

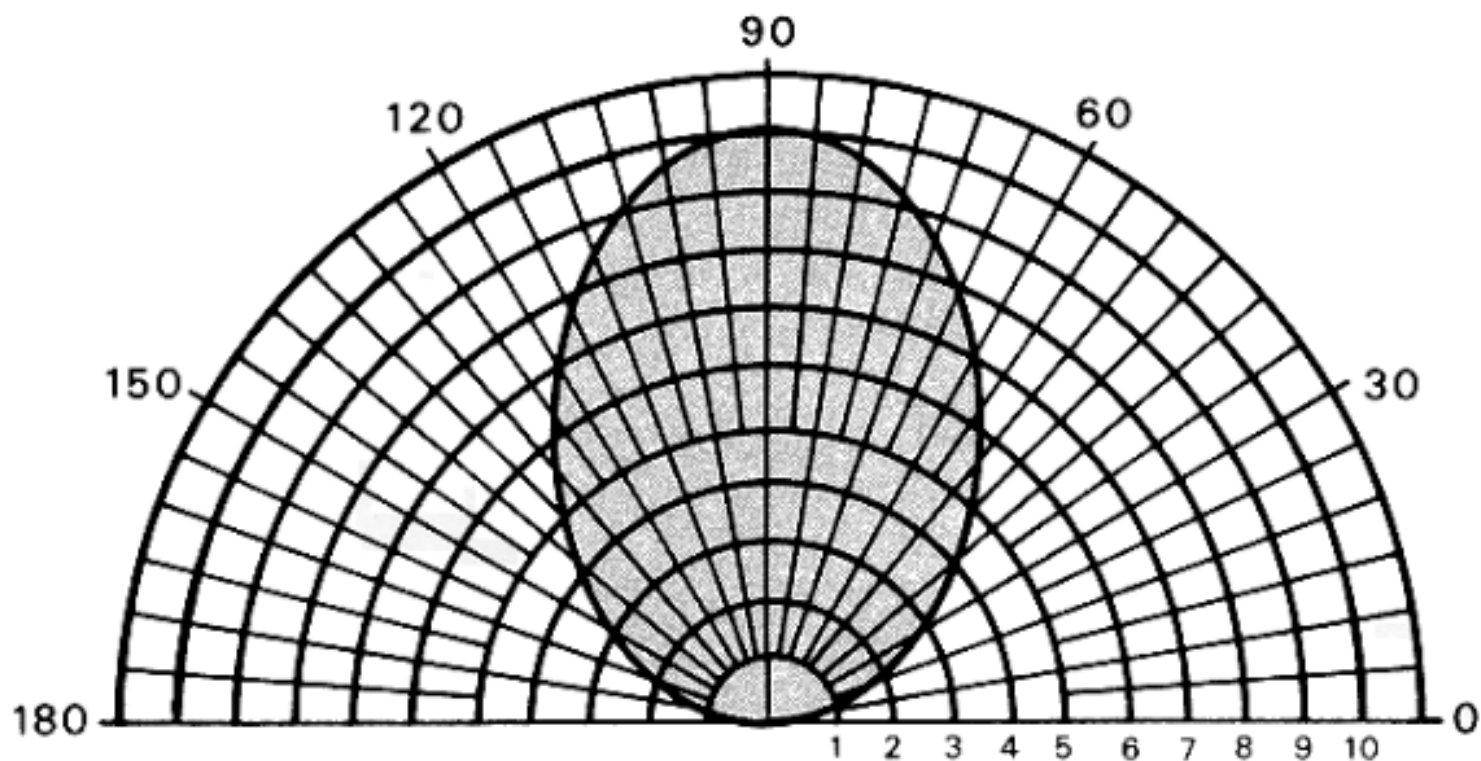

Figure M-6 Typical elevation plane patterns for half-wavelength antennas one-eighth wavelength or less above ground.

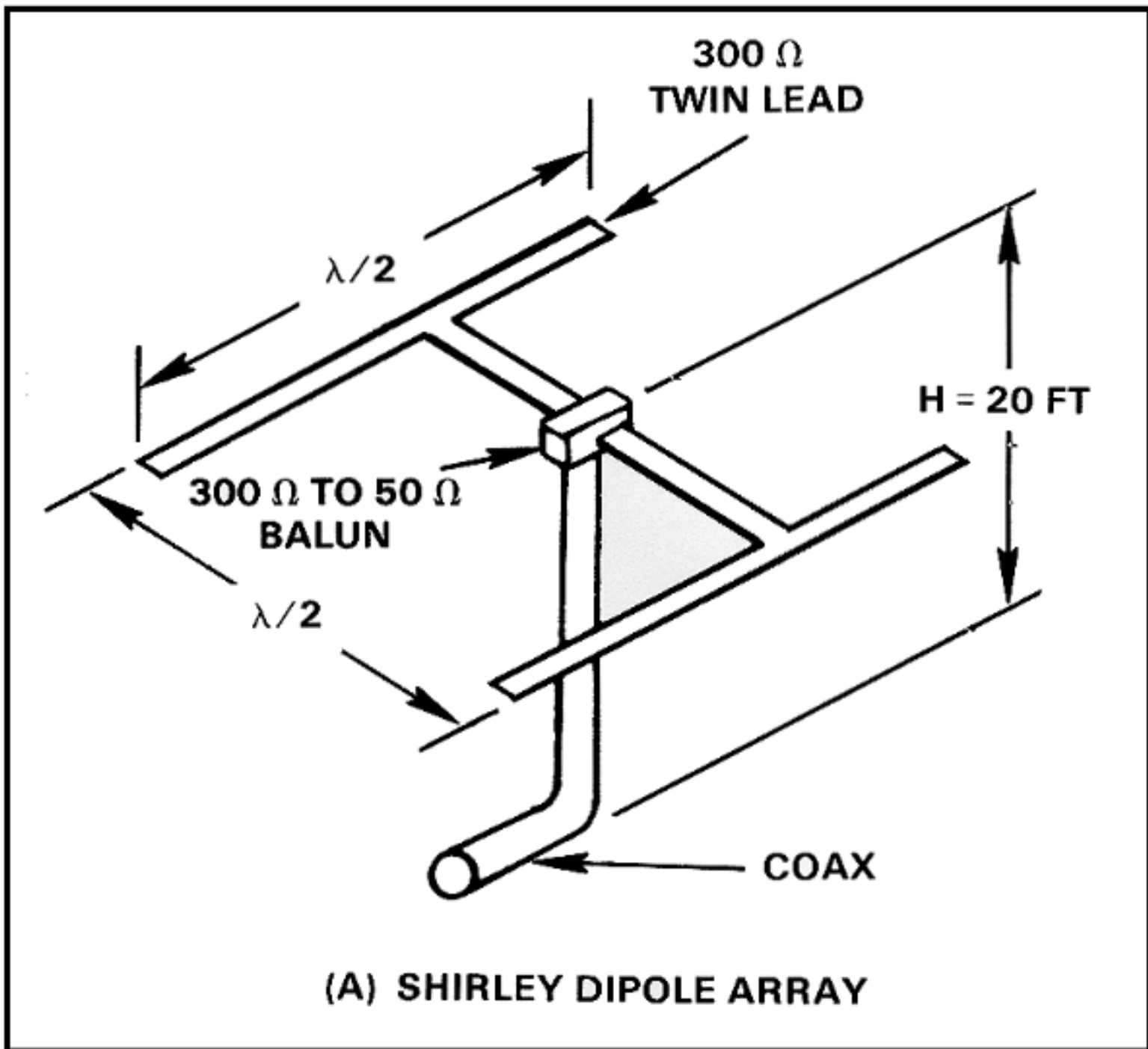

Figure M-7. Half-wave Shirley folded dipole.

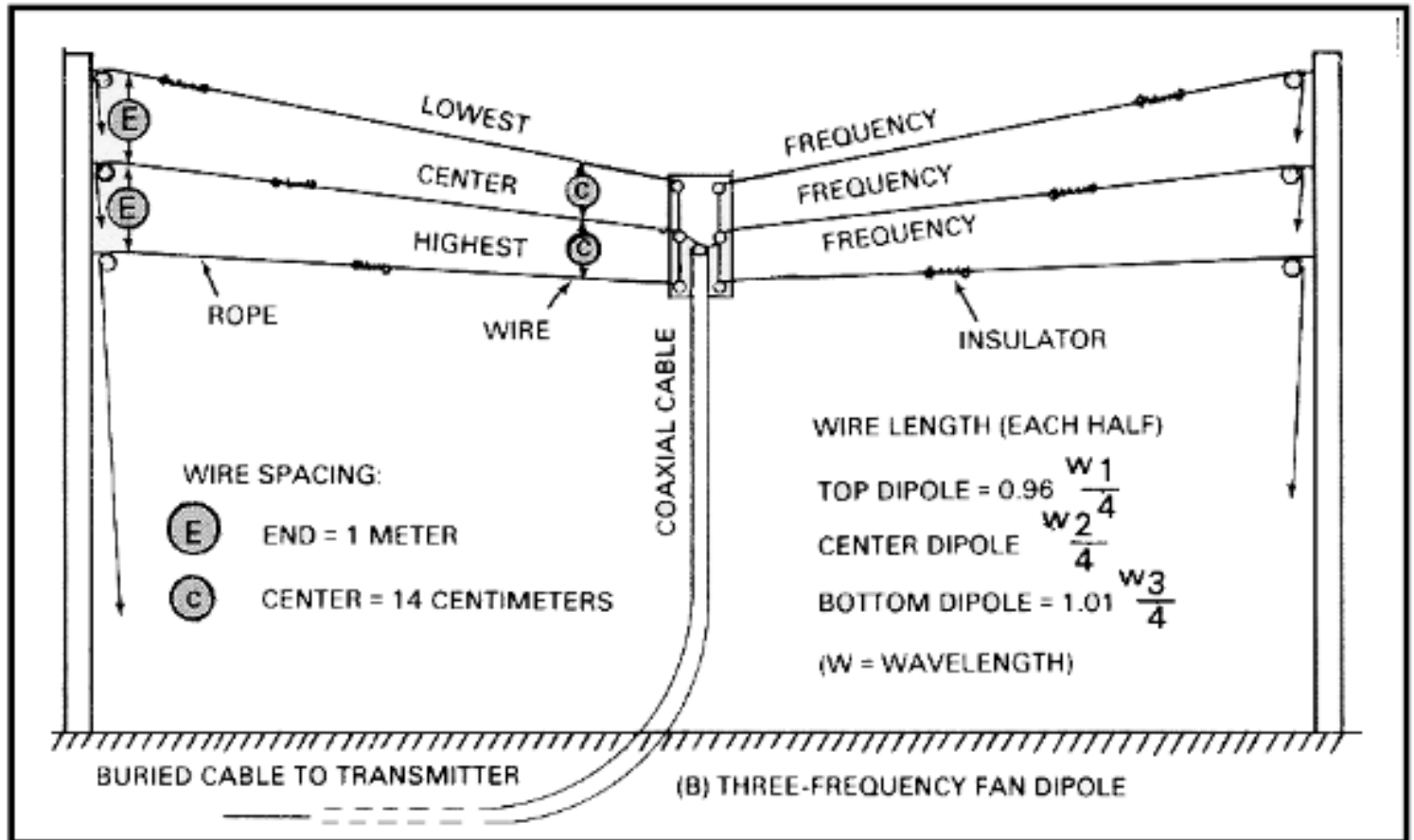

Figure M-8. Fan dipole NVIS base station antenna.

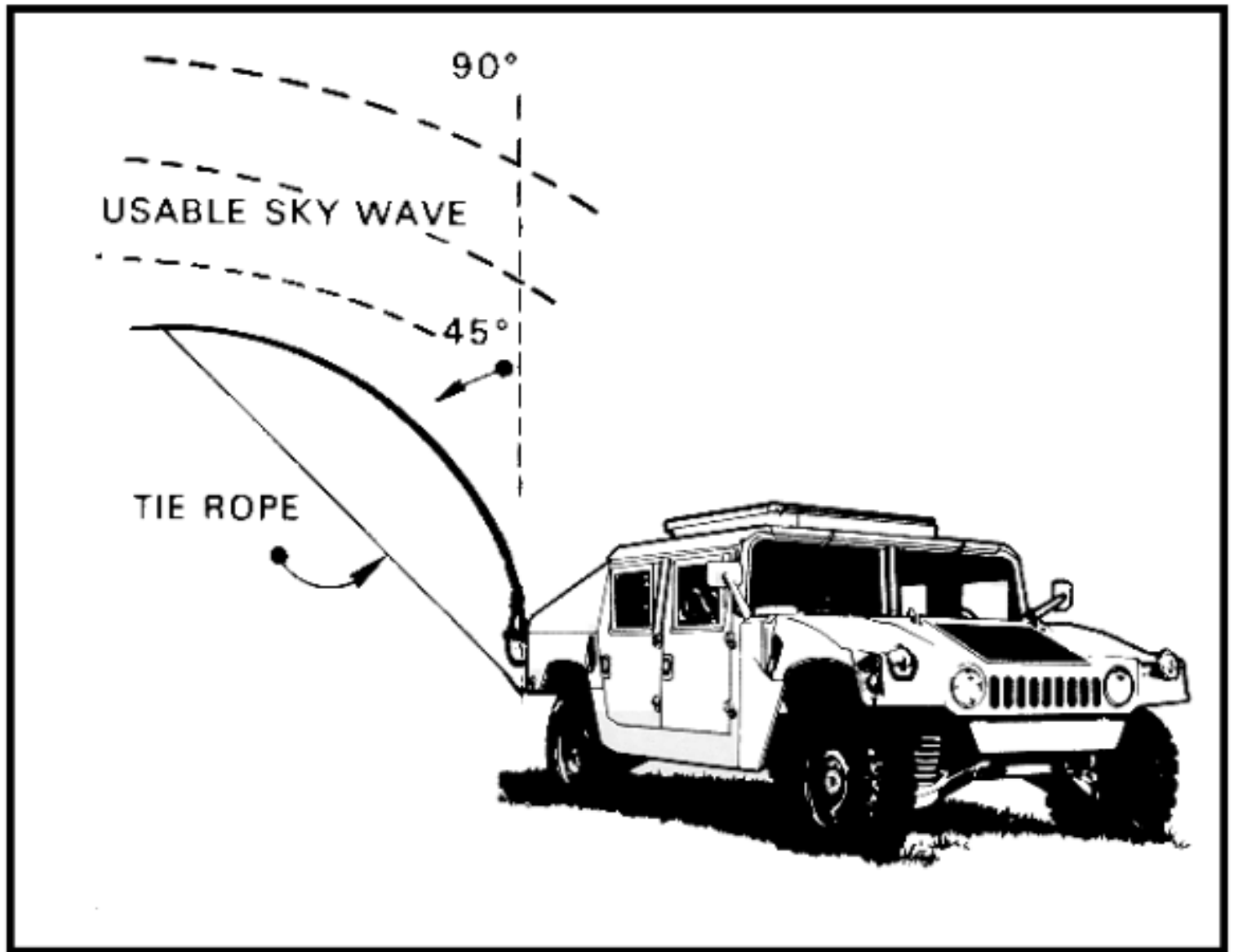

Figure M-9. Tying the whip antenna down.

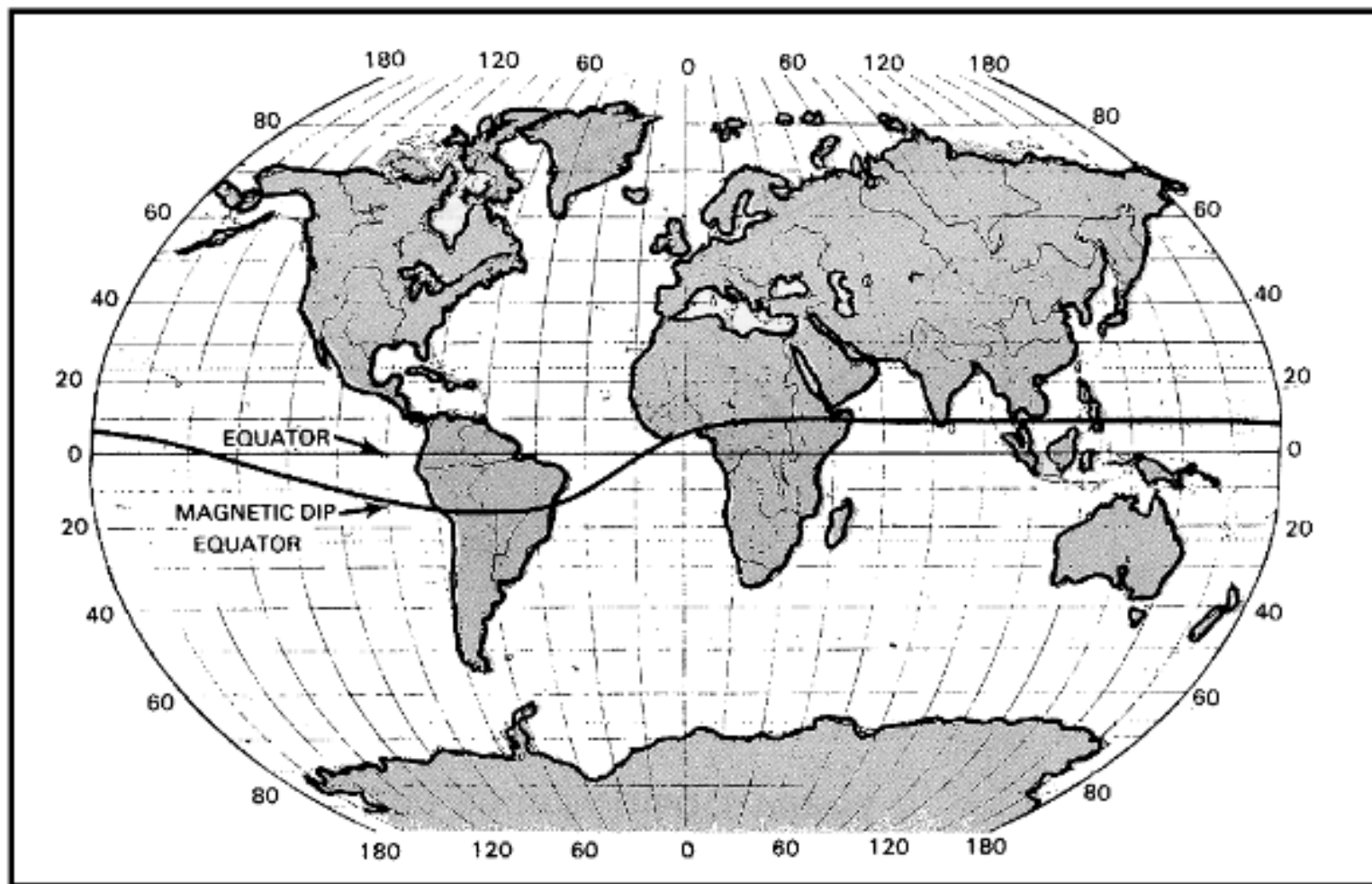

Figure M-10. Magnetic dip equator.

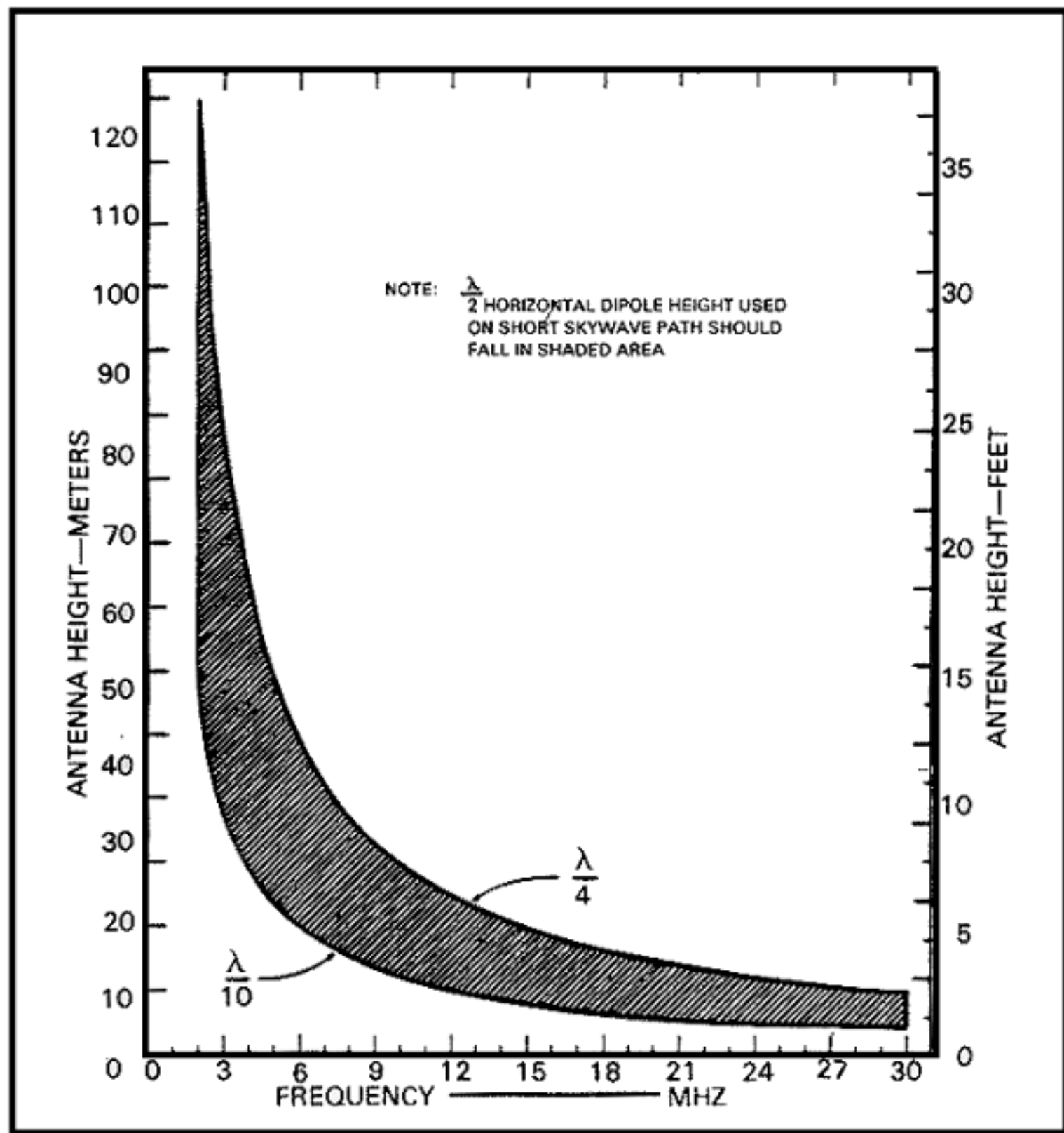

Figure M-11. Recommended dipole height for NVIS applications.

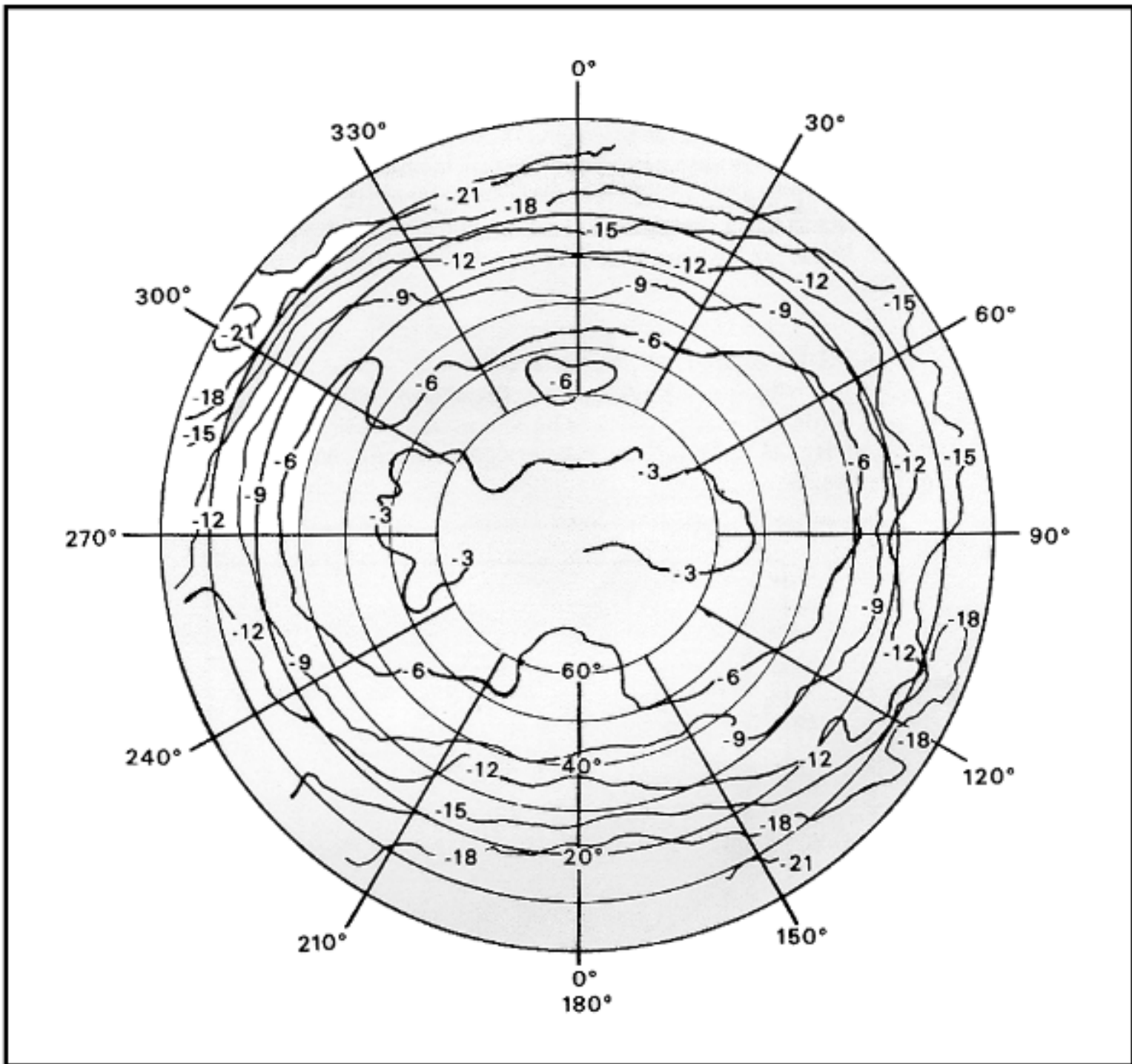

Figure M-12. Measured radiation pattern of the 8-MHz 23-foot high unbalanced dipole.

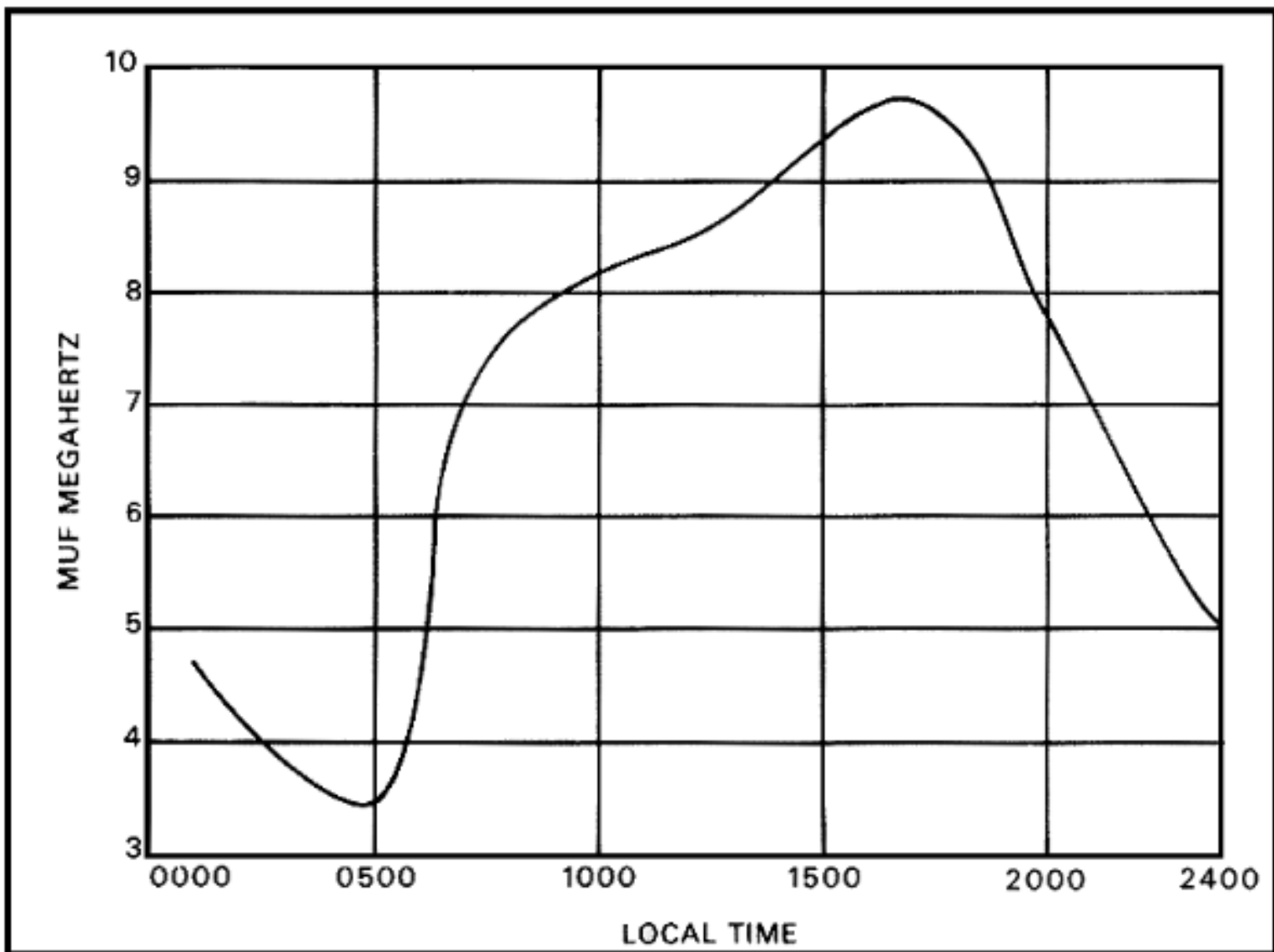

Figure M-13. Maximum usable frequencies in Vietnam.

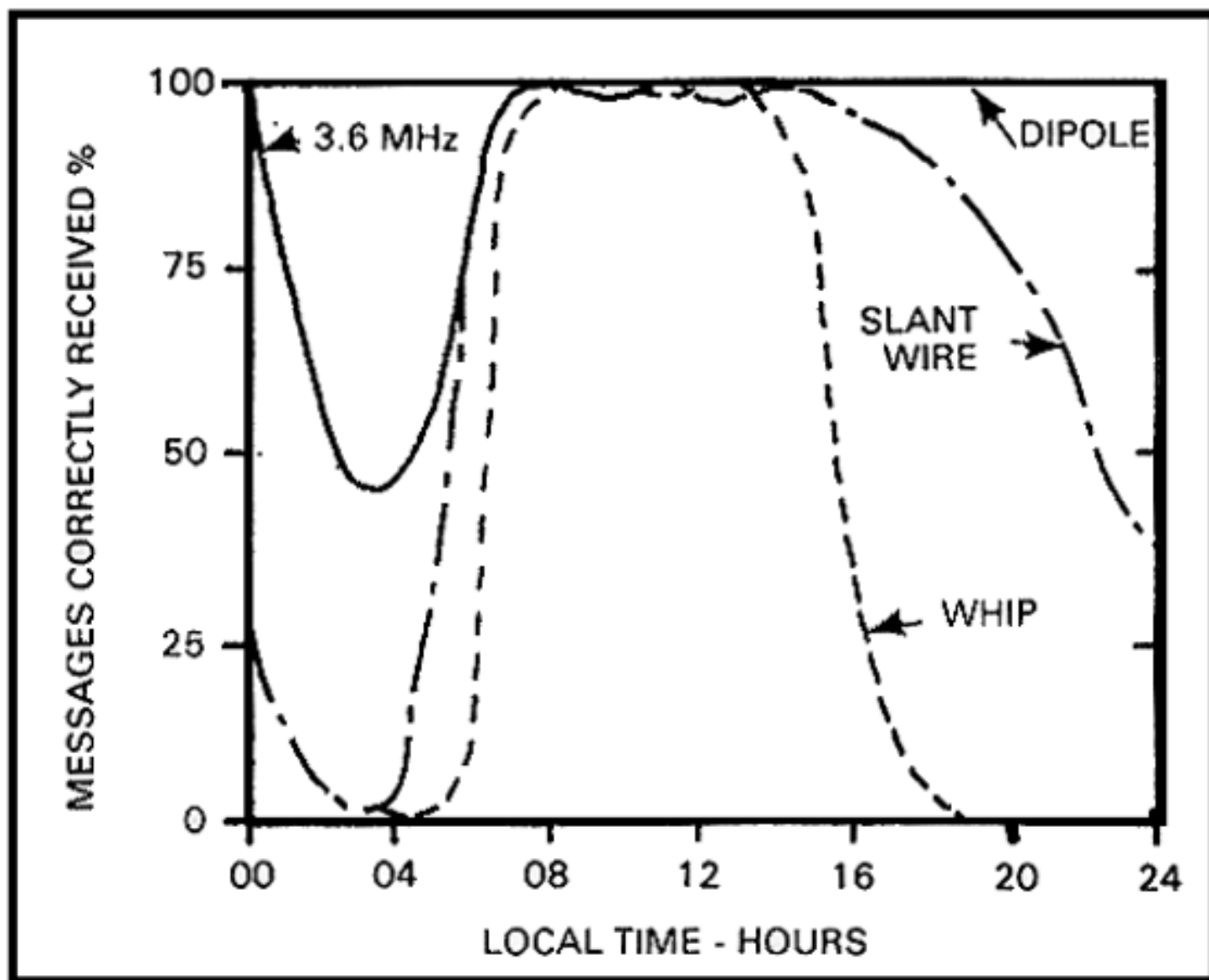

Figure M-14. Communications success with the AN/PRC-74 as a function of time of day and antenna type over a 12-mile path in low mountains, spring and summer 1963.

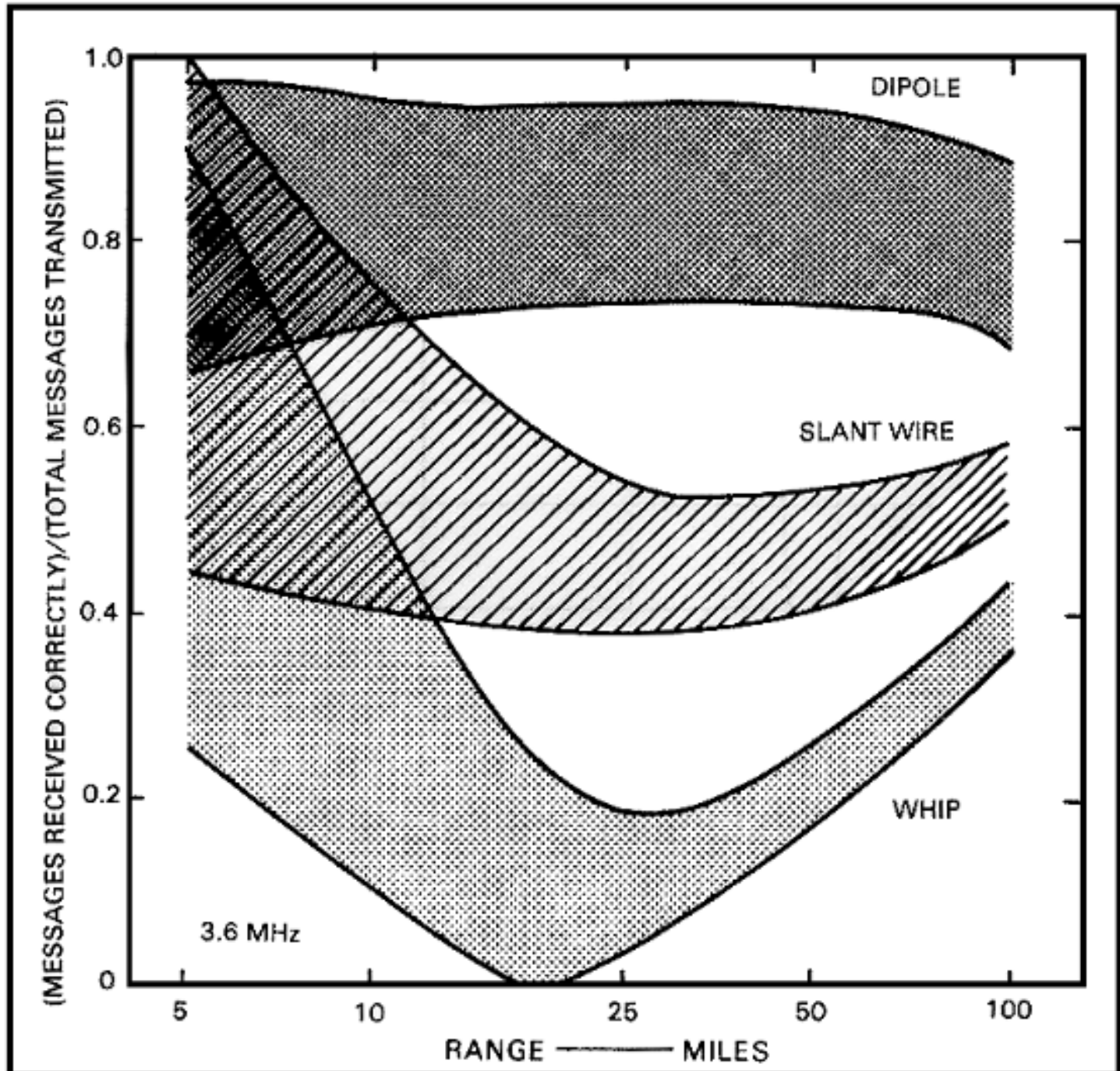

Figure M-15. Communications success as a function of range for the AN/PRC-74 in mountainous and varied terrain—including jungle in Thailand.

GLOSSARY

ABBREVIATIONS AND ACRONYMS

- AC** alternating current
- ADM** atomic demolition munitions
- AF** Audio frequency(ies)
- AH** ampere-hour
- ALTHQ** alternate headquarters
- AM** amplitude modulation(ed)
- ARTEP** Army Training and Evaluation Program
- ASC** area signal center
- ASCII** American Standard Code for Information Interchange
- ASI** additional skill identifier
- aux** auxiliary
- BCS** burst communications system
- BFO** beat frequency oscillator
- bn** battalion
- BPS** bits per second
- BPSK** biphase shift keying
- CB** common battery
- CEP** circular error probable
- co** company
- COMINT** communications intelligence
- COMSEC** communications security
- CP** command post

CRT cathode ray tube

CW continuous wave

dB decibel

dBm decibels above or below 1 milliwatt

DC direct current

DF direction finding

DISCOM division support command

DIVARTY division artillery

DMDG digital message device group

DOD Department of Defense

DS direct support

DSB double sideband

DTMF dual-tone, multifrequency

DX duplex

ECCM electronic counter-countermeasures

ECM electronic countermeasures

EEFI essential elements of friendly information

EHF extremely high frequency

ELF extremely low frequency

EMCON emission control

EMP electromagnetic pulse

ESM electronic warfare support measures

EW electronic warfare

F Fahrenheit

FDX full duplex

FID foreign internal defense

FLOT forward line of own troops

FM frequency modulation(ed)

FOB forward operational base

FSK frequency-shift keying

ft feet

GHz gigahertz

gnd ground

GS general support

HF high frequency

HOB height (depth) of burst

Hz hertz

IC integrated circuit

IED imitative electronic deception

IHFR improved high frequency radio

IMC international Morse code

JEWC Joint Electronic Warfare Center

kHz kilohertz

km kilometer

kW kilowatt

LB local battery

LED light emitting diode

LF low frequency

LOS line of sight

LPI/LPD lower probability of intercept/lower probability of detection

LRRP long-range reconnaissance patrol

LSB lower sideband

LUF lowest usable frequency

m meter

MAC maintenance allocation chart

MCW modulated continuous wave

MED manipulative electronic deception

MF medium frequency

MFP moisture and fungusproofing paint

MHz megahertz

MIJI meaconing, intrusion, jamming and interference

mi mile

MOPP mission oriented protection posture

MUF maximum usable frequency

MWO modification work order

NATO North Atlantic Treaty Organization

NBC nuclear, biological, chemical

NCS net control station

NESTOR a communications security device

NRI net radio interface (replaces RWI)

NSK narrow shift keying

NVIS near vertical incidence sky wave

OJT on-the-job training

OPORD operation order

OP Operator

OWR one-way reversible

PEP peak envelope power

PMCS preventive maintenance checks and services

PROSIGN procedure sign

PROWORD procedure word

PTT push-to-talk

RATT radio teletypewriter

rcvr receiver

RDF radio direction finding

REC radio electronic combat

RF radio frequency

RT Receiver/transmitter

RWI radio-wire integration (replaced by NRI)

SAT satellite

SED simulative-electronic deception

SF special forces

SFOB special forces operational base

SHF super high frequency

SID sudden ionospheric disturbance

SIGSEC signal security

SINGARS single-channel ground and airborne radio subsystem

SO special operations

SOI signal operation instructions

SOP standing operating procedures

spt support

SSB single sideband

STANAG Standardization Agreement

sub subscriber

swbd switchboard

SWR standing wave ratio

tel telephone

TM technical manual

TMDE test, measurement, and diagnostic equipment

TRANSEC transmission security

TTY teletypewriter

USAREUR United States Army, Europe

UHF ultra high frequency

USB upper sideband

UW unconventional warfare

VHF very high frequency

VLF very low frequency

VSWR voltage standing-wave ratio

WPM words per minute

xmtr transmitter

DEFINITIONS

Absorption. Removal of energy from a radiated field by objects which retain the energy or conduct it to ground. Loss by absorption reduces the strength of a radiated signal.

Addressee. The activity or individual to whom a message is to be delivered.

Agency of Signal Communication. A facility which has necessary personnel and equipment to provide signal communication.

Alternating Current (AC). Current that is continually changing in magnitude and periodically in direction from a zero reference level.

Amplification. The process of increasing the strength (current, voltage, or power) of a signal.

Amplifier. A device using an electron tube, transistor, magnetic unit, or other amplifying component that increases the strength of the input signal.

Amplitude. The level of an audio or other signal in voltage or current. The magnitude of variation in a changing quantity from its zero value.

Amplitude Modulation (AM). Modulation in which the amplitude of the carrier wave is varied above and below its normal value in accordance with the intelligence of the signal being transmitted.

Angle of Incidence. The acute angle (smaller angle) at which a wave of energy strikes an object or penetrates a layer of the atmosphere or ionosphere.

Antenna. A device used to radiate or receive electromagnetic energy (generally RF).

ANTIJAMMING. A device, method, or system used to reduce or eliminate the effects of jamming.

Audible. Capable of being heard.

Array (antenna). An arrangement of antenna elements, usually dipoles, used to control the direction in which most of the antenna's power is radiated.

Audio Frequency (AF). A frequency that can be heard as a sound by the human ear. The range is roughly from 15 to 20,000 Hz.

Authentication. A security measure designed to protect a communication system against fraudulent

Automatic Frequency Control (AFC). A circuit used to maintain the frequency of an oscillator within specified limits.

Automatic Gain Control (AGC). A control circuit that automatically maintains a constant output of some amplitude despite variations in strength of the input signal.

Axis of Communication. The line or route on which lie the starting position and probable future locations of the command post of a unit during a troop movement. The main route along which messages are relayed or sent to combat units in the field.

Auzimuth. An angle measured in a horizontal plane from a known reference point.

Band. A range of frequencies between two definite limits.

Bandwidth. The width of a band of frequencies used for a particular purpose.

Beat Frequency. The resultant frequency obtained when signals of two different frequencies are combined in a circuit.

Beat Frequency Oscillator (BFO). An oscillator which produces a signal which mixes with another signal to provide sum and difference frequencies. Generally used to provide an audible signal for reception of CW transmissions.

Calibrate. A process in which an instrument or device is compared with and adjusted to an accurate standard.

Carrier Frequency. The frequency used by a communication channel to transmit intelligence between two or more distant locations.

Carrier Wave. The RF component of a transmitted wave upon which an audio signal, code signal, or other form of intelligence can be impressed.

Channel. An assigned band of frequencies for a radio or television over which transmissions can be made from one station to another.

Circuit. An arrangement of one or more complete paths for current flow.

Coaxial Cable. A transmission line consisting of two conductors, one inside the other, and separated by insulating material. The inner conductor may be a small copper tube or wire; the outer conductor may be metallic tubing or braid. Radiation loss from this type of line is very little.

Command Post (CP). The headquarters of a unit or subunit where the commander and staff perform their functions.

Communications Center. A communications agency charged with the responsibility for receipt, transmission, and delivery of messages. It normally includes a message center, a cryptocenter, transmitting facilities, and receiving facilities.

Communication Security. The protection resulting from all measures designed to deny to unauthorized persons information of value which might be derived from a study of communications.

Conductor (electrical). A wire, cable, or other object capable of carrying electric current. Good conductors are made of metals such as silver, copper, and aluminum.

Continuous Waves (CW). Radio waves having a constant amplitude and a constant frequency. An unmodulated RF signal from a radio transmitter. When properly keyed on and off, CW is used to transmit messages by international Morse code (IMC).

Counterpoise. A conductor or system of conductors used as a substitute for ground in an antenna system.

Coupling. The association of two or more circuits that permit energy transfer from one to the other.

Critical Frequency. The highest frequency at which a given wave at any given time will, if transmitted vertically, be refracted to earth by a layer of the ionosphere.

Cross Modulation. A type of crosstalk in which the carrier frequency being received is interfered with by an adjacent carrier, so that the modulated signals of both are heard at the same time.

Cryptocenter. An establishment maintained for the encrypting and decrypting of messages.

Crystal. A natural substance, such as quartz or tourmaline, that is used to control the frequency of radio transmitters.

Date-Time Group (DTG). The date and time, expressed in digits and zone suffix, when a message is prepared for transmission. The DTG is expressed as six digits followed by a zone suffix--the first pair of digits denotes the date, the second pair the hours, and the third pair the minutes.

Decibel (dB). The standard unit used to express transmission gain or loss and relative power levels. Also a unit used to measure and compare signal levels on a logarithmic scale.

Decibels Above or Below 1 Milliwatt (dBm). The unit used to describe the ratio of the power at any point in a transmission system to a reference level of 1 milliwatt.

Deflection. The displacement of an electron beam from its straight-line path.

Detection. The process of recovering the audio component (audible signal) from a modulated RF carrier wave.

Dielectric. An insulator. A term applied to the insulating material between the plates of a capacitor.

Dipole Antenna. An antenna having an electrical length equal to a half wavelength at the frequency for which it is designated. It may be a single conductor (rarely); but it generally consists of two elements, whose total length is one-half wavelength, separated by an insulator or an air space at the point of connection to the transmission line from the transmitter.

Direct Current (DC). An electrical current that flows in one direction.

Directional Antenna. An antenna designed to transmit and receive RF energy in a specific direction(s).

Discriminator. A circuit that has an output voltage which varies in amplitude and polarity in accordance with the frequency of the applied signal. It is used primarily as a detector in an FM receiver.

Distortion. The amount by which the output waveform differs from the input waveform. Distortion may exist in amplitude, frequency, or phase.

Diversity System. A system of radio communications in which a single received signal is derived from a combination of, or selected from, a plurality of transmission channels or paths. The system employed may include space diversity, polarization diversity, or frequency diversity. The diversity principle takes advantage of the fact that fading characteristics of a given signal generally vary widely, at any given instant, at different receiving antenna locations and with different frequencies.

Doppler Effect. The change in frequency due to a relative motion difference between source and observer.

Double Sideband Transmission. That method of communications in which the frequencies produced by the process of modulation are symmetrically spaced, both above and below the carrier frequency, and are all transmitted.

Dummy Antenna. An impedance device used in place of a regular antenna to prevent unwanted radiation or reception during testing or adjustment.

Dummy Load. A dissipative nonradiating device.

Duplex Operation. Duplex (or full duplex) operation refers to communications between two points, in both directions simultaneously.

Electromagnetic Field. The field of force that an electrical current produces around the conductor through which it flows.

Electromagnetic Wave. A wave propagating as a periodic disturbance of the electromagnetic field and having a frequency in the electromagnetic spectrum.

Facsimile. A system of radio or wire communications by which still pictures, illustrations, maps, or printed pages are transmitted and received. Type-A facsimile is a system in which images are built up of lines or dots of constant intensity. Type-B facsimile is a system in which images are built up of lines or dots of varying intensity.

Feedback. Returning a portion of the output of a circuit to its input. Negative (out-of-phase) feedback reduces gain and distortion. Positive (in-phase) feedback increases gain and can produce oscillation, both acoustical and electrical.

Fading. Variations in the strength of a radio signal at the point of reception.

Frequency. The number of complete cycles repeated in a given period, usually per second.

Frequency Band. A continuous range of frequencies extending between two limiting frequencies.

Frequency Distortion. Distortion caused by the unequal attenuation or gain of the frequencies present in a waveform.

Frequency Drift. The gradual change in frequency of an oscillator or transmitter.

Frequency, Lowest Useful High (LUF). The lowest high frequency effective at a specified time for ionospheric propagation of radio waves between two specified points.

Frequency, Maximum Usable (MUF). The upper limit of the frequencies that can be used at a specified time for radio transmission between two points and involving propagation by reflection from the regular ionized layers of the ionosphere.

Frequency Meter. A device that is calibrated to indicate the frequency of the radio wave to which it is tuned.

Frequency Modulation (FM). The process of varying the frequency of a carrier wave, usually with an audio frequency, in order to convey intelligence.

Frequency Spectrum Designation. VLF (very low frequency): below 30 kHz (0.03 MHz). LF (low frequency): 30 - 300 kHz (0.03 - 0.3 MHz). MF (medium frequency): 300 - 3000 kHz (0.3 - 3 MHz). HF (high frequency): 3 - 30 MHz. VHF (very high frequency): 30 - 300 MHz. UHF (ultra high frequency): 300 - 3000 MHz. SHF (super high frequency): 3000 - 30,000 MHz (3 - 30 GHz). EHF (extremely high frequency): 30 - 300 GHz.

Full-Duplex Operation. Telegraph or signaling circuits arranged for transmission in both directions at the same time.

Fundamental Frequency. The lowest frequency of a complex wave.

Gain. The increase in signal strength that is produced by an amplifier.

Ground. A metallic connection with the earth to establish ground (or earth) potential.

Ground Wave. A radio wave that travels along the Earth's surface rather than through the upper atmosphere.

Half-Wave Antenna. An antenna whose electrical length is half the wavelength of the transmitted or received frequency.

Harmonic. A whole-number multiple of a fundamental frequency.

Hertz (Hz). The standard term used to state frequency. One hertz is the same as one cycle per second.

Hertz Antenna. A half-wave antenna which does not depend upon earth ground or ground plane to operate properly.

Heterodyne. To beat or mix two signals of different frequencies to produce two additional frequencies which are the sum and the difference of the two original signals.

Histogram. A graphical representation of a frequency distribution by a series of rectangles having for one dimension a distance proportional to a definite range of frequencies, and for the other dimension a distance proportional to the number of frequencies appearing within the range.

Horizontal Polarization. Transmission of radio waves in such a way that the electric lines of force are horizontal, parallel to the Earth's surface.

Image Frequency. An unwanted signal combining or beating with the local oscillator signal to form the intermediate frequency (IF). It is twice the frequency of the IF away from the desired signal on the opposite side of the local oscillator signal.

Impedance. The total opposition offered by a circuit or component to the flow of alternating current.

Impulse. Any force acting over a comparatively short period of time.

Indirect Wave. A wave received after being reflected from the layers of the ionosphere or from another reflective surface.

Induction. Process of inducing a current into a conductor by moving the conductor or the magnetic field.

Inductor - Coil. A device for introducing inductance into a circuit.

In Phase. The condition existing when two or more signals of the same frequency pass through their maximum and minimum values of like polarity at the same instant.

Insulator. A device or material that has a high electrical resistance.

Intensity. The strength of value of a current. The symbol I, for current, comes from this word.

Interference. Any undesired signal that tends to interfere with the desired signal.

Intermediate Frequency (IF). The fixed frequency to which the principal amplifier of a superheterodyne receiver is tuned. The intermediate frequency is produced by beating the received RF against the output of a variable frequency oscillator to produce a constant beat frequency. In some receivers, the IF is tunable over a limited range.

Ion. An atom that has more or less electrons than normal.

Ionosphere. Highly ionized layers of atmosphere existing between the altitudes of approximately 48 to 402 kilometers (30 to 250 miles).

Jamming. Deliberate interference intended to prevent reception of signals in a specific frequency band.

Keying. The breaking or interrupting of a radio carrier wave (either manually or automatically).

Kilometer (km). One thousand meters, which is approximately equal to 3,280 feet. To convert kilometers to miles, multiply kilometers by 0.6214. To convert miles to kilometers, multiply miles by 1.6093.

Limiter. A circuit that limits the output amplitude to some predetermined value.

Load. A device that consumes electrical power.

Local Oscillator. An oscillator that is part of the receiver and is used to generate an RF output which is combined with the incoming RF signal to produce an intermediate frequency.

Loop Antenna. An antenna consisting of one or more complete turns (loops) of wire. It is designed for directional transmission or reception.

Marconi Antenna. An antenna system in which the ground is an essential part.

Means of Signal Communication. A medium by which a message is conveyed from one person or place to another.

Message. Any thought or idea expressed in brief form or in plain or secret language and prepared in a form suitable for transmission by any means of communication.

Micro. A prefix representing one-millionth (abbreviated u).

Milli. A prefix representing one-thousandth (abbreviated m).

Modem. Acronym for MOdulator-DEModulator. Modems are primarily used for converting digital signals into analog signals for transmission and reception and for reconvertng the analog signals into digital signals for processing.

Modulate. To mix two or more signals to produce another signal; to vary or change the amplitude, frequency, or phase of the signals to be modulated.

Network. A system consisting of a number of designated stations connected with one another by any means of communication.

Null. The absence of a signal, information, indication, or deflection.

Ohm. The basic unit of electrical resistance.

Originator. The command by whose authority a message is sent. The responsibility of the originator includes the responsibility for the functions of the drafter and releasing officer.

Out of Phase. Two alternating quantities are out of phase when they do not pass through corresponding values at the same time. For example, if the current in a circuit reaches its maximum value before or after the applied voltage does, the current is out of phase with the voltage.

Phase. The difference in time or electrical degrees measured from the beginning of a cycle to any point on the same cycle. A full cycle is considered as having 360 electrical degrees.

Power. The rate of doing work or the rate of expending energy. Unit of electrical measurement is the watt.

Propagation. The travel of electromagnetic waves through space or along a transmission line.

Quarter-Wave Antenna. An antenna with an electrical length that is equal to one-quarter wavelength of the signal being transmitted or received.

Radiate. To transmit RF energy.

Radio Channel. A band of adjacent frequencies having sufficient width to permit its use for radio communication.

Radio Frequency (RF). Any frequency of electrical energy capable of propagation into space. Usually above 20 kHz.

Radio Wave. Electromagnetic waves at a frequency lower than 3000 GHz and propagated through space without an artificial guide.

Rear Echelon. That part of a headquarters which is principally concerned with administrative and logistical matters.

Reflection. The turning back of a radio wave from an object or the surface of the Earth.

Refraction. The bending, or change in direction, of a radio wave passing into a layer of atmosphere or the ionosphere.

Relay. A transmission forwarded through an intermediate station.

Rig. A term (jargon) used by communicators to designate their communications or other equipment. Example: "What rig are you using for NRI?"

Saturation. The condition of a circuit when an increase of the input causes no further increase in the output.

Selectivity. The characteristic that determines the ability of a radio receiver to discriminate between signals of different carrier frequencies.

Sensitivity. The degree, or amount of response, that a circuit has to signals to which it is tuned (related to signal strength).

Sideband. A band of frequencies created by the modulation process located on each side of the carrier frequency.

Sideband Power. The power contained in the sidebands. It is this power to which a receiver responds (not to the carrier power) when receiving a modulated wave.

Single Sideband. A system of radio communications in which the carrier and either the upper or lower sideband is removed from AM transmission to reduce the channel width and improve the signal-to-noise ratio.

Skip Distance. The distances on the Earth's surface between the points where a radio sky wave leaves the antenna and is successfully reflected and/or refracted back to Earth from the ionosphere.

Skip Zone. The space or region within the transmission range where signals from a transmitter are not received. It is between the end of the ground wave and the point where the refracted wave returns.

Standing-Wave Ratio (SWR). The ratio of the maximum to minimum amplitudes of voltage, or current, along a waveguide or transmission line.

Static. Sharp, short bursts of noise on a radio receiver caused by electrical disturbances in the atmosphere or by electrical machinery.

Tone Modulation. A type of transmission obtained by causing the RF carrier amplitude to vary at a fixed AF rate. When the type of transmission is keyed, it becomes modulated continuous wave (MCW).

Transceiver. A combined radio transmitter and receiver made as a single unit, generally used for portable or mobile applications. Some or all of the stages and components are used for both transmitting and receiving. Switches are used to change from transmit to receive or from receive to transmit.

Transmission Line. Any conductor or system of conductors used to carry electrical energy from its source to its load.

Transmitter. A radio transmitter is a piece of equipment that generates and amplifies a radio frequency

signal, adds intelligence to this signal, and then sends it out into the air as a radio frequency wave.

Tuning. The process of adjusting a radio circuit so that it resonates at the desired frequency.

Unidirectional. In one direction only.

Vernier. Any device used to make a fine adjustment.

Voltage. A term used to designate electrical pressure that exists between two points.

Voltage Standing-Wave Ratio (VSWR). The ratio of the amplitude of the electric field or voltage at a voltage maximum to that at an adjacent voltage minimum.

Wavelength. The distance a wave travels during one complete cycle. It is equal to the velocity divided by the frequency.

Wave Propagation. The transmission of RF energy through space.

Zero Beat. The point of complete silence reached when two frequencies being mixed are exactly the same.

REFERENCES

Required Publications

Required publications are sources which must be read in order to understand or to comply with this publication.

Allied Communications Publications (ACP)

- ACP 124() Communication Instructions--Radiotelegraph
 Procedure
- ACP 124 (C) US Supplement to ACP 124() (U)
- ACP 125() Communication Instructions--Radiotelephone
 Procedure
- ACP 126() *Communication Instructions--Teletypewriter
 (Teleprinter) Procedure (U)
- ACP 131() Communication Instructions--Operating Signals

Army Regulations (AR)

- AR 310-50 Authorized Abbreviations, Brevity Codes, and Acronyms

Field Manuals (FM)

- FM 24-35 (O) Communications-Electronics Operation Instructions
 (The CEOI)

FORMS

DA Forms

- DA Form 4158 Operator's Number Sheet

Related Publications

Related publications are sources of additional information. These are not required in order to understand this publication.

Army Regulations (AR)

- AR 70-38 Research, Development, Test, and Evaluation of Materiel for Extreme Climatic Conditions
- AR 105-3 Reporting Meaconing, Intrusion, Jamming and Interference of Electromagnetic Systems
- AR 105-31 Record Communications

*** Allied Restricted**

- AR 105-64 US Army Communications Electronics Operation Instructions (CEOI) Program
- AR 380-5 Department of the Army Information Security Program
- AR 750-1 Army Materiel Maintenance Concepts and Policies

Department of the Army Pamphlets (DA PAM)

- DA PAM 310-1 Consolidated Index of Army Publications and Blank Forms
- DA PAM 738-750 The Army Maintenance Management System (TAMMS)

DOD Regulations and Manuals (DOD)

- DOD 5040.2-C-1 Catalog of Audiovisual Productions--Army
- DOD 5040.2-C-2 Catalog of Audiovisual Productions--Navy and Marine Corps

- DOD 5040.2-C-3 Catalog of Audiovisual Productions--Air Force and Miscellaneous DOD Productions
- DOD 5040.2-C-4 Catalog of Audiovisual Productions--DOD Productions Cleared for Public Release

Field Manuals (FM)

- [FM 3-3](#) NBC Contamination Avoidance
- [FM 3-9](#) Military Chemistry and Chemical Compounds
- FM 11-60 Communications-Electronic Fundamentals: Basic Principles, Direct Current
- FM 11-61 Communications-Electronics Fundamentals: Basic Principles, Alternating Current
- FM 11-65 High Frequency Radio Communications
- FM 11-486-6 Telecommunications Engineering: Base Wire Transmission Engineering
- [FM 21-11](#) First Aid for Soldiers
- FM 24-16 Communications-Electronics: Operations, Orders, Records and Reports
- [FM 24-17](#) Tactical Communications Center Operations
- FM 24-20 Tactical Wire and Field Cable Techniques
- [FM 24-33](#) Communications Techniques: Electronic Counter-Countermeasures
- FM 25-2 Unit Training Management
- FM 25-3 Training in Units

[FM 101-5-1](#) Operational Terms and Symbols

Supply Bulletins (SB)

SB 11-6 FSC Supply Class 6135: Primary Battery Supply Data

SB 11-30 FSC Supply Class 6135: Primary Battery Management Data

Technical Manuals (TM)

TM 11-459 International Morse Code (Instructions)

TM 11-665 CW and AM Radio Transmitters and Receivers

TM 11-666 Antennas and Radio Propagation

TM 11-668 FM Transmitters and Receivers

TM 11-2651 Antenna Groups AN/GRA-4 and AN/GRA-12

TM 11-5038 Control Group, AN/GRA-6

TM 11-5815-200-12 Operator's and Organizational Maintenance Manual: Teletypewriter Sets AN/FGC-20, AN/FGC-20X, AN/FGC-21, AN/FGC-66, AN/FGC-159, AN/FGC159X, AN/FGC-160, AN/FGC-177, AN/UGC-4, AN/UGC-29, AN/UGC-29X and Teleprinter TT-259/FG

TM 11-5815-238-10 Operator's Manual for Teletypewriter Sets AN/GGC-3, AN/GGC-3A, AN/GGC-53, AN/GGC-53A and Teletypewriter Reperforator-Transmitters TT-76/GGC, TT-76A/GGC, TT-76B/GGC, TT-76C/GGC, TT-699/GGC, TT-699A/GGC, TT-699B/GGC and TT-699C/GGC

TM 11-5815-238-20 Organizational Maintenance for Teletypewriter Sets, AN/GGC-3, AN/GGC-3A, AN/GGC-53, AN/GGS-53A, and Teletypewriter Reperforator-Transmitters, TT-76/GGC, TT-76A/GGC, TT-76B/GGC, TT-76C/GGC,

TT-699/GGC, TT-699A/GGC, TT-699B/GGC, and
TT-699C/GGC

- TM 11-5815-334-10 Operator's Maintenance Manual for Teletypewriter Sets AN/GRC-122, -122A, -122B, -122C, -122D, -122E, AN/GRC-142, -142A, -142B, -142C, -142D and AN/GRC-142E

- TM 11-5820-256-10 Operator's Manual: Radio Set, AN/GRC-26D

- TM 11-5820-348-15 Organizational, Direct Support, General Support, and Depot Maintenance Manual: Antenna Equipment, RC-292

- TM 11-5820-401-10-1 Operator's Manual for Radio Sets AN/VRC-12, AN/VRC-43, AN/VRC-45, AN/VRC-46, AN/VRC-47, AN/VRC-48, and AN/VRC-49 (Used without an Intercom Set)

- TM 11-5820-401-10-2 Operator's Manual: Radio Sets AN/VRC-12, AN/VRC-43, AN/VRC-44, AN/VRC-45, AN/VRC-46, AN/VRC-47, AN/VRC-48, and AN/VRC-49 (Used with an Intercom Set)

- TM 11-5820-467-15 Operator's, Organizational, Direct Support, General Support, and Depot Maintenance Manual: Antenna Group, AN/GRA-50

- TM 11-5820-477-12 Operator's and Organizational Maintenance Manual: Radio Set Control Groups AN/GRA-39, AN/GRA-39A and AN/GRA-39B

- TM 11-5820-489-10 Operator's Manual for Control Group, AN/GRA-6

- TM 11-5820-498-12 Operator's and Organizational Maintenance Manual: Radio Sets AN/VRC-53, AN/VRC-64, AN/GRC-125 and AN/GRC-160 and Amplifier-Power Supply Groups OA-3633/GRC and OA-3633A/GRC

- TM 11-5985-263-15 Operator, Organizational, Direct Support, General Support, and Depot Maintenance Manual for Mast, AB-903/G

- TM 38-750-1 The Army Maintenance Management System (TAMMS)

Miscellaneous Films and Tapes

MF 11-5670 TACSATCOM: Tactical Satellite Communications

TVT 11-109 Radio Interference - Causes and Sounds

TVT 11-110 Radio Interference: Remedial Action and Reporting

TVT 11-125 Installation of Antenna Group OE-254/GRC

Training Films

MF 11-1831 Tuned Circuits

MF 11-2091 Tuning Transmitters, Part II: Amplifier and Antenna
Tuning

MF 11-2487 Radio Interference--Part I

MF 11-2488 Radio Interference--Part II

MF 11-2851 Fundamentals of Radio Troubleshooting, Part I: Principal
Technique

MF 11-2852 Fundamentals of Radio Troubleshooting, Part II:
Troubleshooting A Radio Receiver

MF 11-2853 Fundamentals of Radio Troubleshooting, Part III:
Troubleshooting a Radio Transmitter

MF 11-3305 Radio Set AN/VRC-12

MF 11-3314 Radio Teletypewriter AN/GRC-46

MF 11-3401 Radio Set Control Group AN/GRA-39

MF 11-3480 AN/PRC-25, Operation and Operator Maintenance

- MF 11-3493 (C) Cipher Machine TSEC/KY-8, Part I: Introduction (U)
- MF 11-3494 (C) Cipher Machine TSEC/KY-8, Part II: Installation and Operation (U)
- MF 11-3697 International Morse Code, Hand Sending
- MF 11-4359 Single Side Band Radio Communications, Part I: Principles
- MF 11-4362 Single Side Band Radio Communications, Part II: Techniques
- MF 11-4394 Tactical AM SSB Radio Sets
- MF 11-4396 Orientation to C-E Equipments--Part V--Tactical Typewriter Sets
- MF 11-4400 SATCOM Terminal Sets
- MF 11-4531 High Frequency Wave Propagation
- MF 11-4533 Introduction to the Radio Set AN/GRC-106 and AN/GRC-106A
- MF 11-4534 Tuning the Radio Set AN/GRC-106A
- MF 11-4573 Radiotelephone Procedures
- TVT 11-6297 (C) Introduction to Vinson (U)
- TVT 11-6298 (C) Introduction to Vinson, KY-57 Operator Training (U)
- TVT 11-6299 (C) Introduction to Vinson, KY-58 Operator Training (U)
- TVT 11-6300 (C) Net Controller Training, Part I (U)
- TVT 11-6301 (C) Net Controller Training, Part II (U)

DA Forms

Command

Command publications cannot be obtained through Armywide resupply channels. Determine availability by contacting the address shown. Field circulars expire three years from the date of publication, unless sooner rescinded.

Field Circulars (FC)

- FC 11-16 International Morse Code (Instructions). March 1987.
 Commander, US Army Signal Center and Fort Gordon,
 ATTN: ATZH-DTT-D, Fort Gordon, Georgia 30905-5070

- FC 29-2-J Unit Maintenance Operations. December 1985.
 Commander, US Army Ordnance Center and School,
 ATTN: ATSL-TD-DLD, Aberdeen Proving Ground,
 Maryland 21005-5201
 (FC 29-2-J will be rescinded when FM 43-5 is published.)

- FC 50-16 Electromagnetic Pulse Mitigation Techniques. October
 1984. Commander, USACACDA, Nuclear and Chemical
 Directorate, ATTN: ATZL-CAP-DT, Fort Leavenworth,
 Kansas 66027-5300

- FC 50-17 A Technical Overview of Electromagnetic Pulse. June
 1986. Commander, USACACDA, Nuclear and Chemical
 Directorate, ATTN: ATZL-CAP-DT, Fort Leavenworth,
 Kansas 66027-5300

Projected Publications

Projected publications are sources of additional information that are scheduled for printing but are not yet available. Upon print, they will be distributed automatically via pinpoint distribution. They may not be obtained from the USA AG Publications Center until indexed in DA

Field Manuals (FM)

FM 43-5 Unit Maintenance Operations

Training Circulars (TC)

TC 11-74 Fundamentals of FACSIMILE

AUTHORIZATION LETTER

FM 24-18
30 SEPTEMBER 1987

By Order of the Secretary of the Army:

CARL E. VUONO
General, United States Army
Chief of Staff

Official:

R. L. DILWORTH
Brigadier General, United States Army
The Adjutant General

DISTRIBUTION:

Active Army, USAR, and ARNG: To be distributed in accordance with DA Form 12-11A, Requirements for Tactical Single-Channel Radio Communications Techniques (Qty rqr block no. 215).

U.S. GOVERNMENT PRINTING OFFICE : 1994 O - 300-421 (00149)

PIN: 023722-000

Table M-1. Summary of relative gain toward the zenith for field-expedient high frequency antennas (in dB)

ANTENNA	CLEARING	75-FT FOREST	50-FT FOREST
$\lambda/2$ Unbalanced Single-Wire Dipole	+1.0	-2.8	-1.2, -1.7
$\lambda/2$ Balanced Single-Wire Dipole	+0.5	-3.7	No data
$\lambda/2$ Folded Dipole (300:50 ft balun)	+0.2	-1.0	No data
$\lambda/4$ Short (Loaded to $\lambda/2$) Dipole	-3.0	-5.2	No data
$\lambda/2$ Sleeve Dipole (on ground)	-32.1	-28.3	No data
3-Freq. Fan Dipole @ 15 ft	-0.4	-5.1	No data
3-Freq. Fan Dipole @ 12 ft	-2.4	-5.0	No data
3-Freq. Fan Dipole @ 9 ft	-4.0	-8.1	No data
Shirley Folded Dipole	-3.0	-0.3	No data
3 $\lambda/4$ Inverted L (1:h — 2:1)	-0.0	-2.8	No data
3 $\lambda/4$ Inverted L (1:h — 3:1)	-0.8	-3.3	No data
3 $\lambda/4$ Inverted L (1:h — 4:1)	-1.0	-5.8	No data
3 $\lambda/4$ Inverted L (1:h — 5:1)	-2.0	-0.3	-10.7, -12.5
30° Slant Wire ($\lambda/4$ elevated)	-10.1	-14.8	-13.5, -14.2
60° Slant Wire ($\lambda/4$ elevated)	-11.8	-14.8	No Data
10-ft Square (Vertical Plane) Loop @ 6 ft	-21.1	-25.3	No data
16.5-ft Whip	-41.5	-44.0	-25.0, -25.2