

WWW.SURVIVALEBOOKS.COM

YOUR LAST LINE IN DEFENSE AND SURVIVAL

CHECK OUT OUR WEBSITE SOME TIME FOR PLENTY OF ARTICES ABOUT SELF DEFENSE,
SURVIVAL, FIREARMS AND MILITARY MANUALS.

<http://www.survivalebooks.com/>

Thank you for purchasing our ebook package.

SUBCOURSE
IS 0902

EDITION
A

US ARMY ORDNANCE CENTER AND SCHOOL

INTRODUCTION TO
WHEELED VEHICLES

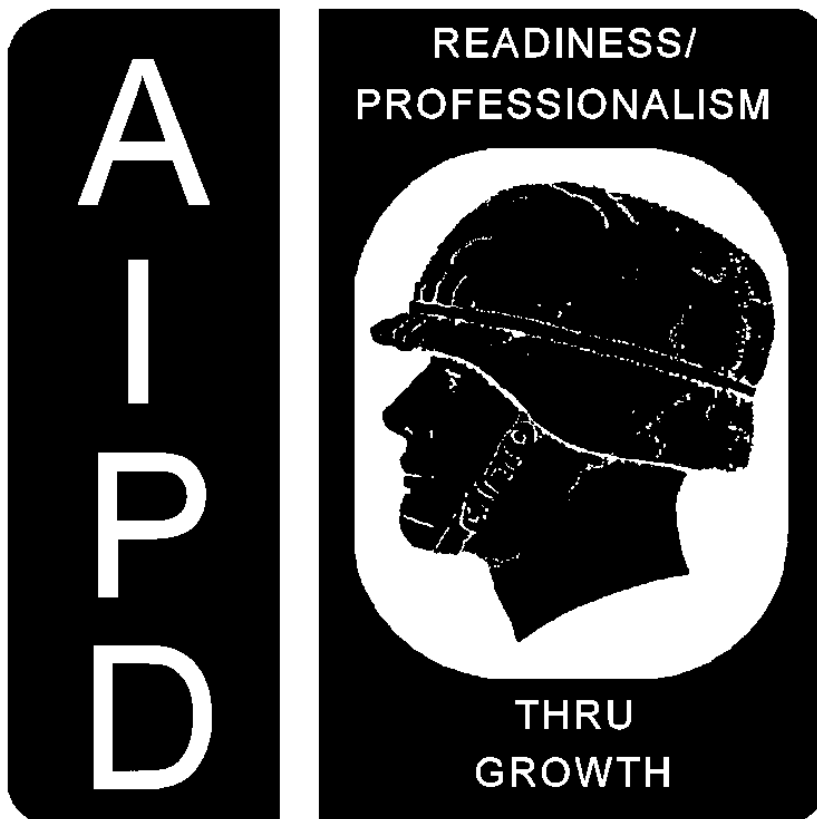

THE ARMY INSTITUTE FOR PROFESSIONAL DEVELOPMENT
ARMY CORRESPONDENCE COURSE PROGRAM

The student services counselors at the Army Institute for Professional Development (IPD) and the subcourse authors at the individual schools are interested in providing timely responses to inquiries.

Use the following At-A-Glance lists to identify your inquiry type. Once you've done this, follow the directions below and write or phone.

ADMINISTRATIVE INQUIRY:

REQUESTS FOR ---

- **Disenrollment**
- **Subcourse Reissue**
- **Enrollment Extension**

CHANGE IN ---

- **Address**
- **Unit**
- **Rank or Grade**

PROBLEMS WITH ---

- **Exam Response Sheet**
- **Enrollment**
- **Incorrect SSN**
- **Incorrect RYE Date**

SUBCOURSE CONTENT INQUIRY:

LESSON OR EXAM IN ERROR WITH ---

- **Field Manual Procedure**
- **Doctrine**
- **Technical Manual Procedure**
- **Equipment Specification**

INCORRECT REFERENCE OR EXTRACT

- **Regulation**
- **Pamphlet**
- **Field Manual**
- **Technical Manual**
- **Policy**

CONFUSING INFORMATION

- **Example**
- **Organization**
- **Wording**
- **Situation**
- **Illustration**
- **Chart**
- **Figure**
- **Table**

DIFFICULTY LEVEL

- **Too High**
- **Too Low**

DIRECTIONS

WRITE:

Use the **Student Administrative Inquiry Form** at the back of this subcourse.

PHONE:

See inside back cover of this subcourse.

DIRECTIONS

WRITE:

Use the **Student Subcourse Content Inquiry Form** at the back of this subcourse if you have inquiries about subcourse content.

PHONE:

DSN: 539-1157

COML: (804) 734-1157

PREFACE

The Army Institute for Professional Development (AIPD) administers the consolidated Army Correspondence Course Program (ACCP), which provides high-quality, economical training to its users. The AIPD is accredited by the Accrediting Commission of the Distance Education and Training Council (DETC), the nationally recognized accrediting agency for correspondence institutions.

Accreditation is a process that gives public recognition to educational institutions which meet published standards of quality. The DETC has developed a thorough and careful evaluation system to assure that institutions meet standards of academic and administrative excellence before it awards accreditation.

The many TRADOC service schools and DOD agencies that produce the ACCP materials administered by the AIPD develop them to the DETC standards.

The AIPD is also a charter member of the Interservice Correspondence Exchange (ICE). The ICE brings together representatives from the Army, Navy, Air Force, Marine Corps, and Coast Guard to meet and share ideas on improving distance education.



TABLE OF CONTENTS

Section	Page
TITLE PAGE.....	i
TABLE OF CONTENTS.....	ii
ADMINISTRATIVE INSTRUCTIONS.....	iii
GRADING AND CERTIFICATION INSTRUCTIONS.....	iii
INTRODUCTION TO WHEELED VEHICLES.....	iv
Lesson 1: IDENTIFY COMMON AUTOMOTIVE TERMS AND CLASSIFICATIONS OF WHEELED VEHICLES	
Learning Event 1: Identify Common Automotive Terms.....	1
Learning Event 2: Describe Classifications of Military Vehicles.....	6
Practice Exercise.....	9
Answers to Practice Exercise.....	10
Lesson 2: DESCRIBE TYPES, PURPOSE, AND CHARACTERISTICS OF WHEELED VEHICLES	
.....Learning Event: Describe Types, Purpose, and Characteristics of Common Military Wheeled Vehicles.....	11
Practice Exercise.....	50
Answers to Practice Exercise.....	51
EXAMINATION.....	52

INTRODUCTION TO WHEELED VEHICLES

United States Army Combines Arms Support Command

Ordnance

Fort Lee, Virginia, 23801-1551

This subcourse is part of the Light Wheel Vehicle Mechanic MOS 63B, Skill Level 3 Course. It teaches the knowledge necessary to identify basic types and characteristics of wheeled vehicles. Information is provided on most of the wheeled vehicles and materials handling equipment that the 63B Skill Level 3 soldier may encounter.

This subcourse consists of two lessons, each with a practice exercise, and a written examination that is graded at the Institute for Professional Development (IPD).

Lesson 1: IDENTIFY COMMON AUTOMOTIVE TERMS AND CLASSIFICATIONS OF WHEELED VEHICLES

TASK: Describe the common automotive terms and classifications of wheeled vehicles.

CONDITIONS: Given information about common automotive terms and general classifications of wheeled vehicles.

STANDARDS: Answer 70 percent of the multiple-choice items on the examination covering the common automotive terms and general classification of wheeled vehicles.

Lesson 2: DESCRIBE TYPES, PURPOSE, AND CHARACTERISTICS OF WHEELED VEHICLES

TASK: Describe the types, purpose, and characteristics of wheeled vehicles.

CONDITIONS: Given information about the types, purpose, and characteristics of wheeled vehicles.-

STANDARDS: Answer multiple-choice items on the examination covering the types, purpose, and characteristics of wheeled vehicles with a minimum of 70 percent accuracy.

INTRODUCTION TO WHEELED VEHICLES

In the year 1912, four commercial trucks were purchased by the US Army. At that time, military men had little faith in the so-called "mechanical contraptions." Very few hard-surfaced roads existed then, and the Army was used to traveling any place their horses or mules would take them. Testing of the first Army vehicles was quite unfair because the vehicles naturally failed to go where the animals could. This is probably when the phrase "Get a horse!" originated, because trucks often got bogged down and had to be pulled out by horses.

The great advantages of motor vehicles were realized in time, however, and when World War I started, the Army had a large fleet of vehicles.

Vehicle maintenance at this time was very difficult, because there were many different makes and many specialized parts were required.

Wheeled vehicles in the US Army today are the best in the world. They are designed to take rough handling, travel over very poor terrain, and move at fairly high speeds.

No matter how good equipment is, it must be cared for. Otherwise, sooner or later, it will stop doing its job. This is where you, the wheeled vehicle mechanic, come into the big picture. Your duty is to keep the Army's wheeled vehicles in operational condition. This is a big job and, to do it right, you must be ready to take care of any trouble that might occur on wheeled vehicles.

LESSON 1
IDENTIFY COMMON AUTOMOTIVE TERMS AND
CLASSIFICATIONS OF WHEELED VEHICLES

TASK

Describe the common automotive terms and classifications of wheeled vehicles.

CONDITIONS

Given information about common automotive terms and general classifications of wheeled vehicles.

STANDARDS

Answer 70 percent of the multiple-choice test items covering common automotive terms and general classification of wheeled vehicles.

REFERENCES

TM 9-8000

Learning Event 1:
IDENTIFY COMMON AUTOMOTIVE TERMS

The maintenance and repair of wheeled vehicles becomes an increasingly larger job each year. New vehicles are being made, new types of systems are being used on the vehicles, and new words are becoming part of the language used by soldiers who perform the maintenance and repair of wheeled vehicles.

To become a good mechanic, you must keep up with all changes that pertain to your job.

In this lesson, we will discuss some of the terms and words that are commonly used when referring to wheeled vehicles, the various ways wheeled vehicles are classified, and where the major assemblies of vehicles are located.

The wheeled vehicle maintenance career field, like all other occupations, contains terms that are not often used outside the field. These words or terms make conversation among people in the trade much easier, because sometimes a single word or a group of two or three words can take the place of long sentences. Let's use the word "subcourse" as an example. If you happened to use "subcourse" in speaking to someone who does not know what it means, you would have to explain: "A subcourse is a bound book that contains training material on a specific subject. It is separated into one or more lessons, and each lesson has a short exercise or query at the end." You could go on for some time explaining the term. However, if the person you are talking to already knows what the word "subcourse" means, using that word is a quick way of communicating. This is exactly what happens in the language of vehicle maintenance. We use one word, or two or three words, to represent what could take many sentences to explain. Because you will hear these terms quite often, learn them well.

VEHICLE

A vehicle can have many shapes and can be large or small. Within your trade, vehicle means any type of equipment with wheels or tracks on it that is used to transport people, equipment, supplies, and so forth. It can be a sedan, cargo truck, wrecker, tank truck, trailer, semitrailer, or many other types. It may have its own power, or it may be a unit that must be towed by another unit. Vehicles are classified as administrative, tactical, or combat.

VEHICLE CHARACTERISTICS

Certain terms are used to express what a vehicle can do. These terms are vehicle performance characteristics:

All-wheel drive

As you know, most civilian vehicles have power to the rear wheels only, but some cars have power to the front wheels instead. Either design works fine for vehicles that travel on hard-surfaced roads most of the time.

However, cars do get stuck in soft ground or snow. If power could be applied to all of the wheels instead of just the front or rear, a vehicle could move much better in mud or snow. This is exactly what has been done to Army tactical vehicles. The operator can engage power to the front wheels when necessary, and then all the wheels on the ground can be driven.

You will commonly hear a vehicle referred to as a four-by-four (4x4), a six-by-six (6x6), or even a four-by-two (4x2). This means that, if a vehicle has four wheels and only the front or rear wheels are powered, it is called a 4x2. If all four wheels can be powered, it is a 4x4. If the vehicle has four wheels in back and two in front, it will be either a 6x4 or 6x6, depending on how many wheels can receive power.

All-wheel drive vehicles are needed in the Army because Army vehicles must travel cross-country in snow, mud, and sand as well as on hard-surfaced roads.

Angle of approach

To understand "angle of approach," just think of driving on level ground and then coming to a steep upgrade. If the grade is too steep, the vehicle bumper will strike the ground. When we say angle of approach, we mean the steepest grade angle that a vehicle can come up to and start to climb with no part of the vehicle scraping or digging into the ground.

Angle of departure

"Angle of departure" is the opposite of the angle of approach.

It is the steepest downgrade a vehicle can leave with no part of the vehicle except the wheels touching the ground.

Cruising range

This term refers to the distance a vehicle can travel on a full tank of fuel under normal conditions. This is important because, as you know, military vehicles cannot always stop at roadside gas stations. Therefore, you need to know how far the vehicle can travel on a full tank so that you can carry extra fuel if you are going to need it to complete a trip.

Drawbar pull

Most military vehicles have a device attached to the rear of the frame to connect a trailer for towing. This device is called a pintle, and it is merely a hinged connection that can be opened for hooking up the trailer and then can be closed in a locked position.

"Drawbar pull" is the amount of trailer load that can be safely handled by the vehicle and trailer connection.

Fordability

In combat situations, wheeled vehicles often have to cross streams and other inland waterways. When this is required, it is important to know whether or not the water is too deep for the vehicle to pass through without a special waterproofing kit. "Fordability" refers to the deepest water, measured in inches, that a vehicle can pass through without adding the special equipment.

Gradeability

Because Army vehicles are expected to travel cross-country, over rough terrain, they must be able to climb very steep hills. "Gradeability" refers to the steepest grade the vehicle can climb at a steady speed in low gear on a smooth, concrete road when fully loaded.

All tactical vehicles must be able to climb a 60° slope under their own power.

Turning radius

This is the distance from the center to the rim of a circle made by the outside front wheel of a vehicle when the front wheels are turned as far as they can go and the vehicle is moved in a circle.

One of your jobs as a wheeled vehicle mechanic will be to adjust the steering turning stops so that the vehicle turns in the correct circle prescribed by the manufacturer.

Ground clearance

This is the distance from the surface of a smooth parking area to the lowest component of the vehicle undercarriage.

As you know, when a vehicle is driven over rough ground, the oil pan, propeller shafts, or other components might be damaged. Therefore, military vehicles are designed with much greater ground clearance than civilian vehicles.

Traction

This is the ability of the vehicle wheels to hold to the road without slipping or spinning. Several factors determine the amount of traction a wheel has, such as the condition of the tire and the type of tire tread.

The road condition also has a lot to do with traction. On icy roads the wheels slip or spin easily, so the "traction" is poor. On dry, paved roads, the "traction" is good.

VEHICLE WEIGHT

Net weight

This is the actual weight of the vehicle only. It does not include the weight of the fuel, lubricants, water, crew, or cargo.

Curb weight

This is the weight of the vehicle with fuel, oil, and water added, fully equipped for operation. It does not include the crew and cargo.

Payload

This is the weight of the cargo or passengers, including the crew, that a vehicle can safely carry. It does not include the weight of the vehicle, fuel, oil, or water.

A vehicle can carry a greater payload when traveling on the highway than when traveling cross-country. The payload that a vehicle can safely carry on a good road is called the "on-highway payload."

Gross weight or fighting weight

This is the weight of a fully equipped vehicle serviced for operation, including the crew plus the full allowable payload.

Learning Event 2:

DESCRIBE CLASSIFICATIONS OF MILITARY VEHICLES

ASSIGNMENT TO UNITS

All vehicles used by the Army are called "military vehicles." They serve many useful purposes but are made mainly to carry the supplies, personnel, and equipment of the Army under combat conditions. All vehicles are classed as "organic" or "nonorganic" vehicles.

Organic vehicles

These are the vehicles that are permanently assigned to, and are part of, your organization or unit. This means they were issued to your unit and will be operated and maintained by the personnel of your unit.

Nonorganic vehicles

These vehicles do not belong to your unit, but your unit temporarily uses them.

An example of organic transportation is the movement of an infantry company using only its own vehicles. The same move using trucks from a transportation company is an example of nonorganic transportation.

MILITARY VEHICLE GROUPS

Military vehicles are divided into three groups called "administrative vehicles," "tactical vehicles," and "combat vehicles."

Administrative vehicles

Administrative vehicles are not specially made for the Army but are ordinary vehicles made for civilian use (trucks, buses, and sedans) that the Army has bought. They are usually repainted and are marked with Army numbers, but they differ very little from the ones you may have used as a civilian.

Tactical vehicles

These vehicles are specially made for the Army. They are made to operate off the highways under almost any type of weather condition and to travel cross-country through sand, mud, or snow. Tactical wheeled vehicles have all-wheel drive to give them more traction, and some have winches to help them through tough spots.

Combat vehicles

These vehicles are made for one reason only - to fight the enemy. These vehicles usually have armor and heavy guns.

Most combat vehicles use tracks instead of wheels. You will have no trouble recognizing a combat vehicle because it is specially made for fighting and not for hauling cargo or personnel.

TYPES OF TACTICAL WHEELED VEHICLES

There are three kinds of tactical vehicles:

General Purpose

Special Equipment

Special Purpose

General purpose vehicles

General purpose vehicles are made to haul all sorts of things, such as ammunition, equipment, rations, and troops. They also tow trailers and artillery. All of these different jobs can be done without modifying or changing the vehicle.

You may sometimes see a general purpose vehicle that has a machine gun mounted on it, and maybe special steel plates (called armor) have been added; but its job is not to fight, but to haul: It is still a general purpose vehicle.

Special equipment vehicles

These vehicles have a general purpose chassis with special equipment mounted. The frame, wheels, axles, and so on are the same as on a general purpose vehicle, but the cargo body has been replaced with something else. Some special equipment vehicles are water-tank trucks, gasoline-tank trucks, and dump trucks. Remember, a special equipment vehicle has the same chassis as a general purpose vehicle; only the body has been changed.

Special purpose vehicles

These vehicles are made to do a certain job that a general purpose vehicle or special equipment vehicle cannot do.

One example of this is a wrecker. The frame of the general purpose vehicle chassis would not be strong enough to take the load. Another example is the truck-tractor that you see pulling a large cargo trailer on the highway.

Truck-tractors are made for towing and not for carrying cargo. The frame is shorter than a cargo-carrying truck.

TRAILER CLASSIFICATION

Some vehicles you will work with are made to be towed. These vehicles are trailers and semitrailers.

Trailers

These vehicles have a drawbar, or tongue, in the front, to be attached to the pintle or coupling mounted on the rear of the vehicle that does the towing. The eye at the end of the trailer's tongue that hooks into the pintle is called a lunette.

Most of the trailers in use today are two-wheeled. However, you will see some four-wheeled trailers (or "full trailers").

Trailers are made in such a way that their wheels support most of the weight of the cargo they are carrying.

Semitrailers

These are also vehicles made to be towed, but there is one big difference between a semitrailer and a tongue-type trailer. The front part of the semitrailer is supported by the towing vehicle. This means the towing vehicle carries a lot of the cargo weight.

The vehicle that carries some of the load and tows a semitrailer is called a truck-tractor. The semitrailer is connected to the "fifth wheel" of the truck-tractor or may be supported by means of a "dolly." A dolly is another set of wheels, a frame, and a fifth wheel.

When the dolly is placed under the semitrailer, it becomes a full trailer and can be towed using an ordinary truck.

PRACTICE EXERCISE

1. The steepest angle that a vehicle can start to climb is
 - a. referred to as the angle of departure.
 - b. angle of approach.
 - c. angle of climb.

2. The term "four-by-four (4x4)" refers to
 - a. front-wheel drive.
 - b. four-wheel steering.
 - c. four-wheel drive.

3. The term "cruising range" refers to the
 - a. distance a vehicle can travel on a full tank of fuel.
 - b. distance a vehicle can travel between breakdowns.
 - c. normal driving speed of the vehicle.

4. General purpose vehicles are used for
 - a. pulling large cargo trailers.
 - b. mounting special purpose equipment.
 - c. hauling ammunition, equipment, troops, and so forth.

5. Which of the following terms refers to the greatest weight?
 - a. Net
 - b. Curb
 - c. Gross

Lesson 1

ANSWERS TO PRACTICE EXERCISE

1. b (page 3)
2. c (page 3)
3. a (page 3)
4. c (page 7)
5. c (page 5)

LESSON 2
DESCRIBE TYPES, PURPOSE, AND CHARACTERISTICS
OF WHEELED VEHICLES

TASK

Describe the types, purpose, and characteristics of wheeled vehicles.

CONDITIONS

Given information about the types, purpose, and characteristics of wheeled vehicles.

STANDARDS

Answer 70 percent of the multiple-choice test items covering the types, purpose, and characteristics of wheeled vehicles.

REFERENCES

TM 9-500
TM 9-8000
SB 700-20
ST 9-159

Learning Event:

DESCRIBE TYPES, PURPOSE, AND CHARACTERISTICS OF COMMON MILITARY
WHEELED VEHICLES

The Army uses many different kinds of wheeled vehicles. Most of the vehicles fall within a few basic groups, but they differ in appearance.

Lesson 2

The type of unit you are assigned to will determine the type of wheeled vehicles you will work on. In an infantry unit, most of the vehicles will fall within the general purpose category, such as 1/4-ton trucks, 1 1/4-ton trucks, 2 1/2-ton cargo trucks, and so forth. If you are in an engineer unit, most of your work will probably be on dump trucks. If you are in a transportation unit, you may be working on cargo trucks, truck-tractors, or semi-trailers most of the time.

The wheeled vehicles discussed below represent some you will see most often, but all military vehicles are not listed. To list all the vehicles used in the Army would take many pages.

As you read the information about each vehicle, study the illustration to get accustomed to the appearance of each model and be able to distinguish each one from the other.

UTILITY TRUCKS

The 1/4-ton, 4x4, utility trucks are designed for use on all types of roads and cross-country terrain in all weather conditions. The vehicle has four driving wheels; front-wheel drive may be engaged when road and terrain conditions require. It is powered by a four-cylinder, in-line, liquid-cooled, gasoline engine and has four-wheel hydraulic service brakes and a mechanical hand brake that operates with a contracting band on the transmission-transfer brake drum. Wheels are individually suspended on coil springs. The body is of unitized construction.

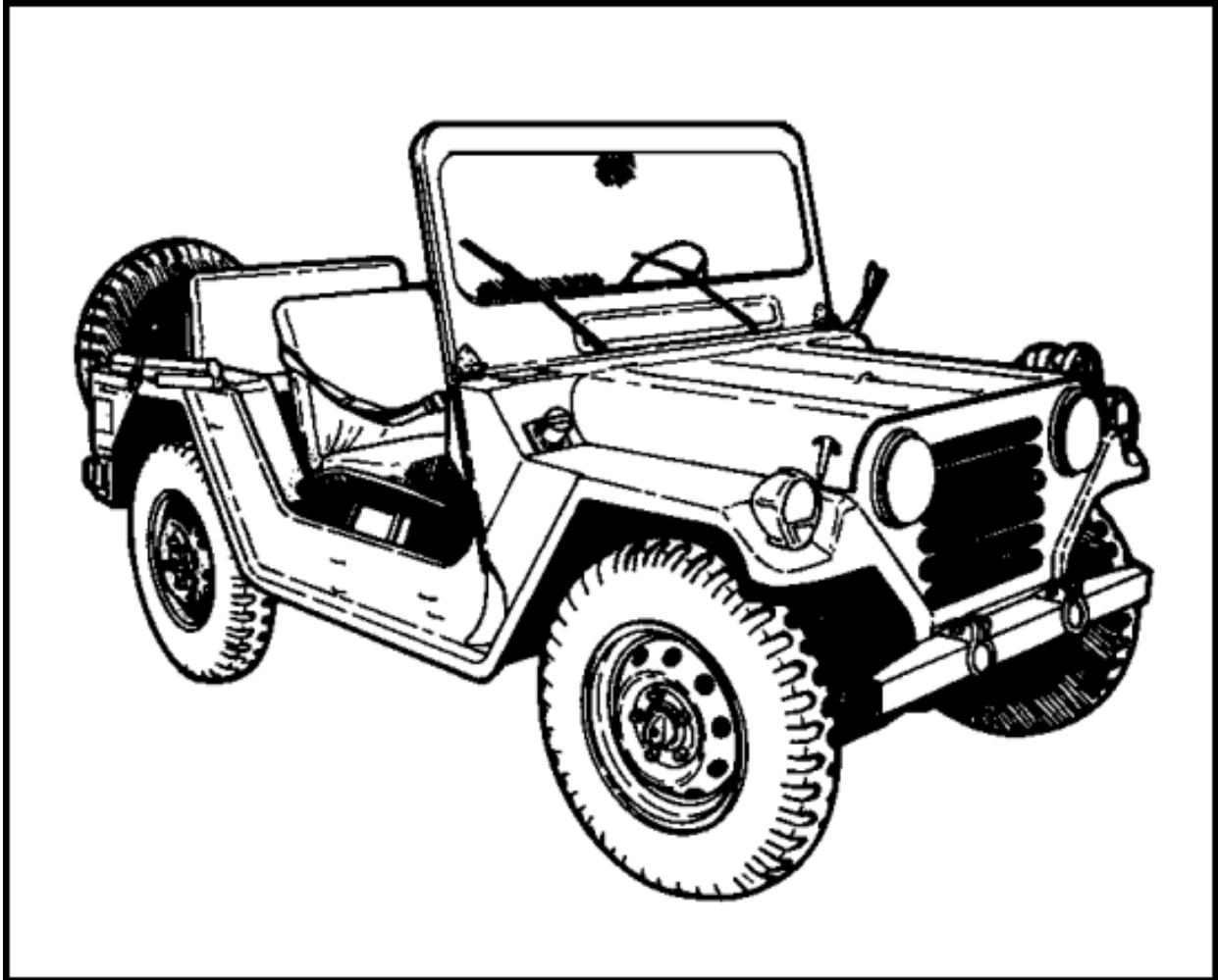

FIGURE 1. M151A2 UTILITY TRUCK.

The M151, M151A1, and M151A2 utility trucks are general purpose personnel or cargo carriers. Including the driver, the truck provides space for four soldiers.

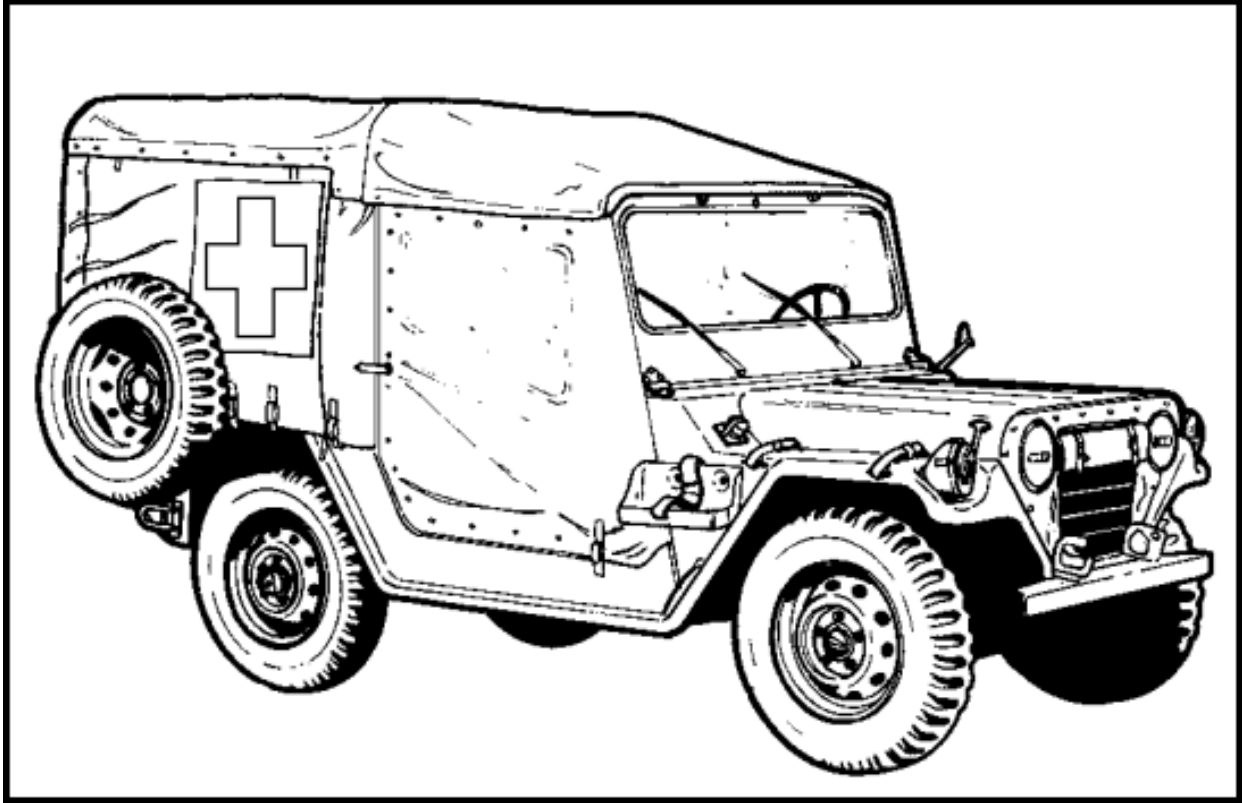

FIGURE 2. M718A1 FRONT LINE AMBULANCE.

The M718 and M718A1 front line ambulance trucks are designed to carry ambulatory and litter patients. The cargo area is 18 inches longer than in the utility vehicles, and the top is 5.3 inches higher.

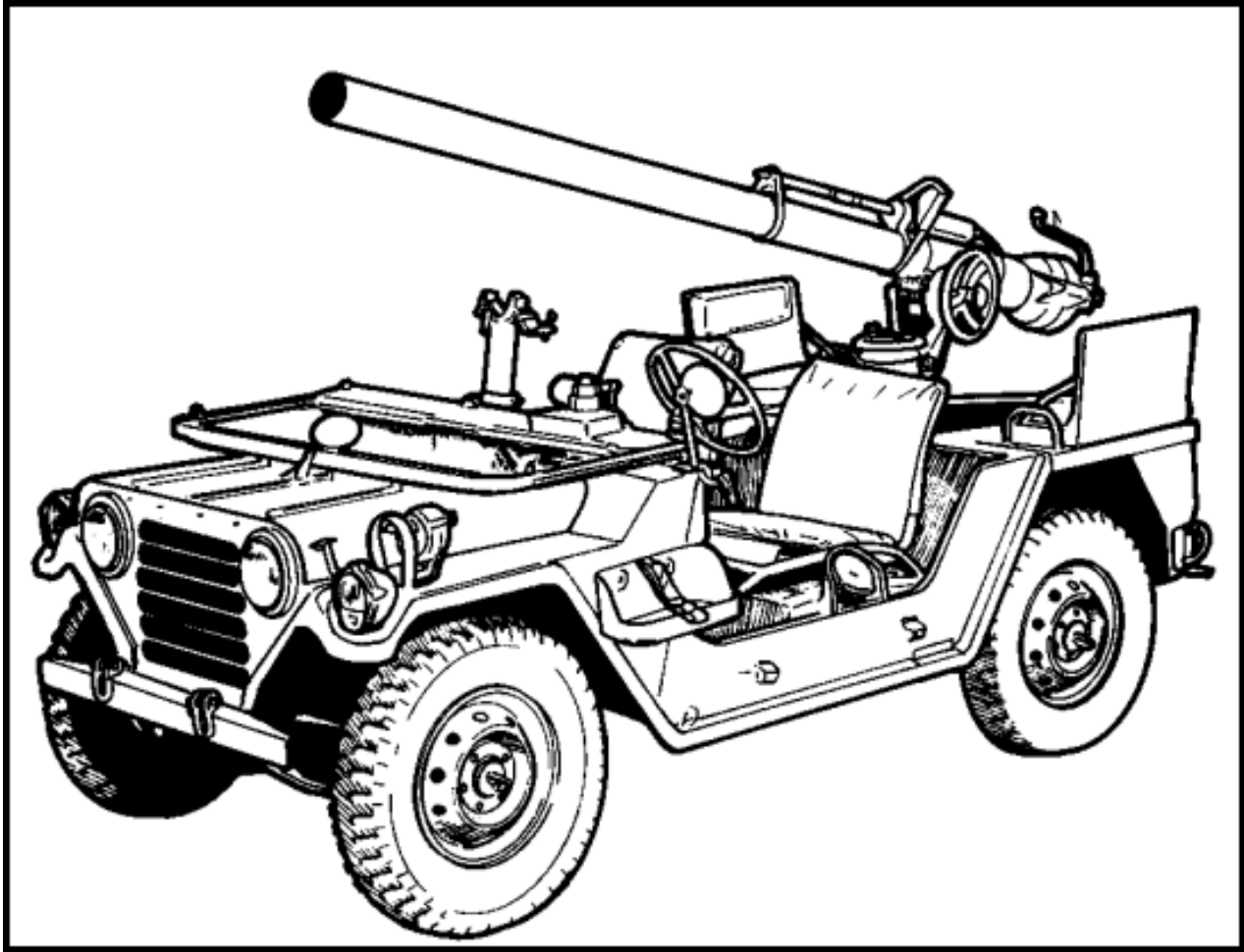

FIGURE 3. M825 RECOILLESS RIFLE VEHICLE.

The M151A1C and M825 vehicles are equipped with 106-mm recoilless rifles and carry six rounds of ammunition and the weapon tools needed to function as a mobile weapon system.

3/4- AND 1 1/4-TON VEHICLES

The commercial utility cargo vehicle (CUCV)

These $\frac{3}{4}$ ton and $1\frac{1}{4}$ ton commercial trucks are designed for use on all types of roads and highways in all types of weather. In addition, they are designed for infrequent off-road operations over selected terrain with most of the operations on primary and secondary roads. CUCVs are capable of intermittent, hard-bottom fording to a depth of 20 inches (51 cm) at 5 MPH (8 KPH) for not less than approximately three minutes without stalling, causing permanent damage to components exposed to water, or requiring any immediate maintenance to continue operation.

Lesson 2

CUCVs have an automatic transmission with three forward speeds and one reverse and a 379 cubic-inch displacement (6.2-liter) V-8 diesel engine. The braking system uses hydraulically activated, power-assisted front disc brakes and rear drum service brakes.

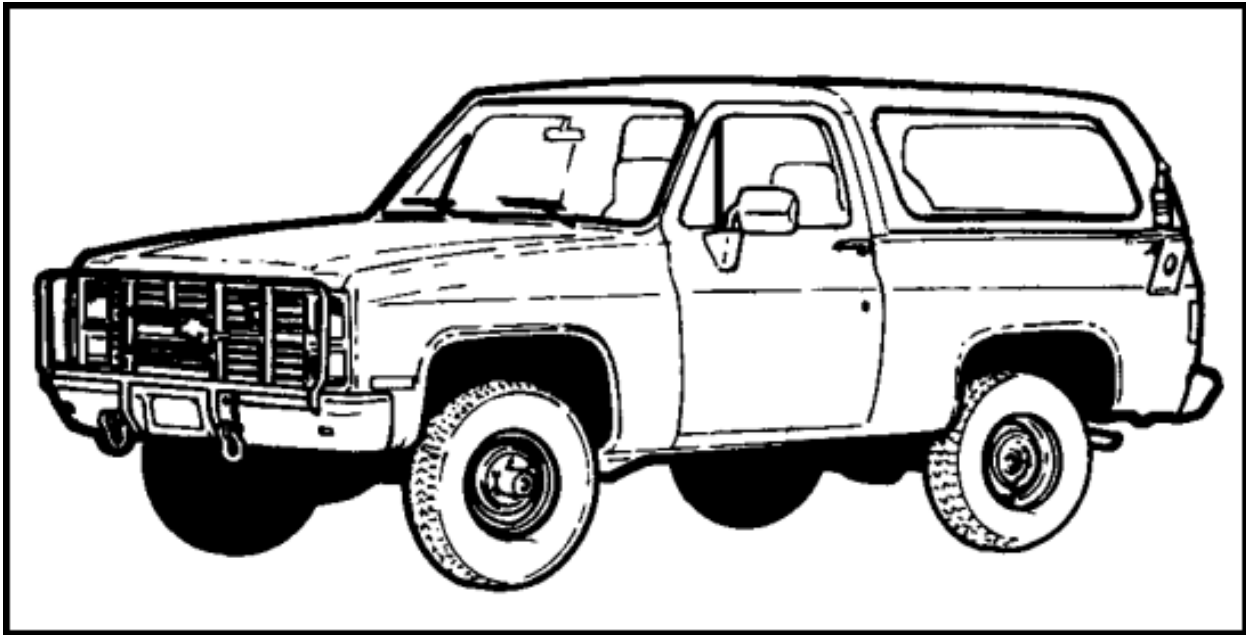

FIGURE 4. M1009 UTILITY TRUCK.

The M1009, $\frac{3}{4}$ ton, utility truck is a general purpose personnel/cargo carrier. It provides space for four people with equipment. It is equipped with a 100-amp/12- to 28-volt electrical system and a communication kit.

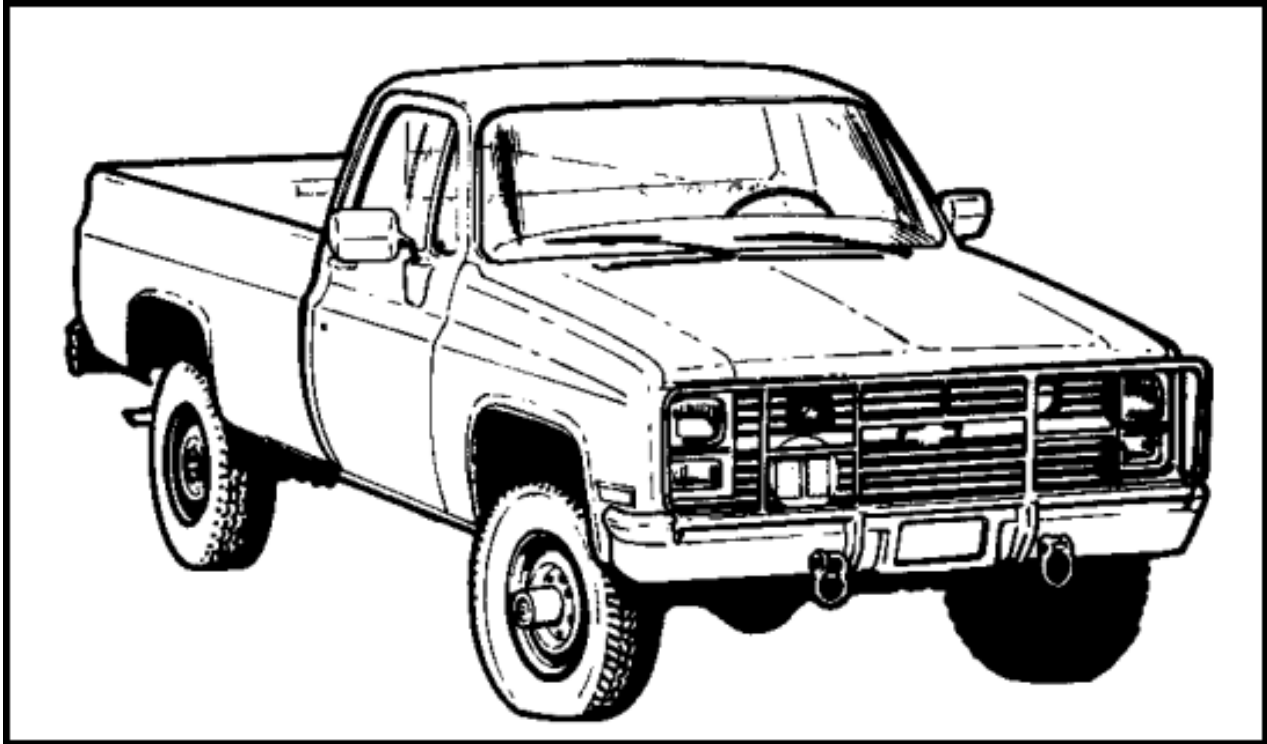

FIGURE 5. M1008 CARGO TRUCK.

The M1008, 1 ¼ ton, cargo truck is a general purpose carrier. It can be equipped with side racks, seats, and a cover for carrying troops. The M1008A1 has provisions for communication equipment, and the M1028 has provisions for carrying communication shelters.

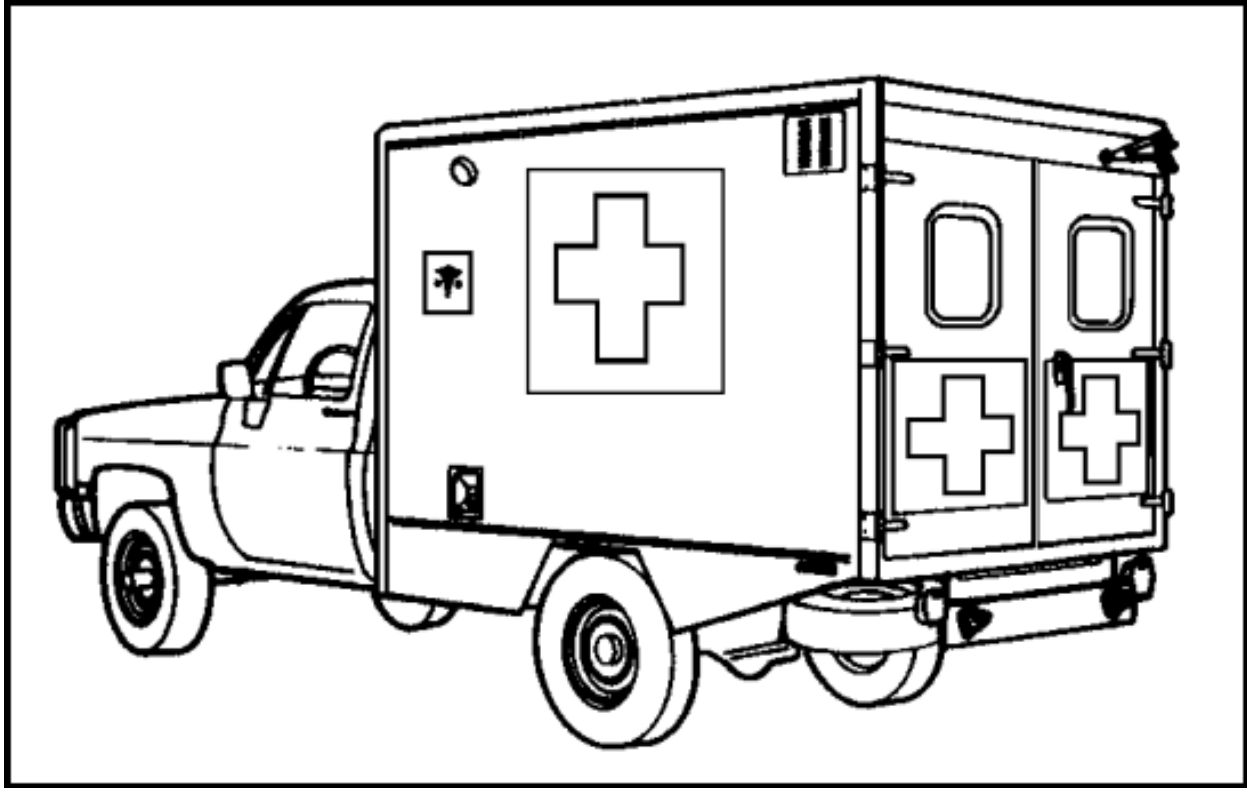

FIGURE 6. M1010 AMBULANCE.

The M1010, 1 ¼ ton ambulance carries four litter patients or eight ambulatory patients. The litter compartment has an air conditioner, a fuel fired heater, and a gas particulate filter unit.

The Gamma Goat

This 1 ¼ ton, general purpose vehicle has a dual-body configuration with six wheels and selectable two - or six wheel drive. Coordinated four-wheel steering of the front and rear wheels is provided. It is powered by a 3-53 Detroit Diesel engine, mounted behind the driver's compartment, and has a four-speed, manual transmission. It is equipped with a six-wheel hydraulic braking system. With its all-aluminum, watertight body, it is capable of swimming calm, inland waterways.

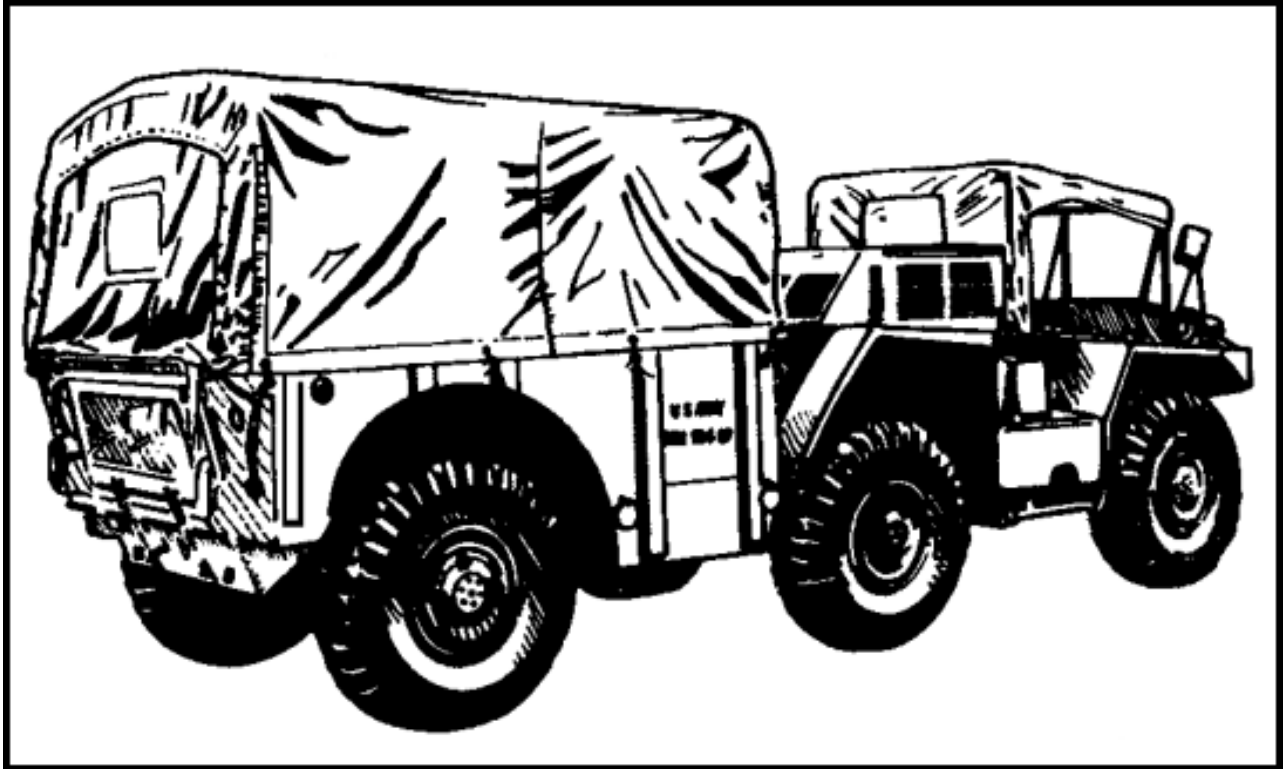

FIGURE 7. M561 CARGO TRUCK.

The M561 cargo truck may be used for carrying personnel or cargo. It is also used for carrying communication shelters.

The M792 ambulance is designed for three litter patients. It is equipped with warm-air ducts and an insulated canopy.

The high mobility multipurpose wheeled vehicle (HMMWV)

The 1 ¼-ton HMMWV is designed for use on all types of roads and cross-country terrain in all weather conditions. The vehicle, powered by a V-8 diesel engine, has four driving wheels, a three-speed power transmission, and a constant four-wheel drive. It is equipped with four-wheel, hydraulic-assist, disc brakes and power steering. The basic truck may be configured for a wide variety of functions.

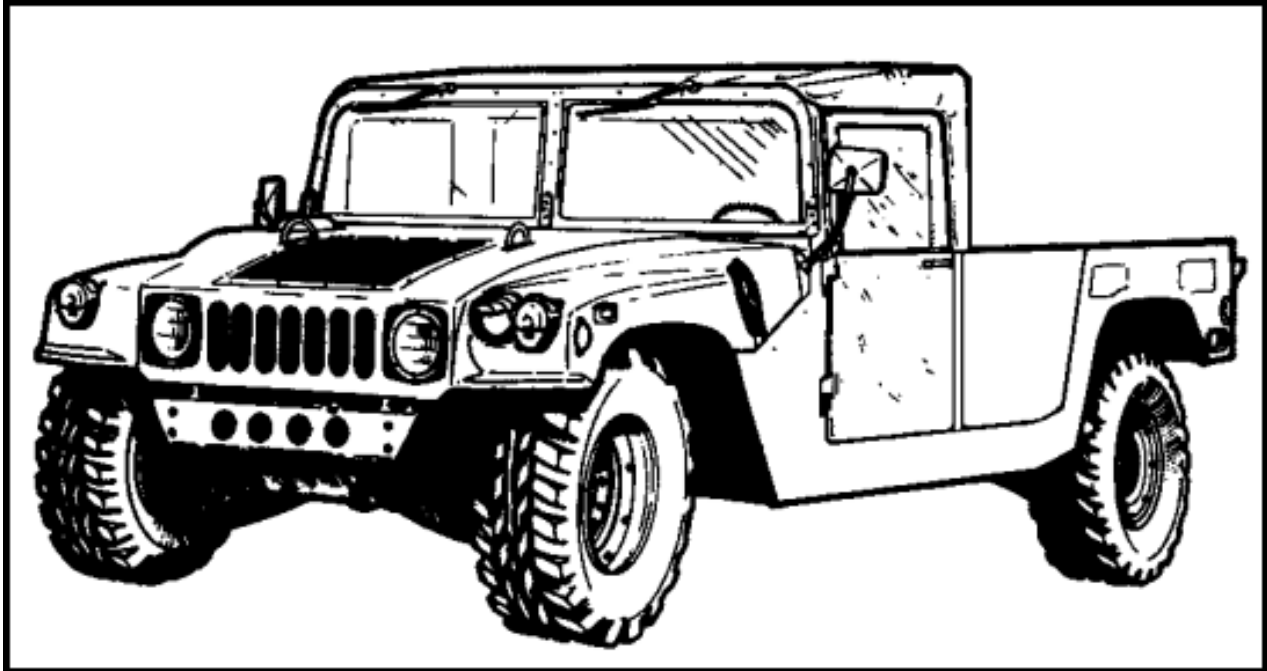

FIGURE 8. M998 UTILITY TRUCK.

The M998 and M1038 utility trucks are multipurpose vehicles. They may be equipped with covers for either two-man or four-man operation. The M1038 is equipped with an electric winch.

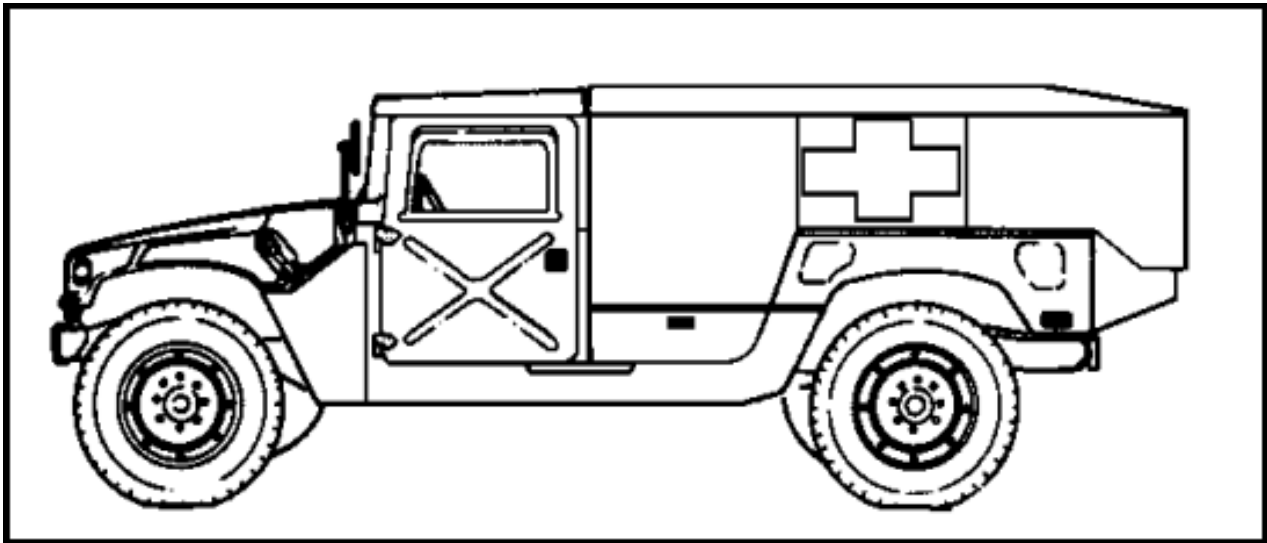

FIGURE 9. M996 AMBULANCE TRUCK.

The M996 ambulance truck has an expandable top to increase the litter capacity from two to four.

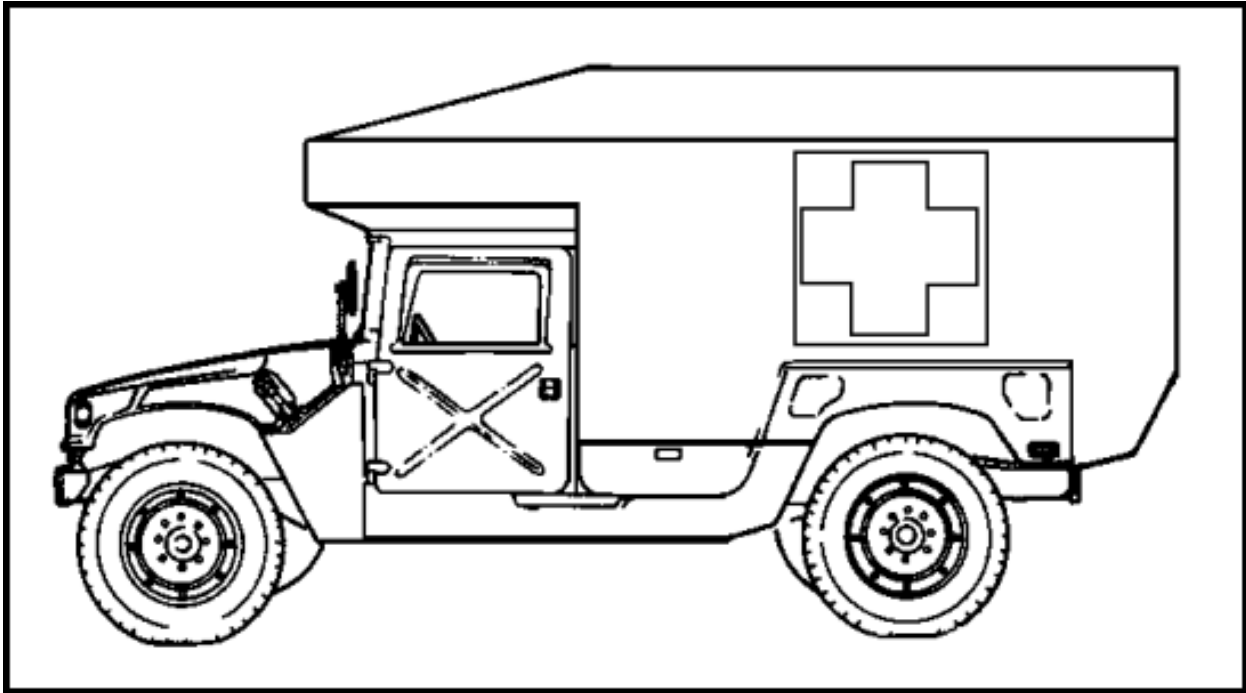

FIGURE 10. M997 AMBULANCE TRUCK.

The M997 ambulance truck has a four-litter capacity. It is equipped with air conditioning for patient comfort.

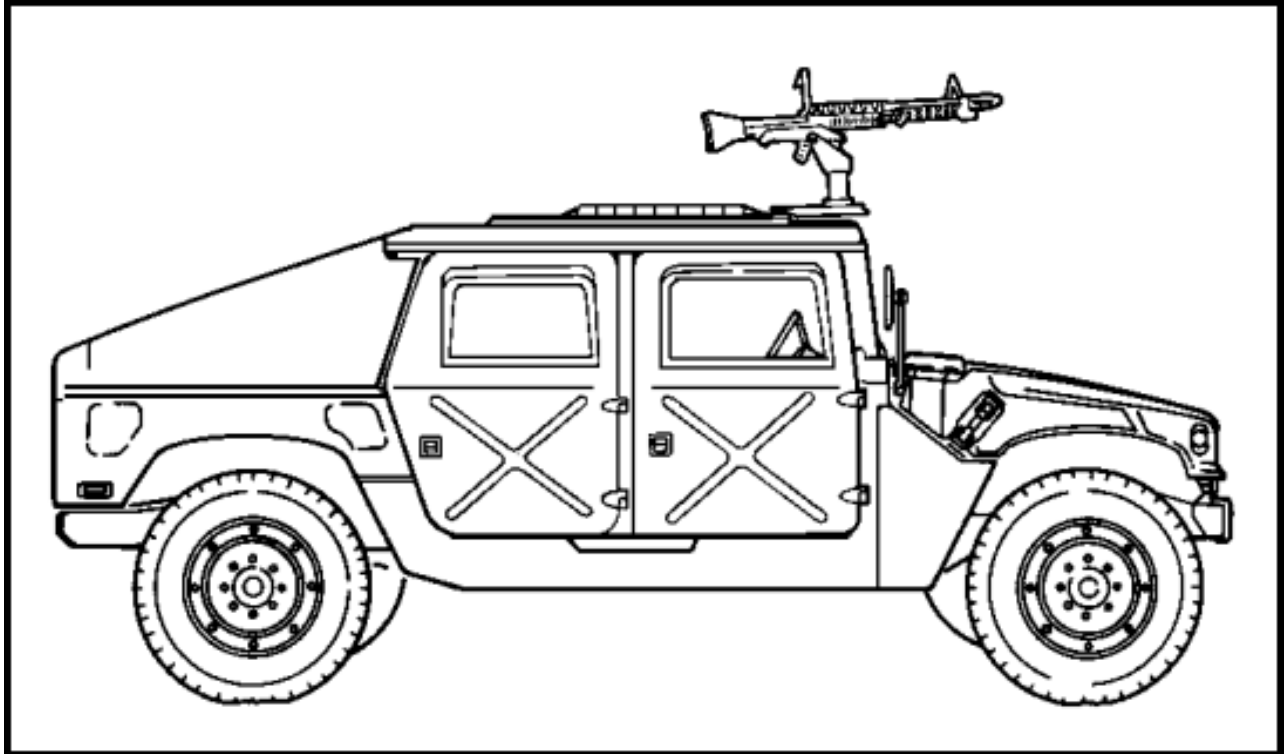

FIGURE 11. M1025 ARMAMENT CARRIER.

The M1025 and M1026 armament carriers are used to transport, mount, and operate the M2 and M60 machine guns and the MK19 grenade launcher. They are equipped with a hard top and a weapons mount. The M1026 is equipped with a winch.

2 ½-TON VEHICLES

The 2 ½-ton series of vehicles is designed for use on all types of roads and cross-country terrain in all weather conditions. It is a six-wheel-drive vehicle, powered by an in-line, six-cylinder, multifuel engine, with a five-speed manual transmission and two-speed transfer case. It has six-wheel, air-assisted hydraulic brakes. The front axle uses leaf-spring suspension, while the rear axles are mounted together on a bogie-type suspension system. All vehicles in this series use the same basic chassis with minor differences in length and power take-offs.

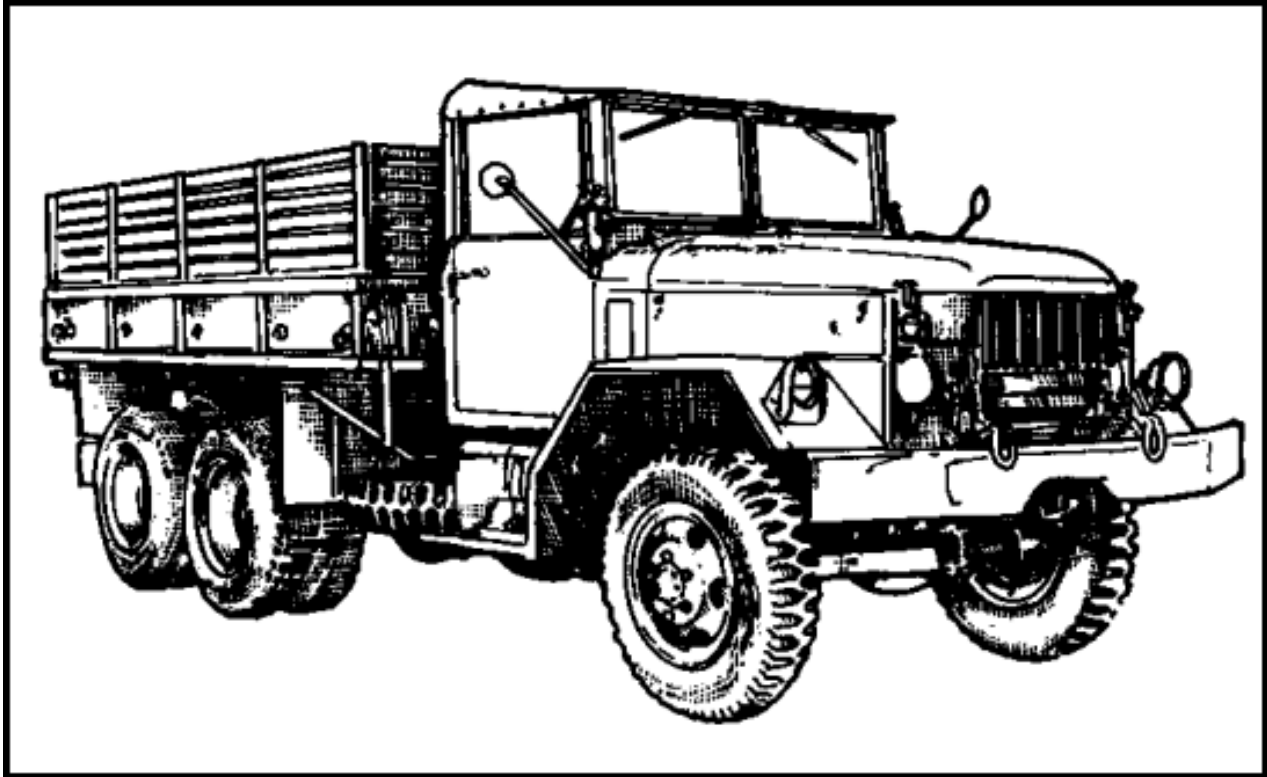

FIGURE 12. M35A2 CARGO TRUCK.

The M35A2 cargo truck is the most familiar vehicle of the series. It has a steel cargo bed and may be equipped with side racks, troop seats, and a canvas cover. It is used for carrying cargo or personnel. It may be equipped with a winch.

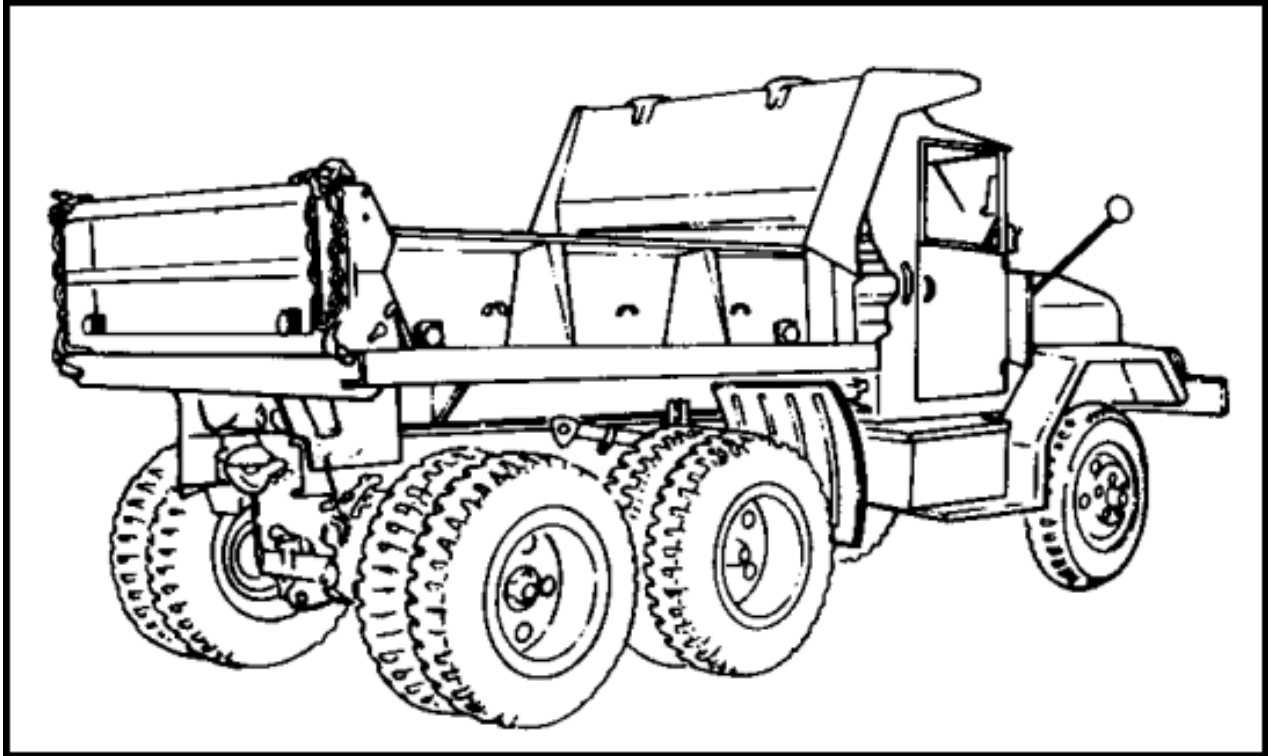

FIGURE 13. M342A2 DUMP TRUCK.

The M342A2 dump truck is used for hauling dirt, sand, gravel, and so forth. It may also be equipped with troop seats and a cover for carrying personnel. It may be equipped with a winch.

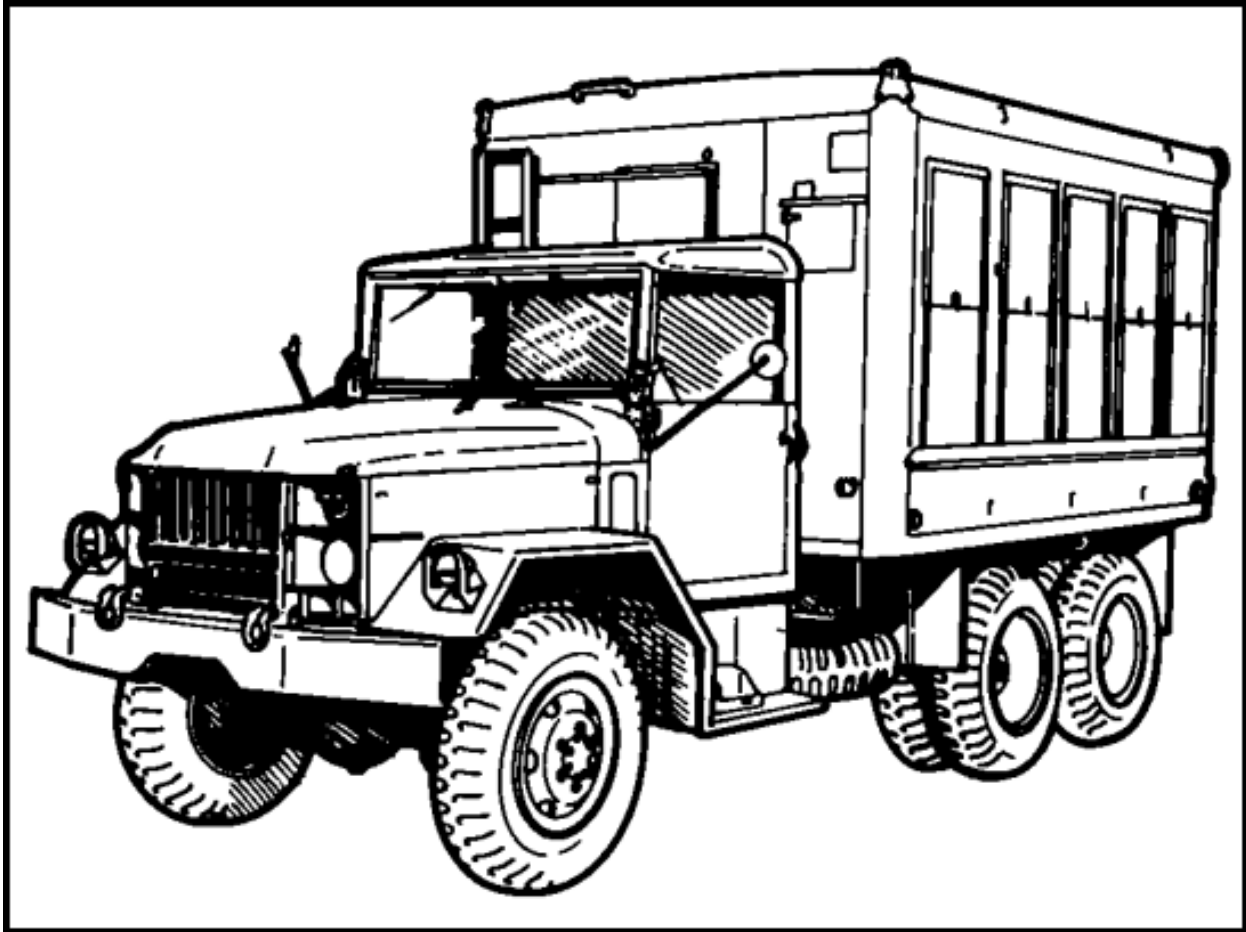

FIGURE 14. M109A2 VAN TRUCK.

The M109A2 van is used for housing mobile shop equipment, such as machine shops, electronic repair shops, and so forth.

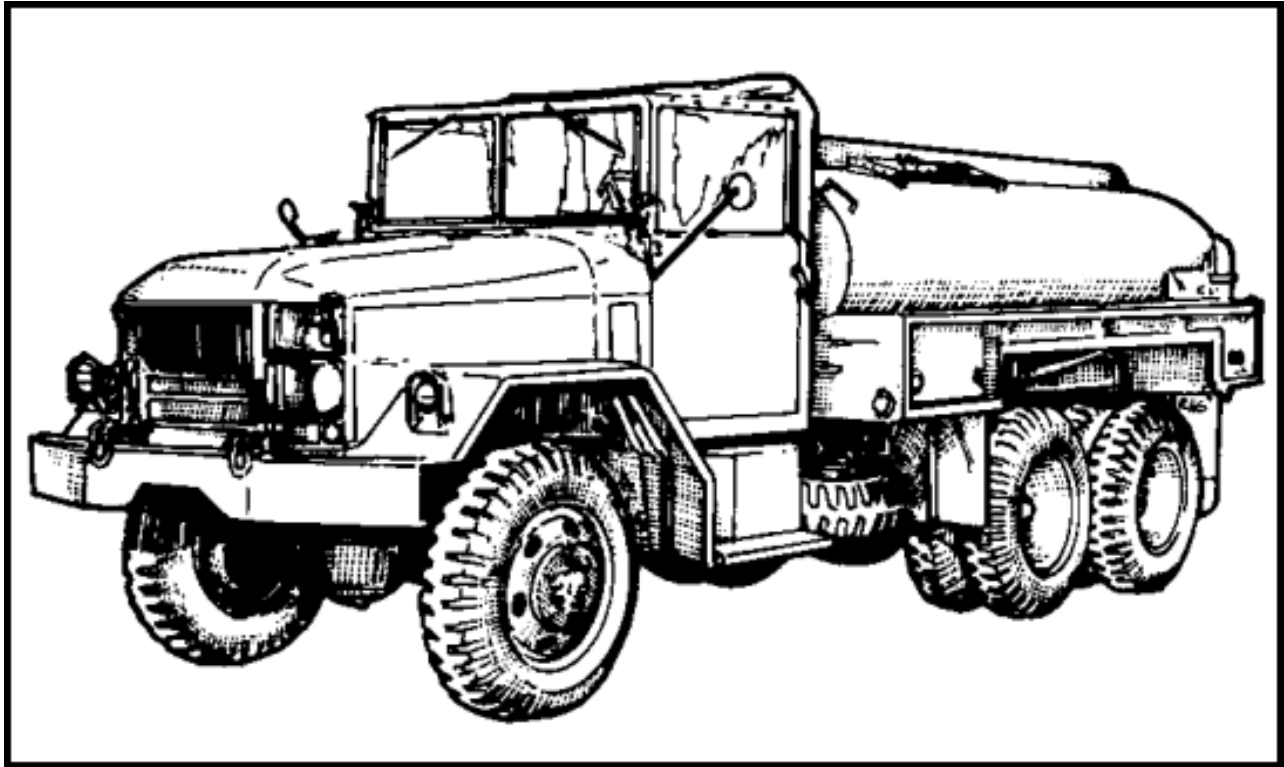

FIGURE 15. M49A2C TANKER TRUCK.

The M49A2C and M50A2 tanker trucks have a liquid capacity of 1,000 gallons. They are equipped with engine-driven dispensing pumps and all necessary hoses and fittings for pickup or dispensing. The M49A2C is used for fuel transport, and the M50A2 is used for water.

5-TON VEHICLES

The 5-ton series of vehicles is designed for use on all types of roads and cross-country terrain in all weather conditions. It is a six-wheel-drive vehicle, powered by a six-cylinder, in-line, multifuel or diesel engine, with a five-speed (manual or automatic) transmission and two-speed transfer case. It has six-wheel air brakes or air-assisted hydraulic brakes. The front axle uses leaf-spring suspension, while the rear axles are mounted together on a bogie-type suspension system. It uses hydraulic-assist power steering. All these vehicles use the same basic chassis with minor differences in length and power take-offs.

The M39A2-series has a multifuel engine, manual transmission, and air-assisted hydraulic brakes.

The M809-series has a diesel engine, manual transmission, and air-assisted hydraulic brakes.

The M939-series has a diesel engine, automatic transmission, and air brakes. Also, it has a one-piece, tilt-forward hood and fender assembly and an improved cab.

Except for the differences listed above, all models are basically the same. The following illustrations show the M809-series vehicles, but the descriptions apply to all three series.

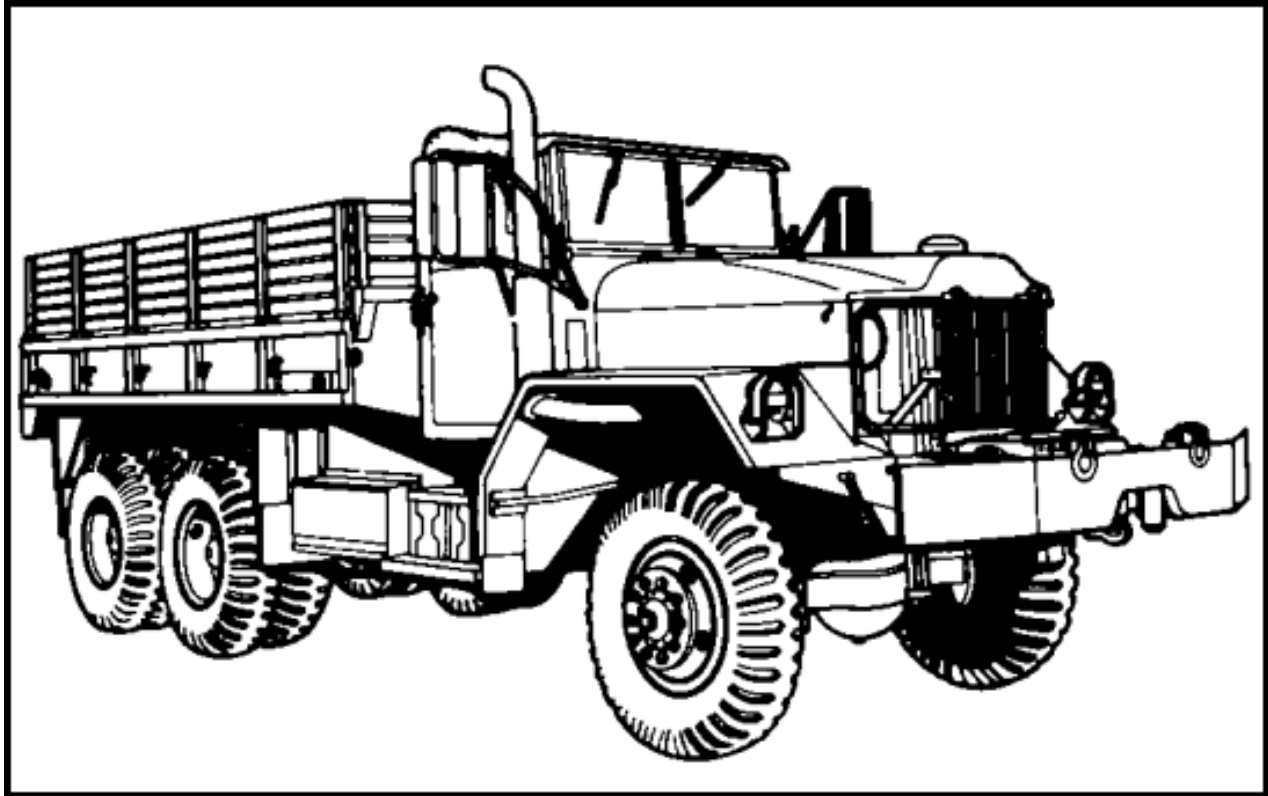

FIGURE 16. M813 CARGO TRUCK.

The M54A2/M813/M924 cargo truck has a steel cargo bed and may be equipped with side racks, troop seats, and canvas cover. It is used for carrying cargo or personnel and may be equipped with a winch.

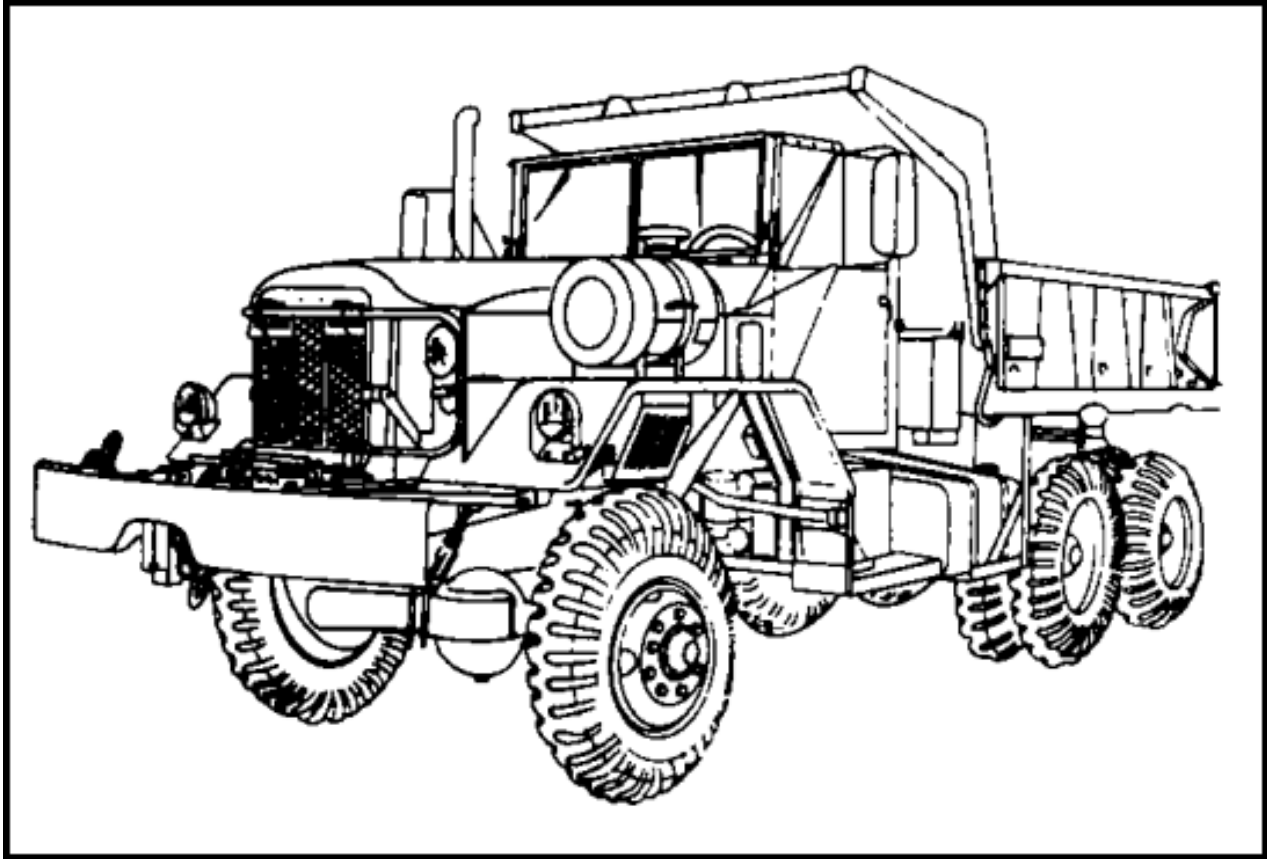

FIGURE 17. M817 DUMP TRUCK.

The M51A2/M817/M929 dump truck is used for hauling dirt, sand, gravel, and so forth. It may also be equipped with troop seats and a cover for carrying personnel and a winch.

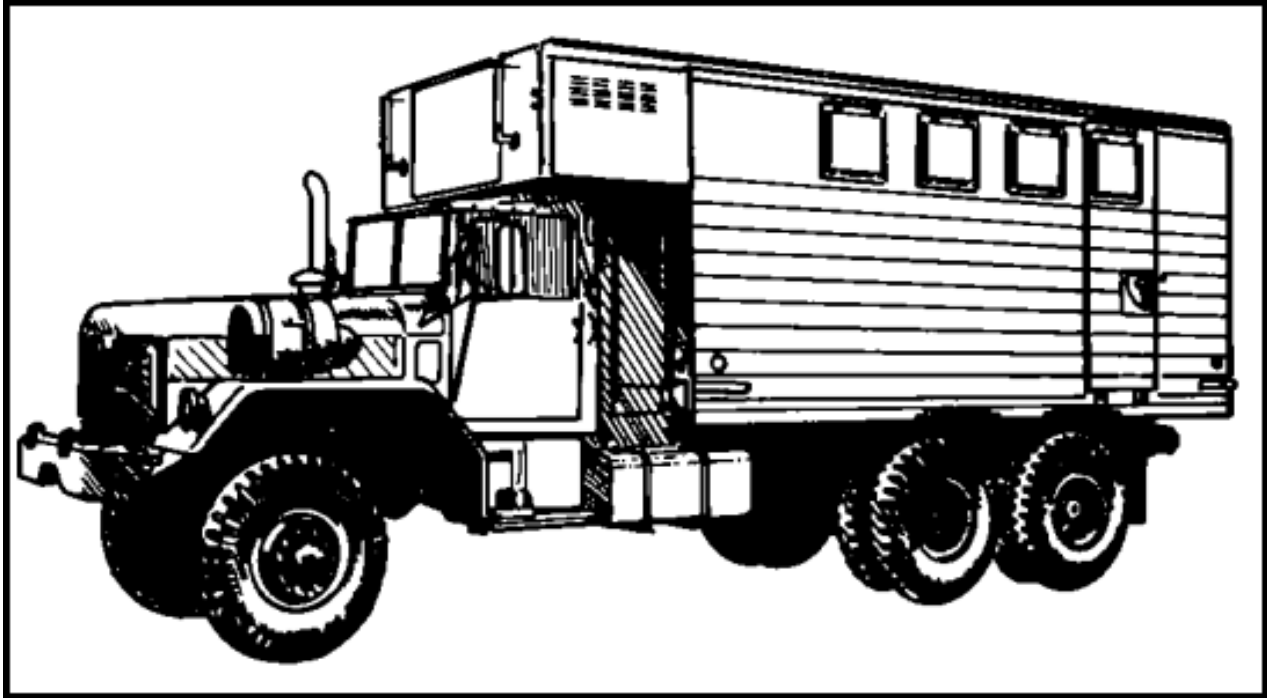

FIGURE 18. M820 EXPANSIBLE VAN.

The M291A2/M820/M934 expansible van is used for electronic equipment, electronic shops, or working space.

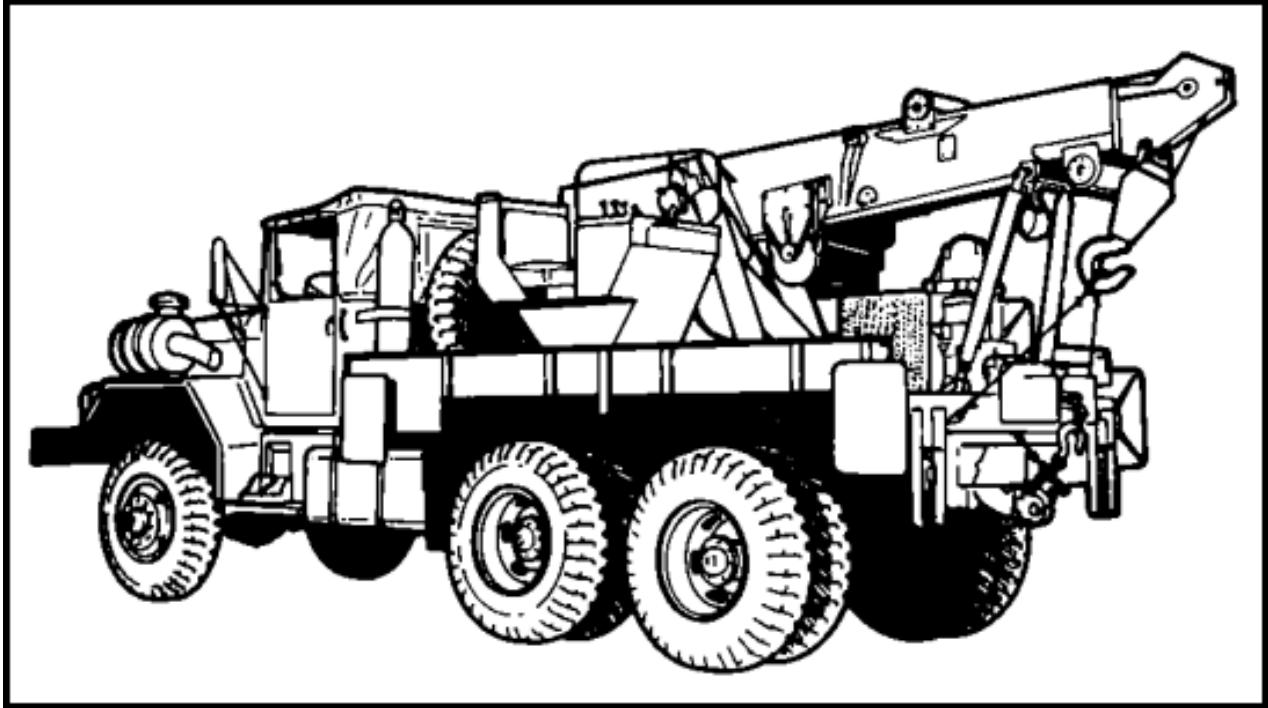

FIGURE 19. M816 WRECKER.

The M543A2/M816/M936 wrecker is used for recovery, maintenance, and lifting operations. It is equipped with a hydraulic crane, front and rear winches, outriggers, and all necessary equipment for recovery or towing operations.

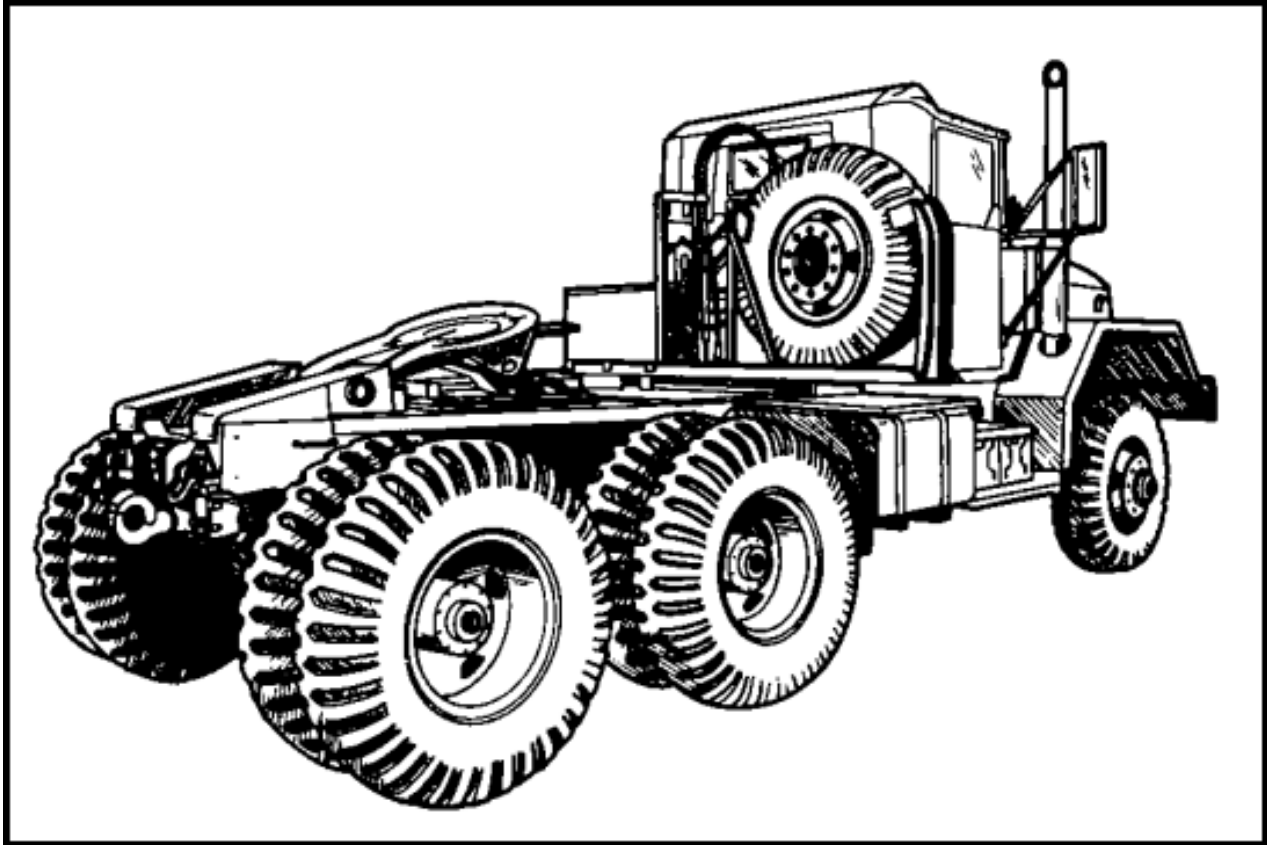

FIGURE 20. M818 TRACTOR TRUCK.

The M52A2/M818/M931 tractor truck is used as the prime mover for a variety of semitrailers, including stake-and-platforms, vans, tankers, low boys, and so forth.

M915-SERIES VEHICLES

The M915 series of vehicles is designed for use on all types of roads and limited off-road operation in all weather conditions. It is powered by an in-line, six-cylinder, diesel engine with a 16-speed semiautomatic transmission or 5-speed full automatic transmission. It has air-actuated brakes and hydraulic-assist power steering. The front axle uses leaf-spring suspension, while the rear axles are mounted together on a bogie-type suspension system. Some models have a nondriven "pusher" axle, mounted ahead of the rear axles.

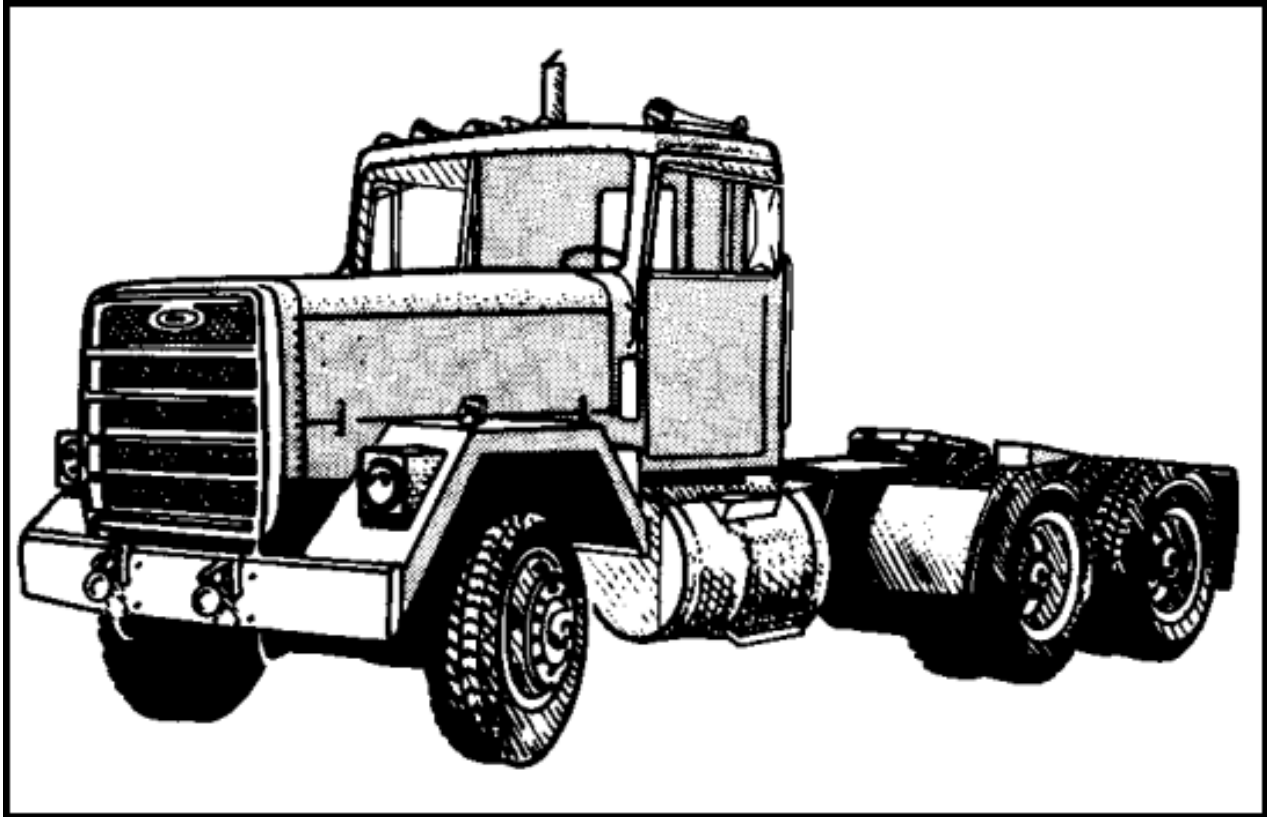

FIGURE 21. M915 TRACTOR TRUCK.

The M915 and M915A1, 6x4, line haul, tractor trucks are used for hauling a variety of semitrailers, including stake-and-platforms, vans, tankers, and so forth. They have no front-wheel drive and are intended for operation on improved roads only. The M915A1 has a five-speed transmission.

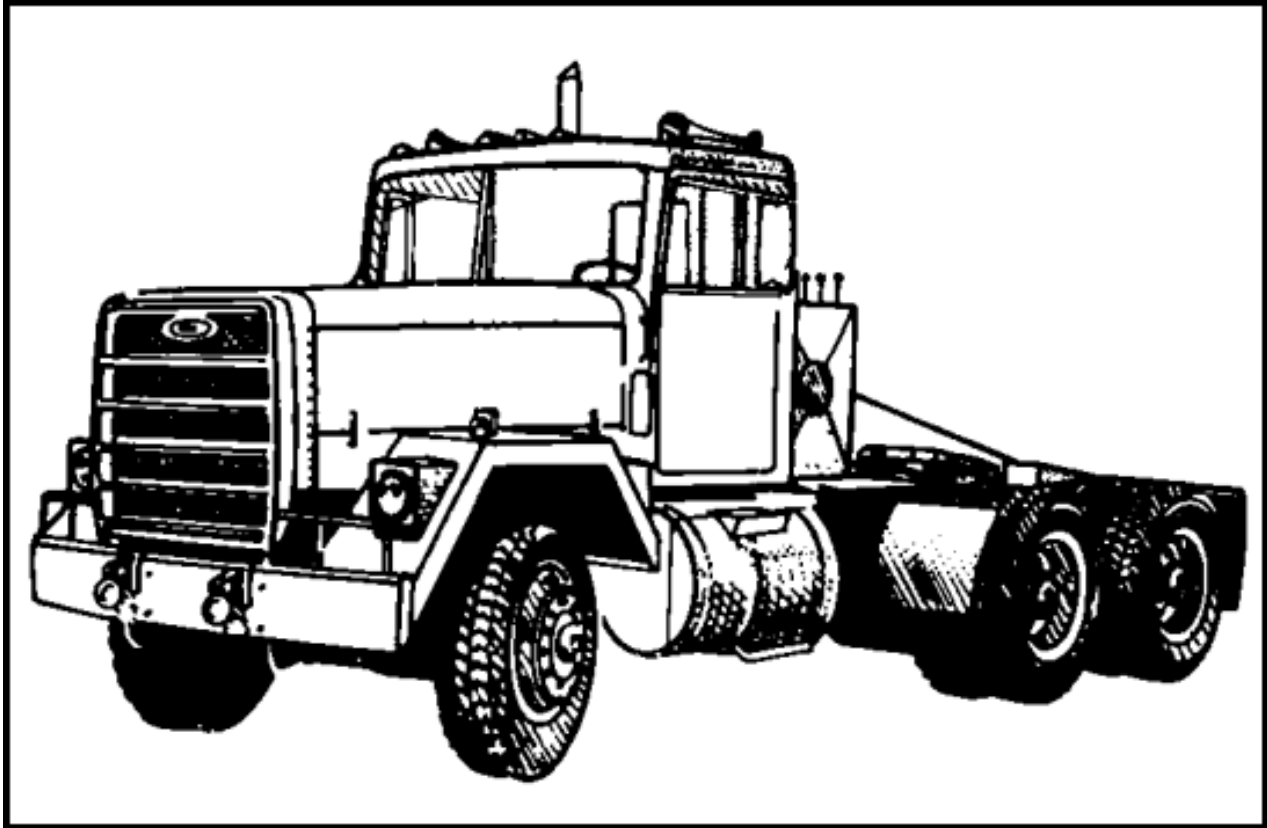

FIGURE 22. M916 TRACTOR TRUCK.

The M916, 6x6, light equipment transporter, tractor truck is used for hauling a variety of semitrailers both on and off the road. It is equipped with a winch.

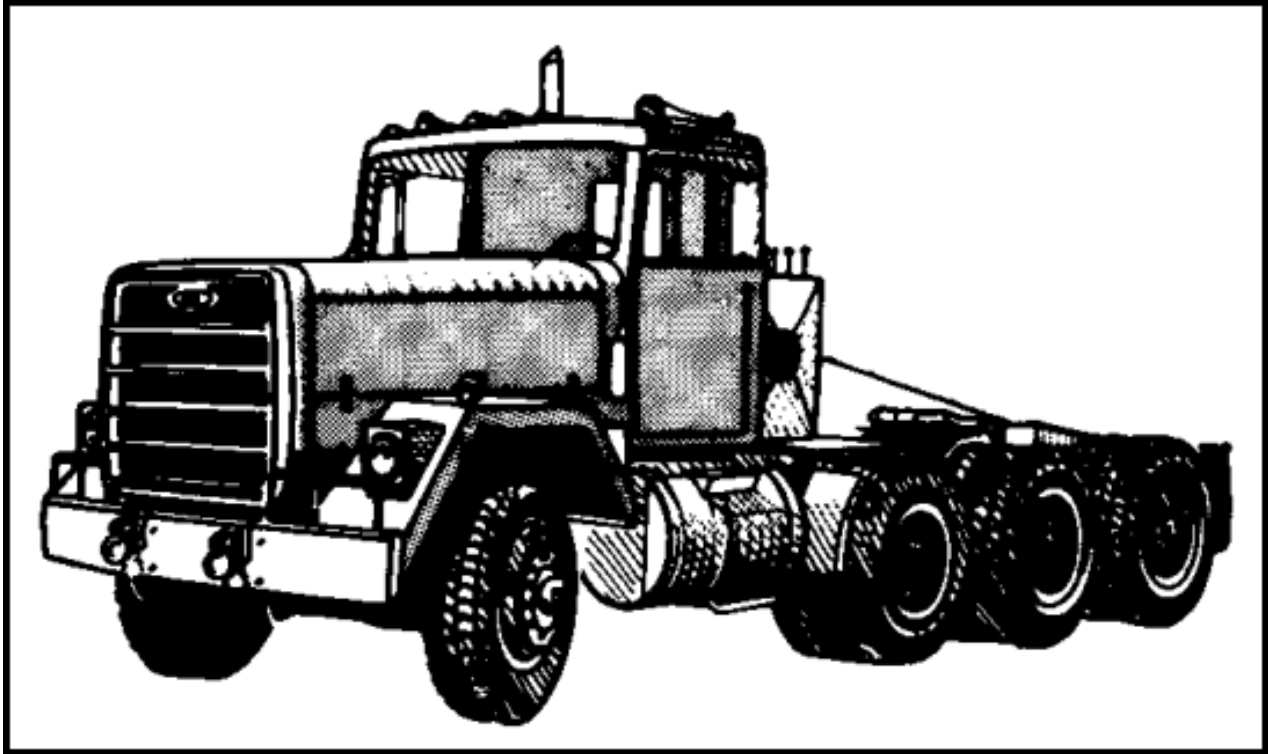

FIGURE 23. M920 TRACTOR TRUCK.

The M920, 8x6, medium equipment transporter truck is used for hauling heavier loads and equipment on and off the road. It is equipped with a pusher axle and winch.

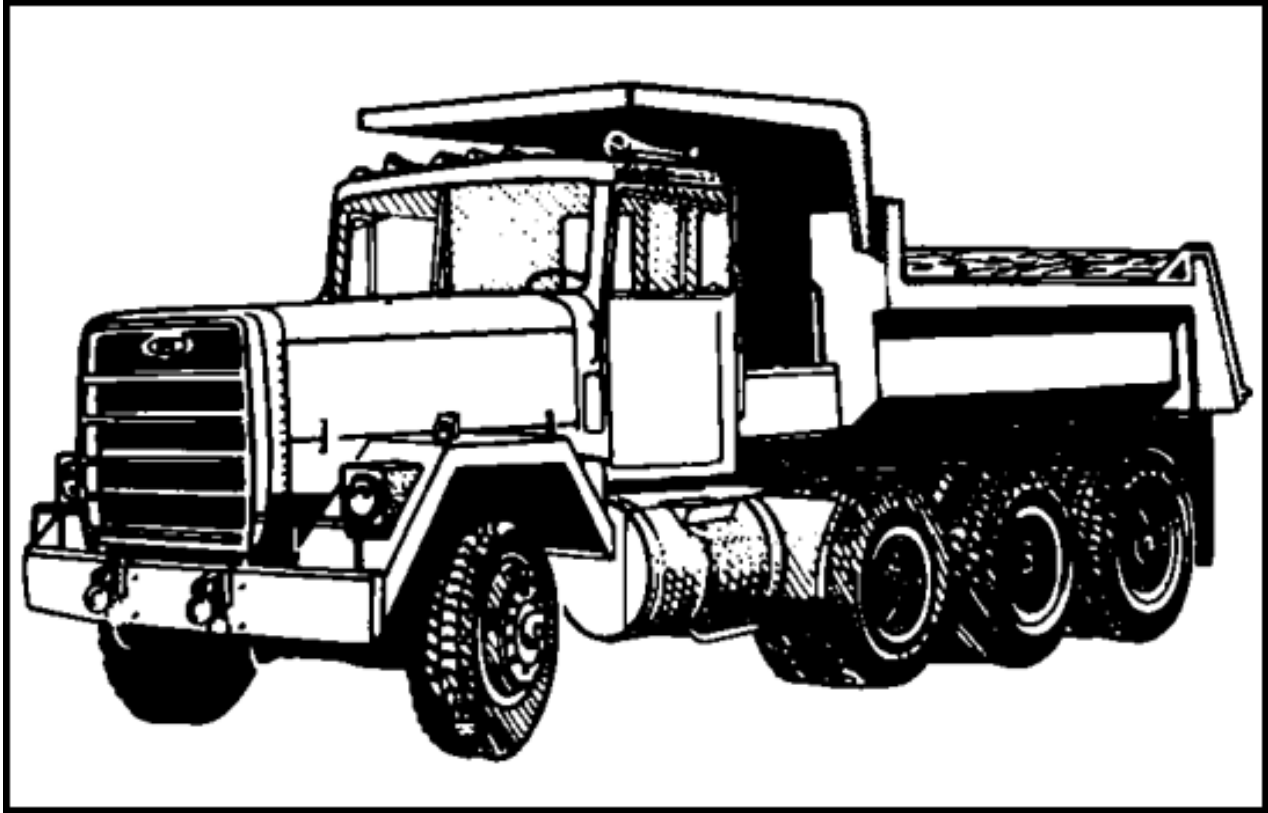

FIGURE 24. M917 DUMP TRUCK.

The M917, 8x6, 20-ton, dump truck is used for carrying dirt, sand, gravel, and so forth. It is equipped with a pusher axle.

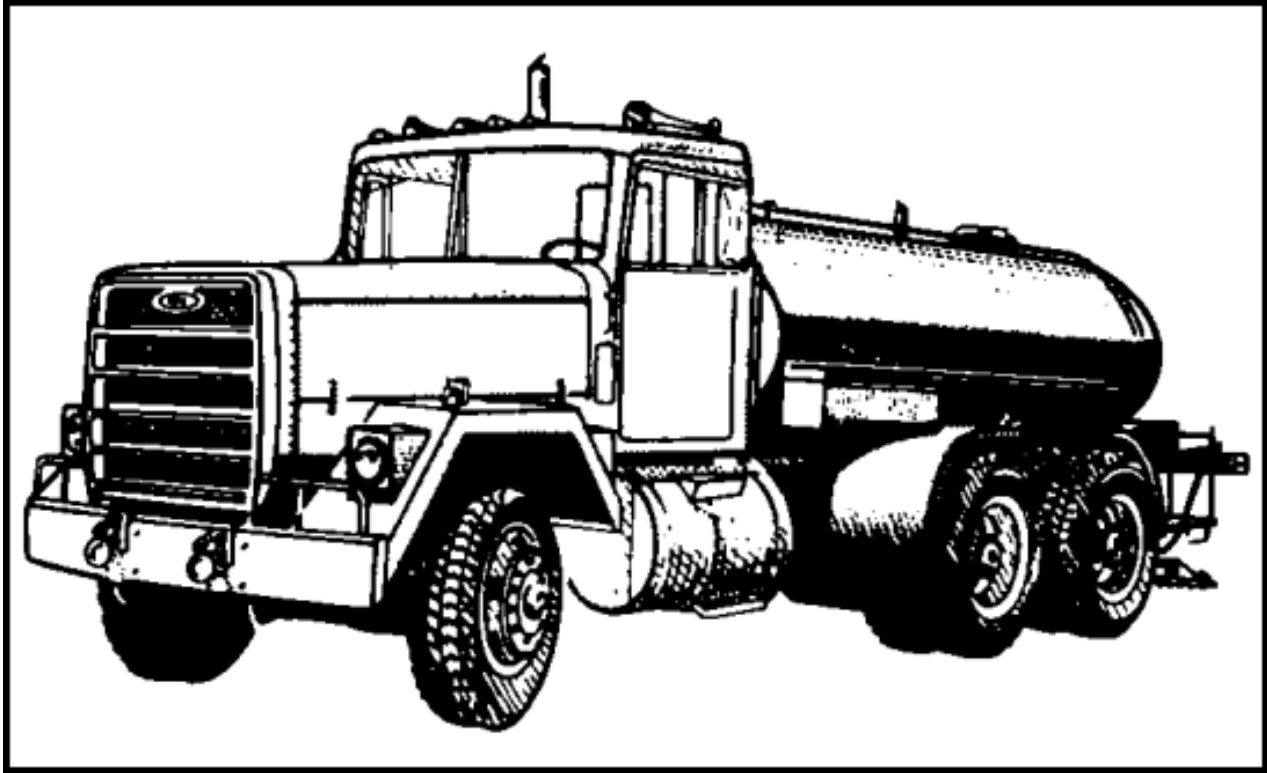

FIGURE 25. M918 BITUMINOUS DISTRIBUTOR.

The M918, 6x6, bituminous distributor truck is used for spreading bitumen for road construction and similar projects.

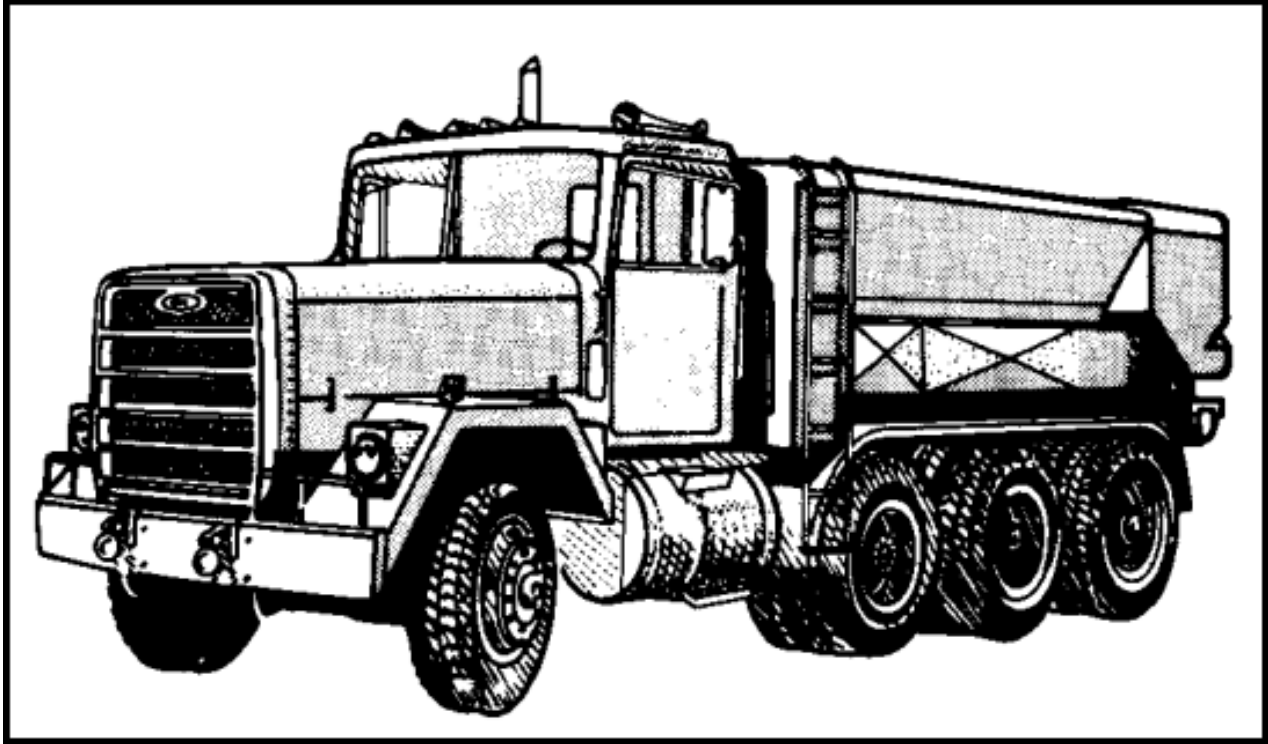

FIGURE 26. M919 CONCRETE MIXER.

The M919, 8x6, concrete, mobile mixer, truck is capable of on-site mixing of up to 8 cubic yards of concrete.

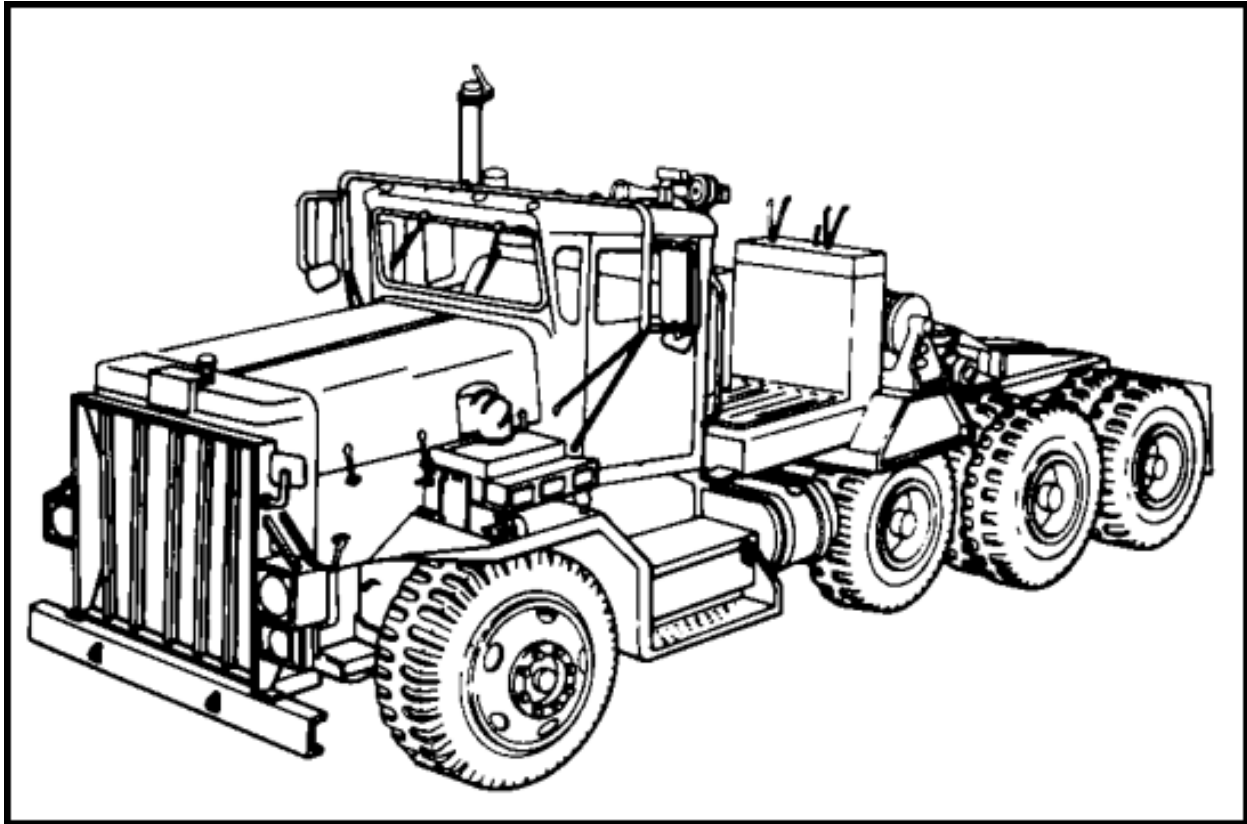

FIGURE 27. M911 TRACTOR TRUCK.

COMMERCIAL HEAVY EQUIPMENT TRANSPORTER

The M911, 8x6, tractor truck, commercial, heavy equipment transporter (C-HET) is the prime mover for use with the M747 semitrailer. It is designed for primary and limited secondary road use. It is powered by a V-8, turbocharged, diesel engine with a five-speed automatic transmission and two-speed auxiliary transmission. It has hydraulic-assist power steering and an air-operated brake system. It is equipped with two winches for loading and off-loading equipment. With the M747, it is capable of hauling up to 60 tons.

HEAVY EXPANDED MOBILITY TACTICAL TRUCK (HEMTT) VEHICLES

The HEMTT series of vehicles is designed for use on all types of road and cross-country terrain in all weather conditions. It is powered by a V-8 diesel engine with a four-speed automatic transmission and two-speed transfer case. It has leaf-spring and equalizer beam suspension with hydraulic-assist power steering on both front axles and eight-wheel, air-actuated brakes.

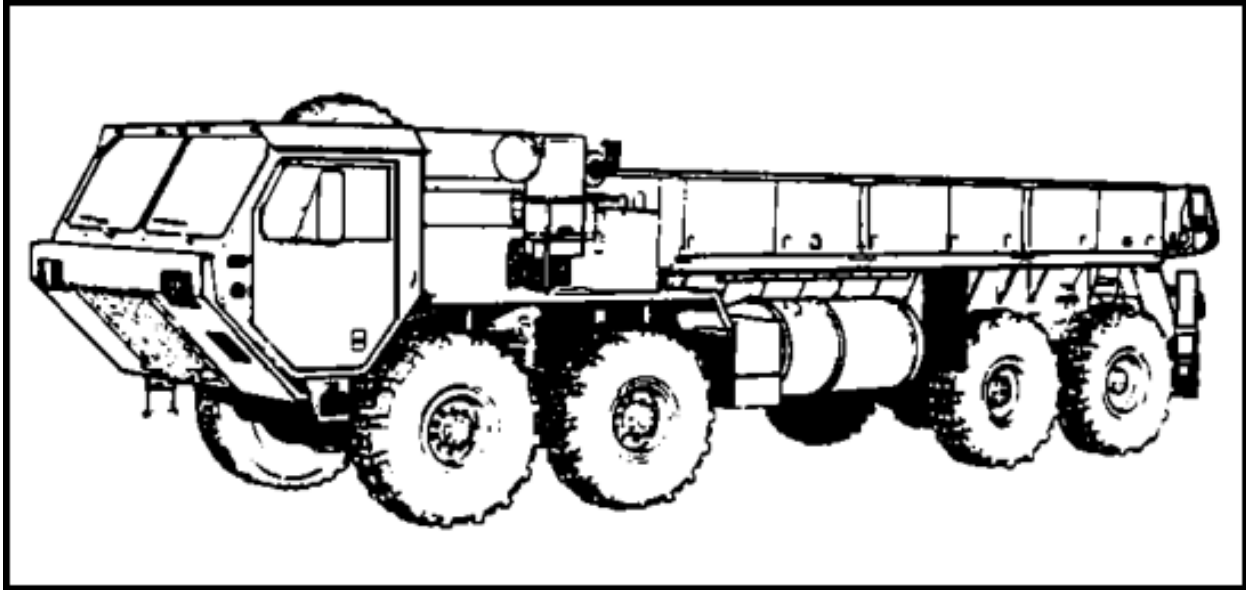

FIGURE 28. M977 CARGO TRUCK.

The M977/M985 cargo trucks are general purpose carriers with a rear-mounted materials-handling crane. They are used for resupply of ammunition to forward units. Some trucks are equipped with a winch.

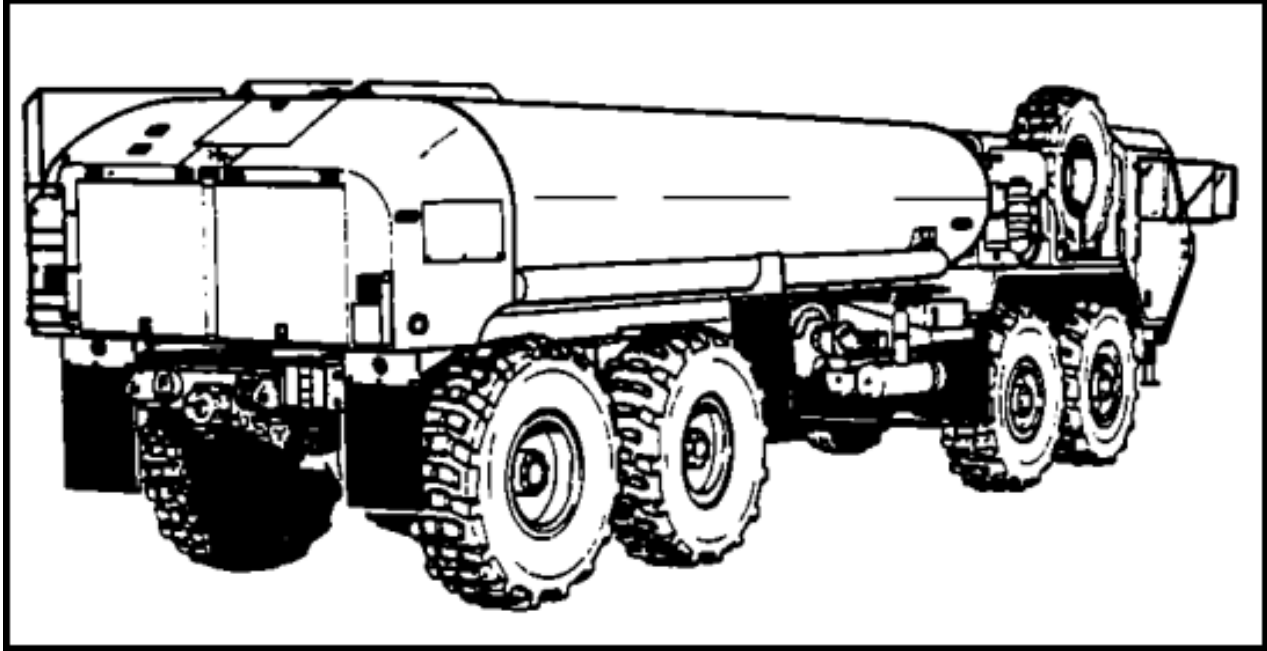

FIGURE 29. M978 FUEL SERVICING TRUCK.

The M978 fuel-servicing truck has a liquid capacity of 2,500 gallons. It is used for supplying fuel to units in forward positions. Some trucks are equipped with a winch.

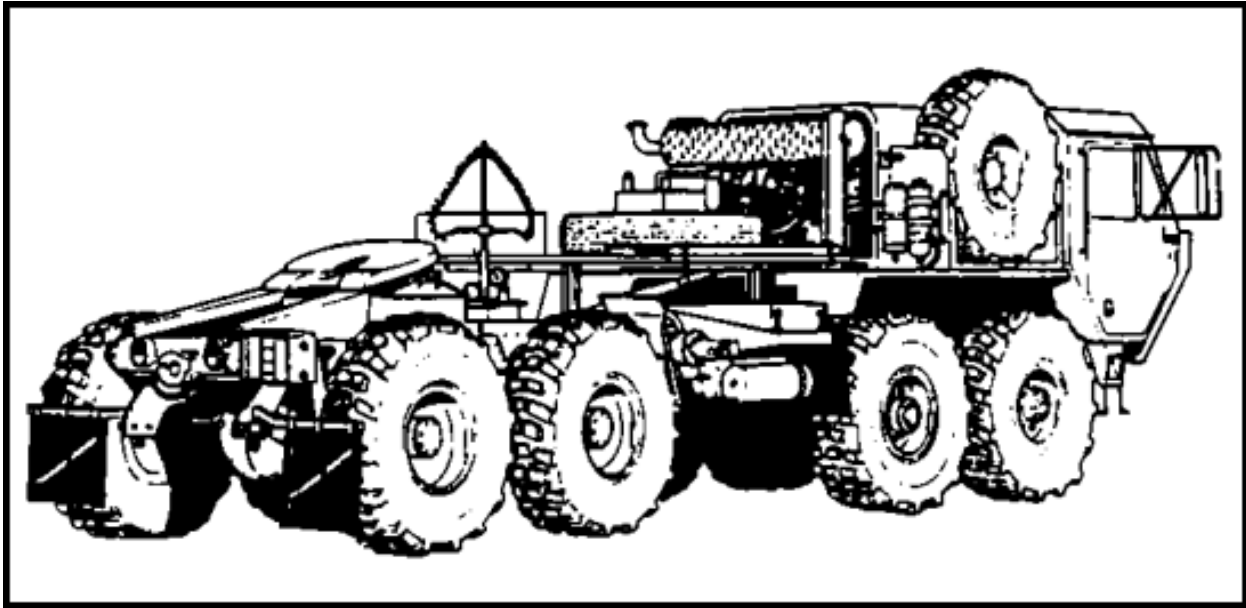

FIGURE 30. M983 TRACTOR TRUCK.

The M983 tractor truck is capable of pulling most Army semi-trailers. It is equipped with a winch, and some trucks have a materials-handling crane.

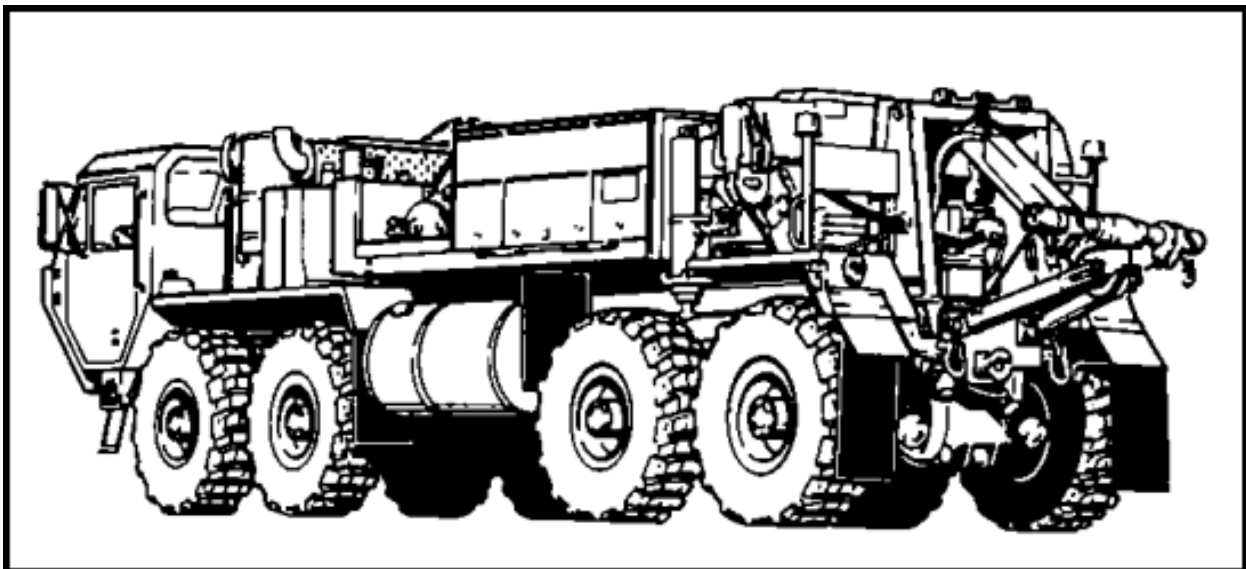

FIGURE 31. M984E1 WRECKER.

The M984E1 recovery truck is equipped with two midship winches and a rear-mounted recovery crane. It is capable of lifting and towing most Army tactical trucks.

TRAILERS

Trailers, like trucks, are made to transport various types of cargo. The following trailers have two wheels and are designed to be towed by a vehicle with the same general tonnage rating.

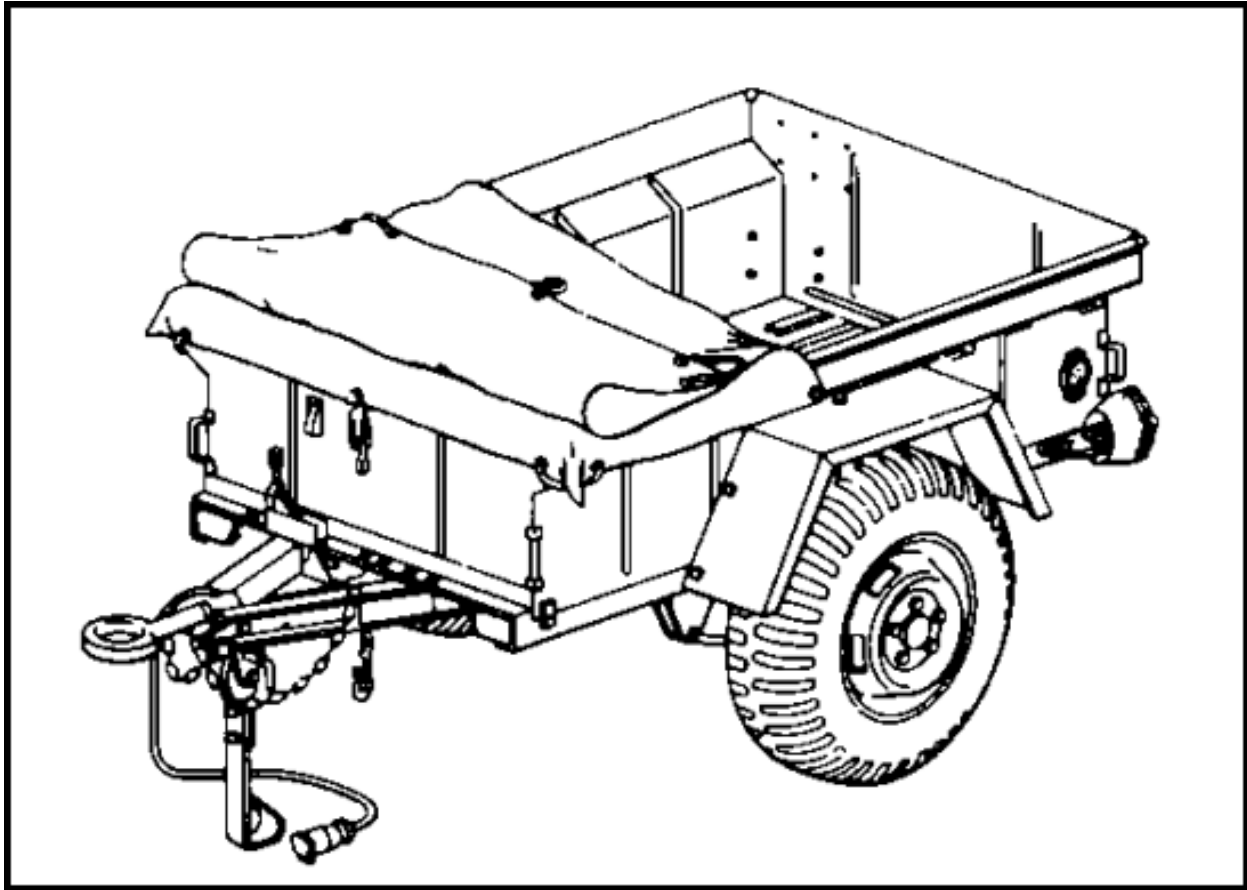

FIGURE 32. M416 UTILITY TRAILER.

The M416/M416A1 $\frac{1}{4}$ -ton trailer is designed to be towed by an M151-series vehicle. The body is of one-piece, welded construction and will carry a 500-pound load. The M416A1 has lunette-actuated hydraulic brakes.

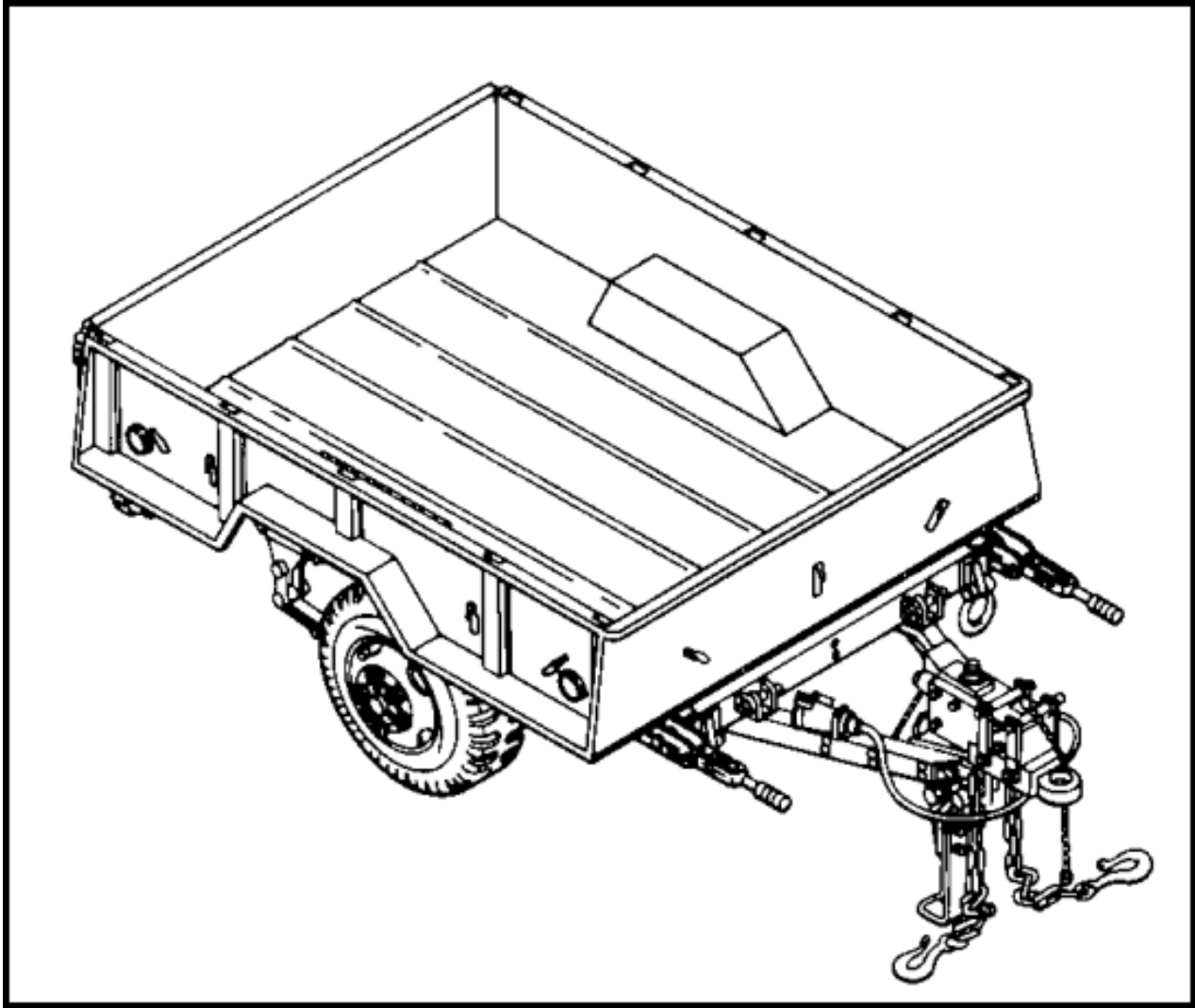

FIGURE 33. M101A2 CARGO TRAILER.

The M101-series, $\frac{3}{4}$ -ton trailer is designed to be towed by $\frac{3}{4}$ - and $1\frac{1}{4}$ -ton vehicles. It is equipped with side racks, cover, and drop tailgate. The M101A1 has lunette-actuated hydraulic brakes.

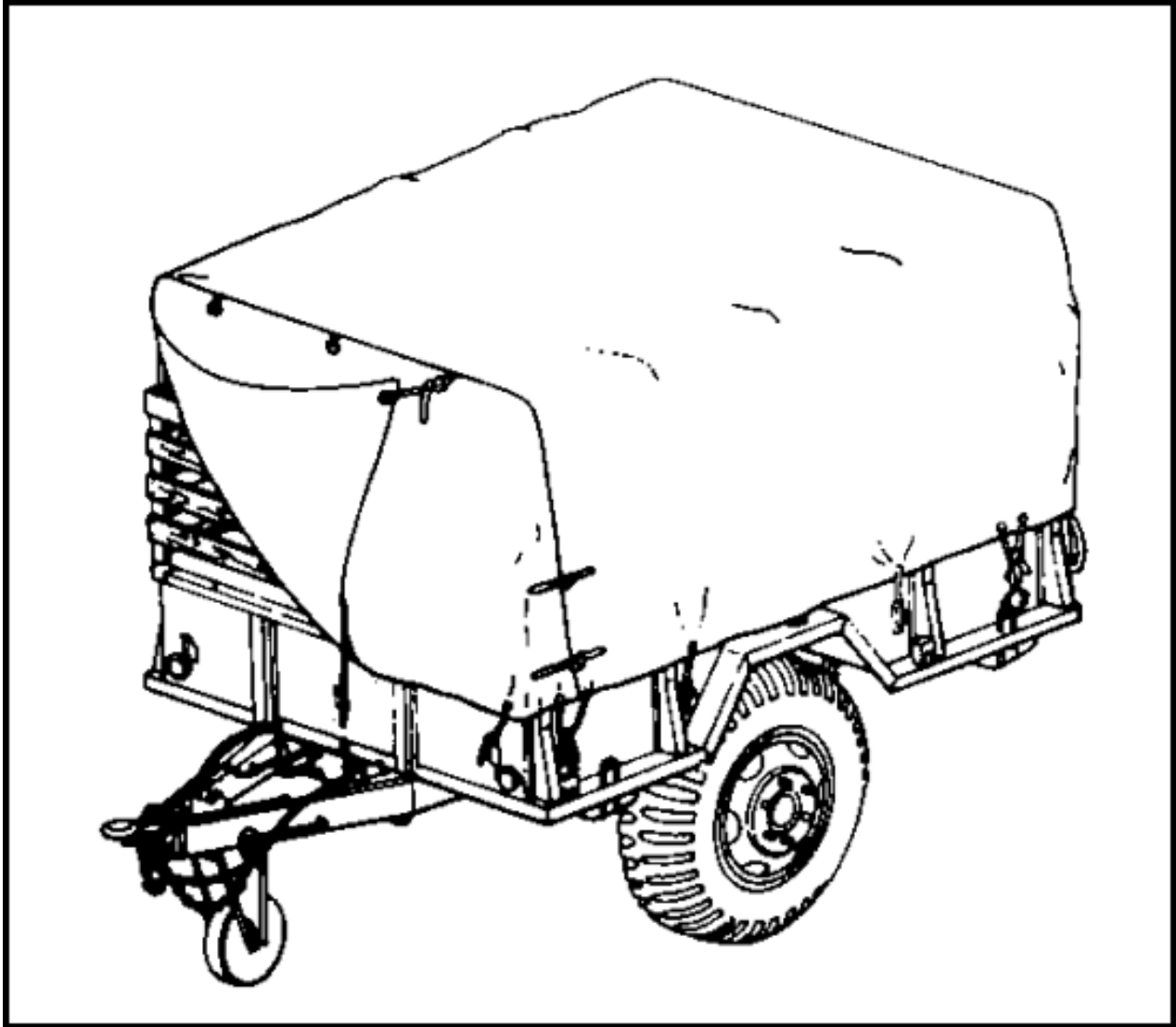

FIGURE 34. M105 CARGO TRAILER.

The M105-series, 1 ½-ton trailer is designed to be towed by the 2 ½- and 5-ton vehicles. It is also equipped with side racks, cover, and drop tailgate. It has air-actuated hydraulic brakes.

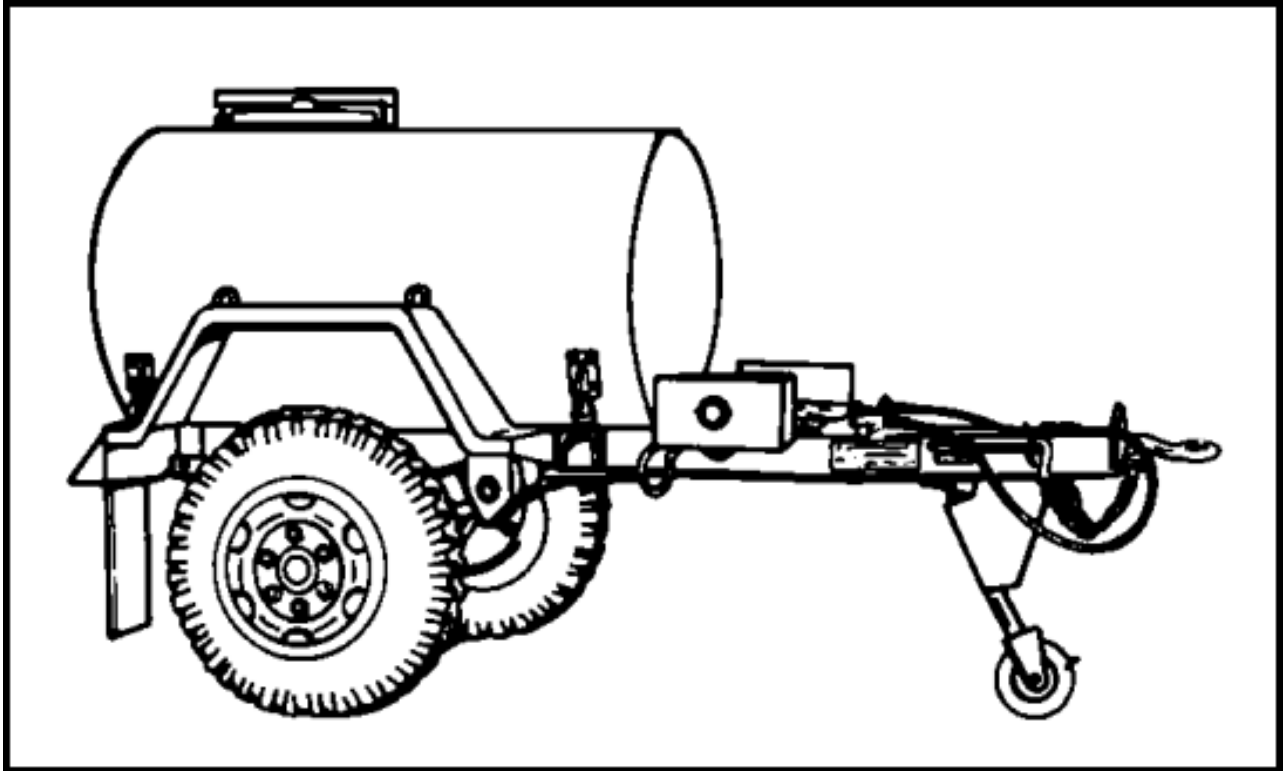

FIGURE 35. M149A1 WATER TRAILER.

The M149-series water trailer is designed to be towed by the 2 ½- and 5-ton vehicles. It has a 400-gallon capacity, with either a fiberglass or stainless steel tank. It uses air-actuated hydraulic brakes.

SEMITRAILERS

Semitrailers are easy to recognize because they have wheels at only one end. On the other end, there is a fifth wheel upper plate with a pin that engages the fifth wheel of a tractor truck for towing. Also, near the fifth wheel end, there is a landing gear that can be lowered to support the trailer when it is not connected to a tractor. Several different types of semitrailers used by the Army are discussed in the following paragraphs.

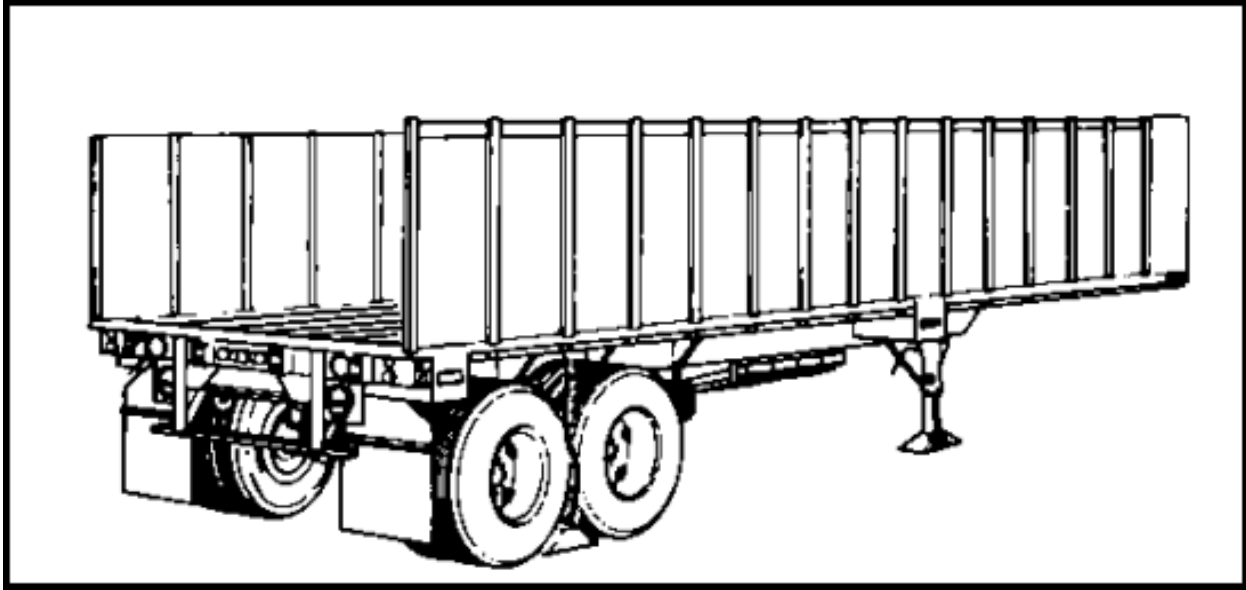

FIGURE 36. M871 TRANSPORTER.

The M871, 22 ½-ton breakbulk/container transporter is designed to carry either conventional or containerized cargo. It is towed by the M915-series or 5-ton tractor trucks. It is equipped with air brakes and removable side racks.

The M872, 34-ton breakbulk/container transporter is similar to the M871. It is longer, has a larger cargo capacity, and is equipped with three axles.

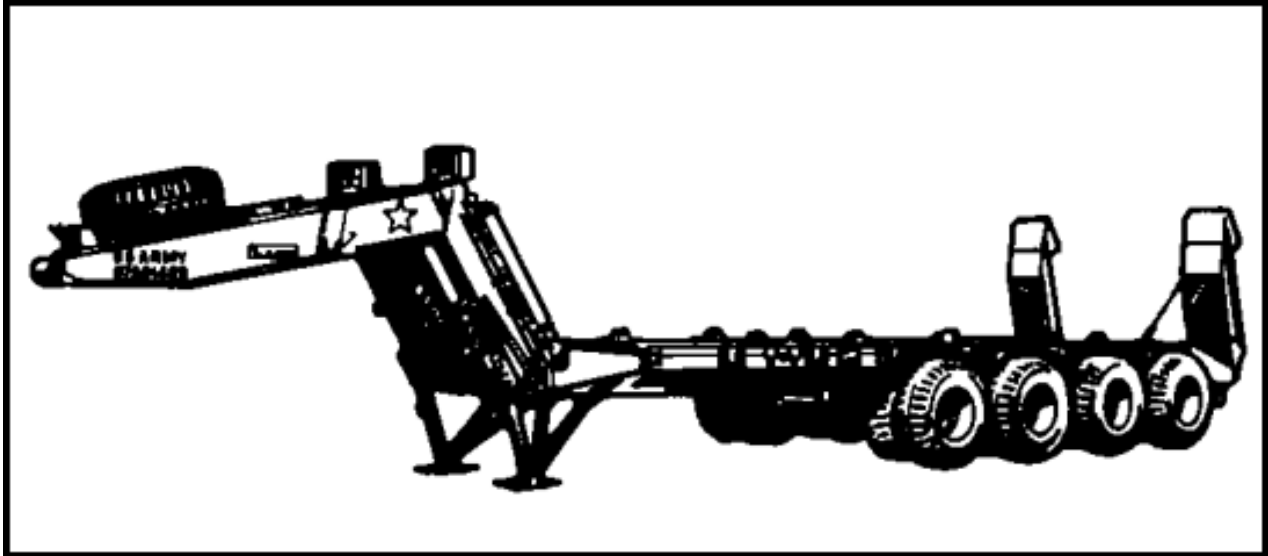

FIGURE 37. M747 TRANSPORTER.

The M747, 52 ½-ton, heavy equipment transporter is used to transport combat vehicles and other heavy equipment. It is towed by the M911 tractor truck.

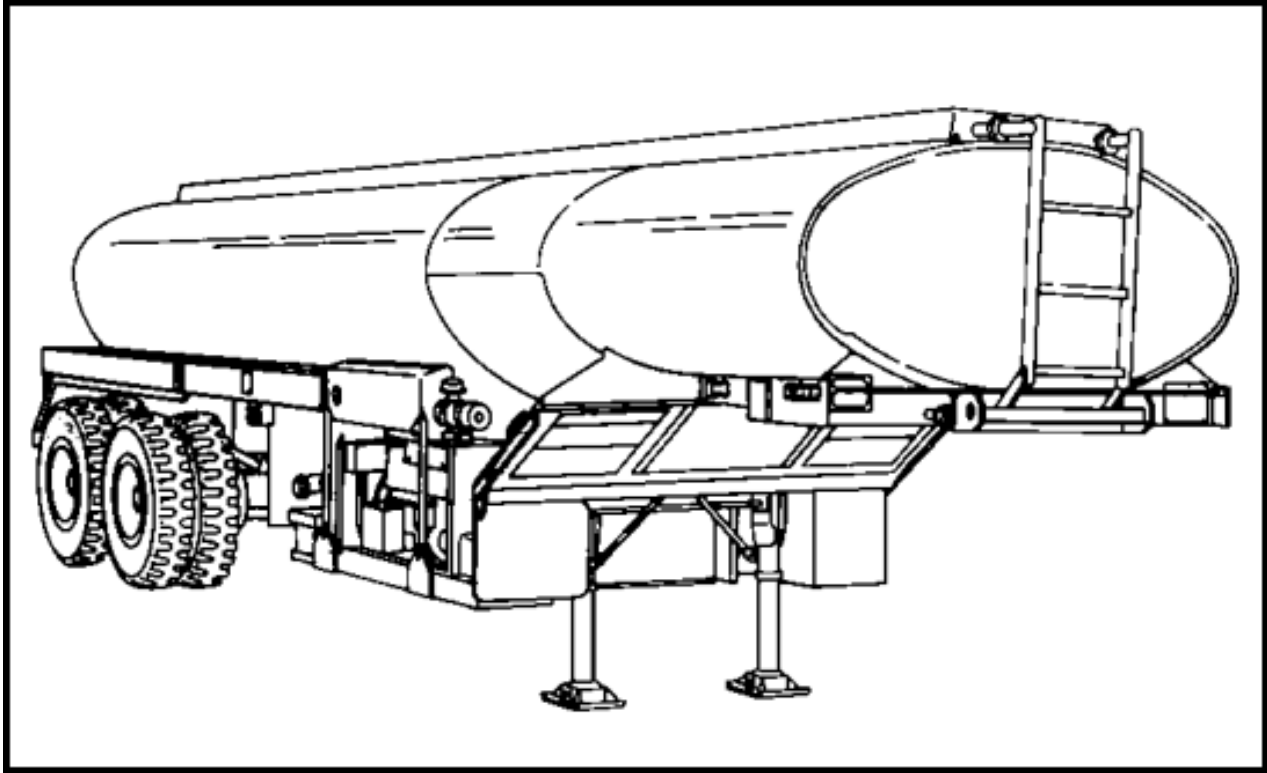

FIGURE 38. M967 TANKER.

The M967-series, 5,000-gallon tankers are designed to transport and dispense automotive and aviation fuel. They are towed by the M915 and 5-ton series of tractor trucks.

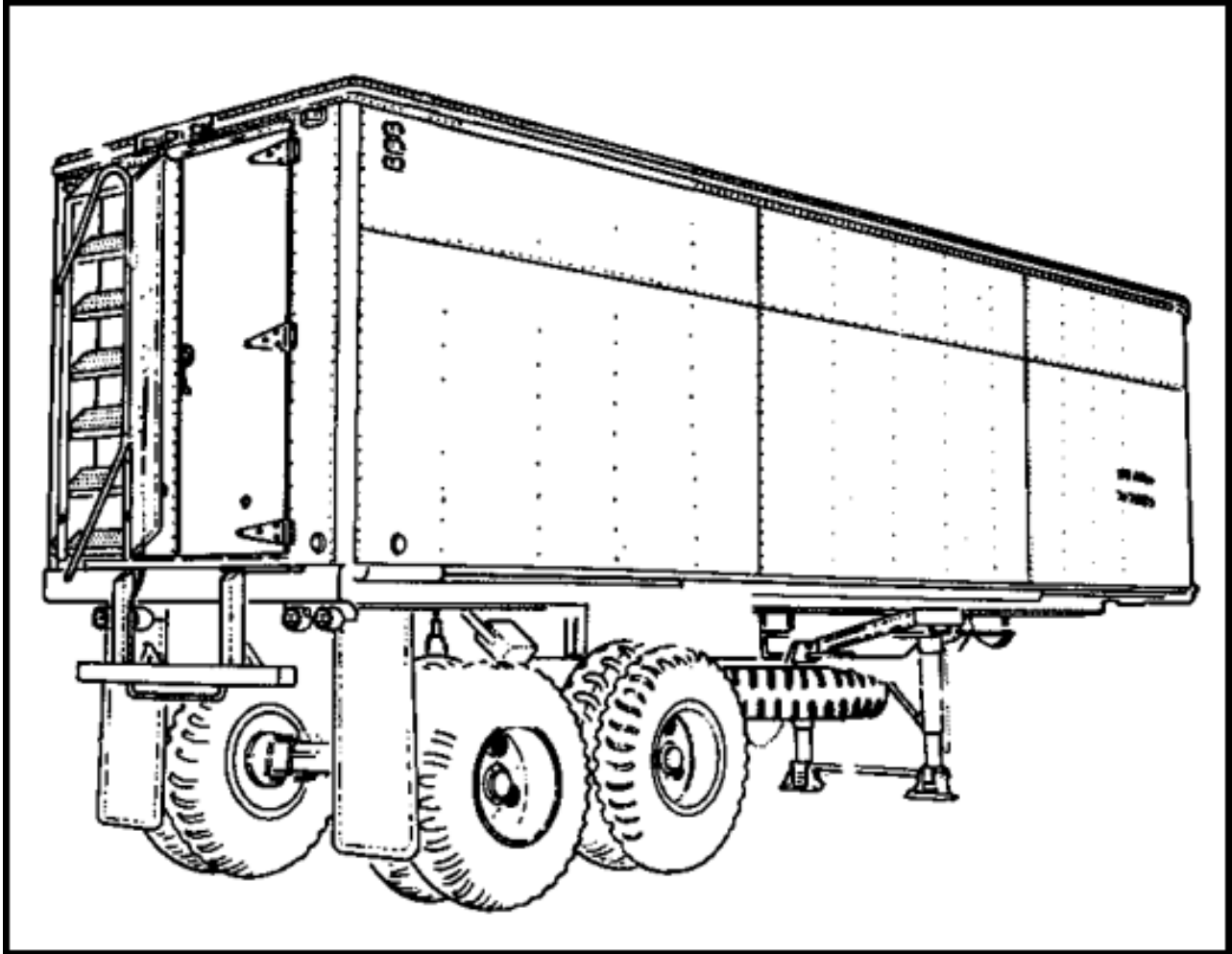

FIGURE 39. M128A1 VAN.

The M128A1 and M129A1, 12-ton vans are multipurpose cargo and supply vans. They are towed by the 5-ton or M915-series of tractor trucks. The M129A1 vans have windows and interior lights.

Lesson 2

PRACTICE EXERCISE

1. What do the letters CUCV stand for?
 - a. Commercial utility cargo vehicle
 - b. Commercial unit command vehicle
 - c. Commercial unit cargo vehicle

2. The 5-ton vehicles have
 - a. air-actuated brakes.
 - b. air-assisted hydraulic brakes.
 - c. either air-assisted hydraulic or air-actuated brakes.

3. The M915-series vehicle all have
 - a. front-wheel drive.
 - b. six-cylinder diesel engines.
 - c. nondriven "pusher" axles.

4. The M911 C-HET is the prime mover for the
 - a. M872 transporter.
 - b. M747 transporter.
 - c. M967 tanker.

5. The HMMWV-series vehicles are powered by
 - a. eight-cylinder, diesel engines.
 - b. eight-cylinder, gasoline engines.
 - c. six-cylinder, diesel engines.

ANSWERS TO PRACTICE EXERCISE

1. a (page 15)
2. c (page 26)
3. b (page 31)
4. b (page 38)
5. a (page 19)

SUBCOURSE
IS 0902

EDITION
A



IS0902-A