

AD-A218 887

R AND D ASSOCIATES ROSSLYN VA F/G 10/2
PROCEEDINGS OF THE AFOSR SPECIAL CONFERENCE ON PRIME-POWER FOR --ETC(U)
FEB 82 P J TURCHI F49620-82-C-0008

UNCLASSIFIED

AFOSR-TR-82-0655

NL

for 9

of 7

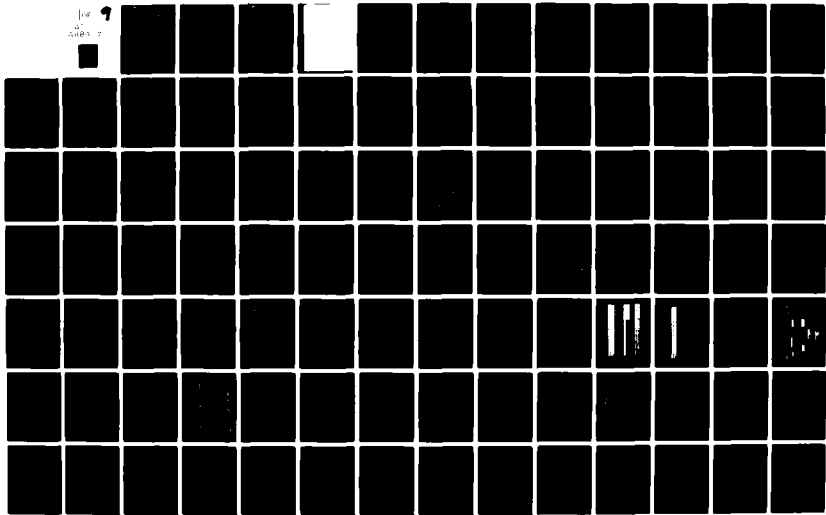

This document is made available through the declassification efforts
and research of John Greenewald, Jr., creator of:

The Black Vault



The Black Vault is the largest online Freedom of Information Act (FOIA)
document clearinghouse in the world. The research efforts here are
responsible for the declassification of hundreds of thousands of pages
released by the U.S. Government & Military.

Discover the Truth at: <http://www.theblackvault.com>

REPORT DOCUMENTATION PAGE

READ INSTRUCTIONS
BEFORE COMPLETING FORM

1. REPORT NUMBER AFOSR-TR- 82 - 0655		2. GOVT ACCESSION NO. AD-A118887	3. RECIPIENT'S CATALOG NUMBER
4. TITLE (and Subtitle) PROCEEDINGS OF THE AFOSR SPECIAL CONFERENCE ON PRIME-POWER FOR HIGH ENERGY SPACE SYSTEMS VOLUME I		5. TYPE OF REPORT & PERIOD COVERED FINAL	
7. AUTHOR(s) P.J. TURCHI		8. CONTRACT OR GRANT NUMBER(s) F49620-82-C-0008	
9. PERFORMING ORGANIZATION NAME AND ADDRESS Research & Development Associates (RDA) Rosslyn, VA 22209		10. PROGRAM ELEMENT, PROJECT, TASK AREA & WORK UNIT NUMBERS 61102F 2301/A7	
11. CONTROLLING OFFICE NAME AND ADDRESS AFOSR/NP BOLLING AFB, DC 20332		12. REPORT DATE 22-25 February 1982	
14. MONITORING AGENCY NAME & ADDRESS (if different from Controlling Office)		13. NUMBER OF PAGES 767	
		15. SECURITY CLASS. (of this report) UNCLASSIFIED	
		15a. DECLASSIFICATION/DOWNGRADING SCHEDULE	
16. DISTRIBUTION STATEMENT (of this Report) APPROVED FOR PUBLIC RELEASE; DISTRIBUTION UNLIMITED.			
17. DISTRIBUTION STATEMENT (of the abstract entered in Block 20, if different from Report)			
18. SUPPLEMENTARY NOTES			
19. KEY WORDS (Continue on reverse side if necessary and identify by block number)			
20. ABSTRACT (Continue on reverse side if necessary and identify by block number) (see next page)			

AD A118887

DTC FILE COPY

DTC
SELECTED
SEP 1 1982
H

SECRET

CLASSIFICATION OF THIS PAGE(When Data Entered)

82-0655

As part of an assessment of research needs in the space prime-power area, a special conference was convened at the Omni International Hotel in Norfolk, VA, 22-25 February 1982. The intent of the Conference was to review the state-of-the-art of space prime-power technology, including new or advanced concepts, and to discuss research needed for progress toward megawatt power levels. The Conference was attended by over 190 scientists and engineers from universities, government, and private organizations. Over eighty papers were presented, including discussions of chemical, nuclear and radiant energy techniques, power conversion, heat rejection, materials, chemical and fluid physics, and also reviews of power requirements for future NASA and DoD systems.

The Special Conference on Prime-Power for High-Energy Space Systems provided a useful opportunity for research scientists and technologists to educate each other on problems and progress in space prime-power. Although the AFOSR interest is basic research, the Conference also served as a forum for description of systems, concepts, and programs with particular mission requirements, and for discussion of research in support of specific devices or needs. The proceedings of the Conference, (consisting of over 1700 pages of text and view graph copies), were compiled and distributed to Conference attendees.

UNCLASSIFIED

SECURITY CLASSIFICATION OF THIS PAGE(When Data Entered)

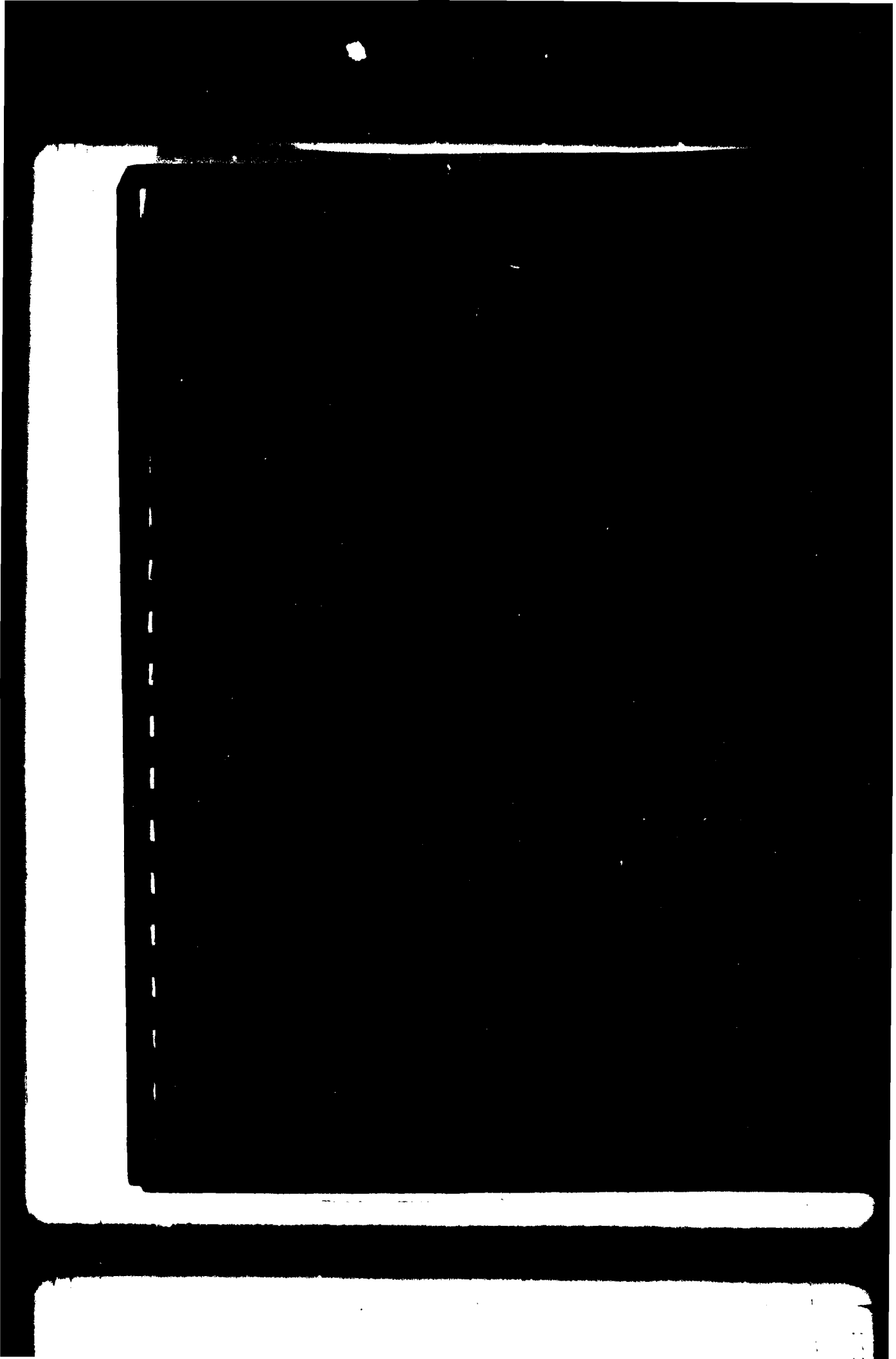

**PROCEEDINGS
OF THE
AFOSR SPECIAL CONFERENCE
ON
PRIME-POWER FOR HIGH ENERGY SPACE SYSTEMS**

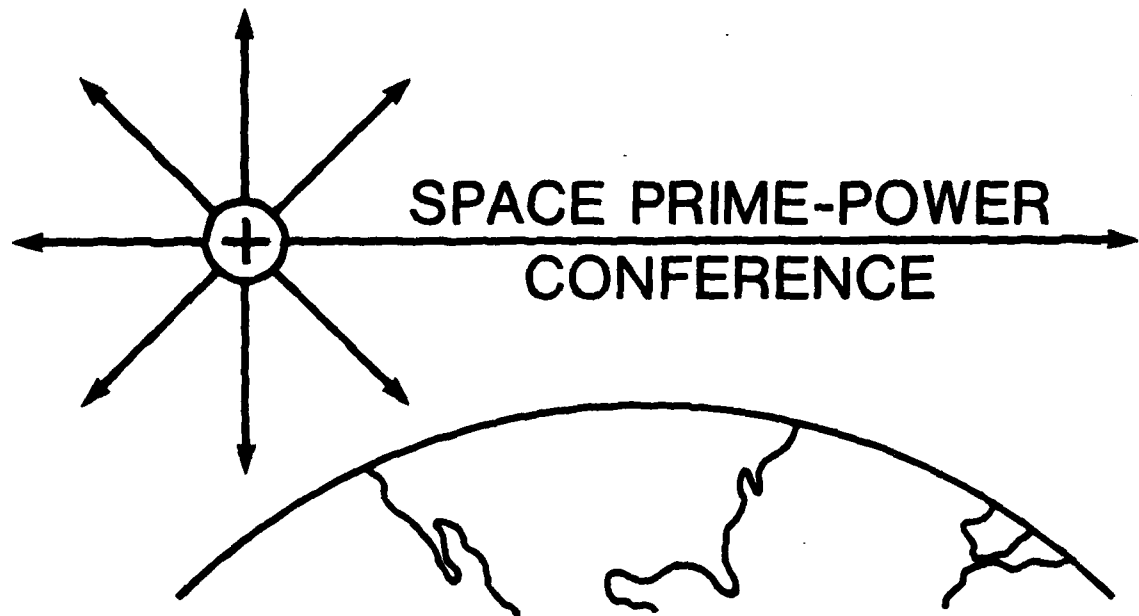

Norfolk, Virginia
22-25 February 1982

Volume I

Accession For	
DTIC GRA&I	<input checked="" type="checkbox"/>
DTIC TAB	<input type="checkbox"/>
Unannounced	<input type="checkbox"/>
Justification	
By _____	
Distribution/	
Availability Codes	
(Avail and/or	
Dist	Special
A	



Preface

By the year 2000, an increasingly large portion of our national defense will depend on space-based systems. Extrapolation of present trends indicates that prime-power sources operating at megawatt levels and beyond will be needed. These power levels must be achieved at significantly higher values of specific power (w/kg) and energy (w-hr/kg) than are presently available in order to satisfy defense needs for maneuverability and survivability. While steady progress has been made and new concepts have provided the potential for further improvements, substantial gains over the next two decades will probably require investment in basic research examining fundamental processes and phenomena in power conversion, material behavior, surface interactions, etc. As part of a broader set of new research initiatives in support of space systems, the Air Force Office of Scientific Research will be sponsoring basic research that may be applicable to the development of megawatt-level space prime-power systems. (The emphasis of this particular new initiative is prime-power versus pulsed power including power conditioning, such as flywheel or inductive storage, for which there are existing programs.)

As part of an assessment of research needs in the space prime-power area, a special conference was convened at the Omni International Hotel in Norfolk, VA, 22-25 February 1982. The intent of the Conference was to review the state-of-the-art of space prime-power technology, including new or advanced concepts, and to discuss research needed for progress toward megawatt power levels. The Conference was attended by over 190 scientists and engineers from universities, government, and private organizations. Over eighty papers were presented, including discussions of chemical, nuclear and radiant energy techniques, power conversion, heat rejection, materials, chemical and fluid physics, and also reviews of power requirements for future NASA and DoD systems. The Conference agenda is displayed in Fig. 1, in terms of technical topics, session chairmen, and first authors.

From the session on prime-power needs, distinctions could be drawn between the continuous power levels required by NASA and DoD missions involving long-term propulsion and station-operation, and the intermittent needs of some proposed DoD missions for very high power levels (10^7 - 10^8 w) for several seconds or longer. The latter DoD requirement, which does not have routine parallel requirements in NASA, tends to broaden consideration of prime-power technology options. For example, it may be reasonable to expect that continuous multimewatt power for orbit changes (including deep space missions away from the sun) will require space-nuclear reactor systems. A few second burst of 100 megawatts, however, might be better provided by a chemically-driven MHD system. In support of possibly broader requirements for high power, it may be anticipated that AFOSR would have broader research interests in the space prime-power area.

The first two days of the Conference were largely devoted to a review of technology so that basic research scientists could learn from technologists about the existence of various systems and critical problem areas. Chemical sources were reviewed, including batteries, fuel cells, and combustion-driven MHD. Related power conversion techniques were also discussed in the form of turbogenerator developments and several MHD methods connected to chemical sources. (Other MHD systems, not strictly chemically-driven, were also described on the first day.)

Discussions of nuclear sources included both developments from earlier NASA/AEC efforts, such as the present SP-100 program, and also advanced concepts in the form of rotating-fluidized bed systems. Attention was also given to safety issues for space nuclear power, shielding considerations, and research needs. The nuclear session was followed by a short session on power conversion technologies (Brayton, Rankine, thermoelectric), which are often closely connected to nuclear sources. The needs for improved data on high temperature materials and better theoretical understanding, (e.g., thermoelectric properties and scaling) were also discussed.

The session on radiant systems covered a range of technologies and concepts involving photons in one way or another. These technologies included photovoltaic concepts (tandem photocells and thermal-photovoltaic), solar-thermal approaches, and various possible ways of generating laser light for transmission of power through space (solar-, nuclear-, optically-pumped lasers). New concepts for converting light to electricity were also described, such as radiation-driven MHD, plasma-diode conversion of laser light, and a device to convert light to RF (actually demonstrated at the Conference).

The last full day of the Conference tended to concentrate on scientific research issues, but also included descriptions of technology and concepts. It was readily anticipated prior to the Conference that materials research would be a critical requirement for progress toward high power in space. Indeed, the session on materials was quite extensive, comprising 15 papers on subjects such as surface modification techniques, reactor materials, ceramics, materials testing, structural characterization, and electrical insulation. Closely related to materials research were topics in chemical physics research and thin films, discussions of which completed the morning's activities.

In the afternoon, thermal energy was considered in various manifestations: thermionic energy conversion research and technology, heat rejection techniques, and thermal stress analysis of large space-structures. The session on thermionics included a review of the DoE program in thermionic research, in addition to descriptions of systems such as in-pile thermionic diodes and prospects for performance improvements by understanding and controlling particle collection geometries. Advanced radiator designs, such as liquid droplet and liquid metal film concepts, were discussed in the session on heat and systems. This session also included consideration of heat pipes, thermal management of power systems, and software for analysis and optimization of power systems. Problems and uncertainties of analysis and prediction of large space-structures, such as required for support of solar arrays, mirrors, radiators, etc., were also discussed.

The last day of the Conference consisted primarily of a morning session in which the session chairmen summarized discussions that took place both within their formal sessions and also at the discussion symposia that concluded each (very full) day of the meeting. (In order to complete the eighty papers of the Conference in a single-session format, questions during the formal sessions were limited to ones of clarification. Detailed questions and answers were obtained in writing and posted at the discussion symposia for inspection by Conference attendees and for continued discussion by interested parties.) On the last day, the session chairmen were also offered the opportunity to present their personal viewpoints on space prime power.

Repeatedly during the Conference, attendees were reminded that AFOSR is interested in basic research issues applicable to space prime-power development, rather than specific mission-oriented devices, schemes, etc. Within the Department of Defense, funding for research is divided along both disciplinary lines (e.g., physics) and mission immediacy. Basic

research is performed under DoD sponsorship at two levels of immediacy: a) directly in support of a single mission requirement (designated "6.2" for physics research) and b) applicable, but not necessarily applied, to more than one mission (designated "6.1" for physics). An example of 6.2 research would be understanding pulsed high temperature plasma radiation sources in regimes of interest for nuclear weapons simulation. Understanding plasma/surface chemistry at a level applicable to lasers, switching, and re-entry vehicles would be 6.1 research. While a variety of specific prime-power systems of Air Force interest may require research, the mission of AFOSR is to foster research at the fundamental (e.g., 6.1) level rather than to fund research and development of particular, single-mission-related devices. Other parts of the Air Force have responsibilities for such development, and also for research needed to accomplish development successfully. (Note that, in the other extreme, fundamental research not clearly applicable to some defense mission may not be of sufficiently immediate interest to qualify even for 6.1-type funding.) To assist qualified and interested scientists in participating in the AFOSR initiative for space prime-power research, a document is being prepared, based in part on the Conference, that will describe fundamental research areas appropriate for AFOSR attention. Similar guidance may be available for other AFOSR space initiatives, such as advanced propulsion for orbit-raising and maneuvering.

The Special Conference on Prime-Power for High-Energy Space Systems provided a useful opportunity for research scientists and technologists to educate each other on problems and progress in space prime-power. Although the AFOSR interest is basic research, the Conference also served as a forum for description of systems, concepts, and programs with particular mission requirements, and for discussion of research in support of specific devices or needs. As with any effort in basic research, the most important results of the Conference may not be measurable for twenty years. All that can be said now is that a small step has been made toward a destination of critical national importance.

Lt. Col. A. K. Hyder and
Air Force Office of
Scientific Research
Bolling AFB
Washington, D. C.

P. J. Turchi
R & D Associates
Washington Research
Laboratory
Alexandria, VA

Mon. 22 Feb.

Tues. 23 Feb.

- 0800 Registration
- 0900 I. Needs
(Turchi;Hyder)
1. Hartke
 2. Mullin
 3. Cohen
 4. Woodcock; Silverman
 5. Caveny
- 1100 II. Chemical Sources
(Barthelemy)
1. Clark
 2. Brown
 3. Stedman
 4. Oberly
- 1230 LUNCH
- 1330 III. Chemical/MHD
(Barthelemy)
1. Dicks
 2. Smith
 3. Louis
 4. Bangerter
 5. Massie
 6. Jackson
 7. Pierson
 8. Goswami
 9. Swallow
 10. Seikel
 11. Koester
- 1630 Discussion Symposium
(Vondra)

- 0800 IV. Nuclear Sources
(Angelo; Lee)
1. Buden
 2. Fraas
 3. Fitzpatrick
 4. Thompson
 5. Elsner
 6. Powell; Myrabo
 7. Lee
 8. El-Genk
 9. Jones
 10. Ranken
 11. Bartine
- 1100 V. Power Conversion
(Layton)
1. Thompson
 2. Peterson
 3. Bland
 4. Stapfer
- 1200 LUNCH
- 1300 VI. Radiant Systems
(Severns)
1. English, Brandhorst
 2. Loferski
 3. Loferski
 4. Holt
 5. Conway
 6. Phillips
 7. Miley
 8. Walbridge
 9. Britt
 10. Finke
 11. Freeman
 12. Lee, Ja
 13. Freeman
- 1700 Discussion Symposium
(Guenther)

Wed. 24 Feb.

Thurs. 25 Feb.

0800 VII. Materials
(English)

1. Saunders
2. Morris
3. Ling Yang
4. Rossing
5. Nahemow
6. Cooper
7. Levy
8. Sarjeant
9. Sundberg
10. Milder
11. Milder
12. Banks
13. Rice
14. Blankenship
15. Gilardi

1045 VIII. Chemical Physics
(Junker)

1. Rabitz
2. Rosenblatt
3. Donovan

1145 LUNCH

1245 IX. Thermionics
(Junker)

1. Ling Yang
2. Huffman
3. Lawless
4. Merrill

1345 X. Heat/Systems
(Badcock)

1. Haslett
2. Taussig
3. Bruckner
4. Ernst
5. Ernst
6. Fowle
7. Teagan
8. Berry
9. Thornton

1700 Discussion Symposium
(Hyder)

0900 XI. Summary
(Turchi)

1. Barthelemy
2. Vondra
3. Angelo
4. Layton
5. Severns
6. Guentner
7. English
8. Junker
9. Badcock
10. Hyder

"The AFOSR FY' Space
Initiatives"
Bryan

1200 Conference End

Executive Committee
Working Session

EXECUTIVE COMMITTEE

Major Joseph Angelo
AFTAC/TAO
(305)-494-2531

Dr. Arthur Guenther
AFWL/CA
(505)-844-9856

Dr. Charles C. Badcock
The Aerospace Corporation
(213)-648-5180

Lt. Col. Anthony Hyder
AFOSR
(202)-767-4908

Dr. Robert Barthelemy
AFWAL/POO
(513)-255-6235

Mr. J. Preston Layton
Consultant
(609)-799-3094

Dr. Frederick Betz
Dr. James G. Severns
Naval Research Laboratory
(202)-767-6559

Dr. Joseph Mangano
Lt. Cdr. William E. Wright
DARPA/DEO
(703)-694-3784

Dr. Robert English
NASA Lewis Research Center
(216)-433-4000 Ext 6949

Dr. Robert Vondra
AFRPL/LKDH
(805)-277-5540

Dr. Peter J. Turchi, Chairman
R & D Associates, Inc.
(703)-522-5400

Table of Contents

	<u>Page</u>
PREFACE	iii
CONFERENCE PROGRAM	vii
EXECUTIVE COMMITTEE	ix
CONFERENCE PRESENTATIONS	
I. Prime-Power Needs	
Hartke, R. H., "Space, the Air Force, and AFOSR"	I-1 (NA)
Mullin, J., "NASA Directions for Research and Technology in Space Power"	I-2 (NA)
Cohen, M., "High Power Requirements"	I-3
Woodcock, G. R. and Silverman, S., "Power Requirements for Manned Space Stations"	I-4
Caveny, L., "Power Requirements for Orbit-Raising Propulsion"	I-5
II. Chemical Sources	
Clark, J., "Chemical Sources: Overview"	II-1 (NA)
Brown, R. A., "Batteries"	II-2
Stedman, J. K., "Alkaline Fuel Cells for Prime Power and Energy Storage"	II-3
Oberly, C. E., "Turbogenerators"	II-4 (NA)
III. Chemical/MHD	
Dicks, J. B., "MHD Power: Overview"	III-1
Smith, J. M., "NASA Lewis Research Center Combustion MHD Experiment"	III-2
Louis, J. F., "THE MHD Disk Generator as a Multimegawatt Power Supply Operating with Chemical and Nuclear Sources"	III-3
Maxwell, C. D., Bangerter, C. D. and Demetriades, S. T., "Self-Excited MHD Power Source for Space Applications"	III-4

(NA) - material not available

Massie, L., "Chemical Sources: Research Needs"	III-5 (NA)
Jackson, W., "Critique of MHD Power"	III-6 (NA)
Pierson, E. S., "Liquid-Metal MHD for Space Power Systems"	III-7
Goswami, A., Graves, R., and Spight, C., "Solar MHD System with Two-Phase Flow with 'Magnetic' Liquid Metal"	III-8
Swallow, D., "Magnetohydrodynamic Power Supply Systems for Space Applications"	III-9
Seikel, G. R. and Zauderer, B., "Potential Role and Technology Status of Closed-Cycle MHD for Lightweight Nuclear Space-Power Systems"	III-10
Koester, J. K., Kruger, C. H., and Nakamura, T., "MHD Generator Research at Stanford"	III-11

IV. Nuclear Sources

Buden, D., "Overview of Space Reactors"	IV-1
Fraas, A., "Technological Boundary Conditions for Nuclear Electric Space Power Plants"	IV-2
Fitzpatrick, G. O. and Britt, E. J., "Effects of Reactor Design, Component Characteristics and Operating Temperatures on Direct Conversion Power Systems"	IV-3
Parker, G. H., "Gas Cooled Reactors for Large Space Power Needs"	IV-4
Elsner, N. B., "Near Term and Future Nuclear Power Conversion Systems for Space"	IV-5 (NA)
Powell, J., and Botts, T./Myrabo, L., "Compact High-Power Nuclear Reactor Systems Based on Small Diameter Particulate Fuels"; "Closed-Cycle FBR/Turbogenerator Space Power System Concept with Integrated Electric Thrusters for Orbital Transport"	IV-6
Lee, J. H., Jr., "Safety Issues for Space Nuclear Power"	IV-7
El-Genk, M. and Woodall, D., "Areas for Research Emphasis in Design of the Space Power Advanced Reactor"	IV-8

Jones, O. C., Jr., "Research Needs for Particulate Bed Nuclear Reactor Space Power Systems"	IV-9
Ranken, W. A., "Selected Research Needs for Space Reactor Power Systems"	IV-10
Bartine, D. E. and Engle, W. W., Jr., "Shielding Considerations for Space Power Reactors"	IV-11

V. Power Conversion

Parker, G. H., "Brayton Cycle Power Conversion for Space"	V-1
Peterson, J., "Rankine Cycle Power Conversion Overview"	V-2
Bland, T., "Nuclear Powered Organic Rankine Systems for Space Applications"	V-3
Stapfer, G. and Wood, C., "Thermoelectric Conversion"	V-4

VI. Radiant Systems

English, R. and Brandhorst, H. W., Jr., "Power from Radiant-Energy Sources: An Overview"	VI-1
Loferski, J. J., "High Efficiency Tandem or Cascade Photovoltaic Solar Cells"	VI-2
Loferski, J., Severns, J. and Vera, E., "Thermophotovoltaic Power Sources for Space Applications"	VI-3
Holt, J. F., "Solar Energy Conversion for Space Power Systems"	VI-4
Conway, E. J., "Solar Pumped Lasers for Space Power Transmission"	VI-5
Phillips, B. R., "A Proposed Optical Pumping System Requiring No Electric Power"	VI-6
Miley, G. H., "Status, Research Requirements and Potential Application for Nuclear Pumped Lasers"	VI-7
Walbridge, W. W., "Prime Power for High-Energy Space Systems: Certain Research Issues"	VI-8
Britt, E. J., "Status of Thermoelectronic Laser Energy Conversion - Telec"	VI-9
Finke, R. C., "Direct Conversion of Infrared Radiant Energy for Space Power Applications"	VI-10

Freeman, J. W. and Simons, S., "The Phototron: A Light to R.F. Energy Conversion Device"	VI-11
Lee, Ja. H. and Jaluska, N. W., "Radiation-Driven MHD Systems for Space Applications"	VI-12
Freeman, J. W., "Interaction Between the SPS Solar Power Satellite Solar Array and the Magnetospheric Plasma"	VI-13

VII. Materials

Saunders, N., "High-Energy Space Power Systems"	VII-1
Morris, J. F., "Some Material Implications of Space Nuclear Reactors (Non-Fuel Materials)"	VII-2
Yang, L., "Nuclear Fuel Systems for Space Power Application"	VII-3
Rossing, B. R., "Materials for High Power MHD Systems"	VII-4
Nahemow, M., "The Westinghouse High Flux Electron Beam Surface Heating Facility (ESURF)"	VII-5
Cooper, M. H., "Applications of a High Temperature Radiation Resistant Electrical Insulation"	VII-6
Levy, P. W., "Radiation Damage Measurements on Nonmetals Made During Irradiation with 1 to 3 MeV Electrons"	VII-7
Sarjeant, W. J., Laghari, J. R., Gupta, R., and Bickford, K. J., "Charge Injection Effects Upon Partial Discharges in a DC and DC Plus AC Laminate Insulation Environment"	VII-8
Sundberg, G., "Deep Impurity Trapping Concepts for Power Semiconductor Devices"	VII-9
Milder, F. L., "Applications of Materials Surface Modification to Prime Power Systems"	VII-10
Milder, F. L., "In Situ Monitoring of Critical System Component Erosion by Nuclear Activation Techniques"	VII-11
Banks, B. A., "Growth of Diamond-like Films for Power Application"	VII-12
Rice, R. W., "Ceramics for High Power Sources in Space"	VII-13
Blankenship, C. P., and Tenney, D. R., "Materials Technology for Large Space Structures"	VII-14

Gilardi, R., "Structural Characterization of Materials for High Energy Space Systems" VII-15

VIII. Chemical Physics

Rabitz, H., "Recent Advances in Molecular Dynamics" VIII-1

Rosenblatt, G. M., "Chemical Physics of Vaporization, Condensation and Gas-Surface Energy Exchange" VIII-2

Donovan, T./Guenther, A., "Thin Films" VIII-3

IX. Thermionics

Yang, L. and Fitzpatrick, G., "Thermionic Conversion for Space Power Application" IX-1

Huffman, F., Lieb, D., Reagan, P. and Miskolczy, G., "Thermionic Technology for Spacecraft Power: Progress and Problems" IX-2

Lawless, J. L., "A Survey of Recent Advances in and Future Prospects for Thermionic Energy Conversion" IX-3

Merrill, O. S., "Fundamental Research Areas on DoE's Thermionic Program" IX-4

X. Heat/Systems

Haslett, R., "Thermal Management of Large Pulsed Power Systems" X-1

Mattick, A. T., Hertzberg, A. and Taussig, R., "The Liquid Droplet Radiator" X-2

Bruckner, A. P., "The Liquid Droplet Heat Exchanger" X-3

Ernst, D. M. and Eastman, G. Y., "The Need for Improved Heat Pipe Fluids" X-4

Ernst, D. M. and Eastman, G. Y., "Enhanced Heat Pipe Theory and Operation" X-5

Fowle, A. A., "Two-Phase Heat Transport for Thermal Control" X-6

Teagan, W. P., "Liquid Ribbon Radiator for Lightweight Space Radiator Systems" X-7

Berry, G., "Software for Comparison and Optimization of Power Systems" X-8

Thornton, E. A., "Uncertainties in Thermal-Structural Analysis of Large Space Structures" X-9

XI. Summary

Barthelemy, R.	XI-1 (NA)
Vondra, R., "Power and Electric Propulsion"	XI-2
Angelo, J.	XI-3 (NA)
Layton, J. P., "Power Conversion: Overview"	XI-4
Severns, J.	XI-5 (NA)
Guenther, A.	XI-6 (NA)
English, R.	XI-7 (NA)
Junker, B. R.	XI-8 (NA)
Badcock, C., "Comments on the 'Special Conference on Prime-Power for High-Energy Space Systems' and Specifically on the Heat/Systems Session"	XI-9
Hyder, A.	XI-10 (NA)
Bryan, H. R.	

AUTHOR INDEX

LIST OF ATTENDEES

CONFERENCE PRESENTATIONS

SESSION I. PRIME-POWER NEEDS

"Space, the Air Force, and AFOSR"

by
Hartke, R. H.

(Paper not available)

Q & A

From; J. S. Zimmerman, General Electric

Please explain division/overlap of missions of AFOSR and DARPA.

A.

AFOSR is the basic research agency within the Air Force. Our research strategy will, therefore, emphasize those areas appropriate for the air force mission areas.

DARPA is a DOD-level basic and exploratory research agency looking at tri-service mission areas.

There is constant coordination between the two, and in many cases AFOSR acts as the DARPA contracting agent.

From: W. R. Seng, TECO

What priority is given to system hardness? Is there any quantified guidance available to describe 1990-2000 (year) requirements?

A.

Second question first: I can offer no quantitative guidance on hardness requirements 20 years hence.

First question: While system hardness is not an issue of the workshop, I understand the tendency to refer to it as a key parameter of concern. At this point, like compactness, reliability, efficiency, etc. , it is a consideration more at the later stages of system design than at these early stages of basic research. Ultimately, at the later stages, it will doubtless rank near the top of the priority list.

"NASA Directions for Research and Technology
in Space Power"
by
Mullin, J.

(Paper not available)

HIGH POWER REQUIREMENTS

M. E. COHEN

OUTLINE

- FUTURE POWER REQUIREMENTS
- POWER SYSTEM GOALS
- POWER SYSTEM TECHNOLOGIES
- TECHNOLOGY ISSUES
- SUMMARY

I-3-4

MILITARY SPACECRAFT MISSIONS IN THE COMMUNICATION, NAVIGATION AND METEOROLOGICAL AREAS CURRENTLY REQUIRE POWER IN THE GENERAL NEIGHBORHOOD OF 1-2 KW. THIS IS EXPECTED TO GROW MODERATELY TO 5-15 KW BY THE 1990's DUE TO ON-BOARD DATA PROCESSING, ENHANCED COMMUNICATION CROSS-LINKING, INCREASED ON-STATION HOUSE-KEEPING REQUIREMENTS AND HIGHER POWERED DOWNLINK TRANSMITTERS TO SUPPORT THE INCREASED USE OF SMALL AND DIVERSIFIED GROUND COMMUNICATION FACILITIES.

A HISTORICAL AND NEAR-TERM TREND IS SHOWN IN THE FIGURE FOR SOME OPERATIONAL AND EXPERIMENTAL SPACECRAFT MISSIONS OF INTEREST.

Evolutionary Space Power Systems Requirements

I-3-5

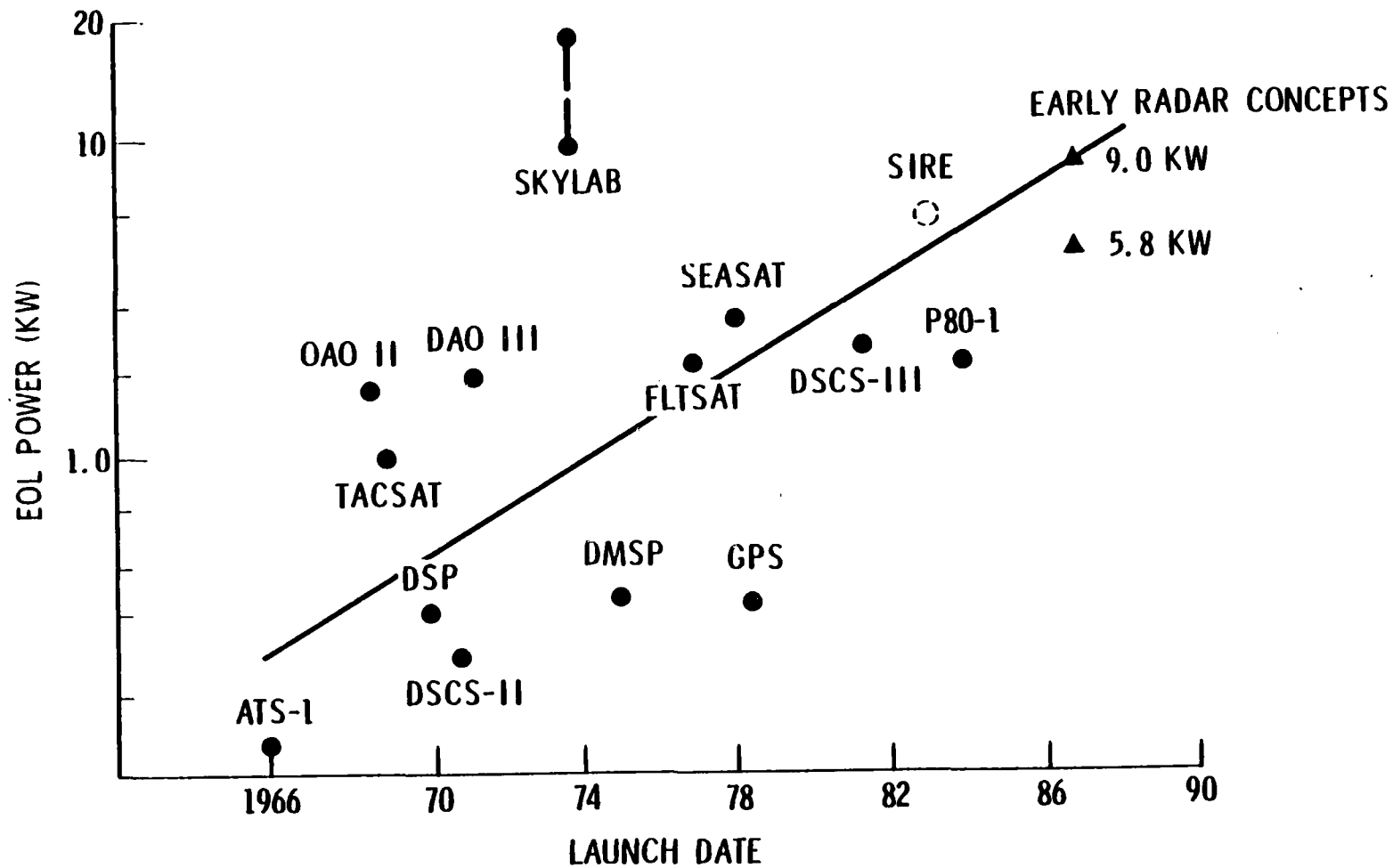

AS ADVANCED SURVEILLANCE, DEFENSE, SPECIAL COMMUNICATION, ELECTRIC PROPULSION AND OTHER CONCEPTS MATURE, POWER REQUIREMENTS ARE ANTICIPATED TO REACH 100-1000 KW IN THE 1990'S AND BEYOND. AS THESE REQUIREMENTS EVOLVED WE WILL GO FROM THE CURRENT SOLAR TECHNOLOGY ARENA TO HIGHER SPECIFIC POWER CONCEPTS SUCH AS NUCLEAR REACTORS AND OTHERS.

POWER REQUIREMENTS/PROJECTIONS

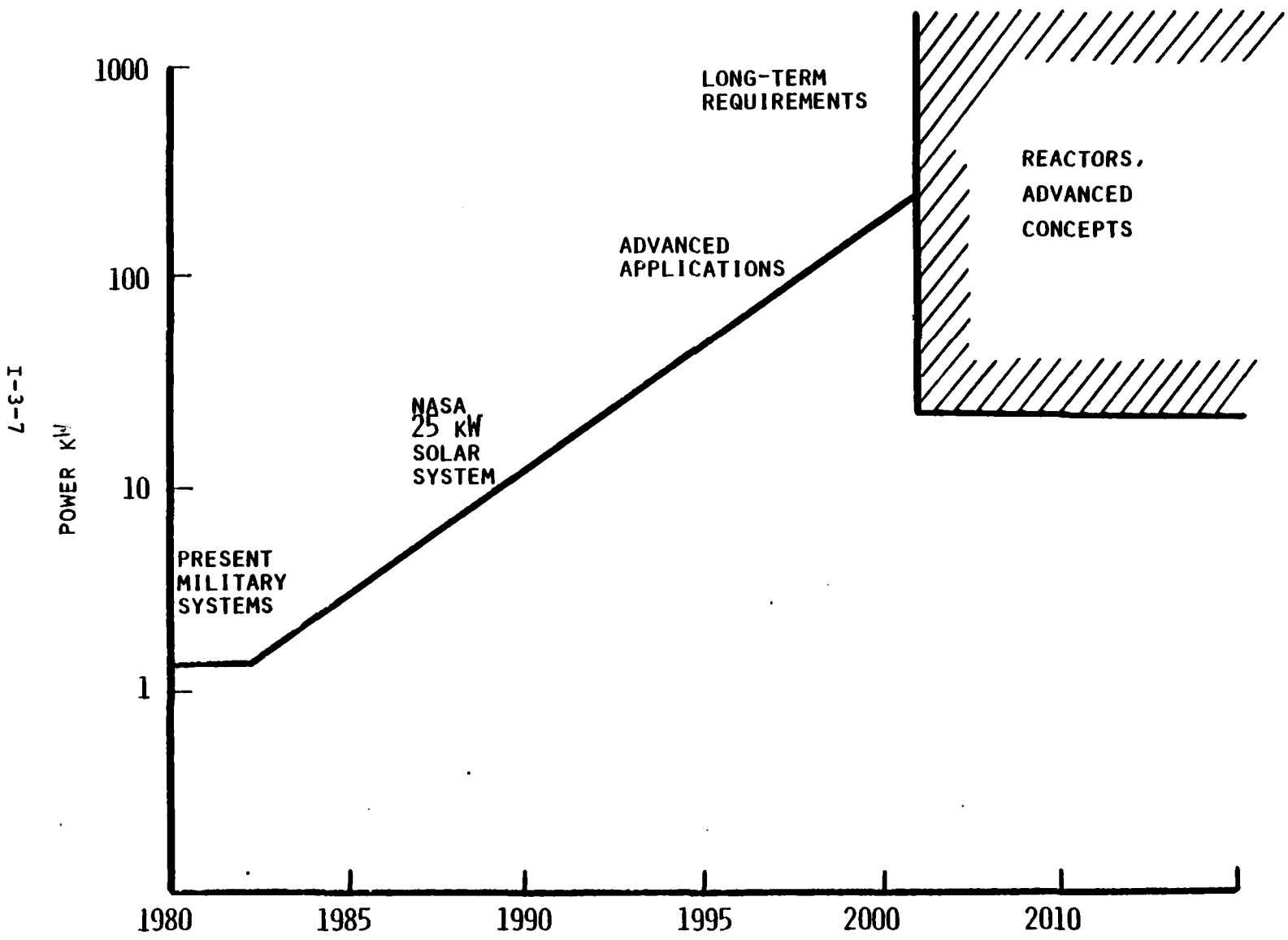

THESE ADVANCED REQUIREMENTS ARE SUMMARIZED IN THIS CHART. RADARS, SURVEIL-
LANCE SYSTEMS, SPECIAL COMMUNICATIONS, ORBITAL TRANSFER VEHICLES USING
NUCLEAR ELECTRIC PROPULSION, AND SPACE JAMMERS WILL REQUIRE STEADY STATE
POWER IN THE 5 TO 400 KWC REGIME.

ELECTRIC LASERS, PARTICLE BEAMS, AND OTHER FUTURE APPLICATIONS COULD PUSH
US TO THE 100's OF MW. AS BEST WE CAN TELL THESE WILL BE PULSED
APPLICATIONS.

DoD POTENTIAL HIGH POWER REQUIREMENTS

<u>APPLICATION</u>	<u>POWER LEVEL</u>
SPACE-BASED RADARS	5 - 400 KW
SURVEILLANCE	30 - 100 KW
COMMUNICATIONS	100 KW
OTV (NEP)	>100 KW
JAMMERS	70 - 200 KW
<hr/>	
LASERS	10 - 100 MW PULSED
PARTICLE BEAM	10 - 100's MW PULSED
ADVANCED CONCEPTS	1 - 100's MW PULSED

POWER SYSTEMS HAVE A KEY INFLUENCE ON THE ADVANCED CONCEPTS. THIS CHART
LISTS SOME OF THE SYSTEM IMPACT AND INTERTECHNOLOGY IMPACT THE POWER
SYSTEM WILL HAVE ON THESE FUTURE SYSTEMS.

I-3-10

IMPACT ON SPACE CONCEPTS

- RADARS
 - INCREASED COVERAGE
 - NUMBER OF TARGETS
 - SIZE OF TARGETS
 - NUMBER OF SPACECRAFT

- COMMUNICATION
 - INCREASED SURVIVABILITY (ANTI-JAM)
 - RANGE
 - LOWER EFFICIENCY TRANSMITTERS

- SURVEILLANCE
 - TYPE OF OBJECTS (COLD BODY - COOLERS)
 - ARRAY SIZE
 - ON-BOARD PROCESSING

- OTV
 - ENABLES ELECTRIC PROPULSION - HIGH I_{SP}
 - HEAVY PAYLOADS TO ORBIT
 - MANEUVERABILITY OF S/C

- JAMMERS
 - INCREASED COVERAGE
 - NUMBER OF S/C
 - EFFECTIVENESS OF SYSTEM

- OTHERS
 - WEAPONS TECHNOLOGY REQUIREMENTS
 - RANGE
 - COUNTERMEASURES EFFECTED
 - SYSTEM UTILITY

THE TIME LINE SHOWN IS TYPICAL OF THE LONG TIME LEADING UP TO IOC OF
FUTURE MILITARY SPACE SYSTEMS. THIS WORKSHOP IS ONE IMPORTANT STEP
TOWARDS MAKING HIGH POWER SYSTEMS AVAILABLE TO THE MILITARY.

I-3-12

Advanced Space Systems

CAN WE HAVE WHAT WE NEED WHEN WE NEED IT?

I-3-13

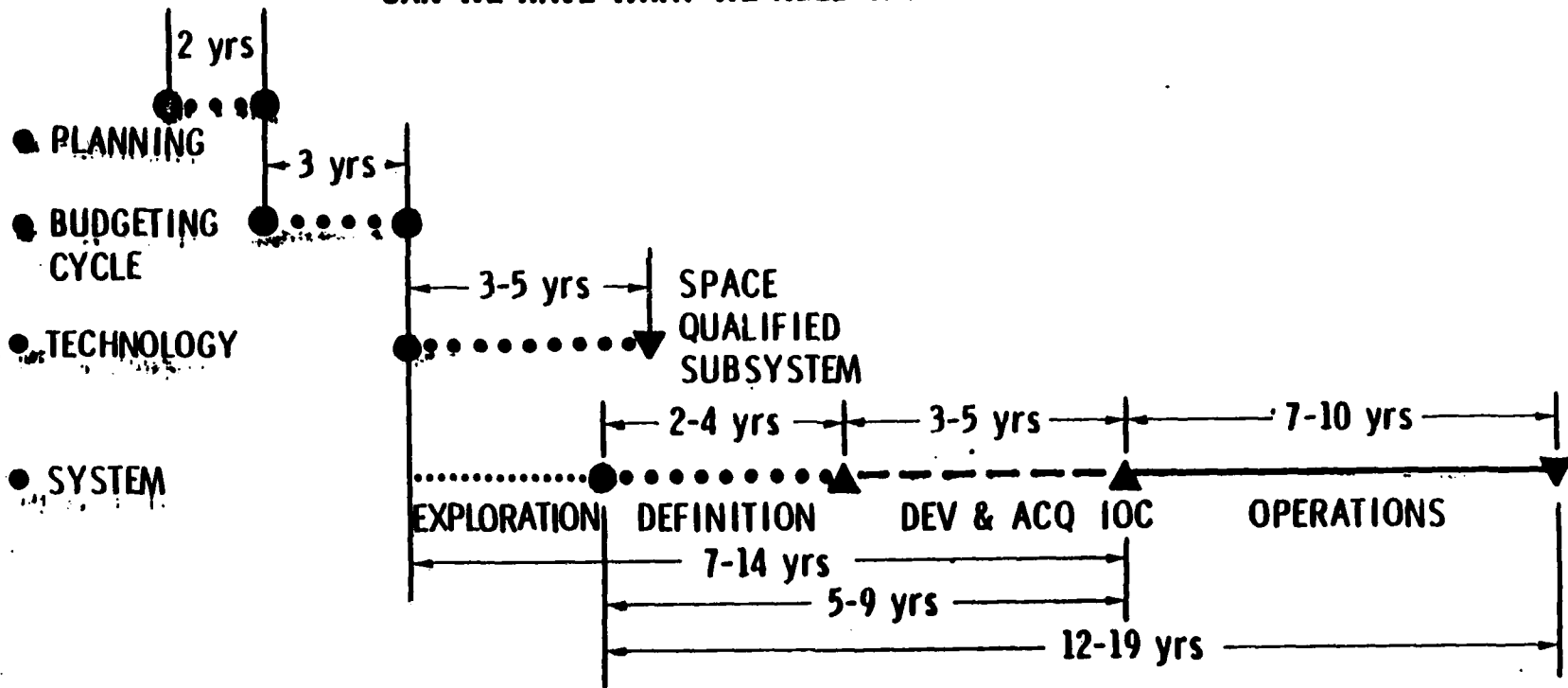

- SPACE SYSTEMS HAVE LONG LEAD TIMES, LONG LIFE TIMES
- PACING TECHNOLOGIES INADEQUATELY FUNDED

A SUMMARY OF ANTICIPATED GOALS FOR SPACECRAFT AND POWER SYSTEMS IS PRESENTED. FUTURE SYSTEMS WILL BE REQUIRED TO PERFORM AUTONOMOUSLY, BEING BOTH SELF-MONITORING AND SELF-CORRECTING. ADDITIONALLY, IT IS ANTICIPATED THAT SYSTEMS WILL BE REQUIRED TO SURVIVE SPECIFIED NUCLEAR AND OTHER PROJECTED THREATS.

DUE TO THE GREATER COSTS OF THE SYSTEM AND HIGHER POWER REQUIREMENTS, SPECIFIED LIFETIMES will increase to 7-10 YEARS AND SPECIFIC POWER (WATTS/LB AND WATTS/\$) MUST INCREASE.

HIGHER VOLTAGE (AC AND DC) AND PULSED POWER TECHNIQUES MUST BE CONSIDERED TO ALLOW REDUCTIONS OF WEIGHT IN THE DISTRIBUTION AND POWER CONVERSION SYSTEM.

SERVICEABILITY MAY BE AN ISSUE DEPENDING UPON THE SPECIFIC APPLICATION AND SAFETY IS A KEY REQUIREMENT IF WE ARE TO USE NUCLEAR SYSTEMS.

POWER TECHNOLOGY GOALS/APPROACHES

- INCREASED LIFE (7-10 YRS)
- AUTONOMOUS OPERATION
- INCREASED SPECIFIC POWER
 - LIGHT WEIGHT (MORE W/LB)
 - AFFORDABLE (MORE W/\$)
 - REDUCED VOLUME (MORE W/FT²⁽³⁾)
- SURVIVABILITY
 - NUCLEAR THREATS
 - OTHER PROJECTED THREATS
- HIGH VOLTAGE (100 TO 500v)
- PULSE POWER (10 TO 10,000 X PEAK/AVG RATIO)
- SERVICABILITY
- SAFETY

INCREASING SOLAR CELL EFFICIENCY RESULTS IN DECREASED SOLAR PANEL SURFACE AREA AND WEIGHT FOR THE SAME POWER OUTPUT. PRESENT SILICON CELLS HAVE EFFICIENCIES OF 14%. BY FY 83, THE THIN "ULTRAPTURE" SILICON CELLS SHOULD APPROACH 16%.

GaAs CELLS ARE PREDICTED TO DEMONSTRATE 18% BY FY 82-84 AS A RESULT OF THE HESP-II AND GaAs MAN-TECH PROGRAMS, ULTIMATELY REACHING 20% BY FY 87-89.

PRESENT MULTIBANDGAP (MBG) CASCADE (DUAL BANDGAP) HAVE A 22% EFFICIENCY POTENTIAL WHICH IS EXPECTED TO INCREASE TO 25% IN FY 87 WITH IMPROVED DIFFUSION TECHNIQUES. BEYOND THIS PERIOD, TRIPLE JUNCTION CELLS SHOULD ULTIMATELY APPROACH 40%.

ONE FIGURE INDICATES ARRAY SPECIFIC POWER LEVEL PER (FOOT)² WITH PRESENT AND PREDICTED EFFICIENCIES WHILE THE LEFT-HAND FIGURE INDICATES THE POWER PER POUND WITH THOSE EFFICIENCIES.

TO DATE 22 W/LB HAVE BEEN DEMONSTRATED WITH FLEXIBLE ARRAYS OF SILICON CELLS. GaAs IS PREDICTED TO OBTAIN 27 W/LB (RIGID) AND 120 W/LB (FLEXIBLE) BY FY 87. MBG (TWO-CELL JUNCTIONS) ARE PREDICTED TO OBTAIN 34 W/LB (RIGID) AND 250 W/LB (FLEXIBLE) BY FY 88 INCREASING TO 62 W/LB (RIGID) BY FY 2000 USING THE THREE-CELL JUNCTION.

I-3-16

Solar Power System Technology Evolution

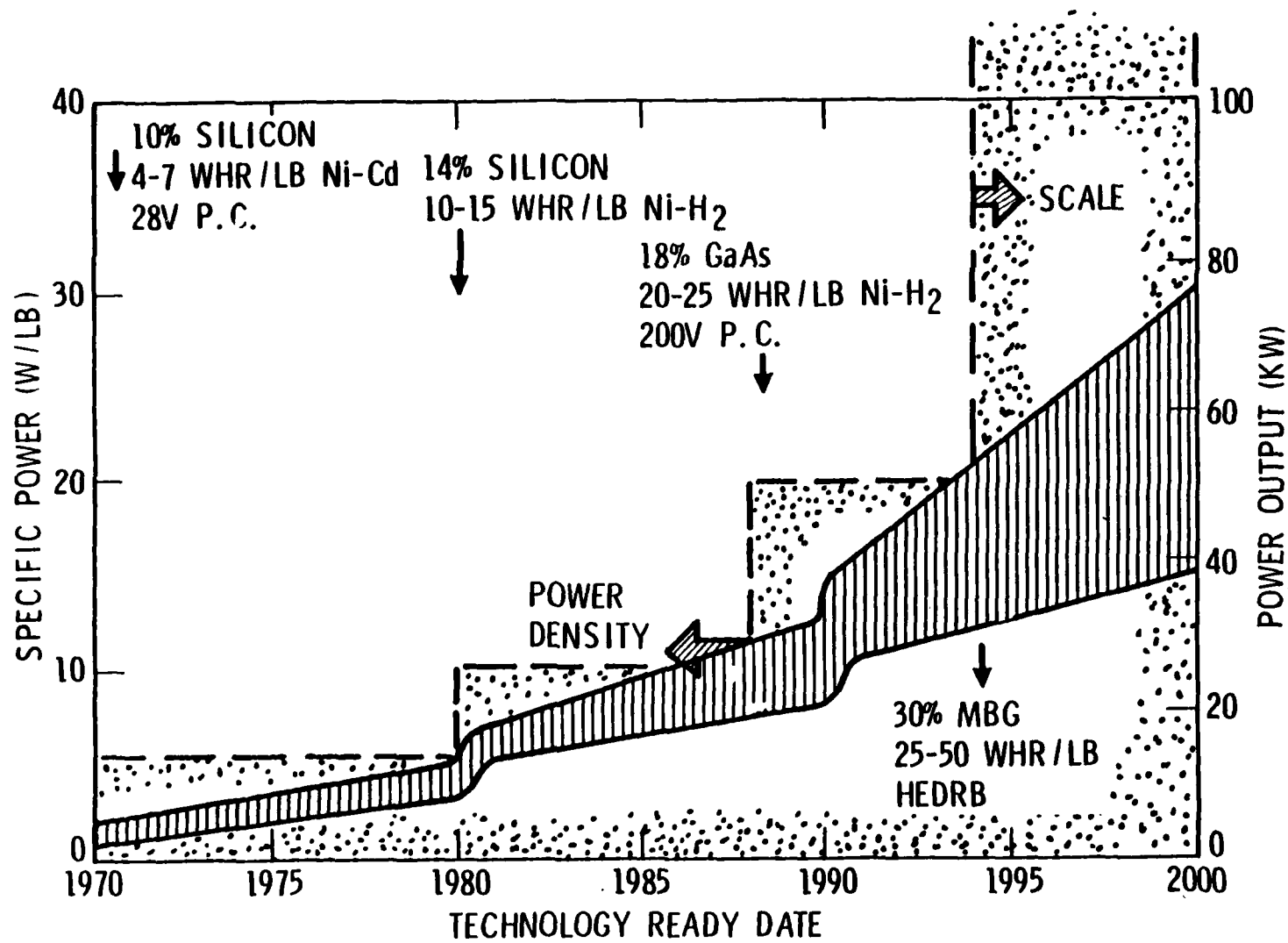

Solar Cell/Array Trends

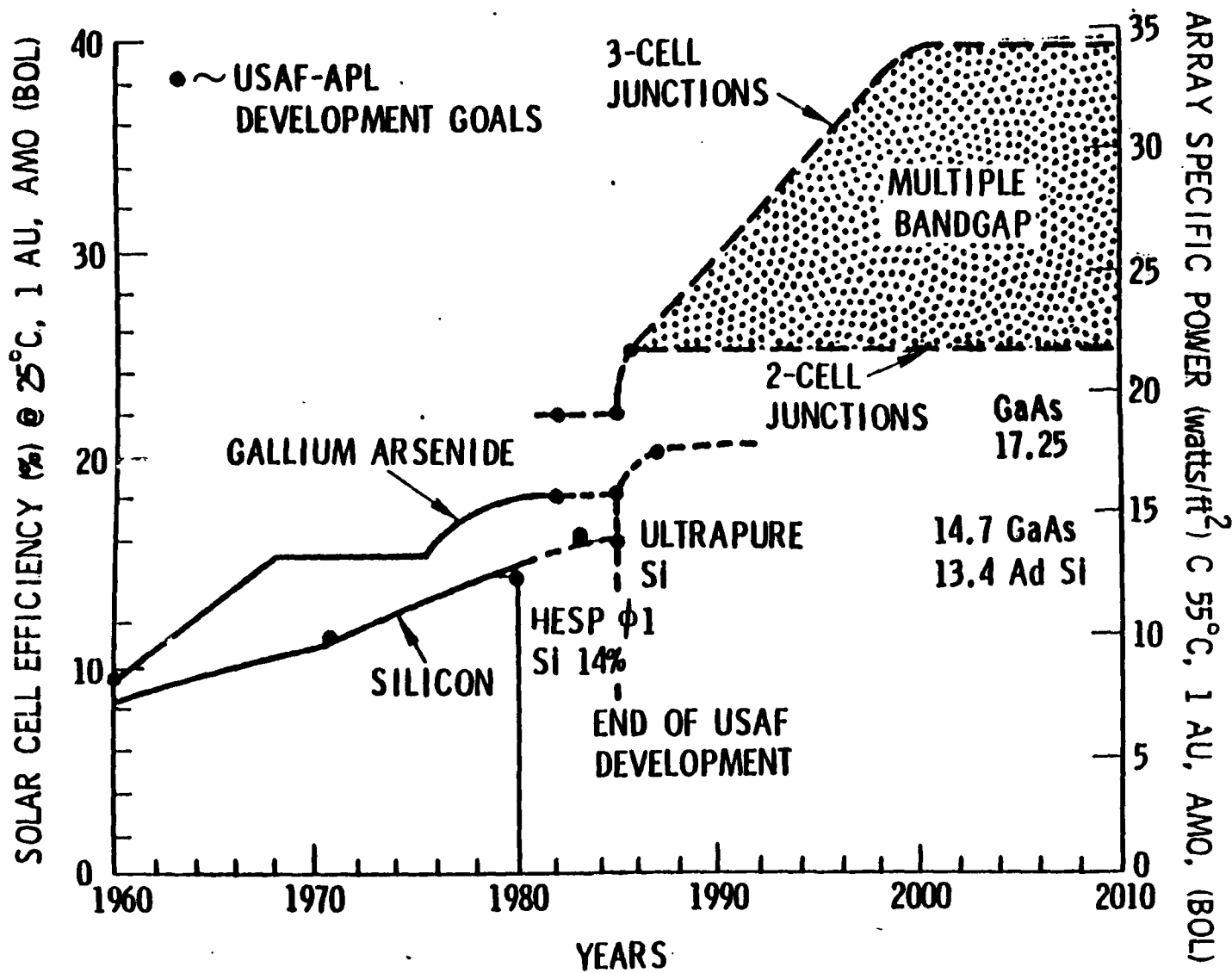

I-3-18

Solar Array Trends

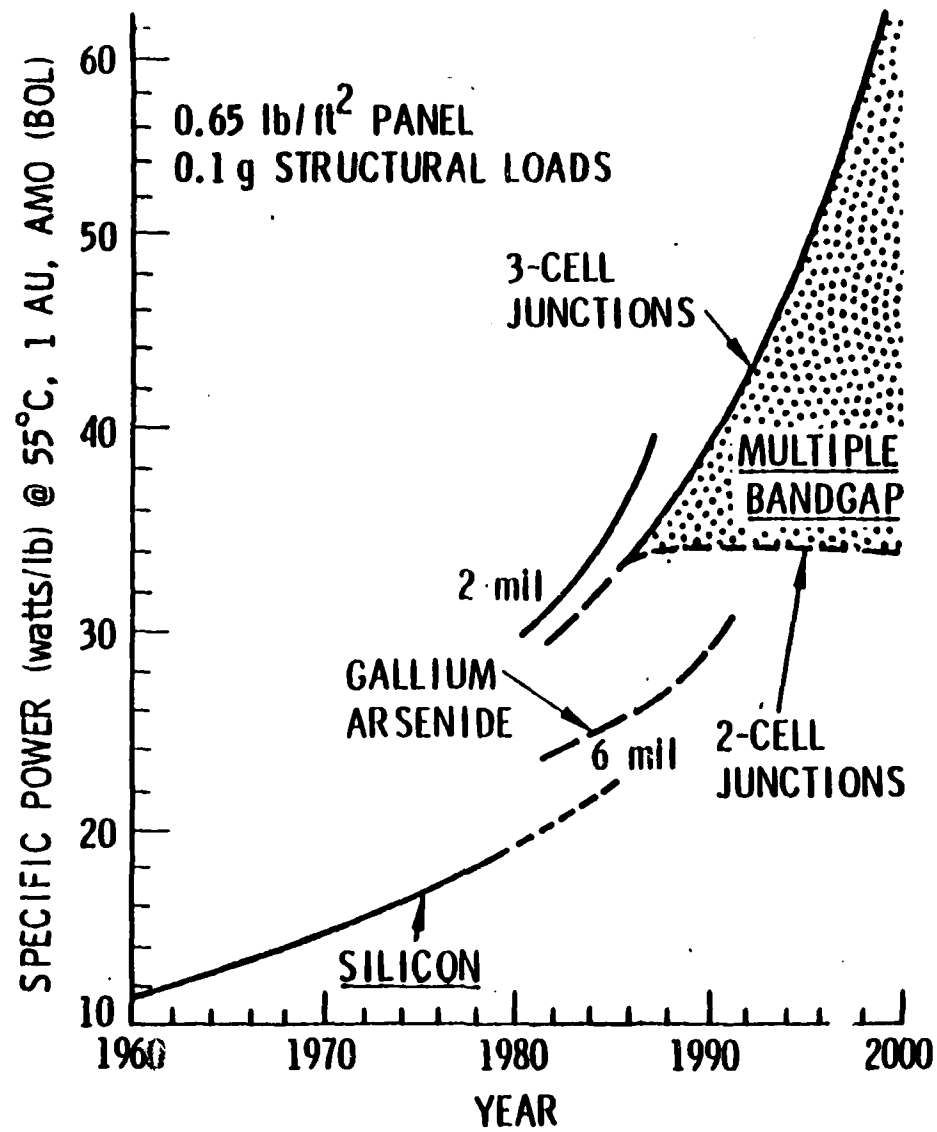

I-3-19

Battery Trends

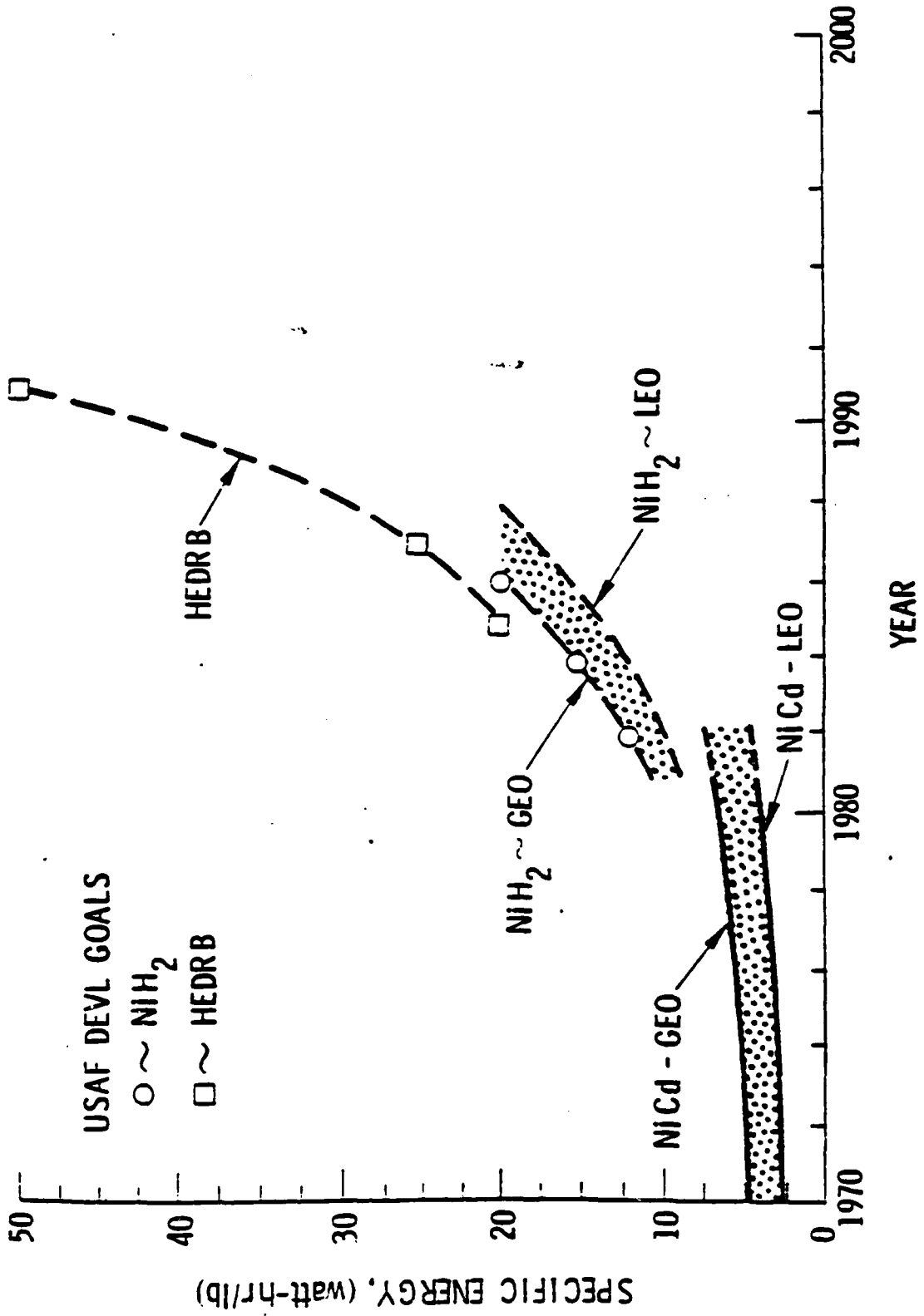

NICKEL-CADMIUM (NiCd) BATTERIES, CURRENTLY USED IN THE MAJORITY OF SPACECRAFT, HAVE OBTAINED SPECIFIC ENERGIES OF 4 W-HR/LB LEO AND 7 W-HR/LB GEO IN 1981.

APL HAS DEVELOPMENT GOALS FOR NICKEL-HYDROGEN (NiH₂) OF 12 W-HR/LB IN 1982, 15 W-HR/LB IN 1984, and 20 W-HR/LB BY 1986 FOR GEO, DUE TO IMPROVEMENTS IN ELECTRODES, SEPARATORS, AND DEVELOPMENT OF A COMMON PRESSURE VESSEL.

GOALS FOR THE HIGH-ENERGY DENSITY RECHARGEABLE BATTERIES (HEDRB) ARE 20 W-HR/LB BY 1985, 25 W-HR/LB BY 1987, AND 50 W-HR/LB BY 1990.

CURRENT NASA/DOE REACTOR DESIGN STUDIES USE THERMOELECTRIC POWER CONVERSION AT 9% EFFICIENCY WHICH OBTAINS 25 W/LB AT THE 100 KW_e POWER LEVEL. THIS SOURCE COULD BE AVAILABLE IN FY 90 TO 92 (DEPENDING ON LEVEL AND TIMING OF DEVELOPMENT FUNDING).

A NEW PROGRAM START IS REQUIRED TO DEVELOP A THERMONIC POWER CONVERSION AT 12-15% EFFICIENCY TO OBTAIN 50 W/LB AT THE 1000 KW_e LEVEL. IT IS PREDICTED THIS SOURCE COULD BE AVAILABLE IN THE MID-1990'S (DEPENDING UPON START-UP AND PROGRAM FUNDING).

THE ROTATING BED REACTOR (RBR) CONCEPT IS IMPORTANT TO THE AIR FORCE BECAUSE IT MAY BE CAPABLE OF PRODUCING HIGH POWER LEVELS (100'S MW_e) FOR LONG-DURATION PULSES. THE RBR CONCEPT IS A SECOND-GENERATION DERIVATIVE OF THE NERVA NUCLEAR ROCKET. THE CONFIGURATION REPLACES THE ROCKET NOZZLE WITH A GENERATOR OR TURBO-ALTERNATOR TO PRODUCE THE POWER, PREDICTED TO BE AT THE 300 MW_e LEVEL. THE DESIGN IS STILL VERY CONCEPTUAL, BUT FUTURE WORK WILL ASSESS THE RBR AS A DIRECT THRUSTER FOR LEO TO GEO TRANSFER AND AS A POWER SOURCE FOR ELECTRIC THRUSTERS AND DIRECTED-ENERGY WEAPONS.

OTHER DERIVATIVES OR DIRECT APPLICATIONS OF PREVIOUSLY DEVELOPED NERVA TECHNOLOGIES MAY GET US TO THE 1-10MW REGIME.

I-3-23

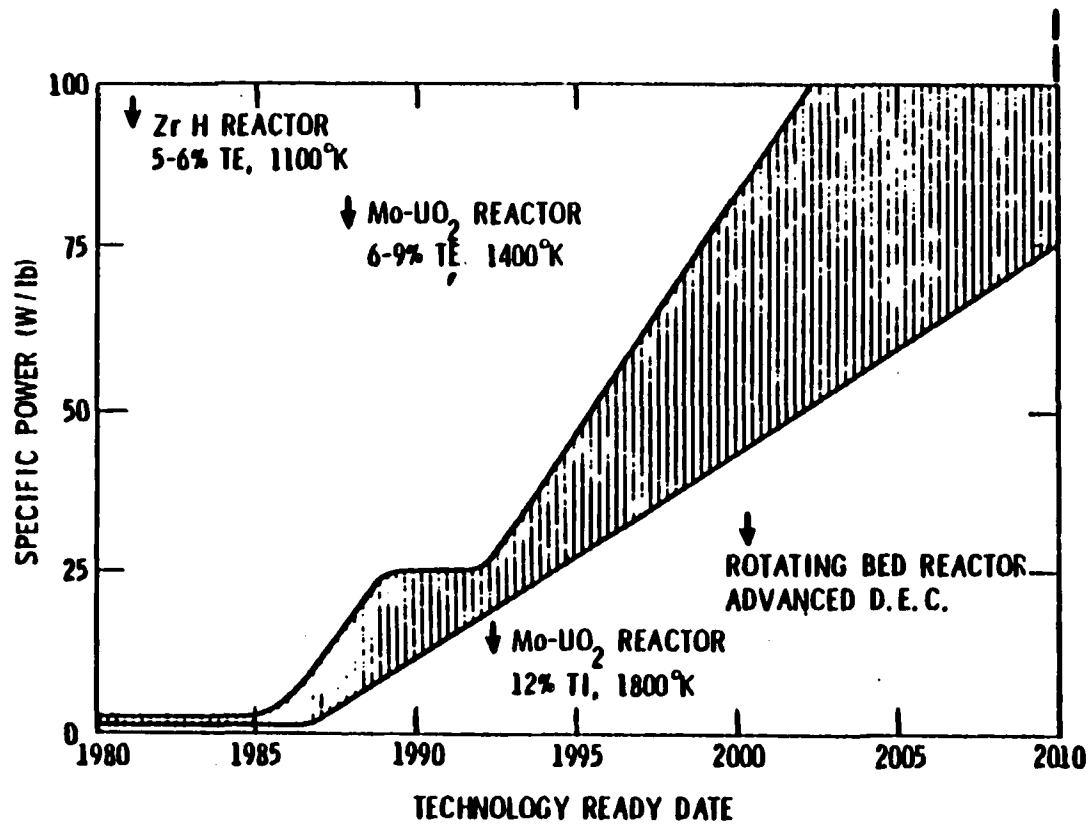

SPACE NUCLEAR REACTOR TECHNOLOGY PROJECTION

LISTED HERE ARE SEVERAL KEY ISSUES WHICH ONE SHOULD CONSIDER FOR FUTURE POWER SYSTEMS. IT IS FELT THAT ALTERNATIVES MUST BE FOUND TO THE SOLAR CELL/BATTERY SYSTEM TO OBTAIN THE HIGH LEVELS OF POWER PREDICTED FOR THE 2000-YEAR ERA, AND THAT FUNDING AND RESEARCH MUST CONTINUE OR BE STARTED WITHIN THE NEAR FUTURE TO GUARANTEE ORDERLY DEVELOPMENT AND ATTAINMENT OF THOSE GOALS.

WITH THE SIGNIFICANT PREDICTED INCREASES IN POWER, METHODS MUST BE INVESTIGATED TO REDUCE THE COST (\$/W) SO THAT SYSTEMS WILL STILL BE AFFORDABLE, AS WELL AS INCREASING THE SPECIFIC POWER (W/LB & W/FT², ETC.) SO THAT SYSTEMS CAN STILL BE REASONABLY INTEGRATED. IT IS FELT THAT HIGH VOLTAGE SYSTEMS COULD OFFER SIGNIFICANT WEIGHT SAVINGS IN THE CONVERSION AND DISTRIBUTION SYSTEMS.

KEY TECHNOLOGY ISSUES

- DEVELOP ALTERNATIVES TO SOLAR CELLS/BATTERIES CAPABLE OF 100-1000 KW (SUCH AS NUCLEAR) IN 2000-2010.
- REDIRECT EFFORTS TO HIGH VOLTAGE BUSES 100-500 V (AC OR DC) TO REDUCE HARNESS, DISTRIBUTION SYSTEM AND CONVERSION ELECTRONICS WEIGHT.
- DEVELOP AUTONOMOUS SYSTEMS CAPABLE OF SELF-MONITORING AND SELF-CORRECTION.
- REDUCE COST (\$/W) AND IMPROVE SPECIFIC POWER (W/LB AND W/FT) TO PRODUCE AFFORDABLE AND PRACTICAL HIGH POWER SYSTEMS.



AS AN EXAMPLE OF THE IMPACT OF COST

THE PRESENT SPACE DIVISION POWER LAUNCH RATE IS ESTIMATED AT 50 KW/YR. A LAUNCH RATE OF 100 TO 200 KW/YR IS ANTICIPATED BY 1985.

A SAVINGS OF 100 TO 200 MILLION DOLLARS PER YEAR IS THEN FEASIBLE IF TOTAL POWER SYSTEM COST DECREASES FROM \$2000/W TO \$1000/W.

REDUCTIONS IN COST CAN BE OBTAINED BY:

- (1) DECREASING COSTS OF CaAs FROM \$2000 TO \$400/W AS A RESULT OF IMPROVED PRODUCTION METHODS — HIGHER EFFICIENCIES AND DEVELOPMENT OF THIN CELLS.
- (2) DECREASING BATTERY COSTS FOR \$600 TO \$400/ BY USE OF NiH_2 BATTERIES INSTEAD OF NiCd .
- (3) DECREASE IN POWER PROCESSING AND CONVERSION COSTS FROM \$400 TO \$200/W BY USING AC AND HIGHER VOLTAGE POWER BUSES.

Total Solar Array/Battery Power System Cost

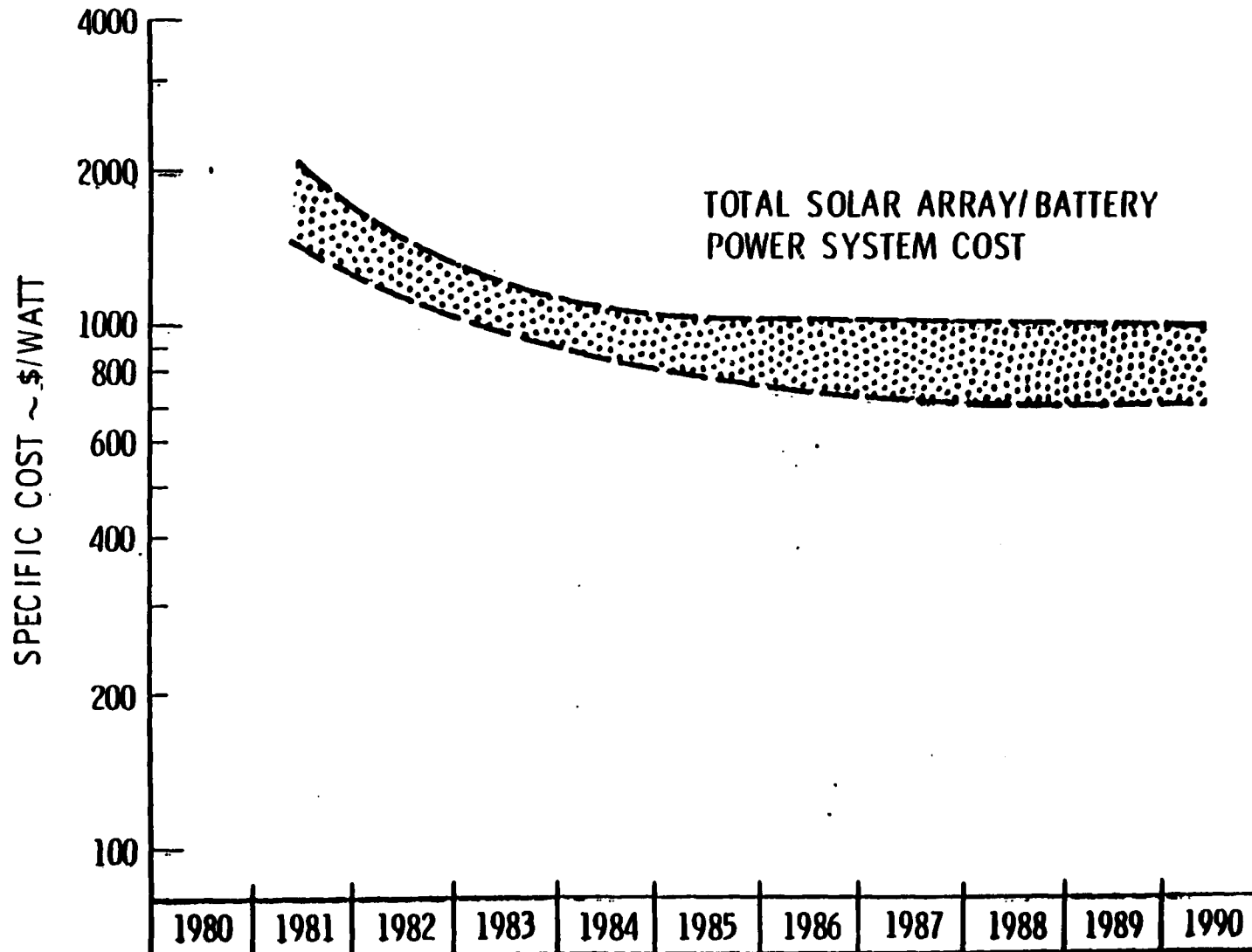

I-3-27

THE IMPACT OF THE SPECIFIC POWER IS SHOWN GRAPHICALLY ON THIS CHART. WE TRADED-OFF SOLAR POWER SYSTEMS WEIGHT VS. ONE VERSION OF A NUCLEAR REACTOR SYSTEM WEIGHT. NOTE, THAT GIVEN IUS CONSTRAINTS, THE POWER SYSTEM DOMINATES THE PAYLOAD TO ORBIT.

I-3-28

ELECTRICAL POWER SYSTEM

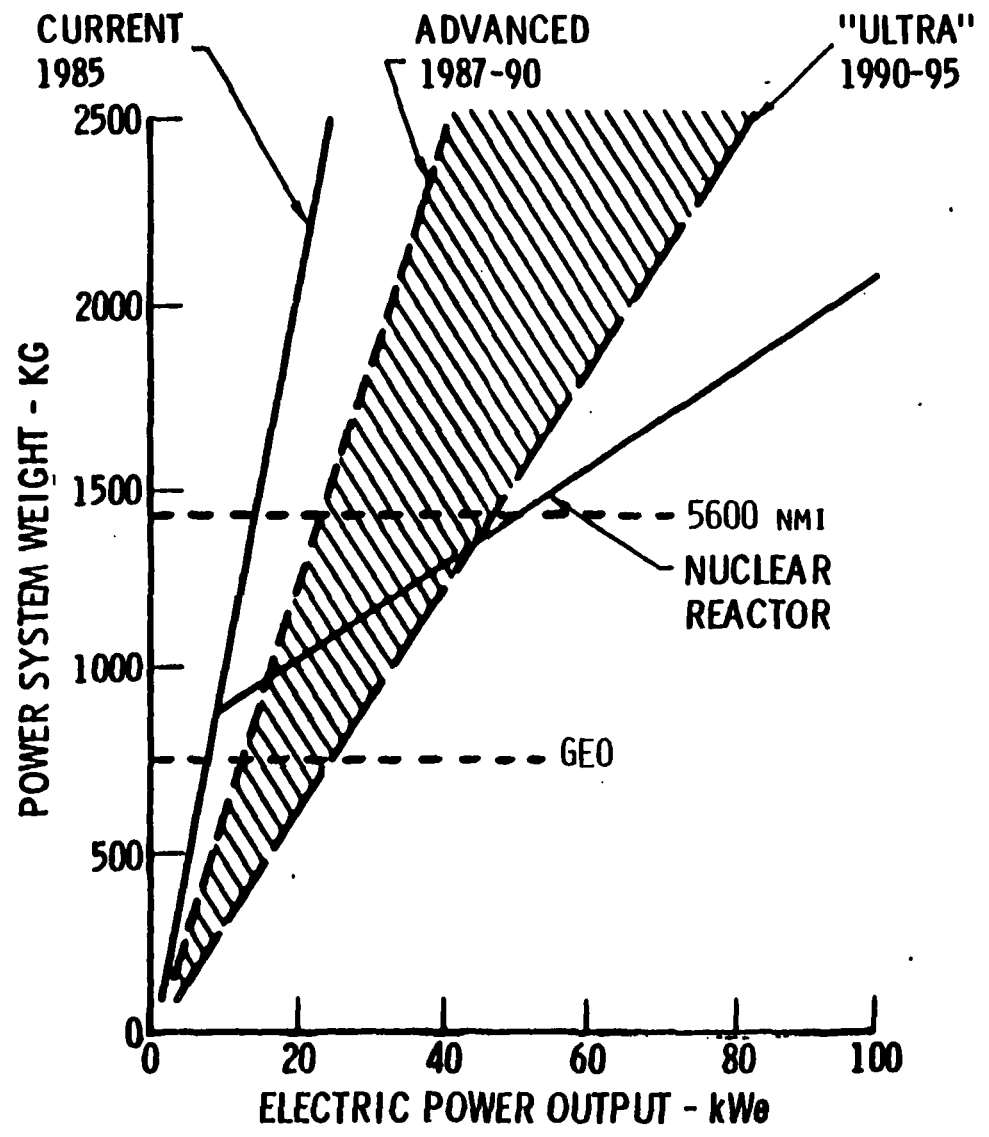

I-3-29

SUMMARY

- FUTURE SPACE SYSTEMS WILL REQUIRE HIGH POWER SYSTEMS
- ADVANCED POWER TECHNOLOGY IS REQUIRED TO ENABLE SUCH SYSTEMS
- THE PAYOFFS ARE:
 - INCREASED PERFORMANCE
 - INCREASED EFFICIENCY
 - LONGER LIFE
 - LOWER COSTS

Q & A - M. Cohen

From: Roy Pettis -

You have emphasized nuclear reactors for future very high power systems. For the pulsed applications--EDLs and Particle Beams--do you believe that open-cycle, combustion-driven sources can fulfill the missions, because of the limited run-times required (100s of seconds)?

A.

We have not ruled out any source for the high power applications. A potential problem with open cycle, combustion sources is that a system may have to be turned on and off a number of times as that resupply. This would be an option to be considered as part of a trade study.

From: Bob Davidson, R & D Associates

Please provide a bibliography of your future requirements studies.

A.

There is no specific bibliography. A starting point is the Military Space Systems Technology Model AF Report SD-TR-82-01 (secret). It is available thru the DTIC.

ABSTRACT

POWER REQUIREMENTS FOR MANNED SPACE STATIONS

by

Gordon R. Woodcock and Sidney Silverman

Manned space stations now in preliminary design will exhibit power needs from 25 to 150 kW. Studies have examined solar cell/battery, solar cell/regenerative fuel cell, and nuclear systems. This paper will summarize the power requirements, the tradeoff between batteries and regenerative fuel cells, including how the electric power system can be integrated with other functions, and nuclear concepts. The influence of mission applications on selection of the power system will be discussed, including low Earth orbit and high Earth orbit civil missions and potential military missions.

SPACE STATION POWER REQUIREMENTS

A space station represents the next step up in space power requirements, with loads estimated in the range from 25 kW to 60 kW or more. The load, of course, depends on the number of people supported and on the mission.

The nature of expected missions is such that significant load fluctuations are expected to occur. Lighting for EVA work at night, and materials processing experiments, are example requirements for multi-kW levels of intermittent power.

A space station in low Earth orbit will be designed for at least a ten-year life. This means it will experience about 60,000 light-dark cycles, a difficult design requirement for energy storage.

Being compatible with manned operations implies both problems and opportunities. There will be frequent proximity operations with the shuttle. Design for safety and rescue requires that a total failure of the electrical power system not be a conceivable failure. On the other hand, the presence of the crew will facilitate maintenance, repair, and workaroud actions not conceivable in an automated system.

The space station poses several configuration constraints that are different from typical automated spacecraft. An example is that one wishes to make the pressurized modules that house the crew as roomy as possible, leaving as little room as practicable for packaging external equipment. Also, since the pressurized module itself tends to be uniform in its mass distribution, one needs to strategically locate internal and external equipment to maximize compatibility with shuttle center-of-gravity limits.

Space Station Power Requirements

BOEING

- **LOAD RANGE 25 KW TO 60 KW**

- **SIGNIFICANT LOAD FLUCTUATION**

- **LONG LIFE ~ 10 YEARS = 60,000 LIGHT-DARK CYCLES**

- **COMPATIBILITY WITH MANNED OPERATIONS**
 - **SHUTTLE DOCKING & PLUME IMPINGEMENT**
 - **MAINTAINABILITY IN SPACE**
 - **SAFETY & RESCUE**

- **CONFIGURATION CONSTRAINTS**
 - **SHADOWING**
 - **PACKAGING**
 - **C.G. LIMITATION**
 - **THERMAL INTEGRATION**

SPACE STATION POWER ISSUES

The issues listed on the facing page are some of the most important ones identified in current space station studies.

As space power systems become larger, benefits of AC distribution will eventually outweigh the disadvantages. Benefits include low losses through use of high voltage without the risks of high voltage DC, and the possibility of rotary transformers for crossing rotating joints. Drawbacks include additional conversion equipment and losses, and the possibility of EMI. At the 50-kW load level anticipated for early space stations, the benefits of AC distribution appear far from compelling.

For the SOC, a DC distribution voltage of 200 has been selected. This is low enough to avoid high-tension issues. Conductor losses and weights are acceptable at this voltage.

A manned system brings forth several issues associated with manned operations, as well as the opportunity to use the crew to resolve issues that would otherwise require more expensive solutions.

Programmatic issues include cost deferral and risk. The ability to add to the electric power system as the load grows is a major contributor to cost deferral. Risk can be managed by selecting systems that will employ technology now in development. Adequate performance is available without new technology.

**SPACE
OPERATIONS
CENTER**

Space Station Power Issues

NASA
SOC-1064

BOEING

ISSUE

- **AC VS DC DISTRIBUTION**
- **DISTRIBUTION VOLTAGE & INTER-ACTION WITH ENVIRONMENT**
- **COMPONENT DEGRADATION & MAINTAINABILITY**
- **LOAD GROWTH**
- **SAFETY**
- **AUTOMATION**
- **COST DEFERRAL**
- **AVAILABILITY**

ANTICIPATED RESOLUTION

- DC**
- 200 VOLTS—NO SIGNIFICANT INTERACTION**
- DESIGN FOR LRU CHANGEOUT IN SPACE**
- DESIGN MARGINS & ADD-ON CAPABILITY**
- (a) DEGRADED-MODE AND REPAIR CAPABILITIES**
- (b) EMERGENCY SUPPLIES**
- MICROPROCESSOR CONTROL WITH CREW INTERACTION AND OVERRIDE**
- INHERENT IN ADD-ON CAPABILITY**
- SELECT HARDWARE IN TECHNOLOGY DEVELOPMENT**

SOC ELECTRIC POWER

The electrical power system for the Space Operations Center was sized to serve the reference sunlit and occulted requirements shown at the far right. The principal load is environmental control and life support. Tracking and communications, and a variety of housekeeping loads such as lighting, cooking, and operation of mission equipment, are the next large increments.

The service module will initially operate in an automated mode during SOC buildup. At that point, it requires relatively little power. The solar array may be only partially extended to reduce drag during this period. Considerable freedom exists in selecting a flight attitude for the initial service module inasmuch as the solar array need not be accurately oriented toward the sun.

A single service module and habitat module can be operated as a four-man station. In this mode, the required power is somewhat less than half the power needed by the reference configuration. If the single solar array is fully extended, off-nominal flight attitudes could minimize attitude control problems, while still supplying adequate power.

The next two bars show the operation of an entire SOC in an emergency mode. In this mode, the environmental control and life support system is operated in an open (non-regenerative) fashion. Only critical voice communications are active. Housekeeping loads are minimized by cutting off non-critical lighting and terminating normal operations of construction and flight support equipment. The SOC battery capacity, even at full discharge, is less than 100 kilowatt-hours. Even though the emergency power requirement is under ten kilowatts, it is clear that some solar array power is necessary to maintain emergency operation for the required 21 days.

In the event of a partial disabling of the power system, the Space Operations Center can be operated in a degraded mode. The load is reduced by eliminating convenience functions, while the vehicle is operated with regenerative environmental control and with most of the flight operations loads.

SPACE OPERATIONS CENTER

SOC ELECTRIC POWER

NASA
SOC-768

BOEING

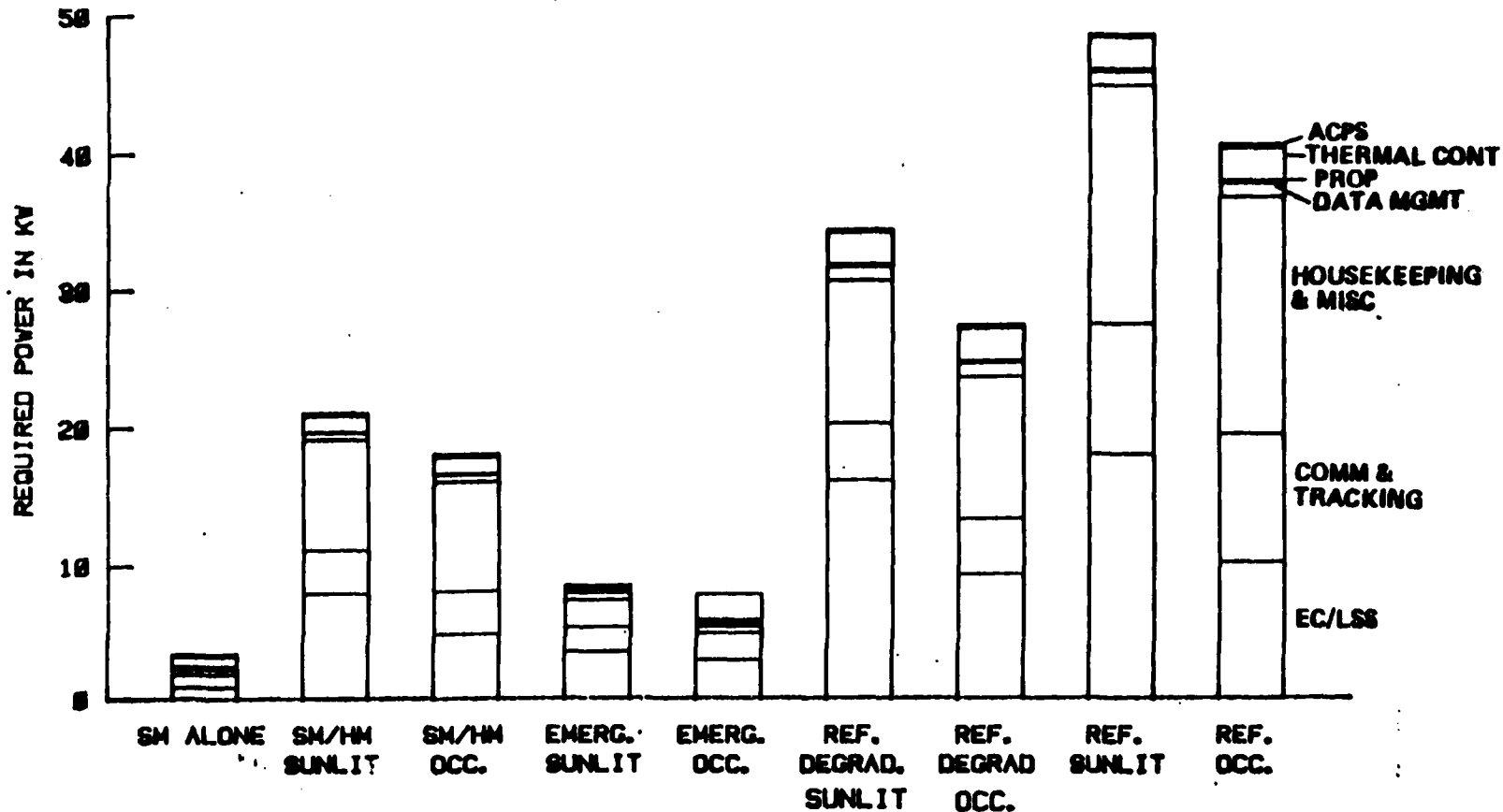

I-4-7

COMPARISON OF H_2-O_2 FUEL CELLS WITH $Ni-H_2$ BATTERIES

The use of fuel cells with electrolysis units to regenerate stored reactants in place of batteries is an option with interesting system integration aspects. It is the integration aspects of this trade that are expected to determine its outcome. Principal factors are summarized on the facing page.

**SPACE
OPERATIONS
CENTER**

NASA
SOC-1834

**Comparison of Regenerative H₂/O₂
Fuel Cells With NiH₂ Batteries**

BOEING

FEATURE	ADVANTAGES/DISADVANTAGES	BENEFITS/DRAWBACKS
<p>FUEL CELLS, ELECTROLYZERS, AND GAS STORAGE TANKS FOR ENERGY STORAGE</p>	<p>(A) LESS VOLUME & MASS THAN NiH₂ BATTERIES</p> <p>(D) LESS EFFICIENT THAN BATTERIES</p>	<p>(1)(B) SIMPLER PACKAGING</p> <p>(2)(B) GREATER MARGIN IN LAUNCH MASS</p> <p>(D) REQUIRES GREATER SOLAR ARRAY/ AREA; HIGHER COST FOR ARRAY; GREATER DRAG</p> <p>(B) REDUCES RESUPPLY MASS</p>
<p>STORED REACTANT GAS USED FOR ORBIT MAKEUP, WITH O₂-H₂ THRUSTERS. PROPELLANT RESUPPLIED AS WATER</p>	<p>(A) HIGHER SPECIFIC IMPULSE</p> <p>(A) ELIMINATES HYDRAZINE FROM SOC SYSTEM</p>	<p>(1)(B) AVOIDS TOXIC, CORROSIVE, REACTIVE FLUID HANDLING</p> <p>(2)(B) ELIMINATES HYDRAZINE SYSTEM COST</p> <p>(3)(B) ELIMINATES HYDRAZINE THERMAL CONTROL PROBLEMS</p> <p>(4)(B) RESERVE REQUIREMENTS FOR EMERGENCY WATER AND PROPELLANT ARE SHARED</p> <p>(5)(D) REQUIRES DEVELOPMENT OF O₂-H₂ THRUSTER</p> <p>(6)(D) REQUIRES ADDITION OF SHUTTLE O₂ CRYOTANK TO RESUPPLY MODULE FOR ATMOSPHERE N₂ MAKEUP</p> <p>(7)(B) ELIMINATES DEVELOPMENT OF ELECTROCHEMICAL HYDRAZINE DECOMPOSITION UNIT</p>

I-4-9

POWER SYSTEMS APPLICATION CHART

THIS IS THE FAMOUS "BUBBLE" CHART SHOWING THE APPLICATION OF ENERGY SOURCES AND CONVERSION METHODS FOR VARIOUS LENGTH MISSIONS. FOR SPACE PLATFORMS THE DURATION IS LONG SO THAT MANY OF THE SOURCES AND CONVERSIONS BECOME COMPETITIVE AS SHOWN ON THE NEXT CHARTS. WITH THE ADDITION OF RECHARGING TO BATTERIES AND REGENERATION TO FUEL CELLS, THEY ALSO BECOME COMPETITIVE FOR LONG TERM APPLICATIONS.

POWER SYSTEMS APPLICATION

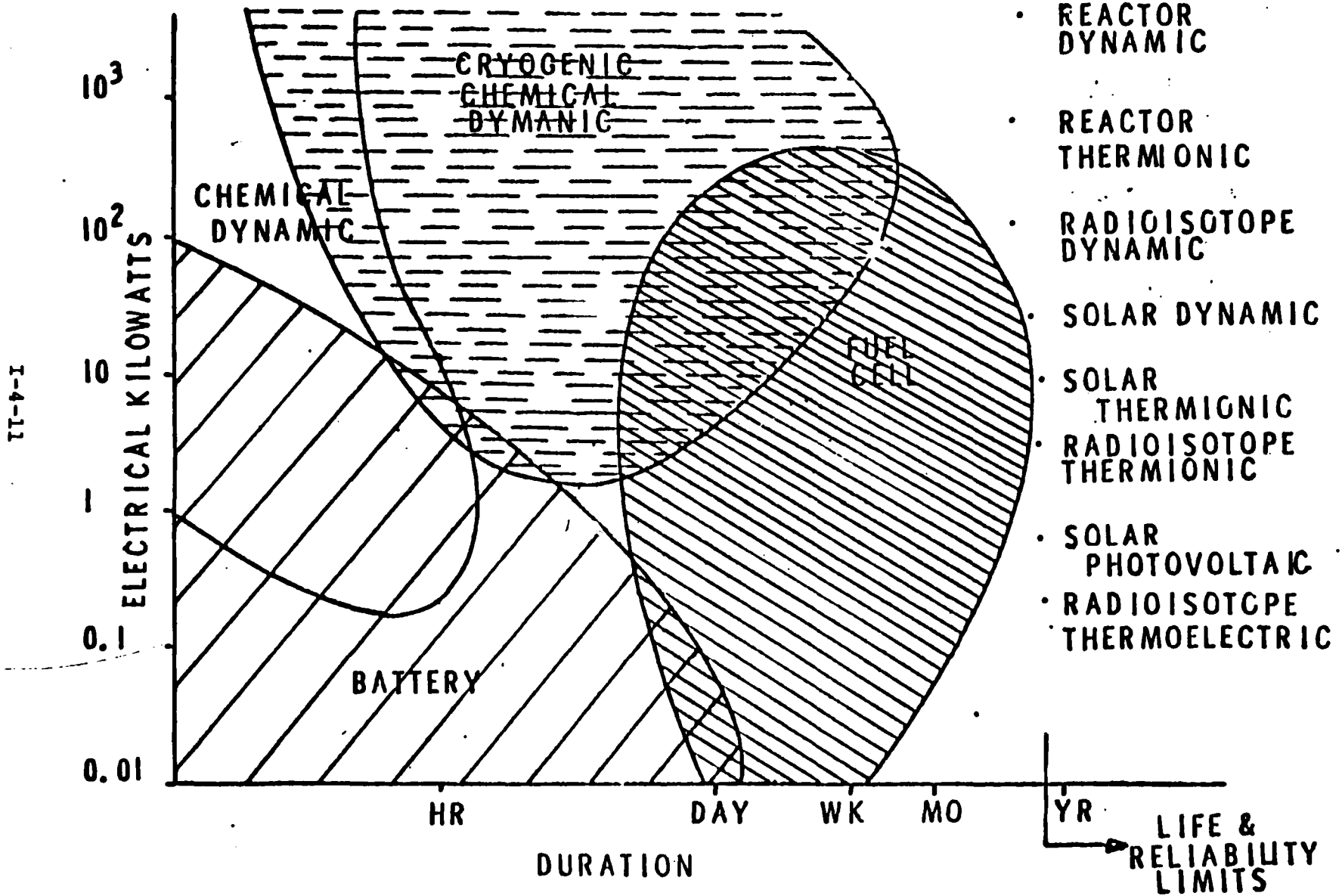

I-4-11

POWER SYSTEM OPTIONS

VARIOUS COMBINATIONS OF ENERGY SOURCE AND CONVERSION METHODS ARE SHOWN WITH RELATIVE RATINGS FOR THE SIGNIFICANT PARAMETERS.

SINCE SOME TECHNOLOGIES HAVE BEEN INACTIVE, THEY HAVE BEEN THUS IDENTIFIED.

Power System Options

STATUS	REQUIRY	SPECIFIC WT (W/LB)	VOL/AREA	RELATIVE	LIFE	ADVANTAGES	DISADVANTAGES
DYNAMIC							
DYNAMIC	MAINTENANCE & REPLACEMENT	HIGH	MEDIUM	(MEDIUM)	(SHORT)	HIGH EFFICIENCY; RADIATION RESISTANT	CONCENTRATORS; CAVITY; CONDENSING
TI	(NOT REQUIRED)	(LOW)	(LARGE)	(LOW)	(LONG)	RADIATION RESISTANT	LOW EFFICIENCY; COST AREA
DYNAMIC	(NOT REQUIRED)	(HIGH)	(LOW)	(LOW)	(LONG)	RADIATION RESISTANT; POTENTIAL HIGH EFFICIENCY	LOW EFFICIENCY; MATERIALS
STATIC							
DYNAMIC							
TI	NOT REQUIRED	(HIGH)	(LOW)	(VERY HIGH)	(LONG)	RADIATION RESISTANT	LOW EFFICIENCY; SAFETY; MATERIALS; COST
DYNAMIC	MAINTENANCE & REPLACEMENT	(HIGH)	(LARGE AREA)	(VERY HIGH)	(SHORT)	RADIATION RESISTANT	CONDENSING; SAFETY; RADIATOR; COST
DYNAMIC							
TI	(NOT REQUIRED)	(HIGH)	(SMALL AREA)	(MED)	(LONG)	POTENTIAL HIGH EFFICIENCY; RADIATION RESISTANT	LOW EFFICIENCY; SAFETY; MATERIALS
DYNAMIC	MAINTENANCE & REPLACEMENT	(HIGH)	(MEDIUM AREA)	(MED)	(SHORT)	RADIATION RESISTANT; POTENTIAL HIGH EFFICIENCY	BEARINGS; CONDENSING; RADIATOR; SAFETY

Power System Options

SECONDARY STORAGE	STATUS	RESUPPLY	SPECIFIC WT (M/LS)	VOLTAGES	RELATIVE	LIFE	ADVANTAGES	DISADVANTAGES
LI-X	POD	TRADEOFF WITH D-O-D	HIGH	VOL-LOW	UNKNOWN	UNKNOWN	RED; VERY LIGHT	UNKNOWN
REGENERATIVE FUEL CELLS H_2-O_2	MATURE	TRADEOFF WITH POWER DENSITY	MED	VOL-MED/LOW	MED	TRADEOFF WITH POWER DENSITY	CAN BE REGEN; OPERATIONAL HISTORY; CAN BE SHARED WITH A/C	RADIATION SAFETY
H_2-Cl_2	POD	TRADEOFF WITH POWER DENSITY	MED	VOL-MED/LOW	MED	TRADEOFF WITH POWER DENSITY	RED; LOWER WT; CAN BE REGEN.	RADIATION SAFETY
H_2-Br_2	POD	TRADEOFF WITH POWER DENSITY	MED	VOL-MED/LOW	MED	TRADEOFF WITH POWER DENSITY	RED; LOWER WT; CAN BE REGEN.	RADIATION SAFETY
FLYWHEELS	INACTIVE	(NOT REQUIRED)	(LOW/MED)	(VOL-HIGH)	(MED)	(LONG)	(NON-CHEMICAL) (NSD) (CAN BE SHARED WITH A/C)	SAFETY RELIABILITY WEIGHT

ELECTRICAL POWER SYSTEM SCHEMATIC

THE GENERIC POWER SYSTEM SCHEMATIC IS SHOWN WITH THE TRADE-OFF PARAMETERS TO BE CONSIDERED. SELECTIONS FOR THE SOC ARE SHOWN IN YELLOW.

FOR THE SOC A FUNCTIONAL DIAGRAM OF THE SELECTED SYSTEM IS SHOWN IN ONE LEVEL LOWER IN DETAIL.

SPACE OPERATIONS CENTER

Electrical Power System Schematic

NASA
SQC-1030

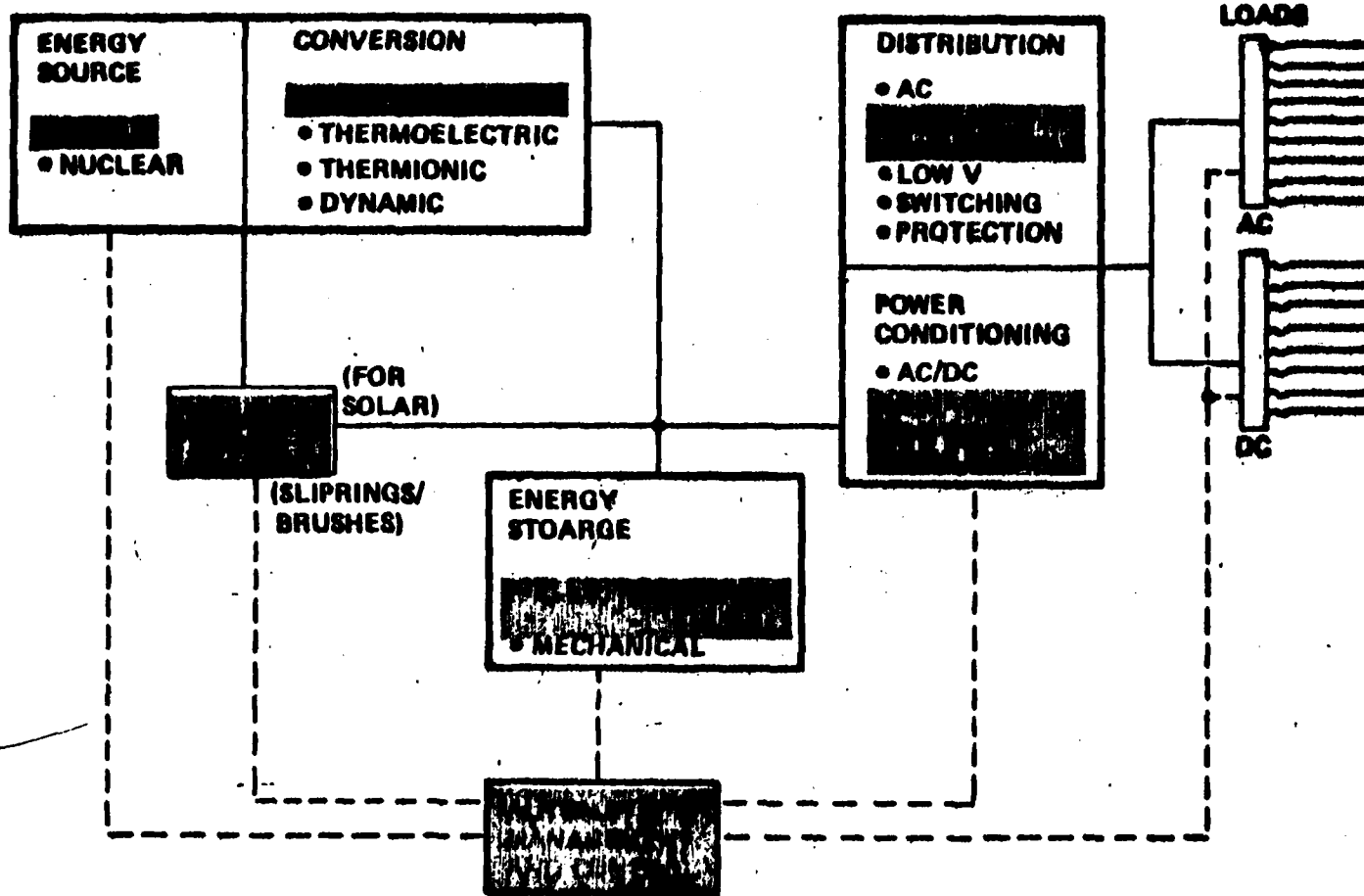

I-4-16

() S.O.C. BASELINE

SPACE OPERATIONS CENTER

ELECTRICAL POWER SYSTEM SCHEMATIC (SHOWN FOR 1/2 S. O. C.)

NASA
SOC-883

BOEING

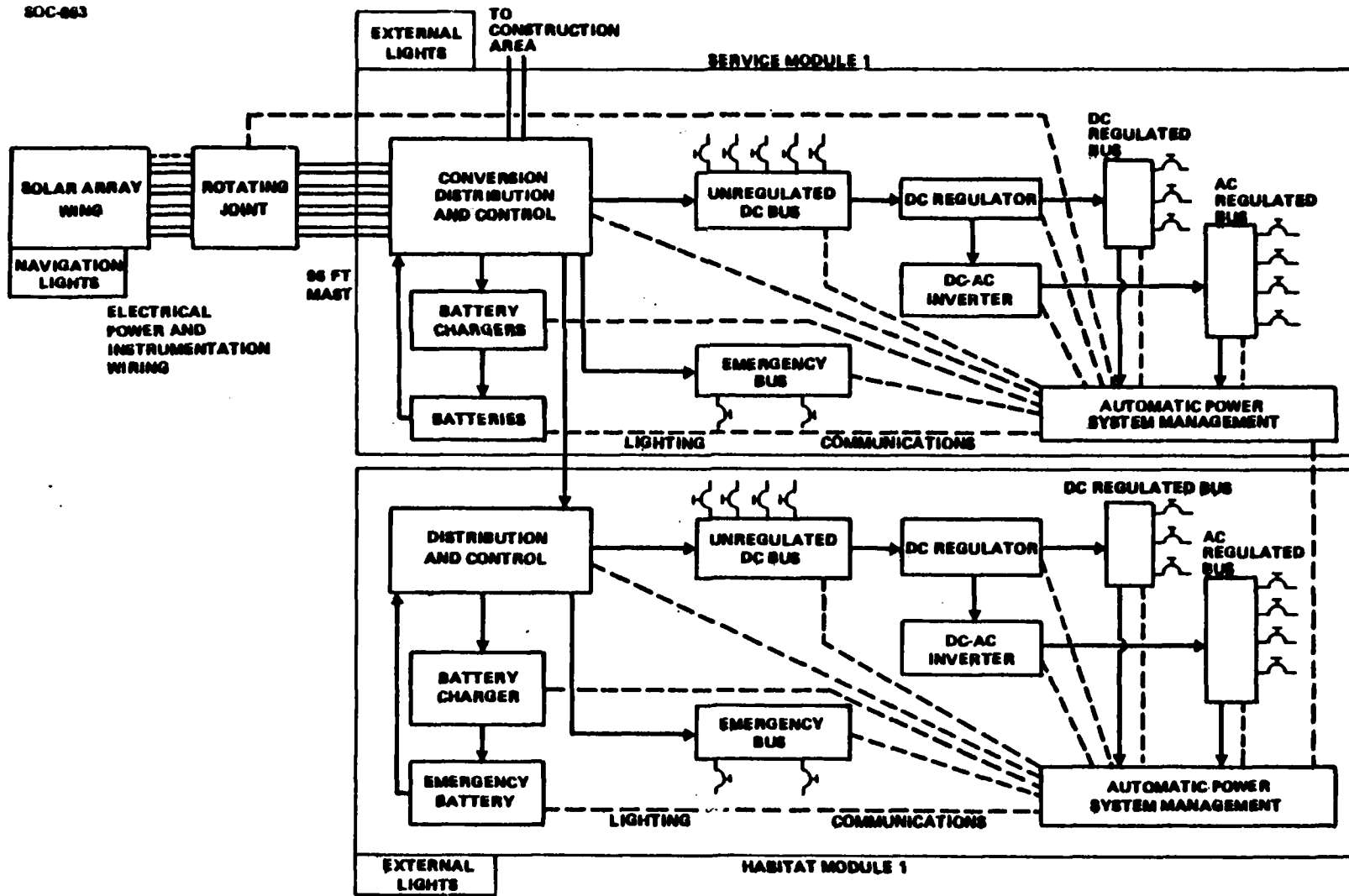

I-4-17

TECHNOLOGY READINESS LEVELS

THIS LIST SHOWS LEVELS FOR RATING TECHNOLOGY LEVELS AND IS USED WITH THE CHART ON THE FOLLOWING PAGE "TECHNOLOGY READINESS LEVELS AND EVOLUTION FOR LARGE POWER SYSTEMS".

80C-983

LEVEL	CATEGORY
1	BASIC PRINCIPLES OBSERVED AND REPORTED
2	CONCEPTUAL DESIGN FORMULATED
3	CONCEPTUAL DESIGN ANALYTICALLY OR EXPERIMENTALLY VALIDATED
4	CRITICAL FUNCTION OR CHARACTERISTIC DEMONSTRATED
5	COMPONENT/BREADBOARD TESTED IN RELEVANT ENVIRONMENT
6	PROTOTYPE/ENGINEERING MODEL TESTED IN RELEVANT ENVIRONMENT
7	PROTOTYPE/ENGINEERING MODEL TESTED IN SPACE
8	ITEM IS ON-THE-SHELF AND QUALIFIED OR QUALIFIED WITH MINOR MODIFICATIONS

SPACE OPERATIONS CENTER

Technology Readiness Levels and Evolution for Large Power Systems

NASA
SOC-1658

BOEING

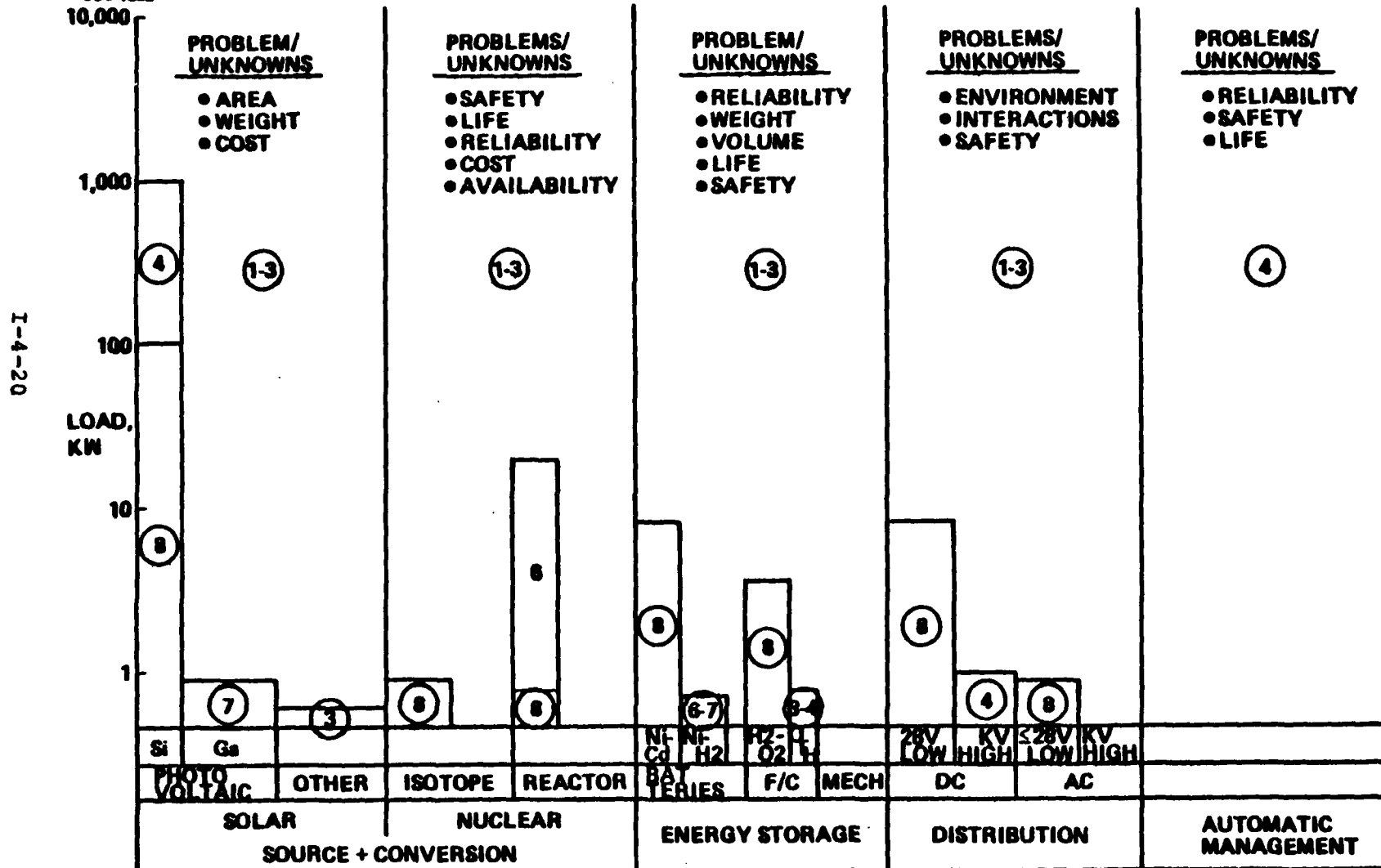

(For proceedings of Conference on Prime Power for High-Energy Space Systems held at Norfolk, VA on 22-25 February 1982)

POWER REQUIREMENTS FOR ORBIT RAISING PROPULSION

Leonard H Caveny
Aerospace Sciences Directorate
Air Force Office of Scientific Research
Bolling AFB
Washington, DC

INTRODUCTION

Future Air Force space missions require substantial increases in propulsion efficiency. Advances are required in both orbit raising and maneuvering propulsion. Several of the more attractive propulsion concepts require continuous electric power at the megawatt level. Propulsion considerations can not be separated from those of power, since advances in space propulsion and power share a number of important technological barriers. Thus Space Propulsion and Power is being pursued by AFOSR as a unified FY83 multidisciplinary research initiative. The emphasis is on establishing long-term basic research which anticipates and supports technology and development programs for the 1995 to 2000 time frame.

In the last decade, many novel propulsion concepts were investigated [Mead, 1972 and Pappiliou, 1975]⁺. Prior to the present considerations, the concepts could have been placed in such categories as:

- Sufficient onboard power did not exist.
- Air Force requirements did not justify additional research.
- Solutions to fatal flaws could not be foreseen.
- An important technology was lacking.
- Knowledge of the concept was narrowly held, thus it escaped attention.
- System performance penalties were too great.

But probably the dominant consideration in previous years was that the Air Force could perform the required missions with conventional chemical propulsion. Consequently, major initiatives to provide technology and to overcome barriers were not warranted.

Advanced concepts for space propulsion periodically receive attention in advanced mission studies but only moderate support for sustained basic research. However, the projections for the end of this century offer the promise of sustained interest and activity. The space shuttle capability plus the inevitability of the expanding Air Force role in space are forcing definitions of major new propulsion requirements. The transfer of large payloads from low Earth orbits to higher orbits coupled with requirements for maneuvering justify the investment required to achieve major advances in propulsion.

⁺Indicates citations in the bibliography which provide background information.

POWER REQUIREMENTS FOR ORBIT RAISING PROPULSION

PROPULSION

Propulsion systems are being considered in two categories: conventional (chemical) and nonconventional (e g, beamed energy and electric). If the investments are made, the Air Force can be assured of having significantly improved chemical propulsion systems available by the end of the century; however the projected specific impulse gains are on the order of 10%. The nonconventional systems offer specific impulse gains of hundreds of percent but involve larger risks and, possibly, higher costs and longer lead times. Development programs will improve the efficiencies, versatility, and payload capabilities of liquid propulsion systems (e g, the advanced RL10 system using liquid H_2 and O_2) and solid rocket systems (e g, the IUS system of motors). These advances are extremely important since each percentage point increase in propulsion system efficiency can yield significantly larger increases in payload weight in geosynchronous orbit (GEO). In particular, typical low Earth orbit (LEO) payloads for subsequent trips to GEO are 50 to 80% propulsion and fuel. Further improvements in chemical systems (e g, replacing O_2 with F_2 , using metal hydrides) should be achievable in the next decade. In addition, advances in refrigeration to permit long term (or even indefinite) storage of H_2 will provide additional options for both propulsion and power. Solid propulsion systems are expected to take advantage of new energetic ingredients (e g, more energetic binders, burning rate control). Thus the Air Force is continuing basic research on specific aspects of chemical propulsion. However, with respect to propulsion the primary emphasis of the FY83 initiative will be on nonconventional propulsion. Consistent with the theme of the meeting, the discussions that follow tend to emphasize those propulsion concepts requiring megawatts of electric power.

Air Force Basic Research

Space Propulsion and Power

— FY83 Initiative —

Propulsion

- **Conventional (Reacting Flows)**
 - **Advanced Liquids (Fluorine, Hydrides, and Throttleability)**
 - **Advanced Solids (Synthesis of Higher Energy/Density Ingredients)**
- **Nonconventional (Plasmas, Free Radicals, Electromagnetic Accelerators)**
 - **Intermittent Combustion**
 - **Beamed Energy**
 - **Magnetoplasmadynamics**

POWER REQUIREMENTS FOR ORBIT RAISING PROPULSION

TYPES OF PROPULSION SYSTEMS

As a means of classification, several types of propulsion concepts are compared on a propulsive efficiency (exhaust velocity) and thrust density plot. In terms of the SI units, exhaust velocity (meters/second) is the appropriate measure of specific impulse for space propulsion systems. (The more traditional measure of rocket specific impulse in lbf/lbm-sec is approximately one-tenth the exhaust velocity in meters/second.) At the lower range of thrust density are the highly efficient ion engines [Finke, 1981] which have reached a developed status through sustained NASA sponsorship. The present embodiments of the ion engines are attractive for NASA planetary missions but do not provide for sufficiently rapid orbit raising for many of the projected Air Force missions. (However, advances in power conditioning systems and operation at higher power levels are expected to lead to more favorable conditions for ion thrusters.) Higher thrust densities are provided by the lower efficiency chemical rockets which are presently being used for orbit raising. As previously discussed, the chemical systems are reasonably well developed and have a limited upside potential. As part of the FY83 initiative AFOSR is concentrating on the large increases in performance that are available in the intermediate thrust-density range. Thus attention is being given to approaches such as solar- and laser-beamed energy [Weiss, Pirri and Kemp, 1979], magnetoplasmadynamics (MPD) [Finke, 1981], nuclear [Layton and Grey, 1976], deflagration driver [Cheng, 1971] and intermittent combustion [Mead, 1972]. The chart does not include some of the approaches which are presently the subjects of adequate programs or which do not fit the time frame of the FY83 initiative. For example, propulsion concepts using atomic hydrogen is the subject of a research effort being coordinated by NASA-Lewis. Furthermore the resources of the FY83 initiative will be concentrated on the basic research which supports two, possibly three, of the most promising propulsion approaches.

Air Force Basic Research

Space Propulsion and Power

- FY 83 Initiative -

- Orbit Raising Needs More Efficient, Intermediate Thrust Propulsion

S-5-I

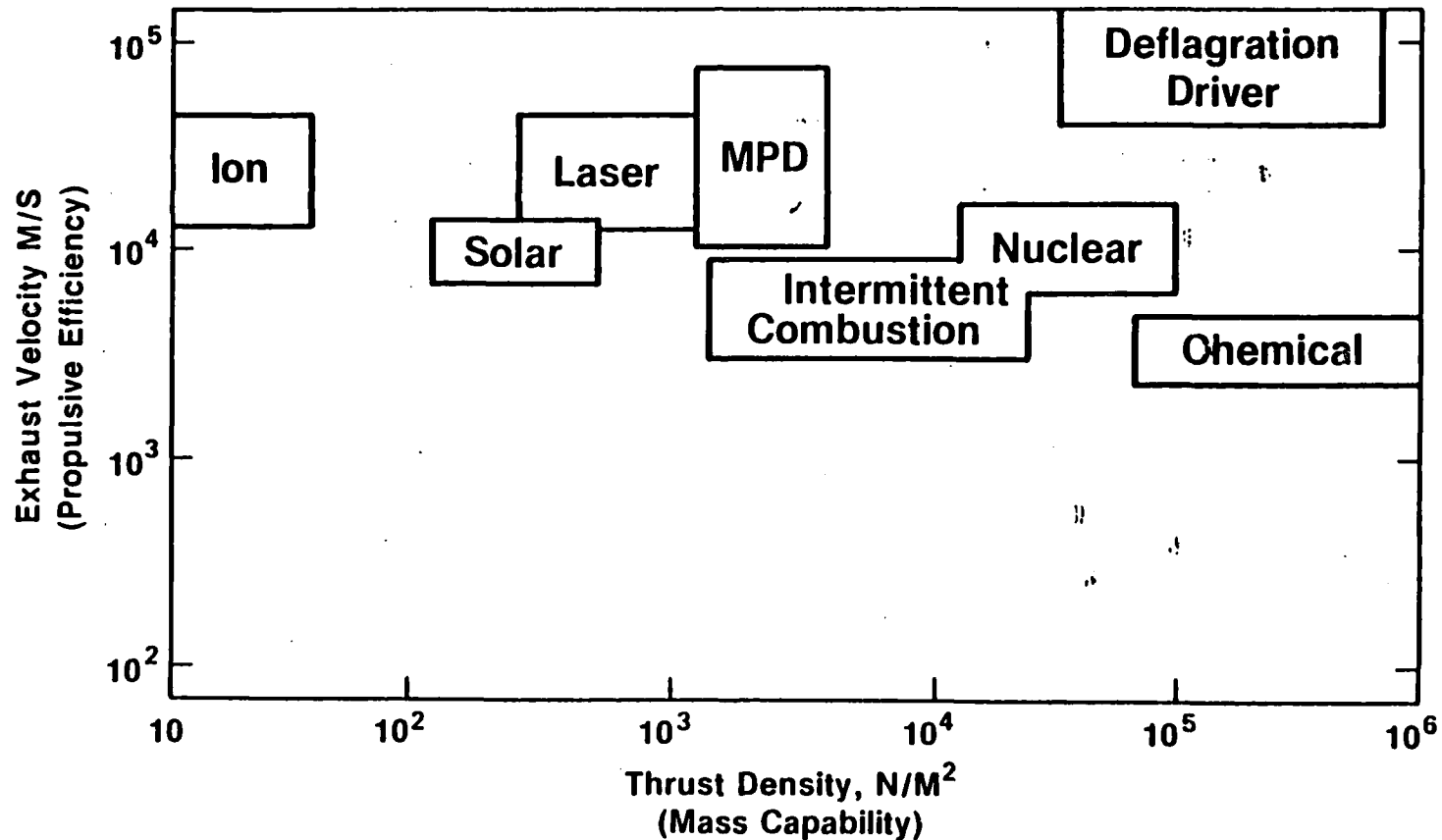

POWER REQUIREMENTS FOR ORBIT RAISING PROPULSION

MAGNETOPLASMA DYNAMIC THRUSTER

The magnetoplasmadynamic thruster is an example of a concept which offers large increases in performance. Thrust densities up to 10^4 newtons/meter² appear to be achievable. Research on this concept at Princeton University under NASA/JPL and AFRPL sponsorship continues to produce encouraging trends. In particular, recent results [Jahn, Clark, Burton, and King, 1981] indicate that electrode configuration and flow field improvements can lead to major improvements in onboard-power-to-thrust-power efficiencies. Efficiencies as high as 60% are being projected. However, major questions relating to items such as electrode life, maximum continuous power, and scaling of laboratory results require continuing research.

Air Force Basic Research

Space Propulsion and Power

- FY 83 Initiative -

Magnetoplasmadynamic Thruster

I-5-7

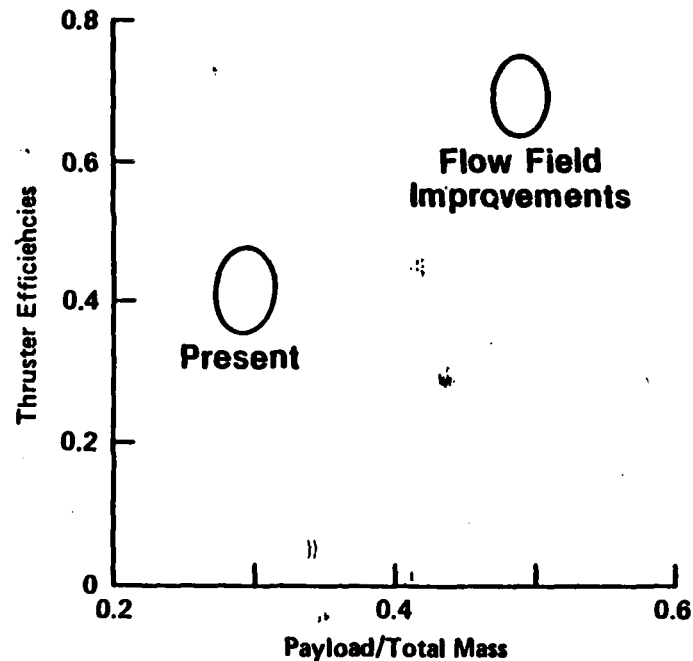
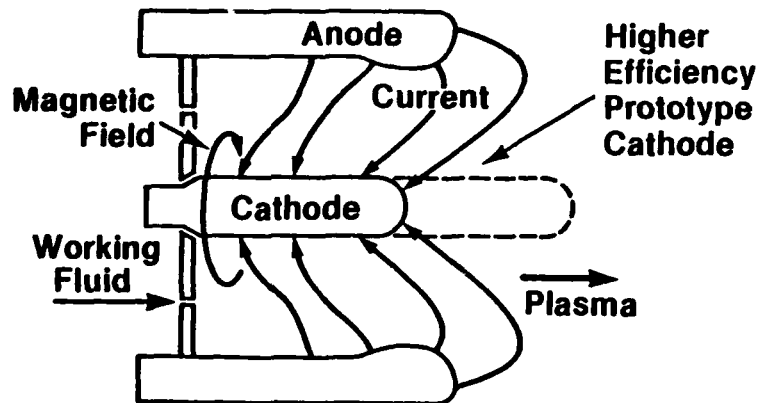

Research:

- Improve Model of Multi-Dimensional Plasma Sheaths on Anode
- Understand Material Loss from Pulse Data
- Refractory Cathode Materials: Geometry for Sustained Flow
- Exhaust Charge Neutralization

POWER REQUIREMENTS FOR ORBIT RAISING PROPULSION

BEAMED ENERGY PROPULSION

The promise of very high energy laser and beamed energy systems, either Earth or orbit based, may lead to very large gains in specific impulse. Since energy is applied from external sources, propellants can be selected without the need for oxidizers to produce combustion. The chart shows two of the many concepts which have been considered [Weiss, Pirri, and Kemp, 1979 and Jones 1981]. The sketch on the left illustrates a pulsed energy thruster. A lower energy pulse is used to gasify a condensed fuel; the resulting region of gaseous fuel is then accelerated by a higher energy pulse to impart impulse to the system. The sketch on the right illustrates a thruster which operates in the continuous mode. Energy beamed through a window heats a continuously flowing working fluid (e.g. H_2 seeded to absorb radiation). Beamed energy can produce temperatures (i.e., 10,000 to 20,000 K) considerably above those produced by adiabatic combustion. Beamed energy propulsion concepts have been the subject of several recent programs. For example, Rocketdyne is conducting a program under AFRPL sponsorship to assess the potential of using solar concentrators to heat the working fluid. The extent beamed energy propulsion systems will require space power will depend on the location of the beamed energy source.

Air Force Basic Research

Space Propulsion and Power - FY 83 Initiative -

Beamed Energy Propulsion

- Promise of Substantial Propulsive Efficiency Improvements
(4000 M/S Present, 20,000 M/S Potential)

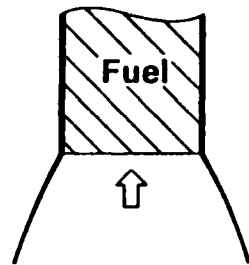

Step 1

Low Flux Pulse
Vaporizes
Fuel

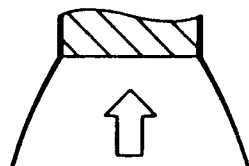

Step 2

High Flux Pulse
Accelerates
Plasma

Expanding Plasma

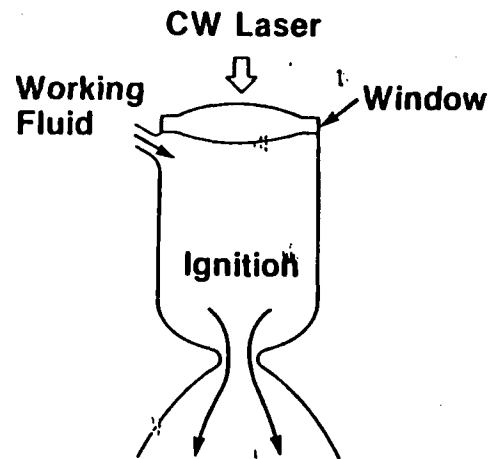

Continuous Deflagration

Research Issues:

- Coupling of Beamed Energy to Working Fluid
- Window Transmission and Degradation
- Molecular Recombination of Working Fluids

POWER REQUIREMENTS FOR ORBIT RAISING PROPULSION

THERMAL MANAGEMENT

All continuously operating propulsion and power systems must deal with the realities of having to reject large amounts of waste heat. Indeed the rejection of waste heat can be the performance limiting factor. In particular, space propulsion devices require cooling of components such as nozzles, chamber, and electrodes. The liquid-droplet radiator [Mattick and Hertzberg, 1981] is a potential breakthrough which may enable the promise of several of the higher performance systems to be realized. The projected weight reductions and reliability increases of the liquid-droplet radiator designs are leading to re-evaluations of the system options. The liquid-droplet radiator is the subject of separate presentation in these proceedings.

Air Force Basic Research

Space Propulsion and Power - FY 83 Initiative -

Thermal Management

- Liquid/Radiator Offers 80% Reduction in Radiator Weight

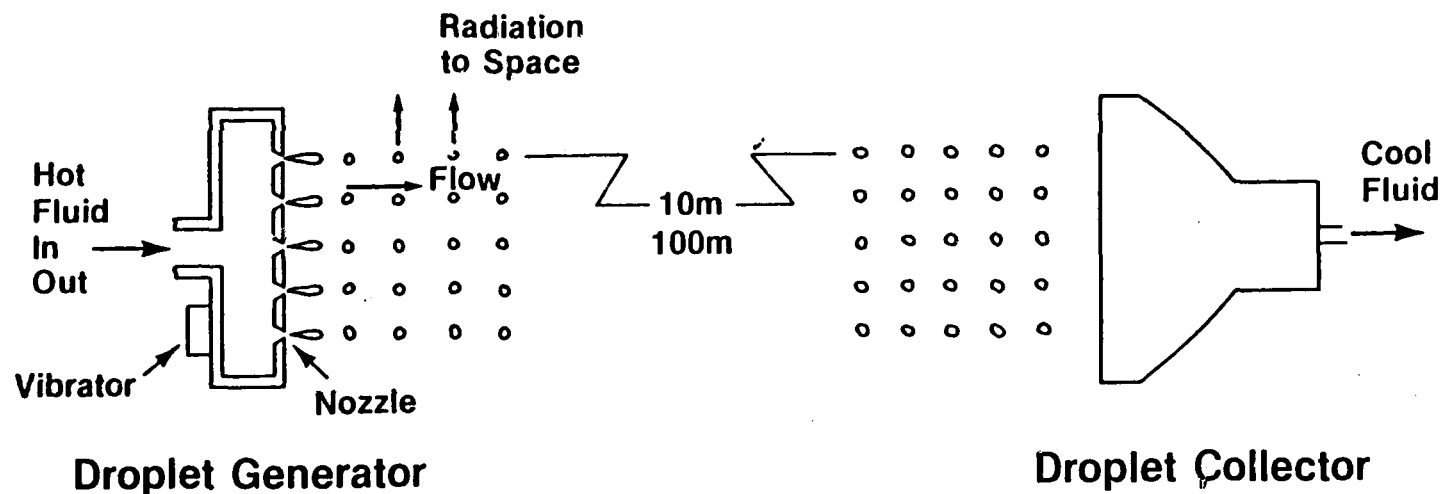

Research:

- Model Fluid Dynamic and Thermodynamic Processes
- Electrostatic Forces on Droplet Array

POWER REQUIREMENTS FOR ORBIT RAISING PROPULSION

POWER FOR ELECTRIC THRUSTERS

Most of the electric thrusters of interest can operate if power of 100 kW and above is available. However, higher efficiencies at more useful thrust ranges will occur at the multi-megawatt level. By way of illustration, an example is given of pulse and continuous thruster operation from a continuous megawatt power source. If the thruster requires pulse power (e g, the deflagration driver), a properly matched power conditioning system is desirable both to make efficient use of the power source and to achieve improved efficiency from the thruster. Other propulsion concepts are expected to achieve maximum performance when operated in the continuous mode (e g, the magnetoplasmadynamic thruster).

Air Force Basic Research

Space Propulsion and Power

- FY 83 Initiative -

POWER FOR ELECTRIC THRUSTERS

- MISSIONS CALL FOR WIDE RANGE OF ACCELERATIONS AND MISSION TIMES
- AN EXAMPLE OF A RANGE OF INTEREST:

CONTINUOUS POWER AVAILABE: 1.1 MW 10 ms CHARGING TIME

I-5-13

TYPE OF OPERATION	INSTANT POWER	DURATION	THRUST	SPECIFIC IMPULSE	AVERAGE THRUST
	MW	SEC	N	M/S	N
PULSE	1000	10^{-5}	15000	~25,000	15
CONTINUOUS	1	-	10	~20,000	10

POWER REQUIREMENTS FOR ORBIT RAISING PROPULSION

CONCLUSION

As part of the planning for the appropriate research, an assessment of space propulsion barriers and research is being conducted and documented. This is being accomplished, in part, by a coordinated group of position papers which are being prepared by investigators who have broad experience in the disciplines impacting space propulsion. The papers are addressing the topics in terms of the broader generic classifications of the concepts. The papers are to provide broad coverage of the underlying technologies leading to descriptions of the technical and research issues. The position papers are not intended to provide solutions to complex issues, rather they are to provide an introduction and perspective on the challenges. The Air Force report containing the position papers will be available after February 1983.

During the next year, AFOSR will continue to establish a research program which addresses the basic research issues. As this is accomplished, we will keep in mind the synergisms among space power and space propulsion.

POWER REQUIREMENTS FOR ORBIT RAISING PROPULSION

BIBLIOGRAPHY

- Burton, R. L., Clark, K. E., and Jahn, R. G. "Thrust and Efficiency of a Self-Field MPD Thruster", AIAA Paper 81-0684, April 1981
- Cheng, Dah Yu, "Application of a Deflagration Plasma Gun as a Space Propulsion Thruster", AIAA Journal, Vol. 9, No. 9, September 1971, pp1681
- Finke, R. C. (Editor) Electric Propulsion and Its Applications to Space Missions Progress In Astronautics and Aeronautics Series, Vol 79, (Martin Summerfield, Series Editor), American Institute of Aeronautics and Astronautics, New York, 1981
- Jones, L. W., "Laser Propulsion - 1980", AIAA Paper 80-1264, July 1980
- Kaufman, H. R. "Large Inert-Gas Thrusters" AIAA Paper 81-1540, July 1981
- King, D. Q., Clark, K. E., and Jahn, R. G. "Effect of Choked Flow on Terminal Characteristics of MPD Thrusters", AIAA Paper 81-0684, April 1981.
- Layton, J. P., Grey, J., and Smith, W. W. "Preliminary Analysis of a Dual-Mode Nuclear Space Power and Propulsion System" 1976
- Mattick, A. T. and Hertzberg, A. "Liquid Droplet Radiators for Heat Rejection in Space", AIAA Paper 80-9477, August 1980
- Mead, F. B., Jr. (Editor), "Advanced Propulsion Concepts - Project Outgrowth", AFRPL-TR-72-31, Rocket Propulsion Laboratory, Edwards AFB, CA, June 1972, (AD750554)
- Papdiliou, D. D. (Editor), "Frontiers in Propulsion Research", Tech Memo, 33-722, JPL, Pasadena, CA, 1975, (N75-22373)
- Powell, J. E., Botts, T. E., and Hertzberg, A. "Applications of Power Beaming from Space-Based Nuclear Power Stations" 16th IECEC Meeting, Atlanta, GA, August 1981.
- Weiss, R. F., Pirri, A. N., and Kemp, N. H. "Laser Propulsion", Astronautics and Aeronautics, Vol. 17, No. 3, March 1979, pp. 50-58.

SESSION II. CHEMICAL SOURCES

"Chemical Sources: Overview"
by
Clark, J.

(Paper not available)

Q & A - J. Clark

From: Robert Taussig, Math Sciences NW

How do you resolve the question of launch weight for your low power, high voltage (LMW) [refer to paper by Manny Cohen for powers greater than 50 kW] if you rely on solar photovoltaic cells for these missions? This approach would seem to be too heavy for single shuttle launch.

A.

It depends on operating time. A Ag-Zn battery system would be about 13 watt-hrs/lb. 13 watt hrs/lb \sim 1.5 MW - minutes/2000 lbs.

So the batteries are no problem. Lithium primary cells would be less than half the weight of the Ag-Zn battery system.

Recharging -- granted, the largest reasonable array may still require considerable time to recharge the batteries. The key is that we are probably talking about short discharge times; seconds to a few minutes.

CHEMICAL SOURCES - BATTERY

Robert A. Brown

Eagle-Picher Industries, Inc.
Electronics Division
Couples Department
Joplin, Missouri
64802

The particular aspects of space power requirements that are critical to batteries are discussed. Power density and energy density values for various electrochemical systems and battery configurations are shown as a function of the time duration of the power pulse. Characteristics of the possible battery systems are listed in order to match specific battery systems to individual power requirements. A general discussion is presented regarding the advantages batteries offer over other types of power sources.

NARRATIVE DESCRIPTION OF VIEWGRAPHS

CRITICAL SPECIFICATION ITEMS

This table presents the particular operational requirements that have the most control over the design of high power batteries. Since the rate at which a battery must convert its chemical energy to electrical energy is extremely critical, the design of high power and high energy batteries are completely different. Other characteristics, such as wet life, cycle life, temperature limits, mechanical features influence the electrochemical system selection and can be traded off against each other and against power and energy density in the design of a specific battery.

DESIGN CONSIDERATIONS

This table presents the choices that are available to the battery designer that are not necessarily dictated by the operational requirements. These factors can influence the over-all battery weight and volume by as much as 50% and have an impact on the battery complexity, reliability, safety, cost, and mechanical interface with other equipment.

BATTERY SYSTEM CHARACTERISTICS

A comparison is shown between four prominent electrochemical systems suitable for military and aerospace applications. The silver-zinc, nickel-zinc, and nickel-cadmium systems have been available for some time; while the lithium-thionyl chloride is relatively new.

SYSTEM POWER DENSITY

This chart shows the power density available from various electrochemical systems and battery configurations as a function of the duration of the power pulse. The lithium-thionyl chloride system is generally thought of as a low power battery, however for fairly long duration pulses this system can offer a higher power density than other systems. This results from the high cell potential and the low weight electrode materials.

SYSTEM ENERGY DENSITY

This chart shows the energy density available from various electrochemical systems and battery configurations as a function of the duration of the power pulse. This data is calculated from the previous chart assuming one pulse of the indicated duration. Shorter duration pulses can be repeated if the battery is allowed to reach equilibrium between pulses, so that the higher energy densities are theoretical possible even at the short duration/high power pulses.

BATTERY ADVANTAGES

This table summarizes the areas where batteries can offer an advantage over other power sources for high power space systems.

CRITICAL SPECIFICATION ITEMS

- ELECTRICAL REQUIREMENTS
 - HIGH POWER vs. HIGH ENERGY
 - PULSE DURATION & FREQUENCY FOR HIGH POWER BATTERIES

- OPERATIONAL LIFE

- CHARGE RETENTION REQUIREMENTS

- CYCLE LIFE

- TEMPERATURES
 - HIGH TEMP DEGRADES LIFE
 - LOW TEMP DEGRADES PERFORMANCE

- VENTING RESTRICTIONS

DESIGN CONSIDERATIONS

- ELECTROCHEMICAL SELECTION
- CONFIGURATION - CONVENTIONAL vs. PILE
- MODULE/SUBMODULE SIZE
- SAFETY
- RELIABILITY

BATTERY SYSTEM CHARACTERISTICS

	<u>SILVER-ZINC</u>	<u>NICKEL-ZINC</u>
OPERATIONAL LIFE LIMIT:	6 MONTHS	3 YEARS
CHARGE RETENTION:	MINIMUM LOSSES	20% Loss-30 DAYS- 25°C 50% Loss-4 DAYS- 71°C
CYCLE LIFE:	10-100	10-250
COST:	\$400/KWH	\$300/KWH
SAFETY:	MINIMUM RISKS	MINIMUM RISKS
DEVELOPMENT STATUS:	PRESENTLY AVAILABLE - IMPROVEMENTS POSSIBLE	PRESENTLY AVAILABLE IMPROVEMENTS POSSIBLE

BATTERY SYSTEMS CHARACTERISTICS

	<u>NICKEL - CADMIUM</u>	<u>LITHIUM-THIONYL CHLORIDE</u>
OPERATIONAL LIFE LIMIT:	5-10 YEARS	5-10 YEARS
CHARGE RETENTION:	20% LOSS - 30 DAYS - 25°C 50% LOSS - 4 DAYS - 71°C	EXPECTED TO BE MINIMAL
CYCLE LIFE:	20 - 250	1
COST	\$450/KWH	\$200/KWH
SAFETY:	MINIMUM RISKS	DEVELOPMENT NEEDED
DEVELOPMENT STATUS:	PRESENTLY AVAILABLE IMPROVEMENTS POSSIBLE	UNDER DEVELOPMENT

AD-A118 887

R AND D ASSOCIATES ROSSLYN VA
PROCEEDINGS OF THE AFOSR SPECIAL
FEB 82 P J TURCHI

F/G 10/2
CONFERENCE ON PRIME-POWER FOR --ETC(U)
F49620-82-C-0008

UNCLASSIFIED

AFOSR-TR-82-0655

NL

249

4888

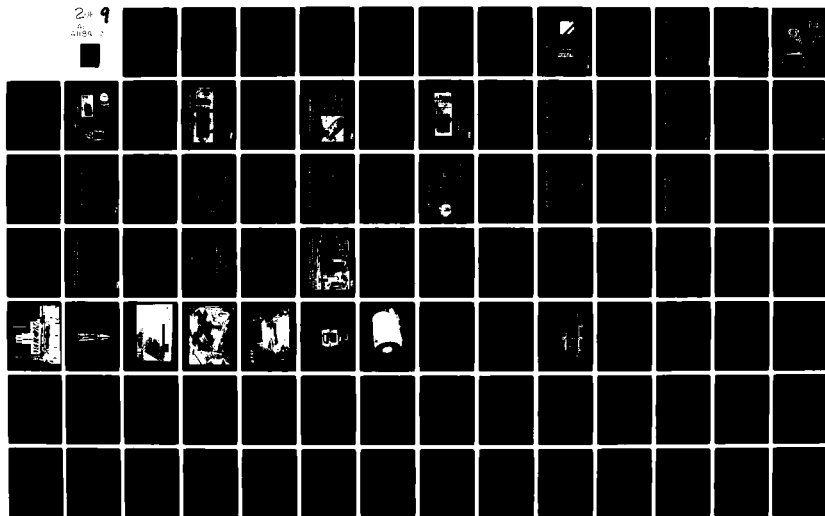

SYSTEM POWER DENSITY

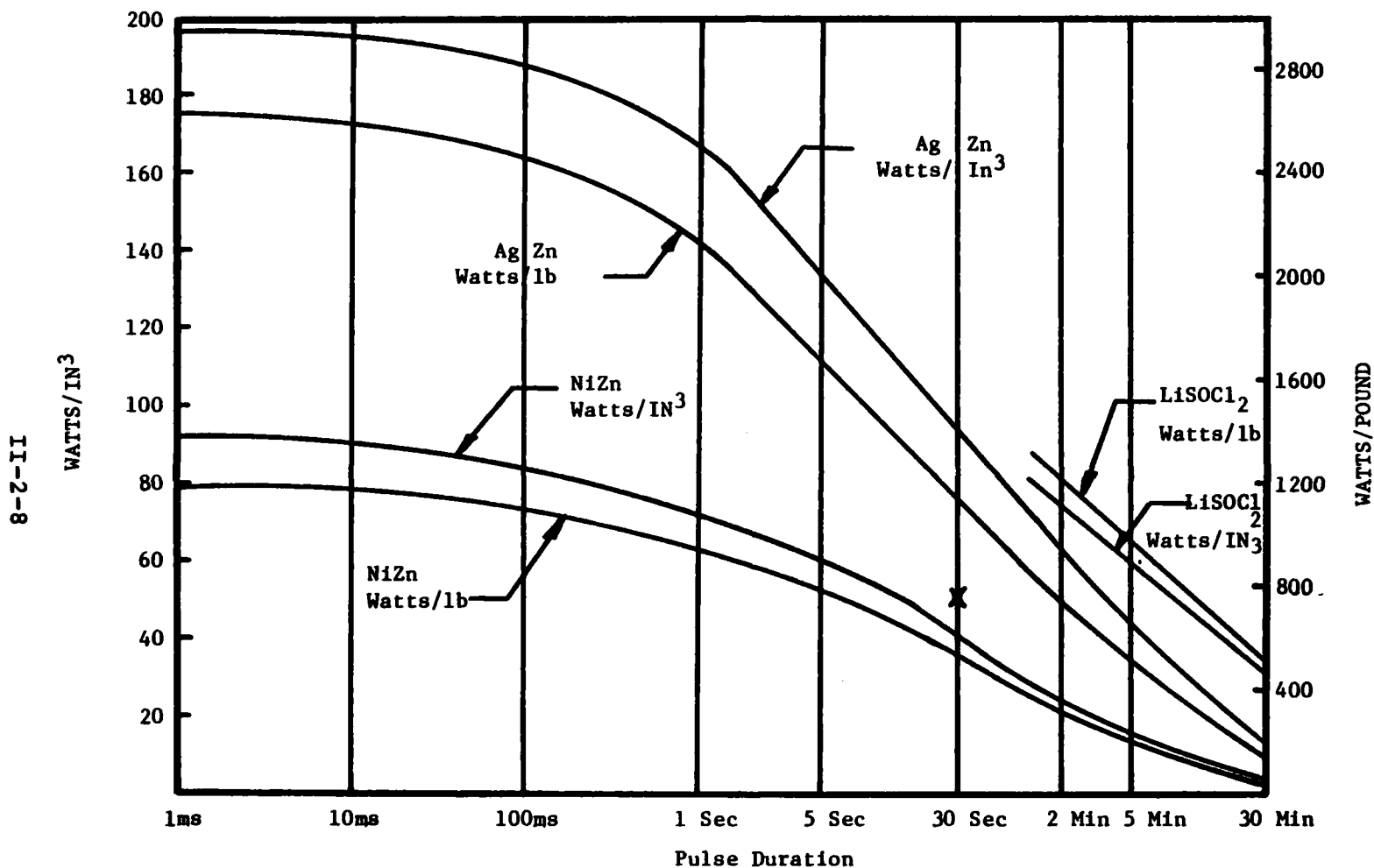

II-2-8

Nickel-Zinc = Conventional Design, 10 Cycle Secondary
 Silver-Zinc = Megawatt Pile Design, 40 Cycle Secondary
 Lithium-Thionyl Chloride - Conventional Design, Primary

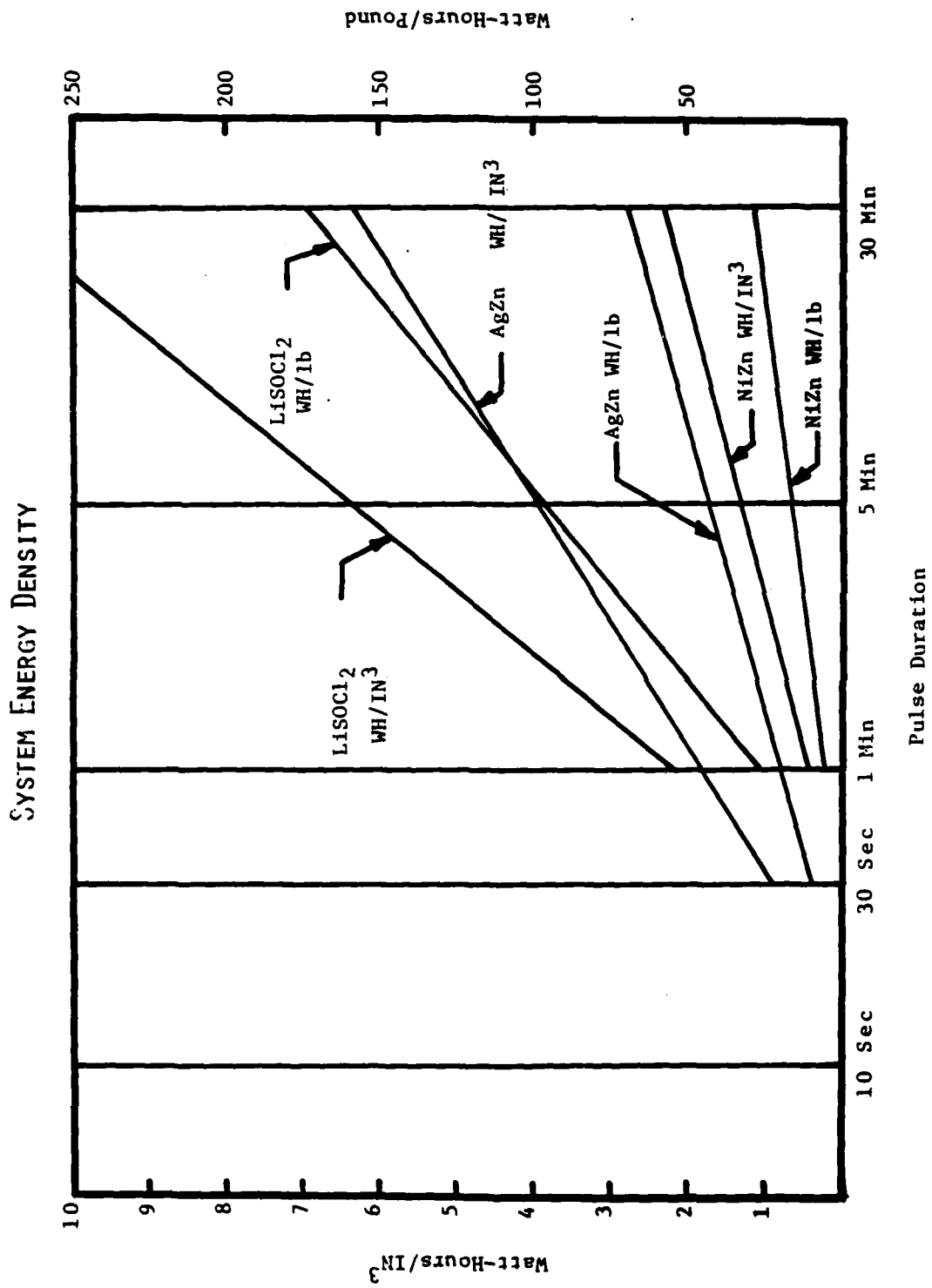

BATTERY ADVANTAGES

- POWER AVAILABLE INSTANTANEOUSLY - NO START-UP REQUIRED
- CAN START & STOP POWER DRAIN AS OFTEN AS DESIRED -
WIDE RANGE OF POWER LEVELS AVAILABLE
- SIMPLE CONSTRUCTION → RELIABILITY
- QUALIFIED FOR RUGGED DYNAMIC ENVIRONMENTS
- NO MOVING MECHANICAL PARTS
- MINIMAL POWER CONDITIONING
- COMPLETELY SELF CONTAINED - NO FUEL OR AUXILIARY EQUIPMENT
REQUIRED
- BATTERIES AVAILABLE TODAY - BETTER SYSTEMS UNDER DEVELOPMENT
- MODULAR CONSTRUCTION - BUILD UP TO ANY DESIRED POWER LEVEL
- INEXPENSIVE
- RAPID TURN-AROUND WITH SECONDARY SYSTEMS

Q & A - R. A. Brown

From: B. R. Junker, Office of Naval Research

What are the limiting factors determining the 10-100 cycle lifetime on AgZn batteries?

Answer:

From: Roy Pettis

In proposed weapon applications, many very-high-power pulses will be required; a reasonable example might be 20-100 pulses of 2-10 second long at ~ 30 MWe. Batteries are appealing because their high energy density is compatible with the total energies above. How much will the battery energy density decrease at such high power levels (30 MWe)? Will the battery system risk damage in fast discharge/rest/discharge cycles? What battery would be the best choice for such a mission, requiring a combination of high energy density and high power density?

Answer:

From: Frank Rose, Naval Scientific Weapons Center

Most of the material discussed by you came from Air Force studies/experiments in the early 70's. Are there new battery concepts in R & D stages? If so, what energy densities appear feasible? What R & D problems remain to be solved?

Answer:

From: P. J. Turchi, R & D Associates

What are the failure modes limiting discharge time vs power density? What measurements need to be made to determine reasons for failure mode development?

Answer:

Q & A - R. A. Brown (Cont)

From: Capt. Steven Wax, Air Force Office of Scientific
Research

What is fundamental limitation (kinetic, etc. diffusion)
for the rate of power removal? What research might improve
the efficient removal of chemical energy at higher rates?

Answer:

Alkaline Fuel Cells for Prime Power and Energy Storage

J. K. Stedman

Presented to the
Space Prime Power Conference
Norfolk, VA
February 22, 1982

ABSTRACT

Alkaline fuel cell technology and its application to future space missions requiring high power and energy storage are discussed. Energy densities exceeding 100 watthours per pound and power densities approaching 0.5 pounds per kilowatt are calculated for advanced systems. Materials research to allow reversible operation of cells for energy storage and higher temperature operation for peaking power is warranted.

FC-4500 : Of the four types of fuel cells under development today, i.e., alkaline acid molten carbonate and solid oxide, the alkaline cell offers the highest performance potential. Both electrodes are catalyzed with precious metals. The matrix contains electrolyte and physically separates the two electrodes. Electrolyte reservoir plate contains additional electrolyte to increase the tolerance to varying operating conditions.

ALKALINE ELECTROLYTE FUEL CELL

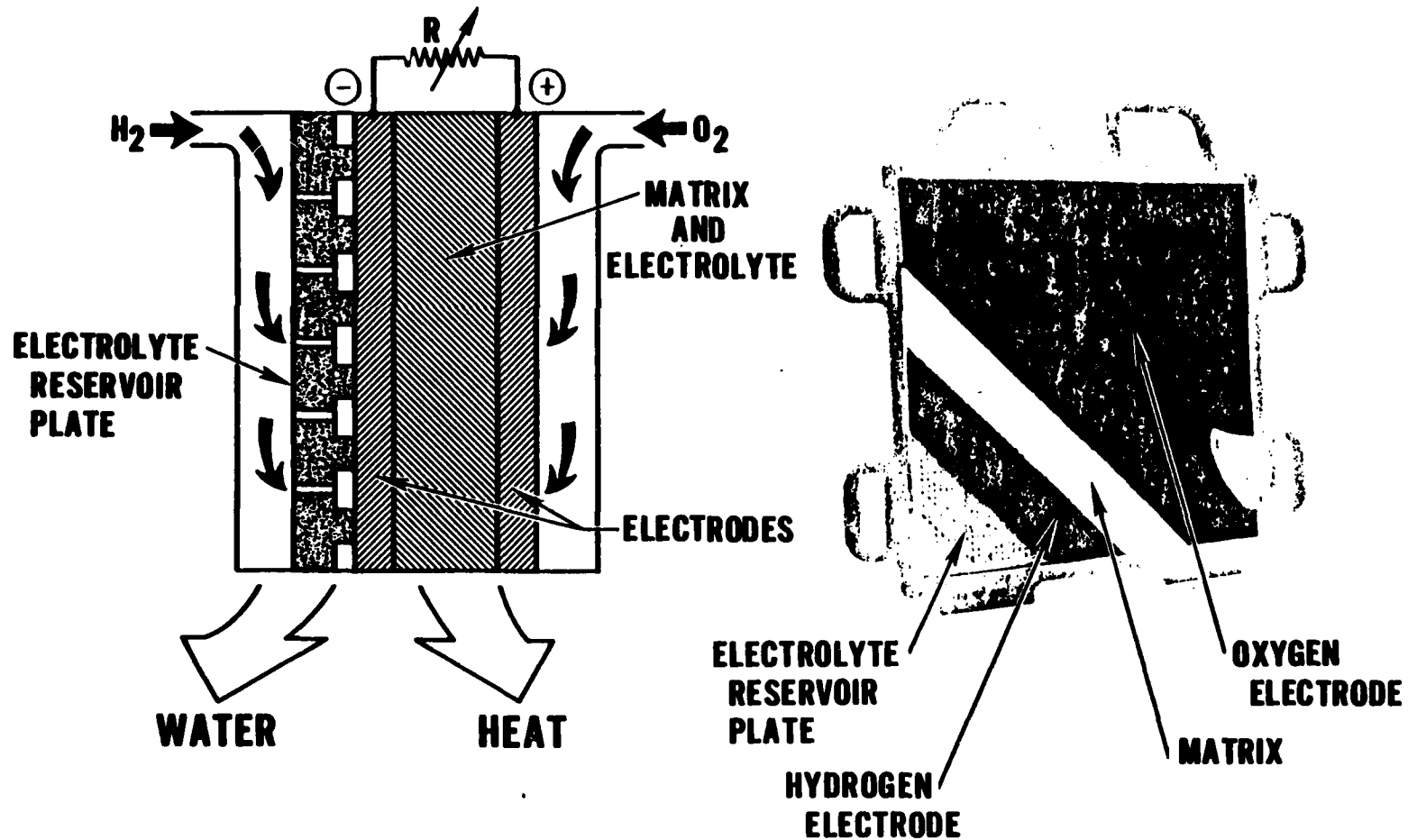

II-3-3

FC-13778 : A volts per cell of 0.9 corresponds to an efficiency of approximately 65 percent. As can be seen, the performance degradation over 5000 hours is quite minimal.

II-3-4

ALKALINE ELECTROLYTE CELL PERFORMANCE

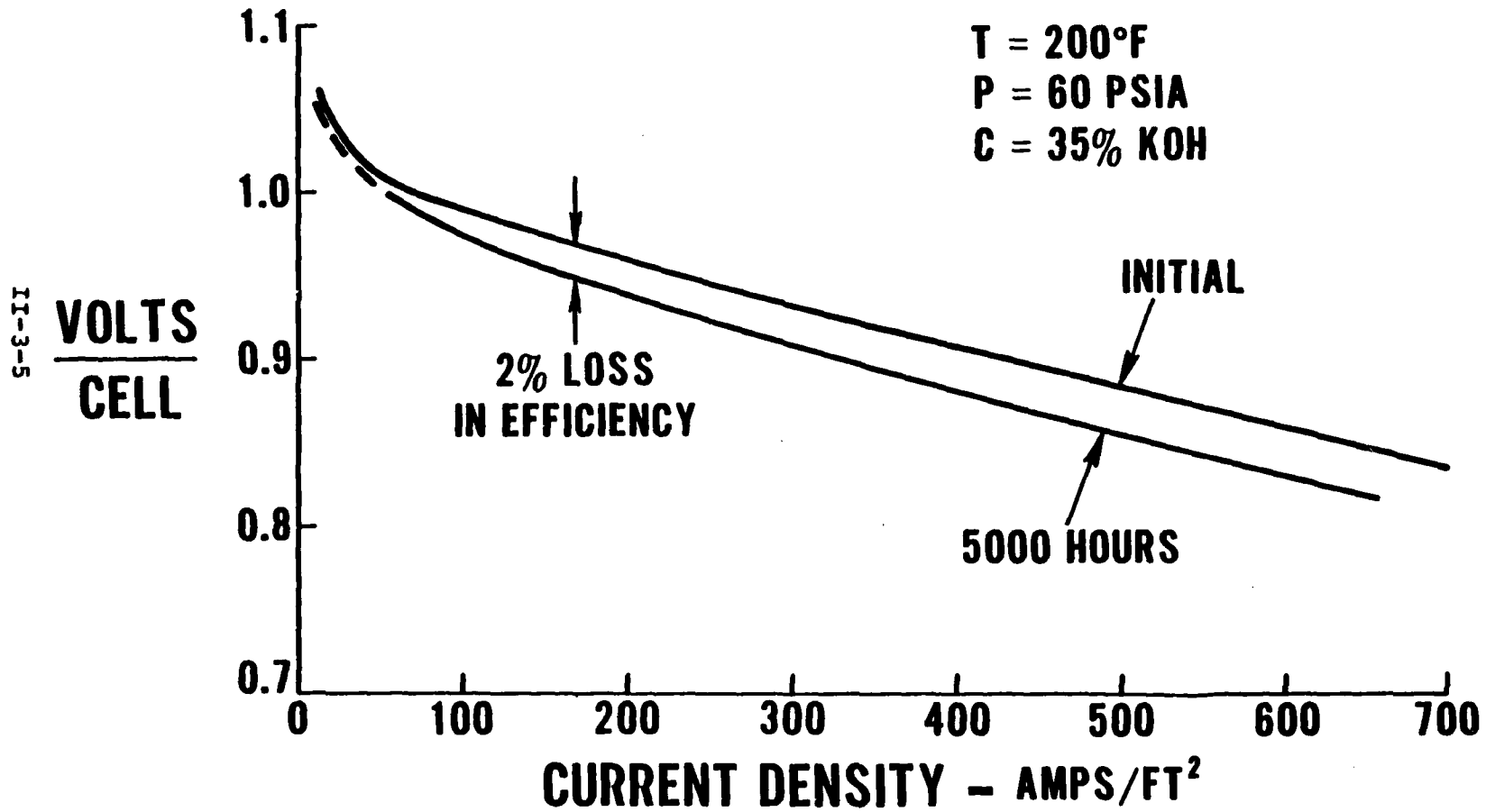

FC-2625 : The individual fuel cells are stacked with bi-polar plates to form a complete power section containing sufficient cells to achieve the desired power unit voltage. This power section coupled with an accessory section which contains the necessary coolant pumps, thermal control valves, water removal components, and interface panel constitutes a complete fuel cell power plant capable of self-regulated operation over loads from 0 to 100 percent of rated.

ELEMENTS OF COMPLETE FUEL CELL POWERPLANT

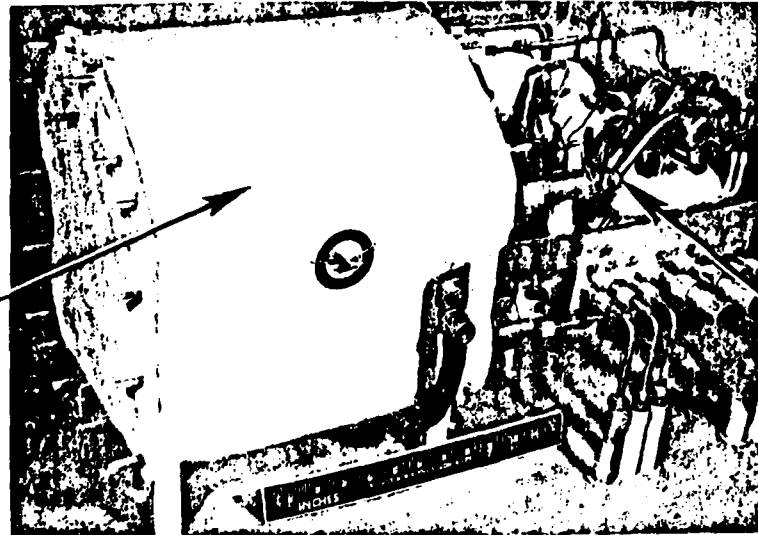

POWER SECTION

ACCESSORY SECTION

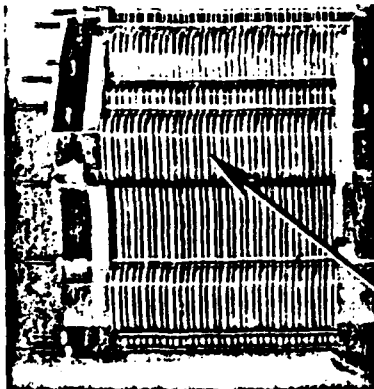

CELL ASSEMBLY

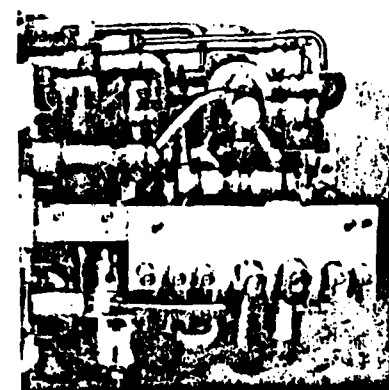

II-3-7

FC2625
742305

FC-1330 : Development was started on the Apollo power plant for NASA in 1961. This unit weighed approximately 250 pounds with an output of 1.5-kW. The Orbiter power plant program was initiated in 1972. The Navy deep ocean power plant program was initiated in 1970 for the Navy Deep Sumergence Rescue Vehicle. Although not used in the DSRV it has provided prime power for a operational submersible as shown in the following charts.

**GOVERNMENT HYDROGEN/OXYGEN
FUEL CELL PROGRAMS**

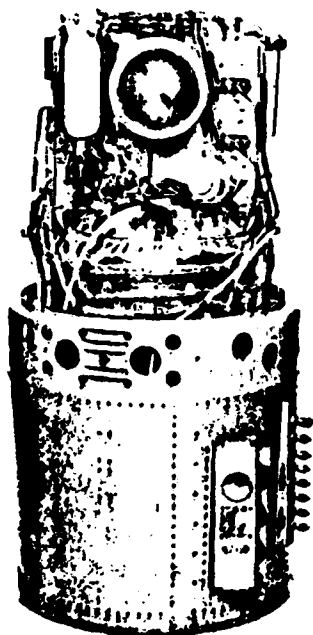

NASA APOLLO

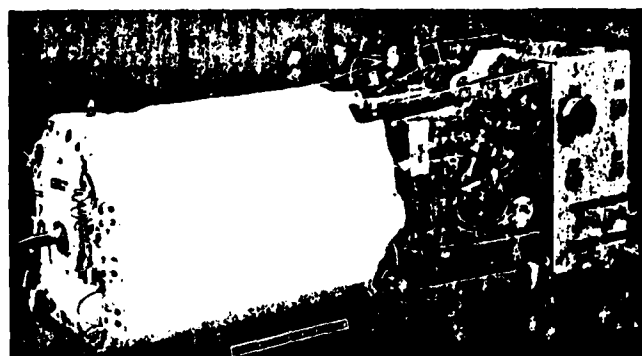

NASA ORBITER

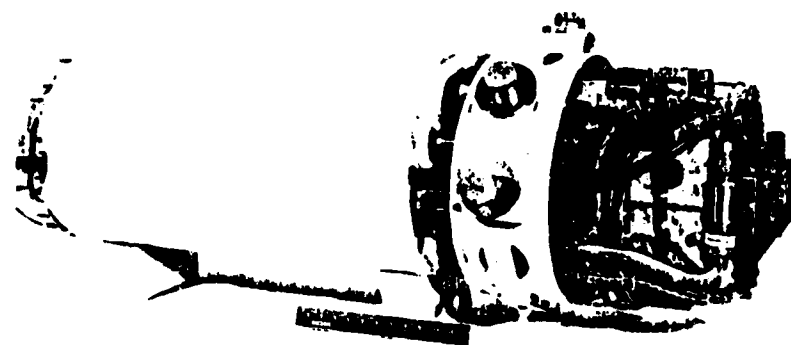

NAVY DEEP OCEAN

II-3-9

II-3-10

FC-16692 : The cell technology in this fuel cell power plant is identical to that in the Space Shuttle Orbiter unit.

30-kW FUEL CELL POWERPLANT

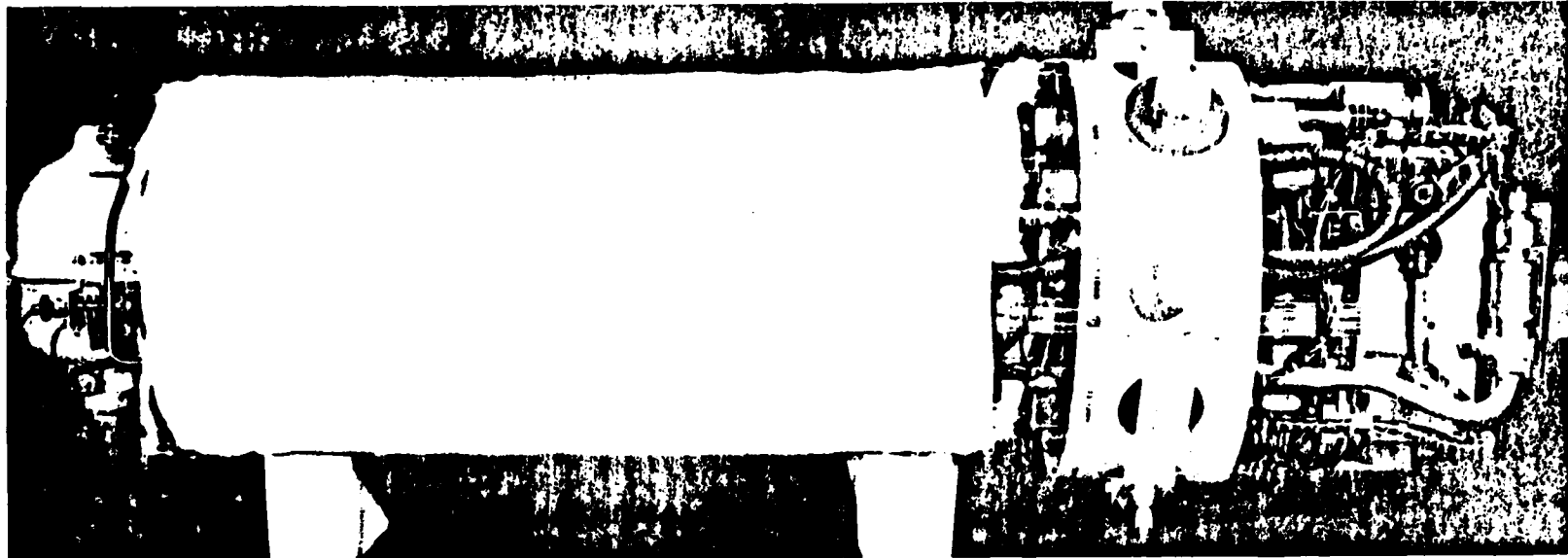

II-3-11

- Power source for Deep Submergence Rescue Vehicle (DSRV)
- Ten powerplants built
- More than 7000 hours of operation
- Weight – 391 lbs
- Volume – 5.5 ft³
- Envelope – 14" dia x 72" long

II-3-12

FC-16689 : Reactants are stored in the spherical vessels shown over the open hatch. The power unit is contained in the horizontal cylinder which also acts as a sea water heat exchanger for rejected waste heat.

OPERATION IN SUBMERSIBLE "DEEP QUEST"

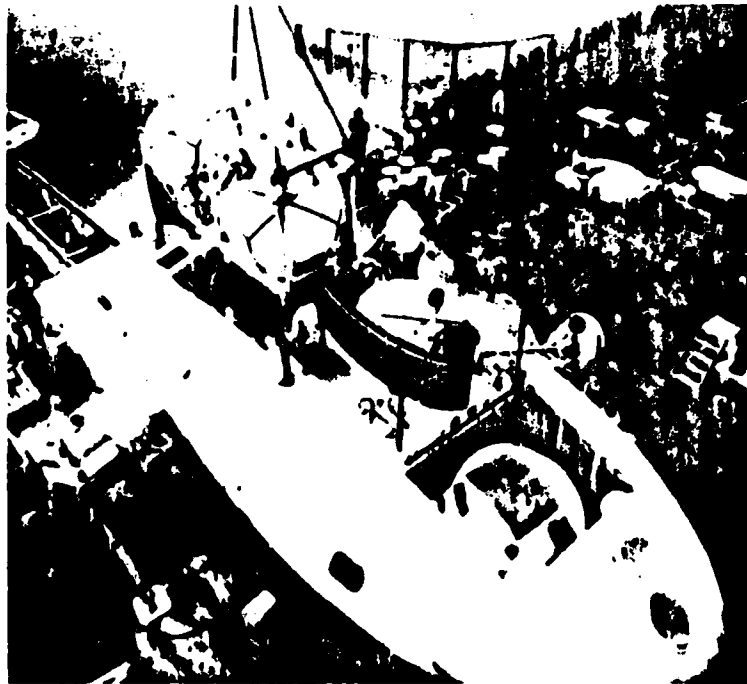

II-3-13

- 360 hours
- 22 dives in 10 months
 - 9/78 to 1/79
 - 4/80 to 9/80
- Verified operation at 5000 ft design depth
- 46 hour endurance record for submersibles
 - 550 kWhr with no purging

FC-16633 : Three of these units are installed in each Orbiter.

ORBITER FUEL CELL POWERPLANT

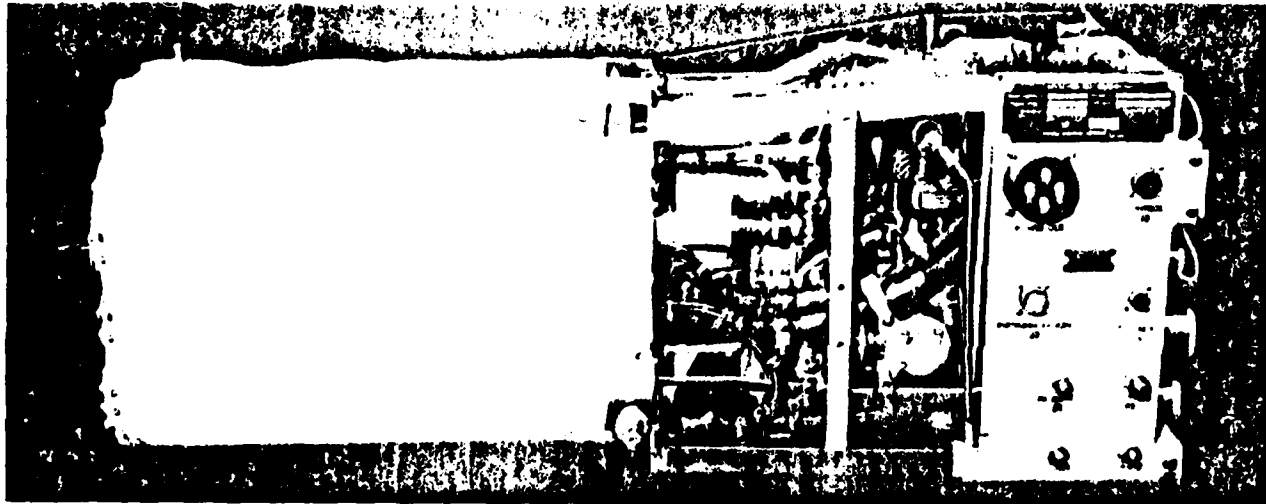

II-3-15

- Power _____ 12 kW
- Voltage _____ 28 volts
- Weight _____ 202 pounds
- Volume _____ 4.6 ft³
- Only source of electric power on orbiter

FC-16697 : The use of fuel cell technology for energy storage, a concept first examined in the last 1960's has received renewed interest and funding as the power level for planned NASA and DOD missions increase. Higher power levels make it practical to consider separate fuel cell units to produce power with independent electrolysis units for hydrogen and oxygen production not only for energy storage but for life support and auxiliary thruster use as well.

FUEL CELL ENERGY STORAGE

Late 1960's: Air Force/COMSAT – 500 Watt regenerable fuel cell

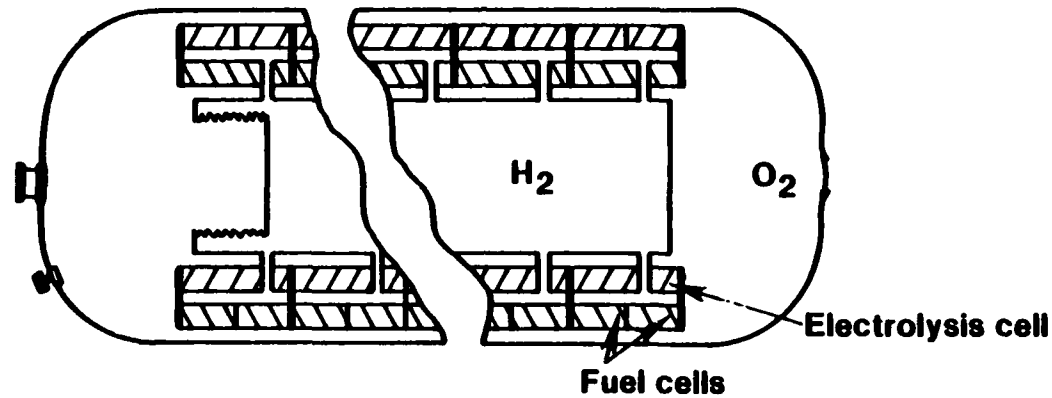

II-3-17

Late 1970's: NASA – 25 to 100's of kW – Combined fuel cell/
Electrolysis energy storage/Reactant processing system

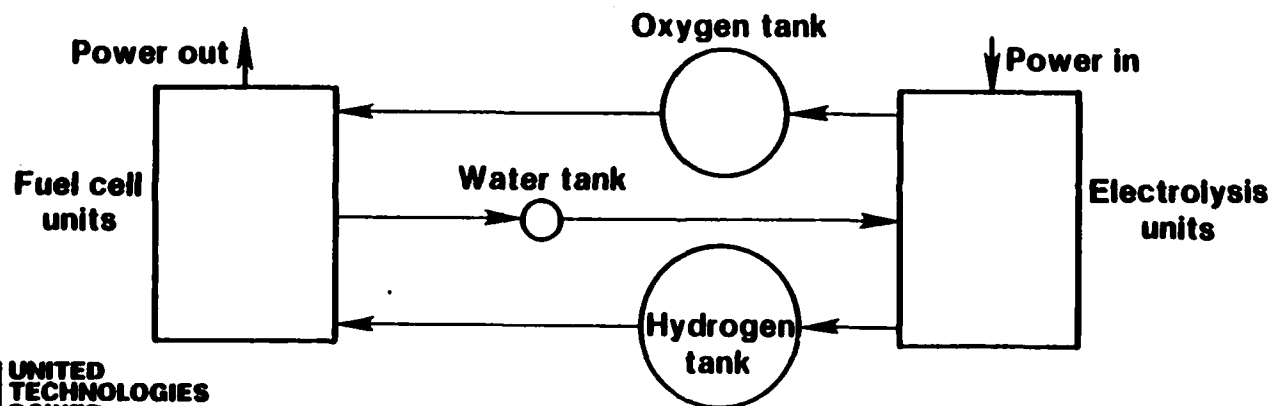

II-3-18

FC-16700 : The weights on this chart reflect state-of-the-art fuel cell and electrolysis module technology, a conservative steel reactant tank set and radiator weights based on NASA input.

ORBITAL ENERGY STORAGE SYSTEM WEIGHT

250 kW output

500 kWh storage

LEO

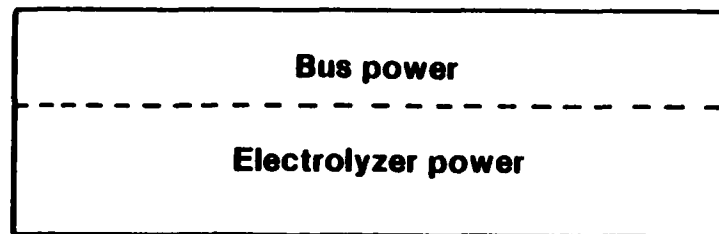

Solar array

• Fuel cell modules	2393
• Fuel cell accessory	307
• Electrolysis cell modules	1622
• Electrolysis cell accessory	348
• Reactant tanks	2807
• Reactants	410
• Radiator	2441
• Heat exchanger	118
• Solar array	18,097

Total - lbs 28,543

• Efficiency	50%
• Watt-hours/lb*	47.9

*Without solar array

II-3-19

FC-16706 : This chart assumes the battery is utilized at 90% DOD.
In geo^{graphical} the energy density increases due to the higher
watt hours per watt required and the smaller electrolysis
unit required due to the longer time available to
recharge the tankage. The atmospheric platform numbers
reflect an 8 hour charge and 16 hour discharge.

FUEL CELL ENERGY STORAGE SYSTEMS

II-3-21

**Energy
density**
Watt-hours/lb

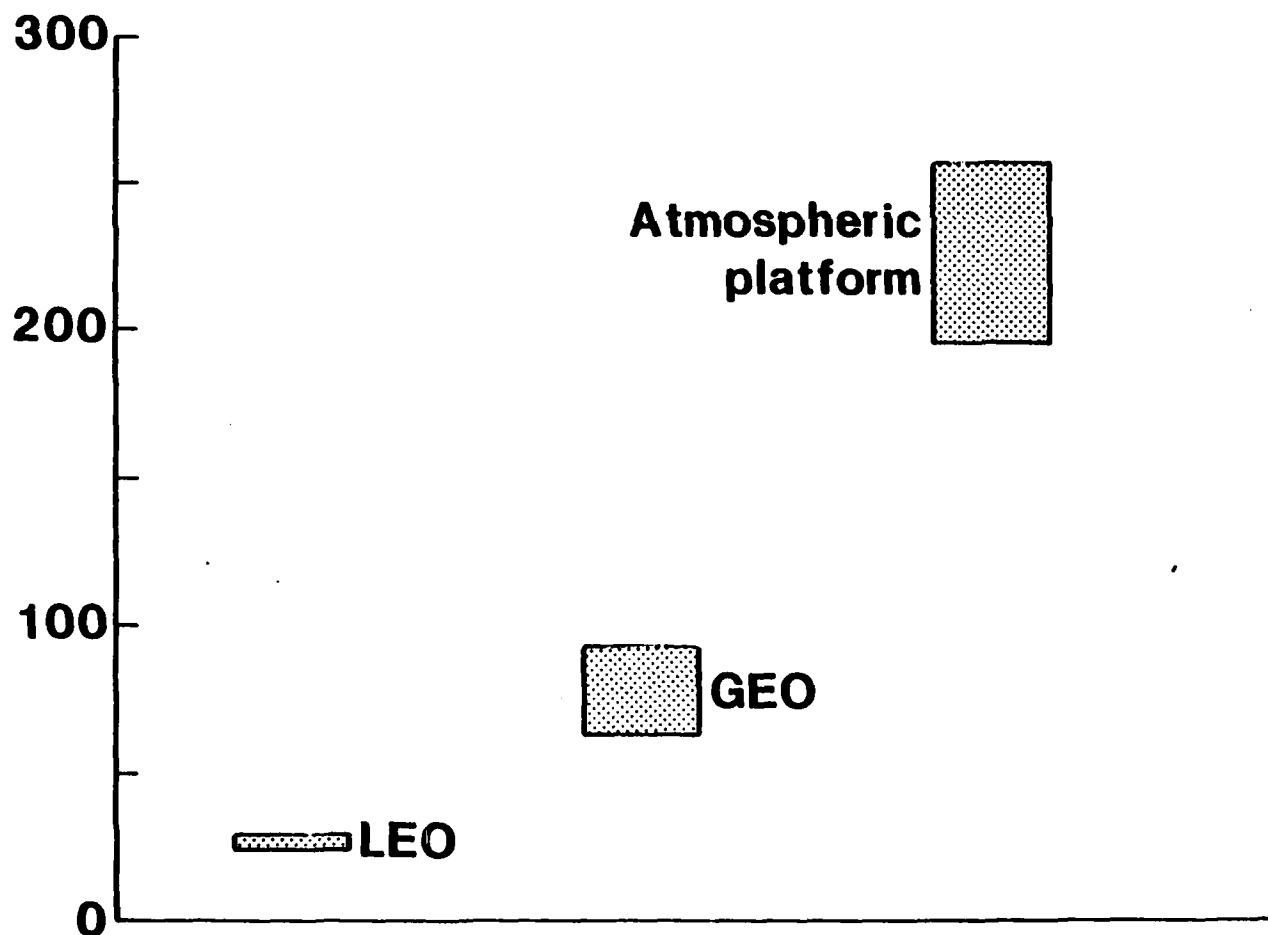

II-3-22

FC-17389 : The previous charts are based on a conservative approach of separate fuel cell and electrolytes of power units. Integrating fuel cells and eletrolyzer cells within a common module might simplify the system and reduce weight. Work in the late 1960's showed the reversible cell although offering promise of significantly reduced weight, suffered severe endurance and performance problems. Recent advances in fuel cell and electrolyzer catalysts may be applicable to this ^{concept} contract and ~~examine~~ an experimental examination of these materials is a needed research project.

ENERGY STORAGE OPTIONS

- Reversible cell
- Separate fuel cell power plant and electrolyzer
- Integrated fuel cell/electrolysis cell

II-3-23

FC-3149 : Previous charts described fuel cells which operate normally over a current density range of 50 to 500 amps per square foot. In 1966 to 1975 United Technologies conducted several exploratory development programs and design studies for the Air Force Aeropropulsion Lab on the use of alkaline fuel cells for short duration high power missions. In this application the fuel cell is operated at up to 10 times the power density of conventional long duration fuel cells.

HIGH POWER DENSITY FUEL CELL

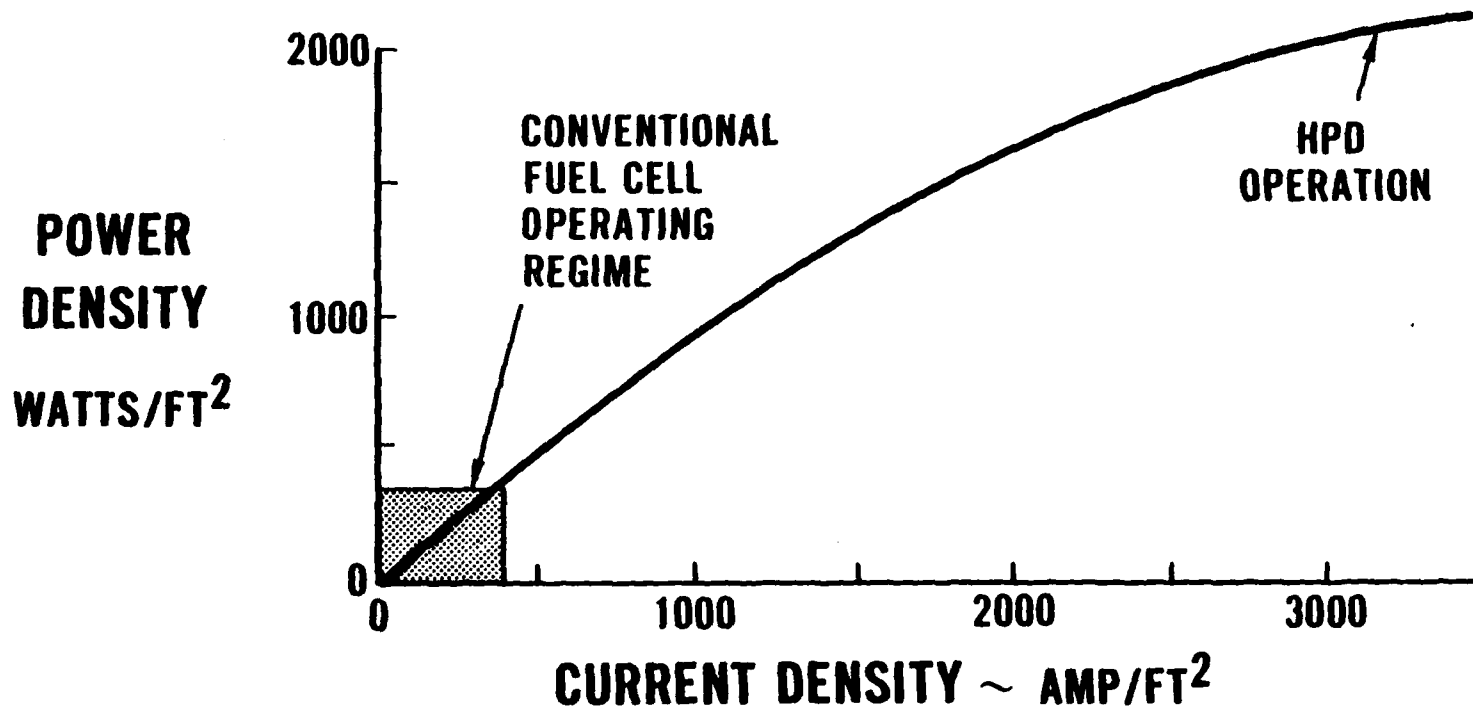

II-3-25

FC3149
742609

FC-3040 : For high power, short duration applications it is not desirable to condense the fuel cell product water or to reject the fuel cell waste heat with a space radiator. Schematic shows one scheme for managing for thermal considerations and product water removal in a fuel cell power plant. Excess hydrogen is vented through the cell stack to remove the product water. Cooling water is brought into the cell stack through separate cooling passages, turned to steam and vented overboard for heat removal. The pump and start idle heater maintain the unit at operating temperature prior to the application of the load.

POWERPLANT SCHEMATIC FOR HIGH POWER MISSION

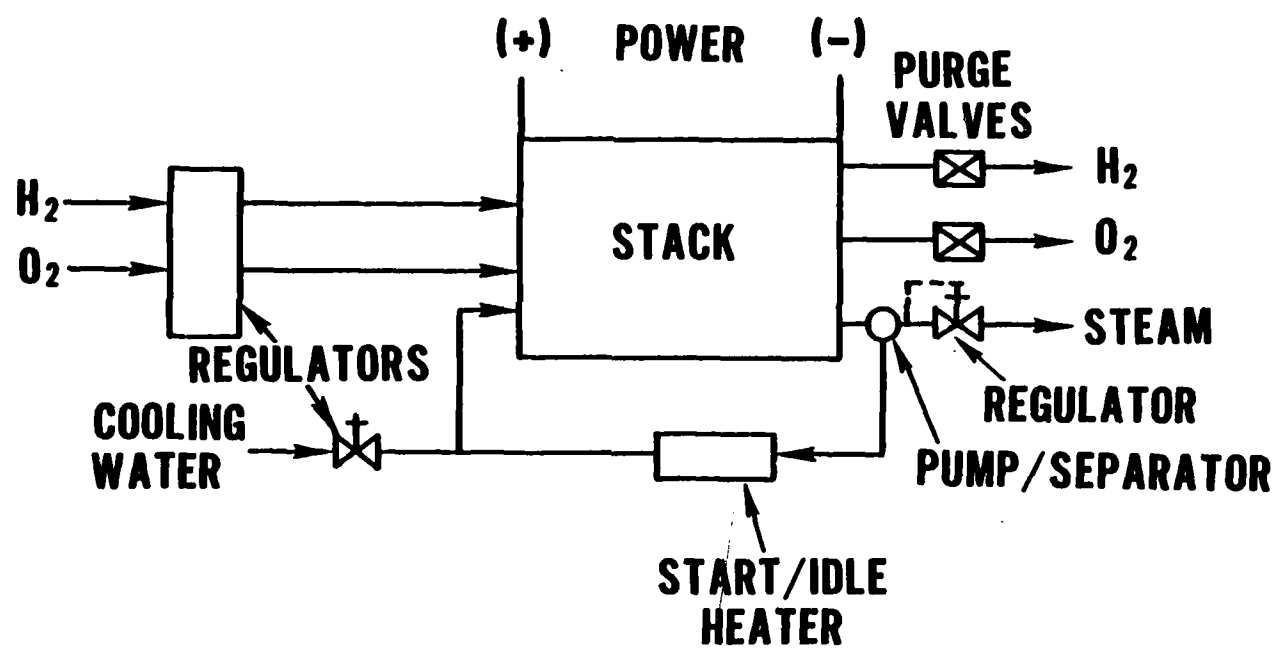

II-3-27

II-3-28

FC-3482 : In a design study of a 4-MW, 30 second duration power supply for airborne high power, conceptual design was prepared for the 575-kW module shown on the right.

BENEFIT OF HIGH POWER DENSITY

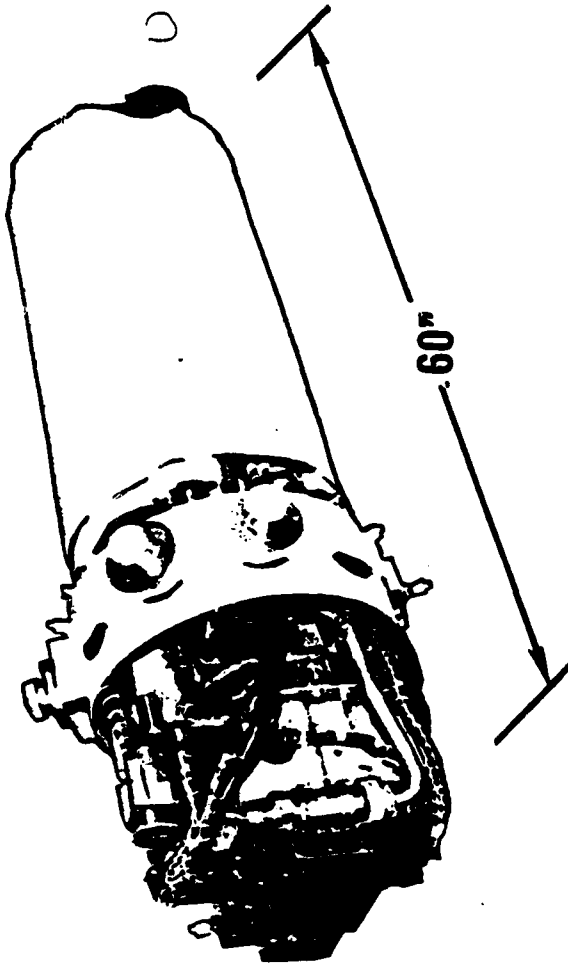

PC15 20-30 KW
 120 VDC
 391 LB

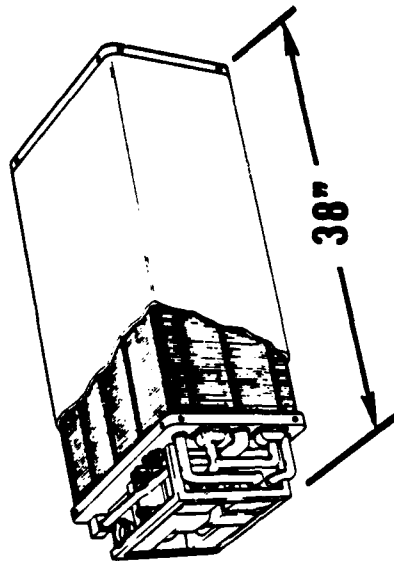

HPD 575 KW
 1425 VDC
 295 LB

FC3482
R752001

II-3-30

FC-2103 : Experimental data obtained in cells similar to that obtained in the conceptual design shown in the previous chart ran with eventually no degradation for periods of up to 60 minutes.

CONTINUOUS OPERATION AT 3000 ASF

CELL CONFIGURATION 3 (0.74 LB/KW POWERPLANT)

CELL
VOLTAGE

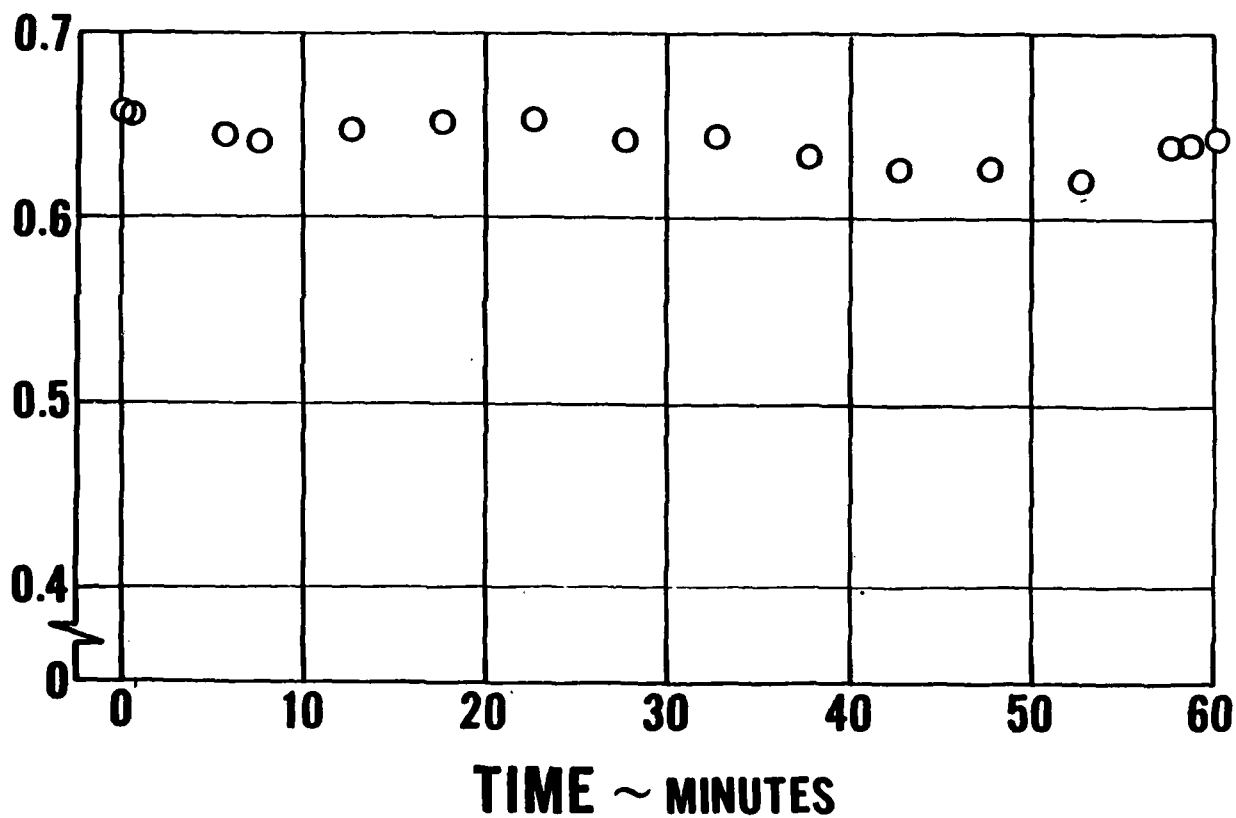

FC2103
R742511

II-3-32

FC-3436 : Cyclic testing of many thousands of cycles over periods
exceed two hours was also obtained in the program.

DEMONSTRATION OF 300-MISSION CAPABILITY

CELL NO. 14 - CONFIGURATION 4
CONTINUOUS PRODUCT WATER REMOVAL
60 PSIA, 250°F, 3 SEC ON/2 SEC OFF

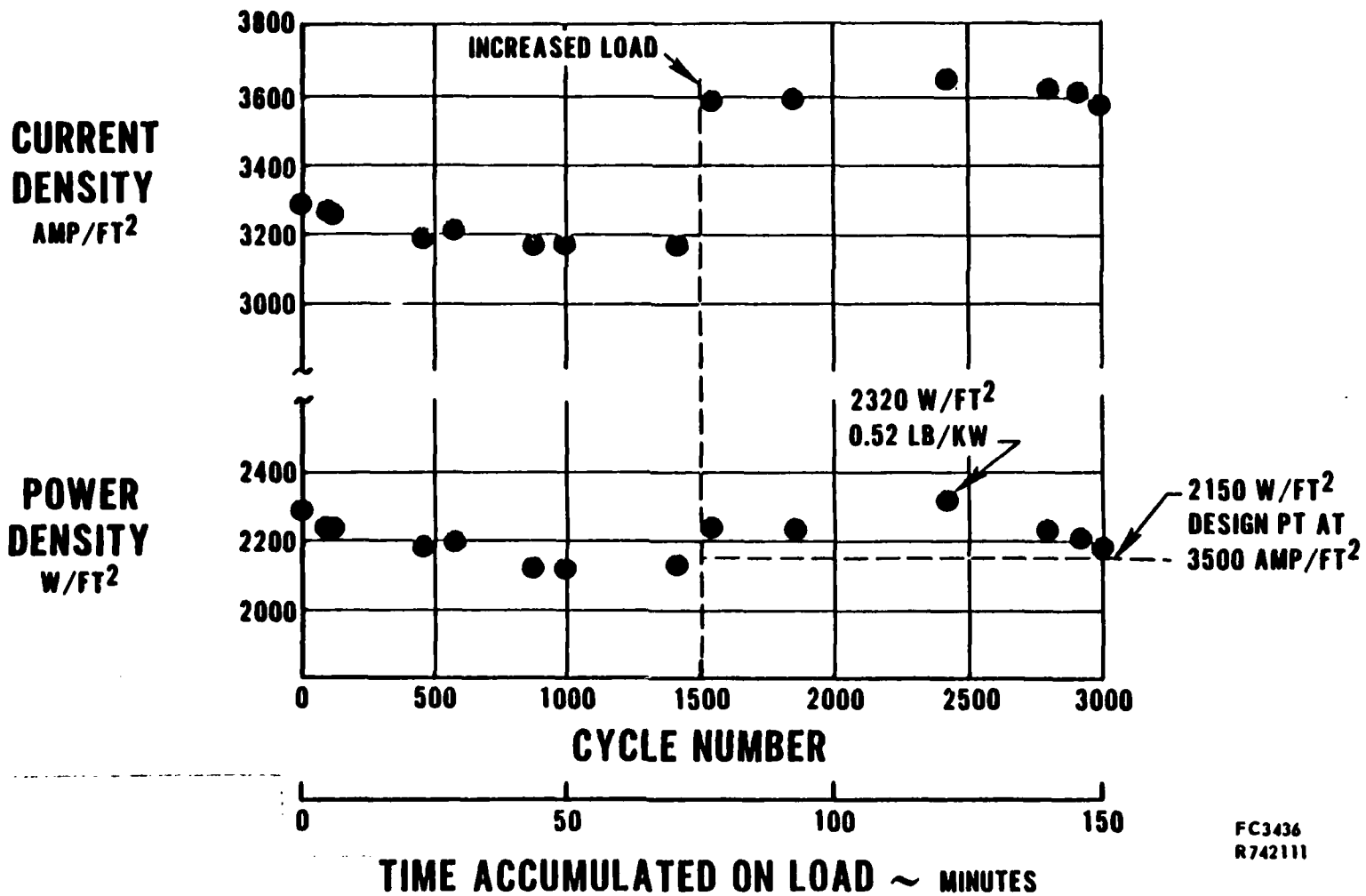

FC3436
R742111

FC-20332 : A dramatic increase in peak power density for pulse power
can be obtained by increasing reactant pressure as shown.

II-3-34

EFFECT OF PRESSURE ON PEAK POWER DENSITY

II-3-35

POWER DENSITY
WSF

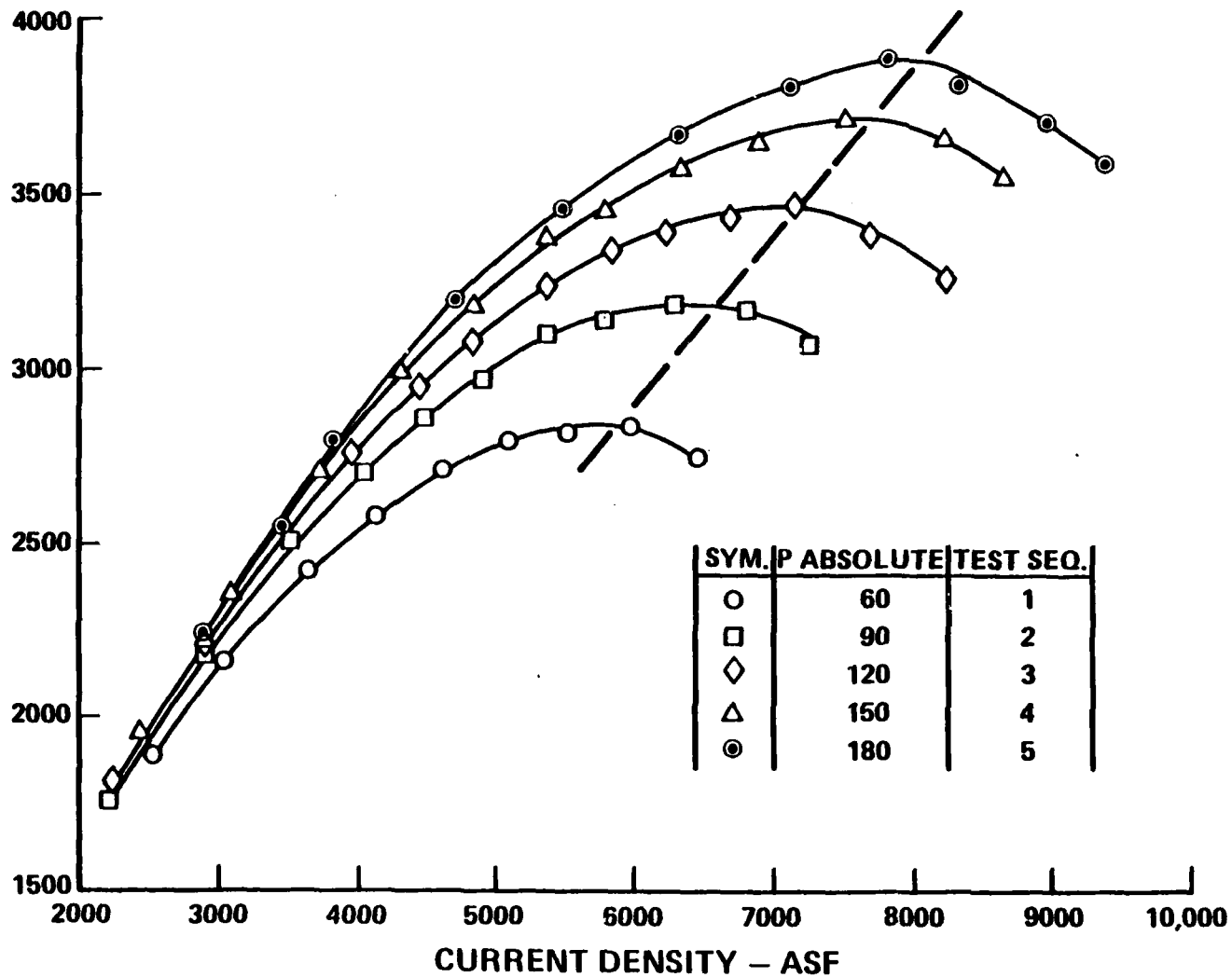

FC-17781 : The system weight on this chart includes complete fuel cell power units, reactants, tankage, and cooling water. As can be seen, the optimum design current density decreases as mission duration increases indicating the influence of cell efficiency on overall system weight.

HIGH POWER DENSITY FUEL CELL SYSTEM WEIGHT OPTIMIZATION

II-3-37

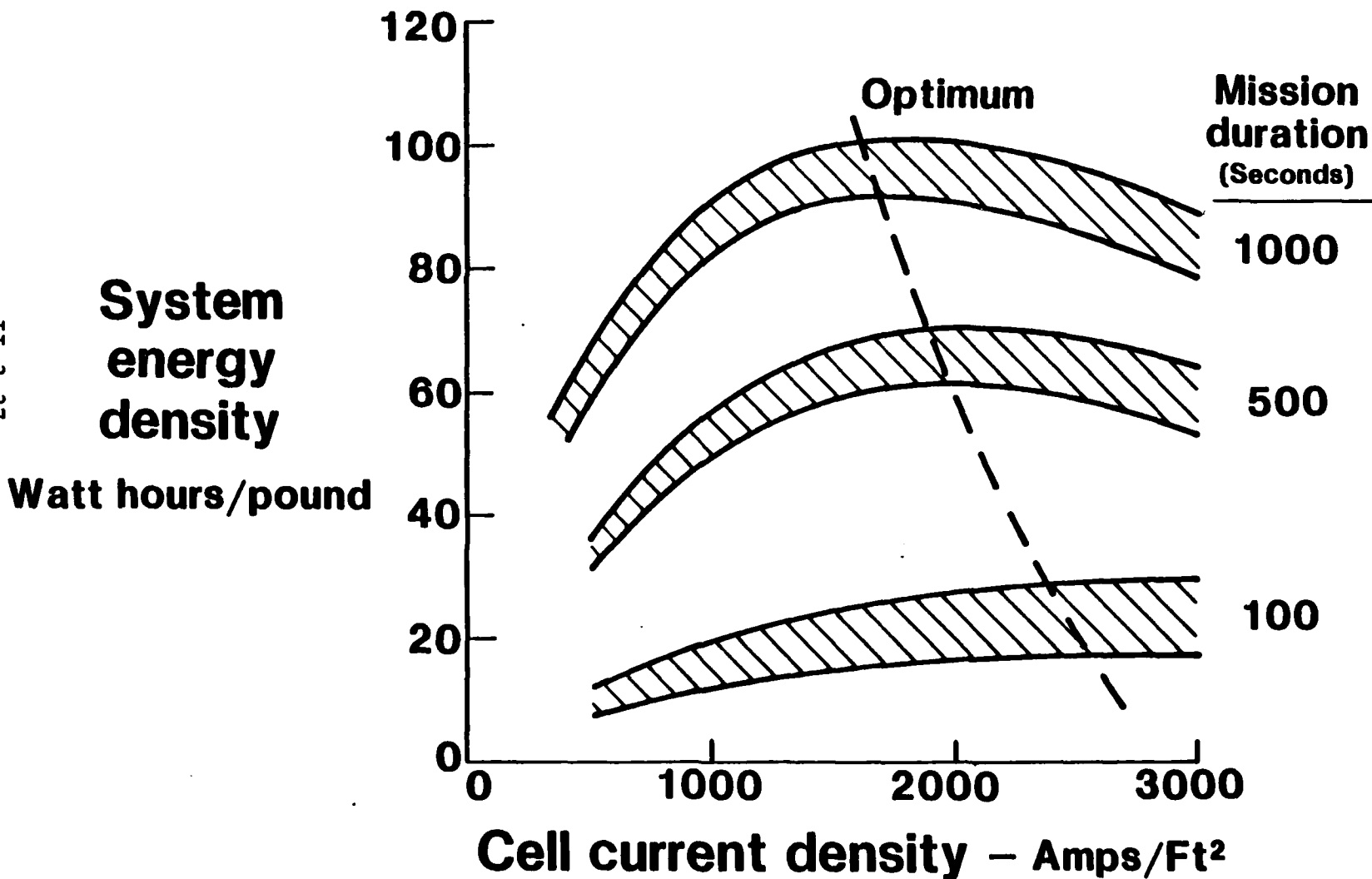

FC-0312 : Operation of the alkaline fuel cell at extreme current density and power density increase the operating temperature and operating pressure of the cell requiring improved materials and construction. Research to explore the upper limits of operating temperature and pressure and to improve the compatibility of the materials of construction is necessary prior to development of an operational power unit.

CELL PERFORMANCE

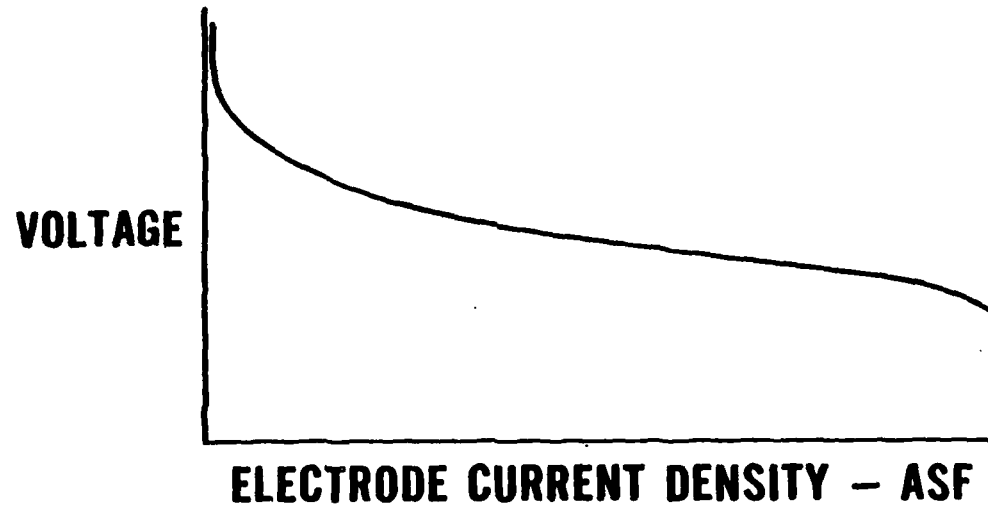

II-3-39

● FACTORS INFLUENCING PERFORMANCE

- OPERATING TEMPERATURE
- ELECTROLYTE CONCENTRATION
- OPERATING PRESSURE
- REACTANT PURITY

FC 0312
732205

FC-17622 : This chart shows the power section pallets for two 4.8-MW Demonstrator power units that United Technologies is currently assembling in New York City and Tokyo, Japan. Each of the four protective shelters contain 10, 250-kW phosphoric acid fuel cell stacks, each made up of approximately 500 cells. Operation of these units will demonstrate that fuel cells can be configured to provide the high power and voltage requirements typical of a future NASA or DOD space high power mission.

POWER SECTION PALLETS FOR 4.8-MW DEMONSTRATOR POWER PLANTS

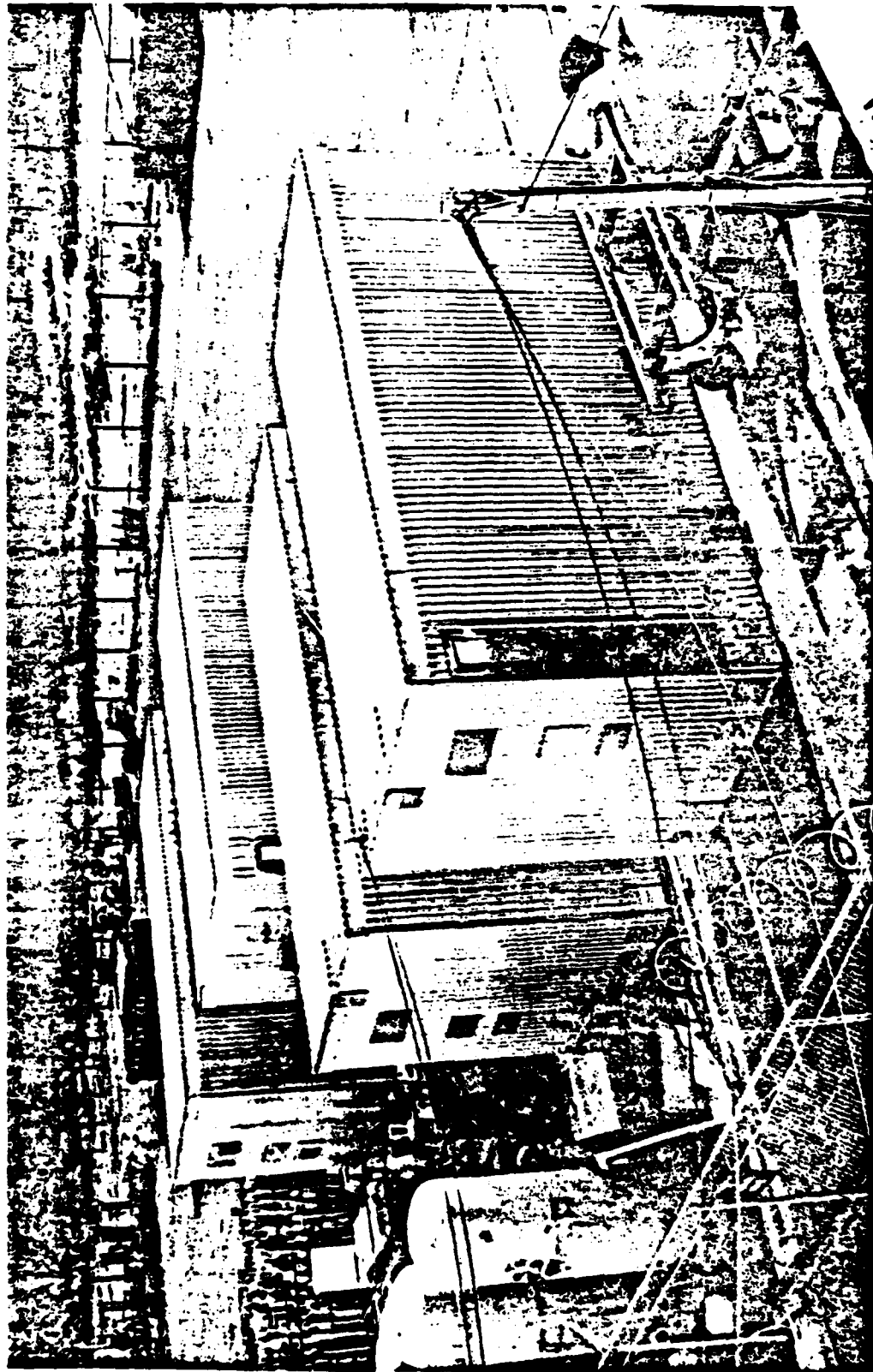

II-3-41



P-017622
811112

Q & A - J. Stedman

From:

What perturbations does the fuel cell exhaust cause on the spacecraft:

A.

In orbiter H_2 and O_2 vents are small and directed 180° opposed to neutralize thrusts.

In high power fuel cell cooled by boiling water same technique could be used. Water flow is nominally 3 lbs/kw-hr @ total pressure of 1 atm, 200° F.

From: P. J. Turchi, R & D Associates

What process(es) have been identified as limiting efficiency of fuel cells:

A.

O_2 electrode activation loss associated with catalysis reduces voltage (eff) by $\approx 20\%$ from a theoretical 100% in H_2-O_2 cells. Remainder of loss is associated with diffusion of reactants and products with electrodes and ohmic losses associated with electrolyte.

From: P. J. Turchi, R & D Associates

Does power density vs current density start to drop off at high current density because of load line effects, or some other effect?

Why does voltage output drop off with current density:

A.

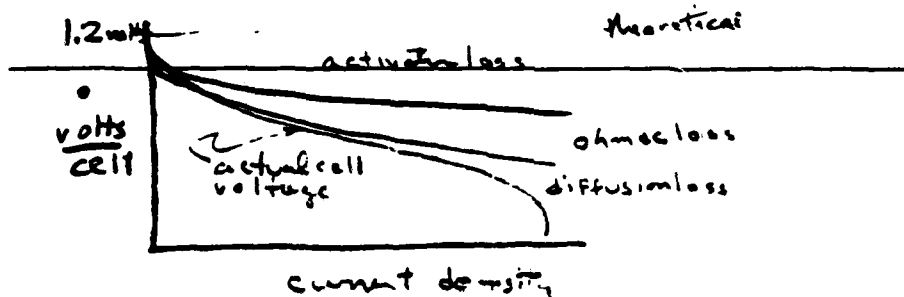

"Turbogenerators"
by
Oberly, C. E.

(Paper not available)

Q & A - C. E. Oberly

From: J. Biess, TRW Systems

Could the insulating material for the superconducting wire be used for capacitor dielectric? What is dielectric factor and recommended operating temperatures?

A.

We are looking at these ceramics as potential capacitor dielectors. They retain the inherent problems of ceramic dielectrics: air bubbles and low energy storage density. If high thermal conductivity material were used, it could be of great advantage for fast repeating pulses but temperatures and refrigeration below 10° K would be required. We are currently evaluating dielectric constants, strengths and partial discharge resistance of these materials.

SESSION III. CHEMICAL/MHD

"MHD Power: Overview"*
J. B. Dicks
Applied Energetics, Inc.

*Omitted are those photographic slides which were not
reproducible.

SPECIAL CONFERENCE ON PRIME POWER FOR HIGH-ENERGY SPACE SYSTEMS
FEBRUARY 22-25, 1982
Norfolk, VA

Figure 1 - Shows the Brilliant concept of MHD application. This application was to proceed as a high priority of the Defense Department in the middle 1960's. It resulted in a project directed by the Air Force Aeropropulsion Laboratory in cooperation with several other Air Force laboratories. Its intent was to gather together the technology needed to make a high power night time illumination system. The project was eventually terminated because the application was no longer of high priority due to changing international conditions and because some delay would have been introduced in order to produce a satisfactory superconducting magnet and illumination system. Contractors on the power system were Chrysler Space Division, J. B. Dicks & Associates (now Applied Energetics), and the University of Tennessee Space Institute.

This is the only attempt ever made by the military to apply MHD to a practical mission. It resulted in studies of apparatus and systems which would allow a high power MHD power supply to be mated to typical aircraft of the date. These requirements do not differ greatly from those presently being considered in space.

Figure 2 - Shows an actual MHD channel constructed for this program in a mock-up of one of the magnets that were constructed by the Air Force laboratories under contract to match the requirement. The general construction and arrangement shown here does not differ greatly from what might be used for a contemporary high power supply in the range between 250 kilowatts to 1000 kilowatts. The general cylindrical design shown on the magnet would be that used whether or not a superconducting magnet is used. Alternates are, a self-excited copper magnet, or a super-coated aluminum magnet. The design shown here allows for pool cooling which might be used in any of these cases. It also allows for the cryogenic cooling by the pool method. However, cooling is not necessary and self-excited magnets would work for the order of 100 to 200 seconds depending upon its weight.

The cylindrical configuration results from the fact that so-called pancake coils pressed around a cylindrical form provide the most efficient magnet. The channel itself is of circular cross section in order to utilize the magnetic field most effectively. A number of circular MHD configurations have been operated in the past and would be used anytime a magnet has no iron used in this construction.

Figure 3 - Shows such a device had mounted the illumination application is purely arbitrary and other suitable applications could be substituted for it. The MHD power supply is particularly appropriate for application in which the time is short. One has to construct the pod so as to avoid upsetting on-board aircraft systems or on-board spacecraft systems. The aircraft mounting and spacecraft mounting do not differ appreciably if it is desirable to have a separate pod or self-contained power supply and any application devices associated with it.

Figure 4 - Shows a pod mounted version of a liquid fuel system of this type. Improvements in combustion and better understanding of fuels represent the greatest advance in MHD power generation for military applications made since this work was done. The present techniques are fuel injection liquid or powdered solid; would allow such applications to equal or better the performance discussed for solid type propellents below. The solid type used in an MHD generator is not as well known as the use of liquids in such a generator and therefore these would be discussed in somewhat more detail.

Figure 5 - Shows the development of the diagonal wall conducting wall generator which in some form or other forms the basis for most American generators that have been operated. This construction of solid conducting frames of copper within the insulator are sandwiched between them, works well for military applications because the heat sink design is particularly easy, the strength is high, and the durability is sufficiently long for any military mission for which MHD is suitable.

The theory of the diagonal wall (DCW) is quite complex, the most complex of all generators, but its construction is the simplest and strongest.

Figure 6 - Shows the result of the technology required in military programs applied to the civilian central power MHD program. This is the CFFF in Tullahoma, Tennessee, a relatively complete pilot plant now in operation and setting records as far as pollution control is concerned. The connection between this technology and military technology is not particularly close as none of the pollution control technology is required for short time military application.

Figure 7 - This shows the high field six Tesla superconducting magnet that has been constructed for the CFFF at the Argonne National Laboratories in Chicago. It was tested twice last summer at 6 Tesla and is a very large magnet. This magnet, on military fuels, is capable of yielding hundreds of kilowatts of power and should be available for testing for any such military power on a non-interference basis with DOE projects.

- Figure 8 - Shows a solid fuel combustor furnished by the Hercules Corporation for a test series by the University of Tennessee Space Institute at Arnold Engineering and Development Center in 1967 under my direction. The cylindrical portion holds a 9 lb. roughly 10 inch long, 6 inch diameter solid fuel grain shown in the next figure. The rectangular portion is a carbon nozzle and this device was bolted to some of the liquid fuel generators that existed at that time.
- Figure 9 - Shows a grain of pollutant used in this testing. The solid loading was of the order of magnitude of 40% with a large amount of potassium and aluminum present. The aluminum oxide and other chemicals coated the walls of the generator to a depth of several millimeters.
- Figure 10- Shows the end of a generator run on the solid point with the coating used protruding from the end. The presence of this coating and the fact (as shown later) that it does not effect power generation in the generator appreciably. It allows one to reduce the heat transfer to the walls of the generator drastically as this deposit builds up.
- Figure 11- Illustrates current voltage and power characteristics from the solid grain. Some of the instability near the end is the result of fluctuations in combustion in the grain as the end of the chamber is reached.
- Figure 12- Shows power curves comparing liquid and solid fuel of the day. One will note that the solid fuel power production is of the order of 200 or more kilowatts while the liquid fuel power production from the same generator is much, much less (about 30-40 kilowatts). This advantage of the solid fuel has been reduced somewhat with later experience by much improved combustion and by more carefully choosing the liquid fuel used to minimize the electron collision cross section in the generator and thus, to maximize power.
- Figure 13- Shows more of the solid deposit on a single electrode. It will be noted that this solid deposit covers the generator so well that no contaminant penetrates into the insulator. Also the covering of the generator by this material allows a much higher standoff voltage in the generator so that the technology of 10 years ago would give, under these conditions, about 10 kilowatts per meter of generator length.
- Figure 14- Illustrates what can be done by using additional additives to the fuel. This is not the result of operating with solid fuel, but by placing high temperature additives in the flow to purposely build up a coating inside the generator. Coatings in this case were as great as centimeter in thickness without drastically effecting the power production of the device. Again the advantage here is that it is possible to operate in this fashion with much, much reduced heating of the generator channel and much, much longer operation in the heat sink mode with much less cooling required in the case in which cooling is used.

- Figure 15 - Shows the Soviet generator operated by Velikhov using two solid fuel rocket charges. One to bring up the field in the coils and the second to produce maximum power.
- Figure 16 - Shows the data given on these experiments, the weight of the system and the pilot plant generator. Such a system is not optimized. Much weight could have been saved through the use of a saddle coil rather than the circular coil shown.
- Figure 17 - Shows the experimental results on a generator run in Mainland China in a self excited mode giving a power output of approximately 500 kilowatts. This simply shows that self excitation is widely performed. In the beginning of the MHD program in the United States, Mr. Tom Brogan, one of the Avco laboratory employees succeeded in getting approximately 30 megawatts from a large self excited liquid fuel generator.
- Figure 18 - Shows a modern combustor designed to run with preheated oxidizer and coal as a fuel. The coal is blown in through a central tube and then spread out into the oxidizer flow. Such a system might be used with granulated solid fuel in order to gain improvements in system over those presently being operated. Such a system would have the advantage of a larger control ability, restart capability, and the possibility of idling power. As a matter of fact, such a system will run with seed control and would allow one to operate a power trajectory as may be required by some of the devices for application.
- Figure 19 - Shows a schematic of this combustor with the coal coming in through the central port. The oxidizer, through a plate which has a hold pattern in it, creates a great deal of turbulence. The oxidizer is preheated through burning with some auxiliary fuel so that the hot oxidizer strikes the fuel in a highly turbulent mixing zone with preheat raising the temperature to the auto-ignition point. Under these conditions a very short combustor can be utilized for nearly complete combustion before the product enters the generator itself. This provides for a minimum heat release to the combustor which, in the kind of applications we are considering here, would be lined heavily with ceramic material. Ceramic material will not last permanently, but would last over the several hours which represents the maximum duty cycle of the MHD generator.

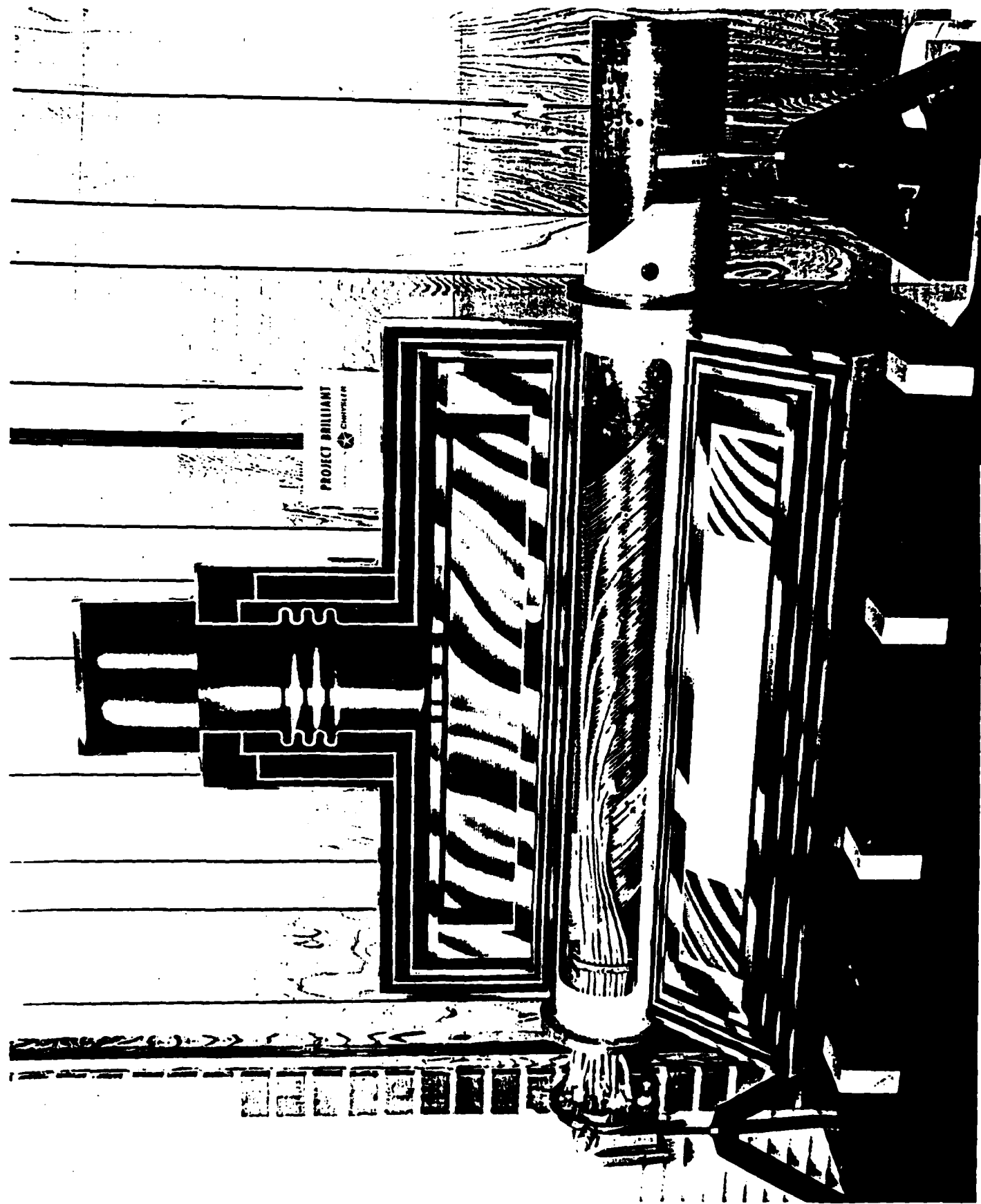

PROJECT BRILLIANT
CHRYSLER

Figure 2

POD CONFIGURATION

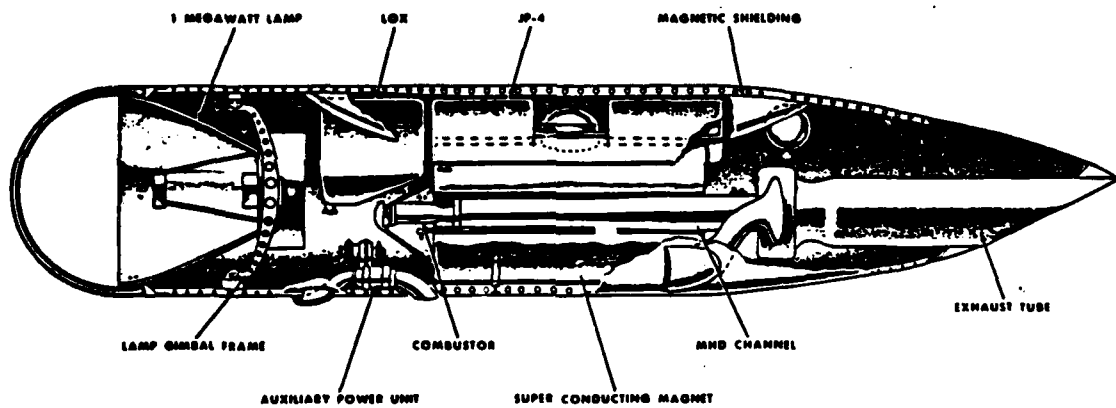

Figure 3

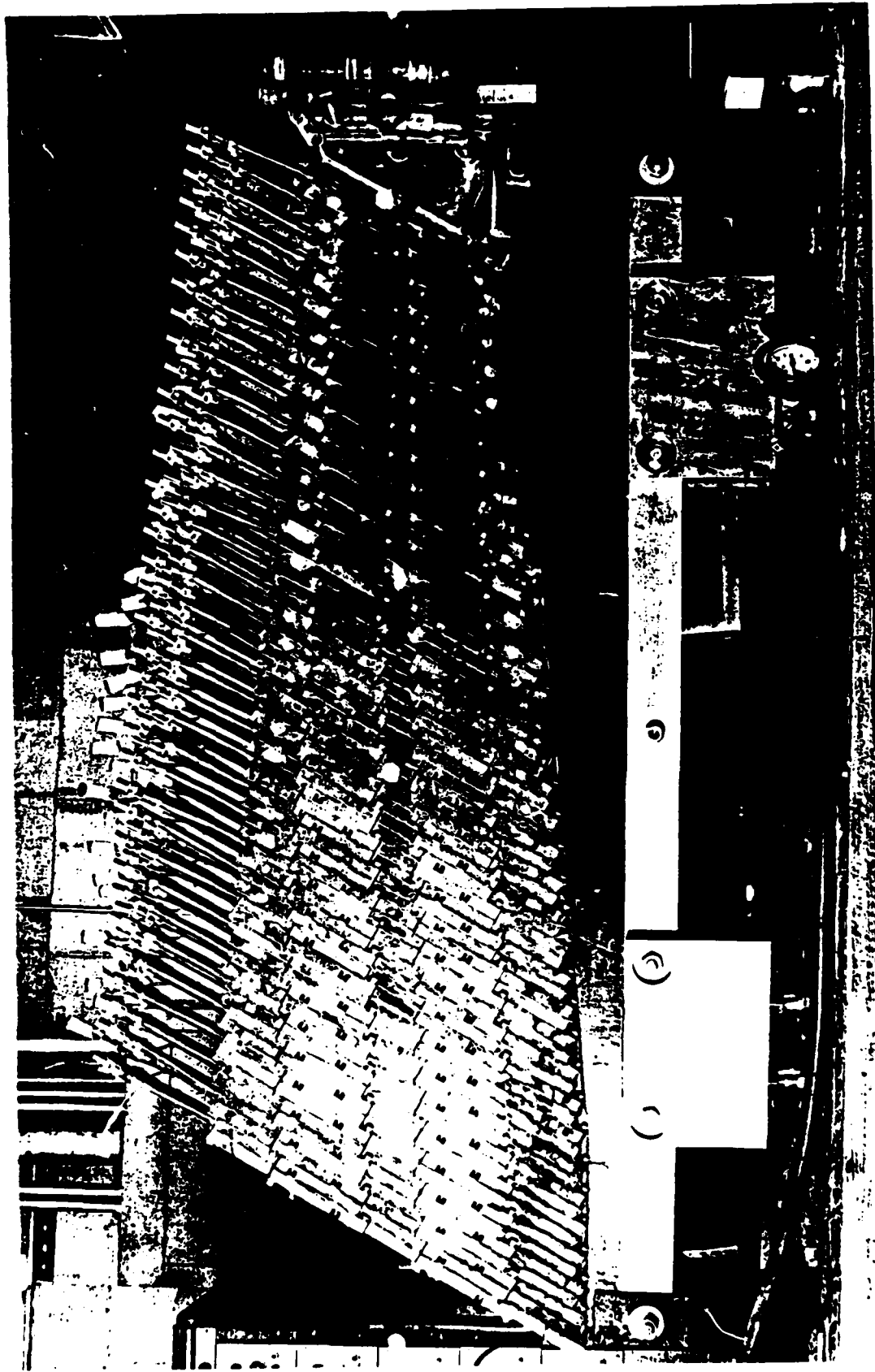
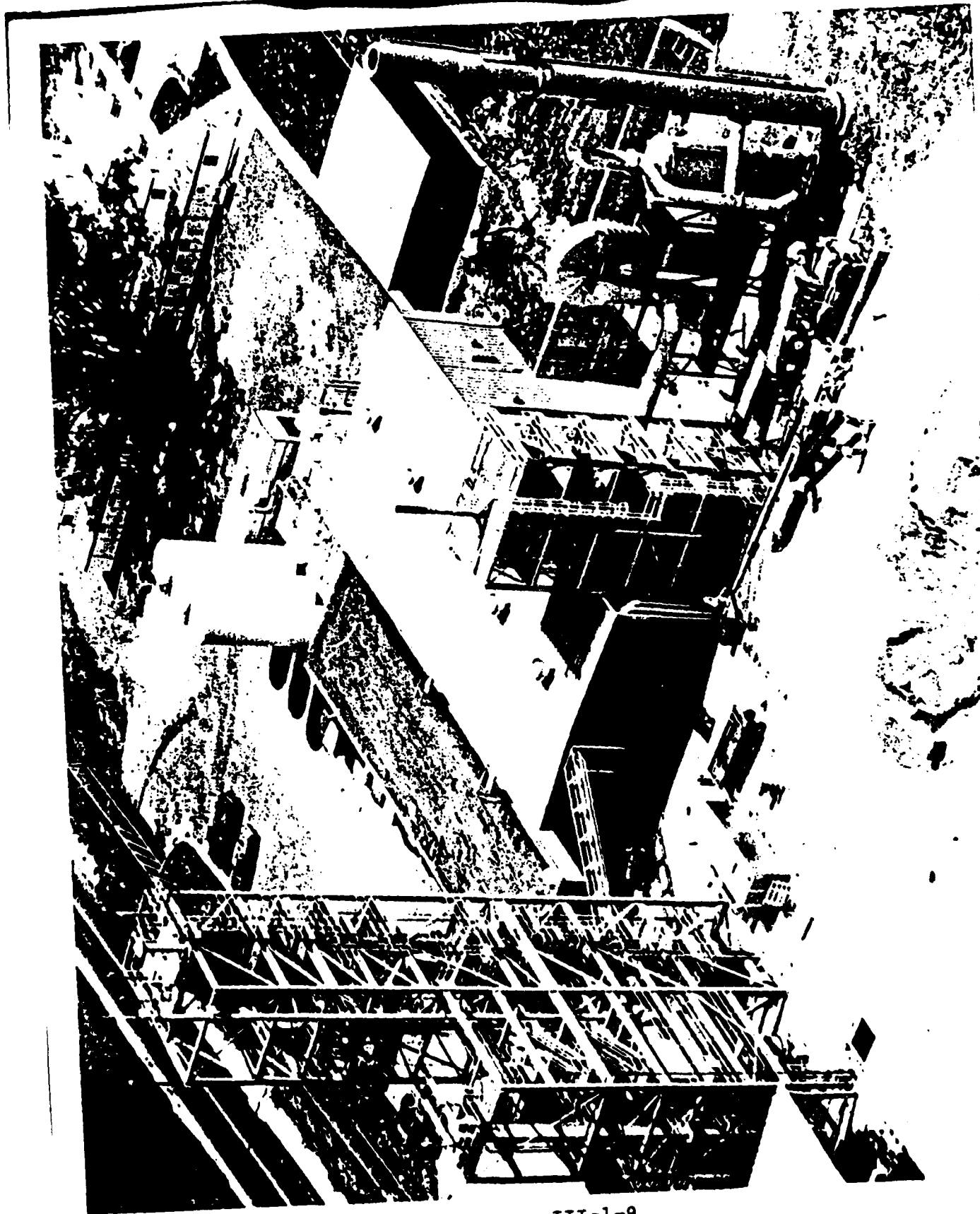

Figure 5



III-1-9

Figure 6

ARGONNI
NATIONAL
LABORATORY

COAL - FIRED FLOW FACILITY
SUPERCONDUCTING MHD MAGNET

UTSI

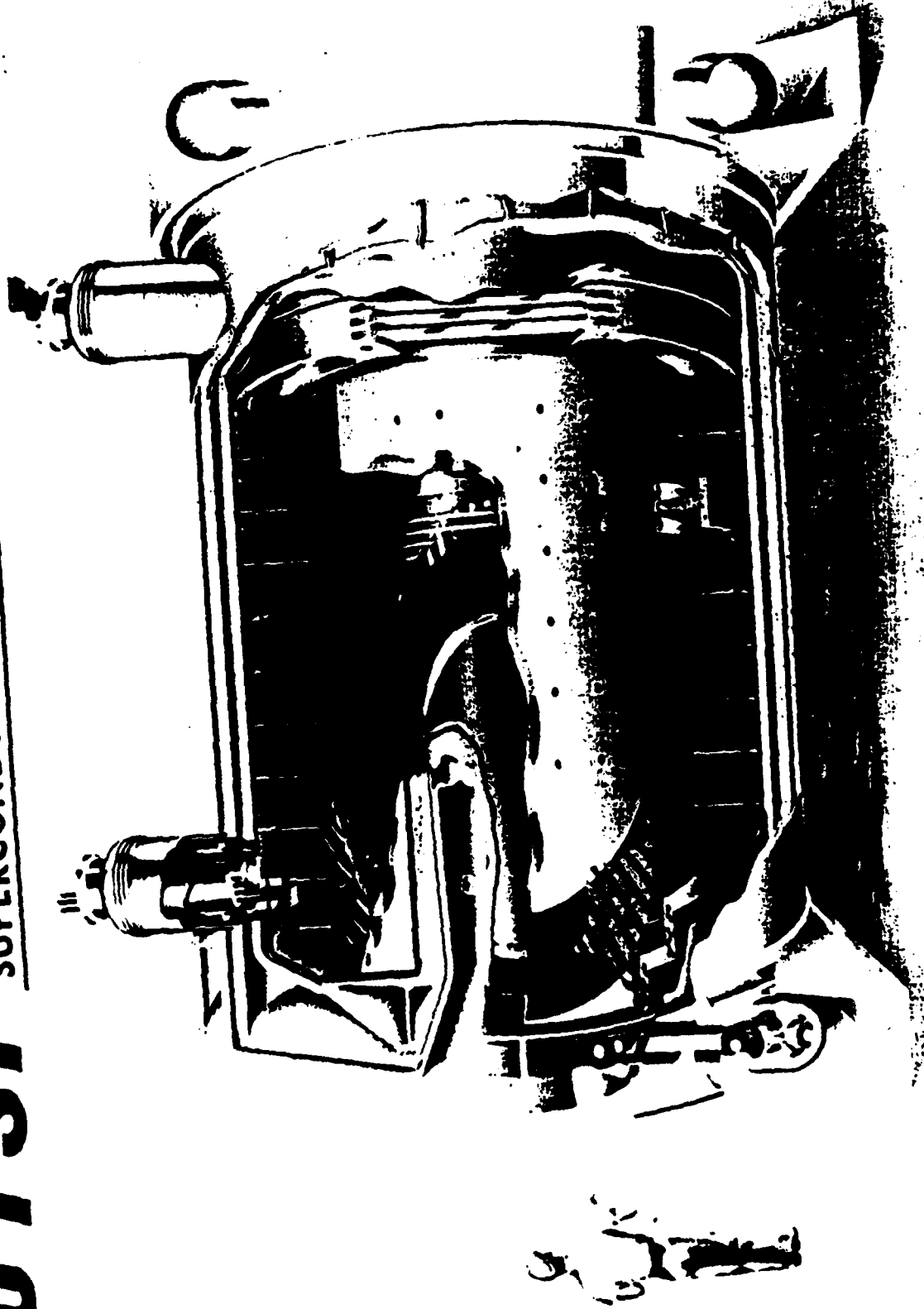

Figure 7



Figure 8

III-1-11

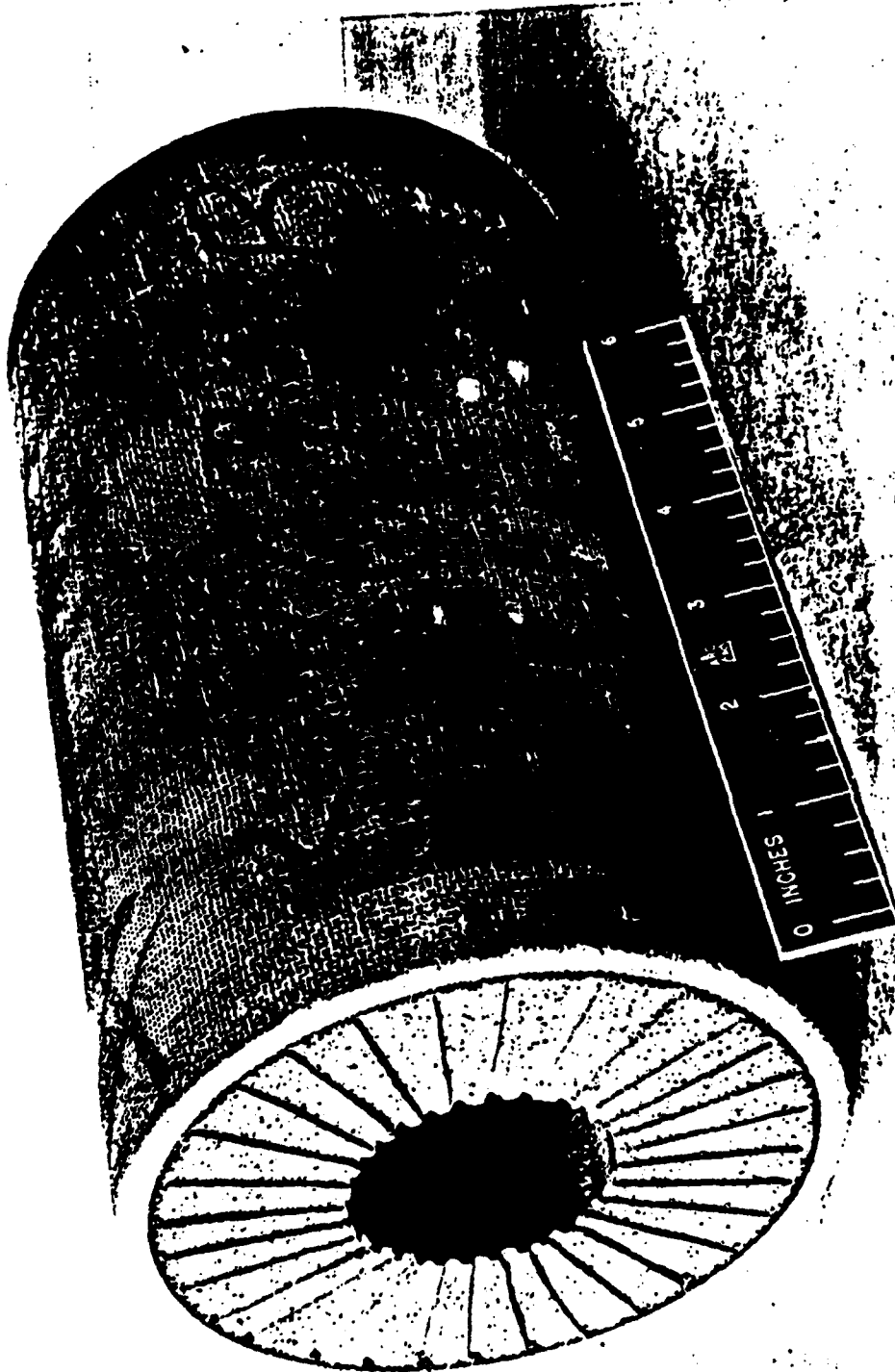

Figure 9

III-1-12

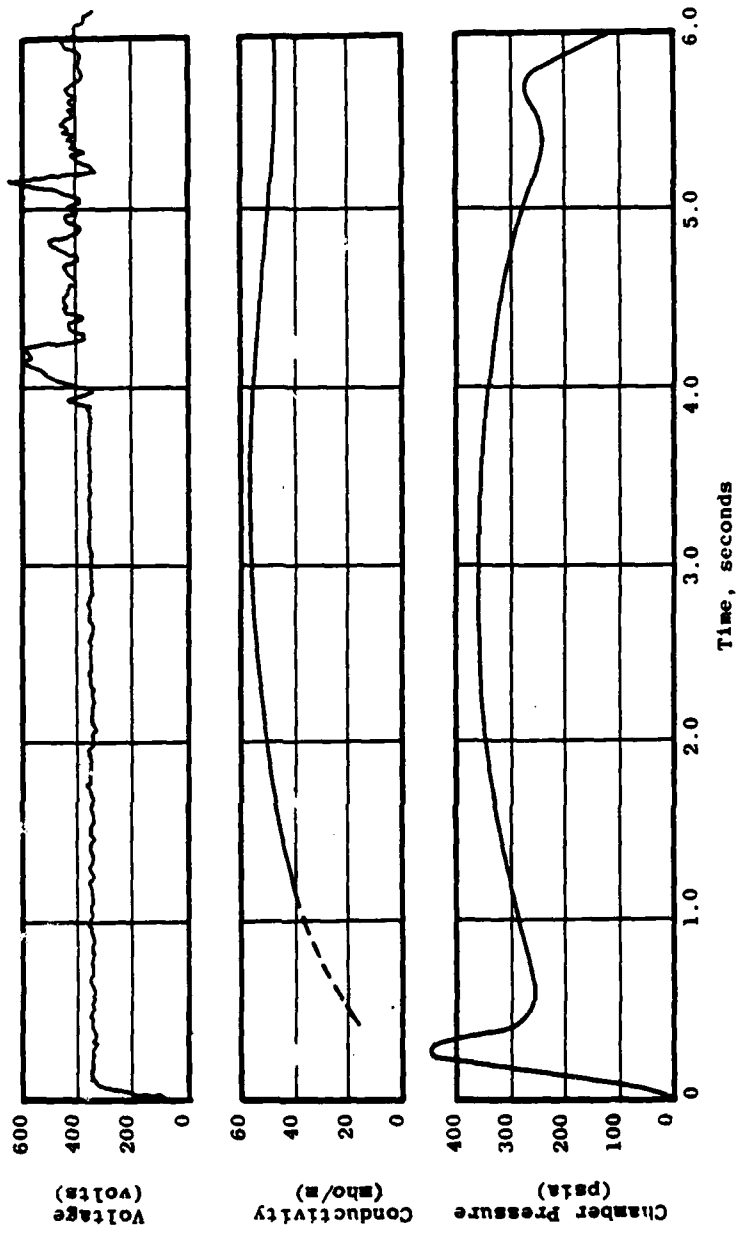

Figure 11

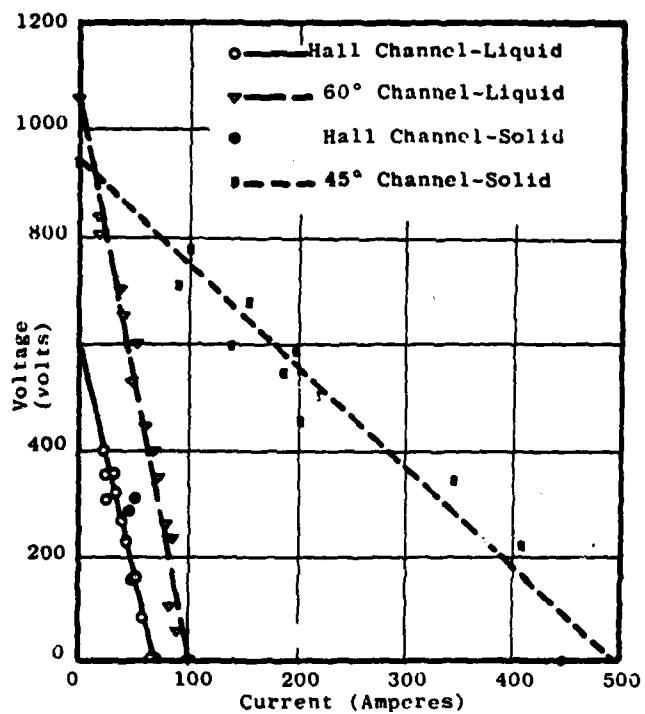

Figure 12

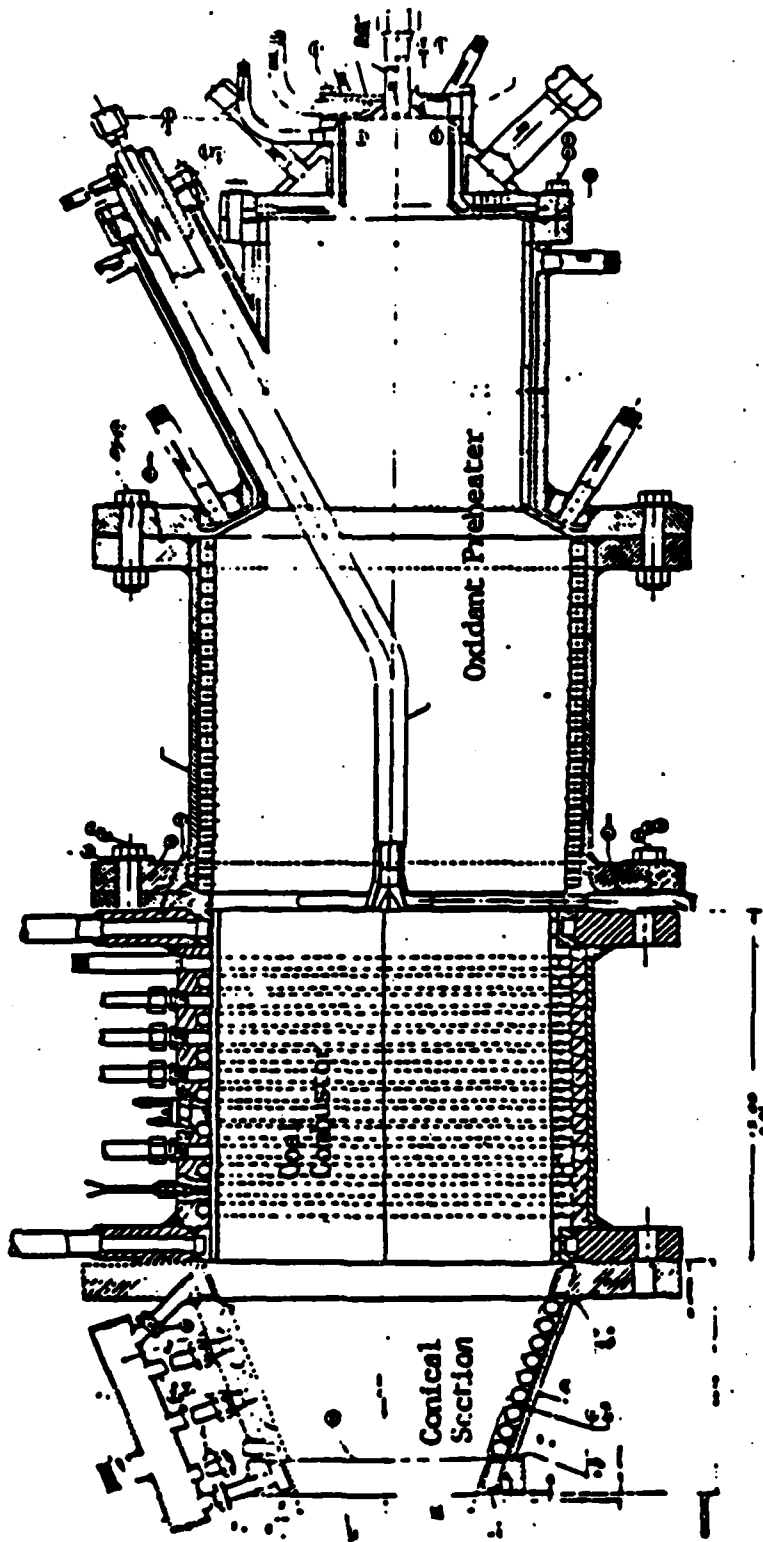

Figure 19

BASIC RESEARCH TOPICS IN MHD

MHD is one of those technologies which has reached an engineering status that would allow it to be applied where the need for short time high powered systems arise. It has the advantage of almost immediate full power production from an inert start, is thus capable of high reliability, but is limited in time to that available utilizing un-cooled heat sink configurations. Such a time at present is of the order of 100-150 seconds with extended lifetime depending on the amount of cooling are placed in the system. All of this technology is based on an engineering understanding of the device, but comparatively little physical understanding. The phenomenon involved are complex, involving a combination of Maxwell's equations with the gasdynamic equations. Furthermore, the phenomena of the boundary layer between the hot plasma and the cold electrodes are in an even more difficult regime of temperature over shoots, recombination, surface interaction, and prevalent surface phenomena. Further there is the coated generator where the walls are covered with combustion products and/or manufactured material where the conductivity through such hot solid state materials is poorly understood. There are, therefore, a variety of basic physical problems in the generator that need to be resolved and which would eventually result in much improved performance if they could be understood from a standpoint of basic physics.

In connection with the generator is the combustion process which is also of great importance and the area in which the greatest improvements are the problems of gasdynamic turbulence, two phase flow, and general plasma chemistry. The plasma chemistry is complicated enough with the questions of electron attachment, collision cross section, species concentration, etc. When these are combined with two phase flow as occurs in the case where a material such as aluminum is added as a fuel resulting in aluminum oxide which may be either in the liquid or solid phase in the flow, one enters an area that has been little explored from a basic standpoint. It is desirable to know the extent of physical interactions between the solid particle and the gas, both gasdynamically and electrically. Such particles, in general, are at a higher temperature than the flow around them because of the time delay in heat transfer as the fluid expands through a nozzle between the particles and the fluid itself. Since it is possible to get a variety of material compositions in such particles which may vary from essentially an insulating particle to one which partially conducts due to the presence of absorbed potassium for example. Thus there is a whole range of basic physics that could be done with profit in this area.

Q & A - J. Dicks

From: A. P. Fraas

- 1) What was the maximum electrical output from one of your coal-fired MHD generators?
- 2) What was the fuel feed rate and chemical energy input rate for the above case?
- 3) What would the compressor power input have been if you had been able to use preheated air instead of liquid O₂?
- 4) What was the equivalent power requirement if you had generated O₂ rather than use stored liquid O₂?

Answer:

NASA LEWIS RESEARCH CENTER
COMBUSTION MHD EXPERIMENT

BY

JOHN M. SMITH
NASA LEWIS RESEARCH CENTER
CLEVELAND, OH

III-2

Lewis Research Center

NASA

MHD MEANS HIGH POWER

> 1 MW

DUE TO HIGH SURFACE/VOLUME LOSSES

III-2-1

ABSTRACT

Combustion driven magnetohydrodynamic (MHD) generators show great promise for both flight and ground-based electrical power generation. The Lewis Research Center (LeRC) has in operation a small (4-12 MW_T) cesium-seeded H₂-O₂ combustion MHD generator to investigate performance and fluid dynamics at high magnetic field levels. This combustion system was chosen because of its attractiveness for lightweight systems, the H₂-O₂ combustion expertise at LeRC, and the simplicity of the H₂-O₂ system which facilitates the understanding of the basic processes involved.

The MHD power generation experiments are conducted in a high field strength cryomagnet (fig. 1) which was adapted from an existing facility. In its original construction, it consisted of 12 high purity aluminum coils pool cooled in a bath of liquid neon. In this configuration, a peak field of 15 tesla was produced. For the present experiments, the center four coils were removed and a 23 cm diameter transverse warm bore tube was inserted to allow the placement of the MHD experiment between the remaining eight coils as shown in the cross section insert in figure 1. In this configuration, a peak field of > 6 tesla should be obtainable. The time duration of the experiment is limited by the neon supply which allows on the order of 1 minute of total operating time followed by an 18-hour reliquefaction period. As a result, the experiments are run in a pulsed mode. The run duration for the data presented here was 5 sec. The magnetic field profile along the MHD duct is shown in figure 2. Since the working fluid is in essence superheated steam, it is easily water quenched at the exit of the diffuser and the components are designed vacuum tight so that the exhaust pipe and demister can be pumped down to simulate the vacuum of outer space.

The primary purpose of experiments conducted to date have been to understand the basic phenomena associated with MHD power generation at high magnetic field strength and to produce data necessary to validate computer codes. The effects investigated are listed in figure 3.

In figure 4 the power output versus the square of the magnetic field is plotted for various MHD channel configurations. Shown are four Hall channels varying in exit to inlet area ratio from 2.56 to 6.25 and one diagonal wall channel having an area ratio of approximately 5. It is noted that the power output increases linearly with B² for Hall ducts up to an area ratio of 6.25. At this area ratio there is an abrupt departure from linearity as shown by the dashed line. This is due to the diffuser shock (supersonic duct) moving upstream into the power generating region of the channel. This shock is removed by operating with vacuum exhaust and the linear dependence with B² is again observed as shown by the solid curve (6.25/1 AR-vacuum). The figure also shows the increased performance obtainable through the use of diagonal wall channels. The single point shown at the top of the figure represents the highest output achieved by operating fuel rich. The point represents a power output of 175 kW which represent an extraction of 3.5 percent of the input enthalpy.

Figure 5 is a list of effects requiring further investigation.

H₂-O₂ MHD POWER GENERATION EXPERIMENT

INITIATED 1973, NASA FUNDING - LASER RTOP

PHASE 1 - MODIFY EXISTING CRYOMAGNET FACILITY

GOAL - 100 MW/M³ PULSED

GOAL OBTAINED

PHASE 2 - REPLACE CRYOMAGNET WITH SUPERCONDUCTING MAGNET

GOAL - 5% ENTHALPY EXTRACTION FOR 10 MINUTES

MAGNET WIRE PURCHASED (\$500K), PRELIMINARY DESIGN COMPLETED

PHASE 3 - FACILITY SCALEUP

GOAL - 20% ENTHALPY EXTRACTION

Figure 1

GH₂-GO₂ COMBUSTION MHD EXPERIMENT INSTALLATION BUILDING 16 ROOM 160

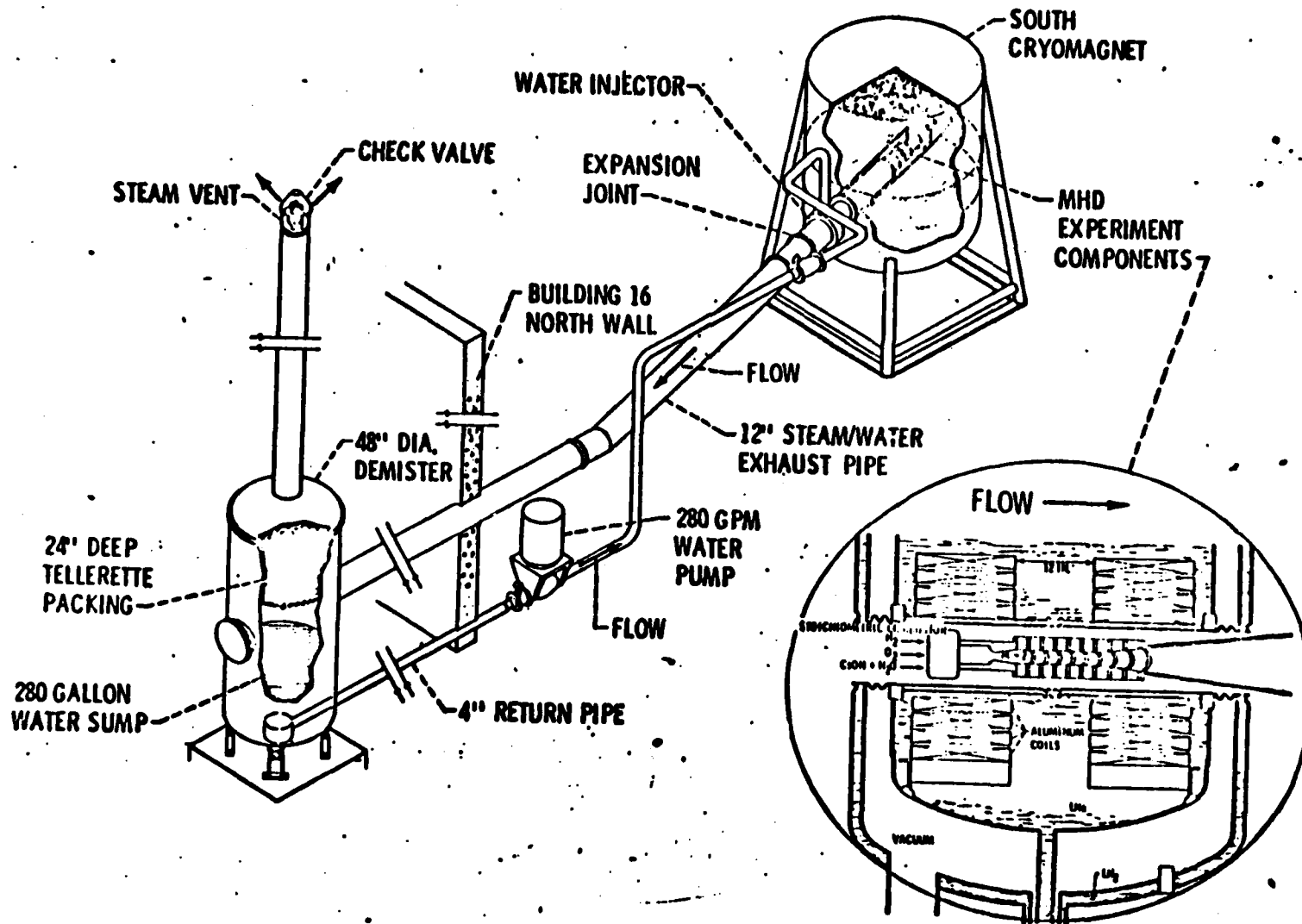

III-2-4

Figure 2

DUCT LOCATION WITHIN MAGNETIC FIELD

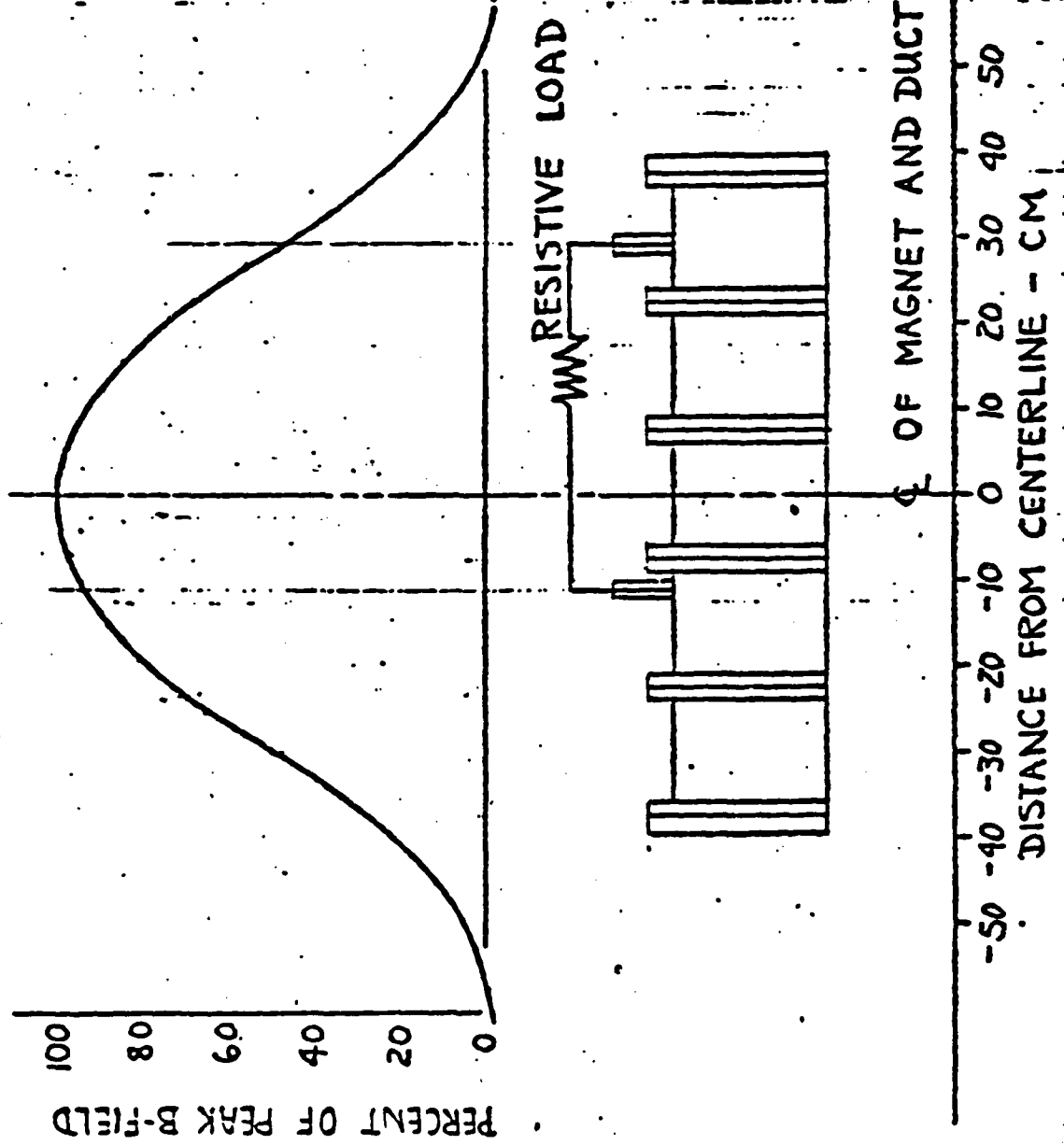

EFFECTS INVESTIGATED IN LERC EXPERIMENTS

- o POWER TAKEOFF LOCATION
- o AXIAL DUCT LOCATION WITHIN MAGNETIC FIELD
- o GENERATOR LOADING (VOLT VS. CURRENT RELATION)
- o B-FIELD STRENGTH (2-5 TESLA)
- o MULTIPLE LOADING OF GENERATOR
- o INSULATOR BREAKDOWN VOLTAGE
- o AZIMUTHAL DISTRIBUTION OF ELECTRIC CURRENT
- o EXIT TO ENTRANCE AREA RATIO (2.56 TO 6.25)
- o VACUUM EXHAUST PRESSURE
- o COMBUSTOR INDUCED GENERATOR FLUCTUATIONS
- o GENERATOR TYPE - HALL AND DIAGONAL WALL

III-2-6

46 13.7

16-10-58

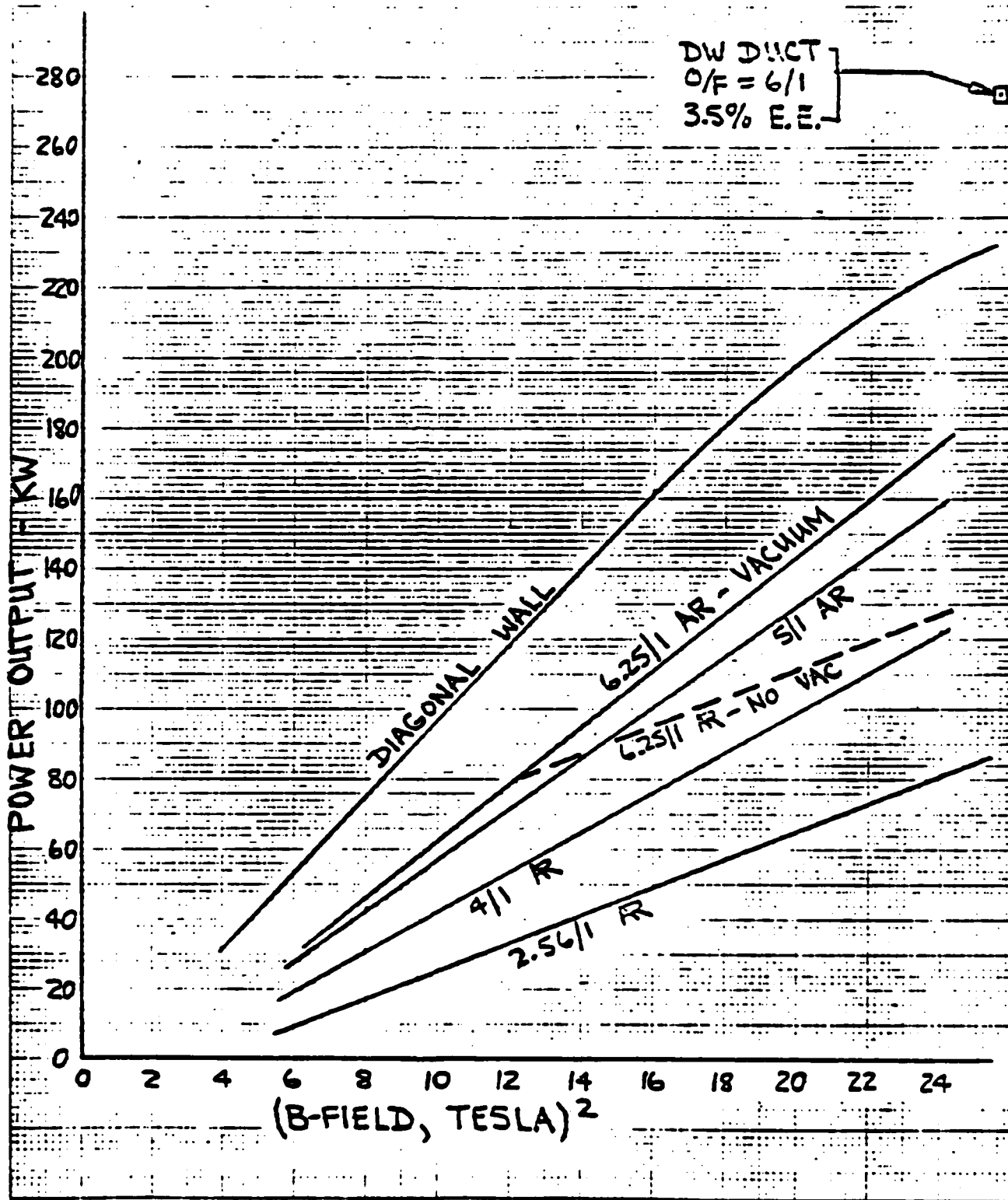

EFFECTS REQUIRING FURTHER INVESTIGATION

- o HOT ELECTRODES (REDUCE BOUNDARY LAYER VOLTAGE DROPS)
 - CERAMIC COATINGS
 - CAPS (GRAPHITE, ETC.)
- o COMBUSTOR REDESIGN TO IMPROVE Cs SEEDING AT LOW COMBUSTION PRESSURE (IMPROVE ENTHALPY EXTRACTION)
- o CORRELATION OF EXPERIMENTAL DATA WITH RECENTLY OBTAINED MULTI-DIMENSIONAL COMPUTER CODES
- o INVESTIGATE USE OF OTHER FUELS AND/OR ADDITIVES (INCREASE ELECTRICAL CONDUCTIVITY)
- o FARADAY GENERATOR CONFIGURATION (IMPROVED PERFORMANCE)
- o IMPROVED DIAGNOSTICS

III-2-8

Q & A - J. M. Smith

From: Robert Clark, Naval Research Laboratory

What multidimensional MHD computer codes do you intend to use to check the design of your devices? References?

Answer:

Bibliography

1. Smith, J. M.: "Preliminary Results in the NASA Lewis H₂-O₂ Combustion MHD Experiment," 18th Symposium, Engineering Aspects of Magnetohydrodynamics, Butte, Montana, June 18-20, 1979.
2. Smith, J. M.: "Results of Duct Area Ratio Changes in the NASA Lewis H₂-O₂ Combustion MHD Experiment," AIAA Paper No. 80-0023, Jan. 1980.
3. Smith, J. M.: "Experiments on H₂-O₂ Power Generation," Third World Hydrogen Energy Conference, Tokyo, Japan, June 23-26, 1980.
4. Smith, J. M.; Wang, S. Y.; and Morgan, J. L.: "High B-Field, Large Area Ratio MHD Duct Experiments," 1981 IEEE International Conference on Plasma Science, Santa Fe, New Mexico, May 18-20, 1981, Paper No. 1F6.
5. Smith, J. M.; Morgan, J. L.; and Wang, S. Y.: "Effects of Vacuum Exhaust Pressure on the Performance of MHD Ducts at High B-Field," 20th Aerospace Sciences Meeting, Orlando, Florida, January 11-14, 1982.

The MHD Disk Generator as a Multimegawatt Power Supply
Operating with Chemical and Nuclear Sources

J.F. Louis

Department of Aeronautics and Astronautics
Massachusetts Institute of Technology

ABSTRACT

The characteristics, performance and status of the MHD disk generator are reviewed as a potential multimegawatt power supply working with both chemical and nuclear sources.

The disk generator is found to be a compact high interaction power unit with simple construction simple power conditioning and using a circular superconducting coil. The radial flow of the disk assures zero thrust in open loop operation and its construction simplicity may provide significant reliability and weight advantages.

The disk generator can be operated as a high voltage, low current power supply. Experiments have shown the disk generator as high power (900 kW), high power density (500 MW/m^3), high enthalpy extraction (15%) device which has been operated with electrical fields up to 37 kV/m. The disk generator can be operated in an open loop with either chemical or nuclear heat sources. In a closed cycle system, the disk generator can be used in a Brayton cycle using He as a working fluid and in a Rankin cycle using either potassium or lithium vapors as working fluid. In both cases, the generator operates in the non-equilibrium mode. The estimated weight of a 1 MWe driven in a Brayton cycle using a fast nuclear reactor is around 5 kg/kW. An important advantage of this closed cycle is the compact radiator operating at high temperature.

In the coupling of the disk generator with a $\text{H}_2\text{-O}_2$ rocket engine, the disk generator operates with an equilibrium plasma (seeded with cesium) of

relatively high conductivity. This high conductivity allows a high interaction and a large fraction (25%-40%) of the inlet enthalpy to be extracted.

The research needs should cover studies on:

- 1) Effective plasma properties in non-equilibrium generators
- 2) Plasma properties in generators operating at Hall coefficient with full seed ionization
- 3) Performance of disk generator with inlet swirl
- 4) Boundary layer effects in disk generators
- 5) Chemical non-equilibrium effects in generator driven by chemical energy
- 6) electrode configuration and electrode effects

ENERGY CONVERSION

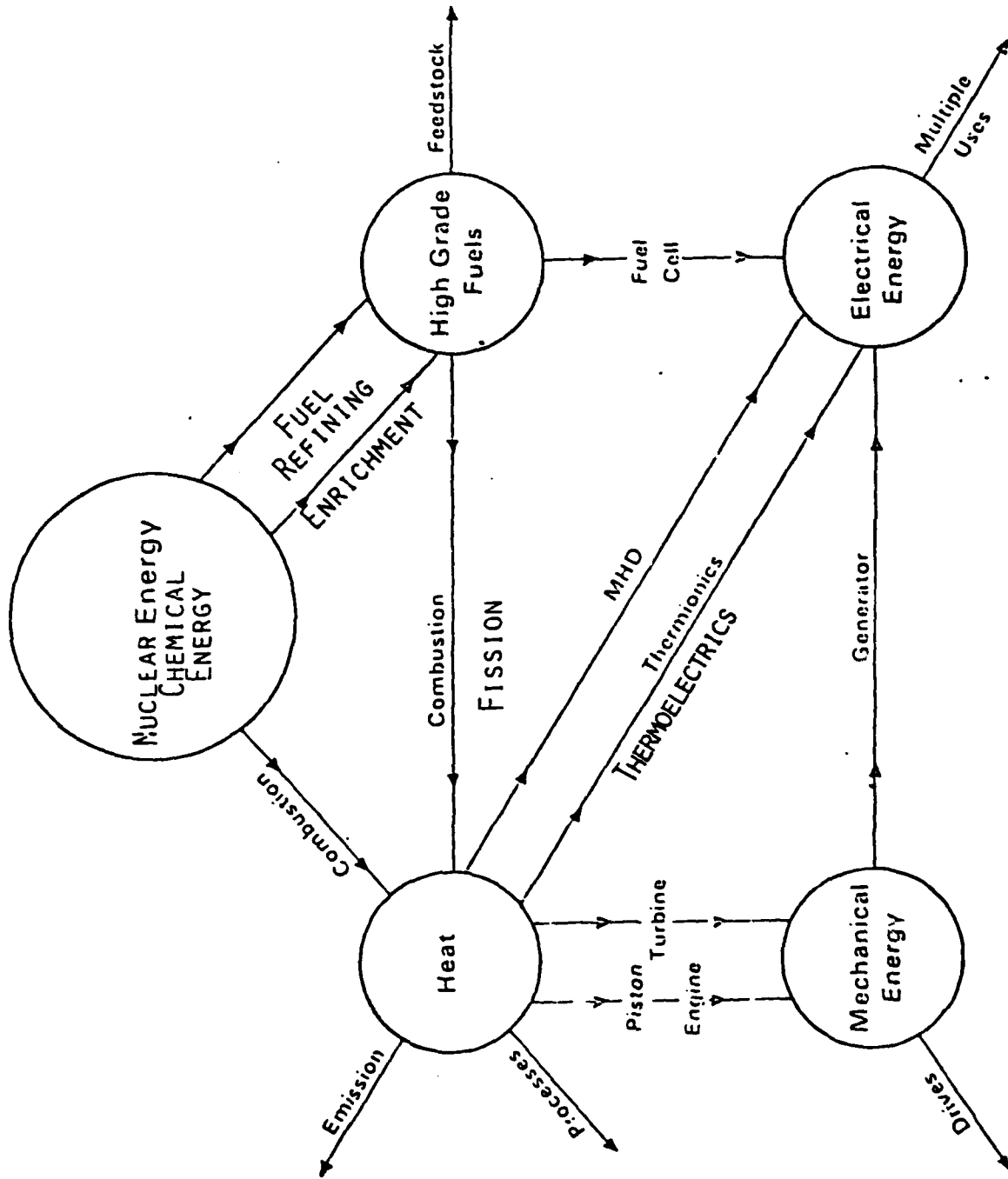

Figure 1 indicates the different paths available for the conversion of chemical or nuclear energies into electricity. All paths except MHD, leading to electricity use surface effects for the conversion process whereas MHD depends on a volume effect.

Energy conversion in a volume rather than through surfaces has significant weight advantages for space application

Figure 2. MHD Generators for Space Power

The volume effects are found to be larger than wall effects at a level in excess of 1 MWe for MHD generators.

MHD generators can be used with high temperature heat sources driven by chemical or nuclear energy.

With chemical energy, the weight of fuel and oxidizer limits the operation to a few minutes. With combustion gases, the electron temperature is equilibrium with the expanding gas. The generator should provide a single output and no net thrust. The exhaust of the combustion gases to vacuum provide a high expansion ratio which allows a high enthalpy extraction limited only by the minimum conductivity. At the low pressure end, the generator has to handle a large volume flow and there is the possibility of non-equilibrium effects at the low pressure end.

Driven by a nuclear reactor, an MHD generator could be operated for a total time close to one hour. The working fluid could be He or H₂. In both cases, the generator would operate with electron temperatures appreciably larger than the temperature of the working fluid. Again, simple loading and no thrust would be required.

Since the MHD generator is a turbine, it can be used either by Rankine or Brayton closed loop cycles operating for long periods of time such as days. The working fluid can be helium, for the Brayton cycle and lithium or potassium supersaturated vapors for Rankine cycles.

MHD GENERATORS
FOR SPACE POWER

- 1) $P_E \geq 1MW (E)$
- 2) CHEMICAL ENERGY
 - A) TOTAL OPERATING TIME IN MINUTES
 - B) EQUILIBRIUM $T_E = T_B$
 - C) SINGLE OUTPUT
 - D) EXHAUST TO VACUUM → HIGH EXPANSION RATIO
→ HIGH ENTHALPY EXTRACTION
→ HIGH VOLUME FLOW/UNIT OF ENERGY
→ POSSIBILITY OF NON EQUILIBRIUM
 - E) NO THRUST
- 3) NUCLEAR ENERGY

NON EQUILIBRIUM OPERATION $T_E > T_B$

OPEN LOOP: TOTAL OPERATION TIME UP TO ONE HOUR
WORKING FLUID He OR H₂

CLOSED LOOP: SPACE POWER AND AUGMENTED THRUST
TOTAL OPERATING TIME = DAY
RANKINE OR BRAYTON CYCLES

Figure 2

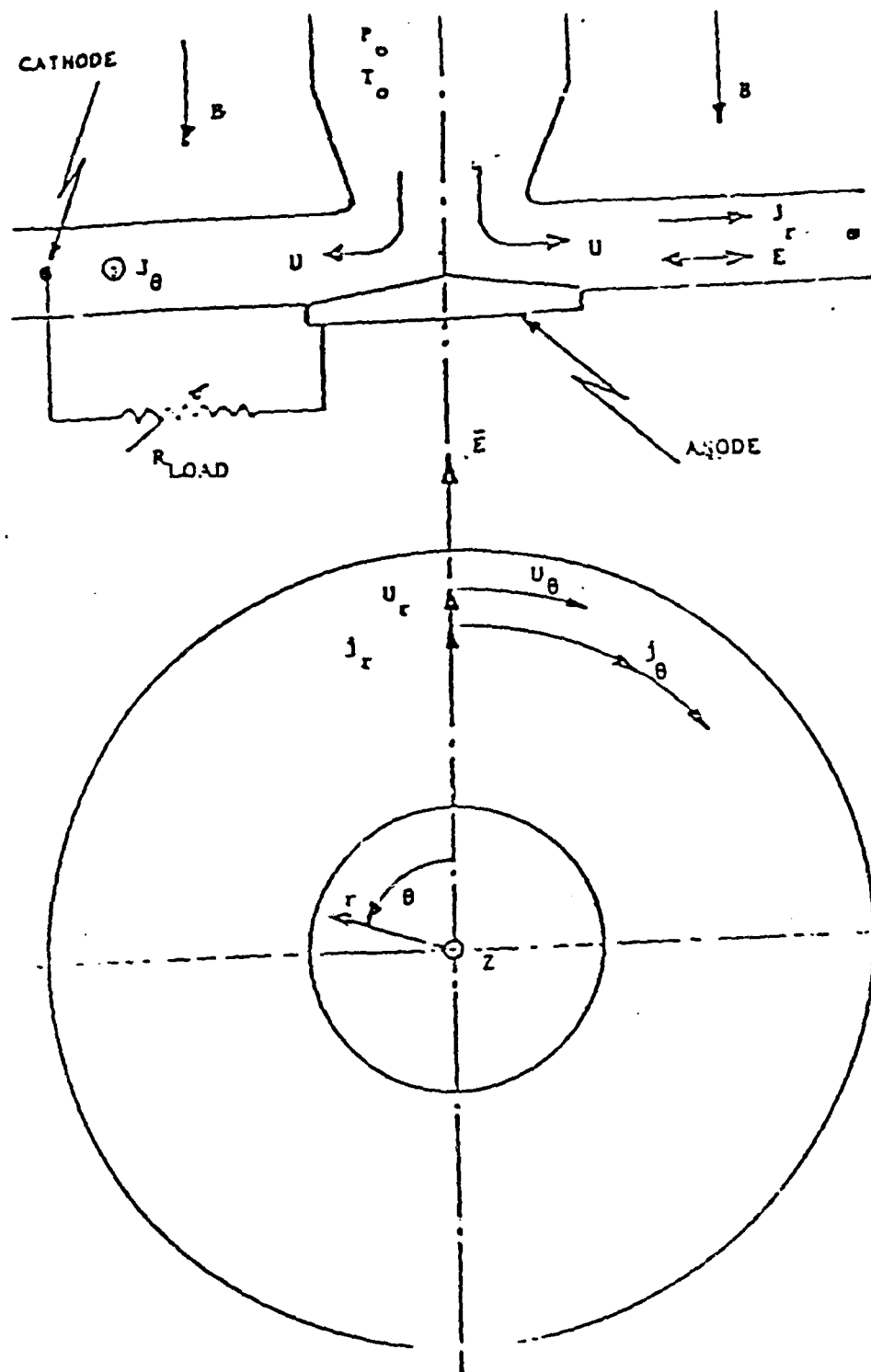

Figure 3. The Disk Generator

The outward flow disk generator shown in Figure 3 is particularly well suited for space power. The generator creates no thrust; it is a single output device; it eliminates the multiple electrodes by circular symmetry; it is made of two circulating walls which can take higher electrical fields than the electrode walls of linear generators. This configuration eliminates end losses associated with the fringing of the magnetic field. The disk configuration can accommodate large expansions and wakes of the magnetic field created by a single pancake coil. The disk generator is a high specific power but also high voltage-low current MHD generator.

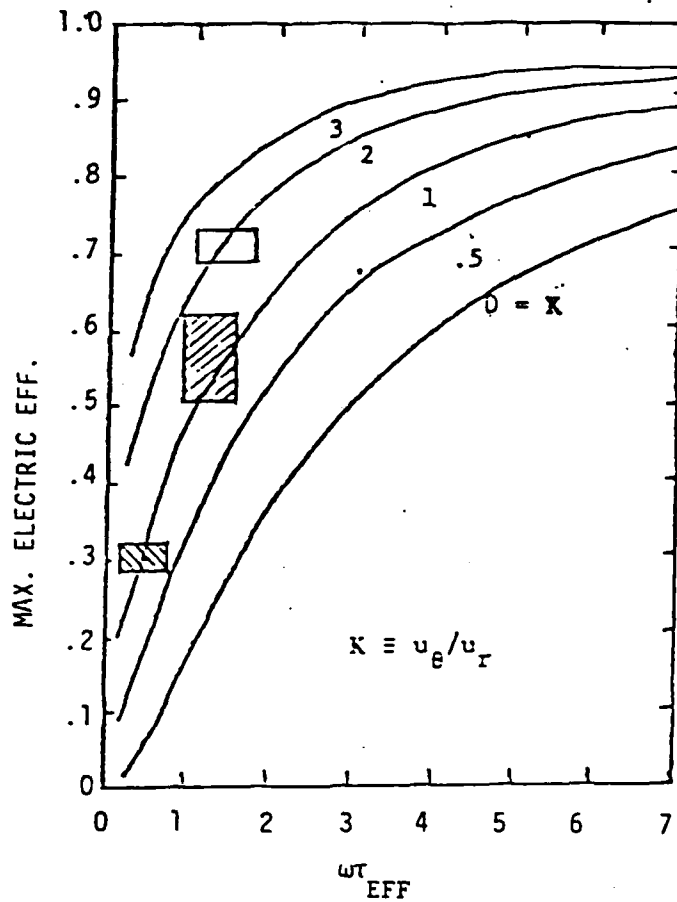

FIGURE 18 ELECTRIC EFFICIENCY VS. SWIRL RATIO AND $\omega\tau$

- $T_0 = 4900$ K (Nitrogen)
- $T_0 = 3350$ K (Argon)
- $T_0 = 2450$ K (Argon)

Figure 4.

The use of inlet swirl allows increases in efficiency as shown and demonstrated in Figure 4.

DISK GENERATOR

1) HIGH EXPANSION \longrightarrow OUTFLOW DISK GENERATOR

2) FEW ELECTRODES

3) HIGH ELECTRIC FIELD

DISSIPATION OVER ELECTRODE WALL $\frac{\sigma E_x^2}{\omega \tau}$

DISSIPATION OVER INSULATOR $\frac{\sigma E_x^2}{[1 + (\omega \tau)^2]}$

$$(E_R)_{MAX} > \omega \tau \cdot (E_x)_{MAX}$$

Figure 5.

The outflow disk generator is indicated for high expansion ratio devices to be used for space power. The few electrodes required by the disk lead to higher reliability and simpler power conditioning than for the linear generator.

Whereas the dissipation over an electrode wall is proportional to the scalar conductivity, the dissipation over an insulating wall is proportional to conductivity expressed as a tensor. As a result the maximum electric field which can be sustained in the disk generator is $\omega \tau$ larger than the maximum electric field sustainable in an linear generator.

Since $\omega \tau$ can easily equal to 4 or 5 in space applications, the disk generator is a high voltage and low current generator.

Electric fields up to 37 kV/m have been measured in the laboratory.

POWER DENSITY

$$\frac{P_E}{\sigma V^2 B^2} = \frac{K(1-K) (\omega_T + S)^2}{(1 + S^2) (1 + (\omega_T)^2)}$$

MAXIMUM POWER DENSITY

$$S = 1/\omega_T \quad K = 1/2 \quad \text{AND} \quad E_R = \frac{\omega_T}{2} VB$$

$$P_{E_{MAX}} = \frac{1}{4} \sigma V^2 B^2$$

$$= \frac{\sigma E_X^2}{(\omega_T)^2} = \frac{\sigma E_R^2}{(\omega_T)^2}$$

$$\left(\frac{P_E}{\sigma V^2 B^2} \right)_{MAX}^{DISK} \geq (\omega_T)^2 \left(\frac{P_E}{\sigma V^2 B^2} \right)_{MAX}^{LINEAR}$$

Figure 6.

The maximum power density can be achieved with little inlet swirl and the maximum power density of disk generator is larger by at least one order of magnitude over the linear generator.

OT-8-III

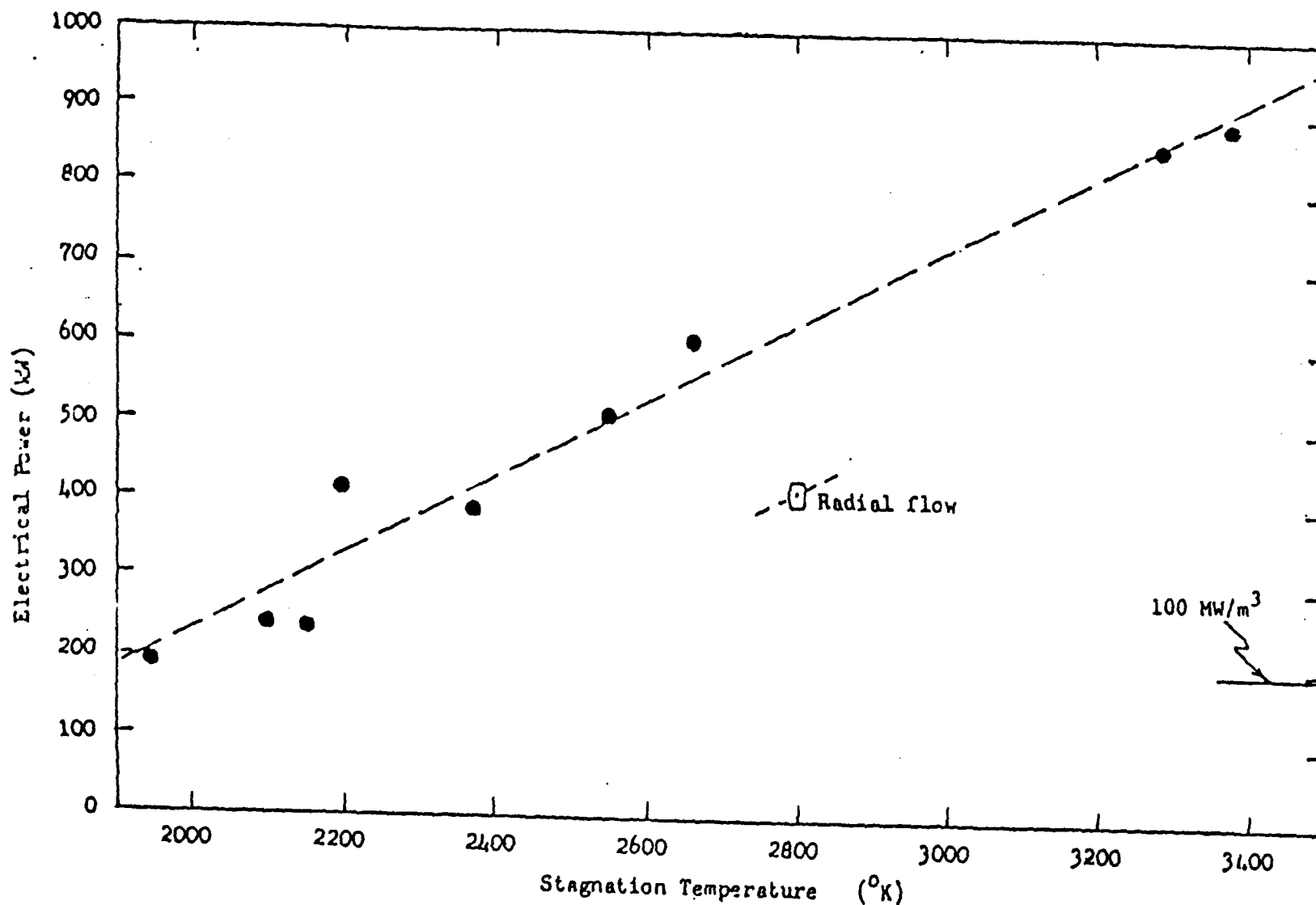
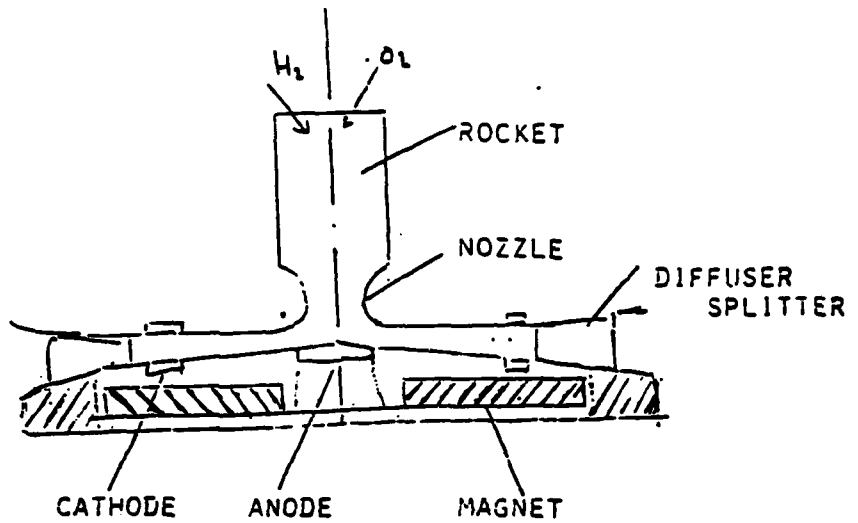
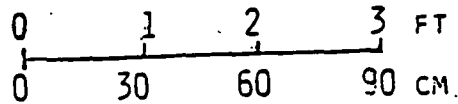

Figure 7. Indicates the electrical power generated by a disk generator with a total volume of 0.002m³ or 120m³ as a function of stagnation temperature. The power density varied from 100 MW/m³ to 500 MW/m³ while the maximum power was close to 1 MWe and the enthalpy extraction was 15%.

CHEMICAL MHD DISK GENERATOR (1 MWe)



SCALE



NUCLEAR MHD DISK GENERATOR (1 MWe)

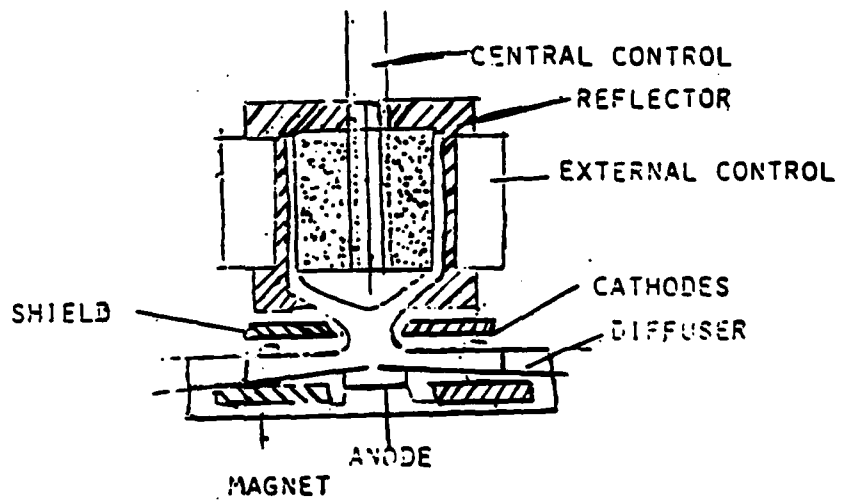

Figure 8. gives sketches of 1 MWe disk generators driven by a H_2-O_2 rocket and by a high temperature fast nuclear reactor.

Preliminary Weight Estimate

System Study #1 - 1 MWE

WEIGHTS:

	1 MWE
	Kgm
Reactor	600
Shield	1200
Generator Duct, Nozzle and Diffuser	70
Magnet	950
Refrigerator (Magnet and Motor) (20 watt)	140
Regenerator (at 1.5 Kgm/m ²)	280
Radiator (at 5.5 Kgm/m ²) 900°K, ε = 0.9	960
Ducts	80
Compressor (at 0.02 Kgm/KW)	90
Motor (12,000 rpm; Multipole)	320
Controls	50
Refrigerator Power (20 KW at 25 kgm/KW)	500
TOTAL	5240
Total Without Shield	4040

Figure 9. gives the weight estimate of a closed loop, Brayton cycle, power system using a fast nuclear reactor. For 1 MWe output, the estimated weight is 5 kg/hWe and should be reduced toward 1 kg/hWe at the 100 MWe level.

STATUS OF DISK GENERATOR

- 1) PLASMA PROPERTIES WELL UNDERSTOOD
(NON EQUILIBRIUM WITH LOW SEED
CONCENTRATION NEED TO BE BETTER UNDERSTOOD)
- 2) DISK PERFORMANCE WELL PREDICTED
FOR SHOCK TUNNEL OPERATION
- 3) TECHNOLOGY OF DISK WALLS CAN ADAPT
TECHNOLOGY OF INSULATING WALLS
OF LINEAR GENERATORS
- 4) WALL EFFECTS UNDER QUASI STEADY
STATE NEED TO BE TESTED
- 5) CHANNEL ENGINEERING NEED TO BE
DEVELOPED

FIGURE 10

PROPOSED PROGRAM
DISK MHD GENERATOR DRIVEN BY CHEMICAL ENERGY

- 1) SYSTEM STUDIES TO DEFINE OPTIMUM OPERATING PARAMETERS
- 2) PULSE EXPERIMENTS USING CHEMICAL ROCKET [10 MW_(TH)]
WITH LOW VACUUM EXHAUST AND EITHER CONVENTIONAL
COPPER MAGNET OR SUPERCONDUCTING MAGNET

- EVALUATE
- 1) CHANNEL CONSTRUCTION
 - 2) CHANNEL PERFORMANCE
 - 3) ELECTRODE EFFECTS
 - 4) WALL EFFECTS
 - 5) POSSIBLE NON-EQUILIBRIUM
EFFECTS

- 3) SHOCK TUNNEL TESTS
TO STUDY:
 - 1) PLASMA PROPERTIES
 - 2) POSSIBLE NON-EQUILIBRIUM EFFECTS
 - 3) ELECTRODE CONFIGURATION
 - 4) PERFORMANCE

FIGURE 11

Figure 11 and 12. describe proposed programs for the use of the disk generator in space. The research topics deal with channel performance, electrode effects, effect of seed concentration and dissipation mechanisms within the generator at high values of the Hall parameter

PROPOSED PROGRAM

DISK DRIVEN BY NUCLEAR ENERGY

- 1) SYSTEM STUDIES TO DEFINE OPTIMUM OPERATING PARAMETERS
- 2) PULSE EXPERIMENTS USING HEAT STORAGE FACILITY WITH PARTIAL VACUUM TO TEST CHANNELS AT DEFINED CONDITIONS
EVALUATE
 - 1) CHANNEL CONSTRUCTION
 - 2) CHANNEL PERFORMANCE
 - 3) ELECTRODE EFFECTS
 - 4) EFFECT OF SEED CONCENTRATION
 - 5) ON EFFECTIVE σ AND ωT
- 3) SHOCK TUNNEL EXPERIMENTS
TO STUDY EFFECTS OF TEMPERATURE
PRESSURE
SEED CONCENTRATION
MAGNETIC FIELD

FIGURE 12

Q & A - J. F. Louis

From: P. J. Turchi, R & D Associates

What are fundamental research issues that distinguish disk generators from standard MHD generators? Azimuthal symmetry?

A.

The fundamental differences distinguishing the disk from the linear generators are associated with the circular symmetry which eliminates the electrodes, this leads to reduced losses, simpler power conditioning and also the disk uses a much simpler magnet. This leads to higher power density.

From: Roy Pettis,

Would pancake coils suffice for the field magnets for a disk generator? What channel construction and magnet construction problems would you expect for a disk generator?

A.

National Magnet Laboratories made studies of the magnet system. These studies indicated that a pancake coil would suffice.

The magnet construction is simple and has been demonstrated. You will find more details on both magnet and generator construction in Ref. 3.

BIBLIOGRAPHY

1. Louis, J.F., "Disk Generator," AIAA J., Vol. VI, p. 1674-1678, September 1968. Proceedings of the IEEE, Vol. 56, p. 1432-1437, September 1968.
2. Louis, J.F., "The Disk Generator, Its Status and Its Potential", Presented at the Specialists Meeting on Coal Fired MHD Power Generation, Sydney Australia, November 4-6, 1981.
3. Retallick, F.D., "Disk MHD Generator Studies", DOE/NASA/0139-1, October, 1980.
4. Klepeis, J.E., and Louis, J.F., "The Disk Generator Applied to Open Cycle Power Generation", Proceeding of the Fifth International Conference on MHD Electrical Power Generation. Vol. I, pp. 649-661, Munich, April 1971.
5. Klepeis, J.E., Cole, J., Hruby V. and Louis, J.F., "The Disk Geometry Applied to Open Cycle MHD Power Generation", The Sixth International MHD Conference, Washington, D.C., June 1975.
6. Loubsky, W.J., Hruby, F.J., Louis J.F., "Detailed Studies in a disk Generator with Inlet Swirl Driven by Argon", Proceedings of the Fifteenth Symposium on Engineering Aspect of Magnetohydrodynamics held at the University of Pennsylvania, May 24-26, 1976.
7. Shamma, S.E., Martinez-Sanchez, M., Louis, J.F., "Ohm's Law for Plasmas with Non-Isentropic Inhomogeneities and Its Effects on the Performance of MHD Generators," Proceedings of the 16th Symposium on Engineering Aspects of Magnetohydrodynamics held at the University of Pittsburgh, Pittsburgh, PA, May 16-18, 1977.
8. Lytle, J.K. and Louis, J.F., "The Effects of Anisotropic Nonuniformities in a Nonequilibrium MHD Disk Generator, presented at the Nineteenth Symposium on Engineering Aspects of MHD, Tullahoma, TN, June 15-17, 1981.
9. Kniffin, M.A., Louis, J.F., Teare, J.D., "Performance Prediction of a Disk MHD Generator with Chemical Nonequilibrium, AIAA Conference, Orlando, FL, January 1982.
10. Daurio, F.H., "Medium Size Nuclear Power Source for Space Propulsion and Applications", Master of Science Thesis, M.I.T., September 1970.
11. Rosen, S.G., "Design and Analysis of MHD Augmented Fast Reactor Nuclear Rocket Engine", Master of Science Thesis, M.I.T., September 1970.
12. Rosa, R., and Louis, J., "Position Paper on Closed Cycle MHD Power Generation", AERL, 1968.

SELF-EXCITED MHD POWER SOURCE FOR SPACE APPLICATIONS

C.D. Maxwell, C.D. Bangerter, and S.T. Demetriades

STD Research Corporation
Arcadia, California

Abstract

Space applications of magnetohydrodynamic (MHD) electrical power generation can meet a variety of mission requirements. These range from moderate amounts of electrical power (1-100 MW) for periods of minutes to hours ("CW-MHD"), to very large electrical pulses (1-1000 GW) over periods of 1-100 microseconds ("Pulsed MHD"). High repetition rates are feasible (thousands per minute). By self-exciting the MHD generator (that is, by applying some of the generated power to produce the magnetic field), system complexity and weight are minimized. Small, self-excited, combustion-driven MHD systems with mass-to-power ratios of the order 1 kg/kW and specific energy extraction rates of 0.8 MJ/kg of fuel are being tested. Small, self-excited, chemical explosion driven giant-pulse generators with mass-to-power ratios of the order 0.001 kg/kW and specific energy extraction rates of 0.4 MJ/kg of explosive have been tested. On the basis of theoretical advances at STD Research Corporation, this paper extrapolates the experimental results to date with CW-MHD and Pulsed MHD devices to the expected performance in the space environment. So far it appears that these specifications can be exceeded in space. The fluid mechanics of high-interaction, moderate-to-high magnetic Reynolds number MHD flows govern (and will ultimately limit) the performance of such devices. These fundamental limitations must be properly understood before devices of these or better specifications can be constructed.

SELF-EXCITATION
LUMPED PARAMETER ELECTRICAL MODEL

● SIMPLIFIED SCHEMATIC - SERIES EXCITATION

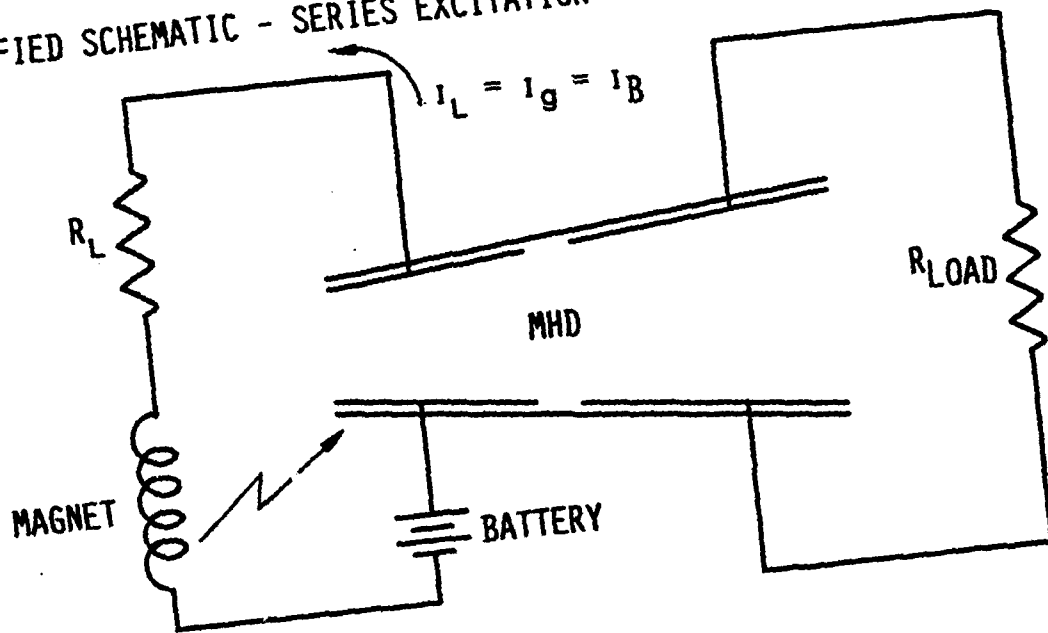

● SIMPLIFIED SCHEMATIC - PARALLEL EXCITATION

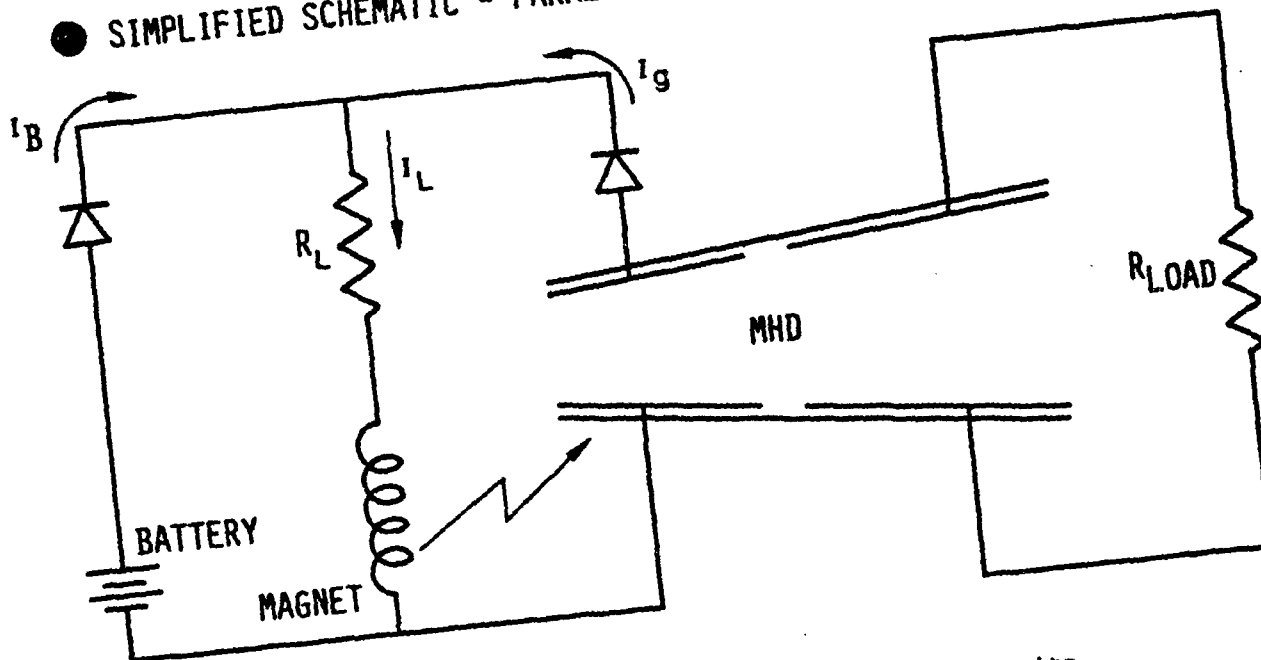

Fig. 18. Schematics of Excitation and Loading Circuits.

III-4-1

AD-A118 887

R AND D ASSOCIATES ROSSLYN VA F/G 10/2
PROCEEDINGS OF THE AFOSR SPECIAL CONFERENCE ON PRIME-POWER FOR --ETC(U)
FEB 82 P J TURCHI F49620-82-C-0008

UNCLASSIFIED

AFOSR-TR-82-0655

NL

3-9

21847

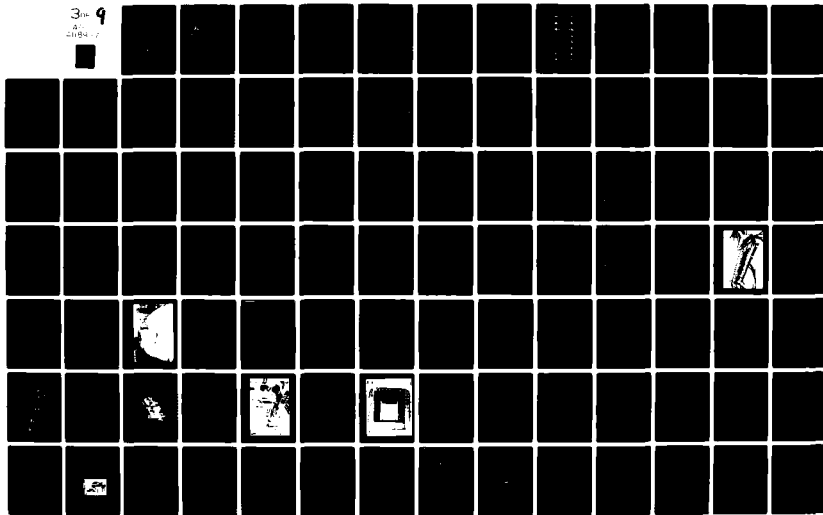

III-4-2

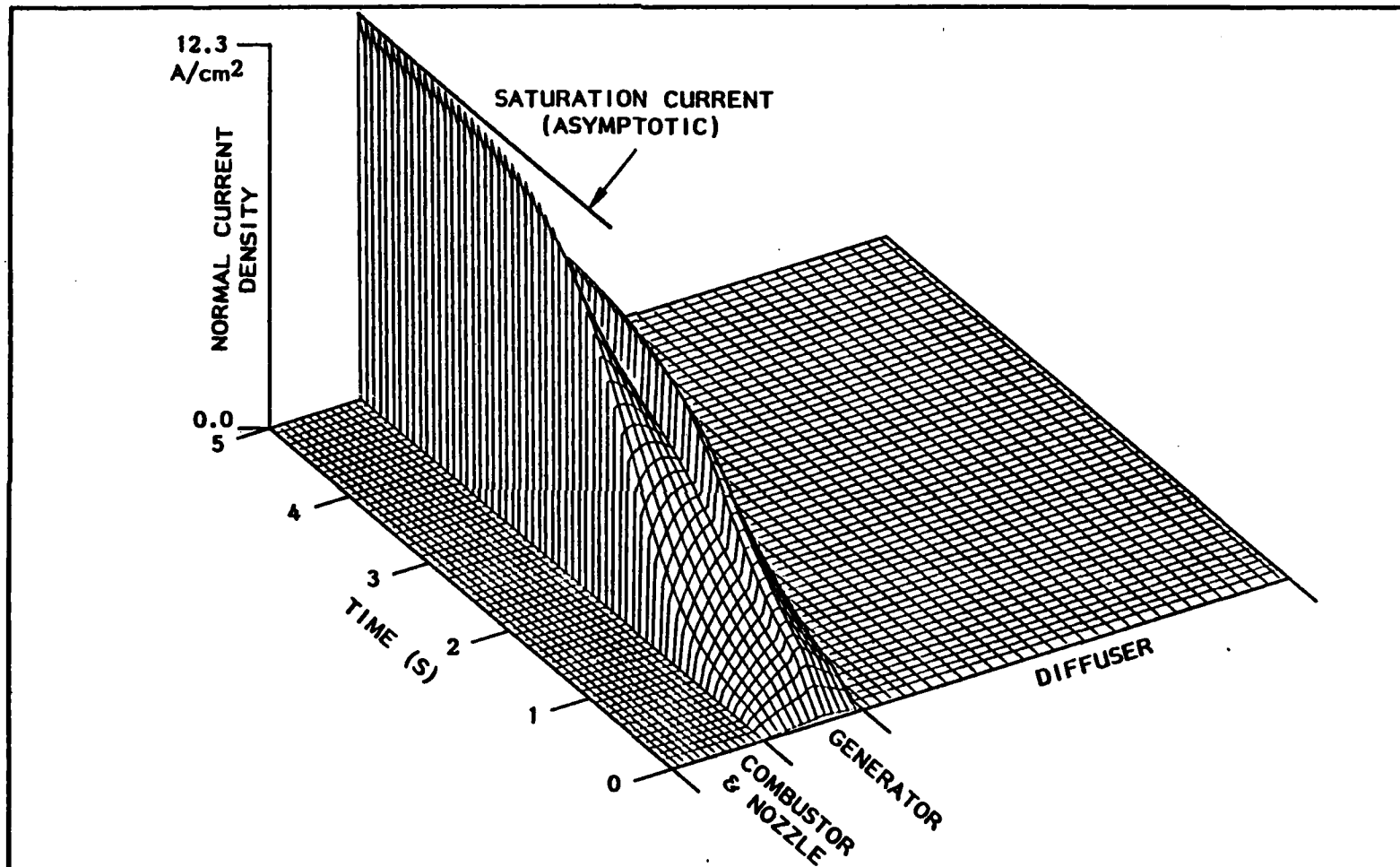

Fig. 20 . Space and time variation of the normal current density component J_y for optimum self-excitation of the split-load continuous electrode Faraday Channel, Peak current density is 12.3 A/cm².

III-4-3

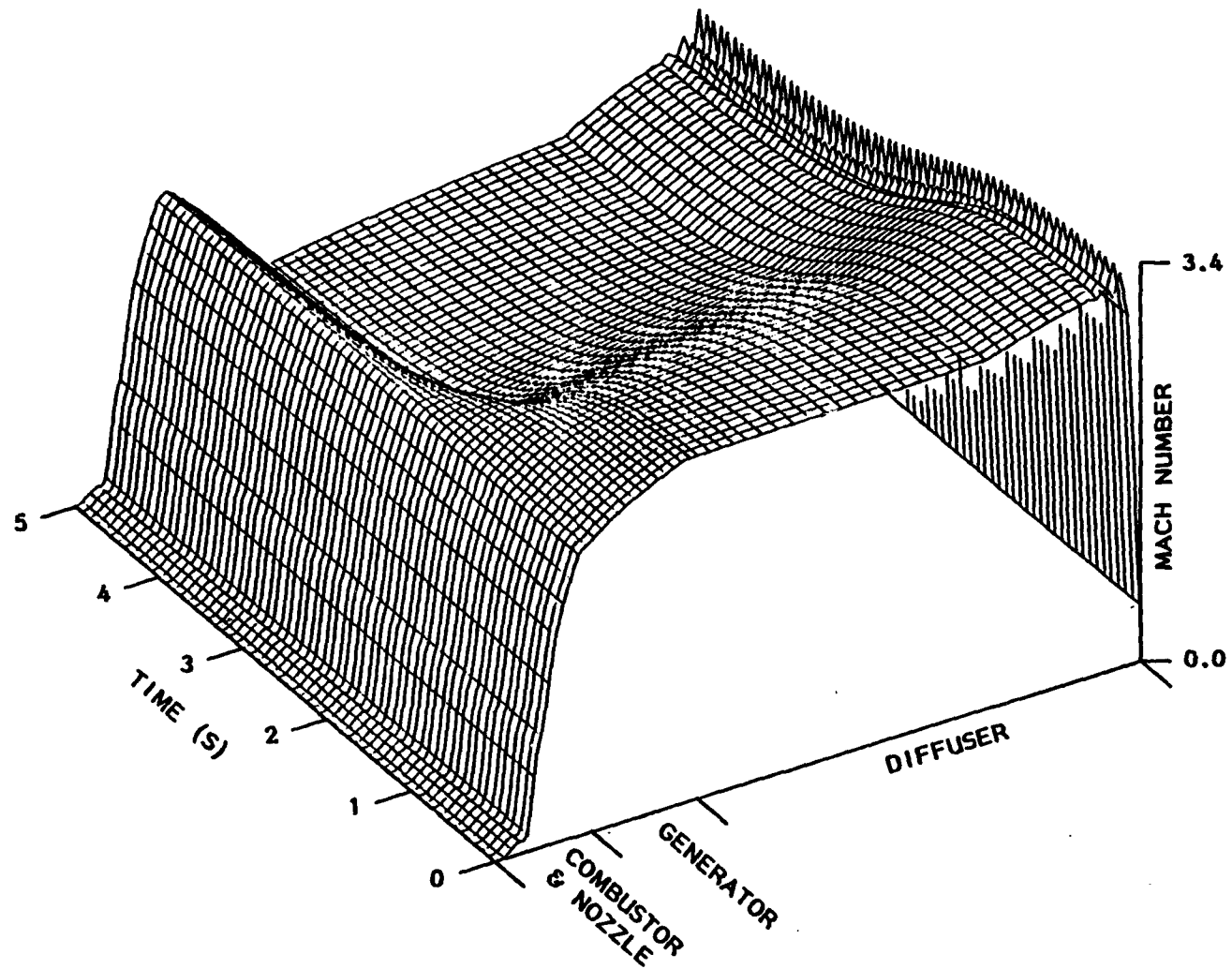

Fig. 21. Space and time variation of the Mach number M for optimum self-excitation of the split-load continuous electrode Faraday channel. Peak Mach Number is 3.4.

1-5912

STD RESEARCH CORPORATION

SELF-EXCITED MHD FOR SPACE PRIME POWER

ADVANTAGES

- COMPACTNESS -- LOW SPECIFIC WEIGHT
- HIGH POWER -- HIGH SPECIFIC ENERGY EXTRACTION
- SIMPLICITY -- NO MOVING PARTS
- STOREABLE -- NO MAINTENANCE
- INSTANT READINESS -- FAST START/STOP CAPABILITY
- HIGH REPETITION RATE

SELF-EXCITED MHD FOR SPACE PRIME POWER

CRITICAL PROBLEMS

- HIGH INTERACTION MAGNETOHYDRODYNAMIC FLOW BEHAVIOR
- POWER GENERATION AT MODERATE-TO-HIGH
MAGNETIC REYNOLDS NUMBER
- CONTROLLED HIGH-CONDUCTIVITY WORKING FLUID GENERATION

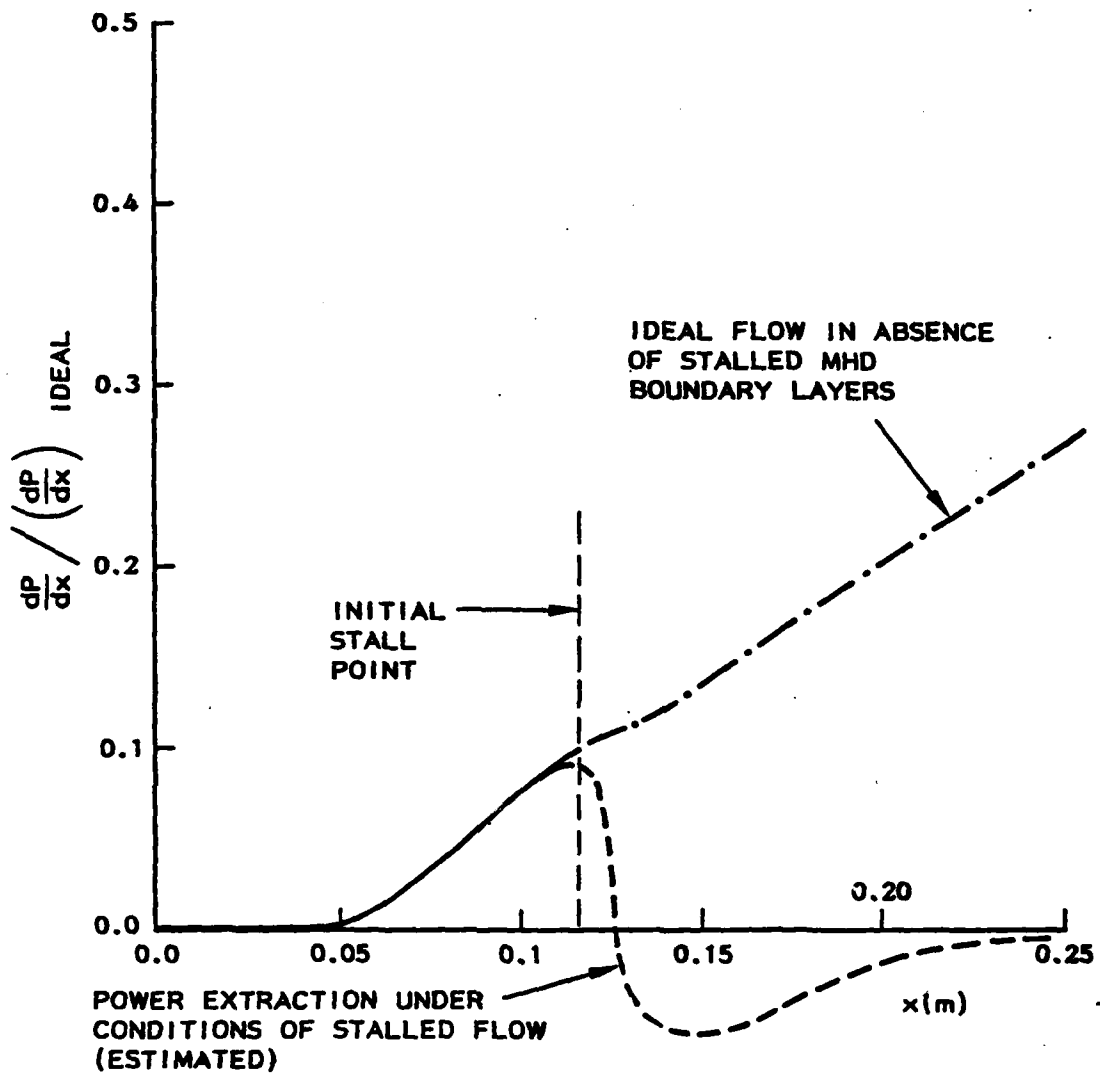

Fig. . Ratio of power extraction per unit length to ideal power extraction. Wall layers stalled over most of channel length. Note that power is consumed in stall region ($dP/dx < 0$).

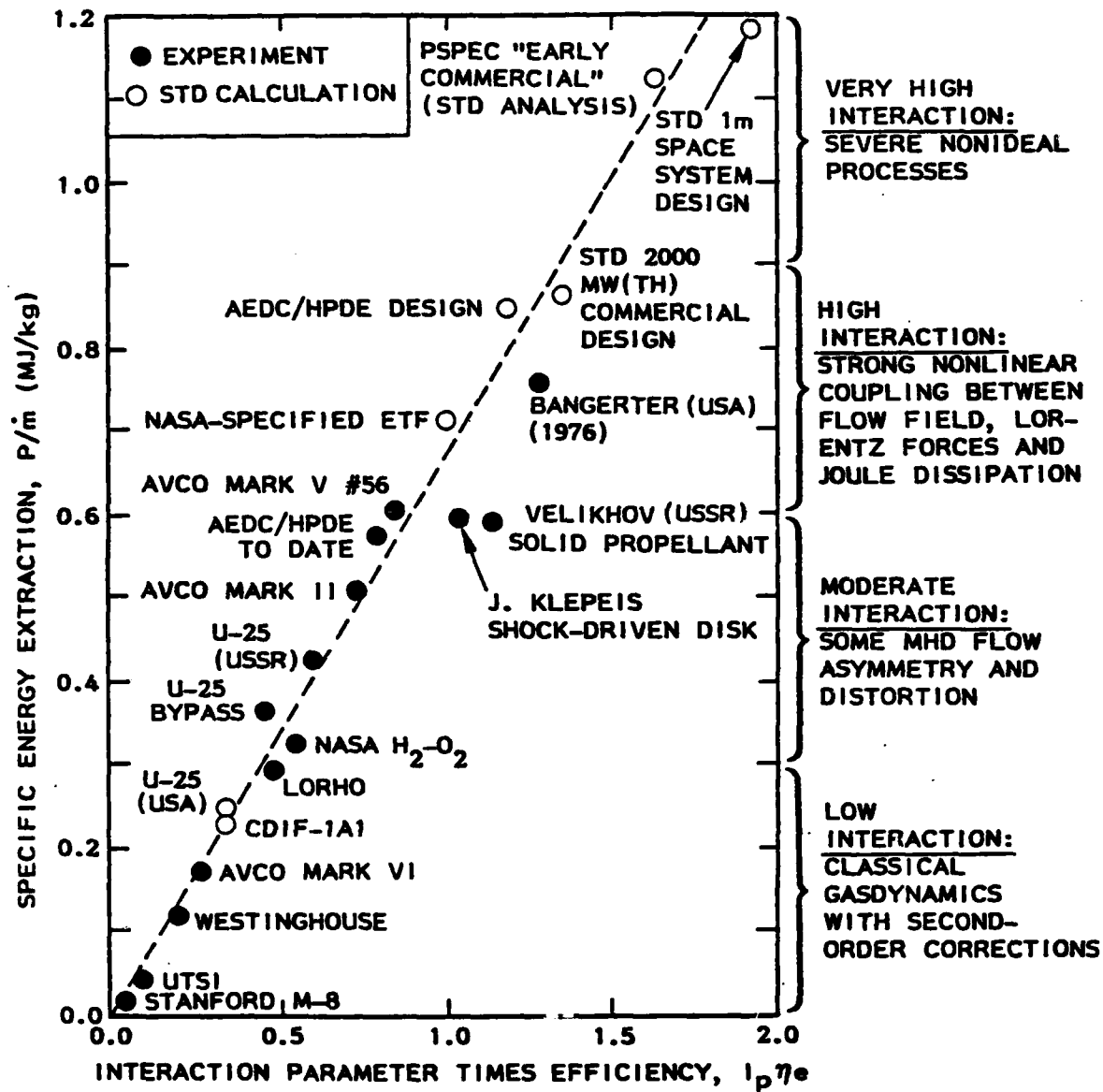

Fig. 1. Interaction levels and specific energy extraction of major MHD power generation experiments and designs in the U.S.A. and the U.S.S.R. All points are STD Research Corporation simulations of design or test conditions. Solid points indicate validation of calculations by experimental test data. Interaction regimes are arbitrarily divided on the basis of the degree of MHD flow distortion in the STD calculations.

2-5941

STD RESEARCH CORPORATION

"USING AN EFFECTIVE SOLID-FUEL PLASMA GENERATOR, SPECIFIC POWER OUTPUT [AND POWER DENSITY] OF UP TO 0.6 MJ/KG AND 500 W/CM³, RESPECTIVELY, WAS GENERATED. FURTHER INCREASING THESE PARAMETERS (AND ACCORDINGLY THE COEFFICIENT OF ENTHALPY EXTRACTION) CAN BE ACHIEVED ONLY IF THE LIMITING EFFECT OF PROCESSES ASSOCIATED WITH STRONG INTERACTION ARE SUPPRESSED. THE NATURE OF THESE PROCESSES IS NOT YET FULLY UNDERSTOOD, THUS IT IS NECESSARY TO CONTINUE THE STUDY OF THESE PHENOMENA."

--VELIKHOV, YE.P., ET AL., "FACTORS INFLUENCING THE SELF-EXCITATION OF PULSE TYPE MHD GENERATORS," JUNE 1975

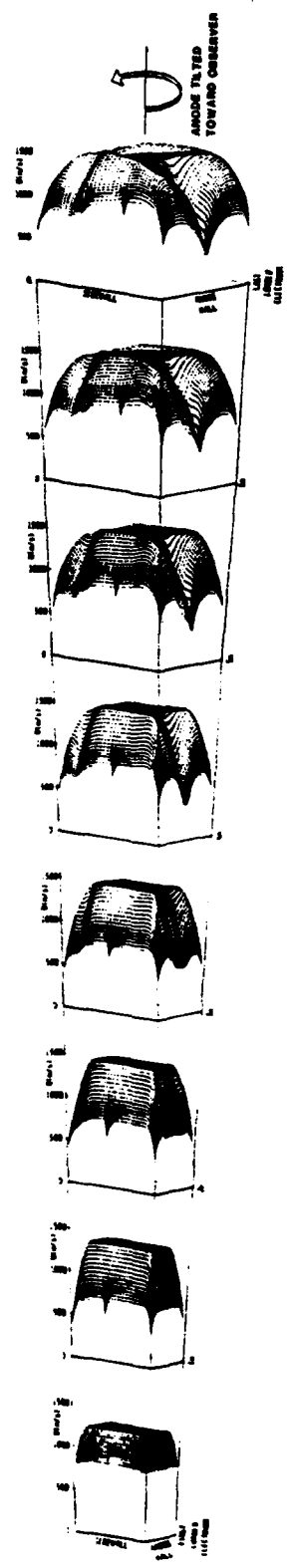
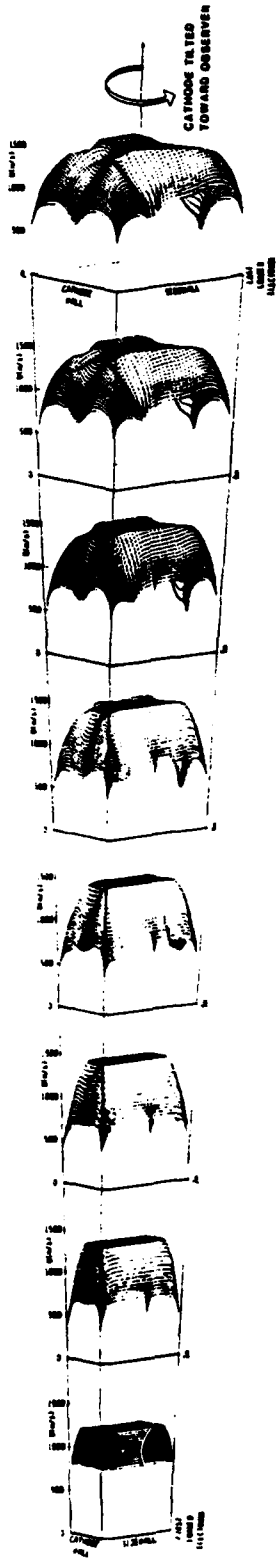

AEDC, HPOE AXIAL VELOCITY

 1-5925

Q & A - C. Maxwell

From: H. Bloomberg, Beers Associates, Inc.

Have the results of 3-D simulations for high interaction actually been confirmed experimentally? Are there references on this?

A.

Yes, see Vetter et al., AIAA-80-0024,
Vetter et al., AIAA-81-0173,
Demetriades, et al., AIAA-80-0249
and Maxwell, et al., AIAA-80-0168

for example. Also, recent experimental work at Arnold Engineering Development Center confirms 3-D magneto aerothermal effect predictions made earlier (see Demetriades, et al., AIAA-81-0248, also Maxwell, et al., AIAA 81-1231 and U.S. Dept. of Energy Report "Analytical Investigation of Critical Phenomena in MHD Generators" presented at the DOE/MHD Division Contractors Meeting 1 February 1982 by STD Research Corporation)

From: Roy Pettis

What factors determine the minimum power and energy required by the battery used in the self-exciting process? Can you always count on this initial excitation system being small, in an absolute sense; or can this sub system itself become physically large?

A.

The self-excitation threshold is determined by the characteristics of the magnet and the impedance of the remaining elements of the circuit. In particular, it is determined by losses in the MHD generator which increase its internal impedance at low current. Chief among these losses is the electrode voltage drop.

For a successful self-excited generator design, the energy supplied by the exciter will always be a very small fraction of the energy delivered by the MHD generator. Depending upon the energy density of the exciter, its size should also remain small compared to the MHD generator system. In addition, there are ways of eliminating the exciter entirely from the system.

Q & A - C. Maxwell (Cont.)

From: P. J. Turchi, R & D Associates

Do your codes include chemistry and heat transfer effects on conductivity near walls/electrodes?

Would they predict spoke phenomena?

A.

Yes. One of the early successes of the STD/MHD codes was their ability to correctly predict near-electrode voltage profiles and nonequilibrium phenomena, which depend strongly upon these effects.

Yes. Not only can they predict the spoke phenomena, the STD/MHD codes can also predict the random "dancing" or flexure of the arc columns as well as the movement of the arc spot on the electrodes.

From: P. J. Turchi, R & D Associates

Please comment on flow nonuniformities, (conductivity and velocity), and their effects on generator performance.

What magnetic Reynolds number values correspond to the extrapolated high interaction-parameter regime?

A.

Both are extremely important. For example, conductivity nonuniformities cause severe deviations from the electrical performance computed by 1- or 2-dimensional models. Velocity nonuniformities cause extreme departures from ordinary 1- or 2-dimensional gasdynamic computations (e.g., boundary layer separation). In addition, there is strong, nonlinear coupling between the two modes of nonuniformity which renders devices impossible to operate as designed by 1- and 2-dimensional models.

We have analyzed MHD generators with magnetic Reynolds numbers as high as $r_m = 400/\text{meter}$ and interaction parameters based on pressure, i_p^m from 0.6 to 6/(meter tesla²). For MGD accelerators, magnetic Reynolds numbers may be of the order 30/meter and interaction parameters based on pressure of 10^3 to $10^6/(\text{meter tesla}^2)$.

"Chemical Sources: Research Needs"
by
Massie, L.

(Paper not available)

"Critique of MHD Power"
by
Jackson, W.

(Paper not available)

Q & A - W. Jackson

From:

What are costs for MHD power that can be estimated for space based system?

A.

Recent MHD cost estimating has been for commercial terrestrial systems. All component costs have been estimated using design approaches and materials described in my talk. In the 1960's, weight and cost estimates were made of the several space power systems described by session authors. It would now be possible to take the methodology and technology base data developed by DoE and use them to refine and update these earlier calculations. I am not aware that this has been attempted.

LIQUID-METAL MHD FOR SPACE POWER SYSTEMS

E. S. Pierson
Argonne National Laboratory
Argonne, IL. 60439

Abstract

The two-phase-generator liquid-metal MHD (LMMHD) energy-conversion concept, developed at Argonne National Laboratory, appears very attractive for space applications. It combines the high-temperature capability and high power density of the previously-proposed LMMHD concepts with a high cycle efficiency unattainable with these previous LMMHD concepts. The operation of the Brayton-cycle (gas-cycle) and Rankine-cycle (vapor-cycle) two-phase-generator LMMHD concepts is explained. The key features which make LMMHD attractive for space applications are summarized. The current status of LMMHD technology is discussed, with emphasis on the experimental data. ANL has the technology base to analyze LMMHD systems for space power applications, and to build prototypes at different temperatures.

LIQUID METAL MHD
FOR
SPACE POWER SYSTEMS

- HISTORY
- DESCRIPTION
- FEATURES
- STATUS

E. S. PIERSON
ARGONNE NATIONAL LABORATORY

VIEWGRAPH 1

Introduction

Liquid-metal MHD (LMMHD) energy-conversion systems were first proposed in the early 1960s specifically for space power systems. The early LMMHD concepts were appropriate for the high-temperature environment envisioned for space systems, but the efficiencies were low because of significant energy losses. Research at Argonne National Laboratory (ANL) in the middle-to-late 1960s, aimed at minimizing these losses, resulted in the two-phase-generator LMMHD concept proposed here. This is the only LMMHD concept discovered to date that appears attractive for commercial applications. One feature is that the efficiencies are higher than for alternative existing or new concepts. Now it is proposed that the circle be closed, and this high-efficiency LMMHD concept be applied to space applications which will utilize the unique combination of high efficiency and high-temperature capability.

VIEWGRAPH 2

Schematic of LMMHD Brayton System

In the Brayton-cycle (gas-cycle) LMMHD concept, an inert gas, e.g., helium, is the thermodynamic working fluid, and a liquid metal, e.g., lithium is the electrodynamic fluid in the MHD generator. In operation, the gas and liquid are combined in the mixer and the resulting two-phase mixture enters the MHD generator. The MHD generator acts as a combined turbine and electric generator; the gas expands, drives the liquid across the magnetic field, and, thus, generates electrical power. Because the liquid has a high heat (energy) content, expansion occurs at almost constant temperature, and a great deal of energy is still available in the gas that leaves the MHD generator. (The liquid acts as an "infinite-reheat" source for the gas, heat energy is continuously transferred from the liquid to the gas, and most of the energy out of the generator comes from the liquid). It is this almost-constant-temperature expansion that accounts for the potentially higher efficiency of the two-phase LMMHD concepts. From the MHD generator, the two-phase mixture enters a nozzle, where additional gas-liquid energy is used (as in the generator) to accelerate the liquid; the resulting high-speed flow is separated in a separator (possibly rotating to minimize losses), and the liquid pressure needed to return the liquid through the primary heat exchanger to the mixer is obtained in the diffuser. The nozzle-diffuser system may be replaced by a liquid-metal pump.

The gas leaving the separator still has considerable thermal energy, which must be used effectively in order to obtain the highest efficiency for the system. It can be transferred from the hot gas to the colder gas in a regenerator, extracted with a gas turbine, extracted with a steam boiler, or used to provide heat for some other process. These components can be combined.

Heat addition can be to the liquid metal, the gas, or both. Because the liquid-metal mass flow rate is much higher than the gas mass flow rate, the heat addition can be solely to the liquid metal, with the gas being heated by the liquid in the mixer, to yield a simpler system without a significant effect on efficiency.

LIQUID-METAL MHD POWER SYSTEM

ANL ENGINEERING DIVISION

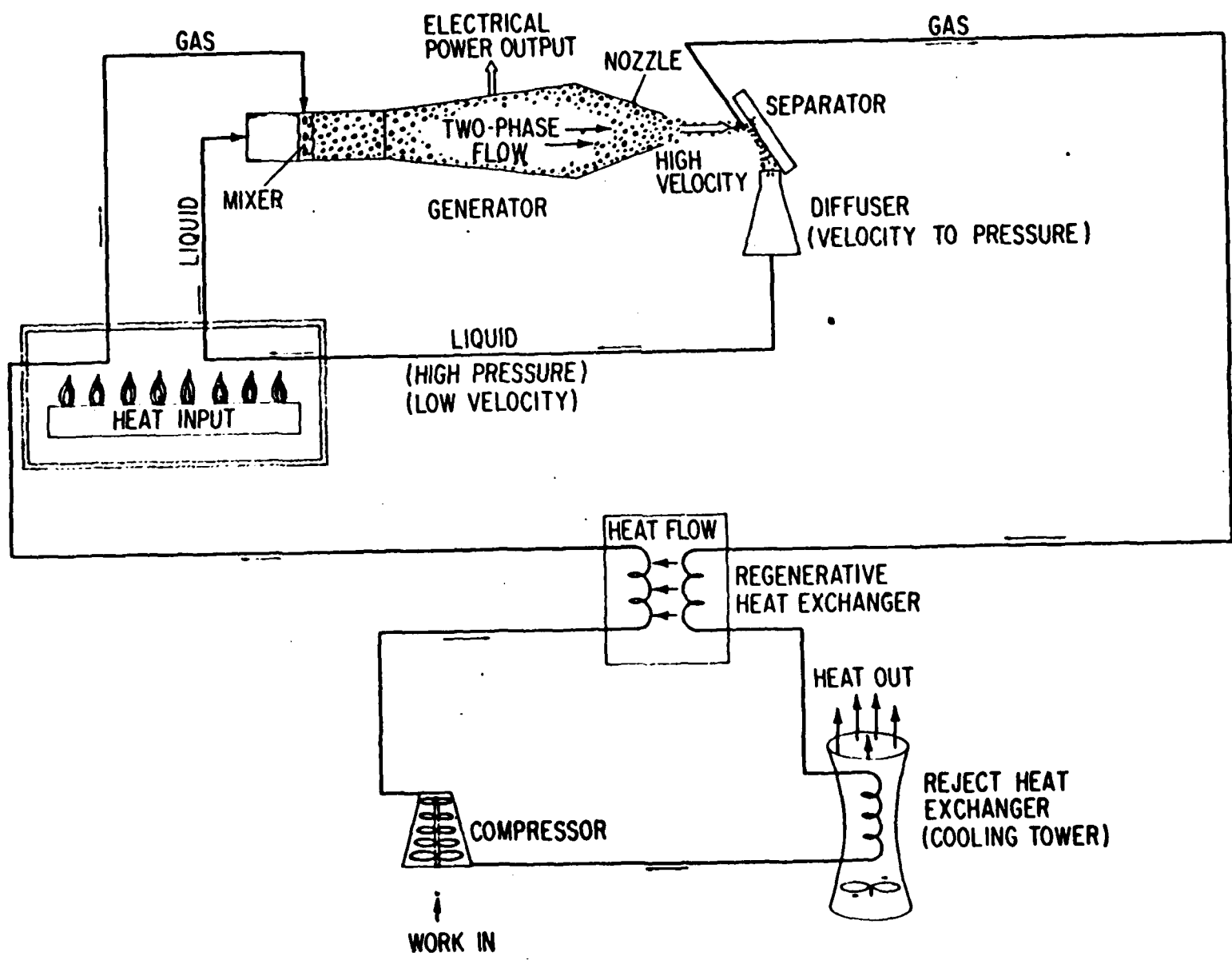

III-7-5

VIEWGRAPH 3

Schematic of LMMHD Rankine System

The Rankine-cycle (vapor cycle) LMMHD concept differs from the Brayton-cycle version only in the use of a condensable fluid, e.g., cesium, as the thermodynamic working fluid with a compatible liquid metal, e.g., lithium. Again the energy in the (superheated) vapor leaving the separator is recovered in a regenerator, a low-pressure turbine, or used for process heat, and heat addition can be solely to the liquid metal, with the vapor being generated from the condensate in a direct-contact mixing boiler. Because of the almost-constant-temperature expansion, LMMHD Rankine-cycle calculated efficiencies are higher than those of conventional steam plants for the same source and sink temperatures.

III-7-7

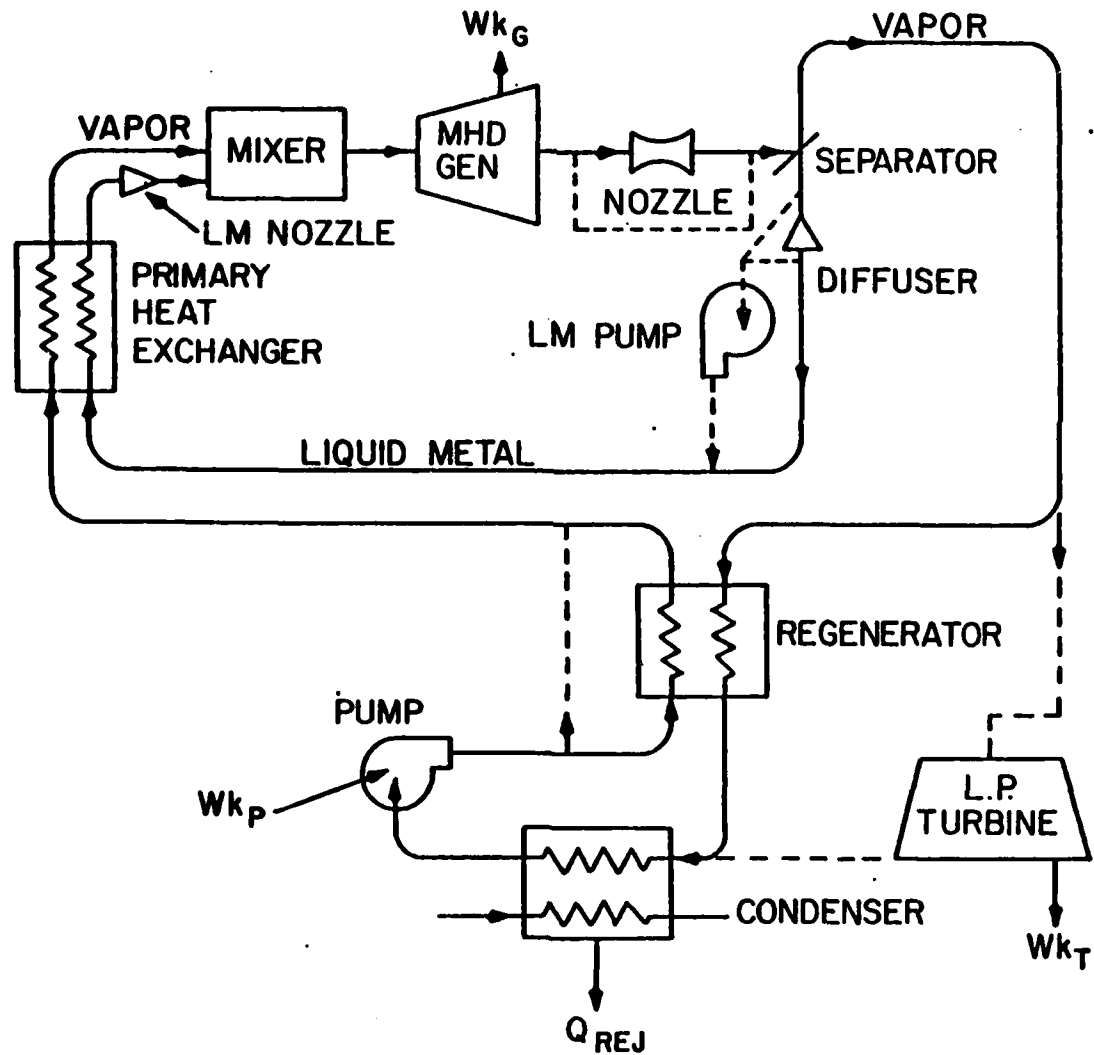

SCHEMATIC OF LMMHD RANKINE CYCLE

FEATURES FOR SPACE POWER SYSTEMS

- HIGH POWER DENSITY
- NO SOLID HIGH-TEMPERATURE MOVING PARTS
- FLUIDS ARE STABLE AT HIGH TEMPERATURES,
E.G., LITHIUM AND CESIUM
- RANKINE-CYCLE FOR BEST EFFICIENCY, LOWEST
WEIGHT AT HIGH HEAT REJECTION TEMPERATURES
- HIGH EFFICIENCY, TYPICALLY $1/2$ TO $2/3$
OF CARNOT EFFICIENCY
- EASILY COUPLED TO MOST HEAT SOURCES
- MATCH DESIRED TEMPERATURE RANGE BY
CHOICE OF FLUIDS
- ENERGY STORAGE IN KINETIC ENERGY OF
FLUID FOR PULSED APPLICATIONS

VIEWGRAPH 4

Features for Space Power Systems

LMMHD has a number of features which make it very attractive for space power systems. The simplicity of the concept, with no solid moving parts required except for the condensed liquid pump at the lowest temperature of the cycle, should result in high power density and high reliability. Although both Brayton and Rankine versions are available, the Rankine version is expected to yield the best efficiency and least weight/volume at the higher heat rejection temperatures required for space. The use of two fluids enables the LMMHD system to be easily and effectively coupled to almost any heat source. Note that heat addition can be to the liquid metal, avoiding the need for a separate boiler or gas/vapor heater. The concept may be well suited to some pulsed power needs because energy can be stored in the kinetic energy of the liquid metal.

STATUS OF LMMHD TECHNOLOGY

- SYSTEM ANALYSIS CAPABILITY EXISTS

- EXPERIMENTAL EXPERIENCE ON UNIQUE LMMHD COMPONENTS --
 - MIXER: AIR-WATER DATA
 - GENERATOR: EFFICIENCIES >0.6 AT HIGH VOID FRACTIONS AND POWER DENSITIES
 - NOZZLE: JPL AND BIPHASE ENERGY SYSTEMS DATA
 - SEPARATOR: BASIC STUDIES, JPL AND BIPHASE ENERGY SYSTEMS DATA
 - DIFFUSER: JPL AND BIPHASE ENERGY SYSTEMS DATA

- MATERIALS GENERALLY AVAILABLE

- LMMHD LOW-TEMPERATURE PROTOTYPE, JOINT ANL-BEN-GURION UNIVERSITY-SOLMECS PROGRAM

VIEWGRAPH 5

Status of LMMHD Technology

ANL has developed extensive energy system analysis and optimization capability. This capability is being applied to LMMHD systems for various terrestrial applications, and the required component models and fluid property routines have been developed.

Experimental and analytical studies of the non-standard components for the LMMHD systems -- gas-liquid mixer, LMMHD generator, nozzle, separator, and diffuser -- have been conducted at ANL and elsewhere since the early 1960s. Examples of recent ANL component development progress are:

1. The measurement of generator efficiencies greater than 0.6 at power densities equal to or greater than anticipated for practical generators, with a small ~20 kWe ambient-temperature generator.
2. The experimental demonstration that the slip ratio (the ratio of gas velocity to liquid velocity) in generators decreases as the electromagnetic interaction, liquid velocity, and temperature increase.
3. The completion of basic studies of mixers and rotating separators, and the development of prototype designs.

Jet Propulsion Laboratory (JPL) and Biphase Energy Systems have extensively studied and tested nozzles, separators, and diffusers. Thus, the technology exists to build and test a system to demonstrate the LMMHD concept.

The materials technology base developed for LMFBRs and CTRs provides a sound basis for LMMHD systems. The extensive JPL experience with high-temperature (up to 1400 K) lithium-cesium systems is especially applicable to LMMHD space systems.

Planning has been underway for approximately a year on a joint program to build a low-temperature LMMHD prototype in Israel. Participants would be Solmeccs Corporation, Ben-Gurion University of the Negev, and ANL. We are waiting for the final go-ahead.

Q & A - E. S. Pierson

From: J. Biess, TRW Systems

For a 10-50 kw liquid metal MHD Space Power System, what would be the operating time or what is the limiting factor? What would be the weight density and efficiency(energy)?

A.

Operating time depends on the needs and the heat (energy) source. There are no inherent time limits other than long-term erosion/corrosion of containment materials.

The power density and efficiency are unknown until studies are done for space, both obviously depend on the heat-source temperature which is undefined.

From: R. English, NASA-Lewis Research Center

Please cite materials data for containing Li-Cs mixtures at high temperature.

Inasmuch as $j \times B$ forces act on the liquid in your MHD generators, please describe how you prevent liquid-gas separation at high void fractions.

A.

Jet Propulsion Laboratory did experiments in late 1960's to ~ 2000° F.

Experimentally gas-liquid separation is not a problem. In fact, the ratio of gas to liquid velocities decreases and approaches unity as the electromagnetic interaction is increased. We suspect that the high electromagnetic pressure gradient breaks up the bubbles. This is a good research area.

From:

What does the separator look like?

What heat source temperature required?

What types of Rankine working fluids have been considered?

Q & A - E. S. Pierson (Cont)

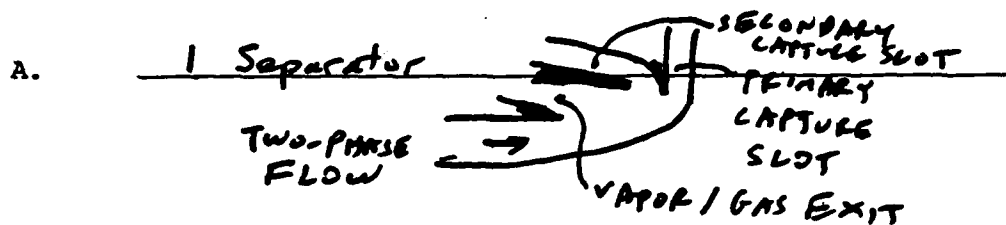

Heat source temperatures of 420-1920 K (300^o-3000^o F) for ground-based systems, probably 1100-1650 K (1500-2500^o F) for space.

NaK - neo-hexane ~ 300^o F, tin-steam ~ 500^o F (53 K),
lithium-cesium ~ 2000^o F (1370 K)

LIQUID-METAL MHD
BIBLIOGRAPHY

- Amend, W. E., Brunsvold, A., Pierson, E. S., "Commercial Liquid-Metal MHD Conversion Systems Coupled to LMFBR and Coal-Fired Fluidized Bed Combustors," 6th International Conference on MHD Electrical Power Generation, Washington, D.C., June 1975.
- Dunn, P. F., "Measurement and Prediction of the Pressure Difference through a Two-Phase Liquid-Metal MHD Generator," International Journal of Heat and Mass Transfer, 23, pp. 1686-1690, 1980.
- Dunn, P. F., Pierson, E. S., Staffon, J. D., Pollack, I., & Dauzvardis, P. V., "High-Temperature Liquid-Metal MHD Generator Experiments," Proceedings of the 18th Symposium on Engrg. Aspects of MHD, pp. D-2.2.7-D-2.2.12, Butte, Montana, 1979.
- Fabris, G., Dunn, P. F., Gawor, J., and Pierson, E. S., "Local Measurements in Two-Phase Liquid-Metal MHD," in MHD-Flows and Turbulence II, Proceedings of the Second Bat-Sheva Seminar, Beer-Sheva, Israel, 1978, pp. 157-171.
- Fabris, G., Pierson, E. S., Pollak, I., Dauzvardis, P. V., and Ellis, W., "High-Power-Density Liquid-Metal MHD Generator Results," Proceedings of the 18th Symposium on Engineering Aspects of MHD, pp. D-2.2.1-D.2.2.6, Butte, Montana, 1979.
- Pierson, E.S., "New Liquid-Metal MHD Concepts for Solar and Coal," Proceedings of the American Power Conference, 42, Chicago, April 1980, pp. 379-385.
- Pierson, E. S., Branover, H., Fabris, G., and Reed, C. B., "Solar Powered Liquid-Metal MHD Power Systems," ASME Paper 79-WA/Sol-22 presented at the 1979 American Society of Mechanical Engineers Winter Annual Meeting, New York, Dec. 1979, or Mechanical Engineering, 102, No. 10, pp. 32-37, 1980.
- Pierson, E. S., Cohen, D., and Grammel, S. J., "Liquid-Metal MHD for Solar and Coal," Proceedings of the 7th International Conference on MHD Electrical Power Generation, Boston, Mass., June 1980.
- Pierson, E. S., Grammel, S. J., Cohen, D., and Frisardi, T., "Liquid-Metal MHD for Solar and Coal: System and Component Status," Proceedings of the 15th Intersociety Energy Conversion Engineering Conference, Seattle, Washington, August 1980, pp. 505-510.
- Pierson, E. S., and Herman, H., "Solar-Powered Liquid-Metal MHD Performance and Cost Studies," Third Beer-Sheva Seminar on MHD-Flows and Turbulence, Beer-Sheva, Israel, 1981.
- Pierson, E. S., Herman, H., and Petrick, M., "Conceptual Design of a Coal-Fired Retrofit Liquid-Metal MHD Power System." Third Beer-Sheva Seminar on MHD-Flows and Turbulence, Beer-Sheva, Israel, 1981.
- Pierson, E. S., Herman, H., Petrick, M., Grammel, S. J., and Dubey, G., "Retrofit of Coal-Fired Open-Cycle Liquid-Metal MHD to Steam Power Plants" Proceedings of the 16th Intersociety Energy Conversion Engineering Conference, Atlanta, Georgia, August 1981, pp. 1525-1530.

SOLAR MHD SYSTEM WITH TWO PHASE FLOW
WITH "MAGNETIC" LIQUID METAL

Amit Goswami,* Ronald D. Graves and Carl Spight
AMAF Industries, Inc.
Columbia, MD

Abstract

Solar power is one of the major resources available to space systems. Whereas the technology of solar cells and its limitations are well known, there is another technique, solar LMMHD, pioneered by H. Branover and, E. Pierson which shows promise as a relatively high efficiency, inexpensive and compact prime power device usable in space. The solar LMMHD system employs a liquid metal to extract heat from a mirror-solar collector system. A second organic volatile liquid is then allowed to come in contact with the hot metal and evaporate. The two phase fluid system then moves along a pipe, the gas imparting part of its flow momentum to the liquid metal. The moving liquid metal passes through a magnetic field perpendicular to the flow direction; thereby an induced current is generated with is collected by the usual electrode ensemble.

The method has obvious merits compared to, say, a Rankine cycle system (in terms of attainable efficiency) or solar cells (in terms of cost), but so far the actual efficiency achieved has been low. This is attributable to the inhomogeneity of the two phase flow.¹ The gas passes through the liquid metal mainly in the form of bubbles without sharing much of its forward momentum. We suggest that an order of magnitude improvement is possible on Branover's system if one combines the magnetic fluid concept² with the two phase flow idea. The term magnetic fluid refers to a suspension of small single-domain ferromagnetic particles in a carrier liquid. A suitable magnetic fluid in the present context is a suspension of iron particles in mercury. We theorize that the use of magnetic fluid liquid metal instead of a regular liquid metal for the two phase flow will inhibit void formation when a magnetic field is employed to align the magnetic particles in the direction of the flow. The primary reason for this is the additional magnetic stress in the medium which tends to inhibit the formation of any nonuniformity such as a bubble or a void in the unperturbed medium. Preliminary calculations bear this idea out.

Our contention is that if the two phase flow consisting of the organic vapor and an aligned magnetic fluid is free of appreciable void fractions, then the momentum of the vapor will be uniformly dispersed to the liquid metal, thus producing much greater velocity for the metal flow. Also the electrical conductivity improves as does the stability of the two phase flow against choking. These factors correspondingly produce greater induced electromagnetic power.

There are some experimental studies in connection with fluidized beds that bear out some of our ideas.⁴ Calculations are now underway to concretize these ideas toward the eventual building of a scale model.

*On sabbatical leave from the University of Oregon

Viewgraph 1. Branover's two-phase liquid metal solar MHD generator. We propose to use a "magnetic liquid", such as single domain iron in mercury with the iron particles aligned with the help of a longitudinal magnetic field, instead of an ordinary liquid metal.

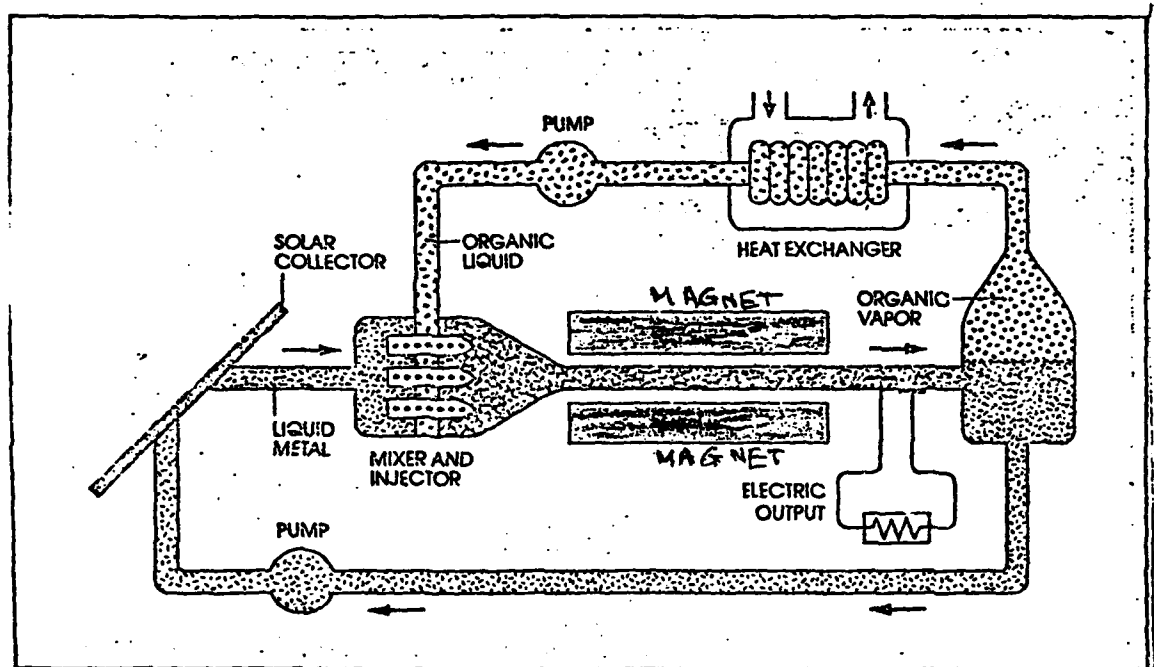

Liquid metal is heated in the solar collector and flows into the mixer-injector, where droplets of an organic fluid are injected. The droplets vaporize and provide the kinetic energy to accelerate the liquid metal. A direct current is generated when the liquid metal moves through the magnetic field.

View Graph 2. The Bernoulli equations for a single bubble.

Ordinary fluid:

$$1/2 \rho |\nabla \phi|^2 + p_b - p_0 = \sigma k$$

Magnetic fluid:

$$1/2 \rho |\nabla \phi|^2 + p_b - p_0 = \sigma k + \frac{(\mu - 1) H^2}{8\pi}$$

Here ϕ is the velocity - potential, σ is the surface tension, k is the curvature of the bubble, H is the magnetic field and μ is the permeability of the "magnetic liquid." Clearly, the effect of the second term on the right side in the second equation is to reduce the bubble size.

Viewgraph 3. The variation of the kinetic energy imparted to the liquid by the bubble is shown as a function of the bubble's shape parameter γ ($\gamma = 2(P_0 - P_0) / (\rho G)^{2/3} f^{1/3}$, G is the shear rate) for a gas bubble in an ordinary fluid, see ref. 3. The bubbles break up when γ reaches the low value for which the imparted kinetic energy tends to be maximum. Since the effect of magnetization is to break up the bubbles to smaller sizes, we conclude that this should improve upon the K.E. imparted to the liquid metal.

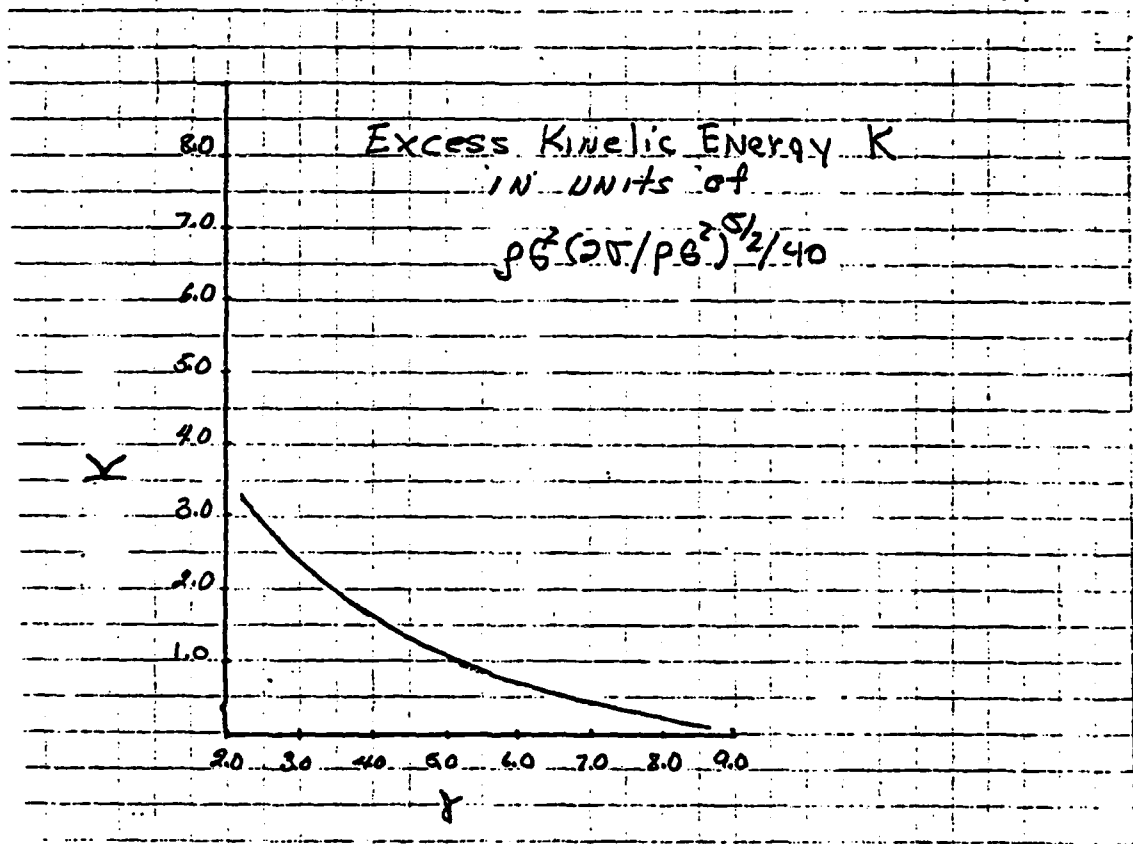

Viewgraph 4. Fluidized bed data of ref. 4 shows that magnetization of the bed improves its fluidization as a gas passes through it, making the two phase flow homogenized and stable. The graph shows the scaling of the transition superficial velocity U_T of the flow with the magnetic field, while the minimum fluidization velocity U_M is independent of the applied field, see ref. 4. In our case, the velocities are scaled up to about 1 m/sec and the applied field required is of the order of a tesla, quite tractable.

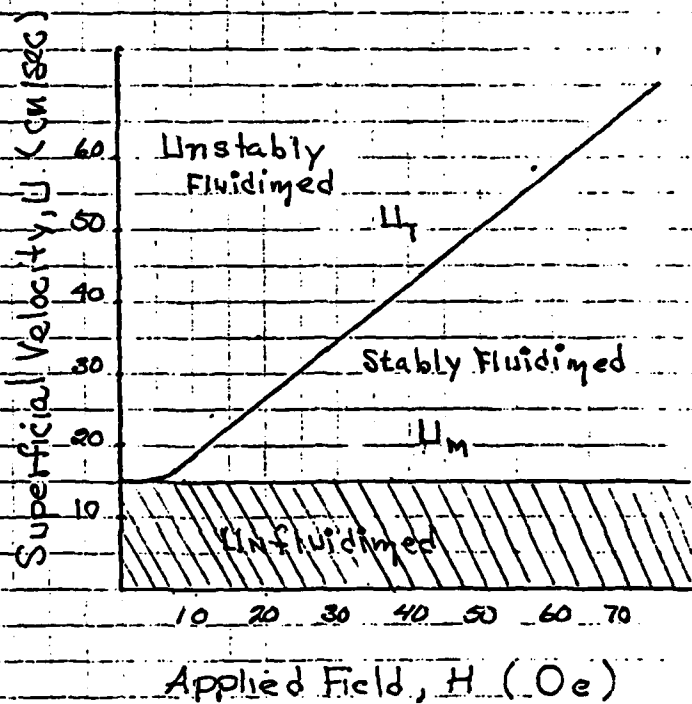

Viewgraph 5. Branover and Yakhot (ref. 5) have derived the following flow equation for their 2 - Phase LMMHD Model:

$$\left(1 - \frac{u^2 \alpha^2 \beta_1^2 \rho_0}{x \rho}\right) = \frac{\rho u^2 (1 - \beta_1 \alpha)}{\beta_2 (1 - x)} \left(-\frac{\lambda}{2D} + \frac{\beta_2}{\alpha} \frac{d\alpha}{dx}\right) - \alpha u B^2 (\beta_2 - k(x))$$

Here u is the velocity of the two phase flow, x is the mixture quality, $k(x)$ is the load factor and α is the void fraction. The rest of the notation is standard. If the void fraction α is reduced as is expected from the employment of a magnetic fluid, the left hand side of the above equation would be much less apt to be ≤ 0 , thus eliminating the condition that leads to instabilities and choking.

Q & A - A. Goswami

From: E. S. Pierson, Argonne National Laboratory

1. The basic ideas and technology for liquid-metal MHD were developed at ANL, not by Herman Brancours.

2. Instabilities in the MHD generator have not been a problem in ANL experiments.

A.

Yes. I'm most fortunate to hear about your work and am looking forward to talking with you at length.

From: Roy Rice, Naval Research Laboratory

In your magnetic fluid are reactions and Curie temperatures a limitation. If so, will the use of ferrites be of significant help.

A.

For solar MHD, consideration of Curie temperature is not important. But for high temperature, we may have to consider ferrites. Thanks.

BIBLIOGRAPHY

1. H. Branover, A.J. Mestel, D.J. Moore, and J.A. Shercliff, J. Fluid Mech., 112, 407, 1981. E. Pierson, See Proc. of this conference.
2. S.W. Charles and J. Popplewell, IEEE Trans. on Magnetics, Mag 16, 172, 1980.
3. M.J. Miksis, Phys. Fluids 24, 1229, 1981.
4. R.E. Rosenweig, Science, 204, 57, 1979.
5. A. Yokhot and H. Branover, 19th Symposium Engineering Aspects of MHD, UTSI, June 1981, p. 7.6.1.

**MAGNETOHYDRODYNAMIC POWER SUPPLY SYSTEMS
FOR SPACE APPLICATIONS**

DANIEL W. SWALLOM

**AVCO EVERETT RESEARCH LABORATORY, INC.
EVERETT, MASSACHUSETTS 02149**

6-III

MHD POWER GENERATION FOR SPACE APPLICATIONS

- HISTORICAL DEVELOPMENT
- STATUS OF DEVELOPMENT
- TECHNICAL MILESTONES
- SPACE POWER SYSTEM REQUIREMENTS
- HIGH POWER MHD SYSTEM DEVELOPMENT
- SUMMARY

I-6-III

K3939

MILITARY DEVELOPMENT OF MHD POWER SYSTEMS

AIR FORCE

- 1971 400 kW_e HIGH POWER DENSITY PROGRAM
- 1974 1.5 MW_e VIKING I PROGRAM
- 1974 EXPLOSIVE MHD STUDY
- 1974 10 MW_e VIKING II STUDY
- 1975 10 - 50 MW_e HIGH POWER STUDY
- 1976 2.5 MW_e SOLID FUEL PROGRAM
- 1977 200 kW_e LIGHTWEIGHT MHD CHANNEL
- 1978 30 MW_e HPMS PROGRAM

NASA

- 1970-71 COMBINED CYCLE NON-EQUILIBRIUM STUDIES
- 1970'S H₂ - O₂ EXPERIMENTS

NAVY

- 1970'S SHOCK TUBE EXPERIMENTS
- 1980'S HYBRID MHD SYSTEM

III-9-2

The development of MHD for various military applications was initiated in the early 1960's and has continued to date. The early activities, such as LORHO and Project Brilliant were directed toward specific requirements. This approach continued through the 1970's as more and more technical efforts were directed toward high performance, lightweight applications requiring airborne or space deployment. These efforts, which included conceptual designs as well as hardware fabrication and experimental programs increased the important performance parameters significantly.

STATUS OF MHD POWER SYSTEM DEVELOPMENT

HEAT SOURCE

- LIQUID FUEL 98.8% C* EFFICIENCY DEMONSTRATED
- SOLID FUEL 2.5 MW_e SYSTEM OPERATED
- NUCLEAR REACTOR NERVA REACTOR SYSTEM STUDIES
ROTATING BED REACTOR CONCEPTUAL DESIGN

SUPERCONDUCTING LIGHTWEIGHT MAGNET

- BRILLIANT PROGRAM 3.9 TESLA FOR 1 MW_e SYSTEM
- 2 MW_e PROTOTYPE 4.5 TESLA (DESIGN)

III-9-4

K3940

The status of each of the major components plays a significant role in the overall system development. For the heat source both liquid and solid fuel combustion devices have been successfully demonstrated during various development programs. Nuclear reactor heat sources of the NERVA type have been developed and advanced concepts such as the rotating bed reactor are being pursued. Superconducting magnet systems have been fabricated for relatively small systems of less than 1 MW_e , and conceptual design studies have been completed for MHD systems as large as $50\text{-}100 \text{ MW}_e$.

STATUS OF MHD POWER SYSTEM DEVELOPMENT

CHANNEL/DIFFUSER

- VIKING HIGH PERFORMANCE PROGRAM
 - 1.5 MW_e POWER OUTPUT ~ 60 MW_e/m³
 - 50 THERMAL CYCLES ~ 5 A/cm²
- LIGHTWEIGHT CHANNEL DEMONSTRATION (~ 40 kg DRY)
 - 200 kW_e POWER OUTPUT 30 MW_e/m³
 - 250 THERMAL CYCLES 2 - 4 A/cm²
- HPMS LIGHTWEIGHT HIGH POWER CHANNEL DESIGN (600 kg DRY)
 - 30 MW_e POWER OUTPUT 200 MW_e/m³
 - 1000 THERMAL CYCLES 6 - 8 A/cm²
- HPMS LIGHTWEIGHT DIAGNOSTICS CHANNEL TEST (63 kg DRY)
 - 30 kg/SEC FLOW RATE 100 g DYNAMIC LOAD
 - 500(DESIGN), 15(TEST) THERMAL CYCLES 600 W/cm² HEAT LOAD

9-6-III

Several development programs have been completed which have substantially increased the MHD channel performance and decreased the MHD channel mass. These results have increased the power density by a factor of three. Electrical power levels investigated in these programs have ranged from a few hundred kilowatts to tens of megawatts.

TECHNICAL MILESTONES FOR SPACE APPLICATIONS OF MHD

8-6-III

- **HEAT SOURCE** **CLOSED CYCLE - HIGH TEMPERATURE HEAT EXCHANGER**
OPEN CYCLE - NONE
- **CHANNEL** **EQUILIBRIUM - LIFETIME AT HIGH CURRENT DENSITY**
NON-EQUILIBRIUM - SUSTAINED NON-EQUILIBRIUM OPERATION
- **MAGNET** **LIGHTWEIGHT SUPERCONDUCTING MAGNET DEMONSTRATION AT**
10 - 30 MW_e SIZE
- **POWER CONDITIONING** **DEMONSTRATION CONNECTING POWER SOURCE WITH LOAD**
- **SYSTEM** **SATISFY SYSTEM MASS, VOLUME, AND INTERFACE**
REQUIREMENTS

K3941

Technical milestones for space applications of MHD are primarily in the channel, magnet and systems portion of the power system. The MHD channel lifetime at high current density must be demonstrated for currents and lifetimes required. The channel design and construction techniques required have been demonstrated in several development programs. The superconducting magnet development requires a lightweight superconducting magnet demonstration for a 10-30 MW_e system. The total system must be developed and packaged to satisfy mass, volume, and interface requirements.

REQUIREMENTS FOR MHD SPACE POWER SYSTEMS

- MASS AND VOLUME REQUIREMENTS
- RELIABILITY, MAINTAINABILITY, RECHARGABILITY
- ADAPTABILITY, DEPLOYABILITY, SPACEABILITY
- HEAT REJECTION SYSTEMS
- THRUST (OPEN CYCLE ONLY)
- EXHAUST PRODUCTS (OPEN CYCLE ONLY)
- MAGNETIC AND ELECTRIC FIELD EFFECTS

III-9-10

K3942

AVCO EVERETT

The primary requirements for MHD space power systems are mass and volume restrictions, reliability and maintainability considerations, heat rejection capacity, and control of thrust and exhaust products. Mass and volume requirements are established by the mission requirements. The control of thrust and exhaust products is required only for the open cycle system. However, the thrust generated is of the same order of magnitude as that generated for comparable sized chemical lasers, and consequently, can be readily neutralized.

HIGH POWER STUDY MHD SYSTEM MASSES AND VOLUMES (SHIELDED DESIGNS FOR LIQUID FUEL SYSTEMS)

POWER	MW	10	25	25	50	50
VOLTAGE	KV	60	60	60	200	200
TOTAL TIME	SEC	63	64	120	75	120
CYCLES	#	3	16	1	3	10
COMBUSTOR, NOZZLE, FUEL	kg (m ³)	900 (0.77)	2100 (2.0)	3690 (3.5)	4700 (4.5)	7250 (6.9)
CHANNEL & DIFFUSER	kg (m ³)	60 (0.11)	115 (0.27)	115 (0.27)	180 (0.53)	180 (0.53)
MAGNET	kg (m ³)	1020 (1.6)	1590 (2.6)	1590 (2.6)	2320 (4.1)	2320 (4.1)
DC-DC CONVERTER	kg (m ³)	250 (0.58)	510 (1.15)	510 (1.15)	1750 (4.3)	1750 (4.3)
CONVERTER COOLANT SYSTEM	kg (m ³)	50 (0.11)	85 (0.19)	110 (0.19)	130 (0.29)	170 (0.29)
OVERALL COOLANT SYSTEM	kg (m ³)	430 (0.47)	540 (0.59)	750 (0.80)	720 (0.78)	900 (0.95)
TOTAL SYSTEM	kg (m ³)	2710 (3.64)	4940 (6.80)	6765 (8.51)	9800 (14.50)	12,570 (17.07)

III-9-12

K3935

 AVCO EVERETT

Data are presented from the High Power Study sponsored by the USAF Aero Propulsion Laboratory for liquid fuel systems for airborne applications. These masses and volumes for the systems shown are complete systems including all power conditioning, controls, and auxiliary equipment. The data show that for a lightweight power supply system operating at 200 kV for 120 sec and producing 50 MW_e the total system mass and volume are ≈12,000 kg and ≈17 m³, respectively.

HIGH POWER STUDY MHD SYSTEM MASSES AND VOLUMES (SHIELDED DESIGNS FOR SOLID FUEL SYSTEMS)

POWER	MW	10	25	25	50	50
VOLTAGE	KV	60	60	60	200	200
TOTAL TIME	SEC	63	64	120	75	120
CYCLES	#	3	16	1	3	10
COMBUSTOR, NOZZLE, FUEL	kg (m ³)	700 (0.5)	1870 (1.3)	3310 (2.3)	4170 (2.9)	6740 (4.7)
CHANNEL & DIFFUSER	kg (m ³)	60 (0.11)	115 (0.27)	115 (0.27)	180 (0.53)	180 (0.53)
MAGNET	kg (m ³)	1020 (1.6)	1590 (2.6)	1590 (2.6)	2320 (4.1)	2320 (4.1)
DC-DC CONVERTER	kg (m ³)	250 (0.58)	510 (1.15)	510 (1.15)	1750 (4.3)	1750 (4.3)
CONVERTER COOLANT SYSTEM	kg (m ³)	50 (0.11)	85 (0.19)	110 (0.19)	130 (0.29)	170 (0.29)
OVERALL COOLANT SYSTEM	kg (m ³)	430 (0.47)	540 (0.59)	750 (0.80)	720 (0.78)	900 (0.95)
TOTAL SYSTEM	kg (m ³)	2510 (3.37)	4710 (6.1)	6385 (7.31)	9270 (12.9)	12,060 (14.87)

III-9-14

K3936

 AVCO EVERETT

Data are presented from the High Power Study sponsored by the USAF Aero Propulsion Laboratory for solid fuel systems for airborne applications. These masses and volumes for the systems shown are complete systems including all power conditioning, controls, and auxiliary equipment. The data show that for a lightweight power supply system operating at 200 kV for 120 sec and producing 50 MWe the total system mass and volume are $\approx 12,000$ kg and ≈ 15 m³, respectively.

MHD SYSTEM PERFORMANCE PARAMETERS

	HPS STUDY	MID TERM	FAR TERM
ENTHALPY EXTRACTION	MJ/kg	1000 kJ/kg	1800 kJ/kg
TOTAL SPECIFIC POWER (DRY)	kw/kg	9	11
TOTAL SPECIFIC VOLUME	kw/m ³	3000	4000
RUN DURATION	sec	120	1000
PULSE CAPABILITY	-	YES	YES

K3943

11-9-16

The MHD system performance parameters are shown for the current systems developed during the High Power Study as well as for the mid and far term systems. The data given are for complete systems which include all power conditioning, controls, and auxiliary equipment. The performance levels represent total system performance including all system losses and inefficiencies. The system shown generates 25 MW_e at 60 kV and provides for run durations of 120 sec. All systems investigated were capable of pulse or steady-state operation.

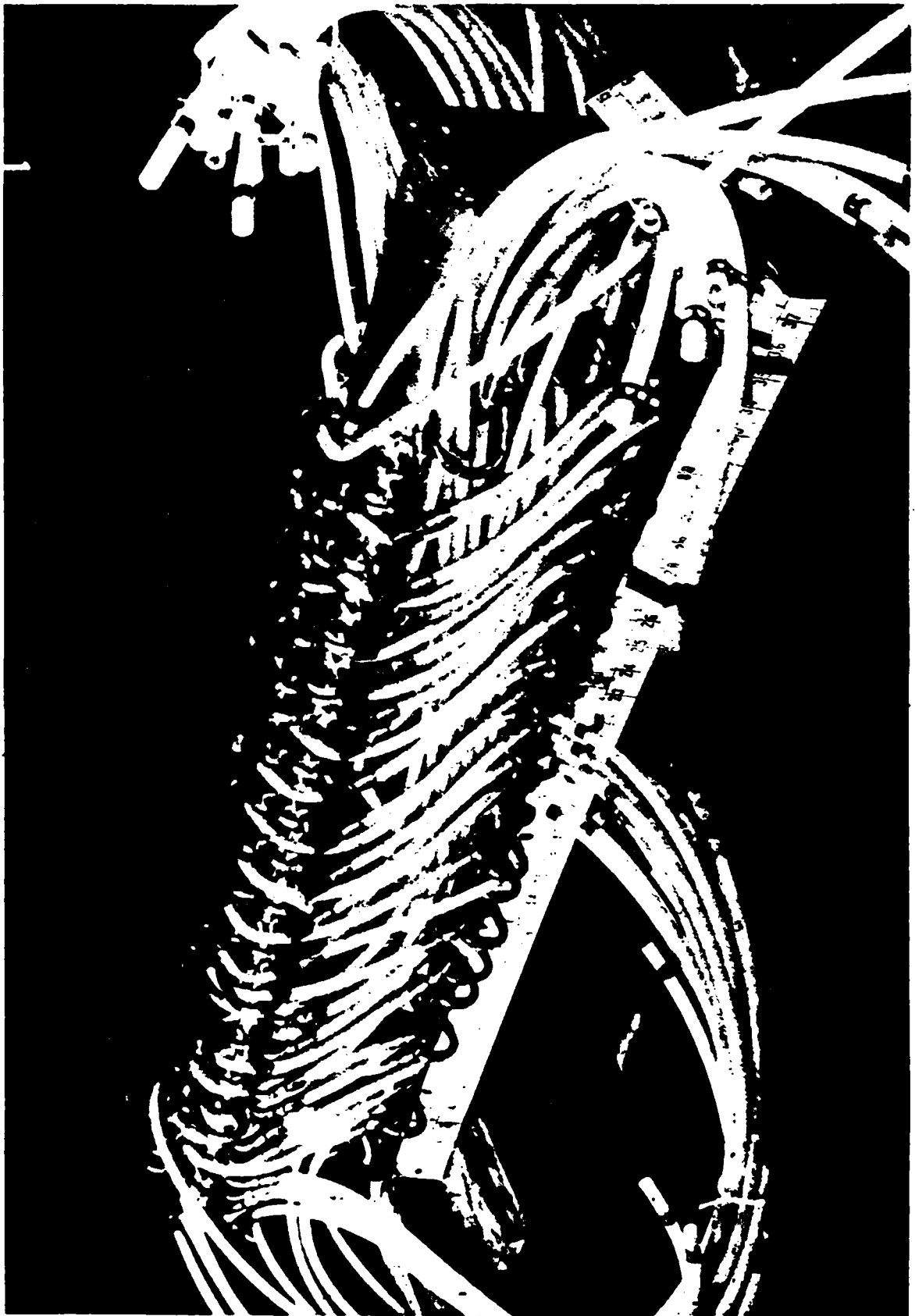

III-9-18

The MHD channel shown in the photograph is the 200 kW_e lightweight channel fabricated using a filament wound epoxy coated fiberglass outer shell. This 40 kg channel successfully completed a 250 thermal cycle test program, which included duration tests of up to 60 sec as well as pulse tests. At the conclusion of the test program the channel was in good condition and producing the design level.

HIGH POWER MHD SYSTEM EXPERIMENTAL CONDITIONS

REACTANTS	JP-4 & LO ₂
SEED	Cs ₂ CO ₃
EMULSIFIER	SPAN-80
MASS FLOW	30 kg/SEC
STAGNATION PRESSURE	30 atm
STAGNATION TEMPERATURE	3420 K
INLET CONDUCTIVITY	15 mho/m
<hr/>	
CHANNEL DESIGN ELECTRIC POWER	30 MW _e
PEAK DESIGN MAGNETIC FIELD	4 TESLA

III-9-20

K3932

 AVCO EVERETT

The experimental conditions for the High Power MHD System development program sponsored by the USAF Aero Propulsion Laboratory are shown. The experimental conditions were obtained during the test program. The performance parameters for the detailed design of the channel and magnet are also shown. The measured conductivity is sufficient to achieve the design power.

APR 1952

MILWAUKEE

APR 1952

APR 1952

APR 1952

APR 1952

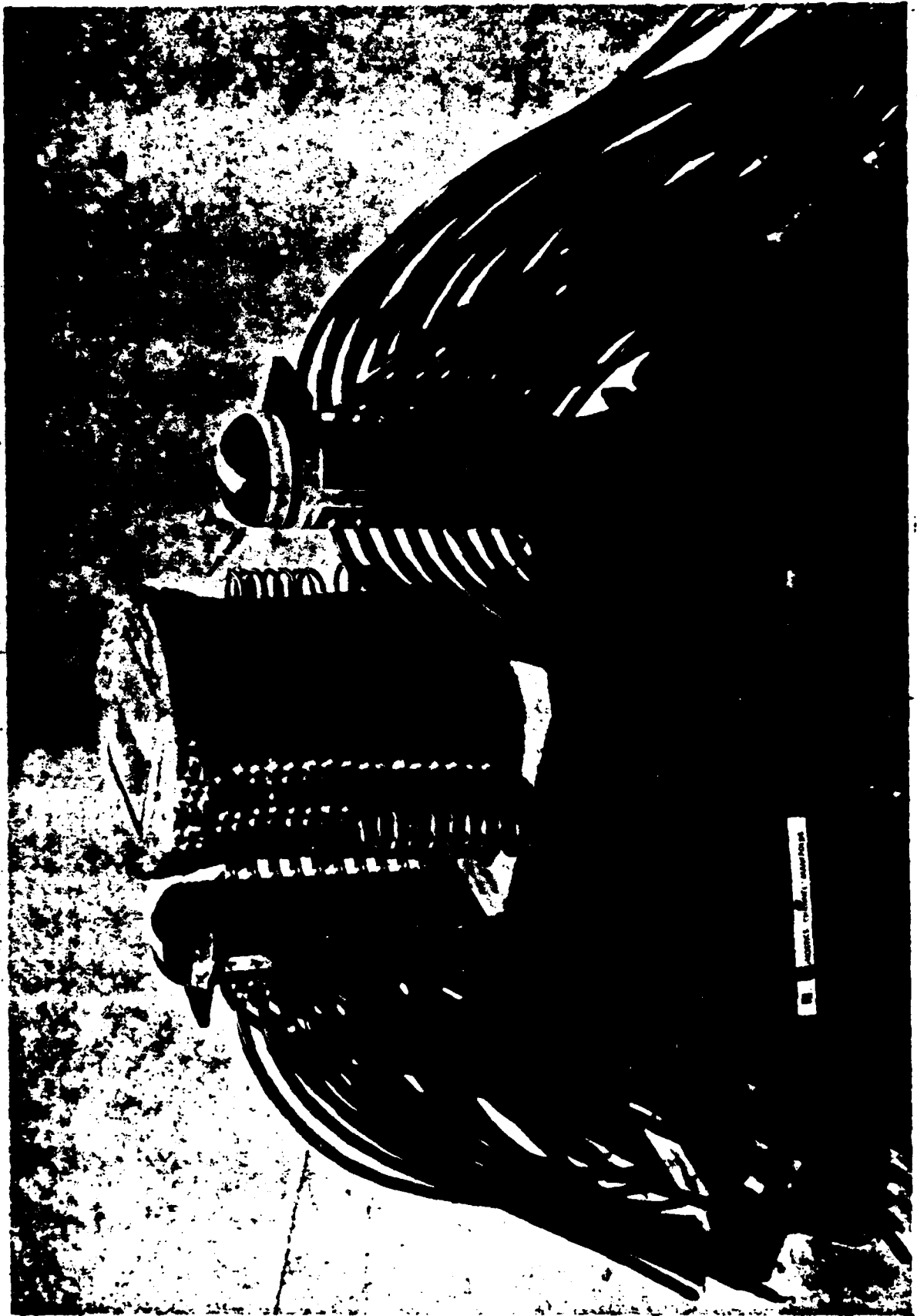

III-9-22

The diagnostics channel shown in the photograph was designed and tested to measure the electrical conductivity in the High Power MHD System program. This 63 kg channel was designed for a flow rate of 30 kg/sec. The channel was constructed using the novel lightweight channel fabrication techniques which utilize a filament wound, epoxy coated fiberglass shell as the principal structural member. The channel was successfully operated during a combustor development test program.

HIGH POWER MHD SYSTEM PERFORMANCE SUMMARY

<u>COMBUSTOR</u>	<u>GOAL</u>	<u>DEMONSTRATED</u>	<u>COMMENTS</u>
● OPERATING CONDITIONS	30.4 kg/sec	YES	-
	30 atm	YES	-
● C [*] EFFICIENCY	99.3%	98.8%	SATISFACTORY CONDUCTIVITY
● STABILITY	STABLE	NO SPONTANEOUS INSTABILITY	DYNAMIC STABILITY NOT DEMONSTRATED
● OPERATION: START TIME SHUTDOWN	1.0 SEC	1.3 SEC	CAN BE REDUCED
	AVOID RAW FUEL, CARBON OR SEED	YES	-
INJECTOR	-	-	PERFORMED WELL
IGNITION	RELIABLE	YES	-
● IONIZATION	-	-	67 cm SUFFICIENT LENGTH
<u>DIAGNOSTICS CHANNEL</u>			
● CONDUCTIVITY	16 mho/m	15 mho/m	ADEQUATE, BUT GOOD POTENTIAL FOR IMPROVEMENT
● DYNAMIC LOAD	4 g	22 g	FRAME & SHELL INTEGRITY UP TO 25 g
● STRUCTURAL PERFORMANCE	-	-	INTEGRITY MAINTAINED

III-9-24

K5334

 AVCO EVERETT

The 30 MW_e liquid fuel generator system is shown in the drawing. The system dimensions are approximately 1.25 m in diameter and 3 m in length. The dry system mass is approximately 5000 kg. The superconducting magnet is approximately two meters in length with a peak field of 4.5 Tesla. The combustor shown is a LO₂/JP-4 system using CS₂CO₃ seed material. The power conditioning and reactant storage tanks are not shown.

SUMMARY AND CONCLUSIONS

- HIGH ENTHALPY EXTRACTION
- FLEXIBILITY FOR VARIOUS OPERATING CONDITIONS
- INSTANT ON/INSTANT OFF CAPABILITY
- PULSE OPERATION
- HIGH EFFICIENCY/LOW MASS & VOLUME

KII-9-28

K3933

The MHD power supply system can provide tens of megawatts of electrical power for space applications. The system has substantially operating flexibility for various operating times, pulse lengths and pulse rates, and power levels. The instant on/instant off capability provides the necessary response to command signals. The overall power system is a high efficiency, low mass and volume device which is attractive for space applications.

Magnetohydrodynamic Power Supply Systems
for Space Applications

Daniel W. Swallow
Avco Everett Research Laboratory
Everett, Massachusetts

The electrical power requirements for future space based weapons systems of the 1990's may require power levels of 1-100MW_e. Generally, these power requirements will be for pulsed power systems, which will often result in a very specific energy conversion and power conditioning system for each application. In addition, other components of the power system such as heat rejection, system controls, and spacecraft environment will be unique to this application.

A high power magnetohydrodynamic (MHD) system is capable of providing high performance, short duration electrical power for the type of applications required by space based weapons systems. The USAF High Power System Programs for the development of portable MHD power supplies have shown that the generator system scales favorably as the generator size increases. Consequently, the MHD generator system becomes more attractive as the required electrical power increases. For MHD systems capable of tens of seconds of pulse lengths, power to mass ratios can be obtained which would allow for multi-megawatt power supplies to be deployed for space applications.

For space applications the power system must meet the requirements associated with satellite vehicles. These requirements include not only mass and volume constraints, but also reliability, maintainability, adaptability, and deployability. With respect to the combustor and channel mass and volume requirements, the USAF development programs have demonstrated lightweight, high performance power system components. Airborne studies have also been completed which have defined the magnet and power conditioning components as well as addressing the overall systems packaging.

The development of MHD technology for space applications will permit the deployment of power systems capable of producing tens of megawatts for pulse lengths of up to hundreds of seconds with tens of pulses per mission. This capability can provide the necessary power for space-based weapons systems envisioned for deployment in the mid 1990's.

Q & A - D. Swallow

From: Roy Pettis

(1) What effects will the effluent from the generator exhaust have on the other parts of the spacecraft, especially sensitive optical components?

(2) Will the high velocity of high-interaction MHD systems lessen the danger of such effluents depositing on the spacecraft?

(3) Is research on these questions underway?

(4) Where?

(5) Is the problem less for "cleaner fuels", H_2 , rather than those filled with particulates?

A.

(1) The effects of the MHD generator exhaust on the sensitive optical components would be similar to a rocket combustor exhaust or chemical laser exhaust.

(2) Probably, but the problem has not been investigated in detail.

(3) No

(4) N/A

(5) The question of fuel deposition may be somewhat dependent on the fuel selected. However, the products of stoichiometric combustion for H_2 systems (H_2O) and hydrocarbon systems (H_2O & CO_2) are gaseous species. Consequently, the stoichiometry (fuel rich condition to maximize the electrical conductivity $\sim 10^9$) will probably be a larger influence on the generation of particulates.

From: P. J. Turchi, R & D Associates

What are the basic research issues that could allow improvements in the system extrapolations you have made?

A.

The basic research issues which could allow for improvements on the system extrapolations are directly related to

Q & A - D. Swallow (Cont)

the technical milestones. These issues can be summarized on a component basis.

Combustor - Basic research directed toward the combustion phenomena of systems using high energy liquid fuels which contain metallic particles for higher performance. In addition research work in the area of emulsions which permit the Cs_2CO_3 seed material to be mixed with the fuel before injection into the combustor.

Channel - Materials development program to insure that the electrode materials available can operate with current densities up to 10 A/cm^2 for operating times of 1000's of seconds. In conjunction with the materials development program, electrode configuration research should be closely coupled to the materials research program to insure that a viable, high temperature MHD electrode emerges as the product of this research.

Magnet - Lightweight, high strength composite material development research is needed to develop the materials necessary for the construction of lightweight, high field superconducting magnets. In addition, development research should be performed to investigate the potential ways of using these composites to provide the highest strength, lightest weight magnet structure.

Power Conditioning - The key research issue for power conditioning is the high current solid state switch technology required for the intermediate dc to ac conversion required for the dc-dc converter.

Systems - Basic research in the area of electric charge and/or effluence build up on the spacecraft surface as a result of the hot, ionized exhaust products from the MHD system.

Bibliography

1. O.K. Sonju and J. Teno, "Study of High Power, High Performance Portable MHD Generator Power Supply Systems," AFAPL-TR-76-87, AD #AO40381, August 1976.
2. O.K. Sonju, J. Teno, R. Kessler, L. Lantai, and D.E. Meader, "Status Report on the Design Study Analysis and the Design of a 10 MW Compact MHD Generator System," AFAPL-TR-74,-47 Part II, June 1974.
3. D.W. Swallow, O.K. Sonju, D.E. Meader, and G.T. Heskey, "MHD Lightweight Channel Development," AFAPL-TR-78-41, June 1978.
4. D.W. Swallow, O.K. Sonju, D.E. Meader, and H. Eecker, "High Power Magnetohydrodynamic System," AFAPL-TR-78-51, July 1978.
5. O.K. Sonju, J. Teno, J.W. Lothrop, and S.W. Petty, "Experimental Research on a 400 KW High Power Density MHD Generator," AFAPL-TR-71-5, May 1971.
6. O.K. Sonju, D.W. Swallow, D.E. Meader, H. Becker, R.V. Burry, A.W. Huebner, and R.F. Cooper, "Development of a Compact, Lightweight High Performance 30 MW MHD Generator System," Proceedings of the 17th Symposium on Engineering Aspects of Magnetohydrodynamics, Stanford University, March 1978.
7. R.E. Eckels, J.F. Holt, and D.W. Swallow, "High Energy Fuel Techniques for Combustion Driven MHD Generators," AIAA Terrestrial Energy Systems Conference, No. 79-1004, June 1979.
8. R.V. Burry, A.W. Huebner, D.W. Swallow, O.K. Sonju, and R.F. Cooper, "Liquid Reactant Magnetohydrodynamic Gas Generator," Proceedings of the 15th JANNAF Combustion Meeting, Publication 297, August 1979.
9. D.W. Swallow, O.K. Sonju, R.V. Burry, and R.F. Cooper, "High Power MHD System Combustor Development Testing," Journal of Energy, Vol. 4, No. 3, pp. 100-105, May-June 1980.
10. O.K. Sonju and D.W. Swallow, "Advanced High Power, Lightweight MHD Generator Systems for Aerospace Applications," No. 77-514, AIAA Conference on the Future of Aerospace Power Systems, St. Louis, Missouri, March 1977.
11. O.K. Sonju, D.E. Meader, D.W. Swallow, G.T. Heskey, R.F. Cooper, J.F. Holt, and D.C. Rabe, "Design, Construction, and Testing of a Compact, Lightweight, Combustion Driven MHD Generator Channel and Diffuser," Proceedings of the 16th Symposium on Engineering Aspects of Magnetohydrodynamics, Pittsburgh, Pennsylvania, May 1977.

POTENTIAL ROLE AND TECHNOLOGY STATUS OF
CLOSED-CYCLE MHD FOR LIGHT-WEIGHT
NUCLEAR SPACE-POWER SYSTEMS

BY
GEORGE R. SEIKEL, SeiTec, CLEVELAND, OH
AND
BERT ZAUDERER, MERION, PA

III-10

PRESENTED AT

AFOSR SPECIAL CONFERENCE ON PRIME
POWER FOR HIGH-ENERGY SPACE SYSTEMS
NORFOLK, VA, FEBRUARY 22-25, 1982

SeiTec P.O. Box 81264, Cleveland, Ohio 44181
Technology
Consulting

ABSTRACT

IF POWER IS REQUIRED IN SPACE FOR MORE THAN A LARGE FRACTION OF A DAY, STEADY STATE POWER SOURCES (SUCH AS SOLAR AND NUCLEAR) WILL HAVE THE LIGHTEST SYSTEM WEIGHT. IF MEGAWATTS OF POWER ARE NEEDED, CLOSED-CYCLE MHD SYSTEMS (IF SUCCESSFULLY DEVELOPED) HAVE THE POTENTIAL OF BEING VERY LIGHT AND HIGHLY EFFICIENT. SUCH MHD GENERATORS ARE UNIQUELY CAPABLE OF FULLY EXPLOITING ADVANCES IN HIGH-TEMPERATURE REACTOR TECHNOLOGY WHICH COULD MAKE UP TO 2500 K LONG-LIFE, INERT-GAS-COOLED REACTORS FEASIBLE. A PARTICULARLY ATTRACTIVE MHD SYSTEM IS A TURBO-MHD CYCLE WHICH HAS A TURBINE DRIVEN COMPRESSOR. IT POTENTIALLY HAS VERY LOW SPECIFIC MASS, HIGH EFFICIENCY, AND RELATIVELY LOW MHD GENERATOR ENTHALPY EXTRACTION. IN ADDITION, THE SIGNIFICANT RECENT EXPERIMENTAL PROGRESS ON THE FEASIBILITY OF THE REQUIRED NONEQUILIBRIUM CLOSED-CYCLE MHD GENERATOR IS REVIEWED.

1-01-111

TURBO-MHD POWER SYSTEM

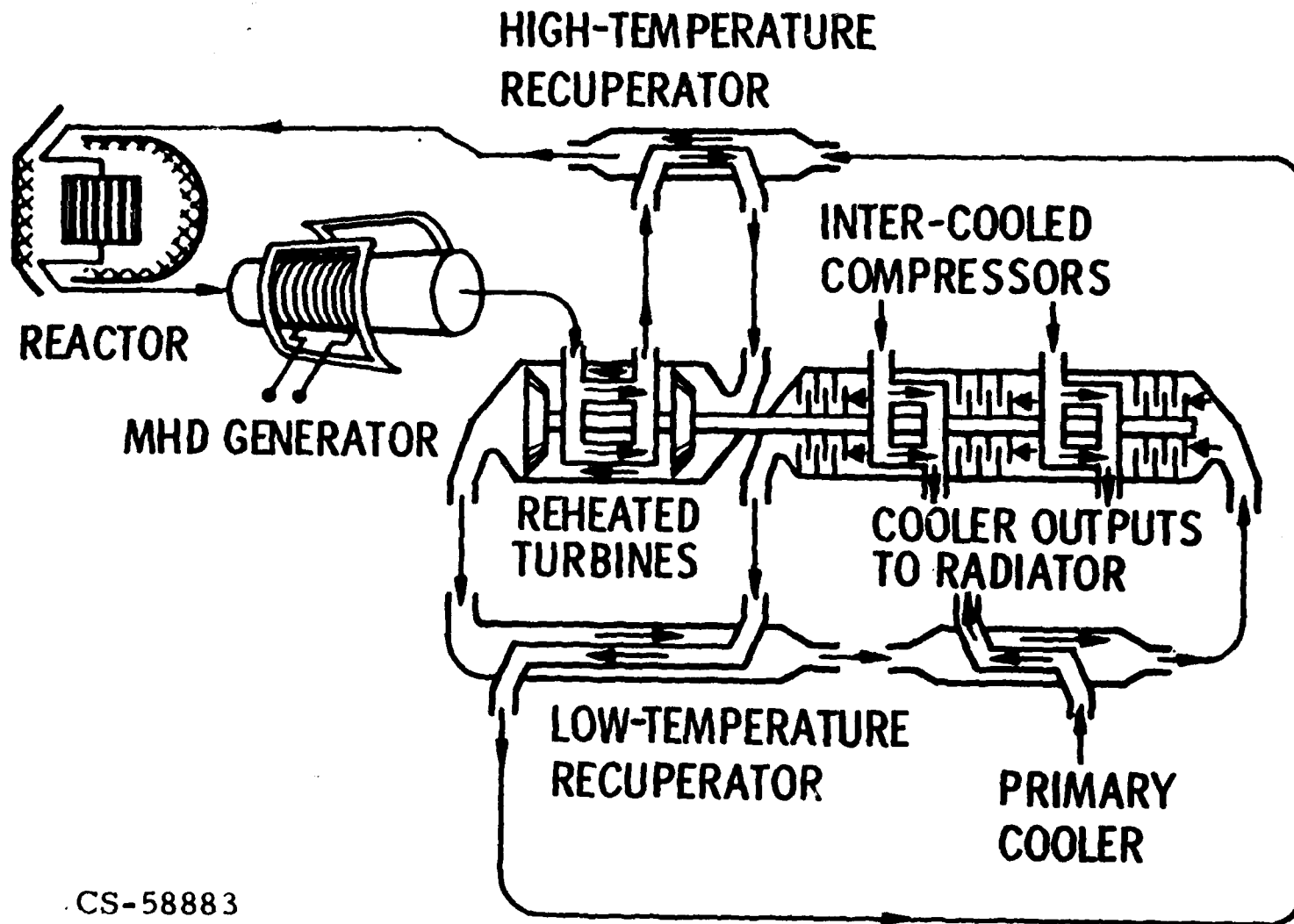

III-10-2

CS-58883

COMMENTS REGARDING TURBO-MHD CYCLE

THE TURBO-MHD CYCLE, PROPOSED BY SEIKEL AND NICHOLS (JOURNAL OF SPACECRAFT AND ROCKETS, VOL. 9, NO. 5, MAY 1972, PP. 322-326) IS PARTICULARLY ATTRACTIVE. IT USES A TURBINE DRIVEN COMPRESSOR AND HAS MINIMUM SYSTEM MASS AT HIGH-CYCLE EFFICIENCY (APPROXIMATELY 40 PERCENT) AND LOW-RADIATOR AREA AND TEMPERATURE. A 2500 K, 10 Mw_e TURBO-MHD POWER SYSTEM, SHIELDED FOR MANNED MISSIONS, COULD ACHIEVE SPECIFIC MASSES OF 3.5 TO 5 kg/kw_e . IF TURBINE INLET TEMPERATURE IS INCREASED FROM 1250 K TO 1500 K, SPECIFIC MASS REDUCES 0.7 kg/kw_e . THE ENTHALPY EXTRACTION OF THE MHD GENERATOR IS 17 TO 19 PERCENT IN THE OPTIMIZED TURBO-MHD SYSTEM COMPARED TO ALMOST 37 PERCENT FOR AN OPTIMIZED ALL MHD SYSTEM WITH AN ELECTRIC MOTOR DRIVEN COMPRESSOR. THE ALL MHD SYSTEM WOULD HAVE SOMEWHAT SMALLER RADIATORS BUT SUBSTANTIALLY HIGHER (200 TO 400 K) RADIATOR AND COMPRESSOR TEMPERATURES AND AN EFFICIENCY OF A BRAYTON CYCLE (21 PERCENT).

NASA
CG-52118

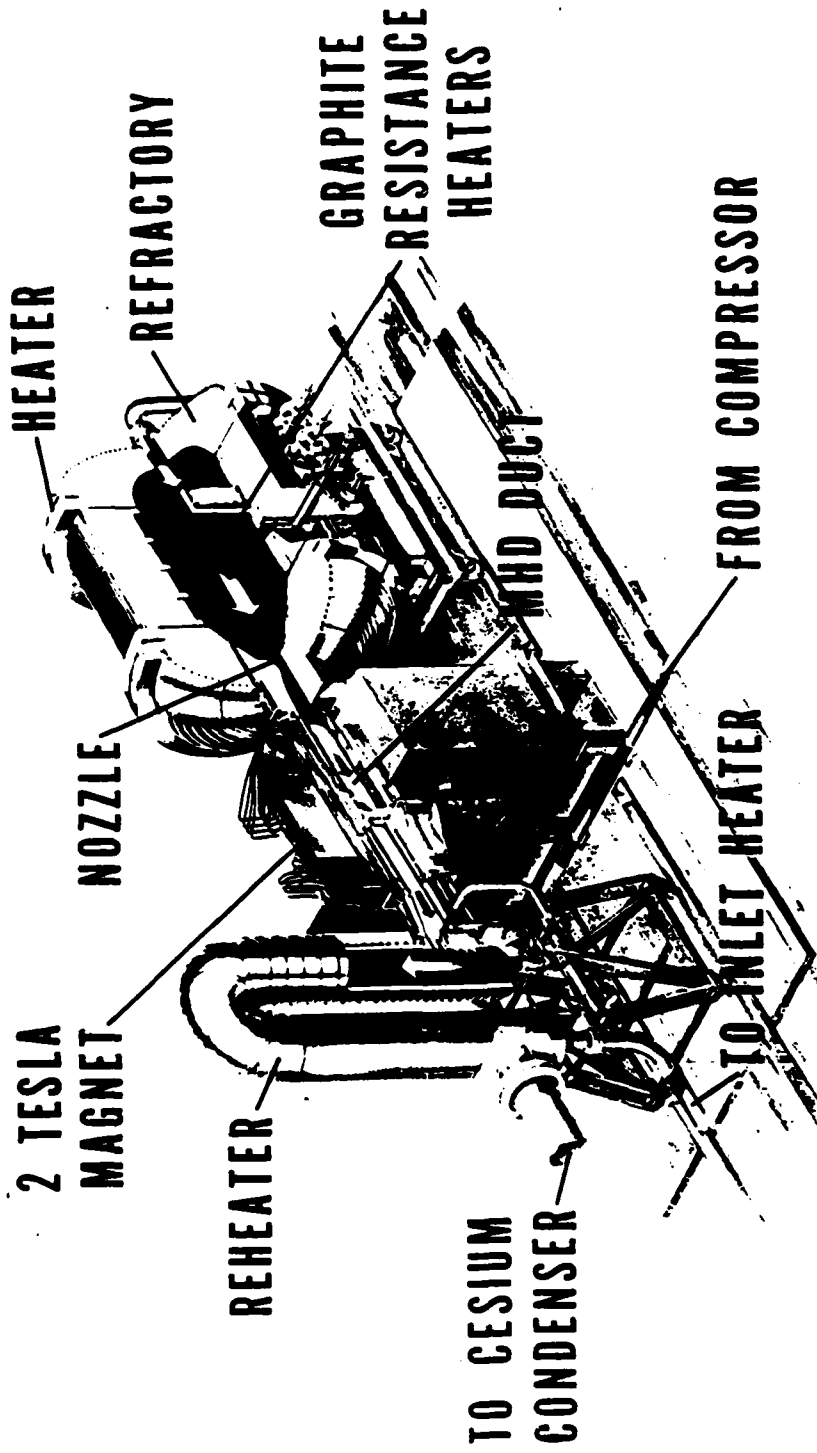

COMMENTS ON NASA LeRC CLOSED-CYCLE FACILITY

BECAUSE OF THEIR RELATIVELY LOW OPTIMUM MHD ENTHALPY EXTRACTION, TURBO-MHD CYCLES SHOULD BE ATTRACTIVE DOWN TO REACTOR OUTLET TEMPERATURES BELOW 2000 K. TESTS IN THE NOW DISMANTLED STEADY-STATE Mw_c CLOSED-CYCLE FACILITY AT NASA LeRC SHOWED THAT STRUCTURALLY RELIABLE LONG LIFE NEARLY ADIABATIC CLOSED-CYCLE MHD CHANNELS COULD BE CONSTRUCTED OF ALUMINA INSULATORS AND WALLS AND TUNGSTEN ELECTRODES FOR UP TO 2100 K FLOWS. THIS NASA LeRC FACILITY WAS THE WORLD'S ONLY SUCCESSFUL CLOSED-LOOP CLOSED-CYCLE FACILITY. IT USED A GRAPHITE RESISTANCE HEATER TO HEAD ARGON UP TO 2300 K. IT HAD, AS CONSTRUCTED, LIMITED VOLTAGE AND MAGNET FIELD STRENGTH CAPABILITIES. TESTING WAS LIMITED TO INTERMITTENT BLOW-DOWN INJECTION OF CESIUM SEED INTO THE STEADY-STATE HOT ARGON STREAM.

III-10-5



5 MW CCMED BLOWDOWN TEST FACILITY - EINDHOVEN, THE NETH.

III-10-6

COMMENTS ON EINDOVEN CLOSED-CYCLE MHD FACILITY

TESTING IN THE NEW 2000 K, 5 Mw_t CLOSED-CYCLE MHD BLOW-DOWN FACILITY AT TECHNISCHE HOGESCHOOL-
EINDHOVEN (THE) HAS DEMONSTRATED SIGNIFICANT PROGRESS IN OBTAINING REQUIRED GENERATOR PER-
FORMANCE. THIS EFFORT IS BEING CONDUCTED UNDER AN "AGREEMENT IN THE FIELD OF MHD POWER
GENERATION" BETWEEN THE U. S. DEPARTMENT OF ENERGY AND THE NETHERLANDS ENERGY RESEARCH
FOUNDATION. THE TOP OF THE FACILITY'S REGENERATIVE HEATER EXCHANGER IS SHOWN IN THE
LOWER RIGHT OF THE PICTURE. THE BLOW-DOWN ARGON FLOWS TO THE LEFT THRU THE LARGE GATE
VALVE TO THE TEST CHANNEL AND EXHAUST EQUIPMENT. THE PICTURE SHOWS THE FACILITY BEFORE
THE MAGNET WAS INSTALLED. A COLD WALL DUTCH CHANNEL DESIGN HAS PRODUCED 375 Mw_e OR
7.5 PERCENT ENTHALPY EXTRACTION FROM A 1900 K FLOW.

THE NOMINAL 60 SECOND DUTCH BLOW-DOWN TESTS WITH 10 SECONDS AT FULL MAGNETIC FIELD (5 TESLA)
UNEQUIVOCALLY DEMONSTRATED NONEQUILIBRIUM POWER GENERATION IN A LINEAR GENERATOR WITH CESIUM
SEEDED ARGON FLOW. RESULTS CONFIRM THE PRIOR NONEQUILIBRIUM DEMONSTRATIONS BOTH IN BLOW-
DOWN EXPERIMENTS AT LOWER MAGNETIC FIELDS AND ENTHALPY EXTRACTION BY THE ITALIANS, AND THE
OVER 20 PERCENT ENTHALPY EXTRACTION RESULTS OBTAINED IN SHOCK TUBES BY G. E. AND THE DUTCH.

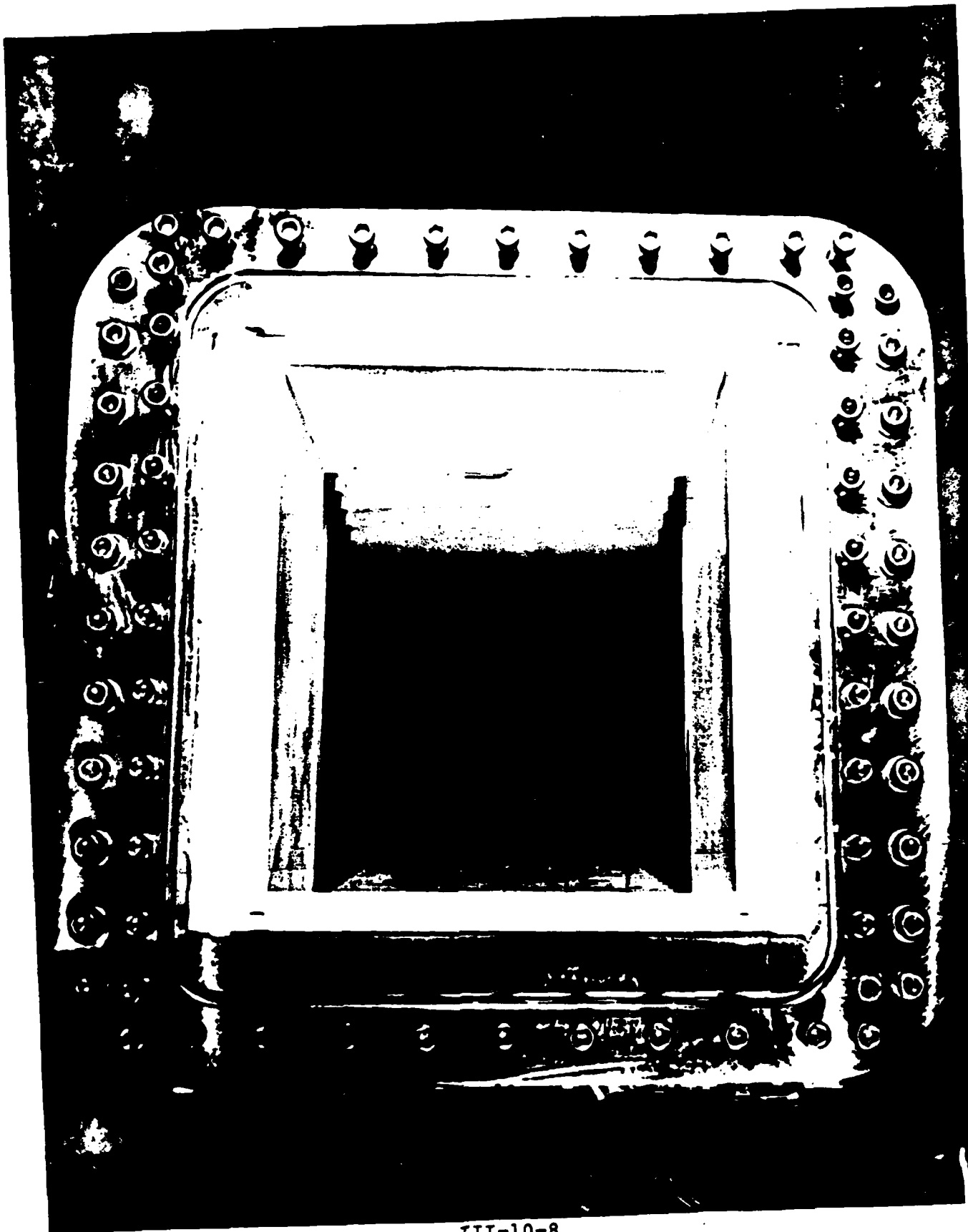

III-10-8

I
I
I
I
I

U. S. DEPARTMENT OF ENERGY/GENERAL ELECTRIC
HOT-WALL MHD CHANNEL FOR TESTING IN EINDOVEN BLOW-DOWN FACILITY

6-01-III

IN 1981 HIGHER CLOSED-CYCLE GENERATOR PERFORMANCE SHOULD BE OBTAINED IN THE DUTCH FACILITY. IN ADDITION TO TESTING OF ADDITIONAL DUTCH CHANNELS, TESTING OF THE HOT-WALL U. S. CHANNEL SHOWN IS PLANNED. IT WAS DESIGNED AND FABRICATED BY G. E. THE CHANNEL IS CONSTRUCTED WITH BORON NITRIDE INSULATION AND MOLYBDENUM ELECTRODES WHICH CAN BE INSTALLED FLUSH WITH THE WALL OR PROTRUDING INTO THE STREAM AS SHOWN. THE ELECTRODE TEMPERATURE CAN BE VARIED OVER A WIDE RANGE BY TWO ALTERNATIVE METHODS OF COOLING. THE U. S. ALSO SUPPLIED A GRAPHITE RESISTANCE HEATER TO BE USED IN AN AUXILIARY LOOP TO PREHEAT THE CHANNEL BEFORE BLOW-DOWN.

MAJOR CLOSED-CYCLE MHD TECHNOLOGY ISSUES

- ° FROM A SYSTEM VIEWPOINT
 - COMPONENT SENSITIVITY
 - DISK VS. LINEAR GENERATORS

- ° FROM A PHYSICS AND ENGINEERING VIEWPOINT
 - NONEQUILIBRIUM FLOW
 - MATERIALS

III-10-10

COMMENTS ON CLOSED-CYCLE MHD TECHNOLOGY ISSUES

THE COAUTHORS, AS RESPECTIVE MANAGERS FROM THE EARLY 60'S (UNTIL RECENTLY) OF THE TWO LARGE CLOSED-CYCLE MHD EFFORTS IN THE UNITED STATES (NASA LeRC AND G. E. VALLEY FORGE), ASSESS THAT THE MAJOR CLOSED-CYCLE MHD TECHNOLOGY ISSUES REQUIRING ADDITIONAL EFFORT ARE:

1. FROM A SYSTEM VIEWPOINT:
 - A. ASSESS SENSITIVITY OF SYSTEM WEIGHT TO GENERATOR PERFORMANCE, REACTOR TEMPERATURE, AND ADVANCED REACTOR AND RADIATOR CONCEPTS.
 - B. EVALUATE POTENTIAL OF DISK VS. LINEAR GENERATOR GEOMETRY. IN DISK GENERATORS, A SWIRLING FLOW IS EXPANDED RADially AGAINST AN AXIAL FIELD WITH POWER EXTRACTION FROM INNER AND OUTER RADII. RECENT STUDIES FOR COAL-FIRED POWER PLANTS INDICATE THAT CLOSED-CYCLE DISK GENERATORS MAY OFFER HIGH PERFORMANCE WITH SIMPLER (POSSIBLY LIGHTER) MAGNETS AND REQUIRE LESS POWER CONSOLIDATION EQUIPMENT.
2. FROM A GENERATOR PHYSICS AND ENGINEERING VIEWPOINT, IT WILL BE ESSENTIAL TO CONTINUE HOT-WALL BLOW-DOWN EXPERIMENTS WITH IMPROVED CHANNELS AT "THE" AFTER THE PLANNED TESTS OF THE INITIAL U. S. CHANNEL. THIS WILL BE NEEDED TO FULLY EVALUATE AND DEMONSTRATE:
 - A. NONEQUILIBRIUM GENERATOR FLOW WITH REAL ELECTRODE VOLTAGE DROPS, HOT-WALL CURRENT LEAKAGE, TURBULENT ELECTRICAL CONDUCTIVITY, AND THREE DIMENSIONAL REAL GENERATOR CORE FLOW AND BOUNDARY LAYER PHENOMENA AND THEIR ANALYTICAL UNDERSTANDING.
 - B. MATERIALS FOR HIGH-TEMPERATURE INSULATORS AND ELECTRODES AND THE ENGINEERING TECHNIQUES FOR RELIABLE CONSTRUCTION OF LONG-LIFE REFRACTORY CHANNELS.

SPECIFIC MASS OF REACTOR PLUS SHIELD

III-10-12

SPECIFIC MASS,
kg/kW_T

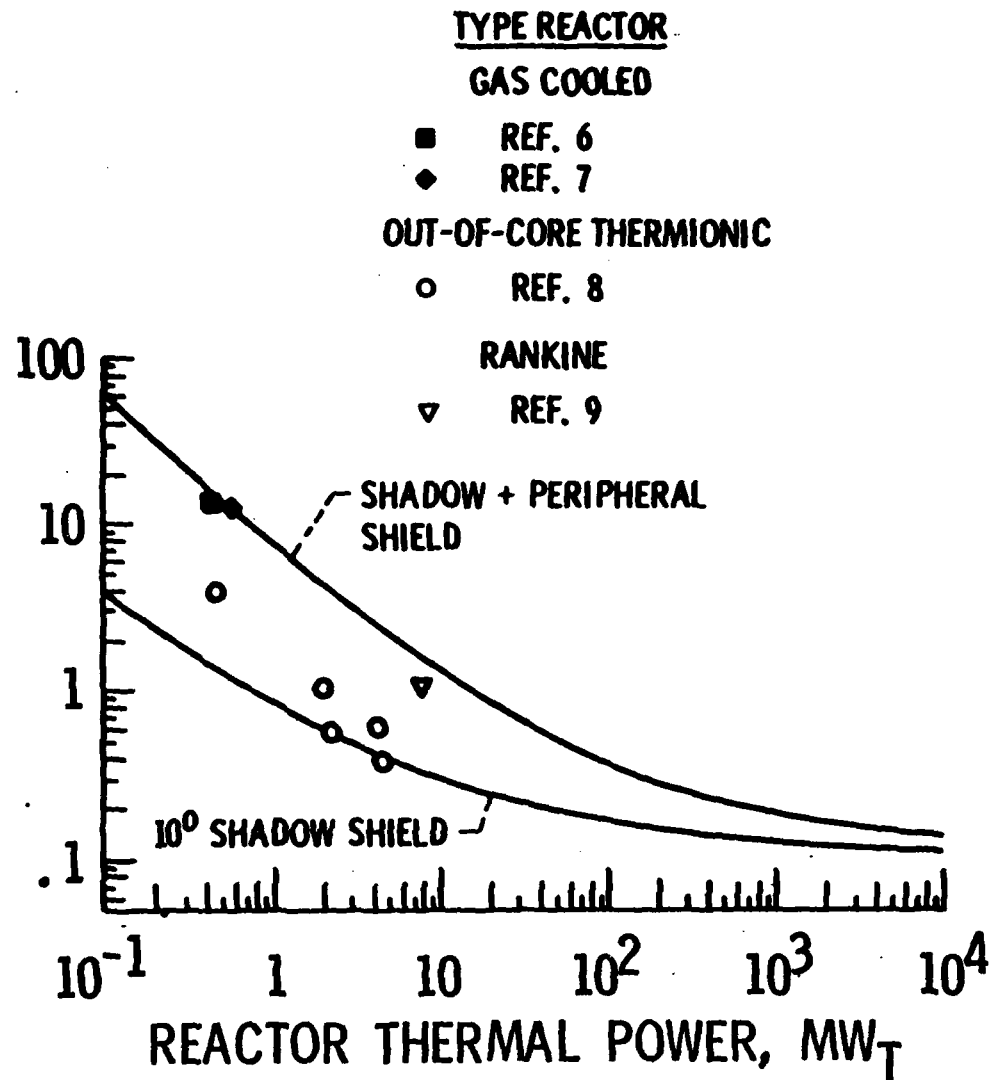

CS-58880

CONCLUDING COMMENTS

IN CONCLUSION, POTENTIALLY ATTRACTIVE NUCLEAR CLOSED-CYCLE MHD SPACE POWER SYSTEMS HAVE BEEN PROPOSED TO UTILIZE BOTH SOLID-CORE AND VERY HIGH TEMPERATURE GAS-CORE FISSION REACTORS AND EVEN FUSION REACTORS. TECHNOLOGY FOR COOLING MHD GENERATORS, DEVELOPED FOR OPEN-CYCLE MHD, PRESENTLY LIMITS COOLANT TEMPERATURE TO HUNDREDS OF DEGREES BELOW A SPACE-POWER SYSTEMS HEAT-SINK TEMPERATURE, THE RADIATOR. IN ADDITION, COOLED GENERATORS MUST BE OPERATED AT A SUFFICIENT POWER LEVEL TO MINIMIZE THE RATIO OF HEAT LOSSES (SURFACE AREA) TO POWER PRODUCED (VOLUME). THE AUTHORS, THEREFORE, FEEL THAT A SOLID FUEL REACTOR OPERATING NEAR THE TEMPERATURE LIMITS WERE NEAR ADIABATIC HOT-WALL MHD NONEQUILIBRIUM GENERATOR DESIGN CAN BE UTILIZED IS THE MOST ATTRACTIVE CONCEPT FOR INITIAL MHD SPACE-POWER SYSTEMS. A 1 TO 10 Mw_e SYSTEM SHOULD BE LIGHT ENOUGH TO MINIMIZE THE REQUIRED SPACE-SUBASSEMBLY OF THE SYSTEM AFTER SHUTTLE LAUNCH. REGARDING NUCLEAR REACTORS, AS SHOWN, THE SPECIFIC WEIGHT OF SHIELDED SMALL REACTORS WILL BE DOMINATED BY THE SHIELDING AND THEIR WEIGHT WILL IN TURN BE A LARGE FRACTION OF THE POWER SYSTEM WEIGHT. THUS, CONCEPTS TO LOWER SHIELDED REACTOR WEIGHT OF SMALL REACTORS ARE DESIRABLE; ALTERNATIVE ISOTOPE SOURCES COULD, ALSO, BE ATTRACTIVE.

III-10-13

Q & A - G. R. Seikel

From: A. Bridgeforth, JPL

Is long life turbine/compressor bearings still a limiting factor?

A. Bob English will discuss this in his paper Tuesday.

III-10-14

REFERENCES

1. SEIKEL, G. R., AND NICHOLS, L.D.: "POTENTIAL OF NUCLEAR MHD ELECTRIC POWER SYSTEMS." JOURNAL OF SPACECRAFT AND ROCKETS, VOL. 9, NO. 5, MAY 1972, PP. 322-326.
2. ANON.: "EVALUATION OF TECHNICAL FEASIBILITY OF CLOSED CYCLE NONEQUILIBRIUM MHD POWER GENERATION WITH DIRECT COAL FIRING." GENERAL ELECTRIC COMPANY: FINAL REPORT - TASK 1 UNDER UNITED STATES DEPARTMENT OF ENERGY CONTRACT NO. DE-AC01-78-ET10818, NOVEMBER 1981.
3. MATTICK, A. T., AND HERTZBERG, A.: "LIQUID DROPLET RADIATORS FOR HEAT REJECTION IN SPACE." JOURNAL OF ENERGY, VOL. 5, NO. 6, NOVEMBER - DECEMBER 1981, PP. 387-393.
4. RETALICK, F. D.: "DISK MHD GENERATOR STUDY." DOE/NASA/0139-1, NASA CR-159872, OCTOBER 1980.

III-10-15

Special Conference on
PRIME POWER FOR HIGH-ENERGY SPACE SYSTEMS
February 22-25, 1982

MHD GENERATOR RESEARCH AT STANFORD
J. K. Koester, C. H. Kruger, and T. Nakamura
Stanford University

ABSTRACT

The behavior of MHD channels have been studied over a wide range of conditions in the High Temperature Gasdynamics Laboratory at Stanford University. This research is primarily experimental in nature with the use of advanced diagnostic methods and comparable theoretical and numerical studies for the interpretation of the data and application of the results to large-scale generators. Experiments are conducted in an 8 MW_{th} flow facility with either clean or dirty fuels and a variable O₂/N₂ oxidizer in the 0.6 m-2.7 T magnet or the smaller 6T superconducting magnet.

Present MHD research areas include MHD boundary layer interactions, Hall-field breakdown, plasma nonuniformities, plasma fluctuations and magneto-acoustic waves, surface deposits of slag, disk generators, and electrode configurations. Plasma velocity, temperature, and electron number density have been measured with spatial and temporal resolution by optical diagnostics. These techniques include laser doppler velocimetry, generalized line reversal, emission spectroscopy, laser fluorescence, far infrared interferometry, laser transmissometry, and optical pyrometry. Other diagnostics used are probe-tube microphones, cinephotography, and the AC resistance instrument. With this extensive diagnostic capability, many channel phenomena such as electrode boundary layer Joule heating, sidewall boundary layer velocity overshoot, slag particle size, effect of radicals (such as PO_x⁻) on electron density, and surface deposit polarization have been observed, measured, and compared with theory. These results are intended to provide support for MHD hardware development in areas where performance limitations and design constraints are not now adequately understood.

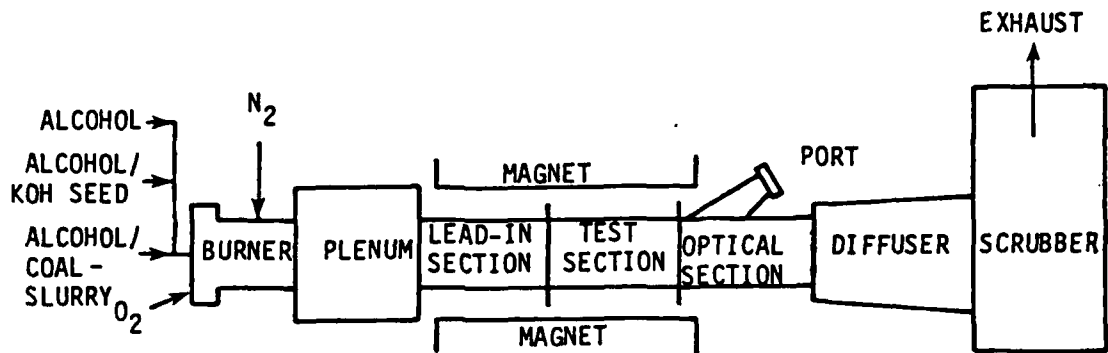

FIG. 1. Schematic of a combustion plasma MHD flowtrain. By combining the flows of liquid fuel, potassium salt solutions, particulate (ash, coal) slurries, oxygen, and nitrogen, a wide range of plasma parameters are produced for experiments. Various test sections with appropriate optical ports have been used with advanced diagnostics (e.g. [1]) for the in situ measurement of MHD plasma behavior and plasma-surface interactions.

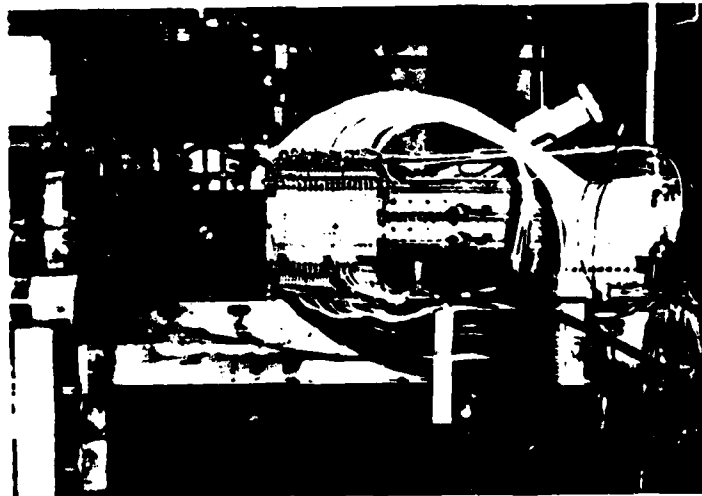

FIG. 2. The M-8 (8 MW_e) slagging electrode generator flowtrain before insertion in the conventional 2.7 T magnet.

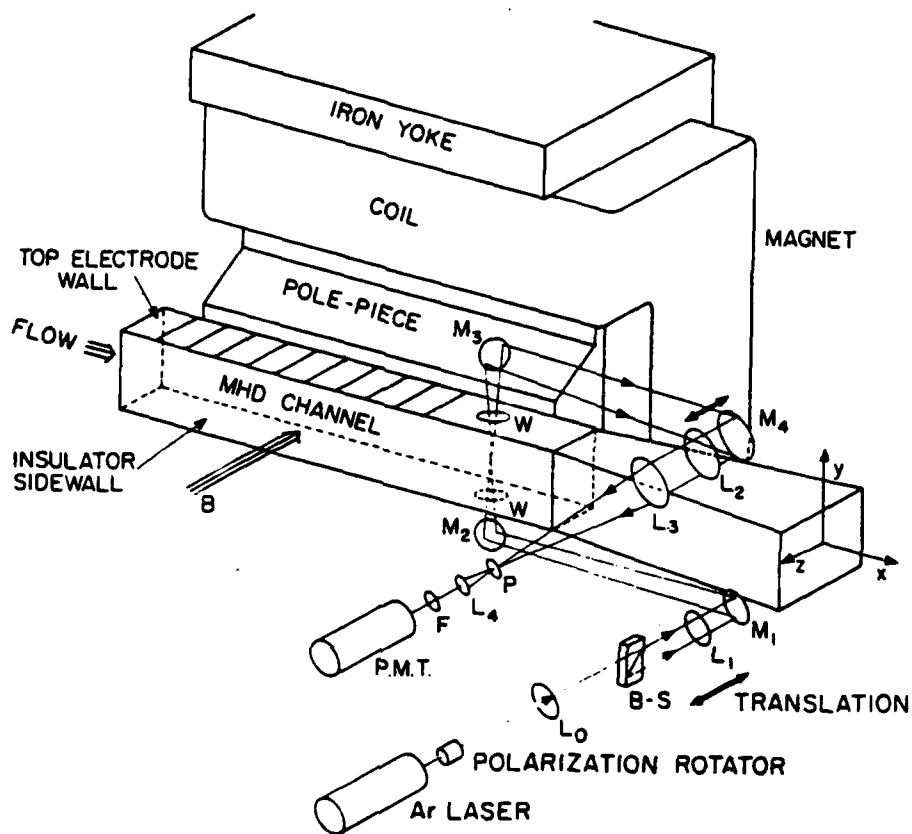

FIG. 3. The dual beam forward scatter anemometer used for measurement of the velocity profiles in the insulator (sidewall) boundary layer [2].

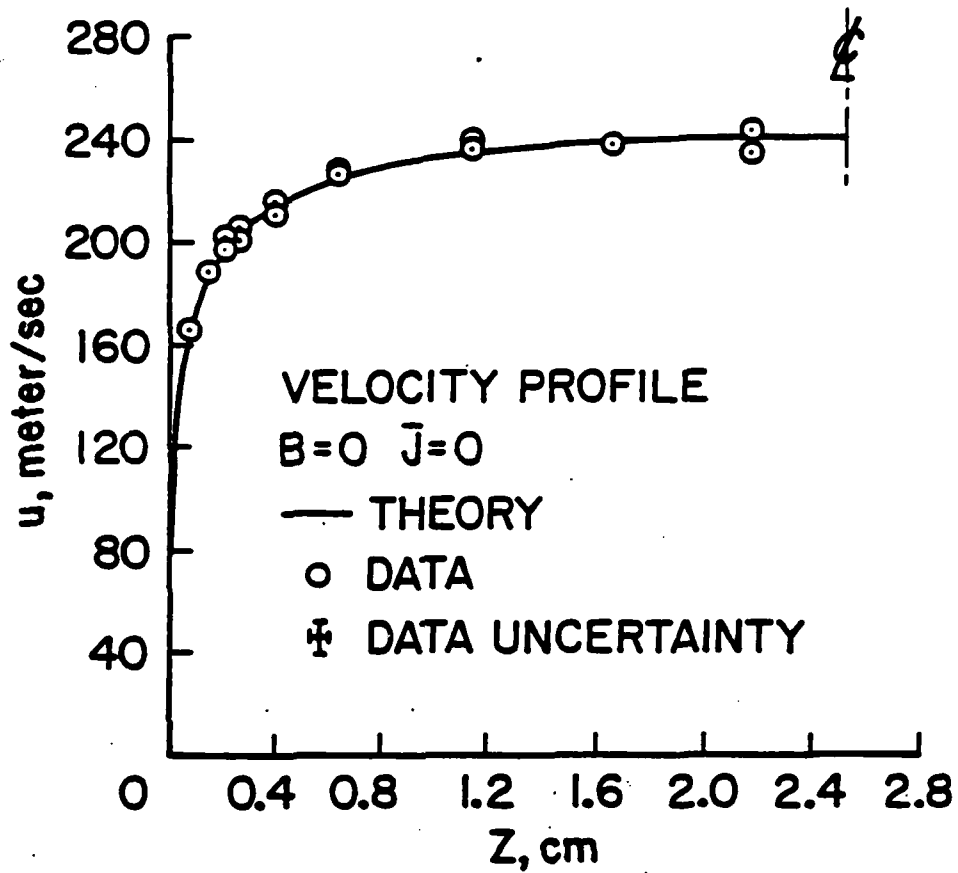

FIG. 4. Sidewall velocity profile for the control case of no magnetic field and no current compared with the Stanford turbulent boundary layer computer code [2].

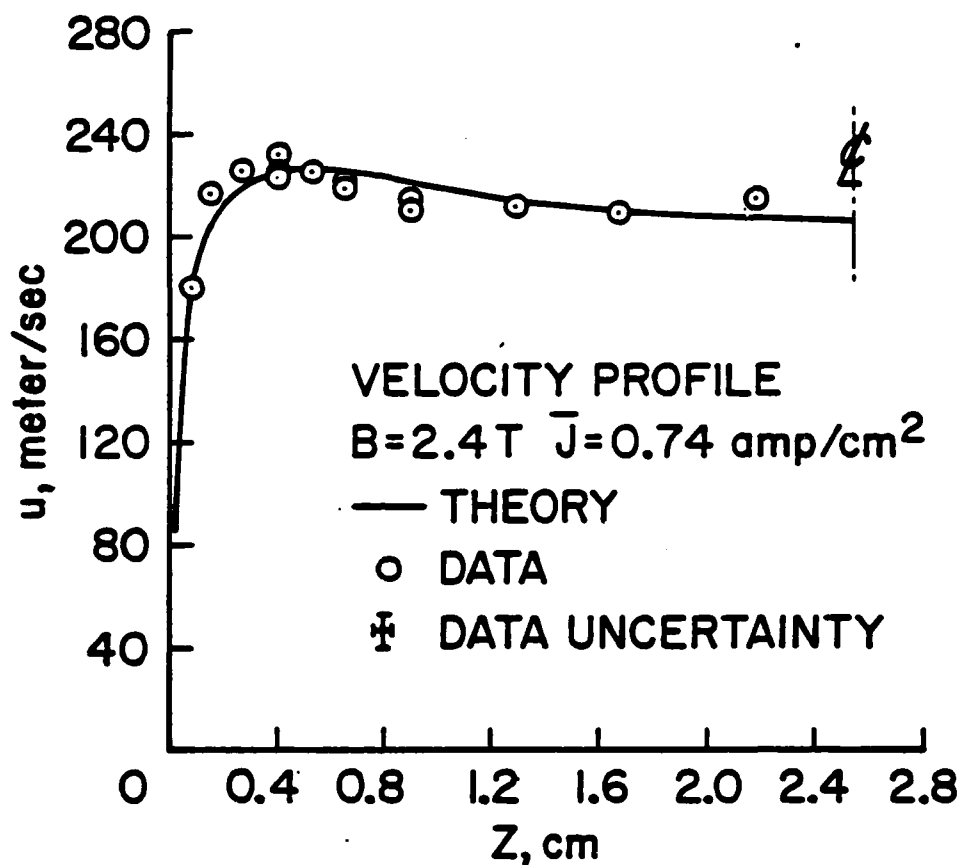

FIG. 5. Sidewall velocity profile showing the velocity overshoot effect caused by the MHD body forces. The data is in agreement with a modified turbulent boundary layer code by selecting the level of channel turbulence. The velocity overshoot effect increases the skin friction and heat transfer rate to the sidewalls [3].

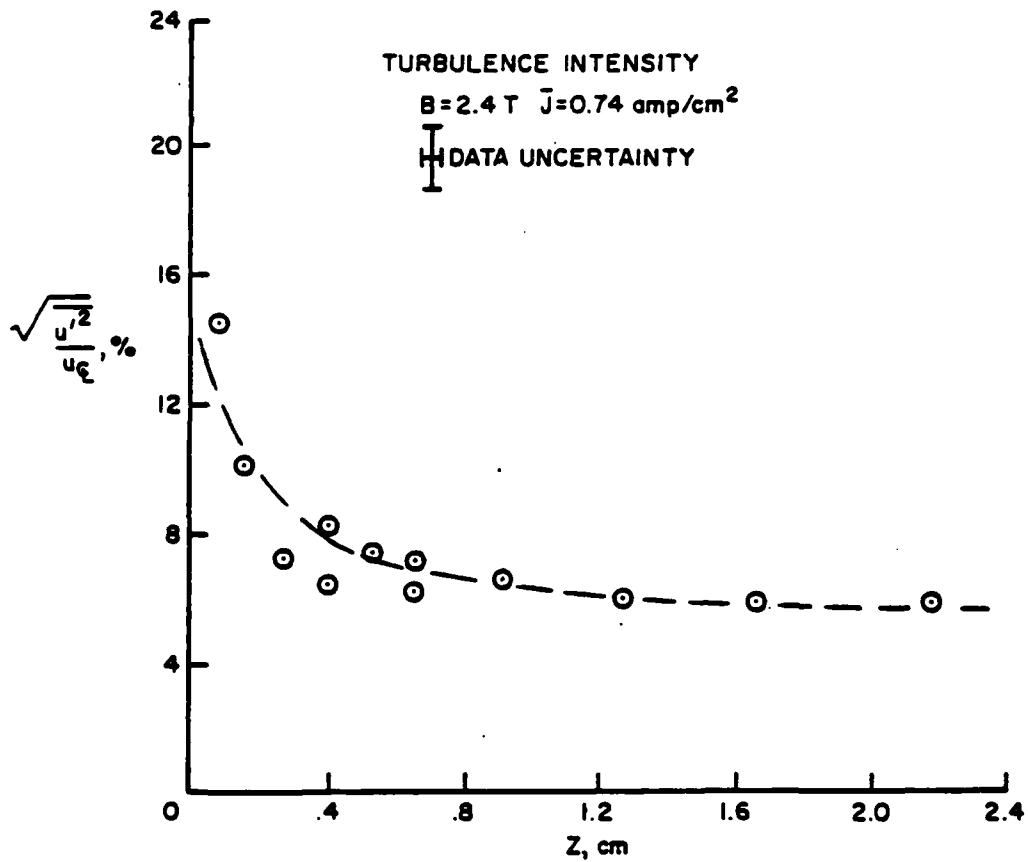

FIG. 6. The turbulence intensity profile corresponding to the previous velocity profile [3]. The effect of magnetic damping and wall roughness on sidewall turbulence is under investigation.

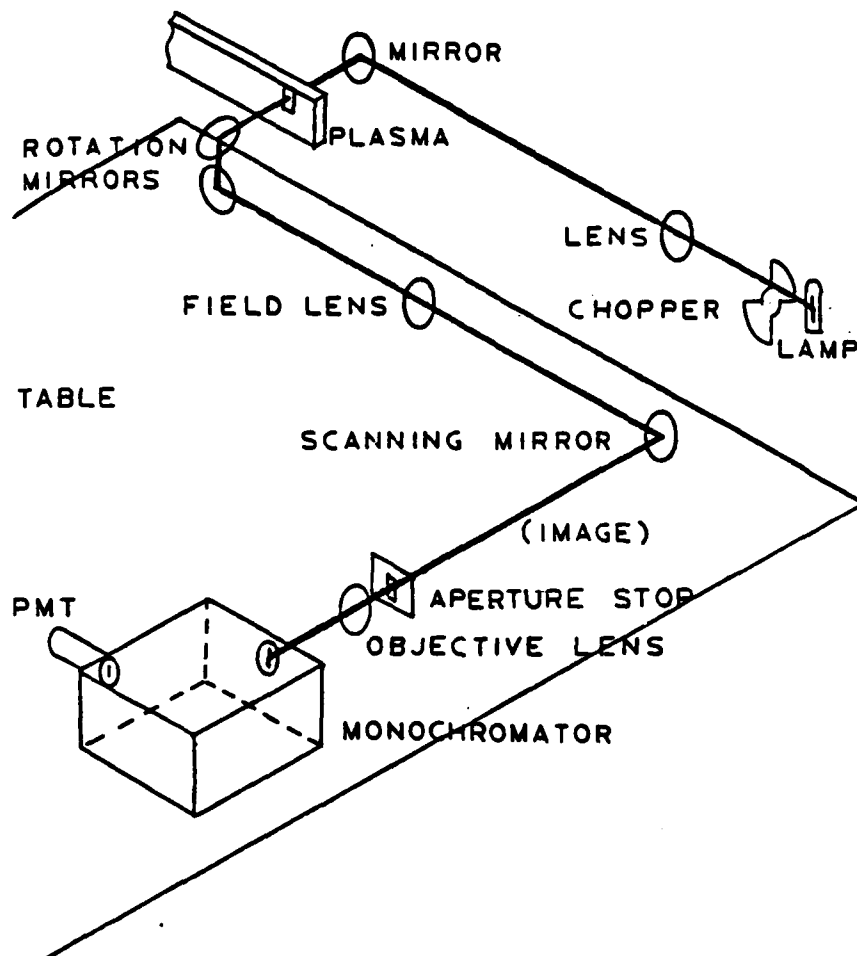

FIG. 7. The optical design of a scanning spectroscopic device for the measurement of temperature and electron number density profiles in the electrode wall boundary layer [4].

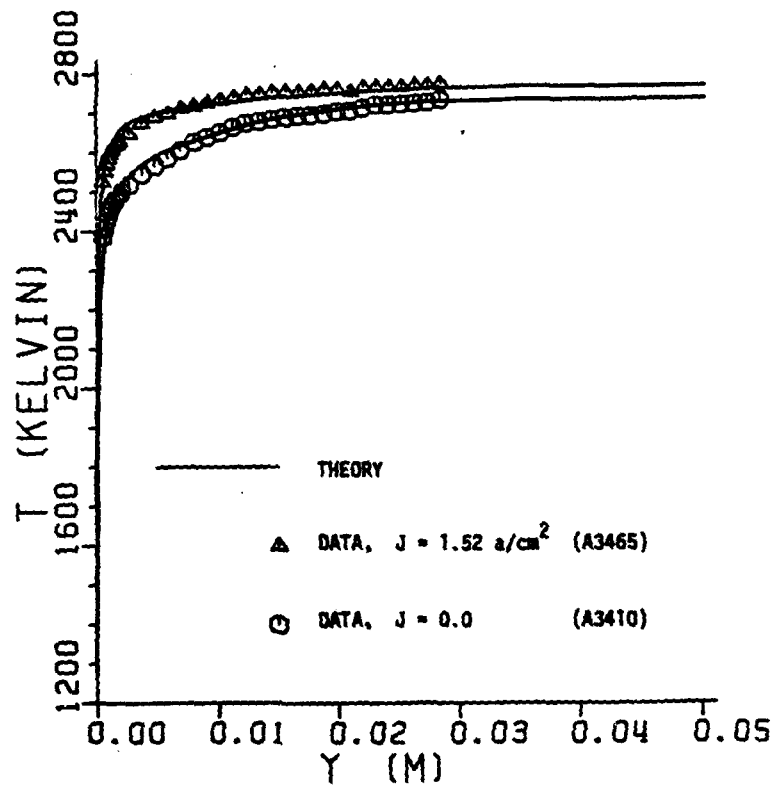

FIG. 8. Measured temperature profiles in the anode boundary layer with and without applied current. The effect of Joule heating on the temperature profile compares well with theory [4,5].

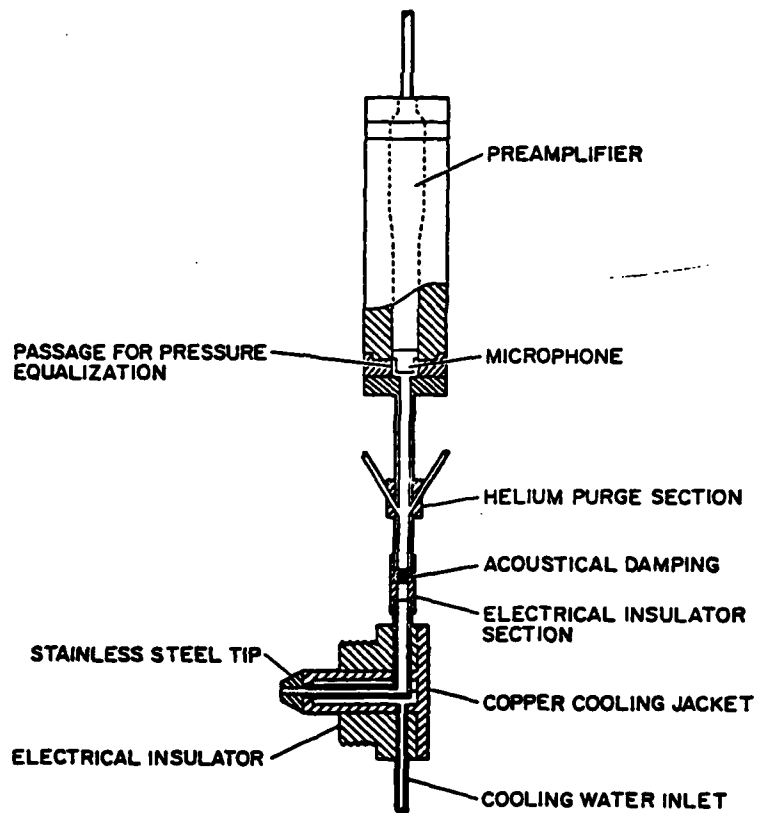

FIG. 9. Cross-section of the probe-tube microphone for the measurement of pressure fluctuations in the harsh MHD environment over a frequency range from a few Hertz to over 10 KHZ [6,7]. The response of this device is made uniform by tailoring the acoustical damping at the center of the probe-tube.

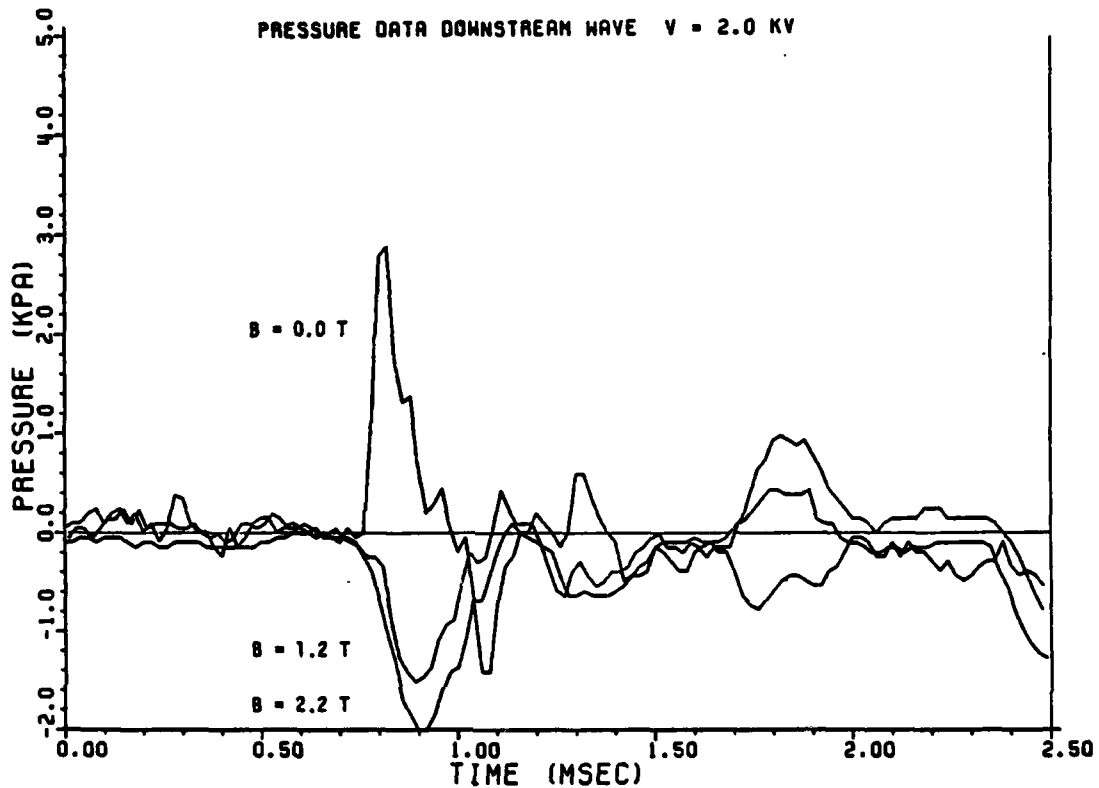
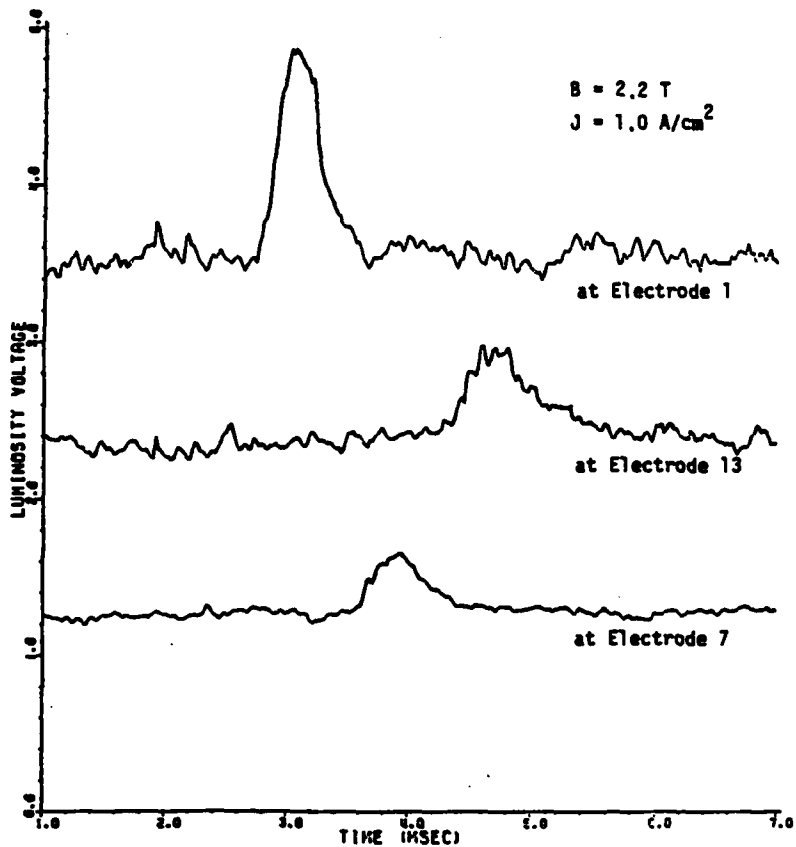

FIG. 10. The effect of magnetic field on pressure pulses formed by a capacitive discharge (at time = 0) across an electrode pair: Note that the MHD body force results in an inversion of the pressure pulse at higher magnetic fields [8].

LUMINOSITY DATA RUN 513, BLOCK 25



Luminosity voltage as a function of time from detectors at the entrance, middle, and exit of the MHD generator.

7.2

FIG. 11. Entropy waves were produced by a capacitive discharge upstream of the test section and measured by luminosity probes viewing through the center of an electrode. The luminosity probe voltage signals versus time at three channel locations show the entropy (temperature) pulse convected through the channel [8].

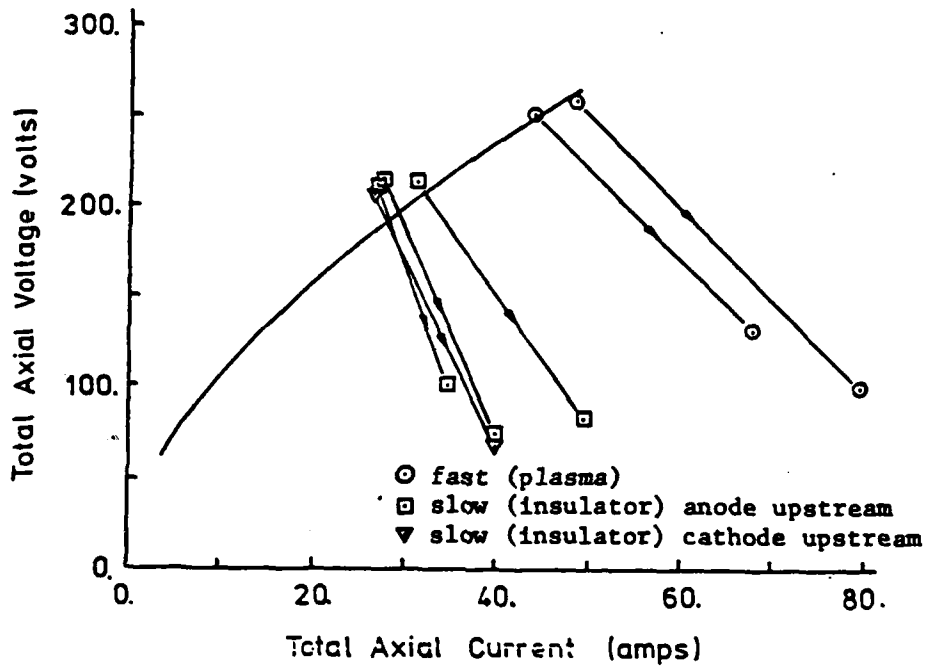

FIG 12. The voltage-current characteristic for an axial discharge across a 19 mm magnesia interelectrode insulator. The transitions to the low voltage-higher current mode result in a destructive arc. Two types of breakdown were observed: a fast plasma breakdown and a slow insulator breakdown which occurs at a lower threshold voltage. [9,10].

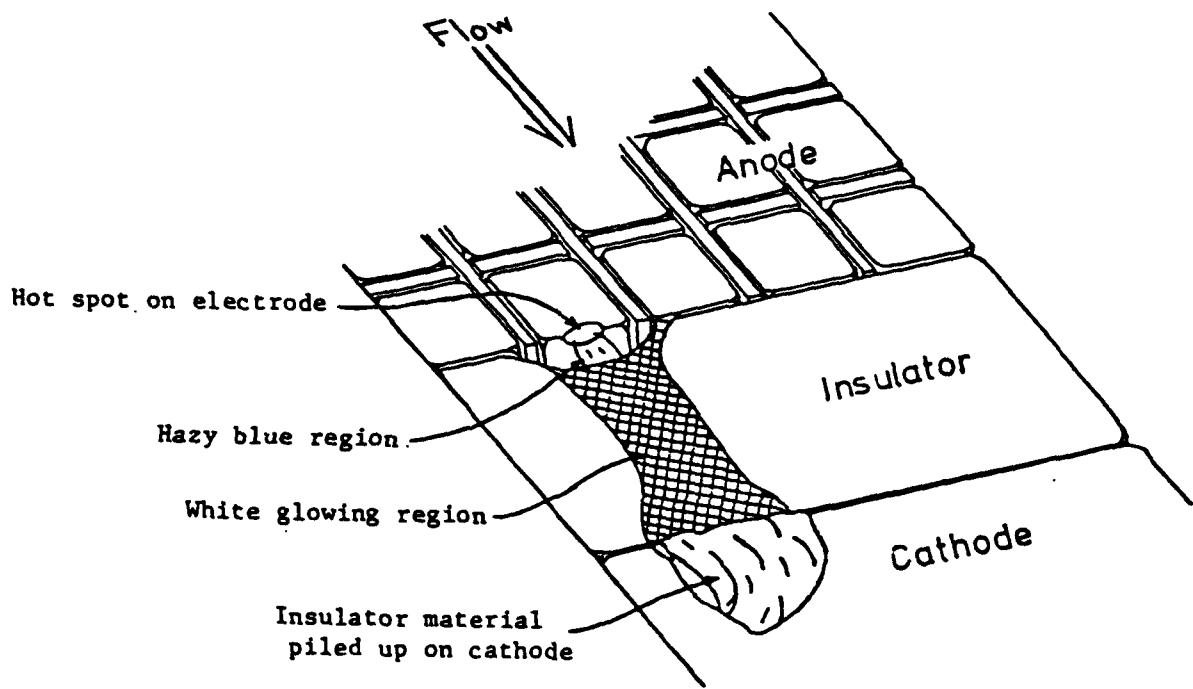

FIG 13. Typical behavior of the inter-electrode insulator region during a "slow" axial breakdown across a 7.5 mm gap. This sketch was constructed from a cine frame taken \sim 4.5 seconds after the voltage was applied [9].

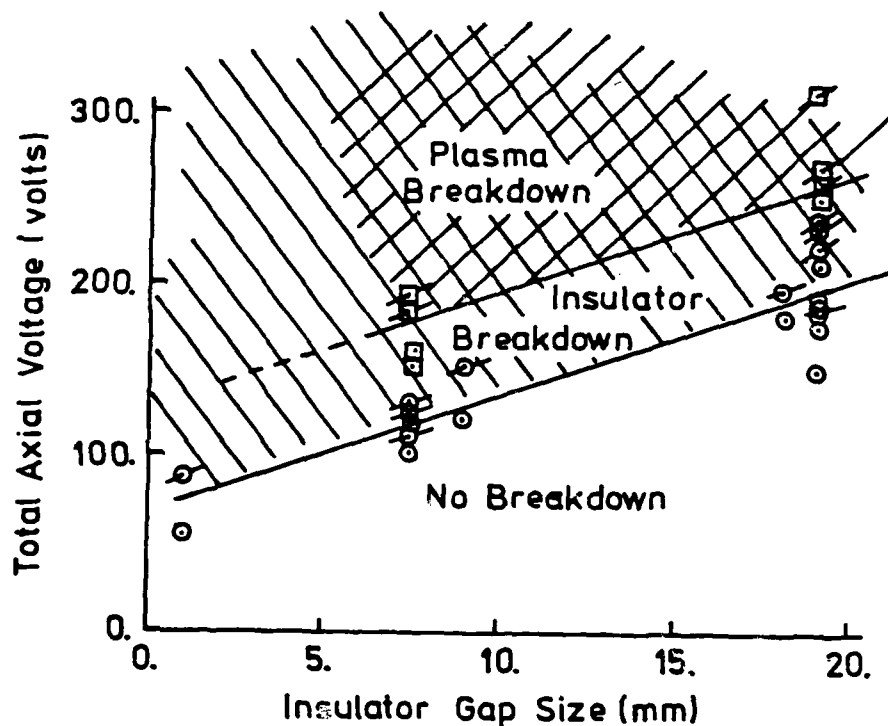

FIG 14. Threshold voltage as a function of insulator gap size. Figure shows the highest voltage for which no breakdown occurred and the lowest voltage for which breakdown occurred, thus establishing the breakdown threshold for plasma and insulator breakdown. Data for 1mm, 9mm and 18mm gaps taken from experiments described in reference [10]. All insulators were MgO except the 1mm gap, which was dense alumina.

AD-A118 887

R AND D ASSOCIATES ROSSLYN VA

F/G 10/2

PROCEEDINGS OF THE AFOSR SPECIAL

CONFERENCE ON PRIME-POWER FOR --ETC(U)

FEB 82 P J TURCHI

F49620-82-C-0008

UNCLASSIFIED

AFOSR-TR-82-0655

NL

4 of 9

of 9

of 9

of 9

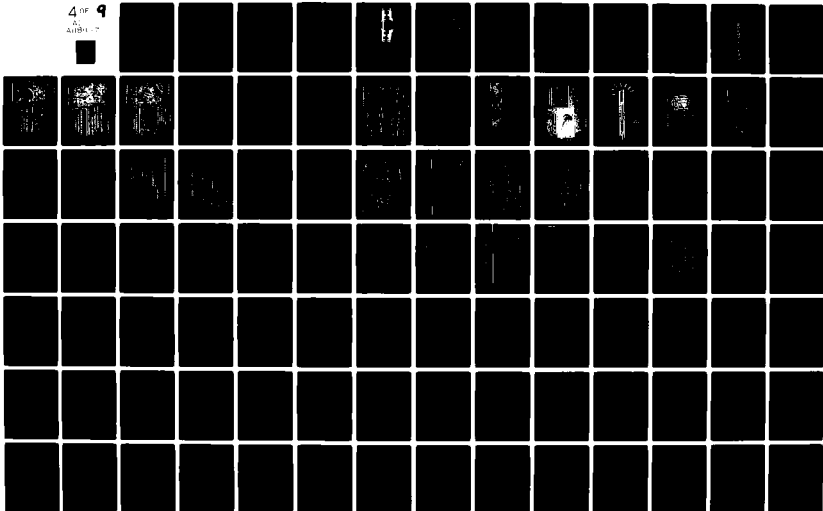

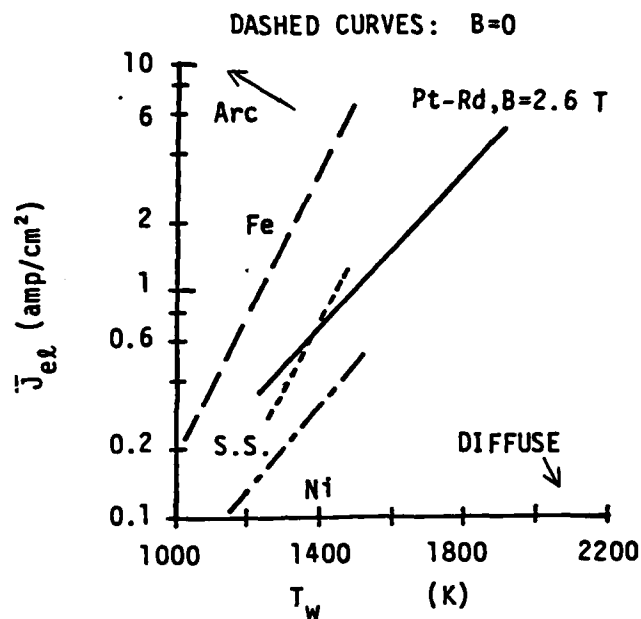

FIG. 15. Transverse discharge mode for slagging metal anodes. The slag film forms from ash deposits which build up until the surface becomes fluid (typically $\sim 1\text{mm}$ in thickness). The critical current density for diffuse to arc mode transition was investigated as a function of electrode temperature for various electrode materials [12,13].

ILLINOIS #6 coal

$B = 2.6 \text{ T}$

$T_w = 1100 \text{ K}$

$I_F = 4.2 \text{ amp}$

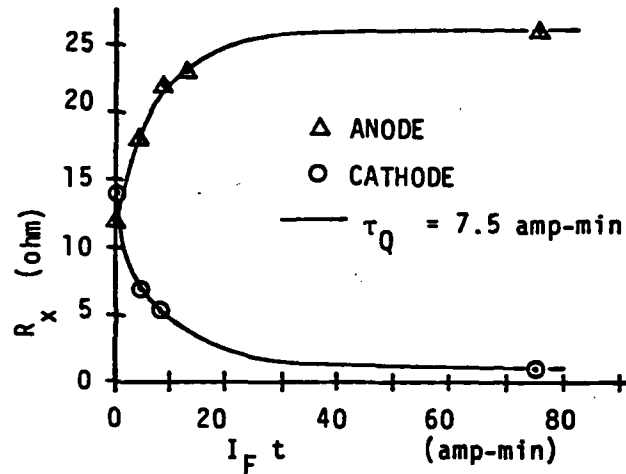

FIG. 16. A large fraction of slag electrical conduction is due to ion transport (largely Fe^{++} and K^+). This causes the slag layers to polarize becoming highly resistive at the anode and highly conductive at the cathode. The axial resistance between neighboring electrodes was measured during MHD generator operation with an AC resistance instrument. Here, the change in axial resistance at the anode and at the cathode is correlated with a charge transfer parameter [14].

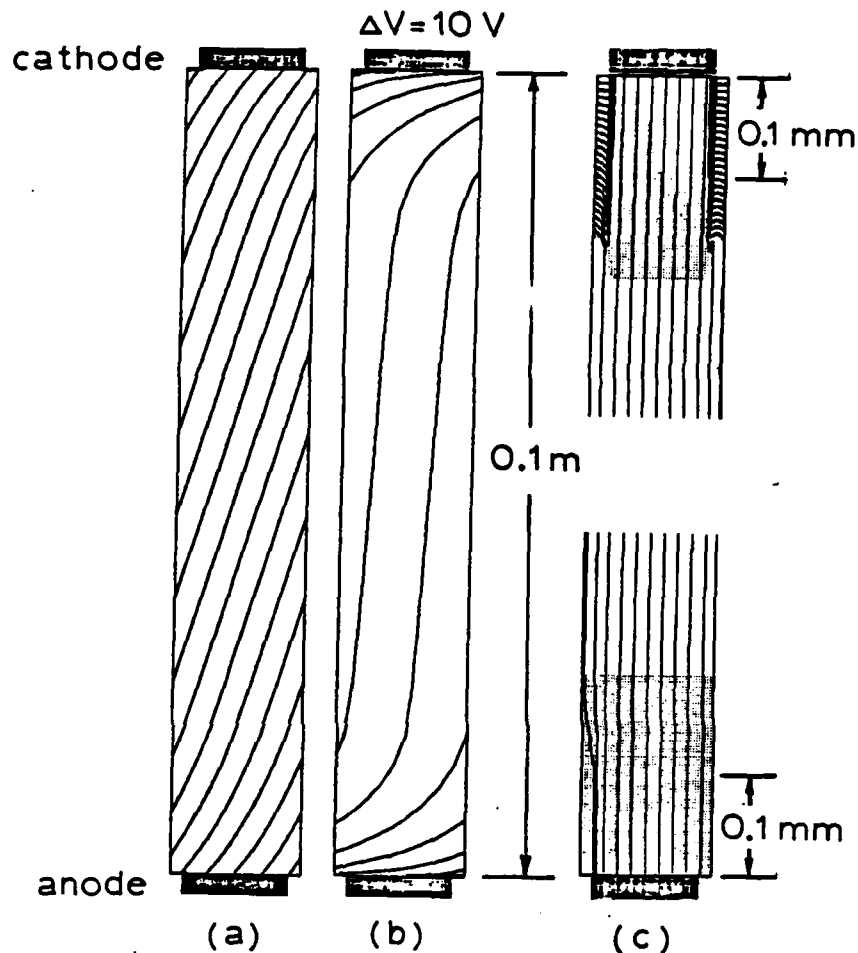

FIG. 17. Computed distributions of current (a) and voltage (b) for the conditions of a slagging platinum-rhodium capped electrode experiment. The magnetic field is 2.6T, electrode temperature is 1700K, and the average current density = 0.8 A/cm². The current distribution in the slag layers is shown by the expanded scale plot (c). The polarized value of slag conductivity was estimated by adjusting its minimum value until the experimental voltage probe distribution matched that of the model. Note the large leakage currents in the slag over the intercathode insulators. This large leakage results in excessive Joule heating with a partial thinning of the slag layer [15].

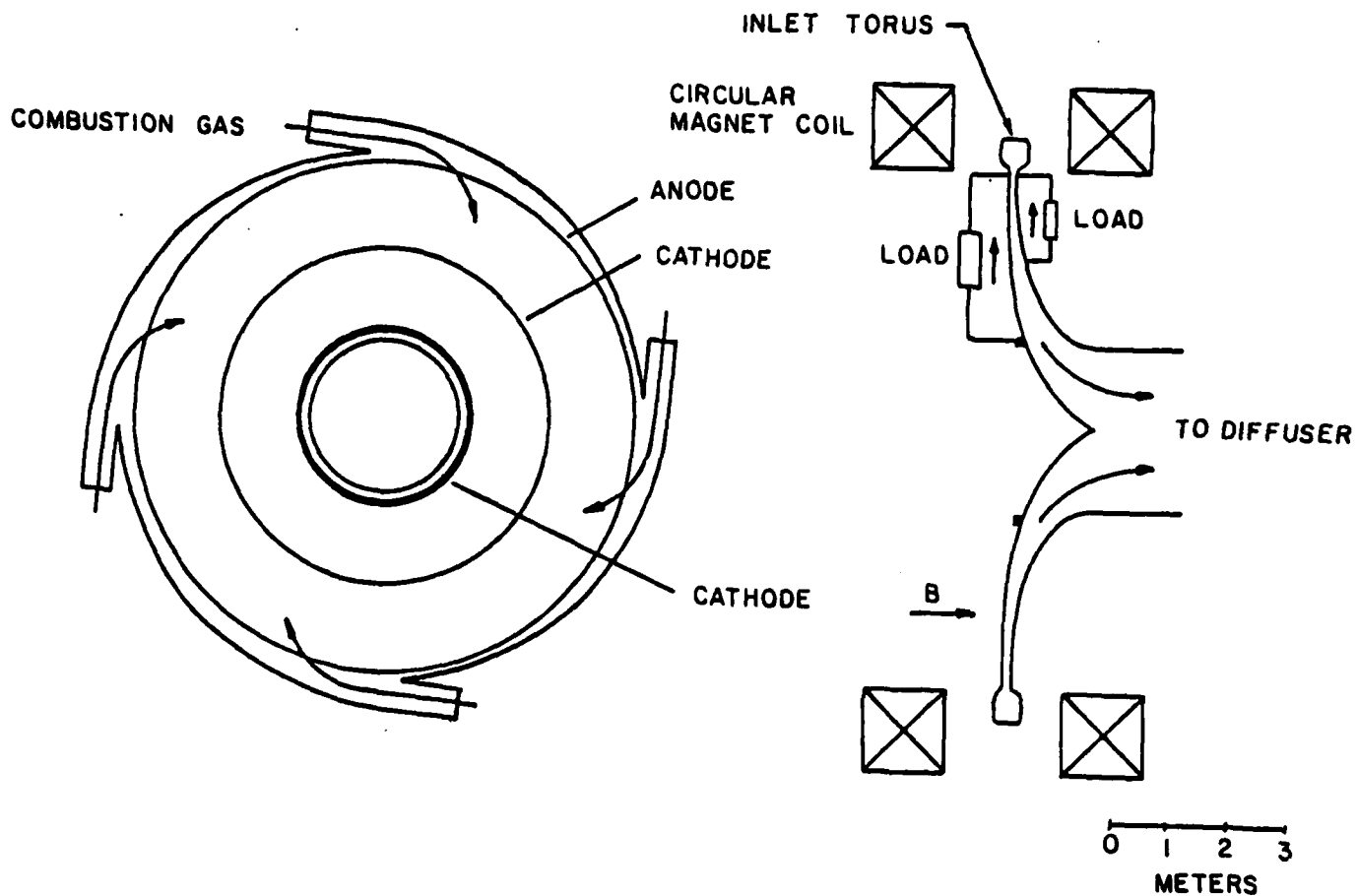

FIG. 18. Conceptual design of a baseload inflow disk generator (1250 MW(th))
 The combustion gas from four combustors is distributed around the outer radius of the channel by a scroll and is injected tangentially inward. At the exit of the channel the gas flows axially out into the diffuser. A feasibility study of the inflow disk MHD generator for baseload applications was performed. Each design element, i.e., the combustor, the inlet flow patch, the generator channel, the diffuser and the magnet, was studied in detail in order to provide a comprehensive assessment of the inflow disk generator. Based on these results, the performance of the inflow disk generator was calculated. It was shown that the performance of the inflow disk generator is similar to that of the diagonal generator within the uncertainty of the analysis.

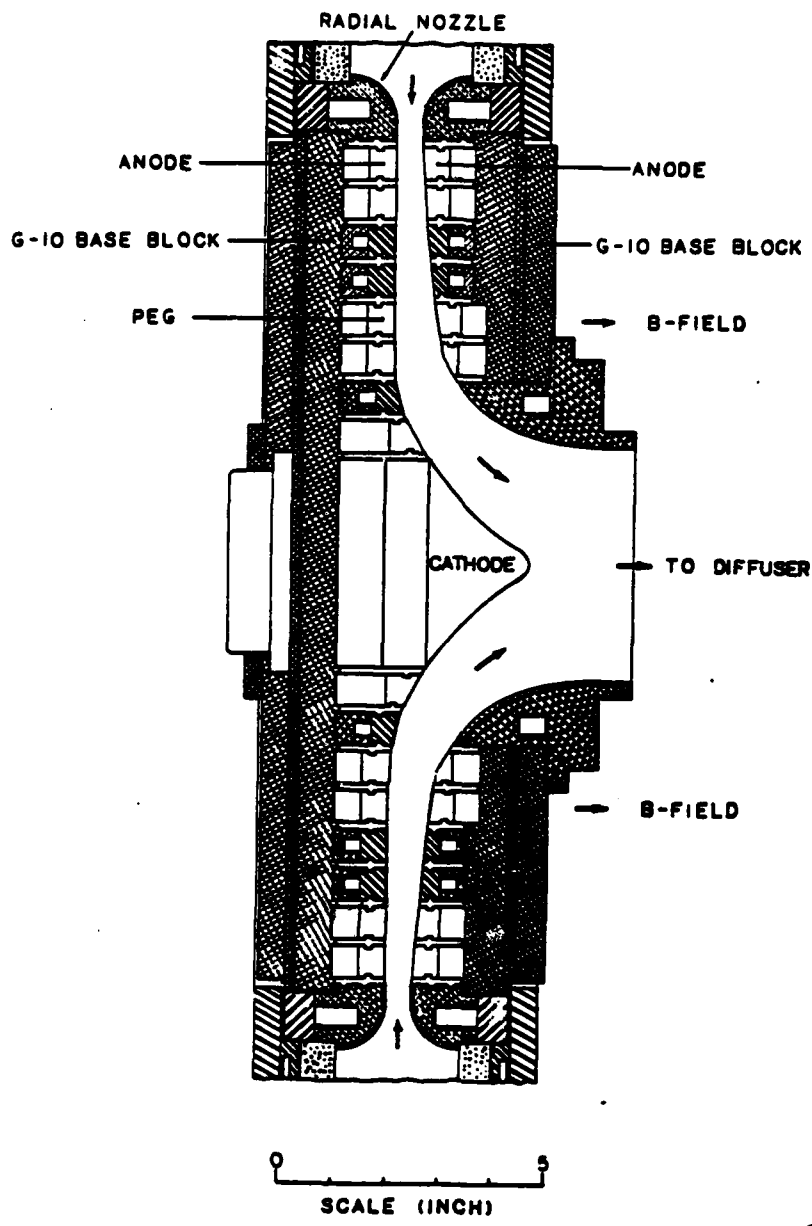

FIG. 19. The generator channel shown in FIG. 19 and 20 is designed to allow experiments both with clean fuel and coal up to a maximum thermal input of 3.5 MW. The channel is of water-cooled peg wall construction. Copper pegs capped with stainless steel are installed in fiberglass reinforced epoxy (G-10). Each peg is insulated in the azimuthal direction as well as in the radial direction in order to measure possible nonuniformities or instabilities. The objective of the program is to investigate:

- (i) The effect of scroll induced nonuniformities on generator performance;
- (ii) The current discharge phenomena taking place at the electrode surface and in the generator core;
- (iii) The boundary layer and the slag surface effects.

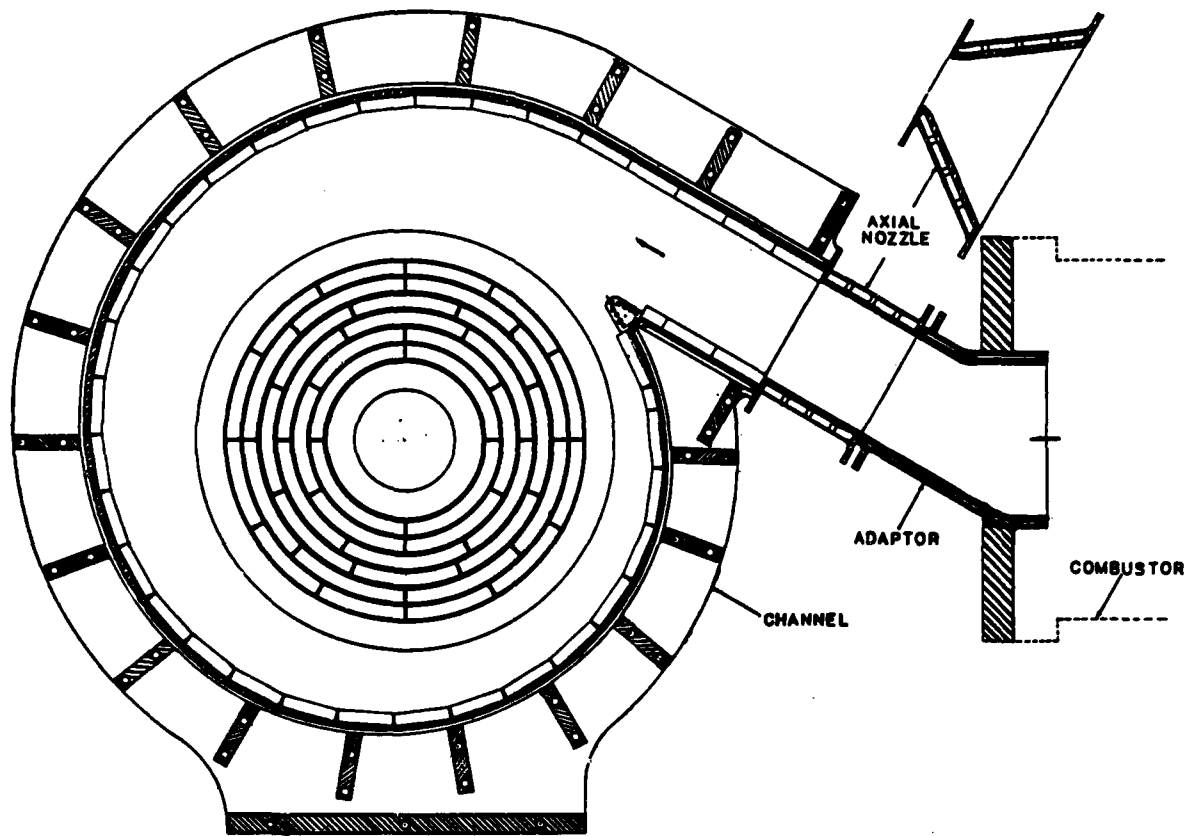

FIG. 20. Planview of the 3.5 MW_c experimental disk generator.

Q & A - J. K. Koester

From: P. J. Turchi, R & D Associates

Why is there a critical current density?

A.

A critical current density occurs at the anode due to the electrothermal instability. Many materials associated with the channel (slag layers, ceramic electrode, the plasma) have electrical conductivity that is strongly temperature dependent. As $\frac{d\ln\sigma}{dT}$ increases, the critical current density

decreases. For the slag coated electrode case, the slag breaks down (into arcs) before the plasma boundary layer.

A critical current density occurs at the cathode due to limitations on the thermionic emission of electrons at the electrode surface (or the slag layer surface).

REFERENCES

1. S. A. Self, "Diagnostic Techniques for Combustion MHD Systems," AIAA International Meeting & Technical Display "Global Technology 2000", Paper #AIAA-80-0926, Baltimore, MD, May 1980
2. R. R. Rankin, "Insulating Wall Boundary Layer in a Faraday MHD Generator," DOE Report #FE-2341-7, April 1978, HTGL Report #106.
3. R. R. Rankin, S. A. Self & R. H. Eustis, "A Study of the Insulating Wall Boundary Layer in a Faraday MHD Generator," AIAA Journal, Vol. 18, No. 9, Sept. 1980, pp. 1094-1100.
4. R. K. James, "Joule Heating Effects in the Electrode Wall Boundary Layers of MHD Generators," HTGL Report No. 115, Stanford University, January 1980.
5. R. K. James and C. H. Kruger, "Plasma Measurements of Joule Heating Effects in the Near Electrode Region of an Open Cycle MHD Generator," 18th Symposium on Engineering Aspects of MHD, June 1979, Butte, Montana.
6. J. P. Barton, J. K. Koester, and M. Mitchner, "Probe-tube Microphone for Pressure-Fluctuation Measurements in Harsh Environments," J. Acoust. Soc. Am., 62, 5 (1977), 1312-1314.
7. J. P. Barton, J. K. Koester, and M. Mitchner, "Fluctuations in Combustion MHD Generator Systems," 18th Symposium on Engineering Aspects of MHD, June 1979, Butte, Montana.
8. T. D. Simons, R. H. Eustis, and M. Mitchner, "Effects of Magnetic Interaction on Acoustic Waves in a Combustion MHD Generator," 19th Symposium Engineering Aspects of MHD, June 1981, Tullahoma, Tennessee.
9. W. C. Unkel, "Axial Field Limitations in MHD Generators," DOE Report #FE-2341-8, April 1978, HTGL Report #107.
10. W. Unkel, C. H. Kruger and J. K. Koester, "Axial Field Limitations in MHD Generators," Sixth International Conference on Magnetohydrodynamic Electrical Power Generation, June 1975.
11. W. Hermina and C. H. Kruger, "Plasma and Insulator Initiated Hall Field Breakdown," 19th Symposium on Engineering Aspects of MHD, June 1981, Tullahoma, Tennessee.
12. J. K. Koester and R. A. Perkins, "Discharge and Corrosion Characteristics of Slagging Metal Electrodes for MHD Power Generators" J. Materials for Energy Systems, 1, 2 (September 1979), 41-54.

13. R. M. Nelson and J. K. Koester, "Diffuse Mode Current Transport in a Slagging MHD Generator," 7th International Conference on MHD Electrical Power Generation, Cambridge, MA, June 1980.
14. J. K. Koester, "Advances in Coal Fired MHD Generator Research," 16th Intersociety Energy Conversion Engineering Conference, Atlanta, GA, August 1981.
15. R. M., Nelson, J. K. Koester, "Electrical Effects of Coal Slag in a Diffuse Mode MHD Generator," AIAA-81-0176, AIAA 19th Aerospace Sciences Meeting, January 1981.
16. T. Nakamura, W. E. Lear and R. H. Eustis, "Feasibility of the Inflow Disk Generator for Open-Cycle MHD Power Generation," AIAA-81-0250, AIAA 19th Aerospace Science Meeting, January 1981.
17. D. Roseman, T. Nakamura and R. H. Eustis, "Current Distribution and Nonuniformities in MHD Disk Generators," 19th Symposium on Engineering Aspects of MHD, June 1981, Tullahoma, Tennessee.

SESSION IV. NUCLEAR SOURCES

**OVERVIEW
OF
SPACE REACTORS**

**BY
DAVID BUDEN**

Los Alamos

SPACE POWER OVERVIEW

- POTENTIAL SPACE POWER MISSIONS
- SPACE POWER TECHNOLOGY CAPABILITIES
 - SNAP
 - SP-100
 - ROVER
 - ROTATING BED
- CONVERSION TECHNOLOGY
- RADIATOR TECHNOLOGY

POTENTIAL DOD HIGH-POWER SPACE MISSIONS

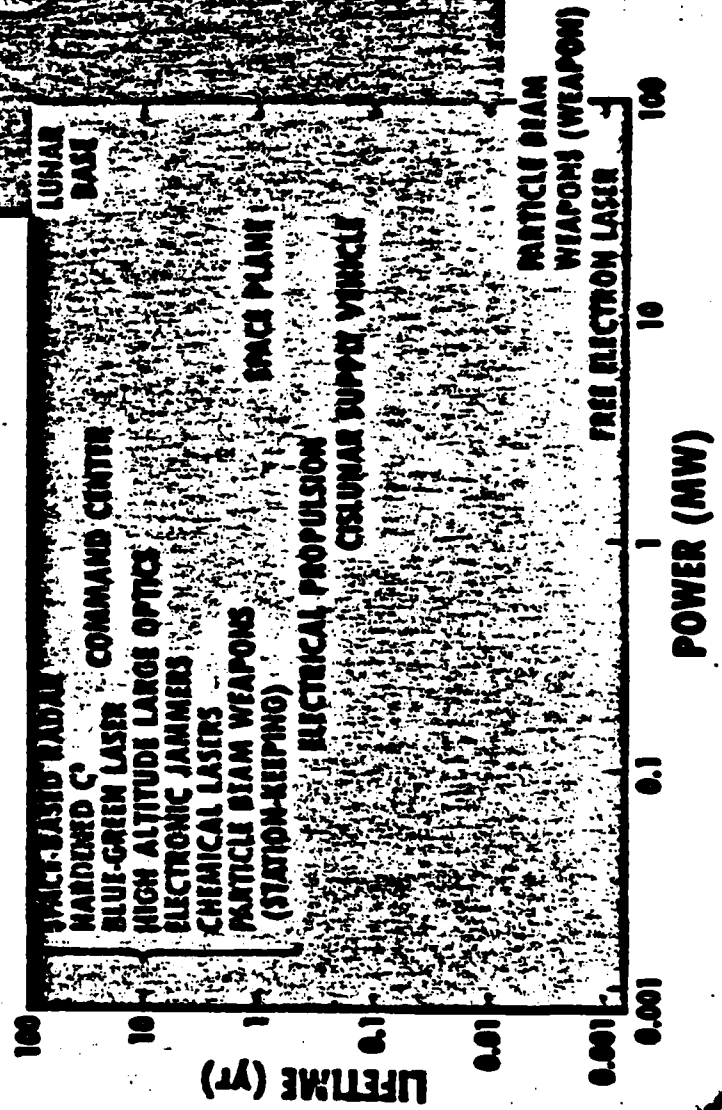
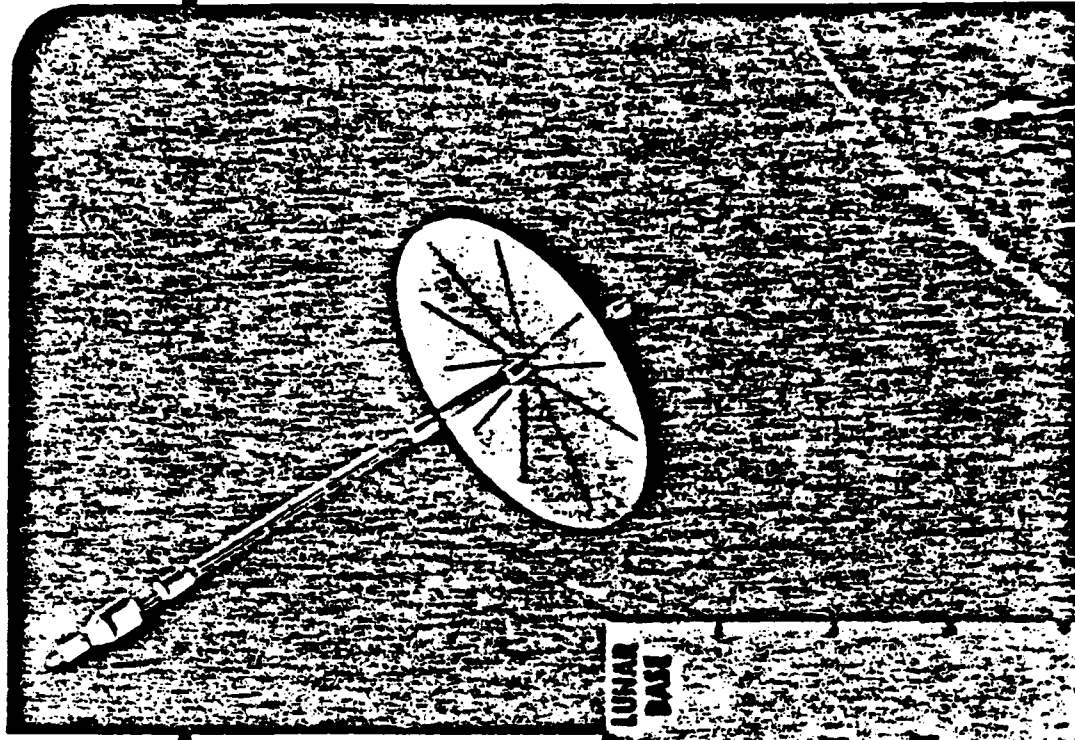

Los Alamos

**POTENTIAL
HIGH-POWER
CIVILIAN MISSIONS**

**PLANETARY EXPLORATION
EARTH ORBITAL
SPACE OPERATIONAL CENTER
COMMUNICATIONS PLATFORM
SPACE SETTLEMENTS**

Los Alamos

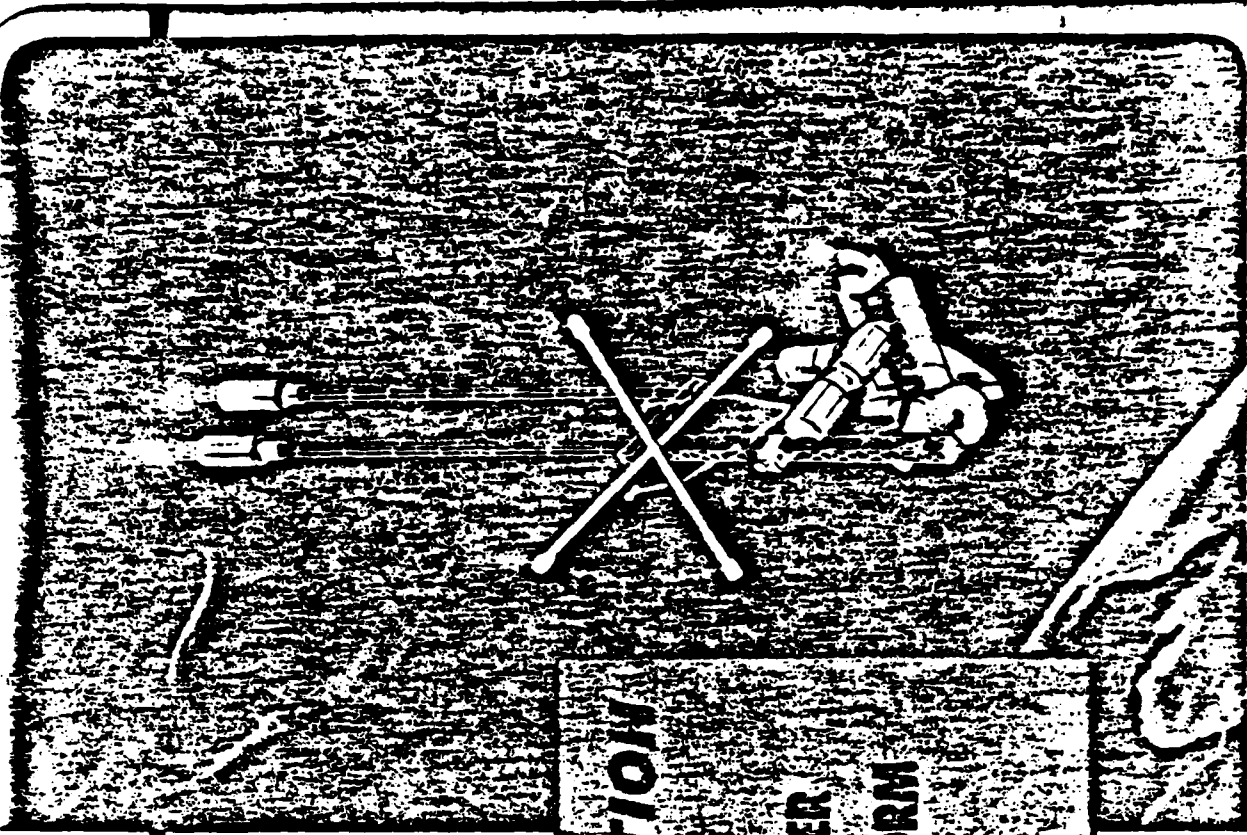

POWER ALTERNATIVES

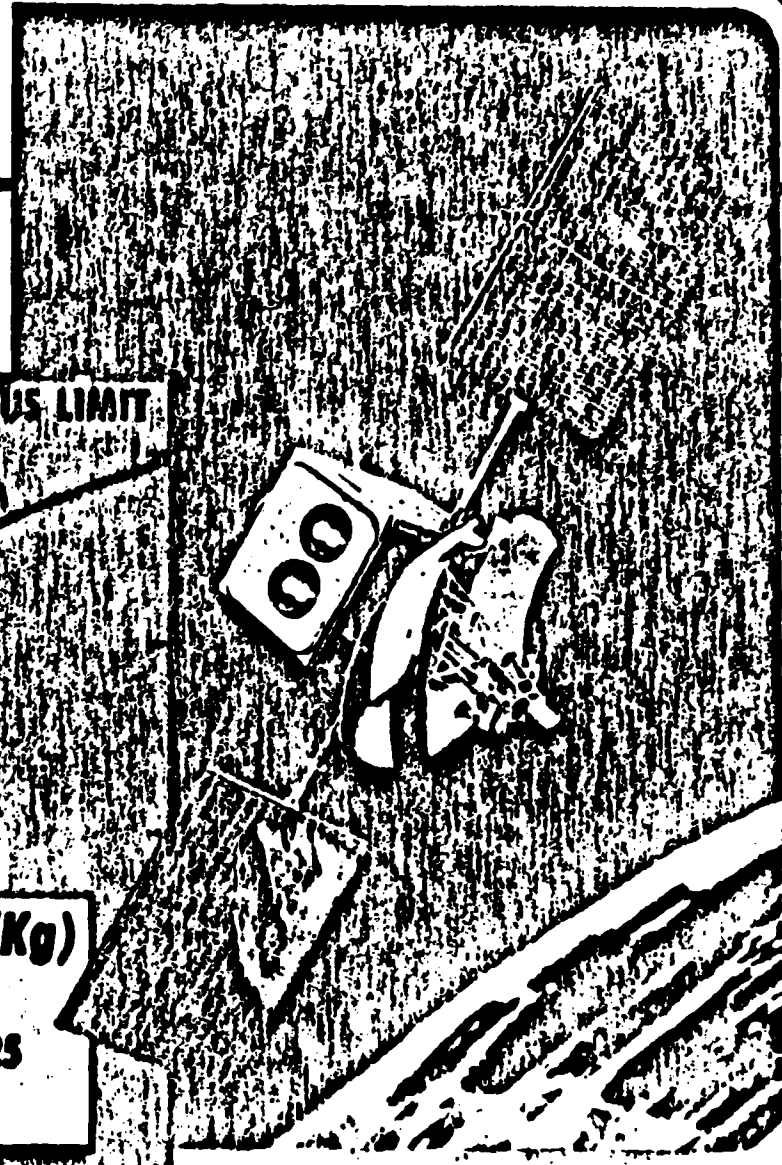
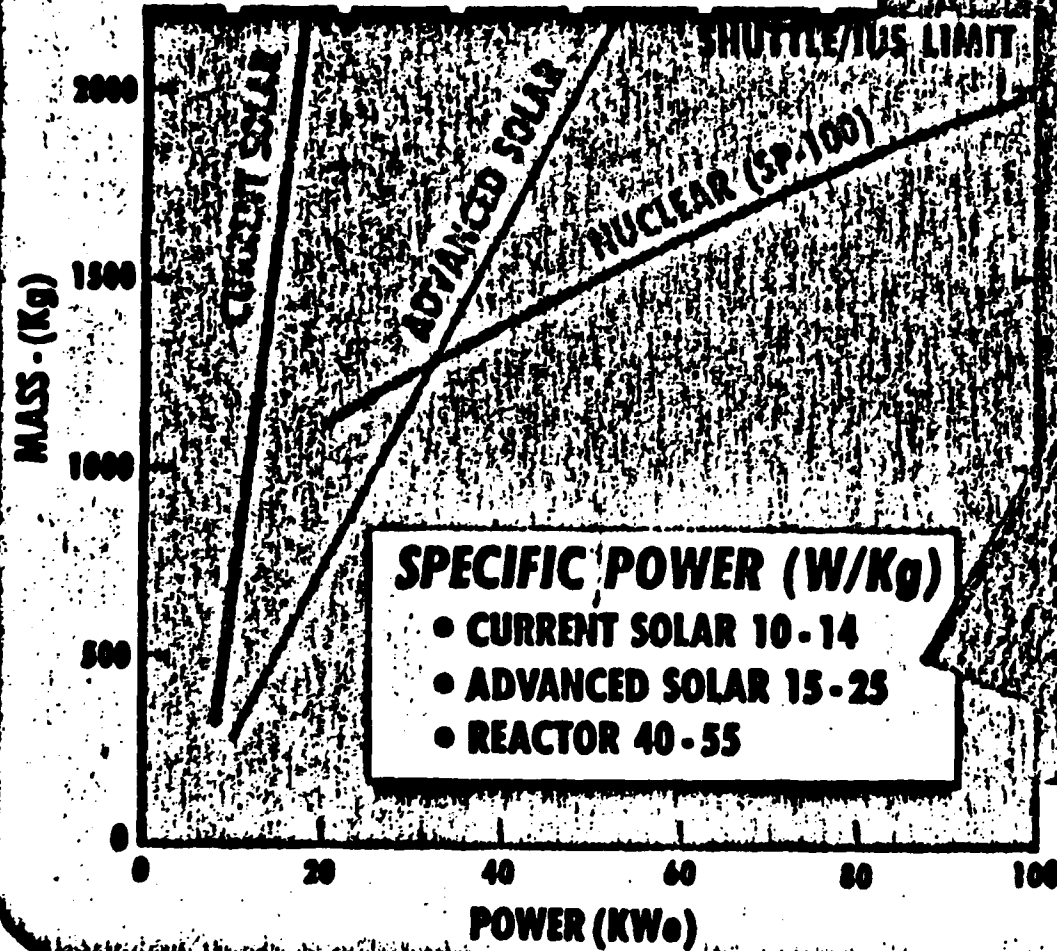

Los Alamos

SPACE POWER TECHNOLOGY

FEATURE	SOLAR		REACTOR		MILITARY UTILITY REACTOR
	CURRENT*	ADVANCED	CURRENT	ADVANCED	
SPECIFIC POWER (W/kg)	10-14	15-25	0.5	40-55	INCREASED PAYLOAD CAPACITY
SIZE (m ² /kWe)	14	10	3	2	REDUCED CROSS SECTION REDUCED DRAG/SOLAR PRESSURES ENHANCED MANEUVERING SIMPLIFIED DEPLOYMENT SIMPLIFIED POSITIONING
POWER DEGRADATION NATURAL ENVIRONMENT (10 YEAR)	20	10	≈ 0	≈ 0	BOL IS APPROXIMATELY EQUAL TO EOL ASSURED LONGER LIFE
VAN ALLEN RANGE*** (1st YEAR)	25-60	7-4	≈ 0	≈ 0	
NUCLEAR EXO ATMOS. (% PER INCIDENT)	3-10	1-5	≈ 0	≈ 0	SURVIVABLE WITH MINIMUM PENALTY
% SPECIFIC POWER REDUCTION FOR LASER PROTECTION**	45-50	25-30	≈ 5	≈ 5	

* Reference DSCS II design

** Synchronous altitude

*** 2000 nm circular orbit, 60/6 mil glass protection

CATEGORIES OF NUCLEAR POWER PLANTS

IV-1-7

- **LONG-LIFE, 10-1000 kWe - i.e., SP-100 OR SP-100 DERIVATIVES**
- **MULTIMEGAWATT, SHORT DURATION (PROBABLY DUAL MODE)**
- **MAINTAINABLE AND REFUELABLE POWER PLANTS, 100-3000 kWe**
- **LUNAR PROCESS HEAT REACTOR, HUNDREDS OF MEGAWATTS**
- **PROPULSION REACTORS**

DESIRABLE POWER PLANT CHARACTERISTICS

RELIABILITY

HIGH-RELIABILITY COMPONENTS
NO SINGLE-FAILURE POINTS

WEIGHT

SINGLE SHUTTLE OR LESS

- 100 kWe RANGE < 20 kg/kWe
- 1 MWe RANGE < 10 kg/kWe
- 10 MWe RANGE < 3 kg/kWe*
- 100 MWe RANGE < 0.3 kg/kWe*

VOLUME

SINGLE-SHUTTLE COMPATIBLE

SHIELDING

10^{12} – 10^{13} nvt
 10^6 – 10^7 rad

* Assumes use of nuclear electric propulsion to higher orbits

Los Alamos

TECHNOLOGY CANDIDATES

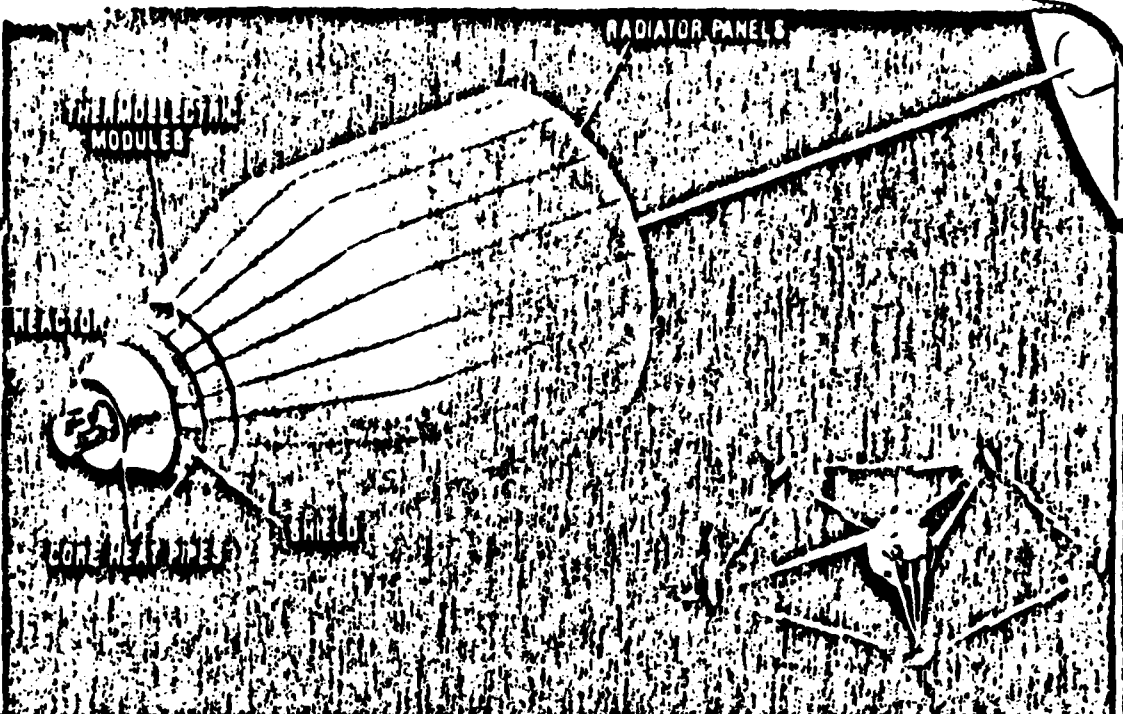

IV-1-AI

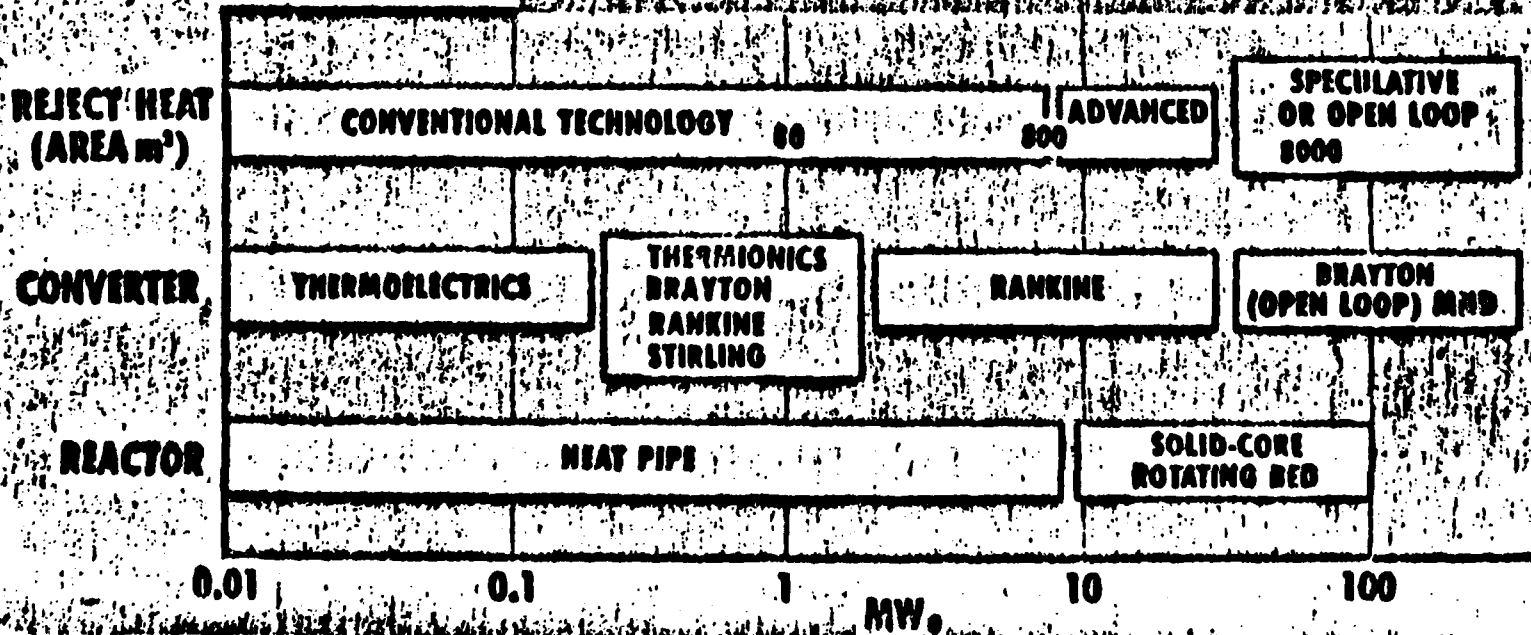

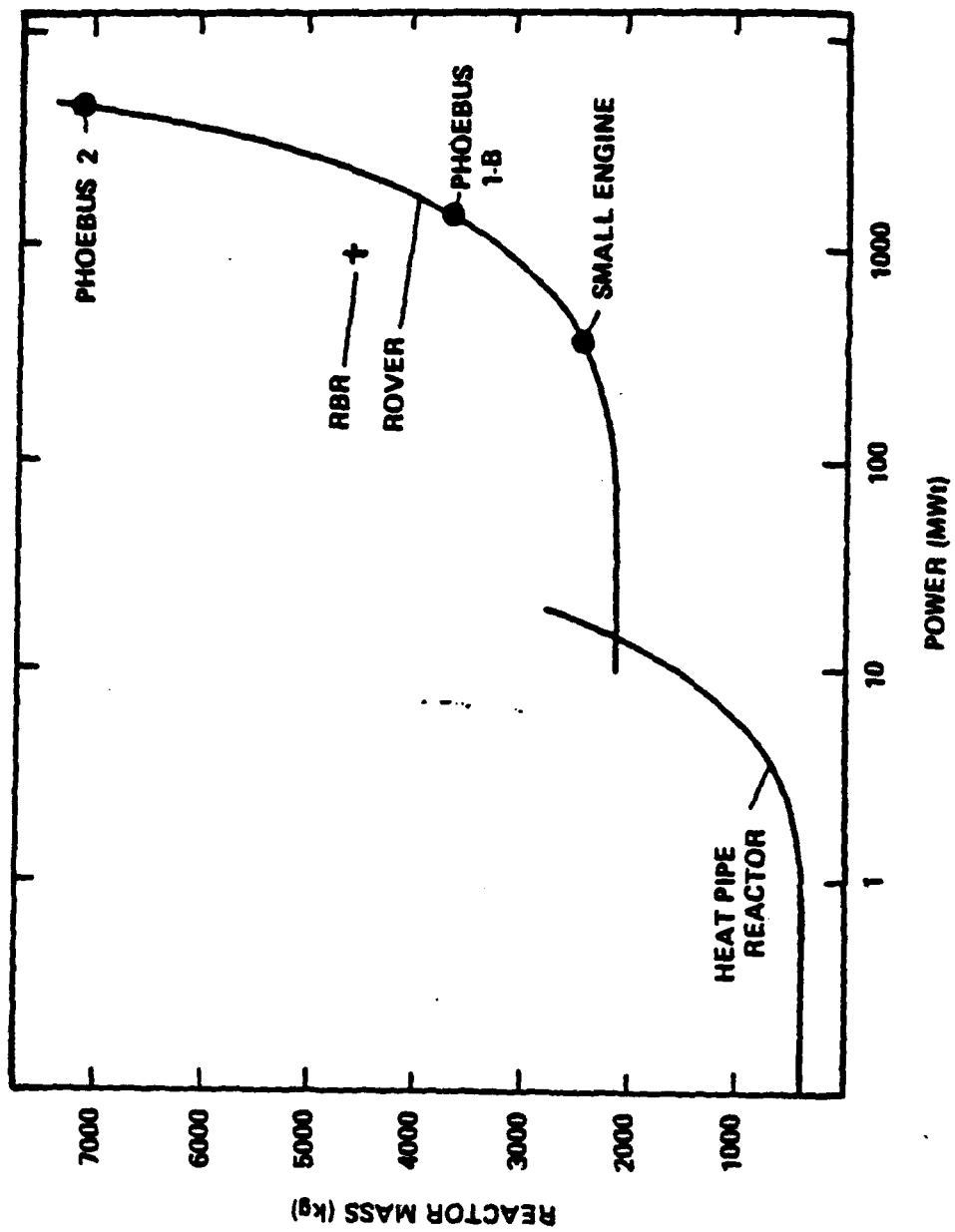

SNAP REACTOR TEST EXPERIENCE



	SNAP EXPERIMENTAL REACTOR (SER)	SNAP DEVELOPMENTAL REACTOR (SDR)	SNAP B EXPERIMENTAL REACTOR (SER)	SNAP 10A FLIGHT SYSTEM (FS-3)	SNAP B DEVELOPMENTAL REACTOR (SDR)
CRITICAL	SEPTEMBER 1959	APRIL 1961	MAY 1963	JANUARY 1965	JUNE 1966
SHUTDOWN	DECEMBER 1960	DECEMBER 1962	APRIL 1965	MARCH 1966	DECEMBER 1969
THERMAL POWER	50 kw	65 kw	600 kw	30 kw	600-1000 kw
THERMAL ENERGY	225,000 kw-hr	272,000 kw-hr	8.1 x 10 ⁶ kw-hr	282,944 kw-hr	4.3 x 10 ⁶ kw-hr
ELECTRIC POWER	.	.	.	402 watts	.
ELECTRIC ENERGY	.	.	.	4020 kw-hr	374 kw-hr
TIME AT POWER AND TEMPERATURE	1000 hr AT 1200°F 3500 hr ABOVE 900°F	2800 hr AT 1200°F 7700 hr ABOVE 900°F	1 yr AT 1300°F 400 TO 600 hr	10,000 hr (417 days)	1000 hr
					7023 hr 1000-1300°F

AF-60-100-25

REQUIREMENTS

POWER OUTPUT (kWe) _____ 10-100

LIFETIMES (year) _____ 7

RELIABILITY _____ NO SINGLE
FAILURE
POINTS

SPECIFIC MASS (kg/kWe) _____ 20-30

RADIATION ATTENUATION

NEUTRONS (mvt) _____ 10^{12}

GAMMA (rad) _____ 10^6

SP-100 PROGRAM

SHIELD



GENERAL ELECTRIC COMPANY

TRACOR

NEUTRONS

GAMMA

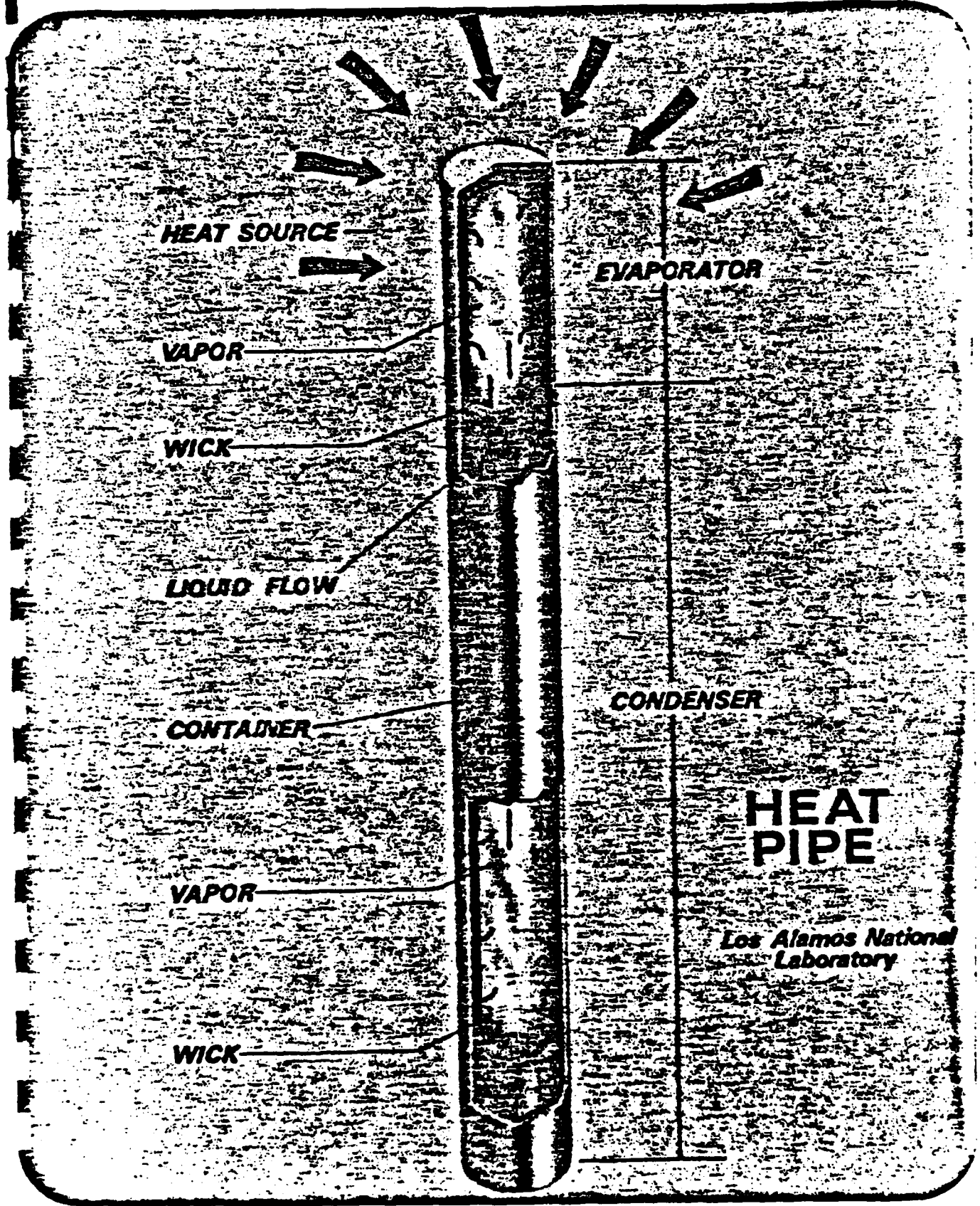

HEAT PIPE SPACE REACTOR

- FAST REACTOR
- FUEL IS UO_2
- HEAT TRANSPORT BY HEAT PIPES
 - NO PUMPS OR COMPRESSORS
 - REDUNDANT HEAT TRANSPORT PATHS
- NO SINGLE FAILURE POINTS

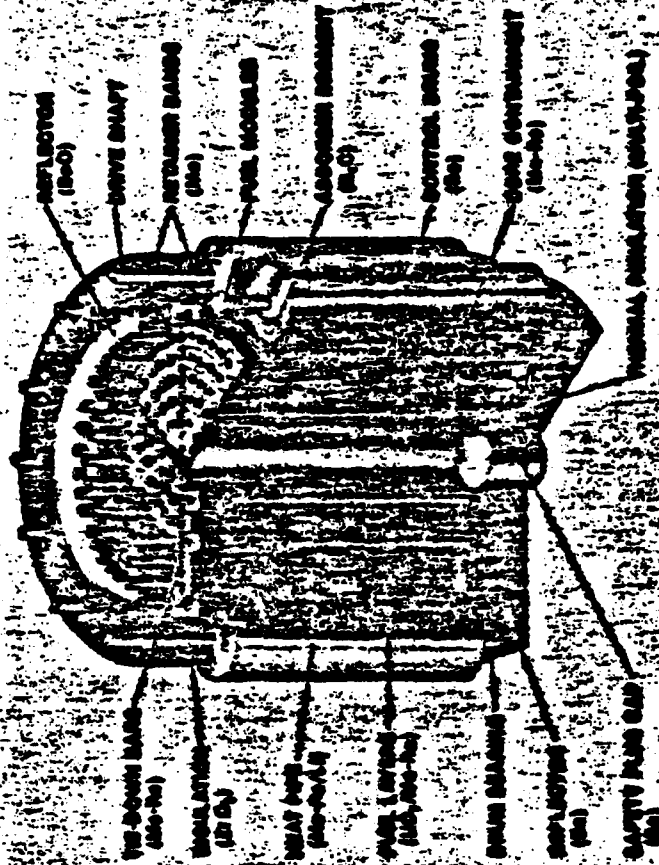

POWER SUBSYSTEM

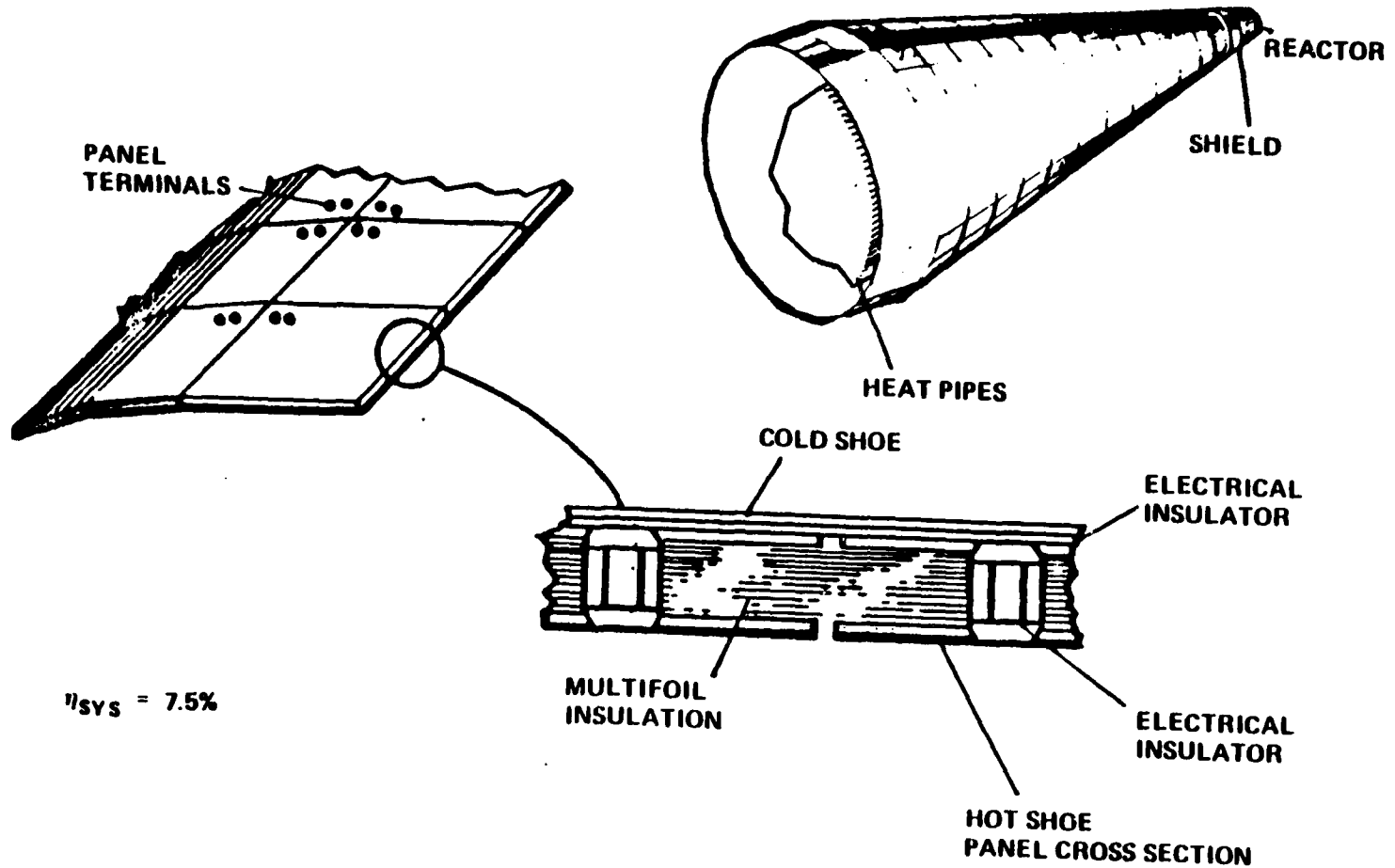

$\eta_{\text{SYS}} = 7.5\%$

SI-1-15

EXTENSION OF SP-100 TECHNOLOGY TO MEGAWATT-LEVEL POWER SUPPLIES

- HEAT PIPE REACTOR CONCEPT EXTENDABLE TO 10 MWe
 - DYNAMIC CONVERSION SUCH AS RANKINE, BRAYTON OR STIRLING, OR THERMIONIC GENERATORS
 - REDUNDANCY THROUGH MULTIPLE INDEPENDENT HEAT EXCHANGERS
- FUEL OF CHOICE WILL REMAIN UO_2
- SP-100 DATA ON SHIELD, CONTROLS, AND REFLECTOR ARE ALL APPLICABLE TO HIGHER POWER LEVELS
- EXPERIMENTAL AND ANALYTICAL DEVELOPMENTS RELATIVE TO SAFETY ARE READILY APPLICABLE TO HIGHER POWER LEVELS
- RADIATOR DEVELOPMENTS DEPEND ON THE COUPLING SCHEME ADOPTED FOR SP-100 COMPARED TO CONVERTER TEMPERATURE FOR HIGHER POWER LEVELS

IV-1-17

<u>REQUIREMENTS</u>	<u>TIME</u>	<u>POWER LEVEL</u>
ASAT, SATELLITE DEFENSE, WEAPONS TESTS	HUNDREDS-OF- SECONDS	TENS-OF-MEGAWATTS
ABM DEFENSE	UP TO SEVERAL HOURS	TENS-OF-MEGAWATTS
STATION-KEEPING	5 - 10 YEARS	TENS-OF-KILOWATTS
ORBITAL TRANSFER VEHICLE AND MANEUVERING	DAYS	MEGAWATTS

REACTOR TECHNOLOGY

NUCLEAR ROCKET AND DERIVATIVES

- POWER LEVELS 45-5000 MW_T AT 2450 K
- DEMONSTRATED LIFETIME - 2 HRS.
- SOLID CORE, GAS COOLED REACTOR DESIGN
- DATA BASE COULD BE RECONFIGURED TO PROVIDE BOTH HIGH AND LOW ELECTRIC POWER LEVELS.
- STATUS--OVER BILLION DOLLARS INVESTED IN DEVELOPMENT,
NOW DISCONTINUED

NUCLEAR ROCKET REACTORS

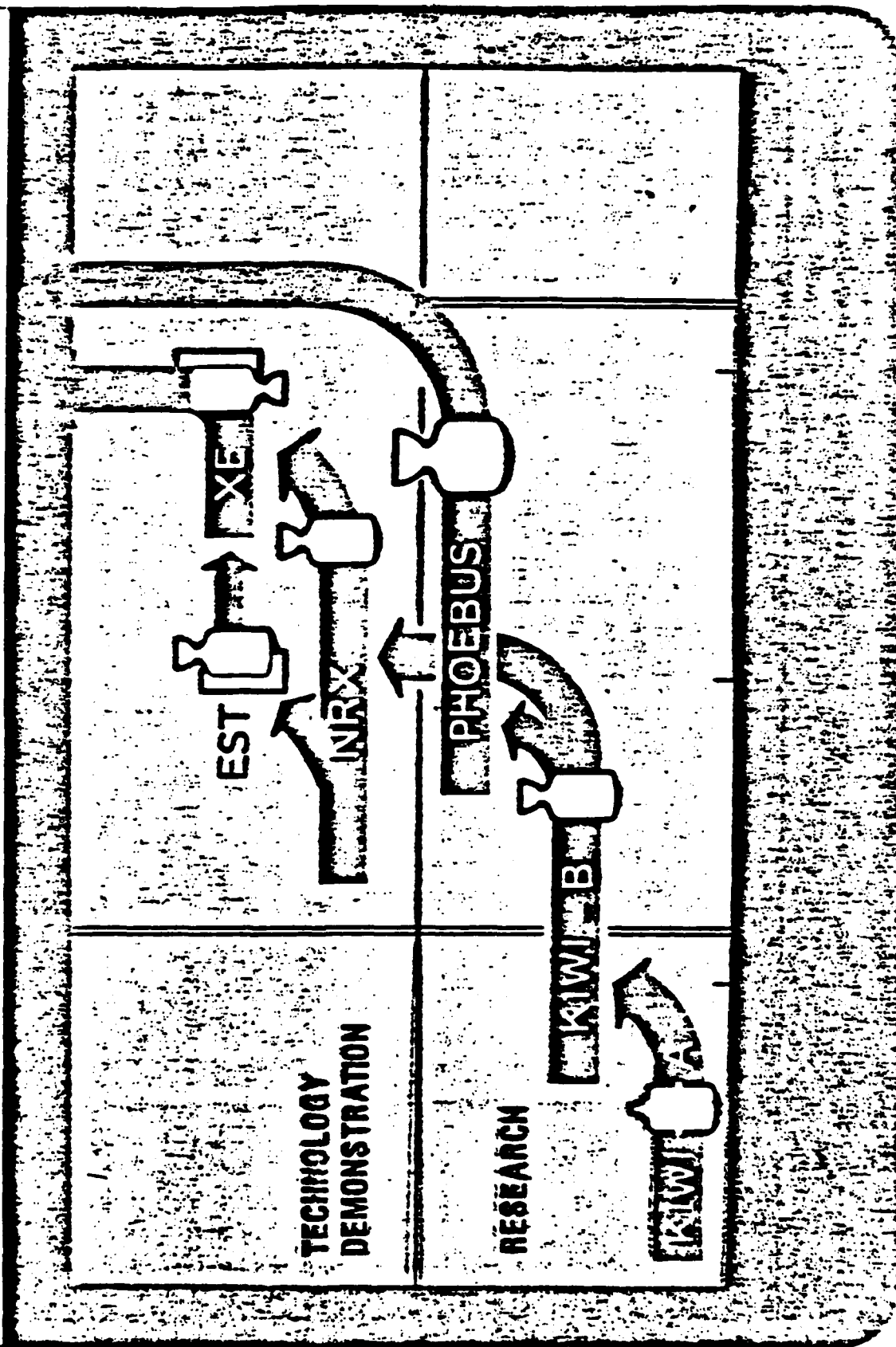

NERVA FLOW DIAGRAM

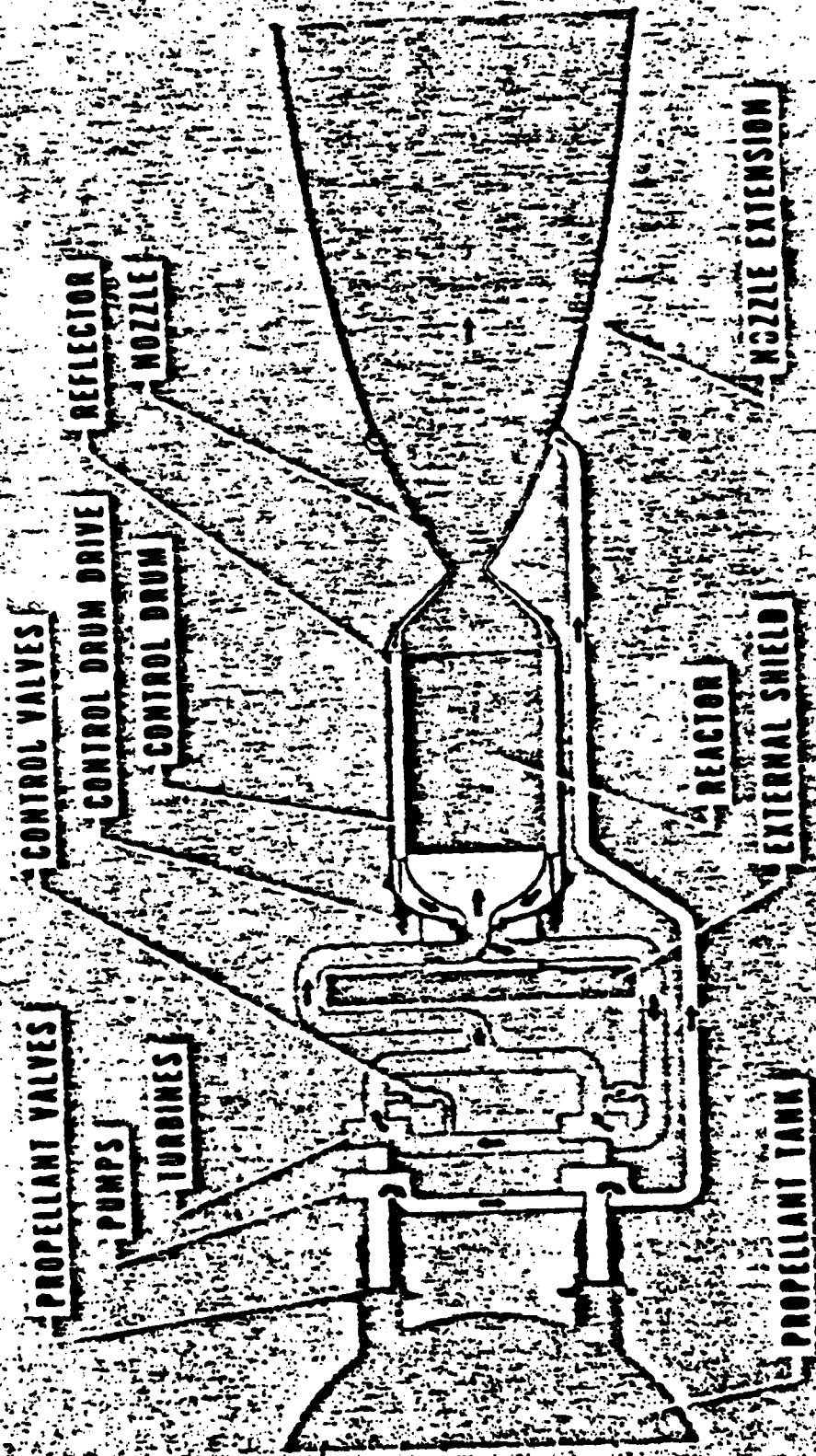

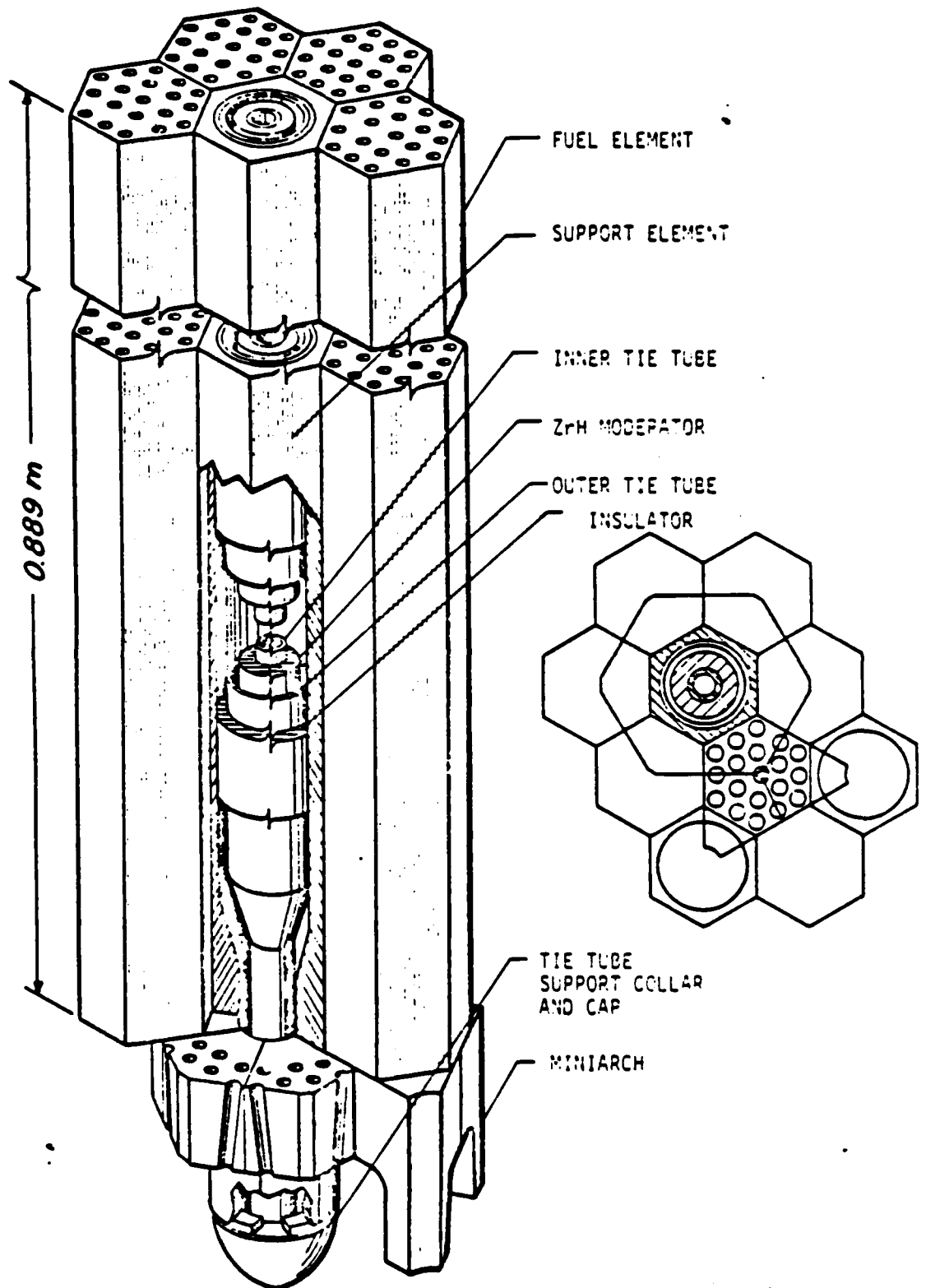

Fig. III-1. Schematic of fuel elements, support elements, and hot end support hardware.

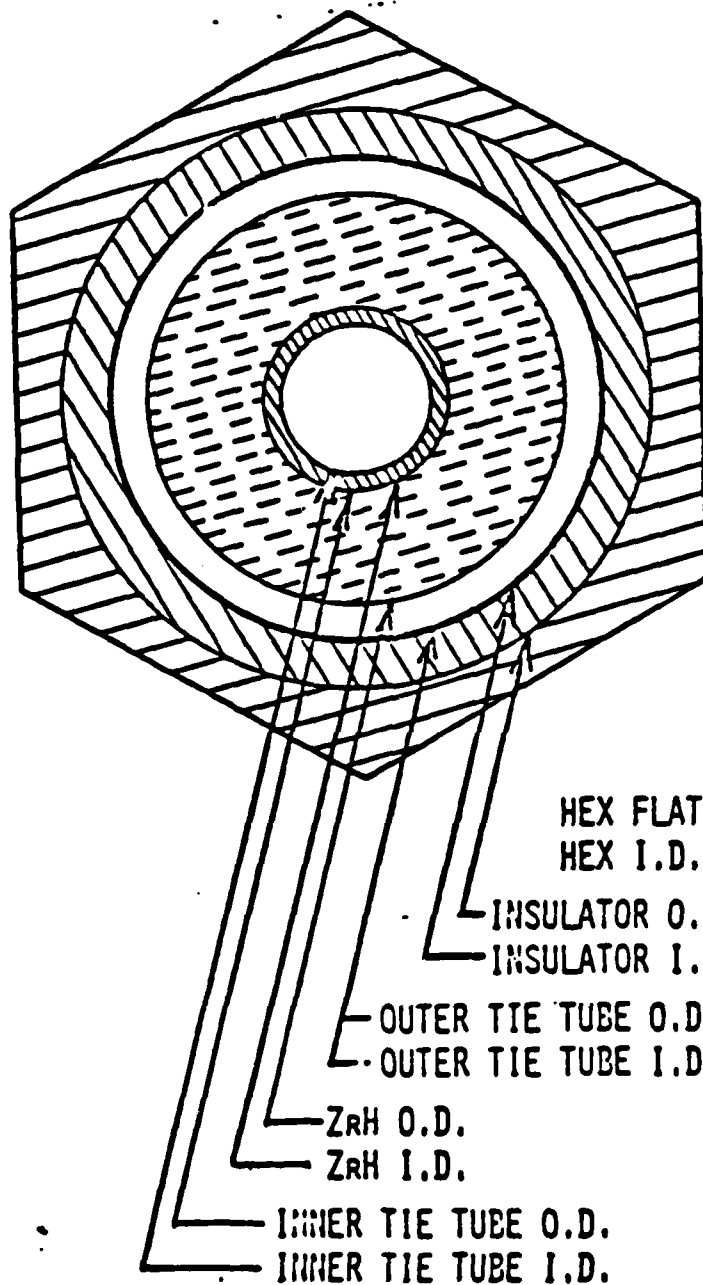
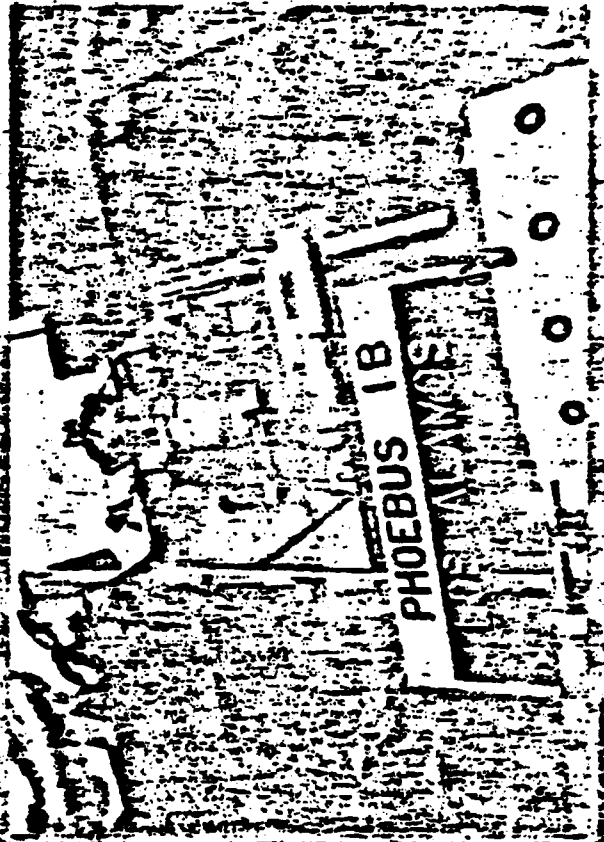

Fig. III-2. Nuclear engine reactor tie tube and support element geometry.

NUCLEAR ROCKET DEMONSTRATED TECHNOLOGY

- TWENTY REACTORS TESTED
- REACTORS TESTED AT 48 MW (INF-1), 1100 MW (NRX), 4000 MW (Phoebus 2A)
- SINGLE REACTOR FUEL TEST 109 MINUTES AT 2440 K (INF-1)
- TWENTY EIGHT RESTARTS OF ENGINE SYSTEM (XE)



NUCLEAR ROCKET TESTS

KIWI-B4D (1 POWER TEST)	May, 1964
KIWI-B4E (2 POWER TESTS)	August-September, 1964
NRX-A2 (2 POWER TESTS)	September-October, 1964
KIWI-TNT	January, 1965
NRX-A3 (3 POWER TESTS)	April-May, 1965
PHOEBUS-1A (1 POWER TEST)	June, 1965
NRX/EST (10 STARTS)	Dec., 1965-March, 1966
NRX-A5 (2 POWER TESTS)	June, 1966
PHOEBUS-1B (1 POWER TEST)	February, 1967
PHOEBUS-2 (COLD FLOW TESTS)	July-August, 1967
NRX-A6 (1 POWER TEST)	December, 1967
XECF (COLD FLOW)	February-April, 1968
PHOEBUS-2A (3 POWER TESTS)	June-July, 1968
PEWEE-1 (2 POWER TESTS)	November-December, 1968
XE (28 STARTS)	December, 1968-August, 1969
NF-1 (4 POWER TESTS)	June-July, 1972

MULTIMEGAWATT ELECTRIC POWER REACTOR

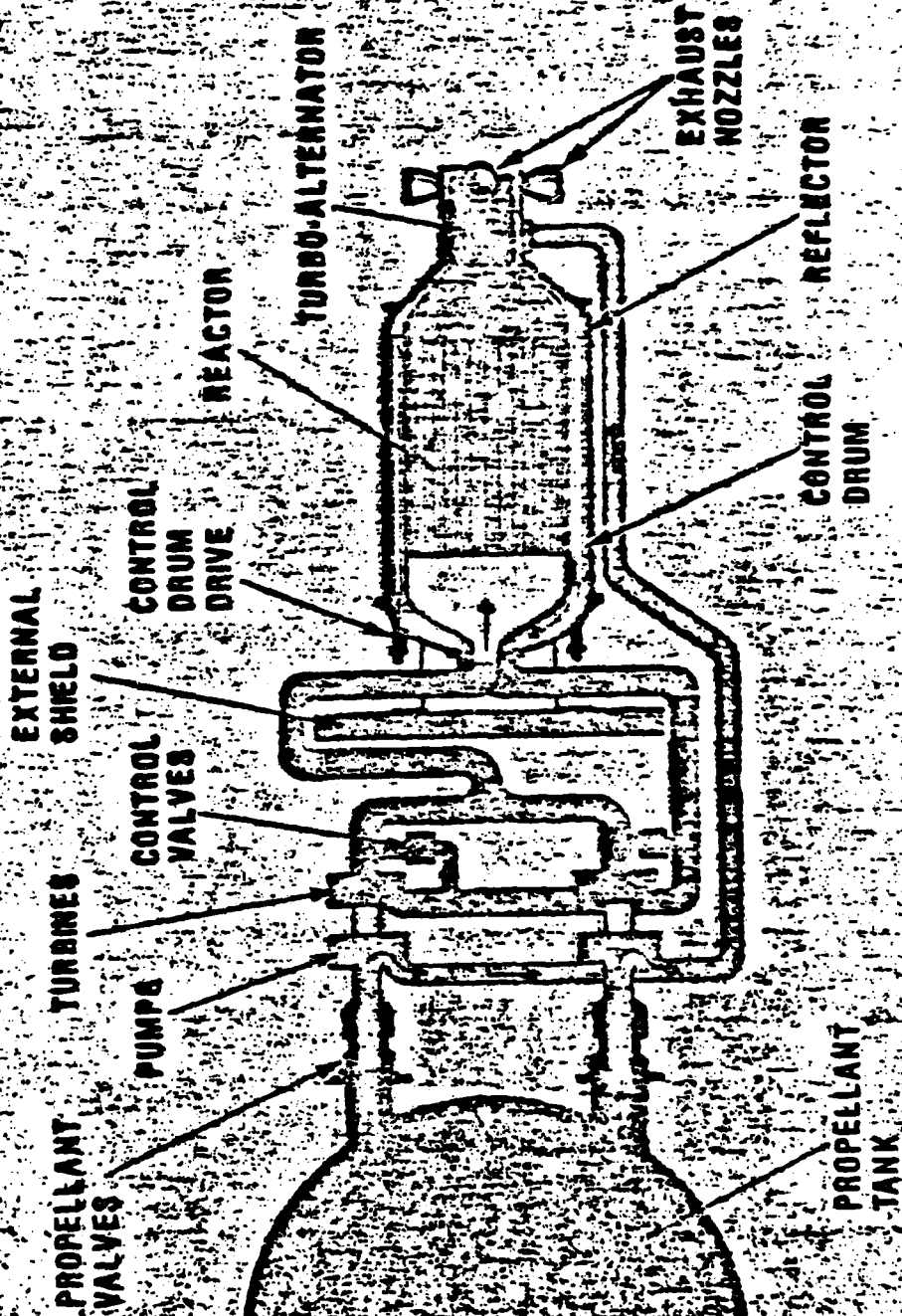

BI-MODAL ROVER POWERPLANT

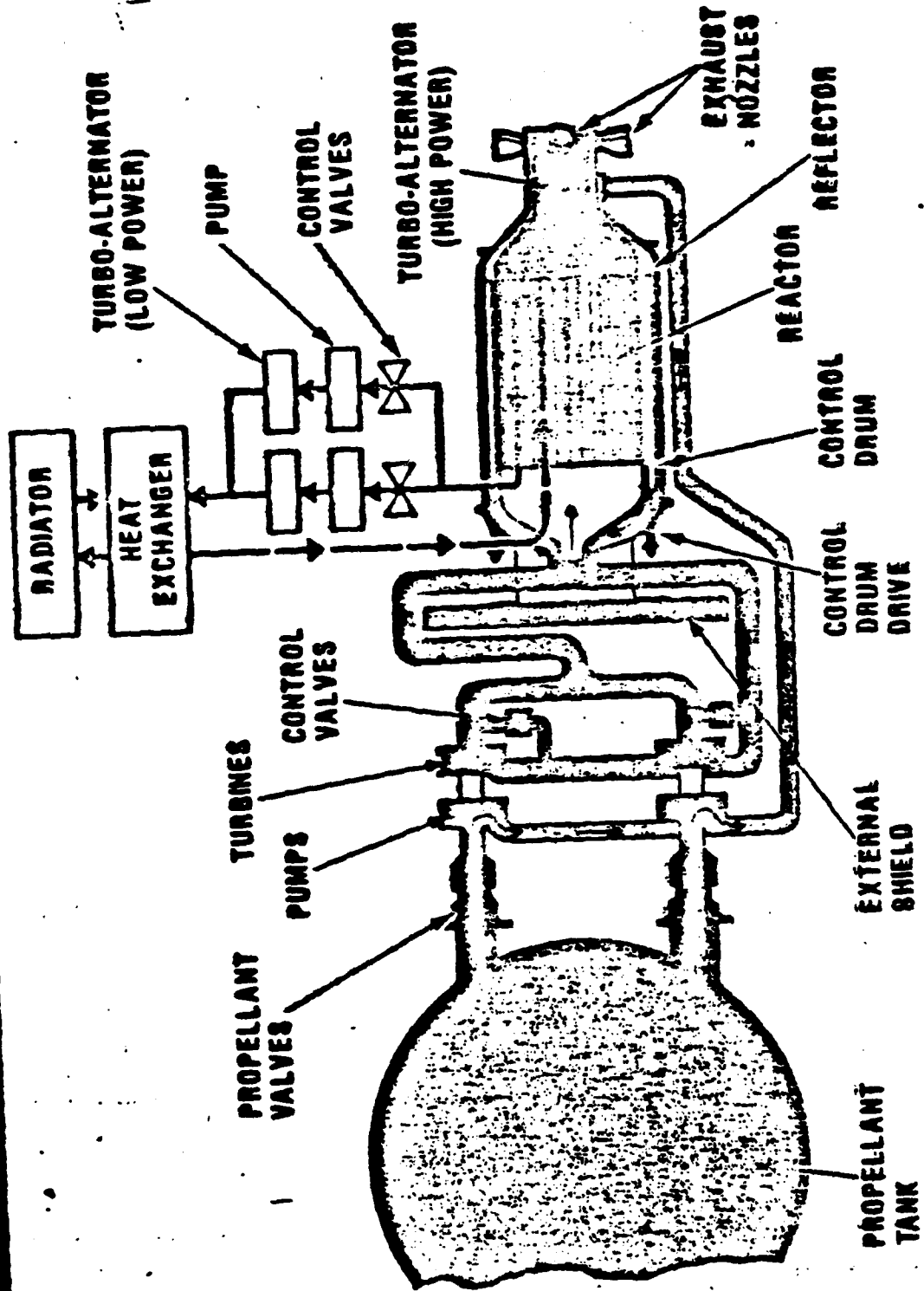

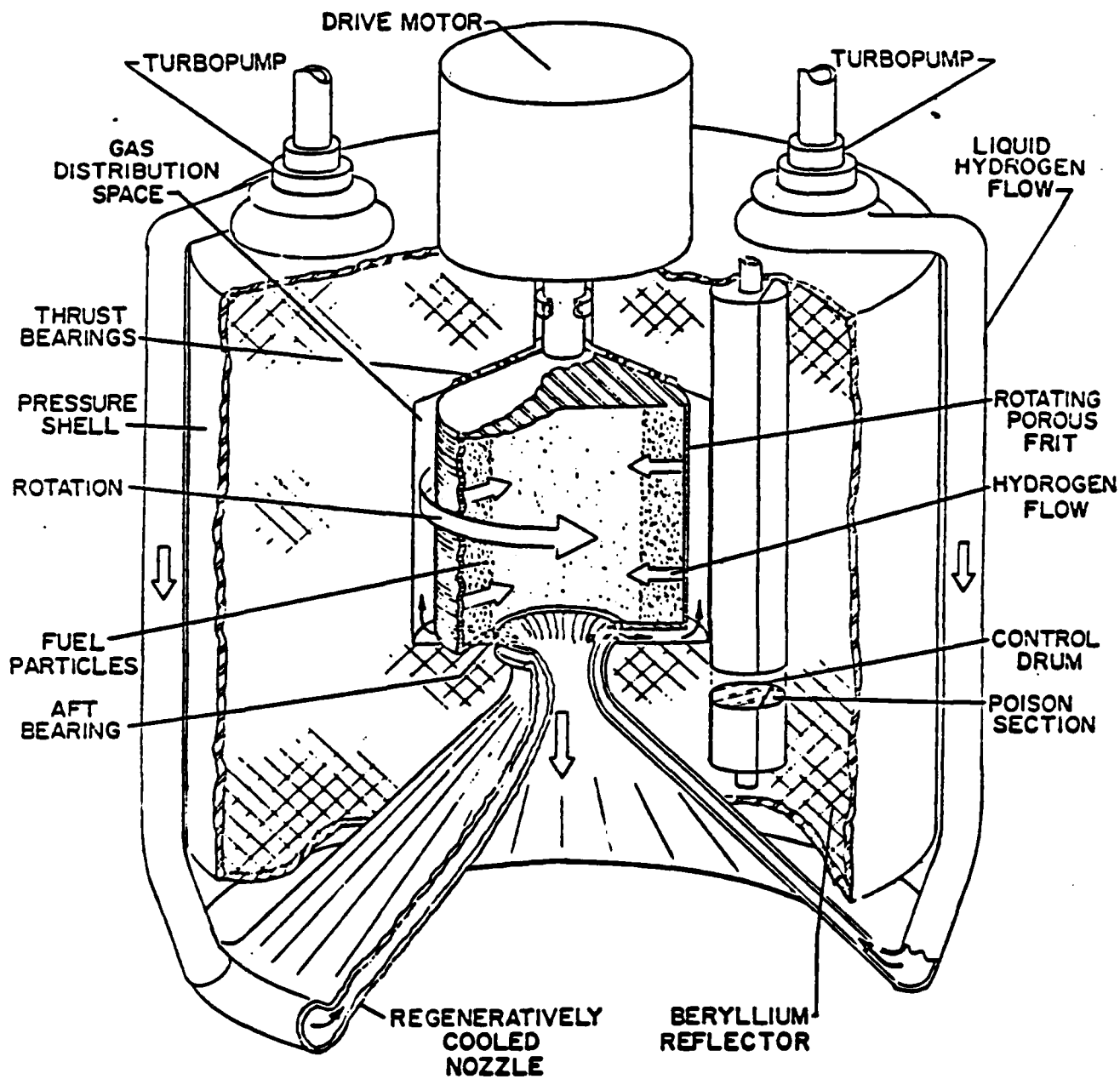

ROTATING FLUIDIZED BED ROCKET ENGINE

ILLUSTRATIVE RBR DESIGNS

	<u>²³⁵U FUEL</u>
BED INTERNAL DIAMETER (cm)	63.5
BED HEIGHT (cm)	63.5
FUEL BED THICKNESS (cm)	10.2
REFLECTOR THICKNESS (cm)	
RADIAL	30
AXIAL	30
THROAT DIAMETER (cm)	18
OVERALL HEIGHT (cm)	123.5
OVERALL DIAMETER (cm)	143.9
CRITICAL MASS (kg)	156
BED VOIDAGE (%)	60
URANIUM CONCENTRATION (at.%)	9.5
CHAMBER PRESSURE (psia)	1125
H ₂ FLOW RATE (kg/s)	20
POWER, MW (T = 3000 K)	1000
REACTOR WEIGHT (kg)	4750
(INCLUDING PUMPS AND PRESSURE VESSEL)	

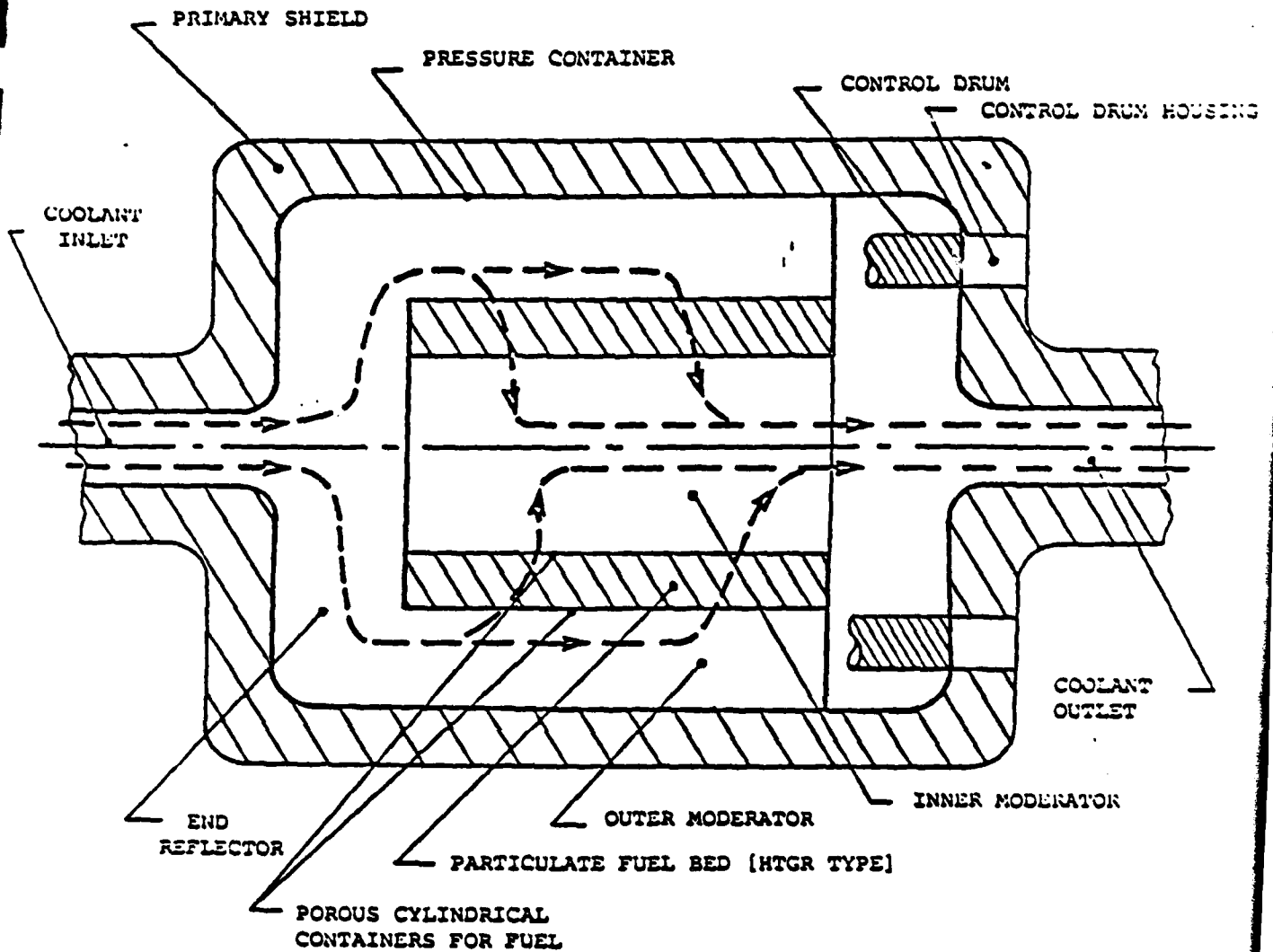

Figure 12: High Power Density Space Reactor (H_2O or Gas Coolant).
 Note: Support ribs for the reactor are not shown. Outer and inner moderator regions also provide radial reflector zones which may be made of either H_2O or ZrH_2 . Control drums extend into the outer moderator/reflector region. The fuel bed dimensions are typically of the order of 45 cm in length and 30 cm in diameter.

STATUS OF ROTATING FLUIDIZED BED REACTOR

- HALF-SCALE MODEL TESTED AT BNL IN EARLY 1970s
 - VERIFIED THERMAL HYDRAULIC PERFORMANCE AT LOW TEMPERATURES
 - N₂ GAS AT 10 atm USED WITH GLASS OR COPPER BEADS TO SIMULATE H₂-COOLED HTGR FUEL BED
 - DEMONSTRATED STABLE OPERATION AND LOW TEMPERATURE DIFFERENTIALS BETWEEN GAS AND FUEL
- USES HTGR FUEL PARTICULATES
- REFLECTOR CONTROL SIMILAR TO ROVER AND SNAP REACTORS

ESTIMATED RADIATOR AREA AND MASS

IV-1-31

	POWER LEVEL (MWe)		
	10	100	1,000
REJECT HEAT (BASED ON 20% EFFICIENCY) (MWt)	40	400	4,000
AREA (BASED ON 1000 K REJECT TEMP.) (m ²)	800	8,000	80,000
MASS ESTIMATE (BASED ON 14 kg/m ²) (kg)	11,000	110,000	1,100,000

EXPENDABLES FOR OPEN LOOP NUCLEAR POWER PLANT

	POWER LEVEL (MWe)		
	10	100	1000
FLOW RATE (kg/s)	1.3	13	125
SINGLE SHUTTLE (H ₂ = 16,800 kg) (s)	12,900	1300	130

CONVERSION CHARACTERISTICS

CONVERSION OPTION / TYPE		FEATURES
BRAYTON	ROTARY ENGINE	LOW HEAT REJECTION TEMPERATURE; LARGE SIZE RADIATOR; LIMITED MODULARITY MUST MAINTAIN HERMETICITY; LABORATORY DEMONSTRATED; HIGH CONVERSION EFFICIENCY
RANKINE	ROTARY ENGINE	HIGH HEAT REJECTION TEMPERATURE; SMALL SIZE RADIATOR; MUST MAINTAIN HERMICITY; COMPONENTS DEMONSTRATED; REASONABLY HIGH EFFICIENCY
MHD	FIELD EFFECT	VERY HIGH OPERATING TEMPERATURES; HIGH HEAT REJECTION TEMPERATURES; NOT DEVELOPED FOR SPACE; LOW EFFICIENCY
THERMOELECTRIC	SOLID STATE	MEDIUM HEAT REJECTION TEMPERATURE; MODERATE SIZE RADIATOR; MODULAR; VACUUM OPERATION; FLIGHT DEMONSTRATED; LOW CONVERSION EFFICIENCY
THERMIONIC	ELECTRON EMISSION	HIGH HEAT REJECT TEMPERATURE; SMALL SIZE RADIATOR; MODULAR; MUST MAINTAIN HERMETICITY; LABORATORY DEMONSTRATED; LOW TO MODERATE CONVERSION EFFICIENCY

IV-1-33

CONVERSION TECHNOLOGY

- **THERMOELECTRICS**

- SiGe DEMONSTRATED OVER 5-yr ON VOYAGER MISSIONS
- SiGe-GaP WITH HIGH-TEMPERATURE COATINGS DEMONSTRATE 40% IMPROVEMENT OVER SiGe. EFFICIENCY \approx 5% WITH $T_{HJ} = 1275$ K; \approx 7.5% WITH $T_{HJ} = 1400$ K
- ADVANCED MATERIALS SUCH AS CARBIDES AND SULFIDES COULD DOUBLE SiGe PERFORMANCE. MATERIALS BEING MADE BUT SAMPLES NOT DOPED. EFFICIENCY \approx 8–10% WITH $T_{HJ} = 1500$ –1550 K

- **THERMIONIC**

- DEMONSTRATED TECHNOLOGY IS 12% EFFICIENCY, 40,000 HOURS AT 1970 K EMITTER TEMPERATURE
- ADVANCED TECHNOLOGY TO REDUCE EMITTER TEMPERATURE TO 1650 K, AT 15% EFFICIENCY, NEEDS MUCH FURTHER WORK
- HIGH-TEMPERATURE INSULATORS A MAJOR PROBLEM

BRAYTON CYCLE

- BRAYTON CYCLE RUN 30,000 HOURS TO DEMONSTRATE LONG LIFE
- SUPERALLOYS AND GAS-BEARING SYSTEM BEING DEVELOPED FOR BIPS PROGRAM (1.3 kWe). SPECIFIC MASS ≈ 34 kg/kWe (BASED ON 100 kWe POWER LEVEL)
- REFRACTORY METAL ALLOYS (Mo OR Ta ALLOYS) NEED TO BE DEVELOPED FOR 1500 K OPERATION. SPECIFIC MASS ≈ 29 kg/kWe.
- CERAMICS COULD INCREASE TURBINE TEMPERATURE TO 1650 K. SPECIFIC MASS ≈ 24 kg/kWe
- MAJOR DEVELOPMENTS NEEDED IN TURBO-MACHINERY AND HEAT EXCHANGERS AS TEMPERATURES INCREASE

HIGH-TEMPERATURE RANKINE CYCLES

IV-1-36

- COMPONENTS DEMONSTRATED IN EARLY 1970s FOR 375 kWe POTASSIUM CYCLE. SYSTEM EFFICIENCY \approx 19%. TURBINE TEMPERATURE 1420 K; REJECT HEAT TEMPERATURE 925–800 K
- NO SYSTEM LOOPS RUN
- PROBLEM AREAS INCLUDE:
 - DEMONSTRATION OF JET CONDENSER IN ZERO GRAVITY CANNOT BE PERFORMED IN GROUND DEMONSTRATION TESTS
 - POTENTIAL PROBLEMS WITH SEALS IN ROTATING UNITS

STIRLING ENGINE

- **POTENTIAL HIGH EFFICIENCY WITH HIGHER HEAT REJECTION TEMPERATURE THAN RANKINE CYCLE**
- **LOW-SPEED PISTONS HAVE POTENTIAL SEAL PROBLEMS AND HEAVY CONVERSION SYSTEM WEIGHTS**
- **HIGH-SPEED CYCLE USING ROTARY MOTION HAS MECHANICAL AND LUBRICATION PROBLEMS**

MAGNETOHYDRODYNAMICS

- NEED HIGH TEMPERATURES, > 2500 K
- A COMBINED CYCLE SUCH AS TURBO-MHD IS NEEDED FOR HIGH EFFICIENCIES
- ONLY TERRESTRIAL COMPONENTS IN DEVELOPMENT. THESE HAVE JUST PASSED 1000 HOUR TEST

HEAT REJECTION

IV-1-39

- **DEMONSTRATED SYSTEMS**
 - PUMPED TUBE AND FIN
- **ADVANCED DEVELOPMENT**
 - HEAT PIPE (0.35 kg/kW)
- **RESEARCH**
 - LIQUID DROPLET (10 MW, ALUMINUM, 1000 K, 0.04 kg/kW)

IV-1-40

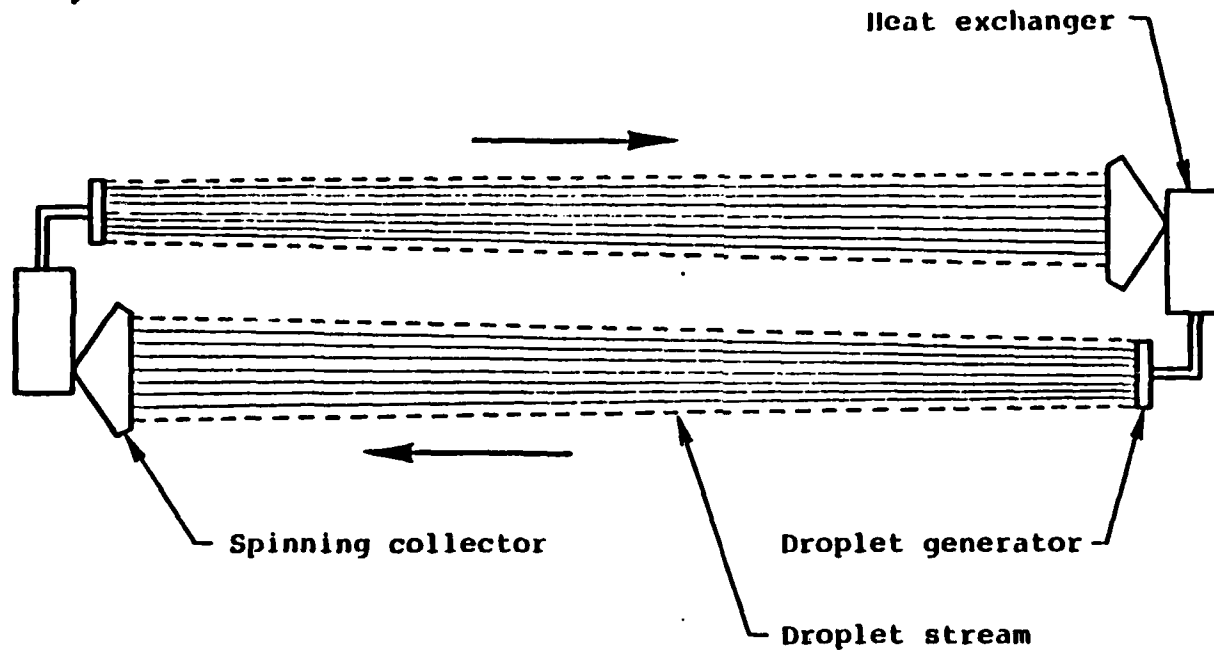

Schematic of a two-station droplet-stream radiator system.

TECHNOLOGY NEEDS

IV-1-41

- ELECTRIC CONVERTERS $> 20\%$ EFFICIENT WITH A REJECT HEAT TEMPERATURE > 1000 K
- LIGHT-WEIGHT RADIATORS, AS LOW AS 0.05 kg/kWt

ENERGY- RELIABLE, PORTABLE, ABUNDANT-

IS A MOST CRITICAL FACTOR IN

ESTABLISHING MAN'S PERMANENT

PRESENCE IN SPACE.

STEPS IN EXTRATERRESTRIAL EXPANSION

- **REUSABLE SPACE TRANSPORTATION SYSTEMS**
- **PERMANENT MANNED SPACE STATIONS (LEO&GEO)**
- **SPACEBASED INDUSTRIES**
- **LUNAR SETTLEMENTS**
- **LUNAR/ASTEROID RESOURCE UTILIZATION**

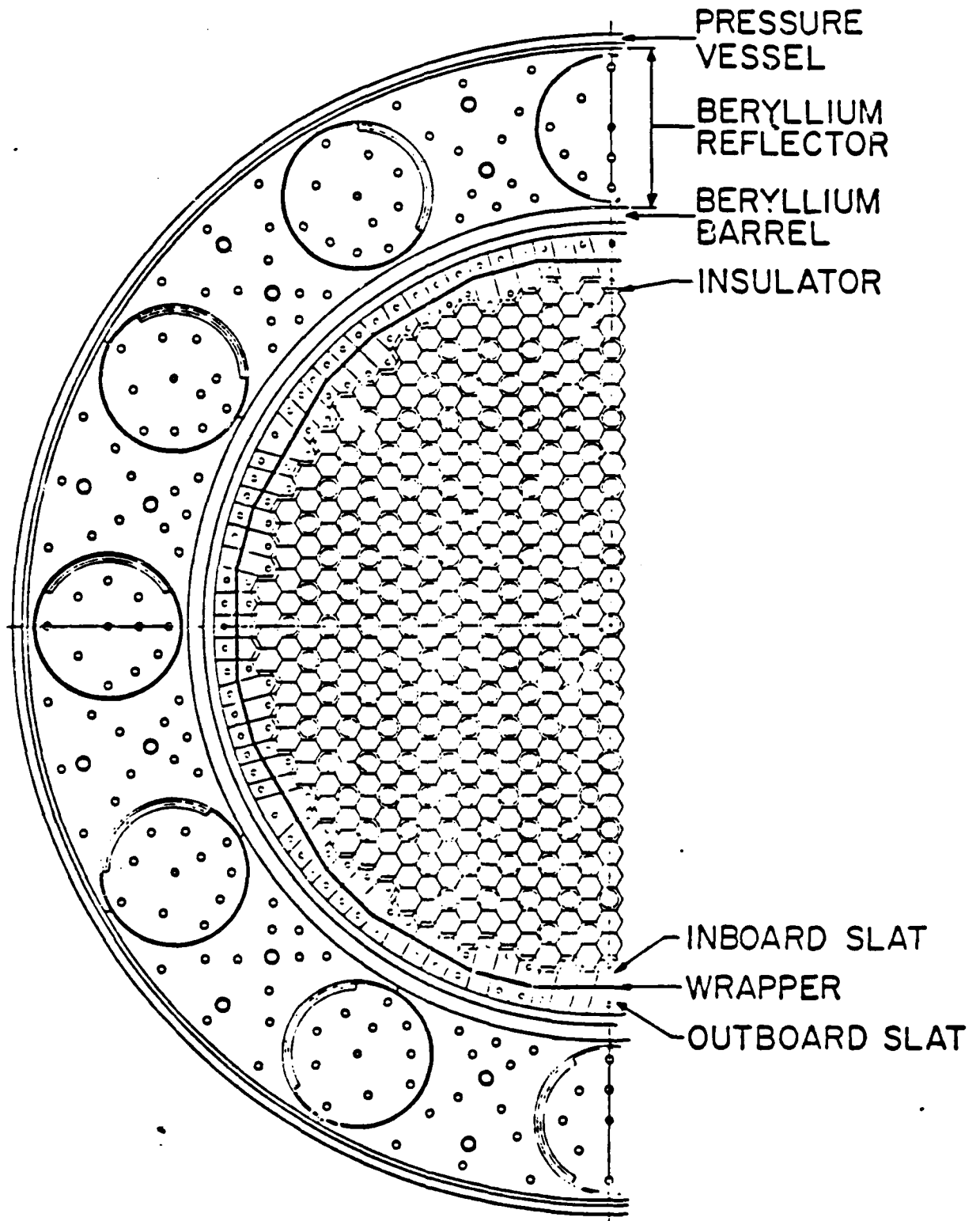

Fig. II-2. Reactor core cross section.

IV-1-44

TECHNOLOGICAL BOUNDARY CONDITIONS FOR NUCLEAR
ELECTRIC SPACE POWER PLANTS

A. P. Fraas

ABSTRACT

A serious attempt to assess the potential and feasibility of the many candidates for nuclear electric space power applications must confront some basic technological facts that limit what one can reasonably hope to accomplish with any given concept. First, the upper limit to the efficiency of any thermodynamic cycle was defined by Carnot, and the subsequent 160 years has not only disclosed the character and magnitude of the many losses that regrettably but inevitably make the efficiency of any actual cycle much less than that of an ideal cycle, but has also shown the upper temperature limit attainable with the materials available for any actual cycle. The cycle efficiency determines not only the thermal energy output of the reactor required for any given electrical power output (and thus the size and weight of the reactor and shield assembly), but also the size and weight of the radiator to reject the waste heat. Materials considerations such as corrosion, strength, and radiation damage at elevated temperatures establish basic limits on the design of the reactor, shield, turbine, generator, and other key components. Allowable radiation doses to personnel, lubricants, elastomers, and electronic components determine the size, weight, and shape of the reactor shield after account is taken of such factors as activation of the reactor coolant, directional differences in the degree of shielding required for the spacecraft in question, and radiation scattering from structures such as the radiator. Further, an exceptionally high reliability with essentially no maintenance is required. Assessments for a wide variety of systems show that they differ greatly in the reliability probably achievable, with only a few systems giving promise of meeting the stringent requirements. This problem is closely related to that of reactor safety - a technically complex subject rendered still more difficult by public perceptions and the current antinuclear hysteria. Again, studies have shown basic differences that make some systems more acceptable than others. Additional problems include the control of free liquid surfaces under zero -g conditions, instrumentation and control, and meteoroid protection of the radiator. The more significant information available on these factors as gained from experiments and design studies is reviewed with particular attention to the implied technological limitations on the size, weight, performance, and developmental feasibility of nuclear electric space power plants.

- Fig. 1. Effects of the emitter ^{temperature} on the output of a typical thermionic cell.
- Fig. 2. The weight of the radiator for per unit of waste heat rejected from the thermodynamic cycle drops as its temperature is increased, but the efficiency of the cycle drops rapidly. The combined effects define both the temperature that gives the minimum specific weight for any given cycle and working fluid. The lowest radiator specific weights are obtained with alkali metal vapor Rankine cycles.
- Fig. 3. In systems handling high temperature fluids, corrosion and deposits are factors that commonly limit the life of the system. Corrosion rates increase with temperature, and hence, corrosion considerations commonly limit the peak temperature in the thermodynamic cycle and thus the cycle efficiency. For Fe-Cr-Ni alloy systems, the highest peak cycle temperature and lowest corrosion rates are given by boiling potassium or cesium systems.
- Fig. 4. The weight of the boiler and high temperature piping for a Rankine cycle system depends on the ratio of the creep strength of the structural alloy to the vapor pressure of the cycle working fluid. Increasing the cycle peak temperature gives a drop in the creep strength and an increase in the vapor pressure so that the resulting increases in the wall thicknesses and component weights reach a practicable limit that often defines the peak cycle temperature.
- Fig. 5. The size and weight of a turbine drop rapidly with an increase in turbine wheel tip speed, but the stresses increase rapidly, and the creep strength drops rapidly with an increase in temperature. These considerations favor the use of the molybdenum alloy TZM, the highest strength alloy available. Plotting both the stress induced in the blades by centrifugal force against tip speed and the allowable creep stress against temperature show graphically the limiting combinations for these three parameters.
- Fig. 6. Reducing the number of stages in the turbine for a given set of conditions reduces its size and weight, but it also reduces the aerodynamic efficiency. The high atomic weight of cesium gives both a smaller number of stages and a smaller diameter turbine than obtainable for potassium when allowances are made for aerodynamic, moisture churning, and seal leakage losses.
- Fig. 7. The smallest number of system components is given by a single-loop system with a boiling reactor and a direct condensing radiator.
- Fig. 8. The subtle nuclear and boiling flow stability problems of a boiling reactor can be avoided by adding components to give a two-loop system with a primary liquid circuit that carries heat from the reactor to the boiler for the Rankine cycle system. This increases the number of components by about 50%.

Fig. 9. A three-loop system can be employed to avoid both the problems of a boiler reactor and a direct condensing radiator as well as provide redundancy in the heat rejection system. This gives about three times the number of components required for the single-loop system.

Fig. 10. Configuration for a 45-degree shadow cone shield for 450-kWt heat pipe reactor core having a diameter of 9.9 in. and a length of 12 in. The shield weight was estimated to be 14,700 lbs for radiation doses at a 100-ft radius of 3 rem/hr within the shadow cone and 100 rem/hr outside the shadow cone. Increasing the shadow cone angle to 90 degrees and reducing the dose at 100 ft outside the shadow cone increased the shield weight to 25,000 lbs.

↳ to 100 rem/hr

Table 2. Comparison of Physical Properties of Potassium, Cesium and Water for Condensing Conditions

	Potassium		Cesium		Water	
	Liquid	Vapor	Liquid	Vapor	Liquid	Vapor
Temperature, °F	1040.0		800		115.6	
Pressure, psia	1.50		0.66		1.50	
Specific volume, ft ³ /lb	0.02269	267.15	0.0091	610	0.01619	228.65
Enthalpy, Btu/lb	283.0	1170.4	69	267	83.56	1111.8
Heat of vaporization, Btu/lb	887.4		232		1028.14	
Specific heat, Btu/lb·°F	0.1823	0.1266	0.056	0.06	0.998	0.43
Viscosity, lb/ft·hr	0.37	0.0189	0.50	0.054	1.42	0.029
Thermal conductivity, Btu/hr·ft·°F	21.0	0.00363	11.2	0.0055	0.371	0.012
Prandtl No., $c_p \mu / k$	0.00321	0.659	0.0025	0.589	3.82	1.04
Surface tension, lb/ft	0.0041		0.0038		0.00469	

IV-2-4

Table 2. Estimated Size and Weight of Each of a Series of Typical 376 kw(e) Power Plants (excluding the shield)

	Liquid-cooled reactor			
	Boiling reactor Direct condenser		Direct condenser	Indirect condenser
	1-Loop	1-Loop	2-Loop	3-Loop
Structural material	Stainless steel	Niobium	Niobium	Niobium
Reactor outlet temperature, °F	1540	2000	2000	2000
Reactor thermal output, Mw	2.2	2.2	2.4	2.55
Radiator height (for a 10-ft-diam), ft	35.8	17.8	27.1	38.3
Power plant weight (excluding shield), lb	5725	4200	6920	8660

Table 3. Comparison of the Relative Mechanical Reliability of One-, Two-, Three-Loop 367 kw(e) Potassium Vapor Systems

System	Boiling reactor direct condenser	Liquid-Cooled reactor direct condenser	Liquid-cooled reactor indirect condenser
Number of loops	1	2	3
Number of key mechanical components	9	14	31
Mechanical reliability for 10,000 hr	0.9	0.7	0.6

IV-2-6

Table 4. Factors Affecting the Reliability of Instrumentation and Controls of One-, Two-, and Three-Loop Systems

System	Boiling reactor direct condenser	Liquid-cooled reactor direct condenser	Liquid-cooled reactor indirect condenser
Number of loops	1	2	3
Number of control functions requiring electronic equipment			
Simple	1	2	2
Complex	0	2	2
Minimum complement of instrument sensors			
Vital for normal operation	3	7	9
Diagnostic	23	45	85
Electric power required for motors for a 367 kw(e) plant, kw	1	30	50
Estimated relative reliability of control system for 10,000 hr	0.9	<0.4	<0.2

IV-2-8

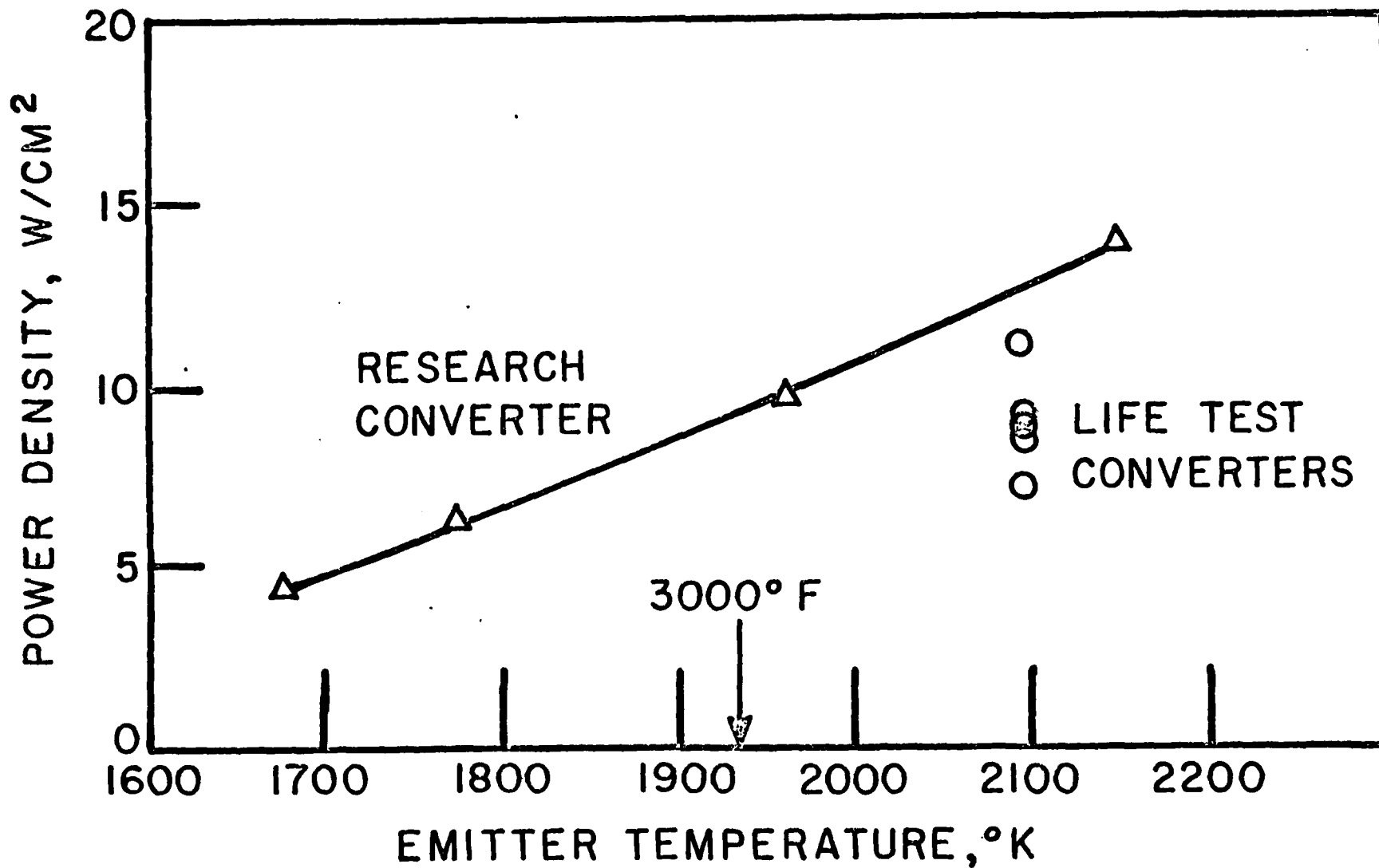

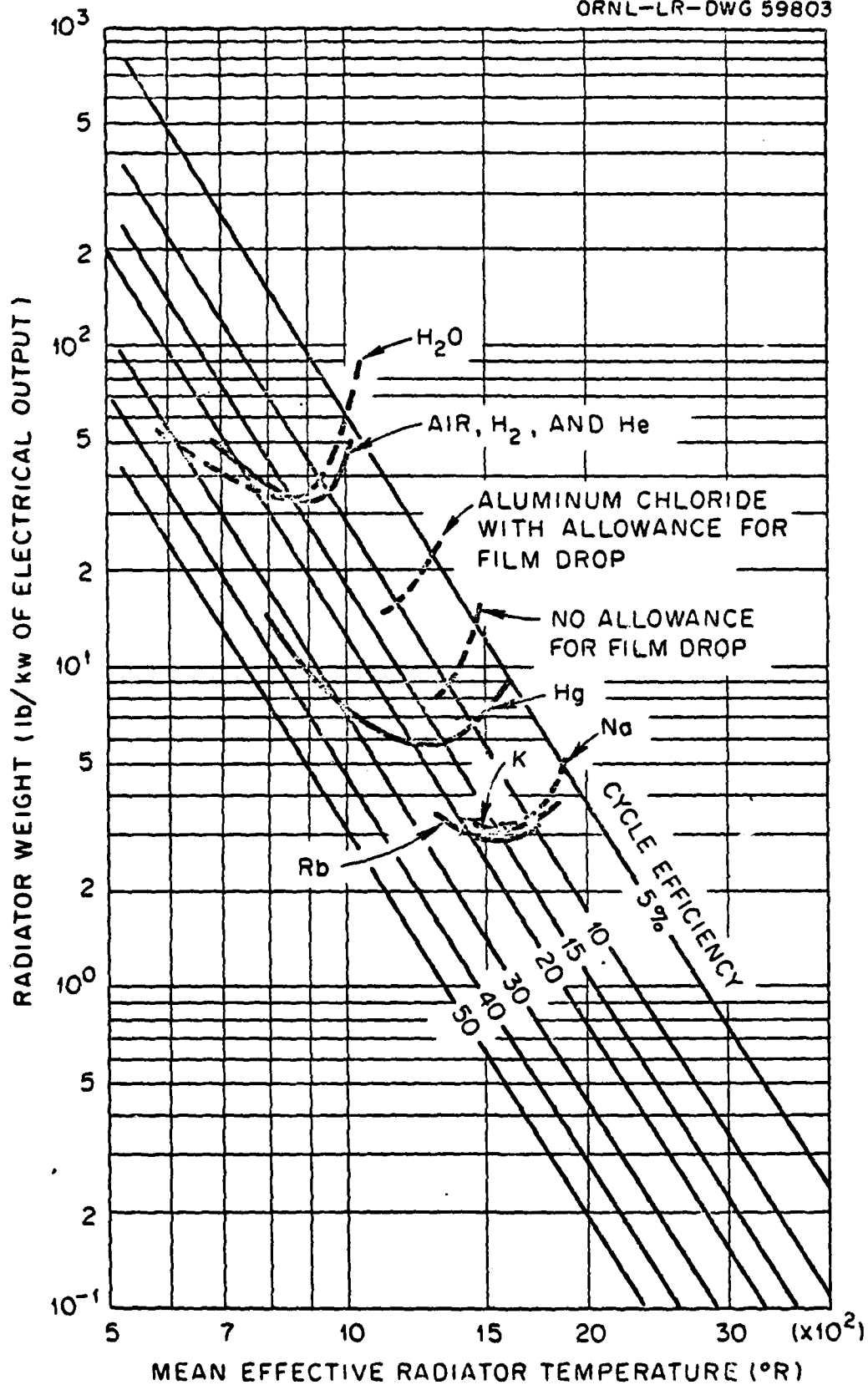

Fig. 2

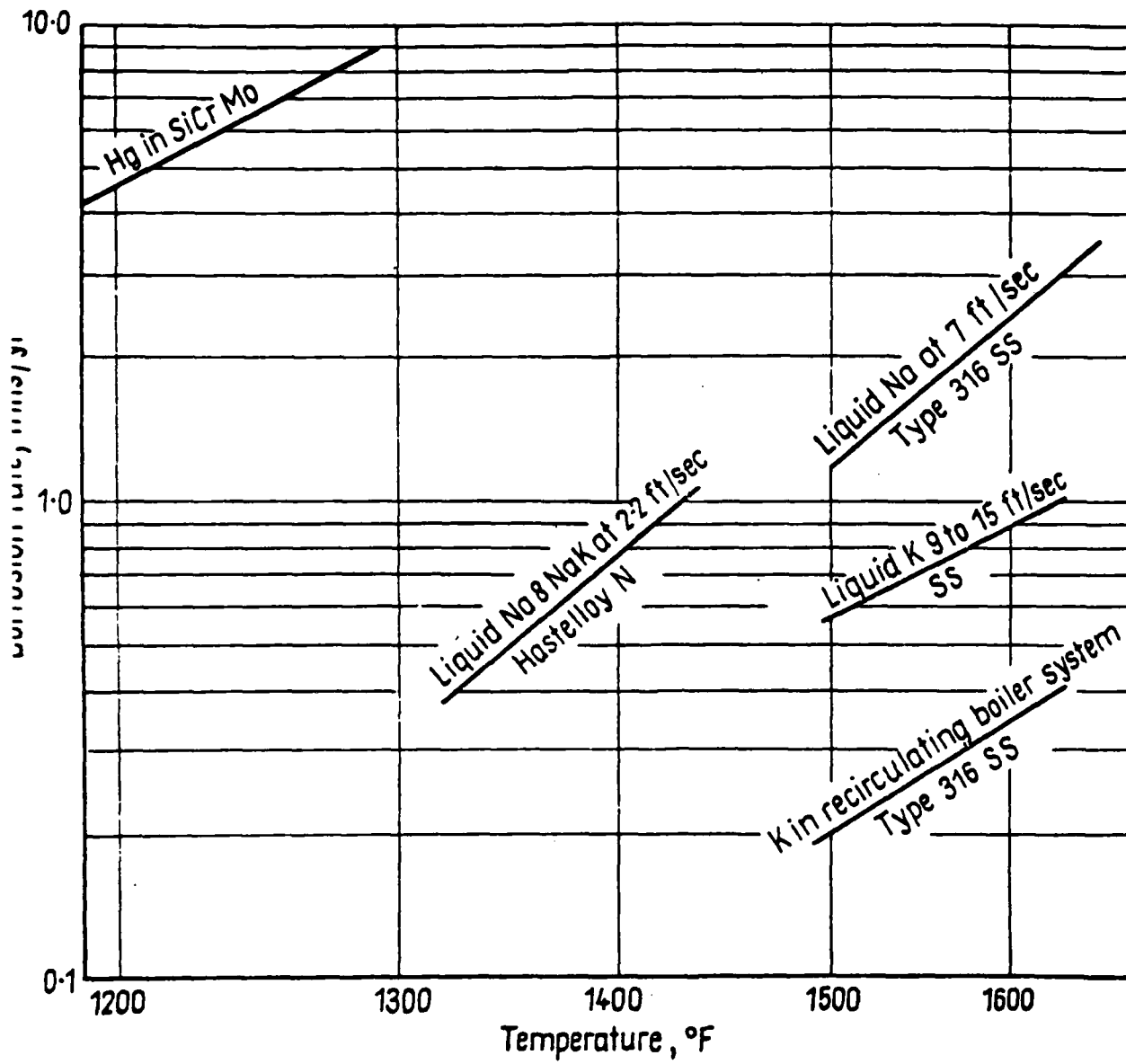

Fig. 3

IV-2-10

IV-2-11

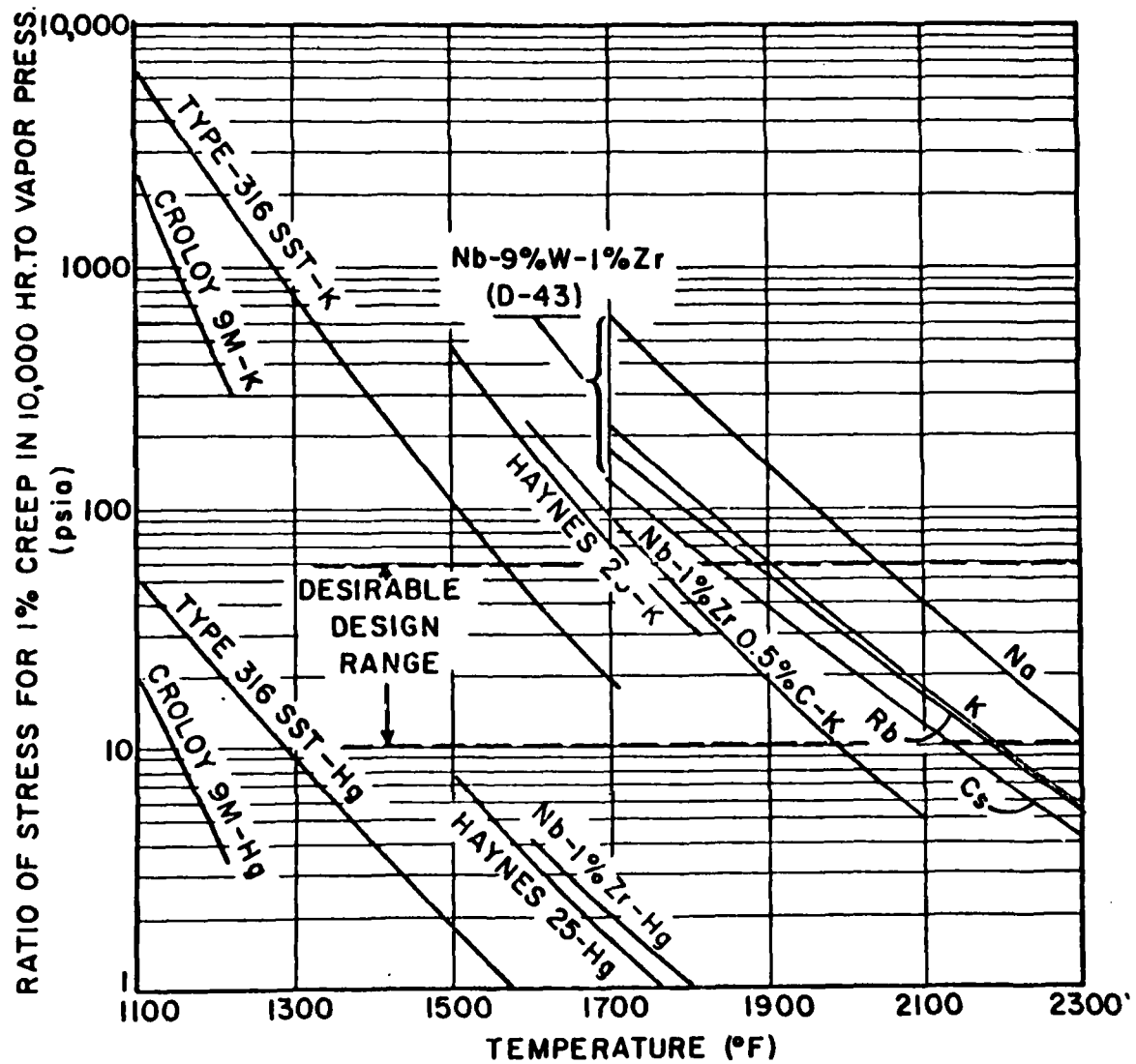

Fig. 1

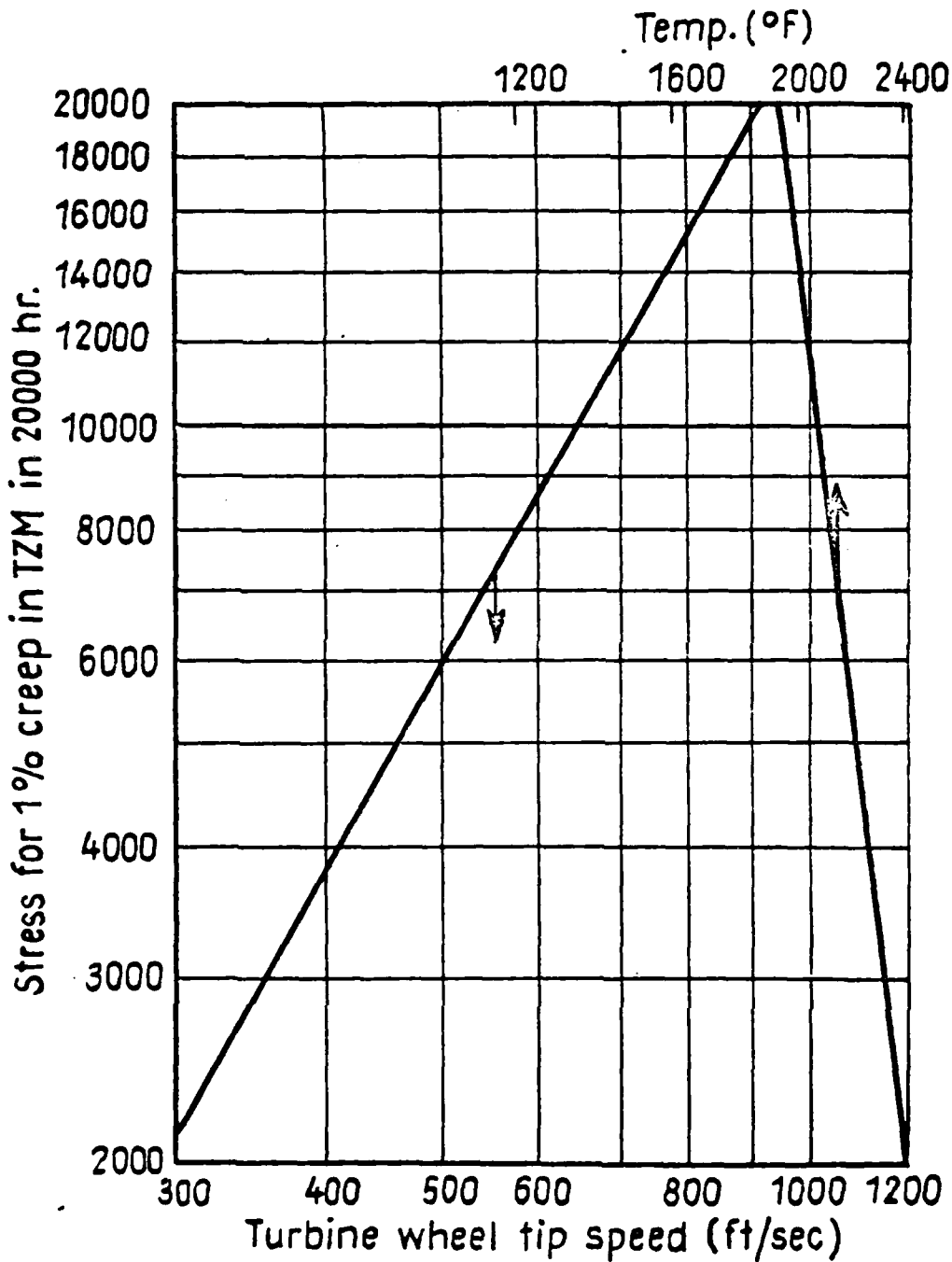

Fig. 5

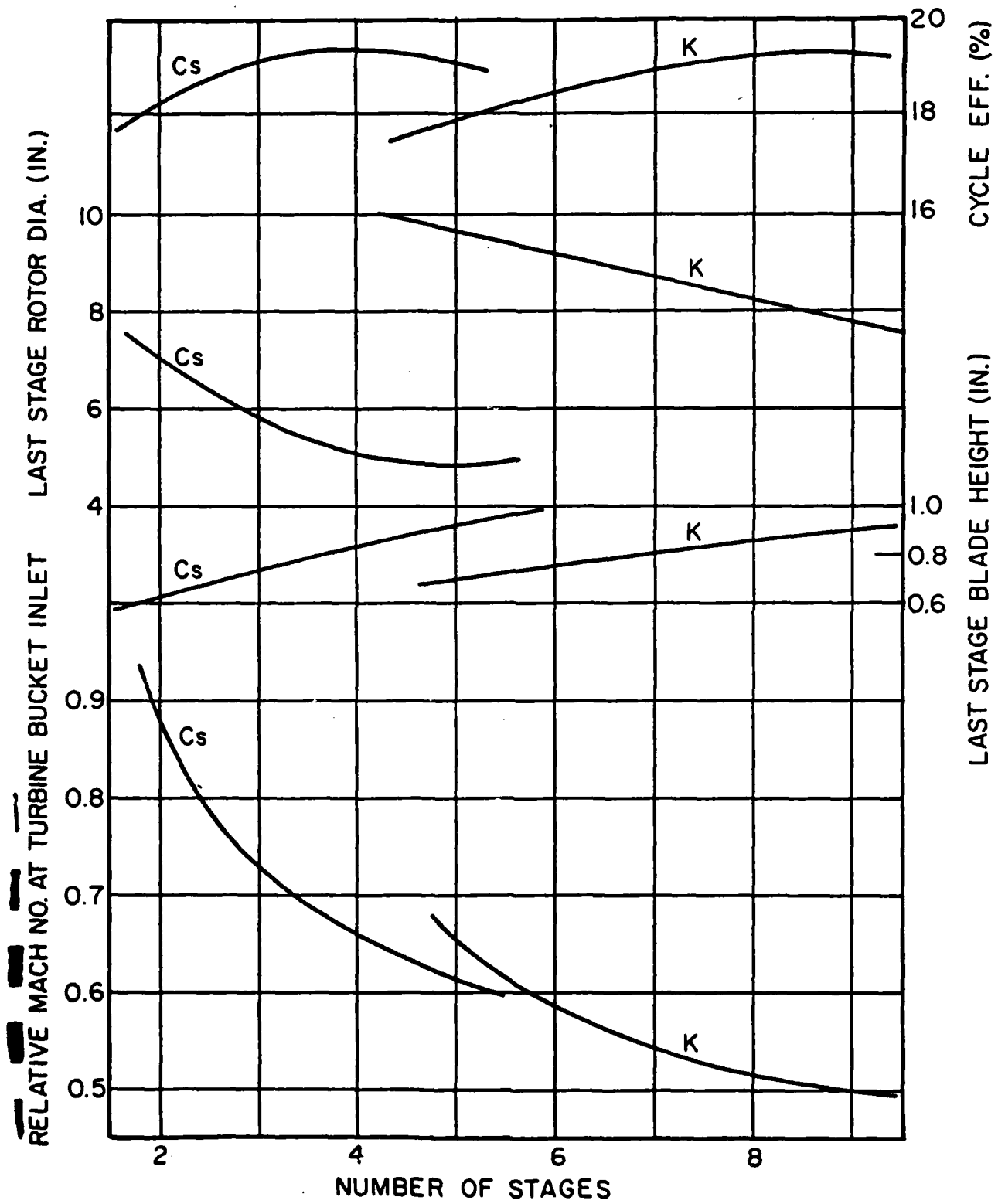

Fig. 6

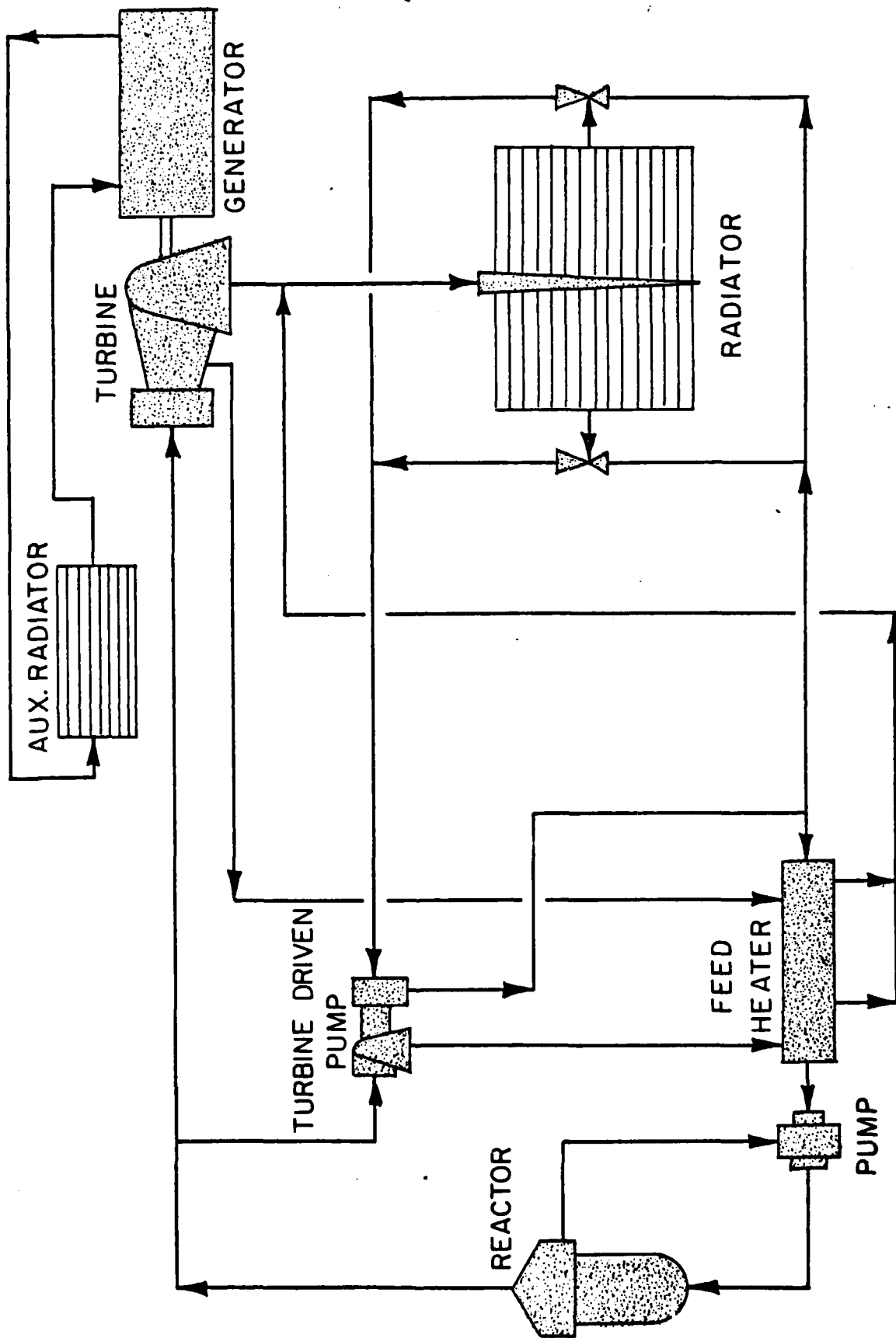
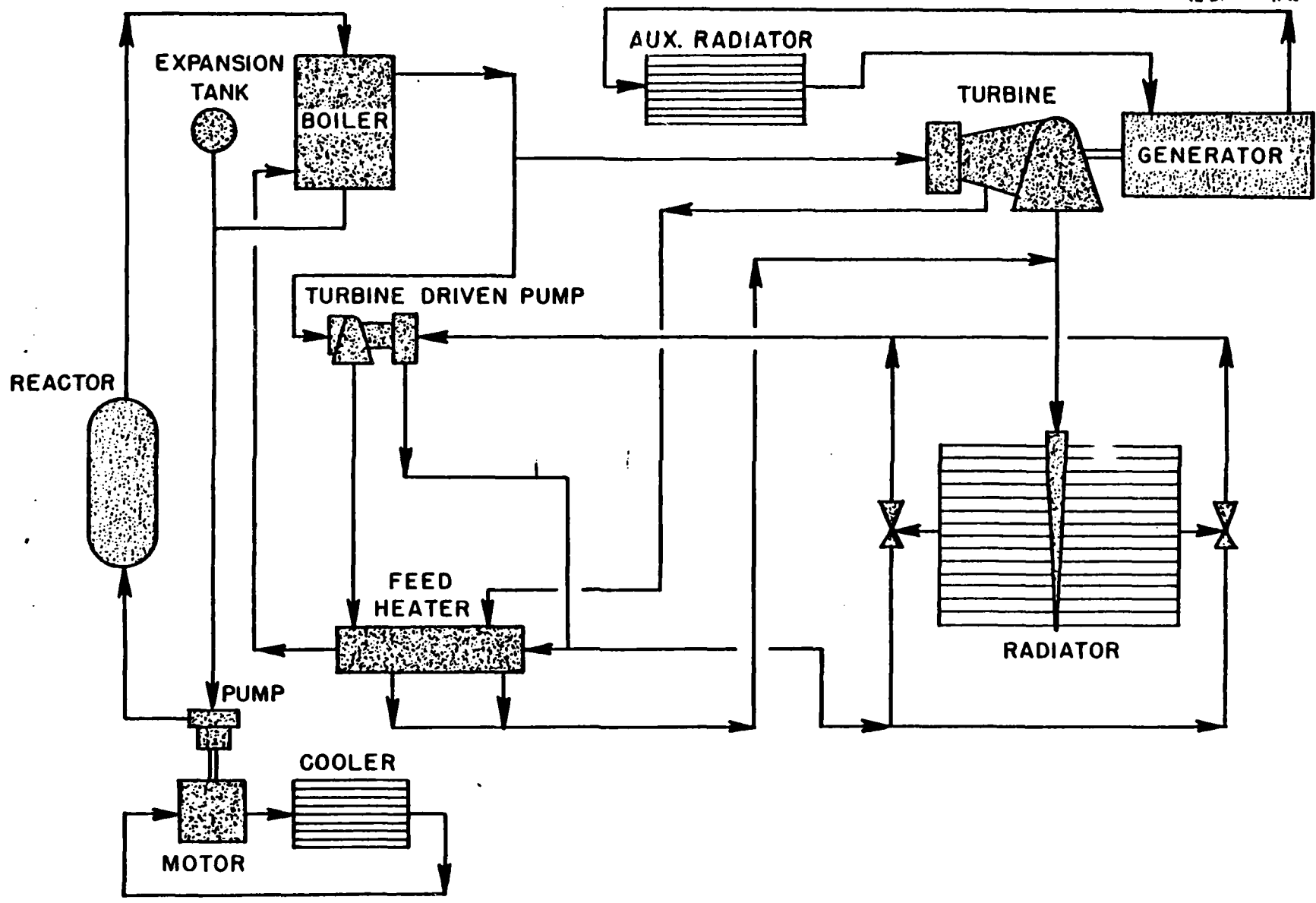

Fig. 7



IV-2-15

Fig. 8

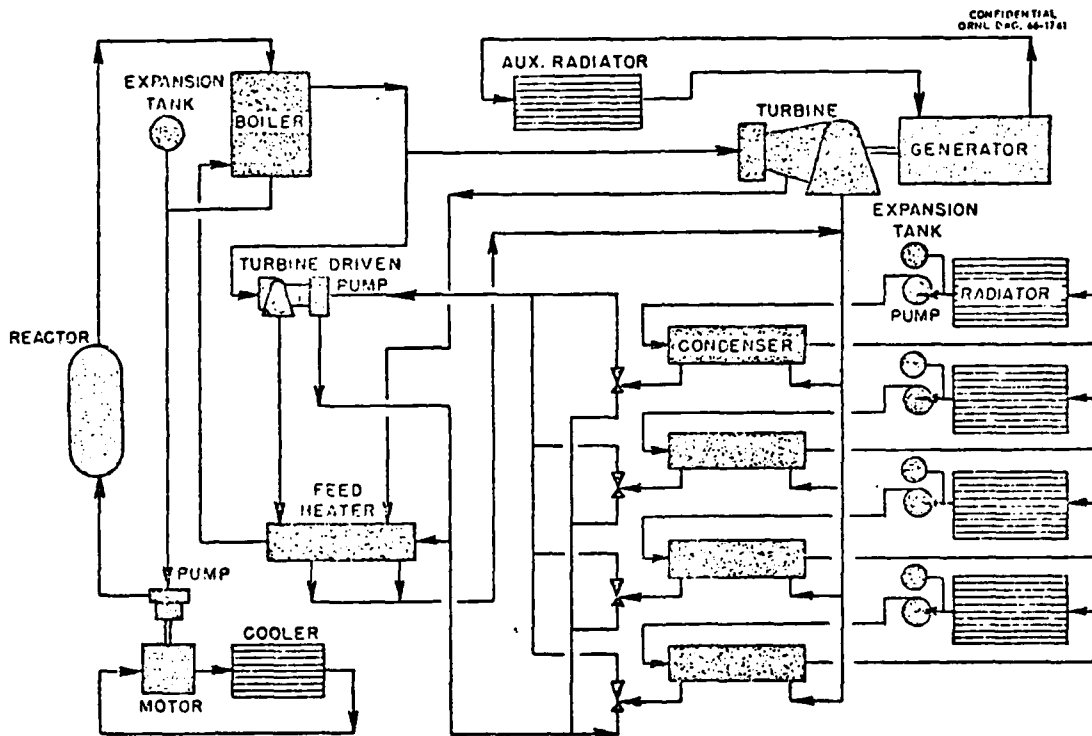

Figure 6. Three-loop system with a liquid-cooled reactor loop heating the boiler of a Rankine cycle loop coupled to a set of parallel indirect radiator loops.

Fig. 9

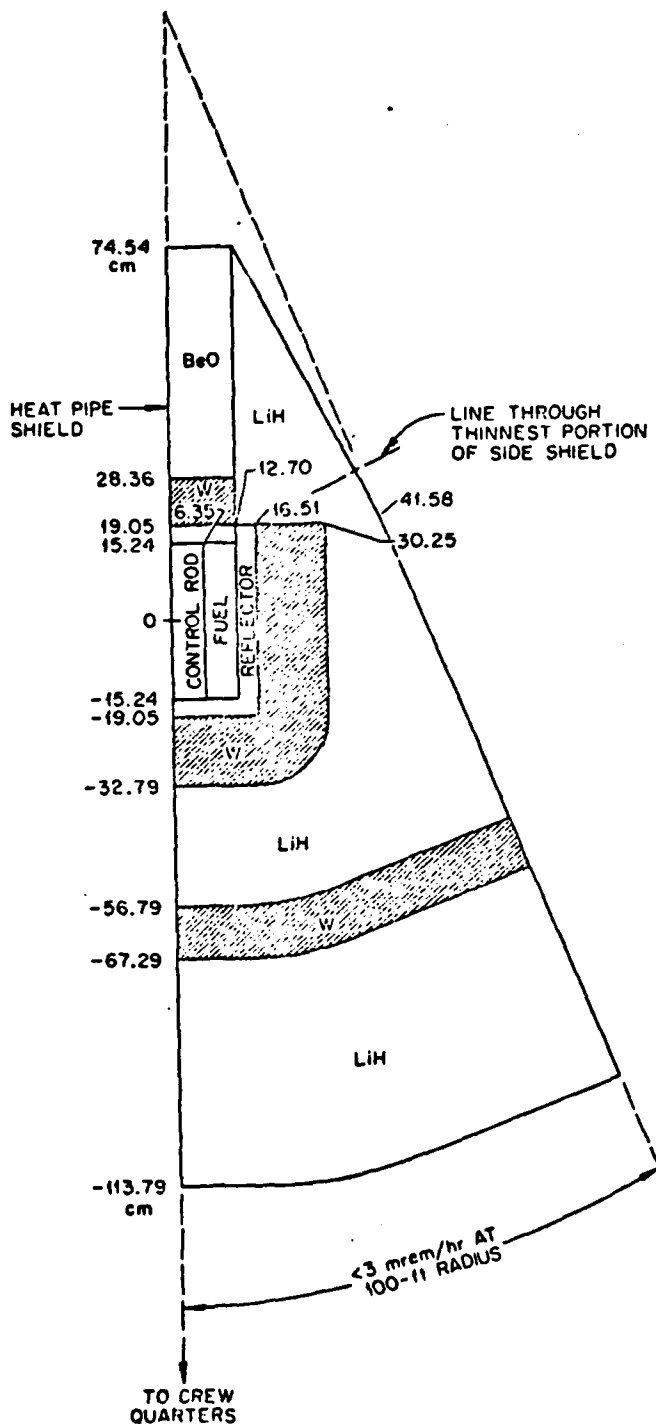

Fig. 10. Configuration for a Two-Cycle Asymmetric Shield with a 45-deg Cone Angle (450 kW).

Bibliography

1. A. P. Fraas, Reactors for Space, Proceedings of the Society for Engineering Science Meeting, Huntsville, Alabama, November 1967, pp. 5-22.
2. A. P. Fraas, "Fission Reactors as a Source of Electrical Power in Space," Proceedings of Second Symposium on Advanced Propulsion Concepts, Vol. III, Avco-Everett Research Laboratory (Oct. 7-8, 1959).
3. R. F. Wilson, "SNAP 10A, A Status Report," pp. 581-593, *Space Power Systems Engineering*, AIAA Progress in Astronautics and Aeronautics, Vol. 16, Academic Press, New York, 1966.
4. R. Breitwieser and H. Schwartz, Thermionics, pp. 239-252, *Proceedings of the Space Power Systems Advanced Technology Conference*, NASA Lewis Research Center, Cleveland, Ohio, Aug. 23-24, 1966.
5. W. L. R. Emmet, "The Emmet Mercury-Vapor Process," Trans. ASME 46, 253 (1924).
6. R. L. Wallerstedt et al., Final Summary Report - SNAP 2/Mercury Rankine Program Review, Vol. 1, NAA-SR-12181, Atomics International Div., Rockwell International, June 15, 1967.
7. H. Derow, Tantalum as a Mercury Containment Material, in Mercury Rankine Cycle System Boilers, and SNAP-8 Power Conversion System, Breadboard Assembly - Materials Evaluation after 8700 hr Operation, Energy 70, Proceedings of the 1970 Intersociety Energy Conversion Engineering Conference, Vol. 1, pp. 11-18 to 11-27.
8. W. J. Pummer, The Kinetics and Mechanism of the Pyrolytic Decomposition of Aromatic Heat Transfer Fluids, Final Report NBS Project No. 3110541, National Bureau of Standards, April 1970.
9. J. H. DeVan, Compatibility of Structural Materials with Boiling Potassium, Oak Ridge National Laboratory Report No. ORNL/TM-1361, April 1966.
10. W. O. Harms and A. P. Litman, "Compatibility of Materials for Advanced Space Nuclear Power Systems," paper presented at the ASME Annual Meeting, November 12-17, 1967.
11. D. H. Jansen and R. L. Klueh, Effects of Liquid and Vapor Cesium on Structural Materials, USAEC Report ORNL/TM-1813, Oak Ridge National Laboratory, June 1967 (AEC Interagency Agreement 40-98-66, NASA Order W-12, 353).
12. Corrosion Studies of Refractory Metal Alloys in Boiling Potassium and Liquid NaK, Proceedings of AEC-NASA Liquid Metals Information Meeting, CONF-650411 (April 1965).
13. K. C. Dean et al., Cesium Extractive Metallurgy; Ore to Metal, *Journal of Metals*, November 1966.

14. R. A. Heindl, Cesium, Mineral Facts and Problems, U.S. Bureau of Mines, Bulletin 650, 1970, p. 650.
15. H. C. Young and A. G. Grindell, Summary of Design and Test Experience with Cesium and Potassium Components and Systems for Space Power Plants, USAEC Report ORNL/TM-1833, Oak Ridge National Laboratory, June 1967.
16. W. D. Weatherford et al., Properties of Inorganic Energy-Conversion and Heat-Transfer Fluids for Space Applications, WADD Technical Report 61-96, November 1961.
17. C. T. Ewing et al., High-Temperature Properties of Potassium, NRL Report 6233 (September 1965).
18. C. T. Ewing et al., High-Temperature Properties of Cesium, NRL Report 6246 (September 1965).
19. H. W. Hoffman and A. I. Krakoviak, "Forced Convection Saturation Boiling of Potassium at Near Atmospheric Pressure," Proceedings of the 1962 High Temperature Liquid Metal Heat Transfer Technology Meeting, pp. 182-203, BNL-756.
20. R. E. MacPherson, "Techniques for Stabilizing Liquid Metal Pool Boiling," II-B/11, Conference Internationale Sur La Surete des Reacteurs a Neutrons Rapides, September 22, 1967.
21. J. R. Peterson, High Performance Once-Through Boiling of Potassium in Single Tubes at Saturation Temperatures of 1300 to 1750°F, NASA CR-842, (August 1967).
22. B. Viresema, Aspects of Molten Fluorides as Heat Transfer Agents for Power Generation, Doctoral thesis, Technische Hogeschool Delft, February 1979.
23. J. E. Kemme, Heat Pipe ^{Capability} ~~Capability~~ Experiments, Los Alamos Scientific Laboratory Report No. LA-3585-MS, 1966.
24. W. L. Stewart, Analytical Investigation of Multistage-Turbine Efficiency Characteristics in Terms of Work and Speed Requirements, NACA-RM E57K22b, Lewis Flight Propulsion Laboratory (February 1958).
25. E. Schnetzer, Comparison Study of Cesium and Potassium for Rankine Cycle Space Power Systems, TMS Report No. 67-1, General Electric Space Power and Propulsion Section, July 1966.
26. SNAP 50/SPUR Program, Nuclear Mechanical Power Unit, Experimental Research Development Program, Final Report, APS-5249, AiResearch Mfg. Co. (December 1966).
27. J. P. Davis et al., Lithium-Boiling Potassium Refractory Metal Loop Facility, Jet Propulsion Laboratory, Technical Report No. 32-508 (August 1963).

28. R. Spies and A. H. Cooke, "Investigation of Variables in Turbine Erosion," paper presented at ASTM 69th Meeting, June 1966.
29. A. P. Fraas, D. W. Burton, and L. V. Wilson, Design Comparison of Cesium and Potassium Vapor Turbine-Generator Units for Space Power Units, ORNL/TM-2024 (February 1969).
30. H. C. Young et al., Survey of Information on Turbine Bucket Erosion, ORNL/TM-2088 (July 1968).
31. T. C. Varijen and C. M. Glassmire, Estimation of Moisture Formation and Deposition and of the Threshold for Turbine Bucket Erosion in Potassium and Cesium Vapor Turbines, WANL-PR(CCC)-003, Westinghouse Astronuclear Laboratory (December 1967).
32. W. R. Zimmerman, Two-Stage Potassium Turbine: IV-Materials Support of Performance and Endurance Tests, NASA CR-925, February 1968.
33. E. Schnetzer and G. M. Kaplan, "Erosion Testing of a Three-Stage Potassium Turbine," ASME Preprint 70-AV/SPT-37 (June 1970).
34. A. P. Fraas, "Design and Development Tests of Direct-Condensing Potassium Radiators," pp. 716-736, in AIAA Specialists Conference on Rankine Space Power Systems, Vol. 1, USAEC Report CONF-651026, October 1965.
35. A. P. Fraas, Operational, Maintenance and Environmental Problems Associated with a Fossil Fuel-Fired Potassium-Steam Binary Vapor Cycle, ORNL/NSF/EP-30 (August 1974).
36. SNAP-50/SPUR Final Summary Report, Pratt and Whitney Aircraft Report No. M-3679, November 1965.
37. A. I. Chalfant, Preliminary Design of a 10 MWe Nuclear Space Power Plant for Electric Propulsion, Pratt and Whitney Aircraft Corp. Report No. PWAC-496, November 1965.
38. S. I. Freedman, Study of Nuclear Brayton Cycle Power System, NASA Study made by General Electric Missile and Space Division, G.E. 65SD4251, NASA CR-54397, August 5, 1965.
39. A. P. Fraas, Summary of the MPRE Design and Development Program, ORNL-4043, June 22, 1967.
40. M. N. Yarcsh and P. A. Gnadt, The Intermediate Potassium System - A Rankine Cycle, Potassium Test Facility, ORNL-4025 (October 1968).
41. A. P. Fraas, Estimating the Reliability of Systems, ORNL/TM-2200, May 1968.
42. A. P. Fraas and J. W. Michel, Comparison of 1-, 2-, and 3-Loop Systems for Nuclear Turbine-Generator Space Power Plants of 300 kW to 5 MW of Electrical Output, ORNL/TM-1366, March 1966.

EFFECTS OF REACTOR DESIGN, COMPONENT CHARACTERISTICS
AND OPERATING TEMPERATURES ON
DIRECT CONVERSION POWER SYSTEMS

BY

G. O. FITZPATRICK AND E. J. BRITT
RASOR ASSOCIATES INCORPORATED
FEBRUARY 1982

EFFECTS OF REACTOR DESIGN, COMPONENT CHARACTERISTICS,
AND OPERATING TEMPERATURES ON DIRECT CONVERSION POWER SYSTEMS

by

G. O. Fitzpatrick and E. J. Britt
Rasor Associates, Inc.
Sunnyvale, California

ABSTRACT

This paper presents the results of a parametric study of unmanned space nuclear reactor power systems utilizing either thermoelectric or thermionic energy converters. An in-core reactor design and two heat pipe cooled out-of-core reactor designs were considered. One of the out-of-core designs utilized long heat pipes (LHP) directly coupled to the energy converters. The second utilized a larger number of smaller heat pipes (mini-pipe) radiatively coupled to the energy converter. In all cases the entire system, including the power conditioning subsystem and its radiator, were constrained to be launched by a single shuttle.

The mass and size of each system was studied as a function of several variables including: power level, lifetime, number and size of core heat pipes, fuel swelling model, reactor and heat rejection temperatures, converter type and performance level, allowable radiation dose at the payload, shadow shield cone angle, power conditioning temperature and efficiency, etc.

The most critical component determining system performance is the reactor. Its design is driven by concerns for fuel swelling rate which is in turn dependent on the nature of the swelling, reactor power level, and the number and size of the heat pipes used to cool the core.

Previous performance projections for the SPAR thermoelectric out-of-core design were largely confirmed, although production of 100 kWe will require a thermal power level of 1600 kW_t, not 1200 kW_t as originally expected. Such a system can potentially deliver up to 300 kWe prior to reaching the size limit of the shuttle if a larger number of reactor core heat pipes are used.

Power levels exceeding 1 1/2 MWe are possible if the reactor core temperature is increased (above ~ 1800 K) to permit use of thermionic converters. Fuel swelling control in this case should be possible if the minipipe core design is used.

Power levels of 5 MWe with lifetimes of thousands of hours may be possible with advances in fuel swelling control and conversion system performance (either thermionic or thermoelectric). Greater than 10 MWe may be possible for short lifetimes. The advances required to achieve these objectives are described.

SPACECRAFT SYSTEM MODEL

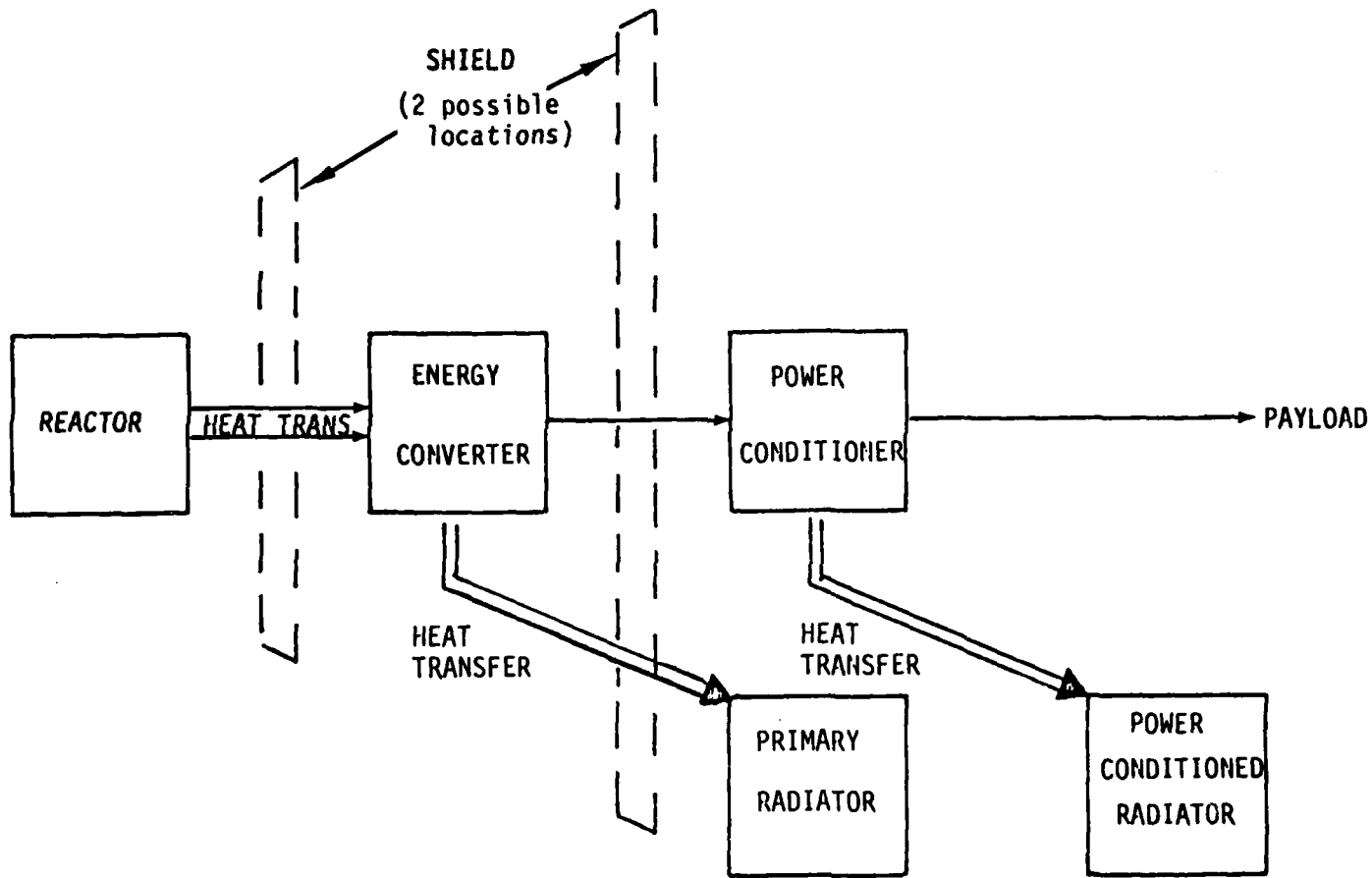

IV-3-2

This study was based on analytical models of each of the key subsystems of an unmanned reactor space power plant, as shown above. These subsystems were combined in an overall power plant model which was constrained to fit within the shuttle bay. Only fast reactors were considered. Two out-of-core heat pipe cooled reactor designs were tested utilizing either thermionic or thermoelectric energy converters. One in-core thermionic reactor design was also considered.

LONG HEAT PIPE TYPE OF OUT-OF-CORE POWER PLANT

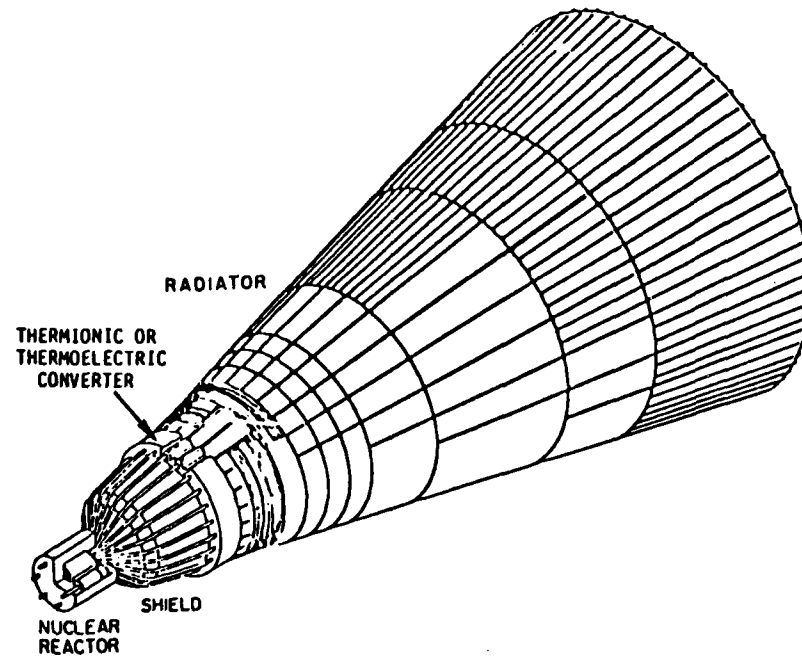

IV-3-4

The first shield location, as illustrated here, is typical of the SPAR-type system. The proximity of the shield to the reactor results in a minimal shield mass. However the high temperature heat pipes from the reactor must pass around or through the reactor, with attendant technical difficulties.

Artist's Concept of an Out-of-Core Space Reactor Power System. The system has a 30° cone 1/2 angle and a "trailing wing" type of shield.

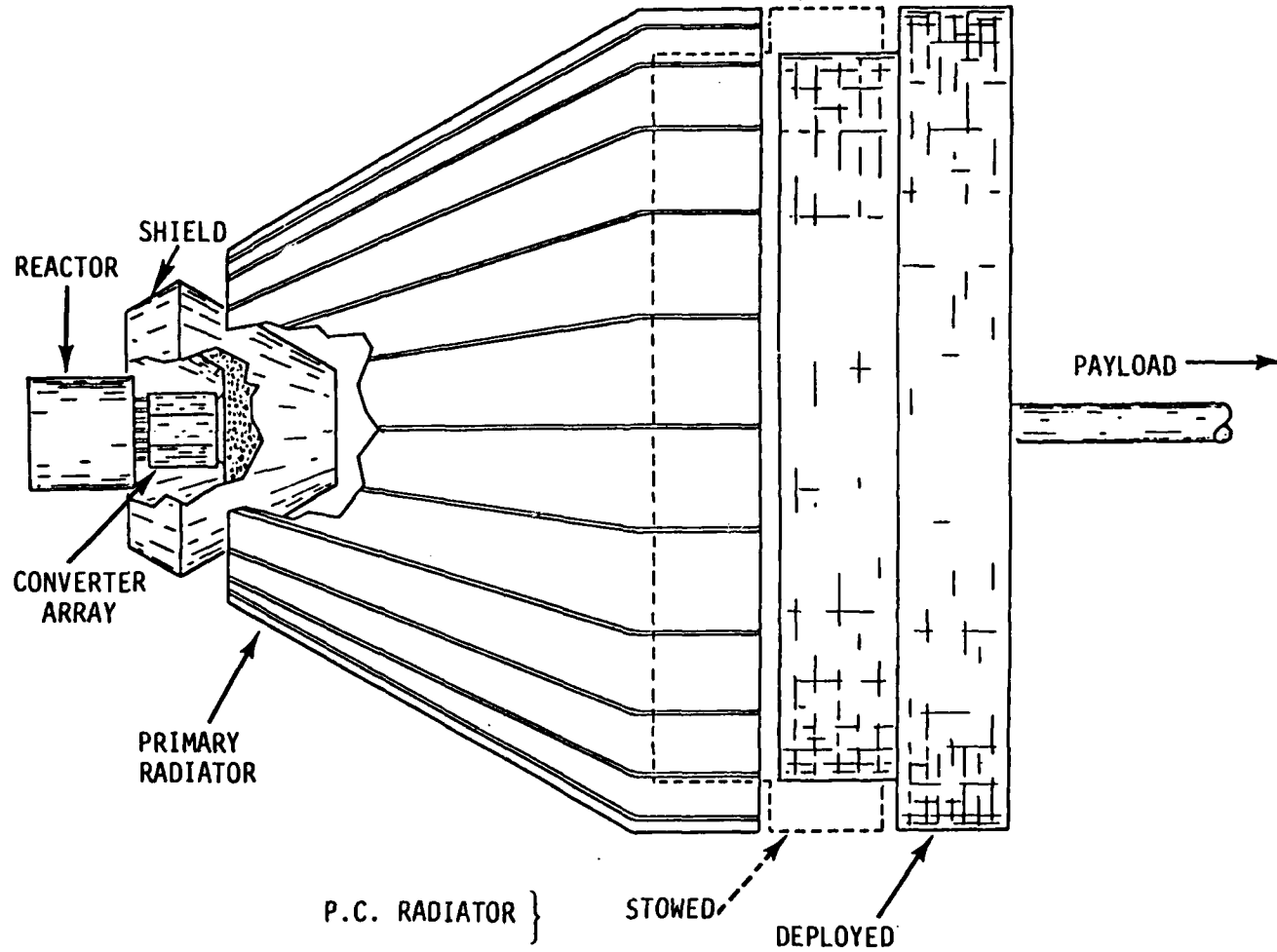

IV-3-6

By locating the converter between the shield and reactor, as shown here in the mini-pipe design, it is possible to minimize the length of the high temperature heat pipes. However a large shield is required, and low temperature heat pipes must still pass the shield to reach the primary radiator.

RADIATION COUPLED MINI-PIPE DESIGN

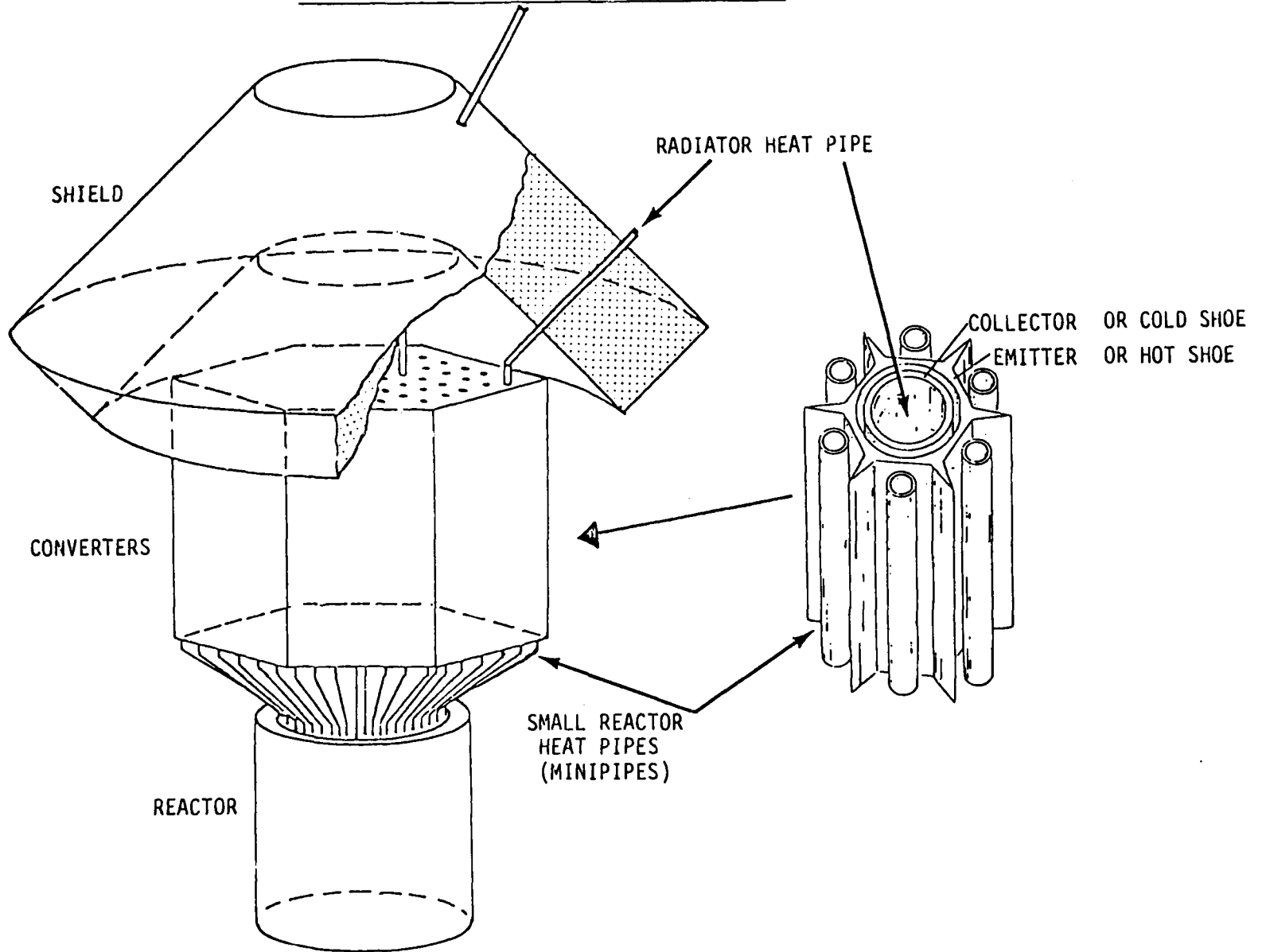

IV-3-8

RADIATION COUPLED MINI-PIPE DESIGN

Radiation coupling of heat from the reactor to the energy converters was used in the mini-pipe design. This concept eliminates the need for a high temperature electrical insulator which also passes heat. It permits mechanical de-coupling of the reactor heat source and energy conversion subsystems, a significant advantage in avoiding differential thermal expansion difficulties.

COMPARISON OF SYSTEM LENGTHS AT 100 kWe

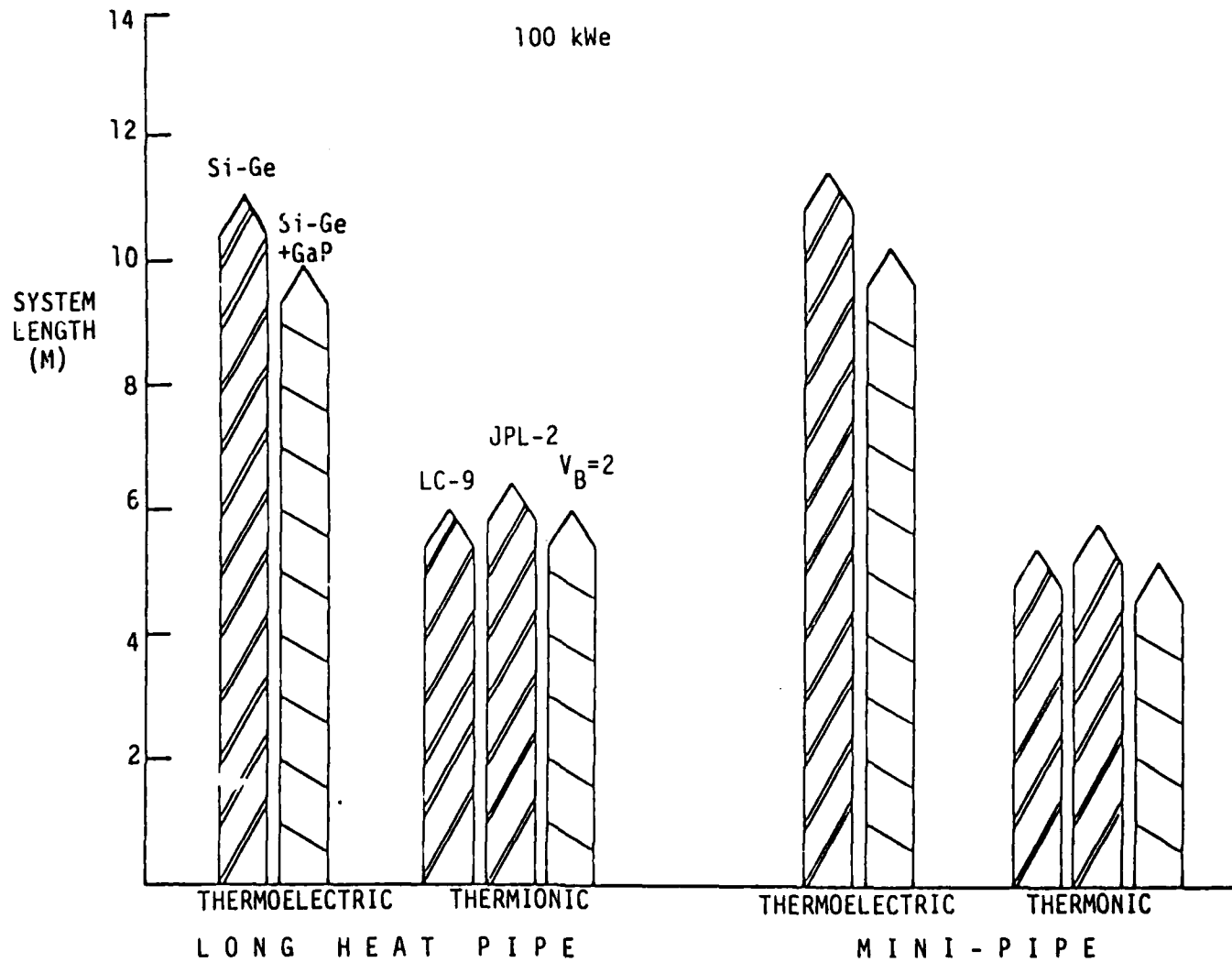

Mass (kg) 1970 - 2200
8,760 - 60,000 hrs

2330 - 2800

2510 - 3040

1650 - 2150

IV-3-10

A variety of 100 kWe designs were studied. Two levels of thermoelectric performance, well demonstrated and near-term were considered. Three thermionic operating points were treated, two corresponding to specific converter demonstrations and the third to an improved near-term performance level. The reactor temperature for the thermionic systems is several hundred degrees higher than that of the thermoelectric systems. Depending on lifetime and design, the specific mass for these systems varied between 16.5 and 30.5 kg/kWe. The biggest differences between systems were in size. The thermionic systems are about half the size of the thermoelectric because of their smaller radiators.

SYSTEM MASS - A STEADY STATE COMPARISON

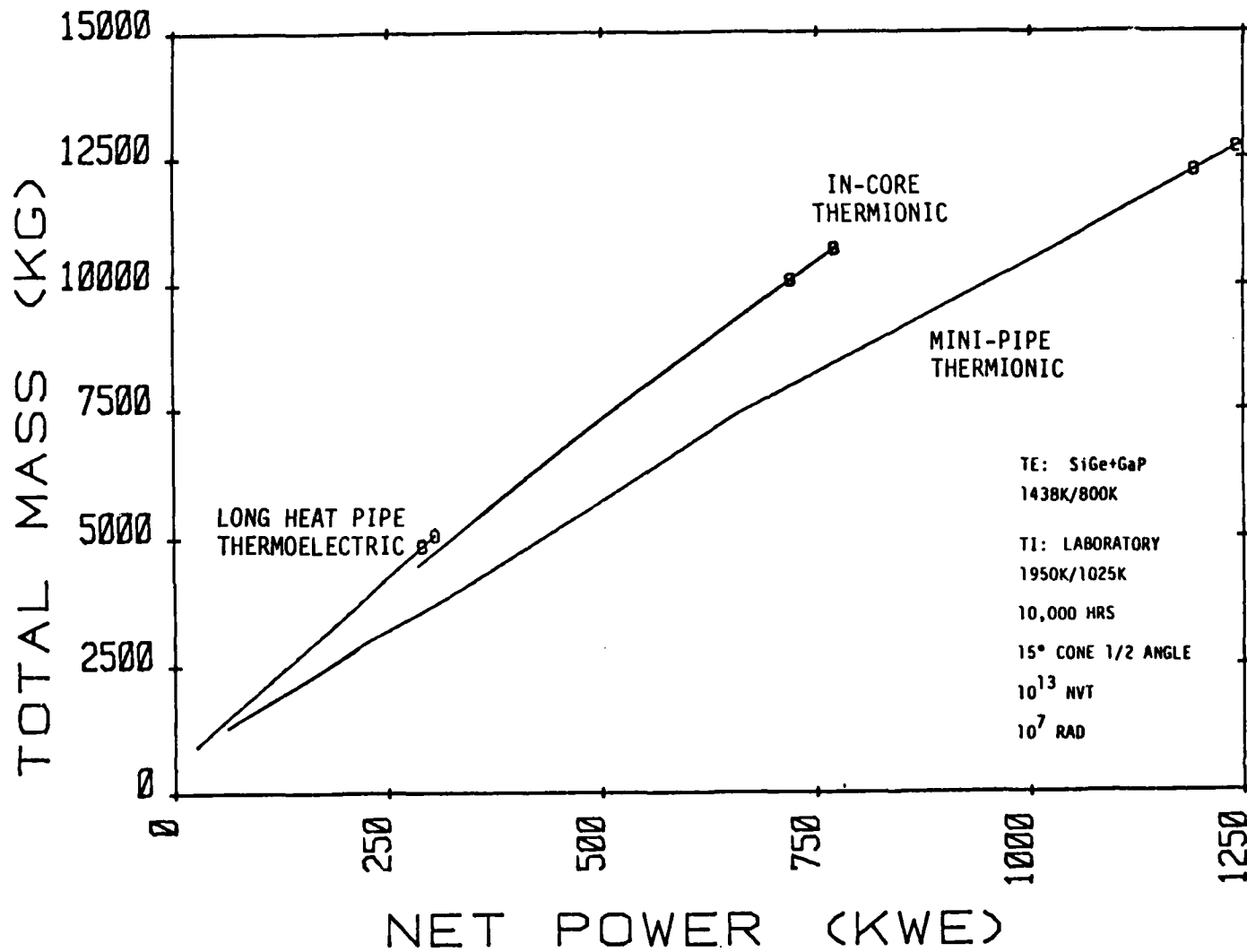

IV-3-12

The ability of various systems to scale-up in power is illustrated here; near-term conversion system performance levels are assumed. Circles appear on each line when the length of the power system exceeds that of the shuttle bay. Because of its lower efficiency and heat rejection temperature the thermoelectric system is size-limited to below 350 kWe. The in-core thermionic system can achieve 700 kWe. The mini-pipe thermionic design reaches 1.2 MWe in a single shuttle launch.

PULSED SYSTEM - NEAR TERM PERFORMANCE

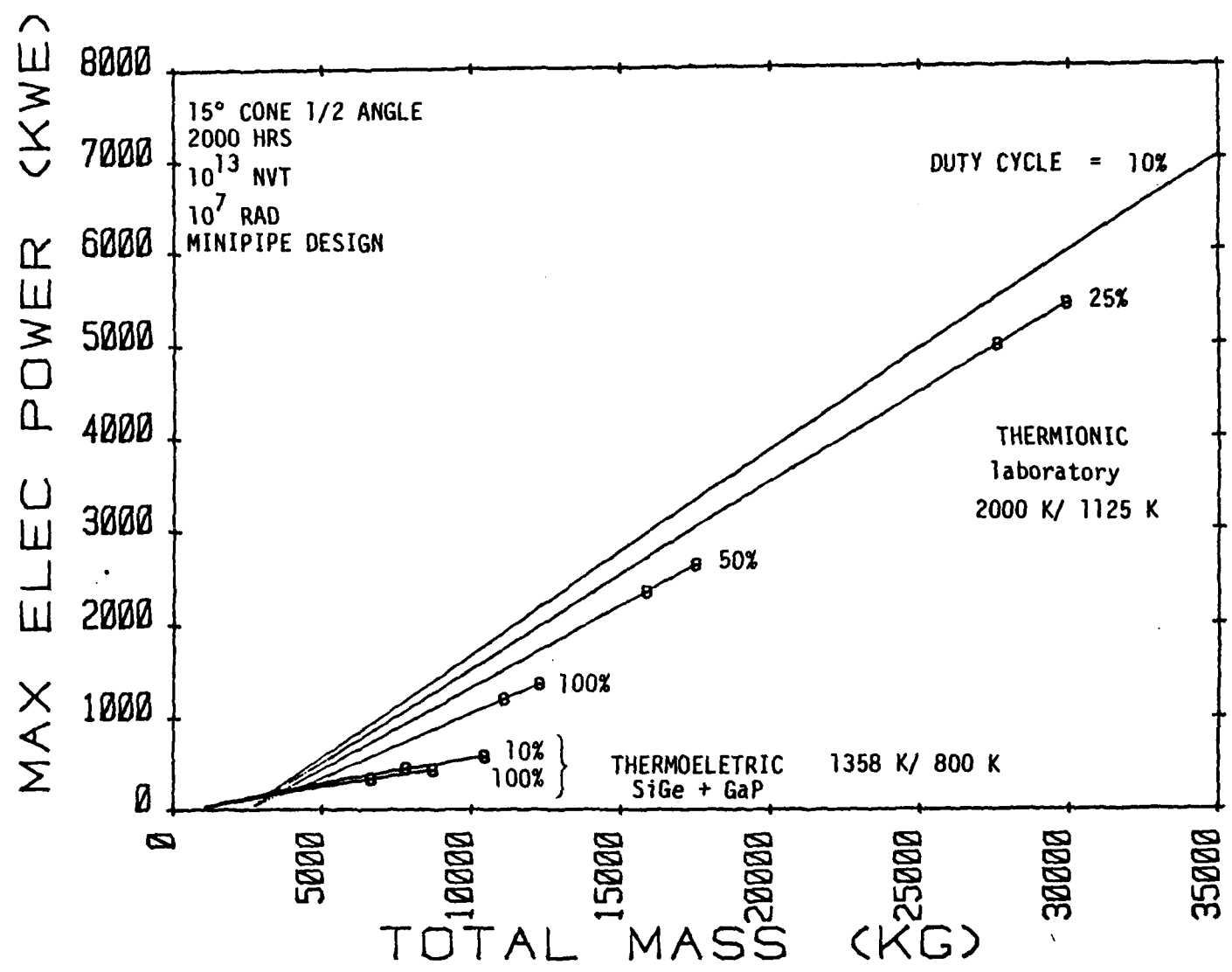

IV-3-14

The peak power delivered in a pulsed system is illustrated here. It is assumed that the pulse length is short, on the order of a second or less. With this constraint the thermionic system can provide pulsed power of up to 5 MWe. This is the result of the fact that proportionately little heat flows through the thermionic converter when it is operating open-circuit and not delivering power. Substantial quantities of heat continue to flow through the thermoelectric converter under similar open circuit conditions. The limiting size of the pulsed thermoelectric system is about the same as a steady-state system.

IV-3-16

PRESENT CONVERTER PERFORMANCE MINIPIPE SYSTEMS

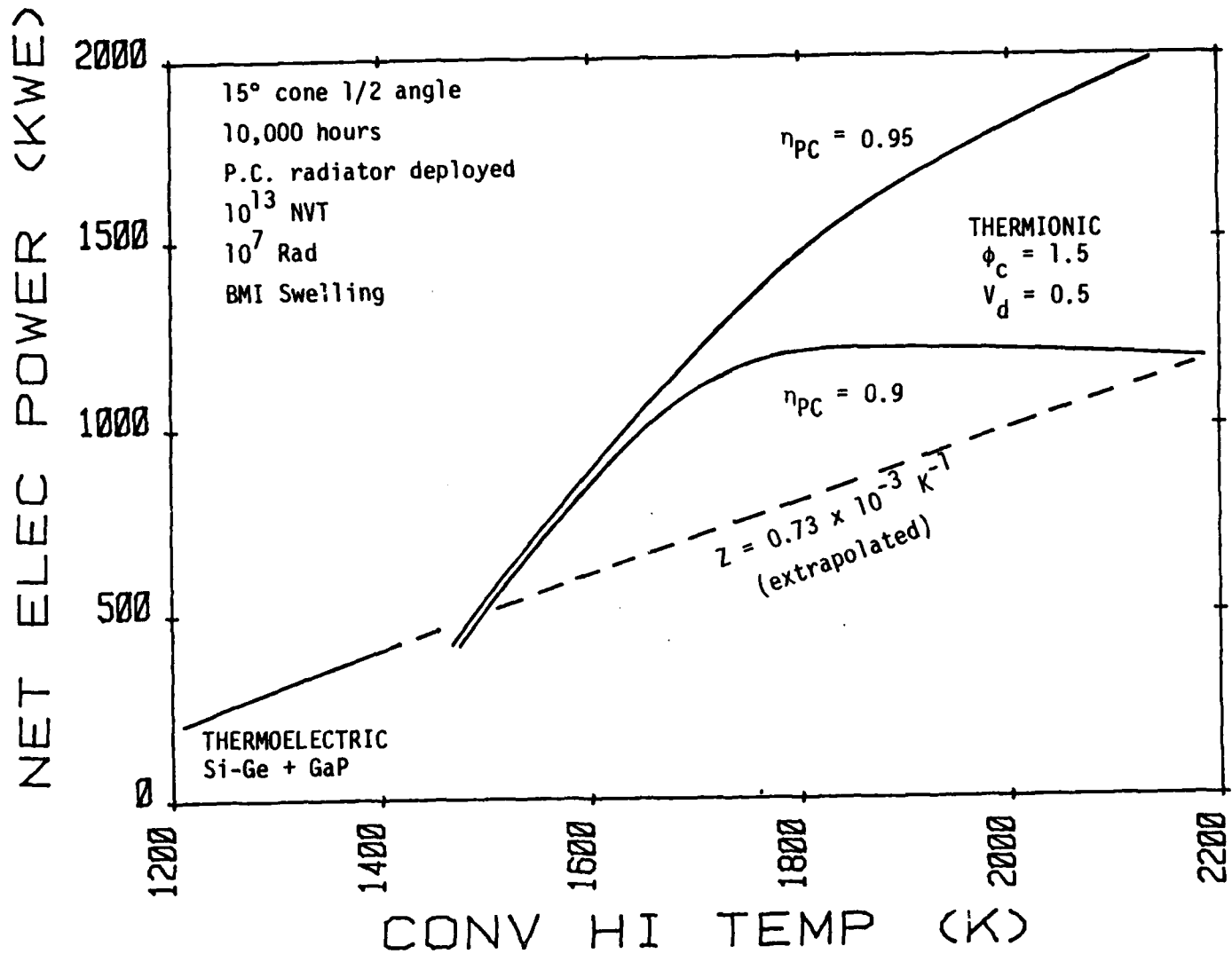

Given shuttle size constraints the thermoelectric system produces substantially more power than the thermionic system if temperatures are held below 1400 K. Above about 1500 K the thermionic system is more effective, even assuming the thermoelectric system could operate at higher temperatures with the same value of Z (for Si-Ge + GaP) achieved at its present high temperature limit. The power conditioning radiator limits the size of the thermionic system to 1.2 MWe, assuming a power conditioning efficiency of 90% and a power conditioning radiator temperature of 408 K. Under these conditions there is little incentive to go above 1700 K with the converter. However, if the power conditioning efficiency is increased, or its temperature increased, its size is reduced. Then further increases in converter temperature result in higher output power levels. As shown, with a power conditioning efficiency of 95% it is reasonable to expect 1.8 MWe with near-term thermionic performance and temperatures of 2000 K.

ADVANCED CONVERTER PERFORMANCE MINIPIPE SYSTEMS

8T-3-18

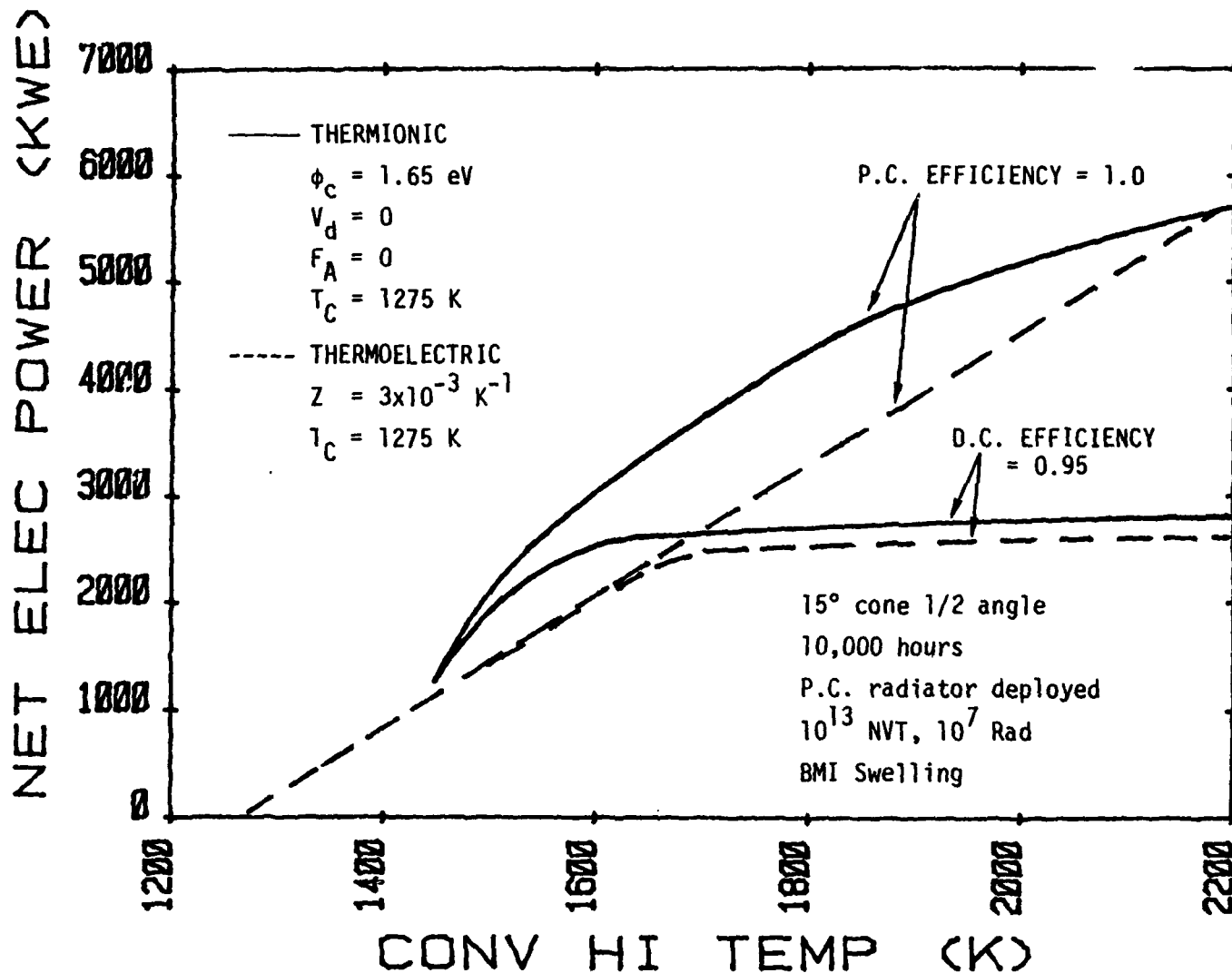

Improvements in conversion system performance can lead to substantially higher power systems. By eliminating the arc-drop in the thermionic converters, continuous power levels between 2.5 MWe and 5 MWe, become possible, depending on power conditioner efficiency and design temperature. Similar levels would be reached with thermoelectric converters if their figure-of-merit Z can be increased to above $3 \times 10^{-3} \text{ K}^{-1}$ at high operating temperatures.

EFFECT OF HIGH TEMPERATURE SWELLING CONTAINMENT

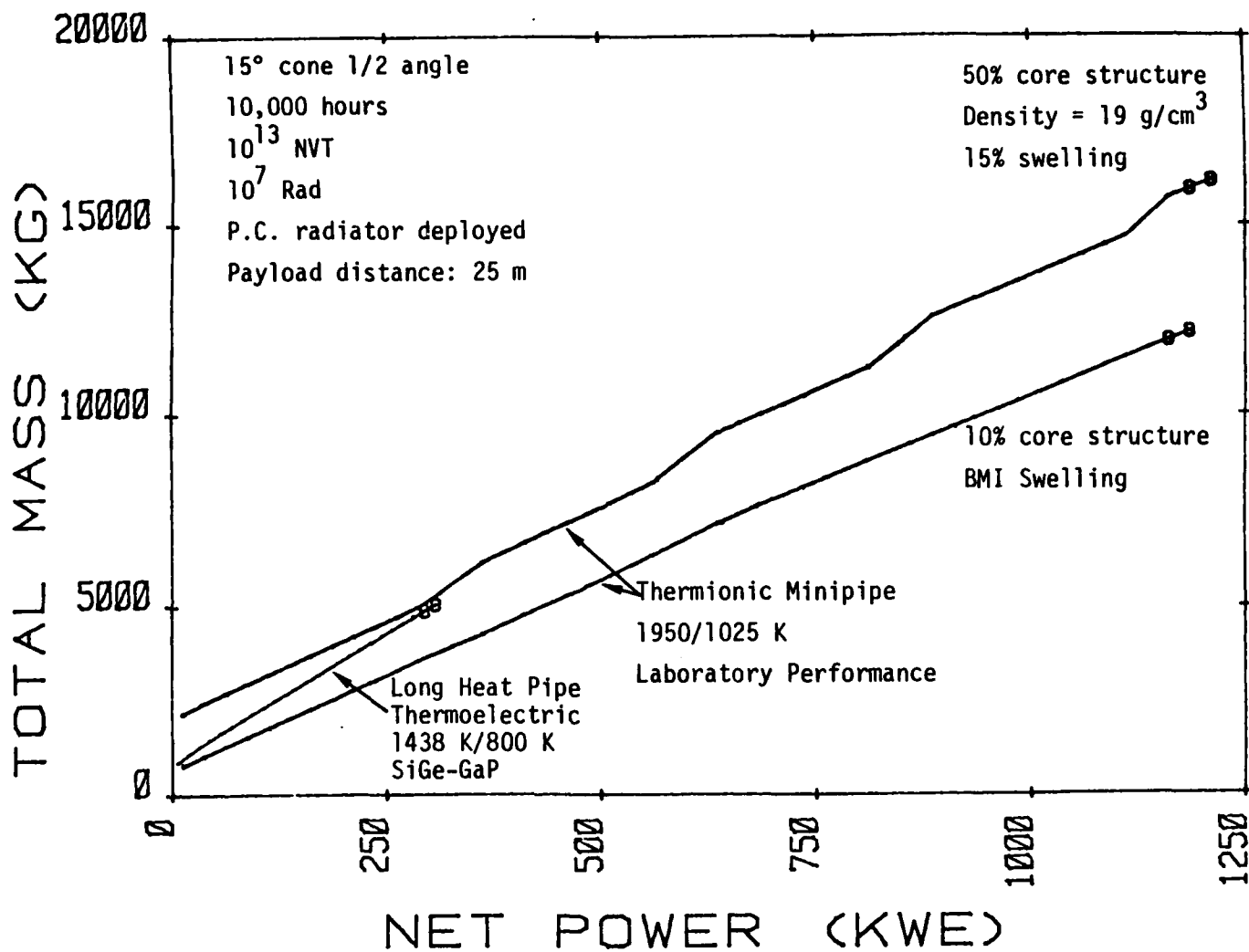

IV-3-20

|||||

An important concern in all reactor power systems with long design lifetimes is fuel swelling. The studies reported here assumed, conservatively we believe, swelling based on Arrhenius functions of temperature as described in Reference 1. This plot shows the impact of an even more conservative assumption; that it is necessary to fill one-half the core with tungsten, to keep swelling levels to 15%. The mass of a low power (100 kWe) system might double if this were done, but at 1 MWe the system mass would increase only 30%. This illustrates that even extreme measures may be taken, if necessary, to control fuel swelling and still produce an acceptable system mass at high power levels.

AD-A118 887

R AND D ASSOCIATES ROSSLYN VA

F/G 10/2

PROCEEDINGS OF THE AFOSR SPECIAL CONFERENCE ON PRIME-POWER FOR --ETC(U)

FEB 82 P J TURCHI

F49620-82-C-0008

UNCLASSIFIED

AFOSR-TR-82-0655

NL

5-9

5-9



20



20

20

20

20

COMPARISON OF NUCLEAR SPACE POWER SYSTEMS

15° CONE 1/2 ANGLE; 10^{13} NVT; 10^7 RAD TI: Laboratory TE: Si-Ge+GaP BMI SWELLING POWER CONDITIONING INCLUDED		SYSTEM MASS AT 100 kWe		GROWTH POTENTIAL TO SHUTTLE LIMIT		COMMENTS	
				CONTINUOUS	PULSED 10% DUTY		
		SYSTEM LIFETIME	7 YRS	1 YR	1 YR		1 YR
LONG HEAT PIPE	TE	2200 kg	1970 kg	300 kWe	350 kWe	INSIGNIFICANT SWELLING	LONG, HI TEMP. HEAT PIPES
	TI	2800	2330	600	2600	SWELLING ACCOMMODATED	
MINI HEAT PIPE	TE	3040	2510	300	320	INSIGNIFICANT SWELLING	LARGE NUMBER OF SMALL HEAT PIPES
	TI**	2150	1650	1200	6000	SWELLING ACCOMMODATED	
IN-CORE "FLASHLIGHT" - TI		-	-	750	-	COMPLEX CORE* PUMPED LOOP COOLING	VERY HIGH TEMPERATURE CAPABILITY

* SANDWICH CORE MAY SOLVE SOME OF THESE DIFFICULTIES

**10 MWe CAN BE PRODUCED FOR APPROXIMATELY ONE HOUR WITH A VARIANT OF THIS DESIGN

In conclusion, our studies show the potential for reactor space power system outputs of one to five megawatts or more. A versatile computer program is available which can be used to study performance trade-offs parametrically. It can easily show the system benefits resulting from advances in reactor design and fuel swelling control, converter performance, heat transfer system capability, power conditioning characteristics, and radiator design. It should prove to be a useful tool to program planners in guiding their research efforts.

BIBLIOGRAPHY

1. Buden, D., et al, "Selection of Power Plant Elements for Future Reactor Space Electric Power Systems," Los Alamos Scientific Laboratory, New Mexico, LA7858, 1979.
2. Chubb, T., Storhok, V. W., and Keller, D. L., "Factors Affecting the Swelling of Nuclear Fuels at High Temperatures," Nuclear Technology, Vol. 18, June 1973.
3. Cohen, M., Fornoles, F., and Mahefkey, T., "Requirements and Technology Trends for Future Military Space Power Systems," Proc. of 16th Intersociety Energy Conversion Engineering Conference, Atlanta, Georgia, August 9-14, 1981.
4. Cooper, K. C., and Palmer, R. G., "System Tradeoffs in Space Reactor Design," Proc. of the 15th Intersociety Energy Conversion Engineering Conference, Seattle, Washington, August 1980, Vol. 1, p. 738-743.
5. "Development of a Thermionic Reactor Space Power System," Gulf General Atomic Company, Gulf-GA-A12608, San Diego, California, June 1973.
6. Gietzen, A. M., "100 kWe Thermionic Power System for Space Base Application," presented at the 1970 Thermionic Conversion Specialist Conference, October 1970, Miami, Florida.
7. Homeyer, W. G., Heath, C. A., and Gietzen, A. J., "Thermionic Reactors for Electric Propulsion--Parametric Studies," Proc. of 2nd International Conference on Thermionic Electrical Power Generation, Stresa, Italy, May 1968, p. 201-219.
8. Kuznetsov, V. A., "Operation of Thermionic Reactor-Converters TOPAZ-1 and TOPAZ-2," Proc. of the 3rd International Conference on Thermionic Elect. Power Generation, Julich, Germany, June 1972, Vol. 1, p. 365.
9. Kuznetsov, V. A., et al, "Power Tests of the TOPAZ-3 Thermionic Reactor," Proc. of the 1975 Thermionic Conversion Spec. Meeting, Eindhoven, Netherlands, September 1975, p. 137.
10. Manda, M. L., Britt, E. J. and Fitzpatrick, G. O., "Power Coupling Alternatives for the NEP Thermionic Power System," Final Report JPL Contract 955121, NSR 7-1, December 1978.
11. Millionshchikov, M. D., et al, "High Temperature Direct Conversion Reactor Romashka," A/Conf., Third United Nations International Conference on Peaceful Uses of Atomic Energy, Geneva, Switzerland, May 1964, 28/p/873.
12. "Thermionic Converter and Fuel Element Testing Summaries at Gulf General Atomic Company," GULF-GA-C12345, October 1972, San Diego, California.

Session IV

**GAS COOLED REACTORS FOR
LARGE SPACE POWER NEEDS**

Presented at Special Conference
Sponsored by
Air Force Office of Scientific Research

February 22 - 25, 1982
Norfolk, Virginia

G. H. Parker

Westinghouse Electric Corporation
Advanced Energy Systems Division
Box 10864
Pittsburgh, PA. 15236

IV-4-1

IV-4-2

GAS COOLED REACTORS SPAN MUCH OF THE HISTORY OF NUCLEAR ENERGY. MAJOR TECHNOLOGICAL ADVANCEMENTS IN COMPACTNESS AND HIGH POWER DENSITY WERE GAINED FROM THE AIRCRAFT NUCLEAR PROPULSION AND NUCLEAR ROCKET (ROVER) PROGRAMS. A MATURE FUEL BEAD TECHNOLOGY HAS BEEN DEMONSTRATED IN RECENT YEARS IN REACTORS BUILT IN THE UNITED STATES AND THE FEDERAL REPUBLIC OF GERMANY.

BACKGROUND

○ STAGG FIELD

○ DANIELS PILE

BRITISH & FRENCH GAS COOLED PROG.

ANP

NUCLEAR ROCKET PROG.

MGCRE

AF/NASA PROG.

○ DRAGON

○ PEACH BOTTOM

○ UHTREX

○ FT. ST. VRAIN

IV-4-3

1940

1950

1960

1970

IV-4-4

STARTING AT THE LOS ALAMOS SCIENTIFIC LABORATORY IN THE MID 1950'S, THE ROVER PROGRAM EVOLVED THROUGH SEVERAL GENERATIONS OF HYDROGEN COOLED PROPULSION REACTORS. THE NERVA SERIES OF TEST REACTORS BUILT BY WESTINGHOUSE PRODUCED MORE THAN 1000MW(t) AT 4000°F - THE OUTPUT OF HOOVER DAM IN THE SIZE OF AN OFFICE DESK! LARGER [4000MW(t)] PHOEBUS REACTORS WERE BUILT BY LASL AND THE NERVA DESIGN WAS APPROACHING FLIGHT RATED STATUS WHEN THE PROGRAM WAS TERMINATED DURING POST-APOLLO SPACE ECONOMIES.

NUCLEAR ROCKET DEVELOPMENT

IV-4-5

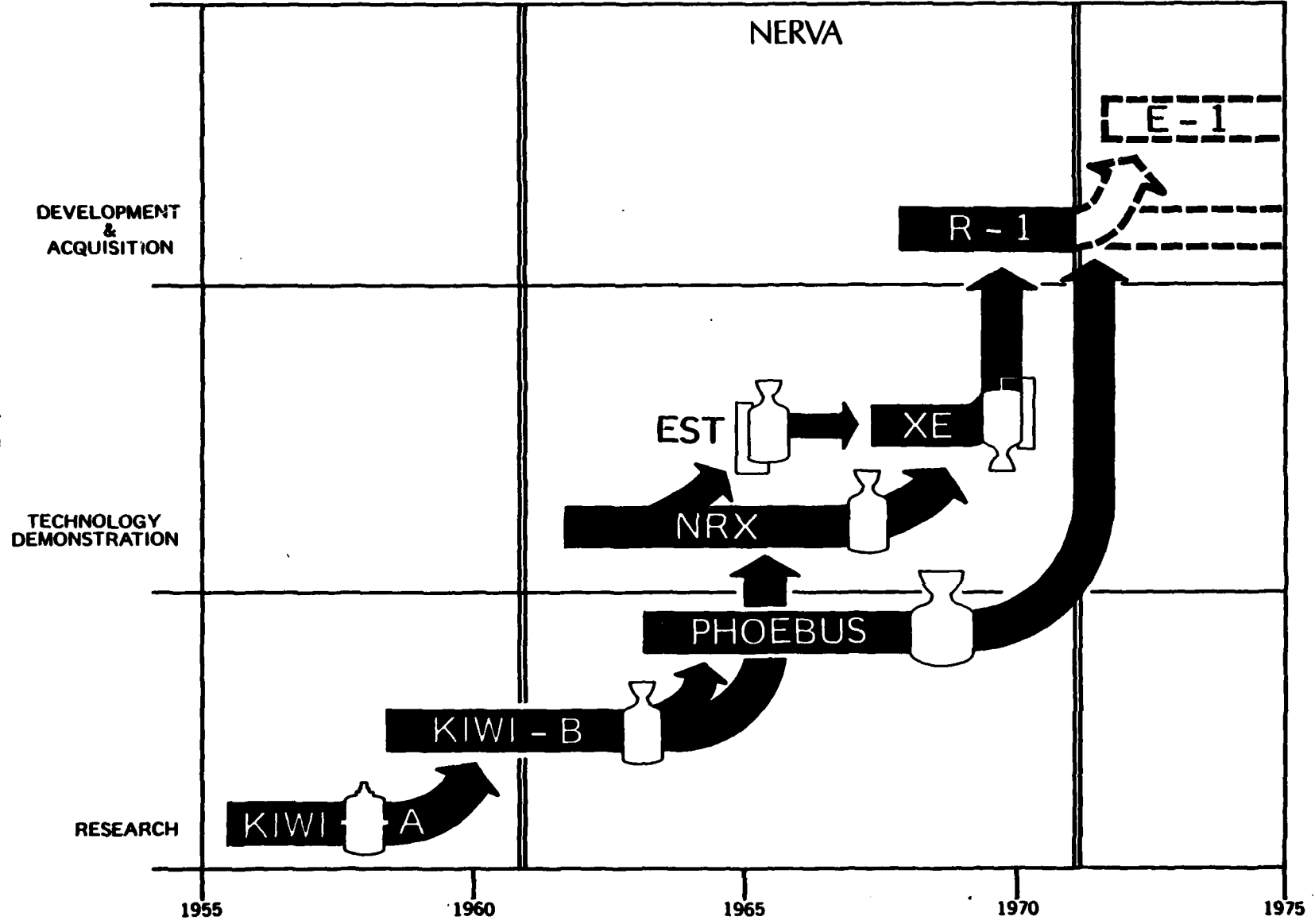

NERVA

DEVELOPMENT & ACQUISITION

TECHNOLOGY DEMONSTRATION

RESEARCH

1955

1960

1965

1970

1975

E - 1

R - 1

EST

XE

NRX

PHOEBUS

KIWI - B

KIWI - A

IV-4-6

THIS TABLE LISTS MAJOR TESTS THAT WERE CONDUCTED UNDER ROVER OVER AN EIGHT YEAR PERIOD AT NRTS, NEVADA. NUMEROUS TESTS AT POWER AND RAPID TRANSIENTS WITH EFFECTIVE AUTOMATIC CONTROL WERE DEMONSTRATED WITH THESE REACTORS - AMONG THE HIGHEST POWER DENSITY HEAT ENGINES EVER BUILT BY MAN.

NUCLEAR ROCKET TEST SUMMARY

KIWI-B4D (1 POWER TEST) _____	May, 1964
KIWI-B4E (2 POWER TESTS) _____	August-September, 1964
NRX-A2 (2 POWER TESTS) _____	September-October, 1964
KIWI-TNT _____	January, 1965
NRX-A3 (3 POWER TESTS) _____	April-May, 1965
PHOEBUS-1A (1 POWER TEST) _____	June, 1965
NRX/EST (10 STARTS) _____	Dec., 1965 -March, 1966
NRX-A5 (2 POWER TESTS) _____	June, 1966
PHOEBUS-1B (1 POWER TEST) _____	February, 1967
PHOEBUS-2 COLD FLOW TESTS _____	July-August, 1967
NRX-A6 (1 POWER TEST) _____	December, 1967
XECF (COLD FLOW) _____	February-April, 1968
PHOEBUS-2A (3 POWER TESTS) _____	June-July, 1968
PEWEE-1 (2 POWER TESTS) _____	November-December, 1968
XE (28 STARTS) _____	December, 1968-August, 1969
NF-1 (4 POWER TESTS) _____	June-July, 1972

IV-4-8

NERVA CORES CONSISTED OF AN ARRAY OF EXTRUDED GRAPHITE HEXAGONAL BLOCKS,
0.75 INCHES ACROSS THE FLATS AND EACH CONTAINING 19 HOLES FOR COOLANT FLOW.
CONTROL PROVISIONS INCLUDED INSERTABLE RODS, PREPOISONING AND ROTATING
Be REFLECTOR DRUMS.

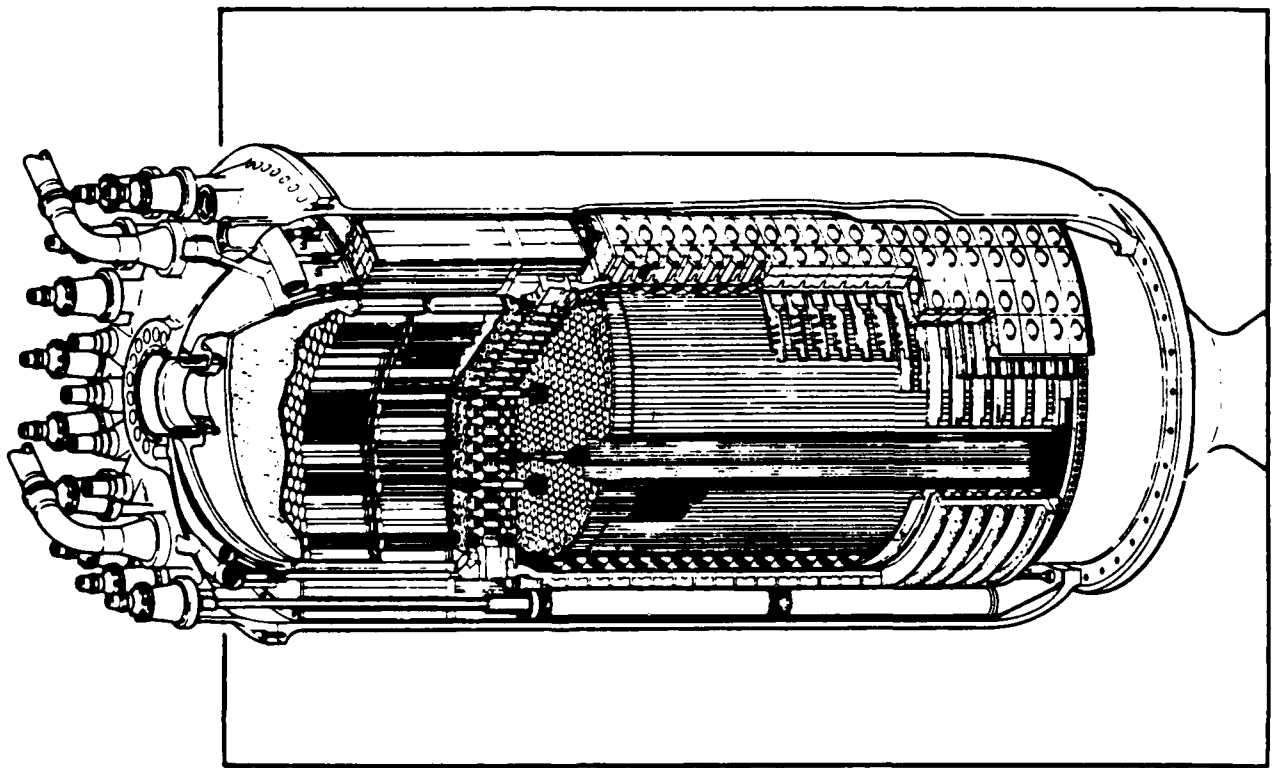

Flight Reactor Design (Terminated 1971)

IV-4-10

WHILE THE NERVA CORES USED SINGLE LAYERED FUEL BEADS IN THE ELEMENTS, THE PRESENT BEAD STATE-OF-THE-ART PROVIDES MULTIPLE BARRIERS FOR FISSION PRODUCT RETENTION. TRISO BEADS HAVE BEEN THOROUGHLY DEMONSTRATED IN HTGR'S. WEST GERMANY HAS OPERATED PEBBLE BED CORES WITH THESE BEADS WHILE, IN THE U.S., THE FORT ST. VRAIN PLANT USES THEM IN FUEL STICKS IN GRAPHITE MODERATOR BLOCKS.

FUEL CONCEPT

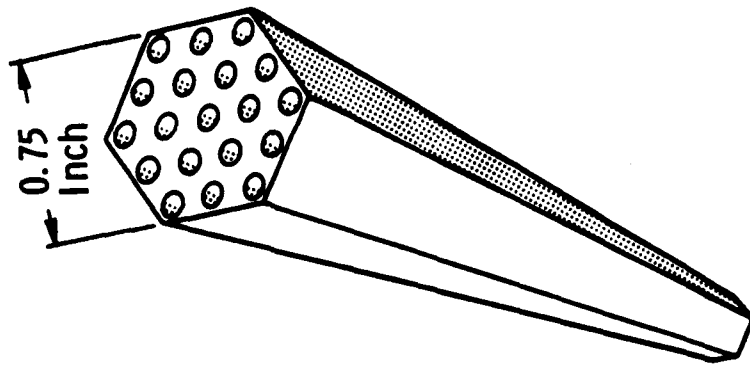

IN NERVA GRAPHITE
FUEL ELEMENT

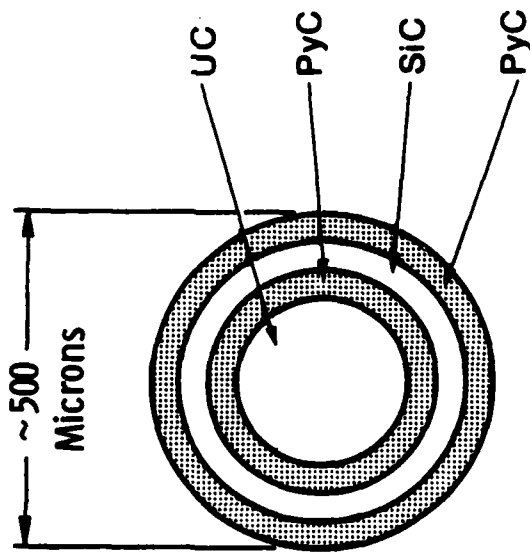

TRISO BEAD

IV-4-12

THIS CHART CONTRASTS THE OPERATING CONDITIONS OF THREE KINDS OF GAS COOLED REACTORS. LIGHT WEIGHT NUCLEAR PLANTS (LWNP) HAVE BEEN DESIGNED RECENTLY BY WESTINGHOUSE FOR POTENTIAL NAVAL APPLICATIONS. SPACE REACTORS COOLED BY HELIUM ARE EXPECTED TO HAVE A GREAT DEAL OF R&D COMMONALITY WITH THE LWNP DESIGNS.

GRAPHITE FUEL ELEMENT REQUIREMENTS

	<u>LWNP</u>	<u>HTGR</u>	<u>NERVA</u>
COOLANT	HELIUM	HELIUM	HYDROGEN
COATING	NONE	NONE	CARBIDE
OPERATING TEMP., °F	850 TO 1950	600 TO 2460	-200 TO 4100
TEMP. GRADIENT, °F/IN.	270	1240	7470
POWER DENSITY, KW/L	300	40	2140
MAX. BURNUP, %	50	75	<0.1
FISSION PRODUCT RETENTION	≥0.9999	≥0.9999	NOT REQ'D.
OPERATING TIME, HRS.	10,000	28,000	10

IV-4-13

IV-4-14

THIS FIGURE ILLUSTRATES A CUTAWAY OF ONE SPACE REACTOR DESIGN CONCEPT, COOLED BY HELIUM AND REFLECTOR DRUM CONTROL SUPPLEMENTED BY BURNABLE POISONS. THIS APPROACH TO SPACE REACTOR CONTROL WAS DEMONSTRATED BY THE UNITED STATES IN 1965 WITH THE SNAP-10A SYSTEM (NAK COOLED) IN POLAR ORBIT WHILE A COMPANION GROUND DEMONSTRATION SYSTEM OPERATED FOR ONE YEAR WITHOUT ACTIVE CONTROL.

SPACE POWERPLANT REACTOR

CONTROL DRUM ACTUATORS

REFLECTOR & HOLD DOWN PLATE

REFLECTOR (BERYLLIUM) WITH DRUM CONTROL

CORE (FUEL)

PRESSURE VESSEL

SUPPORT PLATE

◇ INLET FLOW
◆ OUTLET FLOW

IV-4-15

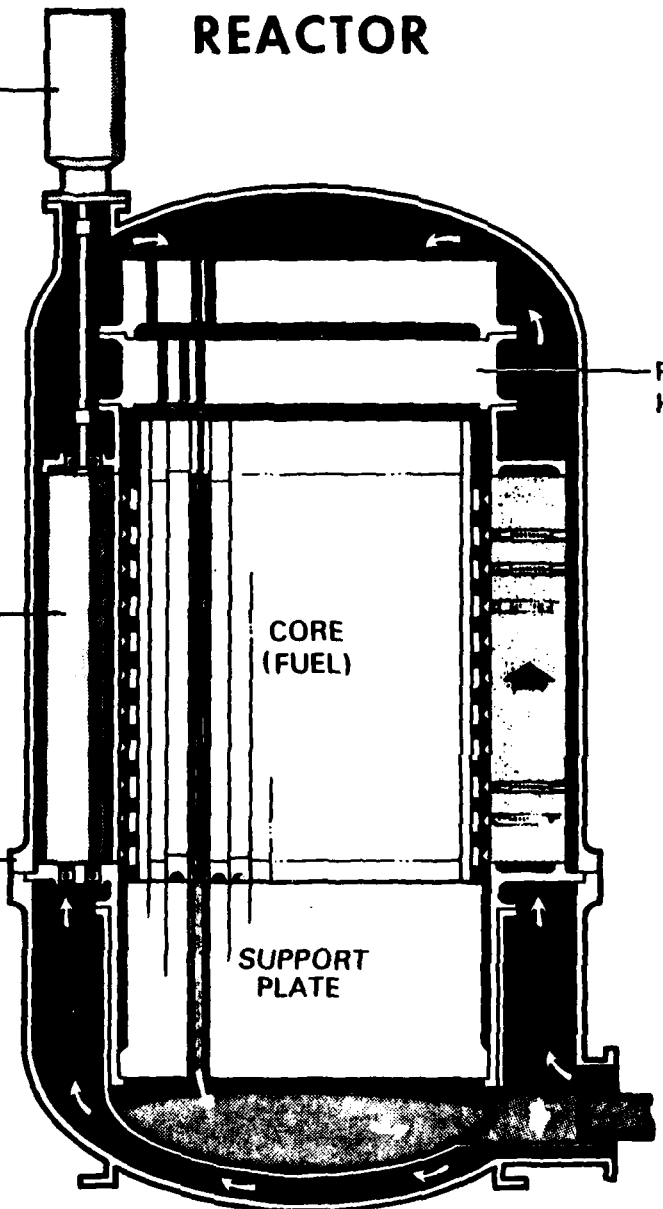

IV-4-16

GAS COOLED SPACE REACTORS CAN BE BUILT IN THE NEXT FEW YEARS AND THEIR PERFORMANCE CAPABILITIES EXCEED THOSE OF THE POWER CONVERSION SYSTEMS (PCS) THAT THE REACTORS WILL DRIVE. FOR SPACE APPLICATIONS REQUIRING MW(e), THE CLOSED CYCLE BRAYTON CYCLE IS A STRONG CANDIDATE FOR THE PCS. FOR THESE HIGH POWER LEVELS, WASTE HEAT REJECTION TO SPACE BY RADIATORS TENDS TO DRIVE SYSTEMS TO HIGH OPERATING TEMPERATURES SO THAT REASONABLY SIZED SYSTEM ENVELOPE DIMENSIONS CAN BE ATTAINED. THUS, COMPACT, HIGH POWER DENSITY, HIGH TEMPERATURE, HIGH BURNUP REACTORS WILL BE NEEDED. THE TECHNOLOGY BASE FOR THESE REACTORS IS WELL ESTABLISHED.

REACTOR TRENDS

	<u>NEAR TERM TECHNOLOGY</u>	<u>ENHANCED PERFORMANCE</u>
FUEL FORM	STATE-OF-THE-ART TRISO	ADVANCED
OUTLET TEMPERATURE	EXCEEDS PCS CAPABILITY	>2500°F
COMPACTNESS AND LIGHTWEIGHT	HIGH POWER DENSITY	POTENTIAL TO ATTAIN GW(t) LEVEL
LIFE CONSIDERATIONS	50% FIMA	TO 75% FIMA

IV-4-17

IV-4-18

THIS CHART SHOWS CANDIDATE MATERIALS THAT HAVE BEEN IDENTIFIED FOR ALL OF THE REACTOR COMPONENTS. WHILE MANY OF THESE MATERIALS WERE USED IN THE ROVER PROGRAM, THOSE TESTS WERE SHORT IN DURATION AND APPROPRIATE RDT&E WILL BE NEEDED TO QUALIFY MATERIALS FOR THE EXPECTED LONG DURATION OPERATION OF SPACE REACTORS.

CANDIDATE REACTOR ASSEMBLY MATERIALS

COMPONENT	TEMP. (°F)	STRESS (psi)	MATERIALS
Pressure Vessel	800	30,000	Inconel 718 - Yield strength >100 ksi at 800°F SA-533 - 56.5 ksi Yield strength at 800°F S_m - 30 ksi at 800°F
Core Support Plate (uncooled)	1700	2,500	M-22 - 1000 hr. rupture life at 1700°F - 28 ksi
Core Support Plate (cooled)	1250	15,000	Inconel 718 - Stress rupture life at 15 ksi - 1250°F - 2.8×10^5 hrs.
Reflector	800	Nominal	Beryllium - swelling <1% at <900°F and 10^{22} nvt
Internal Shield	800	Nominal	Tungsten - pressed and sintered powder and 2.6% Ni, Cu, and Fe (Kennertium W-2)
Lateral Support Springs	800	30,000	Inconel 718 - Yield strength >100 ksi at 800°F Relaxation in 10^{22} nvt fluence may be a problem
Structural Rings & Tubes	800	Nominal	Inconel 718 - Yield strength >100 ksi at 800°F

IV-4-19

IV-4-20

THIS CHART SUMMARIZES MAJOR AREAS WHERE RDT&E WILL BE NEEDED BEFORE
ADVANCED REACTORS CAN BE FLIGHT RATED FOR LONG TIME OPERATION. NONE
OF THESE AREAS REQUIRE BREAKTHROUGHS BUT RATHER A SERIES OF
RIGOROUS R&D TESTS AND ANALYSIS TO SUPPORT DESIGN CHOICES AND MATERIALS
QUALIFICATIONS.

RESEARCH & DEVELOPMENT ACTIVITIES NEEDED

- MATERIALS

- Radiation Effects
- Long Term Creep
- Helium (with impurities) Compatibility

- FUEL BEADS AND ELEMENTS

- Fission Product Retention
- Temperature Limits
- Radiation Effects

- RELIABILITY

- Instrumentation and Control
- Auxiliary Components

"Near Term and Future Nuclear Power Conversion Systems
for Space"
by
Elsner, N. B.

Paper submitted to Session Chairman

(Paper not available)

**COMPACT, HIGH-POWER NUCLEAR REACTOR SYSTEMS BASED ON SMALL
DIAMETER PARTICULATE FUEL**

**J.R. Powell and T.E. Botts
Department of Nuclear Energy
Brookhaven National Laboratory
Upton, New York 11973**

ABSTRACT

Two compact, high-power nuclear reactor concepts are discussed. Both are gas-cooled cavity-type reactors which utilize particulate fuel of the type now used in HTGR reactors. Unshielded reactor volumes are on the order of one cubic meter. The Fixed Bed Reactor (FBR) operating temperature is limited to ~2500 K and the output power to 250 MW(e). In the Rotating Bed Reactor (RBR), fuel is held within a rotating porous metal drum as a rotating fluidized bed. Rotating Bed Reactor outlet temperatures up to ~3000 K and output power levels up to ~1000 MW(e) are achievable. Both reactors can be brought up from stand by to full power in times on the order of a few seconds, due primarily to the short thermal time constant for the fuel particles which have a characteristic dimension of 400 μ .

Turbine and MHD Brayton are the power conversion cycles of choice. Open-cycle operation is generally favored for applications operating at less than ~1000 sec of equivalent integrated full power. At power levels above 1 MW(e), the liquid droplet radiator is the favored means of heat rejection. Power system specific power levels of 10 kW(e)/kg (not including shield) appears to be quite feasible.

Areas of research interest are materials performance and compatibility; experimental verification of generic neutronic and thermal hydraulic designs; and demonstration of fuel performance in the RBR.

VIEWGRAPH SYNOPSES

1. Both FBR and RBR utilize particulate fuel. The FBR can use existing HTGR fuel due to its lower outlet temperature. At low-power levels, turbines are preferred while MHD offers advantages at power levels of hundreds of megawatts. Output power levels as low as 100 kW(e) to as high as 1000 MW(e) (with power densities up to 3000 MW(th)/m³) appear to be feasible. These very high peak temperatures allow heat rejection at fairly high temperatures, which is compatible with radiant heat rejection. Both reactors can be brought from alert to full power in times on the order of a couple of seconds, due to the excellent resistance of particle bed cores to thermal shock.
2. The TRISO particle (b) is a currently produced fuel particulate fuel element which has demonstrated excellent fission product retention to high burnup at temperatures consistent with FBR/turbine operation. Zirconium carbide coatings should be used for higher temperature operation.
3. The RBR (shown here as a direct thrust rocket engine) is an externally moderated cavity-type reactor. Fuel is held in a rotating porous metal drum and coolant flows through the drum and fuel bed. No structural elements except the nozzle and top plate are exposed to hot gas. Control is accomplished in the reflector via rotating drums with a poison on one side. The reactor is thermalized, affording excellent control.
4. The FBR contains the fuel bed with an internal high-temperature porous drum. By trading off some peak temperature, there is no need to maintain rotation. Furthermore, it is possible to place a moderator in the center of the cavity and smooth out axial and radial power profiles. In both reactors, hydrogen is the favored coolant for open-cycle operation and helium is favored for closed-cycle operation.
5. Fixed Bed Reactor fuel is fully-enriched HTGR fuel identical to that in use currently in the Fort St. Vrain HTGR. This same fuel, with ZrC coating, would be used for a RBR. Critical masses of ~40 kg of ²³⁵U have been calculated for the RBR.

Extensive discrete ordinate neutron transport calculations as well as critical experiments on cavity-type reactors indicate that the neutronic behavior of both the FBR and RBR are well understood. Kinetics and control still require further study. No problems are anticipated in these areas based on initial investigation.

Thermal hydraulics of the fixed bed are well understood and have been studied extensively. Half-scale cold flow rotating bed experiments have been carried out. Experiments must still be carried out in a volume heated fluidized bed.

6. For very low power applications, (<1 MW(e)) turbine or thermoelectric power conversion with heat pipe radiators and a FBR is the configuration of choice. Only long operating lifetime, closed-cycle missions are considered to be of interest.

For intermediate power levels, (1 to 50 MW(e)) turbine power conversion is preferred. For closed-cycle (long time) applications, a liquid droplet radiator is chosen.

High power (>50 MW(e)) applications would either be turbine or MHD. Magneto hydrodynamic is only considered for open cycle due to its very high operating temperatures.

Total power system weight is the figure of merit at any given power level used in choosing the preferred configuration.

7. At very low power levels, the radiator weight is relatively small, and the choice of liquid drop material is not as critical. Oil is preferred as the liquid droplet radiator medium. Ease of handling and density are the chief factors influencing this choice. However, vapor pressure and resultant evaporative losses, place an upper operating limit on all of these materials.

Turbines are relatively light, small, and simple at power levels below ~ 100 MW(e). At high power levels (>100 MW(e)), MHD becomes attractive for the same reasons. Generally, the FBR matches turbines and the RBR, MHD.

8. Criticality considerations leave reactor size and weight constant over a very wide range of power levels. By 50 MW(e), the reactor is dwarfed by other components. At power levels above ~ 50 MW(e), specific power is ~ 10 kW(e)/kg.

9. Remaining technical issues pertaining to the FBR pertain chiefly to characterizing the high-temperature reactor materials. An inner, high-temperature porous frit for very high temperatures (i.e., >1500 K) would be of interest and should be investigated. Liquid droplet radiators are vital to all closed-cycle, high-power systems and must be verified. Finally, full-scale thermal hydraulic and critical experiments must be carried out to demonstrate reactor performance.

Remaining technical issues pertaining to the RBR relate primarily to thermal hydraulics and materials concerned. Further cold flow, as well as volume heated rotating fluidized bed experiments are required to map out bed performance more completely. Study of particle fuel performance pertaining to hydrogen compatibility, agglomeration, sintering, and erosion is required to more closely determine the core lifetime limit. Full-scale thermal hydraulic and critical experiments must be carried out in order to demonstrate reactor performance.

FEATURES OF BNL COMPACT NUCLEAR POWER SOURCES

- FINE PARTICULATE FUEL (MAY BE IDENTICAL TO HTGR).
- GAS-COOLED (H_2 , He, ...).
- OUTLET TEMPERATURES UP TO 3000 K.
- OPEN- AND CLOSED-CYCLE OPTIONS.
- FIXED AND FLUIDIZED BED OPTIONS.
- TURBINE OR MHD BRAYTON CYCLES.
- OUTPUT POWER LEVELS RANGE FROM .1 TO 1000 MW(E).
- REACTOR POWER DENSITIES AS HIGH AS 3000 MW(TH)/M³.
- HIGH REACTOR INLET TEMPERATURES ARE COMPATIBLE WITH RADIANT HEAT REJECTION.
- VERY FAST STARTUP.

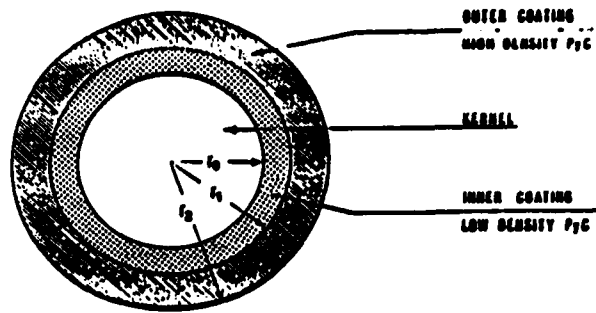

(a)

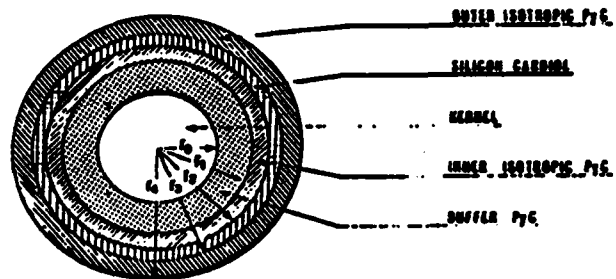

(b)

600 μ

CHARACTERISTICS OF COMMERCIAL HTGR FUEL:

- CAN OPERATE UP TO 1600 K (FBR REGIME).
- HIGH BURNUP OF FISSILE INVENTORY (>75%).
- EXCELLENT FISSION PRODUCT RETENTION.
- IMMUNE TO THERMAL SHOCK AND FATIGUE.
- FUEL FOR HIGH-TEMPERATURE H₂-COOLED SYSTEMS.
- CAN USE ZrC COATINGS.

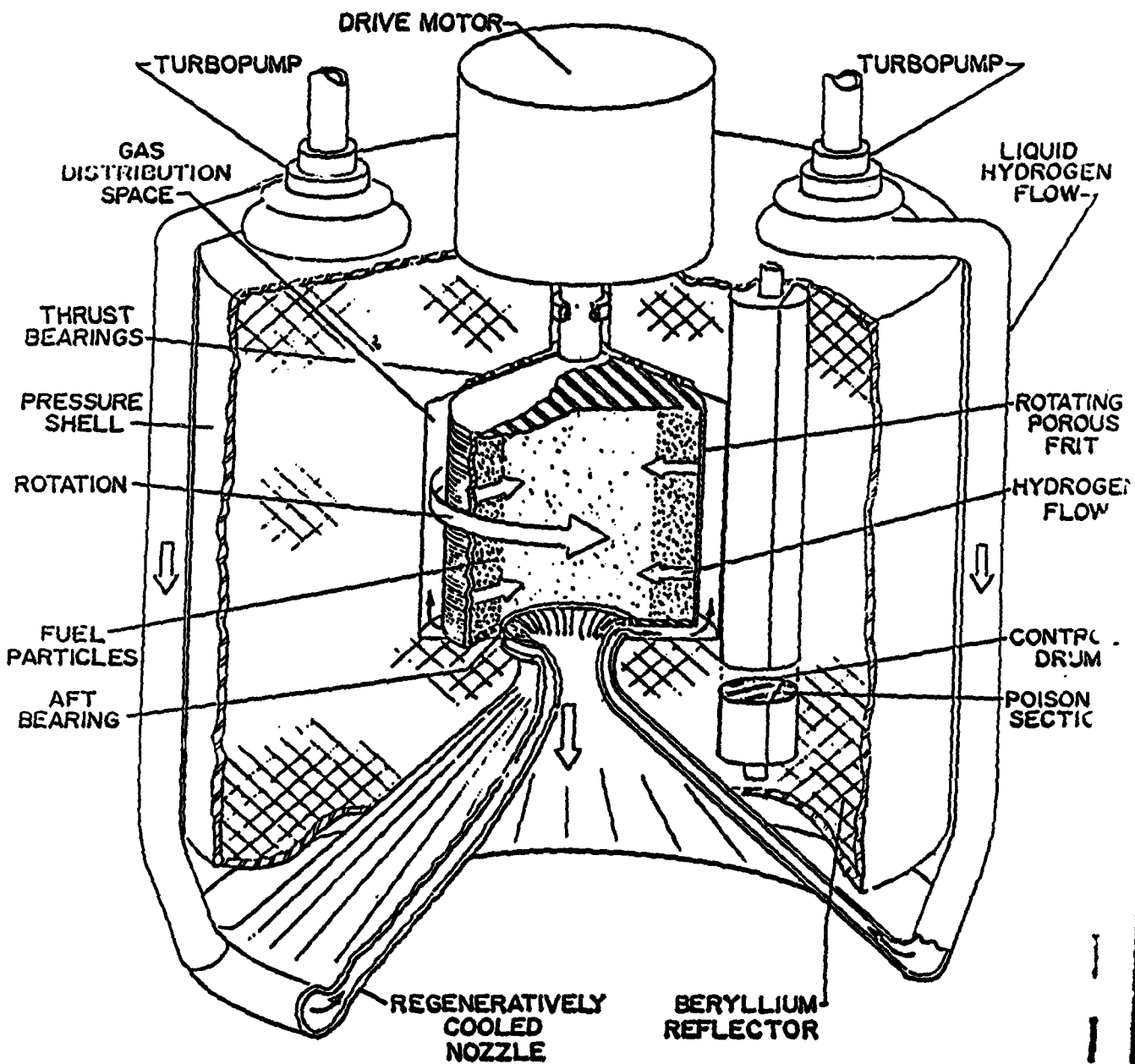

ROTATING FLUIDIZED BED ROCKET ENGINE

FIXED BED REACTOR (FBR)

← 30 cm →

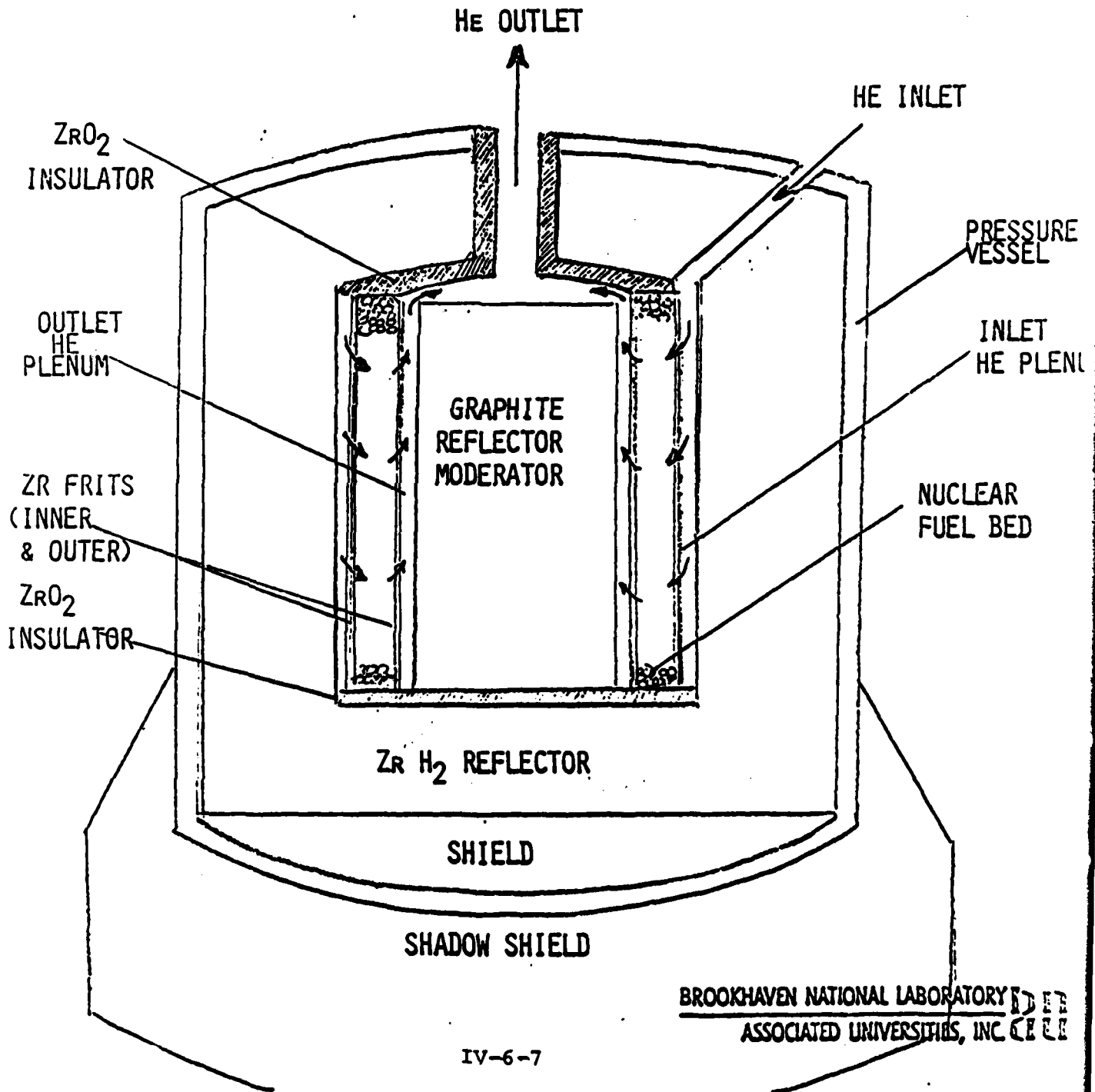

BROOKHAVEN NATIONAL LABORATORY
ASSOCIATED UNIVERSITIES, INC.

TECHNOLOGY STATUS

- FUEL DEVELOPED FOR FBR AND VIRTUALLY DEVELOPED FOR RBR.
- GOOD NEUTRONICS DATA BASE.
- FIXED BED REACTOR THERMAL HYDRAULICS WELL UNDERSTOOD.
- THERMAL HYDRAULICS STUDIED HALF-SCALE COLD FLOW EXPERIMENTS HAVE DEMONSTRATED THE FEASIBILITY OF THE RBR.

PRIME POWER SYSTEM OPTIONS

- LOW POWER ($\dot{W} < 1 \text{ MW}(\epsilon)$)
 - CONVENTIONAL HEAT PIPE RADIATORS
 - TURBINE OR THERMOELECTRIC POWER CONVERSION
 - LONG OPERATING LIFETIME

- INTERMEDIATE POWER ($1 \leq \dot{W} < 50 \text{ MW}(\epsilon)$)
 - TURBINE
 - CLOSED-CYCLE, LIQUID DROPLET RADIATOR
 - OPEN CYCLE FOR SHORT OPERATIONAL LIFETIME

- HIGH POWER ($\dot{W} \geq 50 \text{ MW}(\epsilon)$)
 - TURBINE OR MHD
 - CLOSED-CYCLE, LIQUID DROPLET RADIATOR
 - OPEN CYCLE FOR SHORT OPERATIONAL LIFETIME

PRIME POWER CYCLE OPTIONS—cont'd

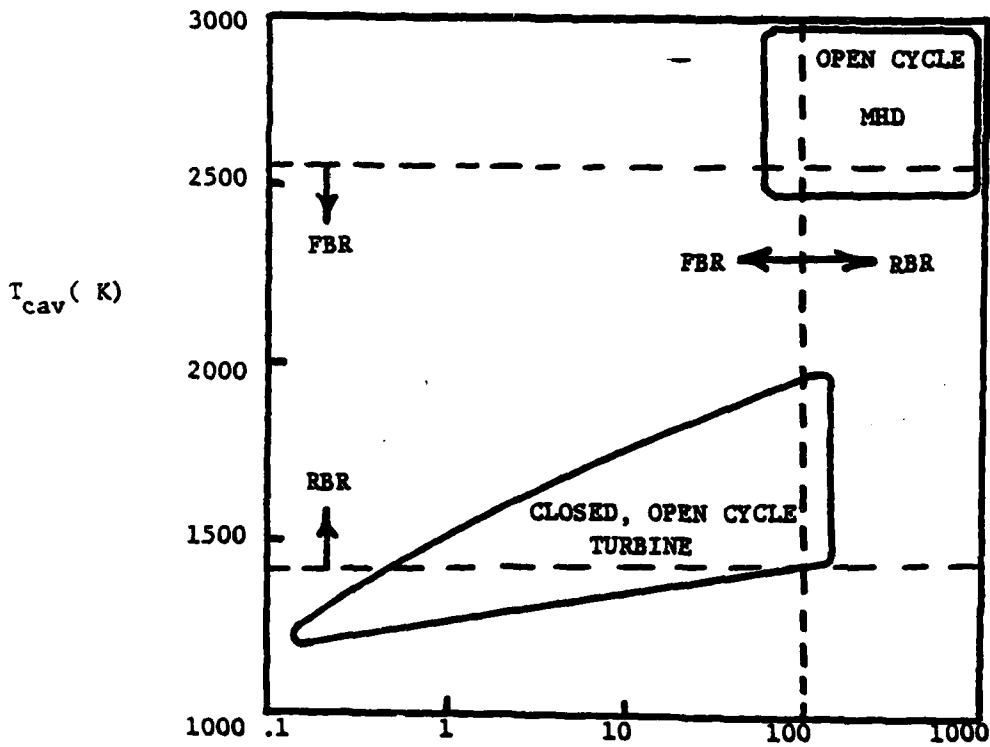
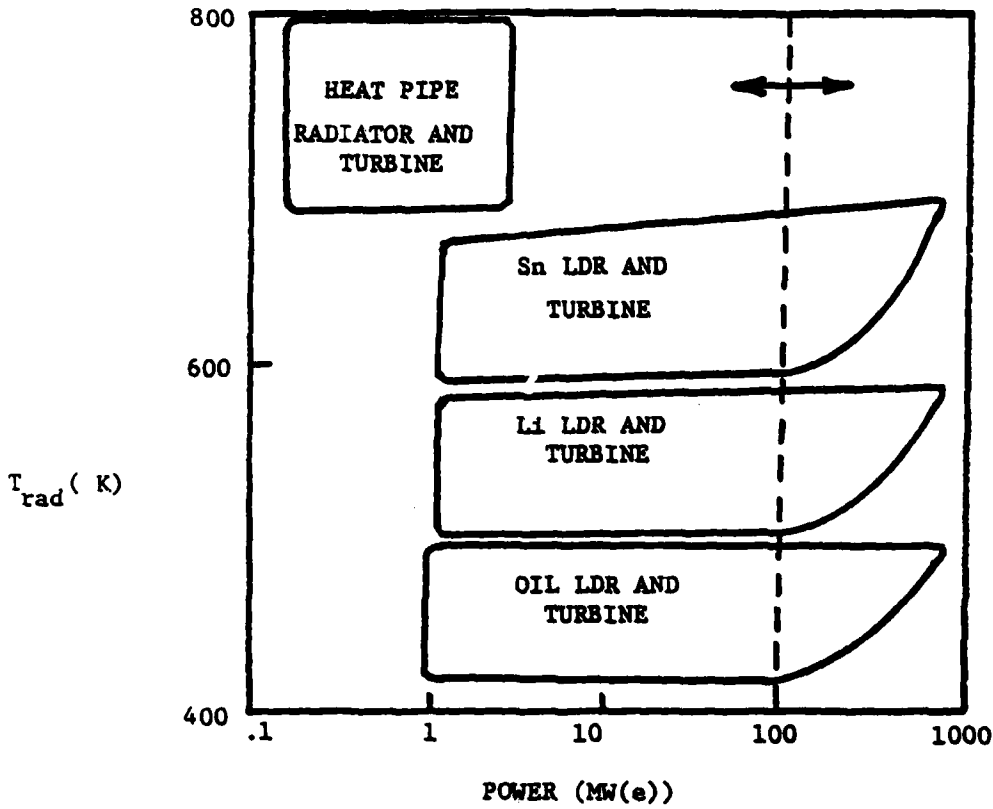

WEIGHT VS OUTPUT POWER FOR PARTICULATE BED REACTOR-
BASED POWER SYSTEMS

11-9-A1

WEIGHT (MT)

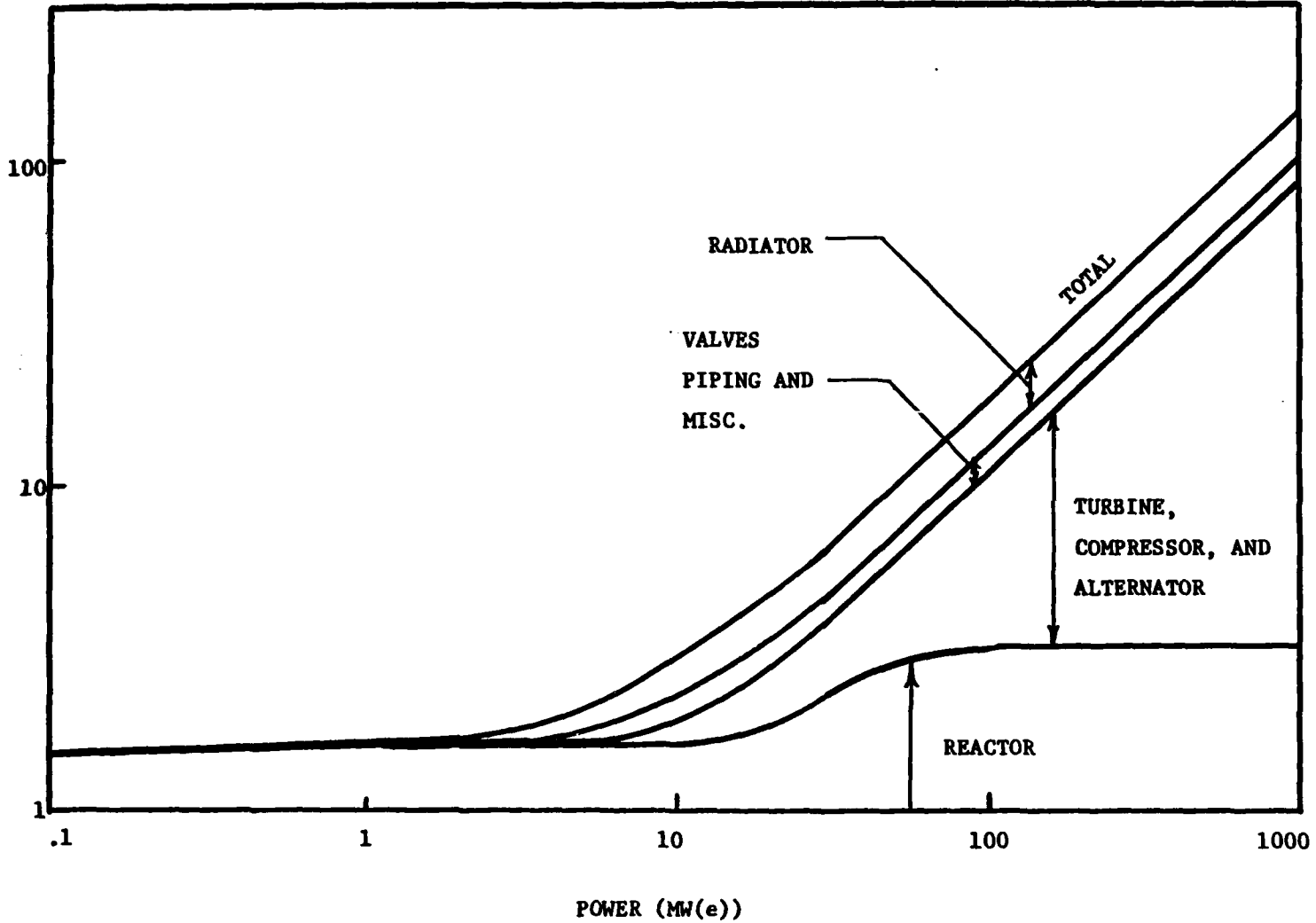

TECHNICAL ISSUES

FBR

- CHARACTERIZATION OF HIGH TEMPERATURE MATERIALS (E.G., FRIT).
- DEMONSTRATION OF RADIANT HEAT REJECTION VIA STREAMS OF LIQUID DROPLETS.
- VERIFICATION OF GENERIC NEUTRONIC AND THERMAL HYDRAULIC DESIGN.

RBR

- THERMAL HYDRAULIC STUDIES OF VOLUME HEATED ROTATING FLUIDIZED BEDS.
- EXTENSION OF COLD FLOW EXPERIMENTS TO MORE FULLY MAP POTENTIAL OPERATING REGIMES.
- MATERIALS COMPATIBILITY (E.G., FUEL-H₂ INTERACTIONS AT HIGH TEMPERATURE).

TECHNICAL ISSUES--CONT'D

- AGGLOMERATION, SINTERING, AND EROSION STUDIES.
- REACTOR KINETICS AND CONTROL.
- VERIFICATION OF GENERIC NEUTRONIC AND THERMAL HYDRAULIC DESIGN.

Q & A - J. R. Powell

From: A. Andrews, Rockwell International

If the rotating bed reactor (RBR) utilizing hydrogen as the working media to drive a turbine is exhausted to space (since it will be used in open-cycle mode only), what is maximum operating time assuming a reasonable tank size?

A.

Acceptable operating times depend on efficiency and mission parameters. For turbines operating at ~ 25% cycle efficiency and a minimal 100 Mw(e), operating times of 1000 to 3000 seconds can be visualized. This would require H₂ tankage of 8 to 24 tons in orbit.

From: P. J. Turchi, R & D Associates

How much migration of fuel particles out of the bed into the flow loop will occur?

A.

None in the Fixed Bed Reactor (FBR) option, since the fuel temperature is low enough (i.e., comparable to HTGR operating temperatures) that mass transport by volatilization is negligible. A small amount will probably occur in the Rotating Bed Reactor (RBR) due to reaction of H₂ with the ZrC coatings on the fuel particle. However, the RBR will only be used in the open cycle mode, with exhaust directly to space.

CLOSED-CYCLE FBR/TURBOGENERATOR SPACE POWER SYSTEM CONCEPT
WITH INTEGRATED ELECTRIC THRUSTERS FOR ORBITAL TRANSPORT

Leik Myrabo
The BDM Corporation
McLean, VA 22209

Figure 1A portrays an integrated vehicle concept utilizing shared power for propulsion and mission payload. This concept was developed in an on-going study under support by AFWL/AFRPL to examine space nuclear-electric systems with power levels in the range of 10 to hundreds of MW(e).

The concept in Figure 1A utilizes a Fixed Bed Reactor configuration in a closed-cycle turbogenerator system which rejects heat with triangular Hertzberg liquid droplet radiators. Power system component technologies are being identified which hold promise of yielding total power system densities in the range of 0.3 to 0.7 kg/kW(e).

A special set of pressing research needs arise out of integrated space vehicle systems which share nuclear prime power between propulsion and mission. For the first time in history, the performance of electric propulsion engines can be assessed without suffering the weight penalty of a massive power supply. In the mission treated here, the power supply is part of the payload. This situation leads to greatly different optimum thruster specific impulses from past scenarios. Also, because of the large amounts of electrical power available, new "high-thrust" electric engines which produce hundreds to thousands of newtons of thrust must be developed--to keep the total number of engines to a reasonable number. At present thrust levels of ion and MPD engines (e.g., 10 to 20 nt), hundreds of engines would be required to raise the orbit to 100-ton payloads. Furthermore, since the vehicle cross-sectional area available for mounting these engines is limited, the thrust/unit exhaust area becomes an important design parameter.

Other potential areas of propulsion/power-related research involve power conditioning elements which are shared between mission and propulsion components. Perhaps new electric engines can be developed to operate directly on the very high voltages required by certain mission payloads. Alternatively, if the mission payload requires the generation of large amounts of rf power, efficient, new electric engines might be designed to use this rf power to significant advantage, e.g., to ionize or otherwise process the propellant prior to electromagnetic acceleration.

Finally, whereas electric engines could potentially operate in a high vibration environment, mission payloads may need superior levels of vibration isolation from nuclear-electric power systems.

Figure 2A illustrates another integrated vehicle concept for sharing power between propulsion and mission payloads requiring 10 to 100 MW(e). The concept is designed around the high-temperature (e.g., 3000 K) rotating bed reactor (RBR) prime power source and open-cycle MHD generation. Orbital transfer is accomplished with direct nuclear rocket propulsion. Reactor afterheat and auxiliary power for station keeping are handled with a small (e.g., 10% peak MHD generator power level) closed-cycle turbogenerator system utilizing a droplet radiator for heat rejection.

As with the previous concept, a number of research issues arise from the need for power sharing between mission payload and propulsion. In this case, the development of high-temperature materials are a key research issue, especially in areas of cooled nozzles and valves which can direct the reactor exhaust flow alternately to the MHD generator, bell nozzle (rocket thruster), or closed-cycle auxiliary turbogenerator system.

Because of the large quantity of H_2 fuel carried for o/c MHD generation which must be stored for long periods, cryogenic reliquefaction systems will be required to minimize tankage insulation penalties. Vibration isolation of the mission payload from the power system and refrigerators will be necessary, and poses an additional research issue.

BDM
INTERNATIONAL, INC.



IV-6-17



BDM
INTERNATIONAL, INC.

IV-6-18

SAFETY ISSUES

FOR

SPACE NUCLEAR POWER

**LT. COL. JAMES LEE
AFWL**

Abstract

This paper addresses key philosophical and technical issues associated with "licensing" reactors to fly in space. First, a short review is presented that emphasizes organizations and study requirements involved in approval of nuclear materials in space. The design objectives of previous safety analysis studies are discussed as well as the key role of the Interagency Nuclear Safety Review Panel (INSRP). The major question of public intervention in the approval procedure is also discussed. Second, the paper offers some new ideas on how safety philosophy and procedures must change to address the realities of the Post-TMI environment. Third, technical areas needing more research are presented with emphasis on new questions raised by needed changes in analysis philosophy. Finally, several challenges are offered to the space power community in the area of safety analysis for reactors in space.

SAFETY ISSUES FOR REACTORS IN SPACE

Good morning. I am Jim Lee from the Air Force Weapons Lab, Kirtland AFB, New Mexico. For a few moments, I would like to address what I see as key issues facing this community as we plan for large reactors in space. This discussion will necessarily ignore many important details and concentrate on a few major items of particular interest. I will first spend a few moments reviewing where we are now in regards to space nuclear safety analysis to include the present "licensing" procedures. I will then offer my ideas on some new philosophies of safety analysis for reactors in space and, finally, discuss some major technology questions that we must begin to address now.

OVERVIEW

WHERE ARE WE NOW?

WHERE MUST WE GO?

TECHNICAL QUESTIONS ALONG THE WAY

WHERE ARE WE NOW?

The plain truth is that the United States has been in the space nuclear business since 1961. We have, over the years, launched 22 spacecraft with nuclear power sources in the 2.7 W(e) to 500 W(e) range.¹ Future RTG missions, such as Galileo and ISPM, are also planned. As a consequence, we have been involved in a nuclear safety analysis program. Since its inception, this program for the safe use of nuclear power in space has involved hundreds of people and many organizations. Every aspect of this program has been dedicated to safety of the public. Throughout these twenty years we have insisted on stringent design and operational flight safety measures. The primary safety design objective has been to minimize the potential interaction of radioactive materials with people and the environment so that any exposure would be within limits established by international standards. To this end, design of reactors has emphasized maintaining subcriticality in all credible accident environments so that fission products are not generated or released with core damage. Operational procedures have also required obtaining of a long enough orbital lifetime to insure decay of the fission product inventory to background prior to reentry.¹

TO DATE

- 22 SPACE CRAFT WITH NUCLEAR POWER SOURCES
- FUTURE RTG MISSIONS ARE PLANNED
- KEYSTONE CONCEPT - SAFETY TO THE PUBLIC
- SAFETY EMPHASIS - MAINTAIN SUBCRITICALITY IN ALL CREDIBLE ACCIDENT ENVIRONMENTS
 - LONG LIFETIME ORBITS

The procedures and organizations involved in flight approval for nuclear sources are shown in this viewgraph. The key player is the Interagency Nuclear Safety Review Panel (INSRP). Its major responsibilities are to perform safety reviews and develop a safety risk index to compare with mission benefits. This safety risk index provides the means for establishing flight approval criteria. Its members are DOE, NASA and DOD, with the NRC, EPA and NOAA participating in the review process. The safety review process begins with the contractor issuance of the Safety Analysis Report (SAR). The INSRP is assisted in its review by scientists and engineers from various government agencies to include the Air Force Weapons Lab. After review, the INSRP issues its Safety Evaluation Report on risk assessment and potential human exposures. The environment impact is addressed separately. Its final report is sent to the President with its recommendation about one year prior to the expected launch date.

SAFETY REVIEW PROCESS

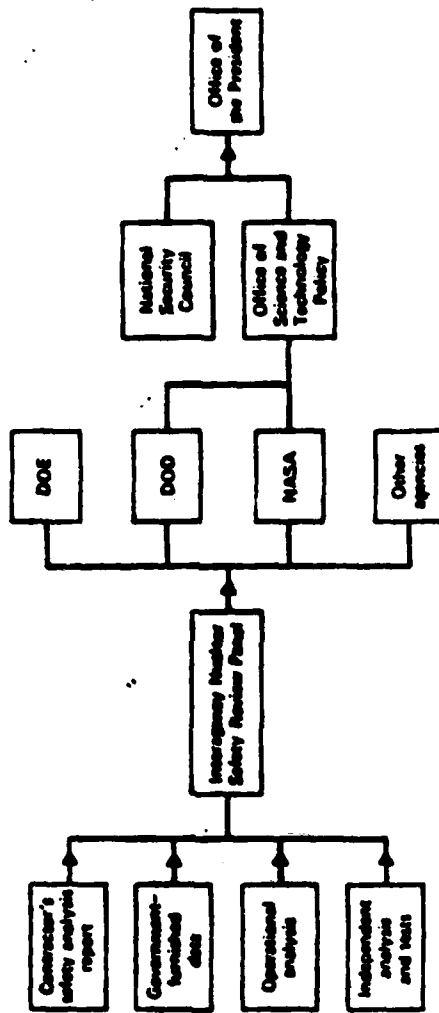

The required safety analysis documents are outlined in this viewgraph. Time does not permit a detailed discussion, but several items are key. First, there are some similarities in the required documents for space applications and for civilian power applications. There is one notable exception that will be addressed later. Second, safety analysis is supposed to begin at the initiation of the design concept and continue through final launch approval. Are we following our own rules for SPAR? Finally, safety analysis will only be as good as the quality of the safety analysis done in support of the INSRP by agencies not involved as contractors. Do we now have that independent expertise needed to support the INSRP for space reactors?

PRESENT REQUIREMENTS

**SAFETY ANALYSIS SHOULD BEGIN AT INITIATION
OF DESIGN CONCEPT**

PSAR - AFTER DESIGN CONCEPT

- DESCRIBES SOURCE AND MISSION
- RADIOLOGICAL RISK ASSESSMENT

UPDATE SAR - FAILURE MODE ANALYSIS

- UPDATES PSAR INFORMATION
- OUTLINES SAFETY TESTS AND
DATA REQUIRED

FSAR - RESULTS OF SAFETY TESTS.

The above procedures do not properly address the question of public intervention as a legitimate part of the review system. I know what you are thinking. For DOD missions, does the public really have a right to comment on space reactor use plans? My conclusion is that they will intervene anyway! I have personally faced the same issue in our technology development efforts for the M-X missile system. Who could have foreseen massive intervention by the public in a small Air Force soil compressibility test on government land? Yet, my officers had to go to Federal District Court to get permission to do the test. We must plan for direct or indirect public intervention in our review process when we consider reactors for space.

MAJOR QUESTION

WHAT WILL BE THE DIRECT/INDIRECT ROLE OF

PUBLIC INTERVENTION IN THIS PROCESS?

WHERE MUST WE GO?

We must first address some philosophical issues related to safety analysis. Some of these issues relate to technical questions, such as, do we design the reactor to disperse upon reentry or reenter as large pieces that could be recovered? While these questions are of great interest, they must wait for future discussions. Other issues are related to management functions and procedures. Of key importance is, who within the government should do the safety reviews in support of the INSRP? In order to separate advocacy and oversight, I recommend that a center of safety analysis expertise be established within DOD to support the INSRP. While DOE should retain its safety responsibility mission, I do not think the safety reviews should be done within the same organization that is advocating particular reactor designs. A logical place for this center in DOD would be the Air Force Weapons Lab. Whenever this center is formed, it should begin, at once, to develop the tools and personnel capabilities to support safety analysis of reactors in space.

WHERE MUST WE GO ?

PHILOSOPHY -

- SAFETY ANALYSIS MUST IMPACT DESIGN - EARLY
- NEED A CENTER OF SAFETY OUTSIDE POTENTIAL REACTOR BUILDERS. WITHIN DOD I OFFER AFWL AS THE LOGICAL CANDIDATE.
- CENTER OF EXPERTISE SHOULD NOW BEGIN TO BUILD NEEDED ANALYTICAL AND EXPERIMENTAL TOOLS.

Secondly, our philosophy of safety analysis has been too narrow in scope in the past and must be expanded to address the new realities of large reactor sources in space. We must not only protect the biosphere from radiation, but we must design safety features so the plant can protect itself. Consider TMI for a moment.² The design protected the people and the environment, but GPU lost the ranch. We, the Air Force, cannot afford to build a billion dollar "Death Star" and not insure that power plant safety/protection design is adequate to prevent loss of that expensive resource. It is not simply a question of reliability; it goes well beyond that. Resource protection as a safety concept would prevent adverse public perceptions due to the loss of one of our major space resources. Destruction of a large reactor might mean that, not only the plant was lost, but the application may not be recoverable. For example, it might be possible to on-orbit replace a dead power source and reuse the weapons platform if it were not destroyed or contaminated by the power source failure. This is especially important due to the projected costs and lead times to replace these complex weapons systems. Finally, radiation released during an on-orbit accident might not affect the biosphere but deny us use of certain key terrain (orbits) in space. As the role of man in space increases, especially in military operations, such considerations will become increasingly more important.

We must, therefore, expand our safety analysis such that protection of the reactor itself shares the spotlight with safety to the public. We must expand our consideration of on-orbit operations to better understand the set of credible design basis events. The safety analysis tasks of today have at once become more crucial and more complex.

WHERE MUST WE GO?

RESOURCE PROTECTION -

- **IMPACT OF THREE MILE ISLAND**
- **SAFETY DESIGN TO PROTECT THE SPACE PLATFORM ITSELF MUST SHARE THE SPOTLIGHT WITH SAFETY TO THE BIOSPHERE.**
- **NEW PHILOSOPHY/DESIGN REQUIREMENTS MUST BE INCORPORABLE INTO OUR PRESENT PROCEDURES.**

TECHNOLOGY QUESTIONS

In this forum, we cannot address detailed technical safety questions that must be answered if we are to use reactors in space. We can only summarize them here by general category.

First, we need to better understand the environments associated with postulated safety related events. This is especially true for the space shuttle system. As an example, consider that the overpressure environment on the first shuttle launch was 2.5 psi on the structure instead of the expected 0.5 psi. Uncertainties obviously abound. Careful definition of environments associated with explosion overpressures, projectile impact, land or water impact, or propellant fires is an essential first step in safety analysis.³

Second, as specific Air Force applications evolve, we must develop our capability to perform mission characterization. Dave Ruden has made a first step in this characterization by identifying five mission classes based on orbit altitude and operating scenario.³ This characterization will help us identify potential problem areas and lay the foundation for determining the design basis events.

Third, even with accurate environment definition and identification of proper design basis accidents, the safety analyst must have the proper analytical and experimental tools. A key concern is development of a good tool to perform shock-induced criticality studies.⁴ While bomb codes may offer a starting point, they must at least be tailored and modified to handle our special reactor cases. In the POST-TMI environment, critical safety analysis may have to be backed up with extensive experimental results. We should begin now development of HE simulators to model material behavior under shock loading conditions.

Finally, since safety analysis for reactors in space is not a common event in this country, a detailed review of the state-of-the-art is required. This study should identify analytical and experimental tools as well as data that are applicable to our task. It should also lay out a technology roadway to bring safety analysis for space into the POST-TMI age.

SUMMARY

In closing, we will only be successful in meeting large space power requirements with reactors if we do our safety jobs correctly. I challenge the community to action in the following areas:

- a. Plan now for public intervention.
- b. Establish a center of safety analysis expertise--I recommend AFWL.
- c. Expand our philosophy of safety analysis to include Resource Protection.
- d. Begin now to answer the technology questions associated with the safety of reactors in space.

— — — — —

CHALLENGES

ADDRESS THE ISSUE OF PUBLIC INTERVENTION

FORM A CENTER OF SAFETY ANALYSIS EXPERTISE

**INCORPORATE RESOURCE PROTECTION INTO SAFETY
PHILOSOPHY**

BEGIN NOW TO ADDRESS TECHNOLOGY QUESTIONS

Q & A - J. H. LEE

From: Roy Pettis

How can we best present the use of nuclear power, when technically justified, to maximize public acceptance?

A.

I feel there are two keys. First, I suspect we will only be able to sell reactors in space if we can convince the public that there is no other way to do it (No one likes nuc weapons but all realize we can't do without them.) Second, acceptability will only follow if the public has total confidence in our safety program - again I point to the safety of nuclear weapons as an example.

From: P. J. Turchi, R & D Associates

Please list some research tools needed for space nuclear safety analysis center.

A.

A "partial" list

1. Shock induced criticality codes - adapt hydro codes if possible
2. System analyses codes applied to complex space reactors
3. Better atmospheric dispersion codes and analyze reentry events
4. Pressure volume relationships for reactor materials under shock loading conditions - material properties and models at high loading rates.
5. 2- and 3-D radiation transport codes--vectorized for Cray.

REFERENCES

1. Gary L. Bennett, "Overview of the US Flight Safety Process for Space Nuclear Reactors," Nuclear Safety, Volume 22, No. 4, July-August 1981.
2. Kenneth A. Solomon, Some Implications of the Three Mile Island Accident for LMFBR Safety and Licensing: The Design Basis Issue, N-1559-DOE, The Rand Corporation, August 1980.
3. David Buden, The Acceptability of Reactors in Space, LA-8724-MS, Los Alamos National Labs, April 1981.
4. Private communication with Dr Will Ranken, Los Alamos National Labs, 10 February 1982.

AREAS FOR RESEARCH EMPHASIS IN DESIGN OF THE
SPACE POWER ADVANCED REACTOR

Mohamed S. El-Genk
David M. Woodall
Department of Chemical and Nuclear Engineering
The University of New Mexico
Albuquerque, New Mexico 87131

ABSTRACT

The extension of the current planetary exploration program beyond Saturn depends on the availability of a primary power source that could provide a large amount of electricity over an extended period of time (e.g., 7 to 10 years). For such a purpose, nuclear reactors are superior to other power options such as chemical, radioisotopic, and solar energy. Nuclear reactors unlock limitations on energy production for various space applications. Examples are ion thrusters to transfer satellites from low earth orbit to geosynchronous orbit, laser and particle beam guns, space stations, lunar settlements, high power radars, and large satellites for deep space exploration. Of all the present designs of space nuclear reactors, the Space Power Advanced Reactor (SPAR) appears to be the most complete design. However, additional research is needed before a prototype unit (100 kW(e)) could be built. The purpose of this paper is to identify and discuss some of the areas for research emphasis which are likely to expedite the development of the current SPAR technology.

1. INTRODUCTION

Based on the present technology, the primary power sources available for use in space satellites are either chemical, solar, radioisotopic, or nuclear reactors [1,2]. Figure 1 displays the length and level of power generation the above-mentioned technologies are capable of producing [1]. As shown in Figure 1, chemical combustion is capable of producing very high power due to the high combustion rate of the fuel used. Nevertheless, such a mode of power generation is only feasible for very short missions because of the large mass and volume of the fuel. Radioisotopic units are usually fueled with Pu-238 (half-life of -87.2 years) to provide long operational time. This lowers the specific power and limits the sensible power level of such units to approximately 1 kW(e). Solar arrays and nuclear reactors are both capable of providing power for extended missions of several years. Table 1 compares solar to nuclear power at three levels of electrical power output [1]. For low power requirements (less than 10 kW(e)) solar and nuclear technologies are comparable. For large power requirements, however, nuclear reactors are superior to solar arrays.

Present designs of space reactors are either aimed at under 100 kW(e) or over the 10 MW(e) ranges [1-7]. Of all the designs, the Space Power Advanced Reactor (SPAR) appear to be the most complete and prevalent design. The basic concepts on which the reference SPAR design (100 kW(e)) is based are sound and reasonable. However, only through further advancement in present technology can a prototype unit be built. The objective of this paper is to identify and discuss areas for research emphasis which are most likely to expedite the development of SPAR technology. The design characteristics of the current SPAR design are summarized in the following section. Research areas suitable

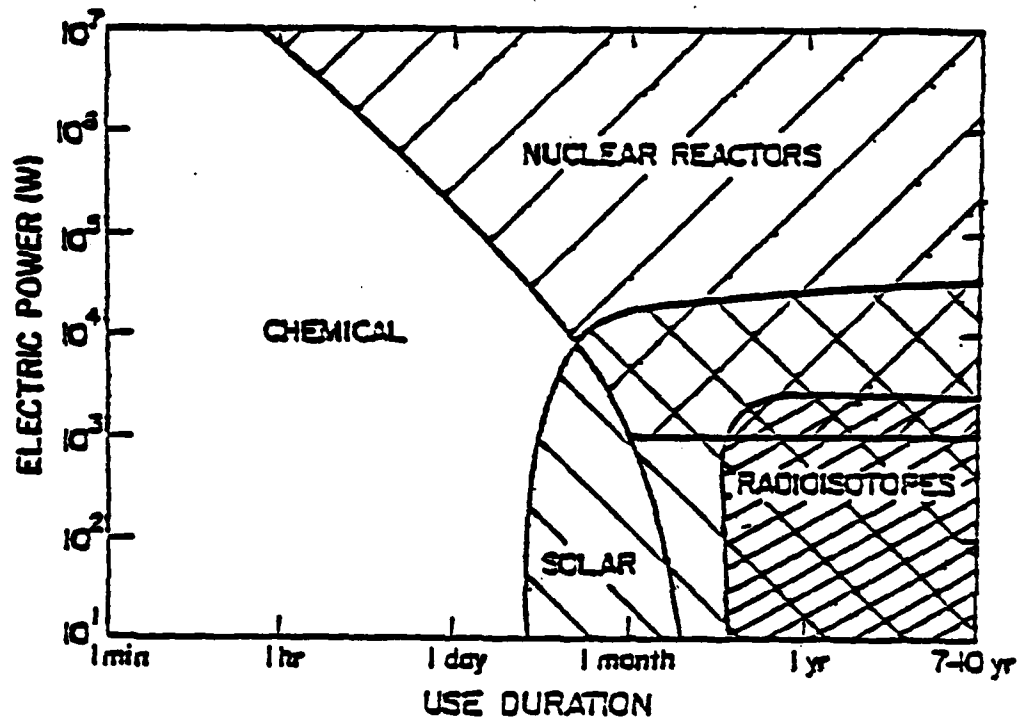

Figure 1. Possible space power source for Department of Defense missions.

Table 1. Comparison Between Solar Array and Nuclear Reactors
Based on Projected Technology

	10 kW _e		50 kW _e		100 kW _e	
	Solar	Nuclear	Solar	Nuclear	Solar	Nuclear
W/kg	24	14	24	41	22	55
Cost (\$M)	8	7	32	10	63	14
Shuttle Compatible (-1910 kg)	Yes	Yes	Difficult	Yes	No	Yes
Space Flight	Demon- strated	Possible	Possible	Possible	Doubtful	Possible

Feature

Orientation	Sunward	None - No power transfer slip rings, array deployment, tracking disturbances, or battery cycle problem
Location	Shadowed by large antennas	Minimize shielding
Maneuverability	Difficult fold-up arrays	No problem
Radiation		
Natural	Degrades	No effects
Induced	None	Shielding necessary
Reliability	70-90%	95%
Safety & Handling	None	Flight-tested on SNAP 10A
Disposal	None	Long-term earth or sun orbit
Maintainability	Large structure interference	Manned shielding

for future investigation relative to the development of the SPAR design are discussed in Section III. Summary and conclusions are presented in Section IV. References are listed in Section V.

2. SPACE POWER ADVANCED REACTOR

The Space Power Advanced Reactor is currently being investigated at both the Los Alamos National Laboratory (LANL) and the Jet Propulsion Laboratory. The SPAR program is an effort initiated by the Department of Energy to bring the technology required to develop such a reactor to the point where a working model is built and operated successfully. SPAR is a 100 kW(e) fast reactor, designed to produce about 1400 kW of thermal energy at a core operating temperature of 1400 K. An overall view of the SPAR system is shown in Figure 2, and a cutaway view is presented in Figure 3. The reactor core shown in Figure 4 consists of 115 layers of 2 mm thick, 93 percent enriched UO_2 tiles sandwiched between 0.5 mm thick molybdenum (Mo) sheets. The Mo sheets function as fins to transfer the heat from the fuel tiles to the core heat pipes, which is the primary core cooling system.

In the reference SPAR design, the core heat pipes are made of Mo with liquid sodium as the working fluid. A Mo-13% Rh alloy which is more ductile than Mo at room temperature is being investigated to better accept the ground handling and launch mechanical loads. A total of 93 heat pipes are spaced in the reactor core so that all pipes receive equal heat loading.

The thermal energy from the reactor core is transferred via the core heat pipes to silicon-germanium thermoelectric modules, where the heat is partially converted into electric power. The conversion efficiency of these modules is about 9 percent; thus, for a 1200 kW(th) reactor unit (~100 kW(e)), the waste heat would be in the order of 1100 kW thermal. Waste heat is transferred from the thermoelectric modules to the radiator panel where it is radiated into space.

The radiator panel consists of 360 titanium-potassium heat pipes, each of which is 5.3 m long, and dissipates up to 3 kW of

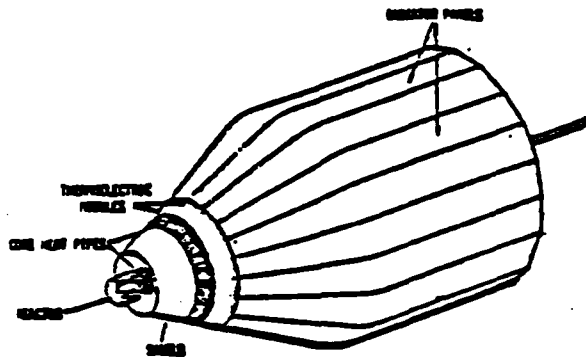

Figure 2. Overall view of SPAR space power system.

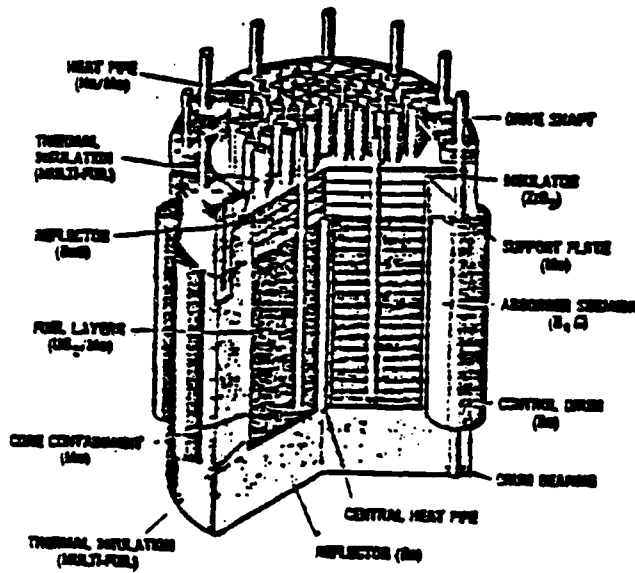

Figure 3. Cutaway view of SPAR assembly.

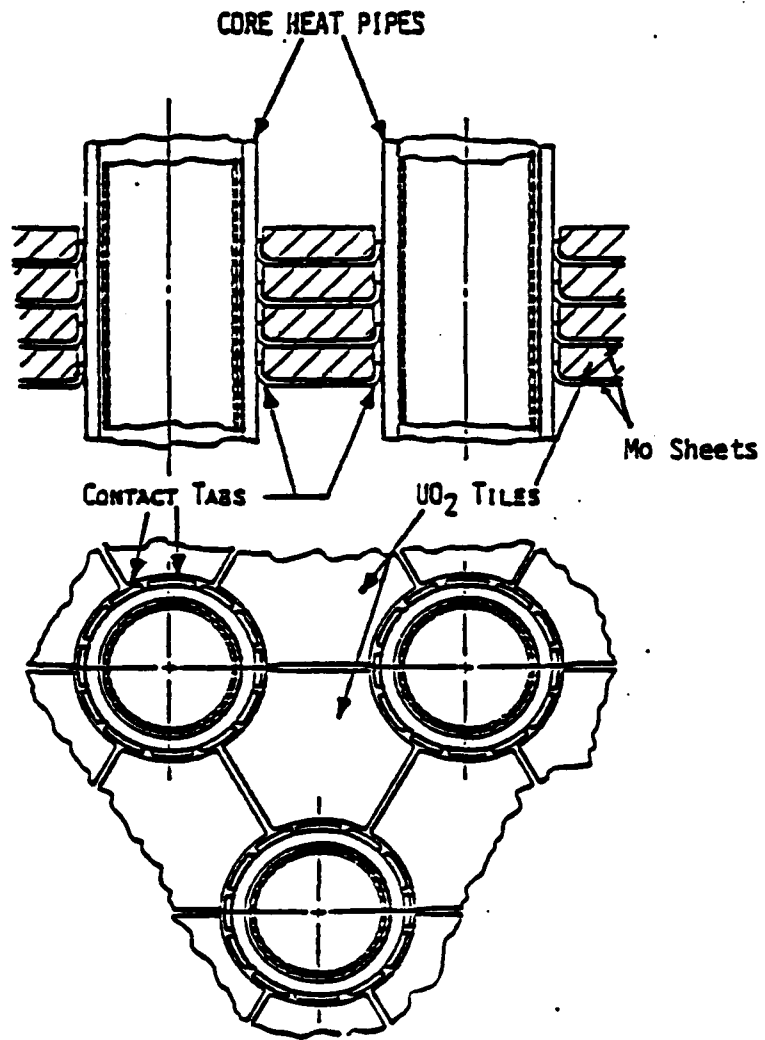

Figure 4. Detail of layered core configuration.

power into space. The radiator temperature is approximately equal to the cold side temperature of thermoelectric modules (-775 K). At such a low temperature, a large surface area for the radiator is required. As a result, the radiator becomes the largest and most massive component of the SPAR power system.

Above the core, there is a 100 mm thick beryllium oxide (BeO) neutron reflector. The reflector and core are contained in a Mo can, which is wrapped in a ZrO insulator to insure that Mo does not react chemically with the BeO reflector. The reactor core is controlled by twelve rotating control drums. Each drum contains an absorber segment of B₄C that sets in a Be body. The radiation shield around the reactor core protects radiation sensitive instruments, and other parts of the spacecraft from nuclear radiation.

The reference SPAR will weigh about 1700 kg and is designed to operate for seven years with no maintenance, thus requiring a minimum of single-failure points. Much research has been done to identify the single-failure points of SPAR and compare them to those for gas- and liquid-cooled reactors [5-8]. It was concluded that a heat pipe reactor with thermoelectric power conversion inherently avoids single-failure points [1-3]. Furthermore, heat pipes are more attractive as heat transport devices than gas- and liquid-cooled systems with respect to reactor emergency cooldown.

To provide emergency cooldown of the reactor core, gas- and liquid-cooled systems require large fluid storage systems, an alternate power source to drive the coolant through the core, a heat exchanger to the radiator, valves and a complex hydraulic control system. The heat pipe reactor offers a better alternative to an emergency cooldown accumulator and fluid system that is reliable, simple, and lightweight. The core heat pipes are extended beyond the converter heat transfer system to a high

temperature radiator which is designed to operate at 1275 K. Heat pipe design for emergency cooldown is delineated in Figure 5. During normal operation, the gas in the reservoir acts to prevent heat from reaching the emergency cooldown radiator. During an emergency shutdown, the heat not removed from the converter would compress the gas and thus allow the heat to be transferred to the emergency cooldown radiator.

The basic concepts on which the SPAR design is based are sound and reasonable. However, further research is needed before a prototype unit could be built and successfully operated. Research areas of concern for the development of the SPAR design are discussed in the following section.

IV-8-10

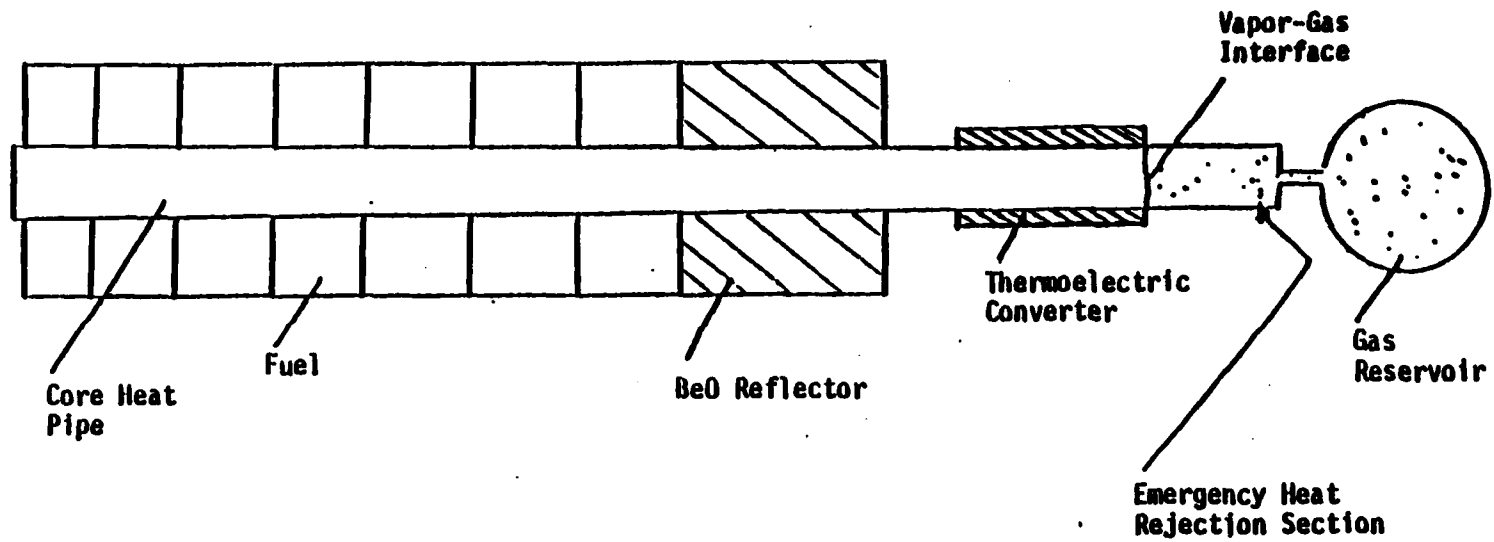

Figure 5. Heat pipe design for emergency cooldown of reactor core.

3. AREAS FOR RESEARCH EMPHASIS IN THE SPAR DESIGN

Research areas of concern at the current time include: UO_2 fuel behavior (e.g., fuel swelling and sublimation); transport process of UO_2 fuel vapor and gaseous volatile fission products, reactor core design, radiator heat pipes, and thermoelectric converters. These areas are discussed with some detail in the following subsection. Table 2 summarizes some of the research ideas suitable for future investigation [9].

3.1 UO_2 Fuel Swelling and Potential Failure of the Core Heat Pipes

The predominant concern with regard to UO_2 fuel behavior and transport are fuel swelling and fuel sublimation. Fuel swelling could cause impingement on the core heat pipes if sufficient clearance is not provided. The impingement of swollen UO_2 tiles on core heat pipes could rupture the pipe walls. The accumulation of impurities in the wick of the heat pipes could impair their performance, and eventually induce hot spots causing the pipes to fail due to the wall melting. Other modes of heat pipe failures are: embrittlement failure of Mo wall due to chemical reaction with gaseous and volatile fission products, and stress-corrosion cracking due to the absorption of fission products such as cesium, iodine, and hydrogen.

The failure of a single heat pipe in the core could induce local overheating and might eventually induce subsequent failure of additional heat pipes. At present, there is a need to develop analytical models to assess the potential causes of a heat pipe failure, and to describe the different modes of failure propagation in the core.

3.2 UO_2 Fuel Sublimation

The sublimation of solid UO_2 fuel does not represent a problem as long as it remains within the reactor core space. In

Table 2. Research Ideas Relative to the Design of the Space Power Advanced Reactor

1. DESIGN OF HEAT PIPE REACTORS
 - (a) Fuel Swelling Models for Unconfined UO_2 Wafers
 - (b) Thermal-Stress Redeposition Models
 - (c) Temperature Brazes Below Heat Pipe Recrystallization Temperature
 - (d) Fission Products Transport Model
2. HIGH-TEMPERATURE HEAT PIPES
 - (a) Thermal-Hydraulic-Chemical Model of Heat Pipe
 - (b) Enhancement of Current Theoretical Model
 - (c) Emissivity Coatings at 1500 K
3. THERMAL COUPLING DEVICES
 - (a) Good Thermal Contact on Clamped Solids
 - (b) Heat Pipe-to-Heat Pipe Coupling Devices
4. Electrical Conversion
 - (a) Thermoelectric Theory on Carrier Charge Mobility
 - (b) High-Temperature Insulators (>1500 K)
 - (c) High-Temperature, High-Efficiency Thermoelectric Materials
 - (d) Long-Life, High-Temperature Turbines (1500 K)
 - (e) Long-Life, High-Temperature Electromagnetic Pumps (1500 K)
5. REJECT HEAT SYSTEMS
 - (a) Hypervelocity Devices for Meteoroid Impact Simulation at Elevated Temperatures
 - (b) Innovative Radiator Designs for Megawatt-Level Rejection System

fact, the sublimation of UO_2 fuel provides means to prevent local overheating in the core by transporting UO_2 vapor from the hot to the cold spots within the core. Nevertheless, difficulties might arise as a result of the deposit, and solidification of UO_2 vapor on the walls of the core container. Such deposition could cause the can to be tightly sealed and eventually induce pressurization of the core. This would also increase the residency time of fission products, and in turn, their chemical reaction with core components. On the other hand, the leakage of UO_2 vapor into space might result in a change in core criticality, thus impairing the overall system operation. Better understanding of these transport processes of UO_2 vapor and gaseous fission products could be obtained through the development of physical models which would provide an accurate description of the different transport processes within the core as well as the chemical reaction of fission products with core material.

3.3 Heat Pipes Performance

A concern in the development of longer core heat pipes (more than 2 m long) is to improve the heat pipe model to correlate more closely with experimental data. Another area of investigation is increasing the emissivity of the radiator heat pipes. At present, two of the limiting factors on heat transfer in the core are the conductive heat transfer to the heat pipes from the Mo sheets; and the heat transfer to the thermoelectric modules from core heat pipes. Of interest would be bonding techniques which could reduce the resistivity of these junctions.

3.4 Thermoelectric Converters

Investigation of theory as well as the development of improved thermoelectric materials is desired. However, for future scaling up of the reactor power, liquid-metal dynamic

systems would be superior. Supportive of these interests would be investigation into reliable turbine and electromagnetic pumps. A study to use an MHD system would also be of interest.

3.5 Heat Rejection Systems

Further research is also needed to determine the effect of meteoroid impact on the radiating panels. To facilitate such investigation, a device capable of discharging high-velocity particles is desired. Because of the large mass and volume of the radiator in the present SPAR system, innovative methods of waste heat disposal are of particular interest. Especially with regard to the scale up of SPAR technology to higher powers. Of particular interest is the power range from 1 to 10 MW(e). This would provide self-sufficiency for large satellites, for use as defense stations and for deep space exploration missions.

The key for building a higher power nuclear reactor, utilizing the SPAR technology is twofold: (a) to increase the operating temperature of the core and that of the waste heat radiator, and (b) to improve the efficiency of the energy conversion (thermal-to-electrical conversion) process. The advantage of increasing the conversion efficiency is to reduce the thermal loading of the reactor core for the same electric power output, and to reduce the amount of waste heat to be radiated into space (which means smaller radiator size).

4. SUMMARY AND CONCLUSIONS

The Space Power Advance Reactor design appears to be the most complete and prevalent design at the present time. However, additional research is required before a working model is built. Areas for research emphasis are summarized and discussed. Of major concern are: the UO_2 fuel swelling and potential failure of core heat pipes; transport of UO_2 fuel vapor, gaseous and volatile fission products within the reactor core; the heat rejection system, and the performance of the heat pipes.

Analytical models are needed: (a) to assess the potential causes of heat pipe failure and to describe the different modes of failure propagation in the reactor core, (b) to provide an accurate description of the different mass transport processes in the core (e.g., UO_2 fuel vapor, gaseous, and volatile fission products) and of the chemical reactions of fission products with core material, and (c) to calculate the swelling of unconfined UO_2 fuel in the core.

Improving the heat pipe model to correlate more closely with the experimental data is a major concern in the development of longer heat pipes (in excess of 2 m). Investigation of theory as well as the development of improved thermoelectric materials is discussed. A study to use other energy conversion systems such as liquid-metal cooling, or an MHD system is of interest. These systems are superior to the thermoelectric conversion units for the future scale up of SPAR technology to higher power. Innovative methods for waste heat disposal and for improving the overall efficiency are of equal importance, especially in reducing the size of the reference SPAR design or upgrading the design to higher power (e.g., in the range of 1 to 10 MW(e)).

5. REFERENCES

- [1] D. Buden, et al., "Selection of Power Plant Elements for Future Reactor Space Electric Power System," LA-7858 (Sept. 1979).
- [2] D. Buden, "The Acceptability of Reactors in Space," LA-8724-MS (April 1981).
- [3] W. A. Ranken, "Experimental Results for Space Nuclear Power Plant Design," LA-UR80-1093 (August 1980).
- [4] K. C. Cooper and R. G. Palmer, "System Tradeoffs in Space Reactor Design," 15th Intersociety Energy Conversion Engineering Conference, Seattle, WA (August 18-22, 1980).
- [5] A. J. Gietzen, et al., "A 40 kW(e) Thermionic Power System for a Manned Space Laboratory," Gulf-GA-10535 (July 1971).
- [6] C. M. Stickle, et al., "Cyclone: Applications of Rotating Bed Reactor Power Source," 1981 AIR University Airpower Symposium, Air War College, Maxwell Air Force Base, Alabama (February 23-25, 1981).
- [7] J. A. Heller, et al., "Study of 300-kilowatt Rankine-Cycle Advanced Nuclear-Electric Space-Power System," NASA TM X-1919 (November 1979).
- [8] R. J. Bartholomew, "Failure Mode Analysis Using State Variables Derived from Fault Tree with Application," International ANS/ENS Topical Meeting on Probabilistic Risk Assessment, Port Chester, New York (Sept. 20-24, 1981).
- [9] D. Buden, personal communication, LANL, November 1981.

RESEARCH NEEDS FOR PARTICULATE
BED NUCLEAR REACTOR
SPACE POWER SYSTEMS

by

Owen C. Jones, Jr.
Professor of Nuclear Engineering
Rensselaer Polytechnic Institute
Troy, New York 12181

February, 1982

ABSTRACT

The concept of a particulate-bed nuclear reactor is an attractive option for low weight, high power systems. This paper presents a brief technical description of such concepts and delineates the major research questions currently recognized.

Paper prepared for Conference of Prime Power for High Energy Space Systems, Norfolk, Va., February 22-25, 1982

INTRODUCTION

Commercial nuclear reactors have power densities ranging from about 0.5 MW/m^3 to nearly 400 MW/m^3 [1] with LWR's being between ~ 10 and $\sim 100 \text{ MW/m}^3$, generally limited by the cooling efficiency of the working fluid and the thermal limits of the fuels. Power densities are generally limited by the surface-to-volume ratio of the fuel, for a given coolant. LMFBR's having the highest power densities have area densities of the order of $100\text{-}500 \text{ M}^2/\text{m}^3$.

Attractive options for high power, high power density, low weight applications are Fixed Bed and Rotating Bed Nuclear Reactors in which the heat transfer area densities for the fuel are increased 1-2 orders of magnitude. In the rotating fluidized bed (RBR) system first described by Hatch et al., [2] and later by others, [3,8] the fuel in the form of 100-500 μm -diameter particles is contained in a porous, rotating cylinder. The coolant, which may be a low molecular weight gas to provide high specific impulse in the case of a propulsion system, would flow radially inward through the porous cylinder and the fuel, causing the fuel to partially or totally levitate (fluidize). The high rotational g-fields thus allow for large flow rates with resultant efficient heat transfer. Power densities at 100 MWt may thus easily reach 7000 MW/m^3 and potentials to $50,000 \text{ MW/m}^3$ seem likely, even with gas cooling. With such small fuel particles, the fuel remains within 1-10K of the gas temperature. In the fixed bed (FBR) concept the fuel is simply held fixed. This concept seems appropriate for power levels up to 100 MW.

Because packed and fluidized beds have been used for many years in the chemical industry, there is a wealth of information, mostly empirical regarding the thermofluid mechanics of such devices. However, the application of this technology base to high g-field application is largely unproven. This paper will briefly describe the thermal hydraulic behavior of the RBR and identify the research required to provide a firm technological foundation for RBR design. Research required for the FBR is also identified.

TECHNICAL DESCRIPTION

Pictured schematically in Figure 1, the coolant would flow axially over the outside of a rotating porous cylinder containing spherical fuel particles, probably in the 100-500 μm diameter range. The working fluid would enter the cylinder through the porous wall of the cylinder and cause the particles to expand from the pack due to the induced drag. The degree of expansion would be controlled by the rotational speed of the cylinder which would impart an artificial gravitational field due to centrifugal forces. As a result, high flow rates and relative velocities of the working fluid with respect to the particles could be maintained while keeping bed expansion below the carryover limit.

The net result of this concept is to increase the heat transfer surface area density by a substantial amount (perhaps more than two orders of magnitude depending on particle sizes) from conventional heat systems while still maintaining excellent heat transfer. For instance, typical bed parameters at 15 and 150 times earth-normal gravity are given in Table 1. The area densities for a bed occupying approximately 80% of

the cylinder volume run from about $5000 \text{ m}^2/\text{m}^3$ to well over $100,000 \text{ m}^2/\text{m}^3$ for particles ranging in size from 500 microns down to $20 \mu\text{m}$. The Archimedes numbers (Ar) and Reynolds numbers (Re) range from those typical of linear, 1-g beds to values well over the range of beds encountered in the chemical industry. Nusselt numbers (Nu) are quite large for such small spheres when gas is the coolant and, combined with the small diameters of the particles, lead to quite high values of heat exchange coefficient.^[3] The net result is to gain dramatically in power density relative to currently available hardware.

For this application "up" is considered as "in" with ground being the inside surface of the porous cylinder, the maximum radius of the fuel bed, $r=R$. The drift flux is given by,

$$j_{gs} = \epsilon(1-\epsilon)v_r = \epsilon(1-\epsilon)^{n+1}v_\infty = \epsilon j_g - (1-\epsilon)j_s \quad (1)$$

where $v_r = v_g - v_s$ is the relative velocity between the coolant and the solid particles, the j 's are volume fluxes (superficial velocities), ϵ is the fuel volume fraction, and n is the exponent relating the relative velocity to the terminal settling velocity of the fuel particle, v_∞ , and the coolant fraction. Note that in the present case $j_s = 0$ and $j_g = \dot{m}_g / \pi r^2 L \rho_g$. The coolant mass flow rate, \dot{m}_g , per unit local area ($\pi r^2 L$) divided by the coolant density, ρ_g , varies with position.

δ - μm	Ar	Re	Nu	$h - \frac{kW}{m^2K}$	Ar	Re	Nu	$h - \frac{kW}{m^2K}$	$A_s/V\text{-m}^{-1}$
20	565	17	5.39	120	56	2.4	3.90	87	1.2×10^5
50	8830	123	8.73	78	883	24	5.79	52	5×10^4
100	70650	445	13.3	59	7065	106	8.37	37	2.5×10^4
500	8.83×10^6	5171	39.9	179	8.83×10^5	1635	23.3	21	5000

150 g's
15 g's

Table 1. Rotating bed parameters for beds operating at 150 times earth-normal gravity with hydrogen at 100 bar and 1000°K.

The form of Equation (1) is especially convenient since the term in the terminal velocity vanishes in both concentration limits, $\epsilon \rightarrow 0$ and $\epsilon \rightarrow 1$, while the term in the volume fluxes is linear in ϵ . As shown in Figure 2, (plotted in terms of the coolant volume fraction $\alpha = 1 - \epsilon$), the intersection of the two represents the operating point for the system. As the coolant flux is increased successively from state 1 through to state 6, the fuel bed expands (Figure 3) until no further simultaneous solution is possible at which point "flooding" occurs and fuel particles would begin to be carried over into the exhaust.

The terminal velocity of the fuel particles, v_∞ , may be determined from the relation,

$$C_D Re_\infty^2 = \frac{4}{3} \left(\frac{g \rho_g \Delta \rho \delta^3}{\mu^2} \right) = \frac{4}{3} Ar \quad (2)$$

where C_D is the drag coefficient, Re_∞ the particle terminal Reynold's number, g is the local body force, ρ_g and $\Delta\rho$ are the density of the coolant and difference in density between the coolant and the fuel particles of size δ , and μ is the coolant viscosity. The terms in parentheses is termed the Archimedes number, Ar . Since the drag coefficient is uniquely dependent on the Reynolds number for smooth spheres, the terminal velocity is uniquely determined by specifying the Archimedes number, i.e., the fluid state and particle size.

To avoid the transcendental nature of determining Re_∞ and thus v_∞ , Equation (2) has been approximately inverted through the use of the Schiller and Nauman^[9] drag expressions to yield,

$$Re_\infty = \begin{cases} \frac{Ar}{18} [1 + 0.0487 (\frac{4}{3} Ar)^{0.452}]^{-1} & Ar < 3.227 \times 10^5 \\ 1.74 \sqrt{Ar} & Ar > 3.227 \times 10^5 \end{cases} \quad (3)$$

accurate within 6.5%. Functional continuity is provided at the cross-over value corresponding to a Reynolds number of 989, beyond which the drag coefficient is taken constant at $C_D = 0.44$.

The exponent n in (1) has been taken to be that given by the correlation of Richardson and Zaki^[10] for an infinite field,

$$n = \begin{cases} 4.65 & \text{Re}_\infty < 0.2 \\ 4.35 \text{Re}_\infty^{-0.03} & \text{Re}_\infty \in [0.2, 1.0) \\ 4.45 \text{Re}_\infty^{-0.1} & \text{Re}_\infty \in [1, 200) \\ 2.39 & \text{Re}_\infty \geq 200 \end{cases} \quad (4)$$

The point of minimum fluidization is found from Equation (1) where the solid fraction ϵ , is taken as ϵ_0 , that corresponding to the packing fraction of the packed bed, 0.65 for the results reported herein. This may be written in dimensionless form as,

$$j_{g_{mf}}^* \equiv \frac{j_{g_{mf}}}{\sqrt{\frac{g\delta\Delta\rho}{\rho_g}}} = \frac{\text{Re}_\infty}{\sqrt{\text{Ar}}} (1-\epsilon_0)^{n+1} \quad (5)$$

Calculations are shown for a coolant having a density of 0.8 kg/m^3 and a viscosity of $2 \times 10^{-5} \text{ kg/m-s}$. Fuel density was taken to be 8500 kg/m^3 . Figure 4 shows the results for a thin bed, initial packed bed height of $h_0 = 0.5 \text{ m}$, with $\epsilon_0 = 0.65$. As the gas flows through the bed it accelerates due to decreasing flow area, and experiences a decreasing g-field, $r\Omega^2$. (The fuel bed itself is judged to rotate as a fixed body even though the gas core above the fuel behaves as a potential vortex.) Since h_0 is small, changes in j_g and g are small and the bed expands relatively uniformly. A reduction in g-field by a factor of 25 due to speed reduction only results in a doubling of the bed height. For the thick bed shown in Figure 6, $h_0/R=0.4$, both the coolant volume flux and the local g-field changes substantially through the bed and the expansion

is much less uniform. In this case, reduction in speed by a factor of 3 yields nearly double expansion of the bed which approaches the flooding limit at the inner periphery.

Figures 5 and 7 show similar calculations for the case of hydrogen as a coolant where the density was calculated based on the ideal gas law. It is clearly seen that the decreased density with increased temperature causes steeper coolant volume fraction profiles. In the thick bed case (Figure 7) there is little heating being accomplished in the inner third of the bed due to the reduced fuel concentration, indicating that thinner beds may be more desirable.

RBR RESEARCH QUESTIONS

Because packed and fluidized beds have been used for many years in the chemical industry, there is a wealth of information, mostly empirical regarding the thermofluid mechanics of such devices. However, the application of this technology base to high g-field application is largely unproven. In view of this and in some areas a complete lack of information, research topics have been identified as delineated below and in Table 2.

Packed Bed Zone

Pressure gradients in the packed bed include gravitational, accelerational and frictional effects, and must account for the variable flow area and body forces. The former are straightforward but empirical methods for calculating frictional losses need to be verified for the broad range of RBR conditions. Neither global nor local fuel coolability has been examined in the case of rotating, high g-beds. If the existing

<u>Steady State</u>	<u>Transients</u>
Packed Bed	
1. Pressure gradient	
2. Global fuel coolability	
3. Local fuel coolability	12. Departures from steady state values
Transition	
4. Zone of incipient fluidization	13. Changes due to kinematic waves
Fluidized Bed	
5. Fuel expansion profiles	14. Additional accelerational effect
6. Fuel bed expansion fluctuations	15. Clearance of kinematic waves and effects on bed expansion, stability and carryover
7. Fuel bed stability limits and bubbling intensity	
8. Fuel particle carryover (elutriation) limits	
9. Global fuel coolability	16. Departures from steady values
10. Local fuel coolability	
11. Fuel particle migration and thermal cycling	17. Transient particle migration and interplay with thermal gradients
Reactor Control	
18. Integrated thermofluid-power dynamic behavior	
Fuel Behavior	
19. Fuel vapor pressure and evaporation rates	
20. Mechanical degradation	

Table 2. Research questions relative to particulate bed nuclear reactors
IV-9-9

correlations work in steady state there is no guarantee they will work in transient situations. In addition, with g-fields perhaps as much as 100-150 times as large as those normally encountered, natural convection effects could be quite large and alter the normal fixed-bed cooling relationships.

Packet-to-Fluidized Bed Transition

Since the g-field, flow area, and fluid density all decrease as the coolant flows through the bed, the gas velocity increases and the bed is less stable. The onset of fluidization will thus occur in stages from the inside out as gas flow increases or rotational speed decreases. The packed bed would be "peeled away" in differential layers and become fluidized. It is important to determine the point of incipient fluidization in order that the bed behavior be predicted adequately. Many empirical equations exist, which vary from each other due to data base scatter, and different operating conditions and geometries. None of these empirical correlations have been tested against RBR-like data.

Fluidized Bed Zone

Little work has been done in devising simple methods for prediction of fluid bed gas volume fraction of fuel expansion profiles, mainly because expansion is uniform in most chemical process situations and only carryover limits must be avoided. Extensions of drift flux methods applied to gas-liquid systems seem appropriate, and a brief description of the use of these techniques was given in the preceding section, but these methods including the fuel particle carryover limits need to be verified under prototypical RBR conditions.

In the case of transients, quasi-static behavior can probably be accepted if the clearing time for concentration (fuel volume) waves is short relative to transient periods of the system. The speed of these waves is determined from the same equation which describes the drift flux behavior. Generally, as long as the transient periods are much longer than h/C_w where h is the fuel bed height and C_w is the kinematic wave speed, the flow can be considered quasi-static and most steady state correlations could be utilized with some degree of assurance. It is seen, however, that confirming the behavior of the drift flux is central to much of the thermal hydraulic behavior of the RBR.

Reactor Control

A short remark regarding reactor control is in order. The very factors which make the RBR so attractive lead one to the need to understand the control aspects and interactions quite well. The very high power densities coupled with the small sizes and thermal mass of the fuel particles leads to potentially high adiabatic ramp rates of, say, 5000K/s. Thus, the thermo-fluid-nuclear interaction dynamics must be adequately understood and addressed in designing and reactor control system.

Fuel Behavior

For particulate bed reactor systems, especially those operating at high temperatures, the question of fuel sublimation must be addressed. The best conservation estimate of fuel evaporation is shown in Figure 8. As seen, fuel particle lifetimes could be quite limited at very high

temperatures. But the data on which these calculations are based could be off by 1-2 orders of magnitude and must be more accurately determined. For fluid bed systems, the question of particulate impacts and resultant mechanical degradation must also be addressed.

REFERENCES

1. Jones, O.C., Jr., Nuclear Reactor Safety Heat Transfer, Hemisphere/McGraw Hill, New York, 1981.
2. Hatch, L.P., Regan, W.H., and Powell, J.R., "Fluidized Beds for Rocket Propulsion," Nucleonics, 18, p. 102, 1960.
3. Lindauer, G.C., "Heat Transfer in Packed and Fluidized Beds by the Method of Cyclic Temperature Variations," AIChE J., 13, 6, pp. 1181-1187, 1967.
4. Hendrie, J.M., et al, "Rotating Fluidized Bed Reactor for Space Nuclear Propulsion, Annual Report: Design Studies and Experimental Results," June, 1970, to June, 1971.
5. Hendrie, J.M., et al., *ibid.* for the period June, 1971 - June, 1972.
6. Hoffman, K.C., et al., *ibid.* for the period June, 1972 - June, 1973.
7. Ludewig, H., Manning, A.J., and Raseman, C.J., "Feasibility of Rotating Fluidized Bed Reactor for Rocket Propulsion," J. Spacecraft and Rock., 11, 2, pp. 65-71, 1974.
8. Botts, T., Powell, J., Grand, P., and Makowitz, H., "A Compact, High-Performance Electrical Power Source Based Upon the Rotating Bed Reactor," BNL-27460, January, 1980.
9. Schiller, L., and Nauman, A., "Über die Grundlegenden Berechnungen bei der Schwerkraftausbereitung," Z. Vereines Deut. Ingen., 77, 12, pp. 318-320, 1933.
10. Richardson, J.F., and Zaki, W.N., "Sedimentation and Fluidization Part 1," Trans. Inst. Chem. Eng., 32, pp. 35, 1954.

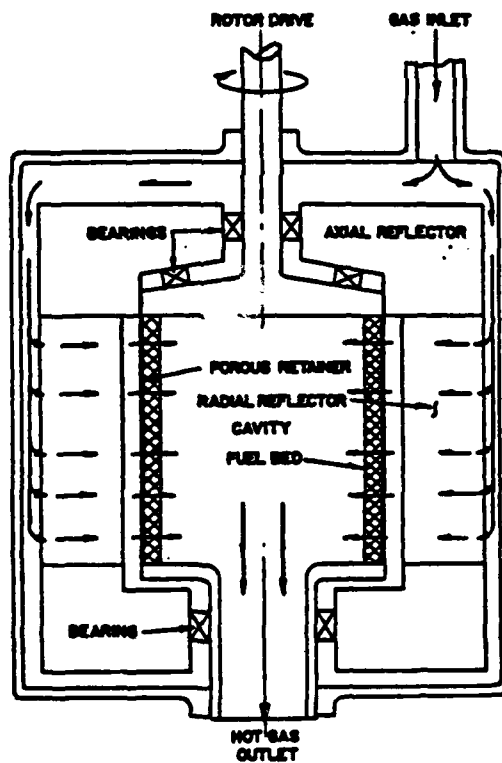
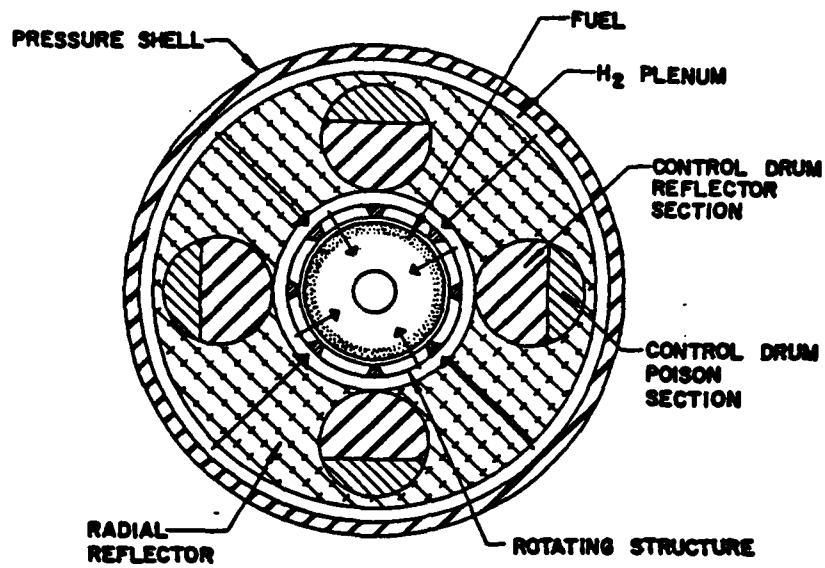

Figure 1
Schematic layout of a Rotary
Fluidized Bed Reactor

- a) Radial Cross Section
- b) Axial Cross Section

IV-9-14

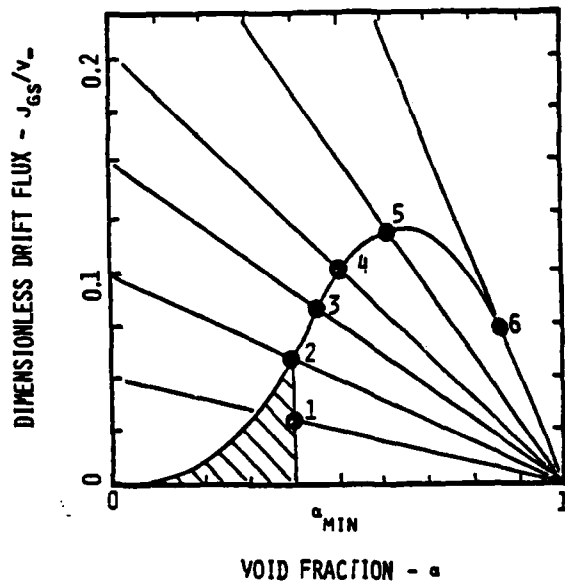

Figure 2

Schematic of the effect of increasing gas flow in the drift flux plane on bed expansion

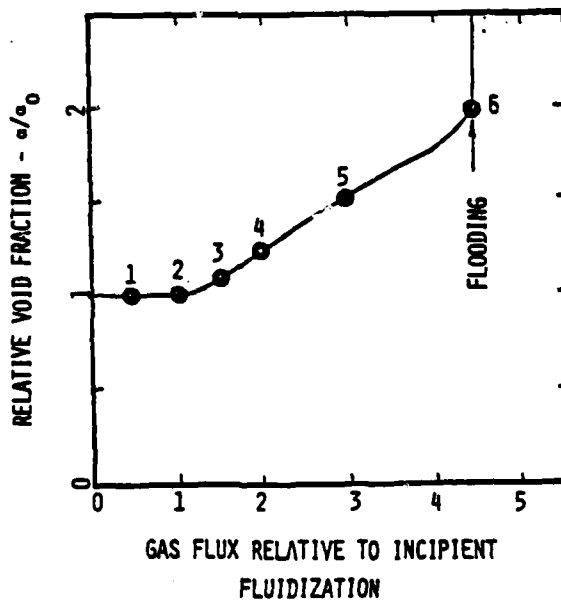

Figure 3

Successive bed expansion state (void fractions) to increasing gas flow rate

AD-A118 887

R AND D ASSOCIATES ROSSLYN VA
PROCEEDINGS OF THE AFOSR SPECIAL CONFERENCE ON PRIME-POWER FOR --ETC(U)
FEB 82 P J TURCHI F49620-82-C-0008

UNCLASSIFIED

AFOSR-TR-82-0655

NL

6 of 9

2783

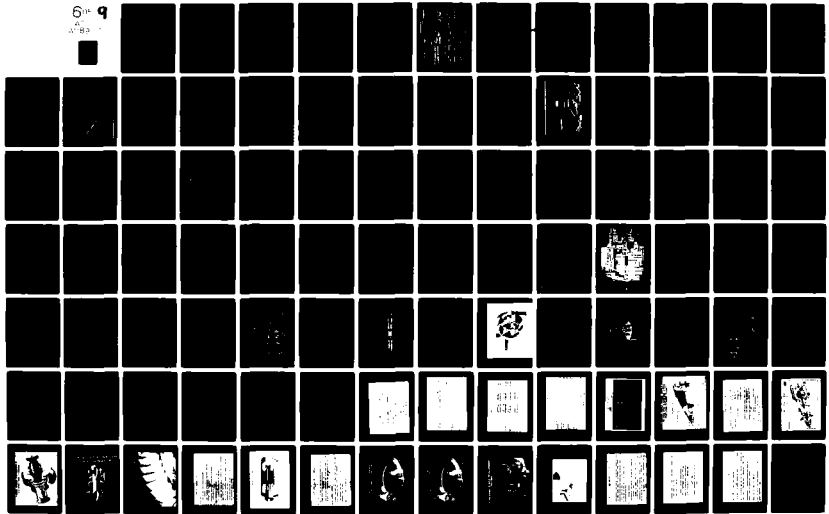

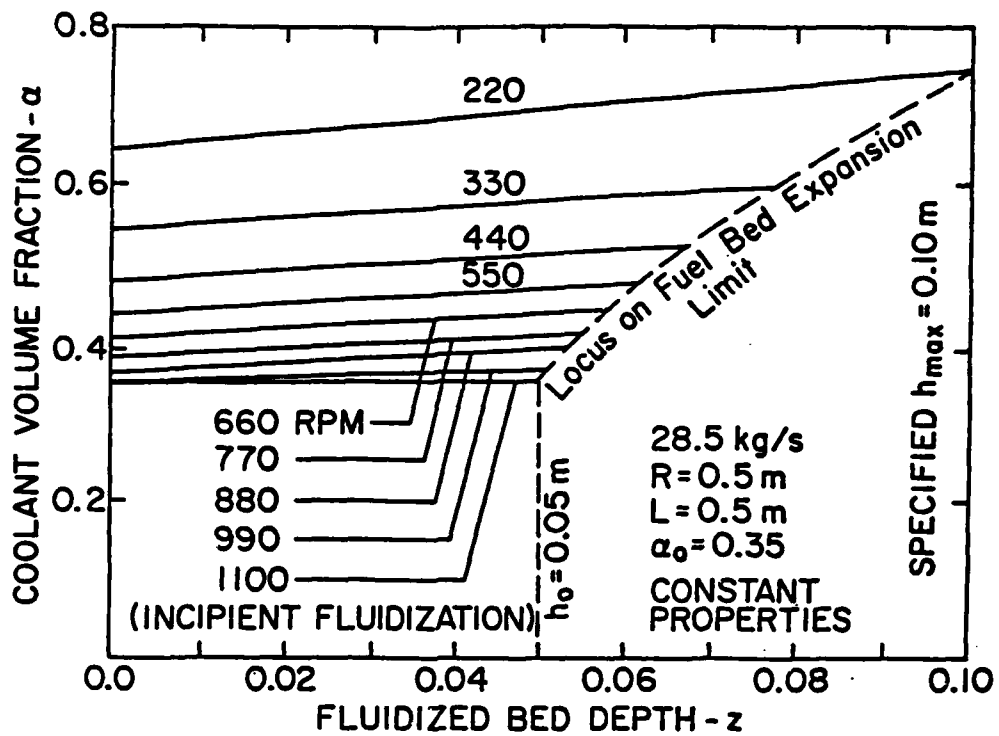

Figure 4
Calculated adiabatic
thin bed expansions

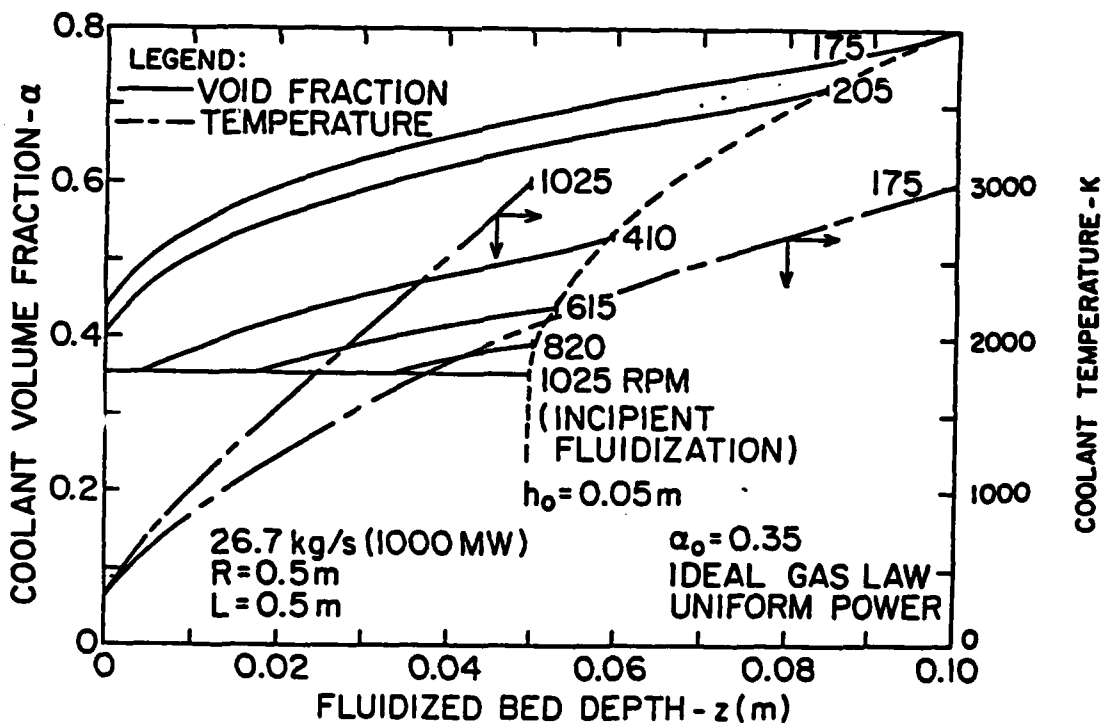

Figure 5
Calculated thin bed expansions
for heated hydrogen

LT-6-ΔI

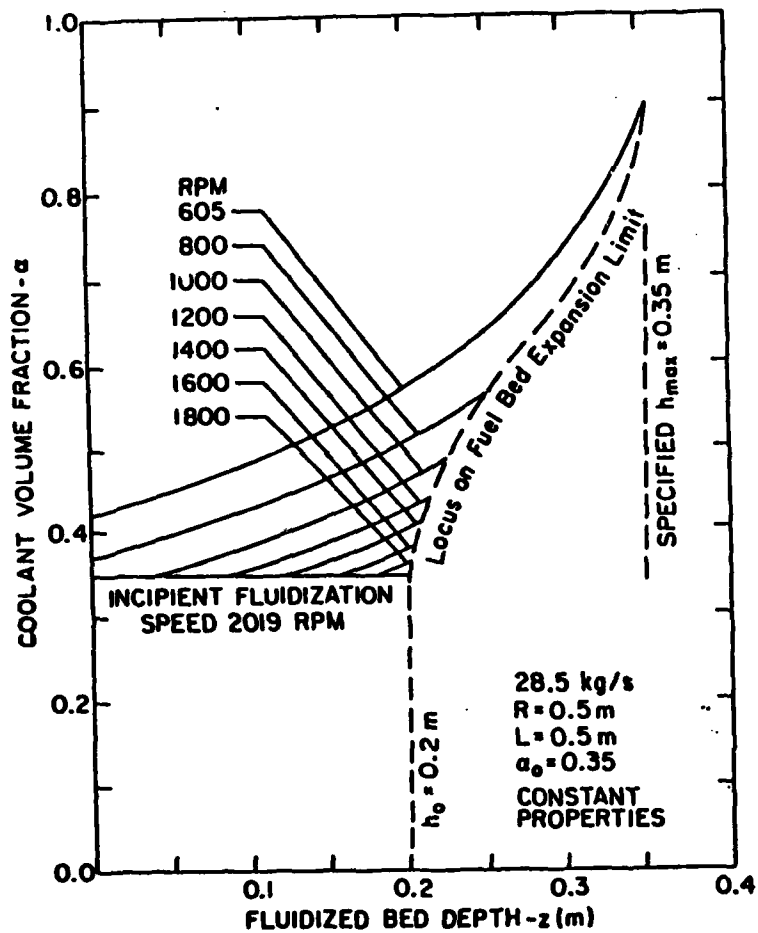

Figure 6
Calculated adiabatic
thick bed expansion

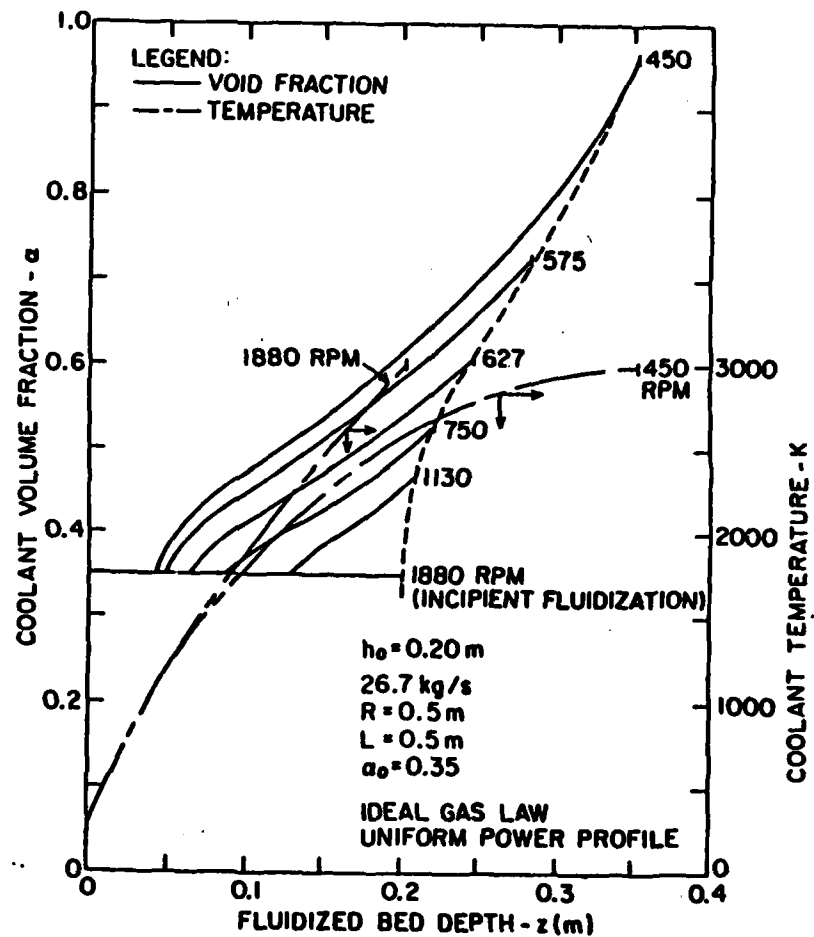

Figure 7
Calculated thick bed expansion
for heated hydrogen

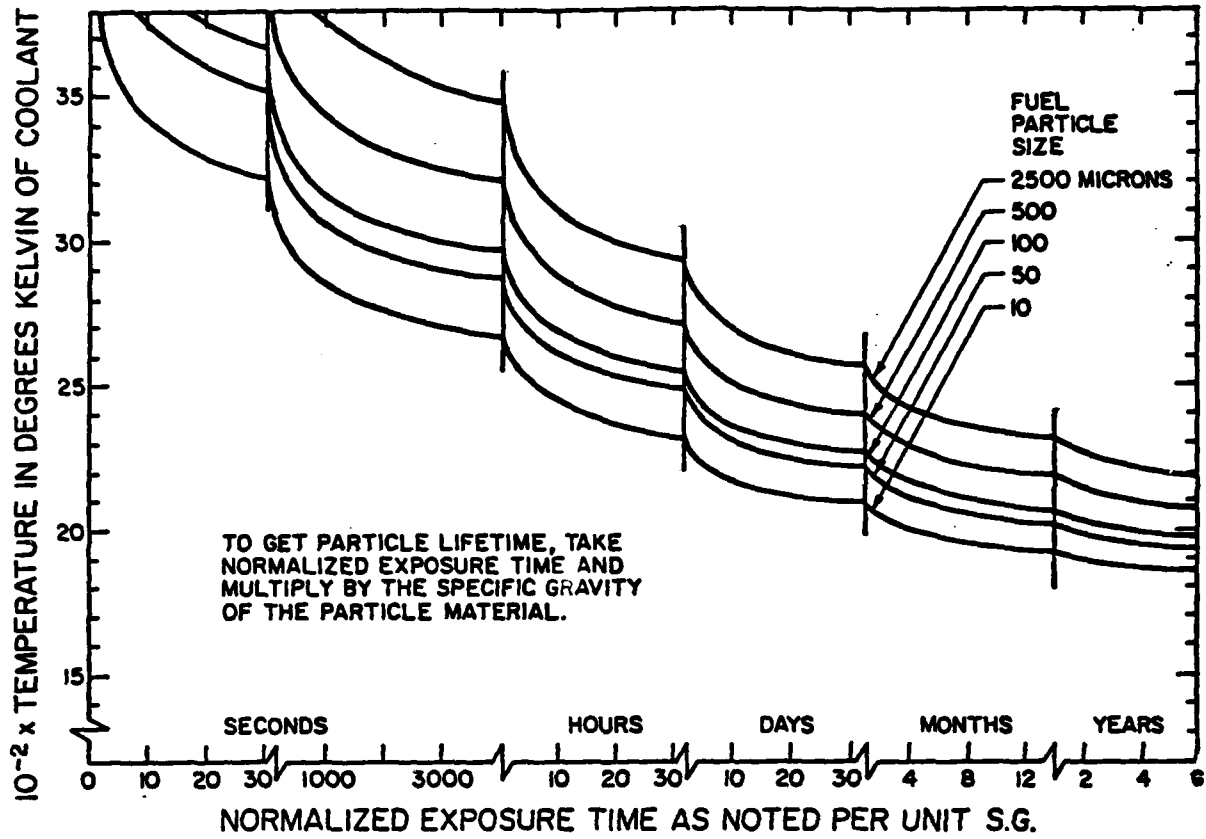

Figure 8
Fuel lifetimes

Q & A - O. C. Jones

From: P. J. Turchi, R & D Associates

Is there a tendency in some flow regimes (say, close to optimum balancing of "weight" and flow pressure) for instability in which flow breaks through bed in spokes or columns?

A.

Definitely in 1-9, gas-solid beds!

Evidence, meager as it is, at high g's indicates flat, layered bubbling with large particles & irregular ballooning-like bubbles at some conditions with fines. Not much known in general and whole question of jetting, channeling, bubbling, etc., must be resolved for RBR conditions.

**SELECTED RESEARCH NEEDS FOR
SPACE REACTOR POWER SYSTEMS**

• • • • •

WILLIAM A. RANKEN

Los Alamos National Laboratory

**SPECIAL CONFERENCE ON PRIME POWER
FOR HIGH-ENERGY SPACE SYSTEMS**

NORFOLK, VA

FEBRUARY 22-25, 1982

IV-10

Los Alamos

TECHNOLOGY CANDIDATES

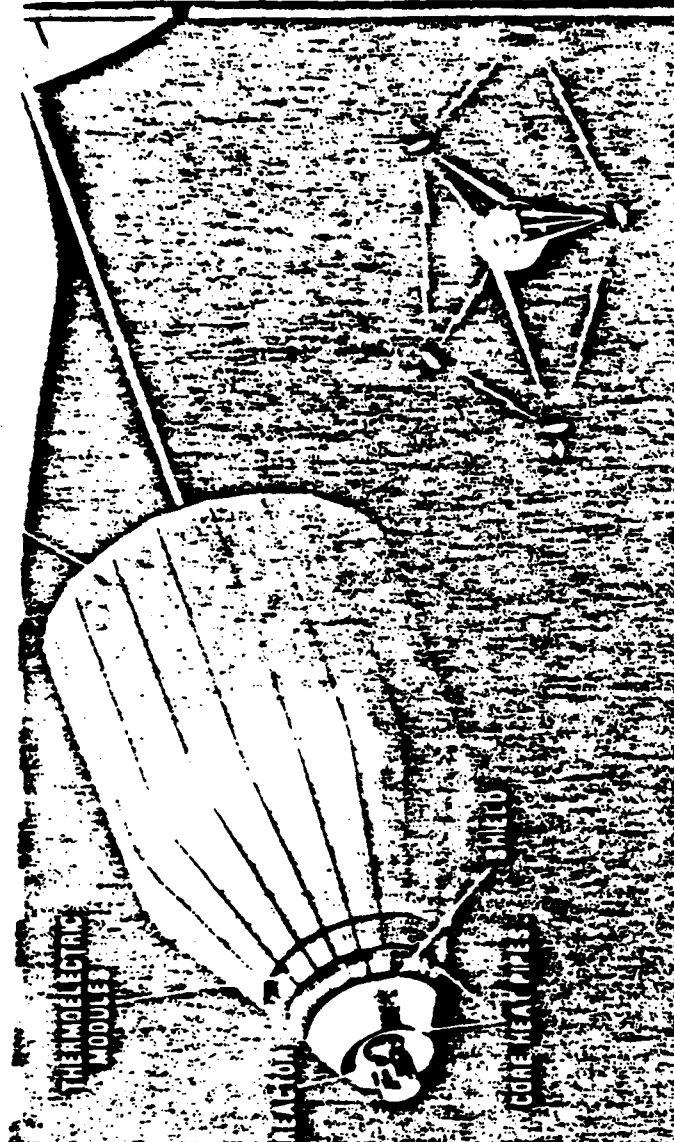

PROJECT HEAT
(AREA m²)

CONVENTIONAL TECHNOLOGY 80

ADVANCED 800

SPECULATIVE OR OPEN LOOP 8000

CONVERTER

THERMIONICS
BRAYTON
RANKINE
STIRLING

RANKINE

BRAYTON
(OPEN LOOP) MHD

REACTOR

HEAT PIPE

SOLID-CORE
ROTATING BED

0.01

0.1

1

10

100

MW_e

RESEARCH CATEGORIES

REACTOR HEAT SOURCE

- FUEL BEHAVIOR
- HEAT TRANSPORT
 - HEAT PIPES
 - THERMAL CONTACT RESISTANCE
 - RADIATIVE COUPLING
- STRUCTURAL MATERIALS
 - COMPATIBILITY
 - JOINING
 - IRRADIATION BEHAVIOR

CONVERSION METHODS

- THERMOELECTRIC CONVERTERS
- THERMIONIC CONVERTERS
- LIQUID METAL RANKINE CONVERTERS
- BRAYTON CONVERTERS
- MAGNETOHYDRODYNAMIC CONVERTERS

WASTE HEAT DISSIPATION

- EMISSIVITY COATINGS
- DROPLET BEHAVIOR
- ADDITIONAL INNOVATION

IV-10-2

Los Alamos

Los Alamos National Laboratory
Los Alamos, New Mexico 87545

SPACE REACTOR RESEARCH

- SOME GIVENS -

SPACE APPLICATIONS TEND TO PUSH REACTOR DESIGN TOWARDS:

- HIGH TEMPERATURE
- MINIMUM WEIGHT EMPHASIS
- LONG UNATTENDED LIFETIME
- FAST SPECTRUM AT LOW POWER LEVEL
- FAST SPECTRUM OR GRAPHITE MODERATING AT HIGH POWER

IV-10-3

Los Alamos

Los Alamos National Laboratory
Los Alamos, New Mexico 87545

FUEL SWELLING

- TENDS TO LIMIT REACTOR CORE TEMPERATURES TO ≤ 1400 K FOR LONG LIFETIME, SMALL SYSTEMS
- FOR HIGH POWERS, LARGER REACTORS ARE INEVITABLE AND FUEL MODIFICATIONS CAN BE CONSIDERED:
 - STRONG CLADDING
 - CERMET CONFIGURATIONS
 - GRAPHITE CLADDING/MATRIX FUELS
- THESE MODIFICATIONS PERMIT HIGHER TEMPERATURE OPERATION
- THE OPERATING LIMITS ARE FUZZY, EXTRAPOLATION TO HIGH BURNUP UNCERTAIN

IV-10-4

Los Alamos

Los Alamos National Laboratory
Los Alamos, New Mexico 87545

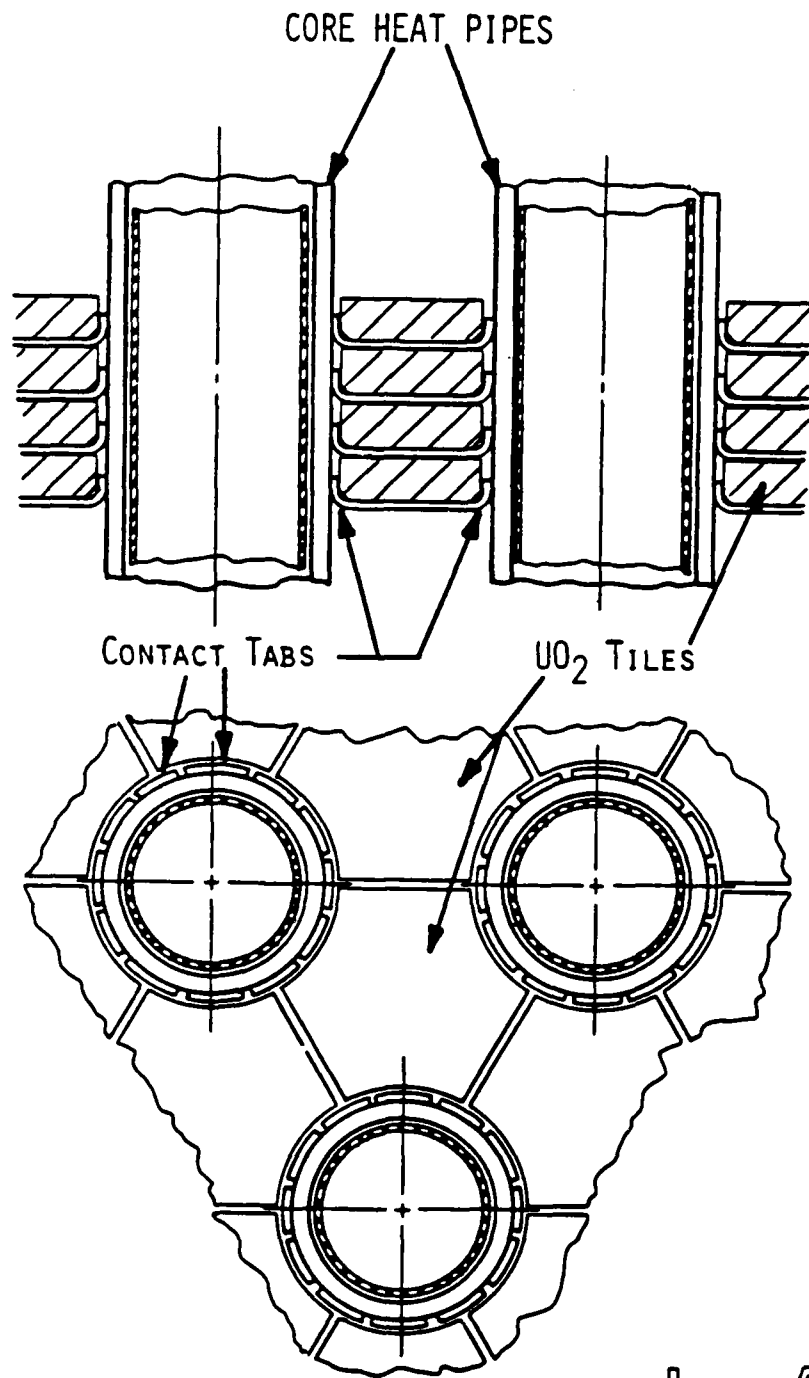

Los Alamos

Los Alamos National Laboratory
Los Alamos, New Mexico 87545

IV-10-5

FUEL BEHAVIOR RESEARCH

GOAL: DEVELOPMENT OF A HIGH-TEMPERATURE, LOW-SWELLING, HIGH-DENSITY FUEL COMPATIBLE WITH STRUCTURAL/CLADDING MATERIALS (AT HIGH TEMPERATURES)

- NEEDS:**
- ISOTHERMAL, UNCONSTRAINED IRRADIATION DATA AT HIGH TEMPERATURE
 - HIGH BURNUP FUEL DATA AT HIGH TEMPERATURE
 - EXPANDED DATA BASE ON HIGH-TEMPERATURE IRRADIATION EFFECTS ON FUEL, CLADDING, AND STRUCTURAL MATERIALS PROPERTIES
 - EFFECT OF STOICHIOMETRY ON FUEL/CLAD INTERACTION
 - REFINEMENT OF FUEL MODELLING CODES; ADAPTABILITY TO NONCYLINDRICAL GEOMETRIES

IV-10-6

Los Alamos

Los Alamos National Laboratory
Los Alamos, New Mexico 87545

HEAT TRANSPORT—HEAT PIPES

- AVOIDANCE OF SINGLE-POINT FAILURE IN COOLANT SYSTEM
- AVOIDANCE OF SINGLE-POINT FAILURE IN DYNAMIC CONVERSION SYSTEM

IV-10-7

Los Alamos
Los Alamos National Laboratory
Los Alamos, New Mexico 87545

8-01-1A

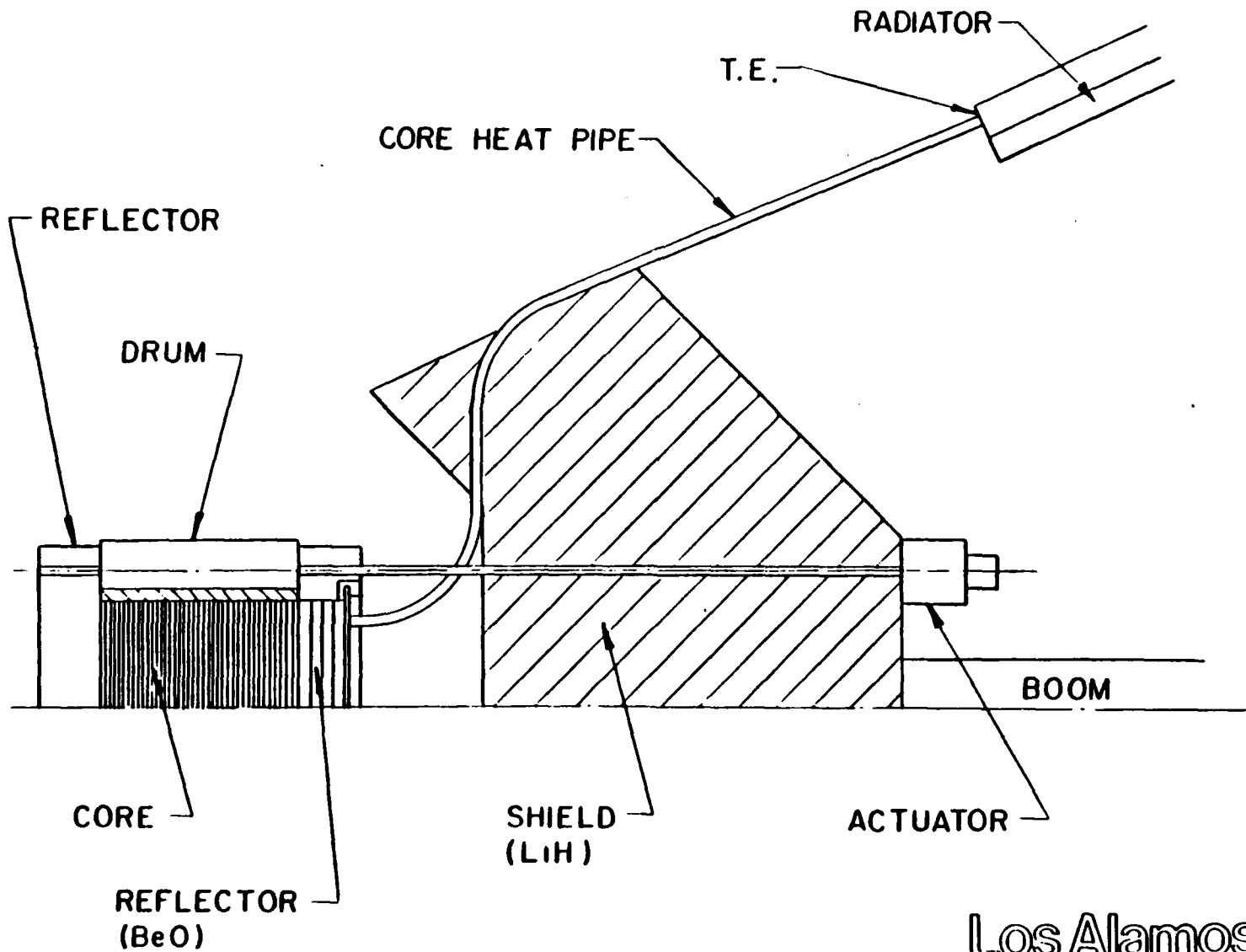

Los Alamos

Los Alamos National Laboratory
Los Alamos, New Mexico 87545

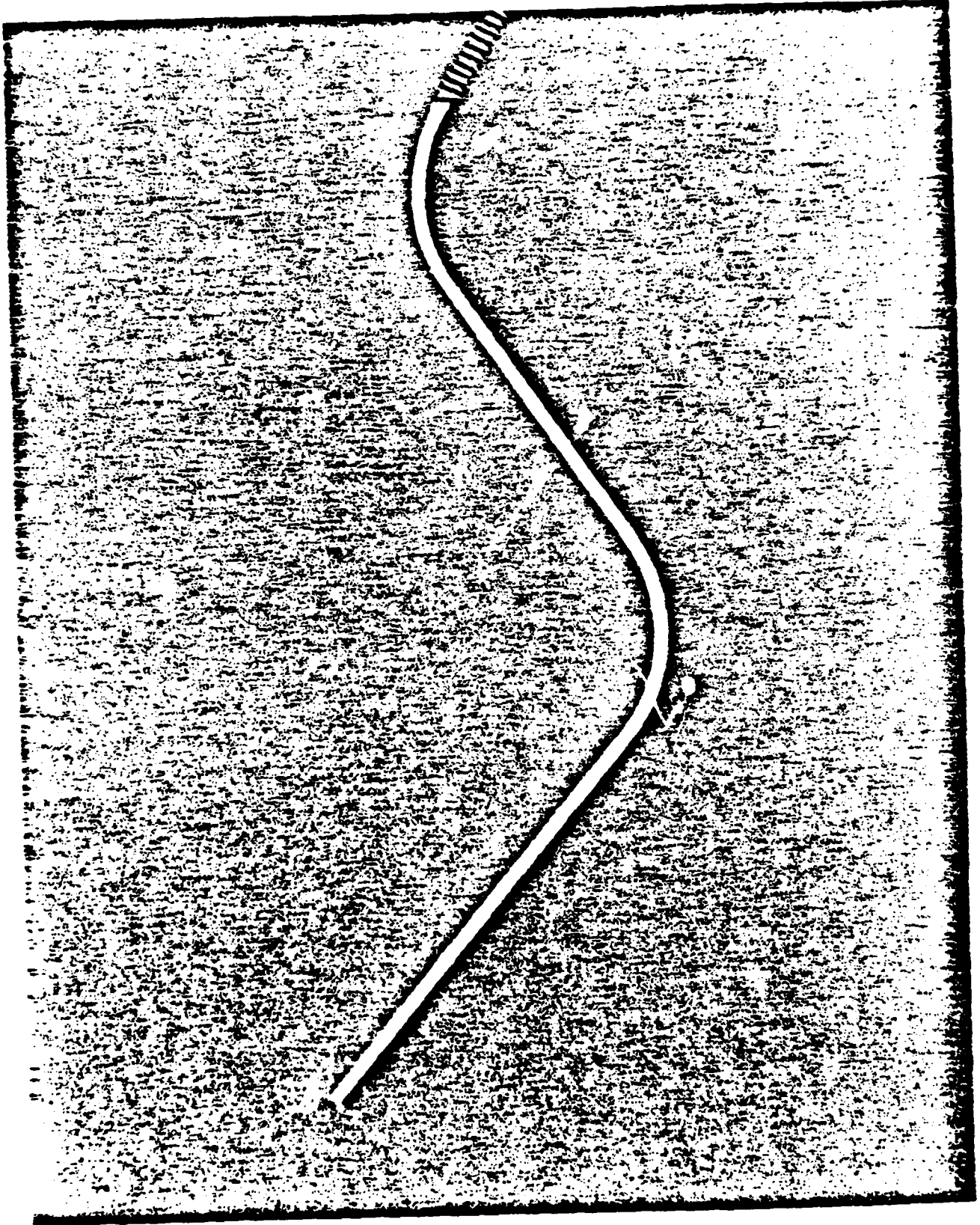

IV-10-9

IV-10-10

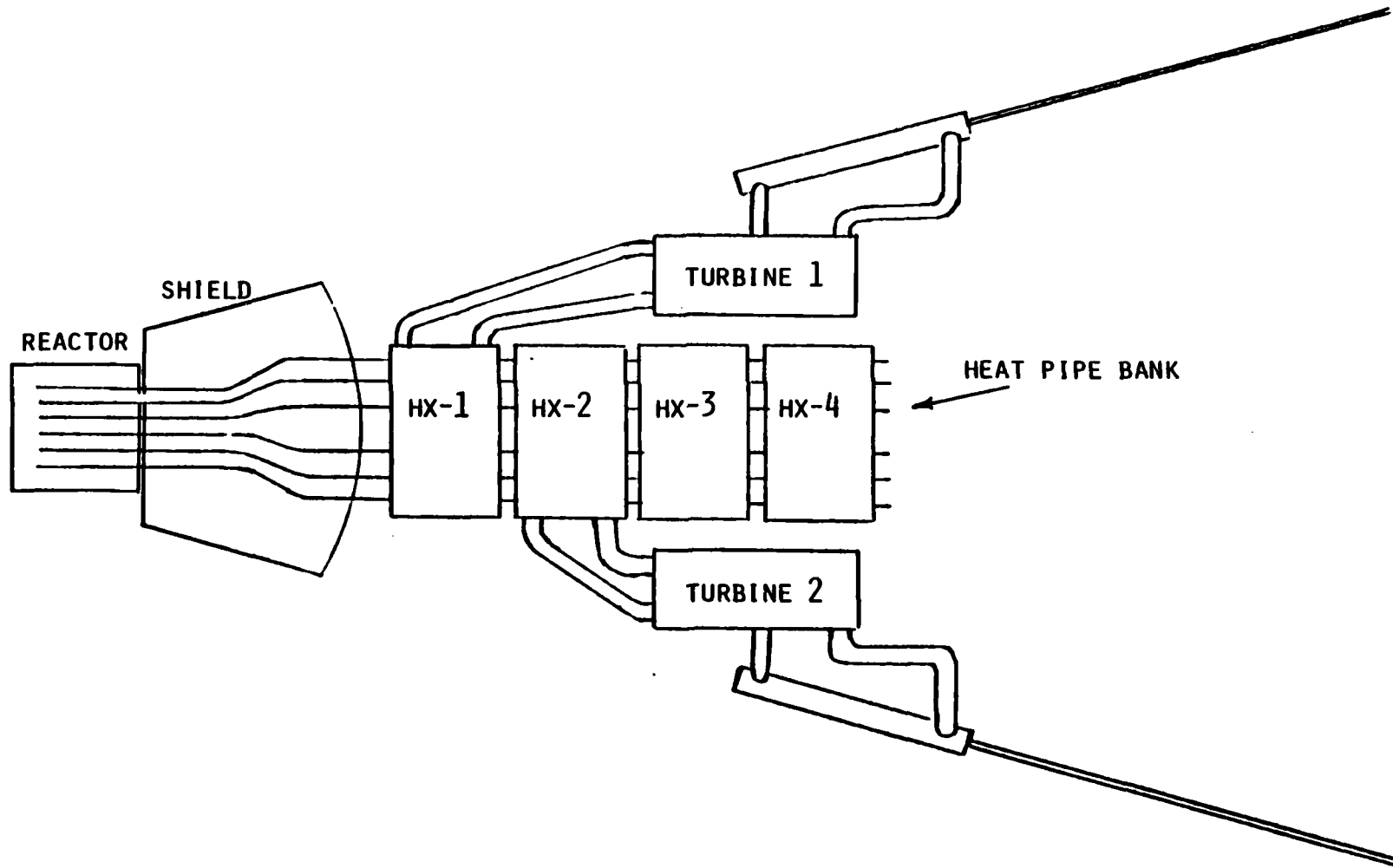

Los Alamos

Los Alamos National Laboratory
Los Alamos, New Mexico 87545

THERMAL TRANSPORT RESEARCH NEEDS - 1

THERMOMECHANICAL COUPLING METHODS (REQUIRED FOR REDUNDANCY IN DESIGN):

- ANALYTICAL MODELING
- INNOVATION AND EXPERIMENT
 - BRUSH STRUCTURES
 - PREFORMED FOIL STRUCTURES
 - LIQUID COUPLING
- HIGH-TEMPERATURE NON-LIQUID-METAL-WETTABLE COATINGS

IV-10-11

Los Alamos

Los Alamos National Laboratory
Los Alamos, New Mexico 87545

THERMAL TRANSPORT RESEARCH NEEDS - 2

HEAT PIPE MODELING:

- TWO-DIMENSIONAL MODELING OF VAPOR DYNAMICS AND VAPOR/LIQUID ENERGY EXCHANGE IN CYLINDRICAL GEOMETRY

- THERMOCHEMOMECHANICAL MODEL OF LIQUID METAL HEAT PIPES
 - MATERIAL TRANSPORT MECHANISM - SOLUBILITY KINETICS
 - EFFECT OF IMPURITIES
 - PERFORMANCE EFFECTS
 - EFFECTIVENESS OF GETTERING

IV-10-12

Los Alamos

Los Alamos National Laboratory
Los Alamos, New Mexico 87545

THERMAL TRANSPORT RESEARCH NEEDS - 3

HIGH-TEMPERATURE STRUCTURAL MATERIALS:

- REQUIRED FOR ALL CONVERSION SYSTEMS

- DESIRABLE CHARACTERISTICS INCLUDE:
 - FABRICABILITY
 - WELDABILITY
 - DUCTILITY - AFTER HIGH-TEMPERATURE OPERATION
 - HIGH-TEMPERATURE STRENGTH
 - COMPATIBILITY WITH FUEL

IV-10-13

Los Alamos

Los Alamos National Laboratory
Los Alamos, New Mexico 87545

THERMAL TRANSPORT RESEARCH NEEDS - 4

FUEL/HEAT PIPE COMPATIBILITY:

- O₂ DIFFUSION COEFFICIENTS IN MOLYBDENUM, TUNGSTEN, RHENIUM, AND ALLOYS THEREOF
- O₂ SOLUBILITY, IMPURITY EFFECTS

IV-10-14

Los Alamos

Los Alamos National Laboratory
Los Alamos, New Mexico 87545

CONVERTER RESEARCH

HIGH-TEMPERATURE THERMOELECTRICS

THERMIONIC AND MAGNETOHYDRODYNAMIC

CERAMIC AND INSULATOR ELECTROLYSIS

- ION MOBILITY MECHANISMS
- DETERMINATION OF ELECTRIC FIELD, TEMPERATURE, LIFETIME LIMITS OF PROMISING MATERIALS
- EFFECT OF METALLIC CONTACTS AS ION SINKS

IV-10-15

Los Alamos

Los Alamos National Laboratory
Los Alamos New Mexico 87545

BASE LINE SYSTEM WITH STRAIGHT HEAT-PIPES RESULTS IN OVERSIZE REACTOR

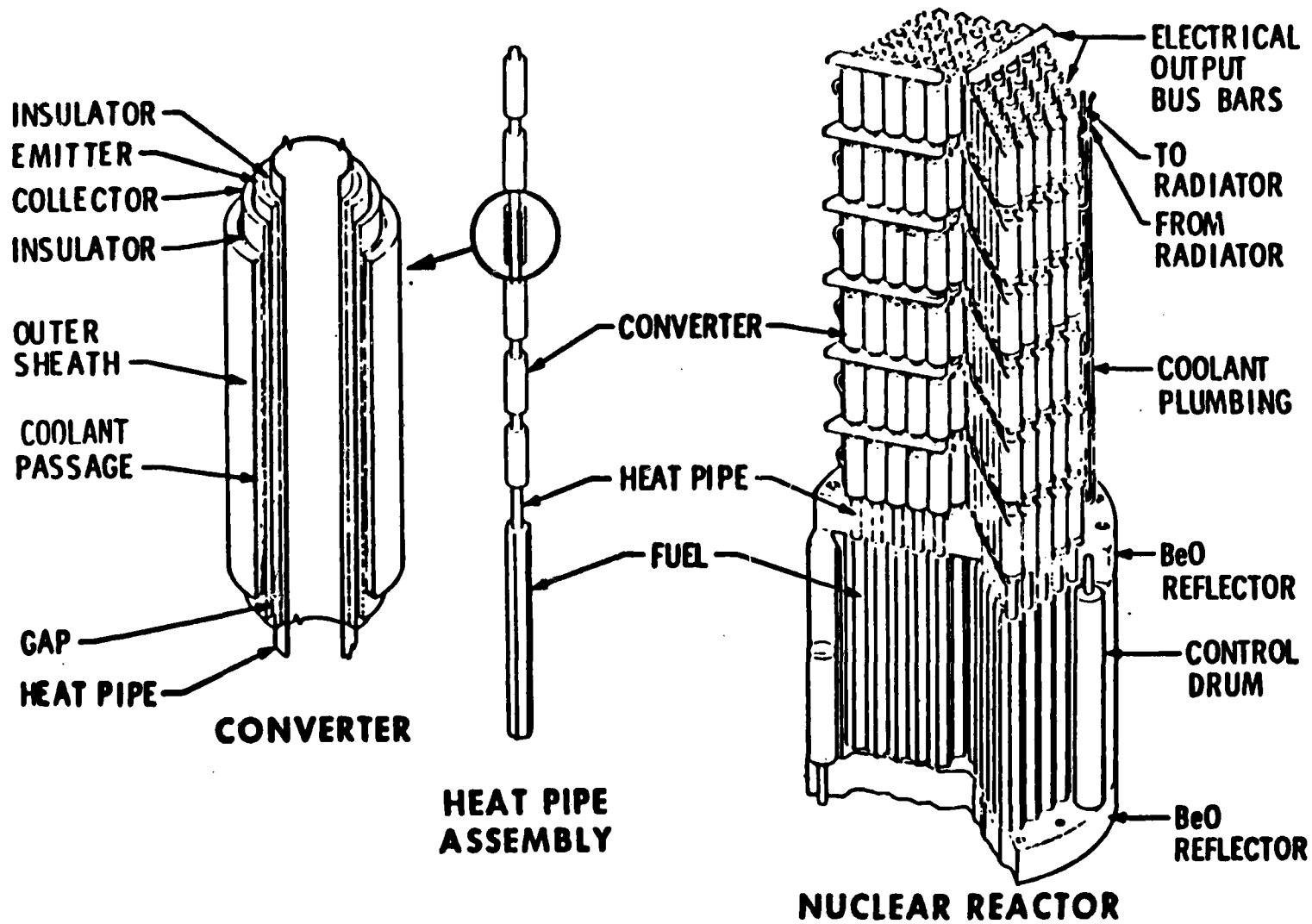

IV-10-16

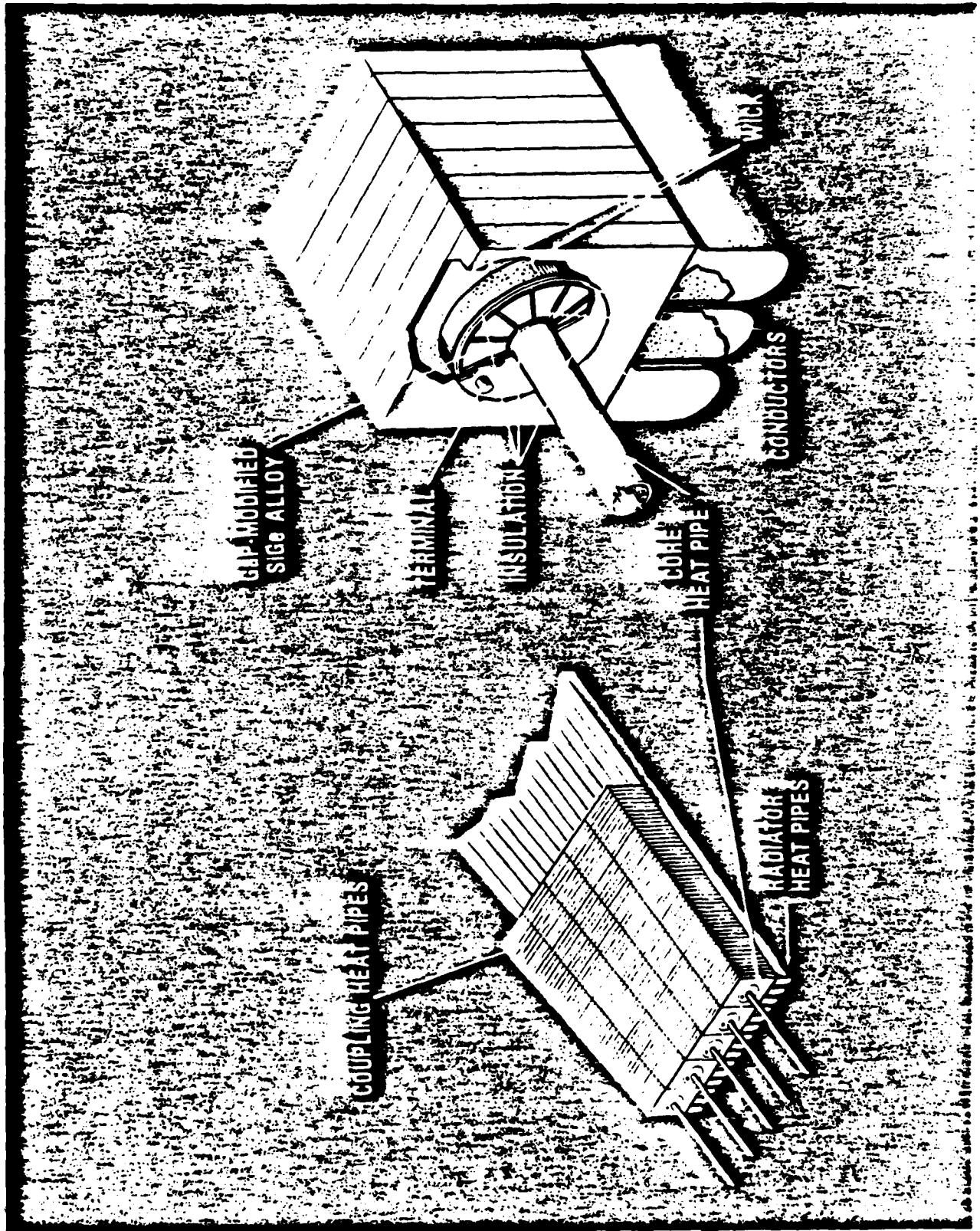

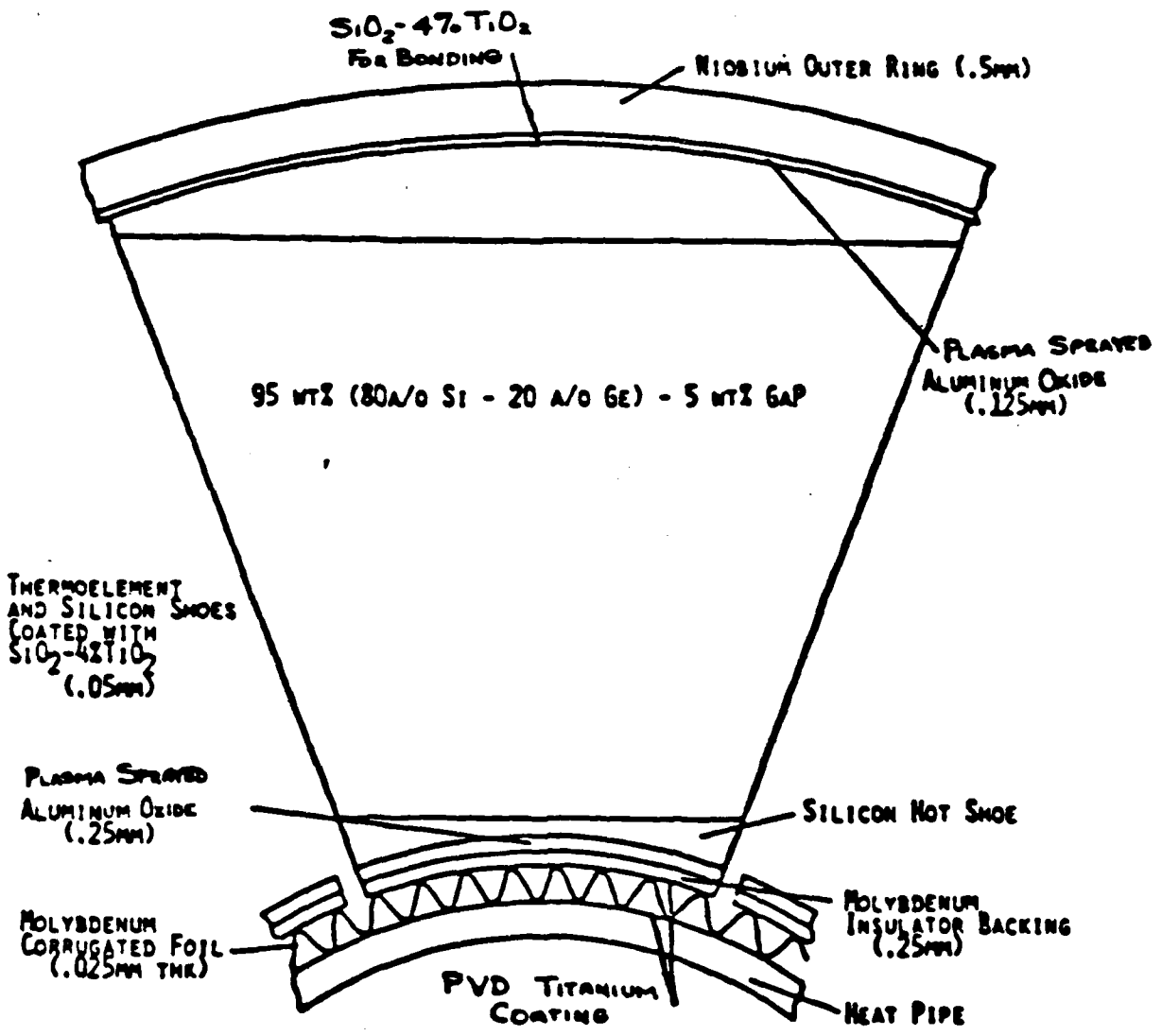

BONDED MODULE WITH ALUMINUM OXIDE INSULATORS

— — — — —
(a)

Nb

Al_2O_3

Nb

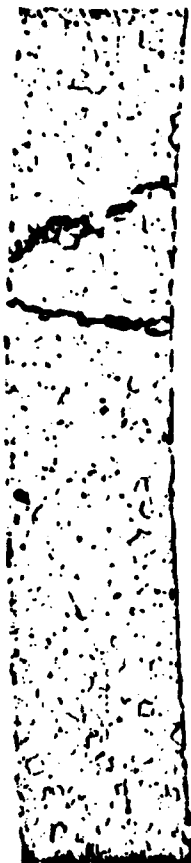

(b)

Nb

Al_2O_3

Nb

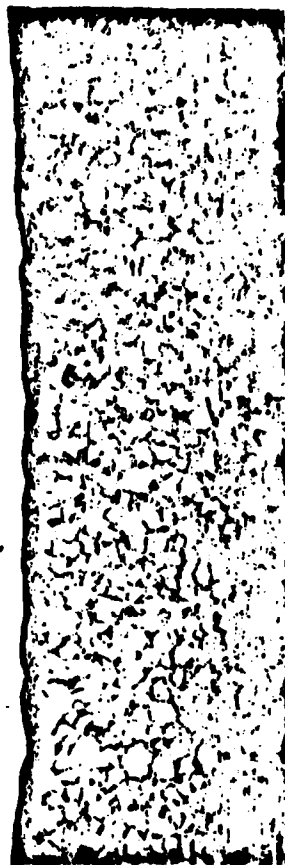

IV-10-19

Photomicrographs (100X) of the test sample (a) before and (b) after thermal stability testing for 5313 hours at $1230 \pm 20^\circ C$ with a 100 V DC potential applied across the alumina layer.

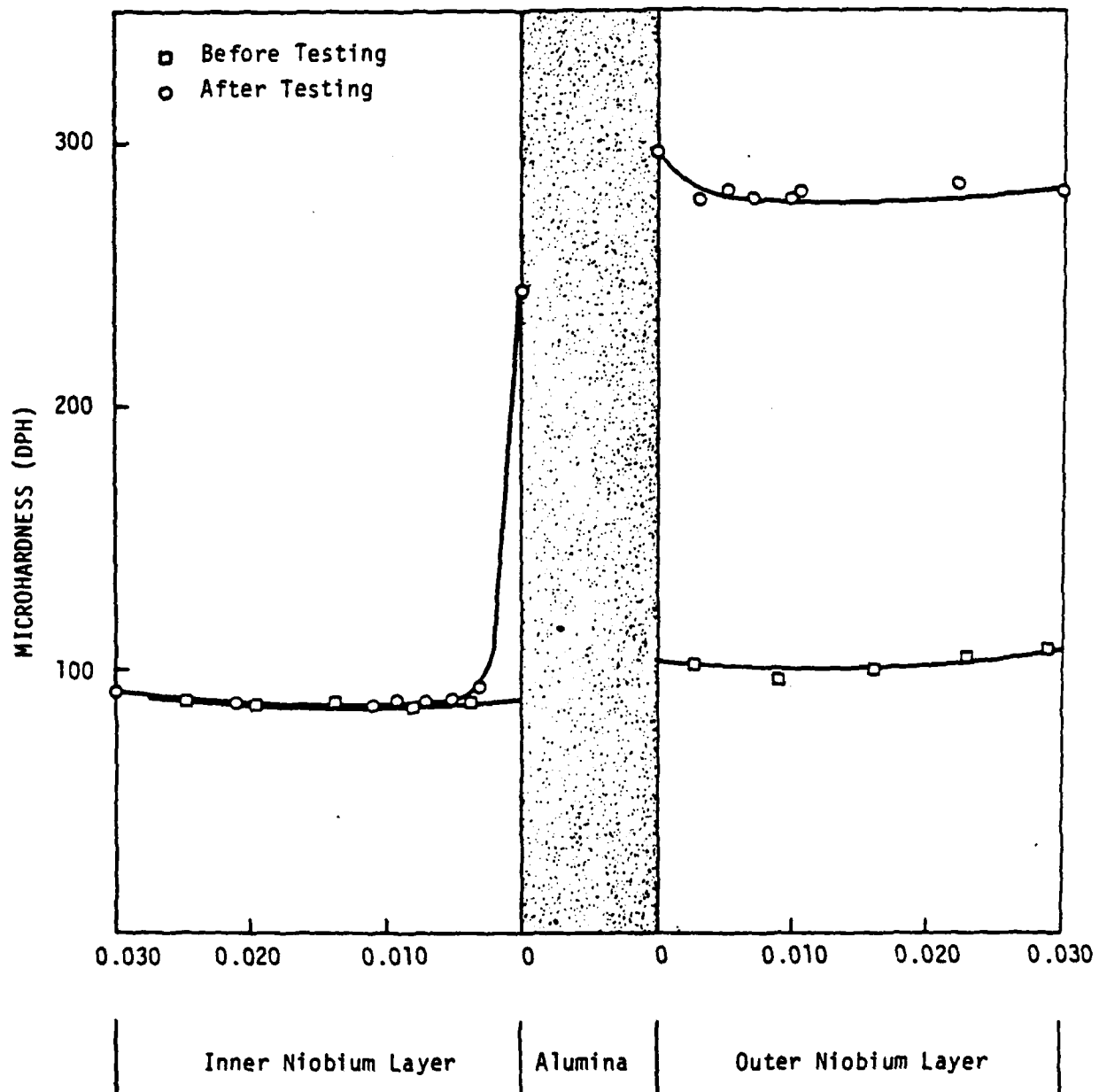

Microhardness Measurements Before and After Thermal Stability Testing of an Electrically Loaded Sample.

CONVERTER RESEARCH

THERMOELECTRICS

- EXTEND THERMOELECTRIC MATERIALS THEORY TO GIVE IT PREDICTIVE CAPABILITY
- INVESTIGATE DECOUPLING OF S AND ρ TERMS IN THERMOELECTRIC FIGURE OF MERIT

$$Z = \frac{S^2}{\rho K}$$

- INVESTIGATE METHODS OF REDUCING K WITH MINIMAL ρ , S REDUCTION
- INVESTIGATE BONDING OF CONDUCTORS TO THERMOELECTRIC MATERIALS

IV-10-21

Los Alamos

Los Alamos National Laboratory
Los Alamos, New Mexico 87545

THERMIONIC CONVERSION

WHAT'S THE MATTER WITH THE BARRIER INDEX?

WHY WON'T IT COME DOWN?

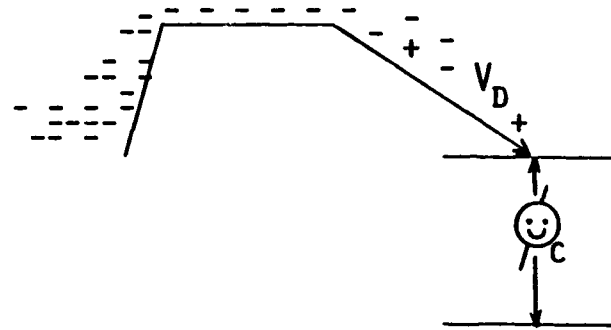

IV-10-22

BARRIER INDEX = ARC DROP + COLLECTOR WORK FUNCTION

ARC DROP = ION GENERATION + PLASMA RESISTANCE $\sim 0.4-0.5$ V

COLLECTOR WORK FUNCTION: $1.0 - \underline{1.6}$ V

Los Alamos

Los Alamos National Laboratory
Los Alamos, New Mexico 87545

BARRIER INDEX VERSUS TIME

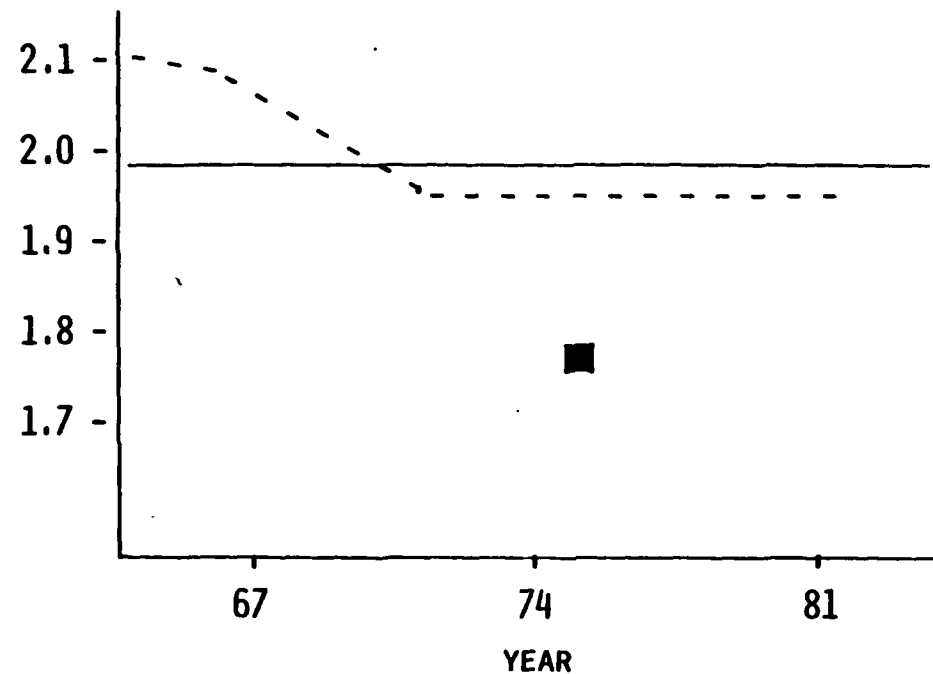

IV-10-23

SURFACE PHYSICS + PLASMA PHYSICS → BASIC UNDERSTANDING

- PLASMA PROBING - PARTICLE AND ELECTROMAGNETIC BEAMS - PLASMA DENSITIES, POTENTIALS, CROSS SECTIONS
- ION LOSS MECHANISMS
- UNIFIED, CONSISTENT TEC THEORY
- ORDERING OF SHOPPING LISTS

Los Alamos

Los Alamos National Laboratory
Los Alamos, New Mexico 87545

HEAT DISSIPATION* AND RADIATION HEAT TRANSFER (TE, TEC)

- HIGH-TEMPERATURE EMISSIVITY COATINGS
 - 600-1000 K - RADIATOR
 - 1400-1600 K - RADIATION HEAT TRANSFER
 - BLACKENING OF LIQUID METAL DROPLETS
- DROPLET EXPERIMENTS - COLLECTION MECHANISMS,
CHARGE EFFECTS
- HEAT TRANSFER TO ROTATING DRUMS
- STUDY OF OTHER CONCEPTS FOR LOW-TEMPERATURE
RADIATORS TO DUMP JOULE HEAT FROM POWER-
USING SYSTEMS

IV-10-24

*COMMON TO ALL CLOSED SYSTEMS

Los Alamos

Los Alamos National Laboratory
Los Alamos, New Mexico 87545

SP-100 NUCLEAR POWER SYSTEM RADIATIVELY COUPLED SYSTEM DESIGN

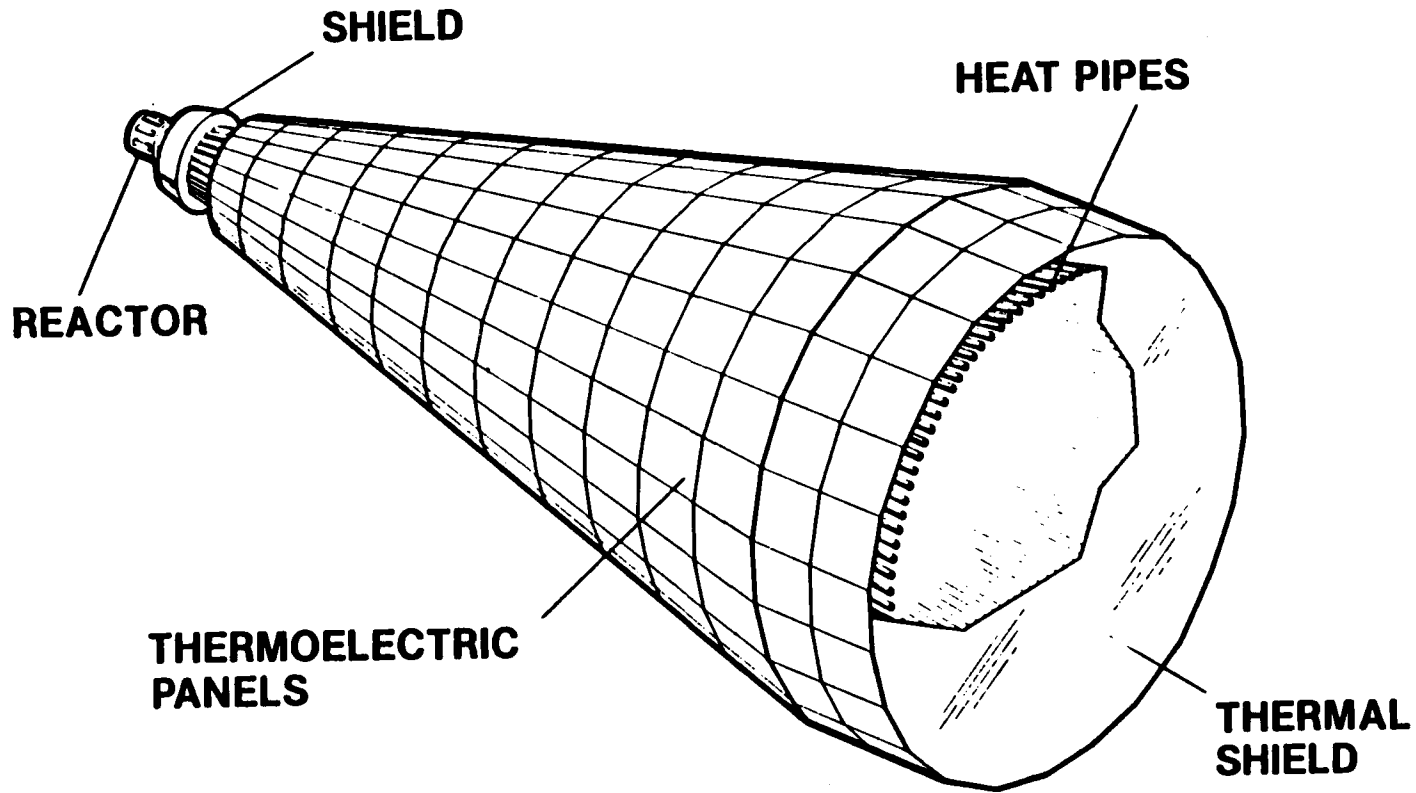

IV-10-25

Los Alamos

Los Alamos National Laboratory
Los Alamos, New Mexico 87545

MISCELLANEOUS

- STUDY OF INERTIAL EFFECTS OF ROTATING MACHINERY
IN SPACECRAFT - STARTUP AND STEADY STATE
- STUDY OF ZERO-THRUST WORKING FLUID DISPOSAL
IN OPEN CYCLE SYSTEMS
- REDUCTION OF SHIELDING REQUIREMENTS BY
HARDENING SIGNAL-PROCESSING ELECTRONICS

IV-10-26

Los Alamos

Los Alamos National Laboratory
Los Alamos, New Mexico 87545

SHIELDING CONSIDERATIONS FOR SPACE POWER REACTORS*

D. E. Bartine
W. W. Engle, Jr.

Engineering Physics Division
Oak Ridge National Laboratory

By acceptance of this article, the publisher or recipient acknowledges the U.S. Government's right to retain a nonexclusive, royalty-free license in and to any copyright covering the article.

(Prepared for the Special Conference on Prime Power for High-Energy Space Systems)

Shielding design considerations are important for space power reactor systems. Shielding is required to meet radiation level constraints for payload and reactor electronic components and perhaps for other materials. Material selection and shield weight and size are important design considerations, requiring careful analysis and verification, but shield design is complicated by radiation streaming paths caused by shield penetrations for coolant and control systems. Resources are available to meet these requirements as a result of previous shielding programs, most notably the NASA SNAP program, the DOD weapons effects program, and the DOE LMFBR program. Available analytic techniques include 1-D and 2-D discrete ordinates and 3-D Monte Carlo for radiation transport, and associated size and shape optimization capability. Facilities available for experimental measurements at Oak Ridge National Laboratory include the Tower Shielding Facility (TSF) reactor and a modified SNAP-2 reactor. The TSF reactor is a 1 MW(th) research facility used to verify cross-section data and calculational techniques for dose attenuation, which could also be used to verify radiation streaming through penetrations, and shield weight and shape optimization. The modified SNAP reactor is a 10 KW(th) system with high-enriched ZrH fuel, Be reflector, NaK coolant, and a LiH shield. The core and reflector assembly are SNAP-10A design, with a SNAP2 shield which could be replaced with other experimental shields to verify prototypic shield designs.

In summary, a shielding technology program is necessary to support space power reactor development. Payload and reactor electronic components must be protected; and shield composition, weight, and shape

*Work performed at Oak Ridge National Laboratory for Union Carbide Corporation under contract with the Department of Energy.

are important design considerations. Techniques are available for design analysis and optimization, and experimental facilities are available for design verification. Shielding analysis should proceed concurrently with reactor design, and experimental verification should follow the analysis closely.

SHIELDING CONSIDERATIONS FOR SPACE POWER REACTORS

by D. E. Bartine

The paper starts by indicating why shielding considerations are important for space power reactors and continues to describe analysis and verification requirements, and the techniques and facilities available to meet these requirements.

The analytical tools for optimizing shield design are presented with illustrations of problems solved in the SNAP program. For 1-D shield optimization, the first figure shows optimized thicknesses for multi-layer tungsten-lithium hydride shields and the second shows a simpler shield with lower dose constraints. For 2-D shield shaping, the figures present the original shield design, neutron and gamma isodose contours, and the optimized design.

The rationale for experimental verification is presented next, followed by some specifications and photographic or schematic views for the Tower Shielding Facility (TSF) reactor and for a modified SNAP reactor, both of which could be available for shielding research at Oak Ridge National Laboratory. Finally, a summary rationale is given for a shielding technology program.

SHIELDING DESIGN CONSIDERATIONS ARE IMPORTANT FOR
SPACE POWER REACTOR SYSTEMS

- Shielding is required to meet radiation level constraints for payload and reactor electronic components and perhaps for other materials
- Minimum weight is a primary consideration
- Shape optimization (minimum size) may be important
- Materials choice is determined by combination of weight, environment, and attenuation characteristics
- Shield penetrations for coolant and control systems create radiation streaming paths and complicate design

A SHIELDING PROGRAM FOR SPACE REACTORS REQUIRES
DESIGN ANALYSIS AND VERIFICATION

- Design analysis techniques are available
 - 1-D and 2-D discrete ordinates, 3-D Monte Carlo radiation transport
 - Size and shape optimization techniques
- Facilities are available for experimental measurements
 - Tower Shielding Facility reactor
 - Modified SNAP* reactor

*SNAP 10-A reactor, 10-A reflector assembly, SNAP 2 shield

ORNL DEVELOPED SEVERAL SHIELD DESIGN/OPTIMIZATION
TECHNIQUES FOR SNAP PROGRAM

- One dimensional weight/thickness optimization
- Shield shaping using two dimensional calculations
- Discrete ordinates-Monte Carlo coupling for 3-D effects

ORNL 1-D OPTIMIZATION INCLUDES TRANSPORT CALCULATION
DIRECTLY IN OPTIMIZATION PROCESS

- Properly describes spectrum shifts at material boundaries
- Properly accounts for secondary gamma ray production
- Does not require complex analytical function to describe transport
- Removes uncertainty due to evaluation of coefficients for complex functions
- Optimization process is simple and has resulted in 30-50% weight savings

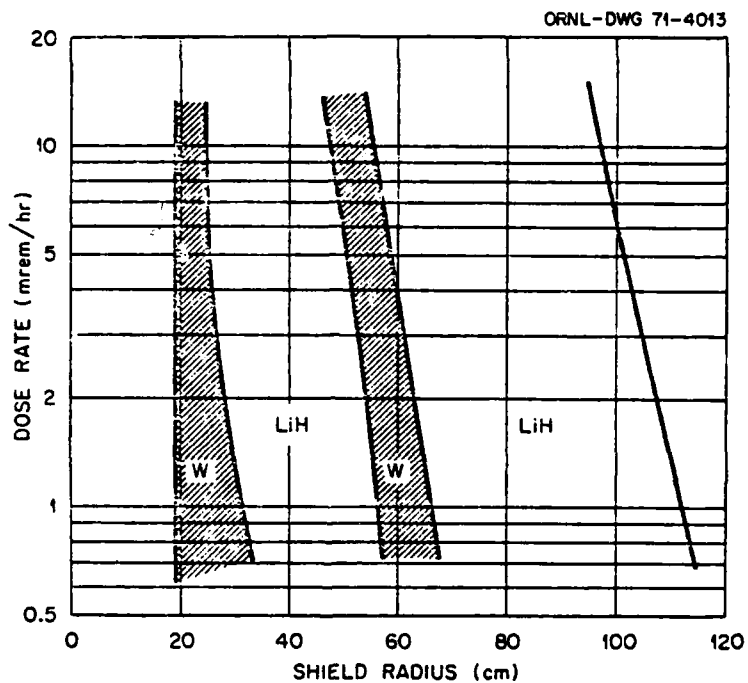

Thicknesses of W and LiH layers in a two-cycle shield as a function of dose rate at a distance of 200 ft (450 kWt).

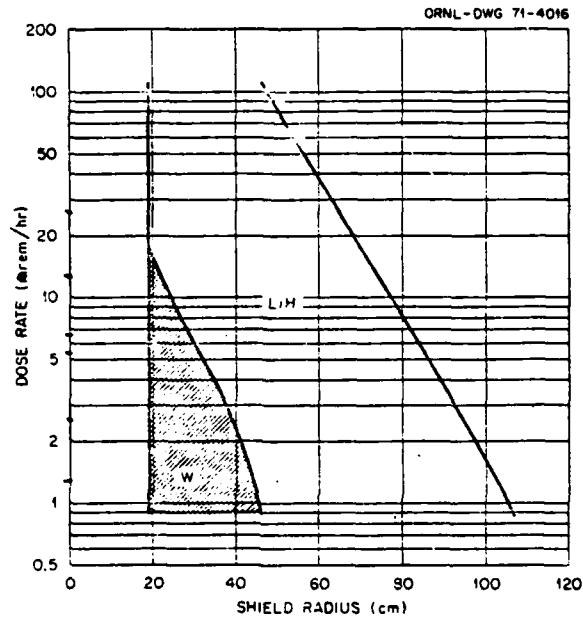

Minimum thicknesses of W and LiH layers in side shield as a function of the dose rate at a distance of 100 ft (450 kWt).

SHIELD SHAPING USING TWO DIMENSIONAL ISODOSE CONTOURS
IS FIRST STEP IN 2-D OPTIMIZATION

- Neutron shield material is shaped to follow neutron isodose contour
- Gamma ray shield material is shaped to follow gamma ray isodose contour
- New configuration is calculated to check shaping
- Technique has resulted in 10-20% weight savings

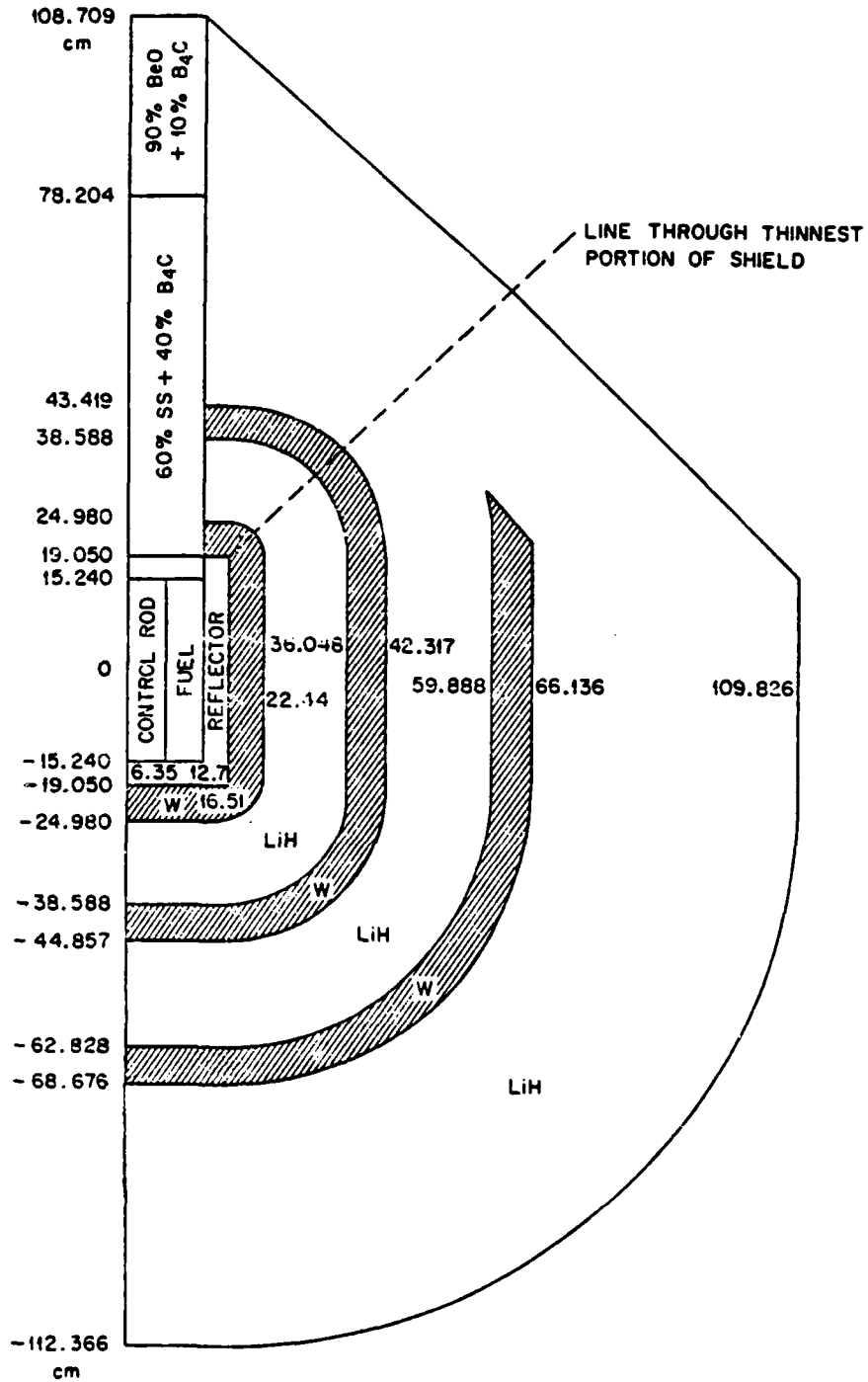

Preliminary configuration for asymmetric shield with a 90-deg. cone angle (450 kw).

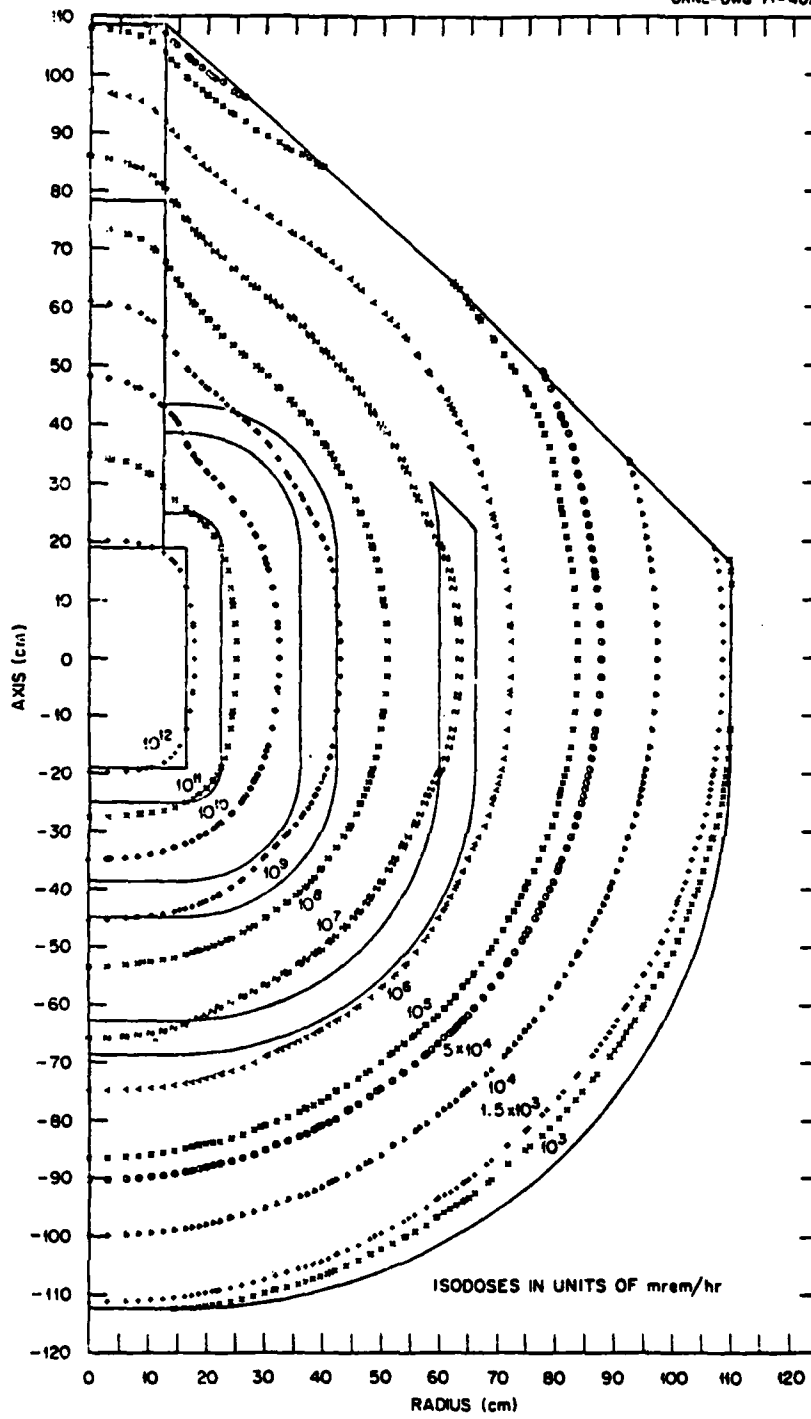

Neutron isodose plots for preliminary asymmetric shield with a 90-deg. cone angle.

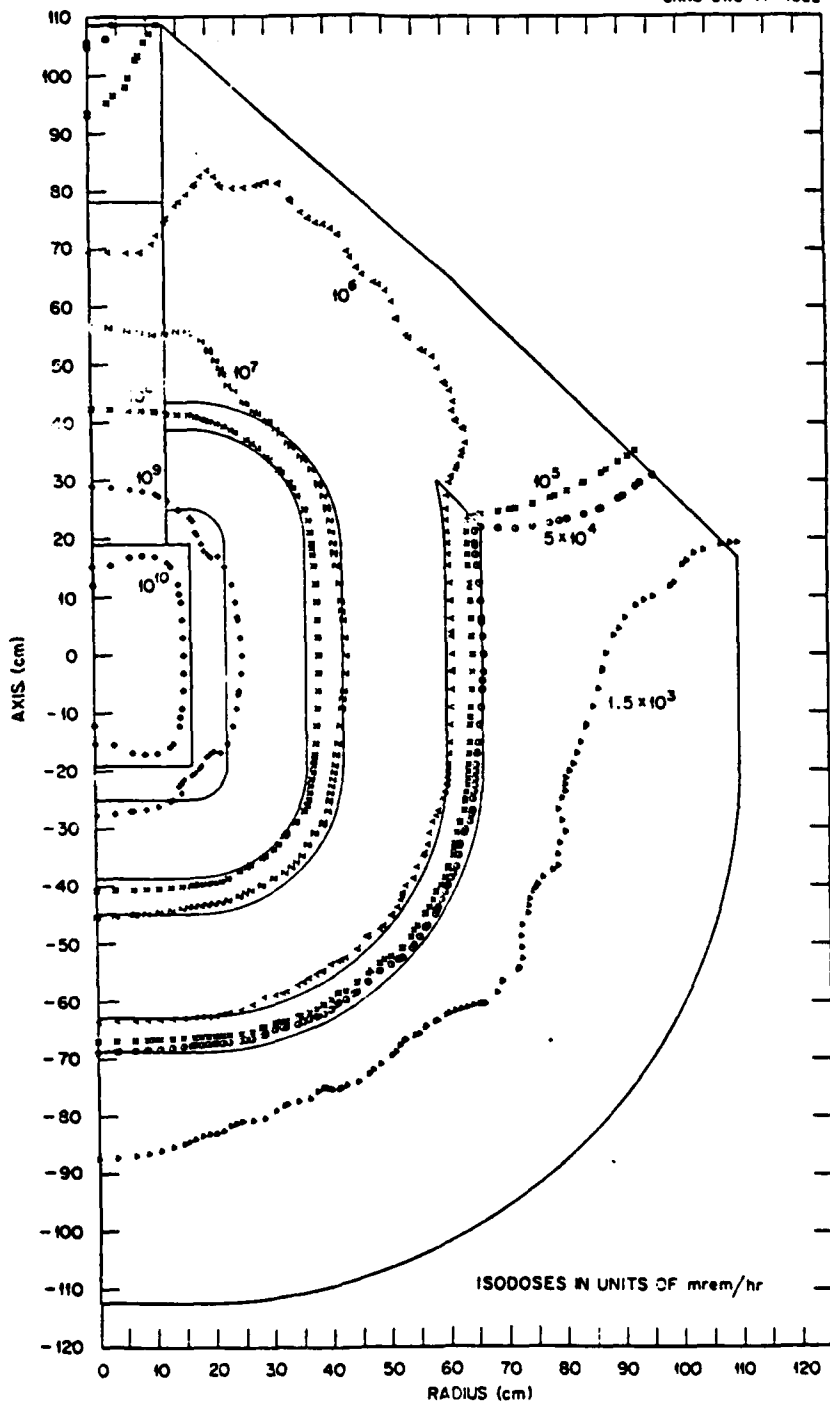

Gamma-ray isodose plots for preliminary asymmetric shield with a 90-deg. cone angle.

INTEGRAL EXPERIMENTS SHOULD BE USED TO VERIFY
THE SHIELD DESIGN AND THE ANALYTIC
METHODS AND DATA

- The Tower Shielding Facility reactor can provide verification of analytic methods and data
 - Determine adequacy of cross-section data for neutron and gamma attenuation and for secondary gamma-ray production
 - Verify calculational techniques for radiation streaming through penetrations and for shield weight and shape optimization
- The modified SNAP* reactor can provide verification of prototypic shield designs

*SNAP 10-A reactor, 10-A reflector assembly, SNAP 2 shield

THE ORNL TOWER SHIELDING FACILITY REPRESENTS:

- 1 MW(th) spherical reactor
- Large experimental area in remote site
- Well-established staff and instrumentation
- Coordination with state-of-the-art analysis capabilities

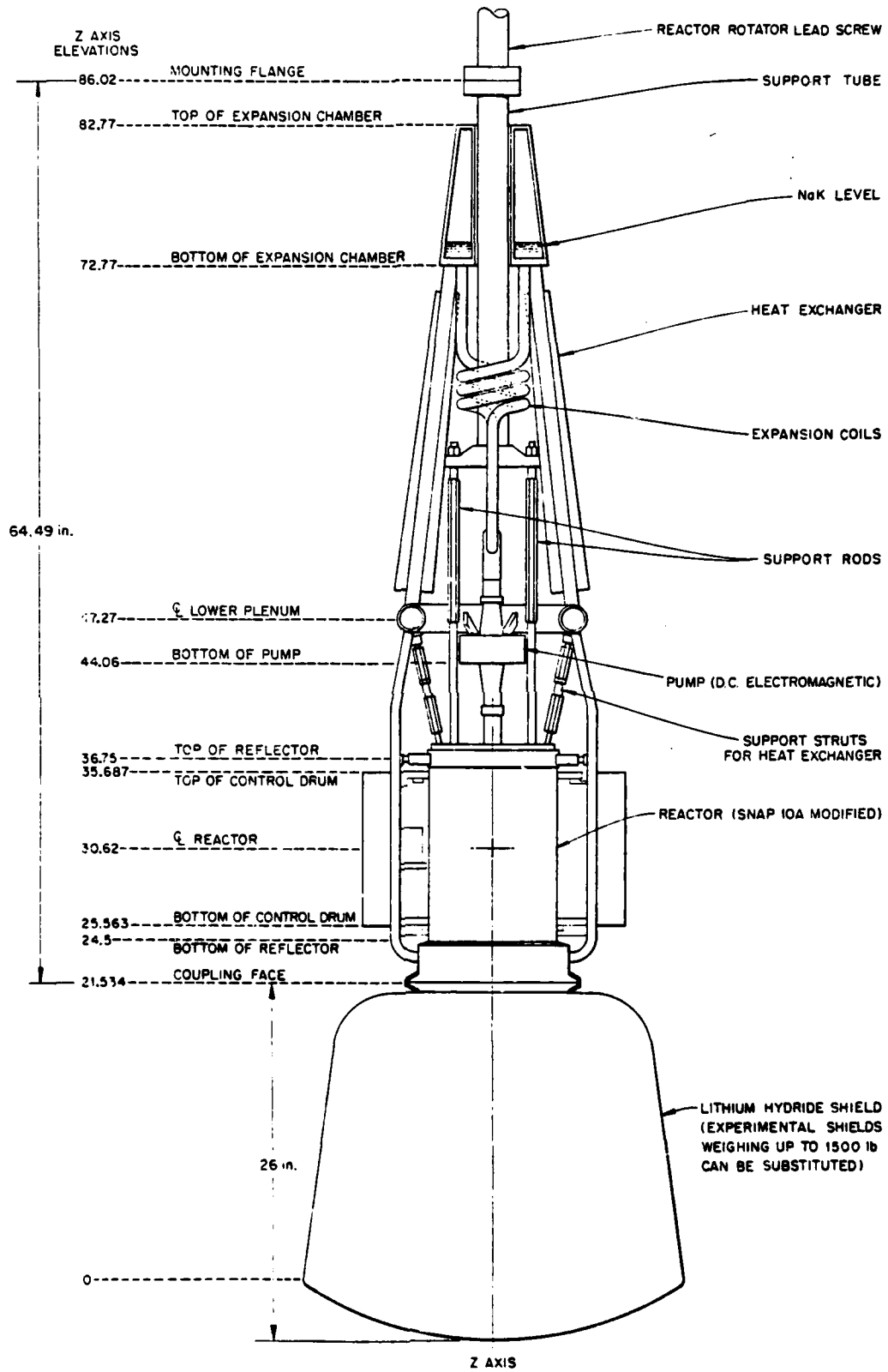

TSF-SNAP Reactor for Shielding Research.
IV-11-17

TSF SNAP* REACTOR SPECS

- 10 KW(th)
- High-enriched ZrH fuel
- Be reflector
 - four control drum cutouts
- NaK coolant
 - top plenum with fin tubes for cooling
- LIH shield
 - internal struts for stability
- High-temperature operating switches and wiring

*SNAP 10-A reactor, 10-A reflector assembly, SNAP 2 shield

ORNL-RES-64-001282

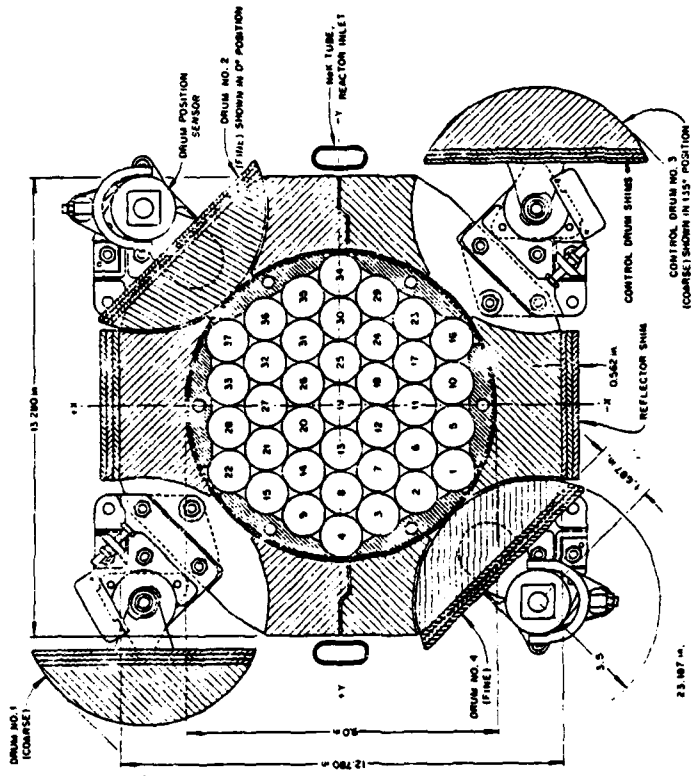

Cross-section view through TSF-SNAP core and reflector.

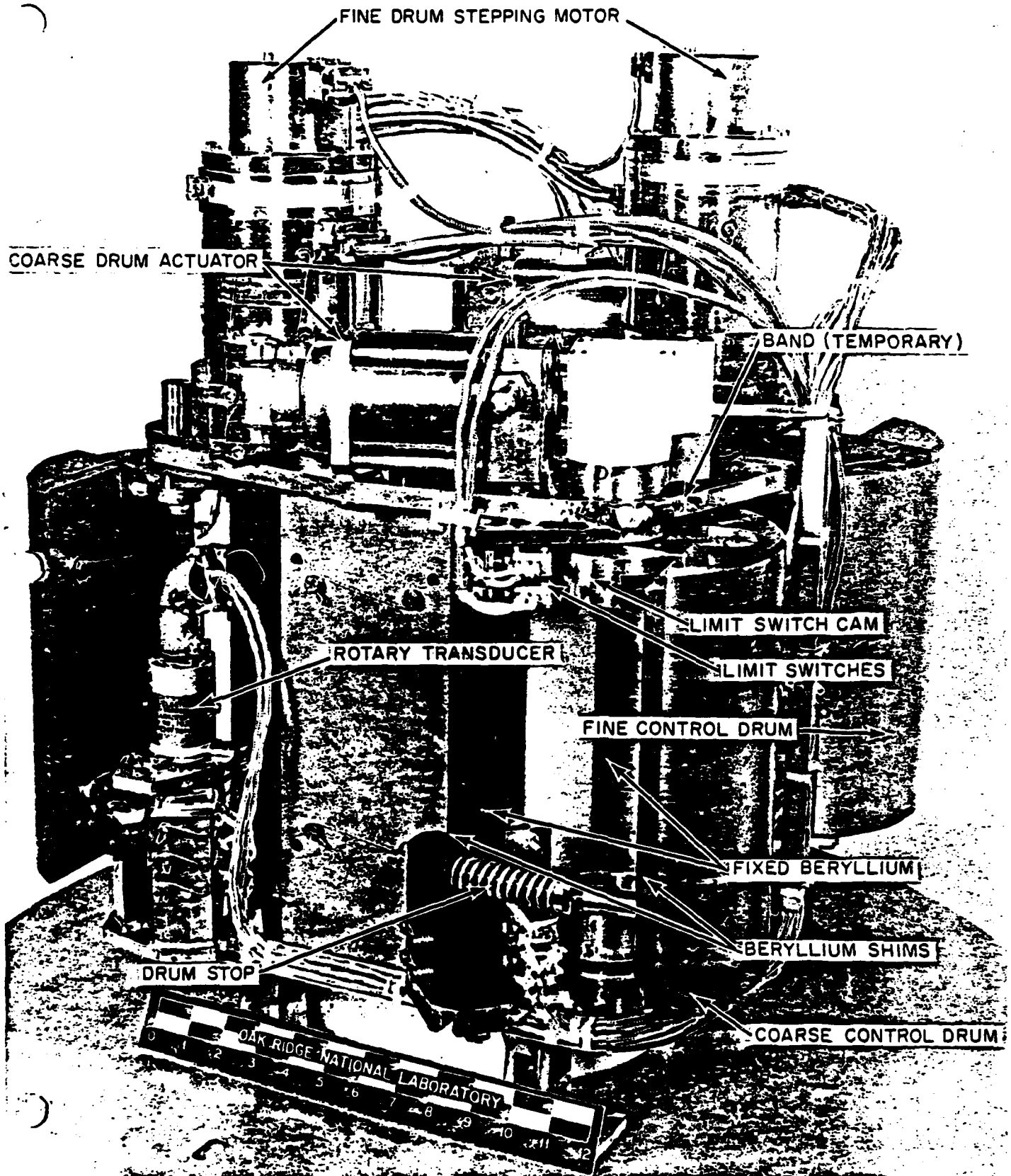

Reflector and controls for the TSF SNAP.

A SHIELDING TECHNOLOGY PROGRAM IS NECESSARY TO SUPPORT
SPACE POWER REACTOR DEVELOPMENT

- Shielding is required to protect payload and reactor electronic components
- Shield composition, weight, and shape are important design considerations
- Techniques are available for design analysis and optimization
- Experimental facilities are available for design verification
- Analysis should proceed concurrently with reactor design
- Verification should follow analysis closely

Q & A - D. Bartine

From: R. Pettis

Are new difficulties introduced into the shielding design by using a reactor where fission products are present in the fluid loop, like the rotating bed reactor, or gas-core reactors? Are radiation safety constraints likely to prevent the use of open-cycle dynamic conversion (for example, MHD) with some reactor systems?

A.

1. The presence of fission products in the fluid loop definitely introduces problems, not only during operation, when shielding would be protecting the payload, but also during shutdown conditions, especially for maintenance/repair operations.

2. Again, the impacts on operation and maintenance will be large. Additional shielding would probably be required behind the conversion mechanism, and safety constraints would certainly be more severe since release probabilities are greater.

From: S. Wax, Air Force Office of Scientific Research

Do you have any ideas for new shielding materials that might offer weight advantages?

A.

Certainly B_4C , graphite, and borated graphite ($\sim 15\%$) should be considered, along with various metals to provide gamma shielding.

Both different materials and different material combinations should be considered. A rational approach would be to compile a list of potential shielding materials (currently used and hypothetical) and examine them for a trade-off of shielding effectiveness, size and weight requirements, and cost, including both r & d requirements for material qualifications and shield fabrication.

SESSION V. POWER CONVERSION

Session V

**BRAYTON CYCLE POWER CONVERSION
FOR SPACE**

Presented at Special Conference
Sponsored by
Air Force Office of Scientific Research

February 22 - 25, 1982
Norfolk, Virginia

G. H. Parker

Westinghouse Electric Corporation
Advanced Energy Systems Division
Box 10864
Pittsburgh, PA. 15236

V-I-1

As a spinoff from jet engine technology, closed gas turbine (Brayton) cycles also have a strong technology base. A wealth of design and testing experience exists for all critical components. Compact configurations ranging from a few kW(e) (DOE sponsored) to tens of MW(e) (ONR sponsored) have been designed.

CLOSED BRAYTON TECHNOLOGY BASE

- A Mature Technology Ready for Application
- More Than 35 Years of Gas Turbine Development
- All Critical Components Demonstrated
 - Turbomachinery
 - Heat Exchangers
 - Bearings and Seals
- Compact Hi Performance Configurations Defined
 - Multi kW Space Systems Evaluated Since 1960's - NASA/AFC
 - Small Solar and Fossil Systems Being Developed for DOE/DOD
 - 50 MW(e) Unit Designed for ONR
- Materials Advancements Will Permit Increases in Cycle Temperature

V-I-V

Westinghouse and AIResearch performed a feasibility evaluation of 70,000 SHP compact configuration for naval applications. This figure indicates the arrangement of components within the package and the helium flow path.

S-T-A

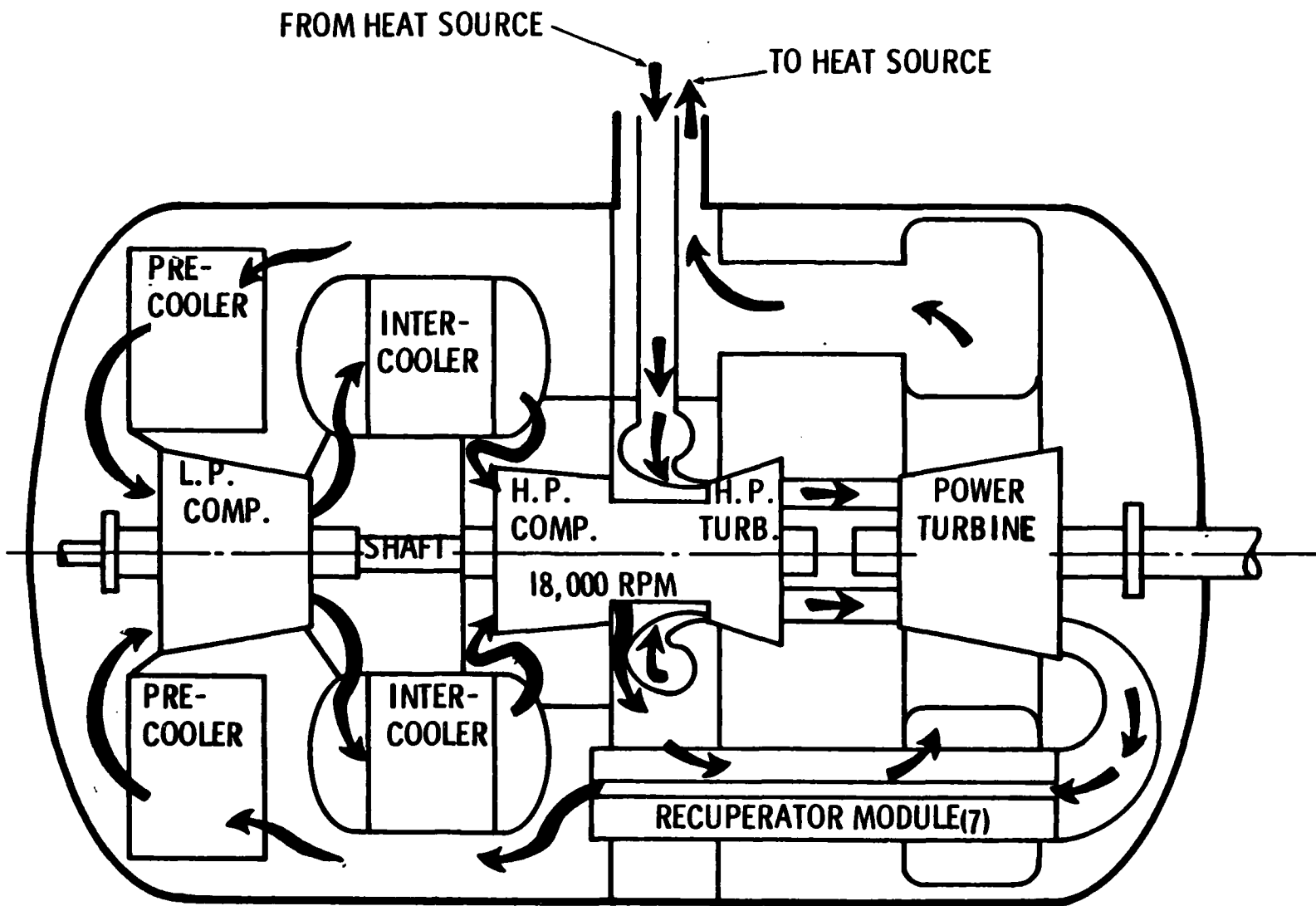

This figure illustrates the layout drawing for the schematic shown on the previous page. At 52 MW(e), its envelope dimensions are comparable to a VW van and its weighs about 47 tons. This corresponds to a 1.8 lb/kW specific weight for the package. While large space systems will not require such compact packaging because the radiators will dominate system size, the axial flow turbomachinery shown here typifies the rotating machinery for multi MW(e) systems. Operated at 1700⁰F turbine inlet temperature, state-of-the-art materials are used without blade cooling.

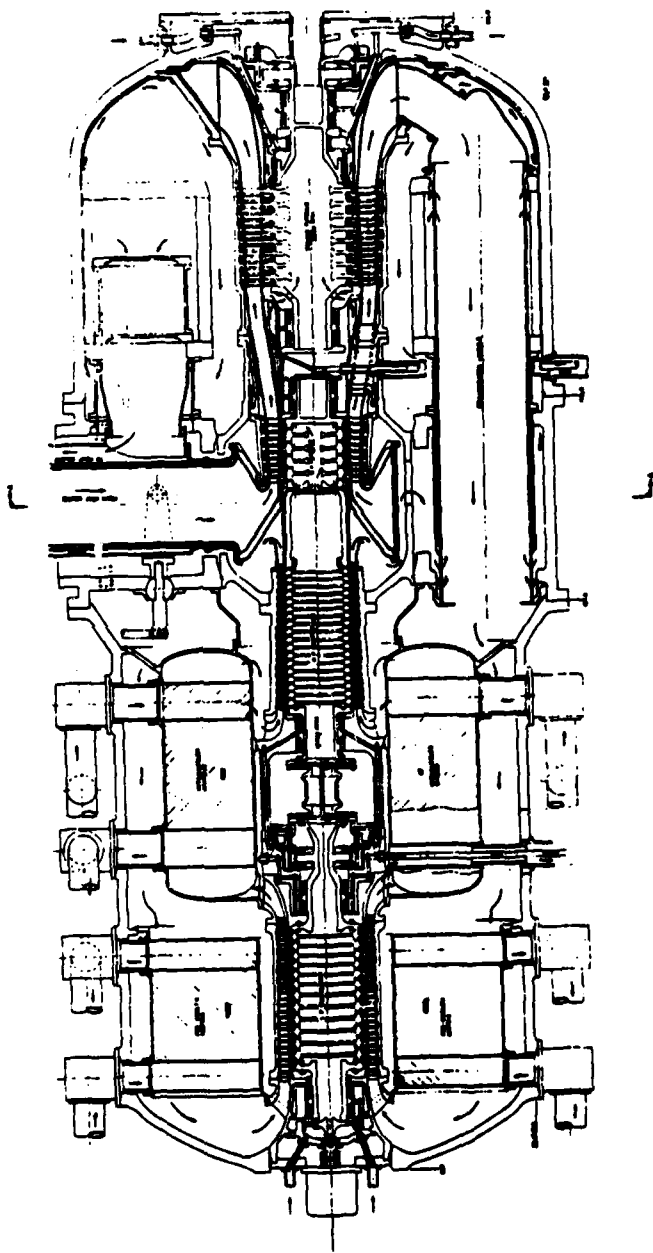

V-1-7

Smaller Brayton systems will likely use a radial flow combined rotating unit (CRU) such as the state-of-the-art AIResearch design shown here. In the range of 500 kW to 1 MW, the radial flow CRU offers substantial advantages when an inert gas mixture (e.g. helium/xenon) is used as the working fluid.

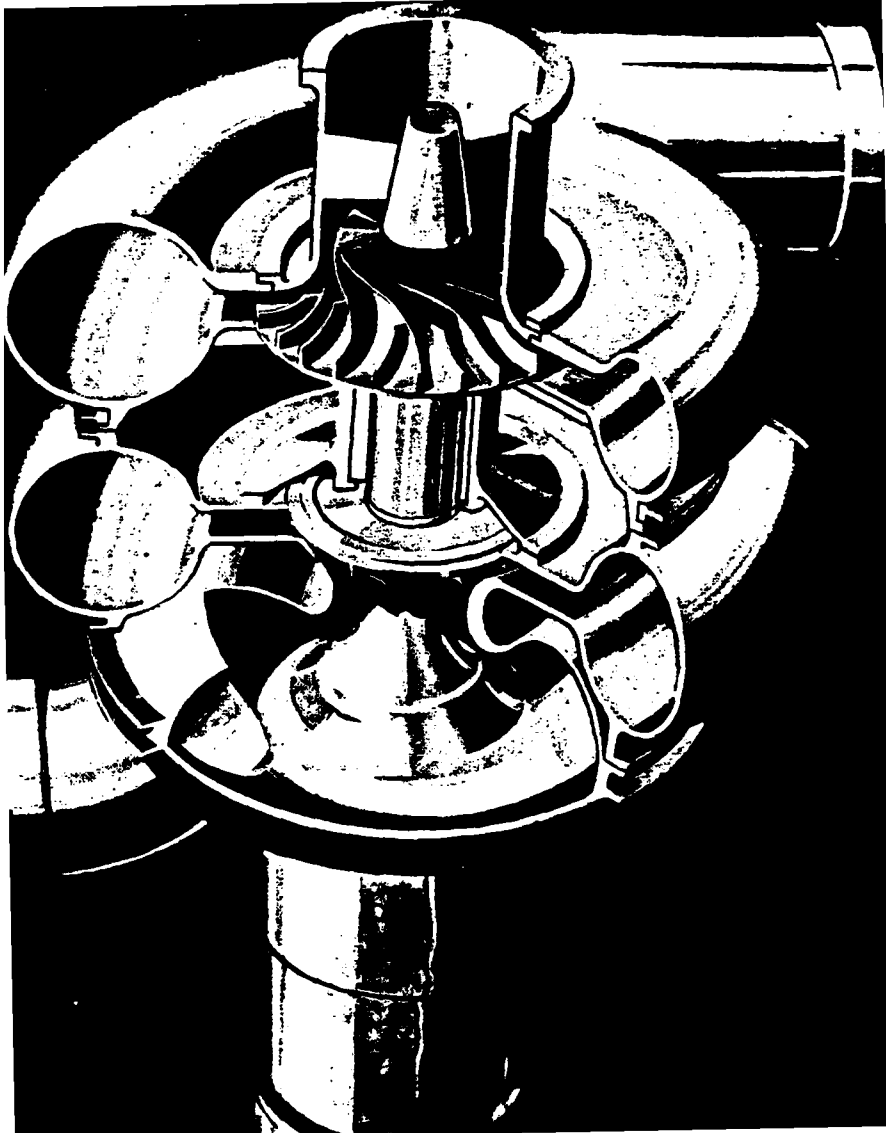

V-1-10

This configuration of a gas cooled reactor driving a closed cycle Brayton system indicates the expected equipment arrangement for space applications. Because the cycle's waste heat rejection is governed by the Stefan-Boltzman law, the cycle temperature ratio tends toward 0.75 with intentional sacrifices in cycle efficiency in order to minimize radiator area.

**NUCLEAR BRAYTON CYCLE
SPACE POWERPLANT**

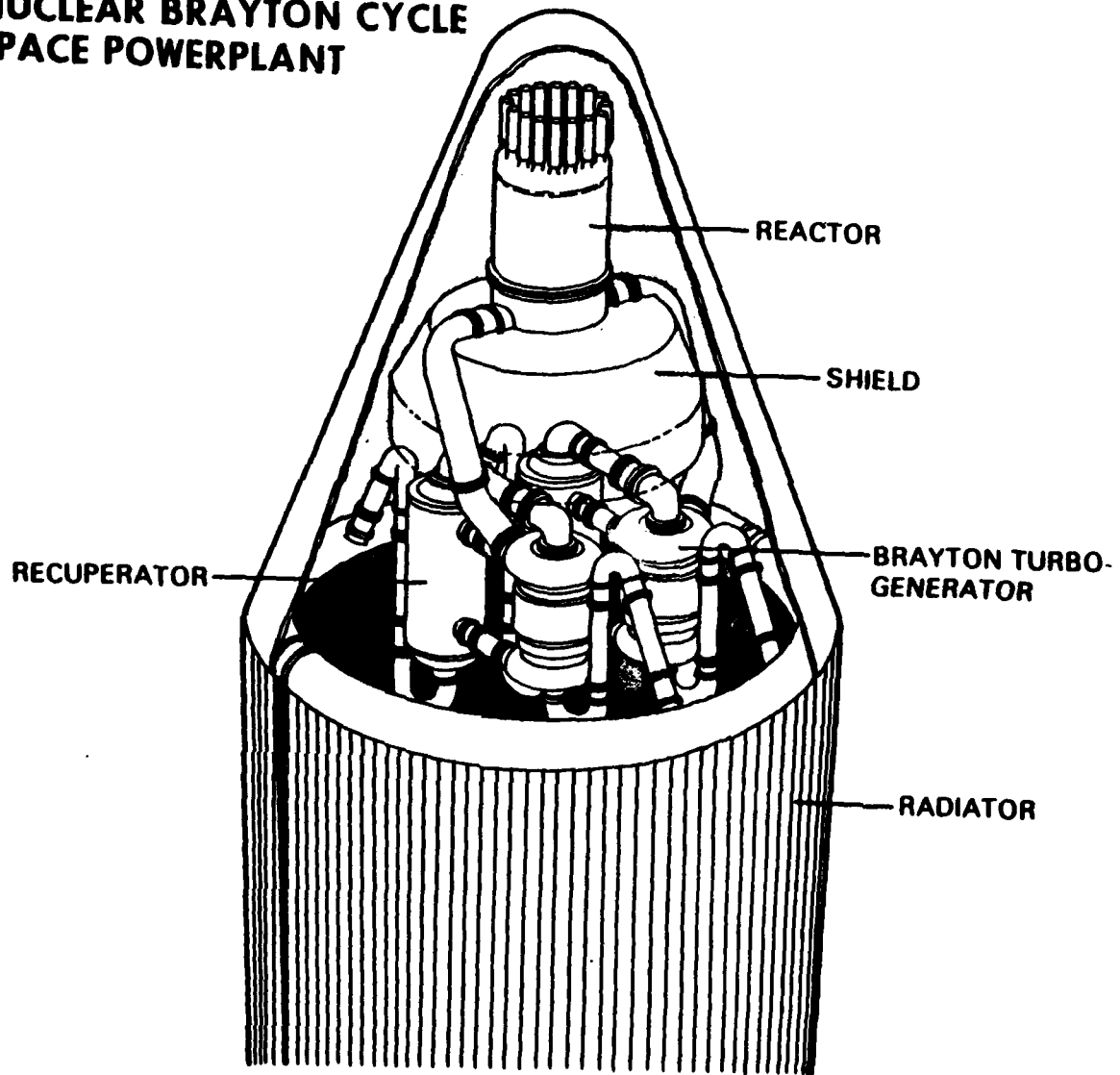

V-1-11

V-1-12

The heat pipe radiator design (AIResearch) shown here provides a reference point for space radiator design for Brayton systems. Multiple heat pipes and armored manifolds for the cycle's working gas provide meteoroid protection. For multi MW systems, the radiator's size and weight dominance on the system may dictate assembly on-orbit.

AIRESEARCH MANUFACTURING COMPANY OF ARIZONA

A DIVISION OF THE GARRETT CORPORATION
PHOENIX, ARIZONA

V-1-13

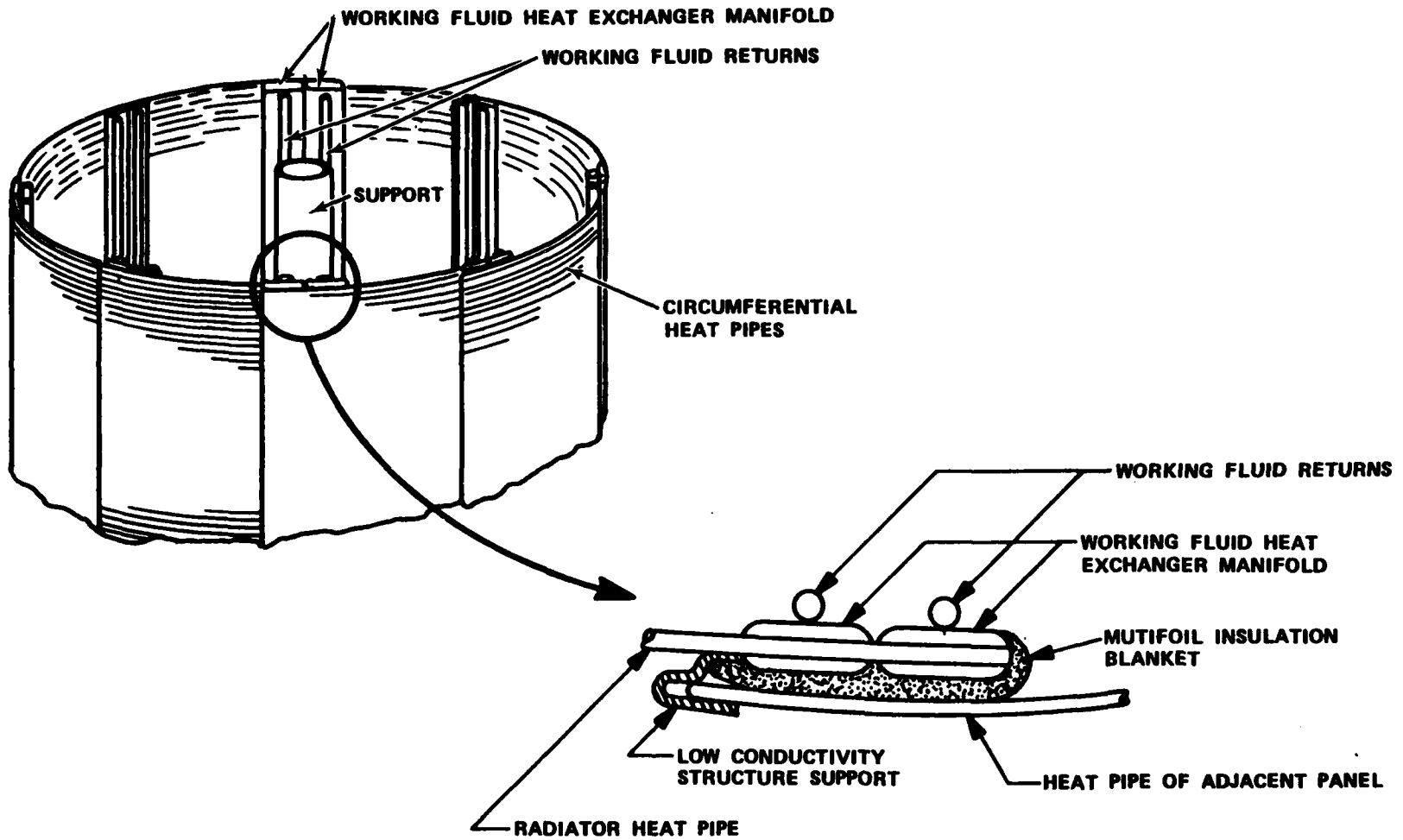

Cylindrical Heat Pipe Radiator Conceptual Design

V-1-14

THE ABILITY OF HIGH TEMPERATURE MATERIALS TO FUNCTION RELIABLY WILL LARGELY DETERMINE THE SELECTION OF CYCLE PEAK TEMPERATURES IN FUTURE SYSTEMS. CLASSES OF MATERIALS AND THEIR EXPECTED DATES OF AVAILABILITY FOR USE ARE SHOWN IN THIS TABLE.

EXPECTED INCREASES IN MAX CYCLE TEMPERATURE

<u>WHEN</u>	<u>TYPE</u>	<u>TURBINE INLET</u>
Now	SUPERALLOYS	1750°F
MID 80's	● ADVANCED SUPERALLOYS ● REFRACTORY METALS	1950°F
LATE 80's	ADVANCED REFRACTORIES	2250°F
EARLY 90's	CERAMICS	2500°F

V-1-15

V-1-16

Several of the considerations that we have discussed herein lead to the conclusion that increased operating temperatures, both at the turbine inlet and compressor inlet, will enhance the potential for closed cycle Brayton space systems in the multi MW range. Our ability to obtain temperatures approaching or exceeding 2500⁰F will be paced by the development and qualification of advanced refractories and ceramics.

CRITICAL PATH R&D NEEDS

- Development and Qualification of High Temperature Materials For Turbomachinery and HX's.
- Multi MW(e) Systems Need High ($> 1000^{\circ}\text{F}$) Space Heat Rejection To Minimize Radiator Area and Weight
 - Heat Pipe Configurations
 - Advanced Concepts

Some leading candidate materials in each of the classes are
listed in this chart.

INDICATED TRENDS IN MATERIALS USE

CLASS

Superalloys

Mechanical Alloy
Oxide Dispersion Strengthened
Powder Met
Rapid Solidification

MA-754

IN-100

Advanced Superalloys

Mechanical Alloy (ODS)
Directional Solidification
Single Crystal

MA-600E

MAR-M-247 (Mod)

MAR-M-247 (Mod)

Refractory Metals

Niobium Alloys
Moly Alloys

B88, B89

TZM

Advanced Refractory

Composite - Tungsten Wire
Reinforced Matrix

Ceramics

Silicon Carbide

Silicon Carbide

RANKINE POWER CONVERSION OVERVIEW

by

J. R. Peterson
General Electric Company

SPECIAL CONFERENCE ON PRIME POWER FOR HIGH ENERGY SPACE POWER SYSTEMS

A B S T R A C T

Extensive work was conducted in the 1960's and early 1970's toward the development of Rankine cycle space power systems, using organics, mercury and potassium as boiling/condensing working fluids. The mercury and potassium development sponsored by NASA stopped in the early 1970's, whereas organic Rankine cycle work directed towards isotope heat sources continued to the late 70's. This presentation summarizes the general status of Rankine space power conversion technology. The potassium Rankine cycle is projected to be most attractive for high energy space power systems, above one megawatt; the technical status of this system is discussed in more detail.

The potassium Rankine cycle offers the potential for the smallest radiator and lowest specific weight of any dynamic space power conversion system for large (megawatt) power levels. The cycle is a close approximation to the ideal Carnot cycle, and the potassium working fluid has thermodynamic characteristics such as to permit optimization of radiator temperature for lowest system specific weight. The specific weight projected for a potassium system providing 300kW_e to the user is 59 lb./kW_e -- lower values are anticipated for higher power levels. The most recent development work on the potassium Rankine system, sponsored by NASA, was directed towards component and materials technology. A good technology base was established, and development had proceeded to the level of subscale component endurance testing. Further fundamental development in the direction of direct condensing radiators and direct boiling/heat-pipe reactors would lead to lower system specific weight. A strong materials effort is also needed. Full scale component development and testing followed by a ground system test are required to fully establish the technology.

RANKINE CYCLE CHARACTERISTICS

HIGH EFFICIENCY

**CONFORMS CLOSELY TO CARNOT CYCLE
SMALL RADIATOR/LOW SPECIFIC WEIGHT**

EXTENSIVE COMMERCIAL EXPERIENCE

UTILITY SYSTEMS

REFRIGERATION

TOTAL ENERGY SYSTEMS

RELATIVELY COMPLEX

BOILING & CONDENSING

CORROSION/EROSION/MASS TRANSFER

RANKINE SPARE POWER TECHNOLOGIES

MAJOR PROGRAMS	WORKING FLUID	POWER	TURBINE TEMPERATURE	RADIATOR SPECIFIC AREA	CONTAINMENT ALLOYS
DIPS	THERM	1.3kw	350°C	30	STEELS
SNAP 8	MERCURY	35 kw	675°C	5.7	STAINLESS STEELS
SNAP-50/ SPUR ADVANCED RANKINE	POTASSIUM	300kw UP	1150°C	1.0	REFRACTORY METALS

SPACE RANKINE TECHNOLOGY STATUS

	MATERIALS TECHNOLOGY	COMPONENT TECHNOLOGY	GROUND SYSTEM
ORGANIC (1.3 kw)	ESTABLISHED	> 10,000 HRS	> 10,000 HRS
MERCURY (35 kw)	ESTABLISHED	> 10,000 HRS	> 10,000 HRS
POTASSIUM (300 kw)	LARGELY ESTABLISHED	> 5000 HRS SUBSCALE	—

RANKINE CYCLE APPLICATION VS POWER LEVEL

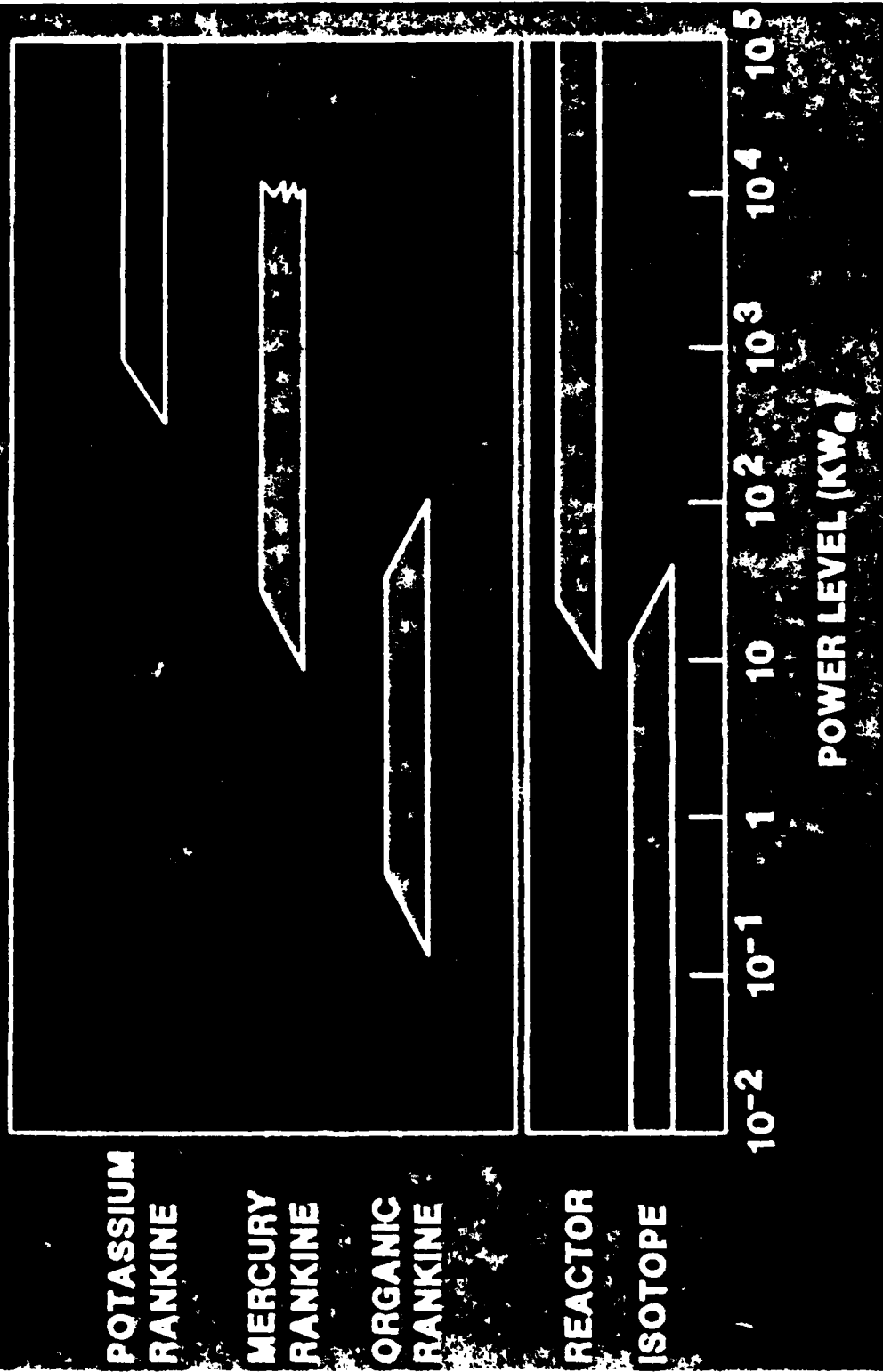

POTASSIUM
RANKINE

MERCURY
RANKINE

ORGANIC
RANKINE

REACTOR

ISOTOPE

10^{-2} 10^{-1} 1 10 10^2 10^3 10^4 10^5

POWER LEVEL (KW)

POTASSIUM RANKINE CYCLE

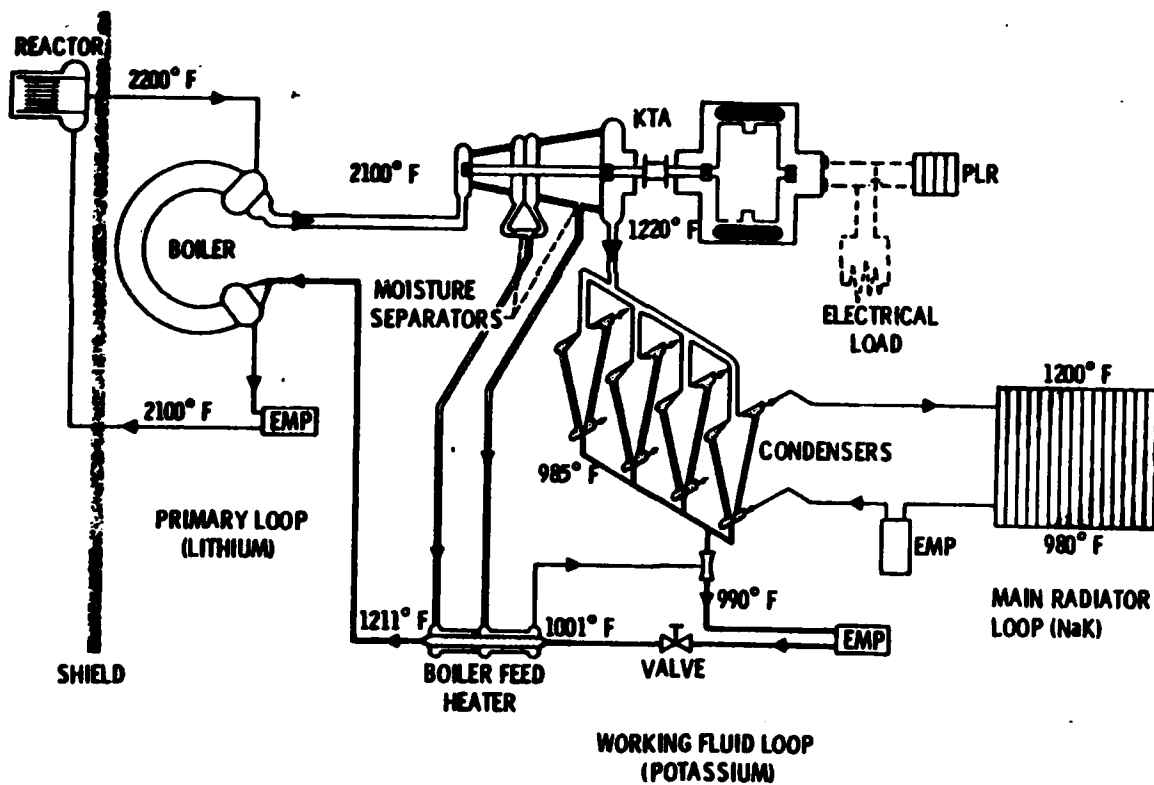

V-2-5

CD-10446-03

UNMANNED SPACE PROBE APPLICATION OF 400 KW RANKINE CYCLE NUCLEAR POWER PLANT

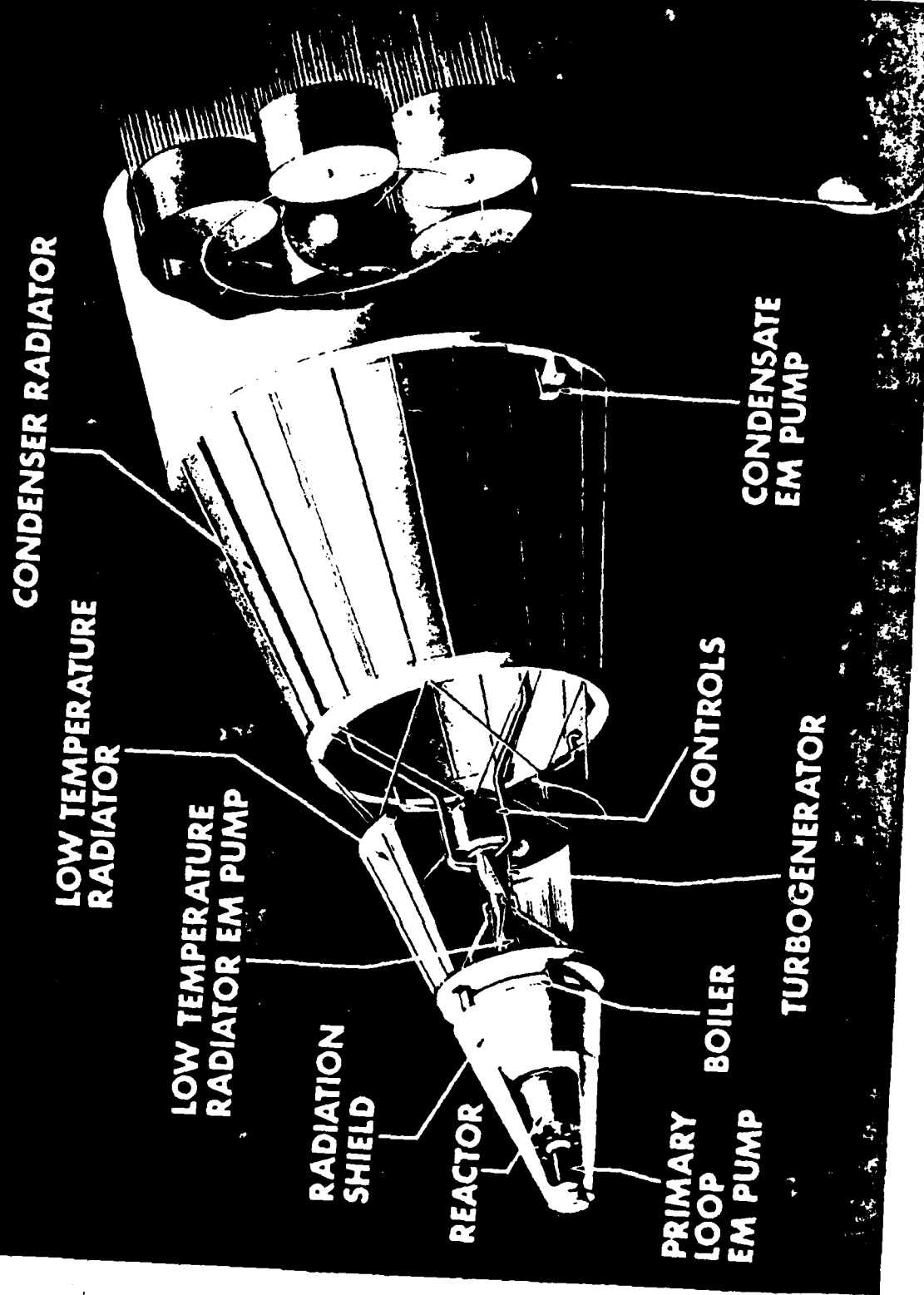

Copy available to DDC does not permit fully legible reproduction

MATERIALS STATUS

HIGH TEMPERATURE CONTAINMENT,
PUMPS, BOILER

T-111 (Ta-8W-2Hf)
Cb-1Zr

TURBINE WHEELS

TZM (Mo-.6Ti-.1Zr-.03C)

POTASSIUM BEARING MATERIALS

SEVERAL TESTED SUITABLE

RADIATOR LOOP

STAINLESS STEELS

CONTAINMENT & MATERIAL FABRICABILITY AND LIFE
VERIFIED TO 10,000 HRS AT SYSTEM CONDITIONS

HIGH TEMPERATURE CREEP AND STRESS RUPTURE
DATA ARE INSUFFICIENT

FURTHER DATA NEEDED FOR LONG TERM MATERIALS
INTERACTIONS AND MASS TRANSPORT

MAJOR MATERIALS SUPPORT REQUIRED FOR
FABRICATION SCALE-UP

POTASSIUM TURBOALTERNATOR

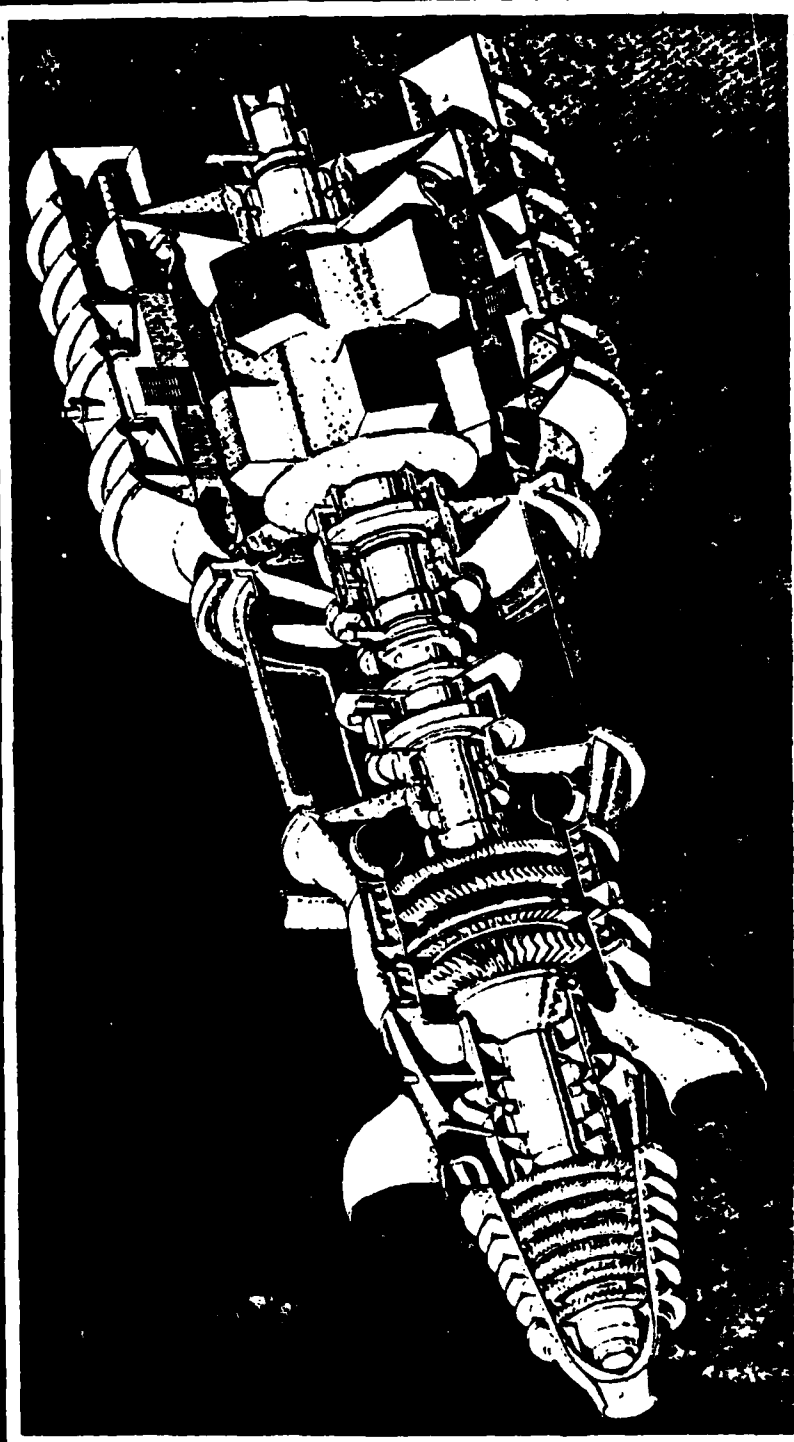

THREE STAGE CONDENSATE EXTRACTION TURBINE



Copy available to DTIC does not
permit fully legible reproduction
V-2-9

CONDENSATE EXTRACTION VORTEX SEPARATOR

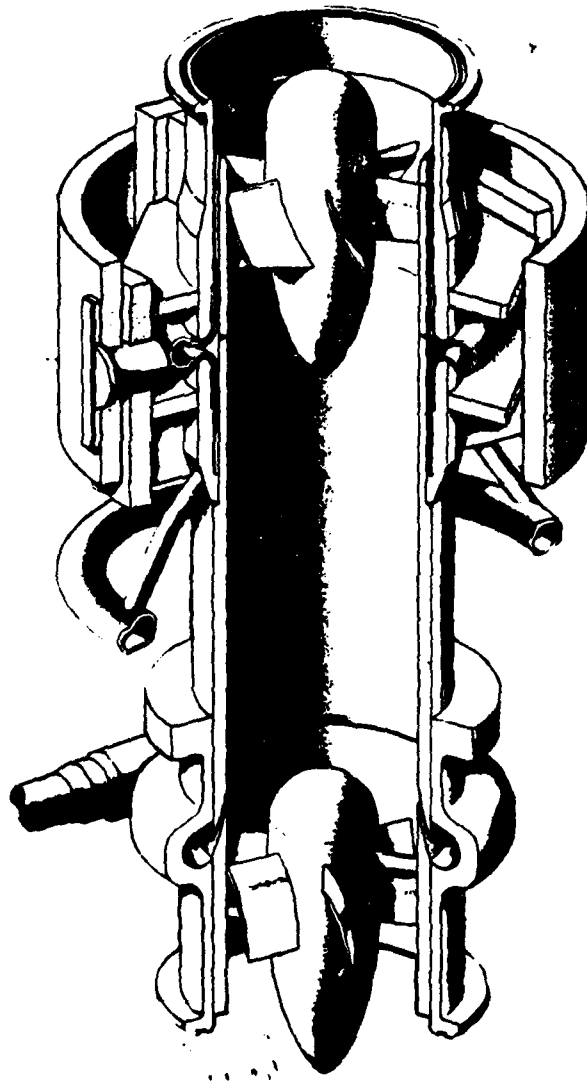

V-2-10

**SECOND STAGE TURBINE WHEEL AFTER 5000 HOUR
ENDURANCE TEST AND VAPOR BLASTING (FORWARD FACE)**



TURBOALTERNATOR TECHNOLOGY

STATUS

- FULL SCALE, FEW STAGE MACHINES TESTED TO 500 HOURS
- 75% TURBINE EFFICIENCY AND PERFORMANCE PREDICTIONS CONFIRMED
- EROSION LIMITS AND CONTROL EQUIPMENT CONFIRMED BY TEST

DEVELOPMENT REQUIRED

- POTASSIUM BEARING PROOF TESTING
- ALTERNATOR BORE SEAL FABRICATION, DEVELOPMENT AND PROOF-TESTING
- FULL-SCALE TURBOALTERNATOR FABRICATION AND ENDURANCE TESTING
- LIQUID EROSION AND EXTRACTION DEVICE MECHANISMS DEVELOPMENT

EM BOILER FEED PUMP

3.25 LBS/SEC - 240 PSI - 1,000°K

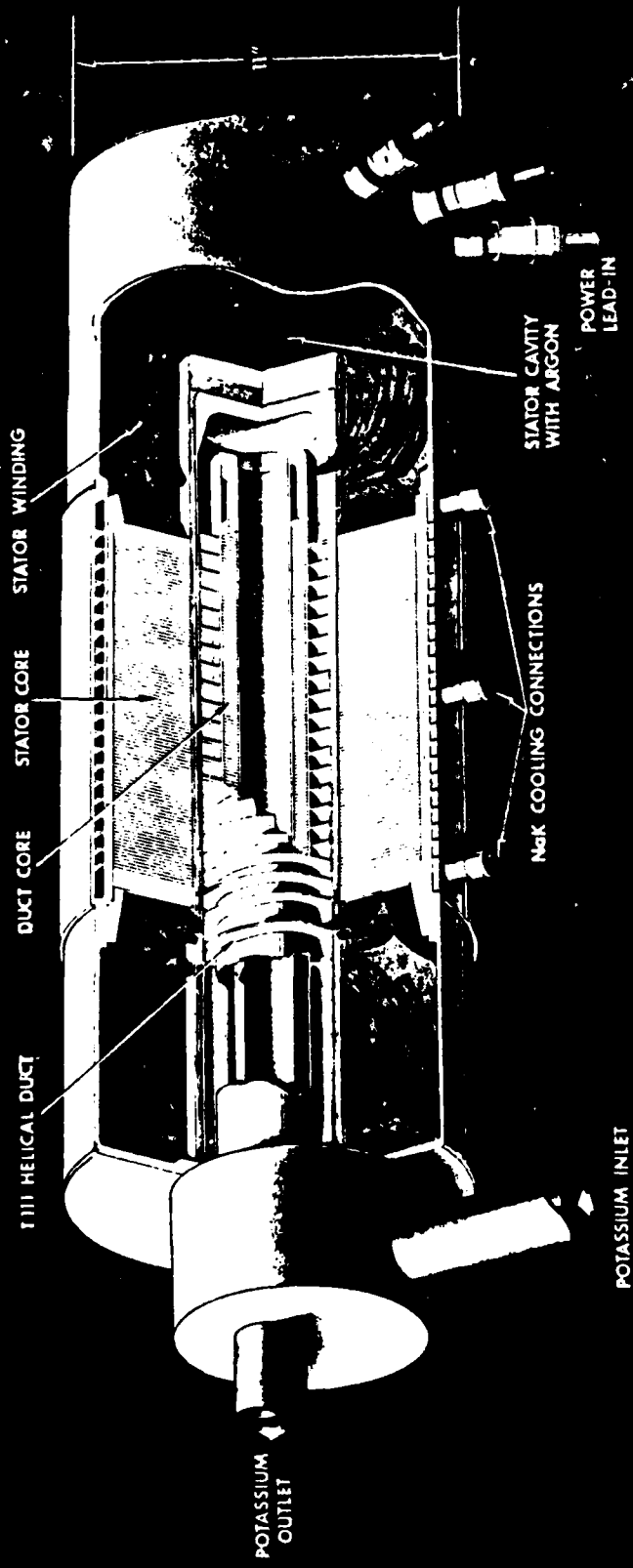

Copy available to DTIC does not permit fully legible reproduction

PUMP AND VALVE TECHNOLOGY

STATUS

PROTOTYPE BOILER FEED EM PUMP FABRICATED AND COMPLETED 10,000 HOUR ENDURANCE

SUBSCALE HIGH TEMPERATURE VAPOR AND LIQUID VALVES SUCCESSFULLY DEVELOPED AND ENDURANCE TESTED

DEVELOPMENT NEEDS

FABRICATION AND TEST OF REACTOR COOLANT EM PUMP, OR ALTERNATIVE HEAT PIPE/BOILER ASSEMBLY

DEVELOPMENT AND TEST OF FULL-SCALE HIGH TEMPERATURE VALVES

IMPROVED PUMP EFFICIENCIES

3 MW ONCE-THROUGH POTASSIUM BOILER ADVANCED RANKINE SPACE POWER SYSTEM

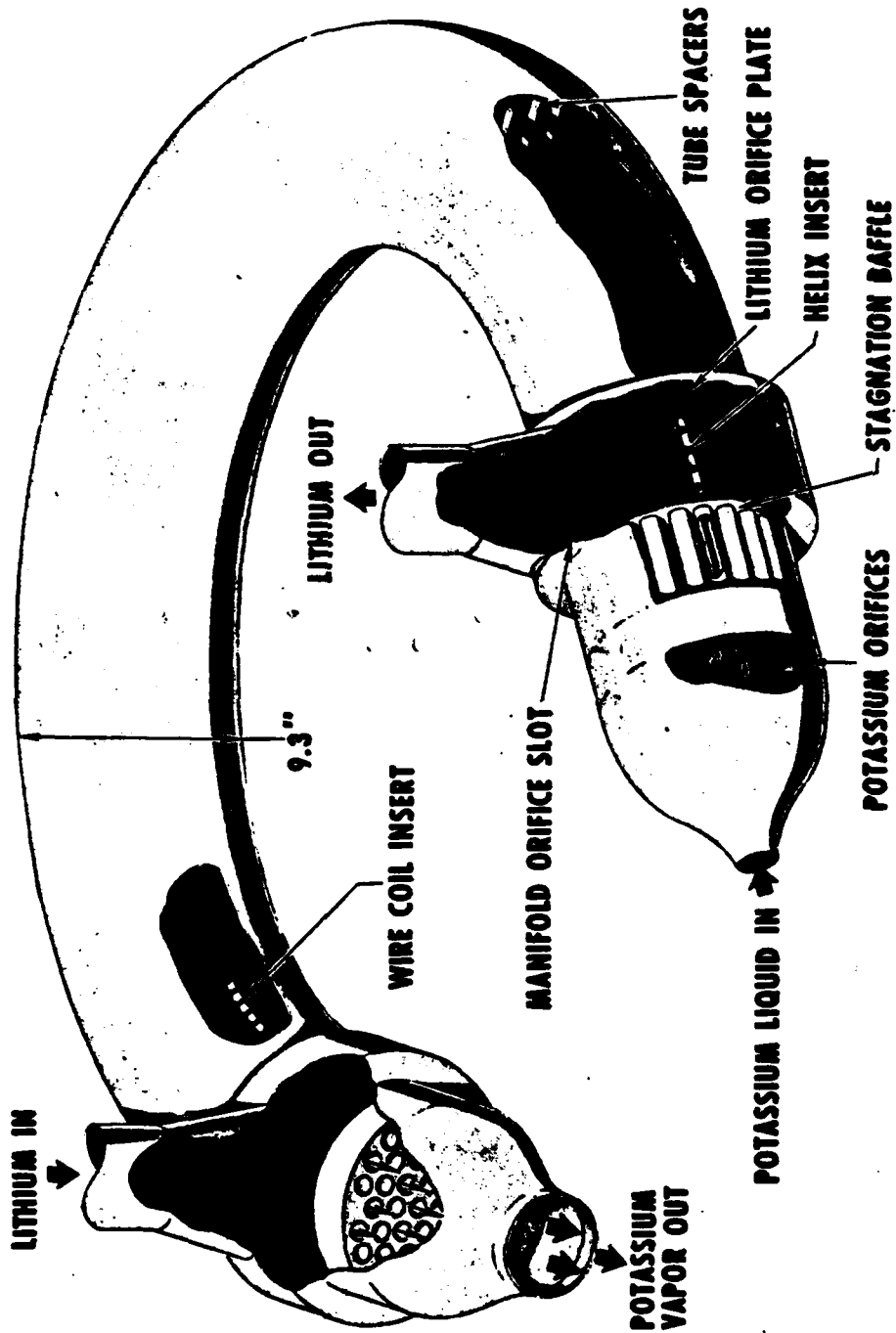

3 MW ONCE-THROUGH POTASSIUM BOILER ADVANCED RANKINE SPACE POWER SYSTEM

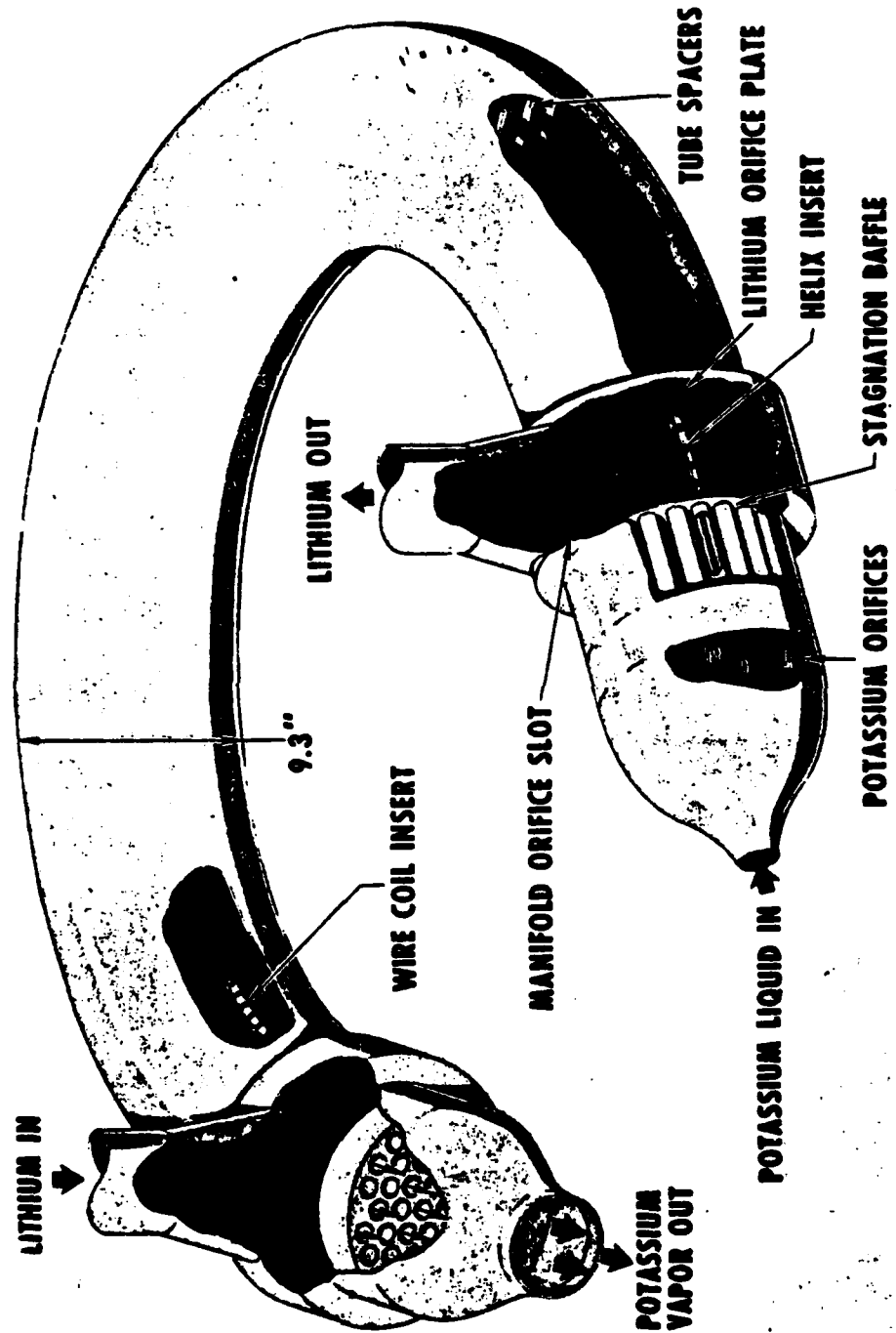

POTASSIUM BOILER DEVELOPMENT TEST RIG

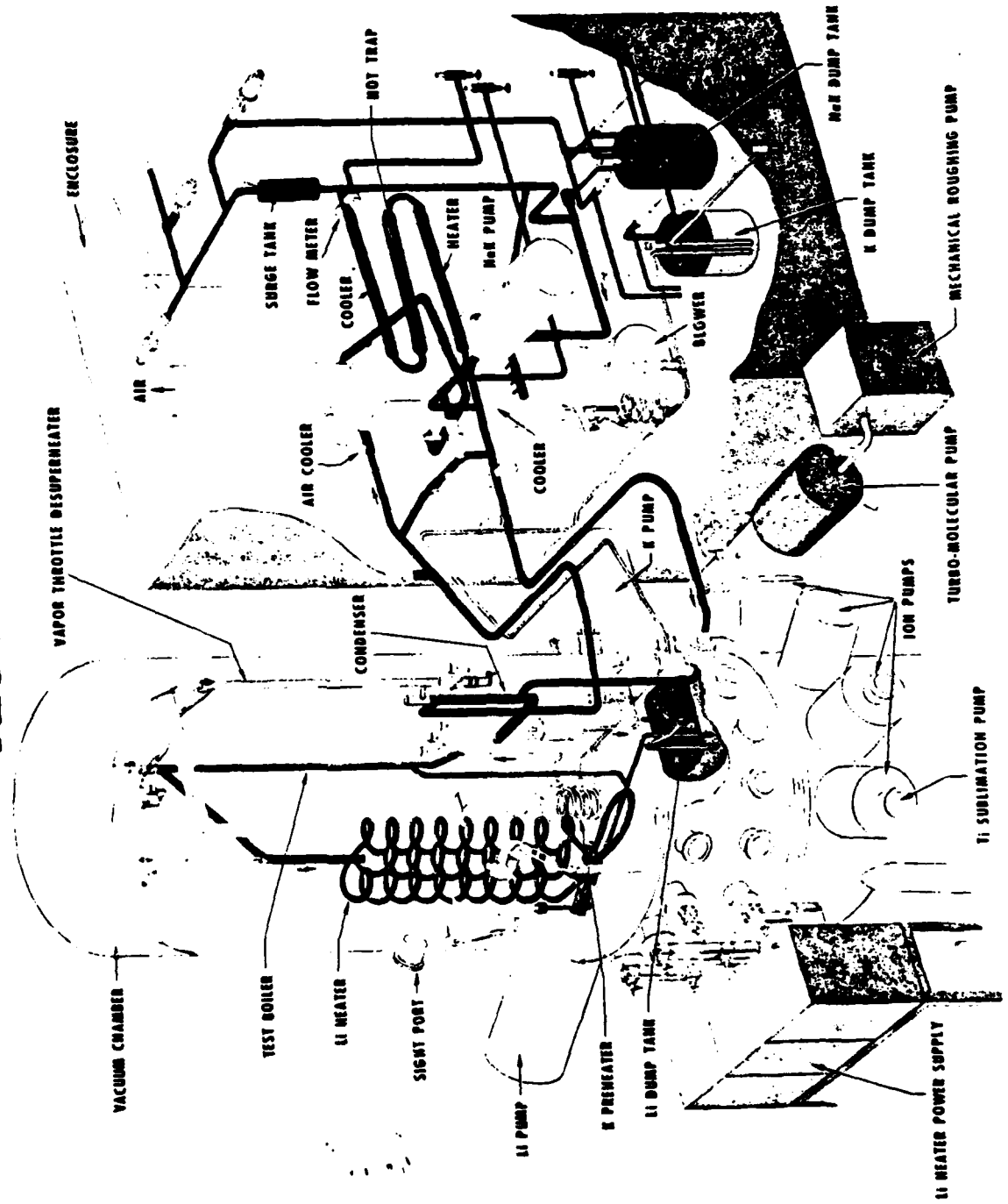

LITHIUM HEATER & POTASSIUM THROTTLE
100 kW @ 2100°F POTASSIUM TEST

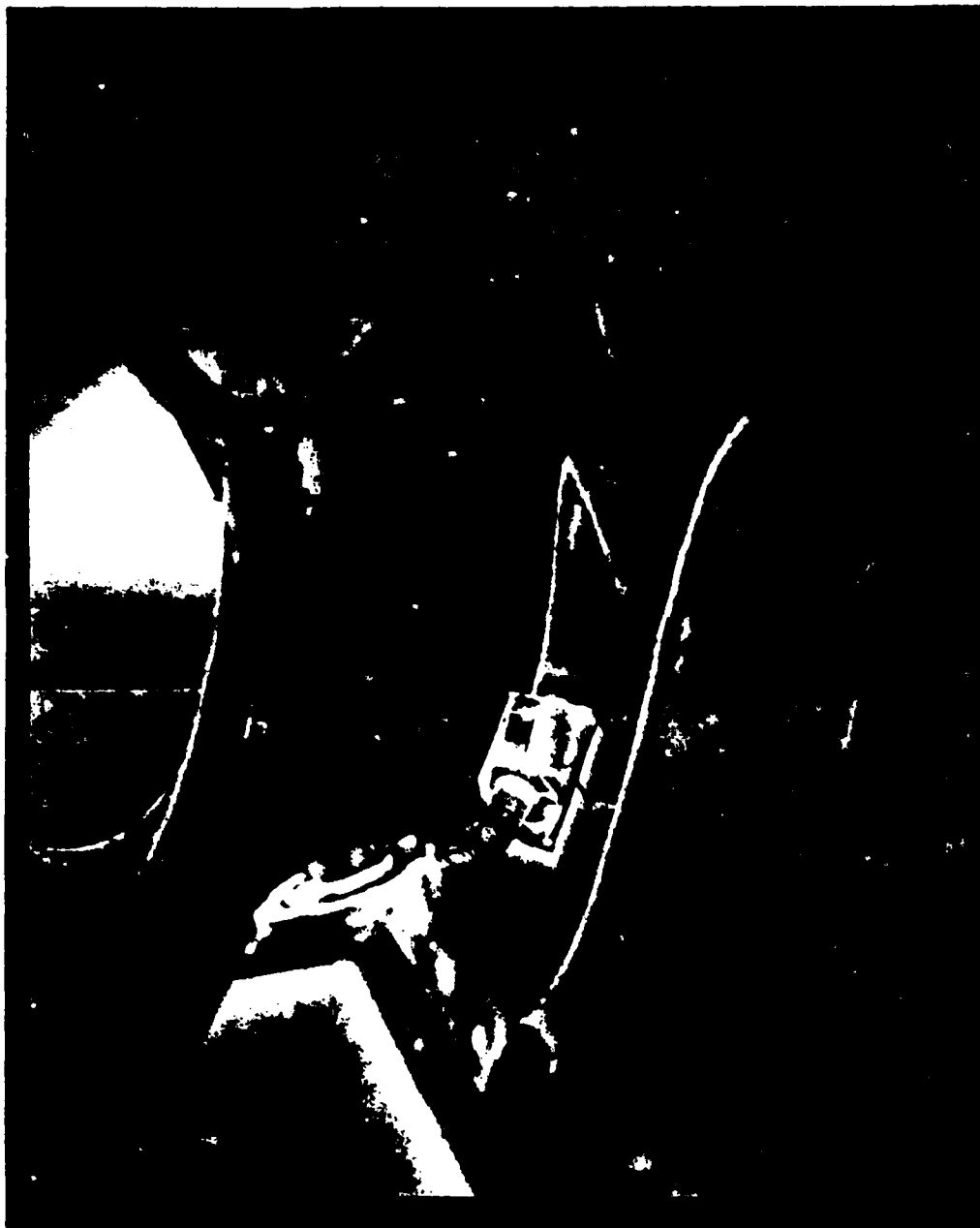

Copyright © 1964 by General Electric
permitted by the Patent and Trademark Office
does not constitute an admission of liability

BOILER/CONDENSER TECHNOLOGY

STATUS

FUNDAMENTAL TWO-PHASE FLOW AND HEAT TRANSFER DATA OBTAINED INSIDE TUBES WITH & WITHOUT SWIRL INSERTS
DESIGN METHODS ESTABLISHED AND PROVEN BY SINGLE & FEW-TUBE TESTING
BOILING NUCLEATION AND LIQUID CARRY-OVER PROBLEMS RESOLVED

DEVELOPMENT NEEDS

FUNDAMENTAL TWO-PHASE FLOW AND HEAT TRANSFER DATA OUTSIDE TUBES
DEVELOPMENT AND DEMONSTRATION OF HEAT PIPE/BOILER COUPLING OVER LOAD RANGE
FUNDAMENTAL HEAT TRANSFER/HYDRAULIC STABILITY DATA AND DESIGN METHODS FOR DIRECT CONDENSING RADIATORS
FULL SIZE COMPONENT FABRICATION & ENDURANCE TESTING

POTASSIUM RANKINE CYCLE OUTLOOK

PROBABLY BEST SYSTEM FOR MEGAWATT POWER LEVELS
SMALLEST RADIATOR
BEST SPECIFIC WEIGHT

CYCLE PERMITS FURTHER IMPROVEMENT
DIRECT CONDENSING OR HEAT PIPE RADIATOR
DIRECT BOILING OR HEAT PIPE REACTOR
INCREASE IN REACTOR TEMPERATURE

LONGEST DEVELOPMENT TIME
TEAMS DISPERSED / NO RECENT ACTIVITY
DIFFICULT TECHNOLOGY

Copy available to DTIC does not
permit fully legible reproduction

**DIRECTIONS FOR FUNDAMENTAL DEVELOPMENT
POTASSIUM RANKINE CYCLE**

HIGH TEMPERATURE, LONG-TERM MATERIALS PROPERTIES

LIQUID METAL BEARING DESIGN METHODOLOGY DEVELOPMENT

**HEAT TRANSFER AND TWO-PHASE FLOW RELATIONSHIPS FOR
ZERO-GRAVITY BOILING AND CONDENSING OUTSIDE TUBES**

**MECHANISMS OF TURBINE EROSION AND IMPROVED
PREDICTIONS FOR MOISTURE CONTROL**

IMPROVED FM PUMP EFFICIENCIES

**EVALUATION OF CASCADED RANKINE CYCLES AND/OR
MIXED WORKING FLUIDS**

REFERENCES

1. J.A. Heller, T.A. Moss and S.J. Barns, "Study of a 300 KW_e Advanced Nuclear-Electric Power System", Proceedings of the Fourth Intersociety Energy Conversion Engineering Conference, The Science Press, Ephrata, Pennsylvania.
2. H.O. Slone and L.I. Shure, "Nuclear Power for Manned Orbiting Space Stations", NASA TM X-52774, presented at the Conference on Aerospace Nuclear Applications, Huntsville, Alabama, April 28-30, 1970.
3. R.E. English, "Technology for Nuclear Dynamic Space Power Systems", ANS Conference on Aerospace Nuclear Applications (April 1970), to be presented.
4. S.V. Manson, "A Review of the Alkali Metal Rankine Technology Program", 1968 Intersociety Energy Conversion Engineering Conference, University of Colorado, August 13-17, 1968.
5. M.H. Krasner, H.W. Davison and A.J. Diaguilla, "Conceptual Design of a Compact Fast Reactor for Space Power", American Nuclear Society Annual Meeting, June 13-17, 1971, Boston, Mass.
6. T.A. Moss, R.L. Davies and P.E. Moorhead, "Material Requirements for Dynamic Nuclear Space Power Systems", paper presented at Winter Meeting of the ASME, Pittsburgh, Pa., November 12-17, 1967, NASA TMX-52344, 1967.
7. T.A. Moss, "Materials Technology Presently Available for Advanced Rankine Systems", Nuclear Applications, Volume 3, February, 1967.
8. E.E. Hoffman and J. Holowach, "Cb-1Zr Rankine System Corrosion Test Loop", Contract NAS3-2547, Topical Report No. 7: General Electric Report R67SD-3016.
9. R.W. Harrison and J.P. Smith, "Advanced Refractory Alloy Loop Program", Quarterly Progress Report 21, GESP-546, General Electric Co., Cincinnati, Ohio, August 12, 1970, Contract NAS3-6474.
10. R.W. Harrison, E.E. Hoffman and R.L. Davies, "Recent Materials Compatibility Studies in Refractory Metal-Alkali Metal Systems for Space Power Applications", Fifth Intersociety Energy Conversion Engineering Conference, Las Vegas, Nevada, Sept. 21-25, 1970.
11. J.A. Bond and G.L. Converse, "Vaporization of High-Temperature Potassium in Forced Convection at Temperatures from 1800°F to 2100°F", NASA-CR-843, Contract NAS3-2528, July 1967.
12. J.R. Peterson, "High Performance 'Once-Through' Boiling of Potassium in Single Tubes at Vapor Temperatures from 1500°F to 1750°F", NASA-CR-842, Contract NAS3-2528, August 1967.
13. S.G. Sawochka, "Thermal and Hydraulic Performance of Potassium During Condensation Inside Single Tubes", NASA-CR-851, Contract NAS3-2528, 1967.

AD-A118 887

R AND D ASSOCIATES ROSSLYN VA
PROCEEDINGS OF THE AFOSR SPECIAL CONFERENCE ON PRIME-POWER FOR --ETC(U)
FEB 82 P J TURCHI F49620-82-C-0008

NL

UNCLASSIFIED

AFOSR-TR-82-0655

7th
486.7

9

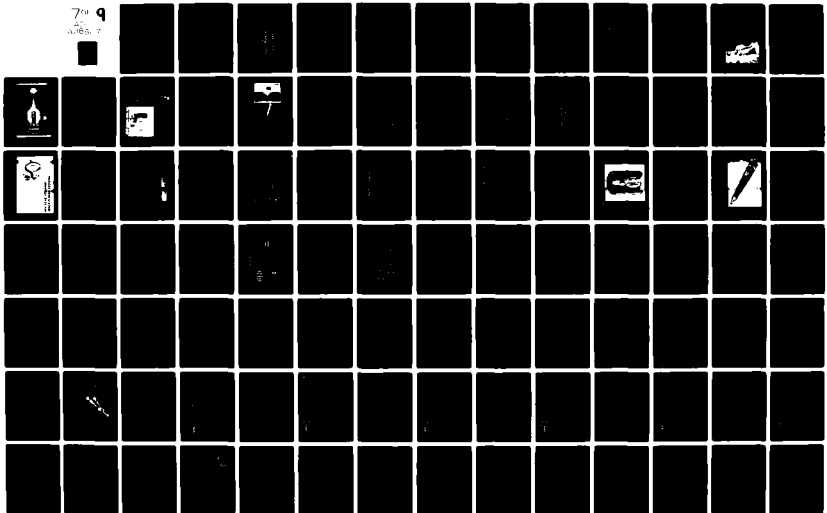

REFERENCES (Cont'd.)

14. M.U. Gutstein, G.L. Converse and J.R. Peterson, "Augmentation of Single-Phase Heat Transfer in Tubes by Use of Helical Vane Inserts", Fourth International Heat Transfer Conference, Versailles, France, September, 1970, Elsevier Publishing Co.
15. J.R. Peterson, G.L. Converse and M.U. Gutstein, "An Experimental Study of Pressure Loss and Phase Distribution for Air-Water Flow in a Tube Containing Swirl Generators", Fifth Intersociety Energy Conversion Engineering Conference, Las Vegas, Nevada, September 21-25, 1970.
16. J.R. Peterson, R.N. Weltmann, and M.U. Gutstein, "Thermal Design Procedures for Space Rankine Cycle System Boilers", Paper presented to Intersociety Energy Conversion Engineering Conference, Boulder, Colorado, August 13-16, 1968.
17. J.R. Peterson, "Computer Program for the Thermal Design of Two-Fluid 'Once-Through' Potassium Boiler", Nuclear Systems Programs, MSD, General Electric Company, prepared for NASA under Contract NAS3-9426, December, 1968.
18. J.A. Bond, "The Design of Components for an Advanced Rankine Cycle Test Facility", Fifth Intersociety Energy Conversion Engineering Conference, Las Vegas, Nevada, Sept. 21-25, 1970.
19. R.W. Harrison and J. Holowach, "Refractory Metal Valve for 1900°F Service in Alkali Metal Systems", General Electric Co., Cincinnati, Ohio, GESP-508, April, 1970.
20. M.U. Gutstein and J.A. Bond, "Preliminary Results of Testing a Single-Tube Potassium Boiler for the Advanced Rankine System", NASA TMX-52996.
21. J.W. Gahan, A.H. Powell, P.T. Pileggi, and S.R. Thompson, "Fabrication and Test of a Space Power Boiler Feed Electromagnetic Pump. Part I - Design and Manufacture of Pump", NASA-CR (to be published).
22. J.W. Gahan, P.T. Pileggi and A.H. Powell, "Primary Loop Electromagnetic Pump Design", NASA-CR-1571, March 1970.
23. A.H. Powell and J.P. Couch, "Boiler Feed EM Pump for a Rankine Cycle Space Power System", Fifth Intersociety Energy Conversion Engineering Conference, Las Vegas, Nevada, Sept. 21-25, 1970.
24. G.C. Wesling, "Three-Stage Potassium Turbine Performance Test Summary", NASA-CR-1483, Contract NAS3-10606, December, 1969.
25. E. Schnetzer and G.M. Kaplan, "Erosion Testing of a Three-Stage Potassium Turbine", ASME paper 70-Au/Sp T-37, presented at the Space Technology and Heat Transfer Conference, Los Angeles, June 21-24, 1970.
26. E. Schnetzer, "Potassium Turboalternator Preliminary Design Study, Phase II", NASA-CR-1587, Contract NAS3-10933, June, 1970.

REFERENCES (Cont'd.)

27. R.A. Rackley, et al., AiResearch Mfg. Co. of Arizona, APS-5312-R (1969).
28. S.E. Eckard, R.J. Rossbach and G.C. Wesling, "Three Stage Potassium Vapor Turbine Condensate Extraction Test", Contract NAS3-12977, April, 1971, NASA-CR (to be issued).
29. Electrical Conductor and Electrical Insulation Materials Topical Report, NASA Lewis Research Center Report, NASA-CR-54093, October, 1964. Prepared by Westinghouse Electric Corporation, Aerospace Electrical Division, Lima, Ohio.
30. Bore Seal Technology Topical Report, NASA Lewis Research Center Report, NASA-CR-54093, December, 1964. Prepared by Westinghouse Electric Corporation, Aerospace Electrical Division, Lima, Ohio.
31. Magnetic Materials Topical Report, NASA Lewis Research Center Report, NASA-CR-54091, September, 1964. Prepared by Westinghouse Electric Corporation, Aerospace Electrical Division, Lima, Ohio.
32. High Temperature Magnetic Materials, Westinghouse Electric Corporation, Aerospace Electrical Division, Lima, Ohio. Report No. WAED 67.34E, October, 1967. Prepared on "Contract for Development and Evaluating Magnetic and Electrical Materials Capable of Operating in the Temperature Range from 800° to 1600°F". Contract No. NAS3-6465.
33. W.F. Zimmerman and R.J. Rossbach, "Metallurgical and Fluid Dynamic Results of a 2000-Hour Endurance Test on a Two-Stage 200-Horsepower Turbine in Wet Potassium Vapor", ASME paper 67-GT-9, presented at the Gas Turbine Conference, Houston, Texas, March 5-9, 1967.
34. E. Schnetzer, "Two-Stage Potassium Turbine Three-Thousand-Hour Test", NASA-CR-72273, July 1967, NASA, Washington, D.C.
35. A. Thiruvengadam, G.C. Rudy and M. Gunasekaran, "Experimental and Analytical Investigation on Multiple Liquid Impact Erosion", Report 719/2, August, 1969, Hydronautics Inc., Laurel, Maryland.
36. J.R. Peterson, J.A. Heller and M.U. Gutstein, "Status of Advanced Rankine Power Conversion Technology", presented at the 17th Annual Meeting of the American Nuclear Society, June 13-17, 1971, Boston, Massachusetts.

V-3-1

Nuclear Powered Organic Rankine Systems For Space Applications

ABSTRACT

Organic Rankine Cycle (ORC) experience and its technology base are briefly discussed. The Dynamic Isotope Power System (DIPS) and its current status is reviewed. The characteristics and attributes of the ORC system are presented along with a discussion on the compatibility with different heat sources. System weights are given for isotope and reactor systems. System reliability is enhanced by redundant power conversion systems and a heat pipe radiator.

Presentation Outline

- **Dynamic Isotope Power System (DIPS) Status**
- **Organic Rankine Cycle Characteristics**
- **Nuclear Space Power Systems**
- **Summary**

V-3-3

V-3-4

Considerable experience has been obtained in ORC systems with several types of heat source. Initial hardware experience was obtained with solar powered systems. However, starting in the mid 1960s a technology program was started, aimed at solving component technology problems for space power systems. This led to the DOE funded DIPS program in which a ground demonstration system was built and tested. In parallel with this effort were several programs for terrestrial power, starting with a fossil-fueled system, and moving towards waste heat recovery as fuel costs escalated. Currently six 600 KWe and 750 KWe waste heat recovery systems are being field tested, and a 200 KWe solar powered system is in daily use for irrigation purposes.

ORC Experience

V-3-5

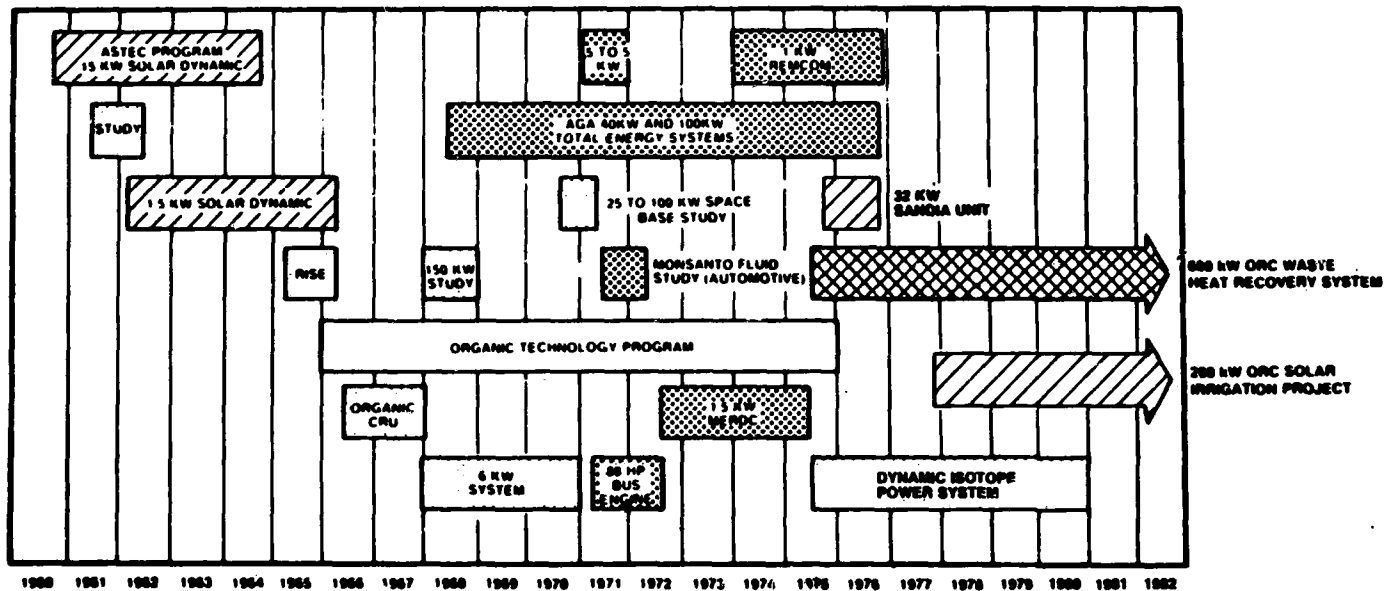

-  — SOLAR
-  — WASTE HEAT
-  — FOSSIL FUEL
-  — NUCLEAR



This shows an artist's concept of a design for a 22 KWe point focussing solar-powered program. This is one of many ORC systems that Sundstrand has designed in over 21 years of development of this type of system. Eleven different systems have been built with different heat sources, fluids and at different power levels. Fluid investigations have been ongoing and over 50,000 hours have been accumulated on both Dowtherm A and Toluene systems.

Sundstrand's Technology Base

- **Over 21 years**
 - Multiple Heat Sources
 - Power Levels (0.5 To 750 kW_e)
- **Hardware**
 - 11 Different Systems
 - CRU's (Over 28,000 Hrs)
- **Fluid Analysis**
 - Multiple Working Fluids
 - Toluene (Over 50,000 Hrs)
 - Dowtherm (Over 50,000 Hrs)
- **Boiler Development**
 - 10 Different Systems.

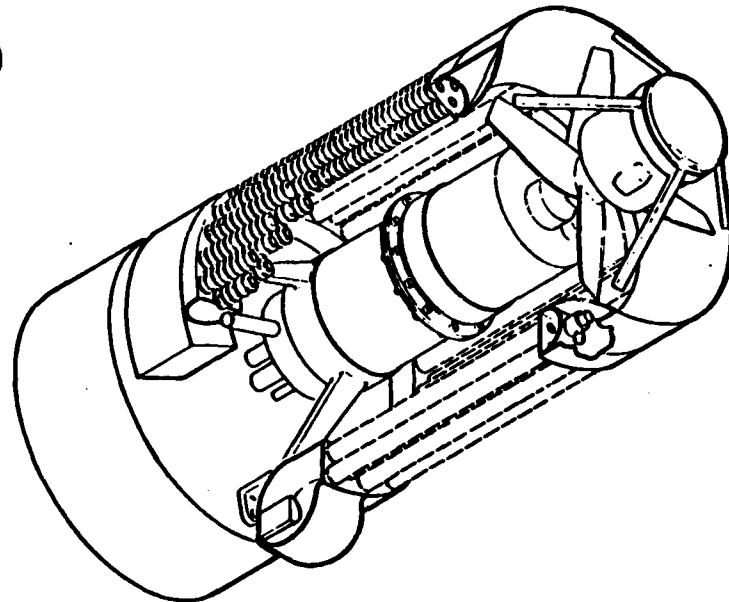

V-3-7



V-3-8

The DIPS contract was initiated in 1975 and included a Flight Conceptual Design and the building and testing of a prototypic ground demonstration system. This program was funded by the Department of Energy and concluded at the end of 1980.

V-3-9



SUNDSTRAND ENERGY SYSTEMS

Dynamic Isotope Power System

UNDER CONTRACT TO THE
Department of Energy

Sundstrand Energy Systems



This shows a simplified schematic of an isotope powered ORC system. An isotope heat source (1) is used to vaporize the working fluid (the entectic mixture of biphenyl and biphenyl ether), which is then expanded across an axial flow turbine. The turbine is an integral part of the turboalternator pump (2), which generates electricity. The turboalternator motor is supported on working fluid lubricated hydrodynamic bearings (3) and drives a centrifugal pump (4) to pressurize the working fluid. When the working fluid leaves the pump the flow splits, part going to the regenerative heat exchanger in the power conversion system (5), and the remainder passing to the radiator (8) where system waste heat is rejected. From here the cold fluid flows to the jet condenser (6) where the vapor leaving the regenerator is condensed. The accumulator (7) is used to maintain and control system pressure levels and the electronic controller (9) rectifies the alternator output and controls speed and voltage.

Dynamic Isotope Power System

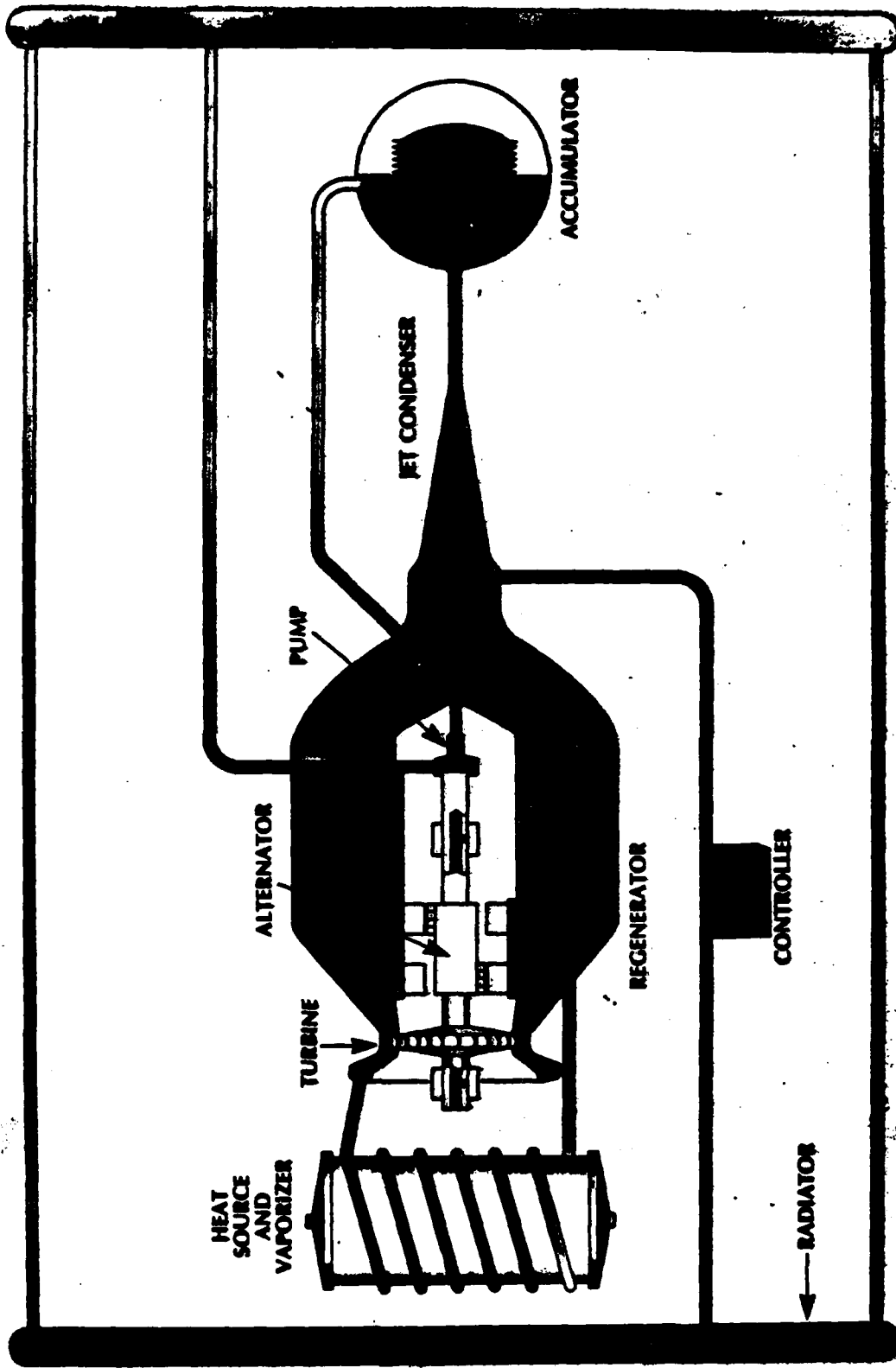

V-3-11

V-3-12

The DIPS comprises a Rankine power conversion system, 3 Mhw or 2 GPHS heat sources and a cylindrical radiator. The system packaging concept shown is one for a non-integrated spacecraft, but the system is very flexible in terms of location of the major components. This shows the final assembly of the ground demonstration system in a clean room prior to installation in a vacuum chamber for testing.

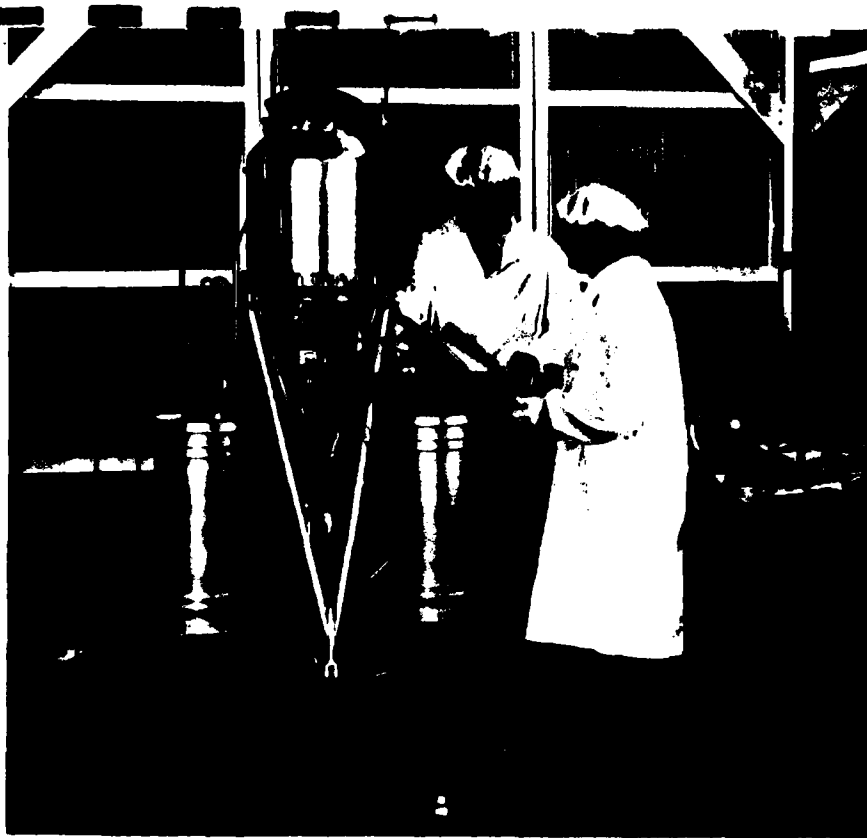

V-3-13

Dynamic Isotope Power System

ATTRIBUTES

- Improved Efficiency
- High Reliability
- Conventional Materials
- Power Level Flexibility

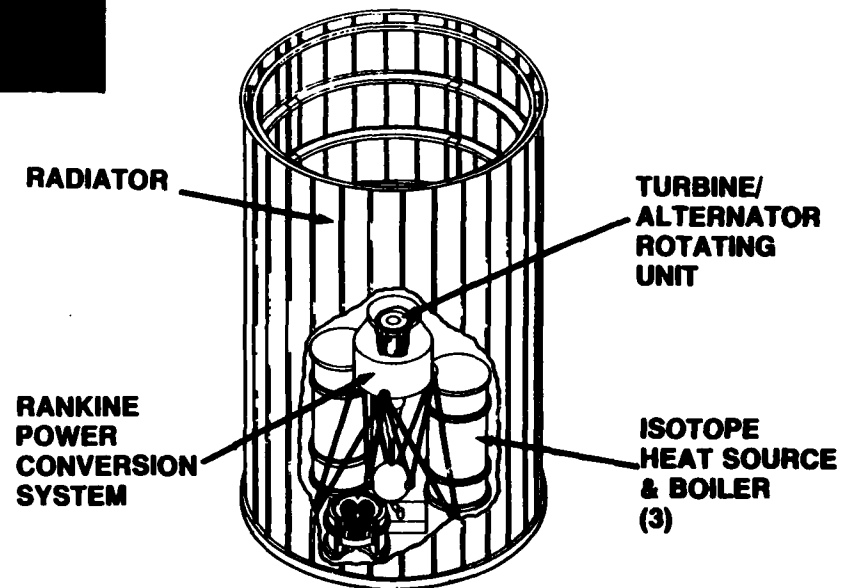

V-3-14

A full size radiator was built and tested hydraulically. Although it was not coupled to the system, thermal tests were performed on full size panels. The thermal control coating was Z93.

V-3-15

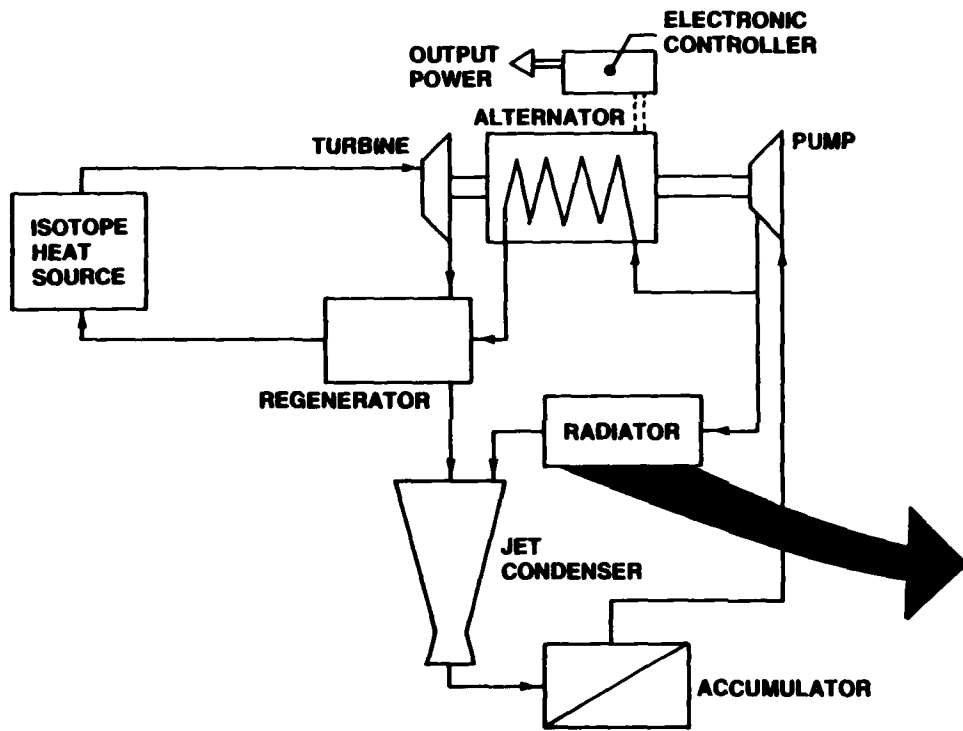

The design specification called for a design point of 1,300 watts electrical, with the capability of operation from 500 to 2,000 watts. The system power level could be extended to 5 KW without major modifications. Radiator and heat source sizes would be adjusted to match power level.

The ground demonstration system was designed to deliver 38V DC, but could deliver AC more efficiently. Projected system efficiencies for a Flight System are 18% for DC, and 19% for AC power.

The use of redundancy in design has resulted in system reliability of .95 for a seven year mission.

The projected Flight System weight is 450 pounds for a 1,300 watt mission while the volume and configuration are adaptable to the mission requirements.

System Summary Data

- **RATED OUTPUT POWER**
GROUND DEMONSTRATION SYSTEM 1,300 W(e)
FLIGHT SYSTEM 500-2,000 W(e) AND HIGHER
- **OUTPUT VOLTAGE**
GROUND DEMONSTRATION SYSTEM 28v D.C.
FLIGHT SYSTEM D.C. or A.C.
- **SYSTEM EFFICIENCY**
D.C. POWER 28v 18%
A.C. POWER 19%
- **SYSTEM RELIABILITY**95+
- **LIFE** 7 YEARS MINIMUM
- **FLIGHT SYSTEM WEIGHT -- 1,300 W(e)** 450 POUNDS
MAXIMUM
- **SYSTEM CONFIGURATION/VOLUME** ADAPTABLE

V-3-17



V-3-18

The technology verification phase of the DIPS program was completed in December 1980 after a 2,000 hour endurance test on the final ground demonstration system. A total time of more than 11,000 hours was accumulated with no component failures. At completion, the system had demonstrated a DC efficiency of 16.6%, and an AC efficiency of 18.5%, to be compared with design goals of 18% and 19% respectively.

DIPS Program Status

- **Technology Development Phase Complete**
- **11,000 Hours Operating Time Accumulated On Ground Demonstration System With No Component Failures**
- **16.6% System DC Efficiency (28V)**
18.5% System AC Efficiency

V-3-19



Organic Rankine Cycle Characteristics

V-3-20

The ORC is a low temperature system, with a maximum fluid temperature determined by the thermal stability of the fluid. The low temperatures typically about 700°F inherent to the system allow the use of conventional materials in the system without recourse to exotics such as refractory metals.

The characteristics of the organic working fluids lead to superheating of the turbine exhaust on expansion. The use of a regenerative heat exchanger allows a closer approach to the ideal Carnot efficiency resulting in relatively high cycle efficiencies for a given inlet temperature. Thermoelectric converters can be inserted between a high temperature heat source and the organic system. In this case the heat rejection device for the thermoelectrics becomes the heat addition device for the organic. Although the thermoelectric device operates at relatively low efficiency the combination of the two systems results in a large performance improvement.

High system reliability is a direct fall-out from the low system temperatures, low system pressures, and low turbine tip speeds, combined with redundancy of critical items where required.

The ORC employs state-of-the-art technology, which has been demonstrated in many different systems.

A pumped loop radiator, such as employed on DIPS, is inherently resistant to nuclear and laser threats.

System Characteristics

LOW TEMPERATURE SYSTEM

- **Low Temperature Heat Sources**
- **Conventional Materials**

EFFICIENT

- **High Efficiency At Low Temperature**
- **Improvement Potential With RTG Topping**

HIGH RELIABILITY

- **Low Temperature**
- **Low Stresses**

STATE-OF-THE-ART TECHNOLOGY

HARDENABLE AGAINST NUCLEAR AND LASER THREATS

V-3-22

The low temperature characteristics of the ORC make it adaptable to most available heat sources. Nuclear heat sources provide greatest versatility for the ORC in space. Studies have shown that for power levels up to about 10 KWe the isotope source, based on Plutonium 238 in oxide form, is lightest weight. The Multi-Hundred Watt (MHW) heat source represents existing technology, while the General Purpose Heat Source (GPHS) is under development at Los Alamos.

A reactor would be used at higher power levels. The low temperature ZrH was developed on the SNAP program and flight tested as SNAP10A. This reactor type is limited to 1,300°F, which is fully compatible with the low temperature organic system. A high temperature reactor, SPAR, is under development at Los Alamos with temperatures in the region of 2,200°F. This could be coupled directly to an organic system, but a thermoelectric intermediate system would make best use of the high temperatures and greatly enhance system performance.

Solar insolation could be used at lower power levels using a parabolic mirror with a thermal storage device. The low temperature of the organic system greatly reduces the accuracy requirements of the mirror.

Hybrid heat sources have been proposed for ultra-high altitude terrestrial systems employing solar or nuclear heat sources for station keeping, with fossil fuel or hydrogen for short-term high-power level requirements.

Heat Source Compatibility

NUCLEAR

- Isotope — Low Power Level
 - MHW — Existing Technology
 - GPHS — Under Development
- Reactor — High Power Level
 - Low Temperature — ZRH — Existing Technology
 - High Temperature — SPAR — Under Development

SOLAR INSOLATION

- Parabolic Mirror With Thermal Storage

HYBRID SYSTEMS

- Solar Or Nuclear With Fossil Fuel Or Hydrogen



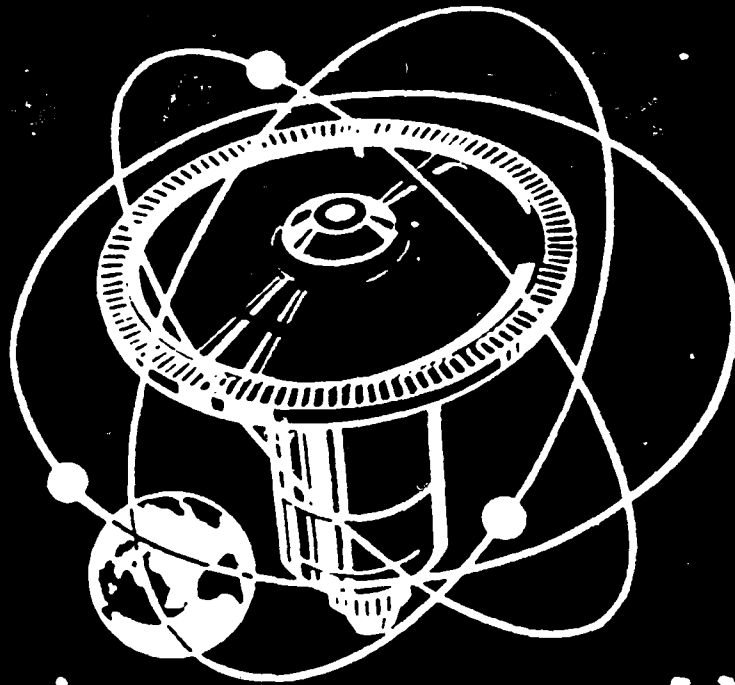

NUCLEAR DYNAMIC SPACE POWER SYSTEMS

Copy available to DTIC does not
V-3-25 permit fully legible reproduction

It is anticipated that requirements for space power will increase dramatically in the coming decades. Commercial and military requirements will be in the 1 to 10 KWe region in the 1980s and therefore within the generally accepted range of isotopes. Military requirements in the 1990s will be in the hundreds of kilowatts and even up to a mega watt. These power levels for military applications are best supplied by reactors.

Anticipated Growth Of Power Needs

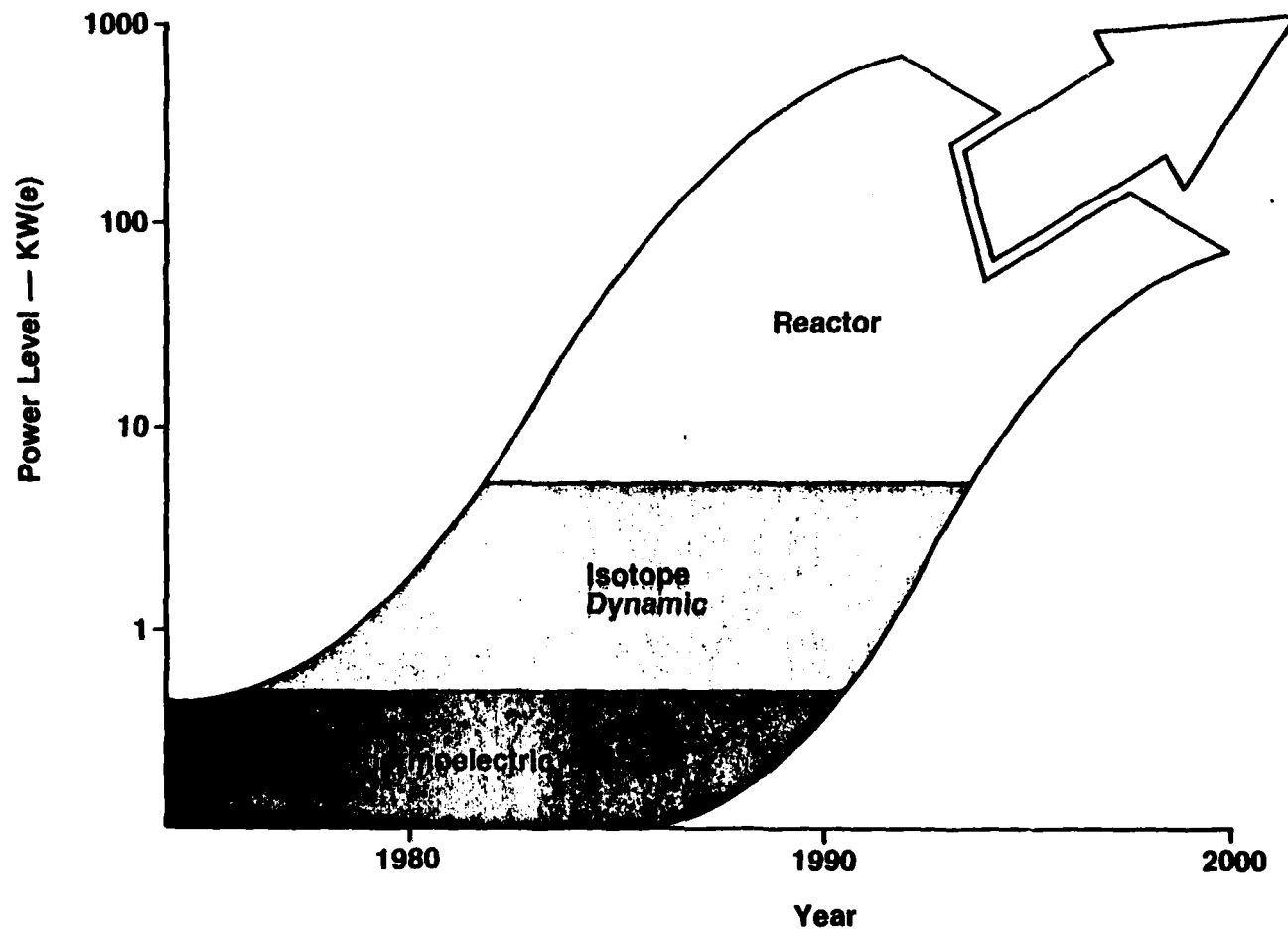

V-3-27



V-3-28

The nuclear source provides significant advantages over other power sources. The reactor operates continuously and is insensitive to orbit and attitude. The system size is relatively small leading to high maneuverability and low visibility. The system is relatively insensitive to nuclear or laser threats, especially with a pumped loop radiator.

Spacecraft Nuclear Power Advantages

- **Continuous Power Availability**
- **Orbit & Attitude Insensitive**
- **Inherent Resistance To Weapon Effects**
- **Low Optical/Radar Signature**
- **Maneuverability**
- **High Power Density**

V-3-29



Efficiency, weight and radiator area characteristics are shown for isotope powered systems up to 10 KWe, based on the General Purpose Heat Source. A maximum fluid temperature of 700°F was used.

DIPS Performance

V-3-31

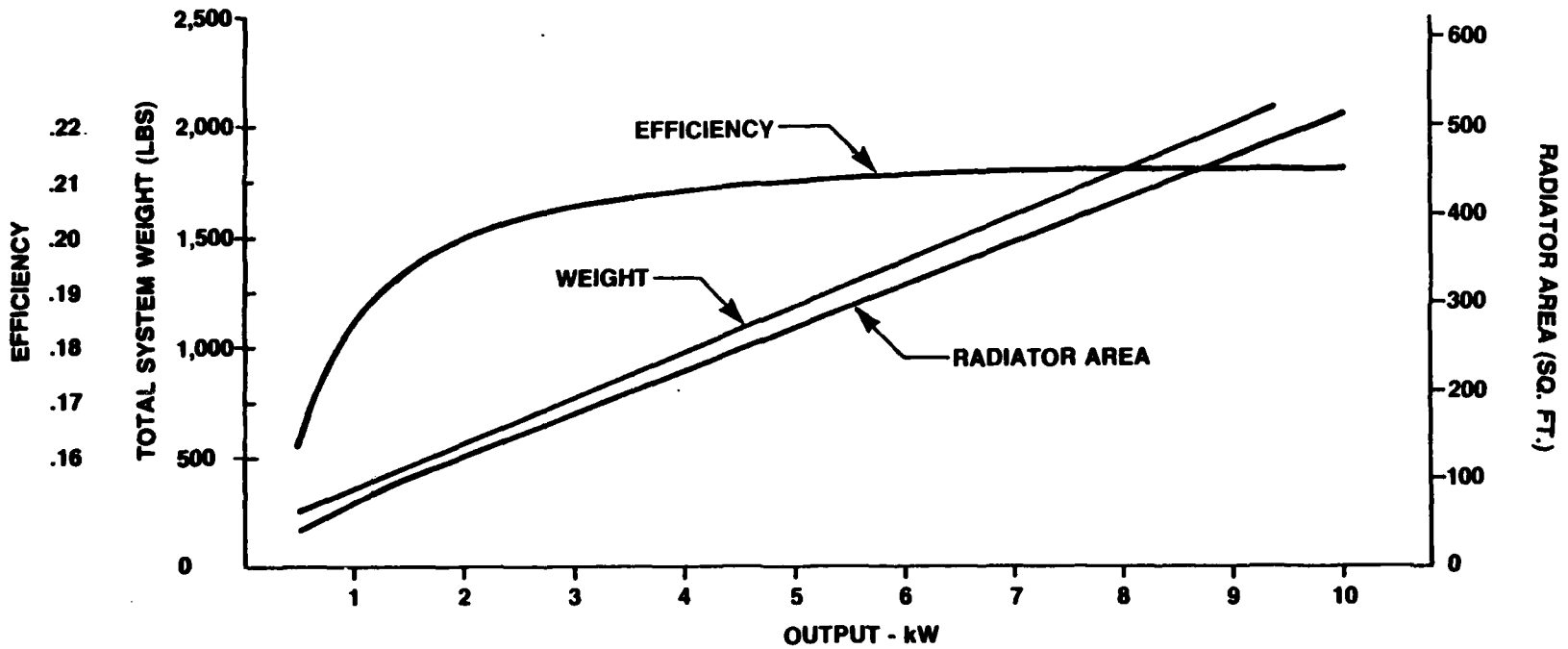

V-3-32

System weight is shown plotted versus power level for isotope systems at low power, and reactor systems at power levels greater than 10 KWe. System reliability is enhanced by increasing the number of power conversion systems sharing a common heat source and radiator at the expense of weight. The shield weight for the reactor system was based on a 5 year mission with a dose of 10^7 Rads and 10^{13} nvt at the payload and pressures 100 ft. separation.

Nuclear Powered ORC System Weight

V-3-33

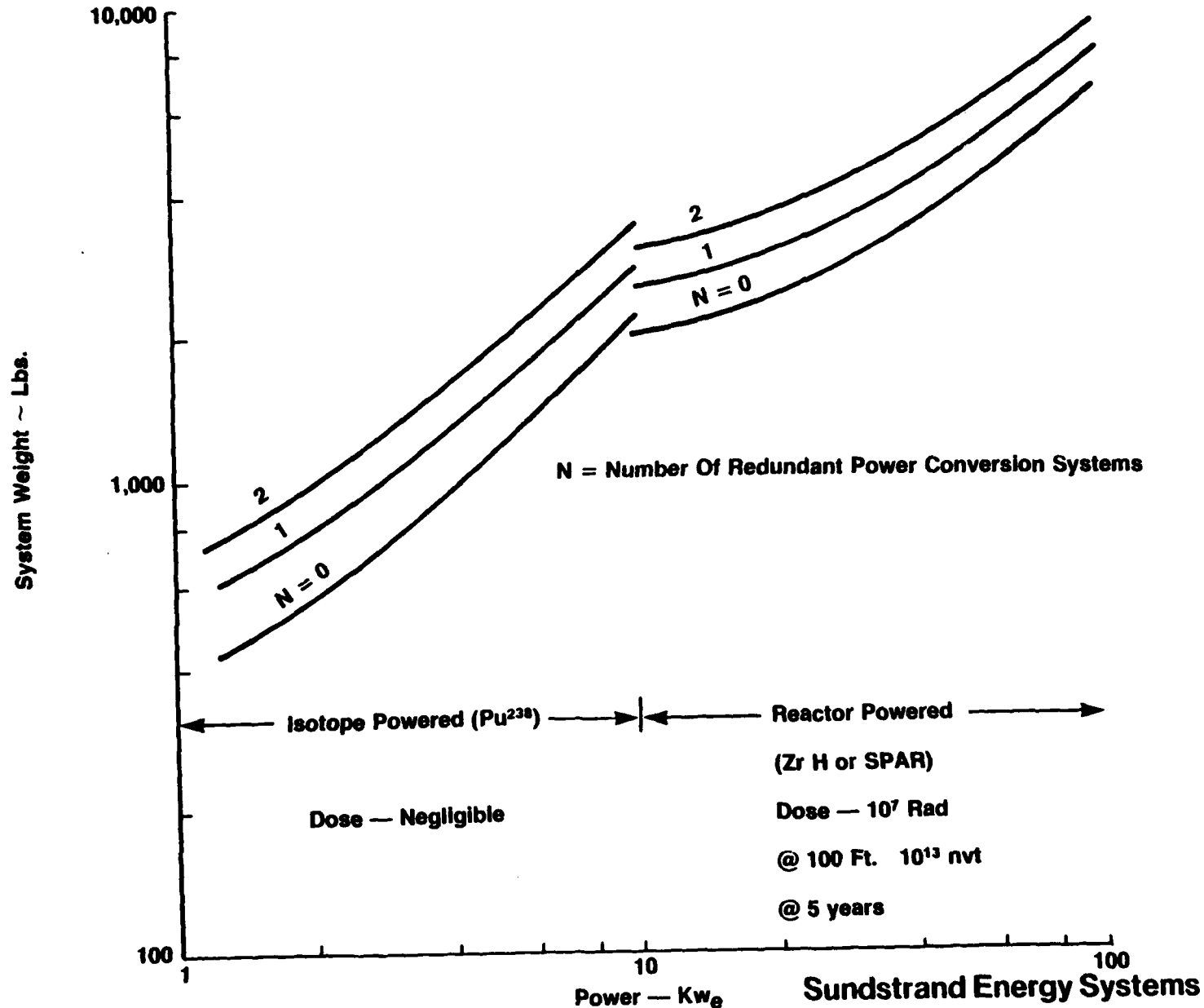

This preliminary conceptual drawing shows a ZrH reactor coupled to an ORC, in the launch configuration.

ORC/Reactor System - Launch Configuration

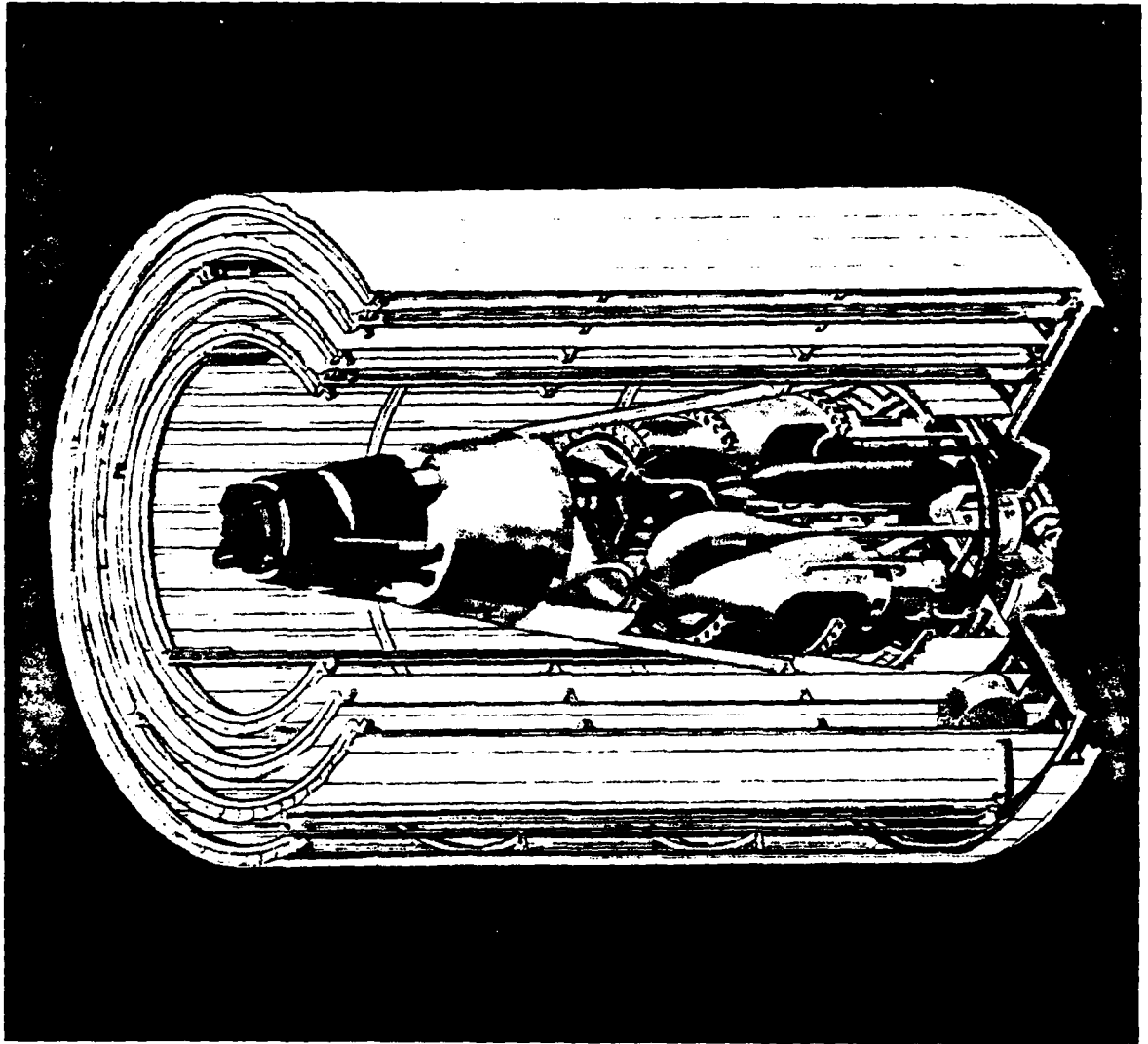

V-3-35

V-3-36

For space operation the radiator panels are deployed telescopically, providing the necessary separation between reactor and payload. Shield weight can be reduced by increasing the separation from reactor to ORC, with the constraint being the length of the Space Shuttle cargo bay.

Deployed ORC/Reactor System

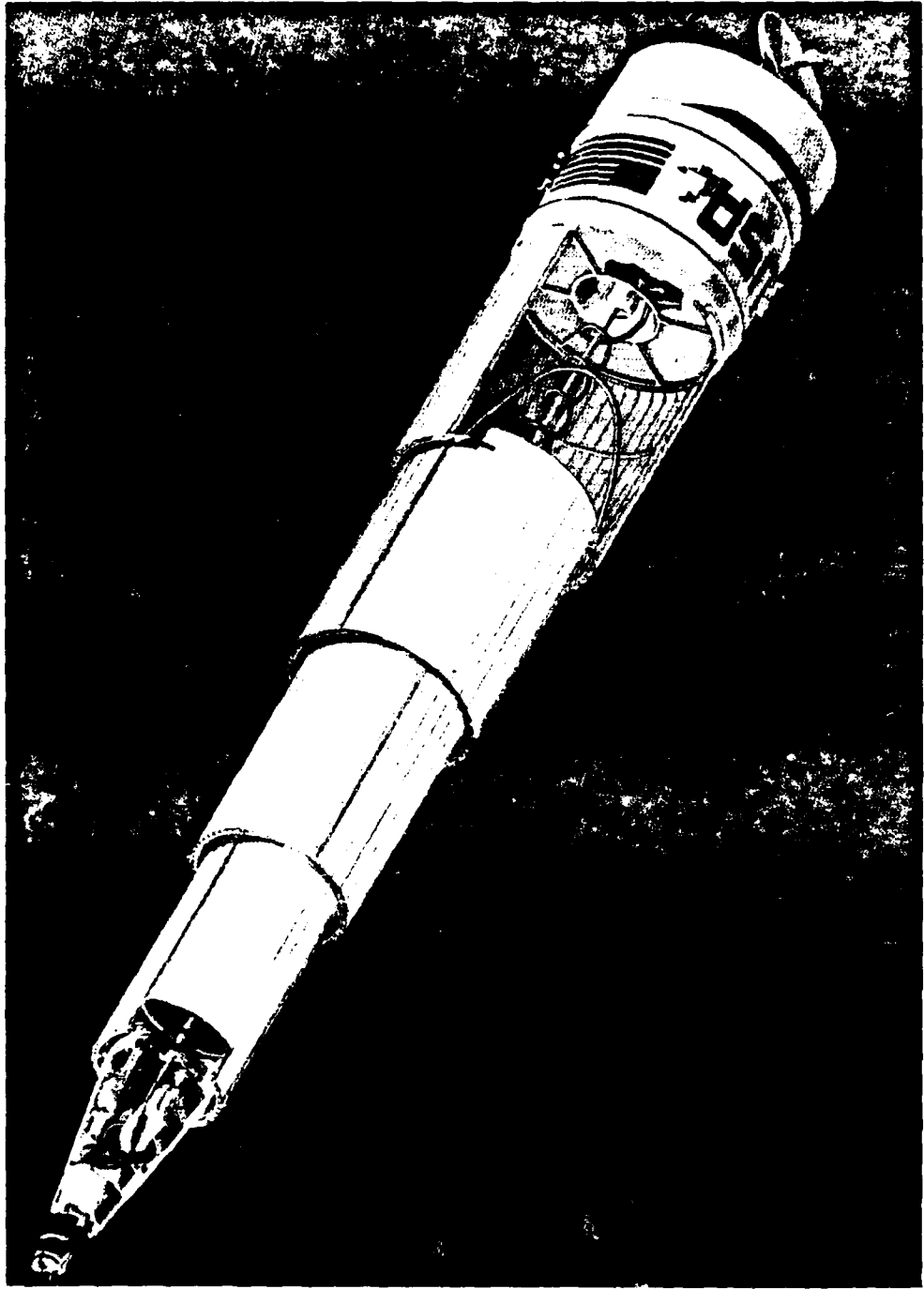

V-3-37



System reliability can be enhanced by having multiple channel power conversion systems sharing common heat source and radiator.

Heat pipe radiators can be used in place of the pumped loop radiator and increase radiator reliability considerably or reduce its weight for a given reliability. The loss of a radiator tube due to micro-meteoroid puncture results in a system failure while the puncture of a heat pipe results in a very small degradation in heat rejection capability.

Reliability Enhancement

MULTIPLE SYSTEMS

- Shared Heat Source
- Shared Radiator

HEAT PIPE RADIATOR

- Parallel Plumbing
- Copper/Water Pipes

V-3-39



Three power conversion systems share a single heat source and radiators.

PCS Redundancy Concept

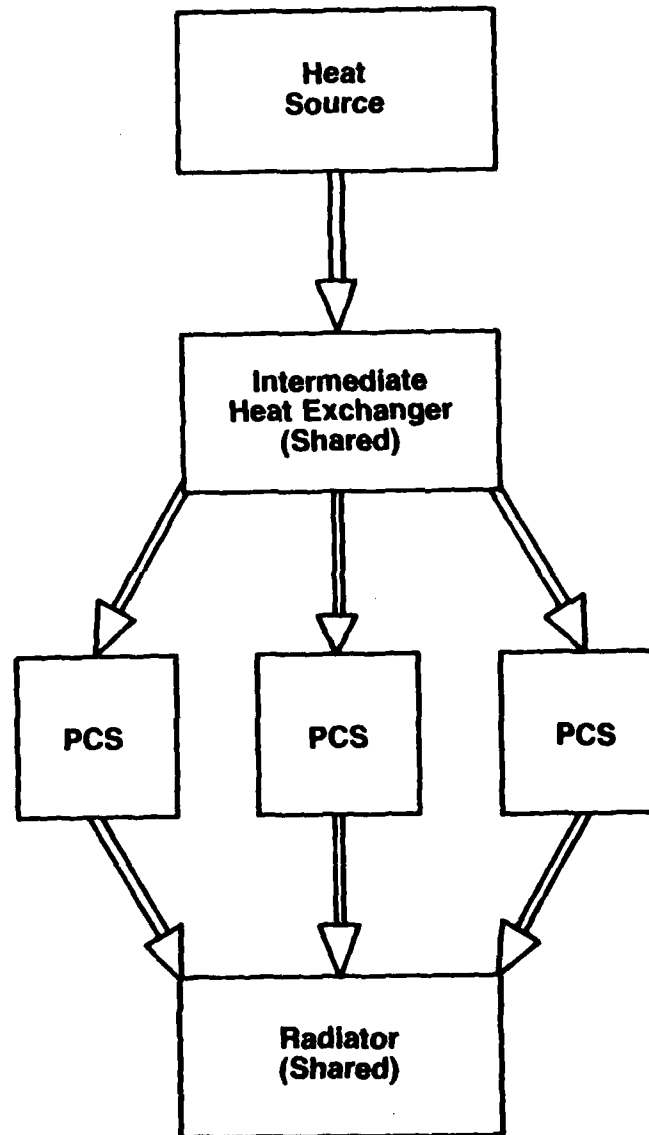

V-3-41



Cylindrical or flat plat radiators can be configured to employ heat pipes for heat rejection by conductivity coupling the working fluid tubes to the heat pipes, which in turn are attached to the radiator shin.

V-3-42

Heat Pipe Radiator Concepts

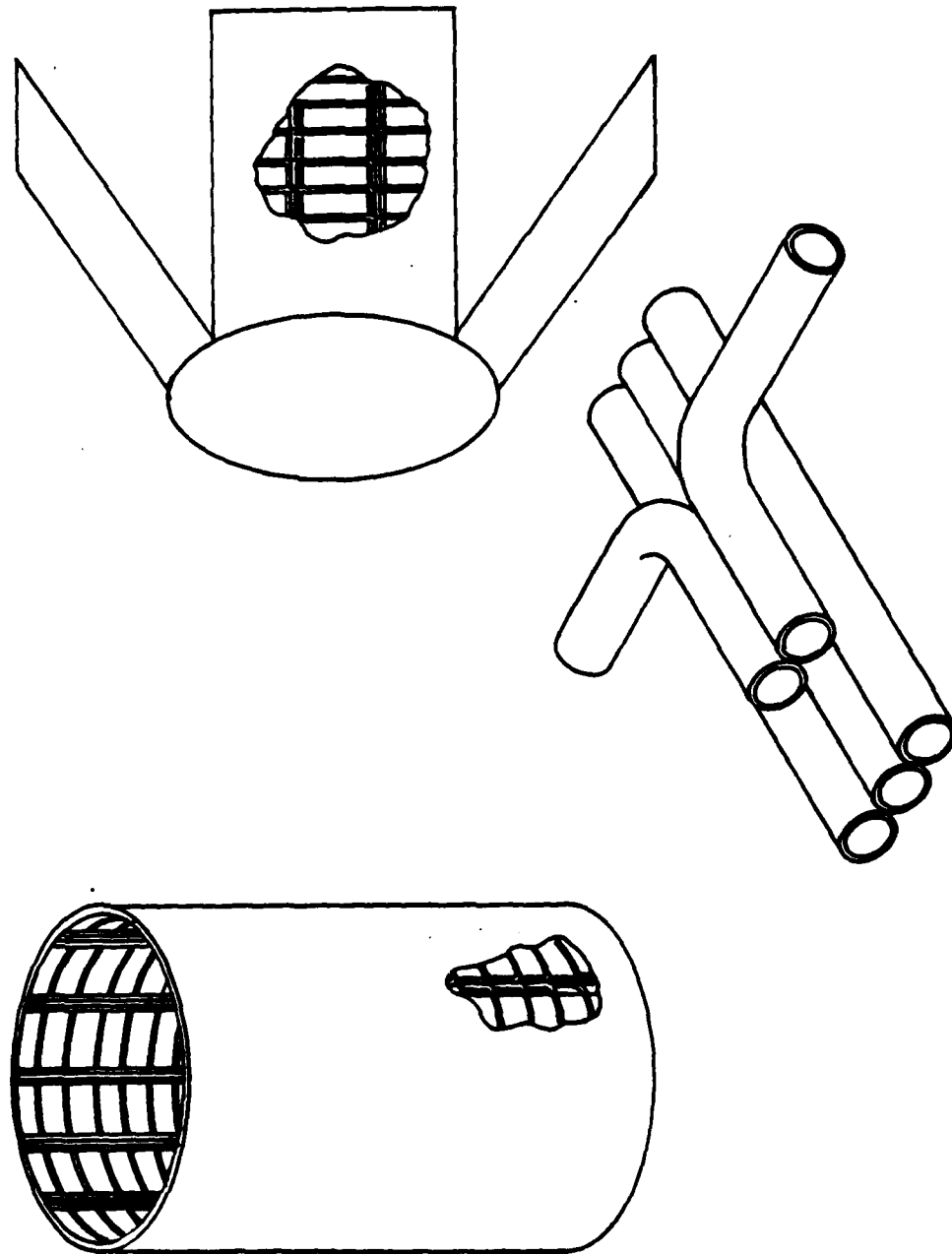

V-3-43

V-3-44

The DIPS program demonstrated that a flight prototypic ground demonstration system could be operated successfully for thousands of hours. This system was designed for low power level and therefore represents a scale model of that required for high-energy systems. Terrestrial systems have, however, demonstrated the viability of the organic systems at high power levels with over 25,000 hours operation on 600-750 KWe systems.

The ORC system is a state-of-the-art system that can be matched to an existing technology low temperature reactor or the high temperature reactor under development.

The use of thermal electric devices located between reactor and ORC can increase power conversion efficiencies dramatically.

Summary

- **DIPS Program Demonstrated System Capability At Low Power Levels**
- **High Power Level Systems Have Been Demonstrated In Terrestrial Systems**
- **Organic Rankine System Can Be Matched To Low Temperature Or High Temperature Reactor**
- **Thermoelectric Topping Can Increase Power Conversion Efficiency By 30-40%**

V-3-45



BIBLIOGRAPHY

1. **Organic Rankine Kilowatt Isotope Power System Final Phase I Report, July 1978. DOE Report C00 4299-032.**
2. **Final Report Technology Verification Phase Dynamic Isotope Power System, Feb. 1982. Sundstrand Report No. AER 2032.**
3. **10 To 75 KWe Reactor Power Systems For Space Applications. Atomic International Report N652T1140013, March 1976.**

"THERMOELECTRIC CONVERSION"

G. Stapfer

C. Wood

Jet Propulsion Laboratory

ABSTRACT

The Conversion of Thermal Energy into electrical power for Space Application by the thermoelectric process is being discussed on this paper. It includes an overview of the present state-of-the art in thermoelectric conversion and reviews the prospects for potential improvements particularly for large power applications (~100kwe). The paper examines and identifies in detail the basic research areas which must be pursued to realize the full potentials of thermoelectric conversion.



OVERVIEW

- WHY THERMOELECTRIC CONVERSION
- ONGOING T/E RESEARCH AND DEVELOPMENT PROGRAM
- REVIEW OF PROMISING T/E MATERIALS
- SPECIFIC T/E RESEARCH NEEDS



WHY THERMOELECTRIC?

- FLIGHT QUALIFIED TECHNOLOGY EXISTS:
 - BASELINE REFERENCE
 - FALL BACK OPTION
- POTENTIAL FOR IMPROVEMENTS ARE REAL:
 - PERFORMANCE (Z)
 - TEMPERATURE
- ADVANCES IN TECHNOLOGY ARE USEFUL:
 - EASILY INCORPORATED
 - COMENSURATE WITH REACTOR LIMITS



FIGURE OF MERIT

MAXIMUM EFFICIENCY η = ELECTRICAL ENERGY DELIVERED TO EXTERNAL CIRCUIT
ENERGY CONSUMED FROM HEAT SOURCE

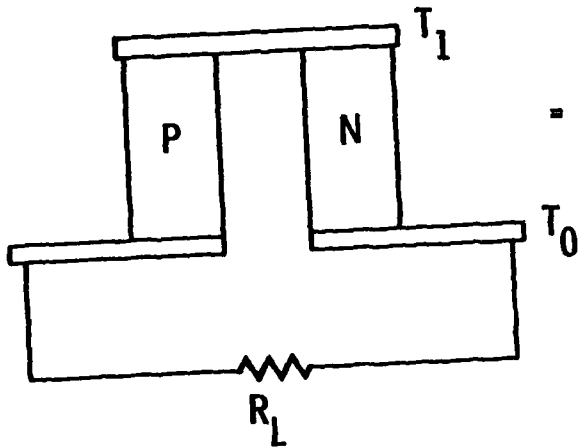

$$= \left(\frac{T_1 - T_0}{T_0} \right) \times$$

$$\left(\frac{M - 1}{M + \frac{T_0}{T_1}} \right)$$

THERMODYNAMIC
EFFICIENCY OF A
REVERSIBLE ENGINE

REDUCTION OF
EFFICIENCY DUE TO
IRREVERSIBLE LOSSES

WHERE M

$$= \sqrt{1 + 1/2 Z (T_1 + T_0)}$$

AND FIGURE OF MERIT Z

$$= \frac{a^2 \sigma}{K}$$

INCREASE IN T_1 INCREASES BOTH TERMS

TYPICAL Z VALUES (AT 300⁰K)

METALS	$3 \times 10^{-6} \text{ } ^\circ\text{C}^{-1}$
SEMICONDUCTOR	$2 \times 10^{-3} \text{ } ^\circ\text{C}^{-1}$
INSULATORS	$5 \times 10^{-17} \text{ } ^\circ\text{C}^{-1}$

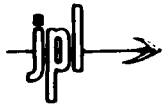

LIMITATION ON MAXIMUM ZT

RITTNER (1959)	}	ONE CARRIER SYSTEM	240
DONAHOE (1960)			17
SIMON (1962)	}	TWO CARRIER SYSTEM	NO LIMIT
RITTNER & NEUMARK (1963)			70
URE (1971)			1.9 - 3.6
GOLDSMID ET AL (1975)	}	RADIATIVE TRANSFER CORRECTION	ZT OF 3.5 REDUCED TO 1 AT 2000 ⁰ K
KELLY & SZEGO (1964)			NO REDUCTION UP TO 2500 ⁰ K FOR TYPICAL MATERIALS



FIGURE-OF-MERIT OF SELECTED THERMOELECTRIC MATERIALS

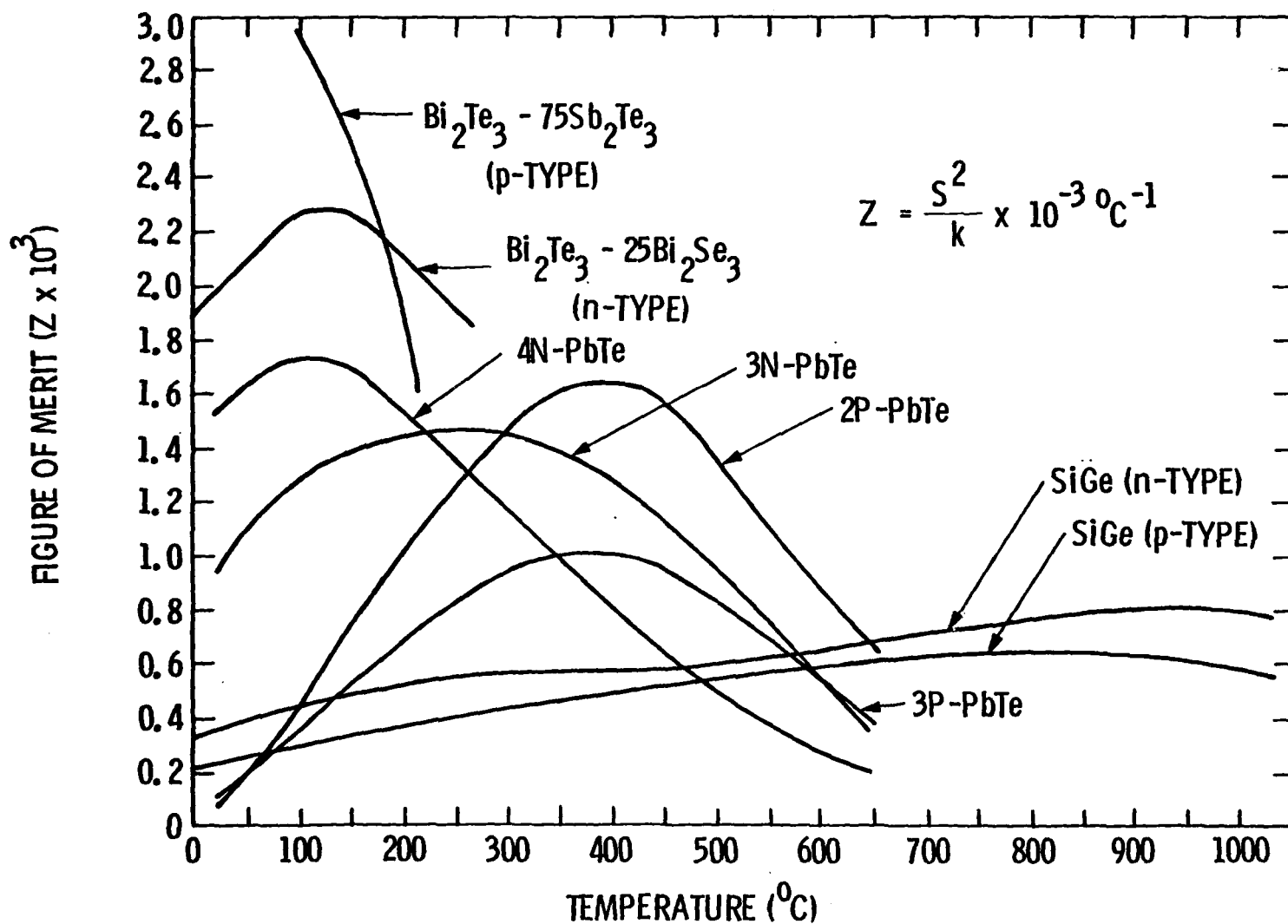



PRESENT WORK

UNITED STATES

SiGe
RARE-EARTH SULFIDES
BORON CARBIDE

RUSSIA

BORON COMPOUNDS
RARE-EARTH CHALCOGENIDES

FRANCE

BORON SILICIDES



ADVANCED T/E TECHNOLOGY (SP-100 PROGRAM)

- LANTHANUM SULFIDE
 - DOPANT STUDIES (COPPER)
 - STOICHIOMETRY
 - BONDING
 - MEASUREMENTS

- BORON-CARBON
 - COMPOSITION
 - DOPANT STUDIES (MAGNESIUM)
 - BONDING
 - MEASUREMENTS



LANTHANUM SULFIDE SYSTEM

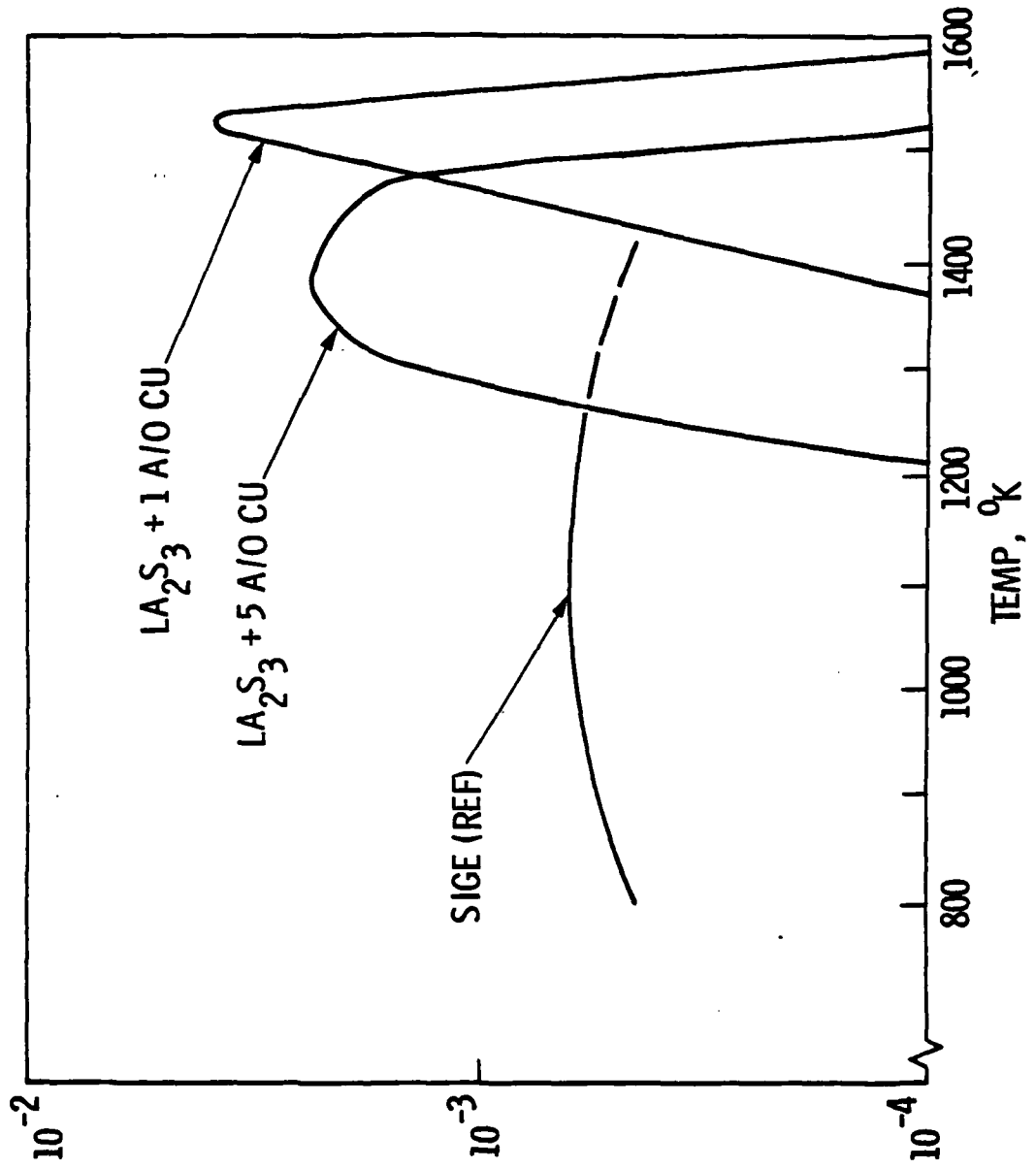
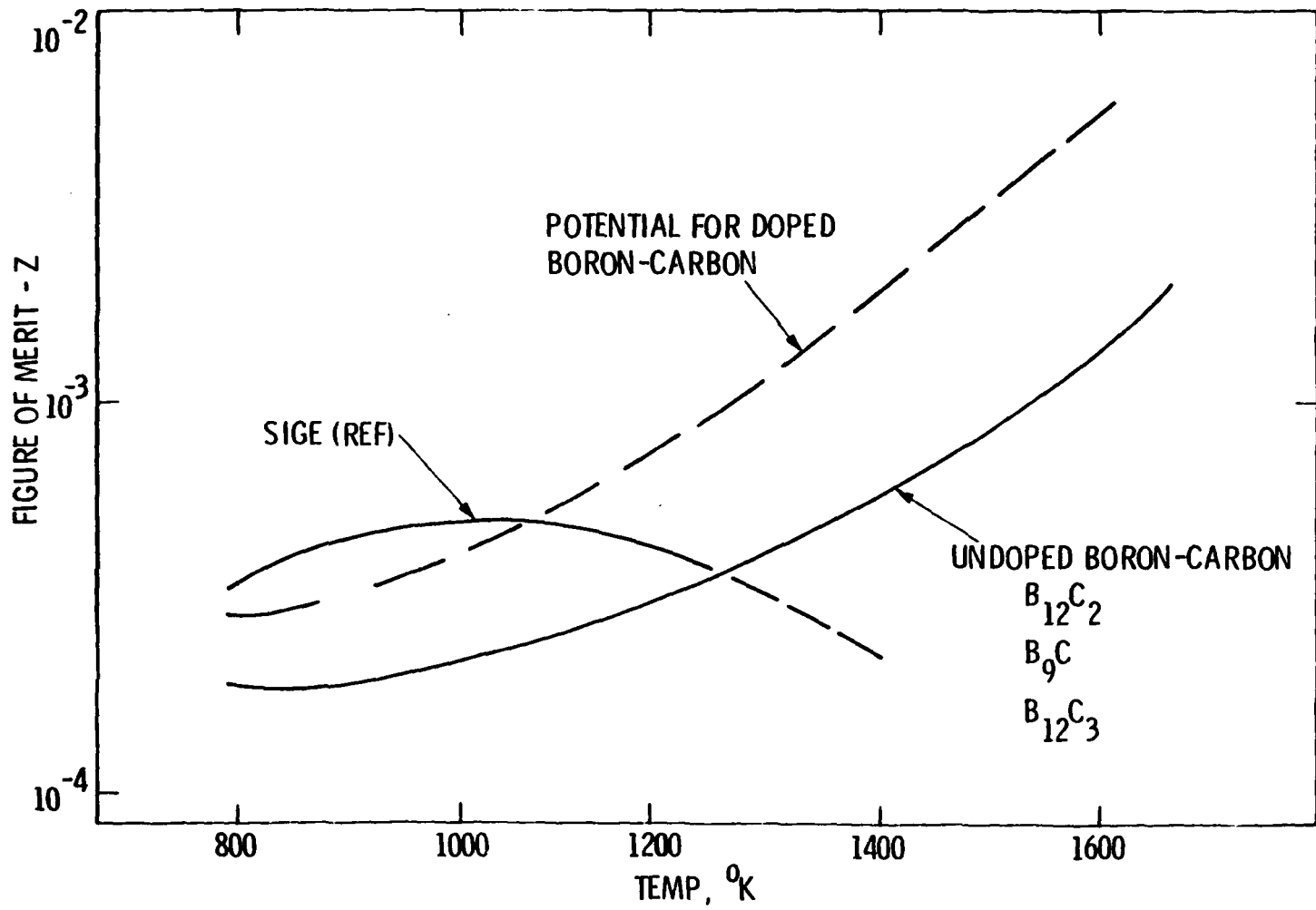

FIGURE OF MERIT - Z



BORON CARBON SYSTEM

V-4-10





RUSSIAN WORK

THERMOELECTRIC EFFICIENCIES OF COMPOUNDS BETWEEN 600 AND 1800°K

MATERIAL	$T, ^\circ\text{K}$	600	800	1000	1200	1400	1600	1750	1800
BORON	$Z \cdot 10^3, \text{deg}^{-1}$	—	0.17	0.24	0.28	0.29	0.32	0.29	0.27
BORON CARBIDE	$Z \cdot 10^3, \text{deg}^{-1}$	—	0.03	0.06	0.10	0.15	0.13	—	—
α - AlB_{12}	$Z \cdot 10^3, \text{deg}^{-1}$	—	0.02	0.04	0.07	0.14	0.30	0.62	—

NO.	COMPOUNDS	$T, ^\circ\text{K}$	$Z_{\text{max}}, \text{deg}^{-1}$	$(ZT)_{\text{max}}$
<i>n</i> -TYPE				
1	RARE EARTH CHALCOGENIDES	1550	$0, 9 \cdot 10^{-3}$	1, 4 [18]
2	CARBIDES OF GROUP IV AND V TRANSIT. MET.	1400	$0, 01 \cdot 10^{-3}$	0, 01 [19]
3	METALS	1800	$0, 06 \cdot 10^{-3}$	0, 11 [20]
<i>p</i> -TYPE				
4	BORON	1600	$0, 32 \cdot 10^{-3}$	0, 51 [21]
5	α - AlB_{12}	1750	$0, 62 \cdot 10^{-3}$	1, 09 [22]
6	SILICIDES OF 3d TRANSITION METALS	1500	$0, 10 \cdot 10^{-3}$	1, 15 [23]



FRENCH WORK

FIGURE OF MERIT OF B₁₄Si COMPOUND

$$S = 500 \mu\text{V}/\text{degree}$$

$$\sigma = 300 \text{ S cm}^{-1}$$

$$\sigma = 80 \text{ S cm}^{-1}$$

$$X = 0.02 \text{ W/cm degree}$$

$$\text{AT } 1700^{\circ}\text{K}$$

$$\text{AT } 1250^{\circ}\text{K}$$

ONE WILL DEDUCE:

$$z = 3.75 \cdot 10^{-3} / \text{degree}$$

$$z = 10^{-3} / \text{degree}$$

$$\text{AND } zT_E = 7.5 \text{ AT } 1700^{\circ}\text{K}$$

$$\text{AND } zT_H = 1.25 \text{ AT } 1250^{\circ}\text{K}$$



THERMOELECTRIC CONVERSION TECHNOLOGY

V-4-13

FIGURE OF
MERIT -
 Z
 $\left(\frac{\alpha^2}{\rho k}\right)$

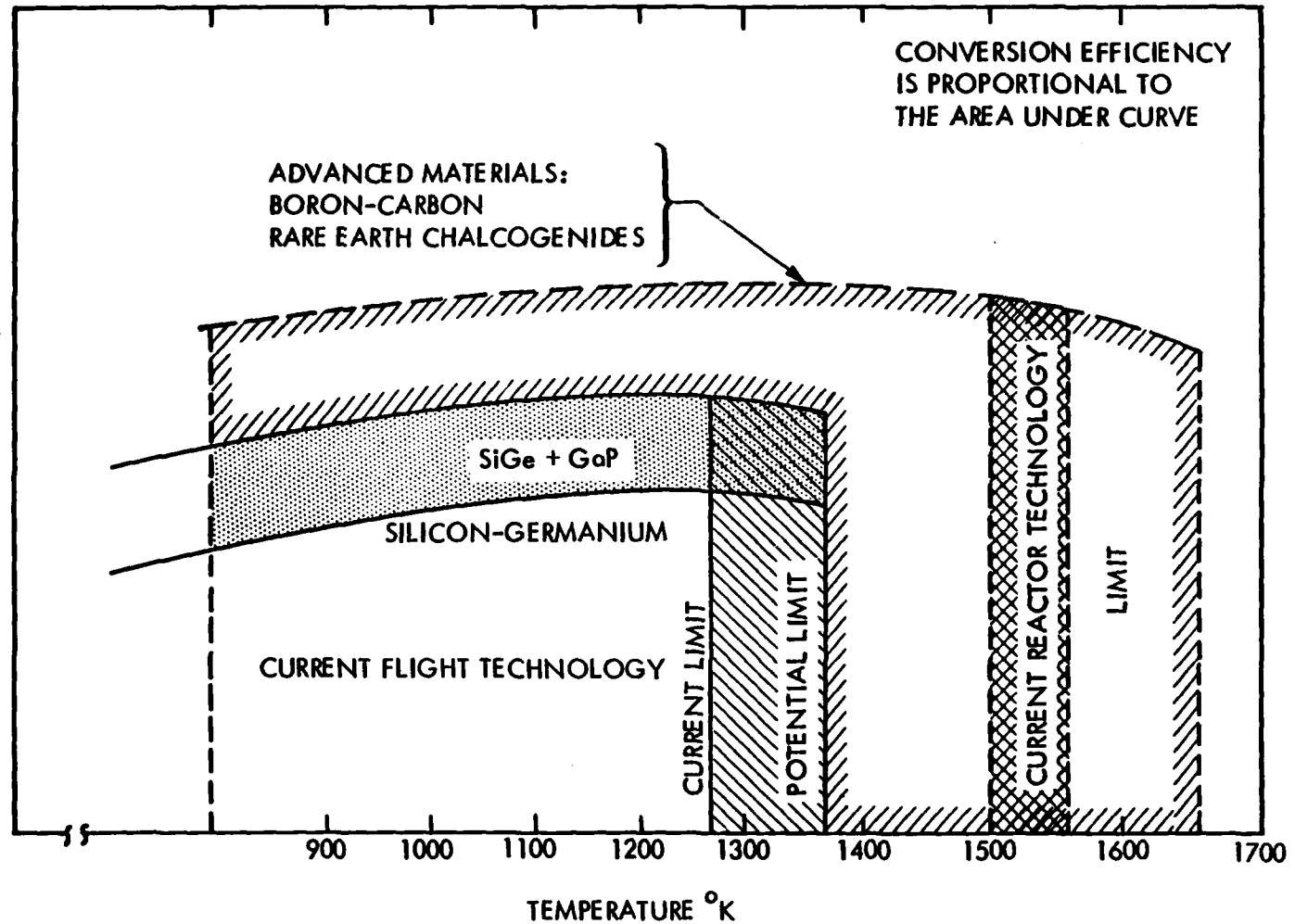



FUTURE WORK NEEDED

THEORY

BAND STRUCTURE
CONDUCTION MECHANISMS
(HOPPING, POLARON, MEDIUM RANGE DISORDER)
THERMAL CONDUCTIVITY

PHYSICAL CHARACTERIZATION

SEEBECK COEFFICIENT
ELECTRICAL RESISTIVITY
THERMAL CONDUCTIVITY
OPTICAL
MAGNETO-OPTICAL
HALL EFFECT
PHOTO EMISSION
LUMINESCENCE
TIME OF FLIGHT
FTIS
PHOTO ACOUSTIC SPECTROSCOPY
RAMAN SPECTROSCOPY



FUTURE WORK NEEDED (CONT'D)

SYNTHESIS

HOT-PRESSING

MELT-GROWTH

SOLUTION GROWTH

CVD

HIGH PRESSURE GROWTH

ELECTRODEPOSITION

SPUTTERING

E. B. EVAPORATION

ION PLATING

ANALYSIS

COMPOSITION

PHASE

STRUCTURE

PURITY

WET CHEMISTRY
X-RAY DIFFRACTION
NEUTRON DIFFRACTION
DTA
MICROPROBE
AUGER SPECTROSCOPY
ESCA
GRAVIMETRIC
XAFS
EMISSION SPECTROSCOPY
XPS
EPS
NEUTRON ACTIVATION
ION BEAM SPECTROSCOPY



METALS

SEEBECK COEFFICIENT

$$a \sim \pi^2 \frac{k}{e} \times \frac{kT}{\eta} \sim 5 \mu\text{V}/^\circ\text{C}$$

THERMAL CONDUCTIVITY

$$\kappa_T = \kappa_{el} + \kappa_{ph} \sim \kappa_{el}$$

WIEDEMAN-FRANZ

$$\begin{aligned} \frac{\kappa_{el}}{\sigma} &= \frac{\pi^2}{3} \left(\frac{k}{e}\right)^2 T \\ &= LT \sim 2.4 \times 10^{-8} T \text{ watt-ohm} \end{aligned}$$

$$Z = \frac{a^2 \sigma}{\kappa_T} \sim \frac{3 \times 10^{-6} \text{ } ^\circ\text{C}^{-1}}{\text{AT } 300^\circ\text{K}}$$

SEMICONDUCTORS

$$a \sim \pm \frac{k}{e} \left(2 + \frac{\eta}{kT}\right) \sim 200 \mu\text{V}/^\circ\text{C}$$

$$\sigma = n e \mu \sim 10^3 \text{ ohm}^{-1} \text{ cm}^{-1}$$

$$\kappa_T = \kappa_{el} + \kappa_{ph} \sim \kappa_{ph} \sim 2 \times 10^{-2} \text{ watt cm}^{-1} \text{ } ^\circ\text{C}$$

$$Z \sim \frac{2 \times 10^{-3} \text{ } ^\circ\text{C}^{-1}}{\text{AT } 300^\circ\text{K}}$$

$$a \sim \pm \frac{k}{e} \left(2 + \frac{\eta}{kT}\right) \sim 1 \text{ mV}/^\circ\text{C}$$

$$\sigma \sim 10^{-12} \text{ ohm}^{-1} \text{ cm}^{-1}$$

$$\kappa_T \sim \kappa_{ph} \sim 2 \times 10^{-2} \text{ watt cm}^{-1} \text{ } ^\circ\text{C}^{-1}$$

$$Z \sim \frac{5 \times 10^{-17} \text{ } ^\circ\text{C}^{-1}}{\text{AT } 300^\circ\text{K}}$$

INSULATORS

SESSION VI. RADIANT SYSTEMS

POWER FROM RADIANT-ENERGY SOURCES: AN OVERVIEW

by
Robert E. English and Henry W. Brandhorst, Jr.
National Aeronautics and Space Administration
Lewis Research Center
Cleveland, Ohio

February 23, 1982

VI-1-1

POWER FROM RADIANT-ENERGY SOURCES: AN OVERVIEW
by Robert E. English and Henry W. Brandhorst, Jr.
National Aeronautics and Space Administration, Lewis Research Center

ABSTRACT

Radiations from the Sun, from microwaves and from lasers are assessed as energy sources for electric power in space. Recent advances in photovoltaic technology have improved the radiation resistance of silicon solar cells and substantially reduced their annealing temperature. Advances in GaAs arrays include the featherweight CLEFT cell and lightweight blankets based on this cell. Use of the 100X miniature cassegranian concentrator is compatible with silicon, GaAs and advanced solar cells and not only reduces array cost but also raises efficiency and increases radiation tolerance. Advanced concepts to raise efficiency above 0.3 are also discussed.

Parabolic mirrors could focus and collect either sunlight or laser radiation at high efficiency. From such heat sources at 1700-2200 K, several competitive concepts can generate electric power. Power can reach 30 kW/m² of radiator area or, alternatively, efficiency can exceed 50 percent. For microwave power transmission over geostationary distances, wavelength must be reduced to 0.1 mm (by a factor of 1000) if collector area is to improve substantially over that of sunlit photovoltaic arrays. Lasers matched in wavelength to GaAs photovoltaic arrays appear capable of providing electric power exceeding 1 kW/kg of array mass.

RADIANT SOURCES OF POWER

THE SUN

PHOTOVOLTAIC CONVERSION
HEAT ENGINES

MICROWAVES

LASERS

VI-1-3

SPACE PHOTOVOLTAIC RESEARCH AND TECHNOLOGY PROGRAM

The research programs of the NASA Lewis Research Center are aimed at increasing the efficiency and radiation tolerance of solar cell arrays while also reducing their weight and cost. The payoffs include enabling heretofore impossible long life LED habitats and ultralightweight, radiation resistant and annealable solar arrays for GEO applications. Primary thrust of the silicon solar cell research is to reduce radiation sensitivity and annealing temperature; gallium arsenide research seeks to reduce cost and weight with increased operation temperature ability advanced concepts are aimed at efficiencies 30 percent and above while welding seeks long life, threat resistant arrays. Miniature concentrators seek to combine the best advantages of all the rest of the research.

SPACE PHOTOVOLTAIC RESEARCH & TECHNOLOGY PROGRAM

VI-1-5

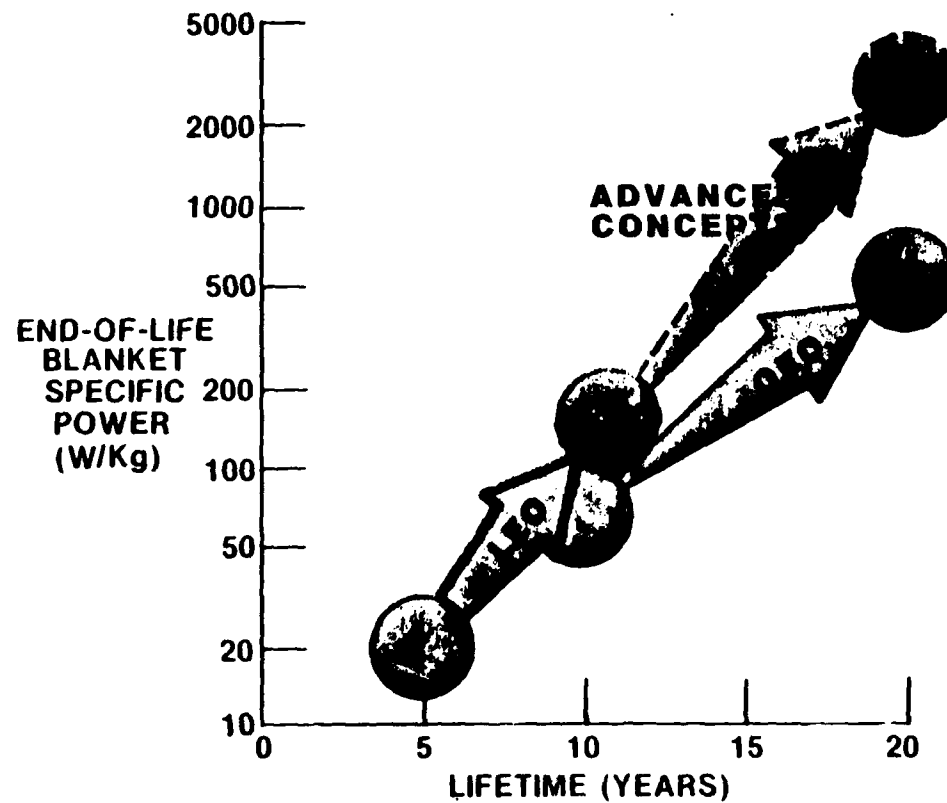

- APPROACH**
- SILICON
 - GaAs
 - CONCENTRATOR CELLS
 - RADIATION TOLERANCE
 - WELDED ARRAYS
 - ADVANCED CONCEPTS

- BENEFITS**
- ENABLES LARGE MULTI-KW IN LEO
 - INCREASES GEO PAYLOAD
 - LONGER LIFE
 - LOWER DRAG
 - LIGHTER WEIGHT
 - LOWER COST

REDUCED ANNEALING TEMPERATURES IN
RADIATION DAMAGED SILICON SOLAR CELLS

Research has shown only three defects as a result of 1 MeV electron radiation damage are significant in reducing cell output. Two of them contain the unwanted impurities carbon and oxygen. Theory predicts lower radiation damage and reduced annealing temperature if these impurities are reduced. In high purity 0.1 ohm cm silicon, processed by ion implantation which did not introduce further carbon and oxygen annealing temperatures as low as 200°C have been measured. This temperature is within the capability of present arrays.



REDUCED ANNEALING TEMPERATURES IN RADIATION DAMAGED SILICON SOLAR CELLS

THEORETICAL PREDICTIONS

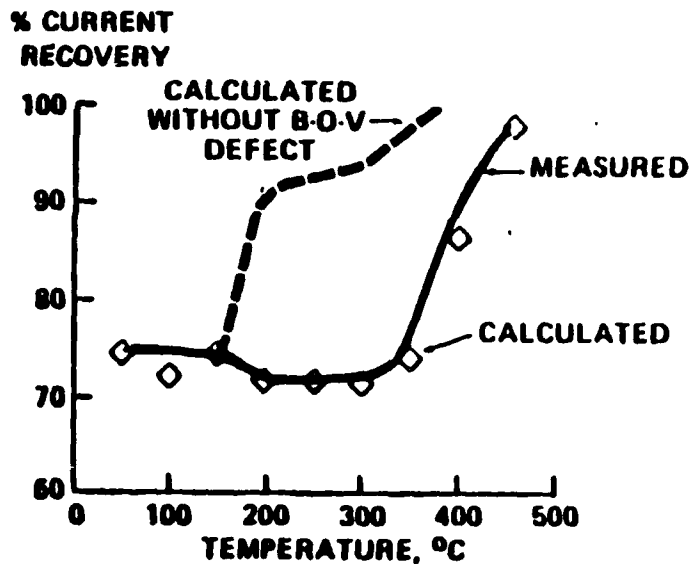

- THEORY PREDICTS REDUCED ANNEALING TEMPERATURE WITH REDUCED OXYGEN

EXPERIMENTAL DATA

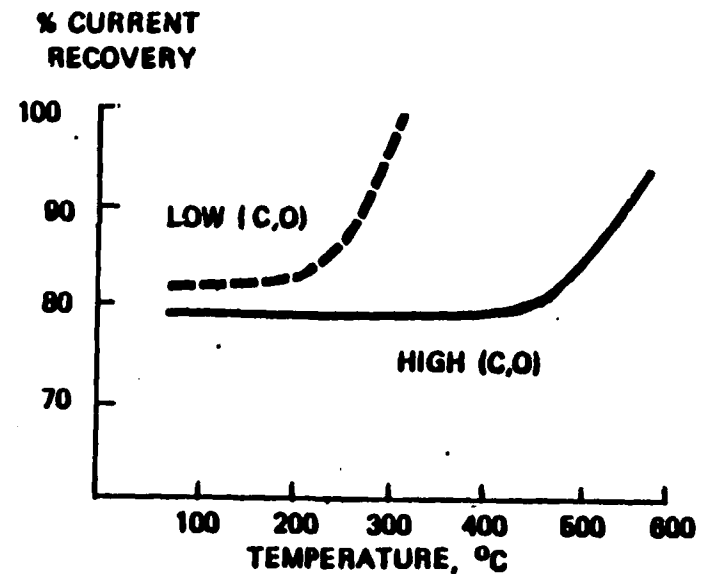

- REDUCED ANNEALING TEMPERATURE DEMONSTRATED IN ION IMPLANTED, LOW C AND O SILICON CELLS

- o NEARLY COMPLETE ANNEALING DEMONSTRATED AT 200⁰ C
- o 200⁰ C OR LESS REQUIRED TO PREVENT ARRAY DAMAGE
- o GOAL IS TO REDUCE DAMAGE TO <15% IN 10 YEARS GEO

ULTRALIGHTWEIGHT GALLIUM ARSENIDE
SOLAR CELL DEVELOPMENT

Lincoln Laboratory has developed a process for producing single crystal gallium arsenide solar cells less than $10\ \mu\text{M}$ thick. The chemical vapor deposition process employs a reusable substrate, and is not area limited. The cell junction and top contacts are fabricated while the layer is on the host substrate. It is then attached to a coverglass, cleaved from the substrate and cell fabrication completed. This is the first example of an ultrathin, single crystal solar cell.

ULTRALIGHTWEIGHT GALLIUM ARSENIDE SOLAR CELL DEVELOPMENT

CELL GROWTH

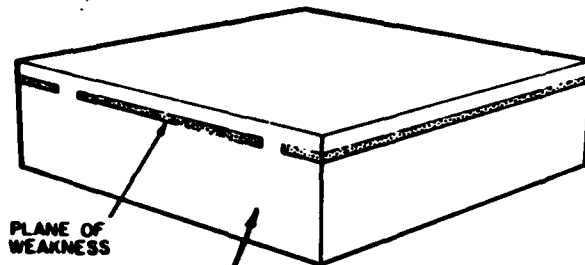

CELL CLEAVAGE

SUBSTRATE

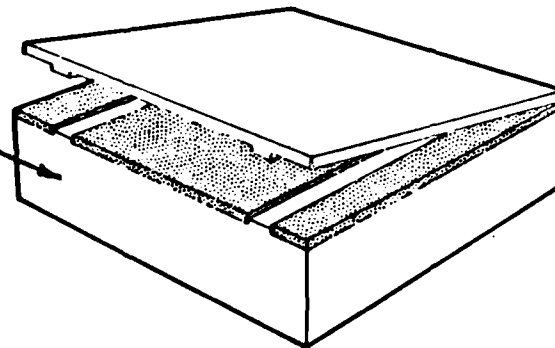

LINCOLN LABORATORY CLEFT PROCESS

- o POTENTIAL LOW COST
- o REUSABLE SUBSTRATE
- o HIGH SPECIFIC POWER

VI-1-1-9

o CELL SPECIFIC POWER ACHIEVED 2.5 KW/KG
(20X CURRENT FLIGHT CELLS)

o CELL THICKNESS 10 μ M

o EFFICIENCY 12.8% TO DATE

FINISHED CELL ASSEMBLY

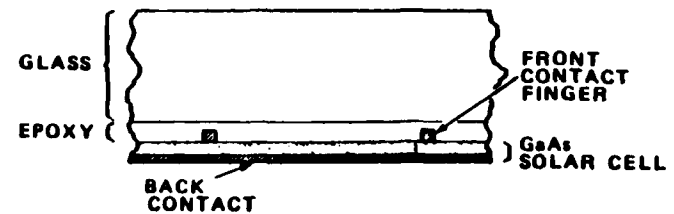

LIGHTWEIGHT BLANKET TECHNOLOGY

Using the ultralightweight CLEFT cell, new lightweight blanket design becomes possible. A design producing 1000 W/kg is projected for a 20 percent cell with 25 μ M substrates and covers. This design also requires significant advances in interconnect design and technology. Conservative values of losses are included.

VI-1-11

	<u>1990 PERIOD</u>		<u>2000 + PERIOD</u>	
SUBSTRATE	50 μ M KAPTON	0.072	25 μ M FUSED SiO ₂ EQUIV	0.056
ADHESIVE	25 μ M 93-500	0.049	-	-
CELL	10 μ M GAAS (CLEFT)	0.036	5 μ M GAAS	0.018
CONTACTS	4 μ M GAAS EQUIV	0.014	4 μ M GAAS EQUIV	0.014
COVER	50 μ M FUSED SiO ₂ EQ	0.112	25 μ M FUSED SiO ₂ EQUIV.	0.056
INTERCONNECT	10 μ M COPPER	0.024	5 μ M COPPER	0.012
MISCELLANEOUS	PADD'G, STIFF, ETC.	<u>0.040</u>	PADD'G, STIFF, ETC.	<u>0.030</u>
TOTAL (KG/M ²)		0.347		0.186
CELL EFFIC.	17%		20%	
POWER (W/M ²)		232		274
EOL SPECIFIC POWER*(W/KG)		<u>412</u>		<u>1008</u>

*LOSSES - PKG FACTOR 0.8, ASS'L'Y & PWR MISMATCH 0.1, 550C 0.05, RAD. DAM. 0.1 (1990) 0(2000)
125 M² WING, SEPS BLANKET = 107 W/KG

GaAs CONCENTRATOR CELLS

A gallium arsenide cell having an efficiency of 13 percent at 200°C has been developed. At the same temperature, a silicon solar cell would only have a 4 percent efficiency. Also, contact stability has been demonstrated. The available data projects a five year lifetime at 200°C with only 4 percent loss in power. Of course, more power would be delivered if the array were operated at a reduced temperature then periodically raised to 200°C for annealing.

GaAs CONCENTRATOR CELLS

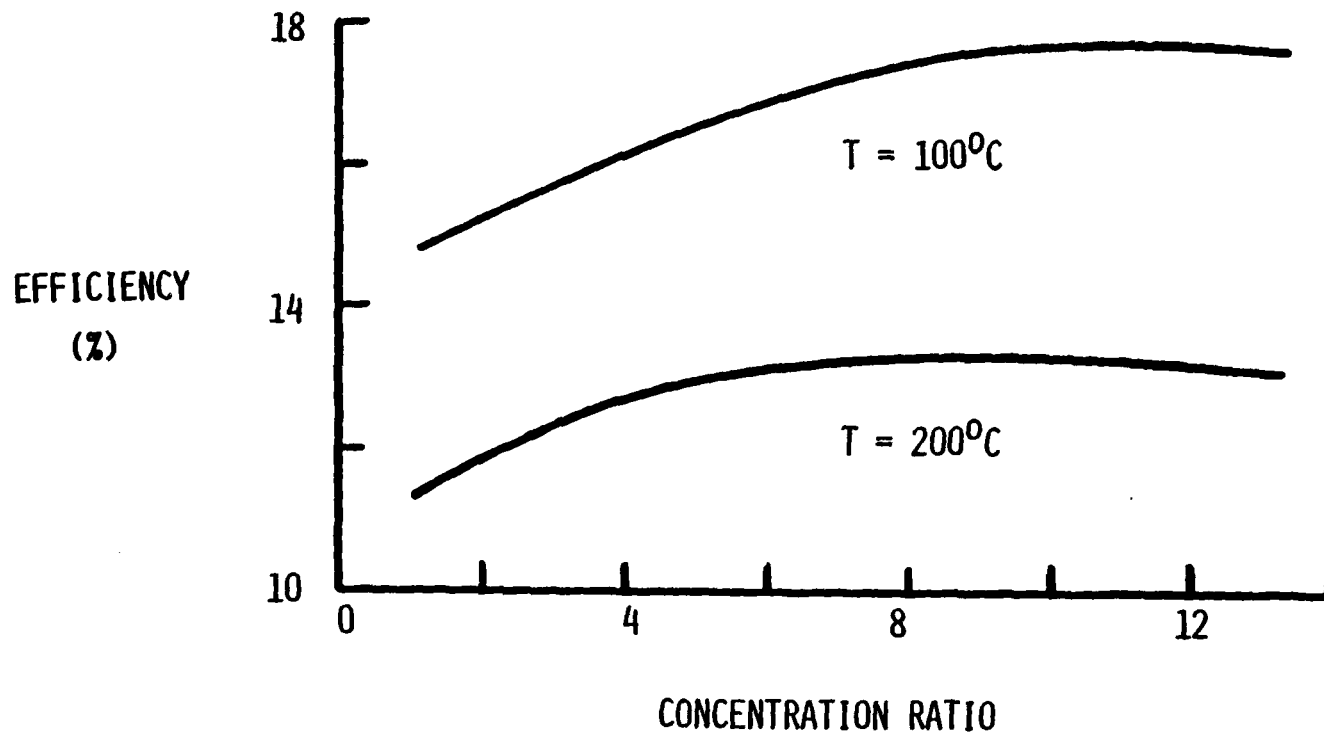

VI-1-13

- SILICON EFFICIENCY 4% AT 200°C
- RADIATION DAMAGE ANNEALS AT 200°C IN GaAs
- THERMAL DEGRADATION 4% AFTER 5 YRS.
- BENEFITS: REDUCED COOLING, CONTINUOUS ANNEALING, INCREASED EOL EFFICIENCIES

MINIATURE CASSEGRAINIAN CONCENTRATOR

The miniature cassegrainian concentrator uses a 4 mm diameter cell in a 125X concentrator about 2" square. The cell temperature under full operational conditions is projected to be only 80°C. The structure offers many significant advantages including its compatibility with the high efficiency cascade cells being developed.



MINIATURE CASSEGRAINIAN CONCENTRATOR

- PROTECTS CELL FROM UNWANTED PARTICULATE AND OPTICAL RADIATION
- ACHIEVES 80⁰C OPERATING TEMPERATURE WITH FULL-AREA RADIATOR
- CAN PRODUCE 200⁰C TEMPERATURES FOR IN-SITU RADIATION DAMAGE ANNEALING WITH APPROPRIATE THERMAL DESIGN
- CAN ACHIEVE 19% EFFICIENCY WITH IMPROVED GAAs CELLS
- IDEAL SYSTEM FOR SMALL AREA CASCADE CELLS (30% EFFICIENCY POTENTIAL)
- COMPATIBLE WITH OTHER ADVANCED CELL CONCEPTS

VI-1-15

BENEFITS OF WELDED INTERCONNECTS

Present solar arrays in the U. S. have only soldered interconnects. Welding technology offers significant advantages that enable new missions. A research development program is underway to realize the benefits of welding technology.



BENEFITS OF WELDED INTERCONNECTS

- HIGH TEMPERATURE SURVIVABILITY
- INCREASED CYCLE LIFE IN LEO
- WIDER CHOICE OF INTERCONNECT MATERIALS (E.G. ALUMINUM)
- LOWER PRODUCTION COSTS

VI-1-17

CASCADE SOLAR CELLS

Cascade solar cells offer the potential for 30 percent sunlight conversion efficiency. The cells are made from combination of III-V elements. For example, two promising quaternary combinations include the AlInGaAs and the AlGaAsSb systems. These materials permit adjustment of both band gap and lattice constant to ensure a matched, high efficiency structure. Metallorganic chemical vapor deposition is the favored technology for developing these cells. Significant materials work must be done to permit this technology to reach its potential.

CASCADE SOLAR CELLS

BETTER UTILIZATION OF SOLAR SPECTRUM FOR INCREASED EFFICIENCY

APPROACH: ABSORB DIFFERENT PORTIONS OF SUNLIGHT SPECTRUM BY
DIFFERENT BANDGAP CELLS STACKED ATOP ONE ANOTHER

GOAL: 30% CONVERSION EFFICIENCY AT OPERATING TEMPERATURE
(= DOUBLE THAT OF SILICON)

VI-1-19

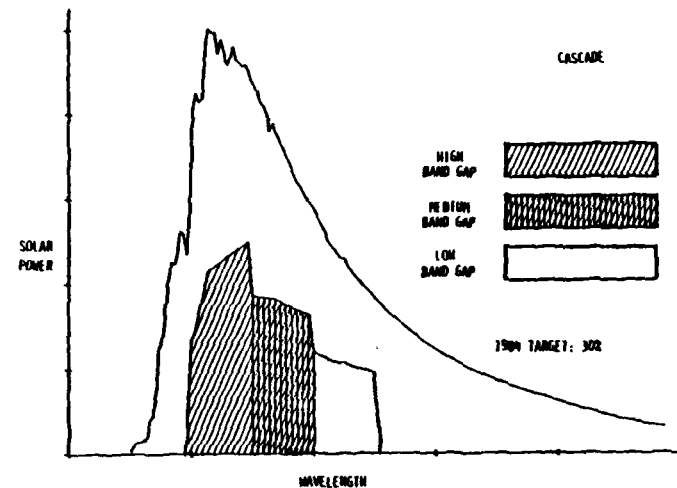
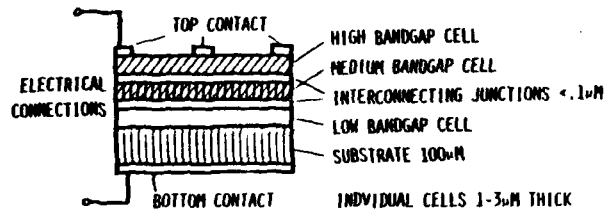

DEVICE CHARACTERISTICS

- USES CONCENTRATED SUNLIGHT
- IN SERIES
- MATCHED FOR CURRENT
- VOLTAGES ADD

DEVELOPMENT AREAS

- PERFECT LOW RESISTANCE INTERCONNECTING JUNCTIONS
- GROWTH OF QUALITY PHOTOVOLTAIC LAYERS BY EPITAXY
- DESIGN FOR USE IN CONCENTRATED SUNLIGHT
- UNKNOWN RADIATION RESISTANCE

PARALLEL PROCESSING
WITH SURFACE PLASMA WAVES

A new concept, invented at the NASA Lewis Research Center, utilizes the wave nature of light to convert its energy into electricity. The light can be spread out into a spectrum and absorbed on a textured surface made of common metals only a few hundred angstroms thick. The absorption is achieved by conversion of the light wave into a relativistic surface plasmon wave. Conversion of 85-90 percent of the light into plasmons has been demonstrated for monochromatic light. Source coherence is not required. The surface plasmons then transfer their energy to electrons which are converting power in a tunnel junction. Calculations of efficiency potential are underway as are experiments to demonstrate feasibility of the concept.

PARALLEL PROCESSING WITH SURFACE PLASMA WAVES

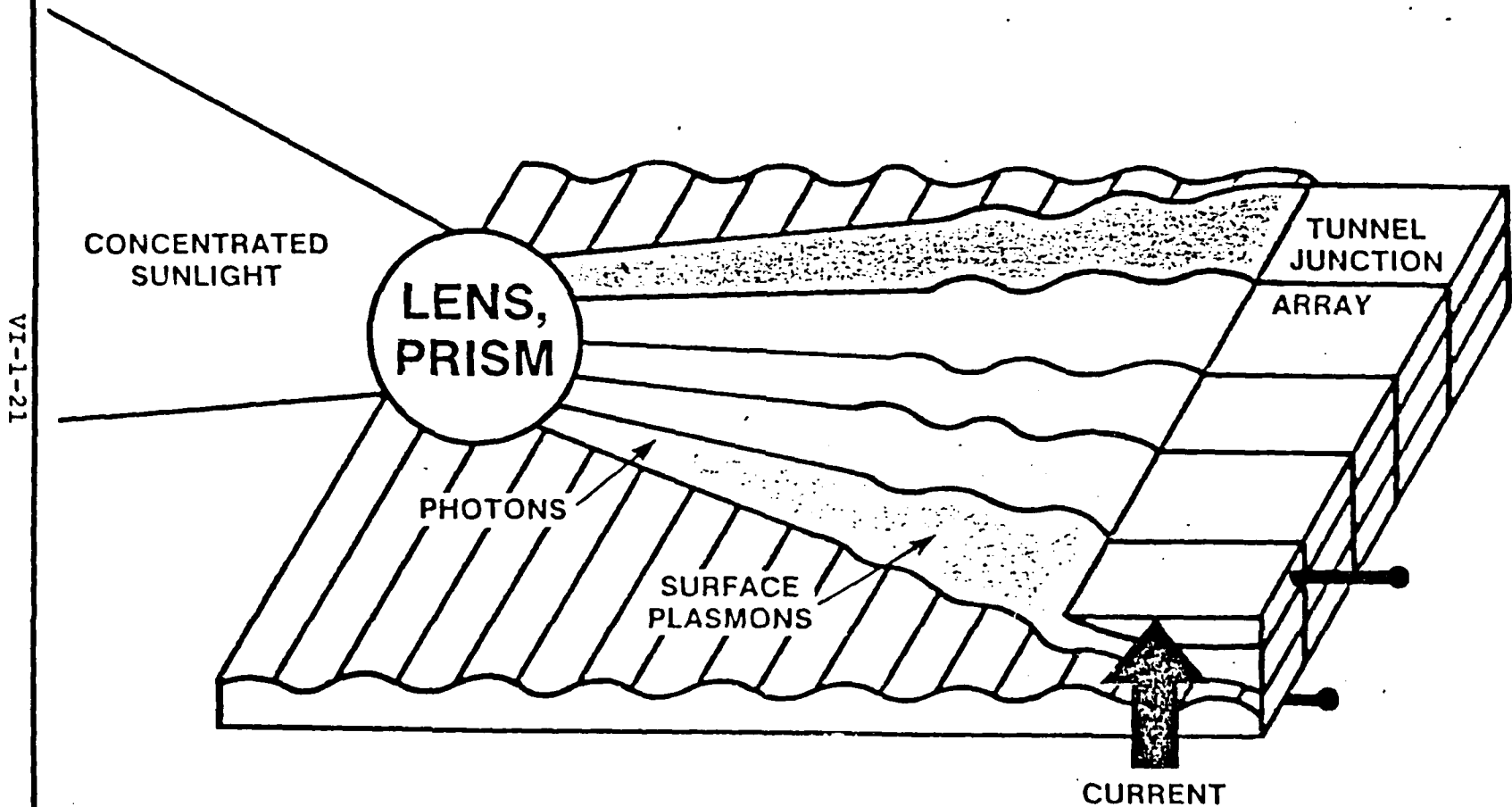

STATUS: EARLY CONCEPTUAL PHASE

HEAT COLLECTION

Paraboloidal collector focuses radiant energy from either the Sun or a laser into a receiver. The size of the receiver's aperture is *chosen to maximize* the difference between energies collected by and reradiated from the aperture.

HEAT COLLECTION

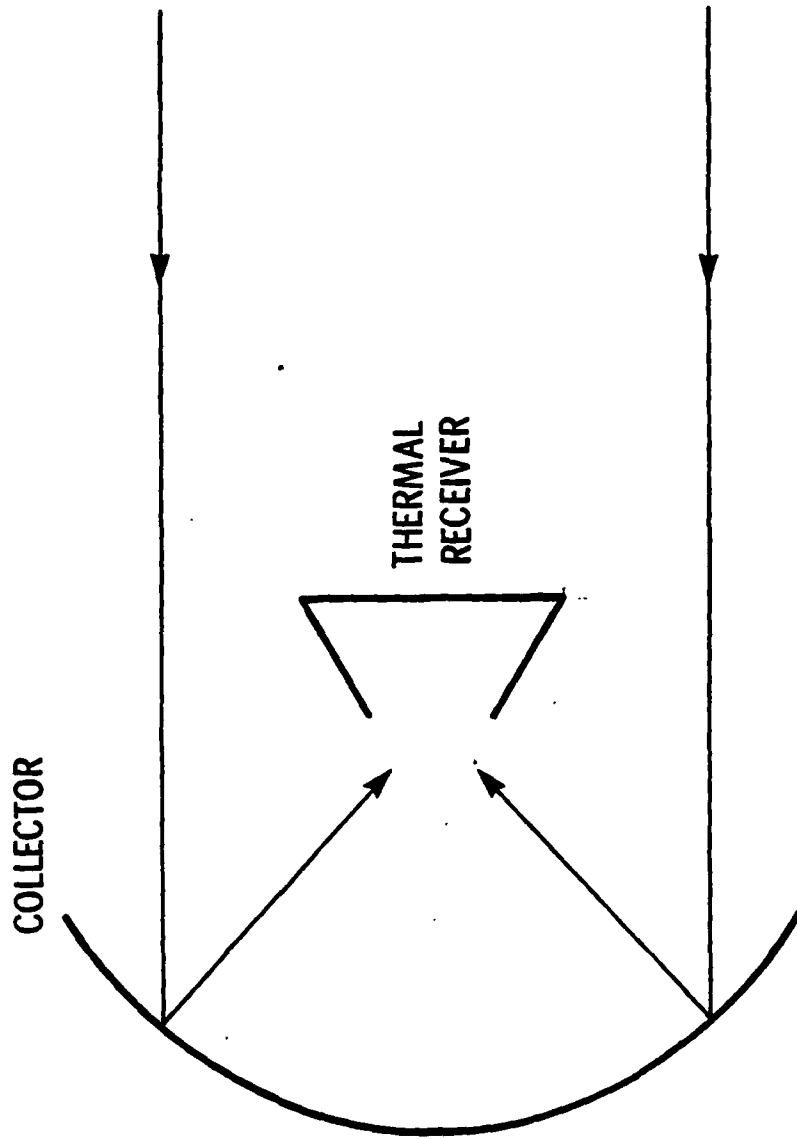

PARABOLOID COLLECTING SUNLIGHT

Paraboloids having surface standard errors of 1-3 arc-minute are state of the art. The usual reflectivity of 0.96 was here degraded to 0.9 to allow for contamination of the mirror's surface. Efficiency of collecting sunlight can exceed 0.8 for temperatures up to 2000K, reradiation from the aperture being accounted for. For illumination by laser, efficiency would be higher.

PARABOLOID COLLECTING SUNLIGHT

REFLECTIVITY, 0.9

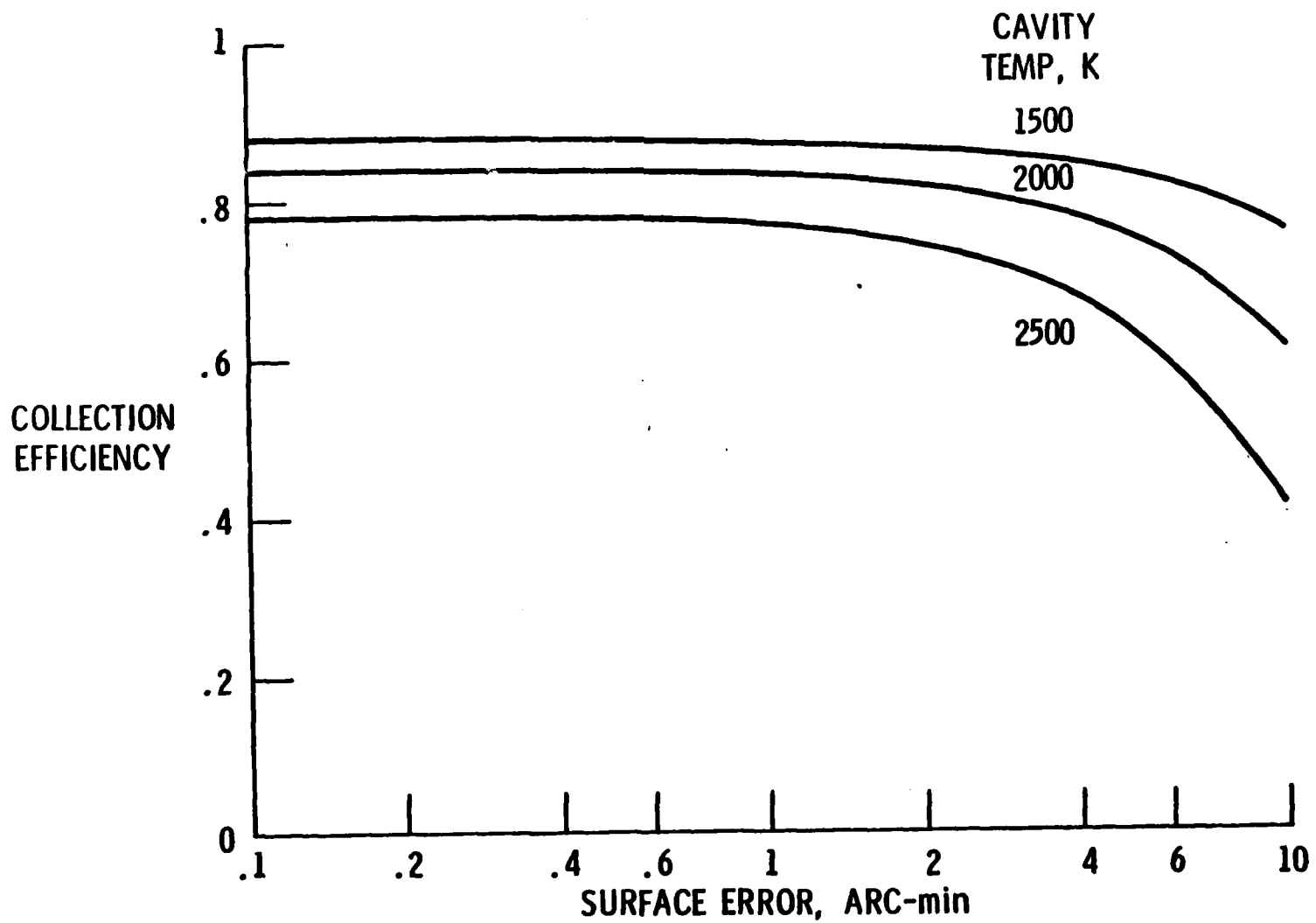

VI-1-25

ONE-PERCENT CREEP OF ASTAR-811C

On the basis of over 250,000 hours of creep testing, the data on ASTAR-811C indicate that an imposed load of 69 MPa (10000 psi) would produce 1 percent creep in the following times:

<u>Temperature, K</u>	<u>Time, hours</u>
1500	40000
1700	100

Reducing this load by 2 standard deviations (to 34 MPa, or 5000 psi) provides a reasonable basis for design.

ONE-PERCENT CREEP OF ASTAR-811C
Ta-8W-1Re-0.7Hf-0.025C 58 TESTS, 188 835 hr

VI-1-27

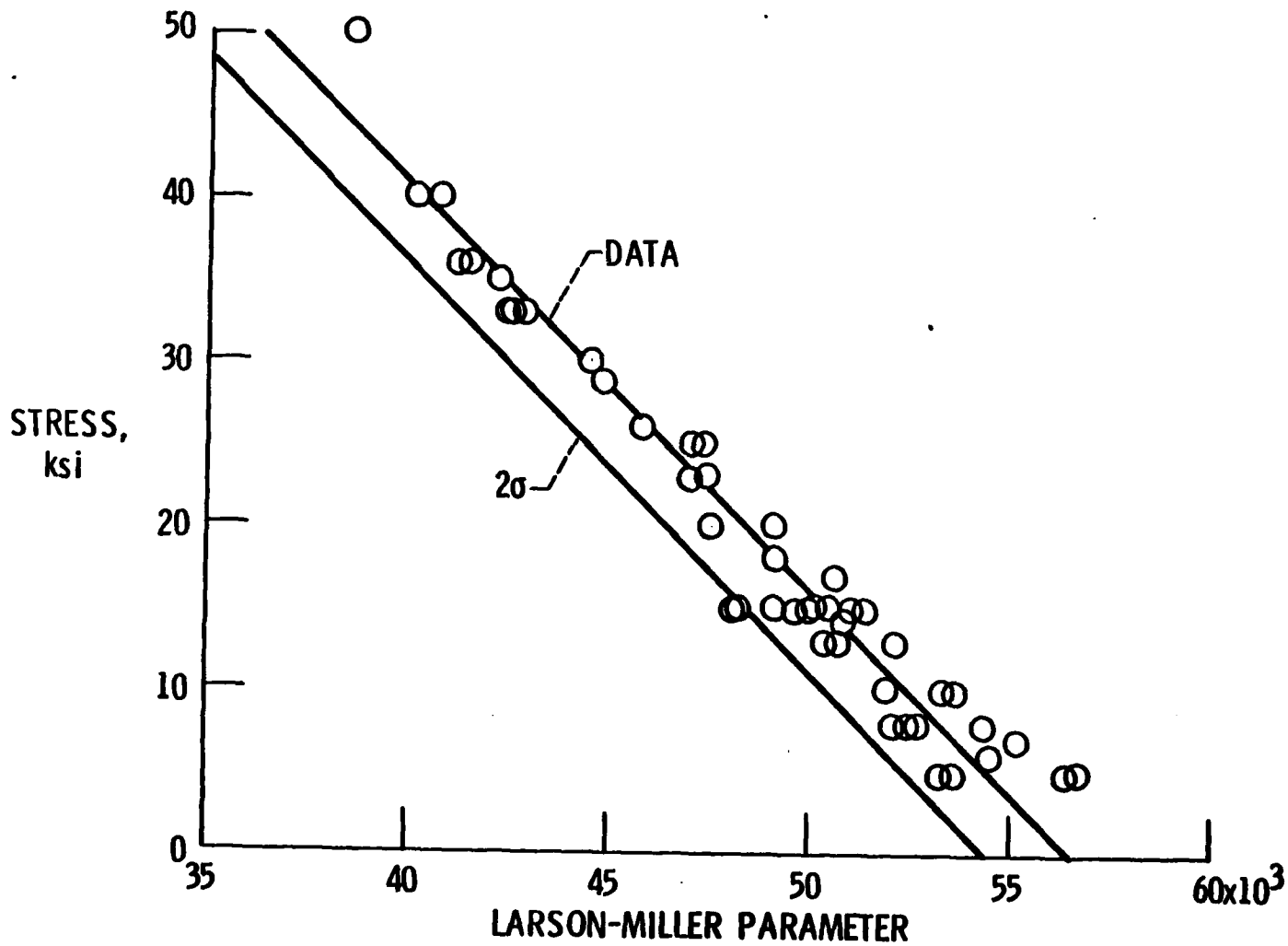

ONE-PERCENT CREEP OF ASTAR-811C

26 TESTS, 116 441 hr

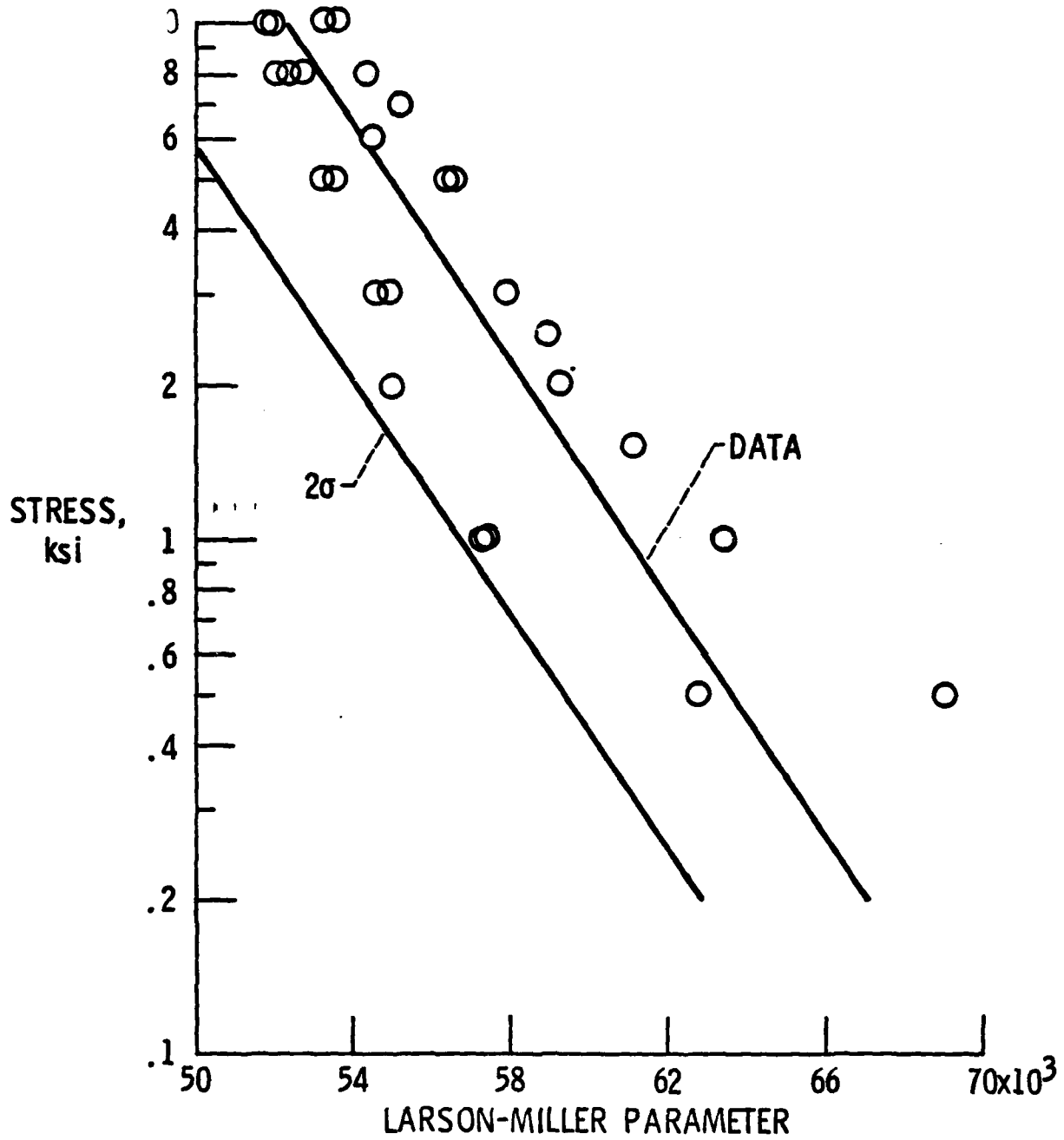

BRAYTON OPTIMIZATION

Overall efficiency of power generation is 0.25 at radiator areas of 0.25-0.5 m²/kWe, depending on turbine-inlet temperature. Operation at 2000K requires better materials than currently exist. Efficiencies exceeding 0.5 are achievable by increasing radiator area.

BRAYTON OPTIMIZATION

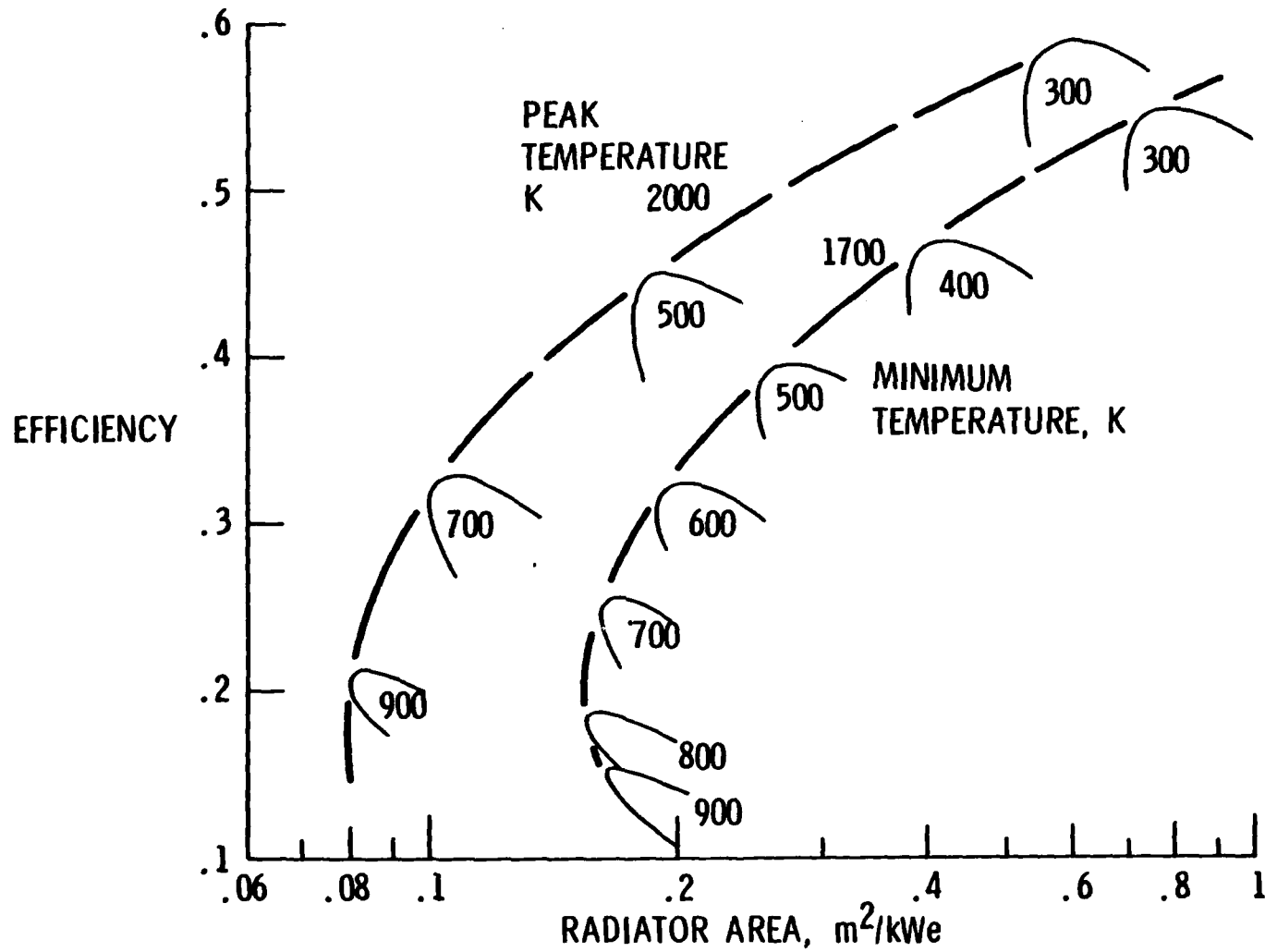

RANKINE VS. BRAYTON

Existing thermodynamic data on the alkali metals extend to only 1650K, but at this temperature radiator area is only .07 m²/kWe. At 2000K, this area would be halved.

AD-A116 867

R AND D ASSOCIATES ROSSLYN VA

F/G 10/2

PROCEEDINGS OF THE AFOSR SPECIAL CONFERENCE ON PRIME-POWER FOR --ETC(U)

FEB 82 P J TURCHI

F49620-82-C-0008

UNCLASSIFIED

AFOSR-Tr-82-0655

NL

8-9

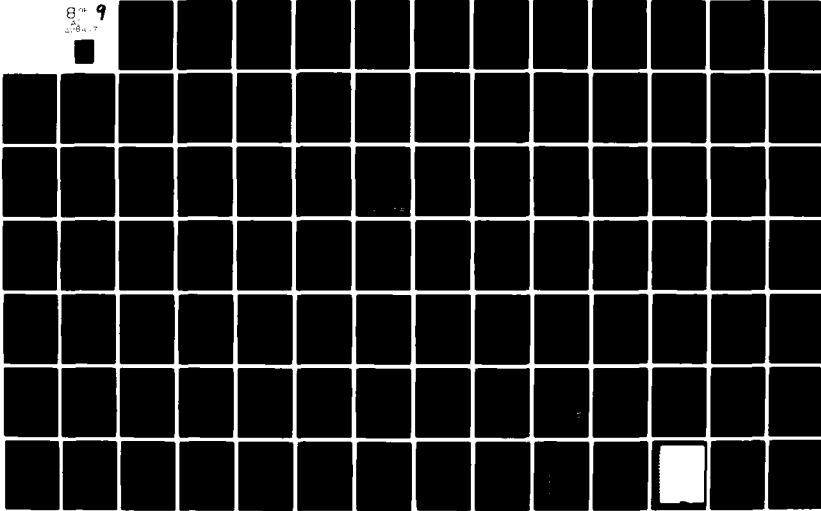

RANKINE VS BRAYTON

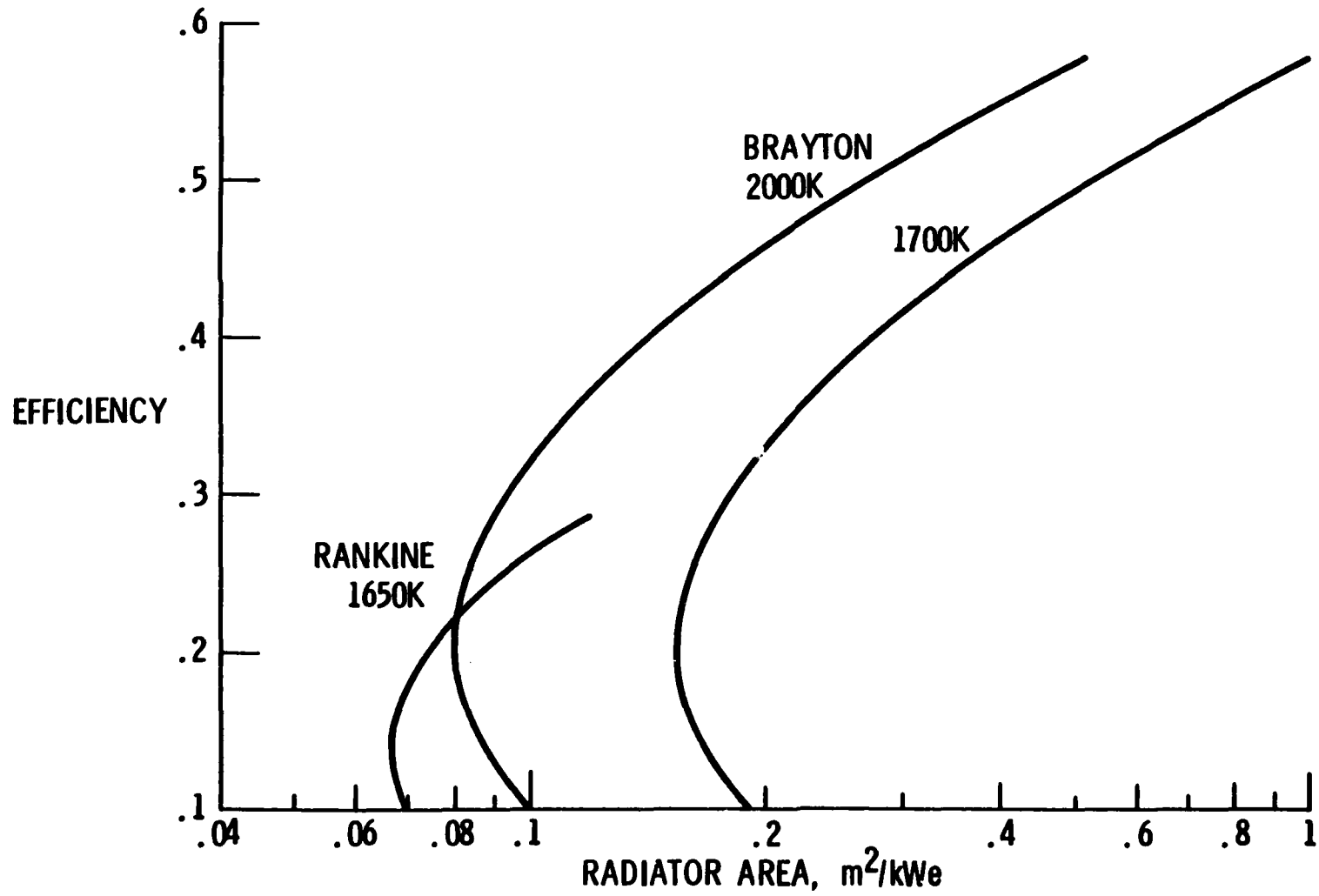

T
*
-
-
[
..
[

PERFORMANCE OF THERMIONIC CONVERTERS

High power density and high temperature boost thermionic performance. The thermionic converter LC-9 operated stably for over 5 years at 1975K.

PERFORMANCE OF THERMIONIC CONVERTERS

NO INTERELECTRODE LOSS

10% BACK EMISSION

MORRIS: NASA TMX-73844

EMITTER TEMPERATURE, K	1650	1800	2000
COLLECTOR TEMPERATURE, K	925	925	925
CURRENT, A/CM ²	5	30	30
POWER, W/CM ²	4.7	31.0	40.0
EFFICIENCY	.235	.302	.338
HEAT INPUT, W/CM ²	20	103	118

THERMIONIC PERFORMANCE

For 925K collector temperature, available data produce large radiator areas. Half this area is required by a power processor of 0.9 efficiency and limited to 100°C. System redesign is required in order that the potential of radiant power input might be fully exploited.

THERMIONIC PERFORMANCE

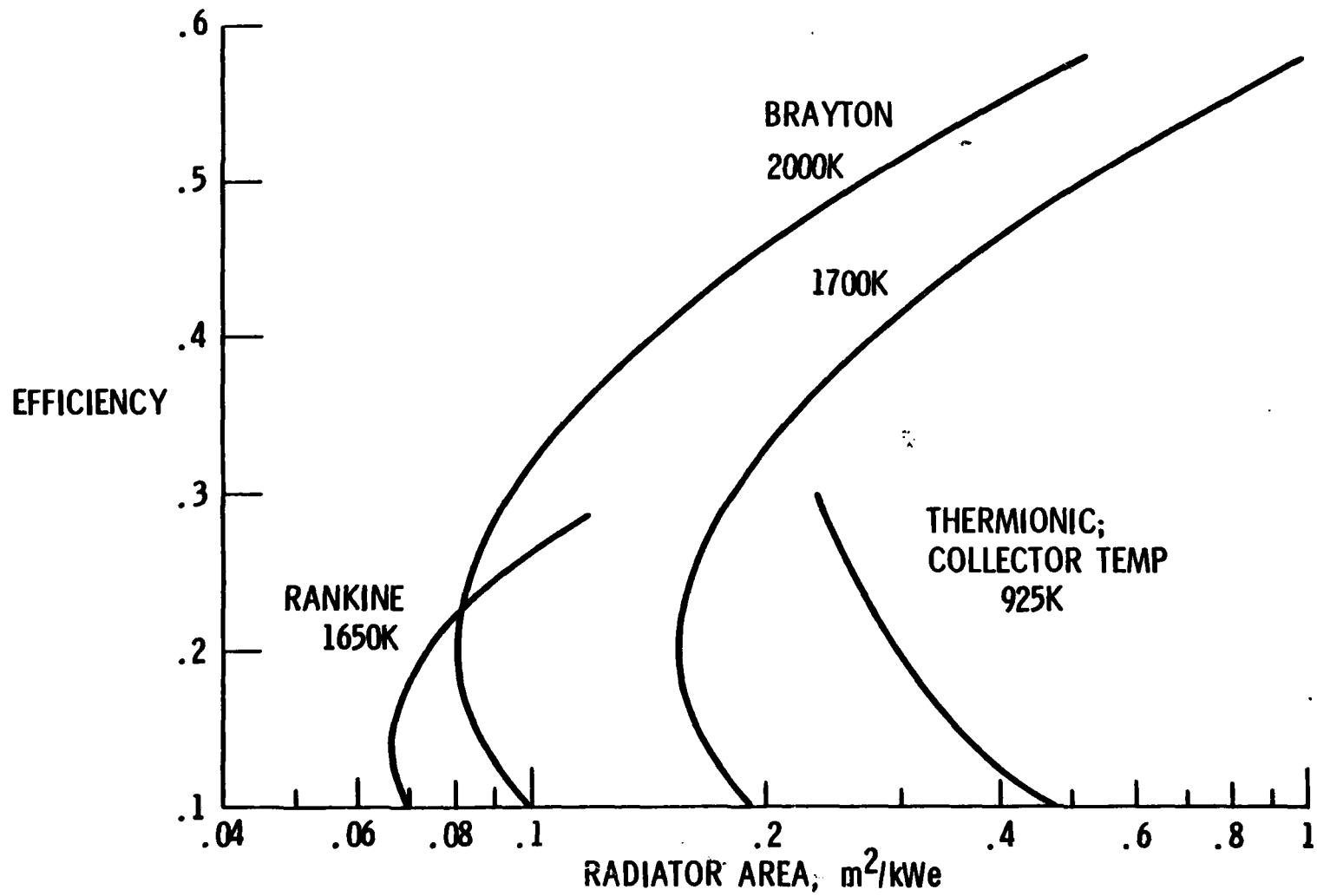

THERMIONICS WITH RADIANT INPUT

Radiant energy input eliminates the high-temperature insulator and its temperature limitations, a factor seriously limiting the voltage generated by nuclear thermionic systems. In turn, both weight and energy losses of power processing can be cut substantially.

THERMIONICS WITH RADIANT INPUT

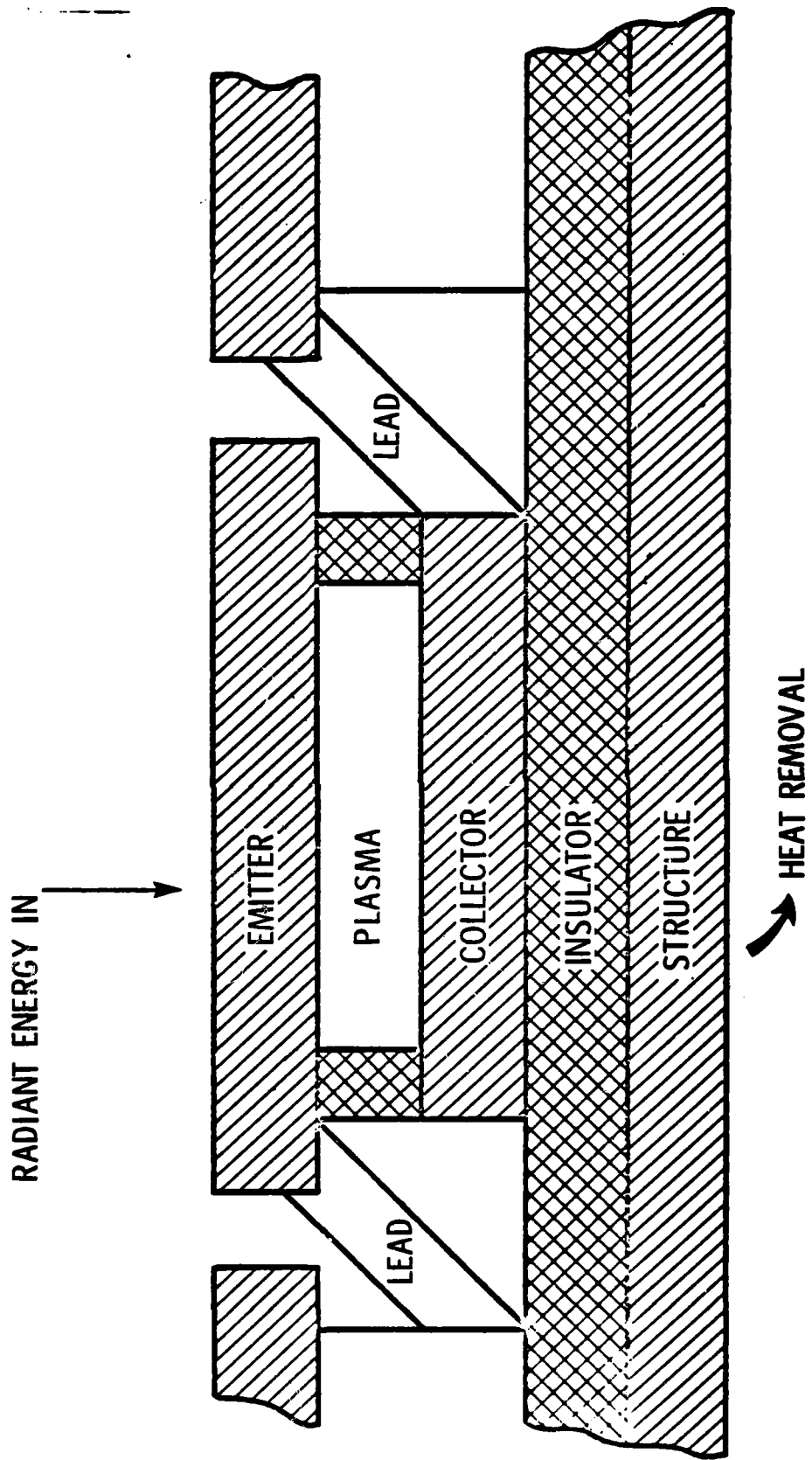

OPTICS REQUIRED

The optics required by 12-cm microwaves are enormous for GEO distances. Lasers would have much smaller optics.

OPTICS REQUIRED

$$dD = 2 \lambda L, \quad D = 2d, \quad L = 42163 \text{ KM}, \quad P = 20 \text{ MW}$$

WAVELENGTH, M	DIAMETER, d, M	AREA, M ²	FLUX, W/CM ²
0.122	2300	4×10^6	.0005
10^{-5}	21	330	6
10^{-6}	6.5	33	60
10^{-7}	2.1	3.3	600

VI-1-40

PHOTOVOLTAICS VS. MICROWAVES

Only by use of wavelengths of the order of 100 μm can microwaves significantly improve on photovoltaic areas.

PHOTOVOLTAICS VS. MICROWAVES

OUTPUT, 10 MW

PHOTOVOLTAICS AT 1 SUN:

EFFICIENCY, 0.18

200 x 200 M

MICROWAVES FOR SAME AREA:

RANGE, 42163 KM

WAVELENGTH, 1.2 MM

MICROWAVES FOR 1/10 THE AREA:

WAVELENGTH, 120 μ M

VI-1-42

FREE-ELECTRON LASERS

Free-electron lasers have three critical features: (1) Because these lasers are tunable, the wavelength of their outputs can be matched to their receivers. (2) The basic technology for the lasers will permit converting a received laser beam back into electric power. (3) Conversion of electric power to laser power, or vice versa, may ultimately exceed 50-percent efficiency.

FREE ELECTRON LASER

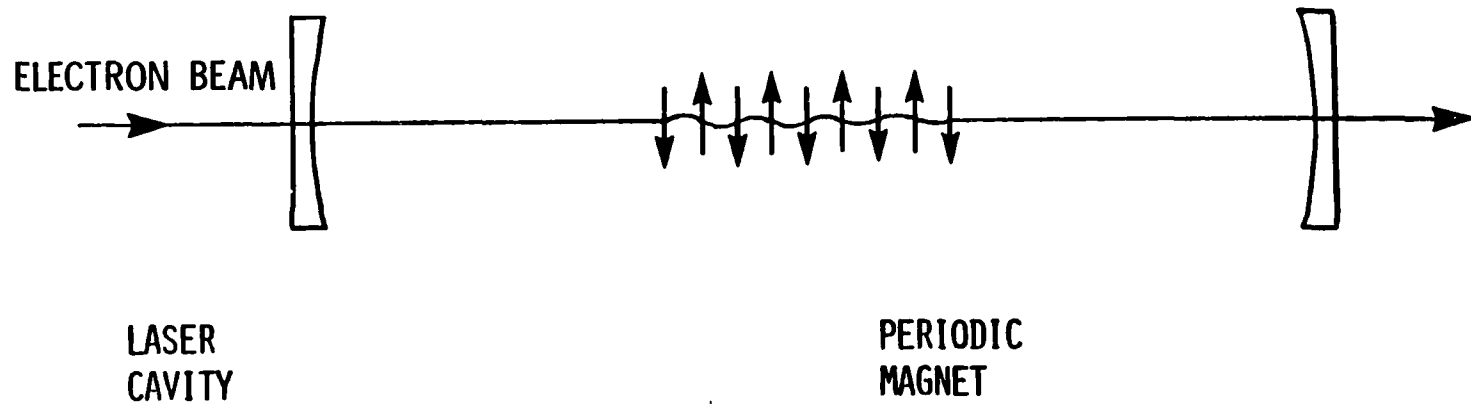

VI-1-44

WHAT WE NEED:

- 1 ELECTRON ACCELERATOR
- 2 WIGGLER MAGNETS
- 3 LASER CAVITY

SCHEMATIC DIAGRAM SHOWING ESSENTIAL FEATURES OF SPACE-BASED FEL

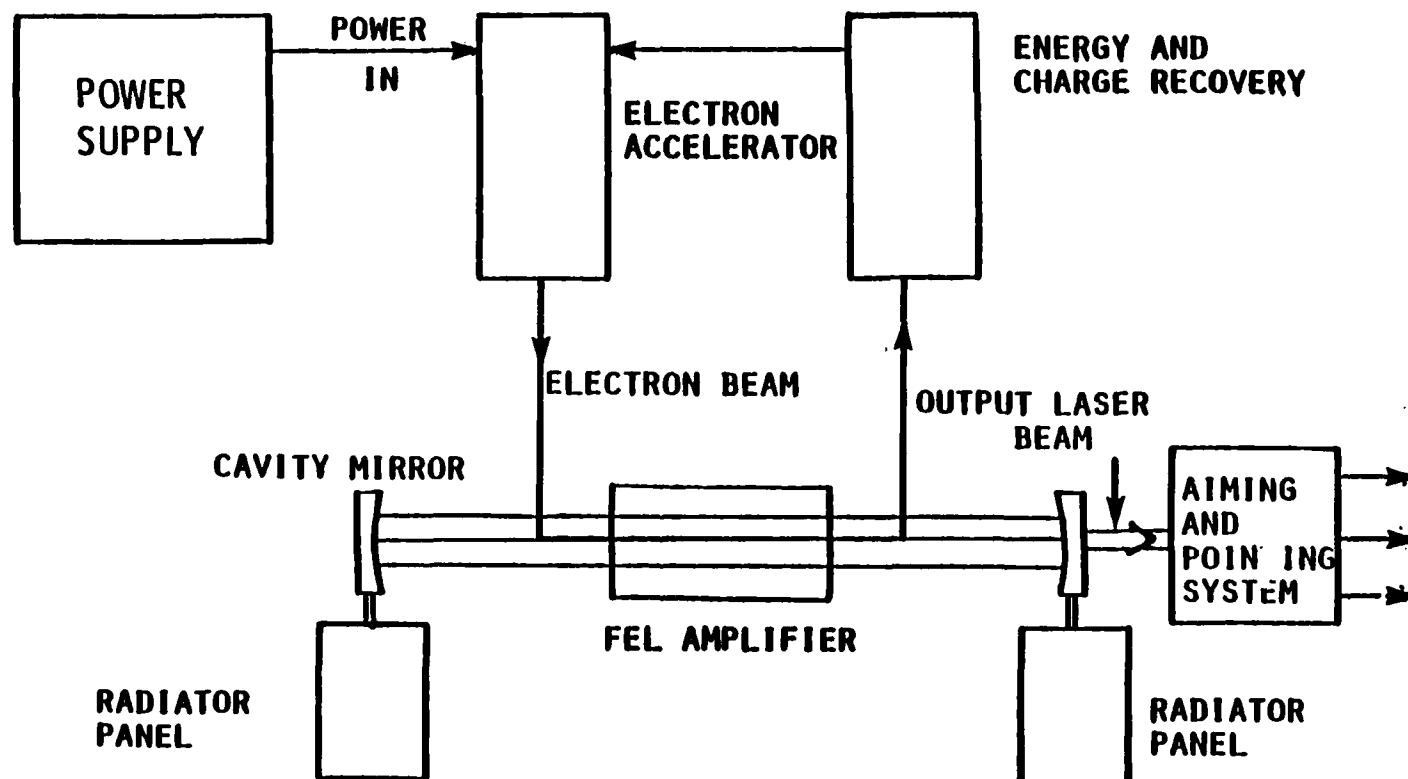

VI-1-45

kms
fusion
inc.

AMPLIFICATION AND ENERGY CONVERSION EFFICIENCY AS A FUNCTION OF INPUT LASER POWER

$L = 10 \text{ m}$ $E_e = 64.5 \text{ MeV}$
 $B = 0.2 \text{ T}$ $I_e = 3 \text{ A}$
 $\lambda_m = 1.5 \text{ cm}$ $\lambda_L = 0.5 \mu\text{m}$

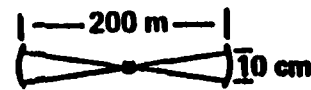

VI-1-46

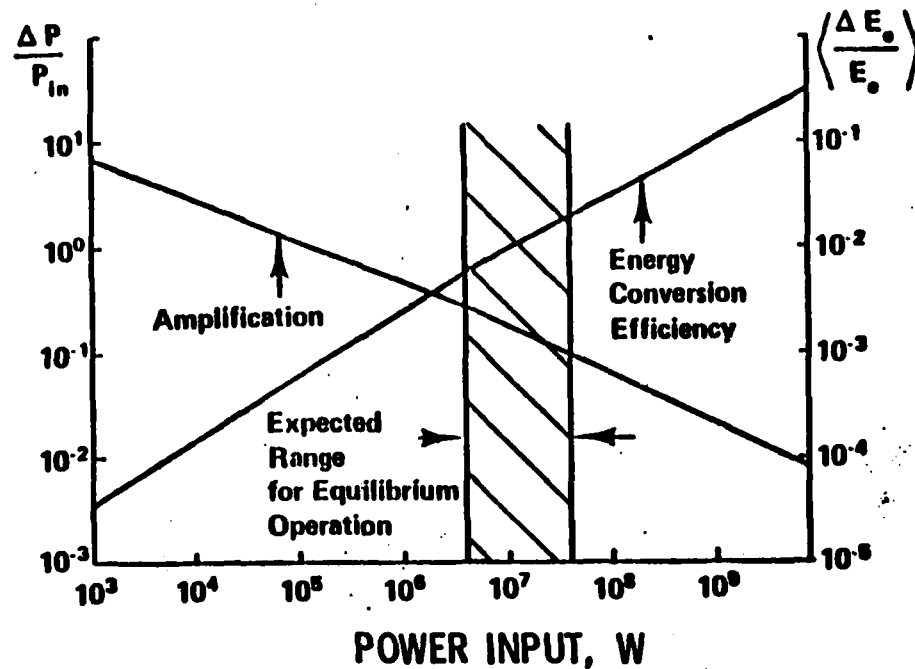

GaAs ARRAYS AND LASERS

Lasers matched in wavelength (850 nm) to GaAs arrays would permit an exceedingly light power supply.

GAAs PHOTOVOLTAIC ARRAYS AND LASERS

ARRAY TEMPERATURE, K	SUNLIT		LASER LIT	
	FLUX, SUNS	POWER, W/M ²	FLUX, SUNS	POWER, W/M ²
323	1	250	1.8	1200
400	2.3	460	3.5	2000
500	5.2	760	6.9	2800
MAX	10	920	10	3000
460			5.3	2500

SEP ARRAY (COMPLETE) = 1.5 KG/M²

LASER-GAAs ARRAY = 0.6 KG/KWE

VI-1-48

RESEARCH ISSUES

1. PHOTOVOLTAICS: REDUCE WEIGHT; DURABILITY IN HOSTILE ENVIRONMENT; ANNEAL AT 200°C; EFFICIENCY OVER 0.3
2. CONSTRUCTION OF LARGE, EFFICIENT MIRRORS
3. DYNAMIC POWER AT 2000K: MATERIALS; THERMODYNAMIC PROPERTIES OF ALKALI-METAL VAPORS
4. EVALUATE THERMIONIC CONCEPT FOR 2000-2200K
5. MICROWAVES: REDUCE WAVELENGTH BY 1000 (TO 0.1 MM)
6. LASERS: VARIOUS CONCEPTS BUT WITH WAVELENGTH MATCHED TO THE CONVERTER. FREE-ELECTRON LASER MATCHED TO GaAs ARRAY APPEARS ESPECIALLY ATTRACTIVE

VI-1-49

ALCA

Q & A - English/Brandhorst

From: P. J. Turchi, R & D Associates
To: Brandhorst

What are requirements (if any) on monochromaticity, and collimation for plasmon excitation with useful efficiency?

A.

None to slight. Device will accept broad band light. Some collimation is beneficial to enhance excitation of plasma waves. We've demonstrated up to 90% conversion of monochromatic green light to plasmons.

From: P. J. Turchi
To: English

For thermionic-radiator package scheme, what insulation is used between electrically-stacked cells? Especially in space plasma and/or high temperature environment.

A.

None. The thermionic converters would be inside a receiver cavity, or hohlraum, thereby being largely protected from space plasma. Thermionic emission of electrons into the cavity should be low because of work function ≈ 4.5 eV.

From: S. Wax, AFOSR
To: Brandhorst

What is current guess of upper bound of efficiency for surface plasma concept? Are there problems with temperature?

A.

Calculations attempting to determine upper bound effic. are underway - key factor appears to be conversion of plasmon to a hot electron excited across the diode. Have demonstrated 85-90% conversion of monochromatic light to plasmons. Reradiation losses of the plasmon seem controllable.

Conversion diodes will probably be adversely affected by increasing temperature. Experiments await suitable devices.

BIBLIOGRAPHY

1. Robert E. English: Alternative Power-Generation Systems. NASA CP 2058, May 1978, pp. 113-131.
2. K.D. Sheffler and R.R. Ebert: Generation of Long Time Creep Data on Refractory Alloys at Elevated Temperatures. NASA CR-134481, TRW rep. ER-7648, Sept. 1973, Table II-11.
3. Robert E. English: Goals of Thermionic Program for Space Power. NASA TM-82616, May 1981.
4. Paul T. Kerwin: Analysis of a 35- to 150-Kilowatt Brayton Power-Conversion Module for Use with an Advanced Nuclear Reactor. NASA TN D-6525, Sept. 1971.
5. A.W. Lemmon et al: Engineering Properties of Potassium. NASA CR-54017, Battelle rep. BATT-4673-FINAL, Dec. 1963.
6. C.T. Ewing et al: High-Temperature Properties of Potassium. NRL rep. 6233, Sept. 1965.
7. J.P. Stone et al: High-Temperature Properties of Sodium. NRL rep. 6241, Sept. 1965.
8. Jack A. Heller et al: Study of a 300-Kilowatt Rankine-Cycle Advanced Nuclear-Electric Space-Power System. NASA TM X-1919, Nov. 1969.
9. James F. Morris: High-Temperature, High-Power-Density Thermionic Energy Conversion for Space. NASA TM-73844, Nov. 1977.
10. S.B. Segall et al: The Application of Free Electron Lasers to the Transmission of Energy in Space. Proceedings of ONR Workshop on Free-Electron Lasers, June 1981.

High Efficiency Tandem or Cascade Photovoltaic Solar Cells
for Space Application

Joseph J. Loferski
Division of Engineering
Brown University
Providence RI 02912

ABSTRACT

High efficiency solar cells are attractive for both space and terrestrial applications because they reduce the overall cost of a system intended to generate a given amount of power from sunlight. This is because every PV system includes components whose cost is proportional to the area covered by the system and this area is inversely proportional to the conversion efficiency of the cells. For single solar cells, the limit theoretical efficiency lies between 25 and 30%. Cascade or tandem cell systems, which consist of a number of solar cells made from photovoltaically active semiconductors (PVAS) having appropriately selected bandgaps in the range 1.0 eV to 2.2 eV have substantially higher theoretical limit efficiencies. For an "infinite" number of cells made from an "infinite" number of PVAS and maintained at 300 K, this flat plate limit efficiency is 68% while the high concentration ratio ($10^4 \times$) limit efficiency is around 86%. For a cascade of twelve cells made from twelve properly selected PVAS, the flat plate limit efficiency is around 50% for 300 K. This paper presents an outline of a research program which would result in cascade solar cells capable of such high efficiencies. It shows how to select PVAS alloy systems having the required range of bandgaps. It describes the optimized "unit cell" of such a cascade stack and discusses requirements other than band-gap which must be satisfied by the PVAS intended for cascade cells. A brief review of the current status of research in this area is included.

SOLAR PV CELLS IN SPACE

SOLAR ENERGY DENSITY 1.4 KW/M^2

FOR 10% EFFICIENT CELLS AND 1.4 MW PEAK,
AREA REQUIRED 10^4 M^2

FOR 20% EFFICIENT CELLS $5 \times 10^3 \text{ M}^2$

FOR 40% EFFICIENT CELLS $2.5 \times 10^3 \text{ M}^2$

SINGLE PV CELLS: AMO

LIMIT EFFICIENCY

FLAT PLATE THEORY	~ 25%
CONCENTRATOR	~ 30%
OBSERVED	~ 20% (GAAs)

TANDEM OR CASCADE PV CELLS: AMO

LIMIT EFFICIENCY (INFINITE NUMBER)

FLAT PLATE THEORY	~ 68%
CONCENTRATOR (10^4)	~ 86%

IF OBSERVED/PRACTICAL ~ 0.8, LIMITS WOULD BE

FLAT PLATE	~ 54%
CONCENTRATOR (10^4)	~ 68%

LOSSES IN SINGLE SEMICONDUCTOR SOLAR CELLS

There are two large photon energy losses in solar cells utilizing a single photovoltaically active semiconductor (PVAS). This bar chart shows the losses in silicon which ultimately result in 10% efficient (AMO) cells, but with respect to the losses of photons which cannot be absorbed (about 23%) and of excess photon energy not utilized in the conversion process (57%), the sum of these losses is of the order of 56.5% in any single PVAS solar cell (Ref 1)

FRACTION OF AVAILABLE ENERGY USED IN CONVERSION

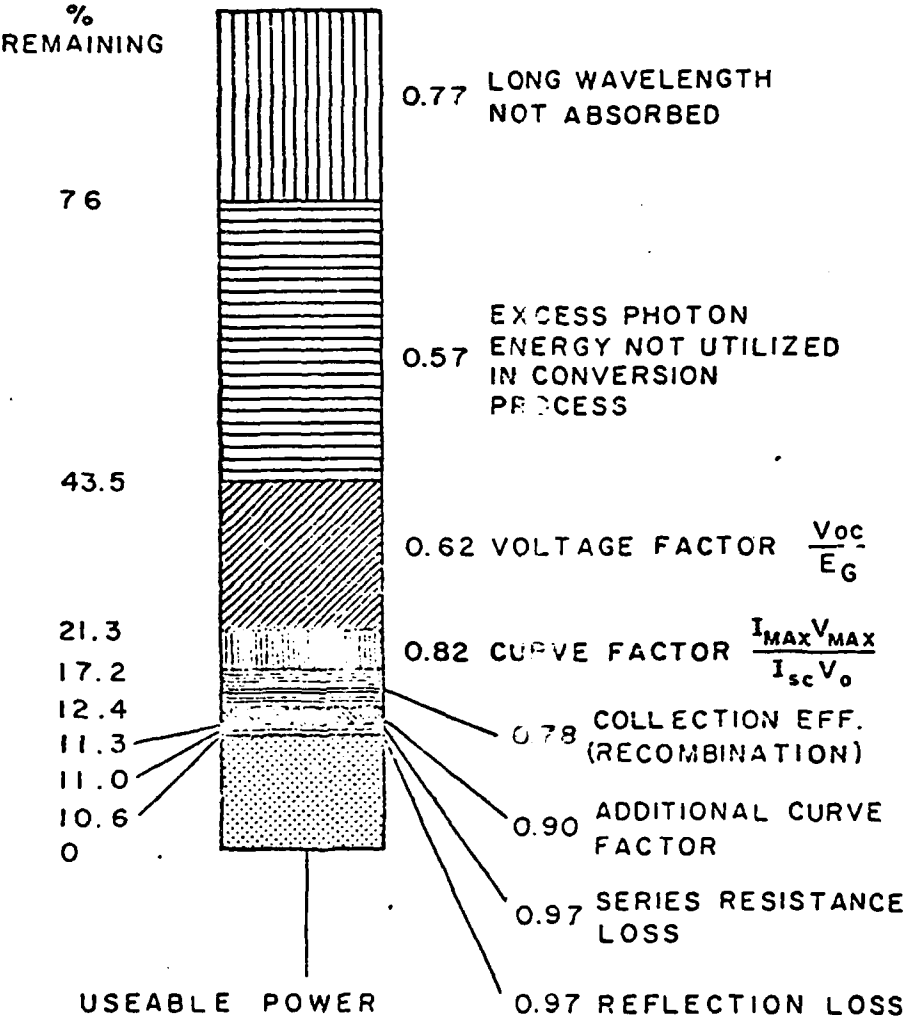

SCHEMATIC REPRESENTATION OF A TANDEM CELL SYSTEM

In a tandem or cascade PV cell system, a group of solar cells each based on a PVAS having a different energy gap are arranged in such a way that the light is incident on the first cell in the stack which absorbs photons with energy greater than the energy gap E_{G1} of its PVAS; the remainder of the photons are directed to the second cell, etc. Tandem cells can be actualized by utilizing selective filters or by constructing monolithic structures with the cells fabricated on top of each other or they can be stacked on top of each other and connected to separate loads as shown in the figure (Ref 2).

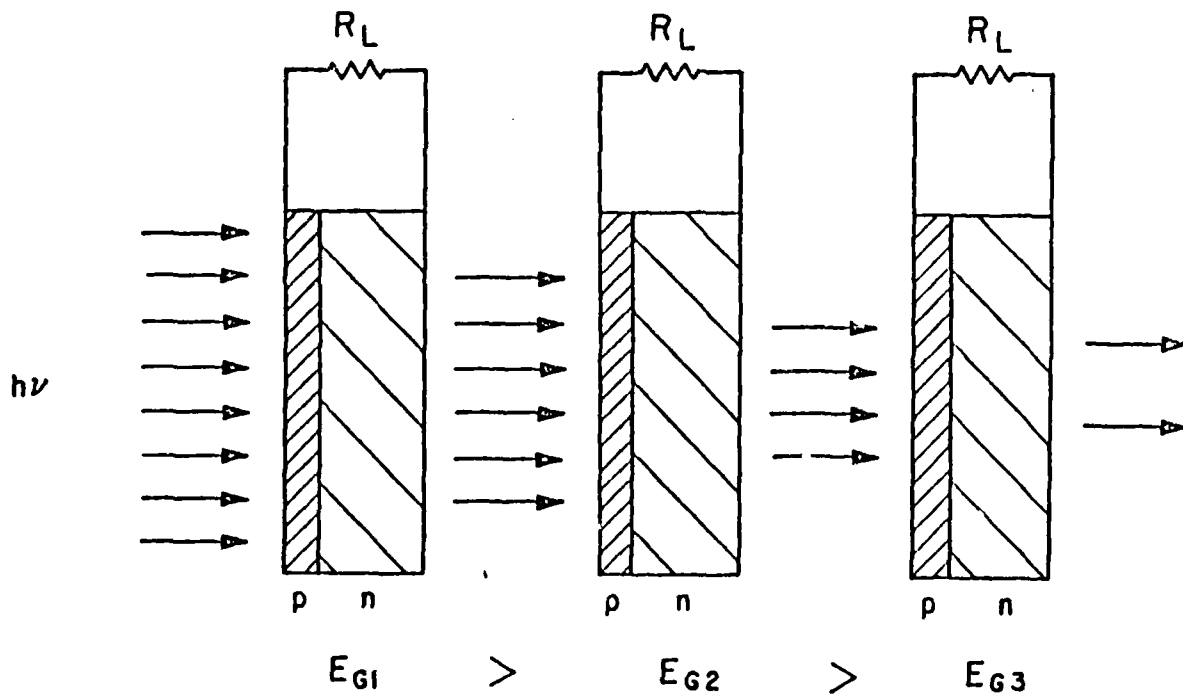
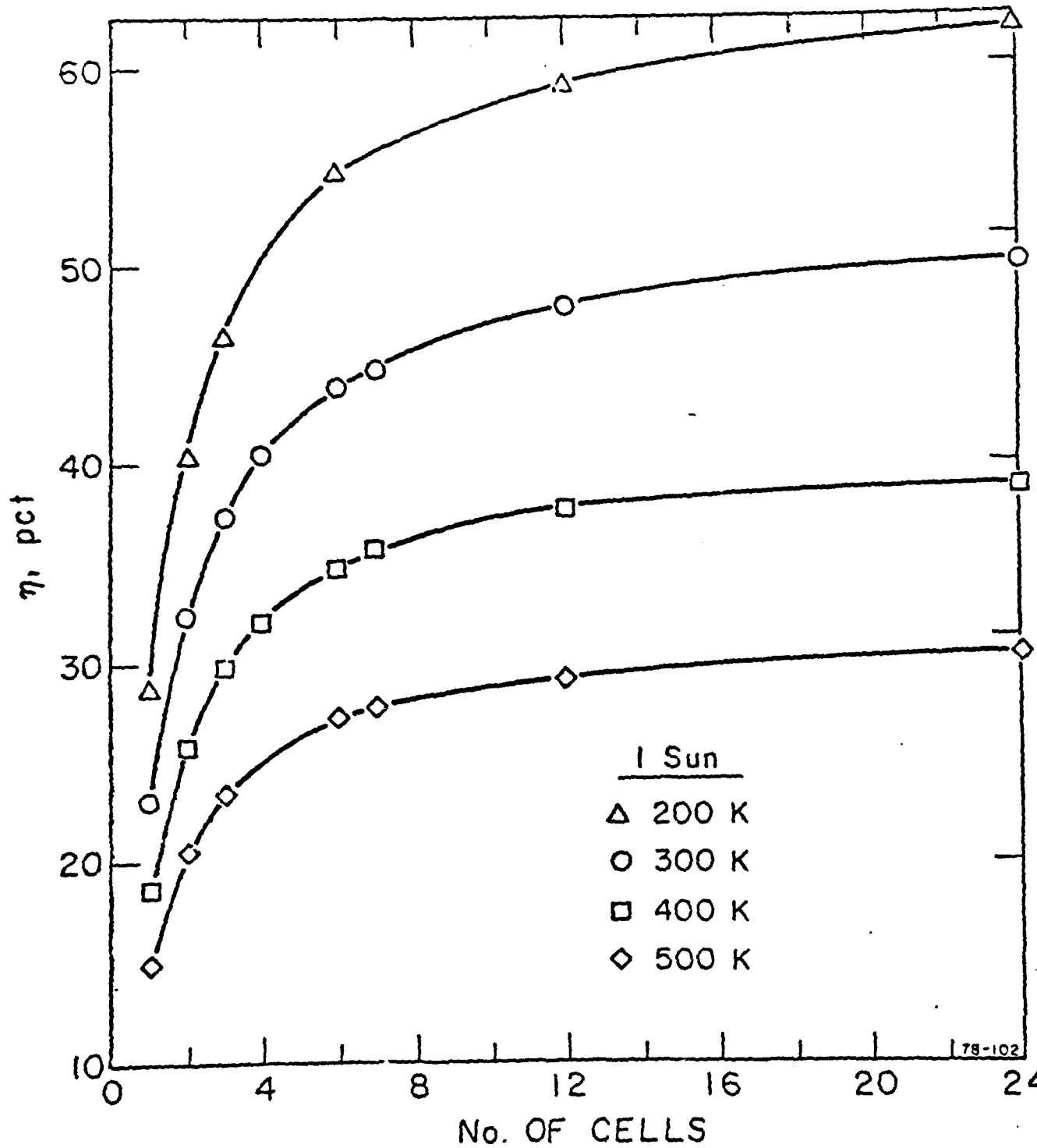

Fig. 1. Schematic representation of a three semiconductor tandem cell system.

RESULTS OF EFFICIENCY CALCULATIONS

The next two figures show the results of efficiency calculations for a finite number (≤ 24) of cells made from different PVAS with properly chosen E_G . Both figures represent efficiencies for AMO calculations. The first refers to a "no concentration" situation; the second to 100X concentrations. Note that at 900K, for no concentration, a six cell system is about 90% as efficient as a 24 cell system. The efficiency of a 24 cell system (56%) is about 82% of the efficiency of a system utilizing an infinite number of PVAS (68%) (Ref 2)



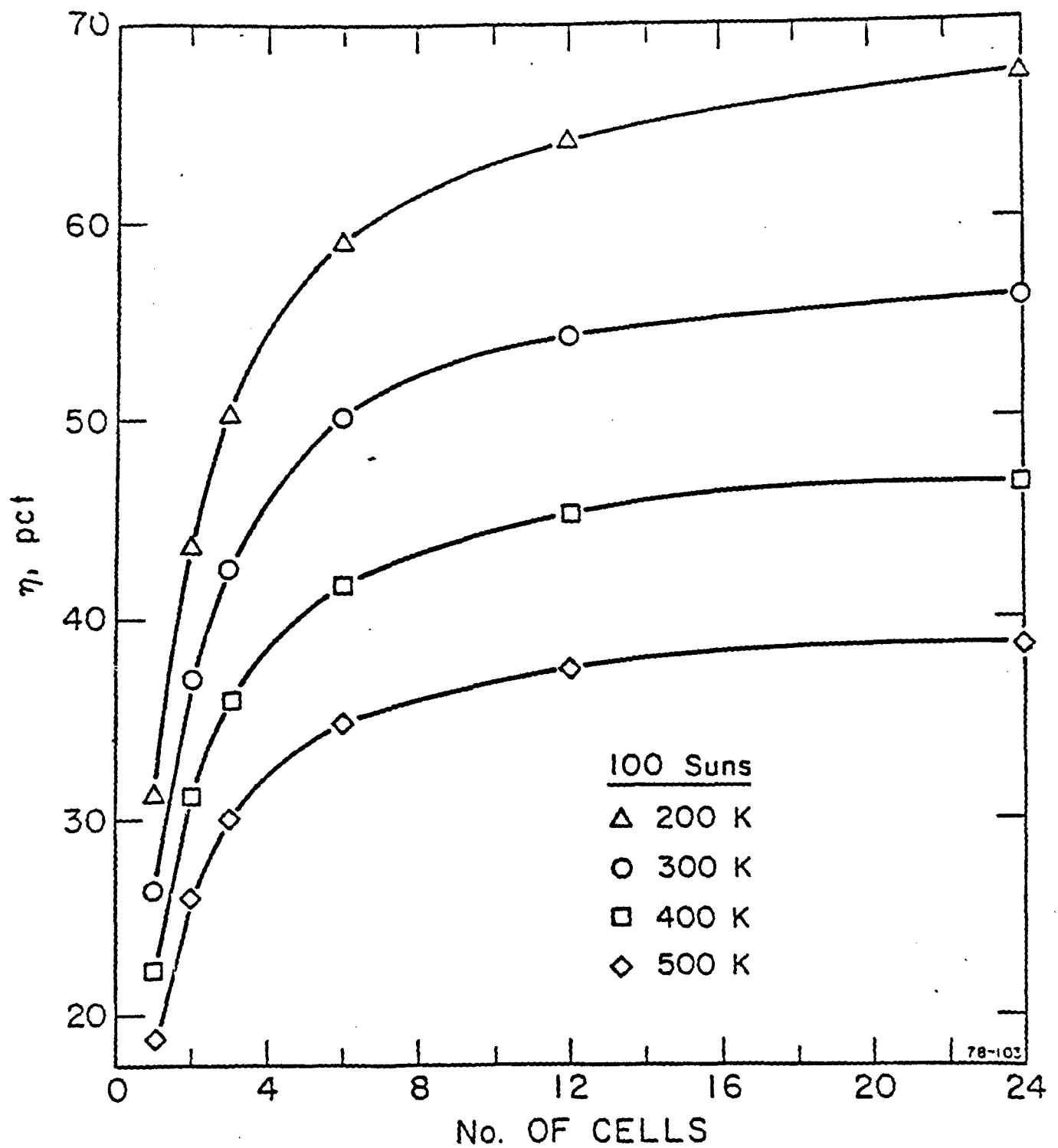

Figure 2. Variation of efficiency with number of cells at various temperatures. Solar Concentration Ratio $C = 100$; AM0 spectrum.

WHAT IS NEEDED FOR MONOLITHIC TANDEM CELLS

UNIT PV CELL ~ 5 MICRONS THICK OPTIMIZED
EFFICIENCY

UP TO TEN PV ACTIVE SEMICONDUCTORS WITH
BAND GAPS BETWEEN ~ 1.0 eV AND ~ 2.0 eV
PROPERLY SELECTED

PREFERABLY DIRECT GAP SEMICONDUCTORS

THEY SHOULD HAVE SAME LATTICE CONSTANT

PROBABLY HETEROJUNCTION CELLS WITH WIDE
BAND GAP (≈ 2.4 eV) WINDOW

"IDEAL" HETEROJUNCTION PV CELL

The next two figures show the ideal cell in which the small band gap PVAS is covered by a wide band gap, transparent (to sunlight) semiconductor. Such a structure reduces or eliminates losses which would occur on the surface of a p/n homojunction cell made from the same small band gap PVAS. The second figure shows the electronic energy band diagram of the cell. In this configuration, the wide band gap material is more heavily doped than the PVAS which shifts most of the space charge region into the PVAS. In the ideal cell there are no interface states in the region where the two semiconductors meet. Interface states increase the diode reverse saturation current I_0 which leads to lowered V_{oc} (Ref 3).

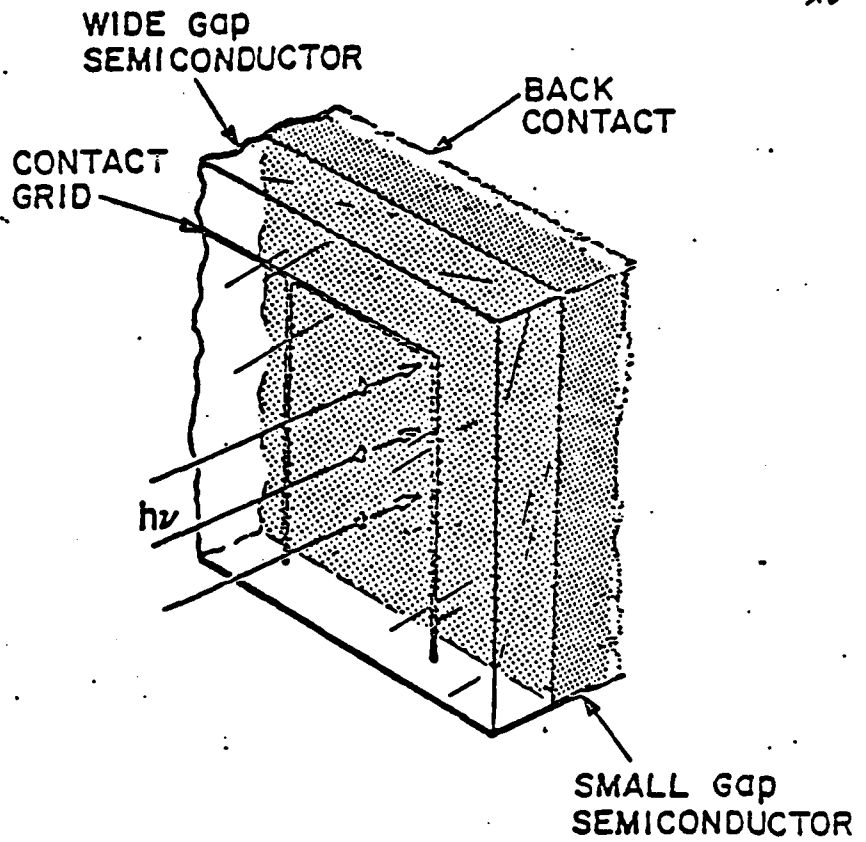
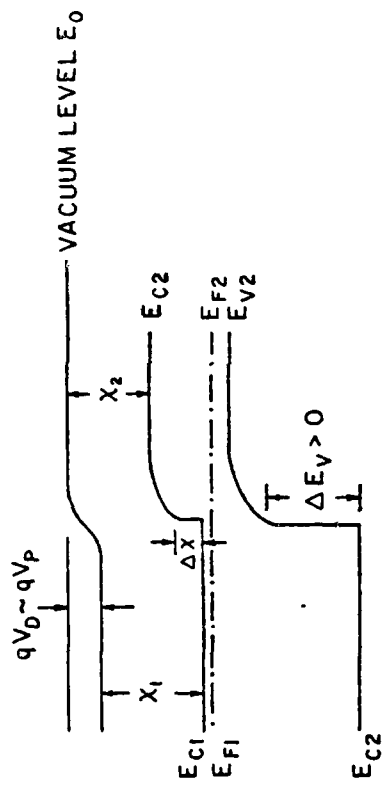

Fig. 13.1 - Schematic representation of a heterojunction solar cell

$I_n P$	0.3	1.25	8-9%
$G_2 A_2$	4	1.35	7%
G_2	4	0.70	17%
$CuTe$	9	1.45	5-6%
	$\frac{43}{2}$	E_G	H



CALCULATIONS OF EFFICIENCIES OF SOLAR CELLS INTENDED FOR TANDEM
CELL SYSTEMS AND FABRICATED FROM DIRECT GAP SEMICONDUCTORS EM-
PLOYING MINORITY CARRIER AND OPTICAL MIRRORS

The next figure in this pair shows the electron energy band diagrams of two p/n homojunction structures which incorporate minority carrier mirrors (MCM) formed in one case by n^+n and p^+p junctions and in the other by placing wide band gap semiconductors at the ends of the photovoltaically active volume. The results can be easily adapted to a heterojunction.

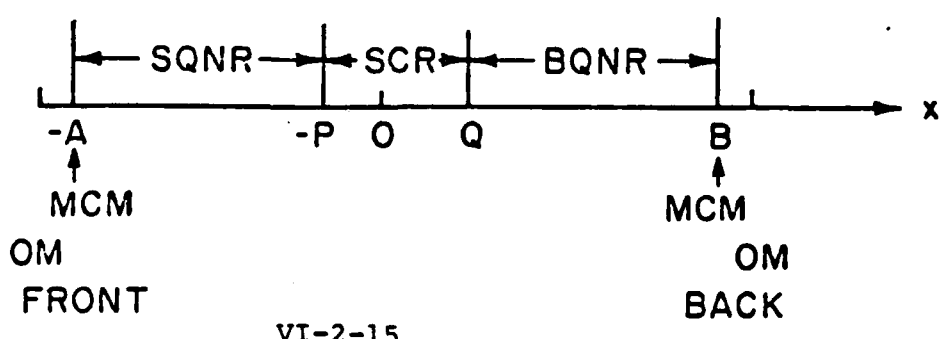
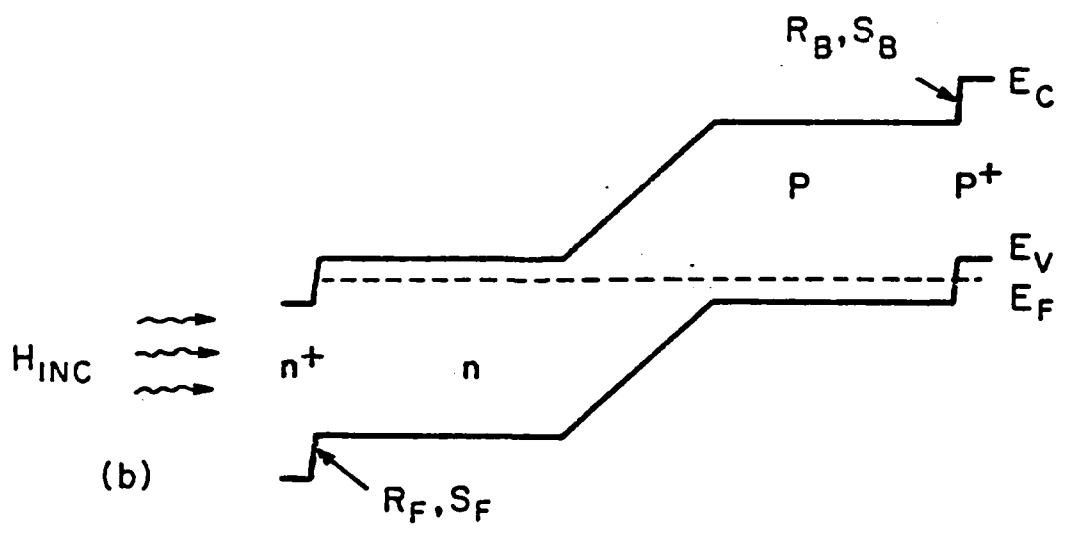
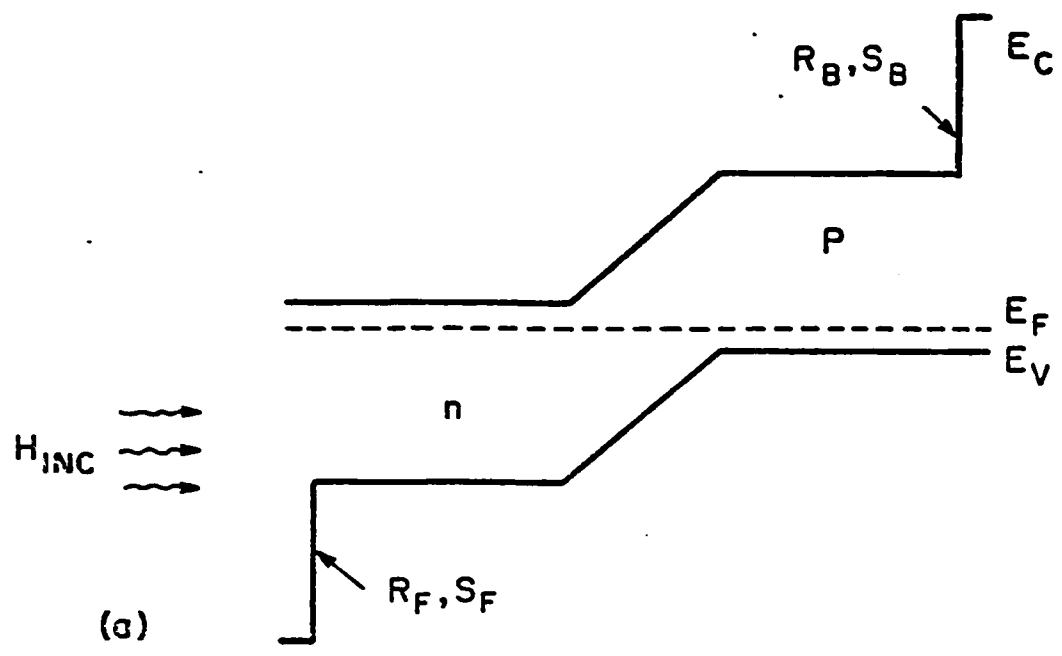

RESULTS OF CLACULATIONS OF EFFICIENCY OF OPTIMIZED INDIVIDUAL CELLS

This figure shows how the efficiency of CuInSe_2 and GaAs cells vary with thickness for certain design parameters. The parameter "A" represents the junction depth. Note that, for both semiconductors, the maximum efficiency occurs for a thickness of about $2\mu\text{m}$. These results can be applied essentially directly to heterojunction cells by extrapolating A to zero.

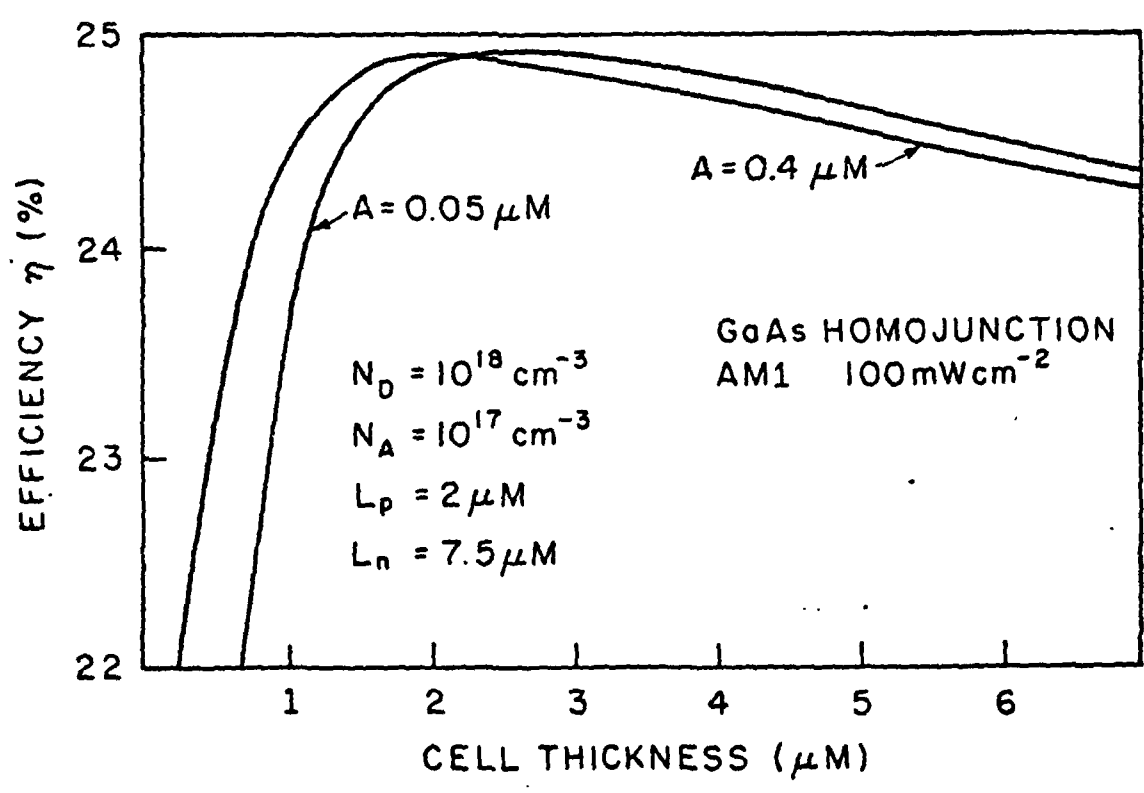
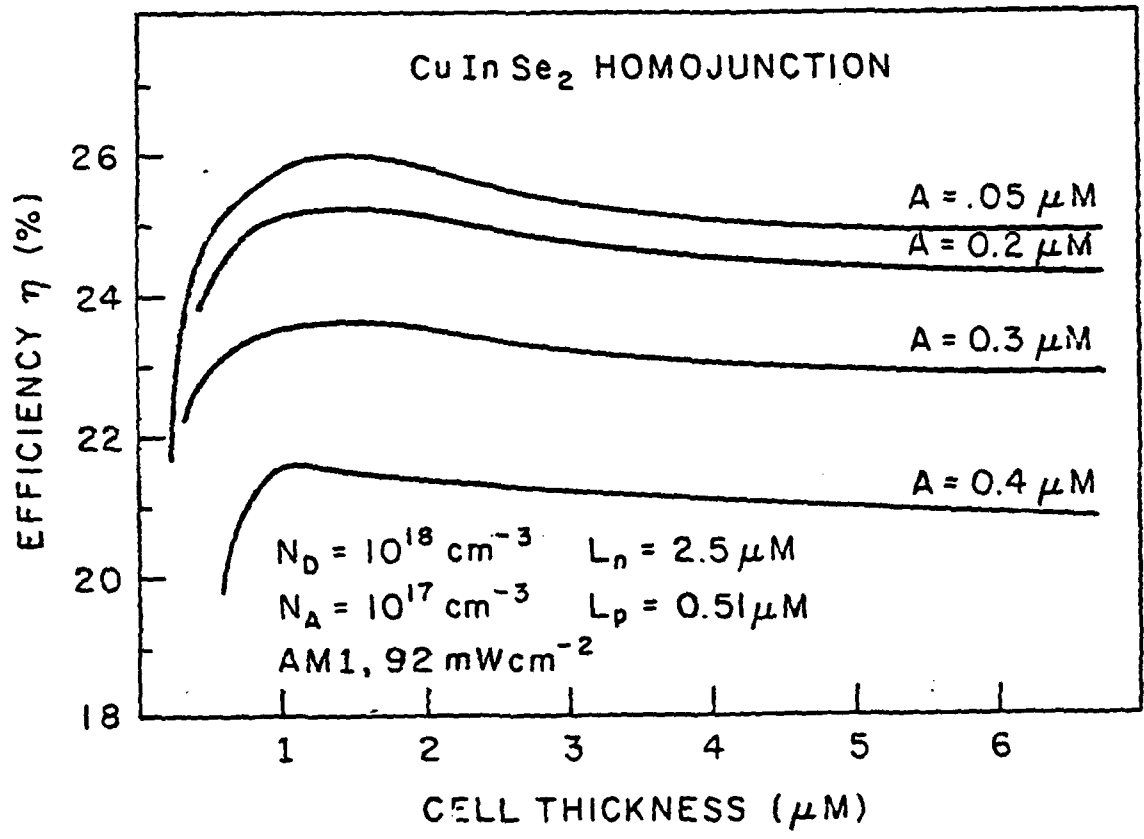

MONOLITHIC TANDEM CELL FABRICATED FROM OPTIMIZED UNIT CELLS

A monolithic tandem cell can be made from optimized hetero-junctions like those shown here on the left side or from homo-junctions as shown on the right side of the next figure. In either case, the sequence must be n^+n/p^+p and the n^+ and p^+ regions must be heavily doped to insure ohmic contacts between cells in the stack. The materials in the cells need to have the same lattice constant and energy gaps ranging from 1.0 to 2.0 eV. Each optimized cell in the stack is only about $2\mu\text{m}$ thick so that a stack of 24 such cells need only be about $50\mu\text{m}$ thick.

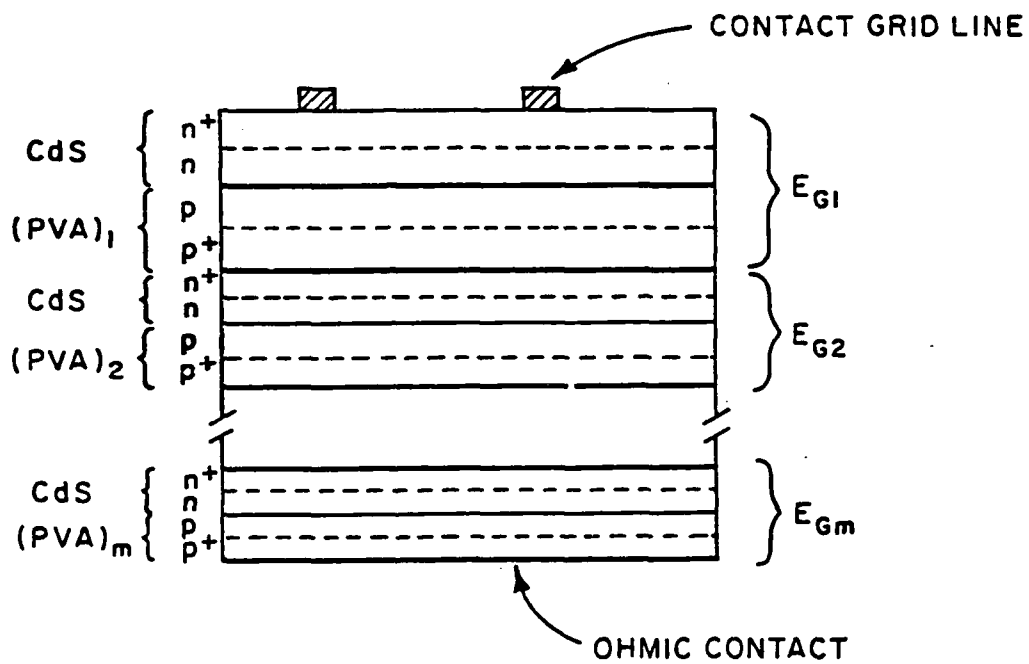

HOW ALLOY SYSTEMS CAN SERVE AS THE SOURCE OF SUPPLY OF SEMICONDUCTORS FOR TANDEM PV CELL SYSTEMS

As shown on the left in this figure, a pseudo-binary alloy of two III-V or two I-III-VI₂ (or other) semiconductors have lattice constant and energy gap which vary with composition. For a given alloy, there is a single value of lattice constant and energy gap. As shown in the figure on the right, it is possible to form quaternary and pentenary alloys by combining the pseudo-binary alloys of these semiconductors (Ref 4)

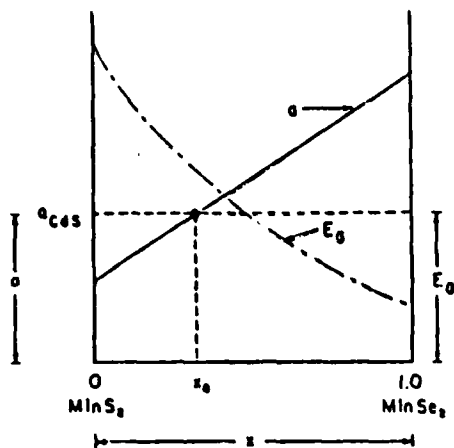

$MnS_{2(1-x_0)}Se_{2x_0}$ HAS THE SAME LATTICE CONSTANT AS CdS

Figure 2. Hypothetical dependence of lattice constant (solid line) and energy gap (dashed line) on composition in a pseudo-binary alloy of two ternary semiconductors.

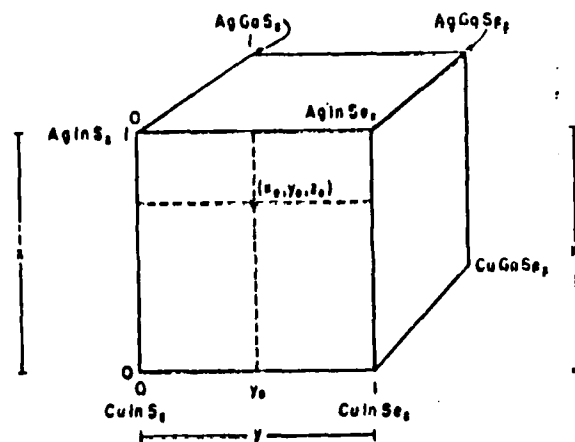

Figure 4. Sketch showing the way alloys are formed between three or more ternary materials.

EXAMPLES OF ALLOY SYSTEMS WHICH ENCOMPASS SEMICONDUCTORS HAVING CONTINUOUSLY VARYING ENERGY GAPS AT A FIXED VALUE OF LATTICE CONSTANT

The first of the next two figures is an iso-lattice constant, iso-energy gap map of the Cu-Ag-In-S-Se system. The dotted lines represent constant lattice constants and the solid lines, constant energy gap. The heavily dotted line corresponds to the lattice constant of CdS which is a suitable wide band gap semiconductor intended to play the role of the wide band gap window of the "ideal" heterojunction cell. The second figure shows similar data for the Cu-Ga-In-Se-Ts system.

Homogeneous alloys of various members of these systems as well as of III-V semiconductors have been prepared. These systems can serve as the PVAS of tandem cells which are the high efficiency cells of the future (Ref 4).

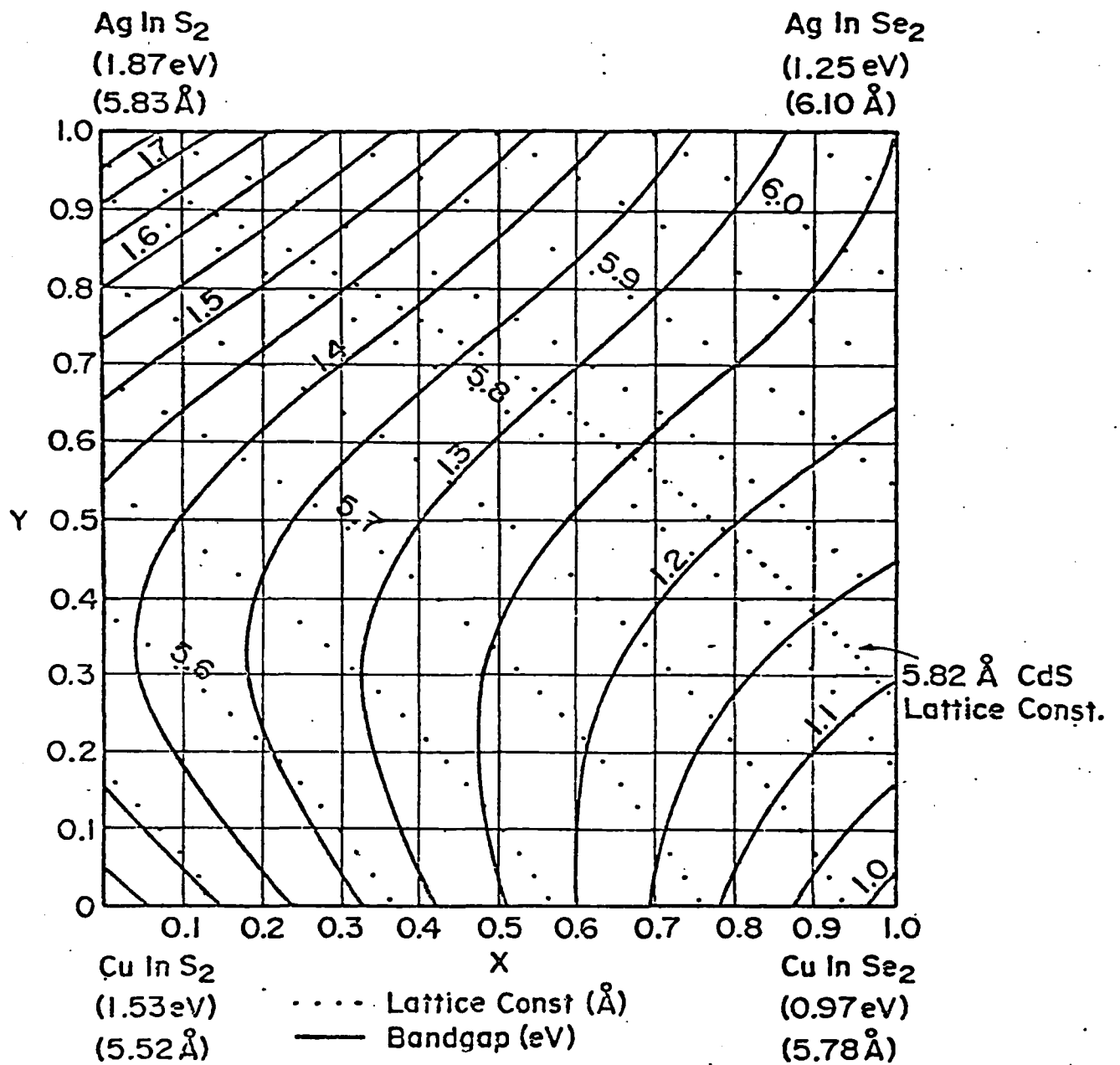
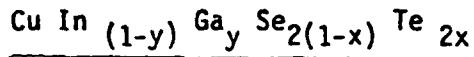

Figure 7: Empirical topological bandgap and lattice constant map of $\text{Cu}_{(1-y)}\text{Ag}_{(y)}\text{InS}_{2(1-x)}\text{Se}_{2x}$ 7(b)

$\text{Ag}_{(y)}\text{InS}_{2(1-x)}\text{Se}_{2x}$ (from the least squares fits of tables IV
 and V) (b) at 77°K.



Bandgap & Lattice Const. Map at 300° K

Linear Estimate

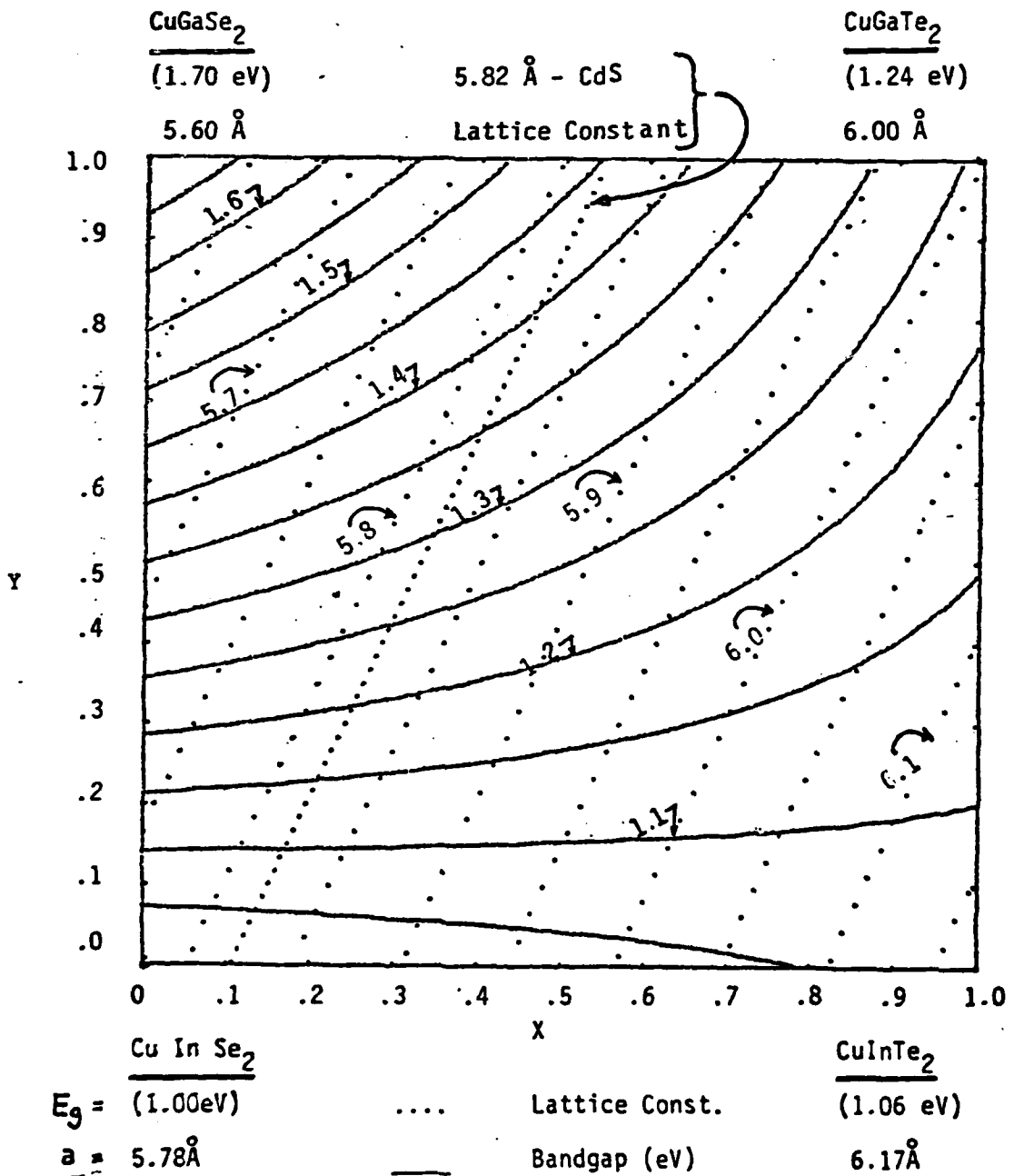

AREAS REQUIRING FURTHER SUPPORT

There is a large payoff for success in fabrication tandem solar cells since they reduce the size of PV systems in space. The theory underlying these high efficiency cells is well understood. Ways to produce the required structures are known. Realization of these very efficient solar cells requires substantial research on the optoelectronic properties of semiconductor alloy systems in the III-V and I-III-VI₂ semiconductor systems. Research is also needed on the fabrication of cells from those materials.

PAPER IV-2

Question:

- a) How difficult is it to make the exotic semiconductors needed for 6 to 10 layer cascade cells with the range of energy gap values required (1 eV to 2 eV) and the same lattice constant?
- b) How would the needed research differ from that being done on semiconductor materials for electronic device applications?

Answer:

- a) Synthesis of the alloys in powder form is easy. At Brown we have made many four and five element alloys in the $A^I B^{III} C_2^{VI}$ (eg. $CuInSe_2$, $AgInS_2$, etc.) with the same lattice constant and energy gaps ranging from 1.0 to about 1.6 eV. At many other institutions, researchers have been making alloys of $A^{III} B^V$ semiconductors with the required characteristics. Making single crystals of these materials is usually more difficult although large grained polycrystalline specimens are readily produced. There is very little effort expended on the problem to date mainly because it is a rather specific photovoltaic cell problem.
- b) There is virtually no work underway on $A^I B^{III} C_2^{VI}$ alloy systems and very little on $A^{III} B^V$ alloy systems because of the lack of significant commercial applications. There is some work on III-V alloys because of their potential application in semiconductor lasers where lattice matching of materials with different energy gaps is important.

Question: (from P.J. Turchi)

Won't tandem cells in monolithic construction degrade significantly due to radiation (say soft x-rays)? (This is a radiation survivability question.)

Answer:

In general, direct gap semiconductors, like those that would be used in monolithic PV cells are much more radiation resistant than silicon. As regards soft x-radiation, they would be essentially insensitive to degradation from such a source. The x-rays might add to the power output from the cells, but would not cause degradation.

References

1. M. Wolf, Proc. IRE, 1963
2. N. Gocsey and J.J. Loferski, Solar Energy Materials 1, 313 (,979).
3. J.J. Loferski, Proc. of the Third European Communities Photovoltaic Conference, Cannes, France, November, 1980.
4. J.J. Loferski, J. Shewchun, B. Roessler, R. Beaulieu, J. Piekoszewski, M. Gorska and G. Chapman, Conference Record of the Thirteenth IEEE Photovoltaic Specialists Conference, 1978, p. 190.
5. J.J. Loferski, M. Kwietniak, J. Piekoszewski, M. Spitzer, R. Arya, B. Roessler, R. Beaulieu, E. Vera, J. Shewchun and L.L. Kaznorski, Conference Record of the Fifteenth IEEE Photovoltaic Specialists Conference, May 1981, P. 1056.

THERMOPHOTOVOLTAIC POWER SOURCES

FOR SPACE APPLICATIONS

J.J. Loferski*, J.G. Severns† and E. Vera*

ABSTRACT

This paper explores some aspects of solar thermophotovoltaic (TPV) power sources for space applications. Such a TPV power supply consists of a mirror for concentrating sunlight onto an absorber whose temperature is raised into the 1500°C to 2000°C range. The absorber then becomes a radiator whose energy output is directed onto solar cells lining a chamber surrounding the radiator. The optimum semiconductor for TPV systems depends on the temperature of the absorber but since the radiator temperature is much lower than the effective black body temperature of the sun, the band gap of the preferred photovoltaic material is closer to that of germanium (0.7 eV) than that of silicon (1.1 eV). The paper discusses optimum design Ge cells; cascade solar cell combinations which lead to higher efficiencies than those obtainable from Ge alone; the use of rare earth oxide coatings on the radiator to shift the output to match the peak response of a Ge cell, etc. Calculations show that for radiator temperatures in the 1500°C to 2000°C range and power densities on the PV cells of about 25 W/cm², solar energy conversion efficiencies in excess of 20% are possible. A preliminary design of a 10 KW module is discussed; larger power levels are achieved by combining the appropriate number of such modules to reach the desired power level. Among the advantages of TPV systems are radiation hardness because the PV cells are mounted inside a sturdy container and the possibility of thermal energy storage so that the system can continue to function even after solar energy input is cut off.

* Brown University, Providence, Rhode Island

† U.S. Naval Research Laboratory, Washington, D.C.

10 KW MODULE CROSS SECTION

Sunlight is concentrated into an absorbing cavity, raising its temperature to 1400°C to 2000°C. Energy is reradiated thermally, illuminating a photovoltaic array. Efficiency is enhanced by emitting the thermal radiation from a selective radiator, i.e., a surface which emits most of its thermal radiation in a narrow wavelength band rather than over a broad black body spectrum. The photovoltaic cells are then designed to respond optimally to this narrow wavelength band. The cells are designed to operate near room temperature, which requires careful design of the waste heat rejection heat pipes and radiator. In order to minimize system weight, the solar concentrator will also be used as the waste heat radiator. The sizes of some of the components for a 10KW module are listed below.

Orbit radius	= 15000 Km
Efficiency of Battery	= 70%
Photovoltaic Efficiency	= 20% (with selective radiator)
Concentrator	= 3 meters wide x 70 meters long
Selective Radiator Temperature	= 1600°C
Photovoltaic Array Area	= .356 m ²

10 KW MODULE

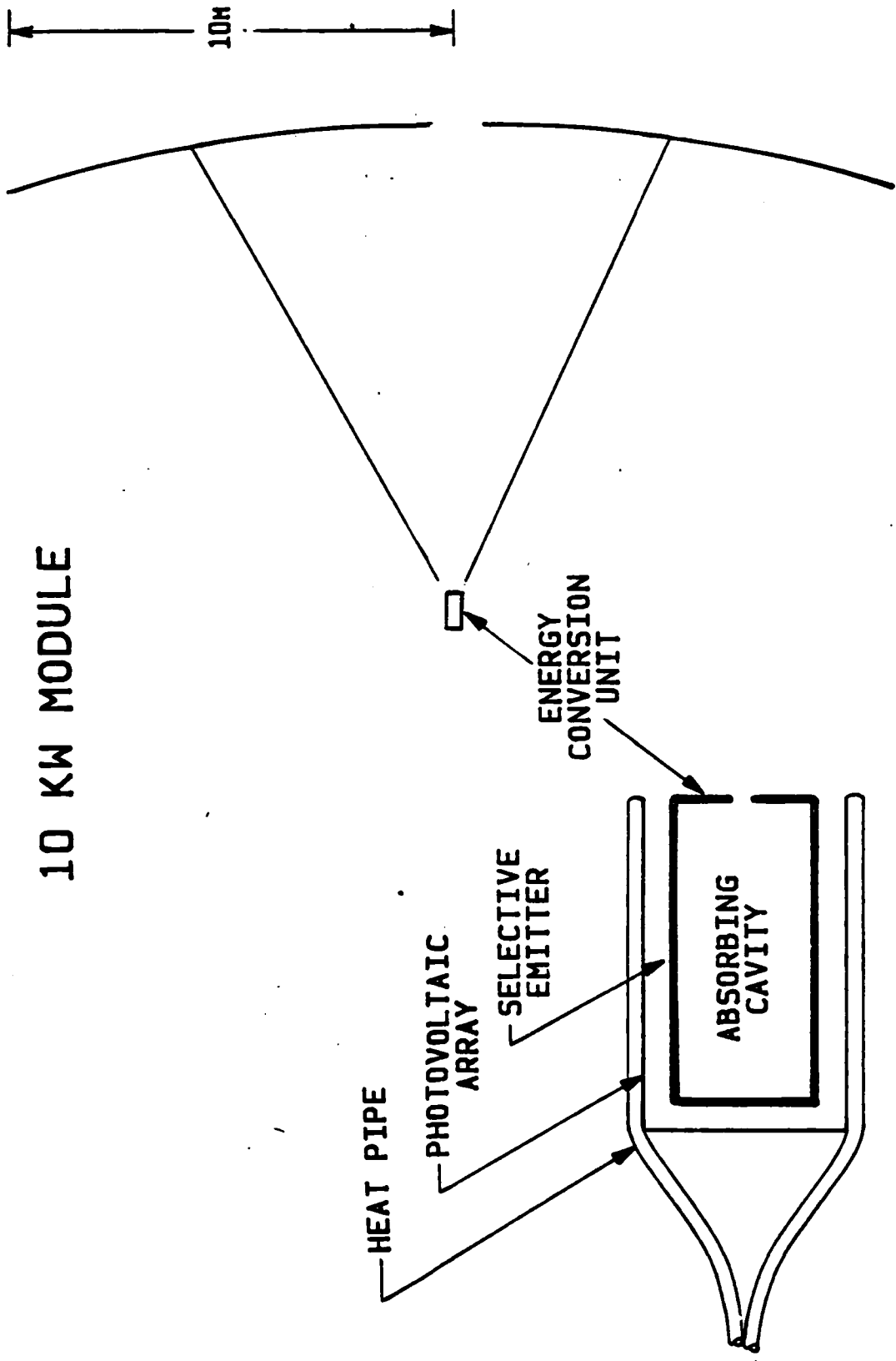

THERMOPHOTOVOLTAIC CONCEPT WITH THERMAL STORAGE

Sunlight is concentrated with reflecting optics and enters the aperture of an absorbing cavity. The walls of the cavity are designed to be good reflectors, except for the blackened outer surface of a sealed thermal storage vessel containing a material which melts at a temperature between 1400°C and 2000°C. Energy is thus stored thermally for the eclipse portion of the orbit. The inner surface of the thermal storage vessel is allowed to radiate to an array of photovoltaic cells designed for use with this thermal radiation spectrum. Efficiency can be enhanced by emitting thermal radiation to the cells with a selective radiator; i.e., a surface which emits most of its thermal radiation in a narrow wavelength band, instead of the broad black body spectrum. The photovoltaic cell is then designed to respond optimally to this narrow band radiation. The photo cells will be designed to operate near room temperature by careful design of the waste heat rejection heat pipes and radiator. This low operating temperature of the energy conversion device promises reliable operation over a long service lifetime. In order to minimize system weight, the solar concentrator will also be used as the waste heat radiator.

THERMOPHOTOVOLTAIC CONCEPT

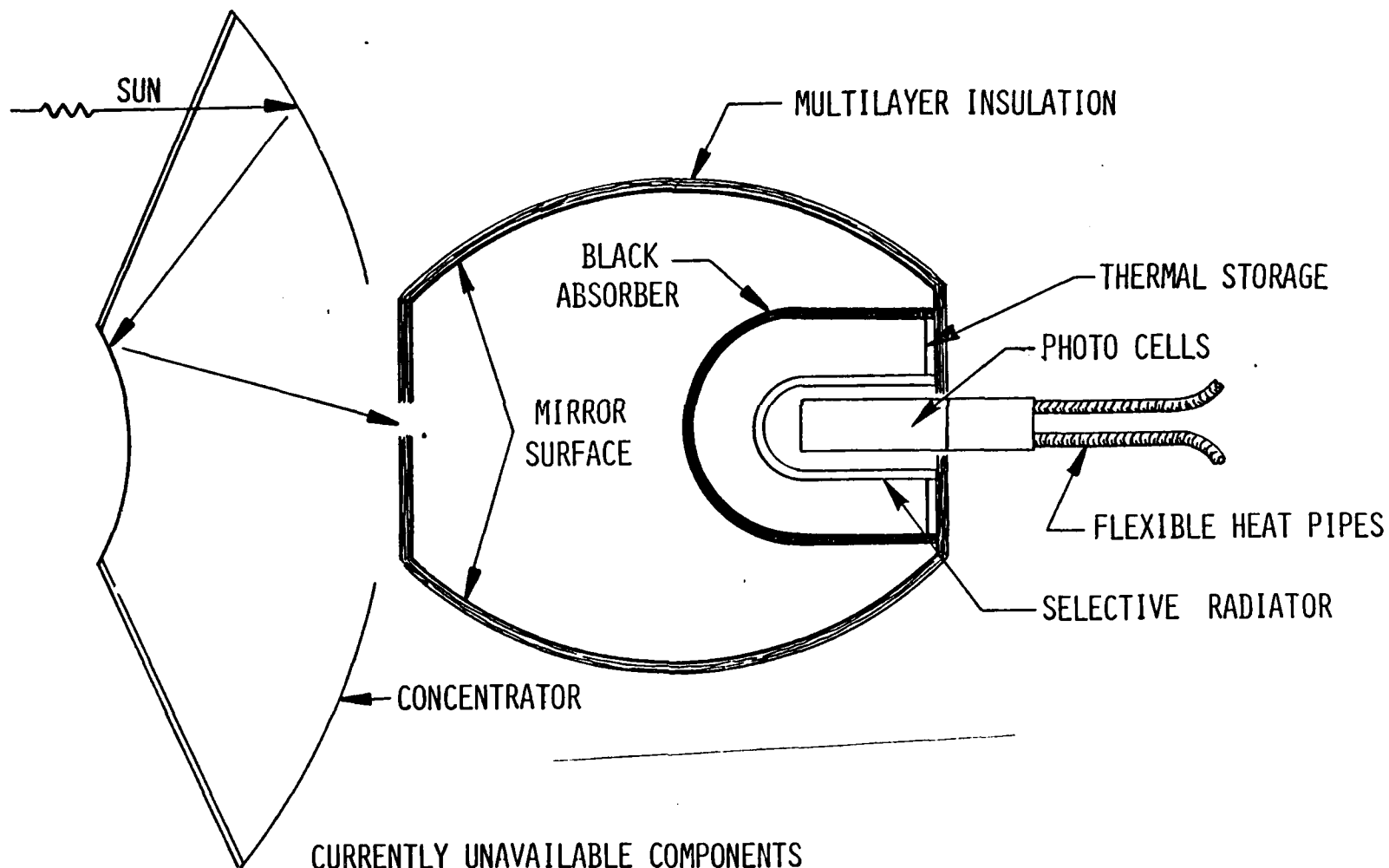

VI-3-4

CURRENTLY UNAVAILABLE COMPONENTS
HIGH TEMPERATURE THERMAL STORAGE
HIGH DENSITY HEAT PIPE
EFFICIENT PHOTOVOLTAIC MATCHED TO SELECTIVE RADIATOR

MODULAR CONCEPT

To service the very large loads contemplated with a thermophotovoltaic system, a modular approach is required. The concept shown in the viewgraph involves tracking the sun in azimuth by rotation of the spacecraft, and tracking in elevation by rotating the horizontal mounting rod to which the modules are attached. A convenient module size appears to be around 10KW, which would require several hundred modules. More than six modules will be needed on one horizontal mounting rod, and additional mounting rods can be placed above and below the first one.

MODULAR CONCEPT

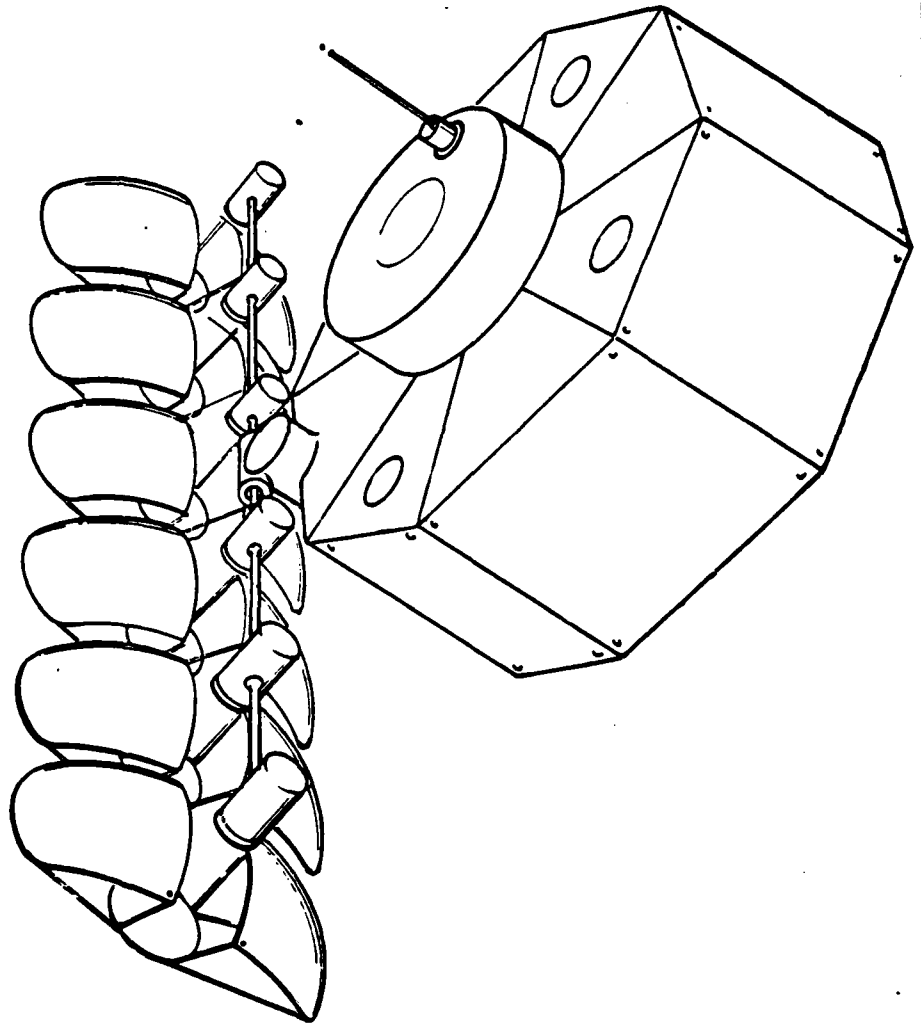

ERBIUM OXIDE SELECTIVE EMITTER

An example of a selective emitter is Er_2O_3 , which has a sharp peak in its spectral radiancy at a wavelength of $1.55 \mu\text{m}$. This is shown to provide a good spectral match to a germanium photovoltaic cell (Ref. 4).

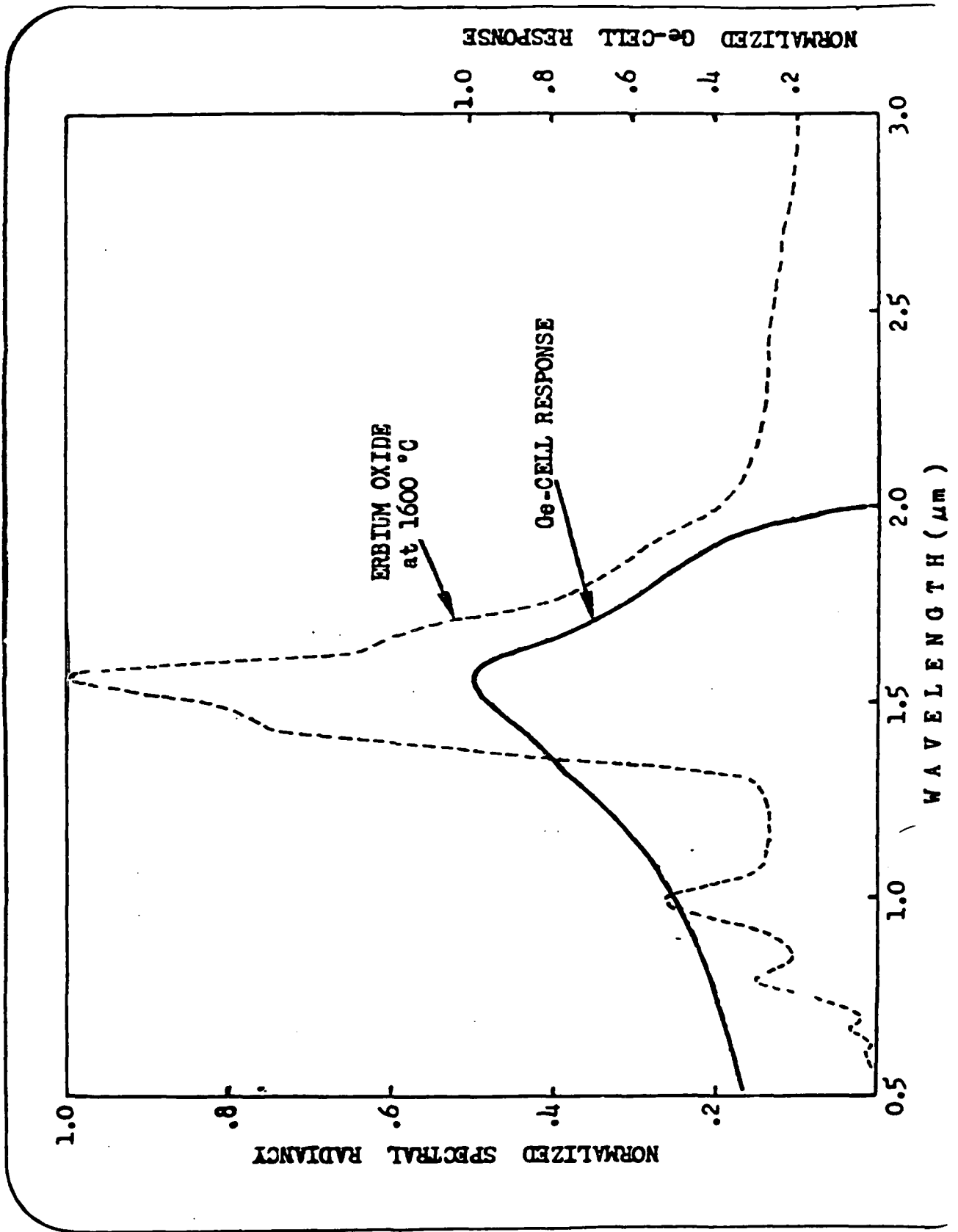

"IDEAL" DESIGN PHOTOVOLTAIC CELLS

The performance of PV cells can be improved by incorporating reflecting mirrors and minority carrier mirrors (electrostatic potential barriers) into the structure as shown in the schematic representation. (Ref 2)

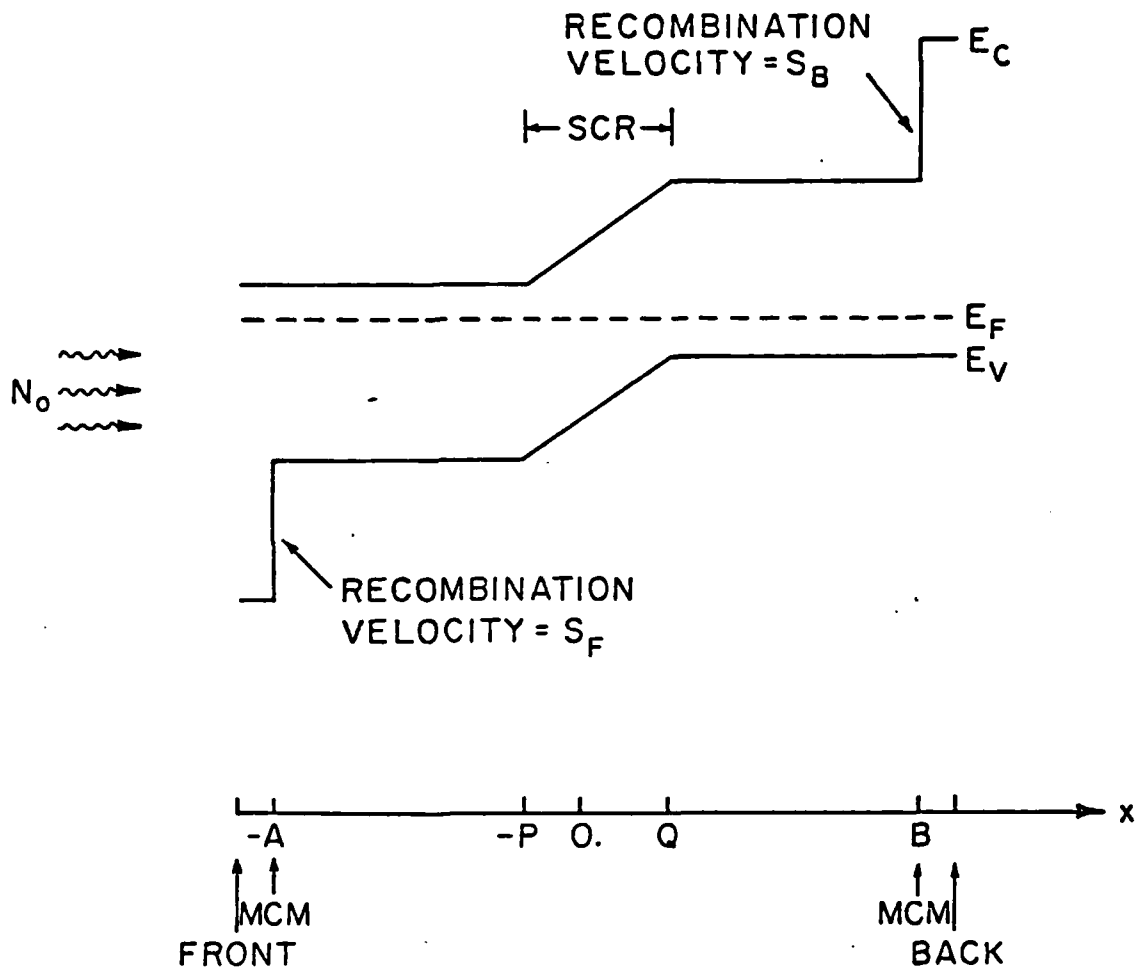

RESULTS OF CALCULATIONS ON "IDEAL" DESIGN SOLAR CELLS

The next two slides present results of calculations of efficiencies of germanium cells exposed to 1500°C black body radiation as a function of total cell thickness with surface recombination velocities on the front and back surfaces as running parameters. Incident Power, 25 W/cm². Values of $s \sim 10^2$ are readily achievable by, for example, covering surface with a germanium oxide (Ref 2). An s value of zero means a perfect minority carrier mirror. R_F and R_B are the internal reflection coefficients of the front and back surfaces, respectively.

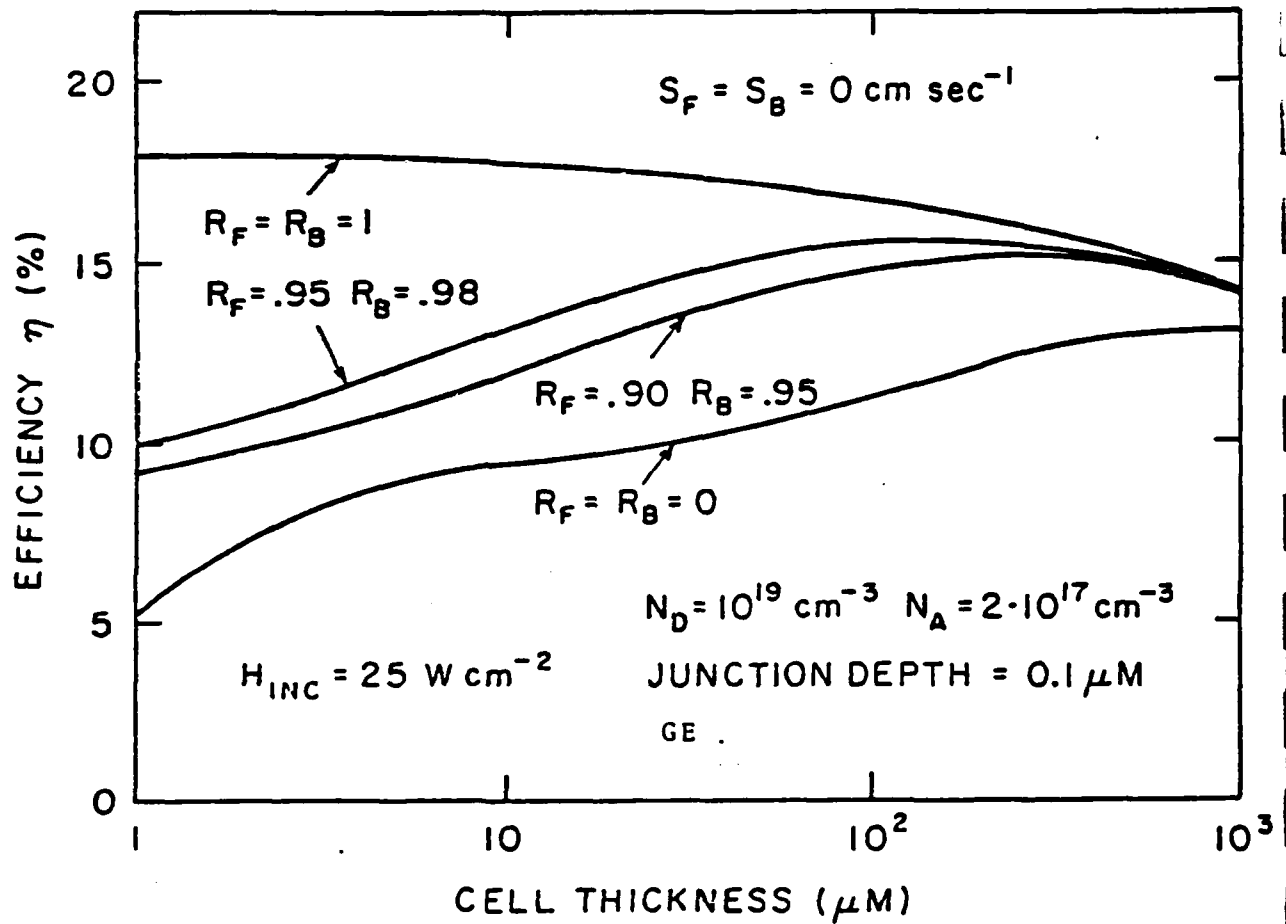

Calculated conversion efficiency as a function of cell thickness with reflectivity of the front (R_F) and reflectivity of the back (R_B) as parameters.

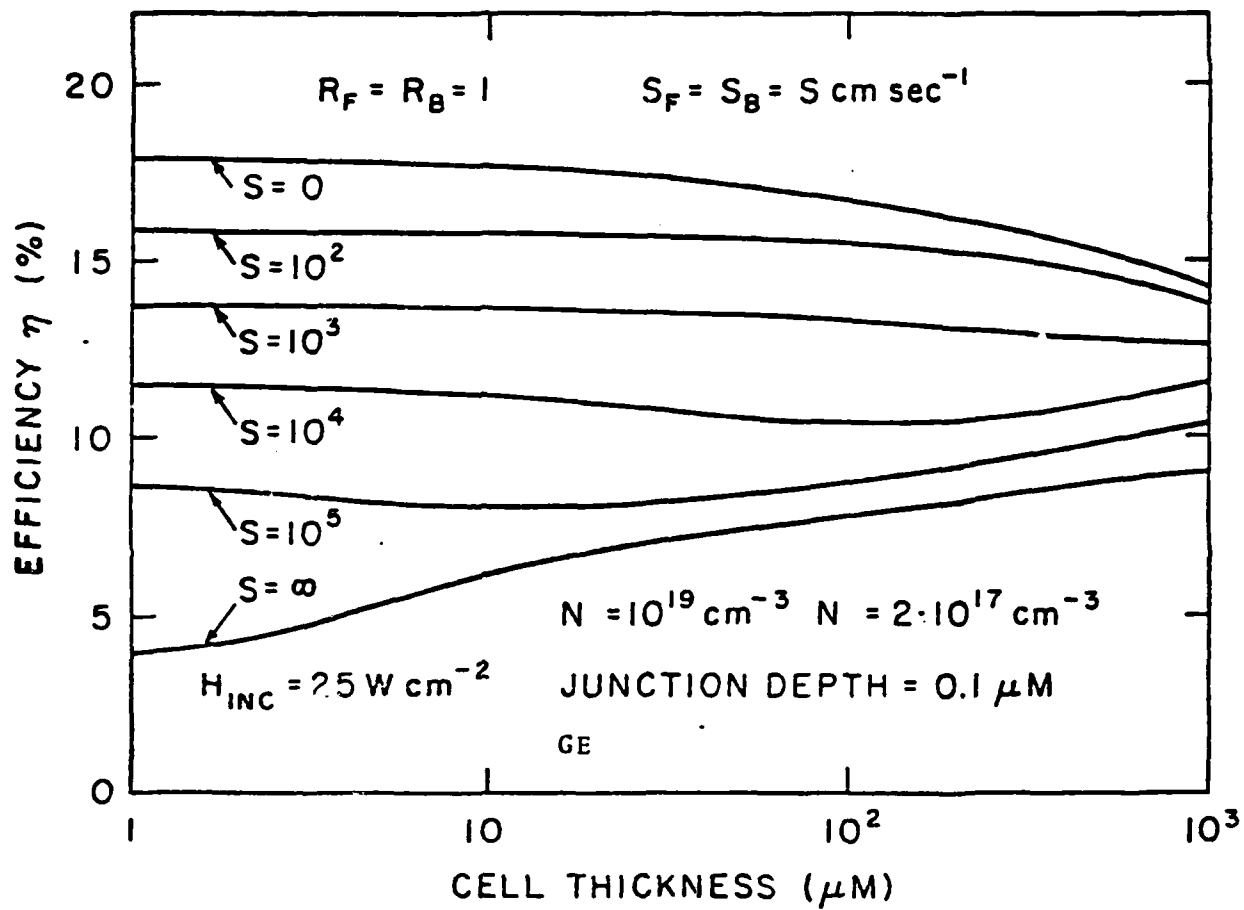

Calculated conversion efficiency as a function of cell thickness with surface recombination velocity as parameter (s).

CALCULATED EFFICIENCY OF CASCADED TPV CELLS

We have calculated the efficiency of a cascaded pair of cells of optimum design, one made from germanium, the other from silicon. The black body source temperature is 2000°C ; the power density, $25\text{W}/\text{cm}^2$. The efficiency of a cascade pair is calculated by adding the efficiencies of the two cells. Example, for $R_F = 0.95$, $R_B = 0.98$ for both the Si and the Ge cell, and 100 thicknesses, the efficiency of the Ge cell is about 18%, and of the silicon cell, 7% so that the pair has a total efficiency of 25% (Ref 3).

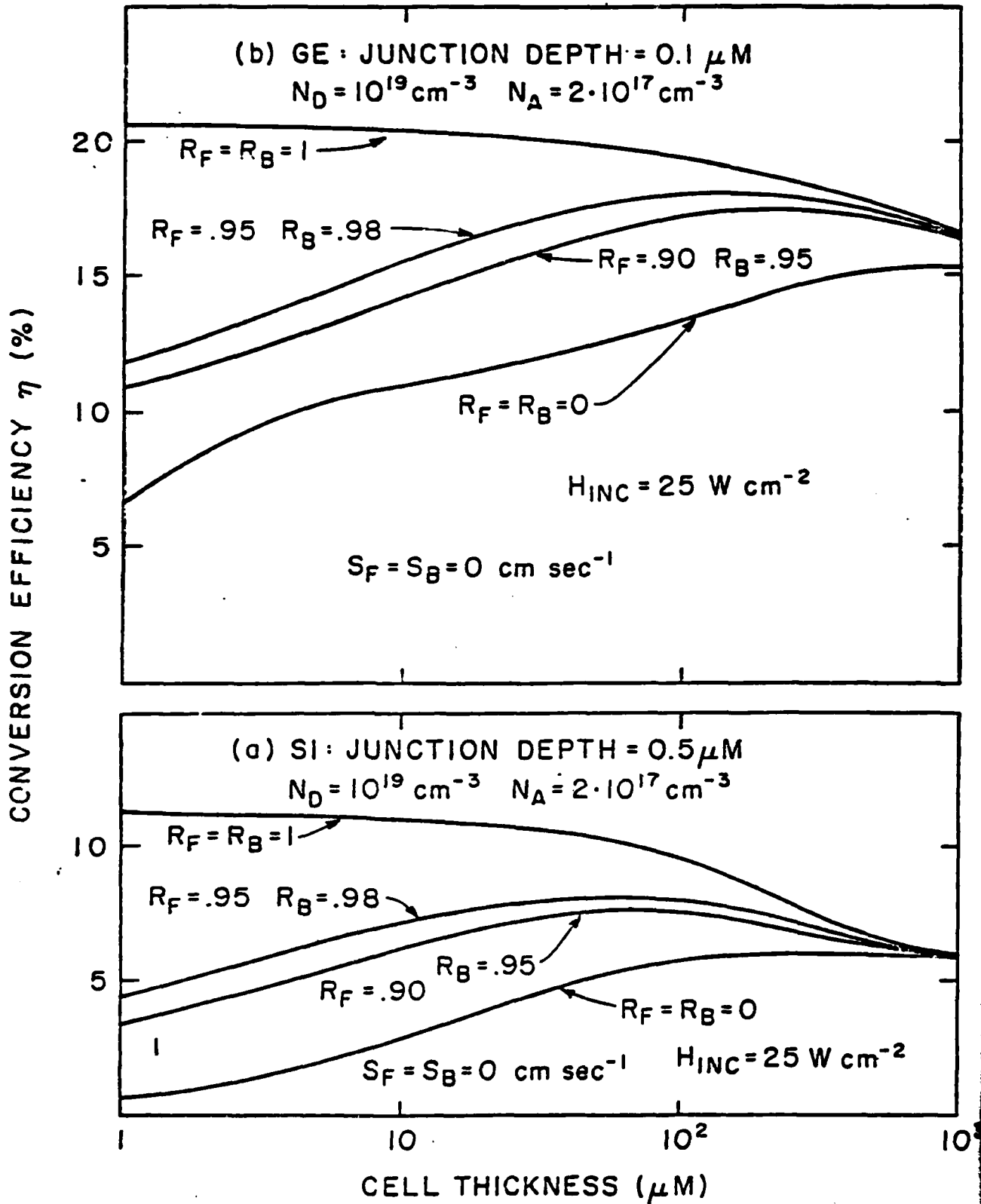

Calculated conversion efficiency versus cell thickness with reflectivity of the front (R_F) and reflectivity of the back (R_B) as parameters for: (a) silicon and (b) germanium p-n junctions.

AREAS REQUIRING RESEARCH

Long term chemical and mechanical stability of the high temperature absorber and selective radiator is a major consideration. Chemical breakdown of refractory materials producing other more volatile components can cause a serious outgassing problem. The selective radiator will most likely be in a powdered or granular form on the emitting surface to obtain low-emissivity away from the major emission band. If this material sinters in operation at high temperature, reflectivity will fall, transmission will grow, and the radiative properties of the substrate will control the emission. Diffusion of the substrate material into the selective radiator surface can cause a similar degradation. If high temperature thermal storage is included, problems of chemical and mechanical compatibility between storage media and container materials will require attention.

Highly efficient photovoltaics, of germanium or other suitable material will be required for optimum performance of this system. For waste heat removal from the photovoltaics at room temperature or below, a heat pipe with ammonia working fluid appears to be the only choice available, and at the power densities expected (20 watts/cm² and above) the ammonia heat pipes available today are not adequate.

PROBLEM AREAS

- HIGH TEMPERATURE MATERIALS
 - RADIATOR & SUBSTRATE
 - OUTGASSING
 - INTERDIFFUSION
 - INSERVICE SINTERING (RADIATOR)
- HIGH EFFICIENCY PHOTOVOLTAIC
- HEAT REJECTION
 - HIGH HEAT FLUX AT LOW TEMPERATURE (25°C)

References

1. J. Severns and M.B. Cobble, Proc. of the 16th Intersociety Energy Conversion Conference, Atlanta, Georgia, Vol. 1, 89 (August 1981).
2. E.S. Vera, J.J. Loferski and M. Spitzer, Conference Record of the Fifteenth Photovoltaic Specialists Conference, Orlando, Florida, May 1981.
3. E.S. Vera, J.J. Loferski, M. Spitzer and J. Shewchun, Proc. of the Third European Community Photovoltaic Conference, Cannes, France (1980), p. 911.
4. E. Kittl and G. Guazzoni, "Design Analyses of TPV Generator System", 25th Annual Proceedings, Power Sources Conference, May 1972, Atlantic City, New Jersey.

ABSTRACT

SOLAR ENERGY CONVERSION FOR SPACE POWER SYSTEMS

James F. Holt
Air Force Wright Aeronautical Laboratories

The Space Transportation System makes possible operating in space various satellite systems using 50kW and above, of electrical power. These systems will be launched and boosted into orbit by the Orbiter and such boosters as the Inertial Upper Stage.

Solar power is especially suited for space based radar and space communications systems. Higher power is more urgently needed in the high altitude orbits.

Recent concepts in solar cells, batteries, and power conditioning will enable the development and operation of up to 30kW continuous electrical power in higher orbits well before year 2000. Before 1990 continuous power of 10 to 15kW levels are possible operating in the higher orbits. This forecast is based upon thin (2 mil) silicon solar cells, thin (2-mil) gallium arsenide solar cells, nickel-hydrogen and liquid metal-sulfur high energy density batteries, and 3 mil multi-band gap advanced solar cells, in that time sequence.

The present power per unit weight would be increased from the present 1-2 watts/lb to 12 W/lb for the total power system.

However, in order to appreciably increase the power capability of systems boosted into the high orbits, better approaches are needed. Herein is the clear need for intensive basic research effort aimed at increasing the Watts/lb of the solar array. The existing highly trained research manpower available as a result of recent non-military support in the solar cell area should be utilized in solving problems being encountered in the advanced gallium arsenide types of solar cells, as well as in investigating other possible high performance approaches in solar energy conversion. New concepts for solar energy conversion should be solicited and investigated through basic research support.

Among the basic problems being confronted in present solar energy conversion approaches are the following:

- (1) Impurities vs. radiation resistance. Means are needed for

accurately determining impurities within the solar cell on the order of less than one part in 10^6 and beyond. Methods are required for producing crystalline cell material of purity on this order.

(2) Methods and technology are required for controlling the formation and stability of ternary and quaternary III-V crystals in the formation of solar cells.

(3) The above problems relate to the fundamental problem of how to maintain high end-of-life efficiency of the solar cell after natural and man-made exposure to space radiations.

(4) An ultra thin cell must be accompanied by ultra light, ultra durable metallization and interconnects. Present technology will not suffice, since the cell-to-metal interactions and thin films are not well enough understood or well enough controlled.

10KW HVHP SYSTEM

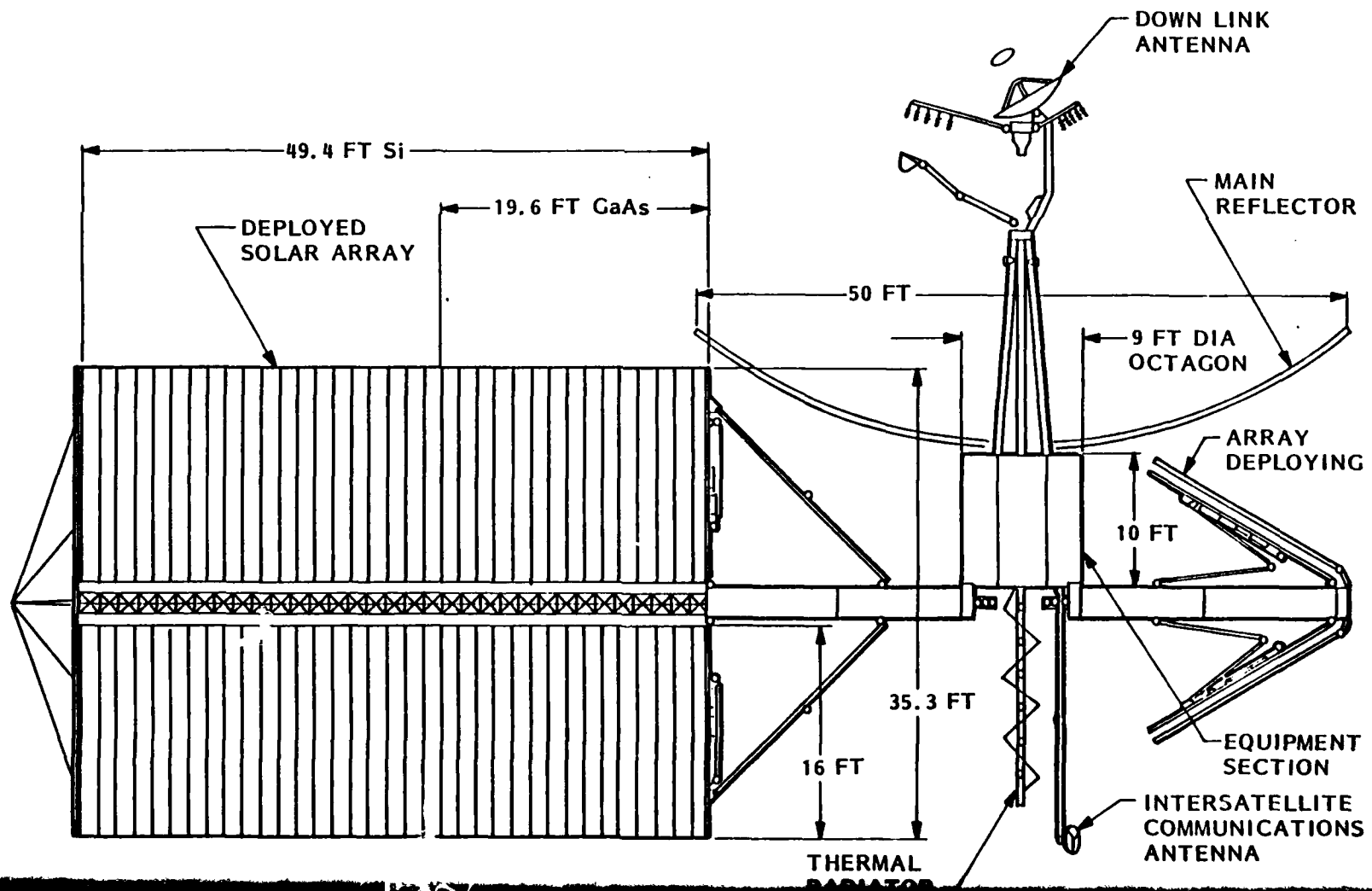

STOWED HVHP SATELLITE

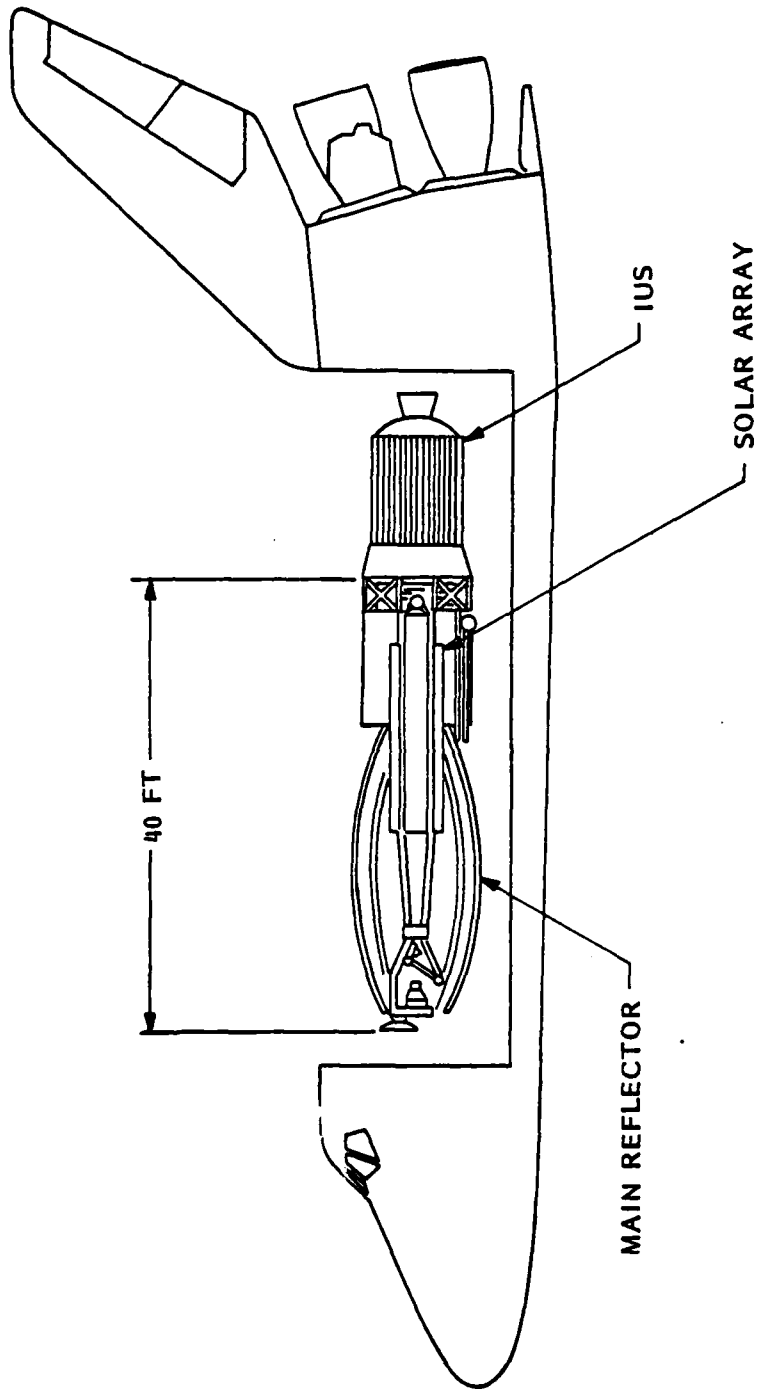

KEY FUNCTIONAL SUBSYSTEMS

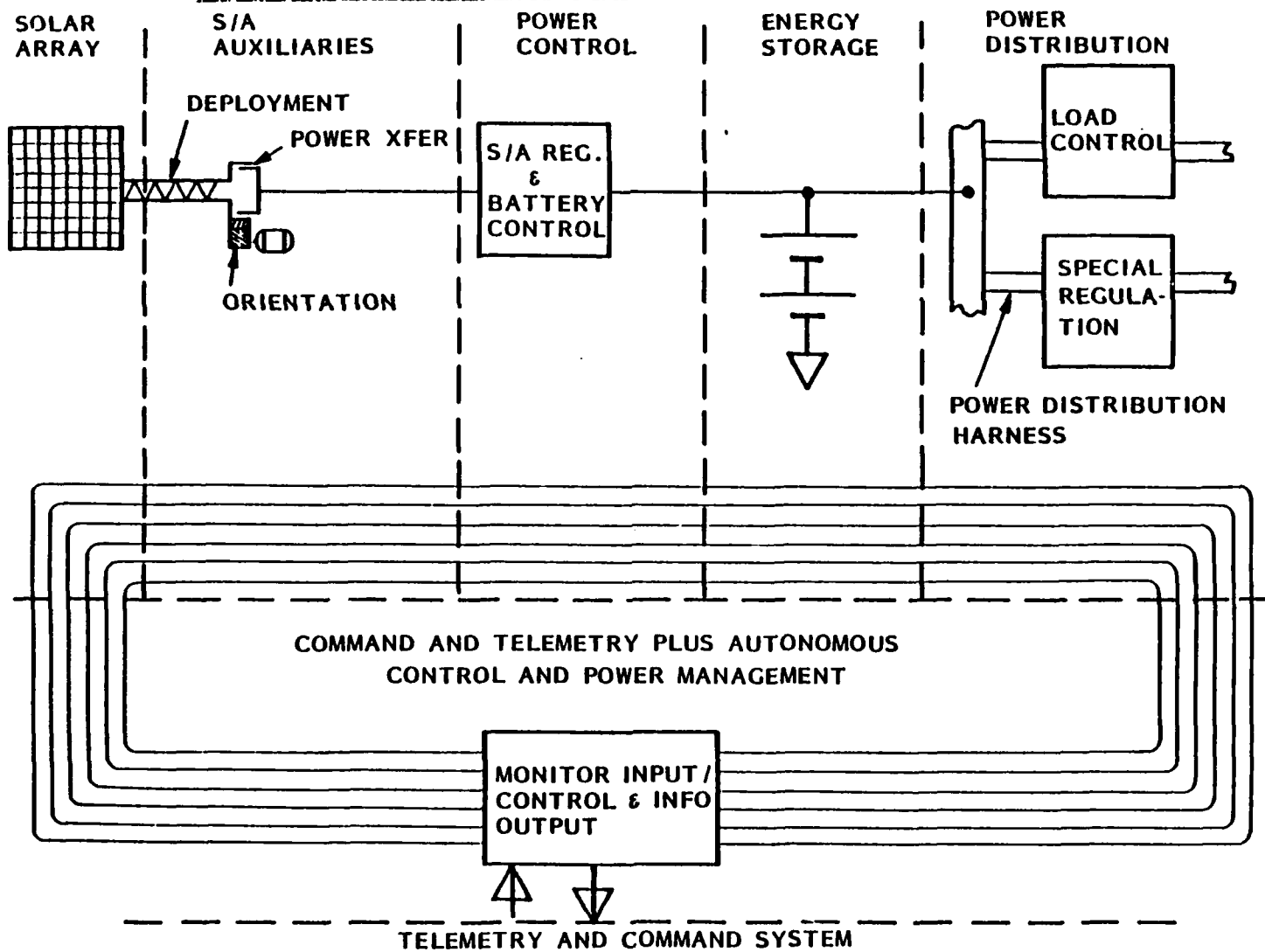

VI-4-5

VI-4-6

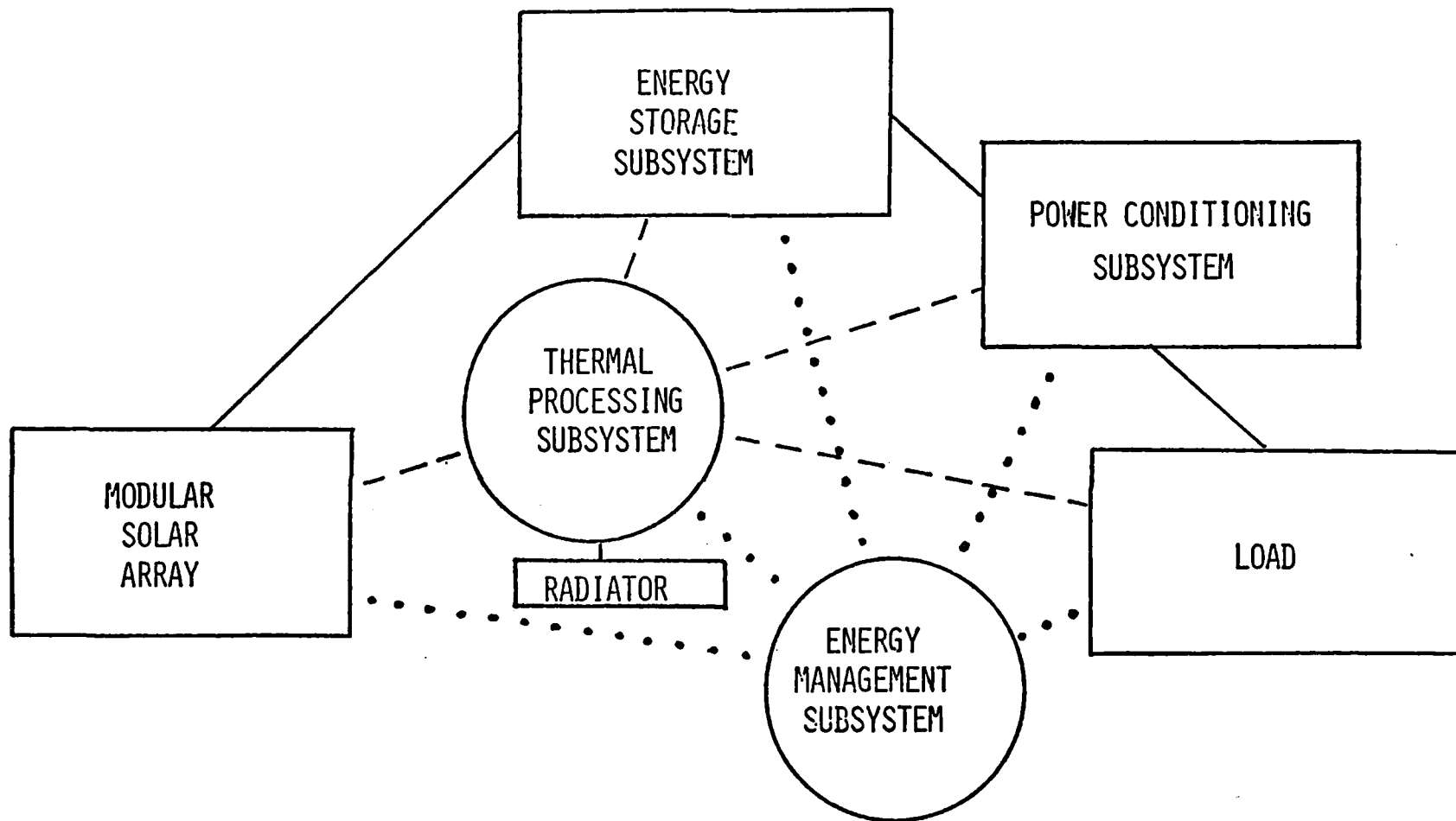

MODULAR AUTONOMOUS SPACE POWER SYSTEM

SOLAR ARRAY SUBSYSTEM REQUIREMENTS

- WEIGHT REQUIREMENT MOST SIGNIFICANT IN ARRAY DESIGN
- IMPORTANT CONSIDERATIONS AFFECTING WEIGHT
 - HIGH EFFICIENCY THIN CELLS
 - RADIATION HARDENED CELLS
 - LOW MASS COVERSLIDES
 - LOW MASS BLANKET SUBSTRATES
 - LOW MASS STRUCTURAL COMPONENTS
 - ASPECT RATIO
 - SOLAR ARRAY STIFFNESS REQUIREMENTS
- ARRAY SIZED BY END OF LIFE LOAD POWER REQUIREMENT
- CONCEPTUAL DESIGN - SPLIT BLANKET, V-STIFFENED FOLDOUT ARRAY
 - V-STIFFENED DESIGN RESULTS IN LOWER MAST WEIGHT

SOLAR ARRAY SUBSYSTEM REQUIREMENTS

- **WEIGHT REQUIREMENT MOST SIGNIFICANT IN ARRAY DESIGN**
- **IMPORTANT CONSIDERATIONS AFFECTING WEIGHT**
 - **HIGH EFFICIENCY THIN CELLS**
 - **RADIATION HARDENED CELLS**
 - **LOW MASS COVERSLIDES**
 - **LOW MASS BLANKET SUBSTRATES**
 - **LOW MASS STRUCTURAL COMPONENTS**
 - **ASPECT RATIO**
 - **SOLAR ARRAY STIFFNESS REQUIREMENTS**
- **ARRAY SIZED BY END OF LIFE LOAD POWER REQUIREMENT**
- **CONCEPTUAL DESIGN - SPLIT BLANKET, V-STIFFENED FOLDOUT ARRAY**
 - **V-STIFFENED DESIGN RESULTS IN LOWER MAST WEIGHT**

SILICON SOLAR ARRAY WEIGHT BREAKDOWN FOR 25kW POWER SYSTEM

5600 NM, 2 x 2 CM, 2 MIL, $\eta = 13.5$ PERCENT
4 MIL MICROSHEET COVERSLIDE

SUBSYSTEM		UNIT MASS (LB)	QUANTITY	TOTAL MASS (LB)
BLANKET	SUBSTRATE	444.62	2	902.2
	CELLS	29.22	2	58.44
	COVERS	1.41×10^{-4}	1.6537×10^6	233.4
	COVER TO CELL ADHESIVE	2.36×10^{-4}	1.6537×10^6	390.0
	CELL TO BLANKET	-	-	39.3
	ADHESIVE	-	-	36.46
	INTERCONNECTS	6.88×10^{-5}	1.6537×10^6	113.74
	HINGES	0.024	205	4.94
	HARNESS	12.93	2	25.86
	STRUCTURE	COVER	39.2	2
CONTAINER		42.8	2	85.6
SUPPORT STRUTS		4	4	16.0
CONTAINER DEPLOYMENT		10	2	20.0
BOOM		43.2	2	86.4
CANISTER		44.4	2	88.8
TENSIONERS		2.4	4	9.6
GUIDE WIRES		2.13	4	8.52
LATCHING MECHANISMS		1.94	2	3.88
MID-TENSION		0.03	2	0.06
ARRAY TOTAL				1300.0

VI-4-9

BLANKET WEIGHT VS SHIELDING - 5600 NM

18.0 kW/WING, EOL AT ARRAY (1/2 OF 25 kW SYSTEM)

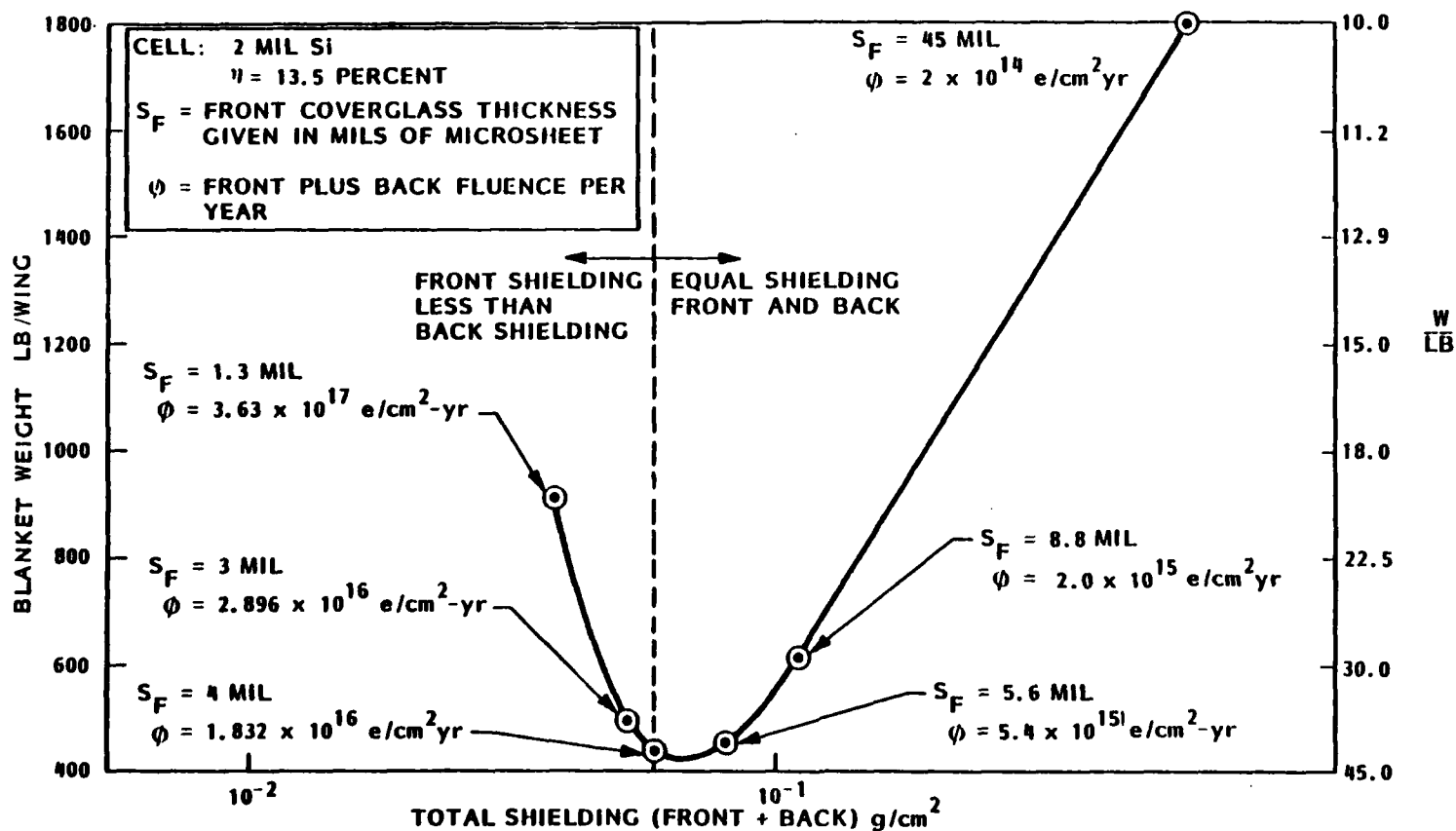

VI-4-10

BLANKET WEIGHT / WING VS CELL TYPE - 5600 NM

18 kW/WING, EOL AT ARRAY (1/2 OF 25 kW SYSTEM)

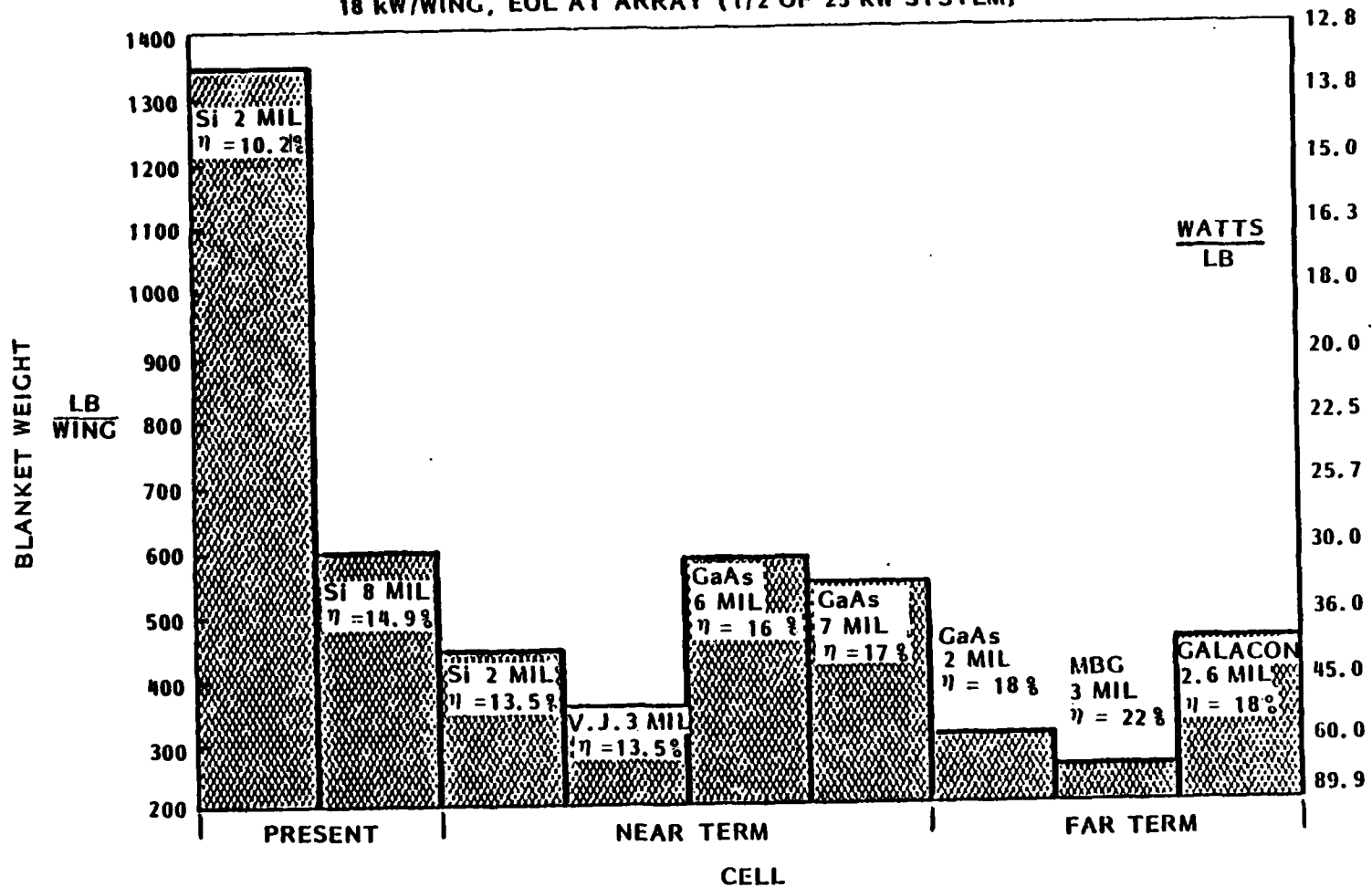

VI-4-11

BLANKET WEIGHT /WING VS CELL TYPE - GEO

17.24 KW/WING, EOL AT ARRAY (1/2 OF 25 KW SYSTEM)

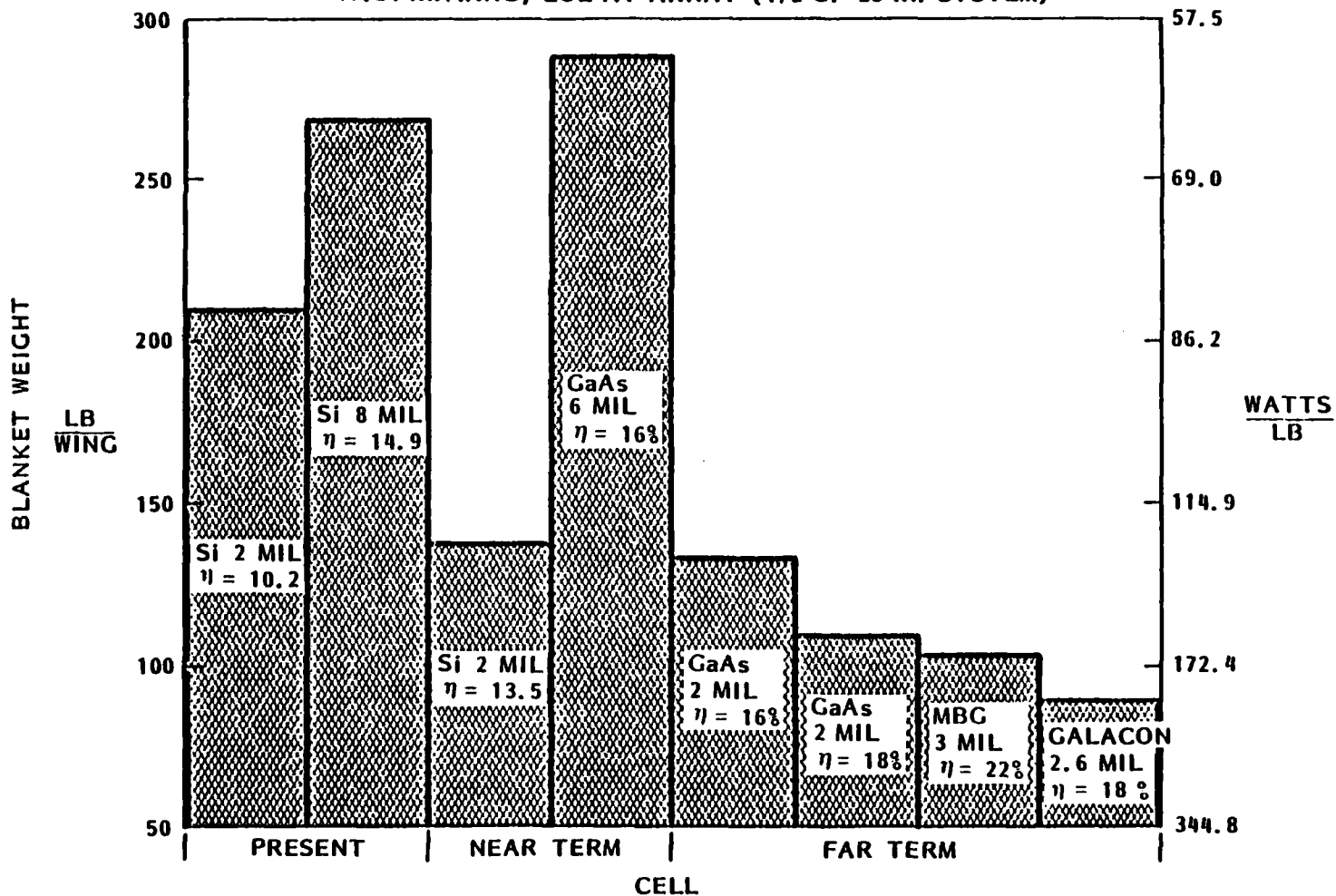

VI-4-12

CONCLUSIONS

- IN HIGH RADIATION ENVIRONMENTS THE RADIATION TOLERANCE AND WEIGHT OF SOLAR CELLS ARE THE DRIVING FACTORS IN SOLAR ARRAY WEIGHT
- IN LOW RADIATION ENVIRONMENTS THE WEIGHT AND EFFICIENCY OF SOLAR CELLS ARE THE DRIVING FACTORS IN SOLAR ARRAY WEIGHT
- NEAR TERM
 - HIGH RADIATION ORBIT: THIN SILICON SOLAR CELLS (2 MIL) RESULT IN A BLANKET WEIGHT APPROXIMATELY 16 PERCENT LIGHTER THAN A BLANKET OF THE SAME POWER USING 7 MIL GaAs CELLS, BUT THE BLANKET USING GaAs CELLS HAS LESS THAN HALF AS MANY CELLS AND IS LESS THAN HALF AS LARGE AS THE BLANKET USING SILICON CELLS
 - LOW RADIATION ORBIT: DUE TO THE FACT THAT SOLAR ARRAY BLANKET WEIGHT IS SUCH A STRONG FUNCTION OF SOLAR CELL WEIGHT, GaAs SOLAR CELLS MUST BE PRODUCED 2 MILS THICK TO COMPETE ON A WEIGHT BASIS WITH ARRAYS UTILIZING THIN SILICON
- FAR TERM
 - SOLAR ARRAY BLANKETS USING SOLAR CELLS DERIVED FROM GaAs TECHNOLOGY ARE THE LIGHTEST AND SMALLEST FOR BOTH HIGH AND LOW RADIATION ENVIRONMENTS
- GaAs TECHNOLOGY IS THE MOST VERSATILE IN TERMS OF BEING ABLE TO MEET LOW WEIGHT REQUIREMENTS FOR A NUMBER OF DIFFERENT MISSIONS AND ORBITS
 - SILICON SOLAR CELLS ARE PRACTICALLY LIMITED TO THICKNESSES OF 2 MILS OR MORE, WHEREAS GaAs CELLS CAN BE MADE AS THIN AS $10\ \mu\text{m}$ WITHOUT A SUBSTANTIAL EFFECT ON EFFICIENCY. THIS ALLOWS ONE TO TAILOR THE FRONT AND BACK SHIELDING OF THE 'THIN FILM' GaAs CELL TO THE RADIATION FLUENCE LEVEL OF THE GIVEN ORBIT

DEVELOPMENT AREAS

- DEVELOPMENT OF LOW MASS COMPOSITE STRUCTURAL COMPONENTS WOULD RESULT IN FURTHER WEIGHT SAVINGS
- DEVELOPMENT OF THIN WRAPAROUND CONTACT TECHNOLOGY WOULD RESULT IN WEIGHT AND COST SAVINGS.
- DEVELOPMENT OF THIN COVERGLASSES WHICH DEMONSTRATE HIGHER UV STABILITY IS ESSENTIAL FOR GEO ORBITS. (SiO₂ OR IMPROVED THIN PLASTIC ENCAPSULANTS)
- DEVELOPMENT OF RADIATION HARDENED SOLAR CELLS IS OF PRIME IMPORTANCE IN HIGH RADIATION ORBITS
- TEST PROGRAM TO OBTAIN SOLAR CELL DATA FOR ANALYSIS OF NATURAL AND ARTIFICIAL ENVIRONMENT EFFECTS
 - GaAs SOLAR CELL DAMAGE COEFFICIENTS
 - REAR SIDE IRRADIATION DAMAGE COEFFICIENTS FOR BOTH GaAs AND Si SOLAR CELLS
 - OPTICAL PROPERTIES OF GaAs SOLAR CELLS

SILICON - RESEARCH

STARTING MATERIAL PURITY

- o HOLD CARBON AND OXYGEN AS LOW AS POSSIBLE
- o DIAGNOSTIC SENSITIVITY ESPECIALLY FOR C AND O,
IMPROVE MORE THAN ONE ORDER OF MAGNITUDE
- o BASIC RESEARCH ON DEFECT FORMATION, INTERACTIONS AND ANNEALING
MECHANISMS FOR LOW T ANNEAL (<200C)
- o COMPARE B AND GA DOPANTS FOR HIGH PURITY SI

SILICON - RESEARCH (CONT'D)

CELL DESIGN/GEOMETRY

- o THIN CELL RESEARCH
- o VERTICAL JUNCTION RESEARCH
- o THE P-I-N DEVICE - RADIATION DAMAGE EFFECTS

CELL FABRICATION

- o RELATIVE MERITS OF DIFFUSION AND ION IMPLANTATION FOR FORMING P/N JUNCTION, WITH RESPECT TO RADIATION DAMAGE

ALGAAS CASCADE CELL, SCHEMATIC

↓ LIGHT

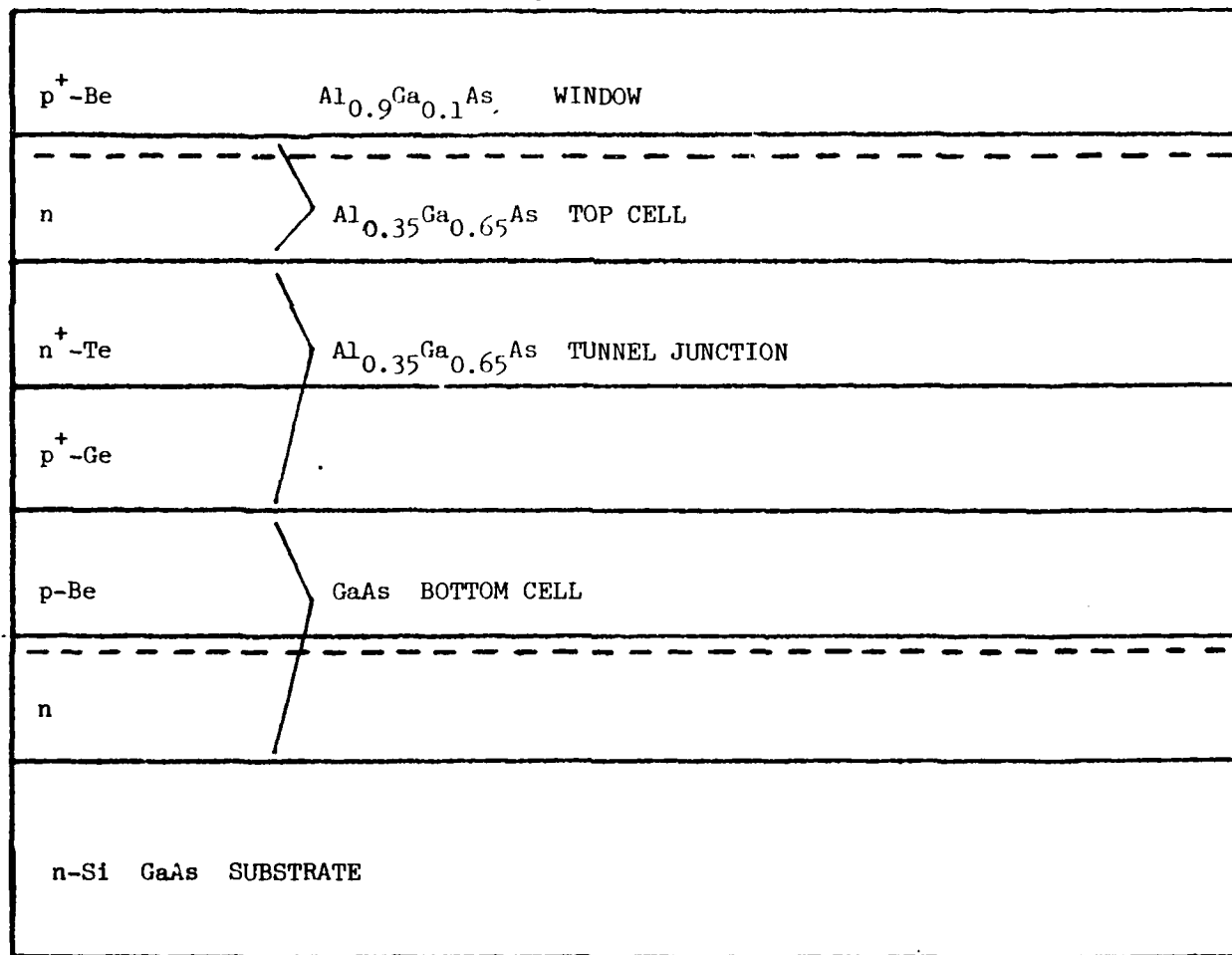

VI-4-17

GALLIUM ARSENIDE - RESEARCH

MATERIAL RELATED RESEARCH

- o SUBSTRATE QUALITY VS RADIATION DAMAGE
- o EFFECTS OF PURITY, CRYSTALLINITY, DOPANTS IN GROWN LAYERS WITH RESPECT TO RADIATION DAMAGE
- o RADIATION INDUCED DEFECTS AND KINETICS
- o INCREASED DIAGNOSTIC, PURITY EVALUATIONS
- o DESCRIBE RADIATION DAMAGE AND RECOVERY VS TEMPERATURE
- o SYSTEMATICALLY STUDY ANNEALING; GOAL 100% RECOVERY <200C, FLUENCES TO $10^{16}/\text{CM}^2$, 1 MEV ELECTRONS
- o ELECTRON AND PROTON DAMAGE EQUIVALENCES, WITH VARIOUS DOPANT SPECIES AND CONCENTRATIONS

GALLIUM ARSENIDE - RESEARCH (CONT'D)

CELL DESIGN, GEOMETRY

- o MODEL GAAS CELL STRUCTURES AS NEW DATA BECOMES AVAILABLE:
SUGGEST NEW ALTERNATE CELL DESIGNS

CELL FABRICATION, PROCESSING

- o EXAMINE LPE AND MO-CVD GROWTH PROCESSES IN RELATION TO RADIATION DAMAGE:
PRE- AND POST IRRADIATION CHARACTERIZATION (E.G., DLTS)
- o LPE AND MO-CVD PROCESSES VS DOPANT SPECIES AND LEVELS

SUMMARY

SOLAR CELL RESEARCH REQUIREMENTS

1. ADVANCE DIAGNOSTIC, IMPURITIES RESOLUTION
2. IMPROVE PURITY OF MATERIALS
3. CHARACTERIZE GAAS MATERIALS
4. LIGHTWEIGHT CELL METALLIZATION AND INTERCONNECTS
5. NEW ENERGY CONVERSION APPROACHES

Q & A - J. F. Holt

From: Steve Wax, AFOSR

What is meant by "new energy conversion approaches"?

A.

There is nothing new under the sun. However, once in a great while a seemingly novel way is proposed to convert radiant energy to electrical. This was the simplest meaning of the expression.

Some of the papers in the Tuesday PM session described examples of innovation aimed at solar and IR energy conversion.

Photovoltaic and other quantum → electric converters are able to by-pass the Carnot efficiency limit of heat engines. These quantum devices thus have in principle very high efficiencies; the limit ultimately dealing with practical technology limits such as leakage currents, series resistance, diode imperfections, etc.

It is thus apparently an area of great hope for the efficiencies in the 50-70% or greater neighborhood; the innovative new ways to directly go from quanta to electrical current.

I am assuming that innovation can turn up these new approaches.

Such new approaches, of course, include the more near term practical advances in complex solar photovoltaic cell technology that are certain to come about for practical power systems, given the dollars in support--there is an ample source of well qualified S & E in the U.S. and allied countries to conduct the work.

SOLAR-PUMPED LASERS FOR SPACE POWER TRANSMISSION

VI-5

Edmund J. Conway
NASA Langley Research Center
Hampton, Virginia 23665

ABSTRACT

Solar-Pumped Lasers for Space Power Transmission
Edmund J. Conway
NASA Langley Research Center
Hampton, Virginia 23665

The concept of spacecraft-to-spacecraft laser power transmission is being considered as a means of achieving plentiful, economical power in space. Several direct solar-pumped laser concepts are discussed, as well as the results of early experiments. Novel laser-to-electric power converters and a laser thermal propulsion concept are identified. Advantages of the solar laser power platform for possible military requirements are described.

DIRECT SOLAR-PUMPED LASER SATELLITE

Space-to-space laser power transmission is being considered as a means for reducing the cost of electrical power and propulsion for spacecraft. In space, the Sun is a low-cost, natural energy source. Direct solar-pumped lasers offer the potential for high power, high efficiency, and no intermediate energy conversion steps prior to lasing. In addition, the continuous nature of solar pumping is suited to continuous lasing required for high average power transmission. To handle high average powers, fluid lasants are required for heat dissipation in thermal radiators.

DIRECT SOLAR-PUMPED LASER POWER STATION CONCEPT

100 MW_L

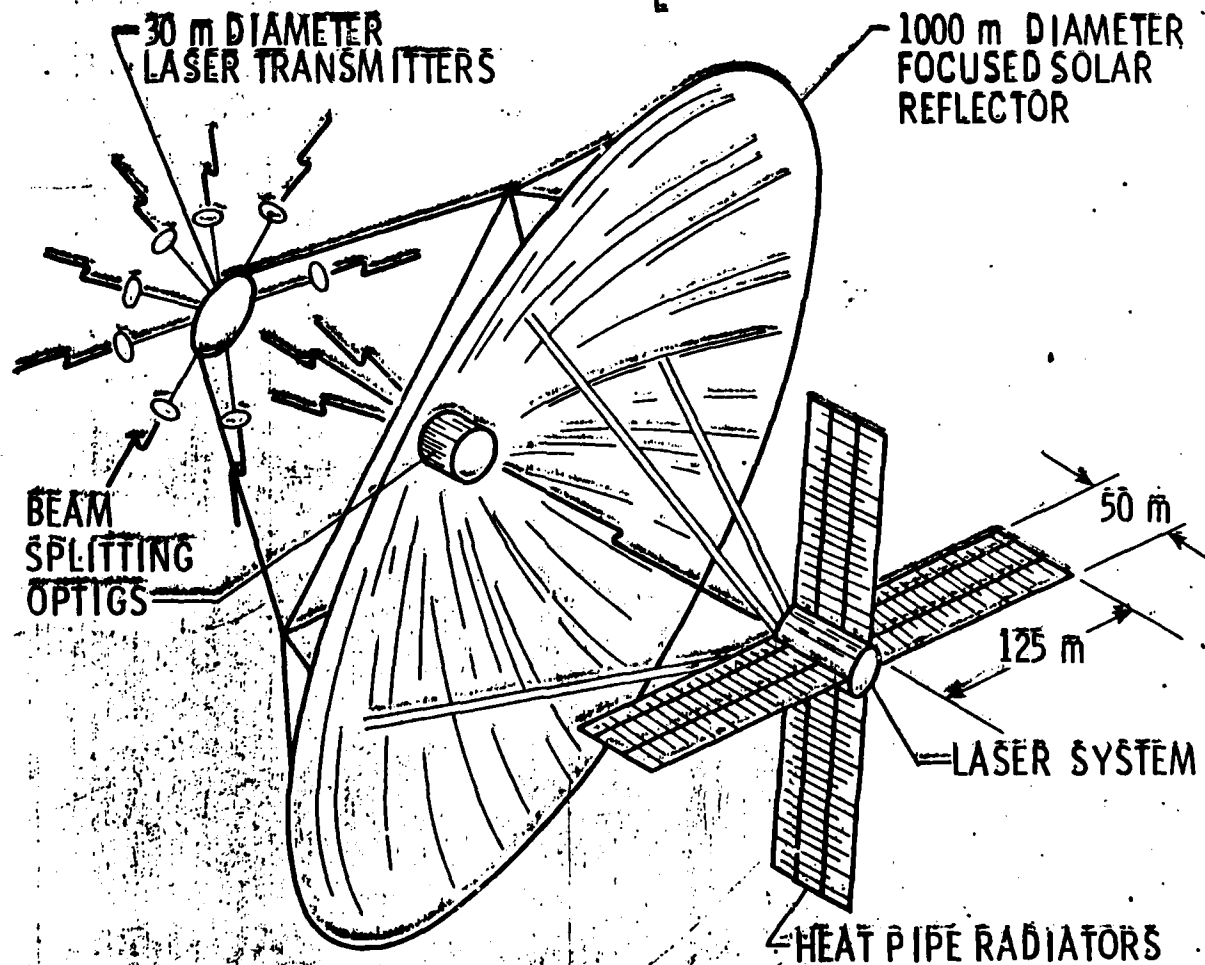

SOLAR-PUMPED LASER EXPERIMENT

Lasants have been tested and lasers developed using flashlamp excitation. However, lasants must ultimately operate with solar pumping. The figure shows simulated sunlight transmitted through a chopper and then focussed to a line by reflection from the inside of a conical reflector. The line focus coincides with the centerline of a tube containing the lasant. The figure also shows mirrors defining a laser cavity and a detector.

VI-5-4

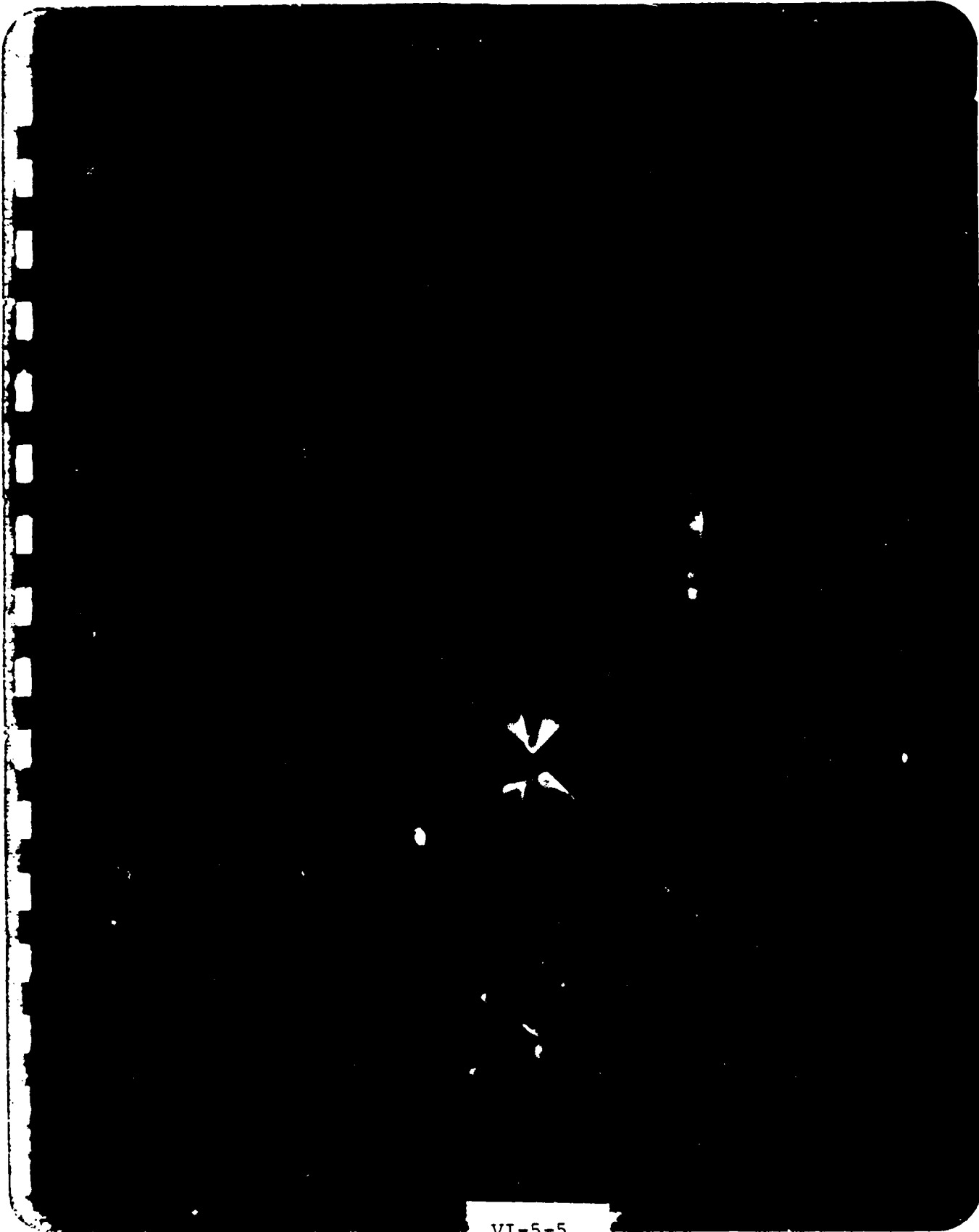

VI-5-5

IODINE PHOTODISSOCIATION LASER

The first solar-pumped lasing of a gas was achieved by photodissociating C_3F_7I . The energy level diagram indicates the major processes occurring within the laser tube. The most important are (1) pumping by sunlight at $0.27 \mu m$; (2) dissociation of excited C_3F_7I into excited I and the radical C_3F_7 ; (3) lasing based on atomic iodine; and (4) recombination of C_3F_7 with iodine to reform C_3F_7I .

IODINE PHOTODISSOCIATION LASER

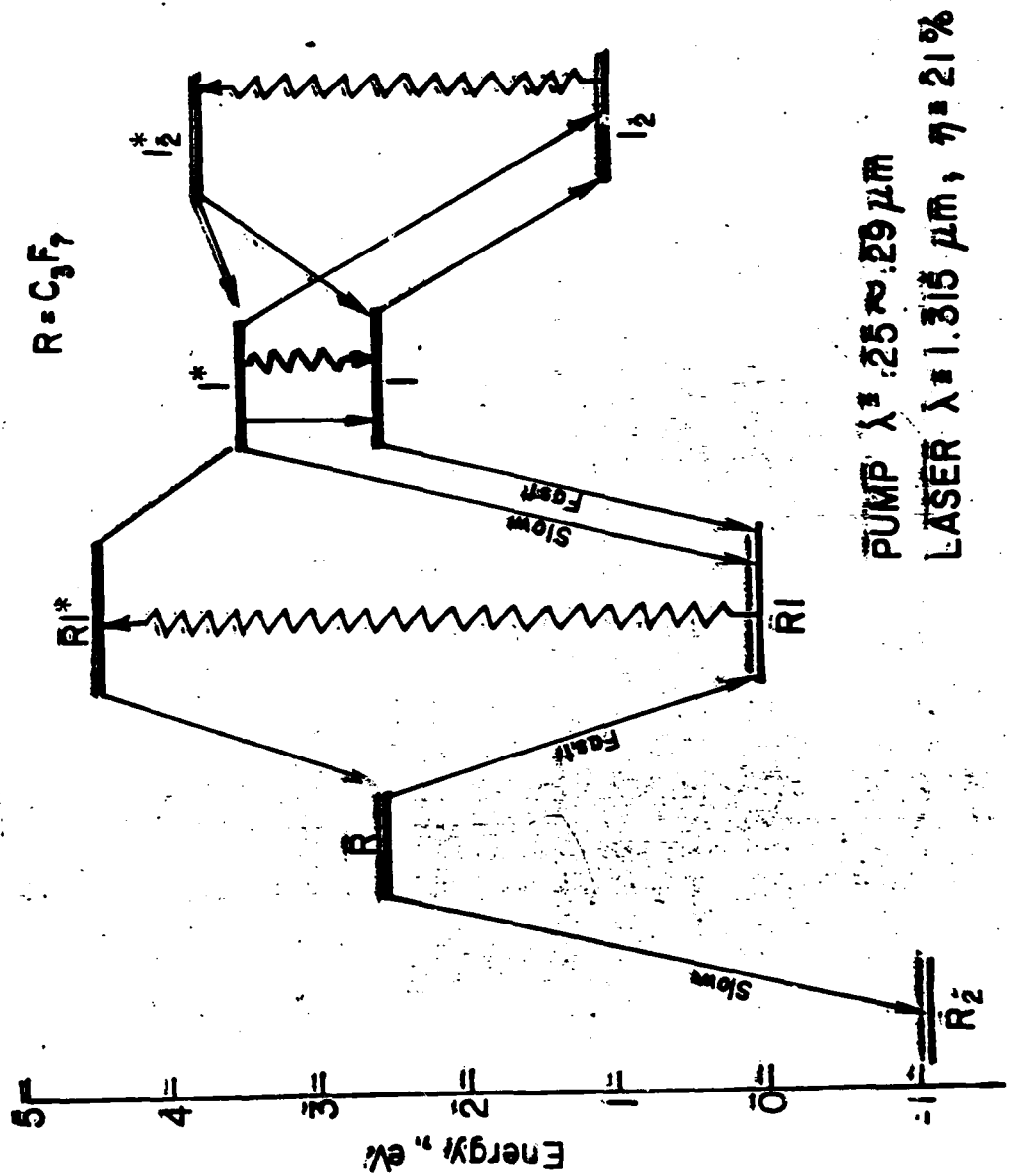

AD-A118 887

R AND D ASSOCIATES ROSSLYN VA

F/G 10/2

PROCEEDINGS OF THE AFOSR SPECIAL CONFERENCE ON PRIME-POWER FOR --ETC(U)

FEB 82 P J TURCHI

F49620-82-C-0008

UNCLASSIFIED

AFOSR-TR-82-0655

NL

9-9

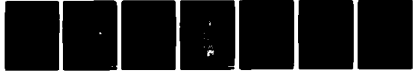

END
 DATE
 10.82
 DTIC

TYPICAL LASER OUTPUT

This figure shows a solar simulator pulse of approximately 3 kW exciting a laser pulse of 3 W. The solar efficiency of this system is approximately 0.1%. The bottom curve shows a theoretically predicted pulse from C_3F_7I . There is remarkably good agreement between the numerical simulation and the measurement. Theoretical estimates of efficiency for this lasant vary from 0.2% to 0.6%. One interesting feature of this lasant is that, flashlamp-pumped in an oscillator-amplifier chain, a pulse of 10^{12} Watts has been reported.

TYPICAL LASER OUTPUT COMPARED TO NUMERICAL SIMULATION

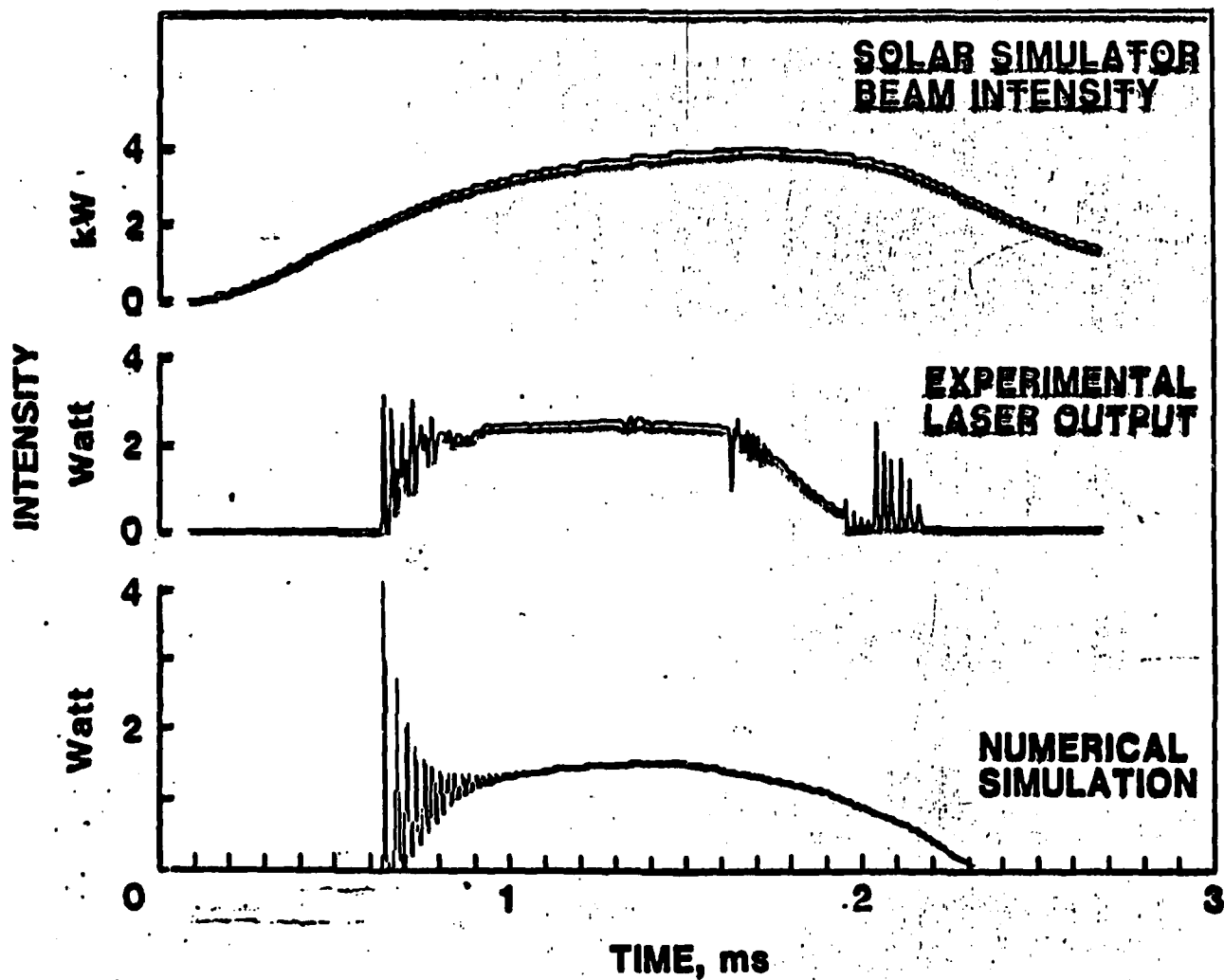

VI-5-9

IBr LASER KINETICS

IBr, which is pumped by light with wavelengths near $0.5 \mu\text{m}$, utilizes much more of the solar spectrum than does $\text{C}_3\text{F}_7\text{I}$. The figure shows the excitation, dissociation, lasing at 2.7μ , and reformation of IBr. The reformation rate has a natural time constant of a few milliseconds.

VI-5-10

IBr Laser Kinetics

Excitation

Lasing

Quenching

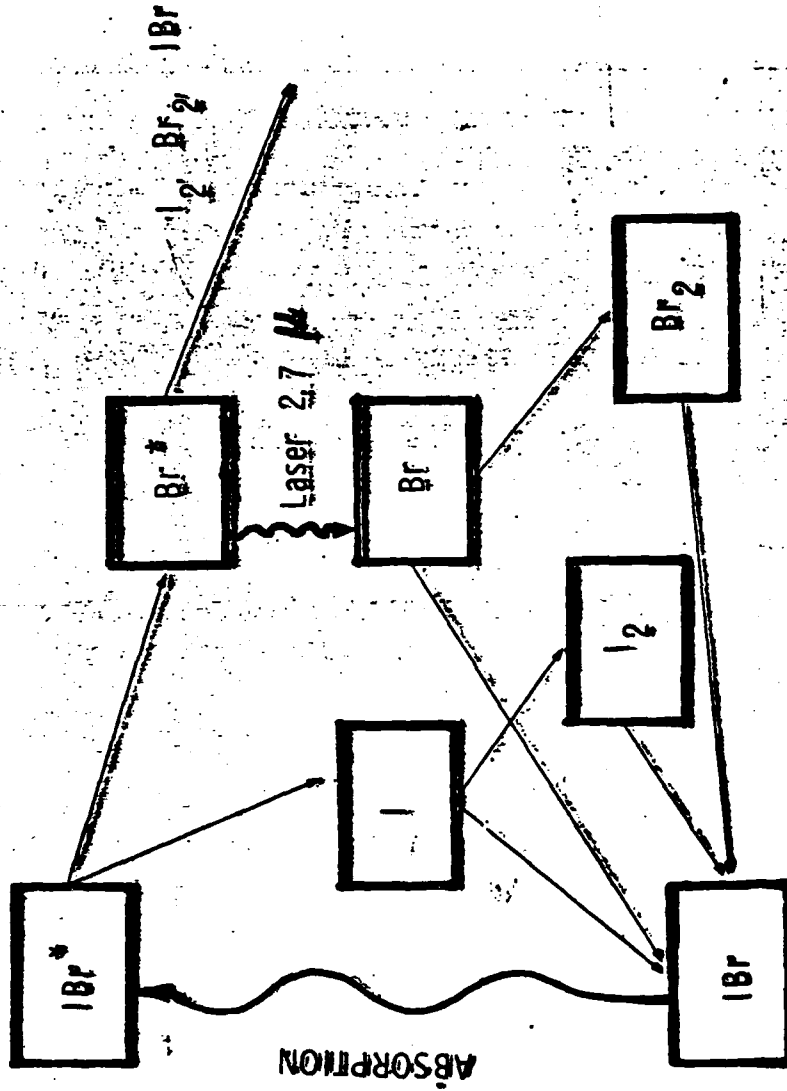

Chemical
Recombination

IBr LASER EXPERIMENT

In an experiment, the IBr can be purified and the pressure in the laser tube controlled by temperature. The figure shows a flashlamp-pumped IBr laser. This lasant has not yet been solar-pumped because the laser threshold requires more intensity over a greater length than we have achieved so far.

VI-5-12

IBr Laser Experimental Setup

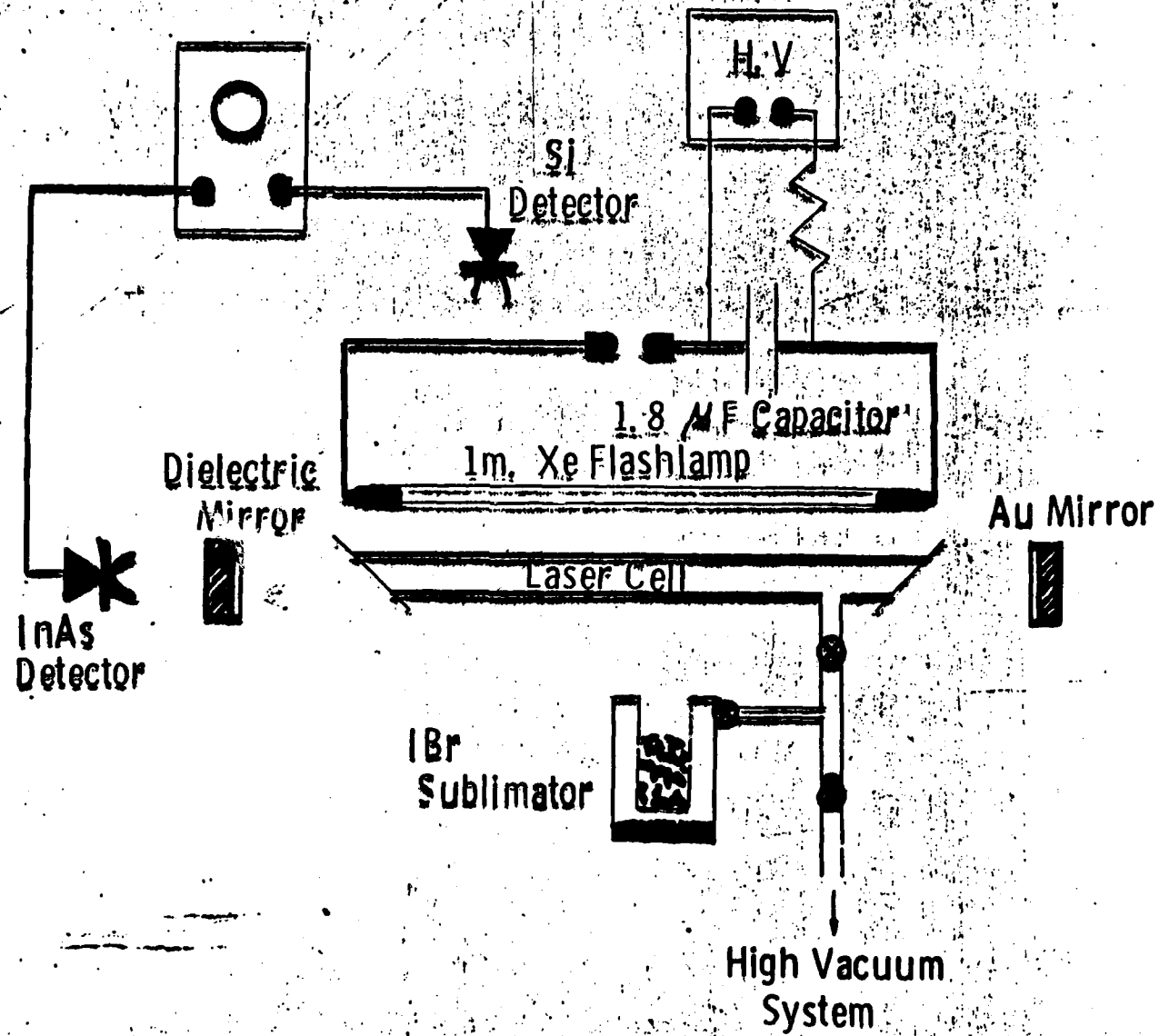

VI-5-13

IBr LASING CHARACTERISTICS

This figure shows IBr and C_3F_7I flashlamp-pumped in the same laser tube. Both lasants were near their optimum pressure. Here the pulse widths are limited by the reduction of the pumping intensity. Early versions of the IBr laser have achieved powers greater than 300 Watts (peak).

VI-5-14

IBr and C₃F₇I Lasing characteristics

Intensity (Rel. Units)



Xe Flashlamp ;
190 Joules

IBr : 6.5 Torr

C₃F₇I : 16 Torr

Time (2μs / Div.)

SOLAR-PUMPED SULFUR LASER

Other potential solar-pumped gas lasants worthy of study include sulfur, selenium, tellurium, and sodium. The figure indicates laser and solar excitation into the vibrational manifold of the first electronically excited state of the S_2 molecule. Laser-pumped lasing of sulfur has been reported. To achieve effective broadband solar pumping requires relaxation of a band of vibrational states into the lowest level, followed by lasing from that level, as depicted in the figure. Preliminary experiments indicate that this relaxation can be achieved.

VI-5-17

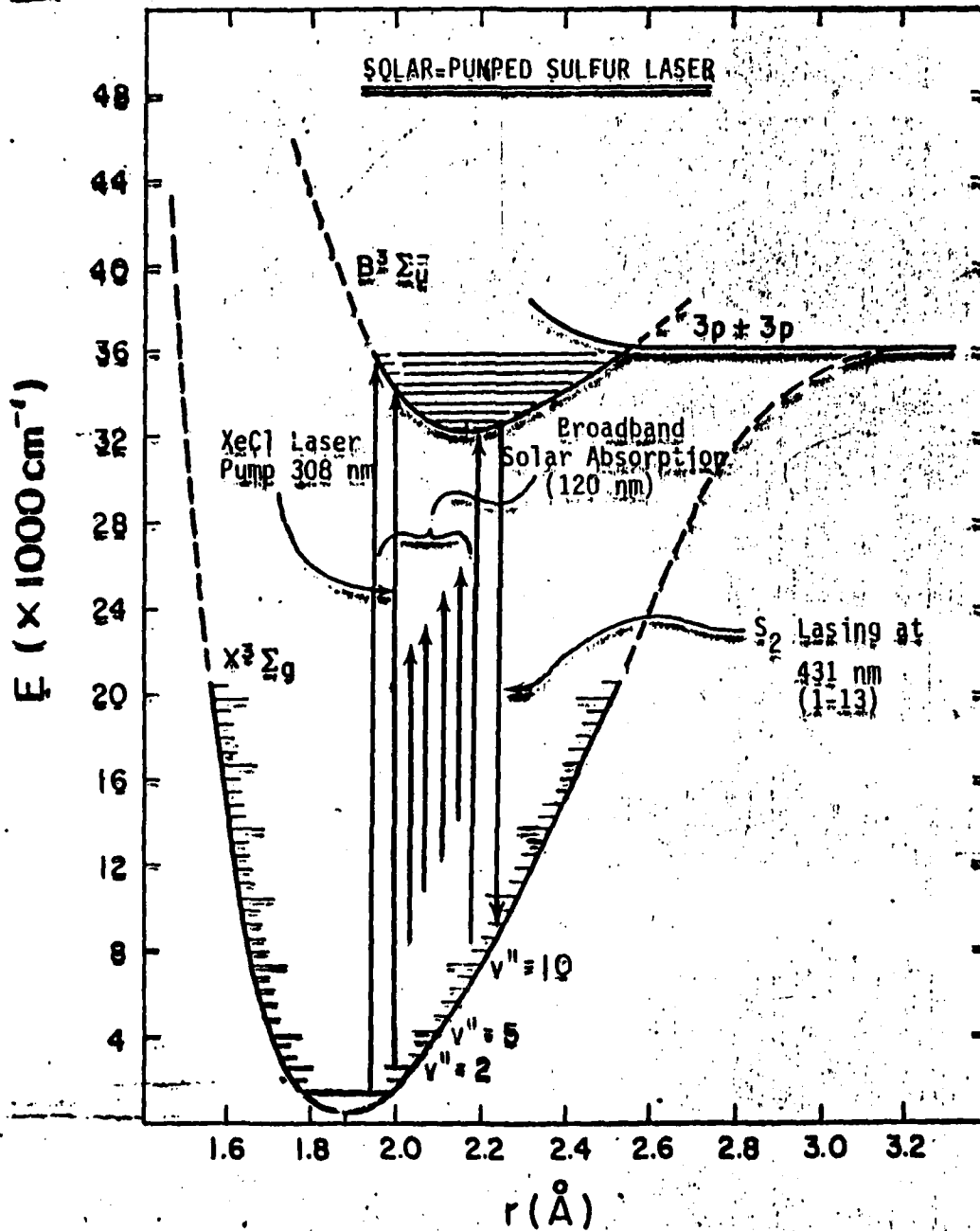

ABSORPTION AND EMISSION OF RHODAMINE 6G

Liquid lasers, although heavier, offer proportionally higher energy density than gas lasers. Thus, two liquid lasants are being investigated for solar pumping: (1) Nd ion in solution, which has a broad solar absorption and could exhibit an efficiency of 5%; and (2) solar-pumped dye lasers, which offer some advantages for power transmission. The figure shows the absorption bands of rhodamine 6G with its good match to the solar spectrum. The laser emission will be only slightly red-shifted from the absorption giving a high value to the ratio of the emitted photon energy to the absorbed photon energy. In addition, power transmission in the red would permit use of state-of-the-art photovoltaic converters for laser-to-electric conversion. Laser quenching arises through the formation of triplets which absorb emission and deplete the groundstate. Development of an efficient solar-pumped dye laser will require reduction of the triplet density in solution.

ABSORPTION AND EMISSION OF SOLAR RADIATION BY RHODAMINE 6G

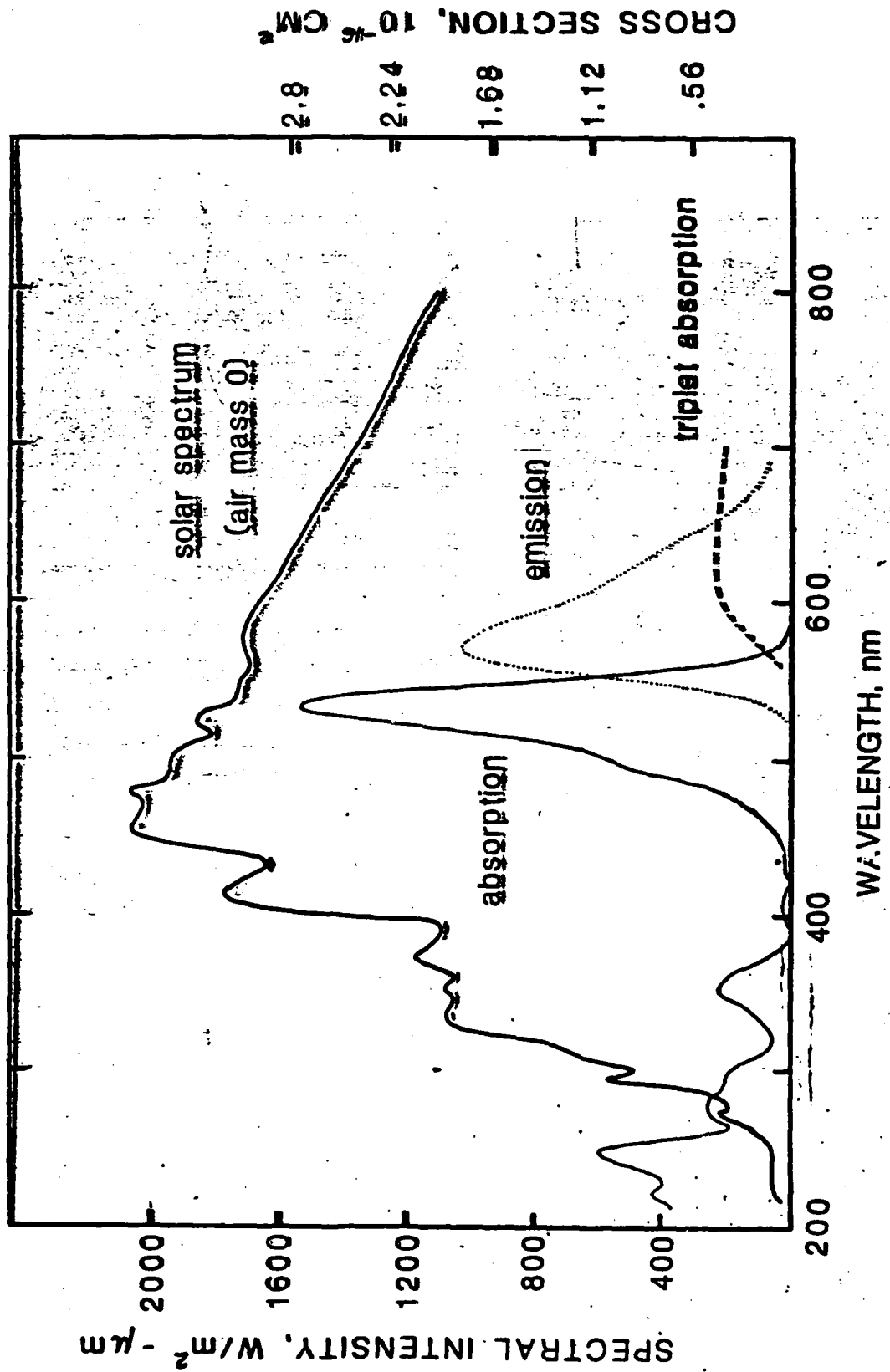

NOVEL LASER-TO-ELECTRIC CONVERTER CONCEPTS

A laser power transmission system not only requires an efficient laser but also an efficient converter. Heat engines and photovoltaic cells are often mentioned for laser-to-electric power conversion. However, novel concepts are also being considered since these offer advantages in weight, power density, and efficiency. Three novel concepts are shown in the figure: optical diodes (which rectify at optical frequency); laser MHD converters (which may be efficient at high power density); and a reverse free electron laser (which couples energy from the laser wave to electrons in an accelerator).

NOVEL LASER ELECTRIC CONVERTER CONCEPTS

OPTICAL DIODES

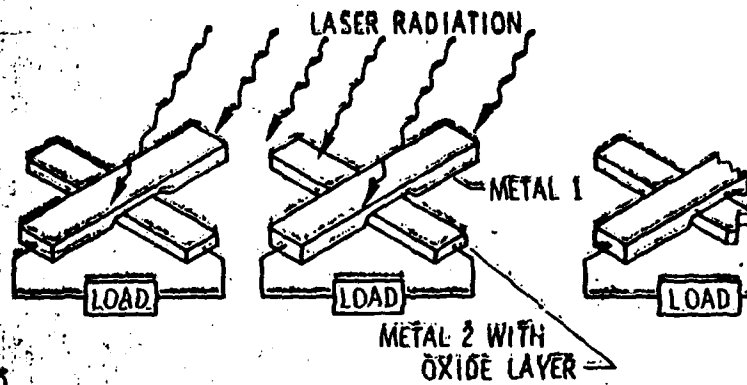

LASER MHD

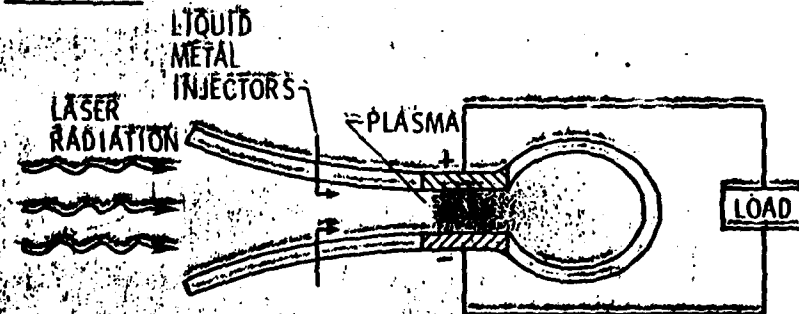

REVERSE FREE ELECTRON LASER

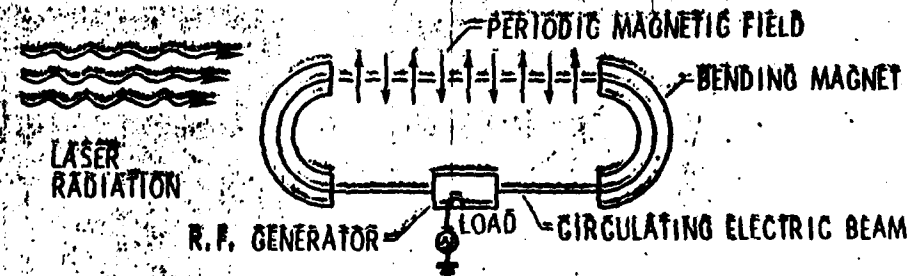

VI-5-21

LASER-SUPPORTED HYDROGEN ROCKET

In addition to transmitting energy for electrical power, laser energy could be used for propulsion. At Marshall Space Flight Center, researchers are investigating one concept of laser thermal propulsion, the hydrogen rocket. The figure illustrates the basic concept.

VI-5-22

LASER SUPPORTED PURE HYDROGEN ROCKET

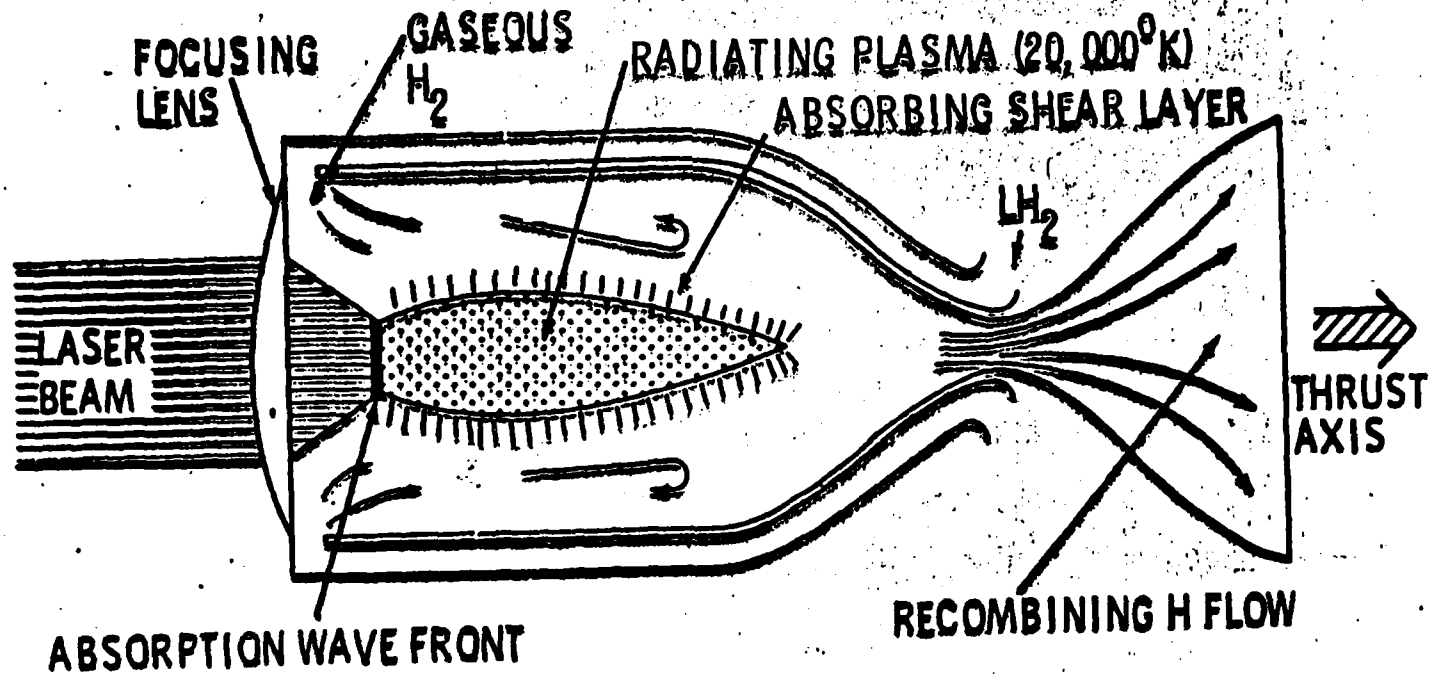

VI-5-23

ADVANTAGES AND APPLICATIONS

LASER TRANSMISSION FOR ELECTRIC POWER

Two spacecraft: one collecting solar power and one consuming laser power.

- Two laser platforms in Sun-synchronous orbit could continuously support several power-consuming spacecraft.
- Power-consuming spacecraft could be smaller and possibly lighter and less expensive than if solar-powered.
- May permit lower altitude, long life, low-drag reconnaissance missions.
- Since solar-pumped laser should be more radiation resistant than solar cells, a laser platform may be suitable for operation in radiation belts.
- Most laser-to-electric power converters are more radiation-resistant than solar cells, thus laser power-consuming spacecraft could operate more freely in the radiation belts.

SPECIAL CONFERENCE ON PRIME-POWER
FOR HIGH-ENERGY SPACE SYSTEMS
AUTHOR INDEX

<u>A</u>			<u>F</u>		
Angelo, J.	XI	3	Finke, R. C.	VI	10
			Fitzpatrick, G. O.	IV	3
			Fowle, A. A.	X	6
			Fraas, A. P.	IV	2
			Freeman, J. W.	VI	11,13
<u>B</u>			<u>G</u>		
Badcock, C. C.	XI	9	Gilardi, R.	VII	15
Bangerter, C. D.	III	4	Goswami, A.	III	8
Banks, B. A.	VII	12	Graves, R. D.	III	8
Barthelemy, R.	XI	1	Guenther, A. H.	XI	6
Bartine, D.	IV	11	Gupta, R.	VII	8
Berry, G.	X	8			
Bickford, K. J.	VII	8	<u>H</u>		
Bland, T.	V	3	Hartke, K. H.	I	1
Blankenship, C. P.	VII	14	Haslett, R.	X	1
Botts, T.	IV	6	Hertzberg, A.	X	2
Brandhorst, H. W., Jr.	VI	1	Holt, J. F.	VI	4
Britt, E. J.	IV	3, VI 9	Huffman, F.	IX	2
Brown, R. A.	II	2	Hyder, A. K.	XI	10
Bruckner, A. P.	X	3			
Bryan, H. R.	XI	11	<u>J</u>		
Buden, D.	IV	1	Jackson, W.	III	6
			Jones, O. C., Jr.	IV	9
			Junker, B. R.	XI	8
<u>C</u>			<u>K</u>		
Caveny, L.	I	5	Koester, J. K.	III	11
Clark, J.	II	1	Kruger, C. H.	III	11
Cohen, M.	I	3			
Conway, E. J.	VI	5	<u>L</u>		
Cooper, M. H.	VII	6	Laghari, J. R.	VII	8
			Lawless, J. L.	IX	3
			Layton, J. P.	XI	4
			Lee, Ja. H.	VI	12
			Lee, J. H., Jr.	IV	7
<u>D</u>					
Dicks, J. B.	III	1			
Donovan, T.	VIII	3			
<u>E</u>					
Eastman, G. Y.	IX	4,5			
El-Genk, M. S.	IV	8			
Elsner, N. B.	IV	5			
Engle, W. W., Jr.	IV	11			
English, R.	VI	1, XI 7			
Ernst, D. M.	X	4,5			

<u>L</u>			<u>S</u>		
Levy, P. W.	VII	7	Sarjeant, W. J.	VII	8
Lieb, D.	IX	2	Saunders, N.	VII	1
Loferski, J. J.	VI	2, 3	Seikel, G.	III	10
Louis, J. F.	III	3	Severns, T. G.	XI	5
			Sheldon, F.	III	9
<u>M</u>			Simons, S.	VI	11
Massie, L. D.	III	5	Smith, J. M.	III	2
Mattick, A. T.	X	2	Spight, C.	III	8
Merrill, O. S.	IX	4	Stapfer, G.	V	4
Milder, F. L.	VII	10, 11	Stedman, J. K.	II	3
Miley, G. H.	VI	7	Sundberg, G.	VII	9
Miskolczy, IX	2		Swallow, D.	III	9
Morris, J. F.	VII	2			
Mullin, J.	I	2	<u>T</u>		
Myrabo, L.	IV	6	Taussig, R.	X	2
			Teagan, W. P.	X	7
			Tenney, D. R.	VII	14
			Thompson, R. E.	IV	4, V 1
			Thornton, E. A.	X	9
<u>N</u>					
Nahemow, M.	VII	5	<u>V</u>		
Nakamura, T.	III	1	Vondra, R.	XI	2
<u>O</u>			<u>W</u>		
Oberly, C. E.	II	4	Walbridge, E. W.	VI	8
			Wood, C.	V	4
			Woodall, D.	IV	8
			Woodcock, G. R.	I	4
<u>P</u>					
Parker, G. H.	IV	4, V 1	<u>Y</u>		
Peterson, J.	V	2	Yang, L.	VII	3, IX
Phillips, B. R.	VI	6			
Pierce, B. L.	IV	4, V 1	<u>Z</u>		
Pierson, E. S.	III	7	Zauderer, B.	III	10
Powell, J. R.	IV	6			
<u>R</u>					
Rabitz, H.	VIII	1			
Ranken, W. A.	IV	10			
Reagan, P.	IX	2			
Rice, R. W.	VII	13			
Rosenblatt, G.	VIII	2			
Rossing, B. R.	VII	4			

