

A.R.E.

TECHNICAL MEMORANDUM # \_\_\_\_\_

Some Psychoenergetic Devices

by

William A. Tiller

A.

Introduction

This report constitutes a more detailed account of the psychoenergetic devices and experiments investigated during a recent A.R.E. fact-finding trip to Russia. As such, it is an extension of the General Technical Report<sup>(1)</sup> written concerning the trip rather than a substitute report. For a complete picture of the information received during this trip, both reports are necessary. Since it was felt that many people would not be interested in the details of these devices and experiments, two reports have been written.

The present report deals with three topics: (1) Kirlian photography, (2) Acupuncture points and the Tobiscope and (3) Telekinesis (PK) experiments and field detectors.

B.

Technical Data

1. Kirlian Photography

In this area of investigation, the important device factors fall into two categories: (a) the operating characteristics of the electrical power source and (b) the configuration and components of the information display and recording devices.

(a) It was indicated that the power source should be a pulsed high-frequency field (somewhat similar to a radar power source). The pulse characteristics are given in Fig. 1 and are (i) pulse height = 20-100Kvolt, (ii) pulse width =  $10^{-4}$  to  $2 \times 10^{-3}$  sec, (iii) pulse repetition period =  $1/50$  sec and (iv) A.C. frequency = 75 to 3000KHertz. They were of the opinion that a single D.C.

pulse would not be effective in producing the effect. [\*However, work carried out in England using this approach has revealed very interesting photographs from radiation in the ultra-violet.] They mentioned that it was dangerous to use D.C. rather than high frequency; with high frequency inside the pulse envelope, one can work with living systems.

Although a static electric field of the same value as used in the A.C. system ( $\sim 10^7$  volts/cm) would also yield cold electron emission, the situation is not straightforward as strong polarization of the electrodes would occur (electrolysis). They feel that it is necessary to have a discharge spacing between the specimen and the film in order for proper channel formation to occur (as a result of positive ion clustering around the electron stream). The electrons exit from the surface with different velocities and this includes information about the object. If one uses a D.C. power source, equilibration of electrons occurs and the image is absent. With D.C., in the first<sup>few</sup> moments an image appears but then disappears later as equilibration occurs. The H.F. signal is also used in the pulse so that one can decrease the size of the equipment. The use of different frequencies allows one to obtain quite different pictures, presumably associated with different resonances from different cells, etc.; i.e., the electrons can come from different parts of the skin.

Actually, one need use only one pulse to obtain a photograph. The slow pulse repetition rate is to provide low average power. It seems that a pulse duration of about  $2 \times 10^{-3}$  sec is maximum and if  $\tau$  is much larger, the image is poor. On the other hand, if  $\tau$  is too small, the channel discharge process doesn't have time to develop (for contact photography, one can use  $\tau \sim 2 \times 10^{-6}$  sec). The total current drawn from the entire surface is less than 1  $\mu$  amp so

that the actual current in a discharge channel is much less. They suggest that this is the reason for the stability of the cold electron emission.

The average power of a generator is about 1 watt (pulse power is much larger, of course). Thus, quite small generators using batteries, transformers, transistors, etc., can be built and taken out into the field. However, such small generators generally do not have as much stability as one would like.

It was stated that any discharge includes photons but that only discharges in a strong field produce an image. This seems to relate to electron acceleration which leads to photon emission. Of course, even the radiation damage effect of the electrons hitting the photographic grains can be expected to produce massive exposure of such grains.

(b) In the simplest Kirlian device, shaped like a sandwich or parallel plate condenser, the object is placed between the two plates to which voltage is applied. If the condenser plates are too close to the object, there will be no effect on the film. In order to get good pictures, there must be a dielectric gap between the object and the film. The exposure time depends on the film speed and on the power density of the electric field.

To improve the effect and augment it, a fine screen (like a silk screen) may be placed between the object and capacitor plate (and film). The film is between the condenser plate and the screen. This screen enhances the effect, probably by its serving as a dielectric. One type of effective screen material is film itself that has been completely exposed and developed.

The device can be placed in a scissors arrangement as illustrated in Fig. 2, the scissors being used to apply a slight but even pressure via the paralon (or sponge) pads. The electrodes are developed x-ray film ( $\text{AgBr} \rightarrow \text{Ag}$ )

and the leads are fastened to them as indicated. The dull matt finish of these electrodes provides poor reflectivity of light and thus is an aid to producing a good image. The spacing between object and film is about 50 microns (can be  $10\mu$  to  $100\mu$ ).

To improve the resolution, a layer of saline water or other conductive liquid is sometimes placed between the object and the film. In this case, the film is placed with the emulsion facing away from the object so that the emulsion won't be disturbed. The capacitor plate is then placed outside of the film. A further improvement can be made by using the conductive liquid as one of the capacitor plates, thereby permitting better resolution and faster work with the film.

For taking pictures of a section of human skin or other part of the body, only one electrode is needed. In this case, the body acts as ground; i.e., only one half of the device, presented in Fig. 2, is needed. This same electrode procedure is used for the Kirlian microscope, illustrated in Fig. 3, when it is applied to the body. Photographs of the one-electrode device and the microscope are shown in Fig. 4.

A simple rolling device, which has the advantage of operating at less than 1 watt average power, was also described. It is illustrated in Fig. 5. In this device, no discharge occurs at points A or C but does occur at point B where the spacing is about 10 microns. The cylinder is rolled at about 10 cm/min and gives a moving line discharge to expose the film in sequence. A device for taking moving pictures is illustrated in Fig. 6. It utilizes the arrangement of Fig. 2. Controlled weights are applied to the device and the film is pulled through at some particular speed while the discharge

process is going on. The film is rolled in the usual way and all is contained within a cassette.

In Fig. 7, an extremely useful device idea is illustrated. The previous methods utilized rigid capacitor plates which do not allow one to take pictures of objects having irregular profiles. In the new method (described in Russian patent #209968 filed in 1966 by Adamenko and Kirlian), the device takes the shape of the body. The transparent electrode is a silicon organic film; however, many other possibilities exist. With this device, any portion of the body can be photographed directly. In fact, one could make a snug-fitting vest or garment of the material which could then be monitored photographically from a distance or displayed continuously via closed-circuit T.V.

This new method grew out of an earlier idea of Kirlian's (patent #164906 in 1963) which utilized a conductive transparent material as part of the capacitor, to which a hinged mirror was attached, and a flexible conductive material which is laid upon the object to be photographed. The mirror is concave and acts as a lens, enlarging the object to be studied. The mirror is apparently used for visual examination when not taking photographs. Between the object and the flexible, transparent condenser plate is placed a dielectric net. A photographic plate is placed over the front or top of the conductor so that the prints were merely contact prints without focusing.

The foregoing devices all operate in air at 1 atmosphere pressure. If the pressure is reduced to  $10^{-5}$  mm of mercury, the image is still retained even with the electrode separation increased to 20-30 cm. At a pressure of  $10^{-6}$  mm of mercury, the image disappears. A visual display system using something like a television tube is illustrated in Fig. 8. In this CRT device,

electrons from the object impinge on a  $200\mu$ -thick dielectric film and their charge pattern induces charge polarization on the other side of the film which, in turn, affects the preferential geometry of electron emission from the film. Thus, the eventual image on the screen is indeed that of the object. This is a very important phenomenon which allows many interesting modifications of device design.

The methods have been developed for image amplification (magnification). In the first case, they use cold emission obtained in the small spacing device ( $50\mu$ ) of Fig. 2 with a high electric field at the edges,  $E_e \sim 10^6$  V/cm. However,  $E$  is caused to decrease in the middle to  $E_M \sim 10^4$  V/cm (see Fig. 9a). Thus, the magnification,  $\mu$ , is given by

$$\mu = \frac{E_e}{E_M} \quad (1)$$

They have obtained values of  $\mu \sim 340$ . The second method is carried out in a CRT type device as illustrated in Fig. 9b. The short electrode (cathode) has a field  $E_1$  and the larger electrode (anode) has a field  $E_2$  ( $E_1 \sim 10^6$  V/cm,  $E_2$  is smaller). In this case, the magnification,  $\mu$ , is given by

$$\mu = \frac{E_1}{E_2} = \frac{S_2}{S_1} \quad (2)$$

where  $S_1$  and  $S_2$  are the tensions of the two electrodes ( $S_1 E_1 = S_2 E_2$  from Gauss' law and charge conservation).

Using the T.V. tube type of device, one might expect that the use of electron lenses would allow one to build an electron microscope with very high magnification. However, because of the high vacuum needed in such a device, a severe limitation exists. At  $10^{-7}$  -  $10^{-8}$  mm of mercury pressure, one gets

no image because of the loss of channeling ions but at  $10^{-4}$  -  $10^{-3}$  mm Hg, one doesn't even need a lens. [\* The use of the dielectric imprinting technique may be a helpful aid here.]

In concluding this section, it was noted that, if a person's fingerprints were sanded off, the Kirlian photographs still revealed the original fingerprints. Likewise, if 2 to 10% of a leaf has been cut away from one edge, the entire radiation pattern of the unaltered leaf was still revealed in the Kirlian photograph. [\* It would be useful to perform the experiment by cutting successive strips from the leaf and photographing in order to see what percentage of the leaf can be removed without an alteration in the total radiation pattern. Dr. Adamenko suggested that the number of radiation sources in the leaf or finger may be so numerous as to produce sufficient redundancy of information that, if a portion of the leaf or skin is removed, the lost sources do not significantly disrupt the multiple array pattern.

## 2. Acupuncture and the Tobiscope

Although it was not possible to obtain a circuit design for the Tobiscope described in Ref. 1, it is possible to piece together conversational information and propose critical circuit design features from which a person, skilled in electronics, could make an instrument. Most simply, the device is a D.C. amplifier with a high input impedance and is battery powered. Very likely, the external skin impedance is arranged to be placed in parallel with the input impedance of the Tobiscope. Thus, if the skin impedance is reasonably large, the total operating input impedance is unaltered by increasing the skin path length. However, if a number of locations are found which



produce shunting or short circuit paths of low impedance, then the effective input impedance of the device is significantly lowered. For contact with such points, the current flowing through the device will be greatly increased and the current change (or voltage change) may be multiplied by the D.C. amplifier to a sufficient degree to light a bulb in the head of the device. The illumination of this light signals the location of a shunting path or an acupuncture point.

The device operates on less than 1 micro amp at 4 volts with the 3 transistor D.C. amplifier being very stable over the voltage range of 1.3 to 3.5 volts. The input resistance is about  $4-5 \times 10^6$  ohms and the device needs dry skin to be effective in locating the acupuncture network points (wet, salty skin leads to surface shunt paths). It is found that a resistance of about  $50 \times 10^3$  ohms exists between these network points and that the value increases greatly during sleep. ~~The equivalent resistance over the same length of skin between two non-network points is in the range  $\sim 10^6$  ohms.~~ At present, they are investigating an alternating current device and find that very interesting effects occur in the region of 1 KHz per second (since one now sees the imaginary part of the impedance).

The D.C. resistance between one acupuncture point and another is about 50 K $\Omega$  for two adjacent network points and varies slowly, as the distance between points increases, to about 100 K $\Omega$ . The same range of variation occurs due to emotional change, light stimulus, etc. The procedure here is to use a small current and a bridge balance method. As pointed out by Adamenko<sup>(2)</sup>, in the case of emotional excitation the points vary in diameter (as revealed by conductivity area) and there is the possibility of the areas overlapping

one another to form high conductivity regions. Again, it must be emphasized that measurements are meaningful only on dry skin.

They have investigated the variation of conductivity between the network points according to the patient's condition in hypnosis (see Fig. 11). The conditions or states of hypnosis are listed along the abscissa as: (1) ordinary state, (2) sleep with closed eyes, (3) sleep with open eyes, (4) suggestion of hallucinations, (5) "artificial reincarnation", (6) work in "reincarnation" state. The four graphs show variations in four groups of subjects ranging from control group A (those not hypnotizable) through B, C and D in increasing order of hypnotizability. As seen from the graphs, there exists a certain relationship between the patient's hypnability and the character of conductivity variations. In the control group, no conductivity variation has been recorded which indicates the absence of emotional reactions to the hypnotist's words. However, in the case of ordinary emotional states, these patients exhibit conductivity variations.

It has also been discovered that a voltage signal can be detected between two network points provided two different types of metals are used as electrodes. On dry skin, using plated circular electrodes of 5 to 7 mm diameter, a Ni-Ag combination yielded a potential difference of about 50 mv. At skin locations where such points are absent, the potential difference is close to zero. Likewise, between two network points, using the same electrode material (Ni-Ni or Ag-Ag, say), the potential difference is again close to zero. It is sufficient to plate cu electrodes with Ni or Ag (they use chrome-Ni and chrome-Ag). Adamenko finds that, the greater the work function difference,  $\Delta\psi$ , between the electrode materials, the greater the voltage,  $\Delta V$ , developed.

They think that this is a galvanic cell effect with the channel of meridian between the two network points acting as an electrolyte (like a Pb-Zn battery). The current drawn from this battery is about 10 micro-amps; however, this current level polarizes the electrodes so they use an impedance to reduce the current level to about  $2\mu$  amps and then amplify the signal for display purposes. In cases of emotional-volitive excitation, the potential difference  $\Delta V$  may increase up to 100 millivolts. Using parallel connections between several network points, the voltage obtained may be as high as 0.5-1 volt and the current accordingly increased up to some saturation limit ( $I_1 = 10\mu A$  for 1 pair,  $I_2 = 18\mu A$  for 2 pairs, etc.). They feel that this high current drain could be dangerous to the body. This network potential difference has been used to power a simple transistor radio and a small toy vehicle.

They find that, as the electrode area,  $A$ , increases, the developed voltage,  $V$ , increases. They also find that an A.C. pulse is diminished as the area of the electrode increases. This is illustrated in Fig. 12 as a plot of  $V$  vs. time; it probably represents an averaging phenomenon, wherein the A.C. signal arises only at the acupuncture point (less than 1 mm in diameter) in the central region of the electrode and potential averaging occurs.

In Fig. 13, the dependence of semiconductor properties of acupuncture points on the physiological state of the internal organs connected with these points is given. The vertical scale shows the difference in resistance ( $dR$ ) between symmetrical points in the direct and reverse directions. Each vertical line represents a particular acupuncture connection. Curves 1 and 4: "healer" before and after treatment. Curves 2 and 3: "patient" before and after treatment.

To fasten electrodes to a plant, glue can be used. To fasten electrodes to humans, around the head for example, an open helmet is used which contains screw contact electrodes that can be moved about and brought into light but constant pressure contact.

An interesting testing or training device, using a cylindrical capacitor of the type illustrated in Fig. 14, was mentioned. One hand was placed on the Al casing grasping the cylinder in a natural way (some acupuncture points touch the aluminum can). The thumb and forefinger of the other hand hold the central contact post (acupuncture points in finger touch the silver-plated contact). The capacitor is held in this way for one minute of charging and it is then discharged through a <sup>microammeter</sup> yielding a maximum signal  $I_1$ , say. Next, charging again occurs for one minute, but this time the investigator also mentally concentrates on charging the capacitor. The maximum discharge current is  $I_2$ , say, yielding a ratio  $K = I_2/I_1$  - the greater is  $K$ , the greater is the ability to use one's mind in controlling the energy body. The imagination of stress (or actual muscle tension) or excitement during this one-minute period can be used to alter  $I_2$ . Using a 30 microfarad capacitor, the author found  $I_1 \approx 10\mu A$ ; a larger capacitor (up to 10,000 $\mu f$ ) would probably be better. This simple device can be used to study one's ability to concentrate and focus the mind and by practice, one should be able to increase  $K$  significantly. It was stated that Alla V, the PK performer, is able to produce  $K = 9$  without too much difficulty.

### 3. Telekinesis (PK)

They find that the placing of a film on Nelya K's head during the PK experiment leads to the presence of a large exposed spot on the film. They

also find that film exposure occurs if the film is placed under the object used in a PK experiment. In addition, the film may also be exposed after the experiment due to a residual charge of some sort on the object. We heard that Nelya K actually caused a frog's heart to stop (and that it then could not be started again electrically). We also learned that she can influence the heart rhythm of other people and can alter their skin condition so as to produce a burning feeling on contact. They have found that hypnosis can be used to enhance PK abilities and that autogenic training was used to help increase Alla V's PK abilities. It was also stated that Nelya K cannot move objects if they are in a vacuum and that after the levitation of a small ball in air, an electrostatic charge of  $5 \times 10^5$  coulombs was found on the ball.

It was not possible to obtain any specific information concerning the Sergeyev detector of pulsating magnetic fields in the vicinity of the PK object. However, it is likely to be the detection of a magnetic field using a sensing element of the barium titanate variety. It was learned that plants make even better detectors of the PK fields, when electrodes are applied to two acupuncture points of the plant. Using 5 mm diameter electrodes of Ni and Ag, they obtain about 50 mv between two points which is amplified. During a PK experiment, current pulses occur which change from 5 mA ambient to over 100 mA at the pulse peak (see Fig. 15).

They have not fully studied the distribution of field strength between the operator and object during PK and find it to be a difficult question. The field intensity does increase as one reaches the object but probably not in the radiation type mode illustrated in Fig. 16. They don't know what type of field pattern exists on the other side of the object and seem to think that

the force is somehow just manifest in the vicinity of the object without tangible intervening field linkages between the operator and object. In the case of the rolling cylinder used in the PK experiments by Alla V, Adamenko thinks that a charge dipole forms, as illustrated in Fig. 17, which gives a moment such that one could move the object in either direction depending on how one held his hand. [This is not clear to me either.]

$\Delta V = 20 - 100 \text{ KV}$

$T = 15 \text{ NH} - 2000 \text{ NH}$

Approved For Release 2000/08/10 : CIA-RDP96-00787R000100200002-9

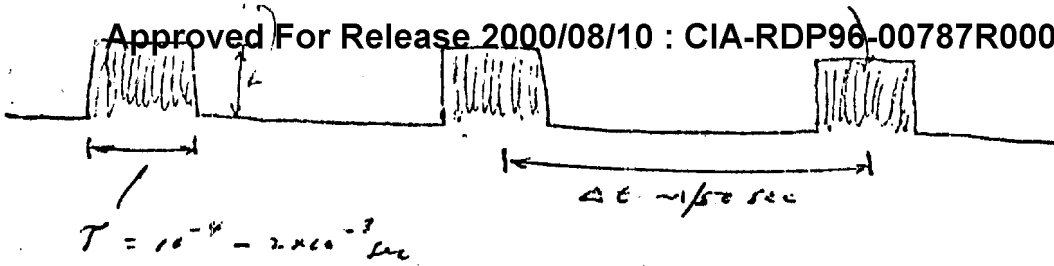

Fig 1

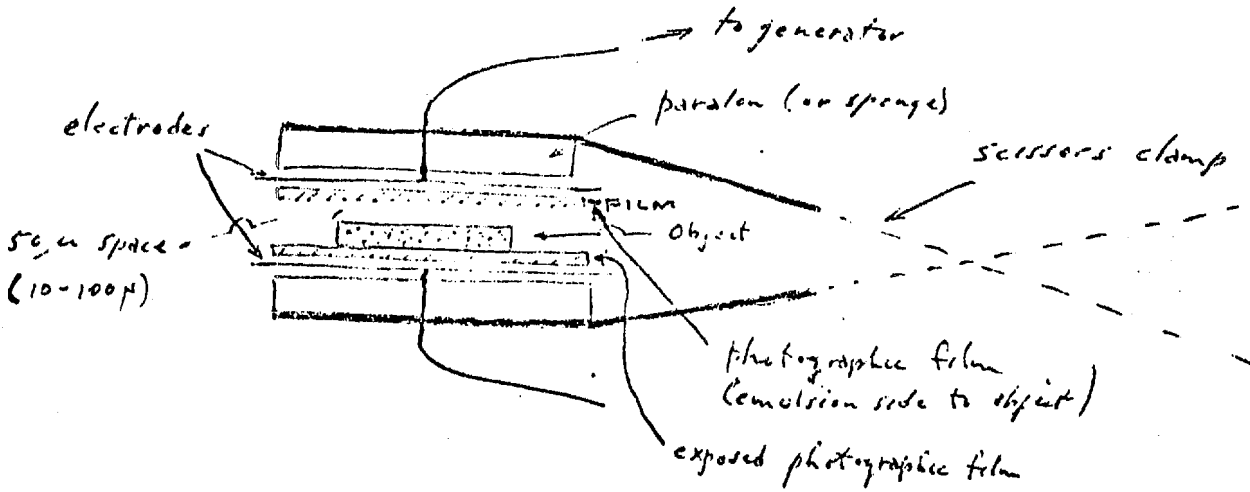

Fig 2

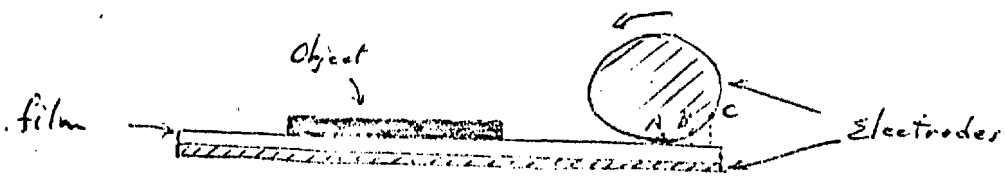

Fig 3

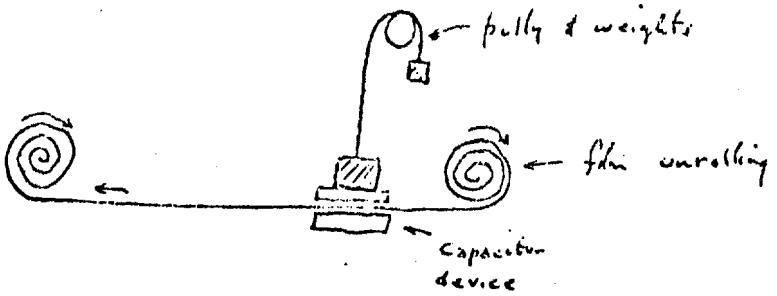

Fig 4

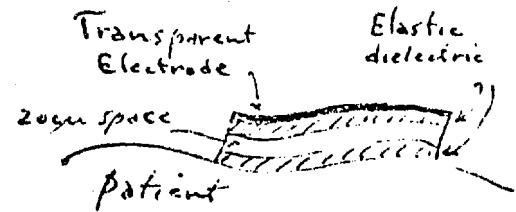
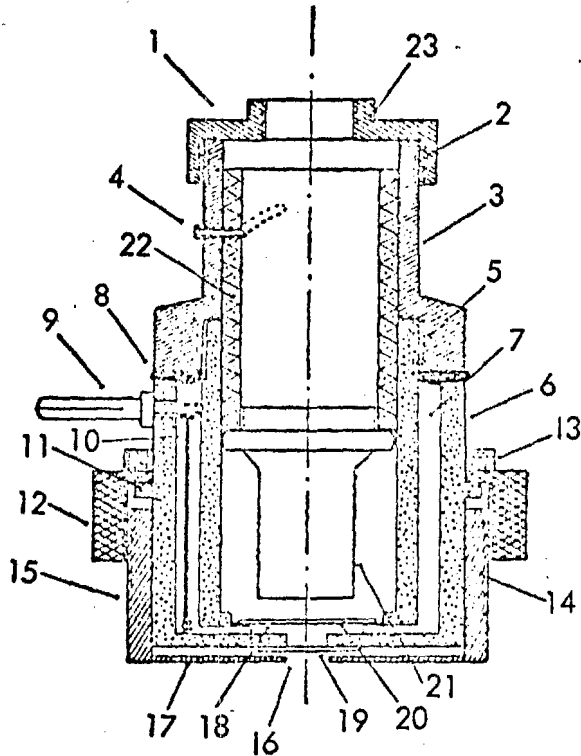

Fig 5



2. Thread
3. Upper half of housing
4. Pin for focusing
5. Thread
6. Lower half of housing
7. Two orifices ( $\phi$  4mm) disposed one in front of the other
8. Rubber washer
9. Contact to power source
10. Metallic wire (for protection against circuit disruption because of water evaporation)
11. Thickening in form of a ring
12. Pressing nut, freely revolving
13. Collars
14. Thread
15. Traverse
16. Orifice  $\phi$  5mm
17. Bottom of the traverse
18. Glass with thickness 0.6-1.0mm
19. Glass with thickness 0.13-0.14mm
20. Chamber (cell), flooded by water through orifice 7
21. 8-12 times objective
22. Bushing which carries objective
23. Thread (in accordance with microscope tube thread)

Fig. 3. Discharge - optical housing

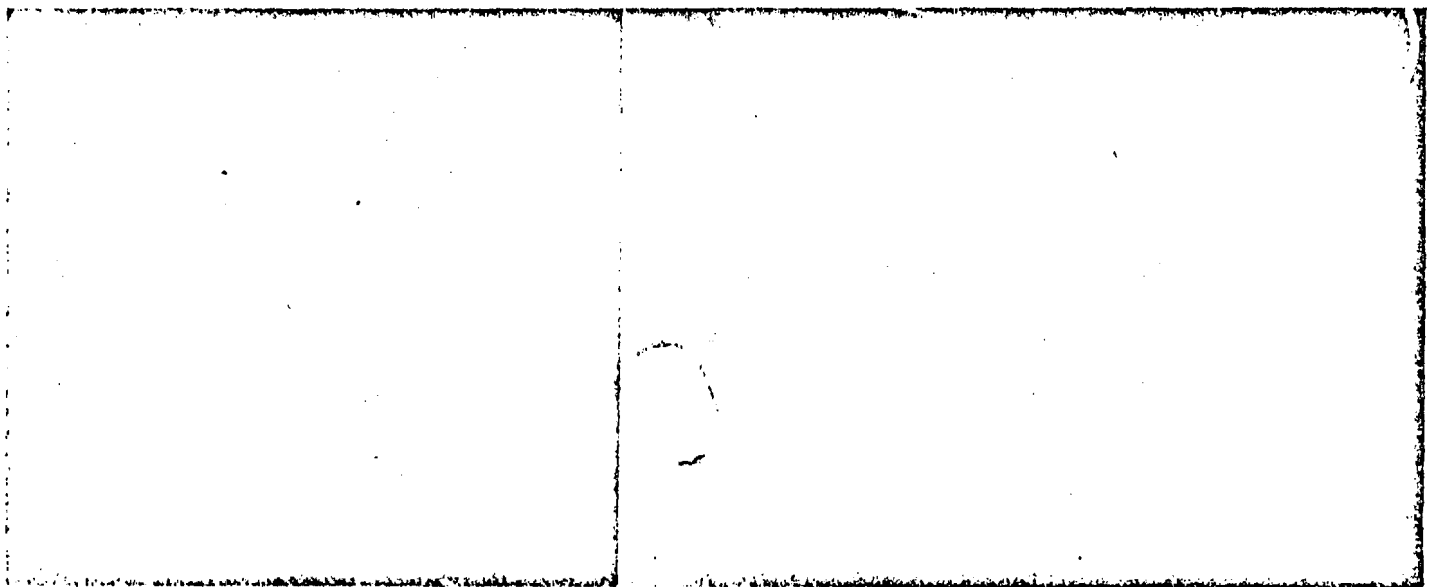

Fig. 4



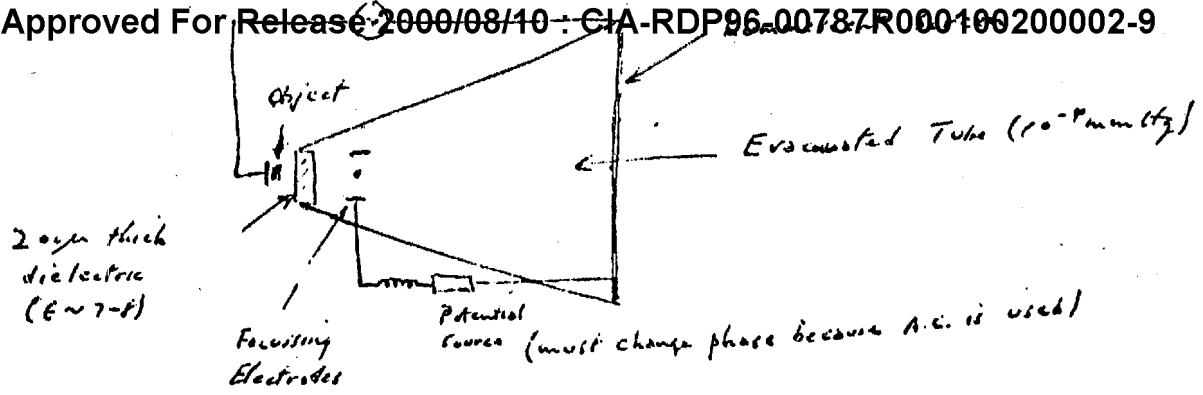

Fig 8

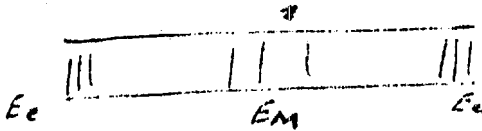

Fig 9

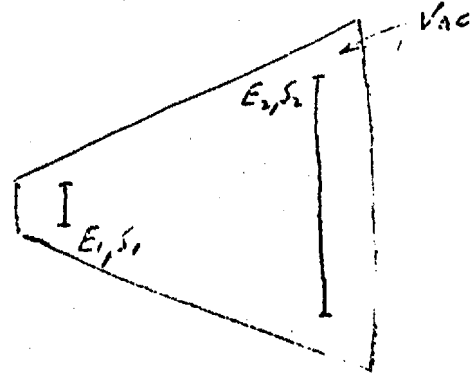

Fig 10

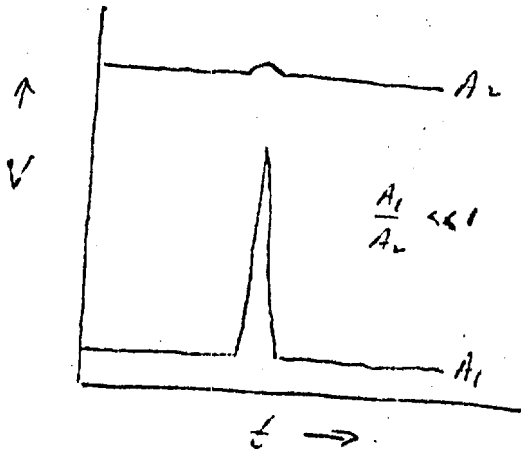
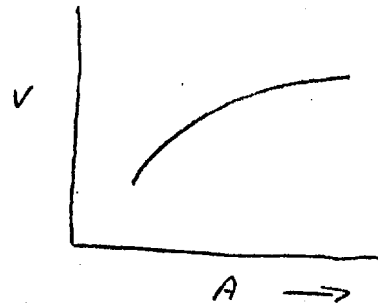
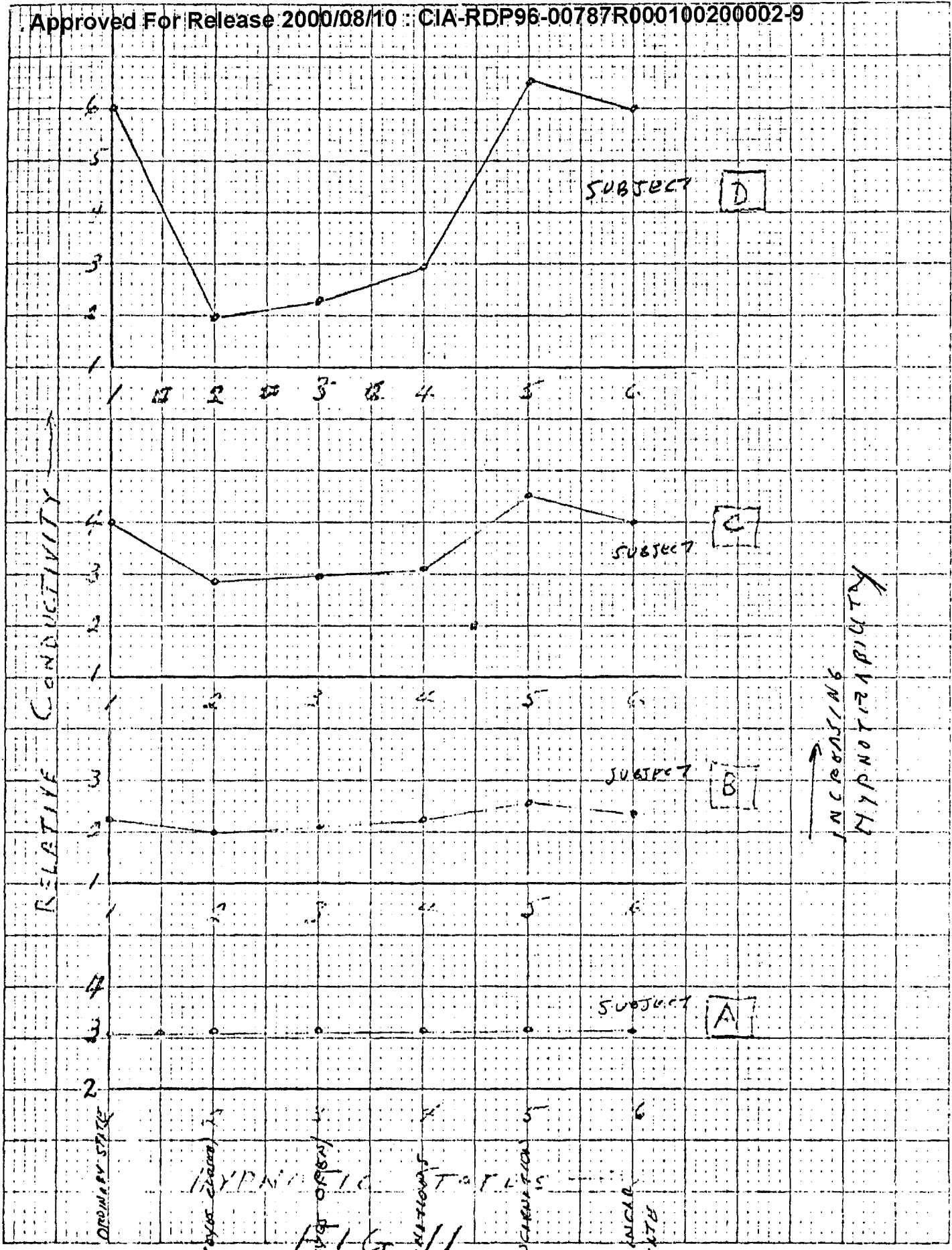
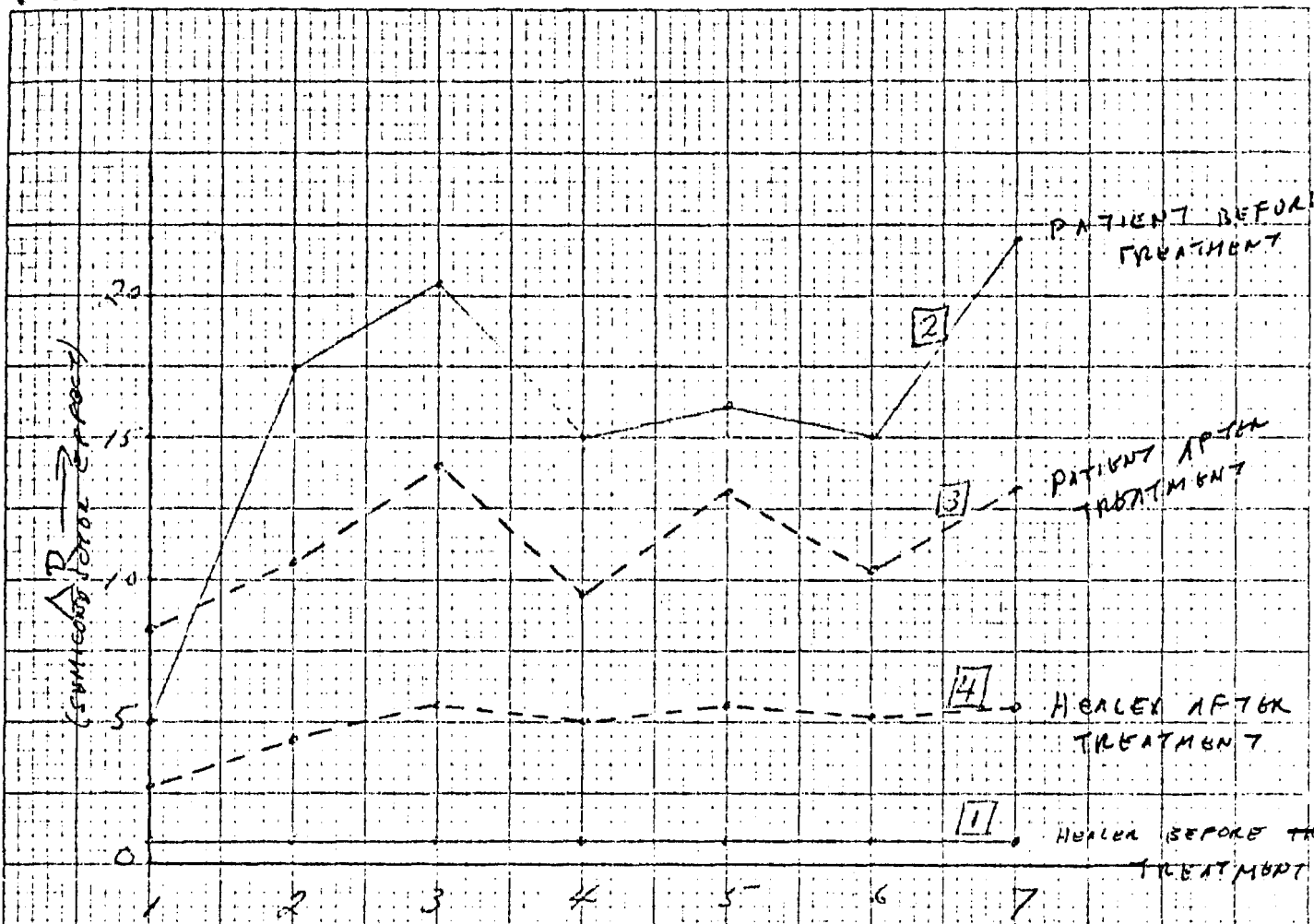

Fig 12







PARTICULAR ACUPUNCTURE CONNECTION →

FIG 13