

THIS FILE IS MADE AVAILABLE THROUGH THE DECLASSIFICATION EFFORTS AND RESEARCH OF:

THE BLACK VAULT

THE BLACK VAULT IS THE LARGEST ONLINE FREEDOM OF INFORMATION ACT / GOVERNMENT RECORD CLEARING HOUSE IN THE WORLD. THE RESEARCH EFFORTS HERE ARE RESPONSIBLE FOR THE DECLASSIFICATION OF THOUSANDS OF DOCUMENTS THROUGHOUT THE U.S. GOVERNMENT, AND ALL CAN BE DOWNLOADED BY VISITING:

[HTTP://WWW.BLACKVAULT.COM](http://www.blackvault.com)

YOU ARE ENCOURAGED TO FORWARD THIS DOCUMENT TO YOUR FRIENDS, BUT PLEASE KEEP THIS IDENTIFYING IMAGE AT THE TOP OF THE .PDF SO OTHERS CAN DOWNLOAD MORE!

~~CONFIDENTIAL~~

000030268

Manhattan District History Book II - Gaseous Diffusion [K-25] Project

~~RESTRICTED DATA~~ Vol. 5 - Operation

~~RESTRICTED DATA~~

This document contains Restricted Data as defined in the Atomic Energy Act of 1954. Unauthorized disclosure subject to Administrative and Criminal Sanctions.

Department of Energy Declassification Review	
1 st Review Date: <u>6-19-73</u>	Determination: [Circle Number(s)]
9A <u>Broshier</u> HS-60 Reviewer	1. Classification Retained <input checked="" type="checkbox"/> C
Authority: <input type="checkbox"/> DCR <input checked="" type="checkbox"/> DD	2. Classification Changed To: <input type="checkbox"/> C
Derived From: _____	3. Contains No DOE Classified Info <input type="checkbox"/>
Declassify On: _____	4. Coordinate With: _____
2 nd Review Date: <u>6/18/73</u>	5. Declassified <input type="checkbox"/>
Name: <u>Schaefer</u> HS-60 Reviewer	6. Classified Info Bracketed <input type="checkbox"/>
Authority: DD	Other (Specify): <u>Notes D1+D2 OK</u>
	<u>Missing</u>

**CLASSIFICATION CANCELLED
OR CHANGED TO _____ w/ deletions
BY AUTHORITY OF Michael Kolbay
Memo.....DATE.....7/16/13**

1305

~~CONFIDENTIAL~~

~~SECRET~~

THIS DOCUMENT CONSISTS OF 234 PAGES

COPY NO. 4 SERIES A

~~CONFIDENTIAL~~

~~SECRET~~
T 5-12-58

63481

MANHATTAN DISTRICT HISTORY
BOOK II - GASEOUS DIFFUSION (K-25) PROJECT
VOLUME 5 - OPERATION

~~RESTRICTED DATA~~

This document contains restricted data as defined in the Atomic Energy Act of 1954. Its transmission or the disclosure of its contents in any manner to an unauthorized person is prohibited.

~~REVIEWED AND NOT DECLASSIFIED
BY U. S. DEPARTMENT OF ENERGY
OFFICE OF CLASSIFICATION
JOHN F. WARTSOCK
REVIEWED BY
9/5/79
DATE~~

~~CONFIDENTIAL~~

ORO 93225

~~SECRET~~

1325/15/2/1

FOREWORD

Volume 5 presents an account of the operation of the gaseous diffusion plant. The purpose, administration, and contractual arrangements are discussed, followed by a narrative description of preliminary cascade operations, descriptive accounts of process, process service, conditioning, and power plant operations, and a résumé of production chronology. The volume concludes with a discussion of safety and security aspects, personnel procurement and industrial relations, costs, organization, and personnel. Other phases of the K-25 Project are dealt with in separate volumes of Book II as follows:

Volume 1 - General Features

Volume 2 - Research

Volume 3 - Design

Volume 4 - Construction

Activities described extend from the selection of the principal operating contractor in December 1942 to 31 December 1946, at which time the gaseous diffusion plant existed as an operating entity, and administrative responsibility passed from the Manhattan District to the United States Atomic Energy Commission.

A number of appendices are attached to illustrate the text of the volume by means of plans, flow diagrams, charts, graphs, tabulations, and photographs. References indicated by parentheses, as (App. A3), (App. D15), etc., refer to Item 3 of Appendix A, Item 15 of Appendix D, etc. A separate top secret appendix has been prepared to this volume in which production data, curves and graphs are shown.

The Summary contains an abstract of every major subject treated in Volume 1. Paragraph numbers in the Summary correspond to section numbers in the main text.

~~SECRET~~

~~CONFIDENTIAL/RD~~

MANHATTAN DISTRICT HISTORY

BOOK II - GASEOUS DIFFUSION (K-25) PROJECT

VOLUME 5 - OPERATION

TABLE OF CONTENTS

<u>Par. No.</u>		<u>Page No.</u>
	FOREWORD	
	SUMMARY	
	SECTION 1 - INTRODUCTION	
1-1	Purpose	1.1
1-2	Scope	1.1
1-3	Authorization	1.1
1-4	Administration	1.1
	SECTION 2 - CONTRACTUAL ARRANGEMENTS	
2-1	Carbide and Carbon Chemicals Corporation	2.1
	a. Selection of Union Carbide and Carbon Corporation	2.1
	b. History of Negotiations	2.1
	(1) Initiation of Negotiations	2.1
	(2) Choice of the Carbide Subsidiary	2.2
	(3) Final Negotiations	2.2
	c. Scope of Contract	2.3
	(1) Modifications	2.3
	d. Fee	2.3
2-2	Ford, Bacon, and Davis, Inc.	2.4
	a. Selection	2.4
	b. History of Negotiations	2.4
	c. Scope of Contract	2.5
	d. Fee	2.6
2-3	Hooker Electrochemical Company	2.6
	a. Selection	2.6
	b. History of Negotiations	2.7
	c. Scope of Contract	2.7
	d. Fee	2.7
	SECTION 3 - PRELIMINARY CASCADE OPERATIONS	
3-1	Introduction	3.1

~~SECRET~~

~~CONFIDENTIAL/RD~~

~~CONFIDENTIAL/RD~~

~~SECRET~~

<u>Par. No.</u>		<u>Page No.</u>
3-2	54 Stage Pilot Plant	3.1
	a. Purpose	3.1
	b. Operation	3.1
	c. Results	3.1
3-3	Mechanical Test Runs	3.2
3-4	Acceptance of Facilities	3.2
3-5	Vacuum Testing	3.2
	a. Methods	3.3
	b. Progress	3.3
3-6	Instrument Checking	3.4
3-7	Operations on Nitrogen	3.4
3-8	Operations on n-Perfluorheptane	3.4
3-9	Conditioning with Fluorine	3.5
	a. Purpose	3.5
	b. Methods	3.5
	c. Progress	3.6

SECTION 4 - PROCESS OPERATIONS

4-1	Introduction	4.1
4-2	Cascade Operation	4.1
	a. Main K-25 Cascade (Section 300)	4.1
	(1) Stripping Section	4.2
	(2) Enriching Section	4.2
	b. Purge Cascade (Section 312)	4.3
	c. K-27 Cascade (Section 400)	4.3
	(1) Stripping and Enriching Sections	4.3
	d. Cascade of Cascades	4.4
	(1) Stripping and Enriching Sections	4.4
4-3	Feed Purification and Supply	4.4
	a. Initial K-25 Feed Operations	4.4
	b. Subsequent K-25 Feed Operations	4.5
	c. K-27 Feed Operations	4.5
	d. Feed Operations for the Cascade of Cascades	4.5
4-4	Surge Absorption and Waste Removal	4.5
	a. Initial K-25 Surge and Waste Operations	4.5
	b. Subsequent K-25 Surge and Waste Operations	4.6
	c. K-27 Surge and Waste Operations	4.6
	d. Surge and Waste Operations for the Cascade of Cascades	4.6
4-5	Process Stream Purging	4.6
	a. Initial K-25 Purging Operations	4.7
	b. Subsequent K-25 Purging Operations	4.7
	c. K-27 Purging Operations	4.7
	d. Purging Operations for the Cascade of Cascades	4.7
4-6	Process Gas Recovery	4.8
	a. Initial K-25 Recovery Operations	4.8

~~CONFIDENTIAL/RD~~

~~SECRET~~

<u>Par. No.</u>		<u>Page No.</u>
	b. Subsequent K-25 Recovery Operations	4.8
	(1) Plant II Operating Procedure	4.9
	(2) Plant I Operating Procedure	4.10
	c. K-27 Recovery Operations	4.10
	d. Recovery Operations for the Cascade of Cascades	4.10
4-7	Product Withdrawal	4.11
	a. Initial K-25 Product Operations	4.11
	b. Subsequent K-25 Product Operations	4.11
	c. K-27 Product Operations	4.11
	d. Product Operations for the Cascade of Cascades	4.12

SECTION 5 - OPERATION OF PROCESS SERVICE INSTALLATIONS

5-1	Introduction	5.1
5-2	Process Coolant Supply	5.1
5-3	Cooling Water Supply	5.2
5-4	Dry Air Supply	5.2
	a. Dry Instrument Air Supply	5.4
5-5	Compressed Air Supply	5.4
5-6	Lubricating Oil Supply	5.4
5-7	Dry Nitrogen Supply	5.5
5-8	Service Laboratories	5.5
	a. Analyses of Product and Other Uranium Compounds	
	b. Analyses of Special Chemicals	5.6
	c. Miscellaneous Analyses	5.6
	d. Research and Development	5.7
5-9	Special Chemicals	5.7
	a. Fluorine (Code Name: C-216)	5.7
	b. Perfluorodimethylcyclohexane (Code Name: C-316)	5.7
	c. n-Perfluoroheptane (Code Name: C-716)	5.7
	d. Fluorolubes	5.8
	(1) C-2144	5.8
	(2) MFL	5.8
	(3) MFI	5.8
	e. "C" Rubber	5.8
	f. Fluoroplastics	5.9
	(1) Poly TFE	5.9
	(2) MFP-10	5.9

SECTION 6 - CONDITIONING AREA OPERATIONS

6-1	Conditioning Building Operations	6.1
	a. Converter Conditioning	6.1

	b. Converter Testing		
	DELETED		DELETED ^{6.2}
	d. Converter Inspection		6.2
	e. Stage Pump Conditioning		6.3
	f. Cleaning Operations		6.3
	g. Process Pump Shop		6.4
	h. Seal Shop		6.4
	i. Vacuum Pump Shop		6.5
	j. Vacuum Electronics Shop		6.5
	k. Development Activities		6.5
	(1) Converter Retubing and Testing		6.6
	(2) Engineering Development Laboratory		6.6
	(5) Barrier Testing Laboratory		6.7
6-2	Fluorine Generation		6.8
	a. Production		6.8
6-3	Fluorine Disposal		6.9
	a. Shutdown of Disposal Tower		6.9
6-4	Acid Neutralization		6.10
6-5	Nitrogen Generation		6.10
6-6	Carbon Mixing		6.10

DOE
b(3)

DOE b(3)

~~DELETED~~

~~DELETED~~

SECTION 7 - POWER PLANT OPERATIONS

7-1	Introduction	7.1
7-2	Steam Generation	7.1
7-3	Power Production	7.1
7-4	Power from the T.V.A. System	7.2
7-5	Steam Supplied to S-50	7.2

SECTION 8 - PRODUCTION CHRONOLOGY

8-1	Start-up of the K-25 Plant	8.1
8-2	Start-up of the K-27 Plant	8.1
8-3	Formation of Cascade of Cascades	8.5
8-4	Case Scheduling	8.4
8-5	Interruptions to Operations	8.4
	a. Initial Period through 30 September 1945	8.5
	b. Period from 1 October 1945 through 30 April 1946	8.6
	c. Period from 1 May 1946 through 31 December 1946	8.6
8-6	Maintenance Experience	8.11
	a. Period from April through August 1945	8.11
	b. September 1945	8.11
	c. Period from January through December 1946	8.12
8-7	Plugging of Barrier	8.12

<u>Par. No.</u>		<u>Page No.</u>
	a. Plugging Curves	8.13
	b. Barrier Replacement	8.14
	(1) Process Converters	8.14
	(2) Purge Converters	8.14
8-8	Feed Material	8.15
	a. Fresh Feed	8.15
	b. S-50 Material	8.15
	c. Y-12 Material	8.15
	d. Reprocessed K-25 Material	8.15
8-9	Waste Material	8.16
8-10	Product Material	8.16

SECTION 9 - SAFETY AND SECURITY

9-1	Safety Program	9.1
	a. Organisation	9.1
	(1) District Organisation	9.1
	(2) Contractor Organisation	9.1
	b. Safety Measures	9.3
	c. Statistics	9.5
	d. Special Hazards	9.5
9-2	Security Program	9.6
	a. Organisation	9.6
	(1) District Organisation	9.6
	(2) Contractor Organisation	9.7
	b. Security Measures	9.8
9-3	Diversion Control	9.8
	a. History of Diversion Control	9.8
	b. Organisation	9.9
	(1) Ceded Chemicals Section	9.9
	(2) Accountability Section	9.9
	(3) Consumption Section	9.10
	(4) Diversion Control Section	9.10
	(5) Special Hazards Section	9.10

SECTION 10 - PERSONNEL PROCUREMENT AND INDUSTRIAL RELATIONS

10-1	Personnel Procurement	10.1
	a. Recruiting Program	10.1
	b. Employment Offices	10.1
10-2	Training of Specialized Personnel	10.2
	a. Process Operations Training Program	10.2
	(1) Critical Personnel Period	10.3
	b. Process Maintenance Training Program	10.3
	c. Process Instrument Training Program	10.4
	d. First Aid Training	10.4
	e. Assault Mask Training	10.4
10-3	Employment Statistics	10.5
	a. Enlisted Personnel	10.5
10-4	Work Stoppages	10.6

<u>Par. No.</u>		<u>Page No.</u>
10-5	Labor Relations	10.5
	a. Grievance Procedure	10.6
	b. Disciplinary Procedure	10.6
	c. Union Representation	10.7
10-6	Housing Program	10.7
10-7	Transportation	10.9

SECTION 11 - COSTS

11-1	Introduction	11.1
11-2	Monthly Operating Costs	11.1
11-3	Cost Breakdown	11.1
11-4	Cost Summary	11.1

SECTION 12 - ORGANIZATION AND PERSONNEL

12-1	K-25 Operations Office	12.1
	a. Organisation	12.1
	b. Personnel	12.1
	c. Reorganisation	12.2
12-2	Carbide and Carbon Chemicals Corporation	12.2
	a. Organisation	12.3
	(1) Process Division Organisation	12.3
	b. Personnel	12.4
12-3	Ford, Bacon, and Davis, Inc.	12.4
	a. Organisation	12.4
	b. Personnel	12.5
12-4	Hooker Electrochemical Company	12.6
	a. Organisation	12.6
	b. Personnel	12.6

APPENDIX "A" - PLANS AND FLOW DIAGRAMS

APPENDIX "B" - CHARTS AND GRAPHS

APPENDIX "C" - TABULATIONS

APPENDIX "D" - PHOTOGRAPHS

APPENDIX "E" - CONTRACTS

APPENDIX "F" - KEY PERSONNEL

INDEX

~~SECRET~~

~~CONFIDENTIAL/RD~~

SUMMARY

1. Introduction. - Enrichment of the U-235 concentration in uranium hexafluoride is carried on at the K-25 plant by means of continuous operation of "the largest physico-chemical process in the world". The entire plant is operated by the Carbide and Carbon Chemicals Corporation. The fluorine generating facilities were initially operated by the Hooker Electrochemical Company, and the conditioning plant was originally operated by Ford, Bacon, and Davis, Inc. The operating contracts were formerly administered by the Unit Chief of the K-25 Project, and are now administered by the K-25 Division Chief, for the District Engineer.

2. Contractual Arrangements. - At a meeting on 12 December 1942 between Manhattan District officials and the M. W. Kellogg Company, it was decided to award the principal operating contract to the Union Carbide and Carbon Corporation. As of 18 January 1943, letter contract W-7405-eng-26 was executed with their subsidiary, the Carbide and Carbon Chemicals Corporation, on a cost-plus-fixed-fee basis, providing for study of available technical diffusion plant information, research and experimental work, consultant services, training of operating personnel, organization of an operating staff, and operation of the K-25 plant. The fee was set at \$75,000 per month for full operation of the plant, and subsequently increased to \$96,000 per month for full operation of K-25 and K-27. At Carbide's suggestion, contract W-7407-eng-34, effective 25 October 1943, was awarded to Ford, Bacon, and Davis, Inc. for initial operation of the conditioning plant. The fixed fee for this work was ultimately set at \$202,000. Letter contract W-7405-eng-258, effective 27 September 1943,

~~SECRET~~

~~CONFIDENTIAL/RD~~

~~SECRET~~

~~CONFIDENTIAL/RD~~

was awarded to the Hooker Electrochemical Company, providing for operation of the fluorine generating plant, and for supervision of its design and construction. The fixed fee was set at \$24,500.

3. Preliminary Cascade Operations. - In August 1944, Carbide took over Building "K-303-2x" as an experimental building. It was set up as a 54 stage pilot plant with dummy diffusers. Process flow and pressure conditions were simulated, and the pilot plant was operated on nitrogen until October 1944, and on n-perfluoroheptane until April 1945. Key operating personnel were trained, instrument performance was proved and modified, operational procedures were developed, and performance data were collected pertaining to process equipment and auxiliary systems.

As the individual process buildings reached the point where preliminary operation could be started, the construction contractor made a mechanical test run on each in order to prove operability of equipment. Upon acceptance of each building, Carbide began vacuum testing operations, using the mass spectrometer leak detector with helium probe. Leaks were repaired as detected, and the testing repeated, until all leaks were eliminated. After the completion of vacuum testing, it was necessary to check, adjust, and calibrate all instruments. The cascade cells were then operated on nitrogen as a process gas in order to test seals, pumps, and valves prior to conditioning and operation on UF_6 . A number of the earlier buildings were further tested by operation with n-perfluoroheptane, but this step was found to be unnecessary, and was discontinued. The final step of preliminary operation involved treating all interior process equipment surfaces with elemental fluorine in order to remove the last trace of moisture, and to form a protective fluoride film coating so as to minimize the tendency

~~SECRET~~

~~CONFIDENTIAL/RD~~

for corrosion by uranium hexafluoride.

4. Process Operations. - The 2892 diffusion stages of the main K-25 plant are operated as a cascade in order to sum up the minute isotopic enrichment achieved in all individual stages. The three separately functioning, 42-stage, purge cascades operate on the principle of gaseous diffusion, but serve to separate light diluents from the process gas, rather than to achieve isotopic enrichment. The 540 stage K-27 cascade is similar in all major respects to the K-25 process cascade. The entire gaseous diffusion plant is normally operated as an integrated unit with K-25 and K-27 interconnected so as to form a "cascade of cascades".

To date, it has not been necessary to operate the feed purification plant of the main process area. Feed introduction to the K-25 cascade has been accomplished by means of a simple hot water vaporization and process material filtering system. A similar system is in use at K-27, through which all feed for the cascade of cascades is normally introduced.

Surge absorption and waste removal for the K-25 cascade, operating independently of K-27, were accomplished in Building K-601. The system includes a surge drum reservoir, and suitable equipment for liquefaction of UF_6 and withdrawal to storage cylinders. A similar system, housed in Building K-631, is used for surge and waste removal in conjunction with K-27 operation. In normal cascade of cascades operation, all pressure surges originating either in K-25 or K-27 are absorbed in Building K-631, at which point, also, all waste material is drawn off. The surge drum in Building K-601 acts simply to provide additional damping volume.

~~CONFIDENTIAL/RD~~ ~~SECRET~~

The original method for purging light diluent gases from the process system was based upon condensation of UF_6 in cold traps, using temporary purge and product systems set up at the top of Sections 2a and 2b of the main cascade. When the permanent purge cascades of Section 312 became ready for operation all purging activities were transferred to that point. During the period when K-27 was operated independently of K-25, purging operations were carried on in the top 2-5 cells of the K-27 process cascade.

Most of the main process buildings were equipped with a cold trap room in the basement, which contained equipment for recovering the uranium hexafluoride from a cell which had to be taken off stream and opened for maintenance. The method involves removal of process gas by means of a Beach-Russ pump discharging to a specially designed solidifying heat exchanger, but is relatively slow and costly. An improved method known as "surge for purge" was developed, and put into operation in the early part of 1946. It is based upon the use of a large static volume (evacuated to low pressure) to receive gases from a much smaller volume in which the UF_6 concentration must be lowered to a specified value. The cell to be emptied of process material is first evacuated to the cascade (down to about 0.2 p.s.i.a.) by operation of the stage pumps with suitable manipulation of cell block valves. After repressuring to 3-5 p.s.i.a. with nitrogen gas, the pressure is relieved by equalization with the previously evacuated surge system (i.e., a system formed by interconnection of intersectional cells). The repressuring and equalizing procedure is repeated a sufficient number of times until the UF_6 concentration of the cell has been reduced to a

~~SECRET~~ ~~CONFIDENTIAL/RD~~

~~SECRET~~

~~CONFIDENTIAL/RD~~

permissible level. An analogous method has been developed for use in K-27, involving the use of spare surge drums of Building K-631 to provide the necessary surge volume.

Product withdrawal, during Case I, was accomplished by means of refrigerated mobile cylinders. During Cases II and III, temporary purge and product systems were used. The current method, carried out in Building K-306-7, is based on condensation in small cylinders immersed in liquid nitrogen. Additional product removal facilities have been provided in Building K-415 so as to permit the withdrawal of partially processed material from the K-27 cascade when desired, by means of a cold trap condensation system. In normal cascade of cascades operations, "K-27 product removal" consists simply of transporting the process material in the vapor state from the top process cell of the K-27 cascade to the feed point of the K-25 cascade by connecting pipeline.

5. Operation of Process Service Installations. - Perfluorodimethylcyclohexane, C_6F_{12} , is supplied from the storage and purification plant in Section 800-C, and circulated as coolant through the stage coolers, intercell coolers, and intersectional coolers. The recirculating cooling water system (Section 800 for K-25 and Section 830 for K-27) deliver approximately 135,000,000 gallons of cooling water per day to the process coolant coolers where process heat is extracted from the coolant for ultimate disposal to the atmosphere at the cooling towers. Dehumidified air from Section 1100 is supplied, at minus 100°F dew point, to the process equipment enclosure system so that, in cases of leakage, atmospheric air (with its normal moisture content) will not be drawn into the process stream. Dry air is also supplied to instruments located within

~~SECRET~~

~~CONFIDENTIAL/RD~~

the enclosures. Compressed air at 110 p.s.i. is generated in Section 1200 for instrument use, maintenance, and miscellaneous services. Since original construction, provision has been made for dehumidification of this air to minus 40°F dew point, so that it can be used as a supplementary source of dry air supply. Lubricating oil of approximate grade SAE #10 is supplied to all process pumps by means of a separate circulation system in each process building. Dry nitrogen gas is generated at the site, and used for purging equipment of conditioning gas or process gas, as a pump and valve sealant, and in the instrument datum system. Liquid nitrogen is used in the laboratories and in various process instruments. The four plant laboratories contain offices, the plant library, and facilities for performing chemical analysis, isotopic analysis, physical research, and chemical research. A new barrier research laboratory is currently being installed in the conditioning building. Principal special chemicals required at the gaseous diffusion plant include fluorine, which is used as a conditioning gas, perfluorodimethylcyclohexane, which is used as a process coolant, n-perfluoroheptane, which is used as a test fluid, various fluorolubes, which are used as lubricants in the presence of process or conditioning gas, and "C" rubber and fluoroplastics, which serve as gasket and valve seat materials.

6. Conditioning Area Operations. - The conditioning building contains facilities for conditioning, testing, reconditioning, and inspecting converters. Converters are conditioned by means of specially designed furnace stands with suitable gas piping connections, hood covers, and electrical heating elements. 5-10 per cent fluorine in nitrogen is circulated at 300°F for a minimum period of 5 hours. Stage pumps are

conditioned in separate stands provided for the purpose, by subjection to 5-10 per cent fluorine in nitrogen at 285-300°F for a minimum period of 3 hours with impeller running. The conditioning building also contains facilities for thoroughly cleaning piping, valves, tanks, and other equipment prior to installation in the process cascades, as well as shops equipped for process pump repair, precision seal maintenance, vacuum pump repair, and vacuum electronics maintenance. With the completion of the bulk of the conditioning and related activities necessary for preparation of process equipment prior to initial installation in the diffusion plant, facilities are being installed for carrying out a number of development activities, including converter re-tubing and testing, miscellaneous engineering studies, and various barrier research investigations.

Fluorine is generated in Section 1300. The plant was originally designed to handle and compress the gas by liquefaction. Present operation involves mechanical compression by means of a specially developed diaphragm pump. Residual gases from equipment conditioning operations were formerly disposed of by absorption in an alkaline scrubbing tower. Because of the small quantities of waste conditioning gas handled at present, the disposal tower is no longer operated. Spent gases resulting from cascade conditioning operations are allowed to enter the process stream for ultimate removal in the purging system; off gases from the conditioning area are directly vented.

The acid neutralization plant disposes of acid wastes from cleaning operations in the conditioning building, by neutralizing with lime. Nitrogen gas is generated, as required, by vaporization of the liquid. A mixing plant is provided for blending carbon and alumina in order to pro-

vide charging material for the various process carbon traps. Steam for process and heating purposes is generated in Section 1500 by means of six boilers with a total capacity of 270,000 pounds per hour at 175 p.s.i.

7. Power Plant Operations. - Steam for power purposes is generated in Section 700, at 1335 p.s.i. and 922° F , by means of three tangentially fired boilers consuming an average total of 70 tons of pulverised coal per hour. A typical steam rate is 1,530,000 pounds per hour. Fourteen turbo-generators provide electrical power at various voltages and frequencies, carrying a typical total electrical load of 184,210 KW. Power for operation of various auxiliaries is received at 154,000 volts from the T.V.A. system, and transformed to 13,800 volts in the K-25 switch yard. The K-27 plant normally runs entirely on T.V.A. power, which is received and transformed in the K-27 switch yard at an average rate of 114,700 KW.

8. Production Chronology. - The first product was taken off from the K-25 cascade in March 1945, and all K-25 process sections were in connected operation on 15 August 1945. On 12 January 1946, the first product was removed from K-27; on 19 January 1946, combined operation of K-25 and K-27 as a cascade of cascades was begun. A rigid schedule was set up on 20 March 1945 for starting dates of operation of the various parts of the process plant. Five "cases" were contemplated, corresponding to increasingly complete operation. The basic aim was to begin operation by 15 August 1945. Full operation of K-27 was finally scheduled for 10 February 1946. Case II was started nine days late; operation of all other cases was attained on, or ahead of, schedule.

Occasionally, cascade operation has been interrupted by equipment failures or operational errors. Cascade interruptions to date have not

occurred with undue frequency, and have not had serious effect on plant productivity. Cell stream efficiency (ratio of operating cells to available cells) normally runs at over 98 per cent.

~~DELETED~~~~DELETED~~~~DELETED~~DOE
b(3)

Fresh uranium hexafluoride is procured from the Harshaw Chemical Company through the Madison Square Area of the Manhattan District. On several past occasions the plant has accepted as feed various types of process material from the S-50 Project and the Y-12 Project. On certain occasions material drawn from the diffusion cascade at various concentrations has been stored and later re-fed into the process system. All other product from the gaseous diffusion plant has been shipped to Y-12 for further processing. Actual production has, in general, exceeded predictions because of the high stream efficiencies attained, the small effect of process surges, the high separating efficiencies of the barrier material, increased feed rates, and increased power input.

9. Safety and Security. - The chief of the Safety and Security Branch represents the K-25 Division Chief in all matters pertaining to safety and security within the K-25 area, and the Decatur, Detroit, and Milwaukee sub-areas. He is assisted by three section chiefs in charge, respectively, of safety, security, and fire protection and prevention. The original K-25 site operations safety program was initiated for the conditioning area by Ford, Bacon, and Davis, Inc. in March 1944. On 1 May 1945 it was absorbed within the overall safety program developed for the K-25 area by the Carbide and Carbon Chemicals Corporation. The safety

~~SECRET~~

~~CONFIDENTIAL/RD~~

standard for all work has been the Corps of Engineers minimum mandatory "Safety Requirements", supplemented by nationally recognized standards, and by special standards developed at the site. A special hazard is encountered at the K-25 plant involving the physiologically injurious nature of the radiation emanating from uranium which is greatly enriched in concentration of the U-235 isotope. Moreover, care must be taken not to exceed the critical mass; in such a circumstance, a chain reaction might conceivably be initiated. Despite careful equipment design, this possibility still existed through failure of equipment or faulty operations, and a special committee was organized in 1945 to study the problem. Other District Areas have cooperated in theoretical and experimental studies to establish the maximum safe quantities of U-235 at various concentrations which may be handled under specified conditions.

The original K-25 Intelligence and Security Branch was expanded in September 1945 to form the Safety and Security Branch, which supervises the program of physical security, safeguarding of military information, and personnel clearance. Security measures at the K-25 site were instituted by Ford, Bacon, and Davis, Inc. who established a guard force of 80 men in June 1943. The Carbide Security Department was set up in April 1944. At its peak in February 1945, the Carbide Guard Force numbered about 900. Security is enforced by standard District methods involving fence and guard protection, pass and badge control, employee and visitor clearance, and education of employees in the importance and methods of enforcing security regulations.

A number of special studies have been made at the K-25 plant, in order to formulate improved methods of preventing the diversion of

S10
~~SECRET~~

~~CONFIDENTIAL/RD~~

process material by suitable modification of plant design, by changes in operating procedures, and by amplification of security measures. The Uranium Control and Inspection Department was formed in December 1946 to centralize the responsibility for handling and coordinating the problem.

10. Personnel Procurement and Industrial Relations. - Employee recruitment for adequate staffing of the K-25 operating organization posed a serious problem. Thousands of plant operators were needed, in addition to approximately 2000 supervisory and technical employees. Through special arrangements with the National Roster of Scientific and Specialized Personnel, recruiting itineraries were arranged, which included all major universities, and which covered areas where required types of manpower might be available. Employment offices were opened at the Clinton Engineer Works and at various off-site locations. During April and May 1944, the nucleus of the production organization was gathered at the plant site, and a training school was started on 6 October 1944. The Operations Training Department included a Process Training School, which was operated until November 1945, training 3230 employees, and a Vacuum Test Training School which was operated until July 1945, training 1858 employees. A maintenance training program was operated from January 1945 until June 1946, during which time 542 mechanics, operators, and supervisors received specialized instruction in K-25 maintenance procedure. Several hundred instrument men have received instruction at the Carbide Instrument Training School under a program which is still in effect. Courses are also given to various groups of employees in order to provide familiarity with first aid principles, and with the use of the U. S. Army assault mask. Starting with 21 employees on 1 September 1943, the Carbide payroll rose to a

~~SECRET~~

~~CONFIDENTIAL/RD~~

peak of over 11,000 in June 1945. Present strength is 6,823 employees. Enlisted personnel were assigned to the operating contractor up to a peak strength of 500, in various technical capacities, in order to relieve the severe shortage of qualified personnel.

There have been no work stoppages at the K-25 plant. Standard and impartial grievance and disciplinary procedures have been instituted. In September 1946, by means of a National Labor Relations Board election, the C.I.C. was certified as the bargaining agent for Carbide employees, and negotiations for a union contract were begun immediately.

On 9 November 1943, the first Carbide employee moved into family quarters within the Clinton Engineer Works area. A housing scarcity rapidly developed, and it became necessary to adopt a rigid housing policy whereby only top supervisory personnel were eligible for permanent houses; all others earning \$0.90 or more per hour were eligible for semi-permanent houses, pre-fabricated houses, trailers, or dormitories. An absolute shortage of housing units developed by 10 October 1944. V-J Day resulted in curtailment in operations of other C.E.W. contractors, and made more units available. At present, Carbide employees occupy a total of 2879 housing units, and 645 employees are awaiting assignment of houses.

In conjunction with the extensive employee recruitment program, transportation facilities had to be provided for workers residing within a radius of 100 miles. The intra-area and off-area transportation problem soon assumed major proportions. The organization of "Share-the-Ride" automobile clubs did much to alleviate the problem, and with the completion of a smooth surfaced highway between town and plant in September 1945, a significant improvement was effected. Curtailment of off-area bus operations

S12

~~SECRET~~

~~CONFIDENTIAL/RD~~

~~SECRET~~

~~CONFIDENTIAL/RO~~

was begun in August 1945, at which time plant construction was approaching completion. Bus service has continuously improved since that time because of the well established repair and maintenance program.

11. Costs. - As of the end of the fiscal year 1946, total contract costs attributable to operation of K-25 Project amounted to \$81,620,216. At this time, the estimated total cost for completion of contracts was \$145,437,500.

12. Organization and Personnel. - The K-25 operations office was opened on 22 February 1944, with Major J. J. Moran as K-25 Operations Officer, reporting to Lt. Colonel J. C. Stowers, Unit Chief, K-25 Project. Lt. Colonel R. W. Cook succeeded Major Moran on 3 October 1944, and Major N. Randolph Archer was assigned as Executive Officer on 29 December 1944. On 1 May 1946 the position of K-25 Operations Officer was converted to K-25 Division Chief, with overall responsibility for administration of the K-25 Project, including outlying areas. On 1 February 1946, Lt. Colonel H. R. Fraser was assigned as Special Assistant to the K-25 Operations Officer, and on 1 July 1946 was appointed Assistant Chief of the K-25 Division. The office of the K-25 Division at present includes 5 officers and 47 civilian personnel.

The original Carbide operating organization was headed by a Vice-President, who acted as consultant to the Contracting Officer, and to all contractors connected with the Gaseous Diffusion Project. Reporting to the Vice-President, were the General Superintendent, Plant Superintendent, and nine department heads. The current organization differs primarily in the elimination of the general superintendency, and the inclusion of two assistant plant superintendents. Principal key personnel include Dr. G. T. Felbeck, Vice-President, in charge of the Project for the Carbide

~~SECRET~~

~~CONFIDENTIAL/RO~~

and Carbon Chemicals Corporation, and Mr. H. E. Thompson, and Mr. L. A. Bliss, also Vice-Presidents of the corporation, who have rendered advisory services to the District Engineer. Mr. H. D. Kinsey served as General Superintendent from 8 February 1944 until 1 December 1945. Mr. G. E. Center has held the position of Plant Superintendent from 15 February 1943 to date.

The K-25 operations of Ford, Bacon, and Davis, Inc. were directed by Mr. E. S. Caldwell, Vice-President. For the Hooker Electrochemical Company, Mr. T. L. B. Lyster was in charge of contract activities as Chief Engineer.

~~SECRET~~

~~CONFIDENTIAL/RD~~

MANHATTAN DISTRICT HISTORY

BOOK II - GASEOUS DIFFUSION (K-25) PROJECT

VOLUME 5 - OPERATION

SECTION 1 - INTRODUCTION

1-1. Purpose. - The operation of the gaseous diffusion plant comprises the final and continuing phase of the K-25 Project, the ultimate goal of which was the large scale manufacture of a uranium-containing material highly enriched in the U-235 isotope.

1-2. Scope. - Indication has been given in preceding volumes of the size, scope, and special nature of the diffusion plant facilities. Briefly summarized, the operating activities comprise the maintenance of continuous, 24-hour-a-day, operation of what has been called "the largest physico-chemical process in the world". The site occupies a 5,000 acre tract of land. 60³ process buildings house diffusional cascade equipment including 3432 process converters and 6864 process pumps. Most important facilities operated to provide auxiliary services include process feed, waste, and product systems, numerous process service installations, a highly technical equipment conditioning and fluorine generating plant, and a 238,000 KW steam-electric power generating station.

1-3. Authorization. - Authorization of diffusion plant operations was handled similarly to other phases of the K-25 Project as mentioned in Volume 1 of this book, and described more fully in Volume 1 of Book I.

1-4. Administration. - The principal operating company is the Carbide and Carbon Chemicals Corporation, under contract W-7405-eng-26. Initial fluorine plant operations were carried on by the Hooker Electro-

~~SECRET~~

~~CONFIDENTIAL/RD~~

chemical Company under contract W-7405-eng-258. Various other conditioning area operations were handed originally by Ford, Bacon, and Davis, Inc., under contract W-7407-eng-34. The operating contracts were originally administered for the District Engineer by the Officer-in-Charge (Unit Chief) of the K-25 Project, through the K-25 Operations Officer. This responsibility is now vested in the K-25 Division Chief.

SECTION 2 - CONTRACTUAL ARRANGEMENTS

2-1. Carbide and Carbon Chemicals Corporation.

a. Selection of Union Carbide and Carbon Corporation. - At a meeting on 12 December 1942 between Manhattan District officials and representatives of the M. W. Kellogg Company, Mr. P. C. Keith, Vice-President of the company, was asked for his recommendation as to possible operating contractors. He suggested E. I. ^d DuPont de Nemours and Company, the Union Carbide and Carbon Corporation, the Standard Oil Company of New Jersey, the Monsanto Chemical Company, and the Dow Chemical Company. Some of the companies recommended by Mr. Keith were already engaged in other work for the Manhattan District, and others were under consideration for various contemplated projects. It was therefore decided to approach the Union Carbide and Carbon Corporation.

b. History of Negotiations.

(1) Initiation of Negotiations. - On 28 December 1942 General Groves, Colonel Marshall, and Colonel Nichols met with Messrs. J. A. Rafferty, W. F. Barrett, F. H. Haggerson, J. H. Critchett, A. V. Wilker, and Lyman Bliss, all vice-presidents of the Union Carbide and Carbon Corporation or its subsidiaries. The then known size, scope, and methods of operation of the gaseous diffusion plant were outlined to them, and they tentatively agreed to accept a contract for operation. Another meeting was held on 30 December 1942, with Colonel Marshall, Colonel Nichols, Messrs. Kellogg and Keith of the M. W. Kellogg Company, and Messrs. Rafferty, Critchett, Wilker, Dana, Thompson, Bagley, and Bliss of Union Carbide and Carbon present. Mr. Keith outlined the various problems to be solved in the design of the diffusion plant and the general

~~SECRET~~

~~CONFIDENTIAL/RD~~

principles of its operation.

(2) Choice of the Carbide Subsidiary. - During the preliminary negotiations, the Union Carbide and Carbon Corporation advised the Government that they preferred to have the contract written with their major operating subsidiary, the Carbide and Carbon Chemicals Corporation. They pointed out that this operation came closest to the normal operations of the Carbide and Carbon Chemicals Corporation, and that the key personnel furnished by them would come from that subsidiary. Accordingly, on 18 January 1943, letter contract W-7405-eng-26 was executed by the Contracting Officer, and subsequently accepted by the Carbide and Carbon Chemicals Corporation on 20 January 1943. The letter contract provided for the study of the available data and information on the operation of the plant, the conducting of research and experimental work with regard to the design, engineering, construction and operation, the supply of consultant services to the Government, the architect-engineer and the construction contractor, and the training of personnel in the operation of the plant.

(3) Final Negotiations. - Because of the scarcity of engineering information, which prohibited the preparation of a realistic estimate of the cost of operations, the negotiations for the formal operating contract extended over a considerable period of time. By the latter part of the summer of 1943, sufficient information was available to permit drawing up the contract. The formal operating contract W-7405-eng-26 was executed on 23 November 1943, effective as of 18 January 1943. The term of the contract extended until six months after the termination of hostilities with the Axis Powers.

~~SECRET~~

~~CONFIDENTIAL/RD~~

c. Scope of Contract. - Contract W-7405-eng-26 (App. E) was drawn up on a cost-plus-fixed-fee basis, and provided that the contractor furnish technically trained personnel to study available information pertaining to the design, engineering, and construction and operation of the plant, conduct pertinent research and experimental work, render consultant services, train personnel in diffusional operation, prepare for operation, set up an efficient operating organization, and operate the plant.

DOE
(3)

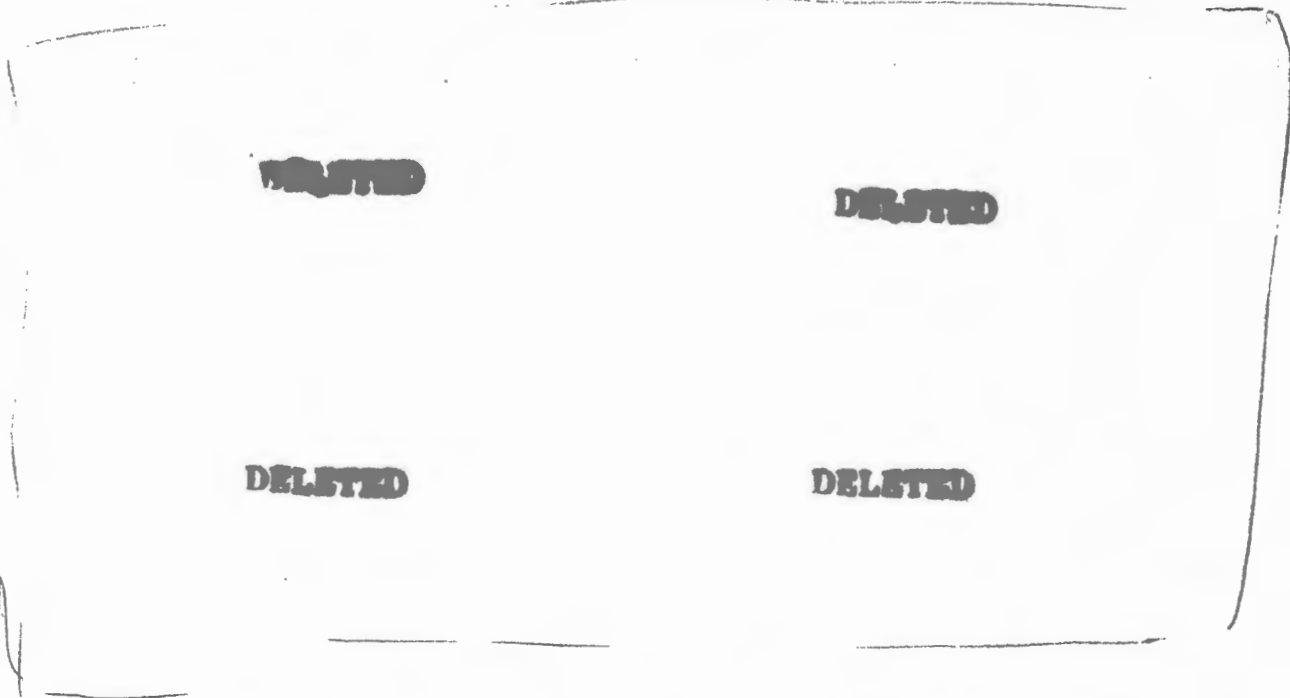

d. Fee. - The contractor's fee was set at \$75,000 per month for full operation of the plant. Fee payments during the start-up period were to be in proportion to the number of process buildings in operation. For full operation of the K-25 and K-27 plants the fee was later increased to \$96,000 per month. Under Supplement No. 9, additional fee payments were authorized as follows:

1. \$24,000 for leak testing services.

~~SECRET~~

~~CONFIDENTIAL/RD~~

2. \$35,000 for conditioning and preparation for operation of process equipment, when these duties were taken over from Ford, Bacon, and Davis, Inc.
3. A nominal fee of \$1.00 was authorized for the supply of steam, water, electricity and other services to the S-50 plant, and for the supply of maintenance and protection services after the S-50 plant was placed in stand-by condition.

2-2. Ford, Bacon, and Davis, Inc.

a. Selection. - It was planned, originally, that the diffusion stages manufactured by the Chrysler Corporation (Vol. 3) would be conditioned at the point of manufacture and then shipped to the K-25 site, ready for installation. Lack of available facilities, including a source of fluorine, at the Chrysler plant made it desirable to do this work at the K-25 site. Carbide did not wish to undertake the responsibility for operating the conditioning area until the main process operations had been established. They suggested that an outside firm be engaged to construct and operate the conditioning plant until such time as the initial conditioning operations were completed, at which time the Carbide and Carbon Chemicals Corporation would take over the plant and its personnel for further operations. The plan was agreeable to the Government, and Carbide recommended the firm of Ford, Bacon, and Davis, Inc., for this phase of the Project. (Construction of conditioning facilities by Ford, Bacon, and Davis under contract W-7406-eng-19 is treated in Volume 4.)

b. History of Negotiations. - Letter contract W-7407-eng-34, dated 25 October 1943, was accepted by the contractor on 2 November 1943.

~~SECRET~~

~~CONFIDENTIAL/RD~~

The letter contract covered the work to 21 November 1943, but subsequent supplements authorized continued operation until the formal contract (App. E) was entered into on 7 July 1944, effective as of 25 October 1943.

e. Scope of Contract. - Contract W-7407-eng-54 (App. E) provided that Ford, Bacon, and Davis, Inc., furnish all necessary skilled and technical personnel, labor, material, tools, machinery, facilities, and supplies not furnished by the Government, and that they operate the conditioning, fluorine disposal, and acid neutralizing plants, for the cleaning, conditioning, adjusting, assembling, testing, and storage of process equipment. Methods and specifications were to be furnished by the Contracting Officer. The Contractor was also required to operate a machine shop and to provide repair and maintenance facilities for process equipment and maintenance services for the fluorine plant. The following specific responsibilities were outlined:

1. Perform cleaning operations for piping, coolers, and other equipment.
2. Perform vacuum testing of piping assemblies and miscellaneous vessels.
3. Operate conditioning furnaces for converters and stage pumps.
4. Operate running test stands to determine separating qualities and porosities of conditioned converters.
5. Prepare vacuum pumps for testing work.
6. Prepare and maintain leak detectors for vacuum testing in the conditioning and main process area.
7. Calibrate and check process instruments.

8. Operate store room and storage facilities for process equipment and small parts.
9. Perform maintenance operations on diffusion stage pumps.
10. Furnish purchasing, accounting, transportation, safety, security, personnel, training, and other similar services to the Hooker Electrochemical Company in connection with the operation of the fluorine plant.
11. Perform cleaning, conditioning, maintenance, and alteration operations on other equipment as authorized. The contractor was required to cooperate and coordinate its work with other contractors, and to train and make available personnel for the continuing operation of the conditioning plant upon the completion of the contract.

d. Fee. - A fixed fee of \$215,000 was provided for the work through June 1945; this was later changed to \$202,000 when the expiration date was changed to 31 May 1945.

2-3. Hooker Electrochemical Company.

a. Selection. - During the early part of 1943 three methods for producing fluorine on a large scale were under consideration (Book VII): the high temperature, carbon anode electrolytic cell developed at Johns Hopkins University; the low temperature, nickel anode cell developed by ^dDuPont; and the low temperature, carbon anode cell developed by the Hooker Electrochemical Company. To meet fluorine requirements at the plant site it was decided to use the Hooker cell, since the Johns Hopkins cell had not reached a suitable stage of development, and the ^dDuPont cell appeared to have certain disadvantages, chief among them

being the high consumption of the nickel anode. This decision was reached after a series of conferences between the Madison Square Area of the Manhattan District, The Kellogg Corporation, and representatives from industrial concerns and university laboratories engaged in research and development on fluorine cells. At the same time, consideration was being given to the question of whether the fluorine should be manufactured at the site, or shipped to the plant from a distant point of manufacture. In view of the highly reactive character of fluorine and the difficulties which have been experienced in bottling the gas, it was decided that shipment by commercial means would not be advisable, and that fluorine should be manufactured at the plant site. The Hooker Electrochemical Company was ultimately selected to supervise construction and initial operation of the K-25 fluorine plant.

b. History of Negotiations. - The work at first was authorized by letter contract to the Hooker Electrochemical Company dated 27 September 1943, and signed by Colonel K. D. Nichols. This letter was renewed periodically until the formal contract covering the work from 27 September 1943 was executed 1 June 1944, between Hooker Electrochemical Company and the Manhattan District, represented by Lt. Colonel James C. Stowers.

c. Scope of Contract. - Contract W-7405-eng-258 (App. E) provided for the preparation of drawings for buildings and supervision of their construction, the design of equipment and supervision of its installation, the procurement of equipment, the procurement and training of operating personnel, and the operation of the fluorine plant to 1 February 1945.

d. Fee. - The fixed fee was set at \$24,500.

~~SECRET~~

~~CONFIDENTIAL/RD~~

check the entire K-25 plant. A smaller, though considerable, additional period was later required for a greatly reduced force to test the K-27 plant. The progress of vacuum testing operations is traced in Appendices B1 and B2. Two months were required to vacuum test some of the earlier buildings, but by May 1945, this period was decreased to two or three weeks per building. This was due to accumulated experience, improved welding techniques, and more efficient testing procedures. Some of the buildings in the upper sections of the plant required longer test periods because of smaller equipment sizes, and greater difficulty in achieving the specified leak rate.

3-6. Instrument Checking. - After vacuum testing was complete, it was necessary to check, adjust, and calibrate all instruments. This was done for each of the many thousands of process instruments throughout the plant, and required an average time for each building of several days to a week. The instrument checking activities were continued during the operational nitrogen runs.

3-7. Operations on Nitrogen. - The cascade cells were operated initially with nitrogen as a process gas in order to test seals, pumps, and valves prior to conditioning the equipment, and placing it in operation with uranium hexafluoride. Nitrogen runs lasted several days; longer when repairs or changes were indicated.

3-8. Operations on n-Perfluoroheptane. - It was originally considered advisable to operate the first three process buildings, and the feed, waste, and product systems of the K-25 area on n-perfluoroheptane, C₇F₁₆. This substance is a heavy gas, when vaporized, with a density approximating that of uranium hexafluoride. It was believed that the

~~SECRET~~

~~CONFIDENTIAL/RD~~

SECTION 3 - PRELIMINARY CASCADE OPERATIONS

3-1. Introduction. - Numerous problems were encountered during the period of initial operations. In order to begin operations at the earliest possible moment, buildings were taken over for operation before construction was complete. This procedure entailed certain difficulties and occasional process interruptions. The personnel were inexperienced in operations of this kind; indeed, many had had no prior operating experience of any description. Moreover, much equipment of a novel nature was to be placed in operation, for which there was no prior industrial experience.

3-2. 54 Stage Pilot Plant. - In August 1944 Carbide took over Building "K-303-2X" as an experimental building. Building K-303-2 is a ten-cell building, but, during the experimental period, nine cells were operated in conjunction with a temporary surge system, and the unit was referred to as the 54 Stage Pilot Plant. Since diffusion barrier was not available at the time, stages were fitted with steel orifices instead of converters containing barrier tubes.

a. Purpose. - No diffusive separation could be obtained, but process flow and pressure conditions were simulated, so as to provide operating experience and quantitative performance data.

b. Operation. - From August until October 1944, the pilot plant was operated on nitrogen, and from November 1944 until April 1945, the building was run on n-perfluoroheptane.

c. Results. - During this period, foremen and key operators were trained, instrument performance was proved and modified, and operational procedures were developed. A large amount of performance data was

~~SECRET~~

~~CONFIDENTIAL/RD~~

accumulated pertaining to pumps, seals, converters, gas coolers, valves, piping, and auxiliary systems for supply of cooling water, dry air, electrical power, etc. Erection and preliminary testing of the 54 Stage Pilot Plant, moreover, provided experience in the transportation, cleaning, and assembly of process equipment, in making vacuum tight field joints, and in vacuum testing large complex units.

3-3. Mechanical Test Runs. - As the individual process buildings reached the point where preliminary operation could be started, the construction contractor made a mechanical test run on each. All pumps were run and instruments checked to prove operability of equipment. These tests were witnessed by the operating contractor.

3-4. Acceptance of Facilities. - After completion of its mechanical test run, each building was turned over to the Carbide and Carbon Chemicals Corporation for operation. Acceptance papers, signed by construction and operating contractors, listed all deficiencies requiring further repair, adjustment, or replacement. In many cases, particularly with the earlier buildings, these lists ran into hundreds of items. Operation acceptance and final transfer dates for the process buildings and other structures are tabulated in Appendix G1.

3-5. Vacuum Testing. - Upon acceptance of each building, and, in some cases, before the acceptance papers were signed, the Carbide and Carbon Chemicals Corporation began vacuum testing operations. The severity of vacuum tightness specifications was without industrial precedent. A process cell, blocked off and pumped down to an absolute pressure of a fraction of a micron, was required to have a maximum leak rate of two microns per hour, i.e., the combined effect of all leaks in the twelve

~~SECRET~~

~~CONFIDENTIAL/RD~~

stage pumps, six converters, piping, instrument lines, and other accessory items, had to be such as to admit no more air than would cause the pressure to build up in the system at a rate of 0.00004 pounds per square inch per hour. The entire main cascade, considered as a unit, was required to be so tight that a single hole made with a No. 80 drill (0.020 inches in diameter) at any point in the system (containing about one hundred miles of piping, 2892 diffusion stages, 5734 process pumps, and 50,000 valves) would admit air to the plant at such a rate as to exceed leakage specifications.

a. Methods. - A mass spectrometer leak detector (Vol. 2) had been developed to provide a rapid and efficient means of vacuum testing equipment. The equipment, taken by cells or by sections of process piping, was evacuated by means of a portable Westinghouse pump wagon (Vol. 2) containing a mechanical vacuum pump and two oil diffusion pumps connected in series. With the equipment at high vacuum, and with vacuum pumps running, a stream of helium probe gas was played over every welded joint, instrument, and valve in the system. The helium would then enter at any points where leaks existed, be swept through the system, and detected by the sensitive mass spectrometer. Instrument response time was a matter of seconds, so that a positive indicator reading quickly disclosed the presence of a leak at the point currently being probed with helium. The point was marked, welders called in, the defective area re-welded, the system re-tested, and the process repeated as often as necessary in order to eliminate all leaks.

b. Progress. - The work was painstaking and tedious, a crew of 400 to 600 operators was required for approximately eight months to

test gas runs would disclose correctable deficiencies with less damage to equipment than if the initial operations were made with UF_6 . Various difficulties were encountered with the test fluid operations, however, having to do chiefly with problems of effective purging of the very dense test fluid from the cells after testing. There was also some consideration given to the possibility of explosive mixture formation with certain possible accidental combinations of conditioning gas and test gas. Finally, it was felt that information obtainable by means of the C_7F_{16} runs could be more simply obtained with very little disadvantage directly during the initial process gas operating periods, and that considerable time and labor could be saved by omitting the routine test fluid operation. It was finally decided during the middle of February 1945 to start up directly on UF_6 , since cell 10 in Building K-502-3 had been operating satisfactorily on process gas since 20 January 1945.

3-9. Conditioning with Fluorine.

a. Purpose. - It is necessary to condition process equipment by circulating fluorine prior to the introduction of uranium hexafluoride. Traces of moisture present in equipment react vigorously with UF_6 to form non-volatile oxyfluoride hydrolysis products. The most serious disadvantage of this action is the resultant plugging of the fine apertures of the diffusion barrier tubes. Fluorine removes traces of water and also reacts with exposed equipment surfaces, forming a protective metallic fluoride film coating which minimizes the tendency for further reaction with uranium hexafluoride.

b. Methods. - Stage pumps and converters were fluorinated in the conditioning building prior to installation in the cascade (Section 6).

Consequently, only a supplementary "flash conditioning" was required in the process area. It was necessary, however, to provide adequate treatment for such accessory parts as process gas stage piping.

~~DELETED~~

~~DELETED~~

~~DELETED~~

005
601

One cell, several cells, or an entire process building may be conditioned at one time; the ^{last} latter procedure is preferred.

c. Progress, - The progress of original process area conditioning operations is recorded graphically in Appendices E1 and E2.

SECTION 4 - PROCESS OPERATIONS

4-1. Introduction. - This section presents a résumé of process operating procedures followed at the gaseous diffusion plant. Principles of operation are finely interwoven with design principles of systems and equipment discussed in Sections 4, 7, and 8 of Volume 3. Detailed discussions of routine and emergency methods of operation may be found by consulting the Kellogg Operating Manuals tabulated in Appendix C3. A general layout plan is shown in Appendix A1; aerial photographic views of the operating plant are shown in Appendices D16 and D17. Process control equipment is pictured in Appendices D4, through D7, and typical interior process building views showing the basement, cell floor, pipe gallery, and operating floor are shown in Appendices D8 through D11.

4-2. Cascade Operation. - The cascade arrangement is utilized in order to "integrate" or sum up the "differential" or minute isotope enrichments achieved in all the individual stages (Vol. 3).

a. Main K-25 Cascade (Section 300). - The main cascade consists of 2892 diffusion stages, each containing one process converter (App. D1) and two process pumps (App. D2). Each stage receives a mixture of the enriched diffusate from the stage below with the partially depleted residue from the stage above. The combined stream is passed through the converter barrier under flow and pressure conditions so arranged as to result in diffusion through the barrier of one-half the stage feed, the remainder leaving the converter without diffusing. The diffusate is sent to the next higher stage, and the residue to the next lower stage. A schematic diagram depicting the flow of process gas

through the various process units (stages, cells, buildings, sections) is depicted in Appendix A2. The K-25 cascade, together with its auxiliary process systems (feed, waste, purge, and product) and its process service installations, was originally operated as a self-contained plant.

(1) Stripping Section. - By analogy with a bubble-tray distillation column, that portion of the cascade below the point of feed introduction may be thought of as the "stripping section," since, in this section, concentration of desired component decreases progressively from the feed point to the lower extremity of the cascade, as it is stripped from the descending "B" stream, and sent up the cascade in the ascending "A" stream. The stripping section of the K-25 cascade, operating independently of K-27, would normally include process sections -1, -2, and -3.

(2) Enriching Section. - That portion of the K-25 cascade above the point of feed introduction (normally including process sections 1 through 4) is known as the "enriching section," since in this part of the cascade, the concentration of U-235 in the "A" stream is progressively enriched from the feed point to the upper extremity of the cascade. The logic of the "stripping" and "enriching" designations becomes more apparent when the cascade is idealized in terms of net effects. Thus, the overall result is as though the feed stream were split by the feed stage to form two streams, equal, respectively, to the waste and product rates, and travelling, respectively, up-cascade and down-cascade. The stream flowing down the cascade is processed continuously in such a way as to strip it progressively of desired component until it is ultimately drawn off at the bottom as waste. Likewise, the stream flowing up the cascade is

~~SECRET~~

~~CONFIDENTIAL/RD~~

continuously enriched, until it is drawn off at the top as product.

b. Purge Cascade (Section 312). - K-25 purge cascade operation is based on the principle of gaseous diffusion, but serves to separate light diluents, such as hydrogen fluoride and nitrogen, from the process stream, rather than to separate isotopes of uranium from one another. Actually, it is operated as three separately functioning, but interchangeable, auxiliary 42 stage cascades. One operates as an extension of the K-25 process cascade (as a top purge cascade), one is operated as a side purge cascade, and one is held available as a spare system. Side purge operation is similar to the top purge operation except that, whereas the latter processes material received from the top of the process cascade, the former withdraws a side stream from a somewhat lower point in order to decrease the load on the final, top purging system, and to minimize the volume of inert diluents passing through the small-sized equipment near the top of the process cascade, thereby preventing accumulation of "lean" process material with the displacement (by molecular effusion) of uranium hexafluoride to the lower process sections.

c. K-27 Cascade (Section 400). - The K-27 cascade, containing 540 stages, can be operated as a separate processing system, but normally operates in conjunction with the main K-25 cascade. Principles of operation of the two cascades are basically identical, but a number of differences in design are involved as discussed in Section 14 of Volume 3.

(1) Stripping and Enriching Sections. - When the K-27 cascade is operated separately, with feed introduced from Building K-131,

~~SECRET~~

~~CONFIDENTIAL/RD~~

~~SECRET~~

~~CONFIDENTIAL/RD~~

at the bottom of Building K-402-4, it may be visualized in two portions separated by the feed point. The stripping section then includes process buildings K-402-1, K-402-2, and K-402-3; the enriching section includes Buildings K-402-4 through K-402-9.

d. Cascade of Cascades. - The entire gaseous diffusion plant is normally operated as an integrated unit, with process flow as shown in Appendix A3. The expression "cascade of cascades" arises from analogy with each of the two basic cascades, either of which might be called, in more complete terms, a "cascade of stages." The analogy is fully drawn in Paragraph 15-3 of Volume 3.

(1) Stripping and Enriching Sections. - The distillation analogy may be further extended by considering the cascade of cascades arrangement as being similar to a method of interconnection of two distilling columns. The point of raw feed introduction may be varied between any of several points in the K-27 cascade, and the point of partially processed feed introduction to the K-25 cascade may similarly be varied in order to effect the optimum flow diagram, which is dependent upon the concentration of feed material used, and the concentration of product desired. In any event, each of the two cascades contains a stripping section and an enriching section, with the points of division corresponding to the points of feed introduction to each cascade.

4-3. Feed Purification and Supply. - For reasons as noted in Volume 3, the feed purification system (Section 100) of the main K-25 plant has never been operated, but is available if it should ever become necessary or desirable to accept sub-specification feed material.

a. Initial K-25 Feed Operations. - The K-25 cascade was

~~SECRET~~

~~CONFIDENTIAL/RD~~

operated initially by introducing feed at the desired point through a portable vaporizing and filtering unit. By the latter part of March 1945, a temporary feed system was constructed and put into operation in Building K-309-1. It consisted of a hot water vaporization tank for feed cylinders, and a process material filtering system.

b. Subsequent K-25 Feed Operations. - With some refinement, the temporary system described above became the permanent feed system for the K-25 cascade when operated independently of K-27.

c. K-27 Feed Operations. - The vaporization of feed for the K-27 plant is carried out in Building K-131. Fresh feed for the plant is received from the Harshaw Chemical Company in shipping cylinders containing approximately 460 pounds of uranium hexafluoride. These cylinders are connected to the vaporizing system manifold, and immersed in hot water baths to maintain a UF_6 vapor pressure of 15 p.s.i.g. The process gas is then fed to the K-27 cascade from Section 130 and through feed filters installed in Building K-402-4.

d. Feed Operations for the Cascade of Cascades. - With the K-25 and K-27 plants normally interconnected as a cascade of cascades, the entire feed enters the plant through the K-27 vaporization system. Facilities are available for purification of the recycle stream from the bottom of the K-25 cascade in Building K-131, at which point impurities picked up during prior processing, such as nitrogen and coolant, may be removed by distillation. However, this equipment is not normally used in routine operations.

4-4. Surge Absorption and Waste Removal.

a. Initial K-25 Surge and Waste Operations. - Before the

~~SECRET~~

~~CONFIDENTIAL/RD~~

facilities of Section 600, the permanent K-25 cascade surge and waste system, were ready for operation, a portable unit was used, capable of being connected to the desired cell of the lowest on-stream building (e.g. K-311-1), and containing facilities for condensing uranium hexafluoride and collecting it in cylinders immersed in a refrigerated tank or mobile truck. Surge absorption during this period was accomplished by operating one or two of the lowest cells on inverse recycle (Vol. 3) and using them as a surge reservoir.

b. Subsequent K-25 Surge and Waste Operations. - During the later periods of K-25 operation, but before inter-connection with the K-27 cascade, pressure surges resulting from process disturbances were absorbed in a reservoir at Building K-601. This building also contains facilities for liquefaction of UF₆, and withdrawal to storage cylinders.

c. K-27 Surge and Waste Operations. - A similar system (Vol. 3) housed in Building K-631 of the K-27 area, is used for surge and waste removal in conjunction with K-27 cascade operation.

d. Surge and Waste Operations for the Cascade of Cascades. - In normal operation, all pressure surges originating either in K-25 or K-27 travel to the Section 630 surge absorption system where they are absorbed in a reservoir. At this point, also, all depleted material resulting from plant operation is drawn off. The surge drum in Building K-601 acts simply to provide additional damping volume for the "B" stream flowing from K-25 to K-27.

4-5. Process Stream Purging. - During the course of operation, various light diluents find their way into the process system. Chief

~~SECRET~~

~~CONFIDENTIAL/RD~~

among these is nitrogen gas, which leaks in through pump and valve seals, and from other sources as described in Volume 3.

a. Initial K-25 Purging Operations. - The original method of light diluent removal was based upon condensation of UF_6 in cold traps, using temporary purge and product systems set up at the top of Sections 2a and 2b of the main cascade.

b. Subsequent K-25 Purging Operations. - As soon as the permanent system of Section 312 was ready for operation, all normal K-25 purging activities were transferred to this point. Operating equipment of the purge cascades differs markedly from that of the process cascades (Vol. 3). For example, purge cells contain only two stages, purge stages contain only one pump, purge pumps are of the reciprocating type, and purge converters are of flat plate design, with separately installed stage coolers.

c. K-27 Purging Operations. - During the period when K-27 was operated independently of K-25, purging operations were carried on in the top 2-5 cells of the K-27 process cascade itself. The method involved operation of the top cell on direct recycle, and adjustment of operating conditions in the upper cells so as to ^{facilitate} optimize the diffusional separation of light inert contaminants, rather than separation of the respective uranium isotopes. The light diluents so separated were then passed through a cold trap-carbon trap system in building K-413, before being vented to the atmosphere.

d. Purging Operations for the Cascade of Cascades. - With the formation of the cascade of cascades, purging activities within the K-27 system were discontinued, and all inleaking light diluents permitted

to travel to the top of the K-25 cascade for ultimate removal in Section 312.

4-6. Process Gas Recovery.

DCE
b(3)

DELETED

DELETED

DELETED

DELETED

DELETED

DELETED

00E
6(B)

DELETED

DELETED

DELETED

DELETED

DELETED

DELETED

DELETED

DELETED

DOE
~~████~~
b(3)

DELETED

DELETED

DELETED

DELETED

DOLE
2(3)

DELETED

DELETED

DELETED

DELETED

4-7. Product Withdrawal.

a. Initial K-25 Product Operations. - During Case I operation, product was first drawn into mobile refrigerated cylinders. During Case II and III operation, product was taken off in temporary purge and product cold trap rooms at the top of Sections 2a and 2b.

b. Subsequent K-25 Product Operations. - The current method for product removal (carried out in Building K-306-7 which is the highest process building) is based on withdrawal through a line recorder sample line in the top of the building, and condensation in small cylinders immersed in liquid nitrogen.

c. K-27 Product Operations. - Additional product removal facilities have been provided in K-27 (Building K-413) so as to permit the withdrawal of partially processed material from the K-27 cascade when desired. The operation is based on a cold trap condensation system. In this way, if desired, the K-25 cascade can be shut down, or disconnected from the K-27 cascade, without preventing continued operation and steady removal of enriched material from Section 400. Furthermore, a partially processed stock pile can be accumulated so as to have available a source of material to feed to the K-25 cascade when the K-27 cascade is shut down.

~~SECRET~~

~~CONFIDENTIAL/RD~~

d. Product Operations for the Cascade of Cascades. - Normally, "K-27 product removal" consists simply of transporting the process material from the top process cell of the K-27 cascade in the vapor state to the K-25 cascade by connecting pipeline. All of the final product of the plant as a whole is removed through the K-25 withdrawal system.

~~SECRET~~

~~CONFIDENTIAL/RD~~

SECTION 5 - OPERATION OF PROCESS SERVICE INSTALLATIONS

5-1. Introduction. - Operation of the diffusion cascade system is dependent upon simultaneous operation of a number of process service installations for the supply of auxiliary materials and services.

5-2. Process Coolant Supply. - Perfluorodimethylcyclohexane, C_8F_{18} , is used as a heat transfer medium, or process coolant, in order to remove the heat of pumping from the process stream. Each cell is operated on a separate coolant circulating system supplying the six stage coolers (and, in K-25 only, an intercell cooler). The coolant pumps and surge drum (Vol. ^{P. 3.5} 2) are located in a pit slightly below the operating floor level. The pump discharges to a coolant cooler located in the basement. After passing through this heat exchanger, the flow divides, and passes through each of the gas coolers, which operate in parallel. The cycle is closed with the return of the warm coolant to the surge drum. Coolant pressures are held slightly above the coolant cooling water pressure so as to avoid the possibility of coolant-contaminating water finding its way into the cascade system in cases of coolant leaks to process. Coolant temperatures are controlled at higher levels in K-27 than in K-25 because of higher process pressures (Vol. 3). Contaminated coolant is returned to Section 300-C for purification, as described in Volume 3, via the building drain drum and transfer pump, which serve all cell circulating systems in a particular process building. Coolant leaks are detected by means of the infra-red absorption meter described in Volume 2. Fresh, or purified, coolant is supplied, as needed, from Section 300-C. A graphical record of coolant

inventory, usage, and losses to date is shown in Appendix B15.

5-3. Cooling Water Supply. - The principal function of the recirculating cooling water system (Section 800 for the K-25 area, and Section 830 for the K-27 area) is to deliver cooling water to the process coolant coolers, where process heat is extracted from the coolant for ultimate disposal to the atmosphere at the cooling towers. The main cascade uses about 100,000,000 gallons of cooling water recirculation per day, or 70,000 GPM; the K-27 area uses an additional 35,000,000 gallons per day, or 24,000 GPM. For the K-25 area, make-up water was formerly taken from Poplar Creek through the make-up pumphouse, and sent to the basins of the cooling towers. At present sanitary water is used in order to prevent fouling of heat transfer surfaces. It is circulated through two main supply and return loops serving the process buildings, and returned to the cooling towers. The K-27 process buildings are supplied with cooling water through a separate recirculating and cooling tower system. The sanitary water used for K-27 make-up is also used to cool the synchronous condensers in the K-27 switch house. In case of emergency, the K-27 system can be supplied with water from the K-25 system, or vice versa, through cross-connecting lines. Appendix B3 presents a graphical record by months of cooling water recirculation to date. The total average make-up demand is 2,450,000 gallons per day, K-25 requiring 1,750,000 gallons, and K-27 requiring 700,000 gallons.

5-4. Dry Air Supply. - Dehumidified air from Section 1100 is supplied to the enclosure system for process piping and equipment, so that, in case of any inleakage, atmospheric air (with its normal moisture

~~SECRET~~

~~CONFIDENTIAL/RD~~

content) will not be drawn into the process stream. This ambient air forms the bulk of K-25 dry air requirements. Dry air is also supplied to instruments and control valves located within the enclosures (so that normal bleeding from the instruments will not cause a rise in the dew point of the ambient air) and to the outer compartments of process pump seals. In operation, atmospheric air is filtered, compressed to 12 p.s.i.g., cooled with water, and chilled with brine, removing 85 per cent of the moisture originally present. The partially dried air is then passed through the Hydryers, leaving at 12 p.s.i.g. and minus 100°F dew point. The six Hydryers were designed to produce a dew point of minus 80°F, but this could not originally be obtained on account of inefficiency of air-bed contact, caused by channeling. The defect was corrected by minor internal changes in the Hydryers. The ambient air system was originally operated as a circulating system, but has been converted to operate on a more efficient, "dead-end" basis. Experience has shown that the dead-end system is capable of producing a sufficiently low dew point in equipment enclosures, with a considerably lower dehumidified air generation requirement. Past production of ambient air is shown in Appendix B10. The decreased usage at the end of September 1945 reflects savings attributable to conversion to the dead-end system, as well as improved efficiency resulting from the elimination of most of the leakage in the cell and piping enclosures. The earlier decrease, starting in August 1945, may be attributed to complete operation of the K-25 plant, after which time there was no further occasion for the use of large quantities of dry air, until the K-27 cascade was started up. The K-27 area is also supplied from Section 1100 by connecting pipe line.

~~SECRET~~

~~CONFIDENTIAL/RD~~

a. Dry Instrument Air Supply. - Some of the output of the dry air plant can be compressed by Worthington compressors to 55 p.s.i.g. for use in instruments located within the enclosure system. This part of the dry air plant is now used for standby purposes only, the normal instrument supply being obtained from the compressed air plant described below. Dry instrument air production is recorded graphically in Appendix B9. All instrument air for K-27 was originally supplied from Section 1100 with booster compression in Building K-1251. It is now supplied from Section 1200.

5-5. Compressed Air Supply. - "Plant air" for K-25 and K-27 is compressed in two stages to 110 p.s.i. in Building K-1201, cooled by aftercoolers, and distributed to points of utilization through a loop skirting the process area with branch lines serving auxiliary buildings. The plant air system was originally used to supply compressed air for instruments (not located within dehumidified enclosures), maintenance, and other services. Since original construction, provision has been made for passing this air through a brine chiller and Hydryer system so as to reduce its dew point to minus 40°F. In the event that the low pressure dry air system cannot supply its full demand, the plant air system can be used as a supplementary source of supply. Thus Section 1200 now produces air of low enough dew point to be classified as, and used as, dry instrument air. This is reflected in the curves shown in Appendix B9.

5-6. Lubricating Oil Supply. - Lubricating oil of approximate SAE grade #10 is supplied to the thousands of process pumps of the K-25 and K-27 cascades by means of a circulating system which is complete for each building, and which includes facilities for storing, pumping

and filtering, and supplying the oil to the stage pump bearings.

5-7. Dry Nitrogen Supply. - Dry nitrogen gas is used wherever it is necessary to purge fluorine or uranium hexafluoride from a system. It is also used in stage pump seals, process valve seals, in the K-25 instrument datum system, and at other points as listed in Volume 3, Paragraph 10-7. Liquid nitrogen is used in the laboratories, and in such process instruments as leak detectors and line recorders. The graph in Appendix B17 shows the liquid nitrogen consumed in supplying the plant requirements for both liquid and gaseous nitrogen. The two pronounced peaks correspond to periods of maximum preparatory and preliminary activities in connection with the start-up of the K-25 and K-27 cascades. The nitrogen gas has a dew point below minus 100°F; no difficulties due ^{to} its moisture content have ever been encountered. The gaseous nitrogen used is generated at the site as described in Section 6.

5-8. Service Laboratories. - The diffusion plant laboratories are located in the K-1004 buildings in the administration area (App. A1). Building K-1004-A houses offices and the plant library. K-1004-B, -C, and -D contain, respectively, facilities for performing routine chemical analysis and isotopic analysis, routine chemical analysis and physical research, and chemical research. In the early part of 1946 plans were made for an extensive program of future barrier research; new laboratories are being built for this work in the conditioning building, K-1401.

a. Analyses of Product and other Uranium Compounds. - The analyses of samples for uranium are carried out in Building K-1004-B

~~SECRET~~

~~CONFIDENTIAL/RD~~

(App. D15) and K-1004-C. Determinations are made of uranium content in conditioning gases, carbon, and contaminated solutions; specification assay work is done on uranium hexafluoride received from the manufacturer. Isotopic analyses are made in Laboratory K-1004-C by three different methods;

1. Mass Spectrometer - the gas is ionized, accelerated, and analyzed by a combination of electric and magnetic fields (Vol. 2).
2. Fission Counting - a thin film of electroplated uranium is subjected to bombardment by neutrons from a 5 gram radium-beryllium source. The neutrons cause fission of the U-235 and the electrical impulses are counted.
3. Alpha counting - an indirect method whereby the alpha particles emitted from the sample are counted. This represents, primarily, the U-234 present, and, by correlation, the U-235 can be calculated.

The graph in Appendix B7 shows the number of analyses made each week. During the latter part of May 1945, fission counting replaced the alpha counting method because of greater accuracy.

b. Analyses of Special Chemicals. - A great deal of work has been carried out on the specification analyses of coolant and fluorelubes received from the manufacturers. In addition, plant samples are analyzed and fluorocarbon contents of air and uranium hexafluoride are determined. Samples of fluorine from the fluorine plant and samples of conditioning gases are analyzed for fluorine content.

c. Miscellaneous Analyses. - General works laboratory

~~SECRET~~

~~CONFIDENTIAL/RD~~

~~SECRET~~

~~CONFIDENTIAL/RD~~

analyses are run, including tests on water, coal, and gas samples, dew point of dry air and nitrogen, metallographic and spectroscopic analyses.

d. Research and Development. - Plant problems are continually referred to the research and development departments. Some of the more important research and development projects studied in the laboratories and in the development facilities of the conditioning building (Par. 6-1) are listed in Appendix C5.

5-9. Special Chemicals. - Because of the high reactivity of uranium hexafluoride with moisture and ordinary organic compounds, a number of special chemicals are required at the K-25 plant. A full discussion of the development, procurement, and general characteristics of these materials is contained in Book VII. This paragraph summarizes the operating functions fulfilled by each.

a. Fluorine (Code Name: C-216). - Fluorine (F_2) is used to condition the internal surfaces of all process equipment to be exposed to uranium hexafluoride. Present requirements average about 200 pounds per month (App. B14).

b. Perfluorodimethylcyclohexane (Code Name: C-316). - This substance, (C_8F_{16}) is used as an intermediate heat transfer medium in process coolers in order to avoid the direct use of water or other hydrogenous materials. Approximately 3,289,000 pounds of coolant were required to fill the combined K-25 and K-27 coolant systems. Monthly make-up requirements at present are on the order of 7500 pounds per month (App. B15).

c. n-Perfluoroheptane (Code Name: C-716). - C_7F_{16} approaches uranium hexafluoride in density, but is non-corrosive, and

~~SECRET~~

~~CONFIDENTIAL/RD~~

~~SECRET~~

~~CONFIDENTIAL/RD~~

was developed for use as a test fluid for converter testing (Section 6) and preliminary cell operation (Section 8). This material has only occasional and miscellaneous uses at present (App. B16).

d. Fluorolubes. - These materials were developed in response to the need for lubricants which could be used in contact with fluorine and uranium hexafluoride. It may be noted that the process stage pumps do not require special lubricant, since the bearings are outside the process material system.

(1) C-2144. - C-2144, used in the Stokes pumps (Vol. 2) for evacuating conditioning gas from equipment, was made by fluorination of a commercial grade lubricating oil.

(2) MFL. - Fluorolube MFL, used in the Beach-Russ pumps (Vol. 2) for evacuation of process gas from equipment, was made by polymerization and fluorination of perfluorovinyl chloride. MFL is currently acceptable for all applications where C-2144 has been used, though, because of its high vapor pressure at elevated temperatures, MFL is not so efficient for use in the Stokes fluorine vacuum pumps as is C-2144. The current combined make-up of fluorolubes is about 750 pounds per month (App. B16).

(3) MFI. - MFI grease, used as an impregnant for valve seats and other plastic items, is similar to MFL, except that the polymerization is more complete. The result is a heavy grease or wax-like material.

e. "C" Rubber. - The first material successfully developed for use as a valve seat material was a special grade of natural rubber. It was improved by impregnation with fluorocarbon waxes (Vol. 5).

~~SECRET~~

~~CONFIDENTIAL/RD~~

f. Fluoroplastics. - Fluoroplastics were also developed to meet the requirement for gasket and valve seat materials which would be suitable for use in contact with process and conditioning gases.

(1) Poly TFE. - A copper-filled polytetrafluoroethylene was developed and designated as Poly TFE or D-29.

(2) MFP-10. - The most satisfactory valve seat material developed is MFP-10, which, like MFL and MFI, is a polymerised perfluorovinyl chloride. The material was installed initially in all K-27 valves, and a program is currently underway within the K-25 plant to effect gradual and complete replacement of all "C" rubber valve seats with MFP-10.

SECTION 6 - CONDITIONING AREA OPERATIONS

6-1. Conditioning Building Operations.

a. Converter Conditioning. - A converter conditioning stand is shown in Appendix D12. The converter is placed in the stand, gas piping connections are made, the cover hood placed over the unit, and the stand heated electrically.)

Doc
b(7)

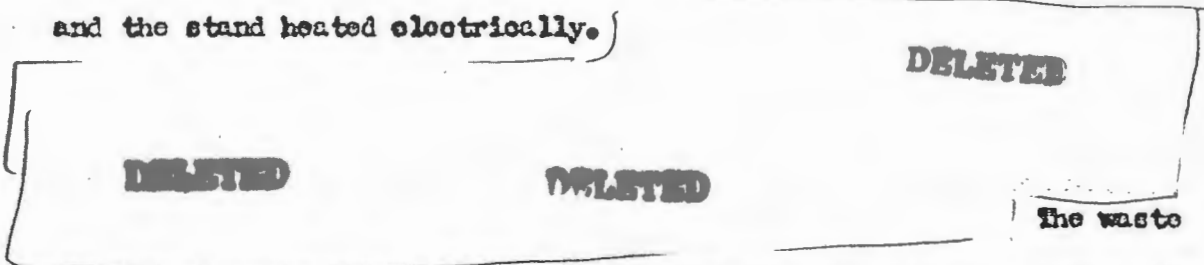

The waste conditioning gas is then pumped out to the fluorine disposal plant, the converter cooled, and the final porosity determined with dry nitrogen. Appendix E3 presents a graphical record of converter conditioning progress. Operations were begun in October 1944, and increased steadily through January 1945, when conditioning of the Size 2 units was completed. The dip in the diffuser conditioning curve in February 1945 was due to decreased rate of reception of the Size 1 units, which arrived from the manufacturer at a slower rate because of the larger number of tubes. The rate increased again during March, April, and May, when the Size 3 and 4 converters were conditioned, and dropped off during the latter part of June when K-25 requirements (plus 10 per cent additional for spares) were filled, a total of 5180 converters having been conditioned for the K-25 cascade. Some concern had been expressed that the converters might not stand shipment without considerable breakage of the barrier tubes. However, experience proved that only a few were damaged in transit. Special handling equipment, and the use of special railway

ears were responsible for the low rejection rate. Converter conditioning for the 540 stage K-27 cascade was begun on 15 December 1945, and completed 8 February 1946.

b. Converter Testing. - A few of the conditioned units were tested in the running test stands (App. D13) by circulation of nitrogen-C₇F₁₆ mixtures. Two Size 1, sixty Size 2, twelve Size 5, and two Size 6 converters were subjected to running tests, yielding reliable data on operating porosities. No conclusive separation efficiency determinations could be made. Recently, the running test stands have been used exclusively for calibrating flow meters prior to installation in the process area.

DELETED

DELETED

DELETED

DELETED

DOE
b(3)

d. Converter Inspection. - On numerous occasions, converters in service have been taken off stream and opened for inspection. The results of these examinations have indicated negligible corrosion and no appreciable uranium deposit. Several units have been inspected after failure during reconditioning. In one instance, the copper tubes of the stage cooler had melted out; in another, the barrier tubes had sagged and broken because of the high temperatures necessary for recovery to a condition approximating initial porosity.

In general, however, the process equipment is considered to be in excellent condition.

DOE
b(3)

DELETED

DELETED

DELETED

The pump seal and blowout preventer are tested with nitrogen, and impeller balance is checked. About ten per cent of the stainless steel seals and two per cent of SAE 52-100 steel seals were rejected at this point (Vol. 2, Par. 5-2e). The progress of stage pump conditioning is traced in Appendix B5. The dip in the curve during October 1944 was due to a delay caused by the change over from stainless steel to SAE 52-100 chromium modified tool steel seals. By 1 May 1945 a total of 6380 stage pumps had been conditioned for the main cascade. Pump conditioning for the K-27 cascade was begun on 15 December 1945 and completed on 7 February 1946.

DOE
b(3)

DELETED

DELETED

DELETED

DELETED

Twelve per cent of the steel pipe assemblies,

and seventeen per cent of the monel pipe assemblies had leaks, and were repaired. The following is an estimate of quantities of equipment handled in the cleaning and testing areas through 31 December 1946:

69,362 valves (1/8" to 14")
242,000 feet of monel pipe assemblies
31,917 pieces of monel pipe (lengths 6" to 24')
383,000 feet of nickel plated pipe assemblies
7,772 pieces of nickel plated pipe (lengths 6" to 24')
235,000 feet of steel pipe assemblies
10,680 pieces of steel pipe (lengths 6" to 24')
1,000,000 feet of copper tubing
69,673 pieces of copper tubing (lengths 6" to 24')
616 heat exchangers
892 circulating pumps

g. Process Pump Shop. - Process pump repair is handled in a special precision shop set up for this purpose in the conditioning building. Difficulty was experienced, during Case I operation in the K-25 area, with impellers rubbing pump casings. It was found that removing the front baffle ring and machining the shaft to give a front clearance of at least 0.090 inches between impeller and casing solved most of the problem. The majority of the Case II and III stage pumps were also removed after installation, and sent to the pump shop for machining. Subsequently, during the period from 18 May to 14 July 1945, all Case IV pumps (a total of 1996) were removed from the process area and sent to the shop for similar changes. Finally, 225 pumps from Case V were also re-machined. These difficulties were corrected before the K-27 pumps were installed, and the problem did not present itself in the K-27 area.

h. Seal Shop. - The seal shop provides facilities for repairing all process pump seals. During Case II operation, many of the stainless steel seals failed. This was due principally to the

fact that stainless steel caused too much resistance, resulting in frequent seizing of metallic parts. Therefore, most of the Case II seals, and about half of the Case IV seals had to be replaced with SAE 52-100 tool steel seals during May 1945. Approximately 2000 seals were changed. Even at present seals require more maintenance and off-stream cell time than any other single item. To date five different types of "H type" seals, and seven different types of "L type" seals (Vol. 2) have been tried. Probably the most satisfactory seals for 3500 RPM pumps are the H-5 (Halscomb 52-100 modified hardened steel), and for the 7000 RPM pumps the L-7 (a nitrided steel).

i. Vacuum Pump Shop. - Stokes fluorine vacuum pumps, Beach-Russ process gas vacuum pumps, and various mechanical high-vacuum models are repaired in the vacuum shop.

j. Vacuum Electronics Shop. - The vacuum electronics shop maintained and serviced 173 leak detectors for use in the K-25 and K-27 process areas. In addition, various subcontractors and vendors were loaned 56 leak detectors which were returned at the completion of separate phases of the work. As these instruments were returned, the vacuum electronics shop repaired them and placed them in storage pending disposal. The critical period occurred during May, June, and July 1945, when an average of 16 leak detectors per week were overhauled.

k. Development Activities. - With completion of conditioning and related activities necessary for preparation of equipment and preliminary operation of the process plant, the scope of operations in Building K-1401 has changed considerably (Vol. 3). Various development activities are now carried on in the northern portion of the con-

ditioning building as follows:

(1) Converter Retubing and Testing. - A program of retubing 90 test converters using three different types of barrier (WB, TL, and NL) was started early in November 1946.

DOE
b(3)

~~DELETED~~

~~DELETED~~

~~DELETED~~

The process pump and seal shop has also been transferred to this area (which is air-conditioned) in order to minimize corrosion of exposed precision parts.

(2) Engineering Development Laboratory. - An engineering development laboratory has been set up in the area formerly occupied chiefly by conditioning stands. The following work is in progress at this point:

1. Development of a gas bearing blower having completely enclosed induction motor, and utilizing process gas as bearing lubricant.
2. Development of improved viscosity plate seals for process pumps.
3. Improved cascade operation.

DOE
b(3)

~~DELETED~~

~~DELETED~~

~~DELETED~~

5. Development of methods for the recovery of UF₆ and other chemicals from plant wastes.
6. Development of KFP-10 and other plastics for plant use.
7. Reduction in the amount of corrosion of various types in plant operations.

DELETED

DELETED

DOE
b(3)

DELETED

DELETED

DELETED

DELETED

DOE
H(3)

~~SECRET~~

DELETED

DELETED

DELETED

8-2. Fluorine Generation. - Production capacity for 200 pounds of fluorine gas per day was installed in Section 1500 (Vol. 5). Amounts required and manufactured (App. B14) have fallen far short of peak capacity for the following reasons:

1. Economics of consumption brought about by changes and improvements in the conditioning cycle.
2. A lower rate of cell repair than originally contemplated.

The plant was originally designed to handle and compress fluorine by liquefaction. Present operation involves compression by means of a specially designed diaphragm pump (Vol. 5). Complete details may be found in the Hooker Electrochemical Company's report of 30 October 1944, entitled "C-216 Manufacturing Plant", and the report dated 1 March 1945

and entitled, "Installations for Mechanical Compression of C-216".

a. Production. - Appendix B14 shows the monthly fluorine production rate from the start of operations to date. Curves are also shown depicting deliveries to the conditioning plant by pipeline, and to the process area by portable tanks. The first delivery of fluorine to the conditioning plant was made on 28 July 1944; bottled fluorine under pressure became available on 1 October 1944. It will be observed that more fluorine was produced than used, particularly during 1944. The difference is due primarily to large quantities of fluorine vented to the disposal plant for experimental purposes, and secondarily to supplying of other C.E.W. Projects.

6-3. Fluorine Disposal. - After equipment has been conditioned, the residual gas, containing 10 to 20 per cent fluorine, is pumped to the disposal plant. The gases were formerly passed through a scrubbing tower where fluorine was absorbed in a sodium hydroxide solution. The tower effluent was treated with lime slurry to regenerate the caustic for re-use, and to precipitate the fluorine as calcium fluoride. Some process gas has escaped to the fluorine disposal plant during minor emergencies in the process area, resulting in the occurrence of uranium in the disposal sludge. The solution of problems introduced by these circumstances is described in Volume 3.

a. Shutdown of Disposal Tower. - As further described in Volume 3, the caustic scrubbing tower is no longer in operation. Spent gases resulting from cascade conditioning operations are allowed to enter the process stream for ultimate removal in the purging system, and off gases from the conditioning area are vented directly to the

atmosphere. These simplified procedures are now possible because of the small amounts of waste conditioning gases handled in present operations.

6-4. Acid Neutralization. - Lime slurry is made up in Building K-1407 and mixed with waste acids from the cleaning area of the conditioning building in an agitated neutralizing pit. The neutralized solution is run to the adjacent holding pond, where solid material settles out, and the clear overflow is discharged to Poplar Creek. At present about 2000 gallons of concentrated hydrochloric acid are neutralized per month. Smaller quantities of dilute acid are also processed.

6-5. Nitrogen Generation. - Project requirements for liquid and gaseous nitrogen (App. B17) are supplied from Building K-1406. The process is essentially one of vaporization of liquid nitrogen received by rail and stored in vacuum-insulated storage tanks. The rate of generation is automatically controlled by means of a line pressure control valve. The gas is supplied to the process and conditioning areas by pipeline, at constant pressure, as required.

6-6. Carbon Mixing. - Carbon and alumina are mixed in Building K-1410 in order to provide charging material for the various process carbon traps. The operation involves a simple blending process, but care is required to prevent coning and segregation (Vol. 8).

6-7.

~~DELETED~~

~~DELETED~~

~~DELETED~~

DOE
6(3)

DELETED DELETED
DELETED DELETED

DBE
b(3)

~~SECRET~~

~~CONFIDENTIAL/RD~~

SECTION 7 - POWER PLANT OPERATIONS

7-1. Introduction. - Power plant design is described in Volume 3, Section 12. This section presents a summary description of power plant operations. Typical operating figures given represent actual average values for the week ending 29 December 1946. Photographic views are shown of the power plant area and of the main electrical control room in Appendices D3 and D18, respectively.

7-2. Steam Generation. - Steam for power purposes is generated by three tangentially fired boilers, consuming an average total of 70 tons of pulverized coal per hour. One boiler is also capable of accepting fuel oil when desirable. The 6,000,000 gallon fuel oil tank farm of the adjacent S-50 area is now used in conjunction with this boiler. Water is fed to the boilers at an economizer outlet temperature of 486°F; steam is generated at a pressure of 1335 p.s.i. and a temperature of 922°F. The normal boiler control system is completely automatic, though several variations, including a fully manual method, are possible. The first boiler was brought up to full pressure on 2 April 1944. A typical coal rate is 1.00 pounds of coal per kilowatt hour, or 12,370 B.T.U. per kilowatt hour. A steam load of 1,330,000 pounds per hour is typical, with two boilers in operation. Overall boiler efficiency averages 88.9 per cent; overall station efficiency averages 27.59 per cent.

7-3. Power Production. - Graphs in Appendix B11 present a record of gaseous diffusion plant power generation and consumption to date. The bulk of the power required is generated at the site. A total of fourteen turbo-generators are operated in order to provide power at required

7-1
~~SECRET~~

~~CONFIDENTIAL/RD~~

frequencies and voltages. Typical average electrical loads for the K-25 plant and auxiliaries (exclusive of K-27) run as follows: 60 cycle constant frequency at 13,800 volts - 29,230 KW, 60 cycle variable frequency at 13,800 volts - 130,530 KW, 120 cycle variable frequency at 4160 volts - 4,450 KW. The first turbo-generator (No. 3) was placed under load on 3 April 1944.

7-4. Power from the T.V.A System. - Power for operation of various auxiliaries is received at 154,000 volts from the T.V.A. System and transformed down to 13,800 volts in the K-25 switch yard. This load is on the order of 33,800 KW. The K-27 plant normally runs entirely on T.V.A. power which is received and transformed in the K-27 switch yard at the average rate of 114,700 KW. All T.V.A power is received and utilized at the standard, constant frequency of 60 cycles. T.V.A power consumption is recorded in Appendix B11.

7-5. Steam Supplied to S-50. - During the period of operation of the S-50 plant (Book VI) from September 1944 until September 1945, the bulk of that plant's steam requirements was supplied from the K-25 power plant. Steam furnished to S-50 (App. B12) reached rates in the vicinity of 1,400,000 pounds per hour. Thus, the available facilities of the K-25 power plant, construction of which was completed well before its full capacity was required for K-25 process operations (Vol. 4), were utilized up until the time that the full capacity was required by the gaseous diffusion plant itself. In order to furnish maximum steam to the S-50 plant, it was necessary to begin operation of some of the turbo-generators. Consequently, prior to March 1945, power generation exceeded K-25 Project requirements, and power was fed into the T.V.A. system. Thus, the re-

~~SECRET~~

~~CONFIDENTIAL/RD~~

quirements for feed water make-up necessitated operation of some of the turbo-generators at high rates, in order that extraction steam pressure would be high enough to operate the feed water evaporators. Moreover, disposition of the vapor, flashed from the hot high-pressure condensate returned from S-50, required operation of a large number of turbo-generators in order to have condensers available for this purpose. Finally, the requirement for a large amount of relatively cold condensate from the condensers, for cooling to pumping conditions that part of the S-50 condensate sent through the heat exchangers, also tended to require a high rate of power generation. After the increase in K-25 process electrical load, beginning in March 1945, it was no longer necessary to feed power to the T.V.A., and subsequent increases in load as the K-25 process cascade was placed in operation, caused steam generating capacity to become the limiting ^factor in filling S-50 requirements. The supply of process steam to S-50 was begun on 28 September 1944, and discontinued on 10 September 1945.

~~CONFIDENTIAL/RD~~

~~SECRET~~

~~CONFIDENTIAL/RD~~

SECTION 8 - PRODUCTION CHRONOLOGY

8-1. Start-up of the K-25 Plant. - When the first process buildings were placed in operation, they were valved together to form a short cascade; as additional buildings became available, they were connected into the system. Thus, the cascade steadily grew in size, from the time the first buildings were operated on uranium hexafluoride in February 1945, until all nine process sections were in connected operation on 15 August 1945. The first product was taken off in March 1945, as soon as enough cells were on stream to produce sufficiently enriched material. The first three buildings to operate in Case I (Par. 8-4) were K-302-3, K-302-5, and K-310-2. On 9 March 1945, Buildings K-302-3 and K-302-5 were connected together for the first attempt at a two-building cascade. However, an open nitrogen valve to the building by-pass lines had escaped notice, and the cascade was flooded with nitrogen. As soon as the nitrogen was purged from the top cell of Building K-302-5, another attempt was made, this time successful. On 12 March 1945, Buildings K-302-3, K-302-4, K-302-5, and K-310-2 were connected together. Appendix B1 shows the initial operating dates for all process buildings of K-25.

8-2. Start-up of the K-27 Plant. - There was relatively little difficulty in starting process operations within the K-27 plant, since prior experience had been gained during the preceding months of K-25 operation. Building K-402-9 was the first K-27 process building to receive its preoperational test run; the acceptance form was signed by the operating contractor on 30 November 1945. It was placed in operation on 18 December 1945. Rapid progress was then made in starting up the re-

~~SECRET~~

~~CONFIDENTIAL/RD~~

~~SECRET~~

~~CONFIDENTIAL/RD~~

maining eight buildings. Preliminary work, such as vacuum testing, and starting of the lubricating oil and coolant systems, was accomplished without major difficulty. On 29 November 1945, seal crews started to install pump seals in Building K-402-3. Their work was held up for approximately 10 days because of more pressing work in the K-25 plant. By 10 December 1945, seals were placed in Buildings K-402-3, -4, and -9. On 13 December 1945, cells in these buildings were started on nitrogen. By 15 December 1945, all cells were running, and preparations were made for conditioning these buildings and the interbuilding process lines from K-402-3 to K-402-9. On 18 December 1945, raw feed material was charged to a pressure of 2.0 p.s.i.a. from a mobile hot bath unit. The buildings were set up as a cascade on total reflux with intermittent purging by a mobile carbon trap unit. On 19 December 1945, a power failure occurred in Vault No. 32, when an extension cord dropped on a 13,000 volt bus at a transformer terminal. This shut the water plant and Buildings K-402-3 and -4 down. The buildings were re-started in a short while, and operations returned to normal. Also on 19 December 1945, all cells in Buildings K-402-5 and -6 were started on nitrogen. These cells were conditioned, but were held up for charging ^{with} uranium hexafluoride because of the lack of a third feeder in Vault No. 33. On 8 January 1946, the two buildings were being charged with uranium hexafluoride, when a power emergency in the K-25 plant necessitated a temporary halt so that all available power could be routed to the main cascade. On 9 January 1946, Buildings K-402-3, -4, -5, -6, and -9 were operating on total reflux. Buildings K-402-1 and -2 were started and conditioned, and on 10 January 1946, all seven buildings were operating in cascade on total reflux at 4.0 p.s.i.a. On 12 January 1946, uranium

~~SECRET~~

~~CONFIDENTIAL/RD~~

hexafluoride feed was started, and product was removed at the top of K-27. Mobile units were used to condense both waste and product. On 5 February 1946, after sufficient feeders were installed in Vault No. 34, Buildings K-402-7 and -8 were started and conditioned; all cells were charged to 2.0 p.s.f.a. on 7 February 1946, thus forming the entire K-27 cascade. On 8 February 1946 product was removed. The starting date for each K-27 process building is indicated in Appendix B2.

8-3. Formation of Cascade of Cascades. - On 19 January 1946, combined operation of K-25 and K-27 was started. At this time, the initial interplant flow was begun from Building K-402-9 to K-302-2, but stopped after a short time to repair the control valve on the line from K-27 to K-25. Uranium hexafluoride normal feed to K-25 was stopped on 30 January 1946, and K-27 product that had been accumulated since 12 January 1946 was fed into the K-25 cascade at K-302-2. During the evening of the same day flow was resumed, and Section 600 was condensing at full capacity to keep surge drum pressure at the proper level. The K-25 feed point was shifted as the concentration gradient increased through that section of the plant. After 24 hours, all of the stored K-27 product had been fed to the cascade. It was necessary to vary the interplant flow rate until a stabilization point was reached at which the waste concentration was not fluctuating too widely, and the surge drum pressures in both plants were level. On 22 January 1946, the interplant lines were found plugged when the electric heaters were off. Uranium hexafluoride feed was maintained, and K-27 product was drummed. After 15 hours, the lines were cleared, and normal flow was resumed. Minor difficulties were encountered with the K-27 feed unit, and flow was stopped intermittently. It was necessary, for a short period of time, to use the mobile waste unit. By 25 January 1946, all

~~SECRET~~

~~CONFIDENTIAL/RD~~

TABLE 1. - DATES OF COMPLETE OPERATION OF CASES

<u>CASE</u>	<u>BUILDINGS</u>	<u>SCHEDULE</u>	<u>ACTUAL</u>
I	K-510, K-502	None	24 March 1948
II	K-511, K-503	19 May 1948	28 May 1948
III	K-509, K-501	26 June 1948	9 June 1948
IV	K-504, K-506	28 July 1948	28 July 1948
V	K-508	15 August 1948	15 August 1948
-	K-402	10 December 1948	
		23 January 1949	
		10 February 1949	8 February 1949

~~SECRET~~

~~CONFIDENTIAL/RD~~

~~SECRET~~

~~CONFIDENTIAL/RD~~

difficulties were eliminated and operations were normal.

8-4. Case Scheduling. - A rigid schedule was set up on 20 March 1945 for starting dates of operation of the various portions of K-25 (and later of K-27). Five periods or "cases" of K-25 cascade operation were contemplated, corresponding to increasingly complete operation of facilities. The basic aim was to begin operation of every process building as soon as possible after the completion of its construction. The case schedule is tabulated in Table 1, with corresponding actual starting dates for operation of individual cases. Each case is understood to include all buildings of earlier cases, with the addition of those listed for each in the second column of the table. Building K-303-2, the original experimental building, is excluded from Case II. Operation was achieved on the dates shown in spite of several major delays beyond the control of either the operating or construction contractor. For example, Case II was delayed for two weeks because of the required changing of pump seals, and the first few buildings of Case IV were delayed by the necessity for reworking stage pumps. Actual dates of operation on uranium hexafluoride are shown in Appendix B1 for each K-25 building, and in Appendix B2 for each K-27 building. A graphical summary of the number of process cells on stream from March 1945 to date is shown in Appendix B4. Cell stream efficiency (ratio of operating cells to available cells) is shown in Appendix B5.

8-5. Interruptions to Operations. - Occasionally, cascade operation has been interrupted by equipment failures or operational errors. Cascade interruptions to date have not been appreciably more frequent than would be expected by a well-organized industrial concern starting up a new plant in an established operation, and have not had serious effect on plant productivity.

8.4

~~SECRET~~

~~CONFIDENTIAL/RD~~

a. Initial Period through 30 September 1945. - The following cascade interruptions have been recorded during the period from initial operation through 30 September 1945:

1. An open valve, unnoticed, caused flooding of the process system with nitrogen. The cascade was split between K-302-3 and K-302-5.
2. A cooling water line to K-310-2 plugged with asphalt lining material. Rising cell temperatures necessitated shutdown of the building. This, and subsequent plugged water lines, led to the installation of filter screens in water lines to all buildings.
3. An expansion flange failed on the piping of Cell 310-3.5. Dry air from the cell enclosure rushed into the cascade, and surges developed.
4. A welder cut into a 2 inch line to Cell 303-3.1, admitting atmospheric air to the cascade. Surges developed, and the cascade was split.
5. Failure of recirculating cooling water pumps shut down most of the cells.
6. Minor surges developed in the upper part of the cascade during the adjustment of control instruments. The cascade was split between K-302-5 and K-303-1 for two hours.
7. A gas cooler failed in Cell 301-3.6, admitting about 700 pounds of coolant into the cascade. The effect was not serious.

~~SECRET~~

~~CONFIDENTIAL/RD~~

8. Cell 305-3.3 was connected into the cascade with a nitrogen purge valve open. Nitrogen was admitted to the cascade, and the cascade was split at K-303-8 for two hours.
 9. Valve seats in K-310-3 leaked, admitting nitrogen to the cascade. The cascade was split between K-302-5 and K-303-1.
 10. An error in switching operations at the power house interrupted the supply of power to the K-306 Section.
 11. Instrument air failed, shutting down most of the cascade for several hours.
- b. Period from 1 October 1945 through 30 April 1946.
1. On 8 October 1945, the cascade was sectionalized between K-310-1 and K-309-3; K-301-5 and K-302-1; K-303-10 and K-304-1. Variable frequency power was lowered from 60 cycles to 54 cycles in order to reduce the power load and facilitate power house repairs.
 2. On 24 November 1945, K-310-3 was evacuated of uranium hexafluoride when the cooling water lines became plugged. This caused an 8 hour shutdown of the building.
 3. On 2 December 1945, a fire destroyed a large amount of equipment in the K-303-10 purge and product room. The emergency operations consisted of evacuating personnel from K-303-10, isolating the building, splitting the cascade, and stopping feed for two hours.
 4. On 14 December 1945, turbo-generator No. 13 was shut

~~SECRET~~

~~CONFIDENTIAL/RD~~

down because of clogging of filter screens for the condenser cooling water. This caused loss of the K-306 Section for 15 hours. No product was withdrawn during this period.

5. On 19 December 1945, a power failure occurred in Vault No. 32 when an extension cord dropped on a 13,800 volt bus at a transformer terminal. This shut down the water plant and Buildings K-402-3 and -4. The buildings were re-started in a short while, and operation returned to normal.
6. On 4 January 1946, power failed in Buildings K-403-3, -4, -5, -6, and -9 for two hours.
7. On 8 January 1946, rotating screens at the cooling water inlet clogged. All buildings below the K-306 Section were placed on inverse recycle. The K-306 Section was placed on direct recycle, and feed was stopped. The cascade was re-established 16 hours later.
8. On 11 January 1946, a relay tripped out and cut off Buildings K-402-1, -2, -3, -4, -5, -6, and -9 for several hours.
9. On 26 January 1946, the source of power for the entire K-27 area failed because of a faulty current transformer. The cascade of cascades was resumed after 6 hours.
10. On 8 February 1946, a total power failure occurred in the K-25 area. It was the worst failure experienced in the history of the plant. It was caused by clogging of

~~SECRET~~

~~CONFIDENTIAL/RD~~

screens at the water intake to the powerhouse, and a simultaneous T.V.A. power failure.

11. On 27 February 1946, the pressures were reduced for 2-1/2 hours in K-303-6, -7, -8, -9, and -10 because of failure of variable frequency feeder.
 12. On 19 March 1946, a power failure caused the shutdown of Sections K-303, -304, -310, and -311 for 8 hours. This was due to the fact that the ground breaker was not opened on the bus while making a tie-in with the T.V.A.
 13. On 20 March 1946, power was lost to the K-301 and K-309 Sections because of a power surge resulting from a faulty voltage regulator.
 14. On 30 March 1946, power failed in the K-301, -305, and -309 Sections when a voltage surge caused all but 7 cells to cut out. About 32 pump seals failed, and the cascade was interrupted for two hours.
 15. On 2 April 1946, a voltage surge caused cut-off of Sections K-301 and K-309.
 16. On 11 April 1946, a lubricating oil failure in Building K-302-3 caused this building to be off cascade 25 minutes.
 17. On 30 April 1946, one thousand standard cubic feet of nitrogen leaked into Building K-310-3 when a valve was opened by mistake. No serious damage was done.
- c. Period from 1 May 1946 through 31 December 1946.
1. On 26 June 1946, a turbo-generator was accidentally

~~SECRET~~

~~CONFIDENTIAL/RD~~

~~SECRET~~

~~CONFIDENTIAL/RD~~

tripped out, and Buildings K-304-1, K-304-2, K-303-3, K-304-4, K-304-5, K-310-1, K-310-2, and K-311-1 were shut down for approximately one hour:

2. On 24 July 1946 the K-27 plant was shut down for about three hours as a result of a relay cutout (caused by moisture) disconnecting a 154,000 volt bus from the T.V.A. system.
3. On 17 August 1946, a voltage surge tripped out the cell breakers in the K-302 Section, and caused a twenty minute shut down.
4. On 2 September 1946, the K-306 buildings were shut down for approximately 64 hours in order to repair a leak on the steam header supplying the high frequency turbines.
5. On 20 November 1946 about 3000 cubic feet of air leaked into the cascade when an expansion joint ruptured in Cell 301-1.7. This resulted in a period of 30 hours of abnormal cascade operations while the air was being trapped and purged. First, the cascade was split at K-309-1, and that building was put on inverse recycle because of a suspected second leak. K-309-1 was shortly placed back on stream when the leak was not confirmed. Three cells in K-311 tripped off by over-current relay action because of an inventory shift resulting from the leak. The cascade was again split at K-303-1.5, and another split made at K-303-6.2 in order to block upflow of air which had passed the K-303-1.5 split. About an

~~SECRET~~

~~CONFIDENTIAL/RD~~

hour after the leak, the K-601 surge drum pressure had risen to a point where it became necessary to stop interplant flow between K-25 and K-27. Next, the cascade was further split at the top of K-302-5, and the split at K-303-1.5 was closed. Building K-302-5, was isolated on inverse recycle, full of air, one hour later. The cascade was then tied together, by-passing K-302-5, which was placed on direct recycle, and purged to the K-302-5 purge and product station. The building was charged and returned to the cascade approximately five hours later. Interplant flow was resumed at a slow rate after three hours, and became normal after 6-1/2 hours. In the meantime, the suction pressure to Building K-312-2, the side purge building, was raised from 0.67 to 0.70 p.s.i.a., and the frequency was increased from 35 to 40 cycles in order to facilitate the heavy purging required. K-305-3, K-305-2, and three cells of K-305-1 were next taken off stream, and the air evacuated to the cascade under controlled conditions. After approximately eight hours of additional purging, the cascade had returned to normal operating conditions. It is believed that the rupturing of the Cell 301-1.7 expansion joint was caused by excessive vibration resulting from a seal failure in the Stage 5 "B" pump.

6. On 11 December 1946 a 50,000 SCFD air leak occurred in K-301-1 as a result of failure to close a valve com-

~~SECRET~~

~~CONFIDENTIAL/RD~~

pletely before certain scheduled maintenance work was started on the K-309-1 by-pass headers. K-301-1 was isolated for three hours, and the cascade split for about four hours.

7. On 12 September 1946 the instrument air header in K-402-1 was heavily contaminated with process coolant, when an air line was accidentally opened into an operating coolant system. This resulted in contamination of air-operated instruments and stage control valves, requiring a building shutdown of approximately eight hours.

In general, production losses in the case of each of these disturbances were quickly regained, and the overall production maintained. Moreover, the Project has not suffered serious monetary loss on account of these failures. Cell stream efficiencies are shown in Appendix B5. It will be noted that the efficiency runs typically at about 98 per cent, far in excess of the design assumption of 87 per cent.

8-6. Maintenance Experience. - The cell stream efficiency curve reflects lost operation due to breakdown of equipment. As might be expected, the curve shows relatively low values during the initial start-up periods, before rising to the 98 per cent level.

- a. Period from April through August 1945. - Appendix C6 presents an analysis of causes of cell shutdowns from April through August 1945.

- b. September 1945. - A more complete and significant study was possible during September 1945 after full operation had been attained in the K-25 area. Appendix C7 presents the total number of cell days lost on account of each type of failure, and shows this lost time as a percentage

~~SECRET~~

~~CONFIDENTIAL/RD~~

calculated by dividing the number of lost cell days by 14,460 cell days, the theoretical total for the entire 482 K-25 cells operating for 30 days. The average number of cells down per day during September 1945 was 11.0. The total lost operating time amounted to 331.9 cell days, or 2.27 per cent of the theoretical total number of cell days.

c. Period from January through December 1946. - Maintenance experience during the year 1946 is summarized in Appendix C8. Average stream efficiency for the year was 98.8 per cent.

8-7. Plugging of Barrier. - Since the beginning of Gaseous Diffusion Project research, the subject of barrier plugging has been of great importance.

DOE
b(3)

~~DELETED~~ ~~DELETED~~ ~~DELETED~~

Some individual units have plugged seriously as a result of such events as inleakage of atmospheric air through breaks in lines, or seal failures.

DOE
b(3)

~~DELETED~~ ~~DELETED~~
~~DELETED~~ ~~DELETED~~

DOE
b(3)

DELETED

DELETED

DELETED

DELETED

a. Plugging Curves. - The "plug" of a converter is the per cent decrease in permeability occurring during operation, as determined by observation of the stage control valve position (Vol. 3, Par. 8-12b), over a particular period of time.

DELETED

DELETED

DELETED

DOE b(3)

~~DELETED~~ ~~DELETED~~

~~DELETED~~ ~~DELETED~~

DOE b(3)

b. Barrier Replacement.

(1) Process Converters. - It was decided early in November 1946 to tube 90 Size 2 converters, equipping 30 with WB barrier, 30 with KL barrier, and 30 with TL barrier, in order to study the performance of these types of barrier under plant conditions. These converters ^{were} ~~are to be~~ installed in Building K-402-5 and K-402-7 of the K-27 plant.

DOE
b(3)

~~DELETED~~ ~~DELETED~~ ~~DELETED~~

Of the 90 converters removed from K-27, 78 will be placed in K-310 along with 44 spare converters from storage. Spare Size 1 converters will be used in K-309, and spare Size 3 in K-311. It is calculated that, as a result of installation of this higher quality barrier material, K-25 and K-27 combined productivity will be increased by two per cent.

(2) Purge Converters. -

DOE
b(3)

~~DELETED~~ ~~DELETED~~ ~~DELETED~~

It is believed that the WB material will withstand considerably

~~SECRET~~

~~CONFIDENTIAL/RD~~

higher temperatures, and therefore, when plugged, can be more effectively reconditioned to normal porosity with the recovery of valuable deposited material.

8-8. Feed Material. - This paragraph indicates the different classes of feed material which have been accepted by the K-25 plant. Further discussion of schedules, dates, and quantities is presented in the Top Secret Appendix. An overall flow diagram showing sources and quantities of feed materials is presented in Appendix A4.

a. Fresh Feed. - In general, fresh uranium hexafluoride is procured from the Harshaw Chemical Company through the Madison Square Area of the Manhattan District. Representatives of the Harshaw Chemical Company, Kellogg Corporation, Carbide and Carbon Chemicals Corporation, Madison Square Area, and K-25 Operations Office, were jointly responsible for specifications and scheduling of the feed material. This material is of natural isotopic concentration:

0.714 per cent U-235
0.006 per cent U-234
99.28 per cent U-238

b. S-50 Material. - Three classes of process material have been received from the S-50 Liquid Thermal Diffusion Project (Book VI): S-50 product, S-50 waste, and S-50 partially processed inventory shipped to K-25 when the S-50 plant was shut down.

c. Y-12 Material. - Several types (Top Secret Appendix) of partially processed material have been received from the Y-12 Electromagnetic Project (Book V).

d. Reprocessed K-25 Material. - On certain occasions material drawn from the diffusion cascade at various concentrations has been stored

8.15

~~SECRET~~

~~CONFIDENTIAL/RD~~

~~SECRET~~

~~CONFIDENTIAL/RD~~

and later re-fed into the process system.

8-9. Waste Material. - Depleted material, low in concentration of U-235, is drawn off from the bottom of the K-27 cascade (originally from the bottom of the K-25 cascade). A discussion of quantities and concentrations is presented in the Top Secret Appendix.

8-10. Product Material. - All product from the gaseous diffusion plant has been shipped to Y-12 for further processing, with the exception of small quantities which were stored and later re-fed back to the K-25 plant. The production capacity of U-235 at various isotopic product concentrations was estimated by Dr. M. Benedict and Mr. A. M. Squires of the Kellogg Corporation, and Dr. E. M. Corson of the Carbide and Carbon Chemicals Corporation. In most cases, actual production has exceeded predicted production, primarily for the following reasons:

1. Actual cell stream efficiencies are about 98 per cent, whereas the design assumption was 87 per cent.
2. A negative correction of 10 per cent was allowed in the estimates, for the effect of surge disturbances, whereas it has turned out that surges have very little effect on production.
3. Barrier separation efficiencies have exceeded the assumed values.
4. Increase in the plant feed rate.
5. Increase in the power input, permitting higher operating pressures, and greater amounts of material in process.

A discussion of K-25 product concentrations and quantities is included in the Top Secret Appendix. The coordination of K-25 and Y-12 operations and delivery schedules is discussed in Top Secret Supplement No. 1.

~~SECRET~~

~~CONFIDENTIAL/RD~~

~~SECRET~~

~~CONFIDENTIAL/RD~~

SECTION 9 - SAFETY AND SECURITY

9-1. Safety Program.

a. Organisation.

(1) District Organisation. - The overall Manhattan District safety administrative organization is described in Book I, Volume 11. Within the K-25 Project as originally organized, the Safety Section was headed by a chief reporting to the Chief of the Engineering and Supply Branch. In September 1945 a Safety and Security Branch was set up, headed by a chief reporting through the K-25 Executive Officer. The Chief of the Safety and Security Branch was assisted by three section chiefs in charge, respectively, of Safety, Security, and Fire Protection and Prevention. This organization has remained essentially unchanged to date. At present, the Chief of the Safety and Security Branch represents the K-25 Division Chief in all matters pertaining to Safety and Security within the K-25 area, and the Decatur, Detroit, and Milwaukee sub-areas. Responsibilities include staff supervision of all safety activities of the K-25 Division, assistance in determination of needs for research and experimental work in order to establish adequate safety and health control for all operations, liaison with the District Safety Branch, District Insurance Branch, contractors' insurance branch, and preparation and analysis of safety activity summaries, and fire and accident reports.

(2) Contractor Organisation. - The original K-25 site operations safety program was initiated for the conditioning area by Ford, Bacon, and Davis, Inc., in March 1944. On 1 May 1945 it was

~~SECRET~~

~~CONFIDENTIAL/RD~~

~~SECRET~~

~~CONFIDENTIAL/RD~~

absorbed into the overall safety program developed for the K-25 area by the Carbide and Carbon Chemicals Corporation. The Carbide safety program had been inaugurated with the designation of a Safety Supervisor in January 1944. The Safety Department was then expanded until a total of 60 employees was reached on 1 June 1945. By 1 April 1946 safety personnel had been reduced to 40 individuals. Present department strength amounts to 28 employees. The various phases of the safety program are carried out through several units within the Carbide organization, with the Safety Department providing the necessary stimulus, overall guidance, routine inspection, technical procedures, an educational and publicity program, and procurement and issuance of required safety equipment. The Training Department incorporates safety into training courses; the Medical Department assists in specifying the selection and placement of workers, and in the control of special hazards; the Equipment Test and Inspection Division assumes responsibility for mechanical inspection, investigation of mechanical failures, and fire protection engineering and inspection. The Equipment Test and Inspection Division was established as such on 1 July 1944, having previously been a part of the Safety Section. A plant Fire Department was established within the Plant Protection Division, and fire fighting responsibility was assumed by Carbide in June 1944, with the receipt of the first fire equipment. The organization has been expanded to include three pumpers and 162 members, utilizing three fire halls within the K-25 area. The safety standard for all work has been the Corps of Engineers minimum mandatory "Safety Requirements", supplemented by

~~SECRET~~

~~CONFIDENTIAL/RD~~

~~SECRET~~

~~CONFIDENTIAL/RD~~

nationally recognized standards, and by standards developed at the site, in connection with situations where no previous experience was available.

b. Safety Measures. - The following are the principal safety measures taken at the K-25 site:

1. Employment of qualified safety engineers.
2. Organisation of a full-time plant fire department.
3. Investigation of all fires and all accidents resulting in property damage or personal injury.
4. Establishment of regular schedules for the inspection and testing of all equipment and facilities, and development of procedures incidental thereto.
5. Routine inspections to cover all facilities and operations for the discovery of unsafe acts or conditions that might result in accident or fire, and appropriate recommendations for their elimination.
6. Preparation of safety bulletins (App. C2) covering:
 - a. Routine safety hazards.
 - b. Ordinary chemicals in general industrial use.
 - c. Special chemicals developed for the gaseous diffusion process.
 - d. Special procedures to be followed in operation and maintenance.
7. Integration of safety into the training program through employee orientation, job training courses, supervisory training, and first aid training.

~~SECRET~~

~~CONFIDENTIAL/RD~~

~~SECRET~~

~~CONFIDENTIAL/RD~~

8. Integration of safety into design through a review, by safety engineers, of all new construction, all maintenance requests, and all requests for modifications to existing facilities.
9. Emergency plans of action defining plant policies to be followed at times of operating emergencies.
10. Integration of safety into the medical program through specification, by the medical, of:
 - a. Employee physical limitations.
 - b. Limits and control methods incidental to special hazards.
 - c. Justifiability of time losses associated with occupational injuries.
11. Integration of safety into the employee placement program through the preparation of job analysis sheets which describe the functions of a position, physical qualifications, and required safety equipment.
12. A well rounded outdoor and indoor publicity program designed to promote safety through such media as bulletin boards and posters, display cabinets, and the plant newspaper.
13. Maintenance of records pertaining to accidents, injuries, fires, property damage, etc., and preparation of required reports incidental thereto.
14. Maintenance of a properly staffed unit to evaluate and effect continual appraisal of industrial hygiene hazards.

~~SECRET~~

~~CONFIDENTIAL/RD~~

15. Establishment of a convenient and effective system for procuring, issuing, and maintaining safety equipment.

c. Statistics. - The Carbide safety record is compared in Appendix C4 with those of the Clinton Engineer Works as a whole, the entire Manhattan District, and American chemical industry in general. A full account of the K-25 safety program for the year 1946, with a discussion of safety experience, program costs, and methods of operation, is contained in the "Annual Report, 1946 - Safety and Fire Prevention Program", issued by the K-25 Division office, where a copy is on file.

d. Special Hazards. - A special hazard must be considered at the K-25 plant which is not ordinarily encountered in chemical industry. Uranium and its compounds, existing at the natural isotopic concentration, are not physiologically dangerous from the point of view of radioactivity. However, when the concentration of the U-235 isotope is increased (as in the gaseous diffusion process), the intensity of injurious radiation is increased. Moreover, care must be taken not to exceed the critical mass; otherwise a fission chain reaction might conceivably be initiated. The equipment was designed as safely as possible; the sizes of diffuser stages were made smaller at the top of the cascade, and cold traps in the upper sections of the plant were designed for size, and were cadmium coated. However, there did exist the possibility of exceeding the critical mass through failure of equipment or faulty operations. Therefore, a special committee was organized in 1944 to study the problem. The committee included F. C. Hoyt, H. D. Kinsey, C. K. Beck, E. M. Corson, C. E. Rucker, Jr., and F. C. Arnstead, all of Carbide and Carbon; E. Benedict of Kellogg; and Major M. N. Beckwith

and Lt. F. P. Baranowski of the K-25 Operations Office. Late in 1945 a working committee was established in the plant to cope with individual operational problems. The working committee examined operating equipment and procedures, requested necessary investigations, and issued safety rules. Normal and emergency operating procedures were standardized about this time, which served to minimize the possibility of hazardous ^{concentrations} condensations. Other District areas have cooperated in theoretical and experimental studies to establish the maximum safe quantities of U-235 at various concentrations which may be handled under specified circumstances. Early in 1946 the Special Hazards Committee consisted of C. E. Center, P. L. Alspaugh, C. H. Rucker, Jr., C. K. Beck, S. C. Barnett, D. E. Hull, A. G. Kramer, A. P. Huber, G. T. E. Sheldon, W. B. Humes, and M. G. Means, all of Carbide and Carbon; and W. H. Rogers of the K-25 Operations Office. Shortly after this committee was formed, representatives from the Y-12 and X-10 Projects jointly entered into a study of special hazards problems which led to a series of experiments conducted at Los Alamos, New Mexico (Book VIII). As a result of experience gained at that point, related experiments were then conducted in a laboratory located in the adjacent S-50 Area, and formerly used by the Liquid Thermal Diffusion Project. For further details of a more classified nature, reference should be made to the Top Secret

Supplement No. 1
Appendix.

9-2. Security Program.

a. Organization.

(1) District Organization. - The overall Manhattan District security administrative organization is described in Book I,

~~SECRET~~

~~CONFIDENTIAL/RD~~

Volume 14. The original K-25 Intelligence and Security Branch was expanded to form the Safety and Security Branch in September 1945, which functions as indicated in the previous paragraph. Specific responsibilities in connection with security include supervision of the program of physical security, safeguarding of military information, and personnel clearance. Through field inspections and conferences with the contractor, these items are administered in accordance with standard Manhattan District regulations.

(2) Contractor Organisation. - Security measures at the K-25 site were initiated by Ford, Bacon, and Davis, Inc., who established a guard force of 80 men in June 1943. Clearance and badges were then issued to all employees. In April 1944, Carbide set up a security department. The conditioning and fluorine handling areas were separately fenced and guarded, and provisions were made to cover the process buildings as they were taken over for operation. At its peak, the Carbide guard force numbered about 900 in February 1945. It was progressively reduced to an authorized strength of 450 in February 1946, and finally to 377 as of 31 December 1946. The reduction in strength was made possible by the diminution of construction activity, and stabilisation of operations. All major construction work was completed in the inner restricted areas of K-25 and K-27 by July 1945 and January 1946, respectively, and at this later date Carbide identification was extended to cover entry of future construction personnel into these areas. The entire K-25 area is now restricted to Carbide identification; the Kellex Corporation and J. A. Jones Construction Company badges and passes were voided in March 1946 and May 1946.

~~SECRET~~

~~CONFIDENTIAL/RD~~

respectively.

b. Security Measures. - Security is enforced by standard District methods involving fence and guard protection, pass and badge control, employee and visitor clearance, and education of employees in the importance and methods of enforcing security regulations.

9-5. Diversion Control. - The possibility of diversion of uranium that might be used in the fabrication of atomic weapons creates a distinct hazard to national security. In the Baruch report of scientific information to the United Nations Atomic Energy Commission, the maximum tolerable diversion has been defined as the loss of material required to make one atomic bomb per year, or a total of five bombs over any period of time.

a. History of Diversion Control. - Recognizing their responsibility as the operator of the gaseous diffusion plant, the Carbide and Carbon Chemicals Corporation, on 20 February 1946, formed a committee composed of process and engineering division personnel. This committee was to formulate plans for safeguards for the gaseous diffusion plant beyond those in effect and enforced by the Plant Protection Division and the District Security Division. It met frequently during the following three weeks, and issued a report on 15 March 1946, giving a preliminary survey of the problems of diversion control within the plant, with recommendations for changes in design, operating procedures, and security measures. The committee also recommended that a group of engineers be assigned full time to work on the problems in cooperation with the Plant Protection and other Divisions. Such a

group was set up on 22 March 1946, and the original committee continued to function in an advisory capacity for some time. Several design changes were made in order to make it more difficult to remove material from the main process, and better techniques of weighing were instituted. A summary report was published on 15 October 1946. This report, "Control of Process Material Diversion" by F. Mills and N. H. Van Wie (Bldgs. 304-1 thru 312-5), outlined detailed design changes, presented plans for restriction of Plant II, where "unsafe" material is processed, including possible gate control plans, proposed an educational program, and outlined an inspection system. At a meeting of the Process Materials Department Council on 4 November 1946, a proposed program for diversion control was prepared on the basis of the Mills-Van Wie report. This program was approved on 6 November 1946.

b. Organization. - The Uranium Control and Inspection Department, functioning as a staff organization responsible to the Assistant Plant Superintendent, was formed early in December 1946 to centralise the responsibility for handling and coordinating the many related problems which are involved in adequate control of uranium within the plant. The following sections were set up to carry out the program:

(1) Coded Chemicals Section. - Orders, receives, stores, transfers, and keeps records for accounting of all uranium bearing materials.

(2) Accountability Section. - Prepares procedures concerning the storage, handling, and accounting of uranium bearing materials. Makes engineering studies for improving the precision and

~~SECRET~~

~~CONFIDENTIAL/RD~~

accuracy of material balances.

(3) Consumption Section. ← Makes engineering studies and designs, and coordinates the consumption programs being carried out by various plant departments. Most of this work is done by other service groups.

(4) Diversion Control Section. ← Makes engineering studies and prepares recommendations concerning the diversion control policies and practices. The Plant Protection Division is staffed to carry out the responsibilities for over-all security.

(5) Special Hazards Section. ← Makes studies, investigations, and recommendations on all problems concerning radiation and critical mass. A physicist and an engineer are assigned. The Director of Research, Dr. C. K. Beck, acts as consultant on special hazards problems.

~~SECRET~~

~~CONFIDENTIAL/RD~~

~~SECRET~~

CONFIDENTIAL/RD

SECTION 10 - PERSONNEL PROCUREMENT AND INDUSTRIAL RELATIONS

10-1. Personnel Procurement. - Employee recruitment for adequate staffing of the K-25 operating organization posed a serious problem. In the latter part of 1943 and the first six months of 1944, a serious shortage of manpower existed throughout the country. At K-25, which was situated within a critical labor region, thousands of plant operators were needed, in addition to approximately 2000 supervisory and technical employees.

a. Recruiting Program. - Recruiting emphasis during the latter part of 1943 was placed on the technical and supervisory groups. Through special arrangements with the National Roster of Scientific and Specialized Personnel, itineraries were arranged for recruiting agents, which included all major universities, and which covered areas where the required types of manpower might be available as a result of curtailment of peacetime industries and revisions in the war industry program.

b. Employment Offices. - An employment office was opened in the city of Knoxville, about thirty miles from the plant site, and additional offices were set up at the east and west ends of the Clinton Engineer Works reservation. The supply of operating personnel obtained through these facilities was still insufficient, and additional offices were established at Nashville, Chattanooga, Memphis, and Johnson City, Tennessee; Atlanta, Georgia; Birmingham, Alabama; and Corbin, Kentucky. In one week in January 1945, a total of 7,142 applicants were interviewed, and 1,125 were accepted for employment.

10.1

~~SECRET~~

CONFIDENTIAL/RD

10-2. Training of Specialized Personnel. - A comprehensive training program was necessary in order to provide adequate instruction for operators and supervisors in the principles and practice of diffusion plant operation, to familiarise maintenance personnel with special techniques and required methods of handling and repairing precision parts, and to familiarise instrument mechanics with the many specialized devices used. Training courses were also provided in safety principles and in first aid procedures.

a. Process Operations Training Program. - During April and May 1944, the nucleus of the production organization was gathered at the plant site, and a training school was started at Wheat School on 6 October 1944. It was moved to Building K-502-3 in the process area on 3 January 1945. The operations training department was subdivided into two sections: the Process Training School and the Vacuum Test Training School. In the spring of 1945, the policy was begun of hiring women for plant operating jobs. The following tabulation shows the number of process operators hired for training during representative periods:

	<u>Male</u>	<u>Female</u>	<u>Total</u>
August to December 1944	604	0	604
January to May 1945	970	1264	2234
June to September 1945	1060	17	1077
October to November 1945	<u>1173</u>	<u>0</u>	<u>1173</u>
	5807	1281	5088

Of this total, 5230 employees were trained in the Carbide Process Training school up until the time it was closed in November 1945. The

remaining 1858 were given the vacuum test training course, which was discontinued in July 1945. After operators had completed initial training, and were assigned on shift, they were given the benefit of additional, on-the-job training by instructors who took them for a few hours at a time, reviewing and clarifying particular points not previously understood. Several hundred individuals have been given this additional instruction.

(1) Critical Personnel Period. - The critical personnel period was reached in July 1945. In preparation for the vacuum testing of process buildings in June and July of 1945, the Vacuum Testing Department started to train vacuum test operators in May. A steady supply of trained process operators was also required as buildings became ready for operation. The critical period was passed by building up available operations personnel through transfer from vacuum testing. A means was devised for vacuum testing two buildings simultaneously by a single crew, thereby helping to avert a shortage of help in the Vacuum Testing Department, and preventing any serious lag in meeting schedules. By 1 August 1945, the vacuum testing of buildings in the K-25 area was nearly complete; all remaining vacuum testing personnel were then transferred to operations.

b. Process Maintenance Training Program. - Carbide's process maintenance training program was initiated in January 1945. It provided for fundamental training in setting up equipment, alignment of motors, preliminary mathematics, shop work, use and care of precision instruments, and fundamental safety principles, with the aim of standardizing jobs insofar as methods and tools are concerned. A minimum of 80

hours training was provided for maintenance mechanics, and a three-day course of study and shop work was set up for process operators and supervisors. The process maintenance training program was discontinued in June 1946, by which time the following personnel had been trained:

- 470 maintenance mechanics
- 30 maintenance supervisors
- 24 process operators
- 18 process supervisors

527 employees were also given training in special process welding techniques under a program which was discontinued in April 1946.

c. Process Instrument Training Program. - Because of the scarcity of skilled instrument men, as well as the unconventional nature of many of the K-25 instruments, training courses for instrument mechanics and supervisors were laid out, according to two basic schedules. Schedule I covers pneumatic instruments, basic electricity, shop instrument work, silver soldering, and special supervisory classes. Schedule II provides special study of the following instruments (Vol. 2): assay machine, line recorder, acoustic gas analyzer, and thermal conductance cell. The program is still in effect. Several hundred men have been trained to date, using over 50,000 man-hours.

d. First Aid Training. - On 1 June 1944 a Bureau of Mines first aid course was set up. To date, 4,245 persons have taken the course. This figure does not include members of the Guard Force (who were given a part of the course) but does include members of the Fire Department, all of whom have received this training.

e. Assault Mask Training. - An opportunity was given to

personnel who might need to use the U. S. Army assault mask in connection with their work to familiarize themselves with its use. 1914 persons in the process operations and maintenance division have been trained in the use of the mask to date.

10-3. Employment Statistics. - Appendix B24 presents a graphical record of the variation of K-25 plant personnel strength from August 1944 to date, broken down by major organizational categories. Starting with 21 employees on 1 September 1943, the Carbide payroll rose to a peak of over 11,000 in June of 1945. With the stabilization of operations, and the curtailment of vacuum testing, conditioning, and training activities, the number of employees has decreased steadily since that date. Present strength is 6,623 employees.

a. Enlisted Personnel. - Because of the serious difficulties encountered by the Manhattan District in obtaining technically trained personnel for its various projects, on 22 May 1943 the Commanding General of the Army Service Forces authorized the establishment of a Special Engineer Detachment, which became a part of the 9812th Technical Service Unit, Corps of Engineers. Assignment of enlisted personnel to the various departments of K-25 began in the latter part of 1944, reaching a peak strength in August 1945 of about 600 men. Numerous civilian employees of the operating contractor were assigned to the Manhattan District upon induction into the Army, and were detailed to the K-25 Project. Other technical enlisted personnel were recruited from colleges and universities, Replacement Training Centers, and the Army Specialized Training Program. This source of manpower helped considerably to alleviate the critical shortage at K-25 of

scientific and technical personnel. These men were carefully selected, and were assigned to a variety of jobs in which their technical competence could be best utilized toward the advancement of the overall program.

10-4. Work Stoppages. - There have been no work stoppages during the operation of the gaseous diffusion plant.

10-5. Labor Relations.

a. Grievance Procedure. - All employees are advised that any grievance is entitled to a hearing and an impartial decision. An individual may originate action by discussing the matter in question with his supervisor, who has been instructed to listen with patience and interest. If the problem is not solved in this initial step, the employee is referred to the Labor Relations Department for preparation of a written formal grievance, to be presented to the employee's supervisor. If the employee is dissatisfied with the supervisor's decision, it is taken to the supervisor of the Labor Relations Department who formulates a decision after hearing all relevant testimony. Further appeal, if desired, is then available to the aggrieved party, who may carry the matter to the Plant Superintendent, and finally to the District Engineer. The employee may be represented by another employee of his choice, who has security clearance to handle the information involved. From 1 December 1944 through 31 December 1946, the Labor Relations Department handled 478 grievances.

b. Disciplinary Procedure. - Rules of conduct are published throughout the plant. Any violations are reported to the Labor Relations Department in uniform manner by the supervisor with

~~SECRET~~

~~CONFIDENTIAL/RD~~

recommendations for disciplinary action. If the facts reported agree with those admitted by the employee, discipline is provided without a hearing. If the facts reported are not in accord with those contended by the employee, a hearing may be granted, upon request of the employee, before a representative of the Labor Relations Department Supervisor, who decides the matter after hearing all relevant and material evidence. Careful effort is exerted to make disciplinary action equally severe in all equivalent cases, and to avoid all discrimination.

e. Union Representation. - On 20, 21, and 22 August and 10, 11, and 12 September 1946, a National Labor Relations Board election was held to permit Carbide employees to select a collective bargaining agent. All hourly employees of the contractor were eligible to participate except guards, firemen, time clerks, and cafeteria hostesses. As a result of this election, the C.I.O. United Gas, Coke, and Chemical Workers of America was certified as the bargaining agent, and negotiations for a contract were begun immediately.

10-6. Housing Program. - On 9 November 1943 the first Carbide employee moved into family quarters within the Clinton Engineer Works area. When the overall housing program was laid out by the Roane-Anderson Company (in charge of all C.E.W. housing under District direction) 1,284 family units were allocated to the Carbide and Carbon Chemicals Corporation. 359 of these were permanent type houses. The scarcity of this type made it imperative to adopt a strict housing policy, whereby only top supervisory personnel were eligible for permanent houses, and all other personnel earning wages of \$0.90 or more per hour were eligible for semi-permanent houses, pre-fabricated houses,

~~SECRET~~

~~CONFIDENTIAL/RD~~

trailers, or dormitories. Under this policy the program began functioning early in 1944; by June of that year 512 units were occupied. At that time intensification of labor recruitment caused the housing problem to assume major proportions. An absolute shortage of housing units developed by 1 October 1944. Waiting lists, then started by the housing office, increased to such an extent that, by May 1945, 1524 employees were waiting for various types of family housing units. The shortage was further aggravated by an over-crowded condition in dormitories after October 1944. Starting at this time, all female employees assigned dormitory quarters had to live either two in a single room, or three in a double room. This situation continued until July 1945, at which time 14 new dormitories were opened, and "doubling up" was discontinued. V-J Day resulted in some curtailment in operations of other C.E.W. contractors, which made more housing units available to Carbide workers. At present Carbide employees occupy a total of 2879 housing units distributed as follows:

- 573 Permanent houses
- 523 Apartments
- 1779 Pre-fabricated houses
- 204 "Victory Cottages"

In addition, Carbide has occupied over 450 trailers, and several thousand dormitory rooms. The Happy Valley trailer camp and all barracks have been closed. Carbide employees formerly residing in these facilities have been moved to trailers and dormitories in the Oak Ridge Townsite. As of 31 December 1946, Carbide has 645 employees waiting for assignment of housing units.

~~SECRET~~
~~CONFIDENTIAL/RD~~

10-7. Transportation. - In conjunction with the extensive employee recruitment program, transportation facilities had to be provided for prospective workers residing in outlying districts within a radius of 100 miles. It became necessary to enlist the services of all existing means of transportation, and to supplement these in every conceivable way. Trucks and buses of all types were operated over secondary and tertiary roads wherever passenger loads could be obtained. The organization of "Share-the-Ride" automobile clubs did much to alleviate the problem. A special section of the Transportation Department was established to encourage, coordinate, and assist in the formation and continuance of these clubs. It is estimated that, for a considerable period of time, approximately 50 per cent of the operating employees were utilizing this type of transportation. Through special arrangements with the Office of Price Administration, Carbide operated a Ration Panel which processed upward of 150 gasoline and tire applications per day at the peak of its activities. In cooperation with the C.E.W. Bus Authority and its successor, American Industrial Transit, the Carbide Transportation Department worked to overcome the numerous difficulties inherent in a system which had suddenly mushroomed into being. Constant surveys were conducted with a view toward obtaining optimum loads and adequate schedules for the increasing number of workers being engaged. Unsatisfactory highways to a good many destinations aggravated the problem of maintaining schedules, especially during inclement weather. Intra-area transportation between the residential and plant sites presented additional problems, though not so complex as those encountered in off-area operations, mainly because

~~SECRET~~

~~CONFIDENTIAL/RD~~

~~SECRET~~

~~CONFIDENTIAL/RD~~

most destinations were on a well-established, straight line route. The most effective single bus service innovation was the institution of express routes traversing residential streets and providing direct runs to the plant terminal. With the completion of a smooth-surfaced highway between town and plant in September 1945, a significant improvement was effected, resulting in greatly reduced frequency of bus failures, and increased use of private vehicles. Curtailment of off-area bus operations was begun in August 1945, at which time plant construction was approaching completion. Thereafter, lines and schedules were systematically discontinued in accordance with decreased needs. The percentage of employees living on the area has risen since that time, and bus service has continuously improved because of the well established repair and maintenance program.

10.10

~~SECRET~~

~~CONFIDENTIAL/RD~~

7
~~SECRET~~

~~CONFIDENTIAL/RD~~

SECTION 11 - COSTS

11-1. Introduction. - An overall compilation of costs attributable to the K-25 Project is given in Volume 1, Section 7, together with an explanation of the principles involved in the method of cost presentation used. This section presents total costs chargeable to operation of the K-25 plant.

11-2. Monthly Operating Costs. - Table 2 shows the monthly costs of operation from February 1944 to date. A breakdown of these figures is shown in Appendix B18. Unit costs for the enriched product of the K-25 plant are discussed in the Top Secret Appendix.

11-3. Cost Breakdown. - A breakdown according to prime contracts is shown in Appendix E, which also presents original and modified contract estimates.

11-4. Cost Summary. - Total cost figures for K-25 operation, effective as of the end of the fiscal year 1946, are as follows:

Contract Payments to Date	\$ 68,648,698
Fixed Fee Payment to Date	1,558,030
Material Furnished by Government to Date	<u>11,413,488</u>
Total Contract Costs to Date	81,620,216
Estimated Total Costs for Completed Contracts	145,437,500

~~SECRET~~

~~CONFIDENTIAL/RD~~

~~SECRET~~

~~CONFIDENTIAL/RD~~

TABLE 2. - MONTHLY OPERATING COSTS

1944	February	\$125,000
	March	250,000
	April	500,000
	May	750,000
	June	812,500
	July	750,000
	August	906,250
	September	1,281,250
	October	1,093,750
	November	1,906,250
	December	1,718,750
1945	January	2,625,000
	February	2,781,250
	March	3,250,000
	April	3,750,000
	May	4,187,500
	June	4,031,250
	July	4,125,000
	August	4,843,750
	September	5,000,000
	October	3,607,000
	November	3,951,000
	December	4,330,000
1946	January	3,722,000
	February	4,447,000
	March	3,126,000
	April	3,530,000
	May	3,350,000
	June	4,859,000
	July	4,245,000
	August	4,283,000
	September	3,125,000
	October	3,740,000
	November	7,540,000
	December	<u>2,632,000</u>
	TOTAL	105,174,500

~~SECRET~~

~~CONFIDENTIAL/RD~~

~~SECRET~~ ~~CONFIDENTIAL/RD~~

SECTION 12 - ORGANIZATION AND PERSONNEL

12-1. K-25 Operations Office.

a. Organization. - The K-25 Operations Office was opened on 22 February 1944, with Major J.J. Moran as K-25 Operations Officer. Major Moran reported to Lt. Colonel J. C. Stowers, Unit Chief, K-25 Project (Vol. 1). The Operations Officer was charged with responsibility for supervision of K-25 site operations activities and administration of operating contracts. The line of authority from the District Engineer to the K-25 Operations Officer is shown in Appendix B1 of Volume 1.

b. Personnel. - On 19 April 1944, Mr. H. J. Peyton was transferred from the New York Area to be assistant to the Operations Officer in charge of administration. Lt. Colonel R. W. Cook succeeded Major Moran as K-25 Operations Officer on 3 October 1944, and Major N. Randolph Archer was assigned as Executive Officer on 29 December 1944. Major Moran was transferred on 21 December 1944 to Decatur, Illinois, as Decatur Area Engineer. At this time, the K-25 Operations Office consisted of 8 officers and 5 civilians. As of 31 October 1945, Lt. Colonel R. W. Cook was K-25 Operations Officer, Major N. R. Archer was Executive Officer, Captain John R. Fugard was Chief of the Engineering and Supply Branch (having succeeded Major E. H. Klossner); Major M. M. Beckwith was Chief of the Plant Operations Branch, with Major C. D. Luke as Plant Operations Officer; Major R. E. Johanneson was Chief of the Safety and Security Branch; and Mr. H. J. Peyton was Chief of the Administrative Branch. At this time, K-25 Operations

~~SECRET~~ ~~CONFIDENTIAL/RD~~

~~SECRET~~

~~CONFIDENTIAL/RD~~

Office Personnel included 14 officers, 9 enlisted personnel, and 20 civilian personnel.

c. Reorganization. - On 1 May 1946 the position of K-25 Operations Officer was converted to K-25 Division Chief, with overall responsibility for administration of the K-25 Project, including out-lying areas (Vol. 1). Reporting to the Chief of the Clinton Engineer Works Plant Operations Group, the K-25 Division Chief plans, directs, and coordinates the work of all organizations connected with the K-25 Division, administers all K-25 Project contracts (exclusive of construction contracts) as authorized representative of the District Engineer, and acts as consultant to higher authority for the purpose of coordinating K-25 operations with other Projects of the Manhattan District. He is assisted by the various branch and section heads within the K-25 Division. On 1 February 1946, Lt. Colonel H. R. Fraser was assigned as special assistant to the K-25 Operations Officer, and on 1 July 1946 Lt. Colonel Fraser was appointed Assistant Chief of the K-25 Division. At present Major Archer is Executive Officer; Major Belcher is Chief of the Engineering and Supply Branch; Mr. W. H. Rogers is Chief of the Plant Operations Branch (having succeeded Major C. D. Luke), Mr. F. F. Blakely is Chief of the Administrative Branch; and Mr. Julius Hannoeh is Chief of the Safety and Security Branch (having succeeded Lt. W. S. Anderson). The current organization chart is shown in Appendix B2 of Volume 1. The office of the K-25 Division at present includes 5 officers and 47 civilian personnel. A tabulation of key personnel is presented in Appendix F1.

12-2. Carbide and Carbon Chemicals Corporation.

12.2
~~SECRET~~

~~CONFIDENTIAL/RD~~

~~SECRET~~

~~CONFIDENTIAL/RD~~

a. Organization. - As of 1 March 1944, the Carbide and Carbon Chemicals Corporation employed 394 persons on K-25 activities. Seven of these were located at the plant site, including a resident engineer and staff. The remainder were stationed in New York, and at various plants and laboratories, conducting research, development, and special studies for the K-25 Project. By 27 November 1944, the organization had grown to assume the form shown in Appendix B19. The operating organization was headed by a Vice-President, who acted as consultant to the Contracting Officer, and to all contractors connected with the Gaseous Diffusion Project. Reporting to the Vice-President, were the General Superintendent, Plant Superintendent, and nine department heads responsible, respectively, for process, maintenance, laboratory, power plant, plant engineering, plant protection, equipment test and inspection, industrial relations, and manufacturing office. The present overall organization chart is shown in Appendix B20. The principal changes include the elimination of the general superintendency, and the addition of two assistant plant superintendents.

(1) Process Division Organization. - As of 31 December 1946 the Process Division employs 1641 persons, of whom 1469 are engaged in cascade operations, and 172 are assigned to other process departments (dry air plant, nitrogen handling, fluorine generation, etc.). The Process Division Organization chart of Appendix B21 shows detailed structure, and indicates the lines of authority for Process Division personnel from the Division Superintendent down to the building operators. A dual type organization is used, consisting of (1) technical supervisors of the various sections of the plant, and (2)

12.3
~~SECRET~~

~~CONFIDENTIAL/RD~~

~~SECRET~~

~~CONFIDENTIAL/RD~~

the shift organization including the foremen and operators. A typical process operations "area" (consisting of nine process buildings) is supervised by an area supervisor and two technical assistants. Supervision within the shift organization consists of an area foreman assisted by a three-building foreman and a six-building foreman for each shift. A total of 24 to 26 crew leaders and operators per shift complete the operating force of each nine-building area, exclusive of maintenance personnel.

b. Personnel. - Dr. G. T. Felbeck, Vice-President, has charge of the K-25 Project for the Carbide and Carbon Chemicals Corporation. In addition, Mr. H. E. Thompson and Mr. L. A. Bliss, also vice-presidents of the corporation, have rendered advisory services to the District Engineer. Mr. C. E. Center was appointed Plant Superintendent on 15 February 1943, with responsibility for organization and efficient operation of the plant. On 8 February 1944, Mr. H. D. Kinsey was brought in as General Superintendent of the Project. Mr. Kinsey was transferred from the site on 1 December 1945, and appointed General Superintendent of all the corporation's plants. At present, Mr. C. H. Rucker, Jr. is Assistant Plant Superintendent with responsibility for process, power, and laboratory activities. Mr. W. B. Humes is Assistant Plant Superintendent with responsibility for equipment test and inspection, instrument, and maintenance activities. A tabulation of key personnel is presented in Appendix F2.

12-3. Ford, Bacon, and Davis, Inc.

a. Organization. - An organization chart for Ford, Bacon, and Davis, Inc., is shown in Appendix B22, which depicts the organization as of 31 March 1945, by which time some of the employees had

~~SECRET~~

12.4

~~CONFIDENTIAL/RD~~

~~SECRET~~

~~CONFIDENTIAL/RD~~

been transferred to Carbide and Carbon Chemicals Corporation, in preparation for the turnover of the conditioning plant on 1 May 1945. The K-25 operations of Ford, Bacon, and Davis, Inc., were directed by a Vice-President, in the New York Office, who determined broad policies and maintained close contact with the work at the site. The operating organization at Oak Ridge was headed by the Plant Manager, responsible for representation of the company to the Contracting Officer and other contractors within the Gaseous Diffusion Project, formulation and execution of policies governing the operation of the plant, and supervision of all operations. Reporting to the Plant Manager were nine department heads, responsible, respectively, for planning, engineering, maintenance, operations, inspection, safety, security and personnel, accounting, and cafeteria service.

b. Personnel. - Mr. E. S. Coldwell was Vice-President in charge of management for Ford, Bacon, and Davis, Inc. Mr. C. W. Gray was appointed Plant Manager on 6 December 1943, and was responsible for organization and efficient operation throughout the contract period. Mr. J. A. Elkins was the Planning Manager after 7 February 1944, and was in charge of scheduling materials and equipment through the plant, and the coordination of work with other contractors. Mr. A. A. Ubelacker was appointed Chief Engineer on 22 December 1943, and was responsible for the preparation of operating procedures, and for revising such procedures and techniques where necessary. Mr. C. C. Sperling served as General Superintendent after 6 March 1944, and was in charge of the processing of all materials and equipment to be turned over to the construction contractor.

12,5
~~SECRET~~

~~CONFIDENTIAL/RD~~

~~SECRET~~

~~CONFIDENTIAL/RD~~

12-4. Hooker Electrochemical Company.

a. Organization. - An organization chart for the Hooker Electrochemical Company, effective 3 May 1944, is shown in Appendix B23. The work under the contract was divided between Oak Ridge and Niagara Falls, New York. The Chief Engineer was in direct charge of contract activities, and supervised the work of the engineering and design staff at Niagara Falls and the operating group at Oak Ridge until the plant was turned over to the Carbide and Carbon Chemicals Corporation on 1 February 1945. A Senior Engineer of the Plant Engineering Department of Hooker was in charge of design and engineering, and the Superintendent was responsible for the operation of the plant.

b. Personnel. - Mr. T. L. B. Lyster, Chief Engineer for the Hooker Electrochemical Company, Mr. D. O. Hubbard, Senior Engineer, and Mr. G. Gentes, Junior Engineer of the Plant Engineering Department, were responsible for the detailed design of the plant, supervision of the installation of equipment, and the adjustment and testing of equipment and plant engineering during the operation period. Mr. W. E. Hauth, Plant Superintendent, was in charge of the hiring of the operating force, the actual operation of the plant, and the training of Carbide and Carbon Chemicals Corporation foremen.

~~SECRET~~

~~CONFIDENTIAL/RD~~

~~SECRET~~

~~CONFIDENTIAL/RD~~

MANHATTAN DISTRICT HISTORY

BOOK II - GASEOUS DIFFUSION (K-25) PROJECT

VOLUME 5 - OPERATION

APPENDIX "A"

PLANS AND FLOW DIAGRAMS

<u>No.</u>	<u>Title</u>
1.	Plot Plan of K-25 and K-27.
2.	Flow Diagram for K-25 and K-27 Process Areas.
3.	Cascade of Cascades.
4.	Uranium Production Flow Diagram.

~~SECRET~~ ~~CONFIDENTIAL/RD~~

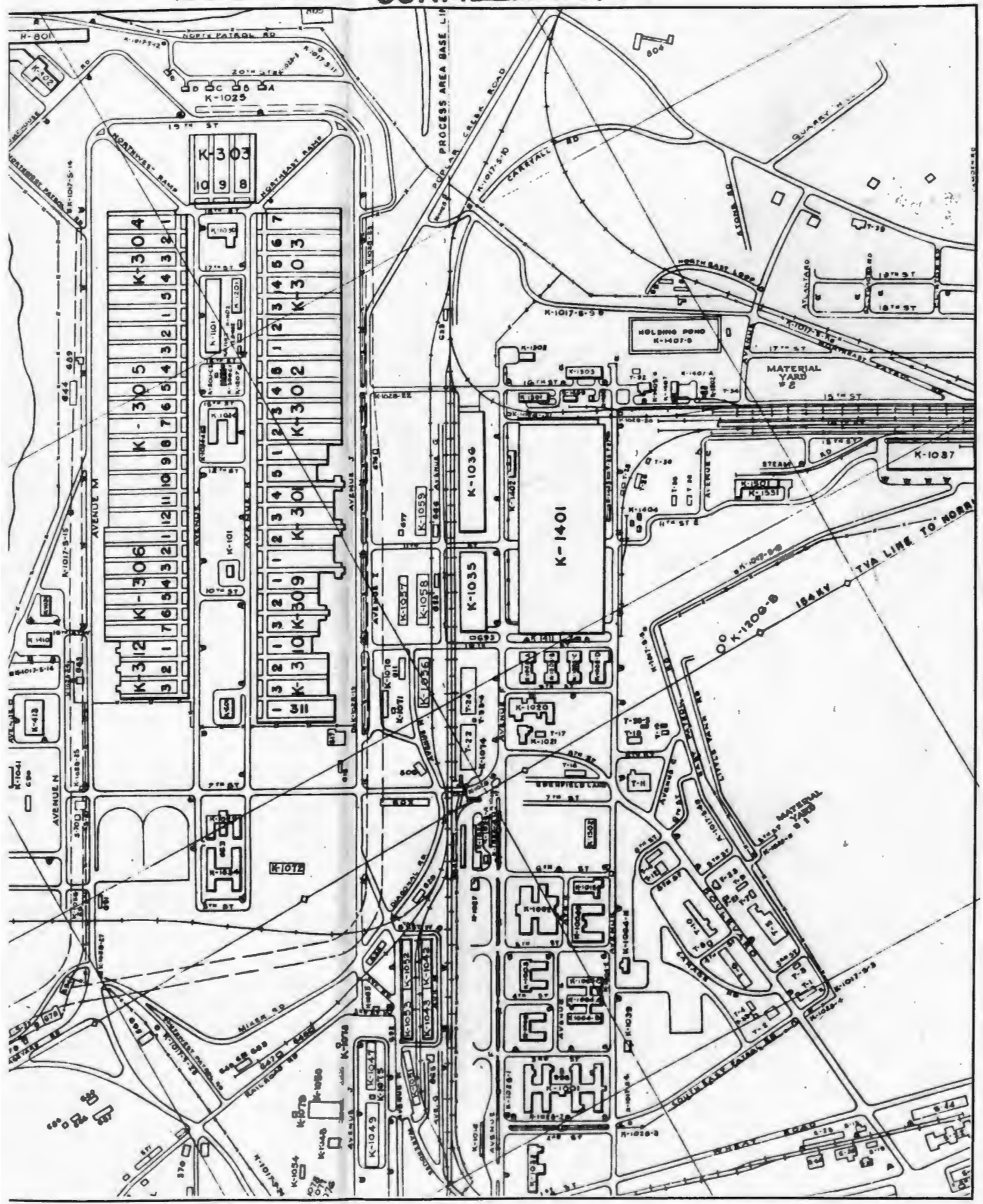

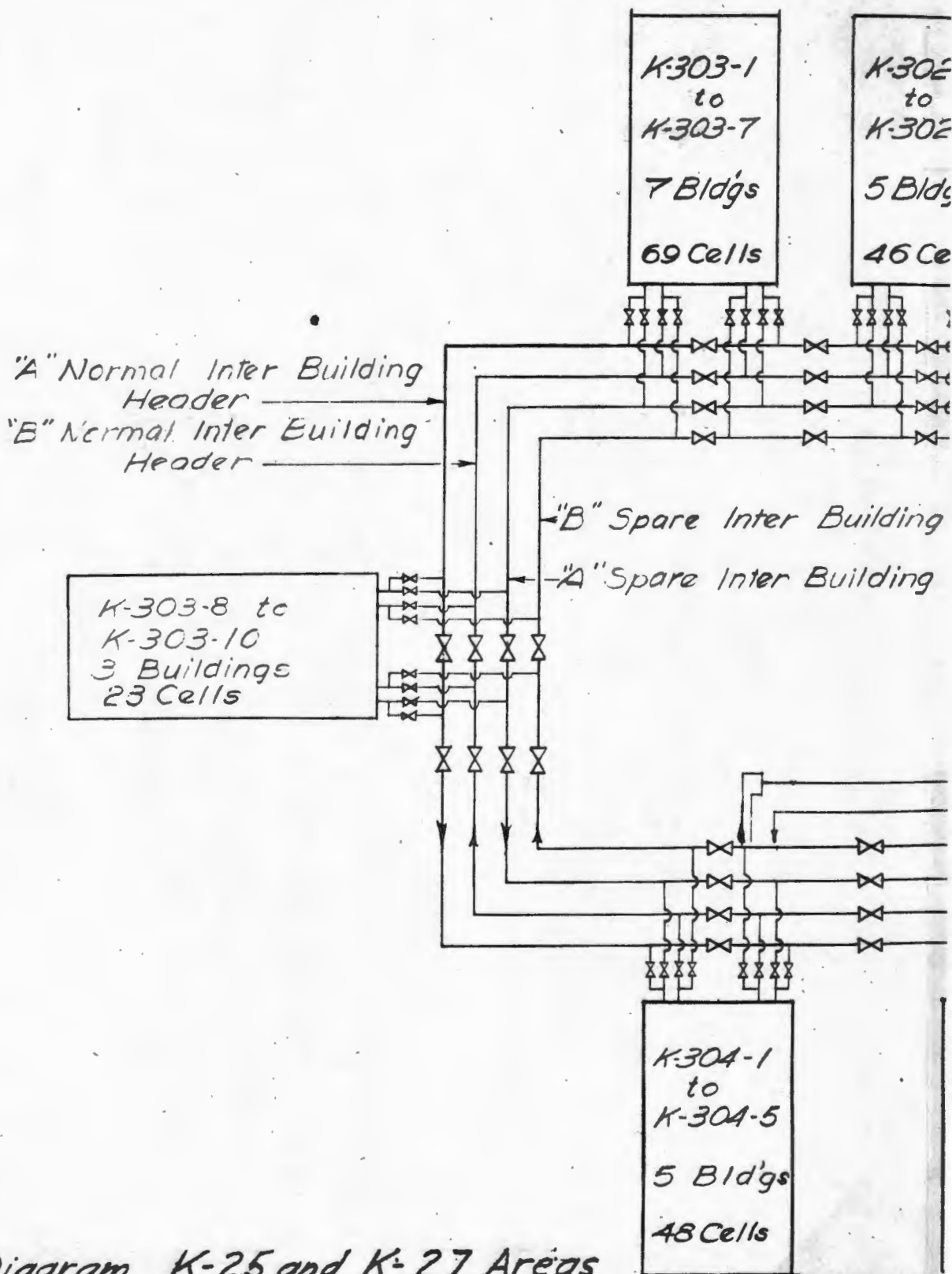

Flow Diagram K-25 and K-27 Areas

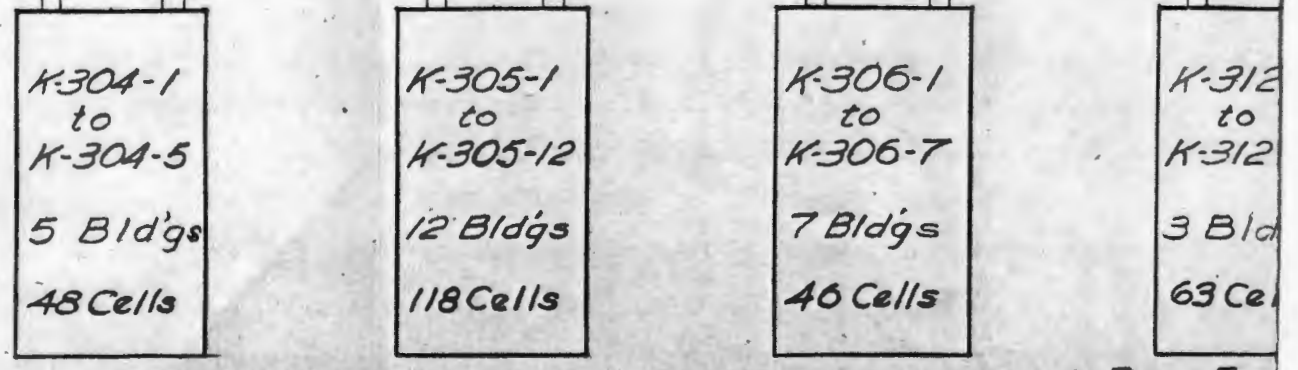
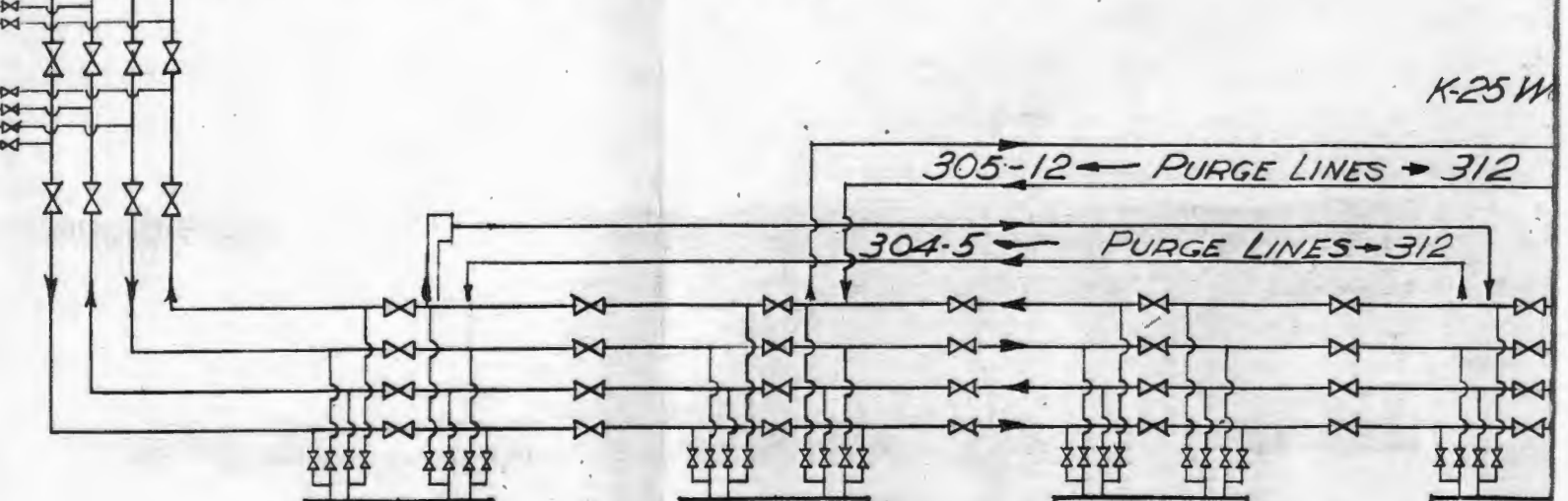
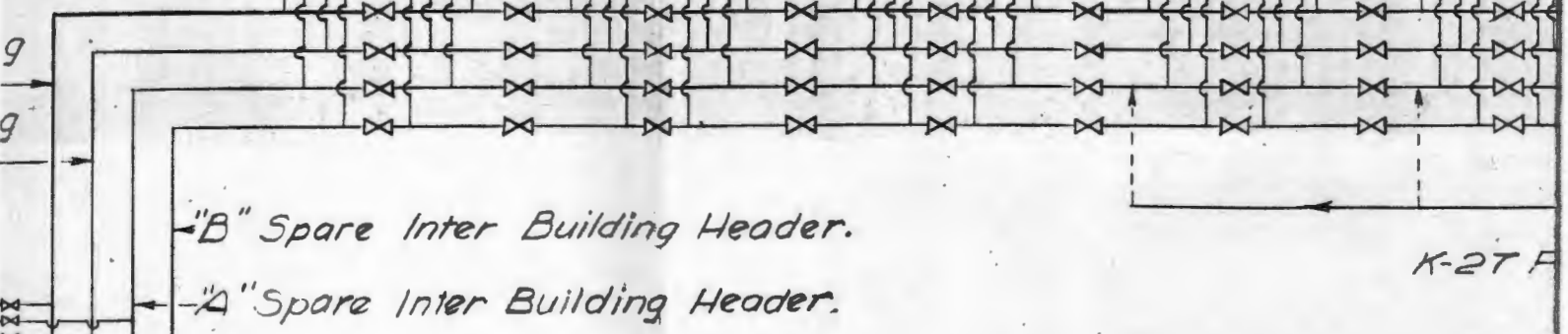
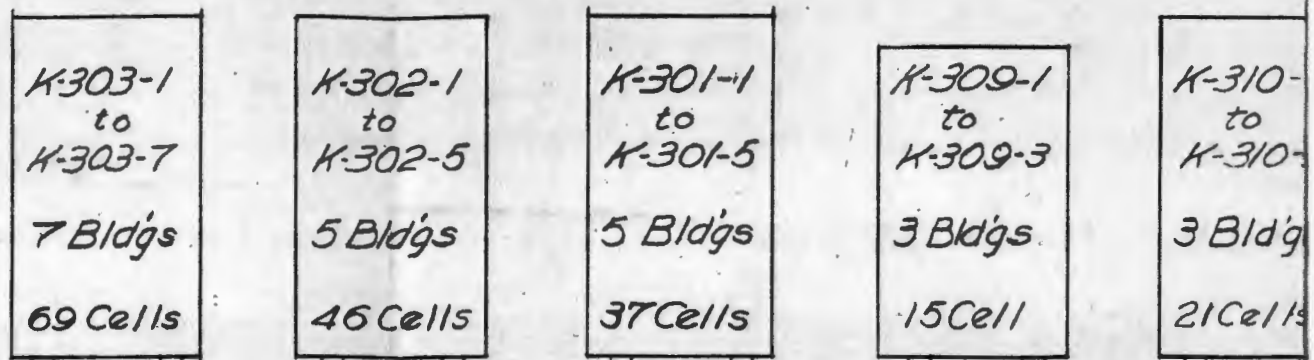

27 Areas

Raw Fee

~~CONFIDENTIAL/RD~~

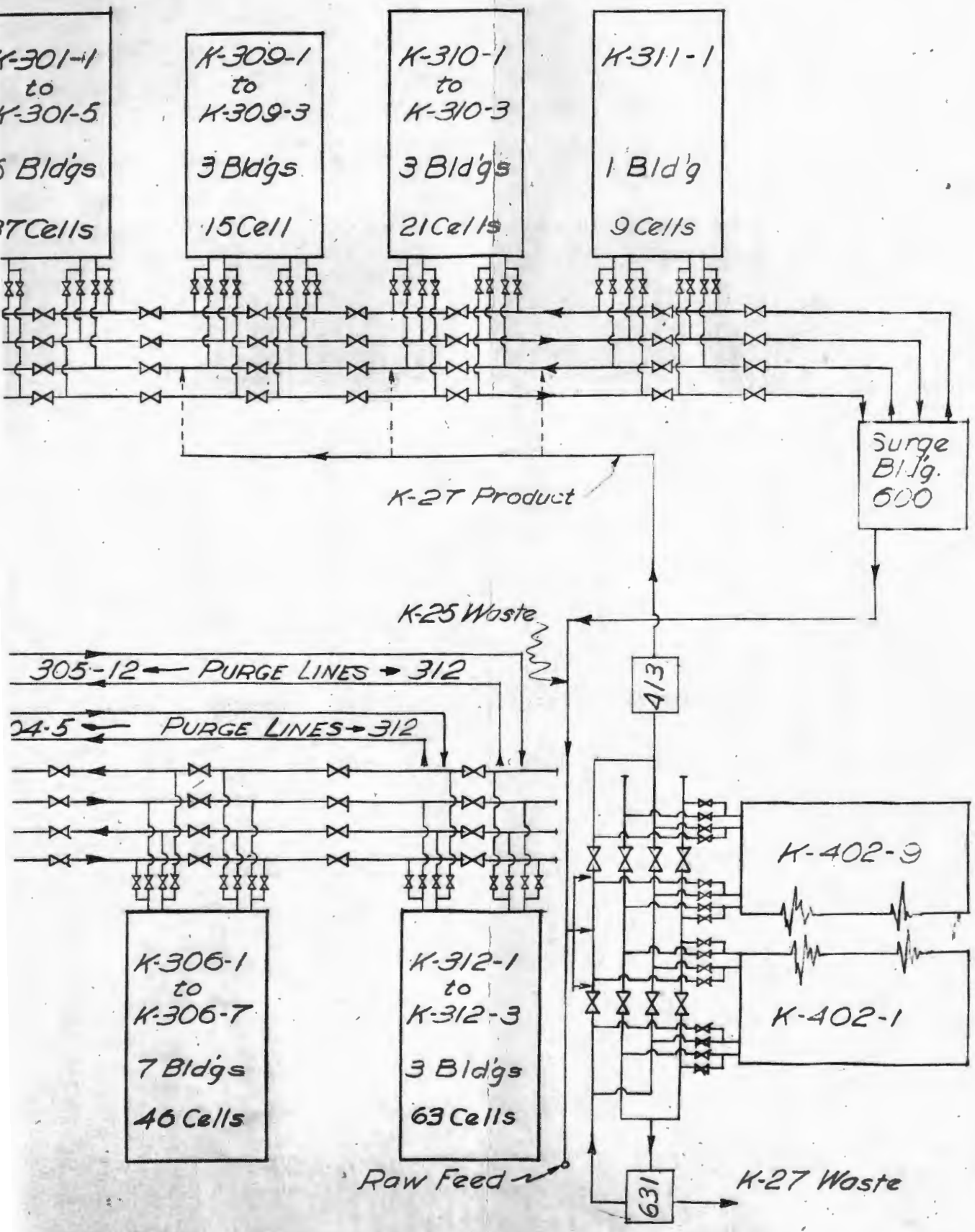

~~CONFIDENTIAL/RD~~

~~CONFIDENTIAL~~

43

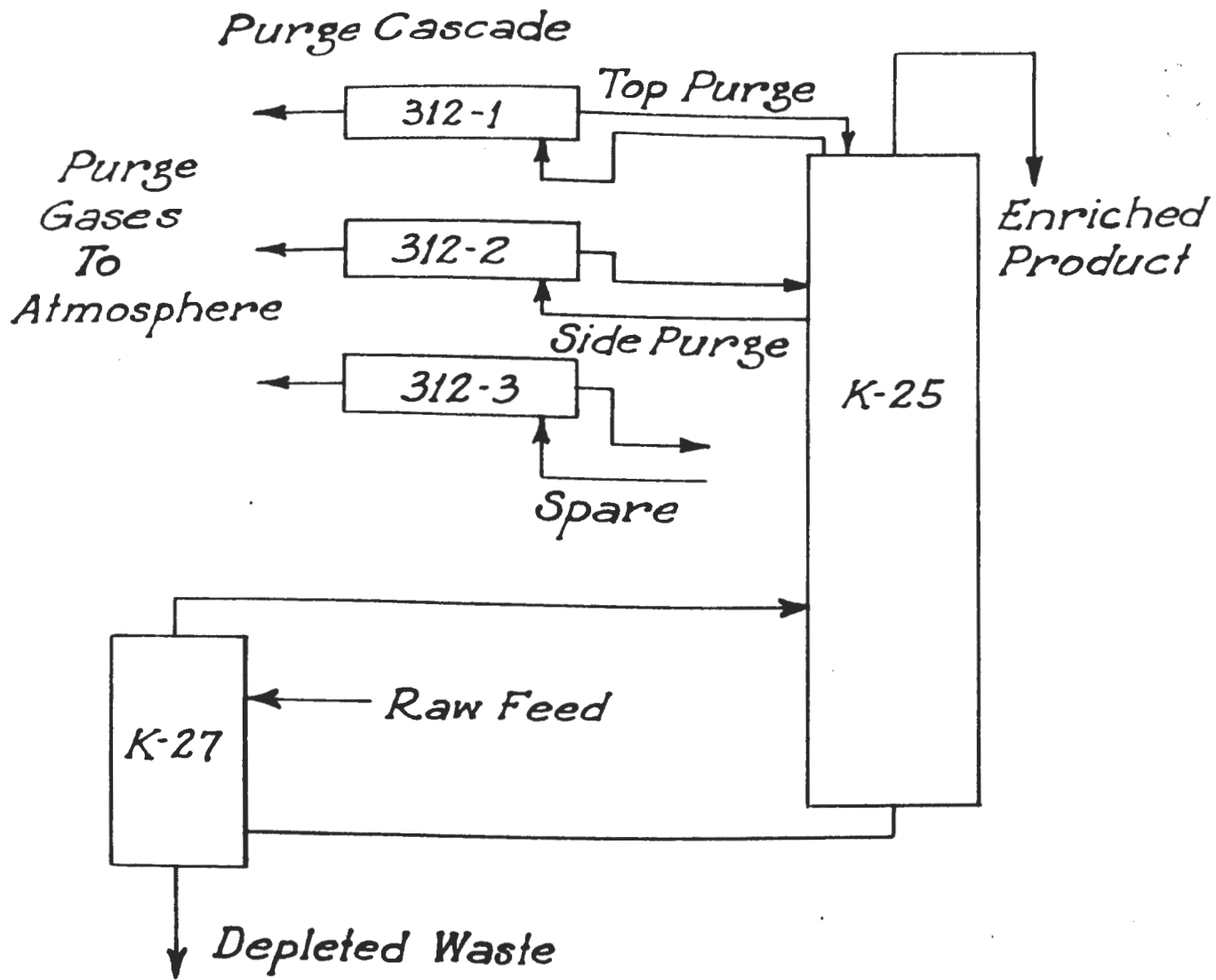

Cascade of Cascades

~~CONFIDENTIAL~~

URANIUM PRODUCTION FLOW DIAGRAM

LEGEND

—— MAIN FLOW
 - - - - - SCRAP AND BYPRODUCTS

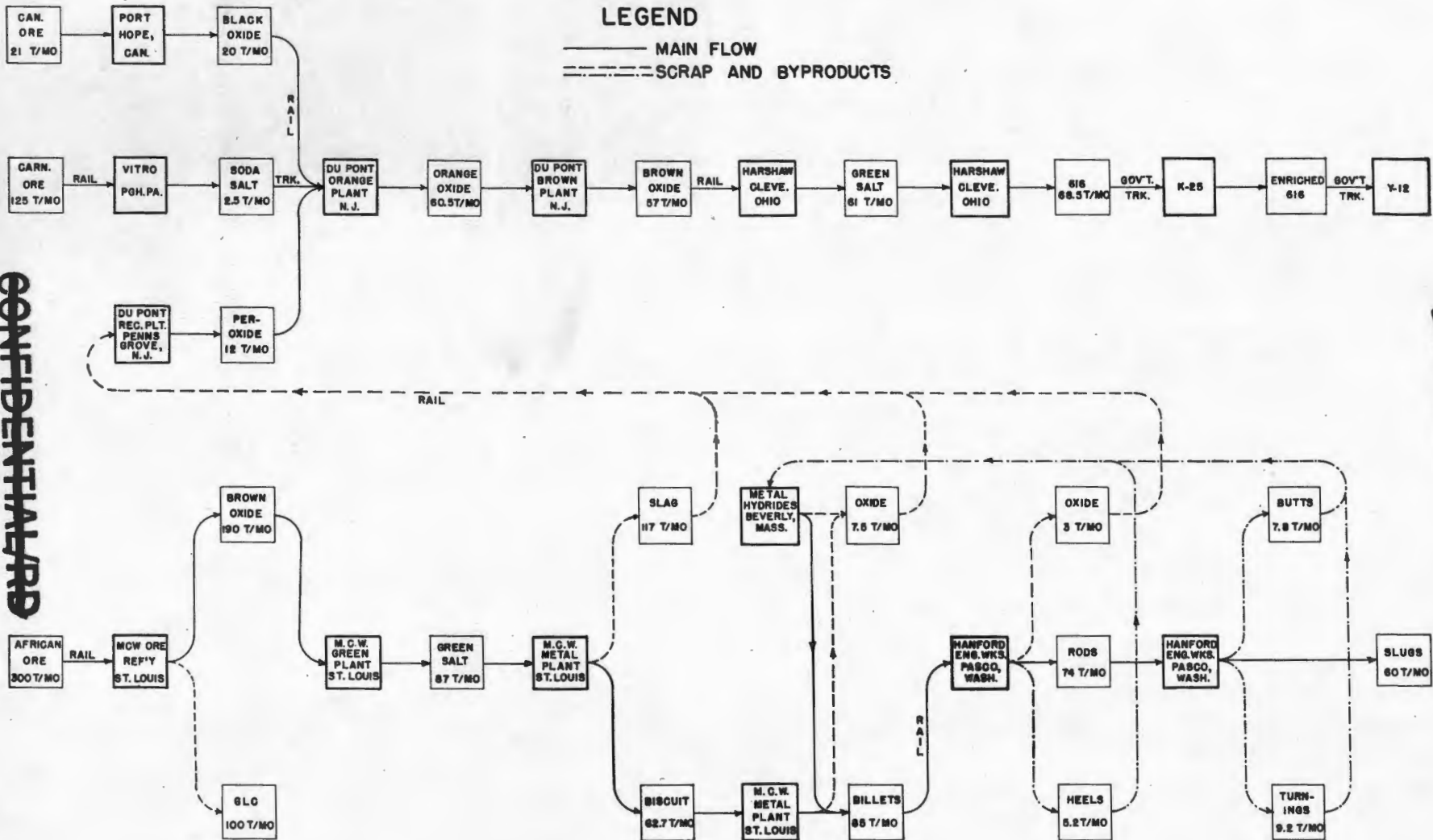

~~SECRET~~

CONFIDENTIAL/RD

CONFIDENTIAL/RD

MANHATTAN DISTRICT HISTORY

BOOK II - GASEOUS DIFFUSION (K-25) PROJECT

VOLUME 5 - OPERATION

APPENDIX "B"

CHARTS AND GRAPHS

<u>No.</u>	<u>Title</u>
1.	Vacuum Testing Operations and Progress Chart for K-25.
2.	Vacuum Testing Operations and Progress Chart for K-27.
3.	Diffusion Stages and Stage Pumps Conditioned.
4.	Cells of Separating Cascade On Stream.
5.	Cell Stream Efficiency.
6.	Status of Plugging in the K-25 and K-27 Converters.
7.	Laboratory Alpha and Fission Count Analyses and Mass Spectrometer Analyses per Week.
8.	Cooling Water Recirculation.
9.	Plant Air and Dry Instrument Air Produced.
10.	Dry Ambient Air Produced.
11.	K-25 and K-27 Monthly Power Supply.
12.	Steam Supplied to S-50.
13.	Low Pressure Steam Produced.
14.	Fluorine Produced and Used.
15.	Coolant Inventory and Usage.
16.	Perfluoroheptane and Fluorolubes Used.
17.	Liquid Nitrogen Consumed.
18.	Operating Costs, Carbide and Carbon Chemicals Corporation.

~~SECRET~~

~~CONFIDENTIAL/RD~~

<u>No.</u>	<u>Title</u>
19.	Functional Organisation Chart, Carbide and Carbon Chemicals Corporation, 27 November 1944.
20.	Functional Organisation Chart, Carbide and Carbon Chemicals Corporation, 31 December 1946.
21.	Process Division Organisation Chart, Carbide and Carbon Chemicals Corporation, 31 December 1946.
22.	Operating Organisation Chart, Ford, Bacon, and Davis, Inc., 31 March 1945.
23.	Organisation Chart, Hooker Electrochemical Company, 5 May 1944.
24.	K-25 Plant Personnel Strengths.

~~SECRET~~ ~~CONFIDENTIAL/RD~~

~~SECRET~~

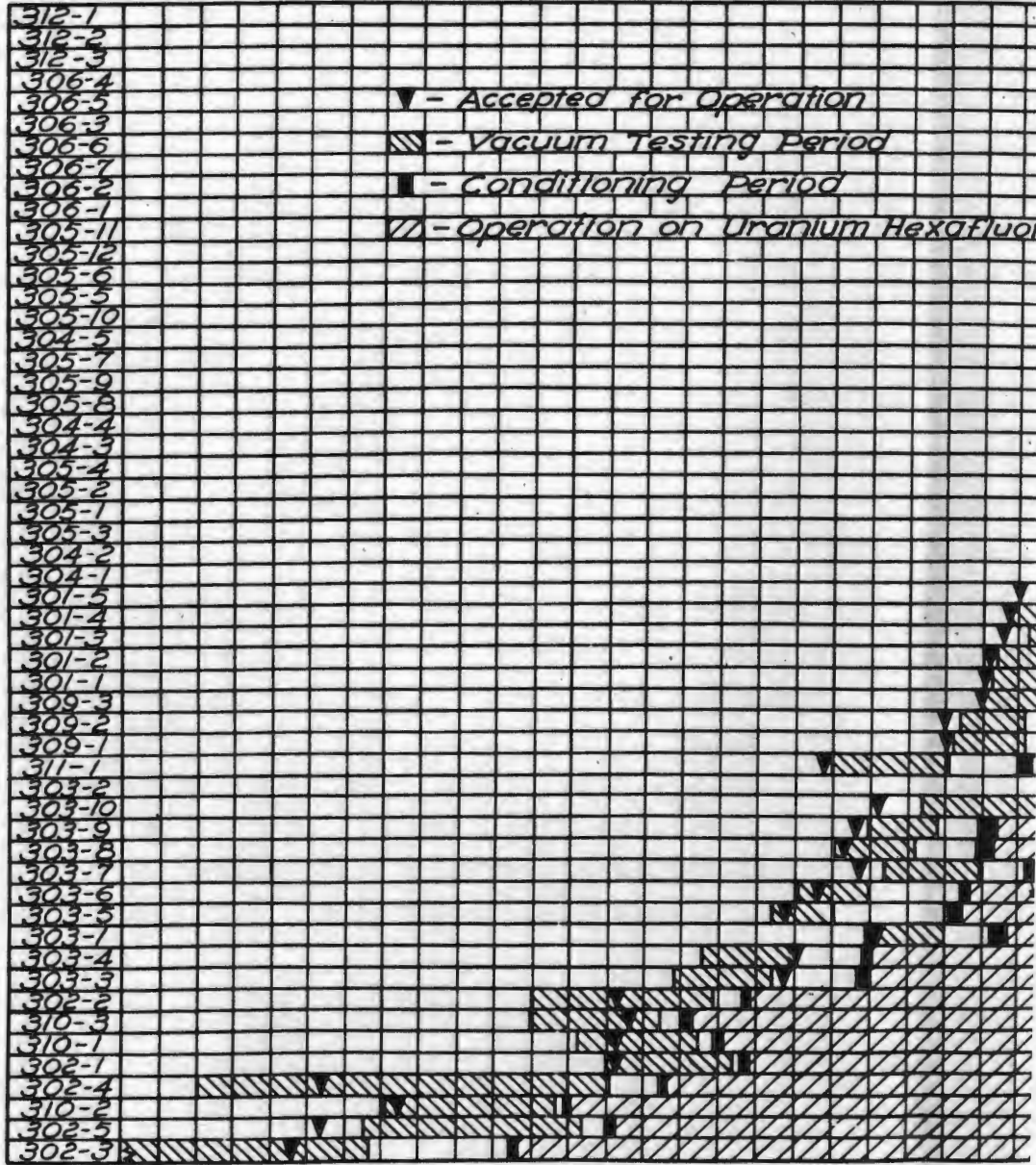

4 11 18 25 1 8 15 22 29 5 12 19 26 5 12 19 26 2 9 16 23 30 7 14
 December January February March April May
 1944 ← | → 1945

VACUUM TESTING OPERATIONS A

FOR K-25

~~SECRET~~

~~CONFIDENTIAL/RD~~

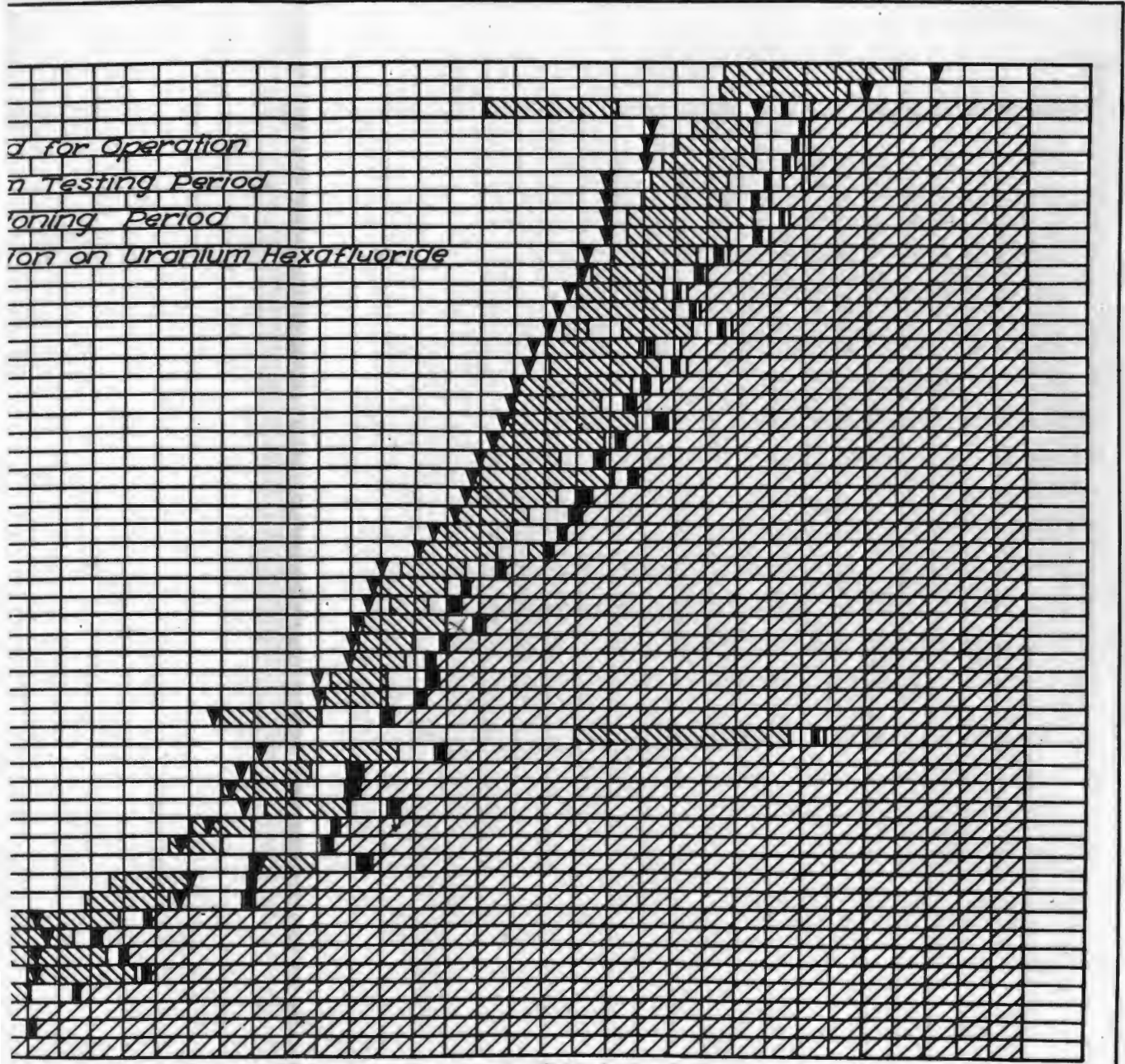

d for Operation
n Testing Period
oning Period
on on Uranium Hexafluoride

26 5 12 19 26 2 9 16 23 30 7 14 21 28 4 11 18 25 2 9 16 23 30 6 13 20 27 3 10 17 24 1
 March April May June July August September

TESTING OPERATIONS AND PROGRESS CHART

FOR K-25

B1
~~SECRET~~

~~CONFIDENTIAL/RD~~

~~SECRET~~

CONFIDENTIAL/RB

VACUUM TESTING OPERATIONS AND PROGRESS CHART FOR K-27

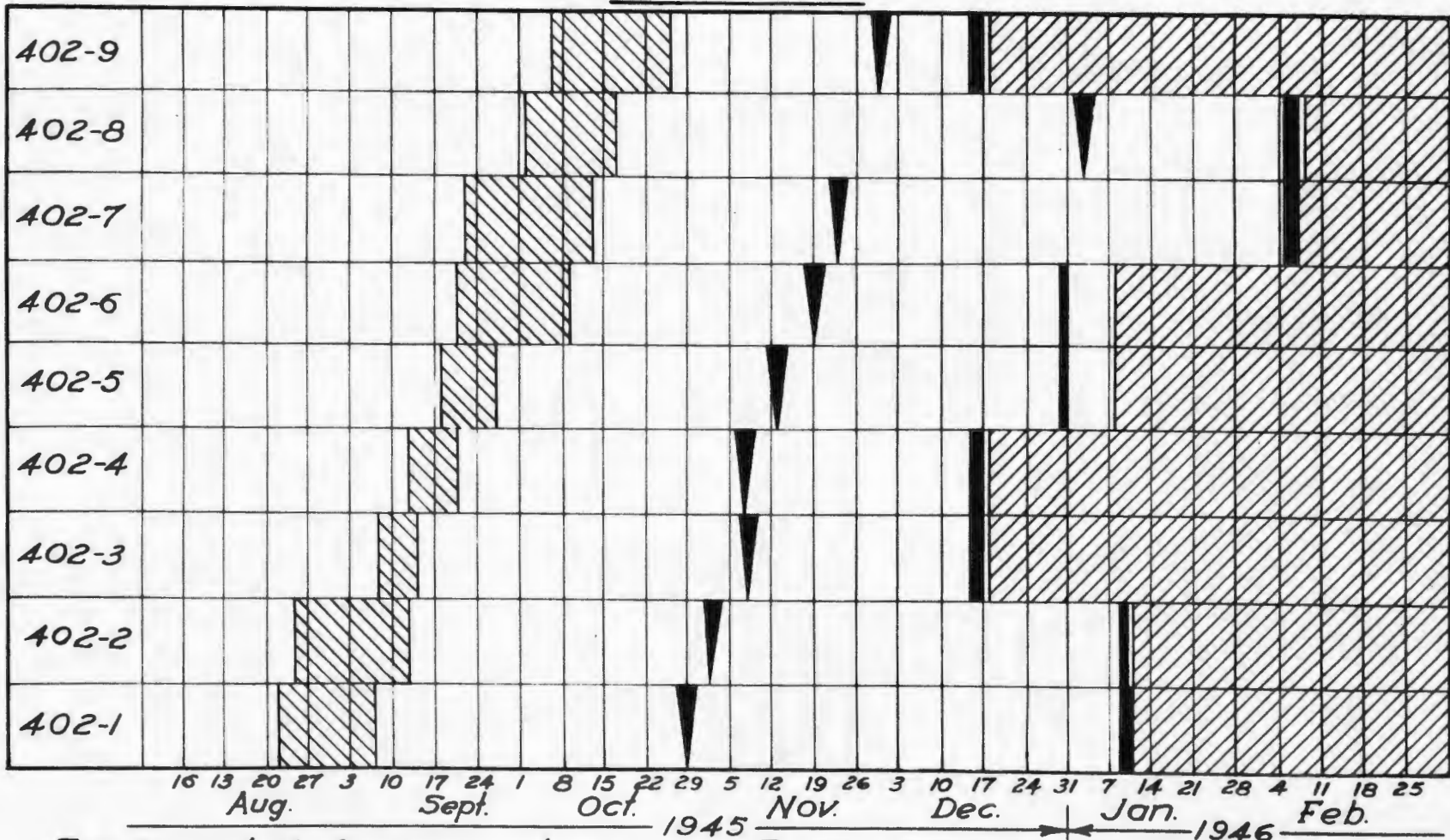

B2

~~SECRET~~

CONFIDENTIAL/RB

▼ - Accepted for operation. ■ - Conditioning period.
 ▨ - Vacuum testing period. ▩ - Operation on Uranium hexafluoride.

~~SECRET~~

DIFFUSION STAGES & STAGE PUMPS CONDITIONED

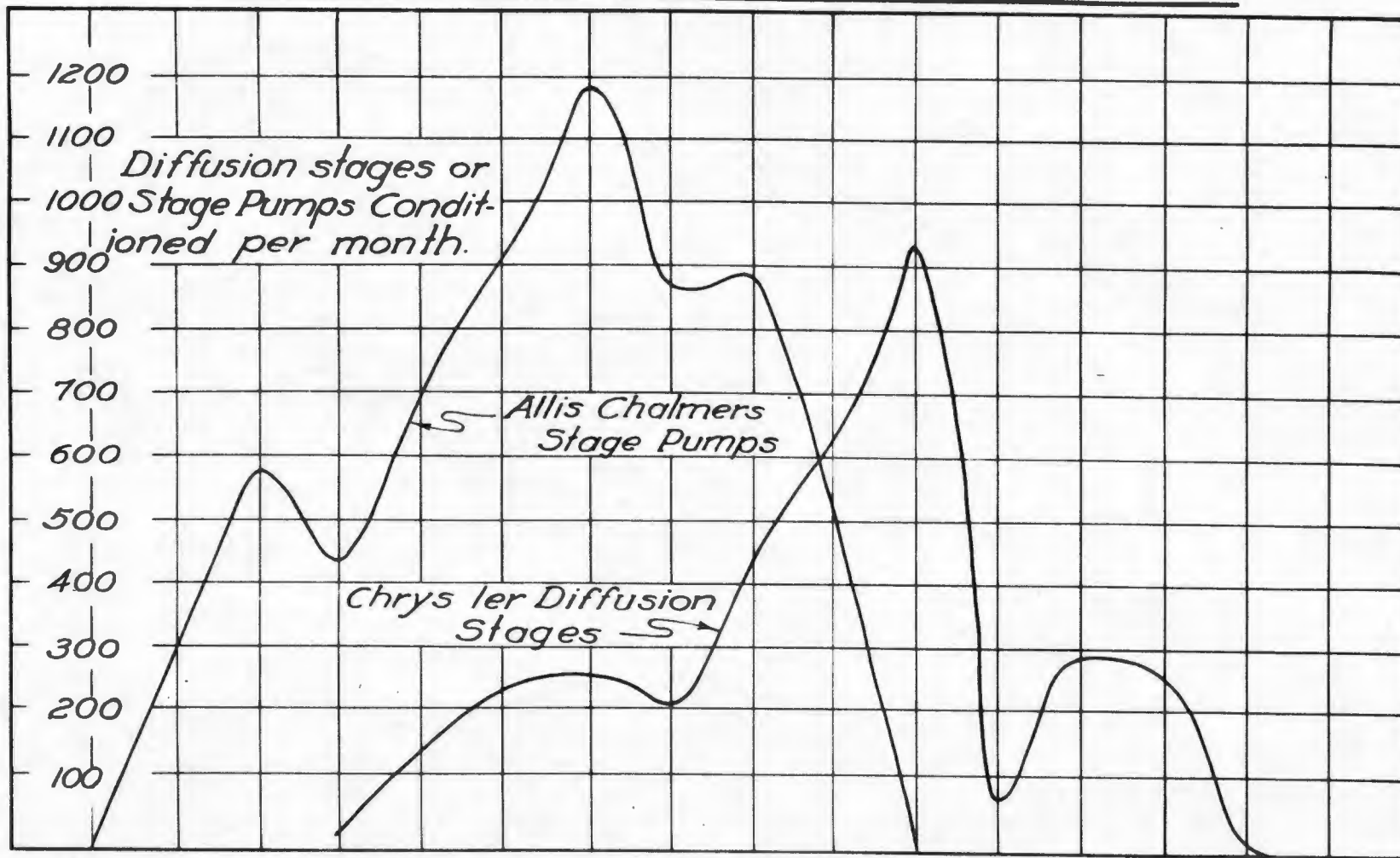

July Aug. Sept. Oct. Nov. Dec. Jan. Feb. Mar. Apr. May June July Aug. Sept. Oct. Nov.
1944 1945

~~CONFIDENTIAL~~

~~SECRET~~

~~SECRET~~

~~CONFIDENTIAL~~

B3

~~SECRET~~

CELLS OF SEPARATING CASCADE ON STREAM

~~CONFIDENTIAL~~

~~SECRET~~

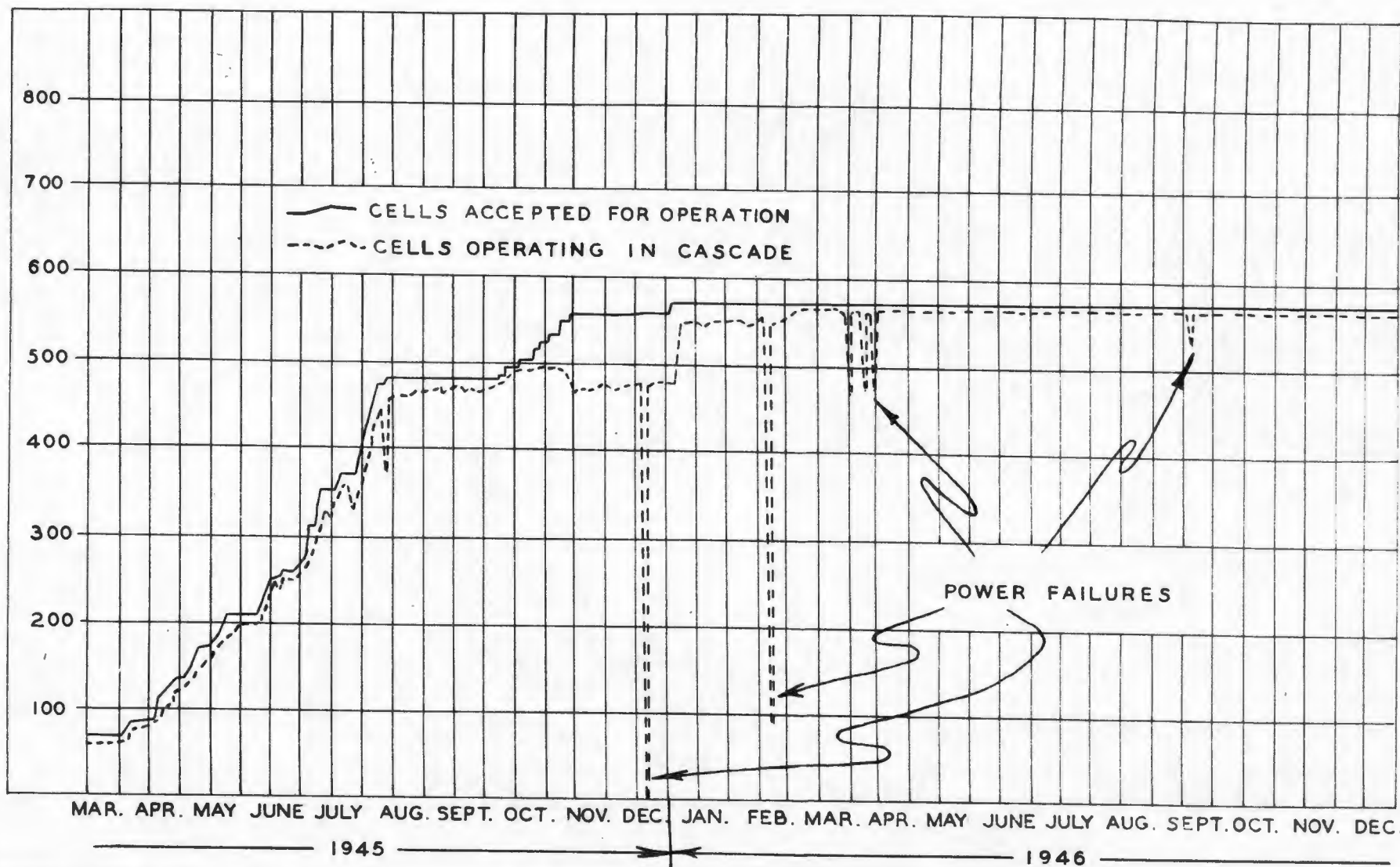

~~SECRET~~
~~CONFIDENTIAL~~

CELL STREAM EFFICIENCY

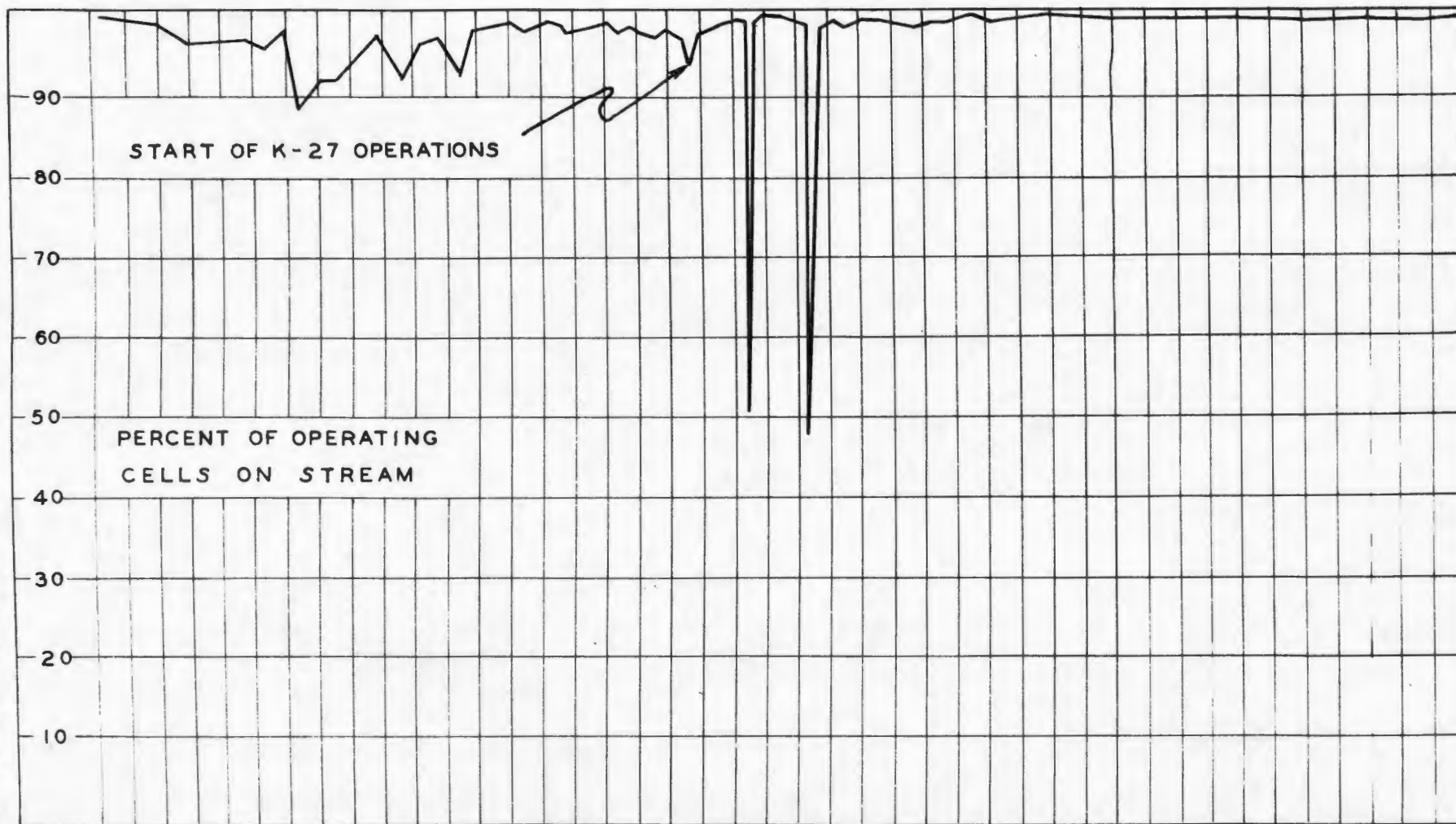

B5

~~CONFIDENTIAL~~
CONFIDENTIAL

~~CONFIDENTIAL~~
CONFIDENTIAL

APR MAY JUNE JULY AUG SEPT OCT NOV DEC | JAN FEB MAR APR MAY JUNE JULY AUG SEPT OCT NOV DEC
1945 | 1946

~~CONFIDENTIAL/RR~~

PROCESS DIVISION

STATUS OF PLUGGING IN THE
K-25 AND K-27 CONVERTERS

DELETED

DELETED

DELETED

DELETED

DELETED

DELETED

~~SECRET~~
~~CONFIDENTIAL/RR~~

DOE b(3)

DIVISION

~~CONFIDENTIAL/RD~~

GGING IN THE
CONVERTERS

DELETED

DELETED

DELETED

DELETED

DELETED

DELETED

~~CONFIDENTIAL/RD~~

~~CONFIDENTIAL/RO~~

~~CONFIDENTIAL/SECRET~~

LABORATORY ALPHA AND FISSION
AND MASS SPECTROMETER ANALY

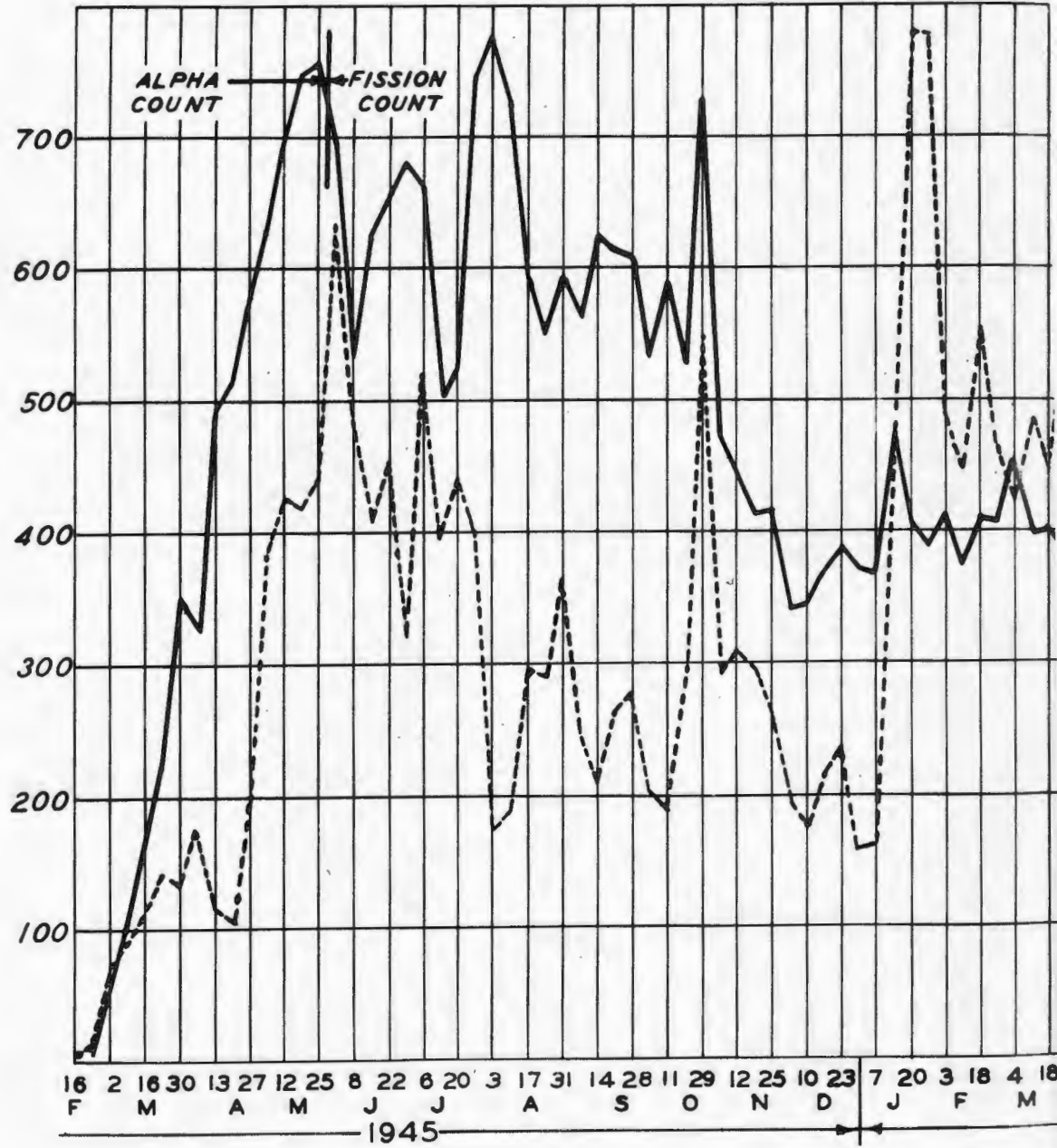

CONTINUOUS LINE: PLANT SAMPLES ALPHA OR FISSION
 BROKEN LINE: PLANT SAMPLES ANALYZED ON MASS
 PLANT SAMPLES INCLUDE ENGINEERING TEST SAMPLES.

~~CONFIDENTIAL/RD~~

LABORATORY ALPHA AND FISSION COUNT ANALYSES
AND MASS SPECTROMETER ANALYSES PER WEEK

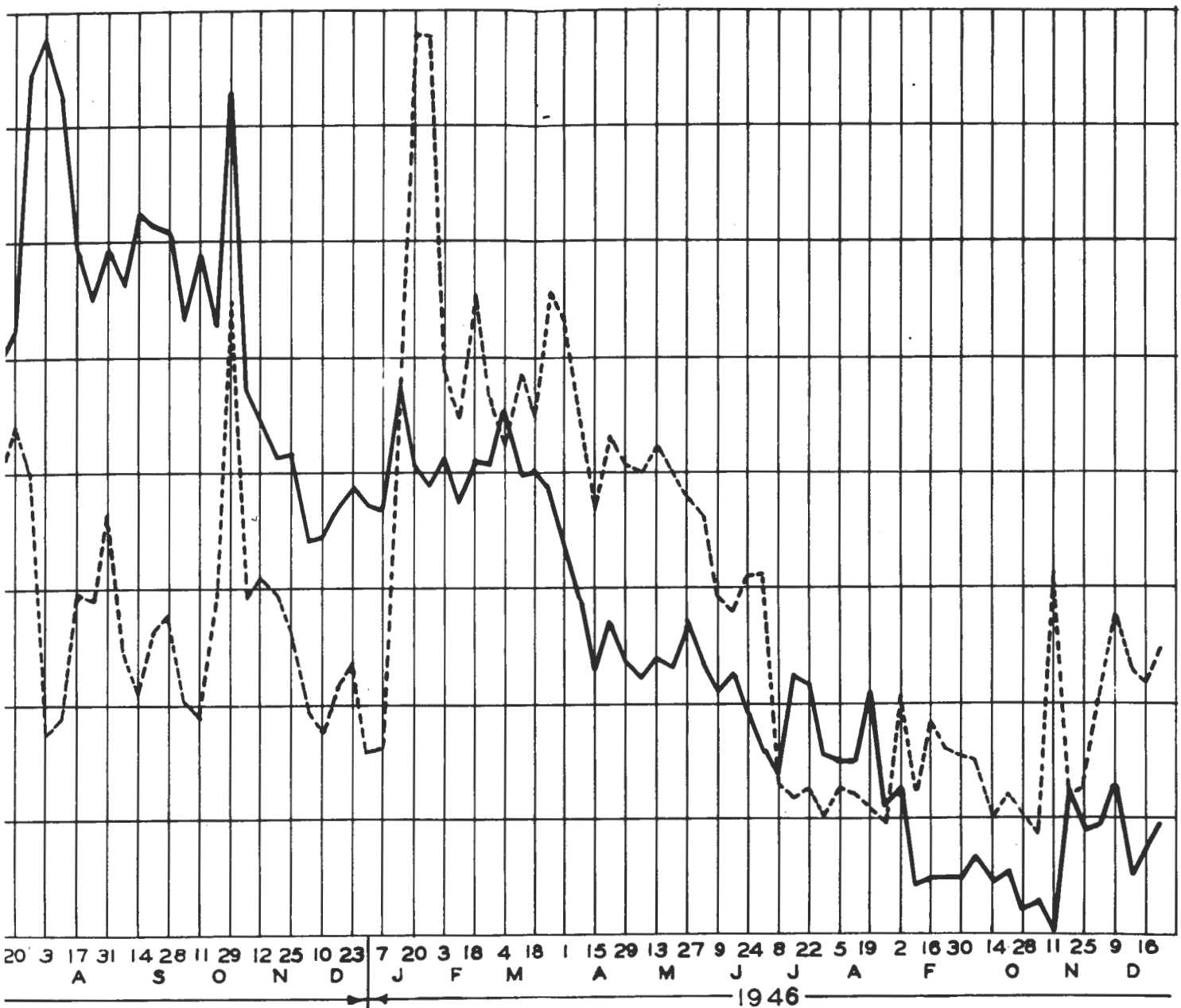

NUMBER OF LABORATORY ALPHA OR FISSION COUNTS PER WEEK.
 NUMBER OF LABORATORY SAMPLES ANALYZED ON MASS SPECTROMETER PER WEEK.
 INCLUDES ENGINEERING TEST SAMPLES.

B7
~~SECRET~~

~~CONFIDENTIAL/RD~~

COOLING WATER RECIRCULATION

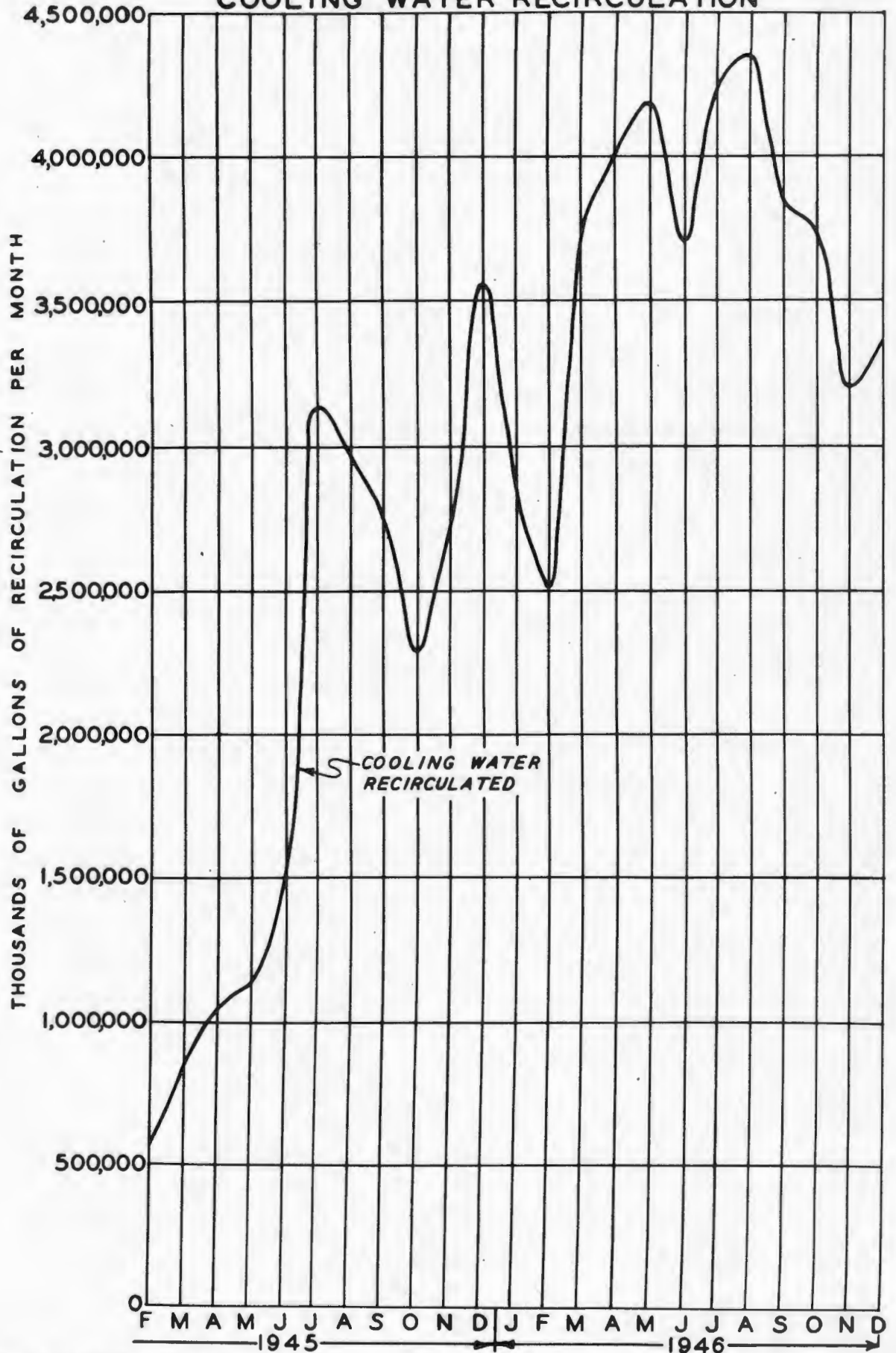

~~CONFIDENTIAL/RB~~

PLANT AIR

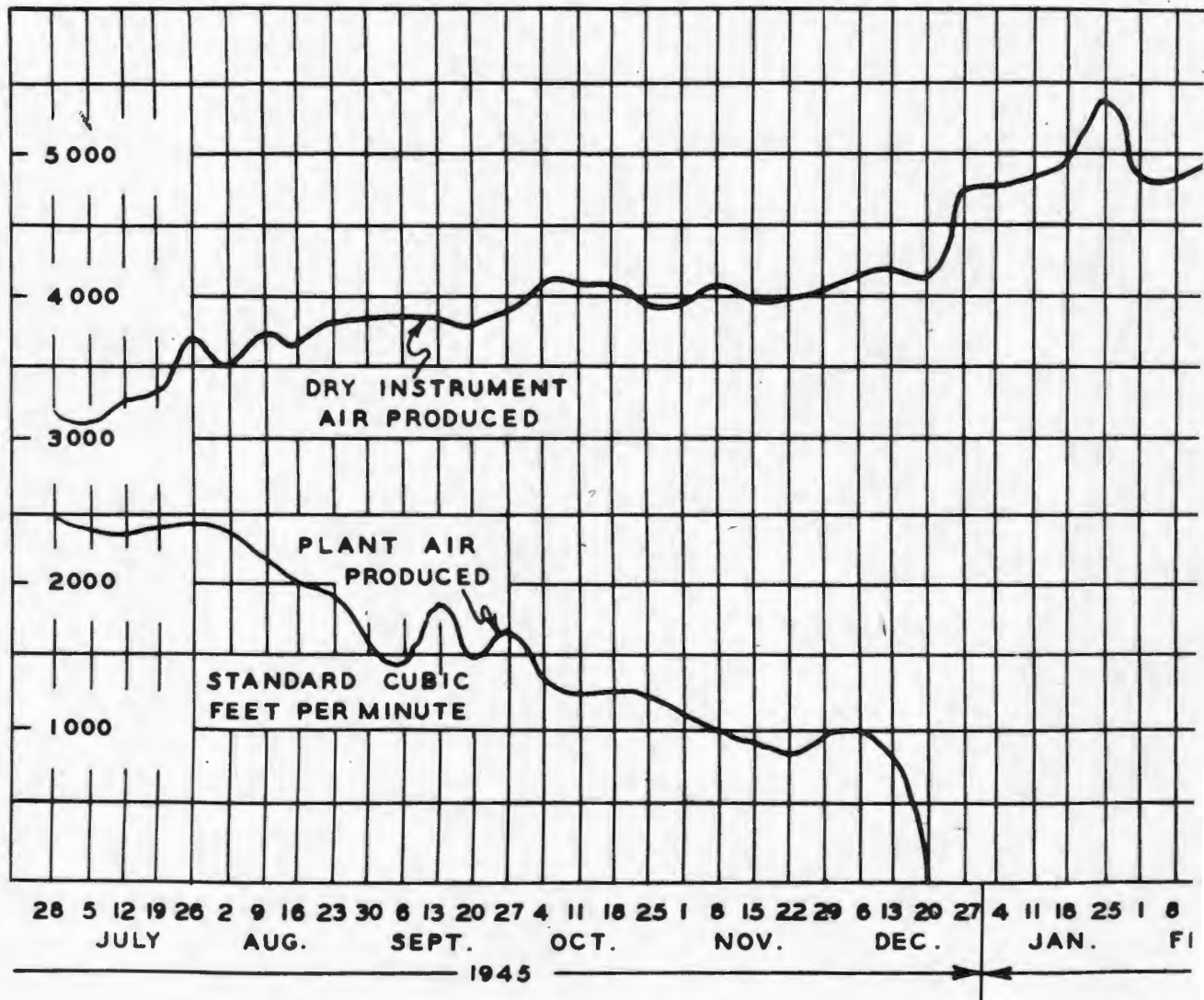

~~CONFIDENTIAL/RB~~

~~CONFIDENTIAL/RD~~

~~SECRET~~

B9-2

PLANT AIR & DRY INSTRUMENT AIR PRODUCED

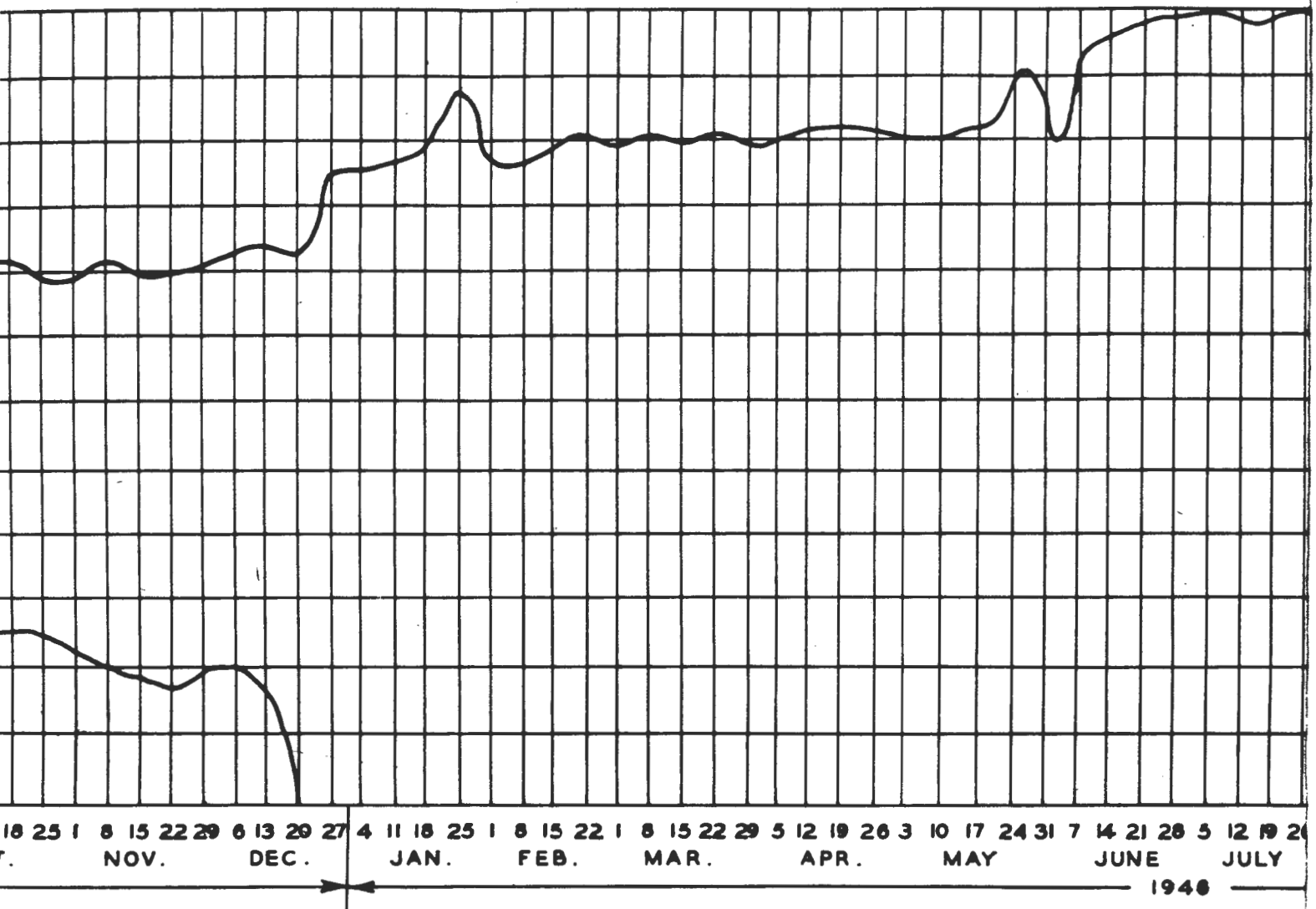

B9

~~SECRET~~

~~CONFIDENTIAL/RD~~

B9-3

~~CONFIDENTIAL/RD~~

TRUMENT AIR PRODUCED

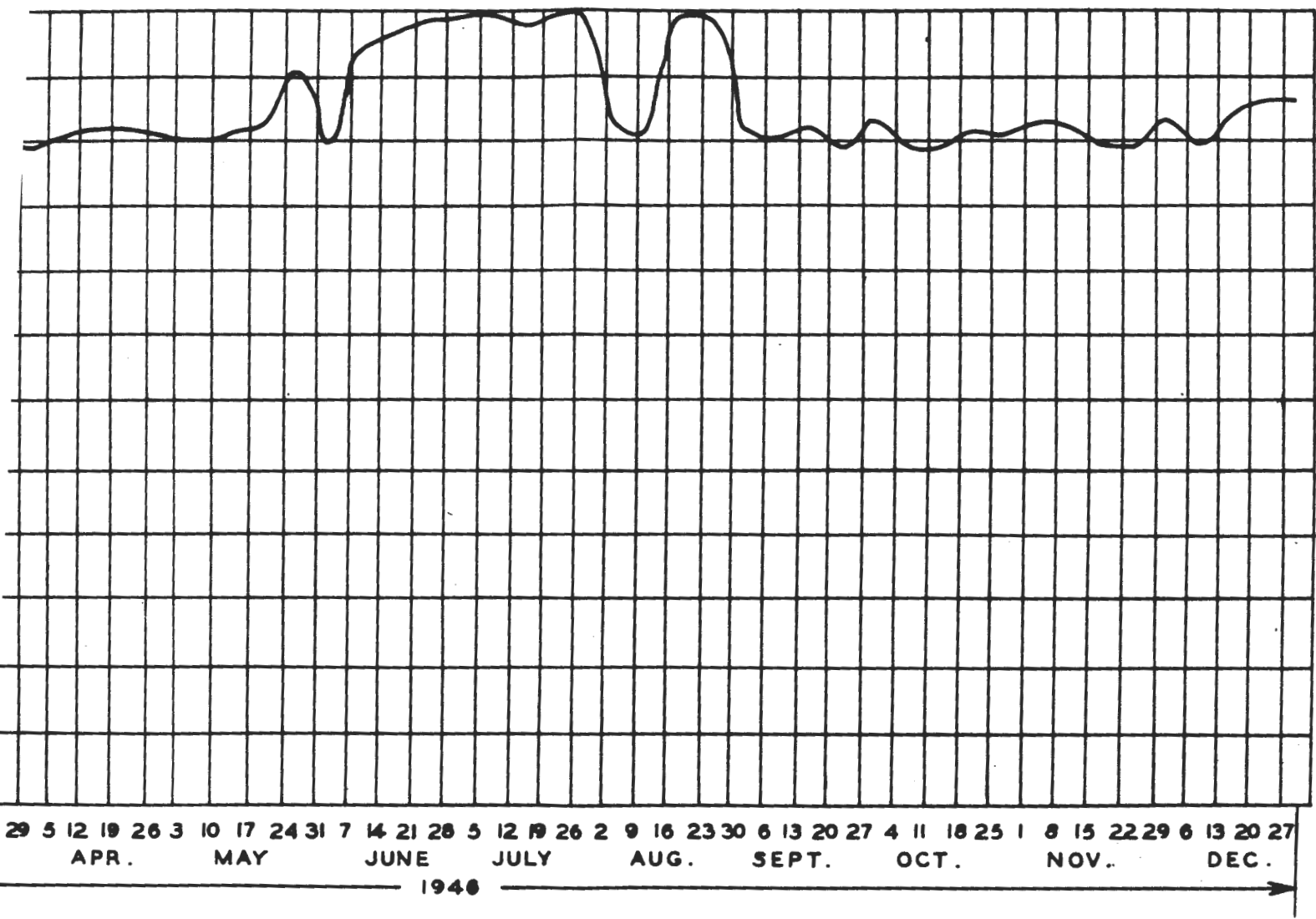

~~CONFIDENTIAL/RD~~

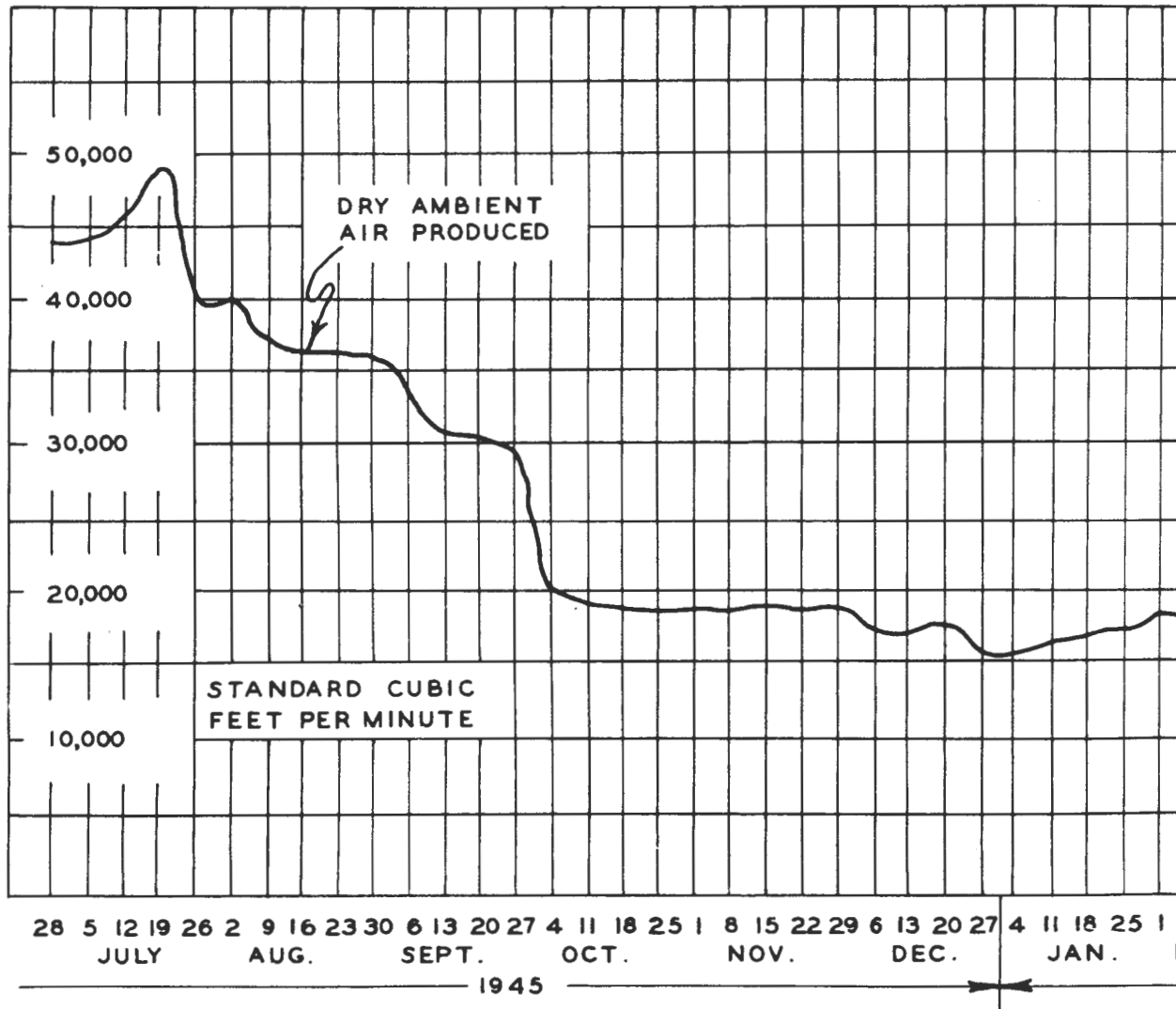

~~CONFIDENTIAL/RD~~

~~SECRET~~

B10-2

DRY AMBIENT AIR PRODUCED

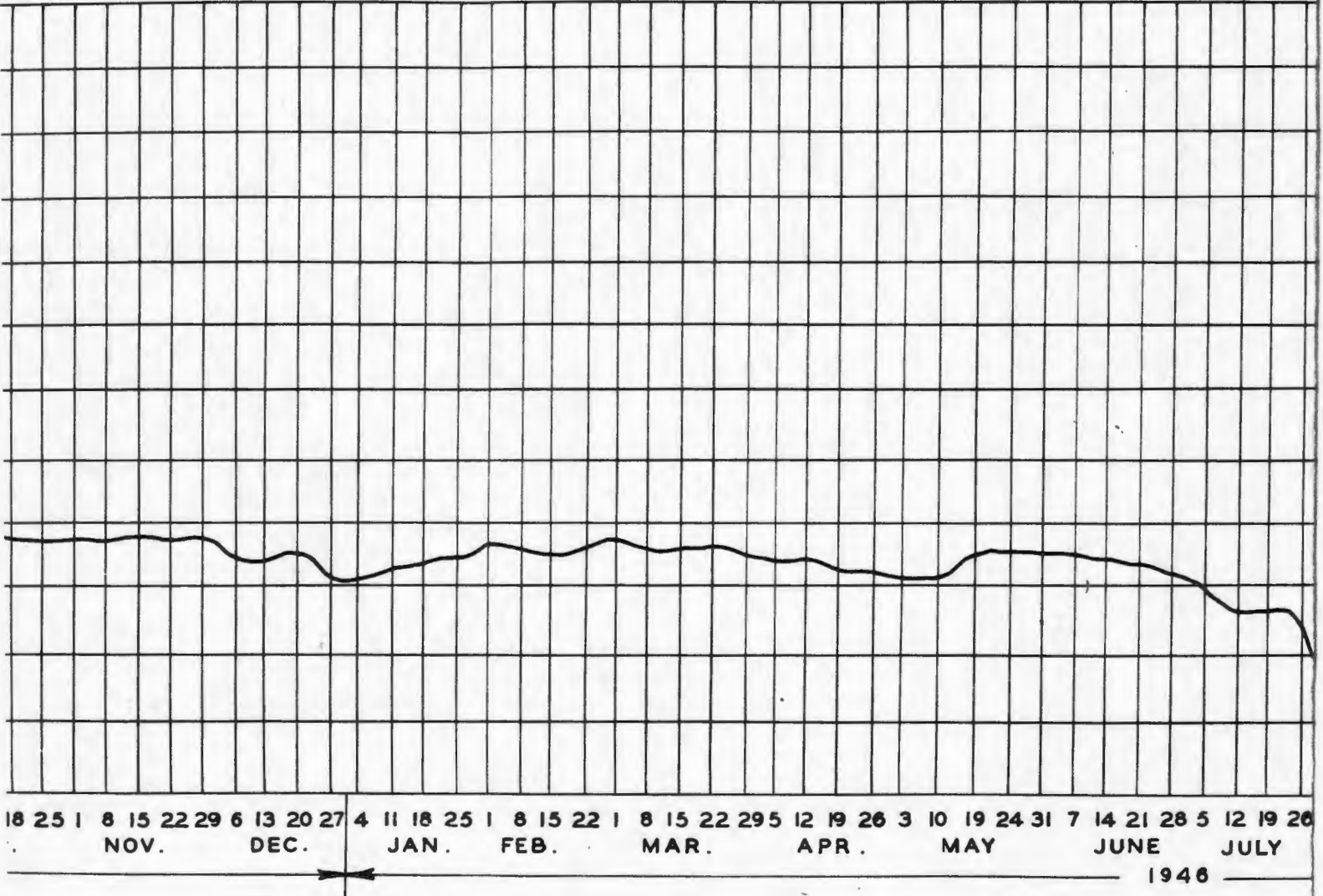

B10

~~SECRET~~

~~CONFIDENTIAL/RD~~

~~CONFIDENTIAL/RD~~

B10-3

R PRODUCED

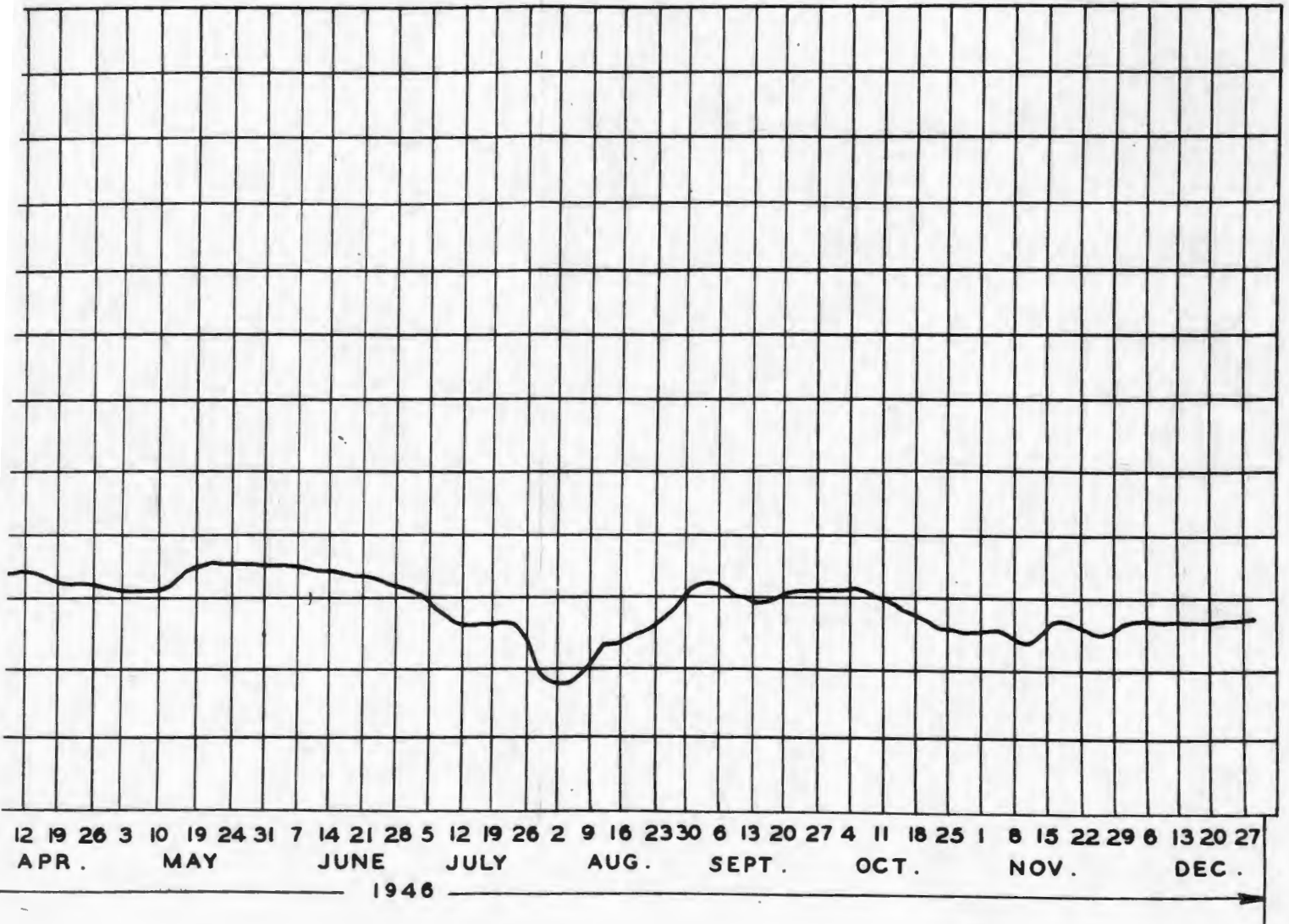

ET

~~CONFIDENTIAL/RD~~

K-25 & K-27 MONTHLY POWER SUPPLY

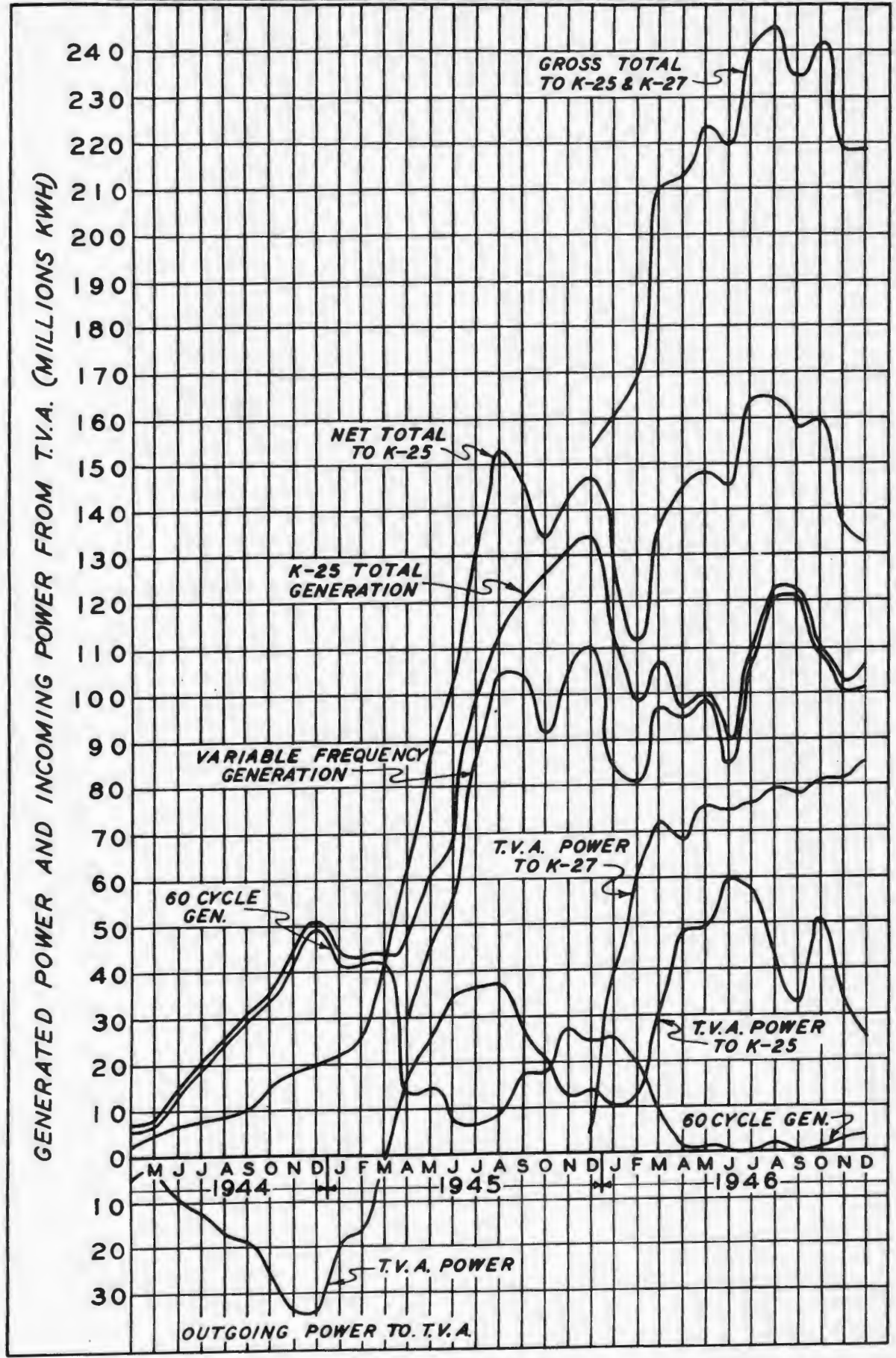

~~SECRET~~

~~SECRET~~

~~CONFIDENTIAL/RD~~

STEAM SUPPLIED TO S-50

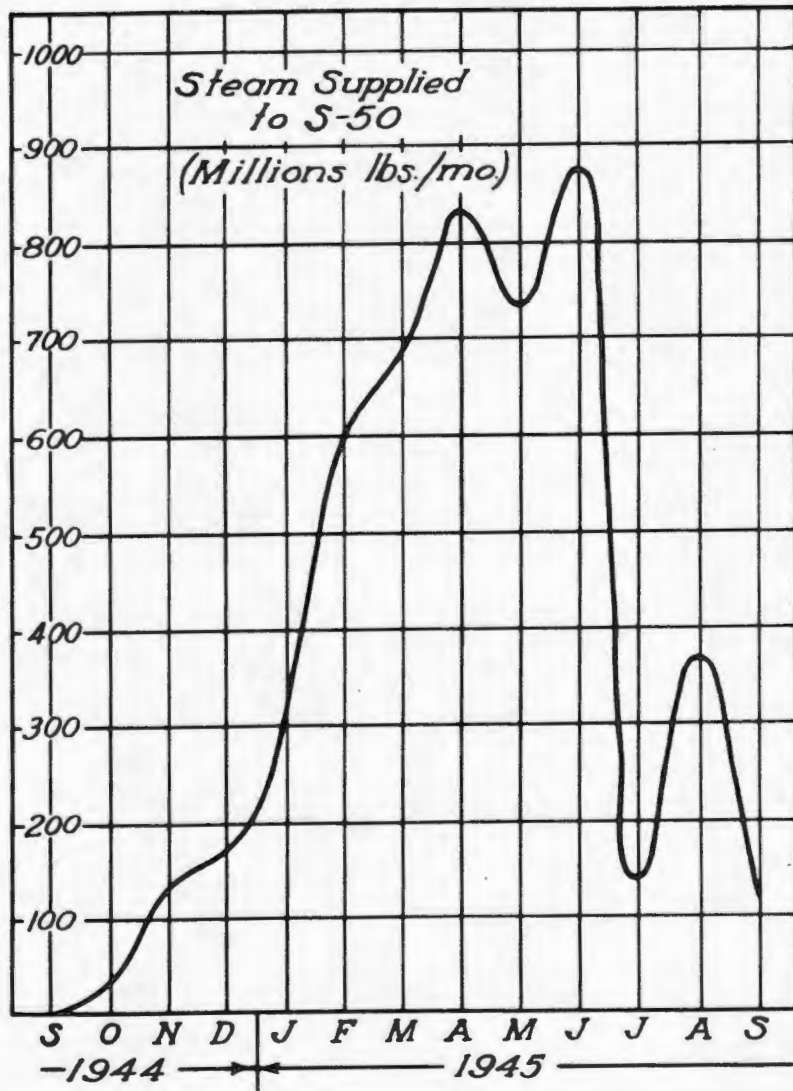

Steam to S-50
discontinued 9/10/45

B12

~~CONFIDENTIAL/RD~~

~~SECRET~~

~~SECRET~~

~~SECRET~~

~~CONFIDENTIAL/RD~~

LOW PRESSURE STEAM PRODUCED

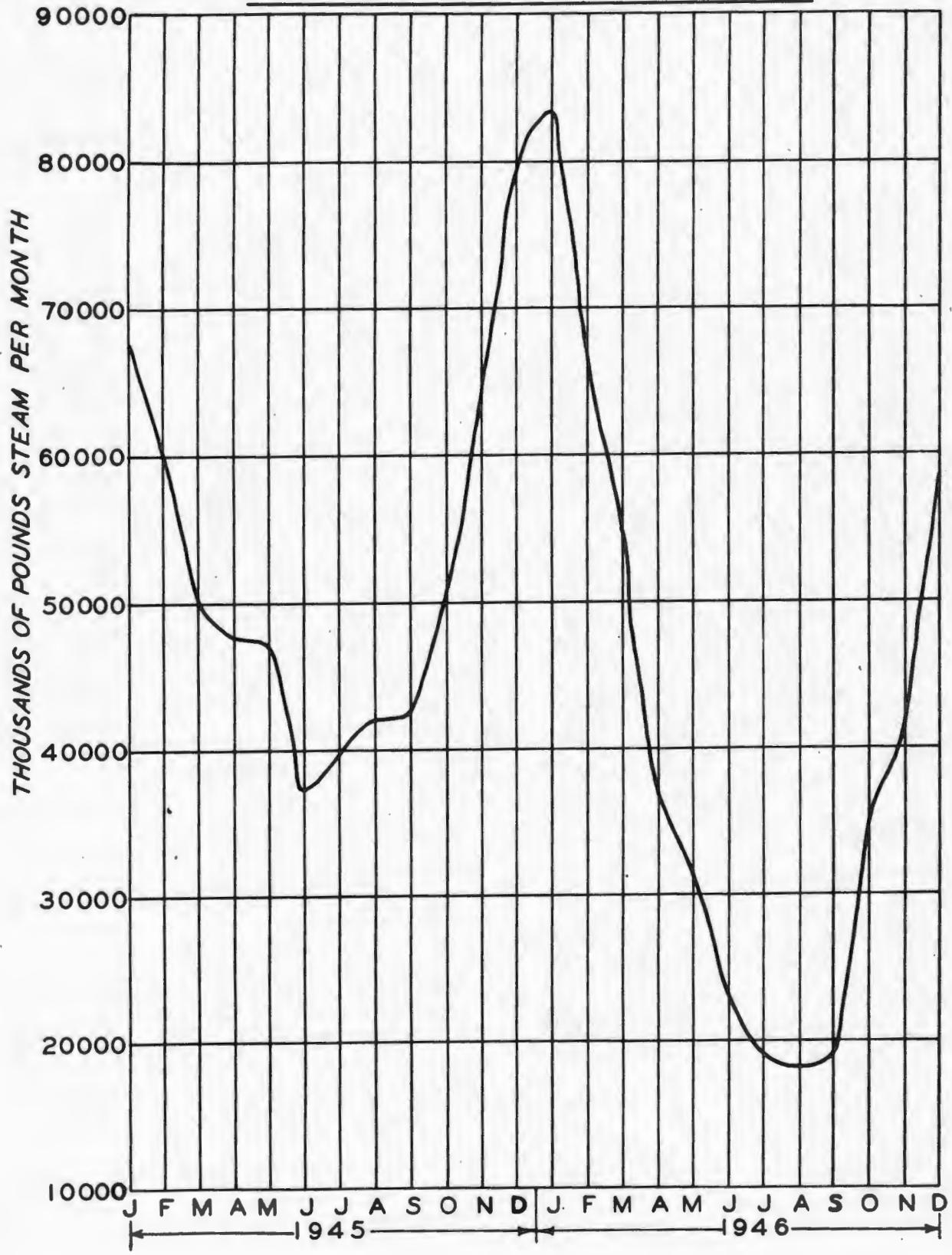

B13

~~SECRET~~

~~CONFIDENTIAL/RD~~

FLUORINE PRODUCED AND USED

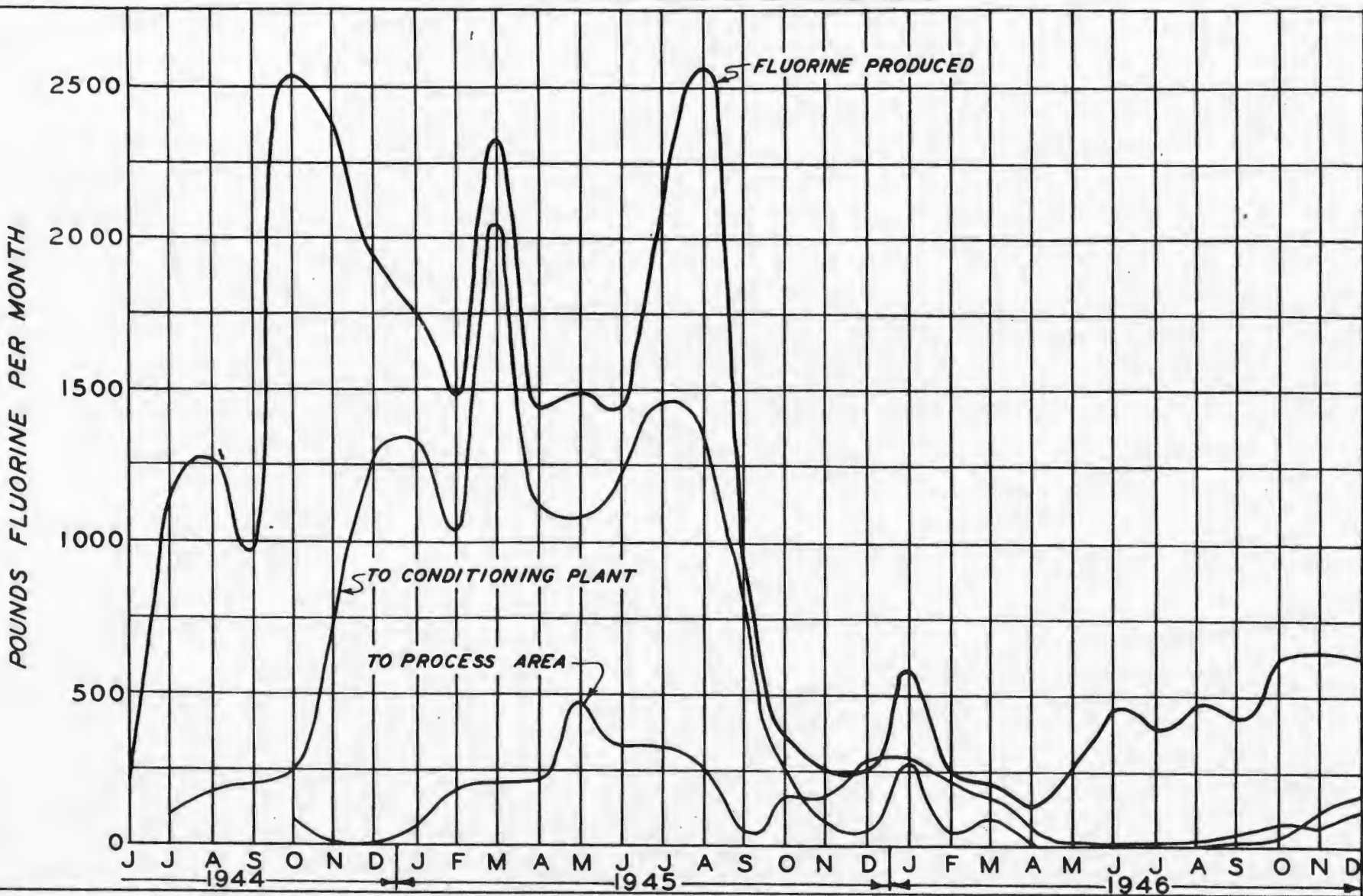

B14 ~~SECRET~~ CONFIDENTIAL/RD

CONFIDENTIAL/RD ~~SECRET~~

COOLANT INVENTORY AND USAGE

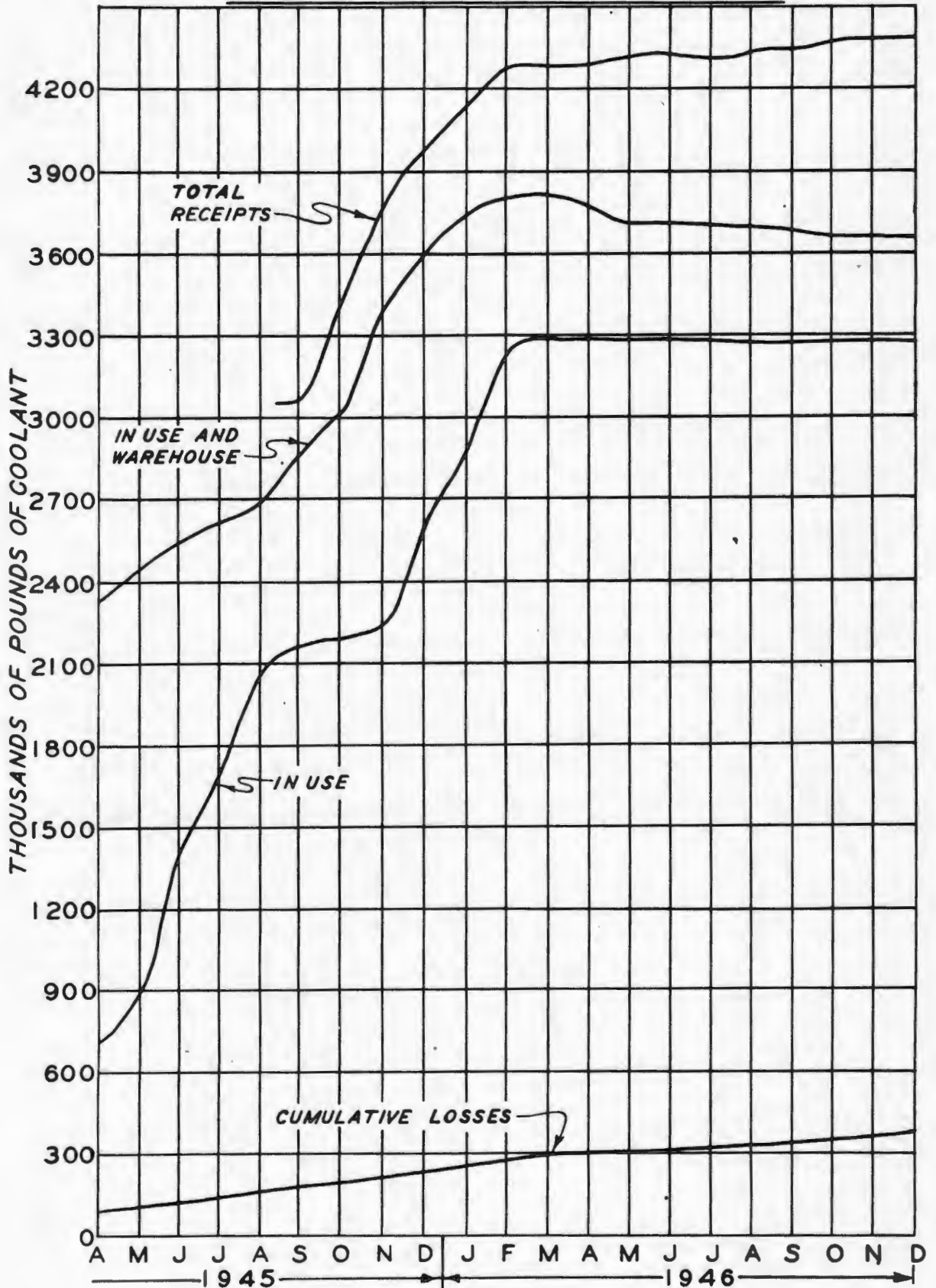

PERFLUOROHEPTANE AND FLUOROLUBES USED

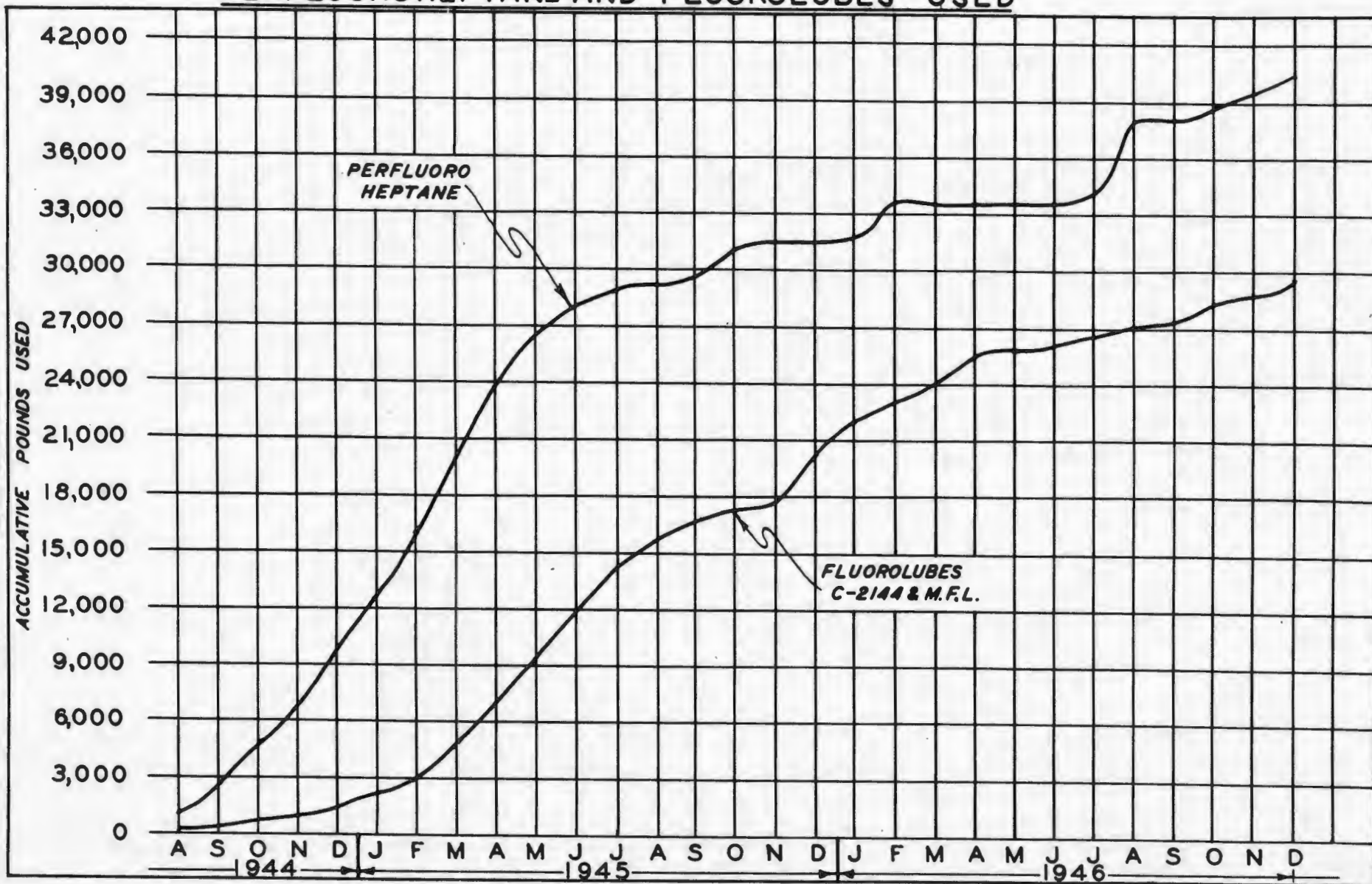

FIG

CONFIDENTIAL/RD

CONFIDENTIAL/RD

~~CONFIDENTIAL~~ B17 ~~SECRET~~

~~SECRET~~ ~~CONFIDENTIAL~~

LIQUID NITROGEN CONSUMED

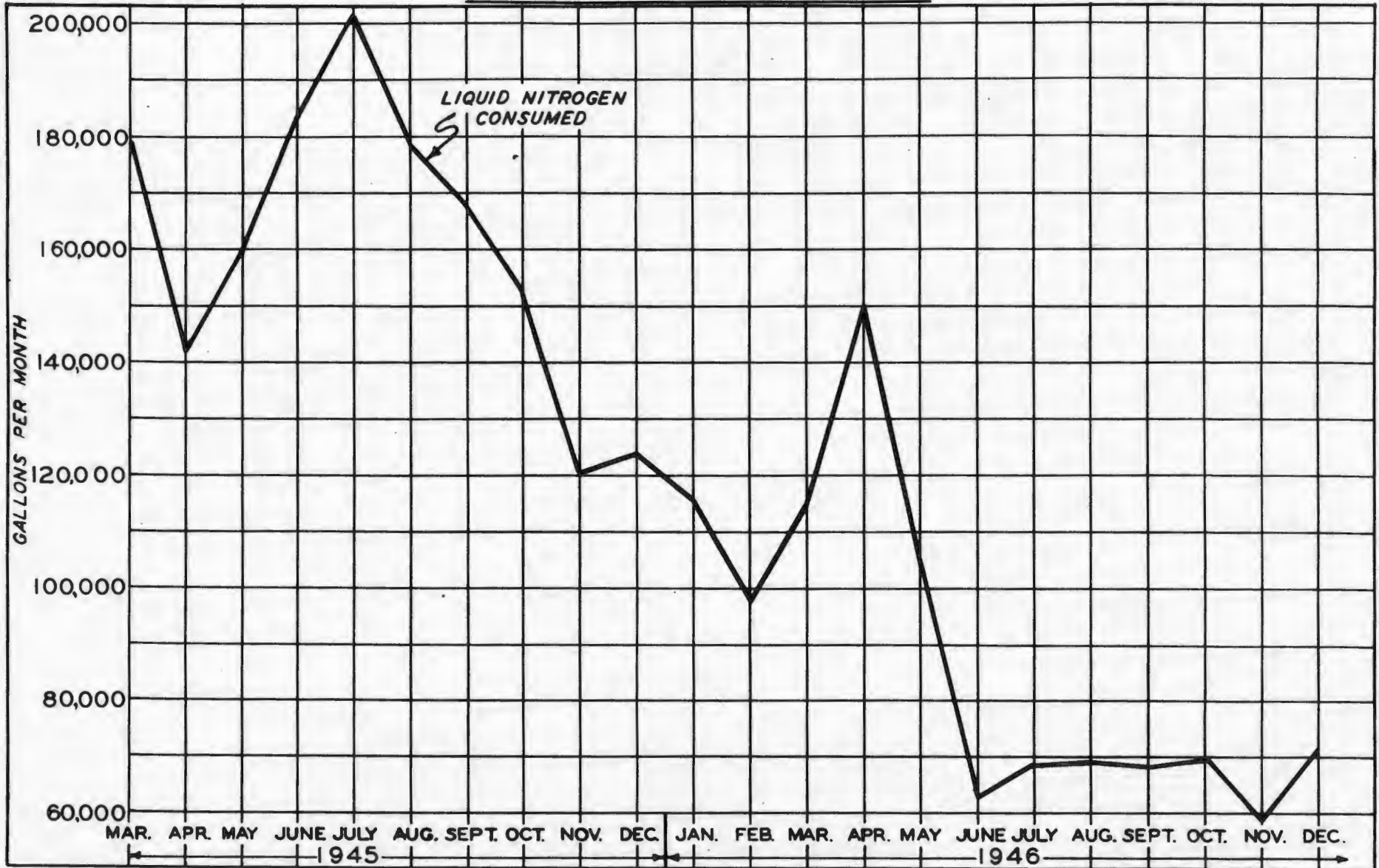

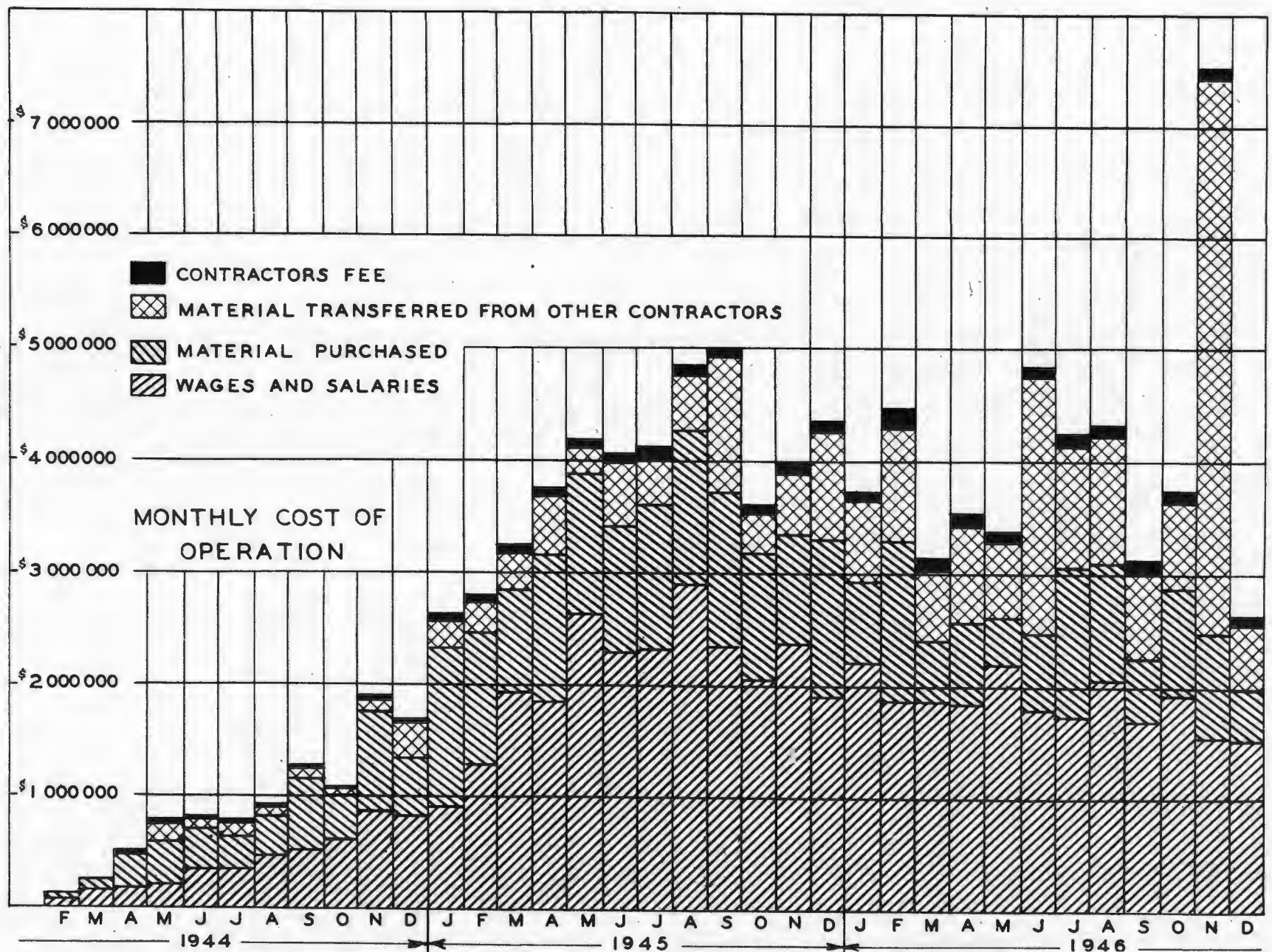

B18 ~~CONFIDENTIAL~~

~~CONFIDENTIAL/RD~~

~~SECRET~~

CARBIDE & CARBON CHEMICALS CORPORATION
FUNCTIONAL ORGANIZATION CHART

27 November 1944

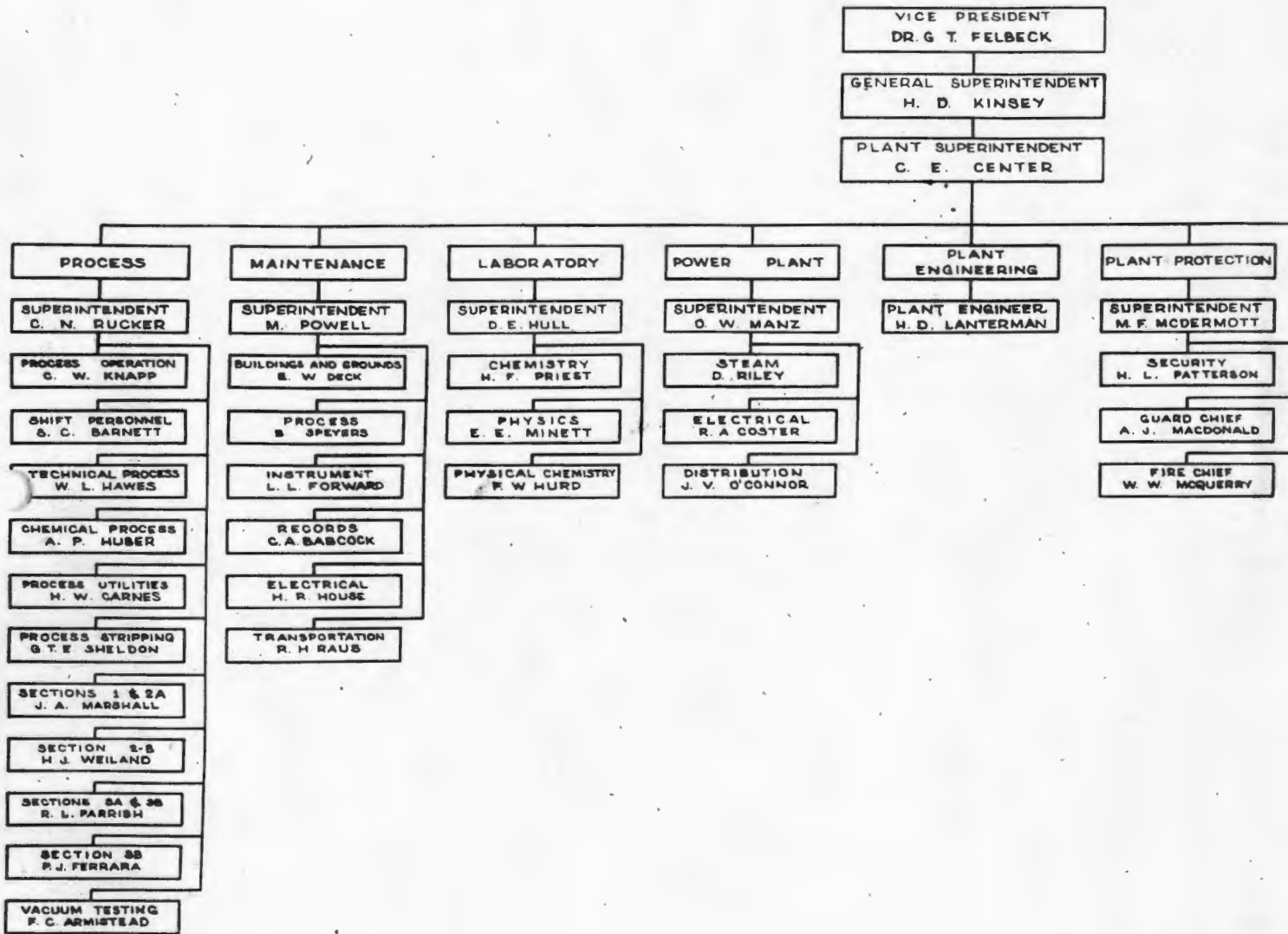

~~CONFIDENTIAL/RD~~

B19
~~SECRET~~

~~SECRET~~

~~CONFIDENTIAL/RD~~

B19-2

E & CARBON CHEMICALS CORPORATION
FUNCTIONAL ORGANIZATION CHART

27 November 1944

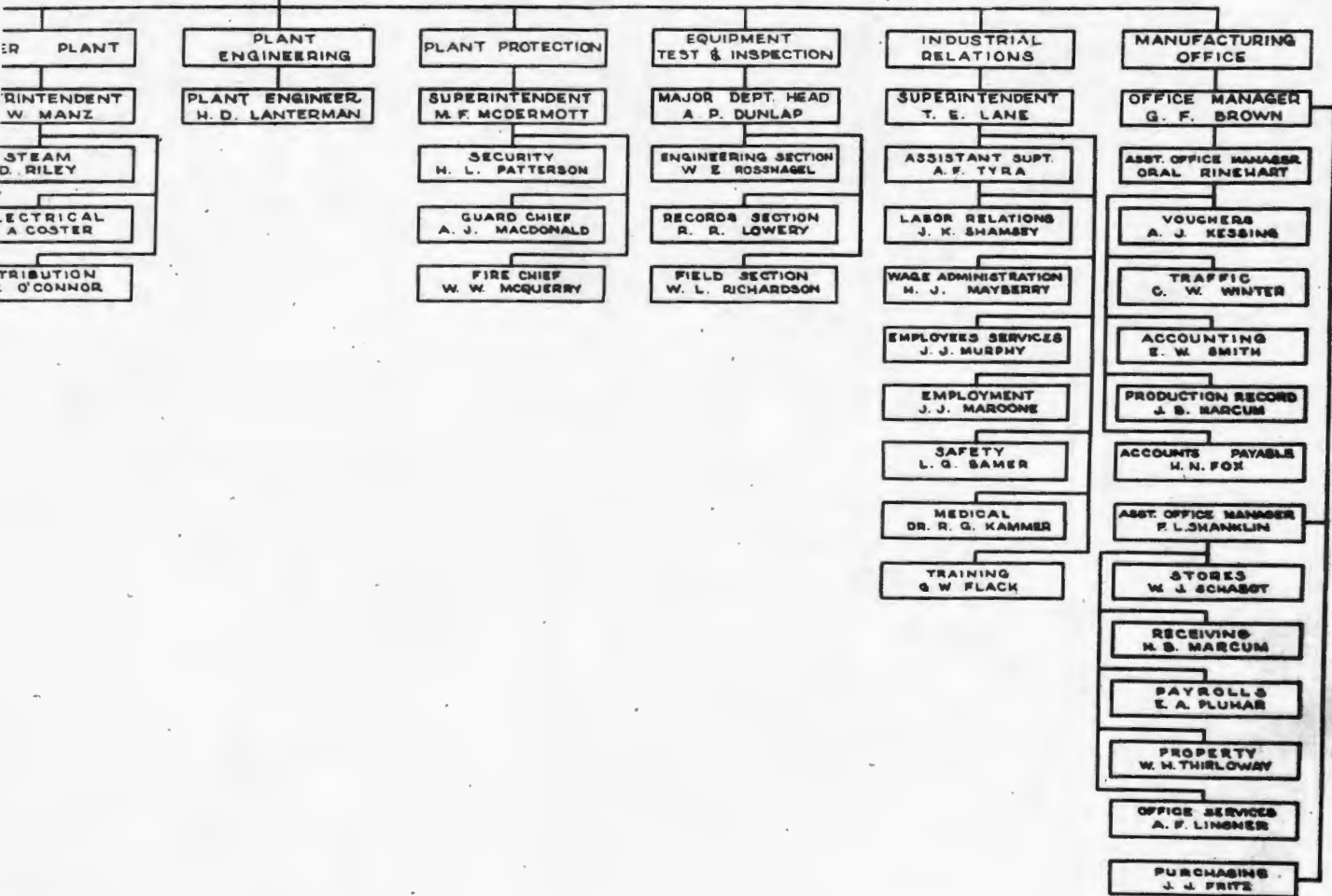
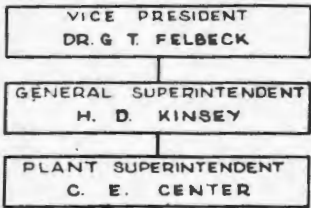

B19
~~SECRET~~

~~CONFIDENTIAL/RD~~

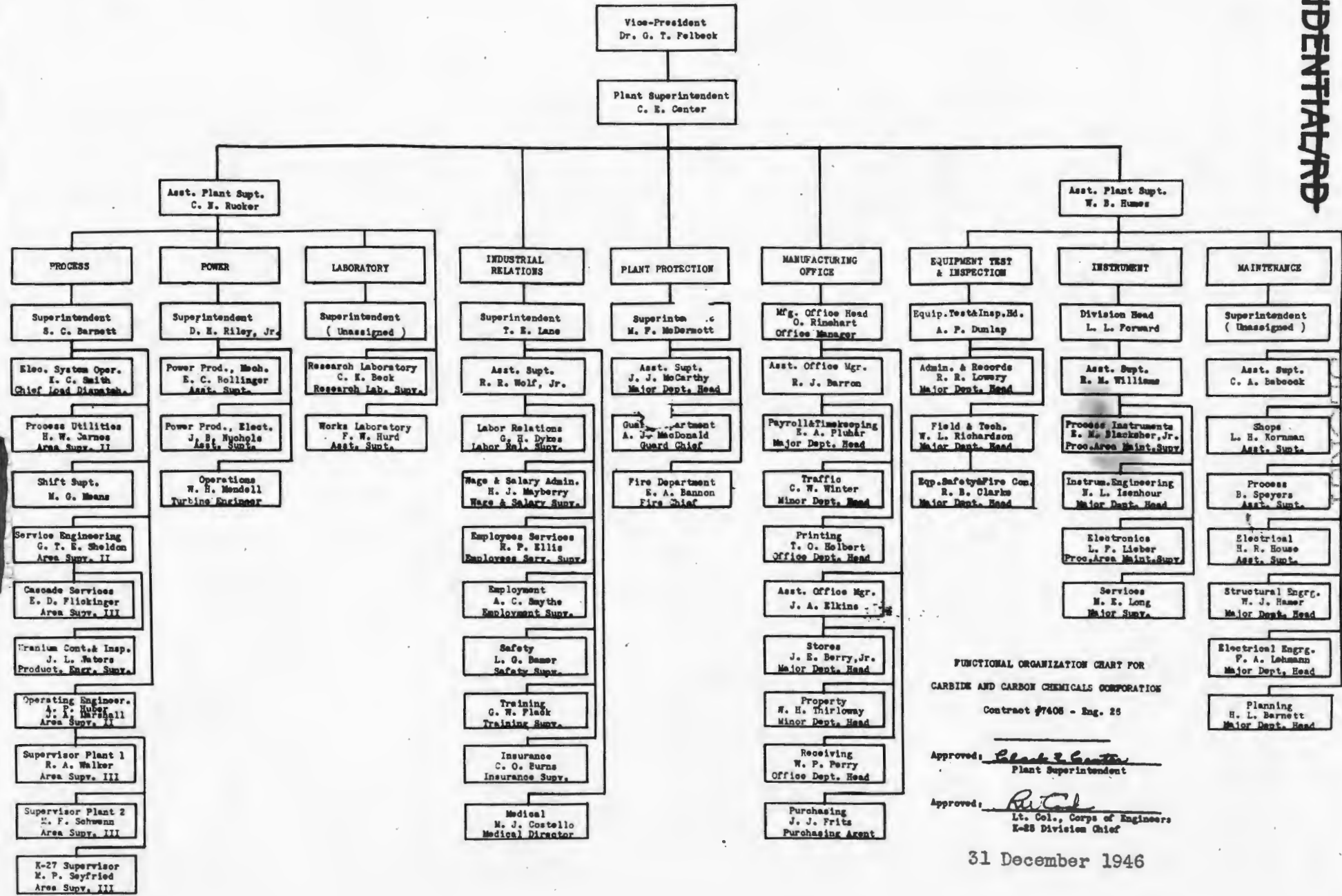

FUNCTIONAL ORGANIZATION CHART FOR
CARBIDE AND CARBON CHEMICALS CORPORATION
Contract #7408 - Eng. 28

Approved: *Charles E. Center*
Plant Superintendent

Approved: *R. J. Frits*
Lt. Col., Corps of Engineers
K-28 Division Chief

31 December 1946

PROCESS DIVISION ORGANIZATION CHART
CARBIDE AND CARBON CHEMICALS CORPORATION
31 DECEMBER 1946

DIV. SUPT.
S.C. BARNETT

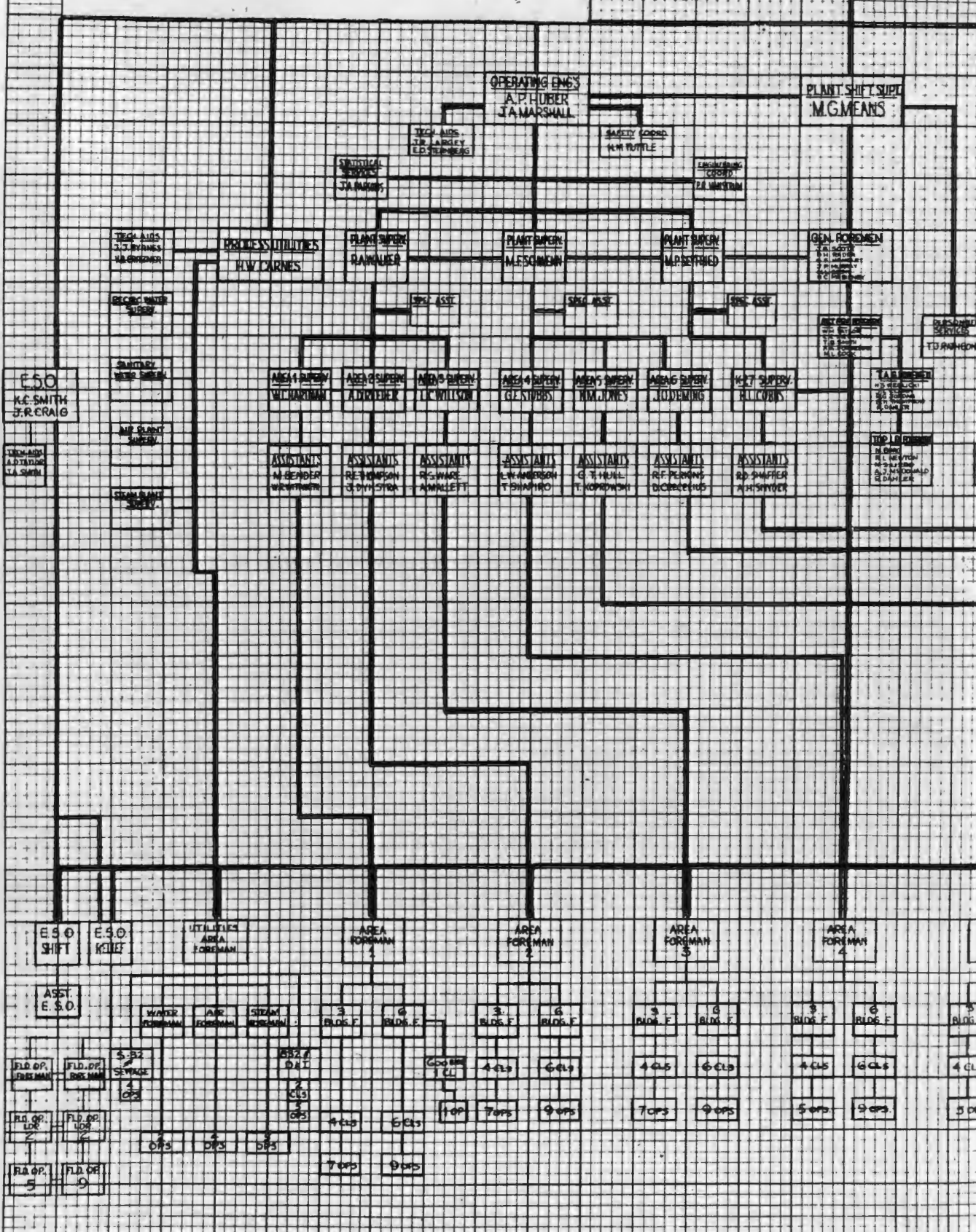

OPER

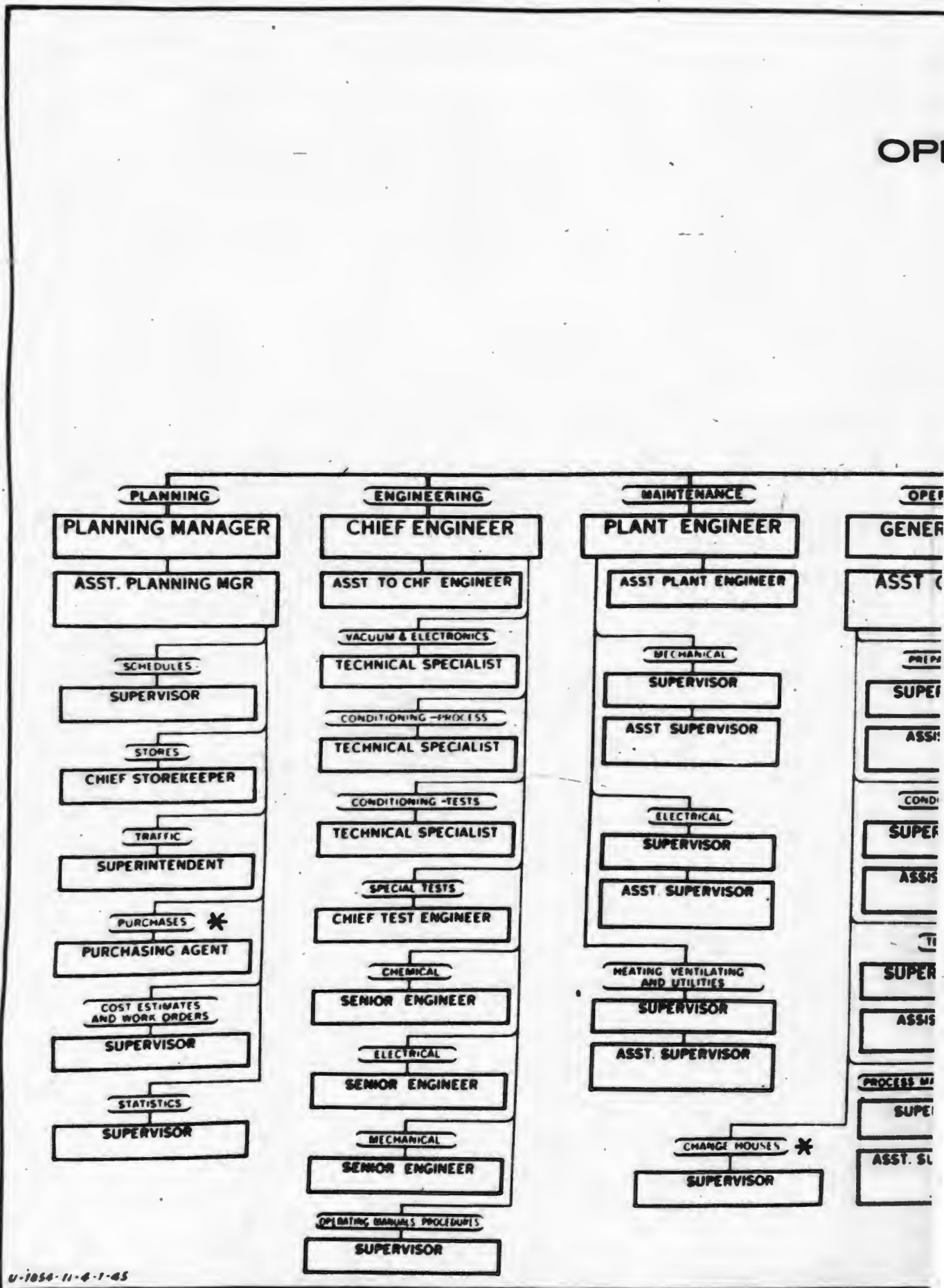

U-1054-11-4-1-45

A-7

CONTRACT W-7407-eng-34

Ford, Bacon & Davis, Inc.
Operators

CHART OF OPERATING ORGANIZATION

MARCH 31, 1945

CORPS OF ENGINEERS
UNITED STATES ARMY
CONTRACTING OFFICER

FORD, BACON & DAVIS, INC
RESIDENT AT NEW YORK OFFICE

PLANT MANAGER
RESIDENT AT SITE

ASST. TO PLANT MGR

OPERATIONS

GENERAL SUPT.

ASST TO GEN SUPT

ASST GEN. SUPT.

PREPARATION AREA *

SUPERINTENDENT

ASSISTANT SUPT.

CONDITIONING AREA *

SUPERINTENDENT

ASSISTANT SUPT.

TEST AREA *

SUPERINTENDENT

ASSISTANT SUPT.

PROCESS MATERIALS TRANSFER *

SUPERINTENDENT

ASST. SUPERINTENDENT

INSPECTION

CHIEF INSPECTOR

ASST CHIEF INSPECTOR

PREPARATION AREA *

SUPERVISOR

ASST SUPERVISOR

TEST AREA *

SUPERVISOR

ASST SUPERVISOR

CONTROL LABORATORY *

SUPERVISOR

CHIEF CHEMIST

CONDITIONING AREA *

SUPERVISOR

ASST SUPERVISOR

PROCESS INSTRUMENTS *

SUPERVISOR

ASST SUPERVISOR

WEIGHMETER AND VACUUM PUMPS *

SUPERVISOR

ASST SUPERVISOR

TRAINING

SUPERVISOR

ACCOUNTING

COMPTROLLER

GENERAL AUDIT

CHIEF AUDITOR

GENERAL ACCOUNTING

CHIEF GENL ACCTM

CASH ACCOUNTS

CASHIER

COST RECORDS

CHIEF COST ACCTM

EXPENDITURES

CHIEF INVOICE ACCT

TRANSPORTATION AUD

AUDITOR

TIME & PAYROLL

CHIEF PAYROLL ACCT

OFFICE MANAGEMENT

OFFICE MANAGER

Ford, Bacon & Davis
Incorporated
Engineers

Number of non-manual employes
as of March 31, 1945

F. B. & D. Payroll	525
C. & C.C.C. Payroll	311
Total under F. B. & D. supervision	<u>836</u>

Note: Asterisk (*) denotes division transferred to Carbide payroll

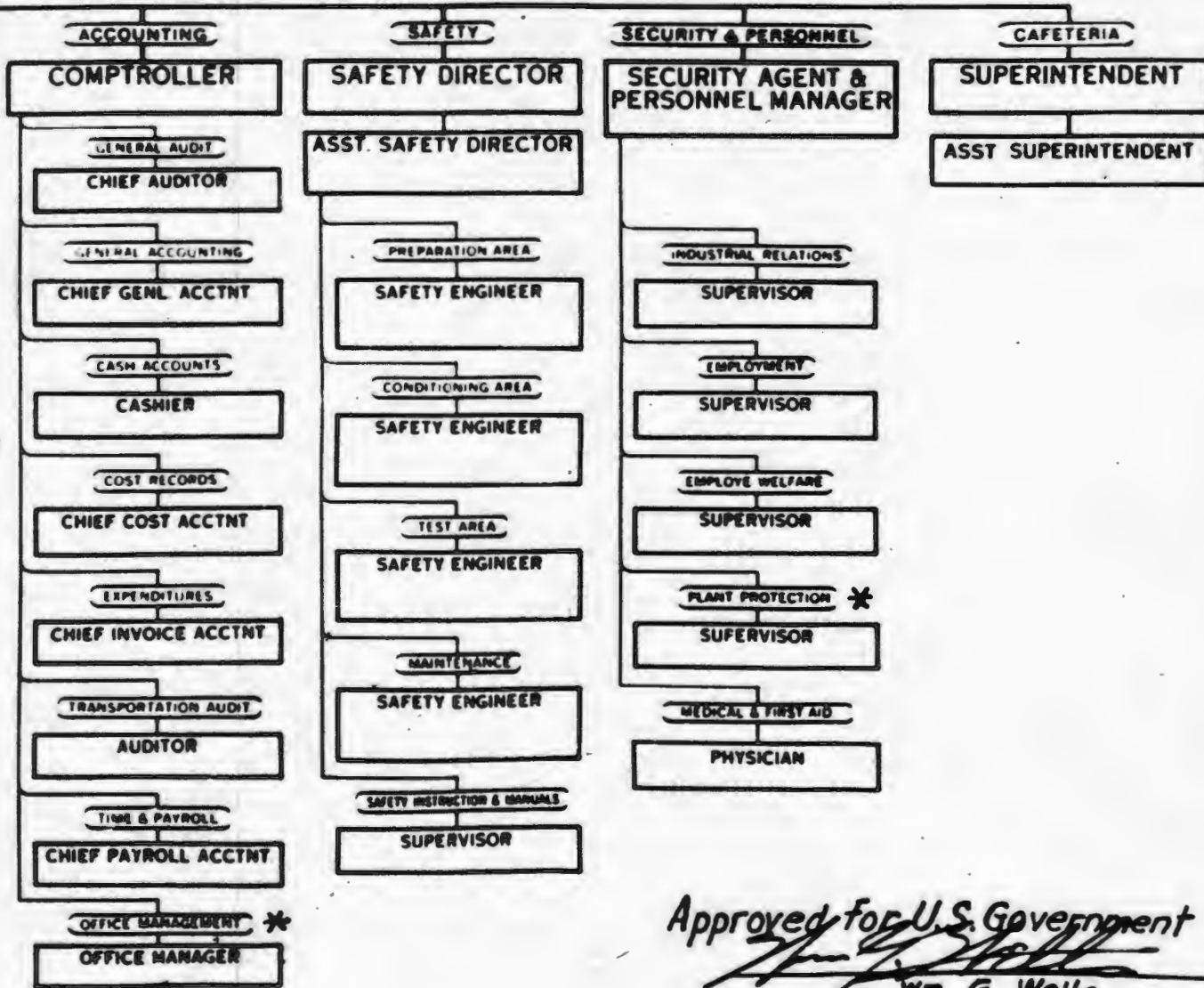

Approved for U.S. Government
[Signature]
 Wm. G. Wells
 Capt. C. E.

HOOKER ELECTROCHEMICAL ORGANIZATION CH
C-216
AT THE SITE

ENGINEERING
T. L. B. LYSTER
P.T.
Chief Engineer

ENGINEERING
D. O. HUBBARD
Senior Engineer
P.T.
GEO. GENTES
Junior Engineer
INCLUDES:
Supervision
Inspection
Etc.
Ⓜ Ⓣ

CONTROL CHEMISTS
A. MITCHELL
Junior Chemist
Ⓜ Ⓣ

LABORATORY TESTERS
Ⓣ

SHIFT FOREMAN
R. CANN
C. HAYES
R. MARSH
K. MINNIE
Ⓜ

CHIEF OPERATOR

CHEMICAL OPERATOR
A AND

P.T. - Part Time
Ⓜ - Monthly Salary Basis
All Others Hourly Pay Basis
Number Of Persons Are Shown In Circles Thus Ⓣ

~~ELECTROCHEMICAL~~ COMPANY

ORGANIZATION CHART

C-216

AT THE SITE

ENGINEERING
 T. L. B. LYSTER
 P. T.
 Chief
 Engineer

SUPERINTENDENCE
 W. E. HAUTH
 Superintendent
 JOHN KLINGEL
 Foreman

CONTROL CHEMISTS
 A. MITCHELL
 Junior Chemist

SHIFT FOREMEN
 R. CANNON
 C. HAYES
 R. MARSH
 K. MINNICK

CLERICAL
 P. J. CARMODY
 Assistant Foreman

REPAIR AND MAINTENANCE
 C. L. DOARE
 Assistant Foreman

LABORATORY TESTERS

STENOGRAPHERS

REPAIRMEN

CHIEF OPERATORS

CHEMICAL OPERATORS
 A AND B

May 3, 1944

~~CONFIDENTIAL~~

~~SECRET~~

K-25 PLANT PERSONNEL STRENGTH

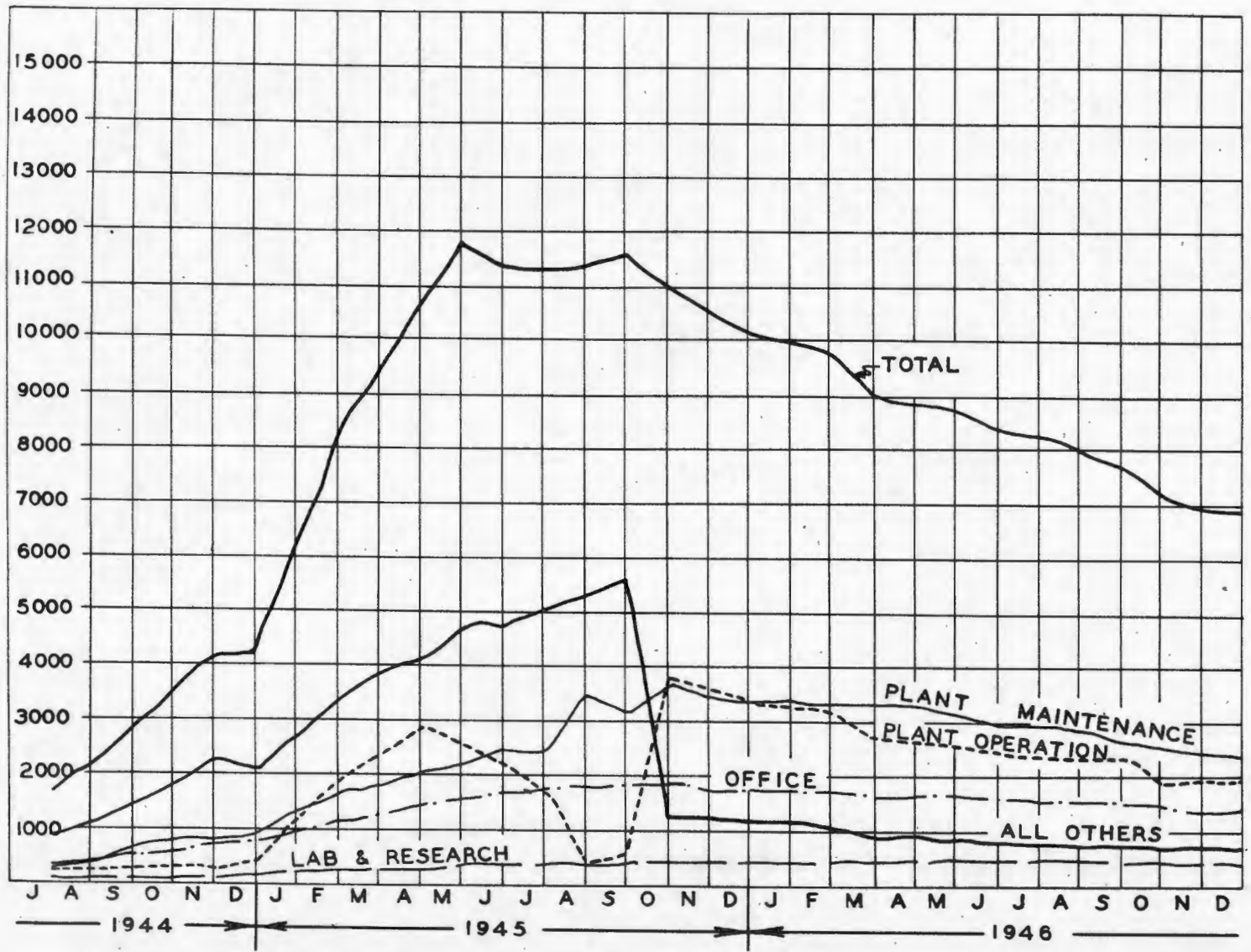

B24

~~CONFIDENTIAL~~

MANHATTAN DISTRICT HISTORY

BOOK II - GASEOUS DIFFUSION (K-25) PROJECT

VOLUME 5 - OPERATION

APPENDIX "C"

TABULATIONS

<u>No.</u>	<u>Title</u>
1.	Operation Acceptance and Transfer Dates for K-25 Plant Buildings.
2.	Plant Safety Bulletins, Carbide and Carbon Chemicals Corporation.
3.	Kellogg Operating Manuals.
4.	K-25 Safety Statistics.
5.	K-25 Plant Research Projects.
6.	K-25 Maintenance Experience, April-August 1945.
7.	K-25 Maintenance Experience, September 1945.
8.	K-25 Maintenance Experience, January-December 1946.

~~SECRET~~

~~CONFIDENTIAL/RD~~

OPERATION ACCEPTANCE AND TRANSFER
DATES FOR K-25 PLANT BUILDINGS

MAIN PROCESS BUILDINGS

<u>Building No.</u>	<u>Description</u>	<u>Accepted for Operation</u>	<u>Final Transfer</u>
K-302-1	Case I	3-2-45	5-2-45
K-302-2	Case I	2-28-45	5-2-45
K-302-3	Case I	12-29-44	5-2-45
K-302-4	Case I	1-6-45	5-2-45
K-302-5	Case I	1-6-45	5-2-45
K-310-1	Case I	2-28-45	5-12-45
K-310-2	Case I	1-19-45	5-2-45
K-310-3	Case I	2-28-45	5-2-45
K-303-1	Case II	4-18-45	6-14-45
K-303-2	Case II	10-20-44	7-7-45
K-303-3	Case II	3-31-45	6-14-45
K-303-4	Case II	4-5-45	6-29-45
K-303-5	Case II	3-31-45	6-14-45
K-303-6	Case II	4-6-45	6-14-45
K-303-7	Case II	4-14-45	7-31-45
K-303-8	Case II	4-11-45	7-31-45
K-303-9	Case II	4-13-45	6-29-45
K-303-10	Case II	4-18-45	6-29-45
K-311-1	Case II	4-7-45	6-14-45
K-301-1	Case III	5-8-45	6-25-45

C1

~~SECRET~~

~~CONFIDENTIAL/RD~~

~~SECRET~~

~~CONFIDENTIAL/RD~~

<u>Building No.</u>	<u>Description</u>	<u>Accepted for Operation</u>	<u>Final Transfer</u>
K-501-2	Case III	5-9-45	7-17-45
K-501-3	Case III	5-11-45	7-17-45
K-501-4	Case III	5-12-45	6-27-45
K-501-5	Case III	5-14-45	7-3-45
K-509-1	Case III	4-30-45	6-25-45
K-509-2	Case III	4-30-45	7-17-45
K-509-3	Case III	5-7-45	6-29-45
K-504-1	Case IV	5-22-45	7-26-45
K-504-2	Case IV	5-25-45	7-6-45
K-504-3	Case IV	6-7-45	7-26-45
K-504-4	Case IV	6-10-45	7-26-45
K-504-5	Case IV	6-15-45	7-26-45
K-505-1	Case IV	6-1-45	7-31-45
K-505-2	Case IV	6-2-45	7-31-45
K-505-3	Case IV	5-30-45	7-31-45
K-505-4	Case IV	6-5-45	7-31-45
K-505-5	Case IV	6-21-45	8-6-45
K-505-6	Case IV	6-23-45	8-6-45
K-505-7	Case IV	6-14-45	8-6-45
K-505-8	Case IV	6-11-45	8-6-45
K-505-9	Case IV	6-12-45	8-6-45
K-505-10	Case IV	6-19-45	8-6-45
K-505-11	Case IV	6-27-45	8-6-45
K-505-12	Case IV	6-28-45	8-6-45

C1

~~SECRET~~

~~CONFIDENTIAL/RD~~

~~SECRET~~

~~CONFIDENTIAL/RO~~

<u>Building No.</u>	<u>Description</u>	<u>Accepted for Operation</u>	<u>Final Transfer</u>
K-506-1	Case V	6-30-45	8-13-45
K-506-2	Case V	6-30-45	8-13-45
K-506-3	Case V	7-10-45	8-13-45
K-506-4	Case V	7-11-45	8-13-45
K-506-5	Case V	7-10-45	8-13-45
K-506-6	Case V	6-30-45	8-13-45
K-506-7	Case V	6-30-45	8-13-45

PURGE BUILDINGS

<u>Building No.</u>	<u>Description</u>	<u>Accepted for Operation</u>	<u>Final Transfer</u>
K-512-1	Purge Cascade	8-11-45	10-18-45
K-512-2	Purge Cascade	8-27-45	9-18-45
K-512-3	Purge Cascade	8-3-45	8-18-45

TRANSFORMER VAULTS

<u>Vault No.</u>	<u>Location</u>	<u>Accepted for Operation</u>	<u>Final Transfer</u>
1	510-3/511-1	5-3-45	6-8-45
2	510-1/510-2	5-3-45	5-30-45
3	509-2/509-3	5-12-45	6-15-45
4	509-1/501-1	5-3-45	6-15-45
5	501-2/501-3	5-18-45	6-15-45
6	501-4/501-5	5-18-45	6-15-45
7	502-1/502-2	5-3-45	6-30-45
8	502-3/502-4	5-8-45	5-30-45
9	502-5/503-1	5-12-45	5-30-45

~~SECRET~~

~~CONFIDENTIAL/RO~~

<u>Vault No.</u>	<u>Location</u>	<u>Accepted for Operation</u>	<u>Final Transfer</u>
10	303-2/303-3	5-12-45	6-15-45
11	303-4/303-5	3-31-45	6-15-45
12	303-6/303-7	3-31-45	6-15-45
13	303-8/303-9	4-27-45	6-15-45
14	303-10	4-27-45	6-15-45
15	304-1/304-2	6-21-45	7-3-45
16	304-3/304-4	6-21-45	7-3-45
17	304-5/305-1	6-21-45	7-3-45
18	305-2/305-3	6-21-45	7-3-45
19	305-4/305-5	6-23-45	7-3-45
20	305-6/305-7	7-18-45	8-9-45
21	305-8/305-9	7-18-45	8-9-45
22	305-10/305-11	8-5-45	8-15-45
23	305-12/306-1	8-9-45	8-27-45
24	306-2/306-3	8-8-45	8-18-45
25	306-4/306-5	8-8-45	8-18-45
26	306-6/306-7	8-8-45	8-15-45
27	312-1	9-11-45	10-18-45
28	312-2	8-27-45	9-18-45
29	312-3	8-3-45	8-18-45

AUXILIARY BUILDINGS

<u>Building No.</u>	<u>Description</u>	<u>Accepted for Operation</u>	<u>Final Transfer</u>
K-101	Feed Purification	5-8-45	6-21-45
K-300-C	Coolant Storage Building	1-20-45	4-27-45

<u>Building No.</u>	<u>Description</u>	<u>Accepted for Operation</u>	<u>Final Transfer</u>
K-500-G-1	Coolant Unloading Building	2-26-45	4-27-45
K-500-G-2	Coolant Pump Building	2-26-45	4-27-45
K-500-G-3	Coolant Drying	2-26-45	4-27-45
K-601	Waste Disposal	3-3-45	6-26-45
K-700-A-1	Electric Sub-Station K-801	2-26-45	8-20-45
K-700-A-2	Electric Sub-Station K-101	2-26-45	8-20-45
K-700-A-3	Electric Sub-Station K-601	2-26-45	8-20-45
K-700-A-4	Electric Sub-Station K-1001	3-5-45	8-20-45
K-700-A-5	Electric Sub-Station K-1002	3-5-45	8-20-45
K-700-A-6	Electric Sub-Station K-1004-D	3-5-45	8-20-45
K-700-A-7	Electric Sub-Station K-1409	10-23-44	4-30-45
K-700-A-8	Electric Sub-Station K-1401	10-23-44	4-30-45
K-700-A-9	Main Electric Sub-Station, Administration Area	3-5-45	8-20-45
K-700-A-10	Electric Sub-Station at Building K-1003	3-6-45	8-20-45
K-700-A-11	Electric Sub-Station at Building K-1501	3-5-45	8-20-45
K-700-A-12	Electric Sub-Station at Building K-1024	2-26-45	3-20-45
K-801	Intake Pump House	8-24-44	4-4-45
K-802	Recirculating Pump House	8-28-44	4-3-45
H-801	Cooling Tower A	8-28-44	4-3-45
H-802	Cooling Tower B	11-17-44	4-3-45
K-1001	Administration Building	11-17-44	4-3-45
K-1002	Cafeteria	8-12-44	4-4-45

~~SECRET~~~~CONFIDENTIAL/RD~~

<u>Building No.</u>	<u>Description</u>	<u>Accepted for Operation</u>	<u>Final Transfer</u>
K-1003	Dispensary	8-2-44	6-21-45
K-1004-A	Central Laboratory	4-16-45	6-28-45
K-1004-B	Physical Chemistry Laboratory	4-16-45	6-28-45
K-1004-C	Physics Laboratory	4-16-45	6-28-45
K-1004-D	Works Laboratory	1-29-45	6-28-45
K-1004-E	Laboratory Storage	2-29-45	6-28-45
K-1004-F	Laboratory F (Future)		
K-1004-G	Laboratory G (Future)		
K-1004-H	Oxygen and Pyrofax Storage	3-23-45	5-30-45
K-1005	Payroll and Safety Building	7-26-44	9-4-45
K-1008-A	Change House	1-8-45	4-4-45
K-1008-B	Change House	9-4-44	4-3-45
K-1008-C	Change House	9-22-44	4-4-45
K-1008-D	Change House (Temporary Cafeteria)	9-4-44	7-24-45
K-1008-E	Change House (Future)		
K-1015	Laundry	7-15-44	4-3-45
K-1016	Ticket Office and Bus Loading Platform	7-15-44	4-3-45
K-1017	Sentry Houses 1 to 27	2-13-45	8-11-45
K-1020	Gate House No. 2 and Guard Building	7-6-44	4-17-45
K-1021	Ambulance Garage - Fire House	9-7-44	4-3-45
K-1024	Instrument Building	1-15-45	7-3-45
K-1024-A	Oxygen and Pyrofax Manifold Station	2-26-45	7-24-45

C1

~~SECRET~~~~CONFIDENTIAL/RD~~

~~SECRET~~

~~CONFIDENTIAL/RD~~

<u>Building No.</u>	<u>Description</u>	<u>Accepted for Operation</u>	<u>Final Transfer</u>
K-1025 A, B, C, D, E	Warehouses for Shipping Drums	9-7-44	6-15-45
K-1026	Main Bus Terminal	3-8-45	7-19-45
K-1026-A	Boiler House at Main Bus Terminal	3-8-45	7-19-45
K-1027	Bus Repair Shop	3-8-45	7-19-45
K-1028-1	Gate House south of Building K-1001	7-5-45	7-5-45
K-1028-2	Gate House southeast of Building K-1001	-	-
K-1028-3	Gate House southwest of Building K-1001	2-13-45	7-19-45
K-1028-4	Gate House at Main Bus Terminal	3-8-45	7-19-45
K-1029	Field Office Building	-	5-5-46
K-1030	Electric Repair Building	7-19-45	8-7-45
K-1031	Drum Storage	6-16-45	6-16-45
K-1032	Industrial Relations Building	3-26-45	8-3-45
K-1034	Process Area Administration Building	7-26-46	7-30-46
K-1035	Warehouse southwest of Building K-1401	8-23-45	11-30-45
K-1036	Warehouse northwest of Building K-1401	11-23-45	11-30-45
K-1037	Warehouse east of Building K-1501	9-21-45	7-30-46
K-1101	Air Conditioning Building	5-23-45	6-26-45
K-1102	Fan and Transformer Building	5-23-45	6-26-45

~~SECRET~~

~~CONFIDENTIAL/RD~~

<u>Building No.</u>	<u>Description</u>	<u>Accepted for Operations</u>	<u>Final Transfer</u>
K-1102	Fan and Transformer Building	5-23-45	6-28-45
KB-1102	Fan and Transformer Building	5-23-45	6-26-45
K-1201	Compressor Building	10-14-44	5-11-45
K-1202	Lube Oil Storage	1-1-45	7-17-45
K-1203	Sewage Treatment Plant	12-12-45	2-12-46
K-1204-A	Sewer Ejector Station 1	6-21-44	4-17-45
K-1204-B	Sewer Ejector Station 2	7-21-44	5-7-45
K-1204-C	Sewer Ejector Station 3	7-24-45	8-6-45
K-1205-A	Condensate Pump Station A	6-16-45	9-21-45
K-1205-B	Condensate Pump Station B	6-16-45	9-21-45
K-1205-C	Condensate Pump Station C	10-11-44	4-20-45
K-1205-D	Condensate Pump Station D	7-24-45	9-21-45
K-1206-A	Fire Protection Water Tank	-	6-18-45
K-1206-B	Fire Protection Water Tank	6-21-44	4-16-45
K-1207	Plant Air Humidity Conditioning System	11-30-45	2-12-46
K-1301	C-216 Building	6-21-44	11-15-44
K-1302	C-216 Building	7-26-44	11-15-44
K-1303	C-216 Building	7-26-44	11-15-44
K-1501	Steam Plant	1-16-45	2-1-46
K-1502	Auxiliary Steam Plant	-	8-27-45

CONDITIONING AREA BUILDINGS

<u>Building No.</u>	<u>Description</u>	<u>Accepted for Operations</u>	<u>Final Transfer</u>
K-1401	Conditioning Building	6-21-44	4-30-45

<u>Building No.</u>	<u>Description</u>	<u>Accepted for Operations</u>	<u>Final Transfer</u>
K-1402	Control House	9-23-44	4-30-45
K-1403	Fan House	6-21-44	4-30-45
K-1404	Acid Storage	6-21-44	4-30-45
K-1405	C-216 Disposal	9-26-44	4-30-45
K-1407	Line Storage and Neutralizing Building	7-20-44	4-30-45
K-1407-A	Neutralizing Pit	7-26-44	4-30-45
K-1407-B	Holding Pond	7-26-44	4-30-45
K-1408	Nitrogen Building	8-23-44	4-30-45
K-1409	Change House	6-21-44	4-30-45
K-1410	Service Building	4-13-45	6-14-45
K-1411	Timekeeper Office and Clock Alleys	10-28-44	3-31-45

POWER HOUSE AREA BUILDINGS

<u>Building No.</u>	<u>Description</u>	<u>Accepted for Operations</u>	<u>Final Transfer</u>
K-701	Boiler House	7-15-44	3-28-45
K-702	Turbine Room and Discharge Tunnel	7-15-44	3-21-46
K-702-A	Discharge Flume and Culvert	8-20-44	3-28-45
K-703	Service Building	5-6-44	3-16-45
K-704	Main Switch House	5-6-44	4-17-45
K-705	Crib House and Intake Tunnel	2-10-45	3-16-45
K-706	Pump House	3-10-44	3-31-45
K-707	Auxiliary Switch House	4-1-44	3-16-45
K-708-A	Coal Hopper	3-17-44	3-16-45

<u>Building No.</u>	<u>Description</u>	<u>Accepted for Operations</u>	<u>Final Transfer</u>
K-708-B	Transfer Building	3-17-44	3-16-45
K-708-C	Breaker Building	3-17-44	3-16-45
K-708-D	Coal Screen House	5-22-44	3-16-45
K-708-E	Scale Pit	3-17-44	3-16-45
K-709	154 KV Switch Yard	5-16-44	7-9-45
K-710	Sewage Disposal Plant	3-24-44	3-28-45
K-711	Warehouse	7-25-45	7-28-45

MISCELLANEOUS BUILDINGS

<u>Building No.</u>	<u>Description</u>	<u>Accepted for Operations</u>	<u>Final Transfer</u>
S-32	Water Purification Plant	1-25-45	2-19-46
S-33	Water Storage Tank	1-25-45	1-16-46
S-34	Water Storage Tank	1-25-45	1-16-46
S-35	Water Storage Tank	1-25-45	1-16-46
S-43	Pump House	1-1-45	2-27-46
S-47	Water Storage Tank	1-25-45	1-16-46
S-48	Water Storage Tank	1-25-45	1-16-46
S-49	Water Storage Tank	1-25-45	1-16-46
S-52	Chlorinator House No. 1	1-1-45	1-15-46
S-53	Water Storage Tank	1-25-45	1-16-46
S-54	Water Storage Tank	1-25-45	1-16-46
S-55	Water Storage Tank	1-25-45	1-16-46
S-59	Chlorinator House No. 2	1-1-45	1-15-46

MISCELLANEOUS SYSTEMS

<u>Description</u>	<u>Accepted for Operations</u>	<u>Final Transfer</u>
Fire Protection System	2-17-45	8-17-45
Permanent Steam and Condensate Lines	6-16-45	9-21-45
Street Lighting System (K-25)	7-24-45	1-28-46
Street Lighting System (Power House)	-	11-9-45
Fence Lighting	7-20-45	8-31-45
Permanent Overhead Nitrogen Lines	-	6-27-45
Plant Air Lines	-	7-7-45
General Evacuation Lines - G-11	-	7-6-45
Coolant Line	-	7-18-45
Dry Air Lines	-	7-18-45
Storm Sewer System	2-11-46	2-12-46
800 Electrical Work	2-26-45	8-20-45
1000 Electrical Work (Underground)	3-5-45	8-20-45
Loop "A" of the Circulating Water System, Including Supply and Return Cooling Water Lines to the Ford, Bacon, and Davis Conditioning Plant	2-2-45	8-18-45
Loop "B" of Above System	-	8-18-45
Sanitary Sewer System	2-11-46	2-12-46
Sanitary Water System	9-21-45	2-14-46
Fire Alarm System	9-21-45	3-5-46
Roads Parking Areas Drainage, Etc.	9-4-45	9-4-45

<u>Description</u>	<u>Accepted for Operations</u>	<u>Final Transfer</u>
Area Boundary Fence	8-31-45	8-31-45
Underground Transmission Lines	8-31-45	9-24-45

K-27 BUILDINGS

<u>Building No.</u>	<u>Description</u>	<u>Accepted for Operation</u>	<u>Final Transfer</u>
K-131	Feed Purification Building	2-5-46	2-19-46
K-132	Absorption System Building	1-28-46	2-19-46
K-402-1	Process Building	10-29-45	12-1-45
K-402-2	Process Building	11-2-45	12-1-45
K-402-3	Process Building	11-8-45	12-1-45
K-402-4	Process Building	11-9-45	12-1-45
K-402-5	Process Building	11-13-45	2-8-46
K-402-6	Process Building	11-19-45	2-8-46
K-402-7	Process Building	11-23-45	2-12-46
K-402-8	Process Building	1-3-46	2-12-46
K-402-9	Process Building	11-30-45	2-12-46
K-413	Purge and Product Building	2-5-46	2-25-46
K-631	Waste Disposal	1-17-46	2-12-46
K-731	Switch House	2-28-46	3-7-46
K-732	Electric Switch Yard	2-28-46	3-7-46
K-733	Oil Filtering and Handling System	-	2-19-46
K-832	Recirculating Water Pump House	12-17-45	2-12-46
H-832	Cooling Tower	11-7-45	1-5-46
K-833	Cooling Water Return Pump Station	2-8-46	2-12-46

~~SECRET~~~~CONFIDENTIAL/RD~~

<u>Building No.</u>	<u>Description</u>	<u>Accepted for Operation</u>	<u>Final Transfer</u>
K-1040	Fire House No. 5	12-5-45	2-8-46
K-1041	Cylinder and Drum Warehouse	-	11-8-45
K-1151	Shop and Warehouse	1-8-46	1-8-46
K-1231	Compressor House	12-17-45	2-8-46
K-1232	Condensate Collecting Station	2-18-46	2-27-46
K-1531	Heating Plant Extension	11-28-45	2-1-46
K-1045	Condensate Collecting Station	12-28-45	1-5-46
	Drum Storage Area	10-22-45	11-8-45
	Pipe Bridge 512-5 to 402-9	12-5-45	3-4-46
	Pipe Bridge 402-1 to 631	1-21-46	1-25-46
	Pipe Bridge 402-5 to 131	-	3-8-46
	Pipe Lines	12-21-45	1-5-46
	Public Address System	1-18-46	1-28-46
	Grounding System	1-23-46	3-8-46
	Underground Transmission	2-25-46	2-26-46
	Fire Alarm System	2-22-46	3-4-46
	Supervisory Control System	3-22-46	3-28-46
	Area Boundary Fence	10-17-45	2-21-46
	Inter-Phone System	3-26-46	4-1-46
	2300 Volt Primary Distribution System	9-29-45	1-28-46
	Street and Fence Lighting System	2-22-46	2-25-46

NOTE: A dash indicates no papers signed.

01

~~SECRET~~~~CONFIDENTIAL/RD~~

PLANT SAFETY BULLETINS
CARBIDE AND CARBON CHEMICALS CORPORATION

Bulletin No.

Title

"RESTRICTED" BULLETINS

- 1. Cylinder Storage and Handling
- 2. Removal of Stage Pumps and Other Equipment (except converters and cold trap equipment) in 500 Section
- 3. Flash Conditioning, Charging and Evacuation of Cells
- 4. Emergency Evacuation of Personnel During Flash Conditioning, Charging, and Evacuation of Cells
- 5. Operation of Service, and Purge and Product Rooms
- 6. Operation of Feed Purification System
- 7. Operation of Waste and Surge System
- 8. Servicing Cold Traps at Line Recorder Stations
- 9. Cleanup after Minor Leaks
- 10. Handling of Contaminated Equipment (except converters)
- 11. Operation of Degreasing and Pickling Area
- 12. Operation of Furnace Room and Basement
- 13. Evacuation Procedure for the Conditioning Area (Furnace Room and Basement)
- 14. Dumping Carbon Traps
- 15. Entering Cell Enclosures
- 16. Storage, Handling, and Testing of Electrical Protective Equipment
- 17. Trichloroethylene
- 18. Carbon Tetrachloride

<u>Bulletin No.</u>	<u>Title</u>
19.	Dichlorodifluoromethane (Freon-12)
20.	Nitrous Oxide
21.	Hydrogen
22.	Helium
23.	Nitrogen
24.	Acetylene
25.	General Plant Safety Rules
26.	Industrial Accident Prevention Sign Standards
27.	Traffic Control Signs
28.	Effects of Electrical Shock
29.	Portable Electrical Equipment
30.	Standards for Inspection, Storage, and Distribution of Abrasive Grinding Wheels
32.	Motor Vehicles
33.	Care and Use of Ladders
34.	Species of Wood for Ladder Use
35.	Ladder Safety Feet
36.	Wood Step Ladders
37.	Portable Straight (single section) Wood Ladders
38.	Extension Wood Ladders
39.	Fixed Ladders
40.	Wood Scaffold Planking
41.	Safe Practices for the Use of Scaffolds
42.	Outrigger Scaffolds
43.	Foot Scaffolds

<u>Bulletin No.</u>	<u>Title</u>
44.	Painters' Swinging Scaffolds
45.	Boatswains' Chair Scaffolds
46.	Suspended Scaffolds
47.	Needle Beam Scaffolds (Iron Workers' Scaffolds)
50.	Carpenters' Portable Bracket Scaffolds
51.	Horse or Frame Scaffolds
52.	Bricklayers' Square Scaffolds
53.	Chimney Scaffolds
54.	Pole Scaffolds (wood)
55.	Pole Scaffolds Tubular Steel
56.	Fiber Rope
58.	Excavation and Trenches
59.	Manual Lifting
60.	Color Coding for Cylinders Containing Compressed Gas
61.	Lighting Design
62.	Mercury

"CONFIDENTIAL" BULLETINS

C-1	Operation of Fluorine Plant
C-2	Maintenance of Process Equipment

"SECRET" BULLETINS

S-1	Uranium hexafluoride
S-2	Fluorine
S-3	Perfluoroheptane
S-4	Coolant (dimethylcyclohexane)

<u>Bulletin No.</u>	<u>Title</u>
S-5	Hydrofluoric acid
S-6	Fluorinated Lube Oil
S-7	Perfluoroethylcyclopentane

KELLEX OPERATING MANUALS

<u>Volume</u>	<u>Title</u>
I	54 Stage Operating Manual - Building K-303-2A
I	Conditioning and Associated Functions
II	Coolant System
III	Dry 74 System for Section 300
IV-Part I	Mobile Service Units - Vacuum Pumping Equipment
IV-Part II	Mobile Service Units - 716 Supply, Purging, and Disposal Equipment
IV-Part III	Mobile Service Units - 216 Supply and Disposal
IV-Part IV	Mobile Service Units - 616 Disposal Units
V-Part I	Utilities - Heating Plant and Steam Distribution
V-Part II	Utilities - Electrical System
V-Part III	Utilities - Plant Air System
V-Part IV	Utilities - Recirculating Water Cooling System
VI	Lubricating Oil System
VII	Section 100 - Feed Purification System
VIII	Dry Air System
IX	Buildings and Building Utilities
X	Special Valves
XI	Process Control
XIII-Part I	Analyses - Analytical Methods
XIV	Process Pumps
XV-Part I	616 Recovery Cell Servicing System
XV-Part II	616 Recovery CO ₂ Refrigeration System

<u>Volume</u>	<u>Title</u>
XV-Part III	G16 Recovery N ₂ O Refrigeration System
XVI	Temporary Purge and Product System - Top of 2a
XVII	216 Conditioning for Process Area
XVIII	Case I
XIX	Mass Spectrometer and Line Recorder
XX	Bellows Sealed Reciprocating Pumps
XXI	Surge and Waste System
XXII	Temporary Purge and Product System - Top of 2b
XXIII-Part I	Converter Conditioning Stands
XXIII-Part II	Pump Conditioning Stands
XXIII-Part III	216 Disposal Tower
XXIV	Carbon Mixing Plant
XXV	Case II
XXVI	Case III
XXVII	Central Control Room
XXVIII-Part I	Diffusion Purge Cascade
XXVIII-Part II	Alternative Purge Procedure
XXIX	Case IV, V
XXX	Space Recorder and Its Use in Light Diluent System
XXXI	Buildings and Building Utilities for K-27 Plant
XXXII	Dry and Service Air for K-27 Plant
XXXIII	Process Pump Lubricating Oil System for K-27 Plant
XXXIV	K-25, K-27 Combined Operations
XXXV	Coolant System for K-27 Plant

~~SECRET~~

~~CONFIDENTIAL/RD~~

<u>Volume</u>	<u>Title</u>
XXXVI	Dry 74 - System for K-27 Plant
XXXVII	Recirculating Water Cooling System for K-27 Plant
XXXVIII	616 Recovery, Purge and Product Systems for the K-27 Plant
XXXIX	Surge and Waste System for K-27 Plant
XL	Feed Purification System for K-27 Plant
XLI	Central Control Room for K-27 Plant

CS

~~SECRET~~

~~CONFIDENTIAL/RD~~

K-25 SAFETY STATISTICS

		<u>Frequency Rate</u>	<u>Severity Rate</u>
1944	Carbide and Carbon (10 mos.)	8.00	0.21
	Clinton Engineer Works	6.59	0.51
	Manhattan District	6.97	1.15
	American Chemical Industry	10.24	0.91
1945	Carbide and Carbon	8.22	0.92
	Clinton Engineer Works	7.79	1.07
	Manhattan District	6.50	0.76
	American Chemical Industry	10.08	1.06
1946	Carbide and Carbon	4.05	0.29
	Clinton Engineer Works	5.98	0.19
	Manhattan District	5.70	0.19

NOTE: Frequency rate is the number of lost-time injuries per million man-hours of exposure.

Severity rate is the number of days lost per thousand man-hours of exposure.

K-25 PLANT RESEARCH PROJECTS

- | <u>No.</u> | <u>Project</u> |
|------------|---|
| 1. | Radiation - Alpha radiation from surfaces is measured to evaluate uranium deposits. Uranium content in air is evaluated in a similar manner. Gamma radiation is measured to make certain of safe working conditions, and the uranium content of carbon traps is measured by gamma radiation absorption. |
| 2. | Mass spectrometer research and development. |
| 3. | Installing mass spectrometer in the process area to measure directly the U-235 content in the gas stream. |
| 4. | Checking coolant losses. |
| 5. | Barrier laboratory research. |
| 6. | Miniature converters for the study of new barrier materials. |
| 7. | Research on barrier application. |
| 8. | Physical and chemical studies of corrosion products. |
| 9. | Investigation of the physical and chemical properties of fluorocarbons. |
| 10. | Metallurgical research and development. |
| 11. | Analytical research and development. |
| 12. | Research on alpha and fission counting. |
| 13. | Determination of absolute isotopic concentration of uranium. |
| 14. | The development of a dry type vacuum pump. |
| 15. | Mobile uranium hexafluoride condensing unit. |
| 16. | The development of precipitron mist filter. |
| 17. | Tests of purge stage pumps. |
| 18. | Seal development. |
| 19. | Recovery of uranium hexafluoride from conditioning gases. |
| 20. | Development of special instruments and study of principles of instrumentation applicable to process requirements. |

<u>No.</u>	<u>Project</u>
21.	Development of equipment for recovery of metal from waste process material.
22.	Development of a mobile cold trap.
23.	Substitute pumps for 600 Section.
24.	The review of technical data - physical properties of material.
25.	Fabrication of plastic materials.
26.	Installation of a 20 stage pilot plant.
27.	Development of a gas bearing blower.
28.	Thorough study of special hazards.
29.	Consumption and corrosion investigation.
30.	Study of major revisions and additions to the gaseous diffusion plant.
31.	Converter unplugging study.
32.	Recovery of coded chemicals from plant wastes.

~~SECRET~~

~~CONFIDENTIAL/RD~~

K-25 MAINTENANCE EXPERIENCE, APRIL-AUGUST 1945

<u>Cause</u>	<u>Number of Cells Shut Down</u>				
	<u>April</u>	<u>May</u>	<u>June</u>	<u>July</u>	<u>August</u>
Seal Failure	55	80	64	62	154
Pump Impellers	15	27	7	11	7
Pump Motors	-	5	10	7	21
Pump Bearings	-	5	5	9	11
Lube Oil System	7	11	11	23	10
Coolant System	13	5	13	5	2
Instruments	8	4	2	4	9
Plugged Stages	-	-	2	1	5
Electrical Equipment	-	6	23	5	65

~~SECRET~~

~~CONFIDENTIAL/RD~~

~~SECRET~~

~~CONFIDENTIAL/RD~~

K-25 MAINTENANCE EXPERIENCE, SEPTEMBER 1945

<u>Cause</u>	<u>Lost Time</u>	
	<u>Cell Days</u>	<u>Per cent of Total Operating Time</u>
Seal Failure	189.6	1.51
Power Failure	20.2	0.14
Valve Leakage	14.3	0.10
Stage Pumps	22.2	0.15
Lube Oil System	0.7	0.005
Coolant System	13.5	0.09
Instruments	14.3	0.10
Dry Air System	2.6	0.01
Inleakage Checks	29.3	0.20
Tests	7.5	0.05
Miscellaneous	<u>17.6</u>	<u>0.12</u>
Total	351.9	2.27

~~SECRET~~

~~CONFIDENTIAL/RD~~

~~SECRET~~

~~CONFIDENTIAL/RD~~

K-25 MAINTENANCE EXPERIENCE, JANUARY-DECEMBER 1946

<u>Cause</u>	<u>Lost Time</u>	
	<u>Cell Hours</u>	<u>Per cent of Lost Time</u>
Stage Pumps	2,548.85	4.25
Stage Motors	1,551.56	2.59
Stage Pump Seals	10,870.75	18.12
Converters	2,816.45	4.69
Seal System (other than seals)	201.90	.34
Instruments and Automatic Valves	1,584.42	2.64
Lube Oil System	180.59	.30
Coolant System	654.92	1.09
Electrical Power Equipment	25,456.77	42.41
Line Recorder Inleakage Tests	2,006.99	3.35
Excessive Inleakage	1,595.58	2.66
Instrument Air Lines	472.33	.79
Special Engineering Tests	2,200.95	3.67
Inventory Recovery	60.95	.10
Miscellaneous	<u>7,804.59</u>	<u>13.00</u>
Total	60,009.15	100.00

~~SECRET~~

~~CONFIDENTIAL/RD~~

~~SECRET~~

~~CONFIDENTIAL/RD~~

MANHATTAN DISTRICT HISTORY
BOOK II - GASEOUS DIFFUSION (K-25) PROJECT

VOLUME 5 - OPERATION

APPENDIX "D"

PHOTOGRAPHS

- | <u>No.</u> | <u>Title</u> |
|------------|---|
| 1. | Sectional View of a Stage Converter. |
| 2. | Stage Pump installed in a Cell, showing Seal Tubing for Nitrogen, Vacuum, and Dry Air, and Lubricating Oil Lines in foreground. |
| 3. | Electrical Control Room in Main Switch House K-704. |
| 4. | Instrument Panel Boards for two Cells, with Cell Block Valves in foreground. |
| 5. | Rear View of Cell Panel Board, showing Pneumatic Tubing and Electrical Wiring. |
| 6. | Intersectional Cell Panel Board. |
| 7. | Typical Instrumentation within a Process Cell, showing Pressure Transmitting Equipment, Stage Control Valve, and part of the Casing of a Stage Pump. |
| 8. | View of Basement of a Typical Process Building, showing Coolant Coolers, Ventilating Fans, and Ductwork. |
| 9. | View of Cell Floor between two Typical Process Buildings, showing Withdrawal Alley, Cell Enclosures, Stage Pumps, and Ventilating Ductwork. |
| 10. | View of a Typical Pipe Gallery before installation of Dry Air Piping Enclosures. |
| 11. | View of a Typical Operating Floor, showing Cell By-pass, Direct Recycle, and Inverse Recycle Valves; Ventilating Ductwork; Pit, Motor, and Surge Drum for Coolant Pump; (left center); and Seal Exhaust Vacuum Pump and Carbon Trap (center). |
| 12. | Converter Conditioning Furnace Stands in Building K-1401. |

~~SECRET~~

~~CONFIDENTIAL/RD~~

~~SECRET~~

~~CONFIDENTIAL/RD~~

- | <u>No.</u> | <u>Title</u> |
|------------|---|
| 13. | Typical Converter Running Test Stand in Building K-1401, showing Converter in place for Porosity Testing, Circulating Pump, Valves, Piping, Instrumentation, Leak Detector, High Vacuum Pump, and Switchgear. |
| 14. | Process Pump Conditioning Stands in Building K-1401. |
| 15. | Alpha and Fission Counting Room in Laboratory K-1004-B. |
| 16. | Panoramic Aerial View of the Gaseous Diffusion Plant, facing south. |
| 17. | Panoramic Aerial View of the Gaseous Diffusion Plant, facing Northwest. |
| 18. | Aerial View of Power House Area, facing south. |

~~SECRET~~

~~CONFIDENTIAL/RD~~

~~SECRET~~

~~CONFIDENTIAL/RD~~

D1 Sectional View of a Stage Converter, showing:

- A - Process Gas Inlet.
- B - Stage Cooler Tubes.
- C - "A" Stream Outlet, Enriched Diffusate.
- D - Barrier Tubes.
- E - "B" Stream Outlet, Partially Depleted Gas.
- F - Baffle Plates.

~~SECRET~~

~~CONFIDENTIAL/RD~~

~~SECRET~~ ~~CONFIDENTIAL/RD~~

D2 Stage Pump installed in a Cell, showing Seal Tubing
for Nitrogen, Vacuum, and Dry Air, and Lubricating
Oil Lines in foreground.

~~CONFIDENTIAL/RD~~

~~SECRET~~

~~SECRET~~

~~CONFIDENTIAL/RD~~

D3 Electrical Control Room in Main Switch House K-704.

~~SECRET~~

~~SECRET~~

~~CONFIDENTIAL/RD~~

~~CONFIDENTIAL/RD~~



~~CONFIDENTIAL/RD~~

~~SECRET~~

~~CONFIDENTIAL/RD~~

D4 Instrument Panel Boards for two Cells, with Cell
Block Valves in foreground.

~~SECRET~~

~~CONFIDENTIAL/RD~~

~~CONFIDENTIAL/RO~~

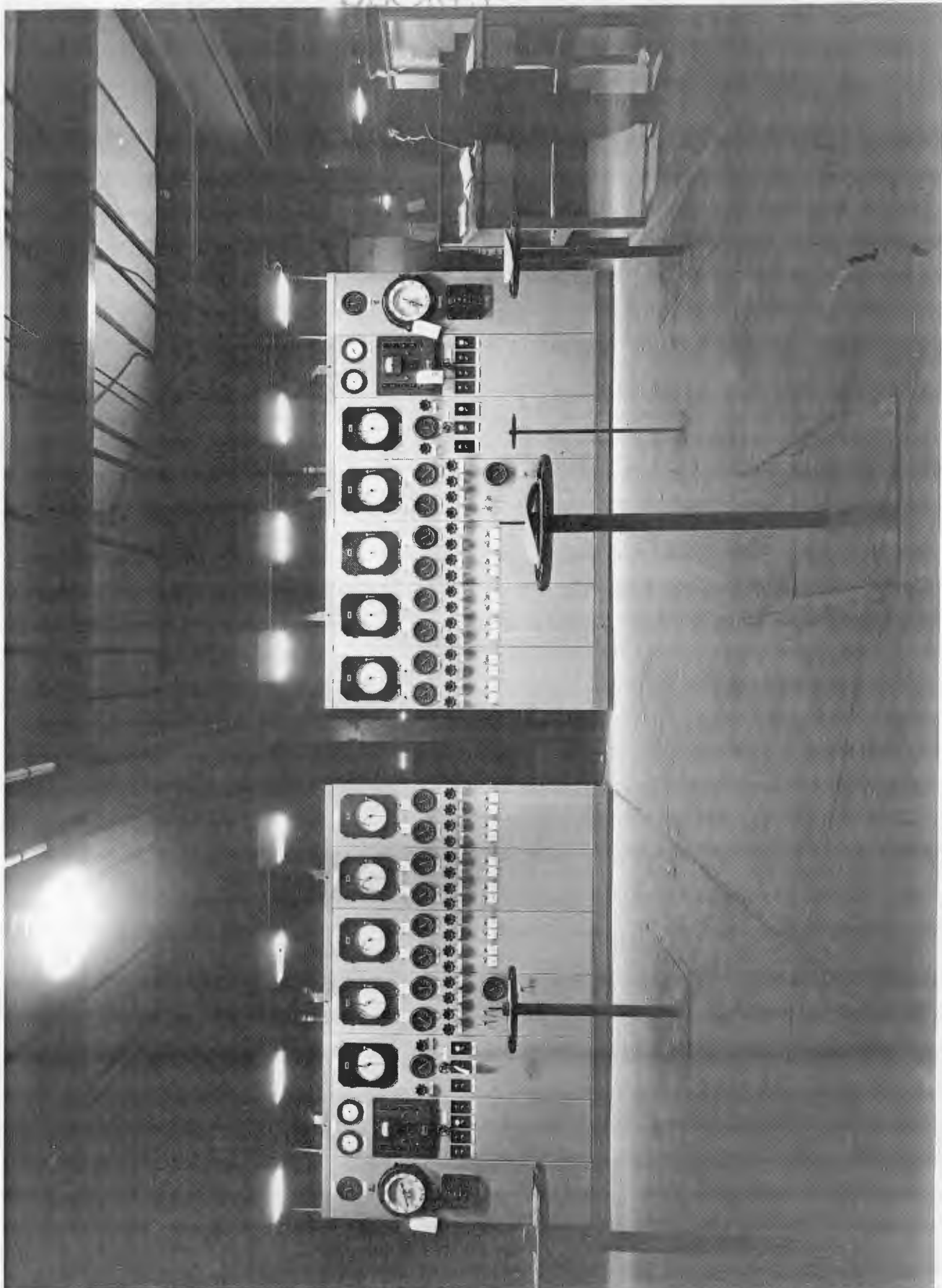

~~CONFIDENTIAL/RO~~

~~SECRET~~

~~CONFIDENTIAL/RD~~

D5 Rear View of Cell Panel Board, showing Pneumatic
Tubing and Electrical Wiring.

~~SECRET~~

~~CONFIDENTIAL/RD~~

CONFIDENTIAL/RD

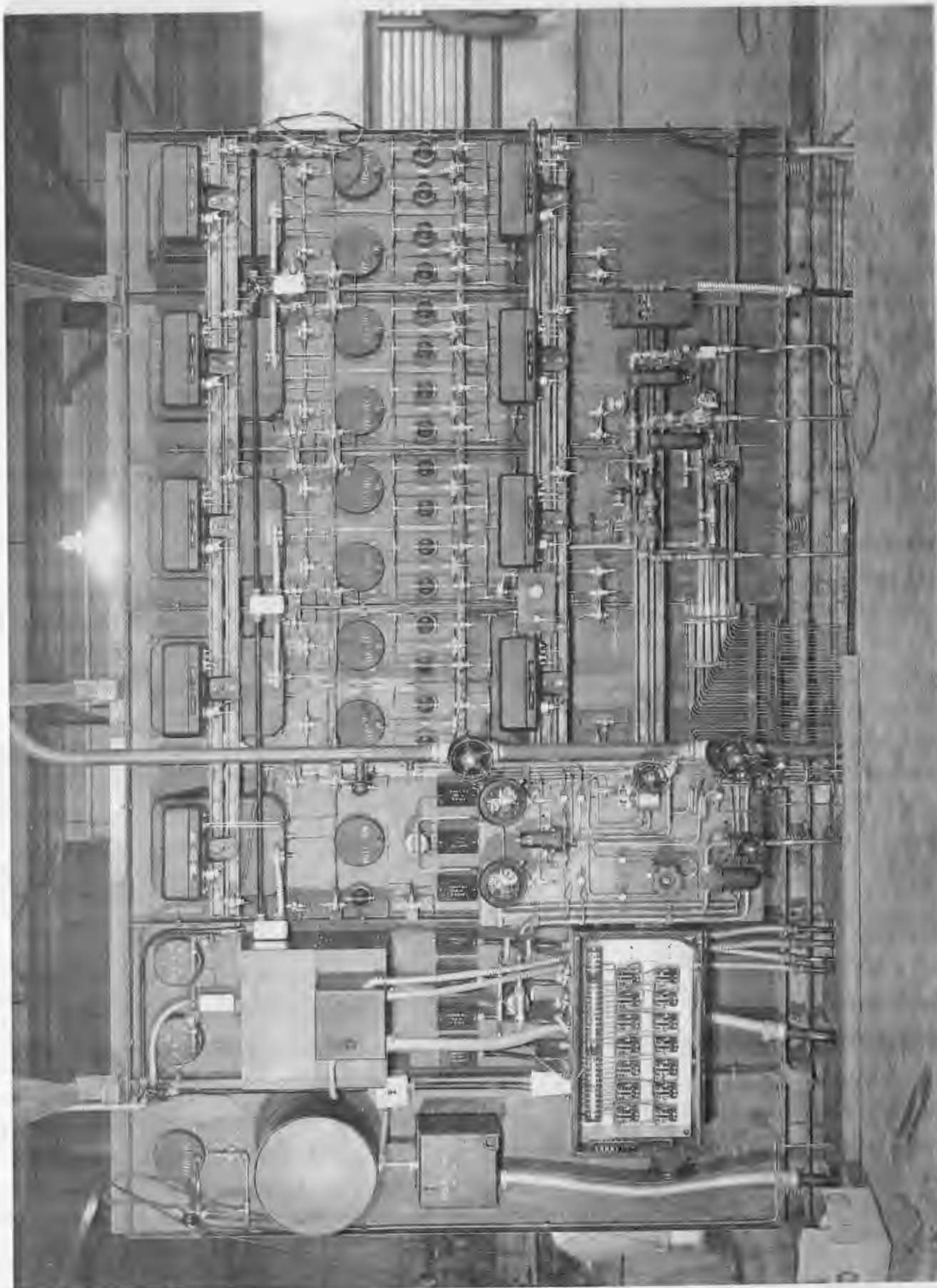

CONFIDENTIAL/RD

~~SECRET~~

~~CONFIDENTIAL/RD~~

D6 Intersectional Cell Panel Board.

~~SECRET~~

~~CONFIDENTIAL/RD~~

~~CONFIDENTIAL/RO~~

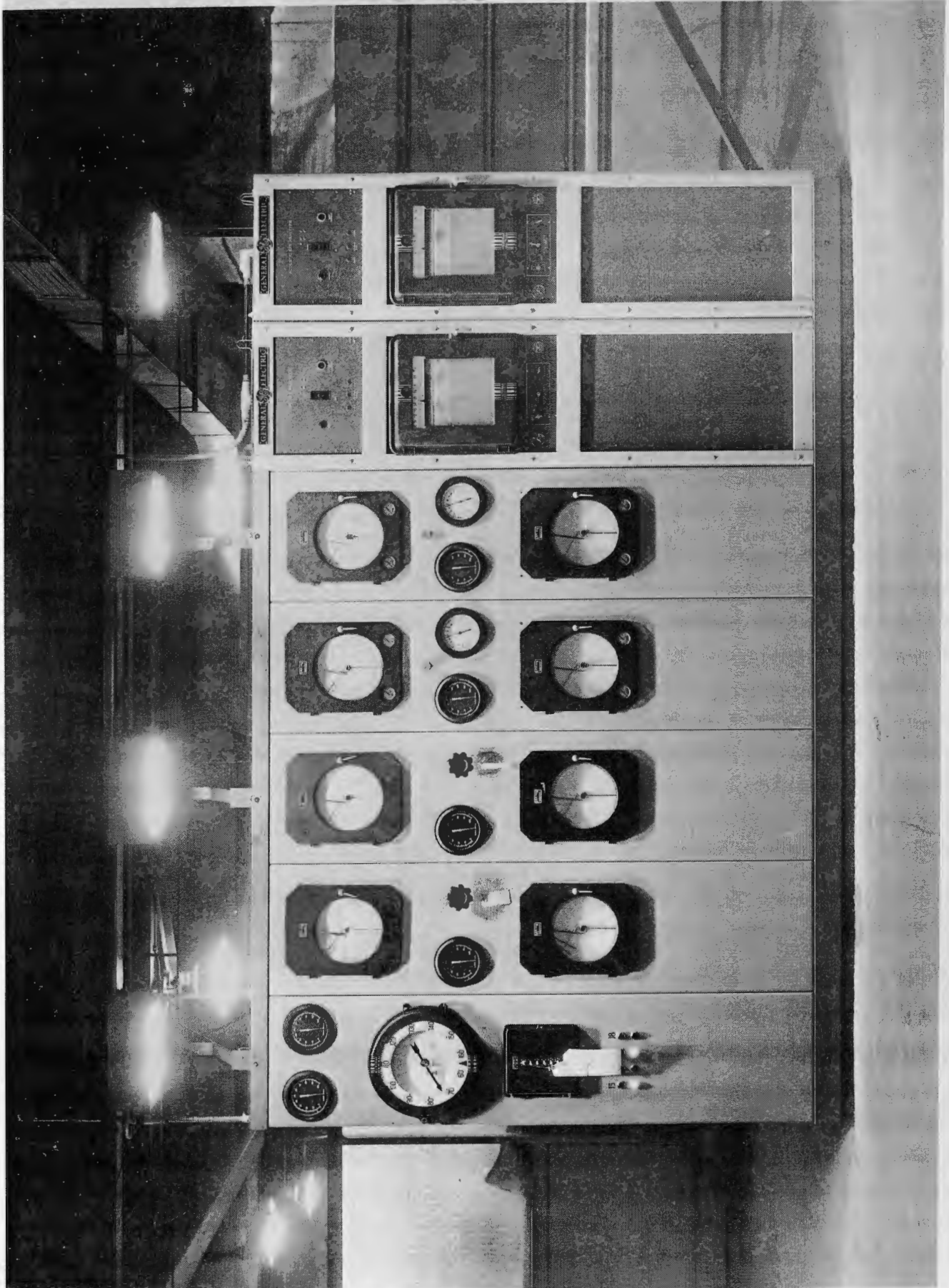

~~CONFIDENTIAL/RO~~

~~SECRET~~

~~CONFIDENTIAL/RD~~

D7 Typical Instrumentation within a Process Cell,
showing Pressure Transmitting Equipment, Stage
Control Valve, and part of the Casing of a
Stage Pump.

~~SECRET~~

~~SECRET~~

~~CONFIDENTIAL/RD~~

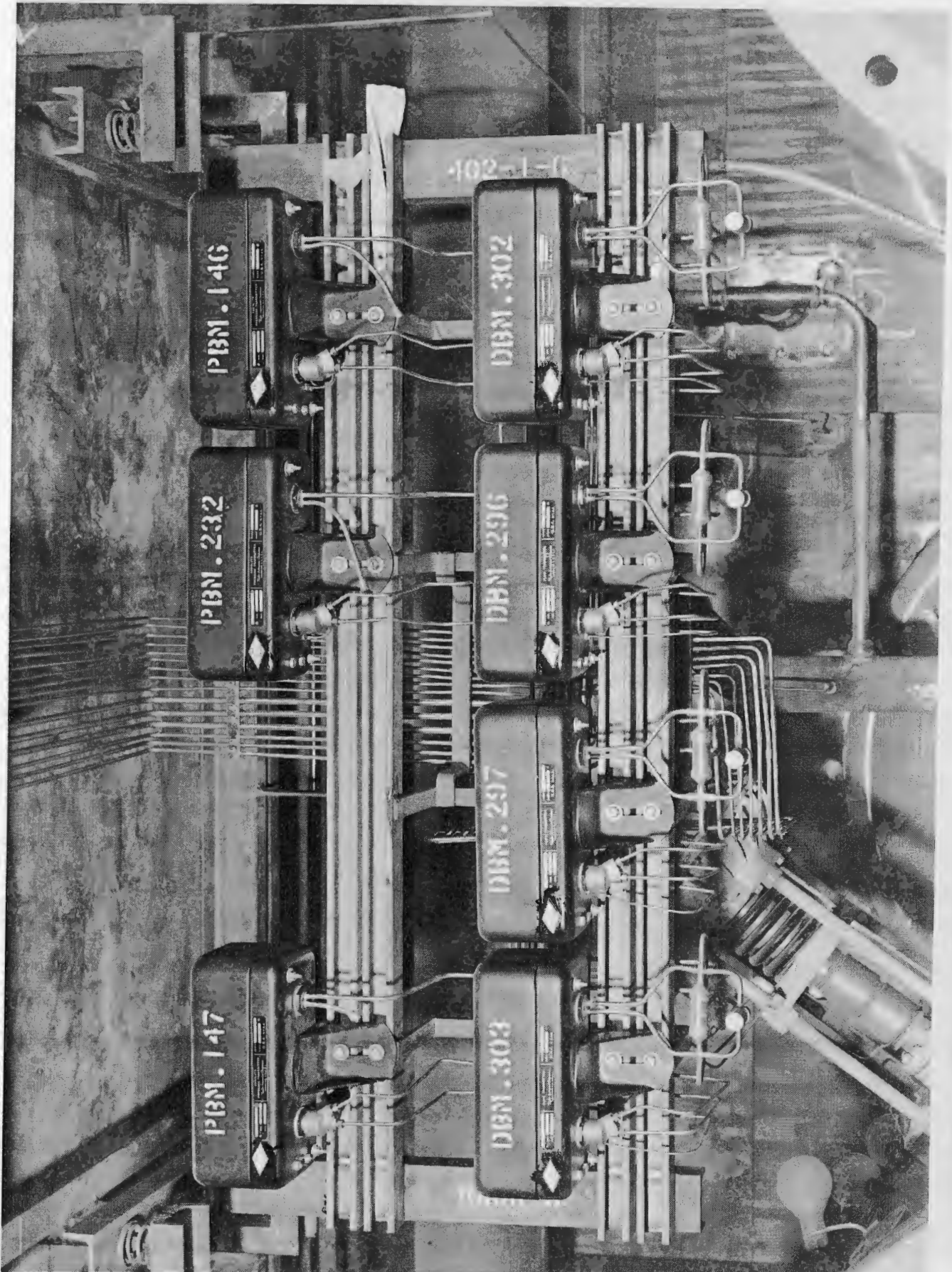

~~SECRET~~

~~CONFIDENTIAL/RD~~

D8 View of Basement of a Typical Process Building,
showing Coolant Coolers, Ventilating Fans, and
Ductwork.

~~SECRET~~

~~CONFIDENTIAL/RD~~

~~CONFIDENTIAL/RD~~



~~CONFIDENTIAL/RD~~

~~SECRET~~

~~CONFIDENTIAL/RD~~

D9 View of Cell Floor between two Typical Process
Buildings, showing Withdrawal Alley, Cell
Enclosures, Stage Pumps, and Ventilating
Ductwork.

~~SECRET~~

~~CONFIDENTIAL/RD~~

~~CONFIDENTIAL~~ RD



~~CONFIDENTIAL~~

CONFIDENTIAL/RD

~~SECRET~~

~~CONFIDENTIAL/RD~~

D10 View of a Typical Pipe Gallery before installation
of Dry Air Piping Enclosures.

~~SECRET~~

~~SECRET~~

~~CONFIDENTIAL/RD~~

~~CONFIDENTIAL/RD~~

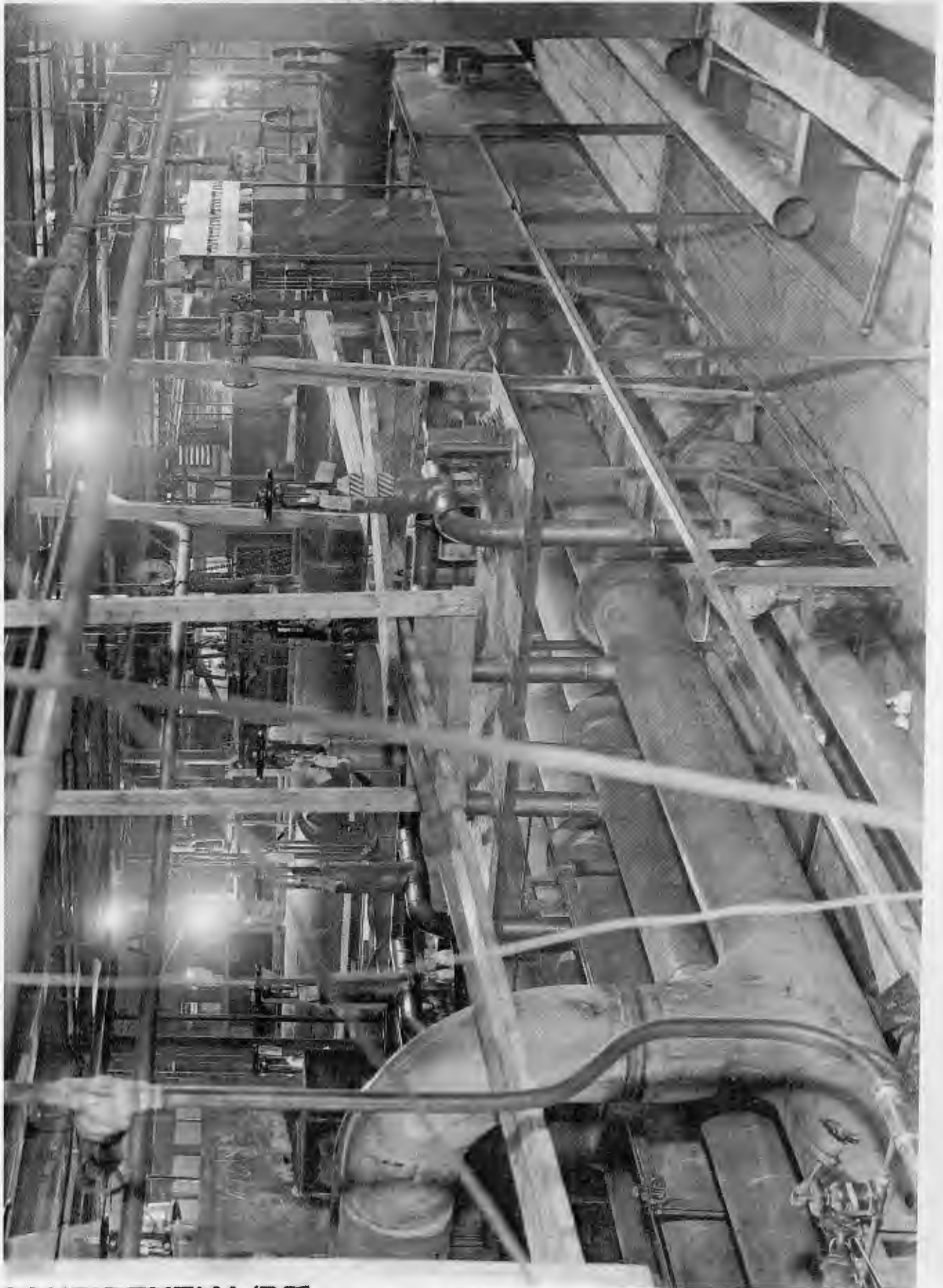

~~CONFIDENTIAL/RD~~

~~CONFIDENTIAL~~

~~SECRET~~

~~CONFIDENTIAL/RD~~

D11 - View of a Typical Operating Floor, showing
Cell By-pass, Direct Recycle, and Inverse
Recycle Valves; Ventilating Ductwork; Pit,
Motor, and Surge Drum for Coolant Pump
(left center); and Seal Exhaust Vacuum
Pump and Carbon Trap (center).

~~SECRET~~

~~SECRET~~

~~CONFIDENTIAL/RD~~

~~CONFIDENTIAL/RD~~



~~CONFIDENTIAL/RD~~

~~SECRET~~

~~CONFIDENTIAL/RD~~

D12 Converter Conditioning Furnace Stands in
Building K-1401.

~~SECRET~~

~~CONFIDENTIAL/RD~~

~~CONFIDENTIAL/RD~~

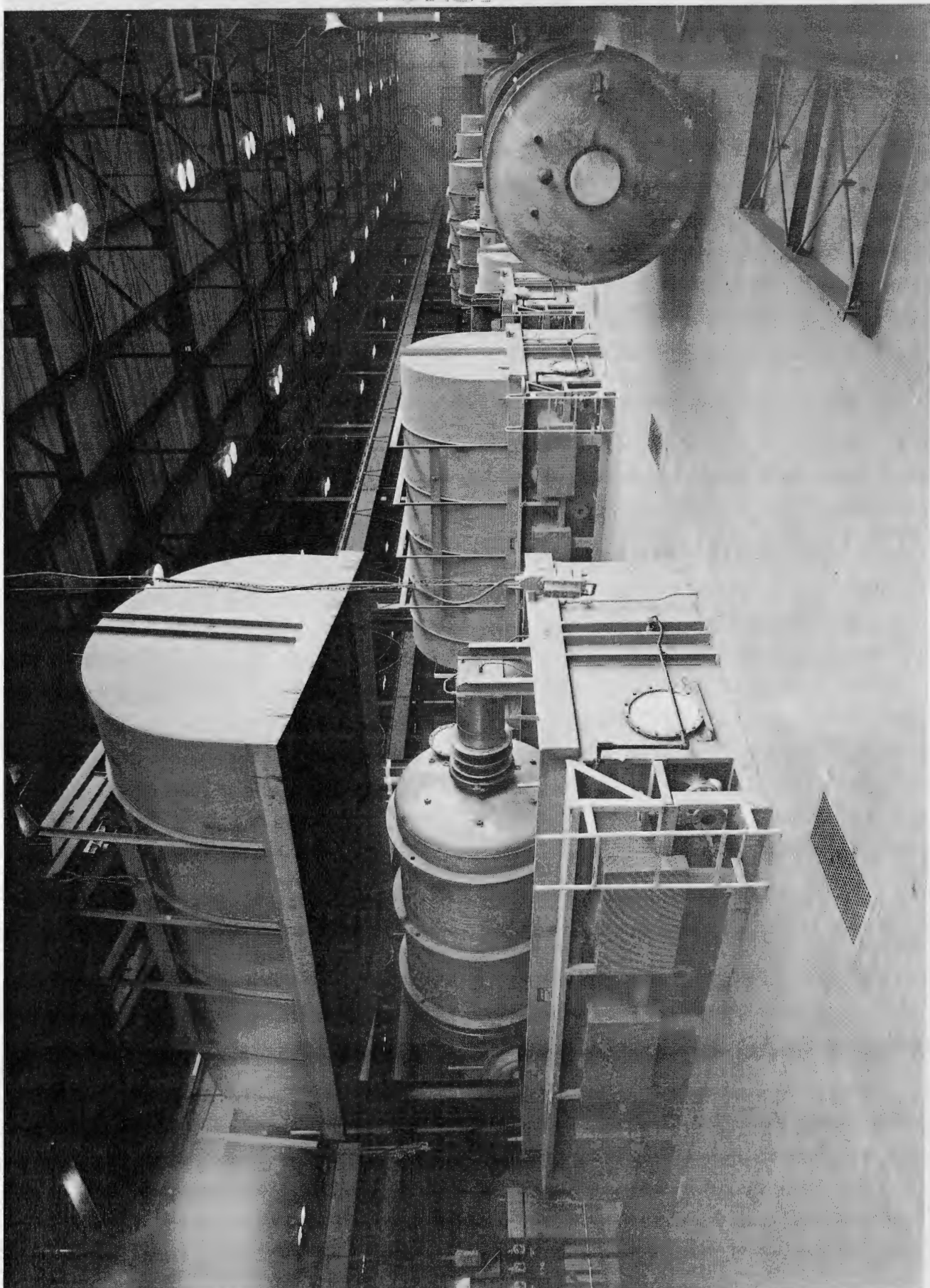

~~CONFIDENTIAL/RD~~

~~SECRET~~

~~CONFIDENTIAL/RB~~

D13 Typical Converter Running Test Stand in Building
K-1401, showing Converter in place for Porosity
Testing, Circulating Pump, Valves, Piping,
Instrumentation, Leak Detector, High Vacuum Pump,
and Switchgear.

~~SECRET~~

~~SECRET~~

~~CONFIDENTIAL/RB~~

~~CONFIDENTIAL/RD~~

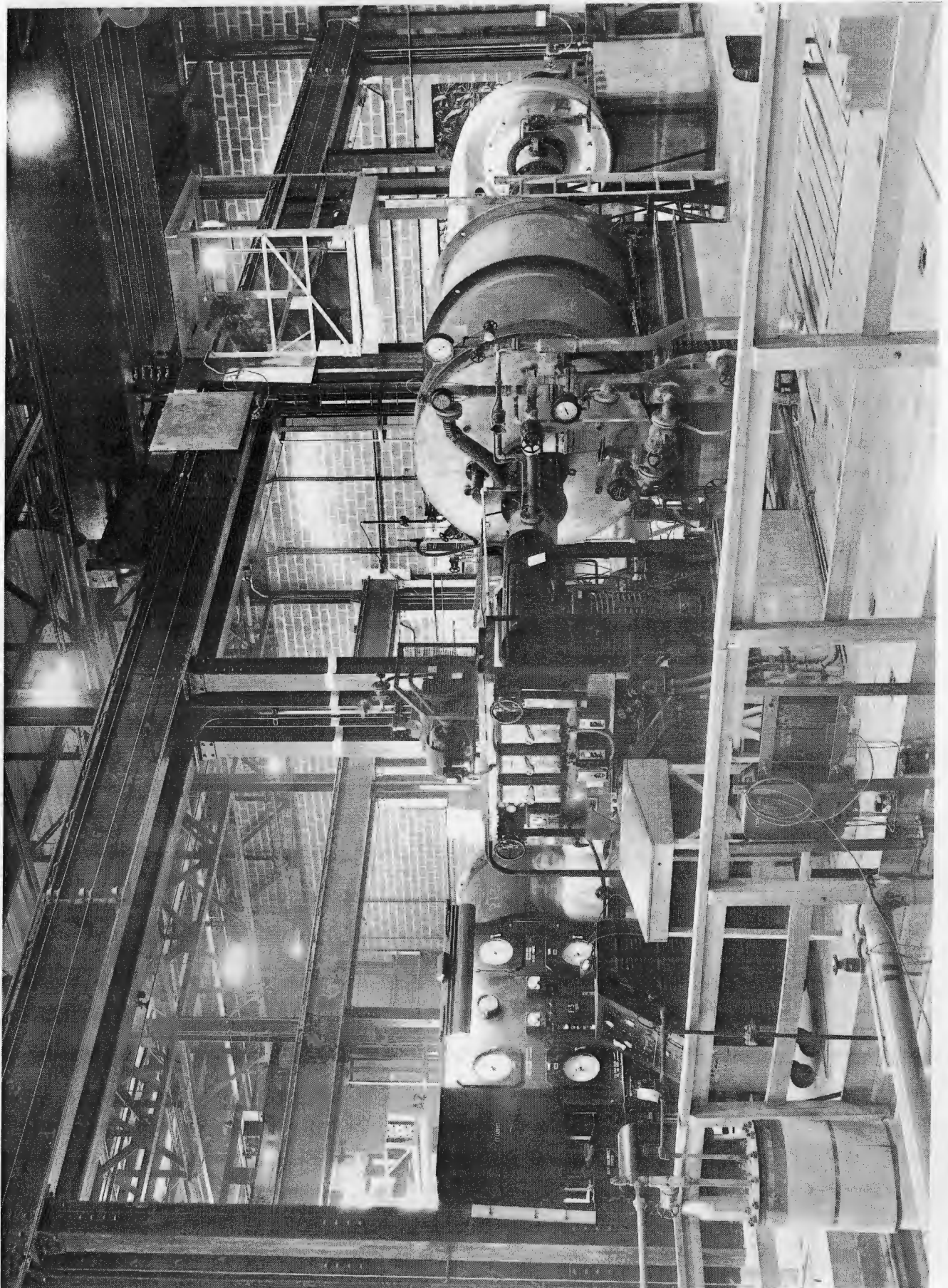

~~CONFIDENTIAL~~

~~CONFIDENTIAL/RD~~

DM

~~SECRET~~

~~CONFIDENTIAL/RD~~

D14 Process Pump Conditioning Stands in Building K-1401.

~~SECRET~~

~~CONFIDENTIAL/RD~~

~~CONFIDENTIAL/RD~~

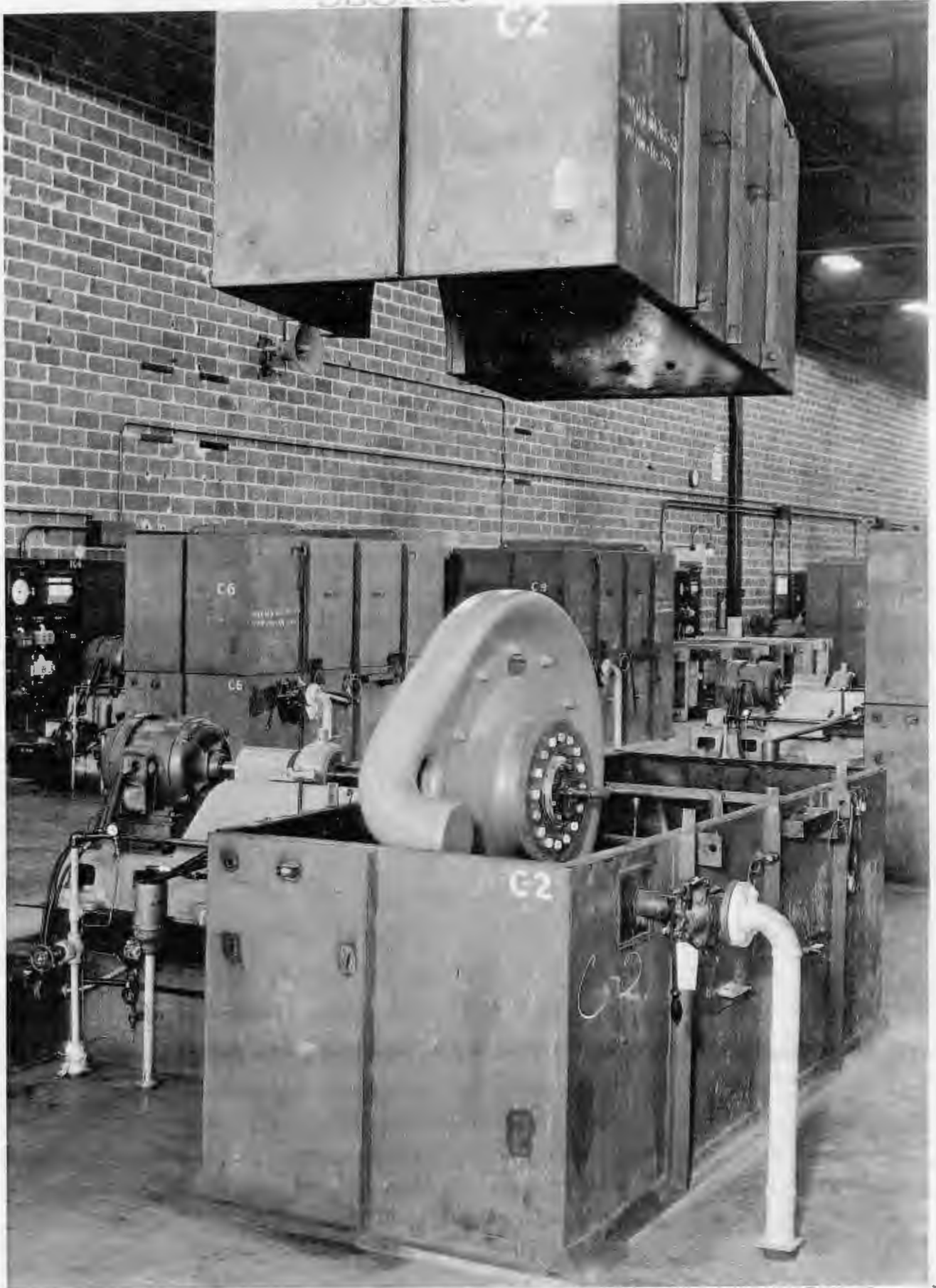

~~CONFIDENTIAL/RD~~

~~SECRET~~

~~CONFIDENTIAL/RD~~

D15 Alpha and Fission Counting Room in Laboratory

K-1004-B.

~~SECRET~~

~~CONFIDENTIAL/RD~~

~~CONFIDENTIAL/RD~~

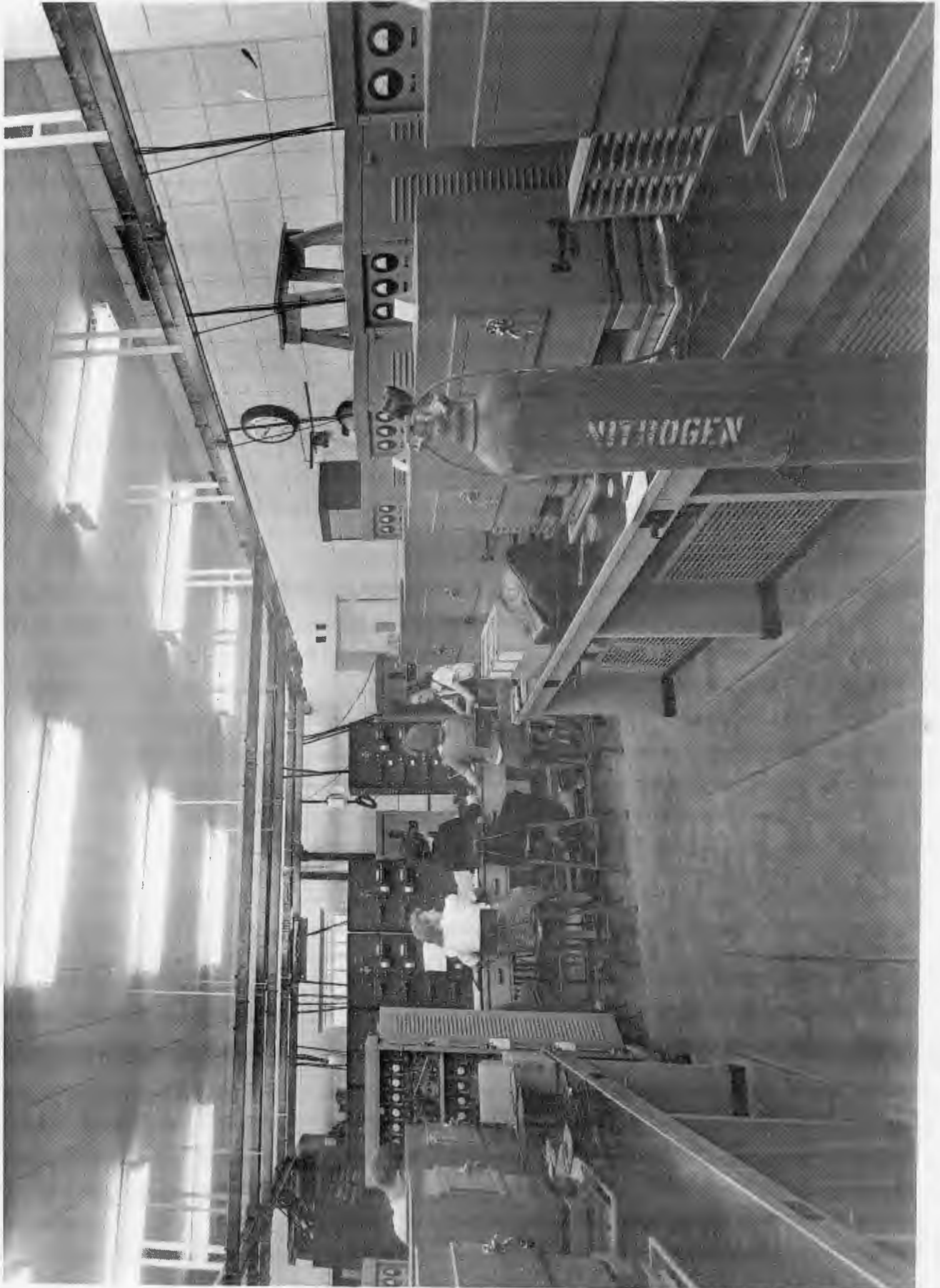

~~CONFIDENTIAL/RD~~

~~SECRET~~

~~CONFIDENTIAL/RD~~

D16 Panoramic Aerial View of the Gaseous Diffusion

Plant, facing south, showing:

Section 300 --Main Cascade - center.

Section 400 - K-27 Area - right.

Section 1400 - Conditioning Area - left.

Section 1000 - Administration Area - left background.

Section 800 - Recirculating Cooling Water Pump
House and Cooling Towers - right
foreground.

Poplar Creek - right.

Clinch River - background.

Proceeding from the Base of the "U" toward the
background, Buildings shown within, and just behind,
the Court are:

K-1030 - Electrical Maintenance Building.

K-1101 - Dry Air Plant. To left of K-1101 are:

K-1201 - Air Compressor House.

K-1102 - Fan and Transformer Building.

K-300-C - Process Coolant Plant.

K-1024 - Instrument Maintenance Building.

K-101 - Feed Purification Building.

K-601 - Surge and Waste Building.

K-1029 - Field Office Building.

K-1034 - Field Office Building.

~~SECRET~~

~~CONFIDENTIAL/RD~~

CONFIDENTIAL/RD

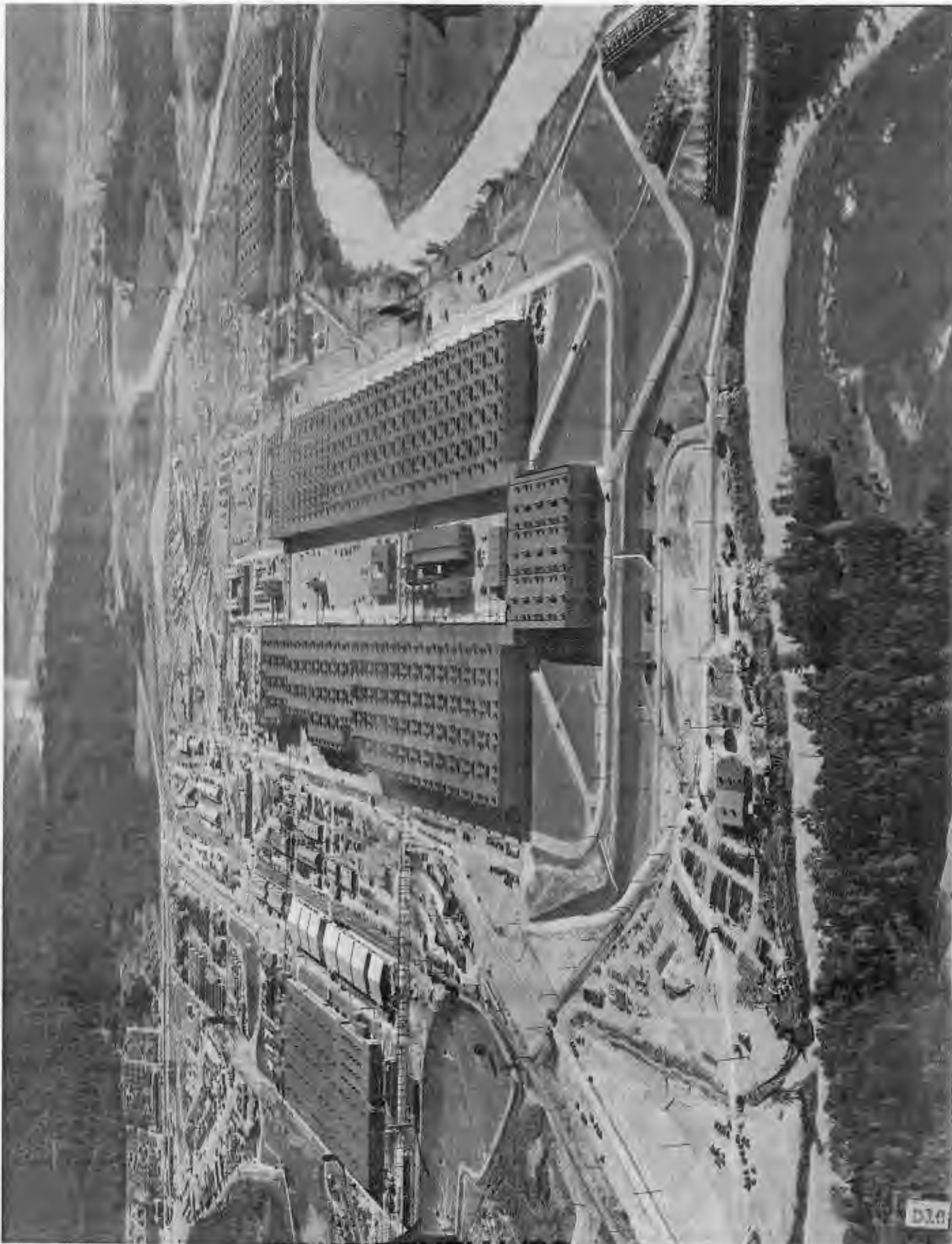

DIA

CONFIDENTIAL/RD

~~SECRET~~

~~CONFIDENTIAL/RD~~

D17 Panoramic Aerial View of the Cassoux Diffusion Plant,
facing northwest.

~~SECRET~~

~~CONFIDENTIAL/RD~~

CONFIDENTIAL/RO



027

CONFIDENTIAL/RO

~~SECRET~~

~~CONFIDENTIAL/RD~~

D18 Aerial View of Power House Area, facing south.

The Clinch River is shown in the background.

Also shown, proceeding diagonally from the lower left corner are:

K-709 - Switch Yard.

K-704 - Main Switch House.

K-702 - Turbine House.

K-701 - Boiler House.

K-707 - Auxiliary Switch House.

K-708 - Pump House.

K-705 - Crib House.

The Coal Storage Pile is shown in the upper left corner, and a Portion of the S-60 Main Process Building and Auxiliary Buildings at the lower right (Book VI).

~~SECRET~~

~~CONFIDENTIAL/RD~~

CONFIDENTIAL RD

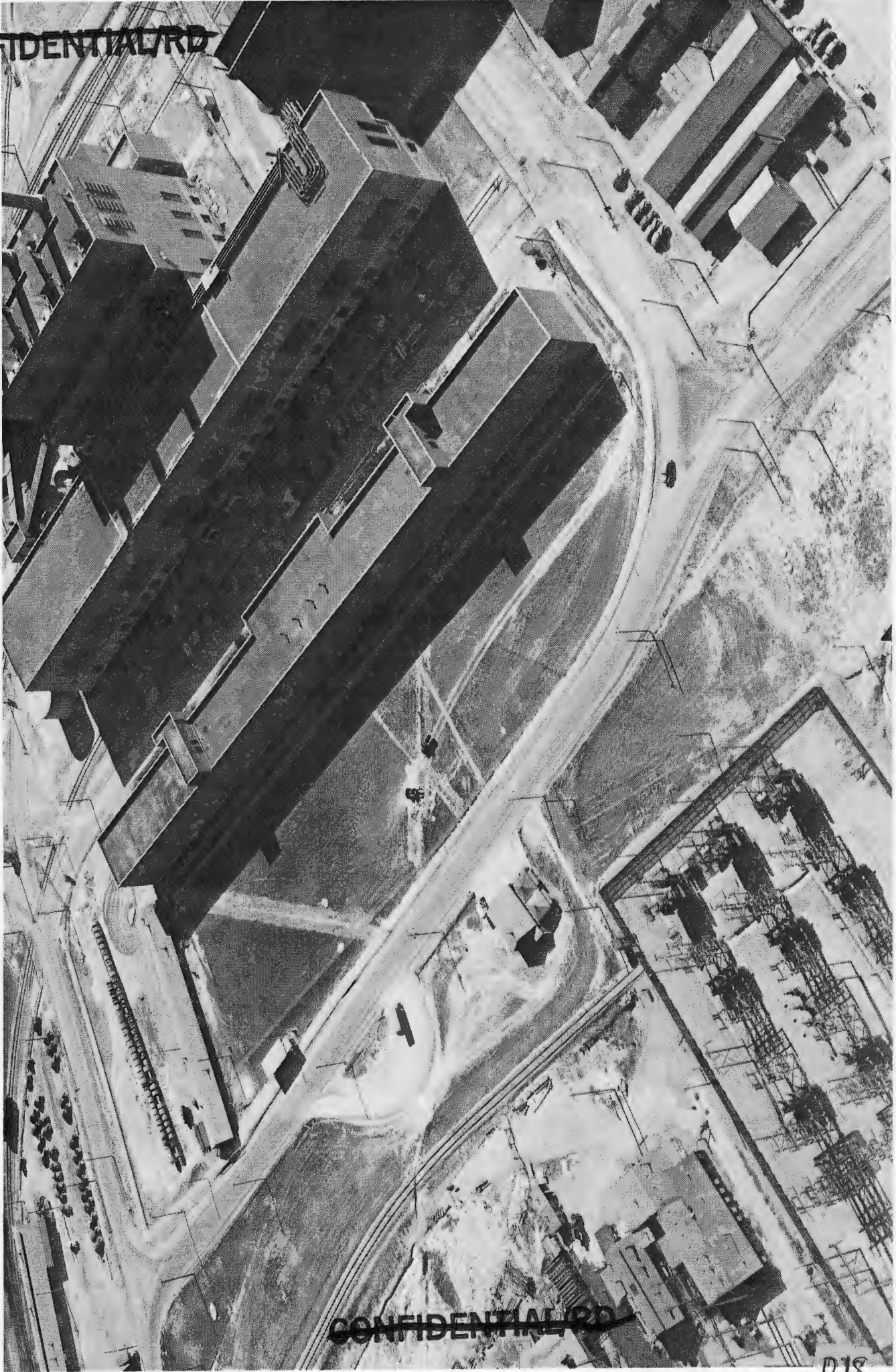

CONFIDENTIAL RD

~~SECRET~~

~~CONFIDENTIAL/RD~~

MANHATTAN DISTRICT HISTORY

BOOK XI - GASEOUS DIFFUSION (K-25) PROJECT

VOLUME 5 - OPERATION

APPENDIX "E"

CONTRACTS

The following list tabulates prime operating contracts pertaining to the K-25 Project. Cost figures are effective as of the end of the fiscal year 1946.

~~SECRET~~

~~CONFIDENTIAL/RD~~

CONTRACT NO. TYPE	NAME OF CONTRACTOR EFFECTIVE DATE METHOD OF LETTING	HOME OFFICE OF CONTRACTOR	SCOPE OF WORK
W-7406-eng-26 Cost-plus- fixed-fee	Carbide and Carbon Chemicals Corpo- ration 18 January 1943 Selected by General Groves, negotiated by New York Area, and approved by General Groves.	New York, N. Y.	Operation of the diffusion plant, and consultant se
W-7405-eng-258 Cost-plus- fixed-fee.	Hooker Electrochemical Niagara Falls, Company 27 September 1943 Negotiated by New York Area.	N. Y.	Engineering, desi- gn, and construction of diffusion plant, procurement, train- ing personnel, and op- eration of C-216 production
W-7407-eng-34 Cost-plus- fixed-fee.	Ford, Bacon and Davis, New York, N. Y. Inc. 26 October 1943 Negotiated by New York Area.	New York, N. Y.	Operation of the conditioning area and acid disposal

~~SECRET~~

~~CONFIDENTIAL/RD~~

SCOPE OF WORK

ORIGINAL CONTRACT ESTIMATED AMOUNT (NOT INCLUD- ING FEE)	MODIFIED CONTRACT ESTIMATED AMOUNT (NOT INCLUD- ING FEE)	CONTRACT PAYMENTS TO DATE (NOT INCLUD- ING FEE)	FIXED FE PAYMENT TO DATE
---	---	---	--------------------------------

Operation of the gaseous
diffusion plant, and research
and consultant services.

\$3,100,000 plus: 800,000 per year for research and 4,500,000 per month for operation.	\$119,000,000 through 30 June 1947 plus 25,000,000 for closing.	\$61,544,187	\$1,354,187
---	--	--------------	-------------

Engineering, design, super-
vision of construction and
commissioning, training of
personnel, and operation of
18 production plant.

\$19,000	\$19,000	335,832	22,000
----------	----------	---------	--------

Operation of the K-25
conditioning area, C-218 disposal
acid disposal plants.

\$8,864,000	\$8,864,000	\$6,768,709	181,800
-------------	-------------	-------------	---------

TOTALS:		68,648,698	1,558,000
----------------	--	-------------------	------------------

~~SECRET~~

~~CONFIDENTIAL/RD~~

~~CONFIDENTIAL~~/RD

MODIFIED CONTRACT ESTIMATED AMOUNT (NOT INCLUD- ING FEE)	CONTRACT PAYMENTS TO DATE (NOT INCLUD- ING FEE)	FIXED FEE PAYMENTS TO DATE	MATERIAL FURNISHED BY GOVERN- MENT TO DATE	TOTAL CON- TRACT COSTS TO DATE	ESTIMATED TOTAL CON- TRACT COSTS WHEN COMPLETED
---	---	----------------------------------	--	---	---

119,000,000 through 30 June 1947 plus 25,000,000 for closing.	\$61,544,157	\$1,354,150	\$11,060,713	\$73,959,050	\$137,415,500
--	--------------	-------------	--------------	--------------	---------------

619,000	335,832	22,050	164,175	522,057	522,000
---------	---------	--------	---------	---------	---------

6,864,000	6,768,709	181,800	188,800	7,139,109	7,500,000
-----------	-----------	---------	---------	-----------	-----------

	<u>68,648,698</u>	<u>1,558,030</u>	<u>11,413,488</u>	<u>81,620,216</u>	<u>145,437,500</u>
--	-------------------	------------------	-------------------	-------------------	--------------------

~~SECRET~~

~~CONFIDENTIAL/RD~~

MANHATTAN DISTRICT HISTORY

BOOK II - GASEOUS DIFFUSION (K-25) PROJECT

VOLUME 5 - OPERATION

APPENDIX "F"

KEY PERSONNEL

<u>No.</u>	<u>Title</u>
1.	Key Personnel, K-25 Operations Office (K-25 Division).
2.	Key Personnel, Carbide and Carbon Chemicals Corporation.

~~SECRET~~

~~CONFIDENTIAL/RD~~

~~SECRET~~

~~CONFIDENTIAL/RD~~

KEY PERSONNEL, K-25 OPERATIONS OFFICE
(K-25 DIVISION)

Cook, Lt. Col. R. W. - K-25 Operations Officer from 5 October 1944 to 30 April 1946. Chief, K-25 Division from 1 May 1946 to present.

Fraser, Lt. Col. H. R. - Special Assistant to the K-25 Operations Officer (K-25 Division Chief) from 1 February 1946 to 30 June 1946. Assistant Chief, K-25 Division from 1 July 1946 to present.

Archer, Major E. R. - Executive Officer, K-25 Operations Office (K-25 Division) from 29 December 1944 to present.

Beckwith, Major E. M. - Chief, Plant Operations Branch from 1 March 1945 to 30 November 1945.

Belcher, Major F. H. - Chief, Engineering and Supply Branch from 25 February 1946 to present.

Johannsson, Major R. E. - Chief, Safety and Security Branch from 7 September 1945 to 27 February 1946.

Klossner, Major R. H. - Chief, Engineering and Supply Branch from 1 March 1945 to 19 October 1945.

Luke, Major C. D. - Chief, Plant Operations Branch from 1 December 1945 to 25 February 1946.

Moran, Major J. J. - K-25 Operations Officer from 22 February 1944 to 2 October 1944.

Bohden, Captain V. L. - Chief, Transportation and Supply Section from 1 March 1945 to 23 February 1946.

Fugard, Captain J. R. - Chief, Engineering and Supply Branch from 20 October 1945 to 24 February 1946.

Huff, Captain W. E. - Chief, Production Data and Shipments Subsection from 15 May 1945 to 5 October 1945.

Tracy, Captain G. G. - Chief, Transportation and Supply Section from 1 March 1946 to present.

Anderson, 1st Lt. W. S. - Chief, Safety and Security Branch from 28 February 1946 to 28 June 1946.

F1

~~SECRET~~

~~CONFIDENTIAL/RD~~

~~SECRET~~

~~CONFIDENTIAL/RD~~

Baranowski, 1st Lt. F. P. - Chief, Research, Special Materials, and Production Data Section from 12 April 1945 to 14 May 1945, and from 6 October 1945 to 4 September 1946. Chief, Research and Special Materials Subsection from 15 May 1945 to 5 October 1945. Assistant to Chief, Plant Operations Branch from 5 September 1946 to present.

Brock, 1st Lt. L. V. - K-25 Security Officer (District Intelligence and Security Division) from 5 October 1944 to 14 February 1946.

Anderson, J. D. - Chief, Engineering Section from 30 July 1946 to present.

Blakely, F. F. - Chief, Administrative Branch from 8 April 1946 to present.

Hannoch, Julius. - Chief, Safety and Security Branch from 29 June 1946 to present.

Haycock, T. J. - Chief, Research, Special Materials, and Production Data Section from 5 September 1946 to present.

Levine, Aaron. - Chief, Engineering Section from 26 February 1946 to 29 July 1946.

Peyton, H. J. - Chief, Administrative Branch from 19 April 1944 to 7 April 1946.

Rogers, W. H. - Chief, Plant Operations Branch from 26 February 1946 to present.

F1

~~SECRET~~

~~CONFIDENTIAL/RD~~

KEY PERSONNEL, CARBIDE AND CARBON CHEMICALS CORPORATION

- Abbatiello, A. A. - (February 1945 to present) Senior Design Engineer. At SAM assisted in development of laboratory apparatus. Directed development of special equipment on pumps, barrier and welding equipment. Directs Design Section of Engineering Development.
- Alspaugh, P. L. - (March 1945 to July 1946) Plant Engineer. Headed original Process Design and Development Department. Design changes and studies were numerous. In addition, supervised inspection and transfer of buildings from construction contractor to Carbide.
- Armistead, Dr. F. C. - (February 1944 to June 1946) Technical Assistant to Superintendent, Process Division. Organized Vacuum Testing Department. Was responsible for development of personnel and training; developed techniques used for testing equipment in place.
- Barber, P. A. - (December 1945 to present) Supervisor, Central Methods Unit. At SAM, served as administrative assistant to head of the barrier program. Established liaison with SAM, Bell Telephone Laboratories, Linde Air Products Company, the Bakelite Corporation, and the New Jersey Machine Corporation, all engaged in barrier development and production. Responsible for editing and issuing consolidated progress reports on barrier.
- Barnett, H. L. - (December 1945 to present) Supervisor, General Engineering Department. Supervised procurement of equipment and spare parts insuring continuous operation of the plant. Coordinated procurement of material with Kellogg Engineering Department. Assisted in development of maintenance procedure.
- Barnett, S. C. - (December 1945 to present) Superintendent, Process Division. Originally assumed responsibility for organization, administration and personnel of Process Division. Initiated organization of shift groups for operation and directed and supervised integration of auxiliary and accessory units into the division. Was responsible for economies evolved through directed consolidation of departments and groups and for increased efficiency through advances in operating techniques.
- Beck, Dr. C. K. - (January 1945 - June 1946) Assistant to General Superintendent. (June 1946 to present) Director, Research Laboratory. Did much of technical work on conditioning of converters and acceptance tests. Served as Chairman of Special Hazards Committee. Directs research laboratory.

Bliss, L. A. - (December 1942 to present) Vice-President, Linde Air Products Company. Took part in original negotiations with Manhattan District. Prior to Carbide's association with the Project, was instrumental in securing uranium materials for research work being carried on by others. Consultant on matters affecting the Project and acted as coordinator between Manhattan District and over-all Carbide activities in the Project.

Boudreau, W. F. - (April 1943 to present) Research Engineer. Assisted in design, development and test of gas bearing blowers and associated control and starting equipment.

Brown, G. F. - (July 1943 to November 1945) Office Manager, Manufacturing Office Division. Set up and supervised accounting, Stores, Receiving, Shipping systems and hired and organized the staff to maintain them. At one time, his force amounted to 1200 employees.

Callihan, Dr. A. D. - (December 1941 to present) Supervisor, Physics Research. (At SAK under Columbia University and Carbide to March 1946, then to Oak Ridge.) Directed and participated in development of methods of stabilizing barrier for plant operation; conducted investigations of material transport through barrier. At Oak Ridge, has supervised physics research laboratory and critical mass measurements and assists in direction of barrier research.

Carnes, H. W. - (May 1944 to present) Assistant Superintendent, Process Division. Conducted design and improvement of special equipment for use in Utilities Department. Developed procedures for water treatment and distribution; for handling low dew-point air system in unprecedented quantities. Supervises all facilities for water, sewage disposal, and air, and the process steam plant.

Center, C. E. - (February 1943 to present) Plant Superintendent. First Carbide man assigned to the Project by Dr. Felbeck. Assumed responsibility for forming an organization to operate K-25. In New York, performed consulting services pertaining to plant layout, design of equipment, and design of auxiliary buildings. At Oak Ridge, was responsible for all administrative functions and establishment of policies. Handled all problems incident to starting up, and brought the plant into operation within prescribed time limits. Was directly responsible for operation of power house and for plant divisions of industrial relations, equipment test and inspection, plant protection, transportation, maintenance of buildings and grounds, and the manufacturing office. Prepared all estimates regarding budget, housing requirements, and personnel. Participated in town management through Central Facilities Advisory Committee.

Conner, R. C. - (March 1945 to April 1946) Administrative Engineer. Responsible for work planning; coordination with construction and direct supervision of Vacuum Test field operations. Organized and directed operations control department.

Connors, J. A., Jr. - (Koller, April 1944 to September 1945; Carbide, September 1945 to present) Supervisor, Special Plant Problems Unit. Responsible for planning and performance of numerous tests covering automatic instrument performance, pump seals, power requirements, operations procedures, chemical and statistical studies and inventory calibrations.

Corson, Dr. E. K. - (February 1943 to February 1946) Technical Assistant to General Superintendent. Theoretical physicist on theory of critical mass, chain reaction, and isotope separation by gaseous diffusion. Directed studies on radiation hazards and production control. Conducted basic researches on release of atomic energy.

Coughlen, C. P. - (February 1944 to present) Supervisor, Converter Specification and Unplugging Unit. Responsible for research on consumption and corrosion in the plant. Research engineer on conditioning specifications and barrier research. Technical representative to Chrysler Corporation on converter manufacturing.

Cromer, S. J. - (SAM, February 1943 to November 1944; Carbide, November 1944 to March 1946; Los Alamos, March 1946 to January 1947; Carbide, January 1947 to present) Head of Engineering Development Division. Organized and staffed development and design department. Directed activities on plant research and development. Supervised design construction and operation of a gaseous diffusion pilot plant at SAM Laboratories. Directed plutonium production at Los Alamos.

Daniel, C. W. - (January 1944 to present) Supervisor, Statistical Analysis Unit. Assisted in test for precision determination of enrichment factors. Initiated and developed application of statistical methods to use in proper measure of precision in assay and analytical laboratories. Directed work on studies of variable causes.

Dunlap, A. P. - (September 1943 to present) Superintendent, Equipment Test and Inspection Division. Concerned with development of program for assembling data and conducting tests on equipment for fire and explosion hazards, to eliminate failures of equipment and sources of fire.

Edmonds, R. G. - (September 1945 to August 1946) Senior Research Engineer. Assisted in studies in relation to all phases of cold-trapping including refrigeration. Assisted in study, development, and engineering of fluorocarbons and barrier materials. Checked operating manuals, drawings, and specifications.

Felbeck, Dr. G. T. - (January 1943 to present) Project Manager. Concerned with technical features and administrative integration of entire gas diffusion Project. Responsible for development of policy and coordination of activities with District officials. Was responsible for a large part of the early successes in barrier development and in construction of a removable pump seal. Responsible for many of the significant design changes made prior to construction.

Flickinger, E. D. - (February 1944 to present) Department Head, Process Division. Organized and trained foremen and operators in procedures for conditioning of the plant. Organized and trained unit in recovery of waste materials from electromagnetic plant. Took over and integrated all process services in the Cascade Services Department.

Forward, L. L. - (September 1943 to present) Superintendent, Instrument Division. Assisted designer in preparation of instrument installation drawings and in selection of special design instruments and control methods. At Oak Ridge, organized and directed from inception the Instrument Division, responsible for complete maintenance and reclamation of instruments.

Freeman, S. S. - (February 1944 to present) Supervisor, General Engineering. Assisted in barrier development program and conditioning pilot plant. Prepared operations manual for Waste and Surge Section (K-601) of K-25.

Garrett, Dr. G. A. - (February 1943 to present) Supervisor, Separation Performance Unit. Responsible for computation and analysis of plant performances. Directs planning of production schedules.

Givens, G. C. - (August 1943 to August 1944) Assistant Superintendent, Power Division. Responsible for organizing and directing start-up of K-25 Power House.

Hale, A. B. - (December 1943 to September 1946) Supervisor, Development Test Section. Assisted in development on uses of fluorine. Organized and directed group for final inspection of cleaning and conditioning of all parts and equipment. Organized and directed group in computations for specifications for acceptance of converters.

Hawes, W. L. - (December 1943 to December 1945) Assistant Superintendent, Process Division. At SAN directed all Carbide personnel on loan to the various sections of the laboratories. At Oak Ridge, organized and directed the Coded Chemicals Section, being responsible for ordering, receiving, storing, dispensing, shipping and accounting for all coded chemicals at K-25.

Henkin, L. A. - (Kellogg, February 1943 to September 1945; Carbide, September 1945 to present) Supervisor, Separation Performance Unit. Responsible for development of methods for computing and analyzing plant performances and planning production schedules.

Huber, A. F. - (January 1944 to present) Assistant Superintendent, Process Division. Supervised and organized the fluorine manufacturing area and the nitrogen vaporization plant. Organized and directed the Field Conditioning group. Served as Area Supervisor in 306 and 312 Sections, and as Cascade Operations Engineer.

Hull, Dr. D. E. - (December 1943 to October 1946) Superintendent, Laboratory Division. Organized laboratory for control of K-25 plant, for isotopic analysis by counting and mass spectrometer methods, as well as chemical and physical tests of raw materials, process gas, and product. Supervised development of isotopic analysis counting methods from laboratory to plant scale.

Humes, W. B. - (Ford, Mason, and Davis, Inc., April 1944 to April 1945; Carbide, April 1945 to present) Assistant Plant Superintendent. As Assistant Division Superintendent (Process) was responsible for bringing Area VI into production. Transferred to Maintenance Division to establish job improvement methods, control records, etc., taking over the Division as Superintendent in January 1946. Responsible for all maintenance in K-25 Area.

Hurd, Dr. F. W. - (October 1942 to December 1943; Carbide, December 1943 to present) Assistant Superintendent, Laboratory Division (later Superintendent) with Manhattan District at SAM. Assisted in design of apparatus and structure at Oak Ridge. Participated in development of mass spectrometer, alpha and fission counting in isotopic analysis. Designed counting laboratory for S-50 Liquid Thermal Diffusion plant. Specialized in various counting methods used.

Kanzer, A. G., M. D. - (March 1944 to September 1946) Director, Medical Department. Organized and directed Carbide Dispensary at K-25. Directed and assisted in studies on occupational illnesses, special hazards exposure, safe job methods. Under his direction, the clinics gave medical attention to as high as 20,000 patients in one month.

Kinsey, H. D. - (February 1944 to present) General Superintendent. Responsible for selection and assignment of qualified personnel. Principal contributions were during design and construction in verification of design of process and changes in design and layout to simplify process. Developed methods of operation which were relieved of theoretical ^{en}cumbrances and resulted in earlier production, in reduction of personnel requirements and costs, intensification of training, and large savings in process materials.

~~SECRET~~

~~CONFIDENTIAL/RD~~

Knapp, C. W. - (March 1944 to January 1947) Assistant Plant Superintendent. Directed operations in conditioning building and was responsible for performance in accordance with standard procedures.

Korsmeyer, R. E. - (March 1944 to present) Department Head, Engineering Development Division. Assisted in pilot plant production of special barriers. Conducted special tests on new type converters. Determined by pre-operation best operating procedures. Coordinates engineering design and development activities.

Lane, T. E. - (September 1945 to present) Superintendent, Industrial Relations Division. Organized and directed division from inception. Responsible for establishment of wage and salary schedules and employee benefit policies. Directly supervises all the divergent functions pertaining to employment, public and labor relations and services.

Lanterman, H. D. - (May 1944 to September 1945) Plant Engineer. Set up requirements for acceptance of equipment installed in Process Area. Set up procedures to be followed and administration of details on taking over buildings from construction. Administered and processed design changes in Process Area.

Lyon, Dr. A. M. - (Urey Project, Yale University, April 1942 to January 1945; SAM, January 1943 to February 1945; Carbide, February 1945 to present) Supervisor, Barrier Research. Assisted in electrolytic research and extraction processes. Research on deuterium separation and heavy water piles. Supervised and assisted in barrier research and development.

Mans, C. W. - (July 1945 to October 1946) Superintendent, Power Division. Responsible for operation of power division and distribution of power for all purposes in the entire K-25 Area.

Maroons, J. J. - (November 1943 to July 1945) Employment Director, Industrial Relations Division. Directed all employment activities. Organized and developed field recruiting groups. Under his directions over 20,000 persons were recruited, hired and processed at Oak Ridge.

Marshall, E. M. - (July 1943 to September 1944) Superintendent, Power Division. Called out of retirement, he represented Carbide in approval and acceptance of design for power house and distributing system. He organized the division and inaugurated operations and directed the division until leaving because of ill health.

Marshall, J. A. - (December 1945 to present) Assistant Superintendent, Process Division. Set up procedures for training and trained first supervisors and foremen on job. Participated in development of centrifugal pumps. Directed and supervised start-up of first cascade. Organized Area Supervision set-up. Also started up Case II and K-27.

~~SECRET~~

~~CONFIDENTIAL/RD~~

McBirney, H. C. - (January 1944 to present) Assistant Shift Superintendent, Process Division. Participated as research engineer on mechanical equipment for pilot work at S&M. At Oak Ridge, assisted in original organization of shift set-up, later taking over supervision of Area VI, then the combined Areas III and IV.

McDermott, M. F. - (September 1944 to present) Superintendent, Plant Protection Division. Responsible for establishment of security policies and procedures. Organized and directed security, guard and fire departments. Promulgated and enforced security regulations.

Means, M. G. - (March 1944 to present) Shift Superintendent, Process Division. Responsible for organization and supervision of all shift personnel in the Division and its auxiliary departments. Instituted all job schedules and assignments (including supervisory) from beginning of operations. Participated in all major decisions concerning operations and policies.

Minett, Dr. E. E. - (January 1944 to October 1946) Senior Physicist. Worked on development of equipment for Line Recording system and for removing traces of C_8F_{18} from UF_6 . Directed work on operating methods for mass spectrometers and for mass spectrometer field installations. Assisted in design of and supervised Laboratory "G".

Moore, W. C. - (April 1944 to present) Supervisor, Pumps and Flow Unit, Development Test Section. Supervised group on running test stands, decontamination and recovery and on pumps and pump seal test and development. Supervised initial operation of the fluorine disposal plant.

Hestler, Dr. F. H. M. - (S&M, January 1945 to June 1944; Carbide, June 1944 to present) Barriers Department Supervisor, Laboratory Division. Supervised research on many phases of barrier work and development. Principally concerned with all conditions of gas absorption and distillation of fluorocarbons and with porosity measurements of barrier.

Howlen, J. D. - (Special Engineer Detachment, February 1944 to October 1945; Carbide, October 1945 to present) Design Engineer. Responsible for major part of design and development of the special assay machine used in the laboratories for determination of U-235 concentration in process stream. Designed new type valve successfully used in the process.

Nowak, H. A. - (November 1945 to April 1946) Supervisor, Line Recorder Department. Assisted in development and design of high vacuum valves and equipment for withdrawal of minute samples of process gas from the stream. Participated in design and development of line recorders used at K-25 and put them into use. Organized and supervised the line recorder department; was responsible for procedures and for training of supervisors and operators.

- O'Connor, J. V. - (November 1943 to June 1946) Electrical Distribution Engineer. (On loan from Consolidated Edison Company of New York). Directed pre-operational checks of electrical system. Organized and supervised Field Operations Section, Electrical System Operations Office. Devised and established work permit and stop-tag system which was adopted as standard in the whole plant. Organized and supervised switch house operations.
- Parker, Dr. A. S. - (May 1943 to September 1945) Senior Research Engineer. Directed group which approved Kellogg drawings for K-25 plant. Influenced many of the improvements and changes in design resulting from this coordination. Collaborated on coolant drying problem, recovery of materials, and others.
- Farrish, R. L. - (January 1945 to October 1945) Supervisor, Operations Design Unit. Edited original operations manual. Supervised unit on design and design changes during initial operating stages.
- Piper, W. G. - (January 1944 to present) Research Engineer. Assisted on design, development and test of gas bearing blowers and electrical control circuits.
- Plowes, Dr. A. C. - (May 1943 to June 1945) Technical Aide to Project Manager. Directed studies on alpha particle counters at SSM Laboratories, and calculations on plant production. Took part in design of physical and chemical laboratories at Oak Ridge.
- Powell, H. - (May 1943 to February 1946) Superintendent, Maintenance Division. At New York, assisted in design of converters. At Oak Ridge, he set up original maintenance organization and procedures. Responsible for layout of Conditioning Building and machine shops. Organized subsidiary departments of Maintenance Division, including the original engineering section. Directed coordination of field activities of groups with construction contractors.
- Priest, H. F. - (SSM, January 1942 to February 1944; Carbide, February 1944 to September 1946) Department Head, Laboratory Division. Direction of research and development involved in setting up control analytical methods for gaseous diffusion. This included special research which developed from "trouble-shooting" in start-up of gaseous and thermal diffusion plants.
- Rafferty, J. A. - (December 1942 to present) Chairman of the Board, Carbide and Carbon Chemicals Corporation. Took part in the original contract negotiations. Directed and set policies of coordination with designer and other contractors. Was directly responsible for all decisions affecting Carbide's participation and policies regarding the Manhattan Project.

Riede, F. M. - (February 1943 to August 1945) Research Engineer, Project Manager's Staff. Among the first Carbide men assigned to Project. Concerned with design and development of equipment for process. Principally, directed liaison and re-design of process pumps and much of the field research on pumps. Assisted in studies on seals.

Riley, D. H., Jr. - (November 1943 to October 1946) Assistant Superintendent, Power Division; (October 1946 to present) Superintendent, Power Division. Responsible for procurement and installation of all equipment in power house laboratory and mechanical testing department. Took over Boiler Department and reorganized it as well as supervising all other departments. Directed start-up of equipment to maintain firm power supply to Process Area. This was a prime requisite to the whole program.

Rinohart, O. R. - (February 1944 to November 1945) Assistant Office Manager; (November 1945 to present) Head of Manufacturing Office Division. Responsible for organization of various departments of the Division and for correlation of established accounting procedures with requirements of the Manhattan District.

Rodes, T. W. - (December 1945 to present) Administrative Assistant to Plant Superintendent. Responsible for administrative work of Plant Superintendent's Office. Assisted in organization of many of the departments. Initiated Standard Practices Manuals and directed set-up of methods of handling classified material and statistical data.

Rucker, C. H., Jr. - (December 1943 to present) Assistant Plant Superintendent. As Process Division Superintendent organized both technical and non-technical staffs for start-up and operation of K-25. Assumed personal responsibility for process pump problems, and was largely instrumental in achieving successfully operating pumps. Reviewed and screened all design changes affecting process equipment. Made significant contribution to overall design of K-25 and K-27.

Schwenn, M. F. - (February 1944 to present) Supervisor Plant II, Process Division. Assisted in design and development of several mobile units. Assisted in organization and supervision of fluorine and nitrogen vaporization sections. Supervises 27 buildings in cascade.

Seyfried, M. P. - (December 1945 to present) Supervisor Plant III, Process Division. Assisted in building and operating 5 and 10-stage pilot plant at SAM. Assisted in supervision of original Vacuum Test organization. Supervisor in start-up of 502 Section. Supervises K-27 plant.

Shafran, F. - (December 1943 to present) Supervisor, Analysis and Report Units. At New York, was shift supervisor in Pilot Plant which was used in barrier development. Participated in Carbide-Kellogg tests to determine operating data. Was responsible for revisions to ambient air systems and coolant systems operations to effect large savings and increase efficiency. Contributed to increasing plant production by parallel operation, frequency, and overlap.

Sheldon, G. T. E. - (March 1944 to present) Assistant Superintendent, Process Division. Area Supervisor of part of initial cascade and Waste and Surge Section. Later, supervised Plant I (half of K-25). Directs Uranium Control and Inspection Department.

Smiley, H. S. - (Kellogg, April 1944 to September 1945; Carbide, September 1945 to present) Technical Engineer, Process Test Section. Assisted in all chemical problems assigned to Research and Development units, correlating all experimental reports. Supervised research group in study of phenomena of barrier plugging under varied operating conditions.

Sperling, C. C. - (March 1944 to April 1946) Assistant Superintendent, Plant Engineering. Supervised Conditioning Area for cleaning and preparation of materials for construction. Supervised transfer of Ford, Bacon, and Davis personnel and operations to Carbide. Organized and directed design section of Plant Engineering.

Tenney, Dr. A. H. - (February 1943 to September 1946) Supervisor, Barrier Development Section. Third full-time Carbide employee hired for the Project. Assisted in the original barrier development program. Initiated cooperative programs of Carbide, Bakelite Corporation, and Linde Air Products Company, in the successful manufacture of effective barriers. Supervised and maintained liaison between laboratory and production groups on barrier.

Tyra, A. F. - (July 1943 to March 1945) Assistant Superintendent, Industrial Relations Division. Assisted in establishing and organizing Labor Relations, Training and Employment Departments. Directed and coordinated employment programs and procedures for departments.

Walker, R. A. - (April 1944 to present) Supervisor Plant I, Process Division. Assisted in development of first training program for foremen and operators and in writing operating procedures. Served in expediting vacuum test program. Supervisor in start-up of 310 Section (including first building to operate as cascade of cells). Supervises 27 buildings in cascade.

Waters, J. L. - (Kellogg, March 1943 to June 1945; Carbide, June 1945, to present) Supervisor, Process Design and Development. Originally directed coordination of groups on C-K tests. Later, headed test section for Carbide. Assisted in basic design of K-25 and K-27. Organized and directed start-up experimental runs.

Weiland, H. J. - (December 1943 to present) Assistant Superintendent, Process Division. Supervised start-up of 306-2L, the experimental building. Directed beginnings of first operating manuals. Had charge of operator training school for Vacuum Test and Operations Departments. Later brought Area IV into production.

Whitehouse, U. G. - (SAM, January 1944 to January 1945; Carbide, January 1945 to February 1946) Assistant Research Director. Assisted in basic barrier research at SAM. Assigned as assistant research director to Bakelite Corporation. Directed and conducted many studies on all phases of barrier production and performance.

Woebeke, H. H. - (Kallex, December 1942 to September 1945; Carbide, September 1945 to April 1946) Senior Design Engineer. Assisted in design of mobile units. Supervised group on basic process design, particularly in movement of gases.

Woodbridge, D. E. - (February 1945 to present) Supervisor, Research. Conducted and directed major portion of research and tests on gas bearing blowers.

INDEX

- "A" Stream, 4.2
Acid neutralizing plant, 2.5
Administrative Branch, 12.1, 12.2
Alpha counting, 5.6
Alspaugh, P. L., 9.6
Alumina, 6.10
Ambient air, 5.2 ff
American Industrial Transit, 10.9
Ammonia solution, 6.5
Anderson, W. S., 1st Lt., 12.2
Archer, H. R., Major, 12.1, 12.2
Area of the plant, 1.1
Area, Process operations, 12.4
Armistead, F. C., 9.5
Army Specialized Training Program, 10.5
Assistant Plant Superintendent, 9.9, 12.3, 12.4
Atlanta, Ga., 10.1
Atomic bomb, 9.8
Auxiliary services, 1.1, 4.3 ff
- "F" spare process lines, 4.9
"F" stream, 4.2
Bagley, J. G., 2.1
Bakelite Corporation, 2.5
Baranowski, F. P., 1st Lt., 9.6
Barnett, S. C., 9.6
Barrett, W. F., 2.1
Barrier
 Plugging, 3.5, 6.2, 8.7, 8.12 ff
 Replacement, 6.5, 8.14-8.15
 Separation efficiency, 8.16
Baruch Report of Scientific Information, 9.6
Beach-Russ Company, 4.8, 5.9
Beck, C. K., 9.5-9.6, 9.10
Beckwith, M. M., Major, 9.5, 12.1
Belcher, F. H., Major, 12.2
Benedict, M., 8.16, 9.5
Beryllium, 5.6
Birmingham, Ala., 10.1
Blakely, F. F., 12.2
Bliss, L. A., 2.1, 12.4
Blowout preventer, 6.3
Bound Brook Plant, 2.3
Brine, 5.3, 5.4
Bureau of Mines, 10.4
- C-2144, 5.8
Cadmium, 9.5
Calcium fluoride, 6.9
Carbide and Carbon Chemicals Corporation, 1.1, 2.1 ff, 3.1, 3.2, 6.15, 6.16, 9.2, 9.5 ff, 10.2 ff, 12.2 ff, 12.6
Carbon, 6.10
Carbon dioxide, 4.8
Carbon traps, 4.6, 6.2
Cascade equipment, 1.1
Case operation, 4.11, 6.4, 6.5, 8.1, 8.4
Center, C. E., 9.6, 12.4
C.E.W. Bus Authority, 10.9
Chain reaction, 9.5
Chattanooga, Tenn., 10.1
Chronic acid, 6.3
Chrysler Corporation, 2.4
Cleaning, 2.5, 2.6, 6.3, 6.4
Clinton Engineer Works, 9.5, 10.1, 10.7, 10.8, 12.2
Coal, 7.1
Cold traps, 4.7 ff, 9.5
Coldwell, E. H., 12.5
Commanding General, Army Service Forces, 10.5
Conditioning, 2.4, 2.5, 2.6, 3.5-3.6, 5.7, 6.1 ff, 8.2, 8.3
Conditioning plant, 2.4-2.5, 9.7
Congress of Industrial Organizations, 10.7
Contracting Officer, 2.2, 2.5, 12.3, 12.5
Contracts
 W-7405-eng-26, 1.1, 2.2 ff
 W-7405-eng-288, 1.2, 2.7 ff
 W-7407-eng-19, 2.4
 W-7407-eng-34, 1.2, 2.4 ff

Control of process material
 diversion, 9.9
 Cook, R. W., Lt. Col., 12.1
 Coolant, 4.5, 5.1 ff, 5.6, 5.7, 8.2
 Coolant cooler, 5.1
 Corbin, Ky., 10.1
 Corps of Engineers, 9.2, 10.5
 Corrosion, 3.5, 6.2, 6.6
 Corson, E. M., 8.16, 9.5
 Critchett, J. H., 2.1
 Critical mass, 4.8, 4.9, 9.5-9.8
 Crossroads Test, 2.5
 Costs, 11.1

D-29, 5.9
 Dam, L. I., 2.1
 Dead end system, 5.3
 Decatur, Ill., 9.1, 12.1
 Decatur Area Engineer, 12.1
 Degreasing, 6.3
 Detroit, Mich., 9.1
 Direct recycle, 4.7, 4.10
 Director of Research, 9.10
 Distillation analogy, 4.2, 4.4
 District Engineer, 1.2, 10.6, 12.1,
 12.2, 12.4
 District Insurance Branch, 9.1
 District Safety Branch, 9.1
 District Security Division, 9.3
 Division Chief, 1.2, 9.1, 12.2
 Dow Chemical Company, 2.1
 du Pont de Nemours and Company,
 E. I., 2.1, 2.6

Electromagnetic Project (see
 Y-12 Project)
 Elkins, J. A., 12.5
 Engineering and Supply Branch, 9.1,
 12.1, 12.2
 Equipment failures, 6.4 ff, 9.5
 Equipment Test and Inspection
 Division, 9.2
 Executive Officer, 9.1, 12.1, 12.2

Felbeck, G. T., 12.4

Fire Department, 9.2, 10.4
 Fire prevention, 9.1, 9.2, 9.3
 Fission, 5.6, 9.5
 Fission counter, 5.6
 Flash conditioning, 3.6
 Fluorination (see Conditioning)
 Fluorine, 2.4, 2.6, 2.7, 3.5-3.6,
 5.5 ff, 6.1 ff
 Fluorine disposal plant, 2.5, 6.1,
 6.9-6.10
 Fluorine plant, 1.1, 2.6, 2.7, 5.6,
 6.8 ff 9.7
 Fluorocarbons, 5.6
 Fluorolubes, 5.6, 5.8
 Ford, Bacon, and Davis, Inc., 1.2,
 2.4 ff, 9.1, 9.7, 12.4 ff
 Fraser, H. R., Lt. Col., 12.2
 Fuel oil, 6.11, 7.1
 Fugard, J. R., Captain, 12.1

General Superintendent, 12.3, 12.4
 Gentes, G., 12.6
 Gray, C. W., 12.5
 Groves, L. R., Major General, 2.1
 Guard Force, 9.7, 9.8, 10.4

Haggerson, F. H., 2.1
 Hancock, J., 12.2
 Happy Valley, 10.8
 Harshaw Chemical Company, 4.5, 8.15
 Hawth, W. E., 12.6
 Hazards, 4.8, 9.5-9.6, 9.10
 Helium, 3.3
 Hooker Electrochemical Company, 1.1,
 1.2, 2.6 ff, 6.8, 12.6
 Hoyt, F. C., 9.5
 Hubbard, D. O., 12.6
 Huber, A. P., 9.6
 Hall, D. E., 9.6
 Humes, W. B., 9.6, 12.4
 Hydrochloric acid, 6.3, 6.10
 Hydrogen fluoride, 4.8
 Hydriyers, 5.3-5.4

Inspection, 9.8
Cells, 4.10
Converters, 6.2-6.5
Instruments, 3.3, 5.1, 5.3, 5.4,
5.5, 6.5, 10.4
Intelligence and Security Branch,
9.7
Intercoll cooler, 5.1
Intersectional cells, 4.9 ff
Inverse recycle, 4.6

Johanneson, R. E., Major, 12.1
Johns Hopkins University, 2.6
Johnson City, Tenn., 10.1
Jones Construction Company, Inc.,
J. A., 9.7

K-27, 2.3, 3.4, 4.1 ff, 5.2 ff,
6.2 ff, 7.2, 8.1 ff, 9.7
Keith, P. C., 2.1
Kellogg Corporation, 2.7, 4.1, 8.15,
8.16, 9.5, 9.7
Kellogg, M. W., 2.1
Kellogg Company, M. W., 2.1
Kinsey, H. D., 9.5, 12.4
Klossner, R. H., Major, 12.1
Knoxville, Tenn., 10.1
Kramer, A. C., 9.6

Labor Relations Department, 10.6,
10.7
Laboratories, 5.5, 6.6, 6.7
Leak detector, 3.3, 5.5, 6.5
Leak testing, 2.3, 2.5, 3.2-3.4,
6.3, 8.2, 10.2, 10.3
Library, 5.5
Line, 6.9, 6.10
Line recorders, 5.5
Liquefaction of UF₆, 4.6
Liquid Thermal Diffusion Project
(see S-50 Project)
Los Alamos, N. M., 9.6
Luko, C. D., Major, 12.1, 12.2

Lyster, T. L. B., 12.6

Madison Square Area, 2.7, 6.15
Maintenance, 2.5, 2.6, 4.8, 4.10,
6.5, 6.8, 9.4, 10.2-10.4
Manhattan District, 2.1, 2.7, 3.15,
9.1, 9.5, 9.6, 9.7, 9.8, 10.5,
10.7, 12.2
Marshall, J. C., Ccl., 2.1
Mass spectrometer, 3.3, 5.6
Means, M. G., 9.6
Medical Department, 9.2
Memphis, Tenn., 10.1
MFL, 5.8, 8-11 ff
Mills, F., 9.9
Milwaukee, Wis., 9.1
Moisture, 3.5, 6.5, 6.7
Monsanto Chemical Company, 2.1
Moran, J. J., Major, 12.1

Nashville, Tenn., 10.1
National Labor Relations Board,
10.7
National Roster of Scientific and
Specialized Personnel, 10.1
Neutrons, 5.6
New York, N. Y., 12.3, 12.5
New York Area, 12.1
Niagara Falls, N. Y., 12.6
Nichols, K. D., Col., 2.1, 2.7

~~DELST 2~~ ~~DELLE~~
Nitrogen, 3.1, 3.4, 3.6, 4.3, 4.5,
4.7, 4.9 ff, 5.5, 6.1 ff, 6.10
Nitrous oxide, 4.8

Oak Ridge, Tenn., 10.6, 12.5, 12.6
Office of Price Administration, 10.9
Officer-in-Charge (see Unit Chief)
Operational errors, 3.4, 9.5
Operations Office, 3.15, 9.6, 12.1
Operations Officer, 1.2, 12.1, 12.2
Oxyfluoride hydrolysis products,
3.5

DOE
1571

Partially processed stock pile, 4.11
 Perfluorodimethylcyclohexane (see Coolant)
 Perfluoroheptane, 3.1, 3.4-3.5, 5.7-5.8, 6.2
 Perfluorovinyl chloride, 5.8, 5.9
 Peyton, H. J., 12.1
 Pilot plant, 6.7
 20 Stage, 6.6
 54 Stage, 3.1-3.2
 Plant I, 4.9-4.10
 Plant II, 4.9-4.10, 9.9
 Plant air, 5.4
 Plant Operations Branch, 12.1, 12.2
 Plant Operations Group, 12.2
 Plant Operations Officer, 12.1
 Plant Protection Division, 9.8, 9.10
 Plant Superintendent, 10.6, 12.3, 12.4

DPE
 631

~~DELETED~~ ~~DELETED~~

Polytetrafluoroethylene, 5.9
 Poplar Creek, 5.2, 6.10
 Power failures, 8.2 ff
 Process buildings, 1.1
 Process Division, 12.3
 Process Division Superintendent, 12.3
 Process Materials Department Council, 9.9
 Process Training School, 10.2

 Radioactivity, 9.5
 Radium, 5.6
 Rafferty, J. A., 2.1
 Reconditioning, 3.6, 6.2, 8.15
 Replacement Training Centers, 10.5
 Roane-Anderson Company, 10.7
 Rogers, W. H., 9.6, 12.2
 Rucker, C. H., Jr., 9.5, 9.6, 12.4
 Running test stands, 2.5, 6.2

S-50 Project, 2.4, 6.11, 7.1-7.3, 6.15, 6.6
 Safety and Security Branch, 9.1, 9.7, 12.1, 12.2

Safety Department, 9.2
 Safety Section, 9.1
 Safety Supervisor, 9.2
 SAI Laboratories, 2.3
 Sanitary water, 5.2
 Seals, pump, 6.3, 6.4-6.5, 6.2
 "Share-the-Ride", clubs, 10.9
 Sheldon, G. T. E., 9.6
 Side purge operation, 4.3, 4.9
 Sodium hydroxide, 6.9
 Special chemicals, 5.6 ff, 9.5
 Special Engineer Detachment, 10.5
 Special Hazards Committee, 9.6
 Specifications, 2.5, 3.2-3.3, 5.6, 6.15
 Sperling, C. C., 12.5
 Squires, A. H., 8.16
 Stage coolers, 5.1, 6.2
 54 Stage pilot plant, 3.1-3.2
 Standard Oil Company of New Jersey, 2.1
 Stokes Machine Company, F. J., 5.8
 Stowers, J. C., Lt. Col., 2.7, 12.1
 Stream efficiency, 8.4, 8.11, 8.16
 Surge for Purge, 4.8 ff

9812th Technical Service Unit, 10.5
 Tennessee Valley Authority, 7.2-7.5, 8.8, 8.9
 Testing
 Auxiliary systems, 3.2
 Equipment, 3.1 ff, 5.9, 6.2, 6.6
 Instruments, 3.1 ff
 Thompson, H. E., 2.1, 12.4
 Training Department, 9.2
 Training of personnel, 2.3, 2.6, 3.1
 Transportation Department, 10.9
 Trichloroethylene, 6.3
 Turbo-generators, 7.1-7.2

Uebelacker, A. A., 12.5
 Union Carbide and Carbon Corporation, 2.1 ff
 Unit Chief, 1.2, 12.1
 United Gas, Coke, and Chemical Workers of America, 10.7

~~SECRET~~

~~CONFIDENTIAL/RD~~

United Nations Atomic Energy Com-
mission, 9.8
Uranium-235, 237, 5.6, 8.15, 8.18,
9.5-9.6
Uranium Control and Inspection
Department, 9.9

Vacuum Test Training School, 10.2
Vacuum testing (see Leak Testing)
Vacuum Testing Department, 10.3
Van Wic, H. H., 9.9
Vaporization of UF_6 , 4.5, 4.8

Westinghouse Electric and Manu-
facturing Company, 5.5
Wheat School, 10.2
Wilker, A. V., 2.1
Worthington Pump and Machinery
Corporation, 5.4

X-10 Project, 9.6

Y-12 Project, 8.15-8.18, 9.6

~~SECRET~~

~~CONFIDENTIAL/RD~~