



# THE BLACK VAULT

This document was obtained from The Black Vault, an online database of declassified government documents. This particular record is housed in the MKULTRA/Mind Control Collection, a compilation of more than 20,000 pages declassified by the Central Intelligence Agency (CIA).

The entire collection is free to download and online at:

**<http://mkultra.theblackvault.com>**

~~28.~~

PHYSIOLOGICAL MECHANISMS, ANALYSIS AND BEHAVIORAL  
SIGNIFICANCE OF THE ELECTRODERMAL RESPONSE

FINAL REPORT

Section

Page

10

11

12

Vascular Effects Upon Skin Potential . . . . .

82

13

References . . . . .

89

PHYSIOLOGICAL MECHANISMS, ANALYSIS AND BEHAVIORAL  
SIGNIFICANCE OF THE ELECTRODERMAL RESPONSE

1. INTRODUCTION

This project was directed toward exploration of physiological mechanisms underlying the electrodermal response in the hopes of establishing a rational basis for quantitative treatment of this measure as a behavioral indicant. A further objective was to gain a better understanding of the adaptive function of electrodermal activity. It was presumed that the role of such activity in our "psychological" life can be understood if such behavior is regarded as essentially a biological adaptation, modified to fit a social structure. Thus, if electrodermal activity is associated with profuse palmar sweating, and this can be shown to be defensive in function, one has grounds for interpreting such activity as a sign of fear or anxiety. If, on the other hand, other forms of electrodermal activity facilitate manipulation or exploration, one would put an entirely different interpretation on its appearance. For example, if, in a situation which is potentially threatening, one notes evidence of the manipulative type of electrodermal activation, it would seem appropriate to conclude that the subject is engaged in coping behavior rather than that he is beset with alarm.

The first portion of this three-year program was devoted primarily to physiological investigations. An assortment of evidence, covered in the interim reports, helped to round out the partially elaborated physiological model of the electrodermal system. Among these experiments were microelectrode observations on sweat ducts and the areas between the ducts, confirmation of potential responses from the nail bed, study of the mechanically elicited local response, further examination of the effect of specific

electrolytes on electrodermal responses, and finally continuing studies on the sweat reabsorption mechanism and its reflex control. These various findings, when integrated with other experimental evidence, lead to the formulation of a model in which sweat reabsorption played a prominent role and in which such activity was reflected in the recovery limb of the skin conductance or resistance response.

According to this model the sweat gland has a dual function; if it secretes profusely, the skin surface becomes well-hydrated and resilient and is thus protected against abrasion. In a biological sense the animal is now able to scamper over the rough ground away from danger without undue mechanical damage to his contact areas. For fine manipulation, however, as may be involved in exploration and assessment of objects in the immediate surrounds, tactile requirements are such that the optimum level of surface moisture is somewhere intermediate between dry and wet. It was supposed that regulation of surface moisture at light to moderate hydration is largely a function of the activity of the sweat reabsorption mechanism. Observation of conditions under which reflex sweat reabsorption occurs led to the conclusion that this mechanism goes into action in preparation for "manipulative" tasks. This activity is reflected in increased positive-going skin potential responses and in acceleration of recovery of conductance responses.

The major effort of this investigation was then directed toward the elaboration of this recovery limb measure, in terms of its measurement, its relation to amplitude, to conductance level, and to behavioral state, and to the comparison of its discriminating strength with that of other electrodermal measures. This report summarizes progress to date. It is broken into a series of separate topics related to these objectives.

... is brought in as appropriate to render as complete a

picture as possible within this report. One full-length paper, "The information content of the recovery limb of the electrodermal response" (in press) has been in part supported by this contract and is included as part of this final report since it summarizes the approach and findings in an optimal manner.

In addition to the various sections on the recovery limb, there is one on the relation of vascular changes to skin potential shifts at the surface. Although some of this material was described in an interim report, it has now been completed and composed as an integrated manuscript to be submitted for publication, and is, therefore, included in toto in this report.

coupling time constant of 10 seconds, the loss of sensitivity becomes negligible for all but the very slowest recovery limbs.

Recovery rate was found to be capable of distinguishing between many behavioral states, even when response amplitude or response frequency could not. Thus, to name a few, it distinguished: orienting responses to a light flash from responses to the same flash when it took on signal properties, responses to an alerting signal from those to a task-execution signal, the resting state from various task situations, mirror tracing from backward counting or cold pressor exposure, problem solving from perceptual or psycho-motor behavior, a deception task from a reaction time task. In the course of these comparisons it was found that recovery rate became slower with habituation, even in a deception task, and that it was also slowed by the entry of a fright stimulus into a task situation. It failed to distinguish a deceptive response from a non-deceptive response in a given series of queries when differences were compared across the entire population, but individual subjects did frequently show a difference. The design of this experiment was unfortunately aimed at group analysis and the number of deceptive responses for a given subject was insufficient to evaluate this individual effect statistically.

An overview of the effect of the various task and stimulus situations upon electrodermal recovery rate indicates that acceleration of recovery reflects mobilization for goal-oriented performance. That the determining factor was not general activation per se was evidenced by the slow recovery accompanying a cold pressor exposure, shown by other electrodermal indicants to be as activating as were performance tests associated with rapid recovery.

The recovery measure for a given individual in a standard situation was shown to be relatively stable over a period of 5 consecutive weeks. There were large characteristic individual differences between individuals even though they changed in the same direction when changing behavioral conditions. Efforts to find a behavioral trait associated with recovery rate were generally unsuccessful although fast recovery in a standard task (reaction time) was found to be associated with low anxiety (SAQ), and with a tendency to maintain electrodermal response without habituation during a reaction time series. This was seen as further evidence supporting the interpretation of fast recovery as reflecting mobilization for goal-directed behavior, since these same subjects habituated to a series of non-signal tones just as fast as did subjects with slow recovery rate. It is still uncertain as to whether the difference in recovery rate between problem solving and simple perception indicates a specific difference in the effects of cognitive and perceptual behaviors on recovery, or whether this simply means that the problem-solving task was associated with higher anxiety.

An examination of the relationship of recovery rate to other parameters of the response showed it to have a low negative correlation with amplitude, that is, responses of higher amplitude in a given behavioral state tended to have slightly slower recovery. When measured between different behavioral states, however, there was often a tendency for the reverse to be true. In view of the evidence showing that mobilization for goal-directed behavior is associated with faster recovery, this observation probably reflects the fact that mobilization for task performance frequently causes an increase in activation resulting in electrodermal responses of high amplitude. This same consideration probably explains the fact that recovery rate is related (positively) to skin conductance level in

(e.g., cold pressor).



During the course of a comparison of the discriminating strength of the recovery rate measure with other electrodermal measures, a new frequency measure was devised. This measure is different from other measures of "GSR frequency" or "count" in that it examines, for any given task or epoch, not the total number of responses but rather the maximum frequency displayed in a "burst" of three consecutive responses. This measure, termed f max, demonstrated a surprising strength in distinguishing between stimulus conditions, although not the same conditions as were distinguished by recovery rate. Thus f max distinguished the deceptive response from listening to instructions, but recovery rate was not able to do so. Contrariwise, recovery rate distinguished perception from problem solving while f max did not. The highest f max and the fastest recovery rates were both found during the reaction time test, but the level of f max reached by any subject during this task, unlike recovery rate, bore no relation to his trait anxiety.

A companion study, one directed at the physiological basis of skin potential levels and changes, demonstrated that a one minute engorgement of cutaneous vessels produces a slow negative shift and upon release of the cuff a sudden positive shift. With arterial occlusion these potential shifts were opposite in direction and greater in magnitude. Although changes were generally not over 0.5 mv they raise the possibility that vasomotor responses may be accompanied by surface potential waves. Whether these shifts were mediated by an effect of the vascular state on sweat gland potentials or whether they represent changes in vascular potentials remains to be determined.

## 3. ON THE MEASUREMENT OF ELECTRODERMAL RECOVERY RATE:

## RATIONALE

The measurement of electrodermal recovery rate may be approached in several ways, all of which have in common the assumption that there is an intrinsic recovery rate characteristic which may be the same for waves of greatly varying amplitudes. An example of such a condition is that for the exponential curve in which a characteristic time constant or rate constant may be common to all members of a family of curves of different amplitudes. Darrow (1937) concluded that the recovery limb of the skin resistance response (SRR) is exponential in form, and additional evidence, to be presented here, supports this interpretation.

Methods for evaluating the rate constant of the electrodermal recovery limb are suggested from examination of the differential equation describing the exponential relation. The process described by this relation is one in which a variable changes at a rate,  $dE/dt$ , which at any instant is a linear function of the magnitude of that variable. Thus, for the case of voltage change in a condenser discharge.

$$1) \quad \frac{dE}{dt} = -k E$$

which may signify, for example, that the voltage drops by 5% per second, in which case .05 is the constant characteristic of such a process.

Rate Constant

The integral of the above expression provides the common expression for exponential decay, namely

where  $E_0$  is the starting level and  $E$  is instantaneous voltage at time,  $t$ ;  $k$  is the rate constant (rc). If  $E$  is decaying to zero as its asymptote,

$$3) \quad E = E_0 e^{-kt}$$

When  $t = 1/k$ ,  $E = E_0/e$ , that is, it equals 37% of its original value. This time, which is equal to the reciprocal of the rate constant, is called the time constant (tc) and, like the rate constant, is characteristic of the process and independent of amplitude. All curves having this same characteristic regardless of their starting point may be superimposed upon the same large exponential curve. Thus, to the extent that the electrodermal recovery limb is exponential, it may be matched to an exponential curve of the same rate constant. This is the basis of the use of an overlay method for determining the time constant by curve-matching as described in section 6.

#### Half-Time

From equation (2) it can be shown that decay half-time, that is, the time taken for decay to become 50% completed, is equal to  $0.7 \text{ tc}$  and is a constant for all waves having the same time constant, independent of their amplitude. This measure, the recovery half-time, represents a second means of expressing recovery rate and is also described in section 6.

#### Logarithmic Writeouts

Equation (2) represents a means of determining the degree to which the recovery limb fits an exponential curve. Expressed in common logarithmic form,

$$4) \quad \log E = \log E_0 - kt$$

from which it follows that a writeout having logarithmic vertical compression should give for exponential curves a straight line whose slope is a  $-k/2.3$ . The upper trace in Figure 1 is a writeout of an exponential curve obtained by capacitor discharge and a recording of a few skin conductance responses. Baseline of the skin conductance trace has been adjusted so that responses are recovering to approximately zero voltage. Below are the same waves recorded through a logarithmic compression circuit. Note that the portion of the recovery limb which is exponential in form starts about one second after response peak. The slope of the linear portion of the logarithmic recovery limb is proportional to the rate constant provided the asymptotic voltage is zero. Since this is not so, such a method cannot be used directly. One may, however, apply the second derivative to achieve this end.

The time derivative of equation (1) is

$$\frac{d^2 E}{dt^2} = -k \frac{dE}{dt}$$

which may be written:

$$5) \quad \frac{dE'}{dt} = -kE' \quad \text{or} \quad E'' = -kE'$$

Integrating,

$$\ln E' = c - kt$$

which indicates that the first derivative of an exponential curve is also exponential as is its second derivative. The slope of the log-compressed writeout of the first derivative is then proportional to  $k$  and unlike the case for the primary (DC) writeout, the curve, as required, decays toward zero because of the capacitive coupling

... this writeout by electronic conversion. Since

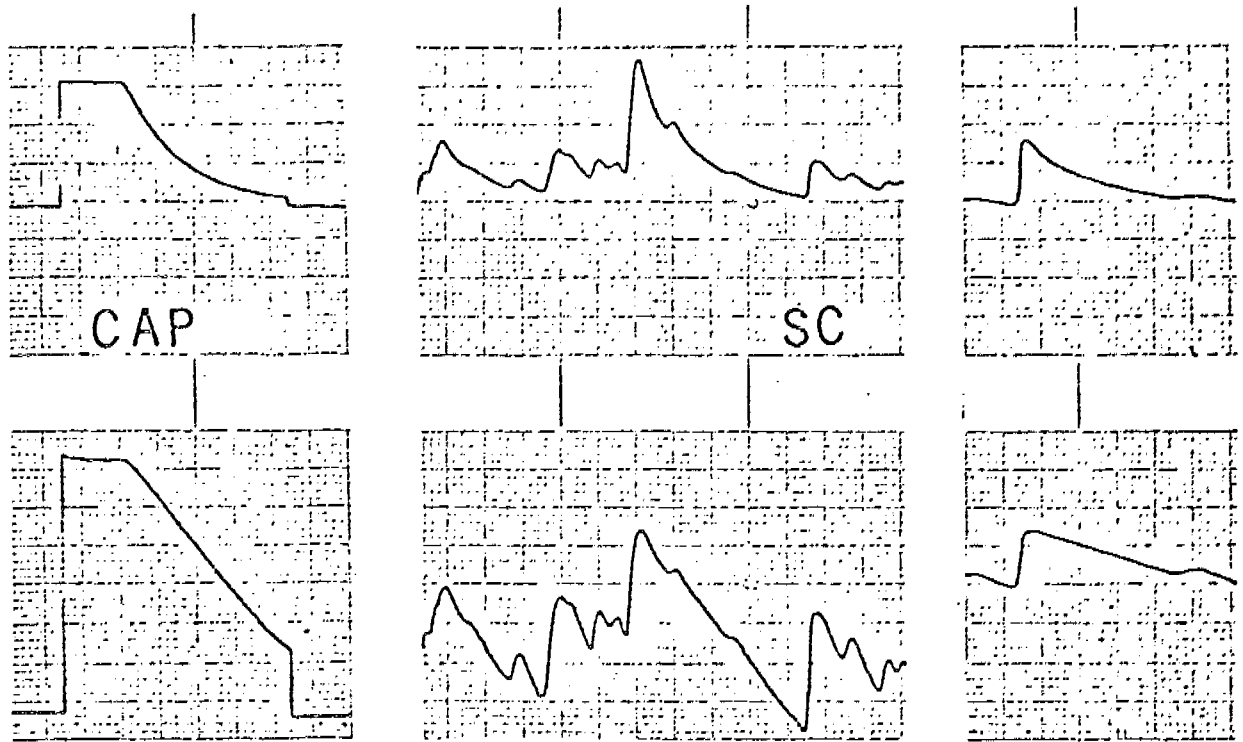

Figure 1. Upper trace: direct writeout of a condensor discharge (CAP) and skin conductance trace (SC). Paper speed 1 mm/sec. Lower trace: same as upper but with logarithmic compression.

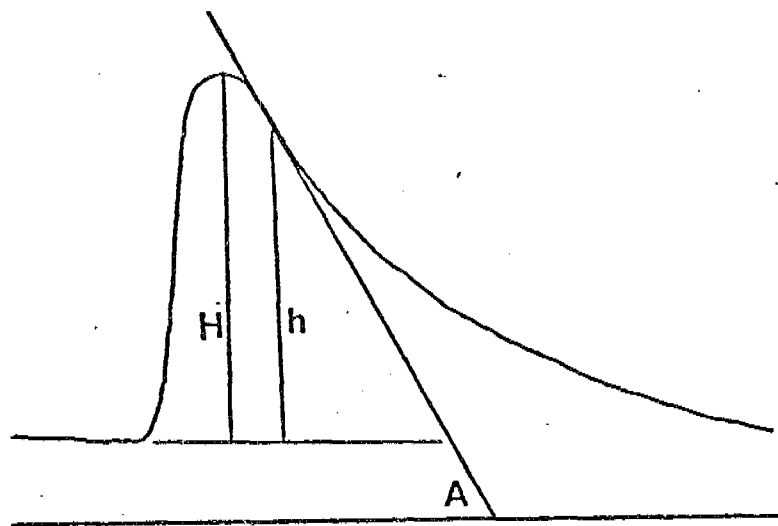

Figure 2. Diagram of method for measuring the rate constant by  $\tan A/H$ .

$$\frac{d(\log E')}{dt} = -\frac{k}{2.3}$$

one is tempted to produce a writeout of  $d \log E'/dt$  to obtain an amplitude reading directly proportional to the rate constant. Unfortunately,  $d \log E'/dt$  often has such a low magnitude in the exponential portion of the recovery limb that its analog form cannot serve reliably as the expression for the rate constant. A similar problem arises if one attempts to determine the rate constant from the log-compressed first derivative curve ( $\log d E'/dt$ ) by manual measurement of the tangent of the acute angle produced between the linear portion of the recovery limb and baseline.

### Second Derivative

Yet another method may be derived from the second derivative form. From equation (5)

$$k = -\frac{E''}{E'}$$

Thus, one may determine the recovery rate constant by calculating at any point on the recovery limb the quotient of the second derivative  $\div$  the first derivative. In practice the method is not too feasible because the magnitude of  $E''$  is so low in the exponential region of the recovery limb that it frequently is exceeded by the noise level of the trace, which becomes rather high for the analog second derivative.

### Amplitude-Slope Method

Another solution is one which requires an amplitude measure as well as a slope. From equation (1), it is seen that

the slope of E, or its first derivative. This is a most useful expression. From it, one can obtain the value for k by taking the slope and amplitude of any point on the exponential portion of the decay (Figure 2). The slope is  $\tan A$ . In practice it must be chosen at a point at or beyond the inflection point on the recovery limb. Because a measurement of wave amplitude would seem to be more precise and because such a measurement could be used independently as an index of responsivity, a test was made of the relation of H to h (Figure 2), i.e., of peak amplitude to the amplitude at the inflection point. The product-moment correlations for 20 responses on each of 6 subjects were: .97, .99, .99, .99, .99, and .96. Thus a convenient substitute measure for the rate constant is

$$6) \quad k' = -\frac{E'}{H} = -\frac{\tan A}{H}$$

This method showed a correlation of 0.81 with measurements made by the template method on the same 66 responses. In making the slope measurement, a line is drawn parallel to the recovery limb at its inflection point. The acute angle at the intersection of this line with the horizontal is measured and its tangent obtained from tables. Another relation in conjunction with this method permits a relatively simple approach to automated calculation of the rate constant. The peak slope of the ascending limb is found to be linearly related to the maximum amplitude of the primary writeout (Edelberg, 1967). A validation check of this relationship in the present investigation confirmed this. Measurement of 44 responses having uncomplicated ascending limbs gave a correlation of 0.94 between the two measures. Hence one may substitute for H the maximum first derivative of the ascending limb, and for  $\tan A$  the maximum first derivative of the

4. ON THE MEASUREMENT OF ELECTRODERMAL RECOVERY RATE BY  
PREFERRED METHODS: TESTING AND COMPARISON

A) Logarithmic Compression

In the discussion of the various means of computing electrodermal recovery rates it was shown that the first derivative of the logarithmic writeout of the recovery limb is directly proportional to the rate constant. This is true when logarithmic compression is accomplished by electronic means, but only if the wave is recovering to a zero voltage level. In such cases, the region of the recovery limb immediately following the peak (by about 1 second) is linear, and it is this portion which should reflect the rate "constant." Unfortunately the DC-recorded trace rarely recovers to zero voltage as its asymptote. Since the first derivative does have essentially a zero voltage asymptote, logarithmic compression of such a writeout should offer a linear section of the recovery limb whose slope is proportional to the rate constant. Unfortunately, the electronically differentiated recovery slope is often of such low amplitude that log compression and manual measurement pose a problem in accuracy.

It has been shown, however, (Section 5) that the recovery rates of electrodermal responses recorded with capacitance coupling are highly correlated with those computed from a DC record provided the coupling has a time constant of 6 seconds or longer. Such condenser-coupled records do approximately satisfy the requirement that the asymptotic voltage is zero. If a record of this kind is subjected to logarithmic compression, the recovery limbs should show a linear portion whose slope is proportional to the rate constant (Figure 3). This study examined such records to determine the degree to which the rate measure computed from their slopes were correlated with the



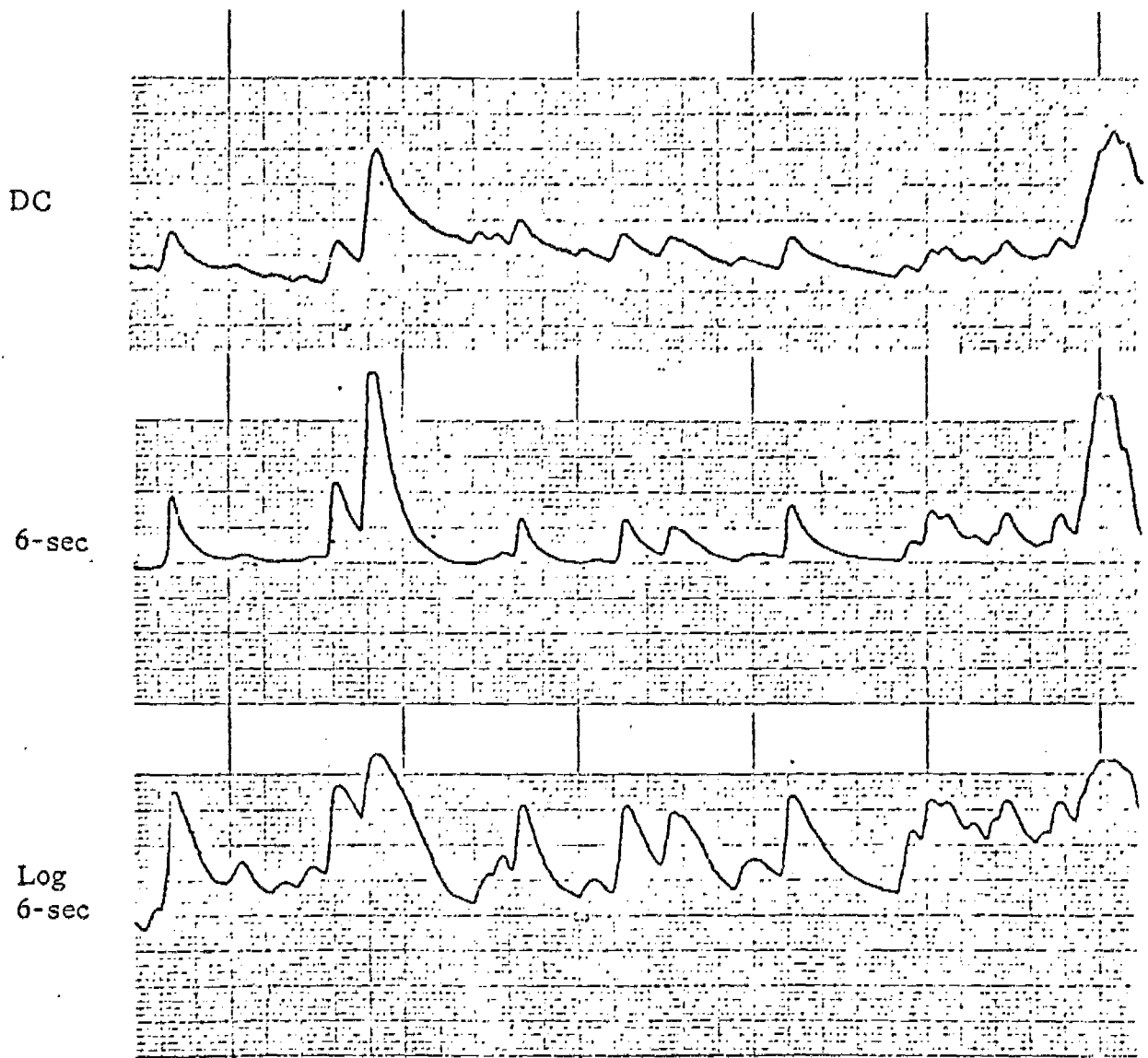

Figure 3. Recording of skin conductance through normal DC (upper), capacitance coupling with a 6-second time constant (middle), and log compression of the 6-second writeout (lower). Paper speed 1 mm per second, normal size.

## Method

Instrumentation

Skin conductance was recorded on a Beckman Dynograph with direct coupling (channel 1). The pen (1) output was coupled to the 2 megohm input of another DC channel through a 3-microfarad condensor to obtain the 6-second time constant. The pen (2) output of this second channel was placed in series with a 220 K resistor and a silicon diode (Texas Instruments G-129). The voltage developed across the diode is a logarithmic representation of the pen (2) output (Kahn, 1962). This voltage was fed into a third channel of the Dynograph and, with zero input into channel (1), and the recording completely restored to baseline, the zero position of pen 2 was adjusted until the voltage across the diode was forward biased by 0.25 volt. Polarity was arranged so that an electrodermal response produced increasing forward bias on the diode.

Measuring Technique

A straight line is drawn parallel to the linear portion of the recovery slope in the region immediately after the peak of the response (Figure 4). One can then measure the acute angle (A) which this line makes with the horizontal, and obtain its tangent from tables. This value is directly proportional to recovery rate constant. An alternative method is to use the L-shaped scale shown in Figure 4. The vertical limb is set so that it passes through the intersection of the slope with the upper edge of the paper channel. The horizontal distance from this point to the intersection of the slope with the bottom edge of the paper channel can be read directly off the metric scale on the foot of the L. Since  $\tan A$  is proportional to the rate constant,  $1/\tan A$  (where  $h$  is a constant).

Upper edge of  
Scale

Bottom edge of  
Scale

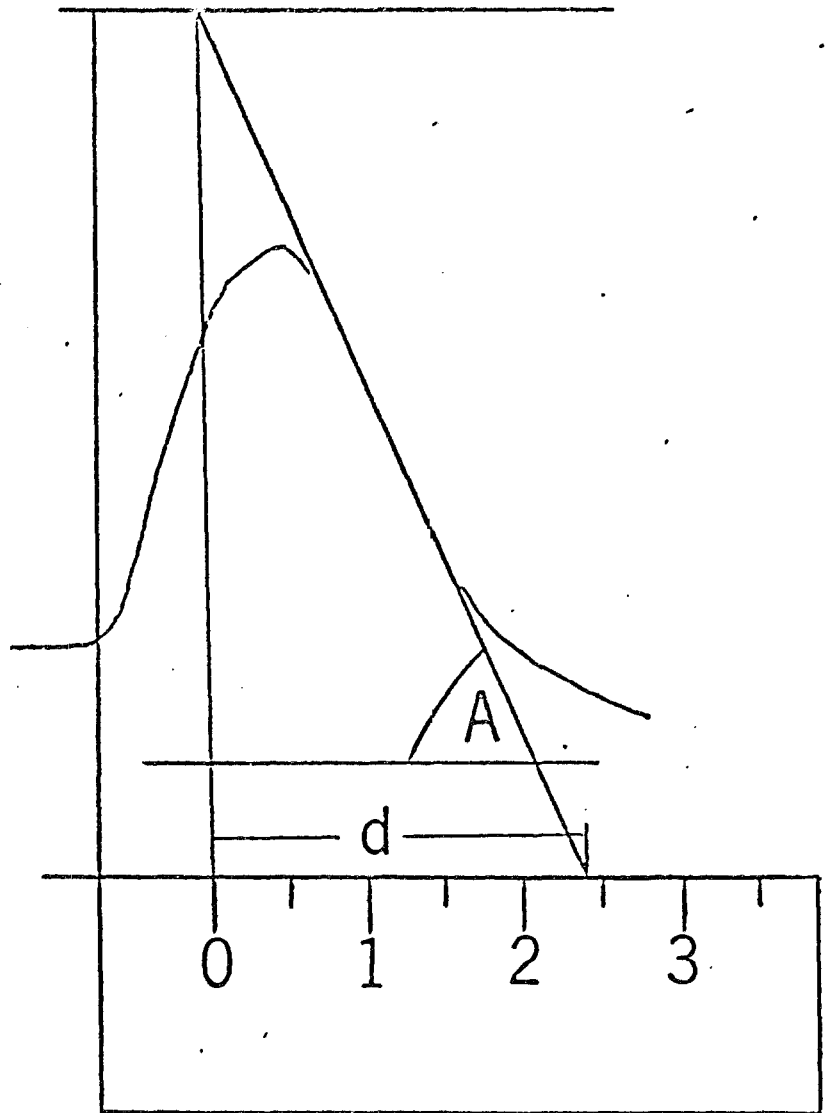

Figure 4. Measurement of recovery rate by measurement of angle A or intercept d.

Also, since  $\tan A = H/d$  where  $H$  is the scale height and  $d$  is the horizontal distance measured,  $d = \frac{H}{\tan A} = bH(tc)$ . Since  $H$  and  $b$  are constants,  $d$  is directly proportional to the time constant.

### Results

The recovery time constants of 66 responses recorded on magnetic tape were read by the electronic method described in Section 4C. This method consists of measuring the peak positive and peak negative first derivatives of the electrodermal response and dividing one by the other. The same population of responses was subjected to the template measurement (Section 6), to the amplitude-slope method ( $H/\tan A$ ), and also to the log-compressed AC recording as described here. Product-moment correlations were determined between the values obtained by the logarithmic method and those from the three other methods. Values were as follows:

Log' E	vs. electronic computer	0.59
Log' E	vs. amplitude-slope	0.87
Log' E	vs. template	0.86

The range of  $d$  in the log method was 3 to 47 mm which corresponds to an 8:1 range in time constants. The correlation of the log measure with response amplitude was like many of the other measures low and positive ( $r = 0.37$ ,  $p < .01$ ).

Because of the simplicity of the manual measurement involved in the measurement of  $\log' E$ , and especially because of its independence from knowledge of baseline level, this seems to be a measure of choice. It has one draw-back, namely the neces-

B) Measurement of the Altitude-Slope Intercept Along Baseline (D)

The notation  $H/\tan A$ , that is, the amplitude-slope measure, leads to yet another approach to time constant measurement. In Figure 5 it is seen that  $\tan A$  is approximately equal to  $H/D$  where  $D$  is the distance along the extended baseline included between the altitude (line  $H$ ) and the extension of the recovery limb slope. As a result,  $H/\tan A$  reduces approximately to  $D$ . The measurement of  $D$  in practice is not unlike the task of measuring  $t/2$ , the time for half recovery, but it has the advantage that  $D$  is about 75% larger than  $t/2$  and, therefore, incurs a smaller relative error in measurement. Furthermore, it allows measurement of a considerable number of responses which fail to recover by 50% prior to the onset of the subsequent response.

To test the usefulness of this method the values of  $D$  were measured for the same 66 responses used to compare the other methods. Values of  $D$  ranged from 1.2 to 8 seconds. Because the paper speed was only 1 mm/second, measurement was not very precise, but the correlation with the measurements obtained by  $H/\tan A$  was nevertheless 0.90, and with those obtained with the curve-matching method, 0.82. Correlation with the electronic method was 0.63 and with  $\log' E$  0.86. At a somewhat higher paper speed, e.g., 2 to 2.5 mm/second, this is a very satisfactory method, especially since the value of  $D$ , when expressed in seconds, can be readily converted to the time constant by the use of a constant factor. The use of a standard notation is highly desirable in making comparisons between results at different laboratories, and the use of the time constant or rate constant seems a reasonable choice for such standardization. To derive the conversion factor for  $D$ , one must keep in mind the fact that in precise terms,  $t_c = h/\tan A$  which is equal to  $d$  in Figure 5. From this

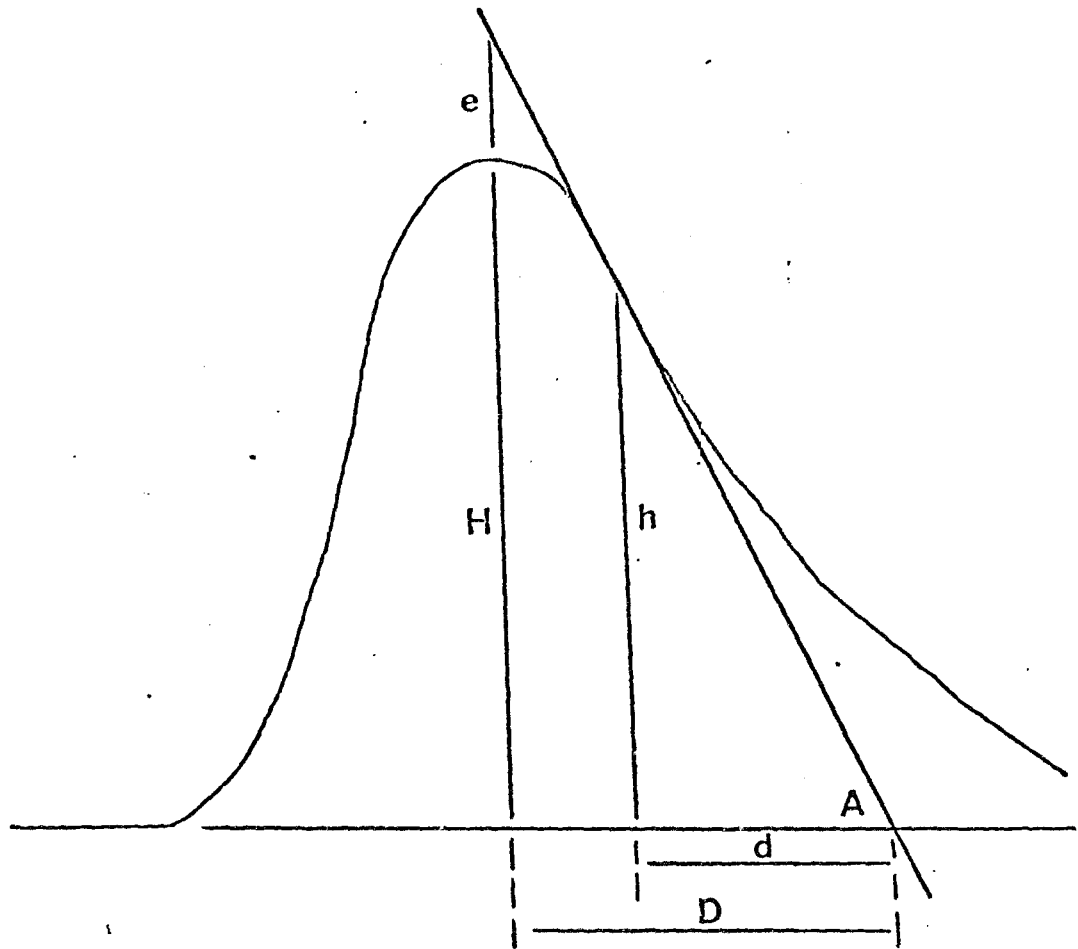

Figure 5. Measurement of recovery rate by altitude-slope intercept,  $D$ .

$$\frac{h}{d} = \frac{H+e}{D} \quad \text{or} \quad d = \frac{h}{H+e} \cdot D$$

Measurements on 40 responses gave a mean value of 0.74 for  $h/H+e$ , whence

$$7) \quad t_c = 0.74 D$$

To convert  $H/\tan A$  to  $t_c$ , one must consider the relation of  $H/\tan A$  to  $h/\tan A$ . Since

$$t_c = \frac{h}{\tan A} = \frac{h}{H} \cdot \frac{H}{\tan A}$$

the conversion factor  $h/H$  must be determined. Calculations of  $h/H$  from 20 responses on each of 6 subjects gave mean values of:

0.84  
0.86  
0.76  
0.84  
0.89  
0.85

$$\bar{X} = 0.84$$

From this

$$8) \quad t_c = 0.84 \frac{H}{\tan A}$$

The agreement of these two relations were tested on 65 responses, with results as follows:

Notation	$\bar{X}$	Factor	Computed $t_c$
D	2.70	0.74	2.00 seconds
$H/\tan A$	2.34	0.84	1.97 seconds

This agreement is surprisingly close and gives confidence in the reliability if not the validity of these measures. Their agreement with  $t_c$  values obtained by curve-matching is not nearly as impressive, the mean of that measure being 2.59 seconds. The possible cause of this discrepancy is described below.

#### The Position of the Asymptotic Level and Its Effect upon Recovery Rate Measurement

All methods described, whether curve-matching,  $t/2$ ,  $D$ , or  $H/\tan A$ , depend for their validity upon the accurate choice of the asymptotic level to which the exponential portion of the recovery limb is decaying. The only exceptions to this are cases in which  $E'/E''$  or  $d(\log E)/dt$  are used to determine  $t_c$ . In the other four measures, the conductance or resistance level at point of response onset has been used as the asymptote, but it is clear from inspection that in numerous cases such an assumption is erroneous. Uncertainty as to the level of the asymptote, and in fact a systematic error in estimating it may explain the fact that recovery rate is found to have a correlation with response amplitude. This correlation though low is consistent for different methods of measurement and is significant. Examples of the correlation for measures on the same population of 65 responses are:

	$r$	$p$
Amplitude vs. Electronic $t_c$	.37	<.01
Amplitude vs. Template $t_c$	.35	<.01
Amplitude vs. $\log' E$	.37	<.01

True asymptotic level may be determined in the following way. In Figure 6, tangents to the recovery limb have been drawn at points 1 and 2. It has been shown earlier that the time constant of an exponential curve =  $h/\tan A$  or  $d$  in Figure 5. If



from either point should be identical. The correct asymptotic level will be that at which  $d_1 = d_2$ .

When this method was applied to a number of skin conductance responses, the asymptotic level was found to vary, sometimes falling almost on the baseline, but more often considerably above it, occasionally near the peak of the wave. As a consequence, the values for  $t_c$  calculated from curve-matching,  $t/2$ ,  $D$  or  $H/\tan A$ , are usually too large, but since all are altered in the same direction by this effect, the inter-correlations are not seriously disturbed. Moreover the error introduced after conversion of either  $D$  or  $H/\tan A$  to  $t_c$  is the same, hence the agreement of the mean time constants obtained from these two measures. Such is not the case for the curve-matching technique. In this case the error is considerably greater and is a likely explanation for the discrepancy shown in the previous section. Since the other methods are less subject to this error, it argues in favor of the abandonment of curve matching in favor of  $D$ ,  $H/\tan A$ , or  $t/2$ . Since measurement of  $D$  allows measurement of more responses than does  $t/2$  and entails no more work than for  $t/2$  and less work than for  $H/\tan A$ , it is considered the method of choice. Moreover, it is faster than curve matching, requires less training, and the one judgement to be made, namely the placing of a straight edge parallel to the recovery limb at its steepest point is a simpler one than is curve fitting.

To reiterate, the most advantageous method for measurement of  $t_c$  is to measure  $D$ , using the conversion:

$$t_c = 0.74 D$$

or, for rate constant:

$$rc = \frac{1.35}{D}$$

It will be recalled that two alternative methods for measurement of recovery rate are inherently independent of any knowledge of baseline or asymptote. The first of these is  $E'/E''$ , i.e., the ratio of the first to second derivative at any point on the exponential portion of the recovery limb. The difficulties with this approach have already been discussed. It does not appear to be feasible at this time. The second alternative,  $d(\log E)/dt$ , that is, the slope of the linear portion of the logarithmically-compressed recovery limb does appear useful, but only with a condenser-coupled recording and with log-compression circuitry.

### C) Electronic Computation

As discussed in Section 3 the notation  $H/\tan A$  forms the basis of an approach to automatic on-line calculation by an analog computer. The analog approach takes advantage of the high linear relation of the peak first derivative of the ascending limb of the DC electrodermal recording and the peak amplitude of the wave (Pearson's  $r$  close to 1). Also convenient is the fact that  $\tan A$  is the maximum first derivative of the recovery limb. Hence:

$$\frac{H}{\tan A} = g \frac{E'_+}{E'_-}$$

where  $E'_+$  is the maximum first derivative of the ascending limb,  $E'_-$  is the same for the recovery limb, and  $g$  is a constant.

There are several complications in the use of this expression for computing

so that a storage requirement exists. The use of  $h/\tan A$  (Figure 5) would be more precise and because  $h$  and  $\tan A$  are taken simultaneously, would be easier to program, but it would require measurement of  $h$  in terms of its distance above the baseline or preferably above the asymptotic level. This becomes a problem in DC recording, because of expected baseline shifts, and such an approach does not lend itself readily to analog computation without cumbersome programming.

Secondly, because responses in close sequence interact, contingencies must appear in the program for selection of waves meeting standard criteria. These criteria are:

- (a) The time of onset of any measurable response must be at least 7 seconds after the onset of the previous response. This is necessitated by the fact that recovery rate of a small wave superimposed upon the recovery of a preceding larger one is spuriously rapid. The effect is shown in Figure 7a.
- (b) Responses which do not last at least 4 seconds prior to the onset of a successive wave must not be accepted for measurement. This requirement prevents measurement of a wave whose peak negative-going first derivative is cut short by the onset of another wave (Figure 7b).

#### Method

A combination of analog computer and digital logic circuitry is used to meet the conversion, storage, and contingency gating requirements of the computation.

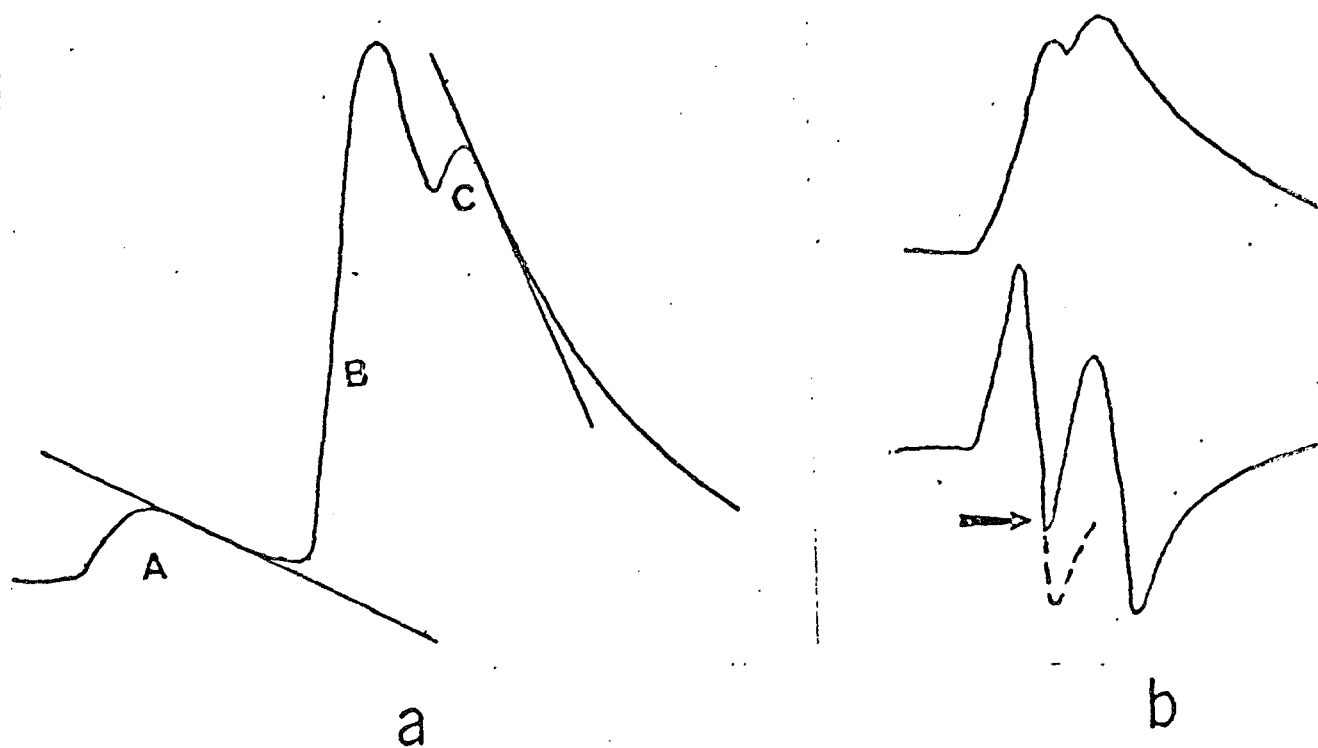

Figure 7. (a) Spurious acceleration of recovery limb of response C by reason of its position on the recovery limb of response B. Response A is similar to C but occurs on a resting baseline. (b) Spurious registration of peak slope of recovery limb due to interruption prior to peak (at arrow).

### Analog-To-Digital Conversion, Storage, and Computation

The skin conductance response is recorded with a constant voltage bridge whose output, proportional to skin conductance, is fed into a Beckman Dynograph amplifier. The voltage at the pen output is fed into two other channels, each using a 0.1-second coupling time constant, thereby achieving derivation of the trace. The output of one of these is used to fire a Schmitt trigger to start analysis at the onset of a response. The output of the other is sorted into positive-going and negative-going components by the use of diode clippers which feed their respective signals to storage capacitors. This storage is arranged as a peak memory circuit so that after a response is over, one of the two capacitors is charged up to the peak voltage of the positive first derivative, the other the negative. Upon a command signal from the associated logic circuitry, both capacitors are read simultaneously by two separate voltage-to-frequency converters. These feed into a preset counter programmed to divide one frequency by the other, thus accomplishing the computation of  $E'_+/E'_-$  or its reciprocal. The quotient is fed into a digital printer and at the same time the value of the positive-going derivative ( $E'_+$ ) is printed out on another printer to furnish amplitude data. Details of the arrangement are shown in Figures 8a and 8b.

### Control Logic System

This system must recognize the onset of a response, must screen out responses which fail to meet the two time criteria, must time and command readout and print, and must reset the storage capacitors. It must also decide, on the basis of a minimum amplitude criterion, which responses are large enough to measure without incurring unacceptable error because of low signal-to-noise ratio. These demands are met by the use of logic modules programmed as follows.

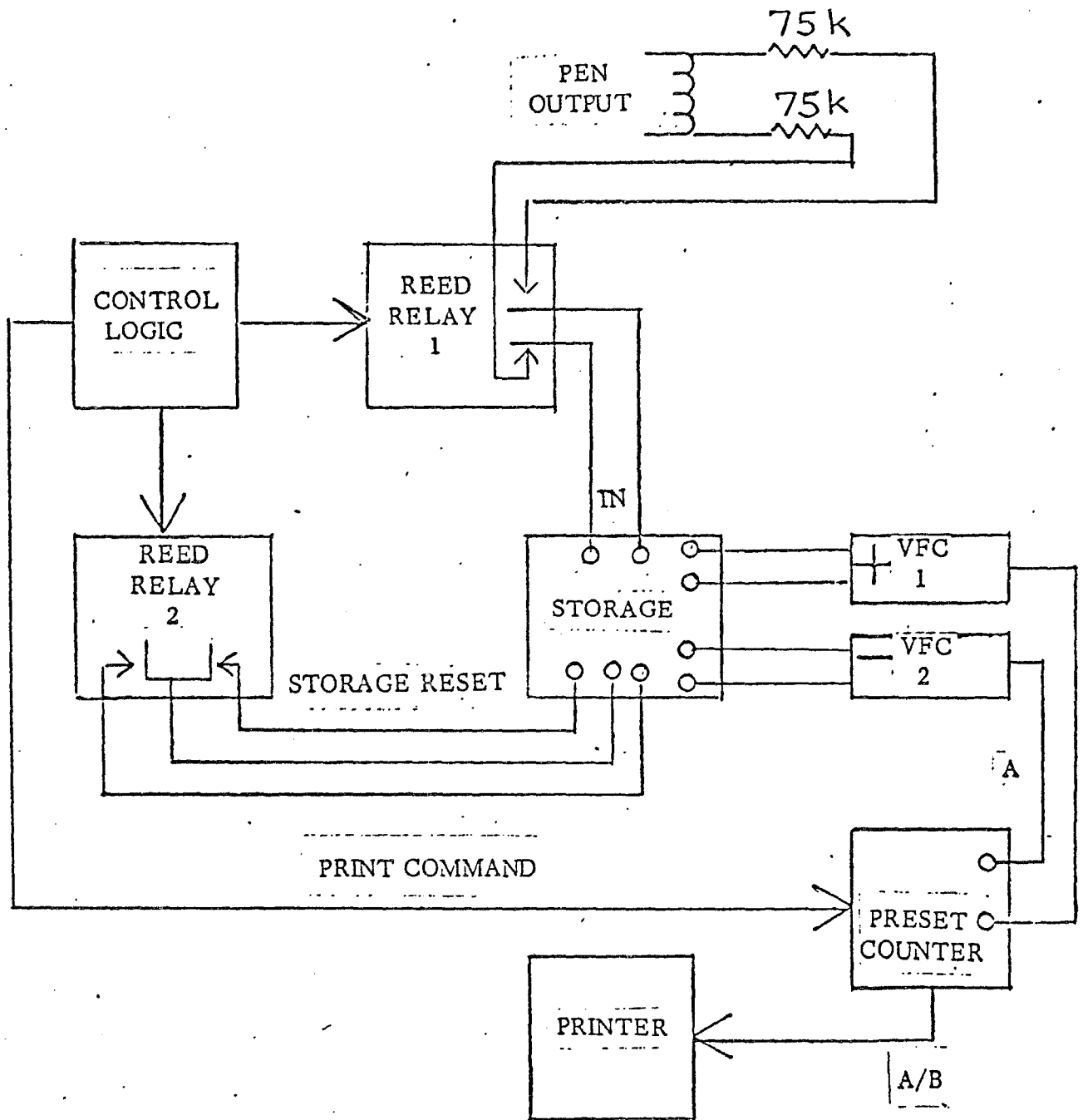

Figure 8a. Diagram of electronic programming for automatic analysis of recovery rate.

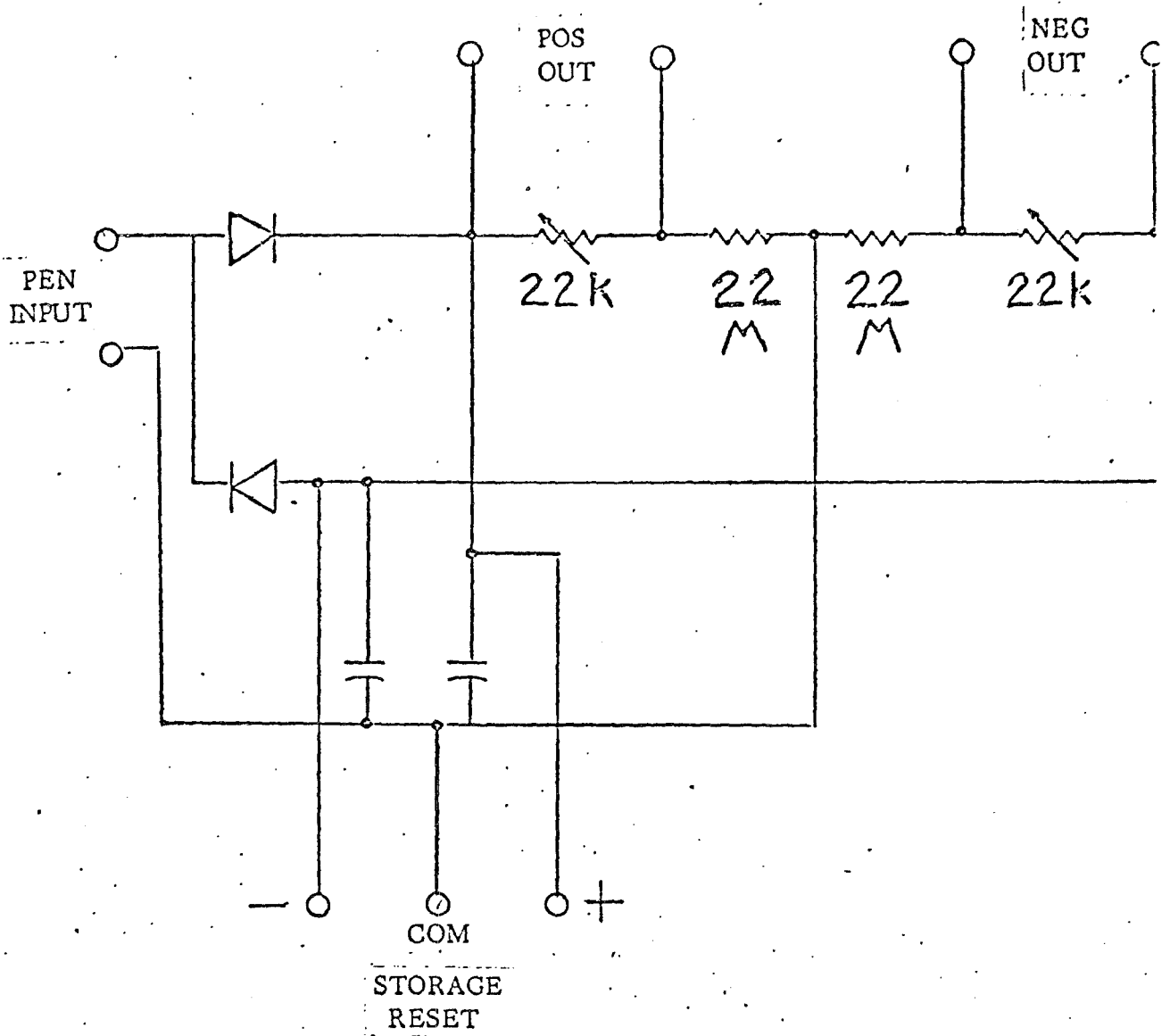

Figure 3b. Storage circuit.

A free-running pulse generator (A) is set to fire at a rate of one per second. Its output is fed into a binary counter (Figure 9). The onset of a response serves to zero the counter so that time gating of subsequent operations may be standardized. This is accomplished by using the first derivative signal from pen 2 of the dynograph. This signal is fed to a Schmitt trigger which fires whenever a positive-going wave occurs in the first derivative trace. Firing of the Schmitt trigger not only resets the binary counter to start counting at the next second, but also fires a one-shot having a 4.1-second output pulse. The ascending limb of this pulse fires a second one-shot whose 0.5-second output is used to trip a reed relay to discharge the storage capacitors (reset). The primary purpose of the 4.1-second one-shot, however, is to act as a gate to prevent processing of the response if a second wave starts within 4.1 seconds after onset. This is accomplished by feeding these one-shot pulses into a quadruple and-gate, the other three inputs of which are fed from the 0-0-1 terminals of the binary counter. When 4 seconds of counting are up, the and-gate can fire only if the one-shot has not returned to its off-state. If this condition is met, the and-gate output acts as a command to the pre-set counter to take the quotient of the two storage outputs. The preset counter, after finishing the division, signals the printer to print. The quadruple and-gate also fires a one-shot which advances a decade counter used to number the responses on the printout. If a second or third response occurs during the initial 4-second period, the 4.1-second one-shot is reset and its off condition output serves as an inhibit signal to the and-gate.

The requirement for at least 7 seconds between processed waves is met by the use of a triple and-gate and two flip-flops interposed between the Schmitt trigger and the 4.1-second one-shot. The triple and-gate is fed by a 1-1-1 output from the



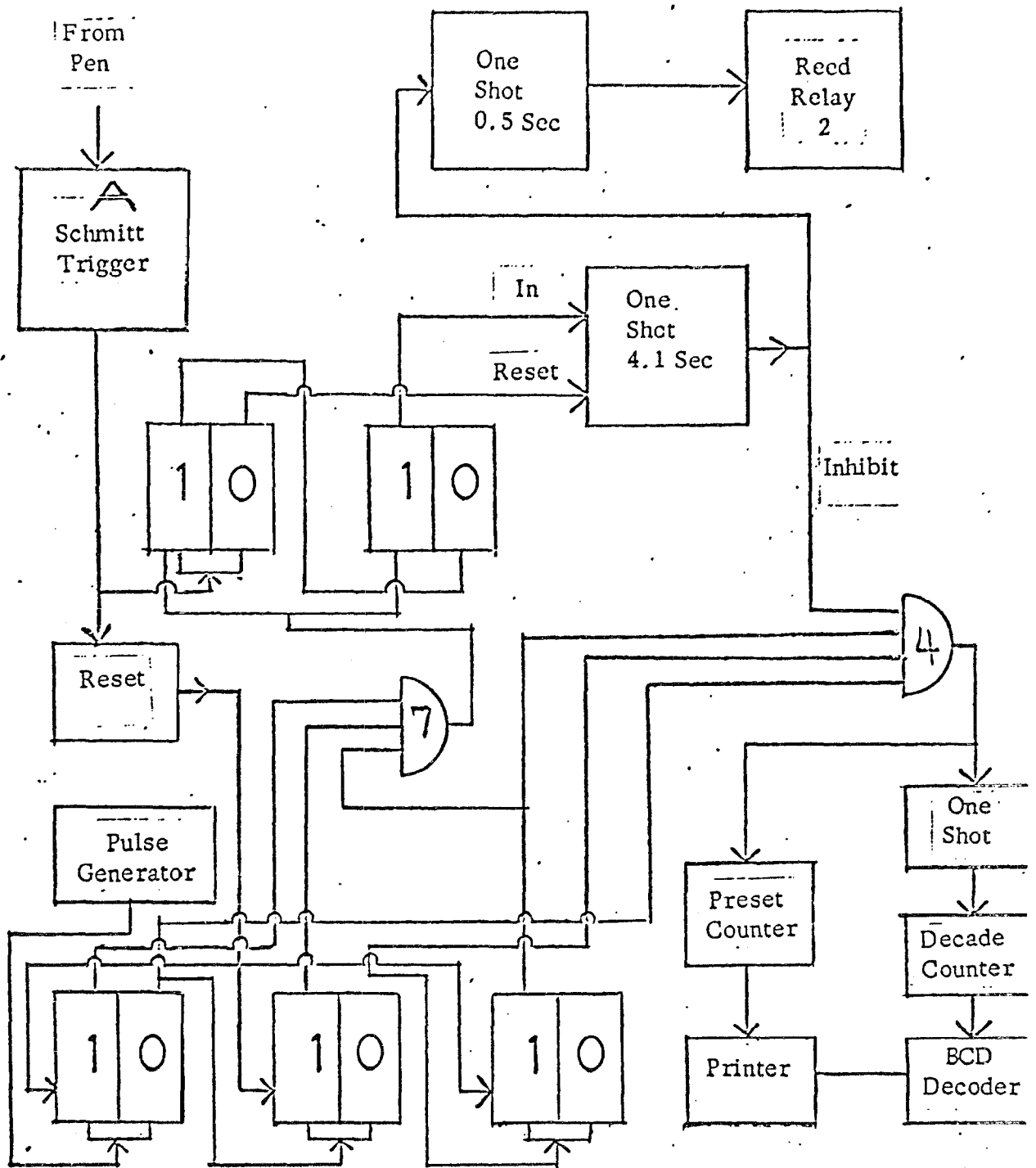

Figure 9. Control logic circuitry.

binary counter so that it fires at 7 seconds after the Schmitt trigger has signalled start of the response. Its output resets the two flip-flops and allows a subsequent firing of the Schmitt trigger to fire the 4.1-second one-shot. Until this triple and-gate fires again seven seconds later, any pulse coming through after the 4 seconds of processing cannot fire the one-shot and therefore cannot initiate another computing sequence. The two flip-flops are connected in such a way that the 4.1-second one-shot cannot be fired again until the triple and-gate fires again. Thus no computation can be started unless the binary counter has been allowed to count for seven seconds after the start of the last response. Any response occurring during these seven seconds starts the count over again.

### Results

This system proved to be very accurate, the print-out data agreeing very closely with values obtained by hand measurement of the positive and negative peaks of the first derivative trace. Values of  $E'$  and of the time constants obtained by the two methods for each of twenty solitary responses of a writeout are plotted against each other in Figure 10. From this standpoint the system is very reliable. The major source of error is caused by responses in which the ascending limb is in fact a slurring of two responses into a single one without an intermediate peak. In such a case the Schmitt trigger fails to recognize the second response because the derivative has not recrossed baseline (Figure 11). The maximum slope is that of one of the two slurred components rather than being additive and is not consistent with total H. The value computed electronically is, therefore, considerably less than that computed

In some instances the ascending limb is composed of a well-slurred sequence

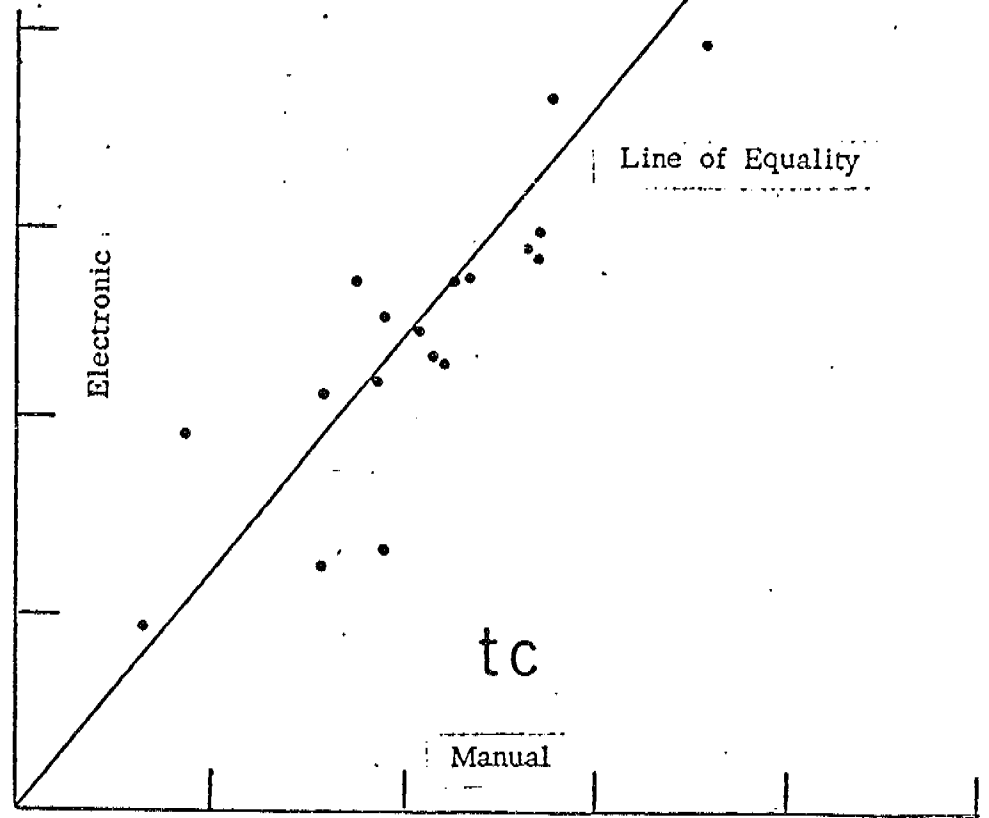
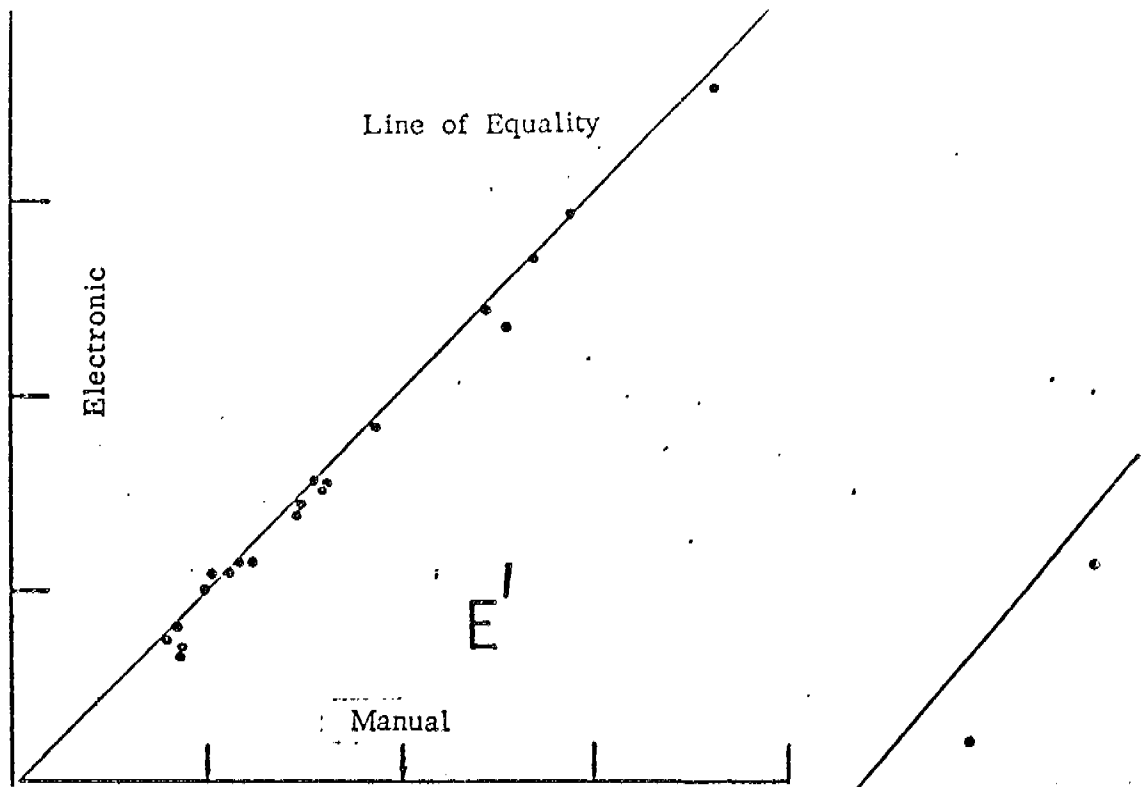

Figure 10. Comparison of manual and electronic measurement of peak first derivative amplitude and of  $tc$ .

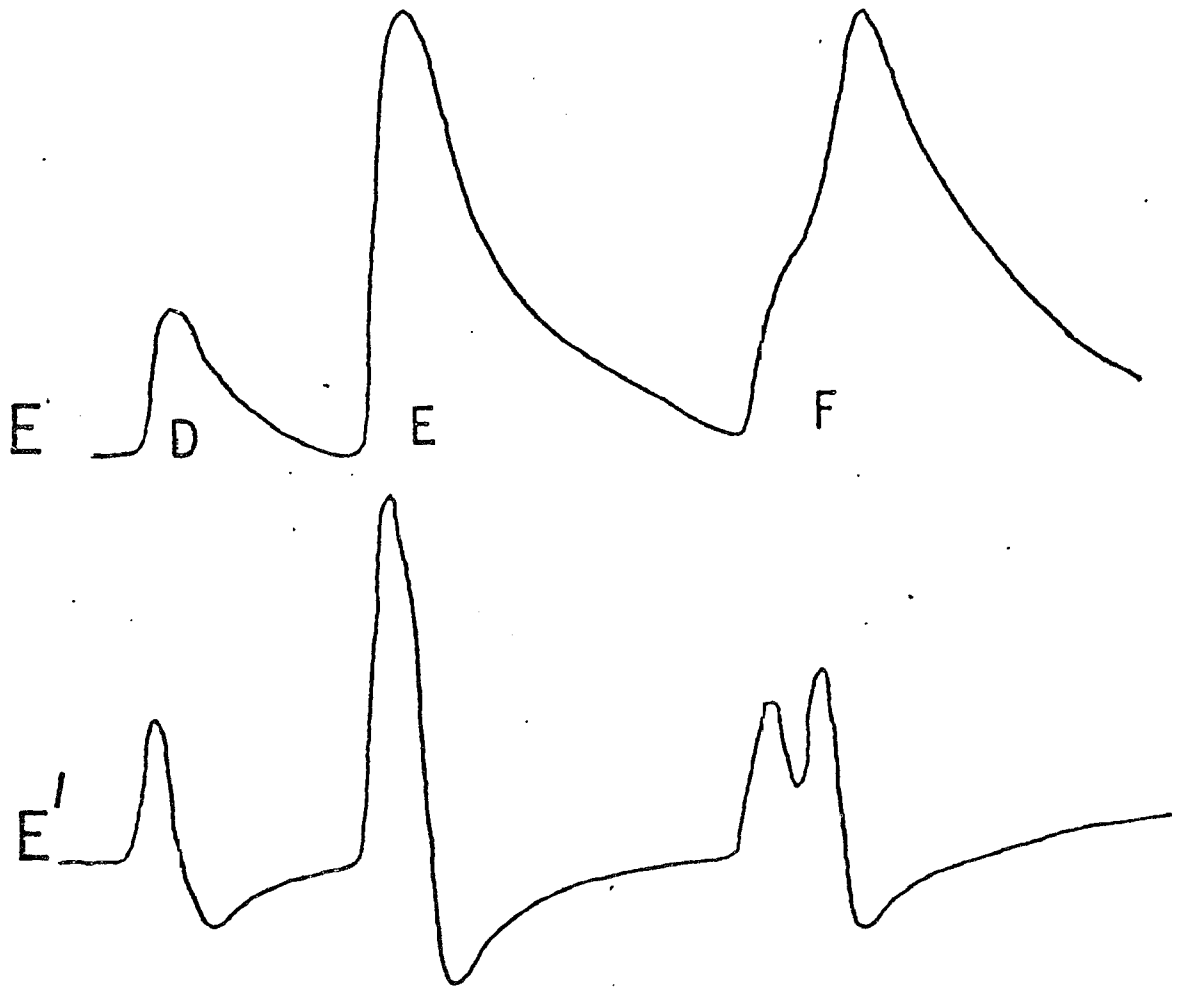

Figure 11. Breakdown of linear relation between primary amplitude and first derivative amplitude in duplex response F. Simple responses D and E show linear relation.

The above deficiency may explain the relatively low correlation of time constants derived electronically from those obtained by the various manual methods. The correlations with other measures for the same population of 65 responses analyzed elsewhere in this paper were as follows:

Electronic vs. $\text{Log}'E$	0.59
Electronic vs. $H/\tan A$	0.68
Electronic vs. Template	0.42

Another problem with the electronic method lies in the selection of the minimum threshold for triggering the Schmitt trigger. If this is chosen too low, many clean high amplitude waves are lost because of the occurrence of a miniscule wave in the previous 7 seconds. If set too high many perfectly useable waves are lost. The compromise between these two conditions is difficult. With the particular threshold used in this test (16% of half scale), the system accepted 65 of 86 responses which met amplitude criteria, the remainder being rejected because of temporal contingencies. The total number of responses, however, was far greater than the 65 having adequate amplitude. For a threshold 8% of half scale (i.e., 4% of full channel width), the total number of responses reaching amplitude criterion would have been 188.

While this automatic system meets minimum requirements for an operationally satisfactory system, its susceptibility to spurious readings of relative wave amplitude when multiple responses fuse in the ascending limb is a rather serious disadvantage. It appears possible to construct an on-line analog system using one of the other approaches and in this regard the measurement of the slope of the log-compressed

D) Summary of Comparisons Between Measures

For convenience a summary of the various intercorrelations examined is shown in the matrix in Table 1.

Table 1. Correlations between time constants measured in different ways on the same 65 responses.

	Template	Electronic	Log' E	H/tan A	D
t/2	.94				
Template		.42	.86	.81	.82
Electronic			.59	.68	.63
Log' E				.87	.86
H/tan A					.90

The overall high correlation between the various manual measures gives confidence that a fundamental form characteristic of the recovery limb is in fact under examination.

various couplings into a Beckman Dynograph equipped with rectilinear ink writers. Time constants of 1, 2, 3, 4, 6, 8, 10 seconds and DC were used. Time constants were measured by the amplitude-slope method described elsewhere. Forty responses were selected with the qualification that they must start at least seven seconds after the start of the previous wave, must have an amplitude at least 5 mm (full scale was 40 mm) and must not be interrupted by a successive wave until at least 50% recovery was completed. In each case the rate constant was calculated from  $\tan A/H$ . Values for each coupling condition were matched with those from the DC record to compute a Pearson's product-moment correlation.

### Results

The correlations found at each value of coupling time constant are shown in Table 2.

Table 2. Correlation between recovery rates ( $\tan A/H$ ) computed from DC records and those from capacitance-coupled records taken with various coupling time constants.

R-C Time Constant (Coupling)	Pearson's r	Slope Of Line Of Regression
1 Seconds	.33	.32
2 "	.51	.44
3 "	.72	.27
4 "	.80	.59
6 "	.86	.43
8 "	.90	.68
10 "	.86	.86

Note that high correlations are found for 6, 8, and 10 second coupling constants, that is when the coupling time constant approaches the time constant of the slowest waves in the population (see Sections 6 and 8). The correlation reaches a relatively constant level at coupling constants of 6 seconds or longer. This constant level is less than 1, and is in part indicative of the departure of the relation from linearity and in part of the repeat measurement reliability. By comparison the repeat measurement reliability for the template measure found in the earlier study was 0.93 (coefficient of concordance).

The DC values of the recovery limbs are plotted against the rate constants found with each coupling constant in Figure 12. As expected, rate constants are increased as compared with the DC value, with greatest acceleration found when shortest coupling constants were used. Moreover, at any given coupling constant, those recovery limbs having the shortest rate constants (longest time constants) are affected the most. Because of this, the relationship between DC rate constants and those found with capacitance coupling is non-linear. Short coupling constants not only cause a greater scattering of points, making the measure less sensitive, but also affect the slope of the relation as seen in Table 2.

Since, as discussed elsewhere, the rate constant of the first derivative is the same as that of the primary wave, one may wonder why intermediate coupling constants, e.g., 1 second, do not give as good a relation. The answer lies in the fact that the time constant for obtaining the first derivative must be so short that all responses, long and short, are affected similarly. With the



29a

RC = 1 Sec

DC

CAP

RC = 3 Sec

DC

CAP

Figure 12. Relation of rate constants of direct coupled responses to rate constants computed on same waves recorded with capacitance coupling.

RC = 4 Sec

DC

CAP

RC = 6 Sec

DC

CAP

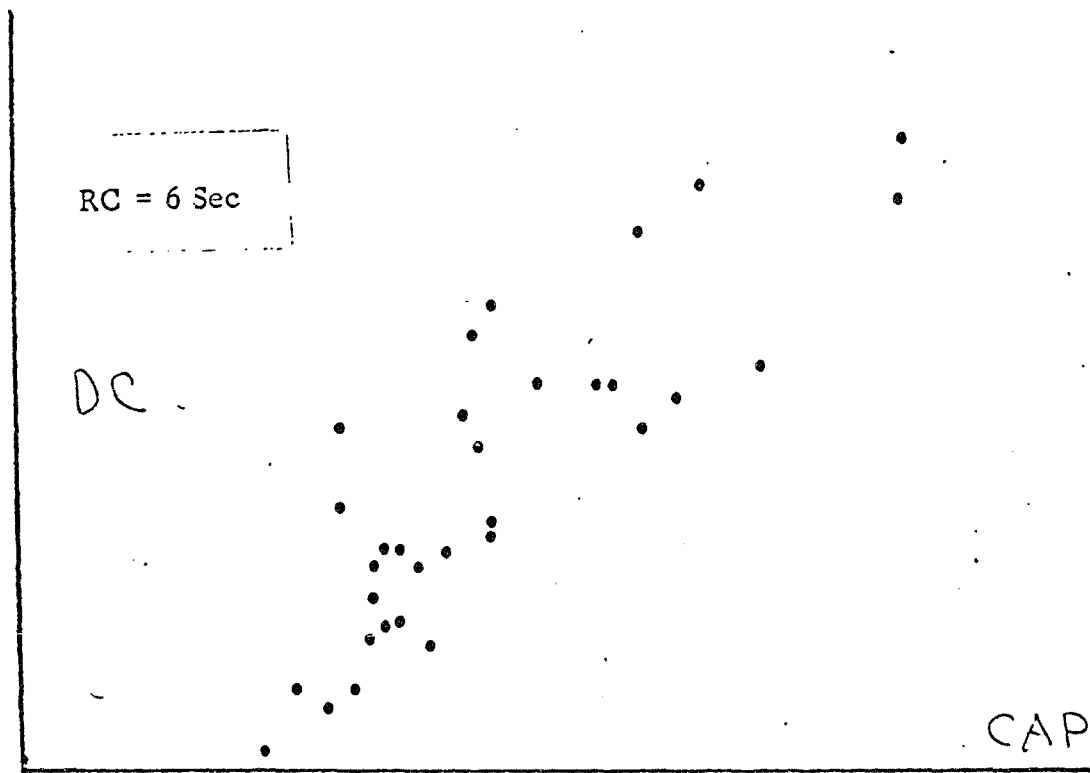
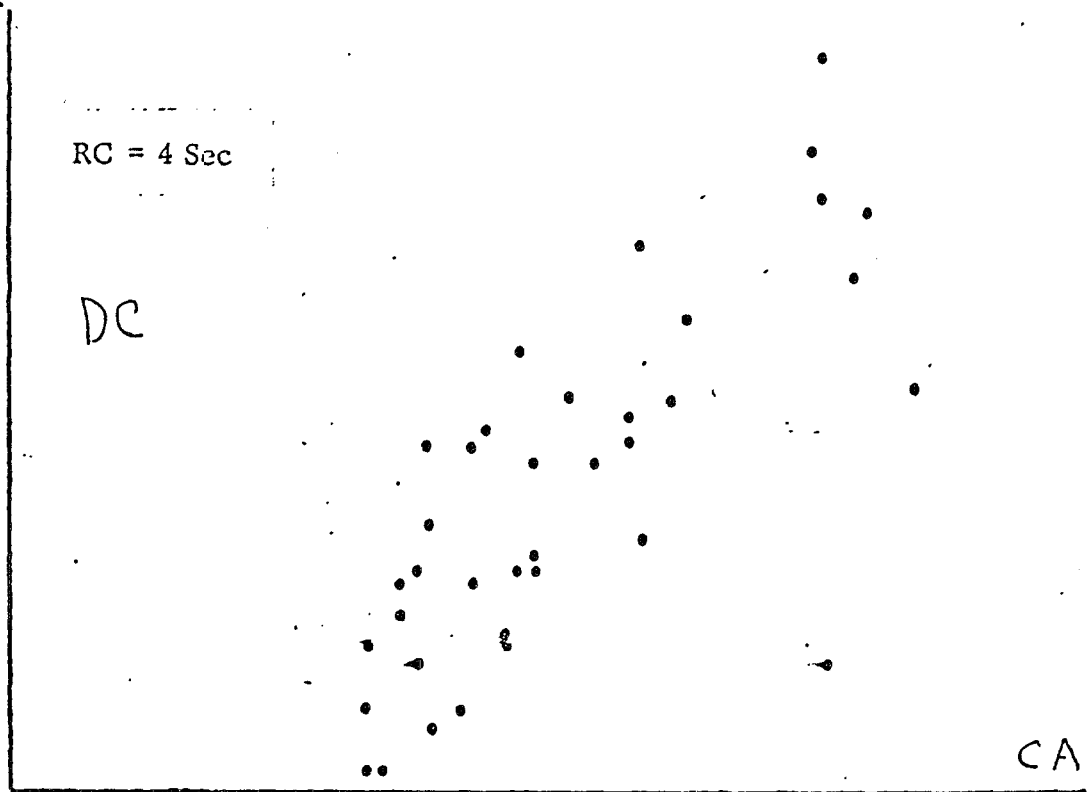

RC = 8 Sec

DC

CAP

RC = 10 Sec

DC

CAP

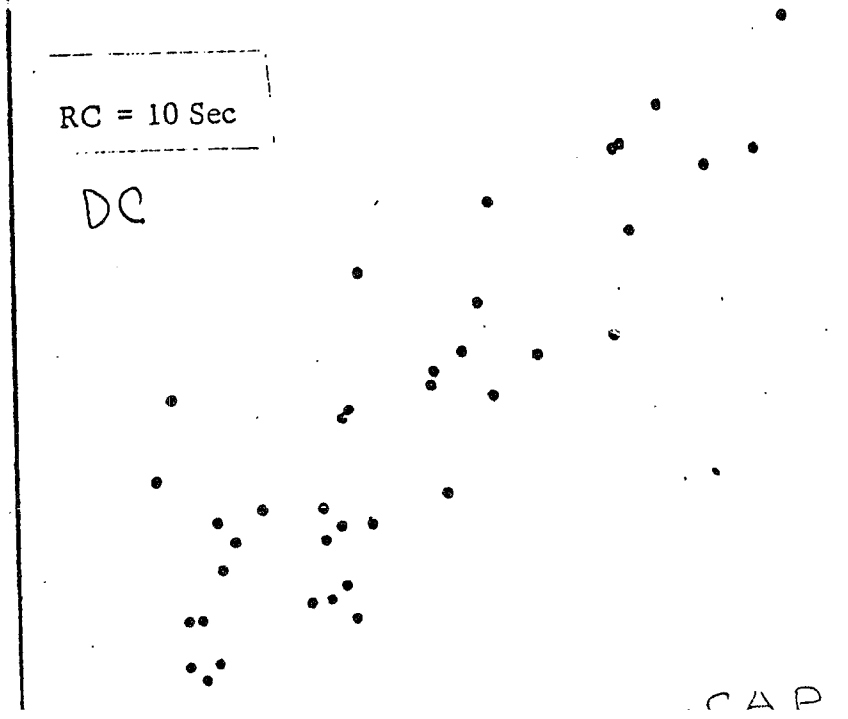
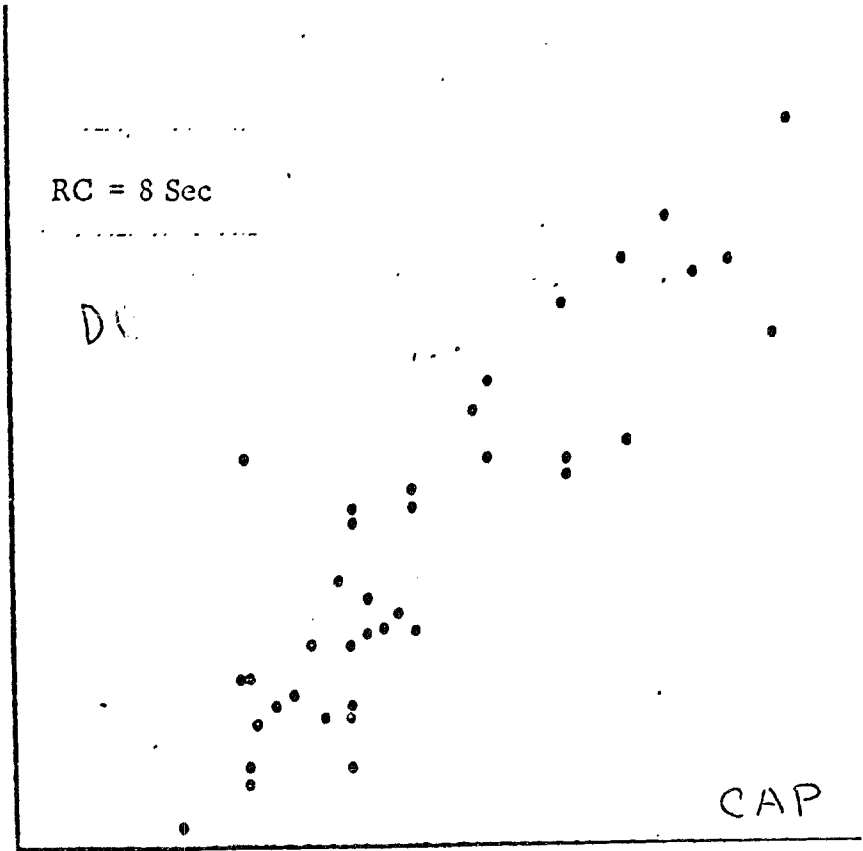

intermediate coupling constants used here, the slower waves will be differentially affected and the relationship breaks down.

These results imply that the use of a capacitance-coupled system having a time constant of 6 seconds or longer is suitable for the determination of recovery time constants. Though values obtained from such recordings are not directly comparable with those from DC recordings, they have similar capacity to reflect changes incidental to shifts in behavioral state.

## 6. THE INFORMATION CONTENT OF THE RECOVERY LIMB OF THE ELECTRODERMAL RESPONSE

A previous study [ ] showed that during an electrodermal response (EDR) there is frequently a sudden decrease in the hydration of the covered skin surface, and that this phenomenon occurs much more often during cognitive activity such as listening to instructions than with startle responses. These hydration responses, which are attributed to absorption of water from the surface, commence at about one second after the onset of the skin resistance response (SRR) and reach peak in about three to four seconds. Their occurrence is not determined by the amplitude of the SRR but is associated with the presence of positive waves in the skin potential response (SPR). Where pure negative SPRs occur, hydration under the electrode either increases (Figure 13) or remains unchanged. These observations suggest that two different kinds of EDRs might be occurring, a supposition consistent with conclusions drawn in an earlier study [ ] Moreover, since skin conductance is in part determined by the level of fluid in the sweat ducts and by the hydration of the corneum [ ] an absorption response might be expected to speed return of resistance or conductance to base level and thereby steepen the recovery limb. An indication of this is seen in Figure 13, where recovery rate of SCR's in the second panel averages twice that of the first.

The absorption response appeared to hold promise as a useful qualitative index of behavioral set, but there are serious difficulties in its direct quantitative measurement due to the complicating effects of simultaneous sweat secretion. It was hoped that the recovery limb of the SRR or SCR might carry the information reflected in the absorption response and at the same time be more amenable to quantitative measure-

ment. This section is concerned with the development of quantitative methods for examining the recovery rate of the EDR and with an examination of its relation to other measures and its sensitivity to behavioral state.

### Method

#### Evaluation of the Recovery Rate

[ ] had developed a measure called the Recovery Quotient for describing the rate of return of skin resistance to base line after response to stimulation. They did this by determining the percent recovery reached in five minutes after peak displacement. Their measure ordinarily was applied to a complex long-lasting response and they interpreted it as an indication of the capacity of the central nervous system to reestablish homeostasis following a disturbance. The Recovery Quotient did not deal with wave form and theoretically should be unrelated to the measure of concern in this paper. For the present purposes, the recovery limb was, as a first approximation, assumed to be exponential, a conclusion also reached by

[ ] One fundamental characteristic of such a curve, its rate constant, or in reciprocal terms its time constant, is independent of amplitude and was selected as a best first approximation of recovery rate. It is viewed as a useful reflection of this rate, but not as indicating a truly exponential form for the recovery limb. Examination of the exponential equation reveals numerous methods for evaluating this constant, but two convenient ones were adopted for use in this study. For either one, DC recordings are mandatory.

Half-time measure. To determine the time constant ( $t_c$ ), one should measure the time required to attain 63% recovery (i.e.,  $1 - 1/e$ ), but the recovery half-time

relation to  $t_c$  ( $t_c = 1.43 t/2$ ) and is more easily measured. It can be quickly determined by the use of a transparent overlay containing a series of parallel horizontal lines bisected by a single vertical line. The central parallel line is made longer than all the rest and contains a metric scale on the right side of the vertical, with zero at the intersection. The vertical line is made to pass through the peak of the wave perpendicular to the base line. The template is moved up and down until the central line is midway between onset and peak of the wave, as indicated by the short parallel lines. The distance from the vertical line to the intersection of the central horizontal line with the recovery slope is read from the scale and converted to half-time by the appropriate calibration. This method can only be used on responses which recover at least 50% before a second response occurs.

Curve-matching. A second method is based on curve-matching. As seen in Figure 14a, if the members of a class of responses of differing amplitudes all have the same recovery time constant, it is possible to superimpose them on a single exponential curve. One may use a transparent overlay bearing a family of exponential curves of known time constant (obtained, for example, by recordings of a condenser discharge through various resistances). The  $t_c$  for any response may be quickly determined by placing the overlay such that its base line (asymptote) is horizontal and passes through the point of onset of the response. A straightedge is then held against the lower margin of the overlay, which should be parallel to the base line, and the overlay is moved horizontally until one of the standard curves coincides with the recovery limb or a best interpolation is made (Figure 14b).

Each of the above methods has its advantages and disadvantages. The half-time

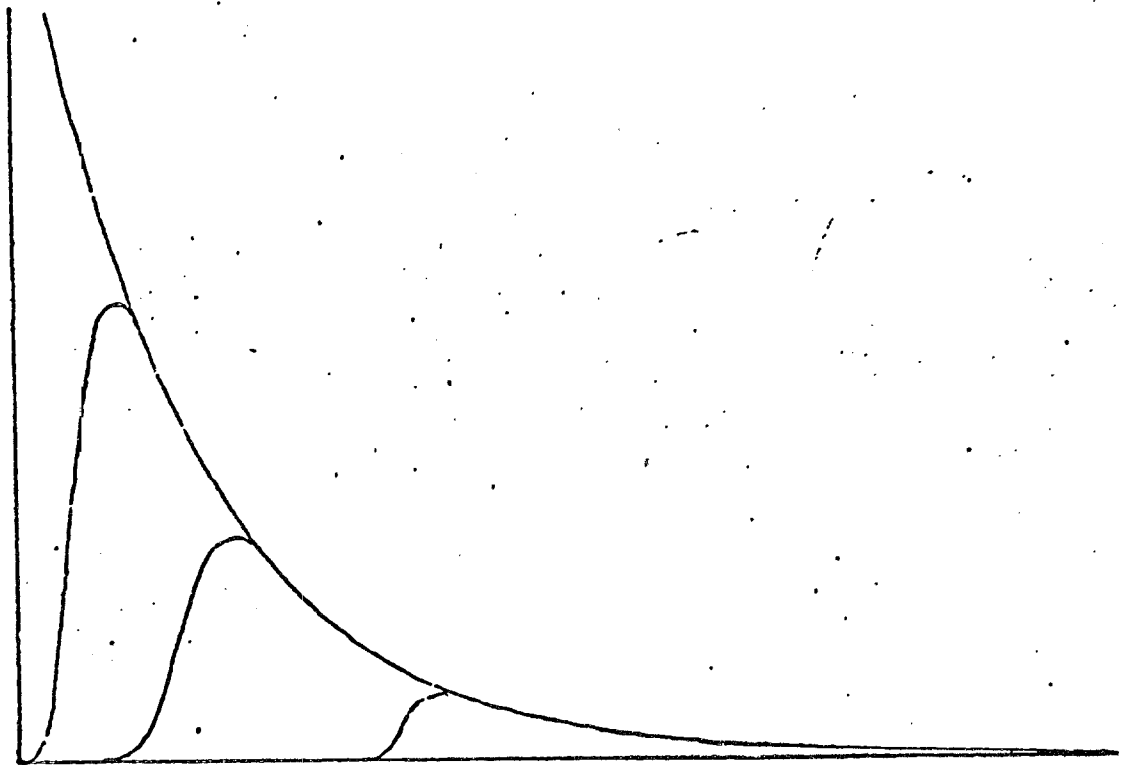

Figure 14a. Drawing of three electrodermal responses of different amplitudes but same recovery rate superimposed upon an exponential curve.



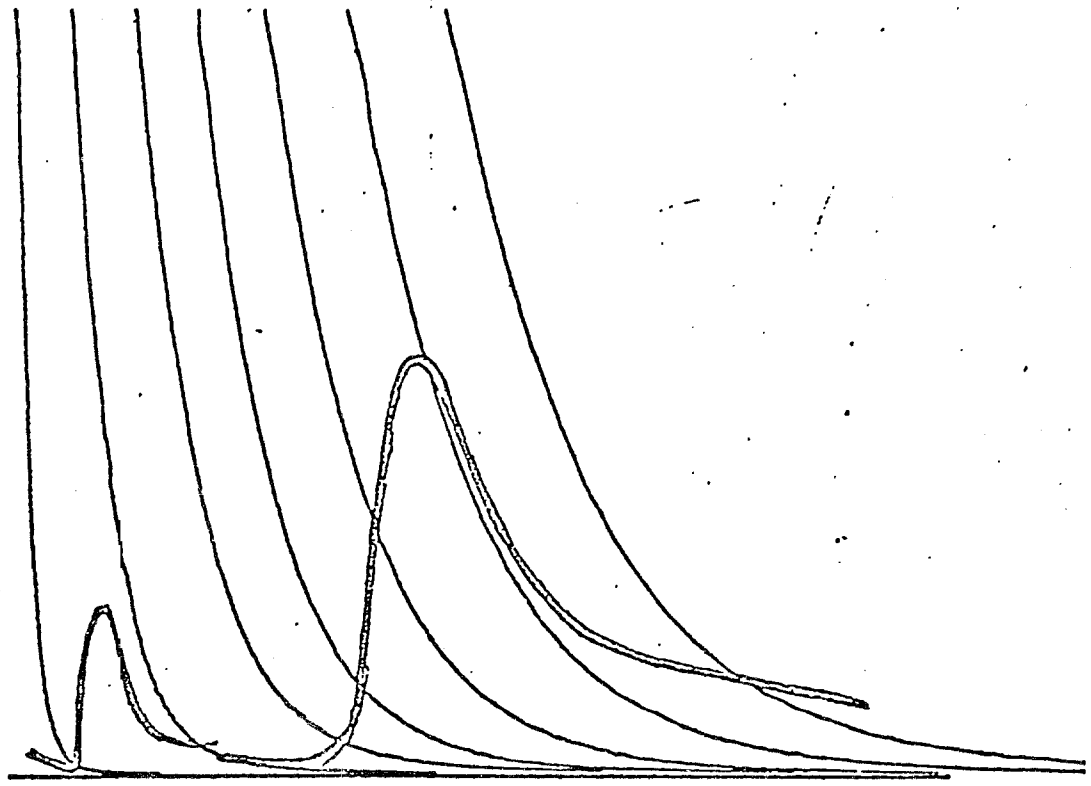

Figure 14b. Illustration of curve-matching to determine the "time constant" of the steepest portion of the recovery limb.

not recover by 50% prior to onset of a subsequent wave and cannot be evaluated. The curve-matching method is somewhat more difficult; it soon becomes clear that many waves depart from the exponential shape and matching is ambiguous. However, by using the early portion of recovery just after the steepest slope has been reached, satisfactory matching can be made for practically any response. Since this can be done on a portion which reaches only 25 to 30% of recovery, many more waves lend themselves to this measure than to the half-time measure. As might be expected, curvilinear recording produces a distortion in the recovery limb which becomes appreciable if the writeout extends beyond the middle third of the scale. The half-time measure is therefore recommended for curvilinear recordings since it is possible to make objective corrections for this effect, for example, using an overlay with an appropriately curved vertical line. Corrections for the curvilinear effect in curve-matching is considerably more difficult and more approximate, and it is recommended that the use of this method be restricted to rectilinear recordings or to the middle third of the curvilinear scale.

#### Procedure

Subjects were 106 normal adults of both sexes, ages 17 to 45. The number used in each experiment varied and is indicated in the presentation of results. Each experiment was run on a different population. Electrodes were silver-silver chloride plates applied to masked sites, 1/4-inch diameter, with a thickening agent in 0.1M NaCl as an electrode paste. A constant current bridge (current density 8 microamp/cm<sup>2</sup>) was used to obtain SRRs and a constant voltage bridge (0.75 V across two active sites) for SCR. All exosomatic electrodermal placements were on the volar

hand. For potential recordings, the reference electrode was over the ulnar bone, one-fifth the distance from elbow to wrist. Hydration was measured with the contact device described elsewhere [redacted] the placement being on the volar surface of the fingertip. Recording of the above variables was accomplished using a directly-coupled Beckman Type R Dynograph. In one series of runs, a reflectance plethysmograph unit was applied to the thenar eminence of the non-preferred hand and finger pulse volume was recorded using capacitance-coupled amplification [redacted]

The subject was seated in a small room and after a 15-minute stabilization period was exposed to stimuli which differed for each experiment as described below.

Experiment 1. This was a replica of an experiment by [redacted] [redacted] which was run for another purpose. In this the subject is given a 3-minute rest period followed by a 1-minute task in which he is frustrated by the experimenter in his attempts to count backwards. He then participates with the experimenter in a guessing game in which the experimenter attempts to guess the number which the subject selects. If he fails, the subject presses a button which supposedly shocks the experimenter. Following this two-minute "aggressive" game, he is given a second rest period.

Experiment 2. A mixed series of eight tones and eight light flashes of moderate intensity is presented to the subject who has been instructed to relax with his eyes open. Following this he is instructed as follows: "This time, when you hear a tone it will be a warning signal for a second one which will occur at any time up to a half-minute later. At the sound of the second tone you are to press this footswitch as rapidly as possible so we can measure your reaction time. In the same way a light flash will be

33

a warning to expect a second light flash at which time you are to note the position of the moving pointer. A third flash will occur shortly after that, at which time you are to report the letter indicating its position." The inter-stimulus interval for each task ranged from 10 to 30 seconds. The pointer rotated at 60 r.p.m. This series was continued until eight trials of each task had been run in randomized order.

Experiment 3. The subject was told to relax with his eyes open and was exposed to a series of five tones (approximately 75 db at the subject, 1 second duration) presented through a speaker at a varying inter-trial interval (10 to 25 seconds). As soon as this habituation series ended, he was instructed for the next sequence which followed immediately. In this series, tones of the same intensity and range of inter-trial intervals as for the first series constituted signals for a reaction time effort (finger-press) without a foreperiod.

Experiment 4. The subject is given two reaction time trials with a foreperiod of 4 to 10 seconds. Both warning and execution signals are 0.5-second tones delivered from a speaker (approximately 65 db at the subject). These trials were intermixed in random order with two word association trials to form a block in which the inter-trial interval varied between 20 and 60 seconds. Blocks were repeated with two-minute intervening rest periods.

Experiment 5. In this series, run earlier for another purpose  the subject wore a contact hydration detector as well as skin resistance and potential electrodes. Stimuli were a mixed series of sounds and lights of moderate intensity interrupted at intervals with a period of conversation.

## Results and Discussion

### Characteristics of the Recovery Measure

Reliability. Inter-scorer reliability of the more subjective of the two methods of measuring recovery rate, namely curve-matching, was determined by having each of three individuals score the same 30 isolated responses chosen at random by a lottery method from a population of 100 useable responses. Time constants ranged from 2.2 to 7.2 seconds. The Kendall coefficient of concordance among their scores was 0.93. The time consumed in making a single measurement was approximately seven seconds. Despite the high inter-scorer reliability indicated in the measurement of isolated responses, i.e., responses which occurred at least five seconds after the peak of the last previous response, there is an apparent source of error in the measurement of recovery rates of responses which themselves fall on the steep portion of the recovery limb of a previous larger wave. For this reason, scoring of responses is best accomplished on waves which occur at least ten seconds after the peak of the preceding wave.

Relation between  $t_c$  and  $t/2$ . The reliability of the half-time measure should be even greater than that of the curve-matching measure, in view of the rigorous method by which it is obtained. It does, however, frequently demand the reading of very short time intervals with precision, a chore which can be difficult when for convenience in making other measurements, slow paper speeds are used, e.g., 1 mm per second. To see how the two measures compared, 22 consecutive responses recorded with rectilinear pens were analyzed by two persons, each using one of the two methods. Time constants ranged from 1.6 to 8.7 seconds. The mean values for  $t_c$  and  $t/2$  respectively were 5.40 and 3.88 seconds. The ratio of these values, 1.39, agrees rather

well with the theoretical ratio of 1.43. The product-moment correlation between  $t_c$  and  $t/2$ , 0.94, can be regarded as a combined test both of the accuracy of measurement and of the validity of the exponential treatment. This result, together with the 1.39 ratio, implies that either measure is acceptable, and that the portion of the curve used does not deviate appreciably from an exponential form.

Resistance vs. conductance responses. In some instances responses were measured concurrently from two sites, one with a constant voltage bridge, the other with constant current. Recovery half-times were determined for corresponding SCRs and SRRs and found to be highly correlated, though different in absolute magnitude. Correlations between 20 pairs of responses on each of three subjects were .83, .82 and .95. Mean values for measurements on SCR and SRR respectively were: subject A, 4.9/6.3; subject B, 3.6/7.3; subject C, 3.6/3.8. Thus although either SCR or SRR may be used for studying changes in recovery rate, if individuals are to be compared it would be desirable to standardize on one of the two systems. Differences between the mean SCR and SRR values, however, may well reflect differences between sites rather than between methods of recording, since despite high correlations, appreciable differences are found between measures taken from simultaneous palmar and dorsal SRRs as seen in the example in Figure 18.

Relation of recovery rate to amplitude. The assumption of an exponential form for the recovery limb implies that the rate constant should be independent of amplitude. This assumption was tested by an examination of the relation of recovery rates to amplitude using the half-time measure on 20 SCRs from each of six subjects. The product-moment correlations were .21, -.20, .28, .62, .74 and .19. These results indicate that amplitude is not an important factor in determining the recovery rate.



trace showing marked absorption and two showing an increase in hydration were selected in a randomized manner, without regard to stimulus. The time constants of the recovery limbs of the corresponding SRRs were measured and an inter-individual comparison made between the two categories. In 12 of the 13 subjects examined, recovery was faster in association with absorption ( $p < .001$ ). The group means were 6.0 and 9.1. The association of faster recovery rate with the occurrence of absorption responses and with positive SPRs is consistent with the third combination of these variables, namely that between occurrence of absorption and of positive SPRs previously reported

#### Sensitivity to Behavioral State

Both measures,  $t/2$  and  $t_c$ , proved highly sensitive to change in behavioral set. In some cases, for example in the comparison of a rest period with a task period, the conventional amplitude or frequency measures would discriminate just as well, but the strength of the recovery rate in differentiating between conditions did not depend upon amplitude. Moreover, in many cases, it distinguished between conditions when amplitude per se could not. In this initial examination of the resolving strength of this measure,  $t/2$  has been sampled in some experiments,  $t_c$  in others. Each clearly demonstrated its value, and the choice of which to use is largely a matter of preference. The results of the various experiments are presented below.

Experiment 1: Rest vs. aggressive game. In examining differences between the recovery limb half-times of spontaneous waves in the rest period and those during the aggressive game, an effort was made to minimize any intrusion of an amplitude effect. The first three responses of at least 5 mm amplitude which met the half-time

... identified earlier were selected from the rest period. For half of the 12



subjects these were taken from the pre-task rest period, for the other half from the post-task period. The first three responses from the game period which fell in the same amplitude range as those of the rest period were used for comparison. Figure 15 shows representative strips taken from each of these periods. The pre-task and post-task relaxation periods (upper and lower panels) both show responses which recover more gradually than those during the task period. As for the other subjects,  $t/2$  in the pre- and post-task periods are rather similar. It is significant that the sharpening of the recovery limb started during the instruction period. A portion of the instruction period is shown in the section of the middle strip to the left of the arrow designating start of the task. The group mean  $t/2$  for the rest period was 5.6 seconds and for the task period 3.3 seconds ( $p < .001$ ). All of the 12 subjects showed a reduction during the aggressive game, the mean decrease being 41% (Tables 3 and 4). The amplitudes of the two groups of response samples were well matched and the small mean difference of 12% with the task responses being larger fell far short of significance ( $t = .87$ ).

Experiment 2: Simple stimuli vs. signals. The half-time measure was also used in this comparison made on 16 other subjects. Here the responses to light flashes during the relaxation period before instructions were compared with responses to the warning lights (not the execution signal) for the perceptual task. The last three useable responses during the rest period were compared with the first three useable responses during the task period. An acceleration of recovery rate occurred in 13 of the 16 subjects (Table 4) when the light flash took on signal properties. The average decrease in  $t/2$  was 29% ( $p < .05$ ). The amplitudes of the response samples averaged 9% less during the task period ( $t = 1.14$ , NS).

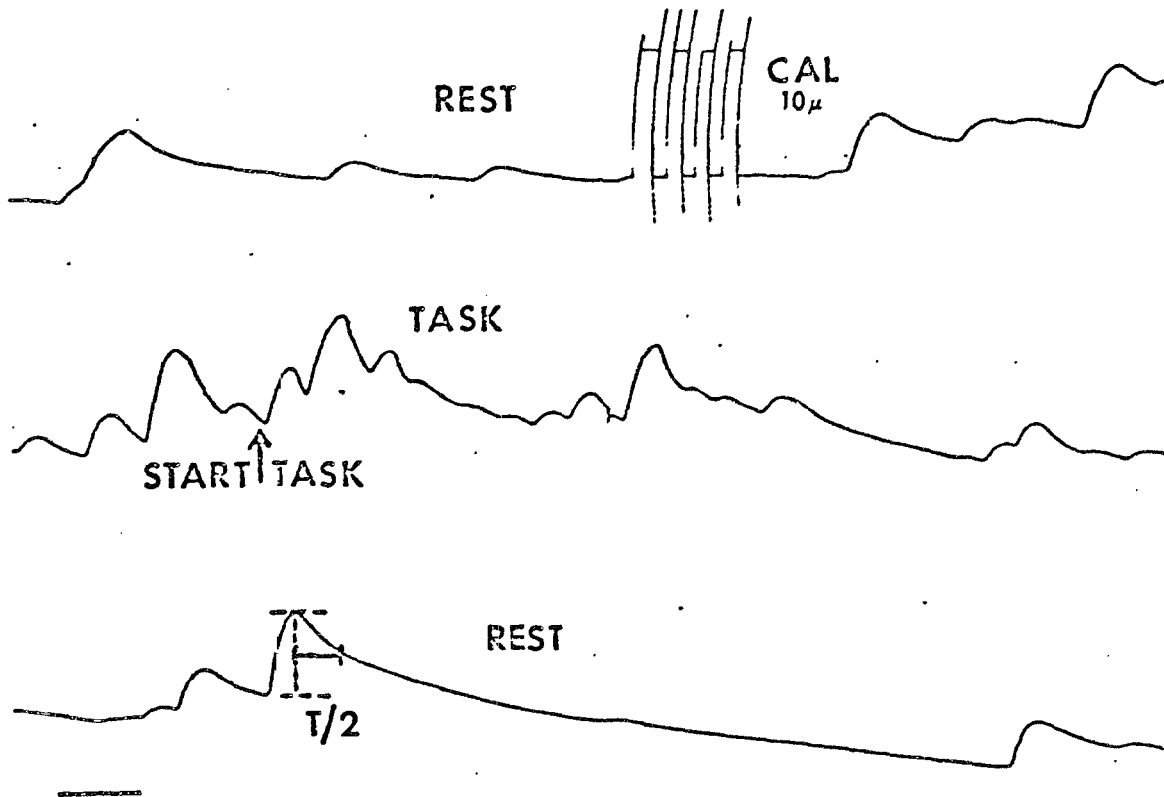

Figure 15. Recordings of skin conductance during pre-task rest (upper), instructions and task (middle) and post-task (lower), showing acceleration of recovery rate during instructions and task. Illustration of half-time measure is shown in lower trace. Time line is 10 seconds.

Table 3. Comparison of average values of recovery half-time ( $t/2$ ) for resting state and guessing game task in 12 subjects.

Subject	$t/2$ (seconds)		% Change
	Resting	Task	
1	6.7	5.6	-16
2	5.0	3.6	-28
3	4.9	3.1	-33
4	5.7	3.1	-46
5	5.3	2.9	-45
6	7.5	2.8	-63
7	3.6	3.1	-14
8	10.0	5.0	-50
9	3.9	3.2	-22
10	3.9	2.9	-26
11	2.2	1.7	-23
12	8.1	3.1	-63

Table 4. Summary of results from three experiments showing change in recovery rate with change in stimulus condition. Symbol "n" designates number of subjects who showed a decrease.

<u>N</u>	n	Measure Used	Condition A	Condition B	Mean Change A to B	p
12	12	$t/2$	Rest 5.6 sec	Aggressive Game 3.3 sec	-2.3 (-41%)	<.001
16	13	$t/2$	Light Flashes 7.9 sec	Perceptual Task 5.6 sec	-2.3 (-29%)	<.05
35	32	t.c.	Tones 10.4 sec	Reaction Time 4.9 sec	-5.5 (-53%)	<.001

Experiment 3: Simple tones vs. reaction time effort. The curve-matching method was used to determine  $t_c$  on the 35 subjects used in this experiment. The largest response to the five tones presented during the habituation series was compared with the response which was nearest in amplitude during the five reaction time trials. Of the 35 subjects, 32 showed acceleration of the recovery limb during the reaction time series, as seen in the representative example of Figure 16. The mean decrease in recovery limb  $t_c$  for the group was 53 percent ( $p < .001$ ). The mean  $t_c$  presentation of non-signal tones was 10.4 seconds for this population (Table 4). In Experiment 2, the mean half time for responses to non-signal light flashes was 7.9 seconds. Converting this to  $t_c$  by multiplying by 1.43 gives 10.3 seconds, in remarkable agreement with the results of Experiment 3. This similarity though perhaps fortuitous provides an added degree of confidence in the measure.

#### Change in Arousal

So far this section has been concerned with the power of the recovery rate in discriminating between responses in two qualitatively different stimulus situations. It can apparently also distinguish between two similar stimulus periods in which the state of the subject is different. Representative examples may help illustrate this point without statistical treatment. Figure 17 shows strips from two consecutive blocks in Experiment 4. In trace A, the subject is exposed to his first block of reaction time and word association stimuli. In trace B taken from a later block, the subject has apparently habituated to the situation, as indicated by reduction in response amplitude and by the fact that he has ceased responding to the alerting signal for the reaction time trials. The slowing of the recovery limb with repeated trials is especially marked

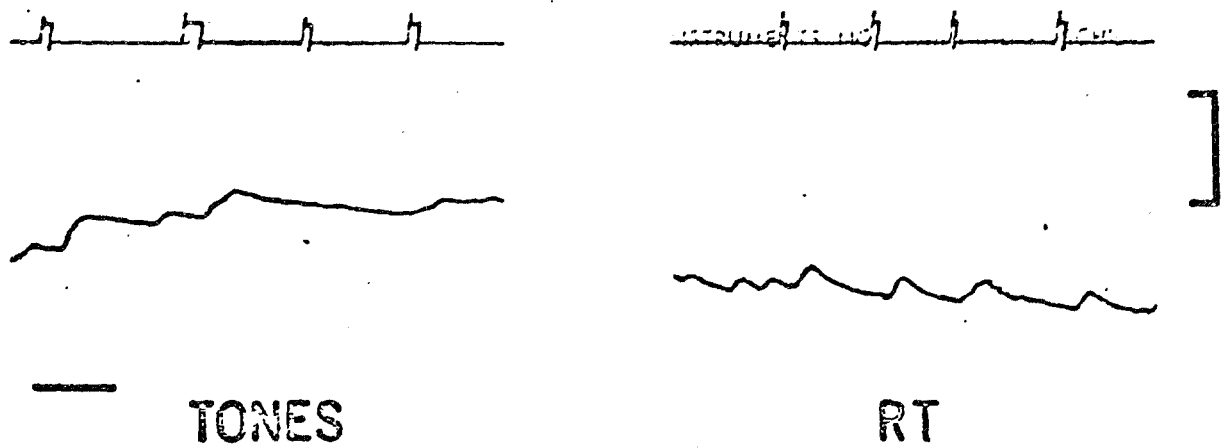

Figure 16. Representative skin conductance recordings from Experiment 3 showing acceleration of recovery rate during reaction time trials. Time line is 10 seconds.

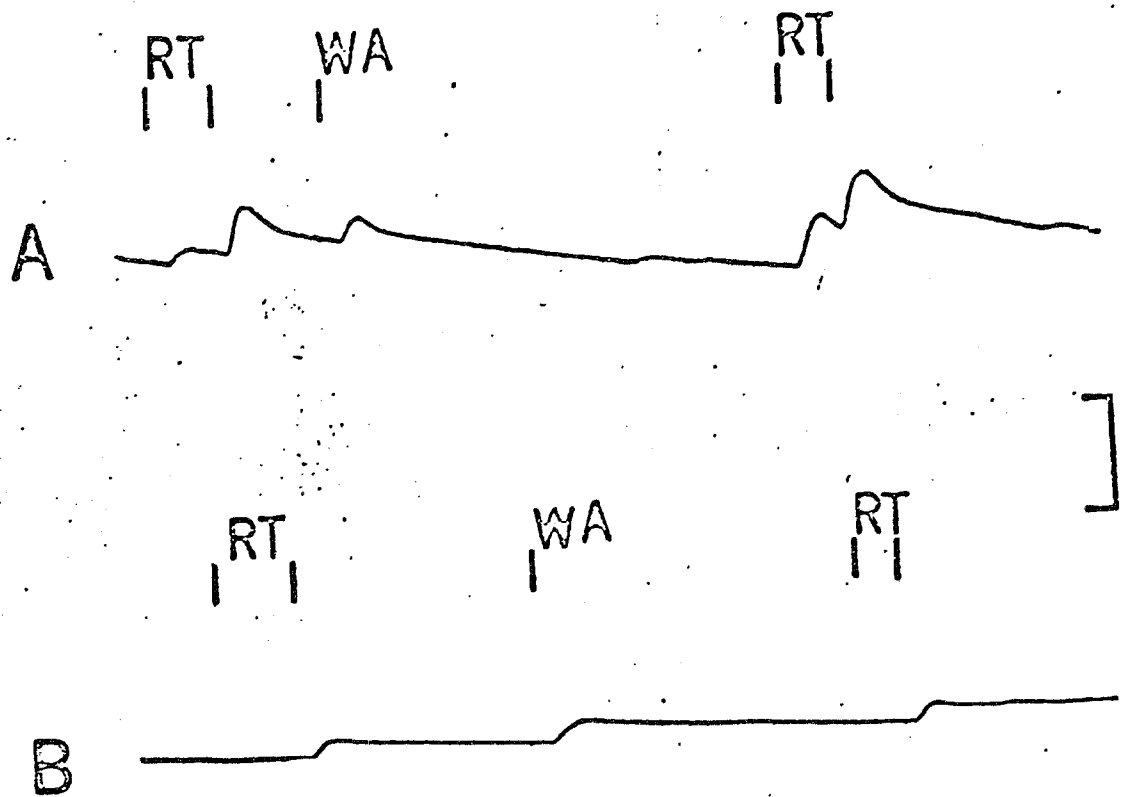

Figure 17. Recordings of skin resistance from blocks 1 (upper) and 2 (lower) of Experiment 4 showing slowing of recovery rate with adaptation. Stimuli are reaction time trials (RT) and word association trials (WA). Vertical calibration line is 25 K; time line, 10 seconds. Resistance of upper trace is 200 K, lower trace 190 K.

tendency, only 7 of these showed an increase of over 30%.

The recovery limb may also distinguish between responses to dissimilar stimuli in the same task period. An example is shown in Figure 18, taken from Experiment 2. It shows simultaneous recordings from the dorsal and palmar surfaces of the fingers of two individuals. The letter A indicates an alerting signal for a forthcoming reaction time trial and E, the execution signal. S denotes a spontaneous wave occurring during the foreperiod. The number below each response is the value of its time constant. For the first subject, the spontaneous response has about the same time constant as does the alerting response, but the execution response is considerably faster. The dorsal and palmar surfaces reflect this same pattern despite absolute differences in their recovery rates. For the second subject, the constant for the spontaneous response is over twice as long as that for alerting; the constant for the execution response is also longer. The difference between recovery rates of responses to alerting and execution responses is in general not a reliable one, but six of the 19 subjects did show an appreciable difference between the two. Two were significant at the .005 level of confidence, three at the .025 level and one at the .05 level. In five of these six cases, the shorter tc occurred with the execution signal.

### Individual Differences

The sensitivity of the recovery rate to differences in stimulus condition and in state of the subject suggested that inter-individual differences in recovery rate, seen for example in Table 3, might be associated with differences in characteristic behavior pattern. The behavioral index chosen to test this idea, namely rate of habituation to tones or to reaction time trials, was derived from Experiment 3. The quotient of the

... as a simple measure

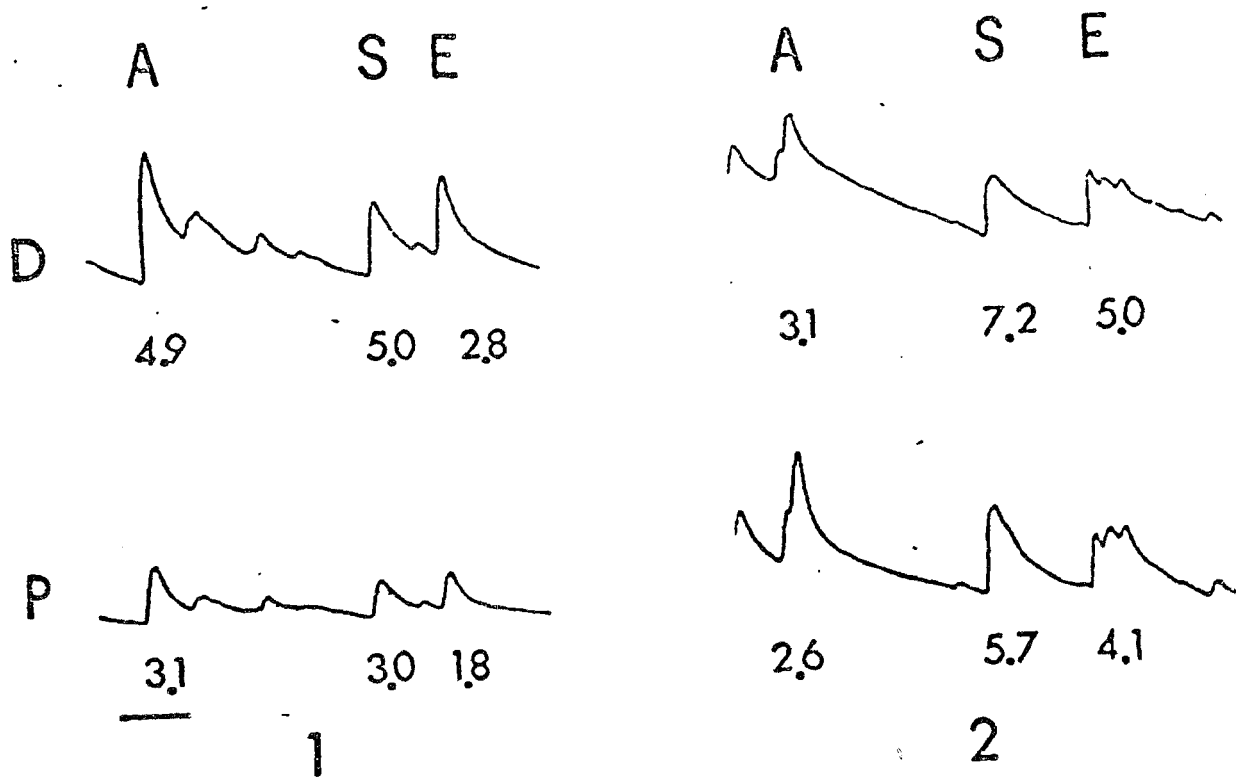

Figure 18. Simultaneous recordings of skin resistance from dorsal surface of the finger (upper) and palmar surface (lower) from two subjects. Stimuli are alerting tone (A) and execution tone (E) for a reaction time trial. S denotes a spontaneous response. Numbers denote recovery limb time constants in seconds. Time line is 10 seconds.



of habituation rate, higher values indicating faster habituation. Time constant measures were taken only from the reaction time series and for 35 of the subjects were the same as obtained for the earlier analysis of this experiment. In 18 other subjects who showed no responses to the tones, the response of median amplitude was used. The group correlations between this time constant and the various measures of habituation are shown in Table 5. Comparison of  $t_c$  with rate of habituation of the reaction time res-

Table 5. Summary of results from Experiment 3 showing product-moment correlation between recovery rate and habituation rate.

<u>N</u>	Habituation Measure	r	p
53	SCR during Reaction Time	.33	<.05
32	SCR during Tones	.13	NS
51	FPV Change during Tones	.30	<.05

ponses ( $r = .33$ ,  $N = 53$ ,  $p < .05$ ), shows that individuals with fast recovery rates tend to habituate more slowly during the reaction time series.

Of these 53 subjects there were 32 whose records permitted analysis of habituation rate of the SCR during the tone series. The correlation between this measure of habituation and the time constant was very low and not significant. However, when instead of SCR, finger pulse volume change was used as the response measure, the rate of habituation to tones showed a significant correlation with  $t_c$  ( $r = .30$ ,  $N = 51$ ,

gression. The two positive correlations found between recovery limb  $tc$  and different habituation measures indicate that individuals with fast recovery rates tend to habituate more slowly (Table 5).

### Conclusions

It has been demonstrated that the time constant or the half-time of the recovery limb of the exosomatic electrodermal response can be used to distinguish between a resting state and a task state, between responses to the same physical stimulus under qualitatively different sets, between responses to the same stimulus at different stages of habituation and finally between individuals who habituate at different rates. In some cases, significant discrimination would also have been made by treatment of amplitude data but in other cases, amplitude could not have distinguished between the two conditions. The rate of recovery accelerated markedly under three conditions, all of which involved activation from a resting state for performance of a task. However activation per se does not imply acceleration of the recovery limb. Bursts of strong spontaneous activity during "relaxation" periods were composed of EDRs showing the gentle recovery limbs characteristic of isolated responses elsewhere in the rest period. A reasonable interpretation is that fast recovery rates reflect a mobilization for goal-directed behavior. Spontaneous activation during rest does not possess this quality. To the extent that slow habituation represents longer maintenance of a set to respond, the inter-individual relation between fast recovery limbs and slow habituation rates is consistent with such an interpretation. For the electrodermal (but not the vasomotor) response the difference in the relationship between  $tc$  and habituation rate for the reaction time series, where it was appreciable, and for the tone series, where it was negligible,

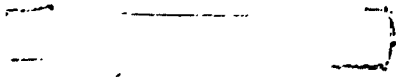
These findings also have an important implication in regard to the nature of electrodermal activity. The recovery limb time constant is a response characteristic by which two exosomatic electrodermal responses may be qualitatively differentiated according to the nature of the stimulus. Another method is by comparison of relative amplitudes of palmar and dorsal finger responses  This stimulus specificity, together with the independence of the recovery rate from a direct amplitude effect, its relation to the occurrence of positive components in the SPR and its relation to the occurrence of absorption waves suggests the existence of a second component in the EDR under independent control. The steeper recovery slopes apparently associated with goal-directed activation are viewed as representing the activity of a sweat reabsorption mechanism which in some way serves as an adaptive process during such behavior.

## 7. THE ELECTRODERMAL RECOVERY LIMB AS AN INDEX OF GOAL-DIRECTED BEHAVIOR

It was demonstrated in Section 6 that the rate of recovery of an exosomatic electrodermal response varies as a function of the state of behavioral activity of the individual, becoming faster when the subject changes from rest to any of a variety of tasks. The rate of recovery, which was expressed in terms of the time constant ( $\tau$ ) of the exponential region of the recovery limb, is faster in the presence of positive-going skin potential responses, and in the presence of the recently discovered sweat reabsorption response  Although observations in the initial study appeared to indicate that acceleration of recovery rate indicates a mobilization for goal-directed behavior, the evidence was suggestive rather than definitive. The tasks and stimuli used generally caused an increase in activation level as reflected in electrodermal activity or finger vasomotor activity, and an equally tenable hypothesis would be that acceleration of recovery rate merely reflects increased general activation. The obvious experiment needed is one in which activation is achieved in one instance by task performance, and in the other by a none-task condition, for example, noxious stimulation. Such an experiment was one of the key aims of this experiment. In addition further data to evaluate the degree of the dependence of recovery upon such things as response amplitude and base level were needed. Information was also needed in regard to the stability of this measure in a given individual over a period of time. This section deals with additional findings relevant to some of these questions.

### Method

In one phase of this experiment a group of 16 male medical students was run on

were monitored. Twelve of these subjects were tested on four successive occasions one week apart, under the same stimulus schedule. Five additional subjects were run only on selected tasks from this list.

Electrodermal electrodes were applied, after which the subject was seated and a stabilization period of 12 minutes allowed. The following schedule of conditions was followed without randomizing the order. Constant order was used to allow maximum similarity of the 5 repeat sessions despite the danger of an uncontrolled order effect.

<u>Sequence</u>	<u>Duration</u>	<u>Situation</u>
1	2 min.	Relax (eyes open)
2	1 1/2 min.	Count by ones at own pace
3	1 1/2 min.	Count backward from 500 by 7s. A new starting point near 500 was used on each successive week.
4	1 1/2 min.	Take deep breaths on command (3 at approximately 30-second intervals)
5	1 1/2 min.	Read aloud
6	2 min.	Mirror tracing
7	2 min.	Relax (eyes open)
8	40 sec.	Cold pressor (hand immersed to wrist in ice water)

Time constants were measured with the curve-matching overlay technique described earlier, the first useable wave following the first 15 seconds of each procedure being taken as the sample. One requirement was that the wave used should

their recovery rates. The average of the initial and final resistance levels for each of the eight procedures was computed for each subject.

## Results

### Effect of Task and Activation on Time Constant

The time constant (tc) was found to vary considerably as a function of task situation, as found in the earlier study. The range of time constants ran from an average of 3.1 seconds in the mirror tracing task to 7.8 seconds for resting with eyes closed. The time constants for the 8 task conditions were ranked for each of 16 subjects and the average rank for each task computed. Results are seen in Table 6. The

Table 6. Average ranks and standard deviations for each of 8 task conditions on 16 subjects.

Condition	Order Run	Rank	S.D.
Rest (eyes closed)	7	2.5 (longest tc)	1.5
Rest (eyes open)	1	3.2	1.5
Cold Pressor	8	3.8	2.3
Deep Breath	4	4.2	2.2
Count Forward	2	4.8	2.0
Count Backward	3	5.2	1.9
Read Aloud	5	5.9	2.0
Mirror Tracing	6	6.4	1.5

average ranks have been arranged in order with the longest tc at the top. The order in which these procedures were run is also shown, and a Spearman's rho test indicated no significant relation between the ranks of the time constants and the order run ( $\rho = -.05$ , N.S.). A Wilcoxon signed-ranks test showed that many of these

test) are shown in Table 7. Slowest recoveries were associated with the two rest conditions and with the cold pressor exposure. The remaining conditions appear to rank themselves essentially in order of increasing task complexity.

In view of the fact that recovery rate during the ice water exposure was not significantly different from that at rest, although that of the last 4 tasks was, it appears that activation per se is not an adequate condition for acceleration of electrodermal recovery. One may challenge the contention that the cold pressor was as activating as mirror tracing, but the report of strong pain by 14 of 16 subjects would suggest that there at least occurred the kind of arousal associated with strong noxious stimulation. Moreover, mean skin conductance levels for the test population were very similar for the cold pressor and mirror tracing conditions, being 28.1 and 27.6 micromhos/cm<sup>2</sup> respectively ( $t = 0.36$ , N.S.). The rate of change of skin resistance during these two tasks also did not differ ( $t = 0.12$ , N. S.), nor did the frequency of spontaneous responses ( $t = 0.12$ , N. S.). Thus, at least according to a few so-called electrodermal activation measures, activation levels during ice water exposure and mirror tracing were not demonstrably different, although both differed from the resting condition.

Twelve of the above 16 subjects were run once per week for 5 weeks and an analysis of variance was performed on the time constants (Table 8). This also demonstrated a significant difference between tasks ( $p < .001$ ).

A final test of the sensitivity of  $t_c$  to differences in task situation was by analysis of the similarity of rankings of these tasks across the 16 subjects, using Kendall's Coefficient of Concordance. This confirmed the significance of the differentiation ( $W = .31$ ,  $X^2 = 34$ ,  $p < .001$ ).

Table 6. Average ranks and standard deviations for each of 8 task conditions on 16 subjects.

Condition	Order Run	Rank	S.D.
Rest (eyes closed)	7	2.5 (longest tc)	1.5
Rest (eyes open)	1	3.2	1.5
Cold Pressor	8	3.8	2.3
Deep Breath	4	4.2	2.2
Count Forward	2	4.8	2.0
Count Backward	3	5.2	1.9
Read Aloud	5	5.9	2.0
Mirror Tracing	6	6.4	1.5

Table 7. Levels of significance of Wilcoxon signed-ranks test for various combinations of task situations.

Condition	Backward Counting	Deep Breath	Cold Pressor	Rest (Eyes Open)	Rest (Eyes Closed)
Mirror Tracing	.05	.02	.01	.002	.005
Reading Aloud		.03	.03	.02	.005
Backward Counting					.005
Deep Breath					.1

#### Stability of the Time Constant in Repeated Trials

Not only did the tc offer a stable index of differences between task situations, but also of differences between subjects. The analyses of variance of the tc's of 12 subjects run in the eight task situations on each of 5 consecutive weeks (Table 8) demonstrated a significant difference between subjects ( $p < .001$ ). In addition there was a significant task-by-subject interaction ( $p < .005$ ) as well as the difference between tasks already noted.



Table 8. Analysis of variance of time constant data from 12 subjects, run in 12 task situations on 5 consecutive weeks

Source	df	Mean Square	F	P
Subjects	11	109.7	14.5	<.001
Tasks	1	355.0	47.0	<.001
Subjects x Tasks	11	28.4	3.8	<.005

An indication of the stability of this measure on repeated trials was obtained by examining the degree to which the 12 subjects maintained the same rank for a given task, over the 5 sessions. The Kendall Coefficient of Concordance for the Backward Counting task was .53 ( $X^2 = 29$ ,  $p < .01$ ) and for the cold pressor exposure .65 ( $X^2 = 36$ ,  $p < .001$ ). These results indicate that a given subject may show variation in time constant according to the task, but the magnitude of his time constants takes a characteristic position in relation to the rest of the population. The 5-week data for the backward counting task are presented graphically in Figure 19. Each vertical line represents the 5-week mean and  $\pm 1$  standard deviation of one of the 12 subjects. They have been ranked in order of their mean time constants (upper series) and rate constants (lower series). The rate constant scale increases downward. Note that fast recovering subjects are consistently fast and slow recovering subjects are consistently slow. Note also that the rate constant shows less dependence of variance upon mean ( $r = -0.21$ ) than does the time constant ( $r = 0.34$ ). The solid circles represent the mean rate constants for the cold pressor condition over the five weeks and in every case they are slower than those for backward counting. An example of the range of time constant means over the 8 conditions for the 5 weeks for a single

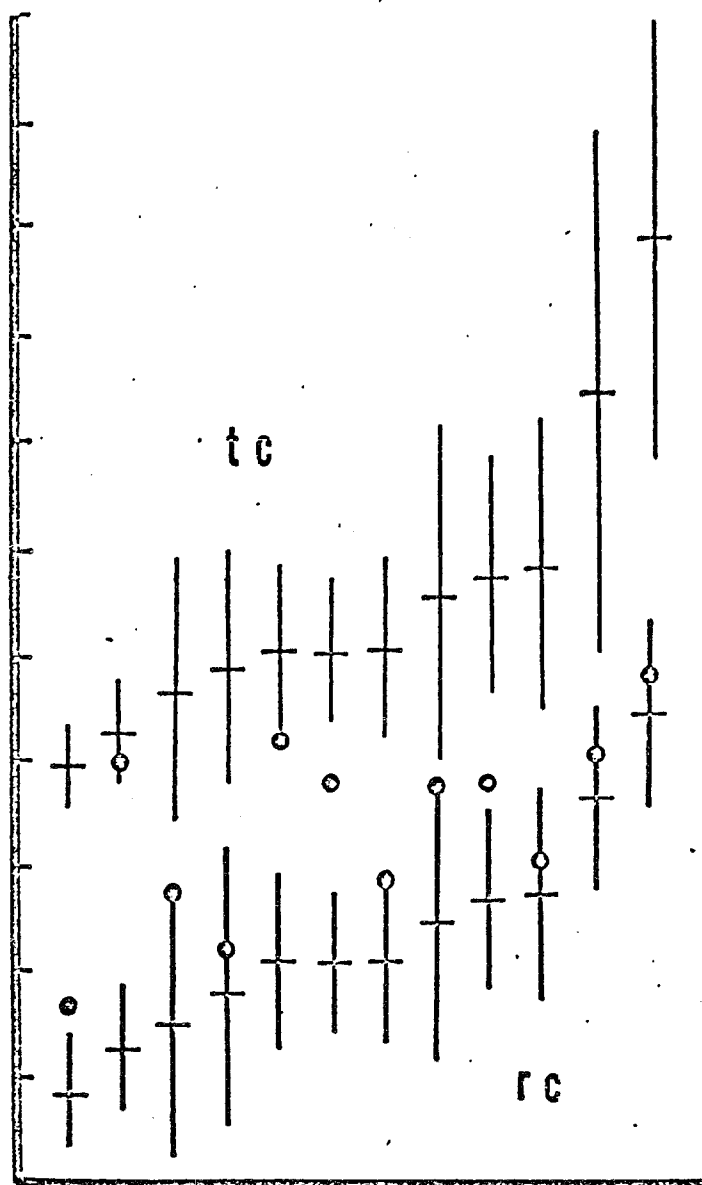

Figure 19. Means and  $\pm 1$  SD of recovery limb time constants (upper group) and rate constants (lower group) for each of 12 subjects tested over 5 consecutive weeks. Vertical line data are for the backward counting task. Solid circles represent the corresponding means for the cold pressor rate constants.

subject chosen at random is given in Figure 20. Each vertical line represents the mean time constant  $\pm 1$  standard deviation.

Thus the recovery limb measure, preferably its rate constant, constitutes a rather stable measure of differences in behavioral situations, and appears to reflect the level of involvement in goal-oriented performance. It is capable of discrimination under conditions in which base conductance level and (from the earlier study) skin conductance response amplitude do not.

#### Relation of tc to Conductance Level

Although conductance usually increases when a resting subject becomes activated for a task, there is no reason to suspect a necessary correlation between conductance and tc, i.e., that the two are causally related. If the type of activation which produces a rise in conductance does not entail mobilization for a goal-directed task, it is to be expected that the correlation would break down. This prediction was tested upon a group of 21 subjects. Two tasks were chosen, both activating, but only one of them involving a cognitive task. The first was a Cold Pressor exposure, the second, the Backward Counting task. Correlations were essentially as predicted. The Pearson's  $r$  between SC and tc during Cold Pressor was  $-.23$  (N.S.) whereas that for Backward Counting was  $-0.49$  ( $p < .05$ ). The above determinations are in themselves inadequate to justify the conclusion that tc is independent of skin conductance level. Another analysis does, however, point toward such a conclusion. The data for the above correlational analysis was subjected to a t-test for differences between tasks. The time constants were significantly different ( $p < .01$ ), but the SC levels were not.

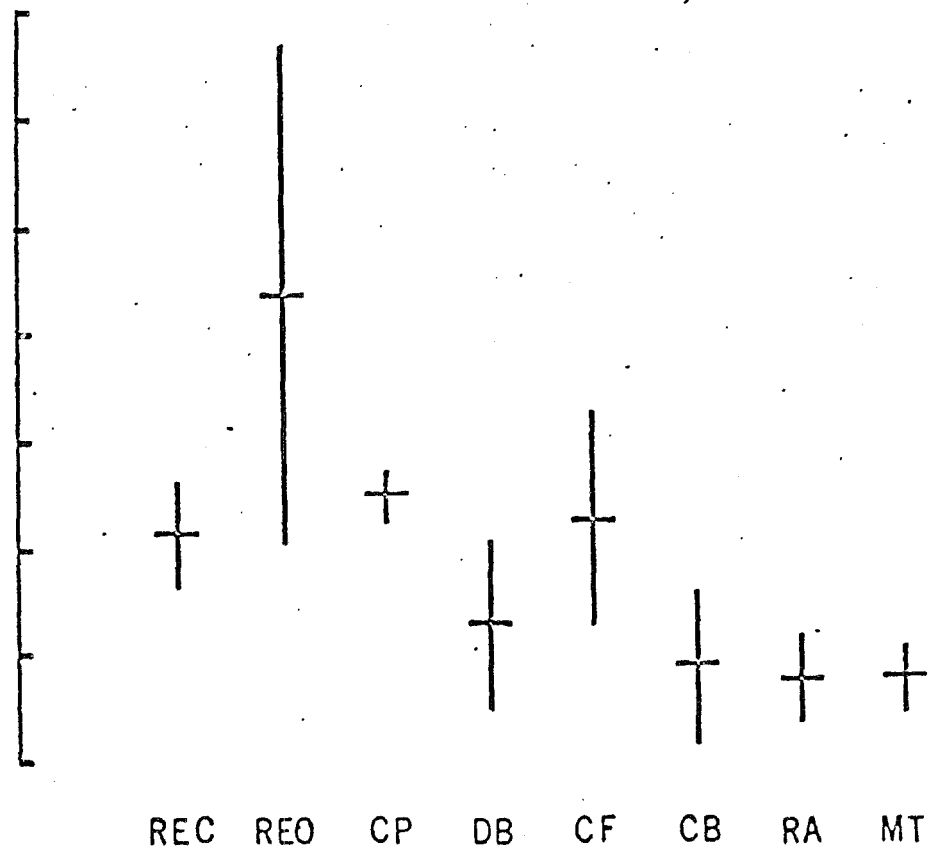



Figure 20. Means and  $\pm 1$  SD of recovery limb time constants for a single subject for each of 8 conditions over a series of 5 consecutive weeks. Abbreviations are: REC, resting (eyes closed); REO, resting (eyes open); CP, cold pressor; DB, deep breaths; CF, counting forward; CB, counting backward; RA, reading aloud; MT, mirror tracing.

### Relation of Time Constant to Performance

The earlier interpretation that the recovery limb time constant was related to mobilization for goal-directed activity implied a relation between the degree to which mobilization occurred and the level of performance. The relationships between  $t_c$  and two measures of performance in the Backward Counting (by 7's) task were examined. One measure was the number of errors made, the other the rate of counting. The number of errors was determined by determining the number of times subtraction of seven from the previous number was in error. The rate was expressed in terms of total span for the backward count in the 90 seconds allowed. Results on a population of 12 showed that subjects with shorter time constants tended to count faster ( $t = 1.96$ ) and to make fewer errors ( $t = 1.82$ ). Levels of confidence for these, using a two-tailed test, were at the 0.1 level. (Note: Although the direction was predicted, this investigator has discontinued the use of one-tailed tests).

### Functional Interpretation

In looking for a functional interpretation, one may point to the results of experiments over the last several years which show the relation of the recovery limb to rate of reabsorption of sweat. In some recent experiments, a new method has been utilized for demonstrating this relation. If a prism is illuminated for maximum internal reflection and placed on the skin as was done by  sweat droplets appear as black points on a white field. This method may be carried to its logical next stage, namely, the placement of a photocell at the proper point in the light path to integrate and follow the field of punctate sweat droplets. Figure 21 shows such a recording. The abbreviation OSR refers to what I call the optical sweat response, the

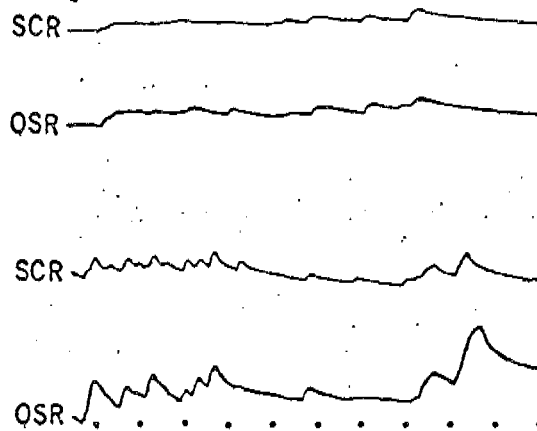

Figure 21. Simultaneous tracing of skin conductance response and optical sweat response from each of two subjects. Time marks are 10 seconds.

covered by a glass plate, do not simply accumulate on the surface during and following a response, but are immediately reabsorbed, so that despite continuing activity, the moisture content of the surface remains relatively constant. The second point of interest is that when the skin conductance trace shows slow recovery limbs as in the upper pair, so does the optical sweat response as compared with the lower pair in which electrical and optical recovery rates are rapid. Such demonstrations, along with those already reported using other methods, imply that changes in the recovery limb are at least in part indicative of a change in the rate of the reabsorption process.

Because differences in the state of hydration of the skin surface are known to influence tactile and manipulative performance, one is tempted to hypothesize that control of reabsorption, like control of sweating, may be part of the adaptive preparation for these types of behavior. This may explain the apparent relation of recovery rate to mobilization for goal-oriented performance.

### Conclusions

The time constant measure appears to be capable of reflecting differences in behavioral situations with a relatively high resolution. It has been demonstrated to discriminate when the base level measures did not, and in the earlier study when amplitude did not. It is relatively stable over time, at least insofar as the position of an individual in a group is concerned. Finally, since  $t_c$  is longest with the subject at rest or exposed to a cold pressor task, and becomes progressively shorter as the task becomes more goal-directed (calculation, reading, and mirror tracing), the findings support the earlier interpretation of  $t_c$  as reflecting mobilization for goal-directed performance.

## 12. VASCULAR EFFECTS UPON SKIN POTENTIAL

Although [redacted] produced experimental evidence that vascular changes play only a negligible role, if any, in accounting for electrodermal activity, the focus of these experiments was upon conductance changes. The possibility that vasomotor effects could account for at least some skin potential changes remained. The observation that potential responses could be recorded from the nail bed which is devoid of sweat glands [redacted] suggested that blood vessels might indeed account for some potential shifts observable at the skin surface.

This study examines the possible role of vasomotor changes in producing change of surface potential. The approach was to induce alterations in the state of peripheral vessels by mechanical means and to observe any concomitant potential changes not ascribable to central reflex effect. Venous occlusion was used as a method for engorging the veins while maintaining flow and arterial occlusion for interrupting flow without engorgement. A simultaneous recording of a non-occluded homologous contralateral site would serve as a control for centrally induced changes in potential.

## Method

Subjects were 11 males and 2 females in the age range from 18 to 42. Skin potential (SP) was recorded from the palmar and the dorsal surfaces of the middle phalanx of the middle finger of each hand. Each site was recorded with reference to an inactive skin site above the ipsilateral clavicle. This reference was chosen to be outside the occluded region so that common-mode effects would not cancel out elicited



changes. A direct-coupled reflectance plethysmograph was attached to the dorsum of the middle segment of the index finger of the experimental arm, i.e., the arm around which the blood pressure cuff was placed.

### Procedure

The pressure cuff around the upper part of the experimental arm was rapidly inflated to 60 mm Hg or to 180 mm Hg and kept at that pressure for one minute. Following deflation at the end of the one minute period of inflation a rest period of one to two minutes preceded the next inflation. Each S received at least 5 trials at 60 and at least 4 at 180 mm Hg. The experimental arm was alternated from one S to the next. Inflation of the cuff to 60 mm Hg prevented venous return from the arm and lead the arm to become engorged distal to the cuff due to the unimpeded arterial flow. Inflation to 180 mm Hg collapses both the arterial and venous systems, thereby completely occluding blood flow to the arm below the cuff. Plethysmographic recordings confirmed these differential hemodynamic effects associated with the two levels of pressure.

### Data Treatment

The analysis was guided by the need to answer two experimental questions. First, does either of the two inflation pressures result in fluctuations of SP at experimental sites and not at control sites? Second, if shifts of SP level are demonstrated for the experimental sites, are these shifts different for venous engorgement than for arterial occlusion?

Each of the four SP channels was scored identically. Since it appeared that the period of greatest change in the two experimental channels occurred about 5 seconds

after the release of pressure, this point was chosen as an arbitrary reference. The slope of SP during the 10 seconds preceding this point was determined by measuring the difference in potential between the reference point and a second point 10 seconds earlier. Likewise the SP slope was also found between the reference point and the level of SP at a point 10 seconds later. If the change during any 10 second period was towards increasing positivity the slope score was also assigned a positive sign, and conversely. A change score ( $\Delta$ -slope) was calculated from the two slopes by taking the absolute difference between them. Thus, each  $\Delta$ -slope score represented the magnitude of the algebraic change in slope between the first and last 10 seconds of the 20-second scoring period, independent of the direction of change.

## Results

### Comparison of Experimental Versus Control Sites

It was predicted that either engorgement, occlusion or both would lead to alterations in SP levels at the experimental sites but not at control sites. This assumption was tested by a between-S comparison of  $\Delta$ -slope scores between experimental and control sites. Analyses were accomplished separately for the 180 mm and 60 mm conditions and, within each of these, palmar and dorsal comparisons were also examined separately. In each of these four conditions, the average  $\Delta$ -slope score of the control site was computed for each S. These average  $\Delta$ -slope scores for experimental and control sites across subjects were subsequently subjected to analysis by t-tests for correlated means. The results of the four between-S t-tests are summarized in Table 15.

Table 15. Change in slope of SP after release of pressure: between-S comparisons of experimental vs. control sites.

Site	Pressure Level	
	60 mm Hg	180 mm Hg
Dorsal	3.30*	5.74*
Palmar	3.40*	5.25*

\* $p < .01$

The significant levels of these t analyses indicate that, for the group as a whole, there were larger shifts at experimental sites than at control sites. This was true for both palmar and dorsal regions and for both 60 and 180 mm Hg.

An effort was also made to examine the intra-subject reliability of this effect. This was accomplished, for each of the 13 Ss, by computing four t-tests for correlated means, based on the distribution of his  $\Delta$ -slope scores across trials. Table 16 indicates how many of these 52 comparisons were significant (i.e., magnitude of SP change greater at experimental than at control sites), and at what level of significance.

Table 16. Change in slope of skin potential: within S comparisons of experimental vs. control sites. Values are in terms of the frequency of each level of significance obtained by t-test.

Condition	Significance Level			
	.01	.05	.10	Nonsig.
60 mm Hg - Dorsal	7	1	2	3
60 mm Hg - Palmar	5	1	1	6
180 mm Hg - Dorsal	10	0	1	2
180 mm Hg - Palmar	9	2	0	2

Table 15. Change in slope of SP after release of pressure: between-S comparisons of experimental vs. control sites.

Site	Pressure Level	
	60 mm Hg	180 mm Hg
Dorsal	3.30*	5.74*
Palmar	3.40*	5.25*

\* $p < .01$

The significant levels of these t analyses indicate that, for the group as a whole, there were larger shifts at experimental sites than at control sites. This was true for both palmar and dorsal regions and for both 60 and 180 mm Hg.

An effort was also made to examine the intra-subject reliability of this effect. This was accomplished, for each of the 13 Ss, by computing four t-tests for correlated means, based on the distribution of his  $\Delta$ -slope scores across trials. Table 16 indicates how many of these 52 comparisons were significant (i.e., magnitude of SP change greater at experimental than at control sites), and at what level of significance.

Table 16. Change in slope of skin potential: within S comparisons of experimental vs. control sites. Values are in terms of the frequency of each level of significance obtained by t-test.

Condition	Significance Level			
	.01	.05	.10	Nonsig.
60 mm Hg - Dorsal	7	1	2	3
60 mm Hg - Palmar	5	1	1	6
180 mm Hg - Dorsal	10	0	1	2
180 mm Hg - Palmar	9	2	0	2

As can be seen from this table, at least 8 of the 13 Ss in each group, except 60 mm Hg-Palmar, demonstrated t values significant at the .05 level or better. In addition, the physiological recordings for certain comparisons which were not significant, clearly appeared to show the experimental effect, but due to variability of the control site significance was not obtained.

#### Polarity of SP Shift as a Function of Venous vs. Arterial Occlusion

The first two analyses confirmed the existence of a shift in SP slope at a point approximately 5 seconds after release of pressure. The two sites on the experimental hand exhibited significantly greater SP fluctuations than control sites for both 180 and 60 mm Hg. However, the pattern of change in SP seemed different for these two degrees of pressure. Typically, with the initiation of venous occlusion, SP became gradually more negative during occlusion and upon release reversed this trend and became more positive beginning about 5 seconds after release. This contrasted with the pattern of SP change induced by arterial occlusion. In this condition SP dipped sharply towards increasing positivity about midway through the inflation period and then changed to a more negative level, again beginning at a point about 5 seconds following deflation.

These distinct response patterns for 60 and 180 mm Hg may be illustrated simply by counting the number of Ss whose SP tended to shift in a positive direction following the termination of venous occlusion and in a negative direction upon the conclusion of arterial occlusion. Table 17 contains these figures. In three groups there was nearly complete congruence; all Ss but one shifted in parallel directions. Five Ss in the 60 mm Hg-Dorsal cell shifted in a negative direction, but for only two of these Ss was this paradoxical reversal at all pronounced.

Table 17. Frequency and average magnitude of positive and negative SP shifts after release of pressure (experimental sites only).

	Pos. Shift	Neg. Shift	$\bar{X}$ Pos.	$\bar{X}$ Neg.
<u>60 mm Hg</u>				
Dorsal	8	5	0.31 mv	
Palmar	13	0	0.17 mv	
<u>180 mm Hg</u>				
Dorsal	0	13		0.73 mv
Palmar	1	12		0.56 mv

The average magnitudes of the positive shifts occurring at the offset of 60 mm and of the negative shift following the end of a 180 mm trial are listed in the last two columns of Table 17. The five subjects whose mean change was negative were not included in the 60 mm Dorsal mean; likewise, the one subject for whom a positive shift appeared after 180 trials and not added to the 180 mm Palmar group for this analysis. As these magnitude figures indicate, changes of SP levels that occurred in relation to 180 mm Hg trials were more salient than the less marked shifts associated with the 60 mm Hg condition.

#### Summary

It has been demonstrated that certain changes in surface potential are consistently brought about by manipulation of vascular state. These changes are particularly marked during the sudden return from the altered state and may indicate a local reflex involving compensatory changes in smooth muscle of the blood vessels. This experiment does

not demonstrate that such changes are also produced by central effects but such a likelihood is made plausible by these findings. While secondary alterations, e.g., of sweat glands, could explain these data, the most parsimonious explanation is that they reflect local vasomotor alterations.