



THE BLACK VAULT

This document was obtained from The Black Vault, an online database of declassified government documents. This particular record is housed in the MKULTRA/Mind Control Collection, a compilation of more than 20,000 pages declassified by the Central Intelligence Agency (CIA).

The entire collection is free to download and online at:

<http://mkultra.theblackvault.com>

MEMORANDUM

12 February 1971

TO:

FROM:

SUBJECT: Comments on U.S. Patent 3,523,538 by Kunio Shimizu

The device as detailed in Figure 2 on sheet 1 of the patent appears to be a working system, capable of delivering a non lethal (to normal healthy subjects) shock to the victim. However, there are practical considerations which could seriously degrade the device's effectiveness.

It is questionable exactly how far the projectile would travel since any kinetic energy imparted the projectile would be partly expended unwinding the wire from the device against the friction of air and the take up motor. The wire would have to be extremely light and flexible, yet strong. This might result in excessive electrical resistance, however. Additional energy from the projectile would be required to overcome the restraining spring tension holding the needle protector in the safe position and to compress the clothing of the victim.

Adequate tenacity of the projectile for proper needle insertion does not appear to be insured by the "spearhead-shaped projections" on the projectile's ogive. The spears might penetrate and slightly compress the clothing but will not insure that the needles would stay implanted in the victim.

To circumvent the possibility that the victim is wearing an overcoat, suit coat, shirt and undershirt, the needles would need to be extended about 2 cm in the protracted position. These long needles, when used on a victim in light attire, would be sufficient to provide lethal penetration or put an eye out.

The possibility of serious infection from contaminated needles, skin or clothing cannot be overlooked. Sterilizing the needles or coating them with an antiseptic gel or paste would not preclude the possibility of infection.

The bore of the pistol (Figure 1) appears to be about 1-1.5 cm in diameter. Scaling the bore diameter to the diameter of the projectile would indicate that the spacing of the needles could be no more than 0.8-1.3 cm. The paralyzing effects on the victim would not extend beyond 1 cm radius from the axis of the needles. Therefore, the effective area of paralysis would resemble an elliptic paraboloid with the approximate dimensions of depth 3 cm, major axis 2.3 cm and minor axis 1 cm.

The "false epilepsy" referred to in the patent, probably is the result of Mr. Shimizu's limited research and confusion on the subject of electroshock therapy. Needless to say electrodes must be correctly positioned on the head before convulsions can be produced. His device cannot do this.

-The basic resemblance of the device to a conventional pistol might cause an armed, nervous assailant into a defensive position, possibly injuring the person with the shocker gun.

Conclusions:

The device invented by Mr. Shimizu will not supply incapacitating energy to disarm or disable a man.

Disadvantages of the device are:

1. Possibility of blinding, bodily harming or killing the victim.
2. Limited range due to friction, air drag and energy required to arm projectile.
3. Incomplete incapacitation of victim due to low volume of tissue subject to paralysis.
4. Basic resemblance to a conventional pistol.

[72] Inventor Kunio Shimizu
 33-2, 1-chome, Asagaya, Minami,
 Suginamiku, Tokyo, Japan

[21] Appl. No. 599,446

[22] Filed Dec. 6, 1966

[45] Patented Aug. 11, 1970

[32] Priority Dec. 6, 1965; Feb. 10, 1966; Mar. 5, 1966

[33] Japan

[31] 40/74,635; 41/7,409; 41/13,713

2,805,067	9/1957	Ryan	43/6X
2,966,621	12/1960	Voll	231/2(E)X
113,766	4/1871	Haviland et al.	124/15
2,033,397	3/1936	Richman	128/303.18X
2,516,882	8/1950	Kalom	128/303.18X
2,763,935	9/1956	Whaley et al.	128/303.18X
3,027,333	3/1962	Friedman	128/417X

FOREIGN PATENTS

476,508	12/1952	Italy	231/2(E)
407,648	3/1934	Great Britain	43/6

[54] **ARREST DEVICE**
 9 Claims, 6 Drawing Figs.

[52] U.S. CL. 128/404,
 124/15, 43/6

[51] Int. CL. A61m 21/00,
 A61d 7/00, A61m 37/00

[50] Field of Search 42/1, 84;
 102/46, 92.1, 92.4; 124/15; 128/303.13, 303.18,
 404, 417; 273/106.5(D); 231/2E; 43/6; 124/3, 15

Primary Examiner— Richard A. Gaudet
Assistant Examiner— Channing L. Pace
Attorney— Eliot S. Gerber

[56] **References Cited**
UNITED STATES PATENTS

8,843	3/1852	Sounenburg et al.	43/6
2,561,122	7/1951	Juergens	231/2(E)

ABSTRACT: A device for subduing a criminal includes a projectile having two needle electrodes which have different potentials and are adapted to pierce the skin, means for propelling the projectile at the criminal, and a supply of electric current connected to the electrodes. The current is of sufficient intensity so that when the projectile strikes the criminal and the electrodes pierce his skin, a false state of epilepsy is induced, thus rendering the criminal helpless.

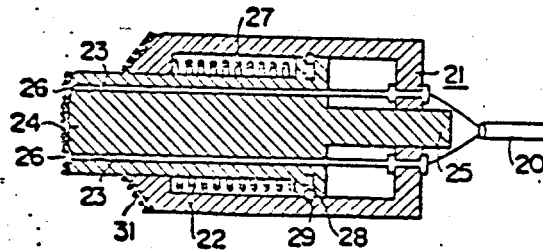

FIG. 1

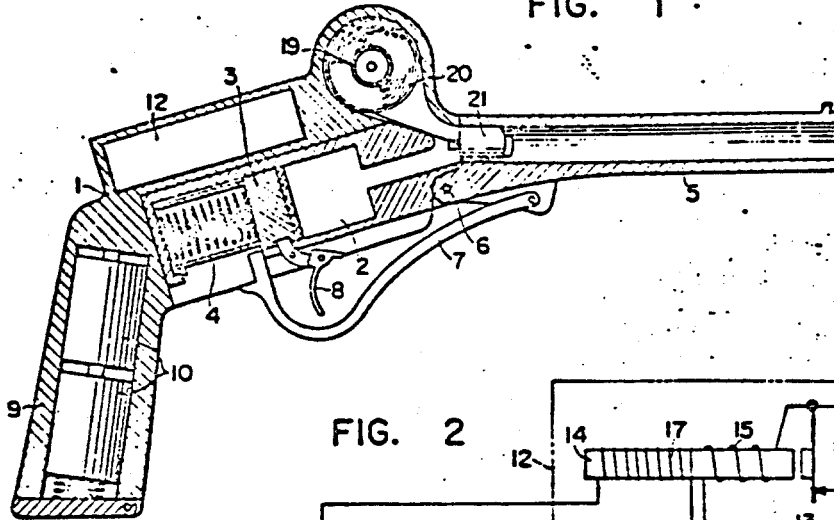

FIG. 2

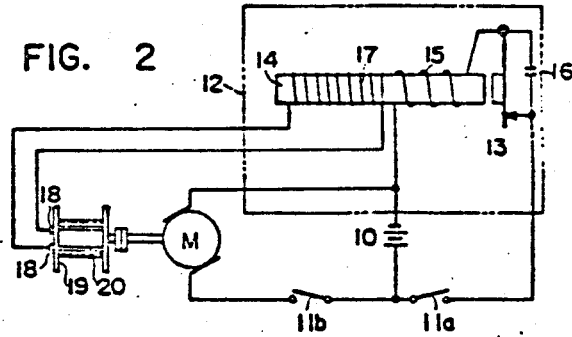

FIG. 3

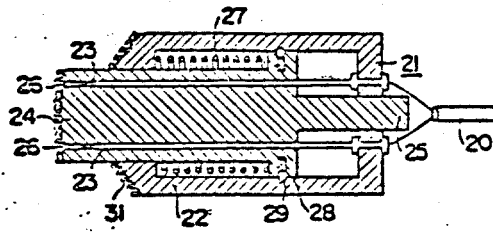
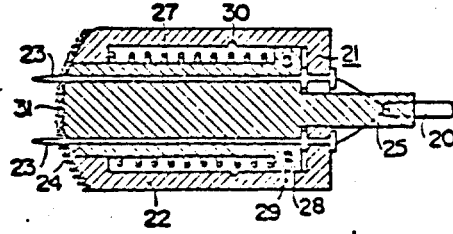

FIG. 4



INVENTOR
KUNIO SHIMIZU
BY
Eliot S. Lurie
ATTORNEY.

FIG. 5

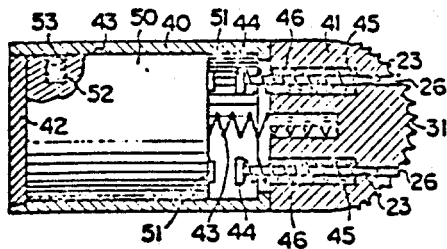
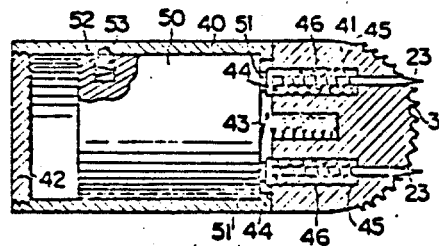

FIG. 6



INVENTOR
KUNIO SHIMIZU
BY
Eliot S. Herber
ATTORNEY.

ARREST DEVICE

The present invention relates to weapons and more particularly to a device with which the police may subdue a criminal.

At the present time the methods of placing a violent criminal or an insane person under arrest may lead to his own injury, or the injury of the police or of innocent persons. If the police use their guns, the criminal may be killed or innocent bystanders shot. If the police attempt to use their clubs, they may be injured by the criminal when they approach him. The use of tear gas is limited to confined places and may only cause the criminal to attack the police.

Similarly, those who wish to protect themselves or their homes may hesitate to shoot a gun at a criminal because of fear that they may kill him. For example, the home owner who hears a burglar now can only attempt to shoot him, if he has a gun, or attempt to strike him, if he can approach the burglar.

It is the objective of the present invention to provide a device for subduing criminals without killing or permanently injuring them.

It is a further objective of the present invention that the criminal may be rendered helpless without the unsafe necessity of approaching the criminal in order to strike him.

In accordance with the present invention, a bullet-like projectile is fired from an air gun. The projectile has two protruding electrode needles which pierce the skin and make contact with the subcutaneous fat layer of the skin. The electrodes are connected, for example, through a wire carried along with the projectile, to an alternating source of current. The current is sufficient to stun the criminal to a temporary state of false epilepsy, which renders him helpless. The shock is not sufficient to kill or permanently injure the criminal.

One embodiment of the invention utilizes a wetted material next to the needle electrodes. The needles and skin area are wetted with a special chemical solution so that less electrical current is needed to produce the desired effect. The projectile may carry a battery and, with the use of such chemical solutions, may be used without wires.

In another embodiment, the needles may be selectively protrudable from a hand-carried device.

Other objectives and features of the present invention will be apparent from the detailed description which follows of an embodiment, taken in conjunction with the accompanying drawing. In the drawings, similar parts are represented by the same corresponding reference numerals.

In the drawings:

FIGS. 1 to 4 illustrate a first embodiment according to the present invention.

FIG. 1 is a cross-sectioned general side view of a special pistol type air gun.

FIG. 2 is a circuit diagram of the electric shock current generating device for the gun of FIG. 1.

FIGS. 3 and 4 are cross-sectional side views of a bullet projectile shown with the tips of electric shock needles not projected and projected, respectively.

FIGS. 5 and 6 are cross-sectioned side views of a bullet which is a second embodiment of the present invention and corresponds to FIGS. 3 and 4, respectively.

The electrical resistance of the skin of the human body varies with its dry or wet state and the size of the contact surface. However, the range of the resistance inside the body is said to be about 150 to 500 ohms. The strength of the electrical shock is related to the strength of the electric current passing through the human body so that, even if the voltage is high and the current is weak, there will be no danger. For example, in the case of an alternating current of the commercial frequency (about 110 volts at 60 cycles), a considerable pain will be felt with about 1 mA. of current, an unbearable pain will be felt with about 10 mA., the muscle will shrink so much as not to move with 20 mA., and a danger of electric shock death will be caused with 50 mA. Such electric shocks have been already utilized for a special therapy (so-called electric shock therapy) in the treatment of psychosis. The present invention utilizes the electric shock effect and flows an electric shock current through the human body. A pair of needles are pushed

into the lower part of the subcutaneous fat layer (instead of the skin surface) in order to cause a temporary false epilepsy. The false epilepsy is effective in rendering the criminal helpless and yet is safe, as it uses a relatively small electric shock current.

In the first embodiment shown in FIGS. 1 to 4, a piston 3 is loaded (compressed) by a strong spring 4. Piston 3 is fitted in a cylindrical air chamber 2, which is fixed to a stock 1. When the barrel 5 is rotated (through a hinge 6) with respect to the stock 1, the spring 4 is compressed by a lever 7. Lever 7 is fitted to both the stock 1 and barrel 5. The piston 3 is selectively released by a trigger 8. After the barrel 5 is charged with a bullet 21 and the barrel is returned to its original position and the trigger is pulled, the disengaged piston 3 quickly advances. The piston gives a strong pressure to the air in the air chamber 2 and shoots the bullet 21. This type of structure is known as a spring-type air gun.

In this embodiment of FIG. 1, the gripping part 9 (handle) of the gun is charged with dry cells 10. A switch 11A is operatively connected with the trigger 8. An electric shock current generating device 12 flows the low voltage current of the dry cells 10 as an electric shock current of a desired strength against the resistance of the human body as the load.

An electric circuit diagram of an example of such electric shock current generator 12 is shown in FIG. 2. In FIG. 2, a circuit breaker (vibrator) 13 and a primary coil 15 wound on a core 14 of a transformer are connected in series. A condenser 16, used for arc suppression, is connected in parallel with the contact point of the circuit breaker. An electric shock current of a desired value may be obtained from the secondary coil 17, by mutual induction, when a low voltage current flows from the cells 10 to the primary coil 15 and is interrupted by the breaker 13. This electric current will pass to a lead wire 20. Wire 20 is wound and fixed at one end on a reel 19. The reel 19 is rotatably fitted to the stock 1 through contacts 18.

The lead wire 20 is electrically connected at the other end with electric shock needles 23. Needles 23, in a pair, are secured to an outside case 22 of the bullet projectile 21. A protective cylinder 24 is provided with small holes 26 in which the electric shock needles 23 are to be fitted. Cylinder 24 is fitted in said outside case 22 and loaded by spring 27. When a push rod 25 in the rear part of the protective cylinder, projecting out of the outside case 22, is pushed against the force of the spring 27, a projection 29 fitted to the protective cylinder 24 engages with a recess 30 in the outside case, due to a spring 28. The tip parts of the electric shock needles slide in the protective cylinder.

The bullet 21 will be projected in this state out of the air gun and will fly while playing the lead wire 20 out of the reel 19. When the bullet 21 hits a criminal, the protective cylinder 24 will be disengaged and will retreat due to the force of the spring 27. The electric shock needles 23 will be exposed (as in FIG. 4), and will be pushed into the body of the criminal. At this moment, an electric current from the generating device 12 will flow into the body of the criminal through the lead wire 20 and the electric shock needles 23. The criminal will fall into the state of a temporary false epilepsy and will be able to be easily arrested.

Preferably, many spearhead-shaped projections 31 are formed on the outer surface of the bullet head. These projections 31 are of a soft elastic material so that the bullet may easily stick to the clothing and not fall down. Preferably in order to recover the lead wire 20 and the bullet into the reel 19, a switch 11b is set. An electric motor M, contained in the stock 1, rotates the reel 19 and winds up the lead wire. As no explosive is used and there is no strong explosive sound, innocent bystanders are not frightened.

The second embodiment is shown in FIGS. 5 and 6. As is evident from the drawings, it is the same as in the first embodiment in some respects. Many spearhead-shaped projections 31, of a soft elastic material, are formed closely together on the outer surface of a bullet head 41 at the tip of a bullet cylinder 40. In this embodiment, the electric source cells and

the electric shock current generating device are contained in a container 50. The container 50 is inserted into the bullet cylinder 40 and then a cover 42 is applied.

Each of the electric shock needles 23, in a pair, is fitted in the bullet head 40 so as to be resiliently pressed on the flange-shaped base part 44 by a spring 45. When the bullet head 41 of the projectile hits a criminal, the container 50 in the bullet cylinder 40 still advances, due to its inertia, against the force of the spring 43. The output terminals 51 which are at different polarities will collide with the base parts 44 of the electric shock needles and cause the electric shock needles 23 to project out of the small holes 26 made in the bullet head 41 against the forces of the springs 45. The tips of the electric shock needles 23 will be pushed into the body of the criminal and, at the moment, the criminal will fall into a state of a temporary false epilepsy due to the electric shock effect.

Further, in this embodiment, each electric shock needle 23 is surrounded by a cotton or sponge body 46 impregnated with a chemical solution. The surface of the electric shock needle 23 is always wet with a solution. When electric shock needles 23 are pushed into the human body, the chemical will also enter the muscle. Preferably, this chemical makes the electric current easy to flow in the human body. A small electric shock current may have the same effect as a large electric shock current and will itself paralyze the muscle. A preferred example of the chemical solution is an aqueous solution of strychnine salt. This salt is of fine white crystals and has the property of being slightly dissolved in water. It has been conventionally used as a medicine.

A projection 53, resiliently pressed by a spring 52, is provided on the peripheral wall of the container 50. Projection 53 engages in a recess 43 on the inside wall of the bullet cylinder 40 when the electric shock needles 23 have been projected to their maximum, and keep the needles pushed out.

Further, the spearhead-shaped projections 31 will stick to the clothing so that the bullet may not fall down. After the criminal has been arrested, the bullet is taken off and it is strongly struck on the bottom part of the bullet cylinder with the bullet head directed upward. The projection 53 will become disengaged and the container 50 and the electric shock needles 23 will return to their original positions.

Only preferable embodiments according to the present invention have been shown above. However, even if any alternation or modification is made within the scope of the appended claims, it will not deviate from the subject matter of the present invention.

I claim:

1. In a device for subduing a criminal including a projector and a projectile, the improvement in the projectile comprising a body, two needle electrodes adapted to pierce the skin, said needle electrodes being normally concealed within said body, means for concealing said two needle electrodes inside of the front face of said body before the projectile hits the criminal and for projecting the said two needle electrodes outside of the front face of said body due to inertia only when the projectile hits the criminal, and passages through which said two needle electrodes are concealed and projected, and a supply of electric current of sufficient intensity to induce false epilepsy, said supply being connected to said needle electrodes.

2. A device for subduing a criminal including a projectile having two needle electrodes adapted to pierce the skin, means to propel the projectile and a supply of electric current of sufficient intensity to induce false epilepsy, said supply being a battery in the propelling means and being connected to the needle electrodes by wires.

3. A device for subduing a criminal as in Claim 1 wherein the projectile has gripping means on its front face for sticking to clothing.

4. A device for subduing a criminal as in Claim 3 wherein the said gripping means are soft plastic hooks.

5. A device for subduing a criminal as in Claim 1 wherein said electric current supply is a battery within said projectile.

6. A device for subduing a criminal as in Claim 1 wherein said electric supply is a battery in the propelling means and is connected to the needles by wires.

7. A device for subduing a criminal as in Claim 1 and also including a wet chemical solution on said needles.

8. A device for subduing a criminal as in Claim 7, wherein said solution is a solution of strychnine salt.

9. A device as in Claim 1 and also including means to adjust the extent of projection of the said needles.

45

50

55

60

65

70