

**ARMY FM 10-530  
AIR FORCE TO 13C7-27-121**

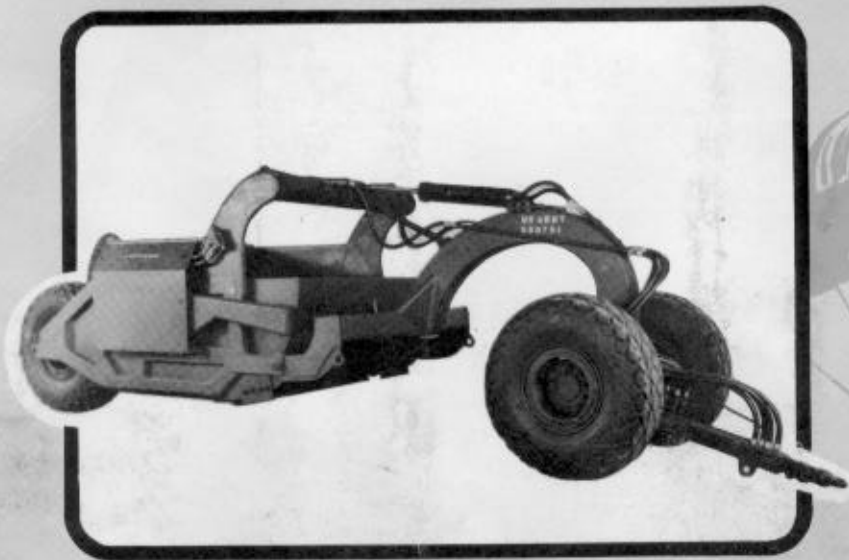

# **AIRDROP OF SUPPLIES AND EQUIPMENT RIGGING EARTHMOVING SCRAPERS**



**DISTRIBUTION RESTRICTION:** This publication contains technical or operational information that is for official Government use only. Distribution is limited to US Government agencies. Requests from outside the US Government for release of this publication under the Freedom of Information Act or the Foreign Military Sales Program must be made to HQ TRADOC, Ft Monroe, VA 23651-5000.

**DEPARTMENTS OF THE ARMY AND THE AIR FORCE**



REPLY TO  
ATTENTION OF

DEPARTMENT OF THE ARMY  
AERIAL DELIVERY AND FIELD SERVICES DEPARTMENT  
U.S. ARMY QUARTERMASTER CENTER AND SCHOOL  
1010 SHOP ROAD  
FORT LEE, VIRGINIA 23801-1502

ATSM-ADFSD

7 October 1998

MEMORANDUM FOR Commander, US Army Training Support Center, ATTN: ATIC-  
TIST (Mr. Baston), Fort Eustis, VA 23604

SUBJECT: Distribution Restriction Notice on Airdrop Rigging Manuals

1. As proponent for development of all 10-500 series airdrop rigging field manuals and the 10-450 sling load manuals, it has been determined that the distribution restriction on these field manuals should be changed to read: Approved for public release, distribution unlimited.
2. It is requested that unrestricted release of these field manuals be made via the Army Training Digital Library.
3. The new distribution notice will be added to the cover pages as future changes/revisions are made to the manuals.
4. Enclosed you will find a numerical list and the number of changes of the manuals that have unlimited distribution.
5. The point of contact for this action is Mr. Roger Hale, DSN 687-4769.

Encl

  
THEODORE J. DLUGOS  
Director, Aerial Delivery and  
Field Services Department

Distribution restrictions for the following Airdrop field manuals should read "**Approved for public release; distribution is unlimited.**"

10-450-3	10-524, c2	10-552, c2
10-450-4	10-526, c3	10-554
10-500-2, c2	10-527, c3	10-555, c2
10-500-3, c1	10-528, c6	10-556
10-500-7, c1	10-529, c1	10-557
10-500-45	10-530	10-558, c1
10-500-53	10-531, c2	10-562
10-500-66, c1	10-532, c4	10-564, c6
10-500-71	10-533	10-567, c1
10-508, c1	10-534, c2	10-569, c1
10-510, c3	10-535	10-571
10-512, c4	10-537, c4	10-572
10-513, c3	10-539, c3	10-573, c1
10-515, c1	10-540, c2	10-574, c4
10-516	10-541, c1	10-575, c2
10-517, c5	10-542, c2	10-576, c1
10-518	10-543, c2	10-577
10-519, c3	10-546	10-579, c2
10-520, c3	10-547, c1	10-584
10-521, c2	10-548, c1	10-586
10-522, c1	10-549	10-588
10-523, c2	10-550, c3	10-591, c1



## DEPARTMENT OF THE ARMY

HEADQUARTERS UNITED STATES ARMY TRAINING AND DOCTRINE COMMAND  
FORT MONROE, VIRGINIA 23651-5000

REPLY TO  
ATTENTION OF

ATCD-SL (70-1f)

21 Oct 96

MEMORANDUM FOR DEPUTY CHIEF OF STAFF OPERATIONS AND PLANS,  
400 ARMY PENTAGON, ATTN: DAMO-FDL, WASHINGTON  
DC 20310-0400

SUBJECT: Quartermaster (QM) Functional Area Assessment (FAA)  
Response

1. References:

a. Message, HQDA, DAMO-FDL, 231825Z Apr 96, subject: QM FAA Results.

b. Memorandum, HQ TRADOC, ATCG, 29 Jul 96, Army Airdrop Capabilities Assessment.

2. At the 29 Mar 96 QM FAA briefing to the Director of Army Staff, the decision was reached to revisit the Army's decision to "shelf" Low Altitude Parachute Extraction System (LAPES) (reference 1a).

a. Reference 1b, solicited CINCs input for their positions on LAPES and assessments of airdrop capabilities. The CINCs responses will be used to chart the direction and role for airdrop in the 21st century.

b. Based on the responses received (enclosure), there is no strong support for LAPES airdrop capability at this time. The consensus for the airdrop capabilities is to continue support for current Low Velocity Airdrop System (LVAD), develop a 500-foot LVAD and further explore Advanced Precision Aerial Delivery System (APADS).

3. Further, we will continue to maintain a range of airdrop capabilities to support all contingencies throughout the Army. The results of the Army Airdrop Capabilities Assessment also will be incorporated into the Operational Concept for Aerial Delivery Operations and Improved Cargo Aerial Delivery Capability Mission Needs Statement being developed by the Quartermaster Directorate of Combat Developments, U.S. Army Combined Arms Support Command (CASCOM).

4. The HQ TRADOC POC is MAJ Higgins, Airborne Airlift Action Office, ATCD-SL, E-mail: higginsn@emh10.monroe.army.mil, DSN 680-2469/3921, datafax DSN 680-2520.

ATCD-SL

SUBJECT: Quartermaster (QM) Functional Area Assessment (FAA)  
Response

FOR THE DEPUTY CHIEF OF STAFF FOR COMBAT DEVELOPMENTS:

Encl

JOHN A. MANDEVILLE  
Colonel, GS  
Director, Combat Service Support

CF:

USACASCOM (ATCL-CG/ATCL-QC/ATCL-MES)

USAQMC&S (ATSM-CG/ATSM-ABN/FS)

USANRDEC (SSCNC-UT/AMSSC-PM)

<b>ORGANIZATION</b>	<b>LAPES</b>	<b>LVAD</b>	<b>500' LVAD</b>	<b>APADS</b>	<b>SPTS/ NOT SPEC</b>
<b>USSOCOM</b>		X	X	X	
<b>EUCOM</b>					X
<b>CENTCOM</b>		X	X		
<b>FORSCOM</b>		X	X	X	
<b>TRANSCOM</b>					X
<b>SOUTHCOM</b>	X			X	
<b>VIII ARMY</b>					X
<b>ACOM</b>					X

**USSOCOM:** Memorandum specifically states that the command does not support LAPES airdrop capability, but supports LVAD as well as APADS.

**EUCOM:** Draft memorandum specifically states that the command support the need for a low level airdrop capability. However, memorandum summarizes that the specific capability is not important as to have a capability to meet the required mission/threat profile.

**CENTCOM:** Memorandum specifically states that the command does not support LAPES airdrop capability, but support both current LVAD and 500-foot LVAD airdrop capabilities.

**FORSCOM:** 1st Endorsement specifically states that the command does not support LAPES airdrop capability, however supports LVAD, 500-foot LVAD and APADS.

**TRANSCOM:** Memorandum does not specifically address any airdrop capability as it talks to the 21st century requiring the full spectrum of tactical delivery methods.

**SOUTHCOM:** Memorandum specifically supports LAPES and APADS airdrop capabilities for their command.

**VIII ARMY:** E-Mail note for VIII Army states that the command has no input to the assessment as their plans call for a limited employment of airdrop.

**ACOM:** Sent request for input on 30 Sep 96. Received verbal response on 16 Oct 96 stating command is indifferent on the specific capability received.



DEPARTMENT OF THE ARMY  
HEADQUARTERS UNITED STATES ARMY TRAINING AND DOCTRINE COMMAND  
FORT MONROE, VIRGINIA 23651-3000

REPLY TO  
ATTENTION OF

6 SEP 1995

ATCD-SL (70-1f)

MEMORANDUM FOR

Major General Thomas W. Robison, Commander, U.S. Army Combined  
Arms Support Command and Fort Lee, Fort Lee, VA 23801-6000  
Major General Robert K. Guest, Commander, U.S. Army Quartermaster  
Center and School, Fort Lee, VA 23801-5030

SUBJECT: Low Altitude Parachute Extraction System (LAPES)  
Disassembly.

1. References:

a. Message, HQ TRADOC, ATCD-SL, 100930Z Jan 95, subject:  
LAPES.

b. OVVM Note, HQ USACASCOM, 30 March 95, subject: TRADOC  
Disassembly of LAPES.

2. The U.S. Army and other services recently have concurred that  
LAPES will be terminated, as this capability is no longer required  
as a viable wartime contingency airdrop option. However,  
Headquarters, Department of the Army (DA), Deputy Chief of Staff  
for Operations and Plans, has agreed that LAPES technology will be  
shelved, and all specialized equipment preserved for possible  
future use.

3. Take the necessary steps to terminate training and leader  
development concerning LAPES operations. Major General Guest's  
questions regarding the disassembly of LAPES (enclosed) with  
following guidance will be utilized:

a. "Does the U.S. Army Quartermaster Center and School  
(USAQMC&S) continue to publish LAPES procedures in their joint  
field manual (FMs)/technical order manuals?" "Do we publish the  
LAPES procedures that have been written but not been printed yet?"  
Publishing LAPES procedures in all joint publications, Army FMs,  
regulations, etc., will be discontinued and addressed in the next  
revision of the aforementioned documents. Concurrently, all LAPES  
procedures that have been written and not printed will not be  
published.

6 SEP 1995

ATCD-SL  
SUBJECT: Low Altitude Parachute Extraction System (LAPES)  
Disassembly

b. "Do we keep LAPES in our programs of instruction (POIs)?" "Do we teach LAPES to other services and our allies?" The USAQMC&S will remove LAPES procedures from PCI and cease teaching LAPES to other services and/or allies.

c. "What do we teach to folks that have LAPES equipment in their war reserves?" All instruction concerning LAPES procedures will be discontinued whether LAPES equipment is located in units or in war reserves.

d. "What is the DA/TRADOC guidance on disposition of unit, depot, and war reserves LAPES equipment?" All LAPES equipment in war reserves and depot should be preserved with the exception of a few items that can be utilized in other existing airdrop capabilities. Specifically, the Type V airdrop platforms and attitude control bars of the LAPES system are being utilized to augment current Low Velocity Airdrop Systems (LVADS) loads.

e. "What is the guidance to U.S. Army Test and Experimentation Command on force development test and experimentation certification of LAPES loads?" The certification of all LAPES loads at the Airborne Special Operations Test Directorate will be redirected toward testing and certification of LVADS loads.

4. HQ TRADOC POC is CPT Higgins or CPT Phillips, ATCD-SL, DSN 680-2469/3921, datafax DSN 680-2520.

FOR THE COMMANDER:

Encl



JOE N. BALLARD  
Major General, GS  
Chief of Staff

CF:  
HQDA (DAMO-FDL)  
CDR, NRDEC (SAFNC-UA)  
CDR, FORSCOM (FCJ3-FC)  
CDR, OPTEC (CSTE-CS, CSTE-OPM)  
CDR, ATCOM (AMSAT-W-TD)  
DIR, ABNSOTD (ATCT-AB)  
HQ TRADOC (ATCD-L, ATCD-RM, ATDO-A, ATTG-IT)



Date and time 07/18/95 10:28:11

From: HIGGINSN--MON1  
To: HIGGINSN--MON1

From: OPT NEIL HIGGINS, (AAACO), 680-2469  
Subject: TRADOC "DISASSEMBLY" OF LAPES

\*\*\*\*\*  
\* AIRBORNE AIRLIFT ACTION OFFICE \*  
\* (AAACO) \*  
\*\*\*\*\*

\*\* Forwarding note from BRUNEAUN--OMSNAMES 07/18/95 10:27 \*\*\*  
Received: from LEE-EMH2.ARMY.MIL by MONROE-EMH2.ARMY.MIL (IBM VM SMTP V2R2)  
with TCP; Tue, 18 Jul 95 10:27:22 EDT  
Received: from LEE1 by LEE-EMH2.ARMY.MIL (IBM VM SMTP V2R2) with SMTP id 2547;  
Tue, 18 Jul 95 10:29:34 EDT  
Comments: Converted from PROFS to RFC822 format by PUMP V2.2X  
Date: Tue, 18 Jul 95 10:29:26 EDT  
From: NORMAN BRUNEAU <BRUNEAUN@LEE-EMH2.ARMY.MIL>  
Subject: TRADOC "DISASSEMBLY" OF LAPES  
To: "NEIL HIGGINS- AAACO " <HIGGIN@MONROE-EMH1.ARMY.MIL>

\*\* Resending note of 06/30/95 09:23

From: LARRY MC MILLIAN AAA <MCMILLI@MONROE-EMH1.ARMY.MIL>  
To: NORMAN BRUNEAU  
Subject: TRADOC "DISASSEMBLY" OF LAPES

NEIL- HERE ARE THE QUESTIONS THAT MG GUEST WANTS DA/ TRADOC TO ANSWER RE LAPES, AS I UNDERSTAND HIS GUIDANCE. I HAVE DISCUSSED THESE W/ OUR ABN DPT. IF THESE QUESTIONS MAKE SENSE, GIVE ME AN "UP" BEFORE I FORMALLY SEND ANYTHING OUT. MG GUEST WANTS SPECIFIC GUIDANCE FM TRADOC ON LAPES, RESPONSE NEEDS TO BE CLEAR AND TO THE POINT. A LOT OF THIS WILL HINGE ON WHAT ACC PLANS TO DO W/ LAPES NOW THAT THE AIR STAFF HAS GIVEN THEM THE GREEN LIGHT TO KILL IT. IF THEY PLAN TO PLACE IT ON THE SHELF OR KEEP A LIMITED OR CONTINGENCY CAPABILITY, THAT WILL DRIVE YOUR ANSWER TO US, AT THIS POINT I THINK ACC WILL DO WHATEVER THE ARMY WANTS, AS THEIR PRIMARY CUSTOMER. I WILL NOT REHASH HOW THE ARMY DECIDED THEY DIDNT NEED LAPES. QUESTIONS FOLLOW:

- DOES THE GMS CONTINUE TO PUBLISH LAPES PROCEDURES IN THEIR JOINT FM/TO MANUALS?
- DO WE PUBLISH THE LAPES PROCEDURES THAT HAVE BEEN WRITTEN BUT HAVE NOT BEEN PRINTED YET?
- DO WE REMOVE ALL LAPES PROCEDURES FROM ALREADY PUBLISHED MANUALS?
- DO WE KEEP LAPES IN OUR POI?
- DO WE TEACH LAPES TO OTHER SERVICES AND OUR ALLIES?
- WHAT DO WE TEACH TO FOLKS THAT HAVE LAPES EQUIPMENT IN THEIR WAR RESERVES?
- WHAT IS THE DA/TRADOC GUIDANCE ON DISPOSITION OF UNIT, DEPOT, AND WAR RESERVE LAPES EQUIPMENT?
- WHAT IS THE GUIDANCE TO TEXCOM ON THE FUTE CERTIFICATION OF LAPES LOADS?

I KNOW THESE ARE TOUGH QUESTIONS, BUT THEY HAVE TO BE ASKED. HQ STAFFS CANNOT SIMPLY SAY "KILL IT" AND MOVE ON TO THE NEXT ISSUE. I DONT THINK WE ARE DOING OUR JOB IF WE LEAVE IT UP TO THE SCHOOLHOUSE TO INTERPRET SKETCHY GUIDANCE. THAT PLACES US IN THE POSSIBLE POSITION OF BEING ACCUSED OF NOT FOLLOWING ORDERS.

LETS TALK.....NORM

TRK 2/47

SEP 11 11 08:30AM CSSRD FT MONROE VA 66 11

**DEPARTMENT OF THE ARMY**  
QUARTERMASTER CENTER AND SCHOOL  
1201 22D STREET  
FORT LEE, VIRGINIA 23801-1601

ATSM-ABN-FS

15 Dec 96

MEMORANDUM FOR RECORD

SUBJECT: Airdrop Equipment Update

Reference:

- a. Phone conversation between CW4 Mahon, CASCOM and Dick Harper, Weapons System Management Office, Army Aviation Troop Command. Subject : sab
- b. Phone conversation between CW4 Mahon, CASCOM and Don Stump, Logistics Management Specialist, Office, Deputy Chief of Staff for Logistics. Subject. sab
- c. Phone conversation between CW4 Mahon, CASCOM and Chief Msgt Okraneck, Hqrs Air Combat Command. Subject sab
- d. msg dtg R 181348Z Feb 94. subject: FCIF item: Type II platforms, PEFTC and SL/CS for Air Force unilateral training

1. Based on information received from the references a-c above, the following update is provided per request ref c, above.

- a. The type II modular platform no longer exists within any contingency stocks. Therefore, maintaining Joint Inspection training program is no longer required for this equipment.
- b. The Parachute Extraction Transfer Force Coupling (PEFTC) no longer exists within any contingency stocks. Therefore, maintaining Joint Inspection training program is no longer required for this equipment.
- c. The metric platform interim rigging procedures are no longer valid as they apply to metric platforms. Those rigging procedures which have dual application with the type V platform are still valid for the type V platform.
- d. The static line connector strap (SL/CS) currently has limited application. Only those loads that specifically require this system are authorized use of this system. The SL/CS is not an across the board substitute for the Extraction Force Transfer Coupling (EFTC). These authorized loads are specific in nature and will normally be found in the special operations arena of airdrop loads. This system is not authorized for use IAW ref d, above.

2. For additional questions/information contact the undersigned at DSN 687-4733, Fax 3084.

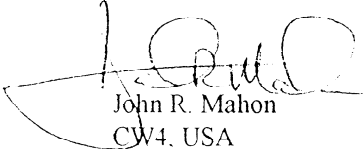
  
John R. Mahon  
CW4, USA  
Senior Airdrop Systems  
Technician

**FIELD MANUAL  
NO 10-530  
TECHNICAL ORDER  
NO 13C7-27-121**

**DEPARTMENTS OF THE ARMY  
AND THE AIR FORCE  
Washington, DC, 9 August 1985**

**AIRDROP OF SUPPLIES AND EQUIPMENT  
RIGGING EARTHMOVING SCRAPERS**

**TABLE OF CONTENTS**

		Paragraph	Page
<b>PREFACE</b>			iii
<b>CHAPTER 1.</b>	<b>INTRODUCTION</b>		
	Description of Items	1-1	1-1
	Special Considerations	1-2	1-1
<b>CHAPTER 2.</b>	<b>RIGGING MURRAY MODEL EARTHMOVING SCRAPER</b>		
	Description of Load	2-1	2-1
	Preparing Platform	2-2	2-2
	Building and Placing Honeycomb Stacks	2-3	2-3
	Preparing Scraper	2-4	2-4
	Installing Suspension Slings	2-5	2-6
	Positioning Scraper	2-6	2-7
	Lashing Scraper	2-7	2-7
	Installing Extraction Attaching Point Extension	2-8	2-9
	Stowing Cargo Parachutes	2-9	2-10
	Installing Extraction System	2-10	2-13
	Installing Load Cover	2-11	2-14
	Installing Release System	2-12	2-14
	Positioning Extraction Parachute	2-13	2-15
	Marking Rigged Load	2-14	2-15
	Equipment Required	2-15	2-16
<b>CHAPTER 3.</b>	<b>RIGGING MRS-100, 8-CUBIC-YARD EARTHMOVING SCRAPER</b>		
<b>Section I</b>	<b>RIGGING LOAD FOR LOW-VELOCITY AIRDROP</b>		
	Description of Load	3-1	3-1
	Preparing Platform	3-2	3-1
	Building and Placing Honeycomb Stacks	3-3	3-2
	Preparing Scraper	3-4	3-3
	Placing and Lashing Front Axle and Tongue Assembly	3-5	3-7
	Installing Suspension Slings	3-6	3-9

---

\*This manual supersedes FM 10-530/TO 13C7-27-121, 28 March 1975.

	Paragraph	Page
	Setting Scraper on Platform .....	3-7 3-9
	Lashing Scraper .....	3-8 3-9
	Stowing Cargo Parachutes .....	3-9 3-13
	Installing EFTC .....	3-10 3-17
	Installing and Safeying Release System .....	3-11 3-18
	Placing Extraction Parachute .....	3-12 3-19
	Marking Rigged Load .....	3-13 3-19
	Equipment Required .....	3-14 3-20
Section II	<b>RIGGING LOAD FOR LAPE AIRDROP</b>	
	Description of Load .....	3-15 3-22
	Preparing Platform .....	3-16 3-22
	Building and Placing Honeycomb Stacks .....	3-17 3-23
	Preparing Scraper .....	3-18 3-24
	Placing Front Axle and Tongue Assembly .....	3-19 3-28
	Lashing Front Axle and Tongue .....	3-20 3-28
	Setting Scraper on Platform .....	3-21 3-29
	Lashing Scraper .....	3-22 3-29
	Installing Extraction System .....	3-23 3-35
	Placing Extraction Parachute .....	3-24 3-37
	Marking Rigged Load .....	3-25 3-37
	Equipment Required .....	3-26 3-38
	<b>GLOSSARY .....</b>	<b>GLOSSARY-1</b>
	<b>REFERENCES .....</b>	<b>REFERENCES-1</b>

## PREFACE

### SCOPE

This manual tells and shows how to rig the Murray model, towed, 7 1/2-cubic-yard earthmoving scraper and the MRS-100, towed, 8-cubic-yard earthmoving scraper for low-velocity airdrop from C-130 and C-141 aircraft. It also tells and shows how to rig the MRS-100, towed, 8-cubic-yard earthmoving scraper for low-altitude parachute-extraction (LAPE) airdrop from the C-130 aircraft. This manual is designed for use by all parachute riggers.

### USER INFORMATION

The proponent of this publication is the US Army Quartermaster School. You are encouraged to report any errors or omissions and suggest ways for making this a better manual. Army personnel, send your comments on DA Form 2028 (Recommended Changes to Publications and Blank Forms) directly to:

**Commandant  
US Army Quartermaster School  
ATTN: ATSM-DTL  
Fort Lee, VA 23801-5036**

Air Force personnel, send your reports on AFTO Form 22 (Technical Order Publication Improvement Report) through:

**Headquarters  
Military Airlift Command (MAC/DOXT)  
Scott AFB, IL 62225-5001**

to:

**Commandant  
US Army Quartermaster School  
ATTN: ATSM-DTL  
Fort Lee, VA 23801-5036**

Also, send information copies of AFTO Form 22 to:

**San Antonio ALC/MMEDTR  
Kelly AFB, TX 78241-5000**

## CHAPTER 1

# INTRODUCTION

---

### 1-1. Description of Items

The description of the items covered in this manual is as follows.

*a. Murray Model.* The Murray model, towed, 7 1/2-cubic-yard earthmoving scraper weighs 12,650 pounds. It is 344 inches long (reducible to 290 inches). It is 100 inches wide and 81 inches high.

*b. MRS-100.* The MRS-100, towed, 8-cubic-yard earthmoving scraper weighs 17,420 pounds. It is 378 inches long (reducible to 306 inches). It is 110 inches wide and

105 inches high (reducible to 81 inches).

### 1-2. Special Considerations

Special considerations are described below.

*a.* When these loads are dropped from a C-141 aircraft, they must be loaded in aircraft compartments I through M according to TO 1C-141B-9.

*b.* A copy of this manual must be available to the joint airdrop inspectors during the before- and after-loading inspections.

## CHAPTER 2

**RIGGING MURRAY MODEL EARTHMOVING SCRAPER****2-1. Description of Load**

The Murray model, towed, 7 1/2-cubic-yard earthmoving scraper (figure 2-1) is rigged on a 24-foot, type II, modular platform. It is rigged with five G-11A cargo parachutes and

other items of airdrop equipment for a low-velocity airdrop. This load can be airdropped from a C-130 or C-141 aircraft.



*Figure 2-1. Murray model, towed, 7 1/2-cubic-yard earthmoving scraper.*

### 2-2. Preparing Platform

Prepare the platform as described below.

a. Inspect, or assemble and inspect, the 24-foot, type II, modular platform as outlined in TM 10-1670-208-20&P/TO 13C3-4-12.

b. Bolt the load tiedown clevises to the clevis holes, and number them as shown in figure 2-2.

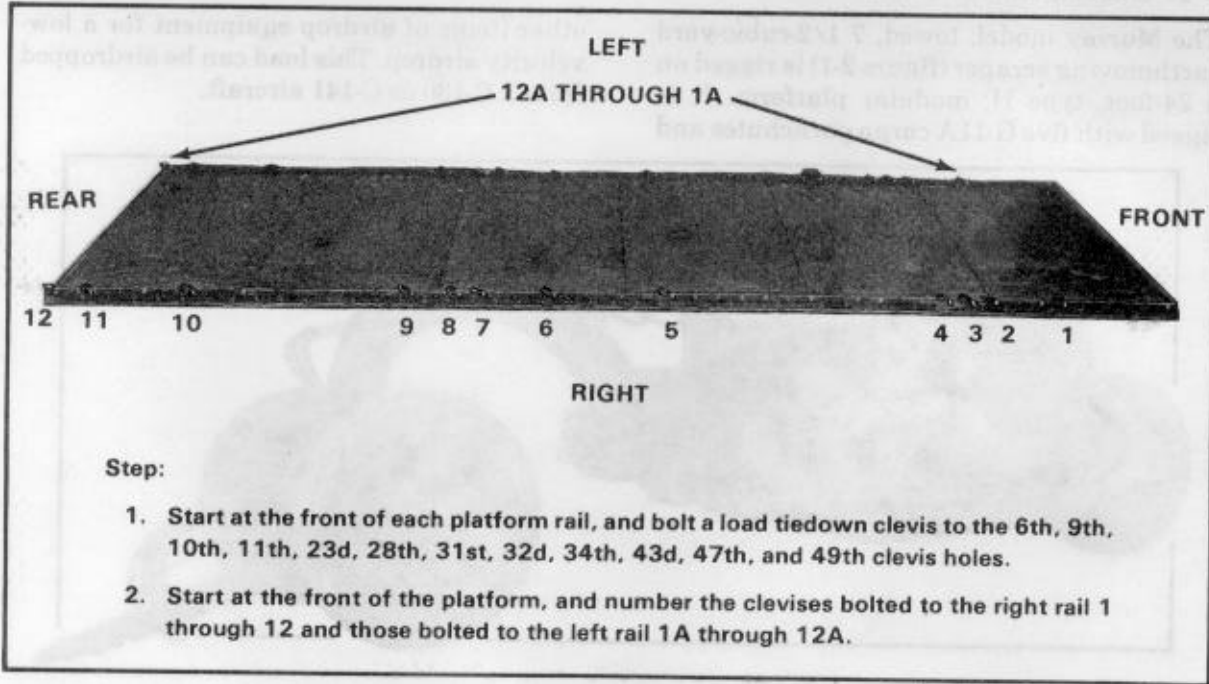

Figure 2-2. Platform prepared.



### 2-3. Building and Placing Honeycomb Stacks

Build nine honeycomb stacks, and place them on the platform according to FM 10-500/TO 13C7-1-5 and as shown in figure 2-3.

**NOTE:** Do not glue stack 2 to the platform because it may need to be moved.

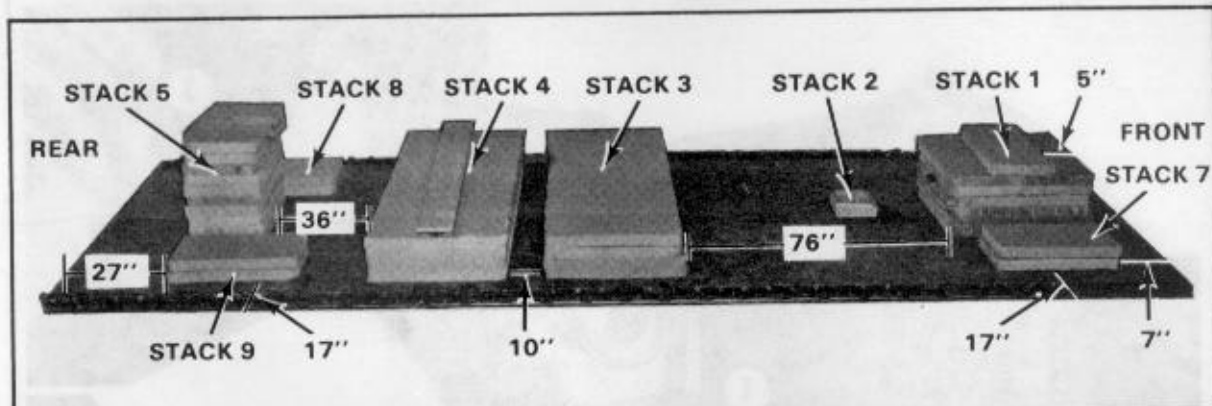

STACK	PIECES	WIDTH (INCHES)	LENGTH (INCHES)	MATERIAL	INSTRUCTIONS
1	6	36	40	honeycomb	Center 7 inches from front of platform. Center 5 inches from front of stack.
	1	18	36	honeycomb	
2	1	12	12	honeycomb	Center in second platform panel. Place 3/4-inch plywood on honeycomb.
	1	12	12	plywood	
3	4	36	90	honeycomb	Center 76 inches from stack 1.
4	4	36	90	honeycomb	Center 10 inches from stack 3. Center 2-inch lumber on honeycomb. Place 3/4-inch plywood on lumber.
	1	10	90	lumber	
	1	10	90	plywood	
5	10	20	36	honeycomb	Center 36 inches from stack 4. Cut out a 12- by 12-inch piece from the center front of top two layers.
6 (not shown)	2	18	36	honeycomb	Place 7 inches from front of platform and 17 inches from left rail.
7	2	18	36	honeycomb	Place 7 inches from front of platform and 17 inches from right rail.
8	2	18	36	honeycomb	Place 27 inches from rear of platform and 17 inches from left rail.
9	2	18	36	honeycomb	Place 27 inches from rear of platform and 17 inches from right rail.

Figure 2-3. Honeycomb stacks placed on platform.

## 2-4. Preparing Scraper

Prepare the scraper as shown in figures 2-4 and 2-5.

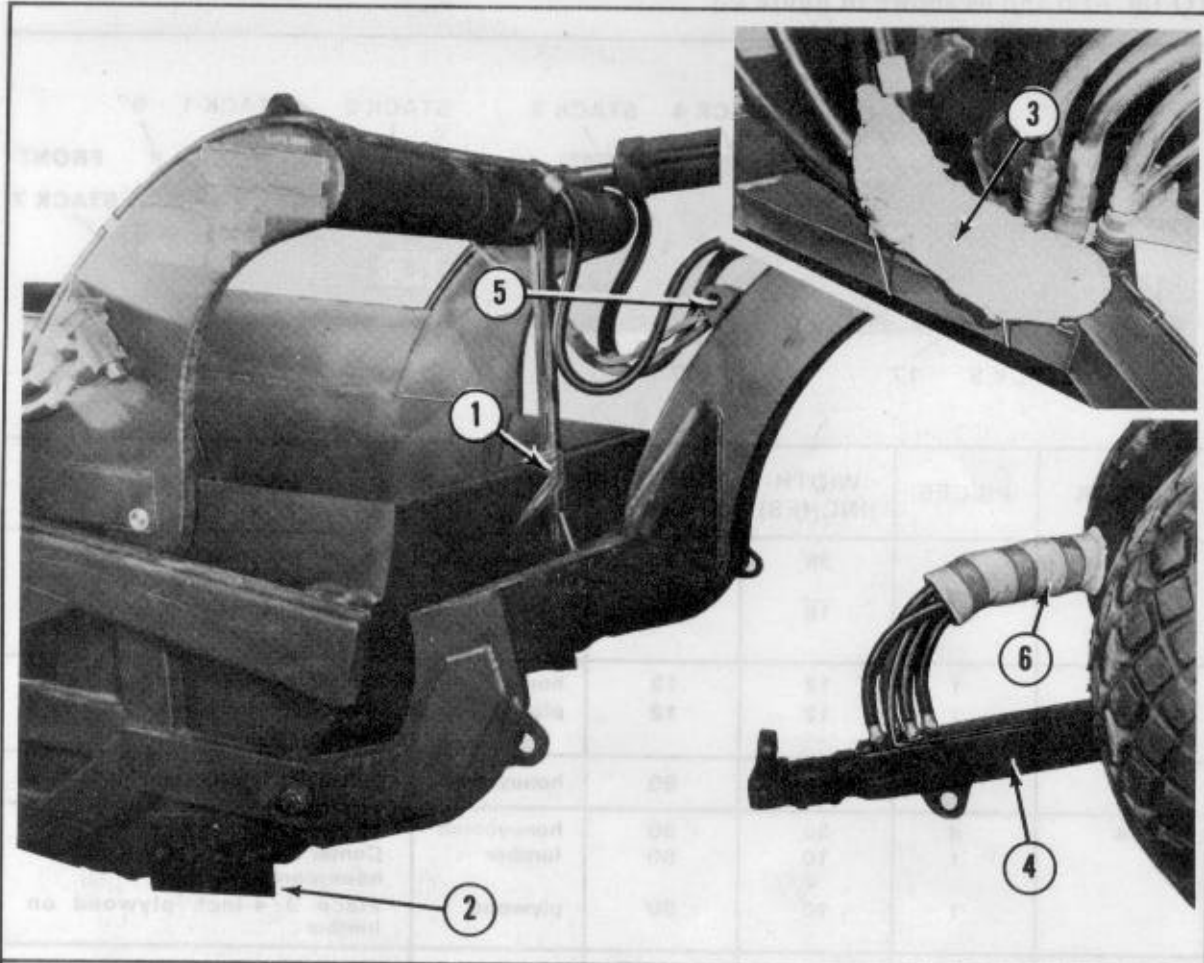

- ① Disconnect the end of the transportation bar from the yoke, and tape it to the bowl.
- ② Lower the scraper bowl until the scraper blade is resting on the surface.
- ③ Disconnect the hydraulic hoses. Pad the hoses with cellulose wadding, and tape the wadding in place.
- ④ Remove the towing tongue from the prime mover. Turn the towing tongue 180 degrees so that it points to the scraper blade.
- ⑤ Pass a 9-foot sling around the cylindrical brace, and attach both ends to the transportation bar bracket on the yoke.
- ⑥ Pad the hydraulic hose attached to the tongue with cellulose wadding. Tape the wadding in place.

Figure 2-4. Scraper prepared.

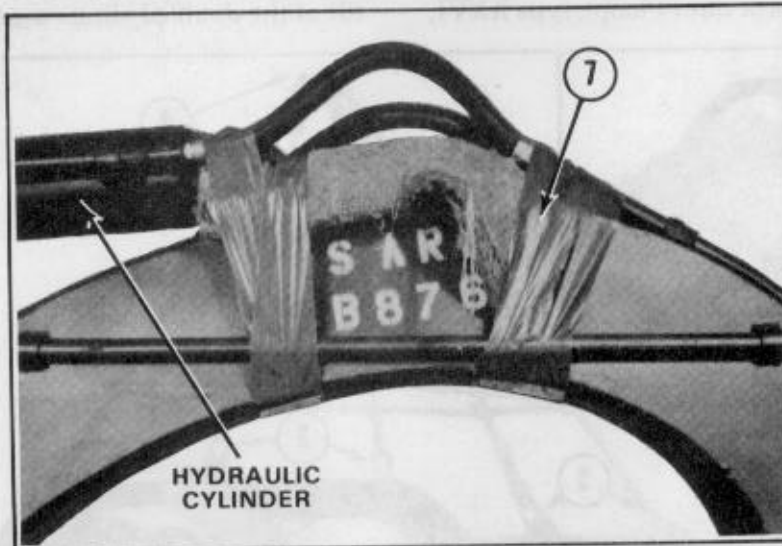

- ⑦ Lay three layers of cellulose wadding on top of the hydraulic cylinder bracket. Tape the wadding in place.

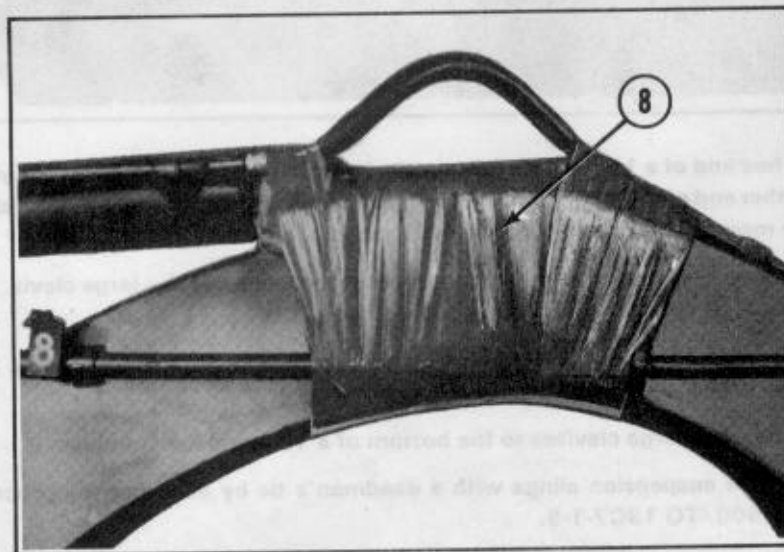

- ⑧ Place a 2- by 6- by 8-inch wood block against each side of the yoke under the cylinder bracket. Tape the wood blocks in place.

Figure 2-5. Yoke prepared for suspension slings.

## 2-5. Installing Suspension Slings

**NOTE:** Use only 5,000-pound-capacity cargo parachute releases on this load.

Use two (2-loop), type X, nylon webbing suspension slings or one (4-loop), type XXVI,

nylon webbing suspension sling on each suspension point as shown in figure 2-6. Do not mix slings on this load. Pad and tape 4 feet of the slings attached to the yoke. Tape all of the doubled slings together.

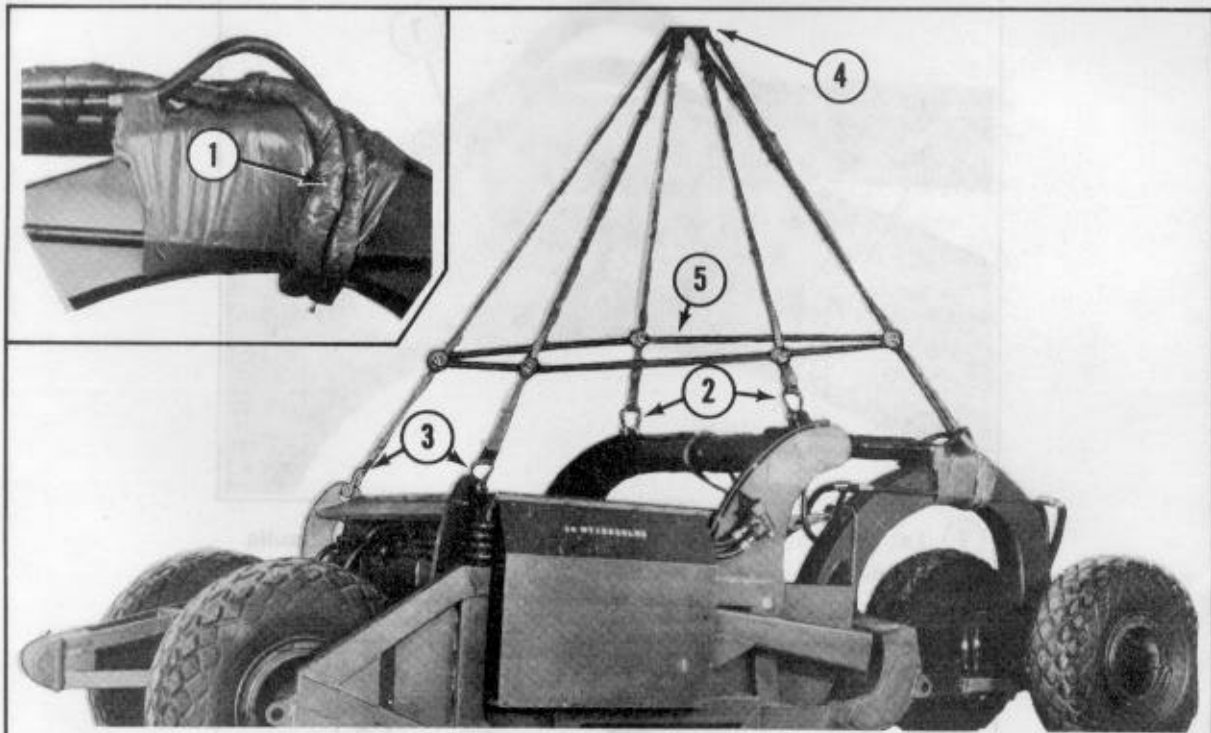

- ① Pass one end of a 16-foot sling under the hydraulic hoses and around the yoke. Pass the other end of the sling through this loop and pull it tight. Install a second sling in the same manner. Place the ends of the slings on a large clevis.
- ② Install two 9-foot slings on each center lifting provision with a large clevis. Place the four ends of the slings on a second large clevis.
- ③ Install two 12-foot slings on each rear lifting provision with a large clevis. Place the four ends of the slings on a third large clevis.
- ④ Bolt the three large clevises to the bottom of a 12-spool load coupler.
- ⑤ Safety the suspension slings with a deadman's tie by adapting the procedures in FM 10-500/TO 13C7-1-5.

Figure 2-6. Suspension slings installed.

**2-6. Positioning Scraper**

Set the scraper on the honeycomb stacks with the rear of the scraper even with the rear edge of the platform.

**NOTE:** Position honeycomb stack 2 under the end of the tongue.

**2-7. Lashing Scraper**

Lash the scraper to the platform as shown in figure 2-7. Safety the load binders according to FM 10-500/TO 13C7-1-5.

**NOTE:** Pad sharp edges that may touch the lashings.

**CAUTION:** Make sure the lashings are not so tight that they cause the platform to bow.

Lashing Number	Tiedown Clevis Number	Instructions
1	1	Pass lashings: Through padded lunette
2	1A	Through padded lunette
3	2	Around towing tongue
4	2A	Around towing tongue
5	3	Through padded right front tiedown provision
6	3A	Through padded left front tiedown provision
7	4	Around right lower bowl arm bracket
8	4A	Around left lower bowl arm bracket
9	5	Through padded eye on tongue
10	5A	Through padded eye on tongue
11	6	Through padded right front tiedown provision
12	6A	Through padded left front tiedown provision

Figure 2-7. Lashings installed.



**CAUTION:** Make sure the lashings are not so tight that they cause the platform to bow.

Lashing Number	Tiedown Clevis Number	Instructions
13	7	Pass lashings: Around right lower bowl arm bracket
14	7A	Around left lower bowl arm bracket
15	8	Through padded right rear tiedown provision
16	8A	Through padded left rear tiedown provision
17	9	Through padded right rear tiedown provision
18	9A	Through padded left rear tiedown provision
19	11	Through padded right rear tiedown provision
20	11A	Through padded left rear tiedown provision
21	12	Around padded lower right outside pusher brace
22	12A	Around padded lower left outside pusher brace

Figure 2-7. Continued.

## 2-8. Installing Extraction Attaching Point Extension

Install the extraction attaching point extension as shown in figure 2-8.

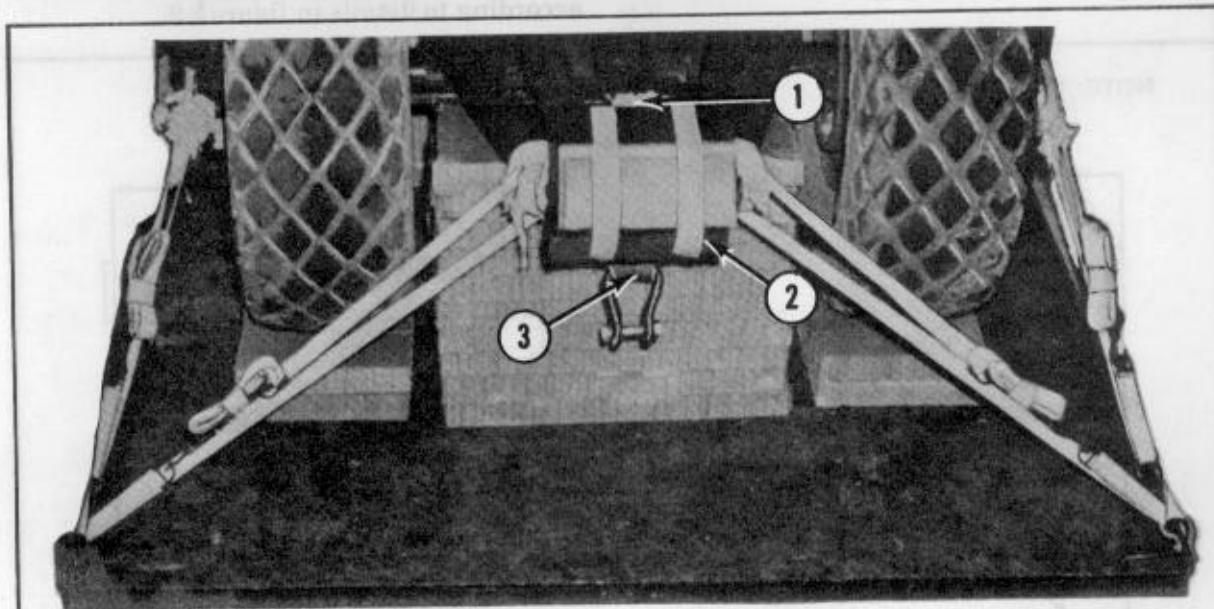

- ① Pad the center pusher brace with cellulose wadding. Tape the wadding in place.
- ② Pad the bottom of the pusher with felt. Tape the felt in place.
- ③ Pass the ends of a 3-foot sling down over the center pusher brace. Place the ends of the sling on a large suspension clevis assembly.

*Figure 2-8. Extraction attaching point extension installed.*

### 2-9. Stowing Cargo Parachutes

Stow the cargo parachutes as described below.

a. Build a parachute stowage platform according to details in figure 2-9.

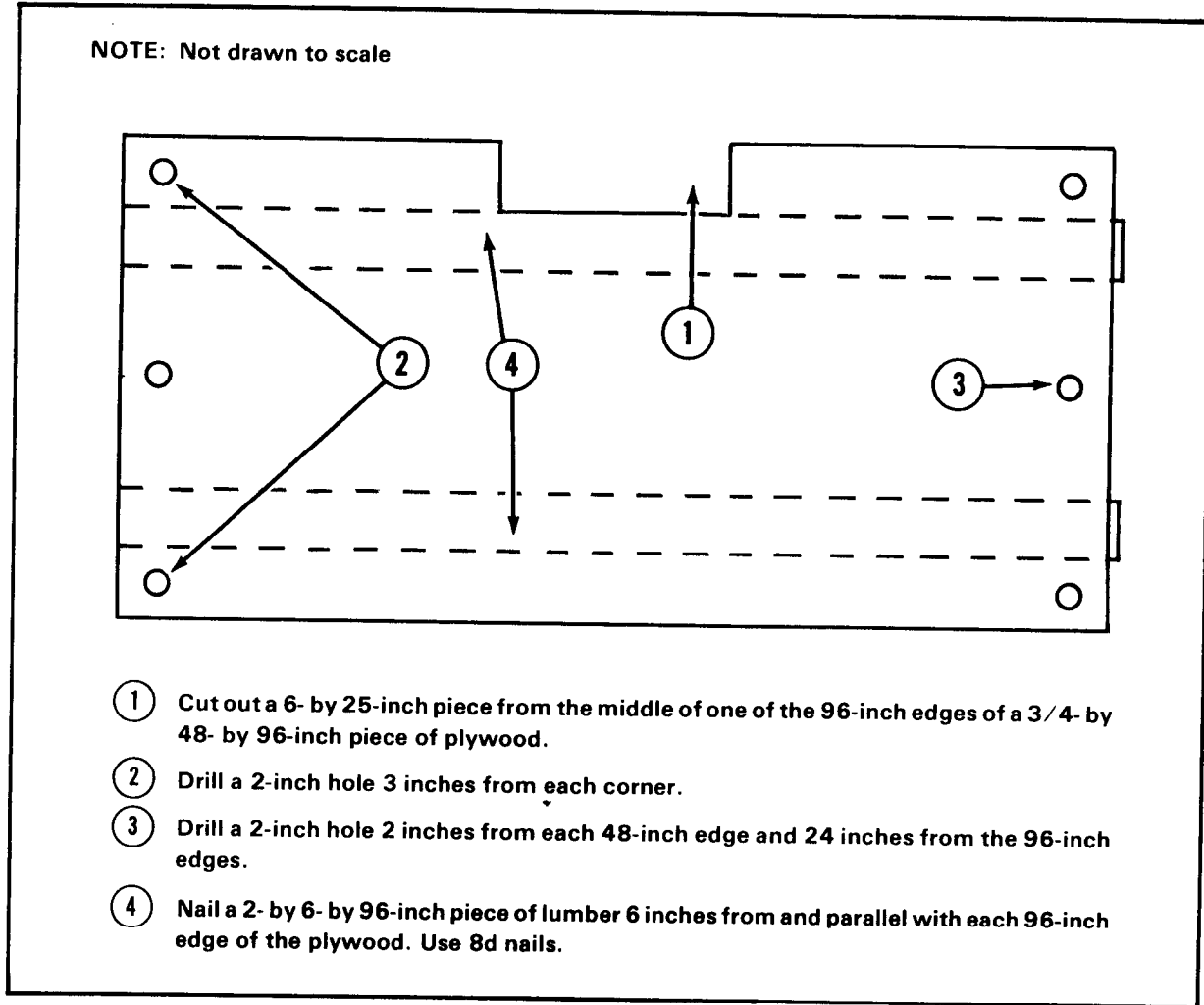
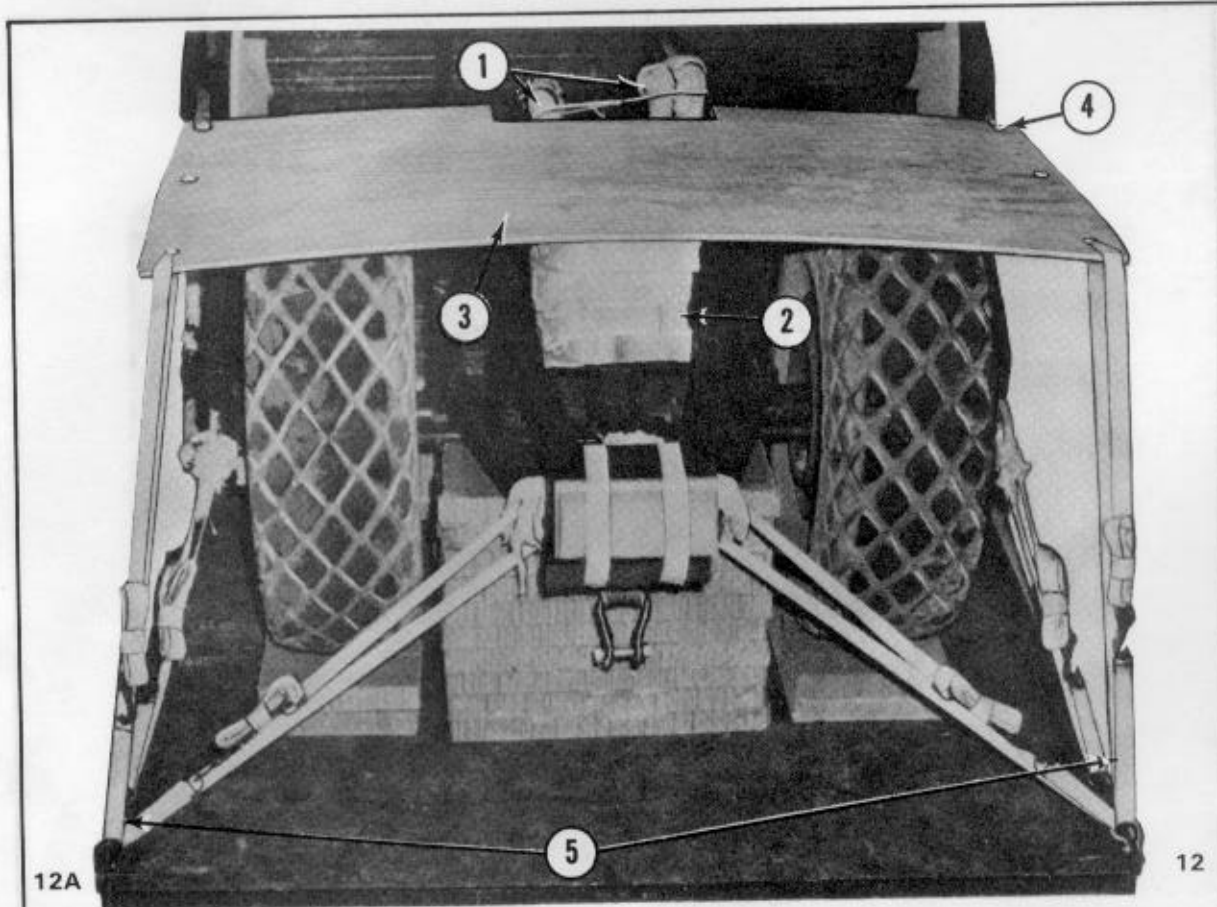

Figure 2-9. Parachute stowage platform construction details.



b. Set the parachute stowage platform on the load and secure it in place as shown in figure 2-10.



- ① Pad the hydraulic hoses with cellulose wadding, and tape the wadding.
- ② Set four 15- by 36-inch pieces of honeycomb on the center of the pusher frame and flush with the rear edge of the cylinder bracket.
- ③ Set the stowage platform on the honeycomb and rear wheels and against the scraper bowl.

**CAUTION:** Hydraulic hoses **MUST NOT** come in contact with the stowage platform.

- ④ Secure the front corners of the platform to clevises 9 and 9A with tiedown assemblies.
- ⑤ Secure the rear corners of the platform to clevises 12 and 12A with tiedown assemblies.

Figure 2-10. Parachute stowage platform installed.

c. Prepare five G-11A cargo parachutes, and stow them on the stowage platform as outlined in FM 10-500/TO 13C7-1-5. Install

two 15-yard, type VIII, nylon webbing restraint straps as described in FM 10-500/TO 13C7-1-5 and as shown in figure 2-11.

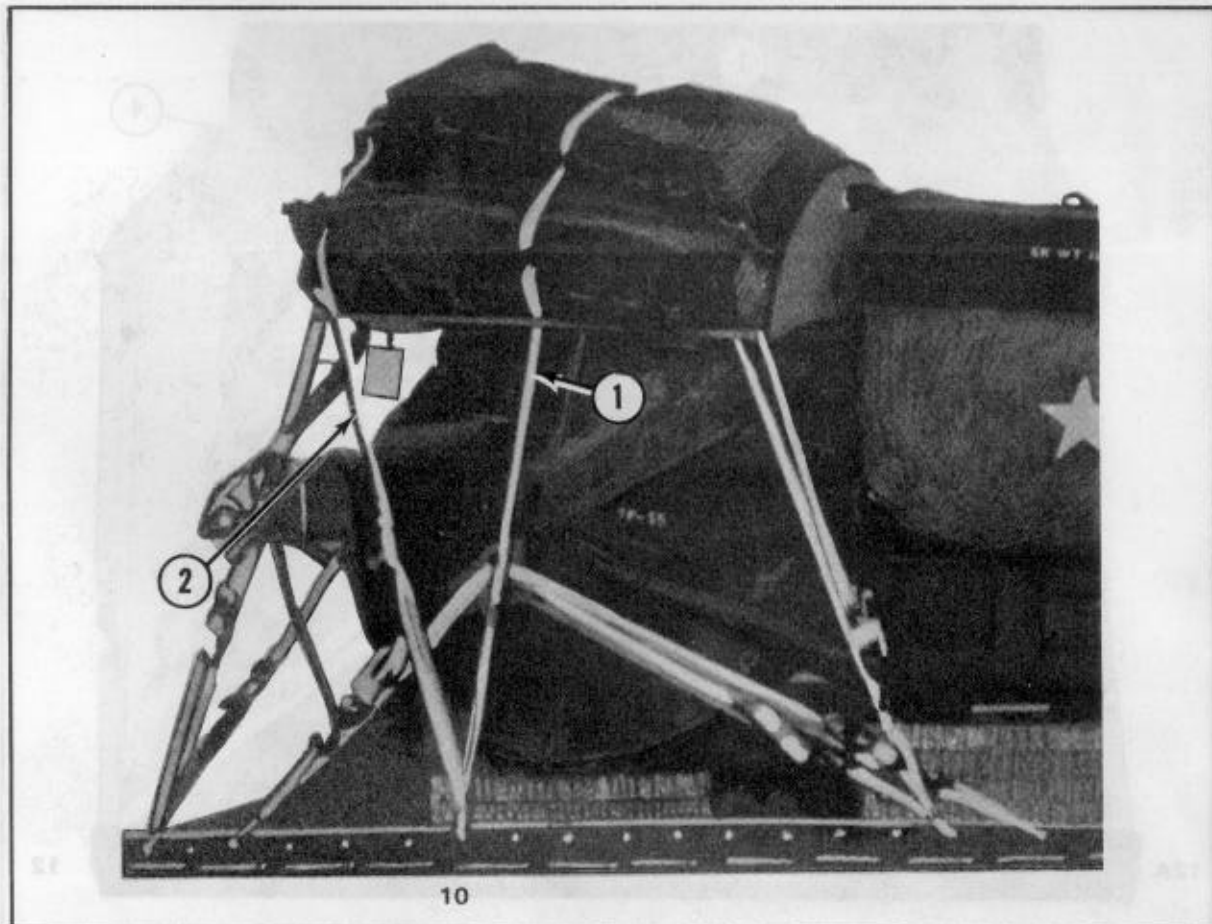

- ① Tie the first restraint strap to clevises 10 and 10A.
- ② Tie the second restraint strap to clevises 10 and 10A.

Figure 2-11. Cargo parachutes stowed and restraint straps installed.

## 2-10. Installing Extraction System

Use either the extraction force transfer coupling (EFTC) or the static line/connector strap (SL/CS) extraction system on this load.

a. *EFTC*. Install the EFTC with a 24-foot cable assembly as outlined in FM 10-500/

TO 13C7-1-5 and as shown in figure 2-12.

b. *SL/CS*. Use a 120-inch connector strap and a 9-foot deployment line. Install the components of the SL/CS as outlined in FM 10-500/TO 13C7-1-5.

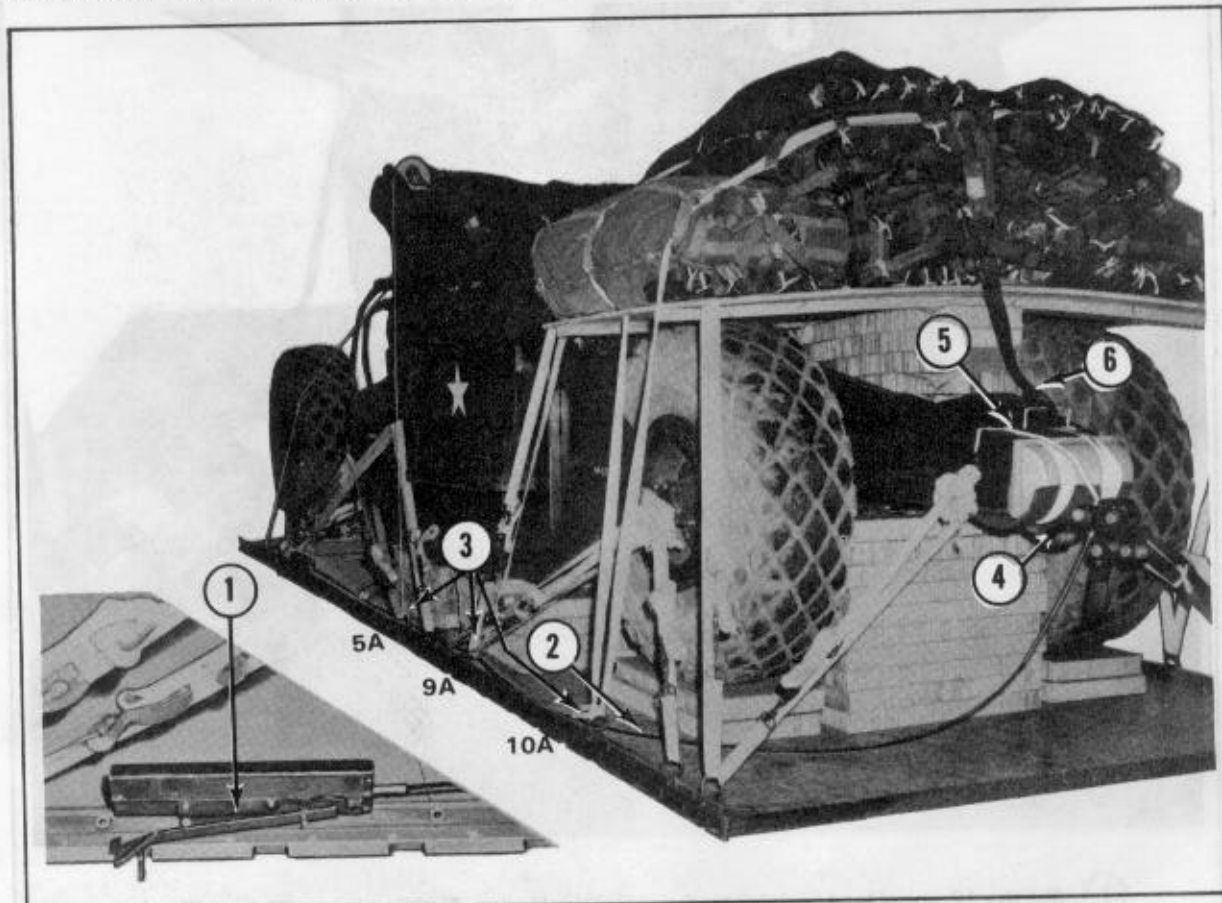

- ① Bolt the actuator bracket to clevis holes 14 and 15.
- ② Run the release cable to the rear of the platform.
- ③ Tie the cable to clevises 5A, 9A, and 10A with double lengths of 80-pound cotton webbing.
- ④ Bolt the latch assembly adapter, with the locking nut down, to the large suspension clevis on the extraction attaching point extension.
- ⑤ Tie the latch assembly to the pusher frame with 1/2-inch tubular nylon webbing.
- ⑥ Bolt one end of the 9-foot deployment line to the top spacer of the link assembly. Bolt the other end to the center large clevis on the parachute deployment lines.

Figure 2-12. *EFTC installed.*

### 2-11. Installing Load Cover

Tie a 4-yard piece of cotton duck cloth over the yoke with type III nylon cord.

### 2-12. Installing Release System

Prepare five 5,000-pound-capacity cargo parachute releases, and attach them to the suspension system as described in FM 10-500/TO 13C7-1-5 and as shown in figure 2-13.

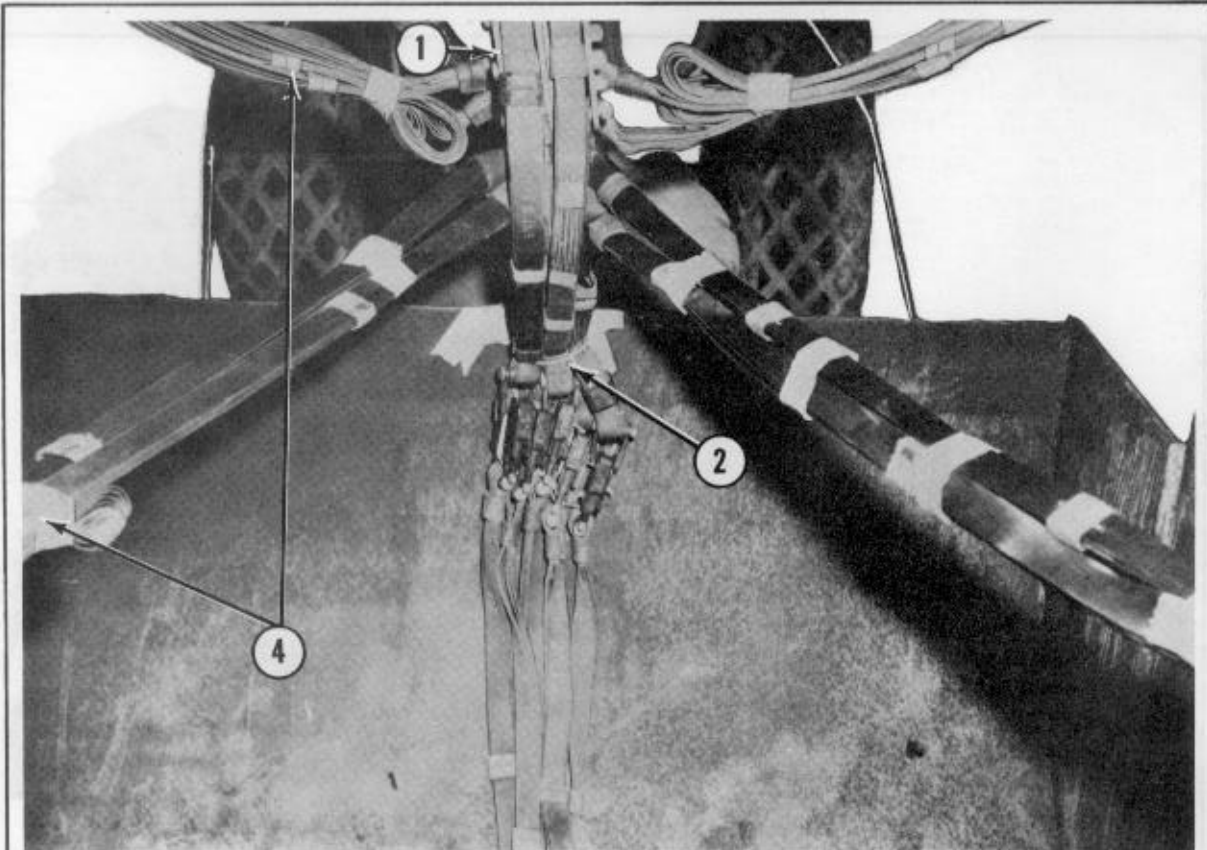

- ① Set the 12-spool load coupler on the cylindrical brace. Tie it in place with type III nylon cord.
- ② Lay the releases in the scraper bowl. Tie them to the transportation bar with type III nylon cord.
- ③ Fold the slack in the front slings. Tape the folds in place on the load cover (not shown).
- ④ Fold the center and rear slings, and tape the folds.

Figure 2-13. Release assemblies and suspension slings safetied.

**2-13. Positioning Extraction Parachute**

Position the extraction parachute as described below.

a. *C-130 Aircraft.* Place a 22-foot cargo extraction parachute with a 60-foot extraction line on the load for installation in the aircraft.

b. *C-141 Aircraft.* Place a 22- or a 28-foot cargo extraction parachute with a 140-foot (3-loop), type XXVI, nylon webbing

extraction line on the load for installation in the aircraft.

**CAUTION:** The extraction line must be a continuous 140-foot extraction line.

**2-14. Marking Rigged Load**

Use the data shown in figure 2-14, and mark the rigged load as outlined in FM 10-500/TO 13C7-1-5.

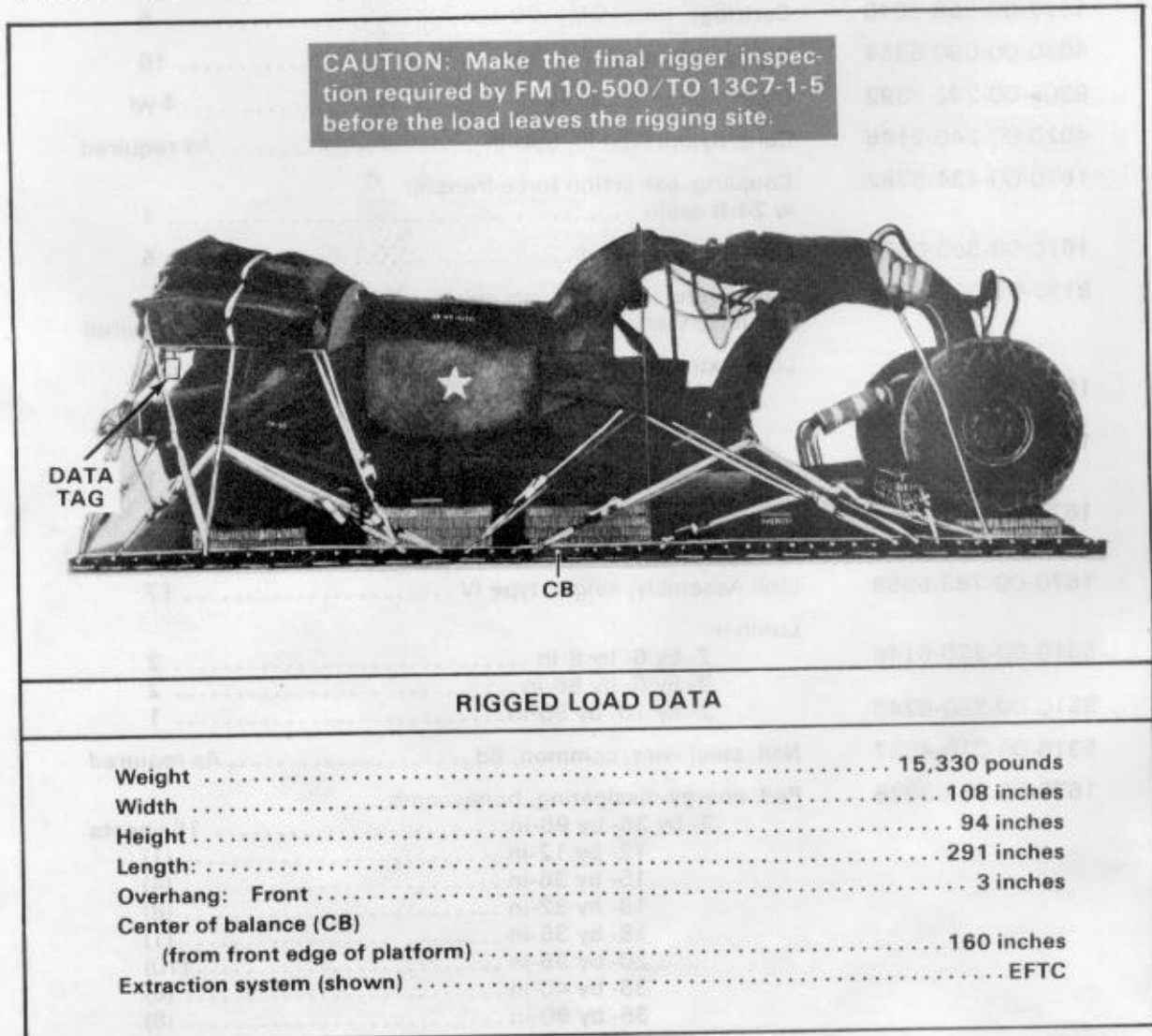

Figure 2-14. Murray model earthmoving scraper rigged for low-velocity airdrop.



**2-15. Equipment Required**

The equipment required to rig this load is listed in table 2-1.

*Table 2-1. Equipment required to rig the Murray model earthmoving scraper for low-velocity airdrop*

National Stock Number	Item	Quantity
8040-00-273-8713	Adhesive, paste, 1-gal . . . . .	As required
1377-00-958-1048	Cartridge, time delay, 20-sec . . . . .	5
4030-00-090-5354	Clevis assembly, suspension, large . . . . .	16
8305-00-242-3593	Cloth, cotton duck, 60-in . . . . .	4 yd
4020-00-240-2146	Cord, nylon, type III, 550-lb . . . . .	As required
1670-00-434-5782	Coupling, extraction force transfer w 24-ft cable . . . . .	1
1670-00-360-0328	Cover, clevis, large . . . . .	5
8135-00-664-6958	Cushioning material, packaging, cellulose wadding . . . . .	As required
	Line, extraction:	
1670-00-856-0266	60-ft (3-loop), type X, nylon webbing <u>or</u> . . . . .	1
1670-01-062-6313	60-ft (3-loop), type XXVI, nylon webbing (for C-130 aircraft) . . . . .	1
1670-01-107-7651	Line, extraction, 140-ft (3-loop), type XXVI, nylon webbing (for C-141 aircraft) . . . . .	1
1670-00-783-5988	Link Assembly, single, type IV . . . . .	17
	Lumber:	
5510-00-220-6148	2- by 6- by 8-in . . . . .	2
	2- by 6- by 96-in . . . . .	2
5510-00-220-6248	2- by 10- by 90-in . . . . .	1
5315-00-010-4657	Nail, steel wire, common, 6d . . . . .	As required
1670-00-753-3928	Pad, energy-dissipating, honeycomb, 3- by 36- by 96-in: . . . . .	16 sheets
	12- by 12-in . . . . .	(1)
	15- by 36-in . . . . .	(4)
	18- by 32-in . . . . .	(8)
	18- by 36-in . . . . .	(1)
	20- by 36-in . . . . .	(10)
	36- by 40-in . . . . .	(6)
	36- by 90-in . . . . .	(8)
1670-00-269-1107	Parachute, cargo, 100-ft, G-11A . . . . .	5
	Parachute, cargo extraction:	
1670-00-687-5458	22-ft . . . . .	1
1670-00-262-1797	28-ft (may be used with C-130 aircraft) . . . . .	1
1670-00-040-8135	28-ft (for C-141 aircraft) . . . . .	1

Table 2-1. Continued

National Stock Number	Item	Quantity
	Platform, modular, 24-ft:	
1670-00-893-1631	Clevis, load tiedown .....	24
1670-00-893-1624	Panel .....	6
1670-00-893-1629	Rail, platform-side, 24-ft .....	2
5320-00-893-1632	Rivet, blind-drive type, 1/4-in diam .....	96
5530-00-128-4981	Plywood, 3/4-in:	
	10- by 90-in .....	1
	12- by 12-in .....	1
	48- by 96-in .....	1
1377-00-799-8494	Release, cargo parachute, 5,000-lb .....	5
	Riser extension:	
1670-00-753-3794	20-ft (2-loop), type X, nylon webbing <u>or</u> .....	20
1670-01-062-6211	20-ft (2-loop), type XXVI, nylon webbing .....	20
	Sling, cargo, airdrop:	
	For deployment lines:	
1670-00-432-2501	9-ft (4-loop), type XXVI, nylon webbing <u>or</u> .....	3
1670-01-062-6305	9-ft (4-loop), type XXVI, nylon webbing .....	3
	For suspension slings:	
1670-00-753-3790	9-ft (2-loop), type X, nylon webbing <u>or</u> .....	4
1670-01-062-6305	9-ft (4-loop), type XXVI, nylon webbing .....	2
1670-00-753-3792	12-ft (2-loop), type X, nylon webbing <u>or</u> .....	4
1670-01-062-6307	12-ft (4-loop), type XXVI, nylon webbing .....	2
1670-00-753-3793	16-ft (2-loop), type X, nylon webbing <u>or</u> .....	2
1670-01-062-6308	16-ft (4-loop), type XXVI, nylon webbing .....	1
1670-00-040-8219	Strap, parachute release, multicut .....	2
7510-00-266-5016	Tape, adhesive, 2-in .....	As required
1670-00-937-0271	Tiedown assembly, 15-ft .....	26
8305-00-268-2411	Webbing, cotton, 80-lb .....	As required
8305-00-263-3591	Webbing, nylon, type VIII .....	30 yd
8305-00-261-8584	Webbing, nylon, type X .....	30 yd
8305-00-082-5752	Webbing, nylon, tubular, 1/2-in .....	As required

CHAPTER 3  
**RIGGING MRS-100, 8-CUBIC-YARD EARTHMOVING  
 SCRAPER**

Section I  
**RIGGING LOAD FOR LOW-VELOCITY AIRDROP**

**3-1. Description of Load**

The MRS-100, towed, 8-cubic-yard earthmoving scraper is rigged on a 24-foot, type II, modular platform with six G-11A cargo parachutes and other items of airdrop equipment for a low-velocity airdrop. This load can be airdropped from a C-130 or C-141 aircraft.

**3-2. Preparing Platform**

Prepare the platform as described below.

a. Inspect, or assemble and inspect, the 24-foot modular platform as outlined in TM 10-1670-208-20&P/TO 13C3-4-12.

b. Attach and number the load tiedown clevises according to FM 10-500/TO 13C7-1-5 and as shown in figure 3-1.

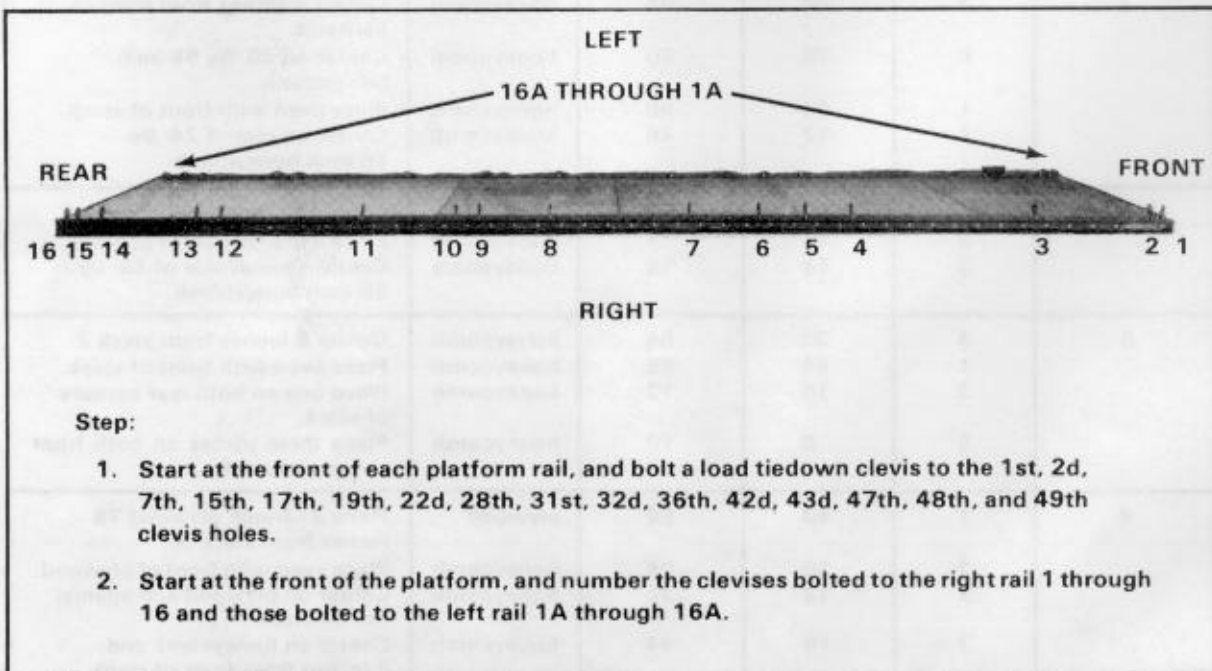
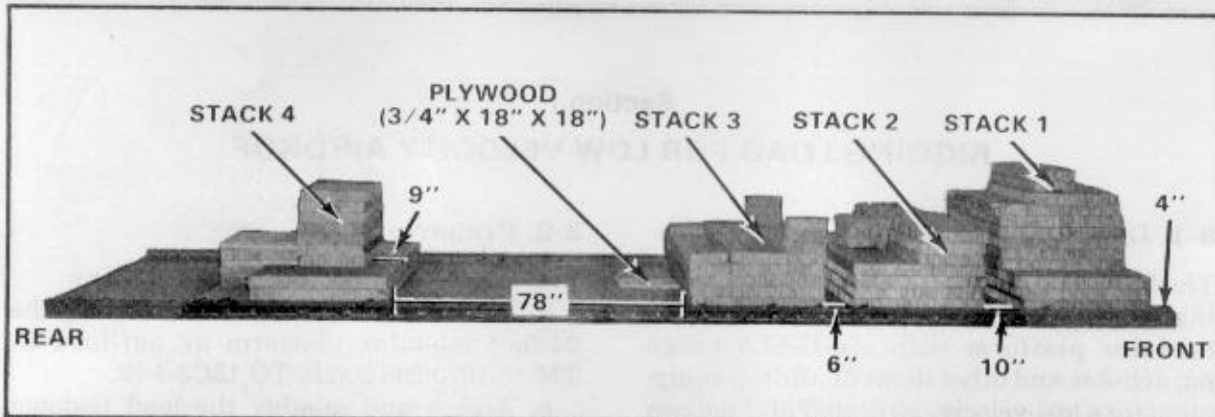

*Figure 3-1. Platform prepared.*



### 3-3. Building and Placing Honeycomb Stacks

Build four honeycomb stacks, and place them on the platform according to FM 10-500/TO 13C7-1-5 and as shown in figure 3-2.



STACK	PIECES	WIDTH (INCHES)	LENGTH (INCHES)	MATERIAL	INSTRUCTIONS
1	3	36	96	honeycomb	Center 4 inches from front of platform.
	6	36	60	honeycomb	Center on 36- by 96-inch honeycomb.
	1	24	60	honeycomb	Place even with front of stack.
	2	12	48	honeycomb	Center on rear of 24- by 60-inch honeycomb.
2	4	36	96	honeycomb	Center 10 inches from stack 1.
	3	18	96	honeycomb	Place even with front of stack.
	3	12	18	honeycomb	Center against rear of 18- by 96-inch honeycomb.
3	4	36	96	honeycomb	Center 6 inches from stack 2.
	1	24	96	honeycomb	Place even with front of stack.
	2	10	12	honeycomb	Place one on both rear corners of stack.
	6	8	10	honeycomb	Place three pieces on both front corners of stack.
4	1	48	96	plywood	Place 3/4-inch plywood 78 inches from stack 3.
	2	36	96	honeycomb	Place even with front of plywood.
	2	12	36	honeycomb	Center on plywood and against rear of stack.
	7	18	44	honeycomb	Center on honeycomb and 9 inches from front of stack.
	1	21	36	plywood	Center 3/4-inch plywood against rear of 44-inch honeycomb.
	1	21	36	honeycomb	Place on top of plywood.
	3	21	36	plywood	Place 3/4-inch plywood on top of honeycomb.

NOTE: Center a 3/4- by 18- by 18-inch piece of plywood against the rear of stack 3.

Figure 3-2. Honeycomb stacks placed on platform.

### 3-4. Preparing Scraper

Prepare the scraper as shown in figures 3-3 through 3-6.

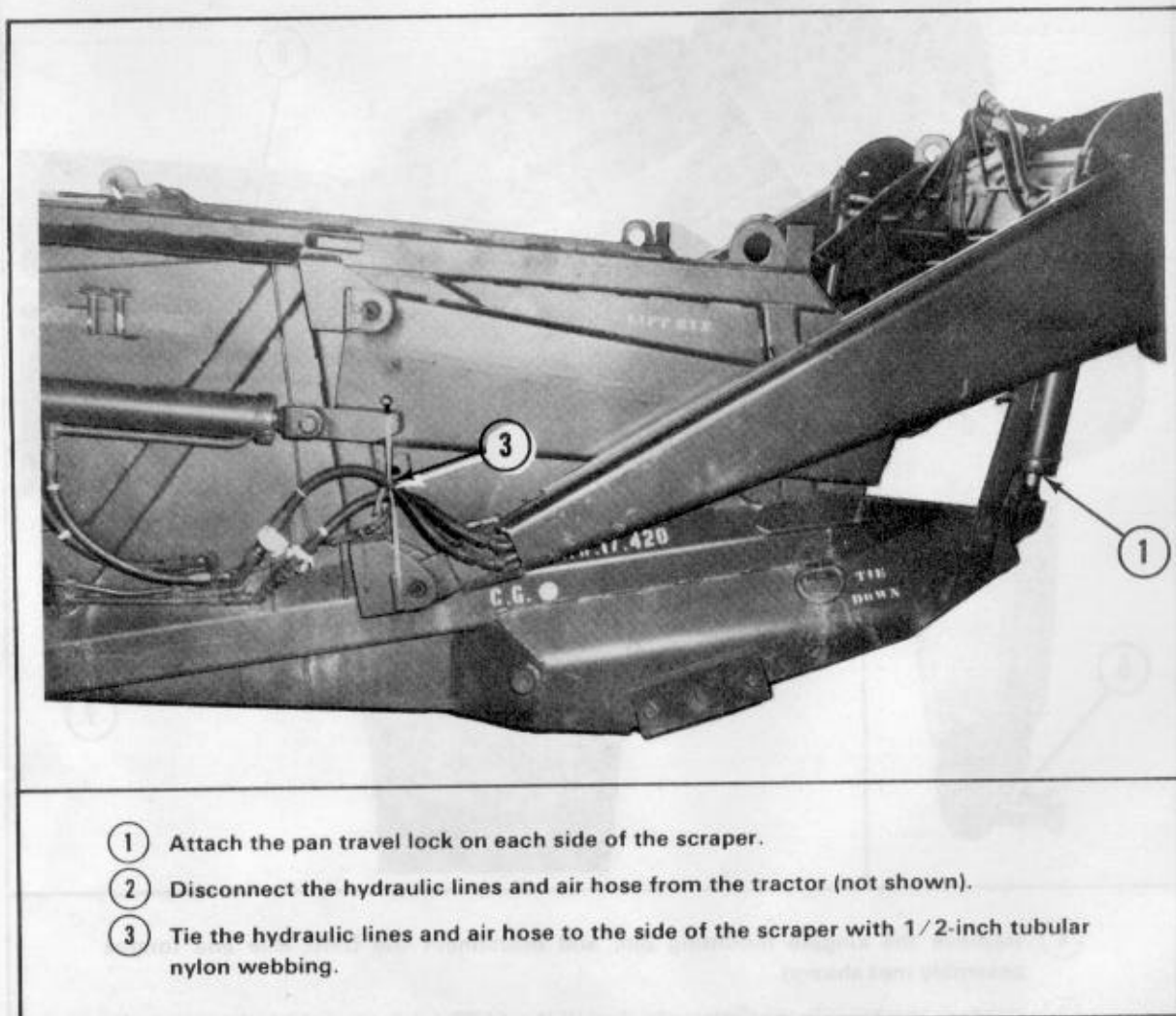
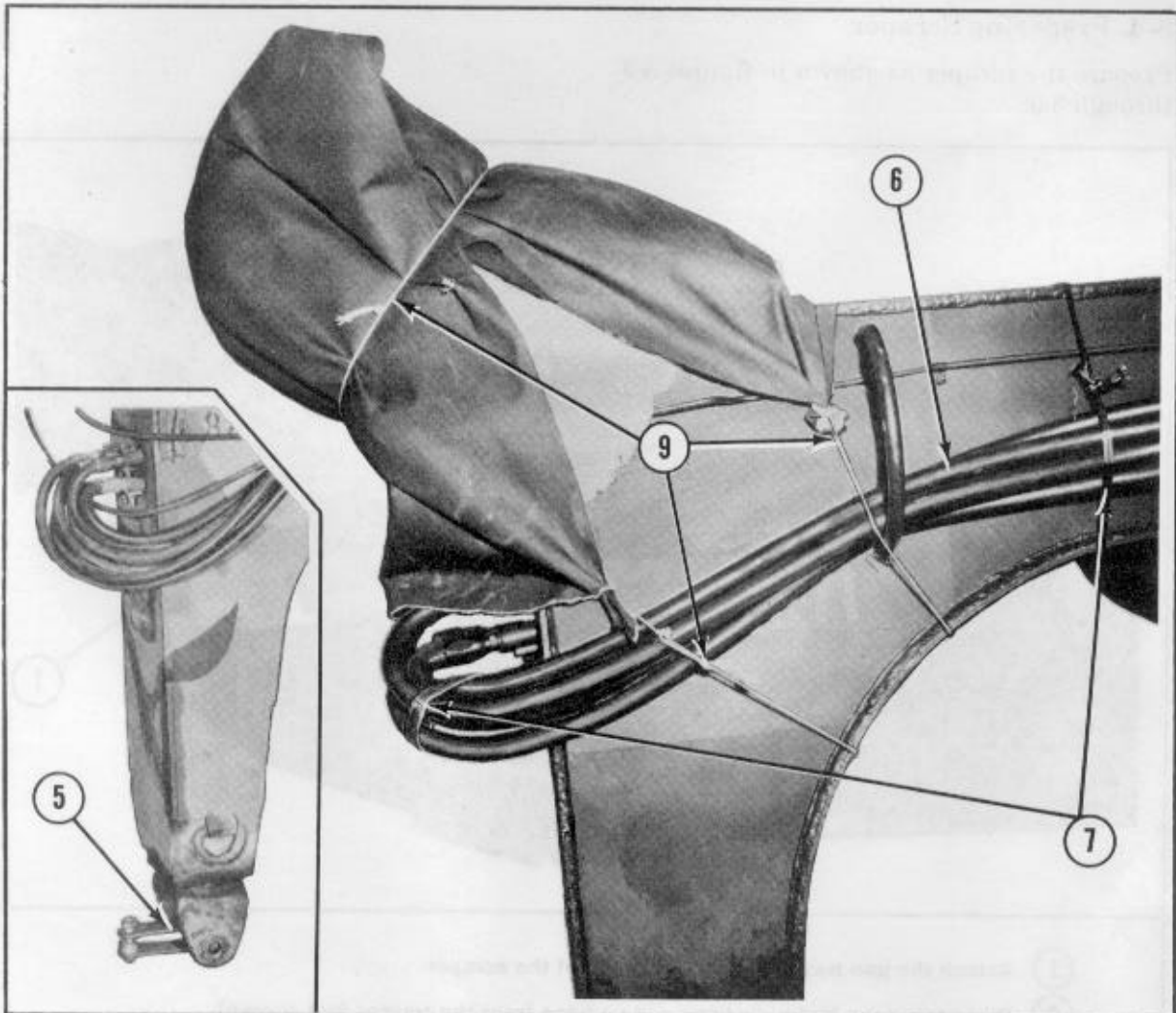
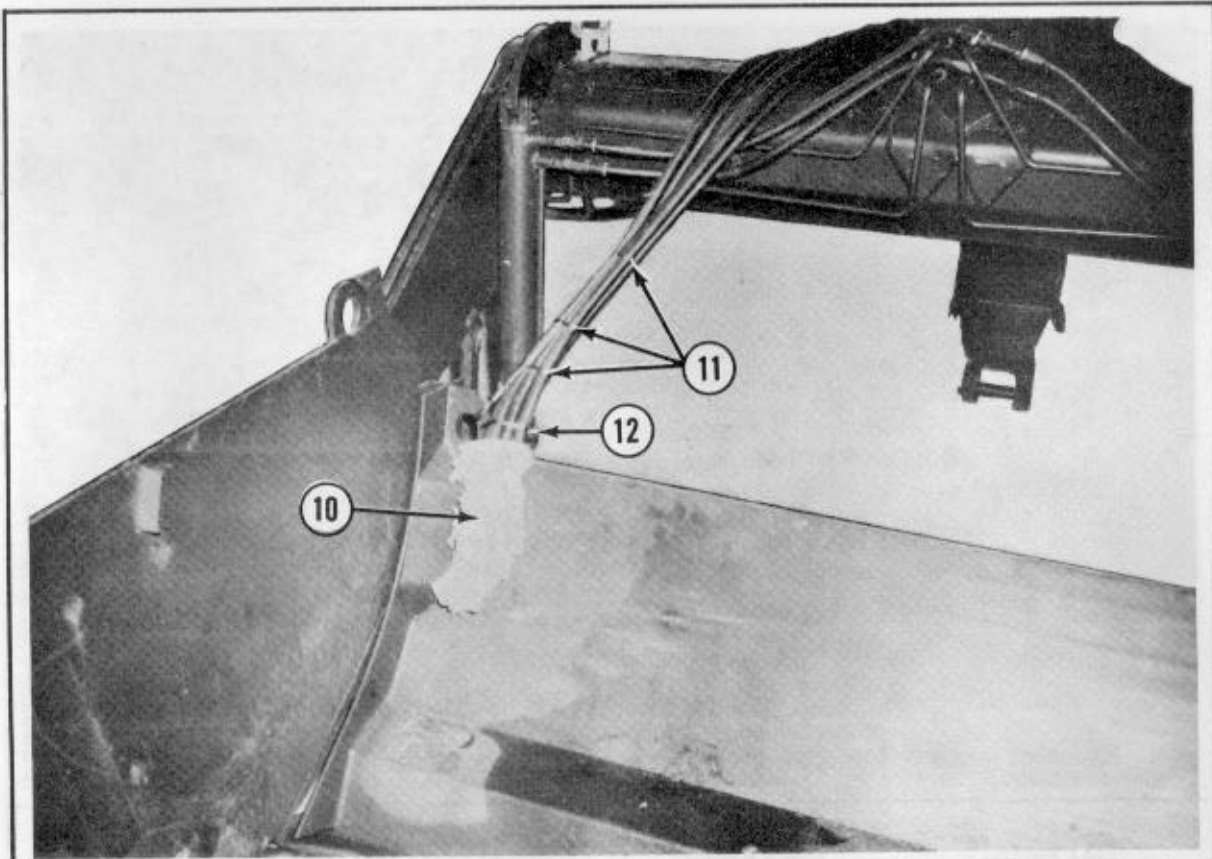

Figure 3-3. Scraper bowl prepared.



- ④ Remove the kingpin mounting pin, and disconnect the front axle and tongue assembly (not shown).
- ⑤ Replace the kingpin mounting pin. Install the EFTC latch assembly adapter on the kingpin mounting pin.
- ⑥ Pass the air hose and hydraulic lines through the traction mast guard, and lay them in the pan.
- ⑦ Tie the air hose and hydraulic lines against the mast with 1/2-inch tubular nylon webbing.
- ⑧ Pad the traction mast with cellulose wadding, and tape the wadding in place (not shown).
- ⑨ Cover the mast with a 2-yard piece of cotton duck cloth. Tie the cover in place with type III nylon.

Figure 3-4. Mounting pin and traction mast prepared.



- ⑩ Pad the air hose and hydraulic lines with cellulose wadding, and tape the wadding in place.
- ⑪ Tie the air hose and hydraulic lines together in three places with 1/2-inch tubular nylon webbing.
- ⑫ Tie the air hose and hydraulic lines in the scraper pan with 1/2-inch tubular nylon webbing.

*Figure 3-5. Hydraulic lines prepared.*

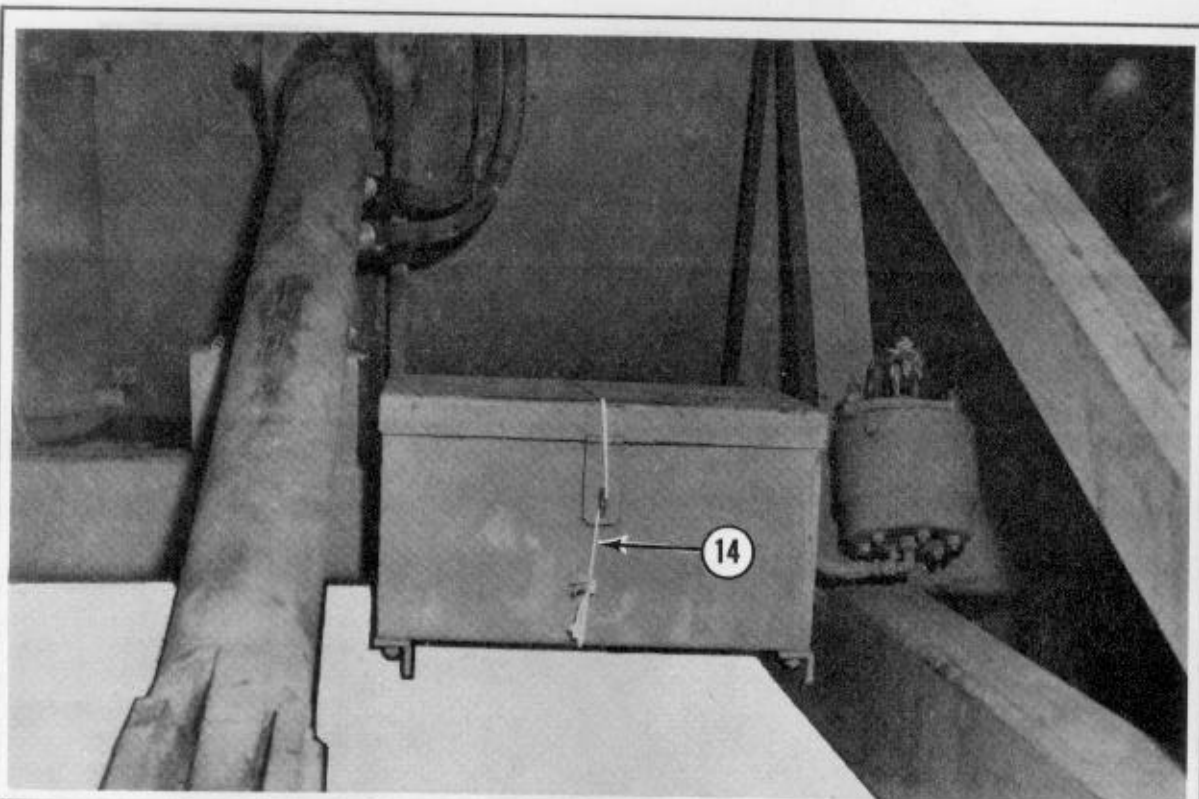

- ⑬ Fill the toolbox with scrap honeycomb (not shown).
- ⑭ Close the toolbox, and safety it with a length of type III nylon cord.

*Figure 3-6. Toolbox prepared.*



### 3-5. Placing and Lashing Front Axle and Tongue Assembly

Set the front axle and tongue assembly on honeycomb stack 4 with the tongue pointing toward the front of the platform. Set the axle on stack 4, and center the wheels between the

side rails (figure 3-7). Lash the front axle and tongue assembly to the platform as shown in figures 3-7 and 3-8.

**CAUTION:** Make sure the lashings are not so tight that they cause the platform to bow.

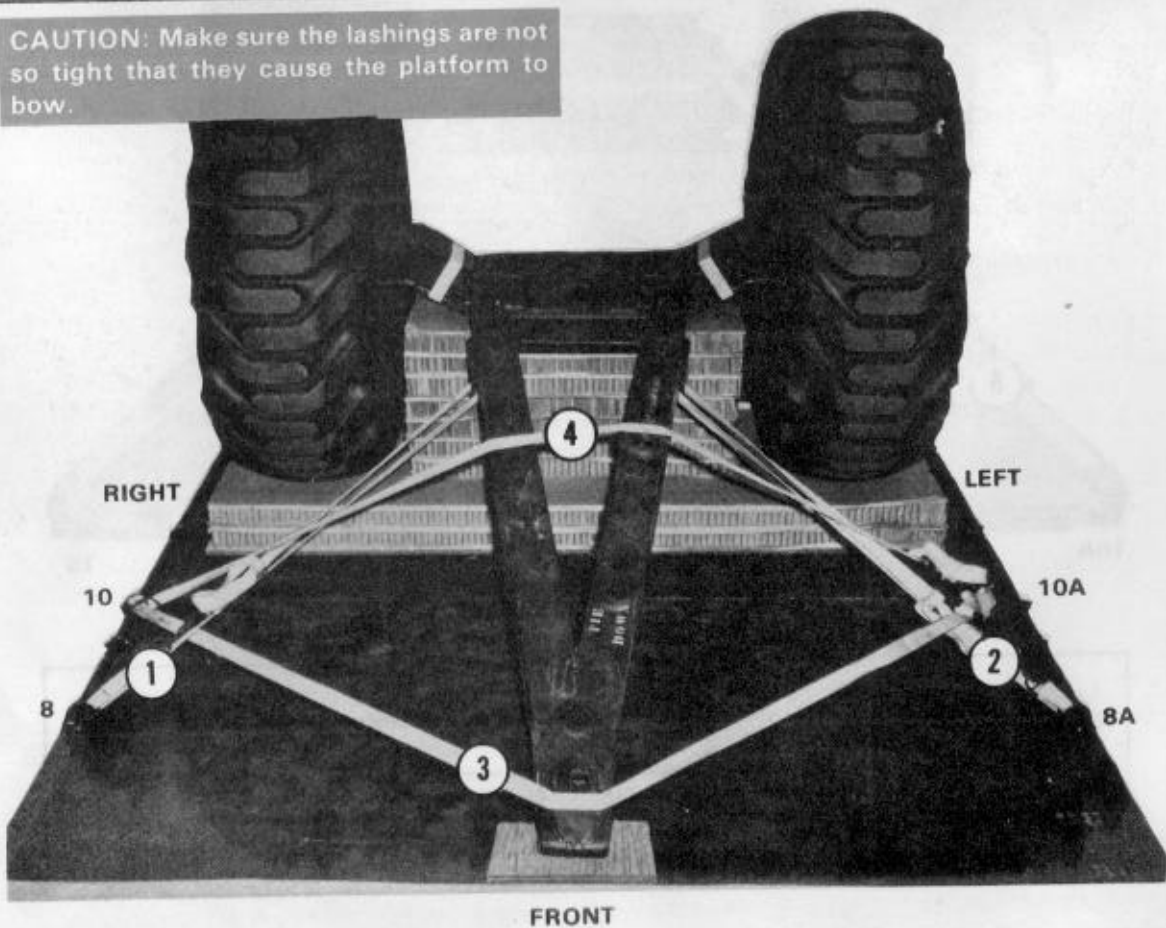

Lashing Number	Tiedown Clevis Number	Instructions
1	8	Pass lashings: Through tiedown provision, right side Through tiedown provision, left side Around front of tongue Around front of tongue
2	8A	
3	10 to 10A	
4	10 to 10A	

Figure 3-7. Axle and tongue assembly positioned and lashings 1 through 4 installed.

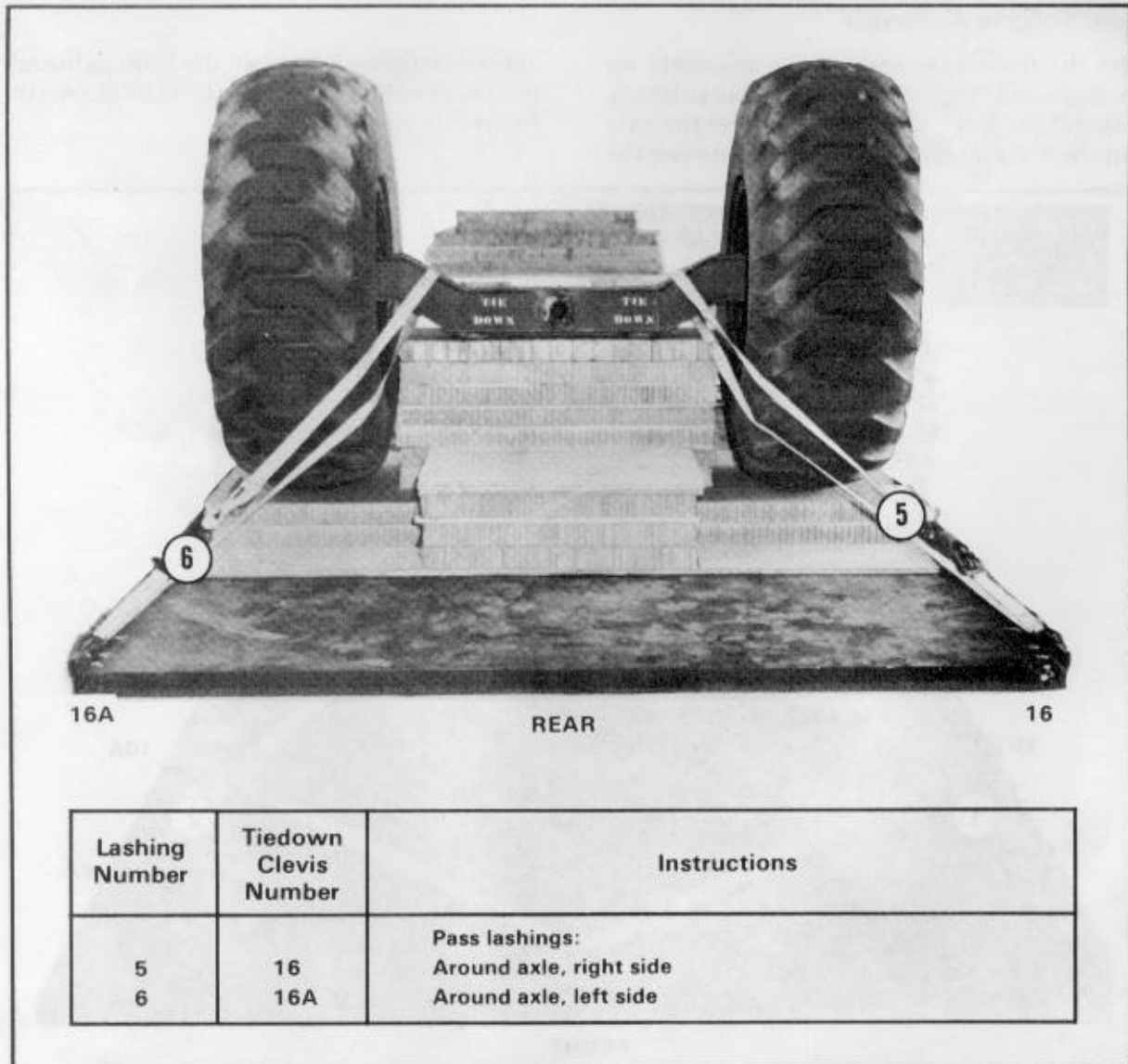

Figure 3-8. Lashings 5 and 6 installed.

**3-6. Installing Suspension Slings**

Attach a 9-foot (4-loop), type XXVI, nylon sling to each of the four lifting provisions. Use a screw pin clevis at each provision. Safety the suspension slings with a deadman's tie 2 feet above the scraper according to FM 10-500/TO 13C7-1-5.

Set the scraper on the honeycomb stacks with the rear of the scraper overhanging the front of the platform 38 inches. Center the scraper on the platform so that it overhangs each side 1 inch.

**3-7. Setting Scraper on Platform**

**NOTICE OF EXCEPTION**

The procedures in this paragraph are different from those in FM 10-500/TO 13C7-1-5. An exception to FM 10-500/TO 13C7-1-5 is granted. The procedures in this paragraph WILL be followed.

**3-8. Lashing Scraper**

Lash the scraper to the platform as shown in figures 3-9 through 3-12.

**CAUTION:** Make sure the lashings are not so tight that they cause the platform to bow.

**NOTE:** Pad sharp edges that may touch the lashings.

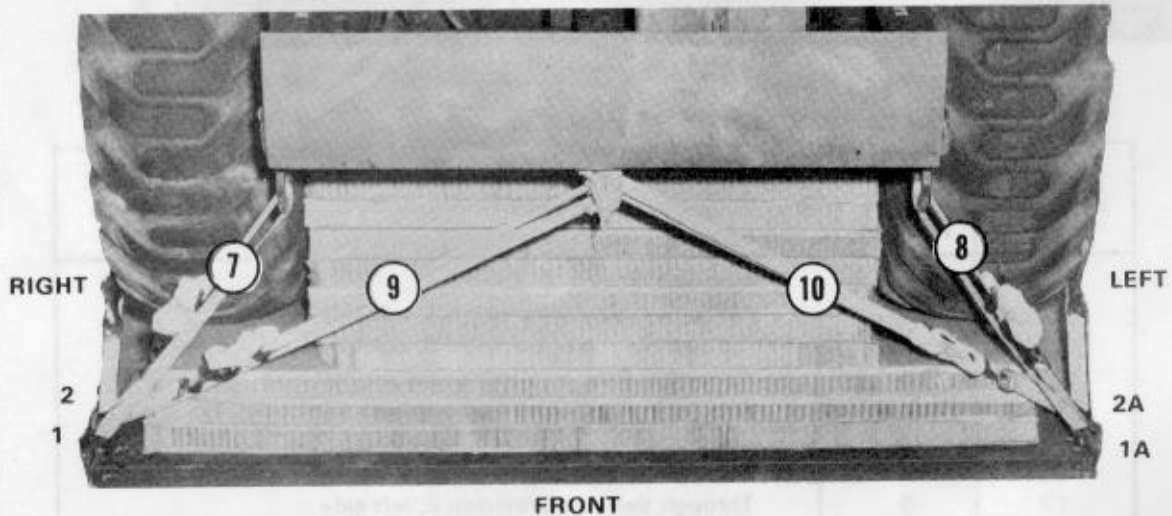

Lashing Number	Tiedown Clevis Number	Instructions
7	1	Pass lashings: Through right rear tiedown provision Through left rear tiedown provision Around rear tow hook Around rear tow hook
8	1A	
9	2	
10	2A	

Figure 3-9. Lashings 7 through 10 installed.



**CAUTION:** Make sure the lashings are not so tight that they cause the platform to bow.

**NOTE:** Pad sharp edges that may touch the lashings.

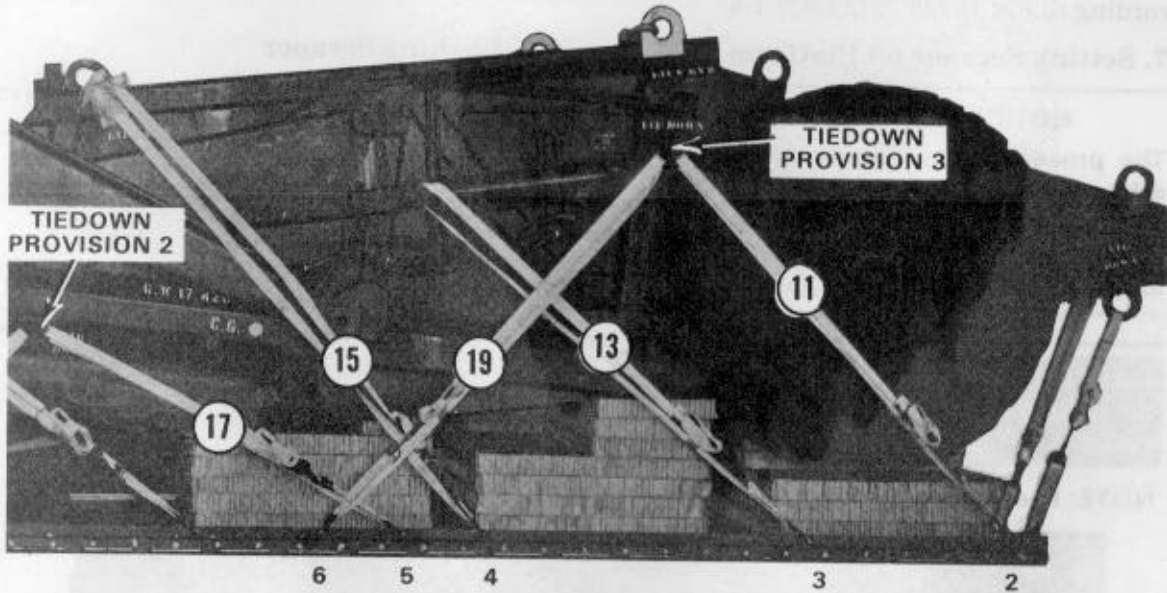

Lashing Number	Tiedown Clevis Number	Instructions
11	2	Pass lashings: Through tiedown provision 3, left side
12	2A	Through tiedown provision 3, right side
13	3	Around hydraulic cylinder arm pin, left side
14	3A	Around hydraulic cylinder arm pin, right side
15	4	Through lifting provision, left side
16	4A	Through lifting provision, right side
17	5	Through tiedown provision 2, left side
18	5A	Through tiedown provision 2, right side
19	6	Through tiedown provision 3, left side
20	6A	Through tiedown provision 3, right side

Figure 3-10. Lashings 11 through 20 installed.

**CAUTION:** Make sure the lashings are not so tight that they cause the platform to bow.

**NOTE:** Pad sharp edges that may touch the lashings.

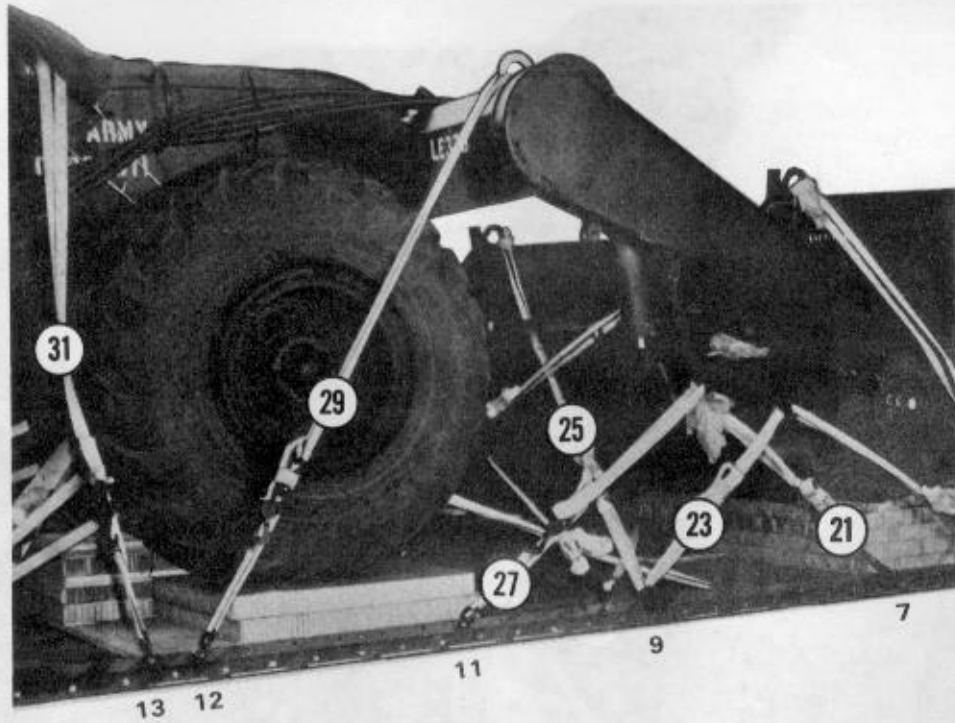

Lashing Number	Tiedown Clevis Number	Instructions
21	7	Pass lashings: Around pan travel lock bracket, left side
22	7A	Around pan travel lock bracket, right side
23	9	Through tiedown provision 2, left side
24	9A	Through tiedown provision 2, right side
*25	9	Through tiedown provision 4, right side
*26	9A	Through tiedown provision 4, left side
27	11	Around pan travel lock bracket, left side
28	11A	Around pan travel lock bracket, right side
29	12	Through top lifting provision, left side
30	12A	Through top lifting provision, right side
31	13	Through lifting provision on traction mast, left side
32	13A	Through lifting provision on traction mast, right side

\*Use a 30-foot tiedown strap made according to FM 10-500/TO 13C7-1-5.

Figure 3-11. Lashings 21 through 32 installed.

**CAUTION:** Make sure the lashings are not so tight that they cause the platform to bow.

**NOTE:** Pad sharp edges that may touch the lashings.



Lashing Number	Tiedown Clevis Number	Instructions
33	14	Pass lashings: Through traction mast tiedown provision, left side
34	14A	Through traction mast tiedown provision, right side
35	15	Through traction mast tiedown provision, left side
36	15A	Through traction mast tiedown provision, right side

Figure 3-12. Lashings 33 through 36 installed.

### 3-9. Stowing Cargo Parachutes

Stow the cargo parachutes as described below.

a. Build the honeycomb stacks on the rear of the platform as shown in figure 3-13.

**NOTE:** Set the honeycomb stacks on the platform so that they will not interfere with the lashings.



- ① Set four 18- by 36-inch pieces of honeycomb on each side of the platform. Place each honeycomb stack at an angle with the outside corner and 18 inches from the rail.
- ② Cut a 14- by 24-inch corner off each of ten 18- by 48-inch pieces of honeycomb. Set five of these pieces on each honeycomb stack in step 1.
- ③ Set one 18- by 18-inch piece of honeycomb on the rear of each stack.

Figure 3-13. Stowage platform honeycomb stacks placed.

b. Build the parachute stowage platform as shown in figure 3-14.

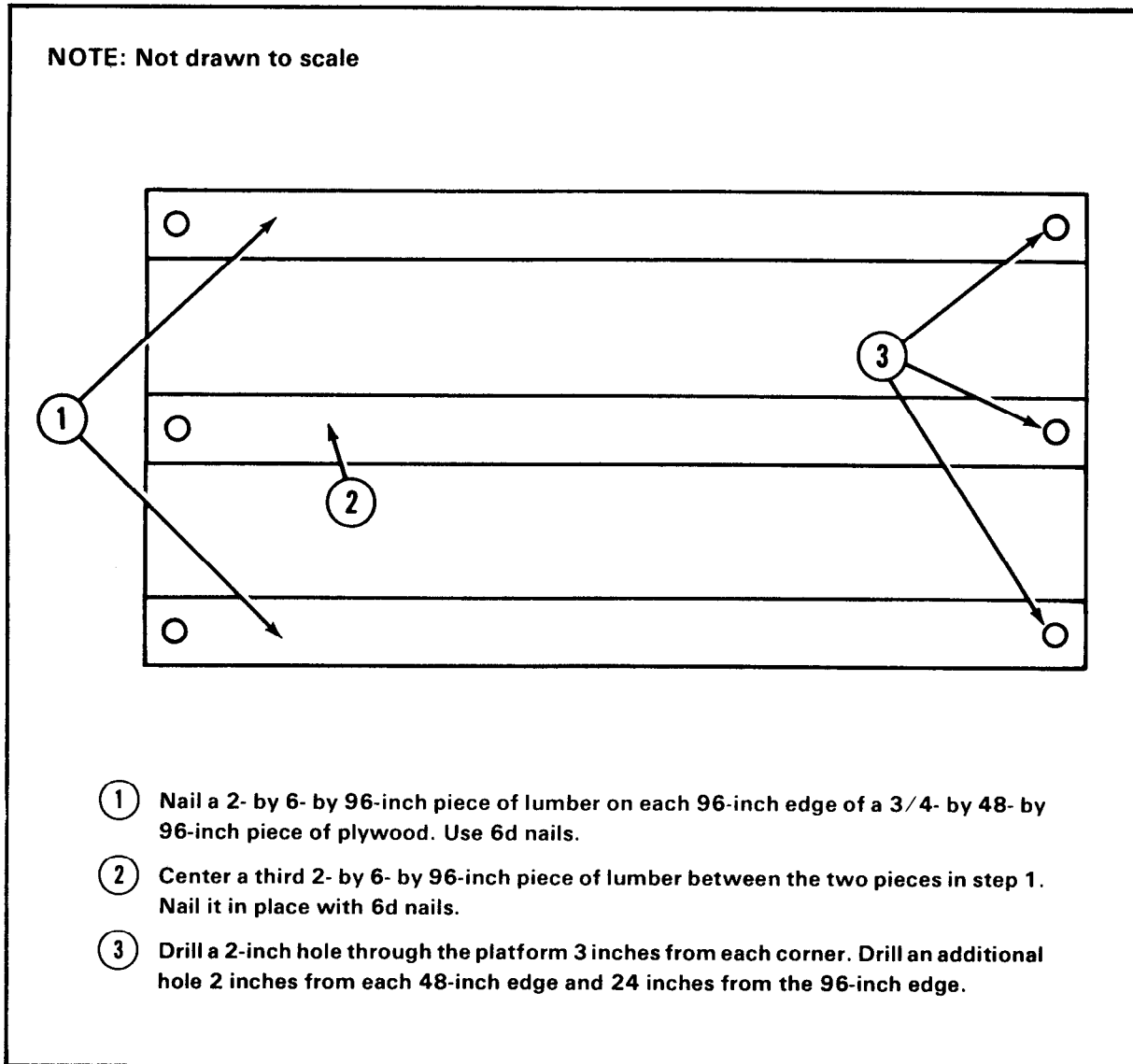
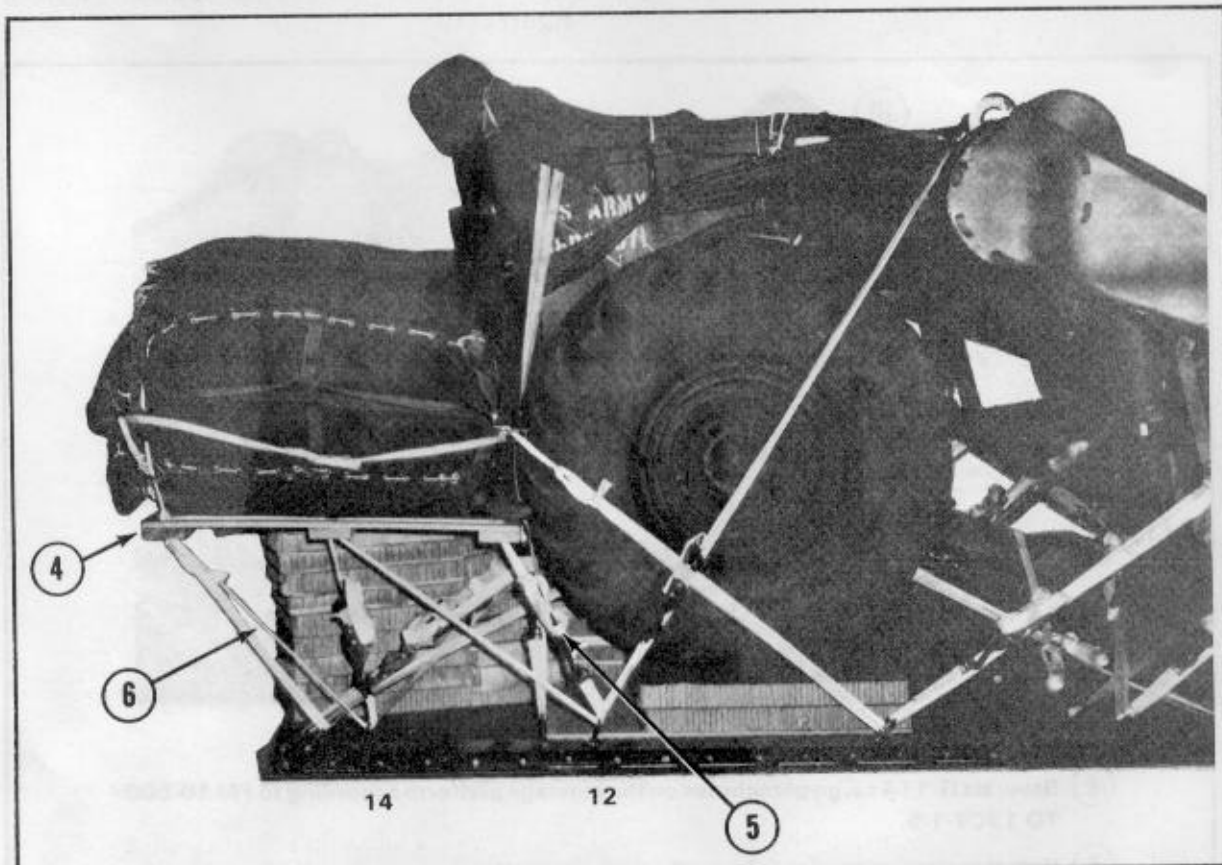

Figure 3-14. Construction details for parachute stowage platform.

c. Set the stowage platform on the honeycomb stacks, and lash it to the platform as shown in figure 3-15.



- ④ Set the parachute stowage platform on the honeycomb stacks.
- ⑤ Pass a tiedown strap through clevis 12, up through the right center stowage platform hole, and down through the right front hole. Hook the ends together with a D-ring and a load binder.
- ⑥ Pass a tiedown strap through clevis 14, up through the right rear stowage platform hole, and down through the right center hole. Hook the ends together with a D-ring and a load binder.
- ⑦ Adapt the procedures in steps 5 and 6 to lash the left end of the stowage platform to clevises 12A and 14A (not shown).

Figure 3-15. Stowage platform lashed in place.



d. Prepare six G-11A cargo parachutes, and stow them on the stowage platform according to FM 10-500/TO 13C7-1-5 and as shown in figure 3-16.

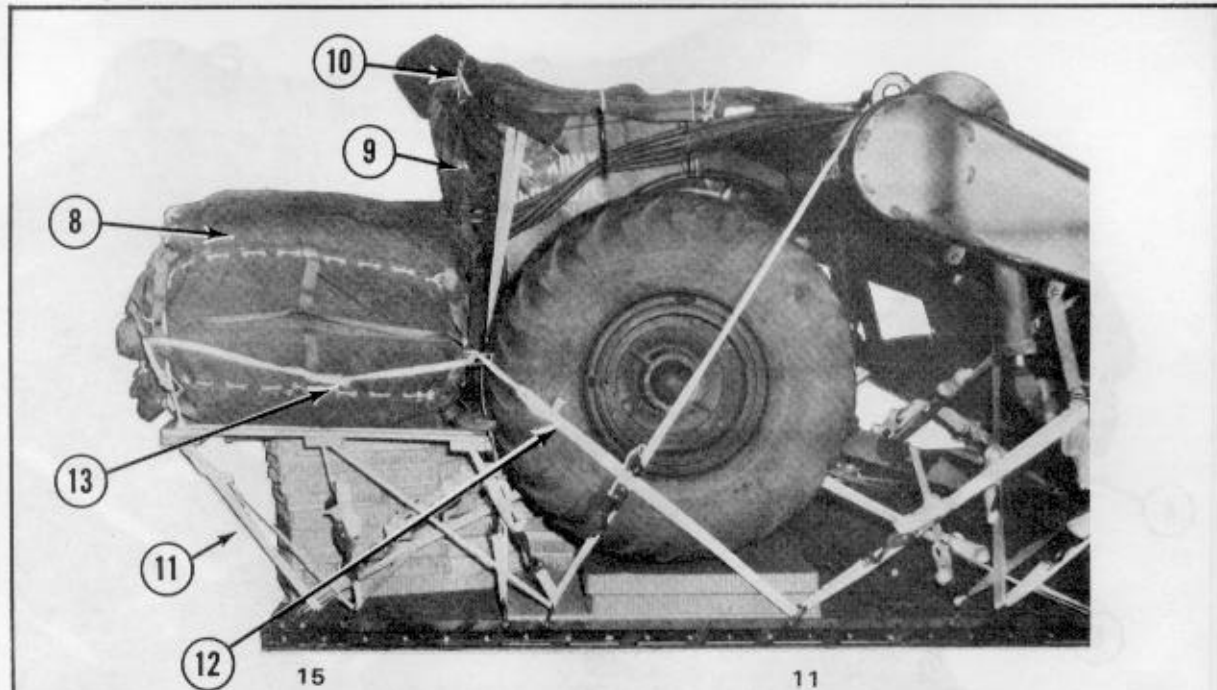

- ⑧ Stow six G-11A cargo parachutes on the stowage platform according to FM 10-500/TO 13C7-1-5.
- ⑨ Pull the riser extensions from the riser extension compartment. Pass the riser extensions up to the right of the traction mast, and lay the ends over in the scraper bowl.
- ⑩ Tie the riser extensions to the traction mast with a length of type III nylon cord.

**NOTICE OF EXCEPTION**

The procedures in this figure differ from those in FM 10-500/TO 13C7-1-5. An exception to FM 10-500/TO 13C7-1-5 is granted. The procedures in this figure WILL be followed.

- ⑪ Use a 15-yard length of type VIII nylon webbing to install a restraint strap according to FM 10-500/TO 13C7-1-5. Tie the strap to clevises 15 and 15A.
- ⑫ Use a 15-yard length of type VIII nylon webbing to install another restraint strap. Adapt the procedures for a seven-parachute load as shown in FM 10-500/TO 13C7-1-5. Tie the restraint strap to clevises 11 and 11A.
- ⑬ Install the parachute release straps according to FM 10-500/TO 13C7-1-5. Tape the center knife provision.

Figure 3-16. Cargo parachutes stowed.

### 3-10. Installing EFTC

Inspect and install the EFTC with a 20-foot cable assembly according to FM 10-500/TO 13C7-1-5 and as shown in figure 3-17. Use either a 3-loop, type X, nylon webbing deployment line or a 2-loop, type XXVI, nylon webbing deployment line.

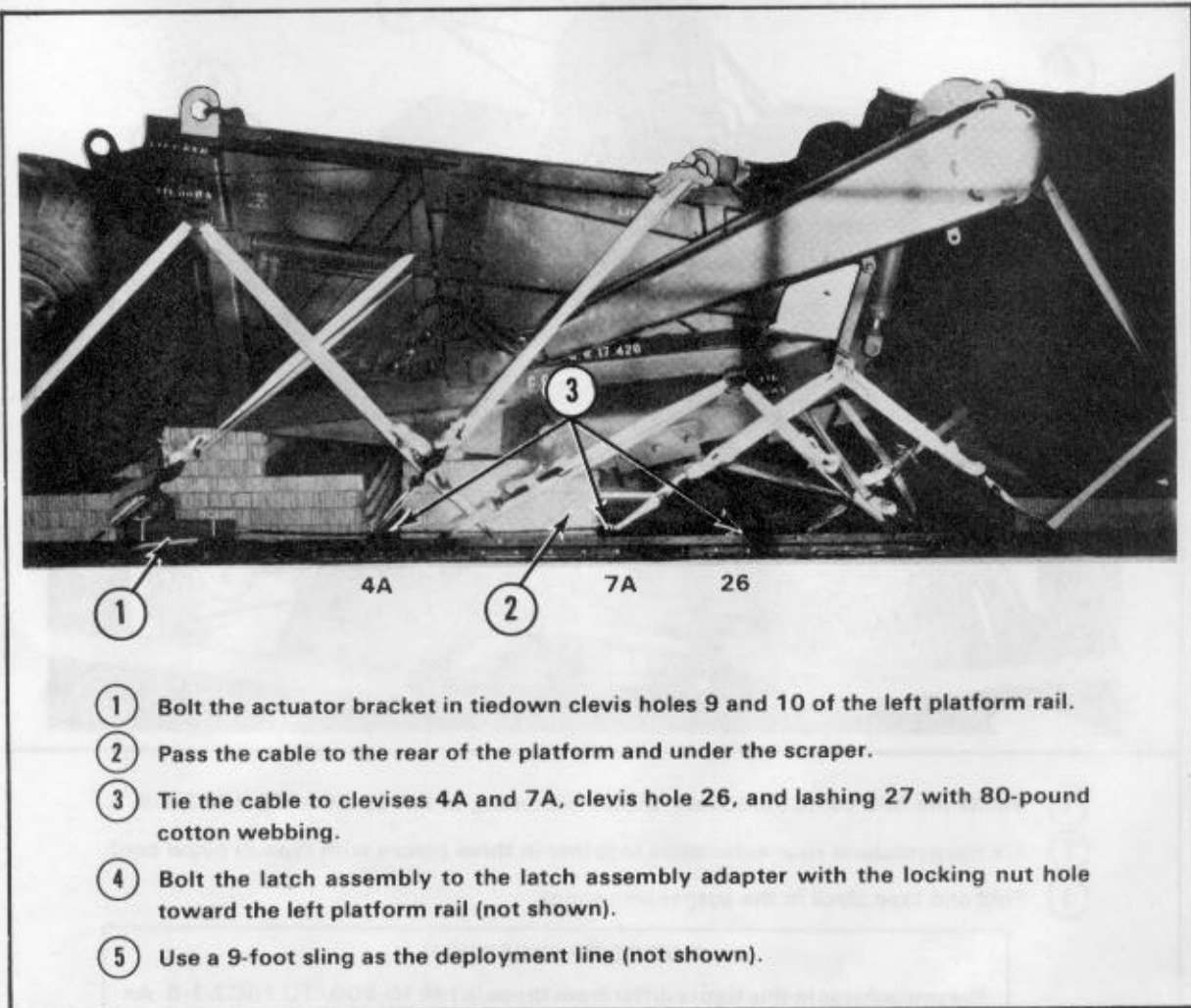

Figure 3-17. EFTC cable installed and safetied.



### 3-11. Installing and Safetying Release System

Test and install the M-2 cargo parachute release assembly according to FM 10-500/TO 13C7-1-5 and as shown in figure 3-18. Safety the release as shown in figure 3-18. If

the M-2 release is not available, prepare and attach six 5,000-pound-capacity cargo parachute releases according to FM 10-500/TO 13C7-1-5.

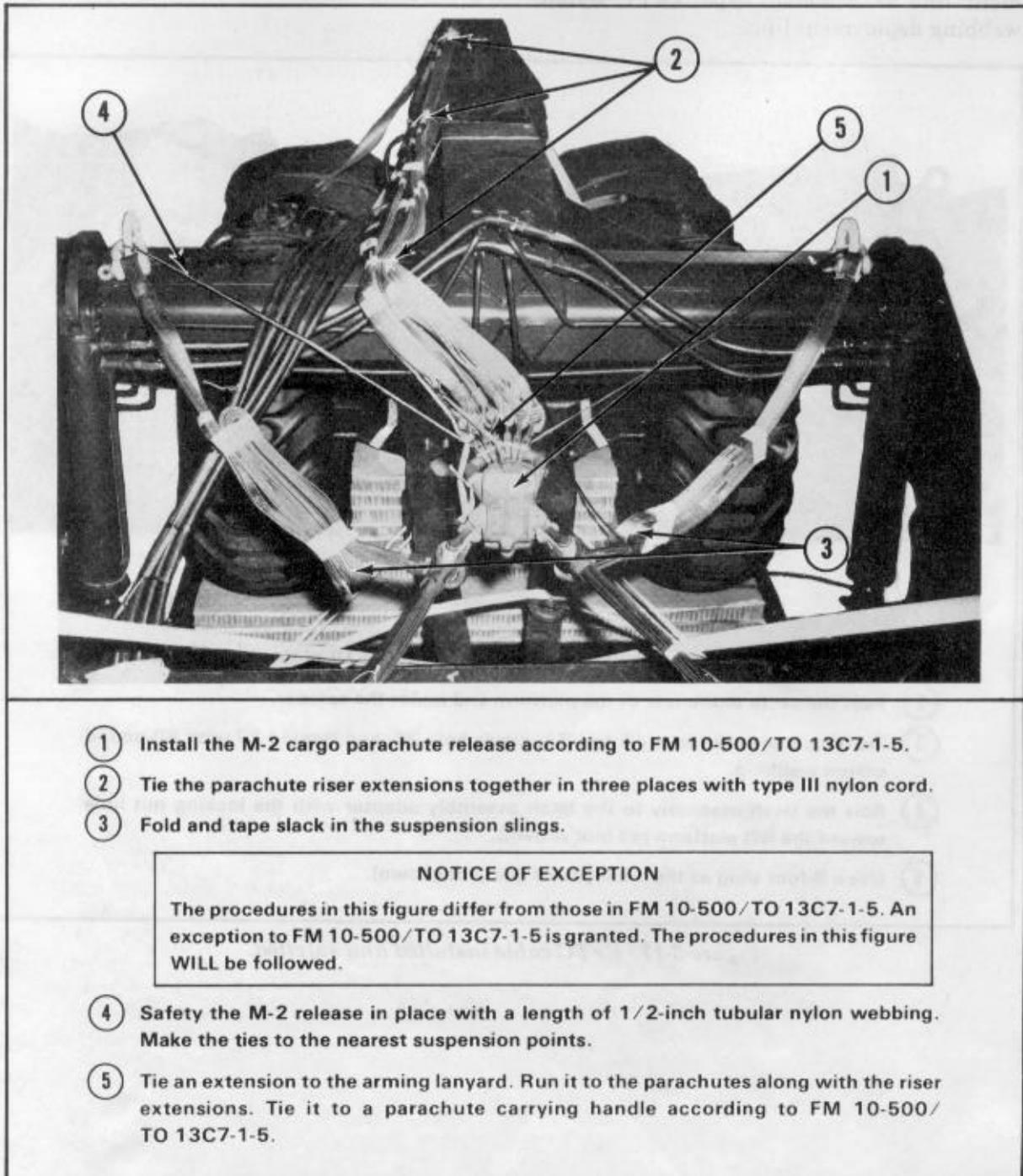

Figure 3-18. Release system installed and safetyed.

### 3-12. Placing Extraction Parachute

Place the extraction parachute as described below.

a. *C-130 Aircraft.* Lay a 28-foot cargo extraction parachute on the load for installation in the aircraft. A light-duty parachute may use either a 60-foot (4-loop), type X, nylon webbing extraction line or a 60-foot (3-loop), type XXVI, nylon webbing extraction line. However, the heavy-duty parachute must have a 60-foot (3-loop), type XXVI,

nylon webbing extraction line.

b. *C-141 Aircraft.* Lay a heavy-duty, 28-foot cargo extraction parachute on the load for installation in the aircraft. This load requires a continuous 140-foot (3-loop), type XXVI, nylon webbing extraction line.

### 3-13. Marking Rigged Load

Mark the rigged load according to FM 10-500/TO 13C7-1-5 and as shown in figure 3-19.

**CAUTION:** Make the final rigger inspection required by FM 10-500/TO 13C7-1-5 before the load leaves the rigging site.

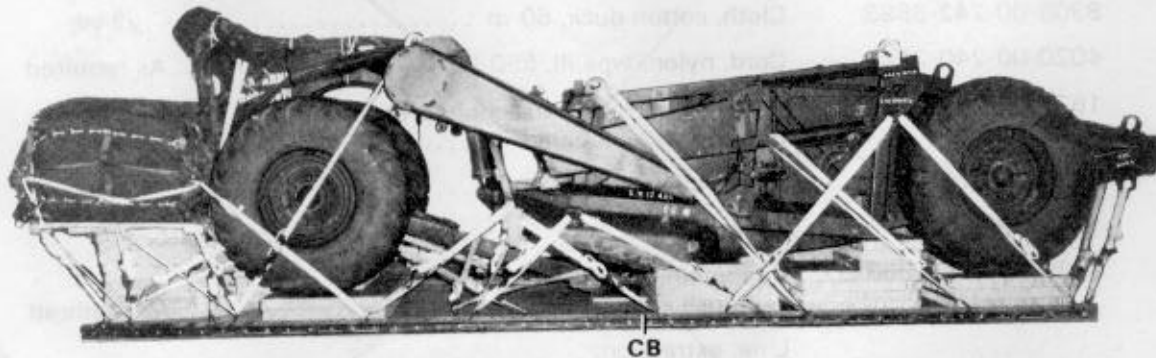

#### RIGGED LOAD DATA

Weight .....	20,830 pounds
Width .....	110 inches
Height .....	96 1/2 inches
Length: .....	338 inches
Overhang: Front .....	38 inches
Rear .....	12 inches
Center of balance (from front edge of platform) .....	129 inches

Figure 3-19. MRS-100 scraper rigged for low-velocity airdrop.

**3-14. Equipment Required**

The equipment required to rig this load is listed in table 3-1.

*Table 3-1. Equipment required to rig the MRS-100 earthmoving scraper for low-velocity airdrop*

National Stock Number	Item	Quantity
8040-00-273-8713	Adhesive, paste, 1-gal . . . . .	As required
1377-00-958-1048	Cartridge, time-delay, 20-sec (use w 5,000-lb releases only) . . . . .	6
1670-00-090-5354	Clevis assembly, suspension, large (add two w 5,000-lb release) . . . . .	6
4030-00-432-2516	Clevis, suspension w screw pin and sleeve . . . . .	4
8305-00-242-3593	Cloth, cotton duck, 60-in . . . . .	2 yd
4020-00-240-2146	Cord, nylon, type III, 550-lb . . . . .	As required
1670-00-434-5787	Coupling, airdrop extraction force transfer w 20-ft cable . . . . .	1
1670-00-360-0328	Cover, clevis, large . . . . .	6
1670-00-360-0329	Cover, link . . . . .	18
8135-00-664-6958	Cushioning material, packaging, cellulose wadding . . . . .	As required
	Line, extraction:	
1670-00-045-9972	60-ft (4-loop), type X, nylon webbing <u>or</u> . . . . .	1
1670-01-062-6313	60-ft (3-loop), type XXVI, nylon webbing (for C-130 aircraft) . . . . .	1
1670-01-107-7651	Line, extraction, 140-ft (3-loop), type XXVI, nylon webbing (for C-141 aircraft) . . . . .	1
1670-00-783-5988	Link assembly, single, type IV . . . . .	19
1670-00-799-8597	Load coupler, 12-spool (for 5,000-lb releases) . . . . .	6
5510-00-220-6148	Lumber, 2- by 6- by 96-in . . . . .	3
5315-00-010-4657	Nail, steel wire, common, 6d . . . . .	As required
1670-00-753-3928	Pad, energy-dissipating, honeycomb, 3- by 36- by 96-in: . . . . .	28 sheets
	8- by 10-in . . . . .	(6)
	10- by 12-in . . . . .	(2)
	12- by 18-in . . . . .	(3)
	12- by 36-in . . . . .	(36)
	12- by 48-in . . . . .	(2)
	18- by 18-in . . . . .	(2)
	18- by 36-in . . . . .	(8)
	18- by 44-in . . . . .	(7)

Table 3-1. Continued

National Stock Number	Item	Quantity
	18- by 48-in . . . . .	(10)
	18- by 96-in . . . . .	(3)
	21- by 36-in . . . . .	(1)
	24- by 60-in . . . . .	(1)
	24- by 96-in . . . . .	(1)
	36- by 60-in . . . . .	(6)
	36- by 96-in . . . . .	(13)
1670-00-269-1107	Parachute, cargo, 100-ft, G-11A. . . . .	6
	Parachute, cargo extraction:	
1670-00-262-1797	28-ft (may be used with C-130 aircraft) . . . . .	1
1670-00-040-8135	28-ft (MUST be used with C-141 aircraft) . . . . .	1
	Platform, modular, 24-ft:	
1670-00-893-1631	Clevis, load tiedown . . . . .	32
1670-00-893-1624	Panel . . . . .	6
1670-00-893-1629	Rail, platform-side, 24-ft. . . . .	2
5320-00-893-1632	Rivet, blind-drive type, 1/4-in diam . . . . .	96
5530-00-128-4981	Plywood, 3/4-in:	
	18- by 18-in . . . . .	1
	21- by 36-in . . . . .	4
	48- by 96-in . . . . .	1
1670-01-097-8817	Release, cargo parachute M-2 (If not available, use six 5,000-lb releases, NSN 1377-00-799-8494.) . . . . .	1
	Sling, cargo, airdrop:	
	For deployment lines:	
1670-00-753-3631	9-ft (3-loop), type X, nylon webbing <u>or</u> . . . . .	1
1670-01-062-6304	9-ft (2-loop), type XXVI, nylon webbing . . . . .	1
	For riser extensions:	
1670-00-753-3794	20-ft (2-loop), type X, nylon webbing <u>or</u> . . . . .	24
1670-01-062-6302	20-ft (2-loop), type XXVI, nylon webbing . . . . .	24
	For suspension slings:	
1670-00-753-3788	3-ft (3-loop), type X, nylon webbing (Add six w 5,000-lb releases) <u>or</u> . . . . .	2
1670-01-062-6301	3-ft (2-loop), type XXVI, nylon webbing (Add six w 5,000-lb releases) . . . . .	2
1670-00-432-2501	9-ft (4-loop), type X, nylon webbing <u>or</u> . . . . .	4
1670-01-062-6305	9-ft (4-loop), type XXVI, nylon webbing . . . . .	4
1670-00-040-8219	Strap, parachute release, multicut . . . . .	2
7510-00-266-5016	Tape, adhesive, 2-in. . . . .	As required
1670-00-937-0271	Tiedown assembly, 15-ft. . . . .	26
8305-00-268-2411	Webbing, cotton, 80-lb . . . . .	As required
8305-00-082-5752	Webbing, nylon, tubular, 1/2-in. . . . .	As required
8305-00-263-3591	Webbing, nylon, type VIII . . . . .	As required

**GLOSSARY**

---

<b>AFTO</b>	<b>Air Force technical order</b>
<b>attn</b>	<b>attention</b>
<b>CB</b>	<b>center of balance</b>
<b>cu</b>	<b>cubic</b>
<b>d</b>	<b>penny</b>
<b>DA</b>	<b>Department of Army</b>
<b>diam</b>	<b>diameter</b>
<b>EFTC</b>	<b>extraction force transfer coupling</b>
<b>FM</b>	<b>field manual</b>
<b>ft</b>	<b>feet; foot</b>
<b>gal</b>	<b>gallon</b>
<b>in</b>	<b>inch</b>
<b>LAPE</b>	<b>low-altitude parachute extraction</b>
<b>LAPES</b>	<b>low-altitude parachute extraction system</b>
<b>lb</b>	<b>pound</b>
<b>sec</b>	<b>second</b>
<b>SL/CS</b>	<b>static line/connector strap</b>
<b>TM</b>	<b>technical manual</b>
<b>TO</b>	<b>technical order</b>
<b>US</b>	<b>United States</b>
<b>USAF</b>	<b>United States Air Force</b>
<b>w</b>	<b>with</b>
<b>yd</b>	<b>yard</b>

## REFERENCES

---

- FM 10-500/TO 13C7-1-5** Airdrop of Supplies and Equipment:  
Rigging Airdrop Platforms
- TM 5-3805-235-13** Operator's, Organizational and Direct  
Support Maintenance Manual for Scrapers,  
Earthmoving, Towed; Hydraulic-Operated,  
8 cu yd (MRS Mfg Co, (Model MS-100)  
(FSN 3805-051-3139) and (Model MRS-100)  
(3805-418-0115) Air Droppable and (3805-  
418-0116) Air Transportable
- TM 10-1670-208-20&P/  
TO 13C3-4-12** Organizational Maintenance Manual  
Including Repair Parts and Special Tools  
List for Platforms, Type II Modular, and  
LAPES/Airdrop Modular
- TO 1C-141B-9** Technical Loading Instructions Aircraft  
C-141B USAF Series

**FM 10-530/TO 13C7-27-121**

**9 AUGUST 1985**

By Order of the Secretaries of the Army and the Air Force:

**JOHN A. WICKHAM, JR.**  
*General, United States Army*  
*Chief of Staff*

Official:

**DONALD J. DELANDRO**  
*Brigadier General, United States Army*  
*The Adjutant General*

**DISTRIBUTION:**

*Active Army, USAR, and ARNG:* To be distributed in accordance with DA Form 12-11A, Requirements for Airdrop of Supplies and Equipment (Qty rqr block no. 228).

Additional copies may be requisitioned from the US Army Adjutant General Publications Center, 2800 Eastern Boulevard, Baltimore, MD 21220-2896.